



10359





LEGO.com/sustainable-packaging



FR
**DONNEZ
OU
RECYCLEZ**



OU



OU



ASSOCIATION MAGASIN DÉCHÈTERIE

Adresses sur quefairedemesdechets.fr



BUILDER



Apple and the Apple logo are trademarks of Apple Inc., registered in the U.S. and other countries and regions. App Store is a service mark of Apple Inc. Google Play and the Google Play logo are trademarks of Google LLC. Tencent and the Tencent logo are trademarks of Tencent Inc.

Q [LEGO.com/devicecheck](https://www.lego.com/devicecheck)



Q LEGO® Builder

Construire la sérénité

Laissez-vous transporter dans un jardin serein et paisible et restez-y aussi longtemps que vous le souhaitez. Peut-être vous donnera-t-il envie de cultiver vos racines créatives ou votre petit espace personnel réservé à des activités de pleine conscience et de réflexion. Ceci est votre espace. Nous espérons que vous vous sentirez comme chez vous parmi les plantes et animaux qui prospèrent près de la fontaine. Vous en reconnaîtrez peut-être certains, vous dans votre propre jardin ou dans un lieu familier que vous avez visité lors d'un voyage vers la destination de vos rêves, dont vous chérissez les souvenirs précieux.

Chaque élément a été conçu pour être le plus authentique possible par rapport à la région, à la culture et à l'architecture. Les magnifiques tuiles décoratives s'inspirent des tuiles *zellige*, qui ont influencé les traditions architecturales en Afrique du Nord et en Europe du Sud au cours de l'histoire. Elles apportent une atmosphère magnifiquement vivante aux bâtiments, à la décoration intérieure et aux jardins. Nous avons également décidé d'ajouter un nouvel élément à la collection de papillons nocturnes et diurnes LEGO® avec le papillon lune espagnol, un papillon de nuit d'un vert envoûtant. Vous pouvez insuffler une nouvelle vie à votre jardin en déplaçant les plantes à différents endroits selon votre humeur, en les exposant au soleil ou en les laissant se rafraîchir à l'ombre. Vous pouvez même déplacer des sections plus grandes du modèle pour créer différentes formes et expressions.



« Donnez vie à ce jardin andalou idyllique,
et ajoutez tout au long de l'année une
touche estivale à votre intérieur. »

- L'équipe de design LEGO®







La vie dans
votre jardin





1

Pelophylax perezi

Grenouille de Pérez



2

Emberiza citrinella

Bruant jaune



3

Graellsia isabellae

Isabelle

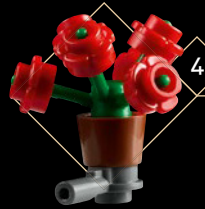

4

Pelargonium x hortorum

Géranium zonal rouge



5

Bougainvillea

Fleur de bougainvillier rose



6

Tagetes patula

Œillet d'Inde



7

Hibiscus rosa-sinensis

Fleur d'hibiscus rouge

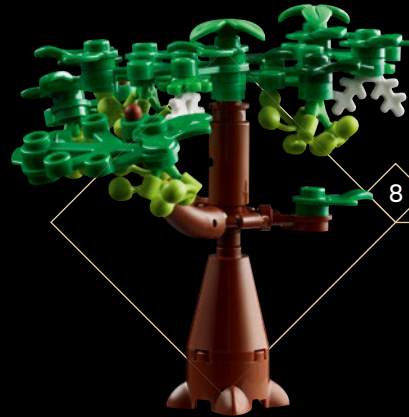

8

Vitis vinifera

Vigne



9

Petunia axillaris

Pétunia blanc

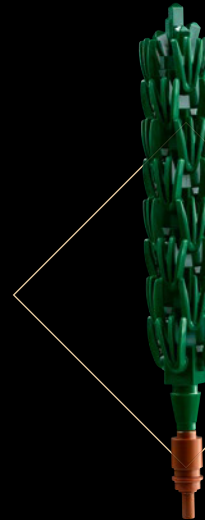

10

Cupressus sempervirens

Cyprès

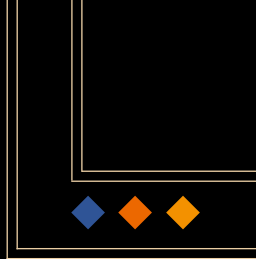

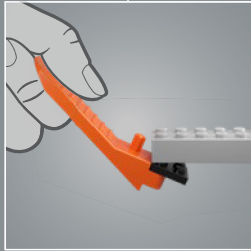
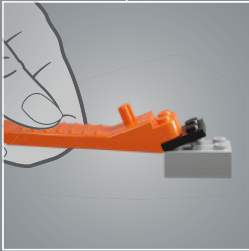
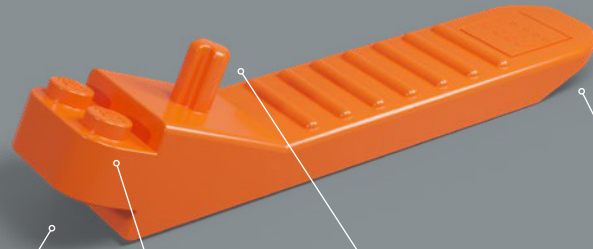

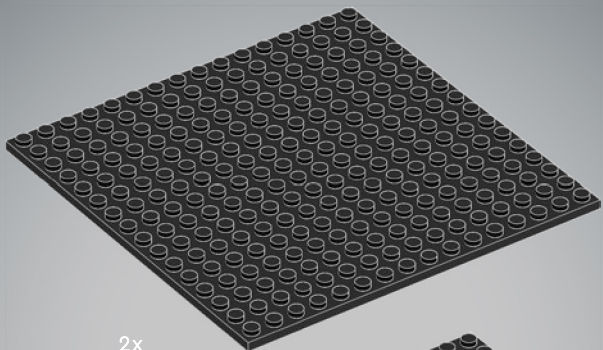

2x

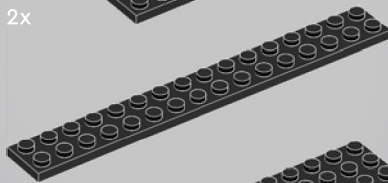

1x

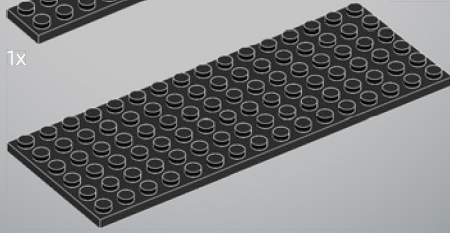

2x

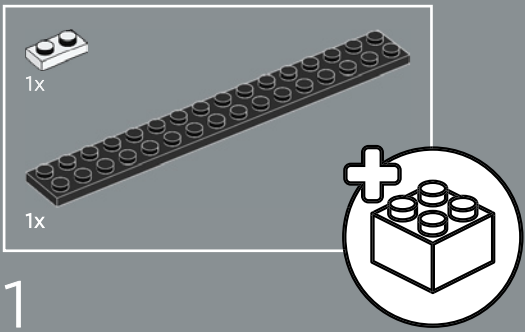

1

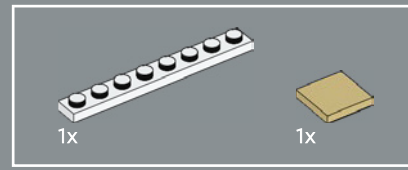
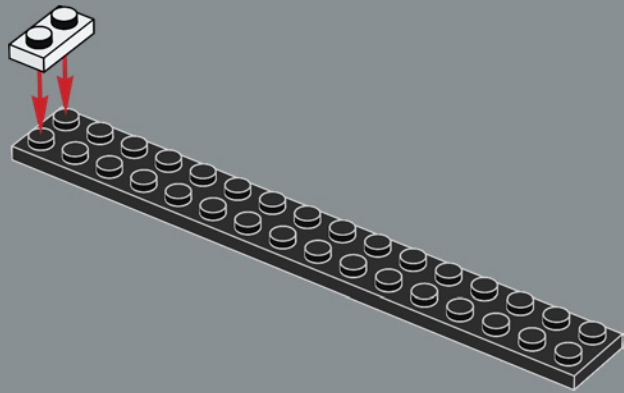

2

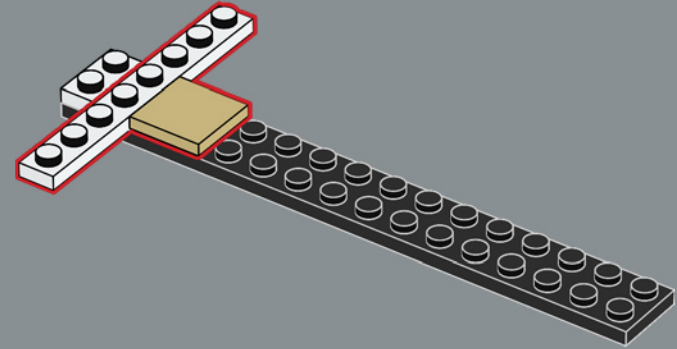

3

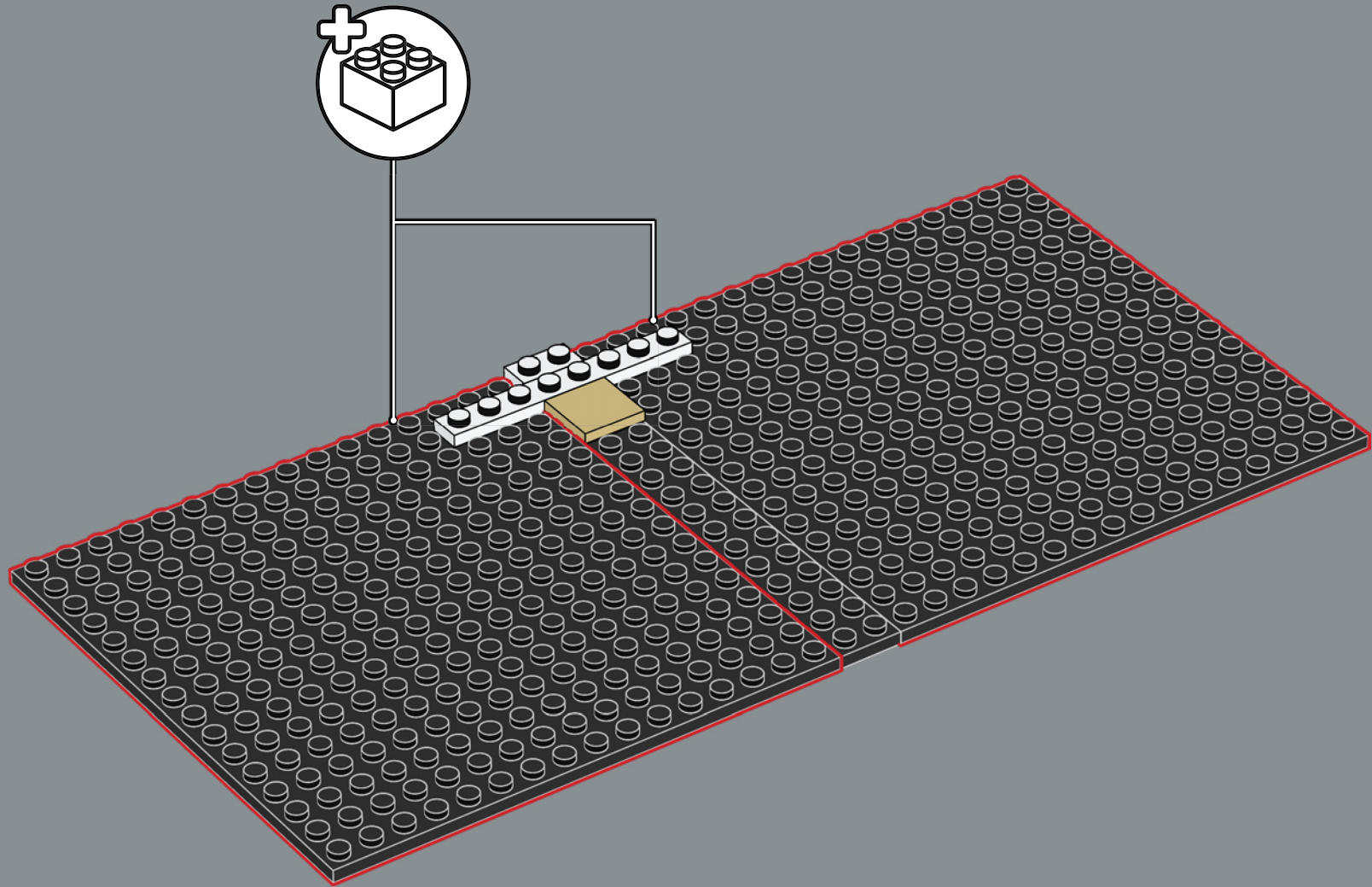

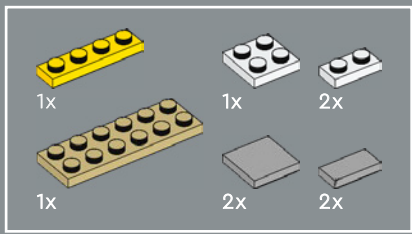

4

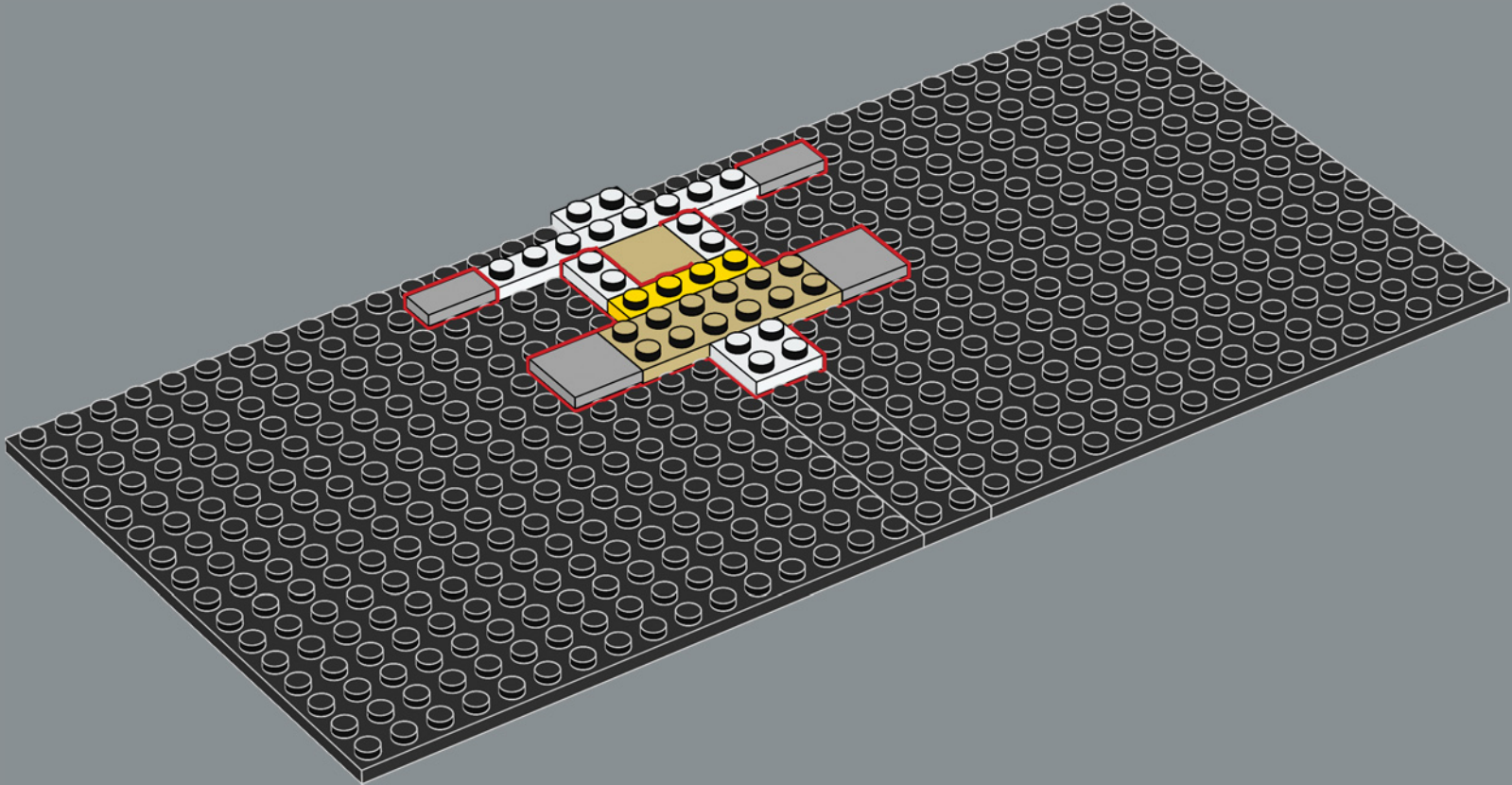

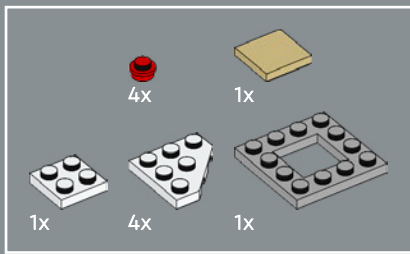

5

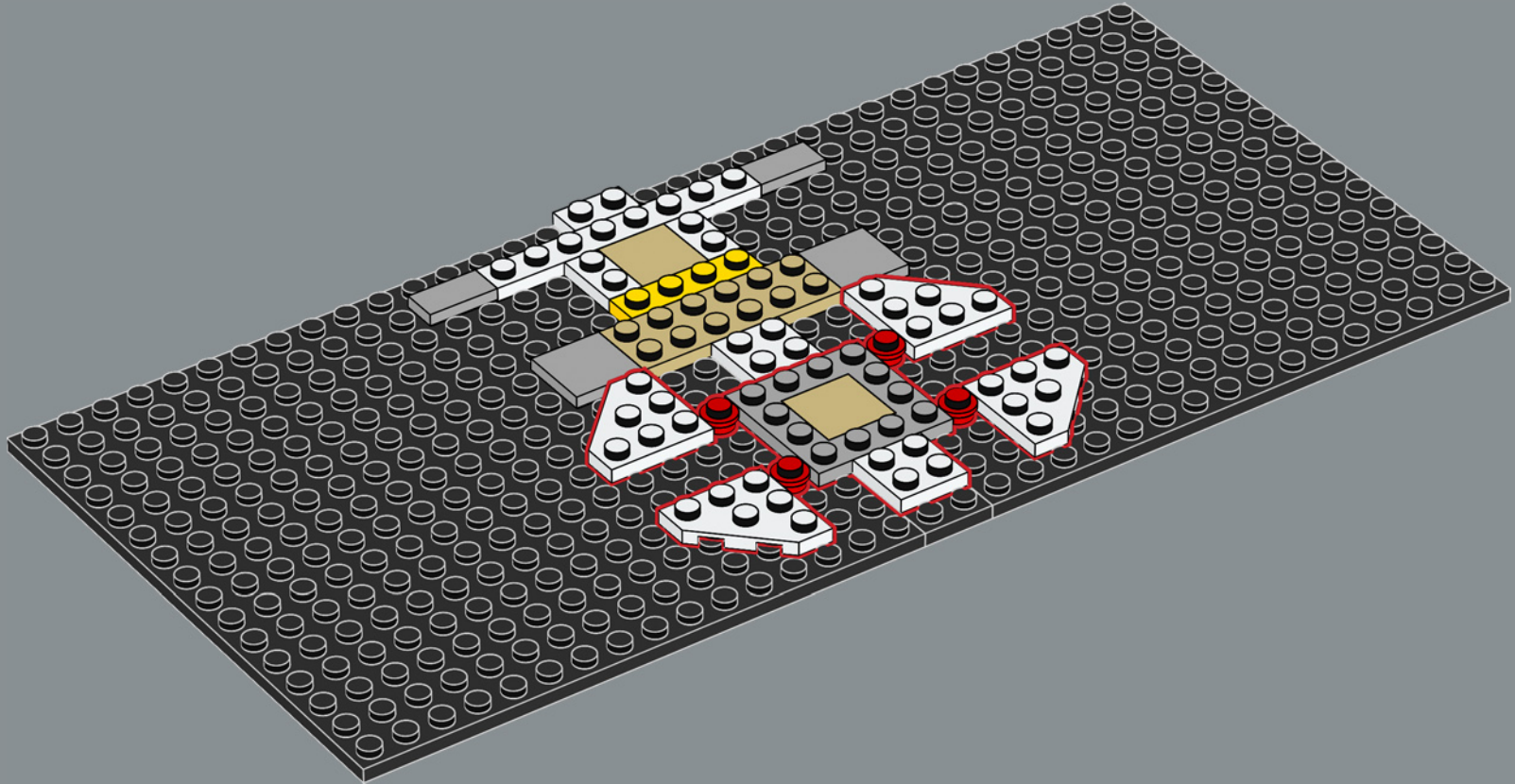

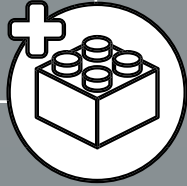
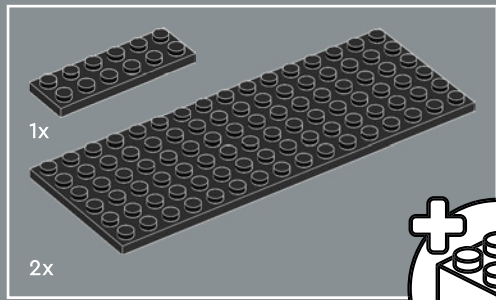

7

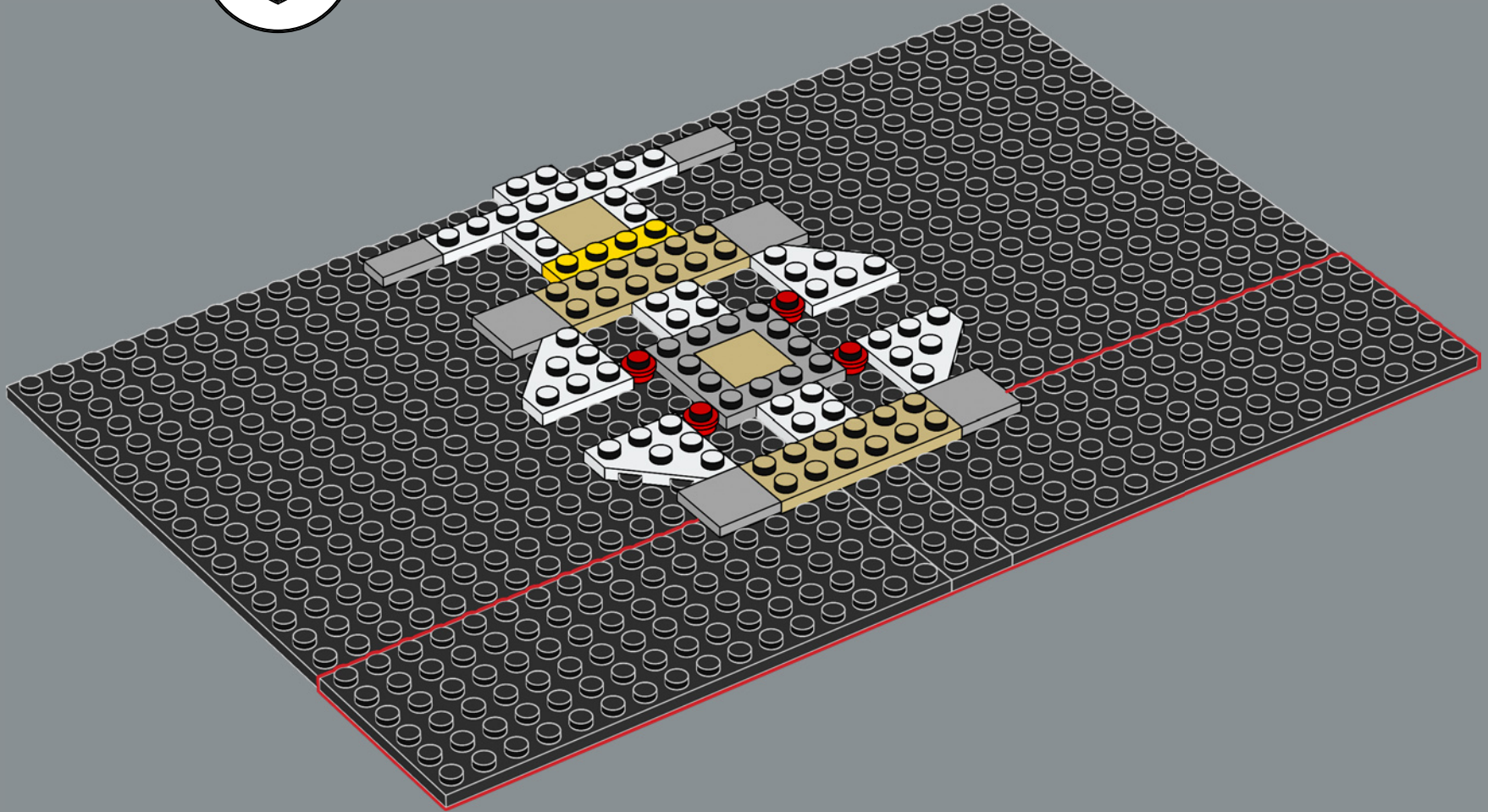

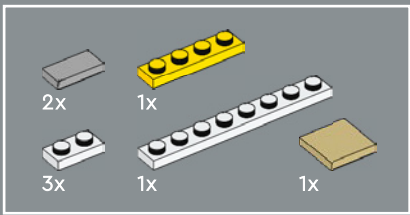

8

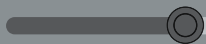
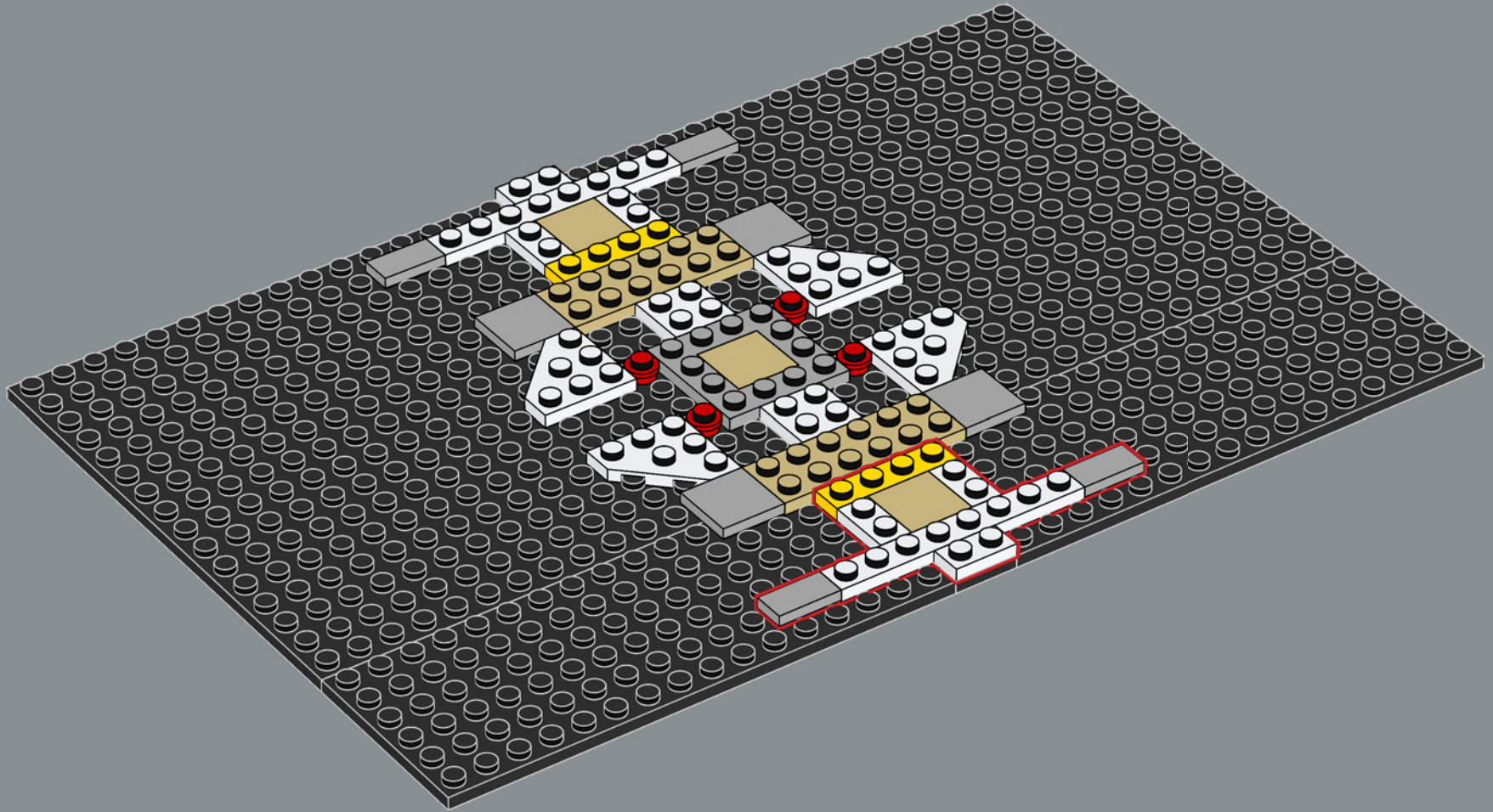

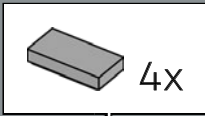
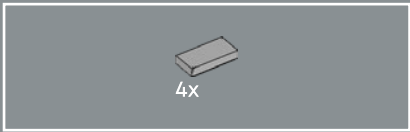

9

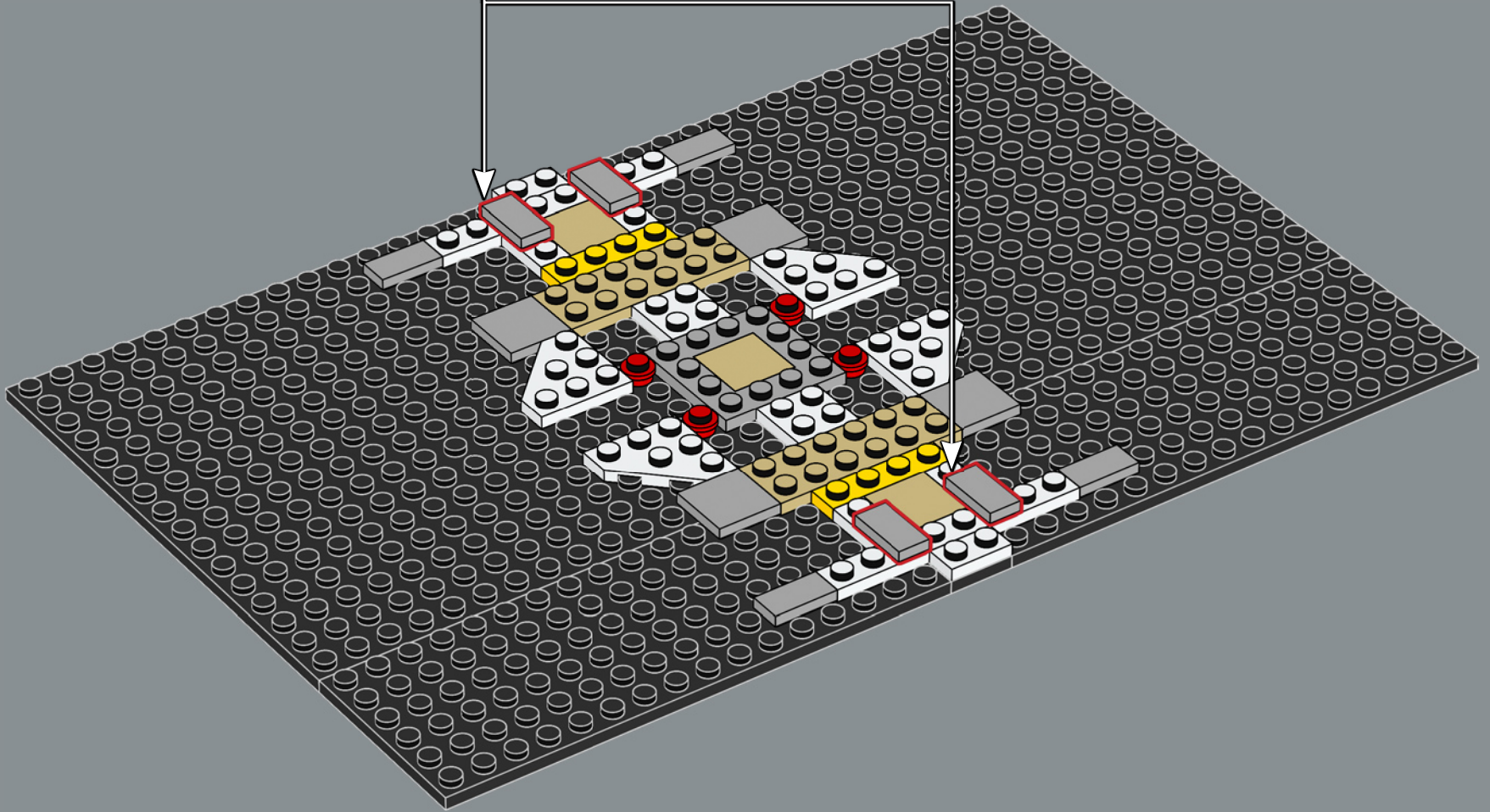

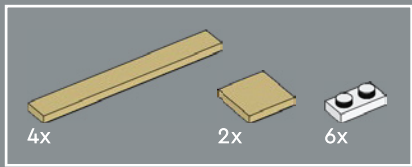

10

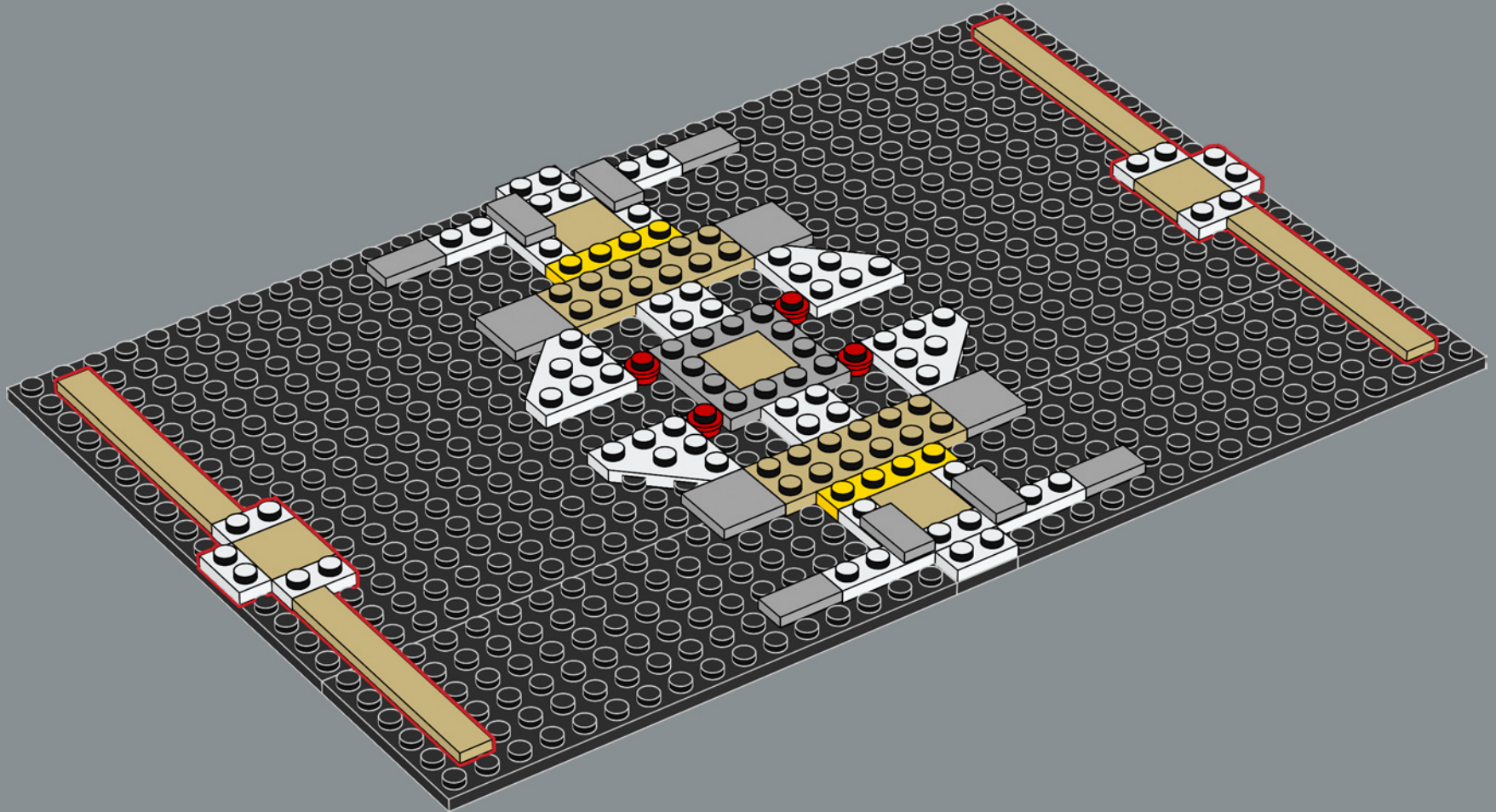

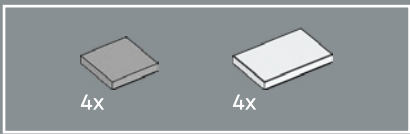

11

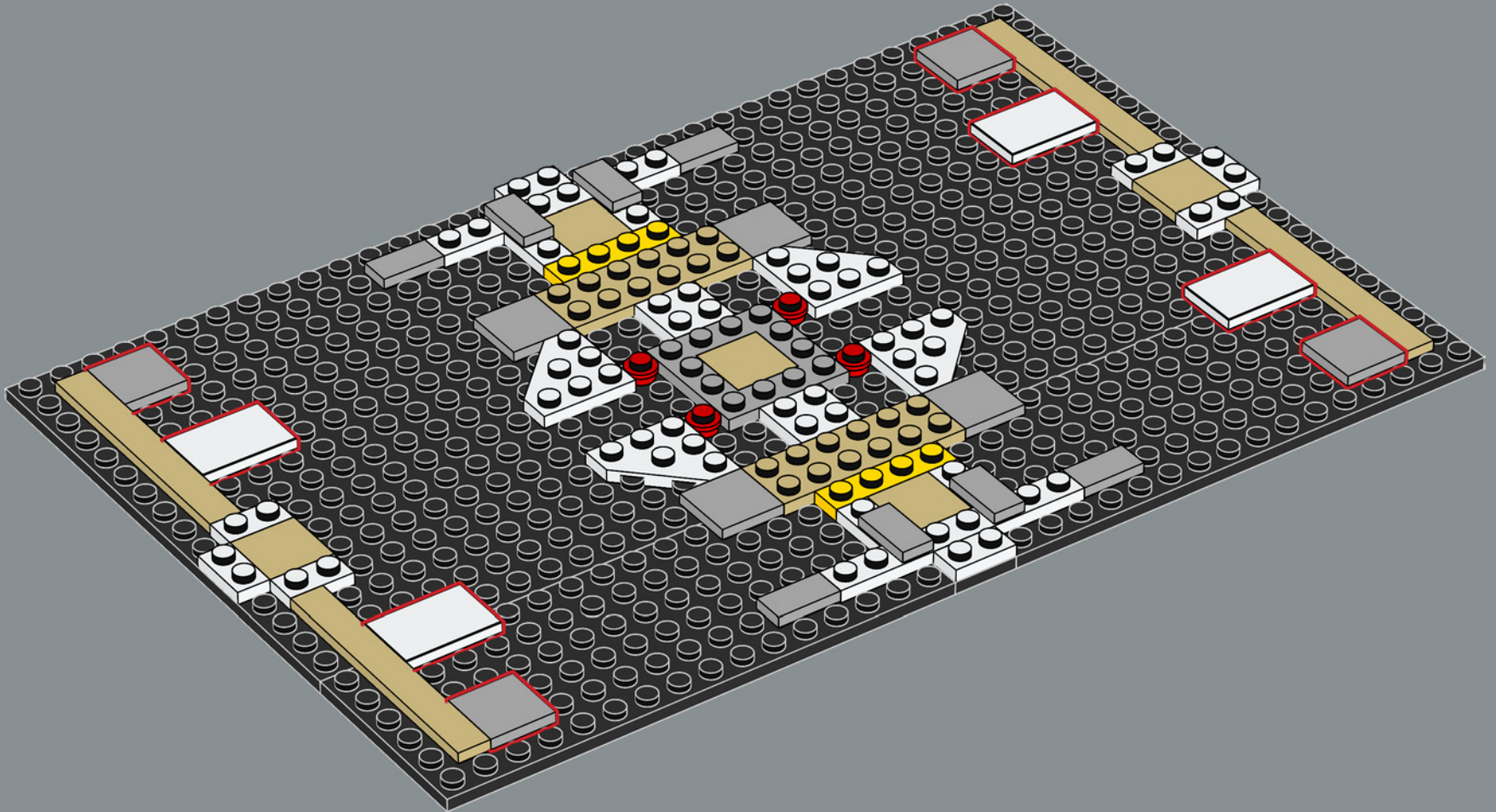

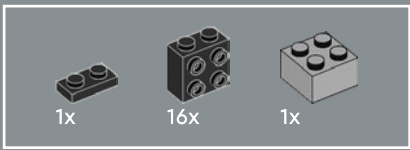

12

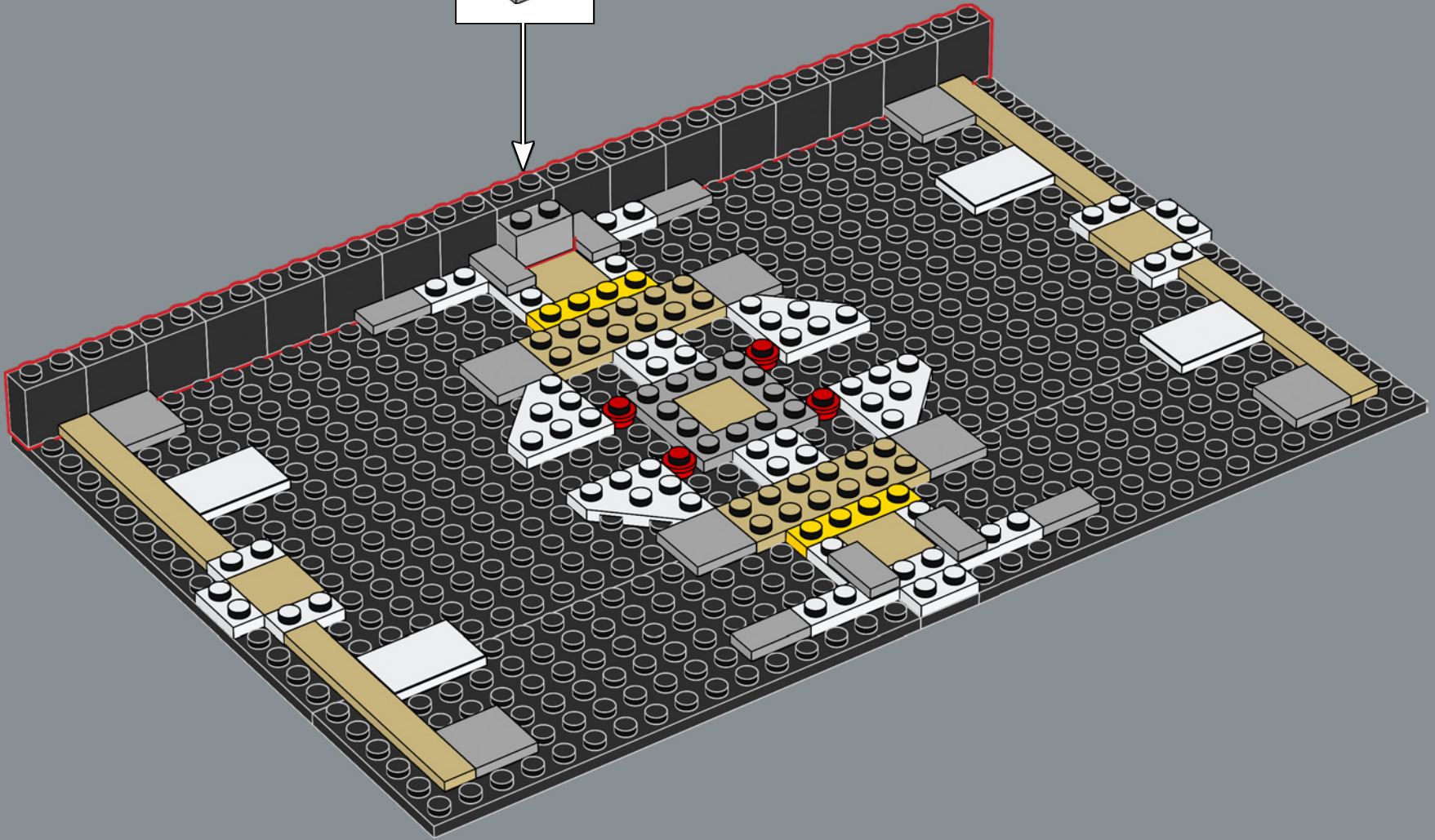
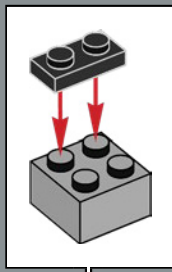

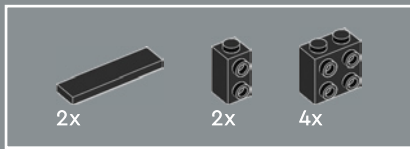

13

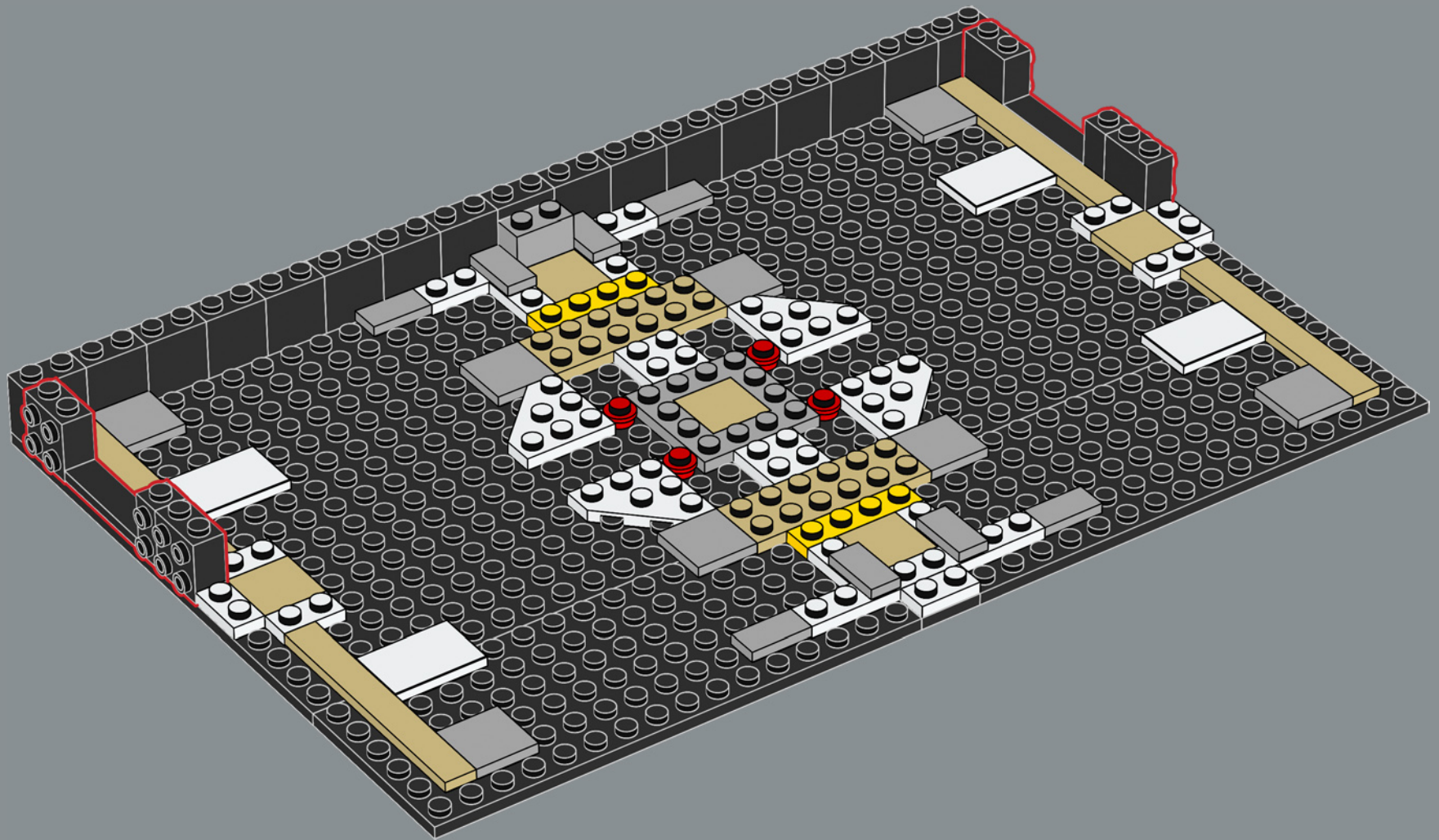

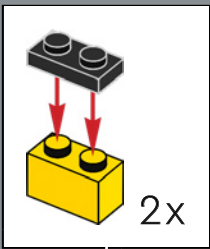
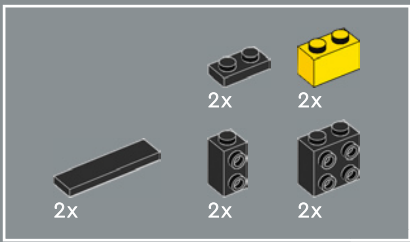

14

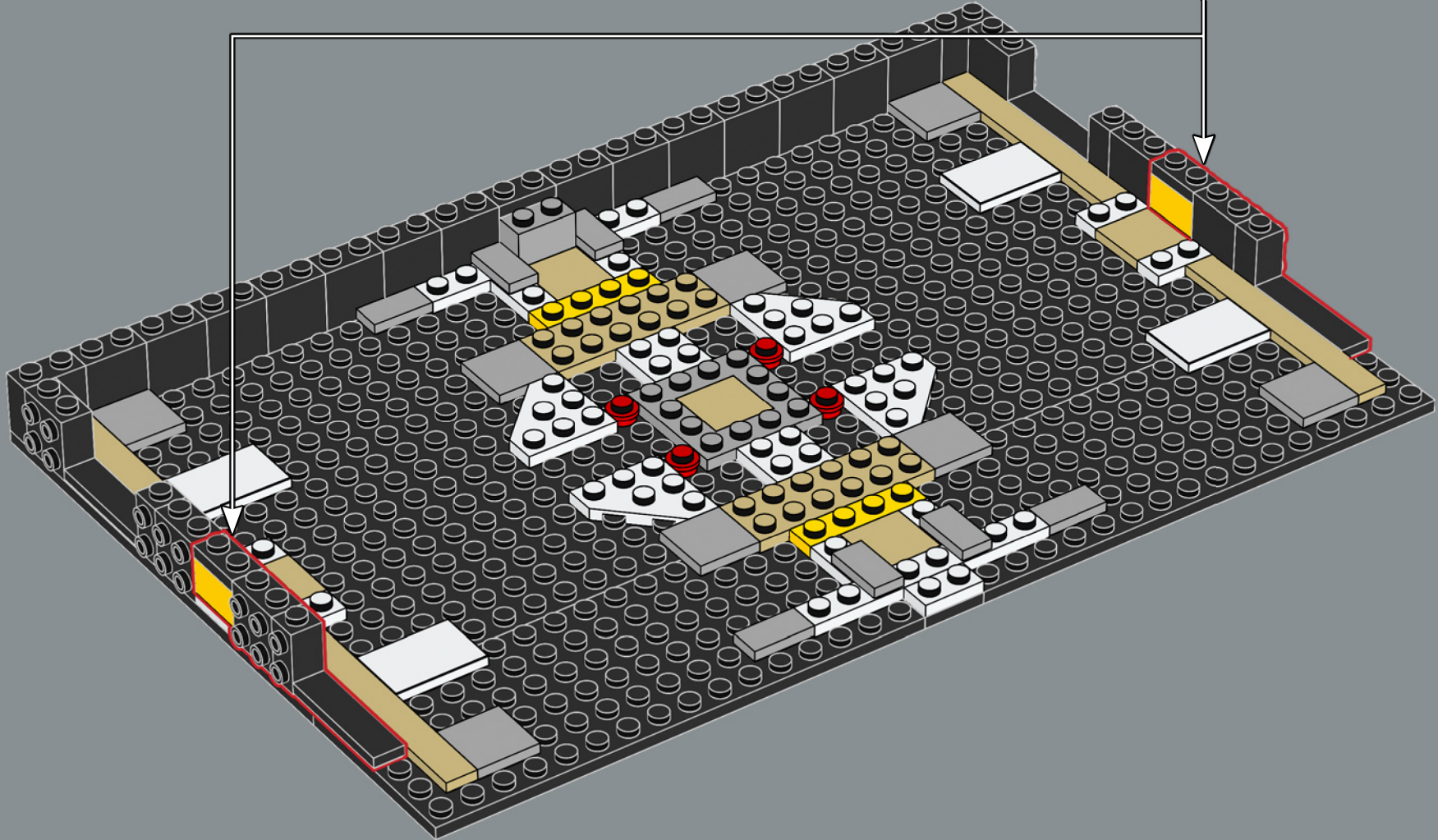

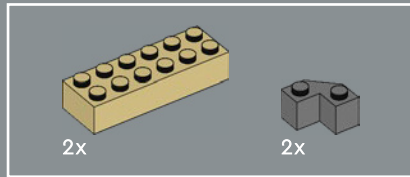

15

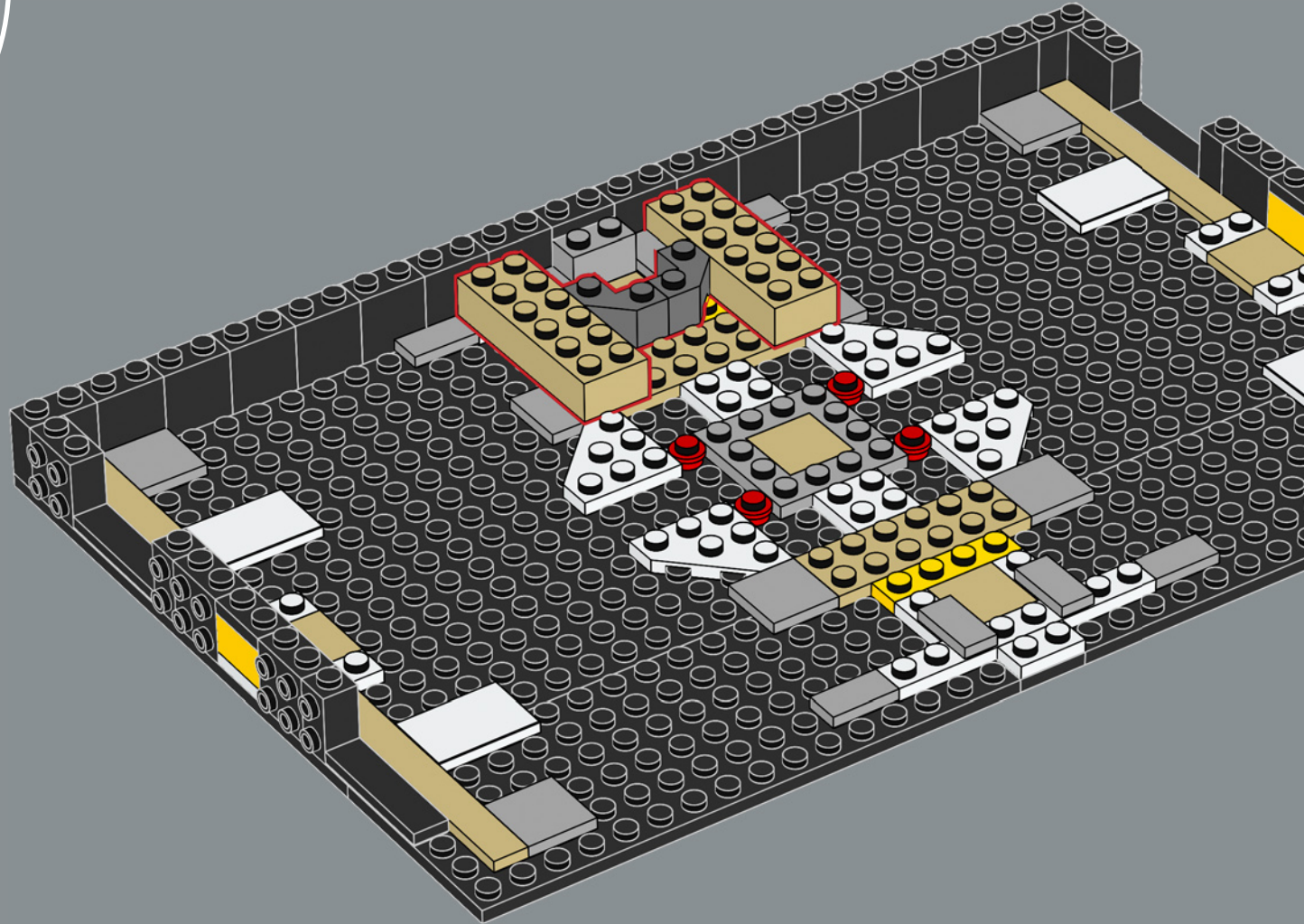

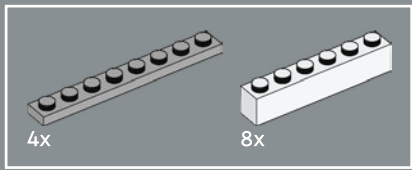

16

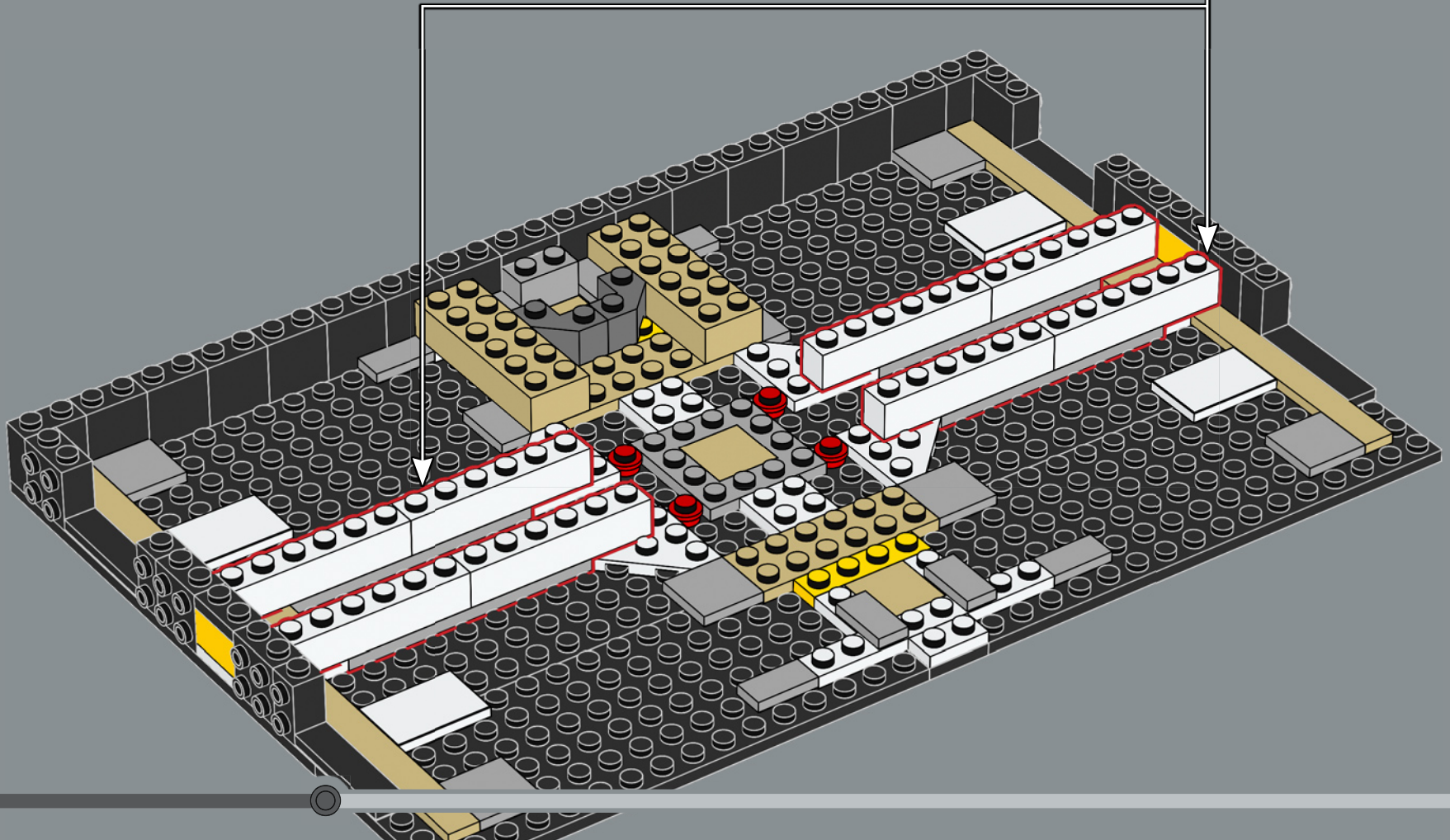
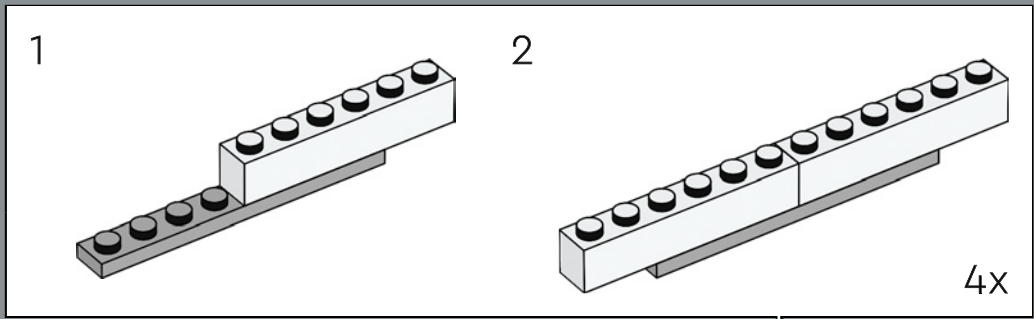

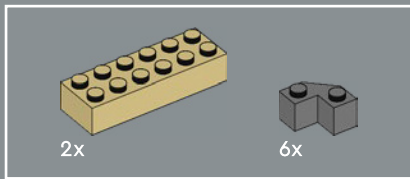

17

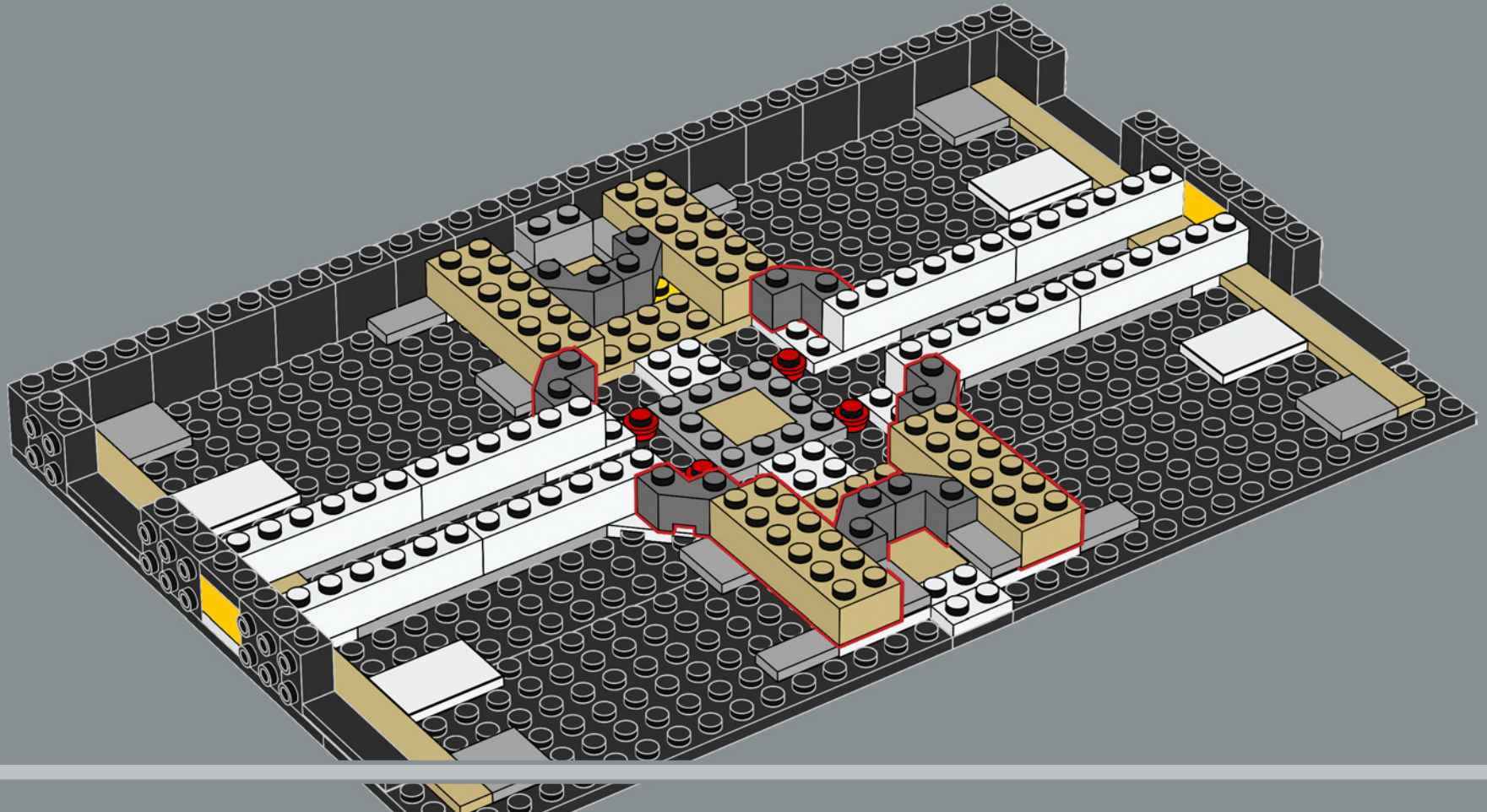

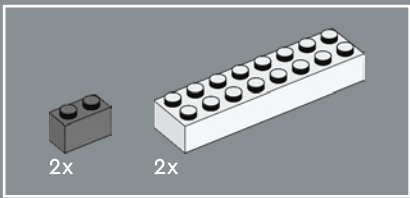

18

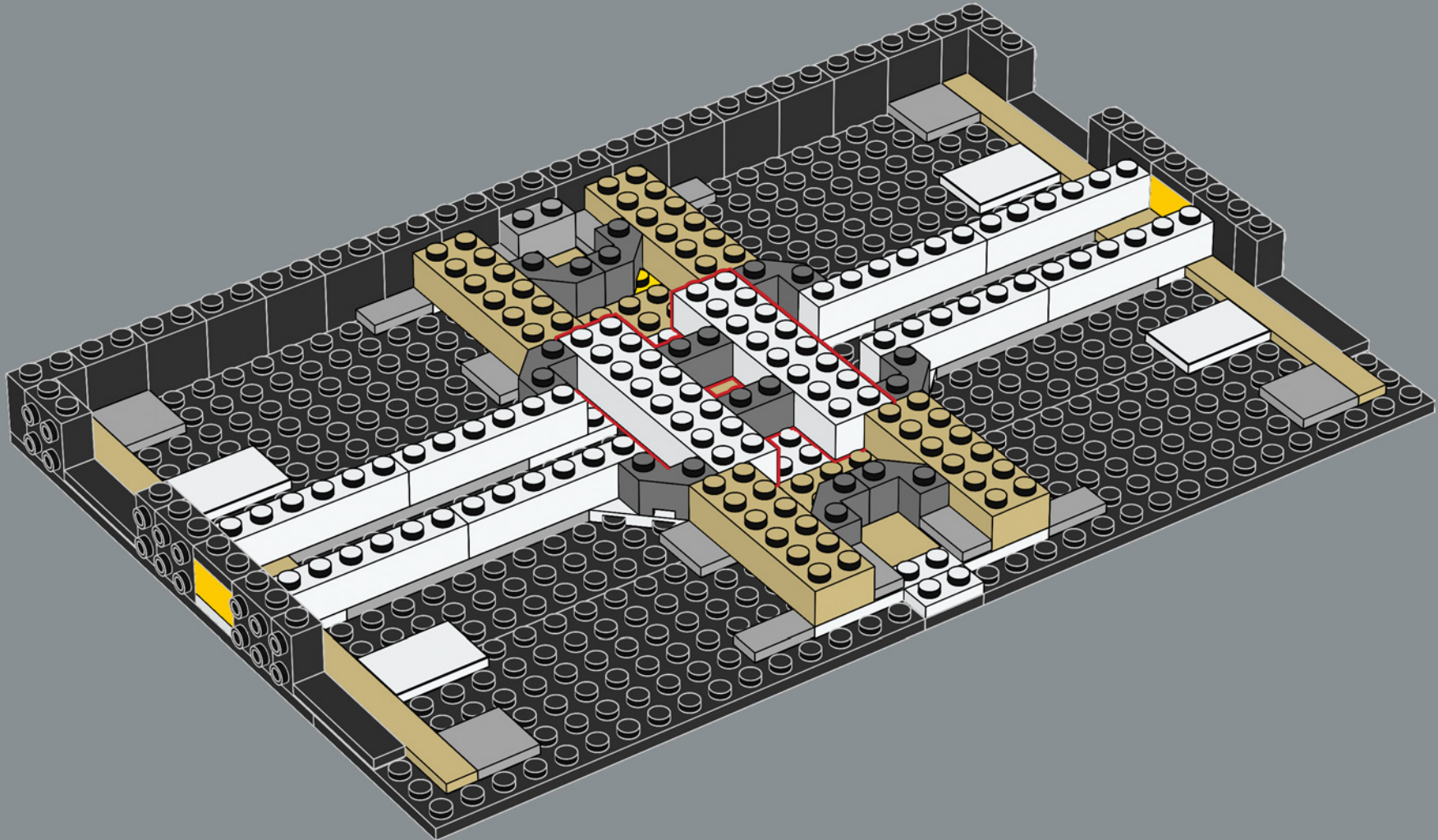

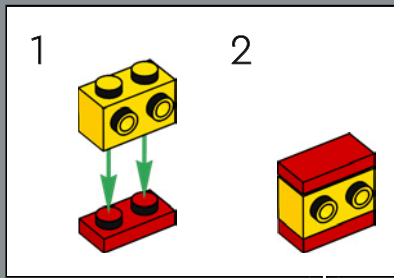
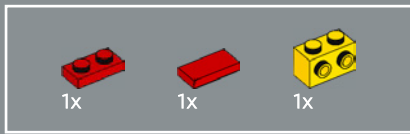

19

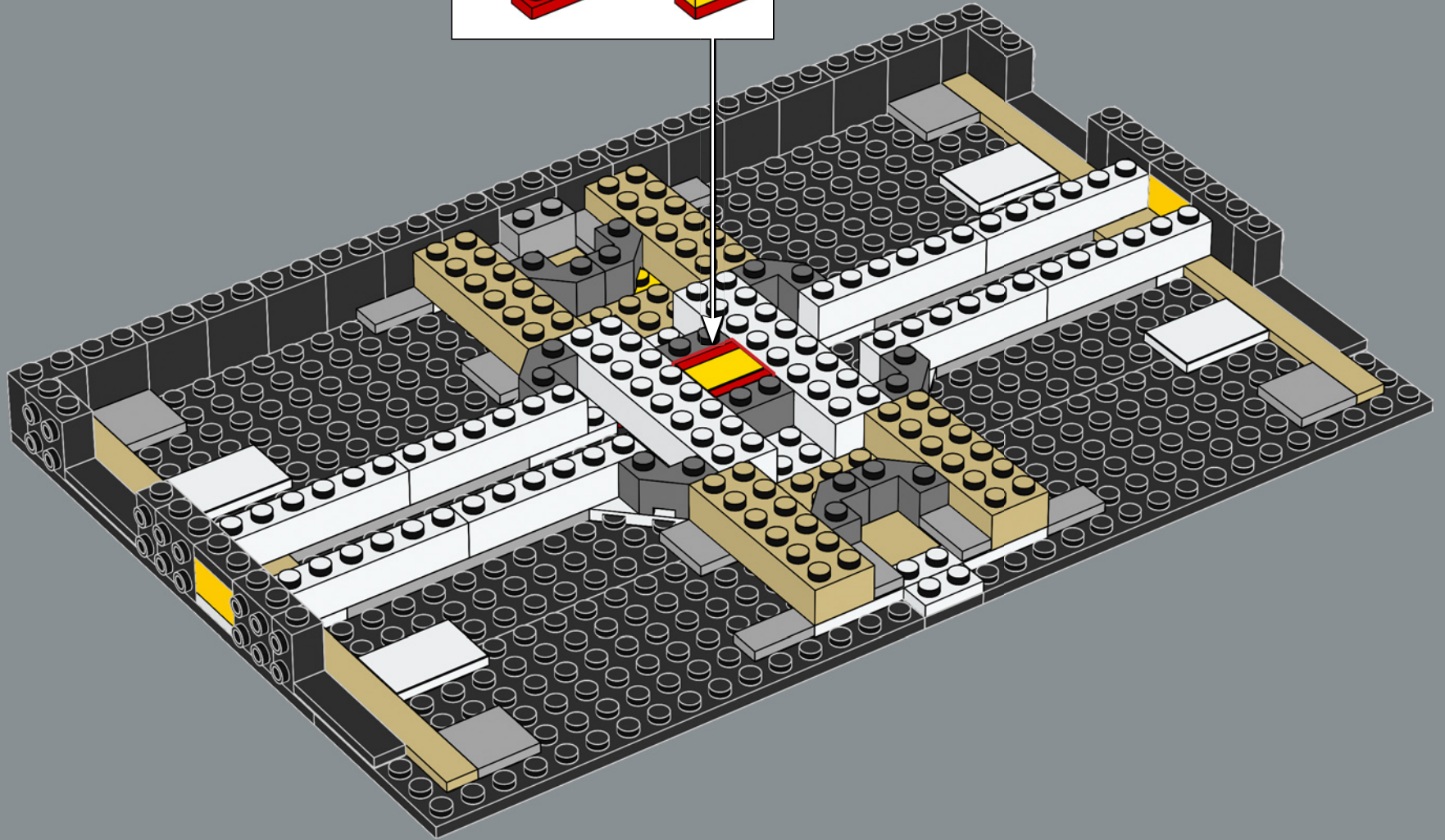

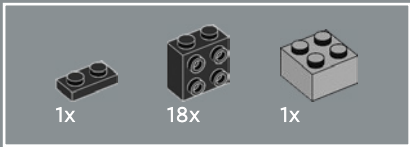

20

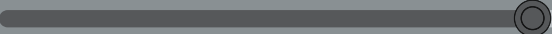
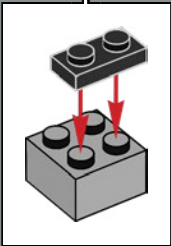
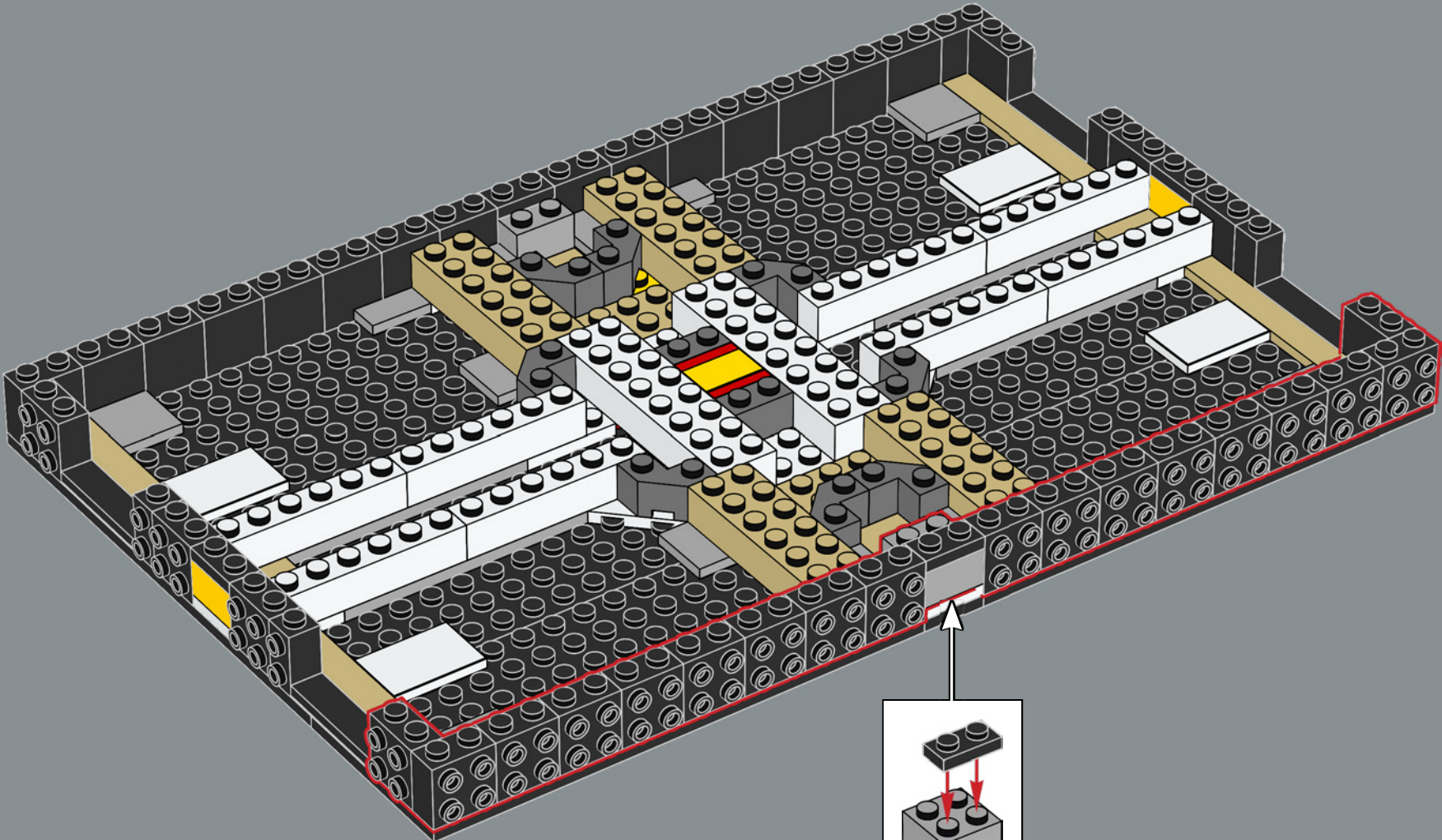

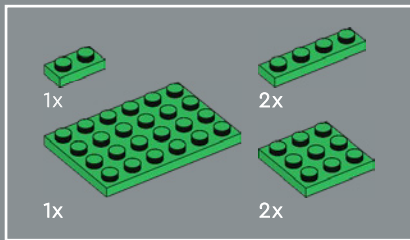

21

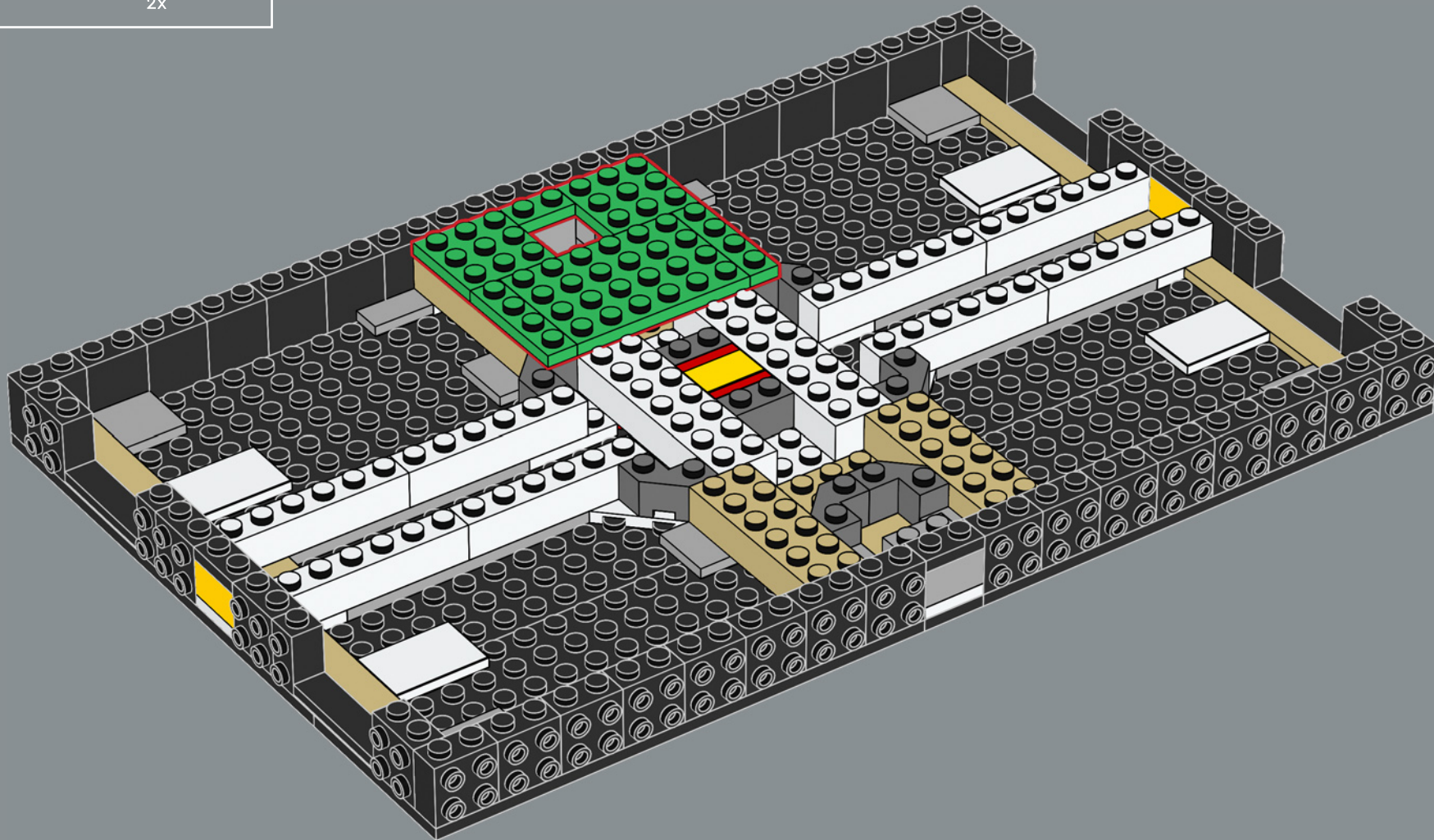

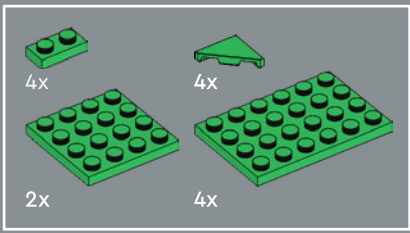

22

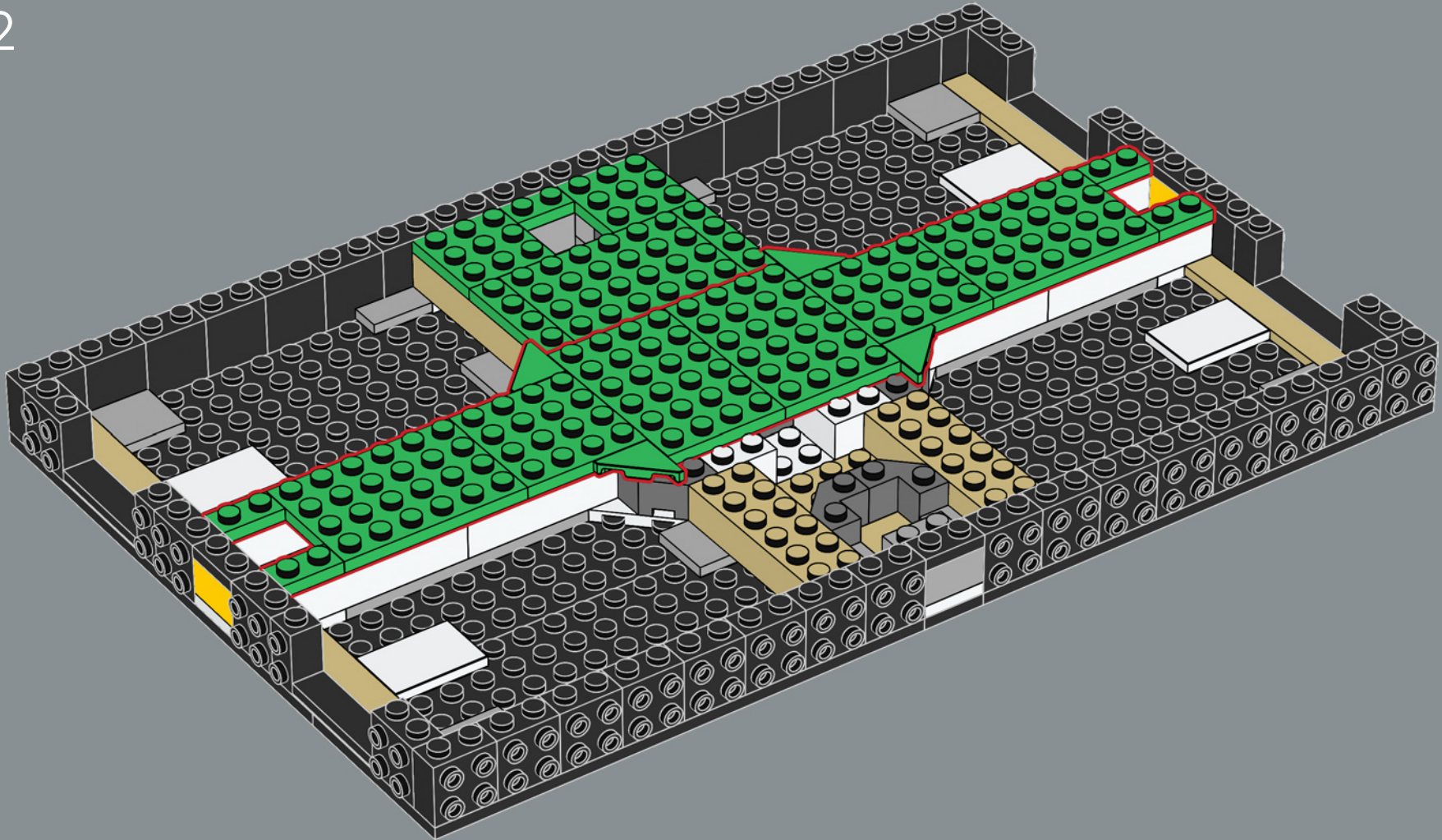

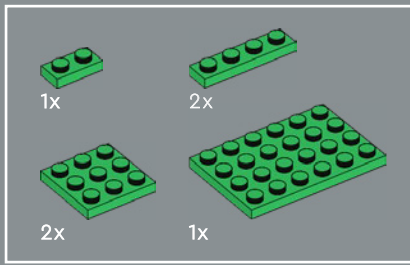

23

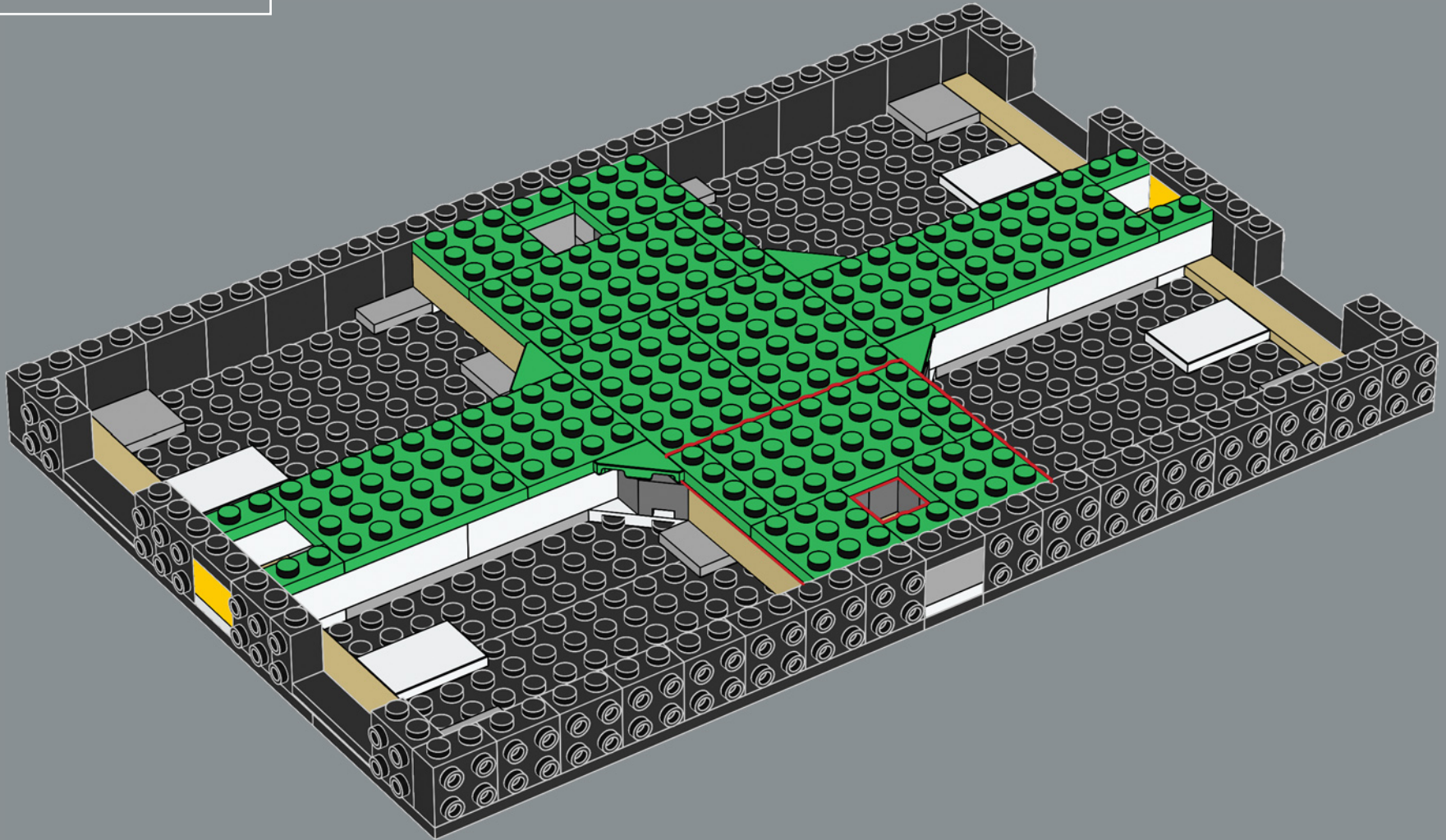



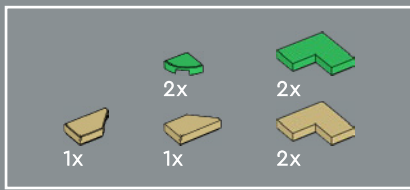

24

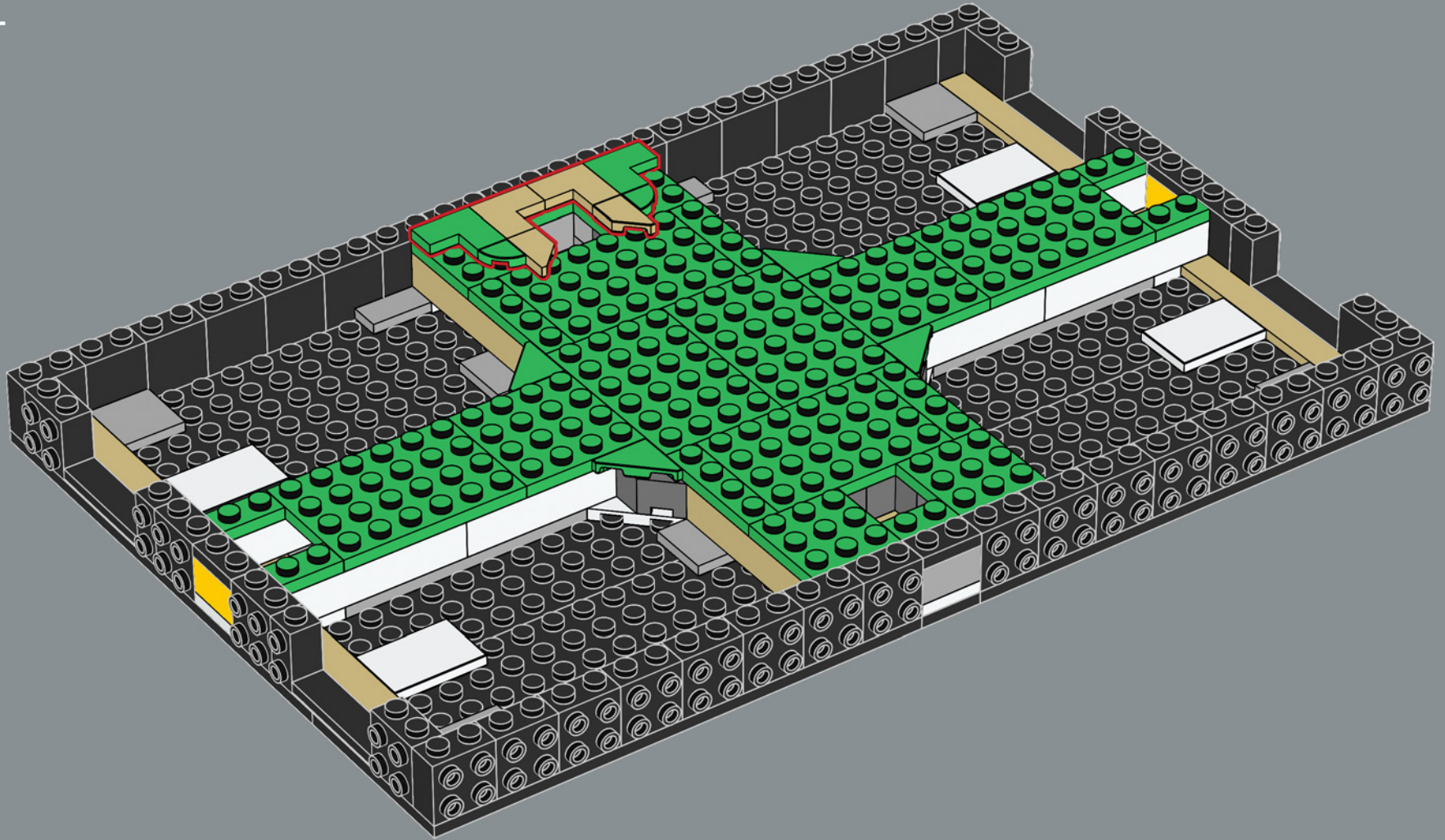



25

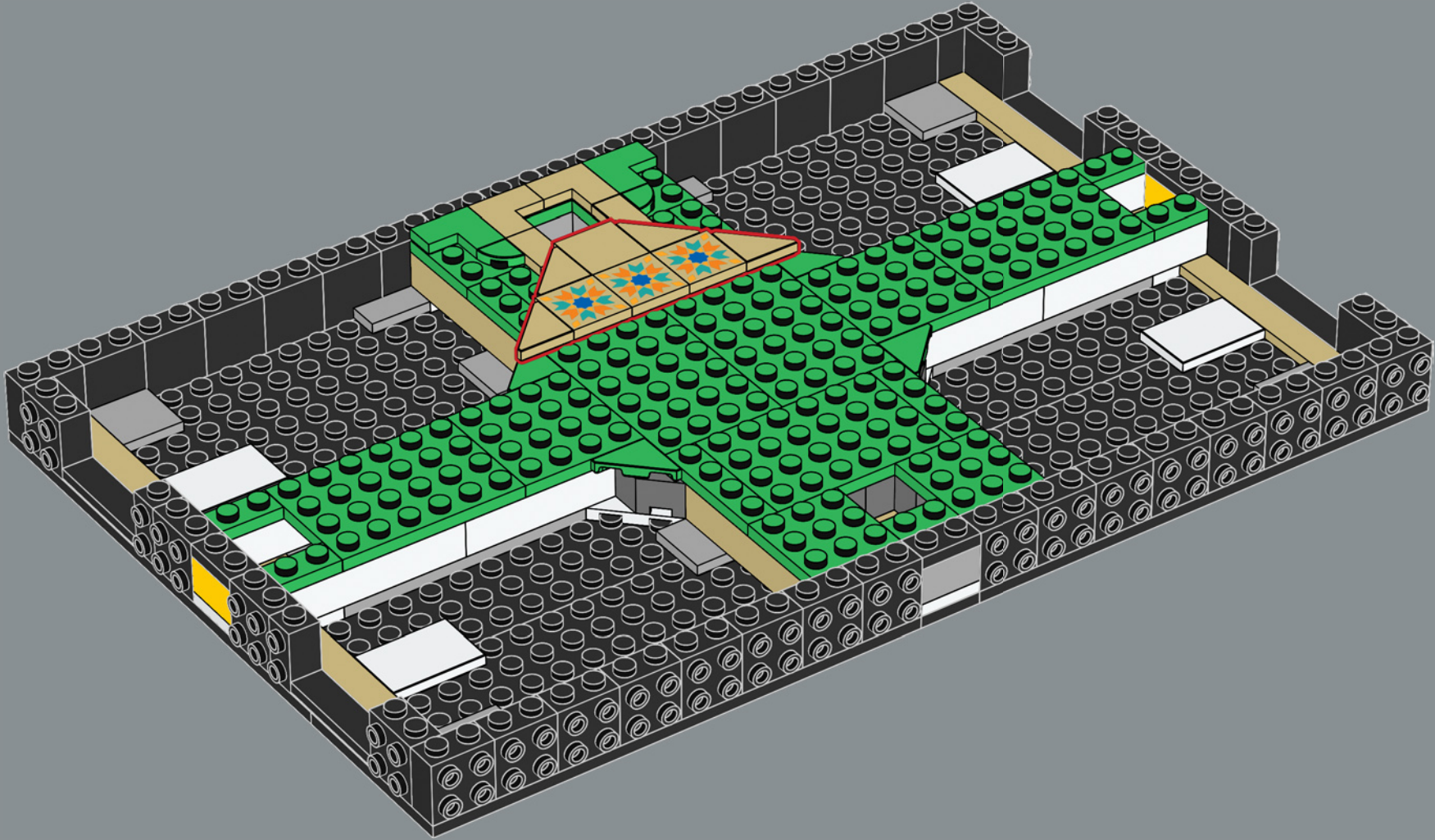

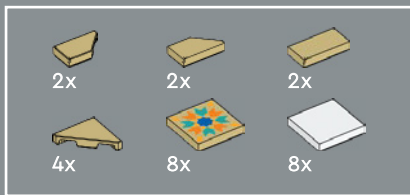

26

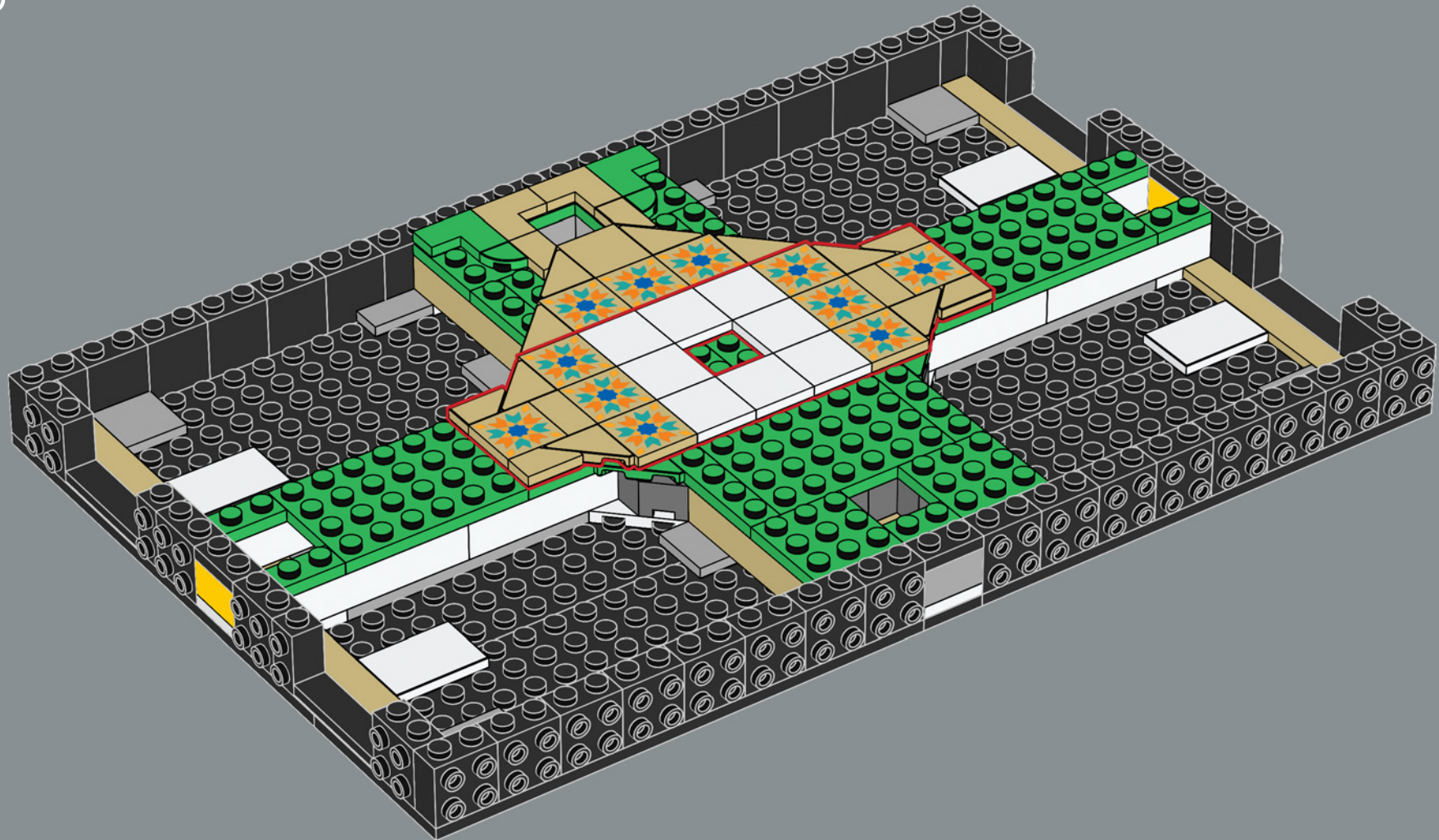



27

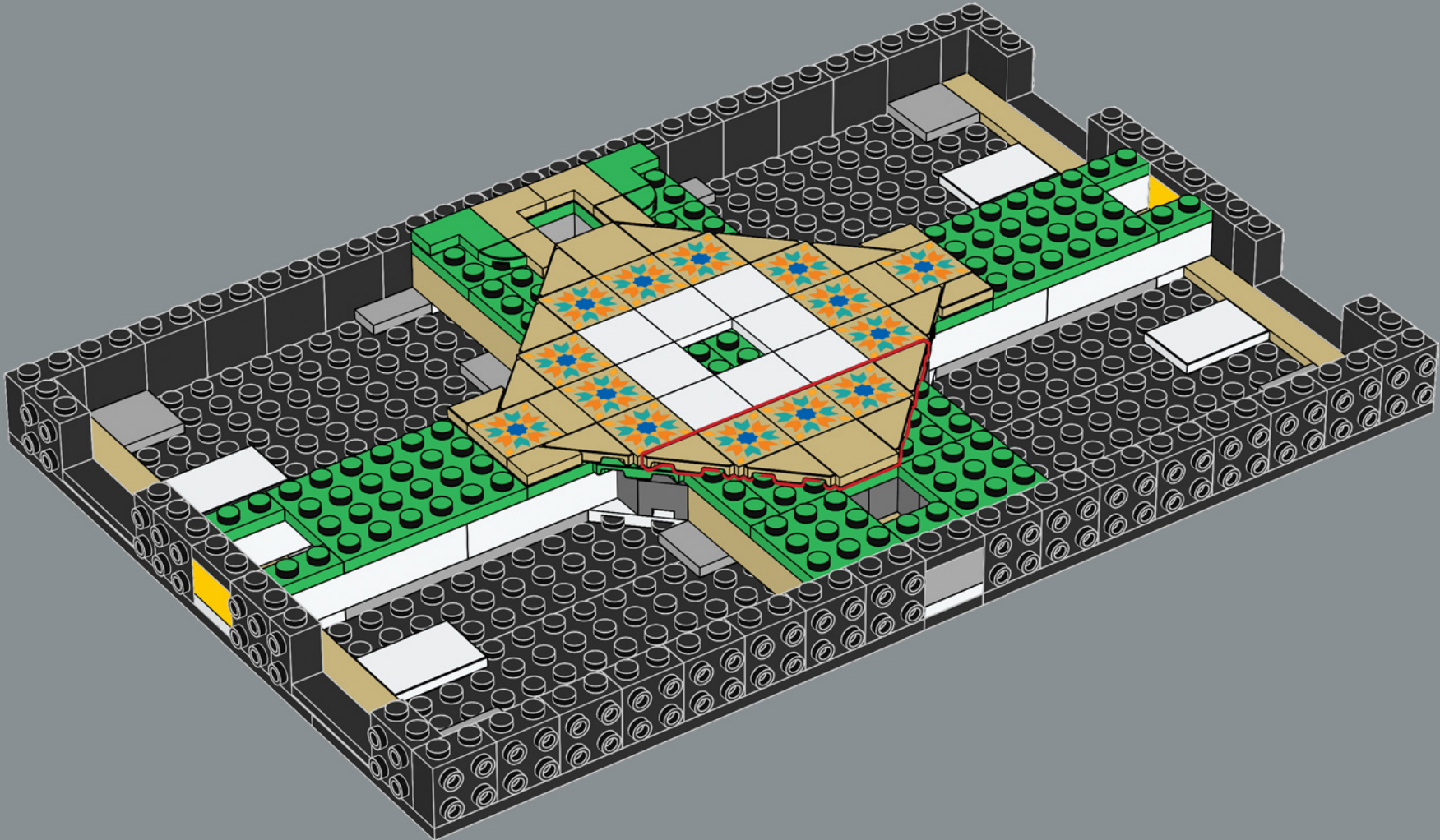

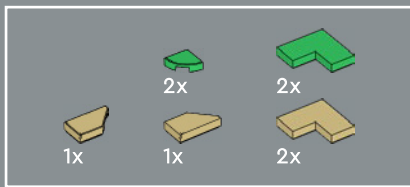

28

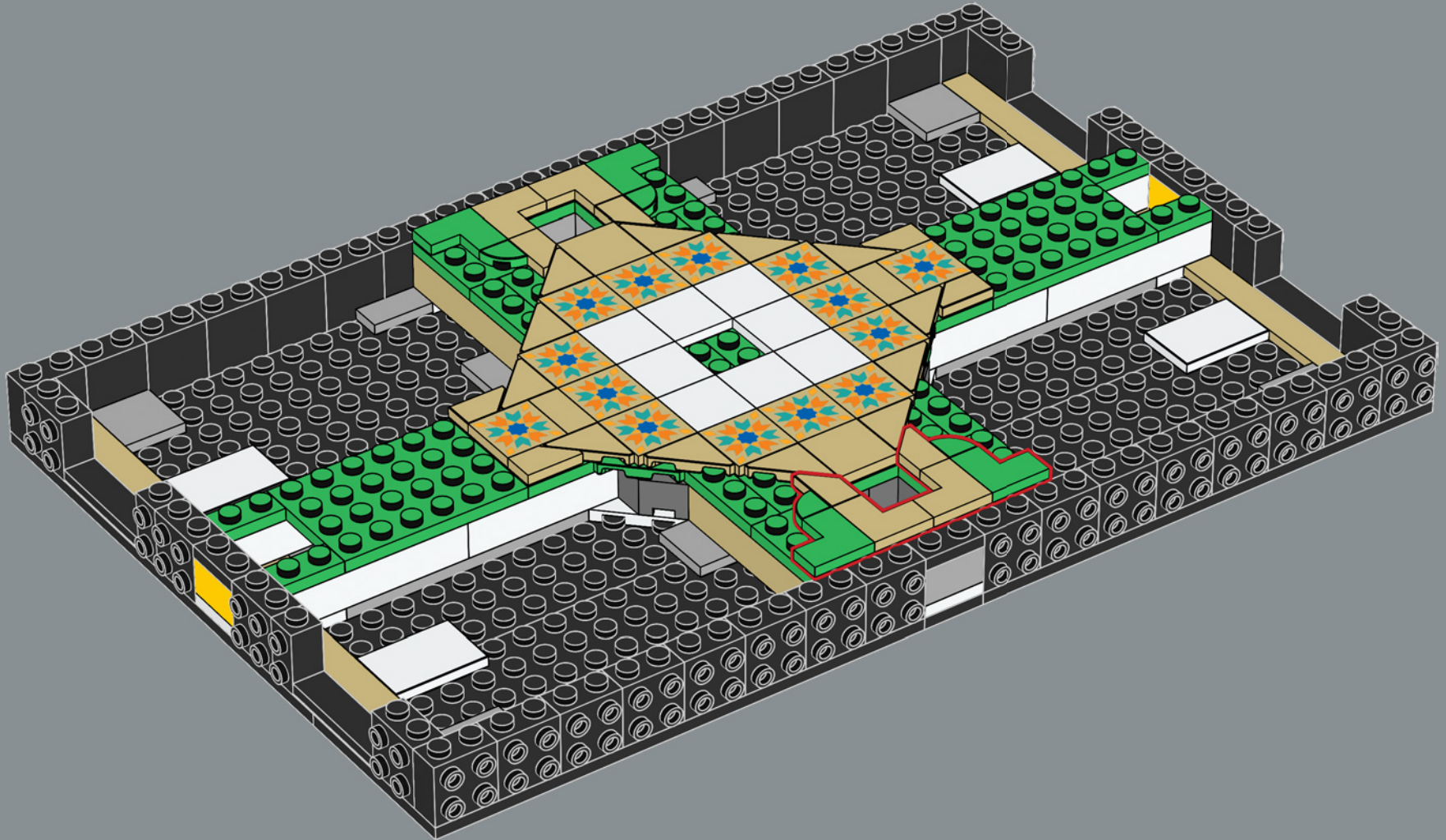

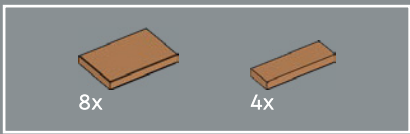

29

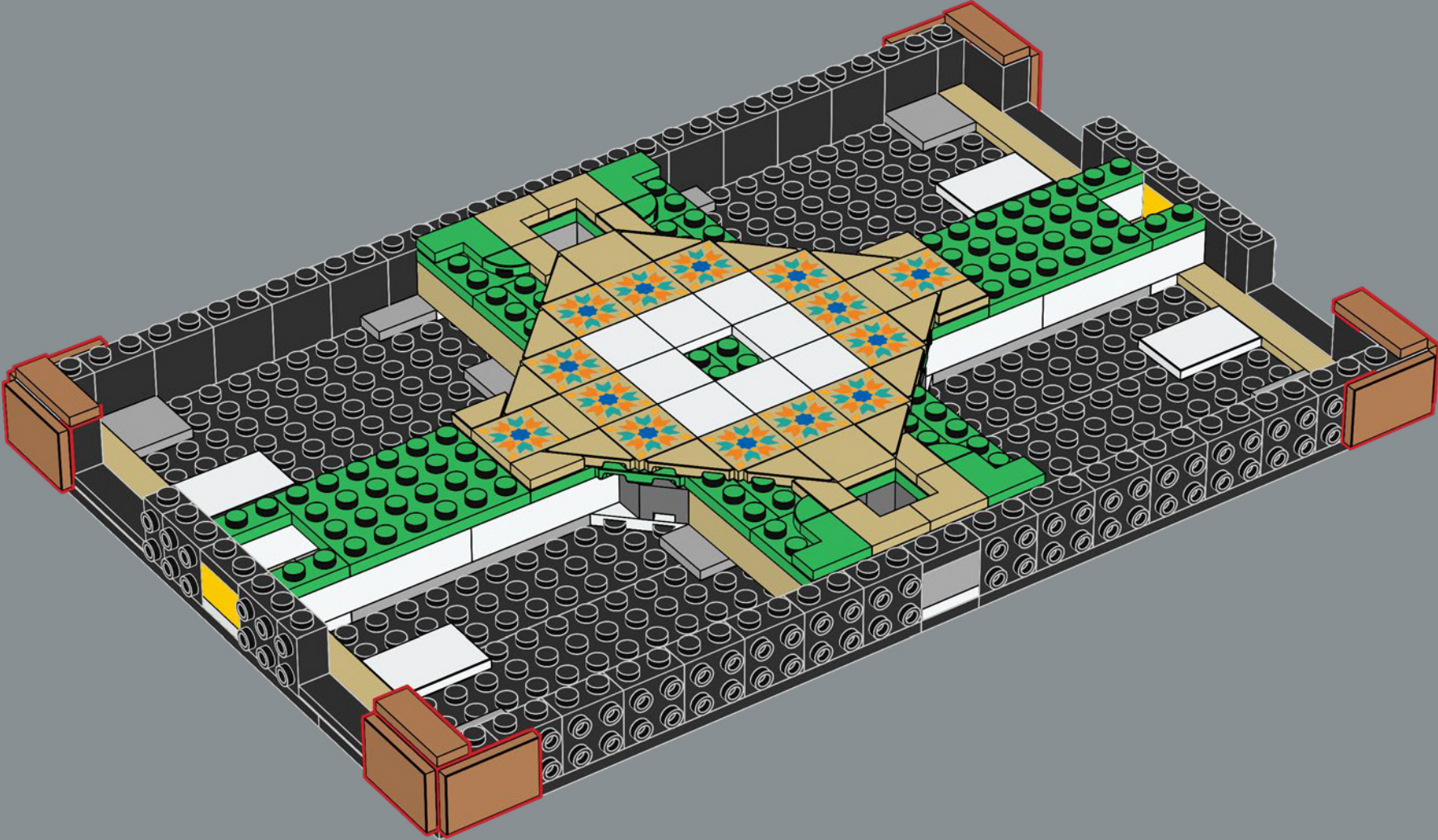



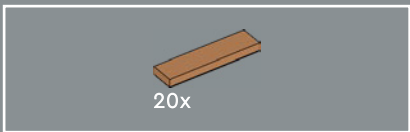

30

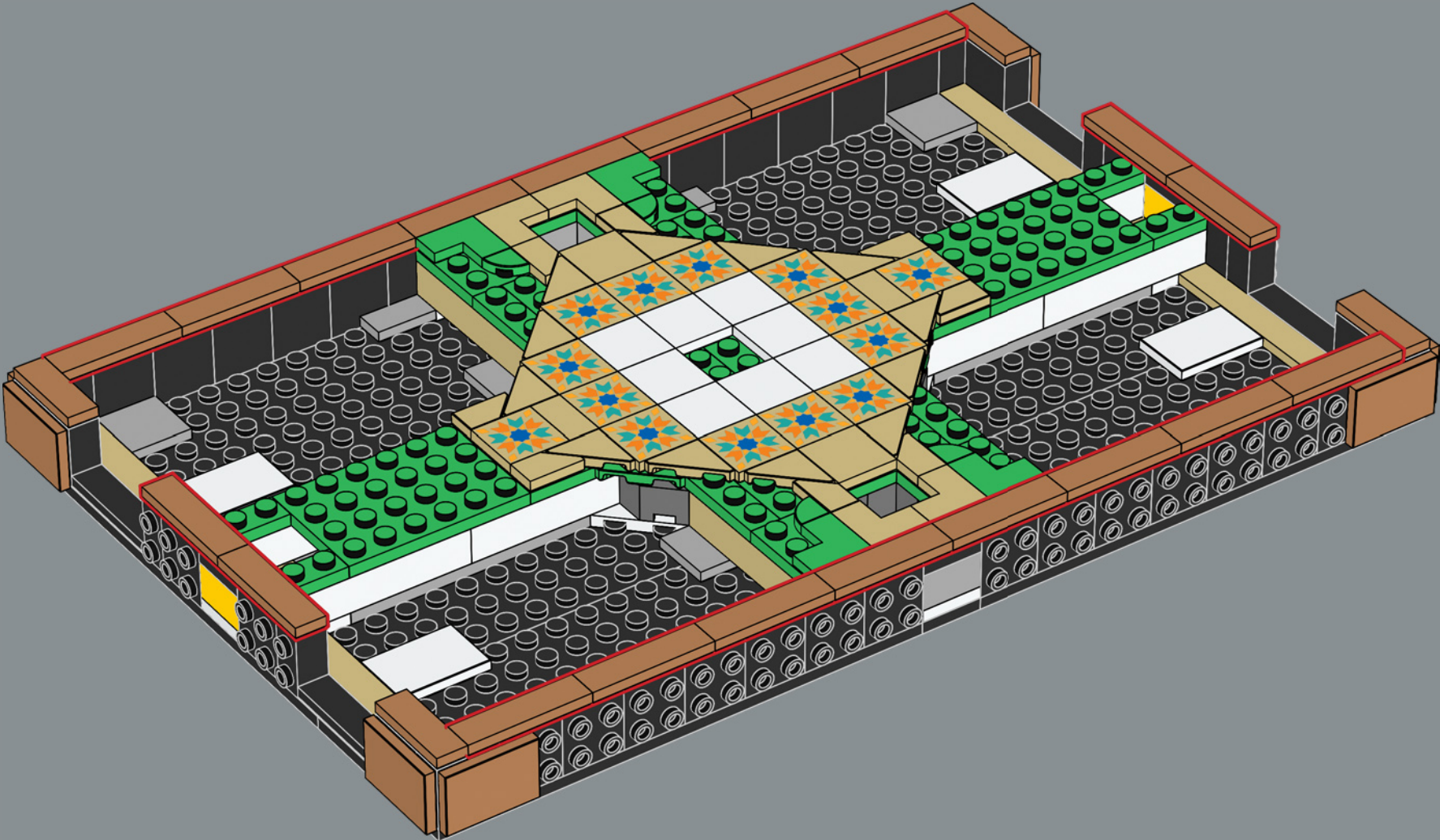

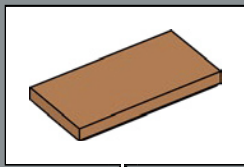

31

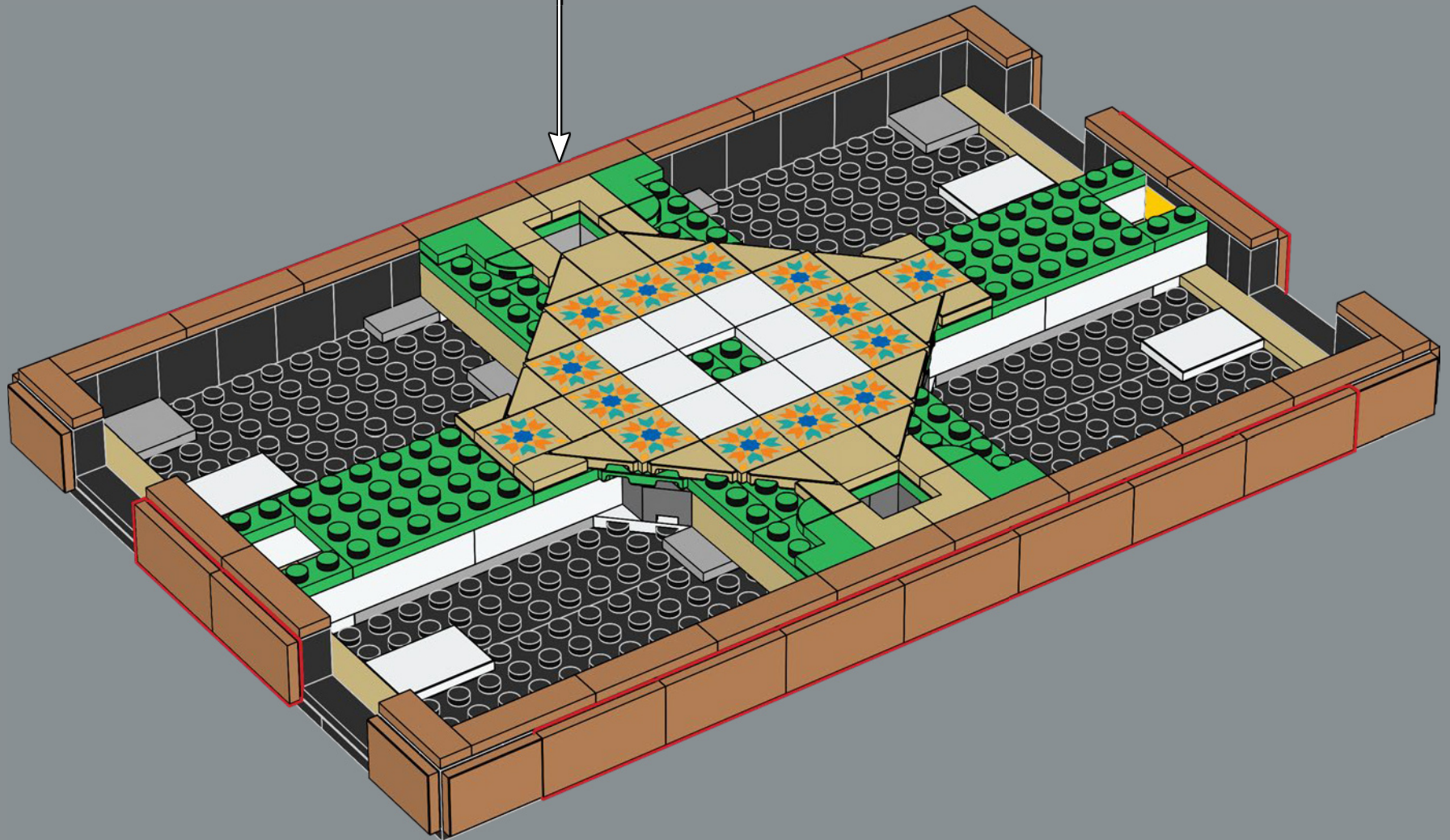

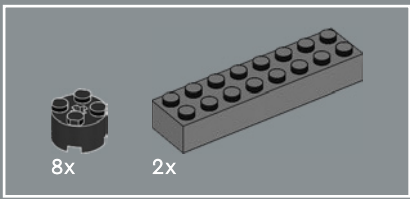

32

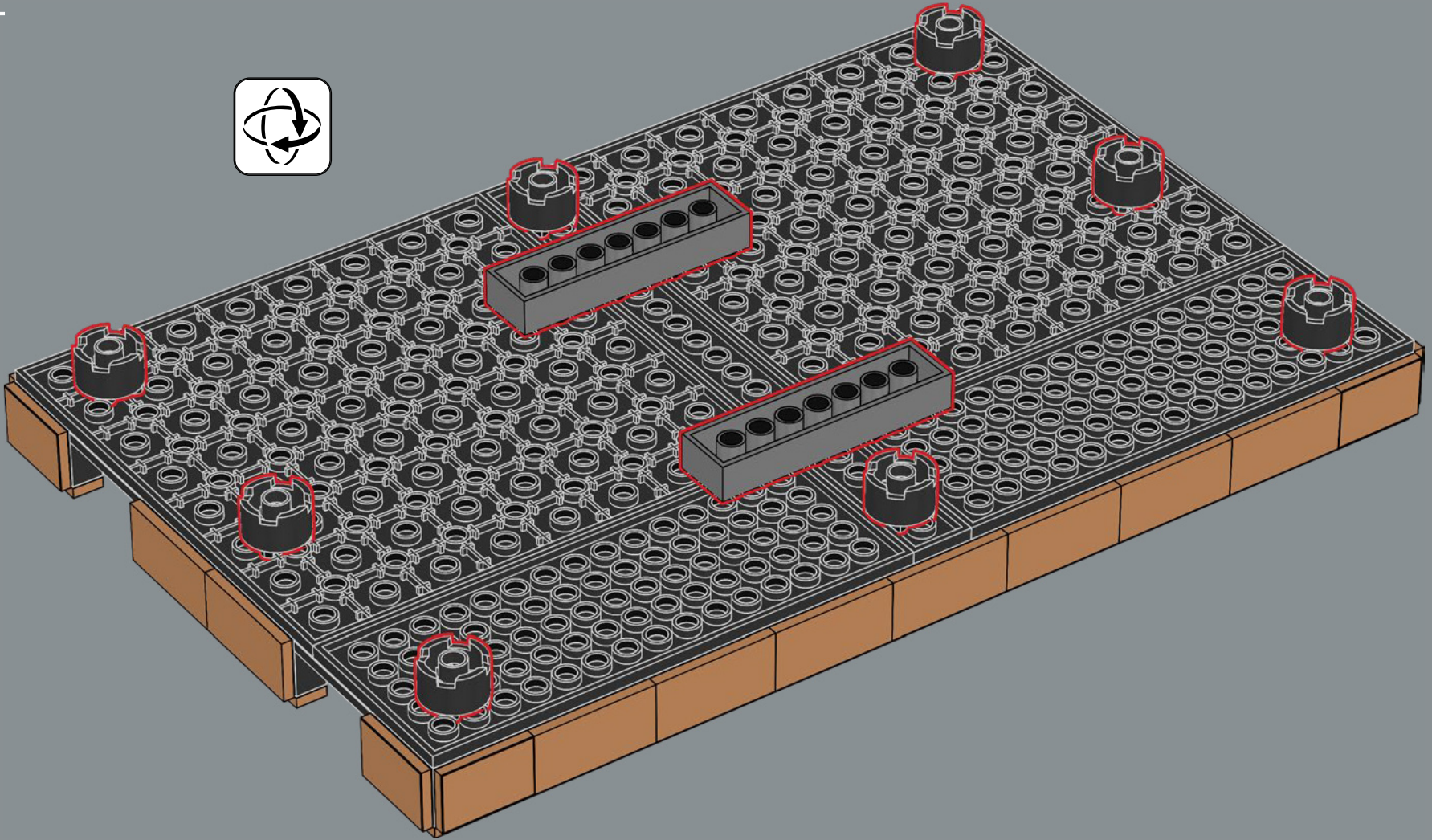

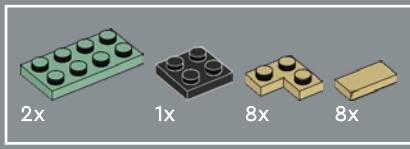

33

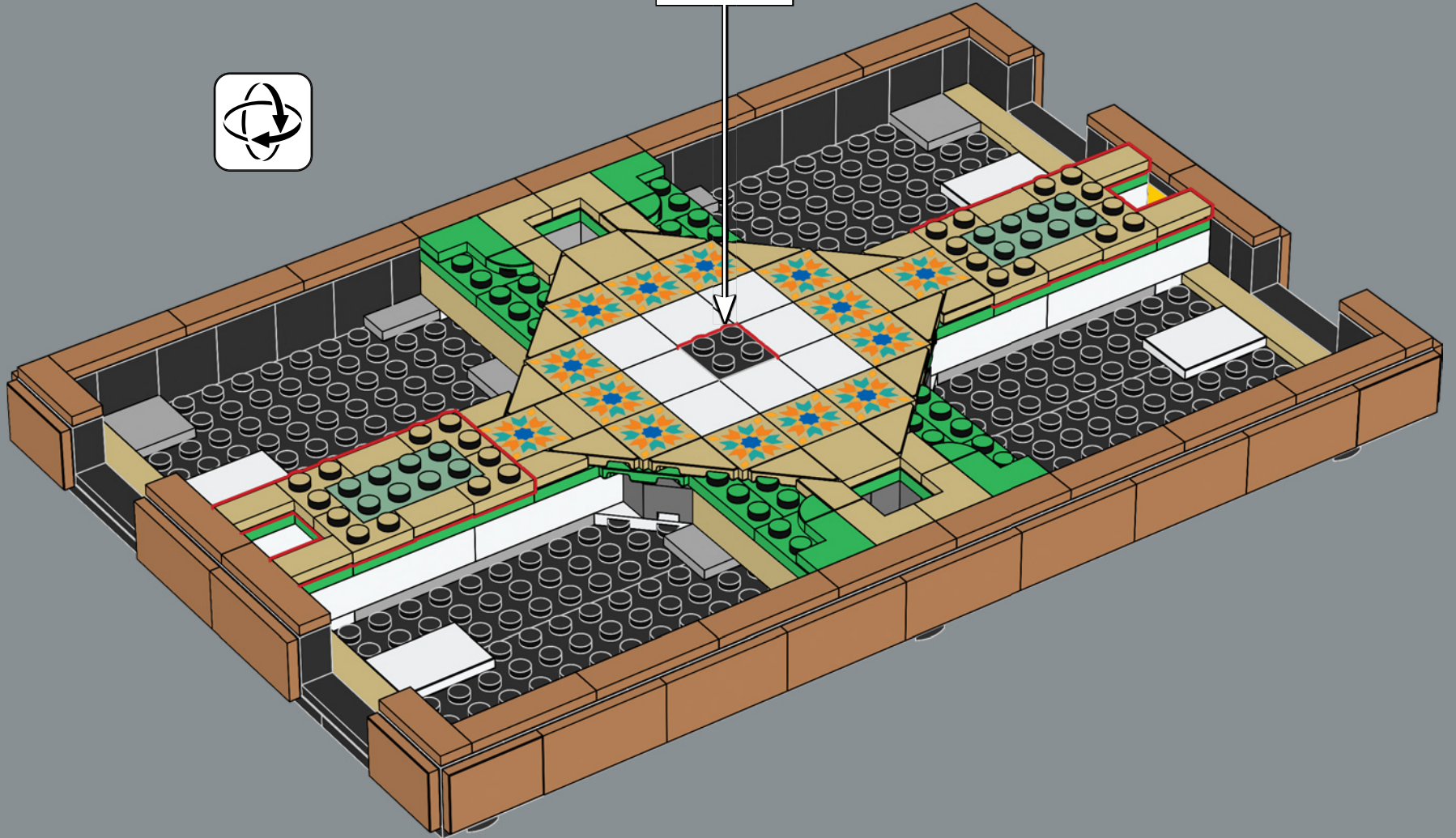
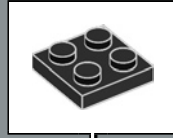



34

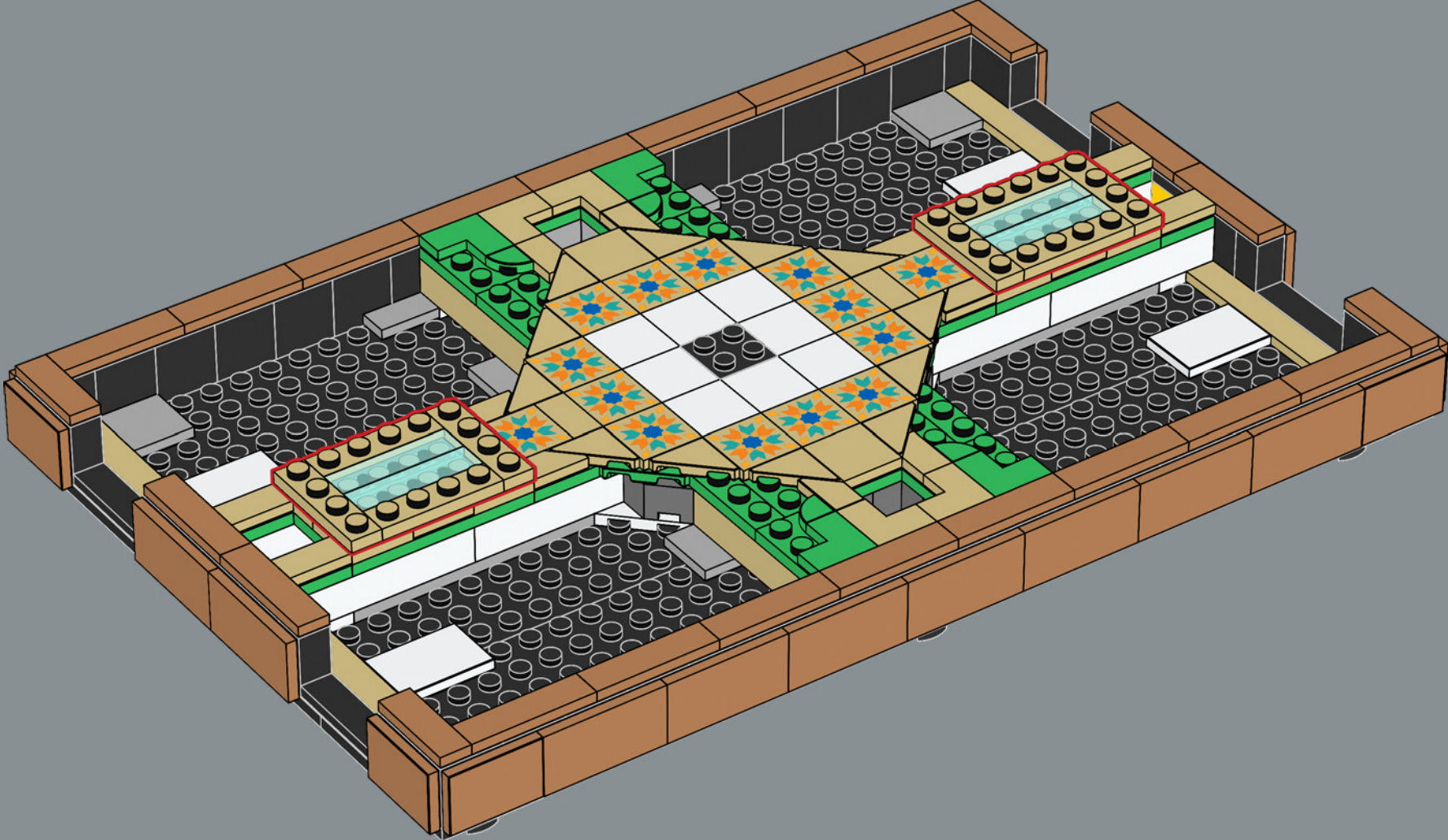

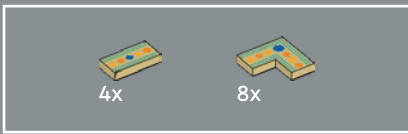

Les pièces décorées créées pour ce set s'inspirent du style de carrelage en mosaïque appelé *zellige*. On les retrouve fréquemment dans l'architecture de sites et monuments historiques anciens, notamment au Maroc, en Algérie, en Tunisie et dans la région andalouse du sud de l'Espagne.

35

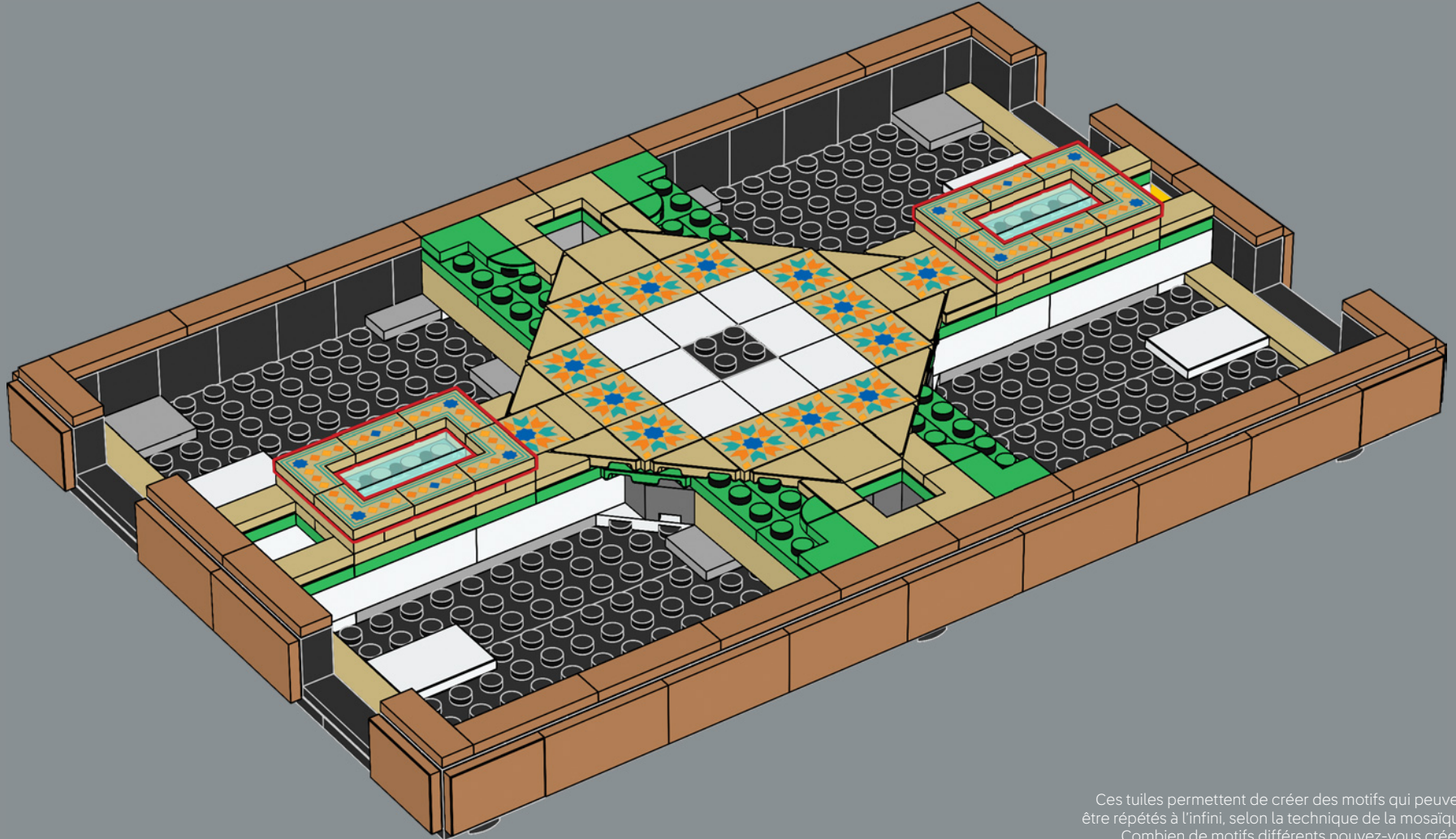

Ces tuiles permettent de créer des motifs qui peuvent être répétés à l'infini, selon la technique de la mosaïque. Combien de motifs différents pouvez-vous créer ?

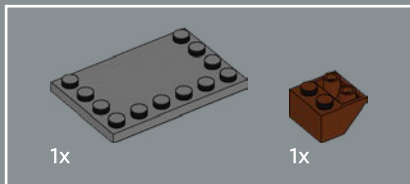
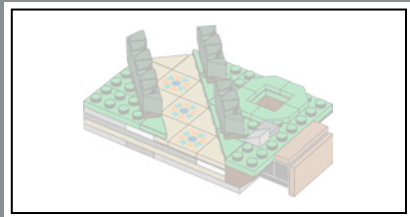

36

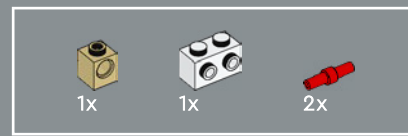
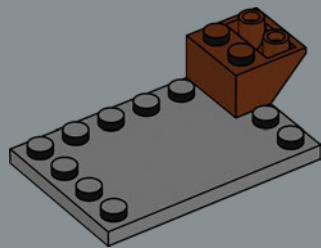

37

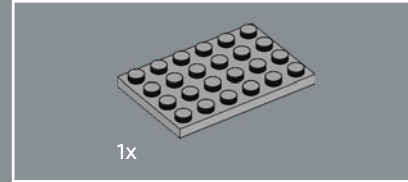
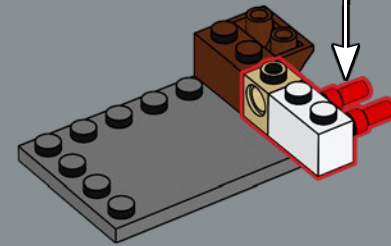
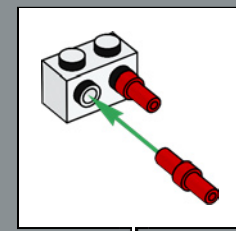

38

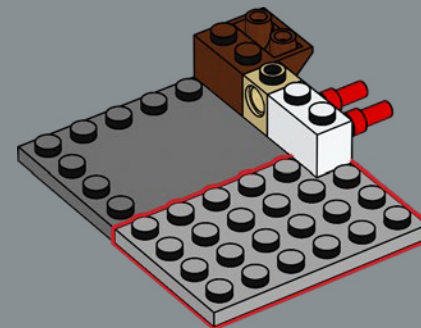



39

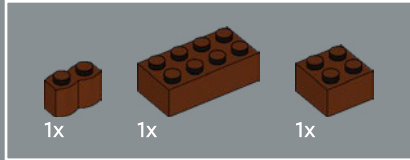
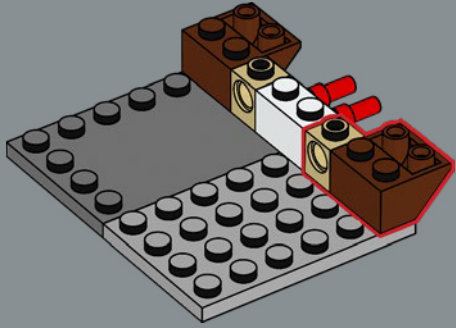

40

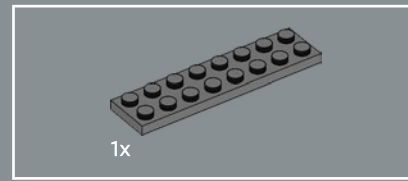
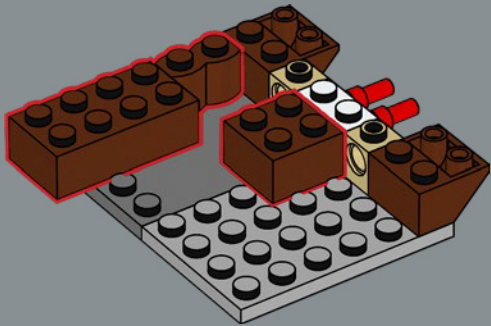

41

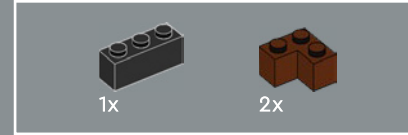
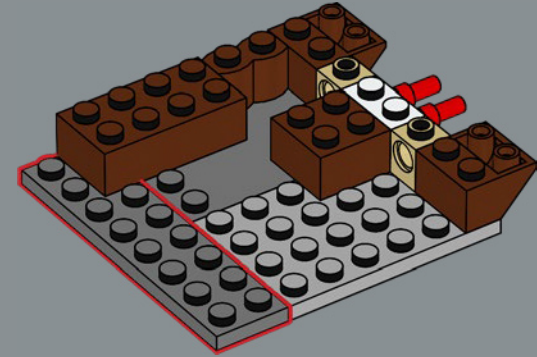

42

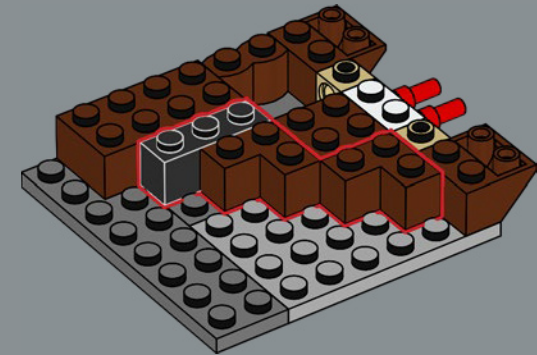

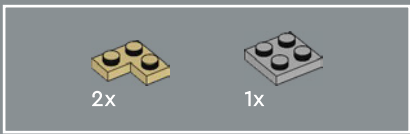

43

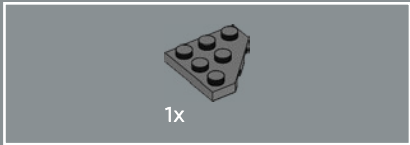
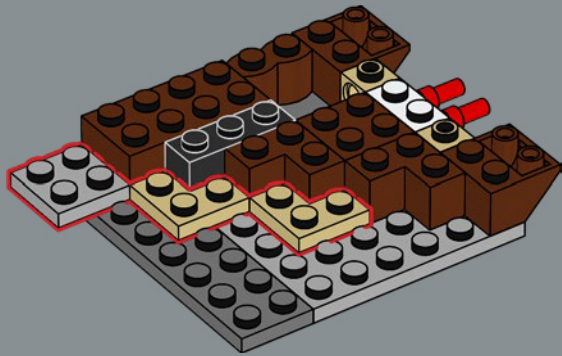

44

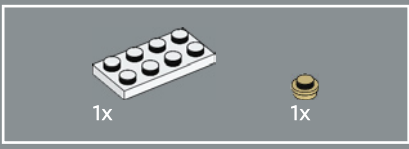
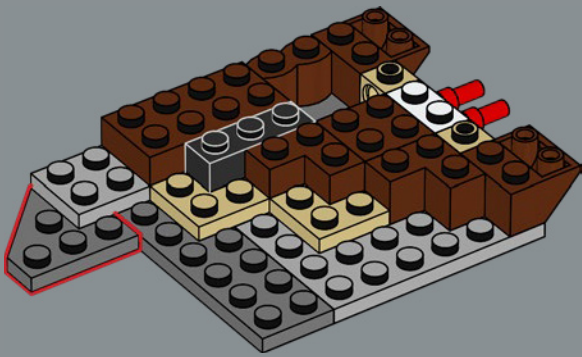

45

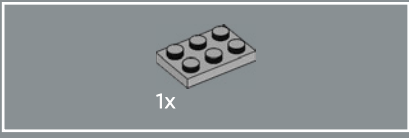
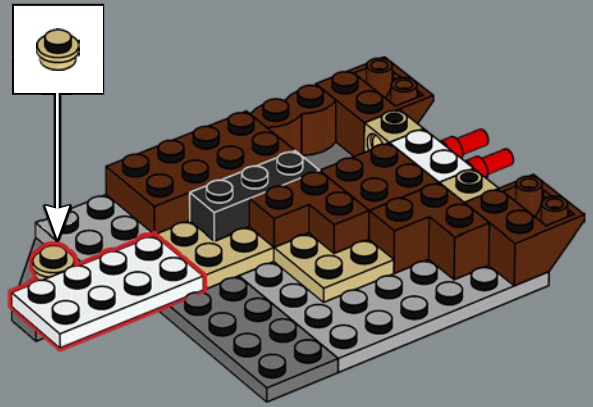

46

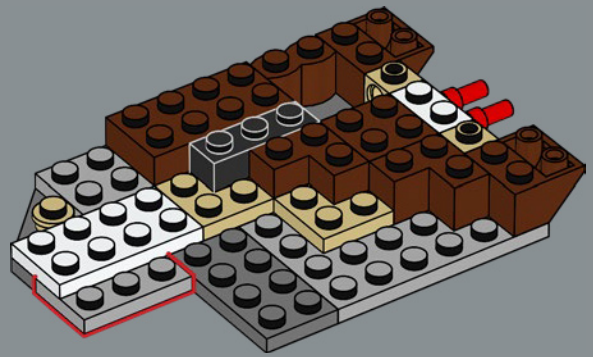

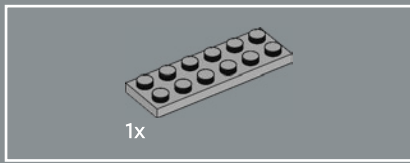

47

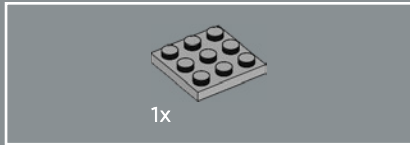
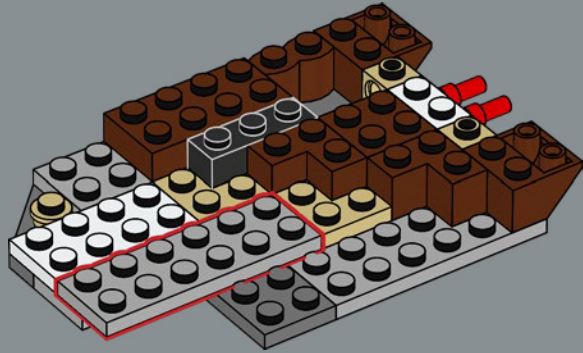

48

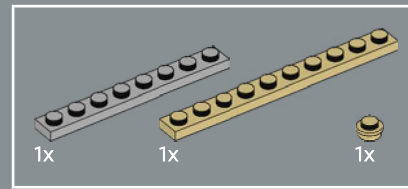
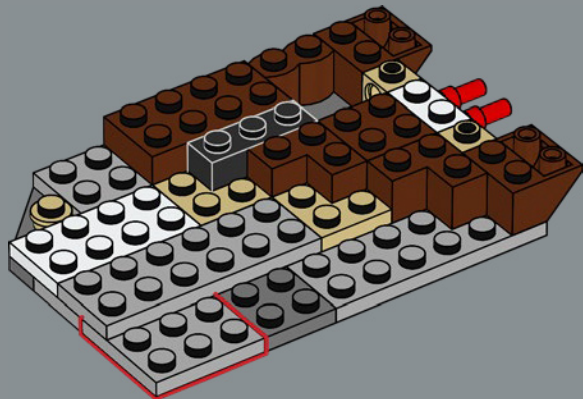

49

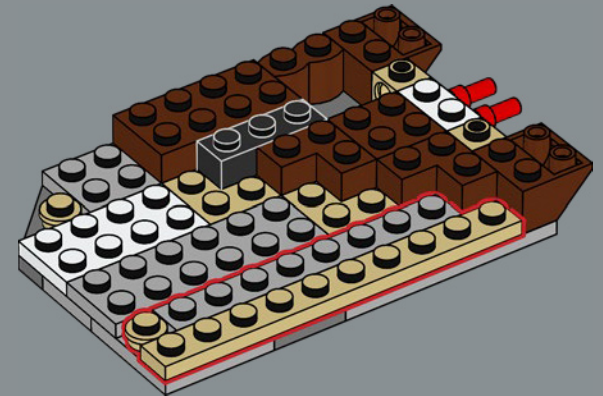

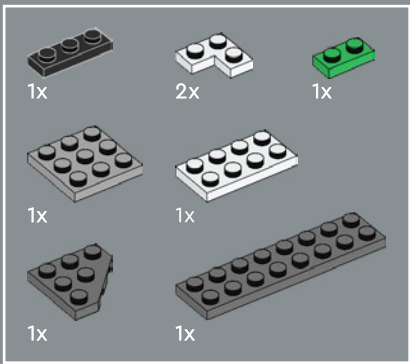

50

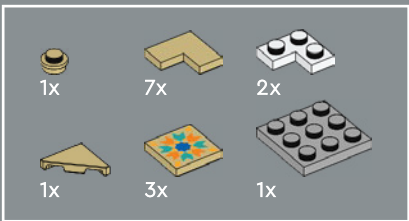

51

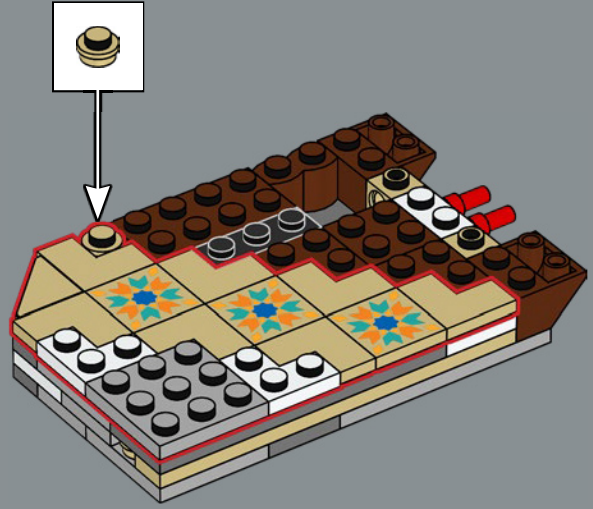

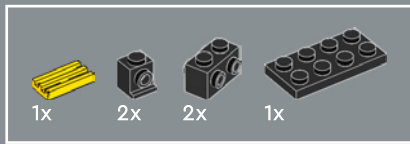

52

1

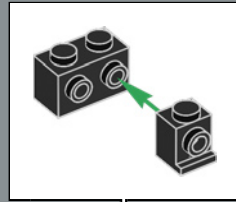
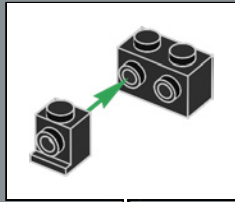
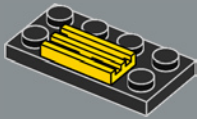

2

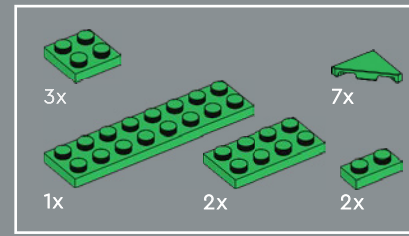
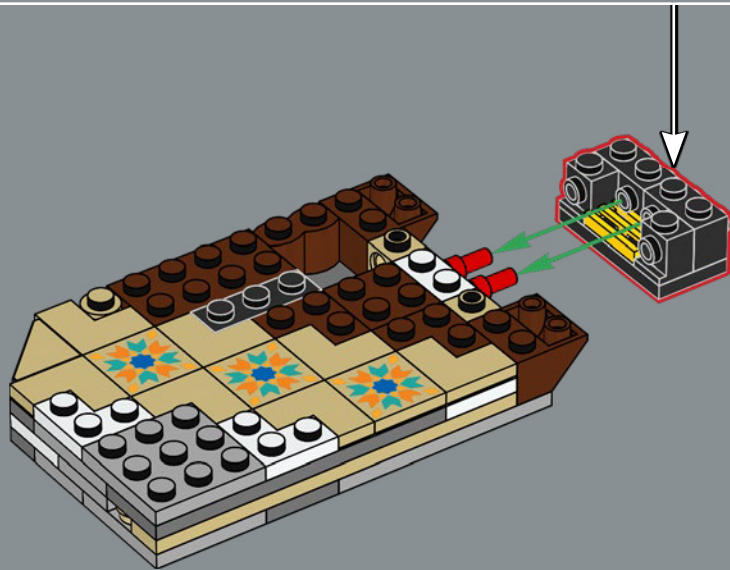
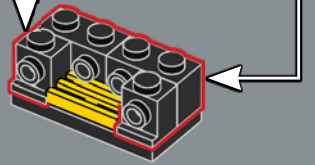

53

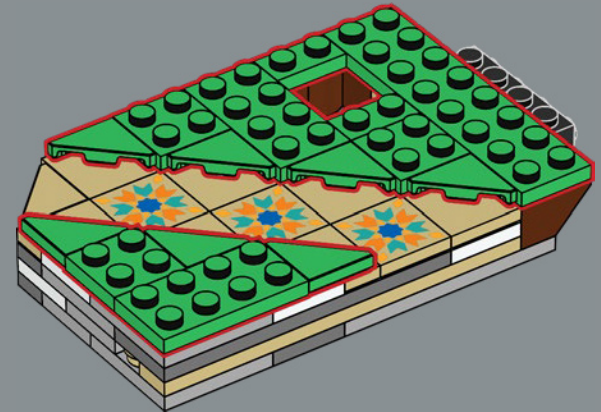



54

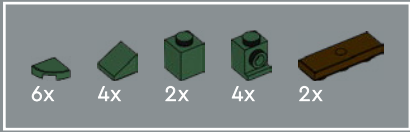
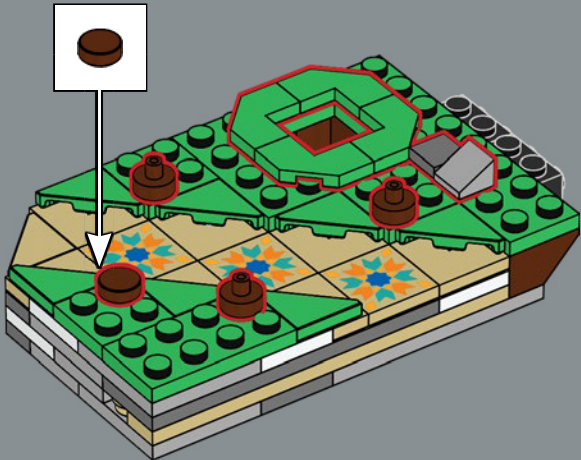

55

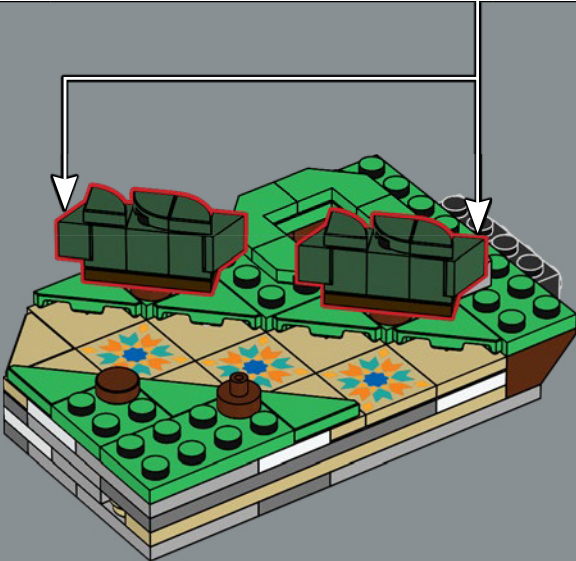
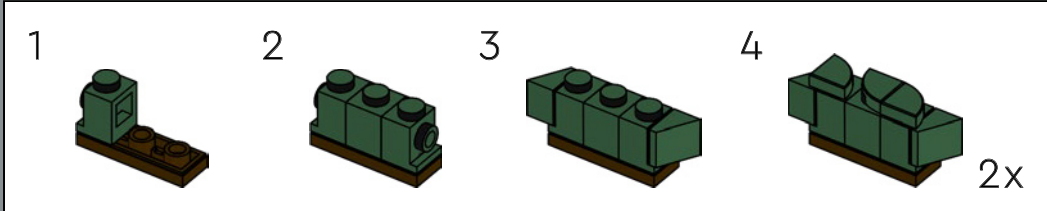

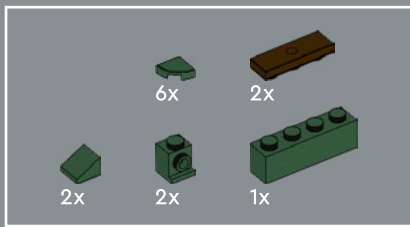

56

1



2

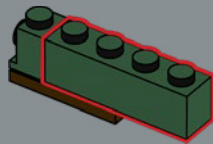

3

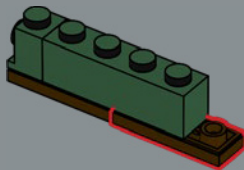

4

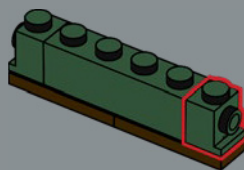

5

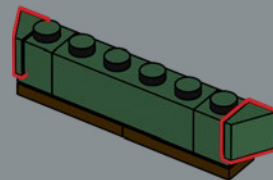

6

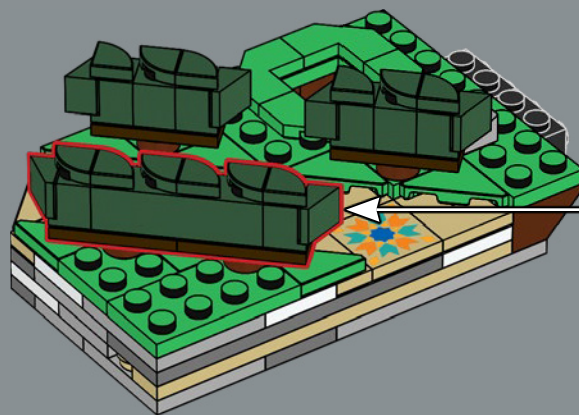
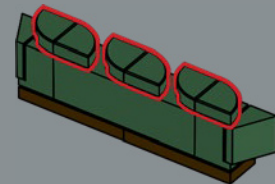

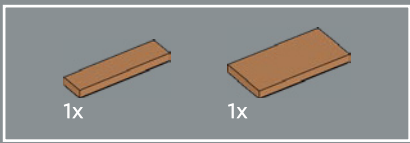

57

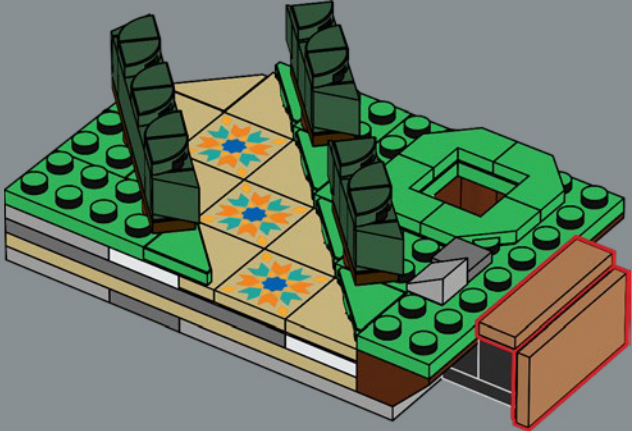

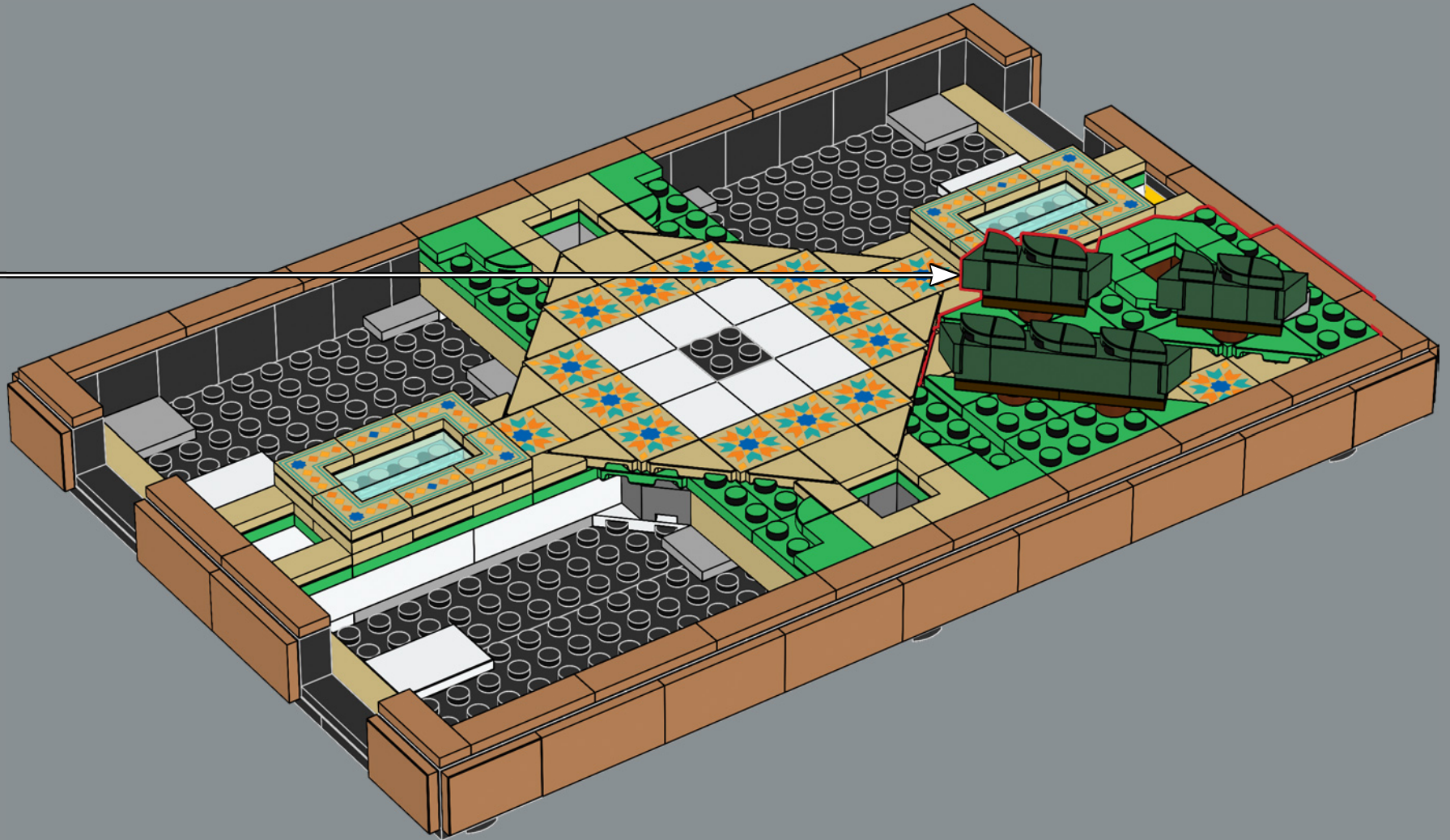

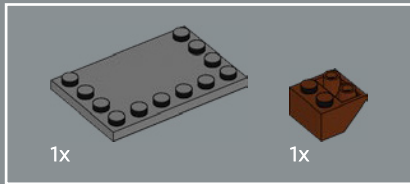
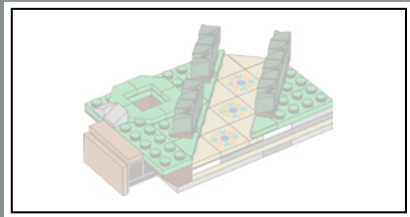

59

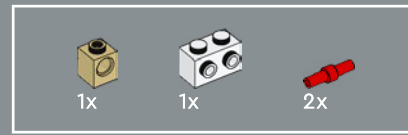
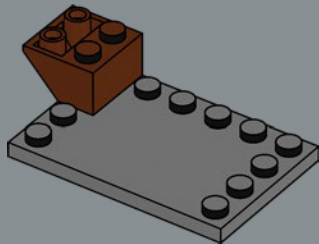

60

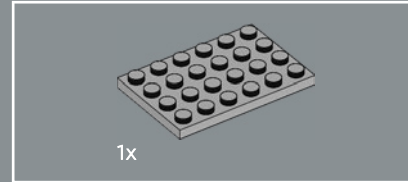
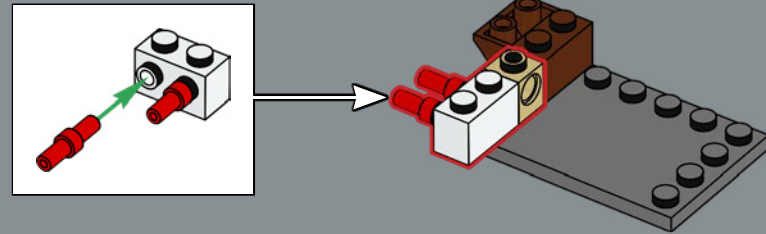

61

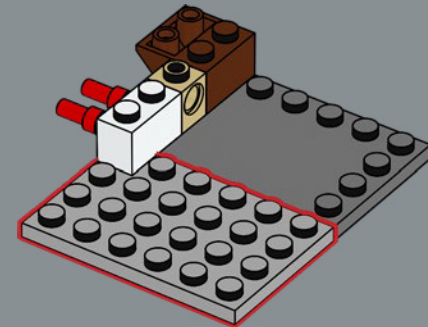

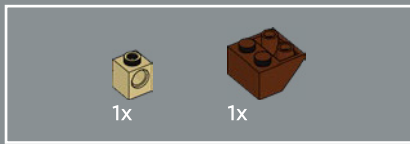

62

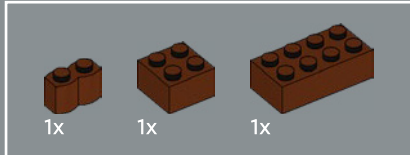
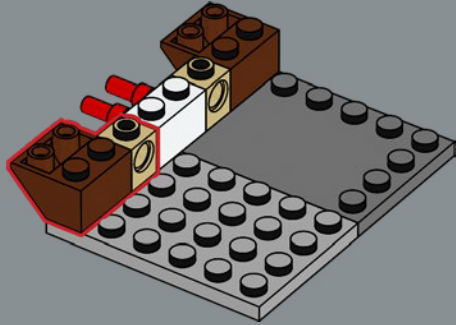

63

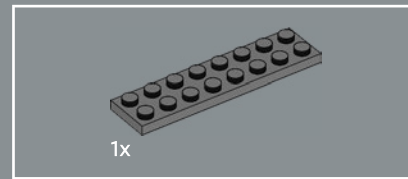
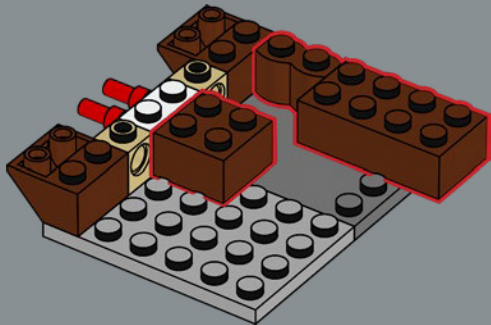

64

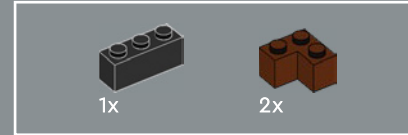
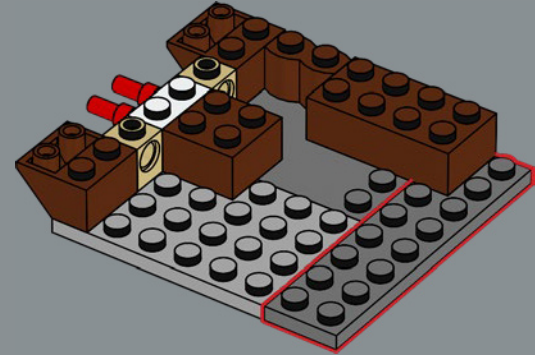

65

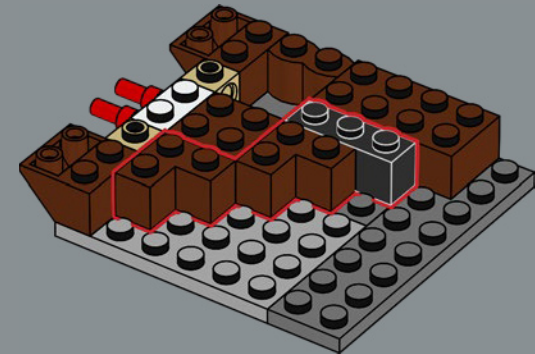

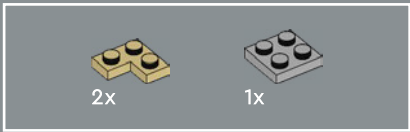

66

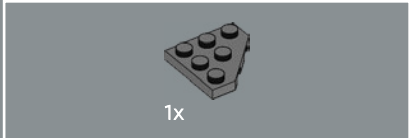
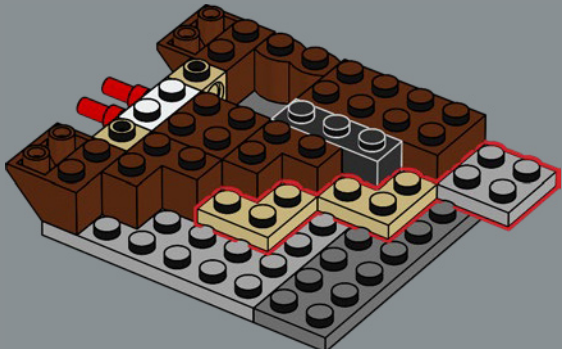

67

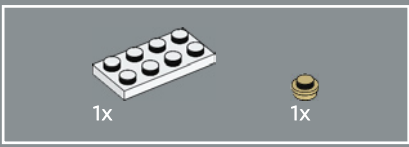
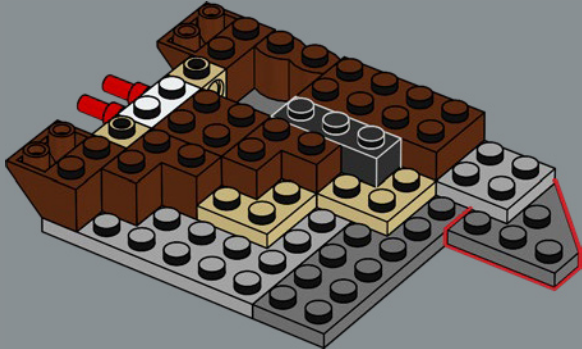

68

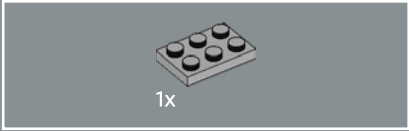
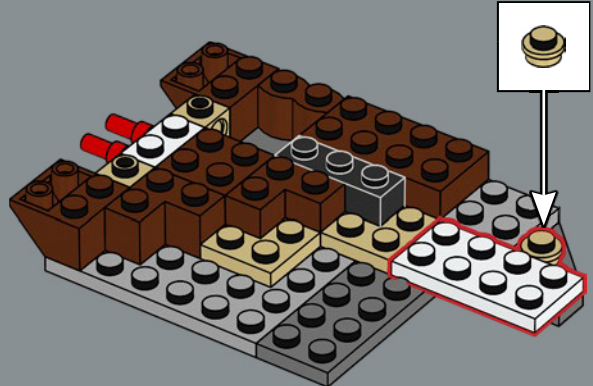

69

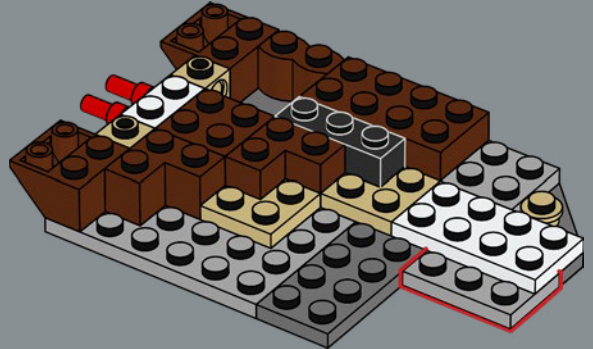

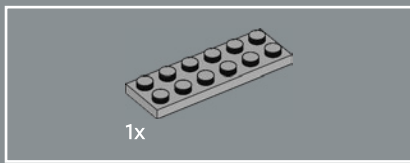

70

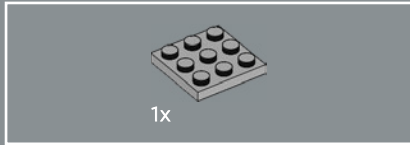
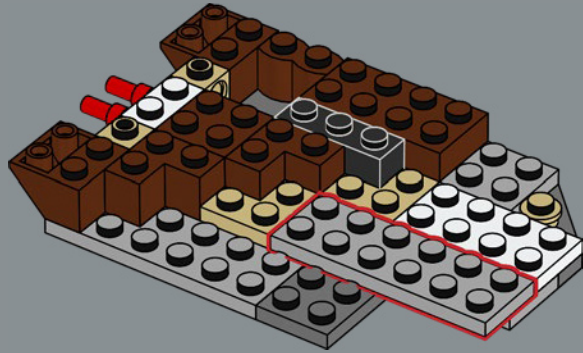

71

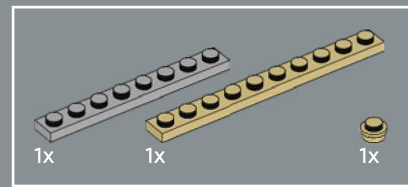
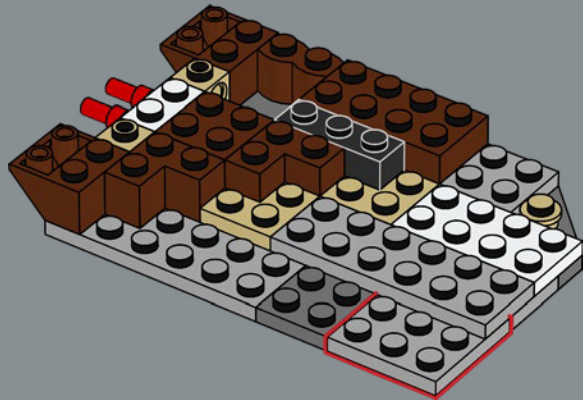

72

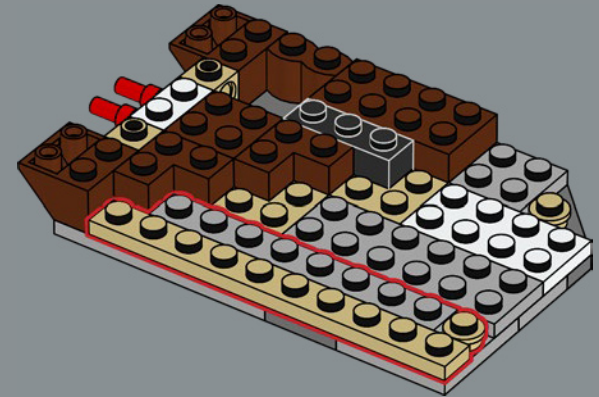

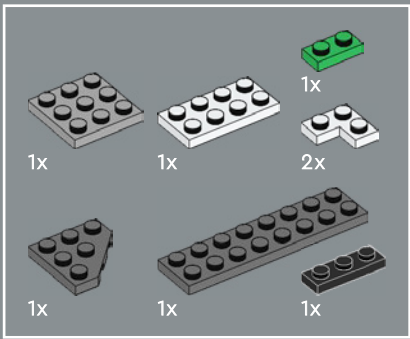

73

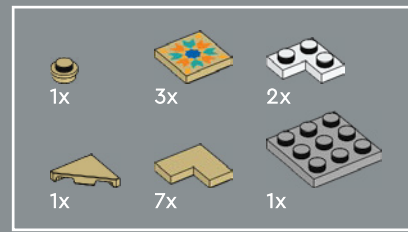
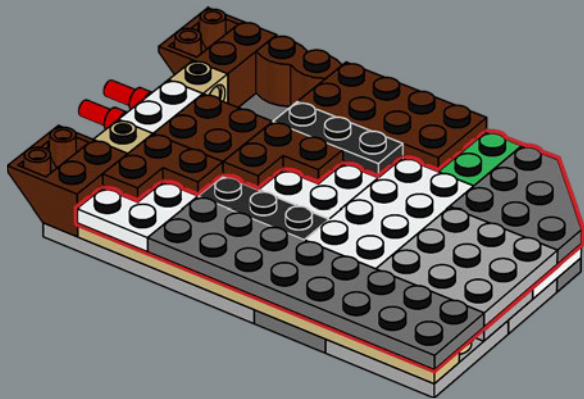

74

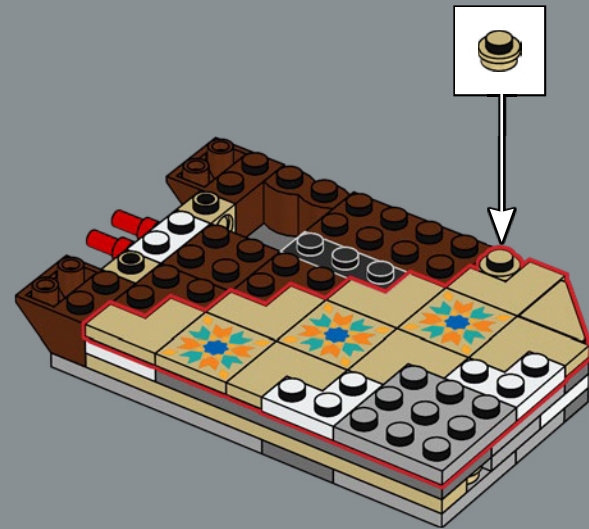

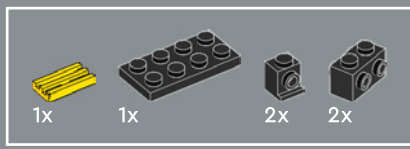

75

1

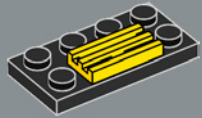

2

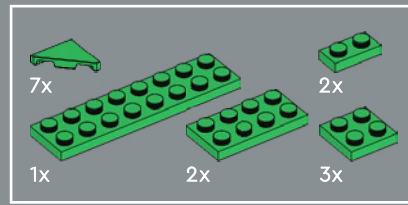
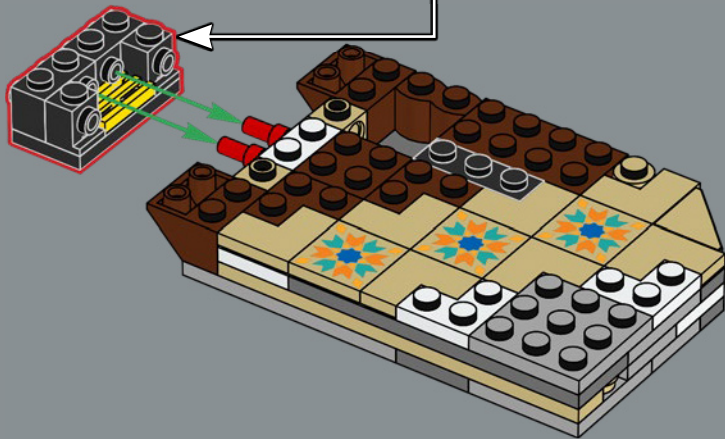
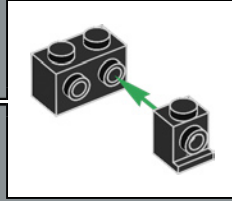
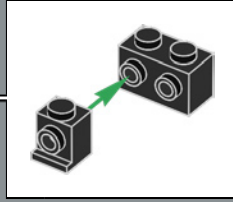
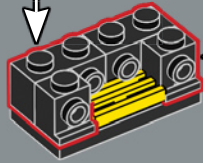

76

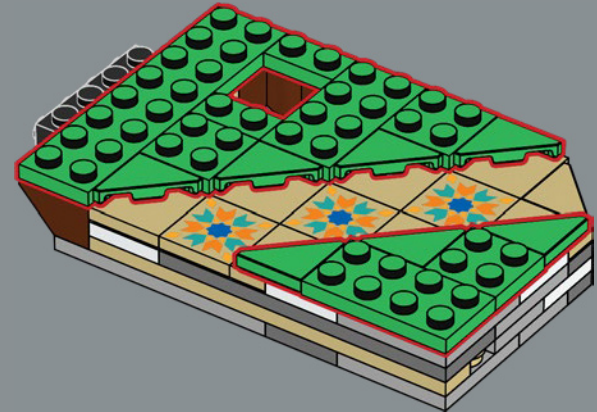

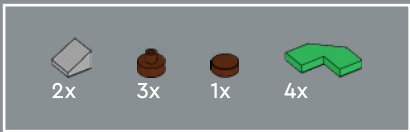

77

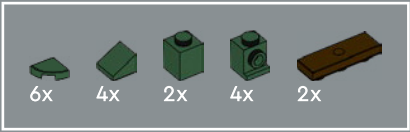
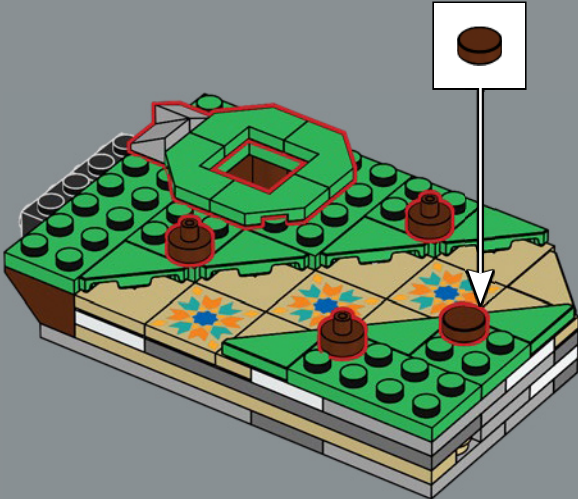

78

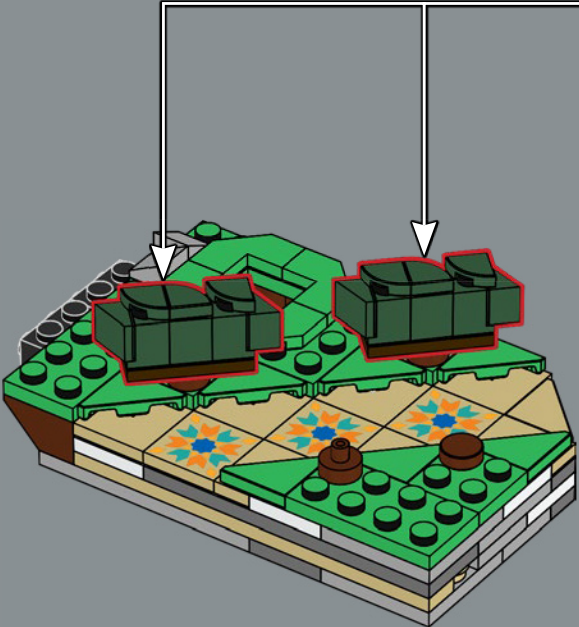
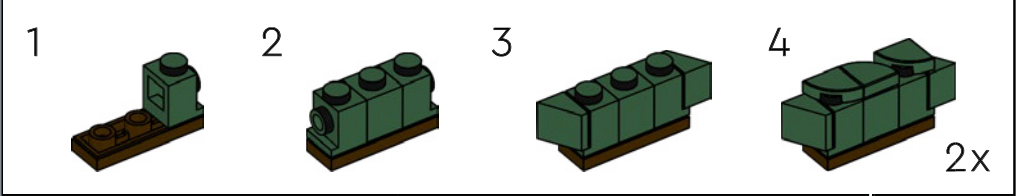

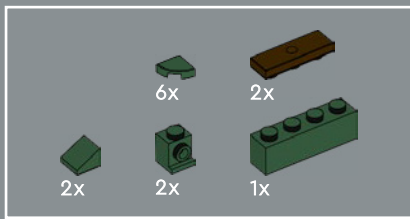

79

1



2

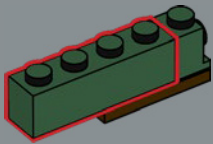

3

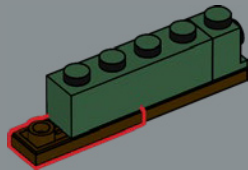

4

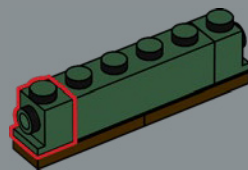

5

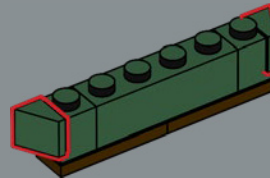

6

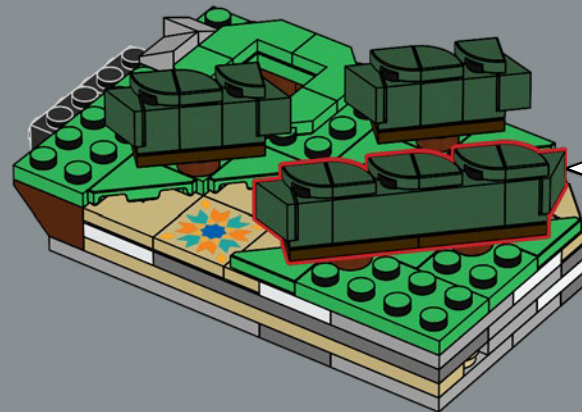
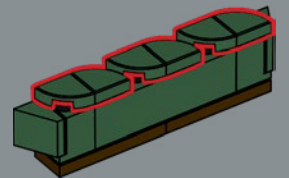

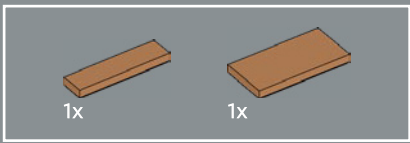

80

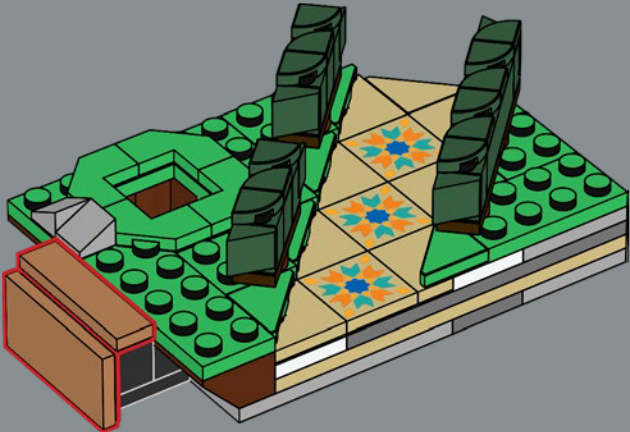

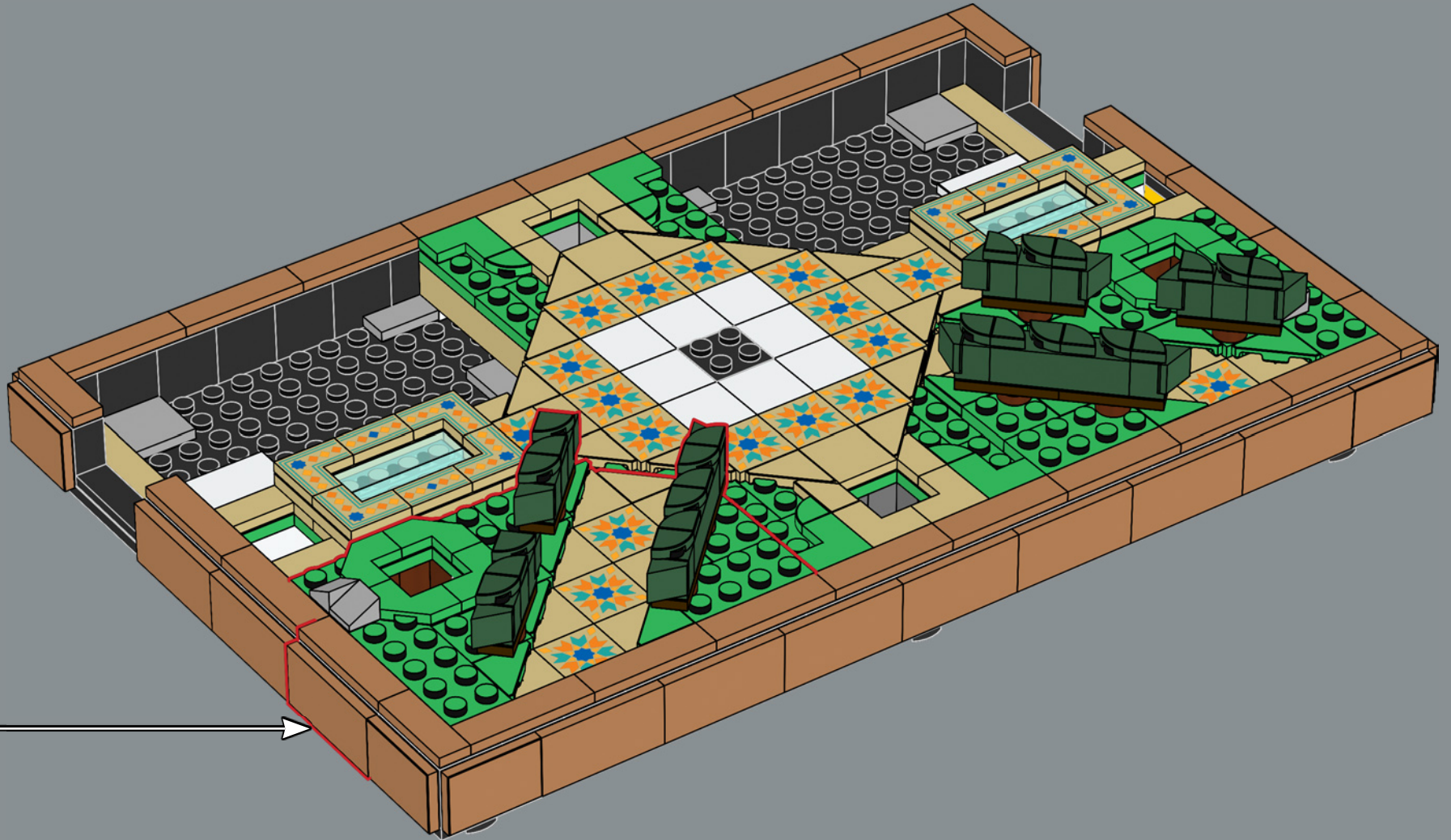

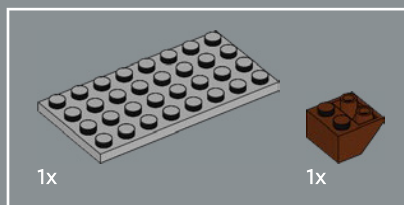
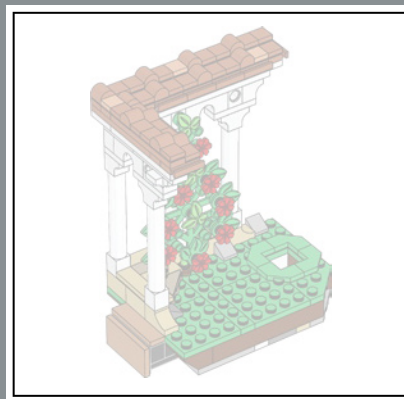

82

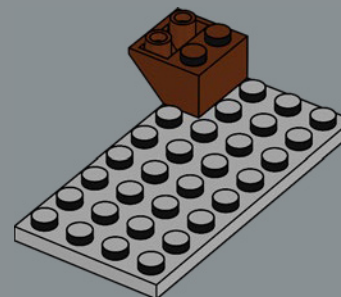

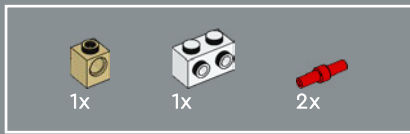

83

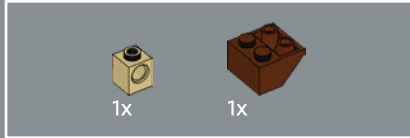
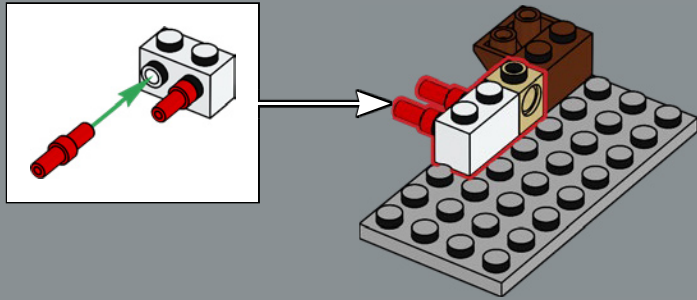

84

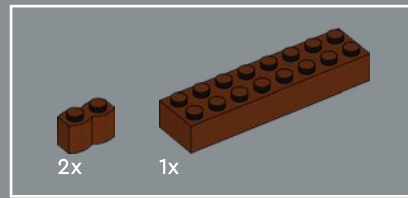
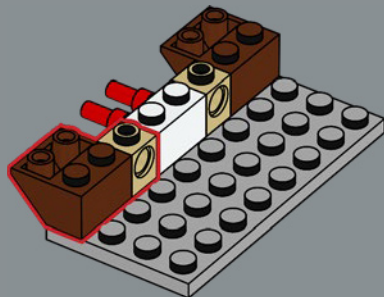

85

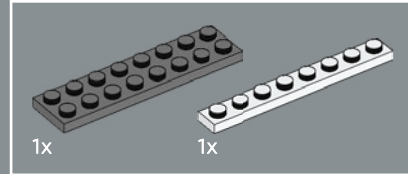
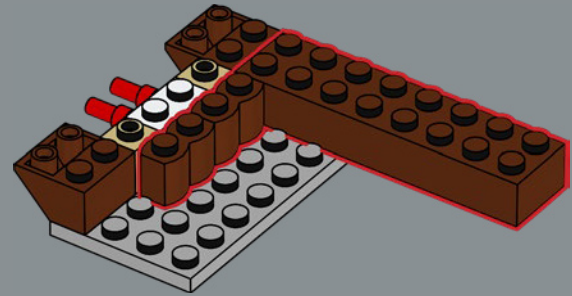

86

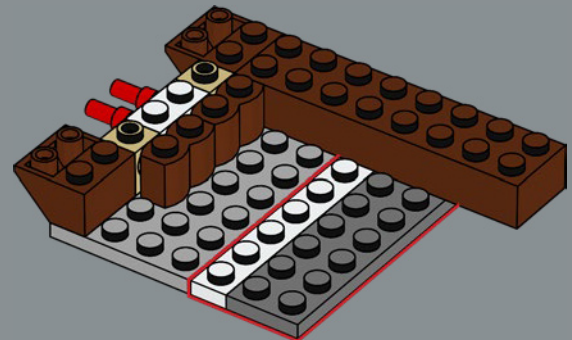

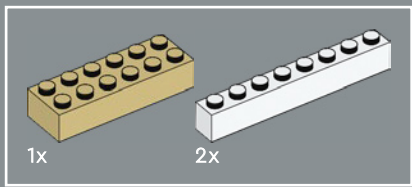

87

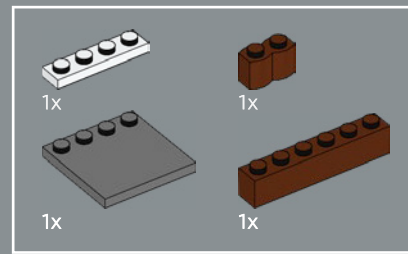
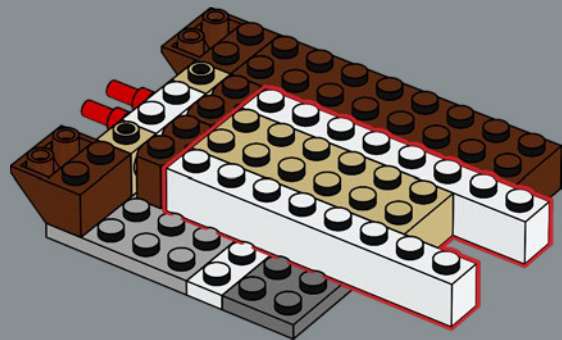

88

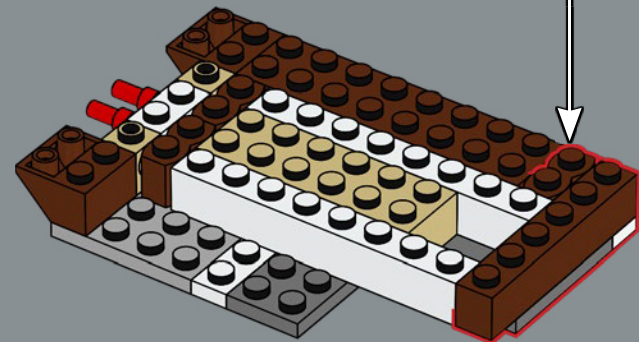
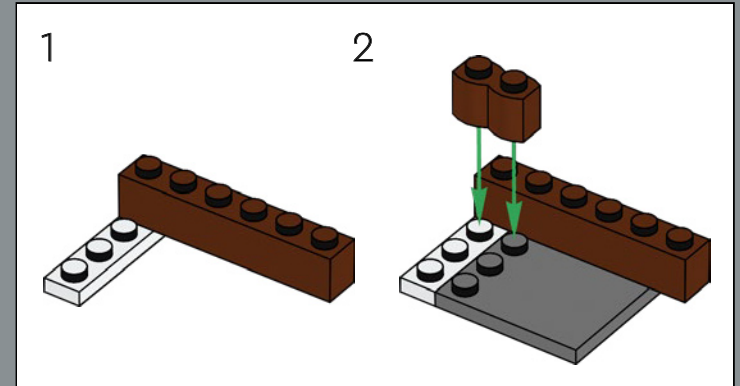

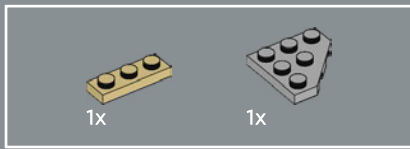

89

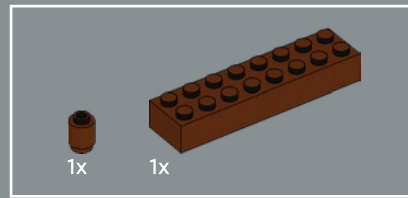
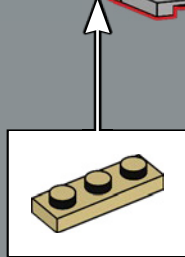
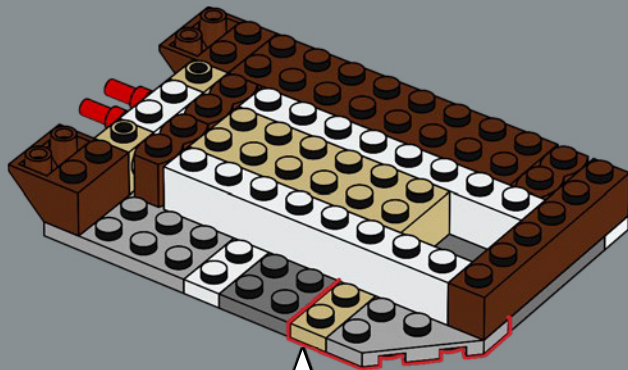

90

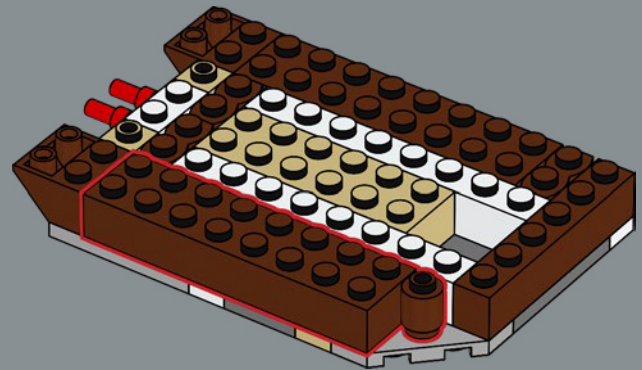

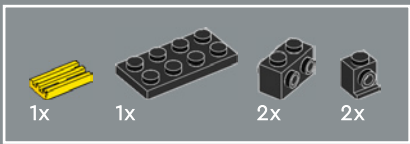

91

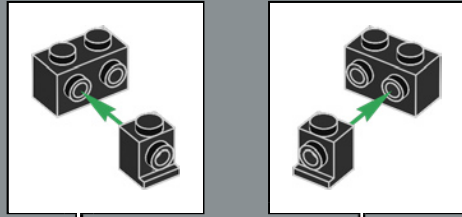

1

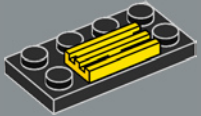

2

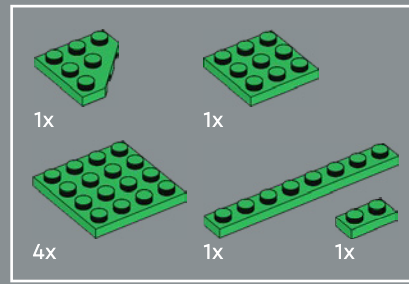
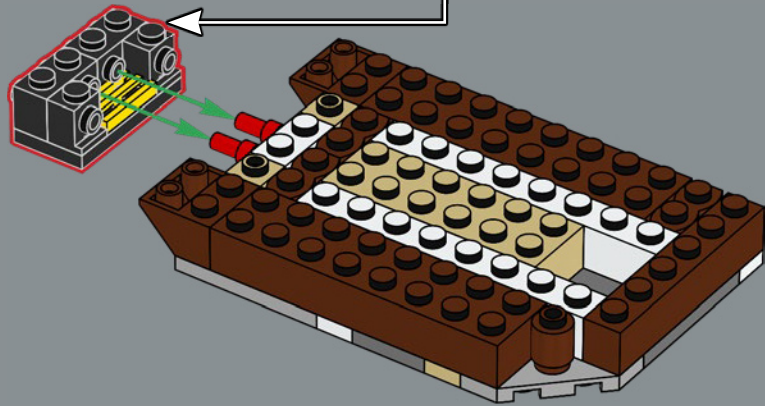
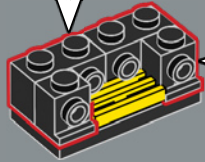

92



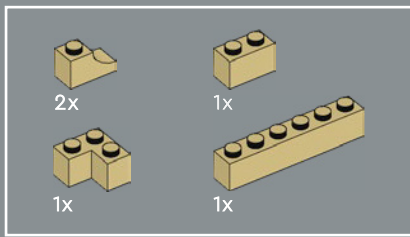

93

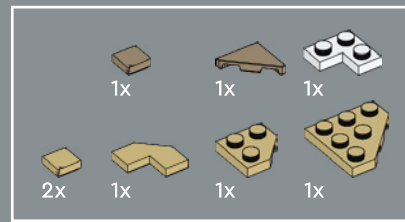
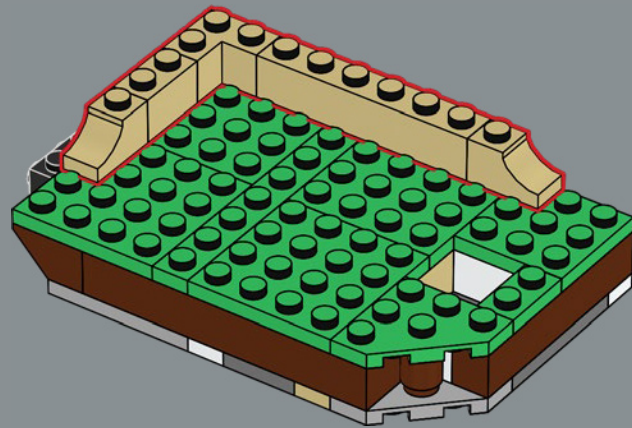

94

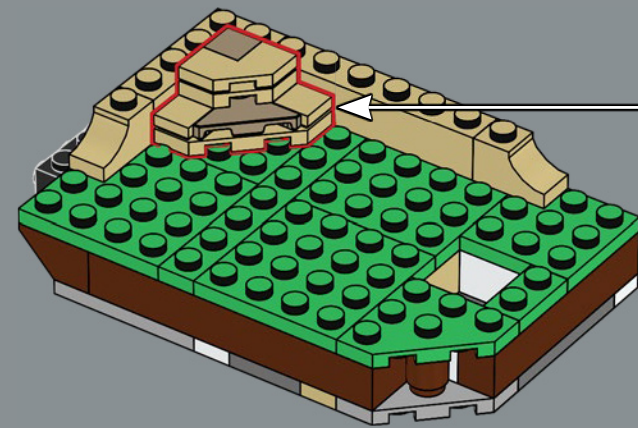
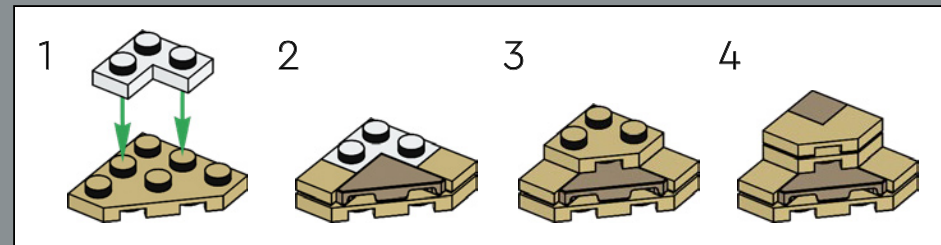



95

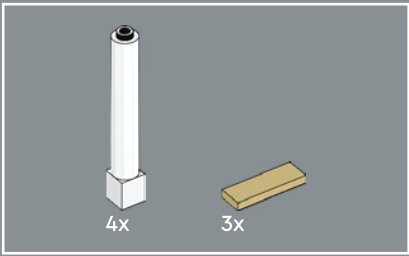
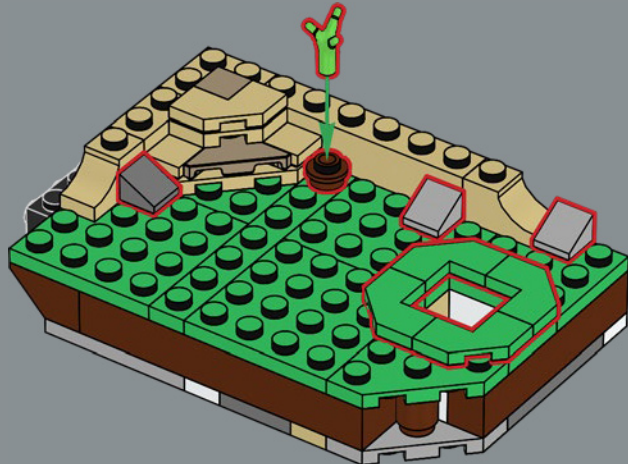

96

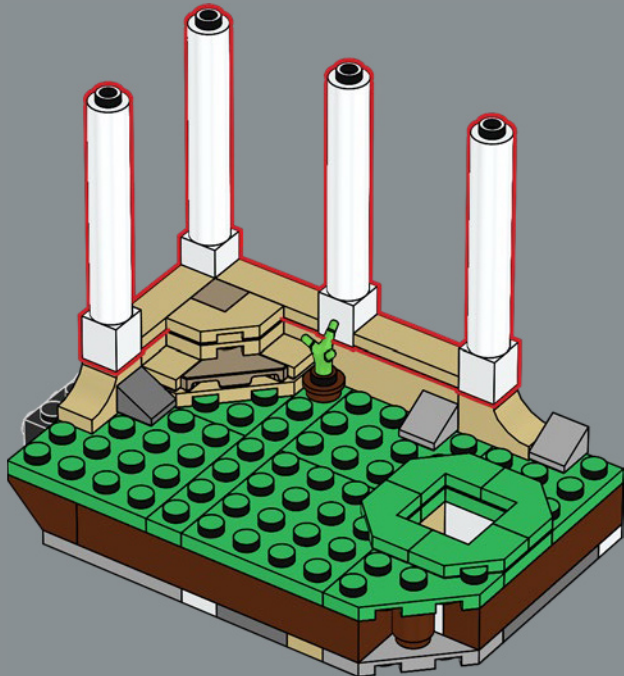

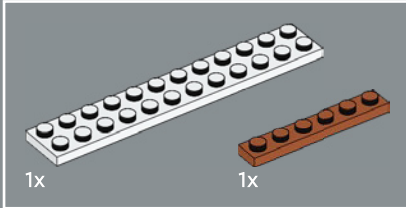
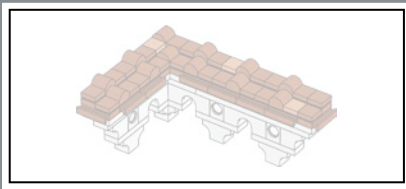

97

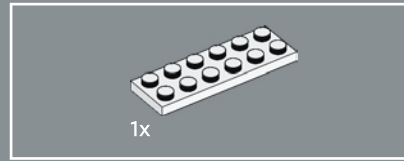
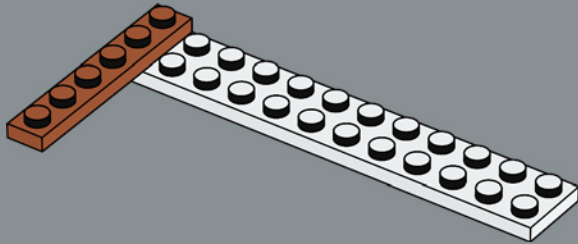

98

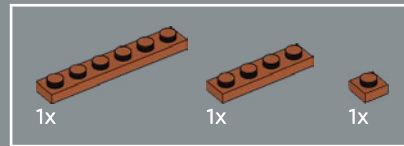
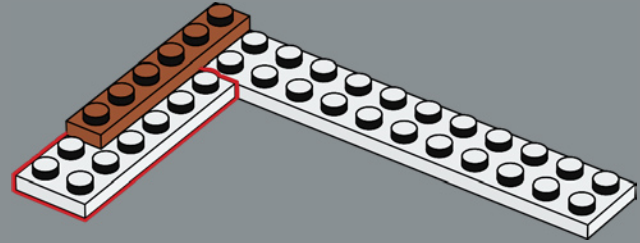

99

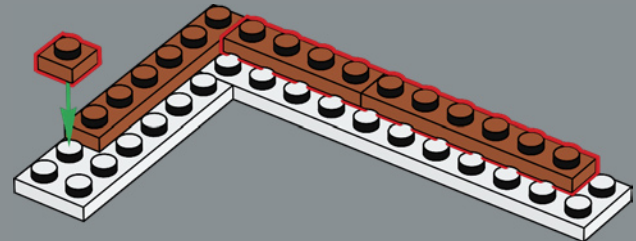



100

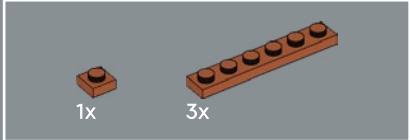
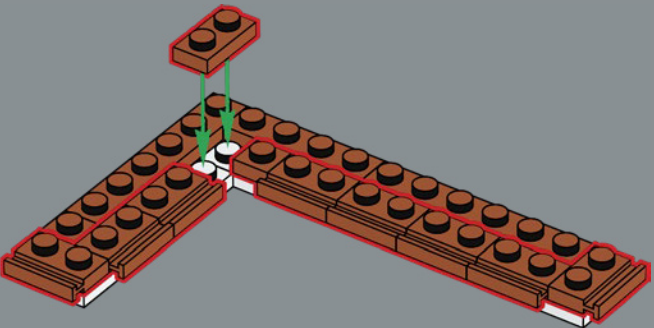

101

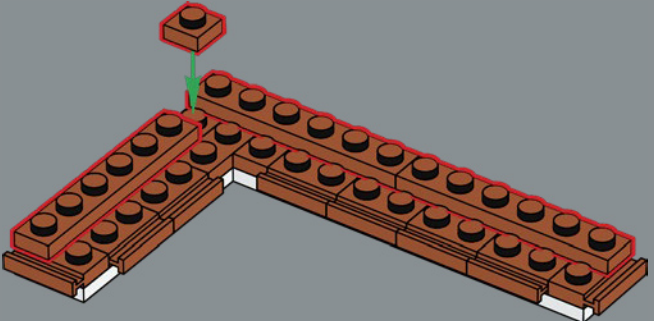

102

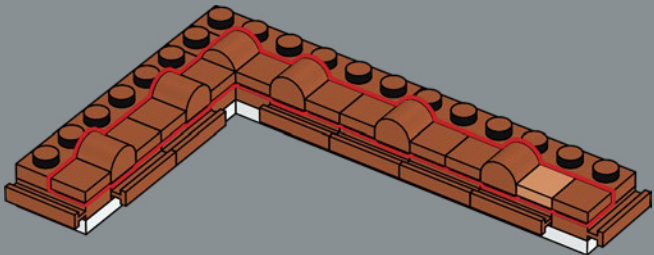

103

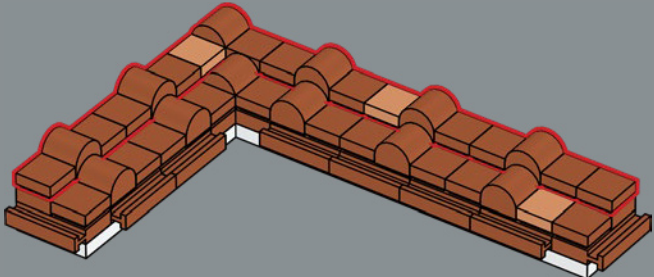

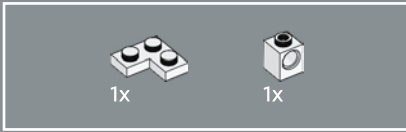
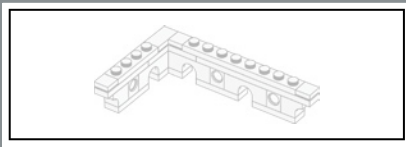

104

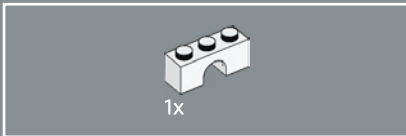
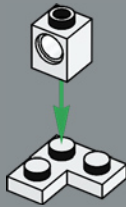

105

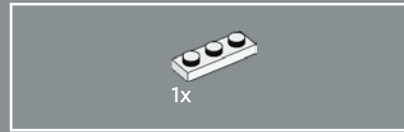
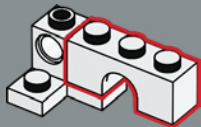

106

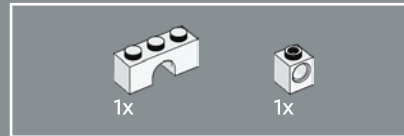
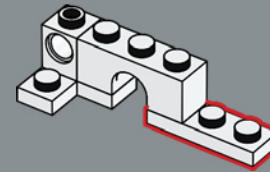

107

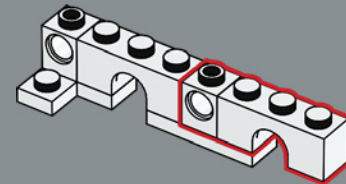

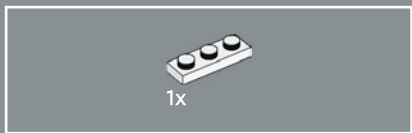

108

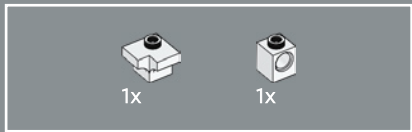
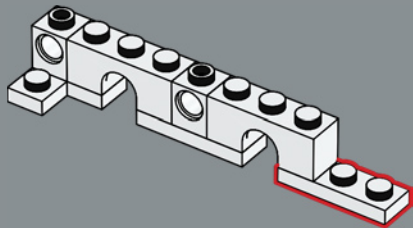

109

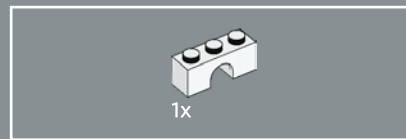
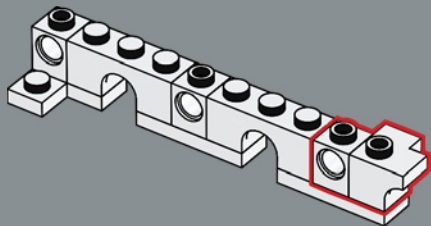

110

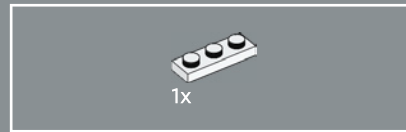
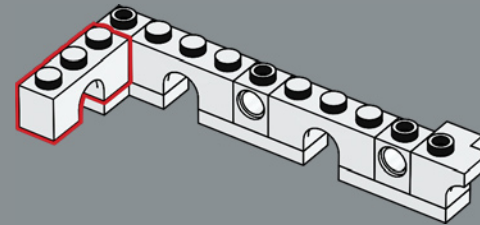

111

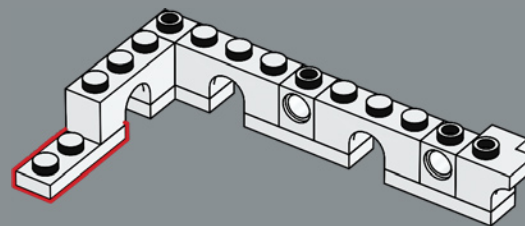

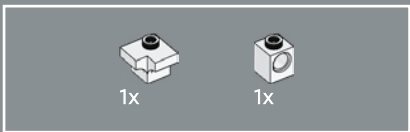

112

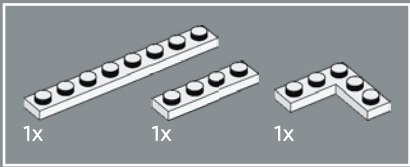
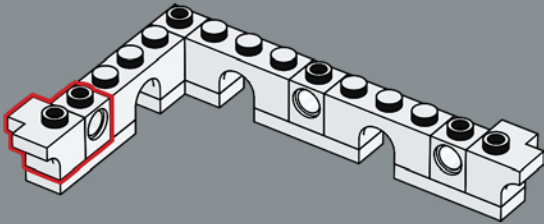

113

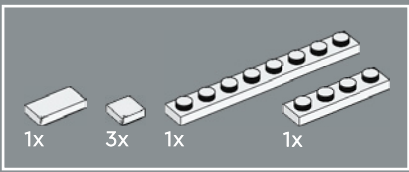
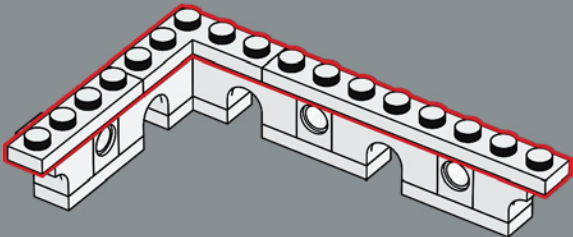

114

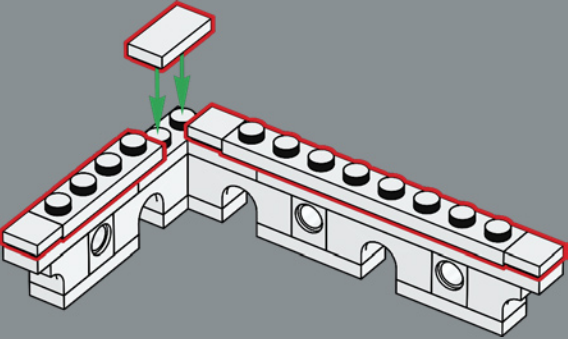

115

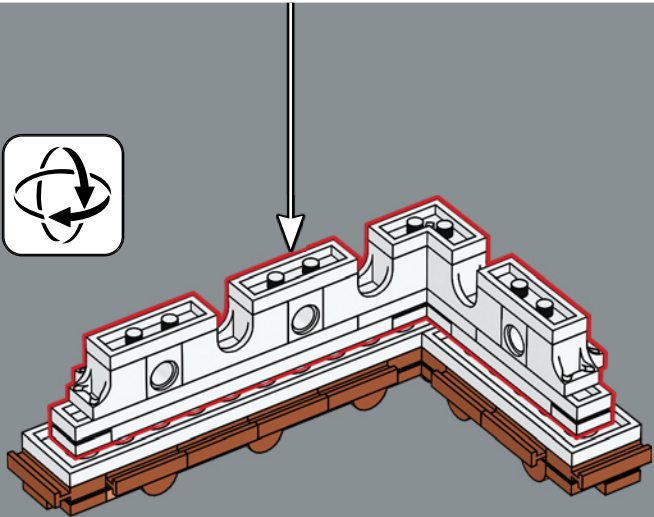

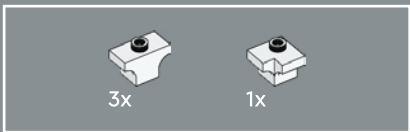

116

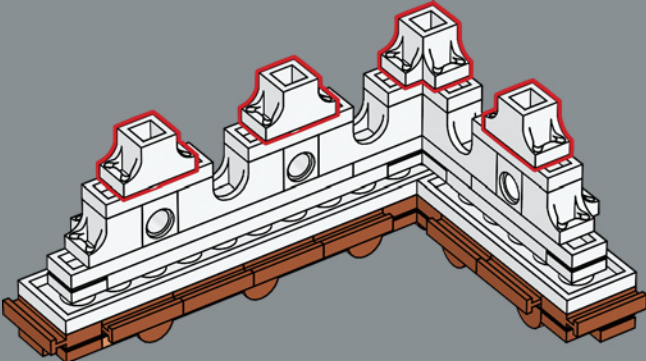

117

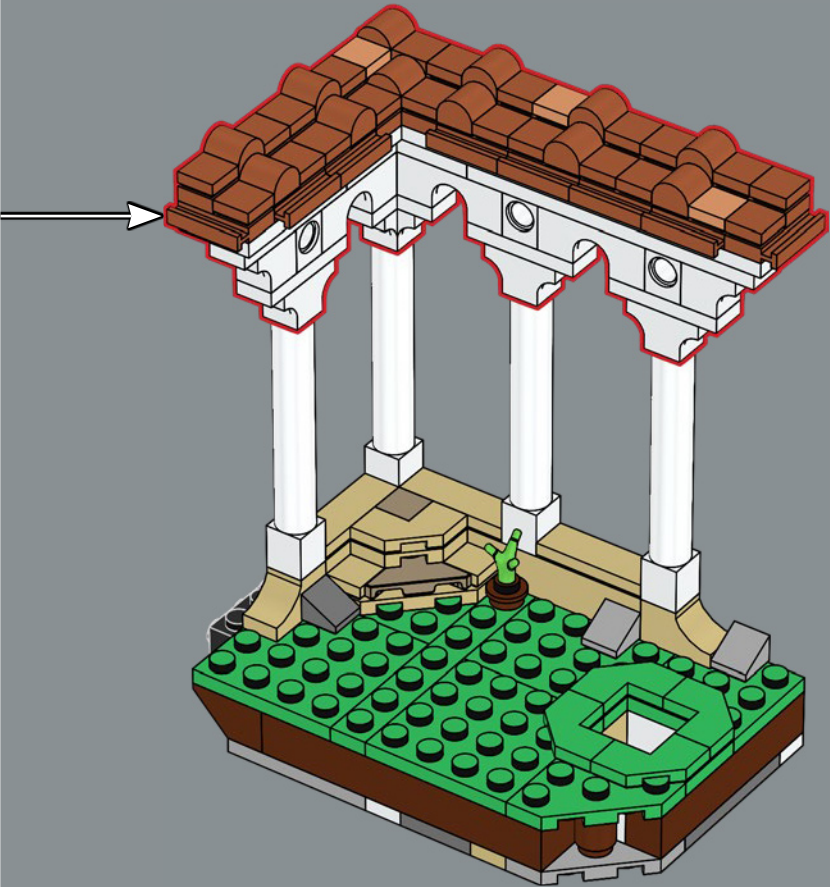

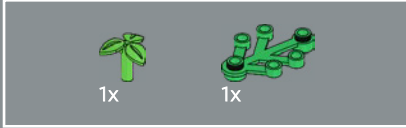

118

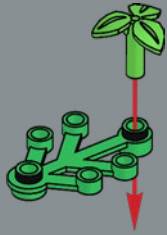

119

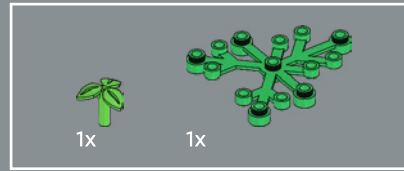

120

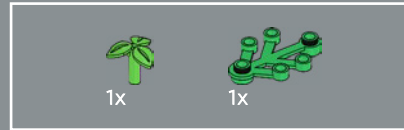
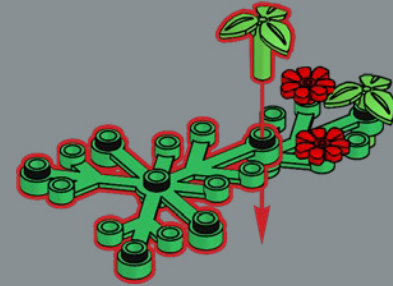

121

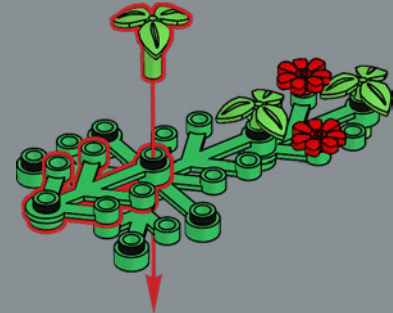



7x

122

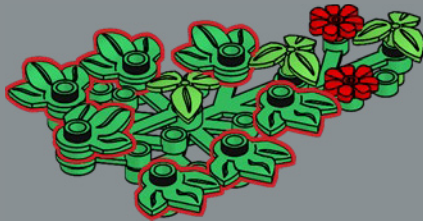

Fleur d'hibiscus rouge (*Hibiscus rosa-sinensis*)
Les fleurs d'hibiscus peuvent être utilisées pour tester l'acidité d'un liquide. Une fleur d'hibiscus devient rose foncé si elle est exposée à l'acide, ou verte si elle est exposée à un produit basique. Idéal pour vérifier l'acidité de votre fontaine !



7x

123

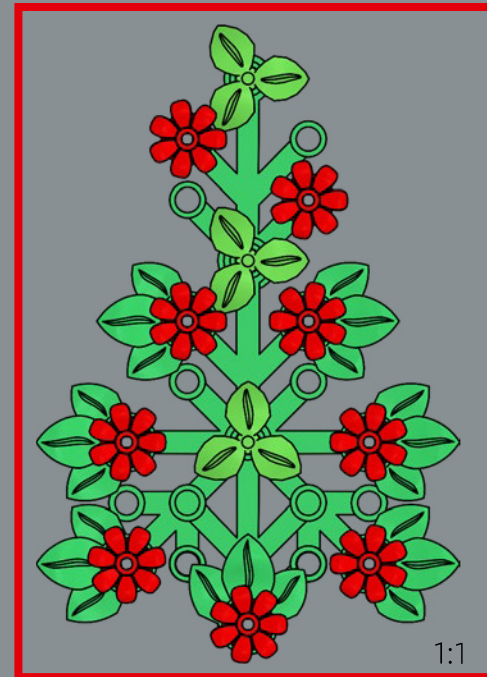
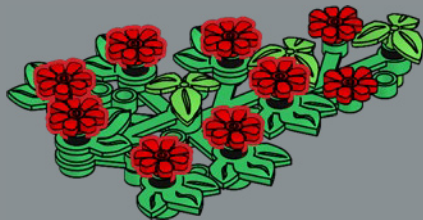



124

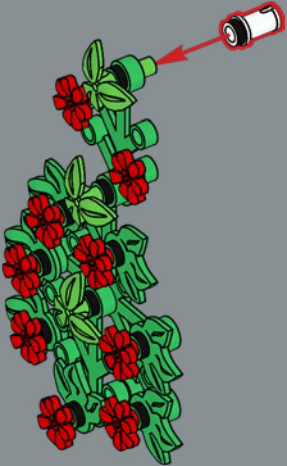

125

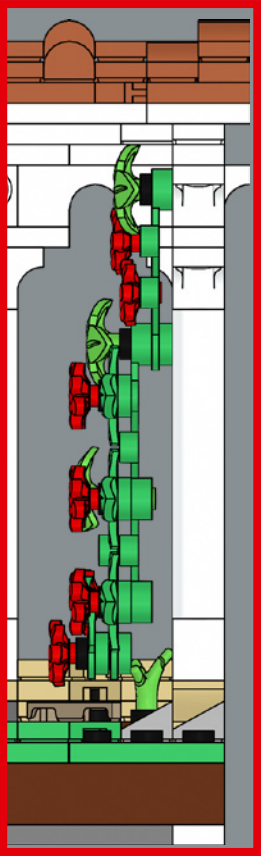

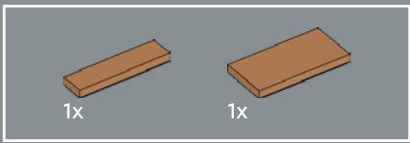

126

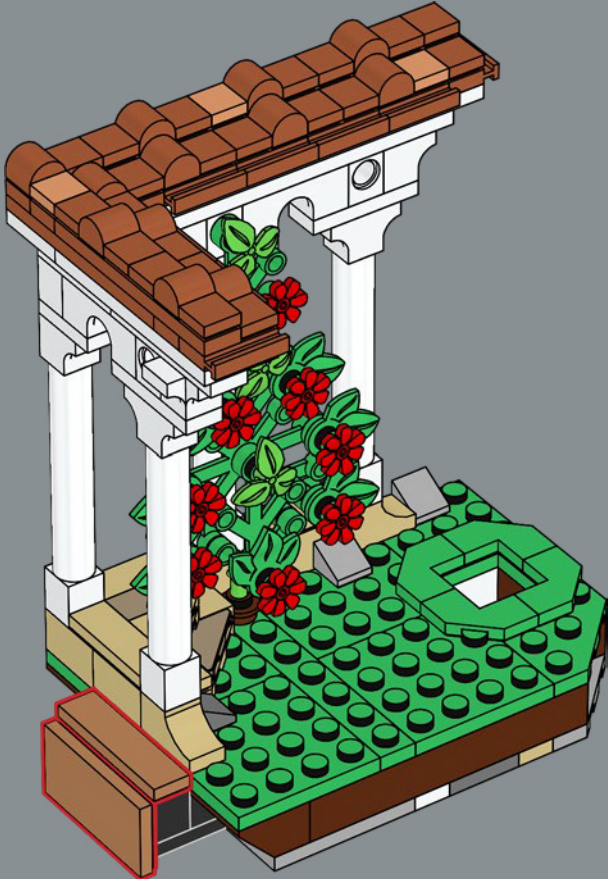

127



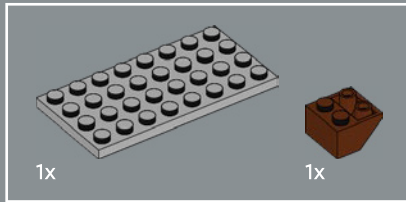
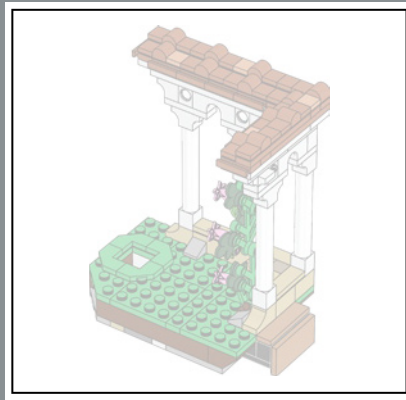

128

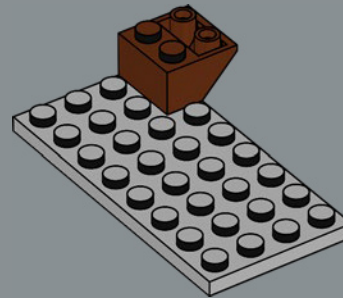

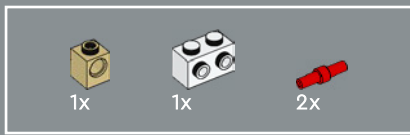

129

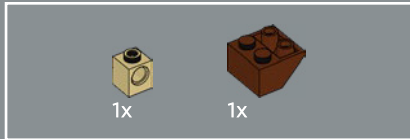
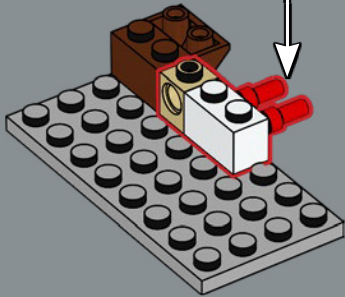
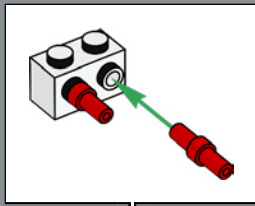

130

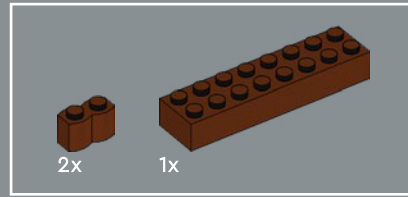
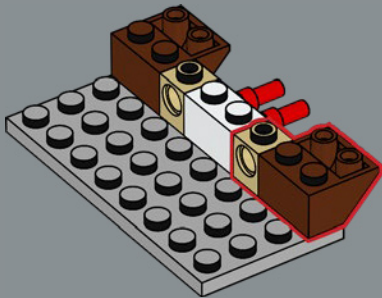

131

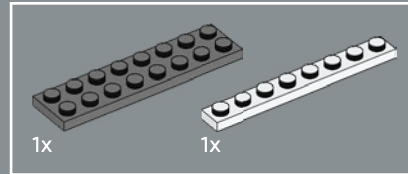
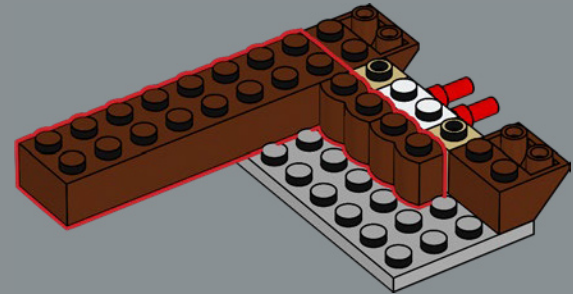

132

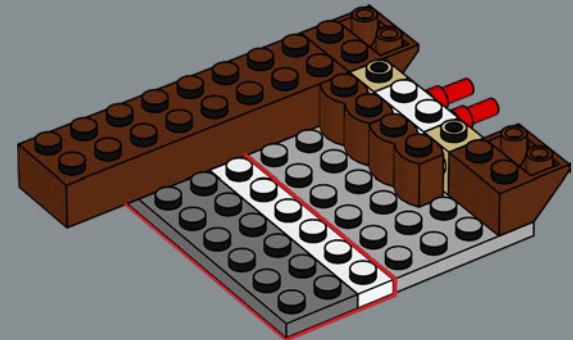

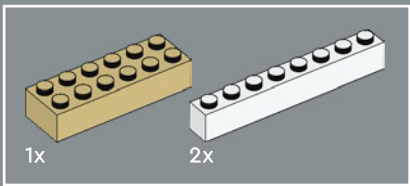

133

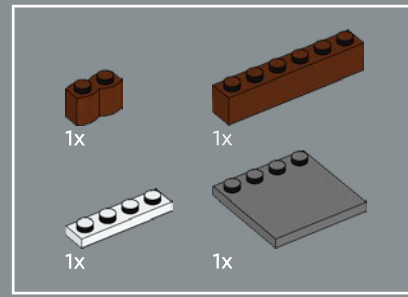
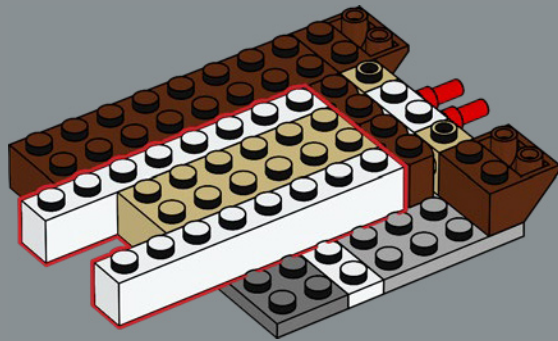

134

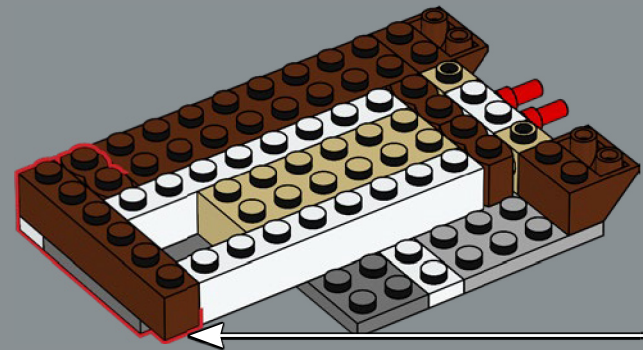
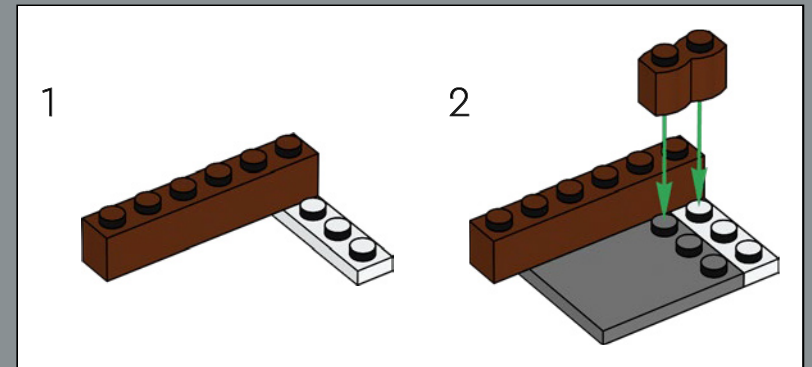

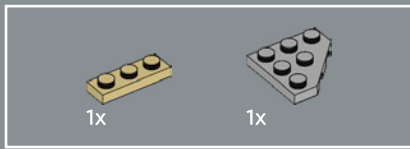

135

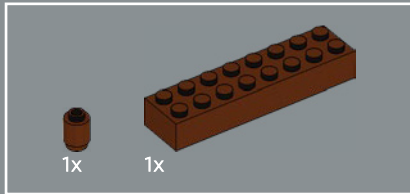
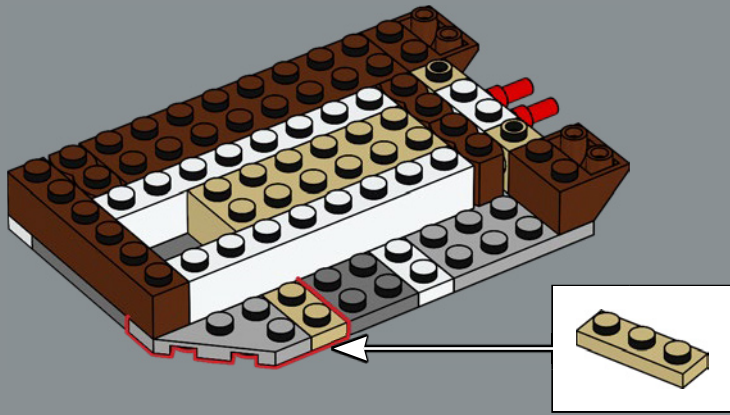

136

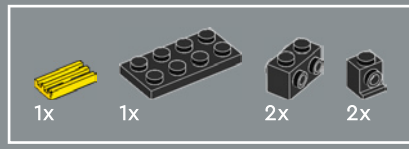
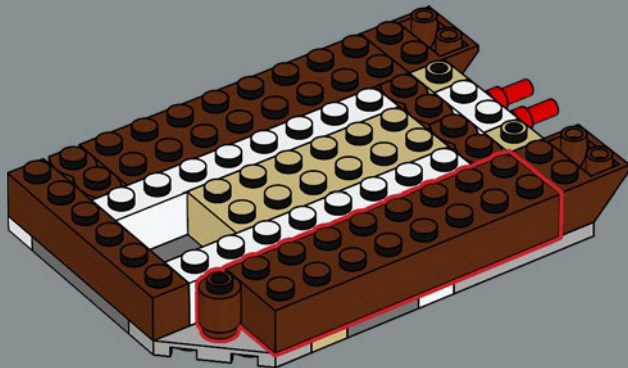

137

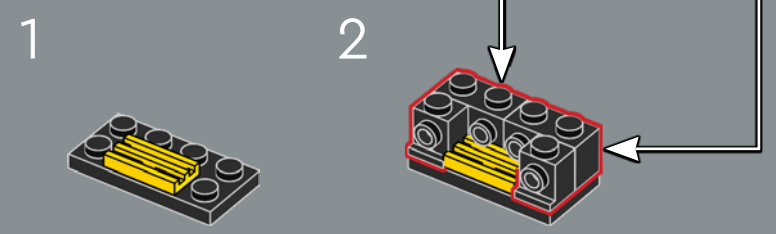
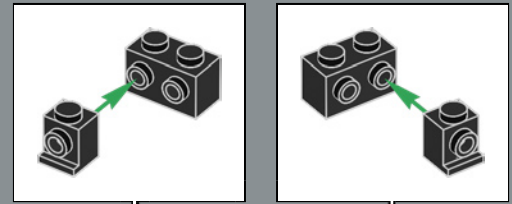

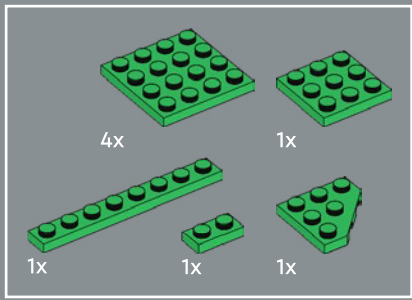

138

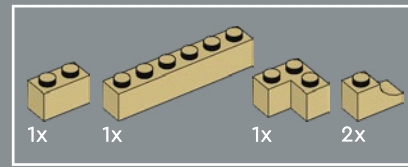
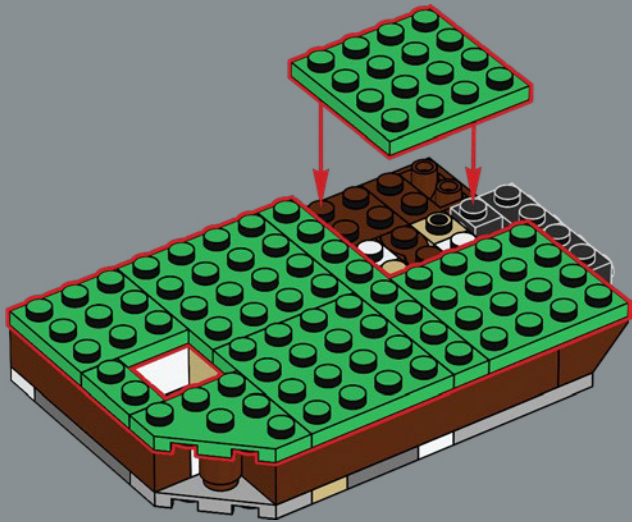

139



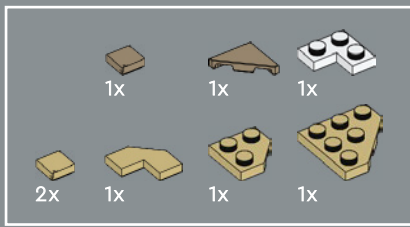

140

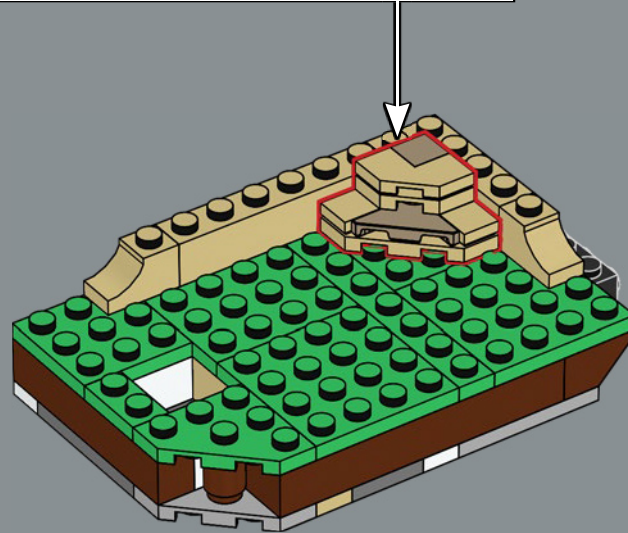
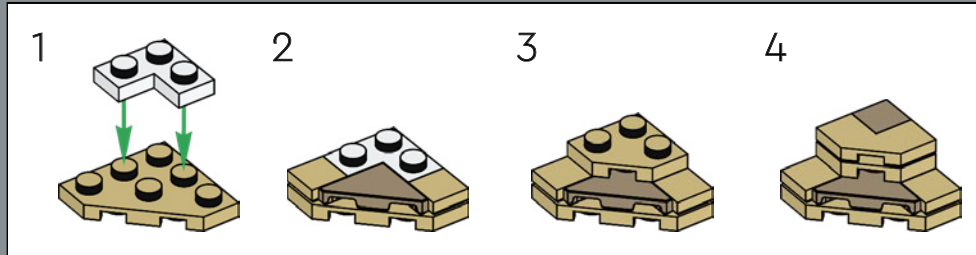

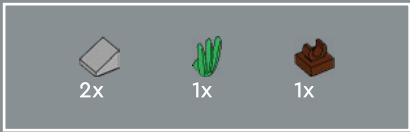

141

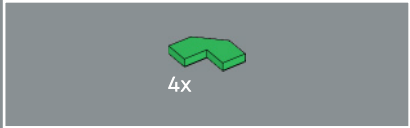
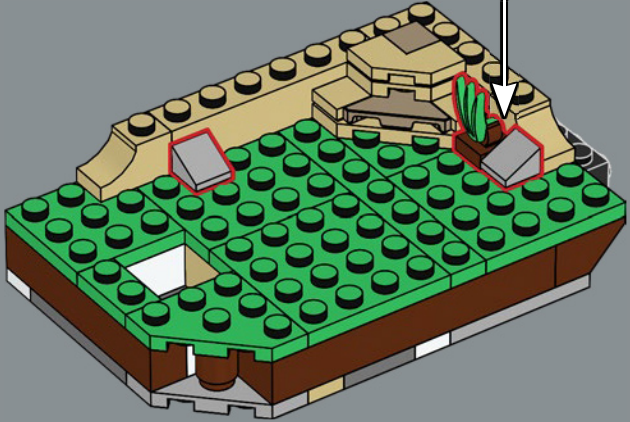
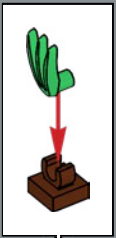

142

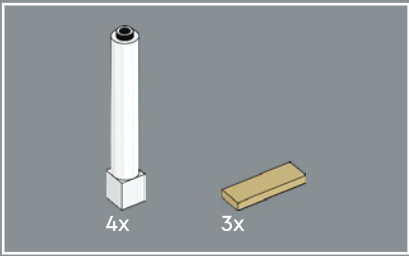
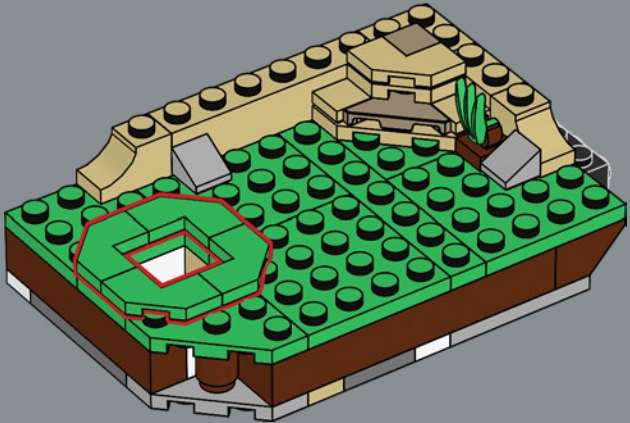

143

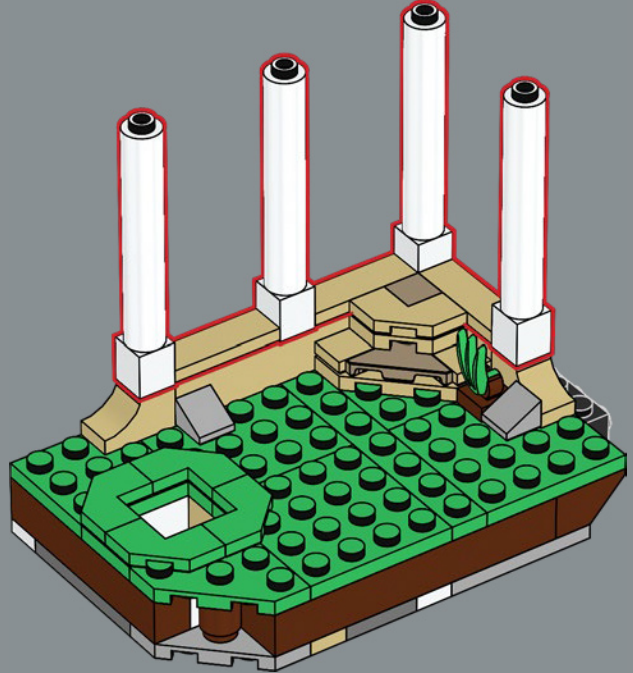

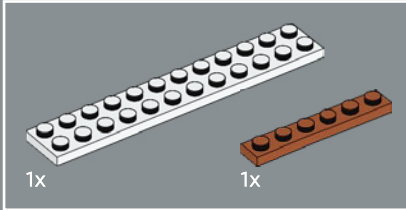
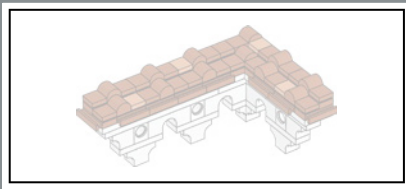

144

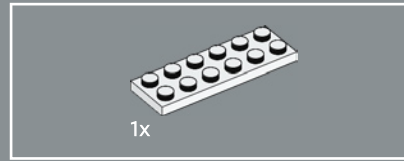
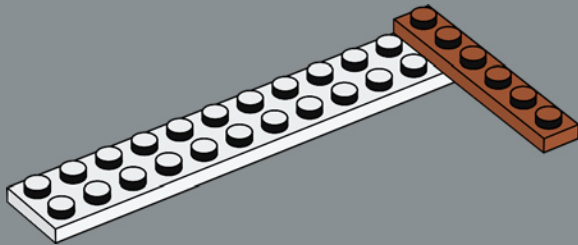

145

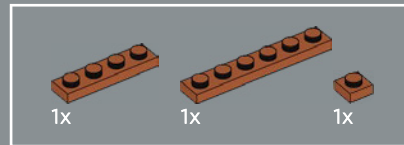
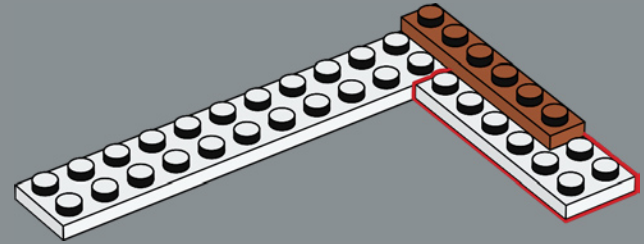

146

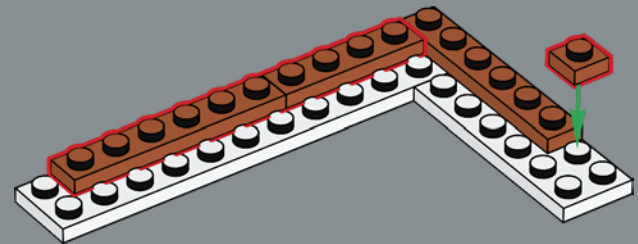



147

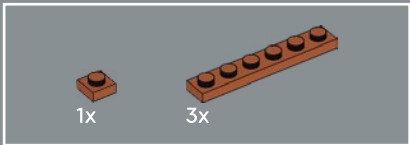
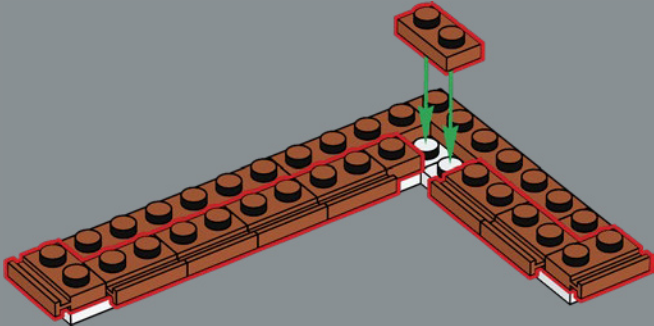

148

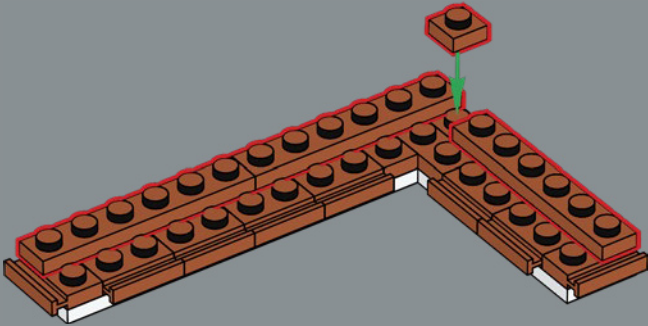

149

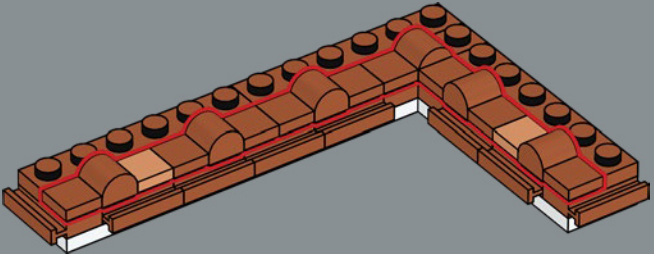

150

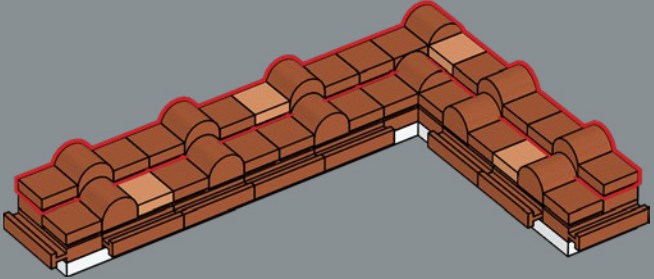

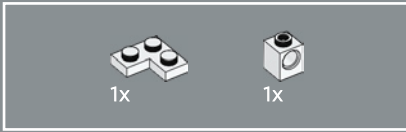
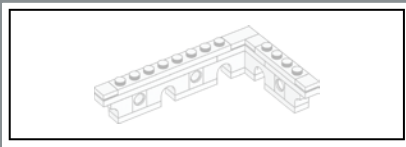

151

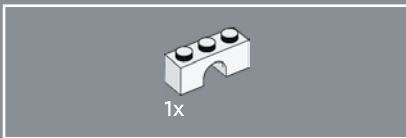
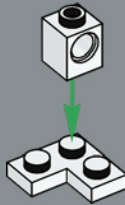

152

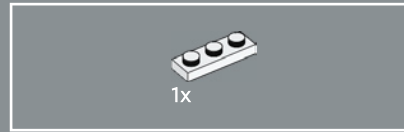
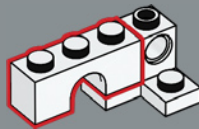

153

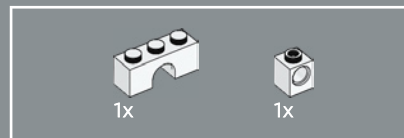
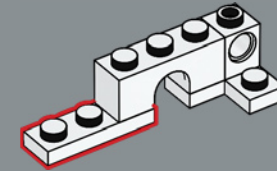

154

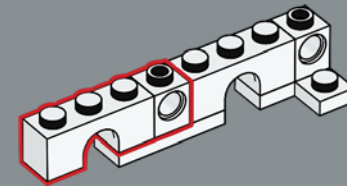

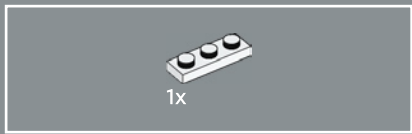

155

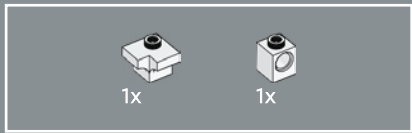
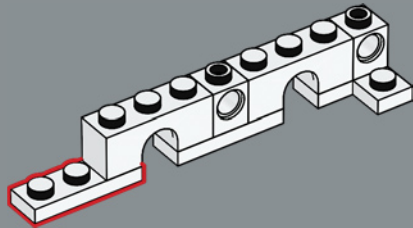

156

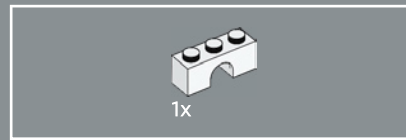
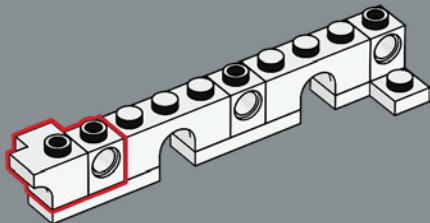

157

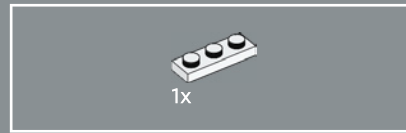
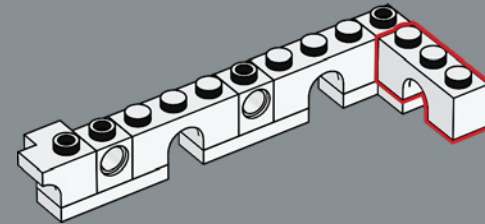

158

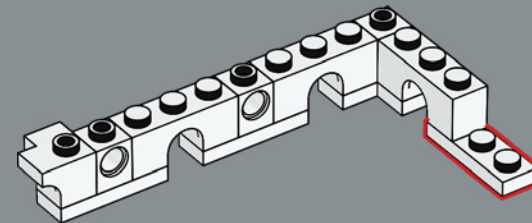

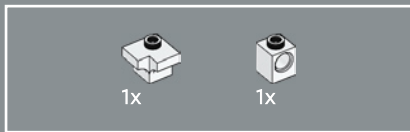

159

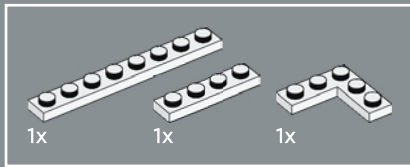
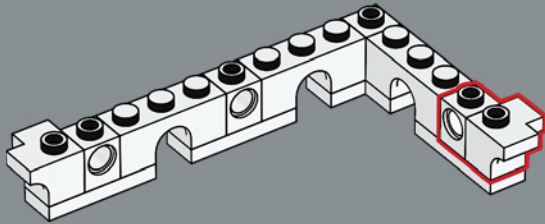

160

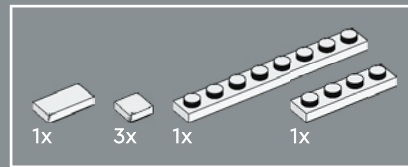
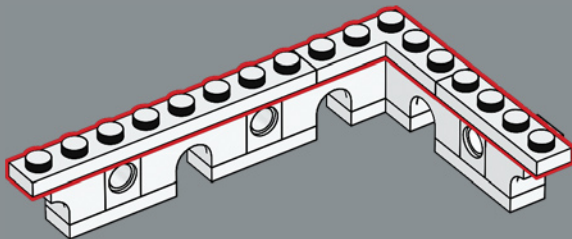

161

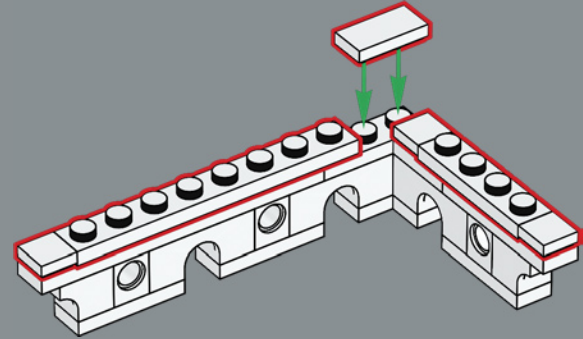

162

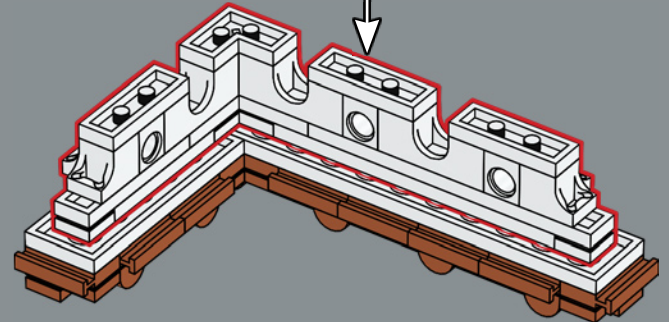

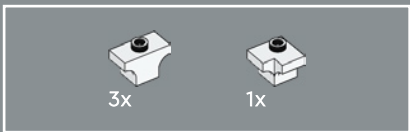

163

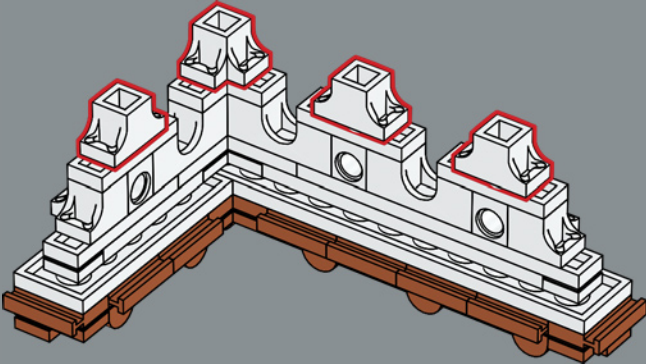

164

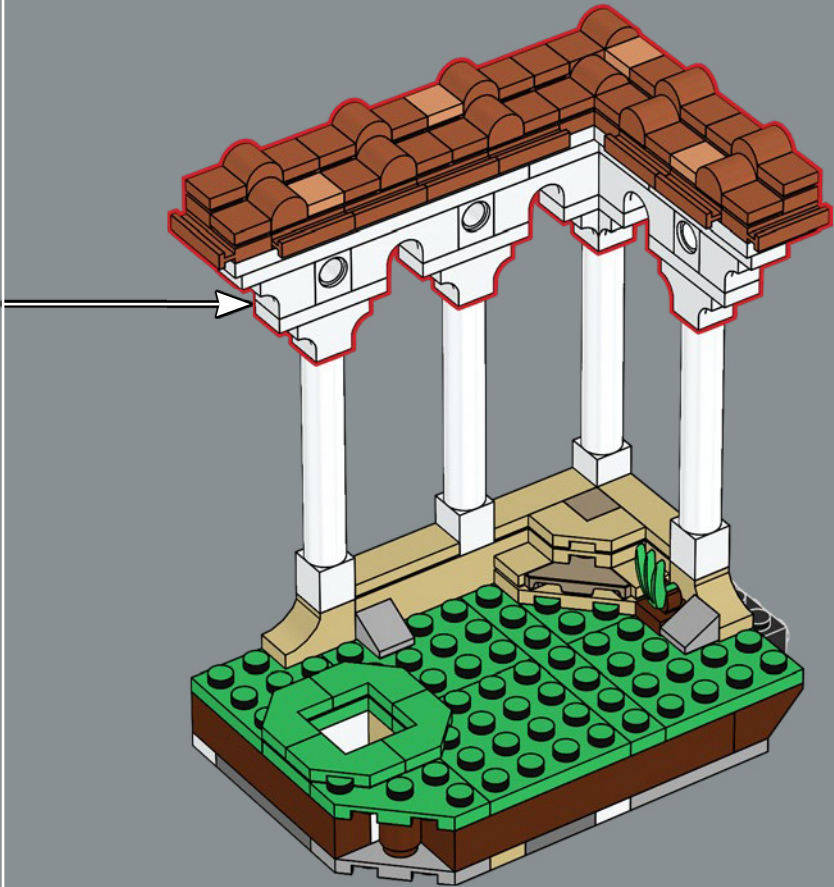

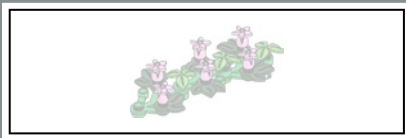

165

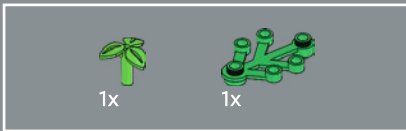
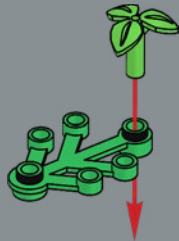

166

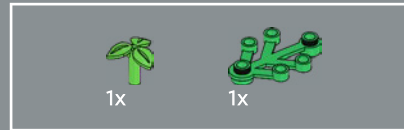
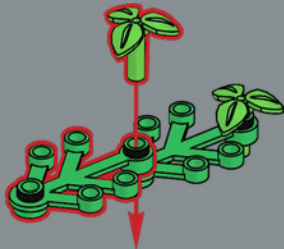

167

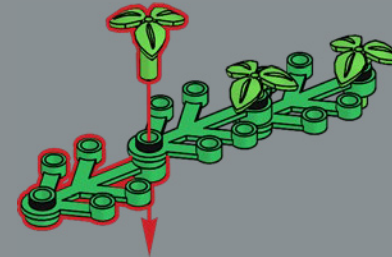

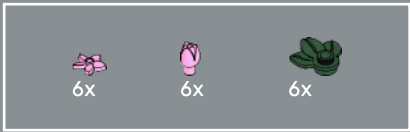

168

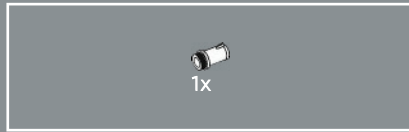
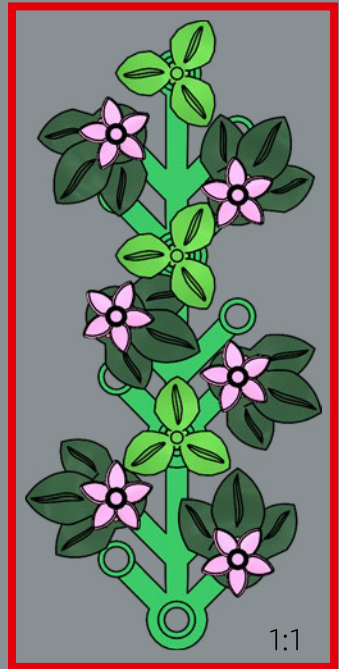
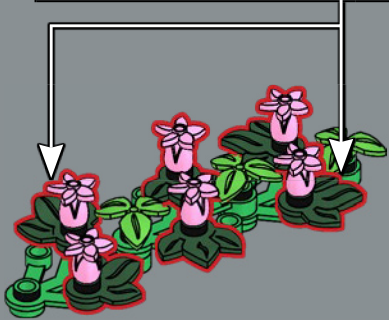
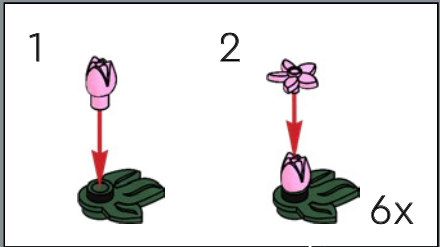

169

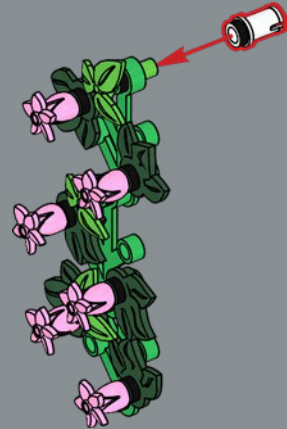

Fleur de bougainvillier rose (*Bougainvillea*)
 Ce que la plupart des gens considèrent comme la « fleur » du bougainvillier correspond en réalité à des bractées ou de « fausses fleurs », un autre type de feuille qui entoure les véritables fleurs de la plante, qui sont minuscules.

170

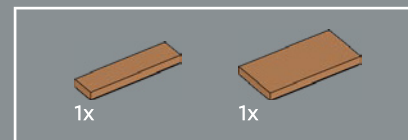
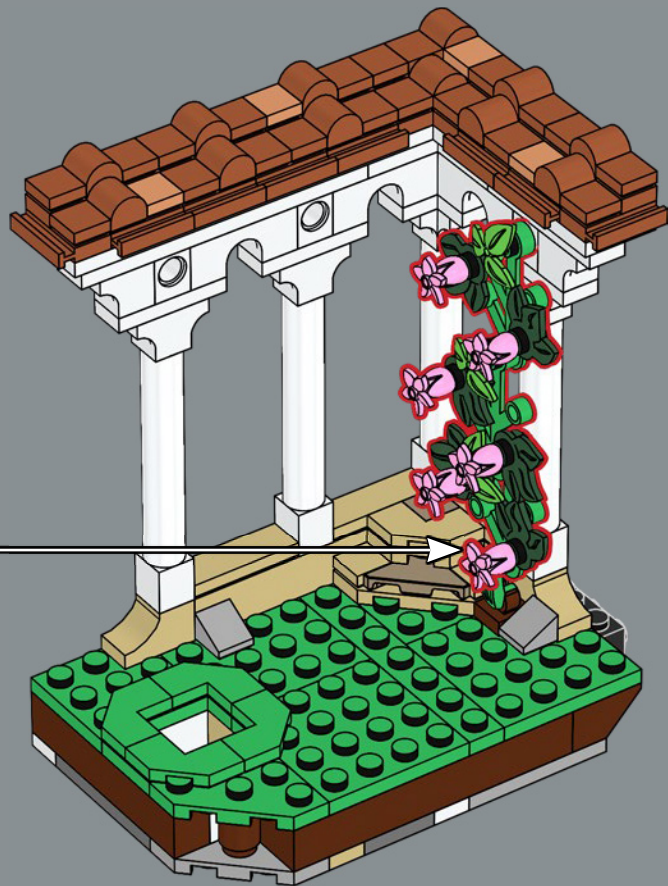

171





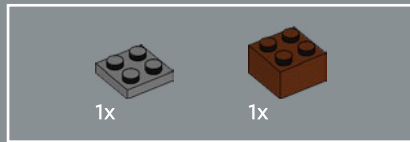
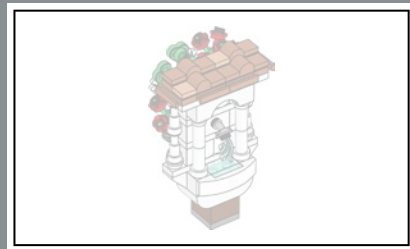

173

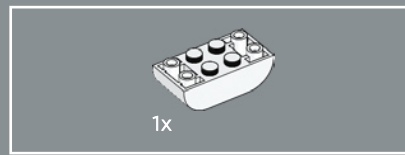
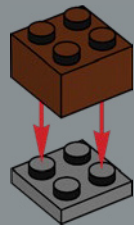

174

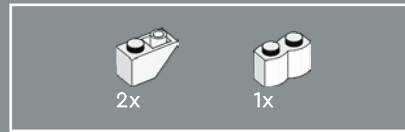
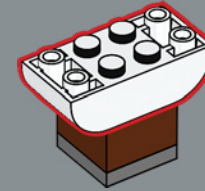

175

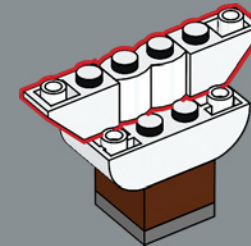

176

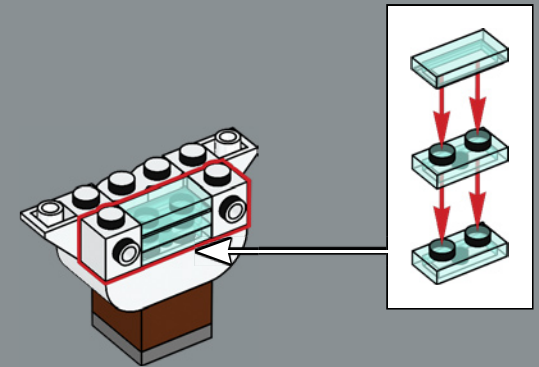



177

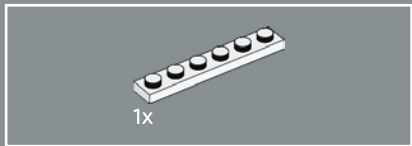
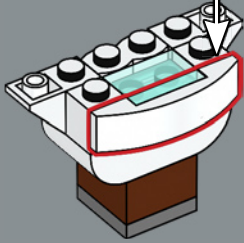
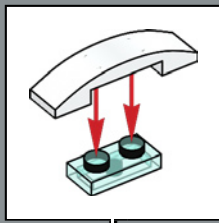

178

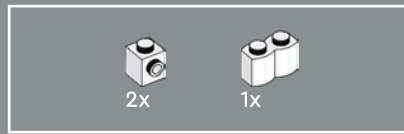
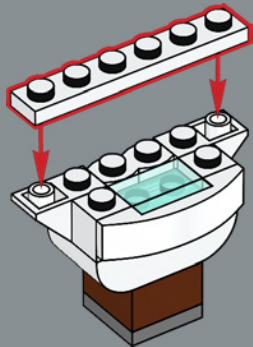

179

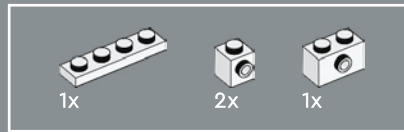
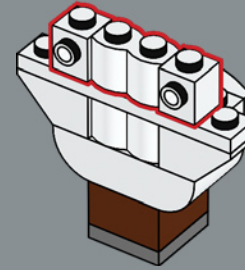

180

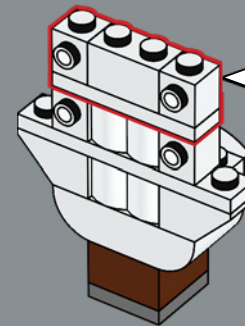
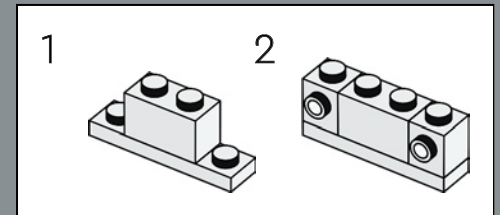

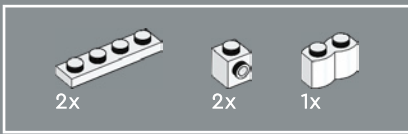

181

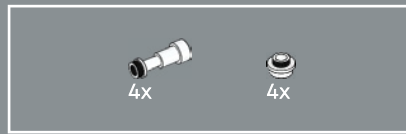
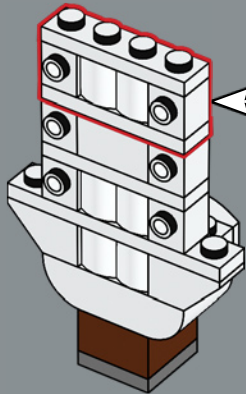
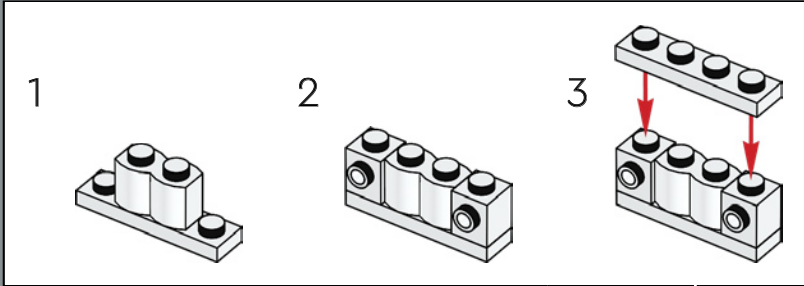

182

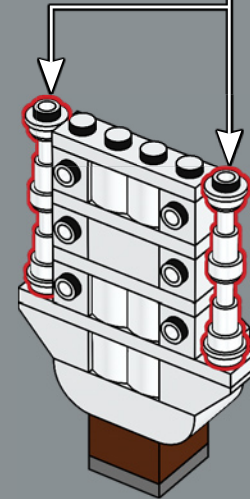
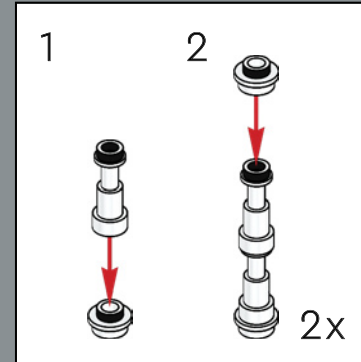



183

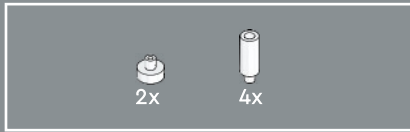
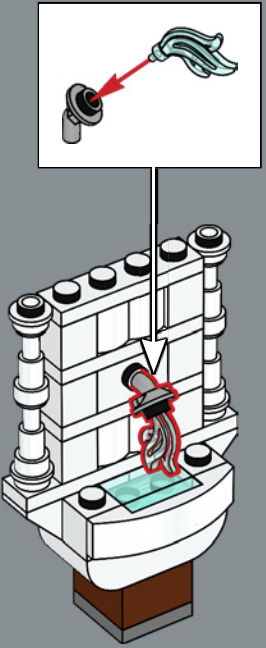

184

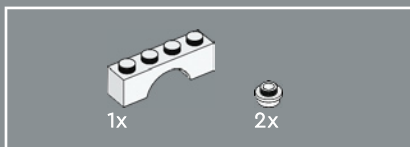
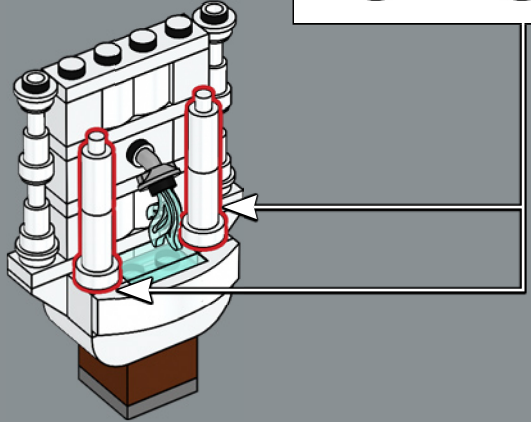
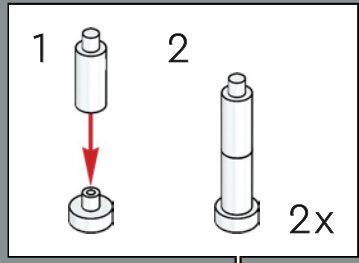

185

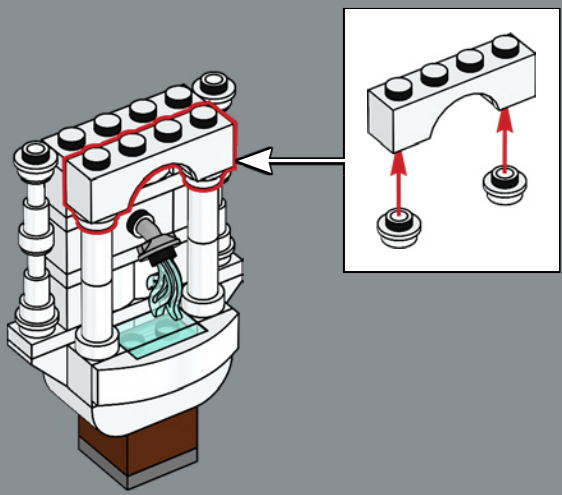

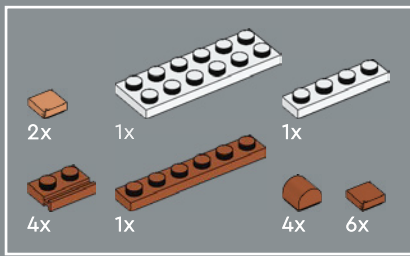

186

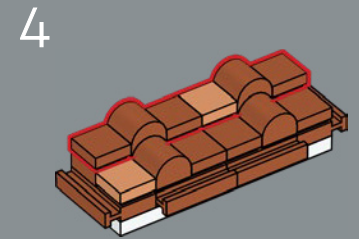
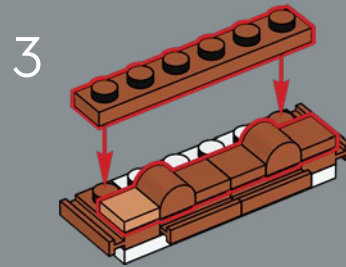
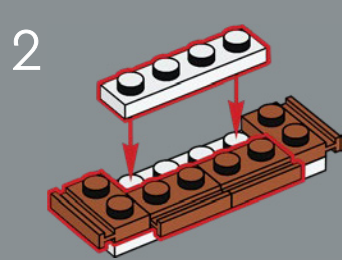
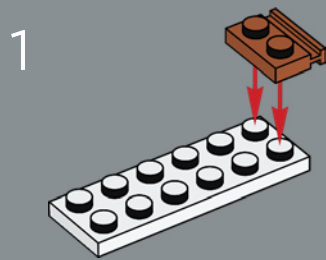



2x

187

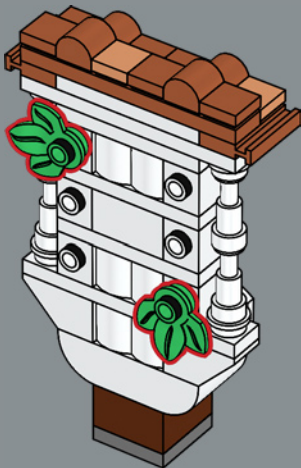

2x

188

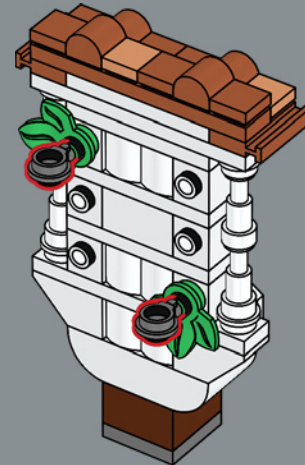

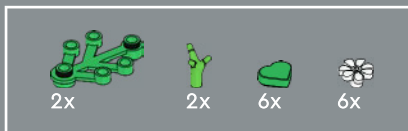

189

Pétunia blanc (*Petunia axillaris*)
 Bien que certaines espèces de pétunias puissent être utilisées en garniture de vos plats, vous préférerez peut-être laisser cette splendeur s'épanouir dans votre jardin. Il appartient à une famille de plantes qui comprend également la pomme de terre, la tomate, mais aussi la belladone !

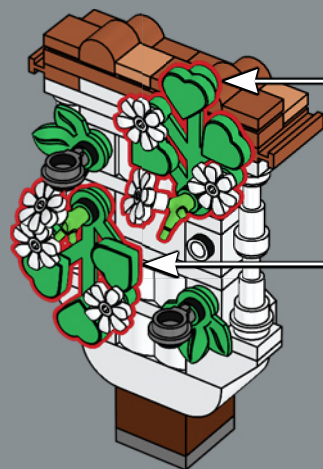
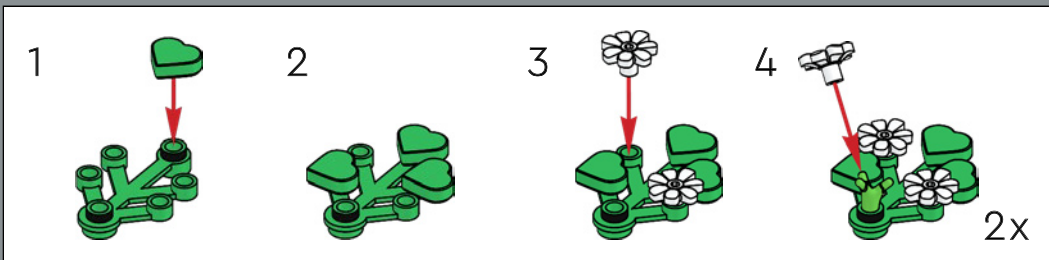

190

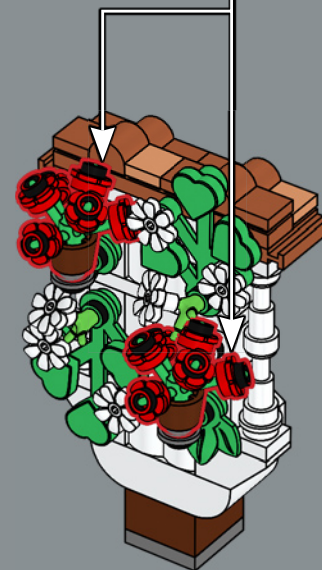
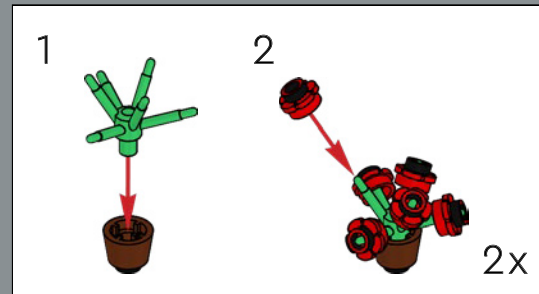

Géranium zonal rouge (*Pelargonium x hortorum*)
 Le géranium zonal parfumé a un usage à la fois pratique et esthétique dans un jardin serein. Ses huiles naturelles dégagent un parfum qui fait fuir les insectes !



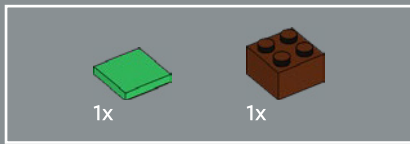

192

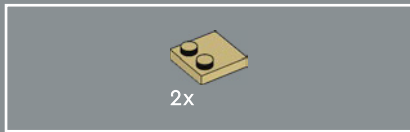
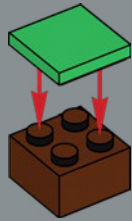

193

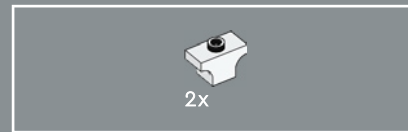
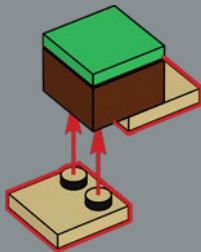

194

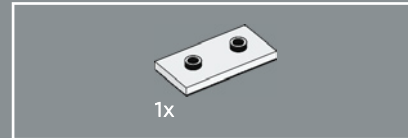
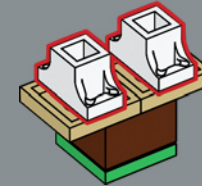

195

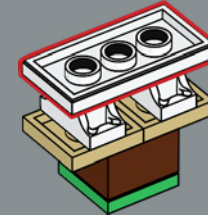

196

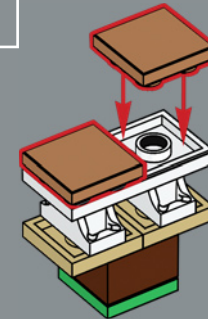



Grenouille de Pérez (*Pelophylax perezii*)
Originare de la péninsule ibérique, cette petite nageuse rapide prospère dans les habitats d'eau douce et les zones humides.

197



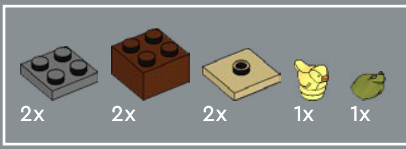

198

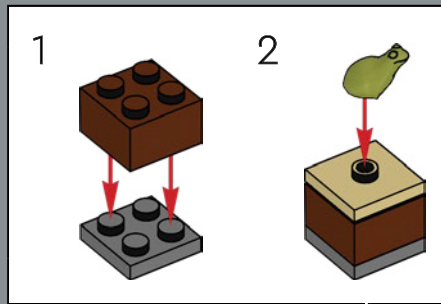

Bruant jaune (*Emberiza citrinella*)
Le bruant jaune, avec son plumage jaune
vif caractéristique et son chant distinctif,
vit dans toute l'Europe.

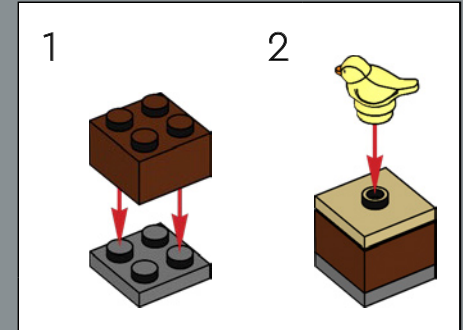

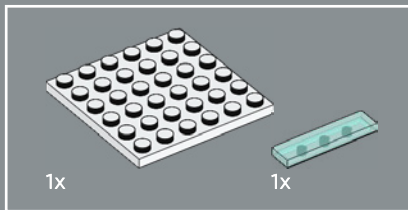
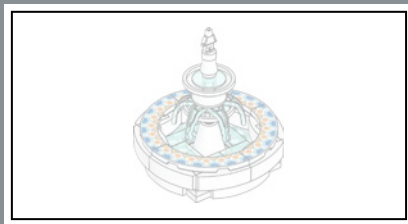

199

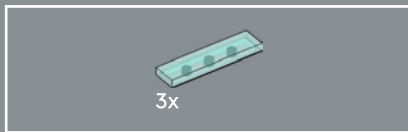
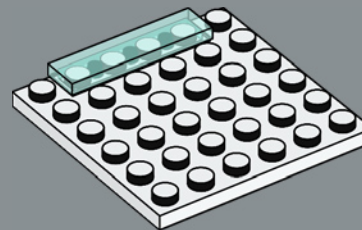

200

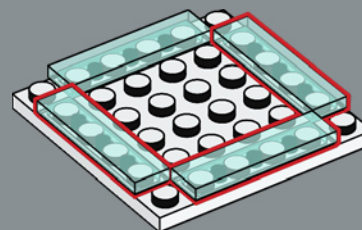

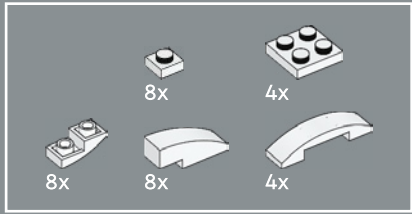
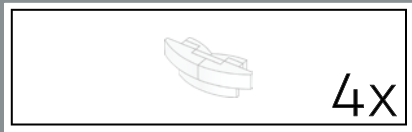

203

1

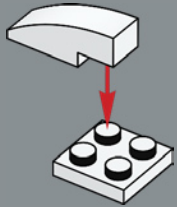

2

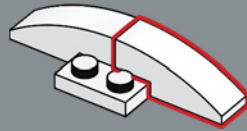

3

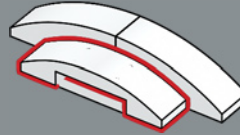

4

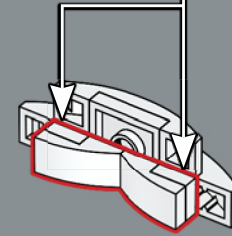
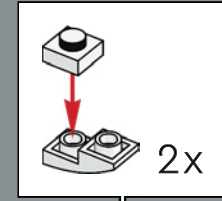

4x



204

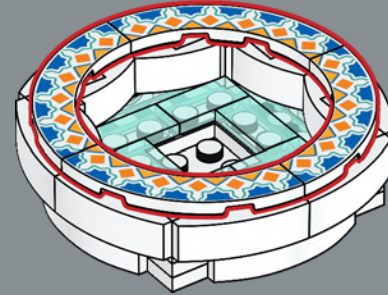
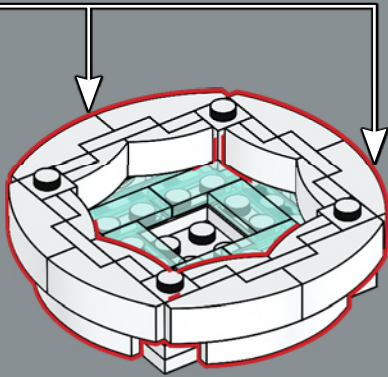

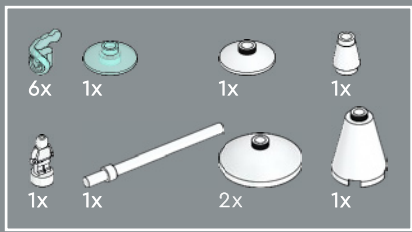

205

1

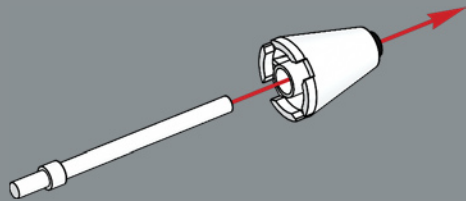

2



3



4



5

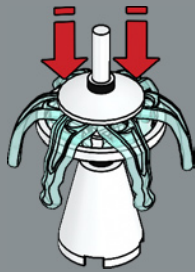

6

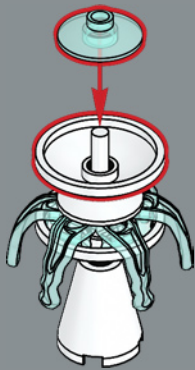

7

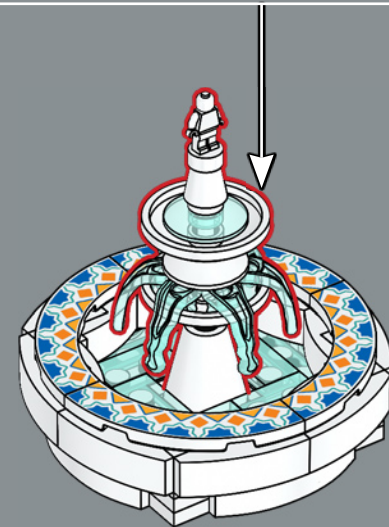
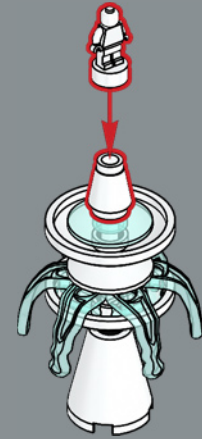



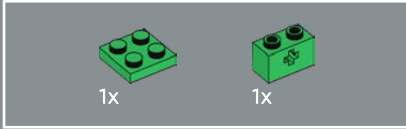

207

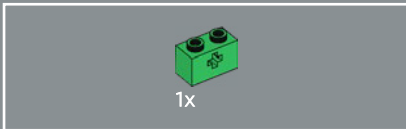
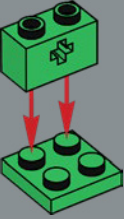

208

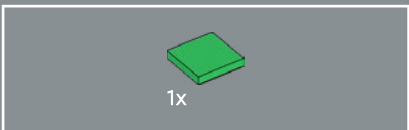
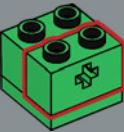

209

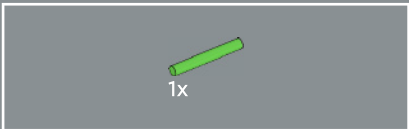
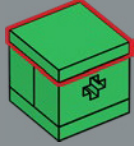

210

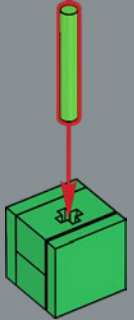

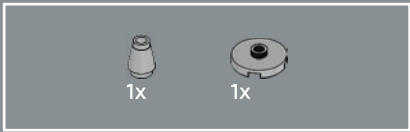

211

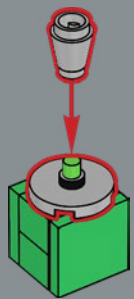

212

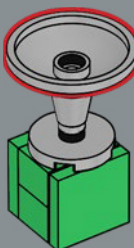

213

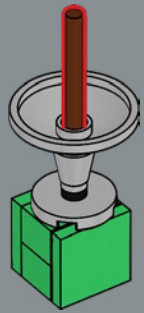



214

1



2

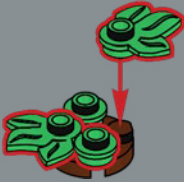

3

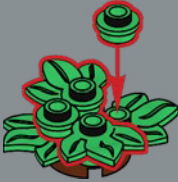

4

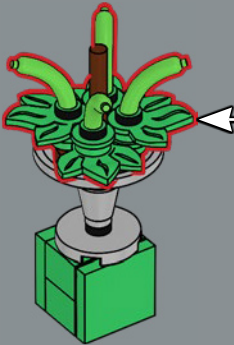

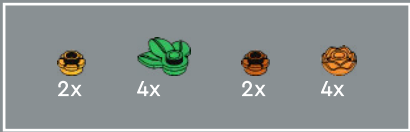

215

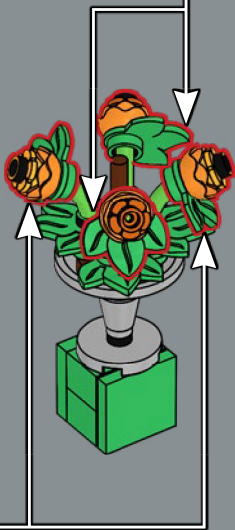
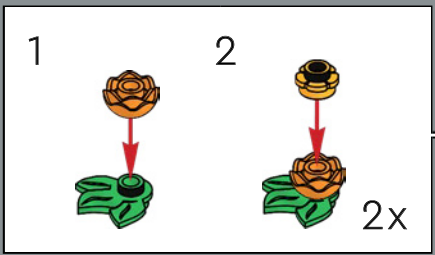
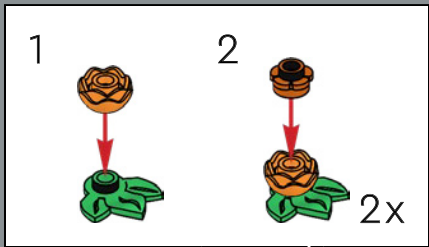

216

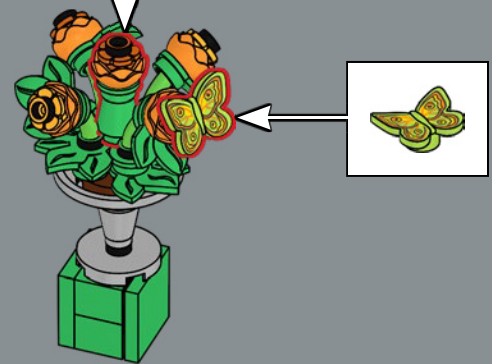
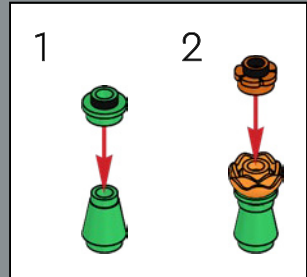

Isabelle (*Graellsia isabellae*)
 Espèce étonnante qui possède des ailes vertes et des ocelles
 uniques, l'Isabelle prospère dans les Pyrénées. Vestige vivant
 d'une époque ancienne, elle est restée quasiment inchangée
 depuis la dernière ère glaciaire.



217

Céillet d'Inde (*Tagetes patula*)
Bien qu'ils soient originaires d'Amérique centrale,
les céillets d'Inde sont de petits rayons de soleil
aromatiques appréciés des jardiniers et des chefs du
monde entier qui les utilisent pour décorer leurs plats
ou ajouter une touche acidulée à leurs desserts sucrés.



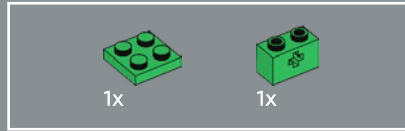
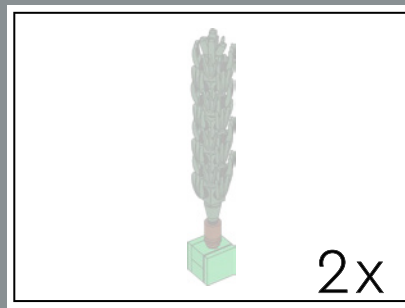

218

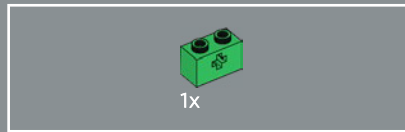
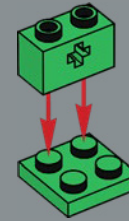

219

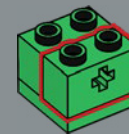

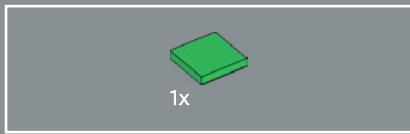

220

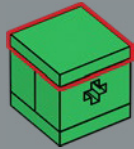

221

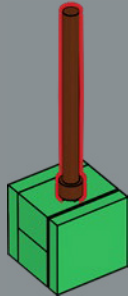

222

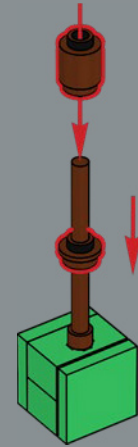

223

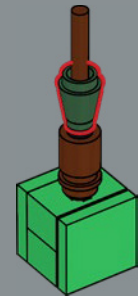

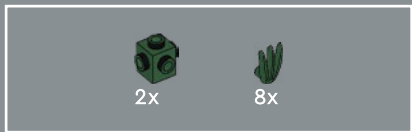

224

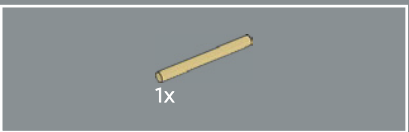
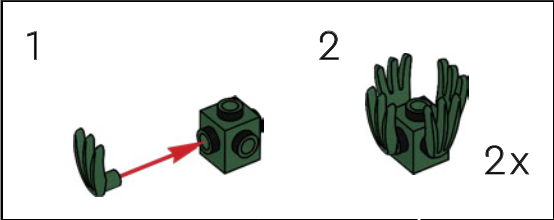

225





226

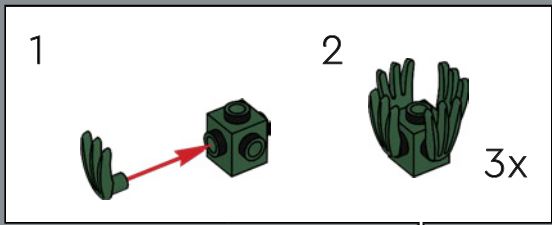

227





228

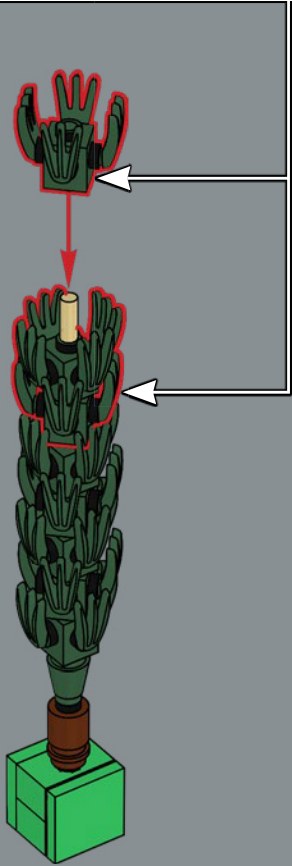
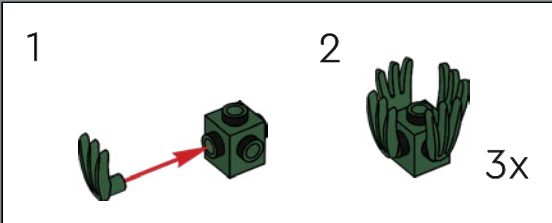

229



Cyprès (*Cupressus sempervirens*)
Connu pour sa forme distinctive et sa beauté, le cyprès est très présent dans les paysages méditerranéens. Saviez-vous que son huile aromatique est un ingrédient précieux dans les remèdes et les produits de beauté ?



2x



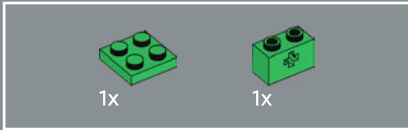
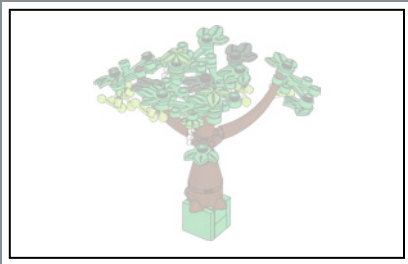

231

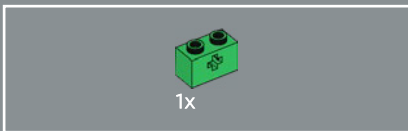
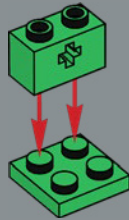

232

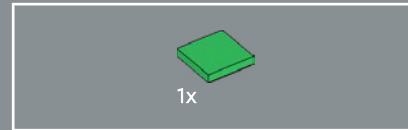
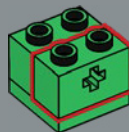

233

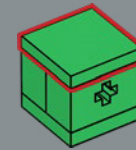

Vigne (*Vitis vinifera*)

Aliment de base délicieusement sucré et juteux, le raisin a été cultivé pour la première fois par des civilisations anciennes il y a plus de 10 000 ans.

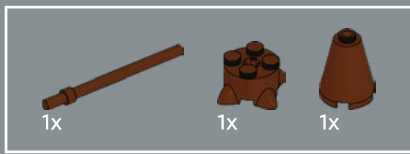

234

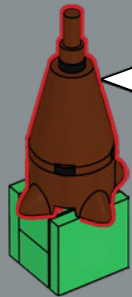

235

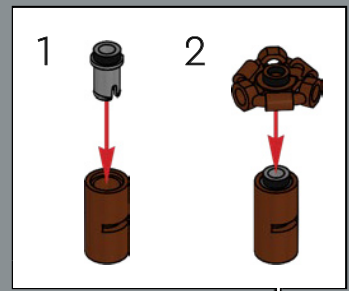

236





237

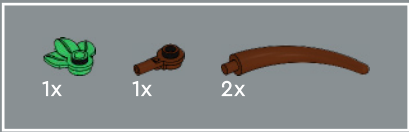

238

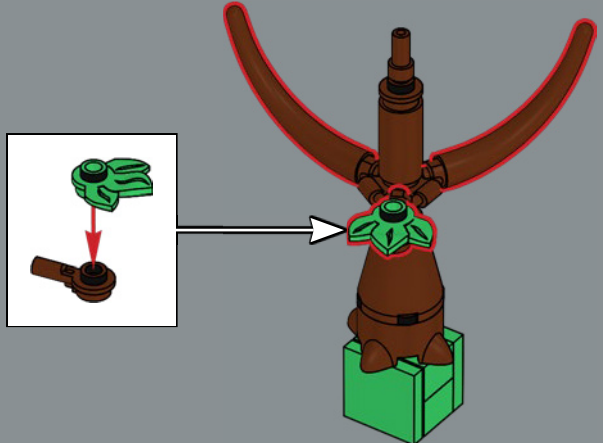

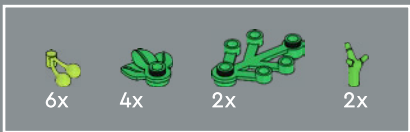

239

1

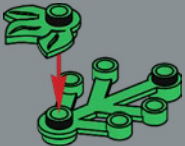

2

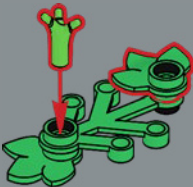

3

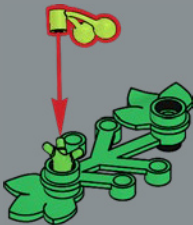

4

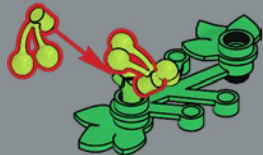

2x

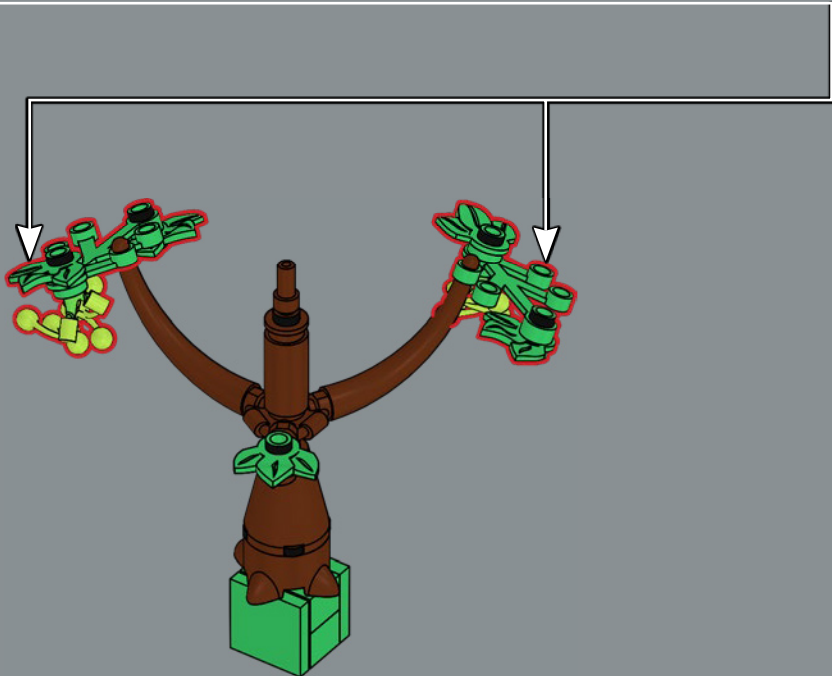

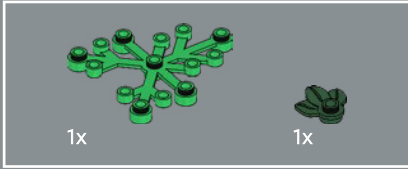
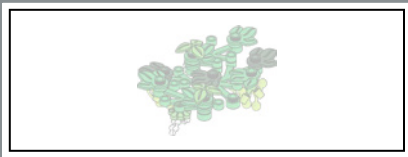

240

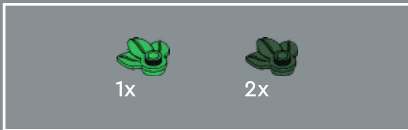
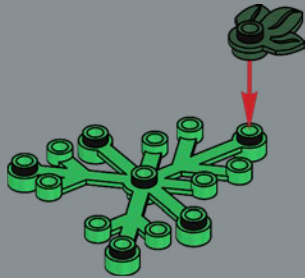

241

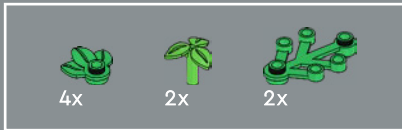
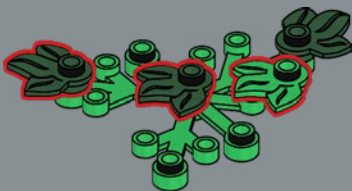

242

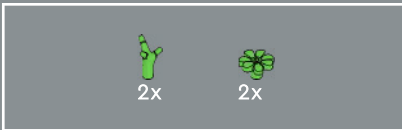
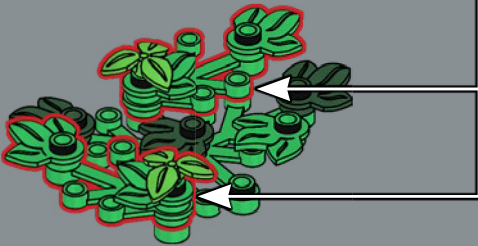
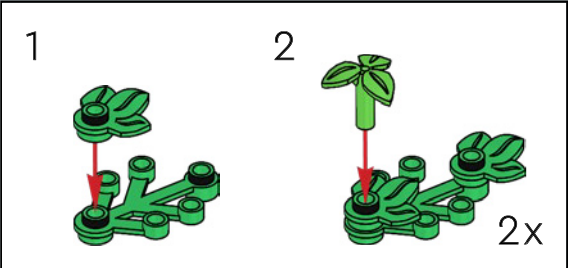

243

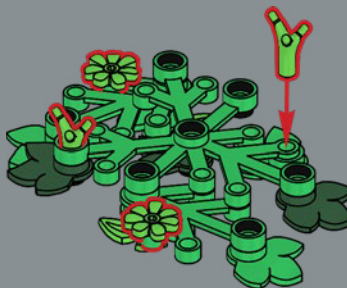



244

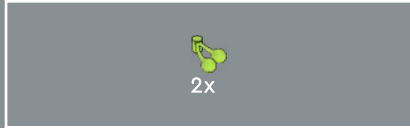

245

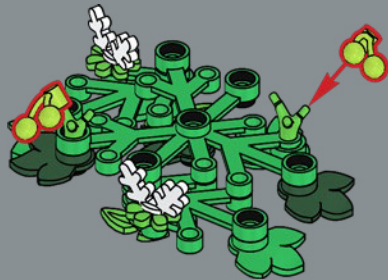

246

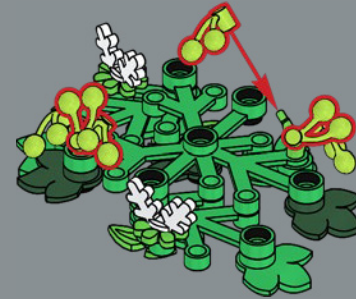

247

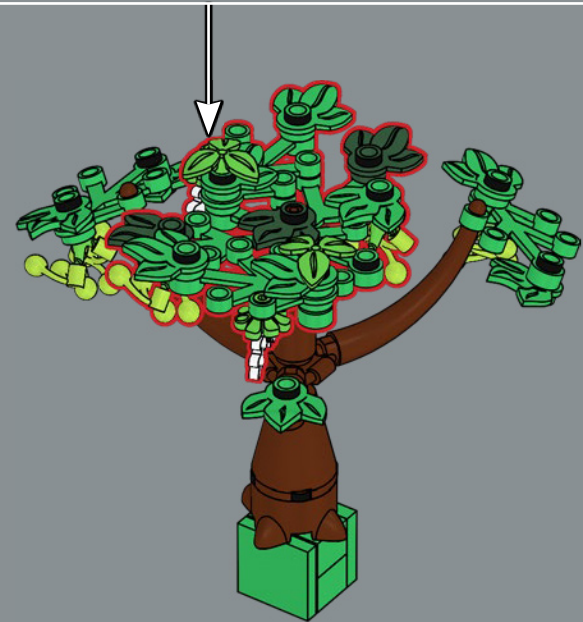



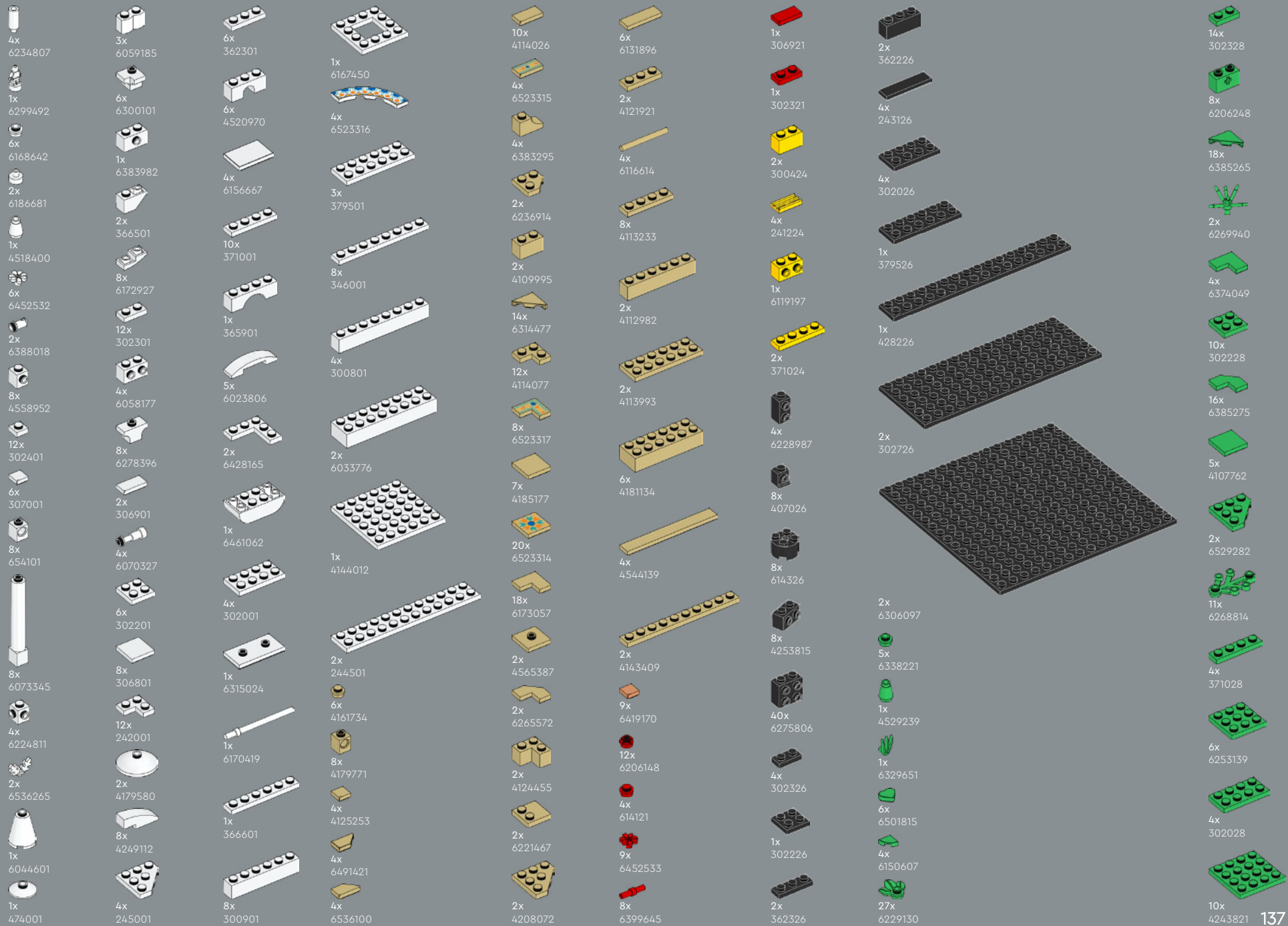



2x
6266968

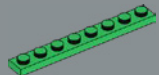

2x
346028

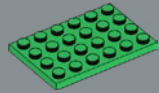

6x
4116671

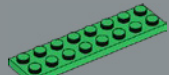

2x
303428



7x
6434871



2x
6488792



4x
6430093



8x
6235080



1x
6161772



[LEGO.com/service](https://www.lego.com/service)

47x
6143431

28x
6439726

6x
6186012

2x
4570877

20x
6228839

2x
6074892

11x
6253418

6x
6353237

1x
6326099

1x
6245307

3x
6514007

7x
6514224

8x
6510178

5x
6550815



12x
6087084

1x
6523318

2x
6055172

2x
6480380

24x
6315608

64x
6532422

2x
6411591

12x
6532421

12x
4504375

4x
4521915

2x
6532423

16x
6532420

9x
6400754

2x
4245571



2x
6249817

2x
6209681

6x
6186673

2x
6284586

4x
4211183

4x
6215659

2x
6173143

1x
6348057

1x
6451002

1x
6306775

1x
4211159

1x
6488490

8x
4211180

1x
6492629

1x
6173132

1x
6468829

6x
4211210

8x
6425510

4x
4211200

1x
6116613

2x
4211201

3x
6170468

2x
6372430

2x
4211193

4x
6096701

1x
4529241

1x
6510189

7x
4521921

1x
6183782

8x
4211414

2x
4211387

8x
4211413

2x
4211397

1x
6070564

2x
4211361

2x
4211396

6x
6015347

1x
4612621

2x
4211452

6x
4211425

2x
4211404

2x
4211407

6x
6519672

6x
6096990

1x
6465604

2x
6395635

1x
4504378

1x
4210848

2x
6388118

2x
4211088

3x
4211094

8x
4624186

4x
4210897

2x
4509911

2x
6199511

2x
6187438

6x
4210997

8x
6272145

2x
6313601

4x
6365746

8x
6187006

24x
6102998

22x
6218359

1x
6472547

3x
6475523



YOU COULD WIN



YOU COULD WIN

Your feedback will help shape the future development of this product series.

Visit:

DU KÖNNTEST GEWINNEN

Dein Feedback trägt zur Weiterentwicklung dieser Produktreihe bei.

Geh auf:

VOUS POURRIEZ GAGNER

Vos commentaires nous aideront à concevoir les futurs produits de cette gamme.

Visitez :

POTRESTI VINCERE TU

La tua opinione ci aiuterà a migliorare la creazione futura di questa linea di prodotti.

Visita:

PUEDES GANAR

Tu opinión contribuirá al futuro de esta serie de productos.

Visita:

轻松获奖

您的反馈将有助于我们在今后改进本产品系列。

请访问:

[LEGO.com/productfeedback](https://www.lego.com/productfeedback)

You also have the chance to win a LEGO® set.

Terms and conditions apply.*

Außerdem hast du die Chance, ein LEGO® Set zu gewinnen.

Es gelten die Teilnahmebedingungen.*

Vous pourriez également gagner un ensemble LEGO®.

Des conditions s'appliquent.*

Hai anche la possibilità di vincere un set LEGO®.

Termini e condizioni sono applicabili.*

También tienes la oportunidad de ganar un set LEGO®.

Aplican términos y condiciones.*

您还有机会赢取乐高®套装。

条款和条件适用。*

*[LEGO.com/productfeedback-terms](https://www.lego.com/productfeedback-terms)

