



10359





LEGO.com/sustainable-packaging



FR
DONNEZ
OU
RECYCLEZ



ASSOCIATION

OU



MAGASIN

OU



DÉCHÈTERIE

Adresses sur quefairedemesdechets.fr



BUILDER



Apple and the Apple logo are trademarks of Apple Inc., registered in the U.S. and other countries and regions. App Store is a service mark of Apple Inc. Google Play and the Google Play logo are trademarks of Google LLC. Tencent and the Tencent logo are trademarks of Tencent Inc.

LEGO.com/devicecheck



LEGO® Builder

Construye tu serenidad

Acepta nuestra invitación a un jardín tranquilo y sereno donde puedes permanecer todo el tiempo que quieras.

Tu feliz estancia podría inspirarte para nutrir tus raíces creativas, o incluso animarte a cultivar tu propio rincón dedicado a la atención plena y la reflexión. Este es tu espacio. Esperamos que te sientas como en casa entre la floreciente vegetación y la vida silvestre que se congregan en torno a la fuente. Quizá reconozcas algunas de las especies que habitan en tu jardín o que hayas contemplado en tu inolvidable viaje al destino de tus sueños.

Cada elemento es lo más fiel posible a la zona, la cultura y la arquitectura. Las preciosas baldosas decorativas están inspiradas en los mosaicos *zellige* creados con pequeñas teselas que han formado parte de la tradición arquitectónica del norte de África y el sur de Europa durante siglos y que aportan una atmósfera armoniosamente vívida a edificios, decoraciones interiores y jardines. También decidimos ampliar la colección de polillas y mariposas LEGO® con la fascinante mariposa isabelina, que destaca por su brillante color verde. Puedes dar un soplo de nueva vida a tu jardín moviendo las plantas a diferentes lugares según tu estado de ánimo, o simplemente dejándolas tomar el sol o refrescarse a la sombra según los ciclos naturales. Incluso puedes reorganizar secciones más grandes del modelo para crear distintas formas y expresiones.



“El resultado de dar vida a este idílico Jardín con Fuente es tener en tu hogar un poco de ambiente veraniego en cualquier época del año”.

El equipo de diseño de LEGO®







La vida de
tu jardín





1

Pelophylax perezi

Rana común



2

Emberiza citrinella

Escribano cerillo



3

Graellsia isabellae

Mariposa isabelina

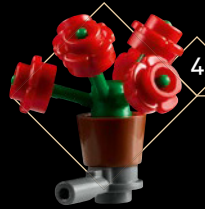

4

Pelargonium x hortorum

Geranio común



5

Bougainvillea

Buganvilla



6

Tagetes patula

Clavel de moro



7

Hibiscus rosa-sinensis

Hibisco

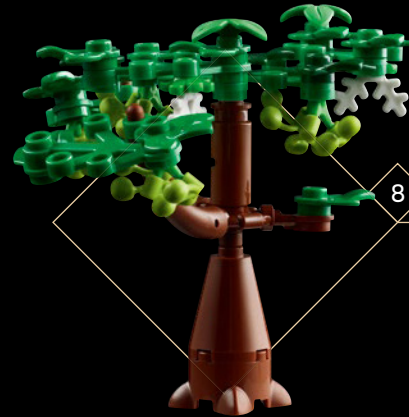

8

Vitis vinifera

Parra



9

Petunia axillaris

Petunia blanca



10

Cupressus sempervirens

Cíprés común

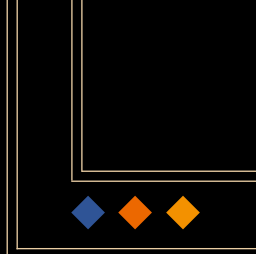

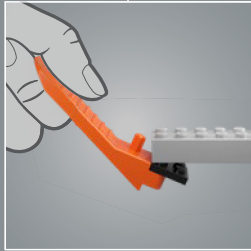
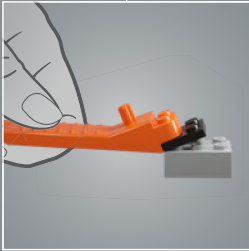
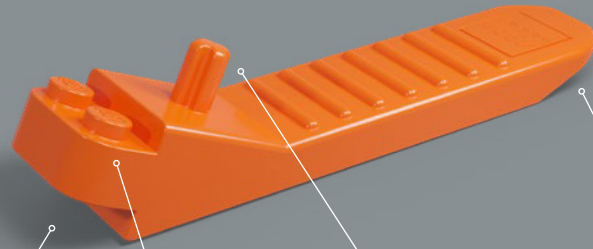

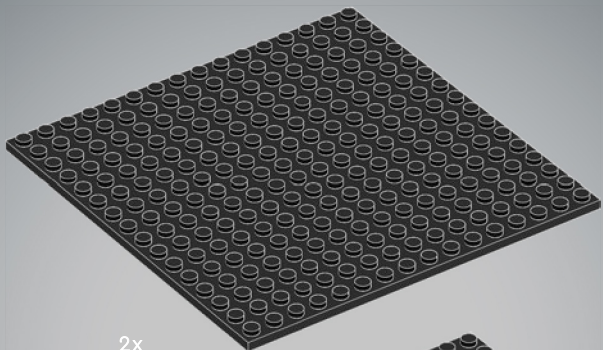

2x

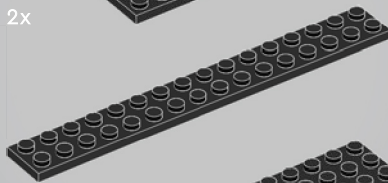

1x

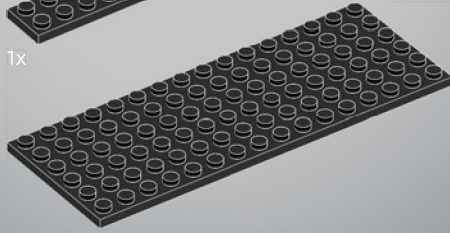

2x

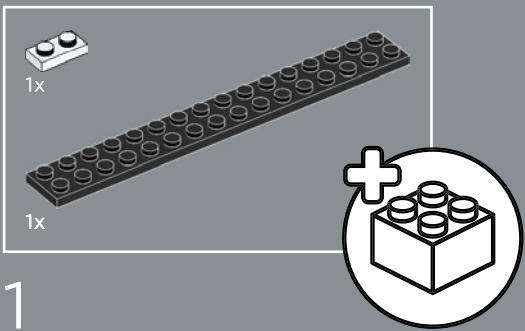

1

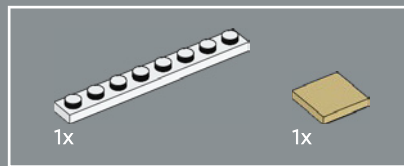
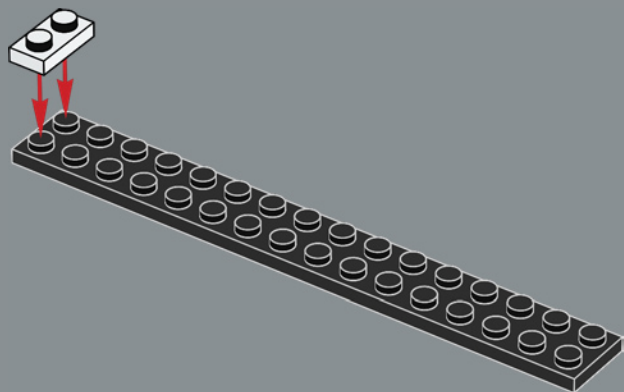

2

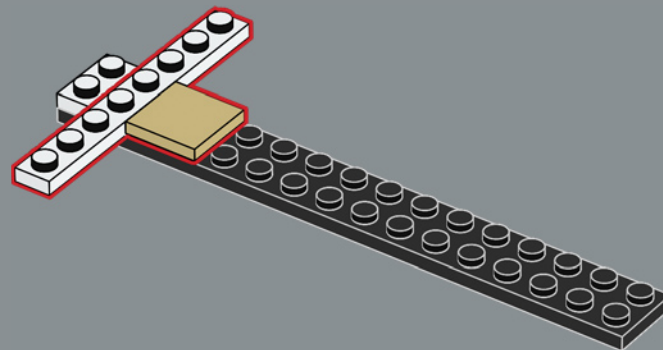

3

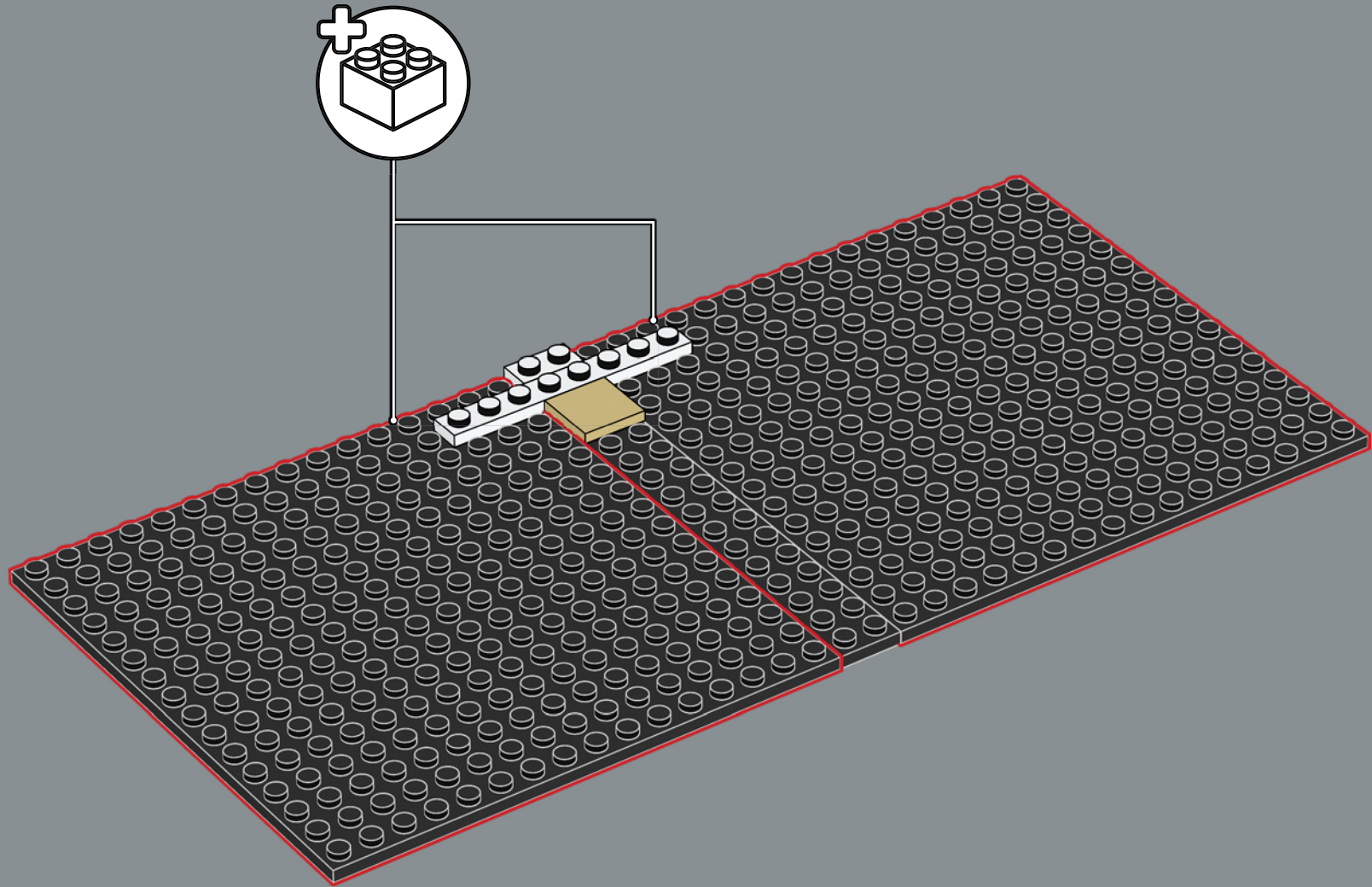

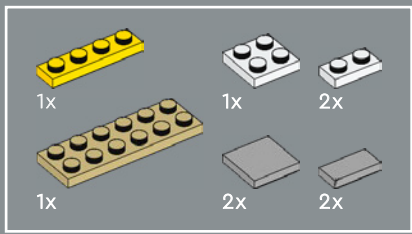

4

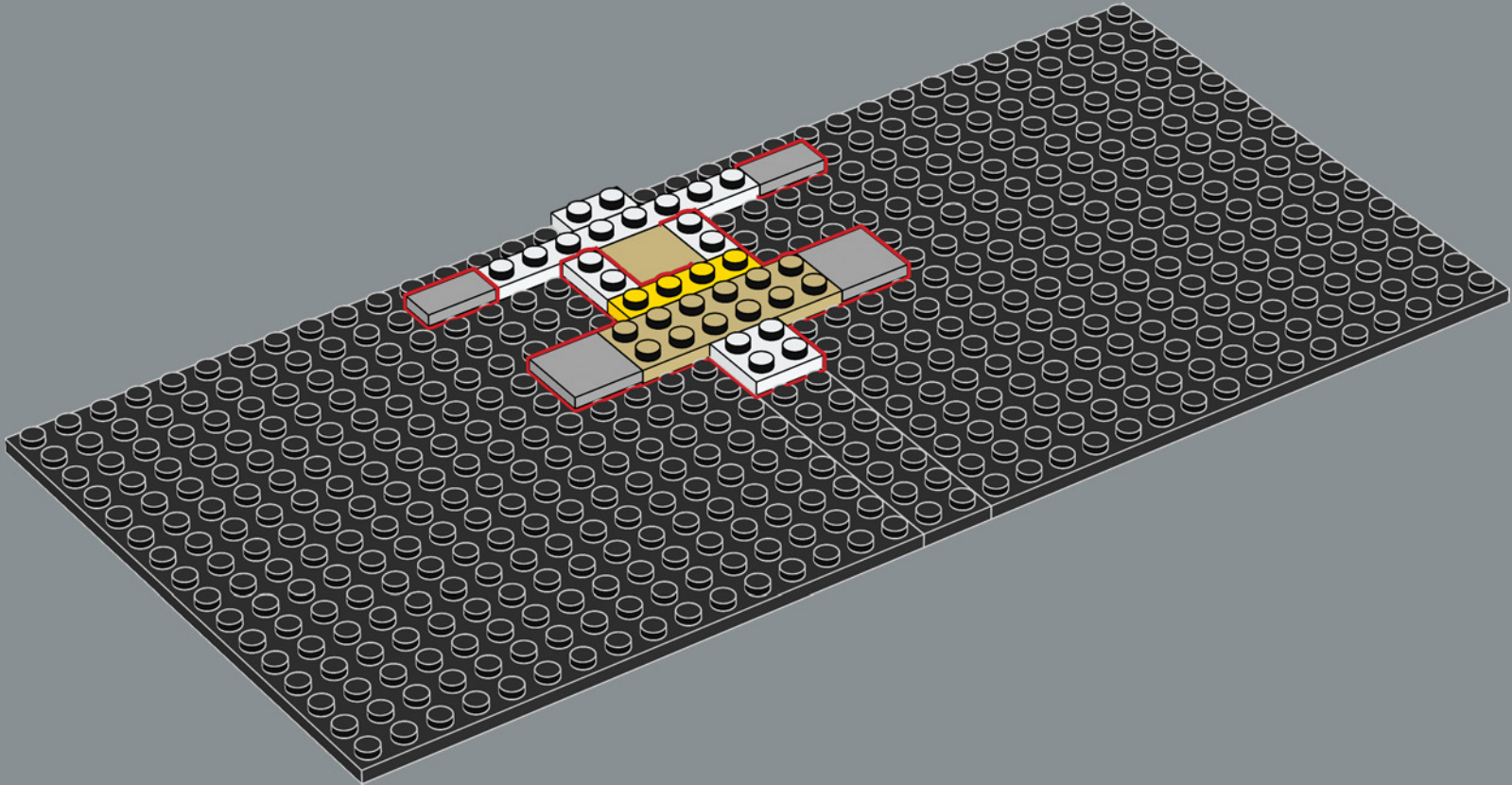

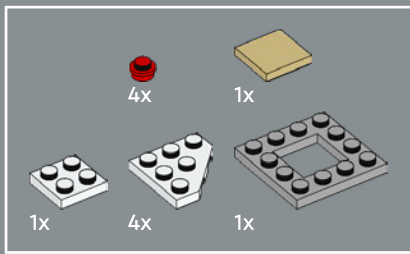

5

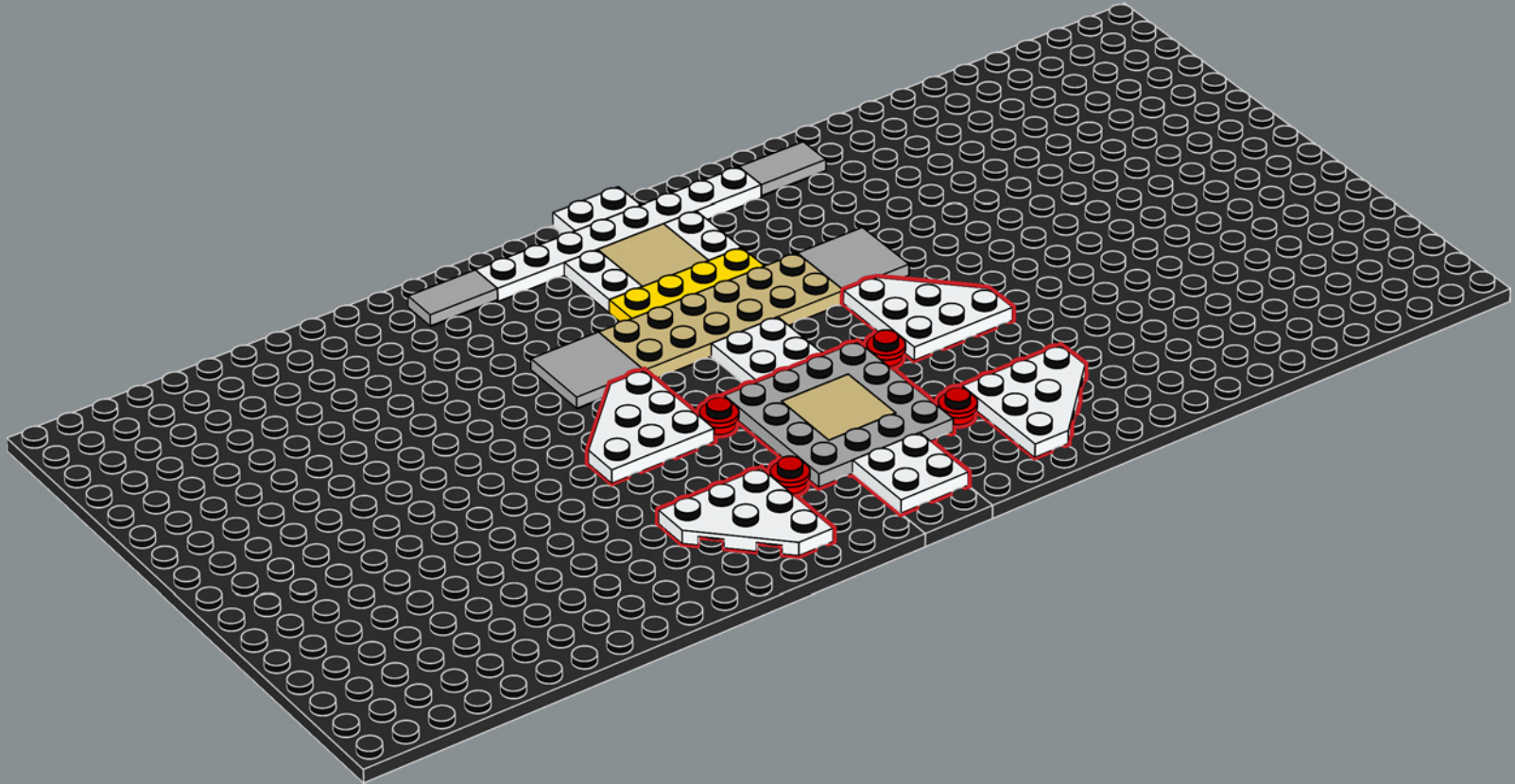

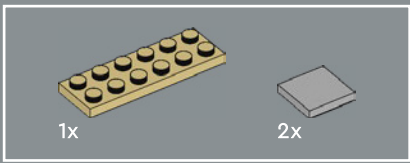

6

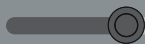
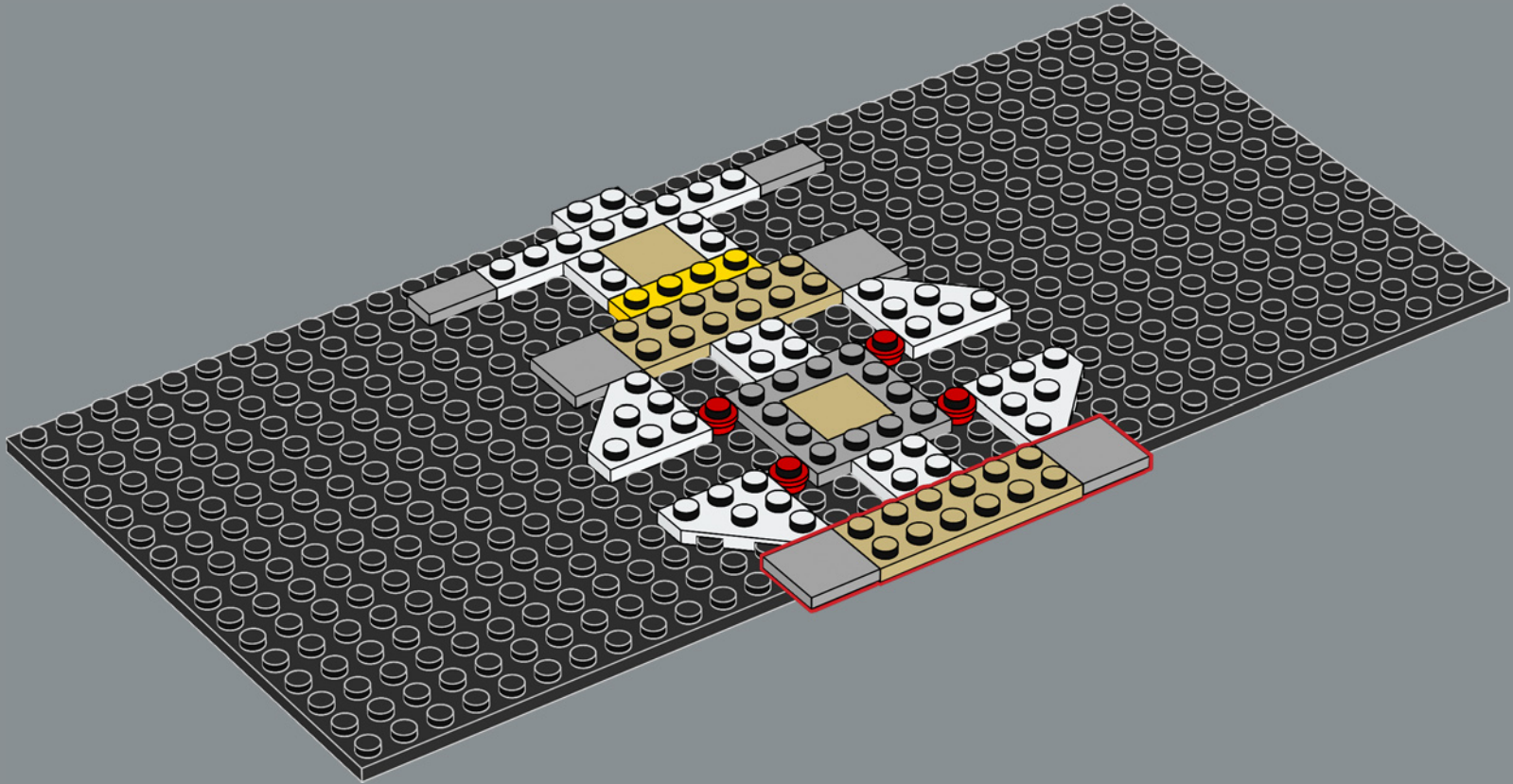

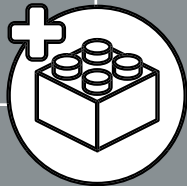
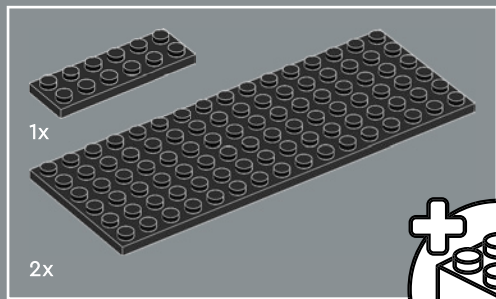

7

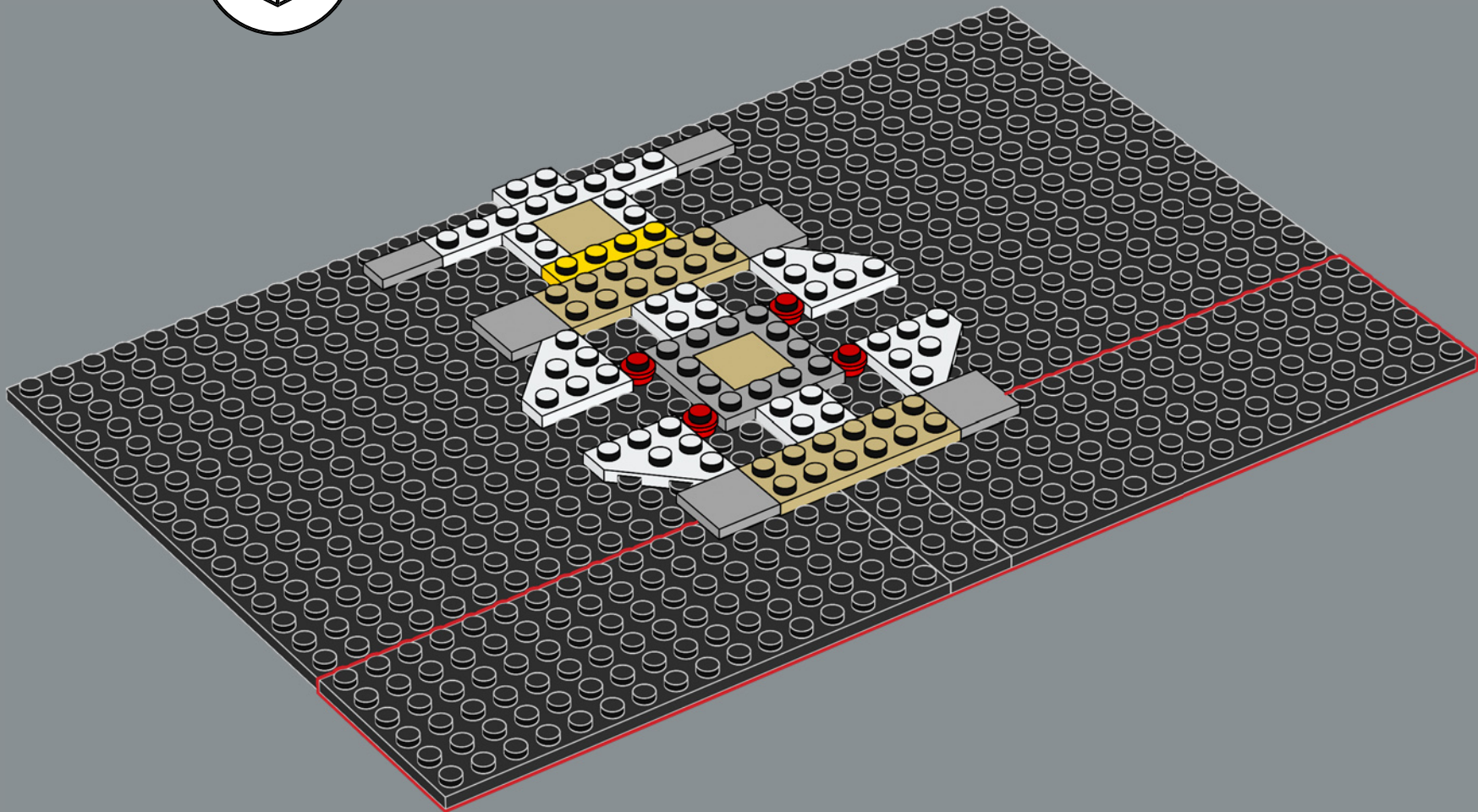

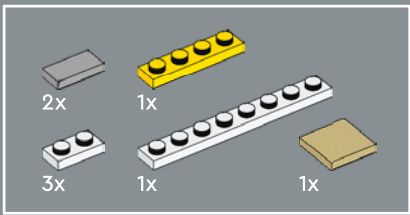

8

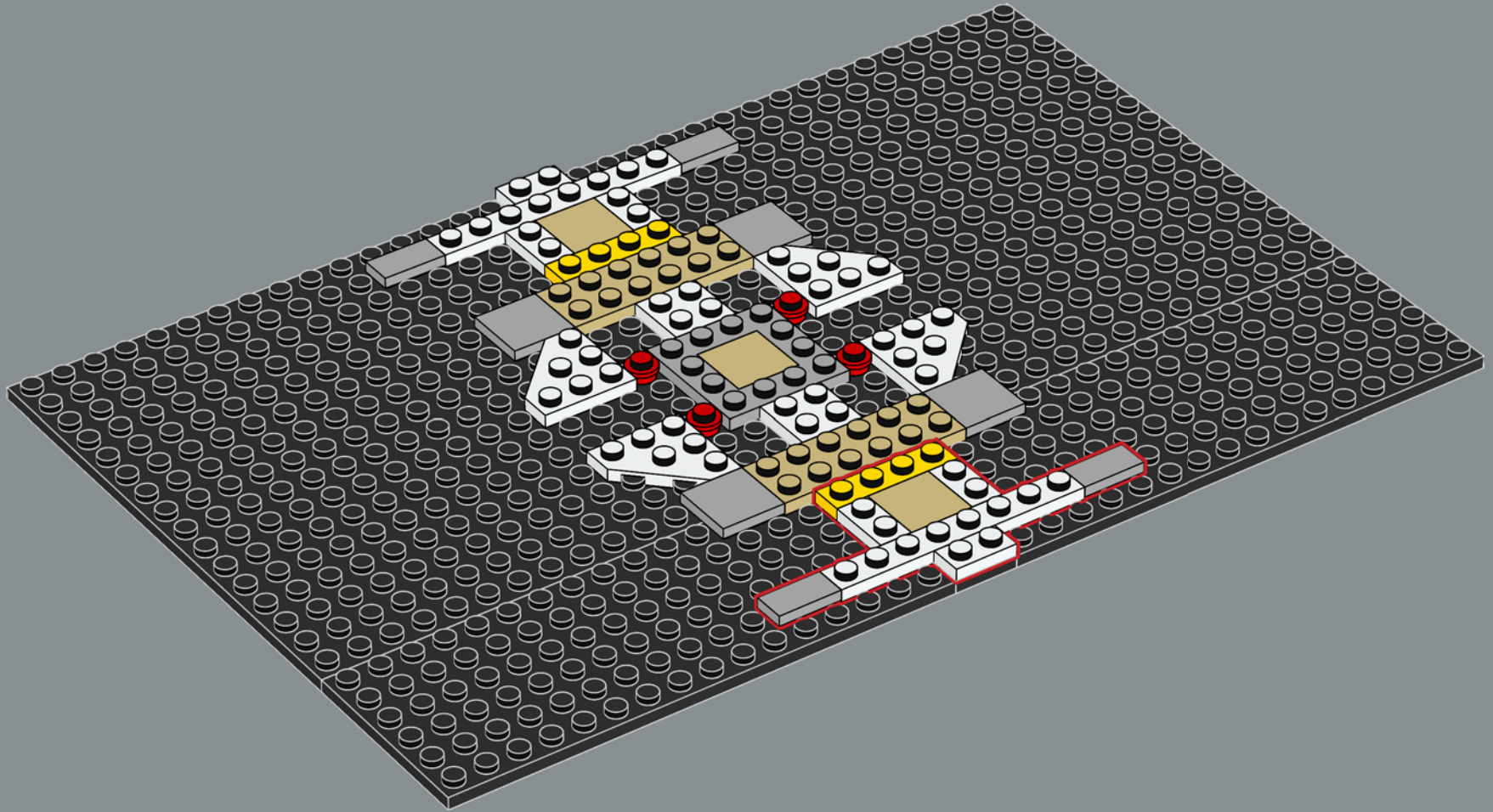

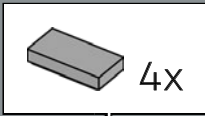
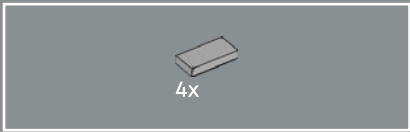

9

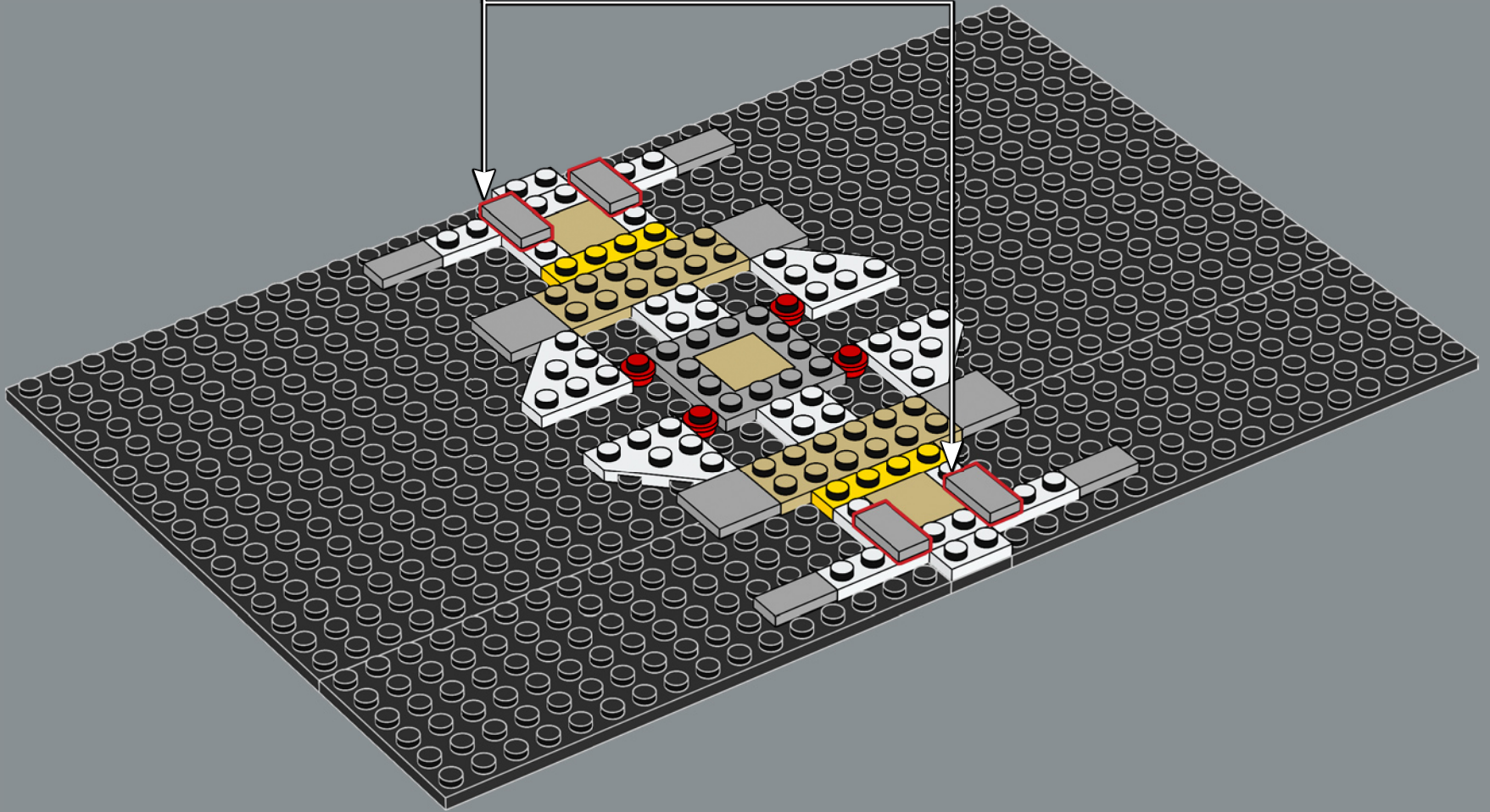

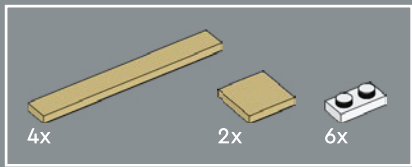

10

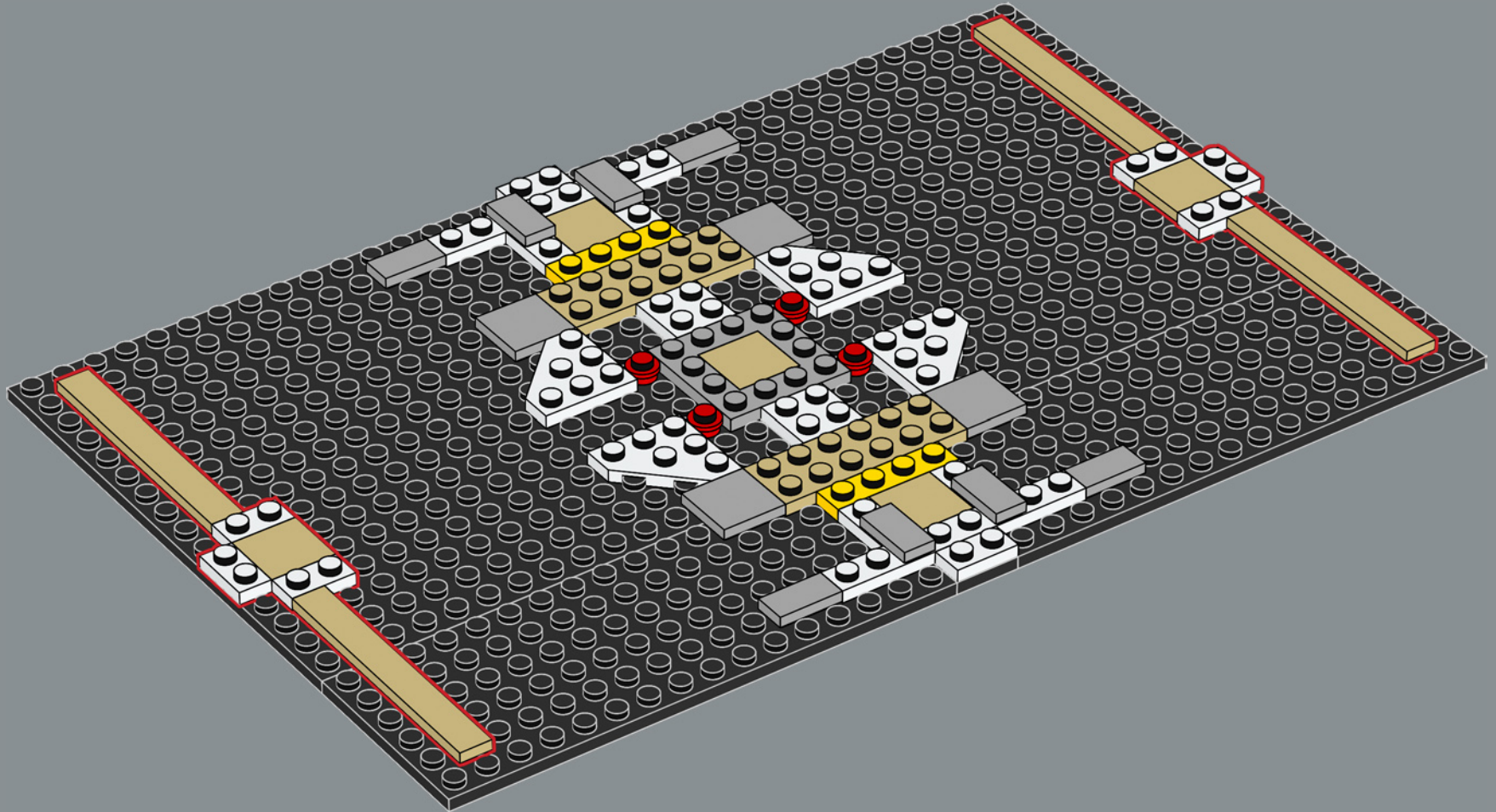

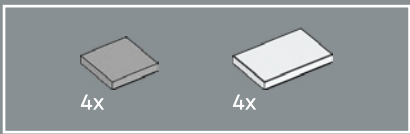

11

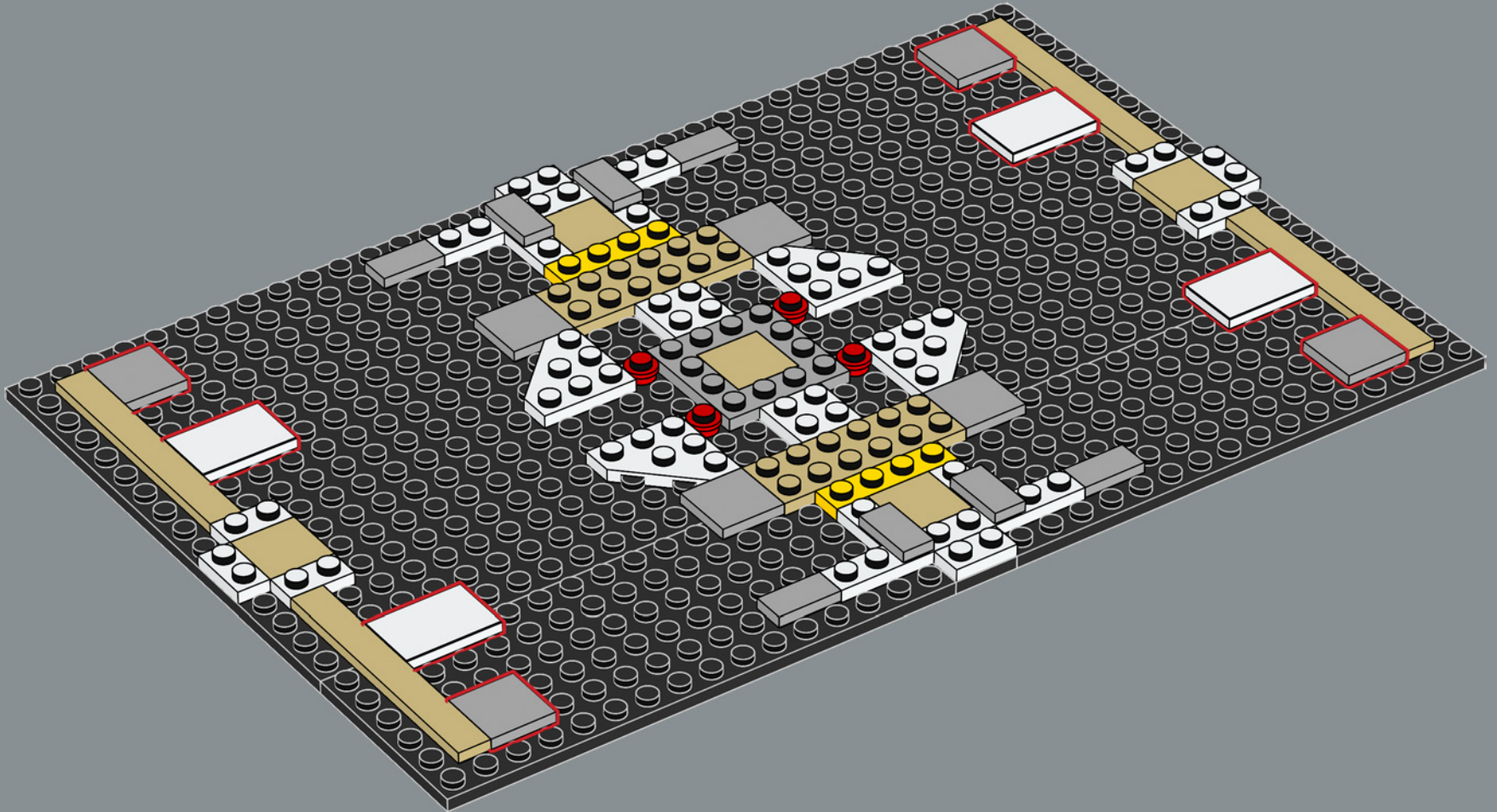

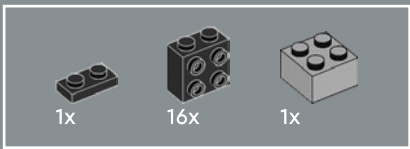

12

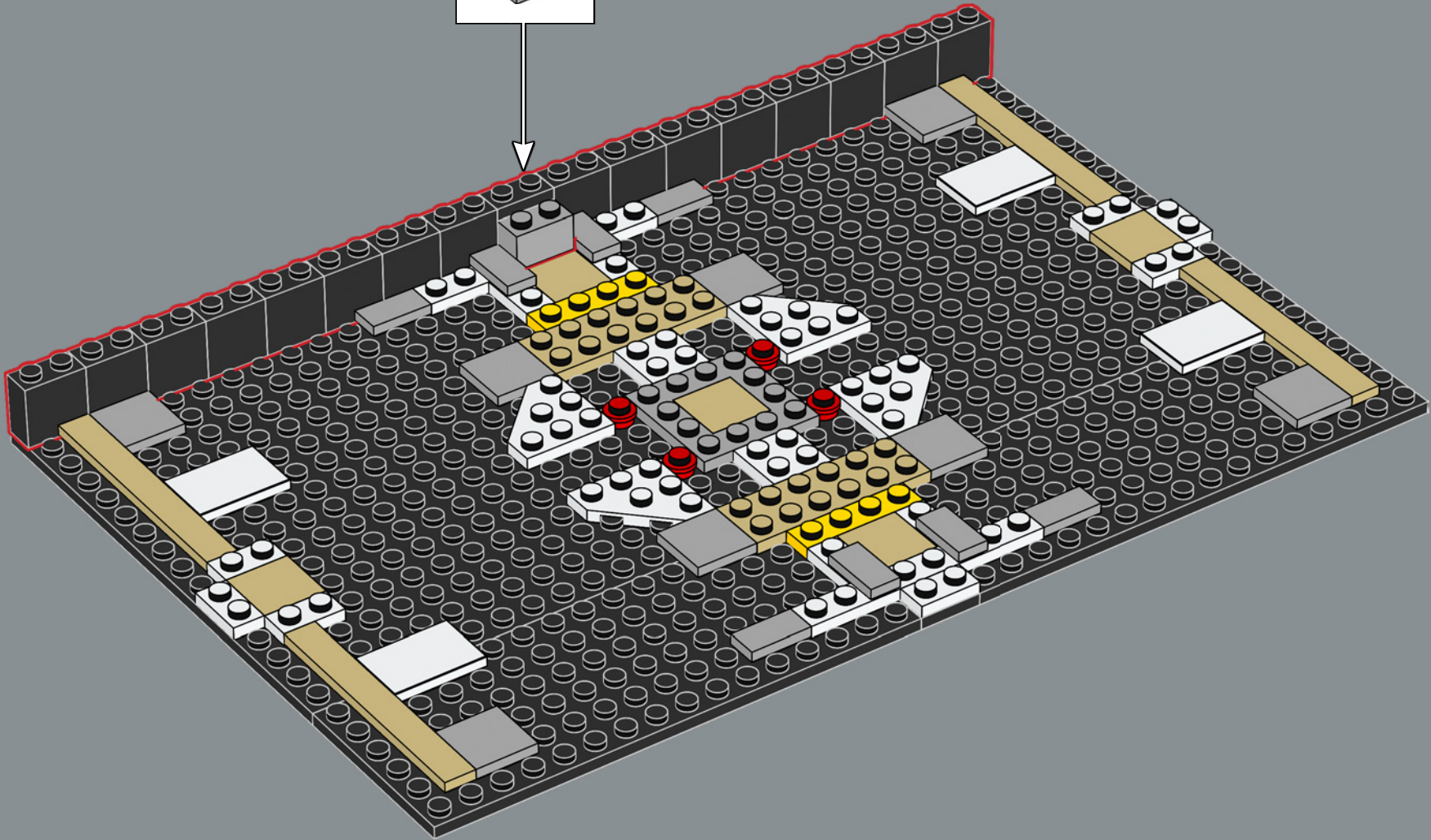
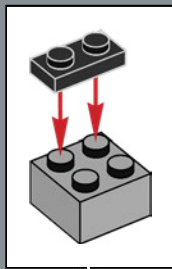

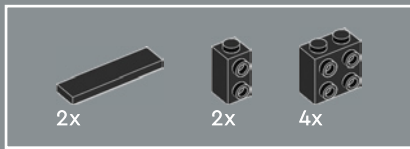

13

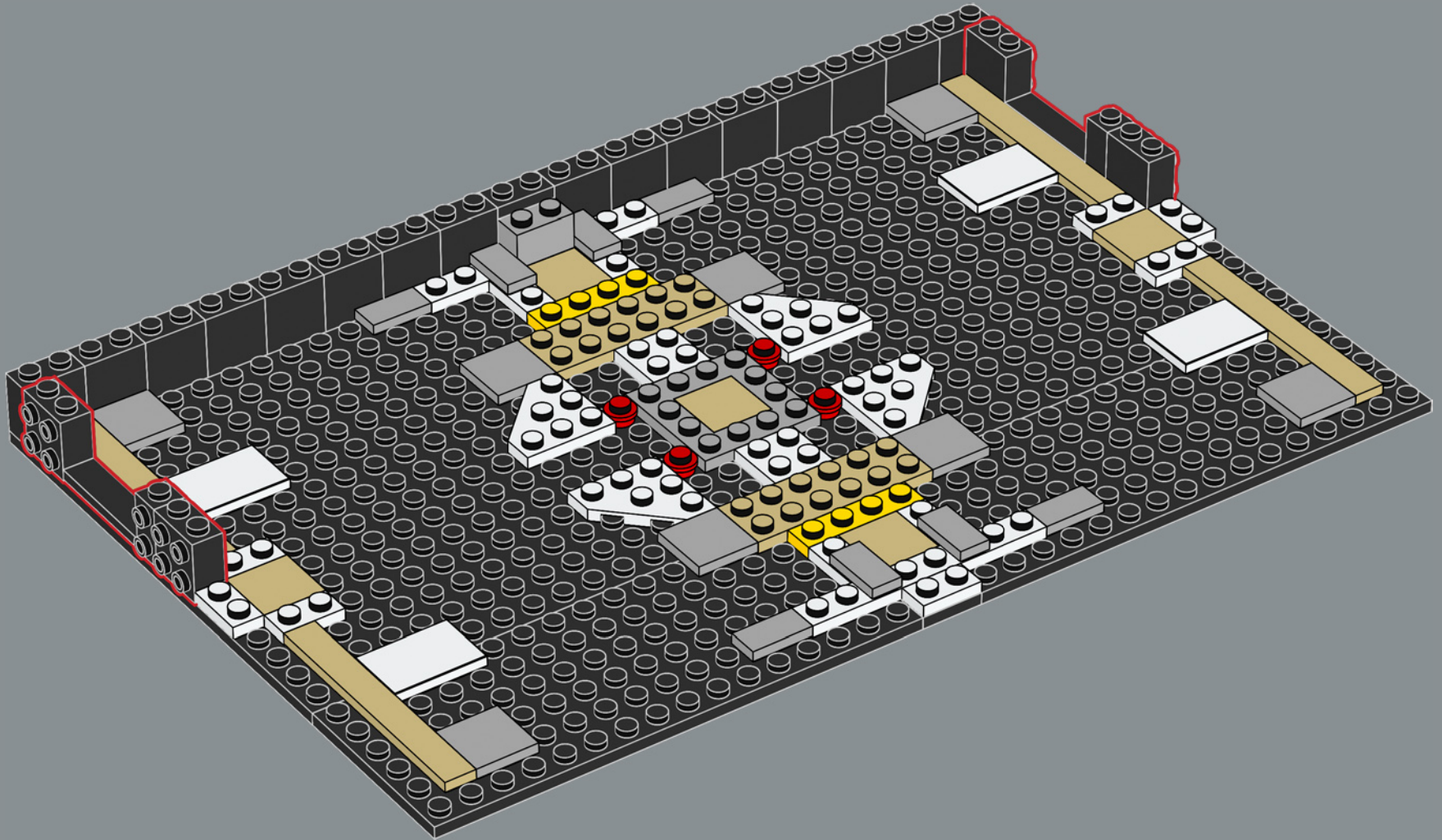

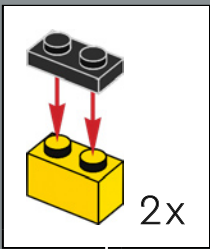
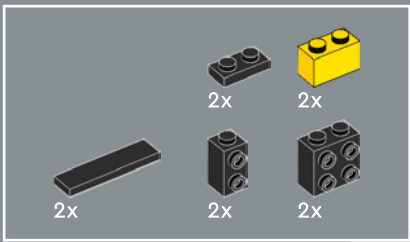

14

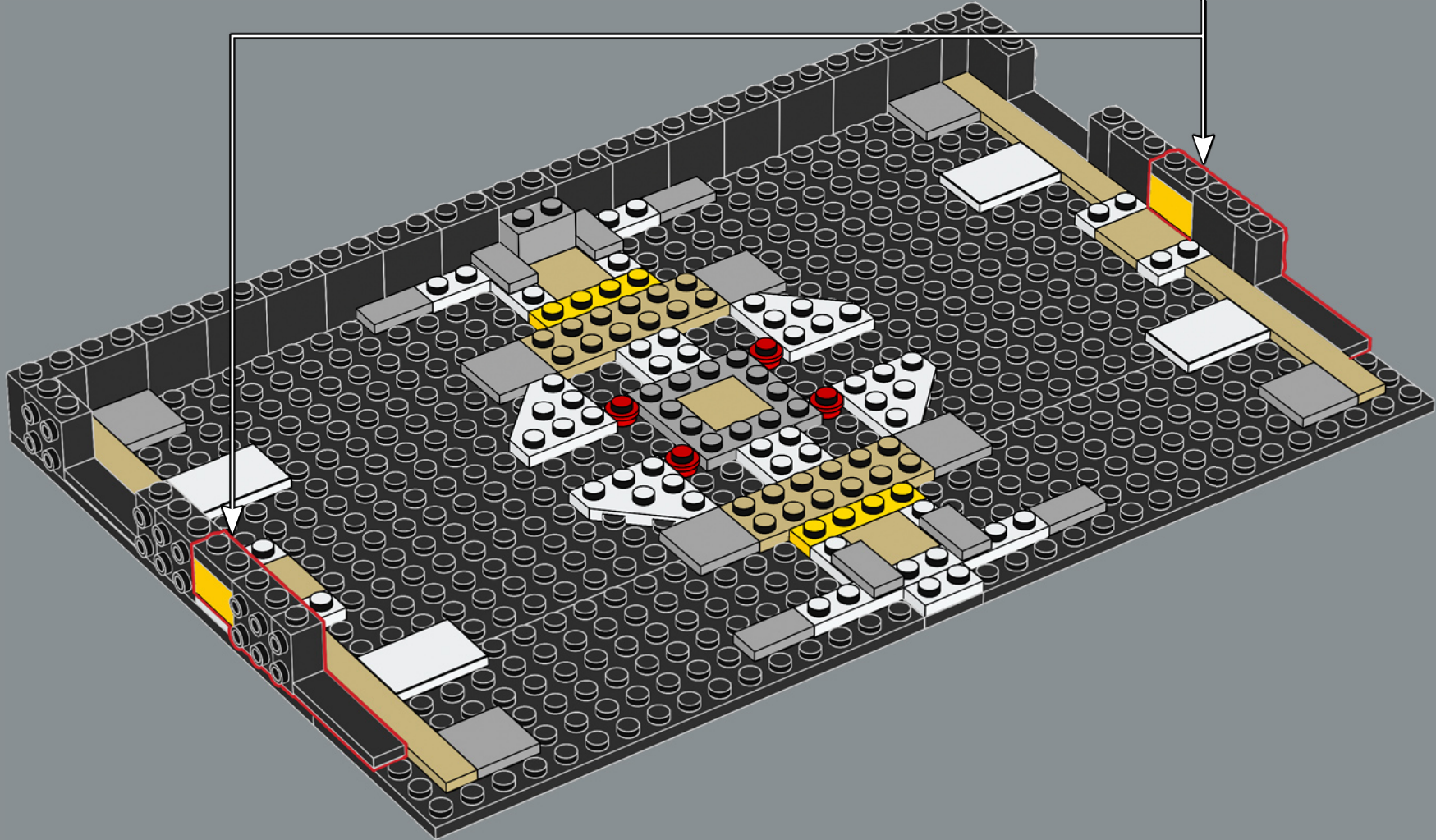

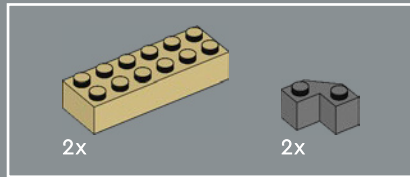

15

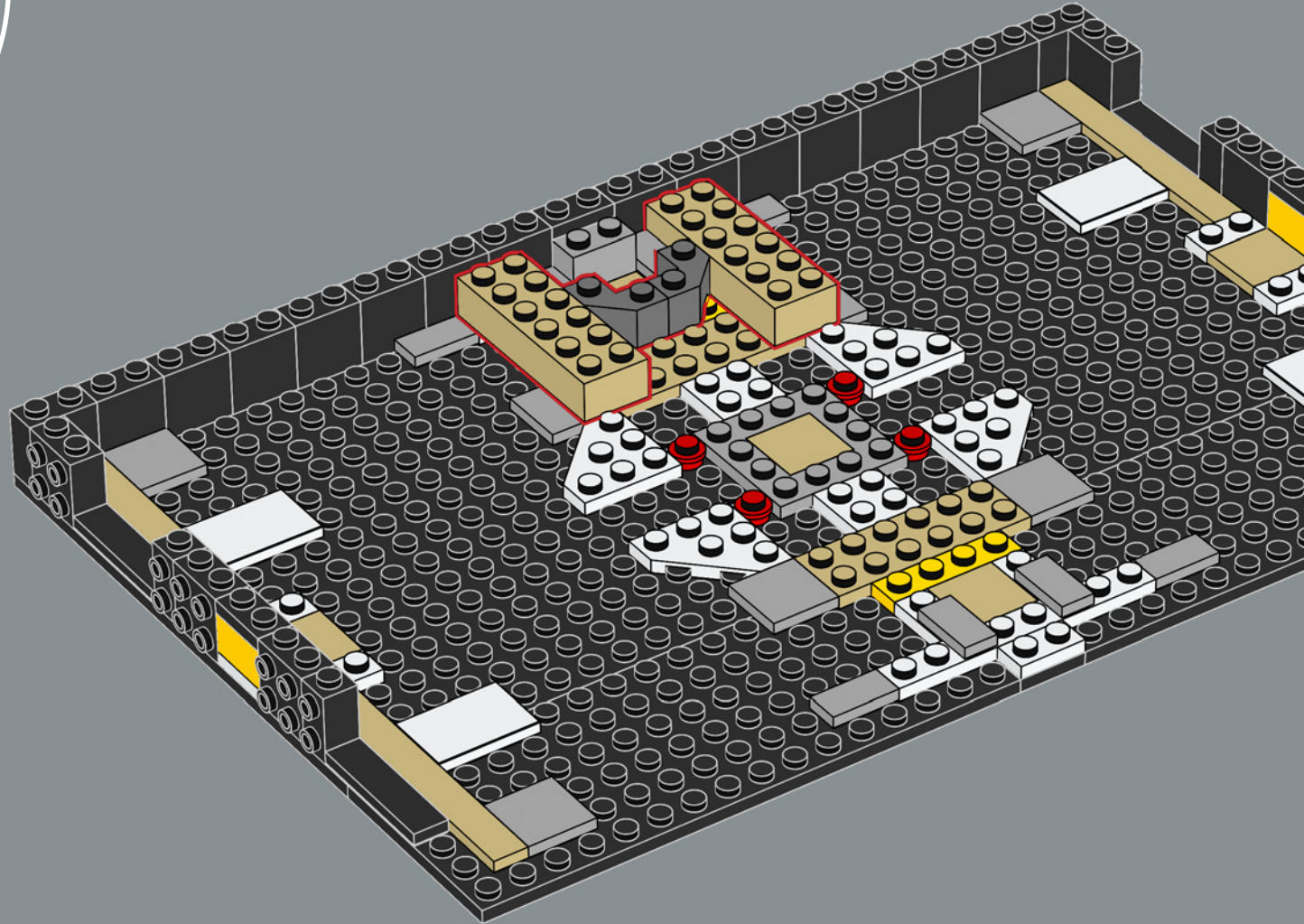

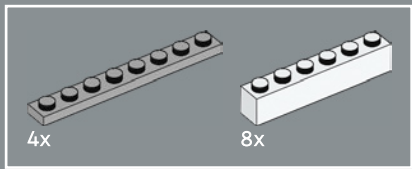

16

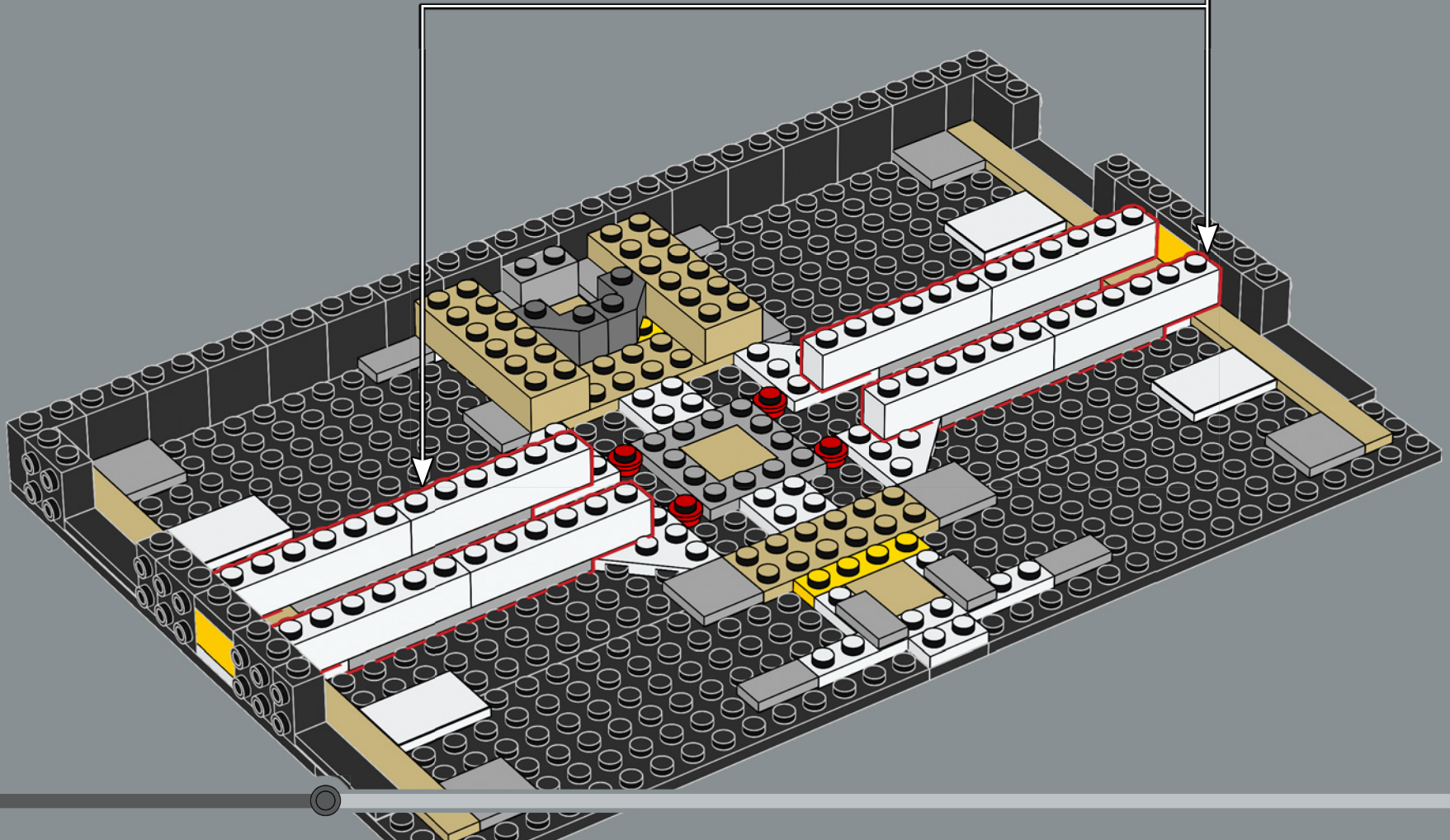
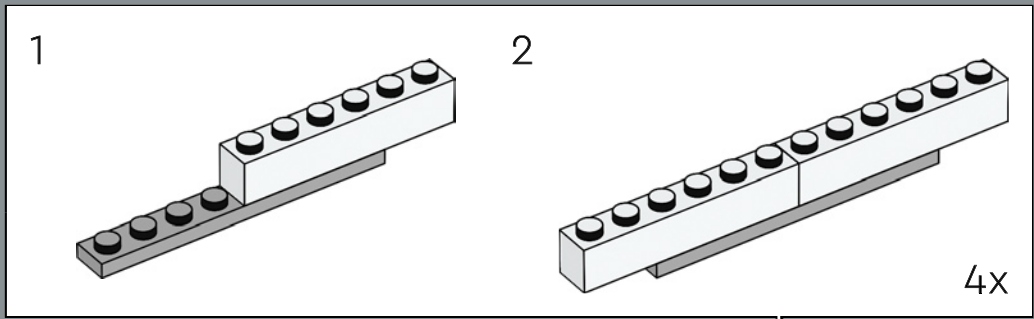

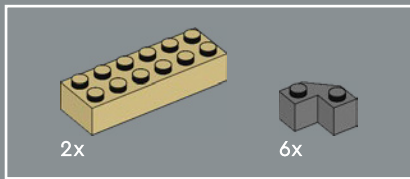

17

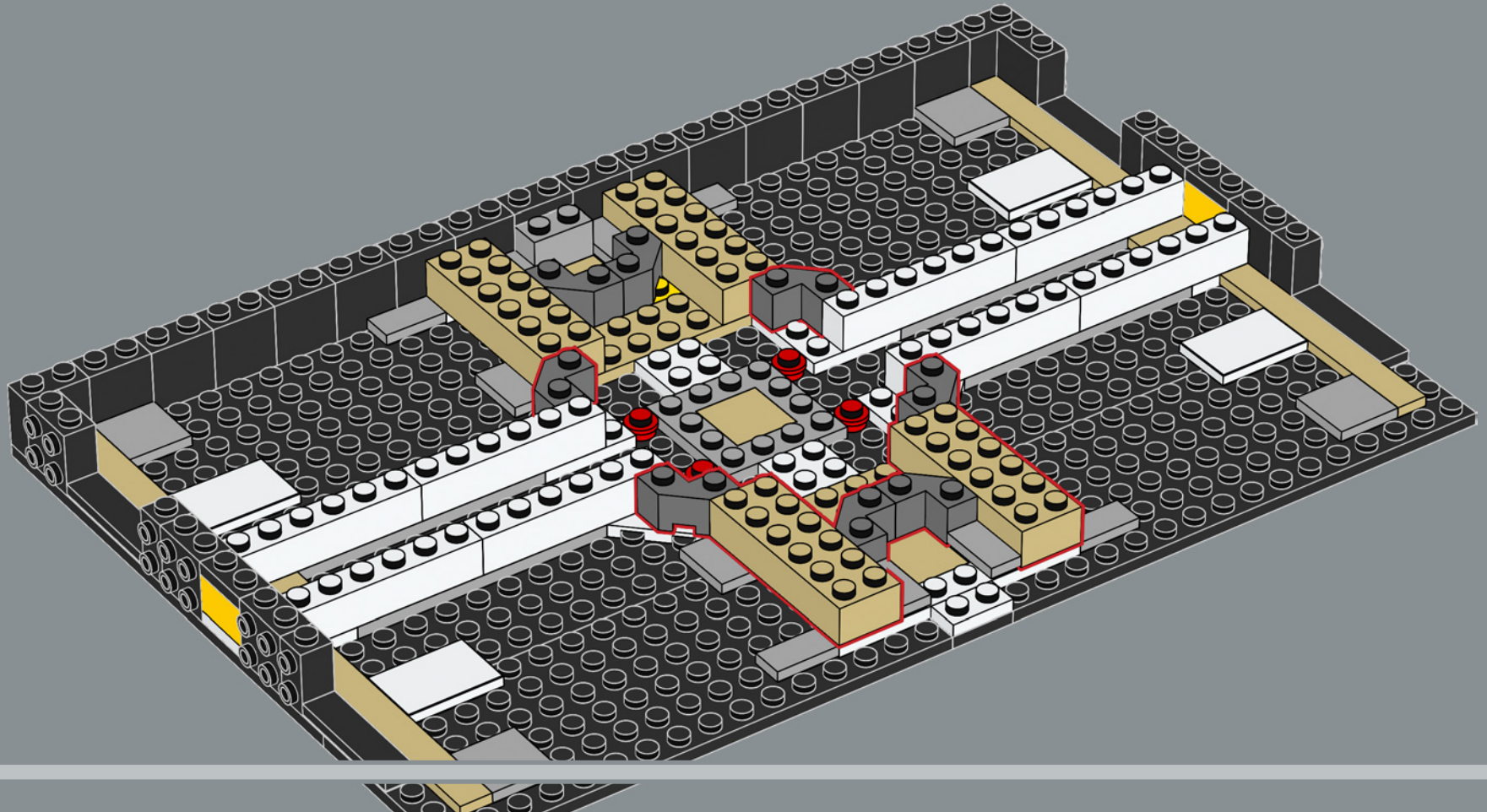

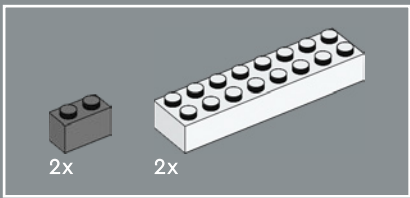

18

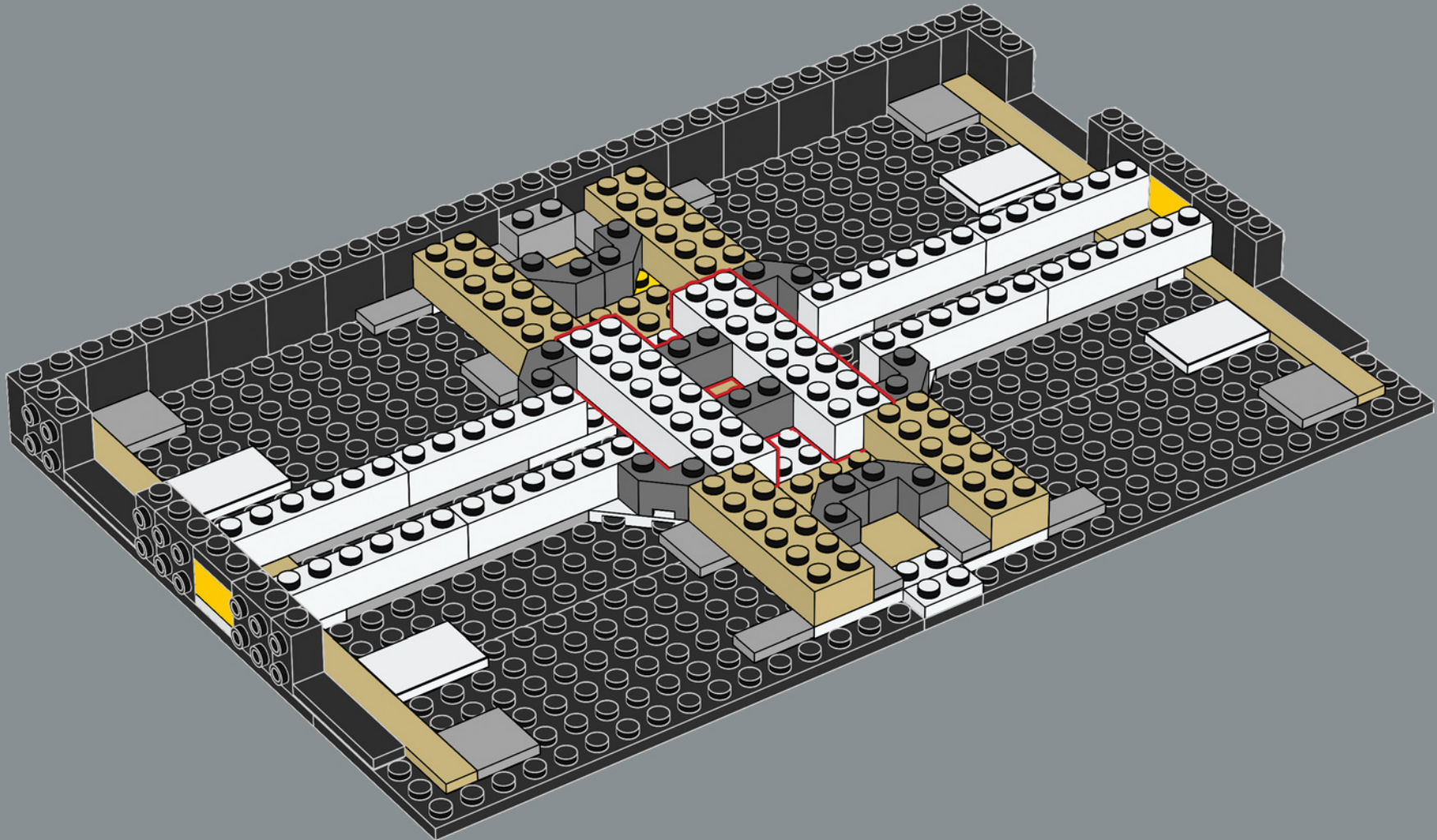

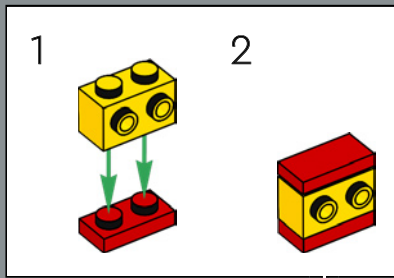
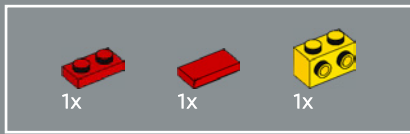

19

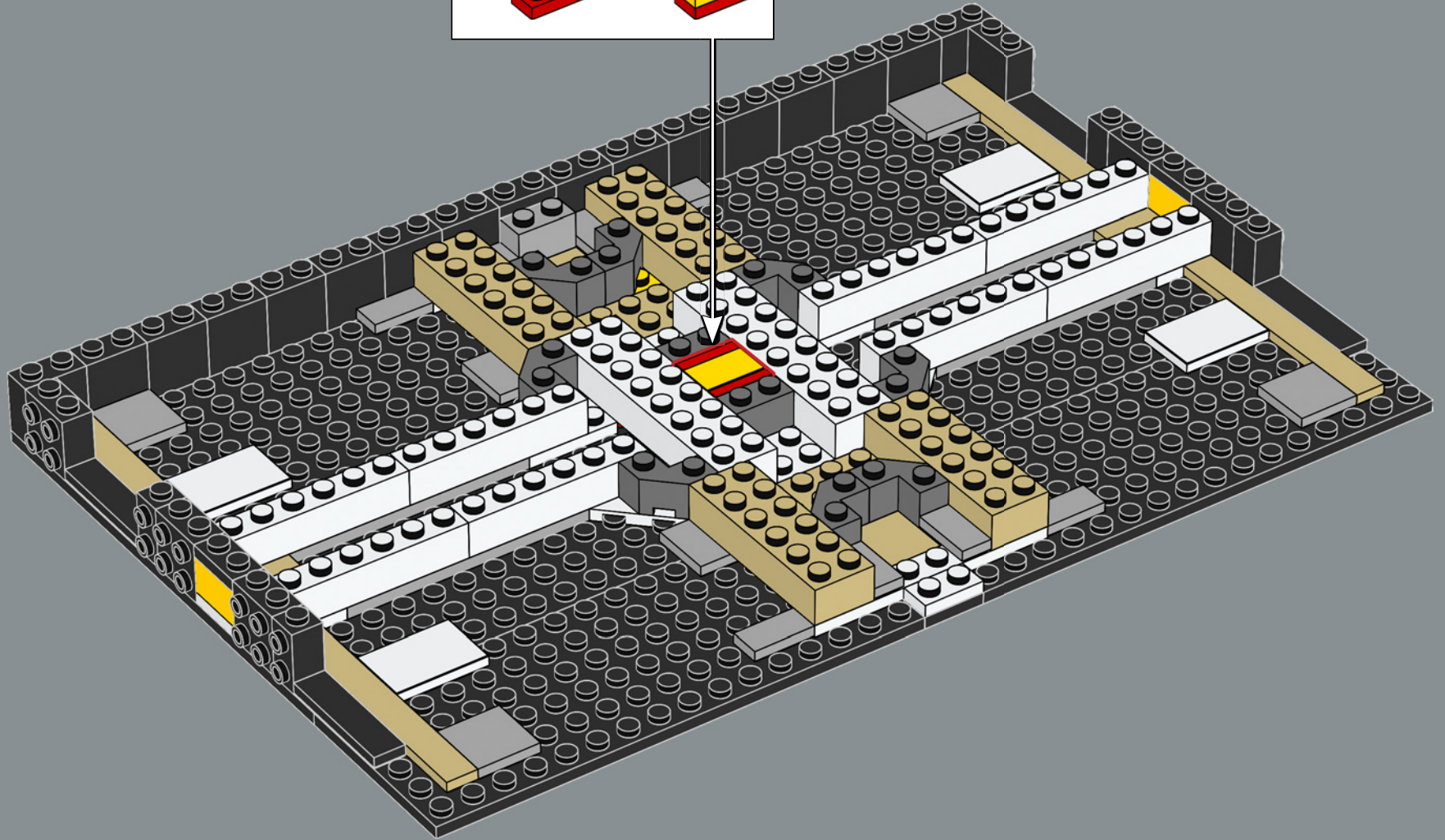

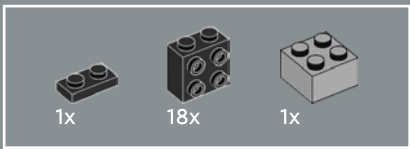

20

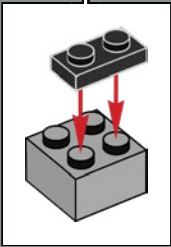
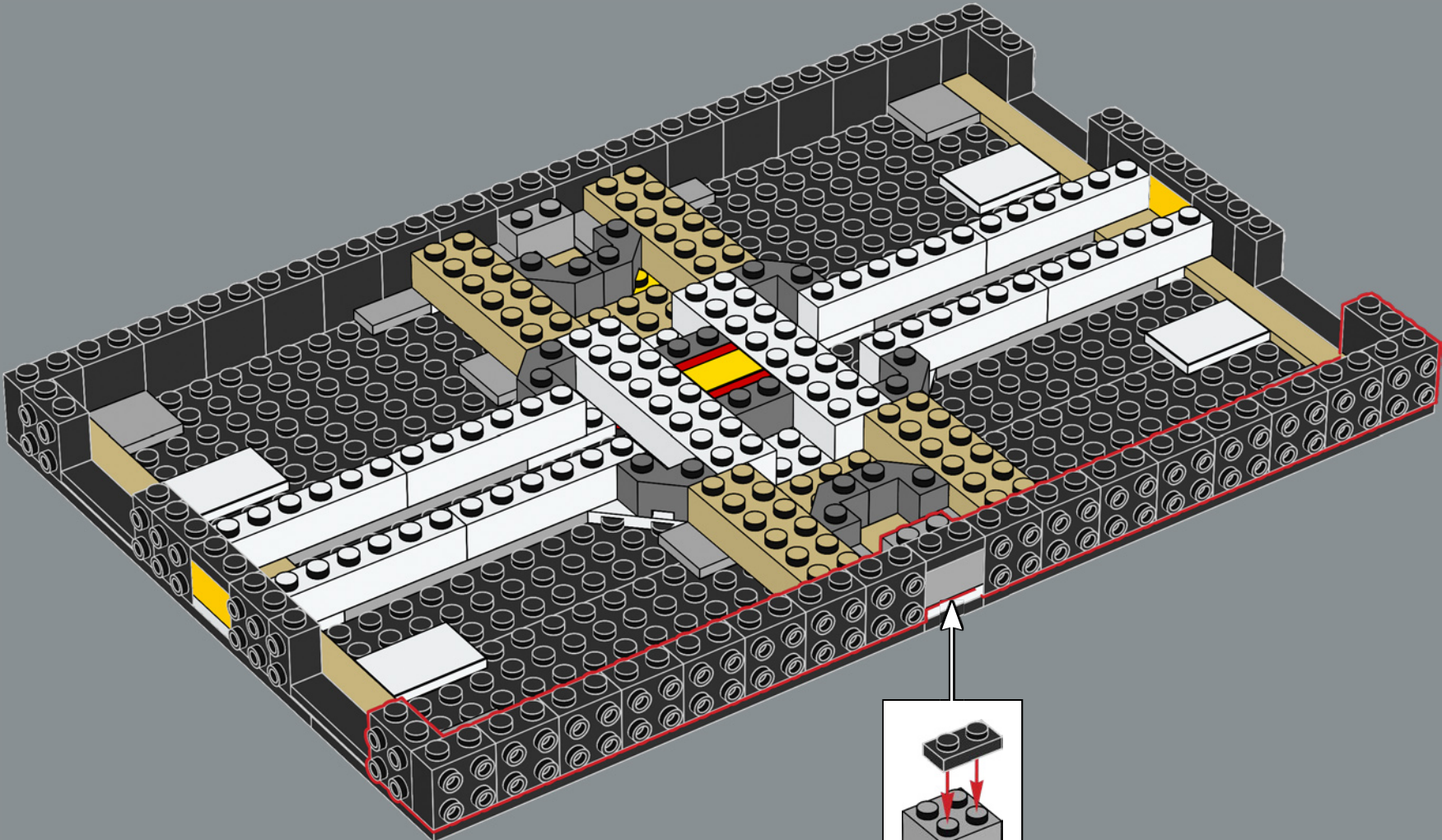

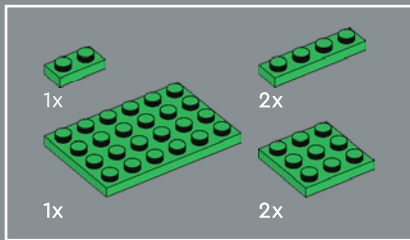

21

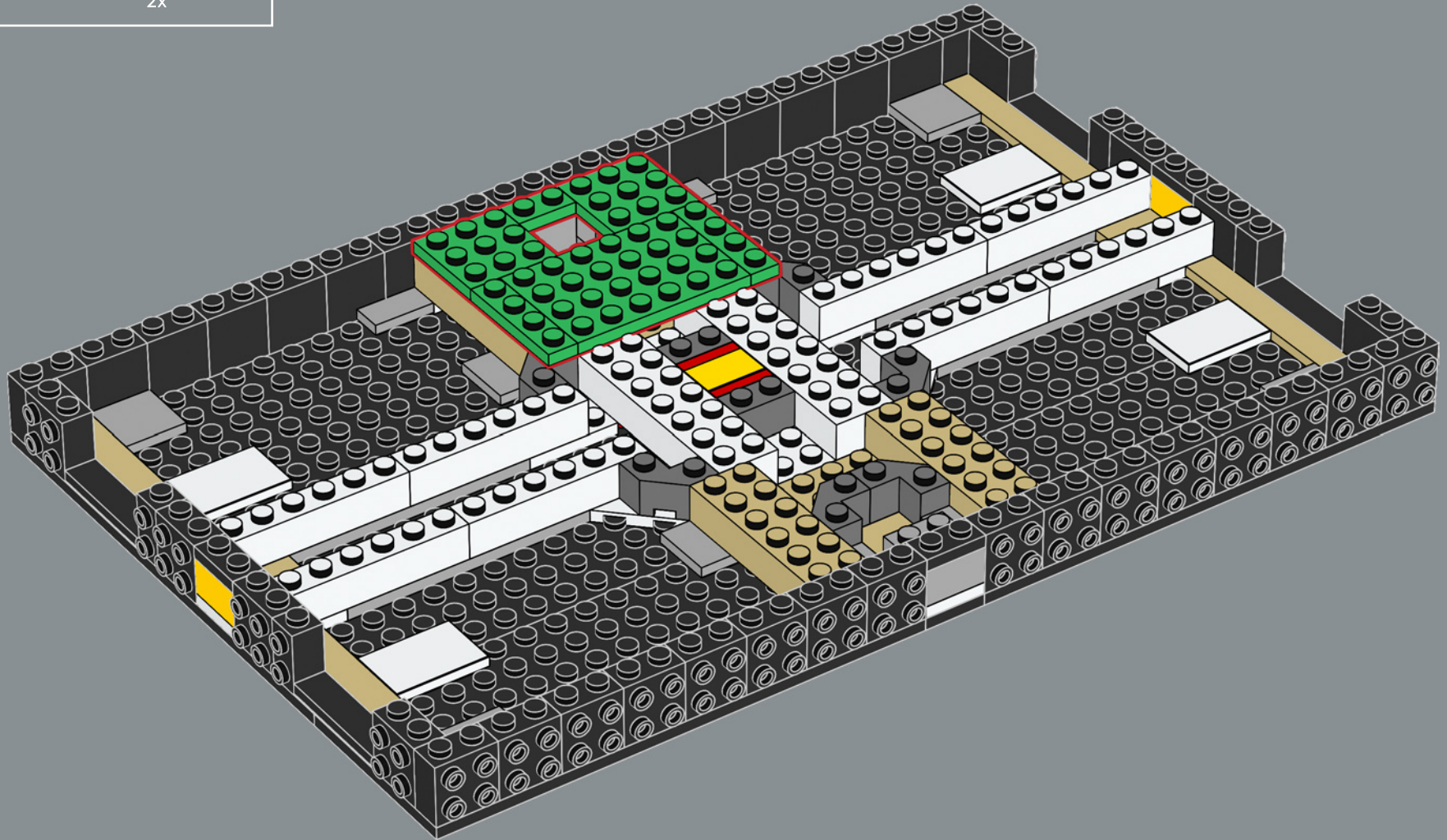

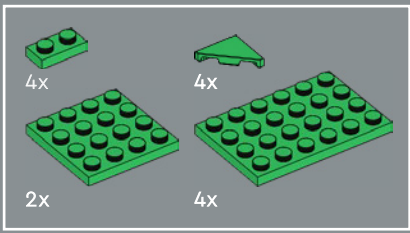

22

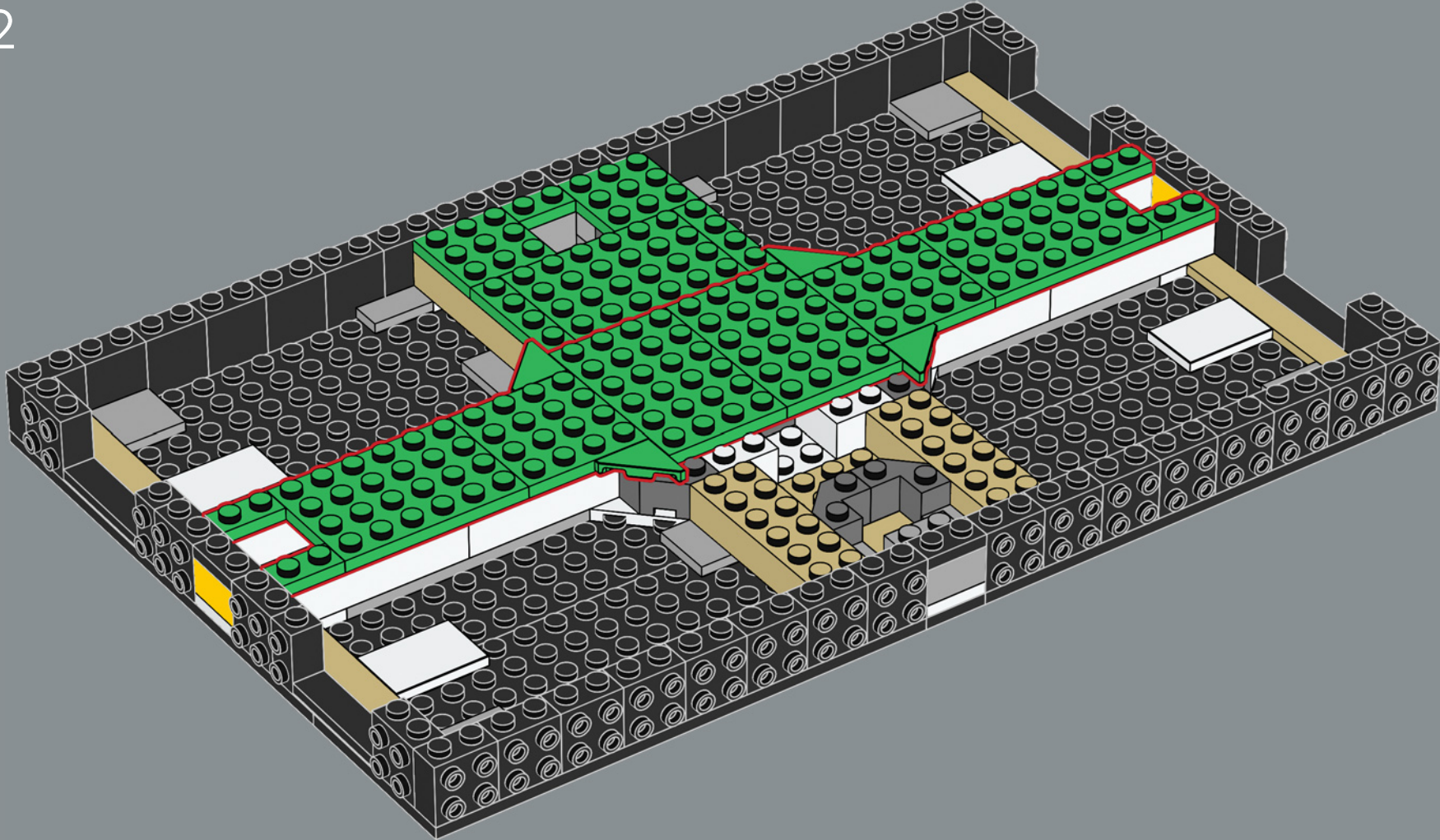

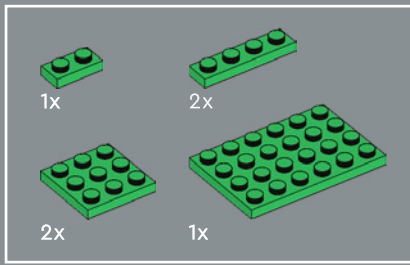

23

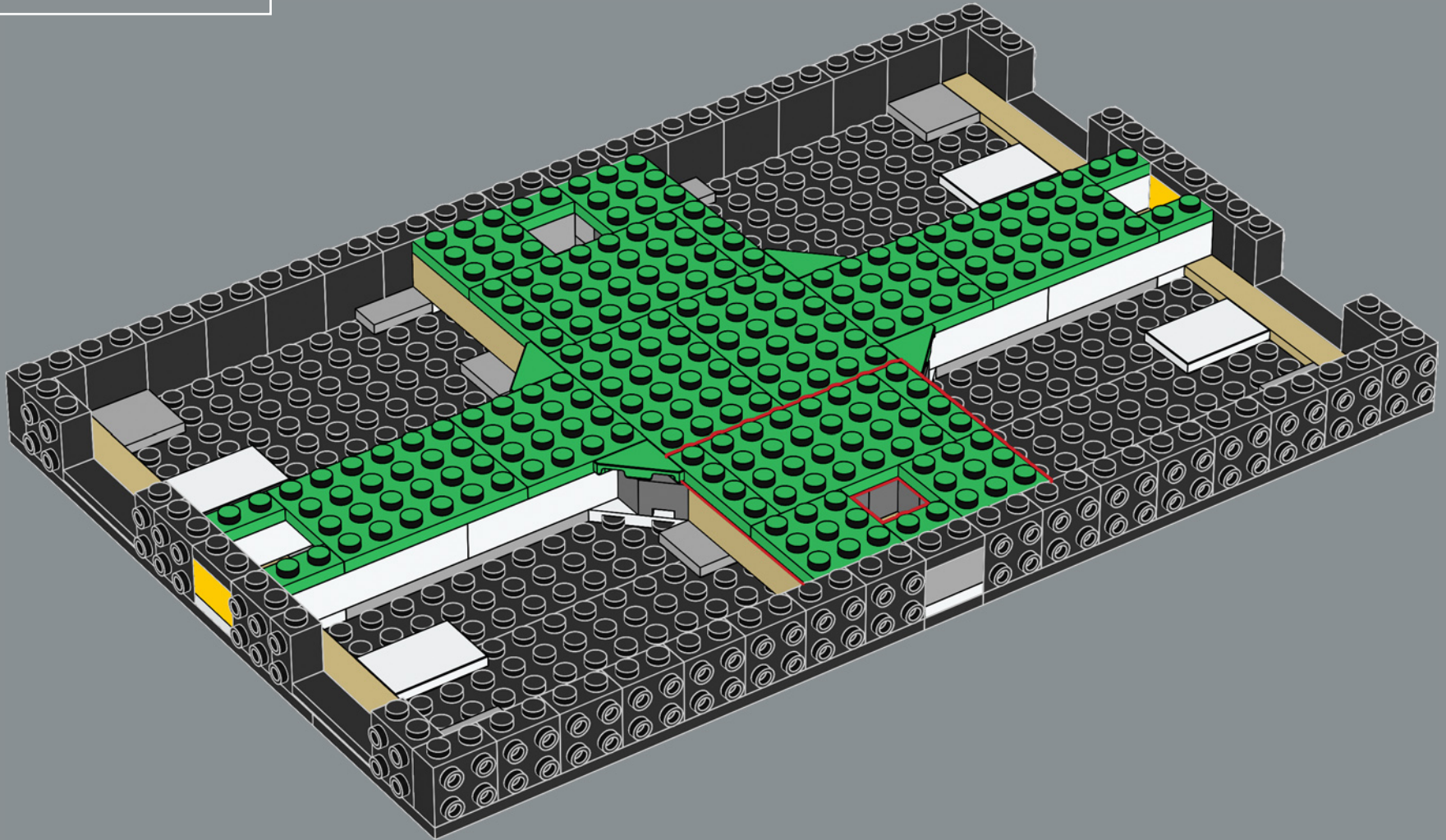



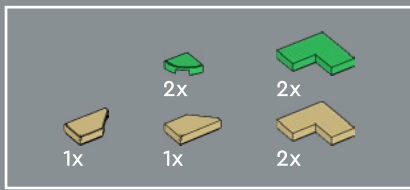

24

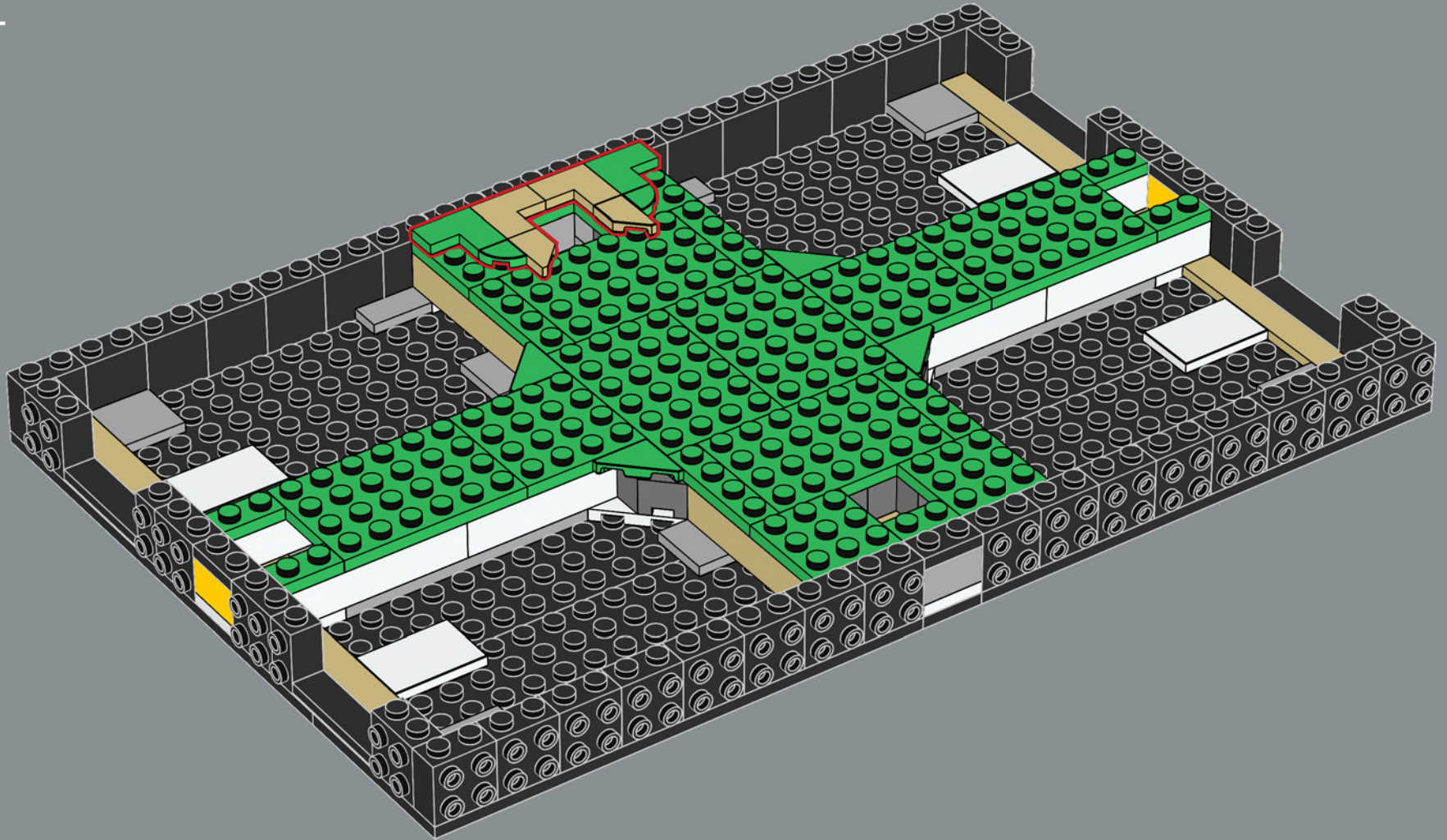



25

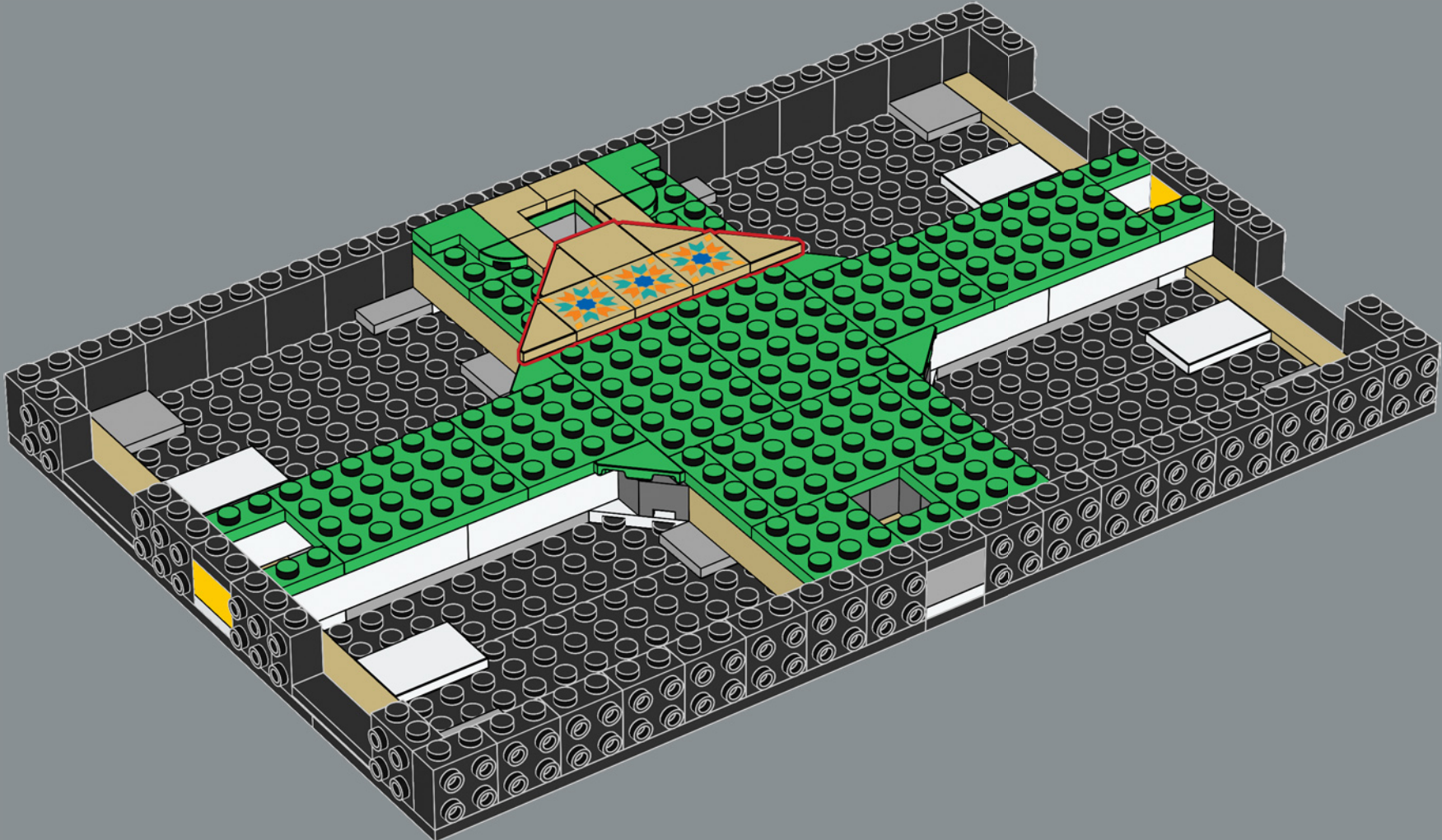

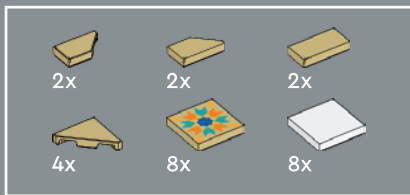

26

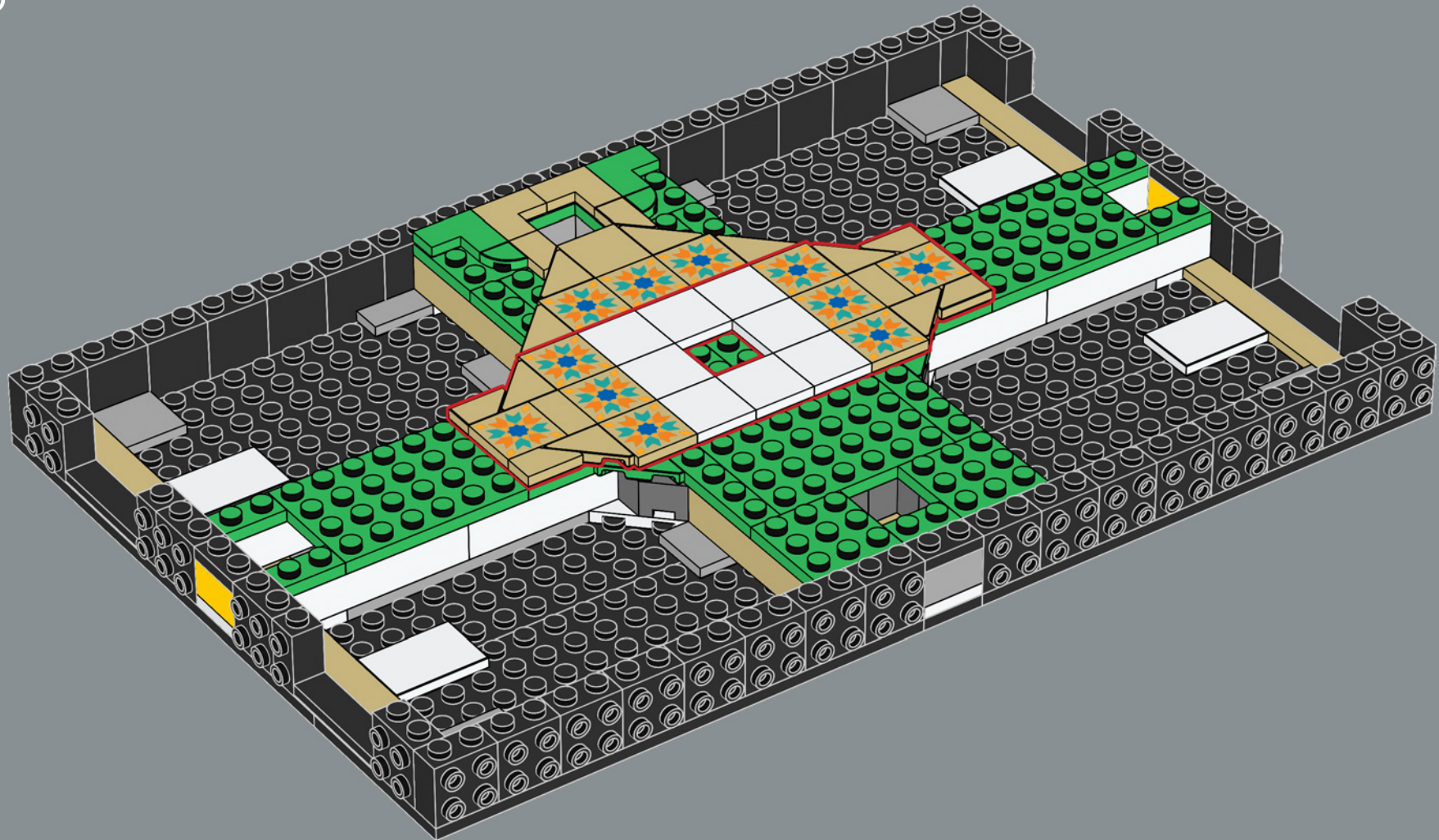



27

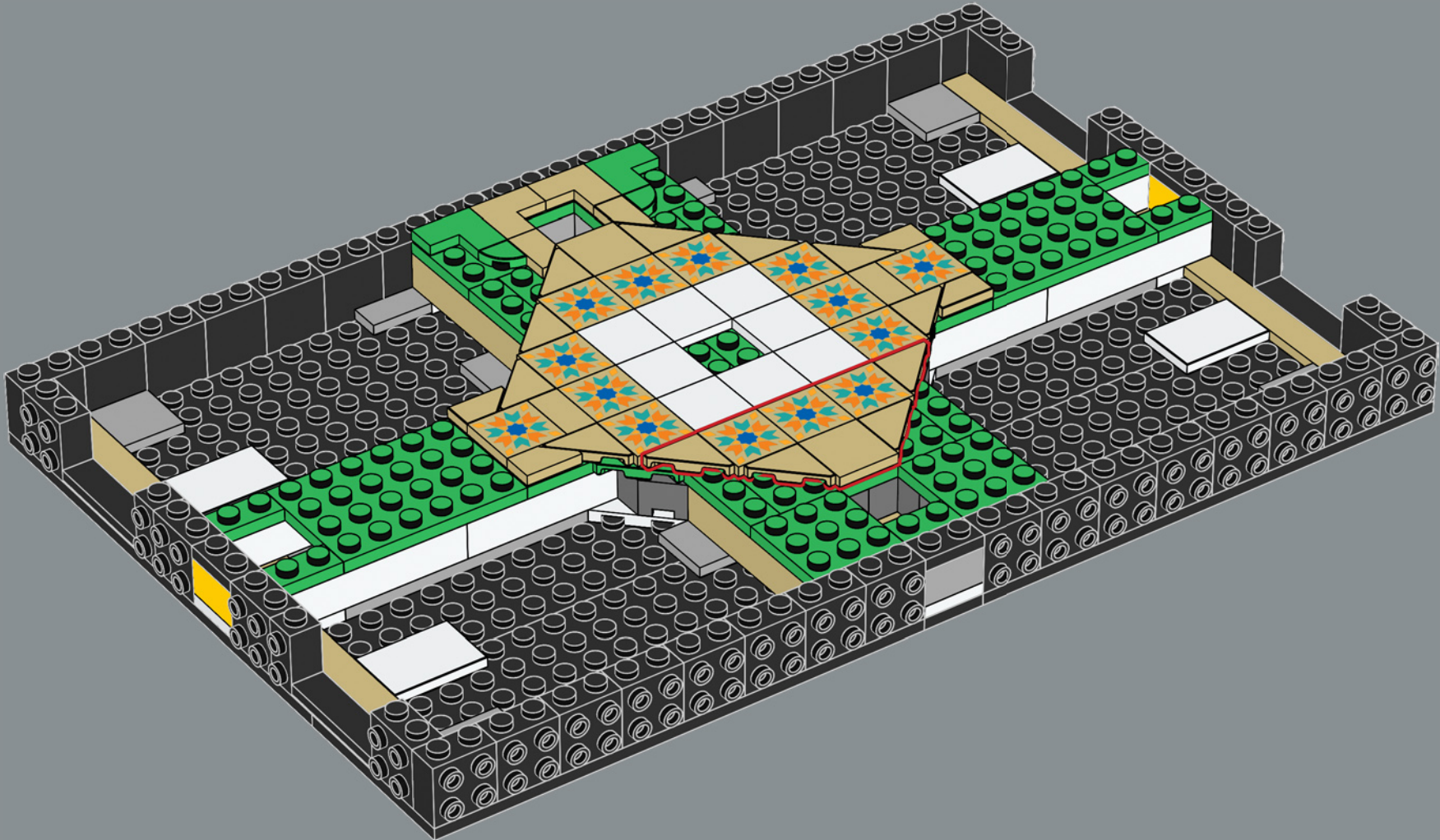

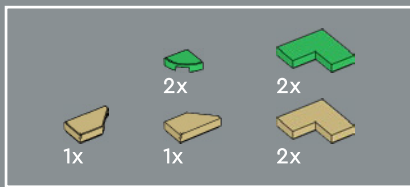

28

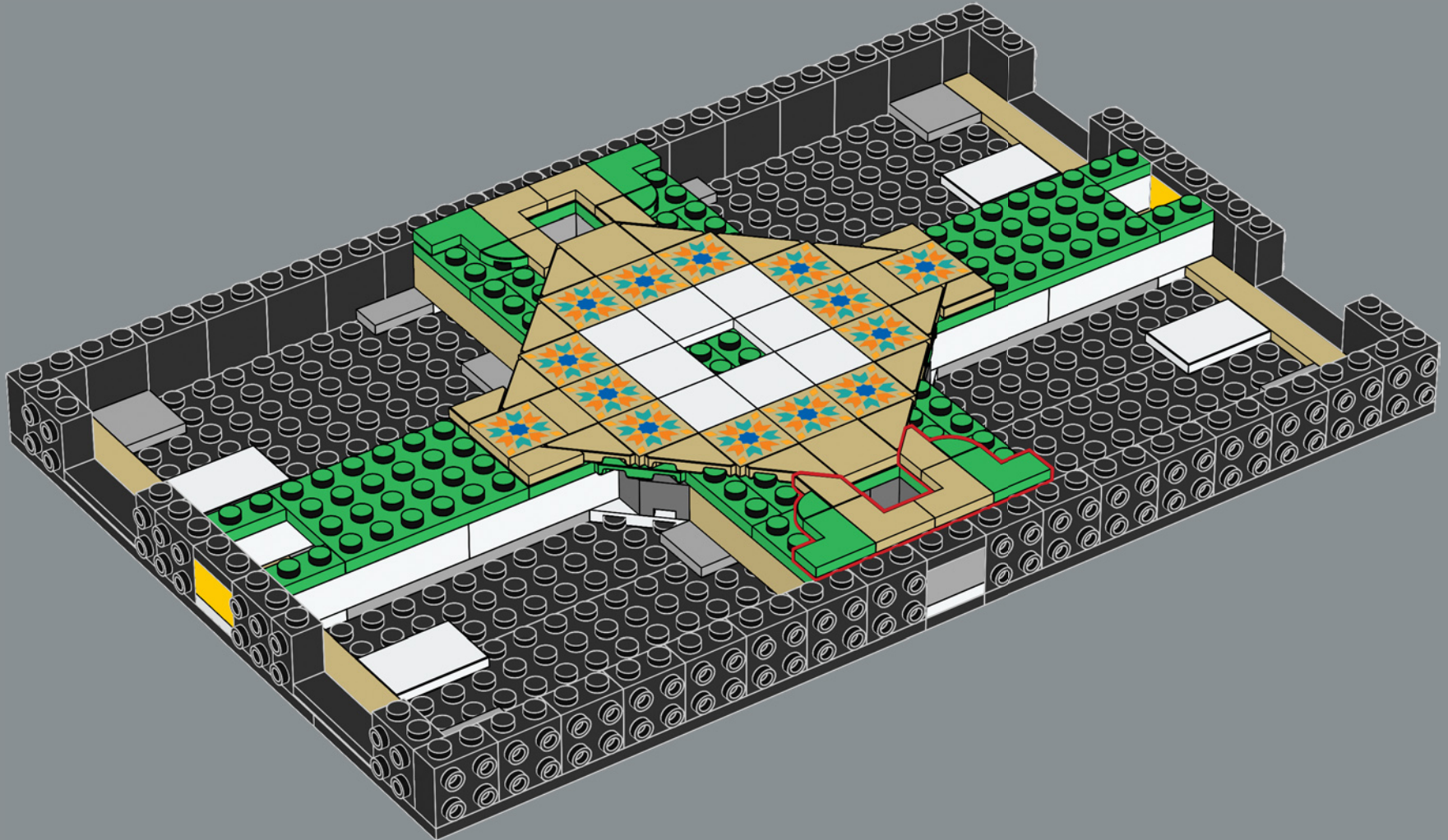

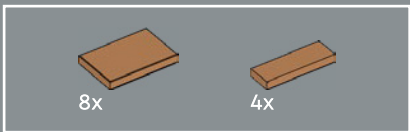

29

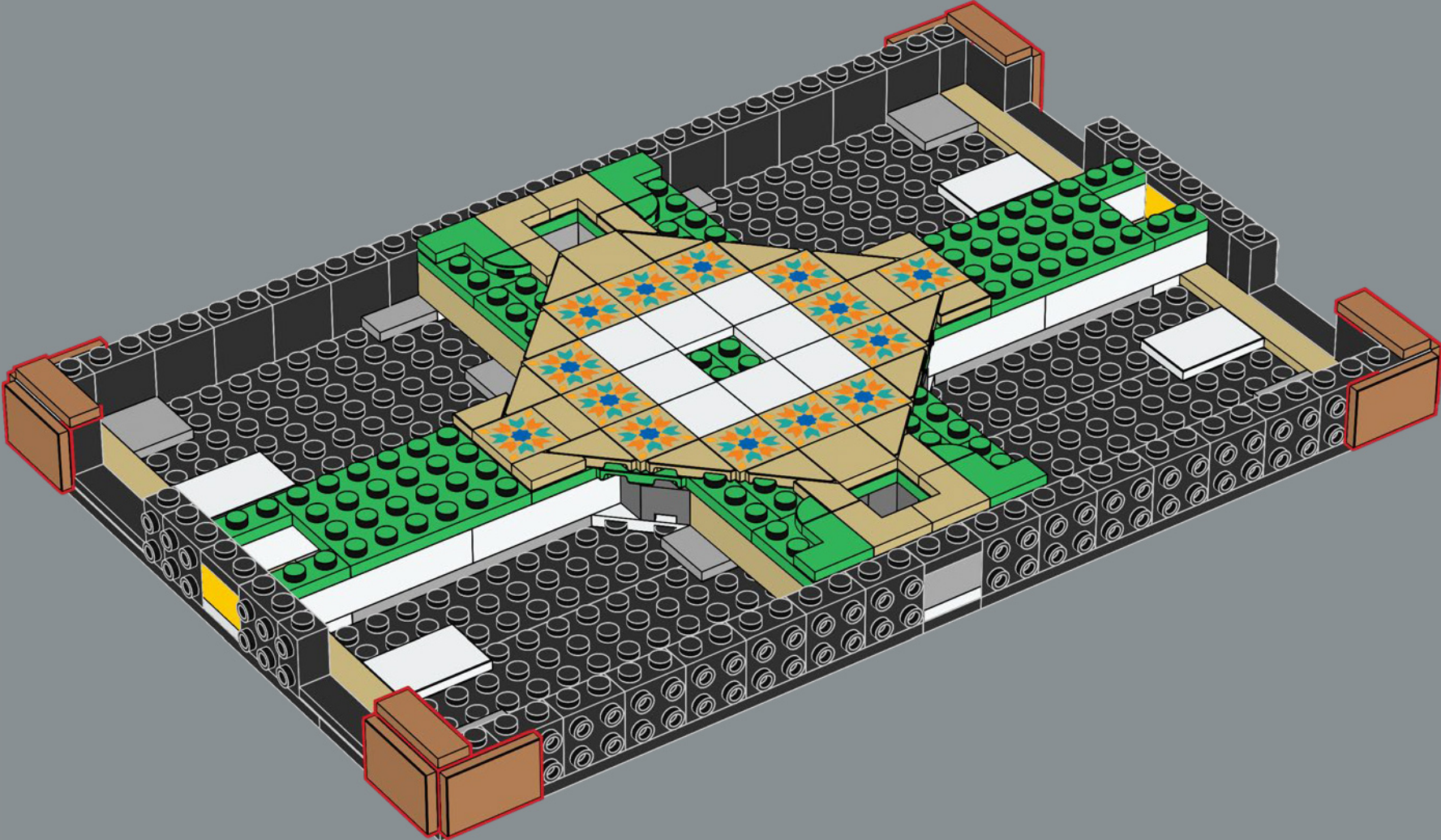



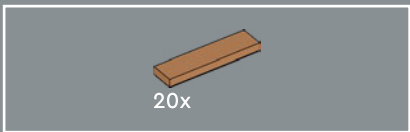

30

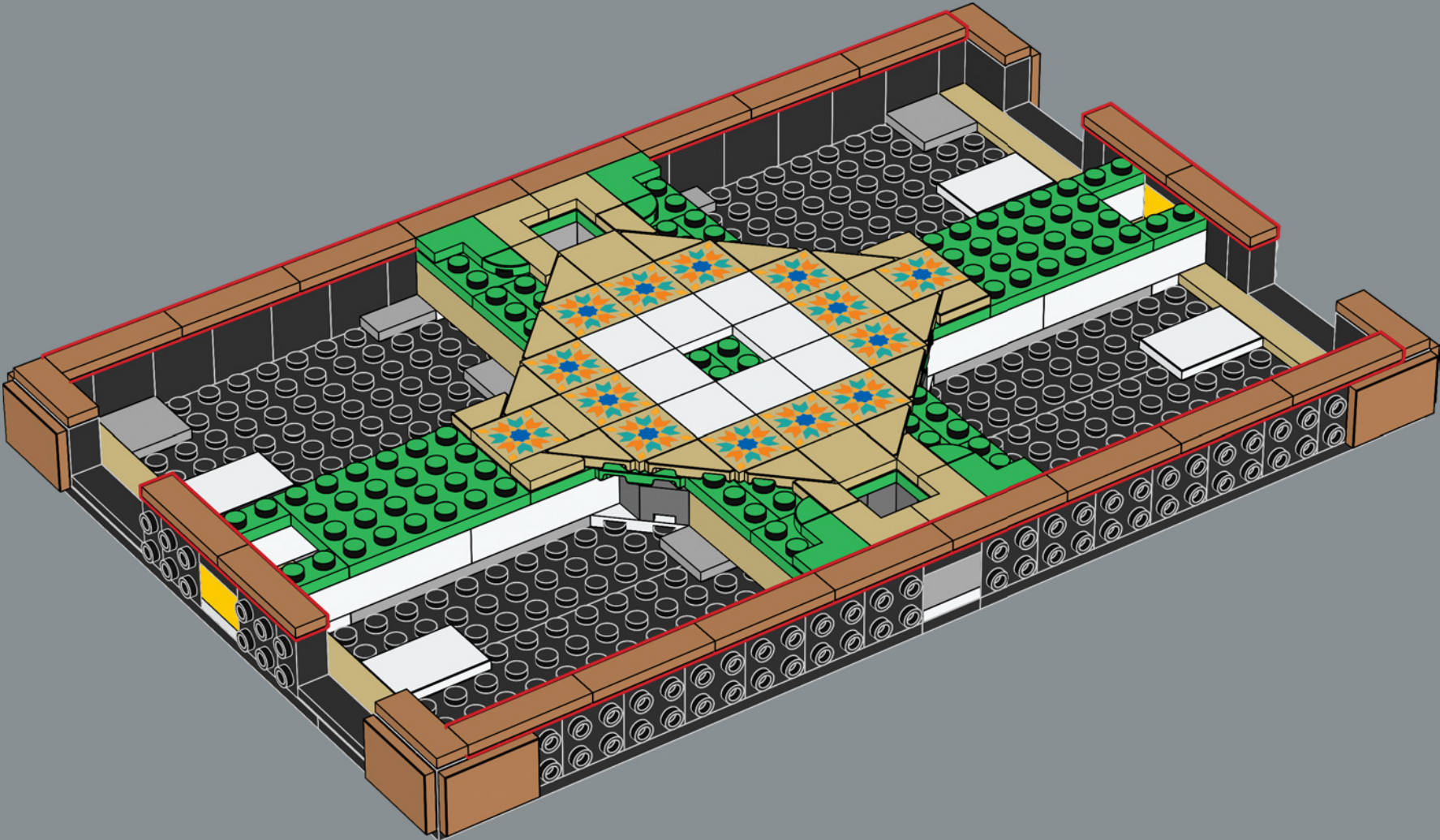

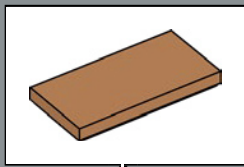

31

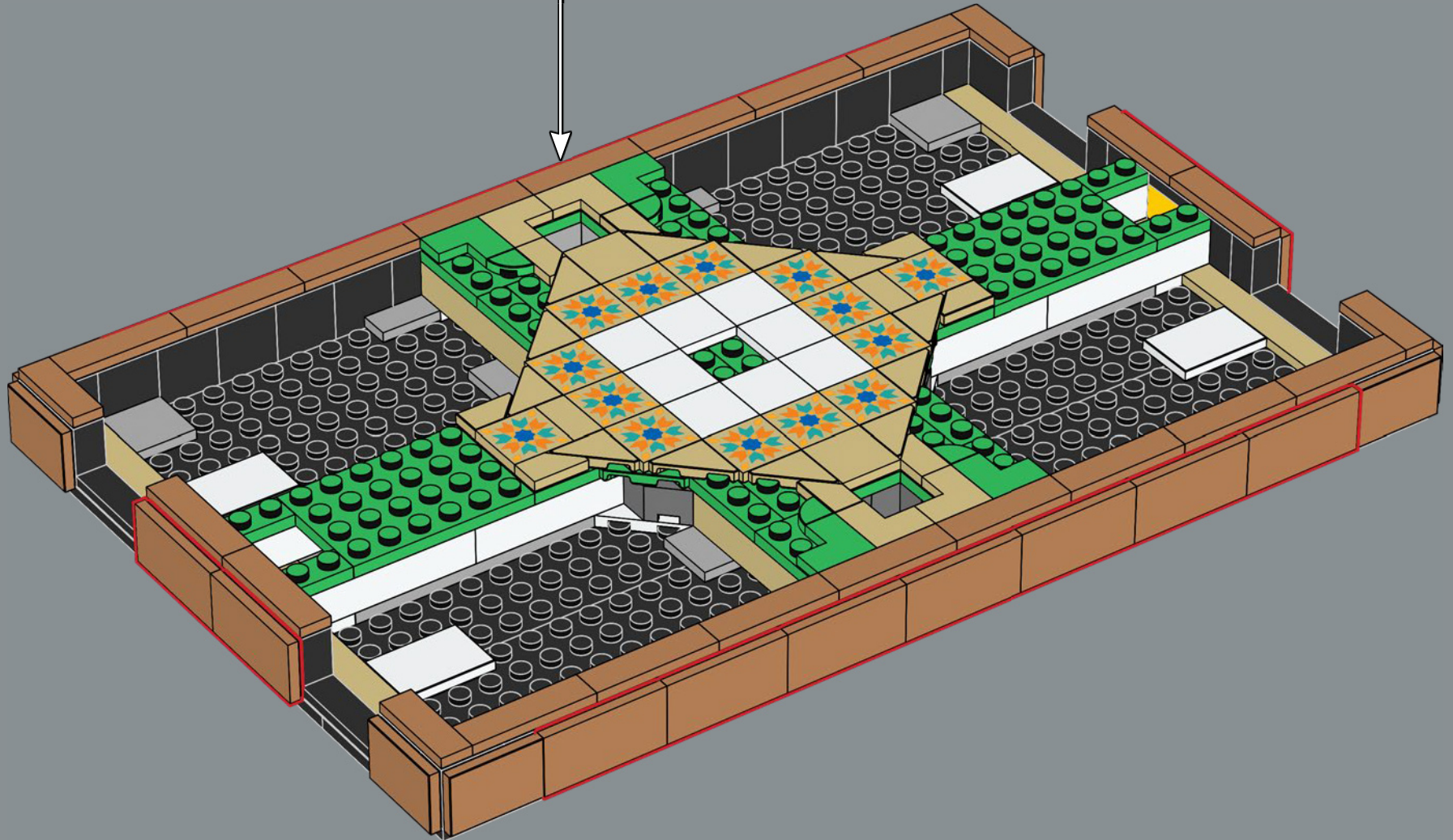

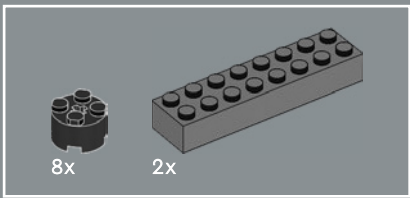

32

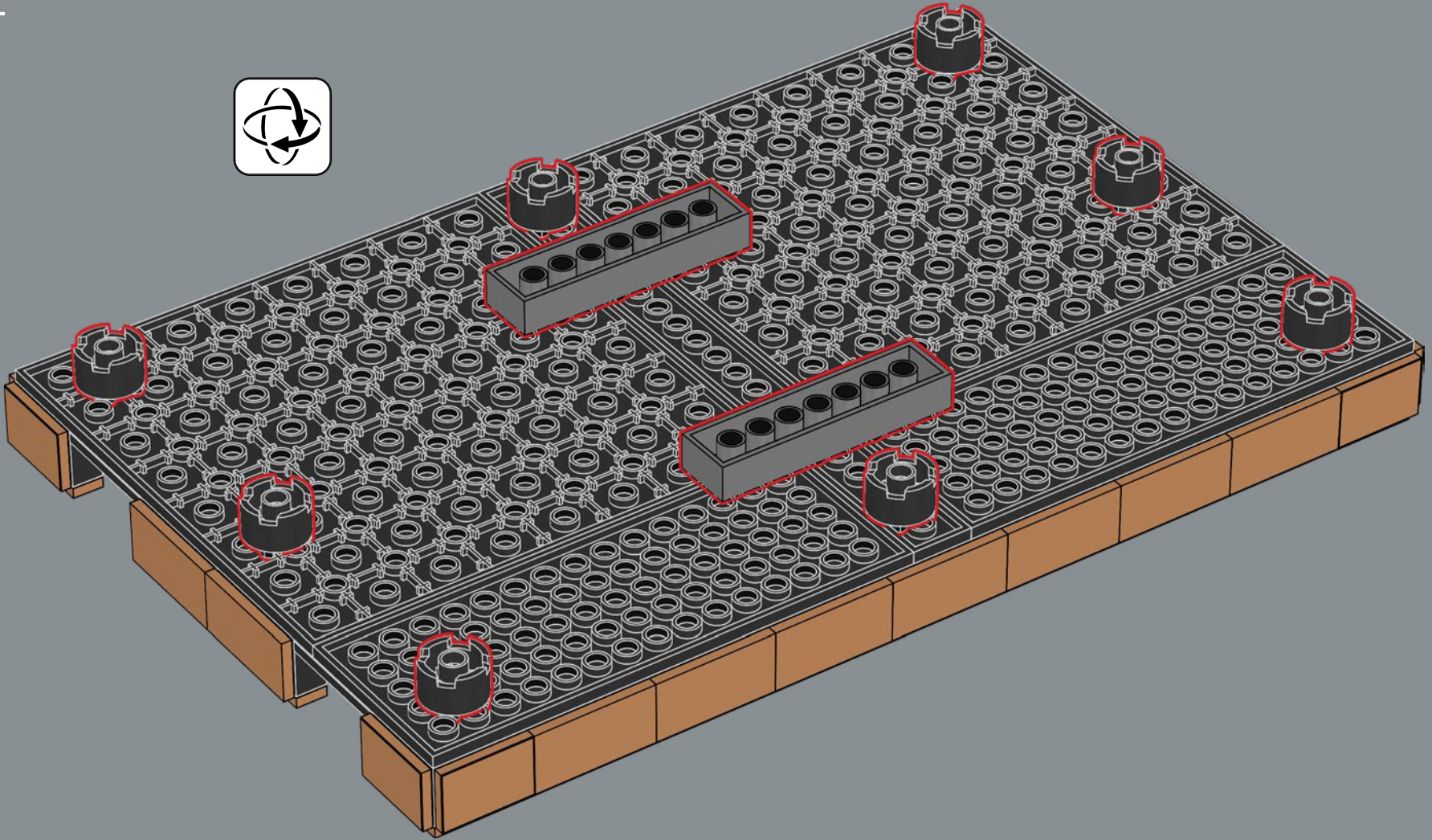

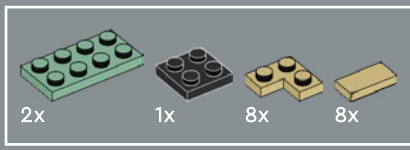

33

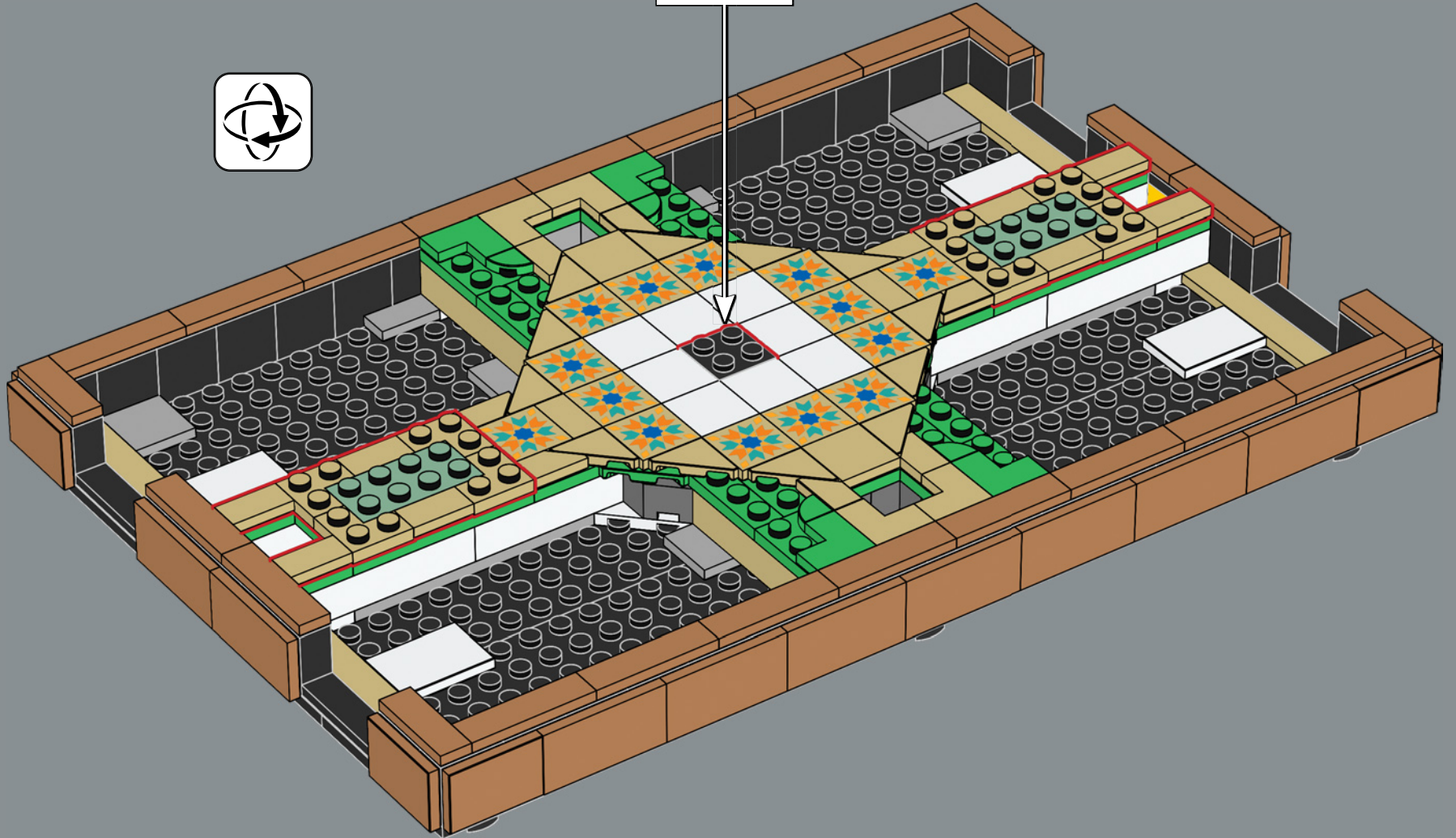
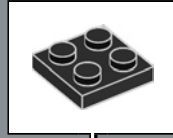



34

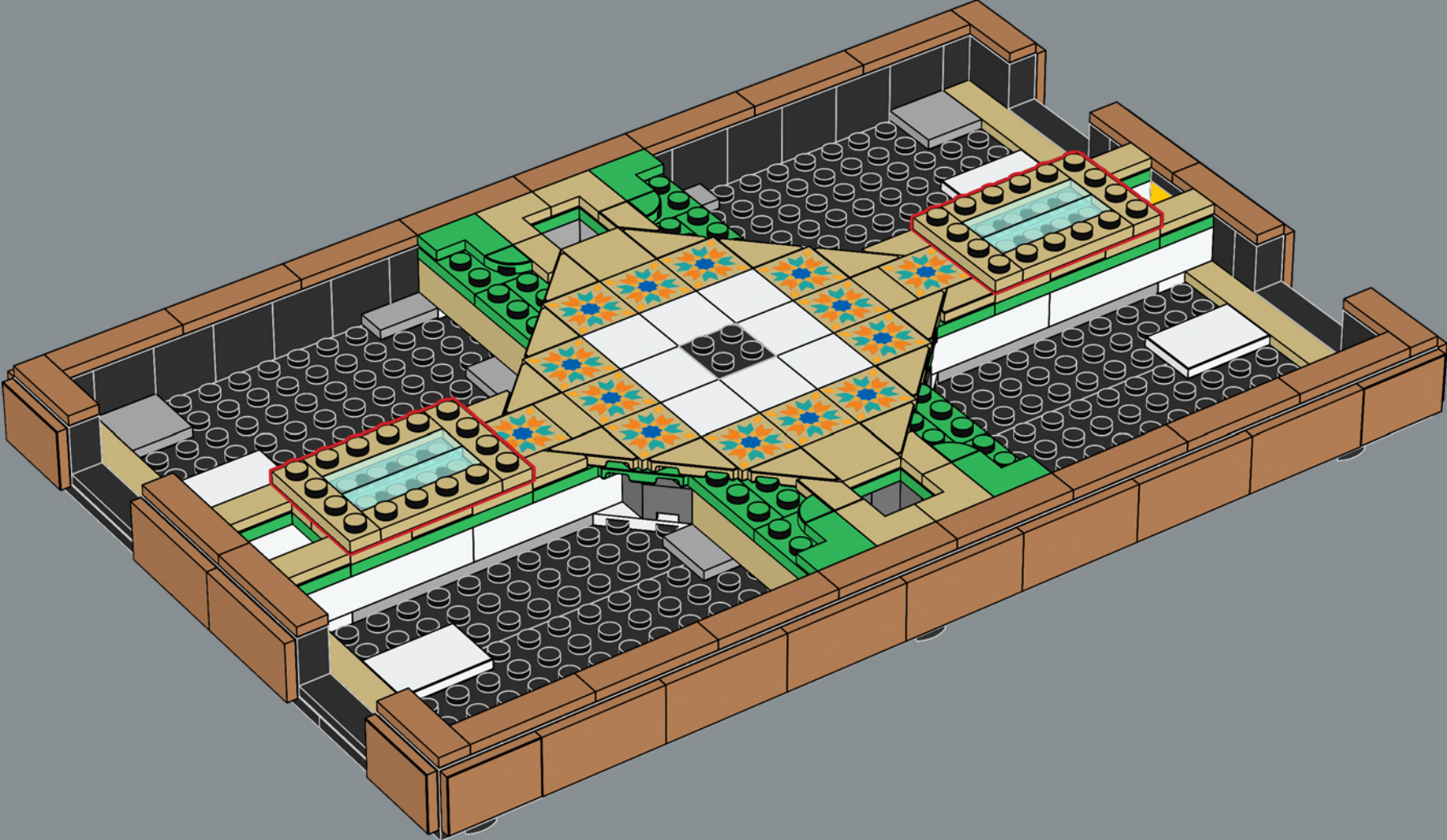

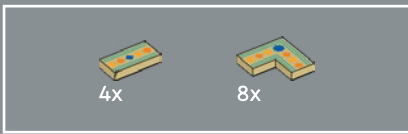

35

Estas piezas decoradas, creadas especialmente para el set, se inspiran en los mosaicos *zellige*, elaborados con pequeñas teselas. Es frecuente encontrar estas composiciones en la arquitectura de lugares históricos y monumentos de países como Marruecos, Argelia o Túnez, y también en Andalucía, en el sur de España.

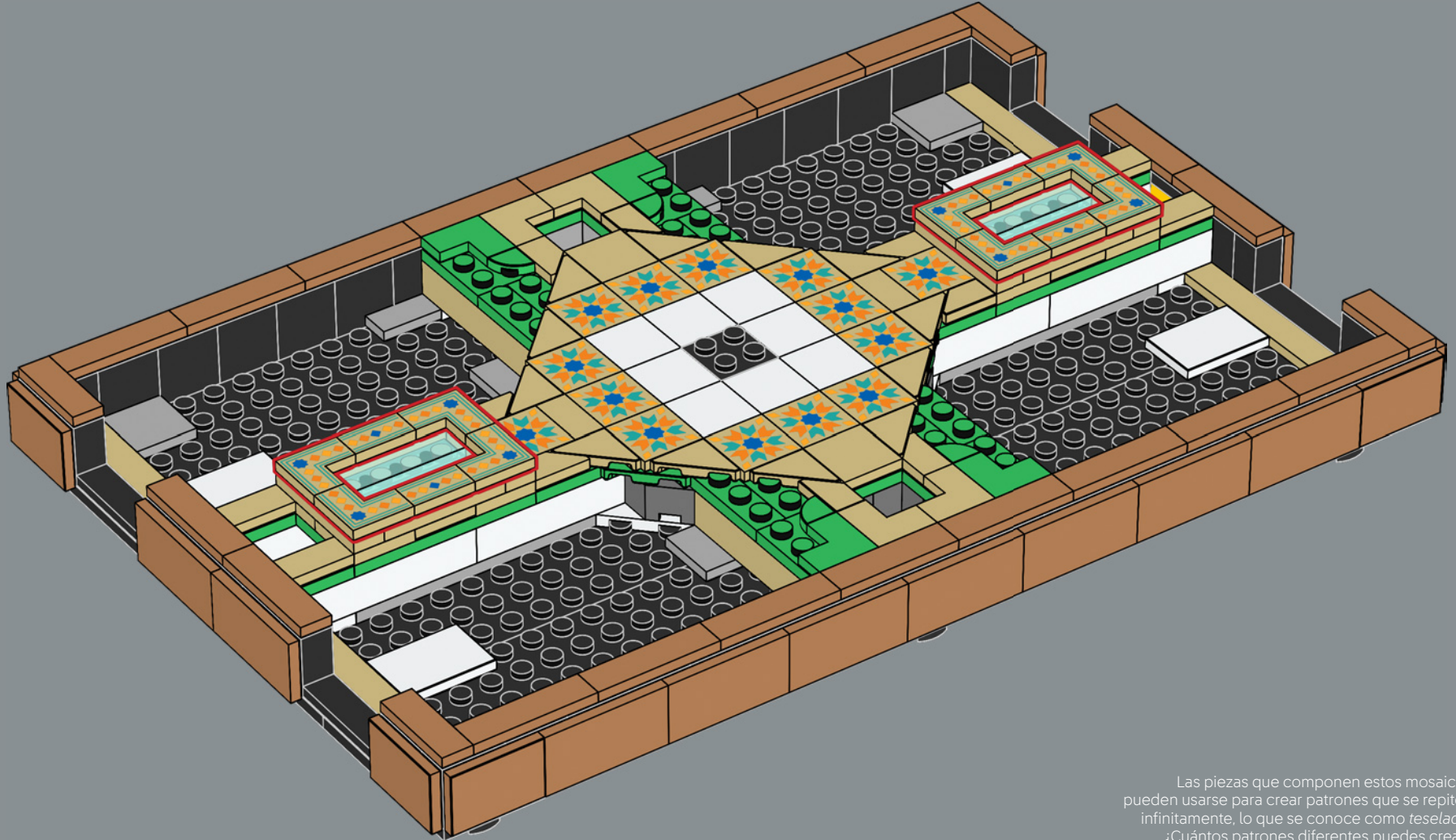

Las piezas que componen estos mosaicos pueden usarse para crear patrones que se repiten infinitamente, lo que se conoce como *teselado*. ¿Cuántos patrones diferentes puedes crear?

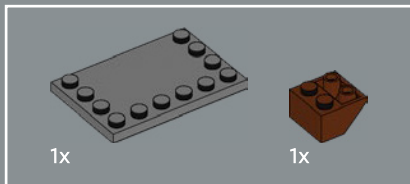
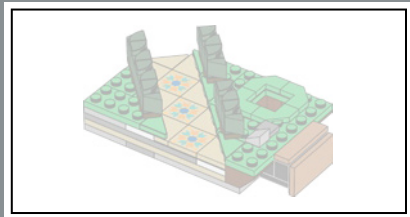

36

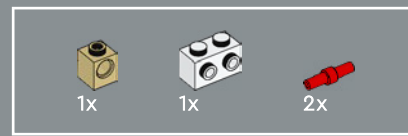
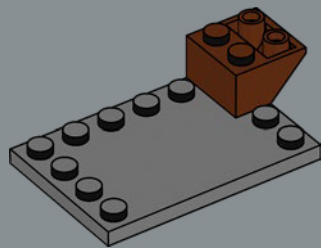

37

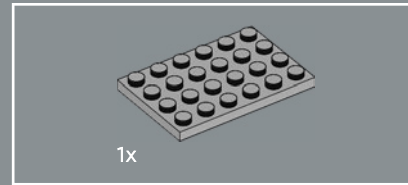
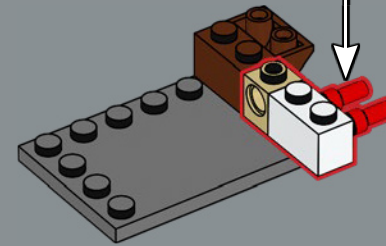
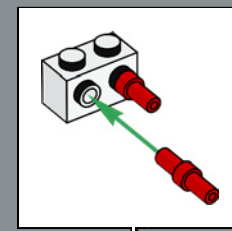

38

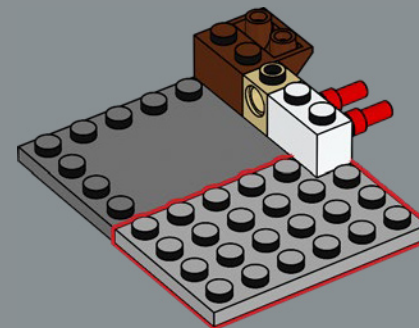

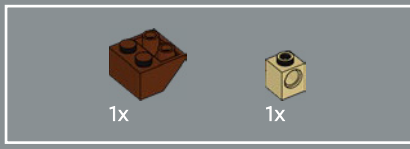

39

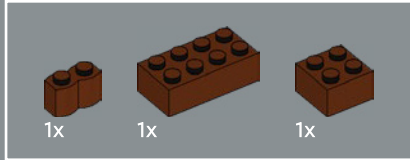
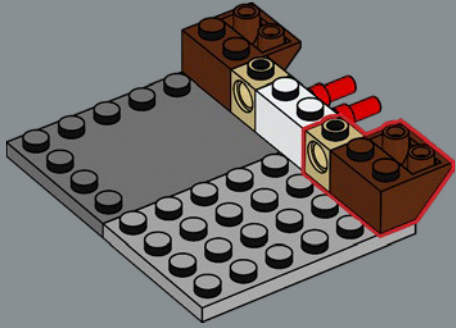

40

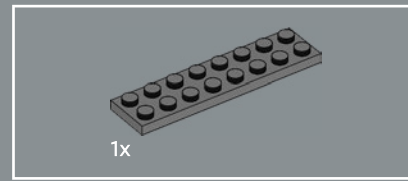
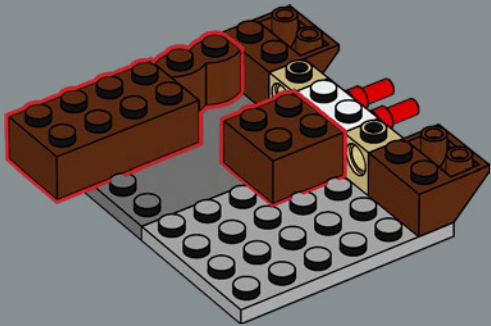

41

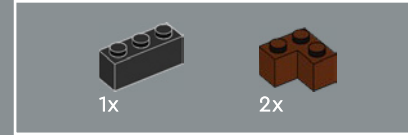
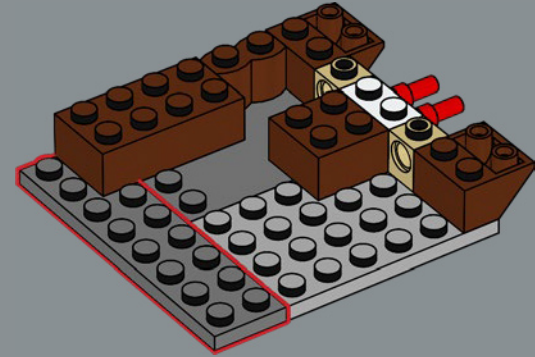

42

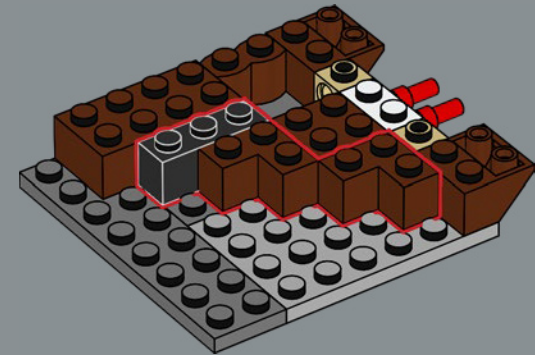

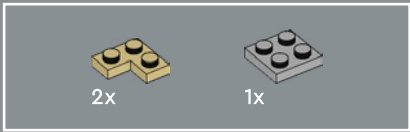

43

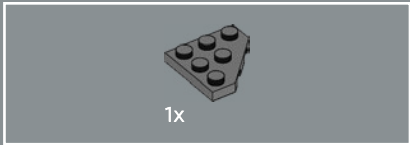
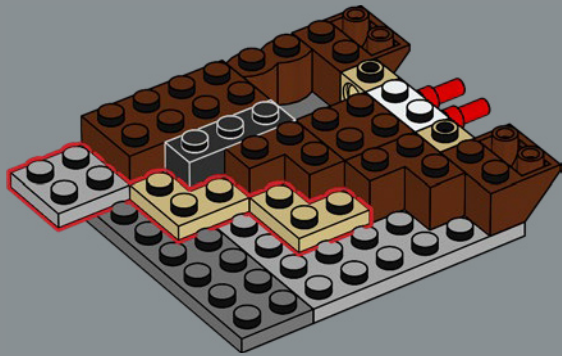

44

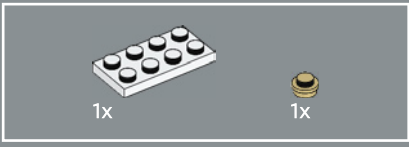
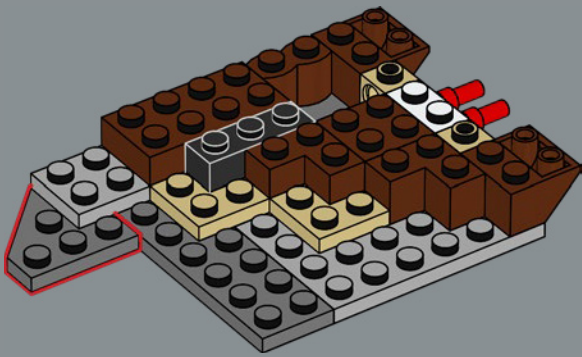

45

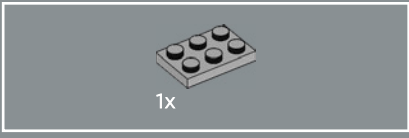
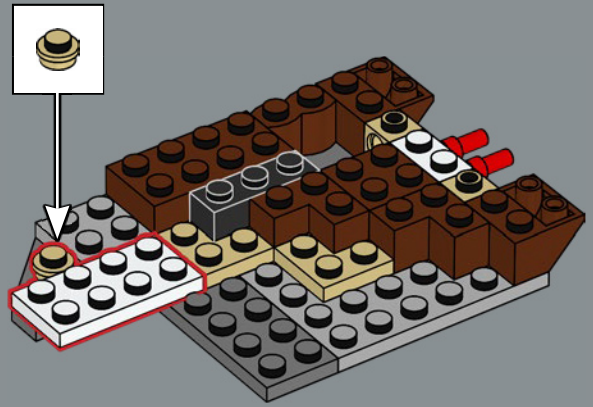

46

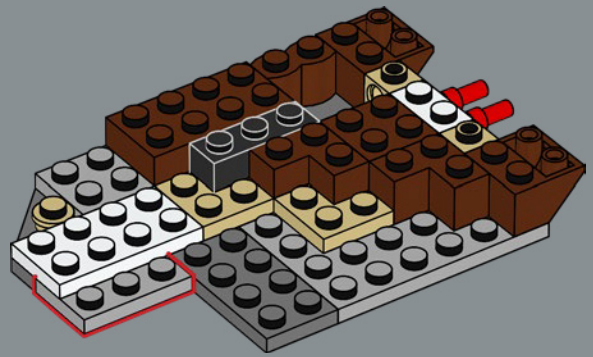

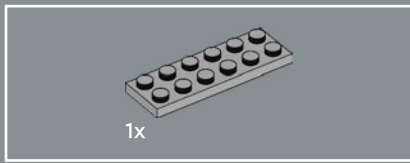

47

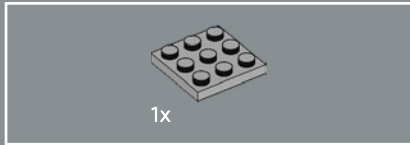
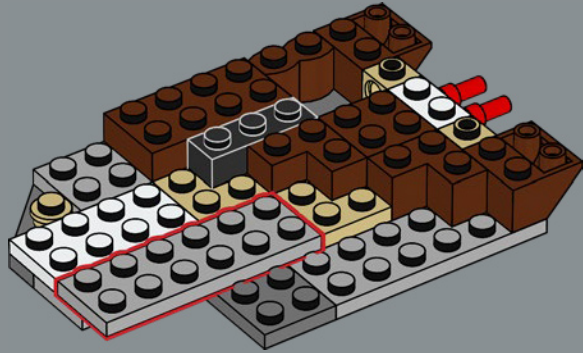

48

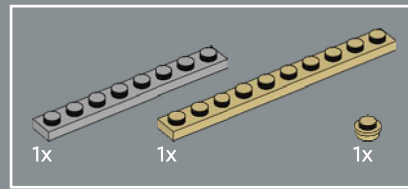
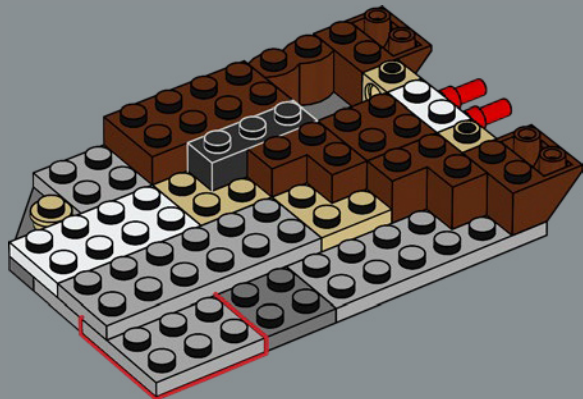

49



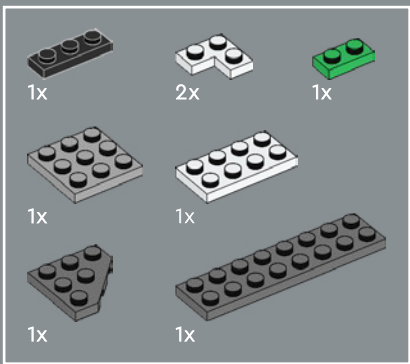

50

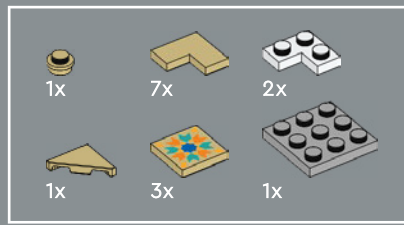
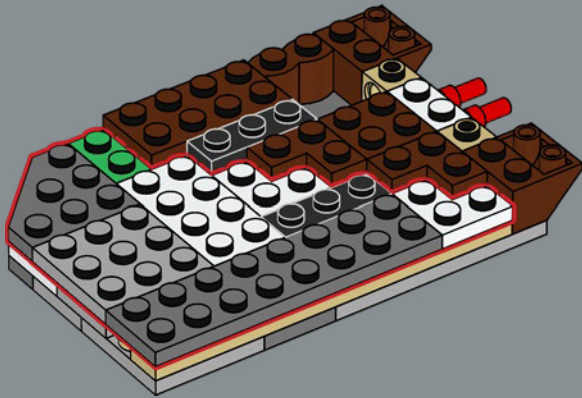

51

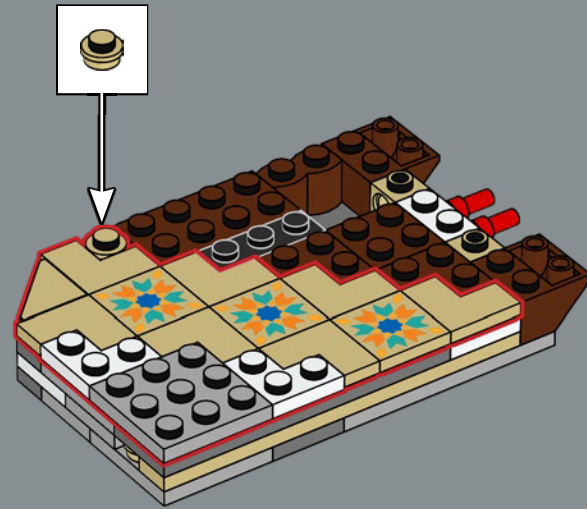

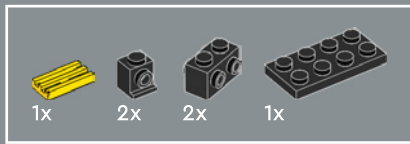

52

1

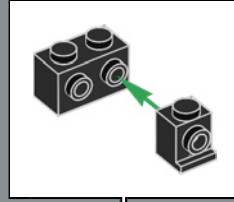
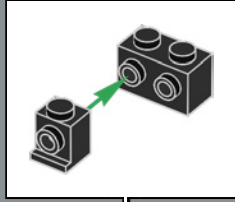
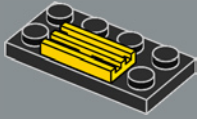

2

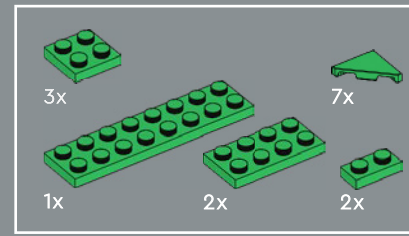
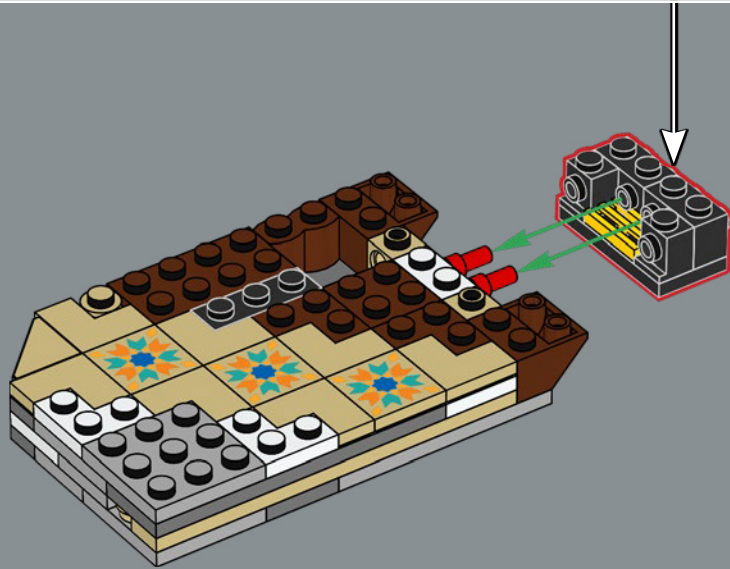
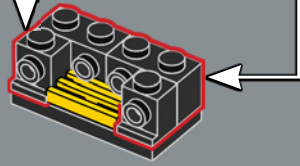

53

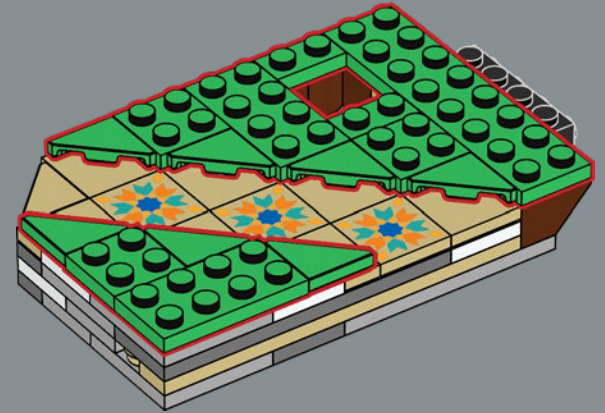



54

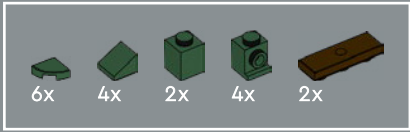
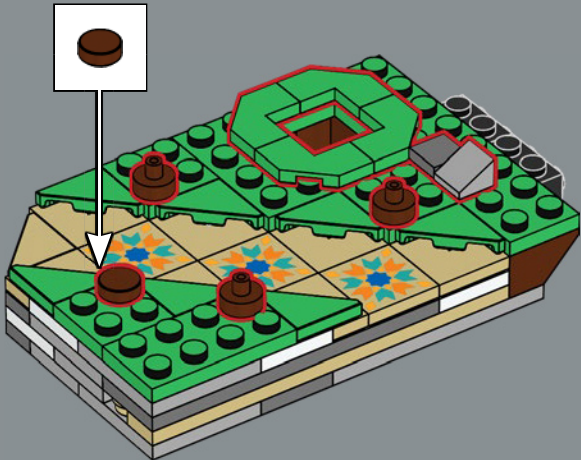

55

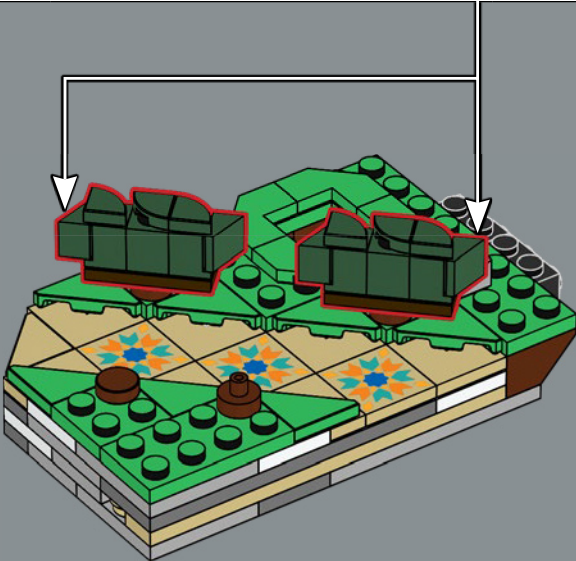
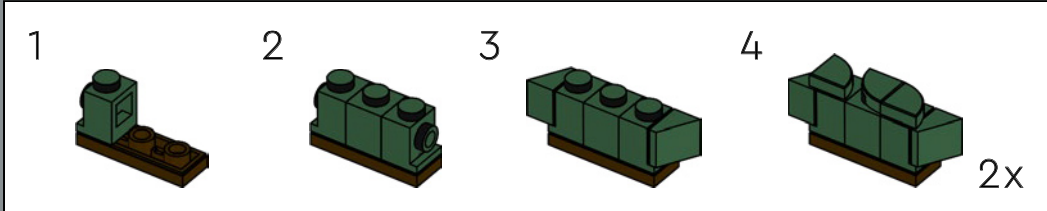

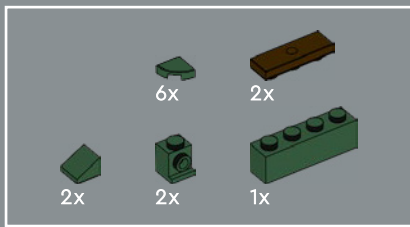

56

1



2

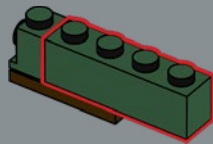

3

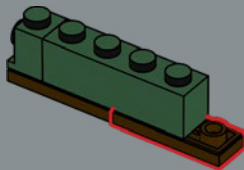

4

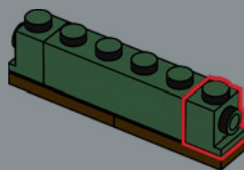

5

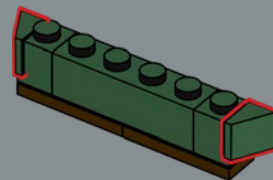

6

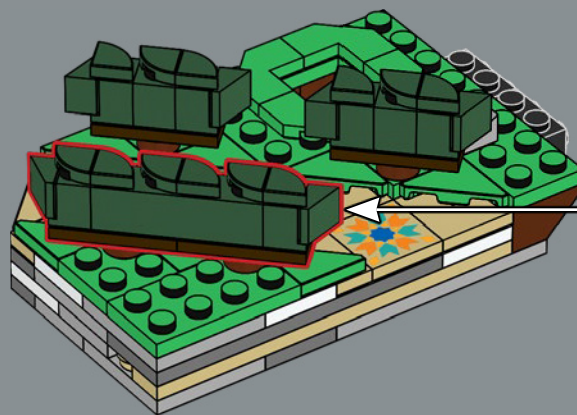
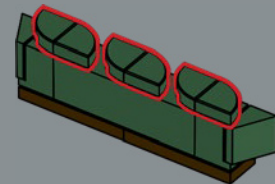

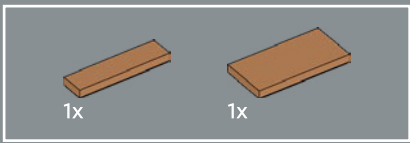

57



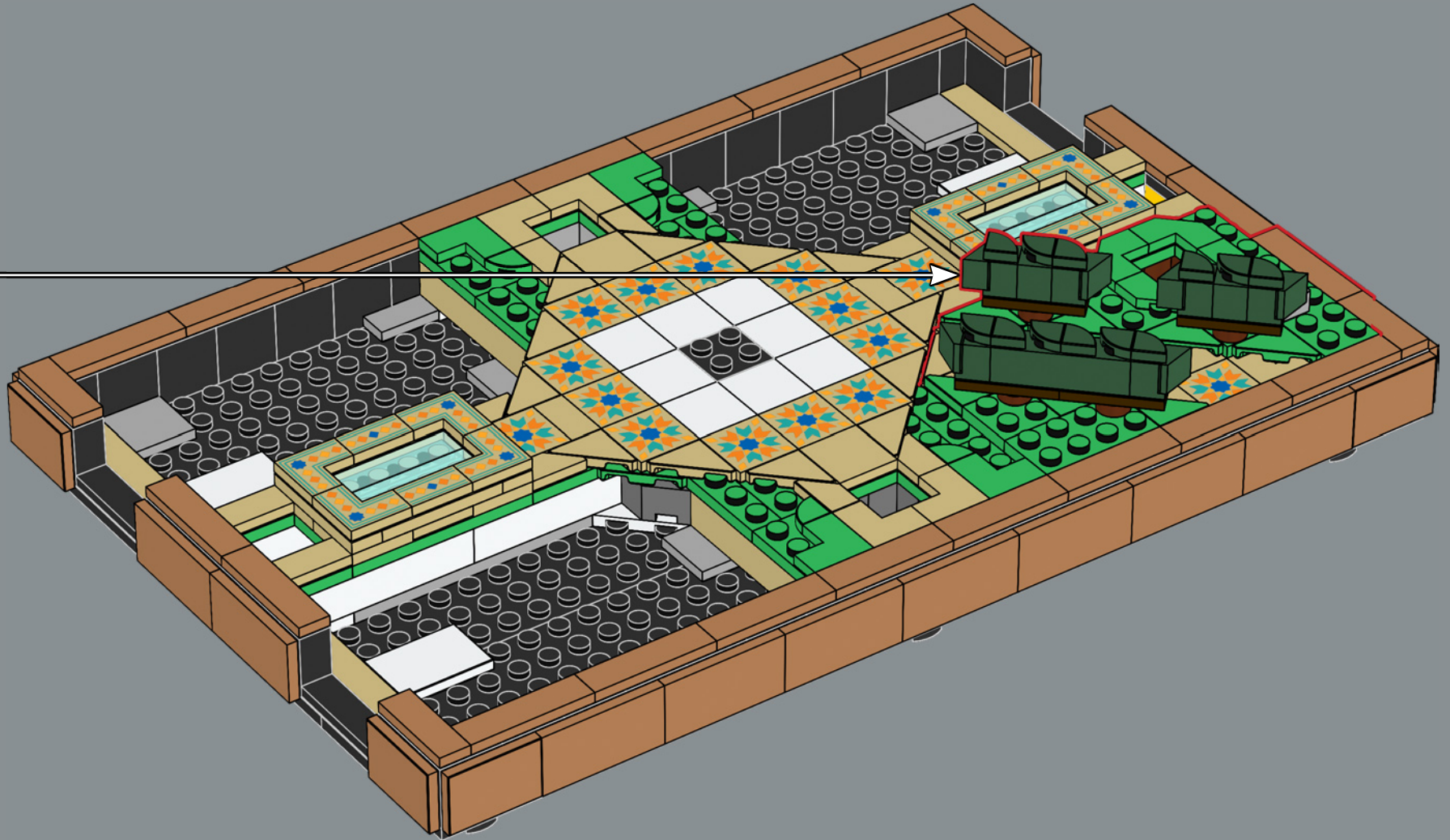

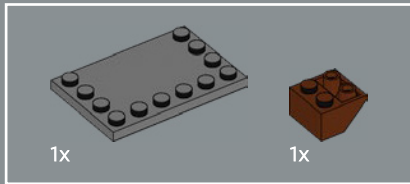
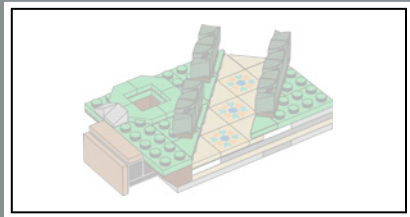

59

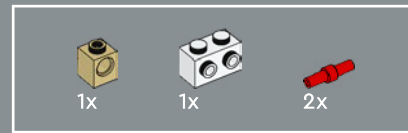
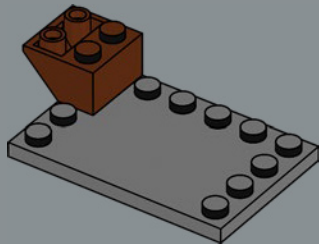

60

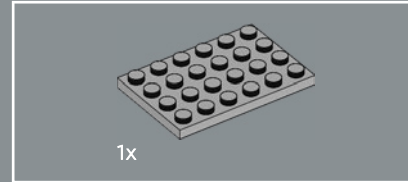
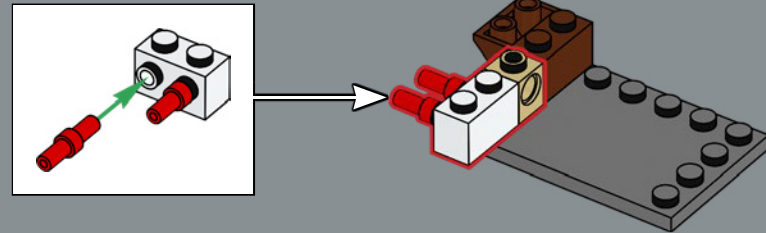

61

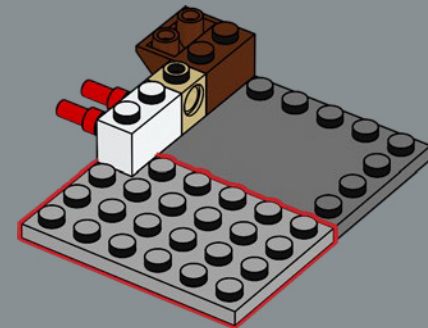

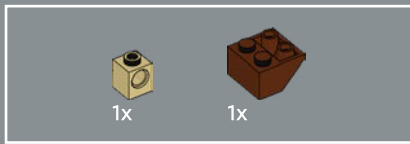

62

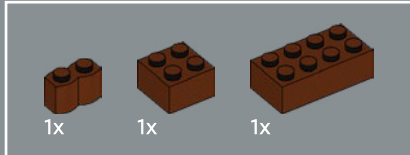
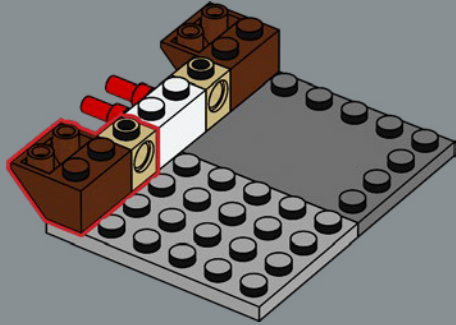

63

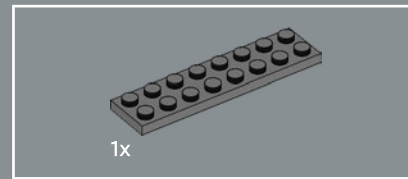
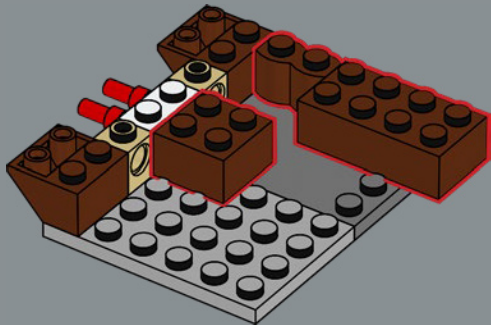

64

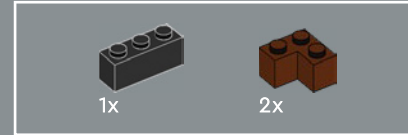
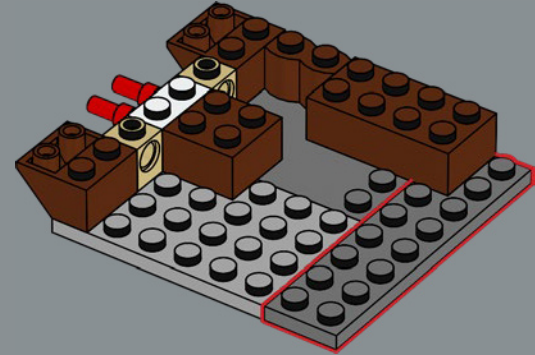

65

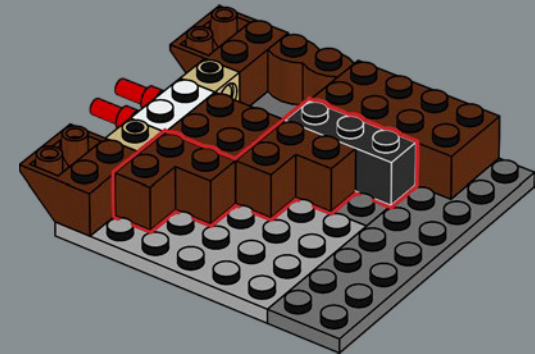

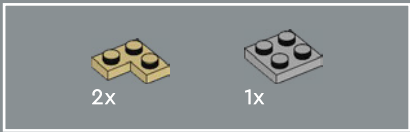

66

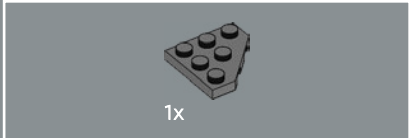
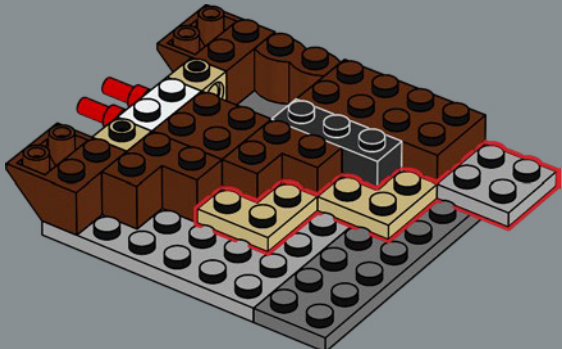

67

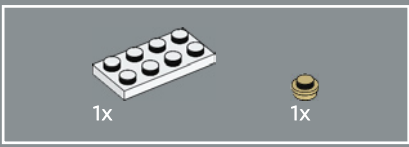
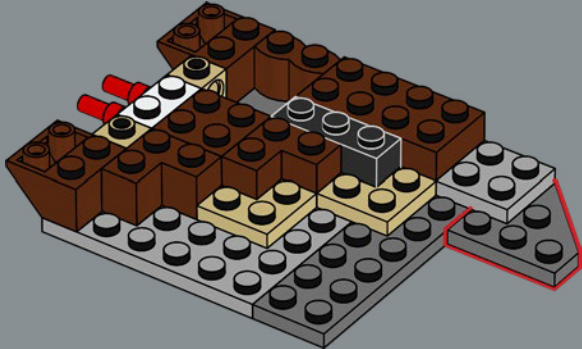

68

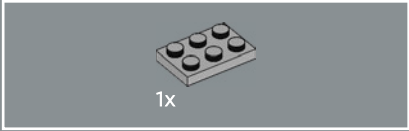
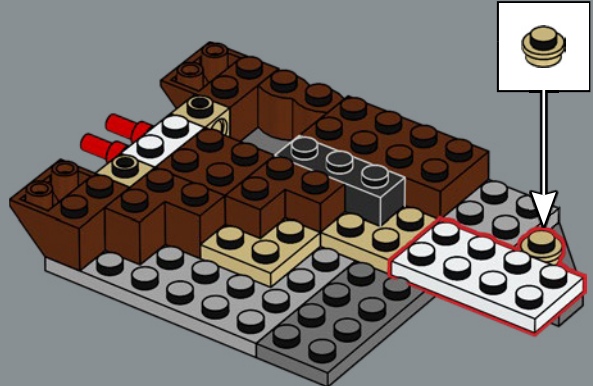

69

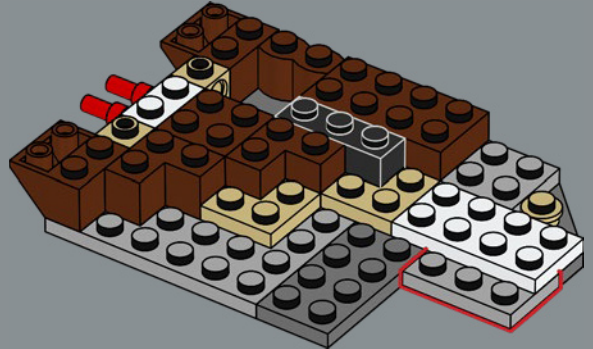

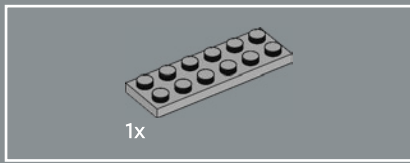

70

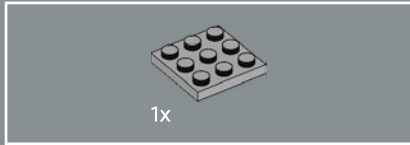
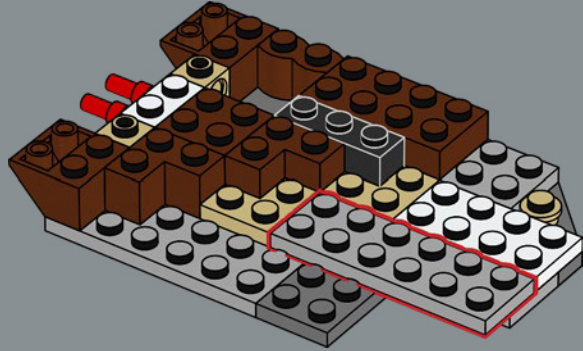

71

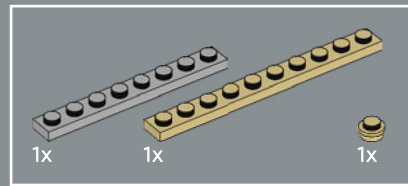
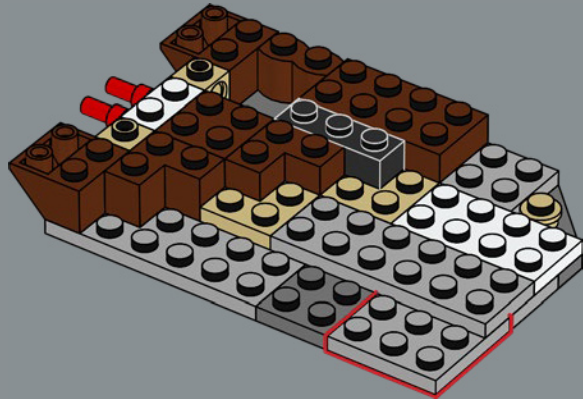

72

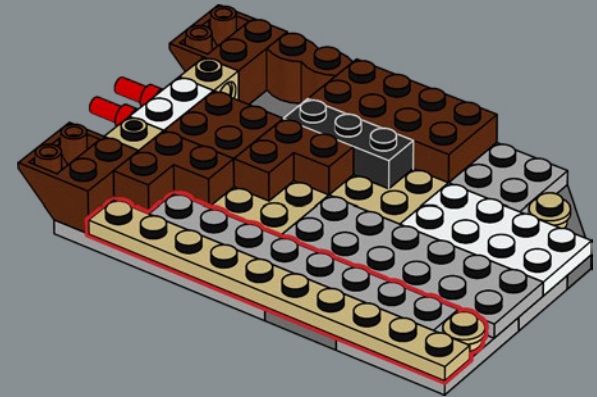

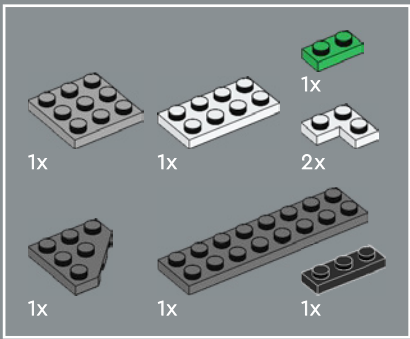

73

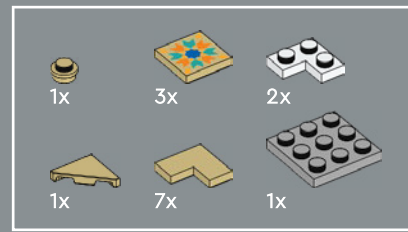
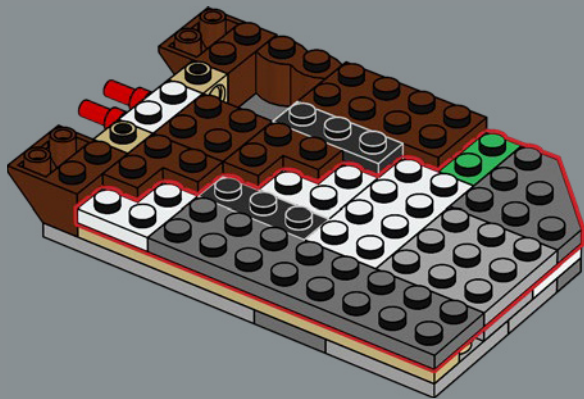

74

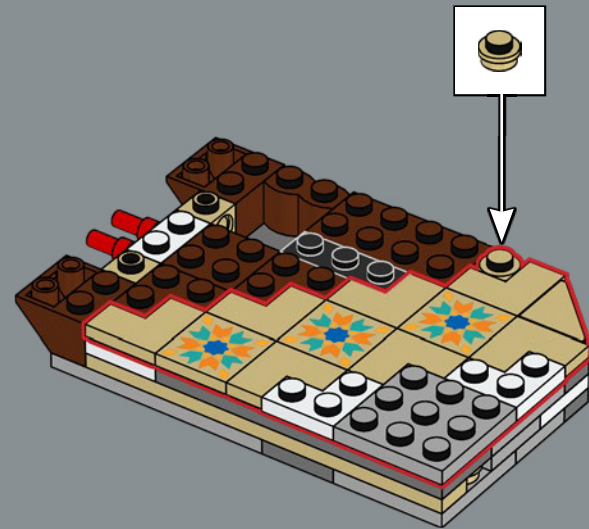

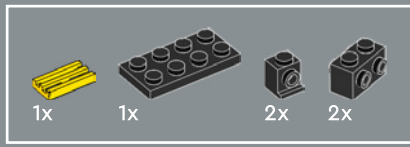

75

1

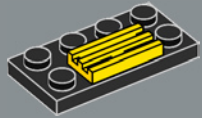

2

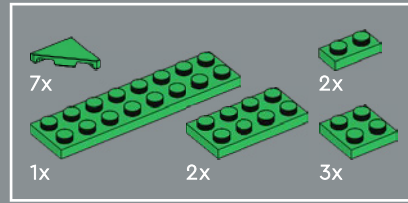
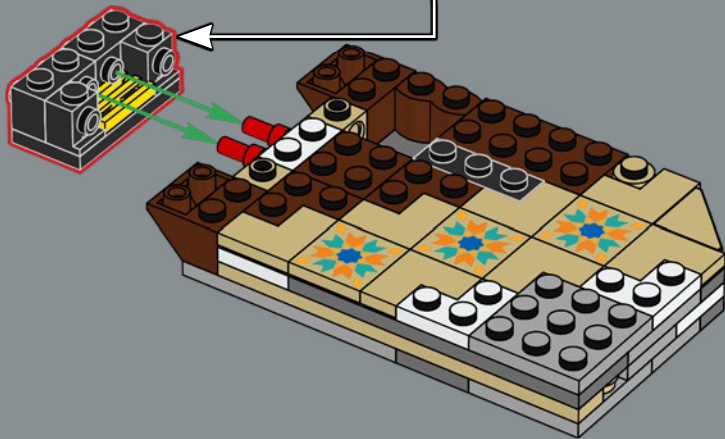
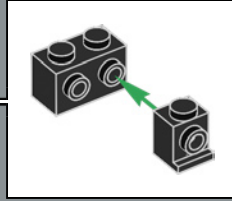
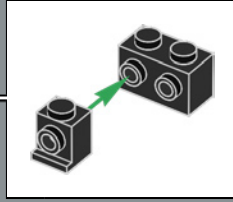
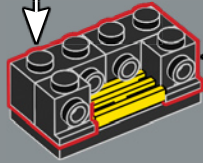

76

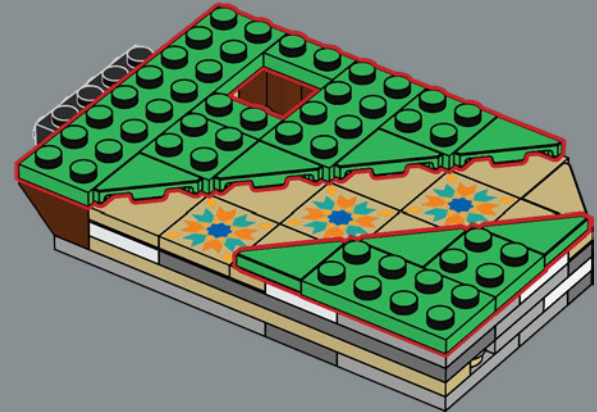

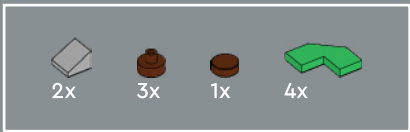

77

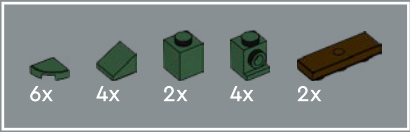
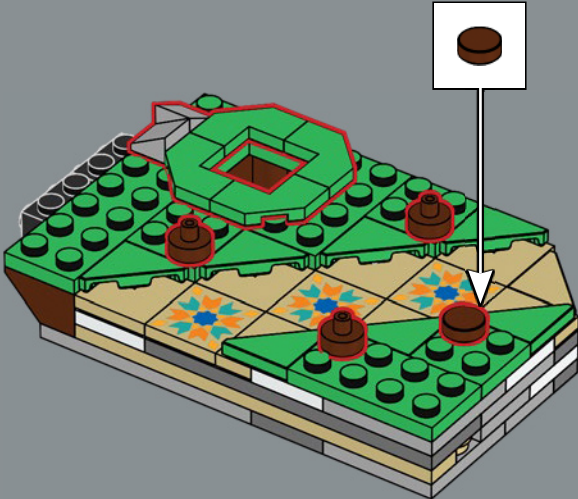

78

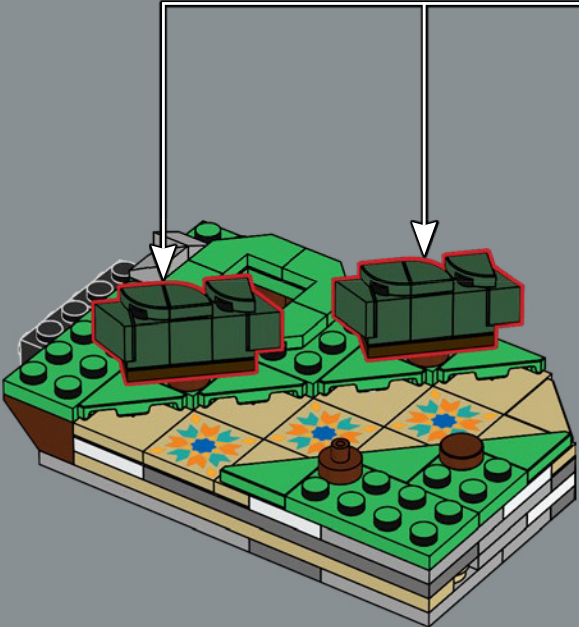
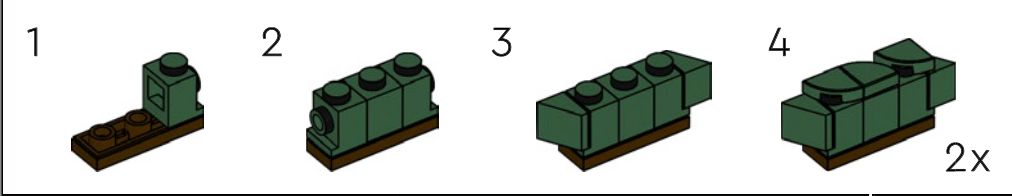

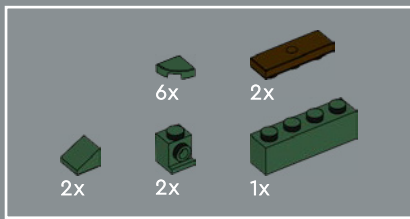

79

1



2

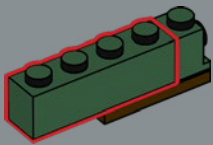

3

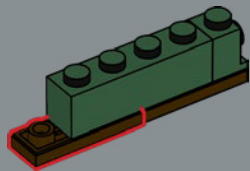

4

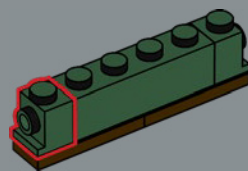

5

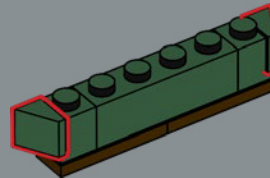

6

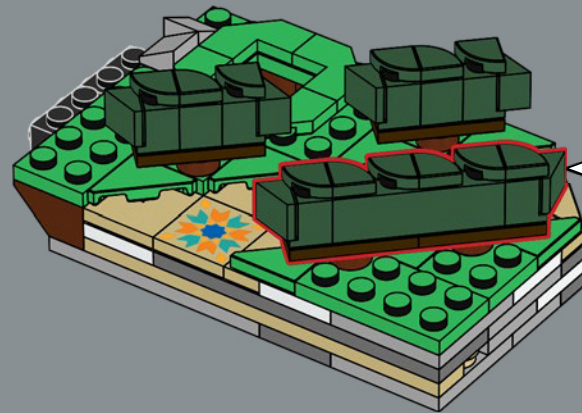
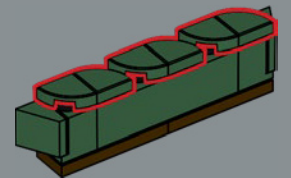

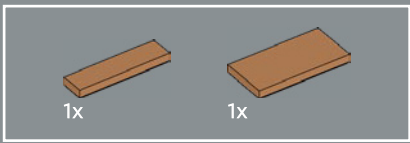

80

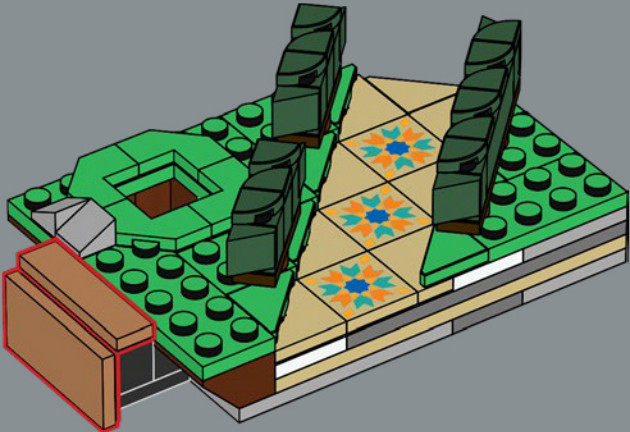

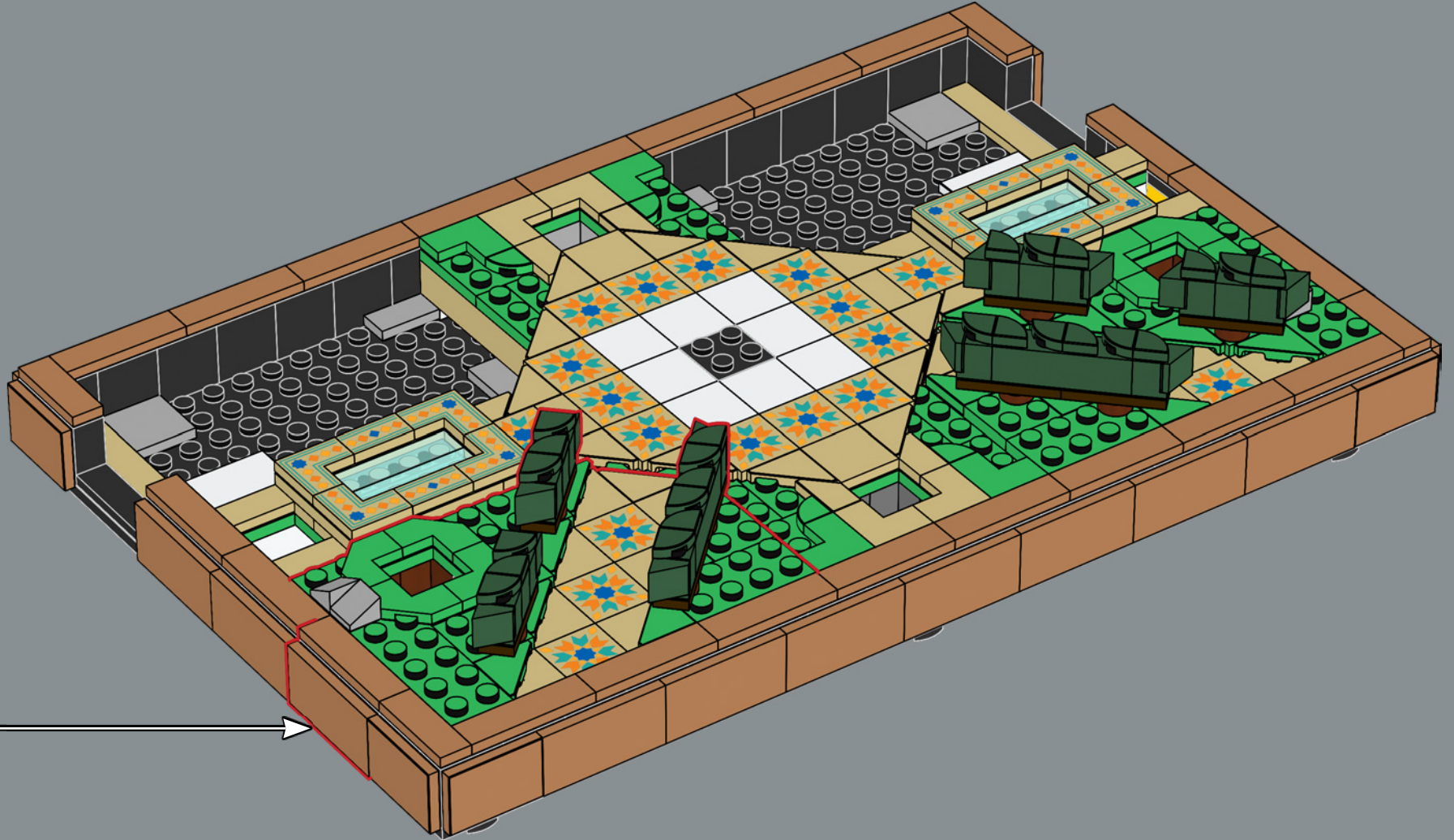

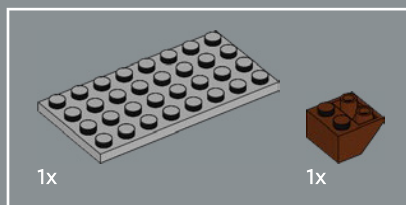
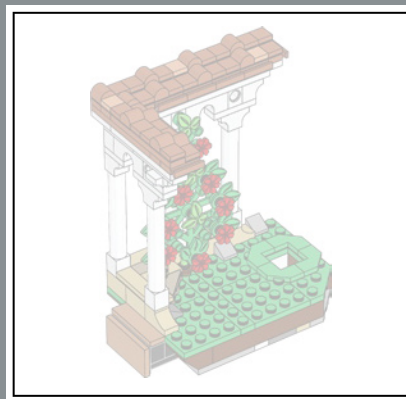

82

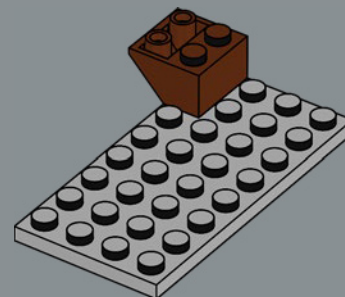

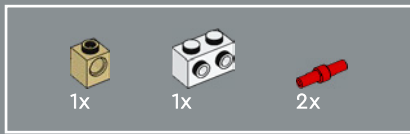

83

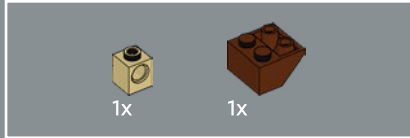
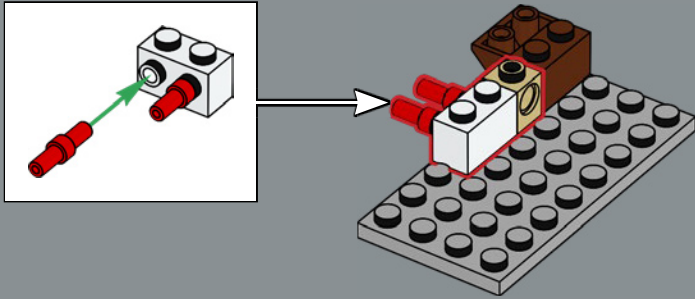

84

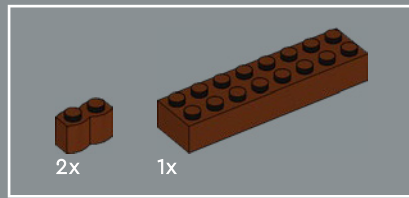
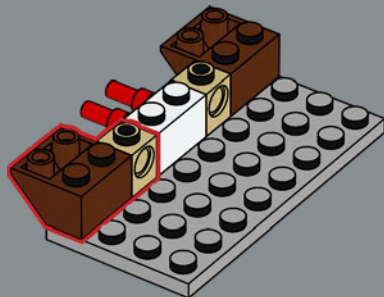

85

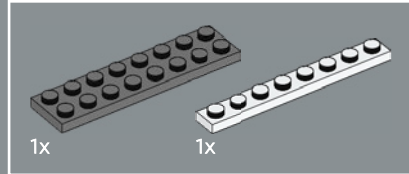
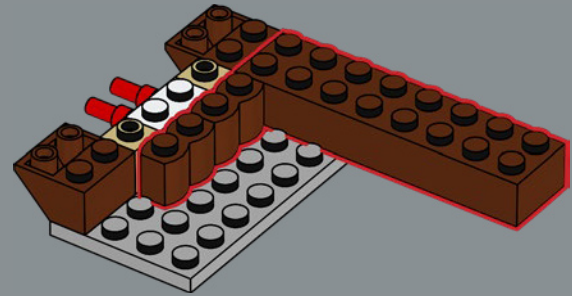

86

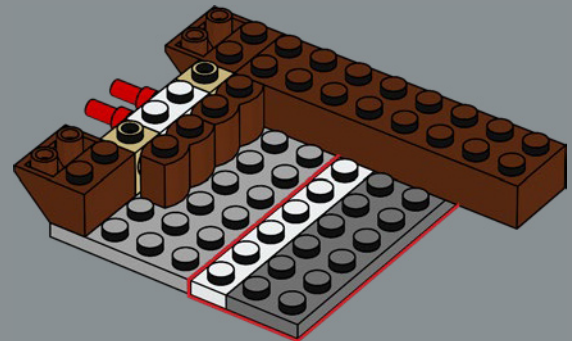

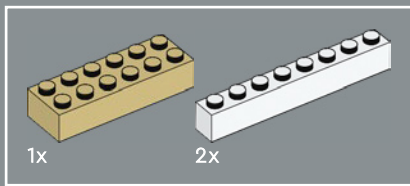

87

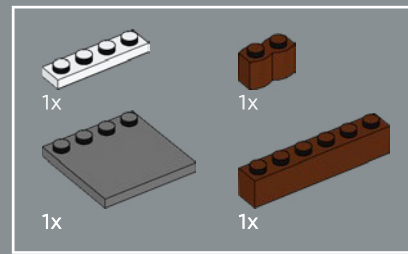
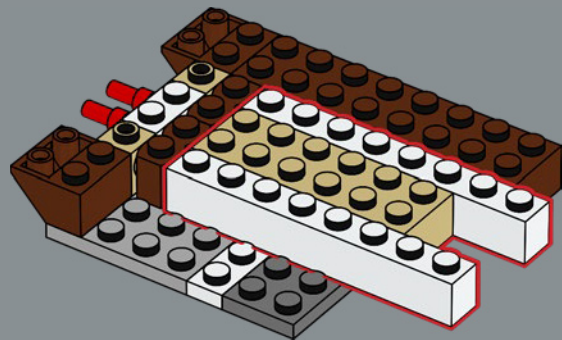

88

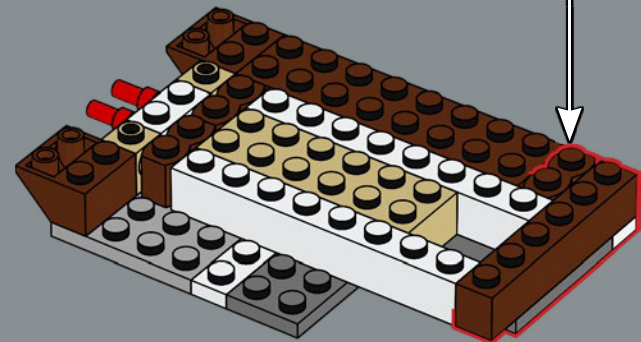
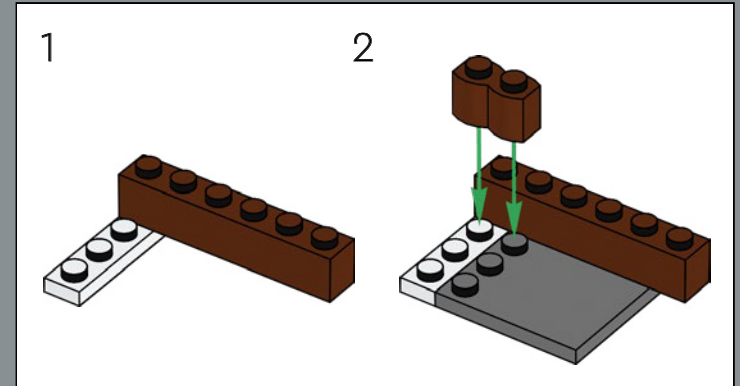

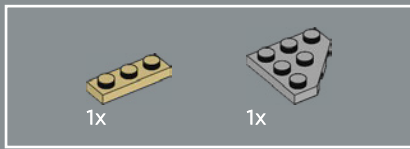

89

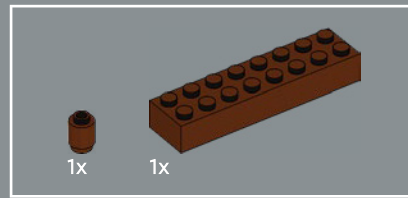
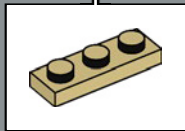
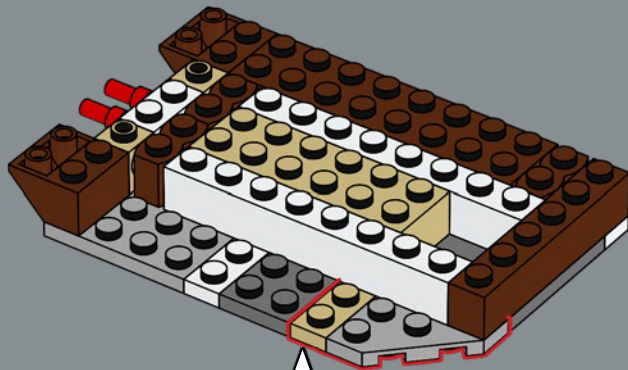

90

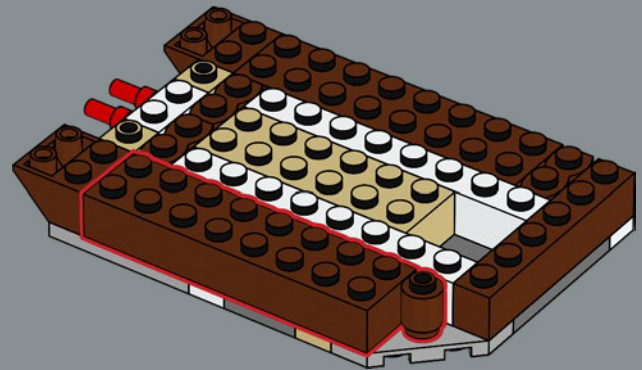

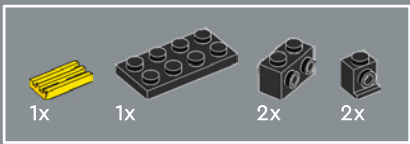

91

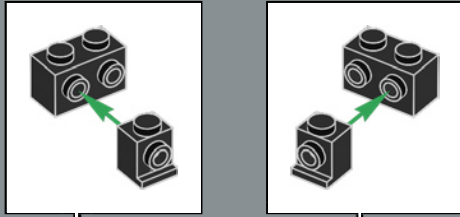

1

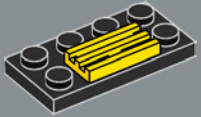

2

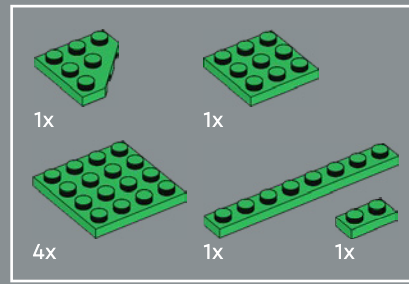
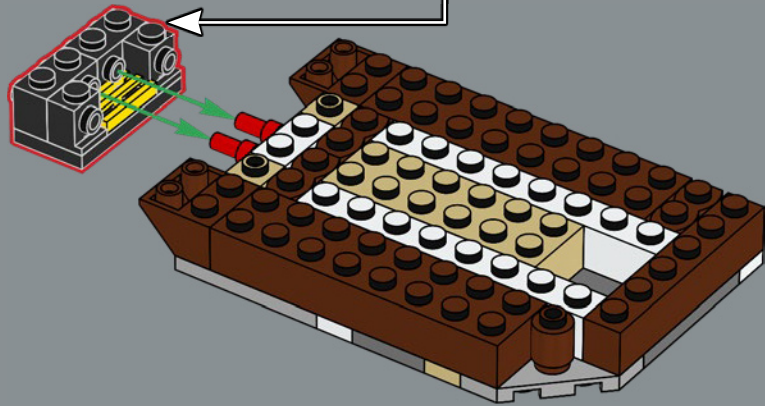
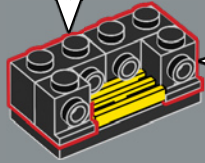

92



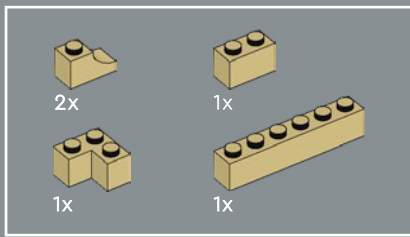

93

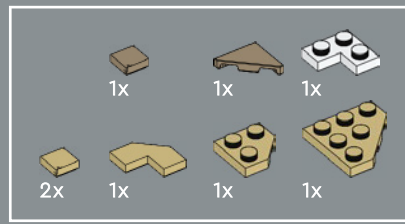
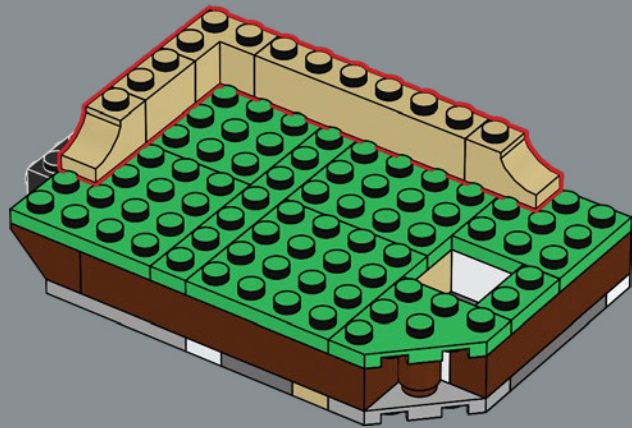

94

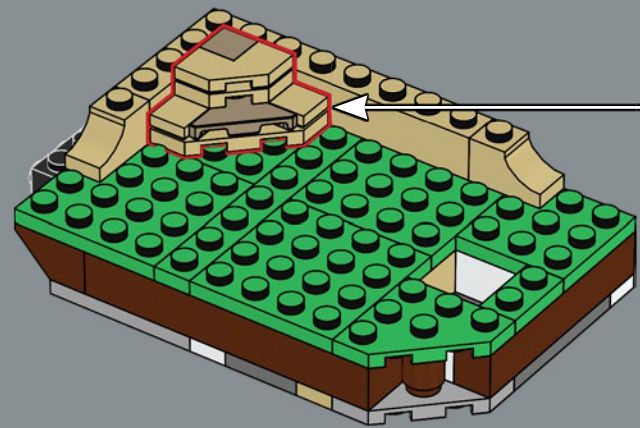
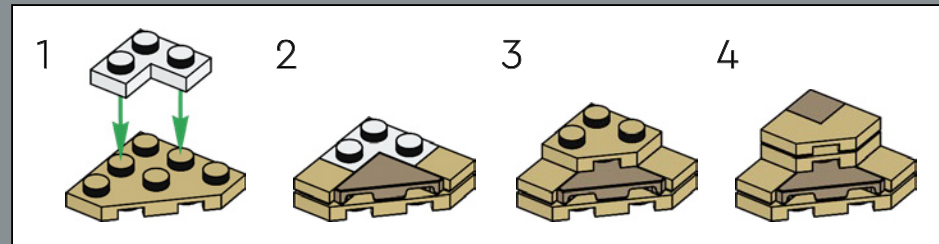



95

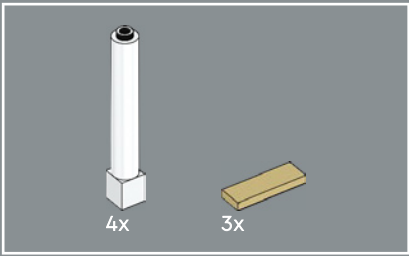
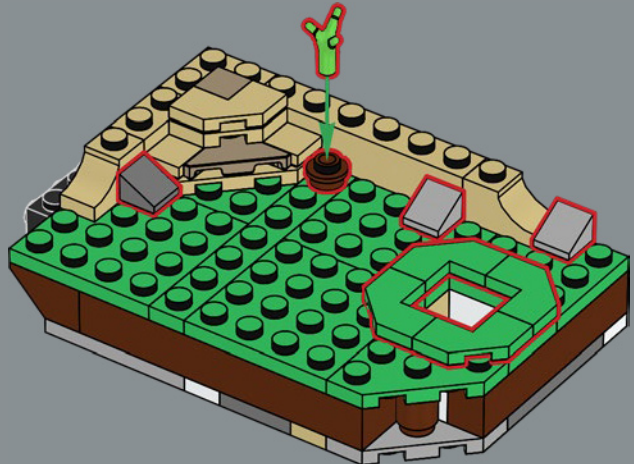

96

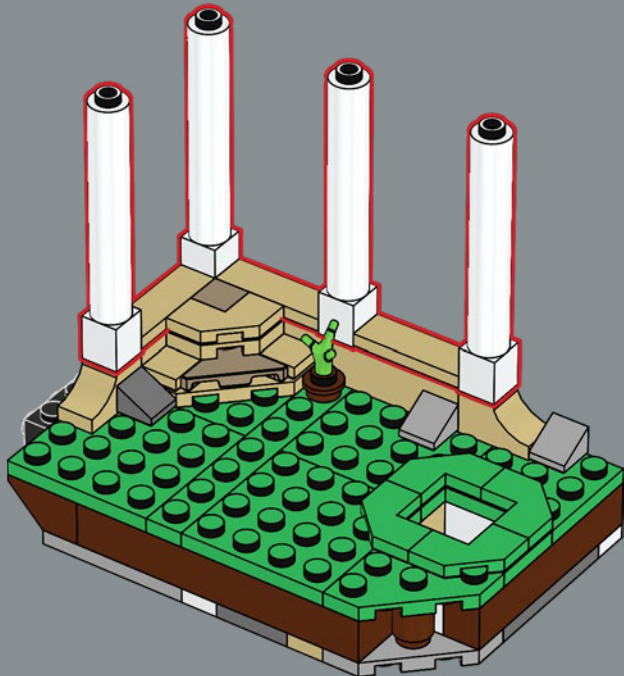

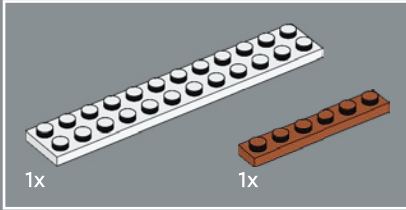
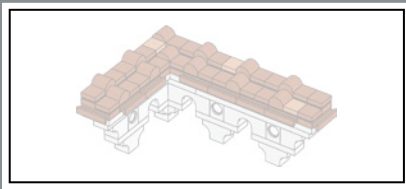

97

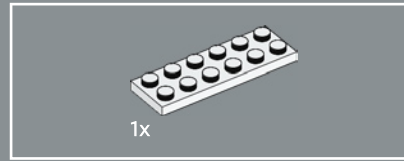
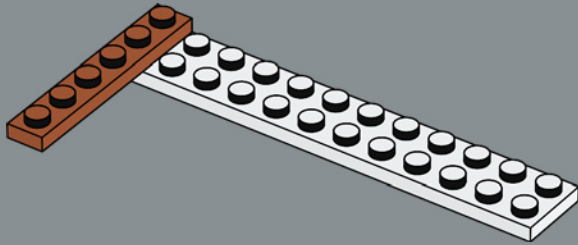

98

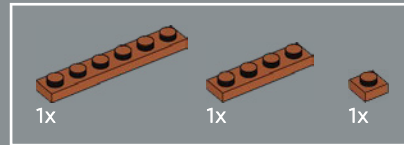
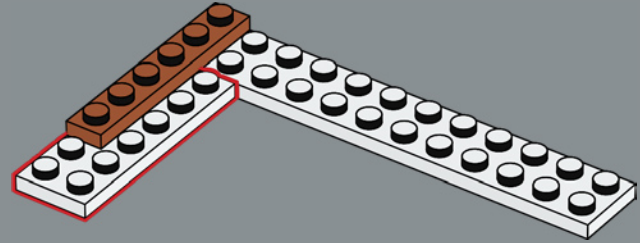

99

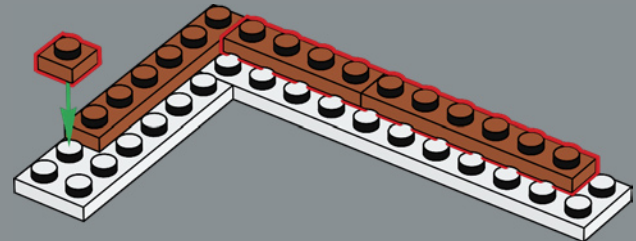



100

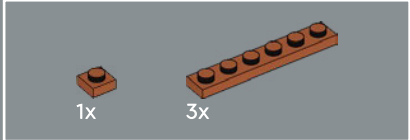
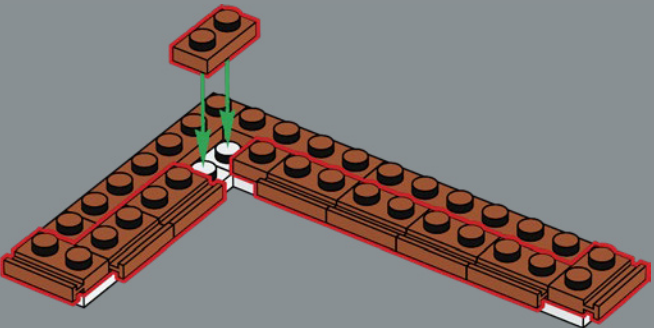

101

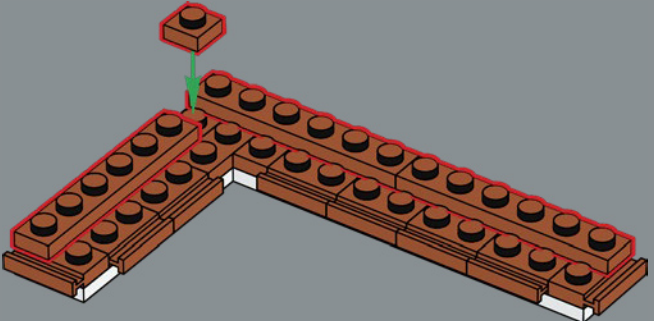

102

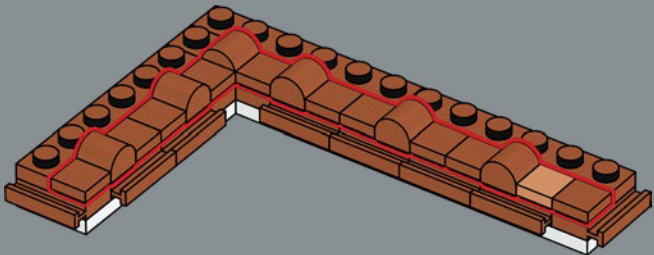

103

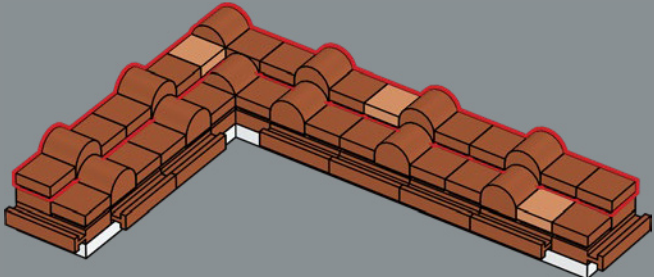

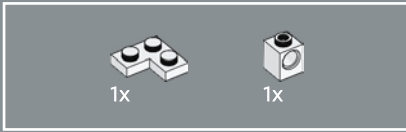
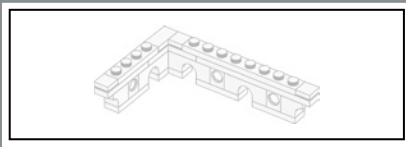

104

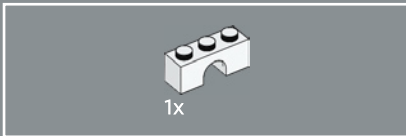
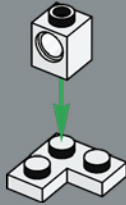

105

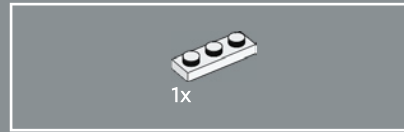
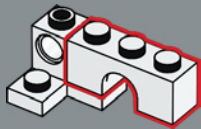

106

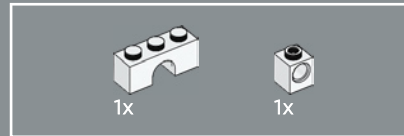
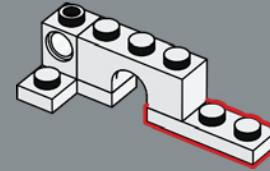

107

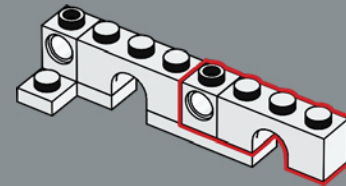

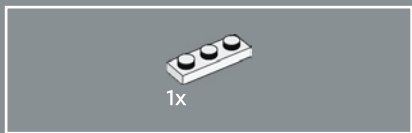

108

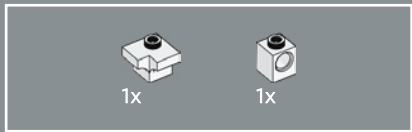
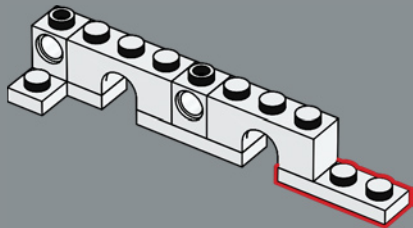

109

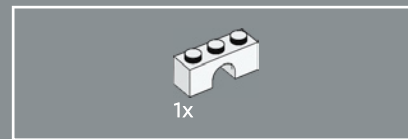
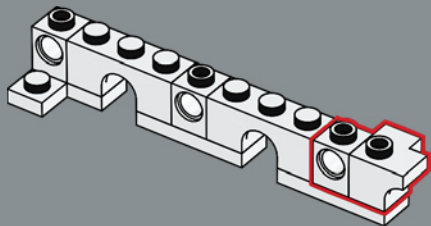

110

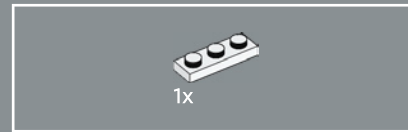
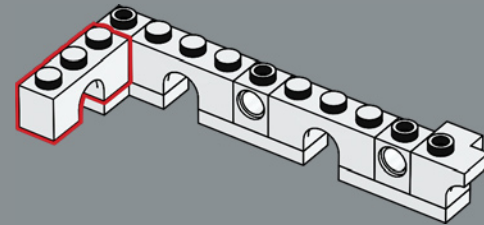

111

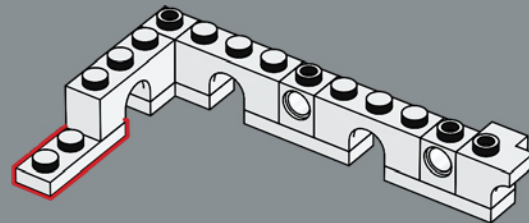

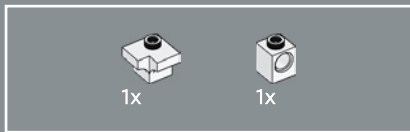

112

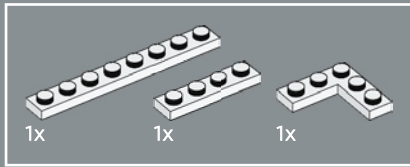
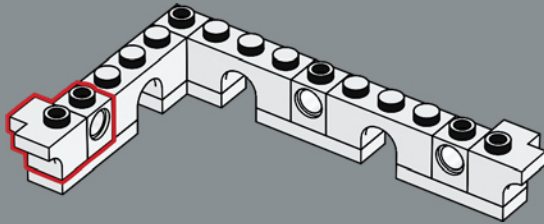

113

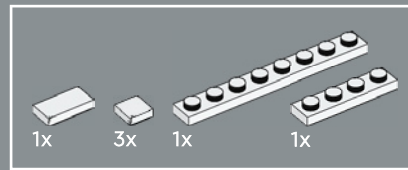
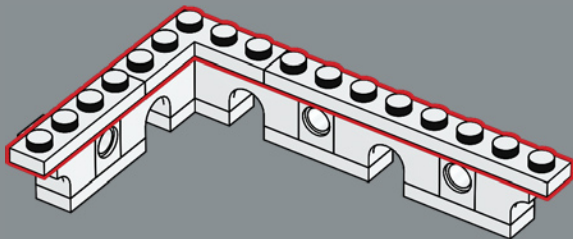

114

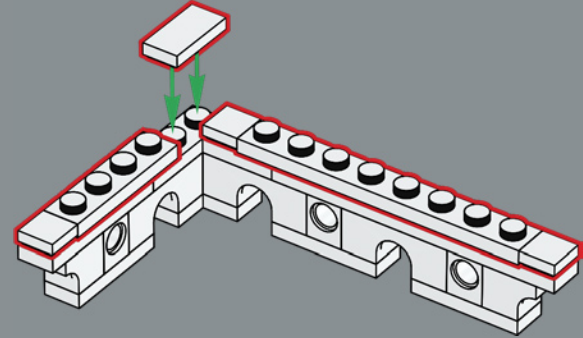

115

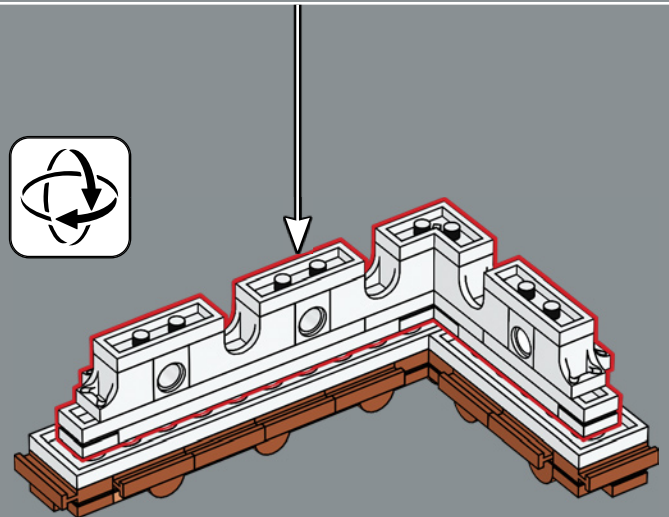

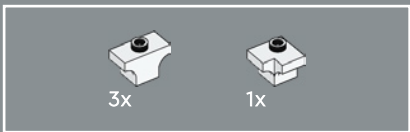

116

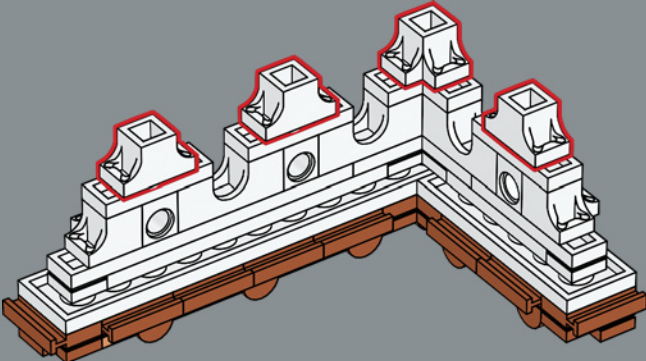

117

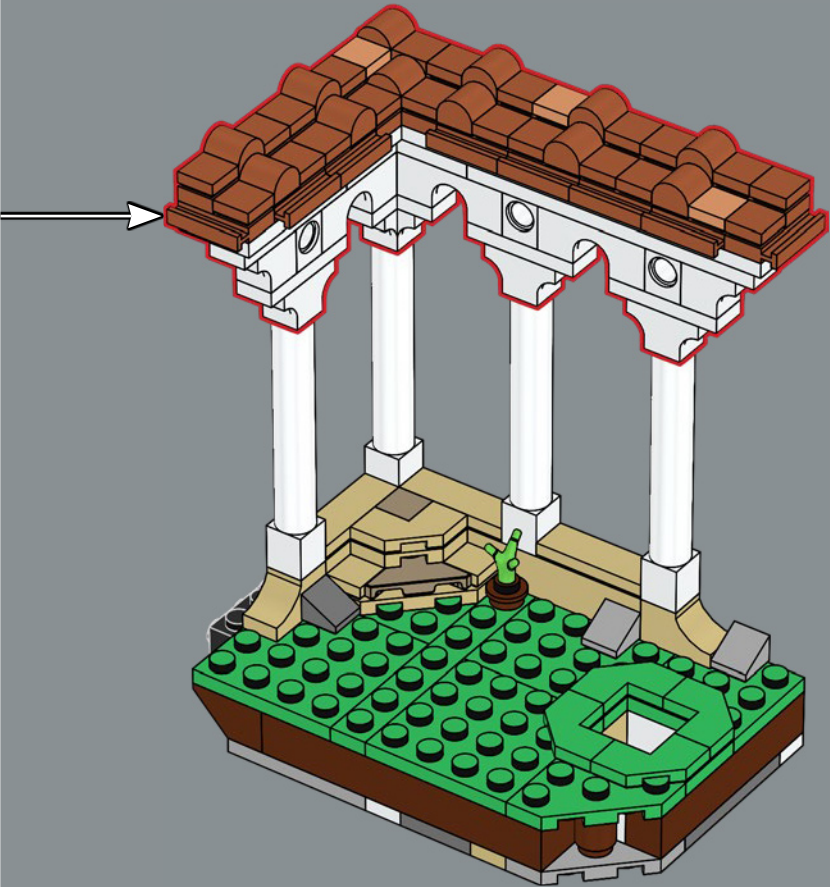

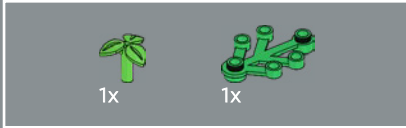
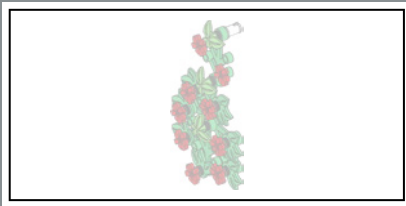

118

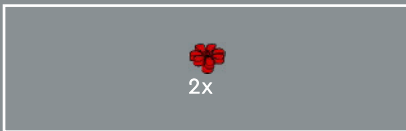
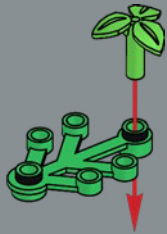

119

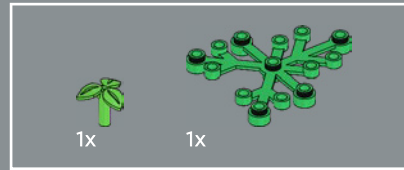

120

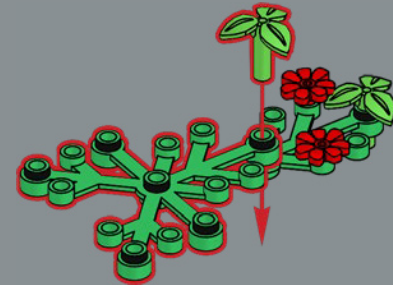

121

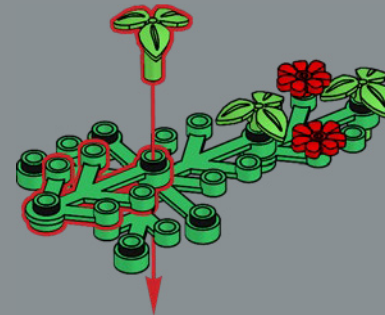



7x

122

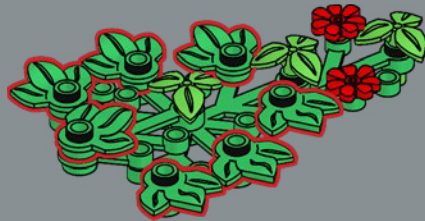

Hibisco (*Hibiscus rosa-sinensis*)
Las flores de hibisco pueden usarse para probar la acidez de un líquido. Sus pétalos adoptan un tono rosa oscuro si se exponen a un ácido, o uno verde si tienen contacto con una base. ¡Son perfectas para medir la pureza de tu fuente!



7x

123

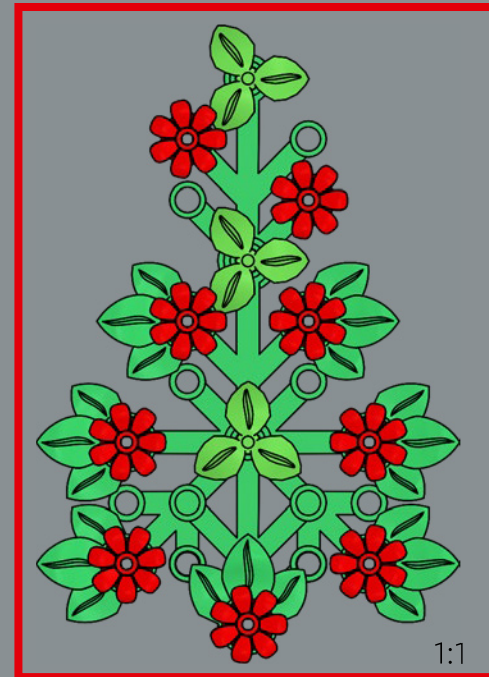
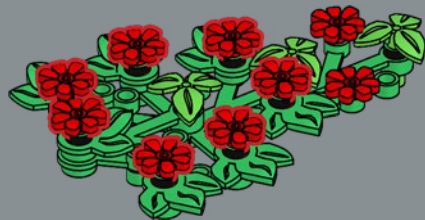



124

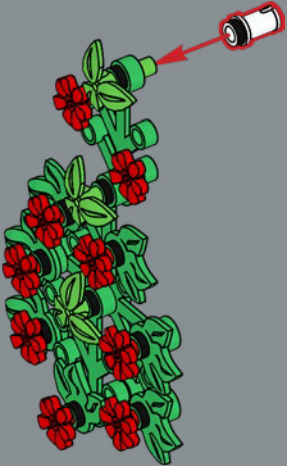

125

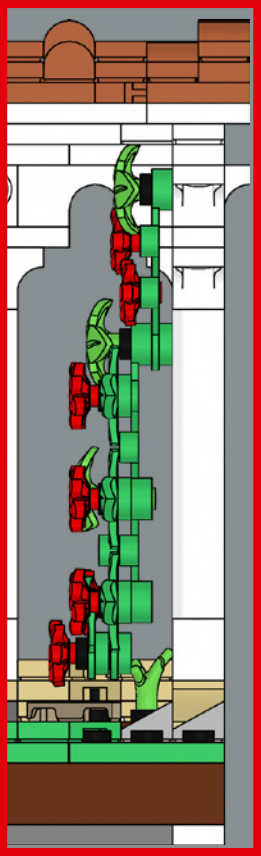

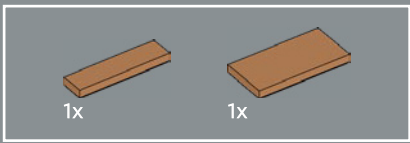

126

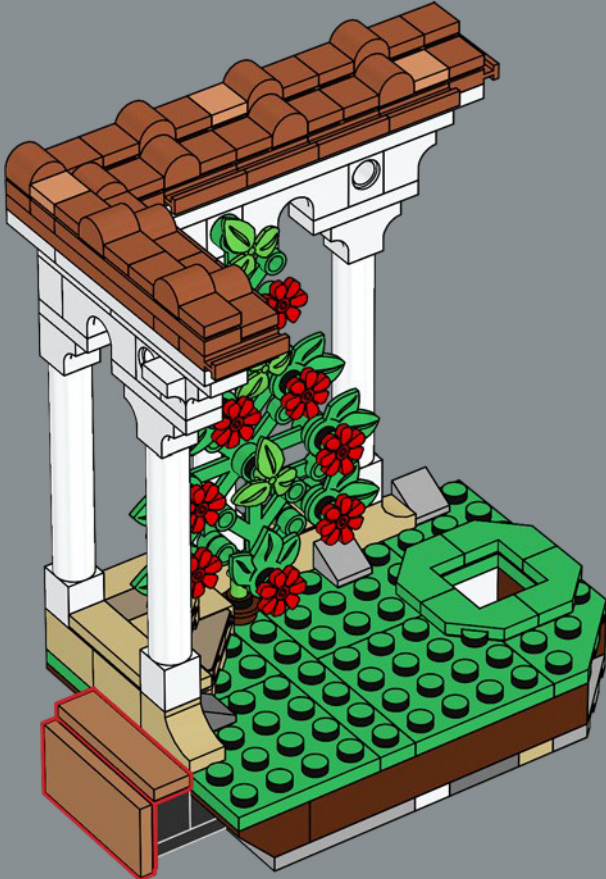

127



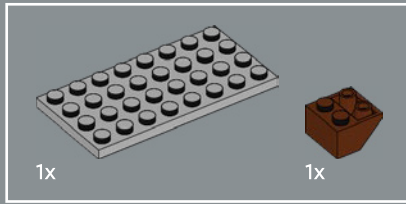
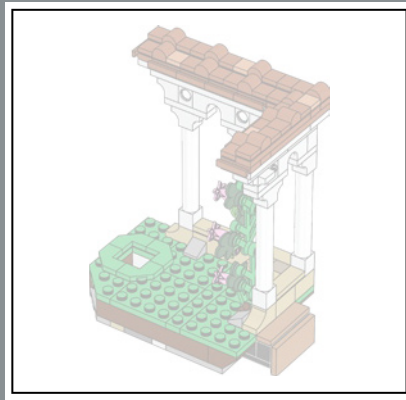

128

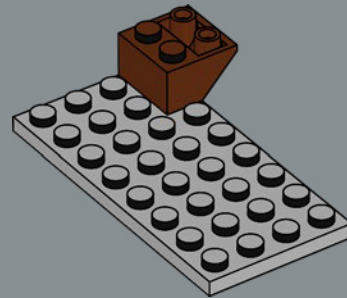

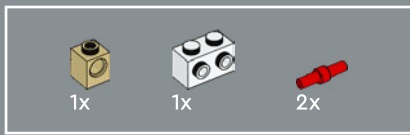

129

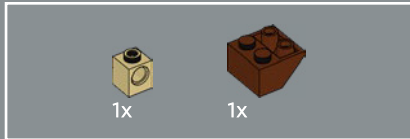
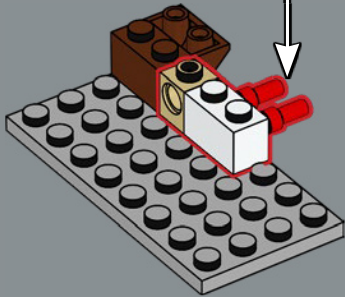
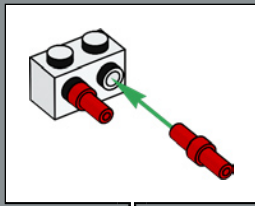

130

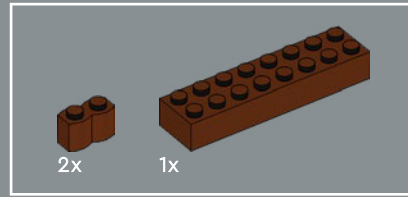
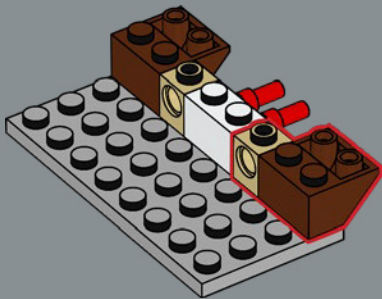

131

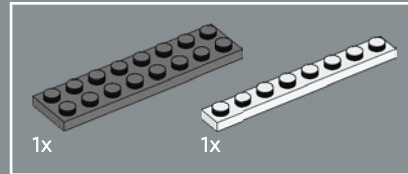
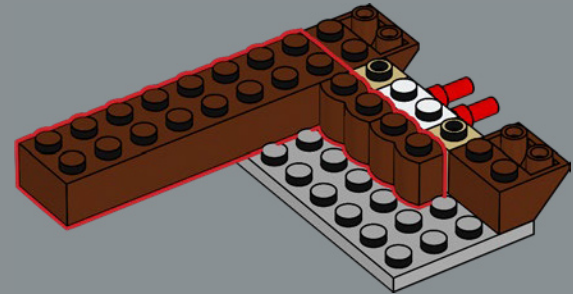

132

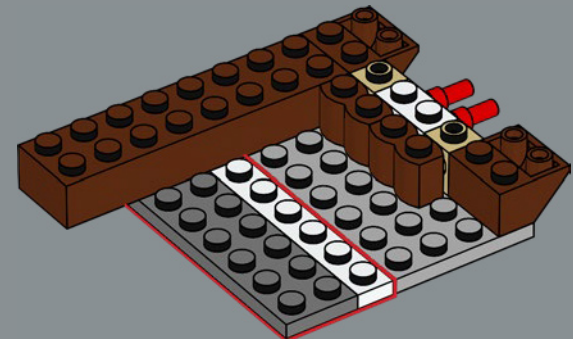

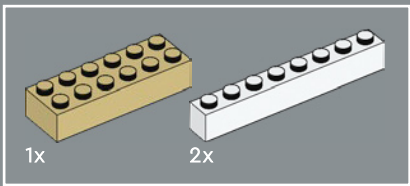

133

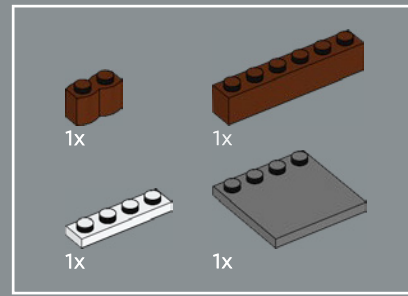
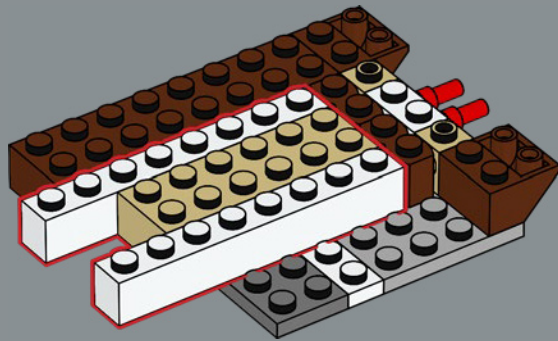

134

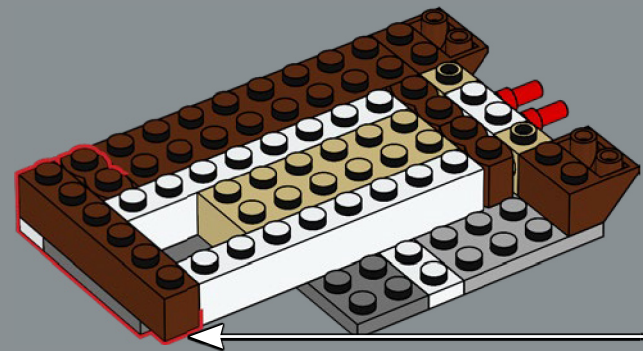
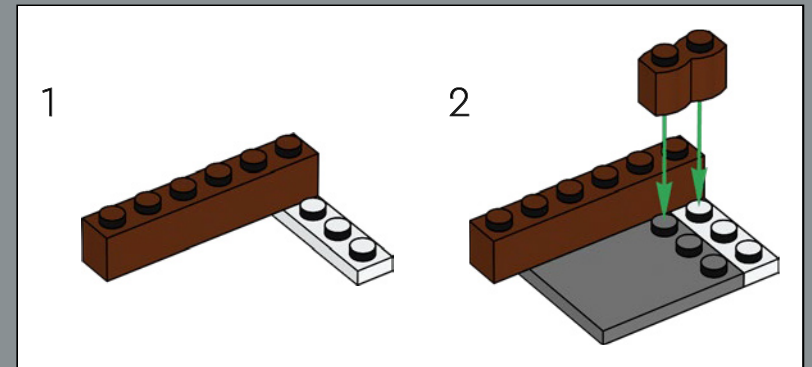

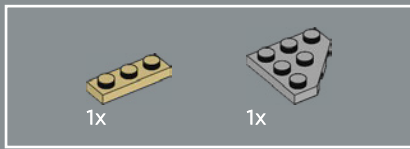

135

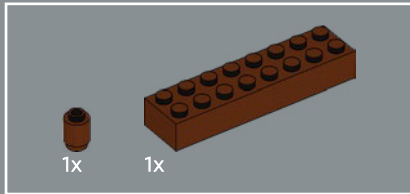
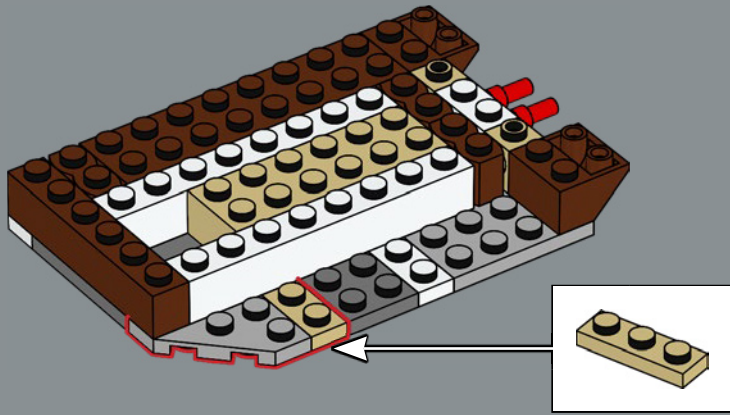

136

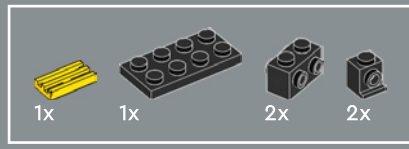
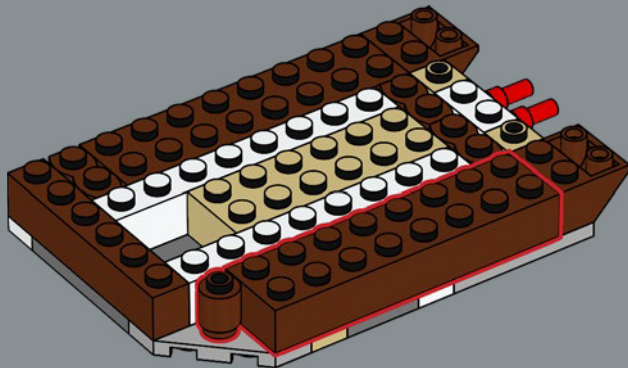

137

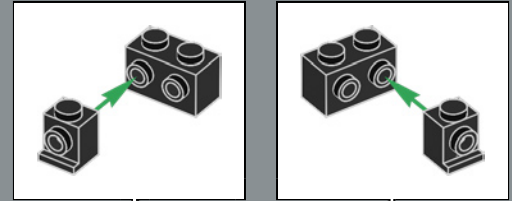

1

2

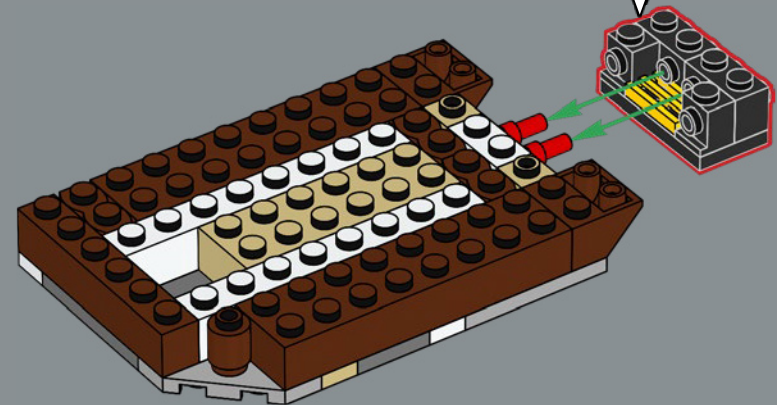
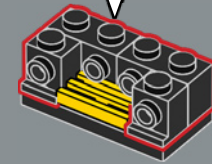
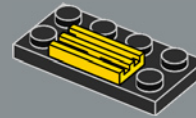

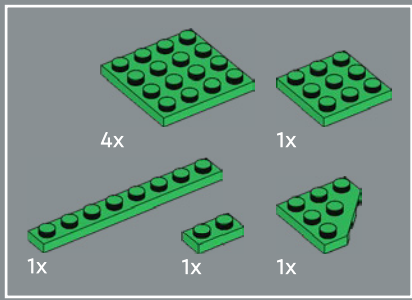

138

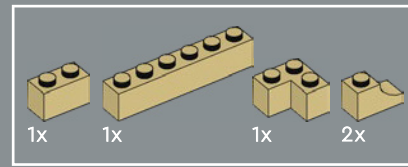

139

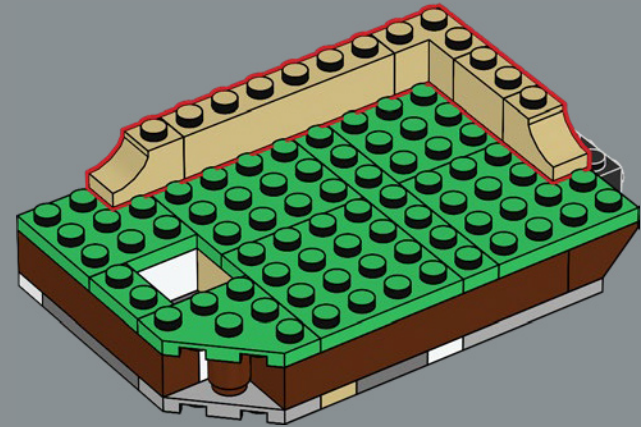

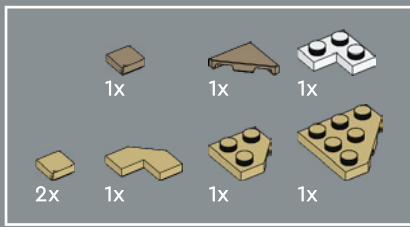

140

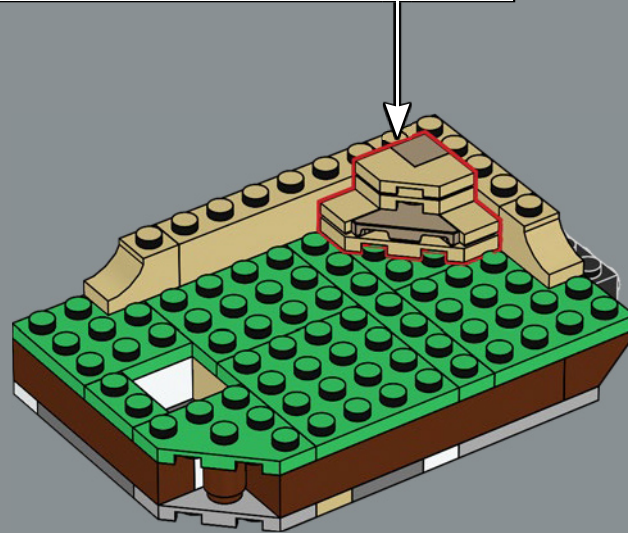
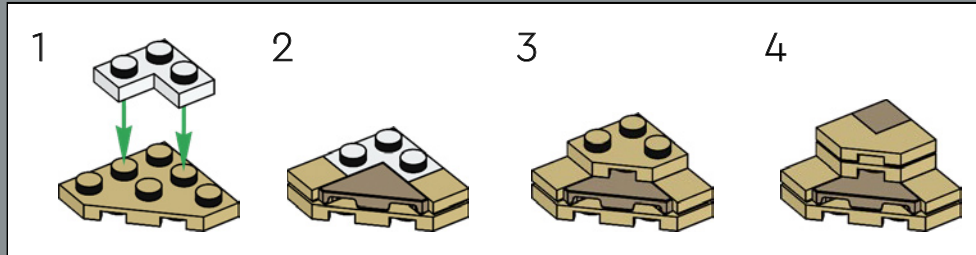

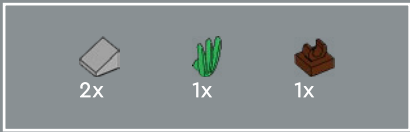

141

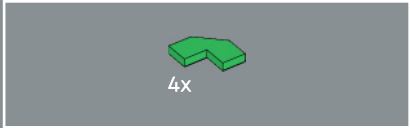
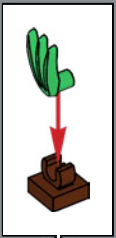

142

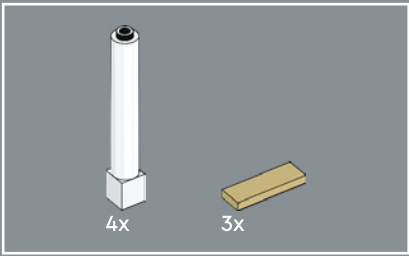
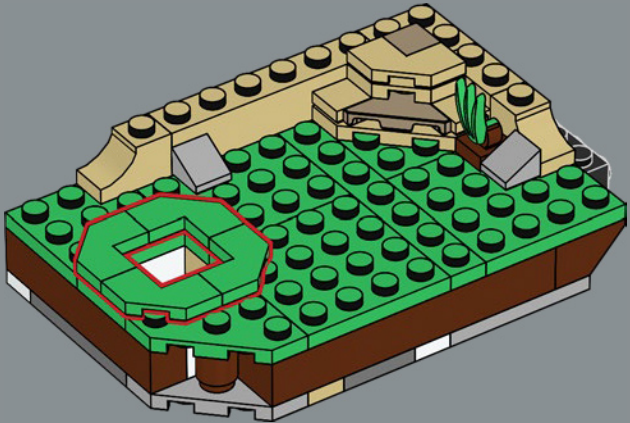

143

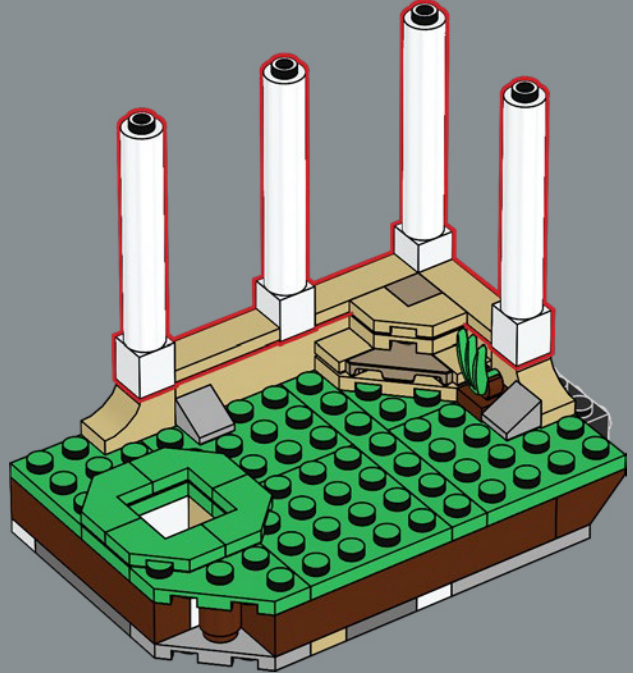

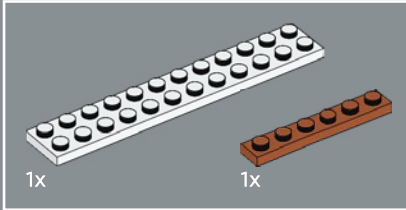
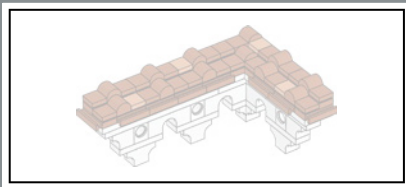

144

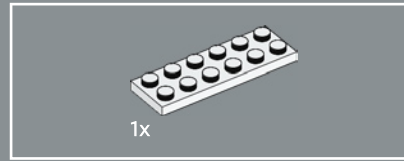
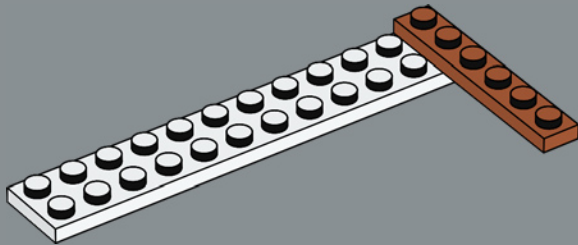

145

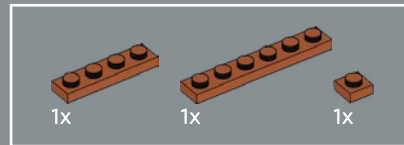
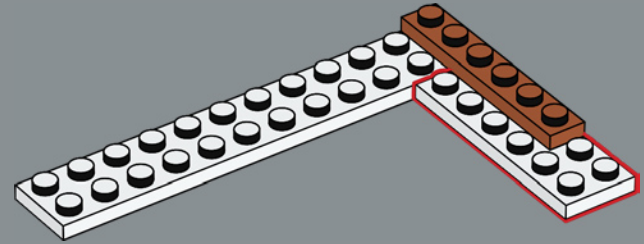

146

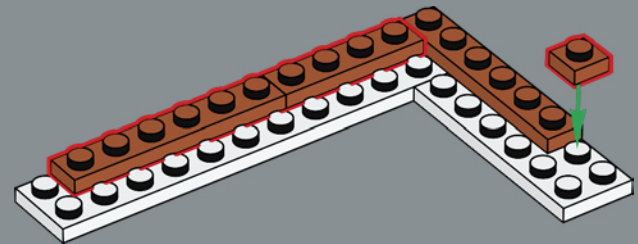



147

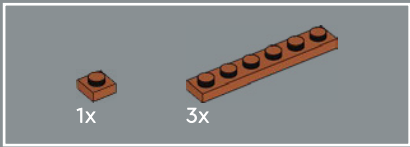
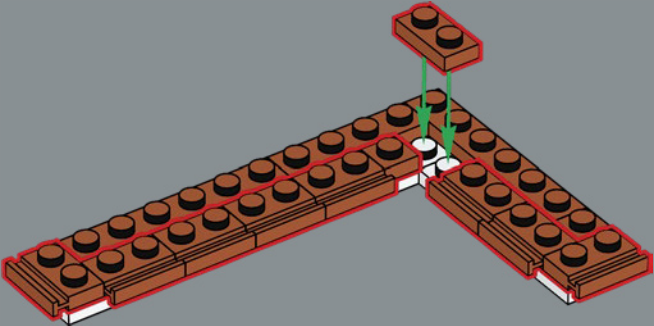

148

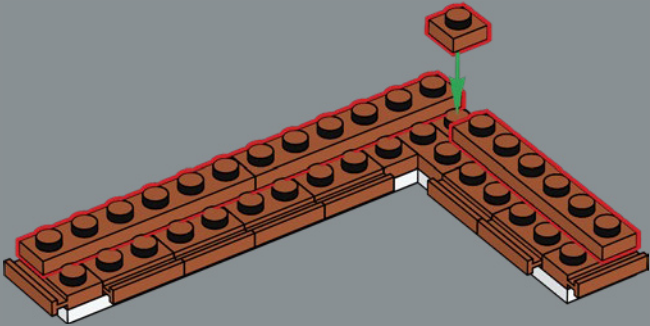

149

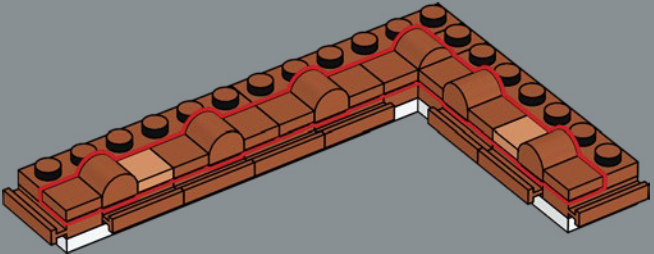

150

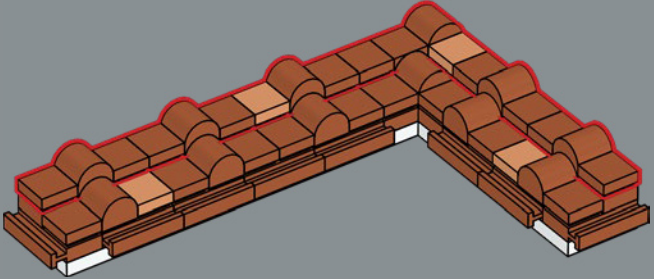

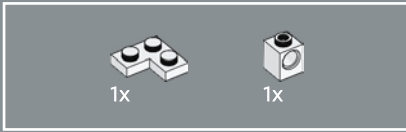
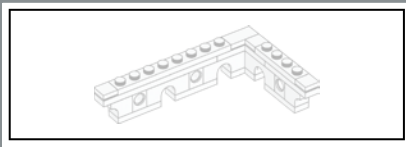

151

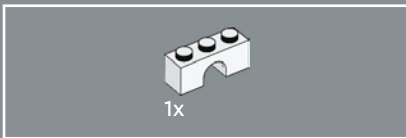
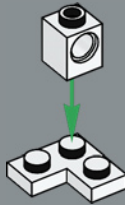

152

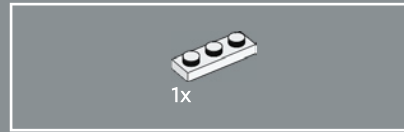
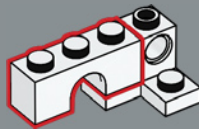

153

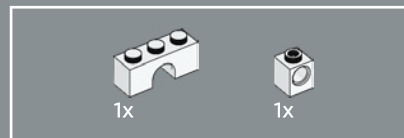
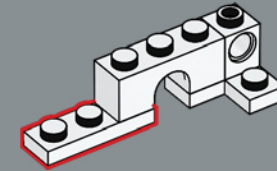

154

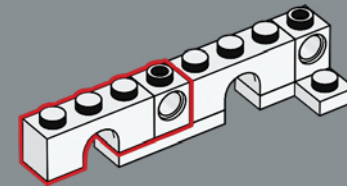

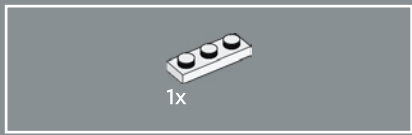

155

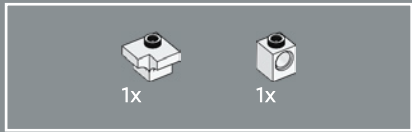
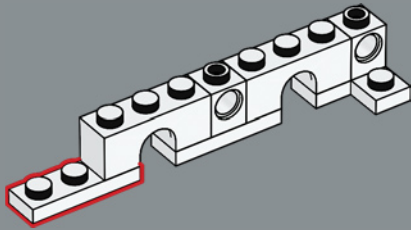

156

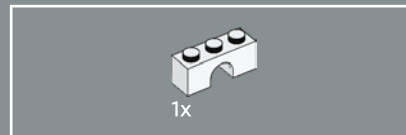
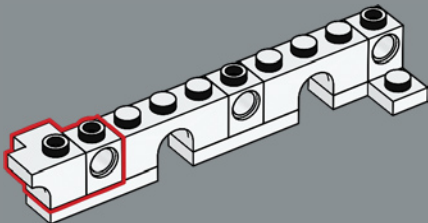

157

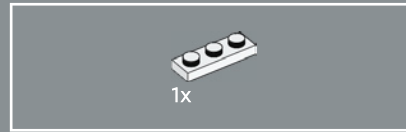
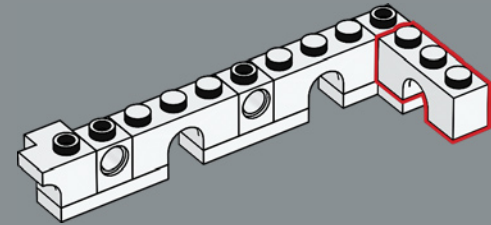

158

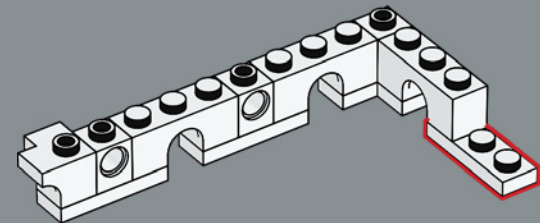

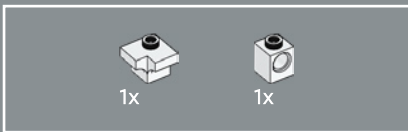

159

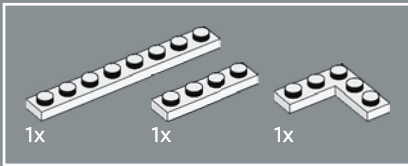
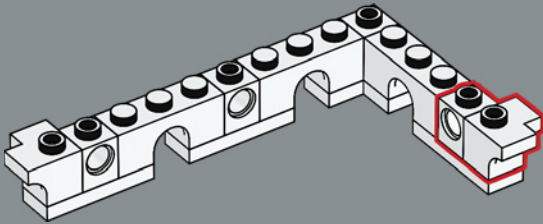

160

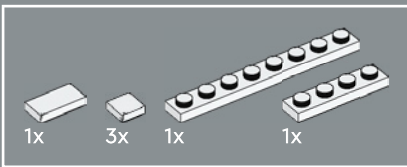
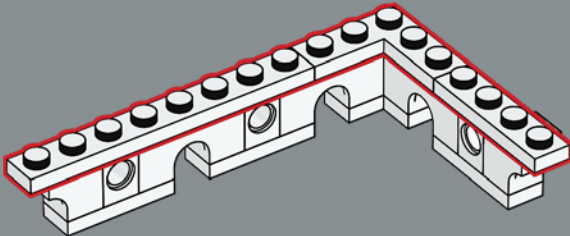

161

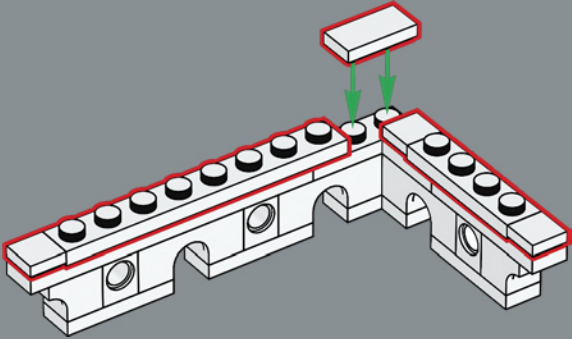

162

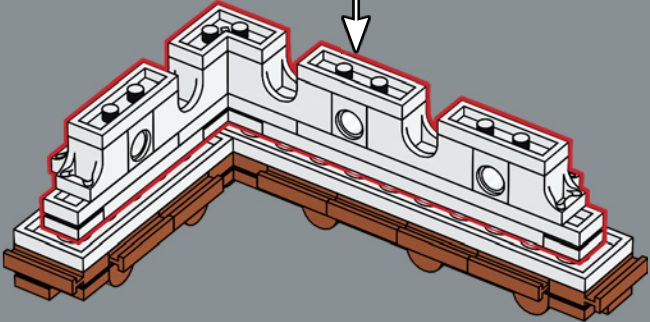

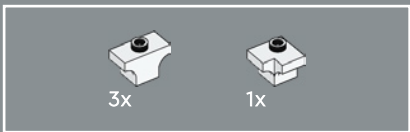

163

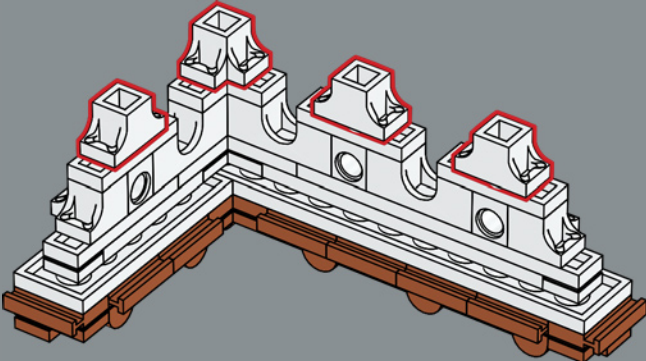

164

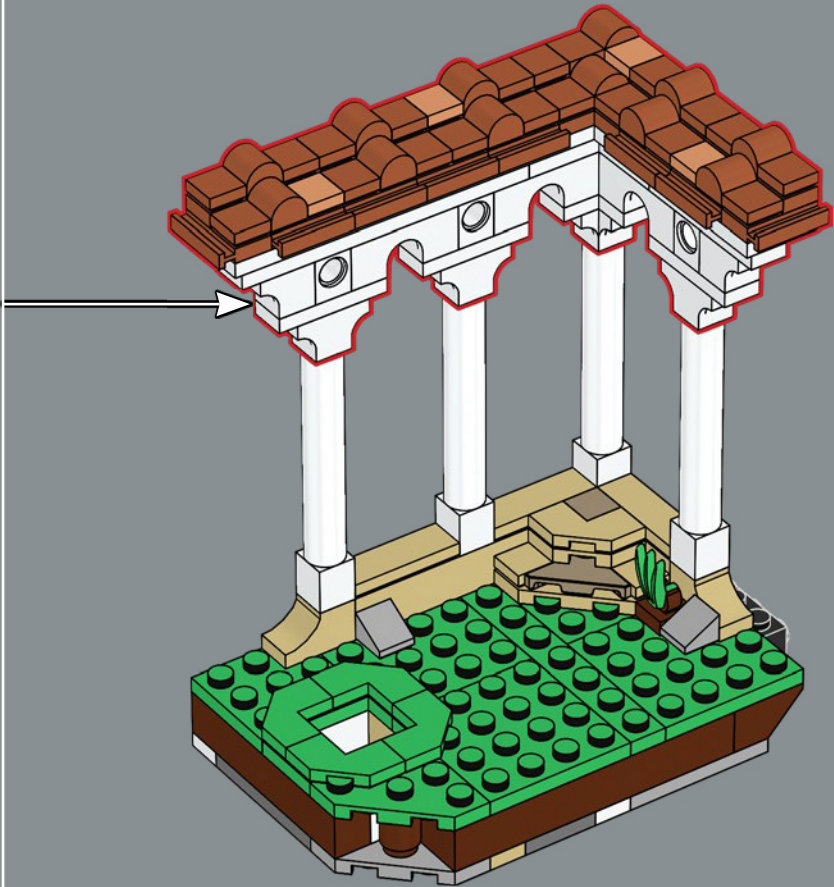

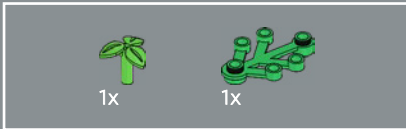
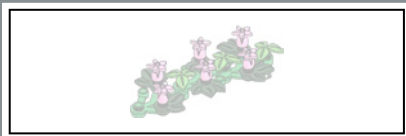

165

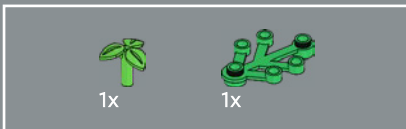
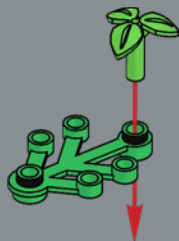

166

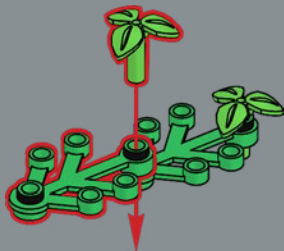

167

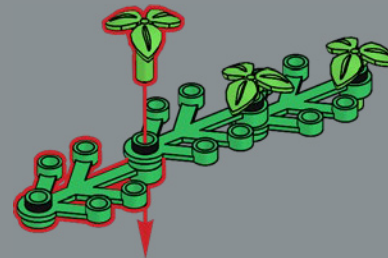

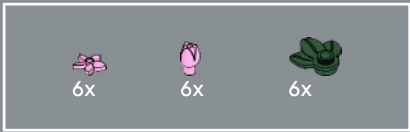

168

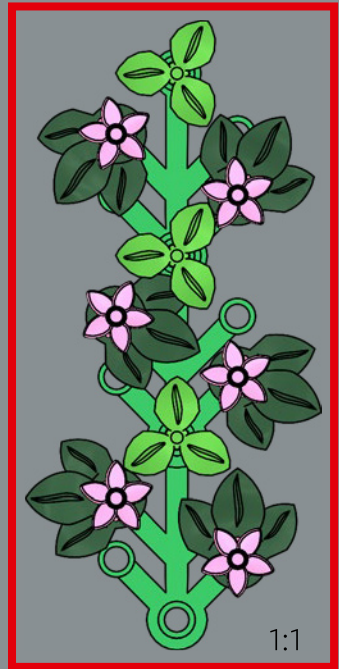
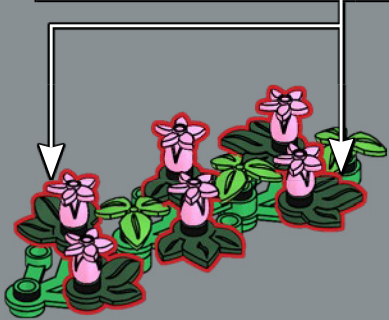
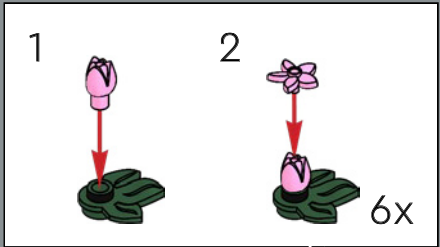

169

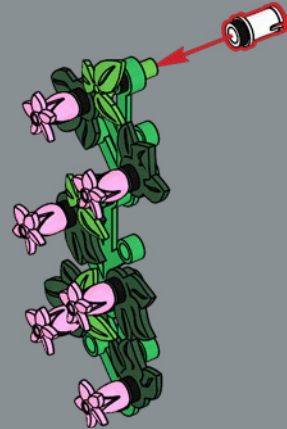

Bougainvillea (*Bougainvillea*)
 Si bien la mayoría de las personas consideran las partes más coloridas de la bougainvillea como sus flores, estas en realidad son brácteas: hojas de un tipo distinto que rodean a las verdaderas y minúsculas flores de la planta.

170

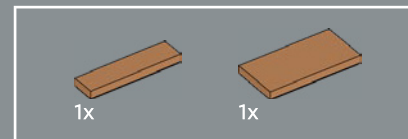
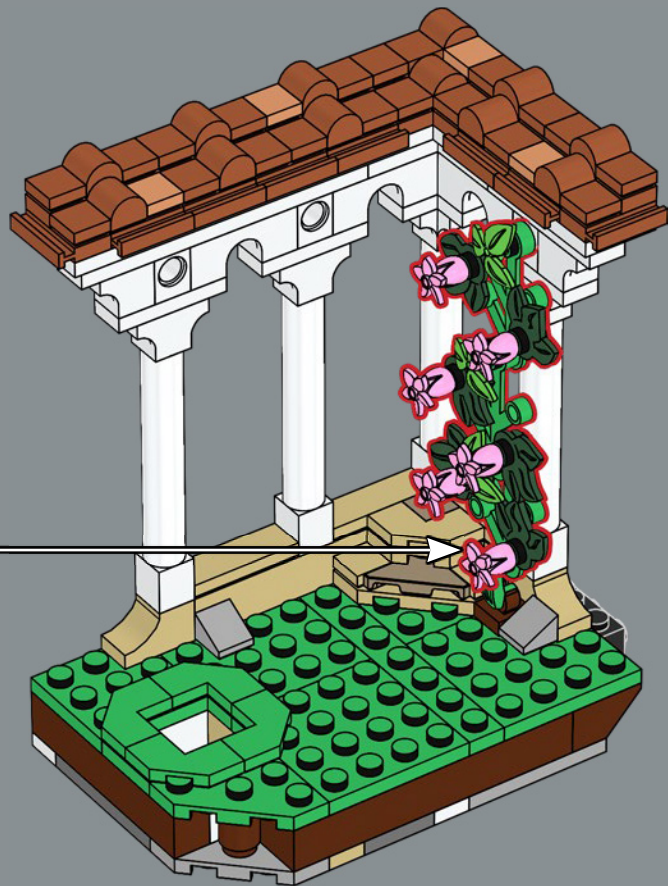

171





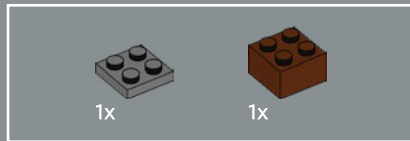
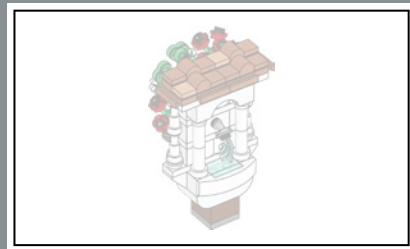

173

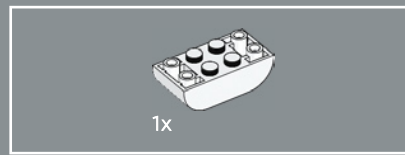
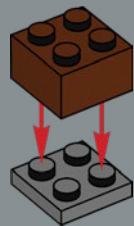

174

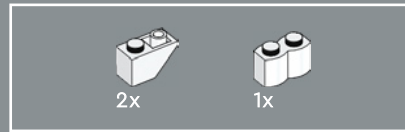
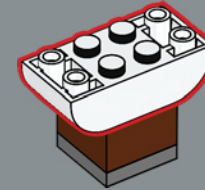

175

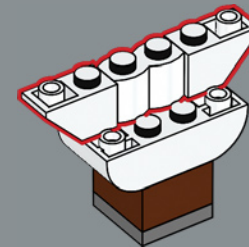

176

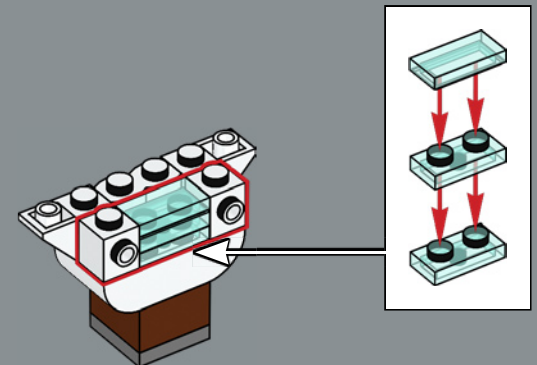



177

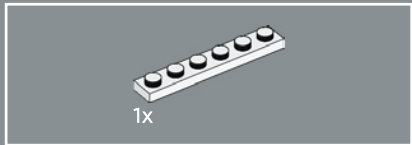
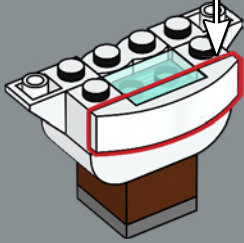
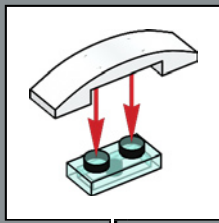

178

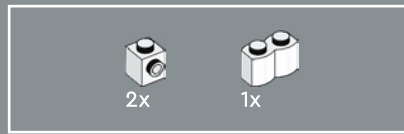
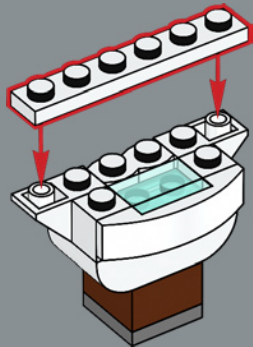

179

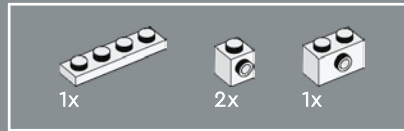
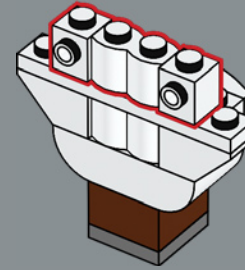

180

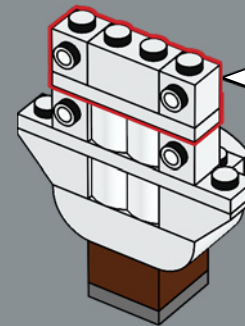
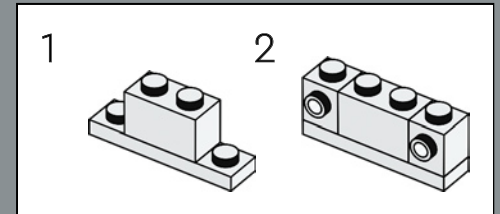

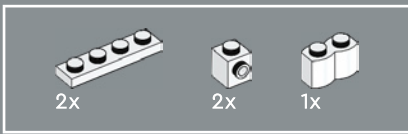

181

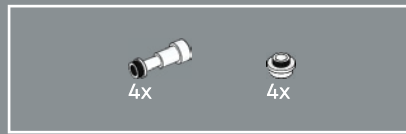
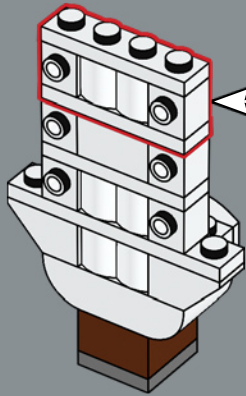
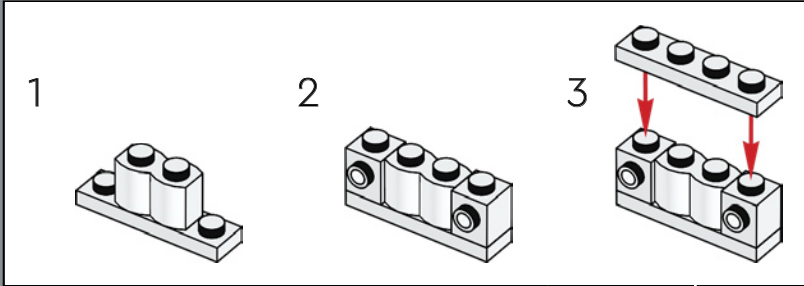

182

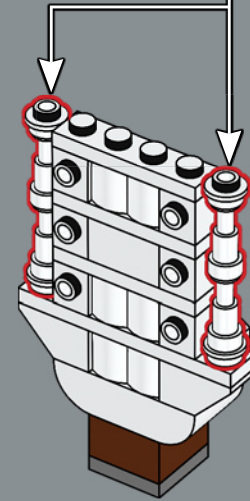
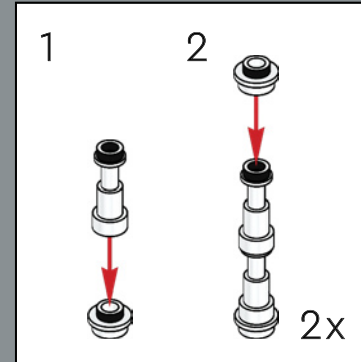



183

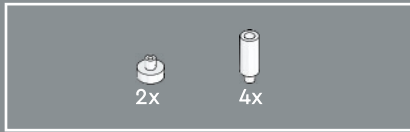
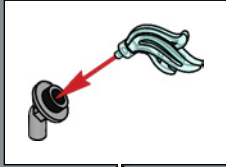

184

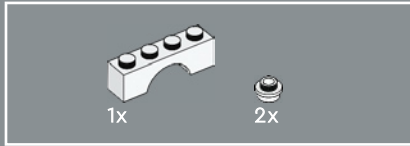
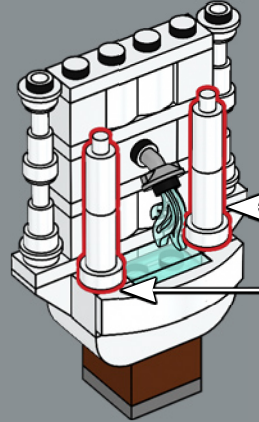
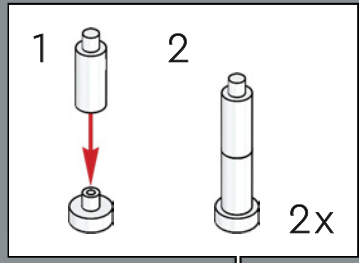

185

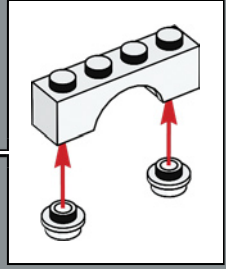
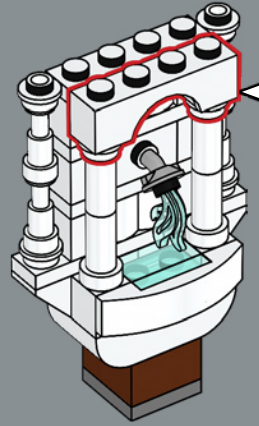

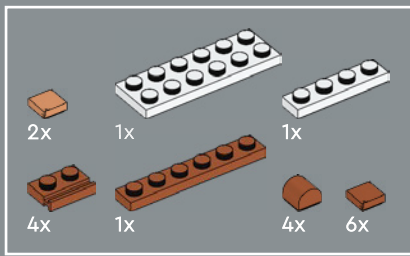

186

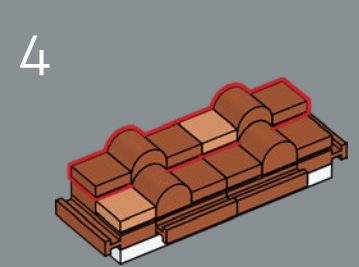
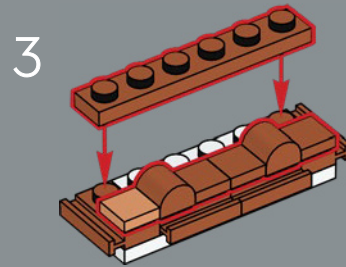
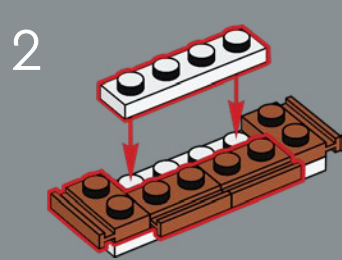
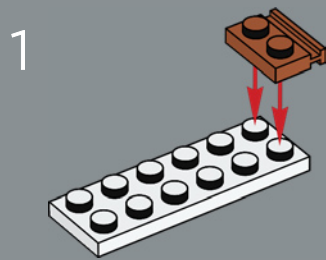



2x

187

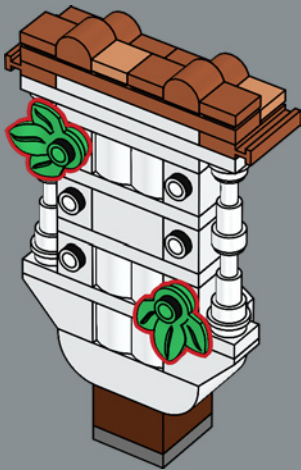

2x

188

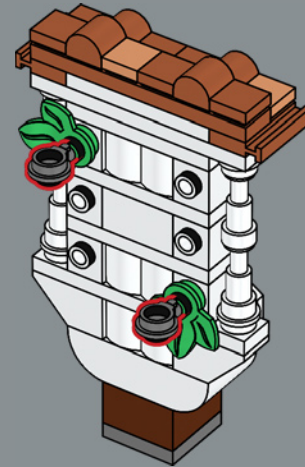

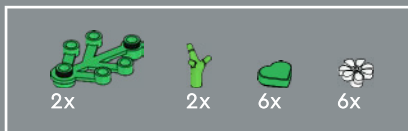

189

Petunia blanca (*Petunia axillaris*)
 Aunque algunas especies de petunias pueden usarse en la gastronomía con una función ornamental, quizá sea mejor dejar que esta belleza florezca en tu jardín. No solo está estrechamente emparentada con las patatas y los tomates, ¡sino también con la belladona!

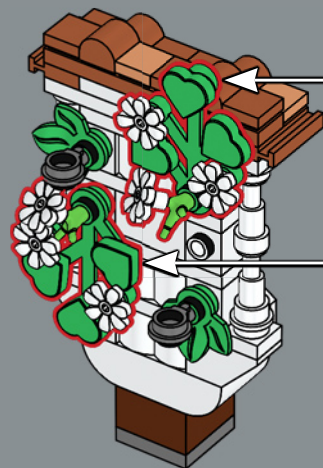
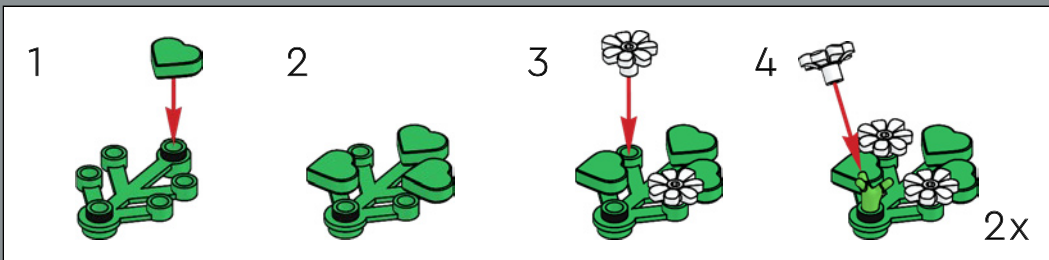

190

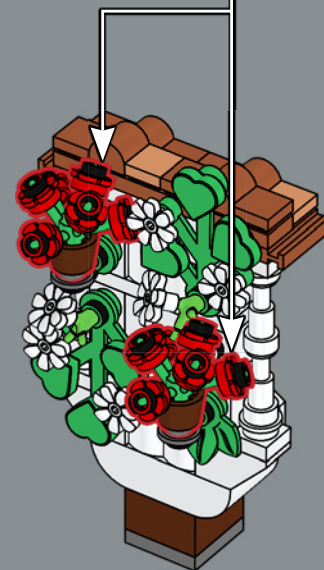
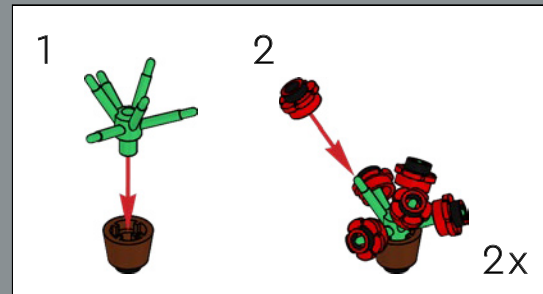

Geranio común (*Pelargonium x hortorum*)
 El fragante geranio común sirve tanto para fines estéticos como prácticos en un jardín sereno. Sus aceites naturales producen un aroma que ahuyenta a los insectos.



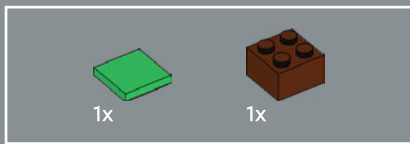

192

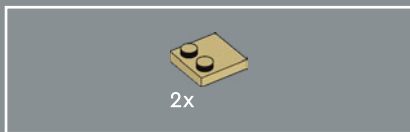
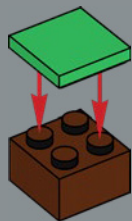

193

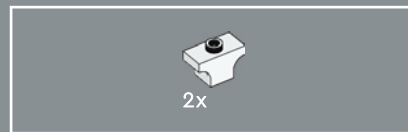
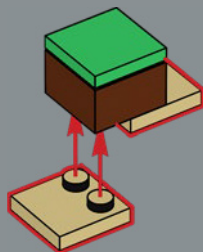

194

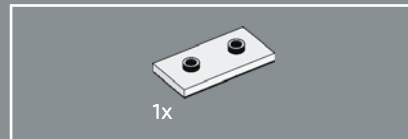
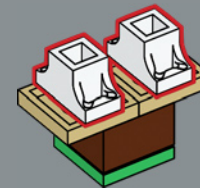

195

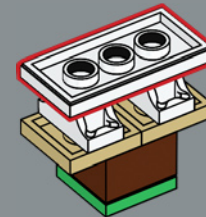

196

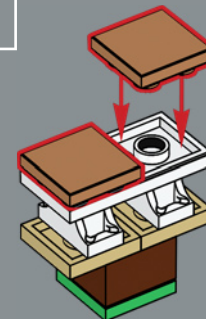



Rana común (*Pelophylax perezi*)
Originaria de la península ibérica, esta pequeña y veloz nadadora vive en hábitats de agua dulce y humedales.

197



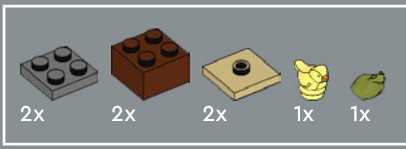

198

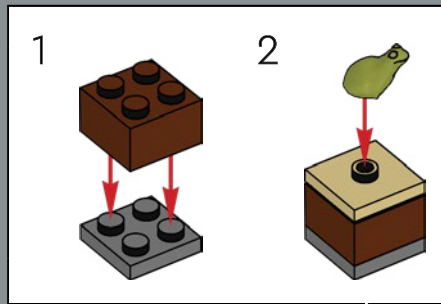

Escribano cerillo (*Emberiza citrinella*)
 El escribano cerillo, con su característico plumaje amarillo brillante y su distintivo canto, se encuentra por toda Europa.

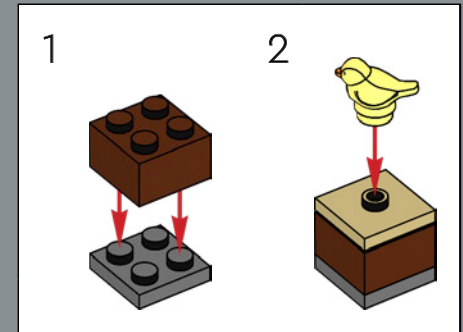

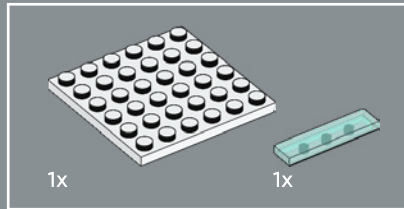
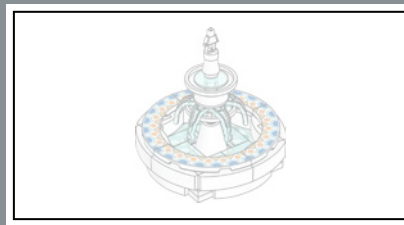

199

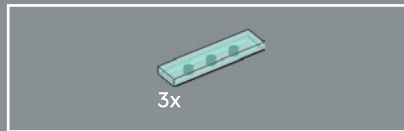
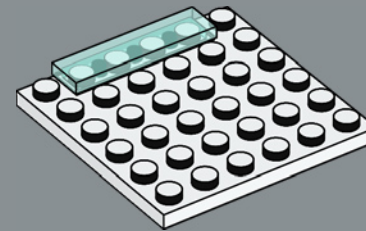

200

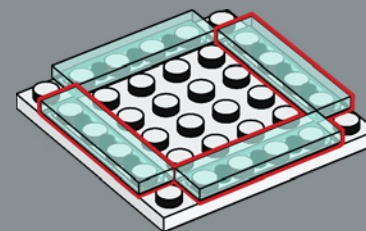

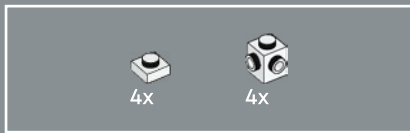

201

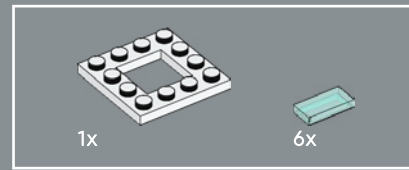
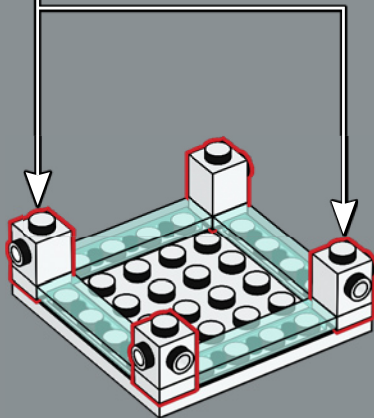
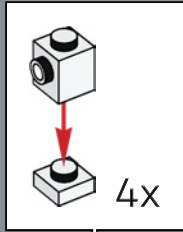

202

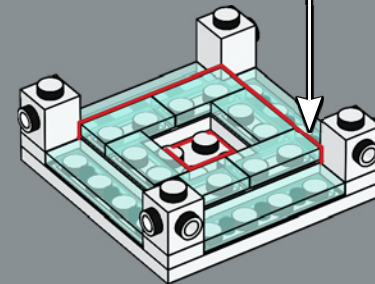
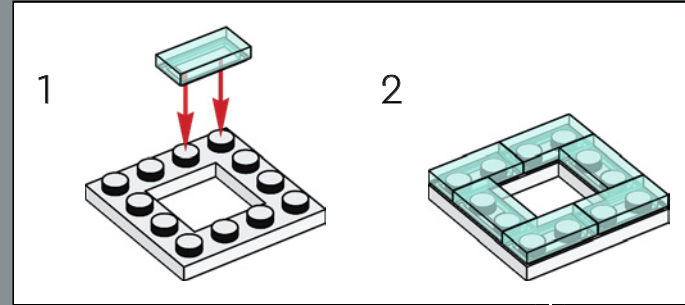

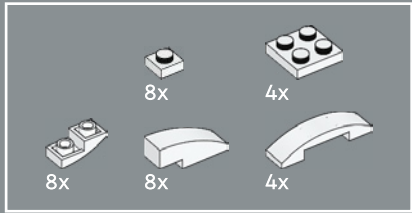
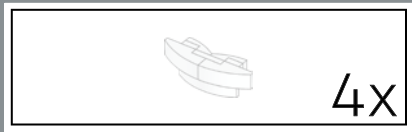

203

1

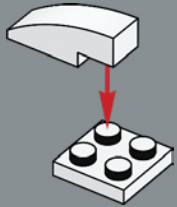

2

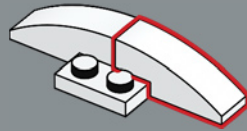

3

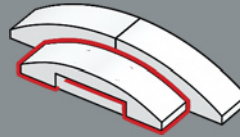

4

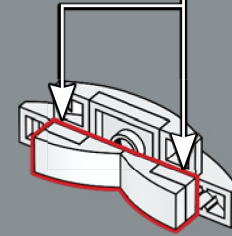
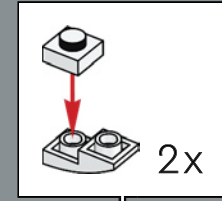

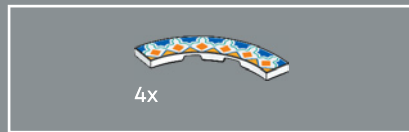

204

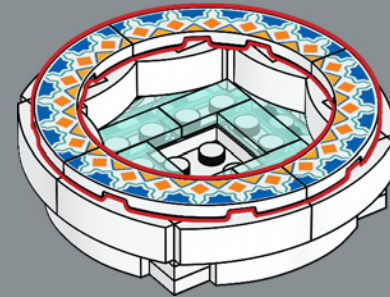
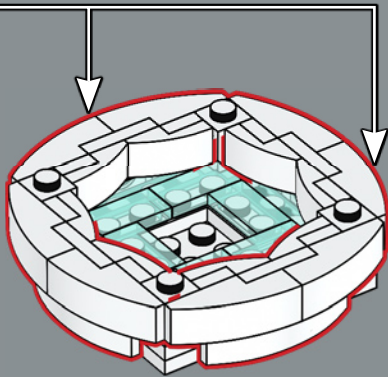

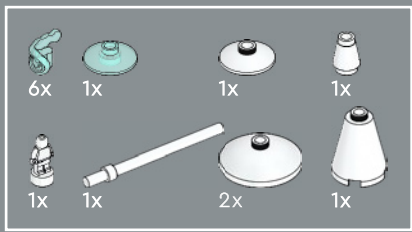

205

1

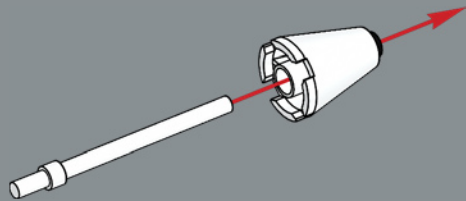

2



3



4



5

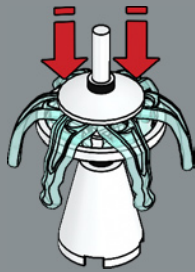

6

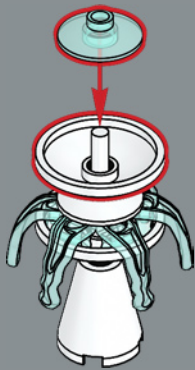

7

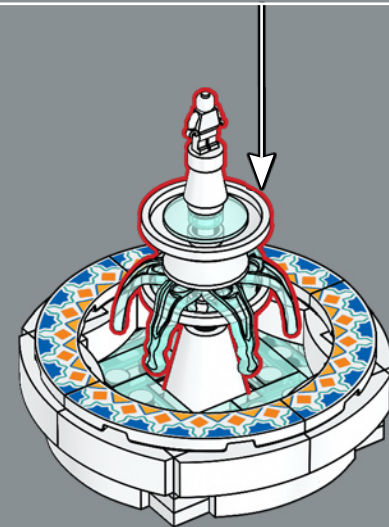
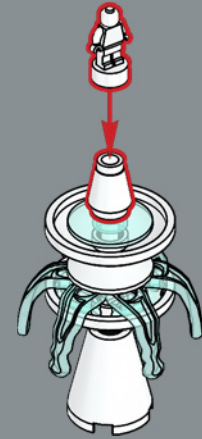



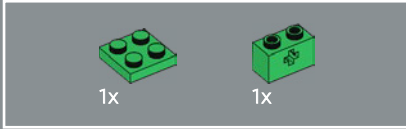

207

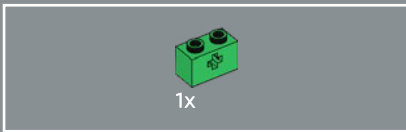
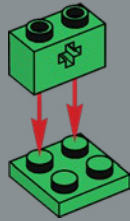

208

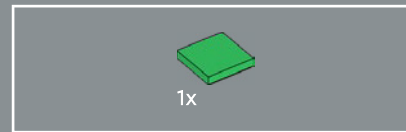
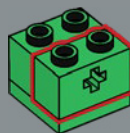

209

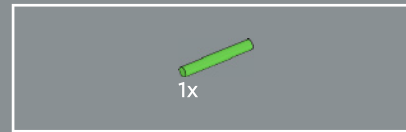
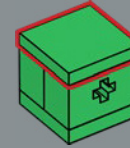

210

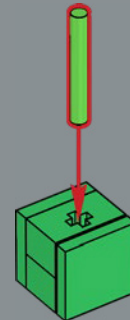
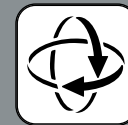

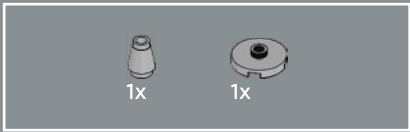

211

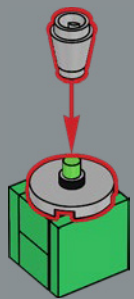

212

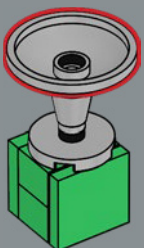

213

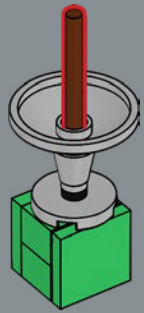



214

1

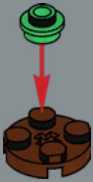

2

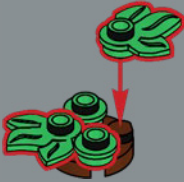

3

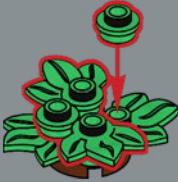

4

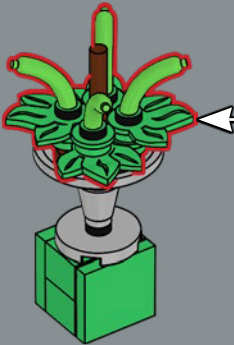

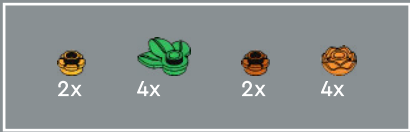

215

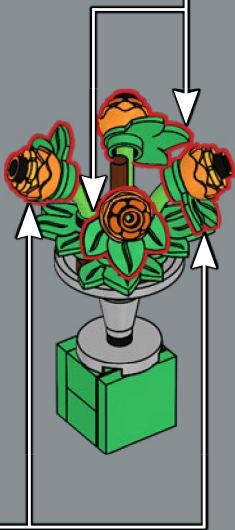
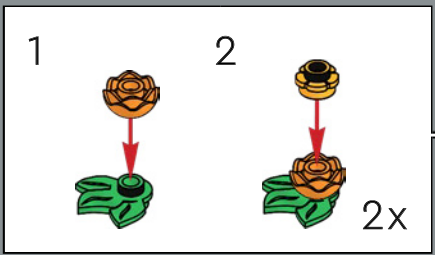
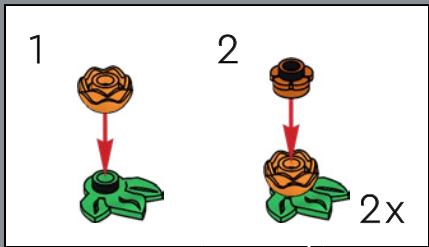

216

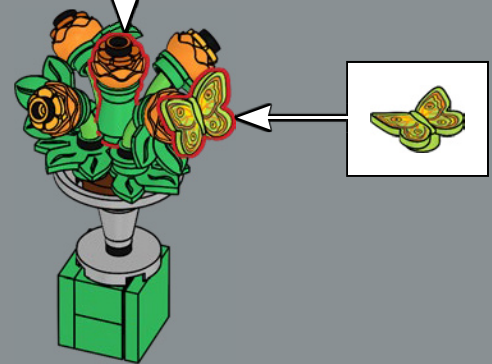
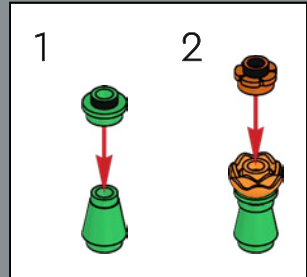

Mariposa isabelina (*Graellsia isabellae*)
 La mariposa isabelina, una impresionante especie con alas verdes y singulares ocelos, habita en los Pirineos. Es una especie "reliquia" que ha permanecido prácticamente inalterada desde la última glaciación.



217

Clavel de moro (*Tagetes patula*)
Originarios de América Central, los aromáticos claveles de moro son muy apreciados por jardineros y cocineros de todo el mundo como decoración o para dar un toque de acidez a los postres dulces.



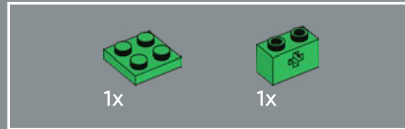
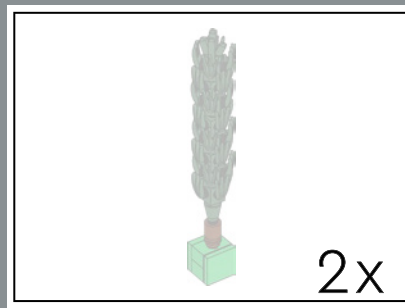

218

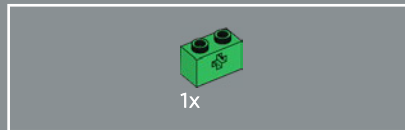
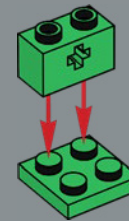

219

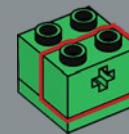

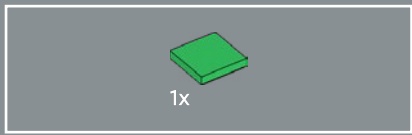

220

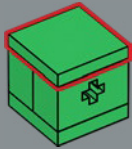

221

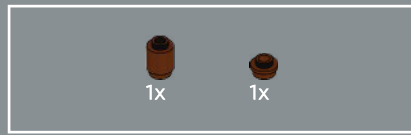
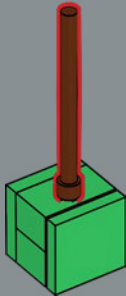

222

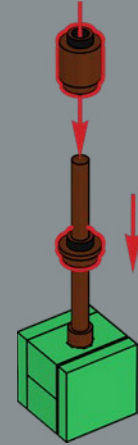

223

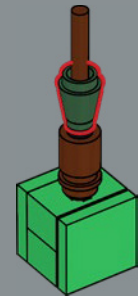

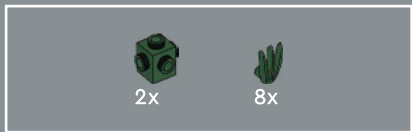

224

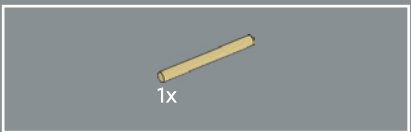
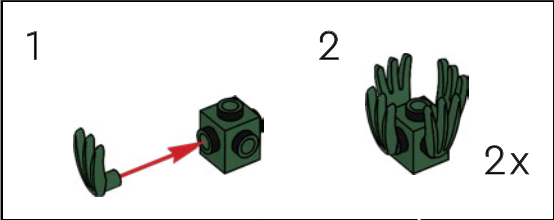

225





226

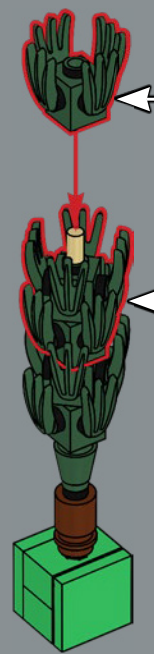
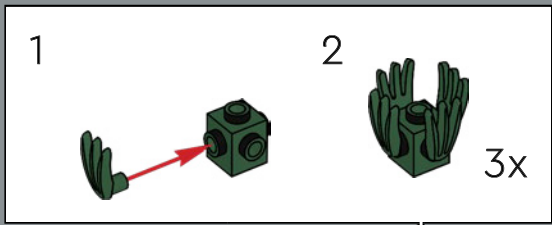

227





228

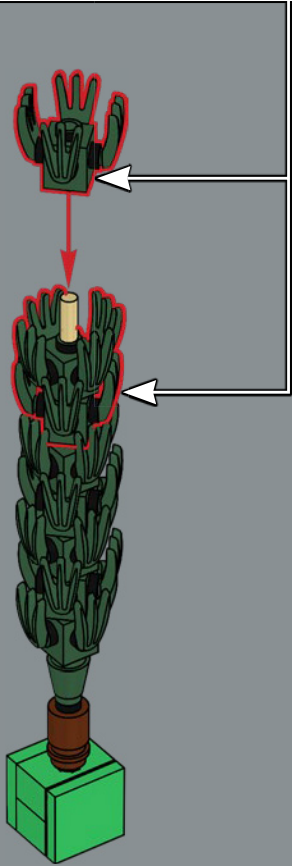
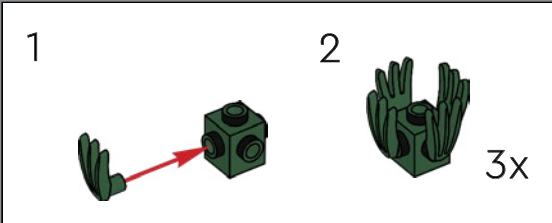

229



Ciprés común (*Cupressus sempervirens*)
Con su forma y belleza características, los cipreses son frecuentes en los paisajes mediterráneos. ¿Sabías que su aromático aceite esencial es un ingrediente muy valorado en la preparación de productos cosméticos y remedios tradicionales?



2x



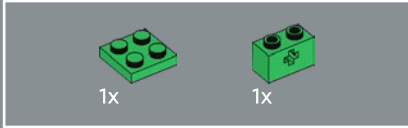
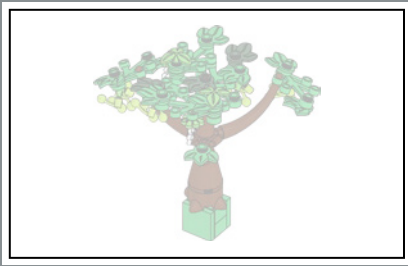

231

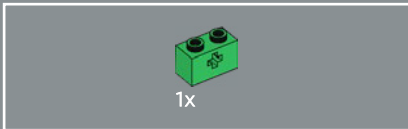
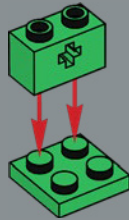

232

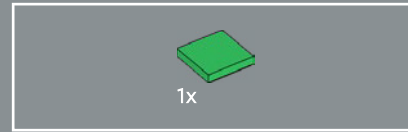
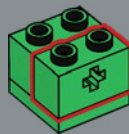

233

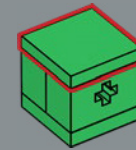

Parra (*Vitis vinifera*)

Las uvas, un alimento básico muy apreciado por su dulzura y jugosidad, fueron cultivadas por primera vez hace más de 10.000 años por las civilizaciones de la antigüedad.

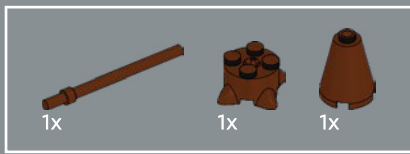

234

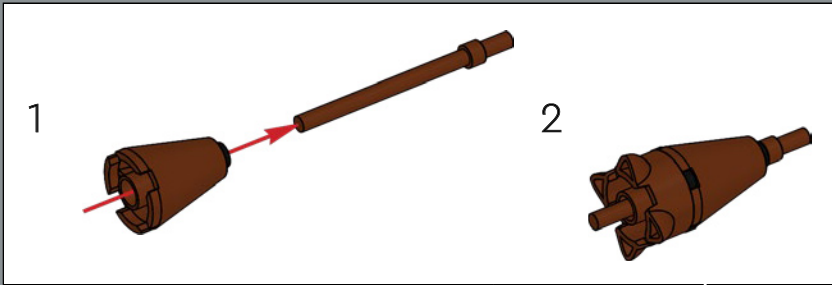

235

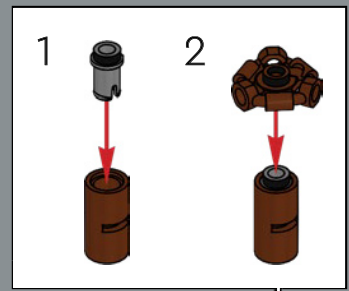

236





237

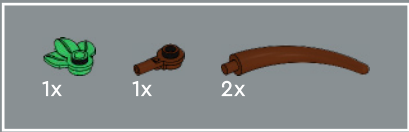

238

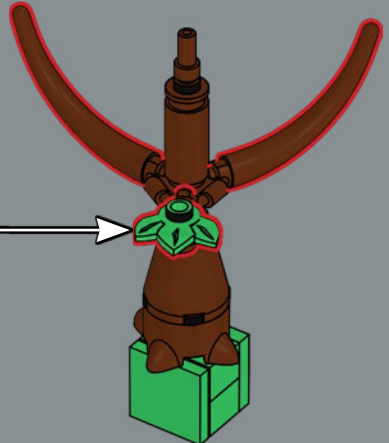
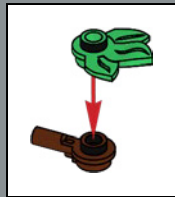

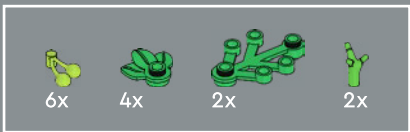

239

1

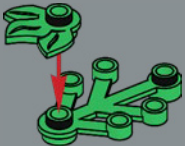

2

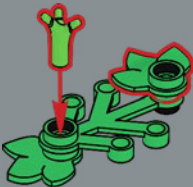

3

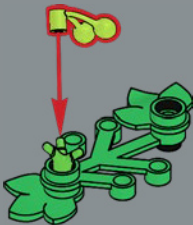

4

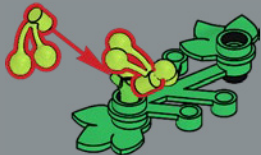

2x

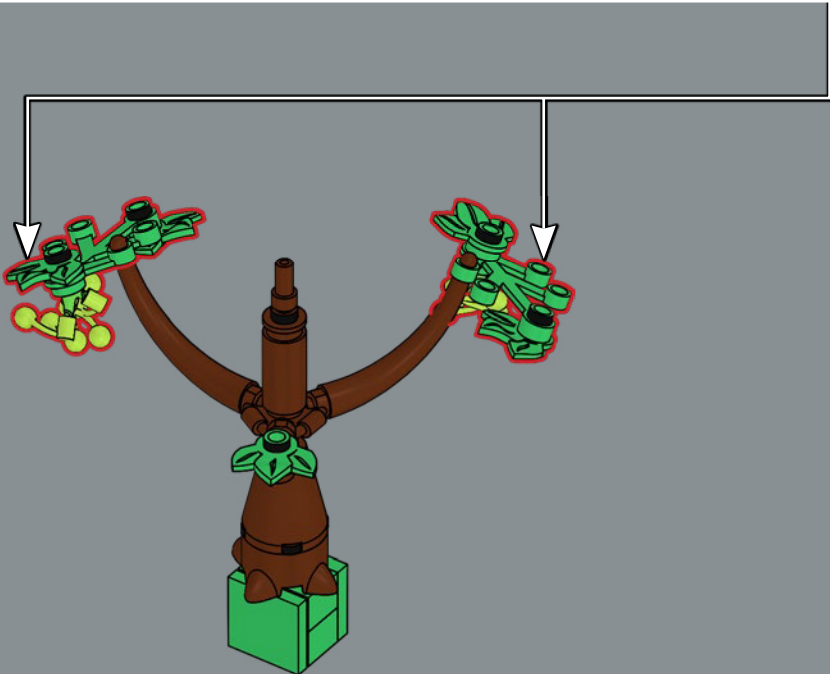

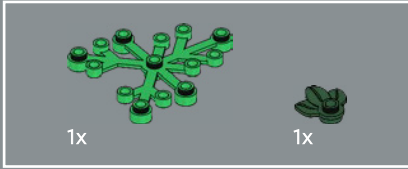
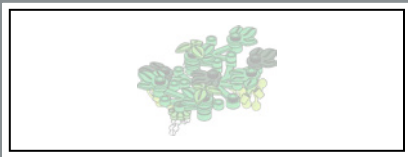

240

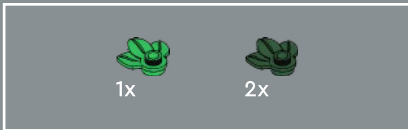
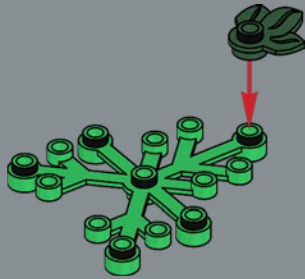

241

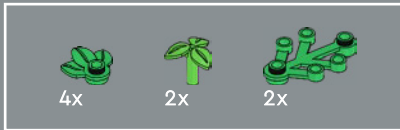
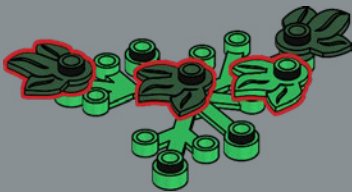

242

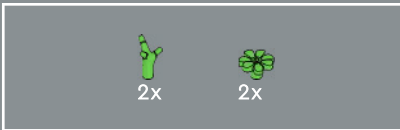
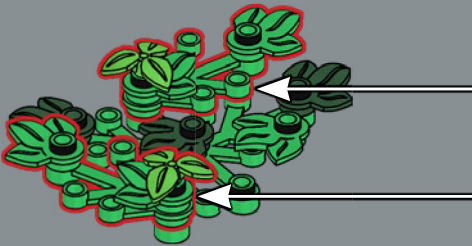
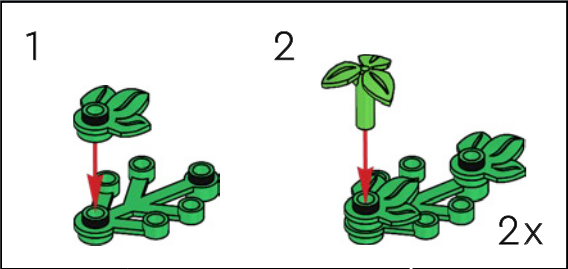

243

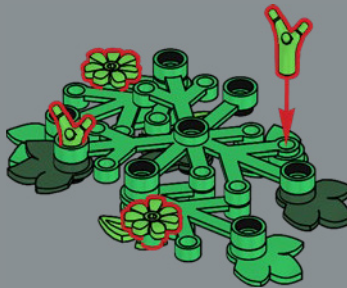



244

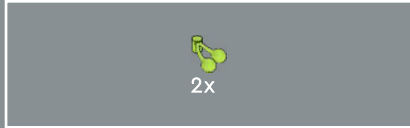

245

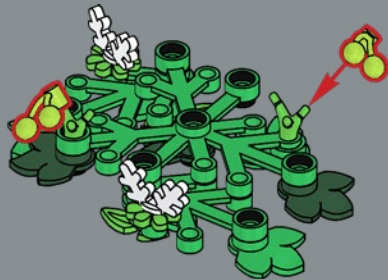

246

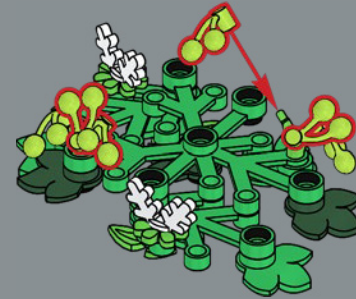

247

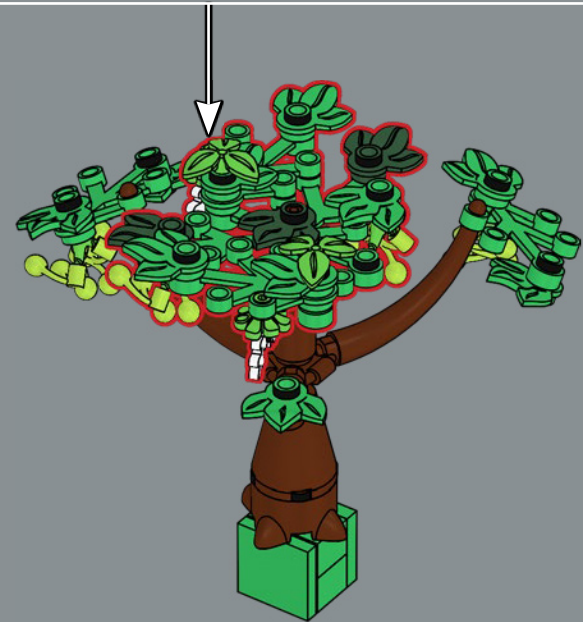



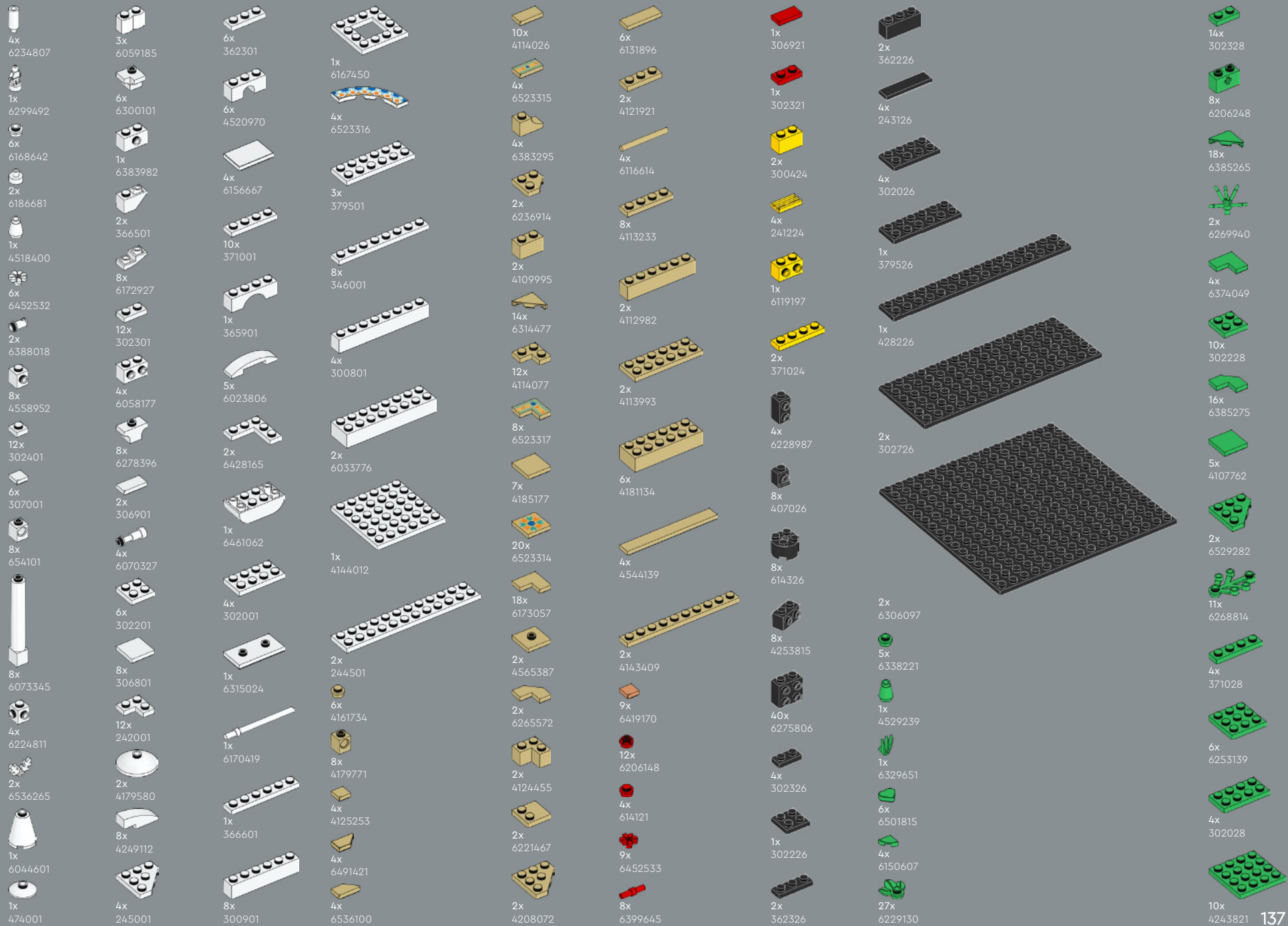



2x
6266968

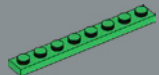

2x
346028

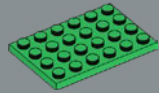

6x
4116671

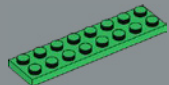

2x
303428



7x
6434871



2x
6488792



4x
6430093



8x
6235080



1x
6161772

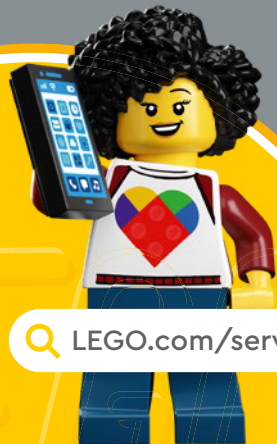

[LEGO.com/service](https://www.lego.com/service)

47x
6143431

28x
6439726

6x
6186012

2x
4570877

20x
6228839

2x
6074892

11x
6253418

6x
6353237

1x
6326099

1x
6245307

3x
6514007

7x
6514224

8x
6510178

5x
6550815

1x
6240515

12x
6087084

1x
6523318

2x
6055172

2x
6480380

24x
6315608

64x
6532422

2x
6411591

12x
6532421

12x
4504375

4x
4521915

2x
6532423

16x
6532420

9x
6400754

2x
4245571

2x
4245571

2x
4245571

2x
4245571

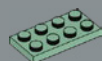

2x
6249817

2x
6209681

6x
6186673

2x
6284586

4x
4211183

4x
6215659

2x
6173143

1x
6348057

1x
6451002

1x
6306775

1x
4211159

1x
6488490

8x
4211180

1x
6492629

1x
6173132

1x
6468829

1x
6468829

1x
6468829

1x
6468829

6x
4211210

8x
6425510

4x
4211200

1x
6116613

2x
4211201

3x
6170468

2x
6372430

2x
4211193

4x
6096701

1x
4529241

1x
6510189

7x
4521921

1x
6183782

8x
4211414

2x
4211387

2x
4211387

2x
4211387

2x
4211387

2x
4211387

2x
4211387

8x
4211413

2x
4211397

1x
6070564

2x
4211361

2x
4211396

6x
6015347

1x
4612621

2x
4211452

6x
4211425

2x
4211404

2x
4211407

2x
4211407

2x
4211407

2x
4211407

2x
4211407

2x
4211407

2x
4211407

2x
4211407

2x
4211407

6x
6519672

6x
6096990

1x
6465604

2x
6395635

1x
4504378

1x
4210848

2x
6388118

2x
4211088

3x
4211094

8x
4624186

4x
4210897

2x
4509911

2x
4509911

2x
4509911

2x
4509911

2x
4509911

2x
4509911

2x
4509911

2x
4509911

2x
4509911

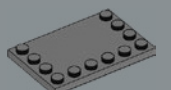

2x
6199511



2x
6187438

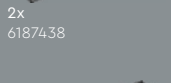

6x
4210997



8x
6272145

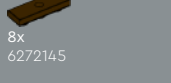

2x
6313601

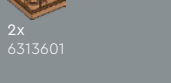

4x
6365746

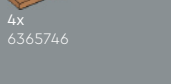

8x
6187006

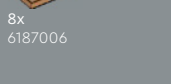

24x
6102998

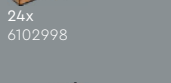

22x
6218359

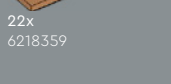

1x
6472547

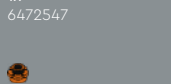

3x
6475523





YOU COULD WIN



YOU COULD WIN

Your feedback will help shape the future development of this product series.

Visit:

DU KÖNNTEST GEWINNEN

Dein Feedback trägt zur Weiterentwicklung dieser Produktreihe bei.

Geh auf:

VOUS POURRIEZ GAGNER

Vos commentaires nous aideront à concevoir les futurs produits de cette gamme.

Visitez :

POTRESTI VINCERE TU

La tua opinione ci aiuterà a migliorare la creazione futura di questa linea di prodotti.

Visita:

PUEDES GANAR

Tu opinión contribuirá al futuro de esta serie de productos.

Visita:

轻松获奖

您的反馈将有助于我们在今后改进本产品系列。

请访问:

[LEGO.com/productfeedback](https://www.lego.com/productfeedback)

You also have the chance to win a LEGO® set.

Terms and conditions apply.*

Außerdem hast du die Chance, ein LEGO® Set zu gewinnen.

Es gelten die Teilnahmebedingungen.*

Vous pourriez également gagner un ensemble LEGO®.

Des conditions s'appliquent.*

Hai anche la possibilità di vincere un set LEGO®.

Termini e condizioni sono applicabili.*

También tienes la oportunidad de ganar un set LEGO®.

Aplican términos y condiciones.*

您还有机会赢取乐高®套装。

条款和条件适用。*

*[LEGO.com/productfeedback-terms](https://www.lego.com/productfeedback-terms)

