



10359





LEGO.com/sustainable-packaging



FR
DONNEZ
OU
RECYCLEZ



OU



OU



ASSOCIATION MAGASIN DÉCHÈTERIE

Adresses sur quefairedemesdechets.fr



BUILDER



Apple and the Apple logo are trademarks of Apple Inc., registered in the U.S. and other countries and regions. App Store is a service mark of Apple Inc. Google Play and the Google Play logo are trademarks of Google LLC. Tencent and the Tencent logo are trademarks of Tencent Inc.

LEGO.com/devicecheck



LEGO® Builder

Baue ein Stück Gelassenheit und Ruhe

Lass dich in einen Garten der Stille und Gelassenheit entführen und verweile dort so lange, wie du möchtest. Vielleicht inspiriert dich dieser Ort dazu, kreative Wurzeln zu schlagen oder deine eigene kleine Nische der Achtsamkeit und Selbstreflexion einzurichten. Das ist deine Kreativ-Zone. Hoffentlich fühlst dich unter all den sprießenden Pflanzen und wilden Tieren am Springbrunnen sofort wie zu Hause.

Vielleicht kennst du ja einige dieser Arten aus deinem eigenen Garten oder von einer Reise ins Land deiner Träume.

Jedes Element ist der Region, Kultur und Architektur, der es ursprünglich entstammt, möglichst authentisch nachempfunden. Die unglaublich dekorativen Steinchen sind den Girih-Kacheln (*Zellij*) nachempfunden, die im Laufe der Geschichte großen Einfluss auf die Bautraditionen in Nordafrika und Südeuropa hatten. Diese Elemente verleihen Gebäuden, den Böden und Wänden in Häusern sowie

Gärten eine lebendige Atmosphäre. Außerdem haben wir die LEGO® Falter- und Schmetterlingssammlung um den faszinierenden grünen Isabellaspinner ergänzt. Wenn du die Pflanzen nach Herzenslust umstellst, kannst du deinem Garten neues Leben einhauchen.

Du kannst sie natürlich auch abwechselnd Sonne tanken und dann im Schatten Abkühlung finden lassen. Natürlich kannst du auch größere Segmente anders anordnen, um dem Garten eine andere Form und einen neuen Ausdruck zu geben.



„Erwecke diesen idyllischen Springbrunnengarten zum Leben und hol dir das ganze Jahr über einen Hauch von Sommer in die eigenen vier Wände.“

– Das LEGO® Designteam

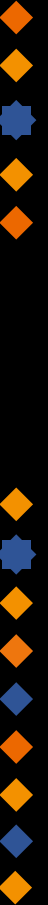





Dein Garten lebt





1

Pelophylax perezi

Iberischer Wasserfrosch

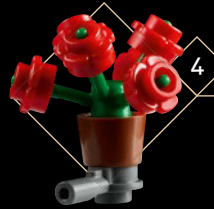

4

Pelargonium x hortorum

Rote Gartengeranie



2

Emberiza citrinella

Goldammer

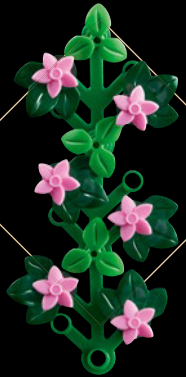

5

Bougainvillea

Rosafarbene Bougainvillea

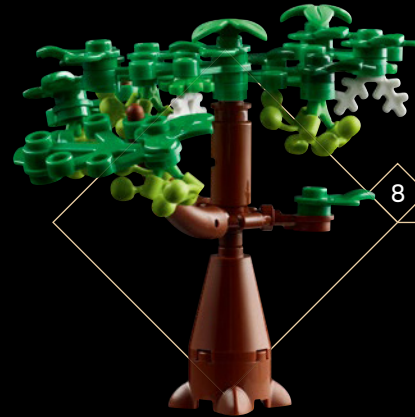

8

Vitis vinifera

Echte Weinrebe



3

Graellsia isabellae

Isabellaspinner



6

Tagetes patula

Studentenblume



9

Petunia axillaris

Weißer Petunie

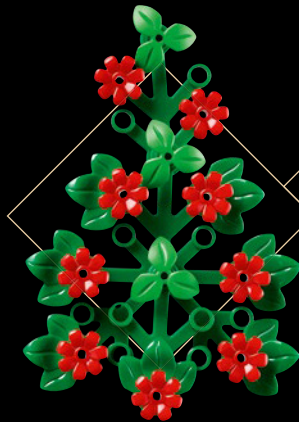

7

Hibiscus rosa-sinensis

Chinesischer Roseneibisch



10

Cupressus sempervirens

Zypresse

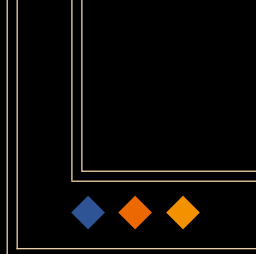

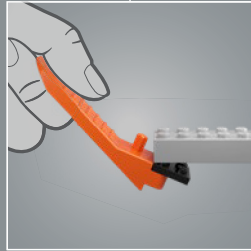
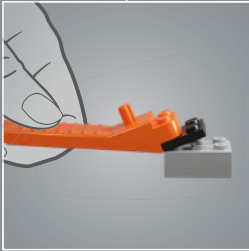
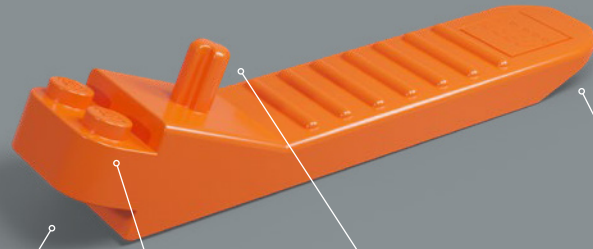

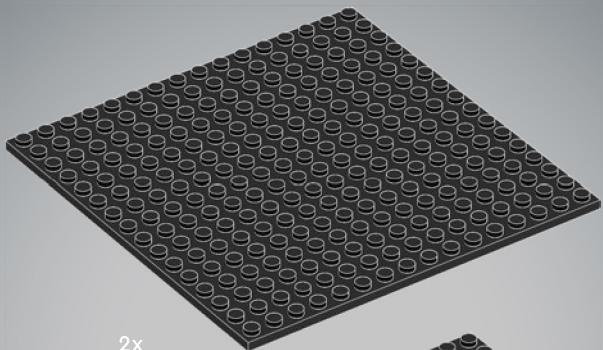

2x

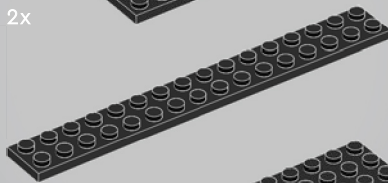

1x

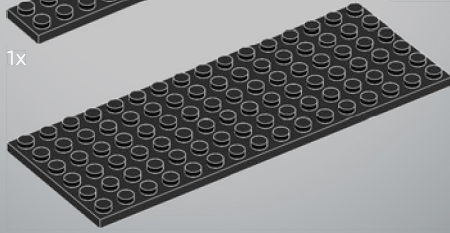

2x

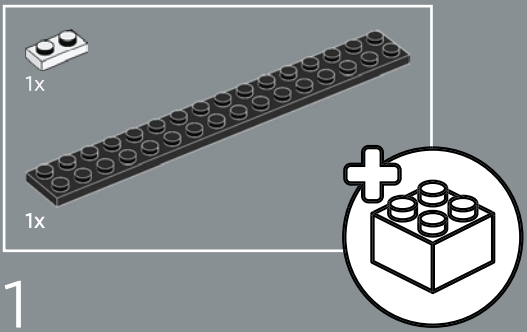

1

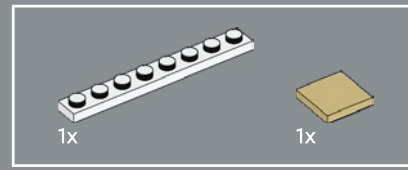
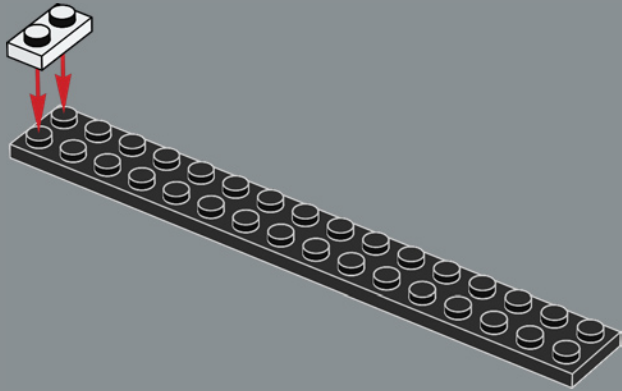

2

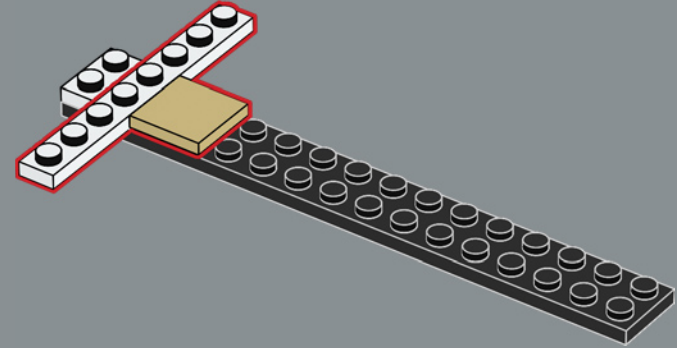

3

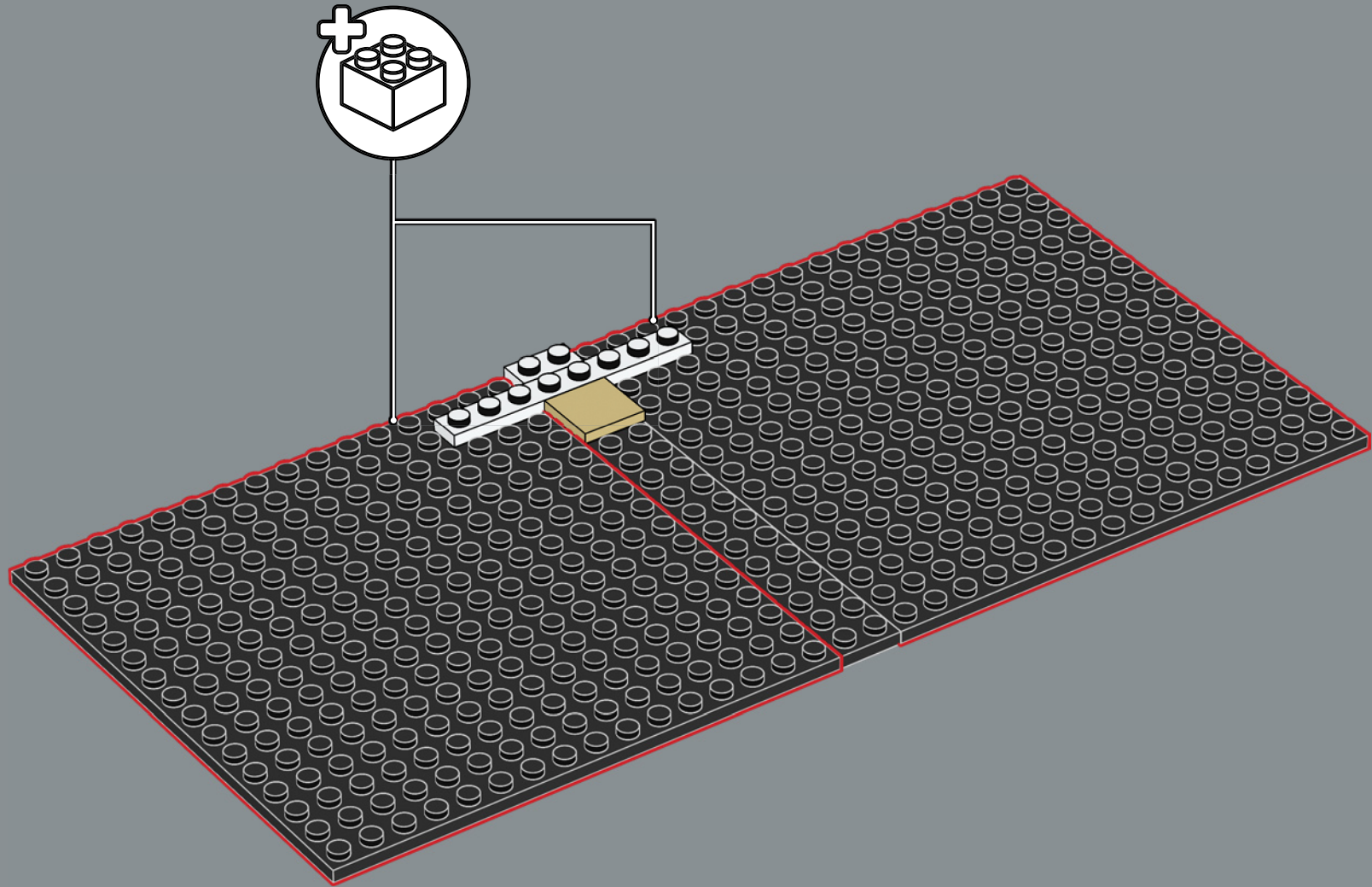

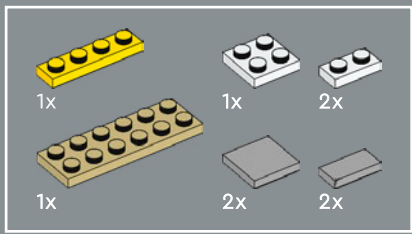

4

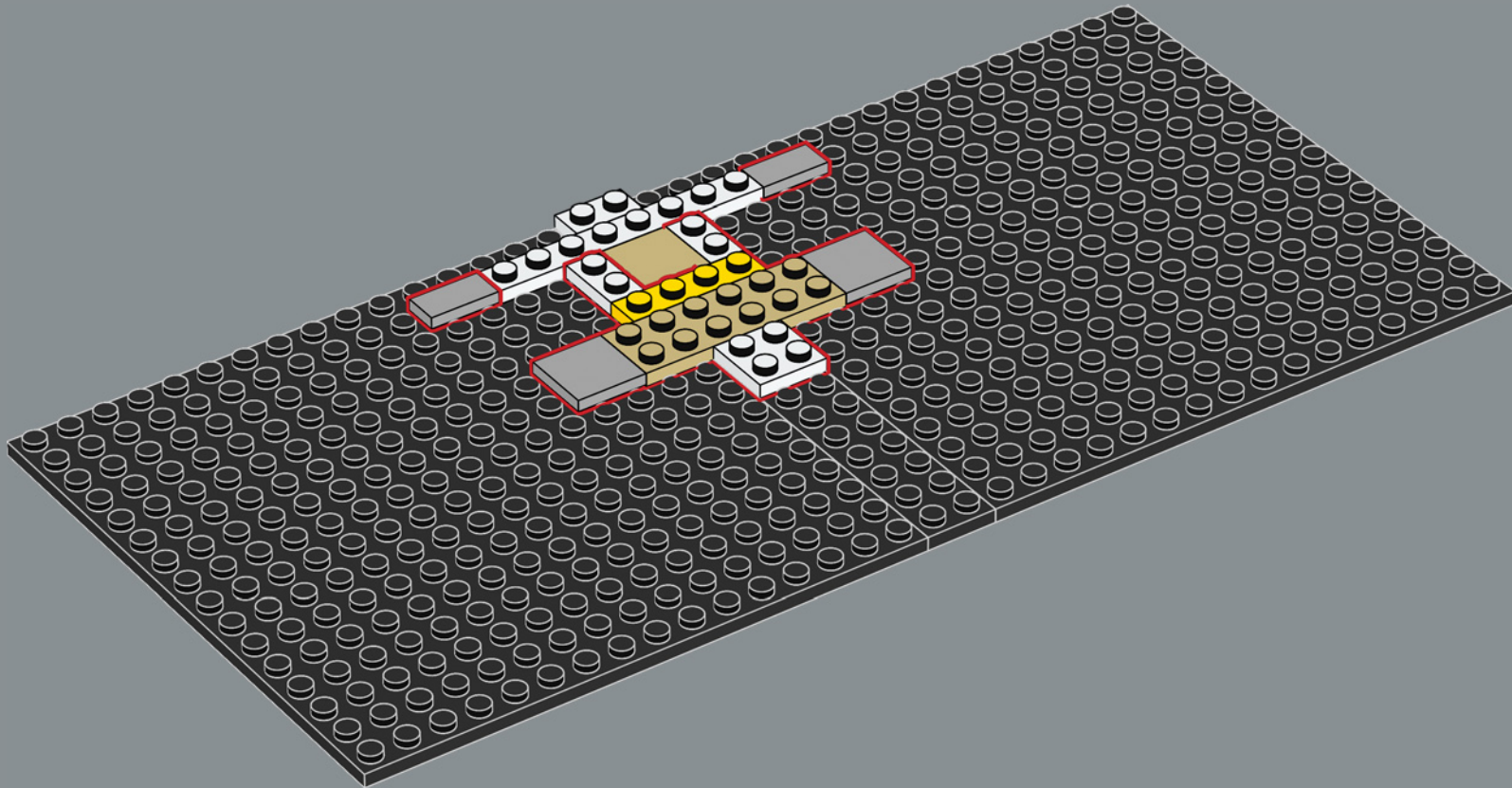

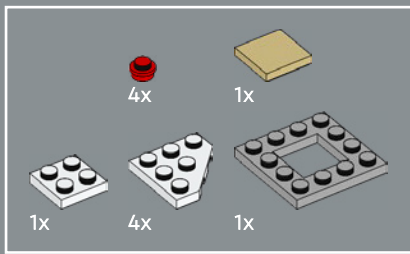

5

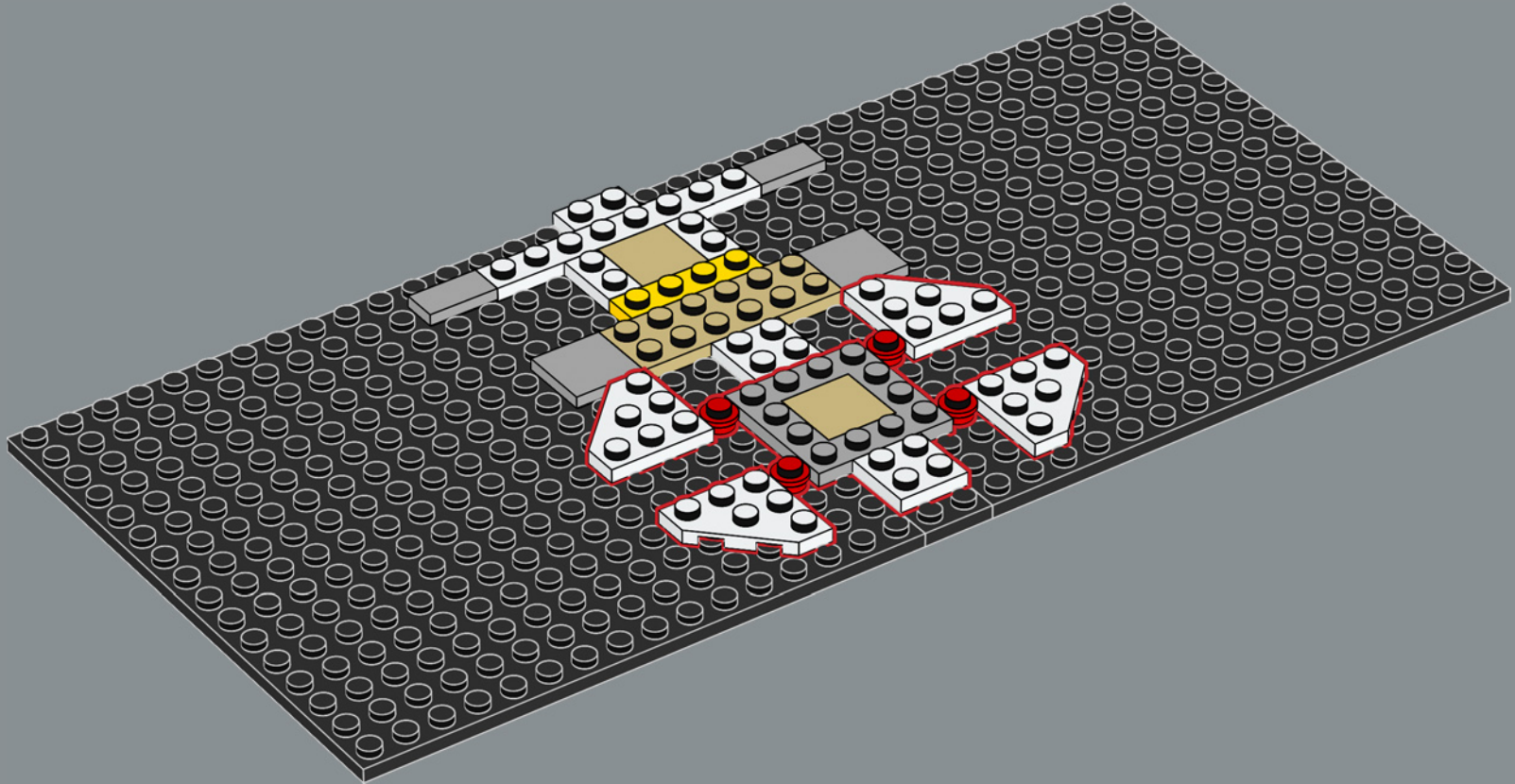

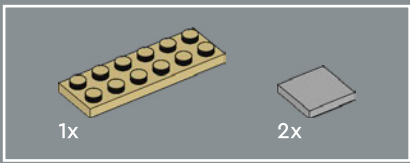

6

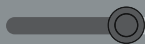
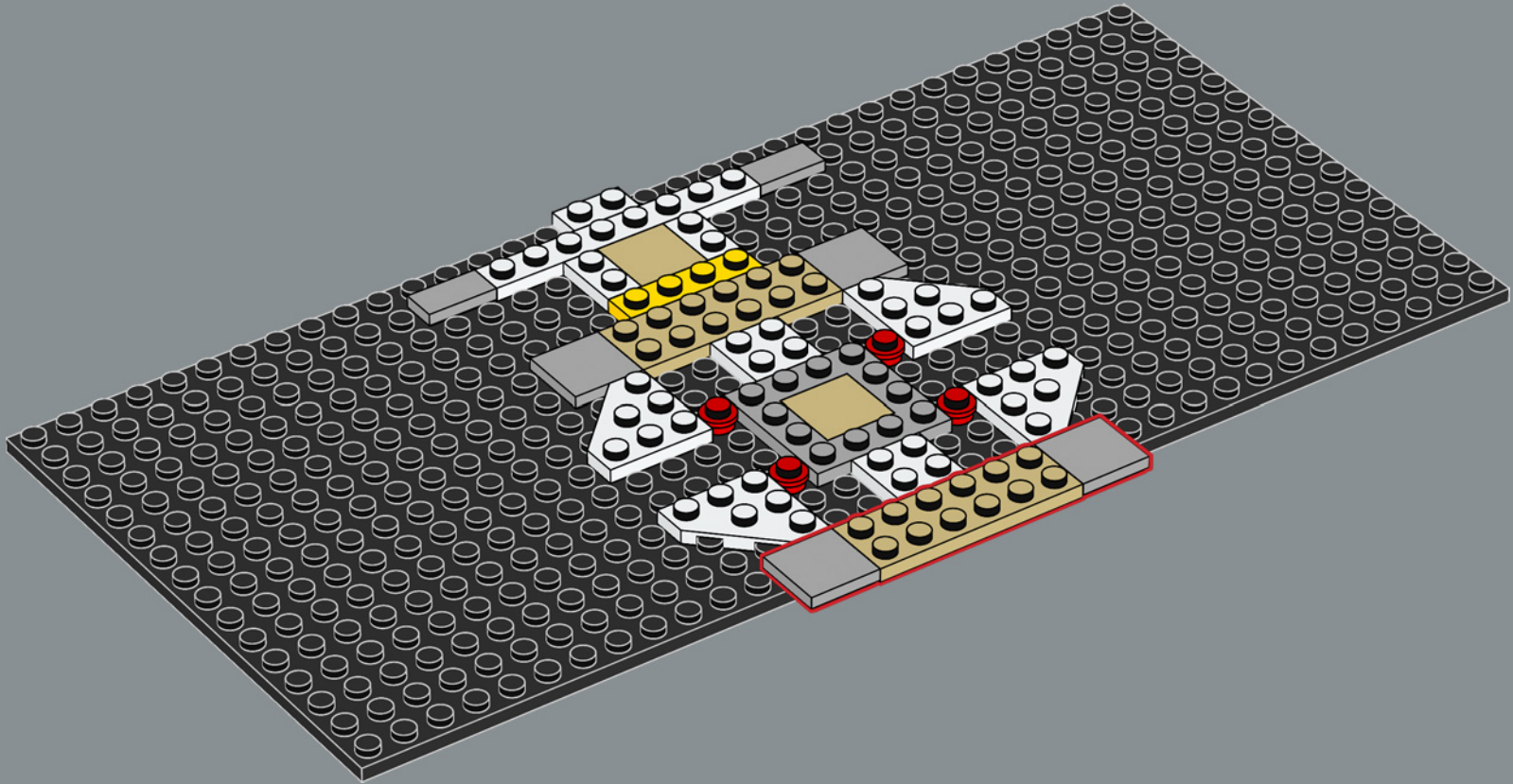

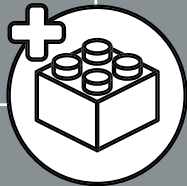
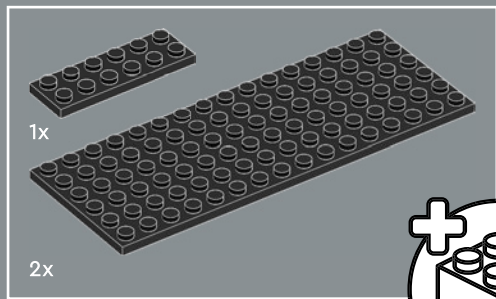

7

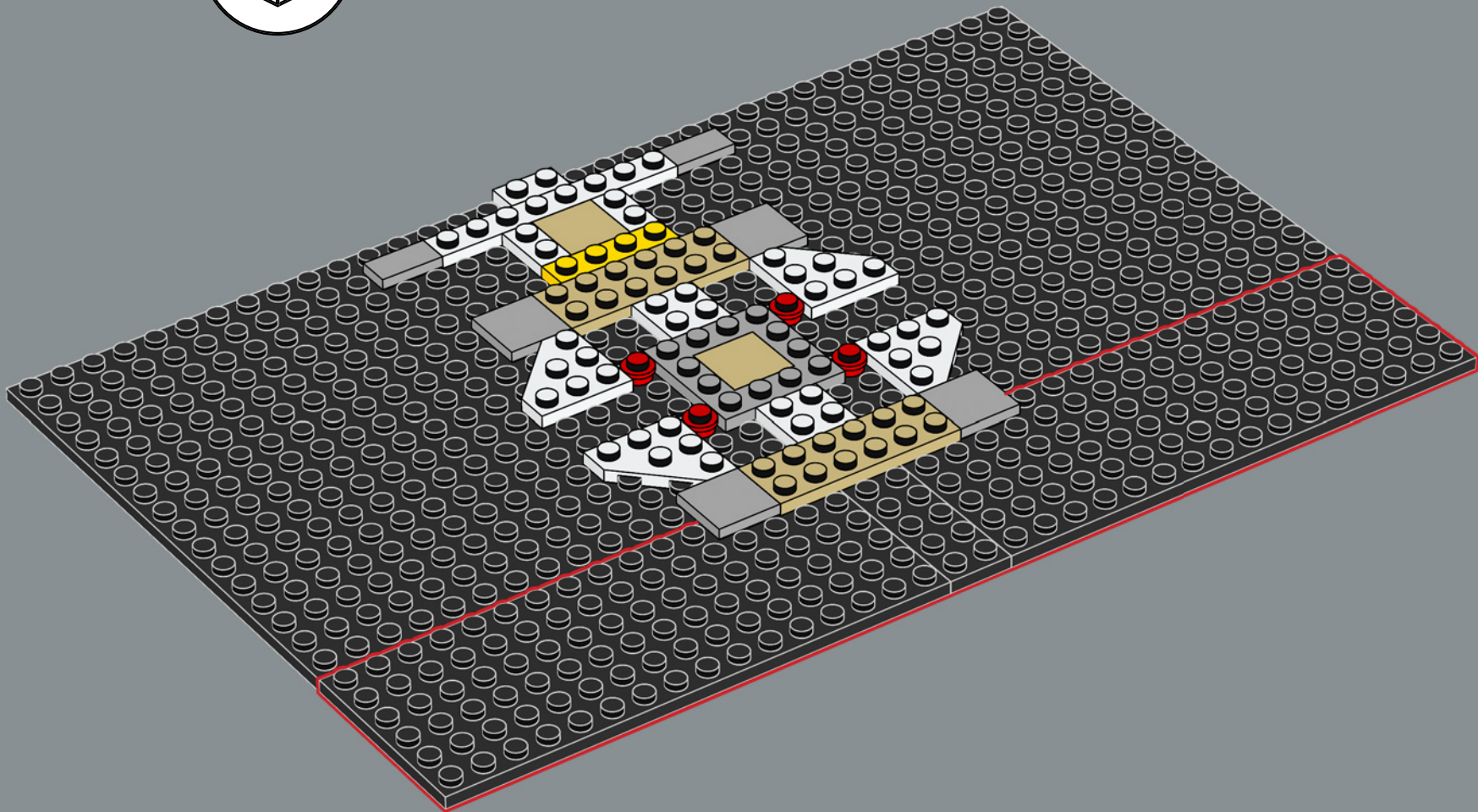

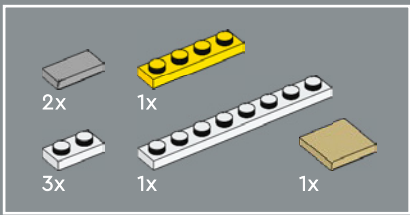

8

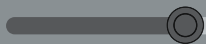
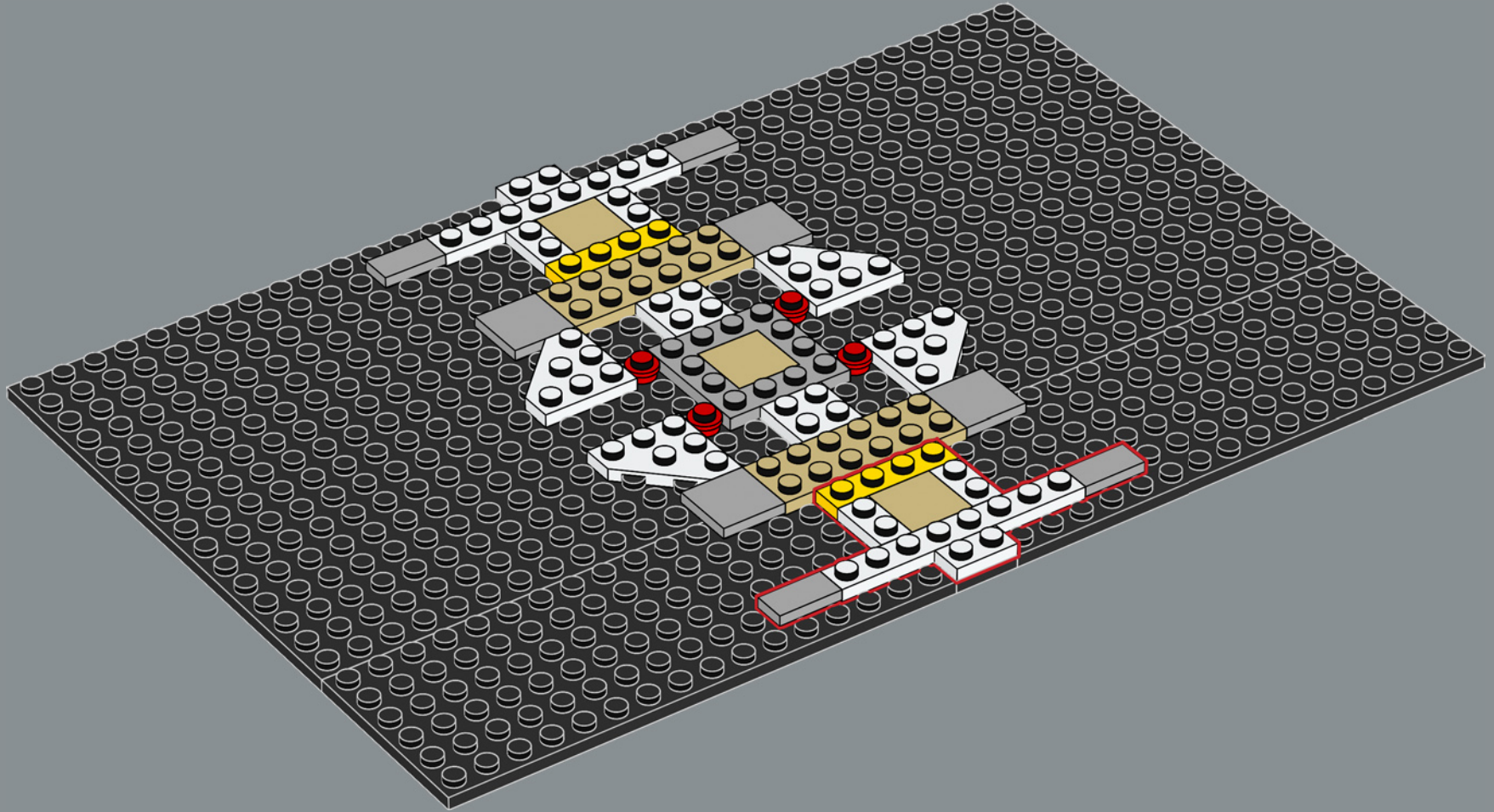

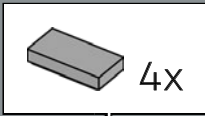
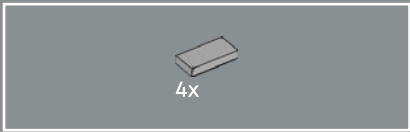

9

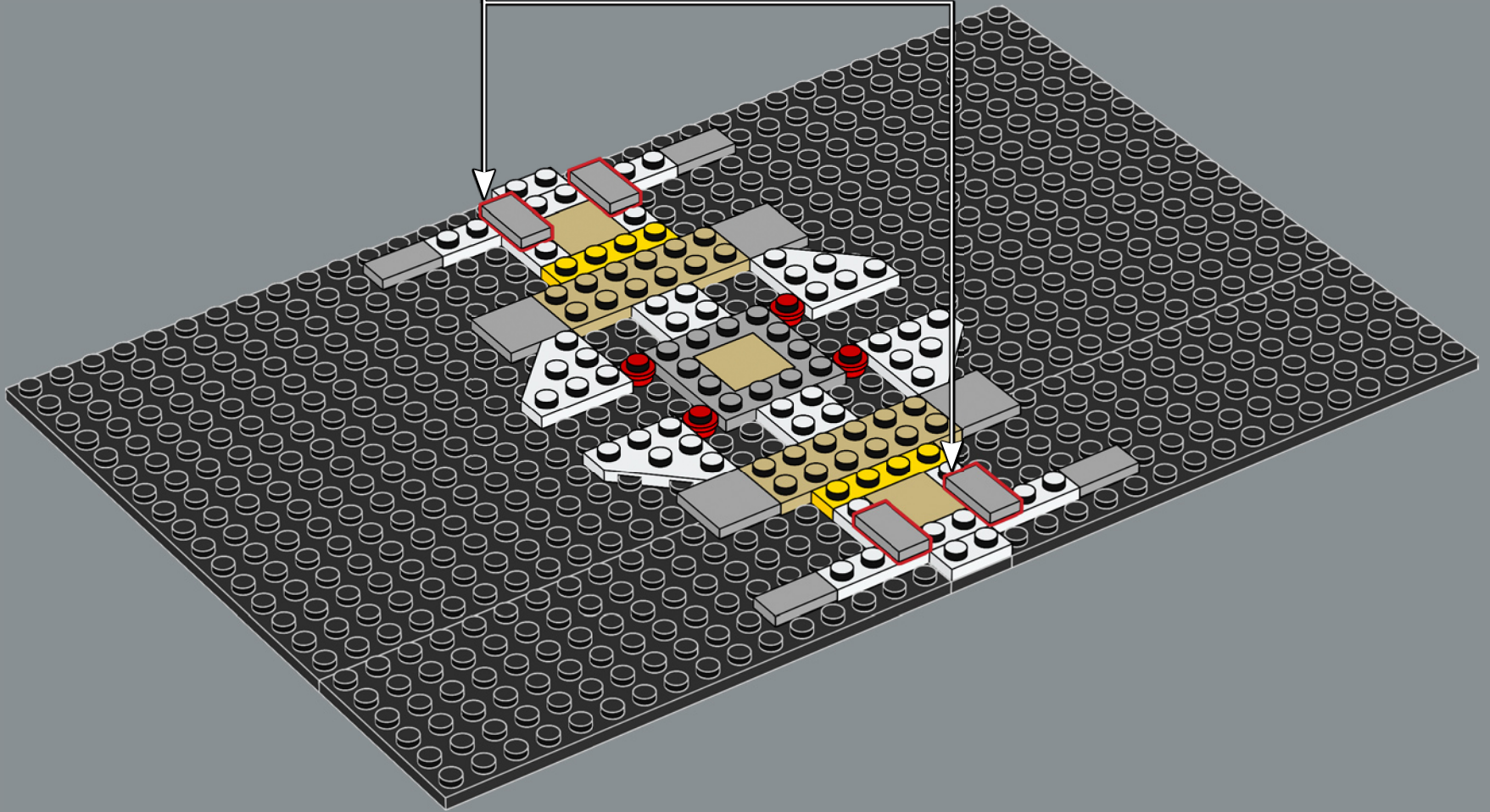

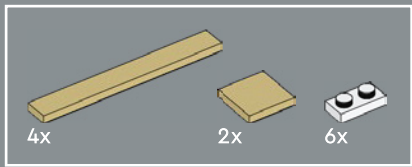

10

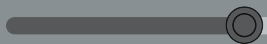
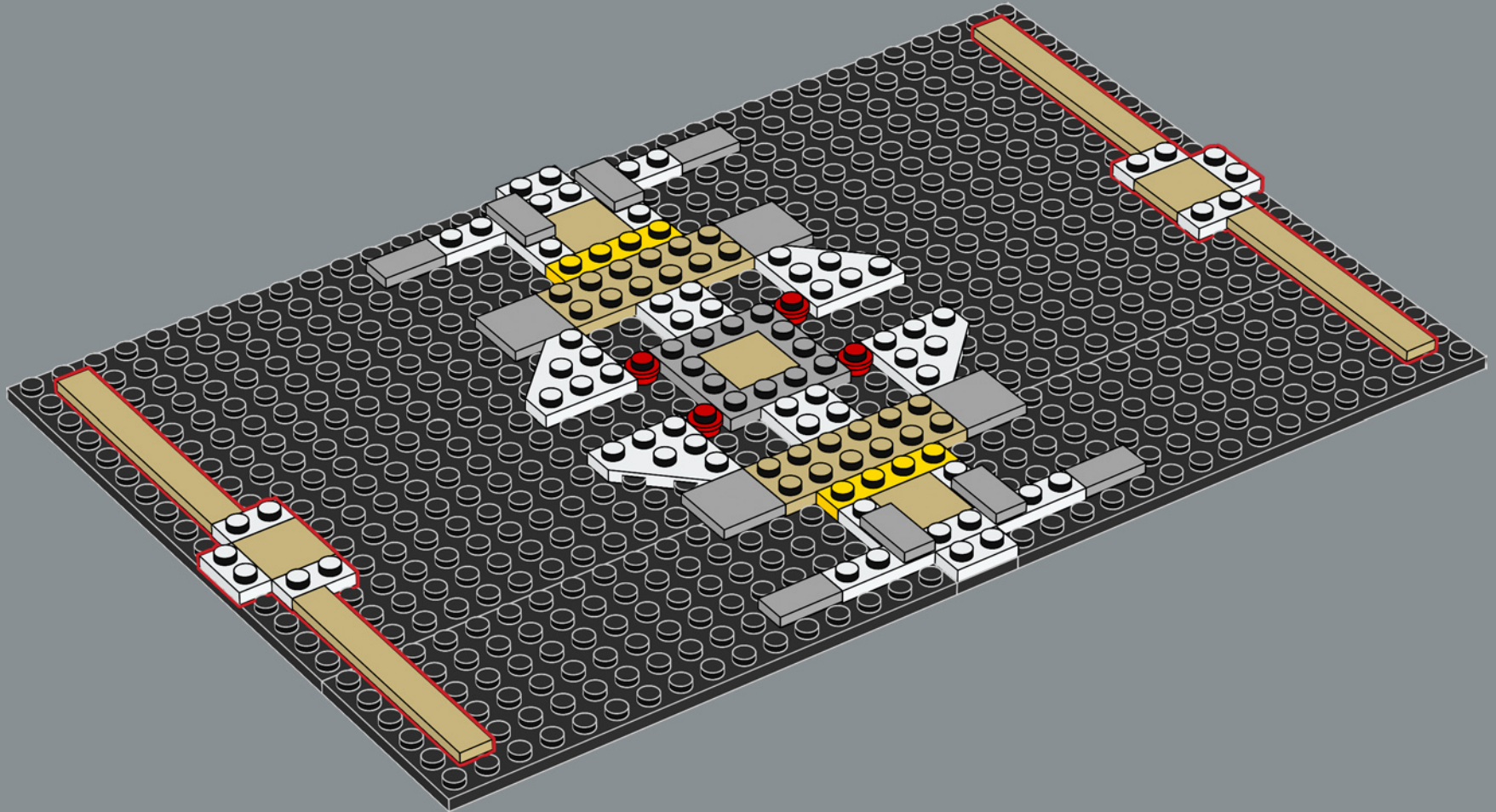

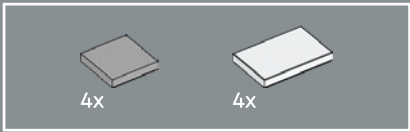

11

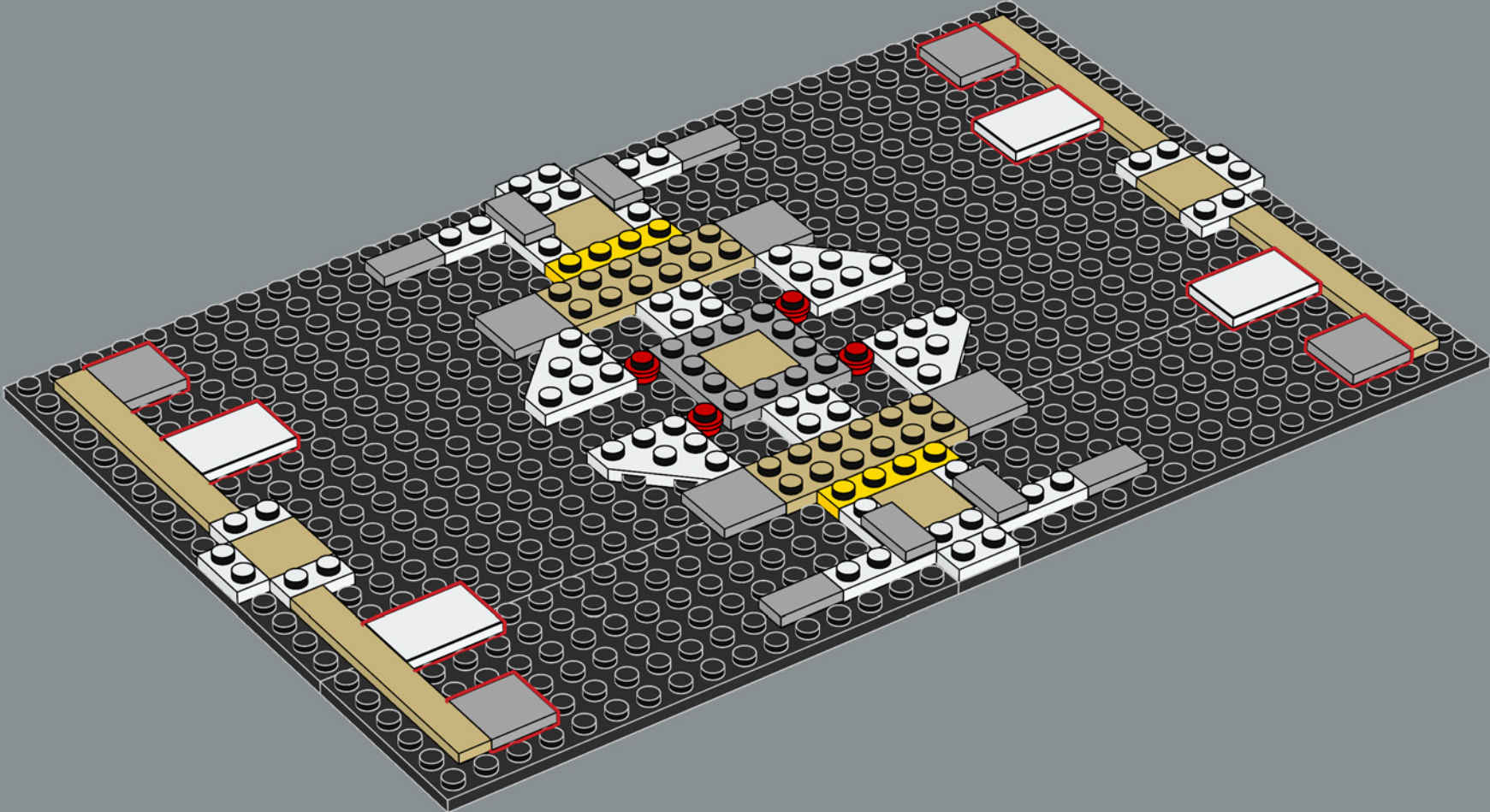

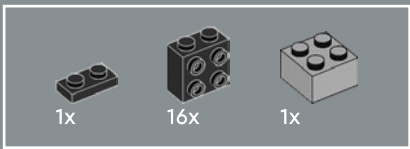

12

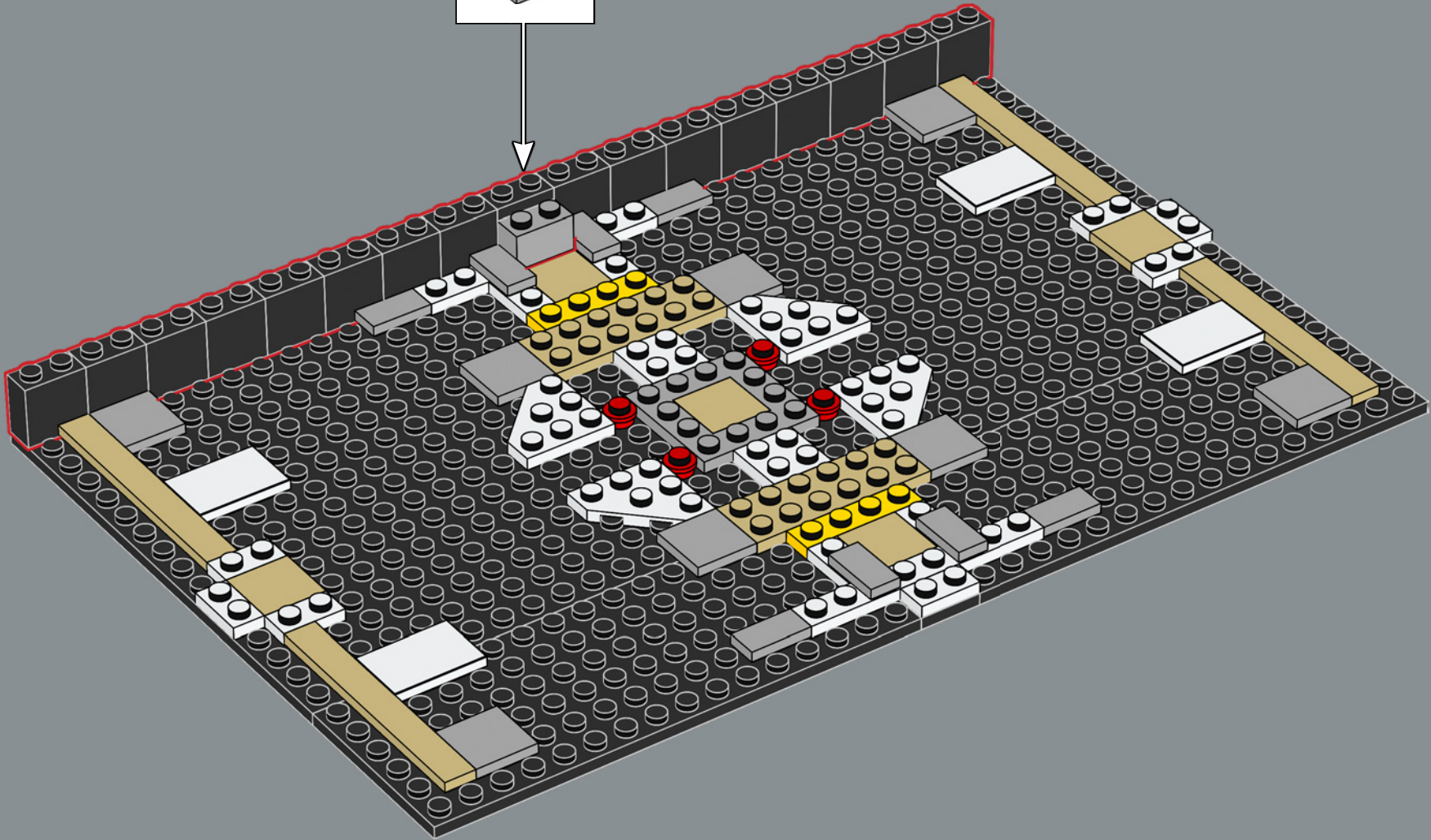
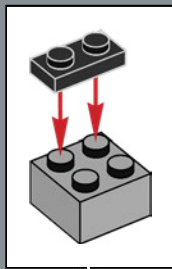

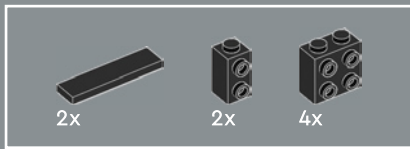

13

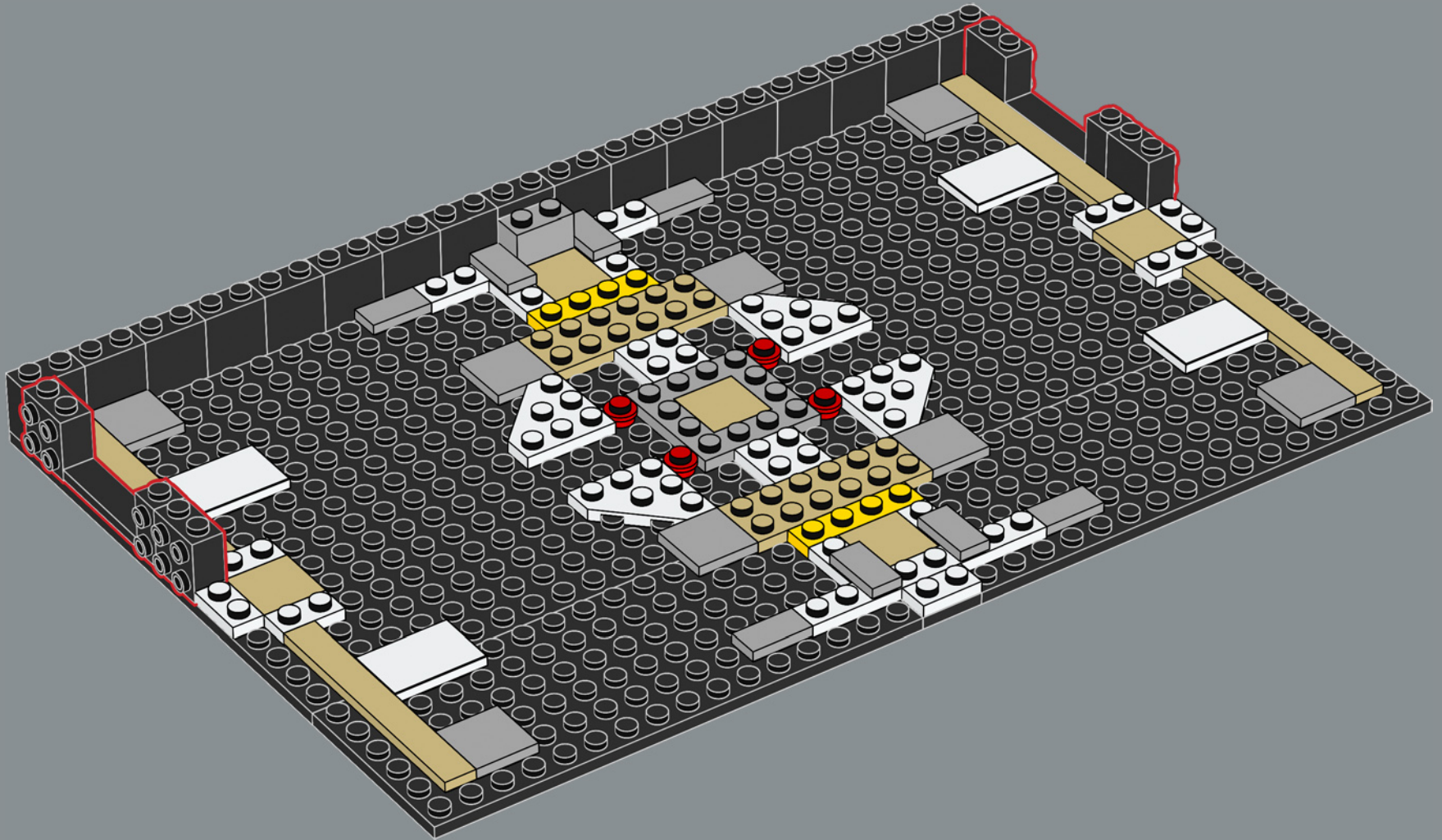

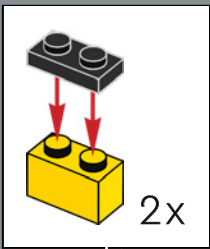
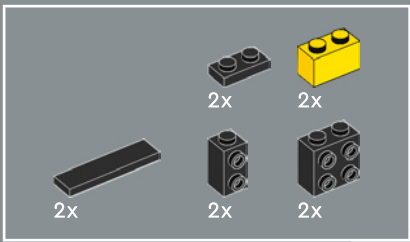

14

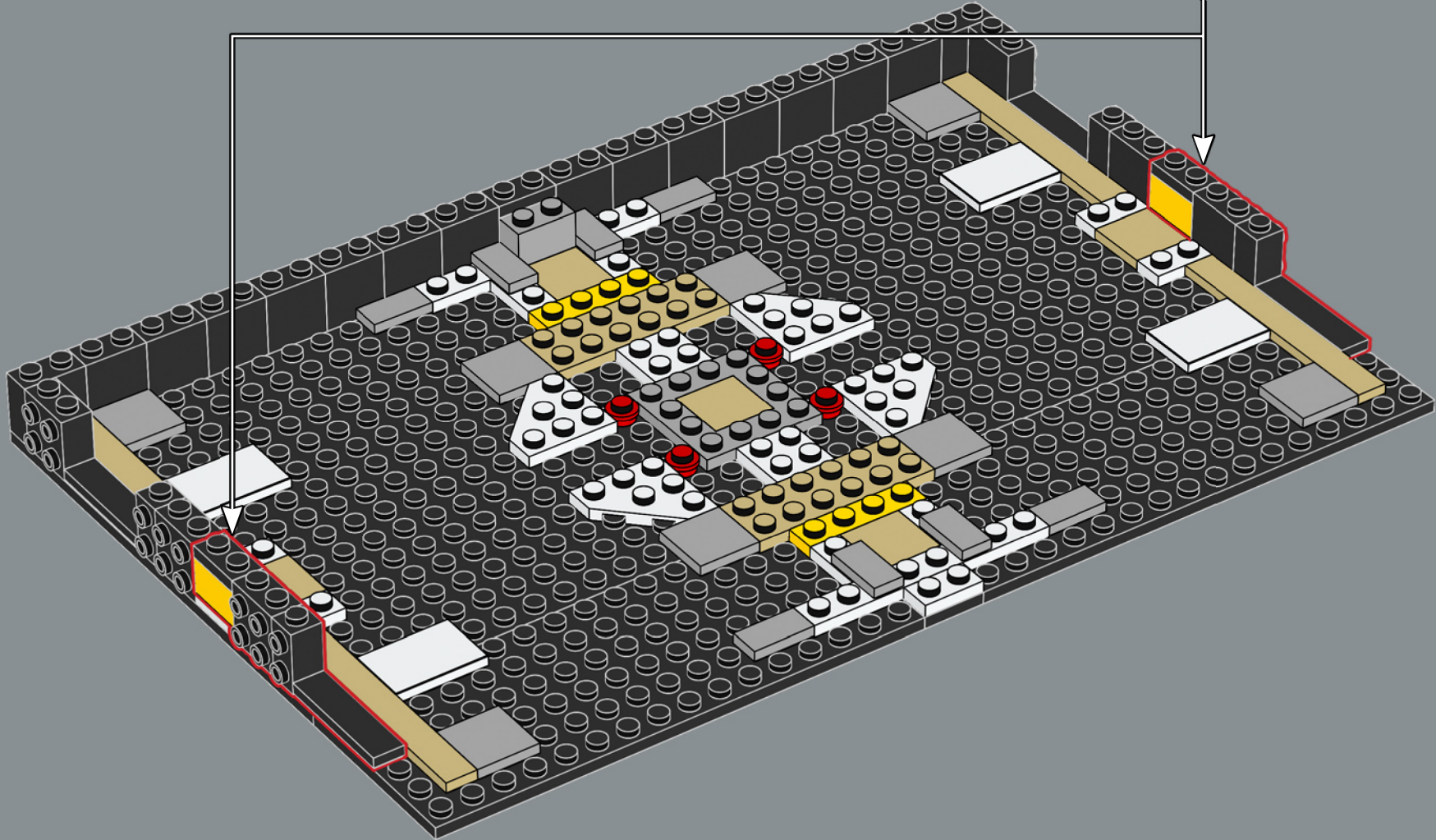

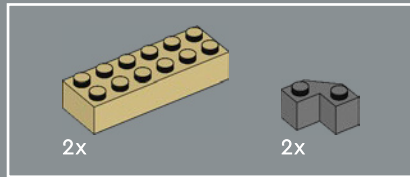

15

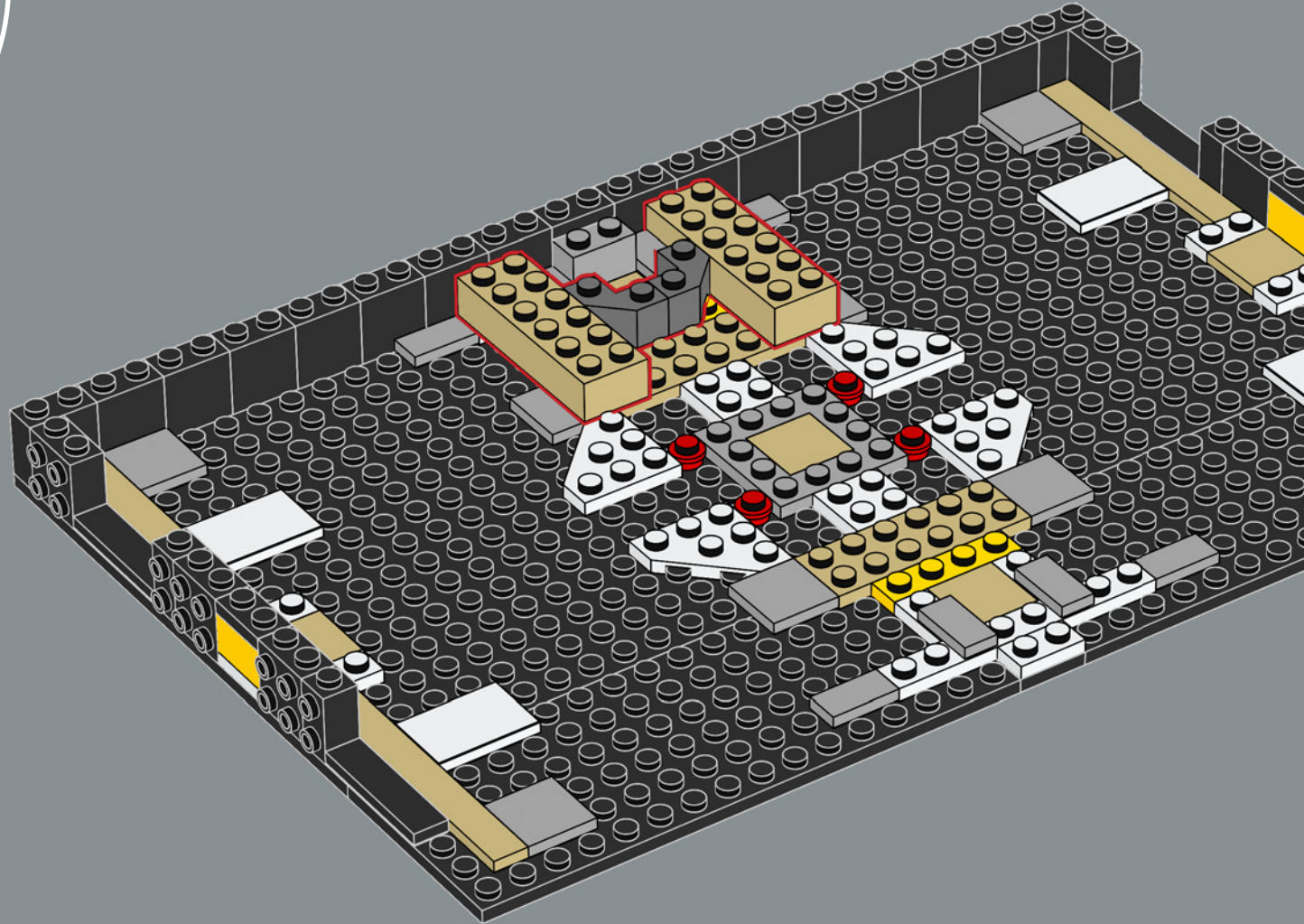

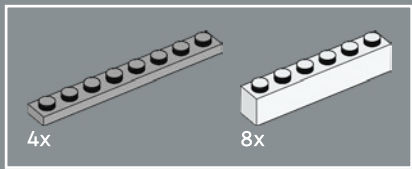

16

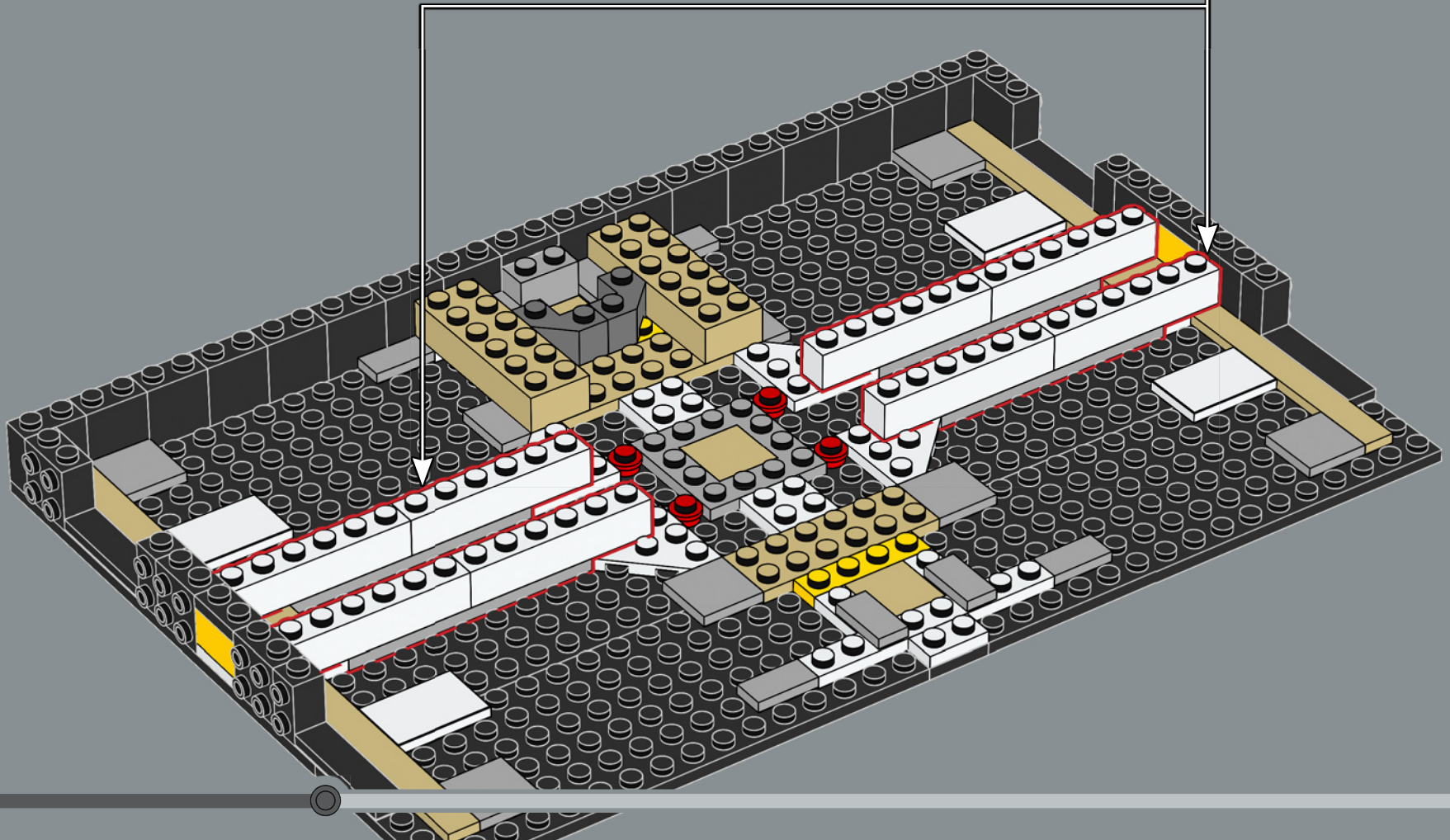
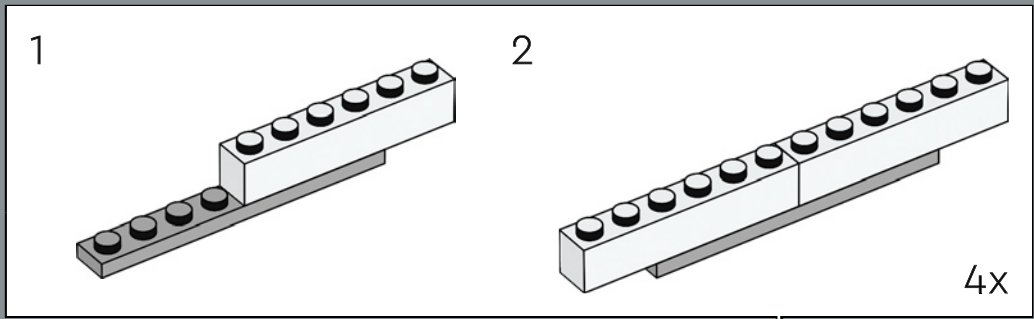

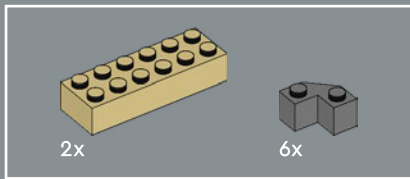

17

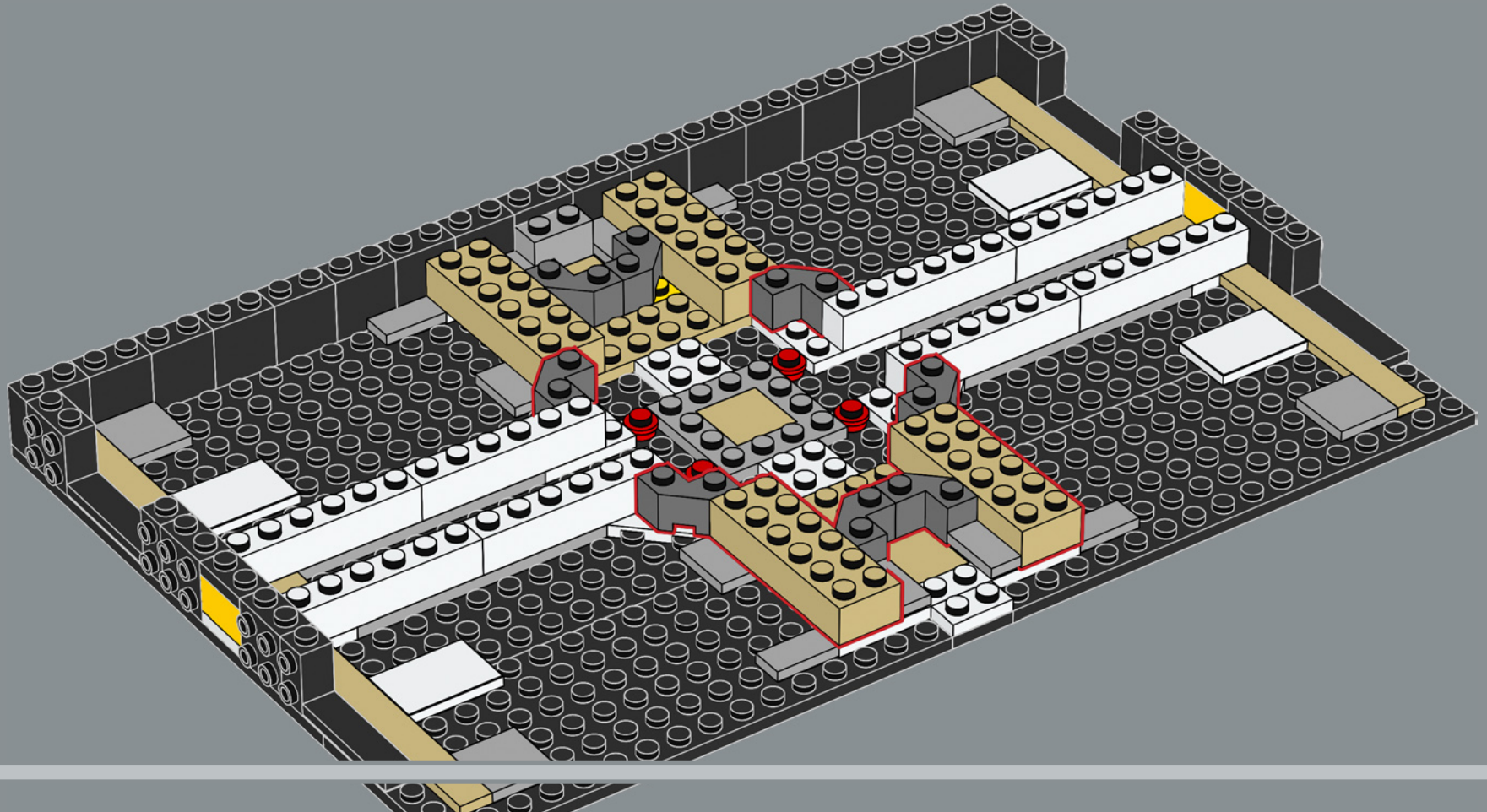

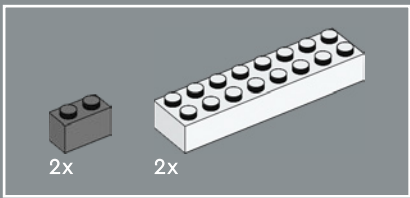

18

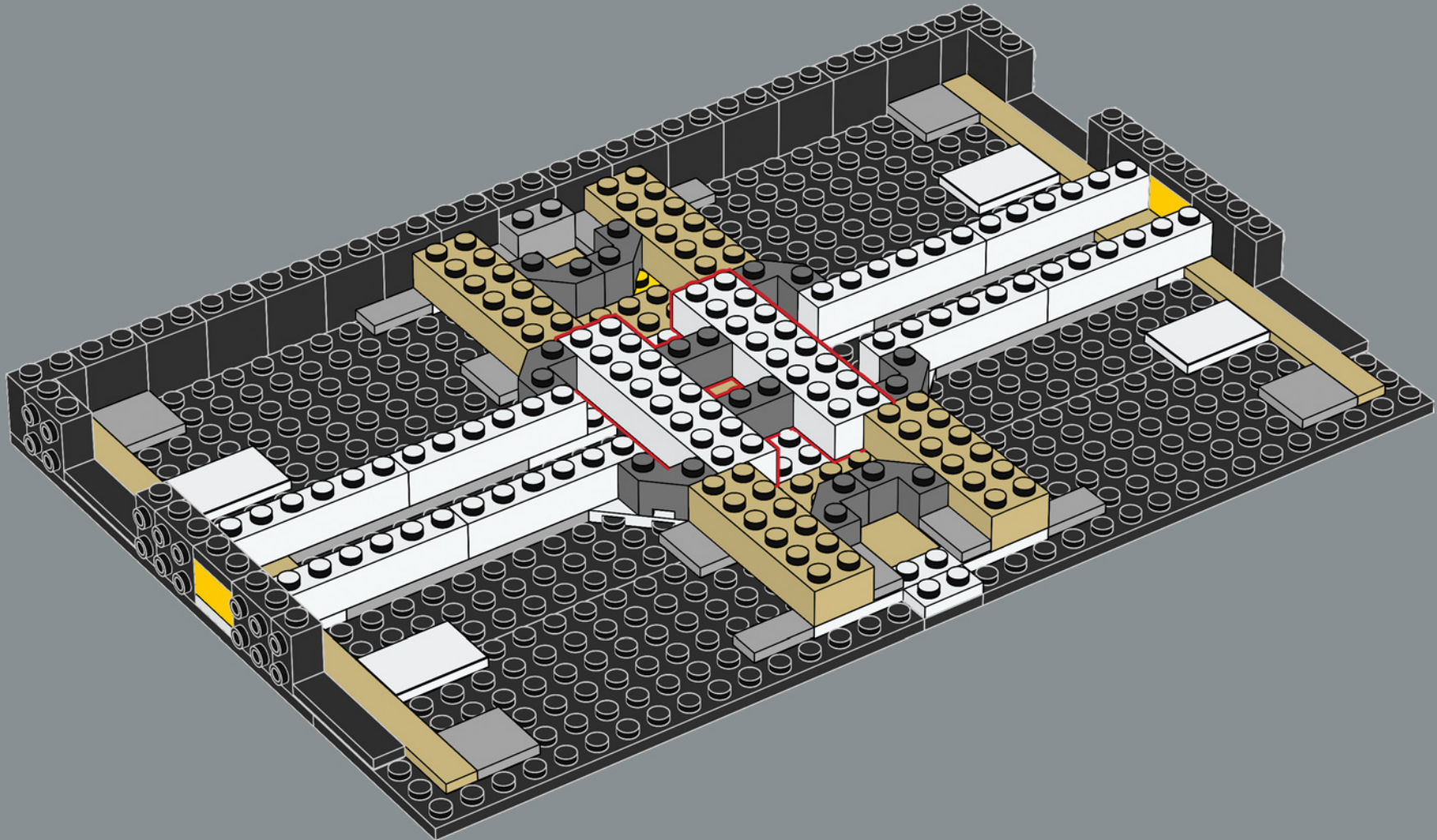

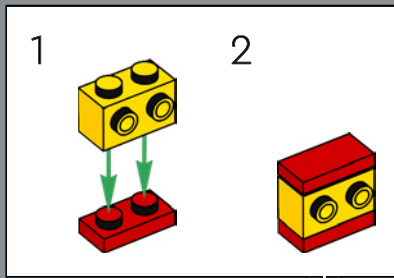
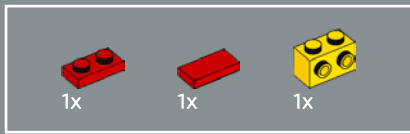

19

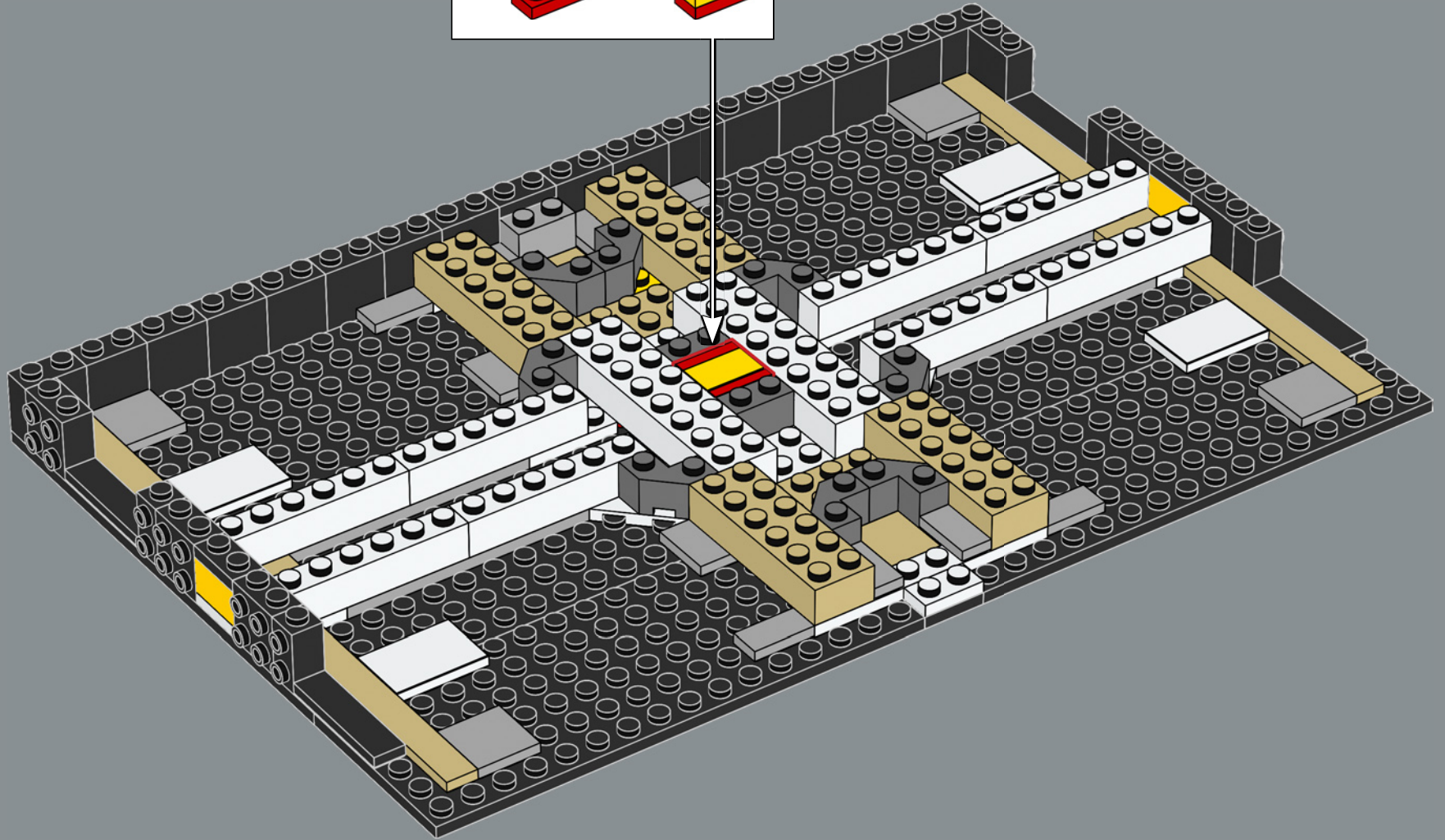

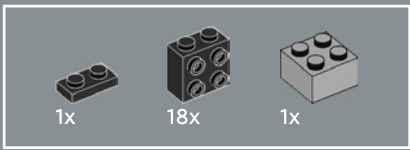

20

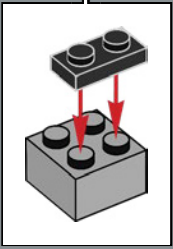
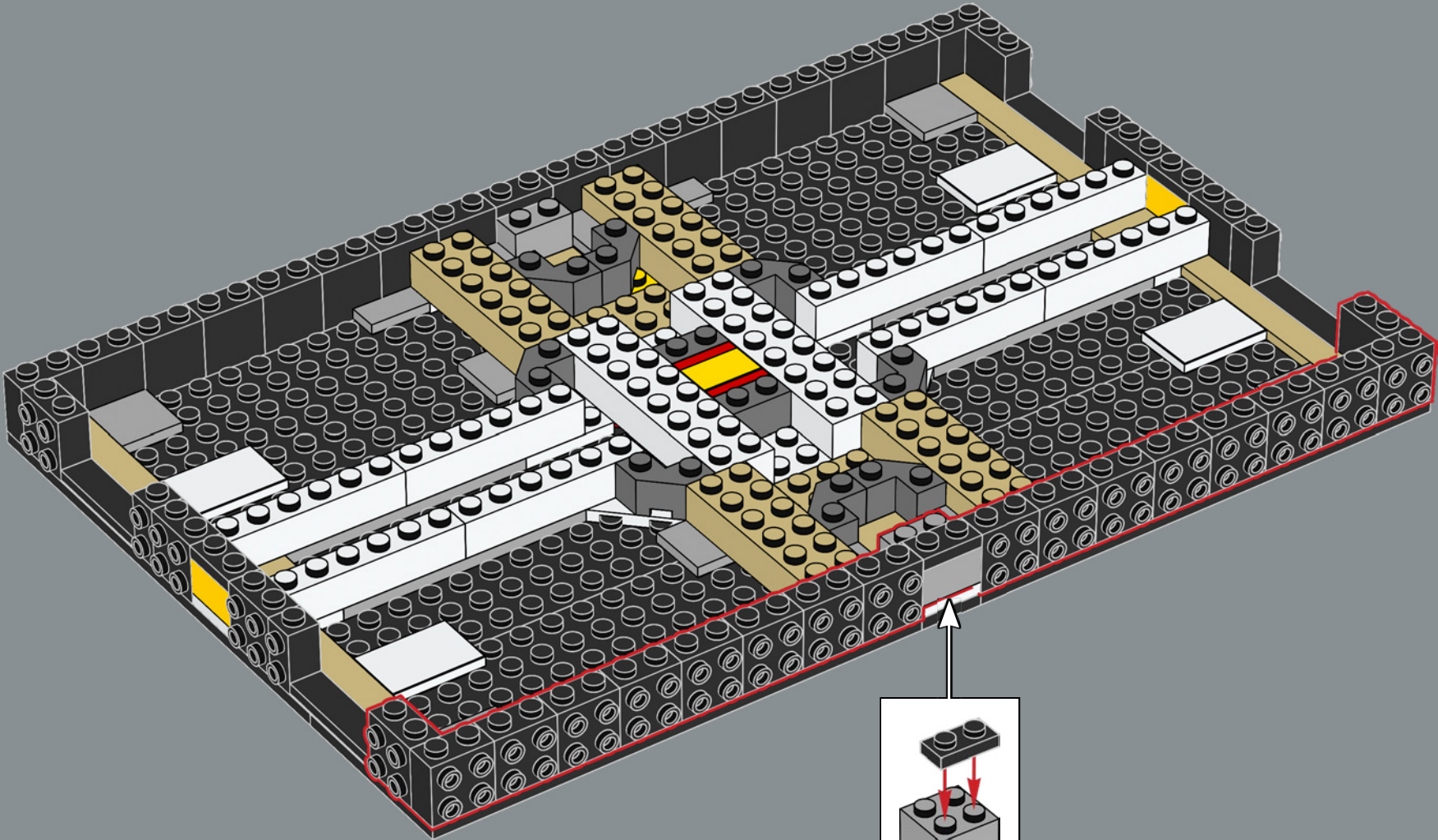

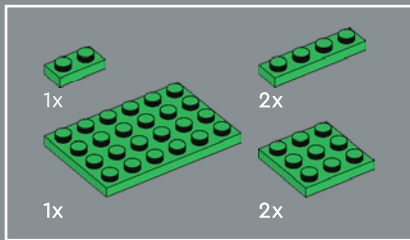

21

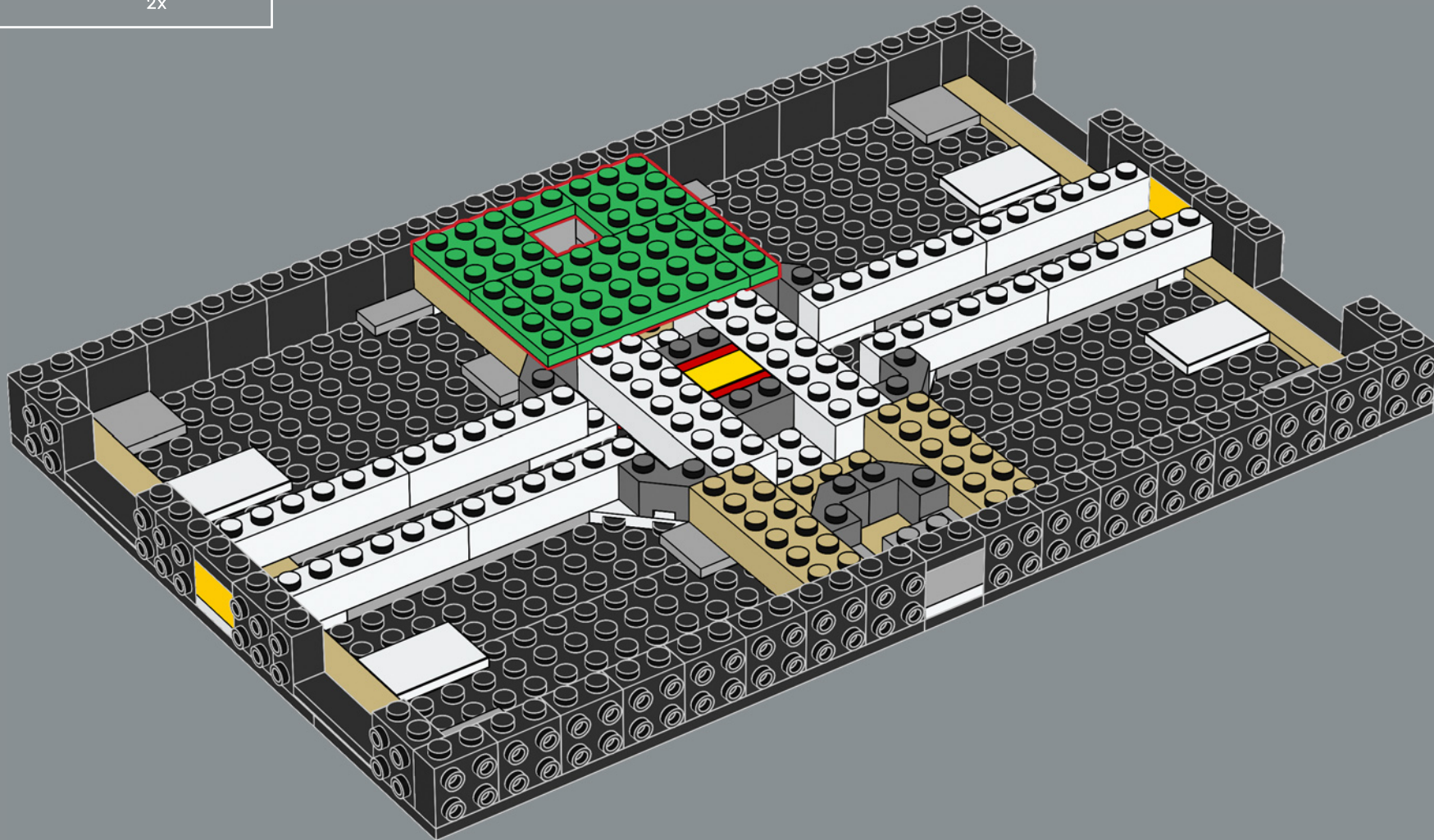

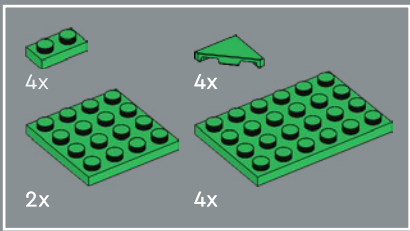

22

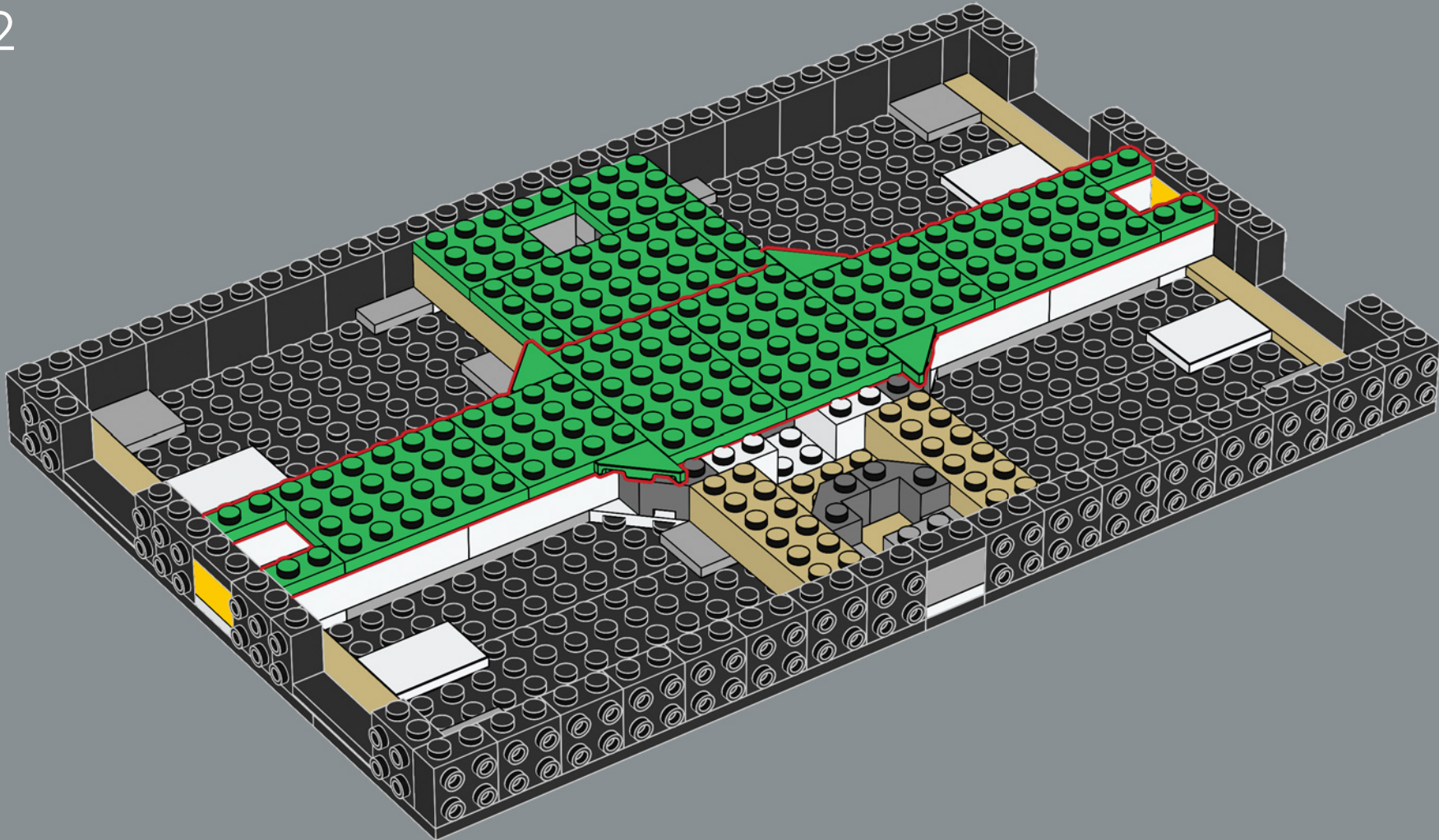

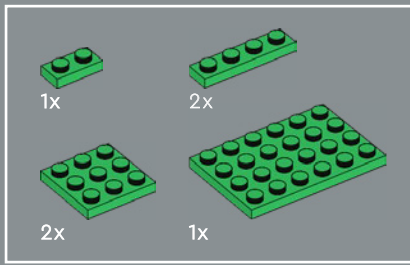

23

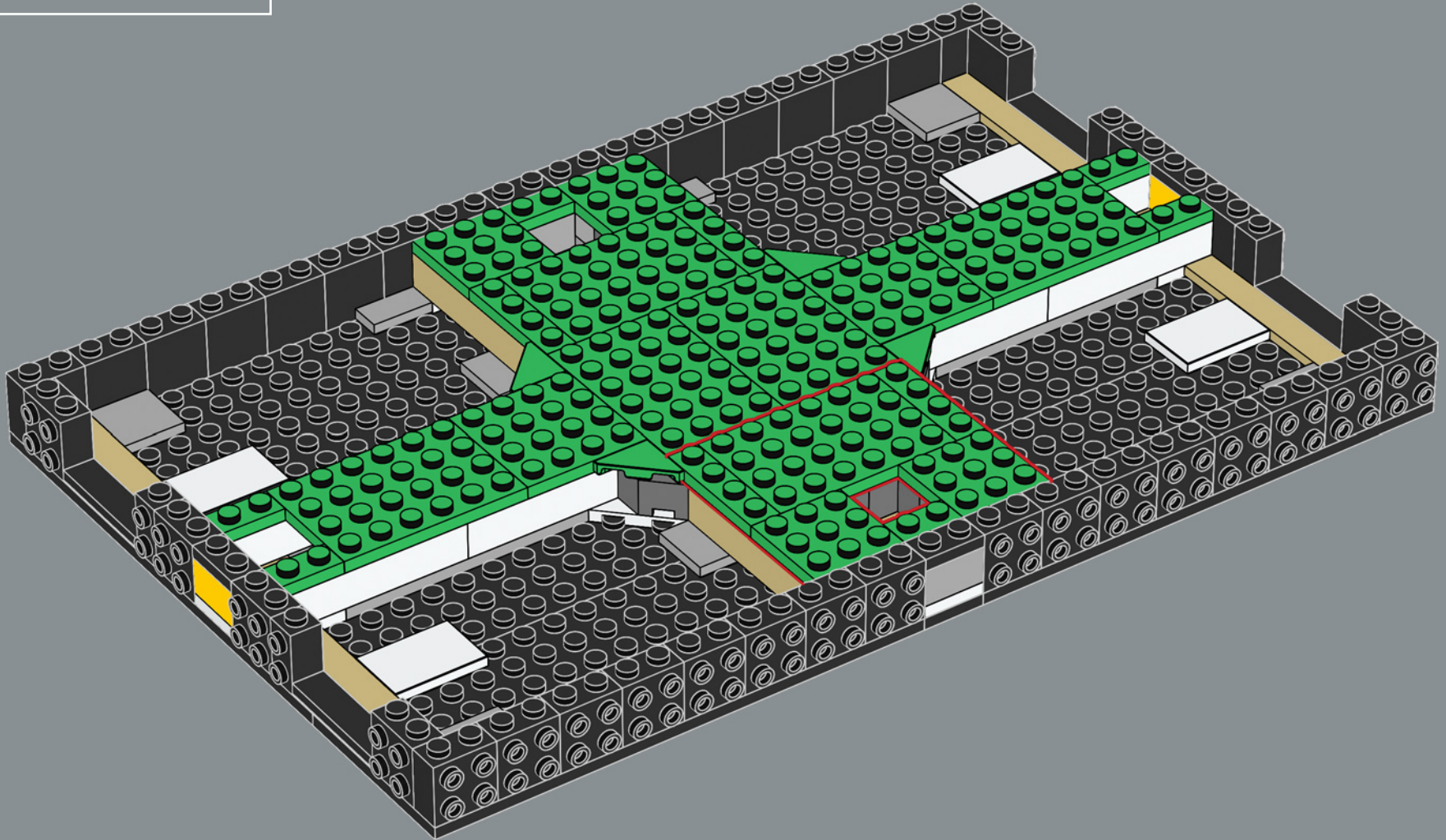



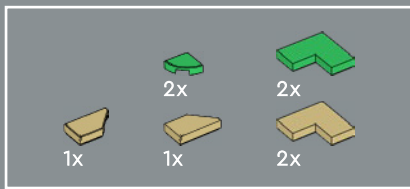

24

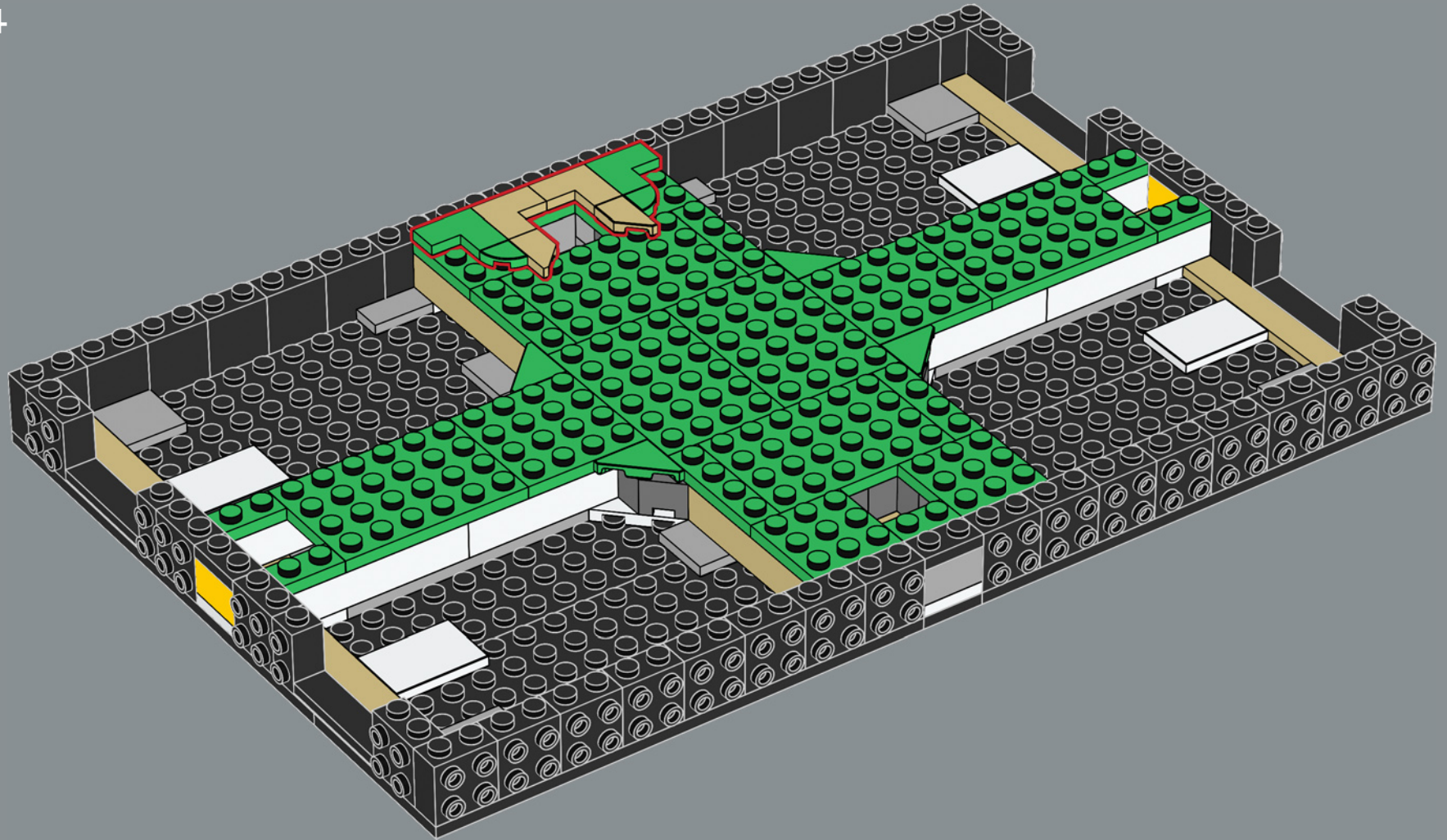



25

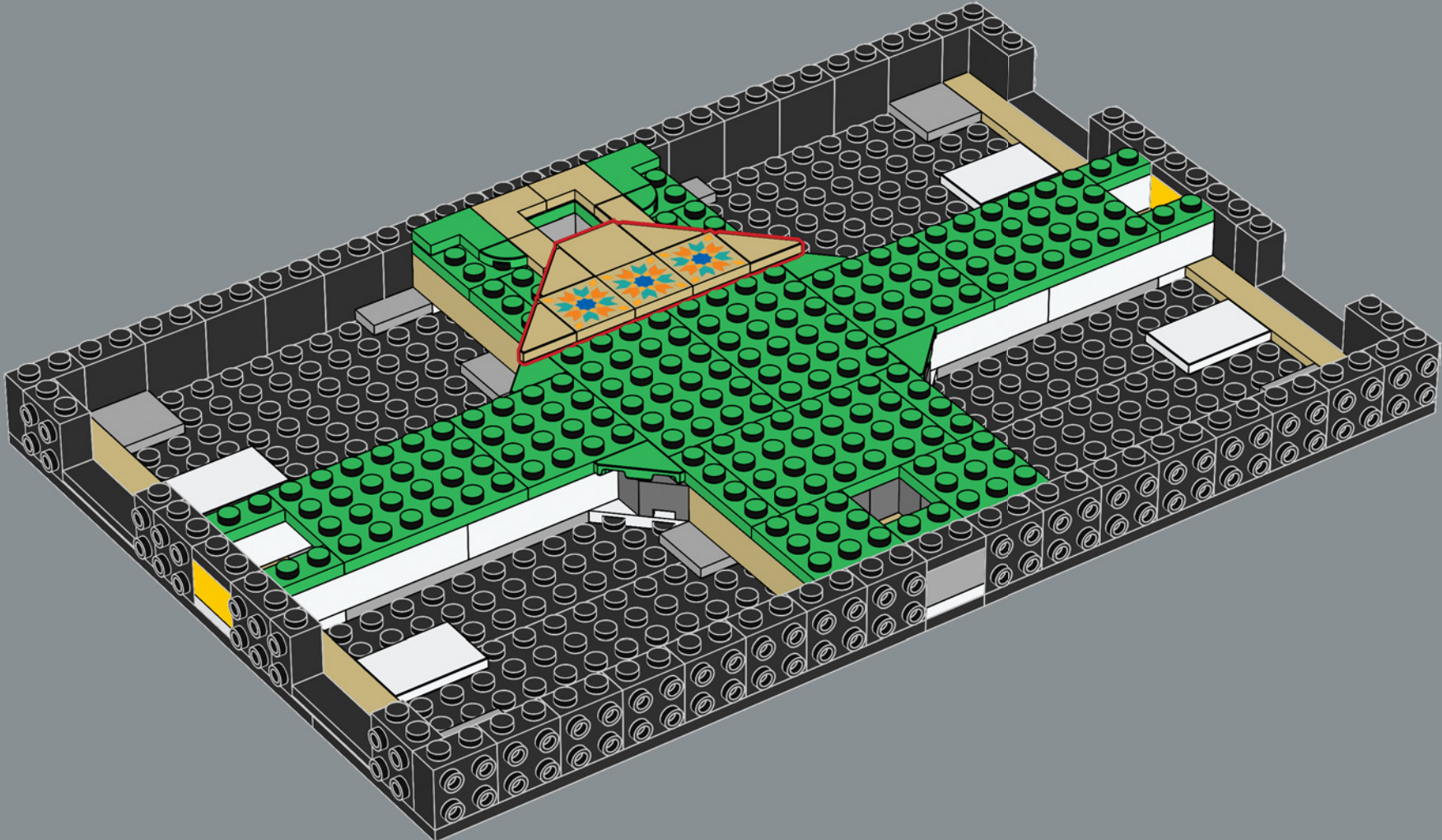

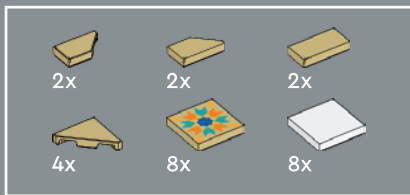

26

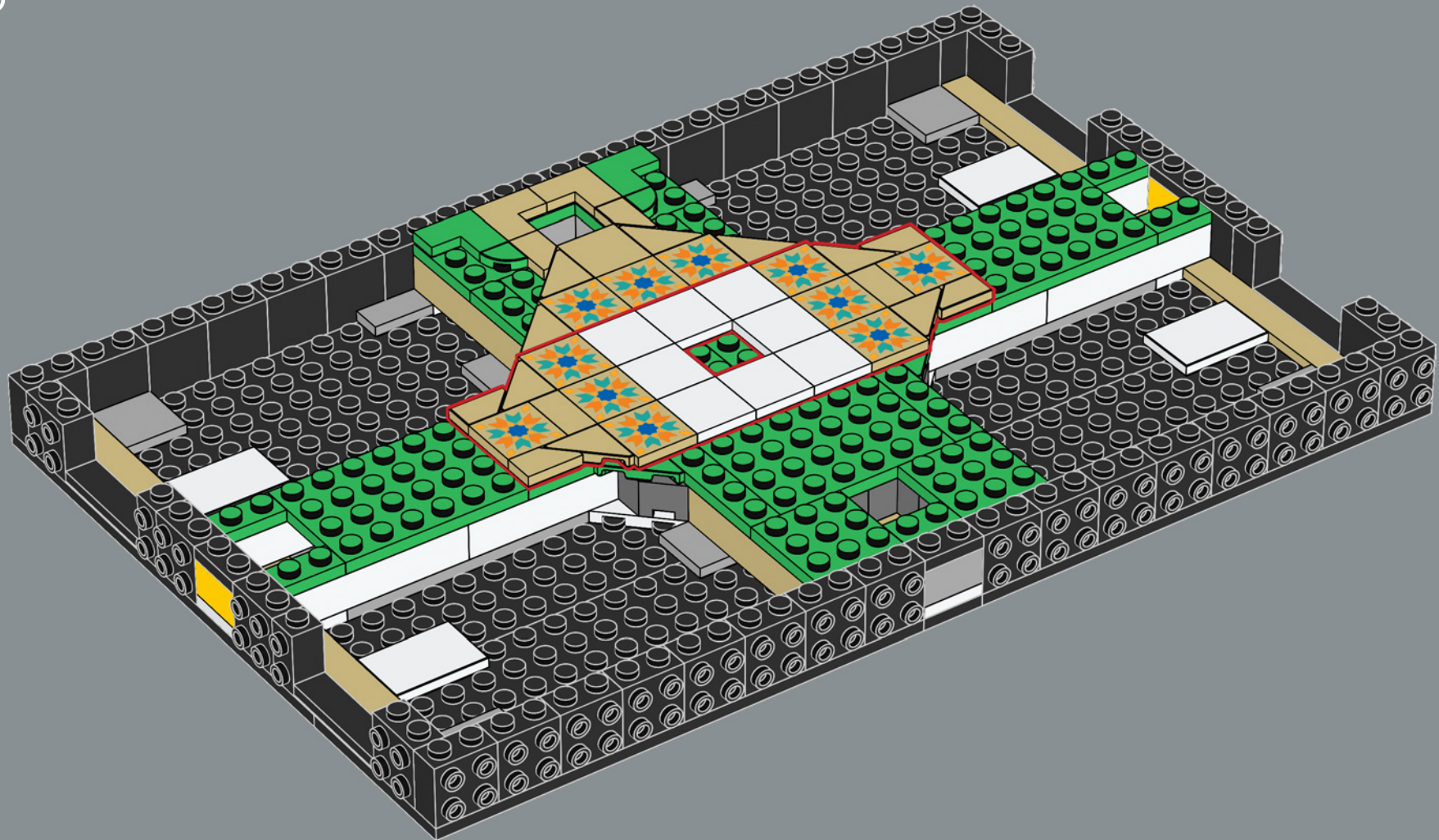



27

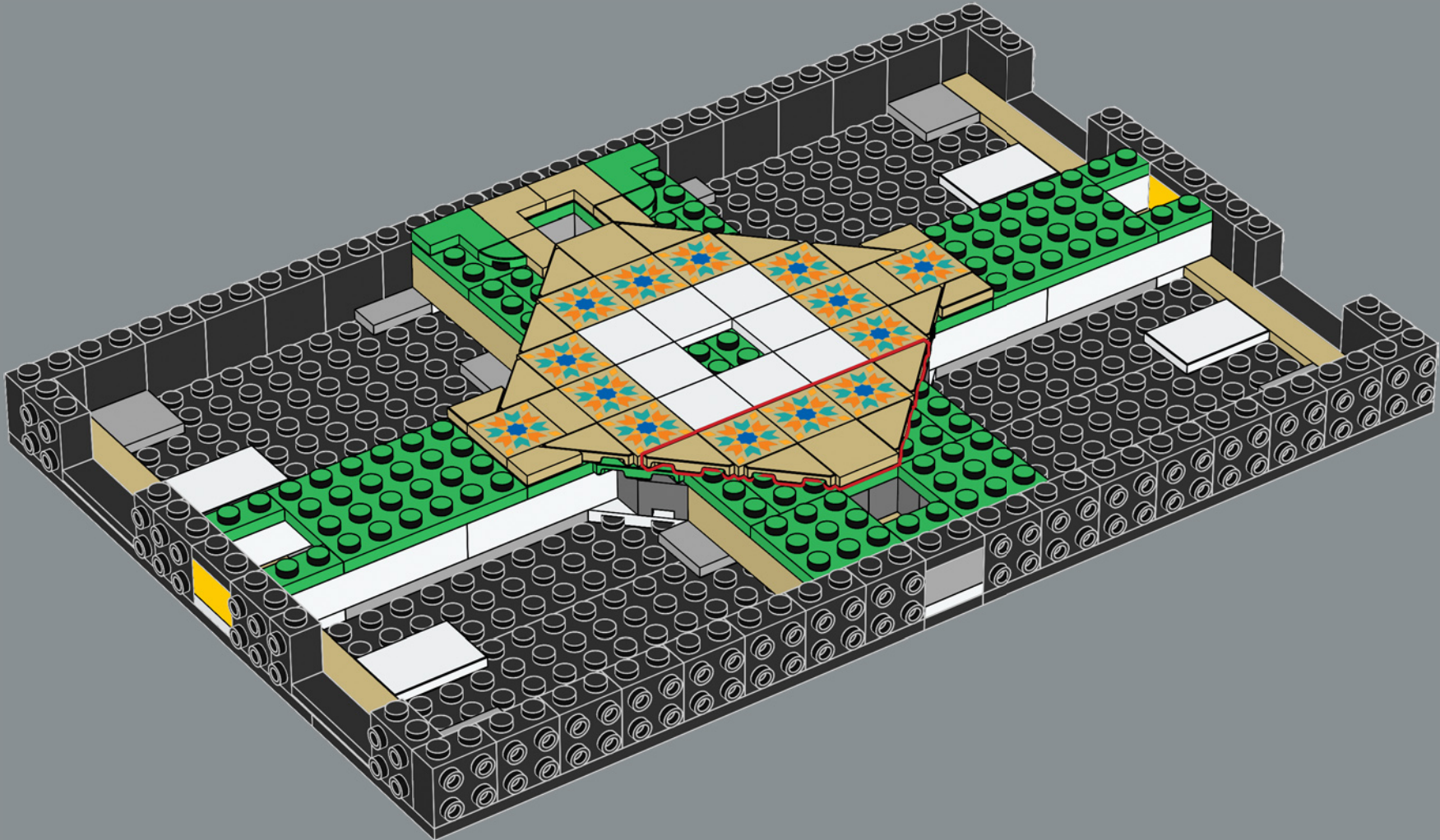

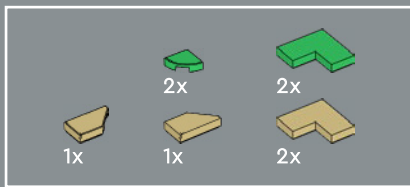

28

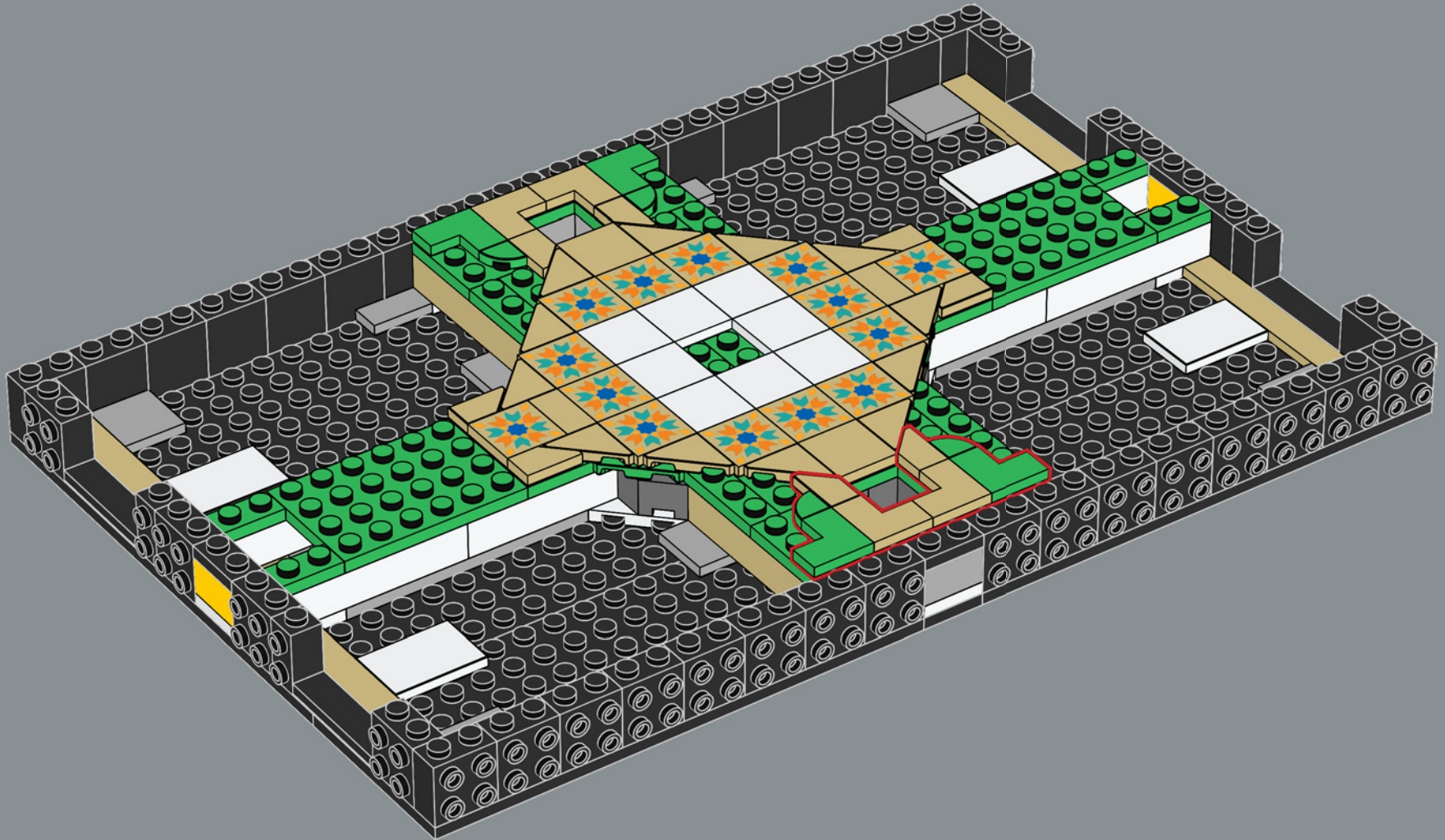

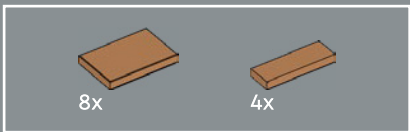

29

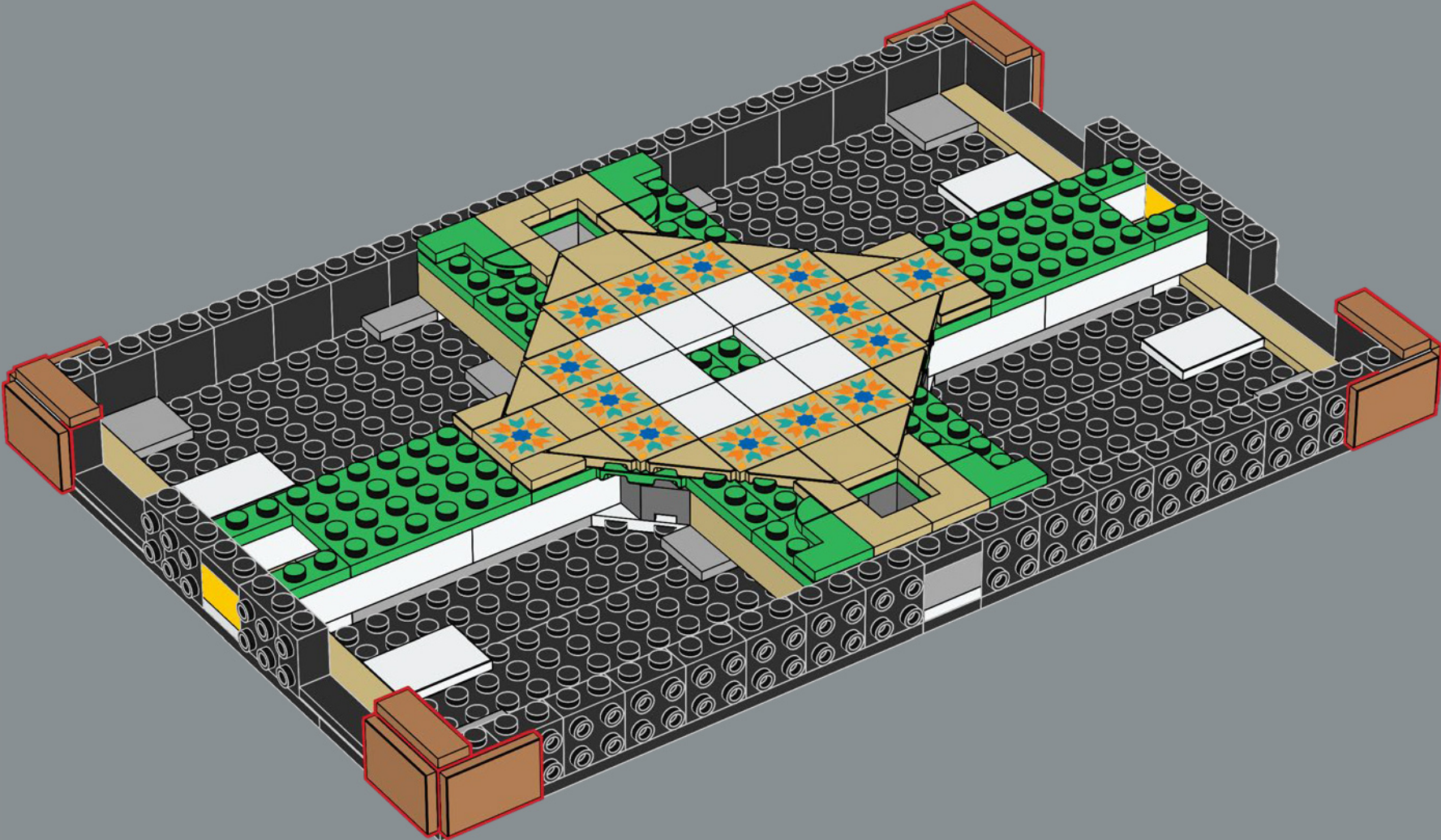



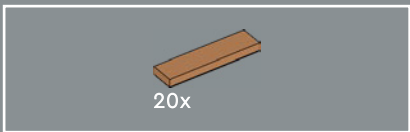

30

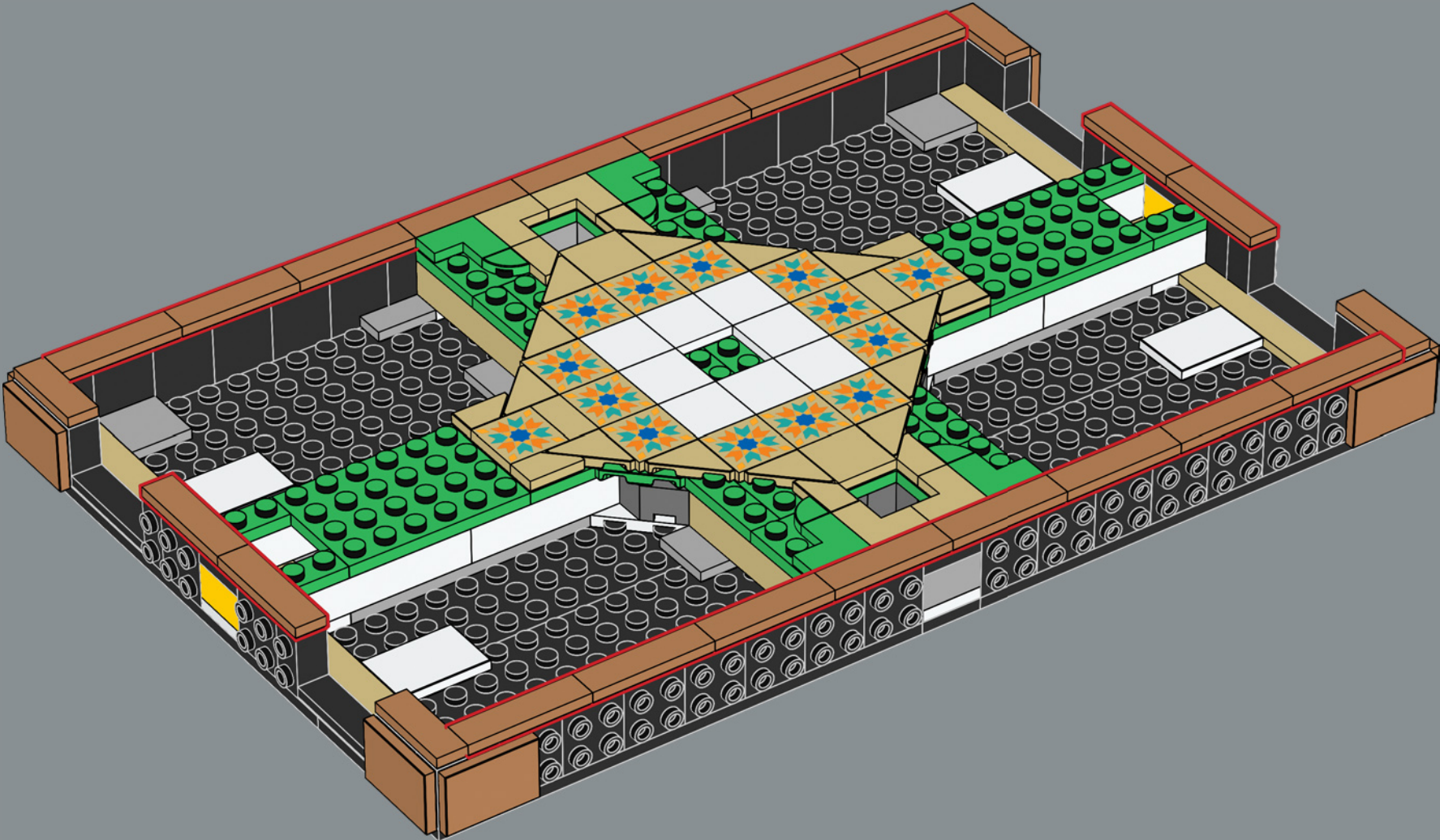

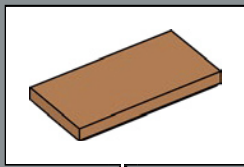

31

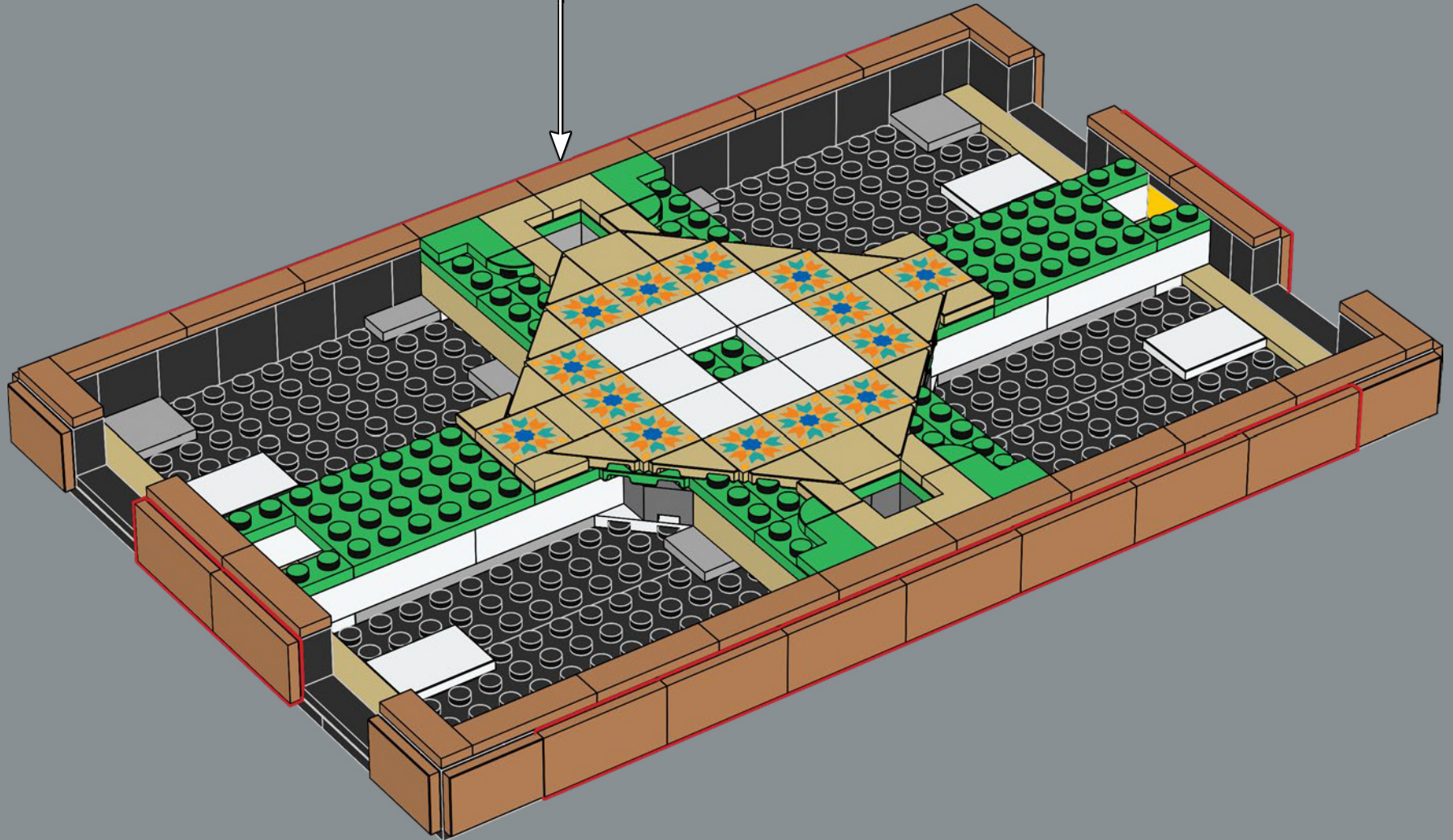

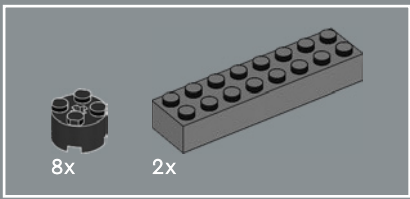

32

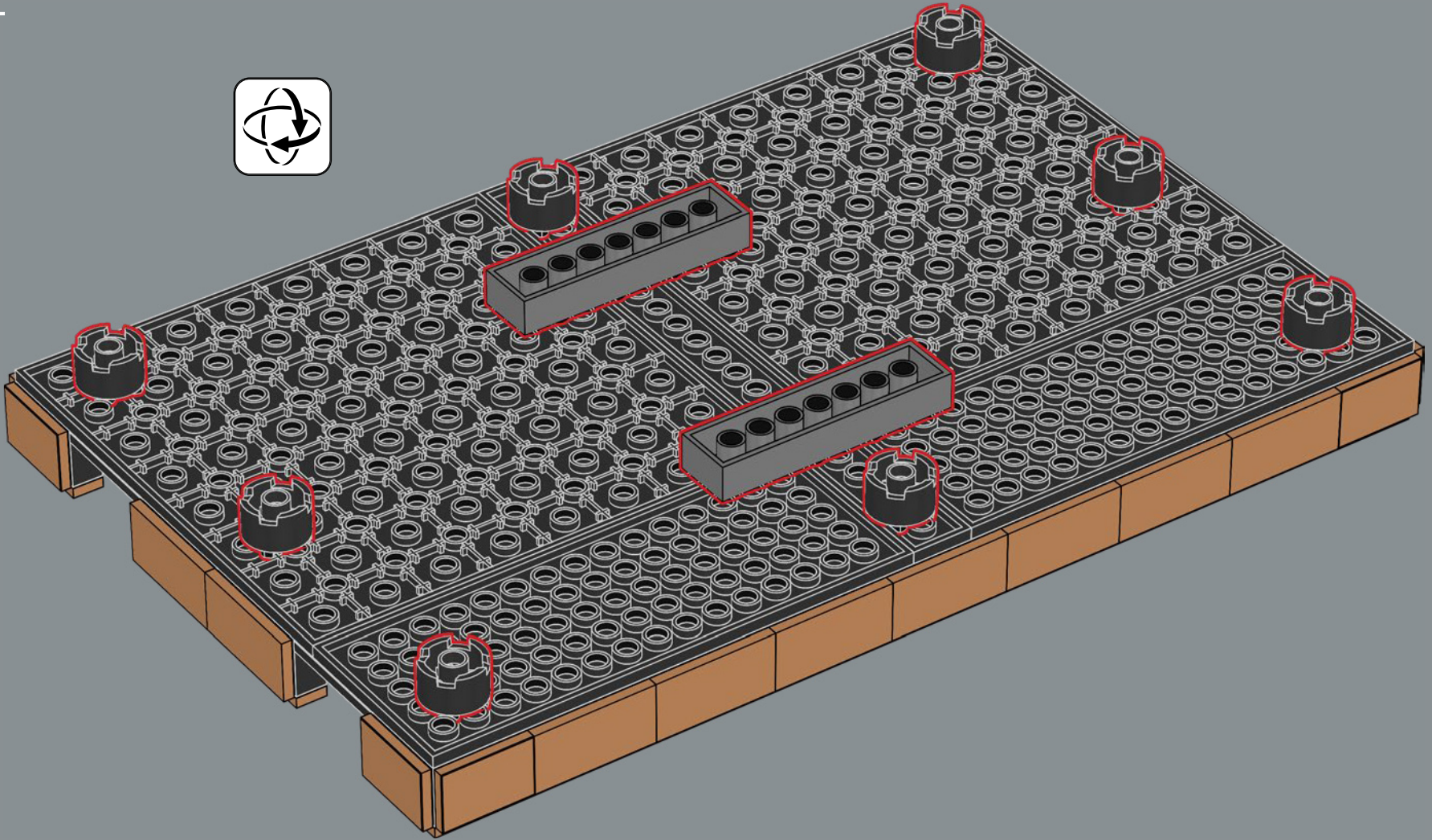

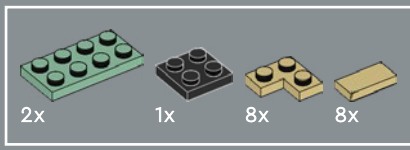

33

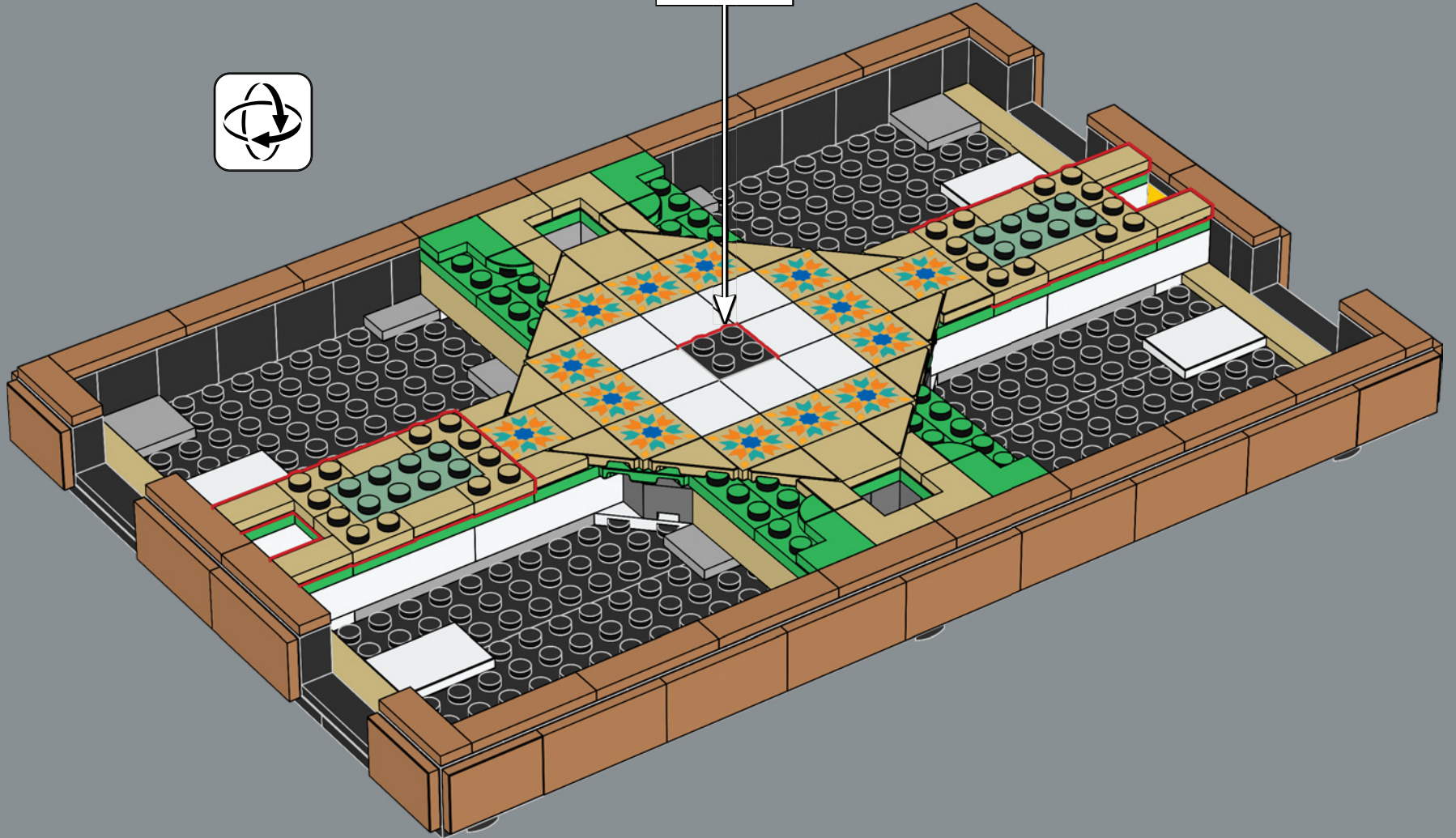
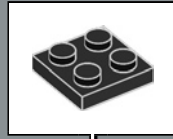



34

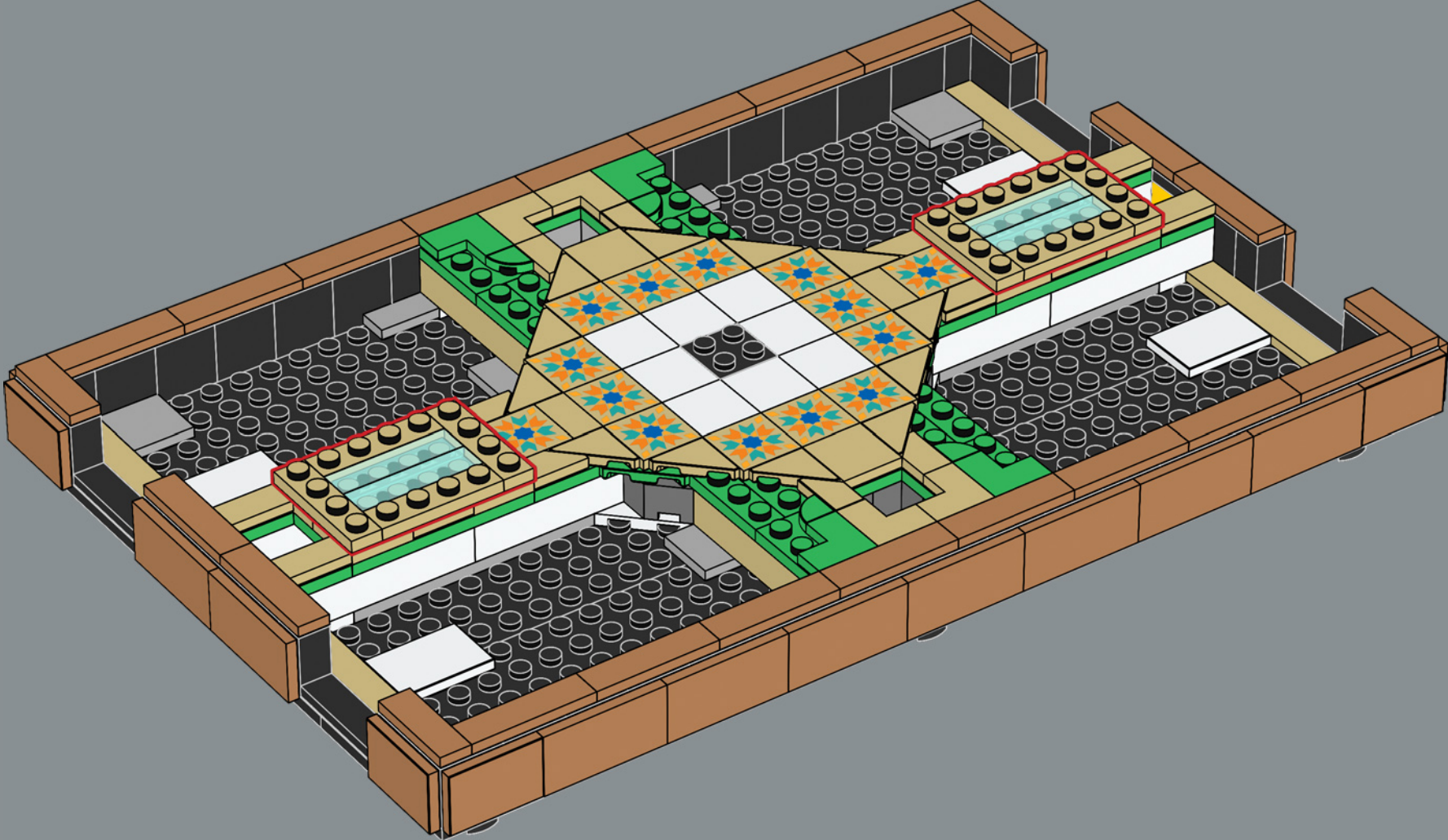

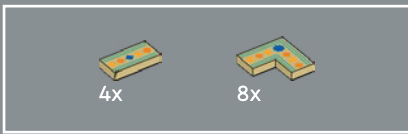

35

Die verzierten Teile, die für dieses Set erschaffen wurden, sind den Girih-Kacheln (*Zellij*) nachempfunden. Solche Mosaik sind häufig in der Architektur antiker historischer Stätten und in Monumenten in Ländern wie Marokko, Algerien und Tunesien sowie in der Region Andalusien in Südspanien zu finden.

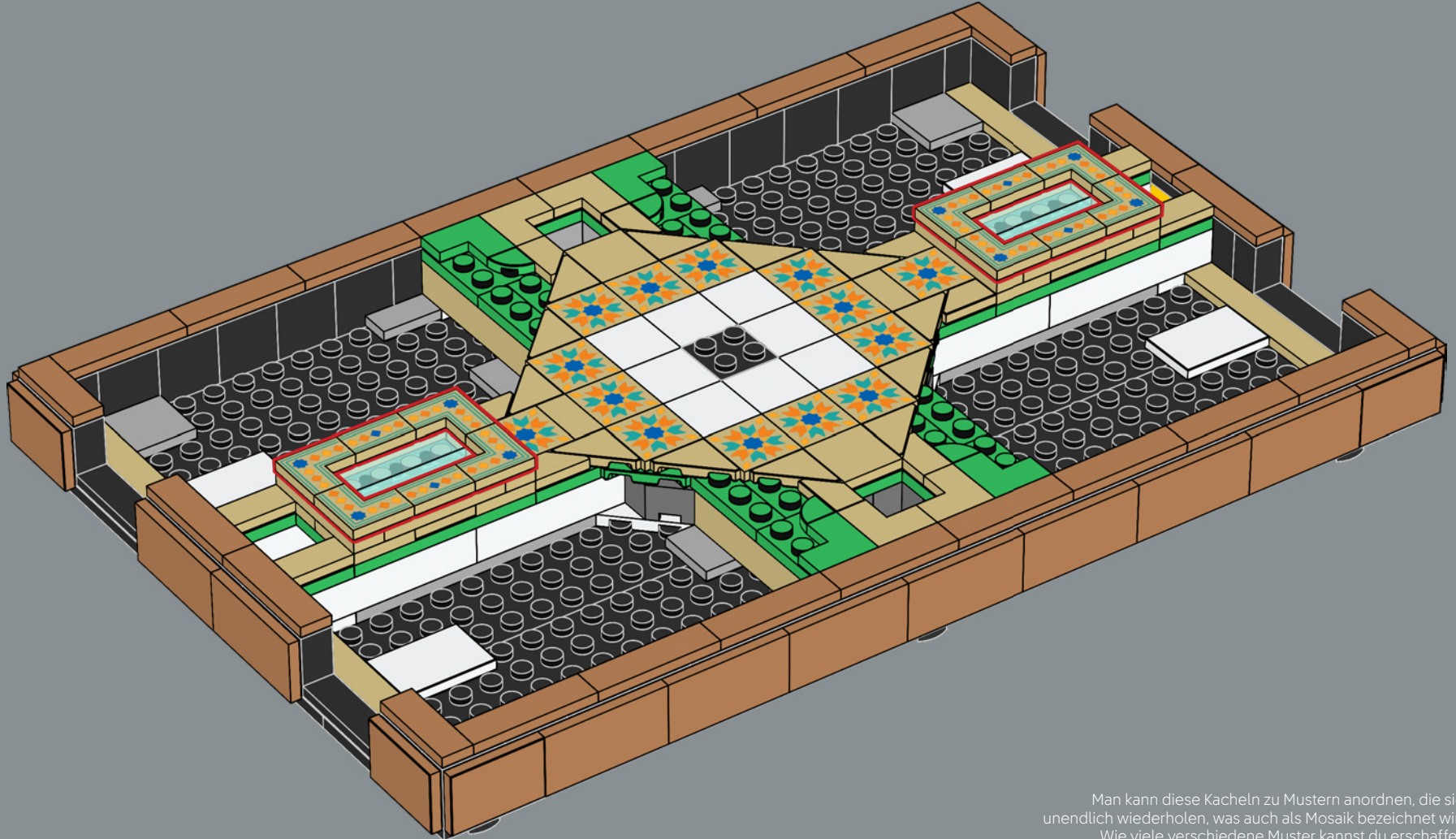

Man kann diese Kacheln zu Mustern anordnen, die sich unendlich wiederholen, was auch als Mosaik bezeichnet wird. Wie viele verschiedene Muster kannst du erschaffen?

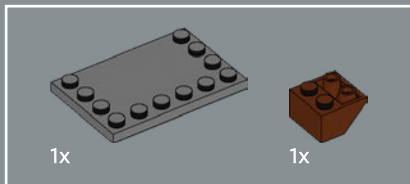
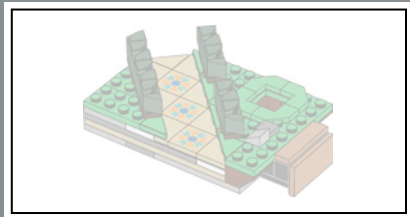

36

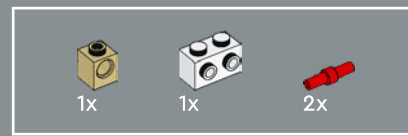
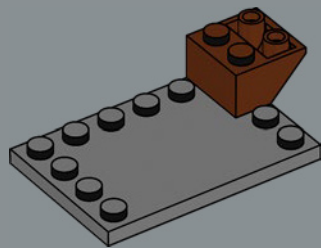

37

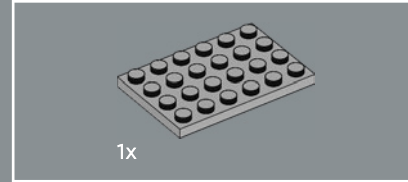
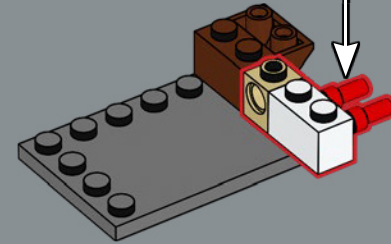
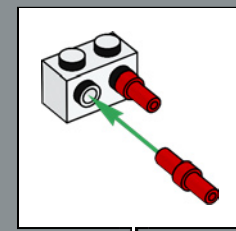

38

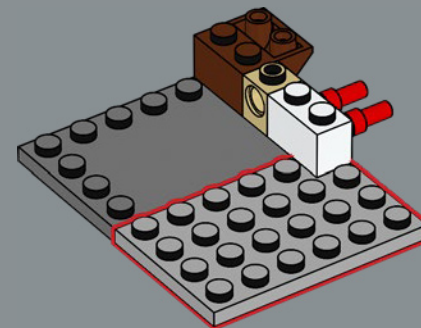

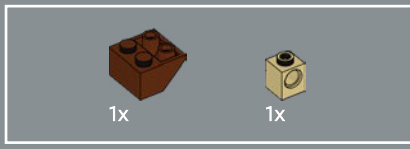

39

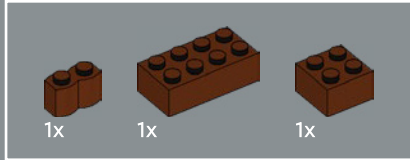
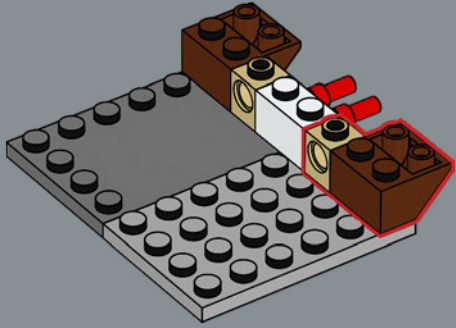

40

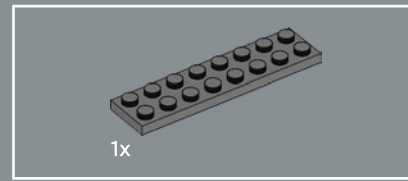
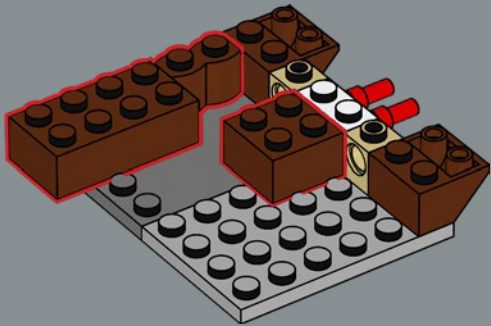

41

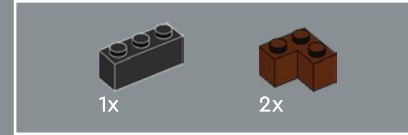
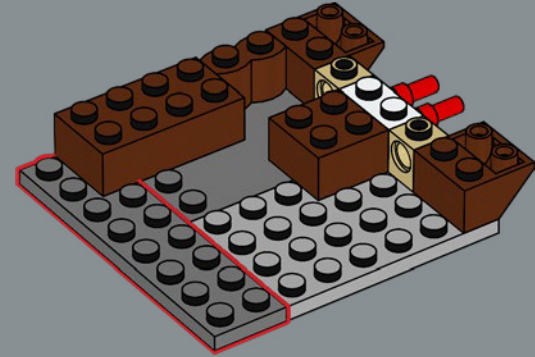

42

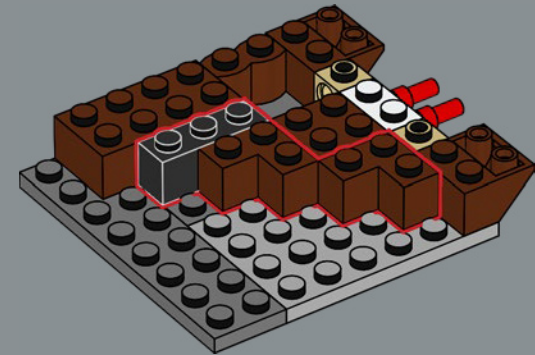

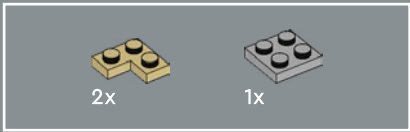

43

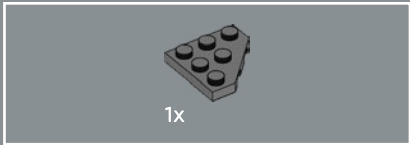
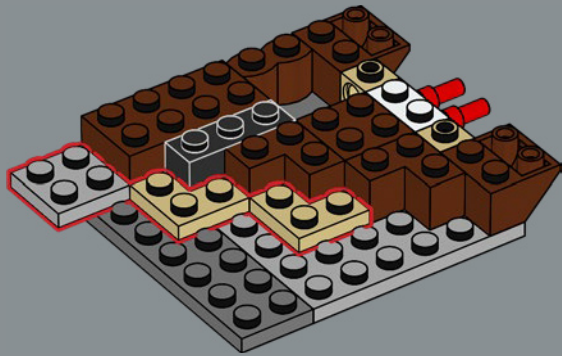

44

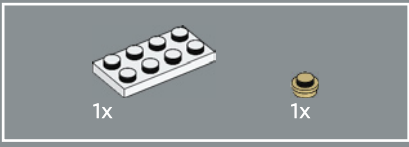
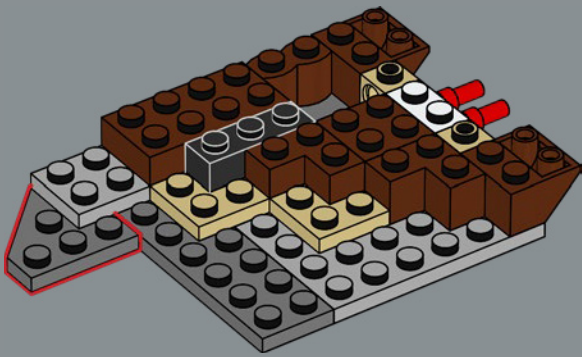

45

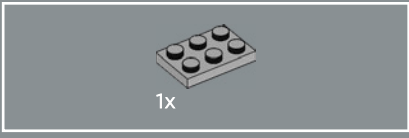
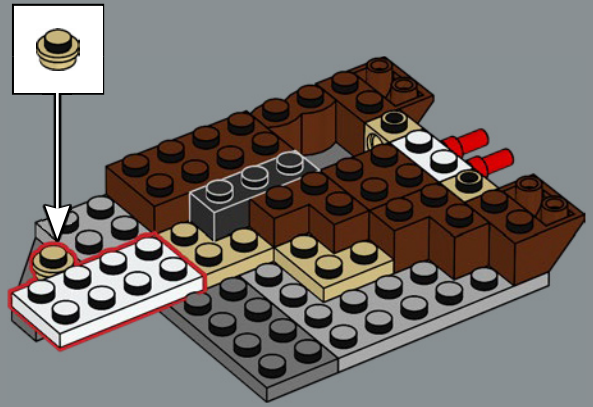

46

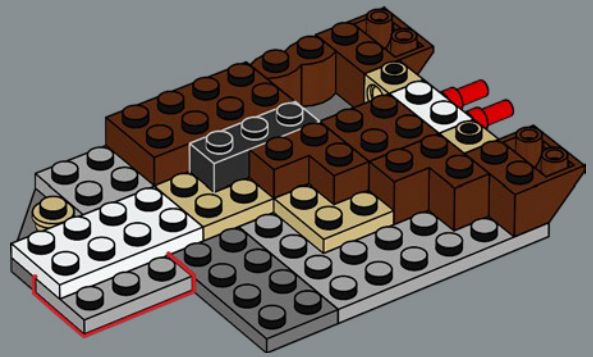

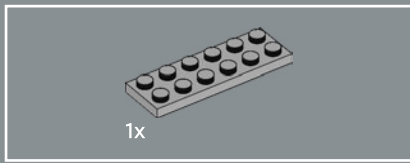

47

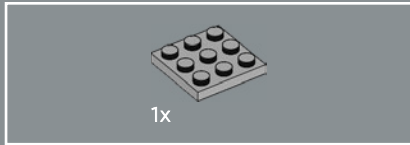
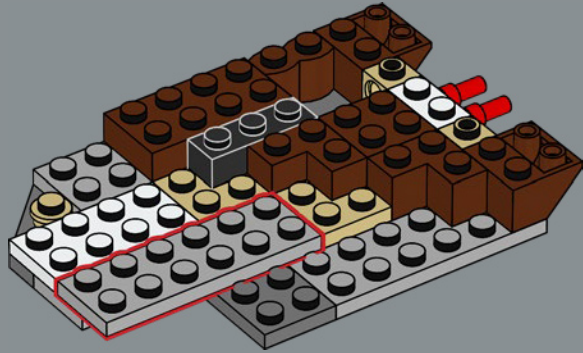

48

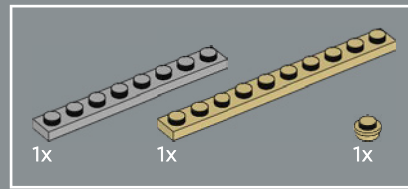
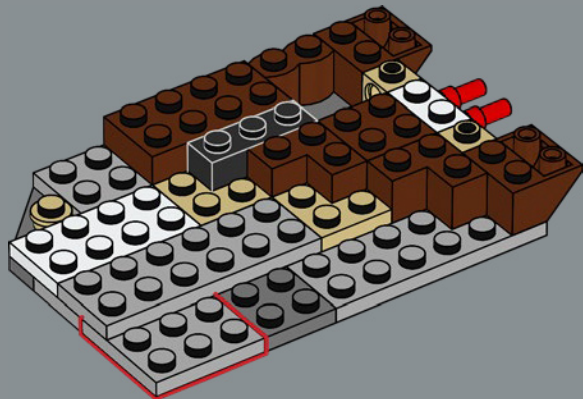

49



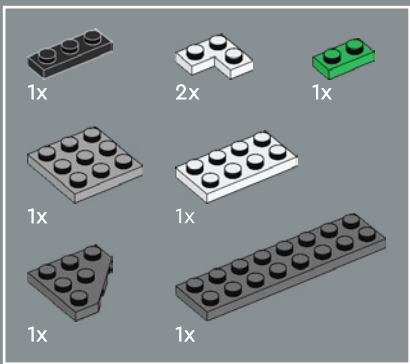

50

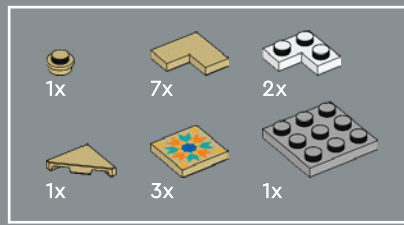
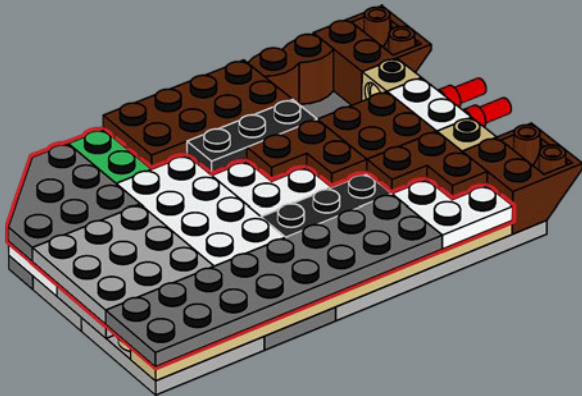

51

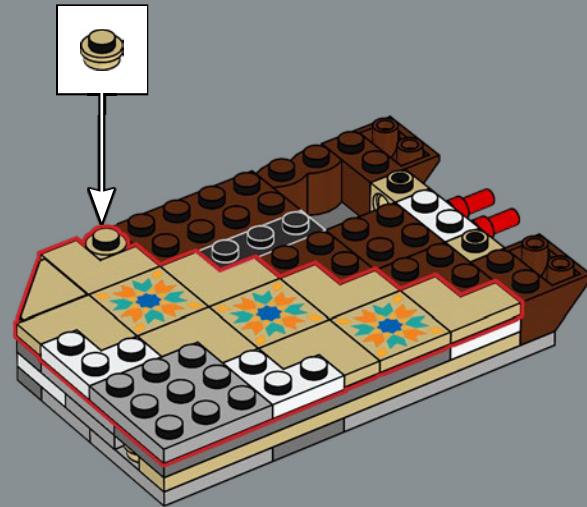

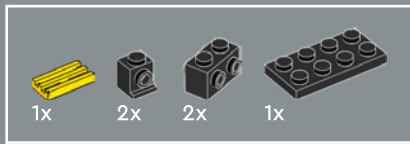

52

1

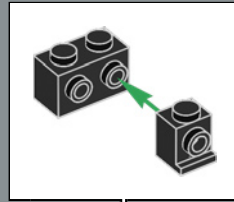
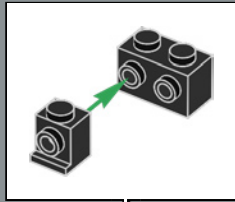
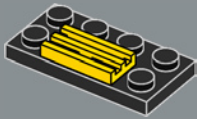

2

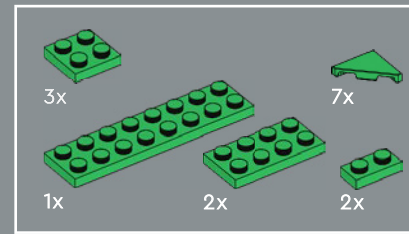
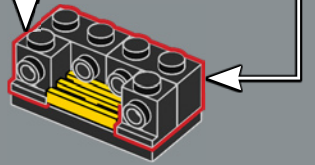

53

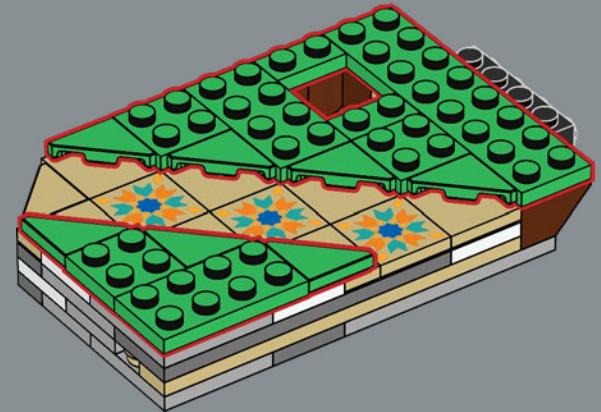



54

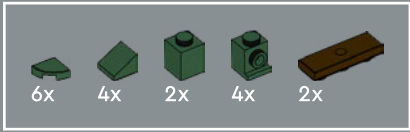
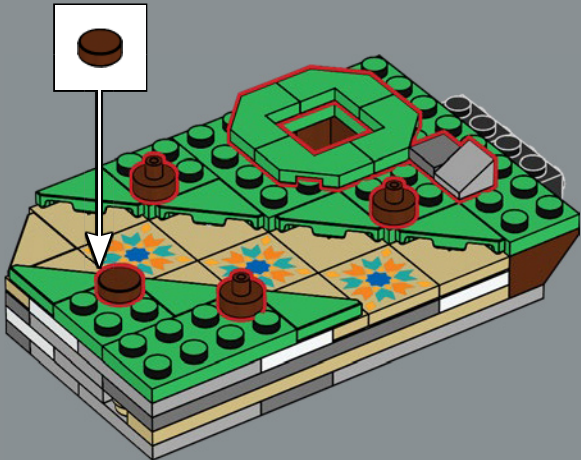

55

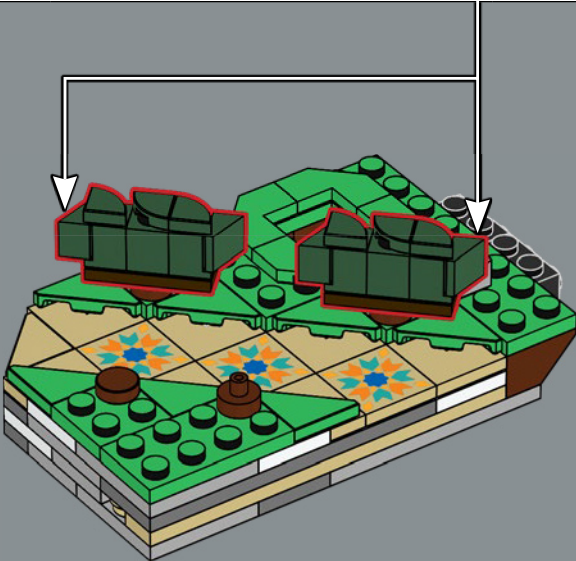
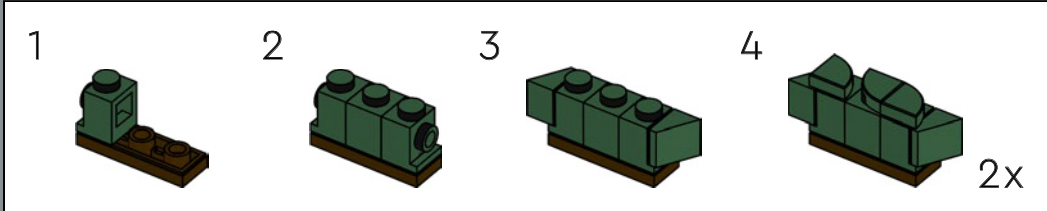

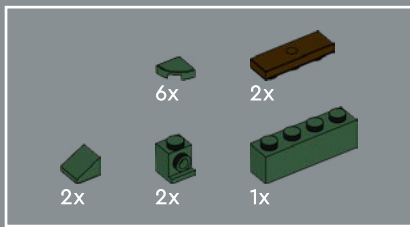

56

1



2

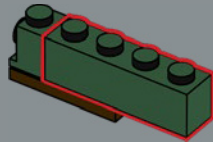

3

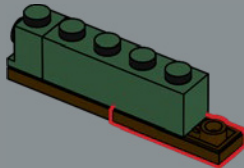

4

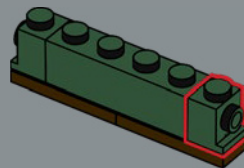

5

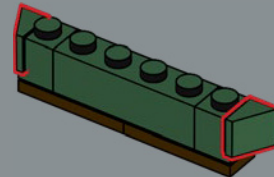

6

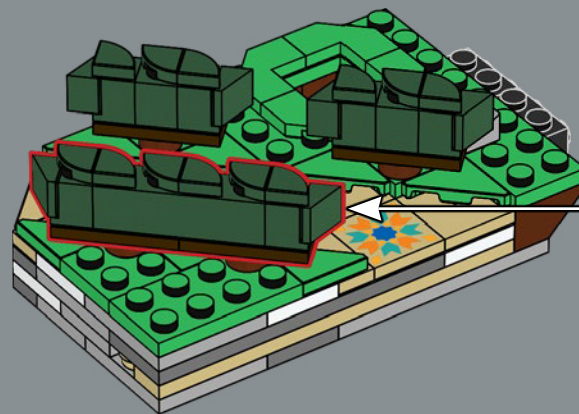
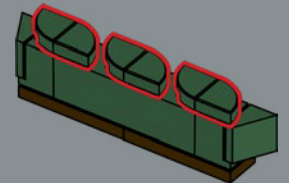

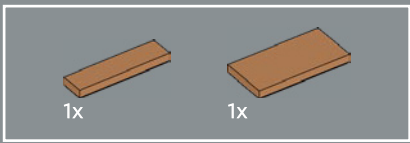

57

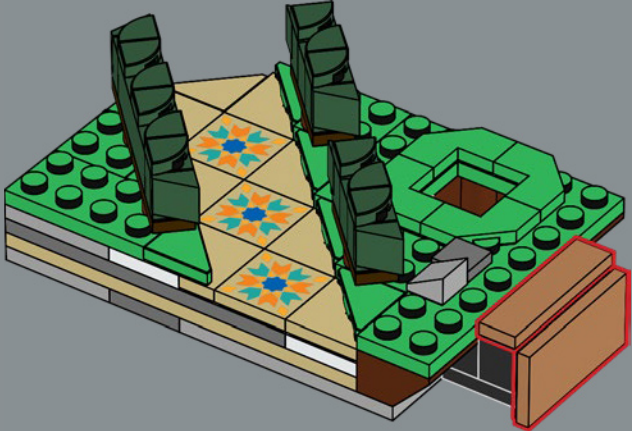

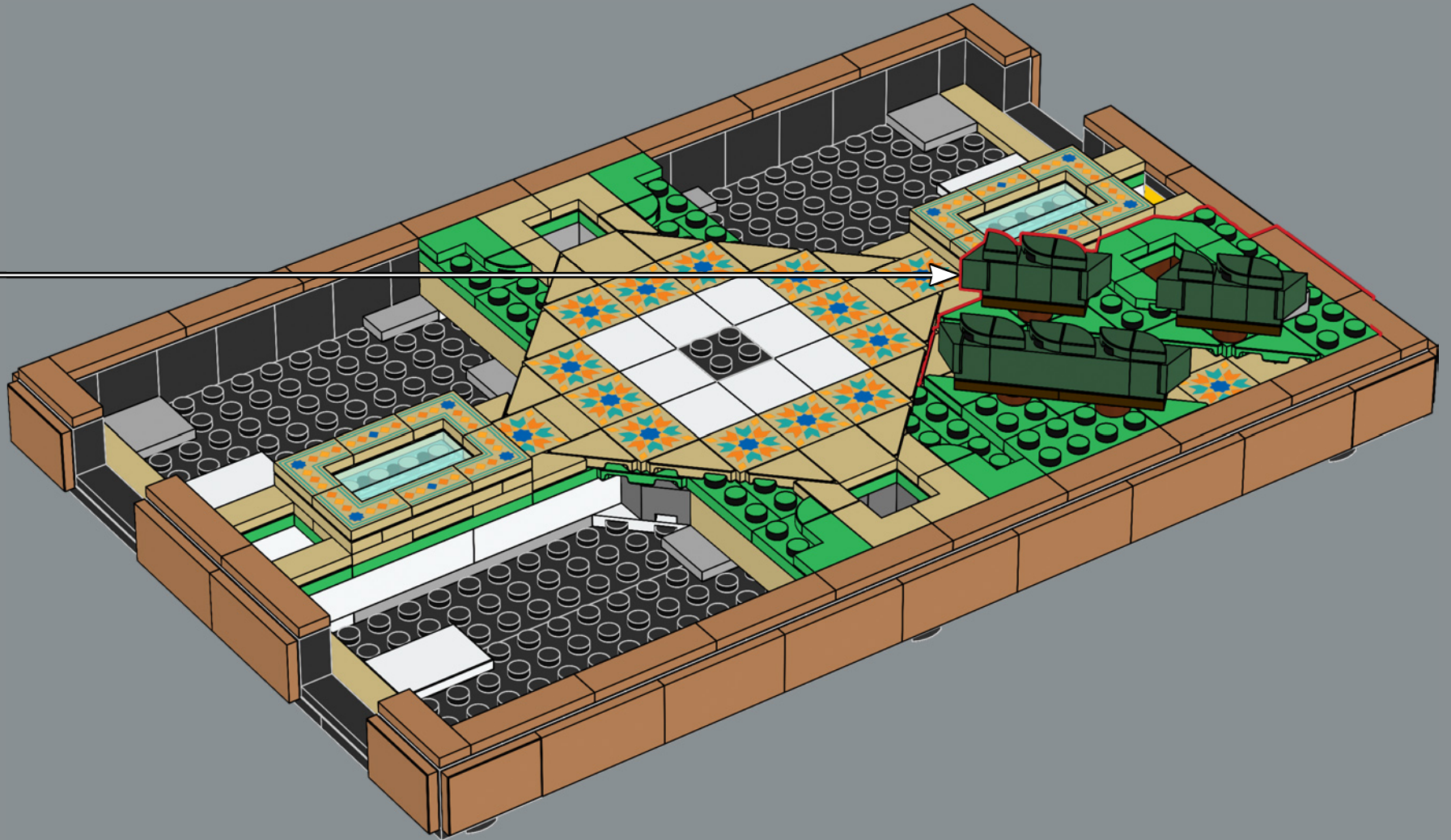

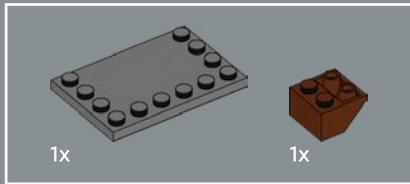
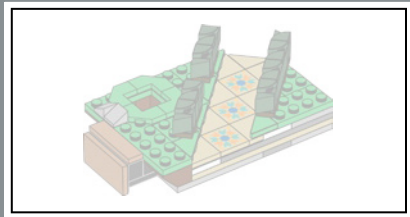

59

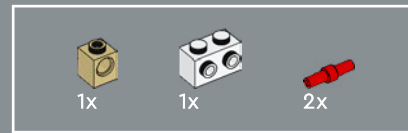
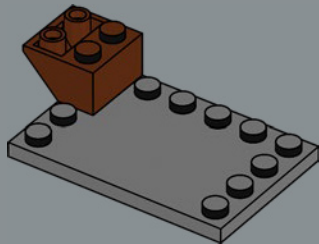

60

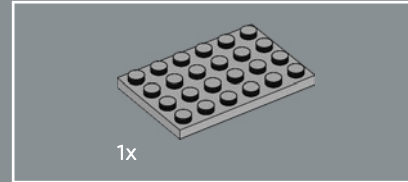
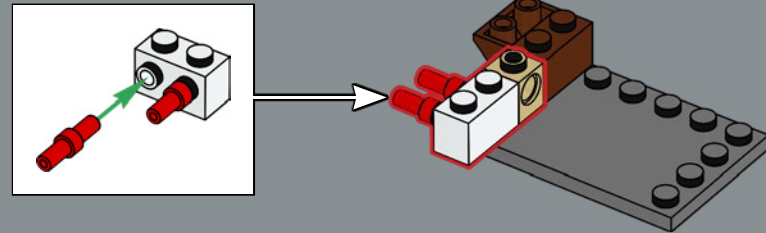

61

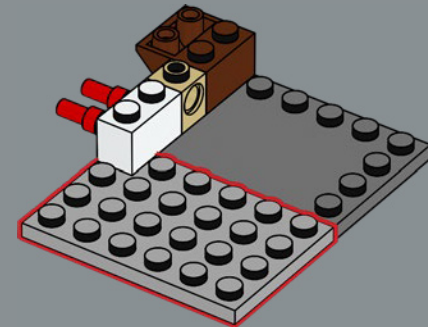

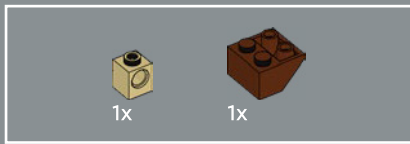

62

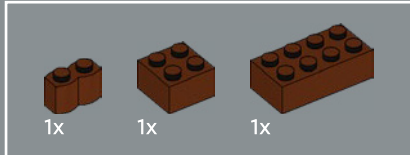
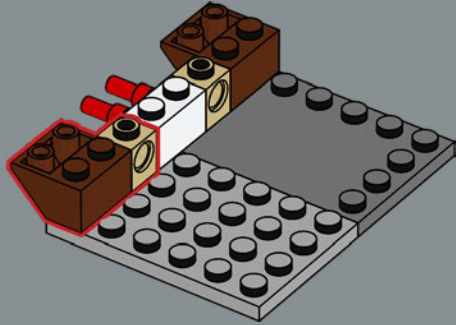

63

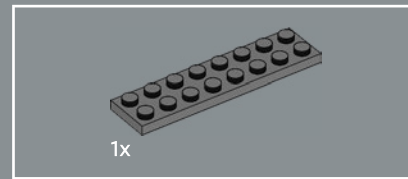
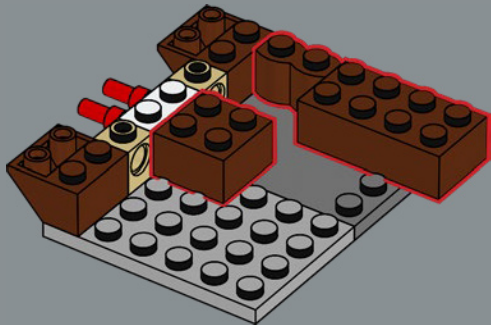

64

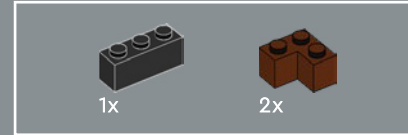
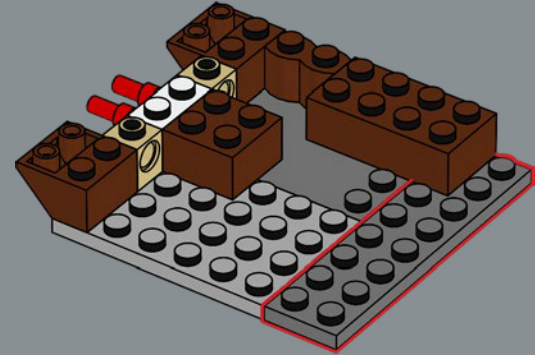

65

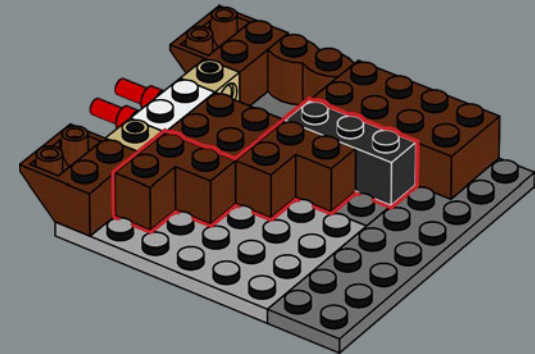

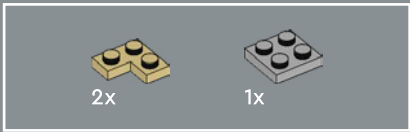

66

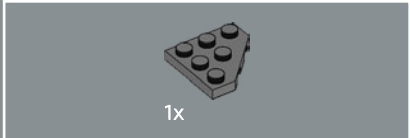
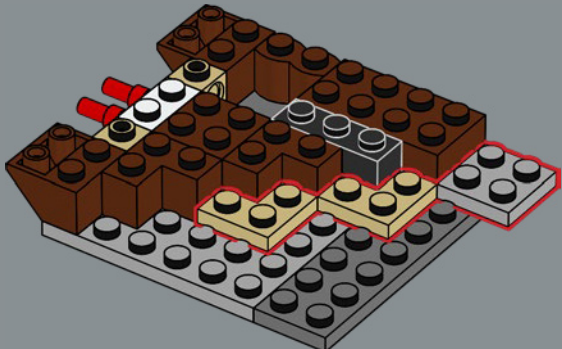

67

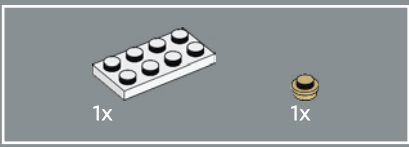
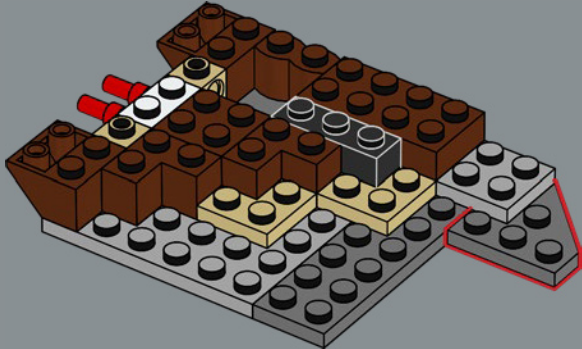

68

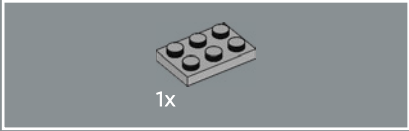
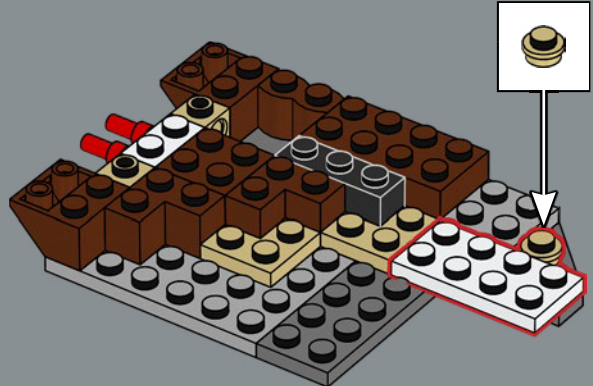

69

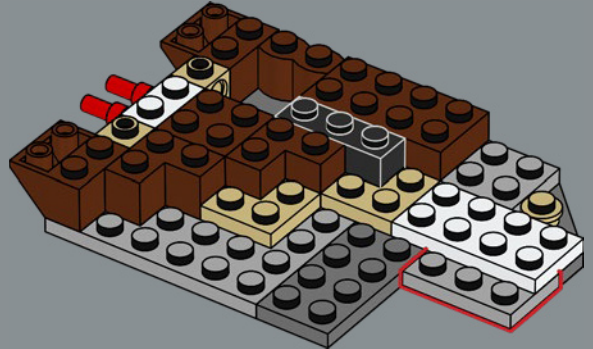

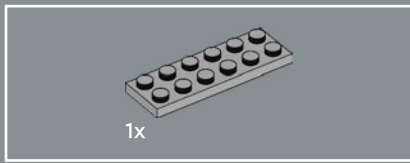

70

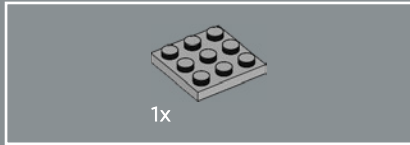
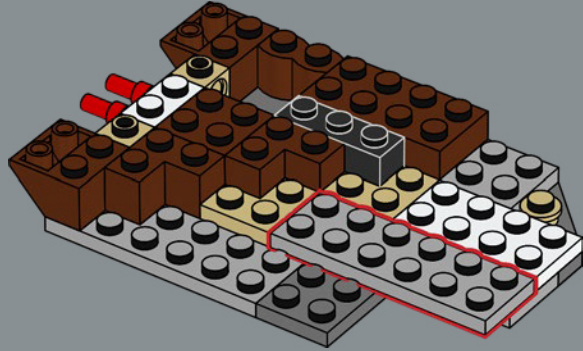

71

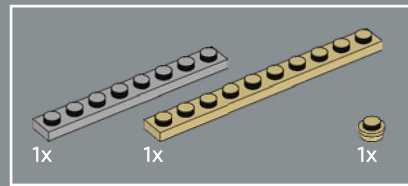
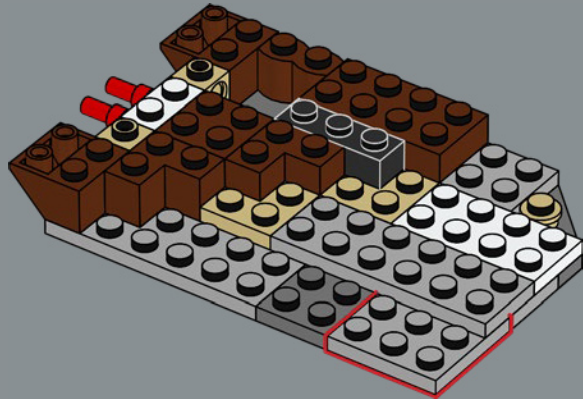

72

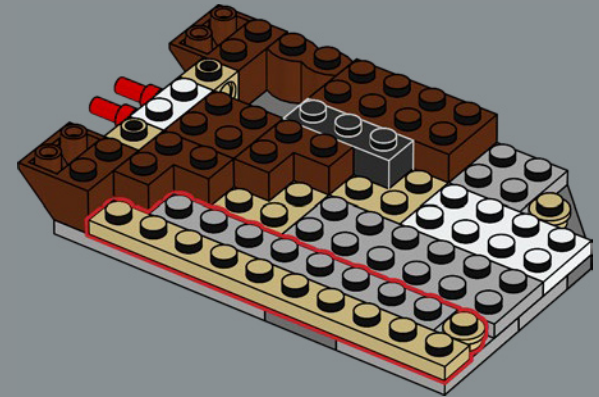

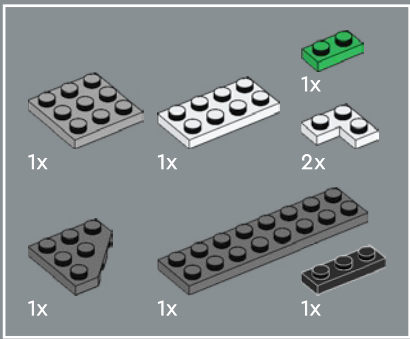

73

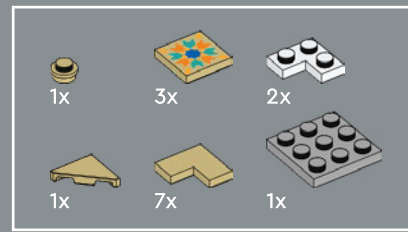
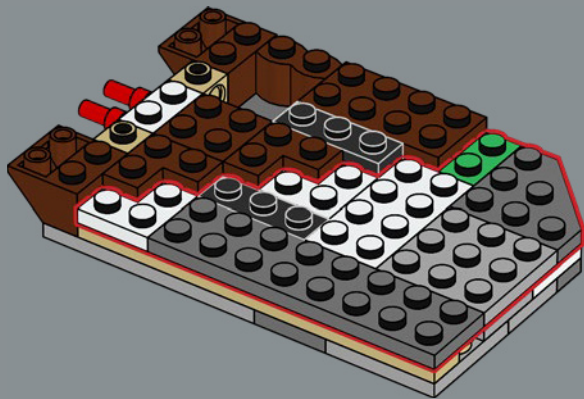

74

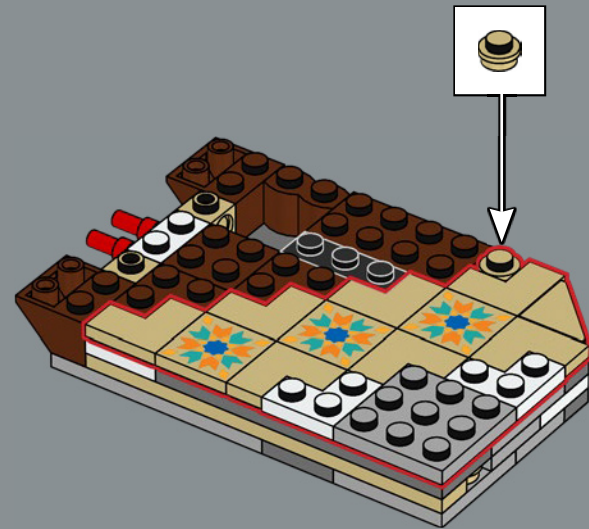

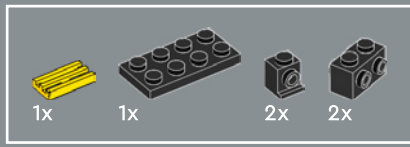

75

1

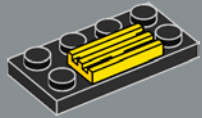

2

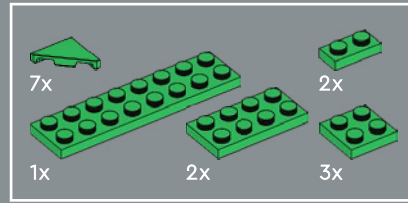
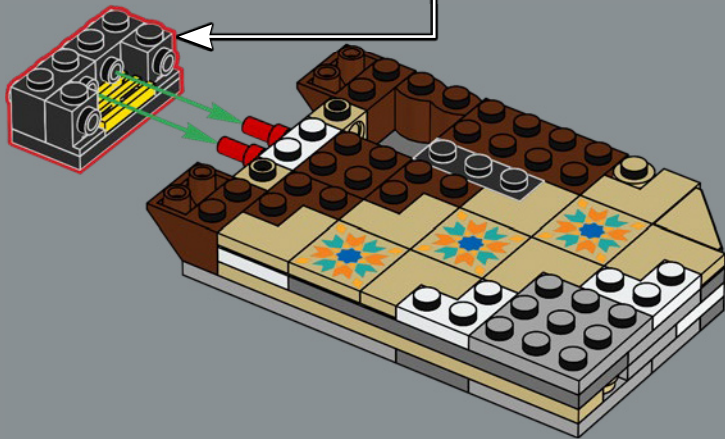
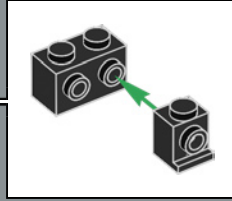
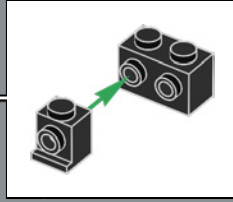
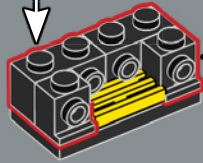

76

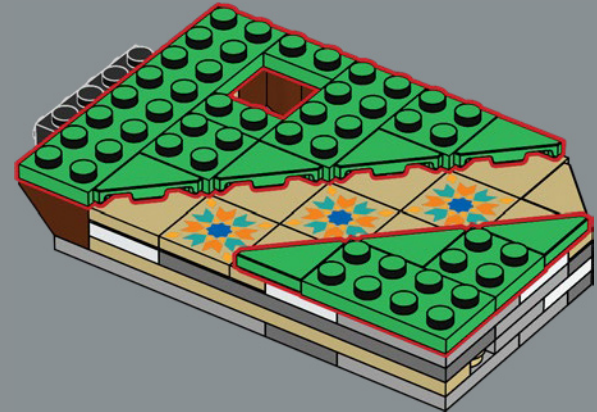

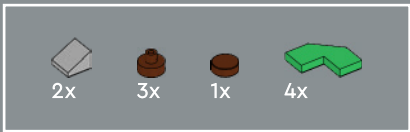

77

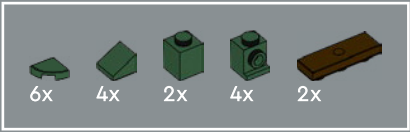
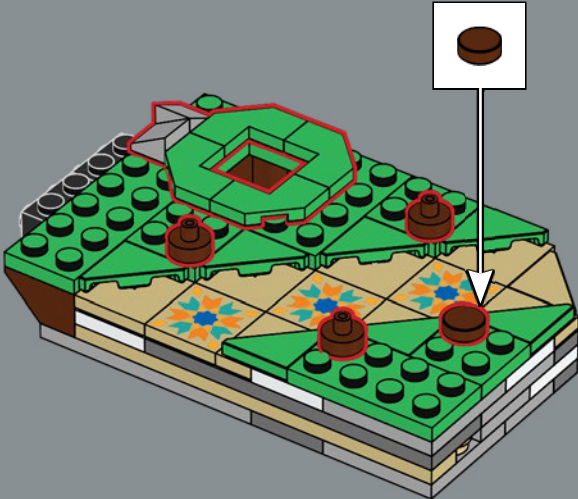

78

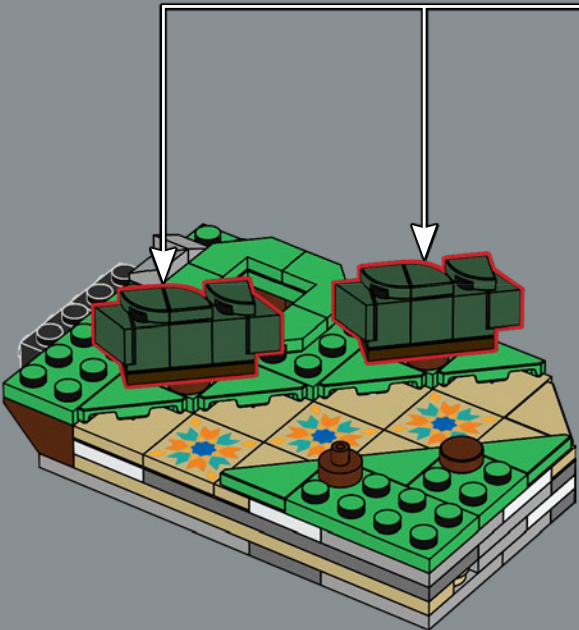
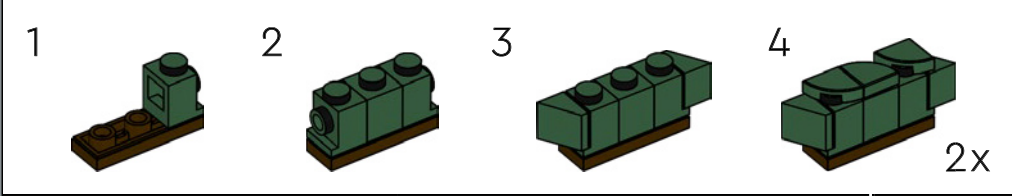

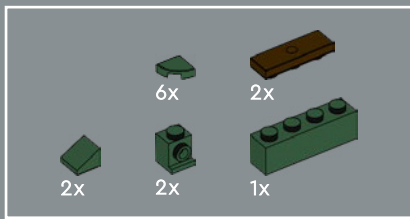

79

1



2

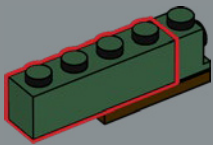

3

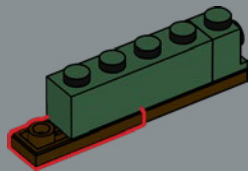

4

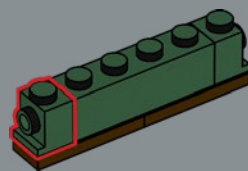

5

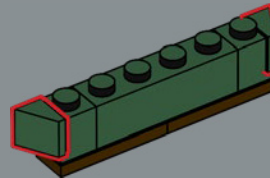

6

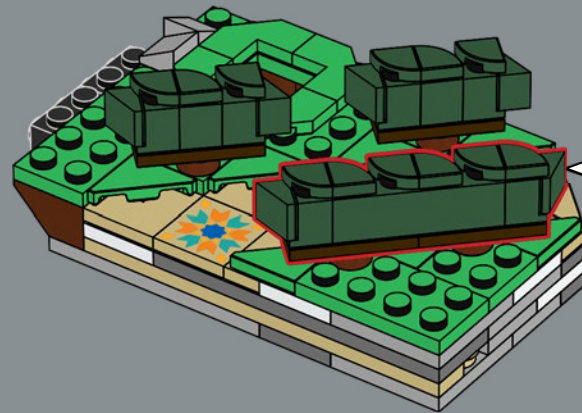
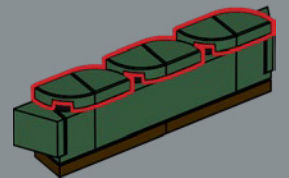

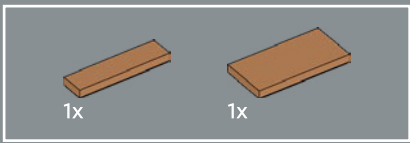

80

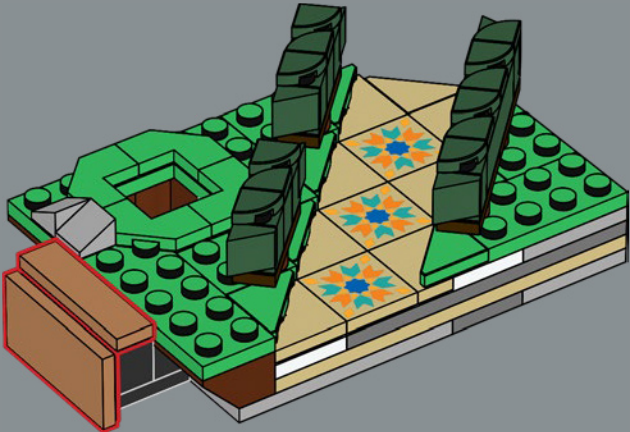

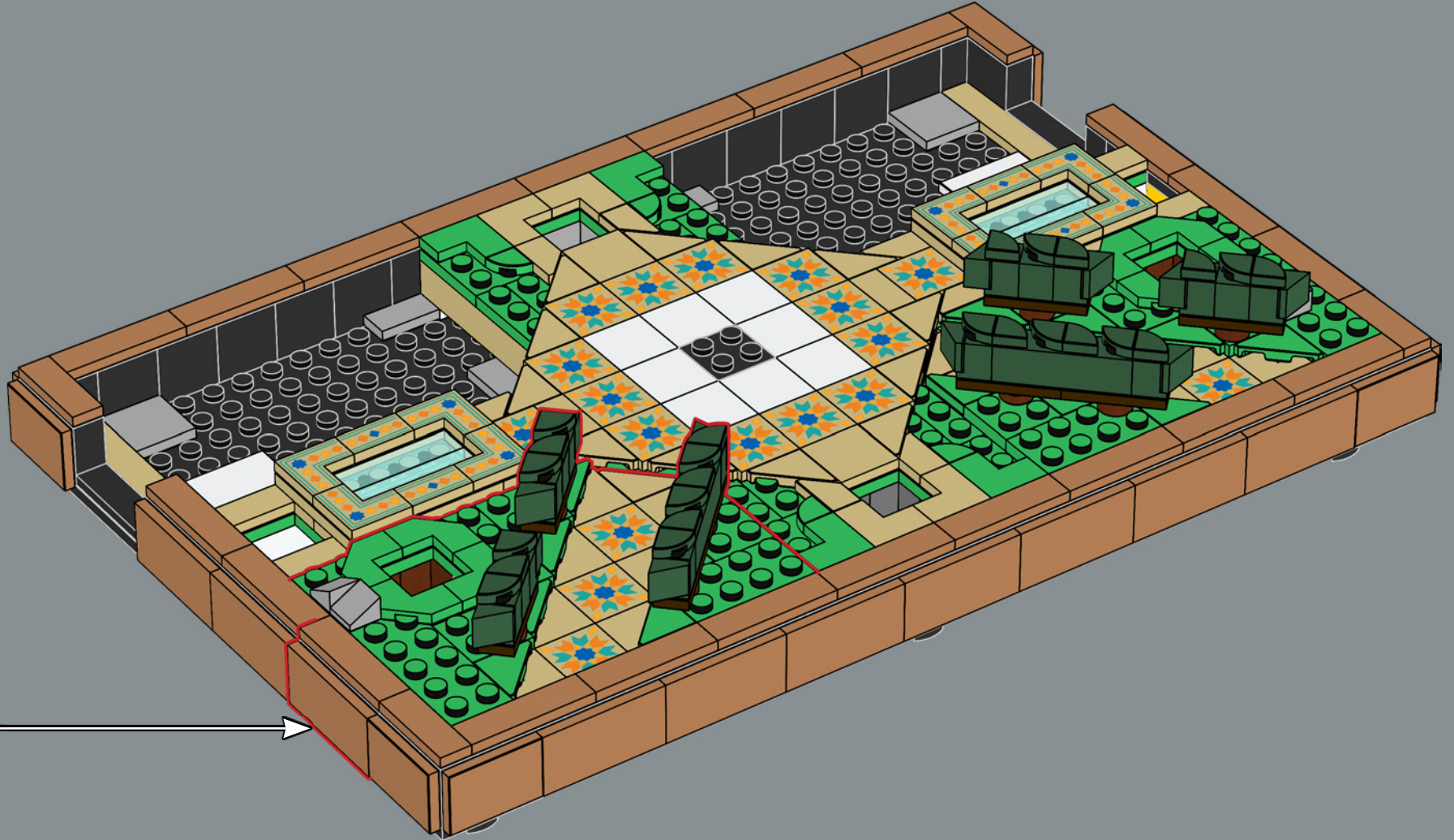

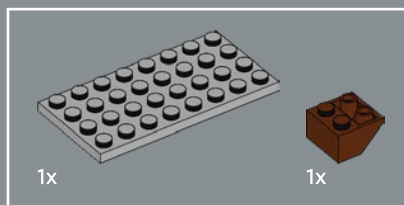
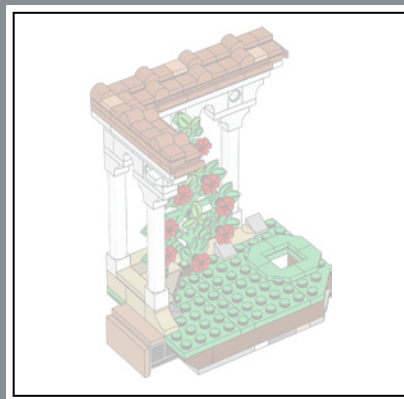

82

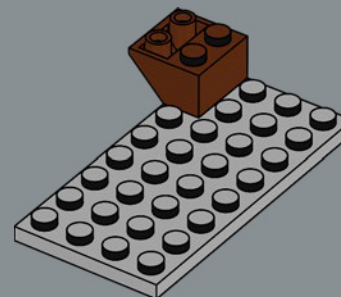

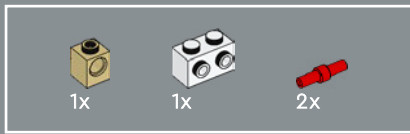

83

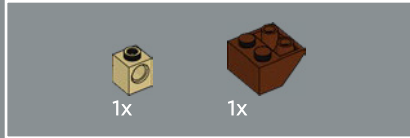
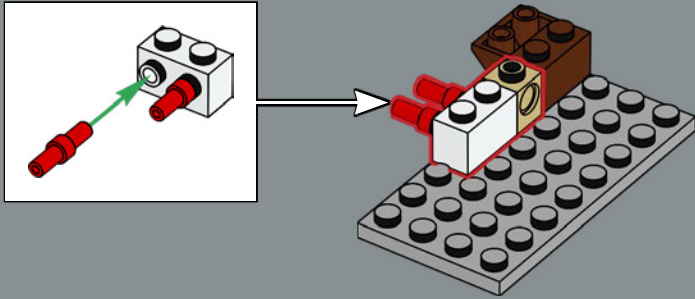

84

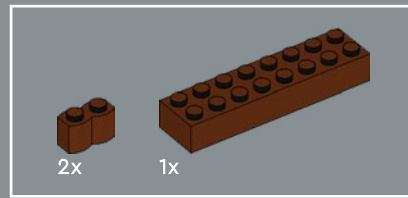
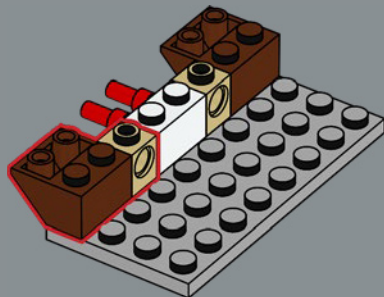

85

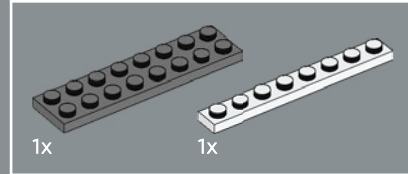
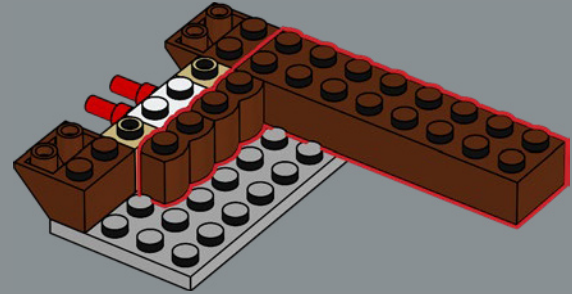

86

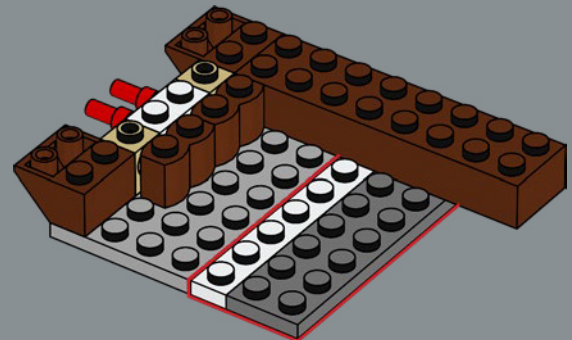

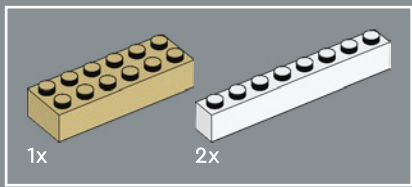

87

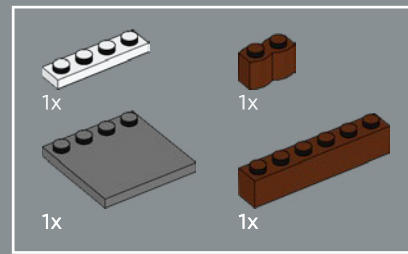
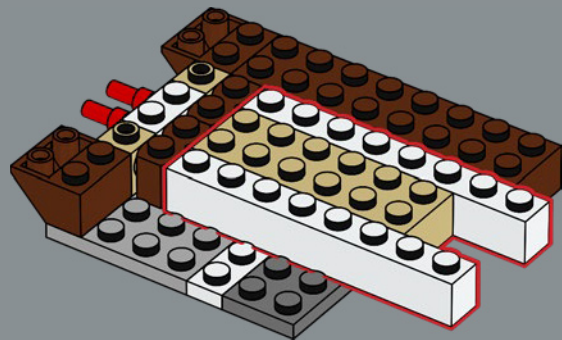

88

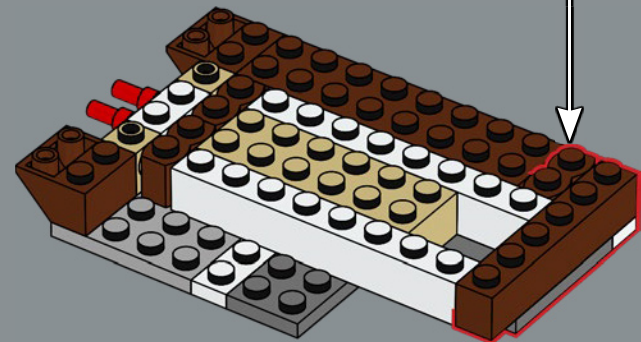
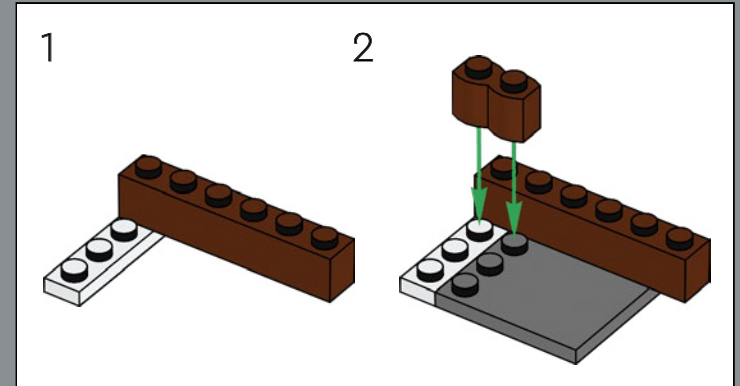

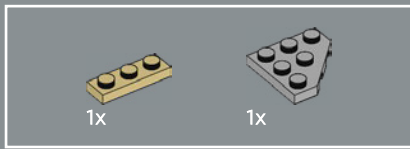

89

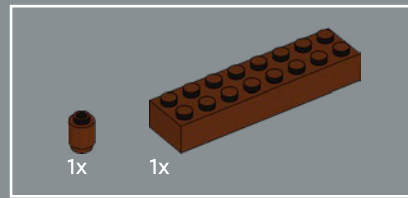
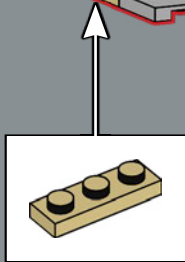
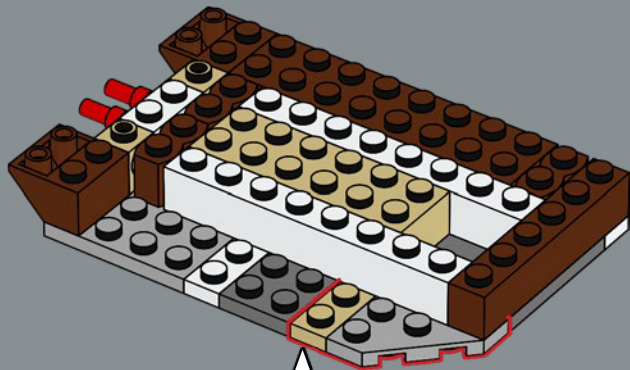

90

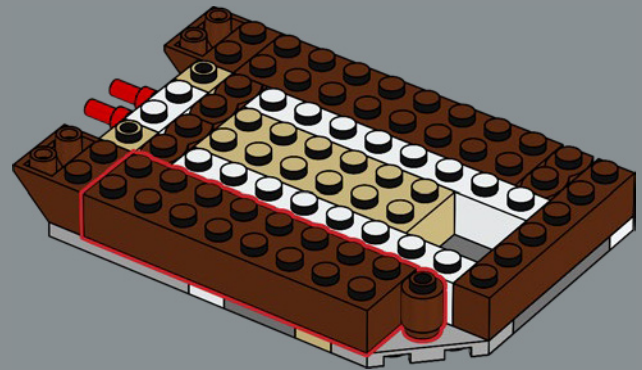

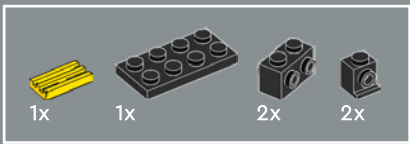

91

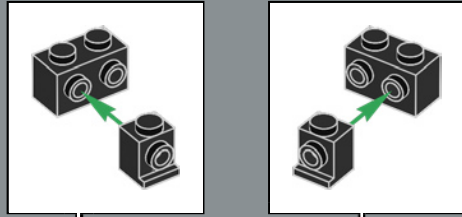

1

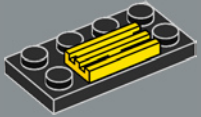

2

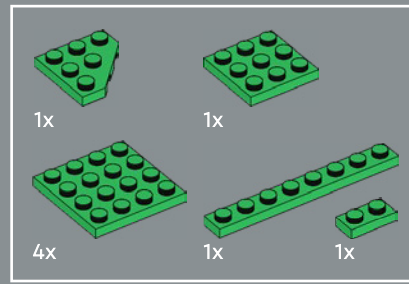
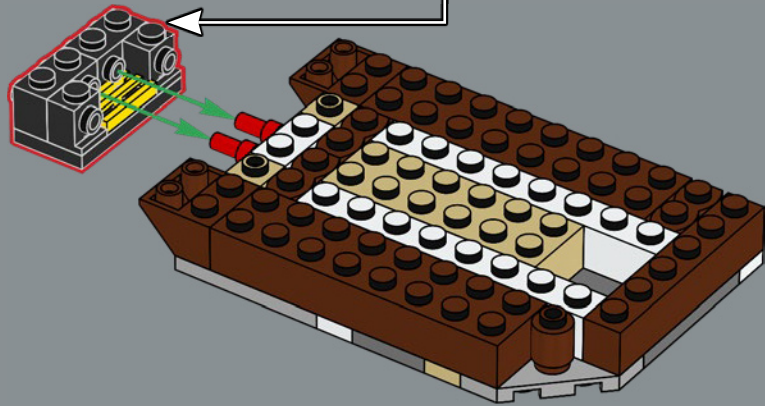
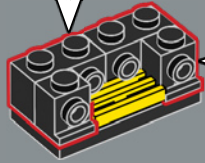

92



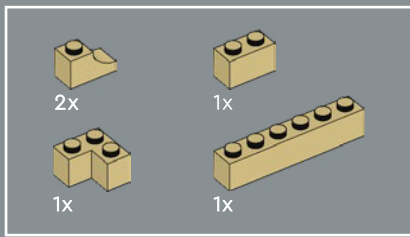

93

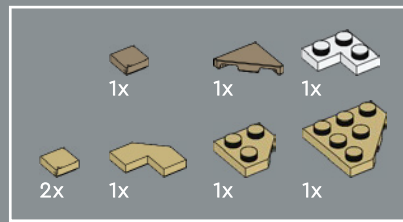
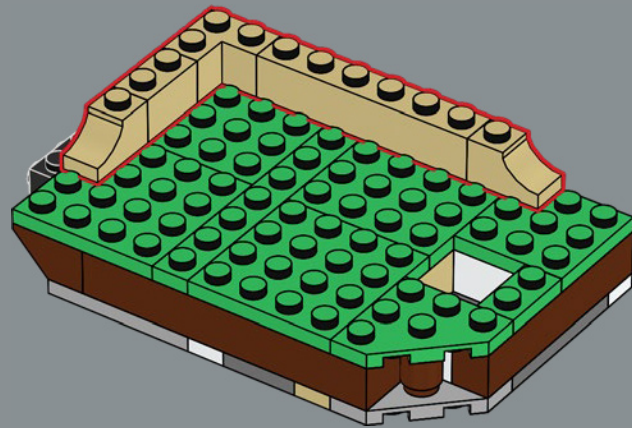

94

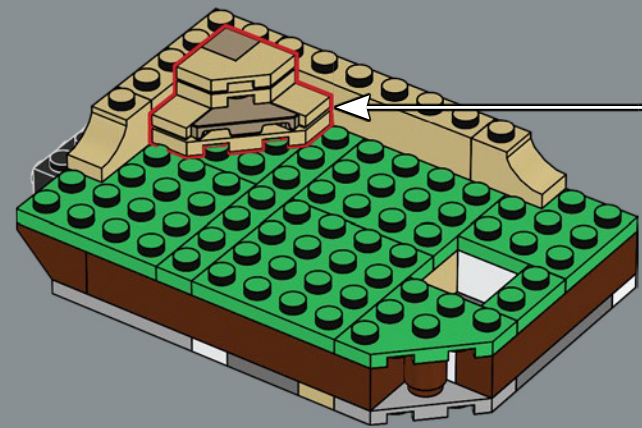
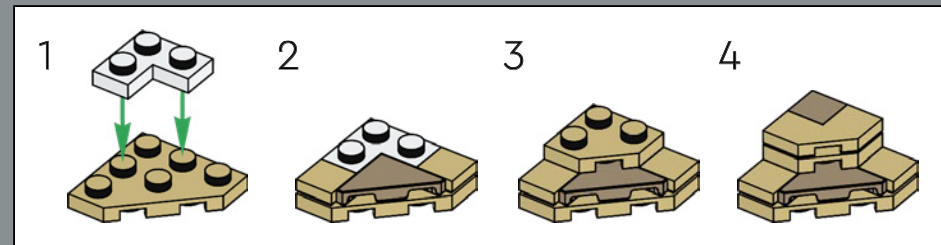



95

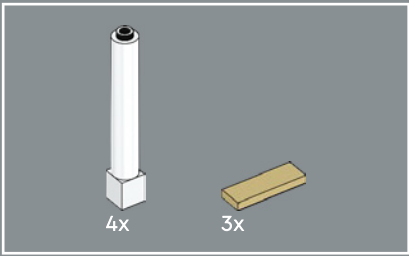
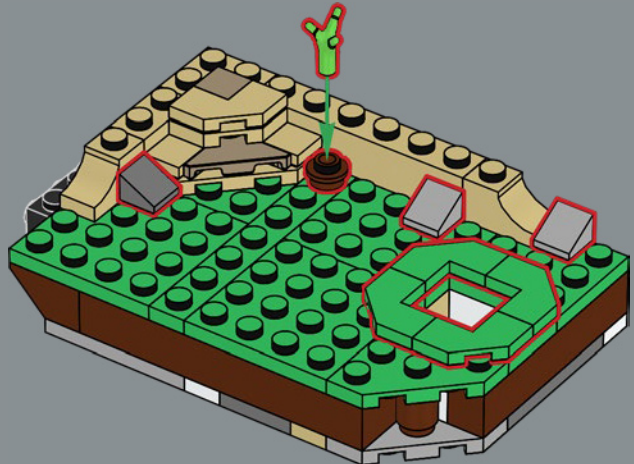

96

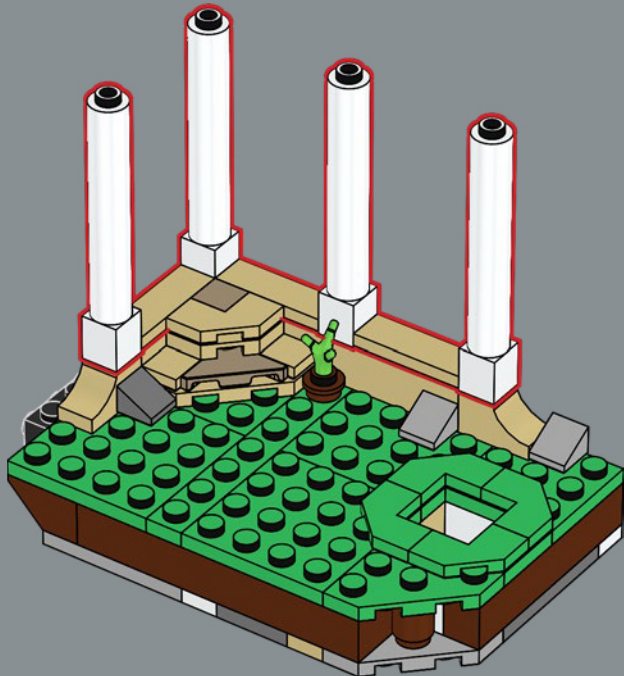

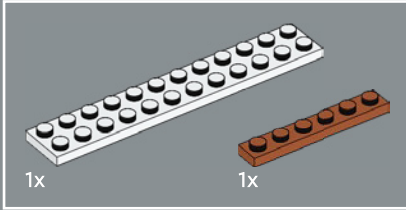
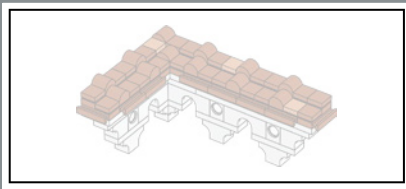

97

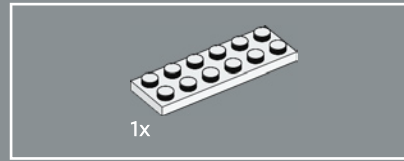
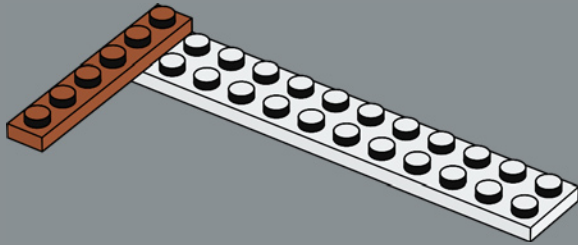

98

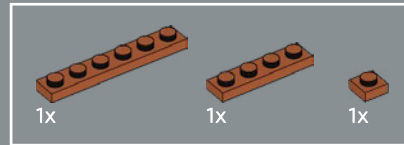
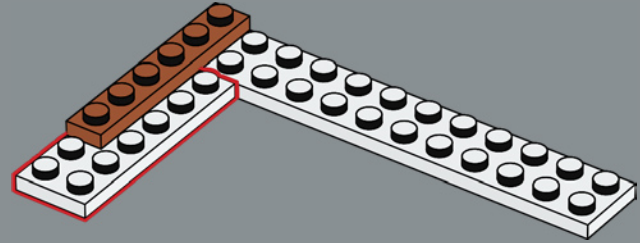

99

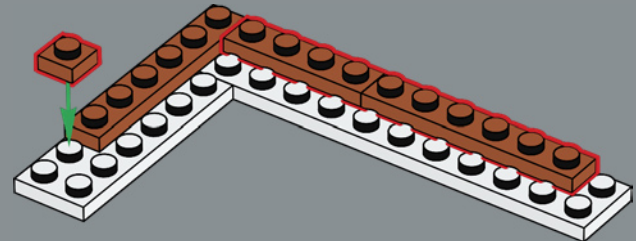



100

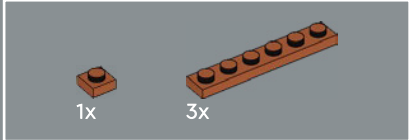
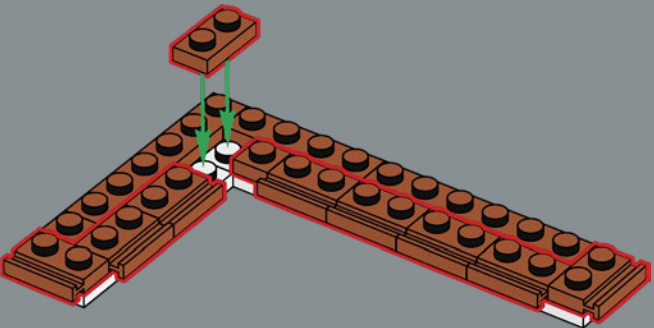

101

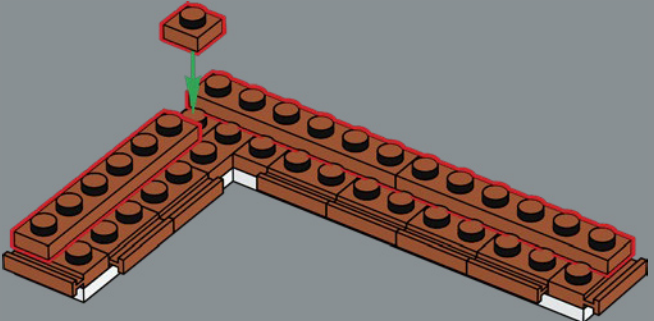

102

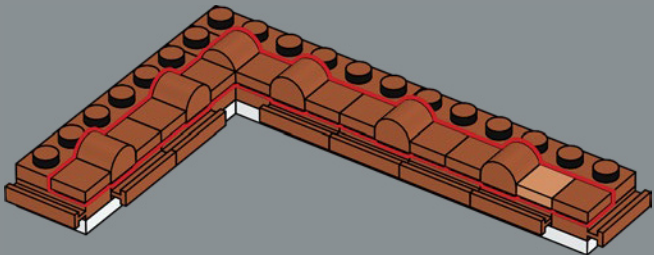

103

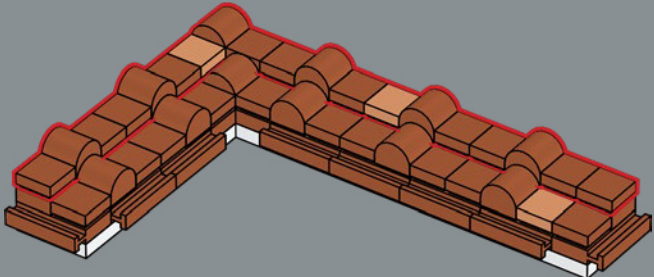

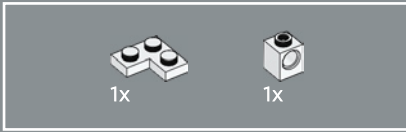
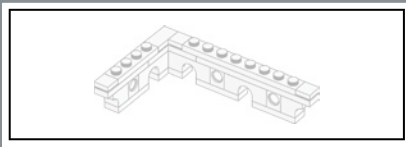

104

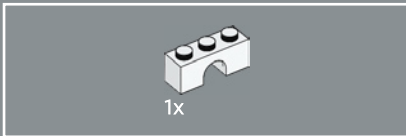
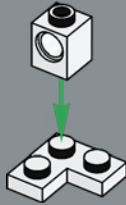

105

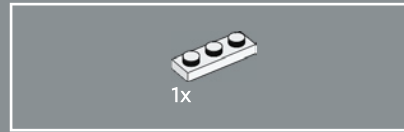
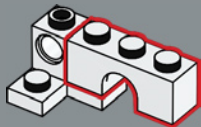

106

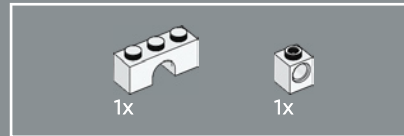
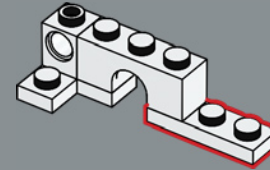

107

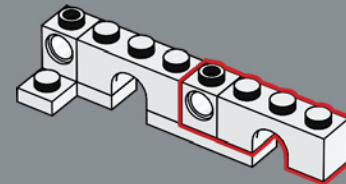

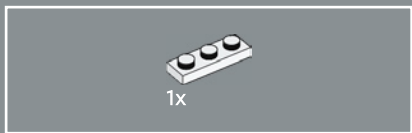

108

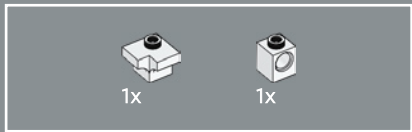
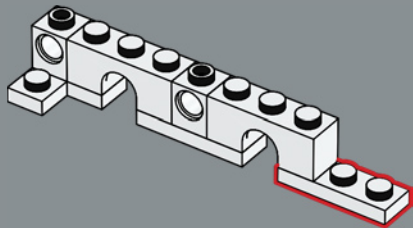

109

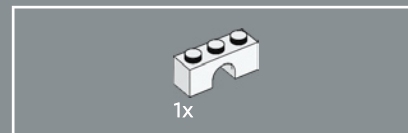
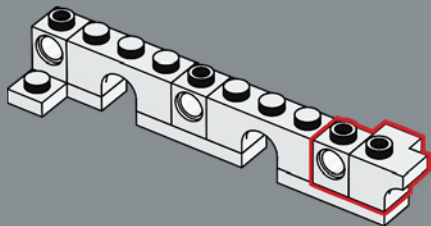

110

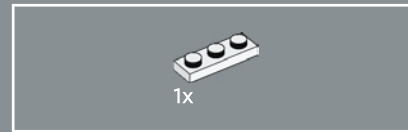
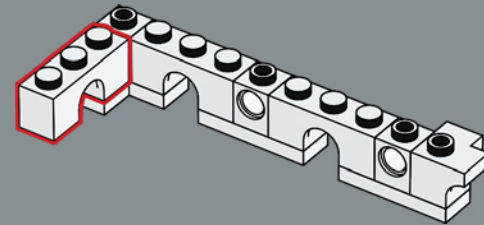

111

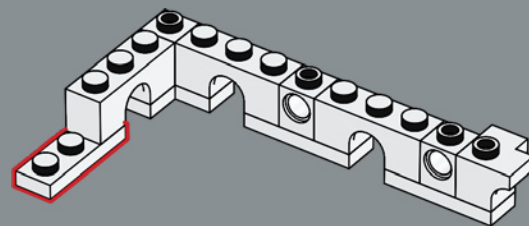

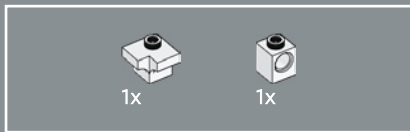

112

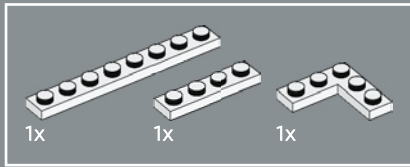
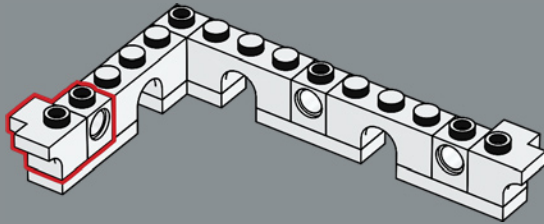

113

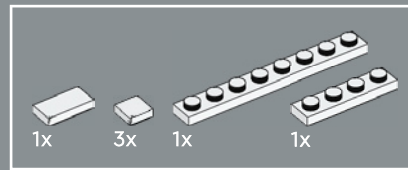
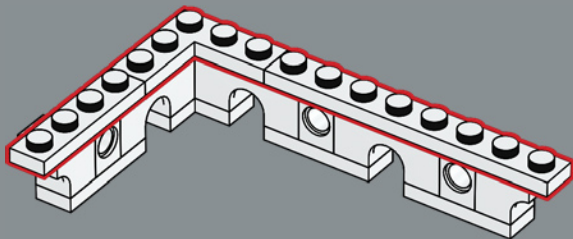

114

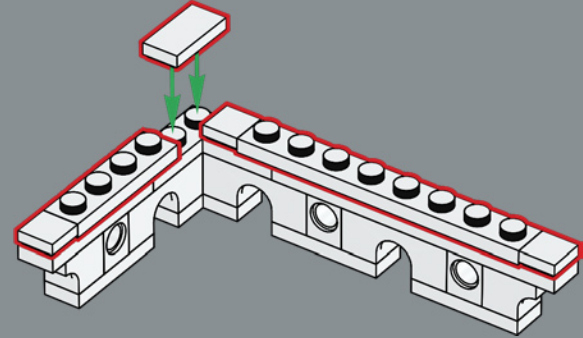

115

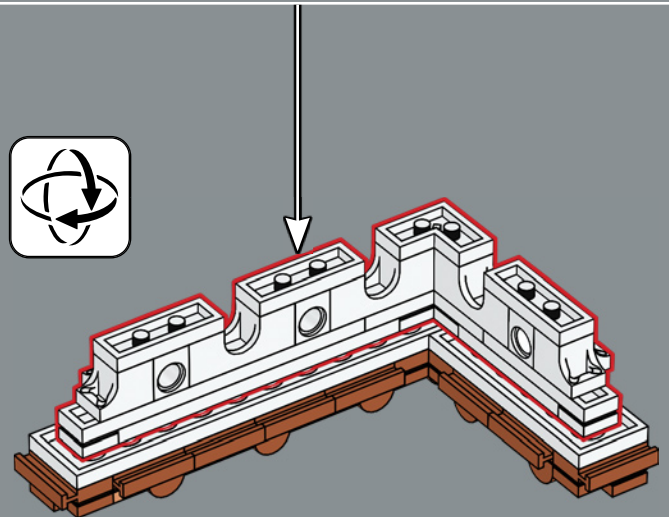

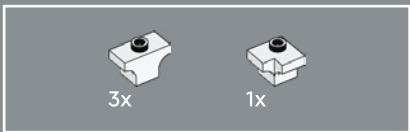

116

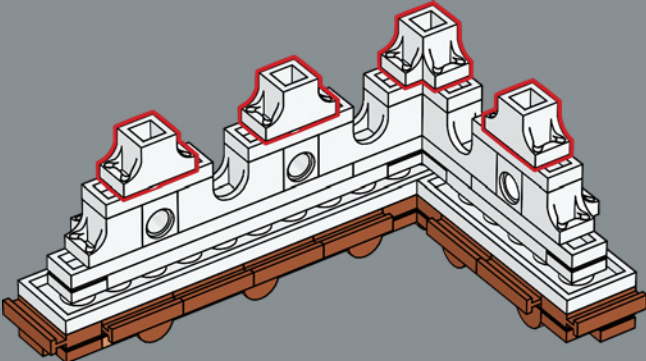

117

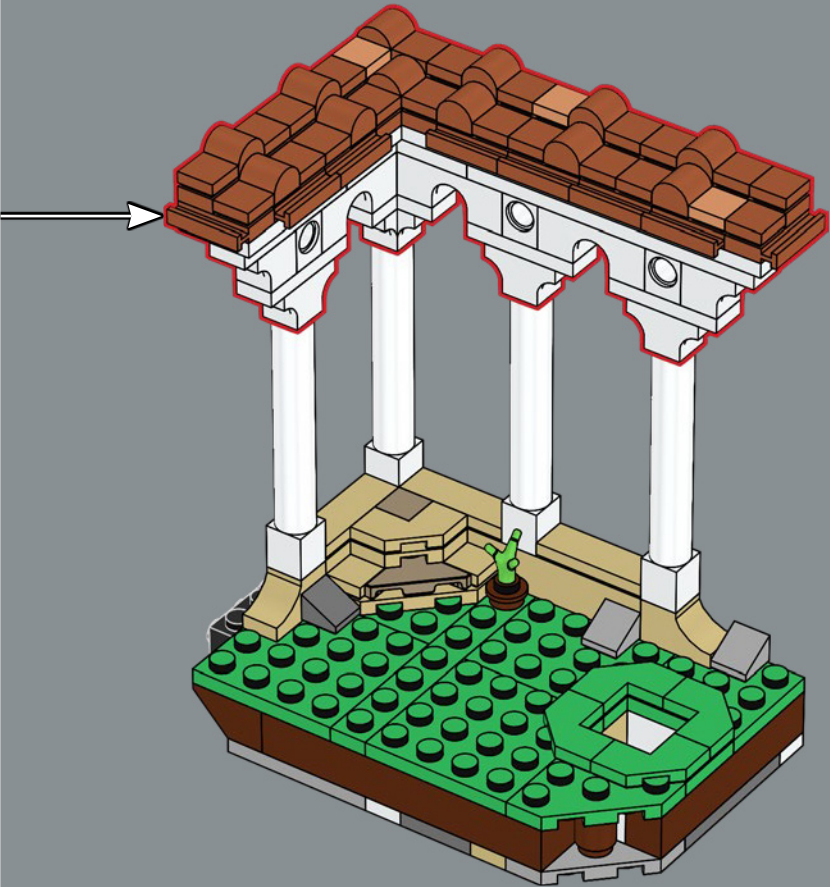

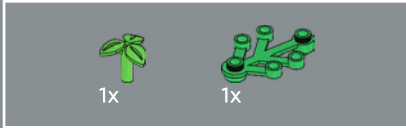

118

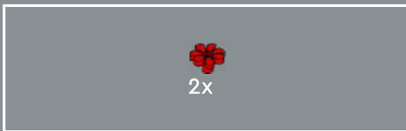
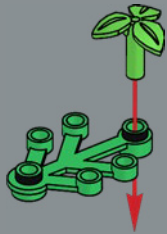

119

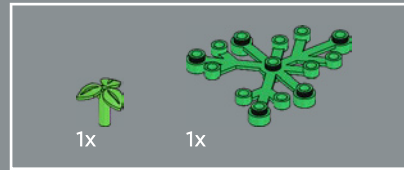

120

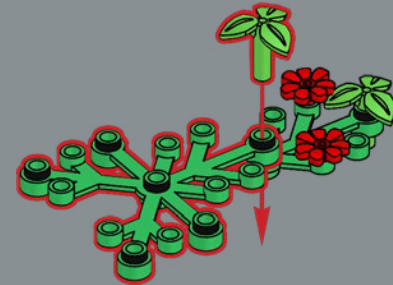

121

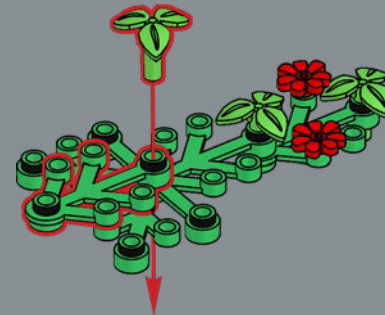



7x

122

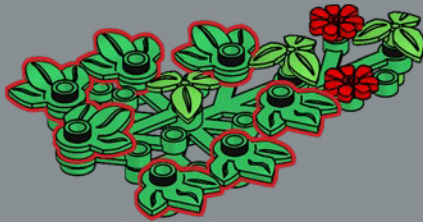

Chinesischer Roseneibisch (*Hibiscus rosa-sinensis*)
Mit Hibiskusblüten kann man prüfen, ob eine Flüssigkeit eine Säure ist. In einer Säure verfärbt sich die Hibiskusblüte dunkelrosa, in einer Lauge wird sie dagegen grün. Das perfekte Hilfsmittel, um den Säuregehalt deines Springbrunnens zu prüfen.



7x

123

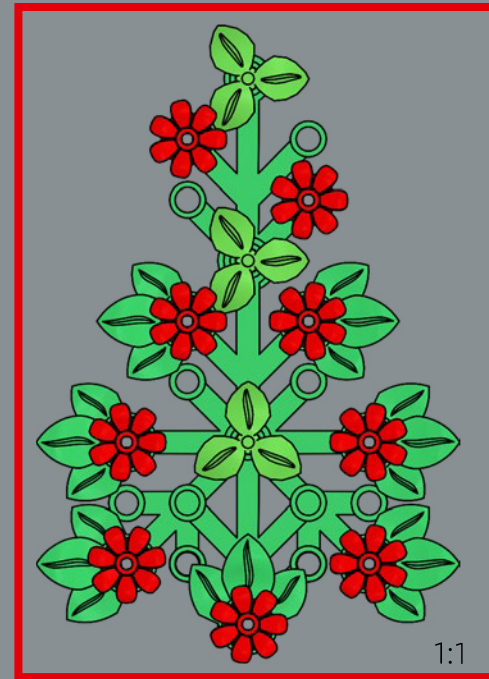
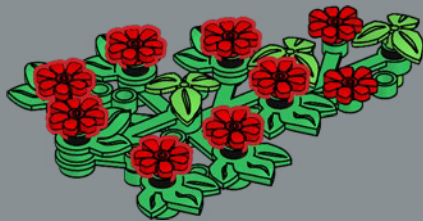



124

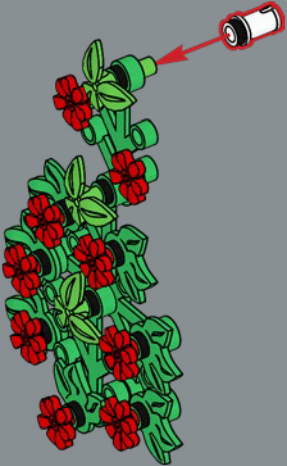

125

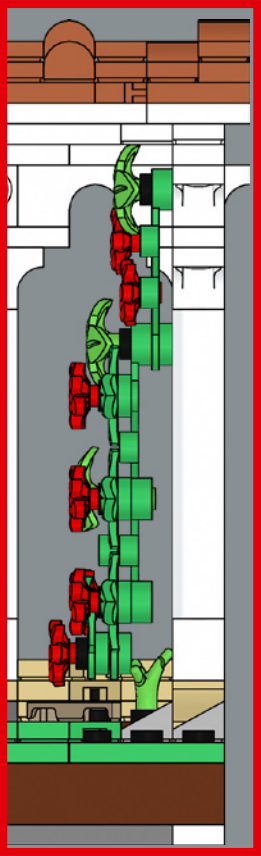

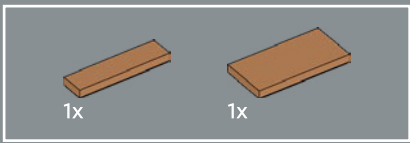

126

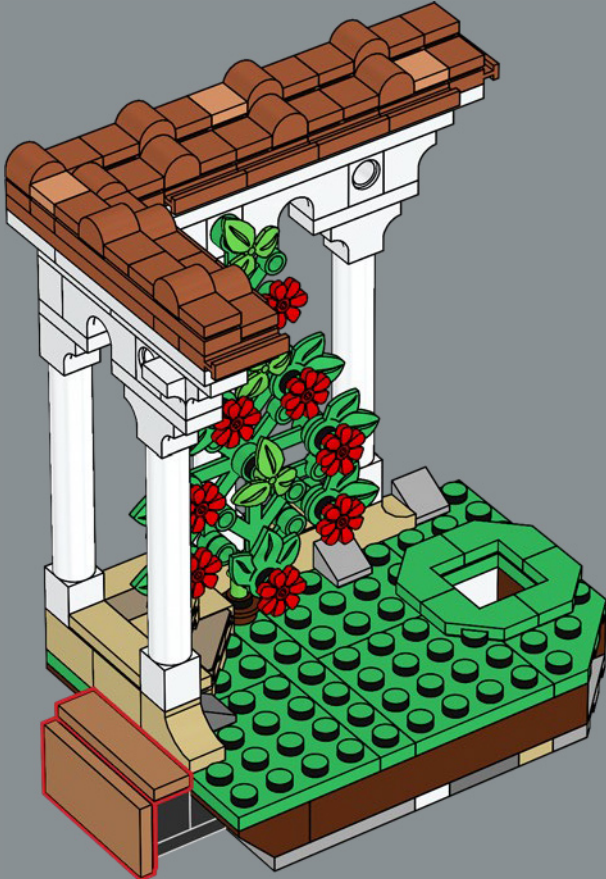

127



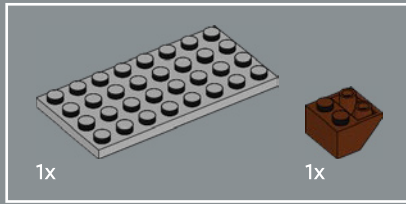
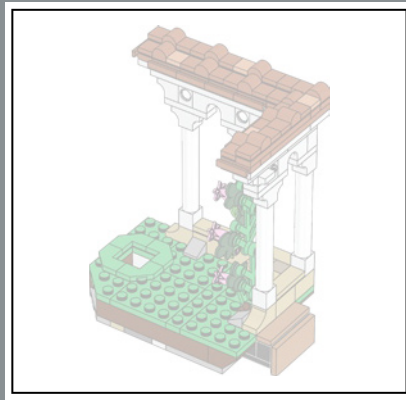

128

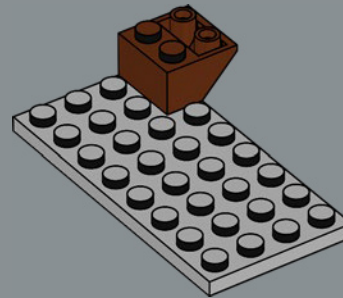

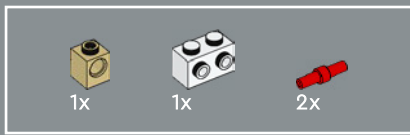

129

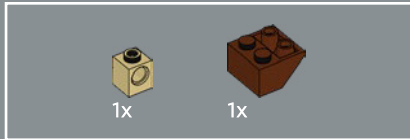
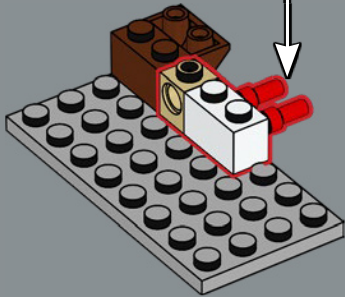
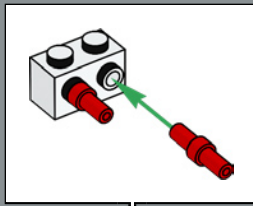

130

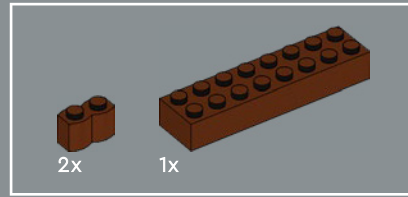
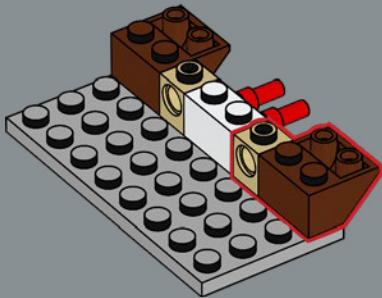

131

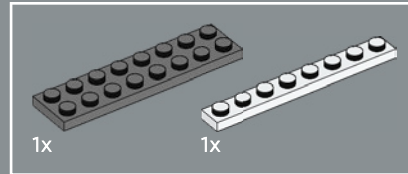
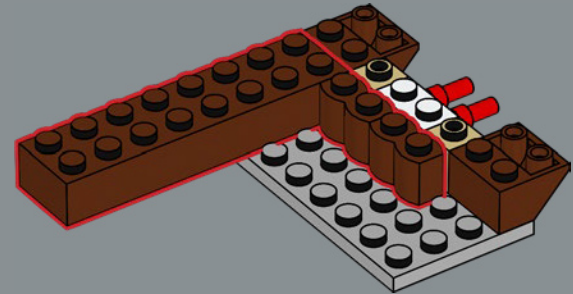

132

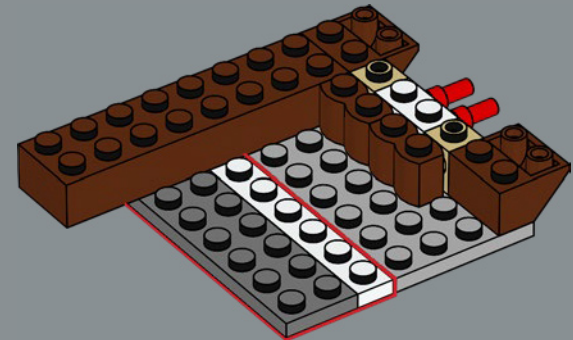

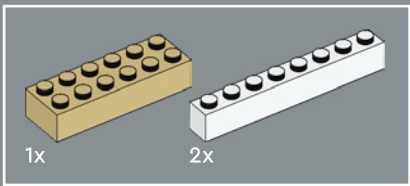

133

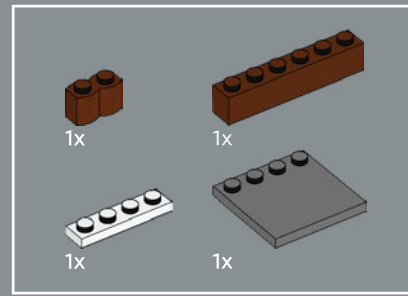
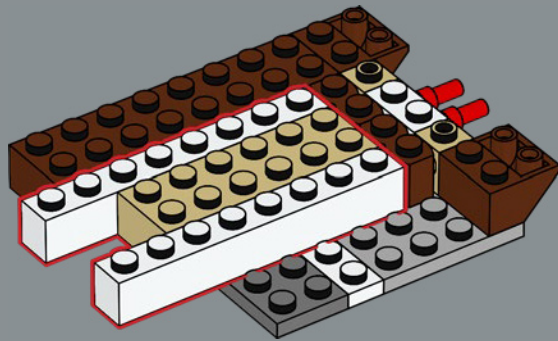

134

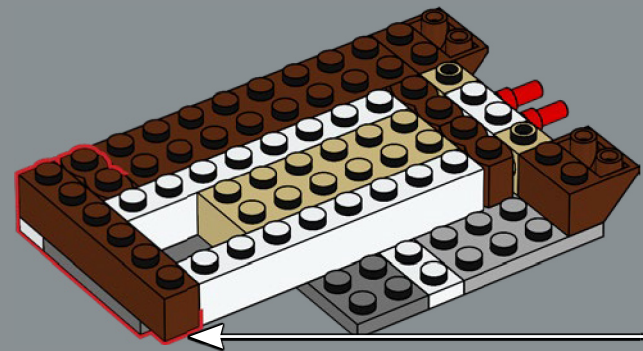
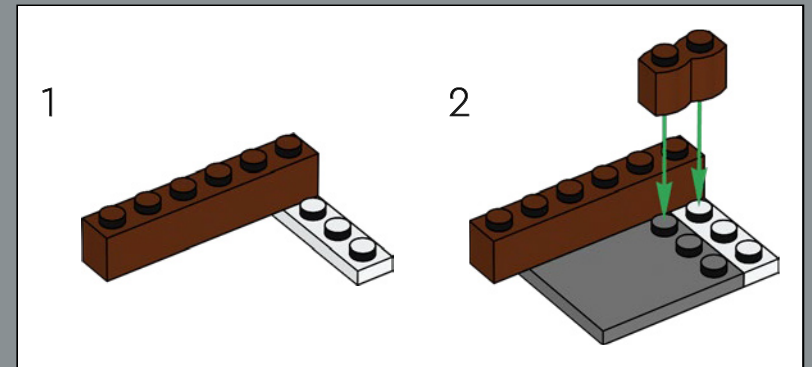

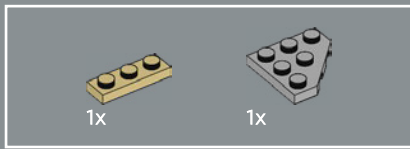

135

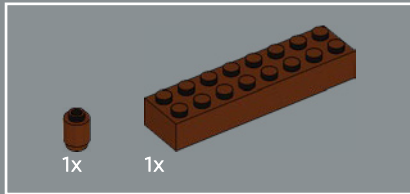
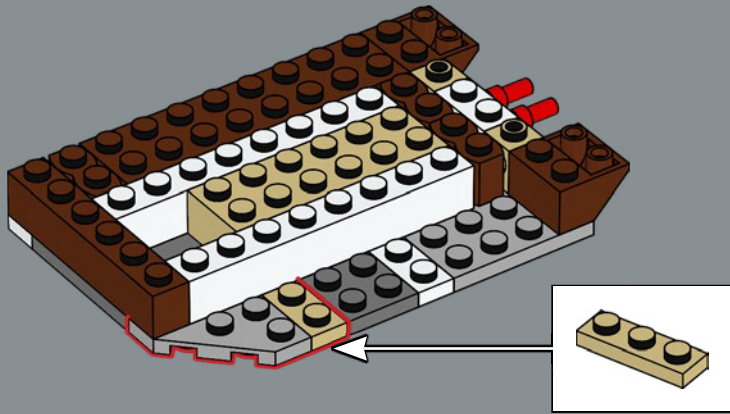

136

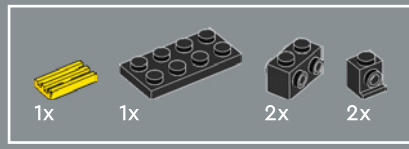
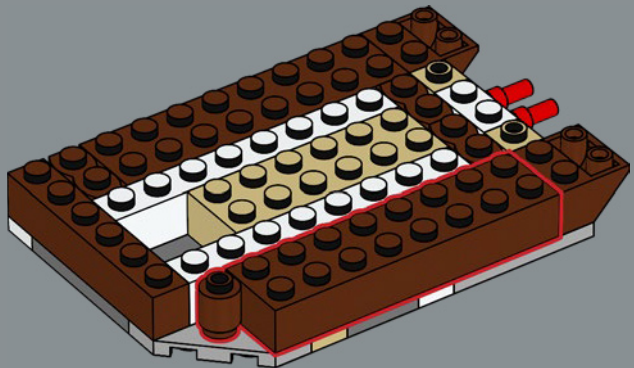

137

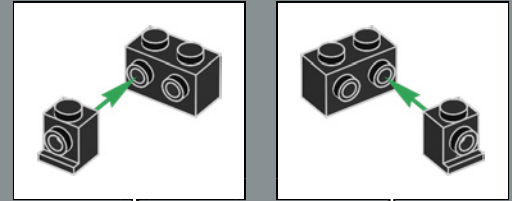

1

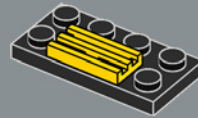

2

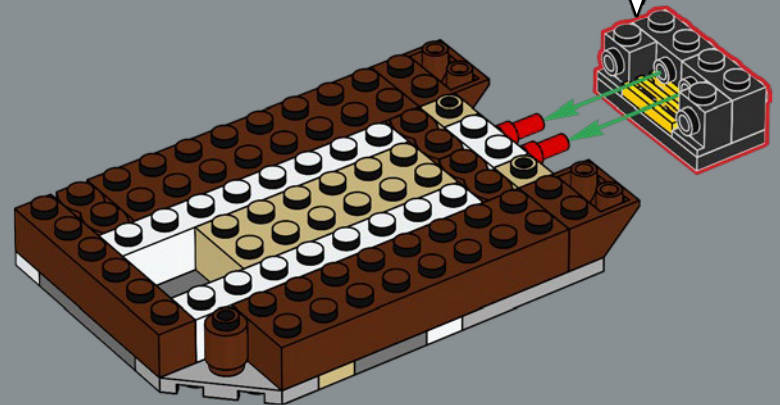
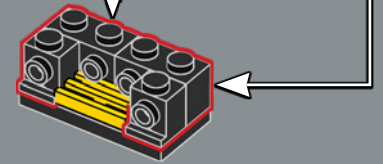

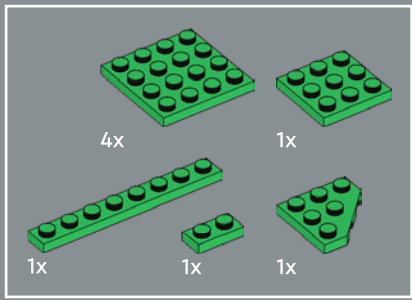

138

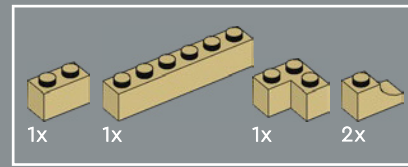

139



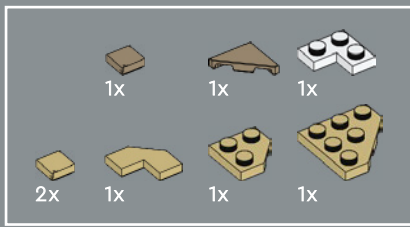

140

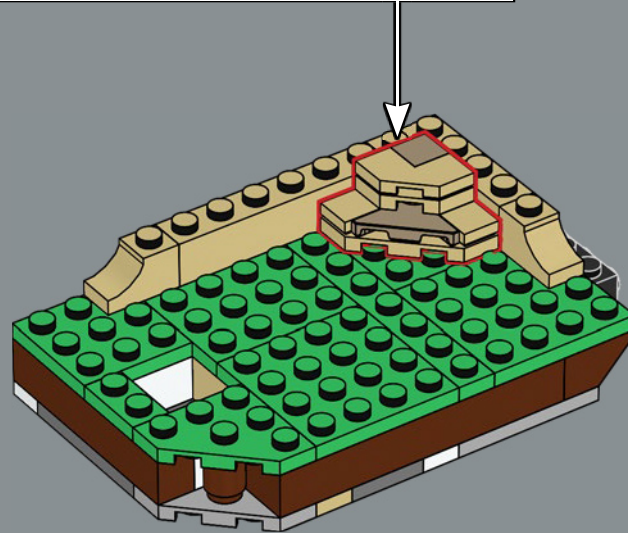
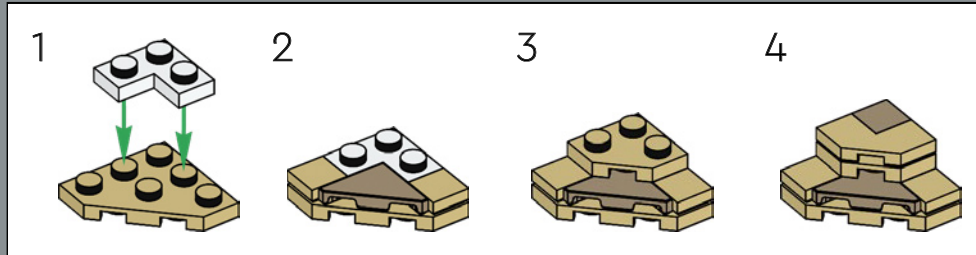

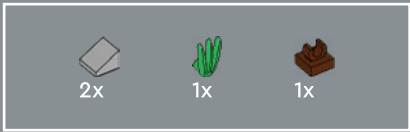

141

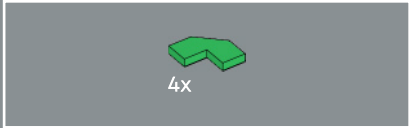
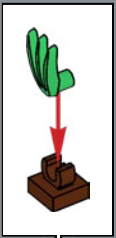

142

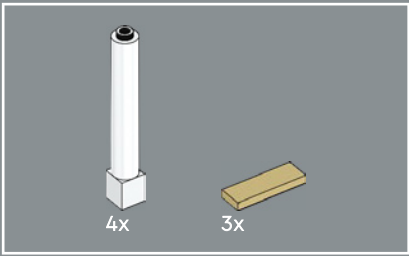
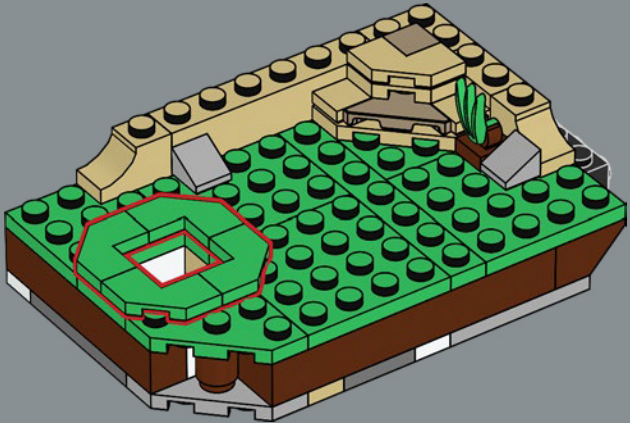

143

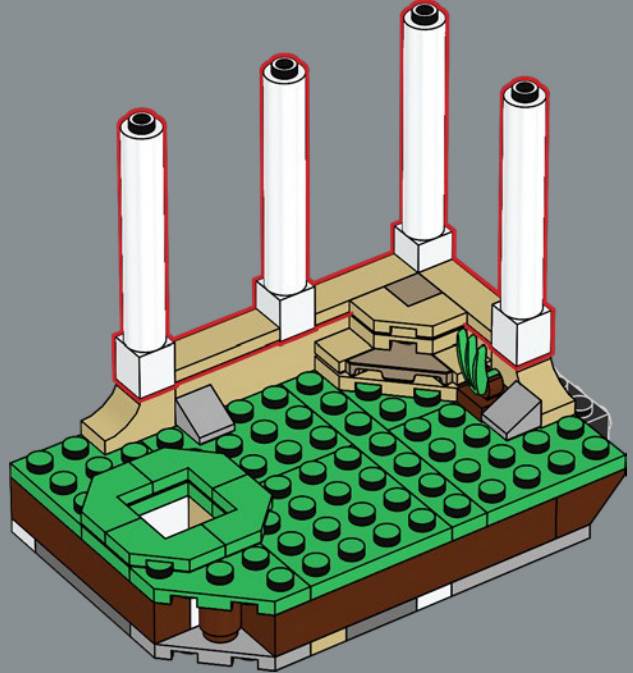

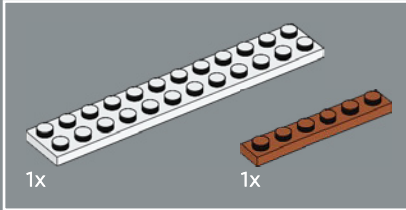
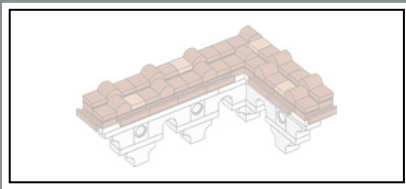

144

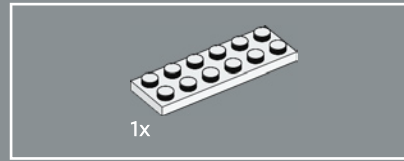
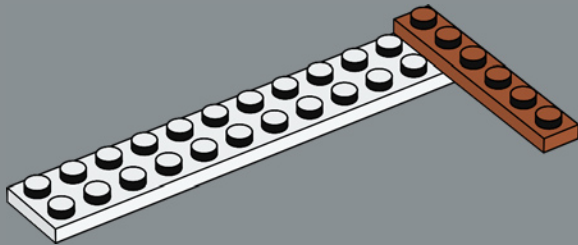

145

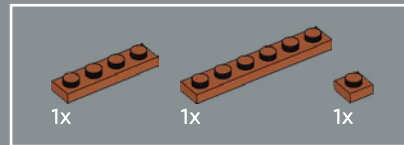
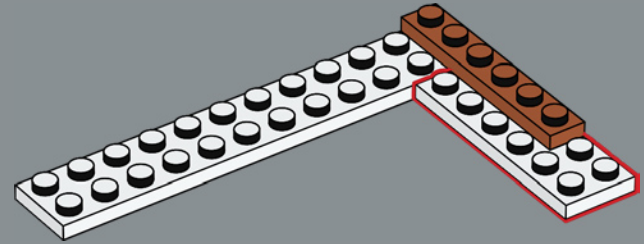

146

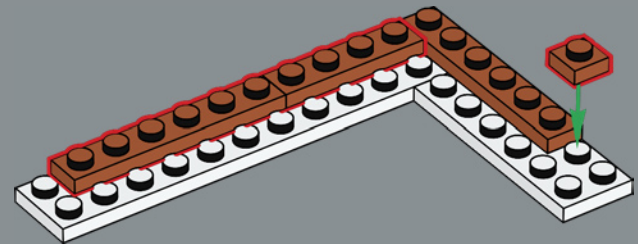



147

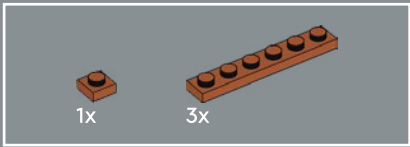
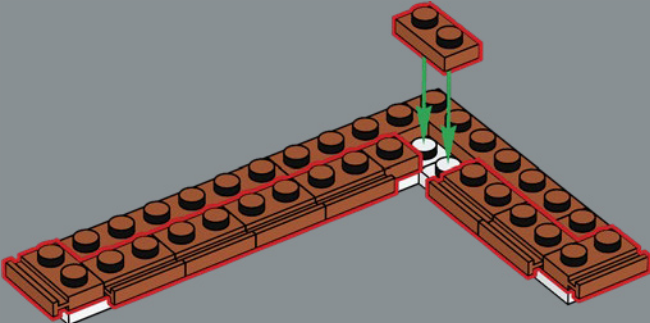

148

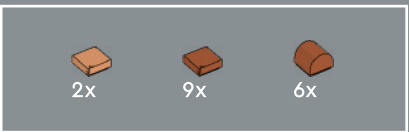
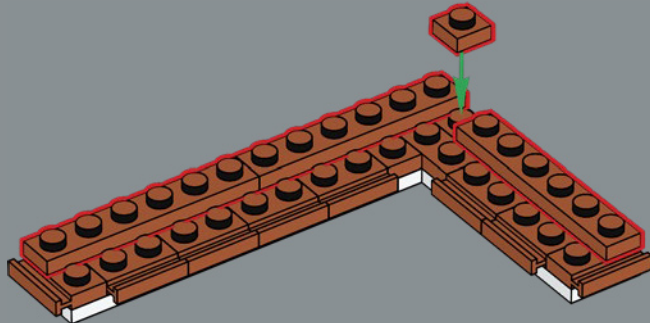

149

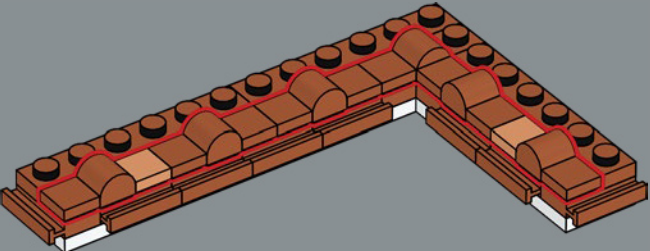

150

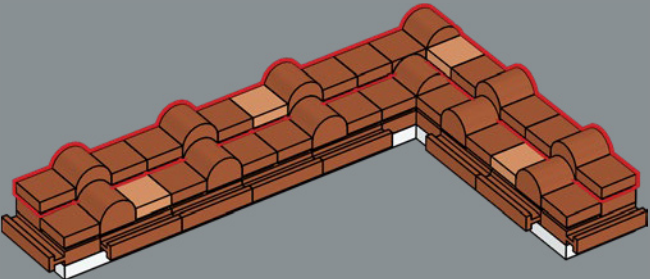

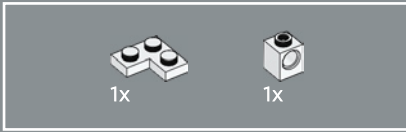
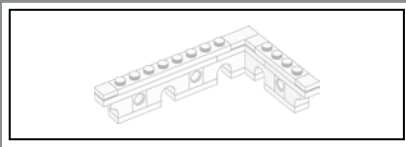

151

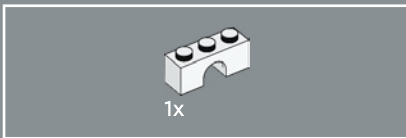
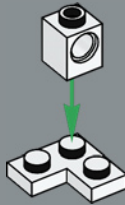

152

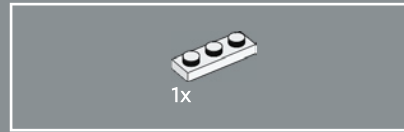
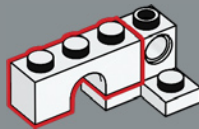

153

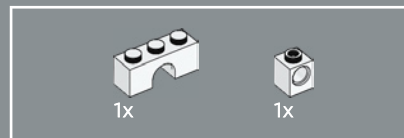
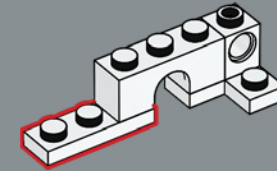

154

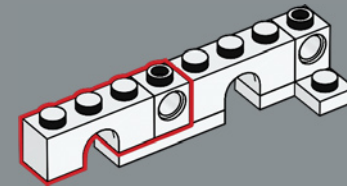

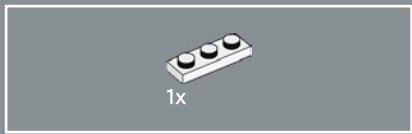

155

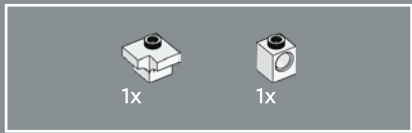
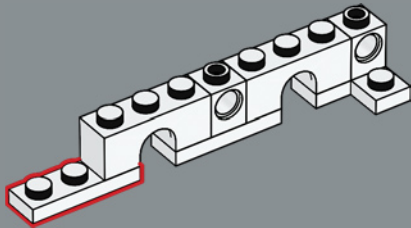

156

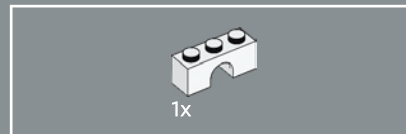
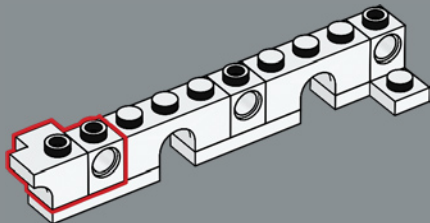

157

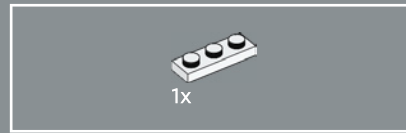
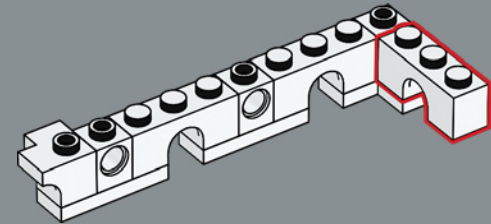

158

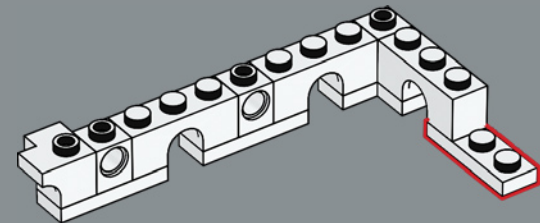

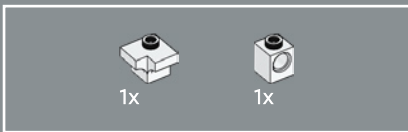

159

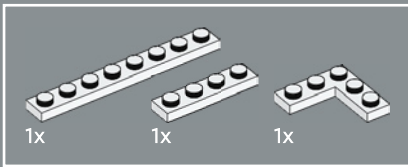
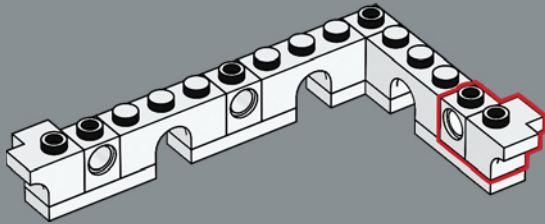

160

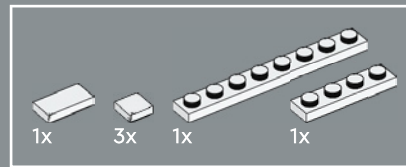
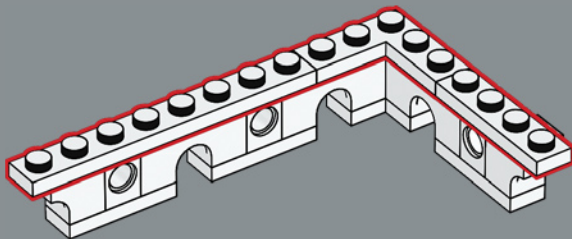

161

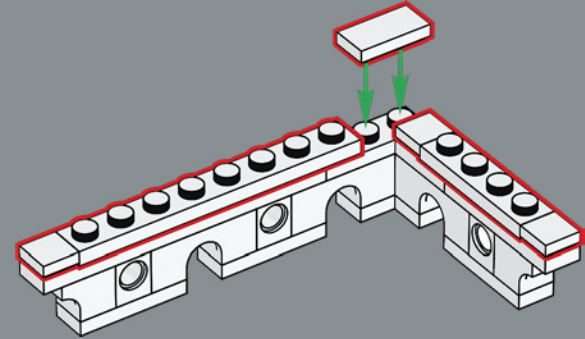

162

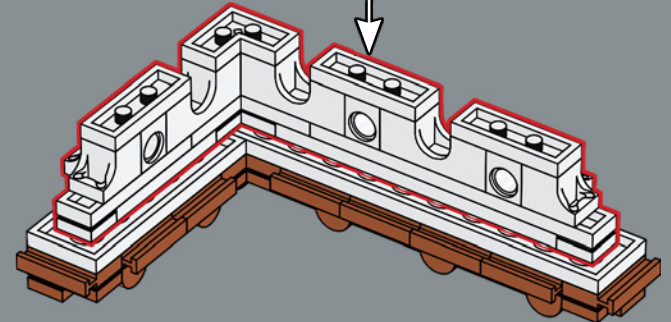
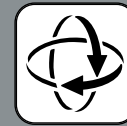

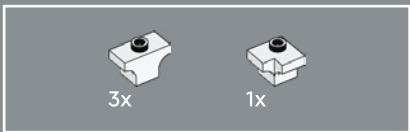

163

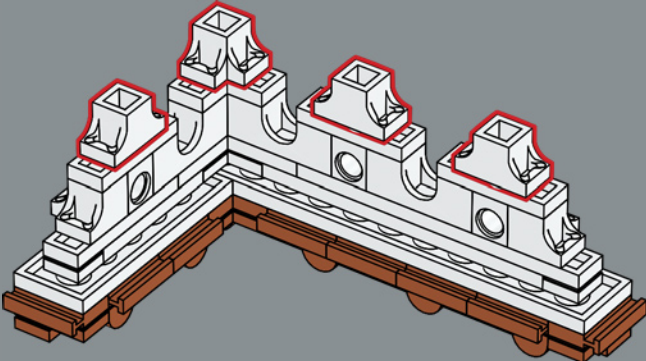

164

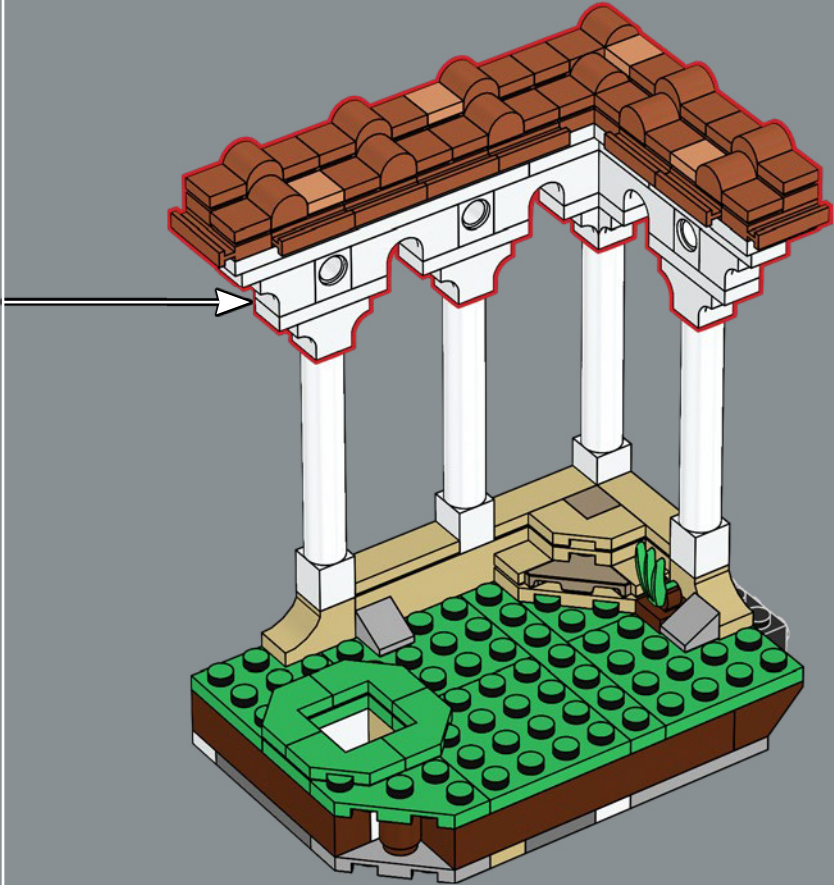

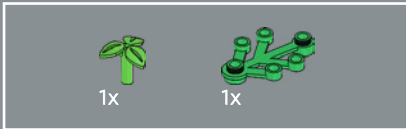
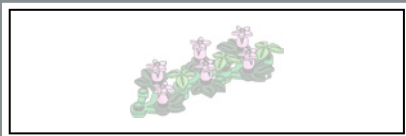

165

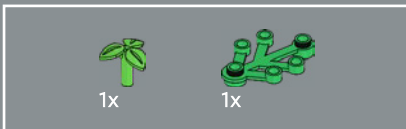
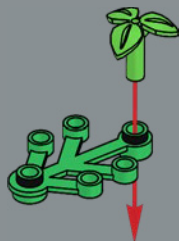

166

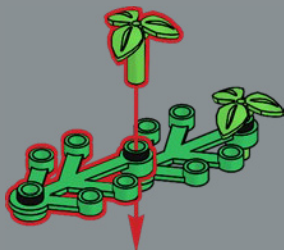

167

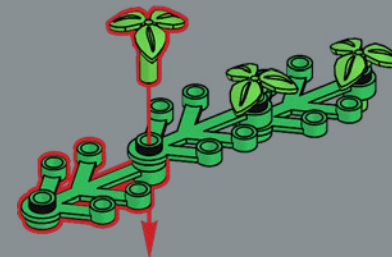

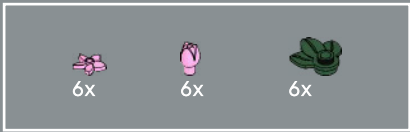

168

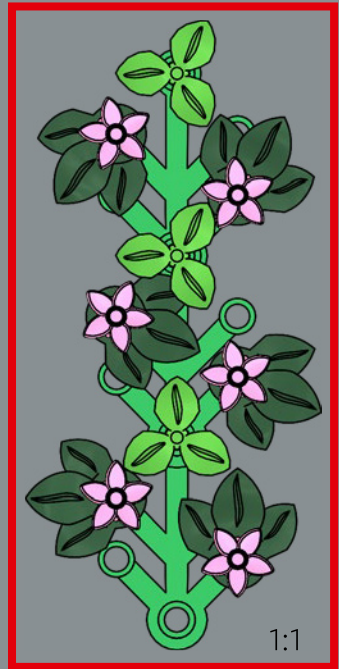
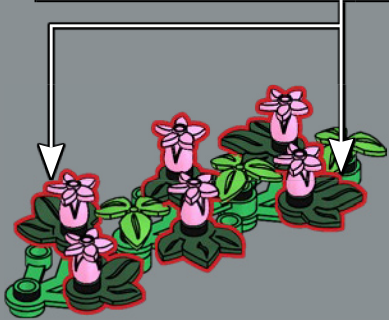
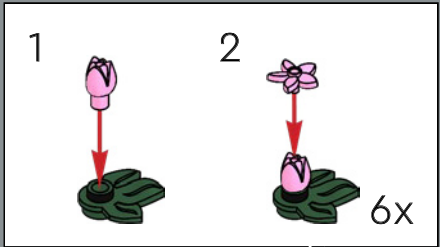

169

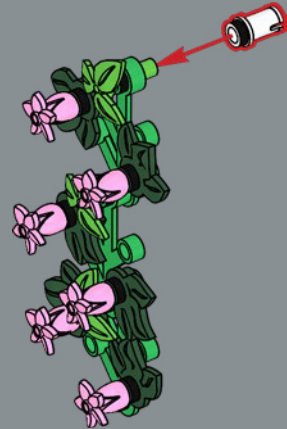

Rosafarbene Bougainvillea (*Bougainvillea*)
 Was viele fälschlicherweise für die Blüte einer
 Bougainvillea halten, sind in Wahrheit Deckblätter oder
 falsche Blüten, also eine andere Art der Blätter, die die
 winzigen echten Blüten der Pflanze umsäumen.

170

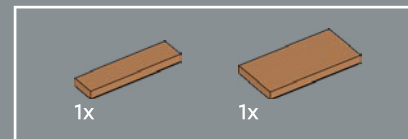
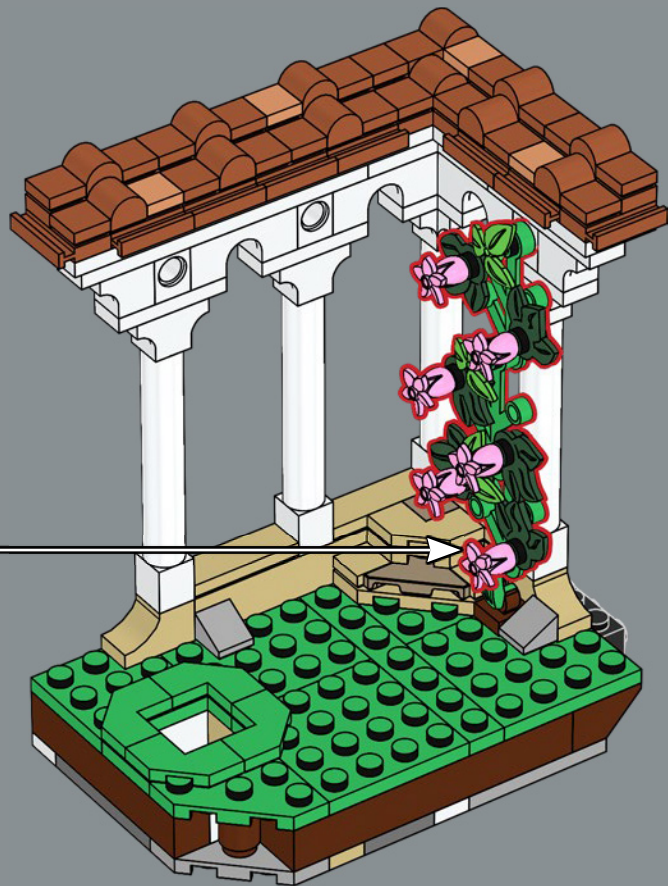

171





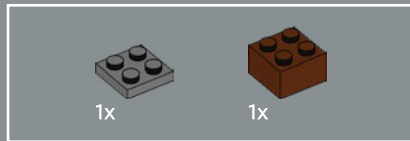
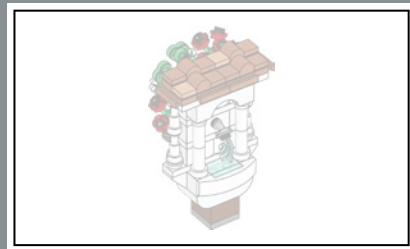

173

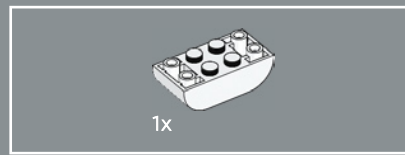
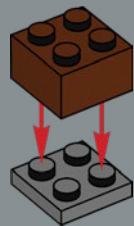

174

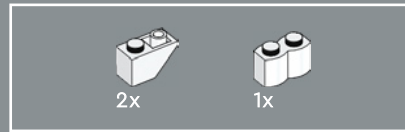
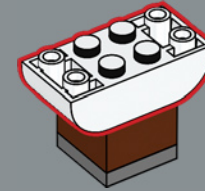

175

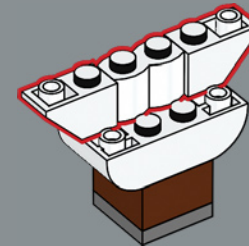

176

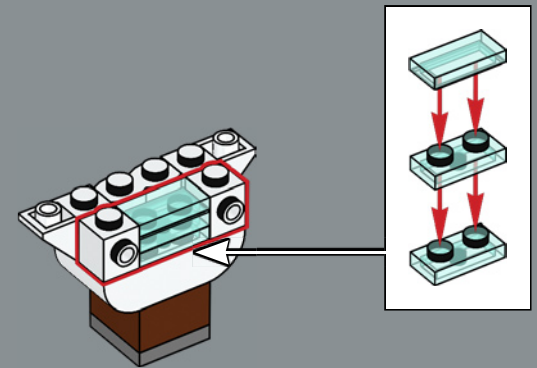



177

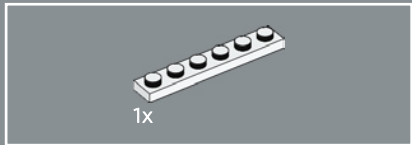
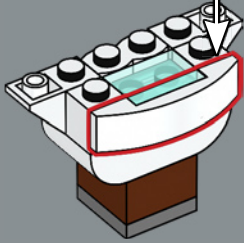
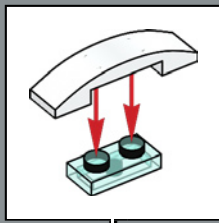

178

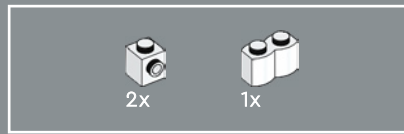
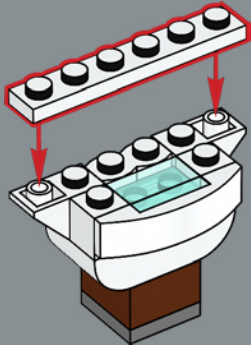

179

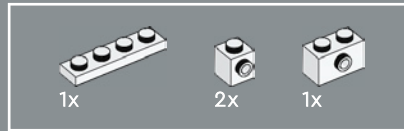
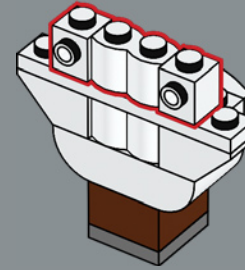

180

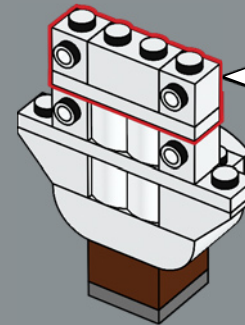
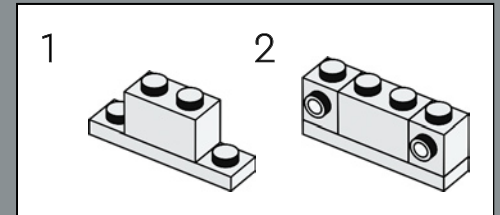

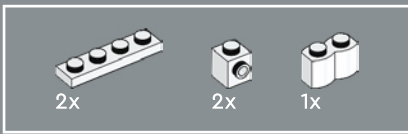

181

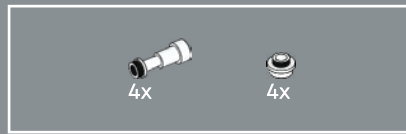
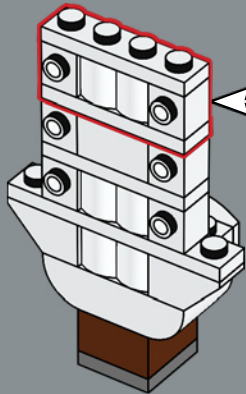
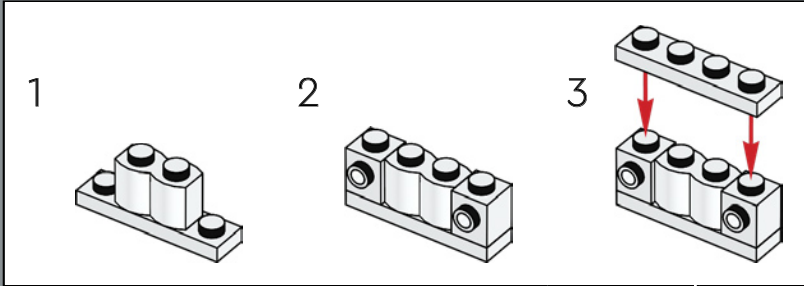

182

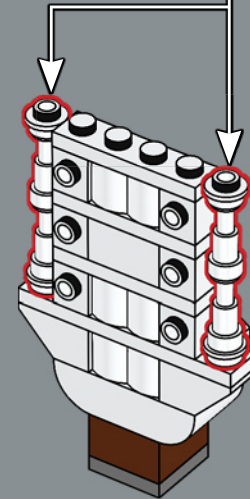
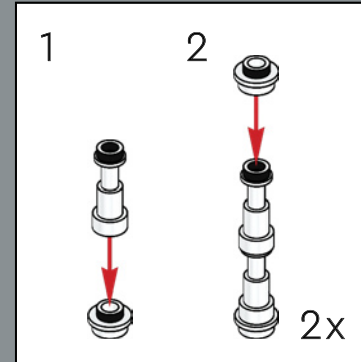



183

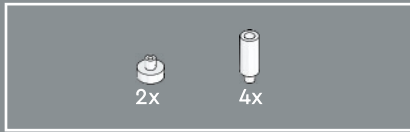
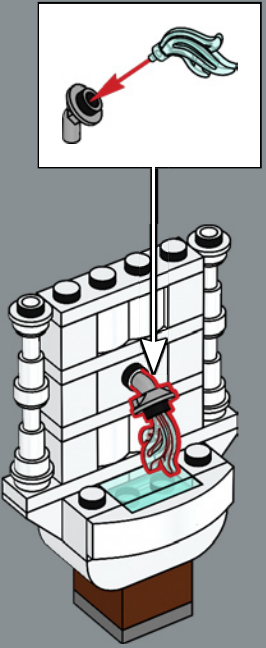

184

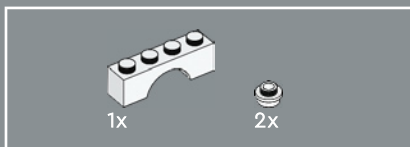
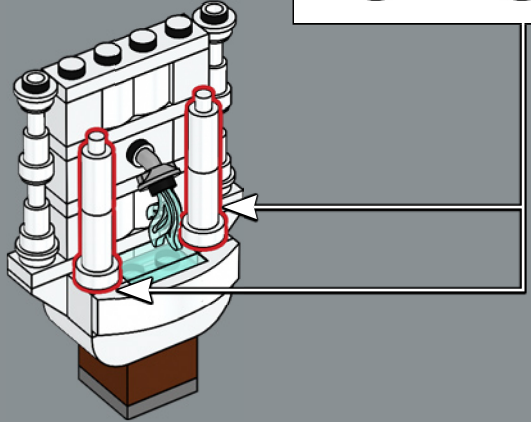
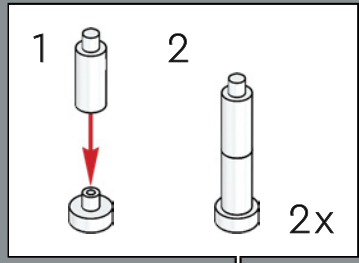

185

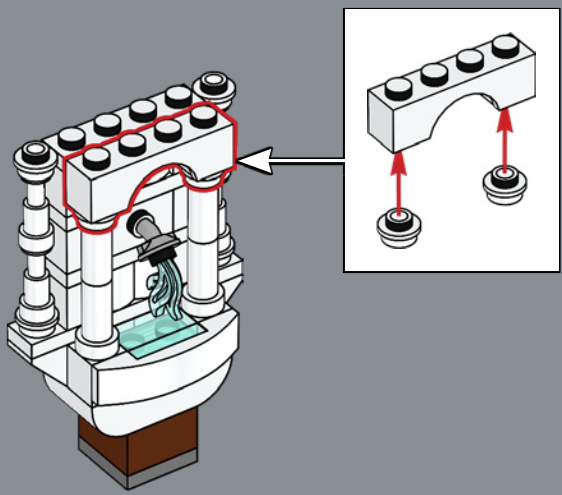

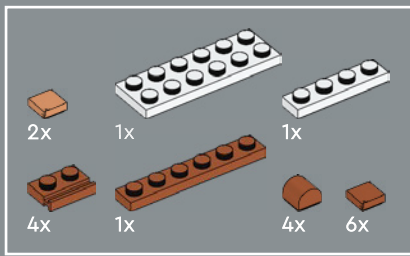

186

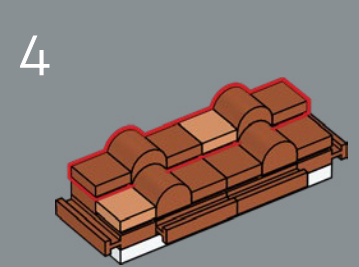
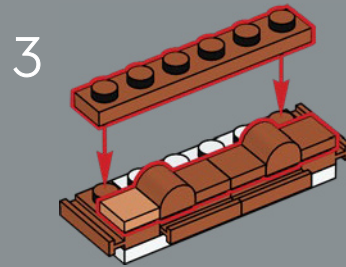
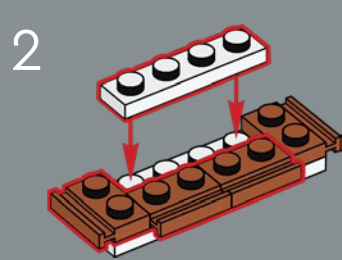
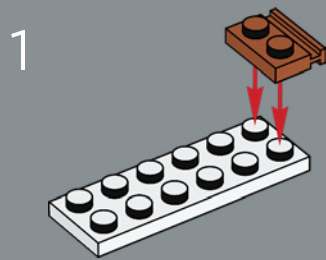



2x

187

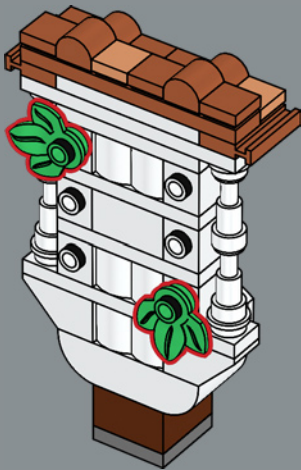

2x

188

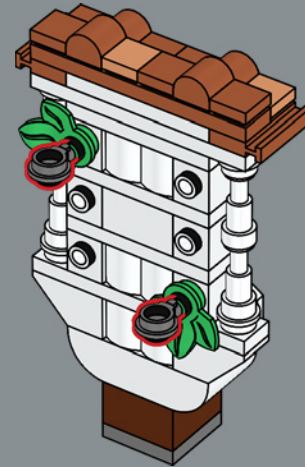

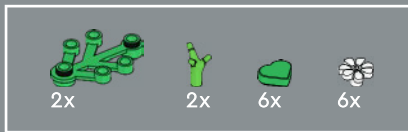

189

Weißer Petunie (*Petunia axillaris*)
 Manche Petunienarten eignen sich zwar zum Garnieren von Speisen, aber vielleicht ist es besser, diese Schönheit lieber in deinem Garten blühen zu lassen. Denn sie ist nicht nur mit Kartoffeln und Tomaten verwandt, sondern auch mit dem tödlichen Nachtschatten!

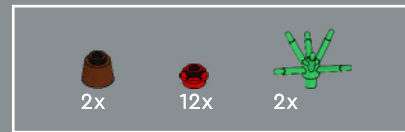
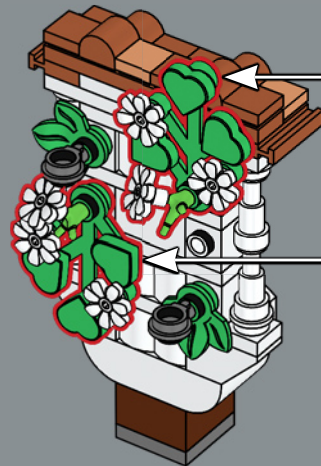
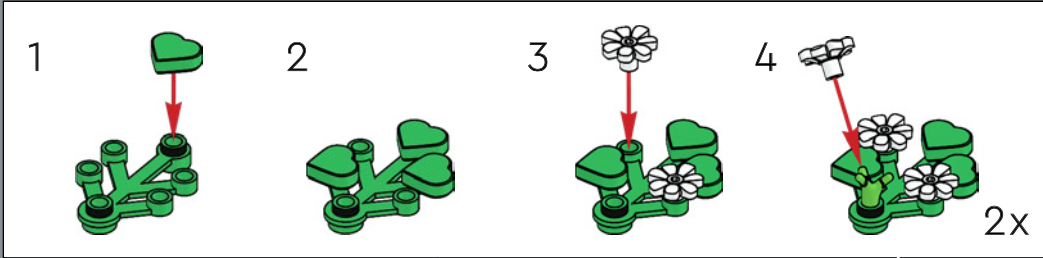

190

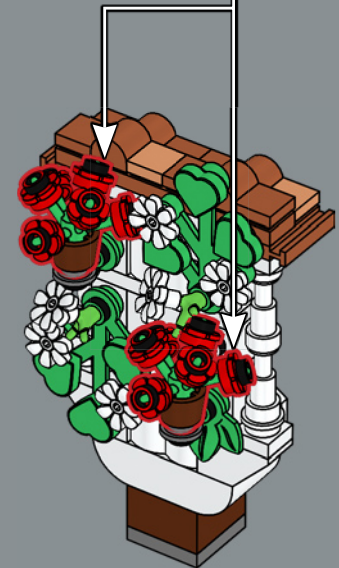
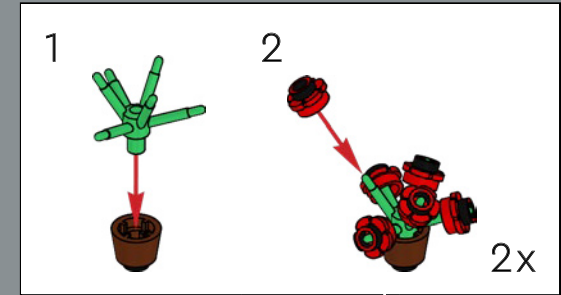

Rote Gartengeranie (*Pelargonium x hortorum*)
 In einem Garten der Stille dient die duftende Gartengeranie sowohl ästhetischen als auch praktischen Zwecken. Ihre natürlichen Öle verströmen einen Duft, der Insekten abschwirren lässt!



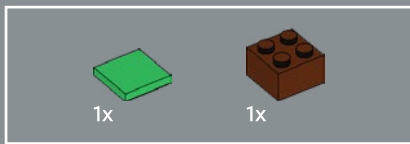

192

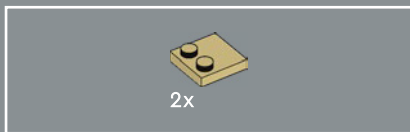
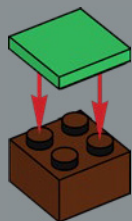

193

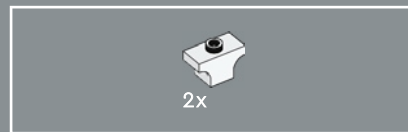
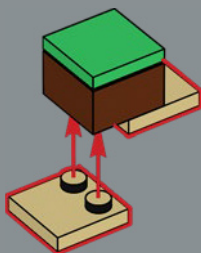

194

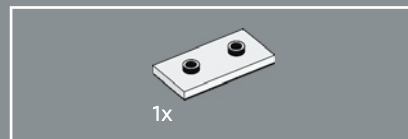
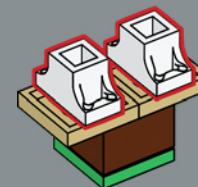

195

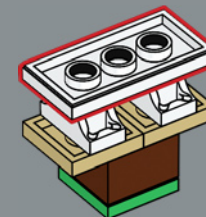

196

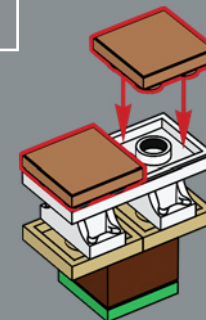



Iberischer Wasserfrosch (*Pelophylax perezi*)
Dieser auf der Iberischen Halbinsel heimische
flinke Schwimmer fühlt sich in Süßwasser und
Feuchtgebieten besonders wohl.

197



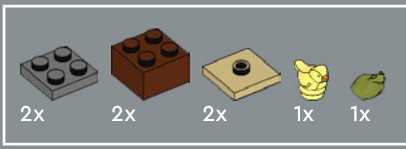

198

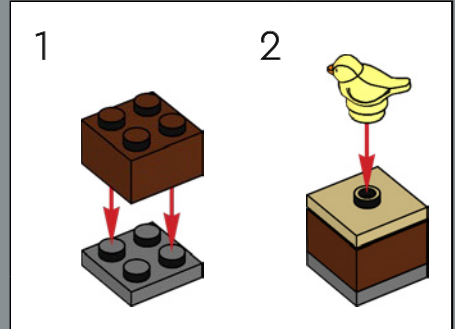
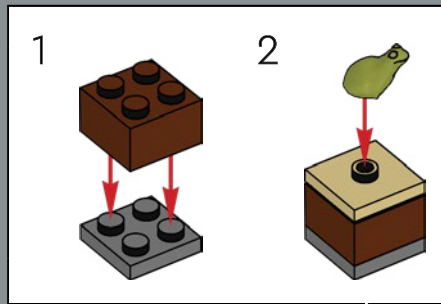

Goldammer (*Emberiza citrinella*)
 Die Goldammer mit ihrem typischen
 hellgelben Gefieder und ihrem markanten
 Gesang ist in ganz Europa heimisch.



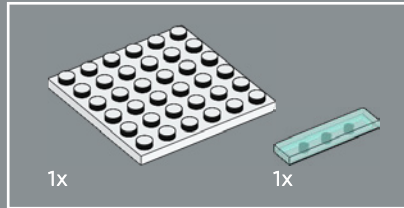
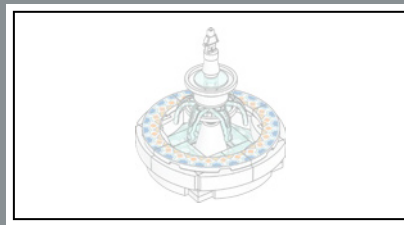

199

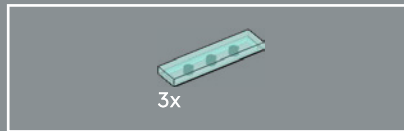
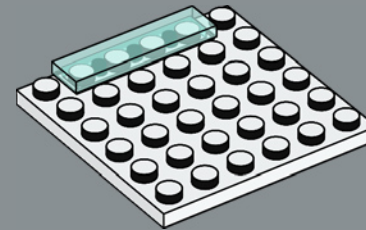

200

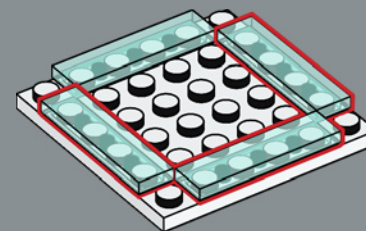

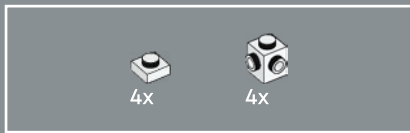

201

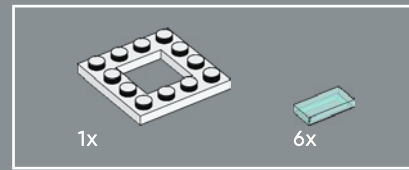
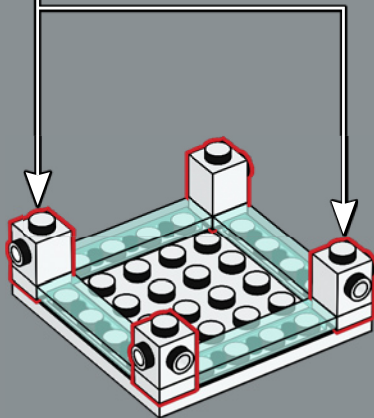
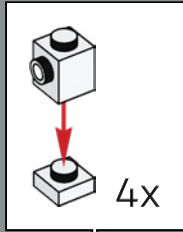

202

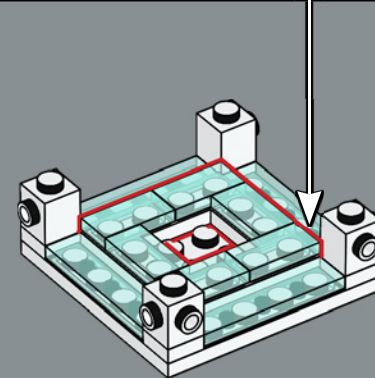
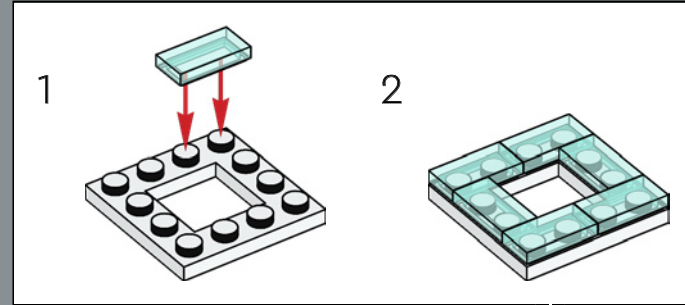

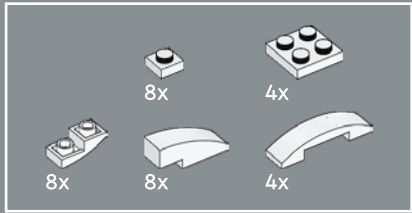
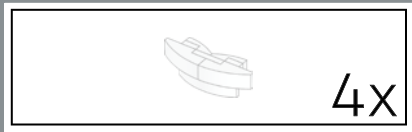

203

1

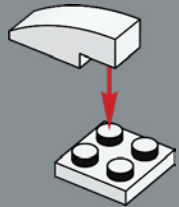

2

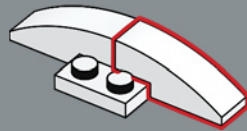

3

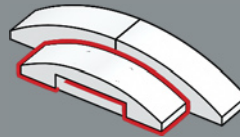

4

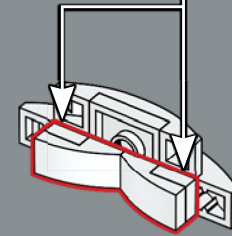
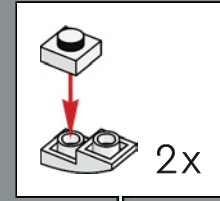

4x

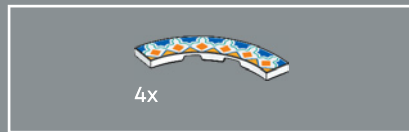

204

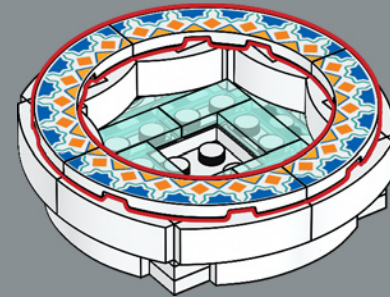
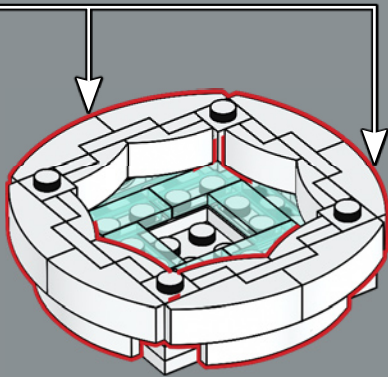

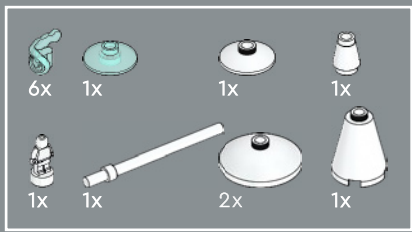

205

1

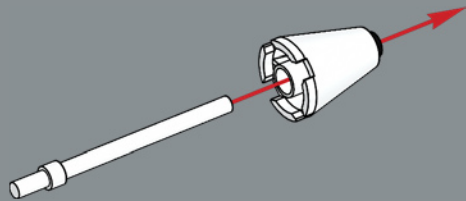

2



3



4



5

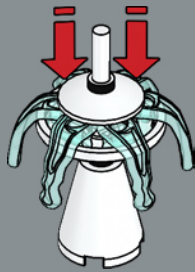

6

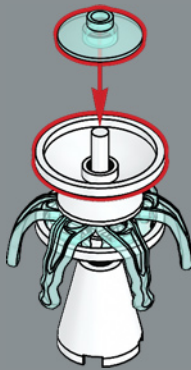

7

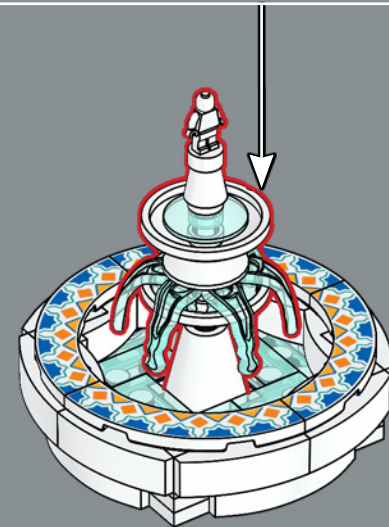
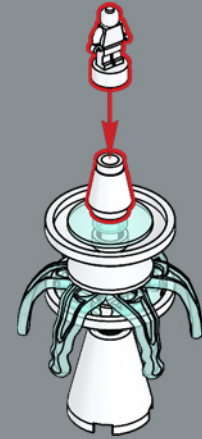



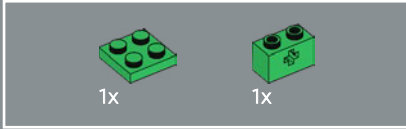

207

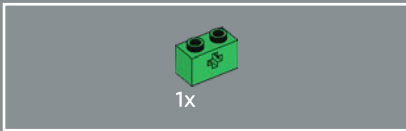
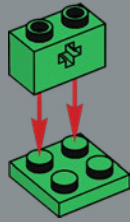

208

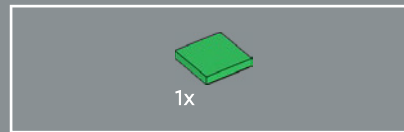
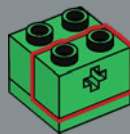

209

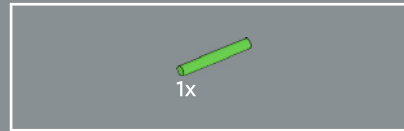
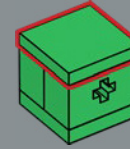

210

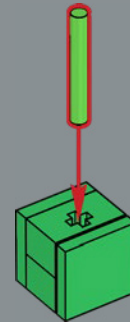

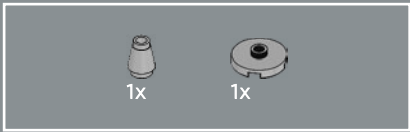

211

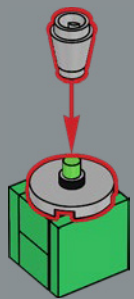

212

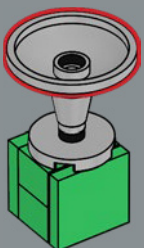

213

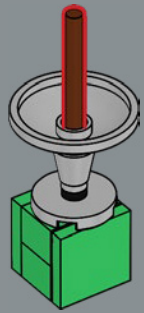



214

1

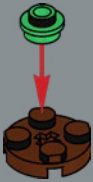

2

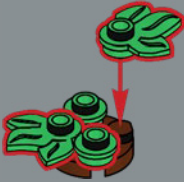

3

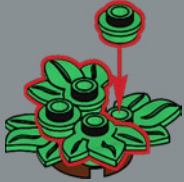

4

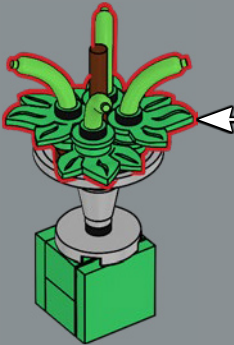

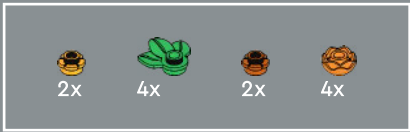

215

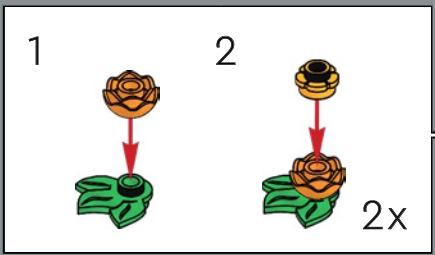
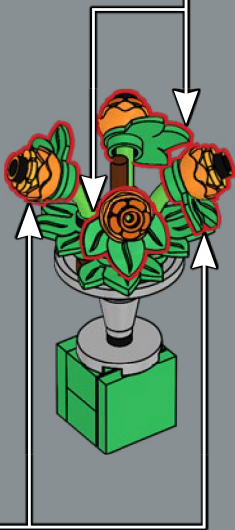
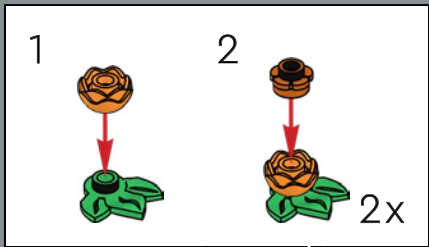

216

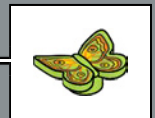
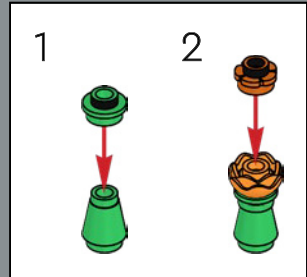

Isabellaspinner (*Graellsia isabellae*)
 Der Isabellaspinner ist eine atemberaubende Falterart mit grünen Flügeln und markanten Augenflecken, die in den Pyrenäen lebt. Diese Art ist ein echtes „Überbleibsel“, das sich seit der letzten Eiszeit kaum verändert hat.



217

Studentenblume (*Tagetes patula*)
Studentenblumen stammen zwar aus Mittelamerika, doch die aromatischen kleinen Sonnenstrahlen erfreuen sich heute bei Gärtnern und Köchen rund um den Globus größter Beliebtheit, denn sie sind sehr dekorativ und verleihen süßen Nachspeisen eine würzige Note.



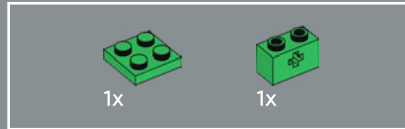
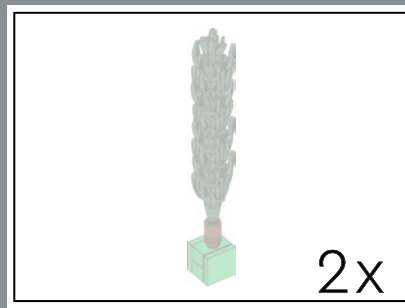

218

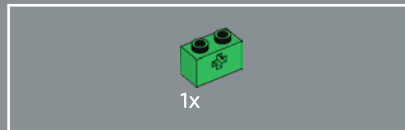
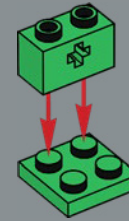

219

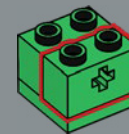

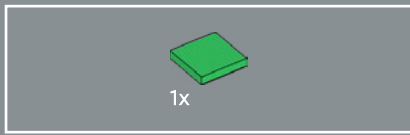

220

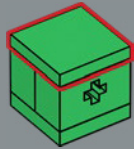

221

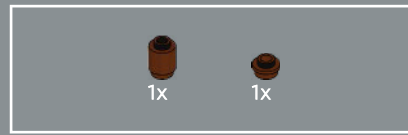
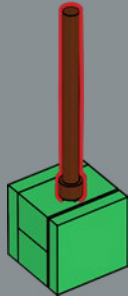

222

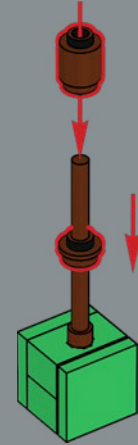

223

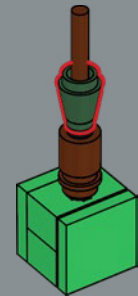

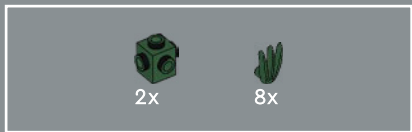

224

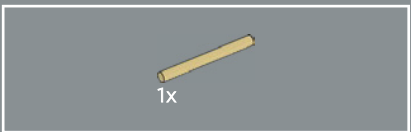
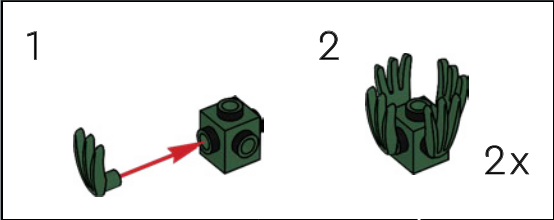

225





226

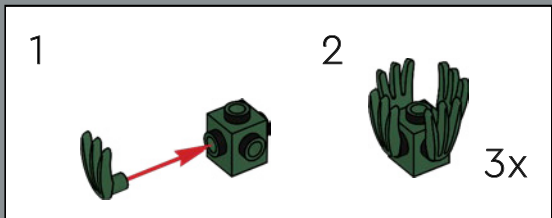

227





228

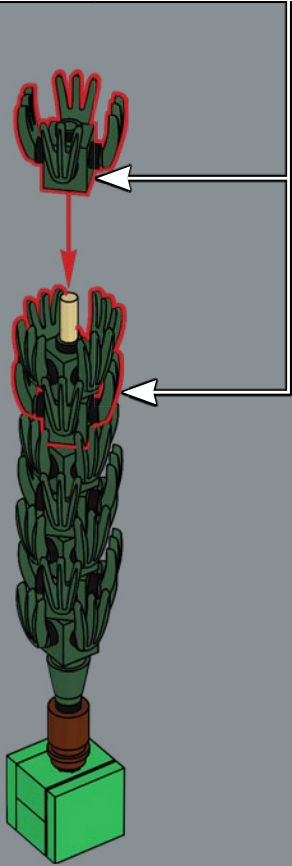
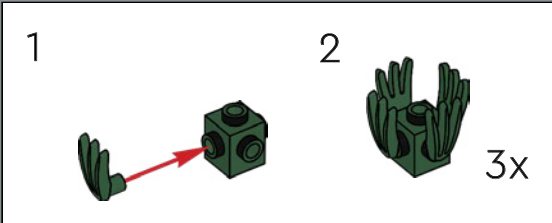

229



Zypresse (*Cupressus sempervirens*)
 Wegen ihrer markanten Form und Schönheit sind Zypressen aus mediterranen Landschaften nicht wegzudenken. Wusstest du, dass ihr aromatisches Öl eine kostbare Zutat in Heilsalben und Kosmetikprodukten ist?



2x



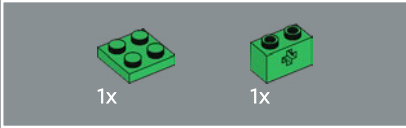
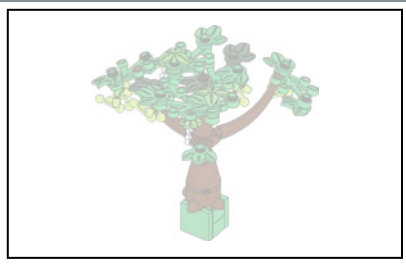

231

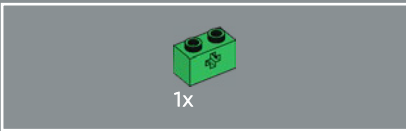
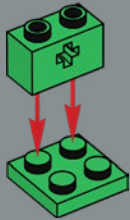

232

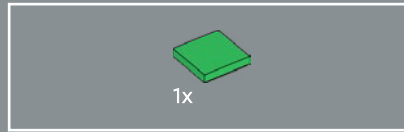
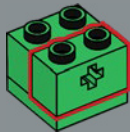

233

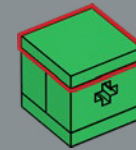

Echte Weinrebe (*Vitis vinifera*)
Weintrauben sind köstlich süße und saftige
Früchte, die von Zivilisationen der Antike bereits
vor mehr als 10.000 Jahren angebaut wurden.

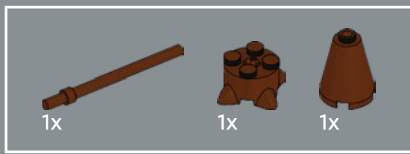

234

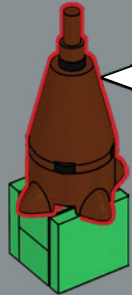
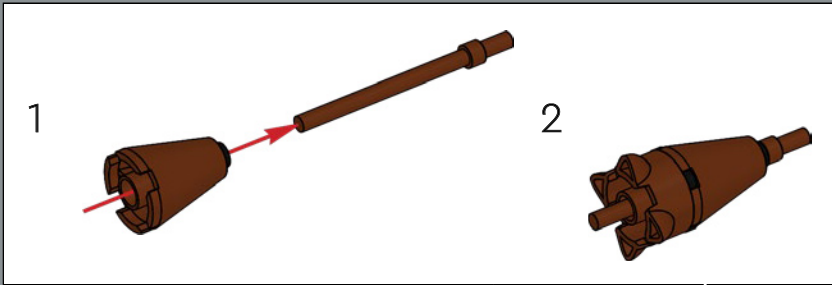

235

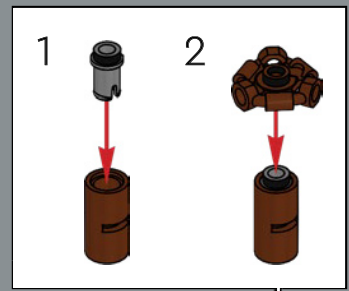

236





237

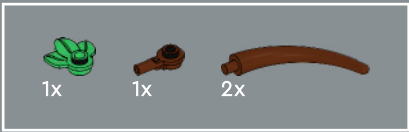

238

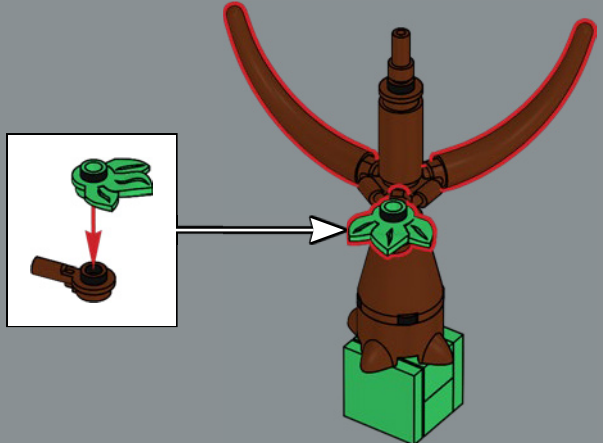

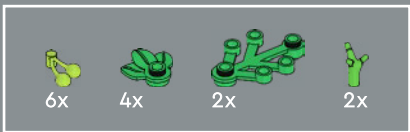

239

1

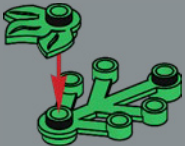

2

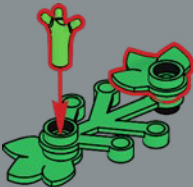

3

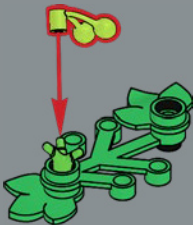

4

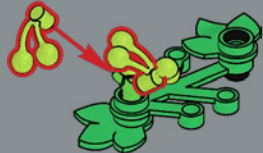

2x

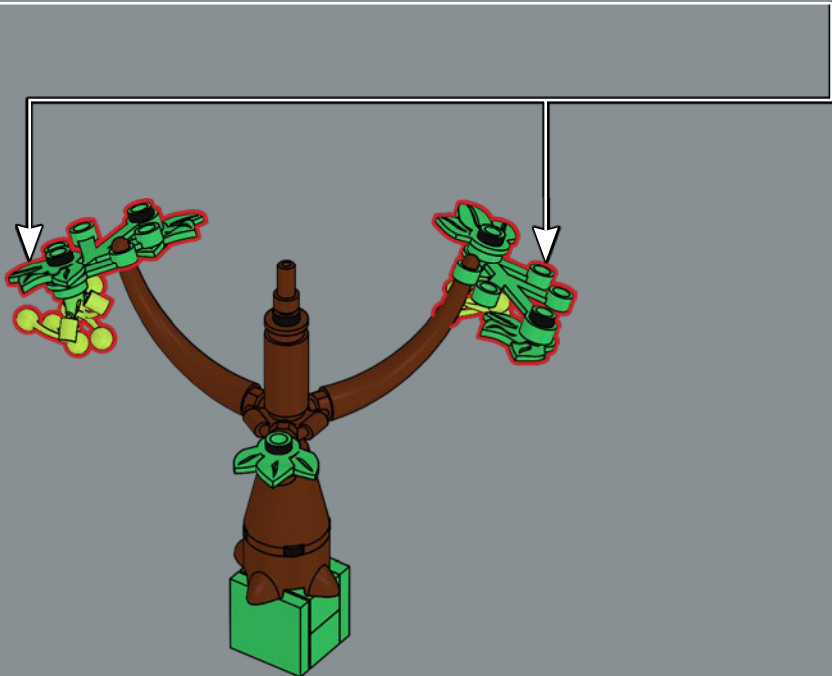

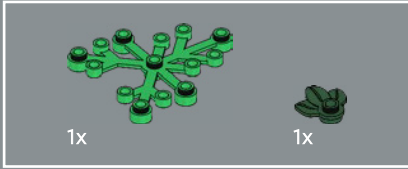
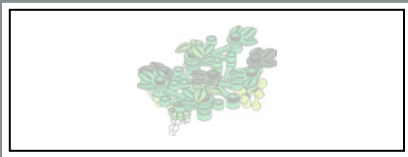

240

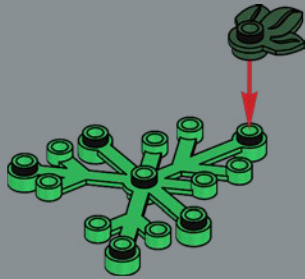

241

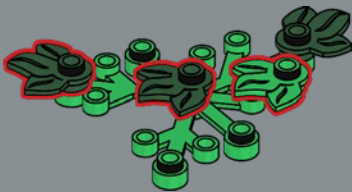

242

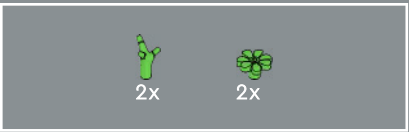
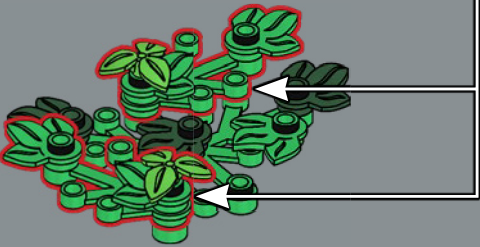
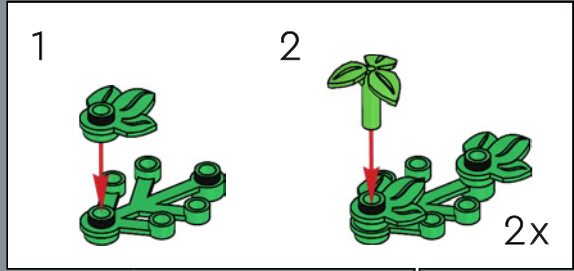

243

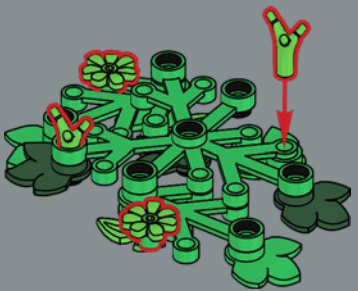



244

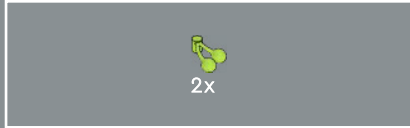

245

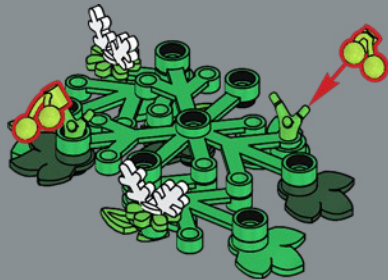

246



247

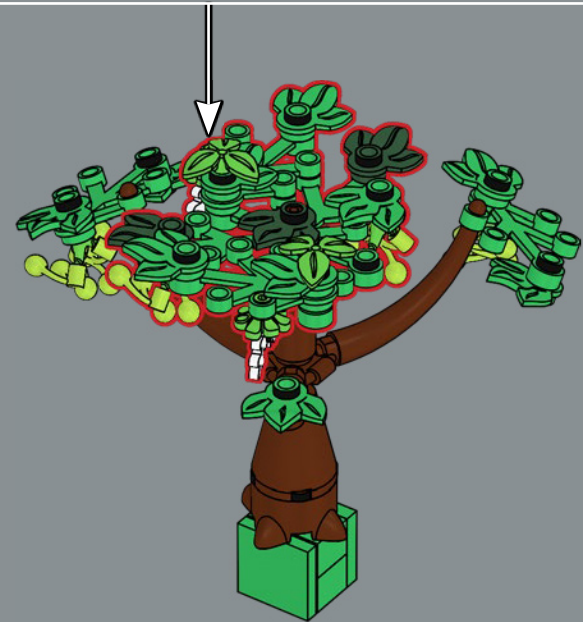



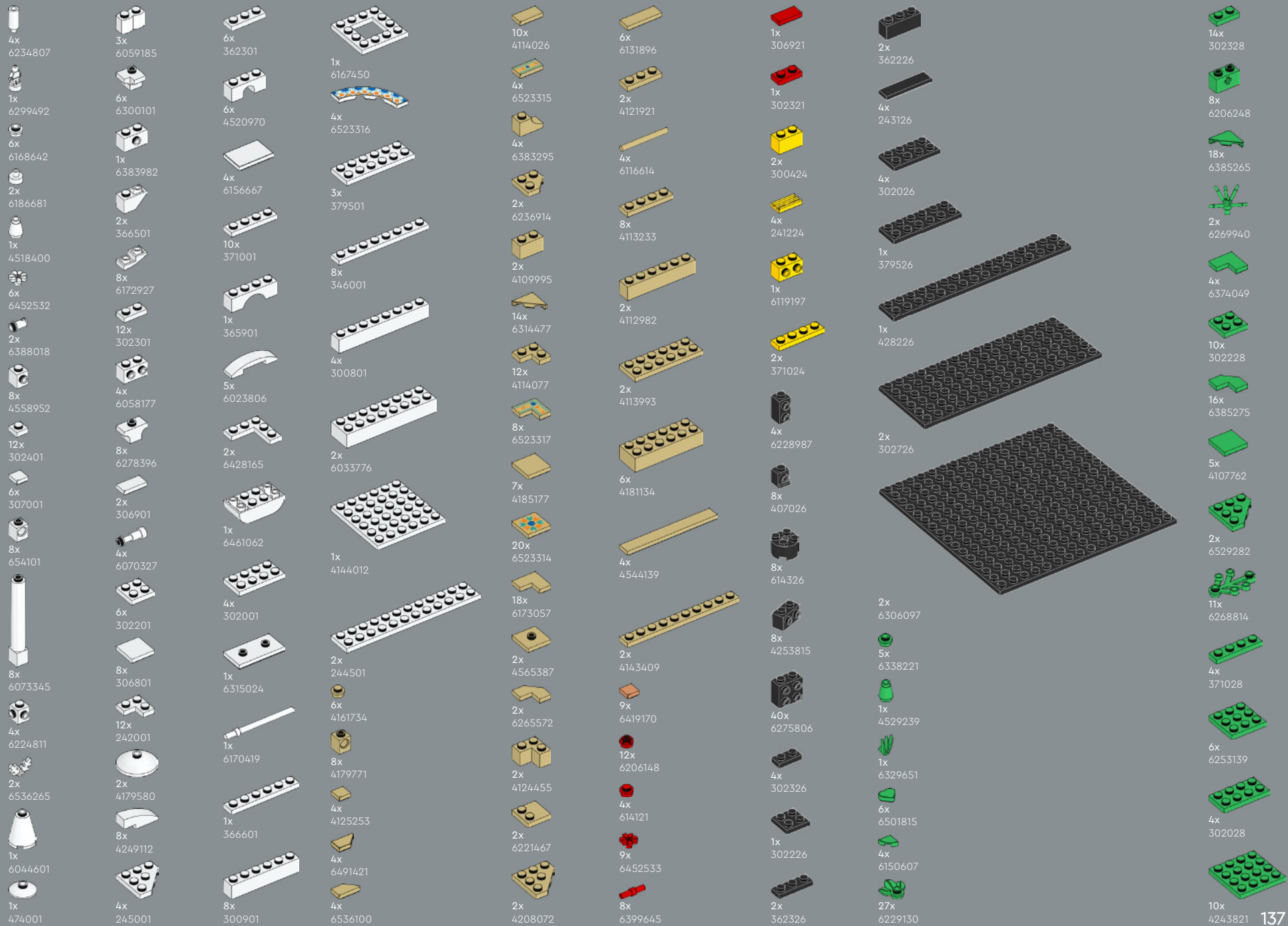



2x
6266968

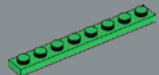

2x
346028

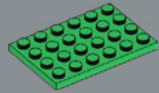

6x
4116671

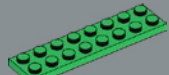

2x
303428



7x
6434871



2x
6488792



4x
6430093



8x
6235080



1x
6161772

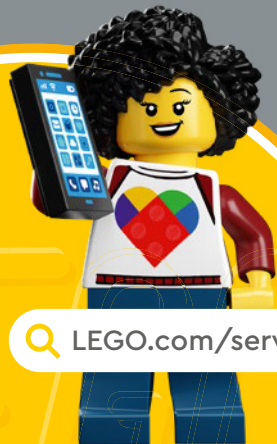

[LEGO.com/service](https://www.LEGO.com/service)

47x
6143431

28x
6439726

6x
6186012

2x
4570877

20x
6228839

2x
6074892

11x
6253418

6x
6353237

1x
6326099

1x
6245307

3x
6514007

7x
6514224

8x
6510178

5x
6550815



12x
6087084

1x
6523318

2x
6055172

2x
6480380

24x
6315608

64x
6532422

2x
6411591

12x
6532421

12x
4504375

4x
4521915

2x
6532423

16x
6532420

9x
6400754

2x
4245571

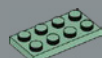

2x
6249817

2x
6209681

6x
6186673

2x
6284586

4x
4211183

4x
6215659

2x
6173143

1x
6348057

1x
6451002

1x
6306775

1x
4211159

1x
6488490

8x
4211180

1x
6492629

1x
6173132

1x
6468829



6x
4211210

8x
6425510

4x
4211200

1x
6116613

2x
4211201

3x
6170468

2x
6372430

2x
4211193

4x
6096701

1x
4529241

1x
6510189

7x
4521921

1x
6183782

8x
4211414

2x
4211387



8x
4211413

2x
4211397

1x
6070564

2x
4211361

2x
4211396

6x
6015347

1x
4612621

2x
4211452

6x
4211425

2x
4211404

2x
4211407

6x
6519672

6x
6096990

1x
6465604

2x
6395635

1x
4504378

1x
4210848

2x
6388118

2x
6388118

2x
4211088

3x
4211094

8x
4624186

4x
4210897

2x
4509911

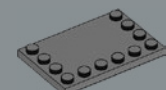

2x
6199511



2x
6187438

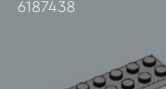

6x
4210997

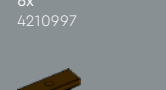

8x
6272145



2x
6313601



4x
6365746

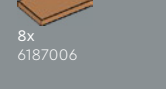

8x
6187006

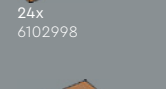

24x
6102998

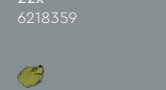

22x
6218359

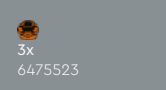

1x
6472547

3x
6475523



YOU COULD WIN



YOU COULD WIN

Your feedback will help shape the future development of this product series.

Visit:

DU KÖNNTEST GEWINNEN

Dein Feedback trägt zur Weiterentwicklung dieser Produktreihe bei.

Geh auf:

VOUS POURRIEZ GAGNER

Vos commentaires nous aideront à concevoir les futurs produits de cette gamme.

Visitez :

POTRESTI VINCERE TU

La tua opinione ci aiuterà a migliorare la creazione futura di questa linea di prodotti.

Visita:

PUEDES GANAR

Tu opinión contribuirá al futuro de esta serie de productos.

Visita:

轻松获奖

您的反馈将有助于我们在今后改进本产品系列。

请访问:

[LEGO.com/productfeedback](https://www.lego.com/productfeedback)

You also have the chance to win a LEGO® set.

Terms and conditions apply.*

Außerdem hast du die Chance, ein LEGO® Set zu gewinnen.

Es gelten die Teilnahmebedingungen.*

Vous pourriez également gagner un ensemble LEGO®.

Des conditions s'appliquent.*

Hai anche la possibilità di vincere un set LEGO®.

Termini e condizioni sono applicabili.*

También tienes la oportunidad de ganar un set LEGO®.

Aplican términos y condiciones.*

您还有机会赢取乐高®套装。

条款和条件适用。*

*[LEGO.com/productfeedback-terms](https://www.lego.com/productfeedback-terms)

