



10355





[LEGO.com/sustainable-packaging](https://www.lego.com/sustainable-packaging)



 **FR**  
**DONNEZ**  
OU  
**RECYCLEZ**

 OU  OU 

ASSOCIATION    MAGASIN    DÉCHÈTERIE

Adresses sur [quefairedemesdechets.fr](http://quefairedemesdechets.fr)



# BUILDER



Apple and the Apple logo are trademarks of Apple Inc., registered in the U.S. and other countries and regions. App Store is a service mark of Apple Inc. Google Play and the Google Play logo are trademarks of Google LLC. Tencent and the Tencent logo are trademarks of Tencent Inc.

Q [LEGO.com/devicecheck](https://LEGO.com/devicecheck)



Q LEGO® Builder

# Vuelve LEGO® Blacktron

Cuando recordamos con nostalgia el apogeo del tema LEGO® Space a finales de los años 70 y principios de los 80, el set Blacktron *Renegade* (6954) siempre parece estar en órbita, flotando sobre nosotros. Desde su lanzamiento en 1987, su viaje a través del tiempo y el espacio como uno de los modelos favoritos de los fans de LEGO Space ha seguido un curso estable. Parte de su atractivo reside en cómo le habla a la imaginación de los constructores, a quienes permite inventar sus propias historias fantásticas acerca de Blacktron, la primera fuerza misteriosa y siniestra del universo LEGO Space. ¿Quiénes son, de dónde vienen y qué quieren? La imponente combinación de colores en negro y amarillo de sus uniformes y naves acentuaba su carácter de “tipos malos”, y los parabrisas amarillos, así como los detalles en rojo traslúcido, aportaban frescura y coherencia a la estética de toda la serie. Su versatilidad llevada al extremo daba a los constructores la libertad de ser supercreativos en sus juegos y exposiciones. Todos los sets se componían de módulos, lo que abría la posibilidad de combinar varios sets o utilizar segmentos de ellos de múltiples formas. Además de ser algo totalmente revolucionario en su momento, este diseño LEGO sirvió de inspiración para generaciones posteriores de modelos de tema espacial.



**BLACKTRON**™



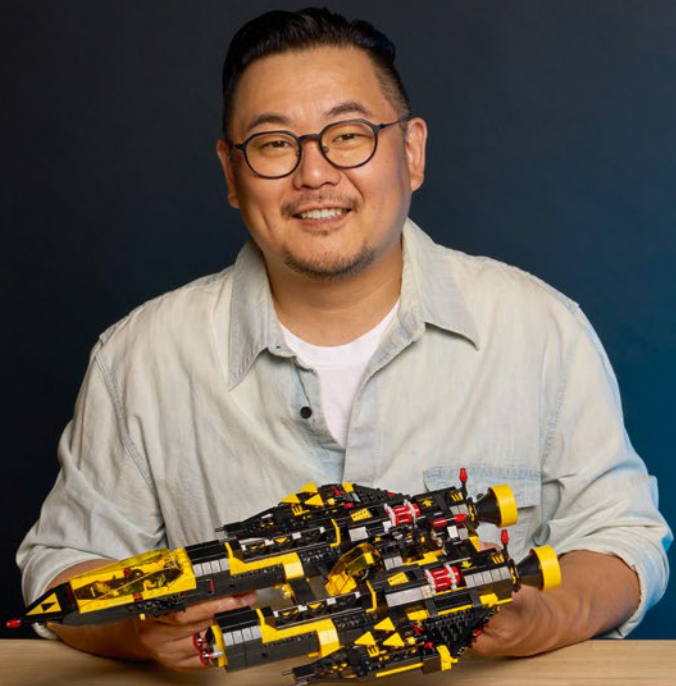

# Impresiones del equipo de diseño de LEGO®

"No podríamos estar más emocionados de revivir el modelo Blacktron *Renegade* (6954) en una versión dirigida a fans de todas las edades que incorpora elementos de los sets *Invader* (6894) y *Battrax* (6941). Manteniéndonos fieles al clásico diseño asimétrico de la *Renegade*, decidimos hacer esta nueva interpretación a una escala aproximadamente 1,5 veces mayor. Esto nos dio la oportunidad de mejorar el modelo con características más avanzadas, funciones divertidas y técnicas de construcción aún más apasionantes. También pusimos a dos pilotos en la cabina y creamos una nueva función de despliegue de recursos, por lo que ahora el pequeño vehículo de carga puede desacoplarse de la nave directamente. Las navecitas espaciales que el original solía llevar en las alas reaparecieron como transportes espaciales individuales para un nuevo droide de aspecto clásico. Con una nueva conexión universal, todos los módulos de la nave pueden construirse por separado y combinarse libremente por la parte delantera y por detrás. Así que no esperes más y prepárate para despegar. ¡No olvides invitar a tus amigos y familiares a compartir la experiencia de construcción!".

## **JAE WON LEE**

*Diseñador sénior de LEGO®*



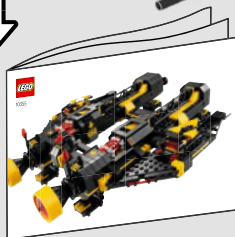
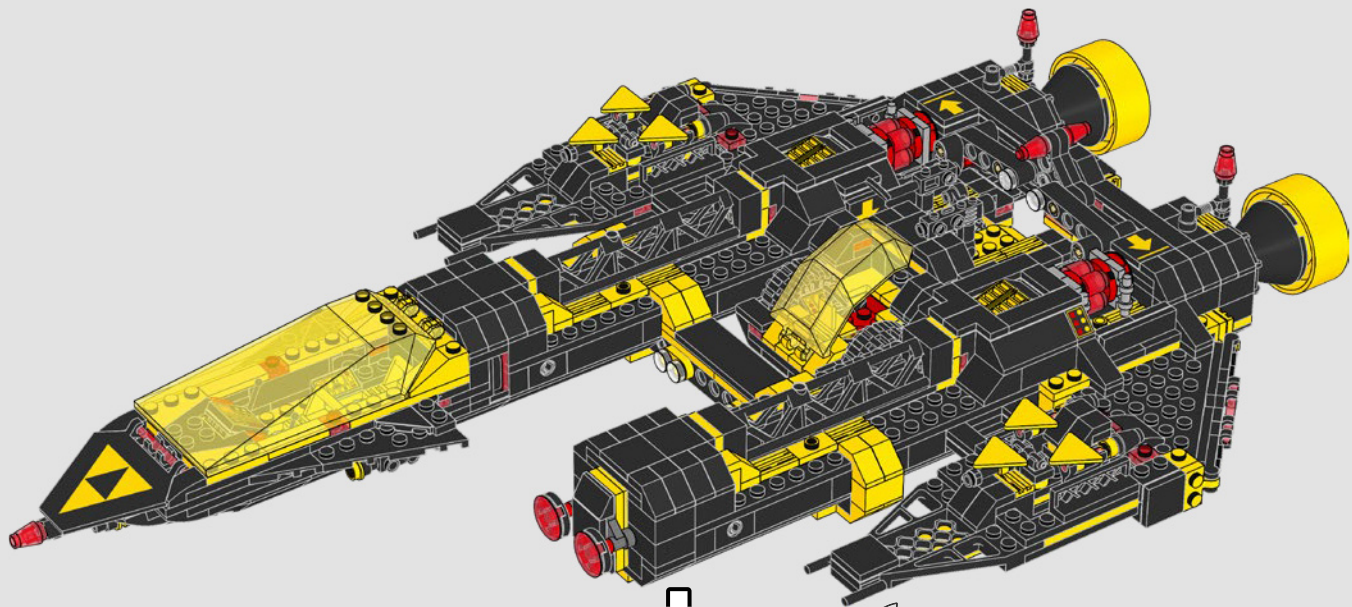



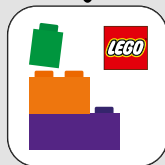
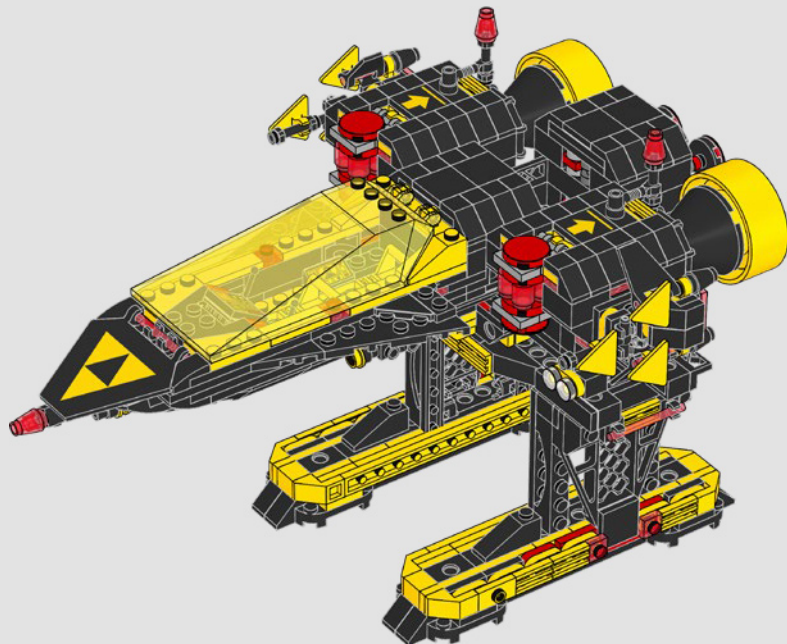

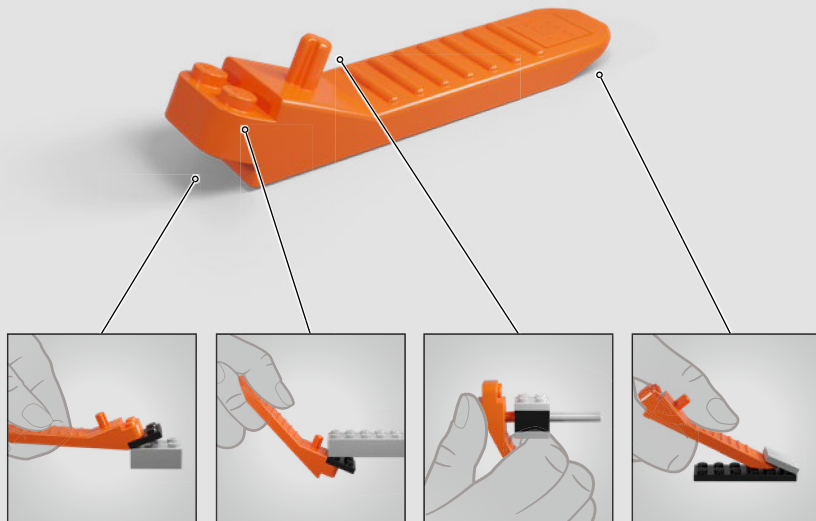



Una inspección detallada del traje de vuelo de Blacktron muestra mejoras de equipamiento en la parte posterior del torso, observadas por primera vez durante el encuentro con la Nave Espacial Blacktron (40580).

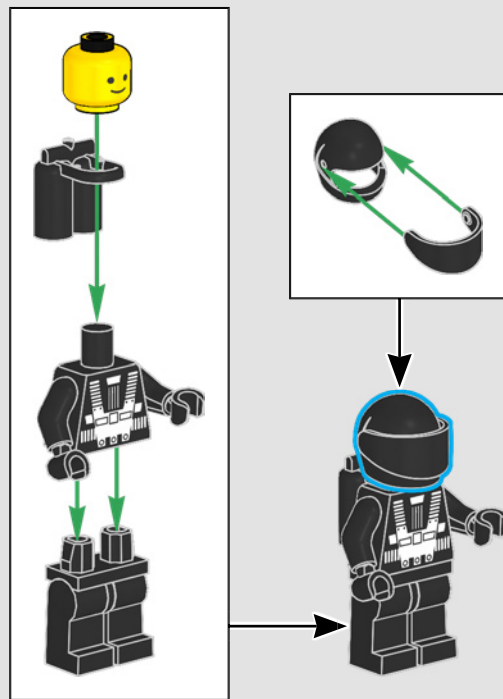

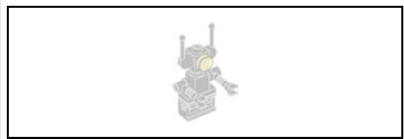

1

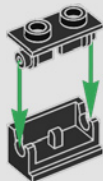

2





3

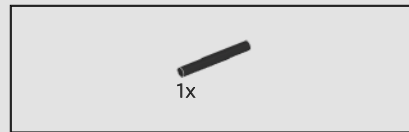
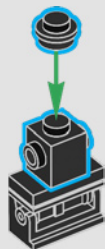

4

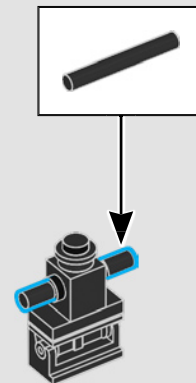



5

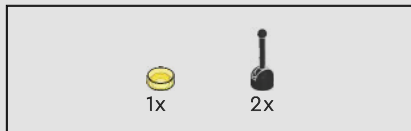
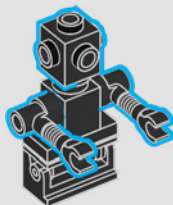

6

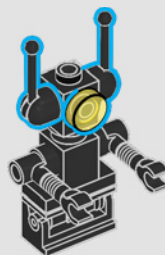

Este robot parece ser una versión alterada por Blacktron del robot de apoyo estándar lanzado con el set Solar Power Transporter (6952).



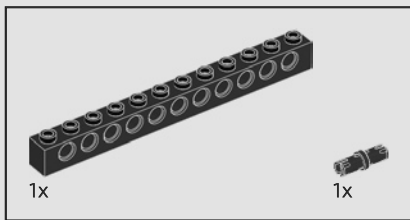
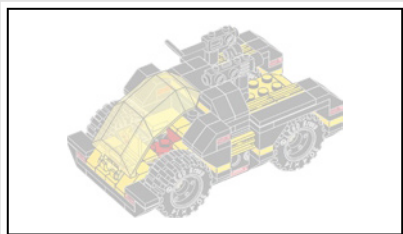

1

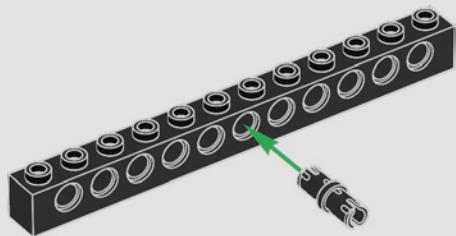

2

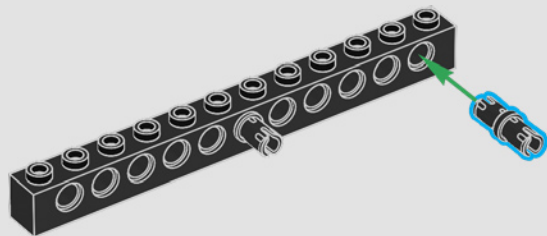



3

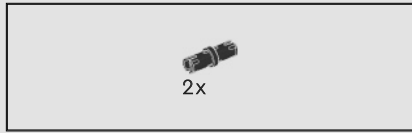
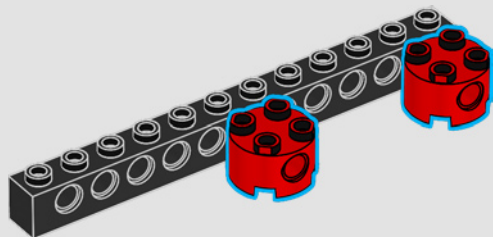

4

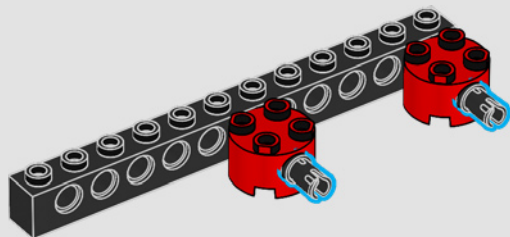



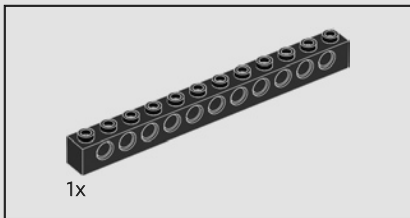

5

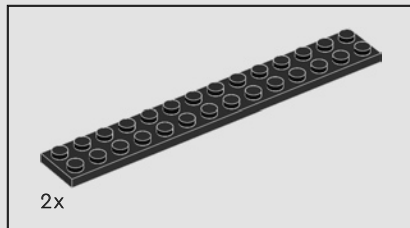
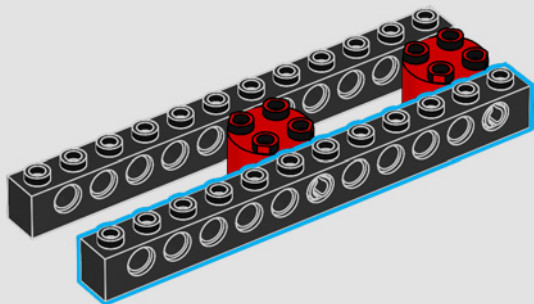

6

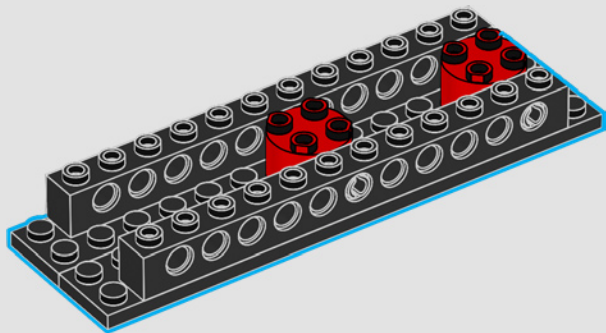

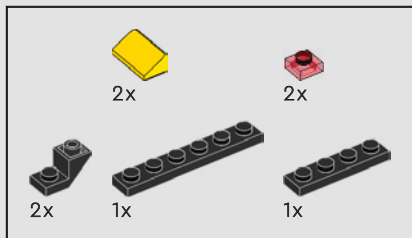

7

1

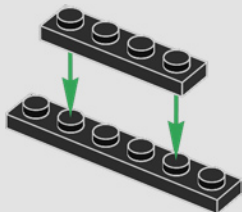

2

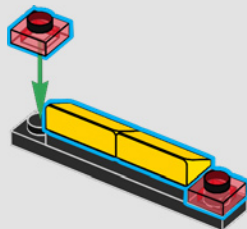

3

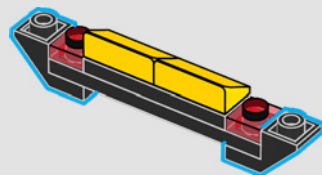

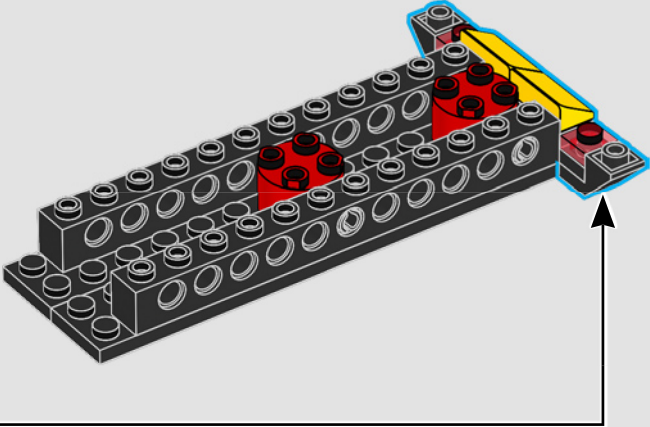

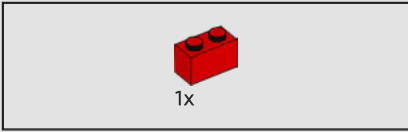

8

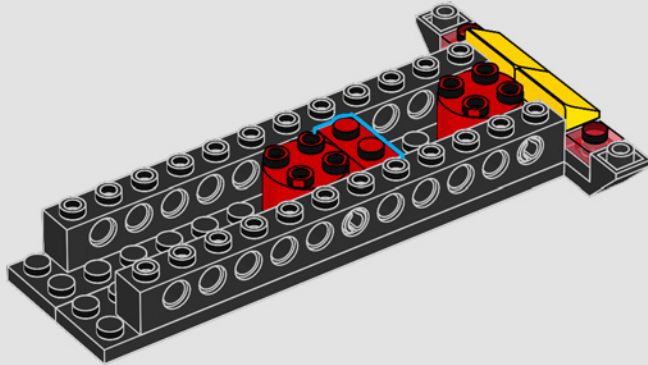

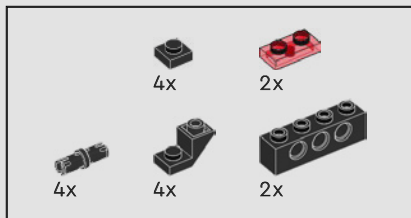

9

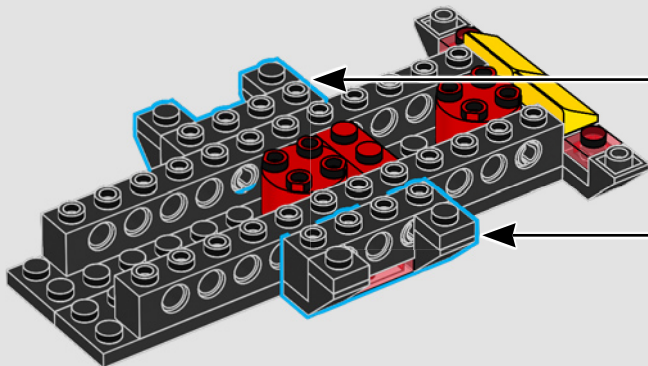
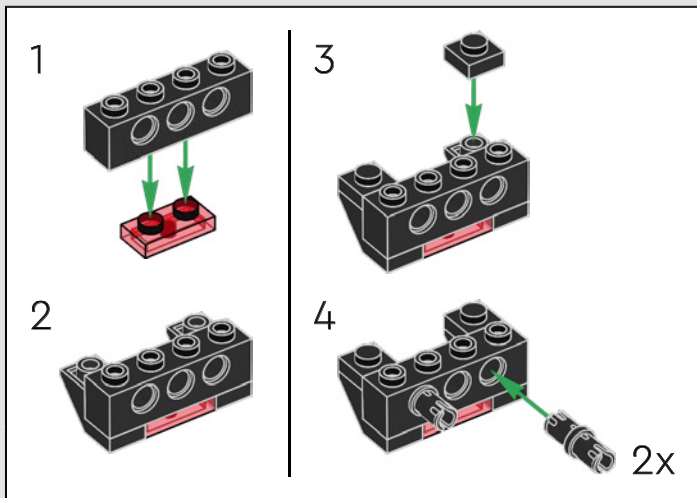

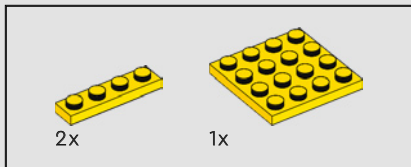

10

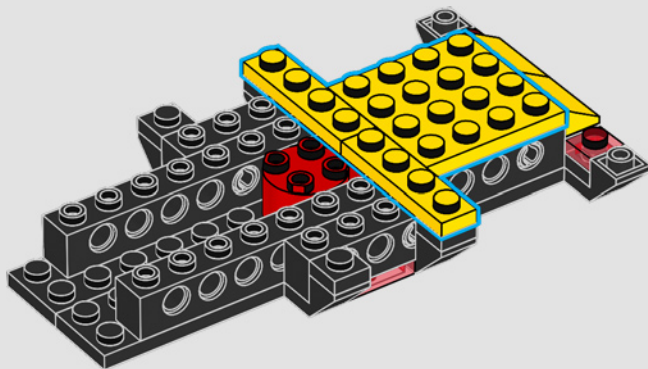

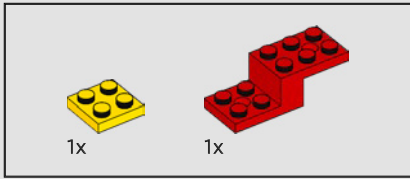

11

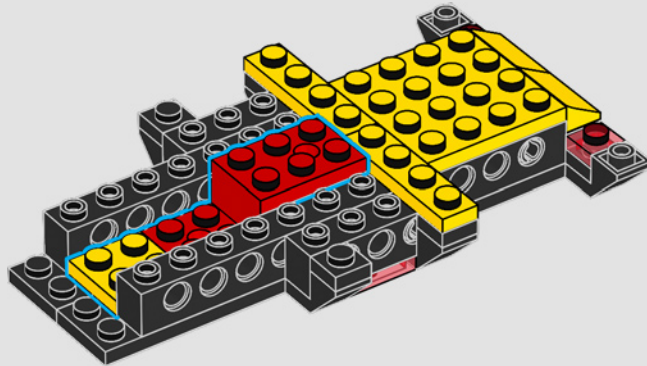

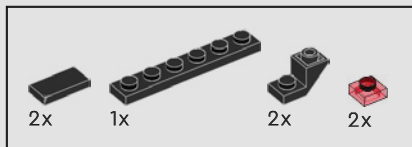

12

1

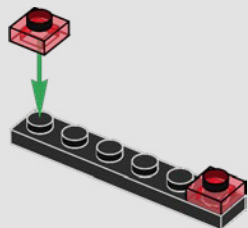

2

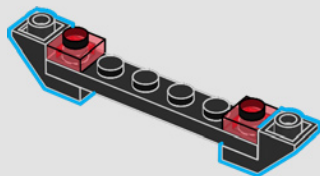

3

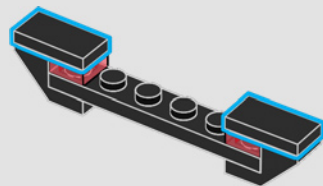



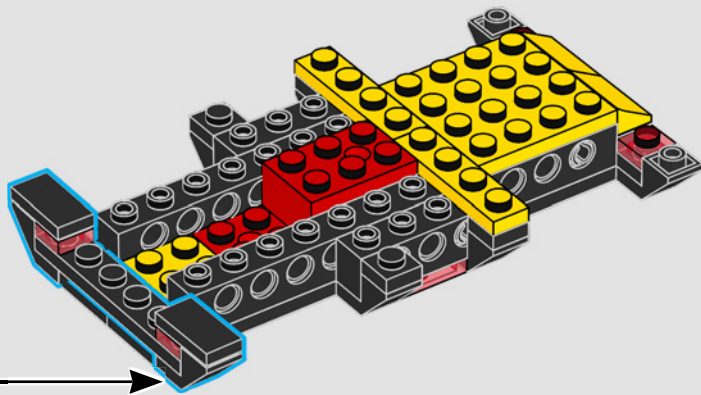

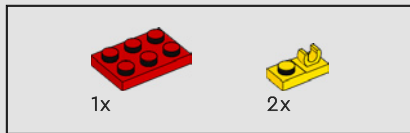

13

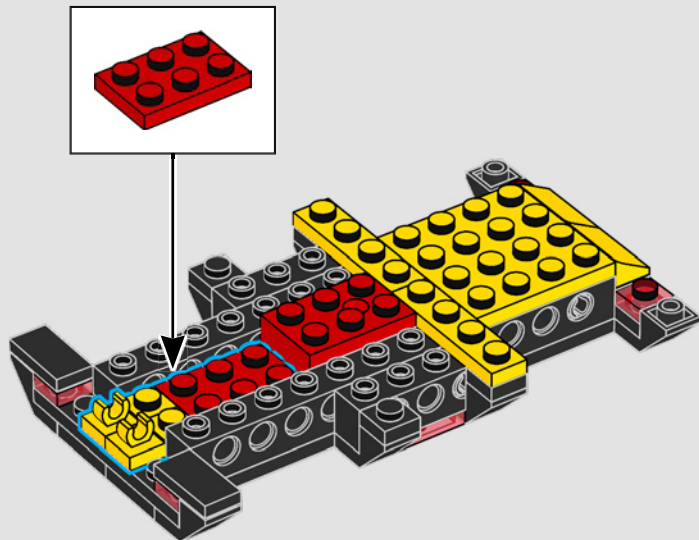

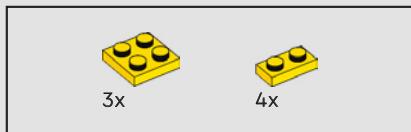

14

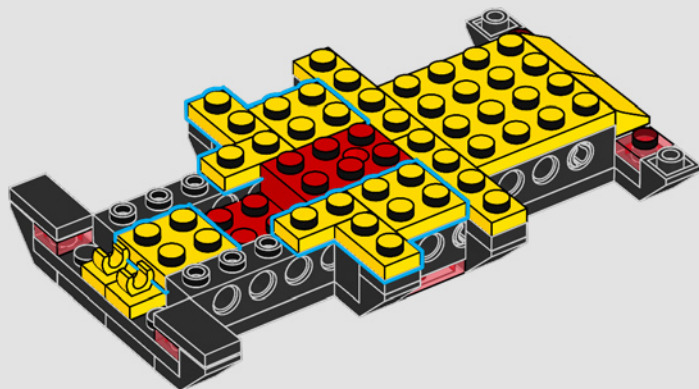

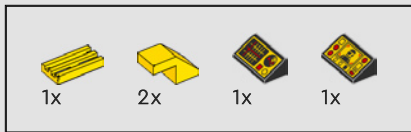

15

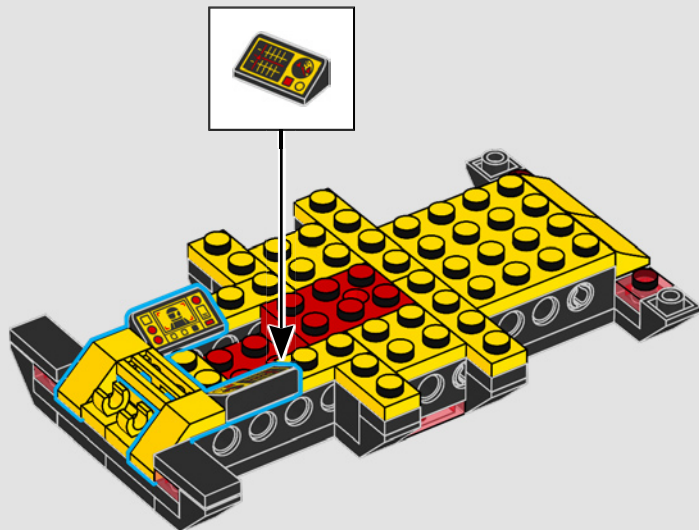

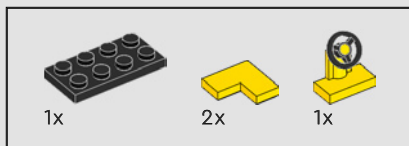

16

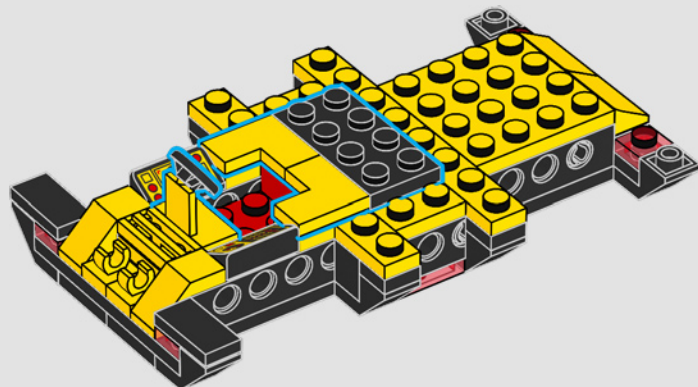

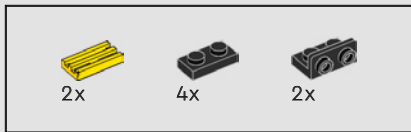

17

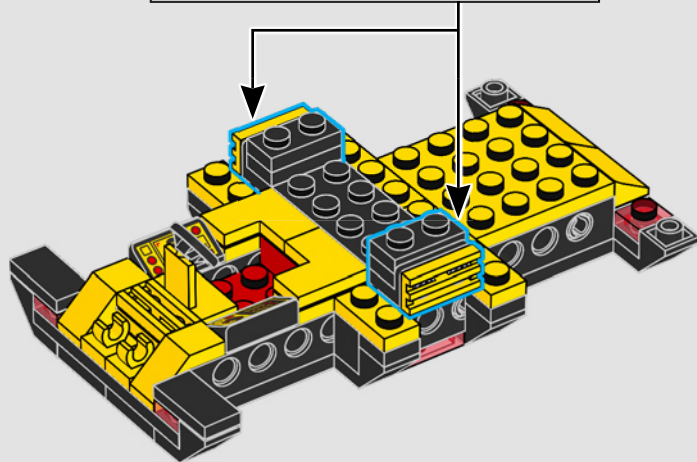
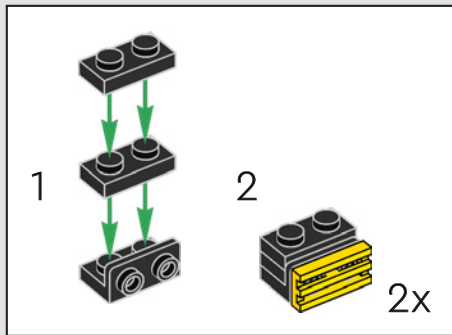

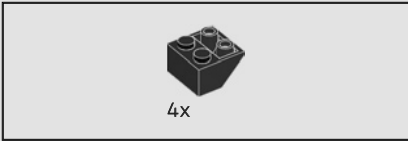

18

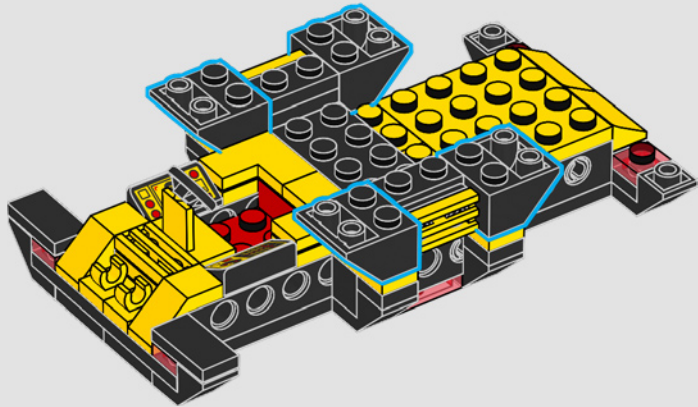

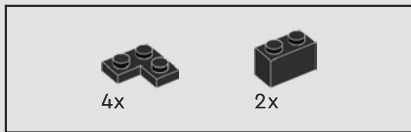

19

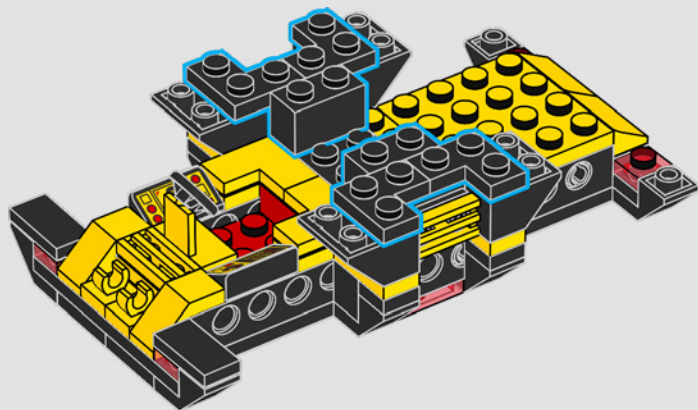



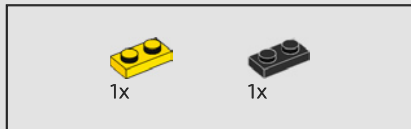
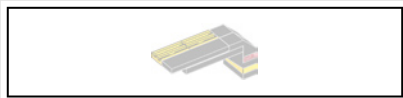

20

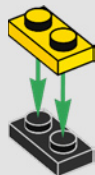

21

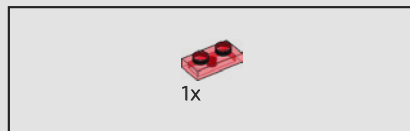
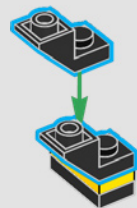

22

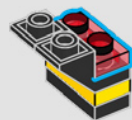

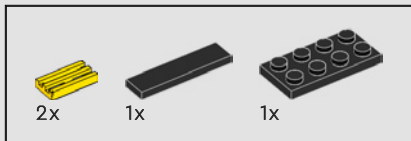

23

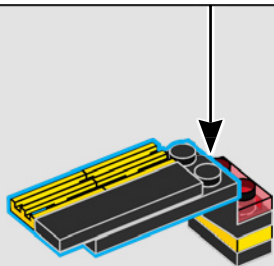
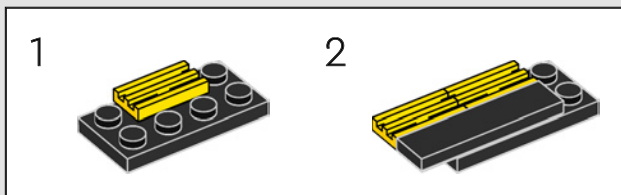

24

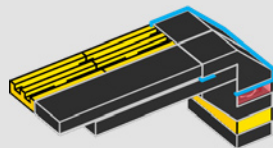

25

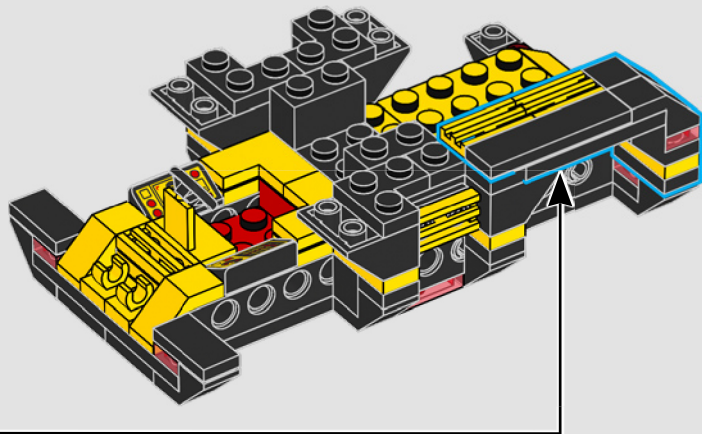

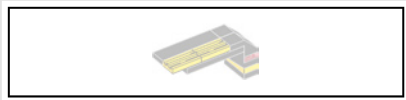

26

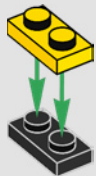

27

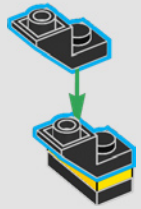



28

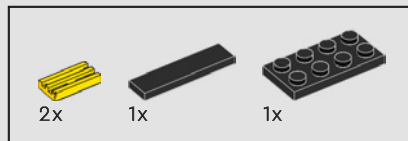
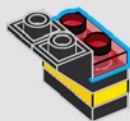

29

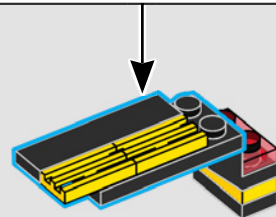
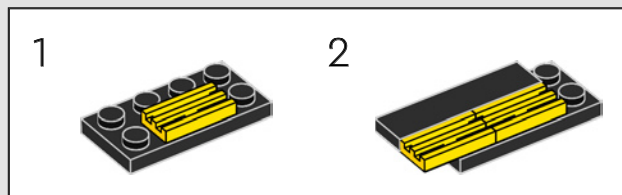



2x

30

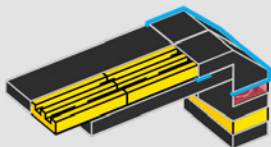

31

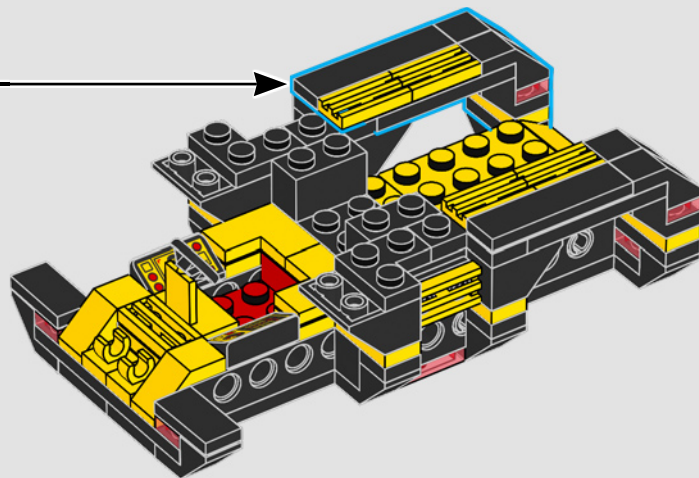

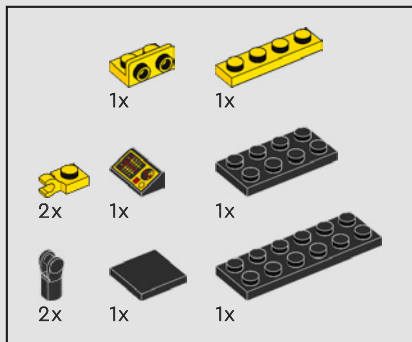

32

1

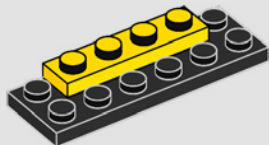

2

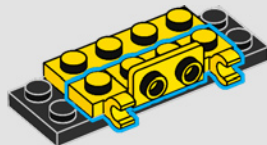

3

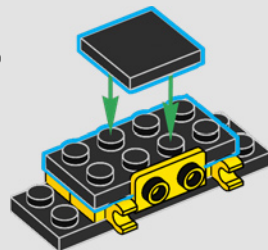



4

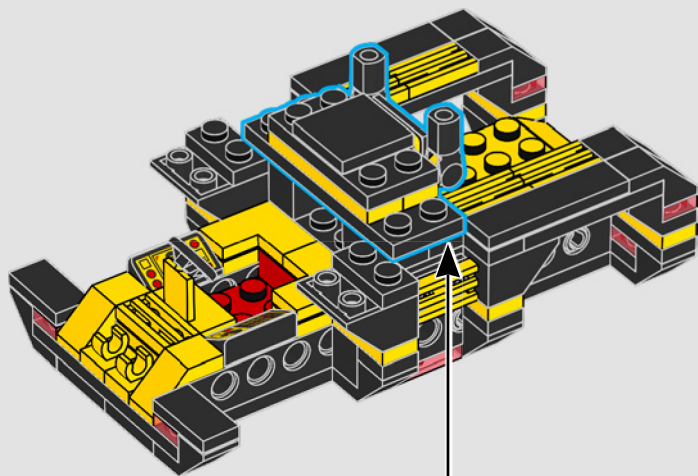
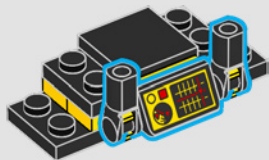



2x

33

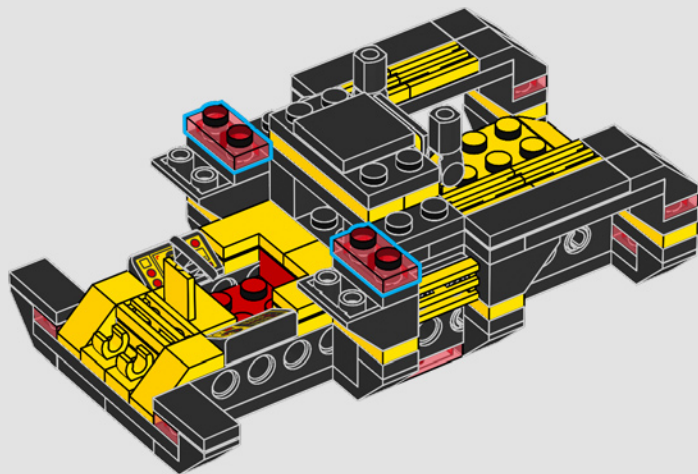



8x

34

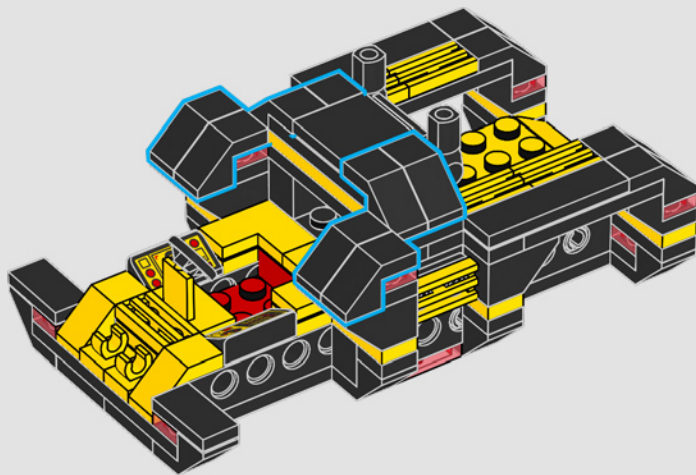

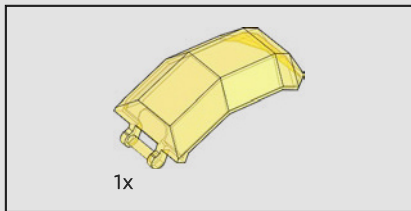

35

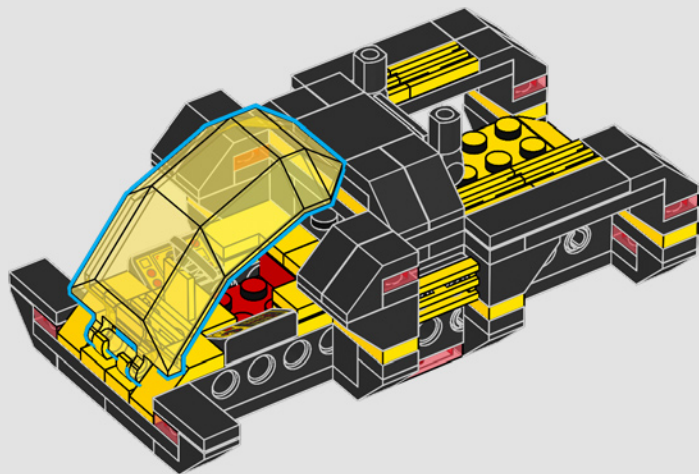



Aplicando técnicas de ingeniería inversa, los expertos de Blacktron han convertido la cámara de exploración espacial estándar en un bláster láser.

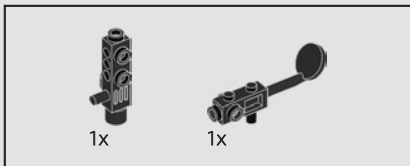

36

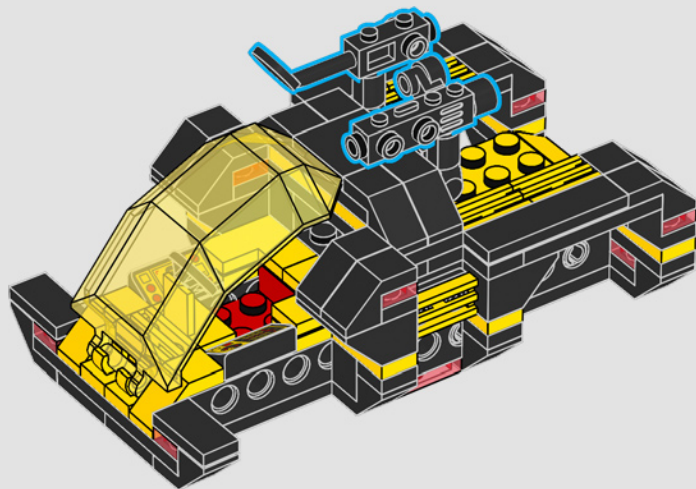

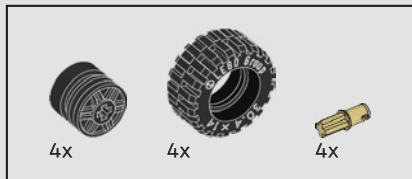

37

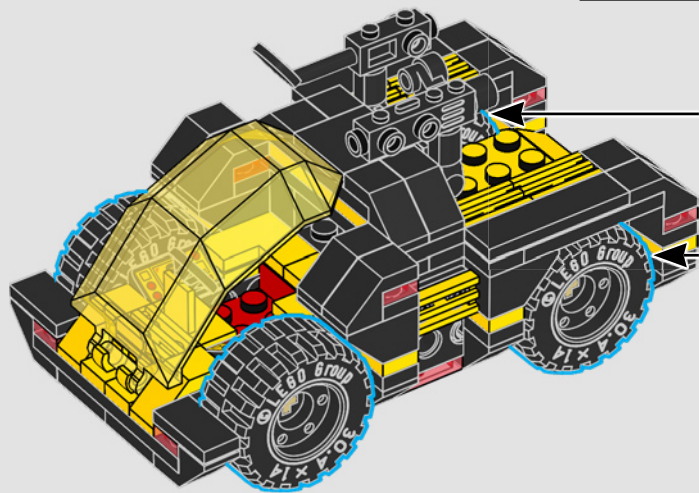
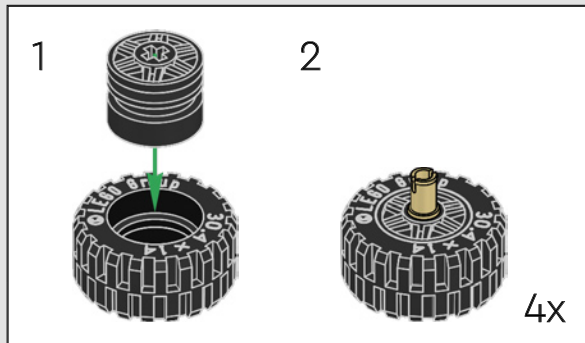

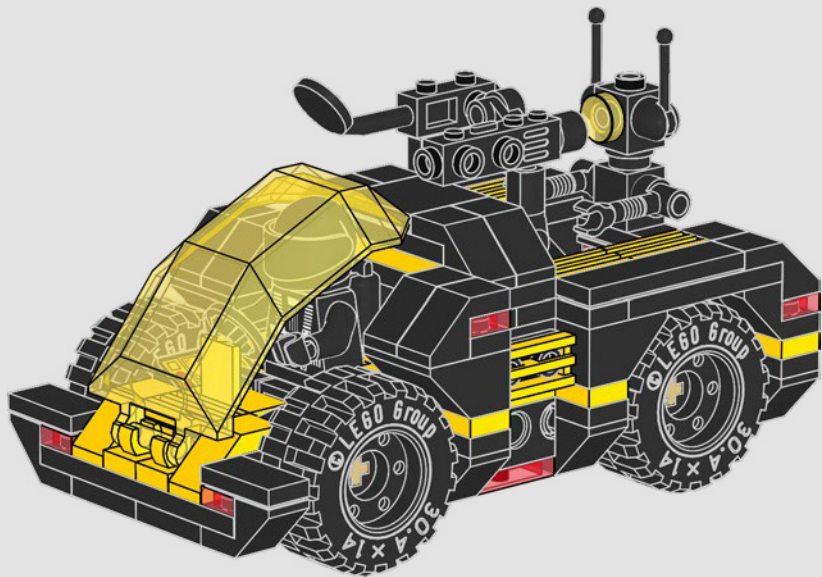

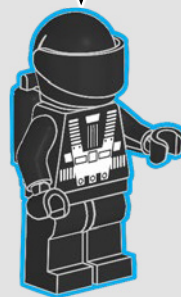
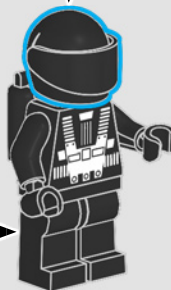
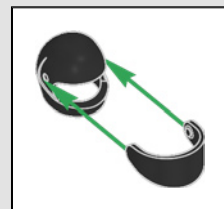
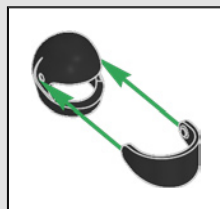
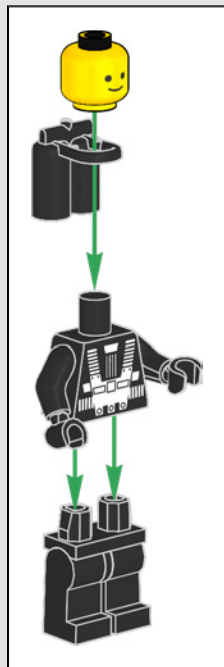



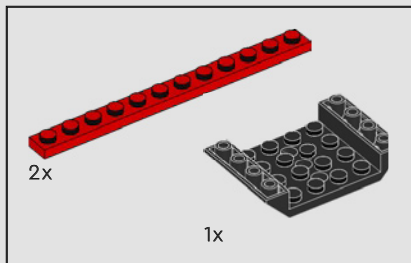
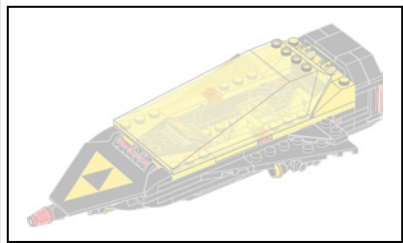

1

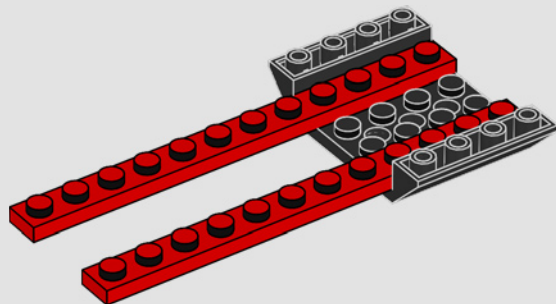

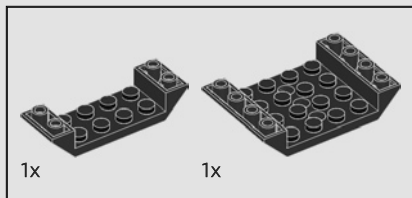

2

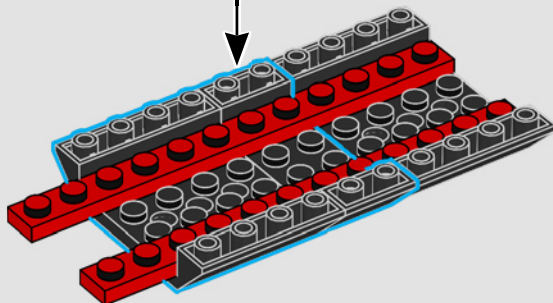
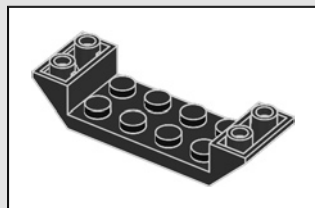

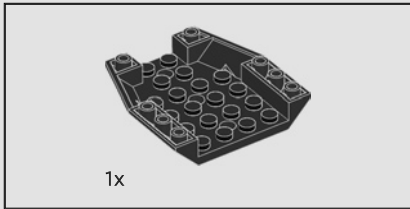

3

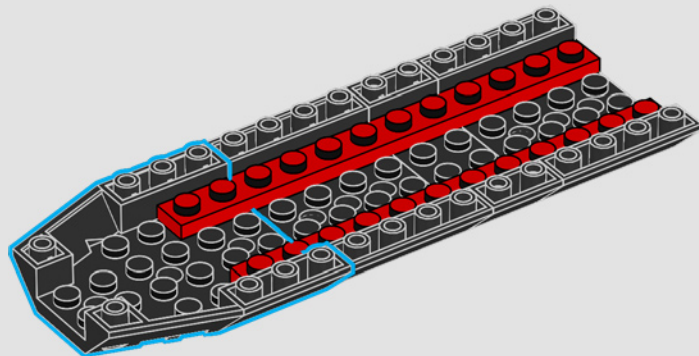

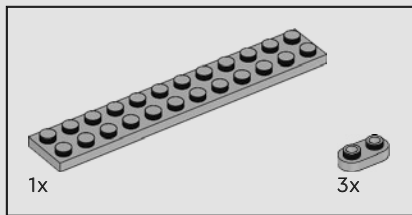

4

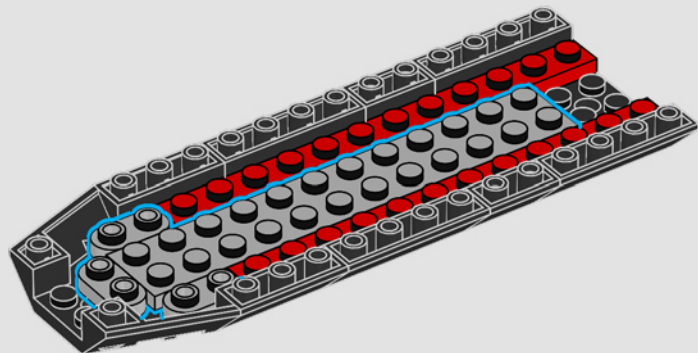

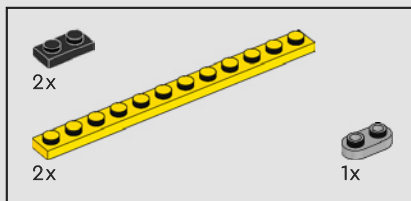

5

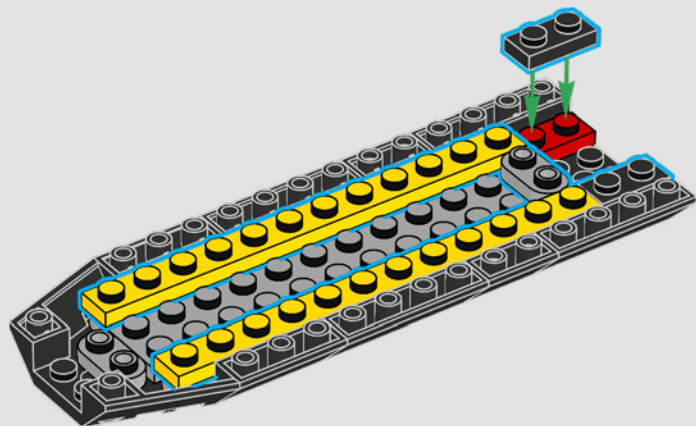

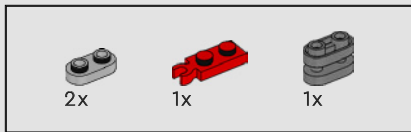

6

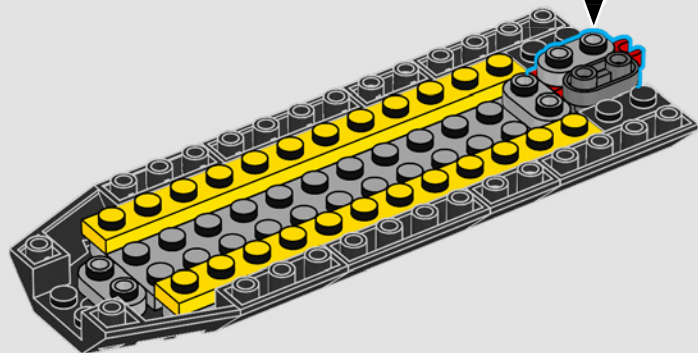
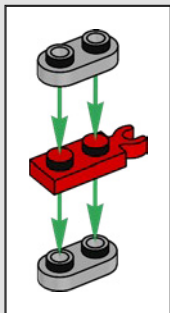

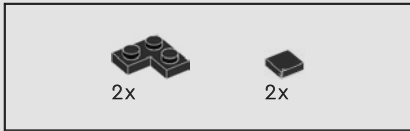

7

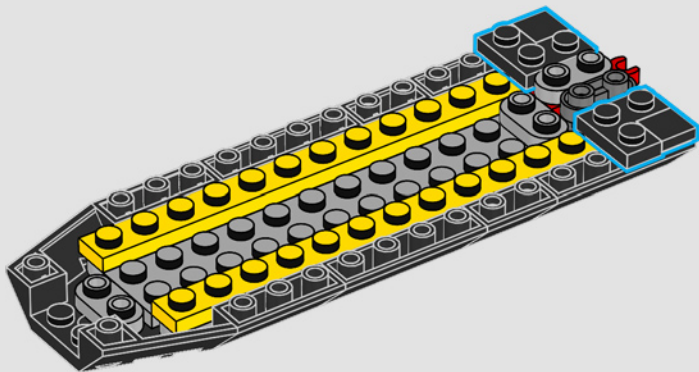

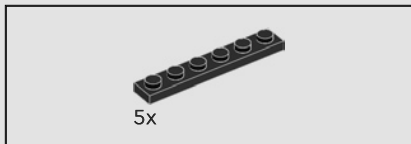

8

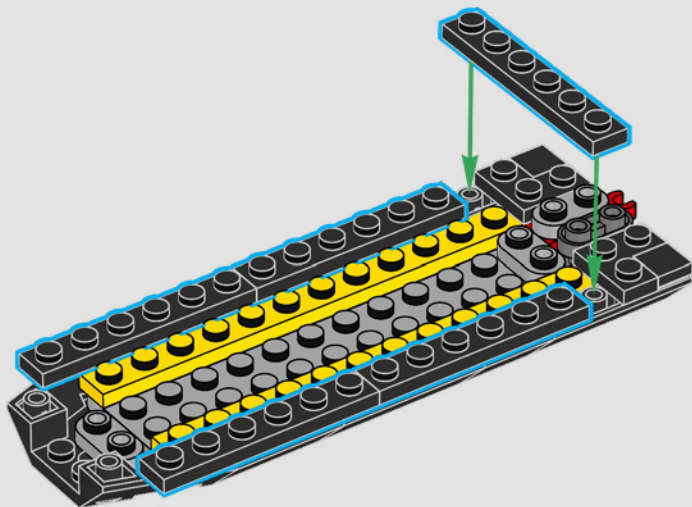



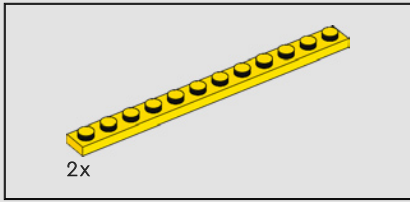

9

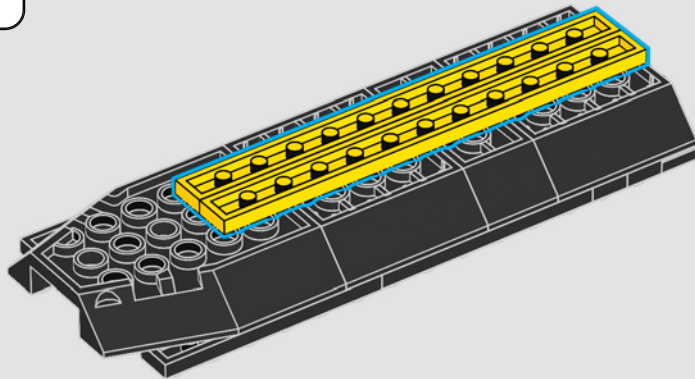

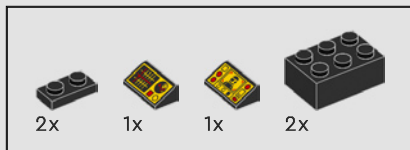

10

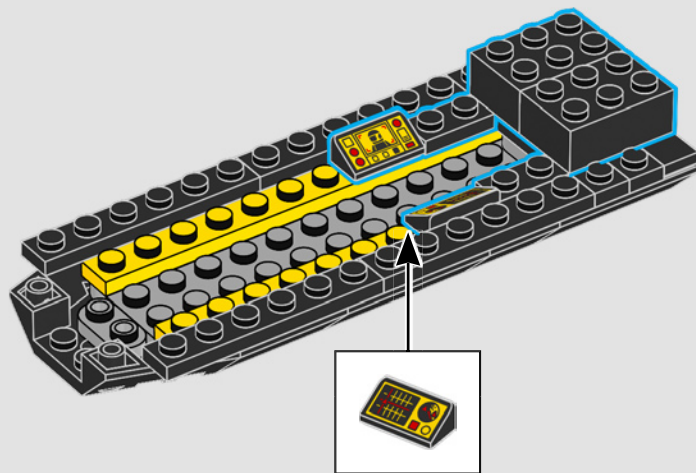



Esta nave mejorada tiene espacio para dos pilotos.  
¡El doble de agentes de Blacktron significa que el peligro para la galaxia se ha multiplicado por dos!

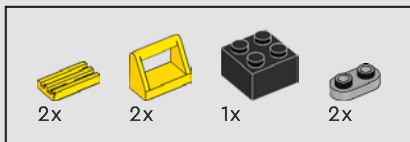

11

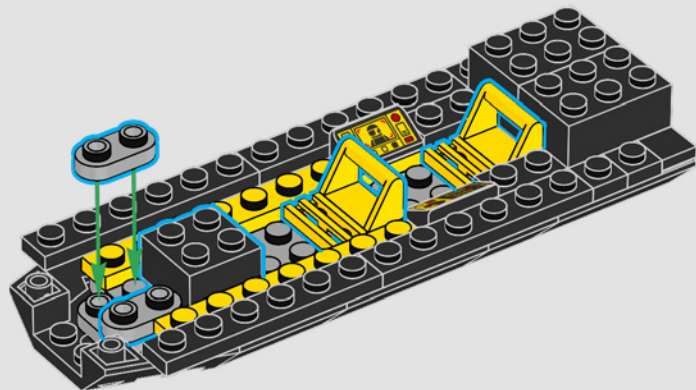



12

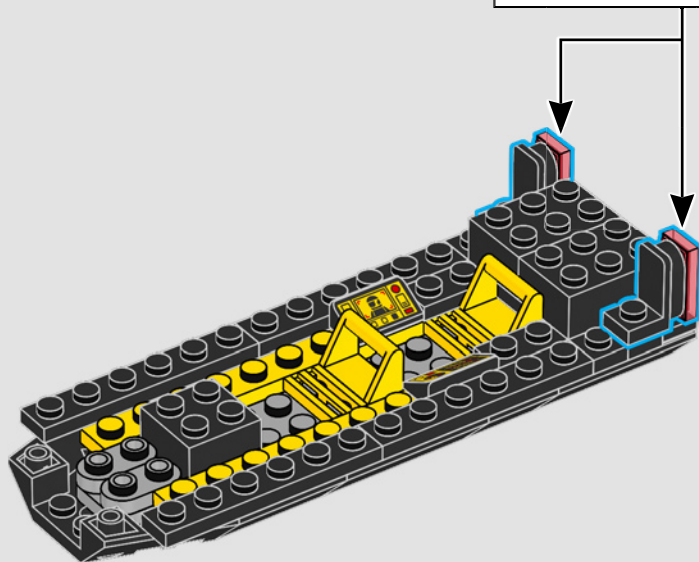
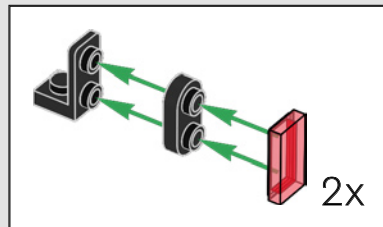

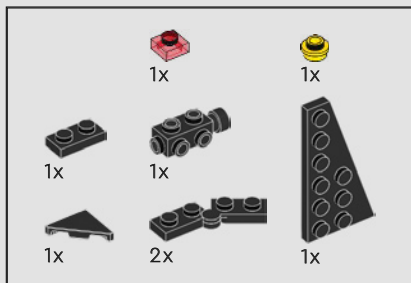
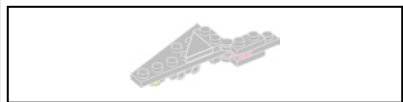

13

1

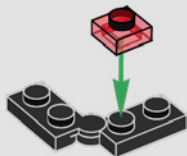

2

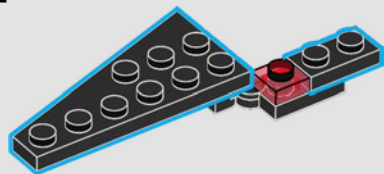

3

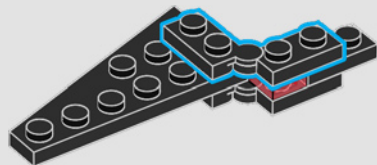

4

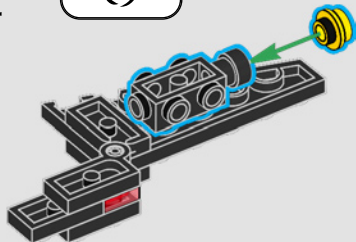
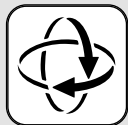

5

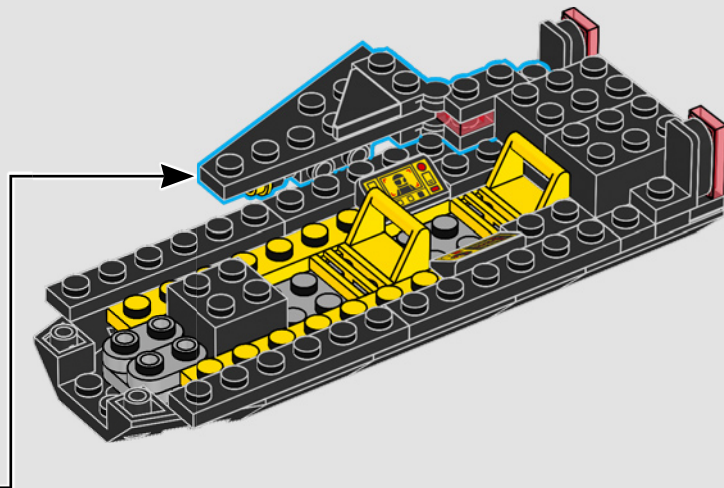
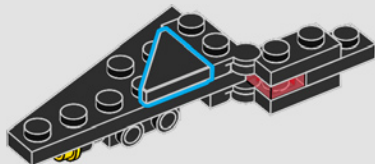

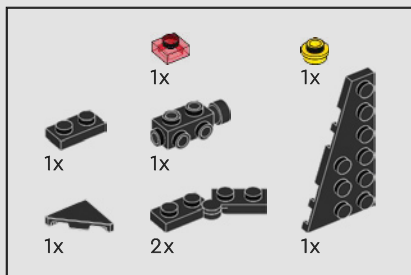
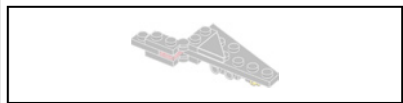

14

1

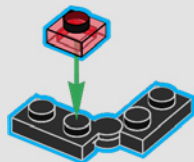

2

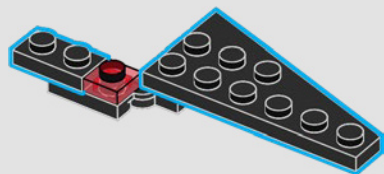

3

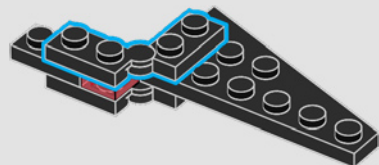

4

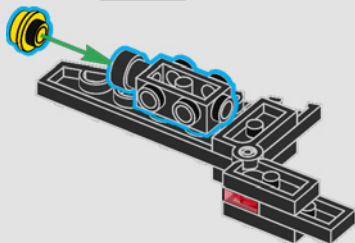

5

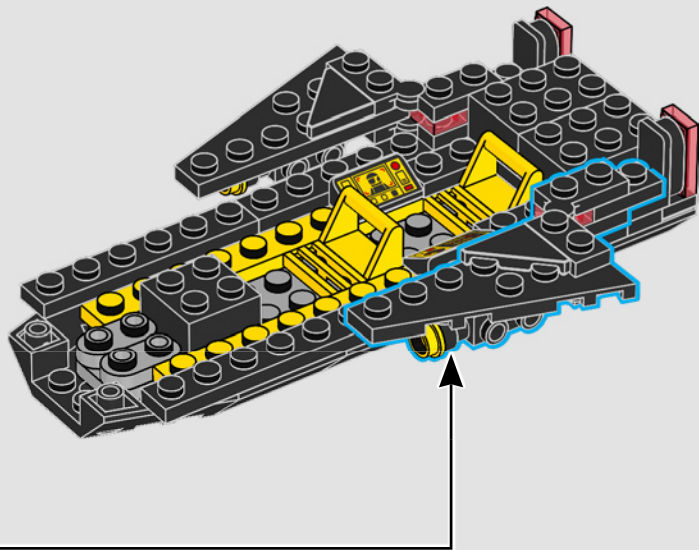
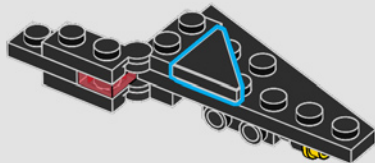
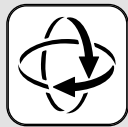



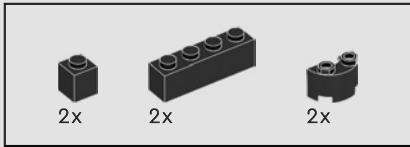

15

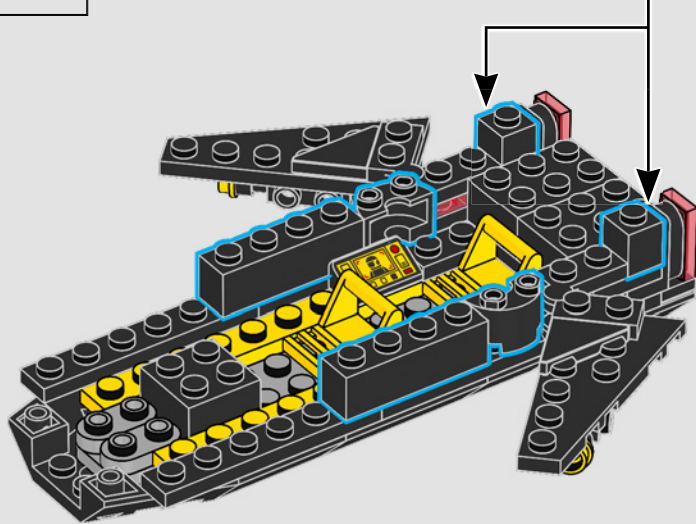

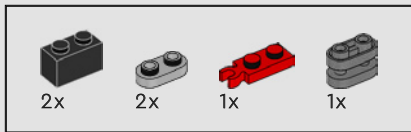

16

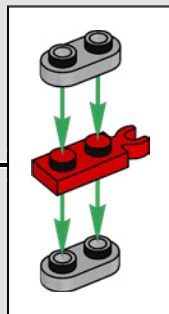
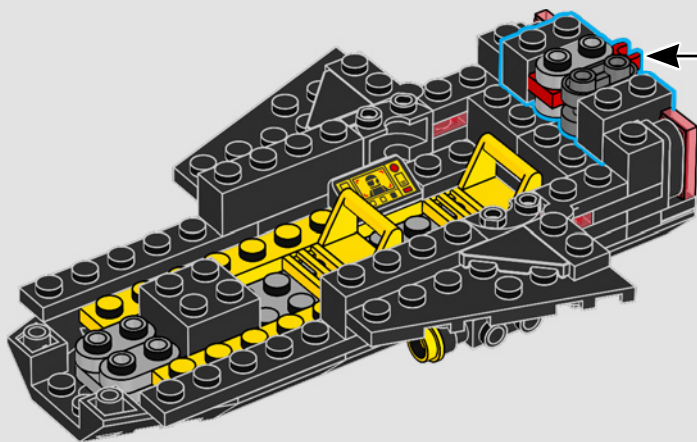

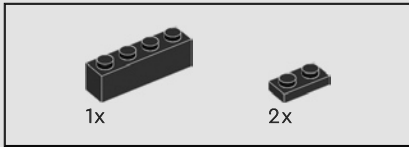

17

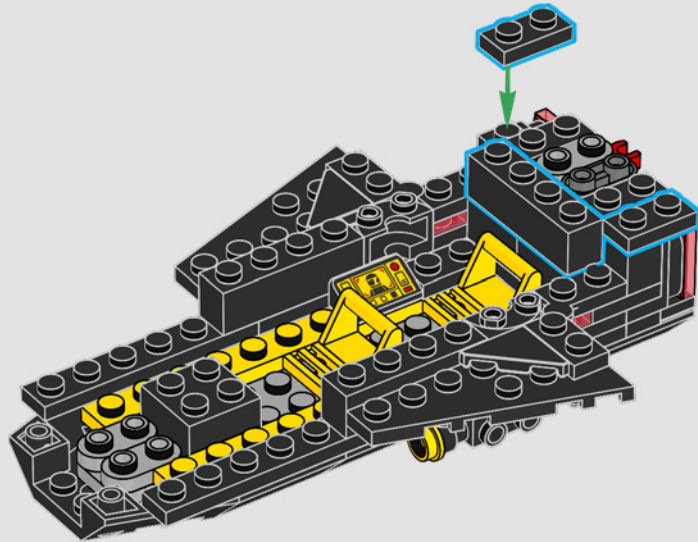

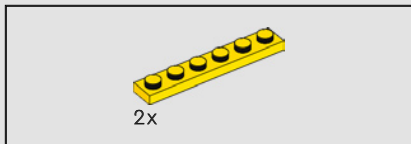

18

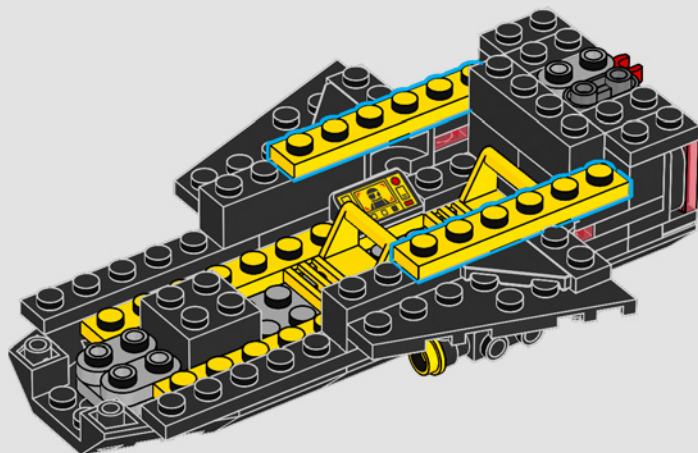

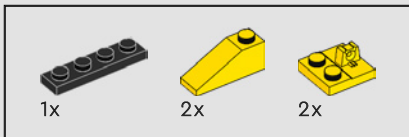

19

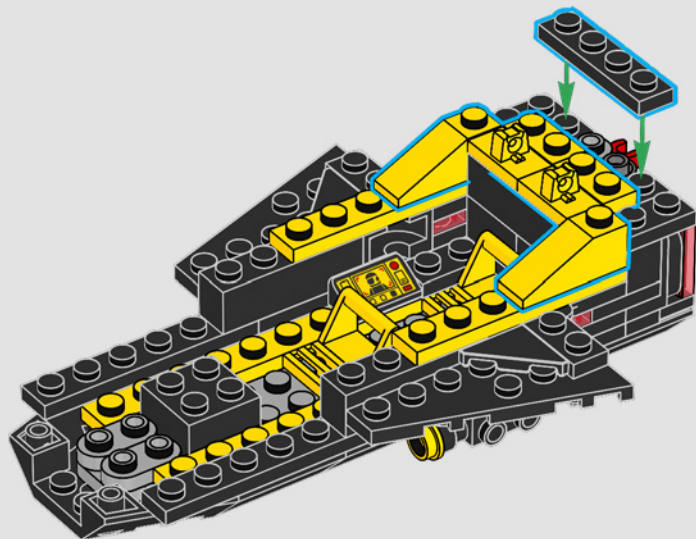

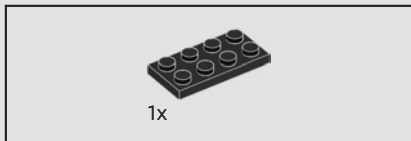

20

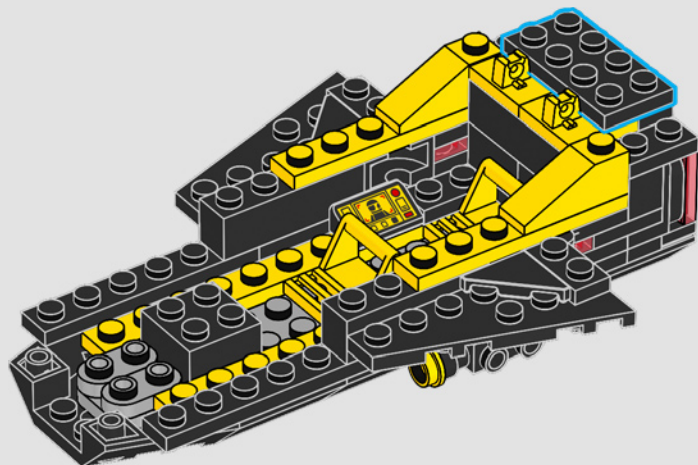

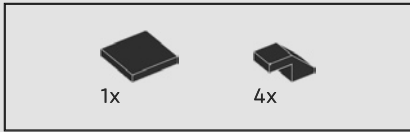

21

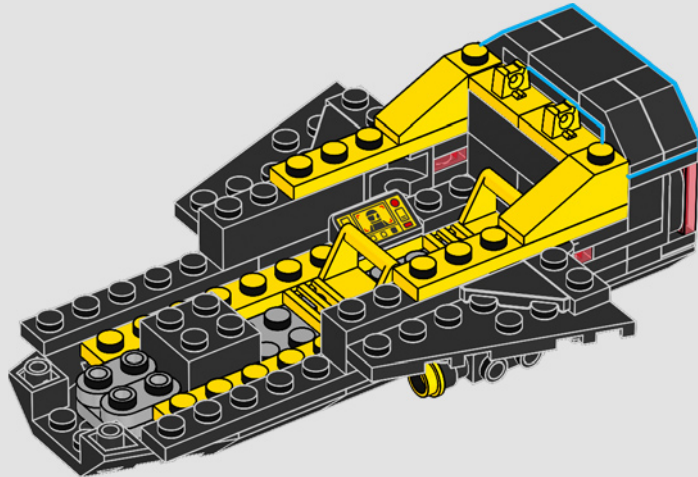

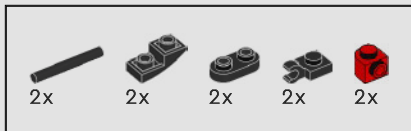

22

1

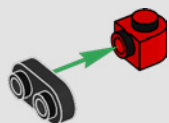

2

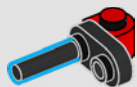

3

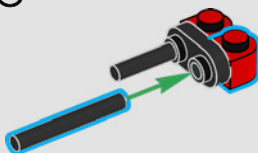

4

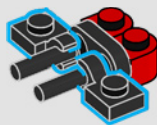

5

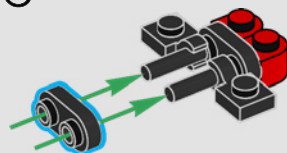

6

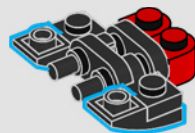



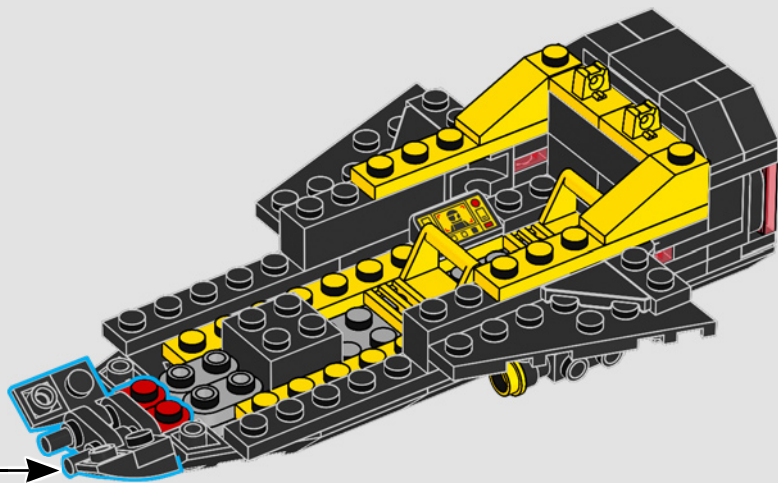

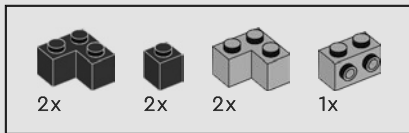

23

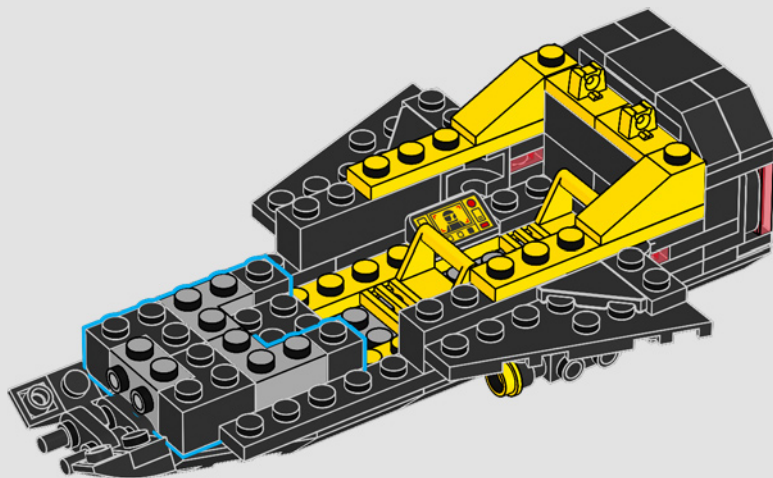

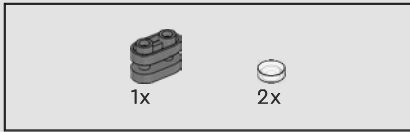

24

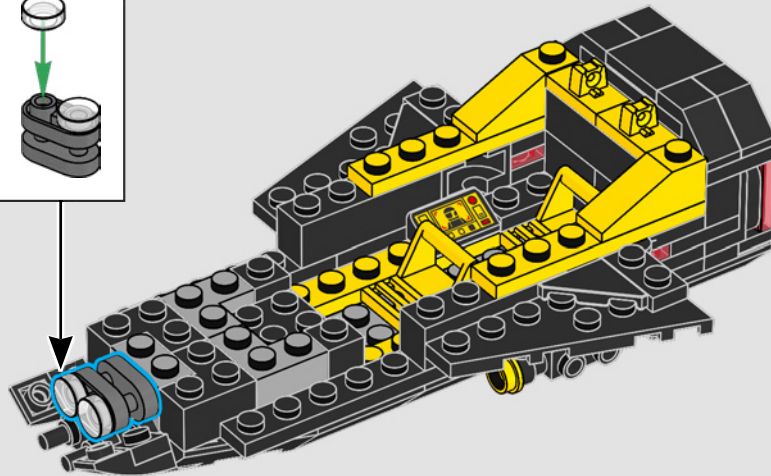
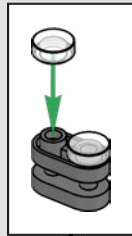



25

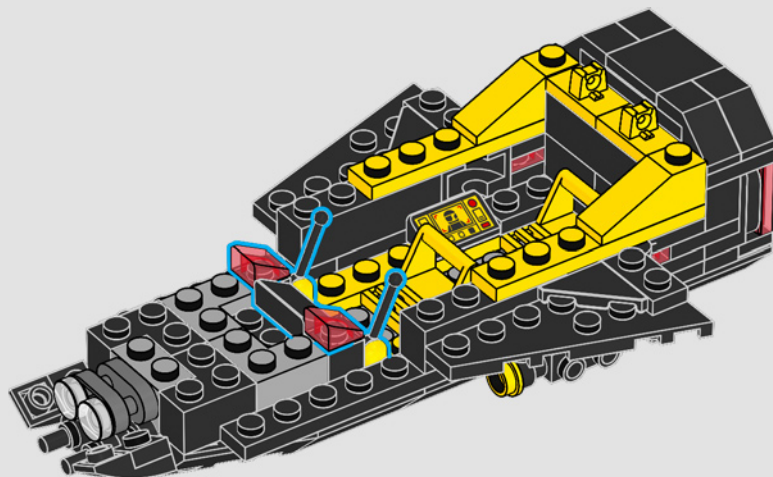



2x



2x



2x

# 26

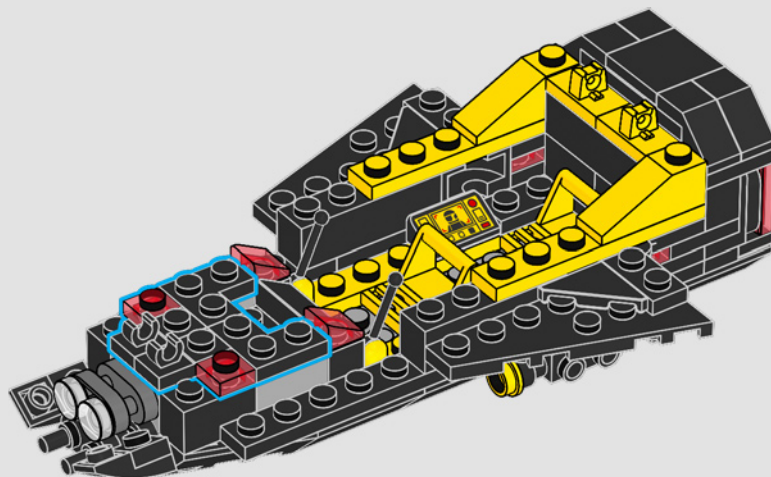

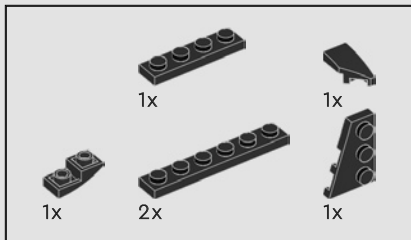

27

1

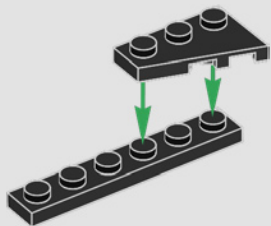

2

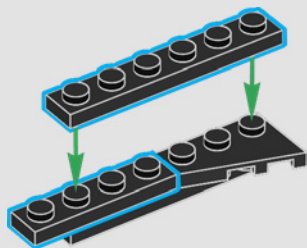

3

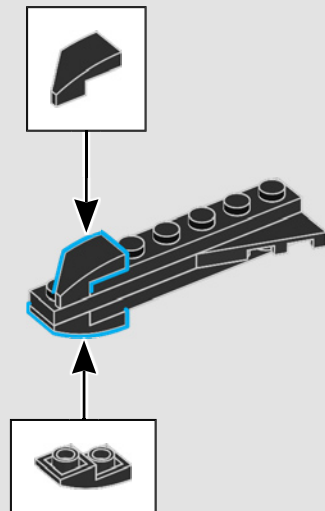

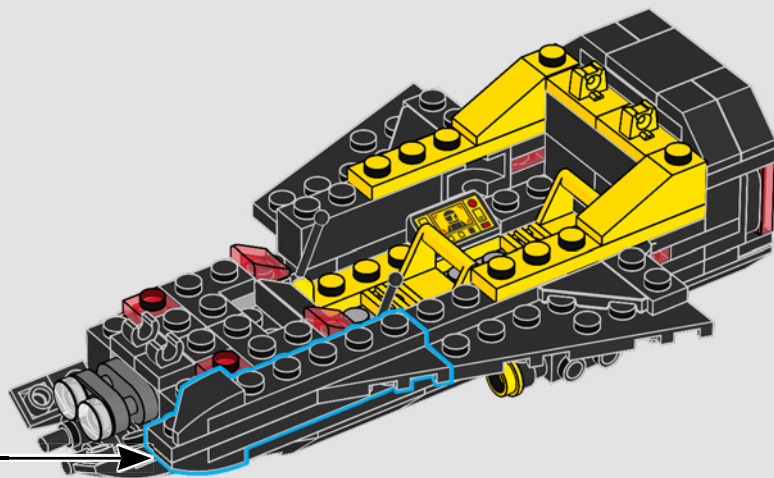

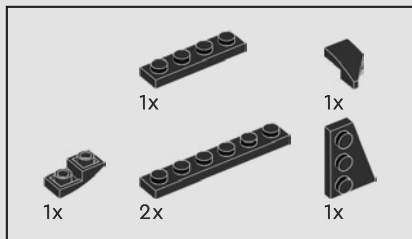

28

1

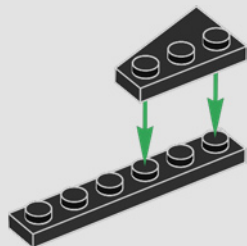

2

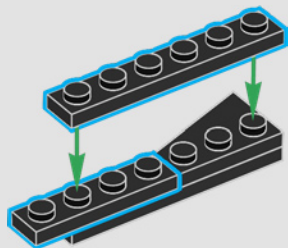

3

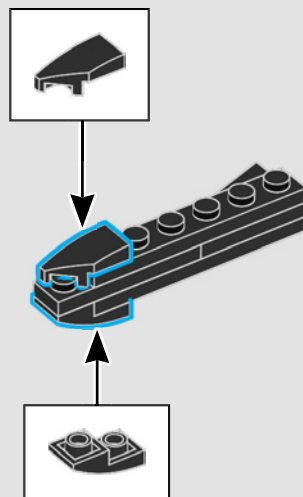



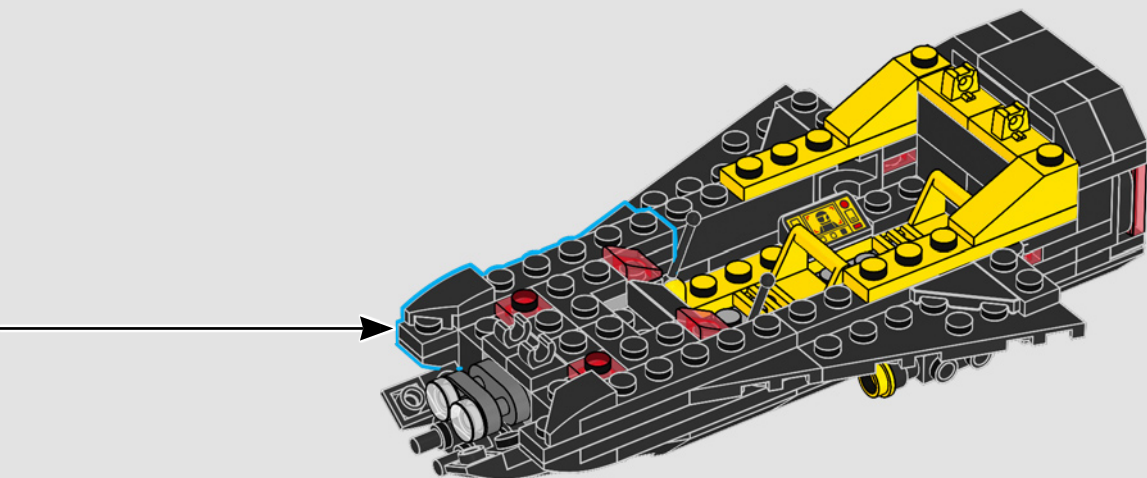

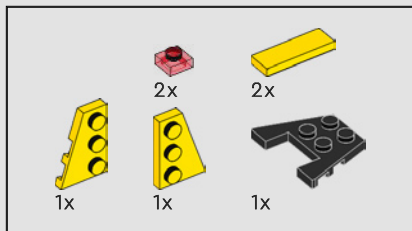

29

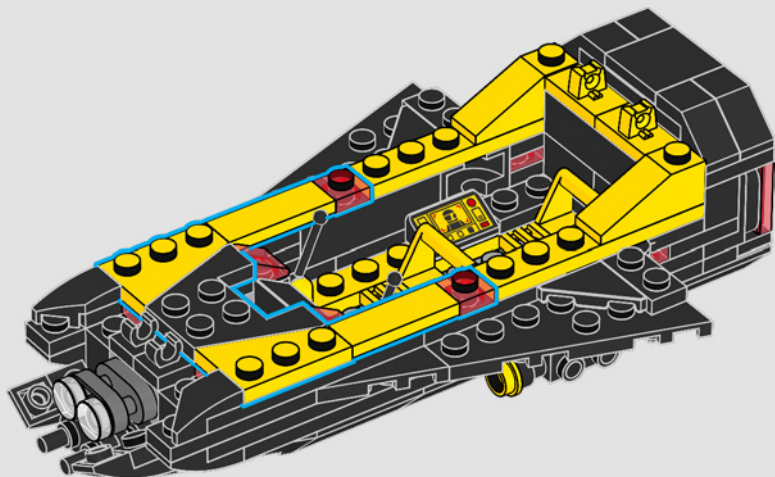



30

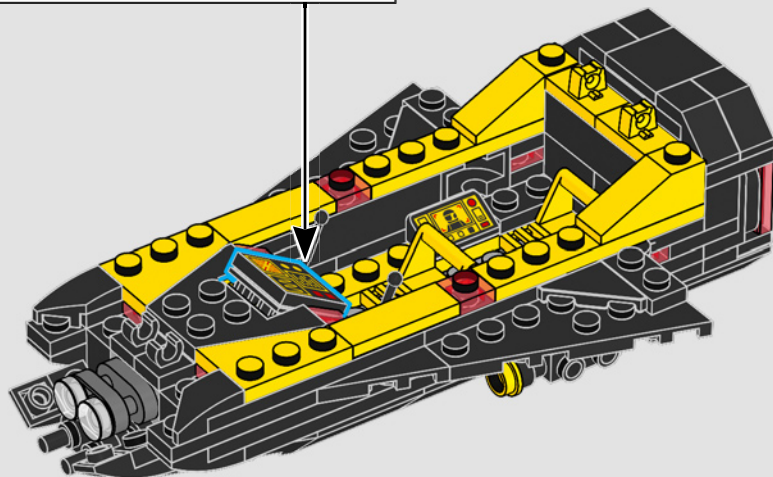
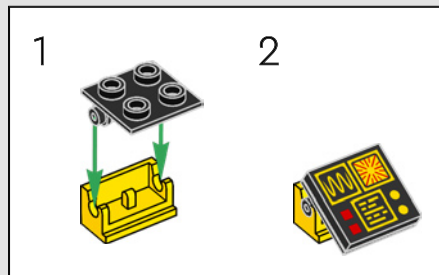



31

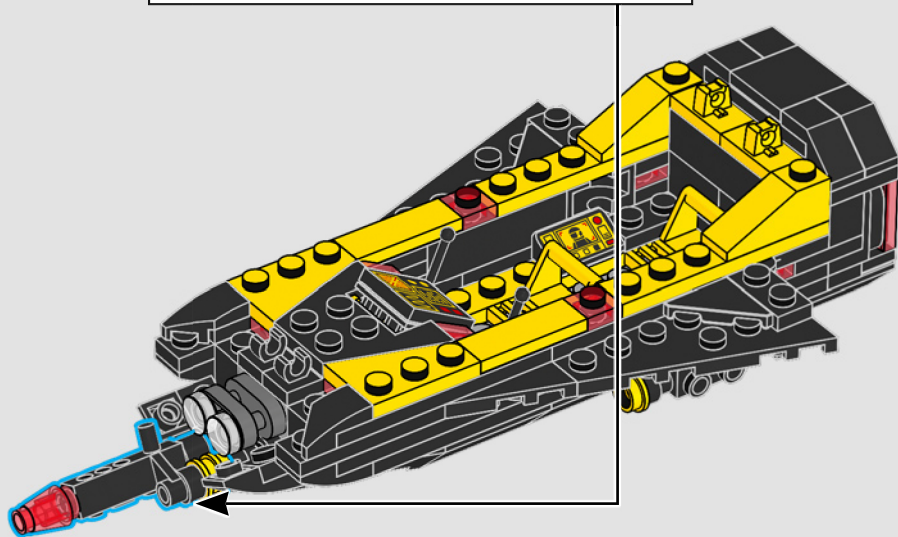
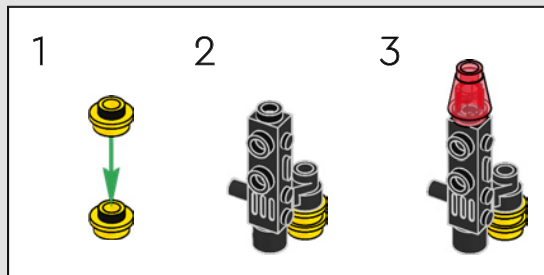

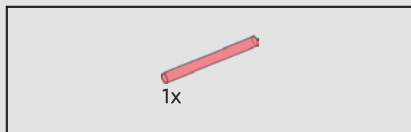

32

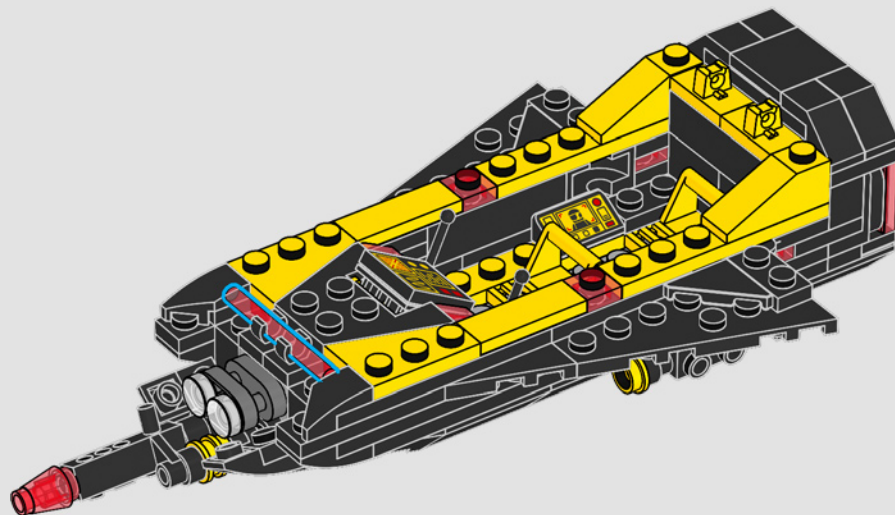

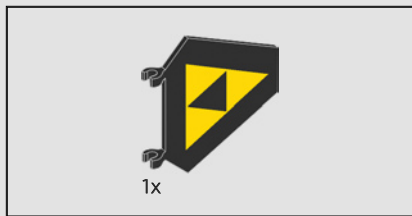

33

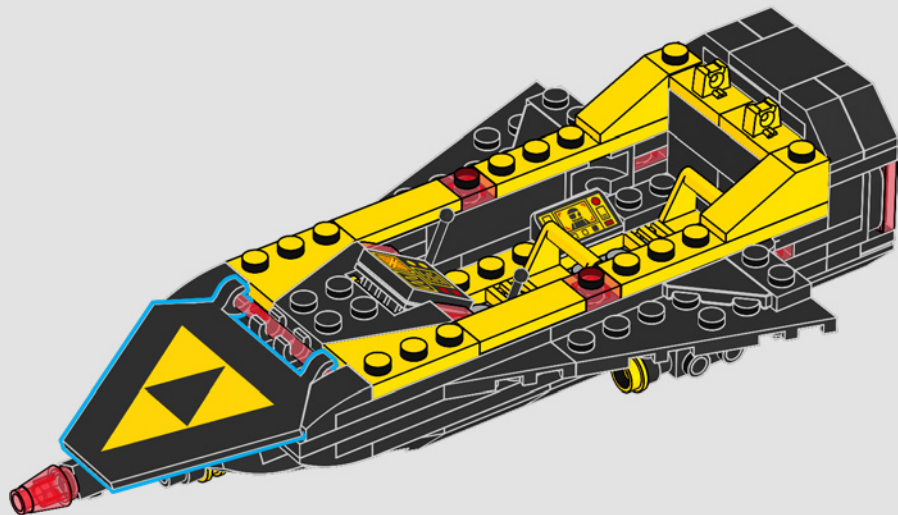

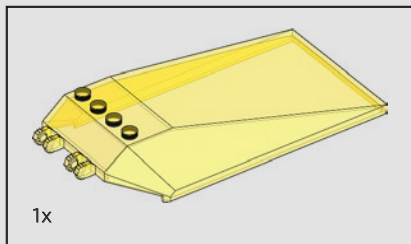

34

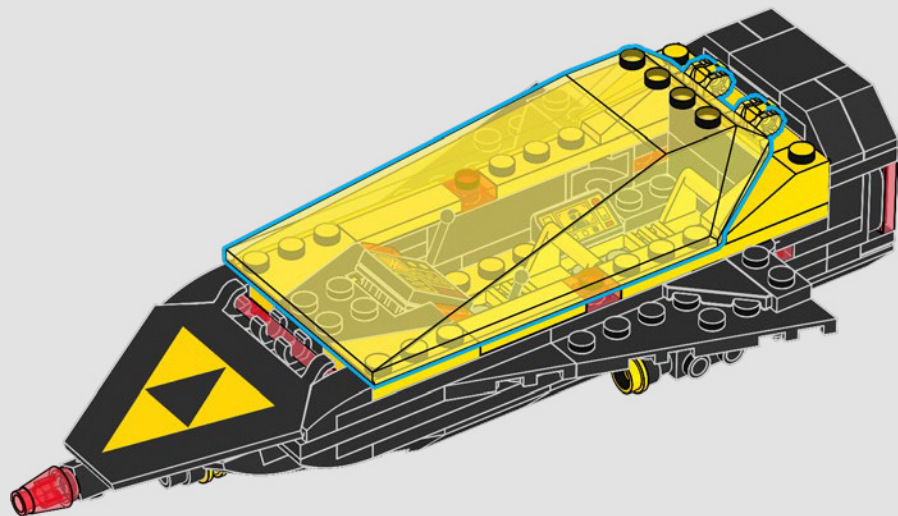



LEGO and the LEGO logo are trademarks of the LEGO Group. ©2025 The LEGO Group.