

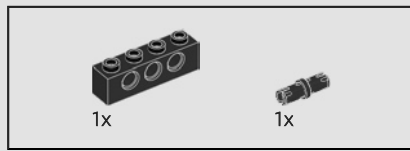

10355





1

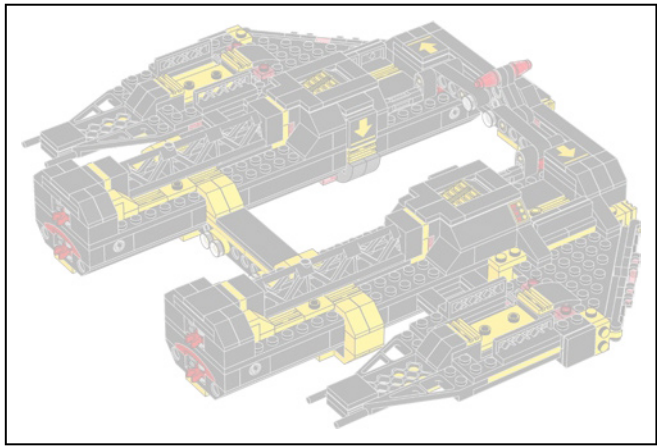
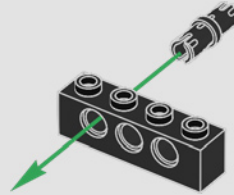

2



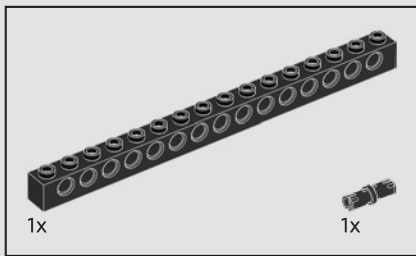

3

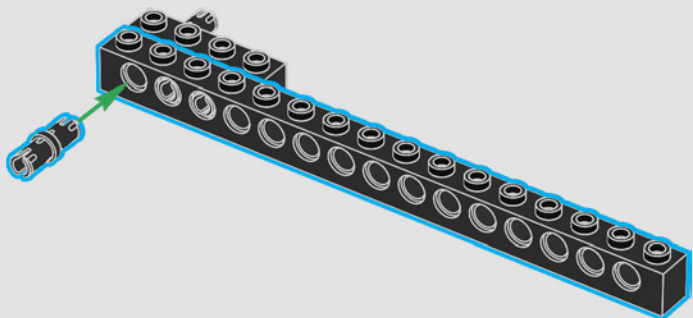

4

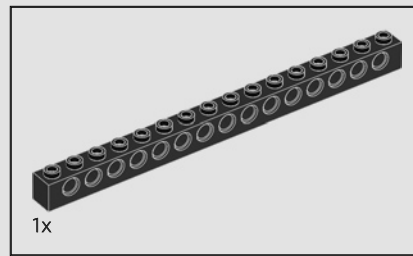
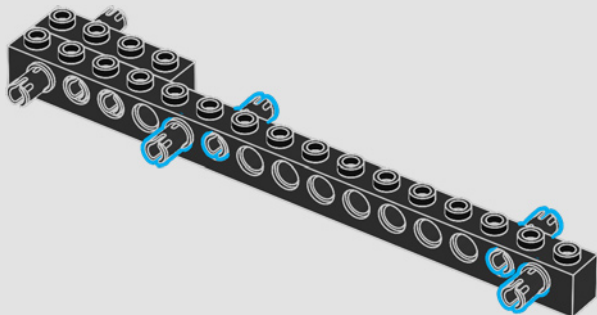

5

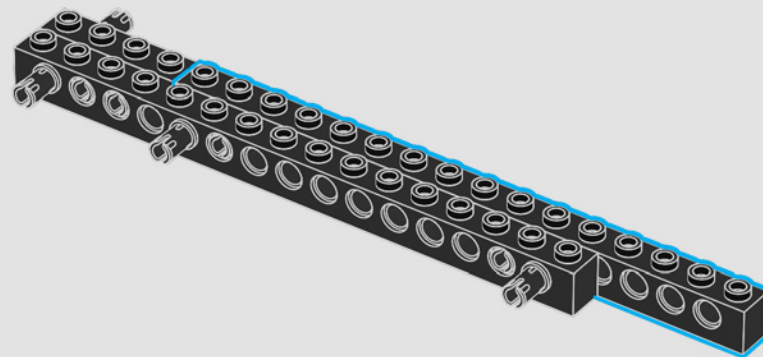

6

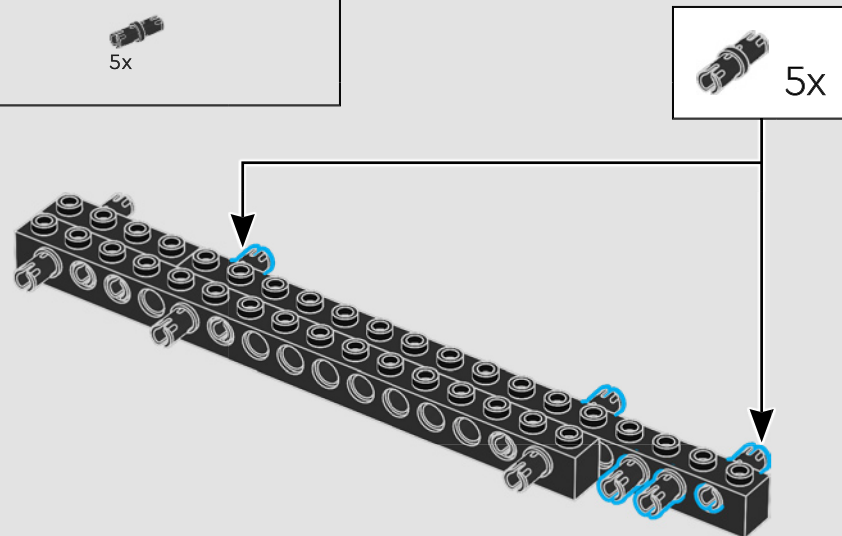

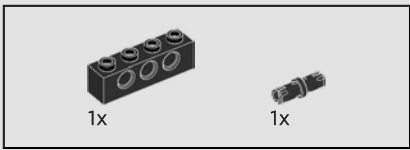

7

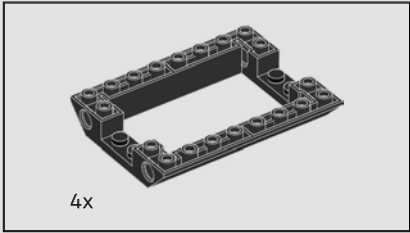
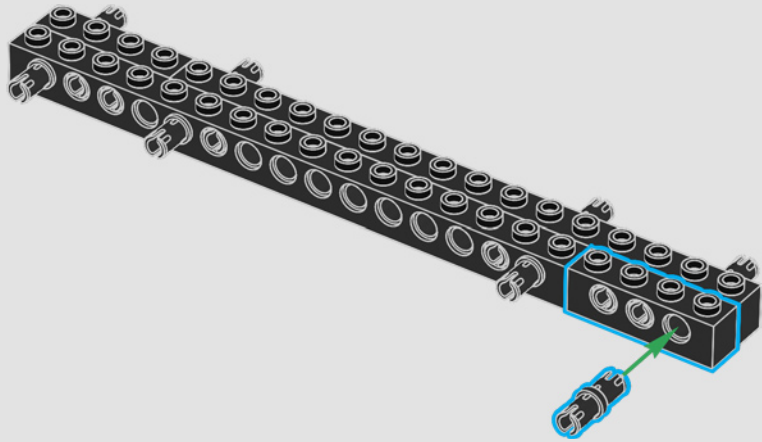

8

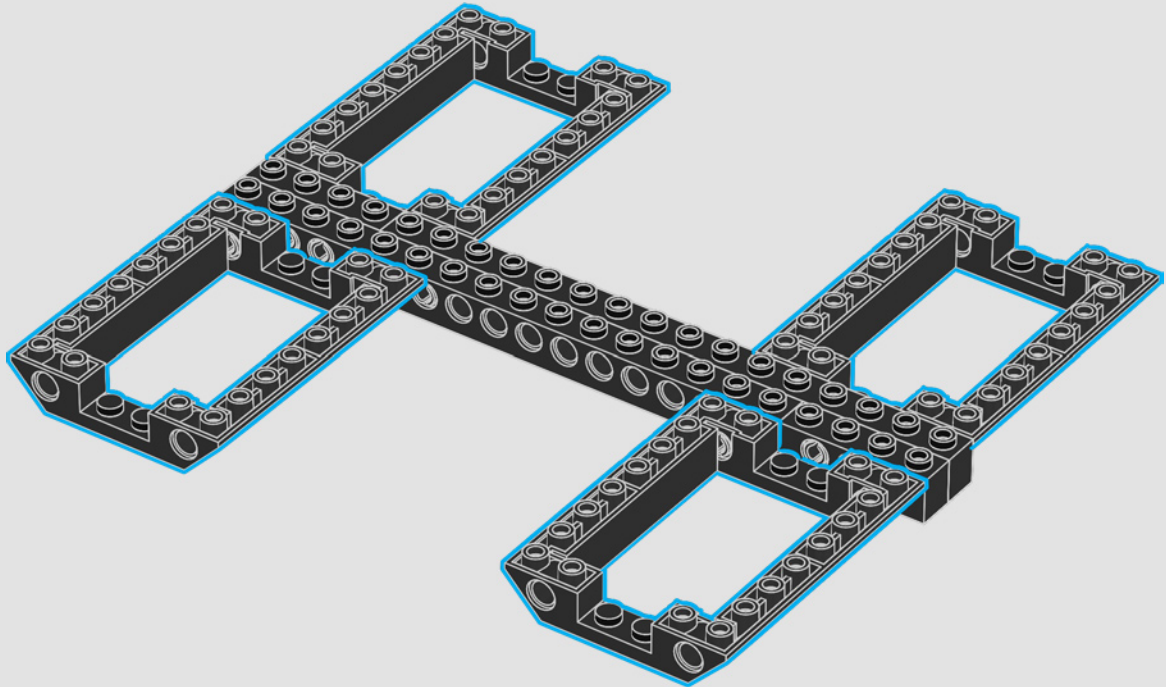

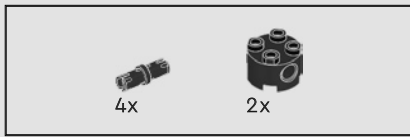

9

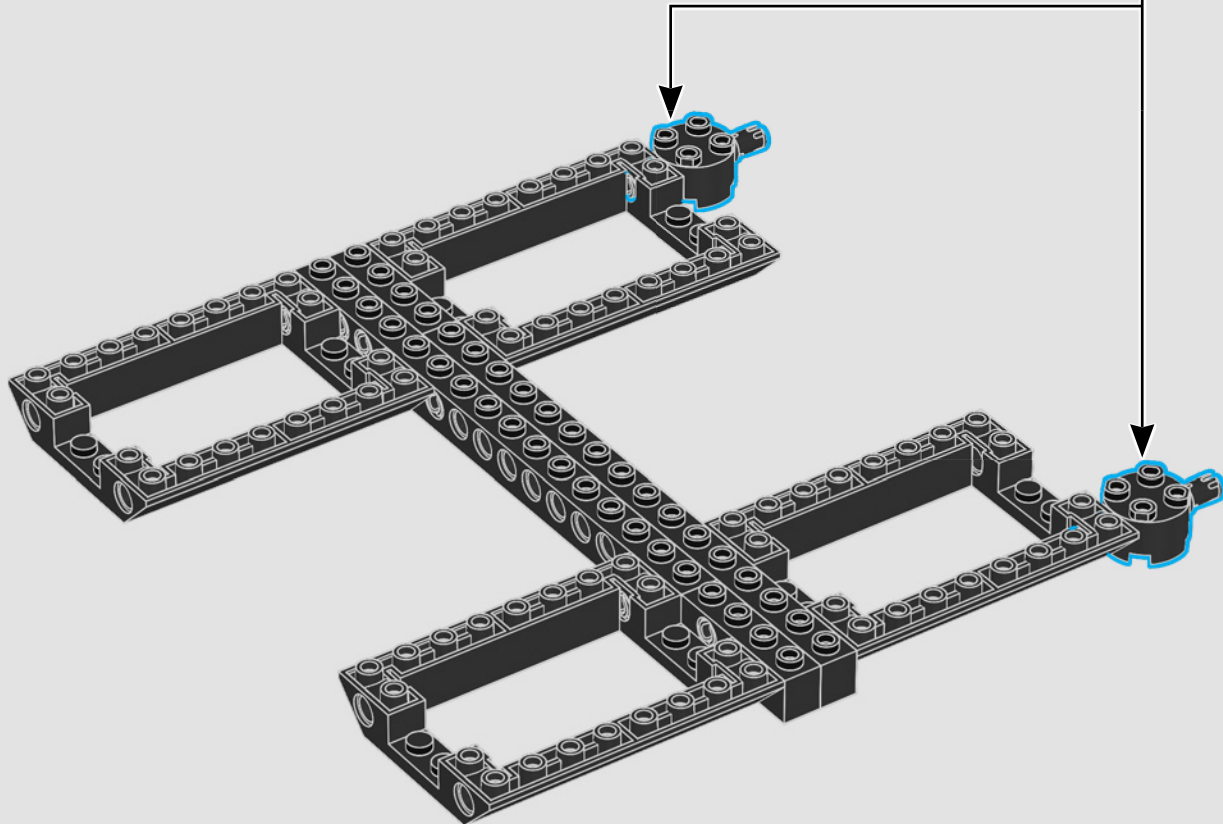
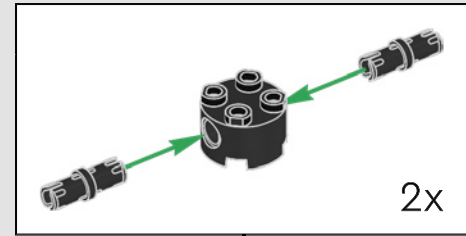

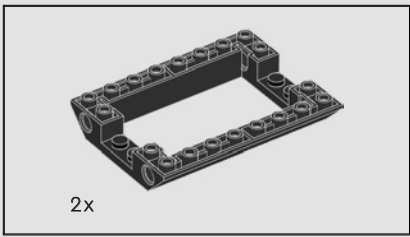

10

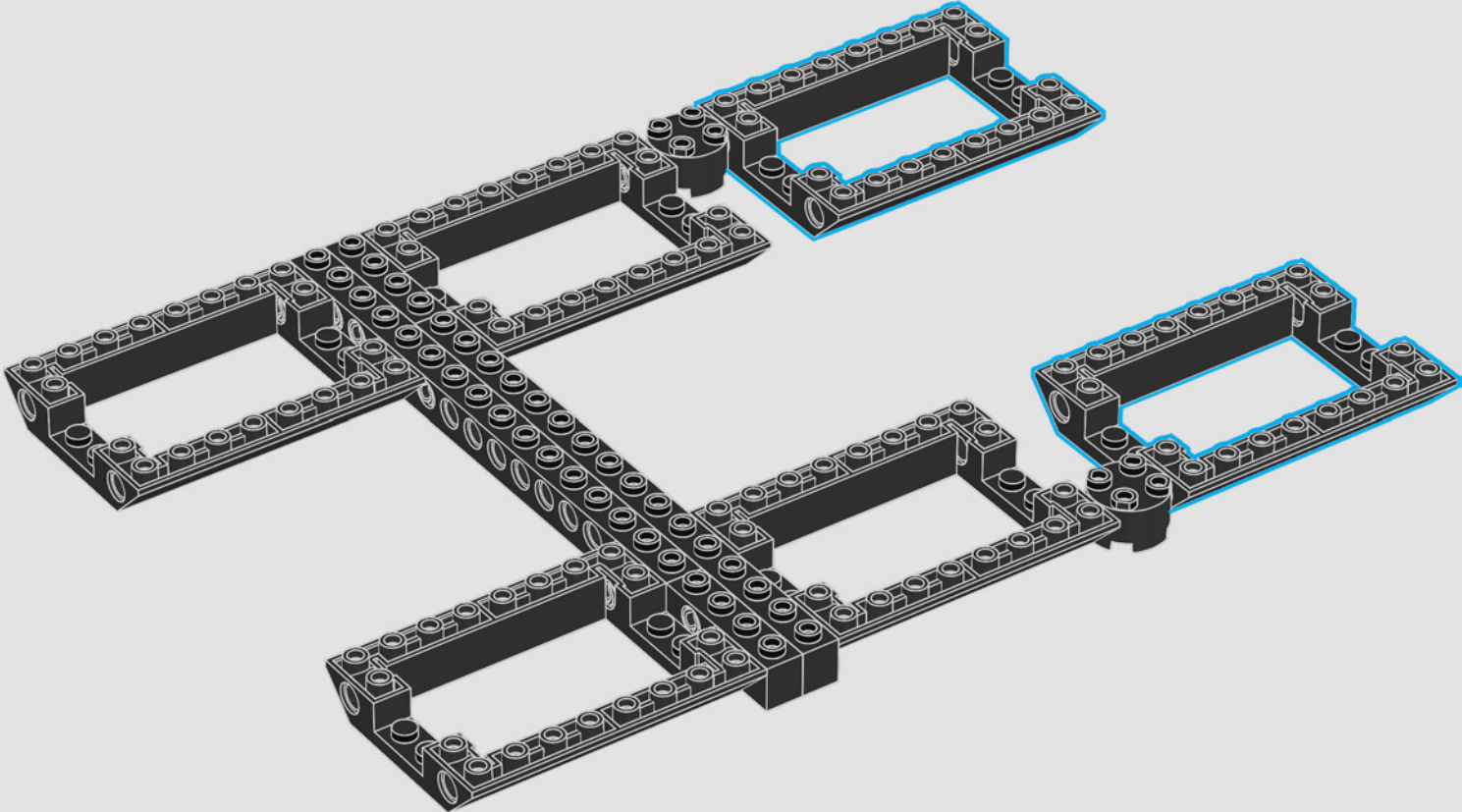

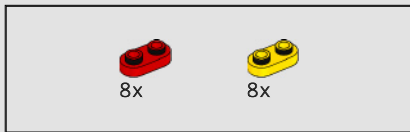

11

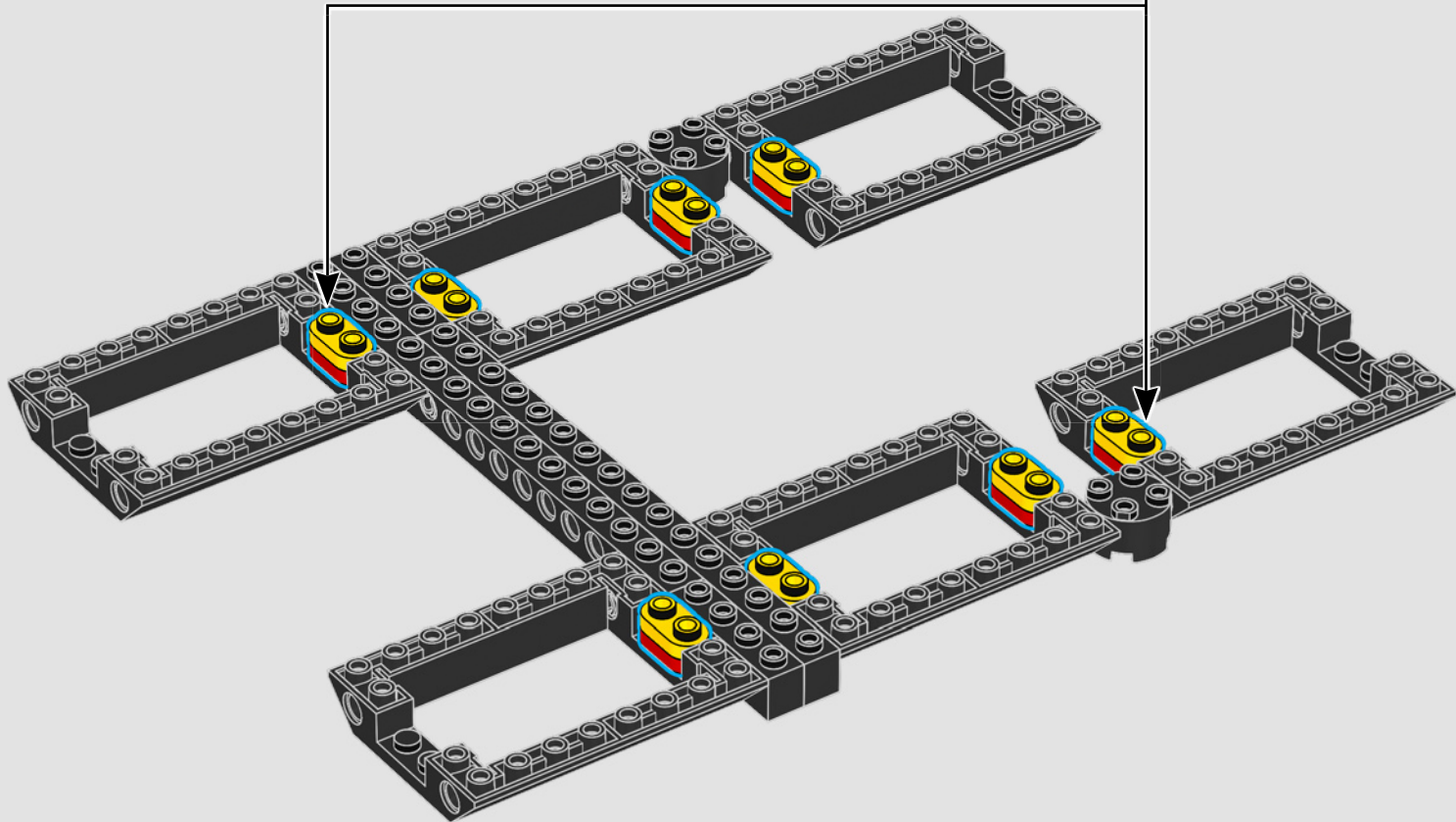
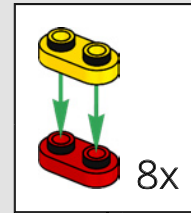

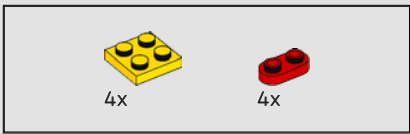

12

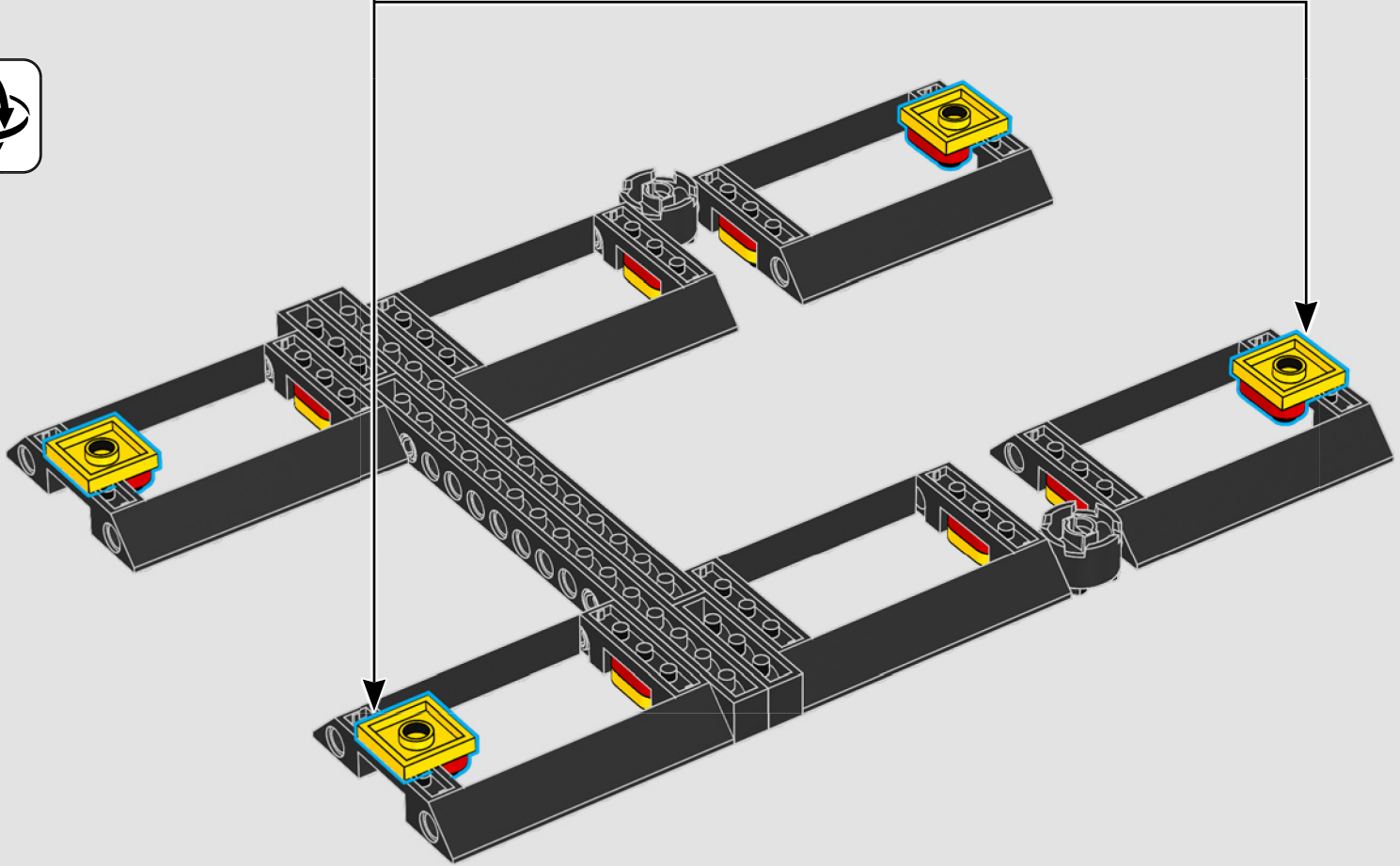
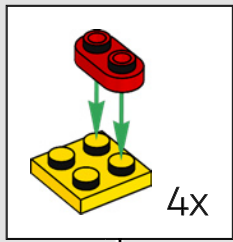

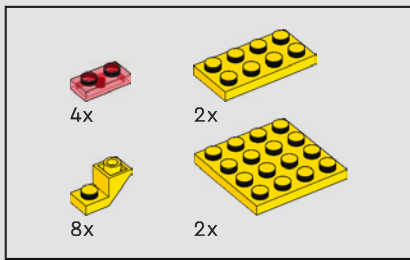

13

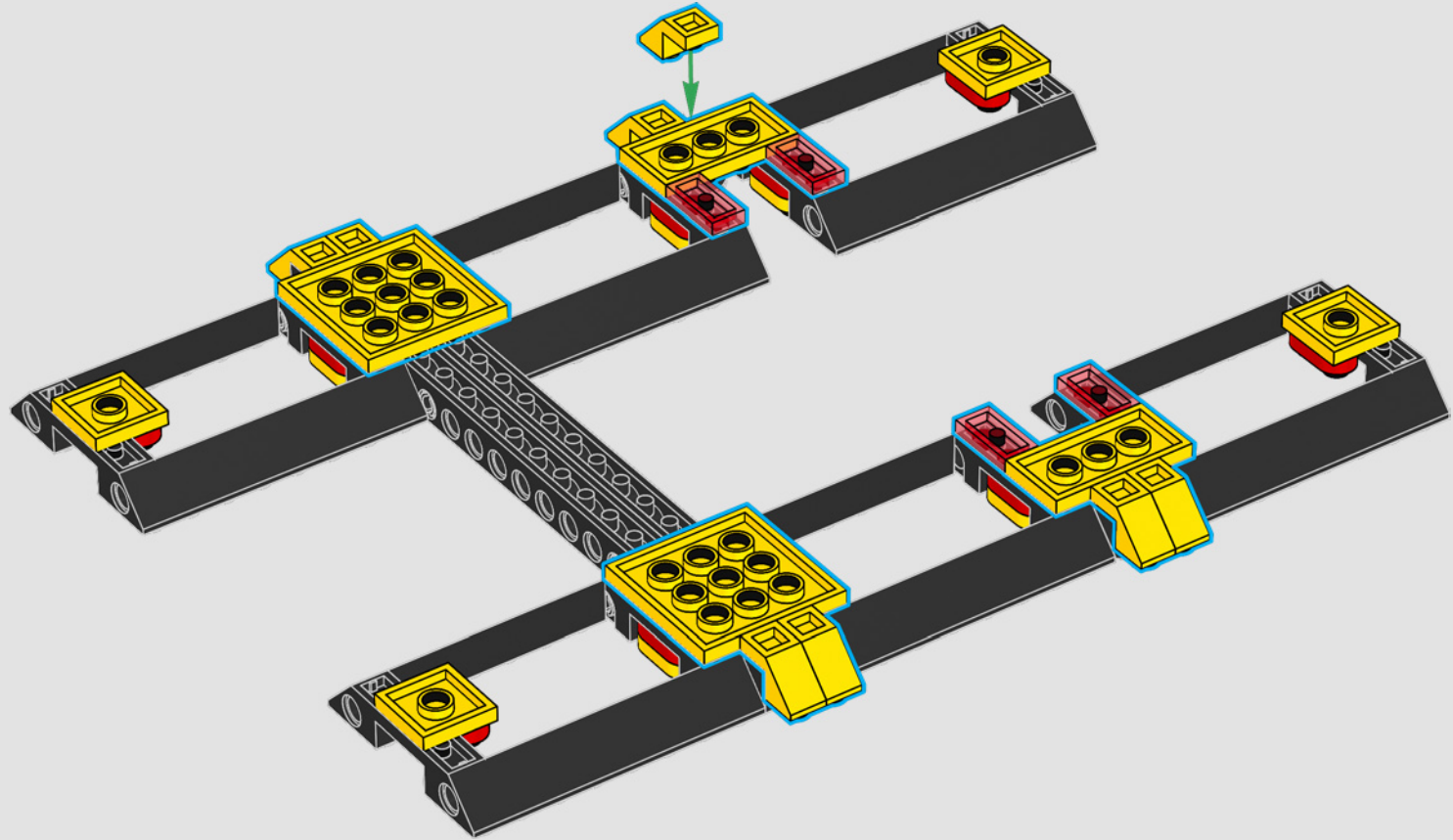



14

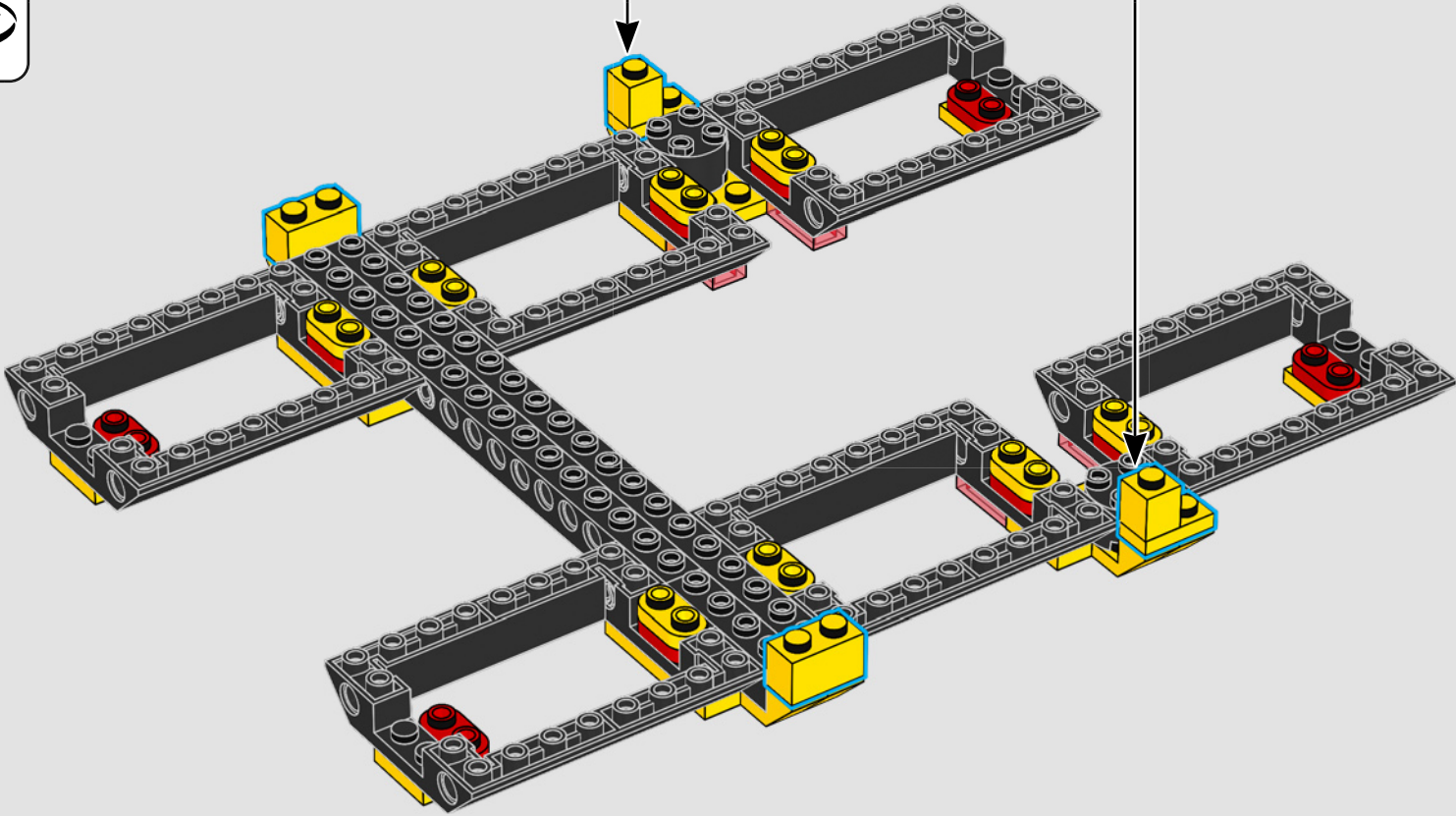
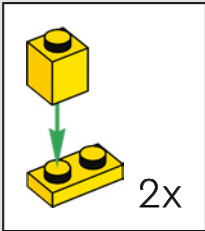

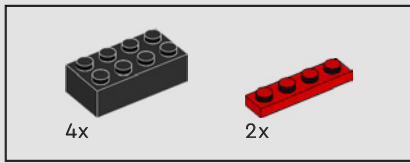

15

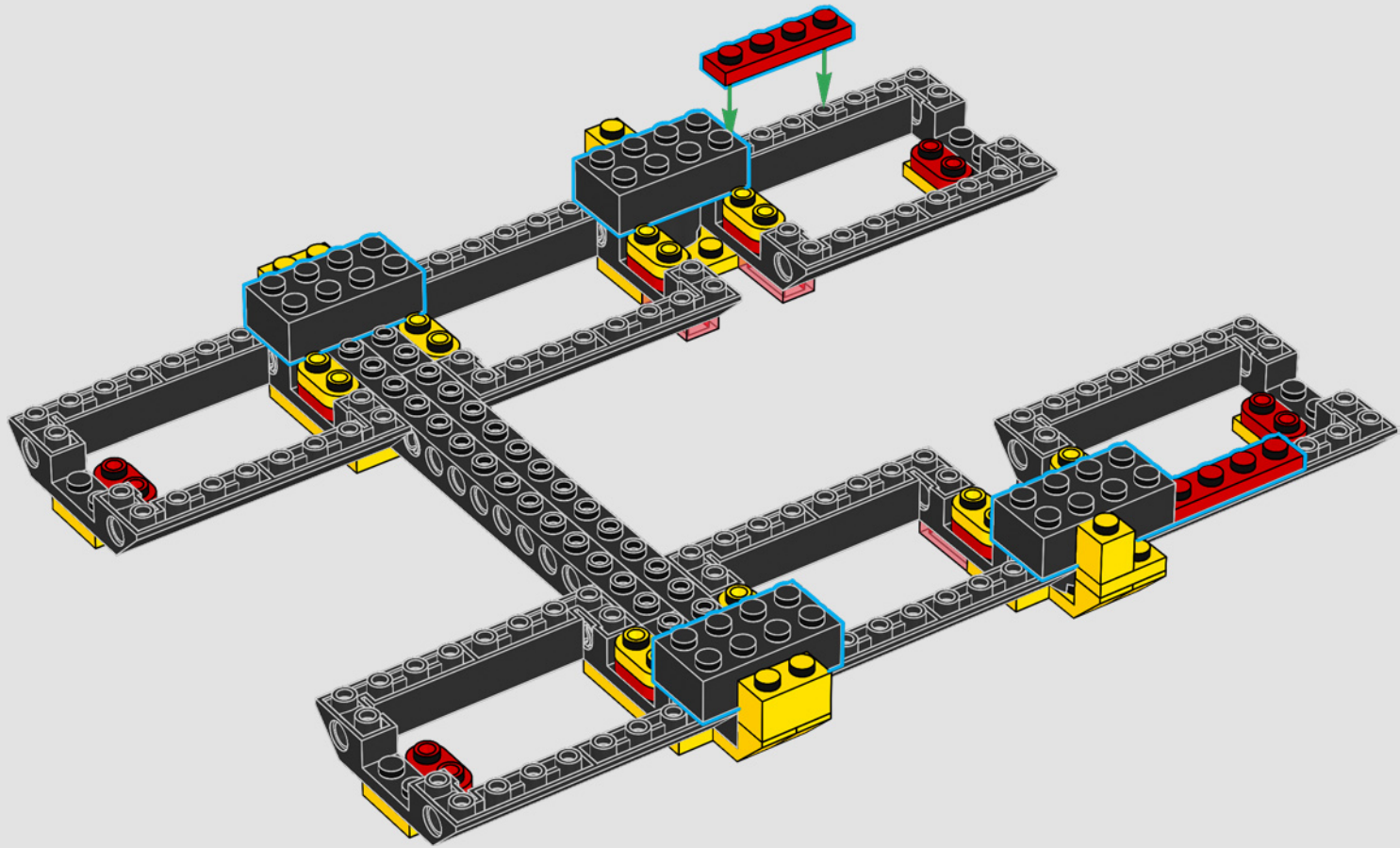

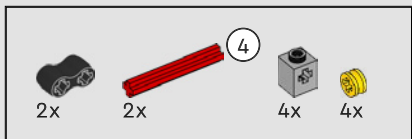

16

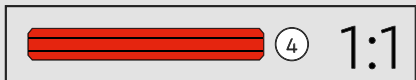
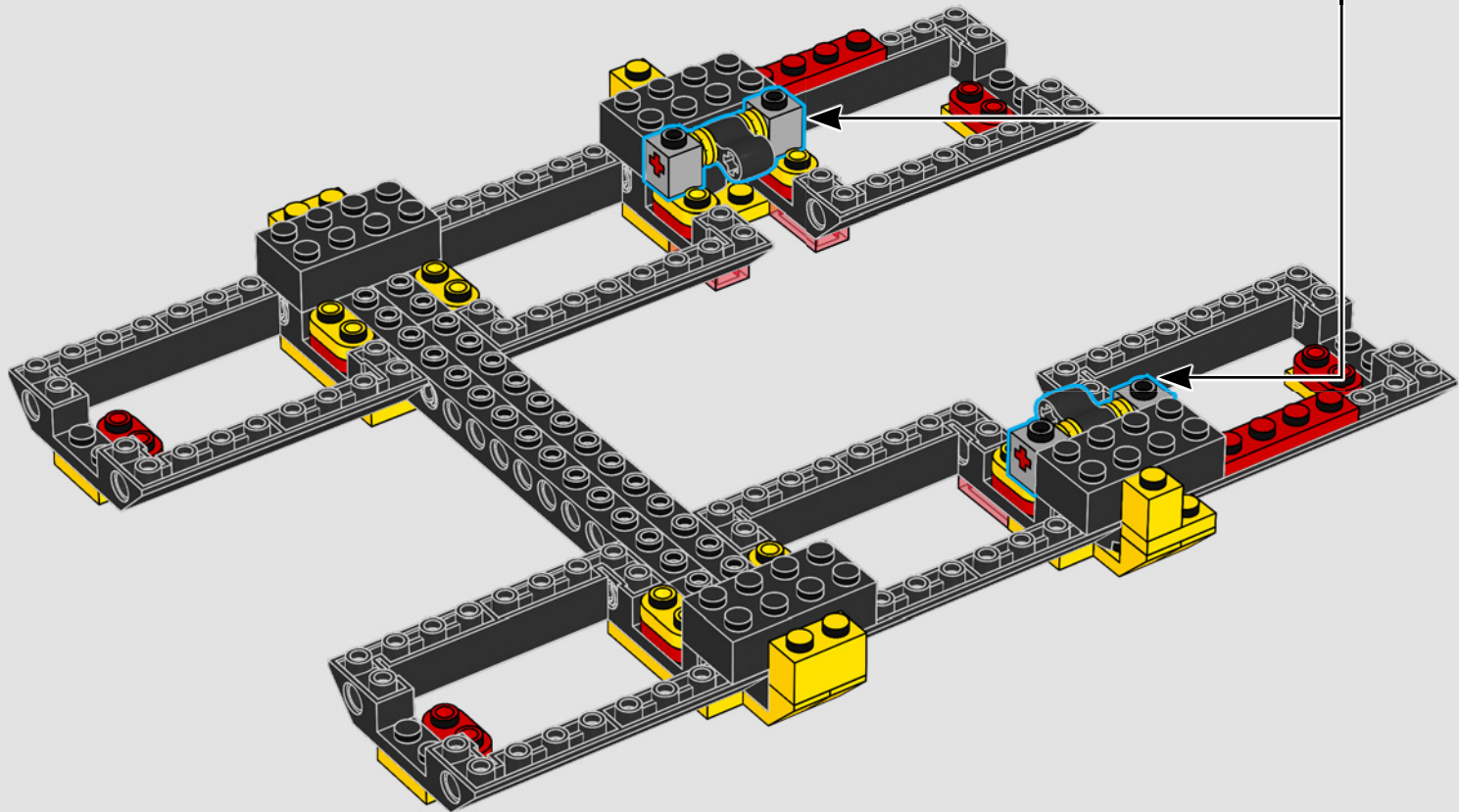
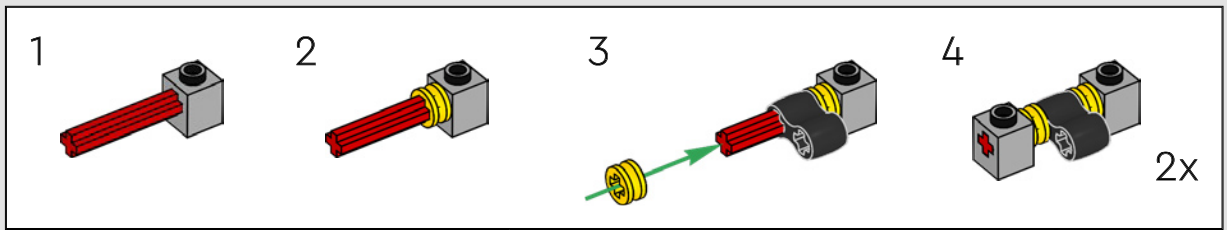

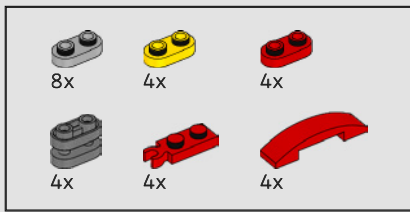

17

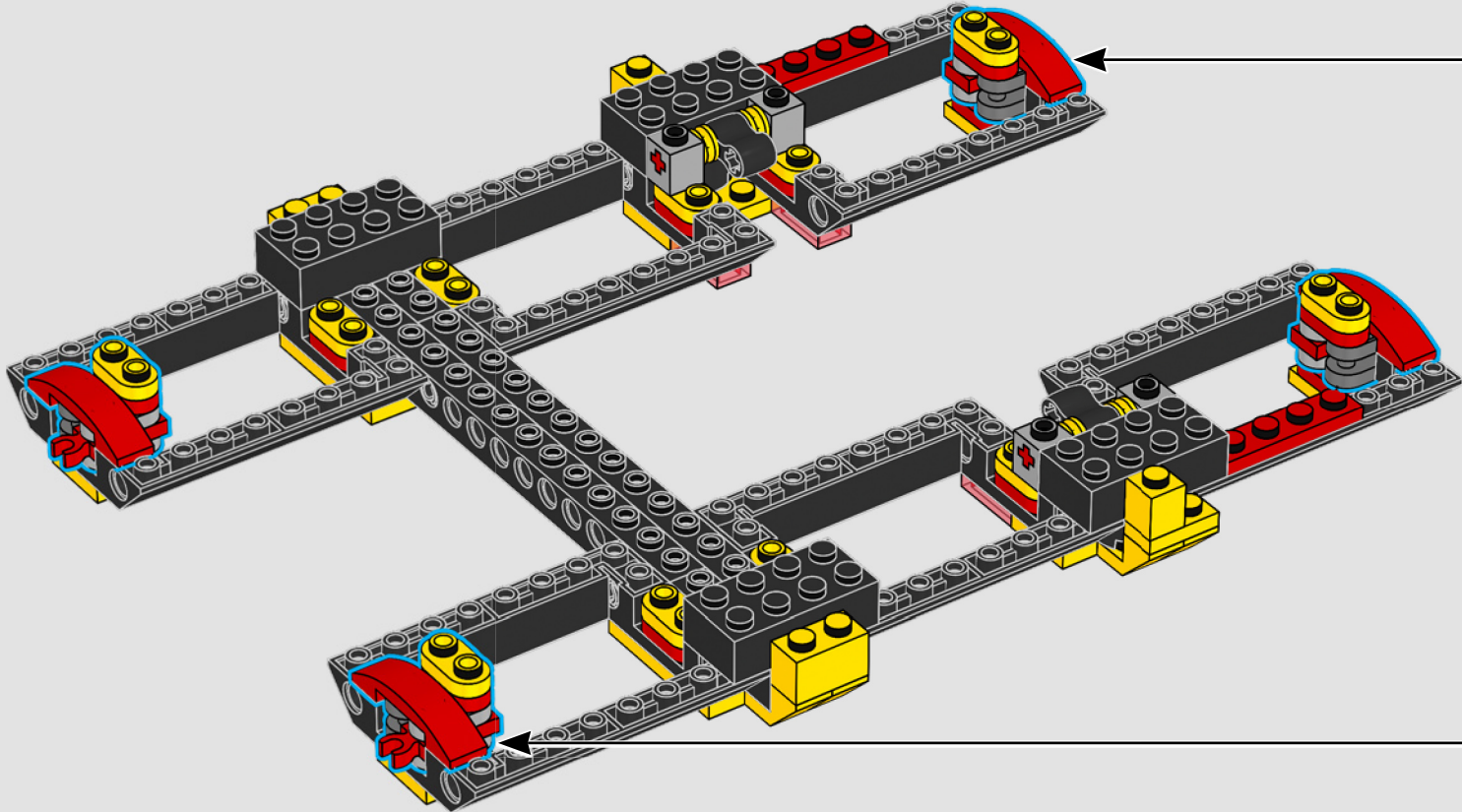
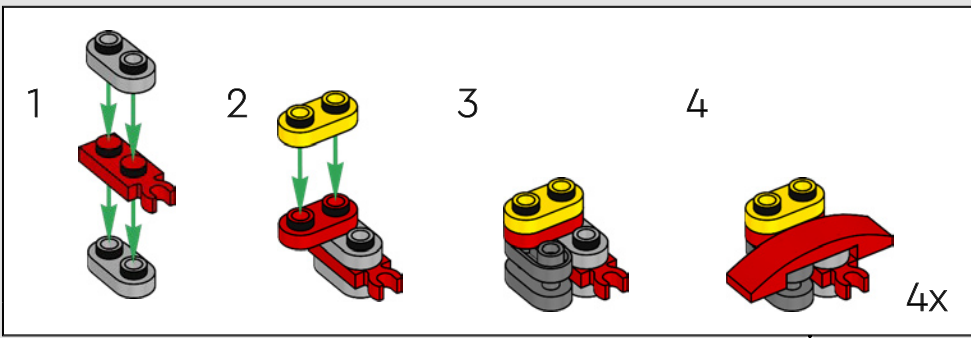

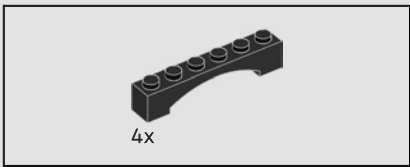

18

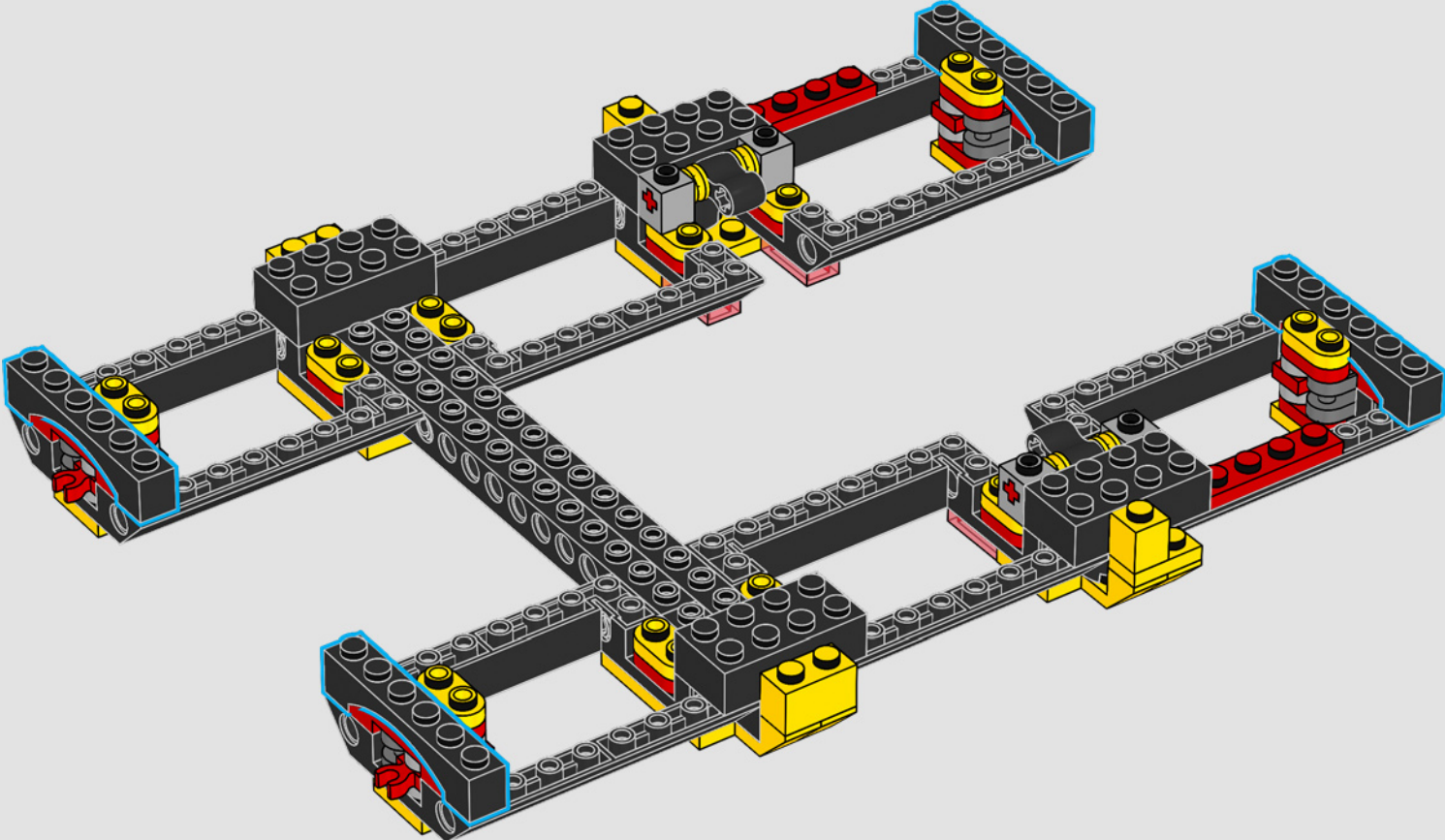

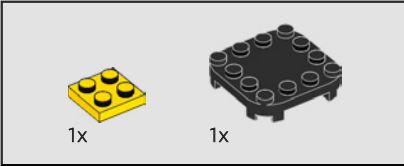
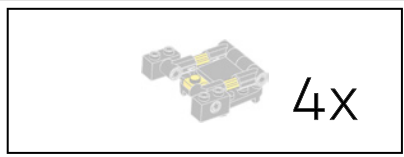

19

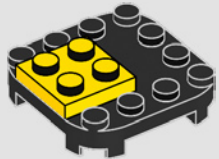

20

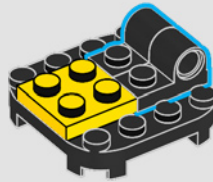

21

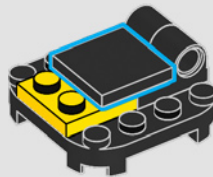

22

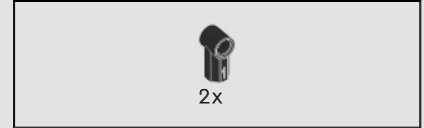
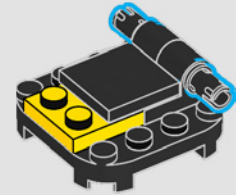

23

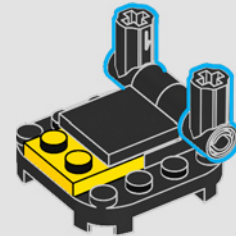

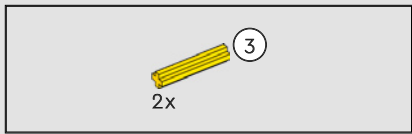

24

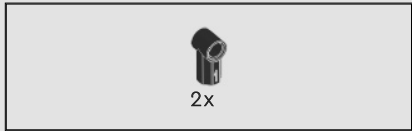
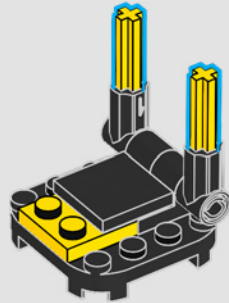
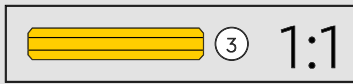

25

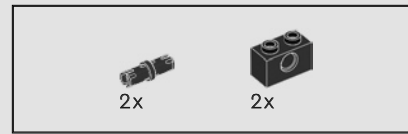
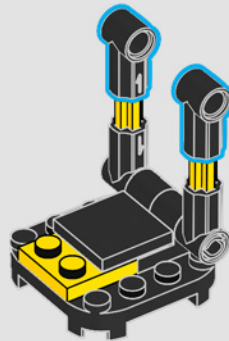

26

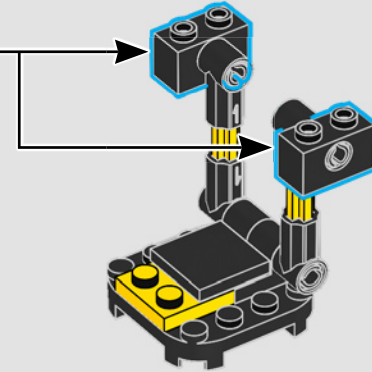
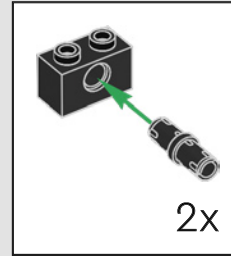

27

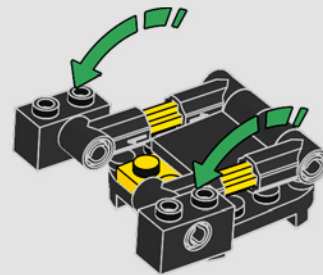

4x

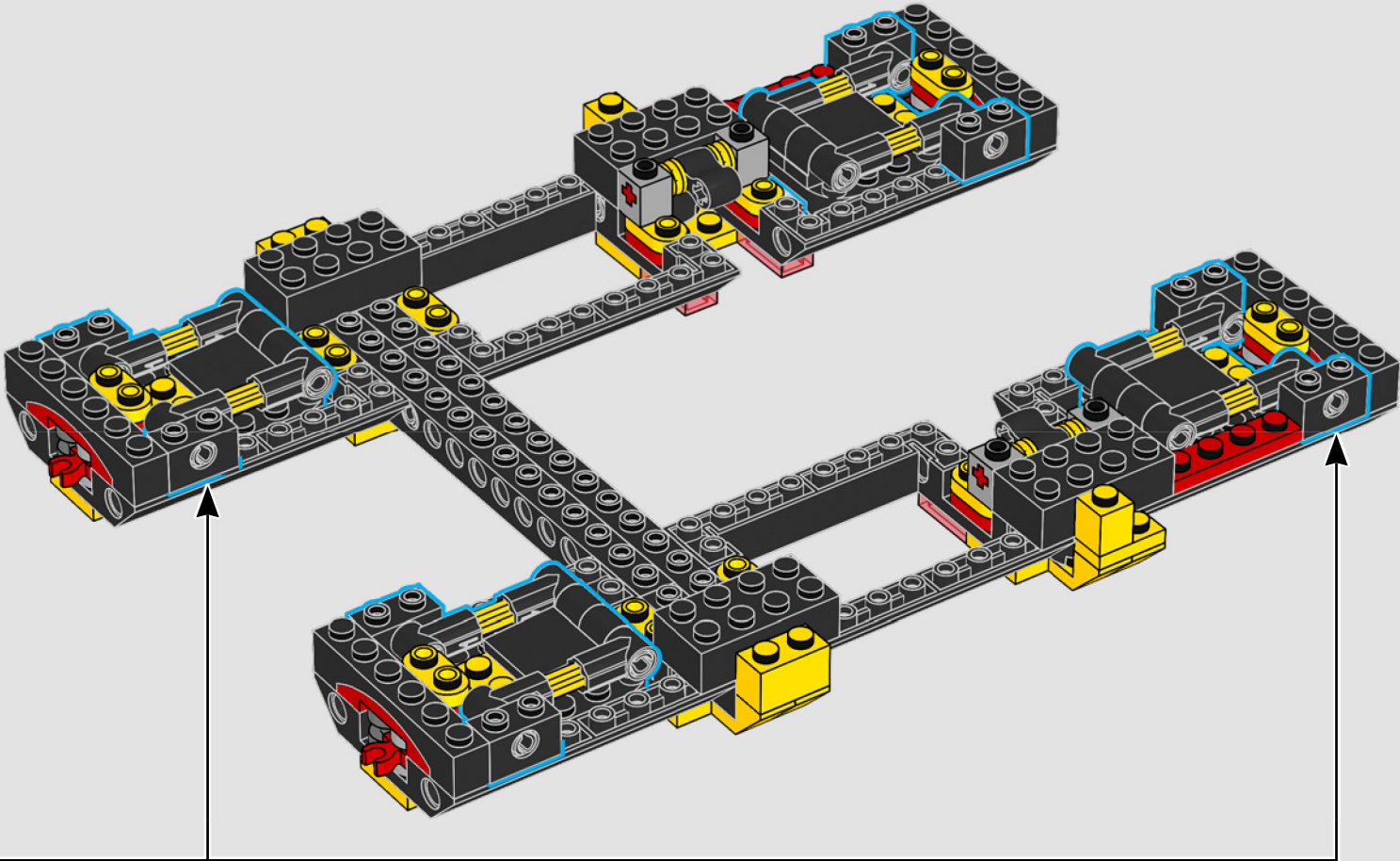

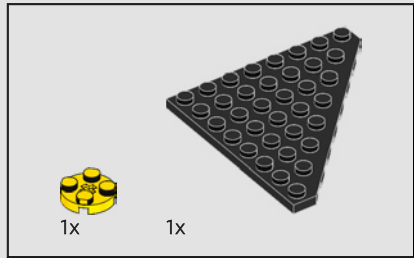
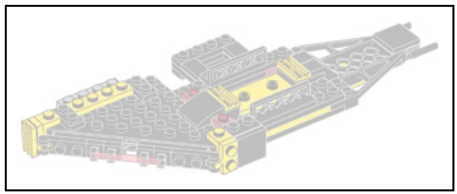

29



30

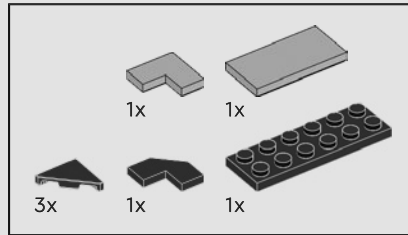
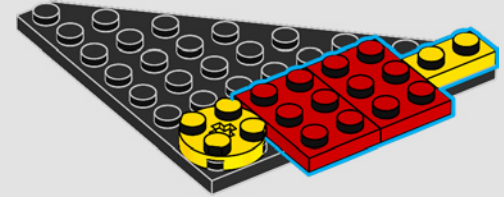

31

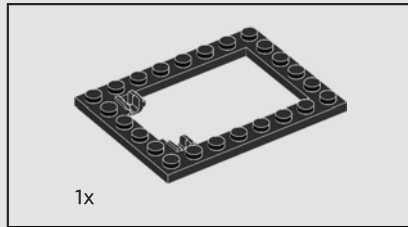
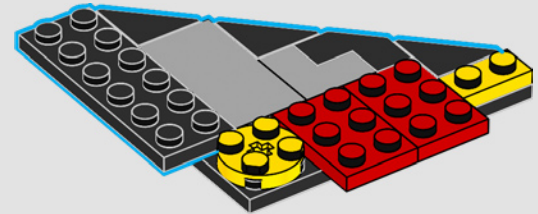

32

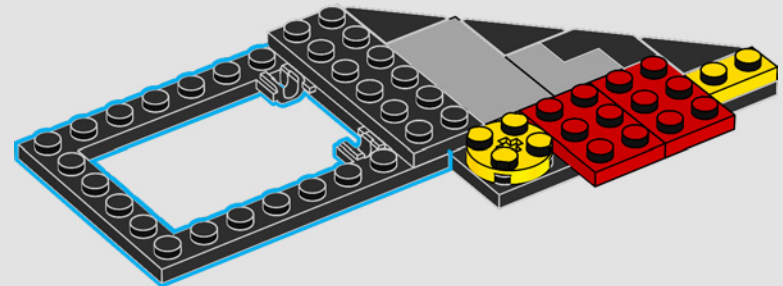

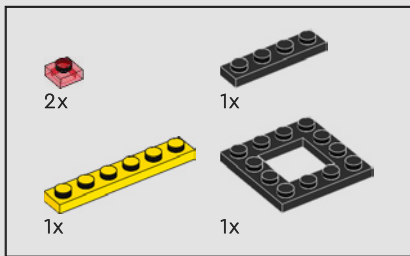

33

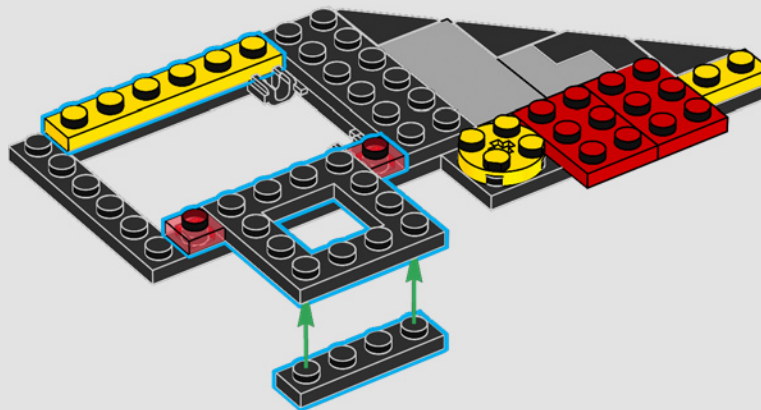

34

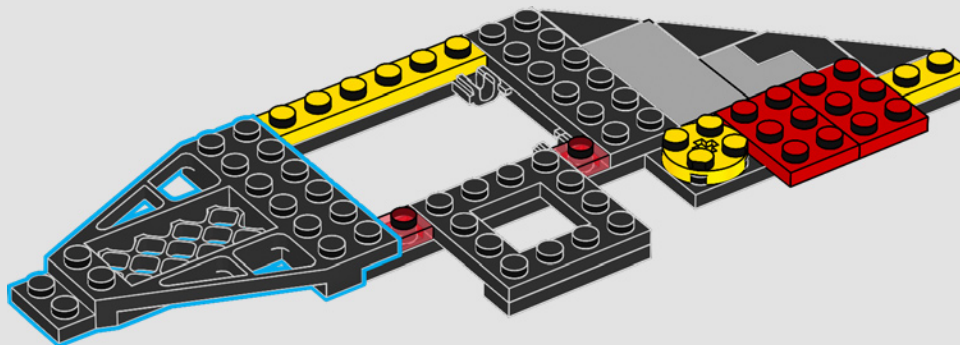

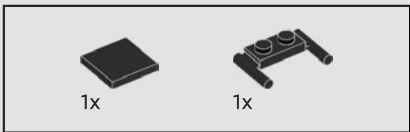

35

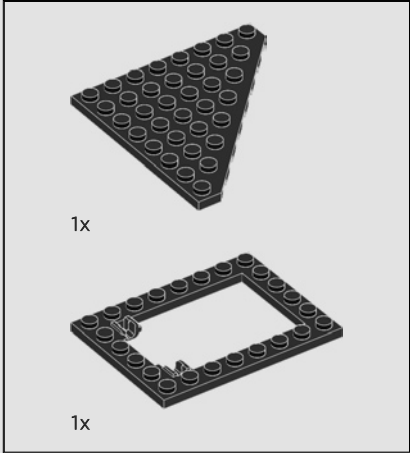
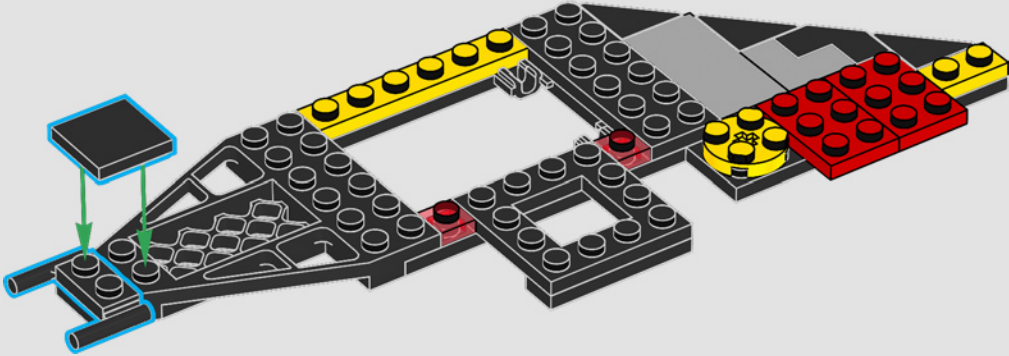

36

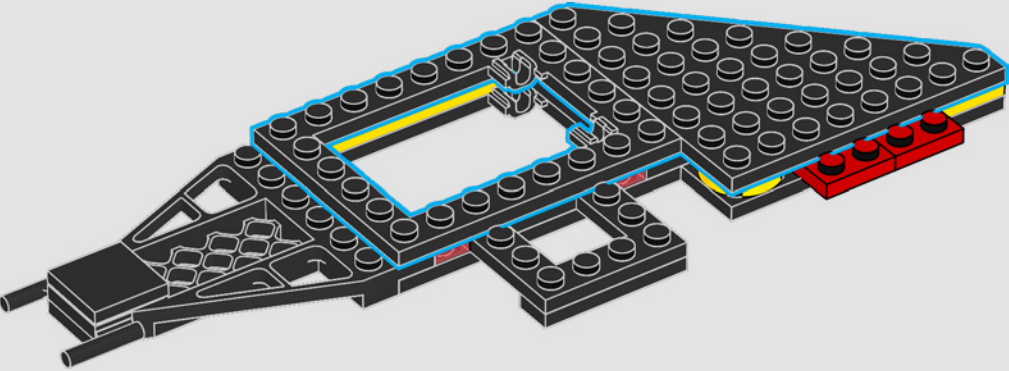

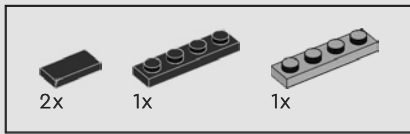

37

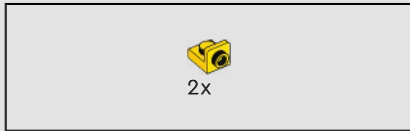
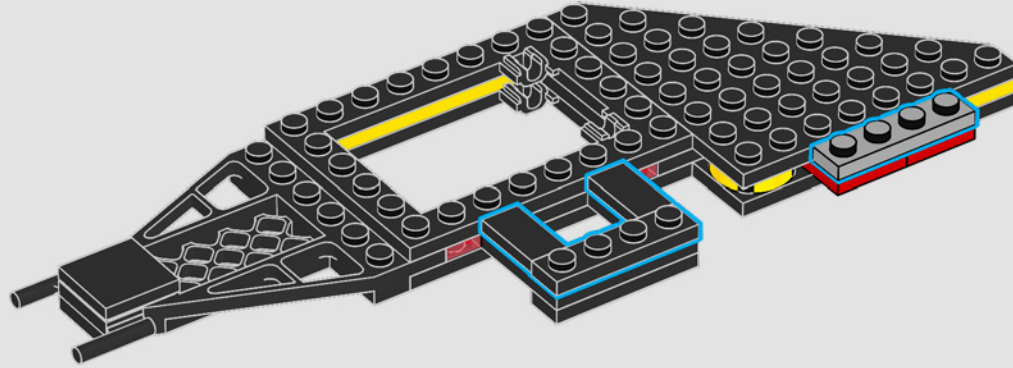

38

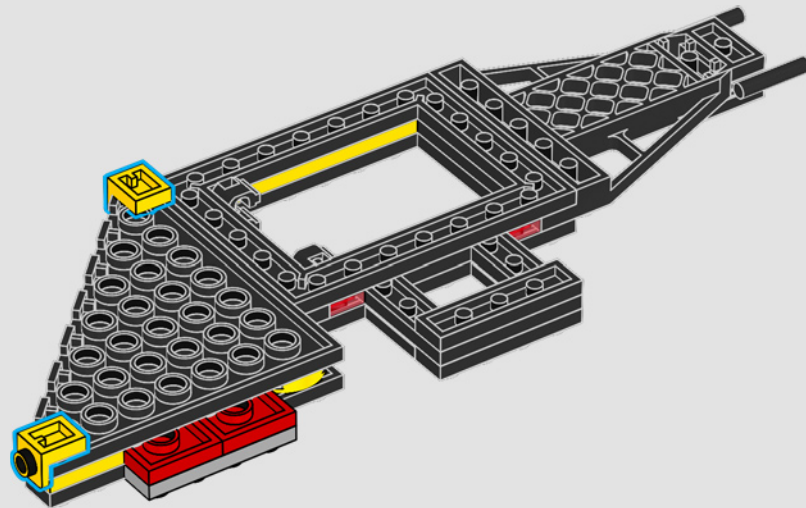
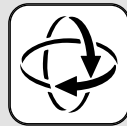

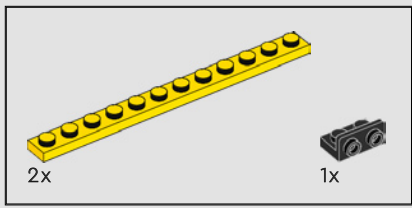

39

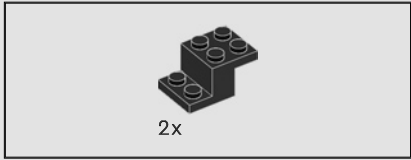
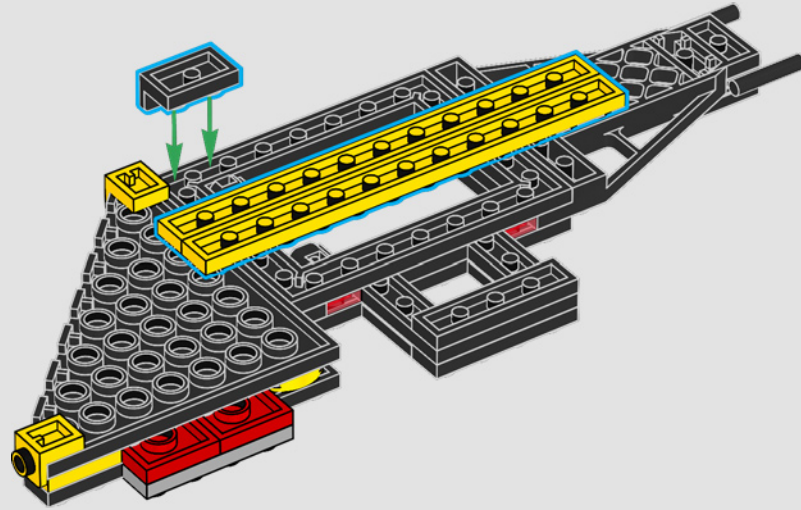

40

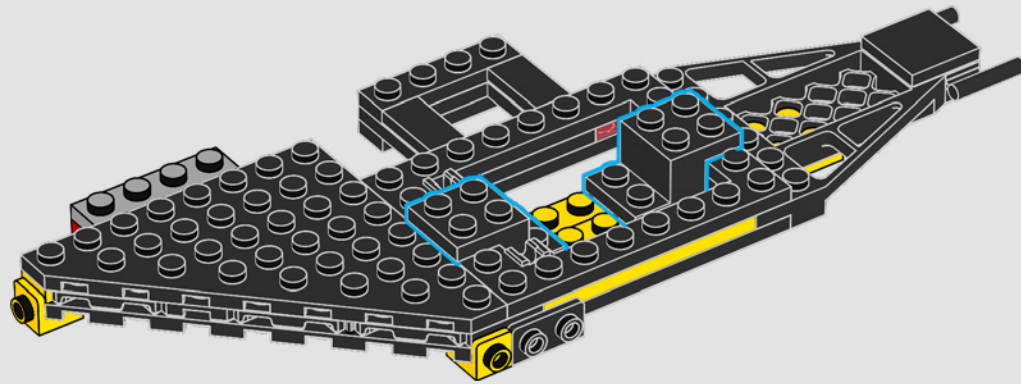

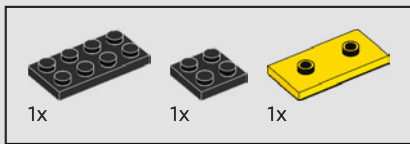

41

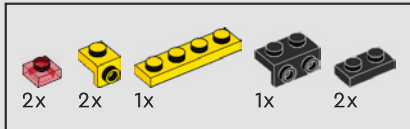
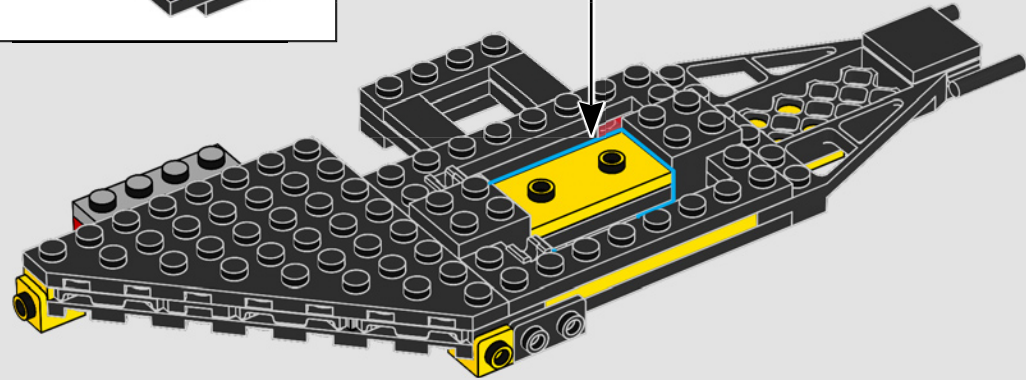
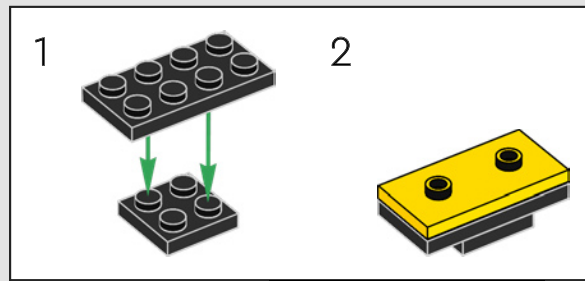

42

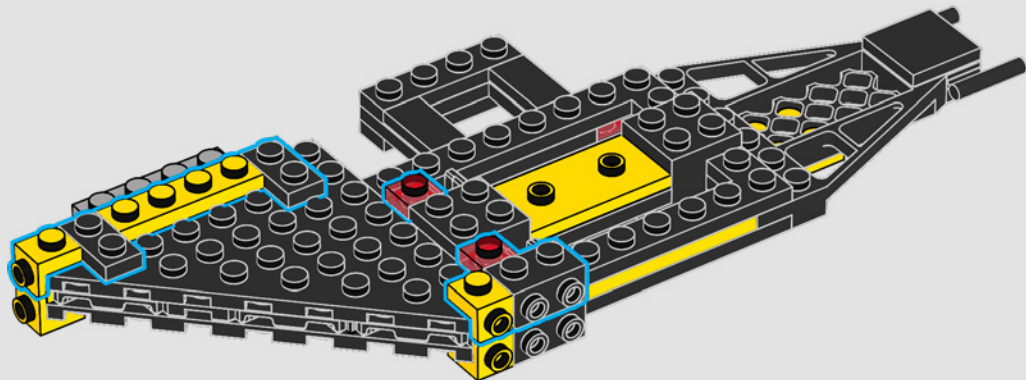

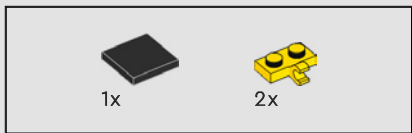

43

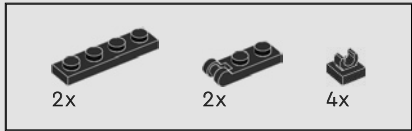
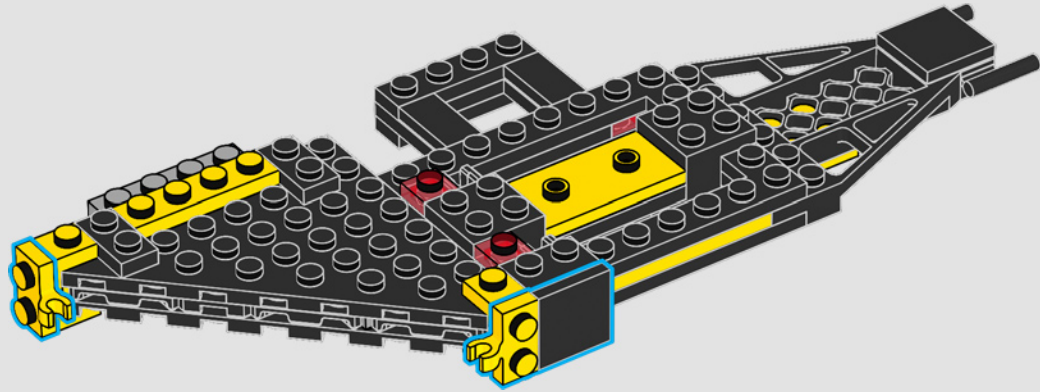

44

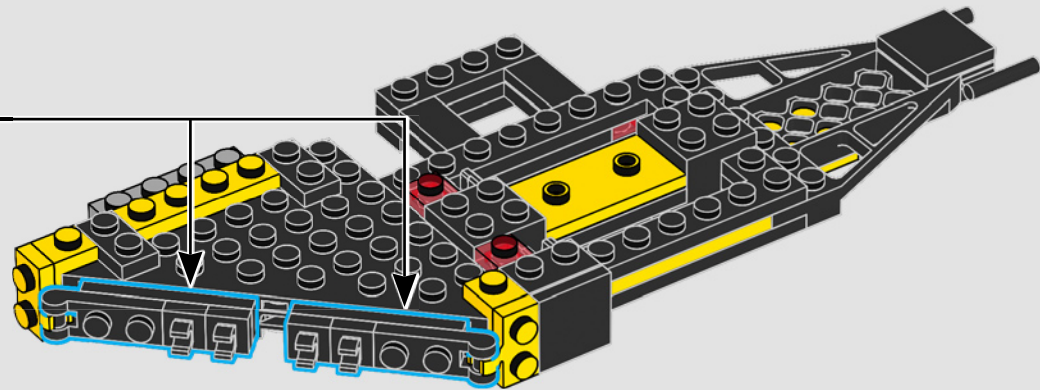
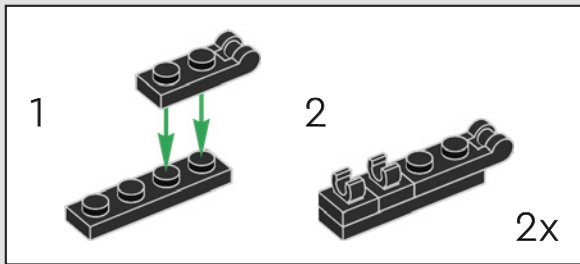

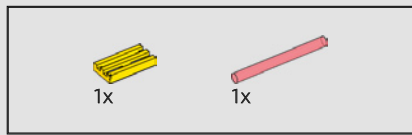

45

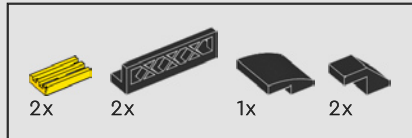
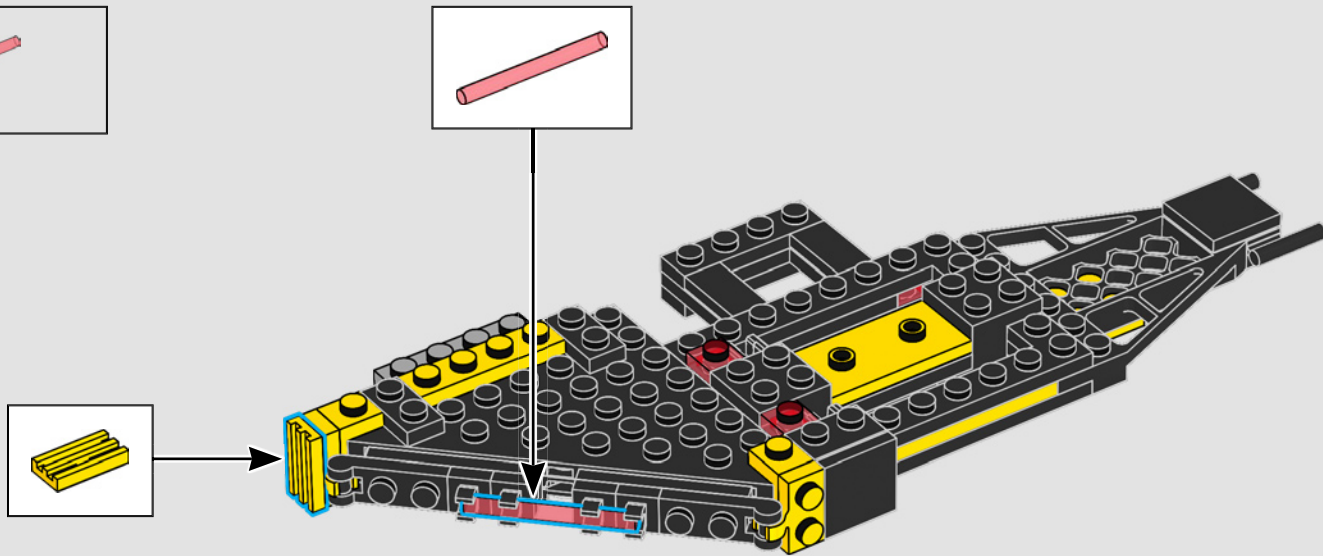

46

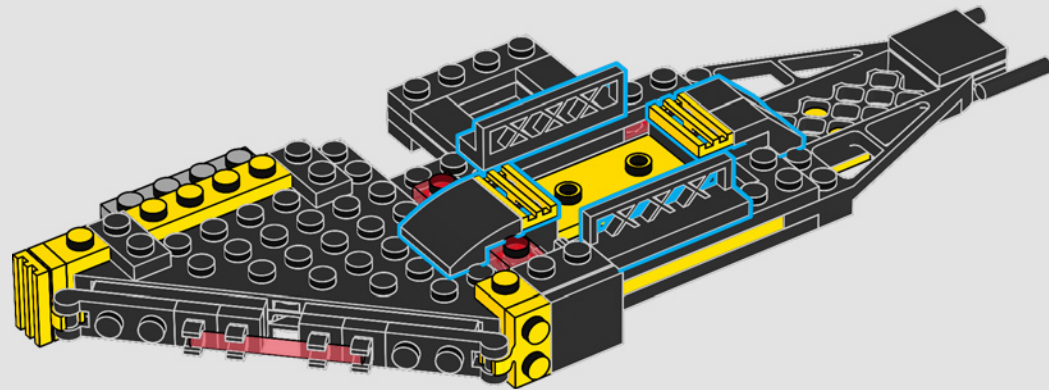

47

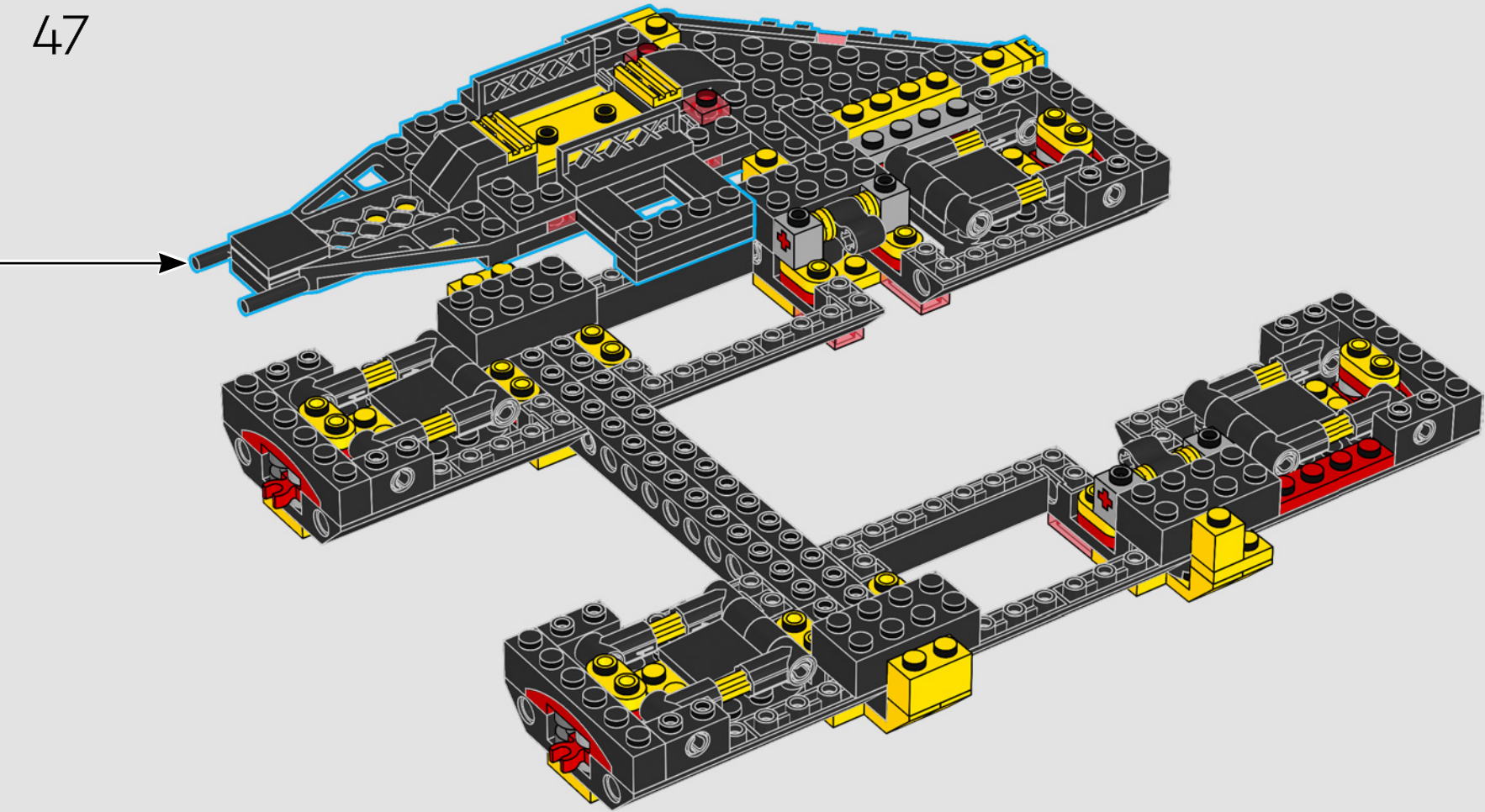

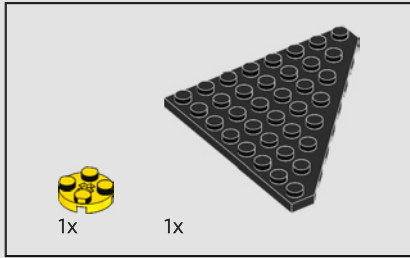
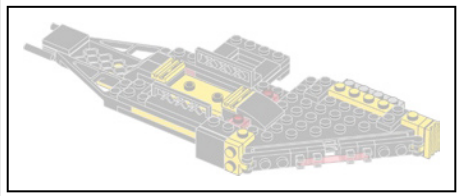

48

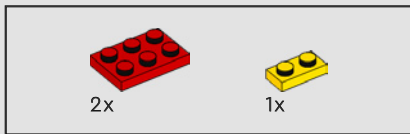

49

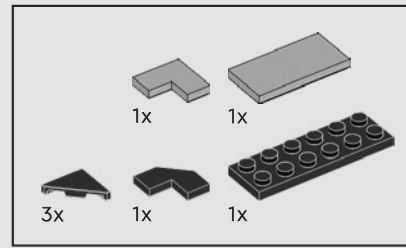
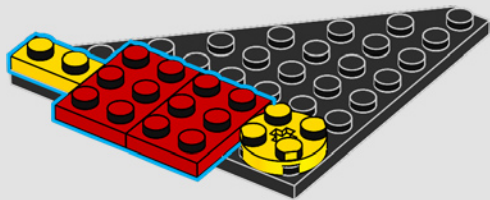

50

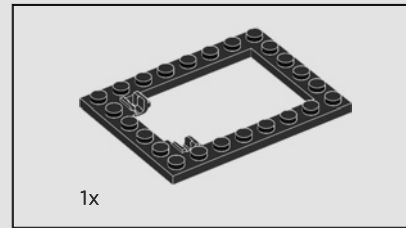
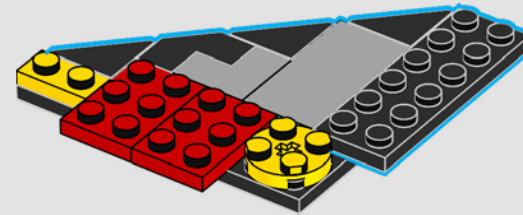

51

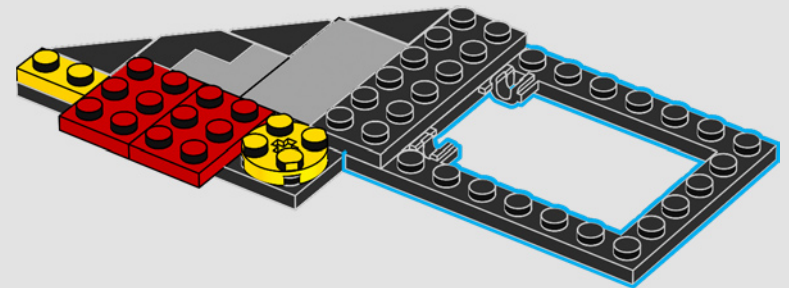

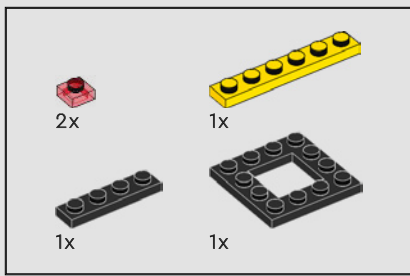

52

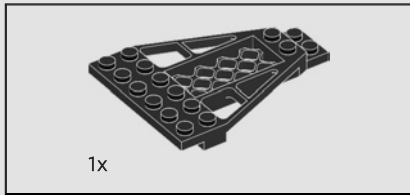
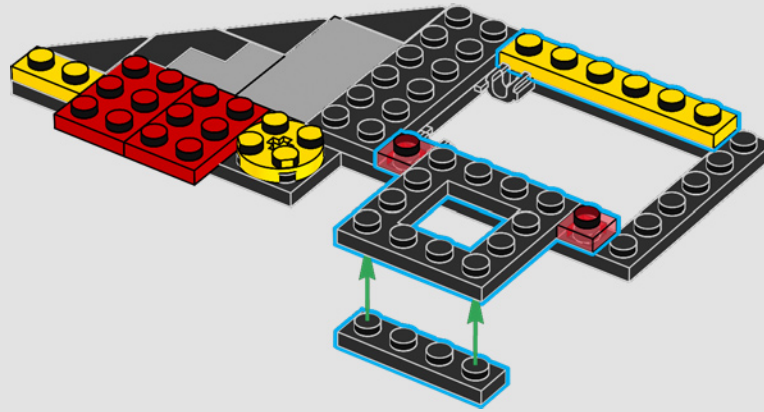

53

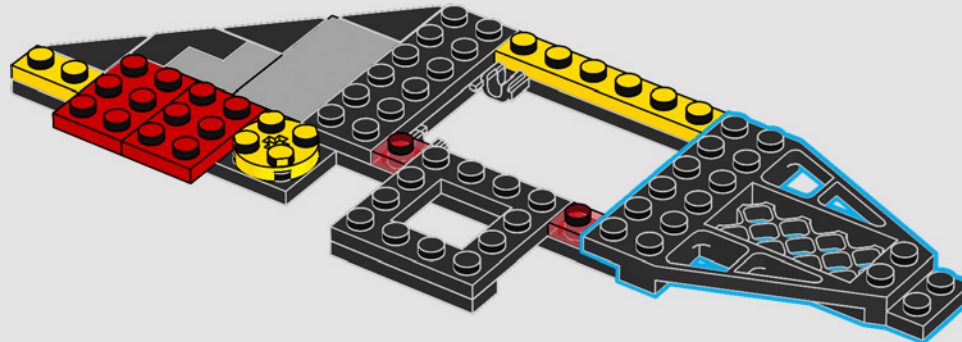

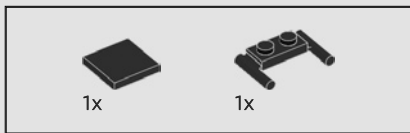

54

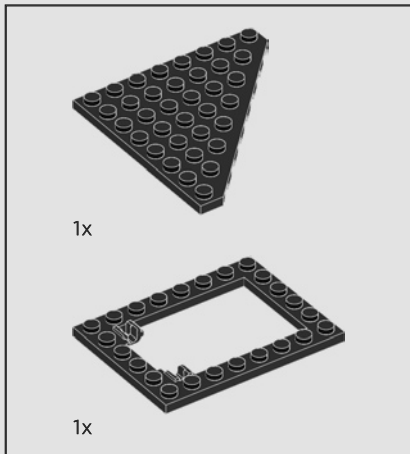
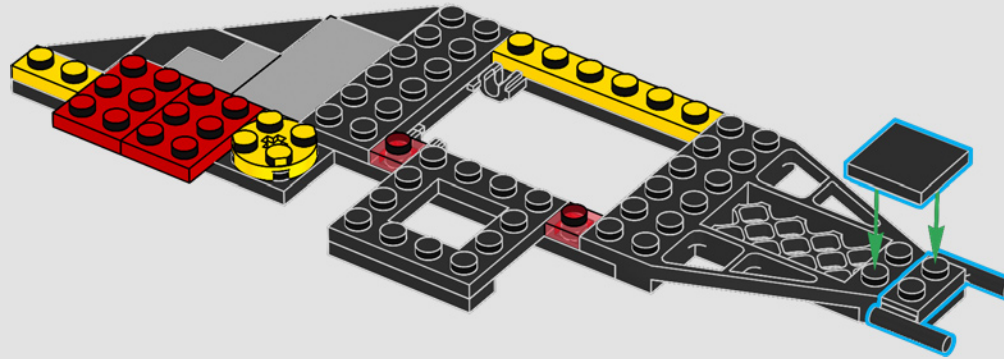

55

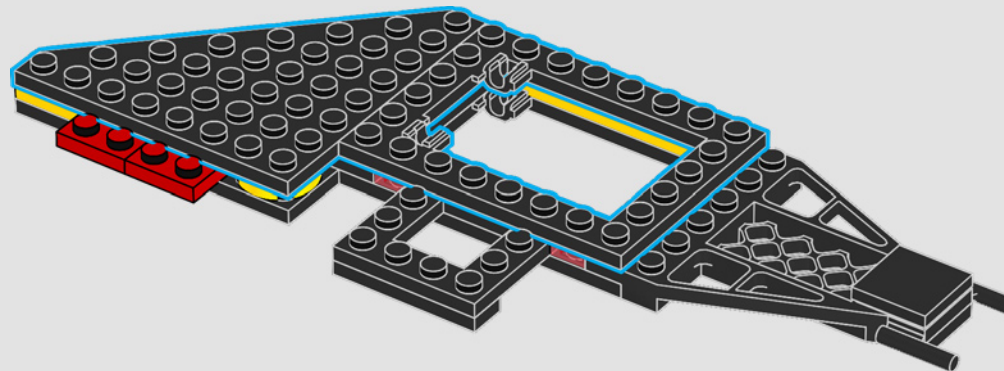

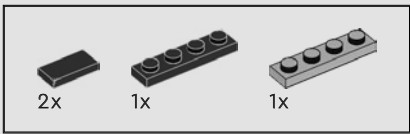

56

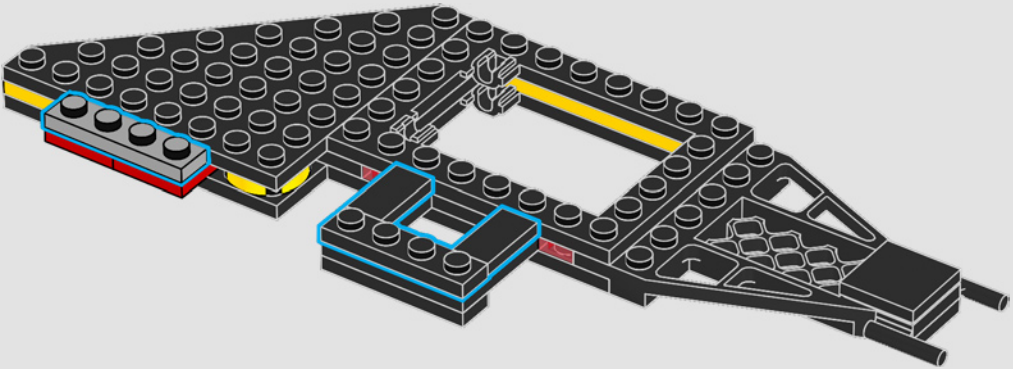

57

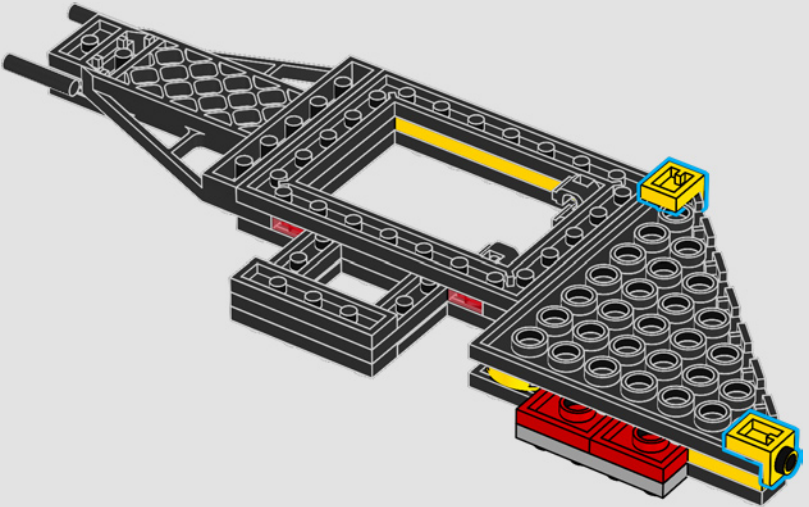

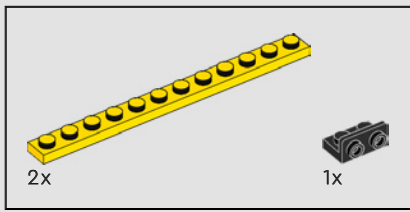

58

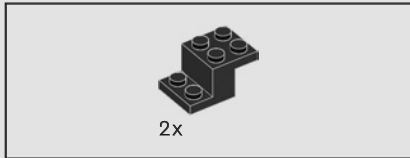
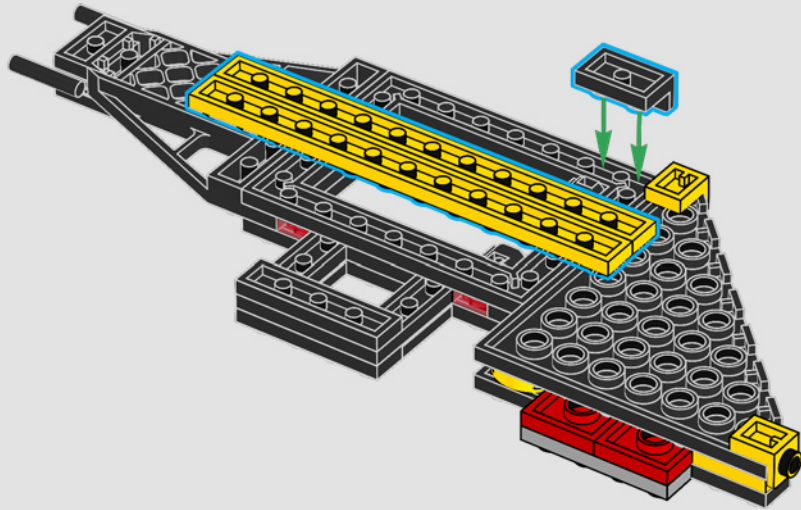

59

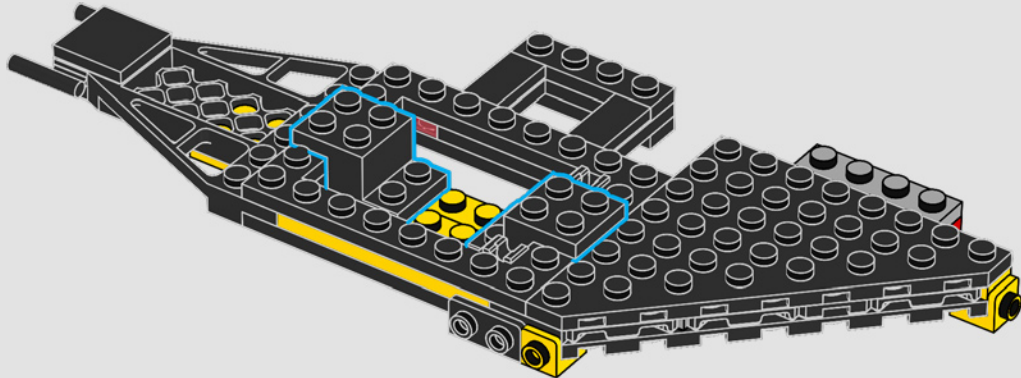

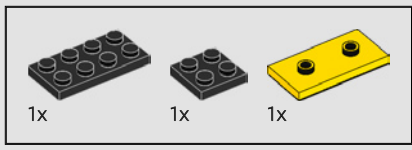

60

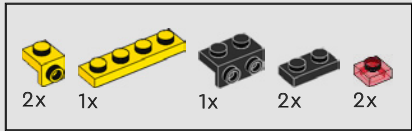
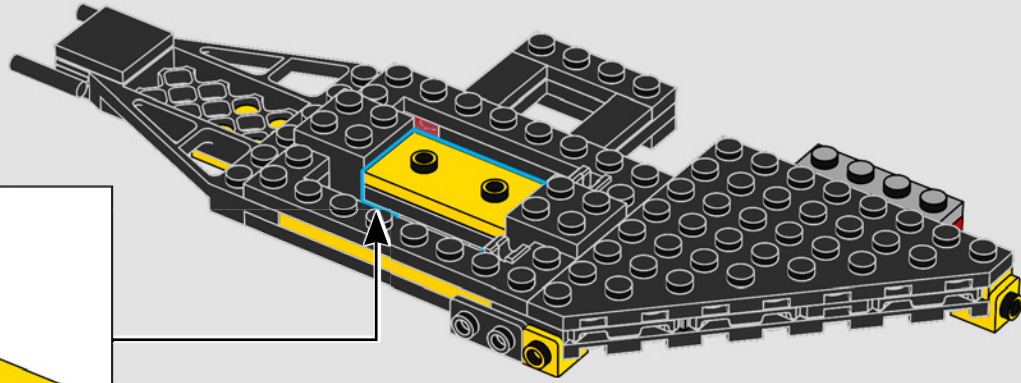
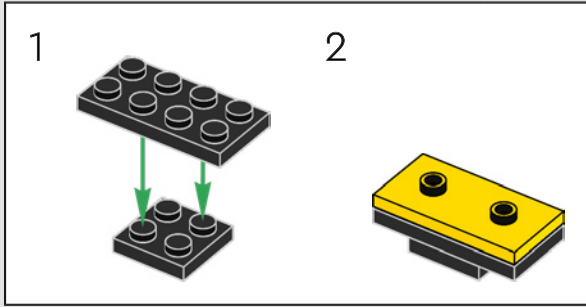

61

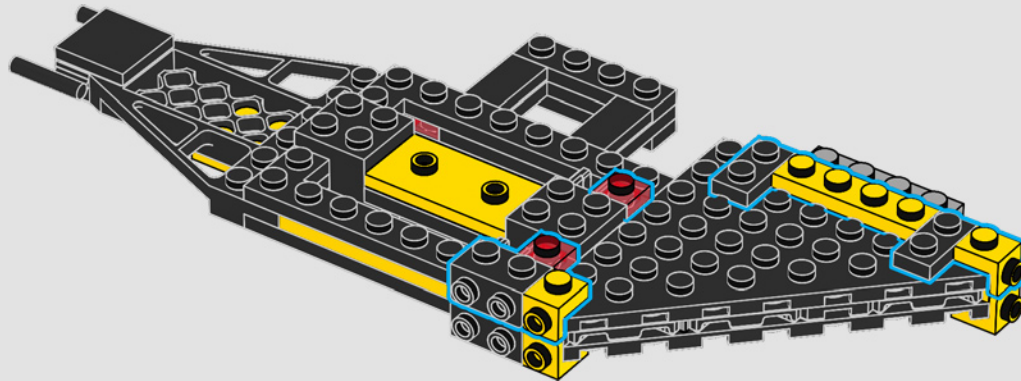

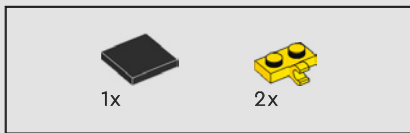

62

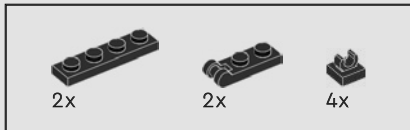
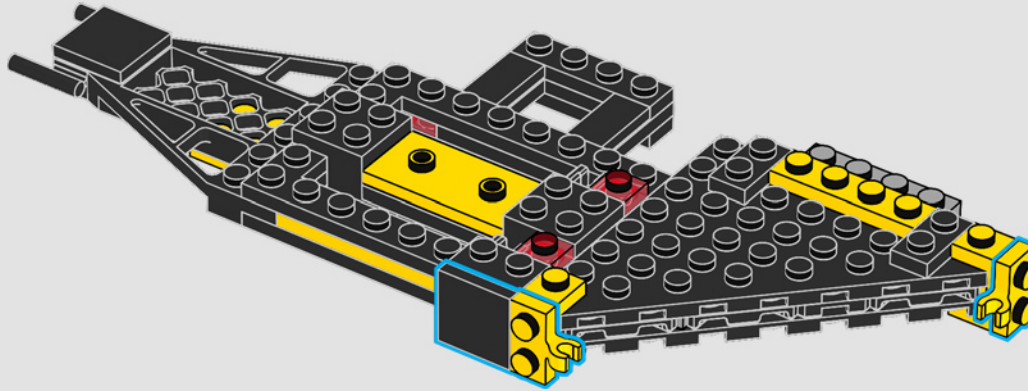

63

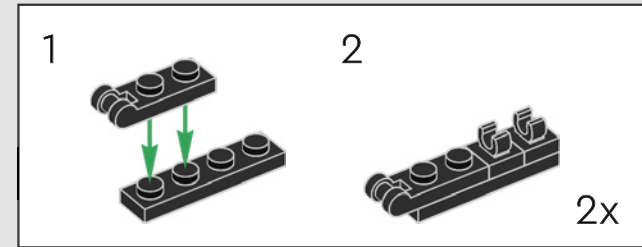
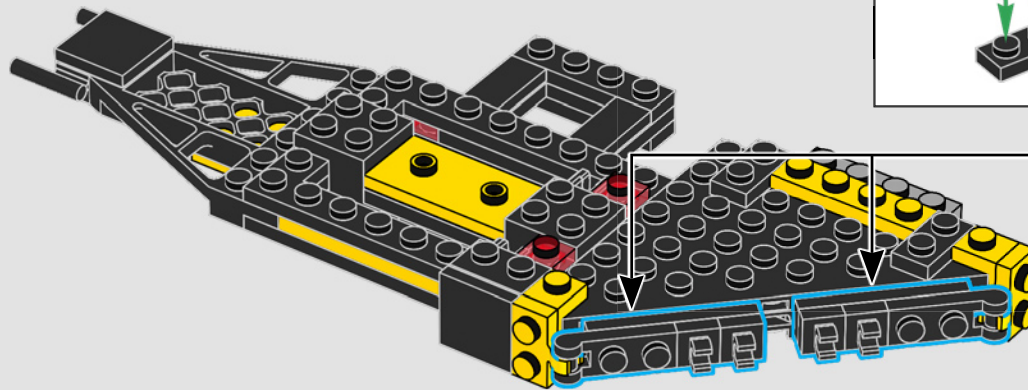

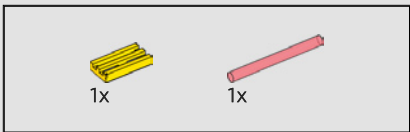

64

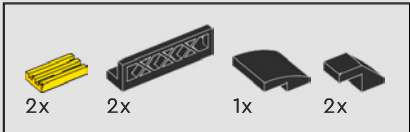
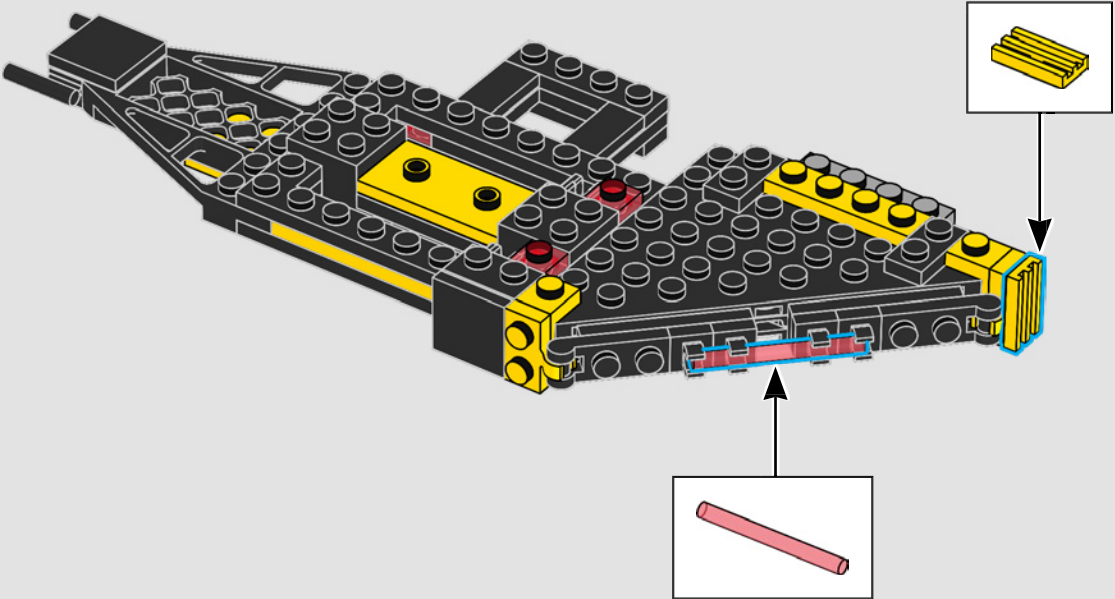

65

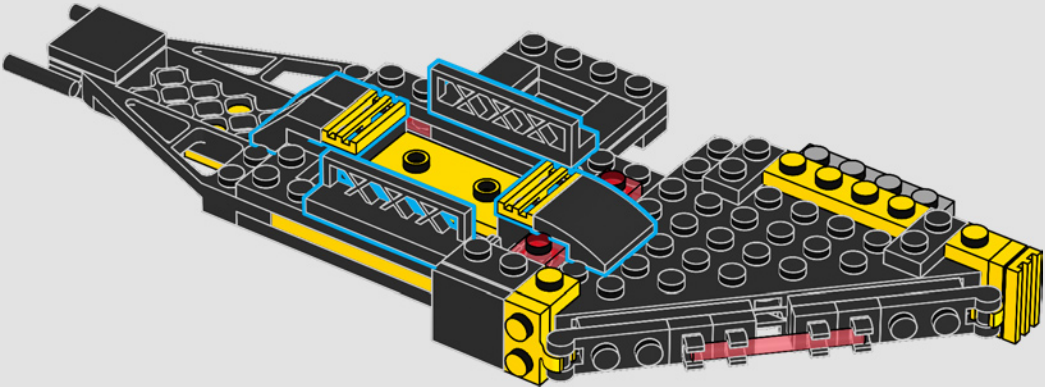

66

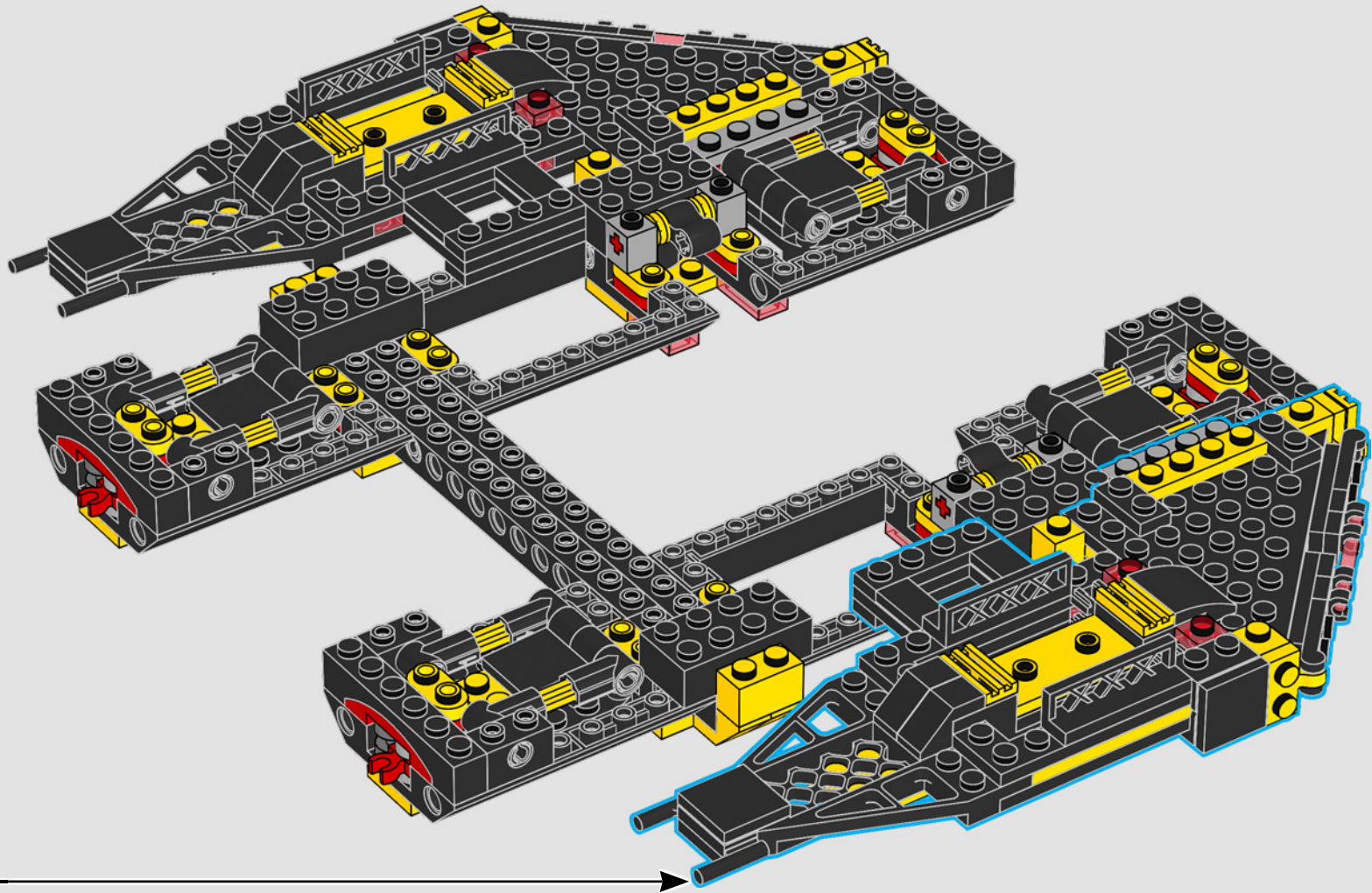

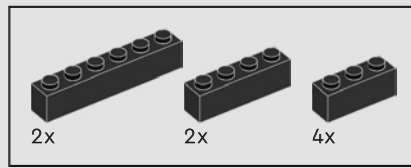

67

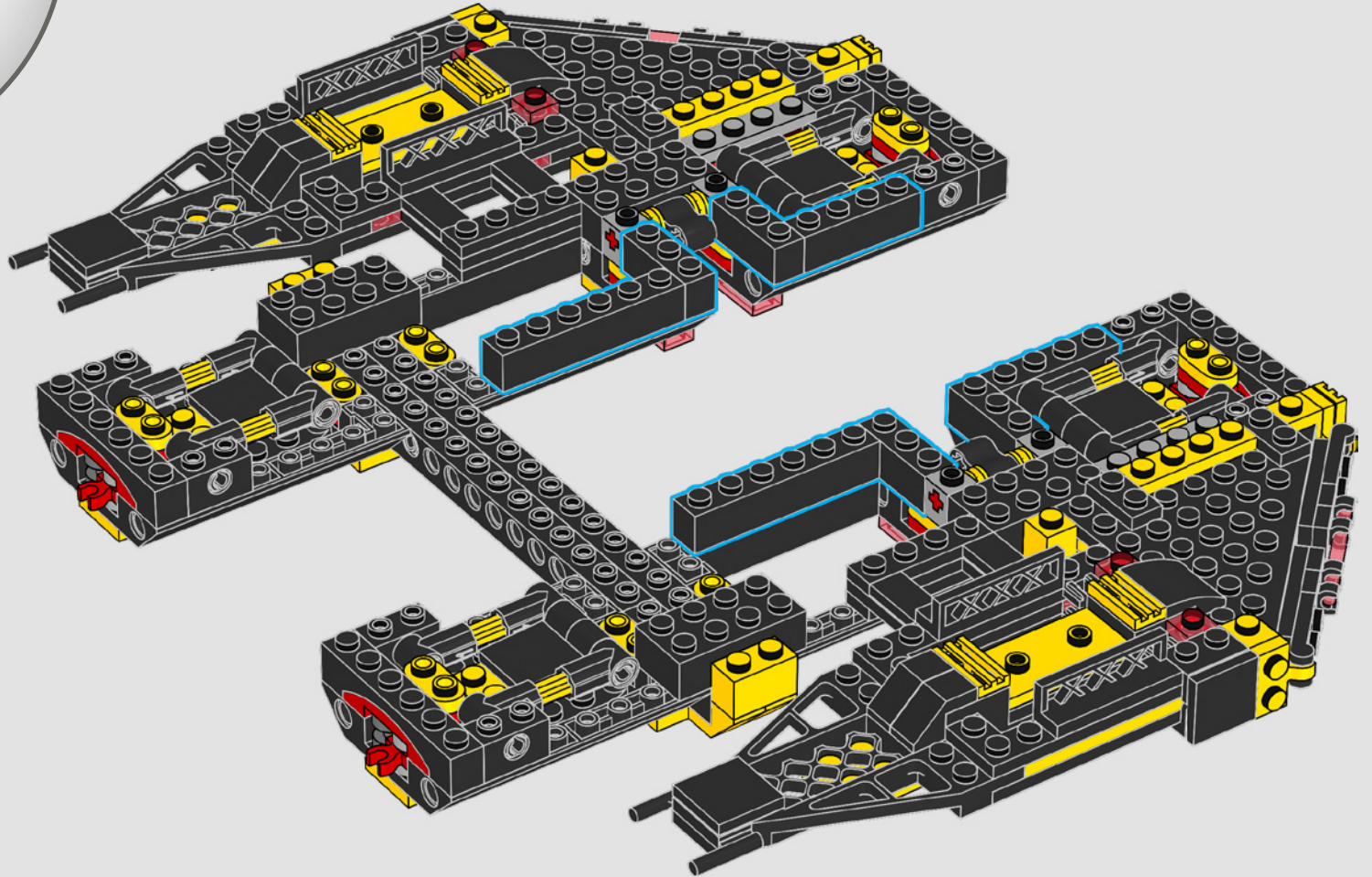

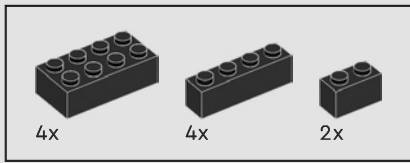

68

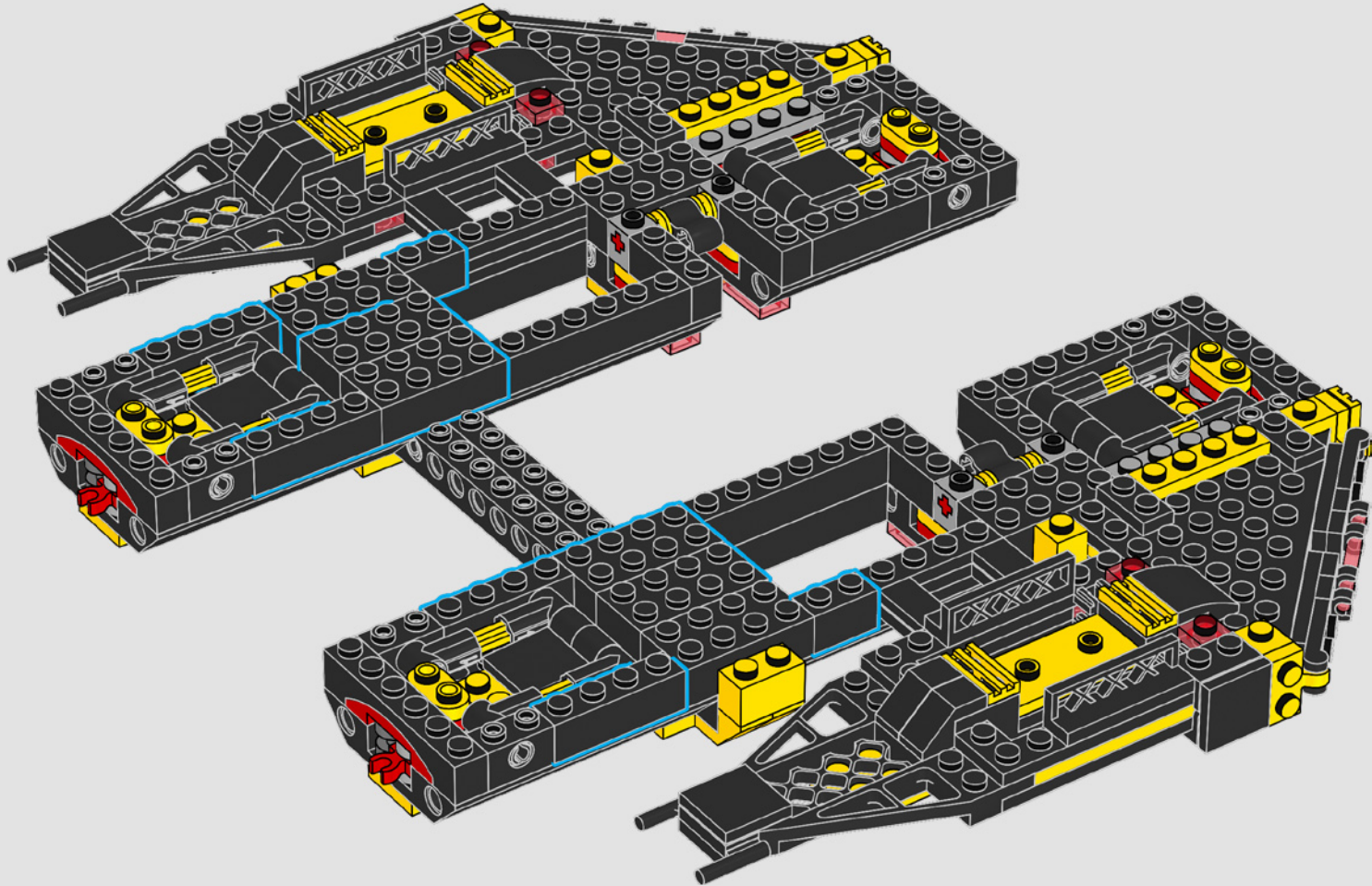

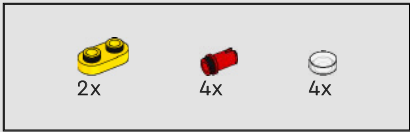

69

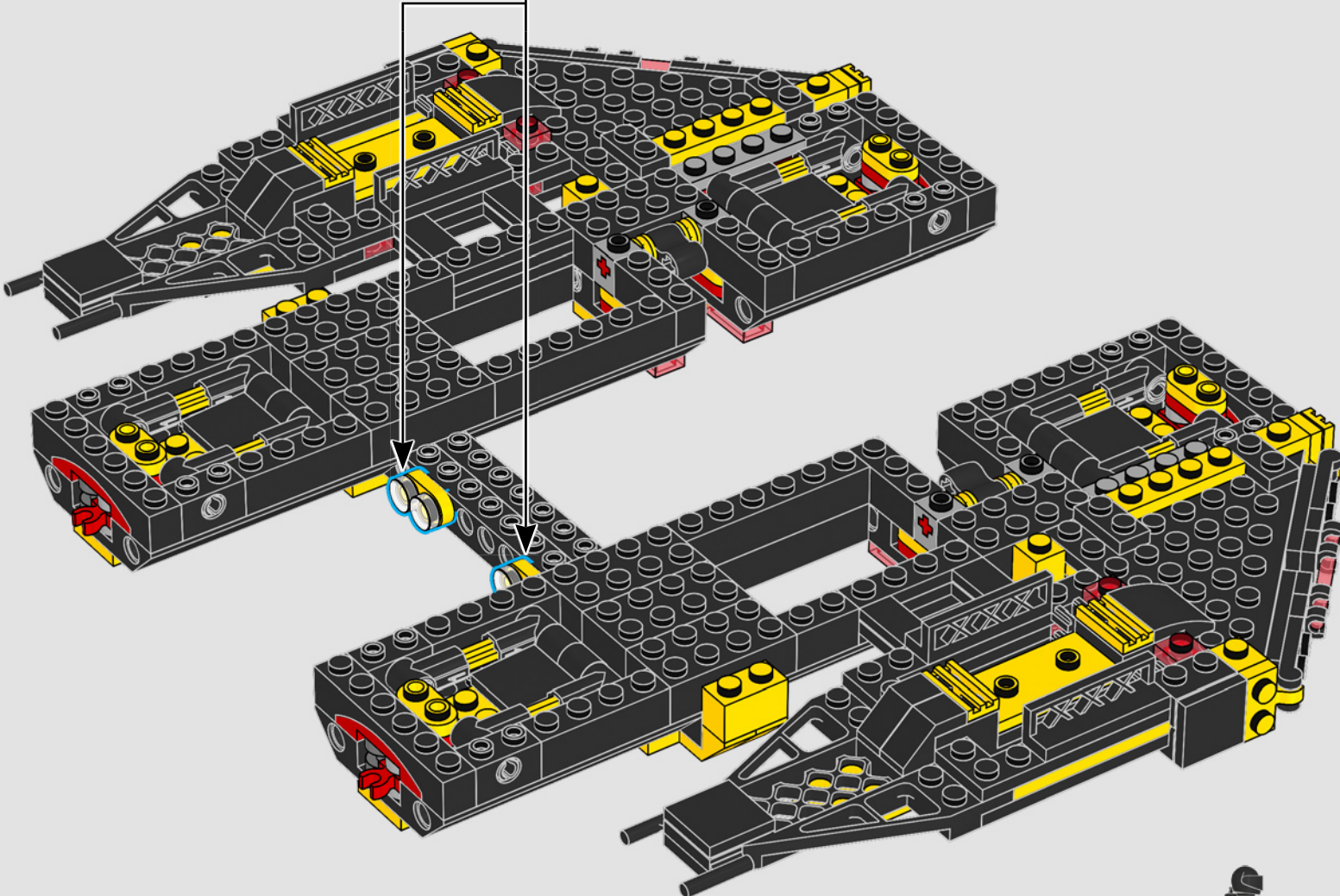
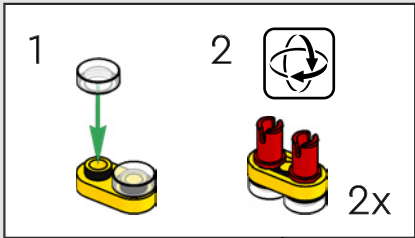

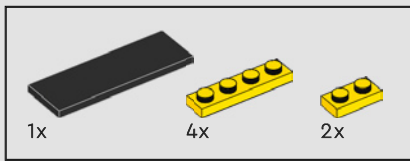

70

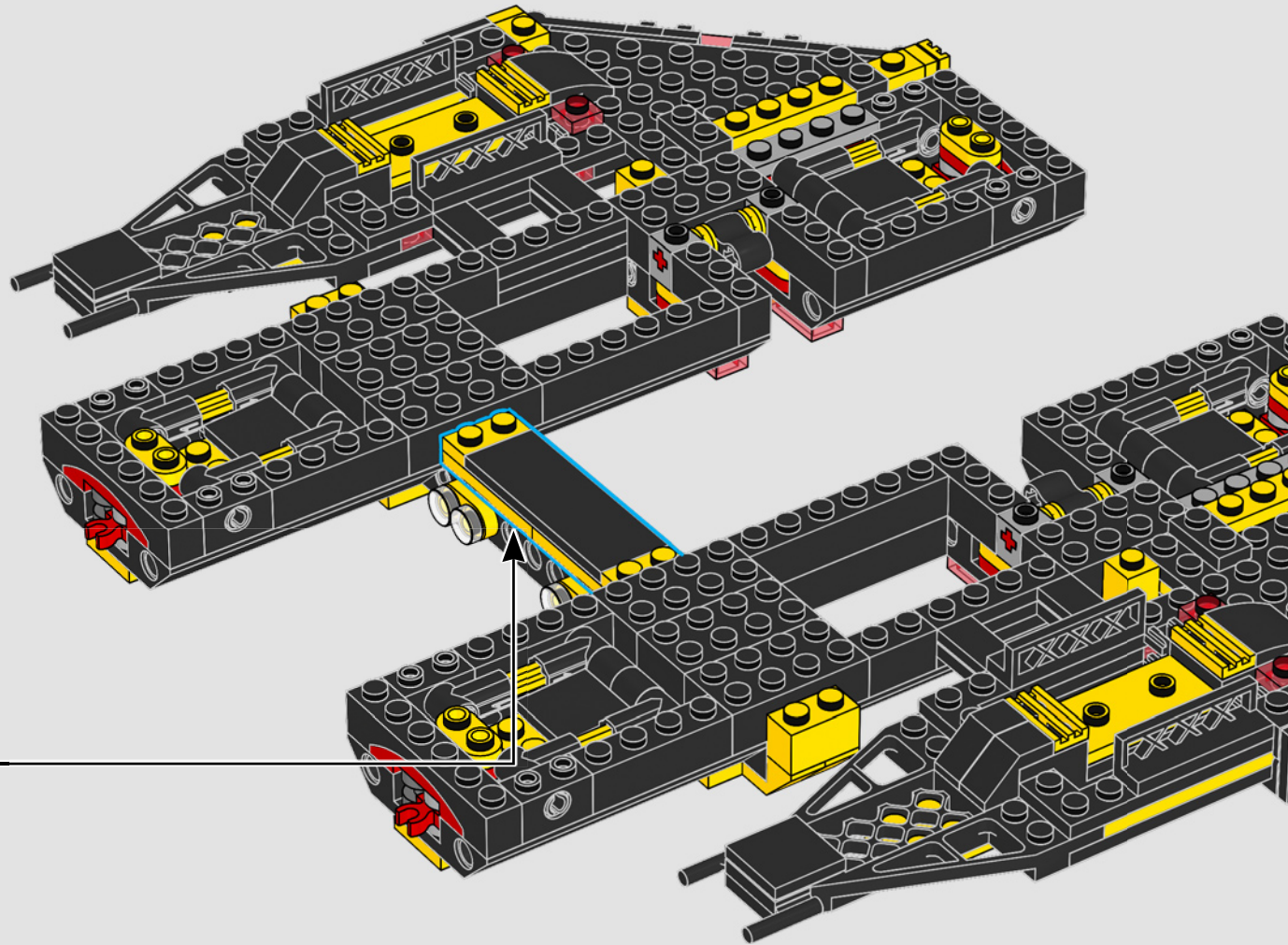
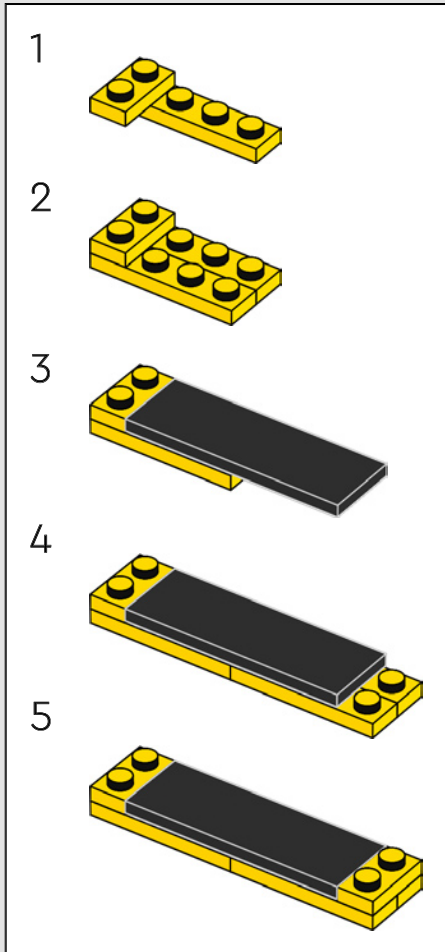

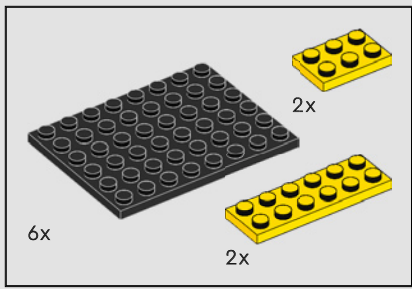

71

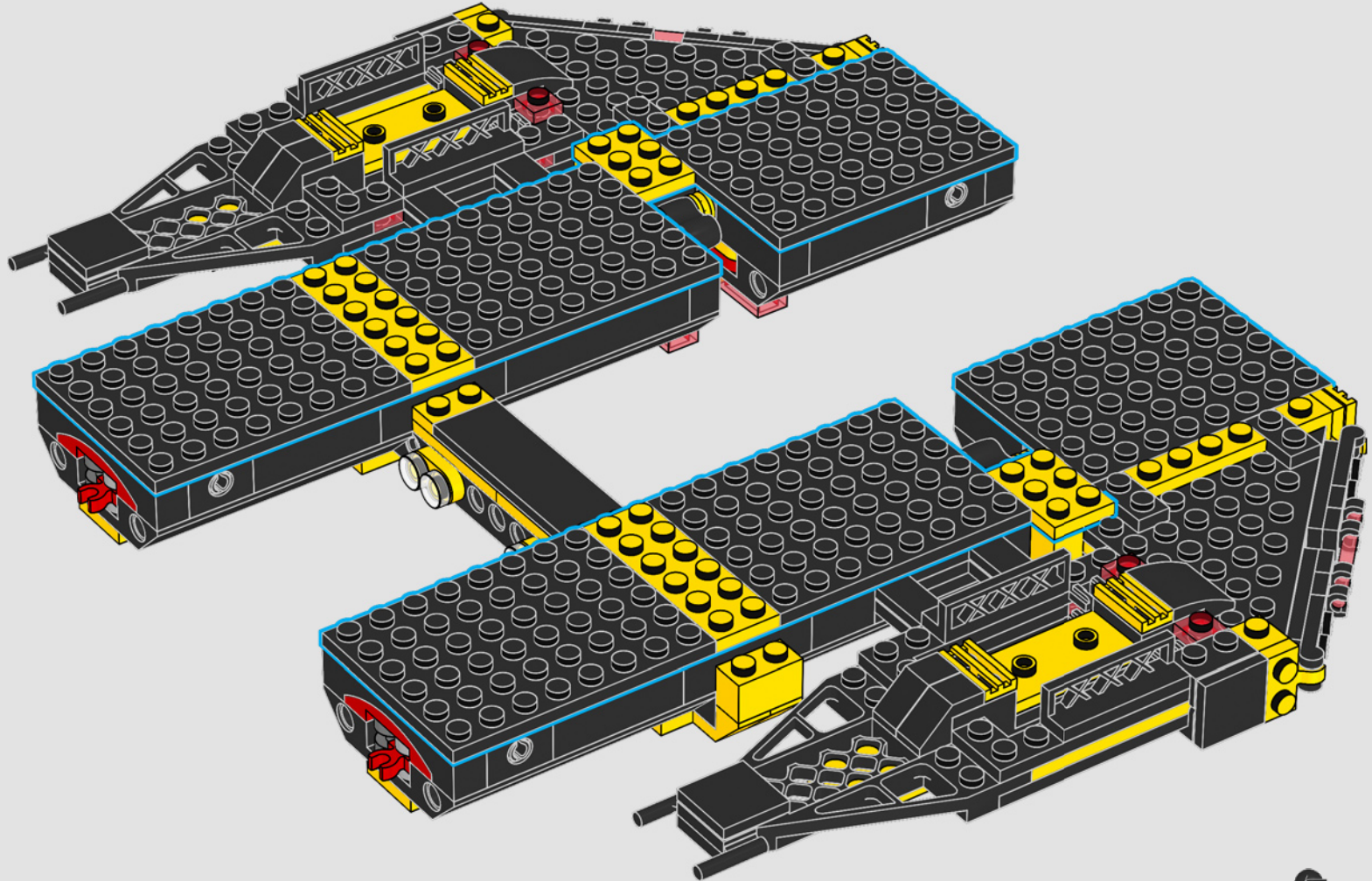

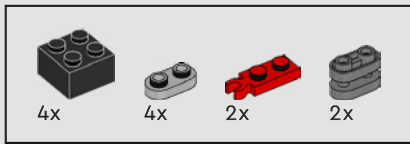

72

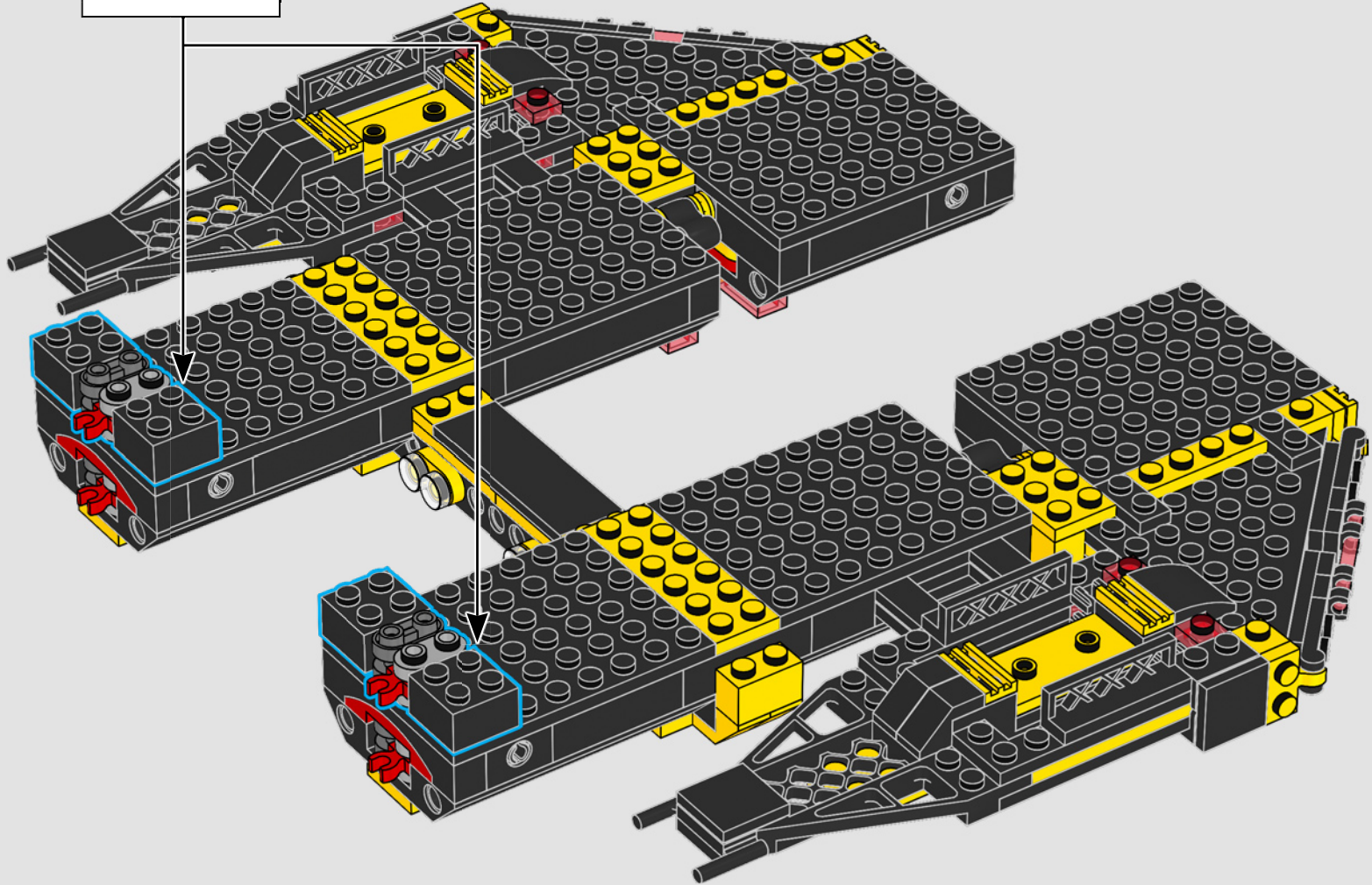
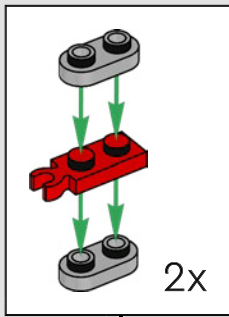

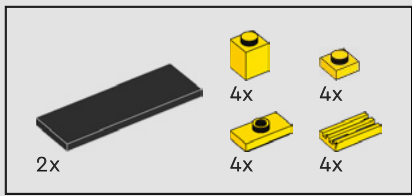

73

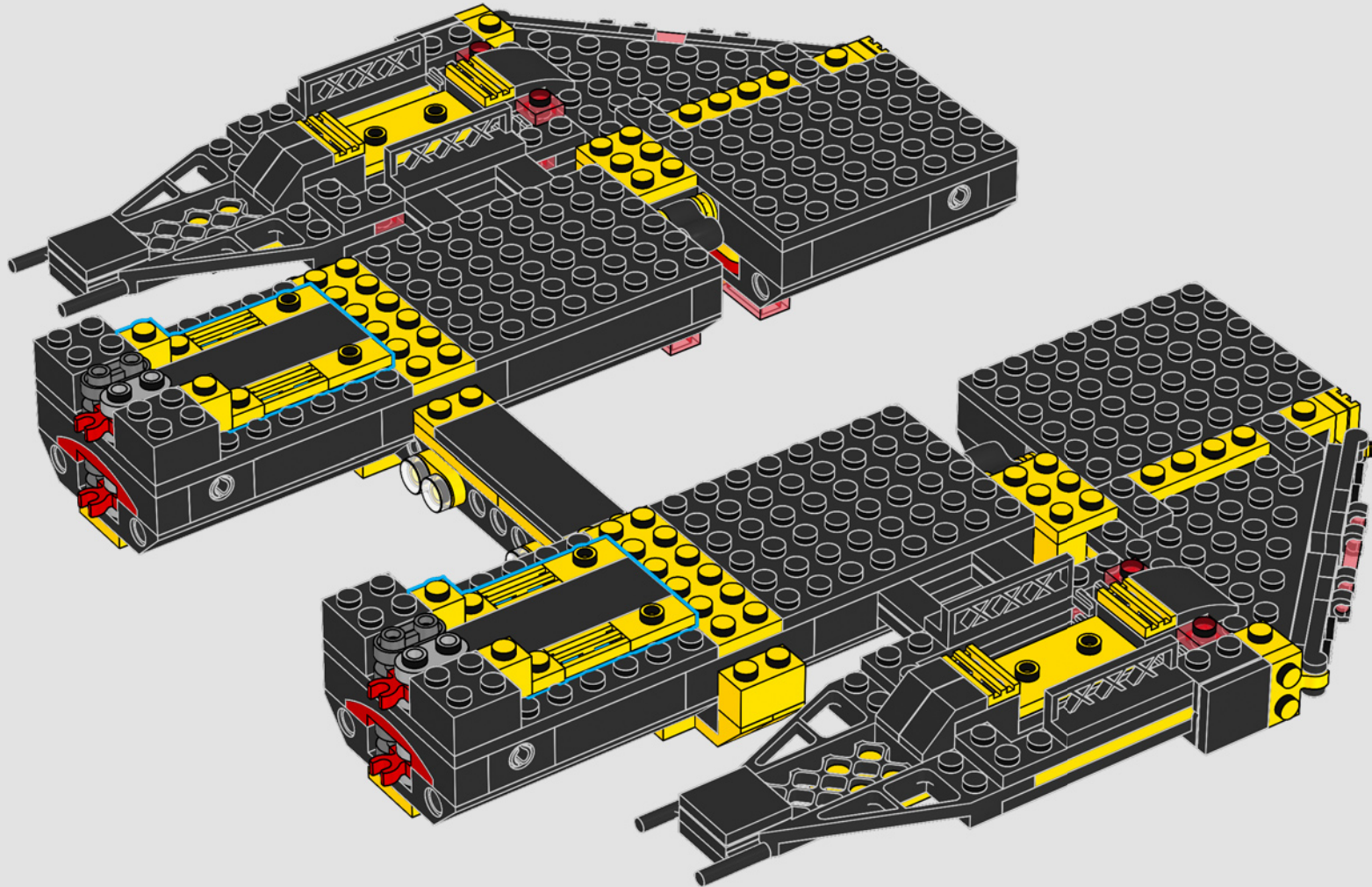

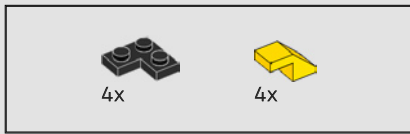

74

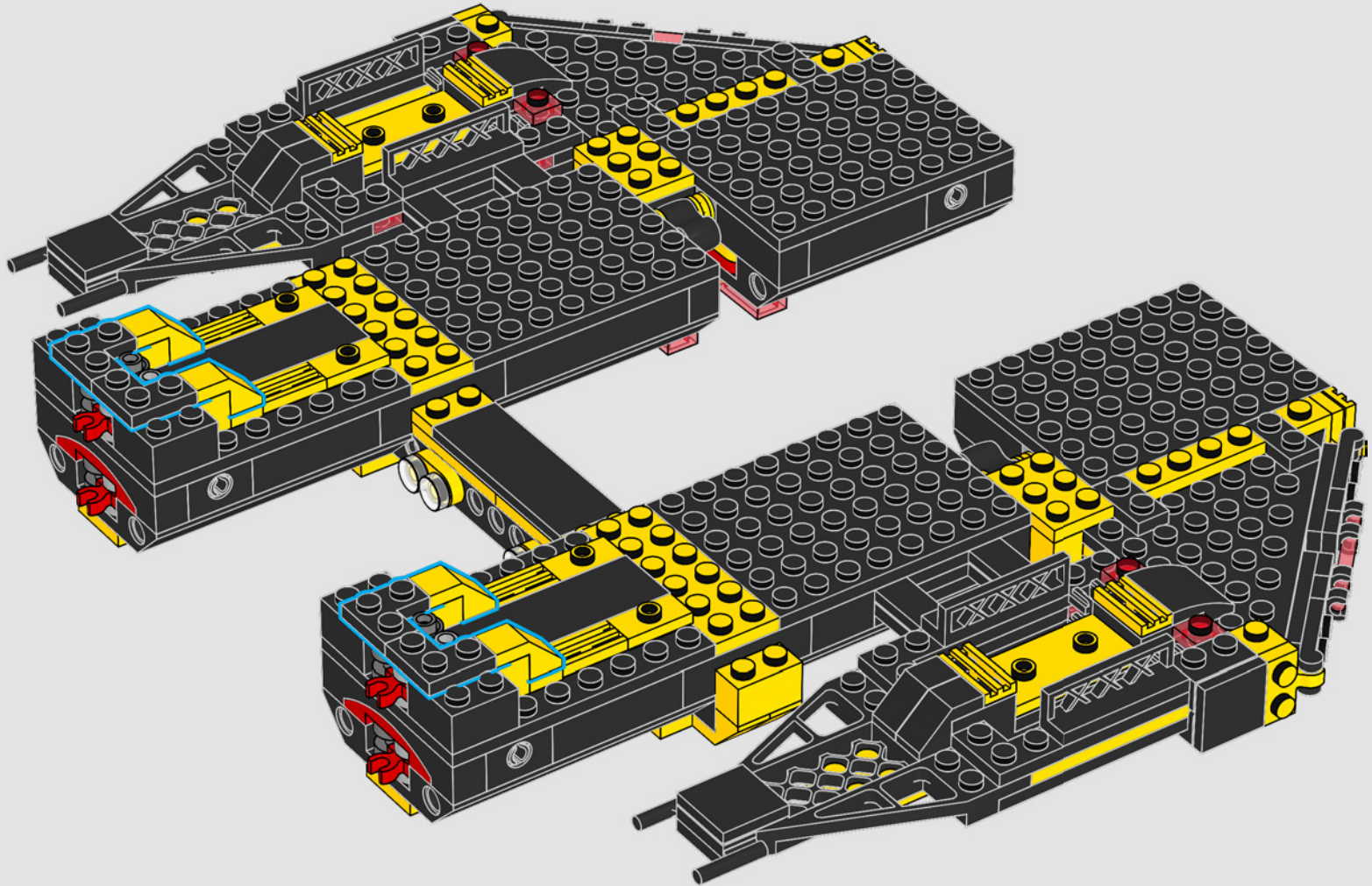

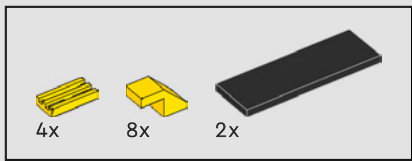

75

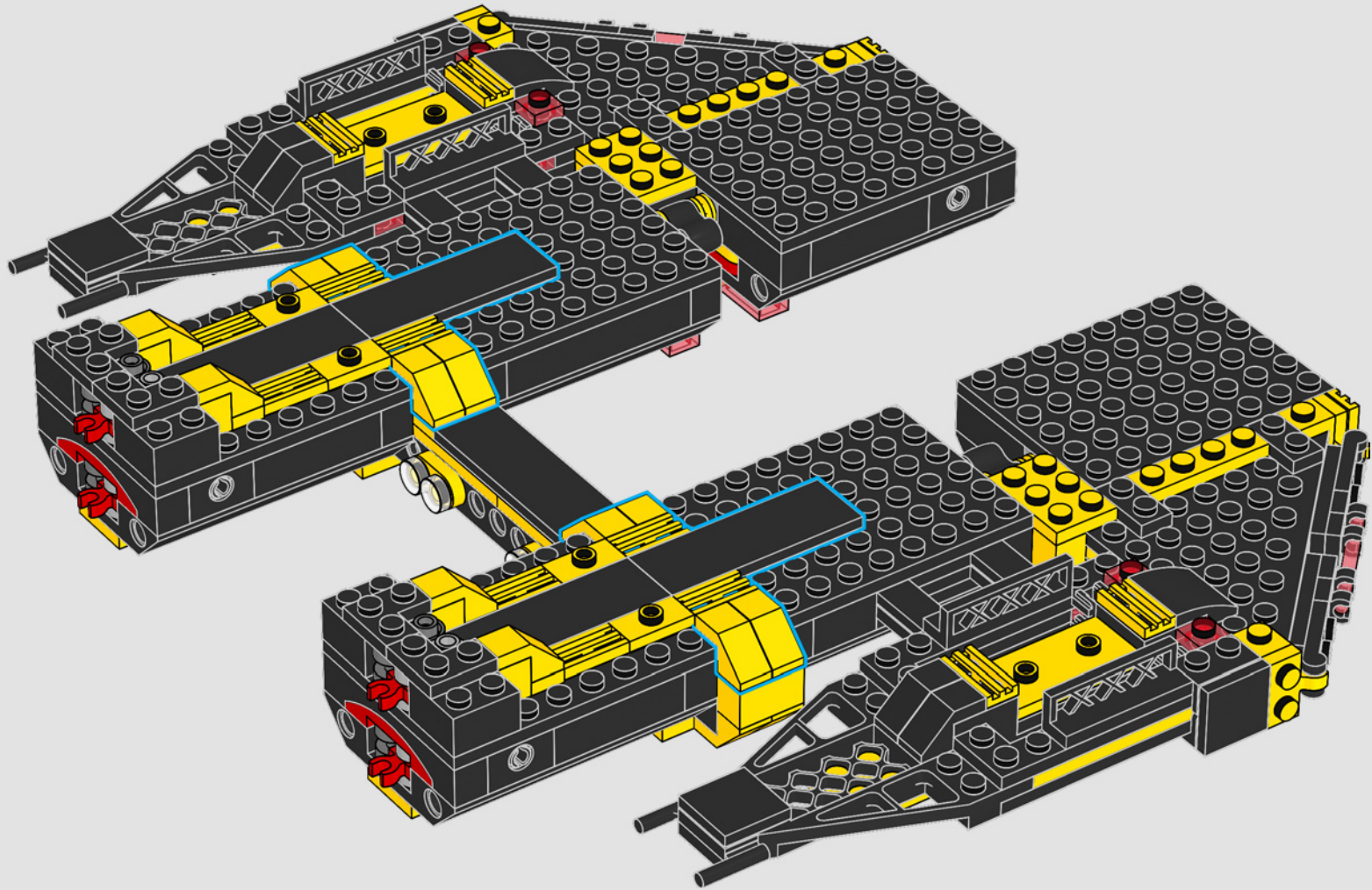

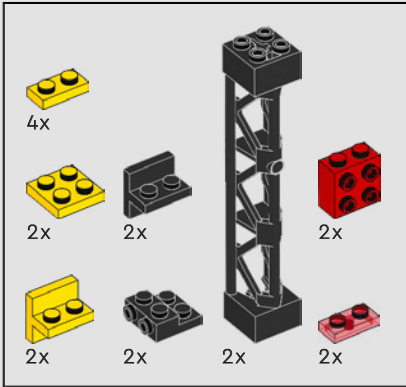
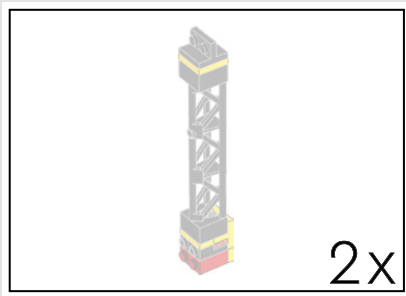

76

1

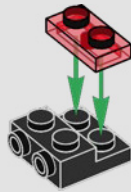

2



3

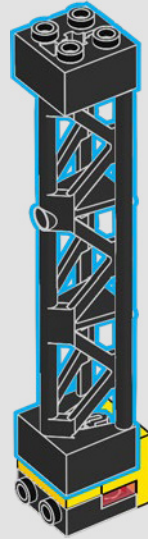

4

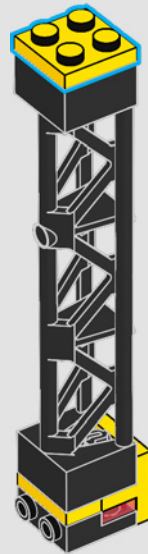

5



6

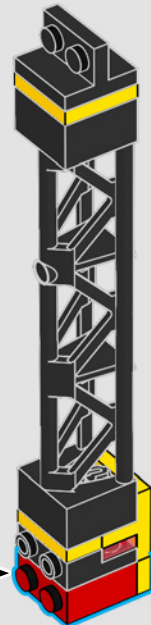
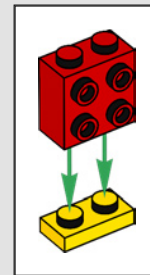

2x

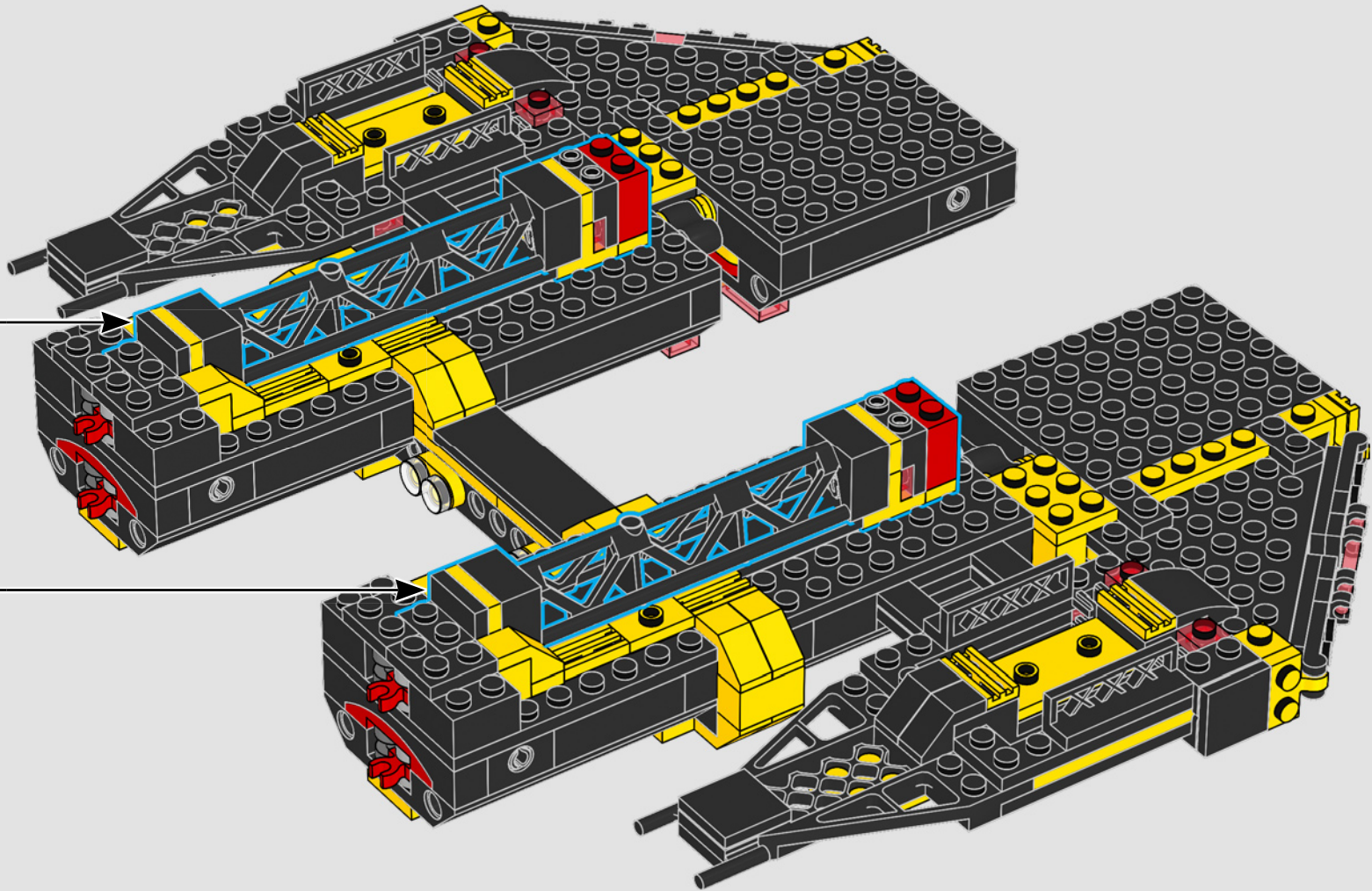

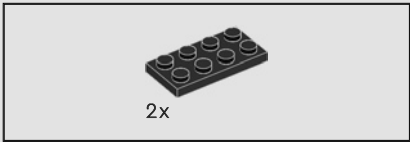

77

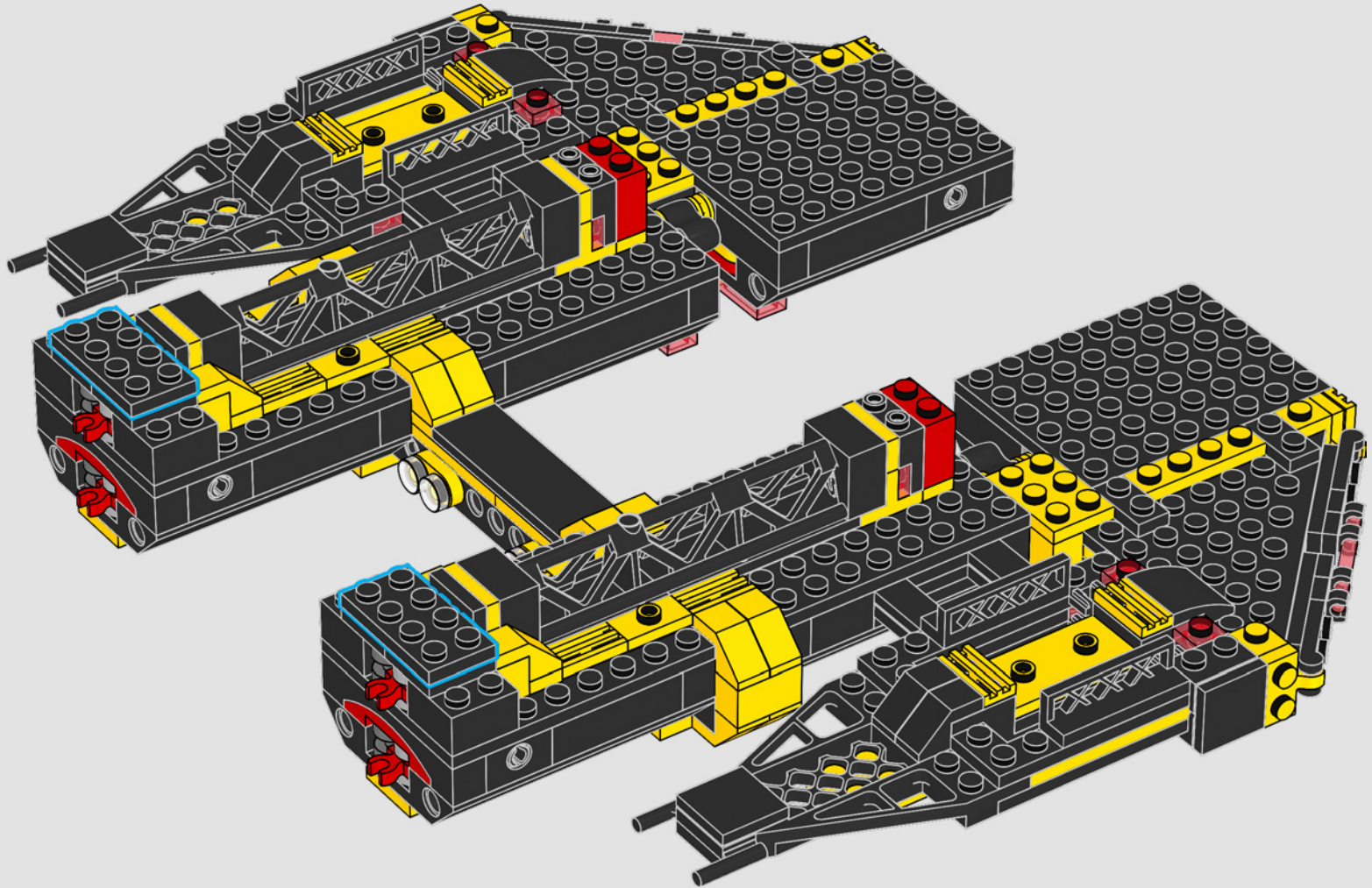



78

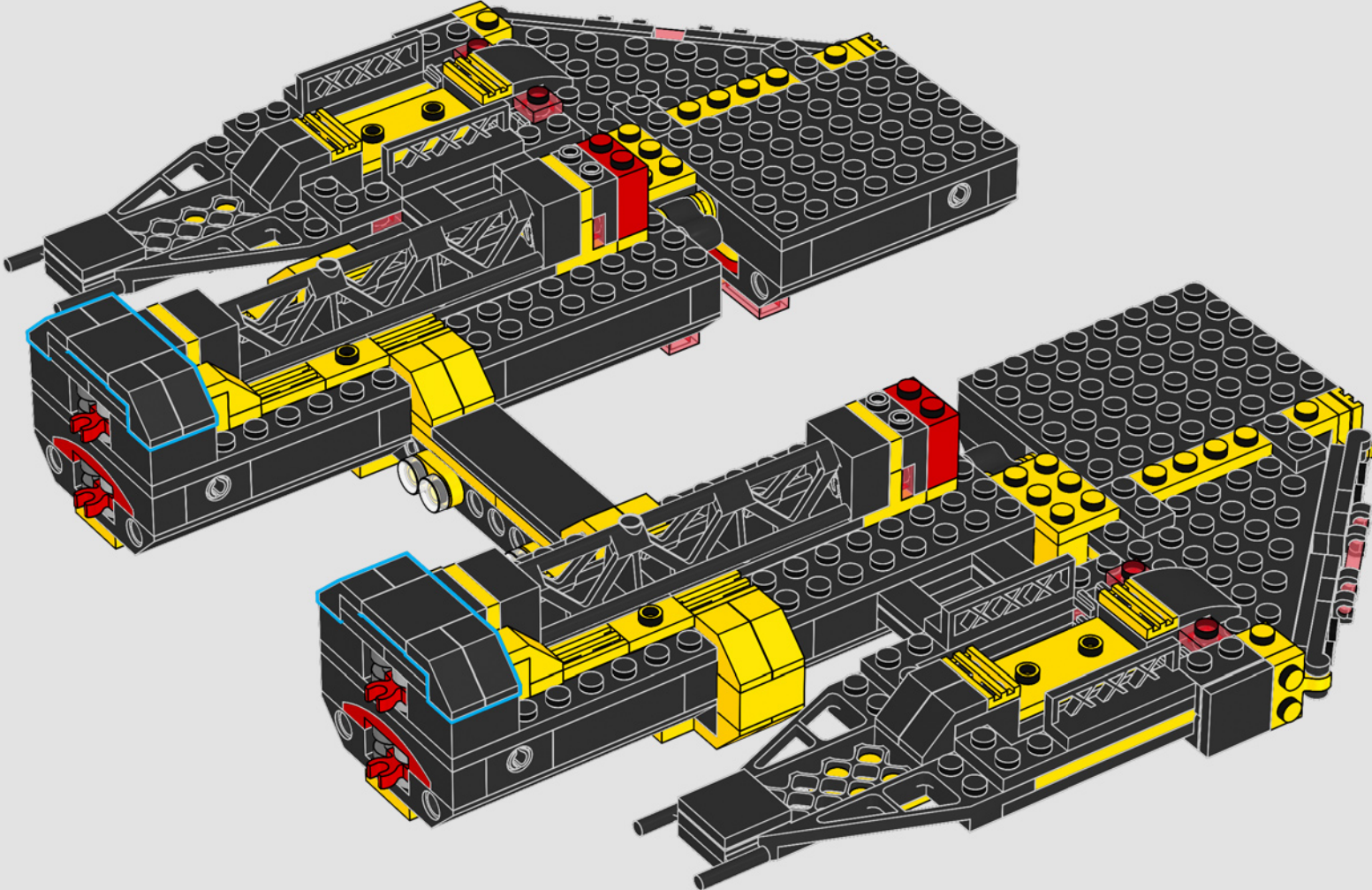

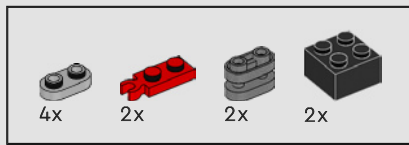

79

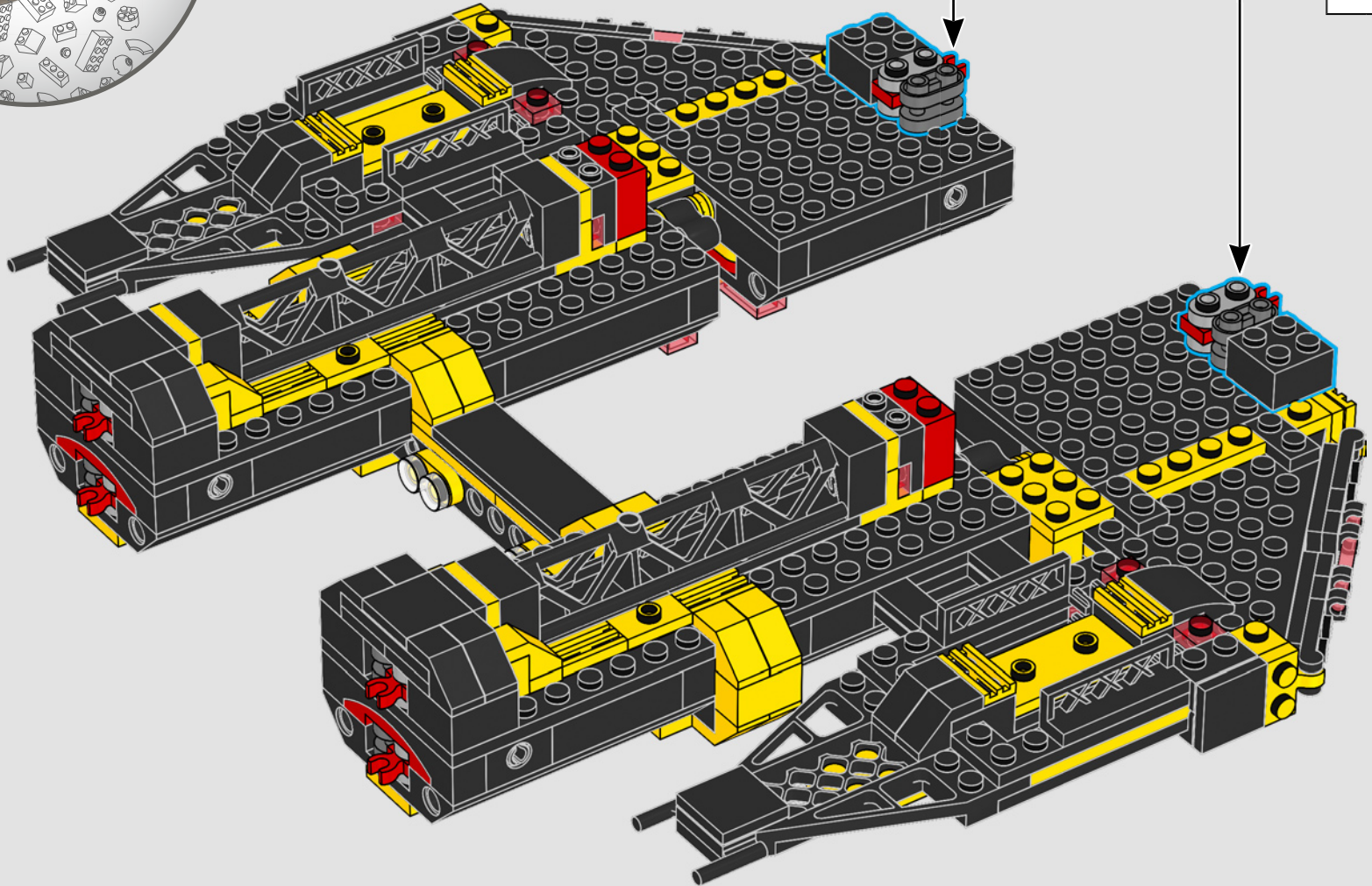
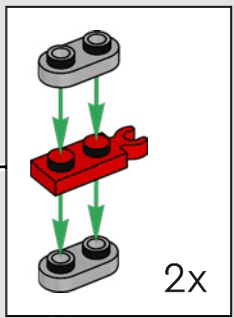

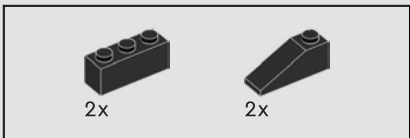

80

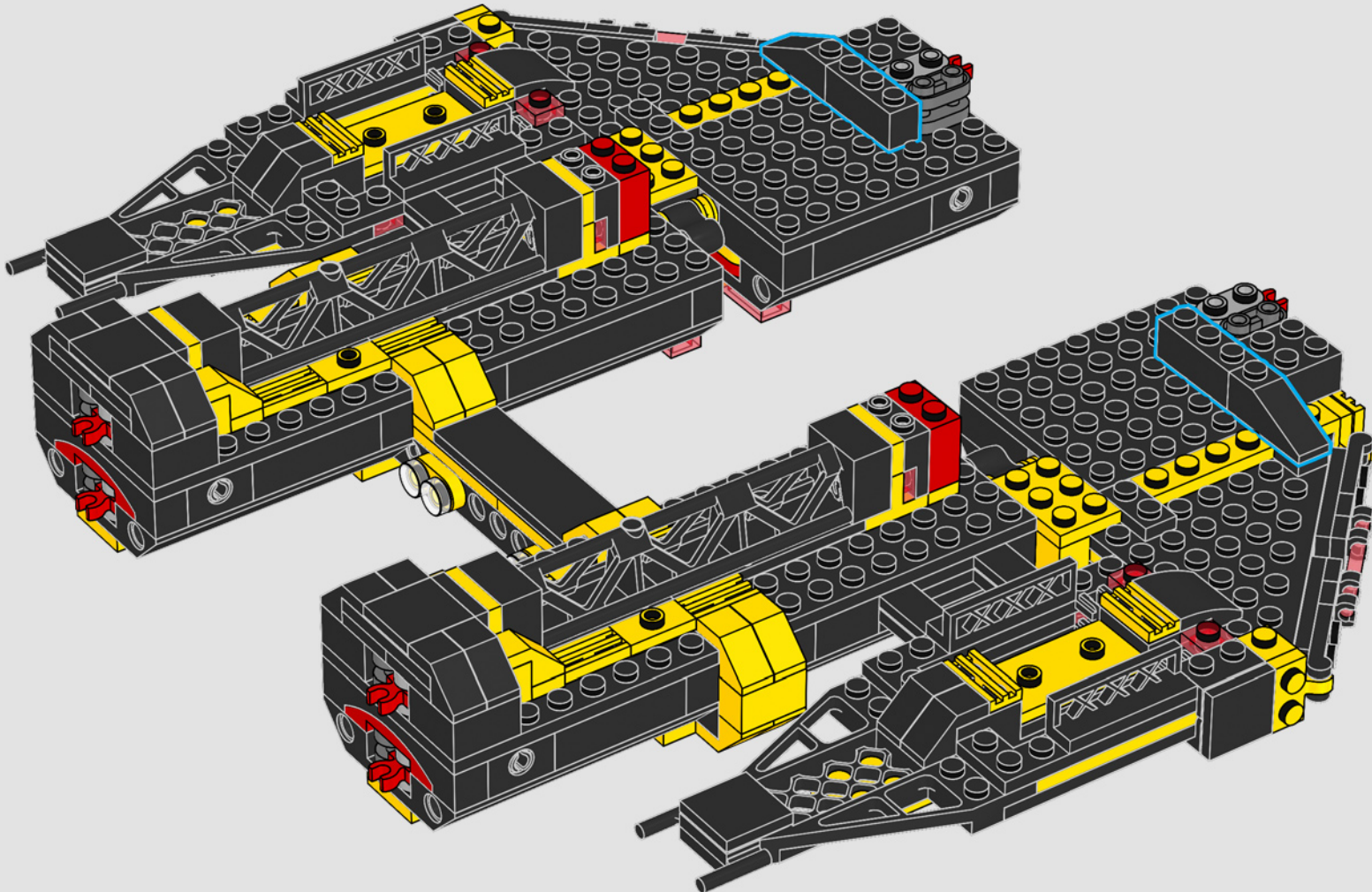

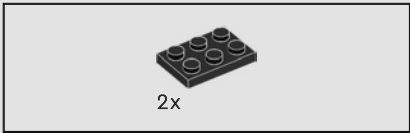

81

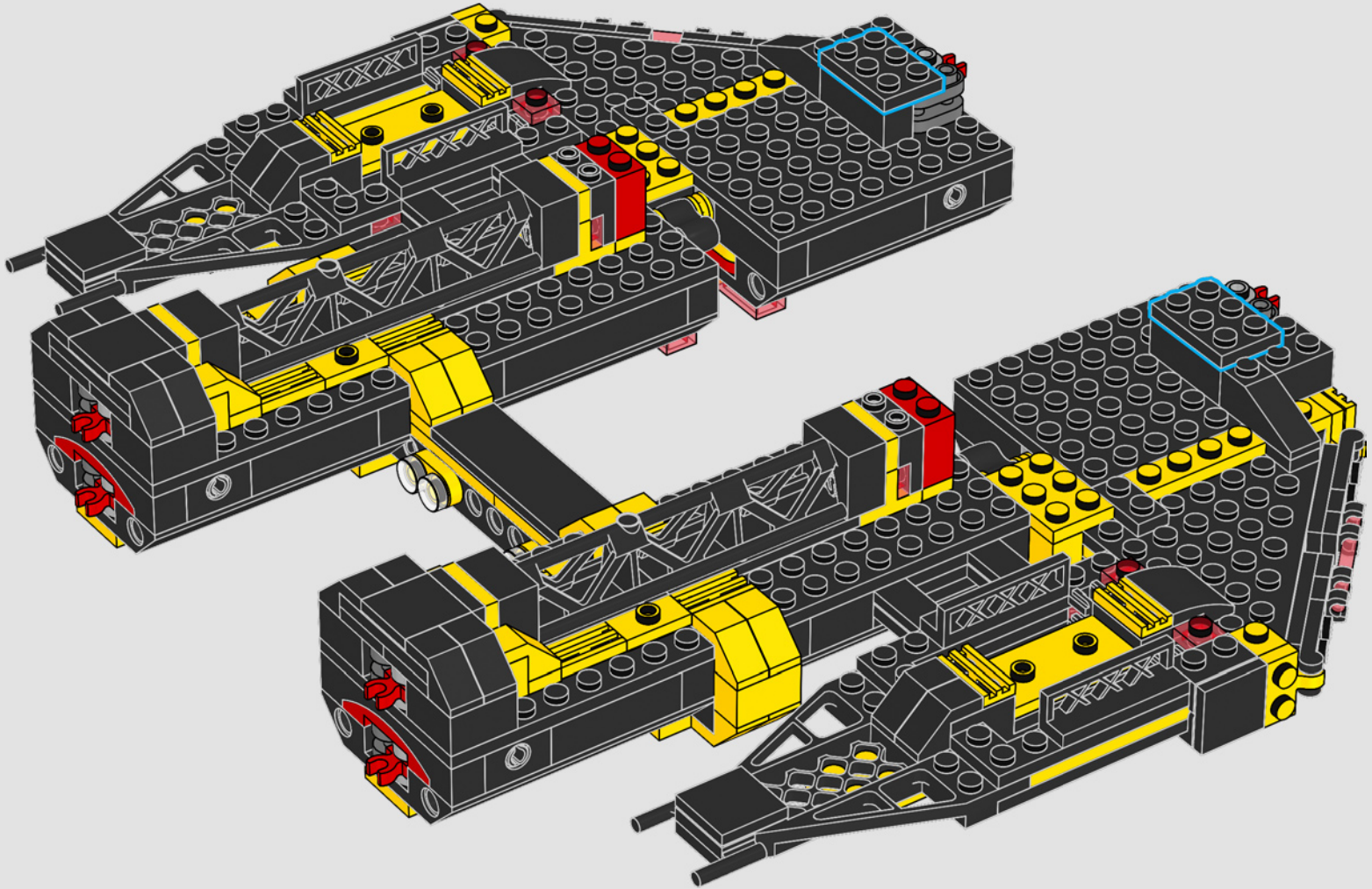

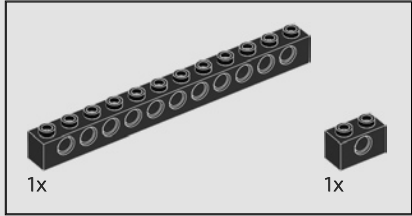
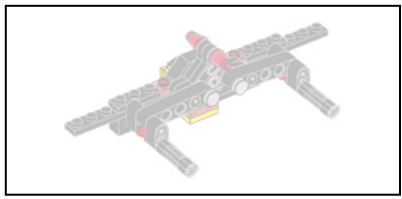

82

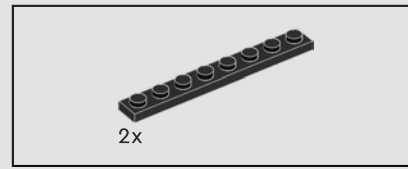
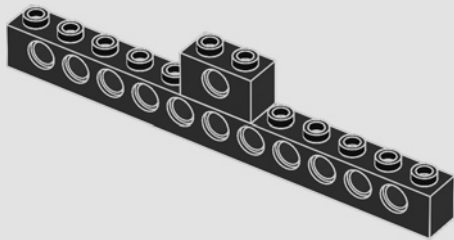

83

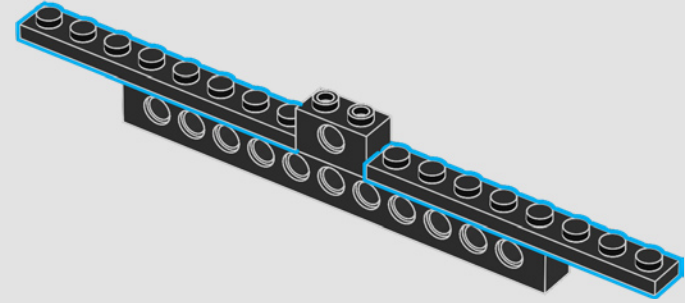

84

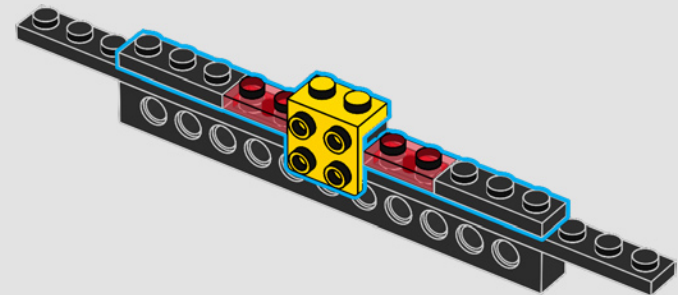

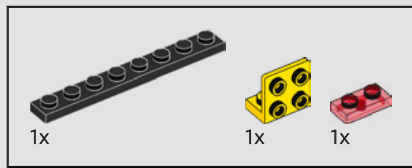

85

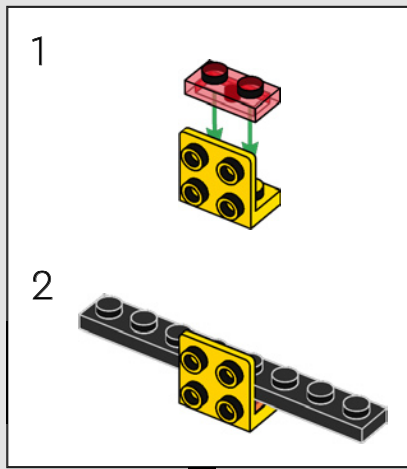
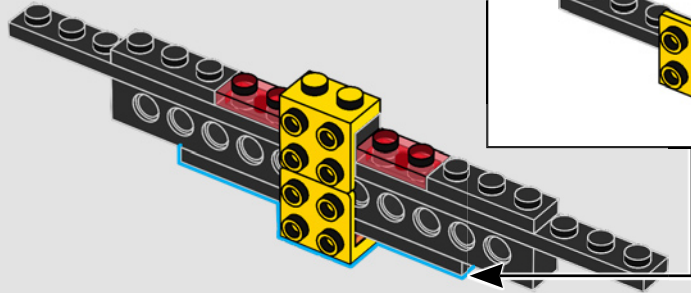

86

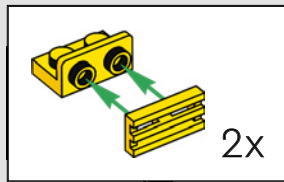
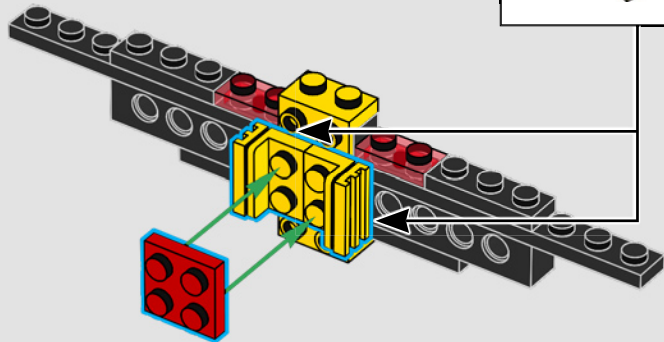

87

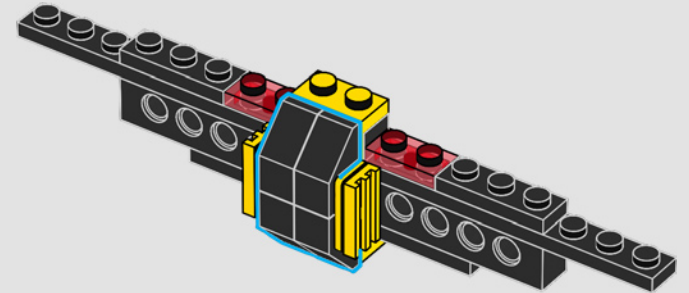

88

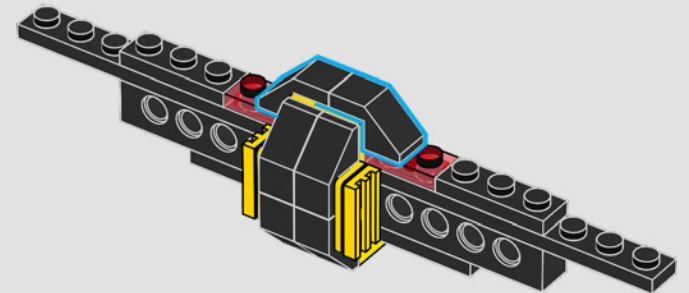

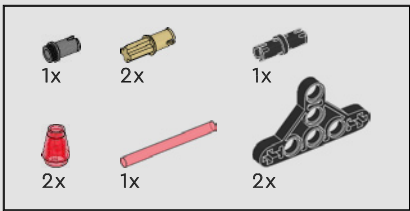

89

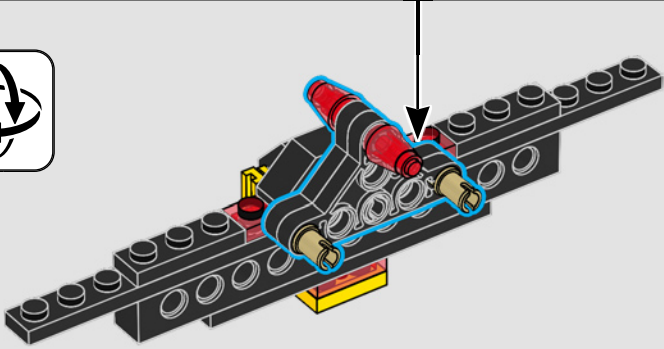
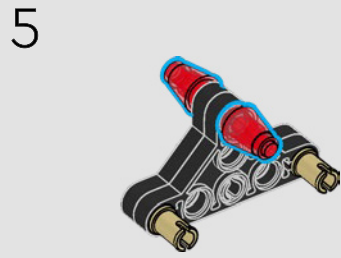
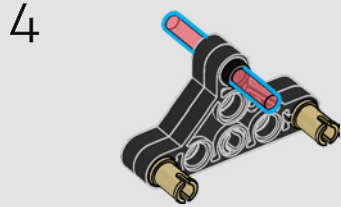
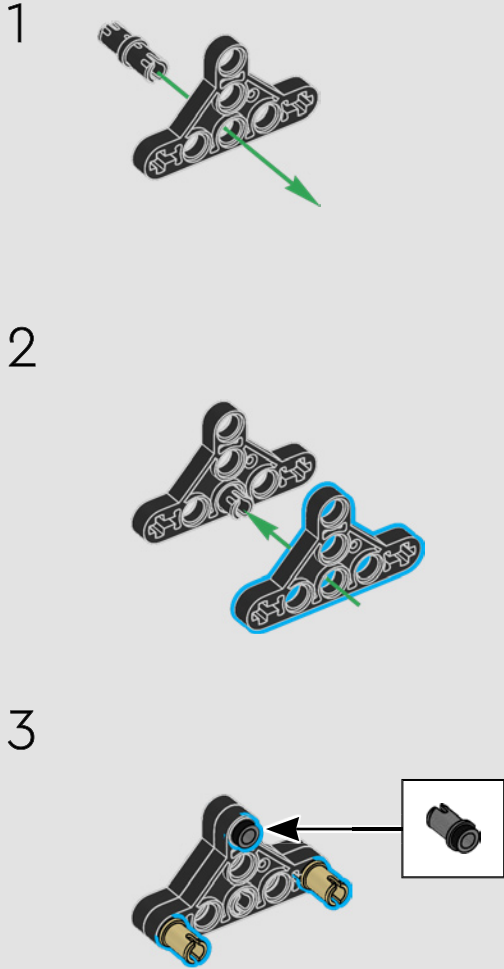

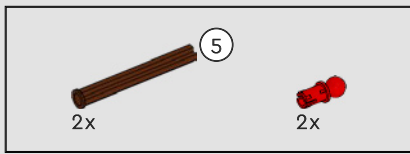

90

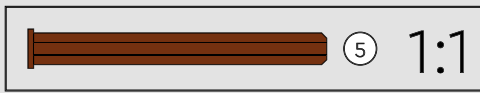
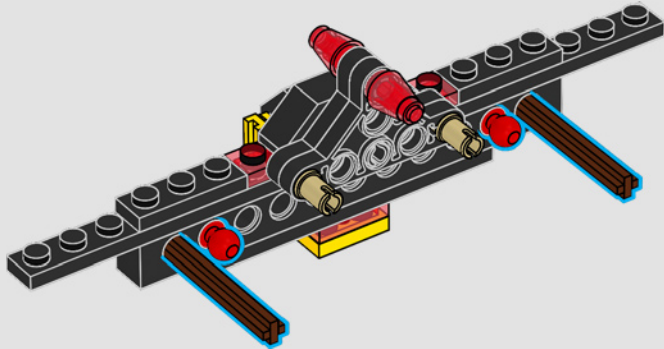

91

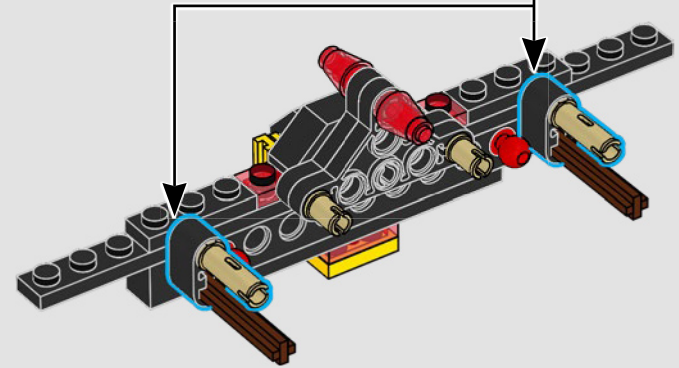
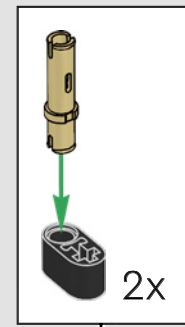

92

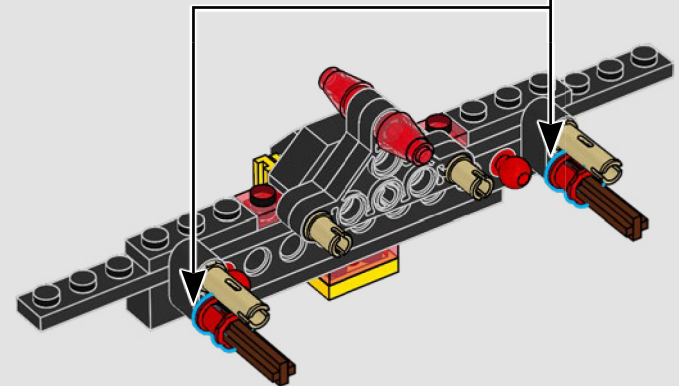

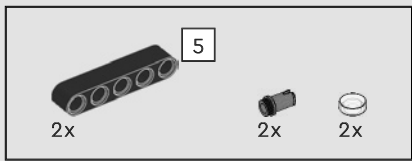

93

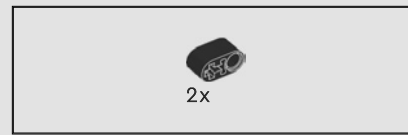
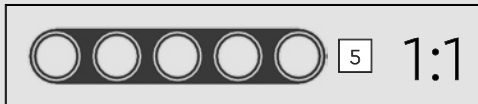
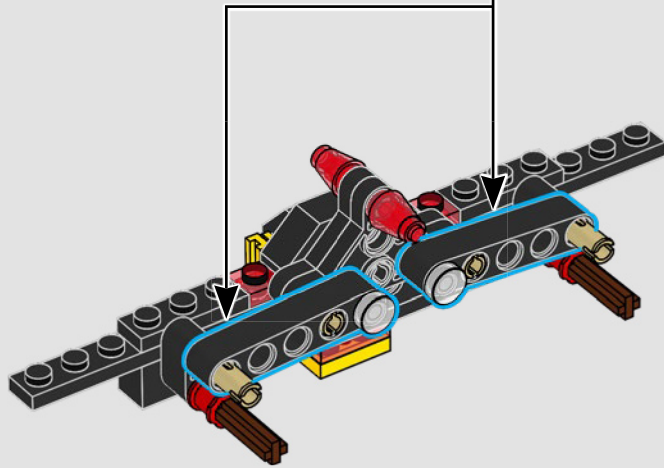
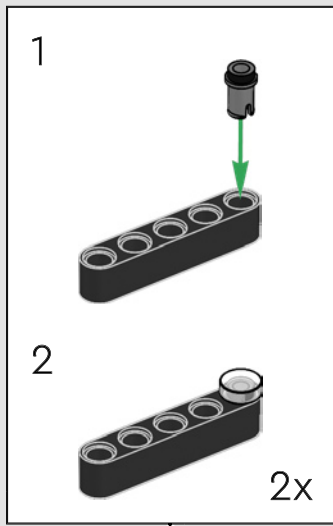

94

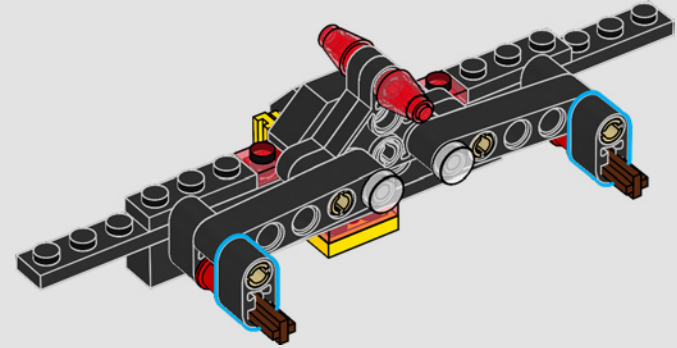

95

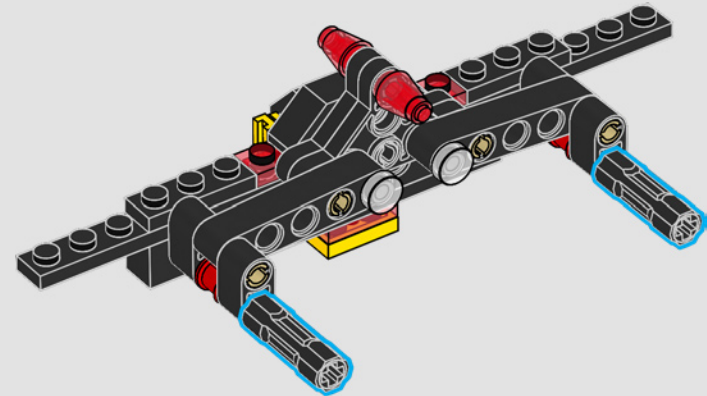

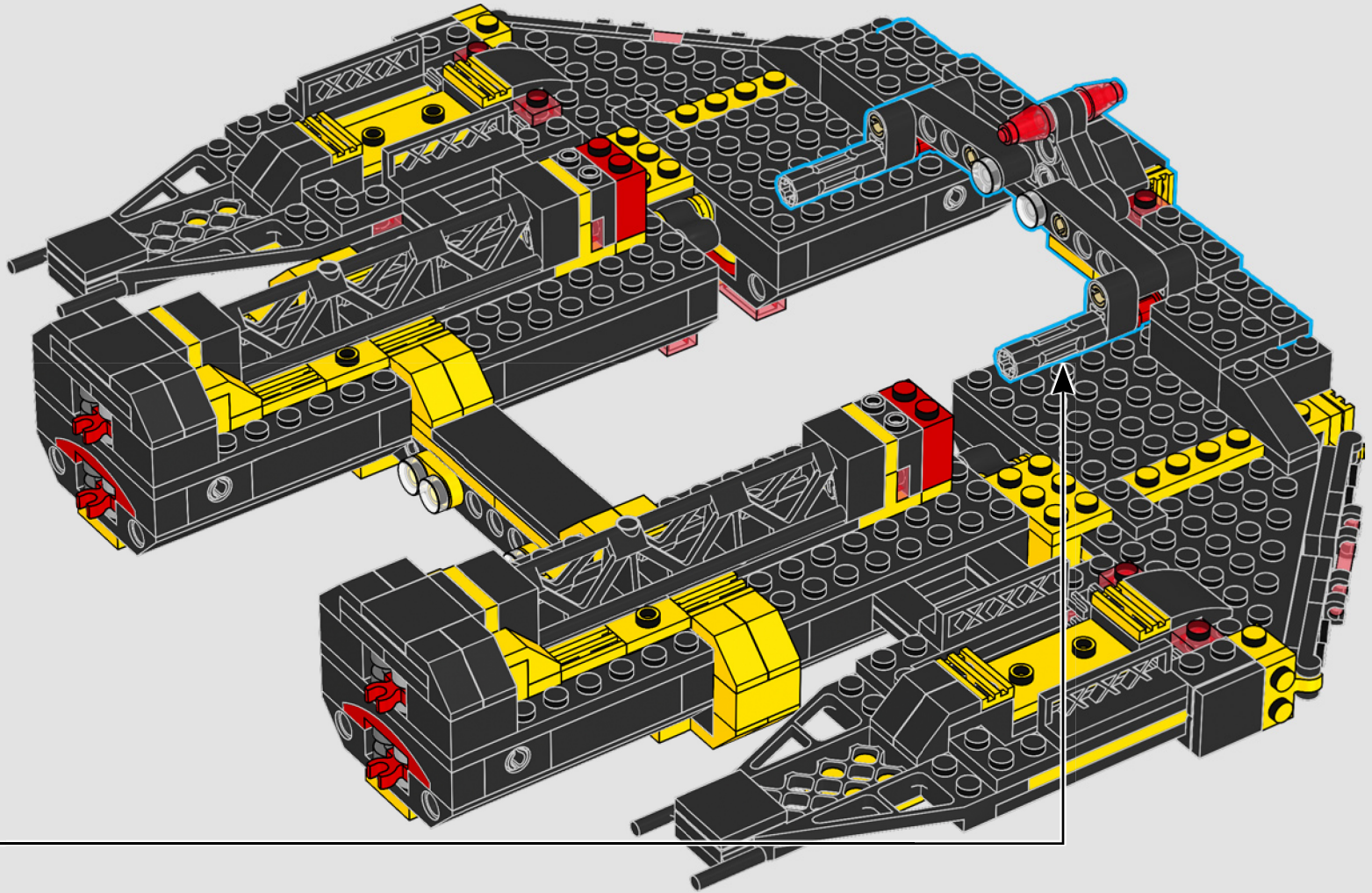

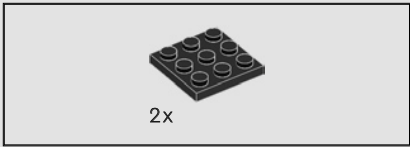

97

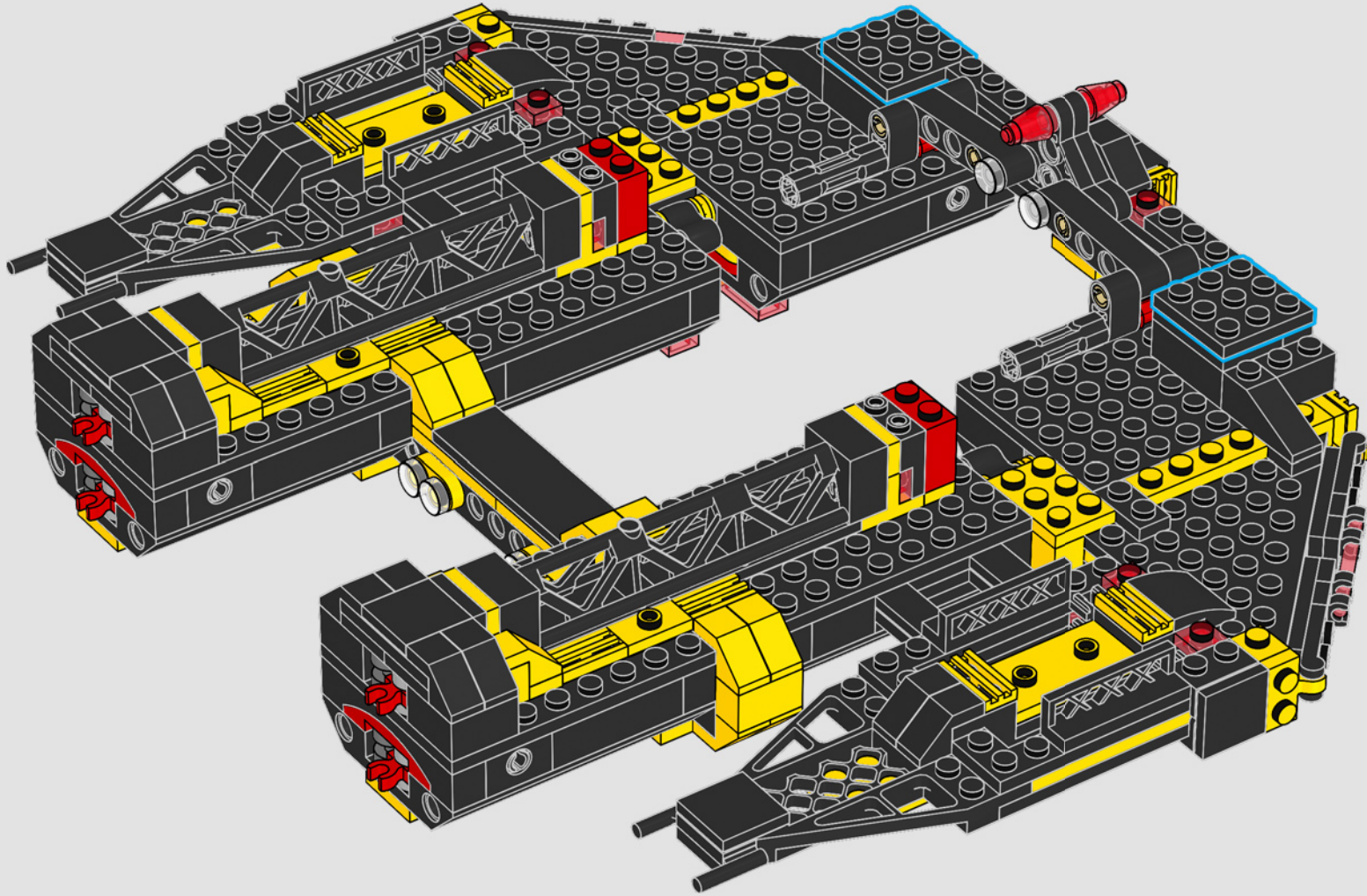

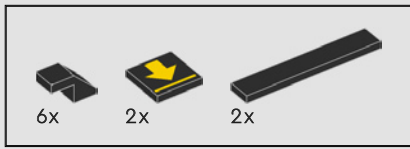

98

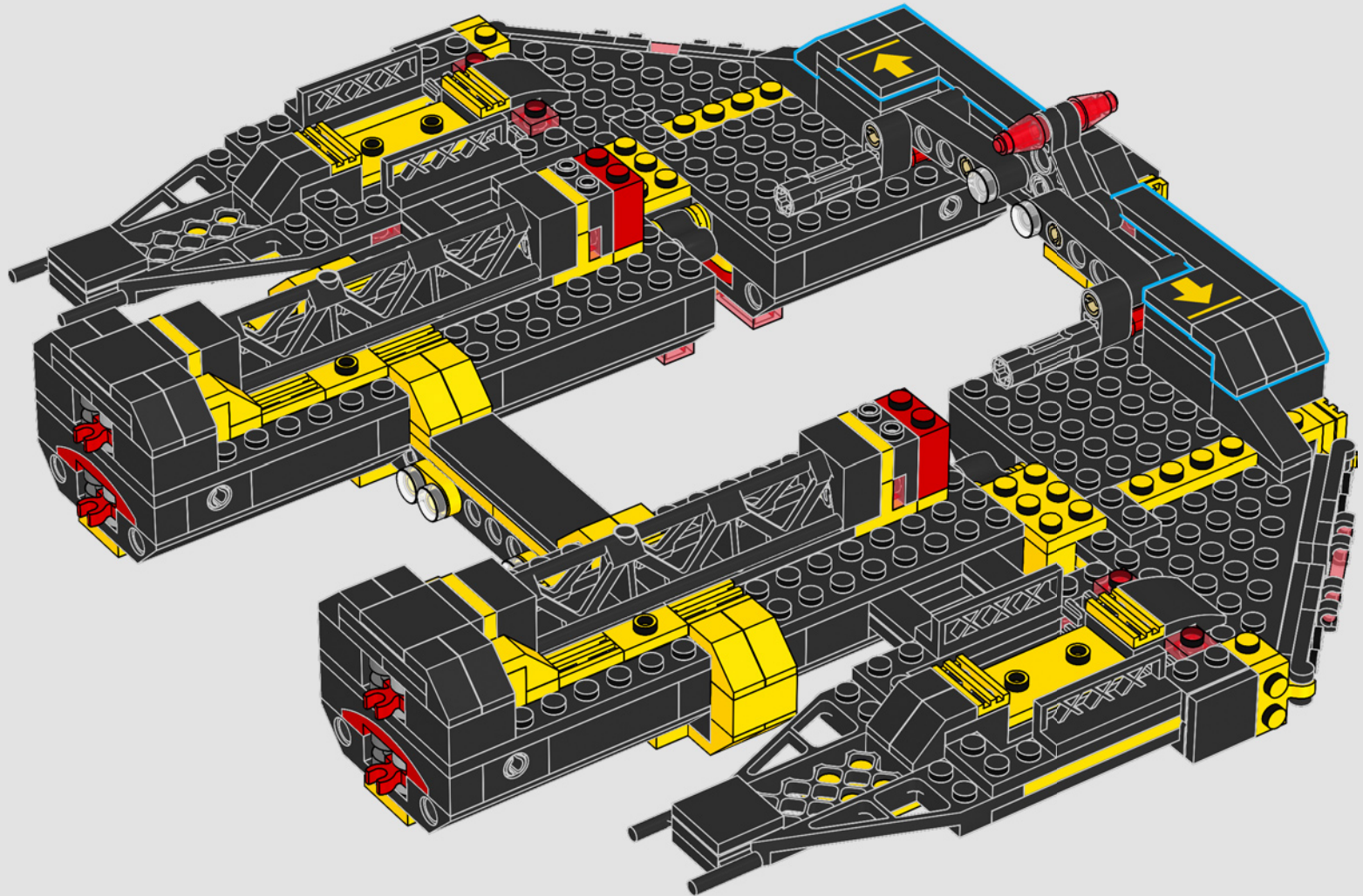

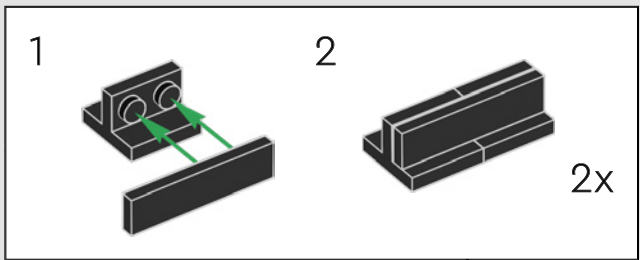
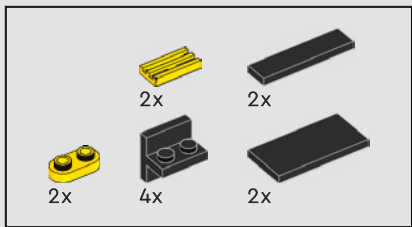

99

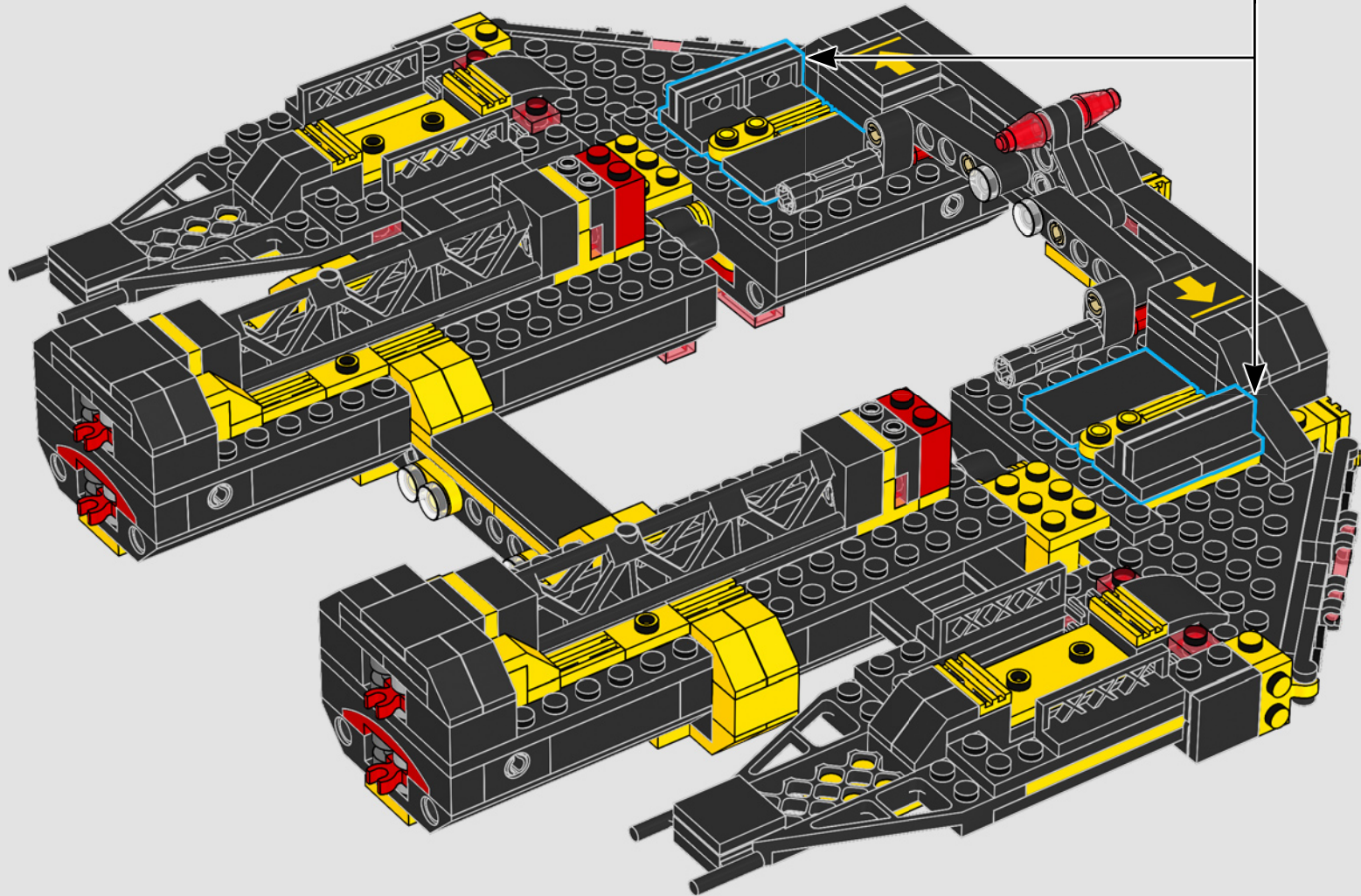

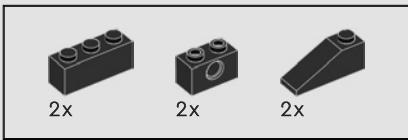

100

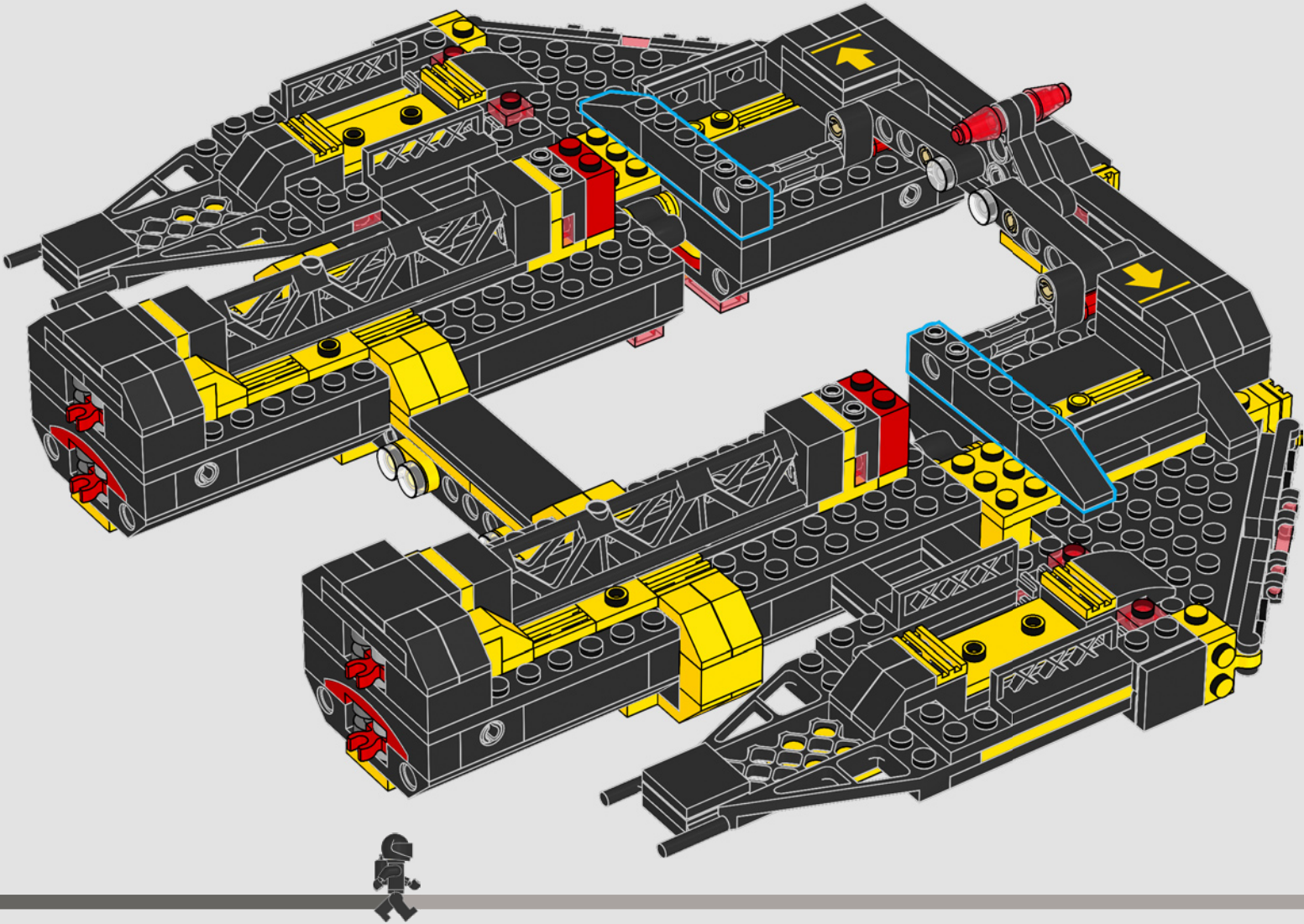

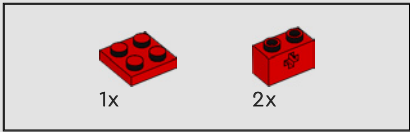
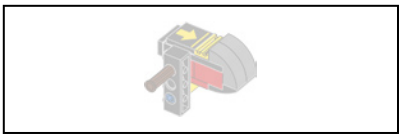

101

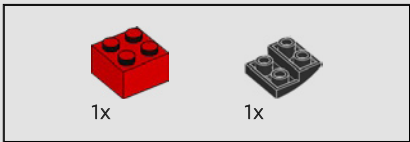
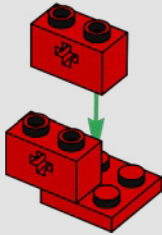

102

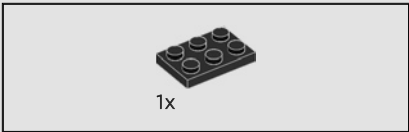
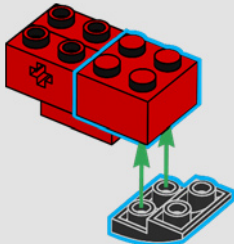

103

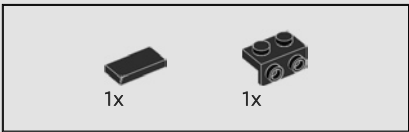
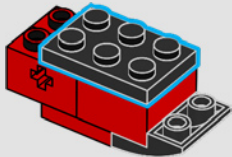

104

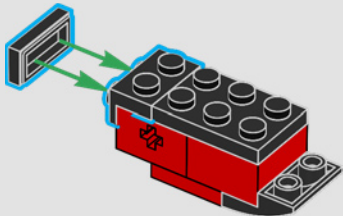

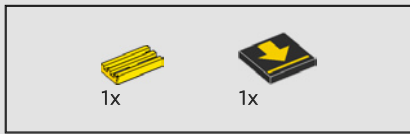

105

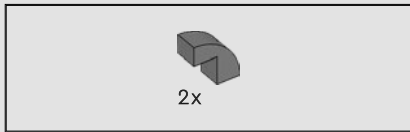
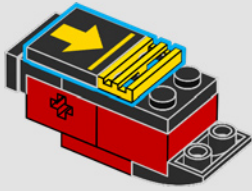

106

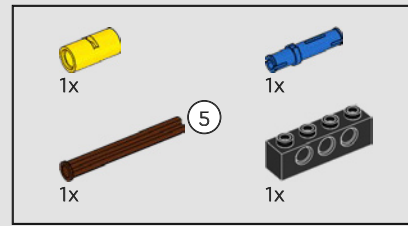
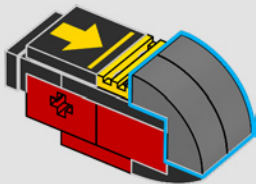

107

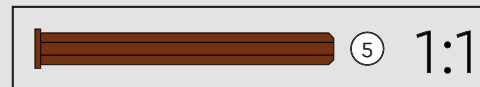
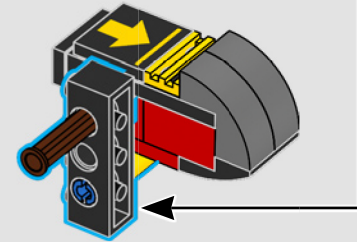
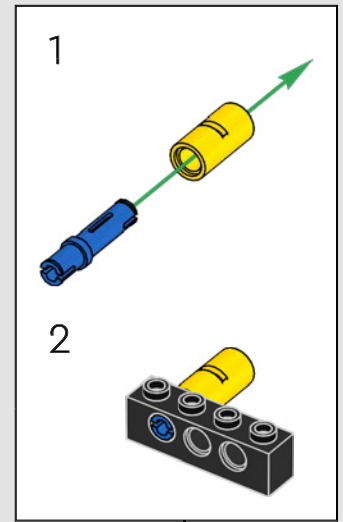

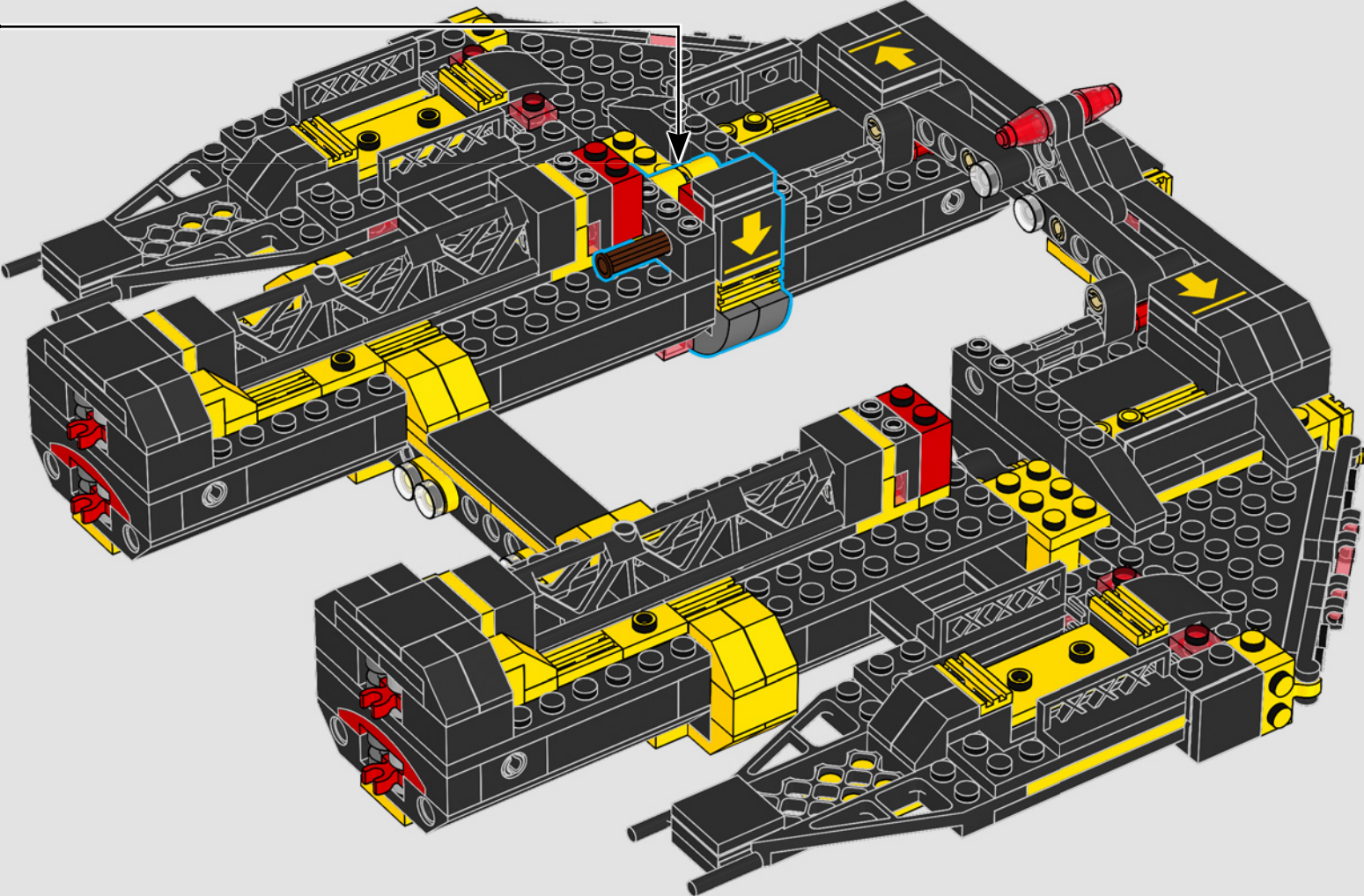

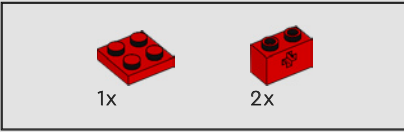
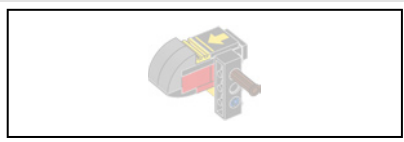

109

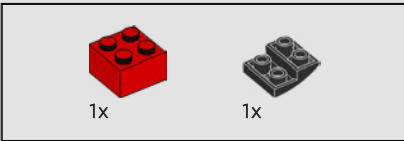
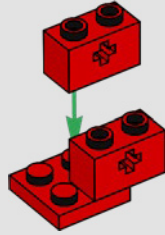

110

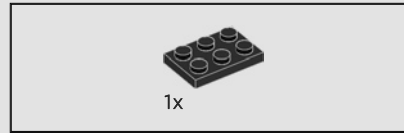
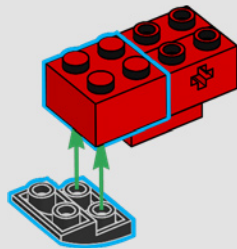

111

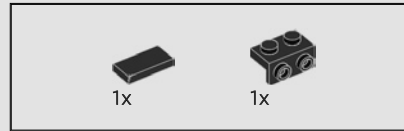
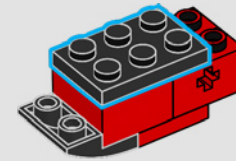

112

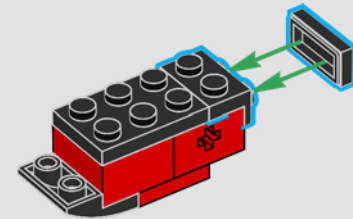

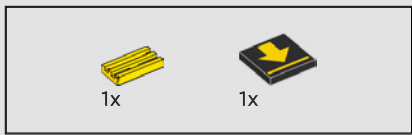

113

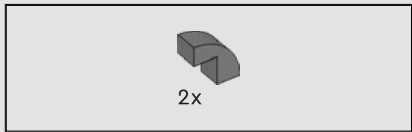
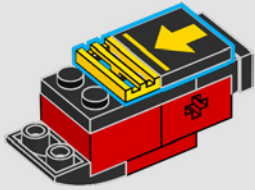

114

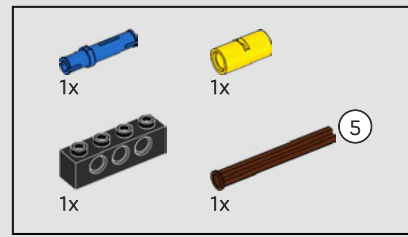
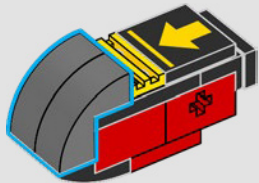

115

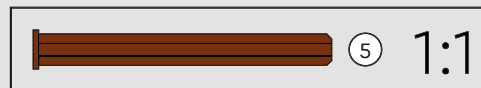
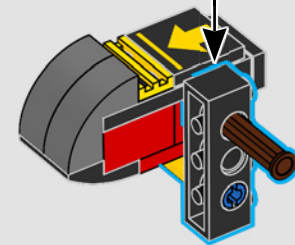
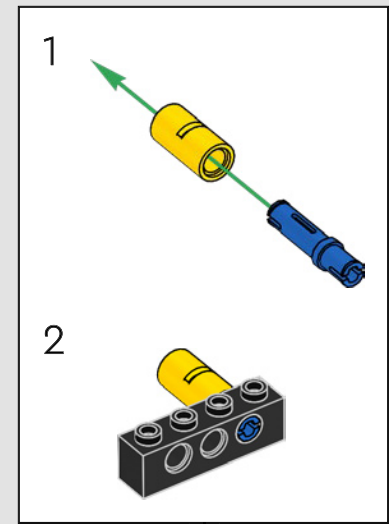

116

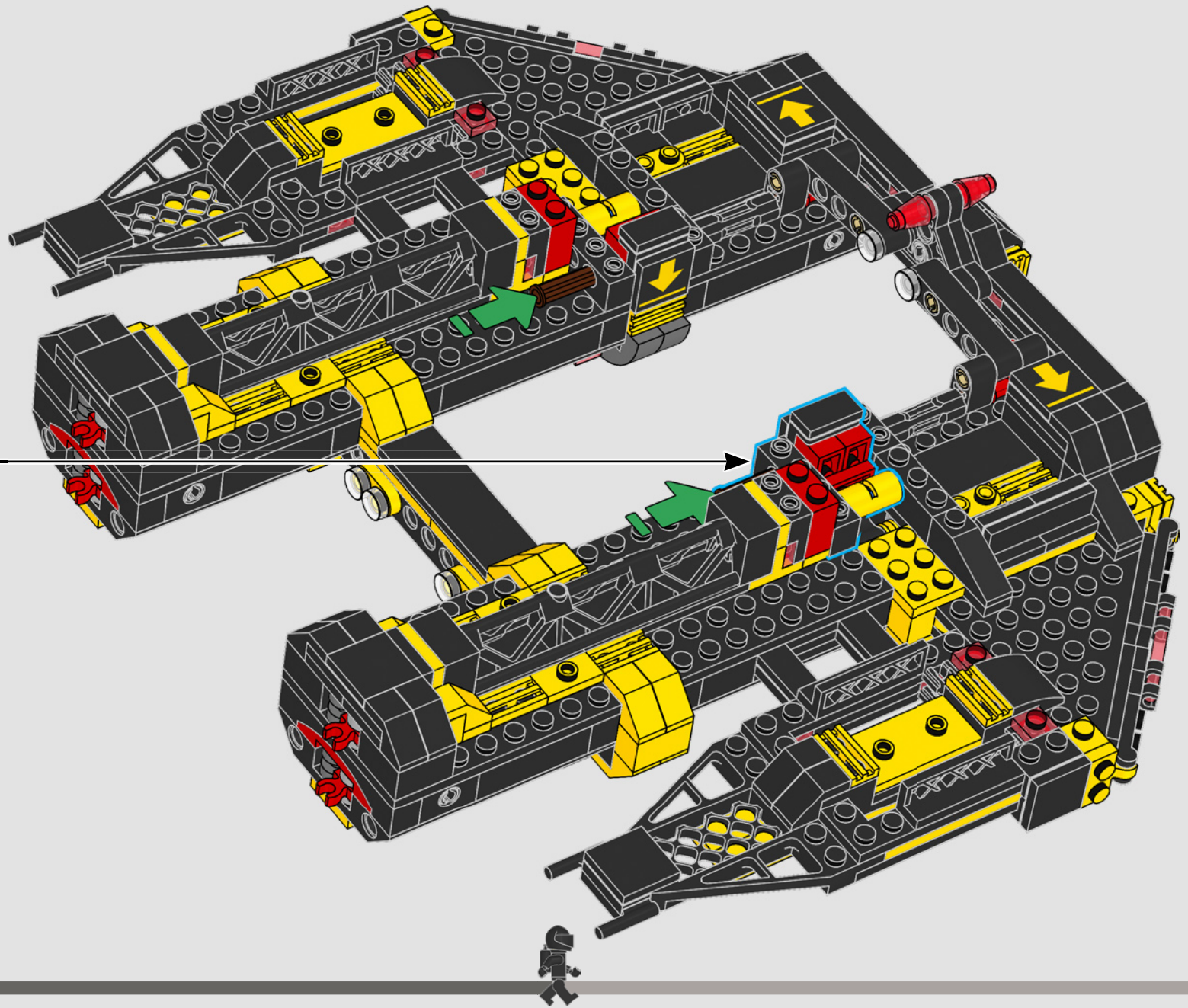

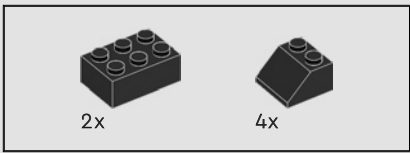

117

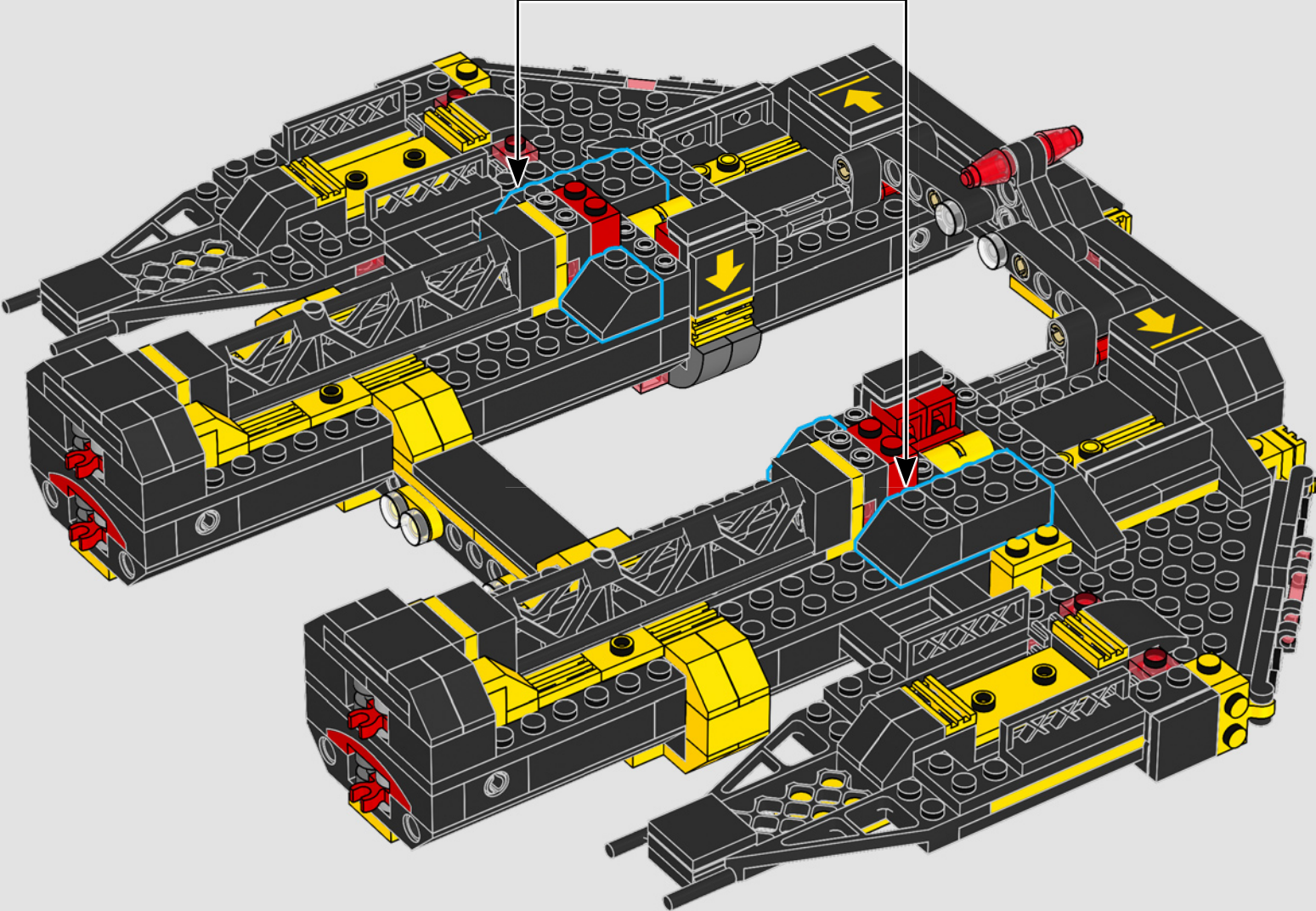
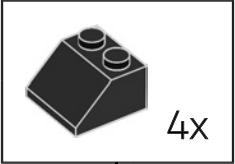

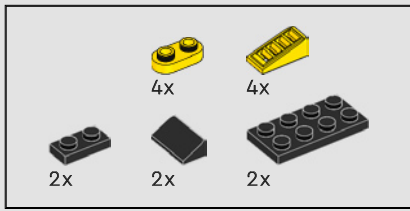

118

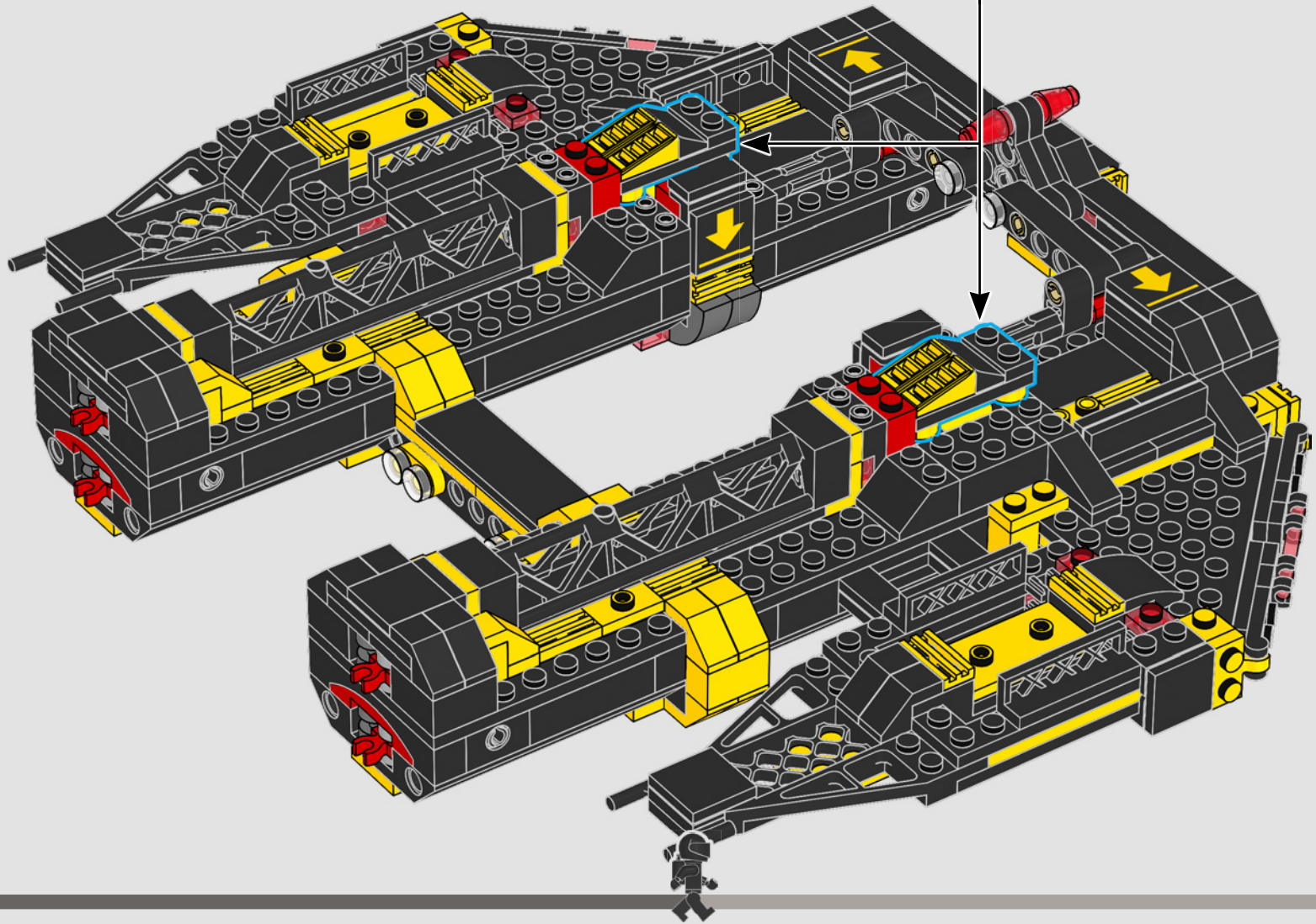
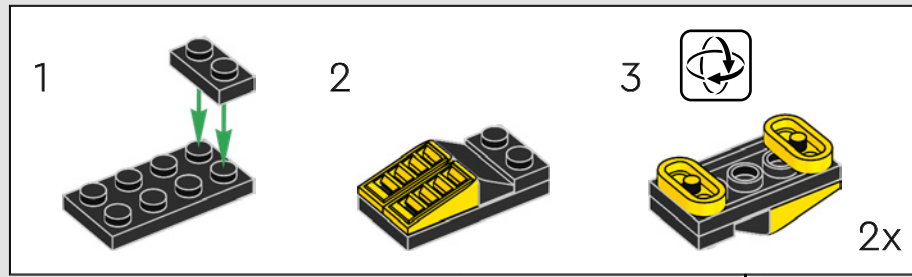

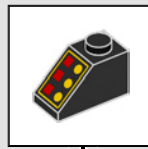
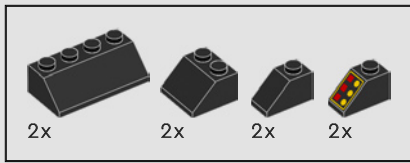

Diese beleuchteten Symbole sind seit unserer letzten Begegnung mit der *Renegade* unverändert geblieben. Wir haben den Zahlen- und Farbcode von Blacktron noch nicht vollständig entschlüsseln können. Vermutlich ist dies jedoch eine Warnung, keinen Hypertreibstoff von minderer Qualität zu benutzen.

119

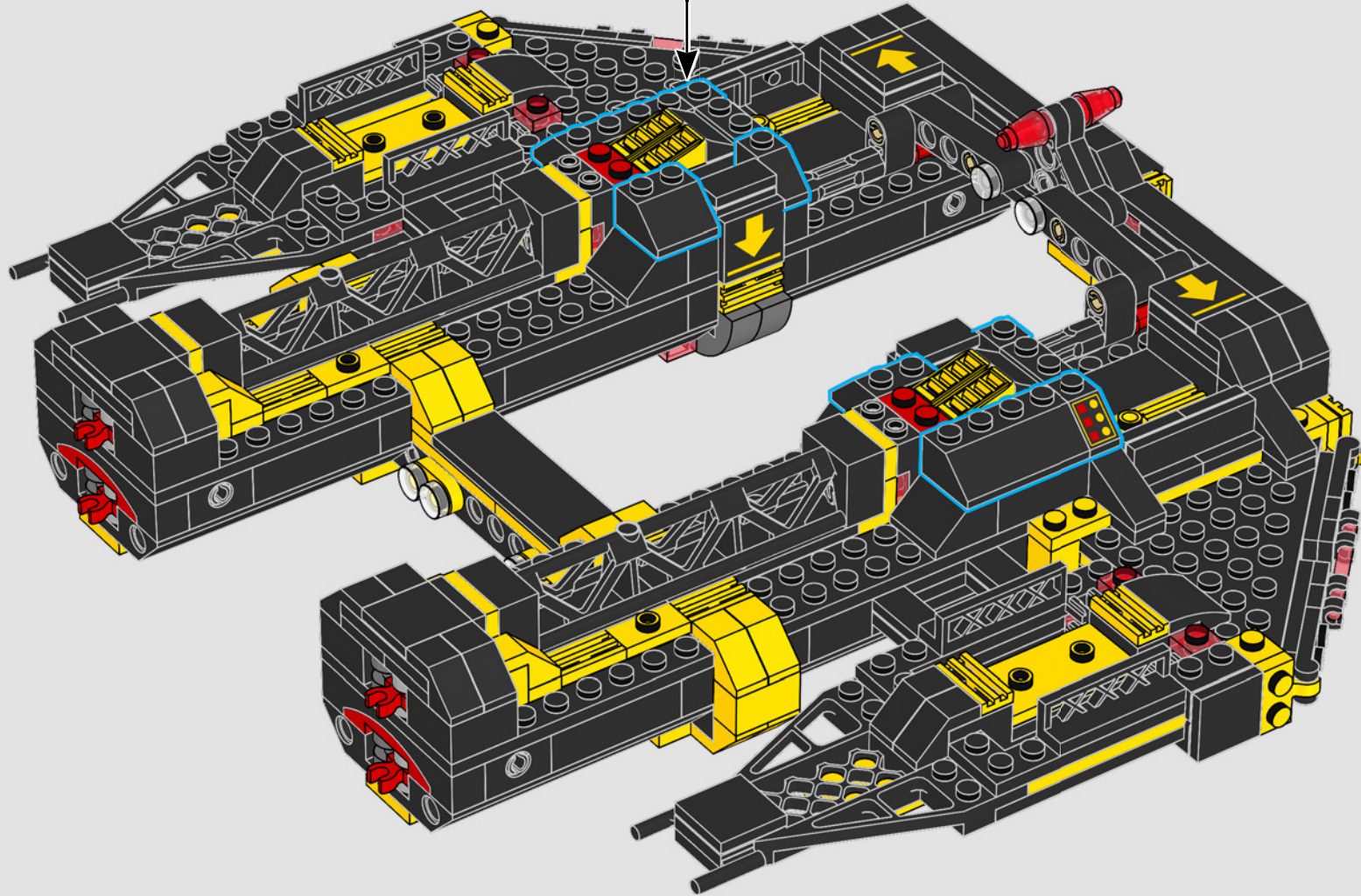

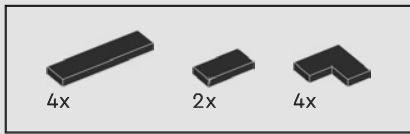

120

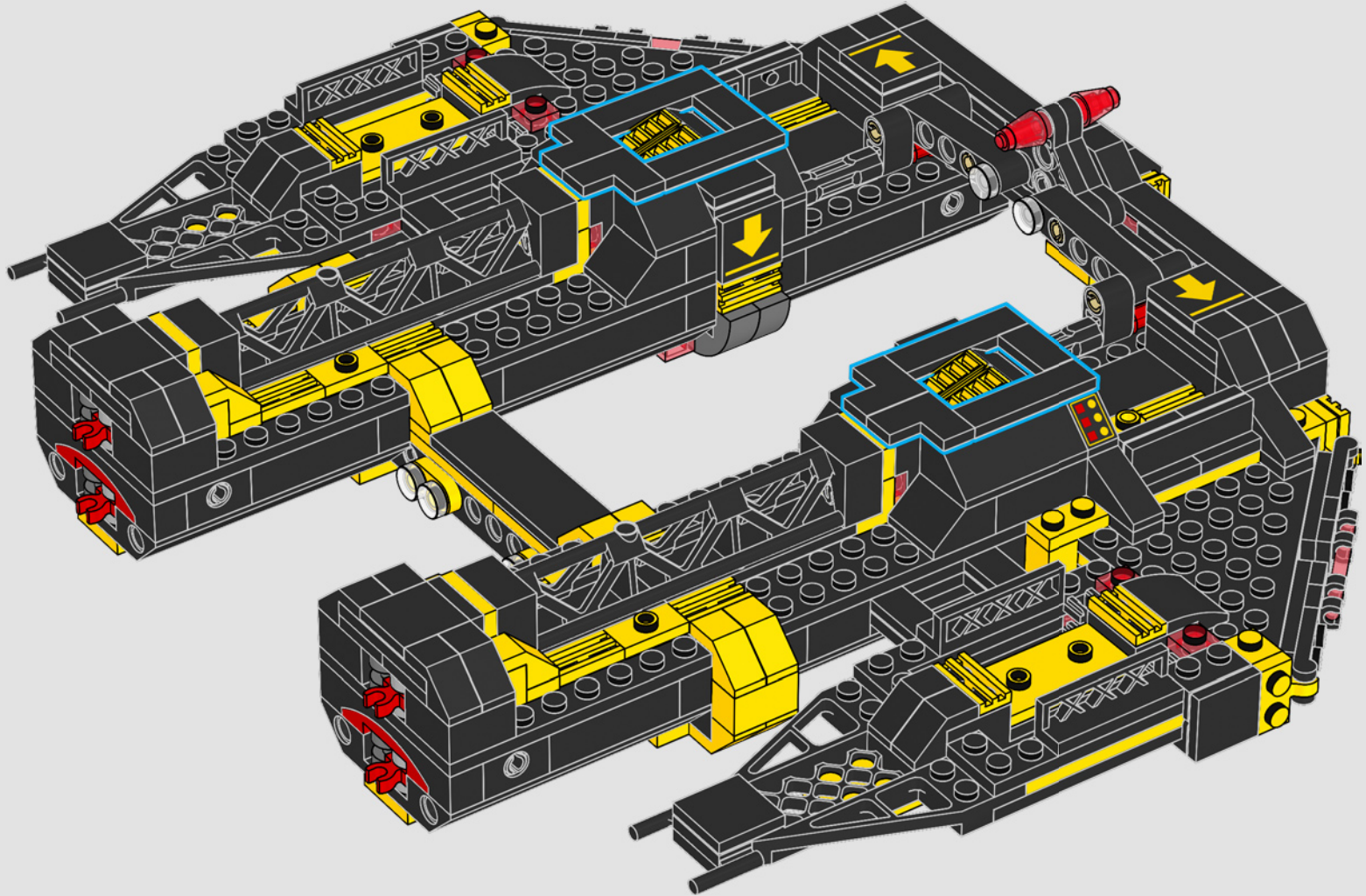

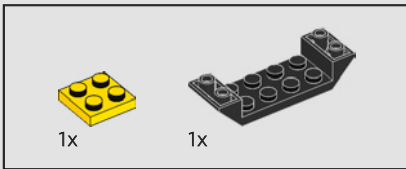
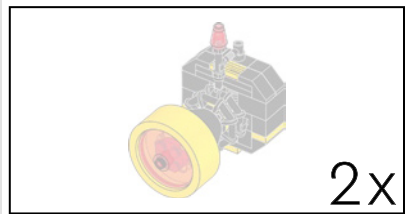

121

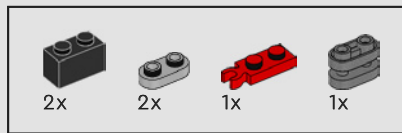
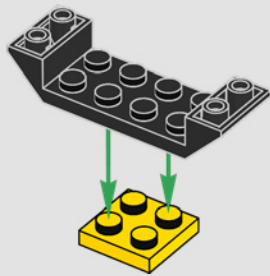

122

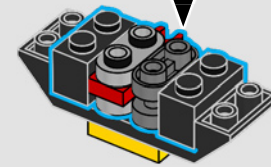
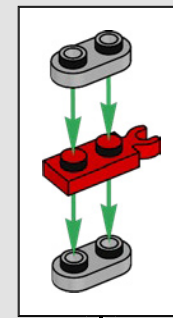

123

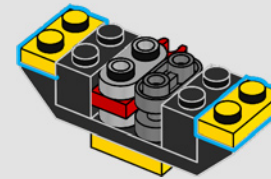

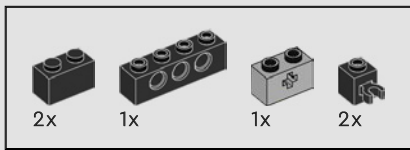

124

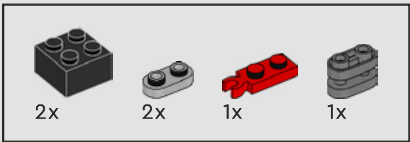
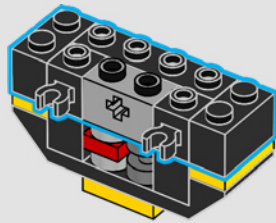

125

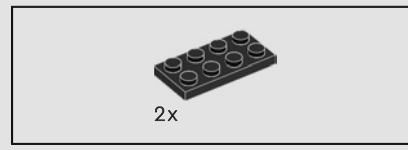
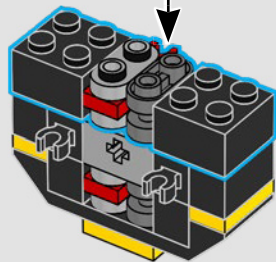
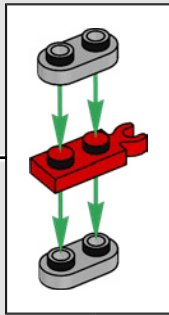

126

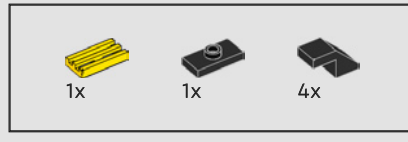
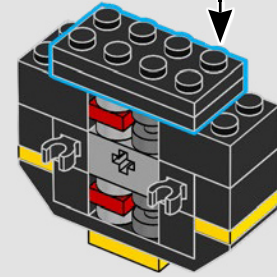
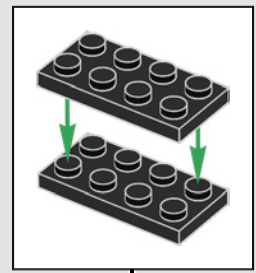

127

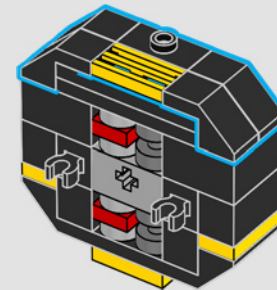

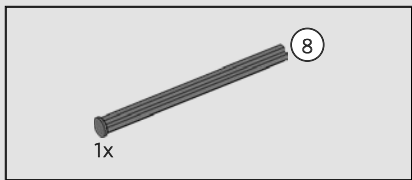

128

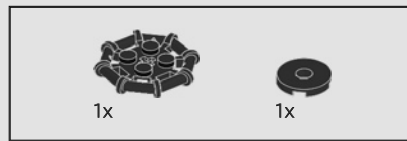
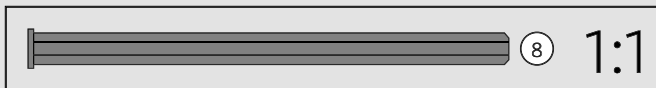
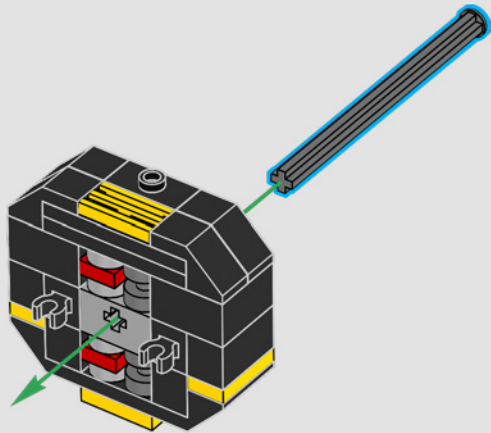

129

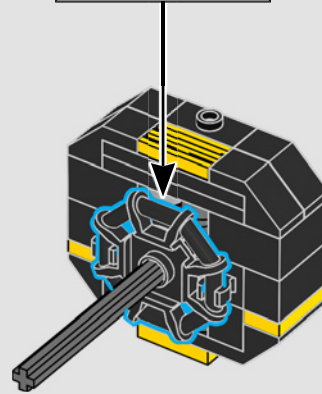
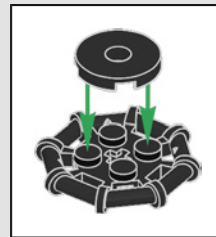

130

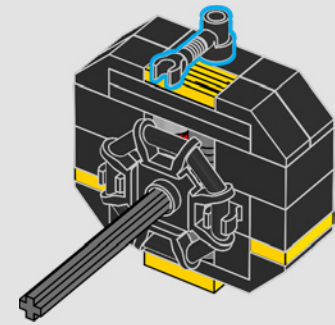

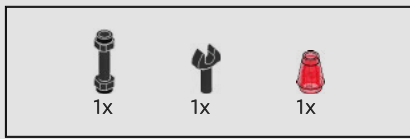

131

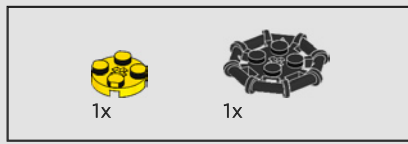
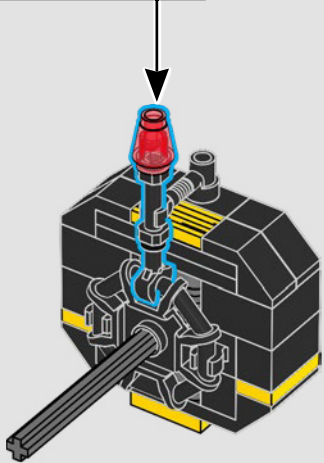
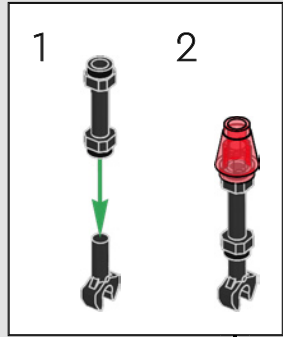

132

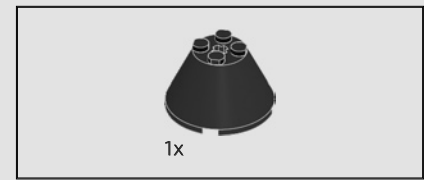
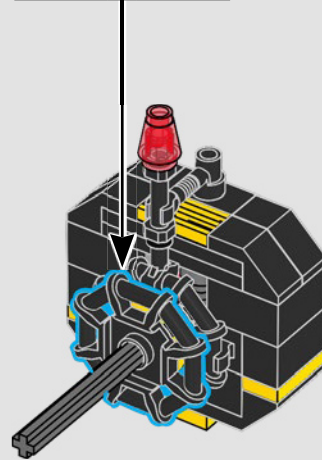
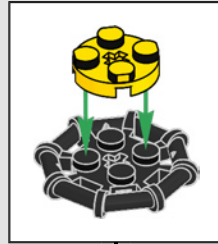

133

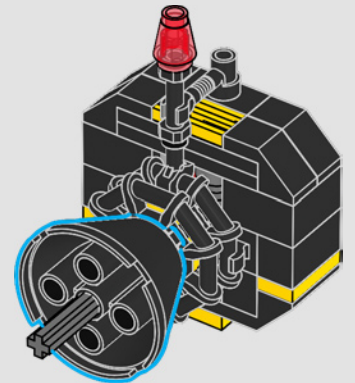

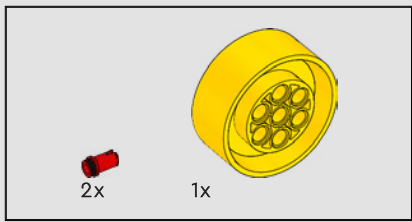

134

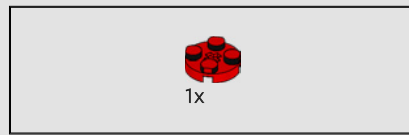
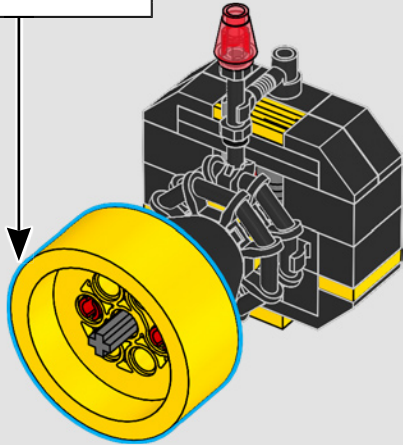
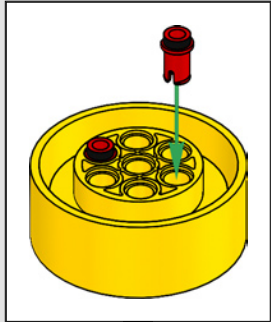

135

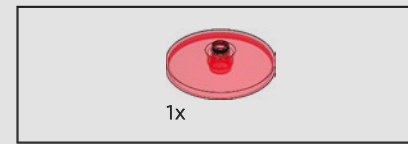
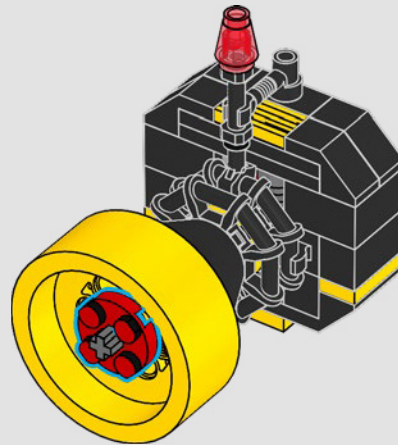

136

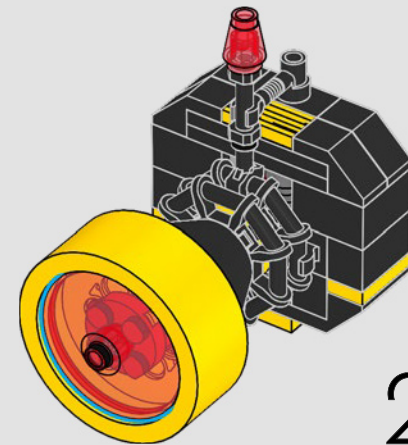

2x



Blacktron Engineering hat sein geniales modulares Design eindeutig verbessert, denn alle Module können jetzt je nach anstehender Mission auch anders angeordnet werden.

137

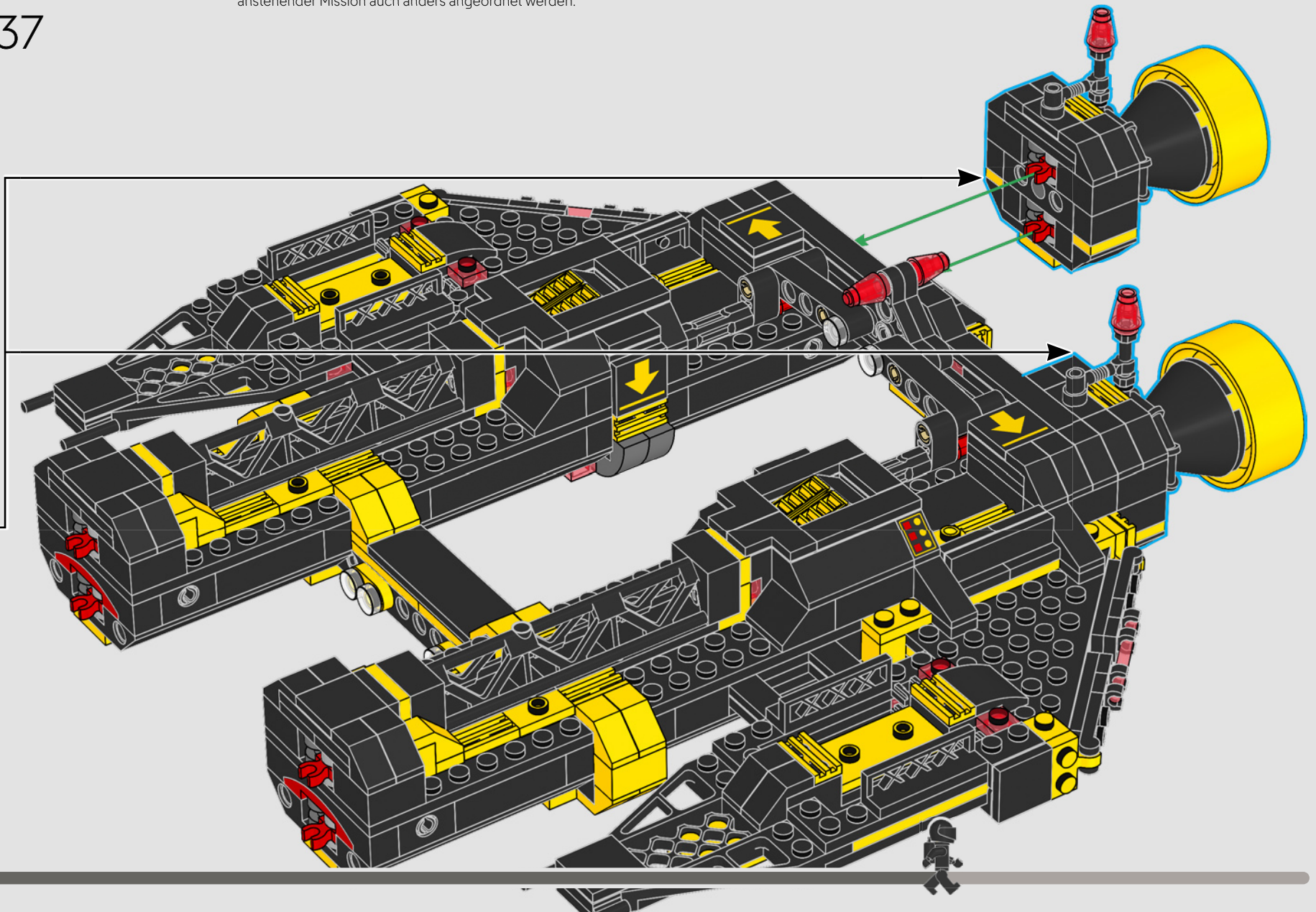

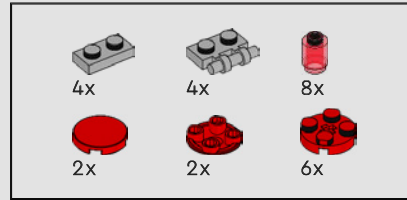
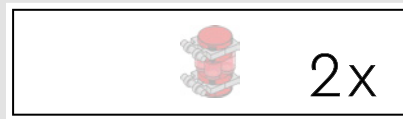

138



Dank dieser fusionsaktivierten Energiekapseln verfügt die *Renegade* nun über deutlich größeren Raketenschub. Wegen ihrer größeren Reichweite kann die *Renegade* jetzt auch die Futuron-Basen in diesem Quadranten erreichen, die zuvor als sicher galten.

1

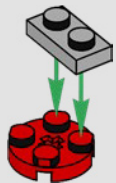

2

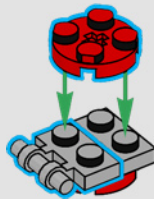

3

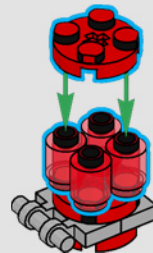

4

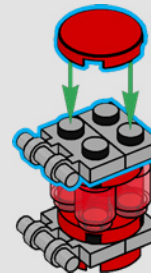

5

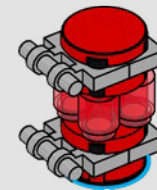

2x



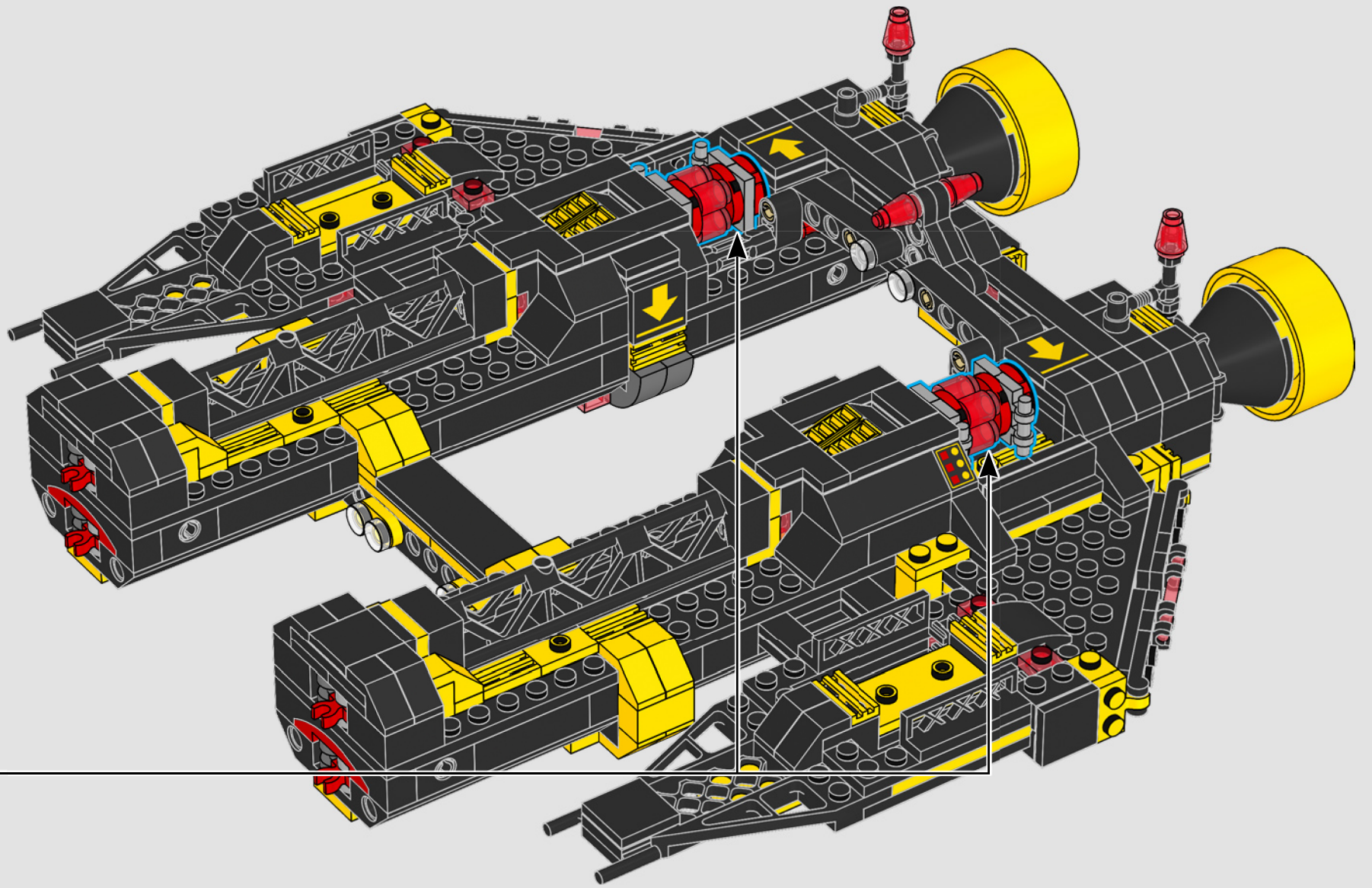

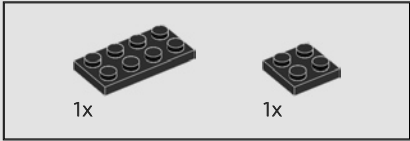
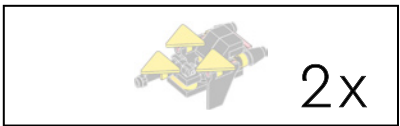

139

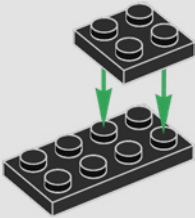

140

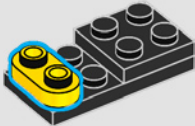

141

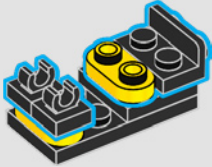

142

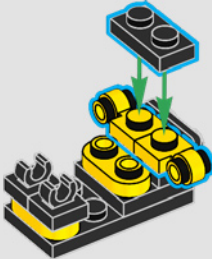

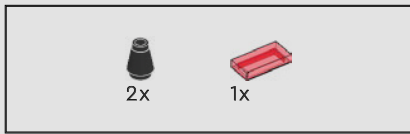

143

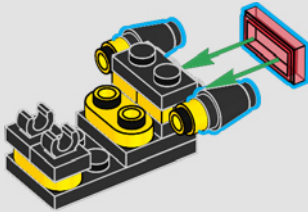

144

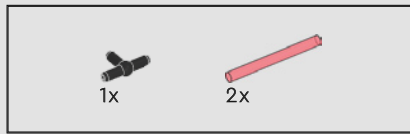
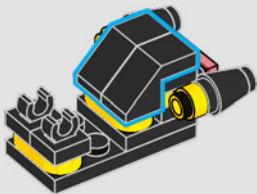

145

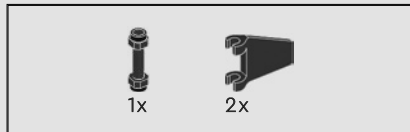
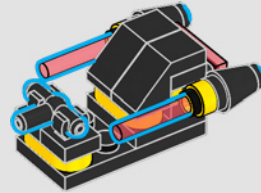

146

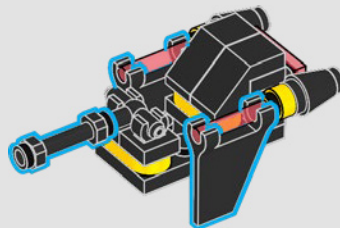

147

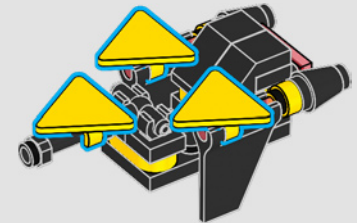

2x





Bleib auch dann äußerst wachsam, wenn die Renegade die Umlaufbahn verlässt! Blacktron-Agenten können auf ihren Einsitzer-Speedern, die als Blacktron-Symbole getarnt sind, auf Spionagemissionen geschickt werden.

148

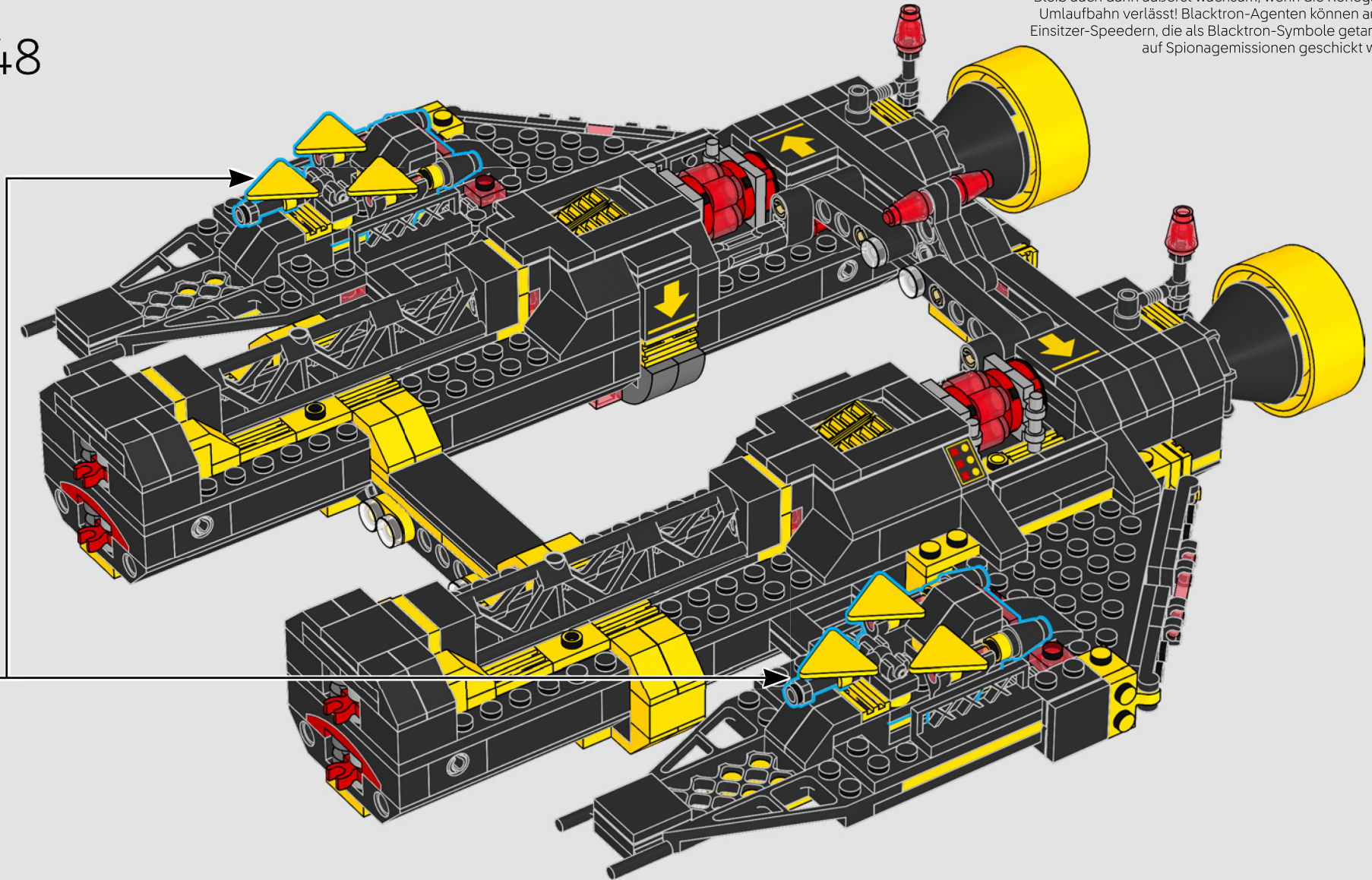

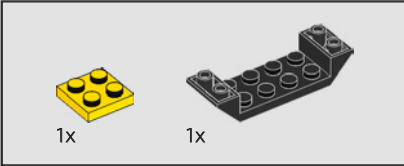
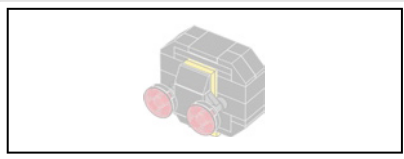

149

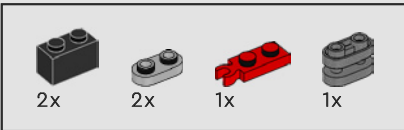
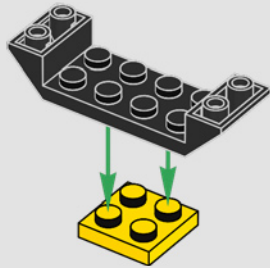

150

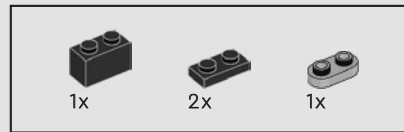
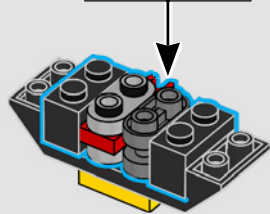
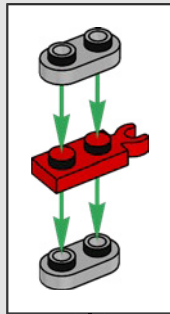

151

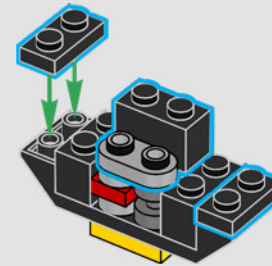

152

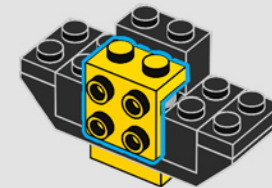

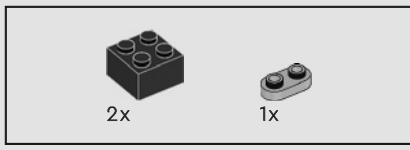

153

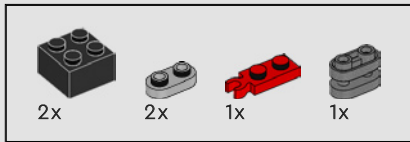
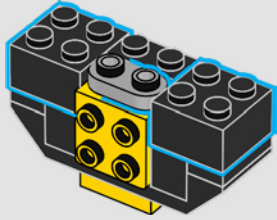

154

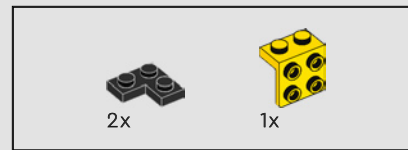
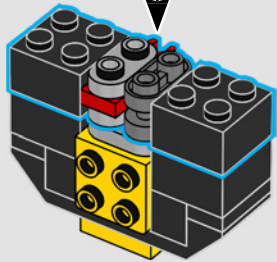
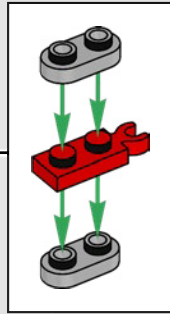

155

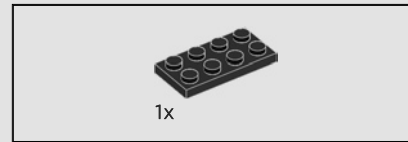
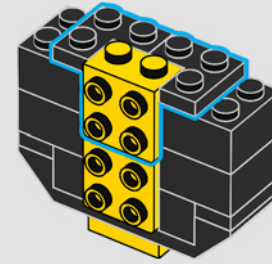

156

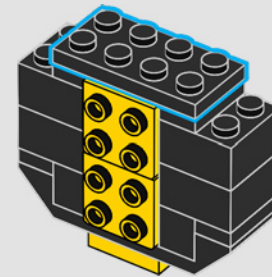

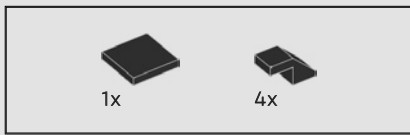

157

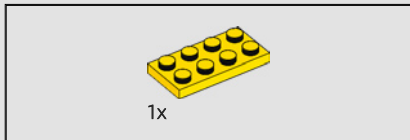
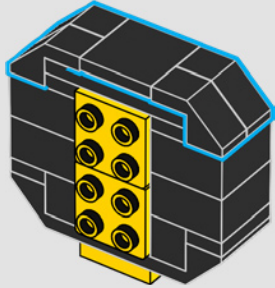

158

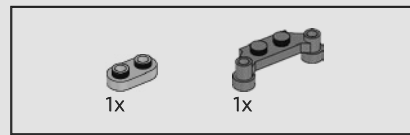
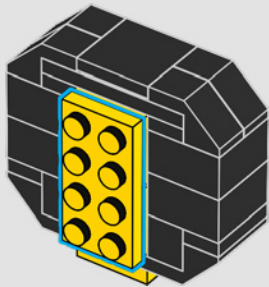

159

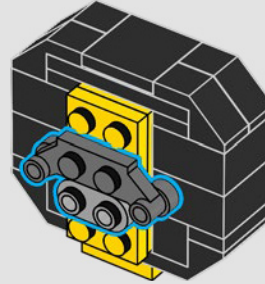

160

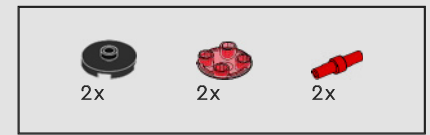
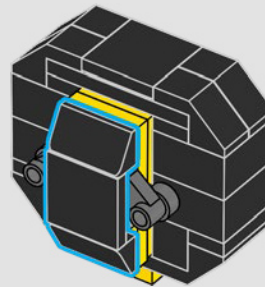

161

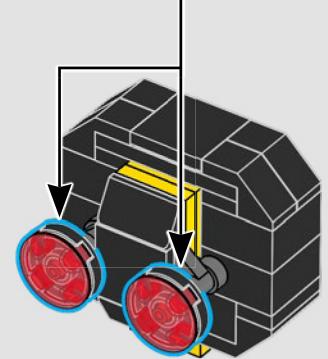
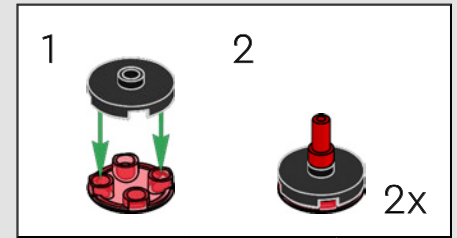



Im Vergleich zu den Vorgängerversionen verfügt das Schiff über einen deutlich moderneren Computer. Dieser Rechner scheint nicht nur für die Videokommunikation benutzt zu werden, sondern bietet auch modernste Erkennungsfunktionen und Signalverarbeitung.

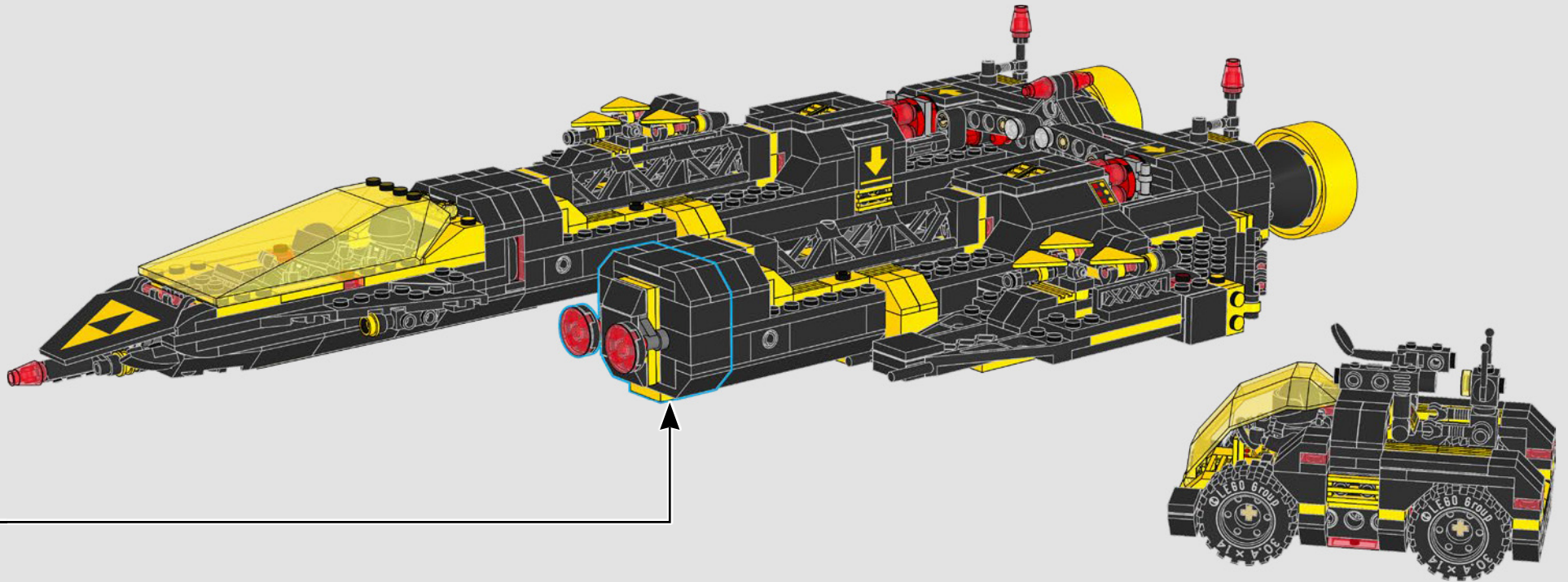

Es gilt nun als gesichert, dass verschlüsselte Nachrichten von diesem Kommunikationsmodul an die Message Intercept Base (6987) gesendet werden. Das Kommunikationsmodul kann abgenommen und mit dem Heckbooster zu einem Relais für die Fernkommunikation kombiniert werden.



Warnung! Wegen der neuen Blacktron-Absetztechnologie könnten jetzt noch schnellere und kaum noch erkennbare Spionagemissionen drohen.

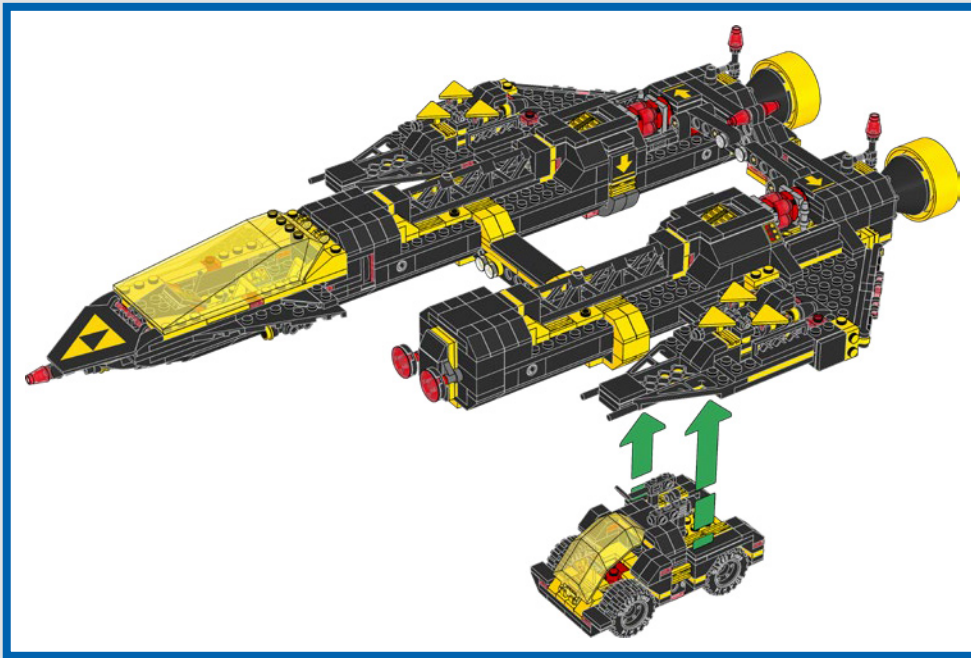

163

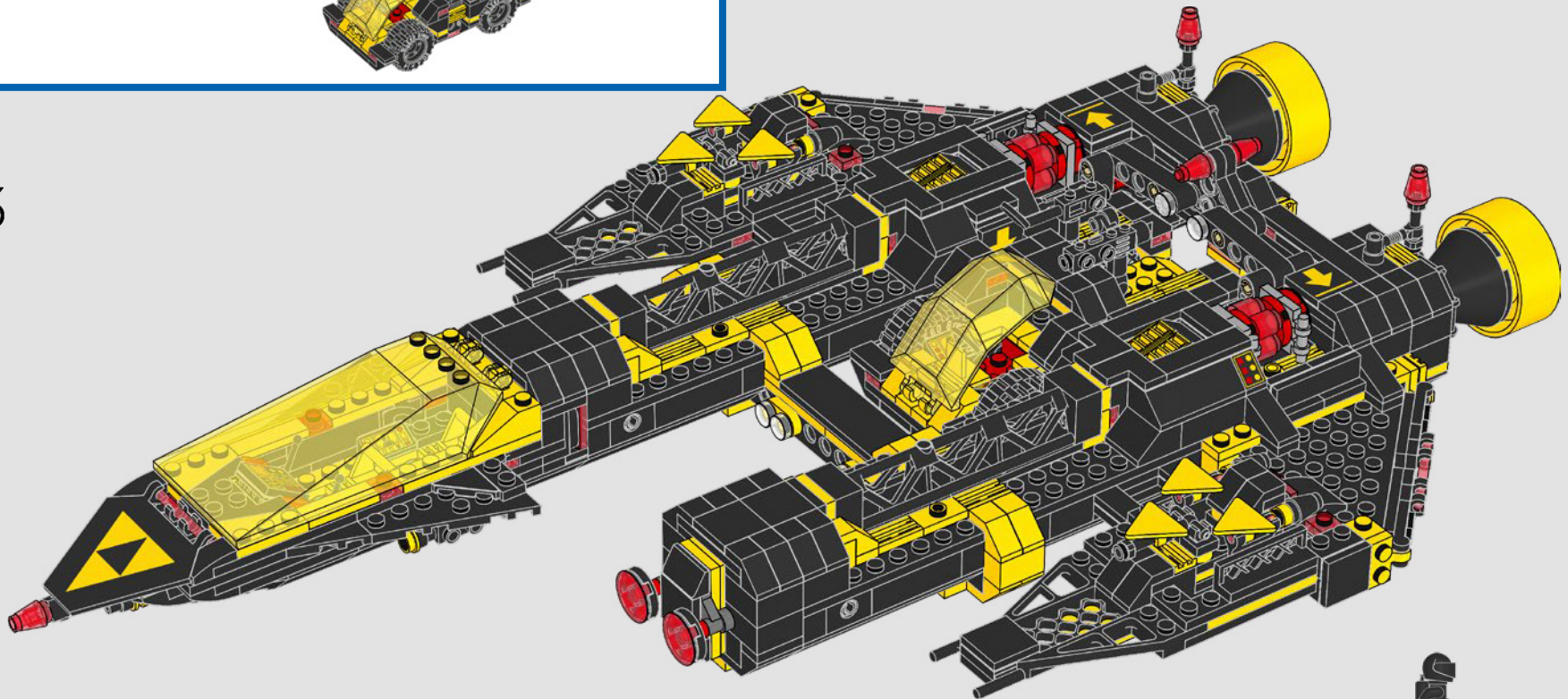

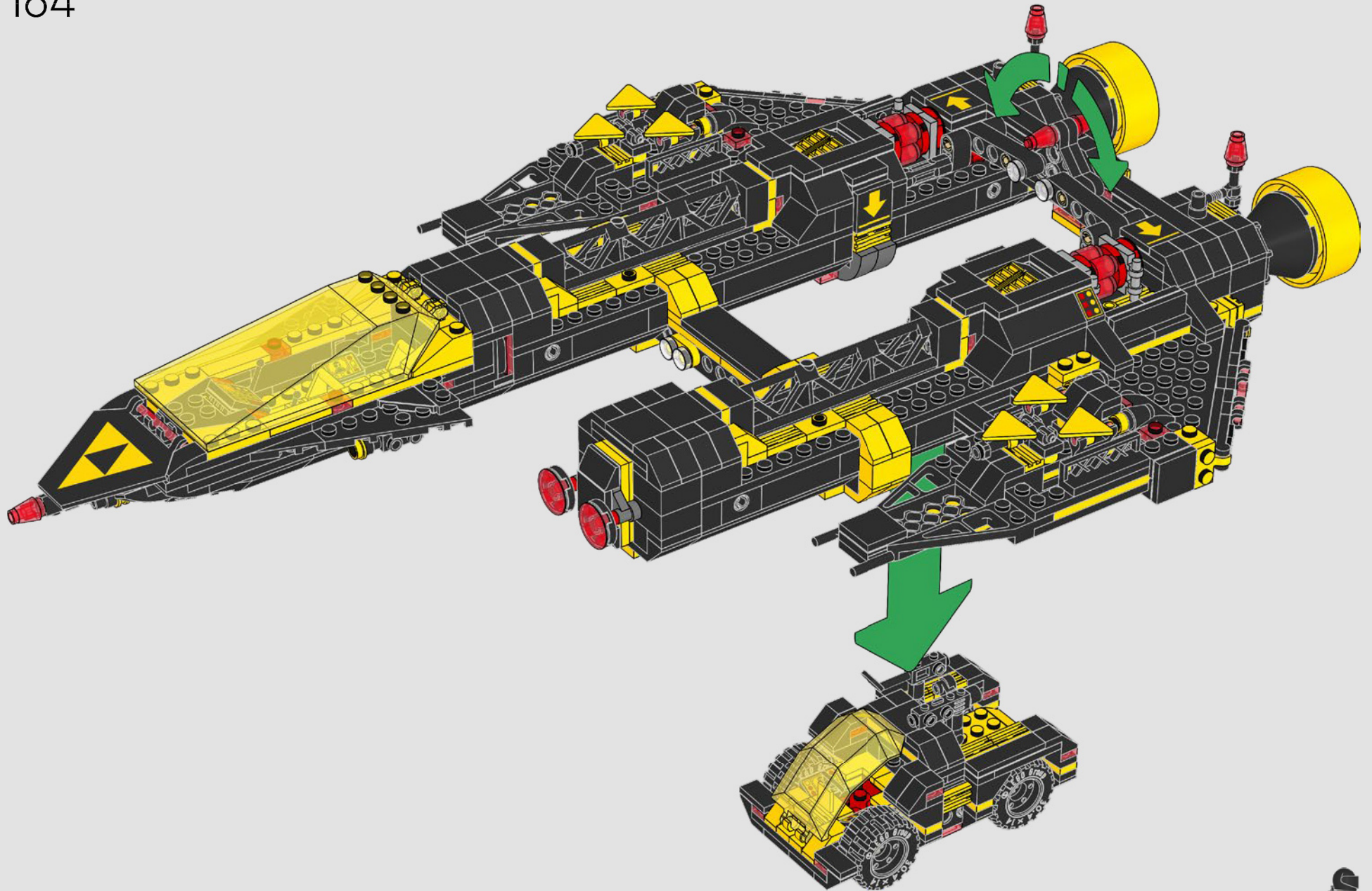

6x 4666579	2x 300321	4x 6280475	8x 6534029	2x 302124	4x 4529236	2x 6104209	3x 9339	12x 6465248	4x 6524424	4x 4515368
2x 6321305	5x 302121	2x 6347294	2x 300424	9x 371024	2x 6439039	2x 6308032	2x 6267487	6x 6020193	2x 6166859	2x 4523339
2x 6494496	2x 302121	24x 6248971	2x 243224	3x 302024	16x 6284699	2x 6308000	56x 6092585	4x 6016172	2x 6053077	2x 6286381
2x 6271820	2x 6129995	1x 4179094	1x 393724	2x 6424448	12x 6335388	2x 6210270	3x 393826	4x 4141580	2x 302226	2x 6286381
8x 6378120	4x 4633914	1x 4179095	1x 393724	2x 6424448	2x 307026	4x 4180508	1x 393826	4x 4141580	4x 302226	8x 362226
2x 6360104	2x 371021	1x 4179095	2x 6360077	2x 6424448	2x 307026	1x 4180508	1x 393726	6x 6250020	4x 6133722	4x 428626
2x 6399645	2x 371021	6x 6534027	3x 6117938	2x 6534032	4x 300526	1x 4180536	10x 306926	4x 6363033	2x 235726	2x 362326
16x 6210269	1x 6029952	2x 4550348	1x 6208753	4x 366624	1x 6181720	1x 6181713	24x 302326	8x 6214807	1x 6524426	3x 6535085
8x 403221	2x 4514843	4x 403224	3x 6057458	4x 366624	4x 302426	5x 4548180	11x 370026	3x 6093525	4x 6425507	4x 302126
2x 4278275	2x 6299413	4x 6281992	2x 6253273	3x 4243817	2x 436026	2x 6525967	17x 300426	1x 6093525	4x 4517737	4x 300226
2x 6066342	2x 74156	14x 6228597	17x 302224	2x 379524	2x 6335317	3x 6525966	2x 4121966	1x 4283046	2x 6211476	4x 300226
2x 6173922	4x 6271167	2x 6173122	2x 302224	8x 4514844	1x 473326	43x 6279875	2x 4121966	1x 4283047	1x 4124096	4x 6395375
2x 6135130	4x 6168644	4x 6313121	2x 6410523	4x 4514844	1x 4214559	2x 6536593	2x 6524425	8x 6114987	2x 4283047	2x 383926
4x 6196217	3x 9336	31x 241224	2x 6308099	4x 6331084	3x 4298619	2x 6143850	8x 6114987	4x 6147050	15x 300326	2x 383926
4x 6196217	3x 9336	4x 4540384	2x 6308099	4x 6331084	3x 4298619	2x 6143850	4x 6147050	4x 6147050	14x 242026	4x 6018805
1x 300421	6x 300524	20x 302324	8x 6130007	4x 73587	4x 6336977	2x 6195325	2x 6347310	2x 6347310	14x 306826	4x 6018805
16x 6372383	4x 302424	4x 6092583	2x 428624	2x 6321194	3x 6268852	2x 4198367	2x 6347310	2x 6347310	14x 306826	8x 243126
3x 302221	4x 6329867	4x 6092583	2x 428624	1x 614126	3x 6268852	4x 6265091	1x 9553	6x 303926	2x 6470981	9x 301026

4

3

- 8x 370126
- 12x 371026
- 4x 4187209
- 4x 4619323
- 2x 4143243
- 1x 6170529
- 2x 6174917
- 4x 6416444
- 2x 6331437
- 1x 6168638
- 8x 300126
- 18x 302026
- 2x 303726
- 2x 4560182
- 2x 4142135
- 4x 6312482
- 1x 6525968

5

- 4x 6131571
- 2x 4541984
- 4x 4620763
- 2x 663626
- 2x 300926
- 11x 366626
- 2x 6058118
- 5x 6318582
- 3x 379526
- 4x 4205347
- 3x 346026
- 1x 6195436
- 2x 6534034
- 6x 303626
- 4x 6057902
- 6x 6534030

- 3x 389526
- 2x 6001494
- 2x 370326
- 8x 6514191
- 8x 6514235
- 5x 6514021
- 2x 6245252
- 18x 6513963
- 2x 6254635
- 15x 6514003
- 4x 6514220
- 8x 6507880
- 2x 6503463

- 1x 6514193
- 1x 6534033
- 1x 6534132
- 4x 6159763
- 4x 6336539
- 41x 6248890
- 4x 4211398
- 2x 6202649
- 1x 6015344
- 4x 4211632
- 2x 6065824

5

- 2x 4211349
- 2x 4211445
- 2x 4560183
- 1x 4211360
- 1x 6240515
- 3x 6395635
- 17x 6510213
- 4x 6549523
- 1x 6302647
- 2x 4499858

8



[LEGO.com/service](https://www.LEGO.com/service)



YOU COULD WIN



YOU COULD WIN

Your feedback will help shape the future development of this product series.

Visit:

DU KÖNNTEST GEWINNEN

Dein Feedback trägt zur Weiterentwicklung dieser Produktreihe bei.

Geh auf:

VOUS POURRIEZ GAGNER

Vos commentaires nous aideront à concevoir les futurs produits de cette gamme.

Visitez :

POTRESTI VINCERE TU

La tua opinione ci aiuterà a migliorare la creazione futura di questa linea di prodotti.

Visita:

PUEDES GANAR

Tu opinión contribuirá al futuro de esta serie de productos.

Visita:

轻松获奖

您的反馈将有助于我们在今后改进本产品系列。

请访问:

[LEGO.com/productfeedback](https://www.lego.com/productfeedback)

You also have the chance to win a LEGO® set.

Terms and conditions apply.*

Außerdem hast du die Chance, ein LEGO® Set zu gewinnen.

Es gelten die Teilnahmebedingungen.*

Vous pourriez également gagner un ensemble LEGO®.

Des conditions s'appliquent.*

Hai anche la possibilità di vincere un set LEGO®.

Termini e condizioni sono applicabili.*

También tienes la oportunidad de ganar un set LEGO®.

Aplican términos y condiciones.*

您还有机会赢取乐高®套装。

条款和条件适用。*

*[LEGO.com/productfeedback-terms](https://www.lego.com/productfeedback-terms)

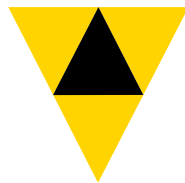

LEGO and the LEGO logo are trademarks of the LEGO Group. ©2025 The LEGO Group.

6553149