



10345





LEGO.com/sustainable-packaging



FR

**DONNEZ**  
OU  
**RECYCLEZ**



ASSOCIATION

OU



MAGASIN

OU



DÉCHÈTERIE

Adresses sur [quefairedemesdechets.fr](http://quefairedemesdechets.fr)



# BUiLDER



Apple and the Apple logo are trademarks of Apple Inc., registered in the U.S. and other countries and regions. App Store is a service mark of Apple Inc. Google Play and the Google Play logo are trademarks of Google LLC. Tencent and the Tencent logo are trademarks of Tencent Inc.

Q [LEGO.com/devicecheck](https://LEGO.com/devicecheck)



Q LEGO® Builder



**BUILD IT  
YOUR  
WAY**

**EN** Build It Your Way | **DE** Bau, wie du willst  
| **FR** Construisez à votre façon | **IT** Costruiscilo come  
vuoi tu | **ES** Constrúyelo a tu manera | **PT** Constrói à  
Tua Maneira | **ZH** 自由拼搭 | **PL** Zbuduj po swojemu  
| **CS** Postavte to po svém | **SK** Postavte to po svojom  
| **HU** Építs kedved szerint! | **RO** Construięște așa cum dorești  
| **BG** Постройте го по своя начин | **LV** Būvē tieši tā, kā  
vēlies | **ET** Ehita enda moodi | **LT** Sukonstruokite savaip



# UN CADEAU DE LA NATURE CRÉATIVE

La collection LEGO® Botanique ouvre la voie à de nombreuses possibilités créatives colorées. Avec des sets inspirés de la flore du monde entier, les amoureux de la nature peuvent se laisser tenter par une version colorée et gaie de ces « fleurs éternelles ». Pour ce set, nous avons imaginé une composition harmonieuse en plaçant des éléments de bouquet dans un joli vase blanc sur pied – transformable à l'infini.



*Camellia x williamsii*

## Le camélia hybride de Williams Night Rider

*Cultivé à l'origine au Royaume-Uni, cet arbuste compact aux feuilles persistantes, sombres et brillantes, est orné de fleurs semi-doubles marron foncé qui fleurissent à la fin de l'hiver et au début du printemps. Dans les jardins, il peut atteindre jusqu'à 1,5 m de haut et de large.*

## La pivoine Itoh

C'est au Japon que la pivoine intersectionnelle a été cultivée pour la première fois, dans les années 1940. Hybride entre les arbres et les pivoines herbacées, ses fleurs peuvent atteindre 20 cm de large.

Bien qu'elle n'apprécie généralement pas de se retrouver dans un pot, cette version LEGO® fleurira à coup sûr toute l'année.



*Paeonia Itoh*

*Hortensia arborescens*

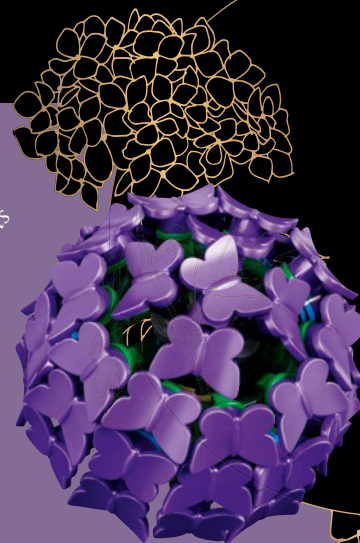

## L'hortensia

Originaires d'Asie, d'Amérique du Nord et d'Amérique du Sud, plus de 70 espèces de ces arbustes majestueux ont pris racine dans les jardins du monde entier. La couleur des fleurs varie selon le pH du sol, du bleu (acide) au rose (alcalin), en passant par le blanc (neutre).

## Le gypsophile

Élément de base prisé dans les compositions florales du monde entier, le gypsophile est léger comme un nuage d'été. Symbole de l'amour éternel, il apporte une touche de grâce à un bouquet ou un centre de table, même lorsqu'il est séché et disposé dans des vases ou sur des couronnes.



*Ranunculus*

## La renoncule des fleuristes

Plante vivace tubéreuse, la renoncule des fleuristes peut atteindre jusqu'à 60 cm de haut. Avec ses pétales densément superposés aux couleurs douces ou vives, cette fleur coupée somptueuse et durable illumine n'importe quel espace, à l'intérieur ou dans votre jardin.





Bouvardia

## La bouvardie

Chaque tige semble être un bouquet miniature et chaque fleur s'ouvre en prenant la forme d'une ravissante petite étoile, inspirant d'autres noms familiers comme « buisson de pétards » ou « trompettes ». Bien qu'elle soit originaire d'Amérique centrale, on trouve également certains membres de sa famille en Europe et au Canada.



## Le lys

Comptant entre 80 et 100 espèces et presque autant de variations de couleurs, le lys nous fascine par son parfum agréable et sa beauté lumineuse. Symbole d'élégance et de pureté intemporelles, il est apprécié et souvent utilisé lors d'occasions spéciales ou pour exprimer des sentiments profonds.



Lilium



# PLANTEZ UNE GRAINE D'INSPIRATION

Construire une composition florale LEGO® Botanique n'est que le début. Chaque fois que vous souhaitez modifier votre composition, il vous suffit d'intervertir les têtes des fleurs entre les tiges ou de combiner plusieurs sets pour créer de tout nouveaux bouquets. Modifiez-la selon la saison, votre humeur et votre décoration intérieure. Si vous êtes déjà un(e) fleuriste LEGO chevronné(e), pourquoi ne pas vous diversifier et transformer votre set en d'autres espèces !







Découvrez encore plus  
d'astuces créatives  
grâce à votre compte  
LEGO® Insiders sur

[LEGO.com/Botanicals-exclusive](https://LEGO.com/Botanicals-exclusive)



À combiner avec le set 10342.  
Vendu séparément.

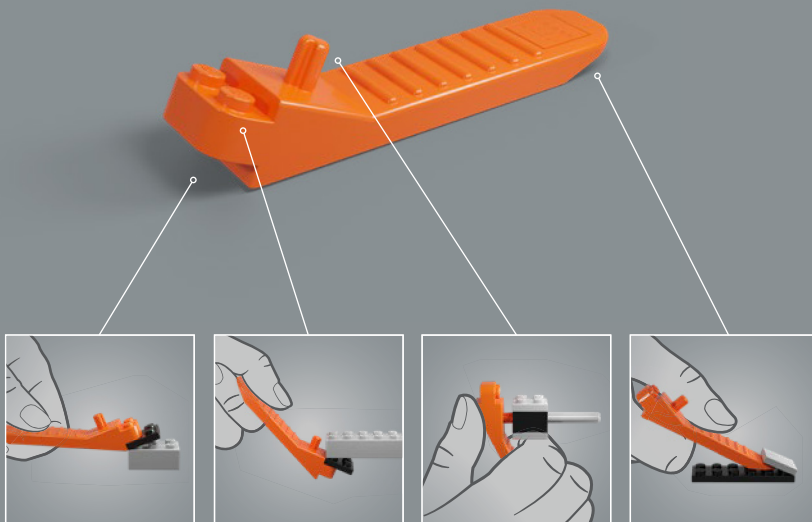

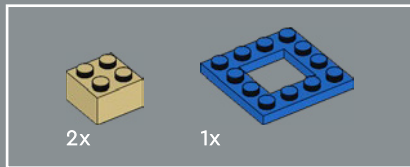

1

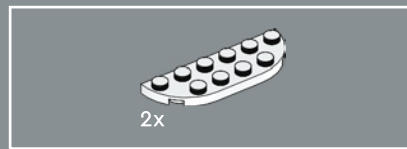
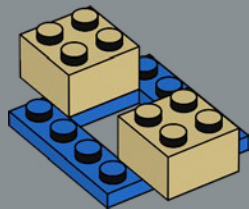

2

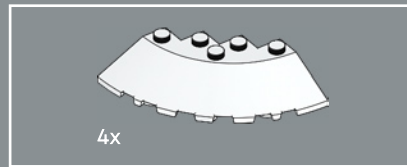
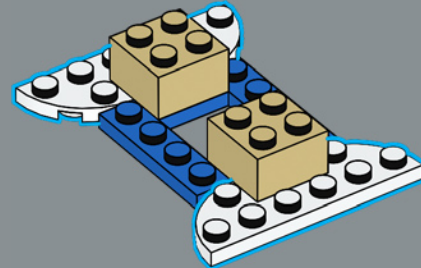

3

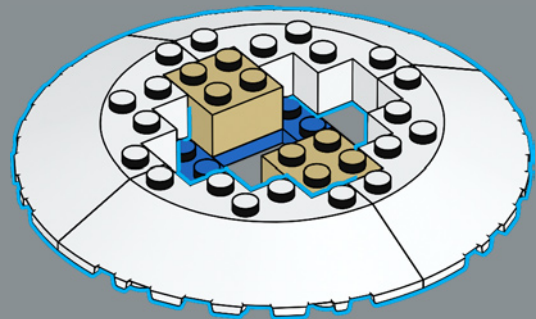

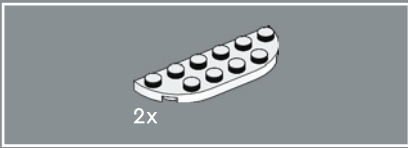

4

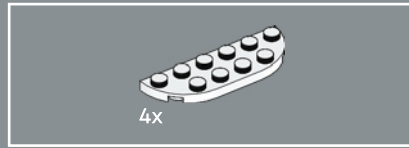
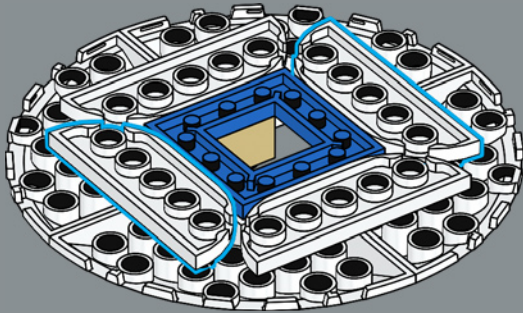

5

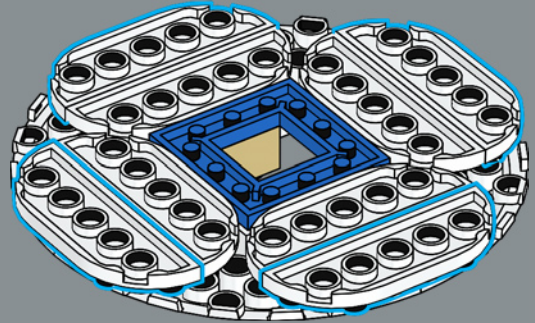



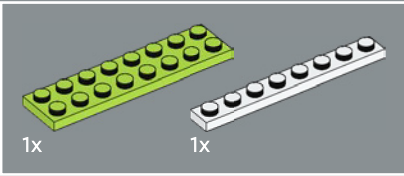
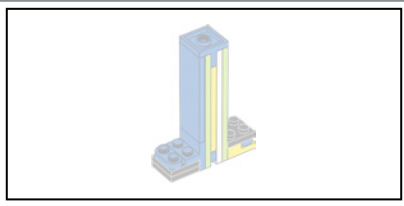

6

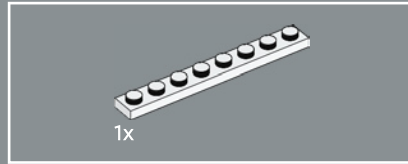
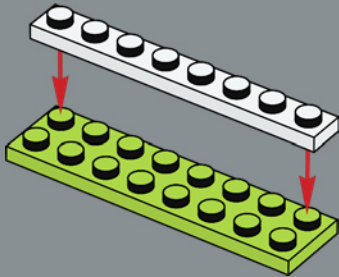

7

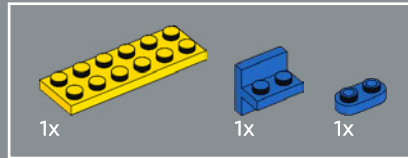
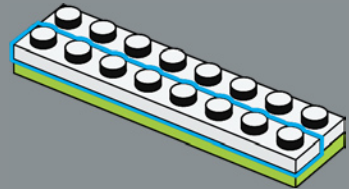

8

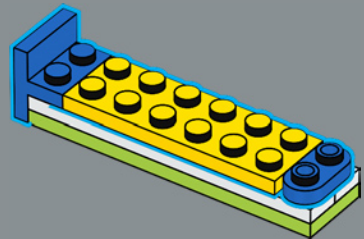

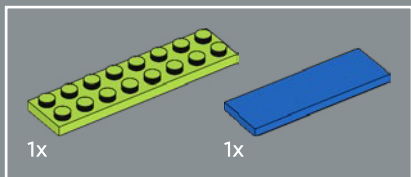

9

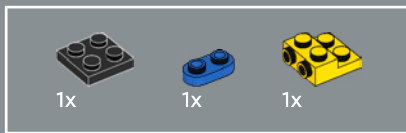
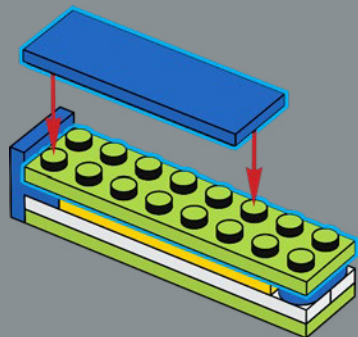

10

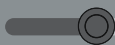
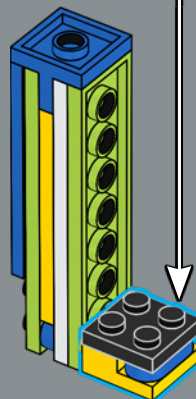
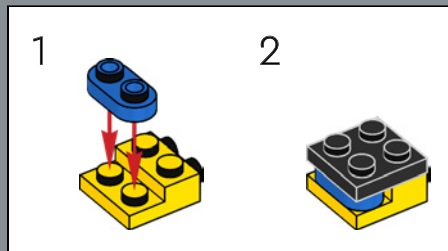

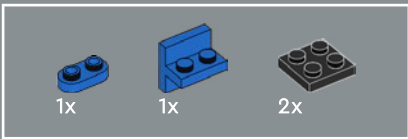

11

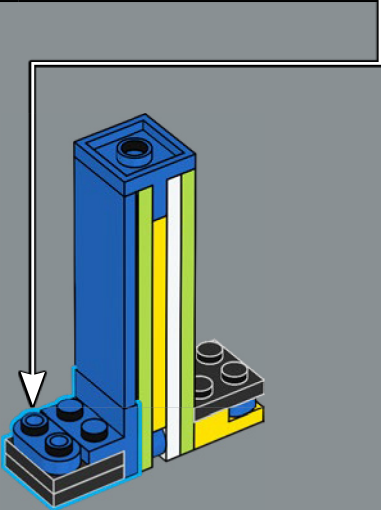
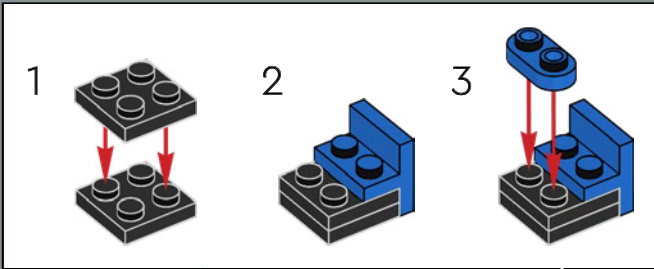

12

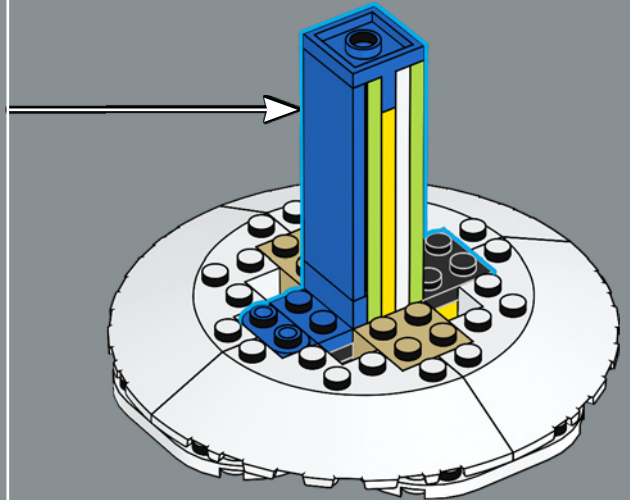

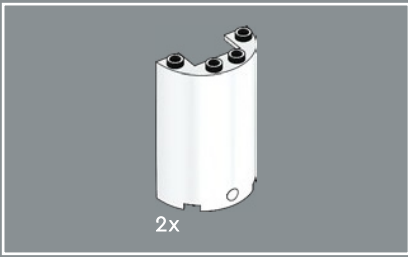

13

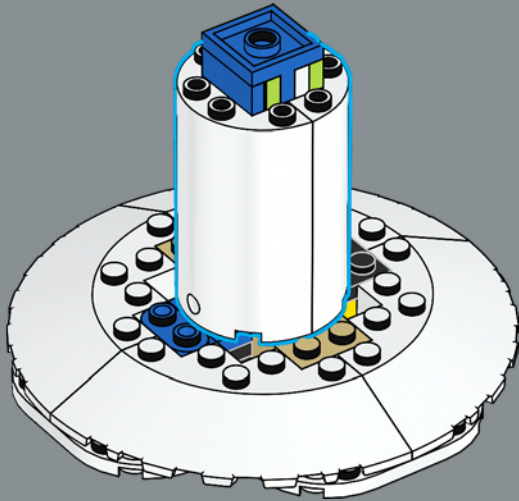

14

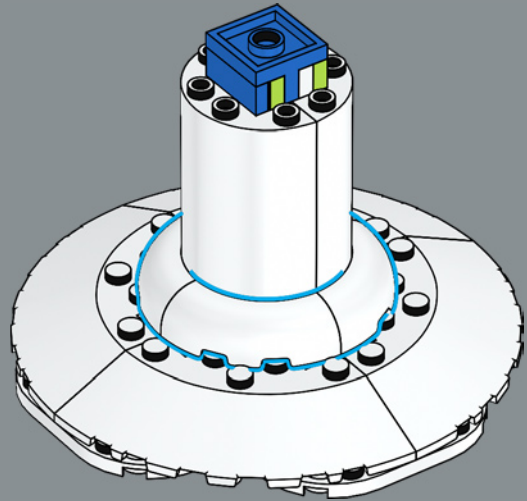

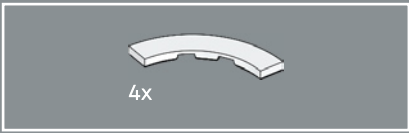

15

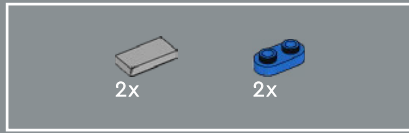
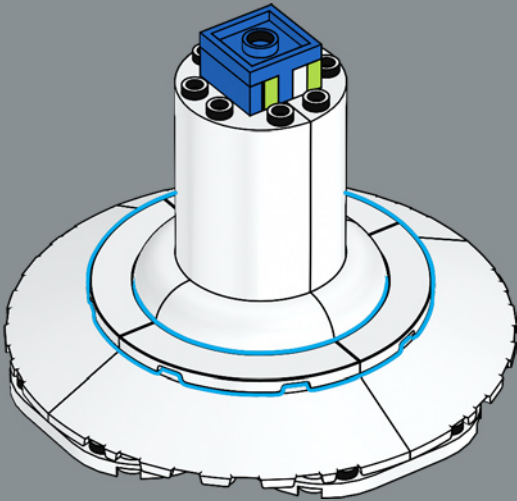

16

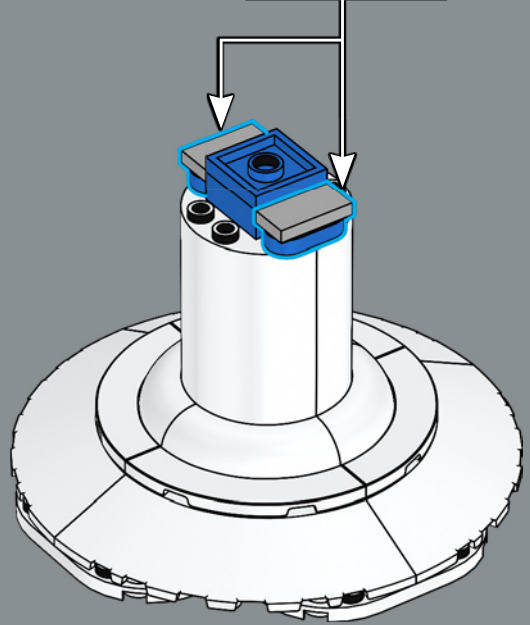
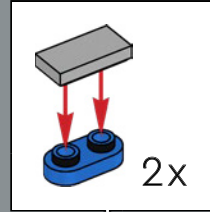



17

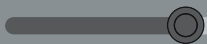
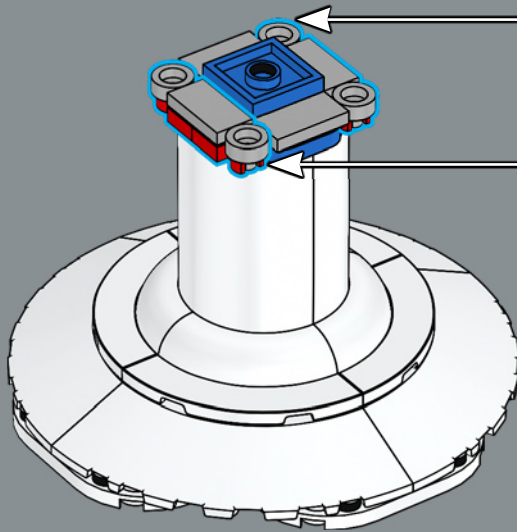
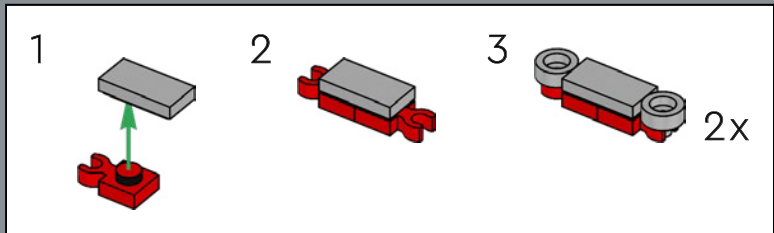

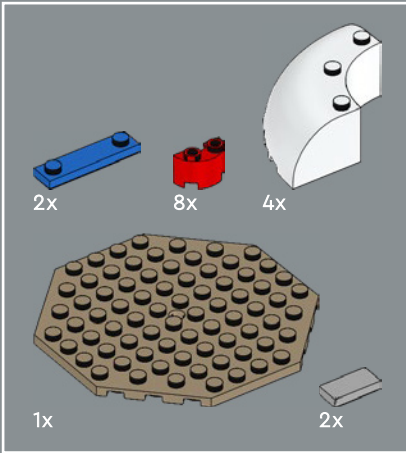
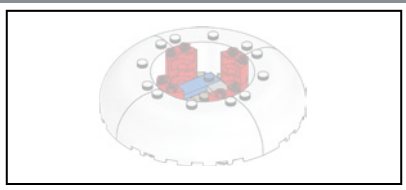

18

1

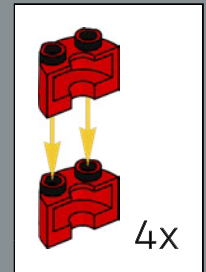
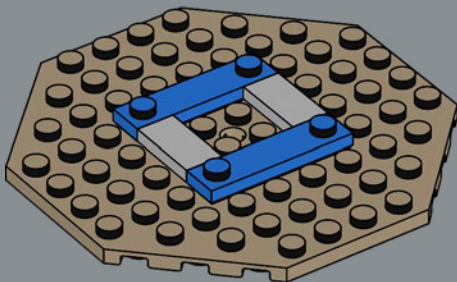

2

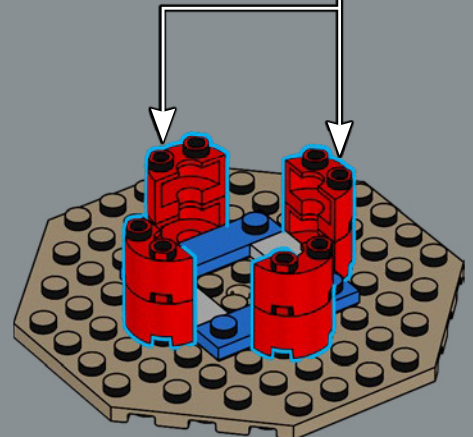

3

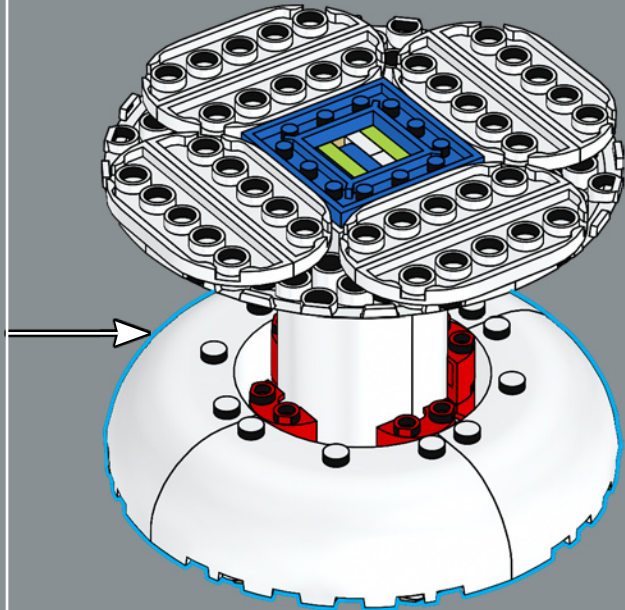
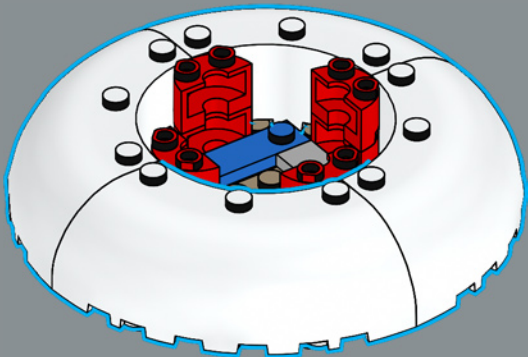





19

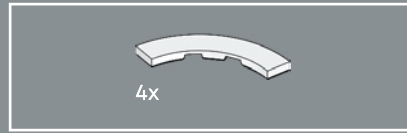
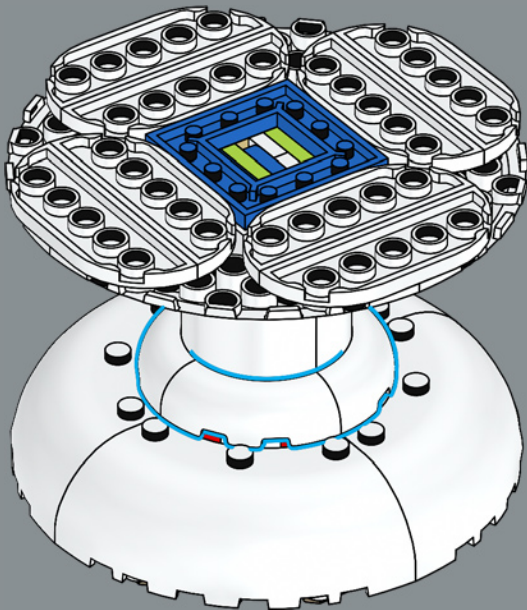

20

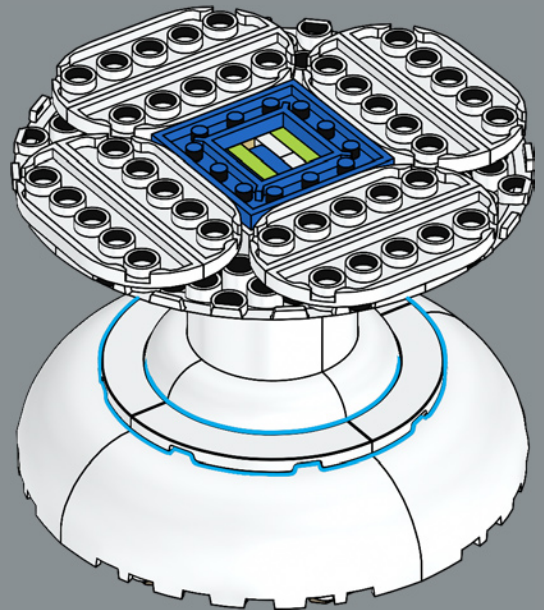



21

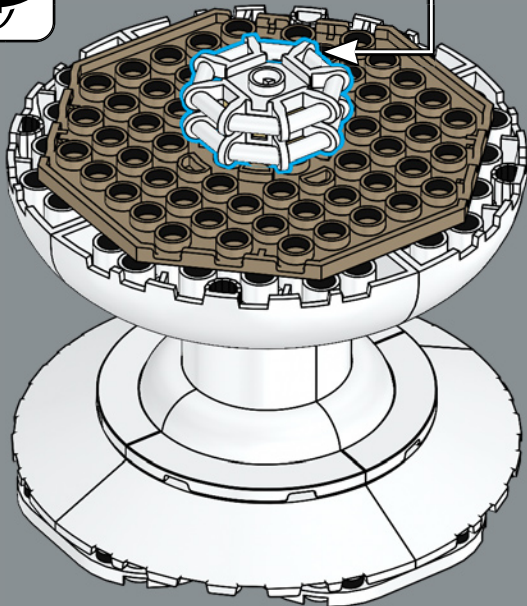
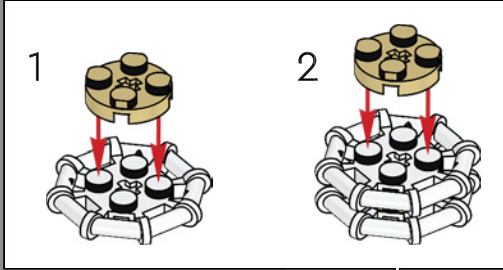

22

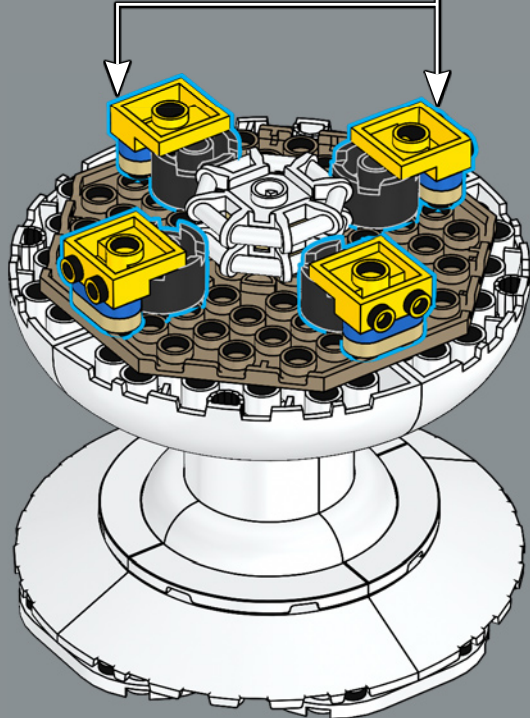
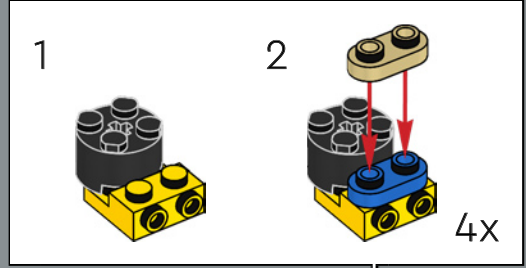

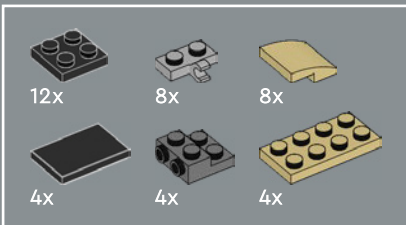
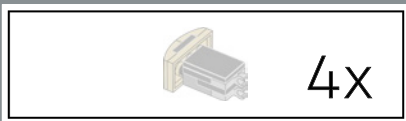

23

1

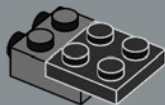

2

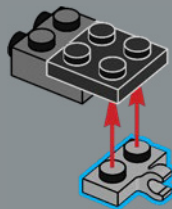

3

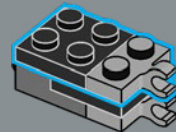

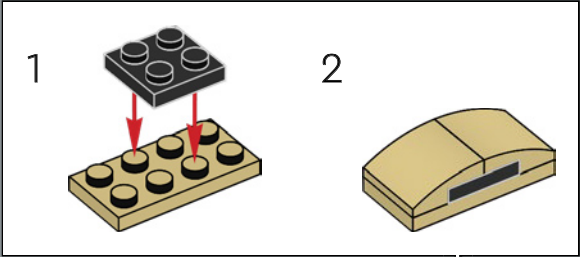

4

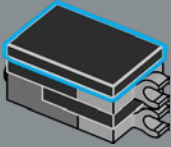

5

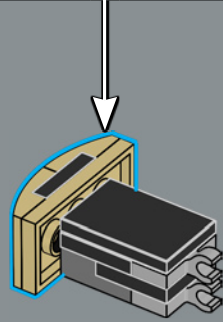

4x

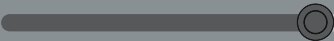

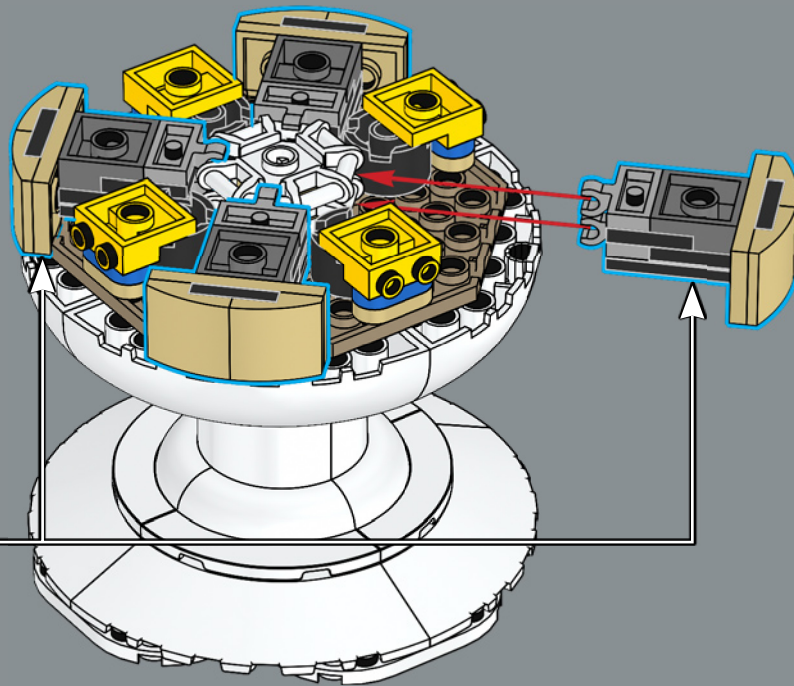

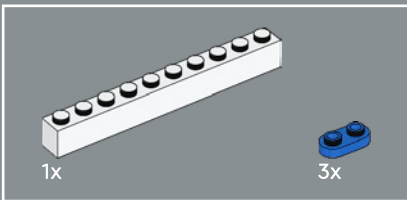
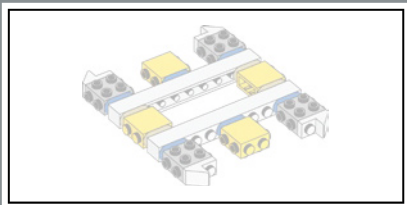

24

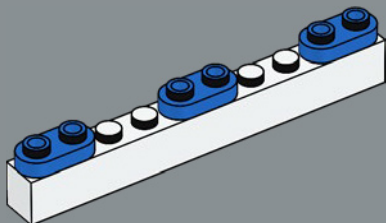

25

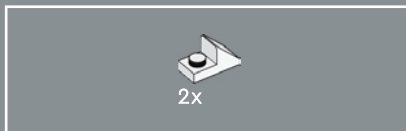
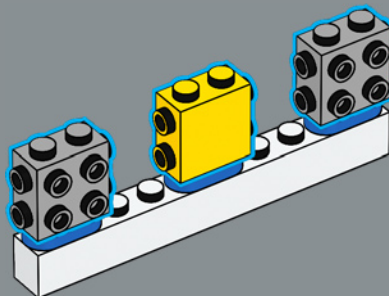

26

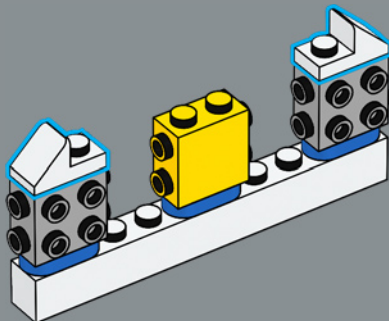



27

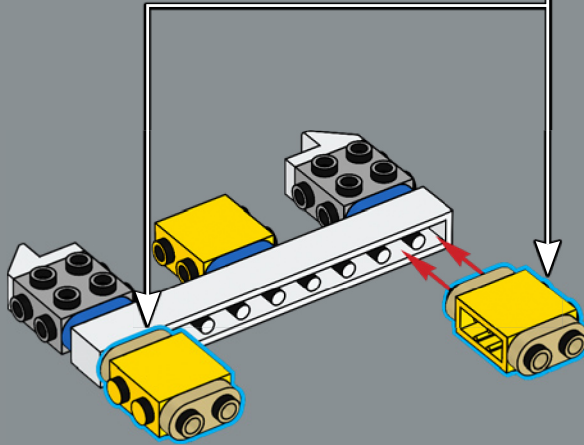
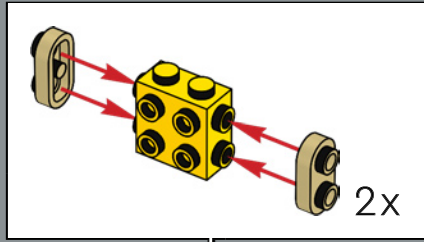

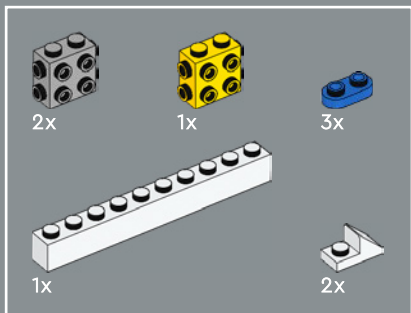

28

1

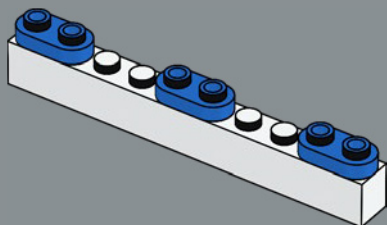

2

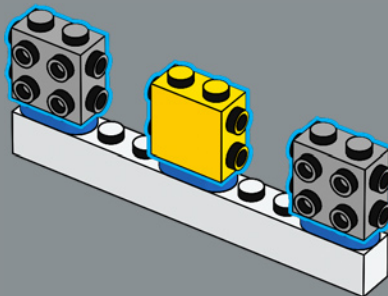

3

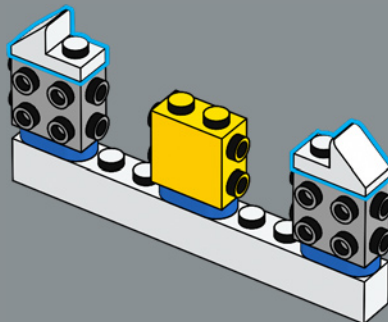



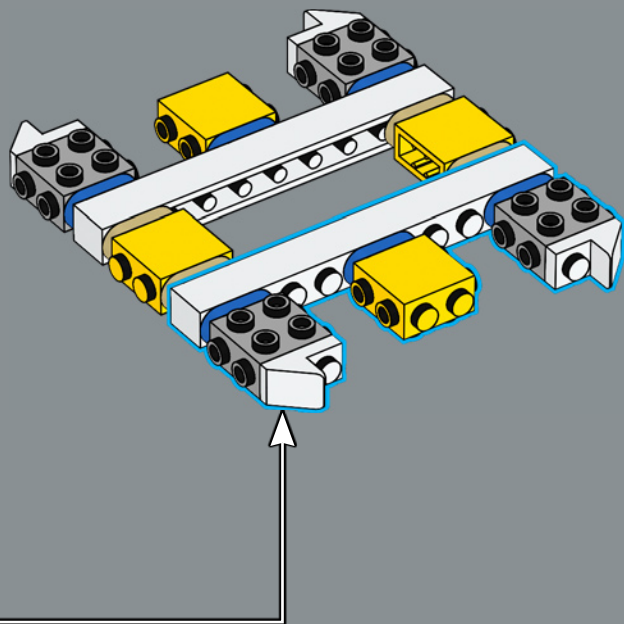

29

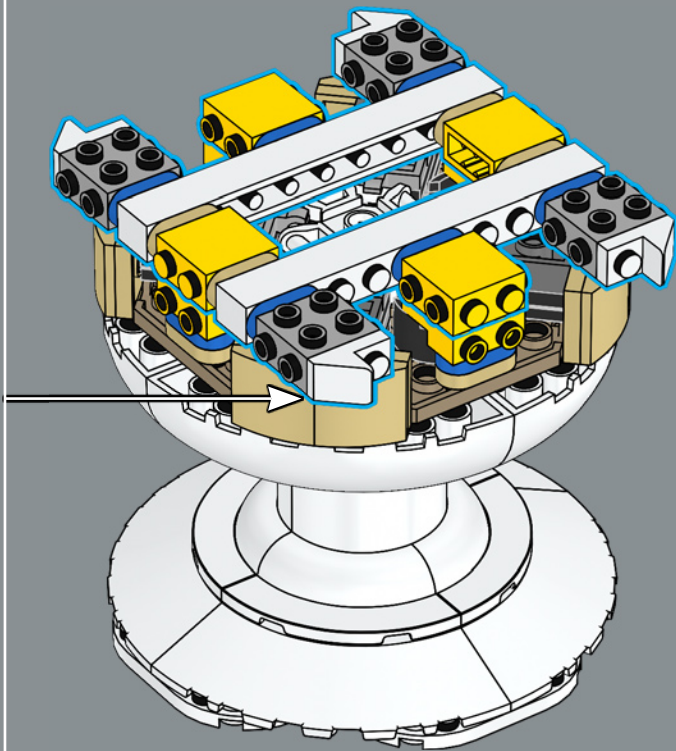

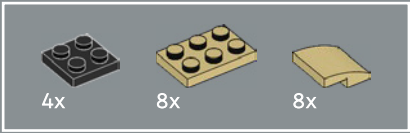

30

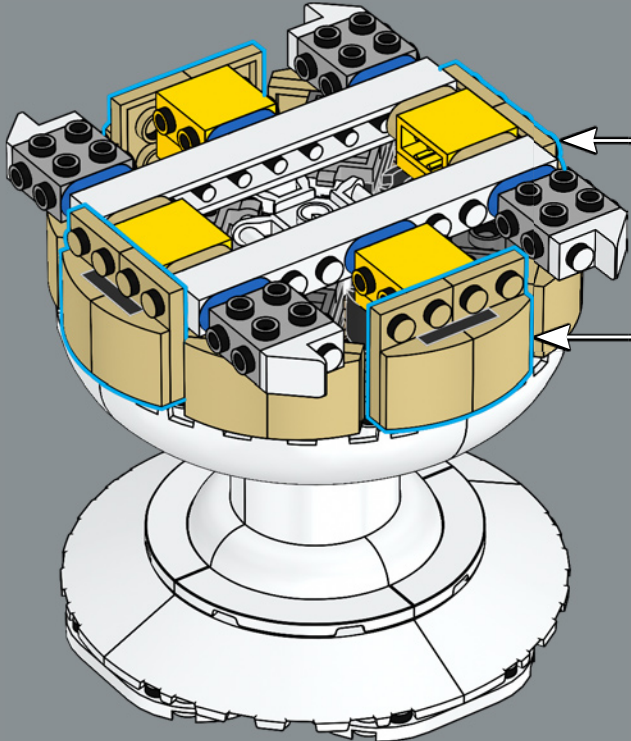
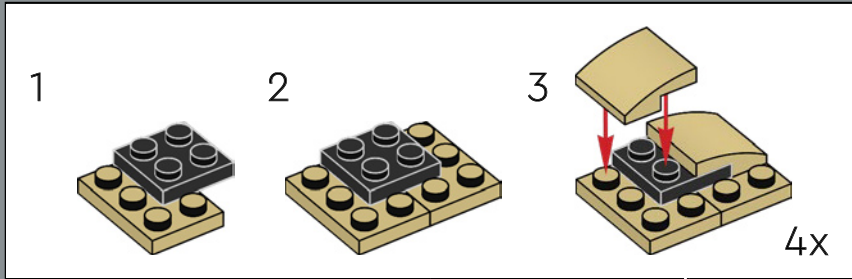

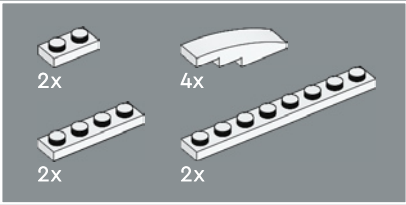
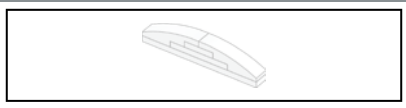

31

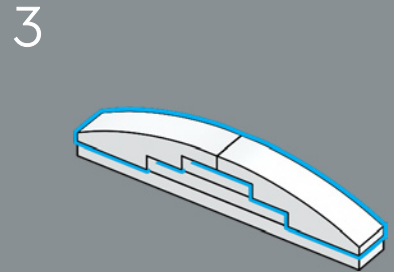
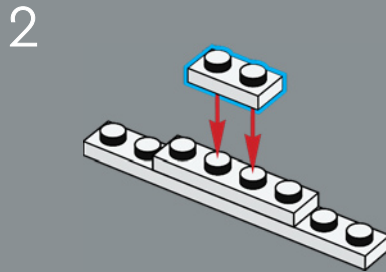
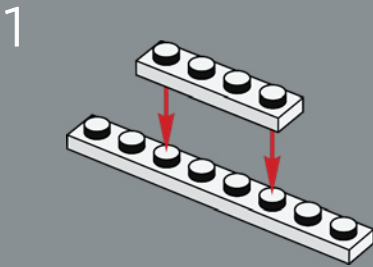

2x

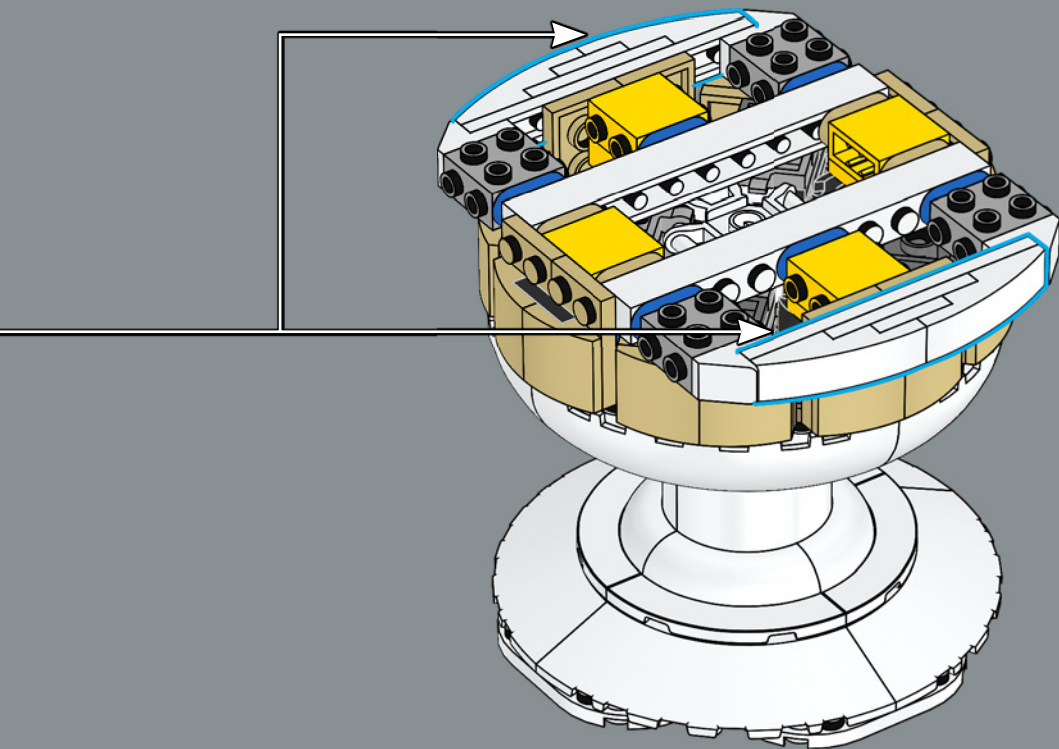

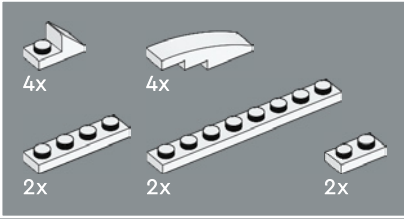
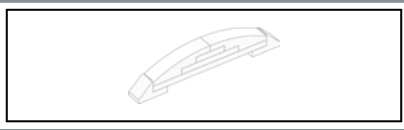

32

1

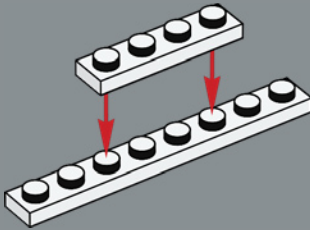

2

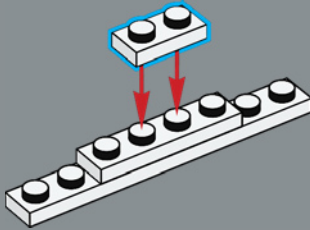

3

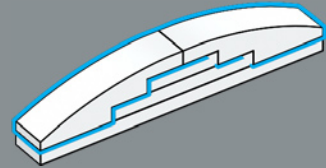

4

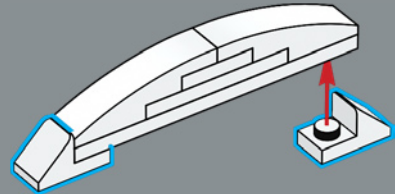

2x

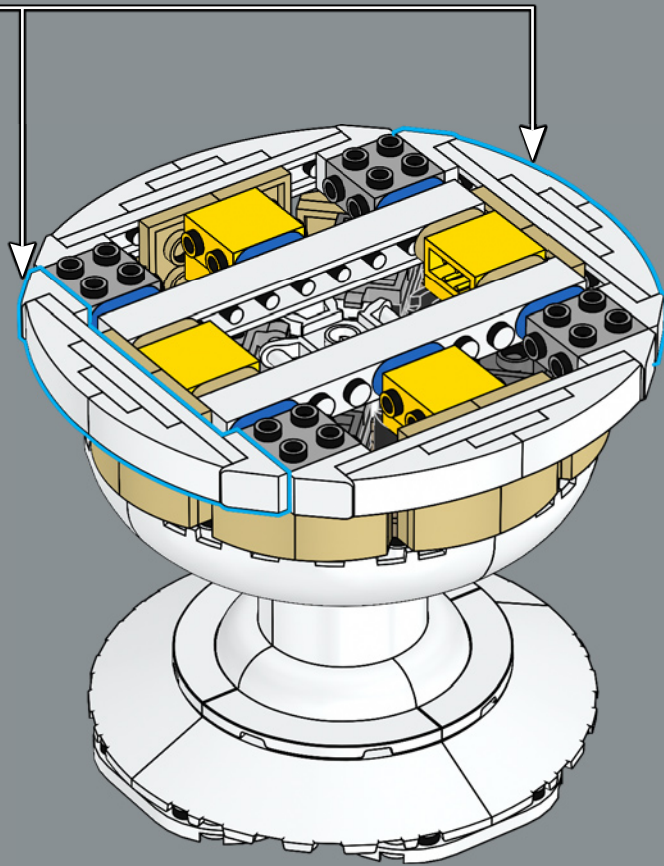

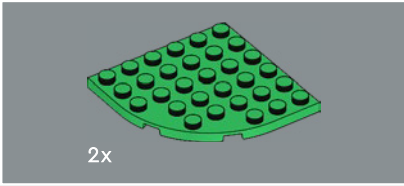
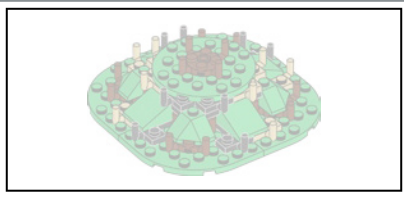

33

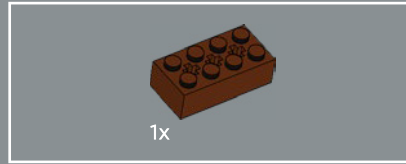
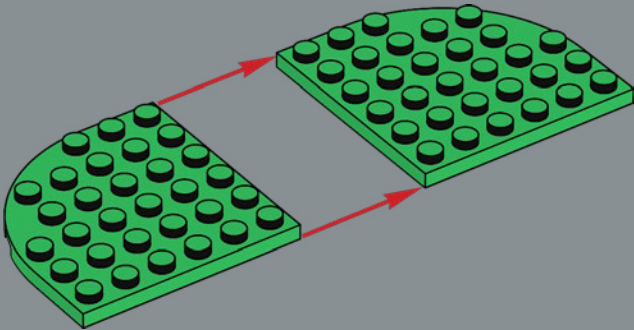

34

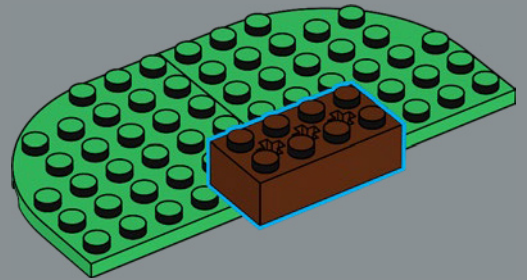

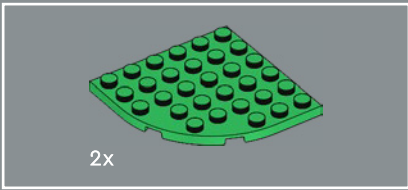

35

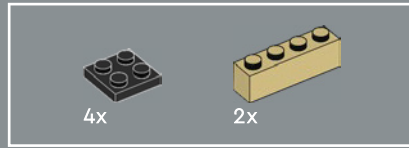
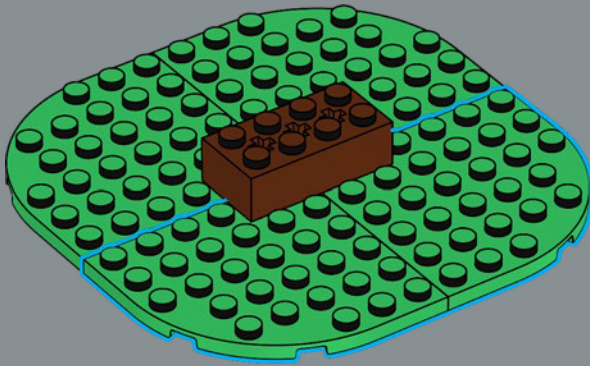

36

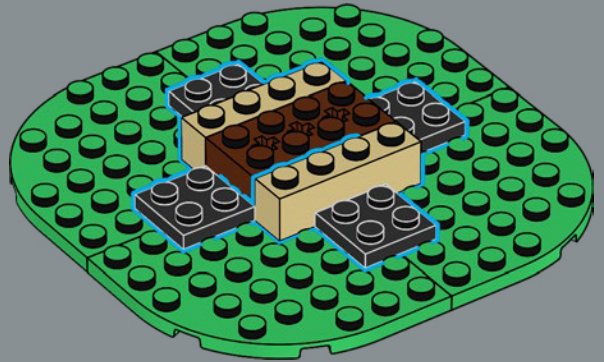





37

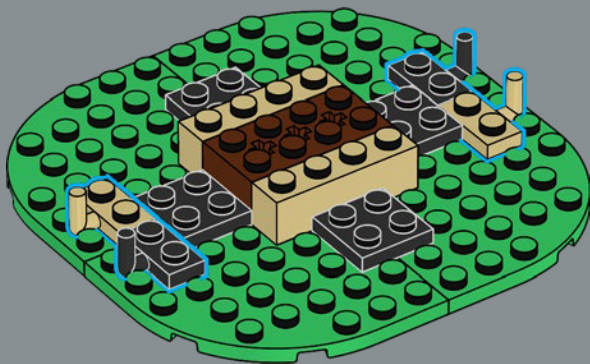

38

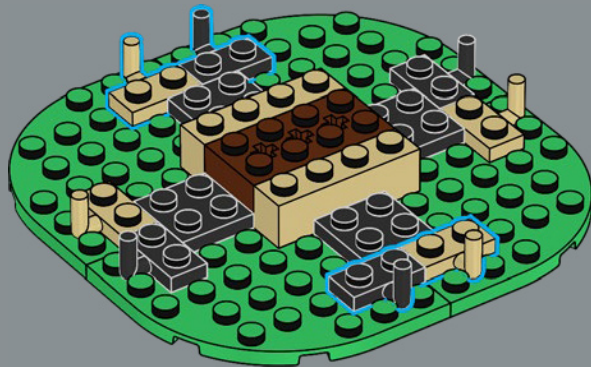



39

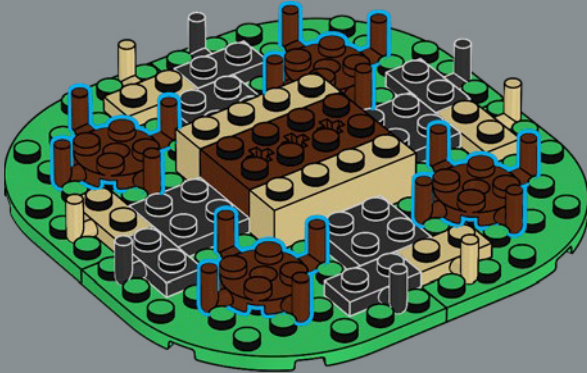

40

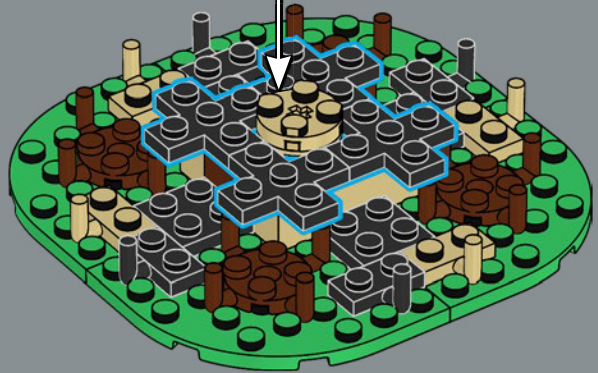
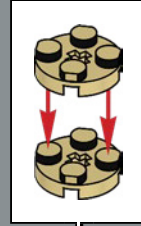

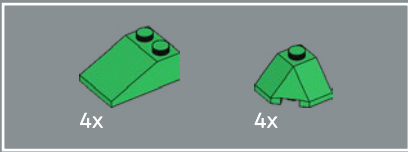

41

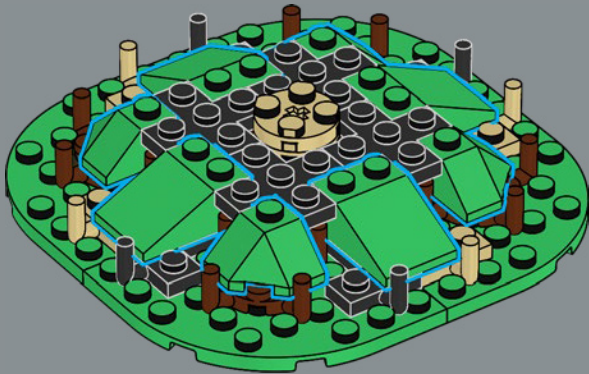

42

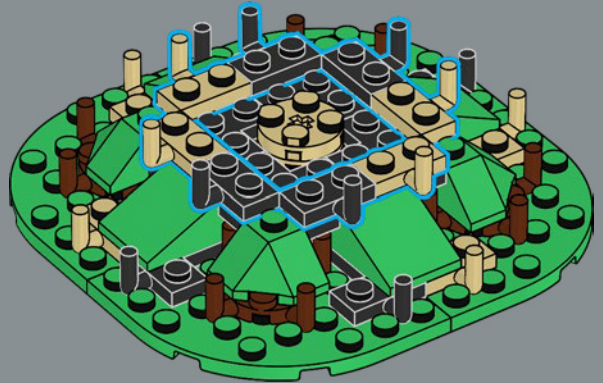

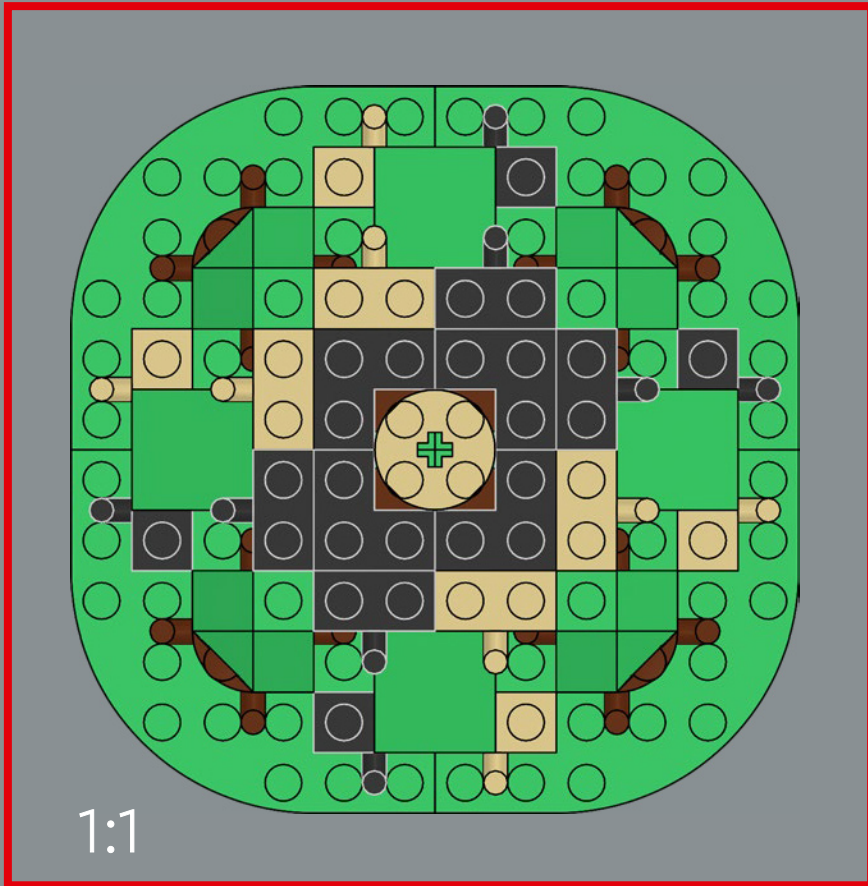

1:1



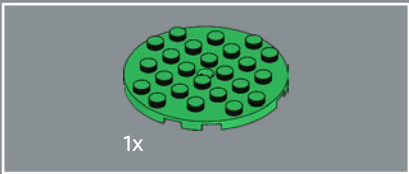

43

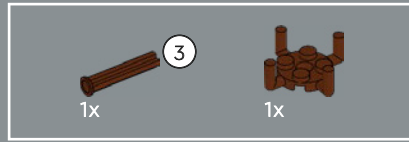
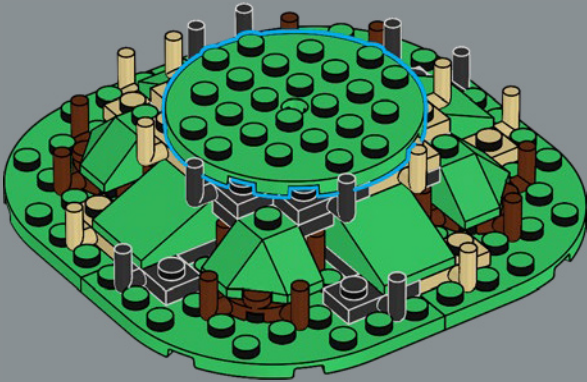

44

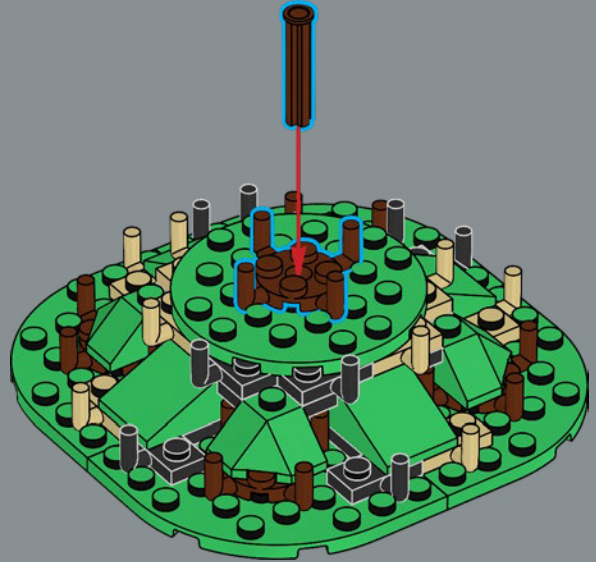

45



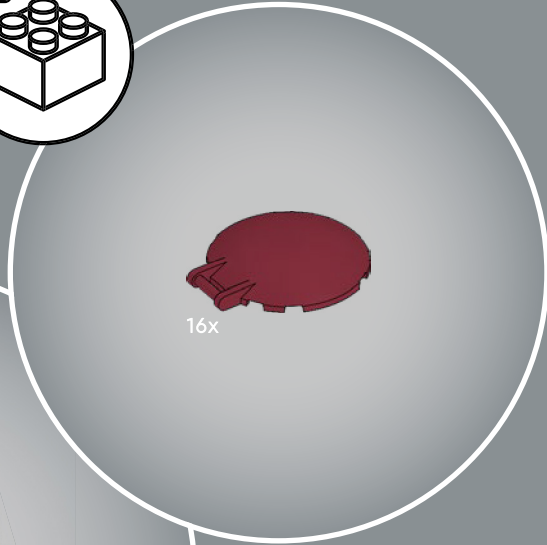
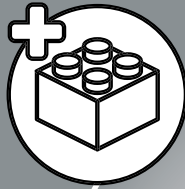

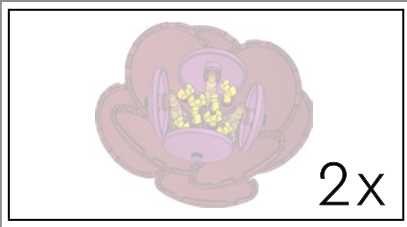

46

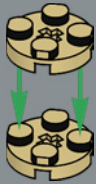

47



48







49

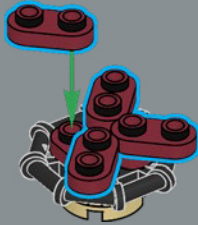

Besoin d'un coup de main pour construire cette fleur ?  
Ici, le cœur est réalisé avec des éléments de main de  
robot LEGO® !



50



51

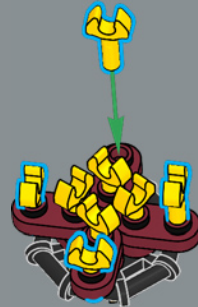

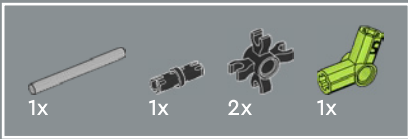

52

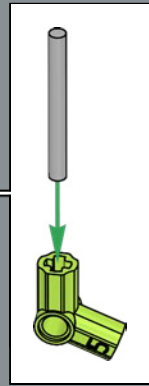
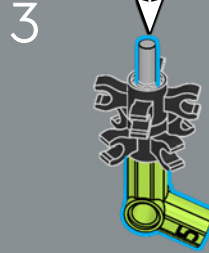
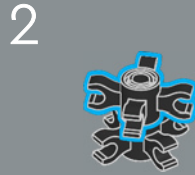
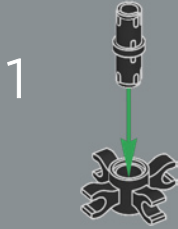



53

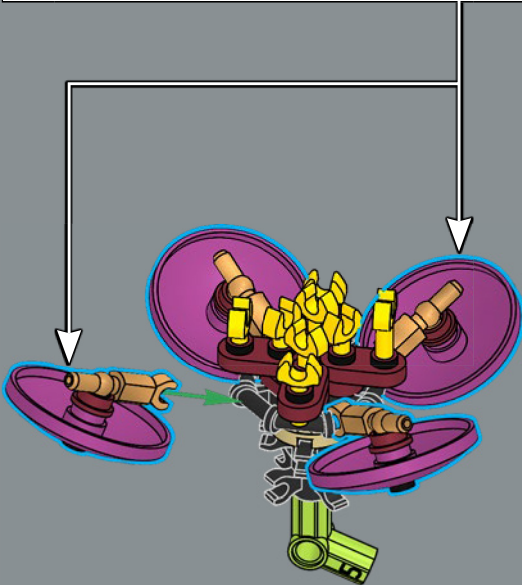
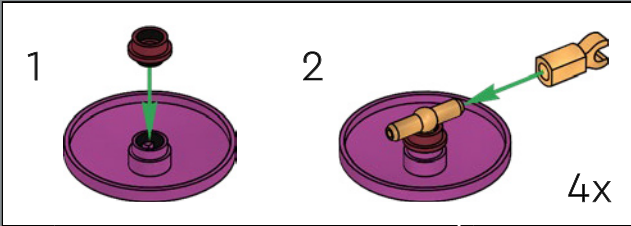

54

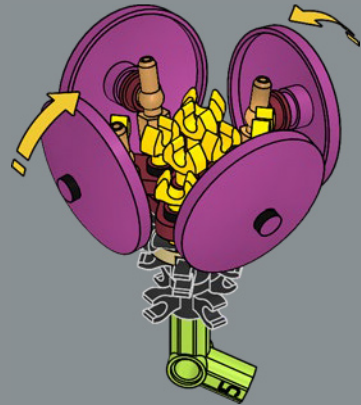

Le camélia hybride de Williams Night Rider :  
ces pétales rouge foncé ont souvent été  
utilisés (dans d'autres couleurs) dans les  
cockpits de différents véhicules LEGO®.

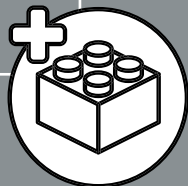
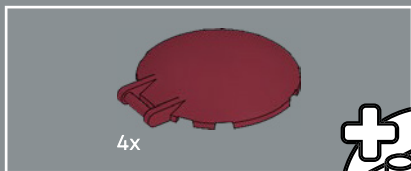

55

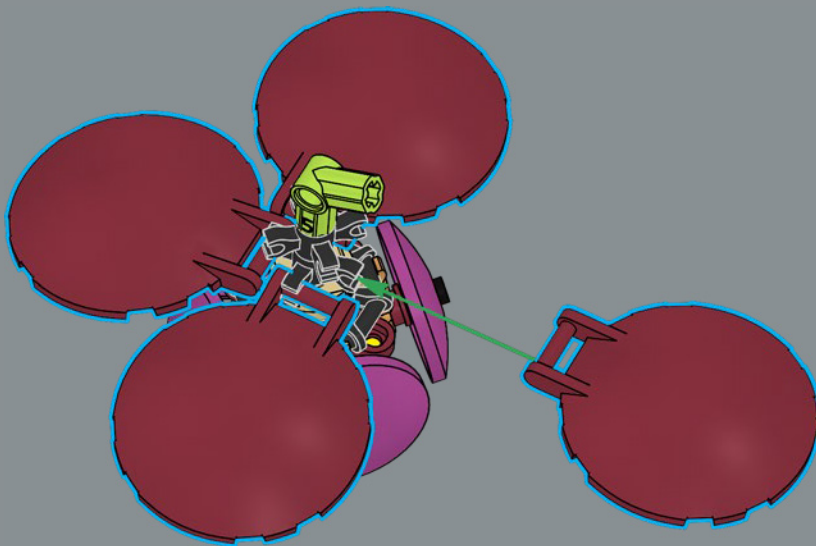

56

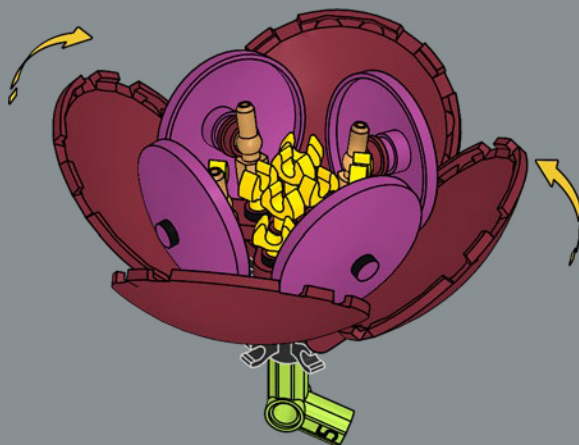

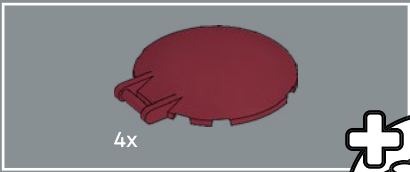

57

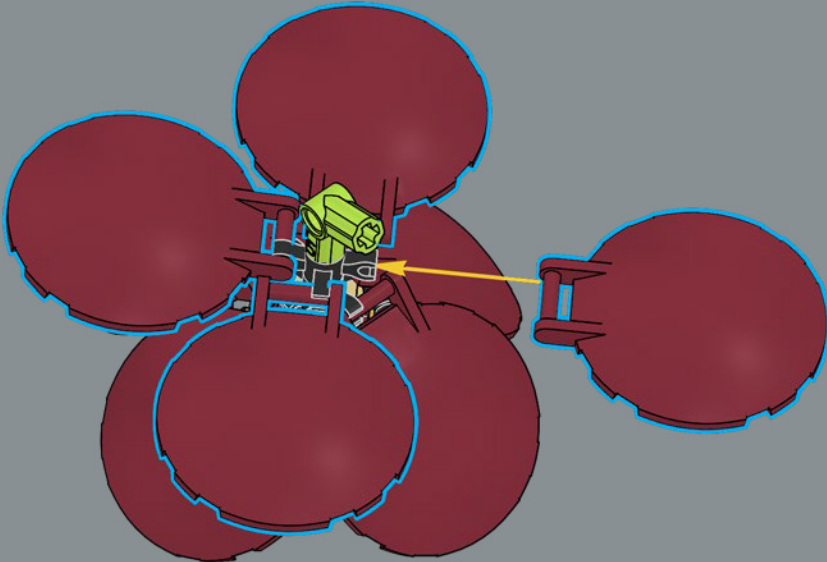
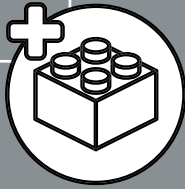

2x



58

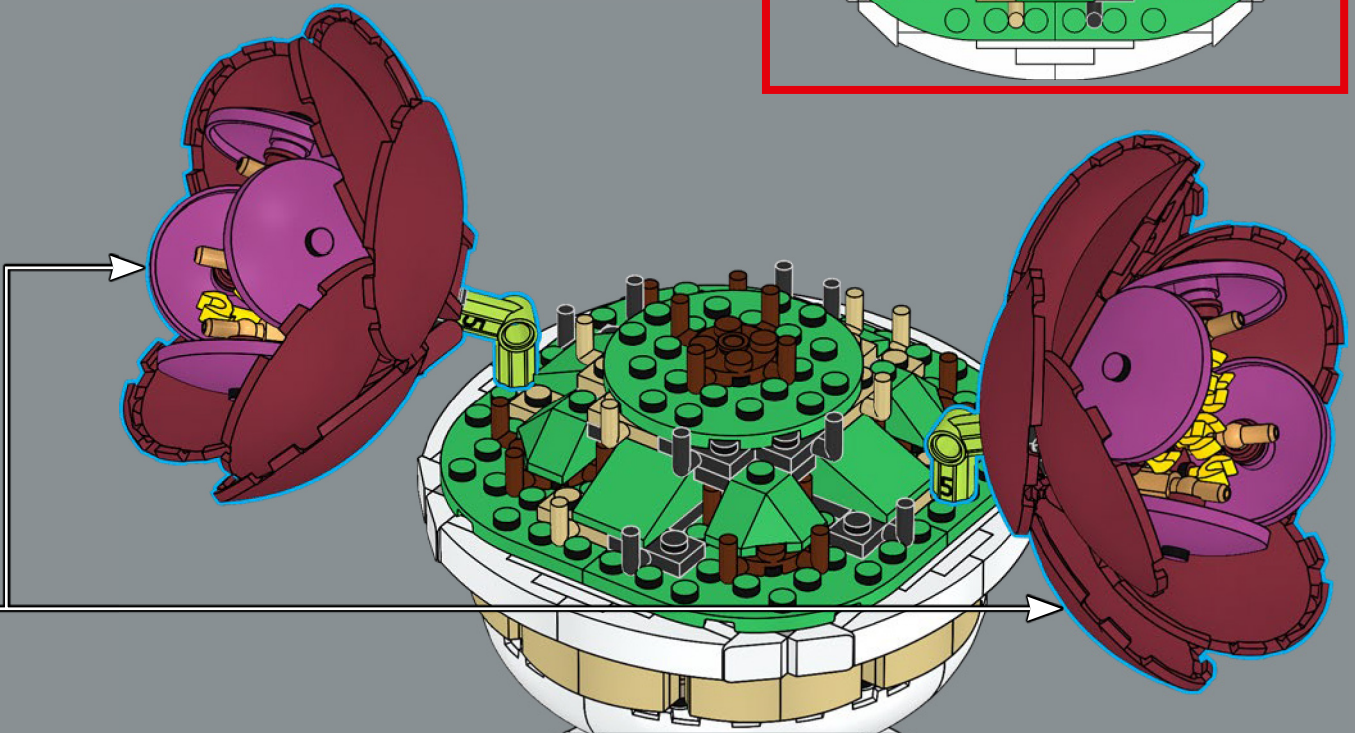
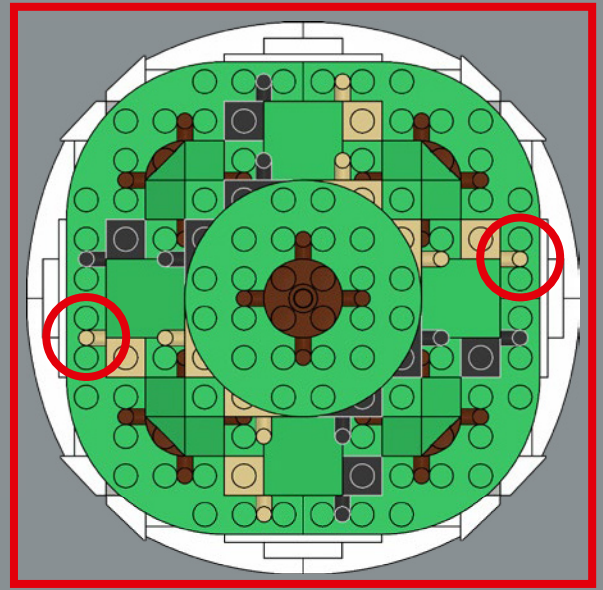

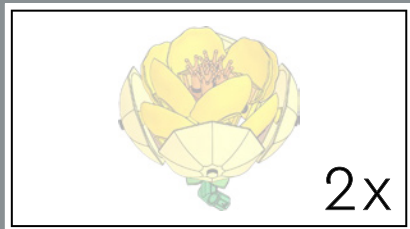

59

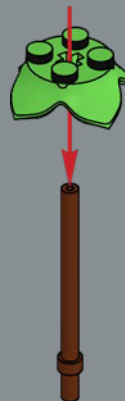

60







61

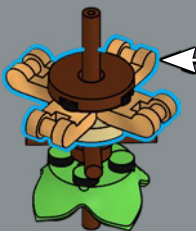
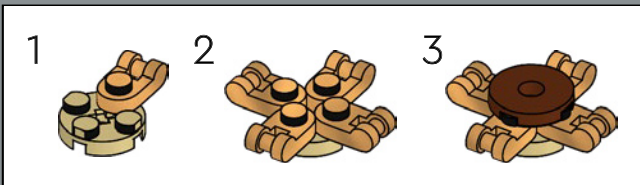

62

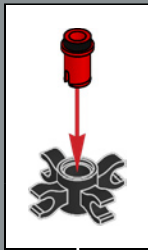



63

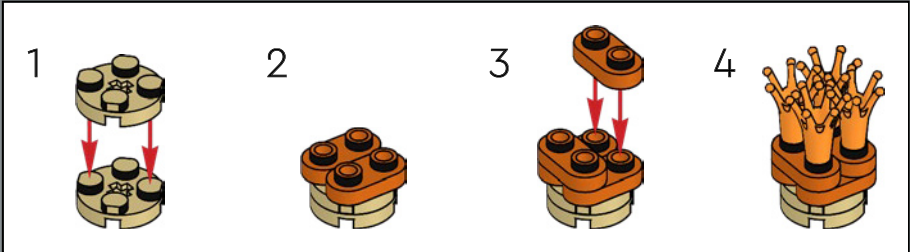



64

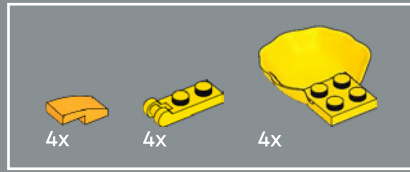

65

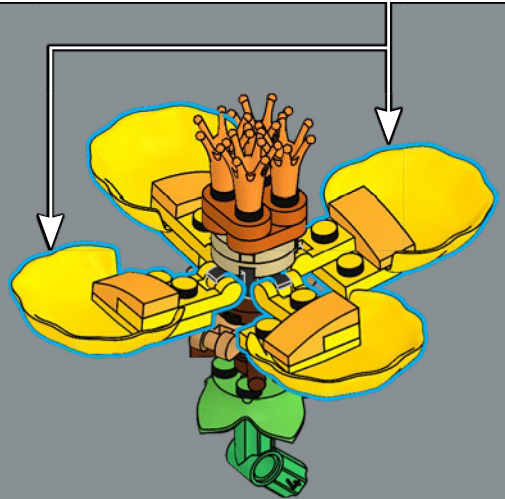
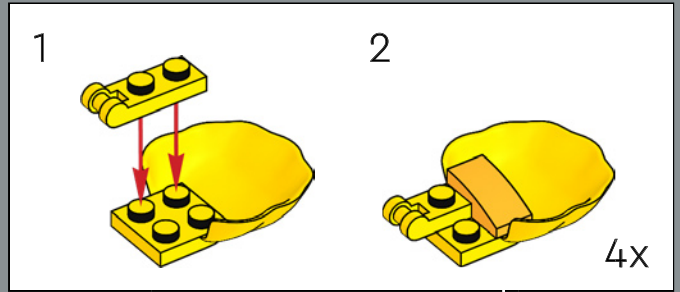

66

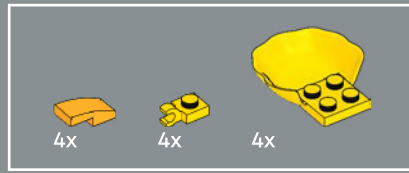
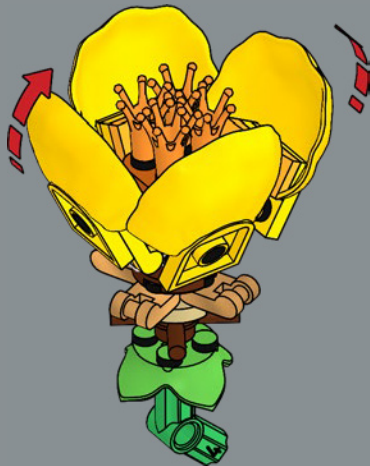

67

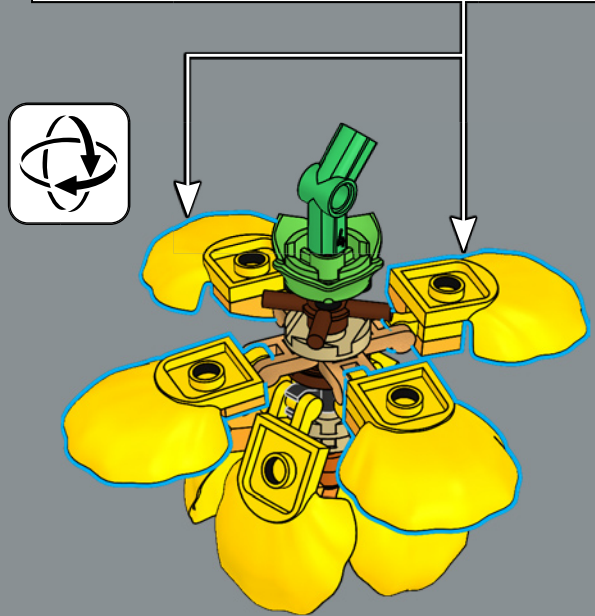
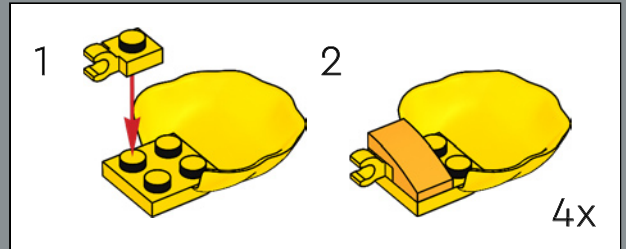

68

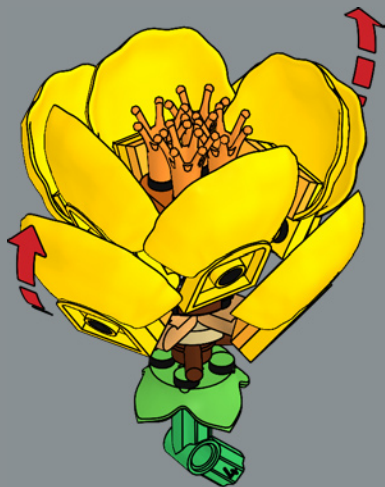

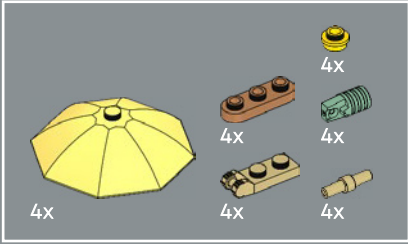
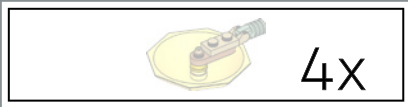

69

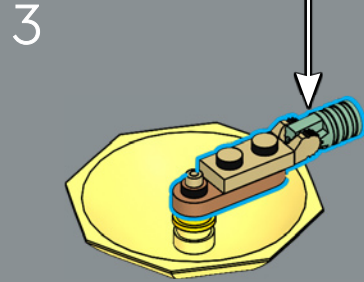
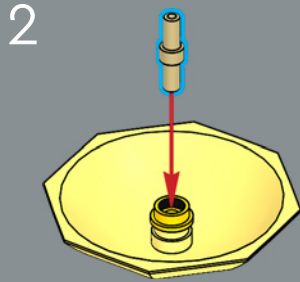
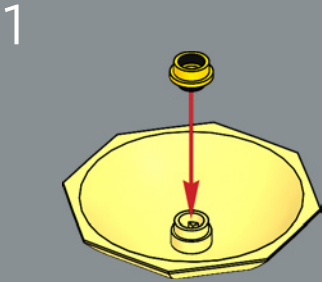
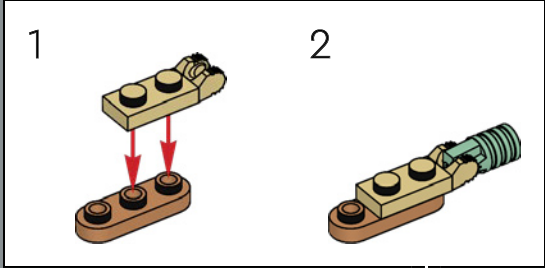

4x



La pivoine Itoh : vous avez une envie soudaine d'aller à la plage ? Peut-être réalisez-vous tout simplement que cette pivoine est composée de parasols, de coquillages et même de quelques couronnes LEGO® !

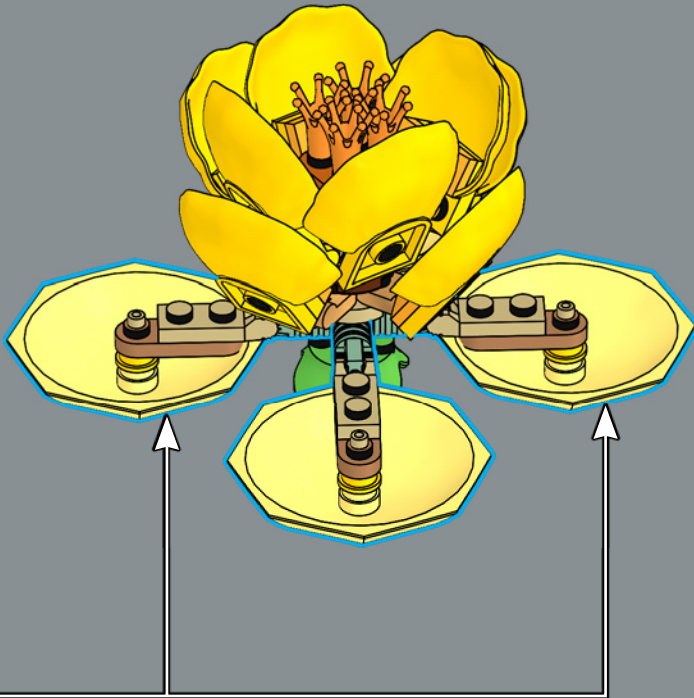

70

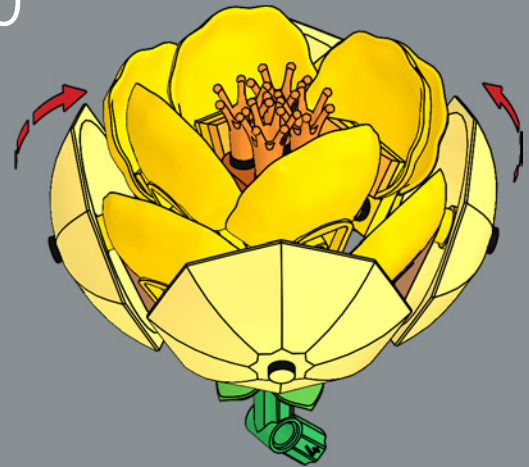

2x

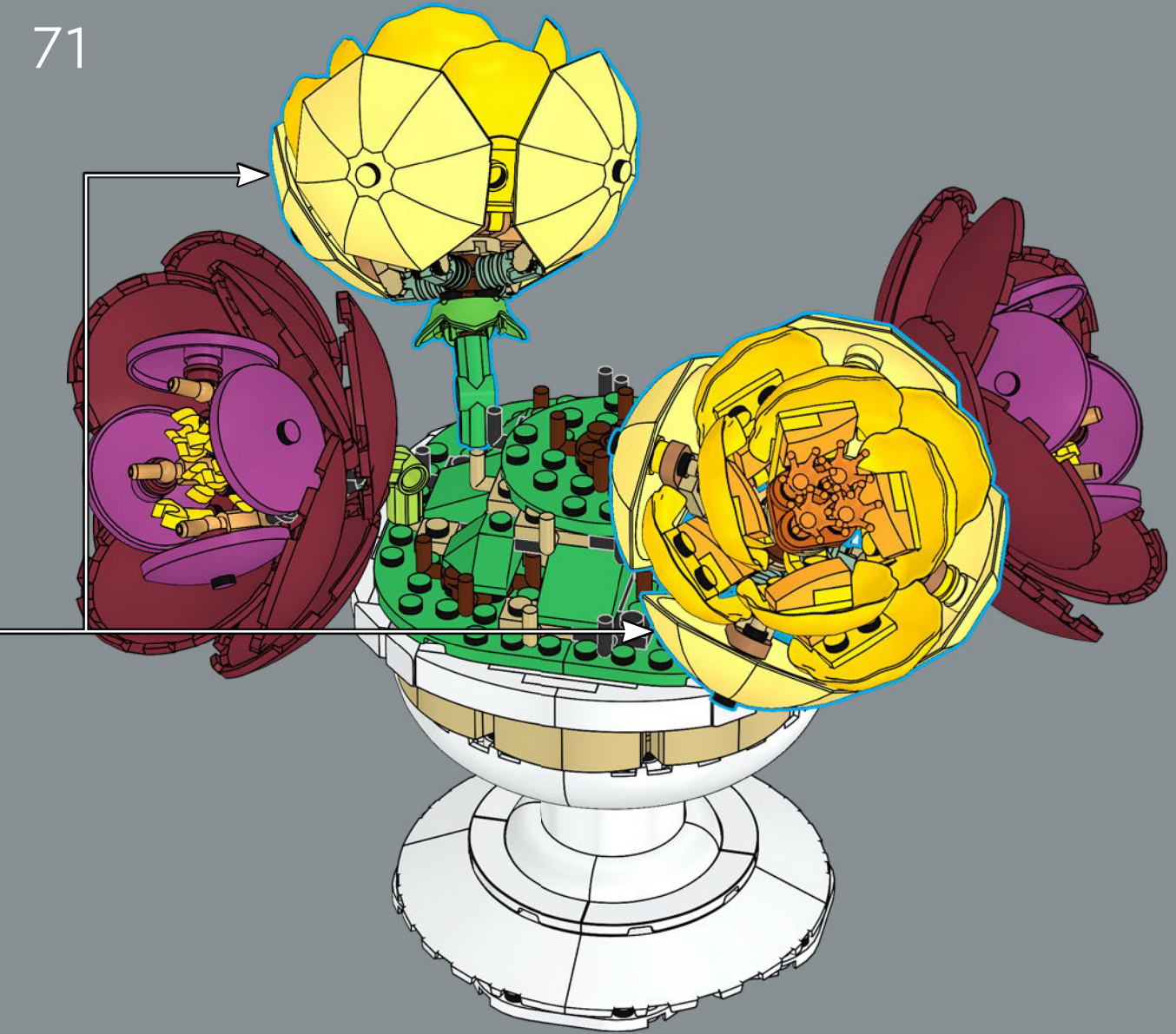



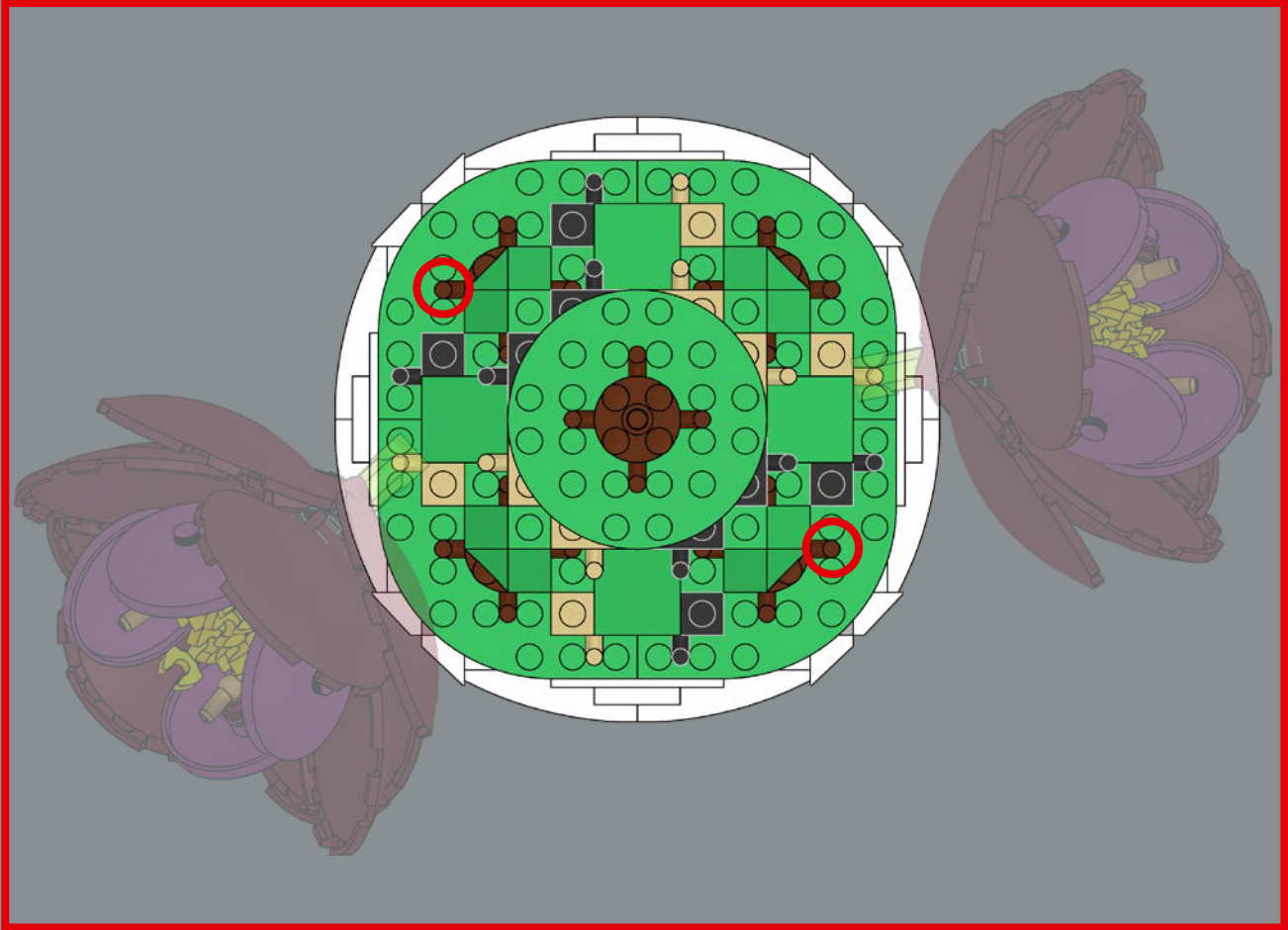

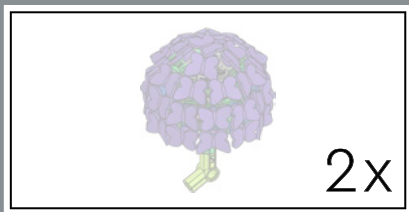

72

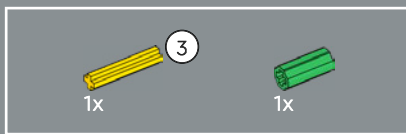

73

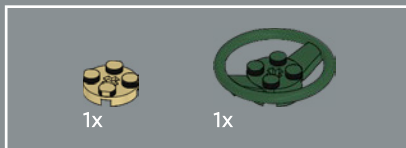
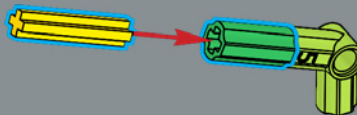

74

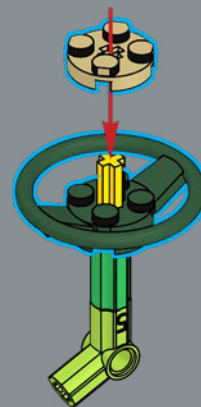

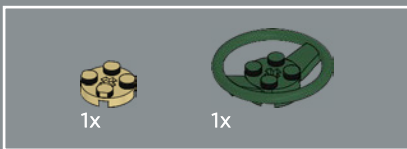

75

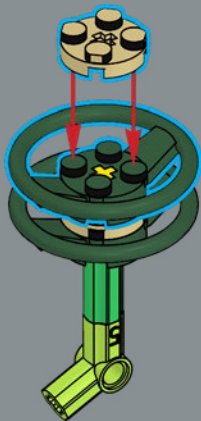

Placez la créativité derrière le volant ! Conçu à l'origine pour de grandes voitures LEGO®, ce volant constitue désormais le centre de nos fleurs LEGO.

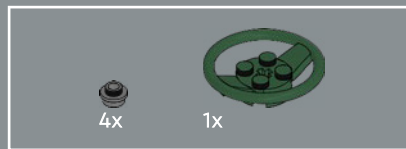

76

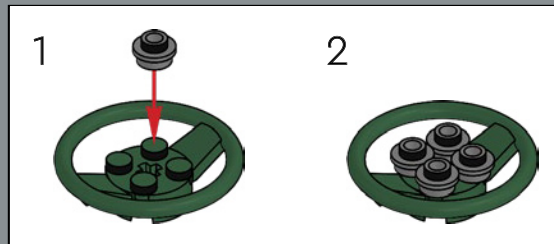

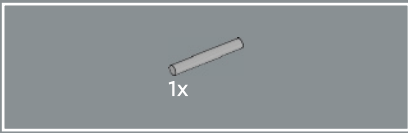

77

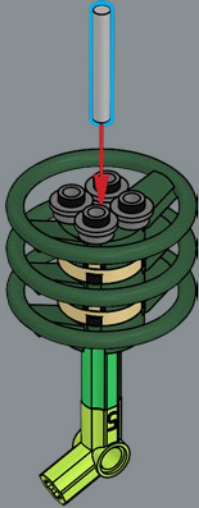

78

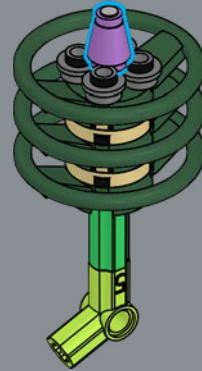

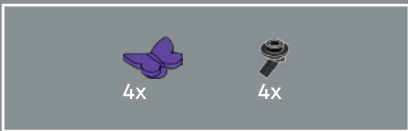

79

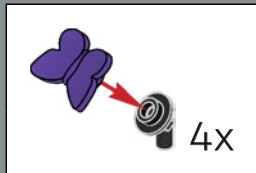

80



L'hortensia : sentez-vous les battements d'ailes ?  
Nous avons fait voler des dizaines de minuscules papillons  
LEGO® pour créer le globe texturé de cet hortensia.

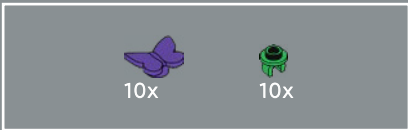

81

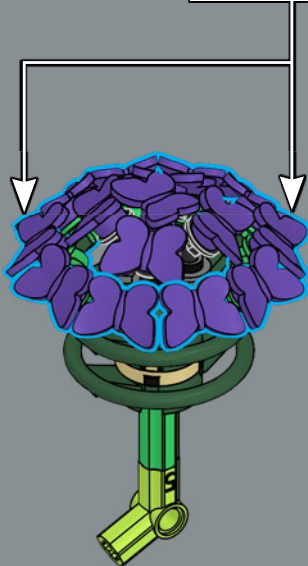
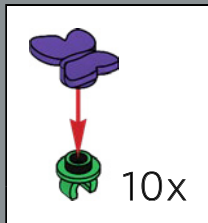

82

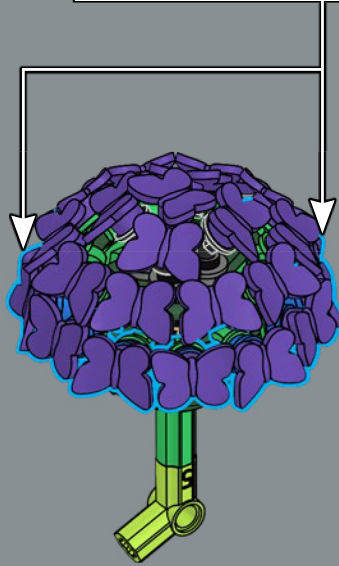
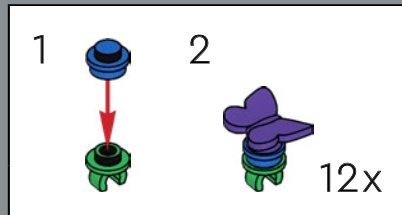



12x



12x



12x

83

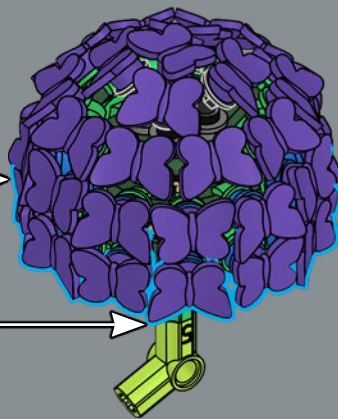
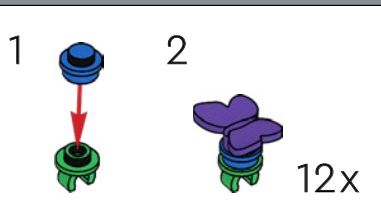

2x

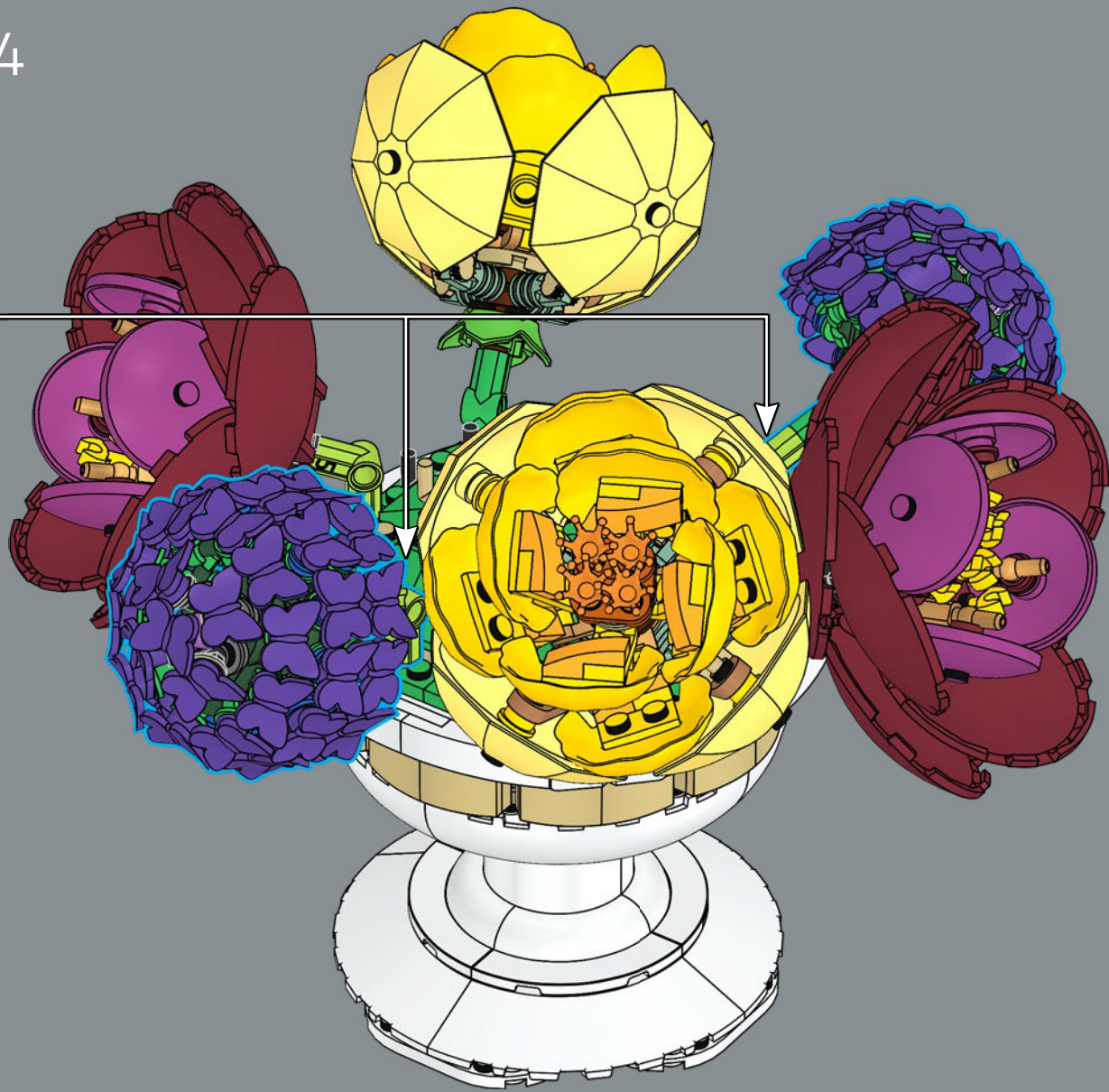



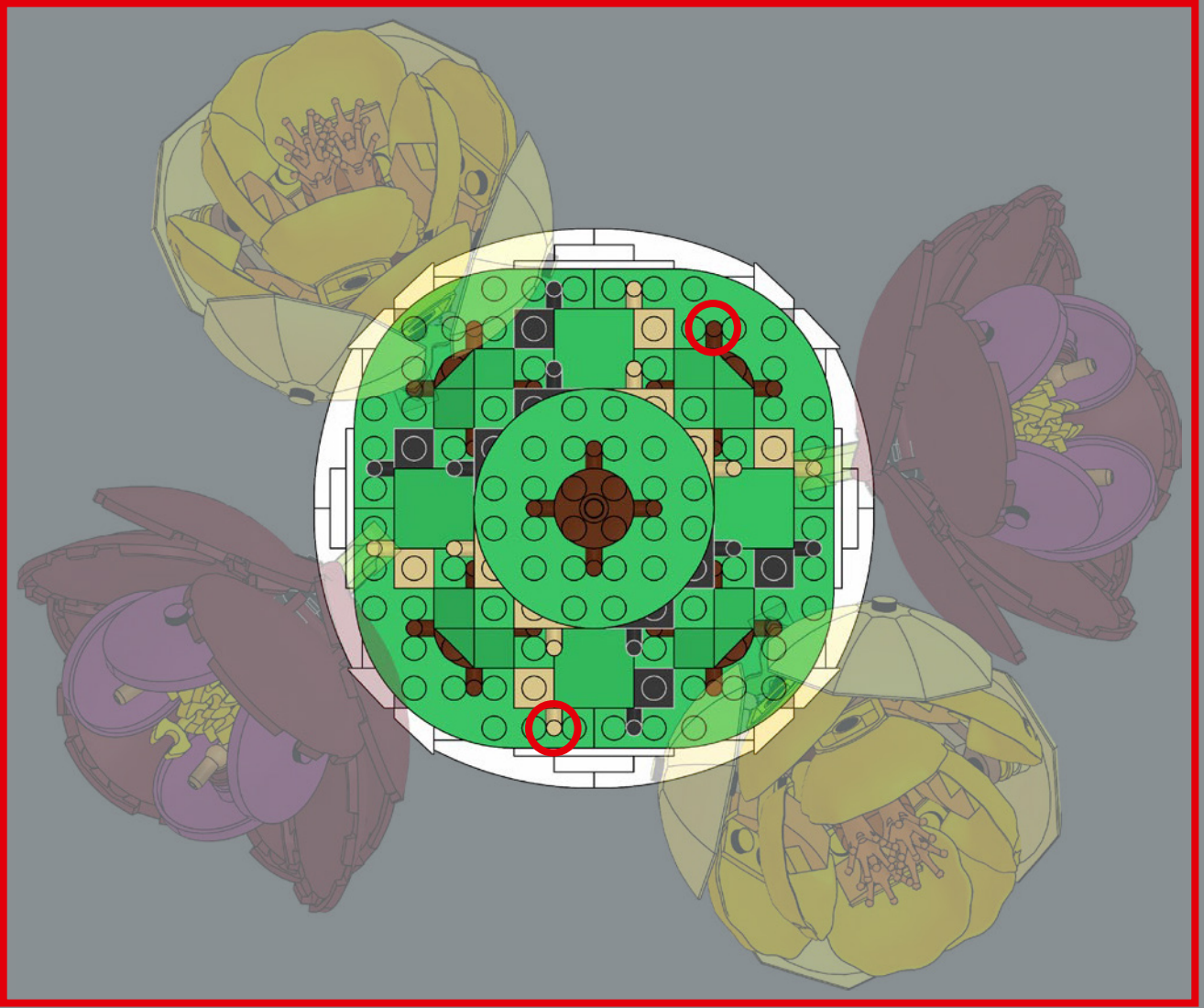

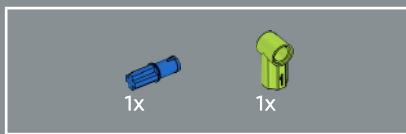
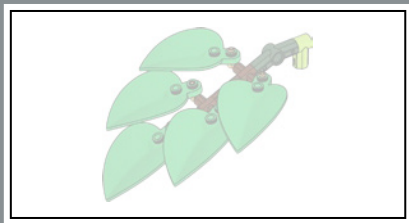

85

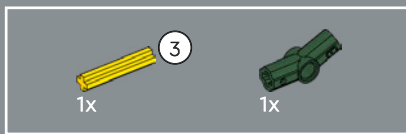
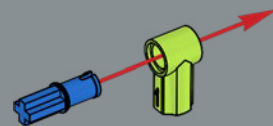

86

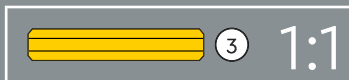
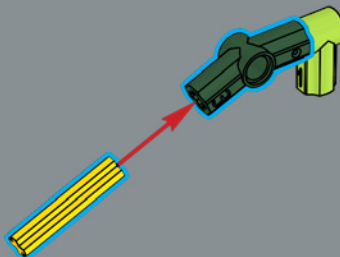



87

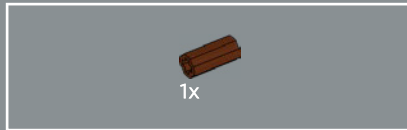
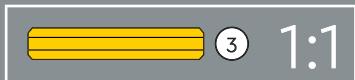
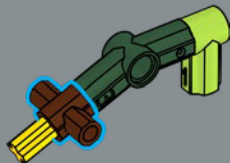

88

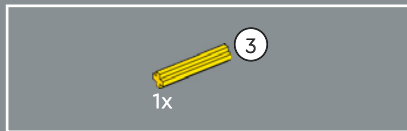
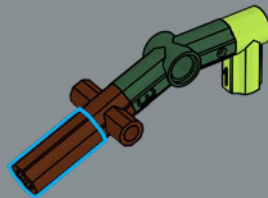

89

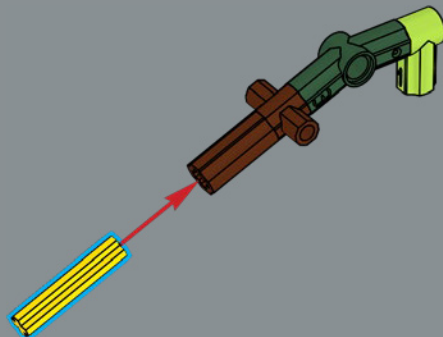



90

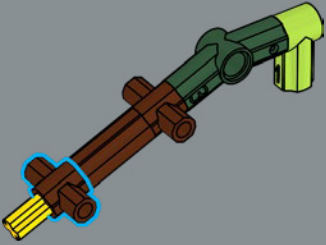

91

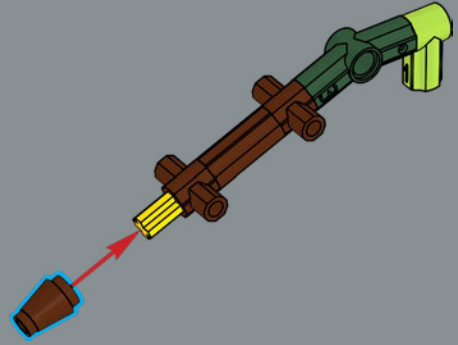



92

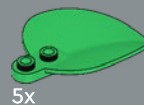
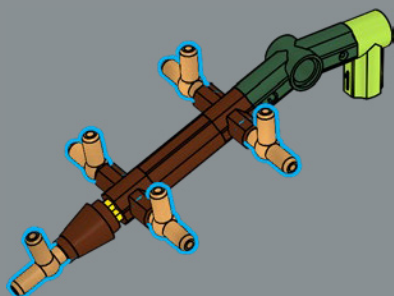

93

Les feuilles : vous tournez une nouvelle page ? Ces feuilles vertes sont de nouveaux éléments conçus pour certains sets de notre série LEGO® Botanique 2025, notamment Le joli bouquet de fleurs roses 10342.

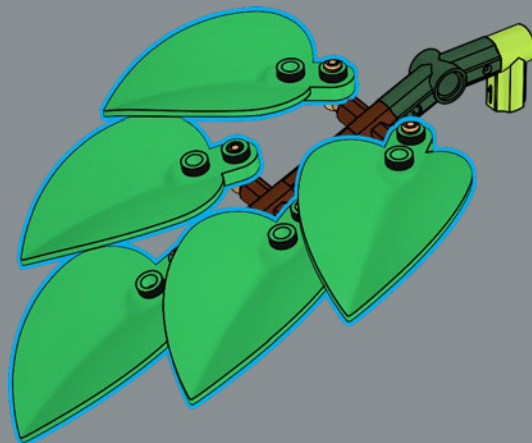



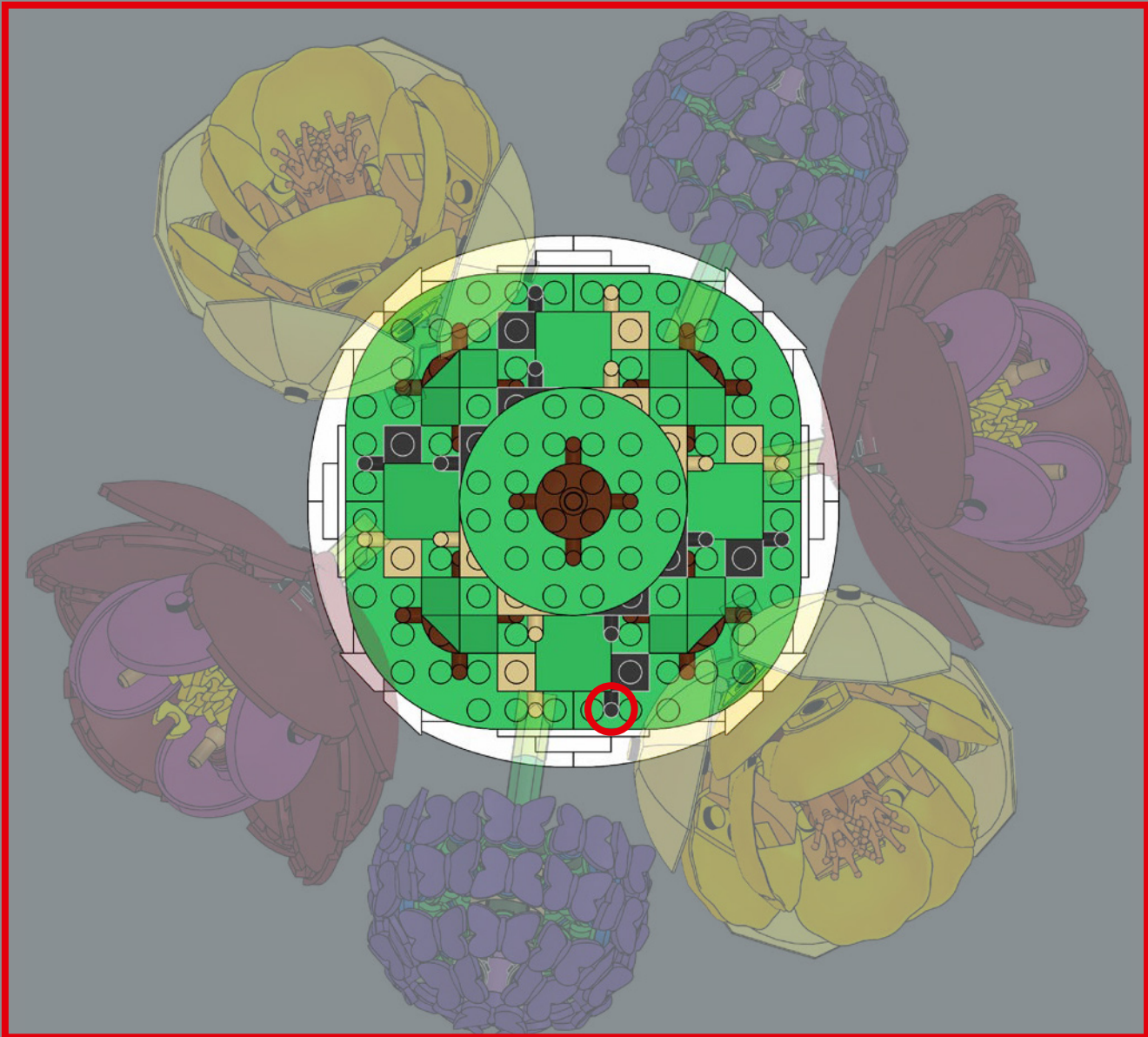

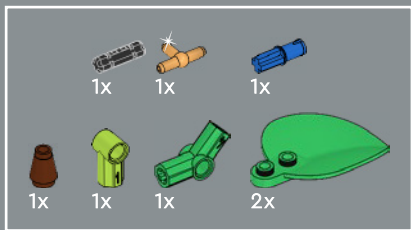

95

1

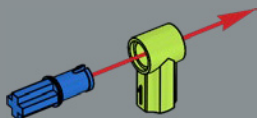

2

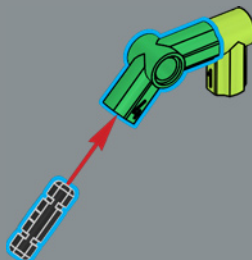



3

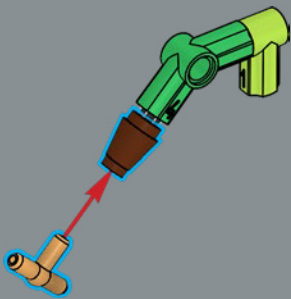

4

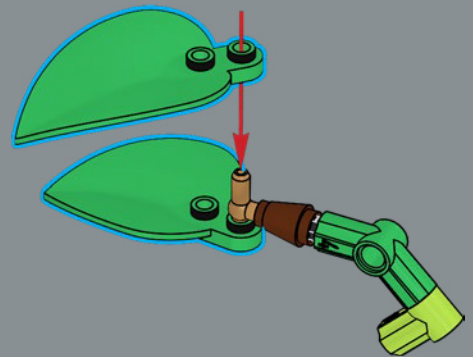

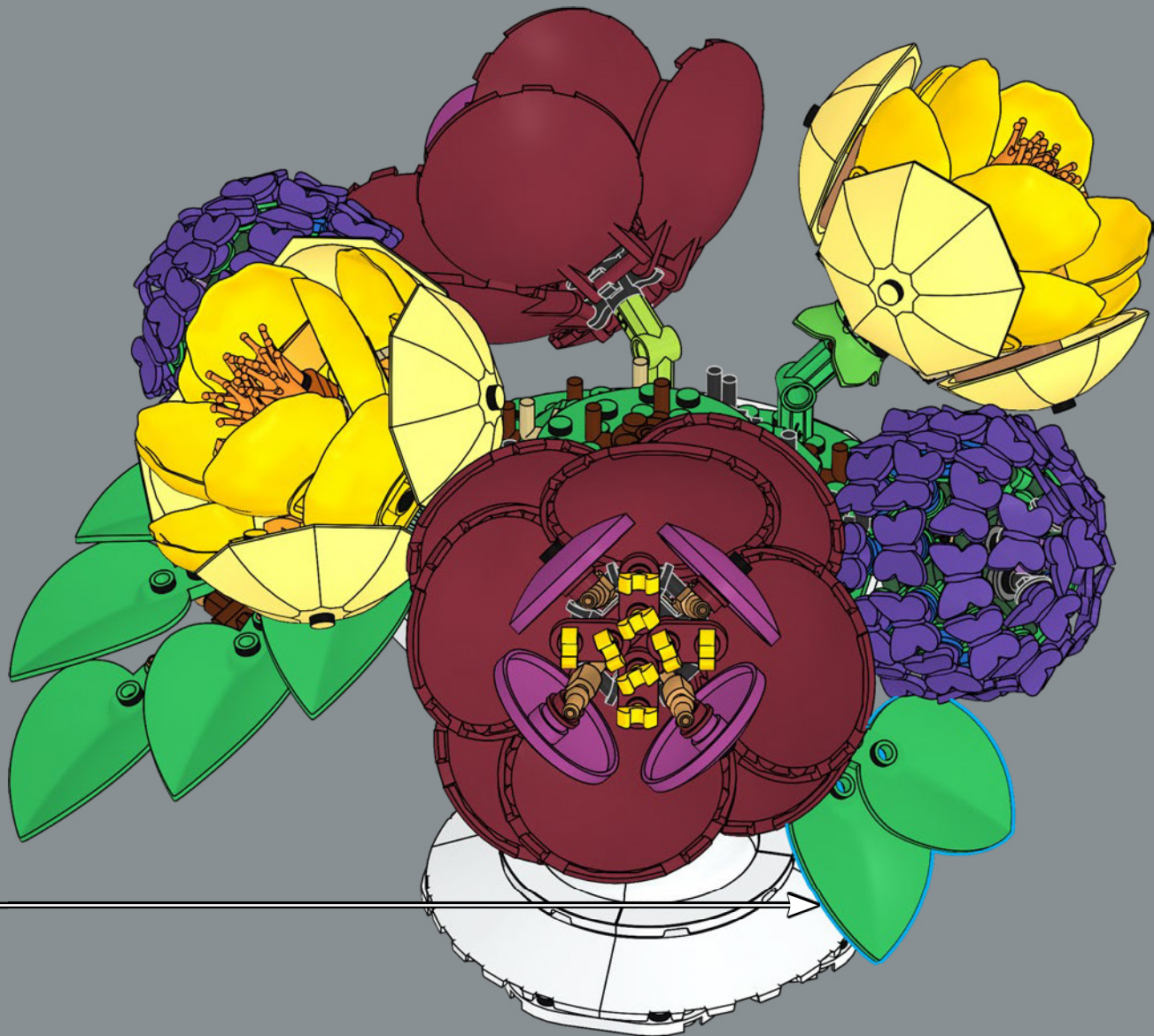

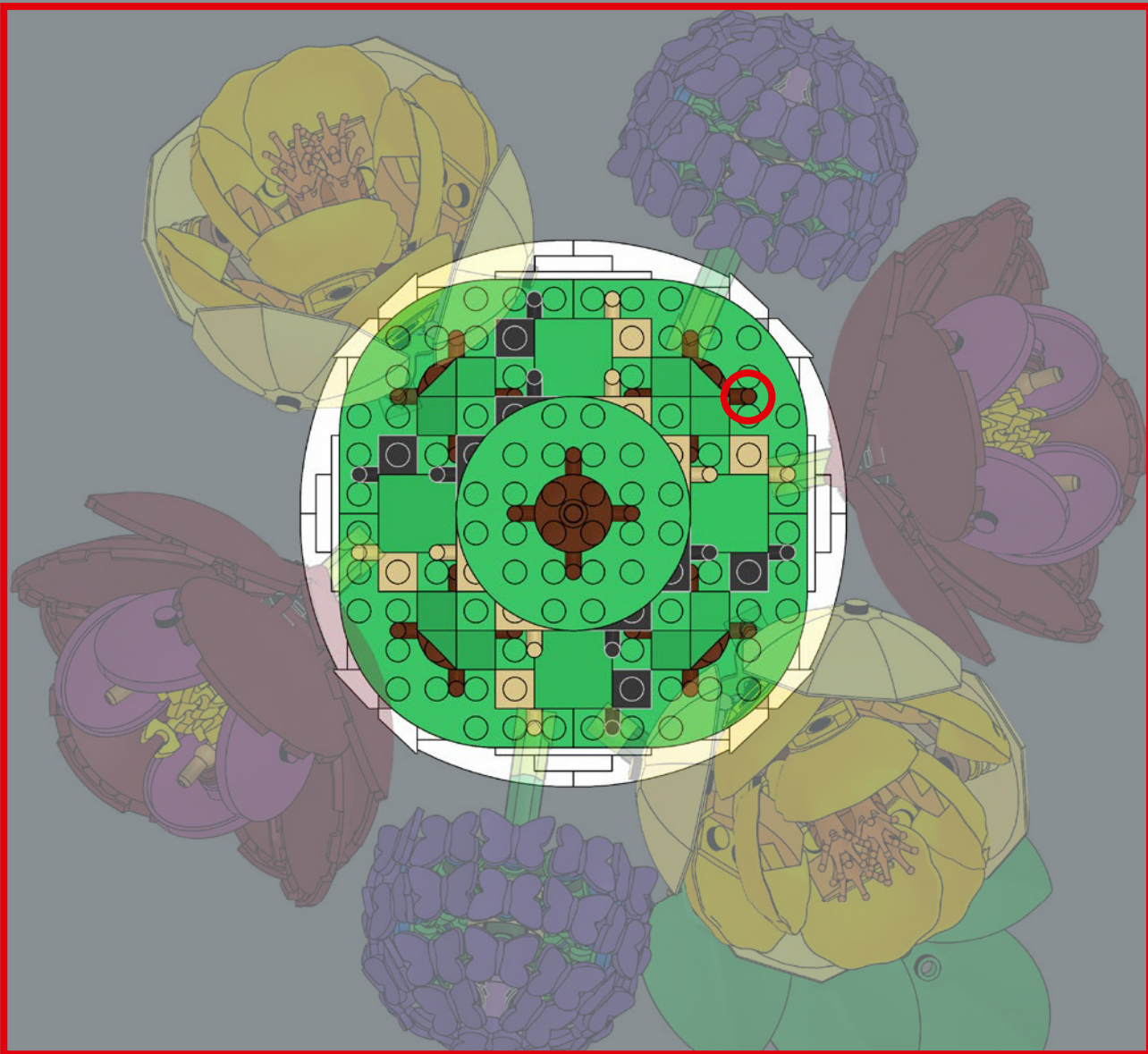

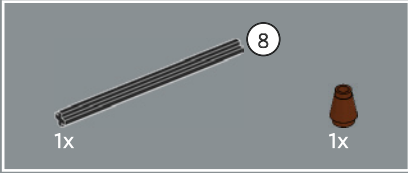
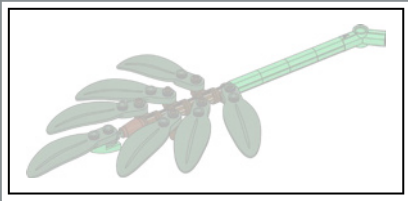

96

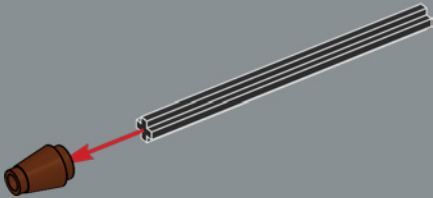

97

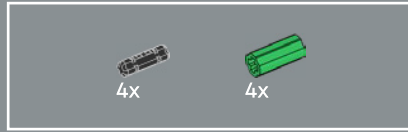
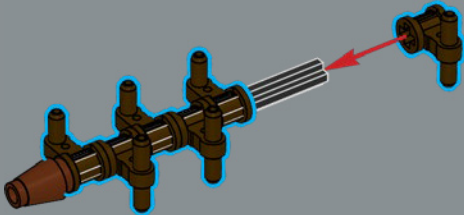

98

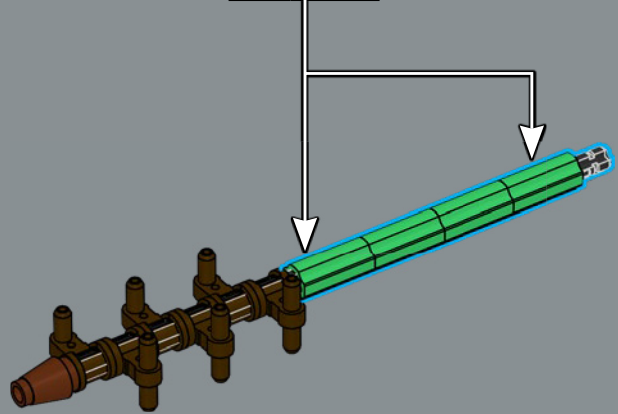
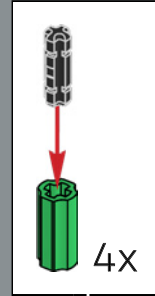

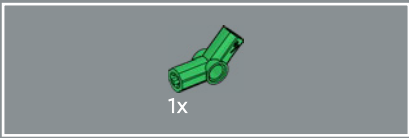

99

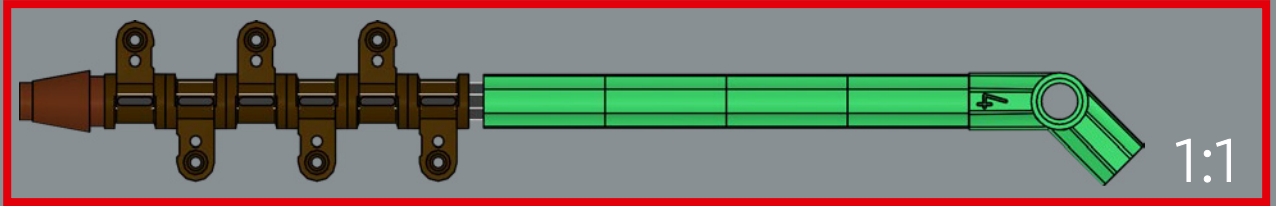
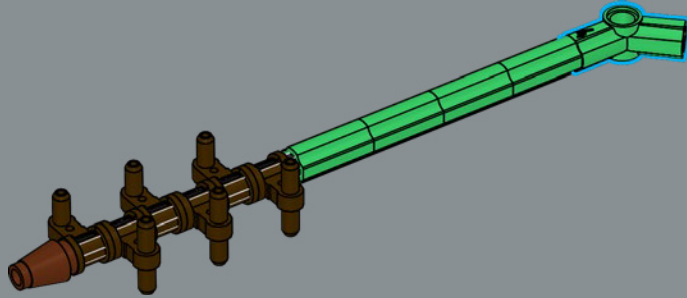

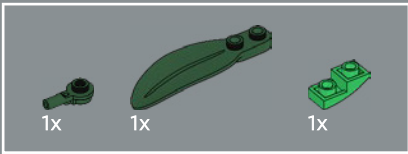

100

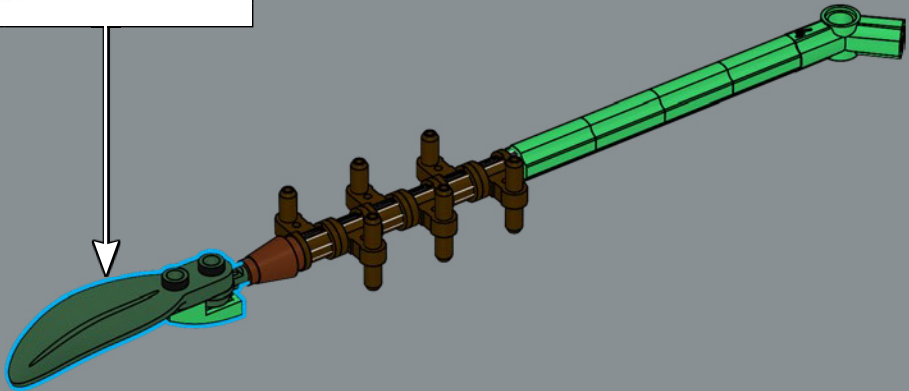
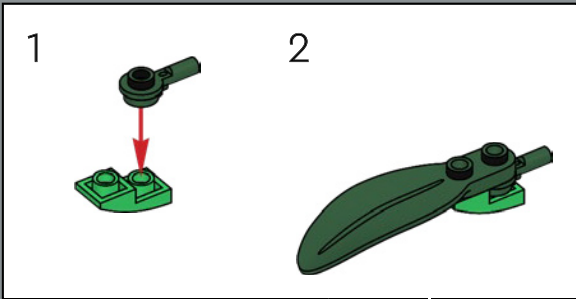

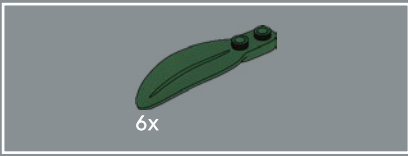

101

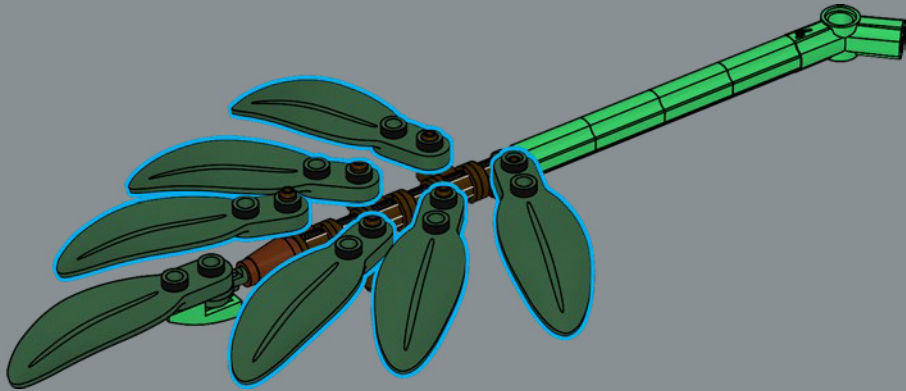





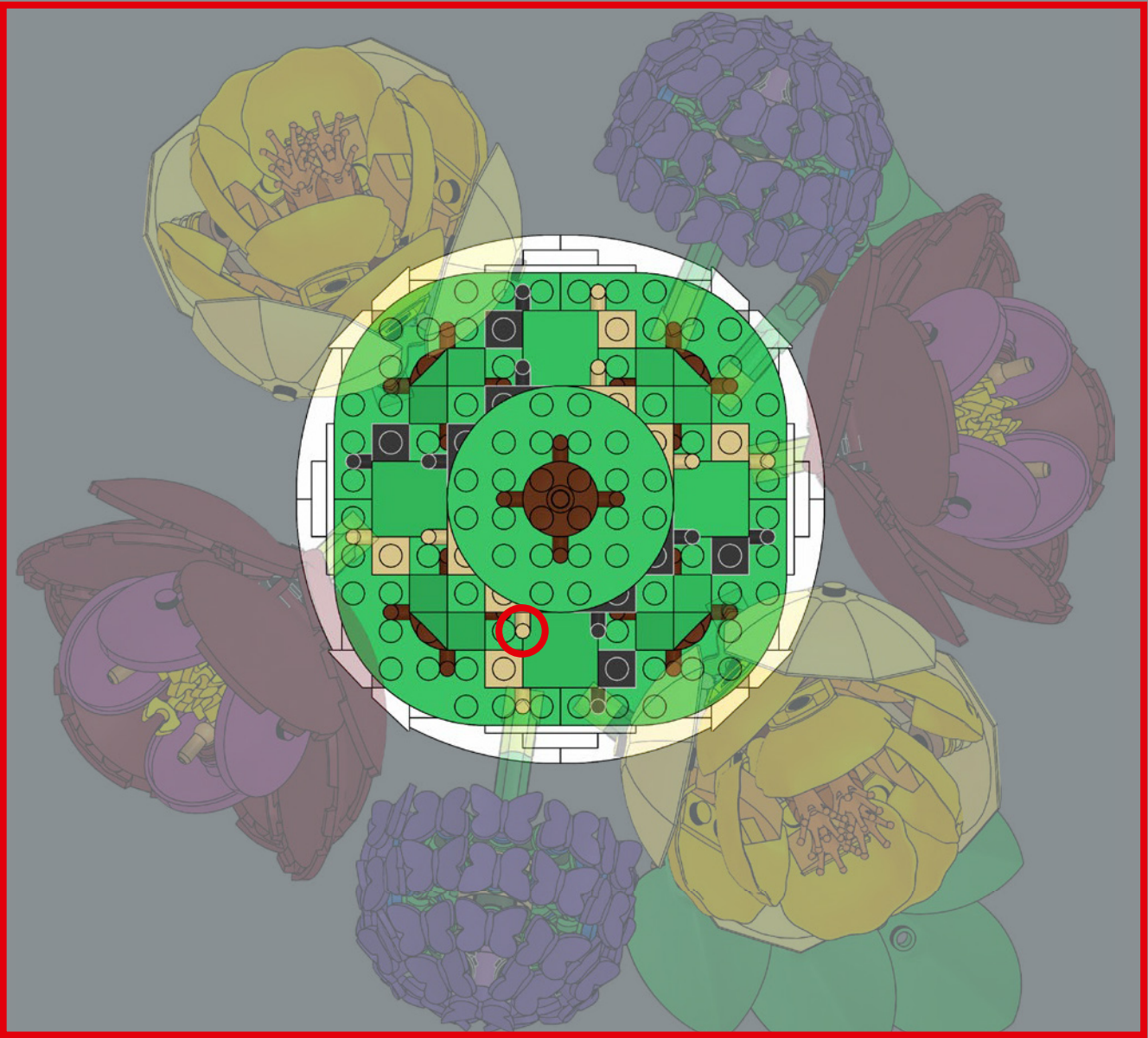

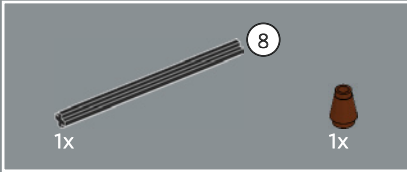

103

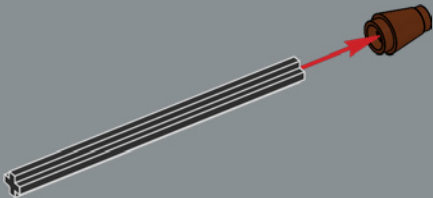

104

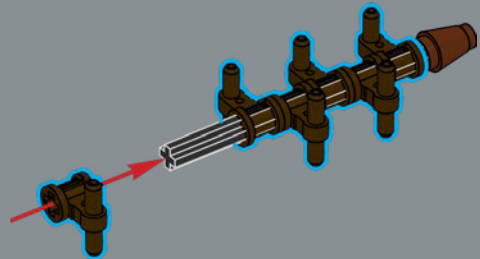



105

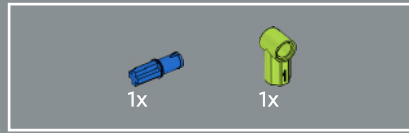
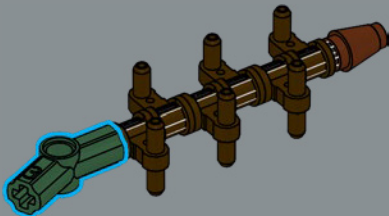

106

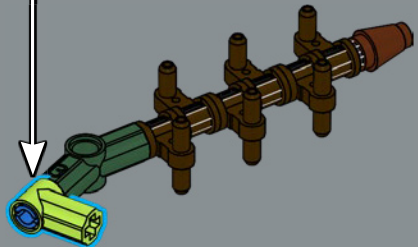
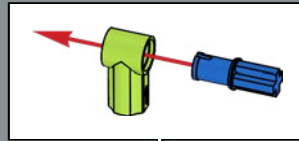

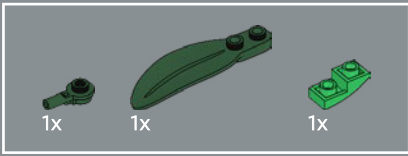

107

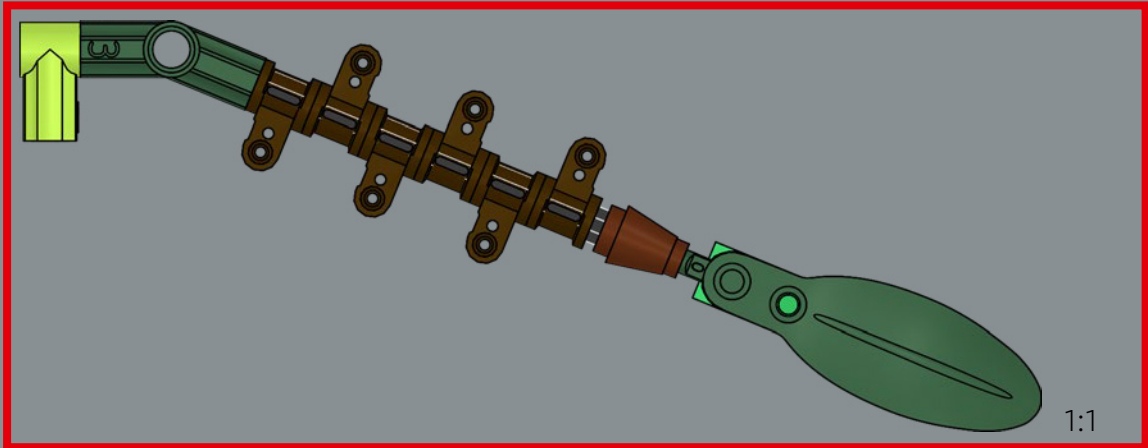
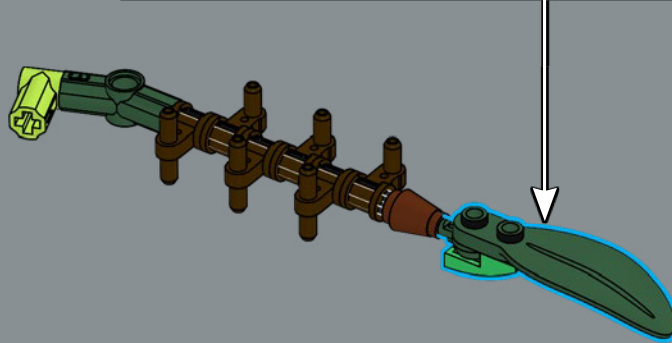
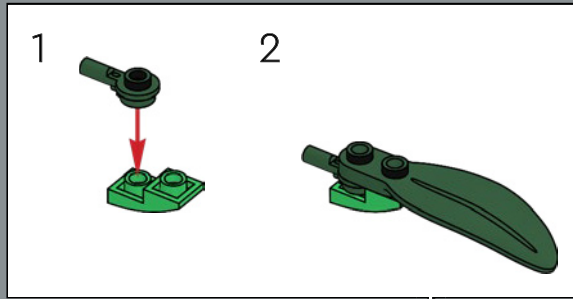

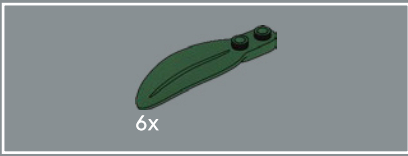

108



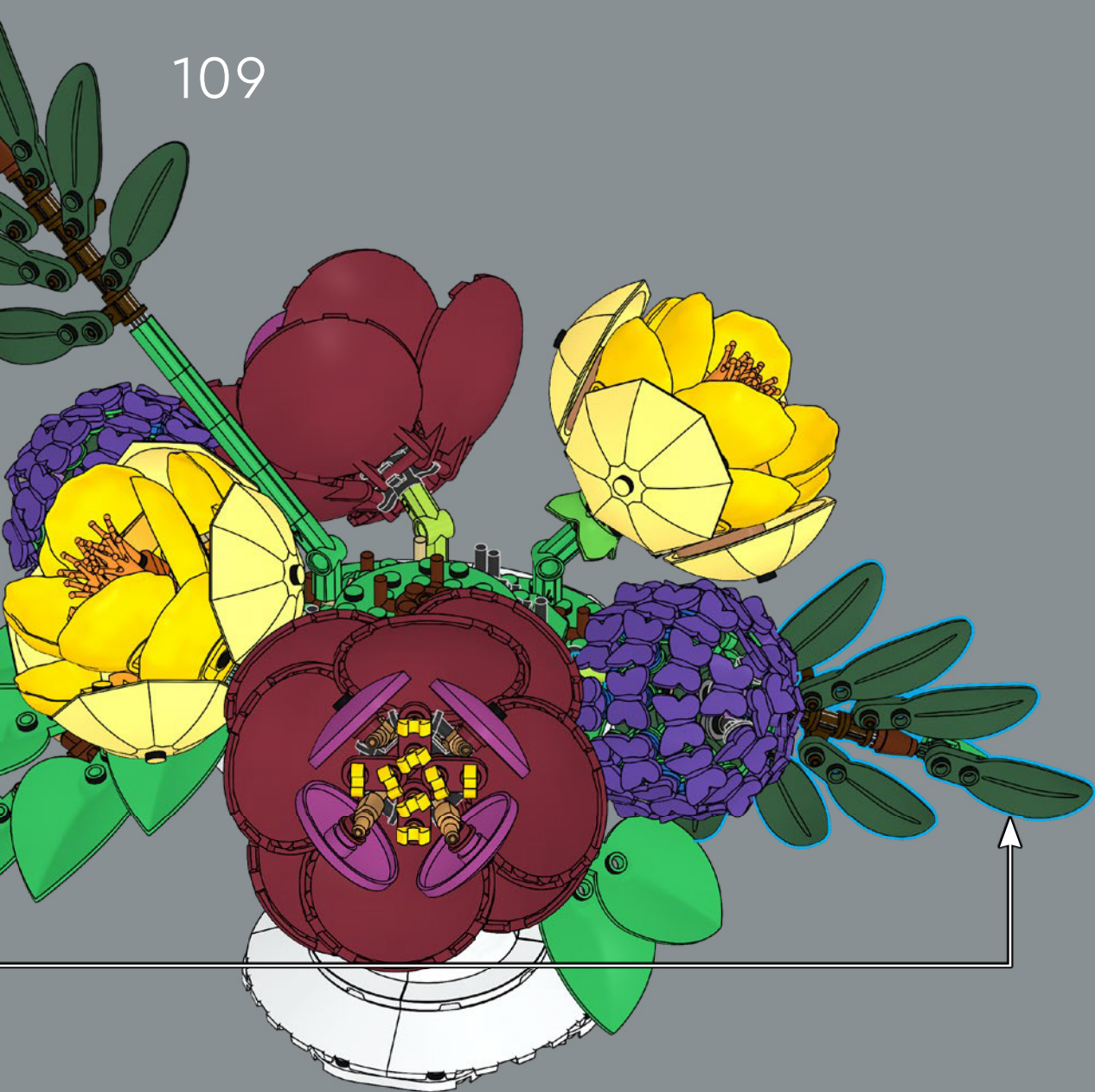

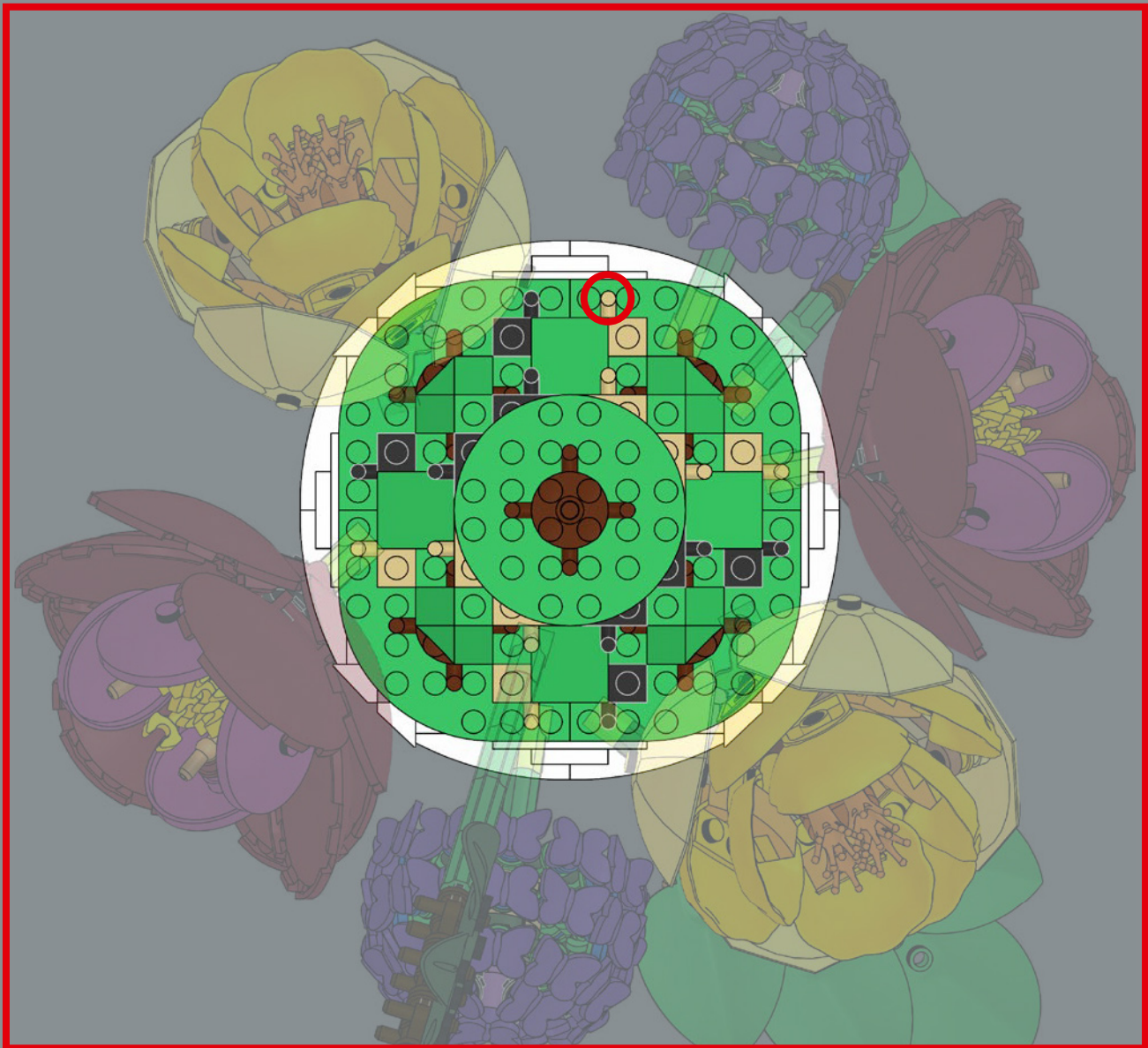

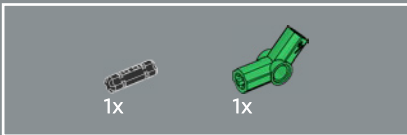
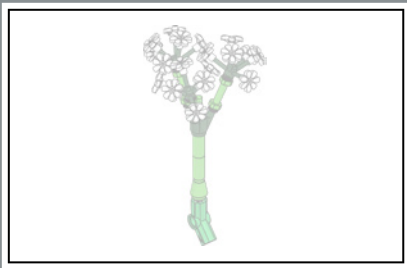

110

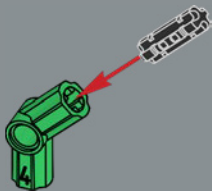

111

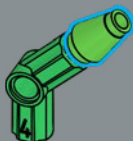

112

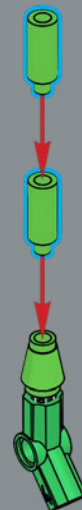



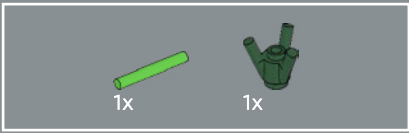

113

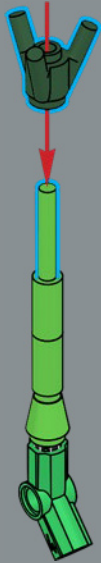

114

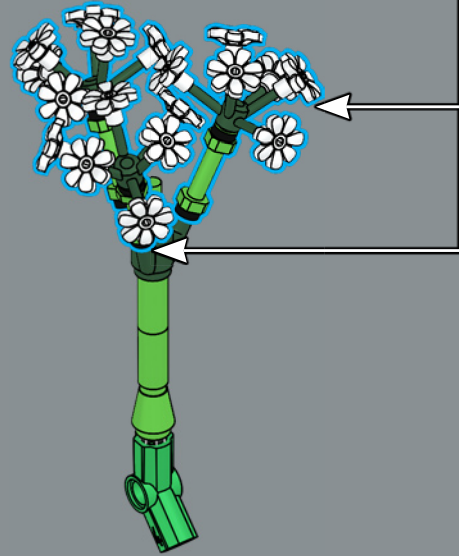
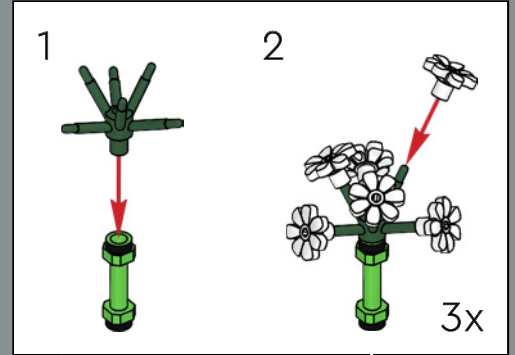

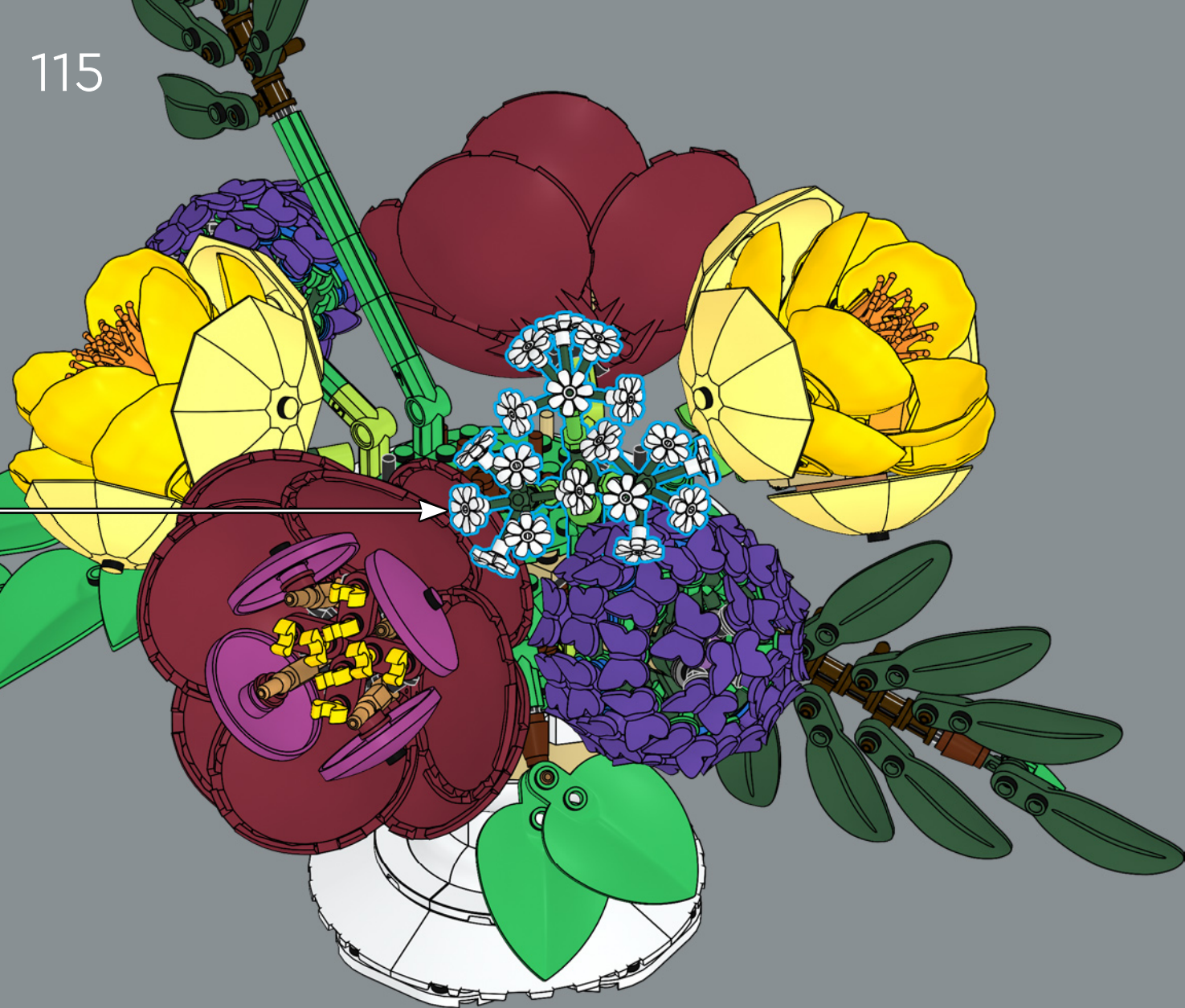

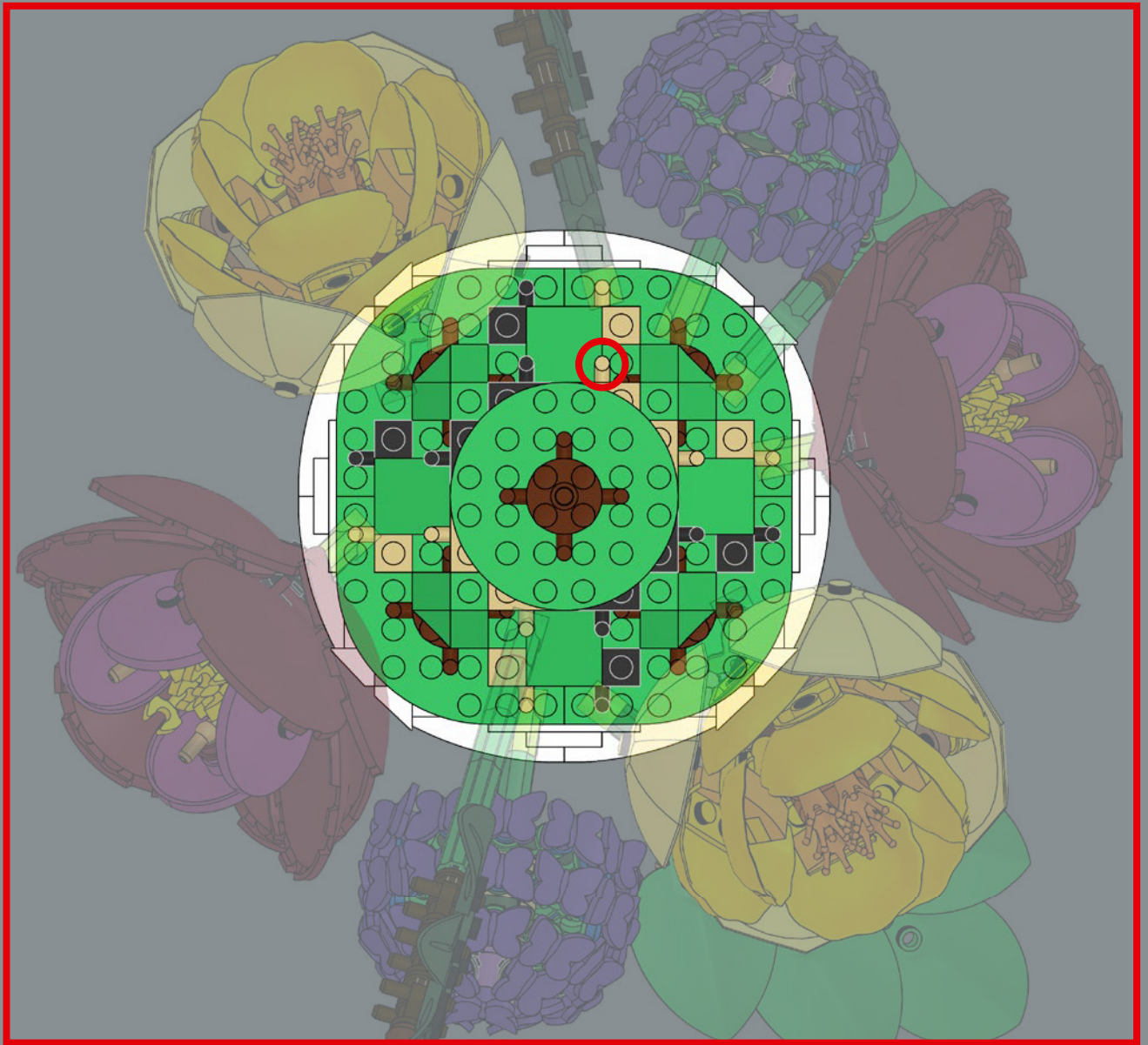

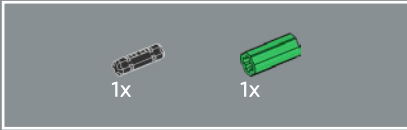
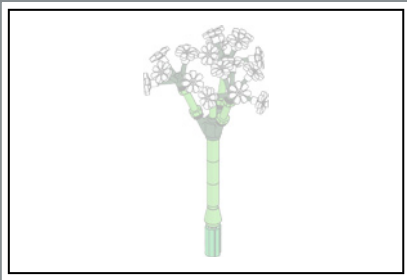

116

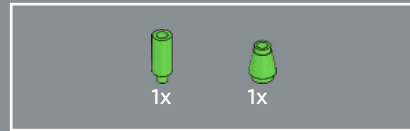

117

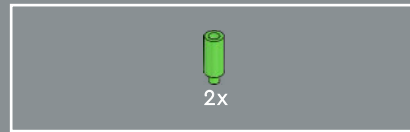

118



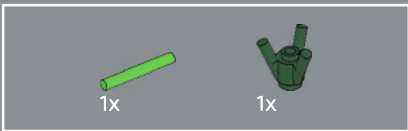

# 119

Le gypsophile : souriez ! La tige est réalisée avec des éléments de trépied conçus à l'origine pour aider les minifigurines LEGO® à stabiliser leurs appareils photos. Ils renferment désormais des bouquets de gypsophiles. C'est peut-être le bon moment pour prendre un selfie afin de conserver un souvenir de vos progrès.

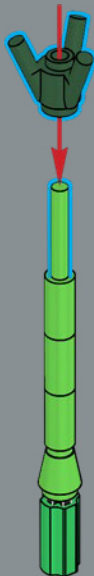

# 120

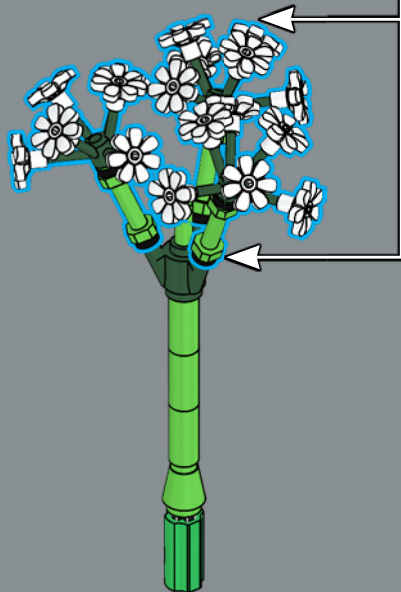
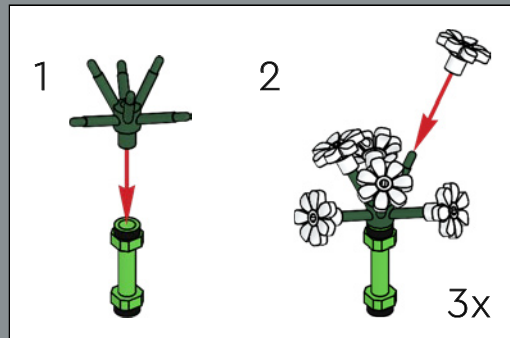



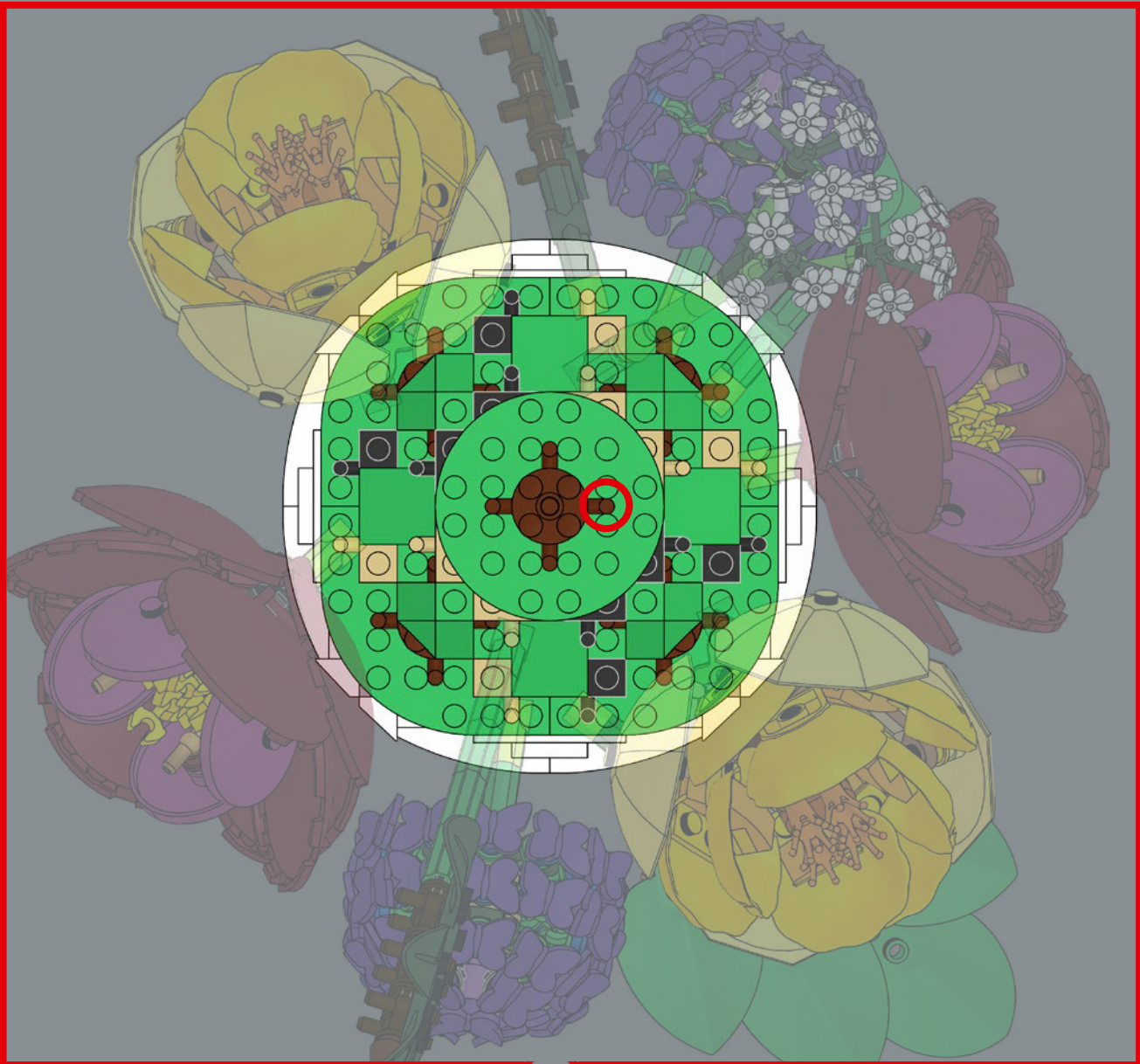

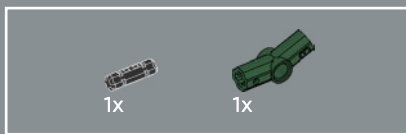
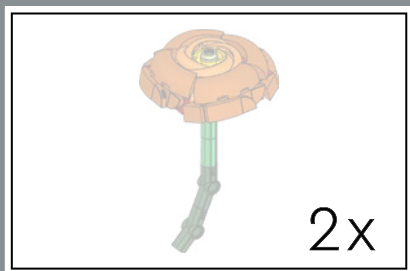

122

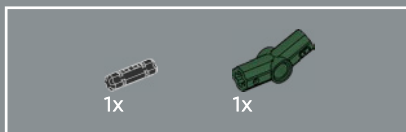

123

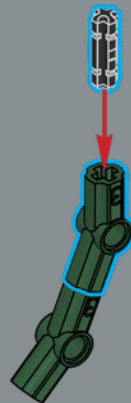



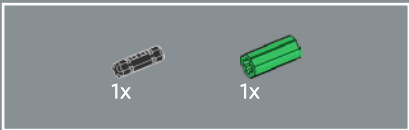

124

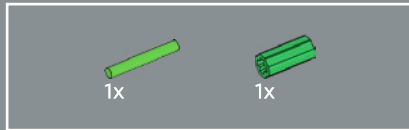
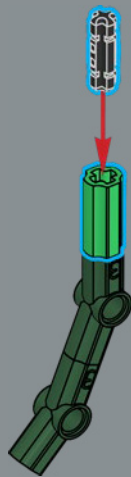

125

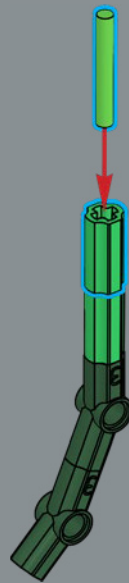



126

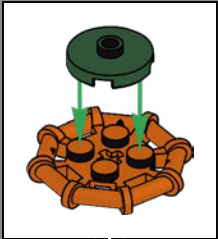

127



128



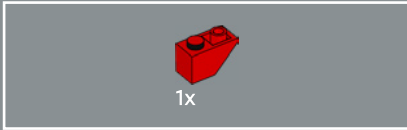

129

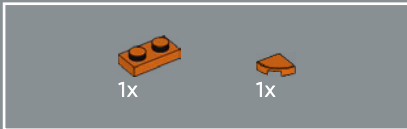
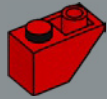

130

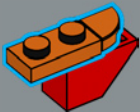

131

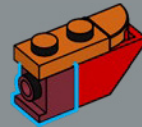

132

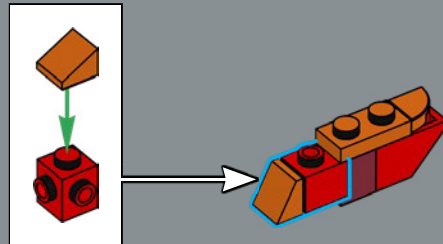

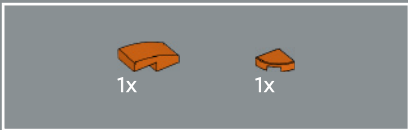

133

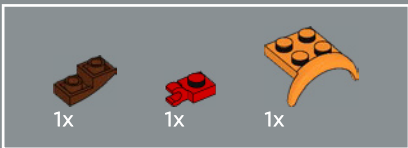
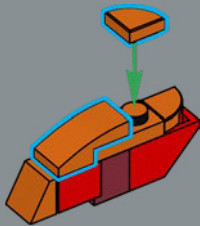

134

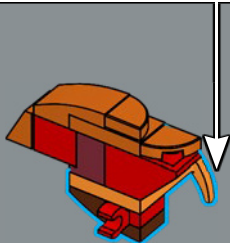
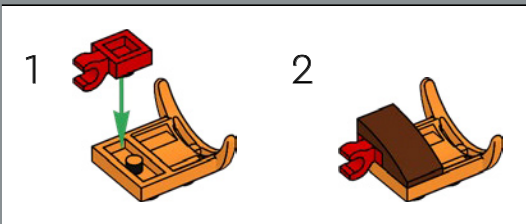

4x

*Ranunculus*: vous pouvez toujours faire confiance aux éléments de voiture LEGO® pour ramener les détails à la maison. Le cœur de cette fleur renferme quatre éléments de garde-boue pour donner l'impression que les pétales sont pliés.

135

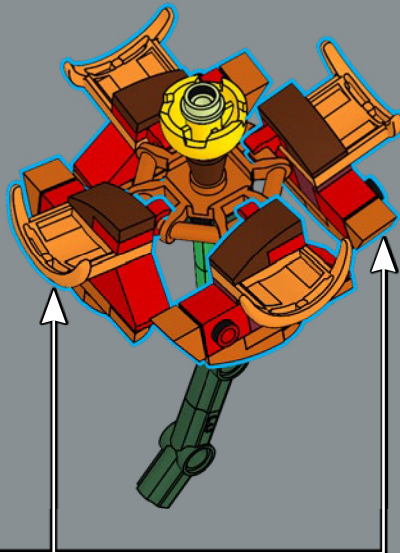

136

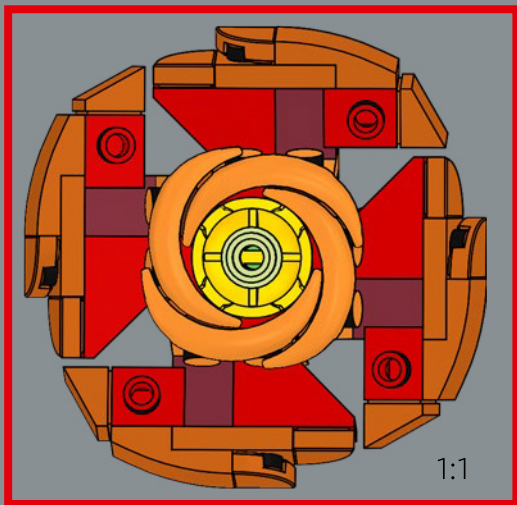
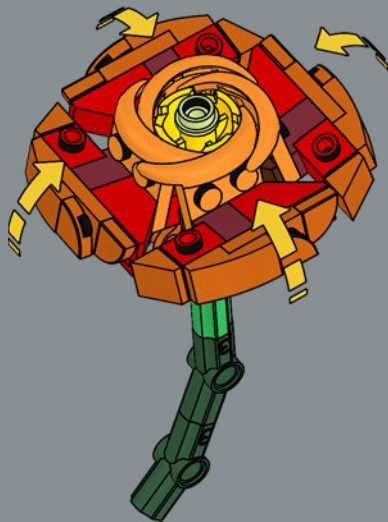

1:1

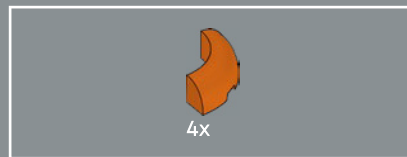

4x

137

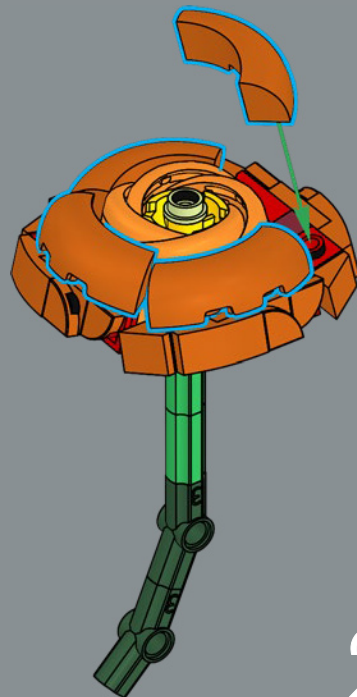

2x





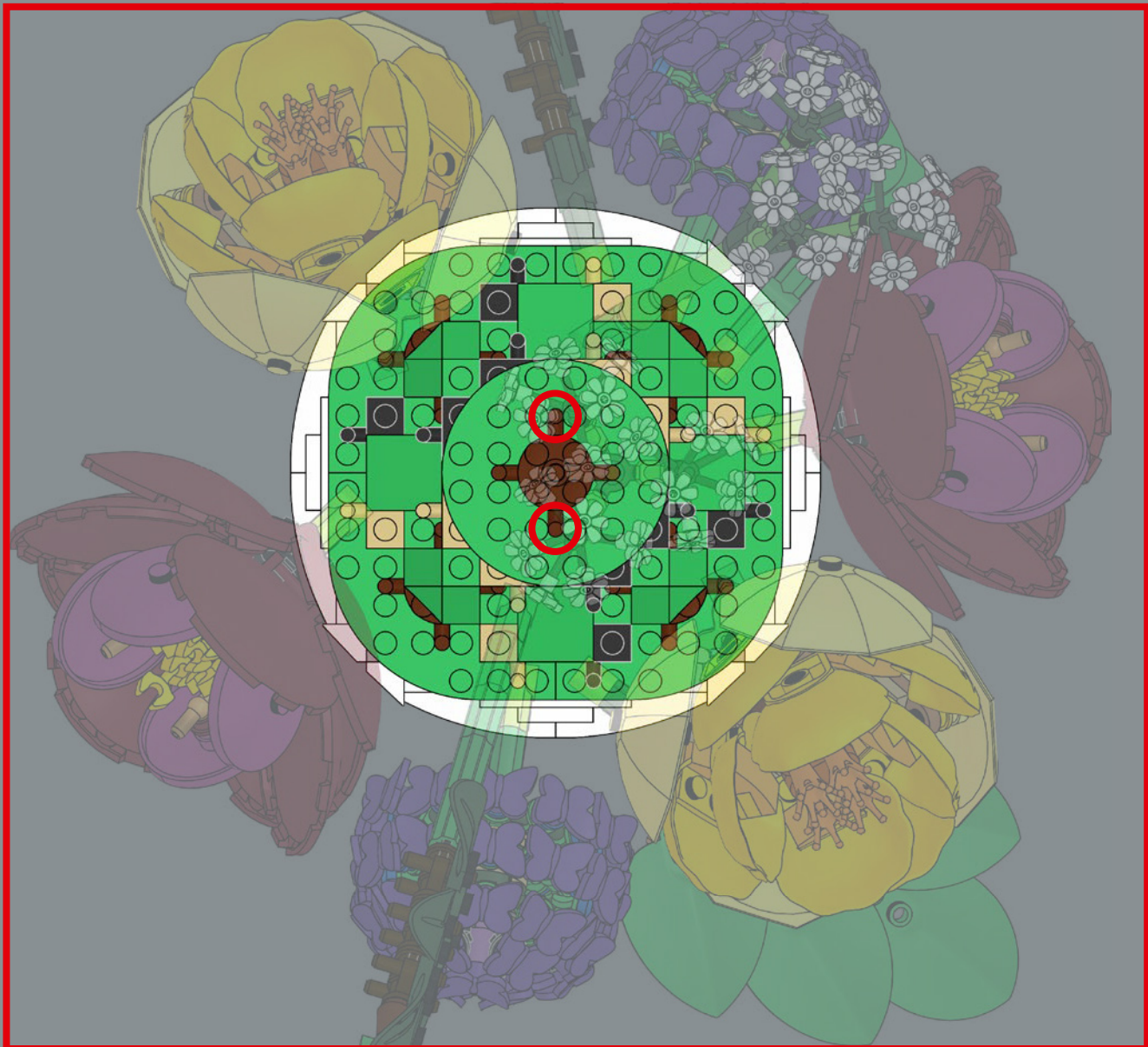

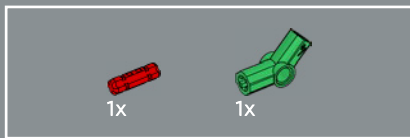
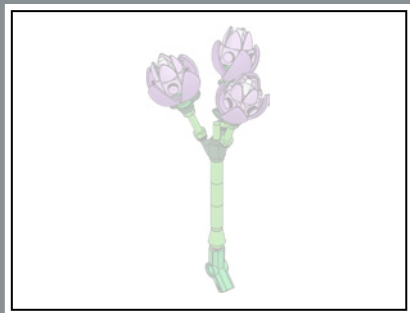

139

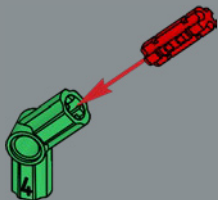

140



141

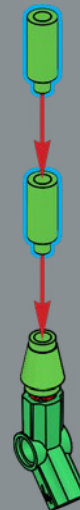



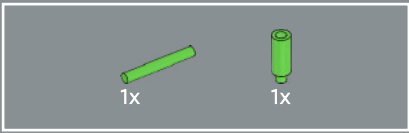

142

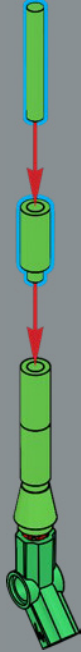

143

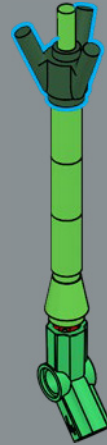

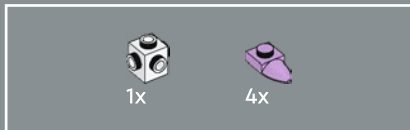

144

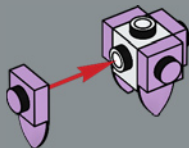

145

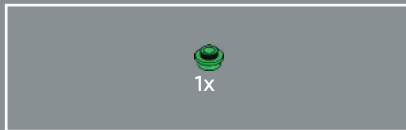
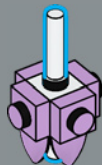

146

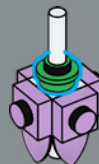

147

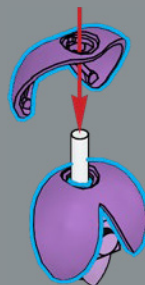

*Bouvardia*: ces parties de la fleur étaient conçues à l'origine pour former les ailes d'une coccinelle LEGO®.



148

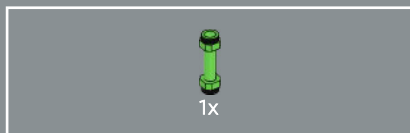
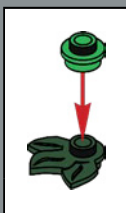

149

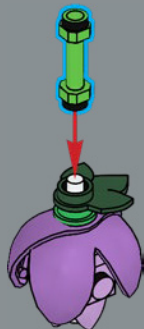

3x

150

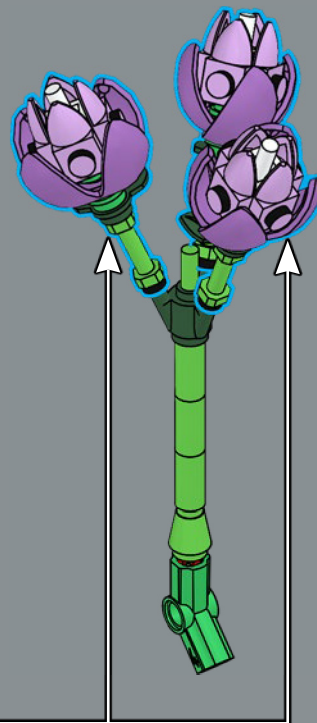





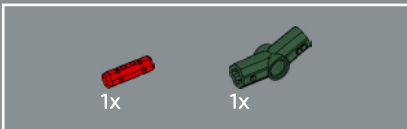
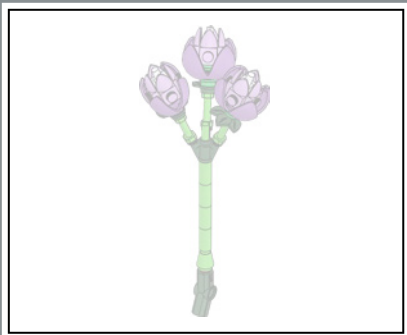

152



153

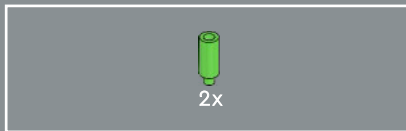

154





155

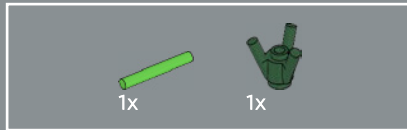

156

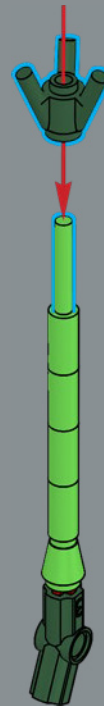

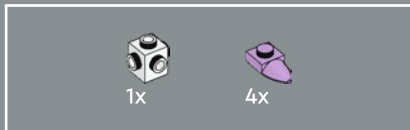

157

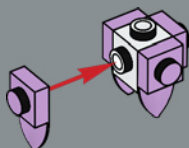

158

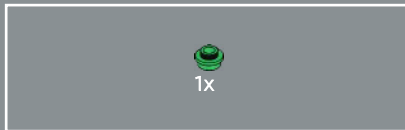

159

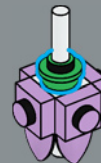

160

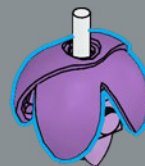





161

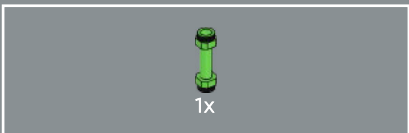
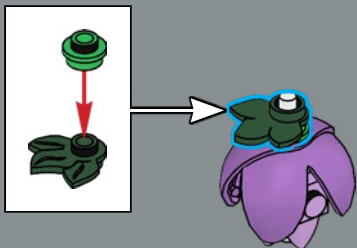

162

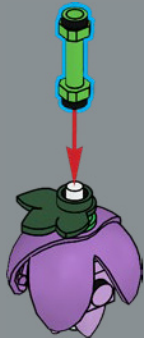

3x

163

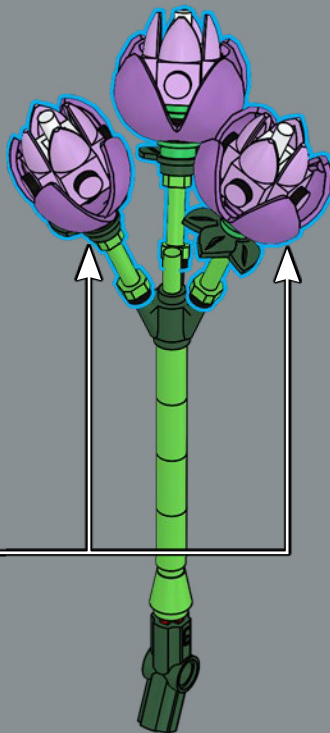



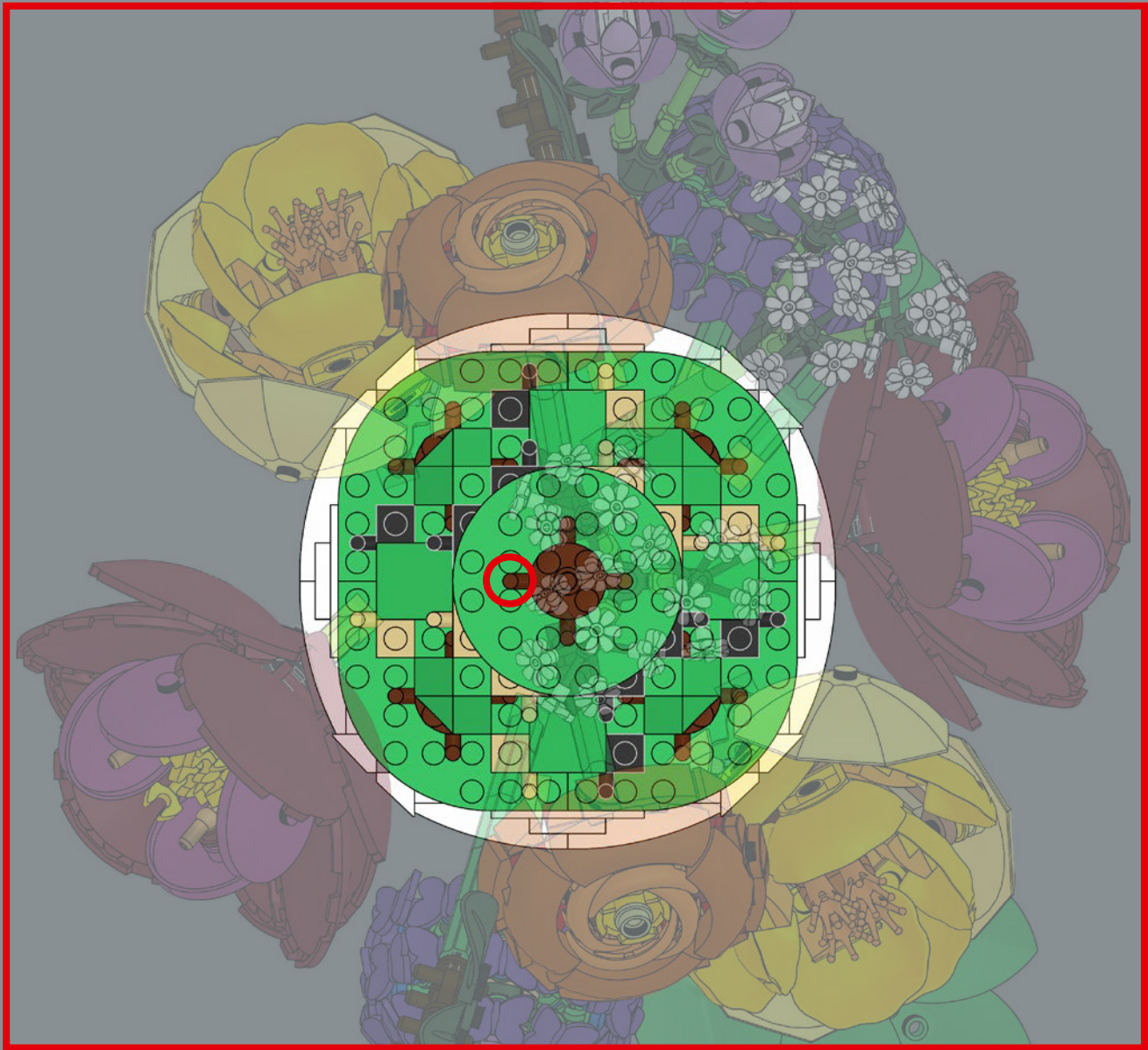

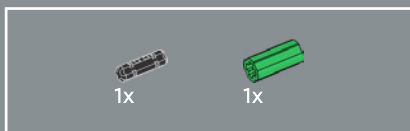
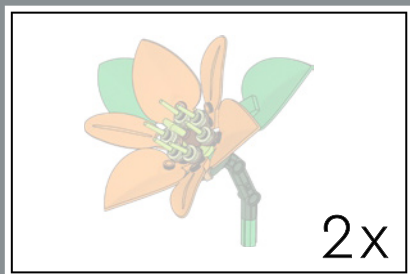

165

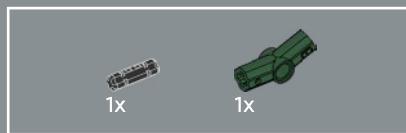

166

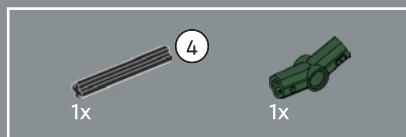

167

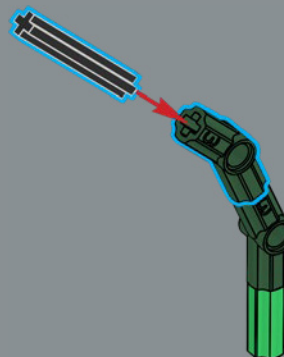

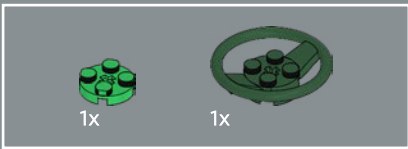

168

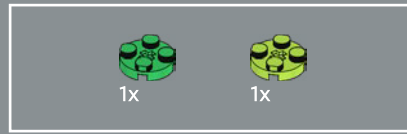
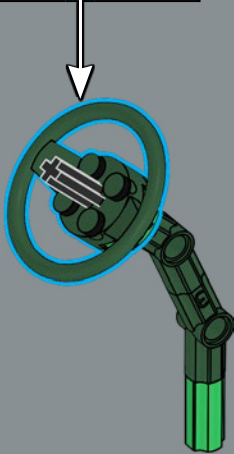
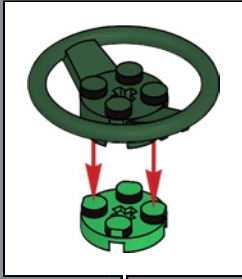

169

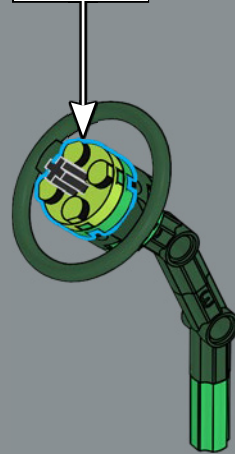
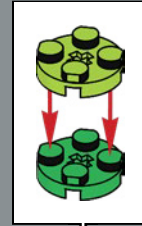



170

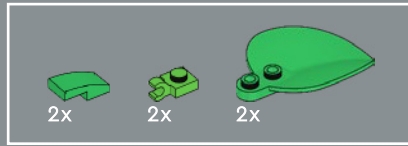
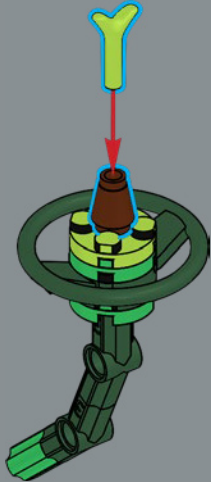

171

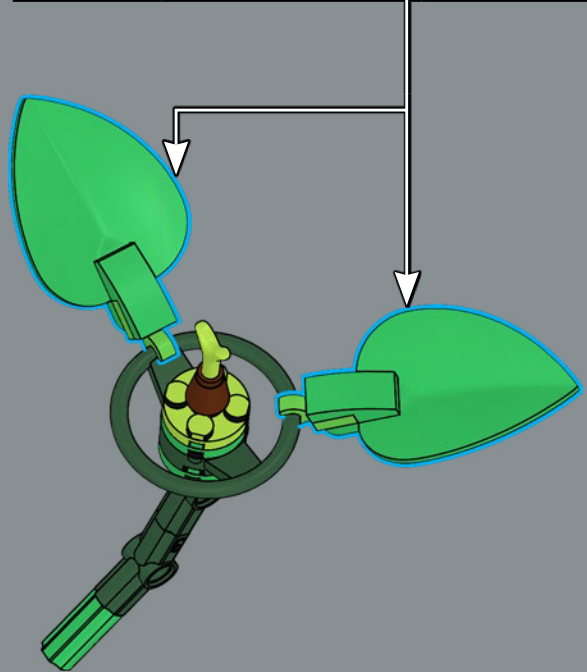
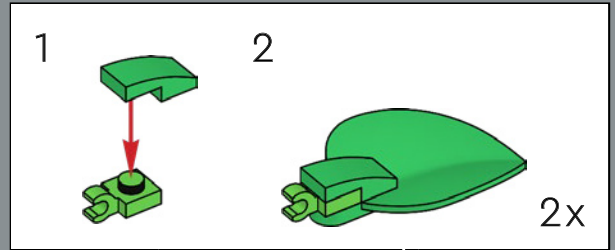



Le lys : attention, cette fleur pourrait vous jeter un sort ! Les étamines sont réalisées avec six baguettes magiques LEGO®.

172

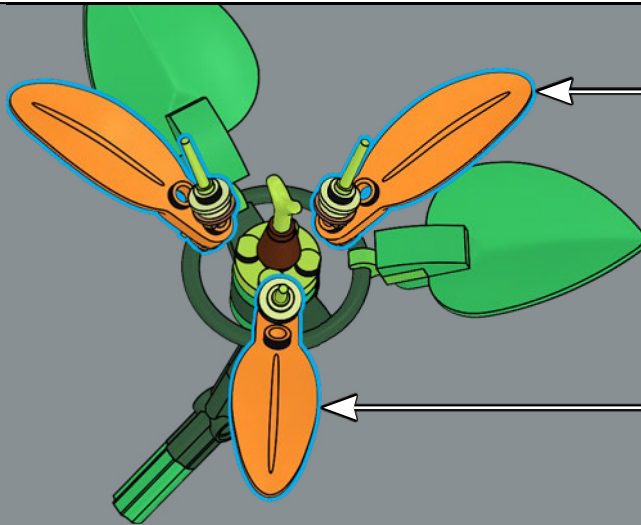
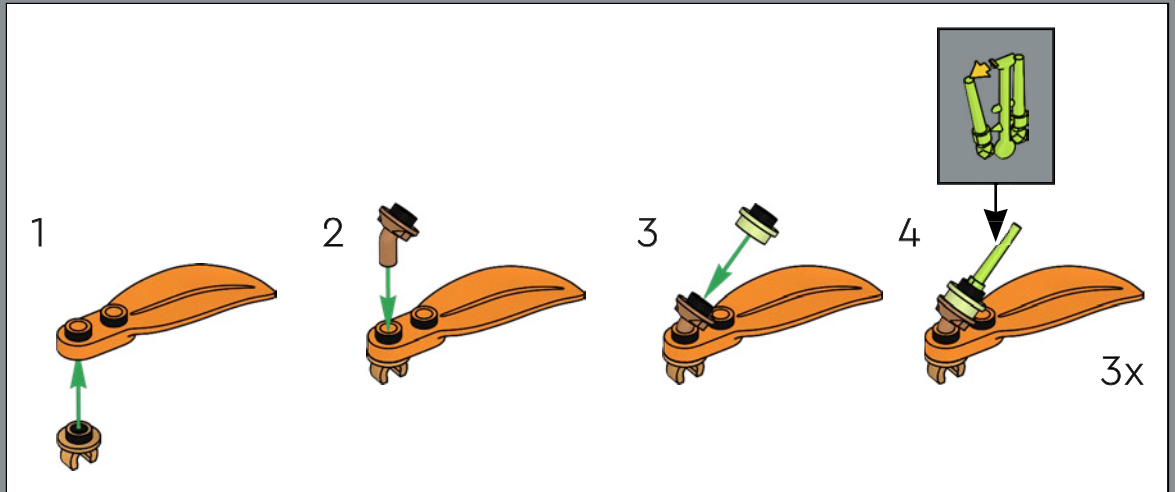



173

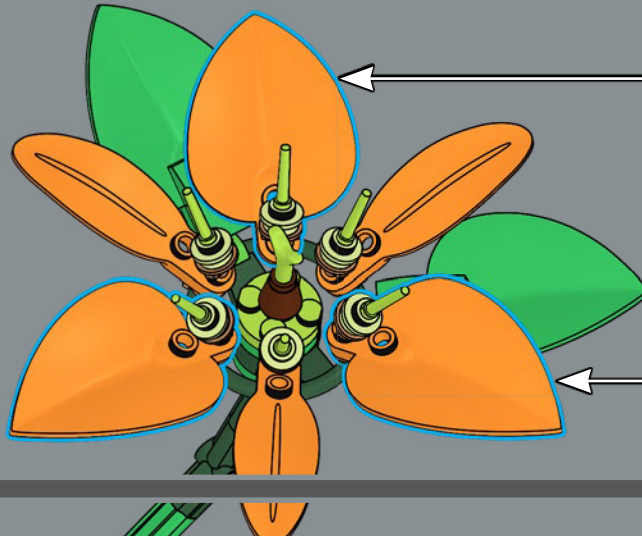
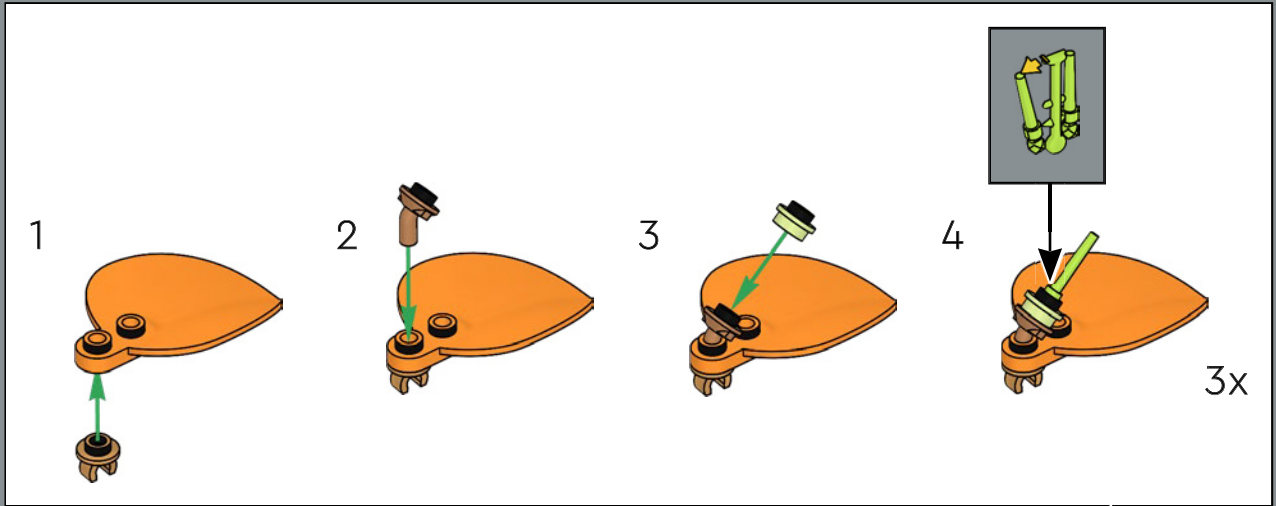



174

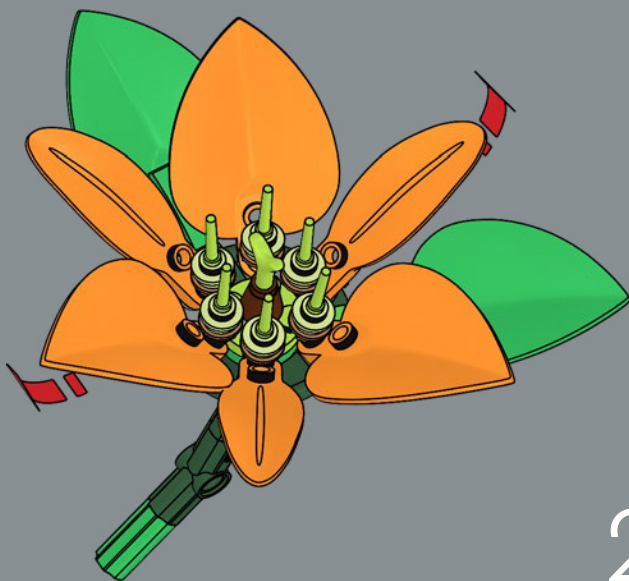

2x



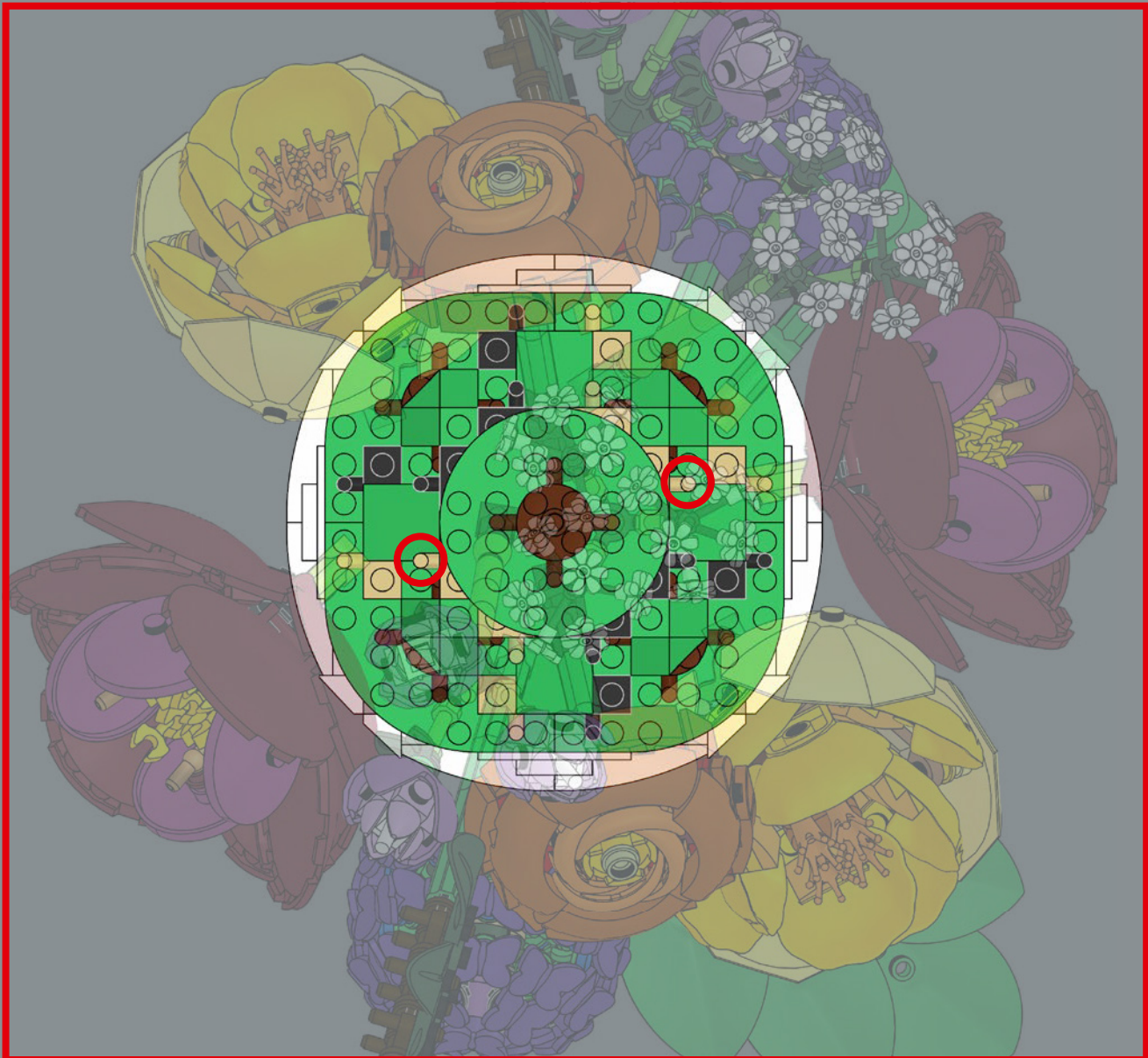



Découvrez d'autres astuces créatives  
grâce à votre compte LEGO® Insiders  
sur [LEGO.com/Botanicals-exclusive](https://LEGO.com/Botanicals-exclusive)





8x  
6527036

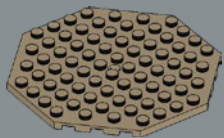

1x  
6288246



2x  
6392974



2x  
6512536



6x  
6400754



6x  
6398343



14x  
6510113



8x  
6329283



4x  
6525927



11x  
6344177



8x  
6348250



8x  
4539092



8x  
6168645



12x  
6212040



16x  
6527035



16x  
6099728



1x  
6365882



8x  
4529242



8x  
6172922



5x  
6313506



2x  
6092568



2x  
6170468



2x  
6459423



1x  
4531751



2x  
6316697



1x  
6135494



4x  
6301870



6x  
4211414



4x  
6258831



8x  
6313114



2x  
6093527



2x  
6116608



4x  
6469463



8x  
6231765



8x  
6527029



78x  
6468346



8x  
6212377



8x  
6252838



12x  
6520665



14x  
6452472



12x  
6265670



8x  
6492538



12x  
6510192



2x  
6482110



12x  
6534648



14x  
6256092



24x  
6468342



8x  
6527034



8x  
6473212



8x  
6468286



8x  
6466720



2x  
6510511



16x  
6492073



8x  
6527033

 [LEGO.com/service](https://www.LEGO.com/service)



# YOU COULD WIN



## YOU COULD WIN

Your feedback will help shape the future development of this product series.

Visit:

## DU KÖNNTEST GEWINNEN

Dein Feedback trägt zur Weiterentwicklung dieser Produktreihe bei.

Geh auf:

## VOUS POURRIEZ GAGNER

Vos commentaires nous aideront à concevoir les futurs produits de cette gamme.

Visitez :

## POTRESTI VINCERE TU

La tua opinione ci aiuterà a migliorare la creazione futura di questa linea di prodotti.

Visita:

## PUEDES GANAR

Tu opinión contribuirá al futuro de esta serie de productos.

Visita:

## 轻松获奖

您的反馈将有助于我们在今后改进本产品系列。

请访问：

---

# LEGO.com/productfeedback

---

You also have the chance to win a LEGO® set.

Terms and conditions apply.\*

Außerdem hast du die Chance, ein LEGO® Set zu gewinnen.

Es gelten die Teilnahmebedingungen.\*

Vous pourriez également gagner un ensemble LEGO®.

Des conditions s'appliquent.\*

Hai anche la possibilità di vincere un set LEGO®.

Termini e condizioni sono applicabili.\*

También tienes la oportunidad de ganar un set LEGO®.

Aplican términos y condiciones.\*

您还有机会赢取乐高®套装。

条款和条件适用。\*

\*LEGO.com/productfeedback-terms



LEGO and the LEGO logo are trademarks of the LEGO Group.  
©2025 The LEGO Group.