



10345





[LEGO.com/sustainable-packaging](https://LEGO.com/sustainable-packaging)



FR

**DONNEZ**  
OU  
**RECYCLEZ**



ASSOCIATION

OU



MAGASIN

OU



DÉCHÈTERIE

Adresses sur [quefairedemesdechets.fr](https://quefairedemesdechets.fr)



# BUiLDER



Apple and the Apple logo are trademarks of Apple Inc., registered in the U.S. and other countries and regions. App Store is a service mark of Apple Inc. Google Play and the Google Play logo are trademarks of Google LLC. Tencent and the Tencent logo are trademarks of Tencent Inc.

Q [LEGO.com/devicecheck](https://LEGO.com/devicecheck)



Q LEGO® Builder



**BUILD IT  
YOUR  
WAY**



**EN** Build It Your Way | **DE** Bau, wie du willst  
| **FR** Construisez à votre façon | **IT** Costruiscilo come  
vuoi tu | **ES** Constrúyelo a tu manera | **PT** Constrói à  
Tua Maneira | **ZH** 自由拼搭 | **PL** Zbuduj po swojemu  
| **CS** Postavte to po svém | **SK** Postavte to po svojom  
| **HU** Építs kedved szerint! | **RO** Construięște așa cum dorești  
| **BG** Постройте го по своя начин | **LV** Būvē tieši tā, kā  
vēlies | **ET** Ehita enda moodi | **LT** Sukonstruokite savaip



# UN REGALO DE NATURALEZA CREATIVA

La colección LEGO® Botanical te invita a explorar un sinfín de posibilidades creativas. Los sets, inspirados en la flora de todas las regiones del mundo, permiten a los amantes de la naturaleza disfrutar de un original y colorido arreglo de "flores eternas". Este set en particular presenta una composición cuidadosamente seleccionada de elementos populares en los ramos de flores, elegantemente expuestos en un jarrón blanco con pie... y versatilidad integrada.



*Camellia x williamsii*

## Camelia Night Rider

*Originario del Reino Unido, este arbusto perenne de porte compacto y hojas brillantes de color oscuro se caracteriza por sus flores de un tono burdeos intenso, semidobles, que florecen a finales del invierno y principios de la primavera. En los jardines, puede alcanzar hasta 1,5 m de altura y de ancho.*

## Peonía Itoh

Las peonías interseccionales se cultivaron por primera vez en Japón en la década de 1940. Como híbridos entre peonías arbóreas y herbáceas, sus flores pueden alcanzar un tamaño de hasta 20 cm de diámetro.

No suelen recomendarse para su cultivo en maceta, pero podemos asegurarte que esta versión LEGO® florecerá en cualquier época del año.

*Peonia Itoh*



*Hydrangea arborescens*

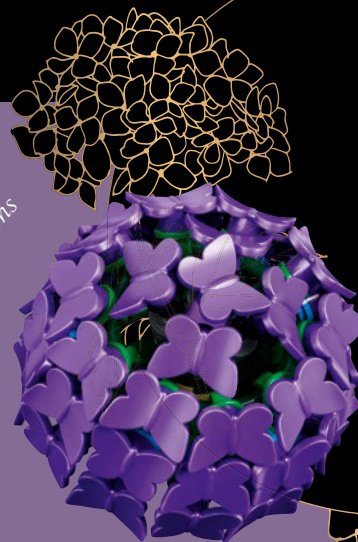

## Hortensia

Originario de Asia, América del Norte y América del Sur, existen más de 70 especies de este majestuoso arbusto repartidas por jardines de todo el mundo. Las flores cambian de color dependiendo del pH del suelo: azules en suelos ácidos, de tonos rosados en suelos alcalinos y blancas en suelos neutros.

## Velo de novia

Muy común en los arreglos florales en todo el mundo, la planta velo de novia es ligera como una nube de verano. Representa el amor eterno y aporta un toque de elegancia a cualquier ramo o centro de mesa, incluso seca en jarrones o coronas decorativas.



*Ranunculus*

## Ranúnculo persa

El ranúnculo persa, una planta tuberosa perenne, puede alcanzar hasta 60 cm de altura. Sus flores, con pétalos densamente estratificados en colores suaves o brillantes, son suntuosas y duraderas, e iluminan cualquier espacio, tanto en interiores como en jardines.





Bouvardia

## Flor de colibrí

Como pequeños ramos que rematan cada tallo, estas flores se despliegan en forma de encantadoras estrellitas, lo que dio lugar a sus otros nombres habituales: "petardo" o "trompetilla". Originarias de América Central, también tienen parientes en Europa y Canadá.



## Azucena

Con entre 80 y 100 especies, y casi las mismas variaciones cromáticas, las azucenas nos cautivan con su agradable fragancia y su intenso brillo. Símbolos de elegancia atemporal y pureza, son una opción muy apreciada en celebraciones y actos de sinceridad.



Lilium



# PLANTA UNA SEMILLA DE INSPIRACIÓN

Construir tu Arreglo Floral LEGO® Botanical es solo el comienzo. Cada vez que te apetezca darle un nuevo aire a tu decoración, cambia las flores entre los tallos o mezcla varios sets para crear ramos totalmente diferentes. De este modo, puedes ajustar el modelo a cualquier estación, a tu estado de ánimo o al nuevo estilo de tu hogar. Y si ya tienes experiencia como florista LEGO, ¡ánimate a reinventar tu set creando nuevas variedades!







Descubre más consejos  
florales creativos con tu  
cuenta LEGO® Insiders en

[LEGO.com/Botanicals-exclusive](https://LEGO.com/Botanicals-exclusive)



Combínalo con el set 10342.  
A la venta por separado.

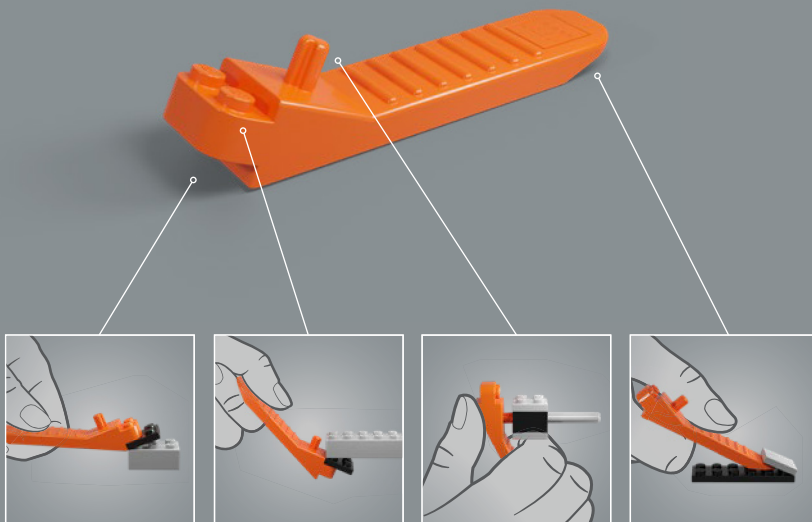

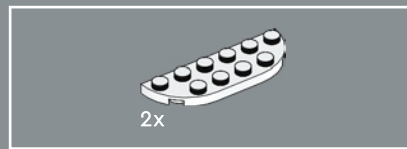

2

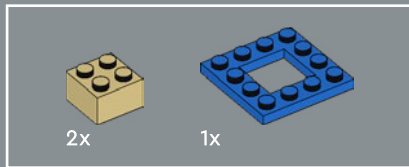
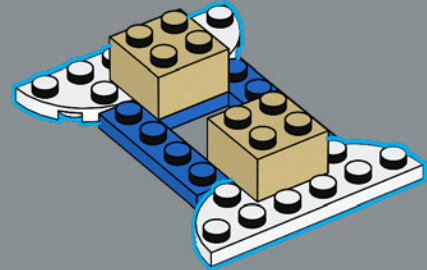

1

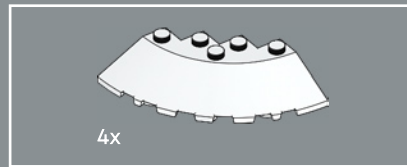
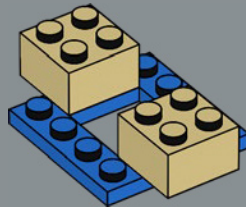

3

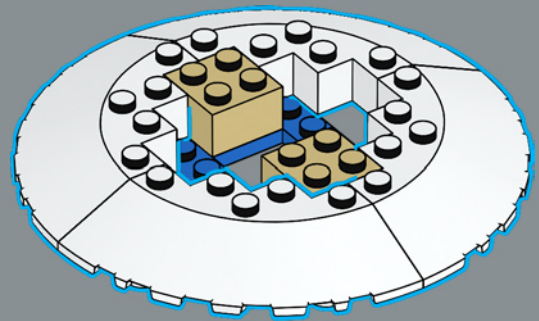

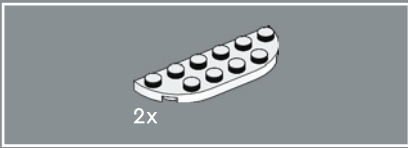

4

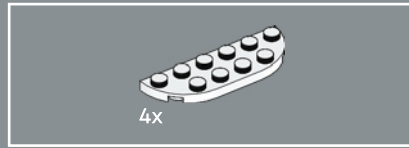
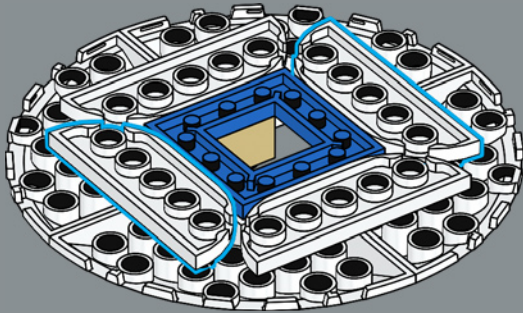

5

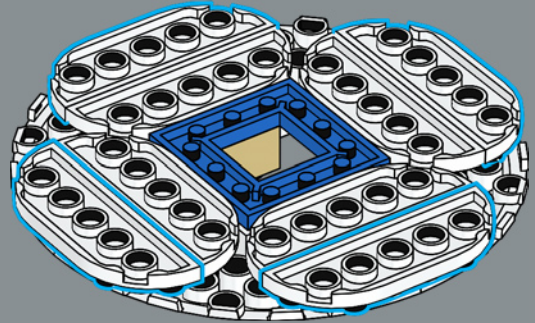



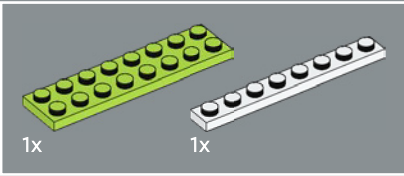
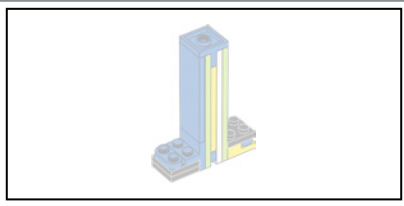

6

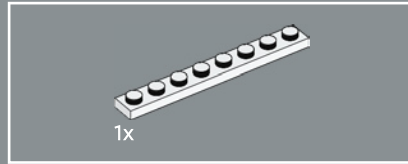
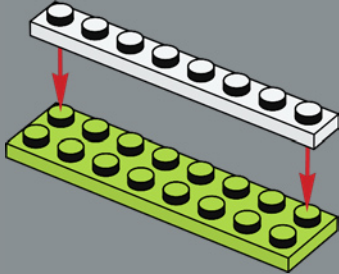

7

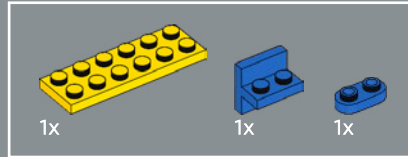
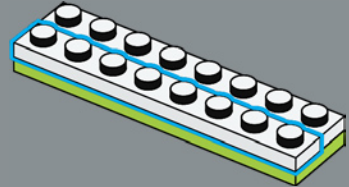

8

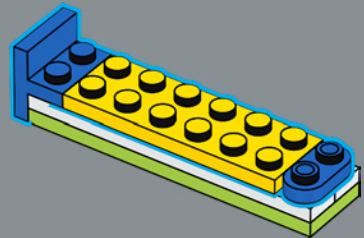

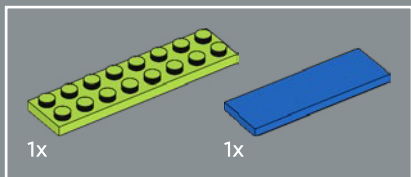

9

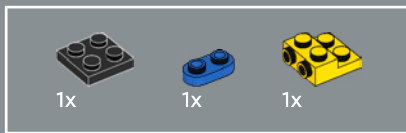
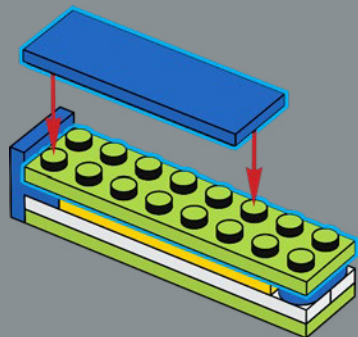

10

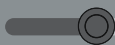
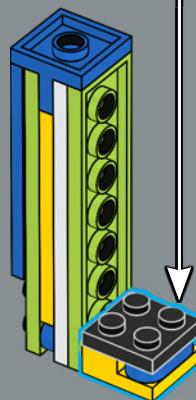
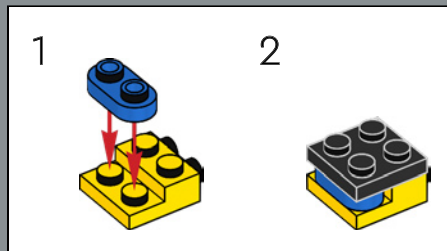

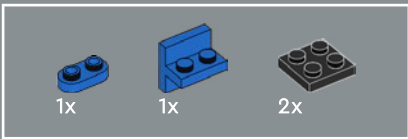

11

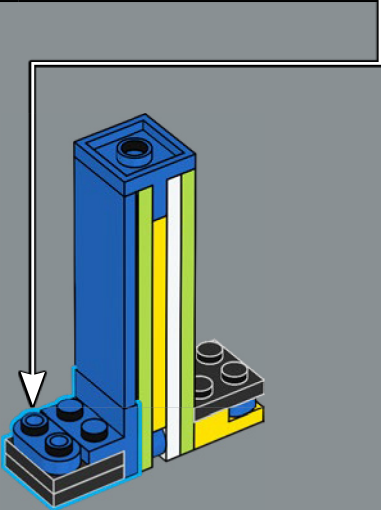
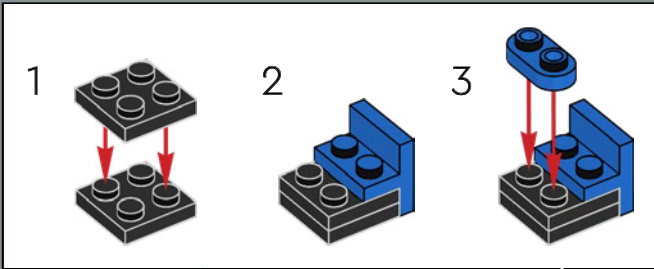

12

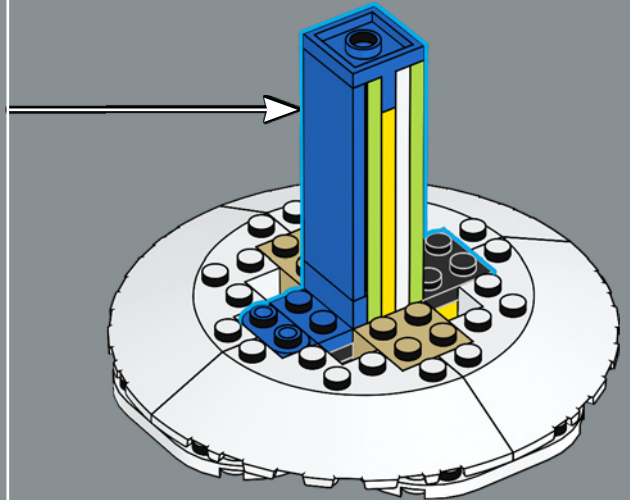

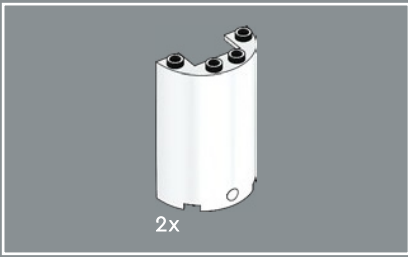

13

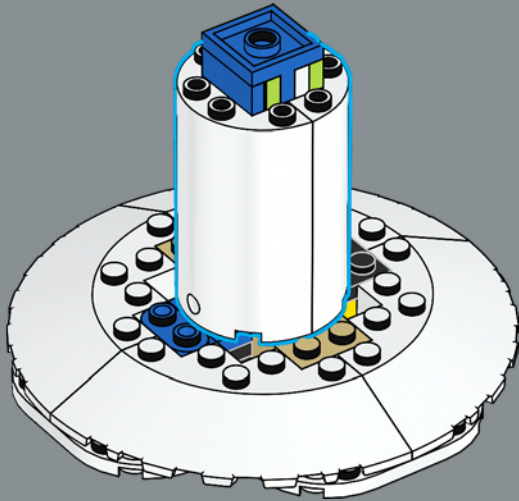

14

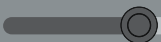
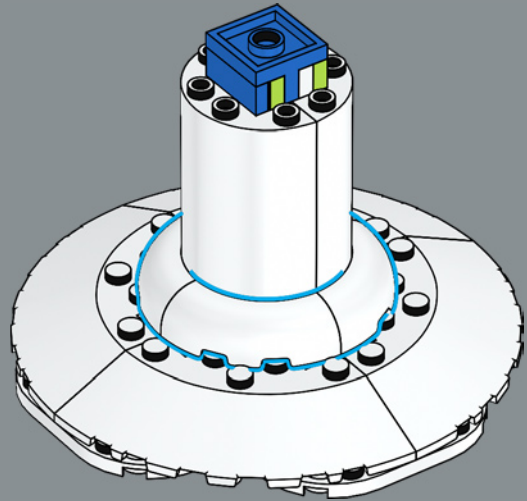

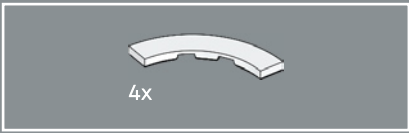

15

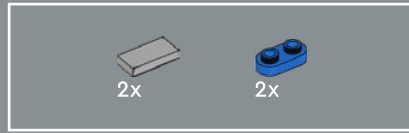
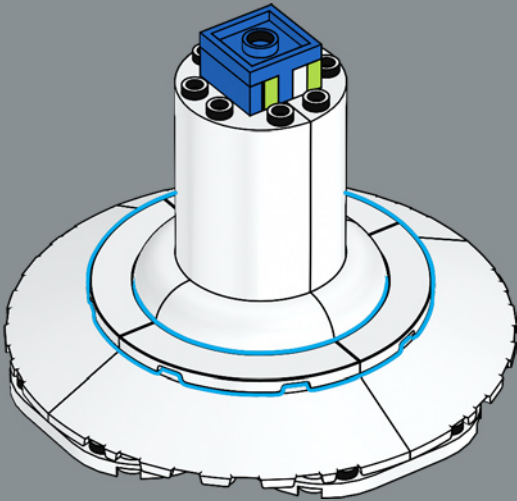

16

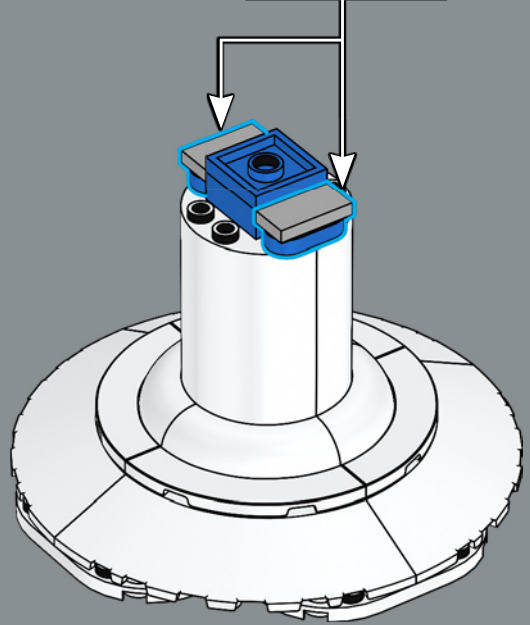
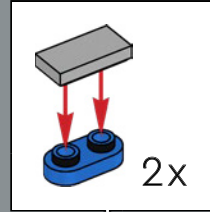



17

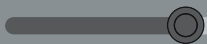
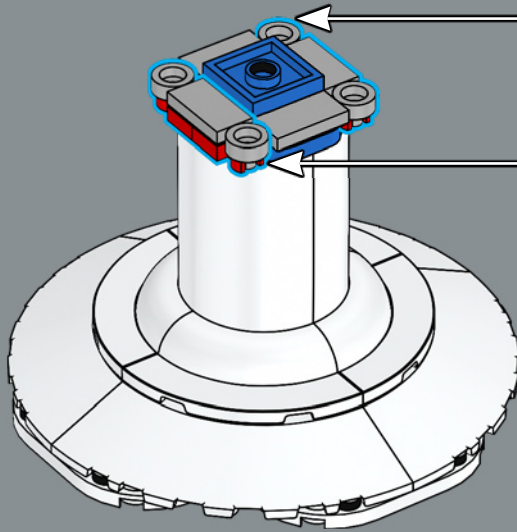
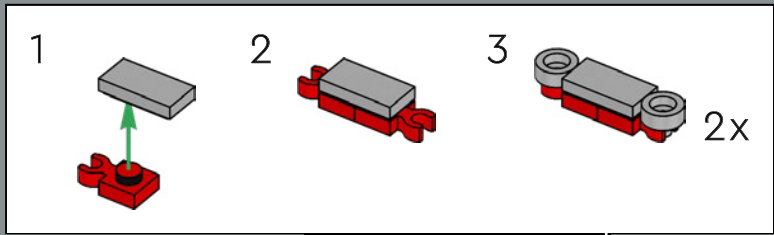

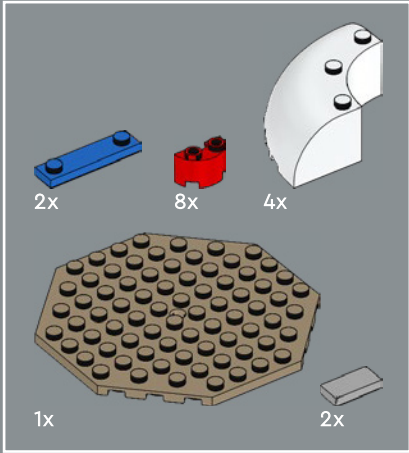
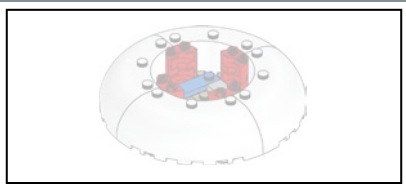

18

1

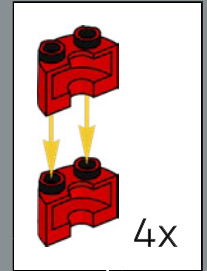
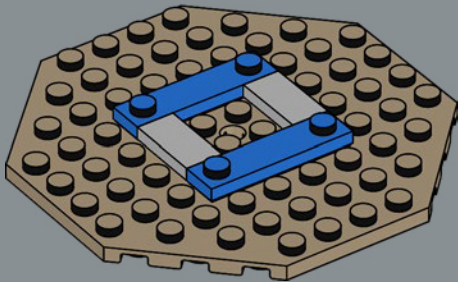

2

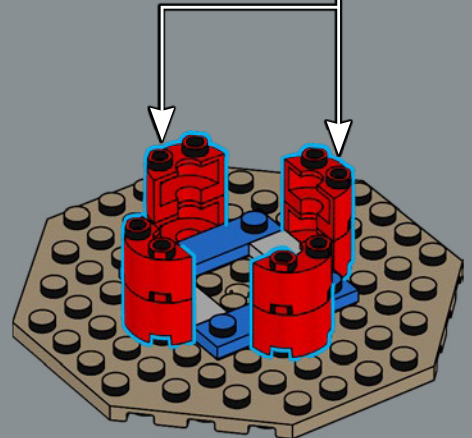

3

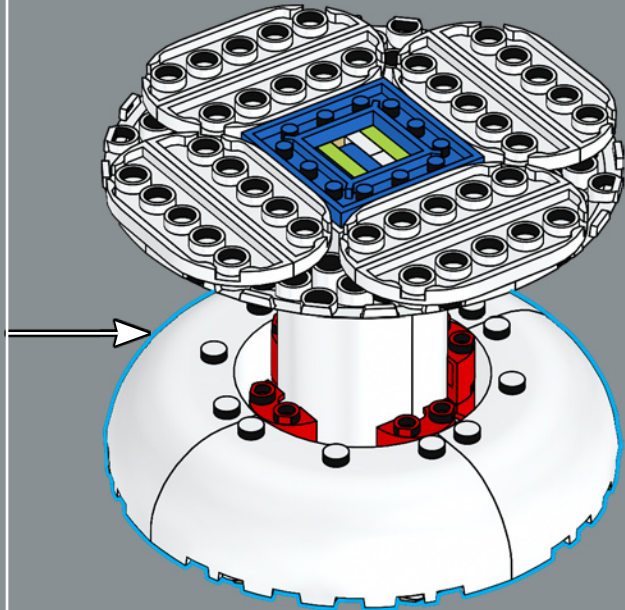
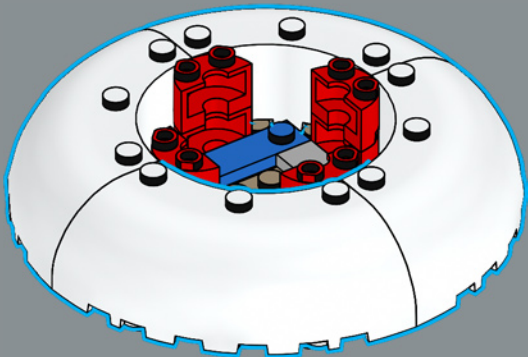





19

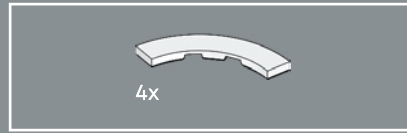
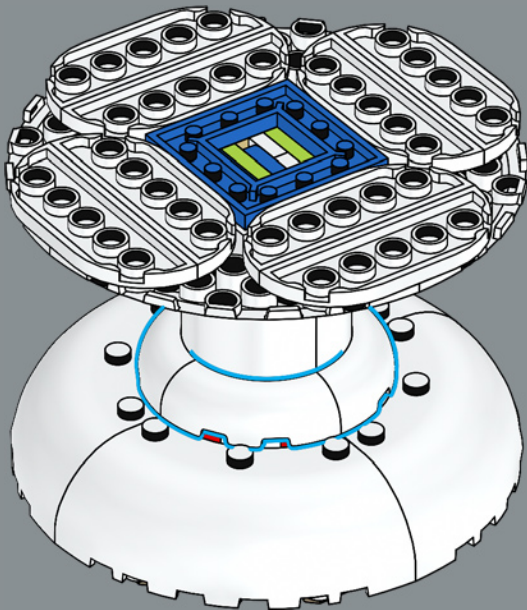

20

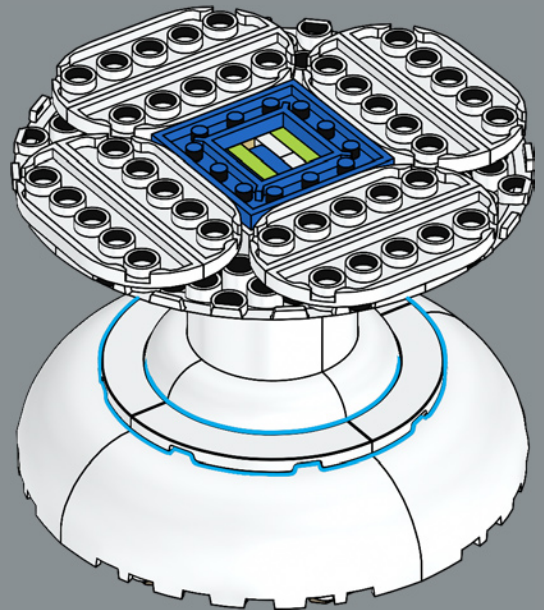



21

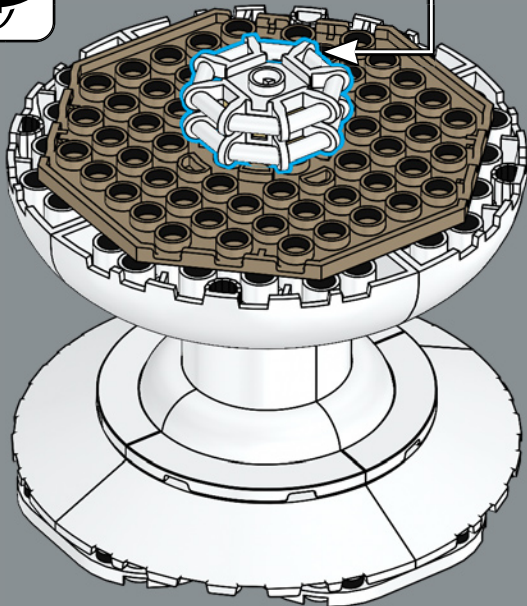
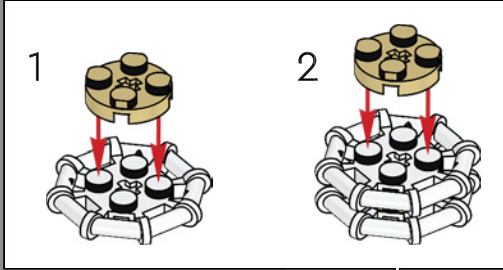

22

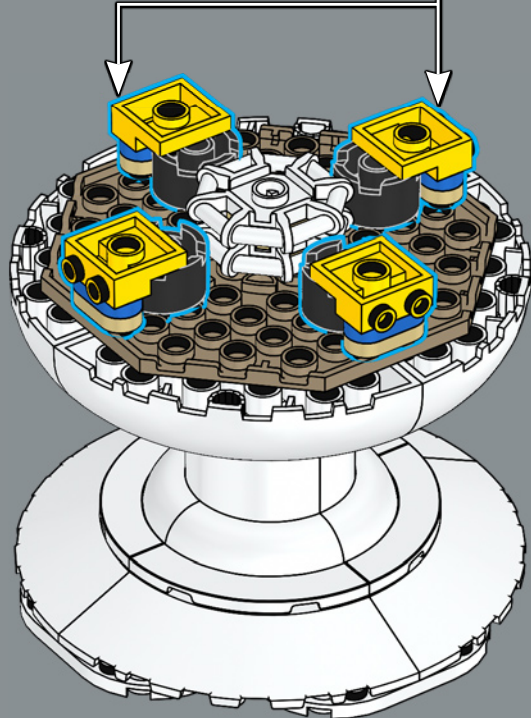
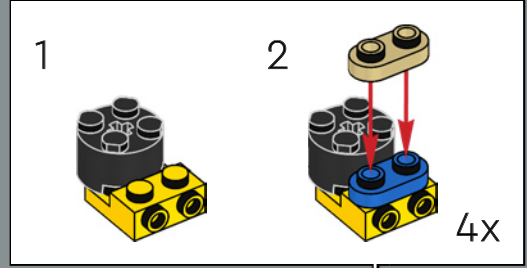

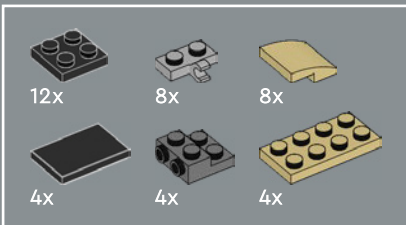
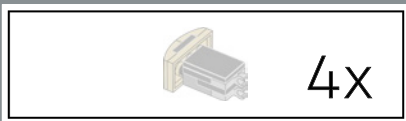

23

1

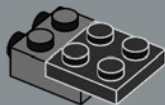

2

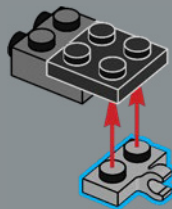

3

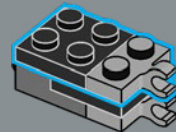

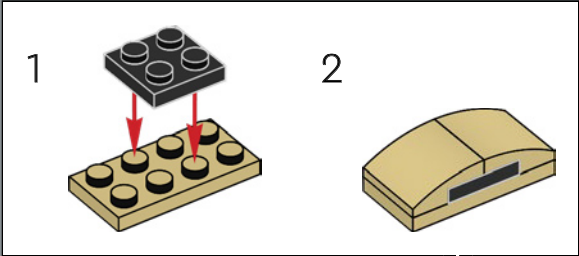

4

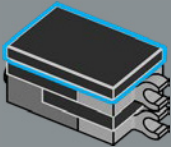

5

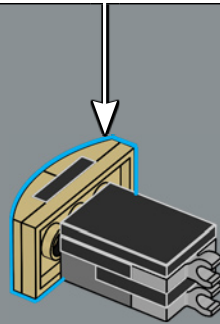

4x

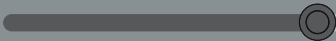

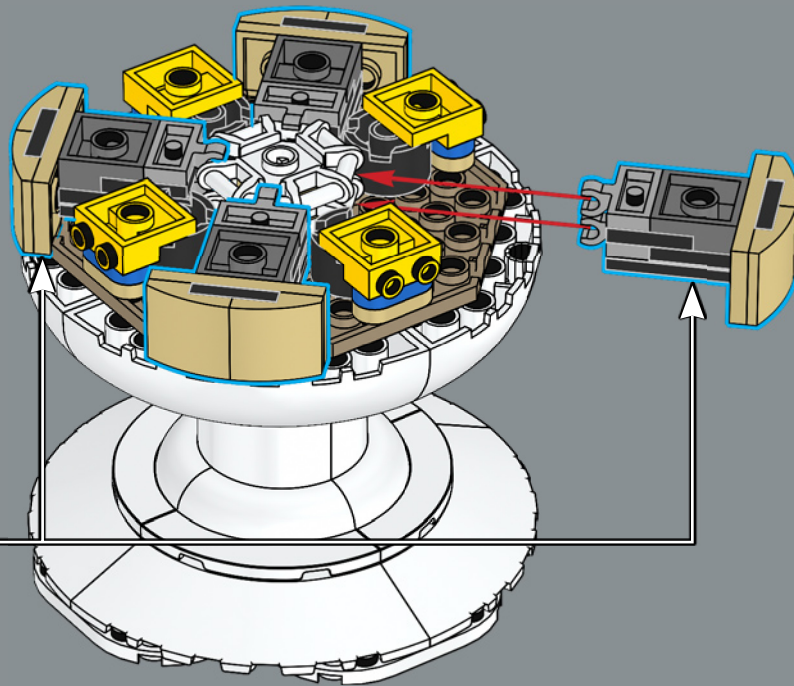

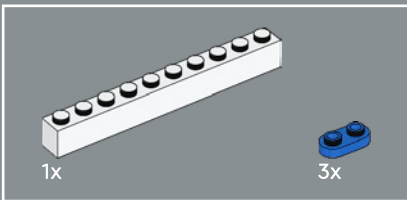
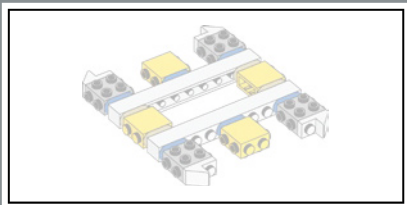

24

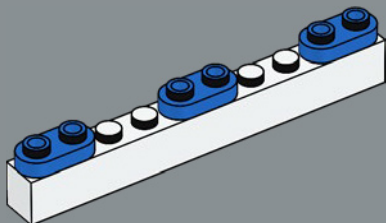

25

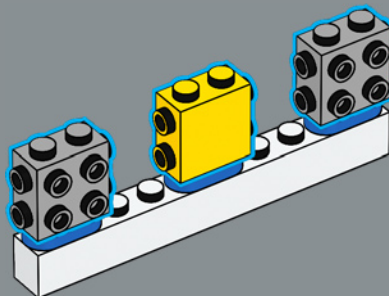

26

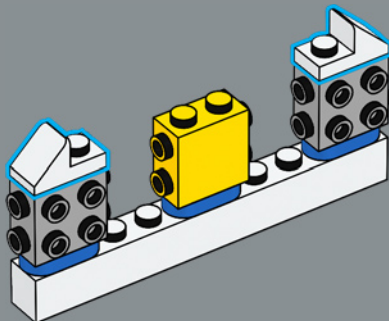



27

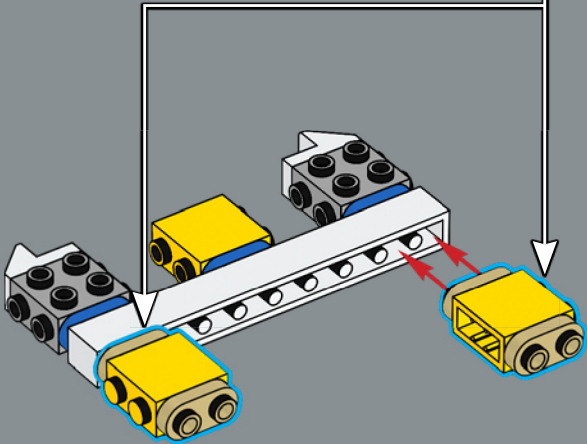
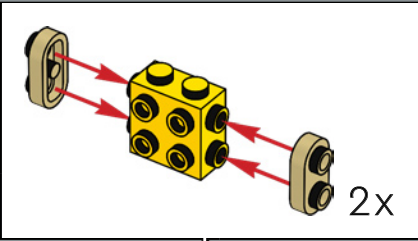

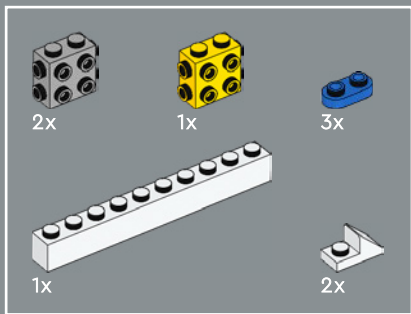

28

1

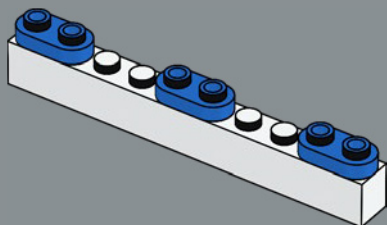

2

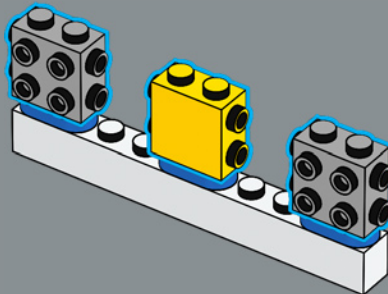

3

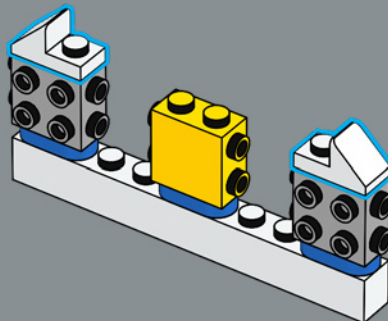



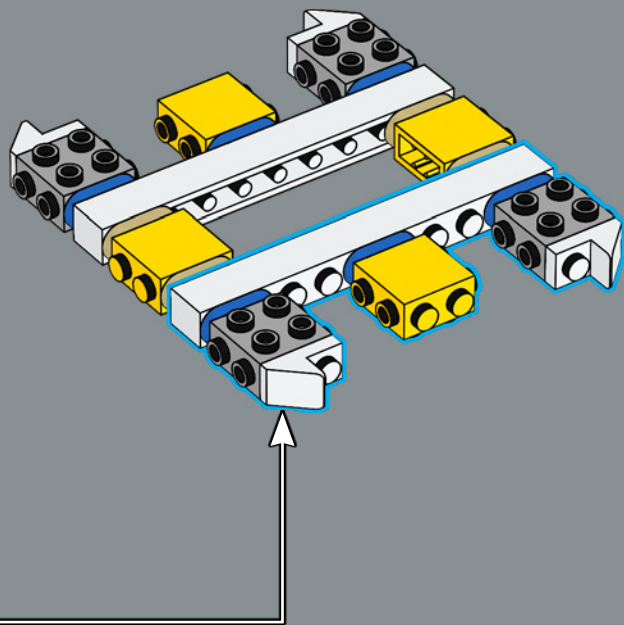

29

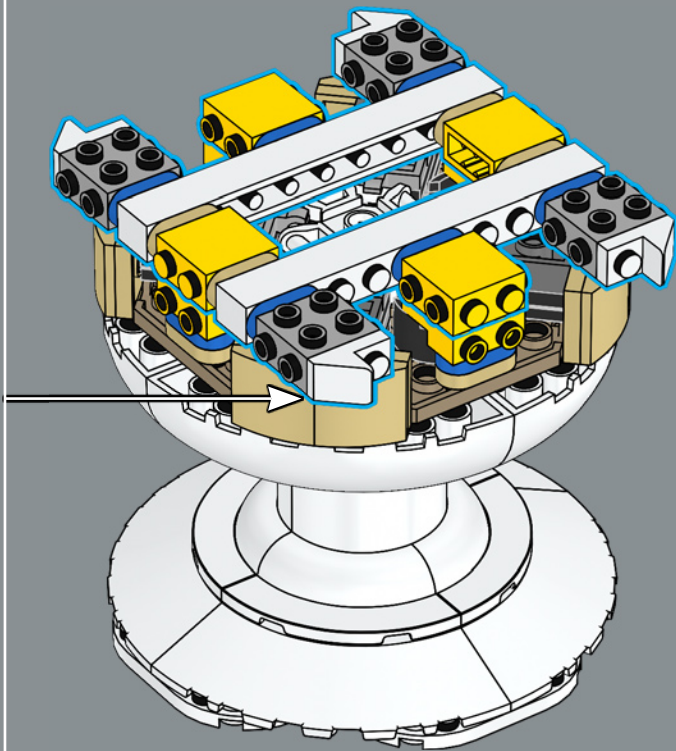

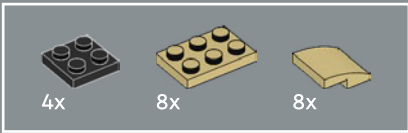

30

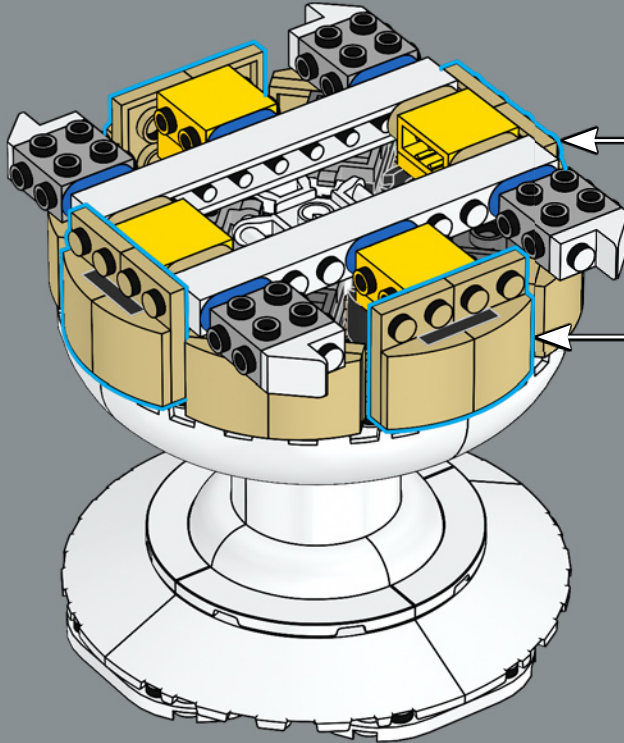
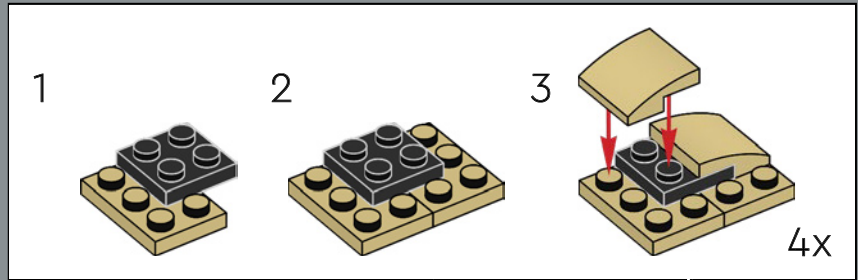

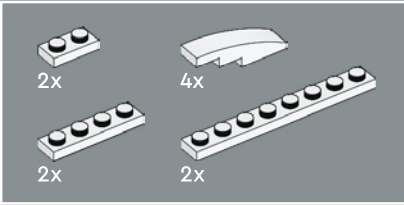
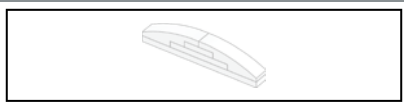

31

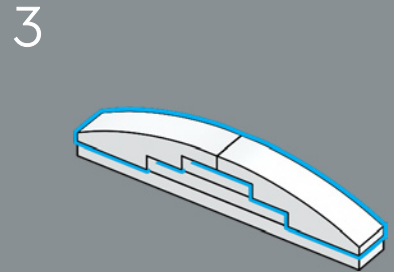
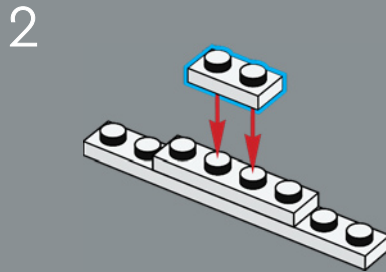
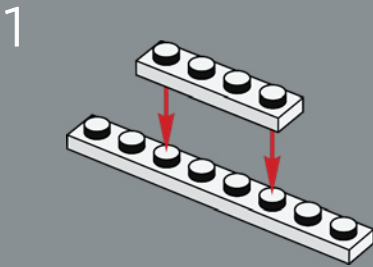

2x

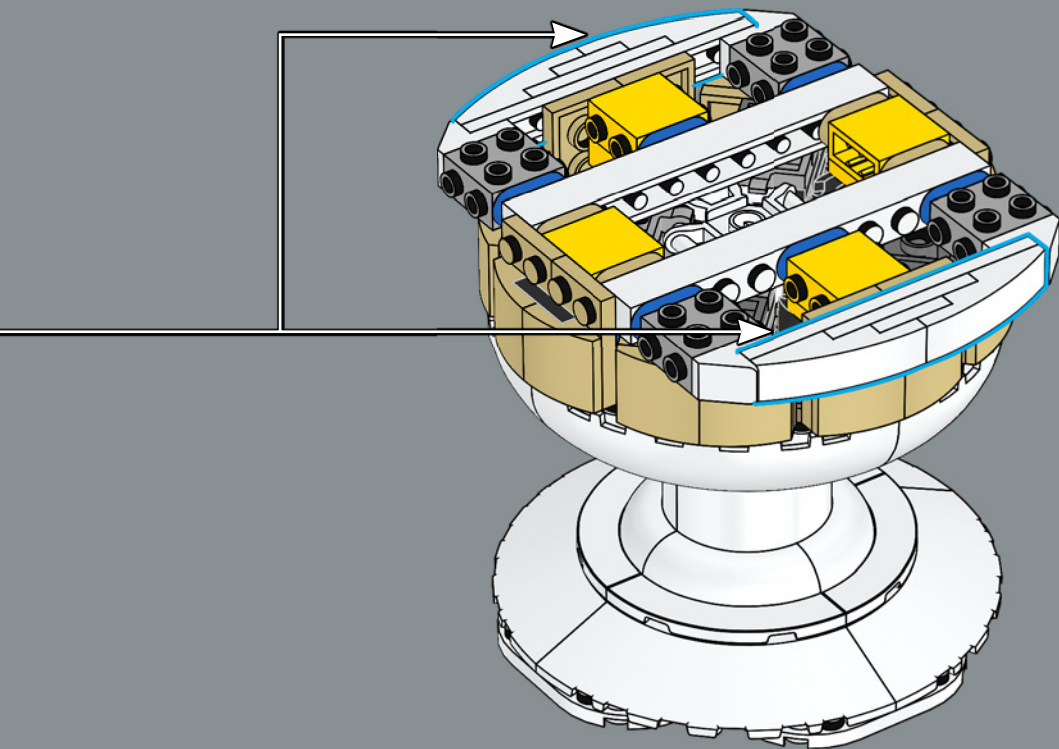

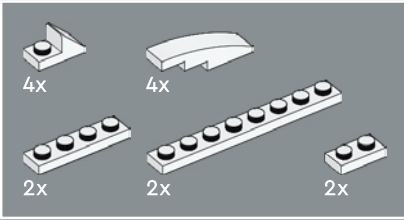
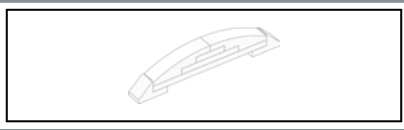

32

1

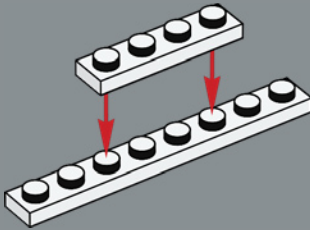

2

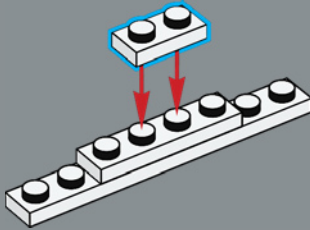

3

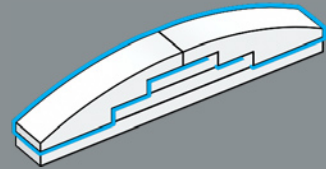

4

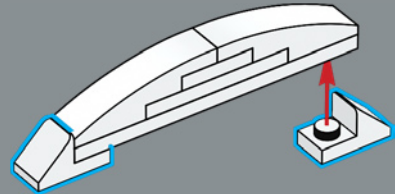

2x

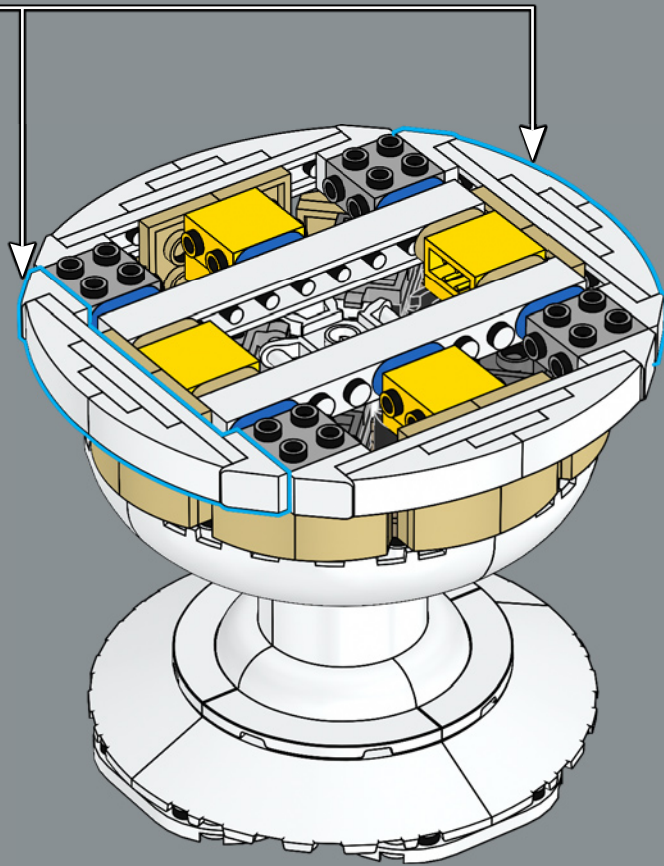

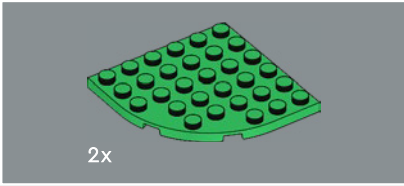
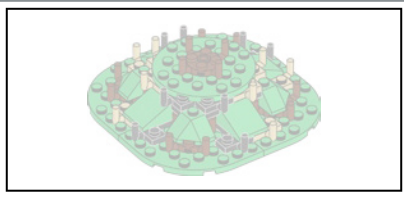

33

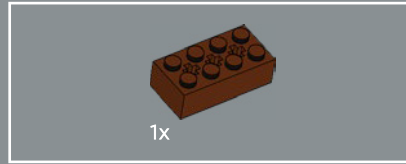
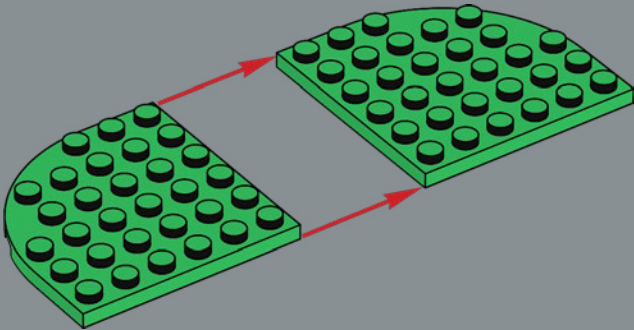

34

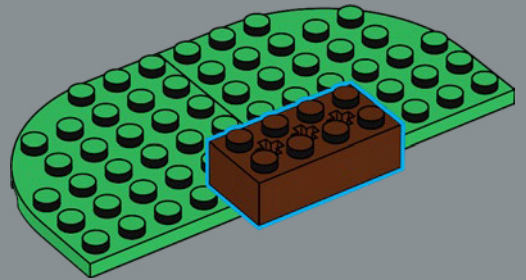

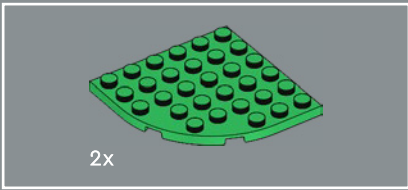

35

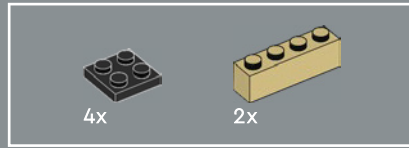
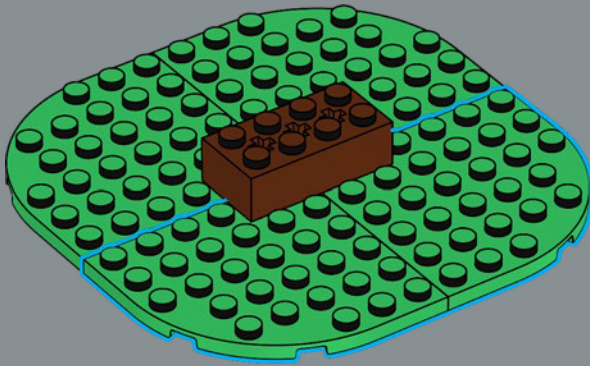

36

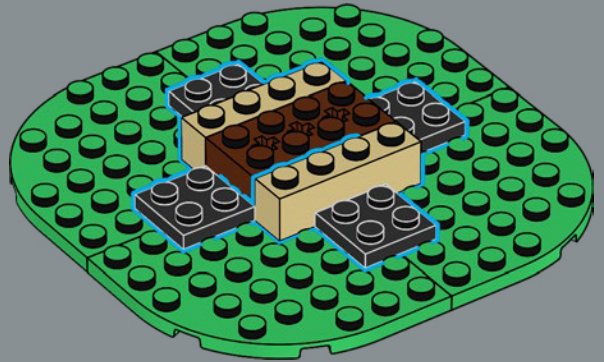





37

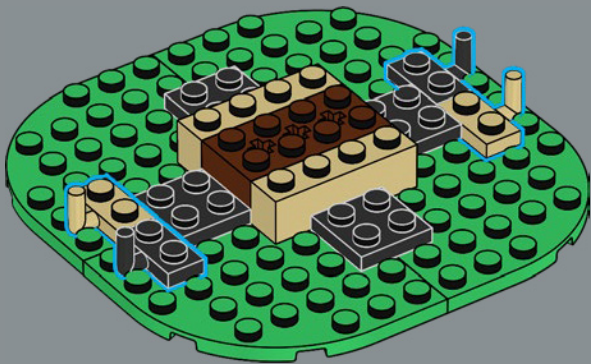

38

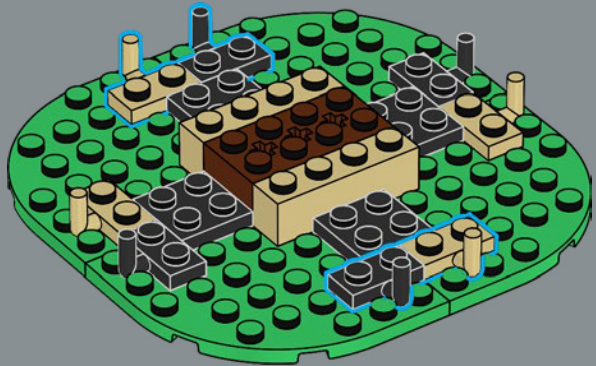



39

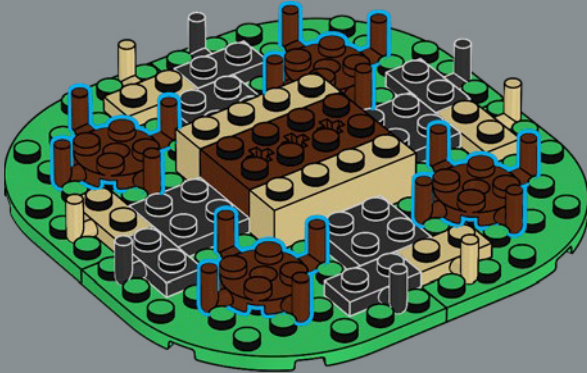

40

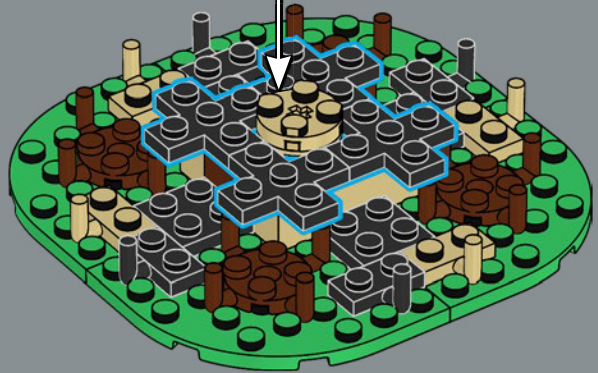
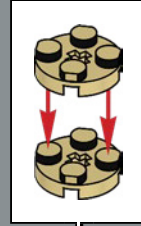

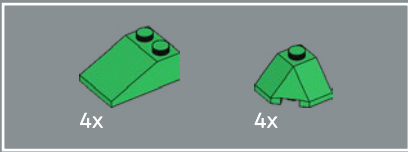

41

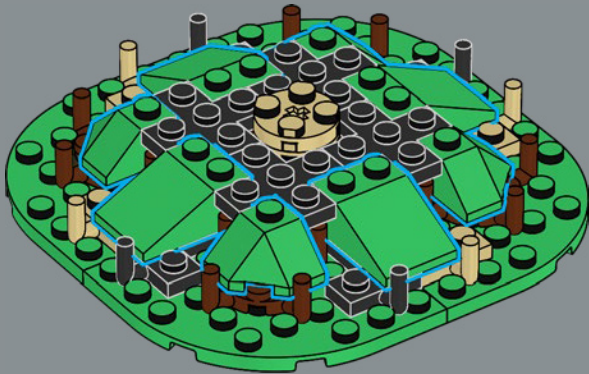

42

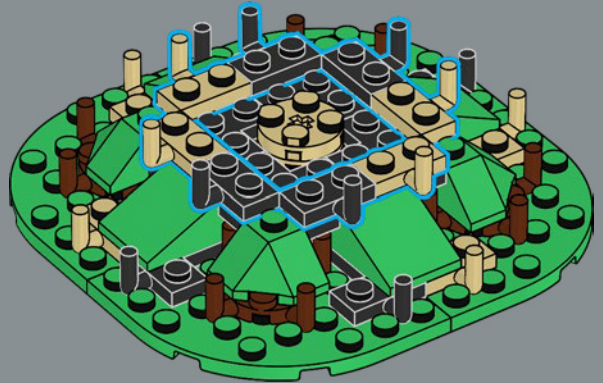

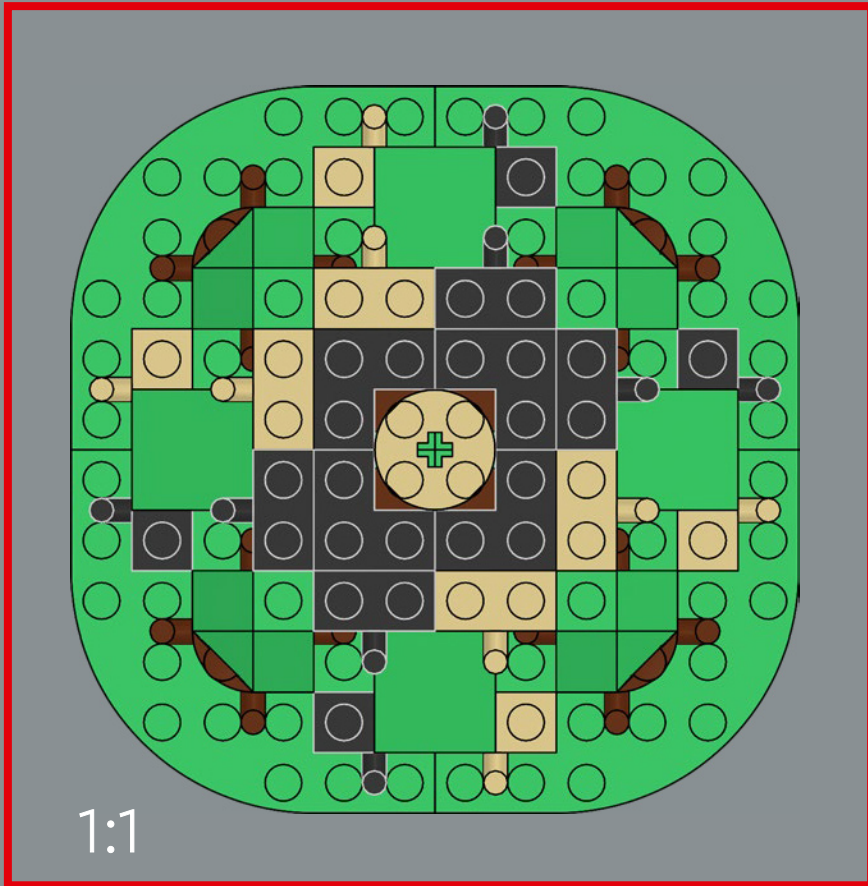

1:1



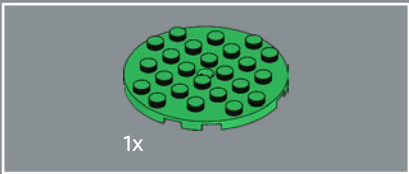

43

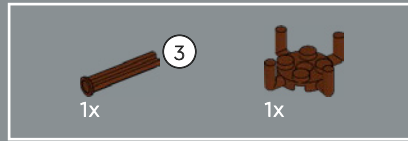
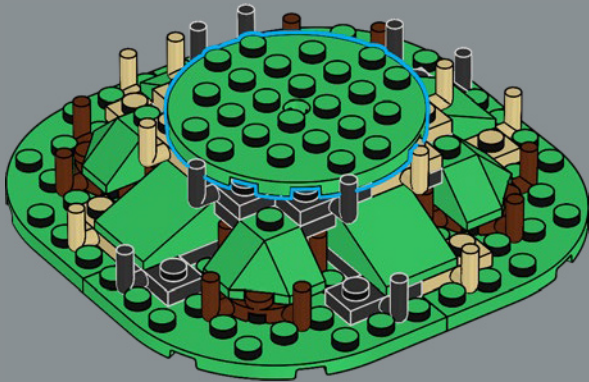

44

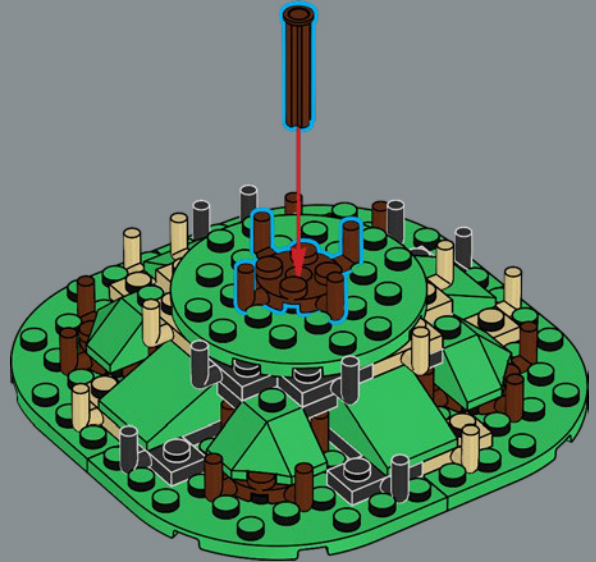

45



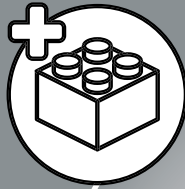

16x



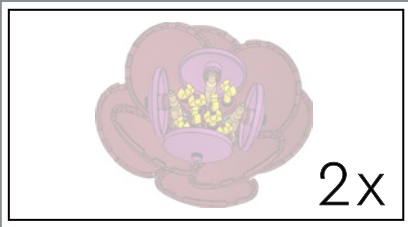

46

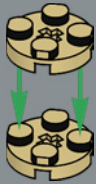

47



48







49

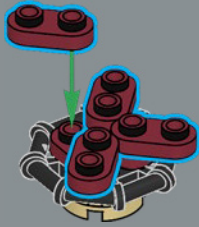

¿Tienen que echarle una mano para construir esta flor?  
En este caso, ¡el centro está formado por elementos  
LEGO® que representan manos robóticas!



50



51

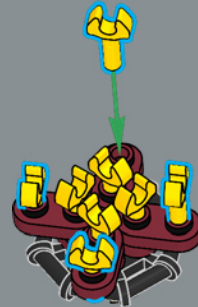

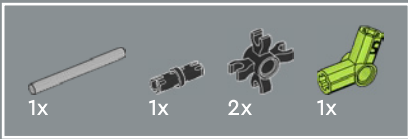

52

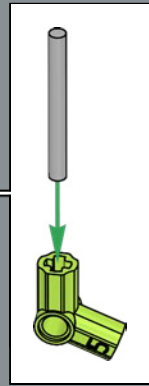
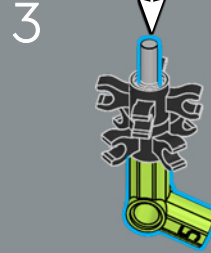
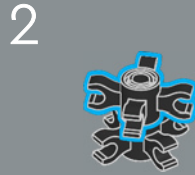
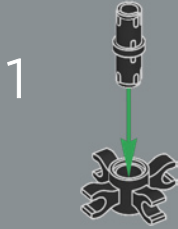



53

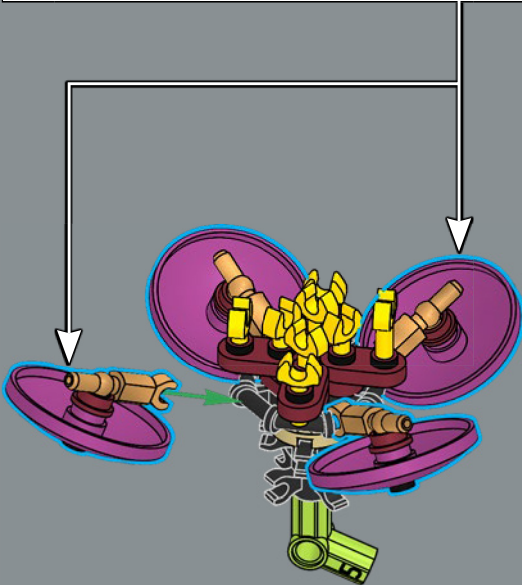
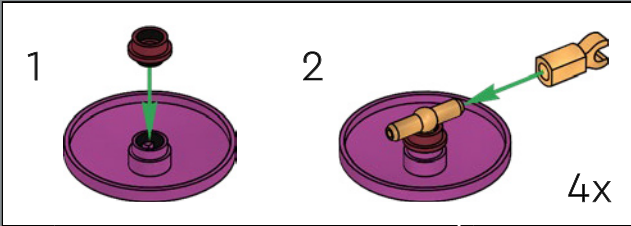

54

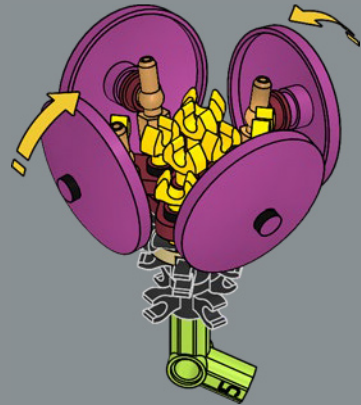

Camelia Night Rider: Estos pétalos de color rojo oscuro se usan con frecuencia (en otros colores) en las cabinas de los vehículos LEGO®.

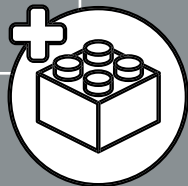
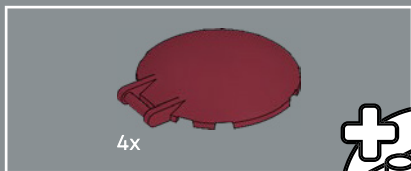

55

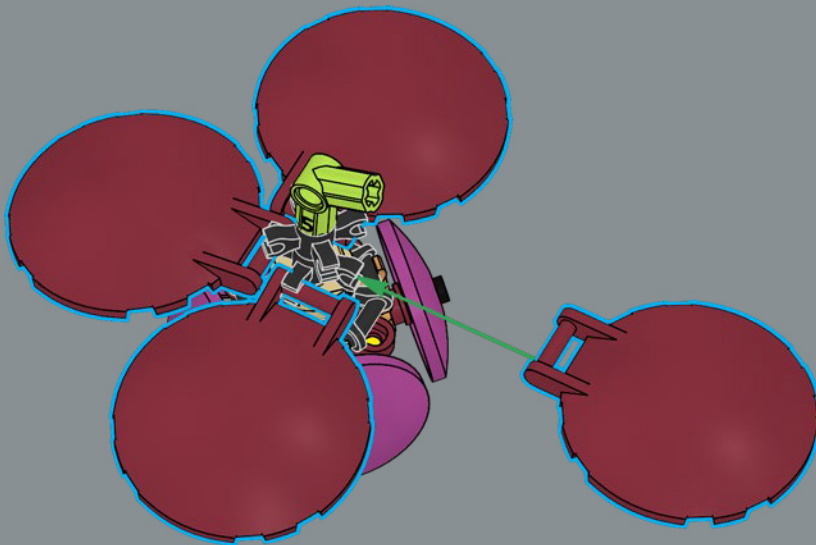

56

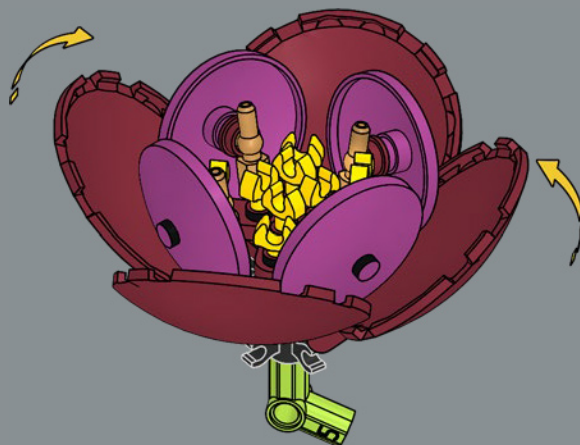

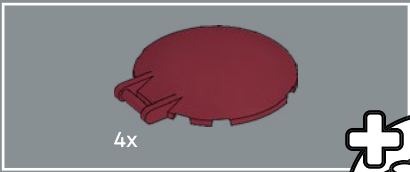

57

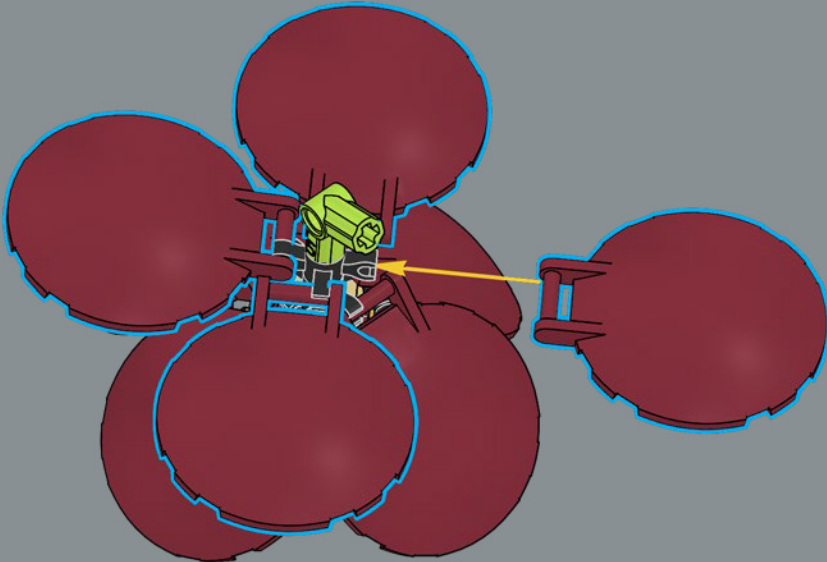
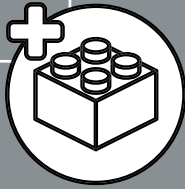

2x



58

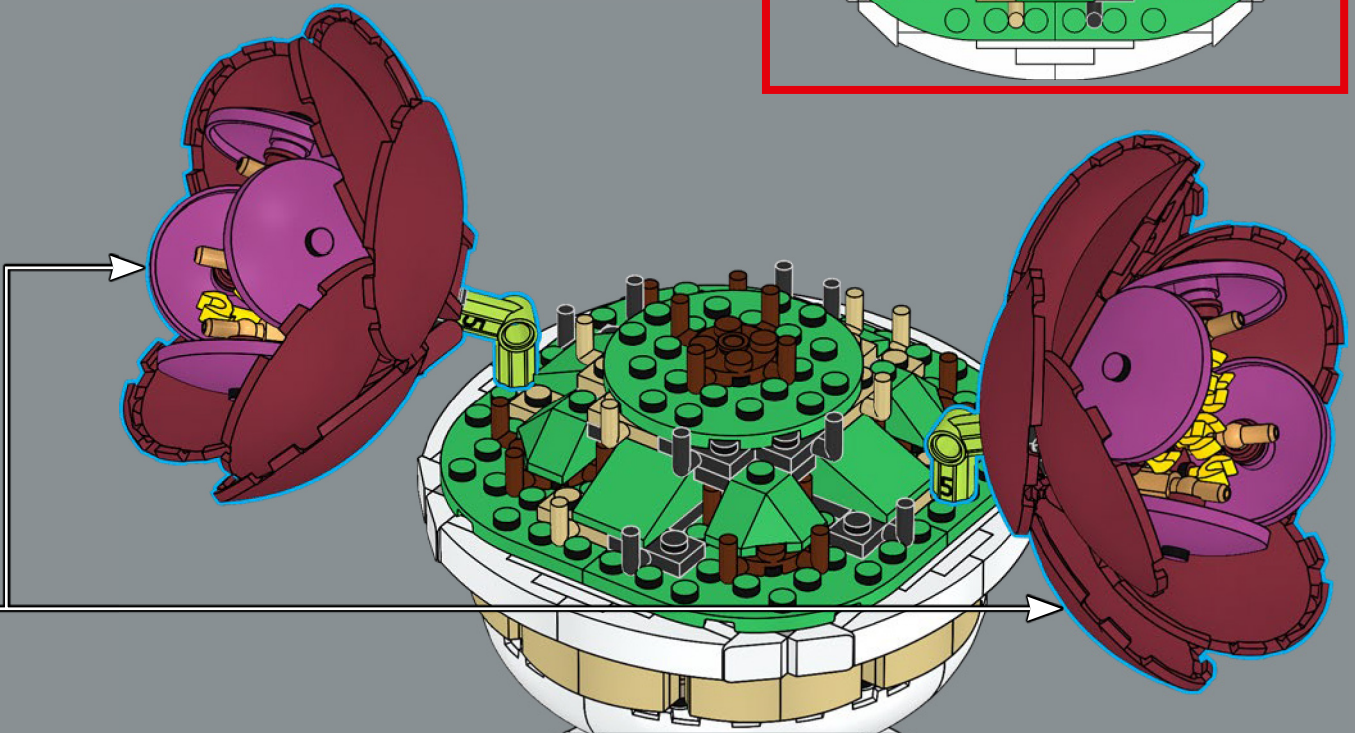
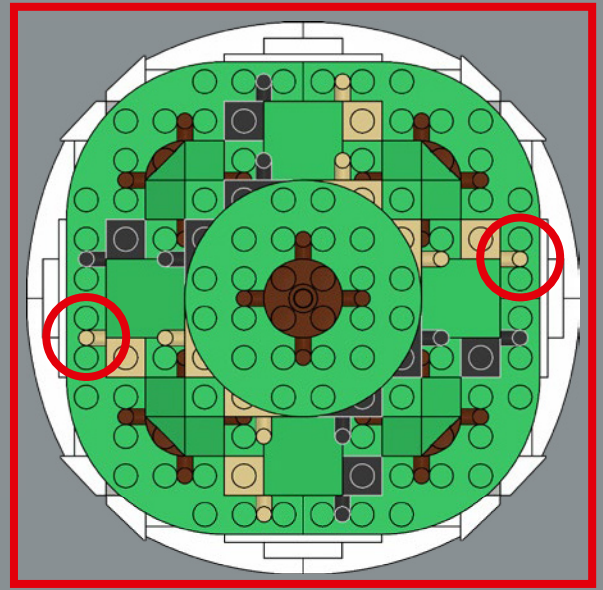

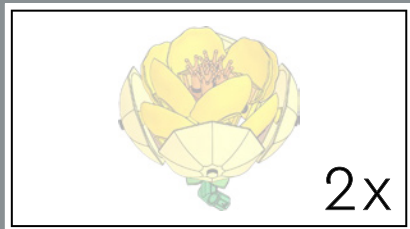

59

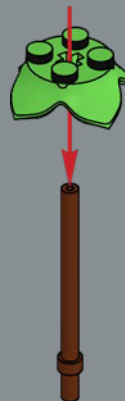

60







61

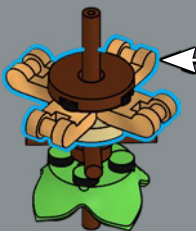
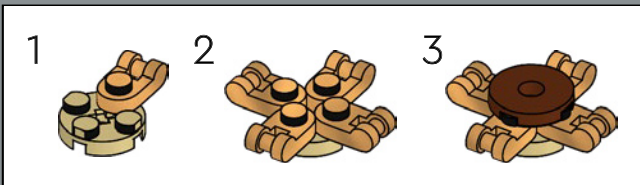

62

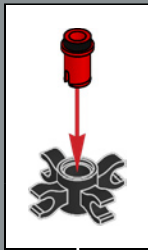



63

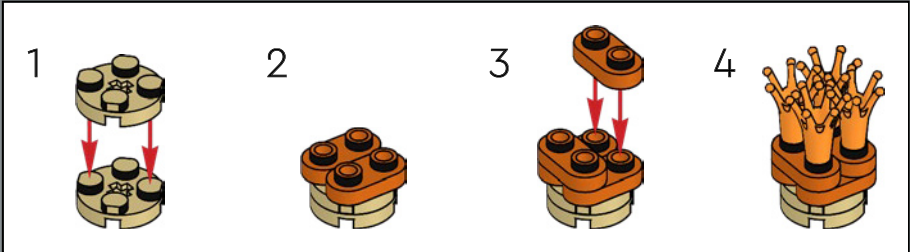



64

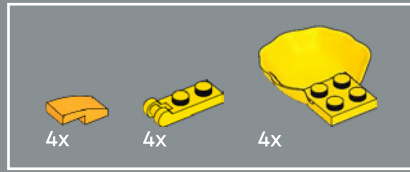

65

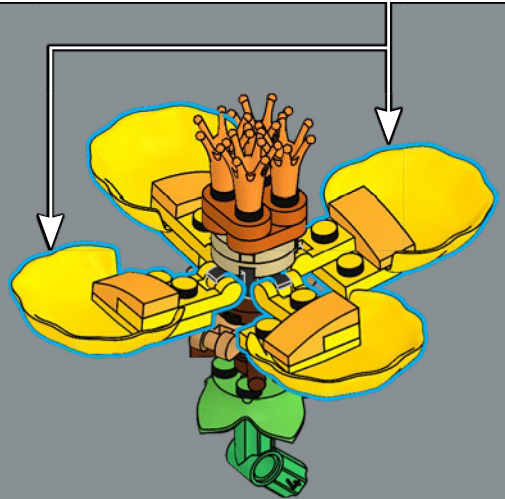
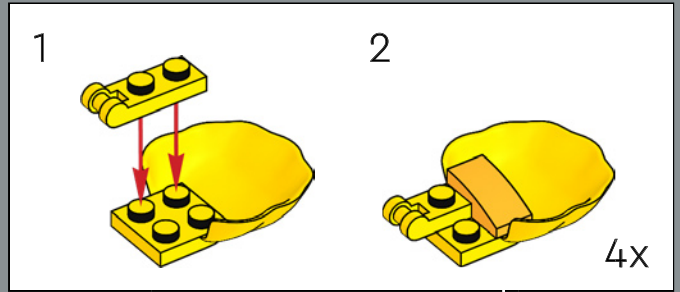

66

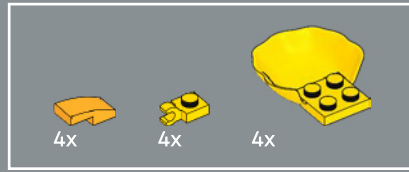
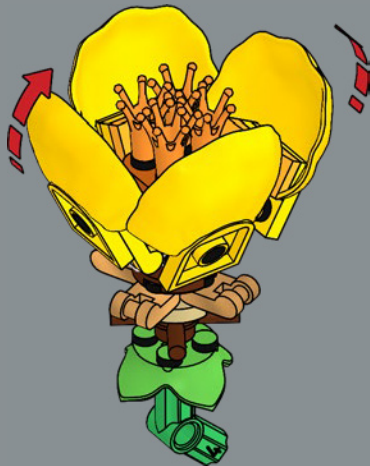

67

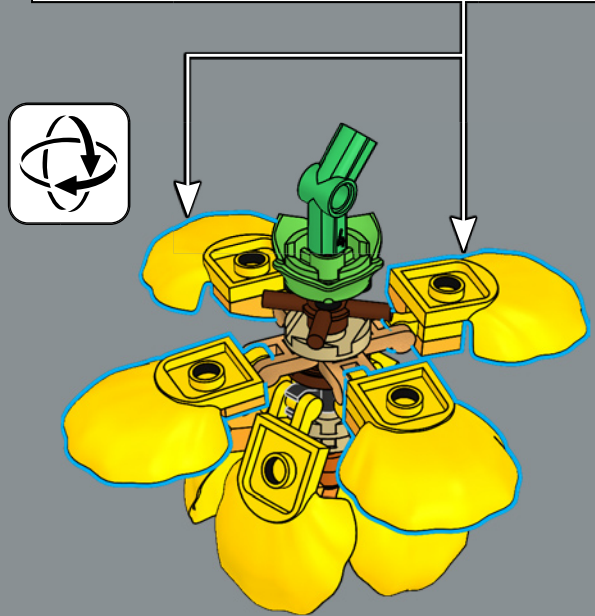
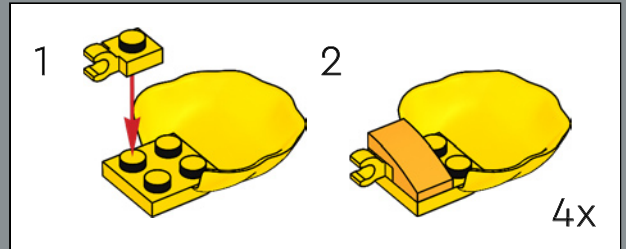

68

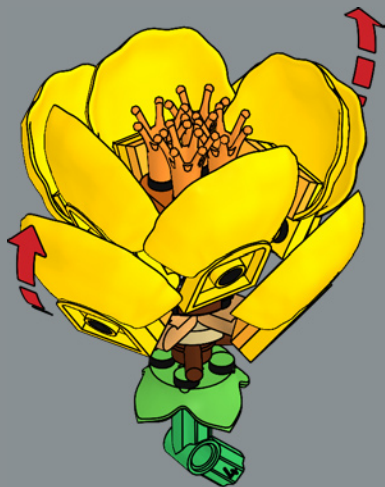

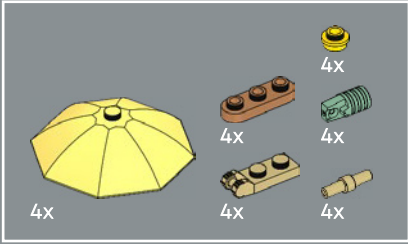
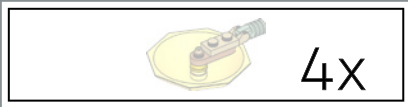

69

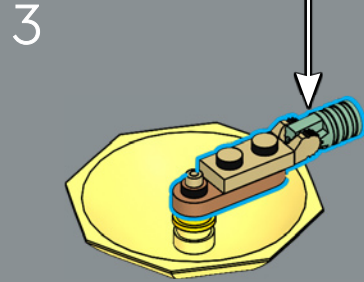
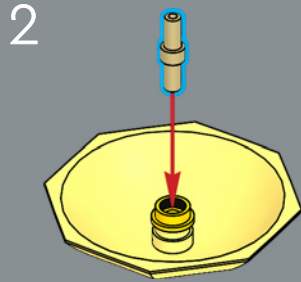
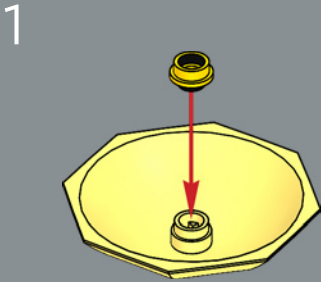
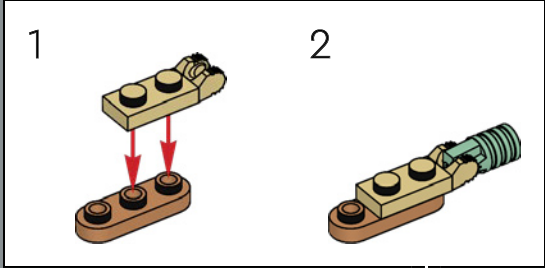

4x



Peonía Itoh: ¿De repente te han entrado ganas de ir a la playa? A lo mejor solo estás dándote cuenta ahora mismo de que esta peonía se construye con sombrillas y conchas LEGO®, ¡e incluso algunas coronas!

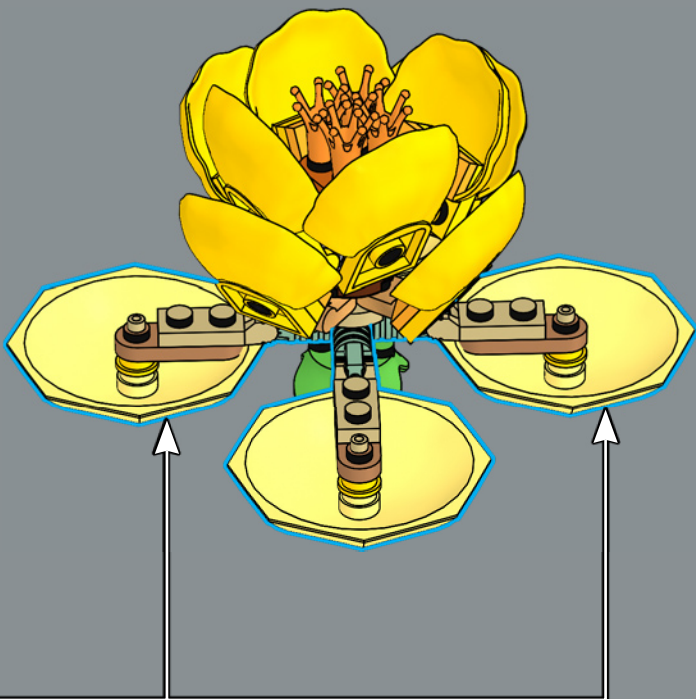

70

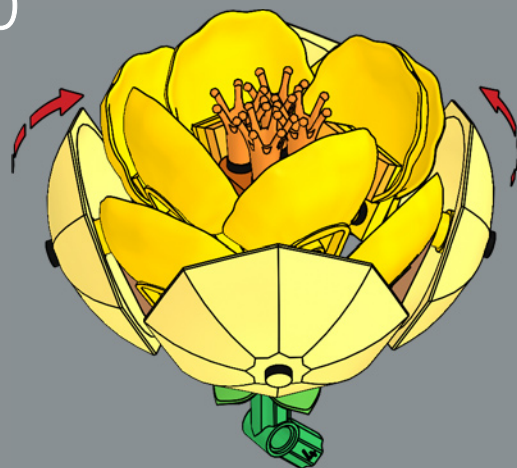

2x

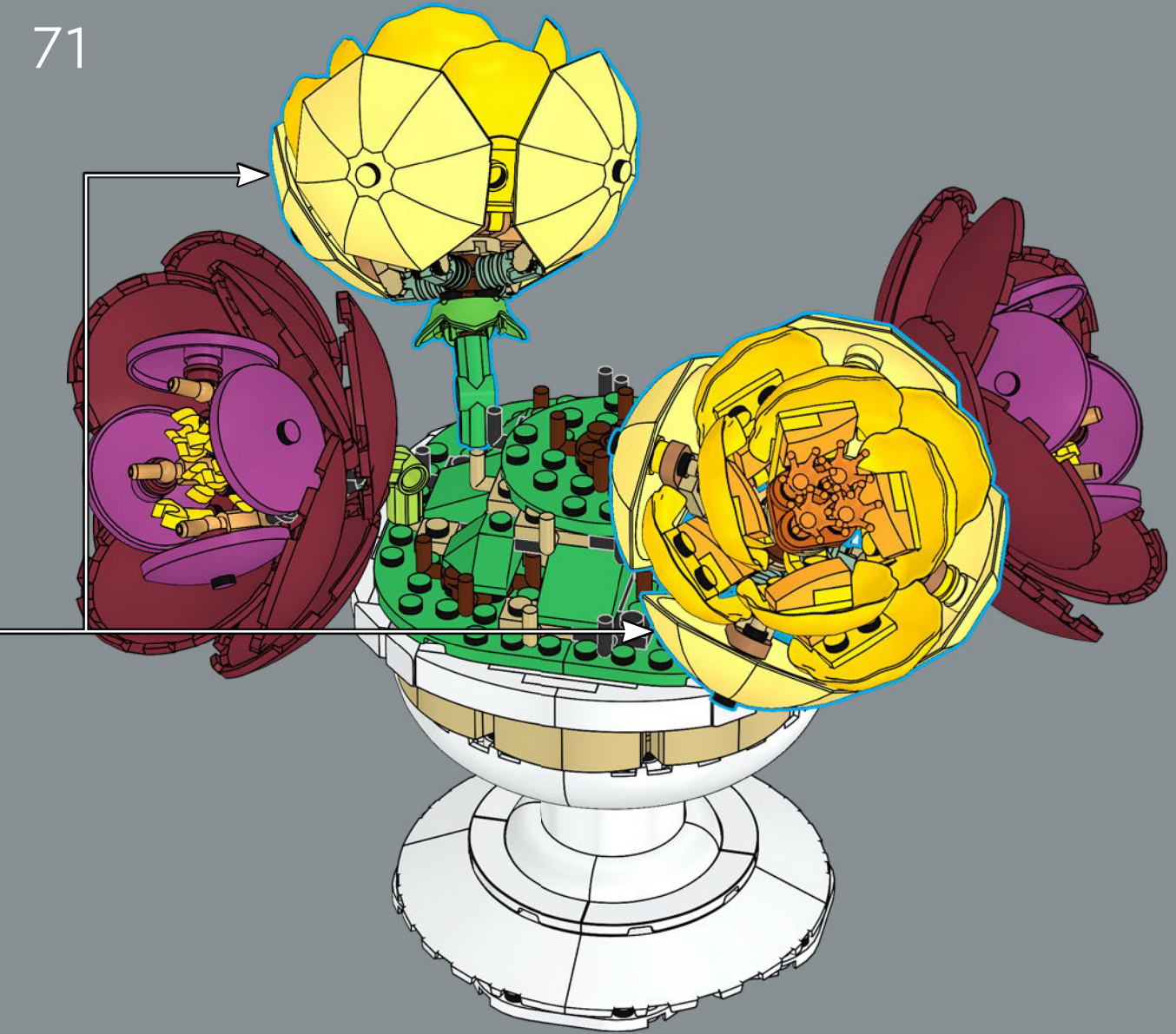



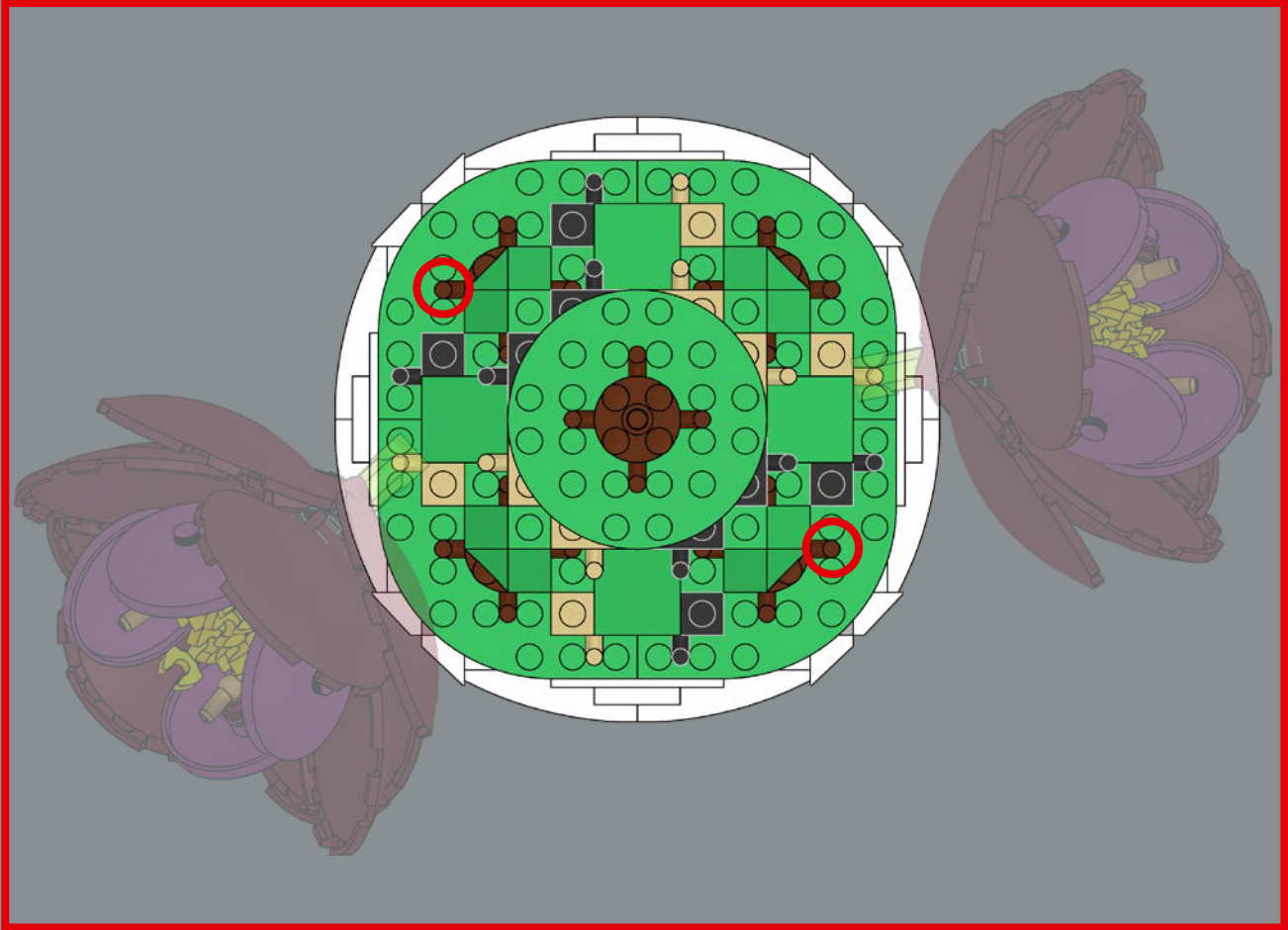

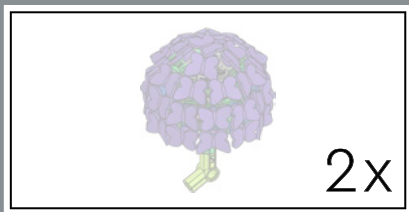

72

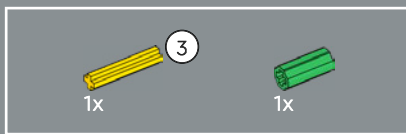

73

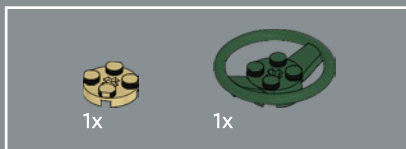
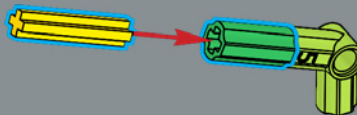

74

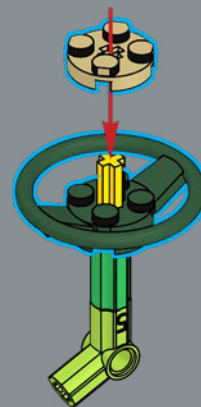

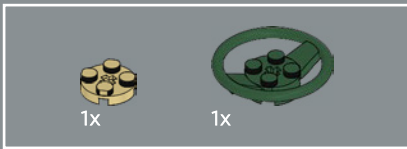

75

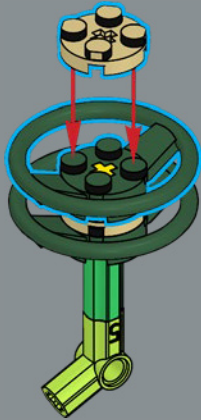

¡Pon la creatividad al volante! Este volante, diseñado para coches LEGO® a gran escala, ahora conforma el centro de nuestras flores LEGO.

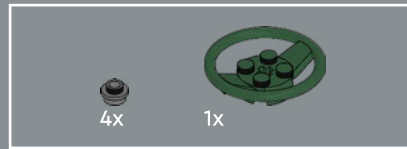

76

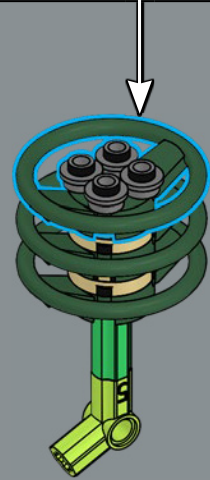
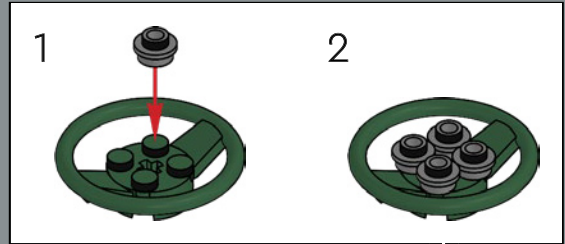

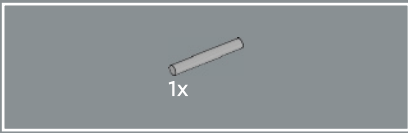

77

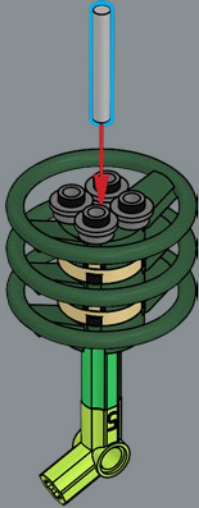

78

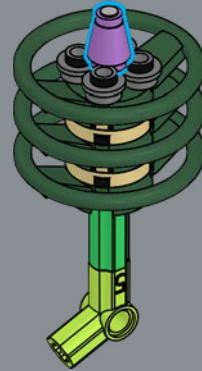

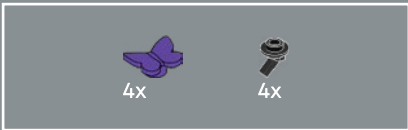

79

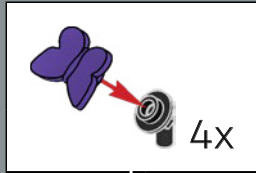

80



Hortensia: ¿Sientes el aleteo? Hemos traído volando decenas de minúsculas mariposas LEGO® para crear el globo texturizado de esta hortensia.

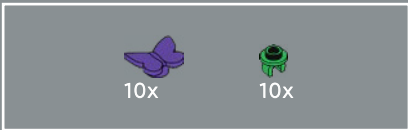

81

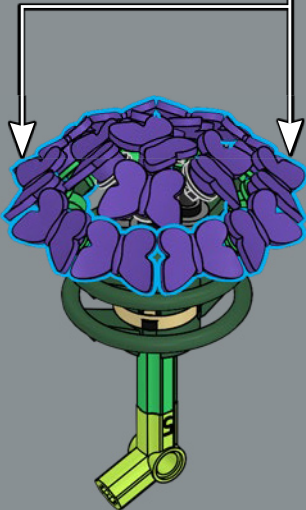
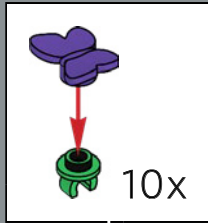

82

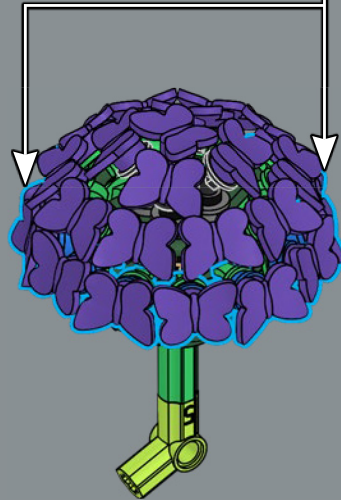
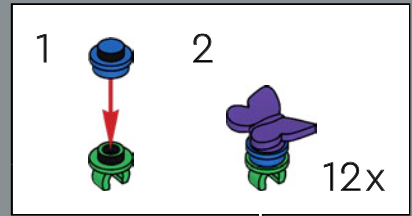



12x



12x



12x

83

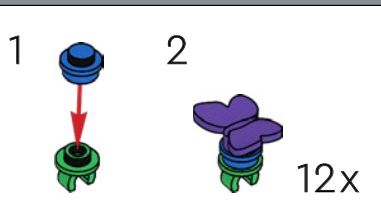

1



2



12x

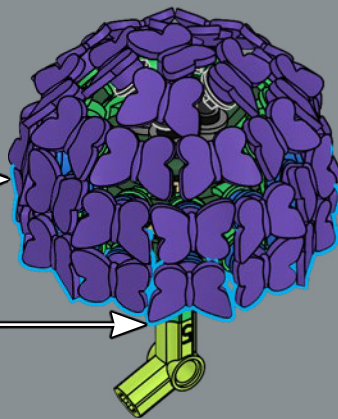

2x

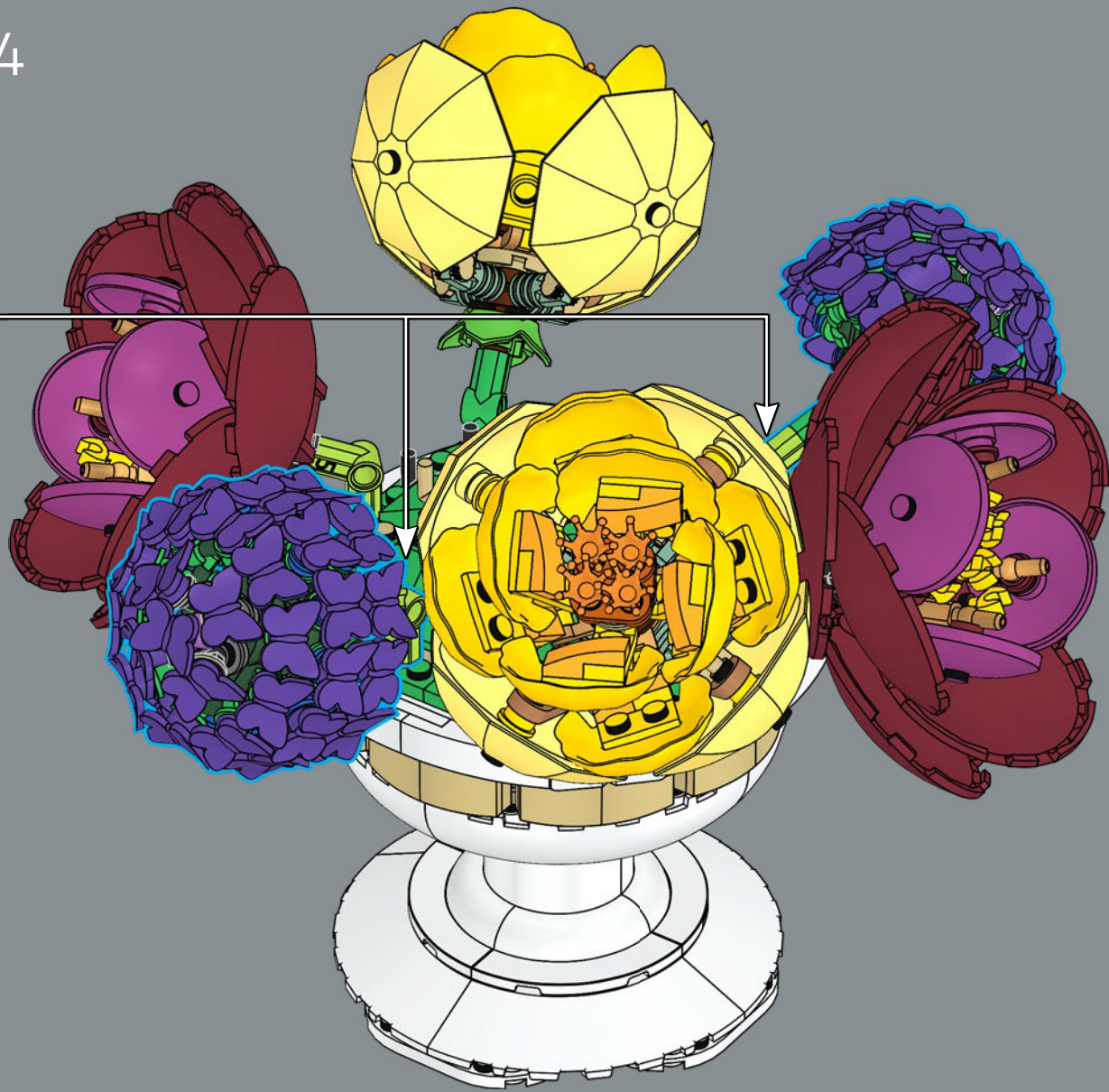



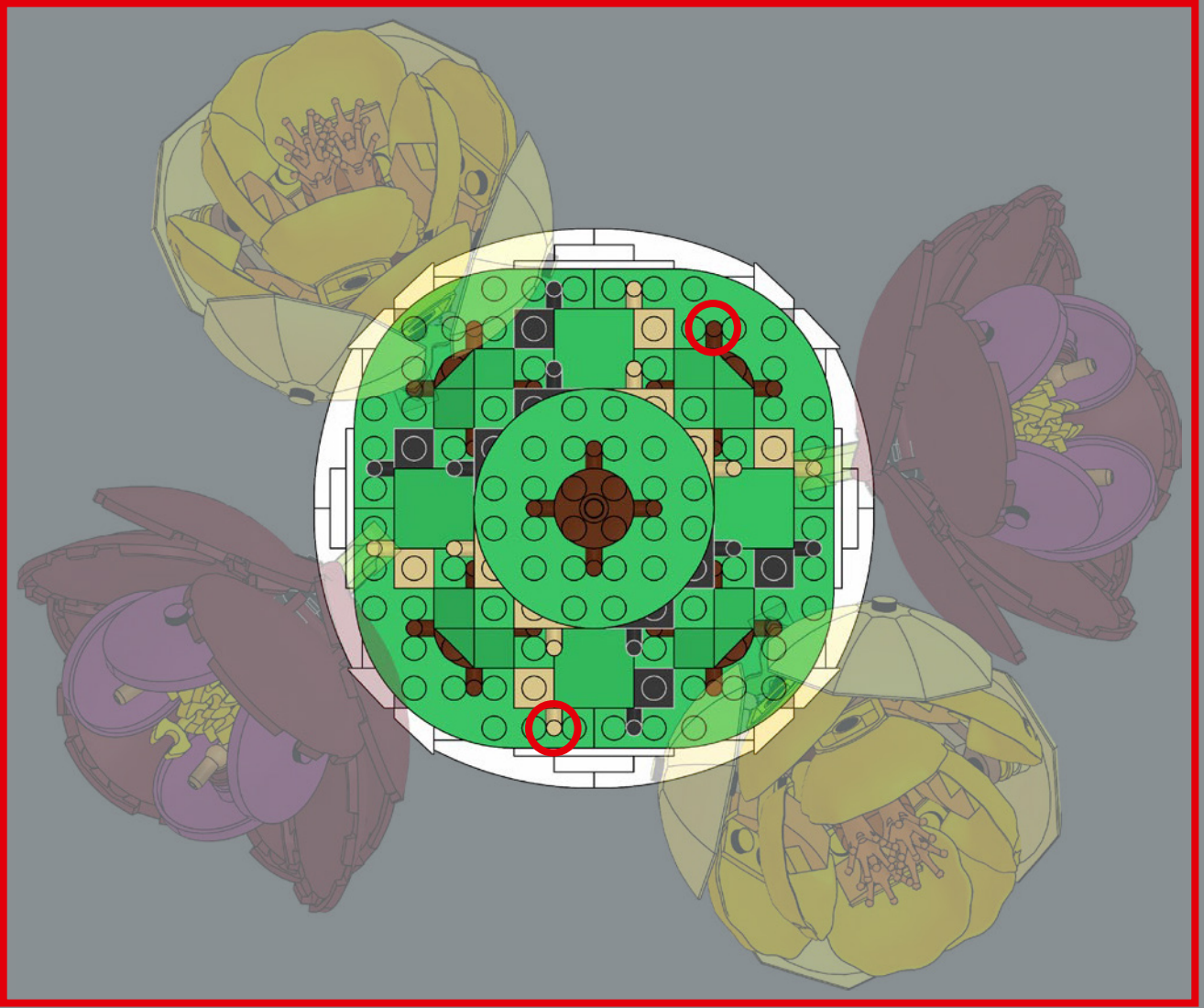

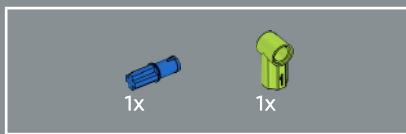
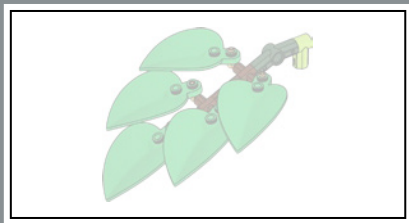

85

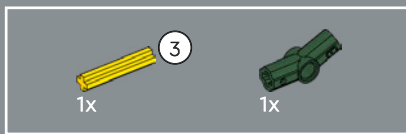
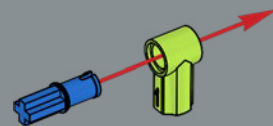

86

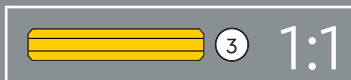
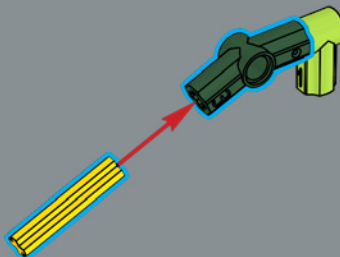



87

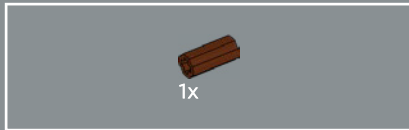
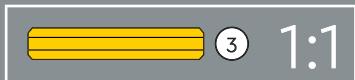
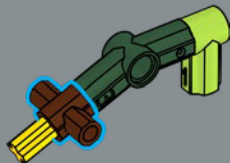

88

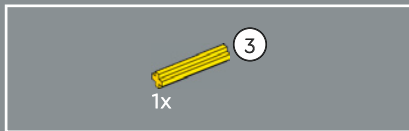
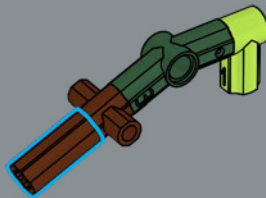

89

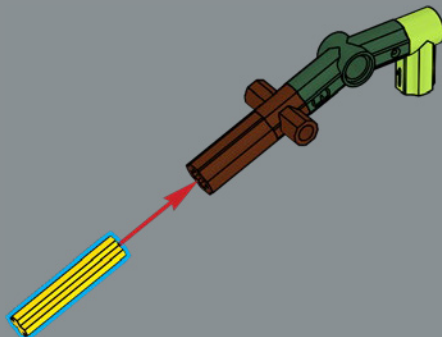



90

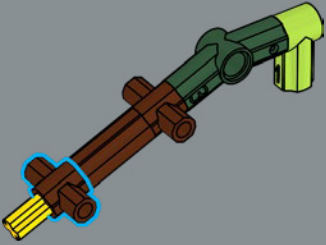

91

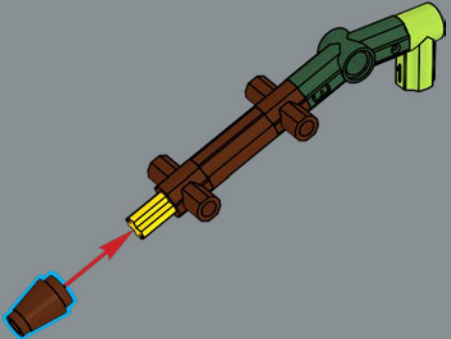



5x

92

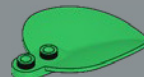
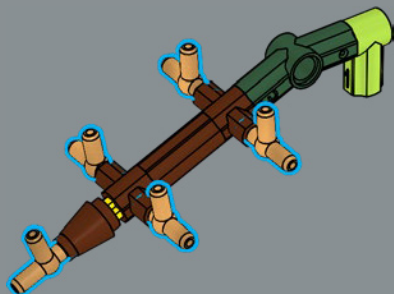

5x

93

Hojas: ¿Borrón y hoja nueva? Estas hojas verdes son nuevos elementos diseñados para algunos de los sets de la colección LEGO® Botanical para 2025, incluido el Ramo de Flores Fantasía en Rosa (10342).

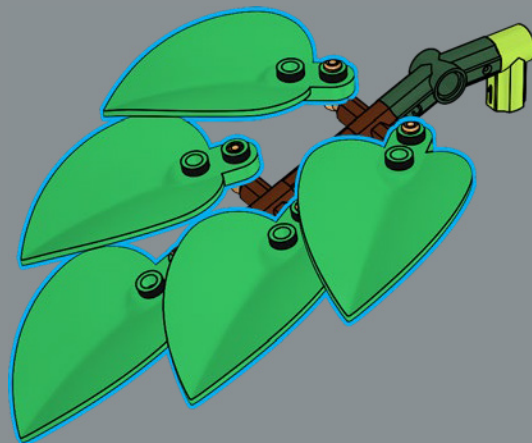



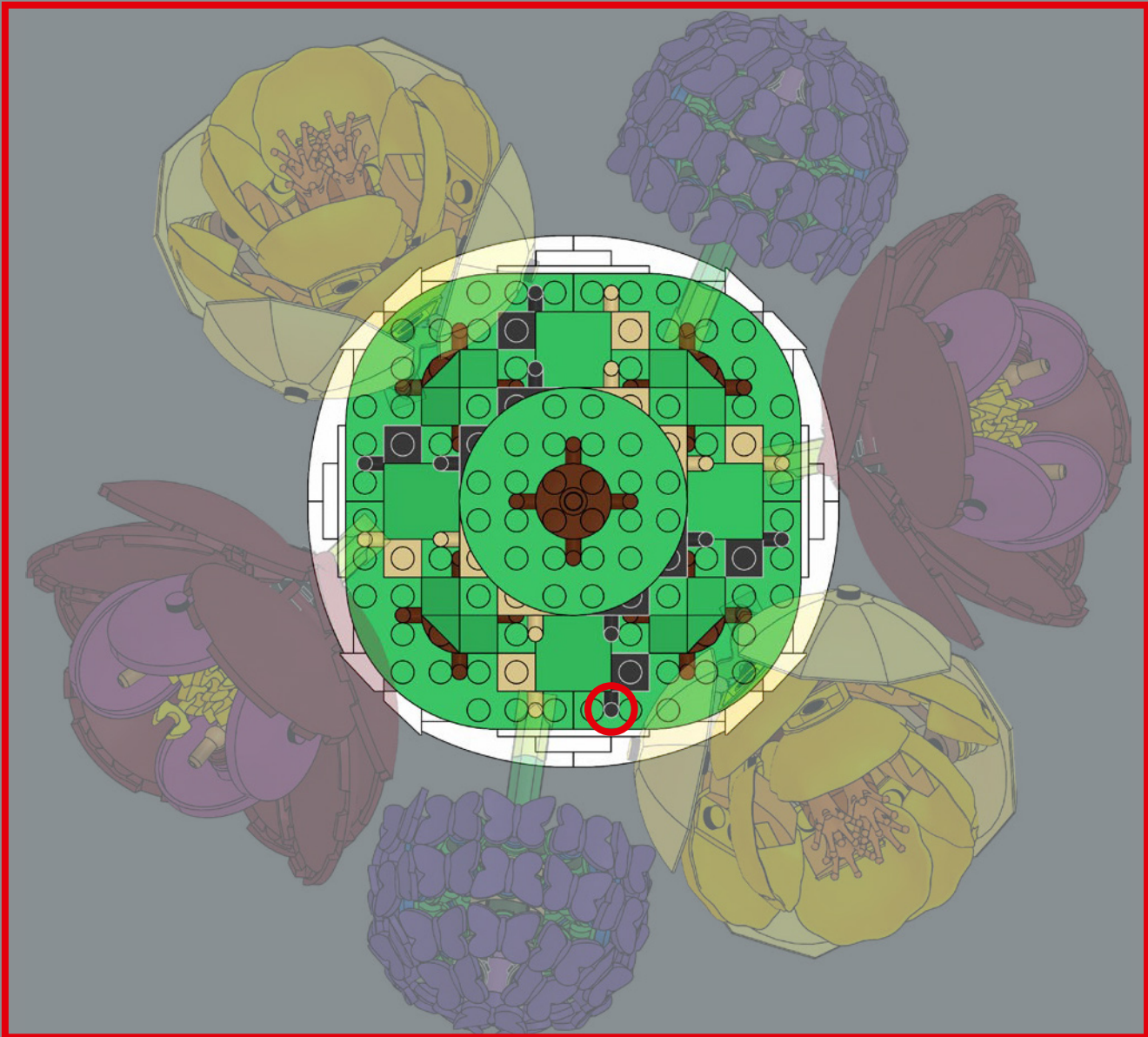

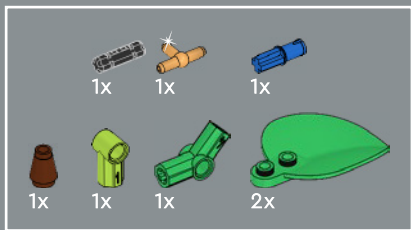

95

1

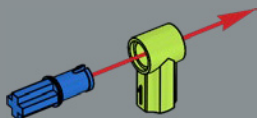

2

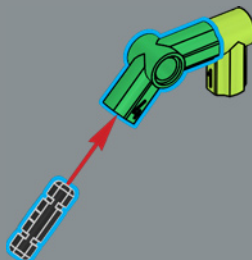



3

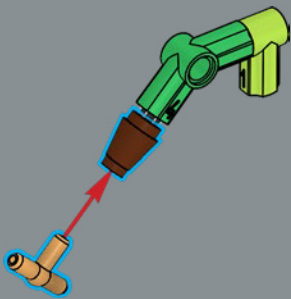

4

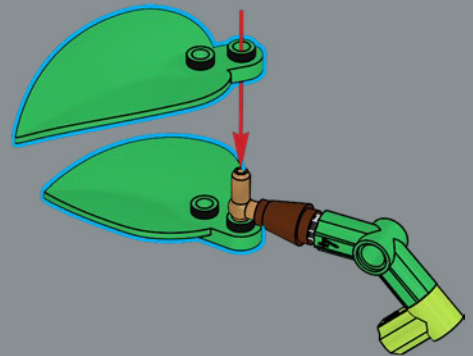

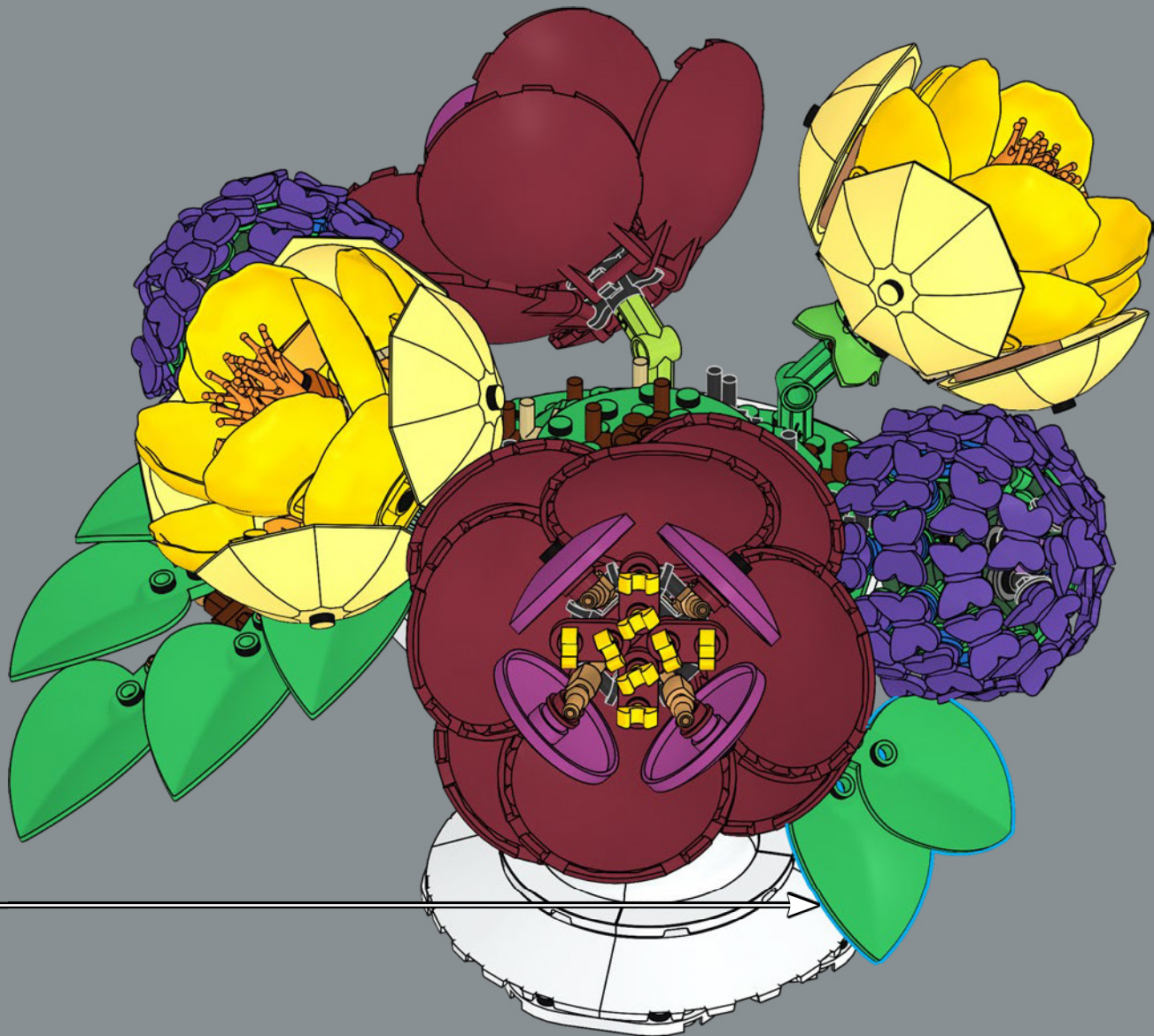

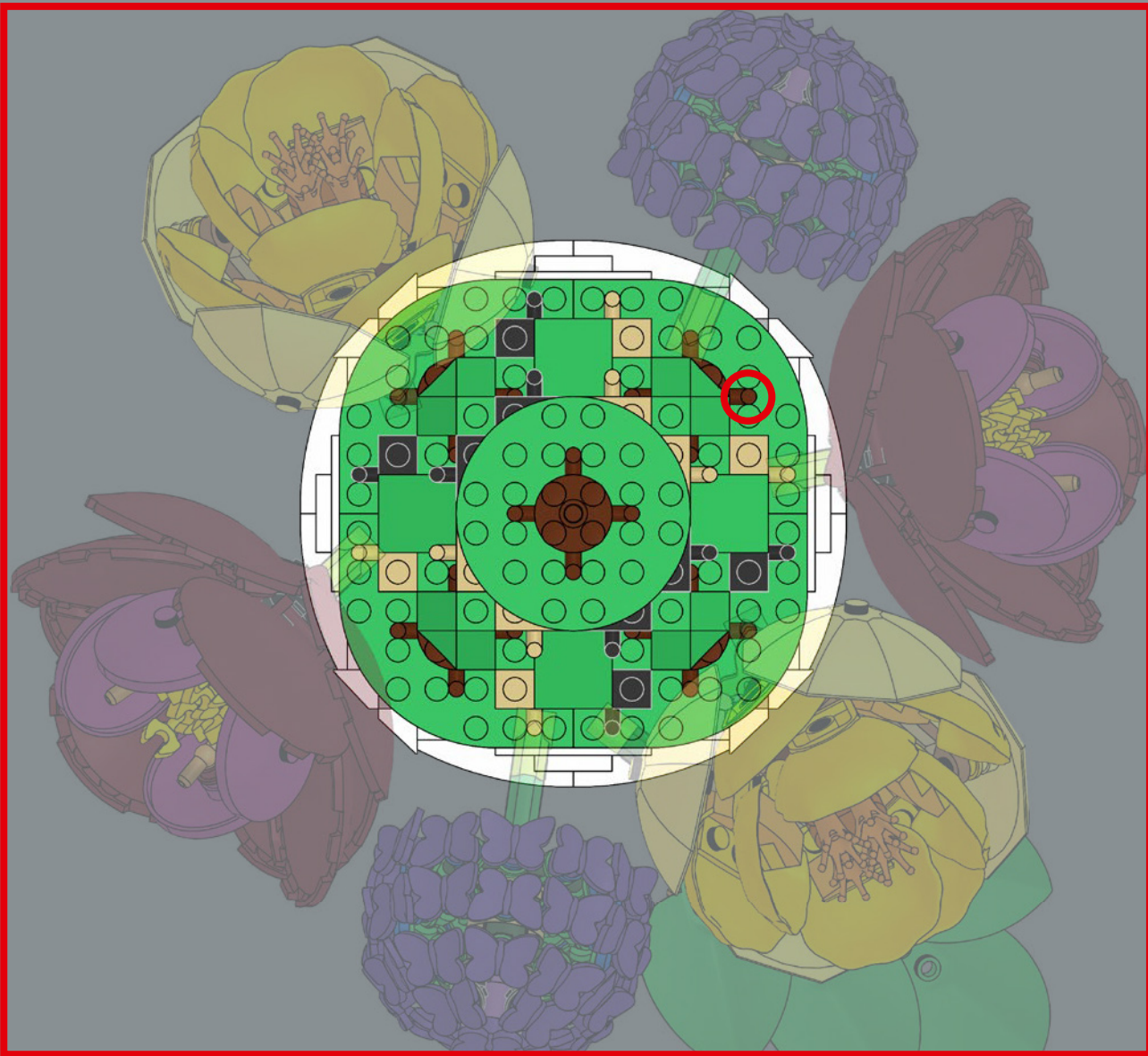

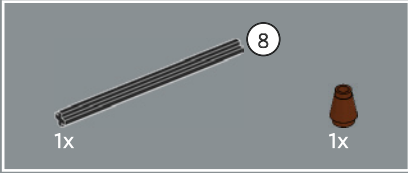
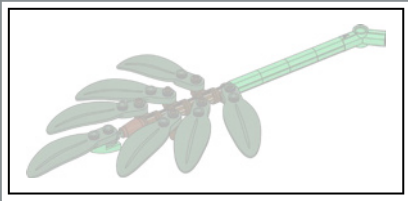

96

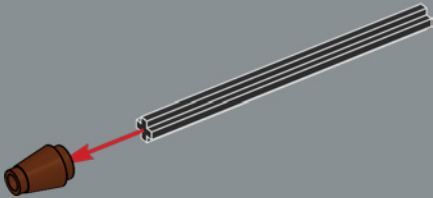

97

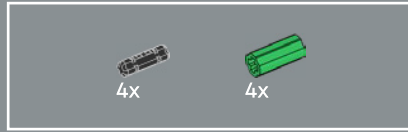
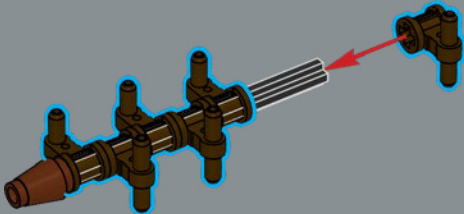

98

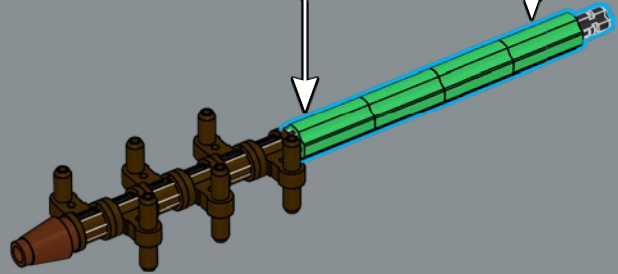
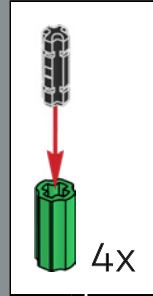

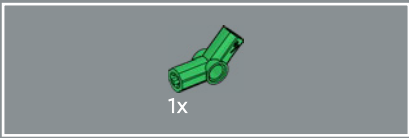

99

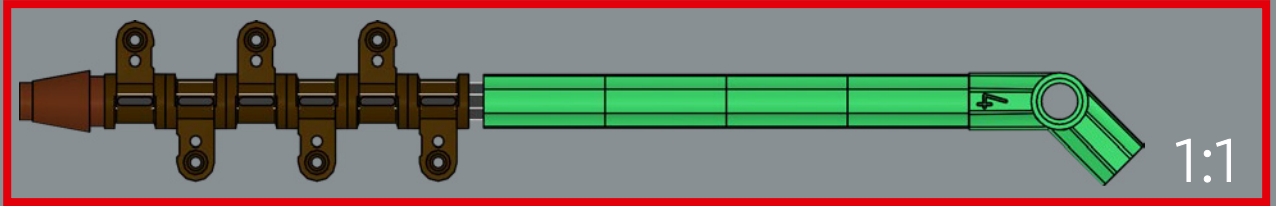
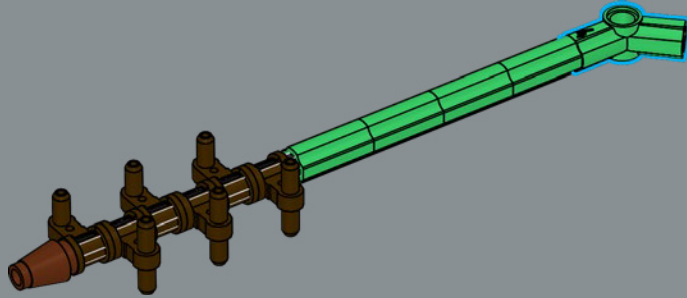

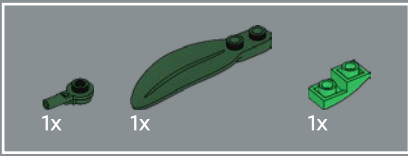

100

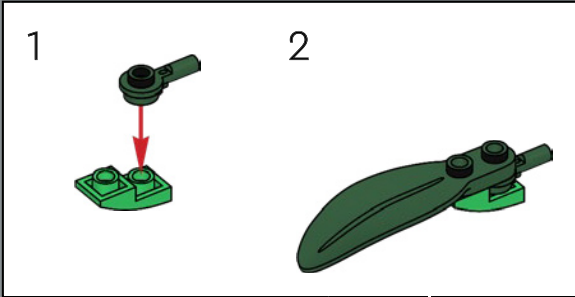

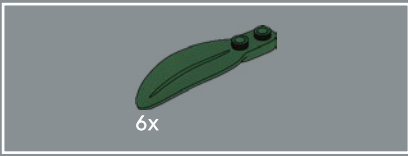

101

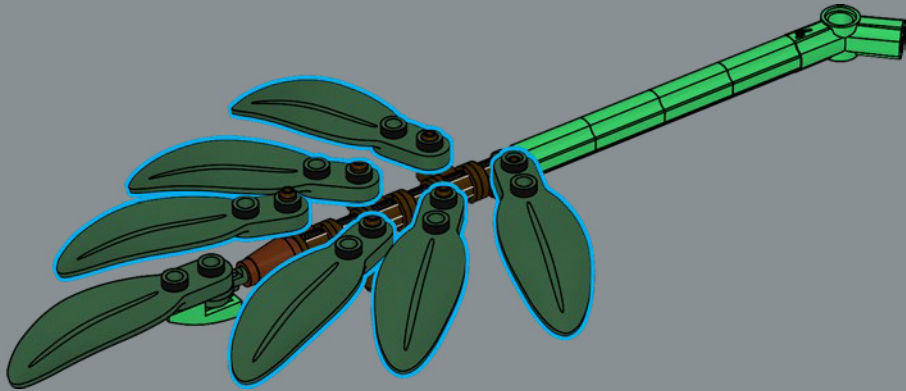





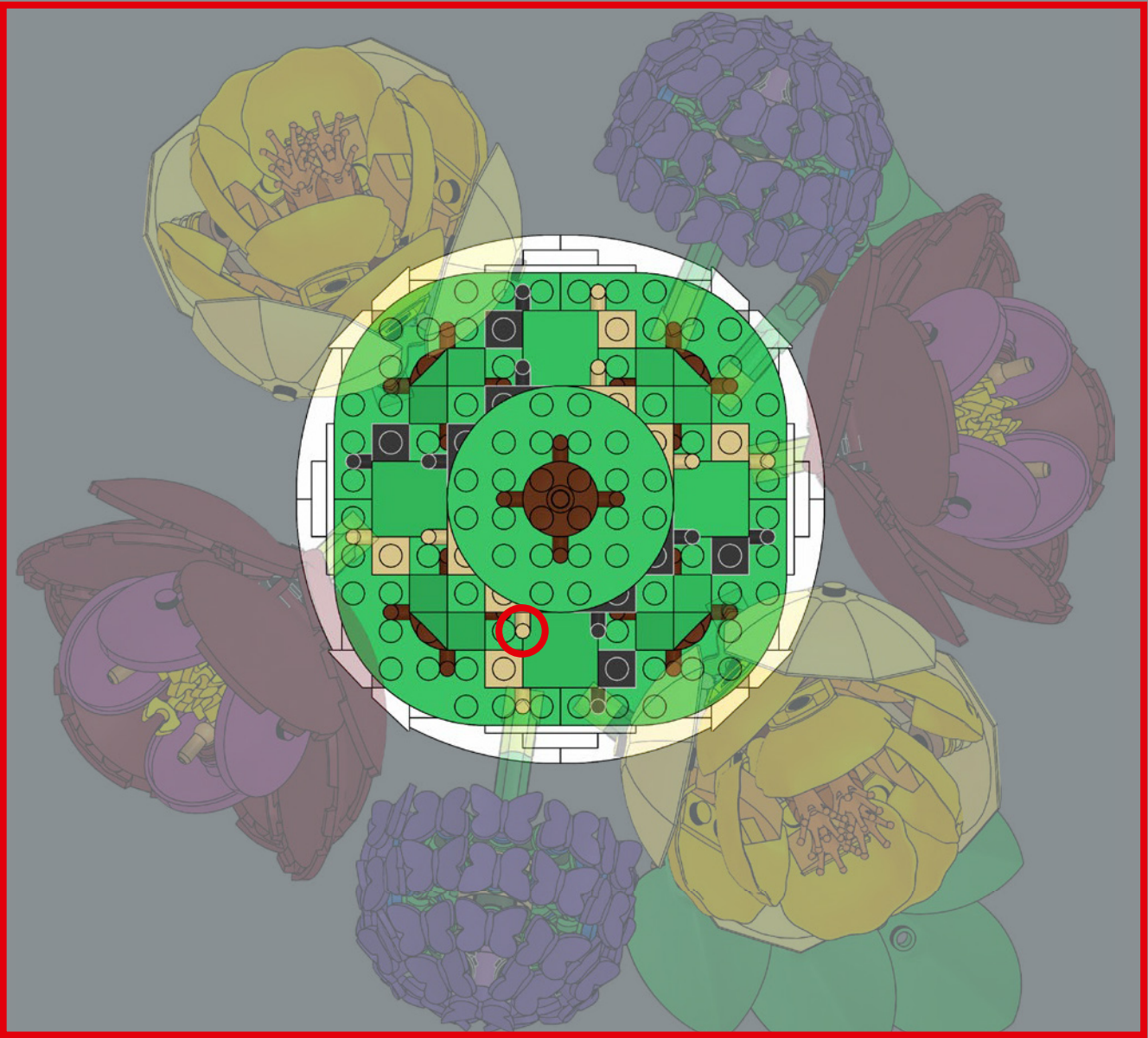

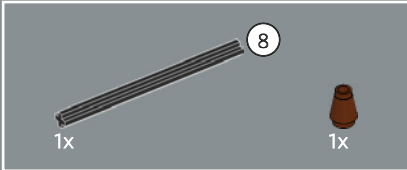

103

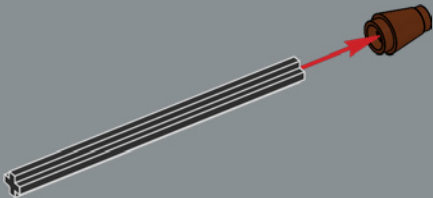

104

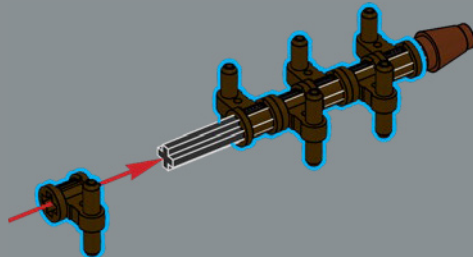



105

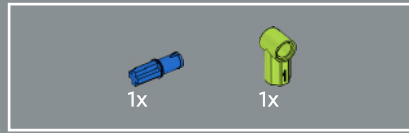
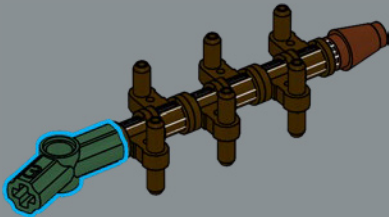

106

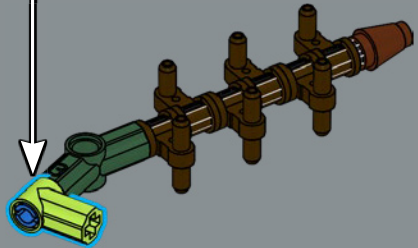
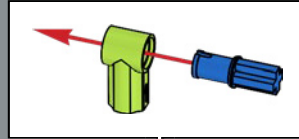

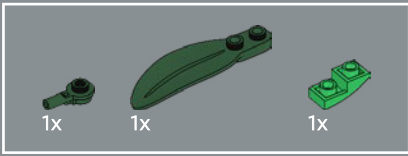

107

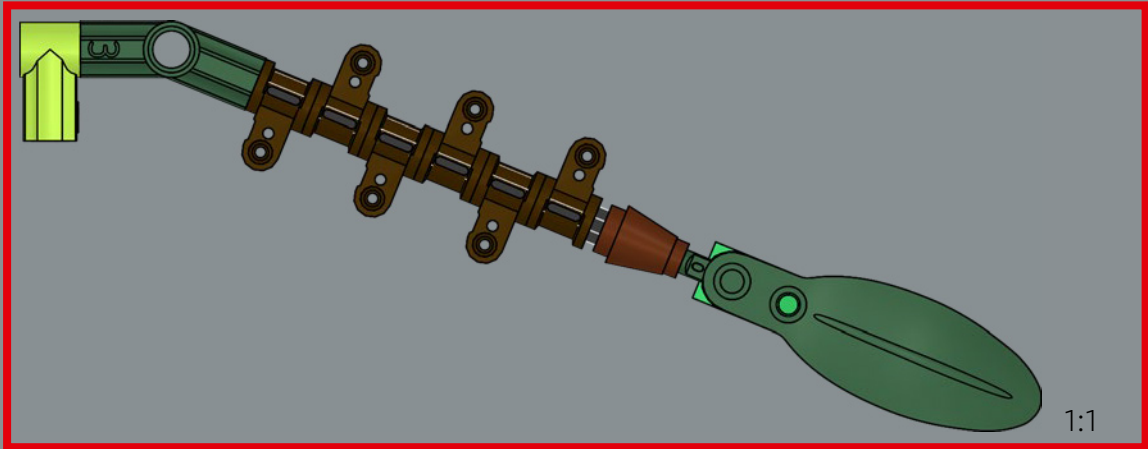
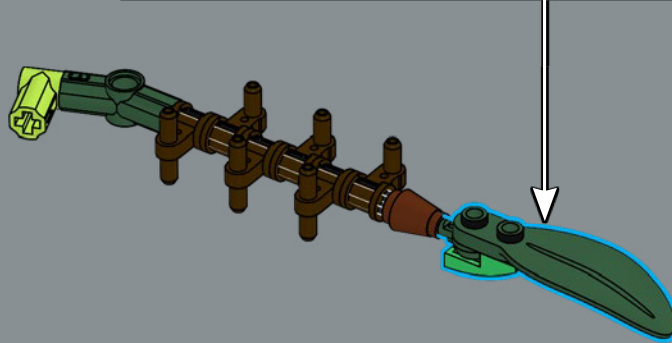
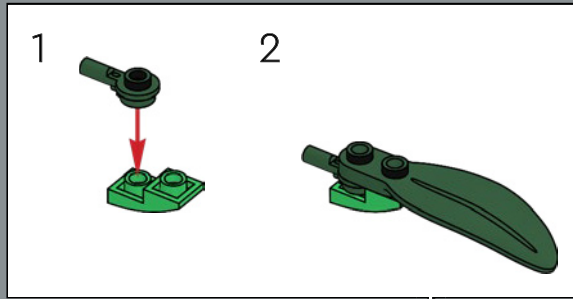

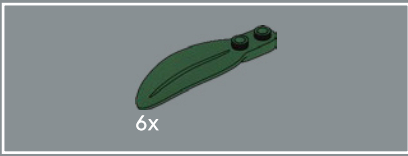

108



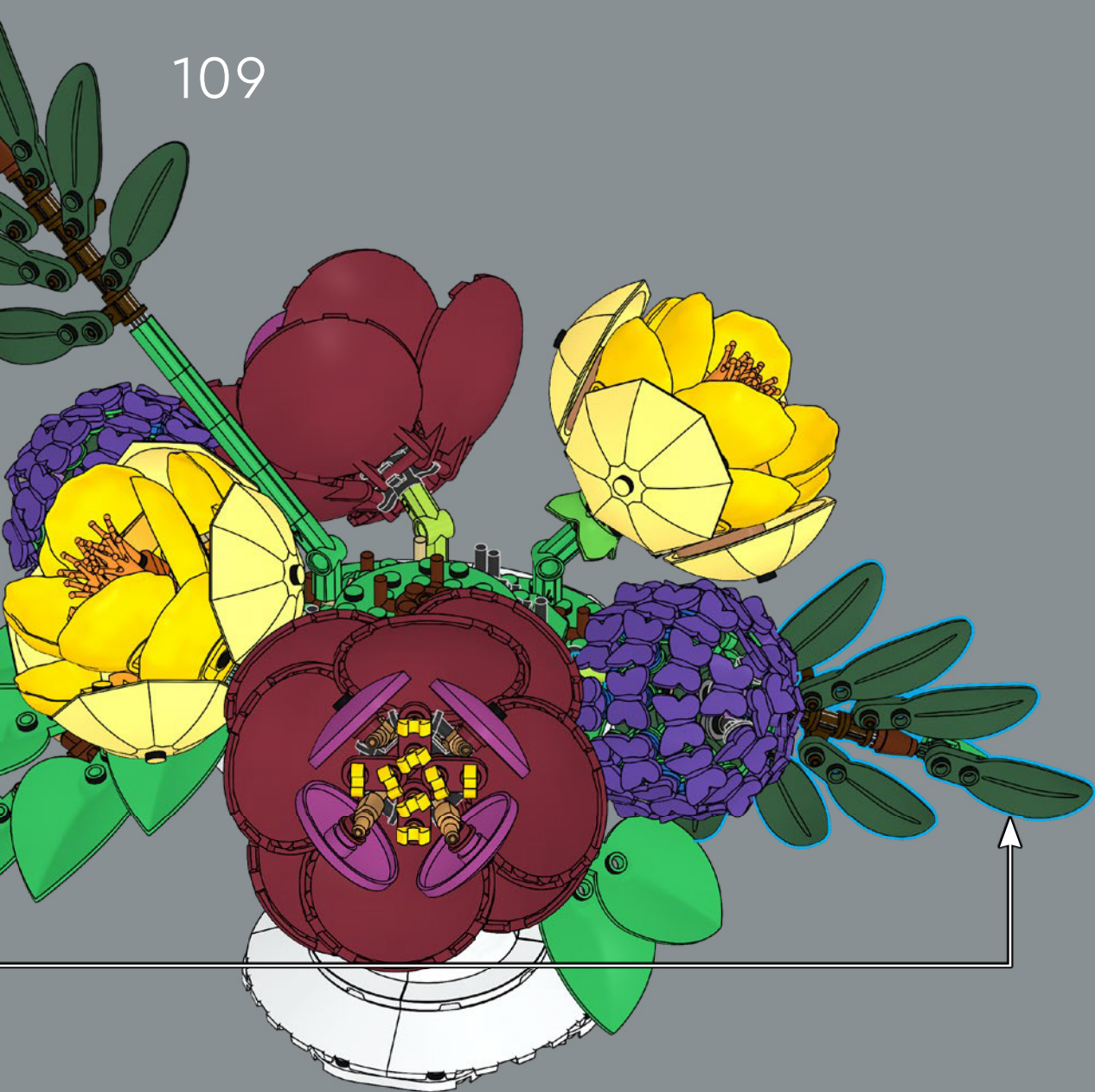

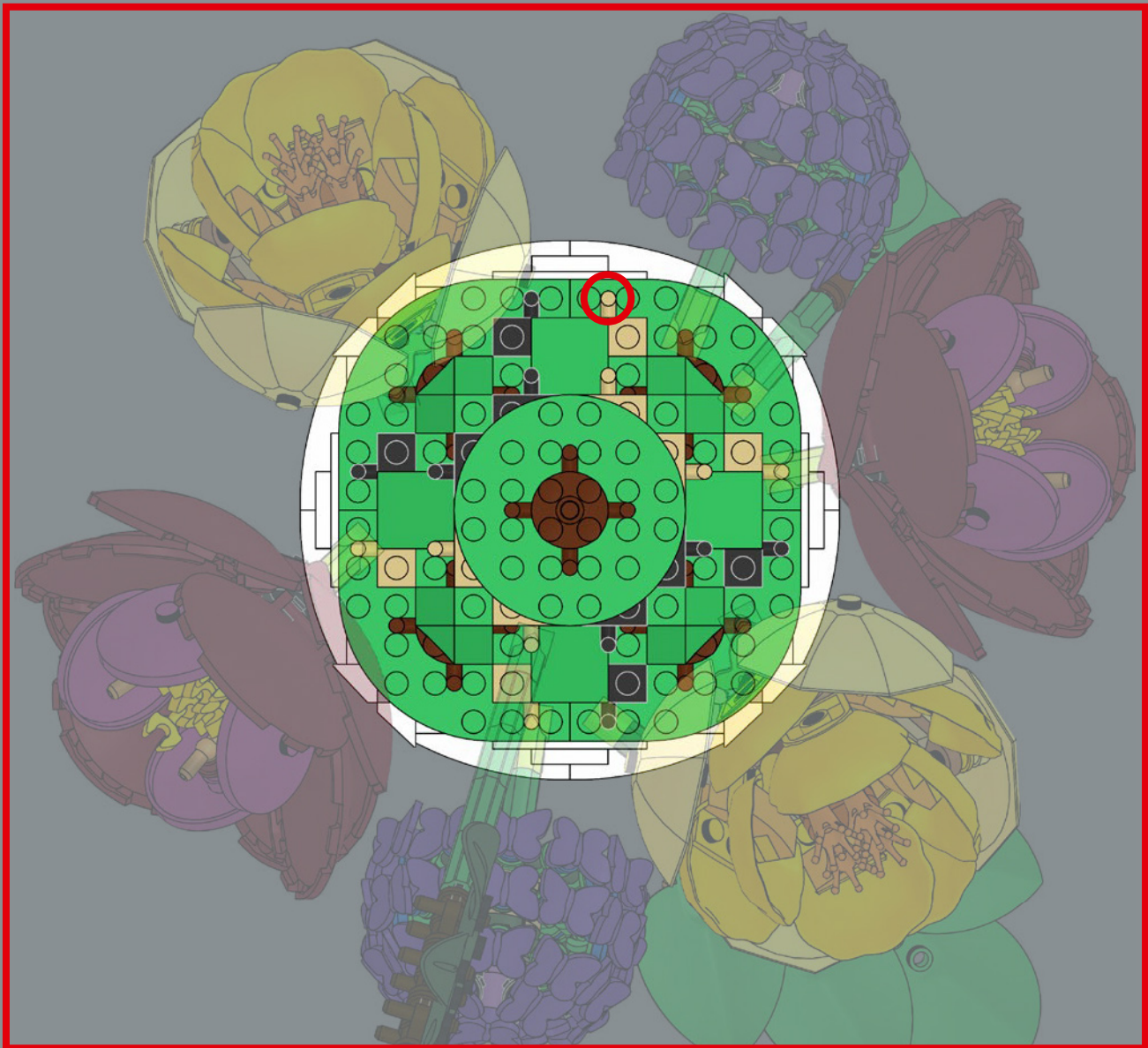

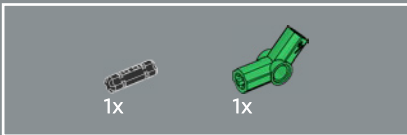
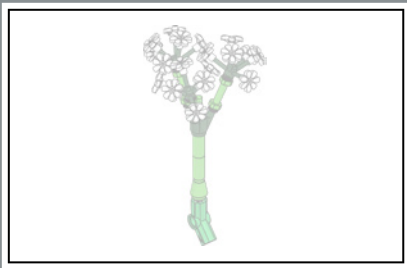

110

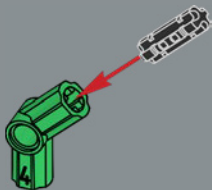

111

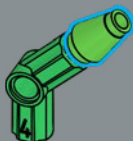

112

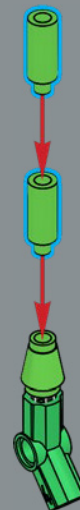



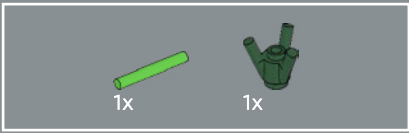

113

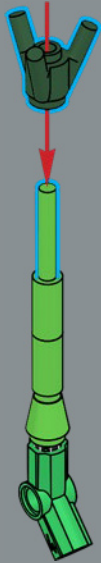

114

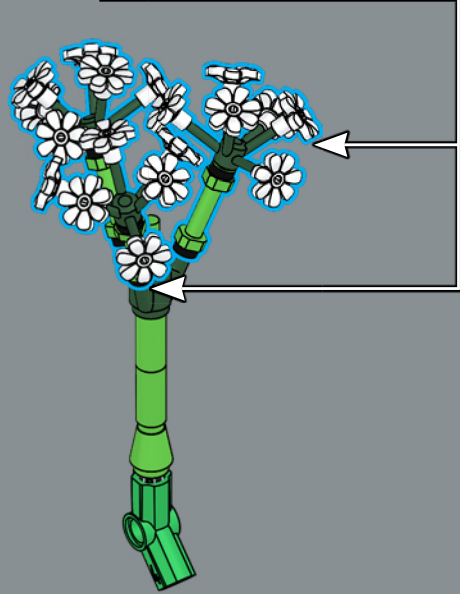
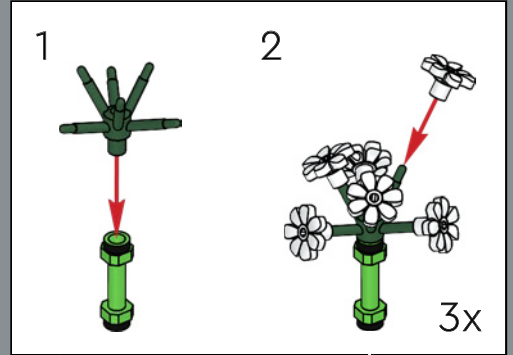

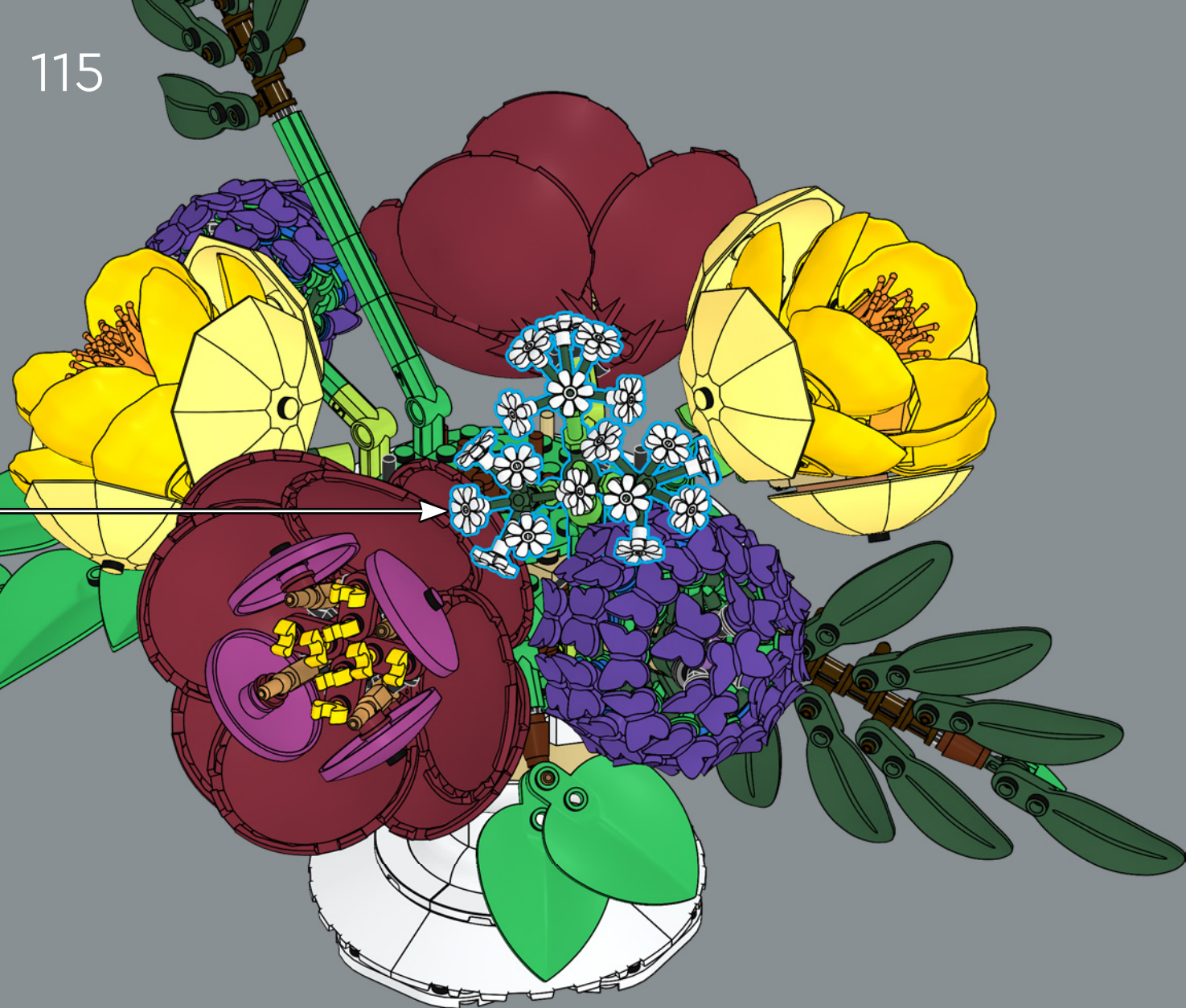

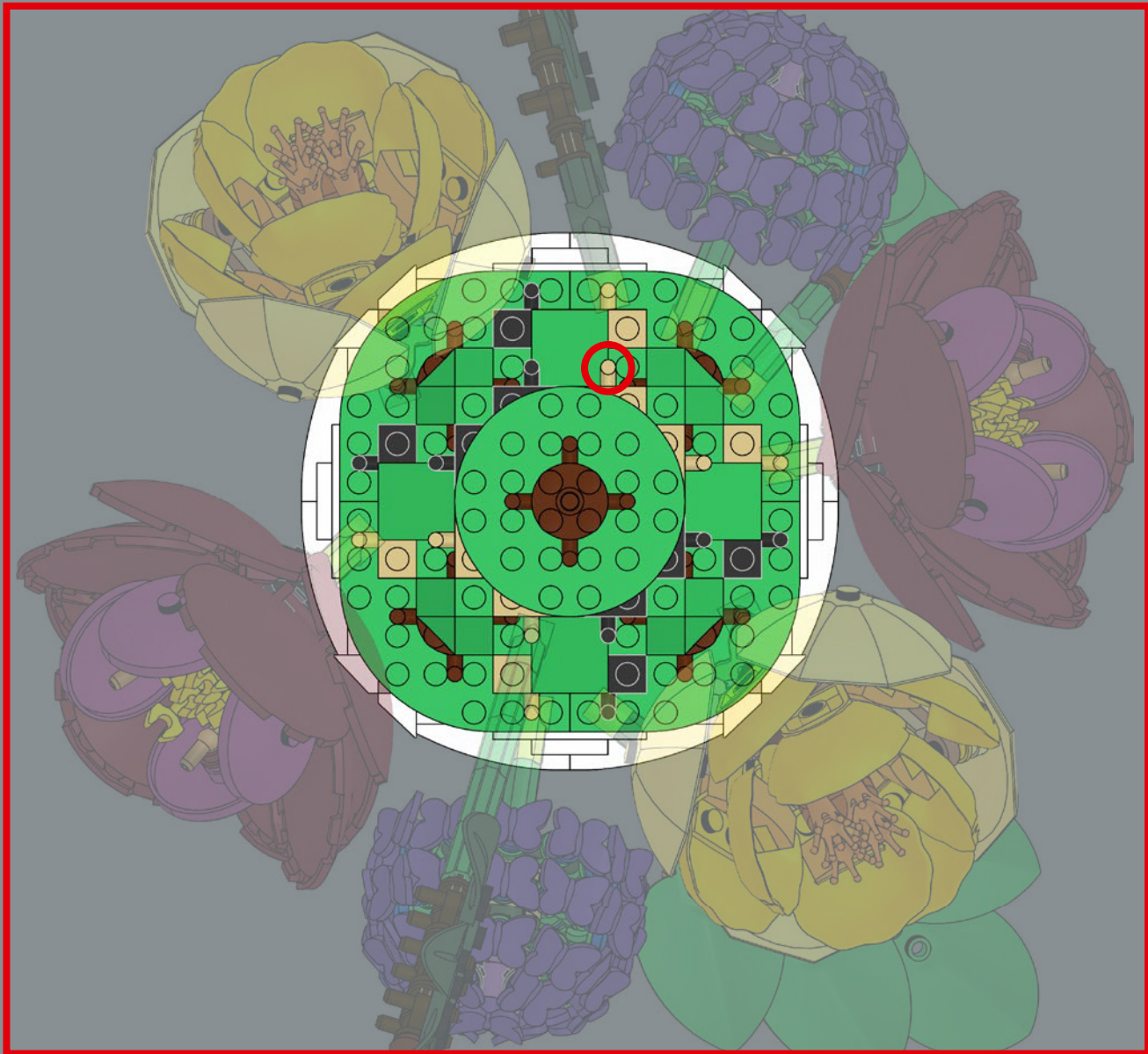

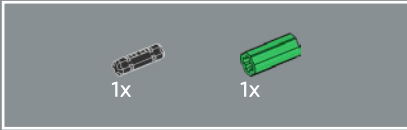
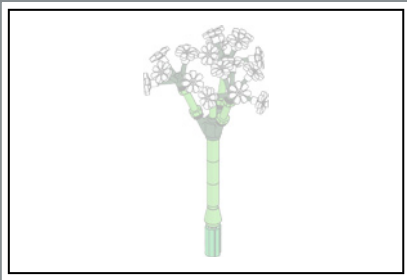

116

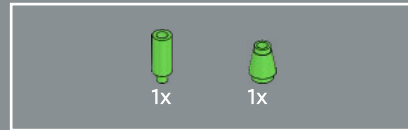

117

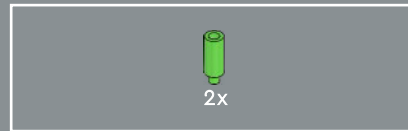

118



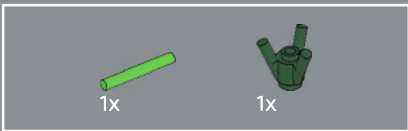

# 119

Velo de novia: ¡Di "patata"! El tallo está hecho de elementos que representan trípodes, originalmente diseñados para ayudar a las minifiguras LEGO® a mantener firmes sus cámaras. Ahora, sostienen ramilletes de velo de novia. Este podría ser un buen momento para hacerse un selfi y documentar lo que has avanzado.

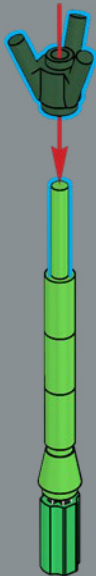

# 120

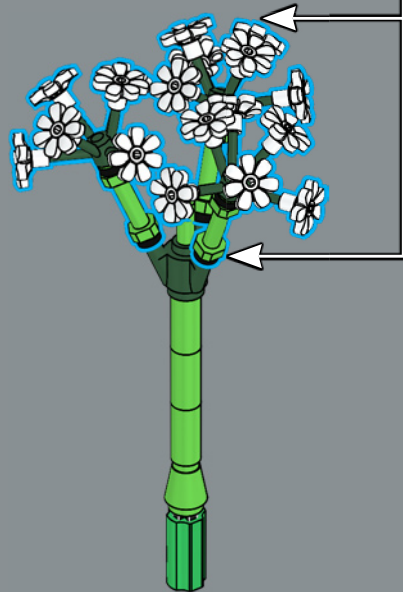
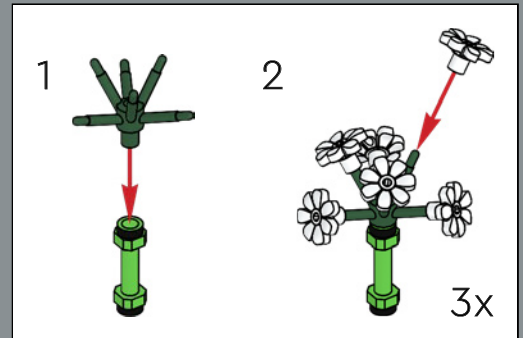



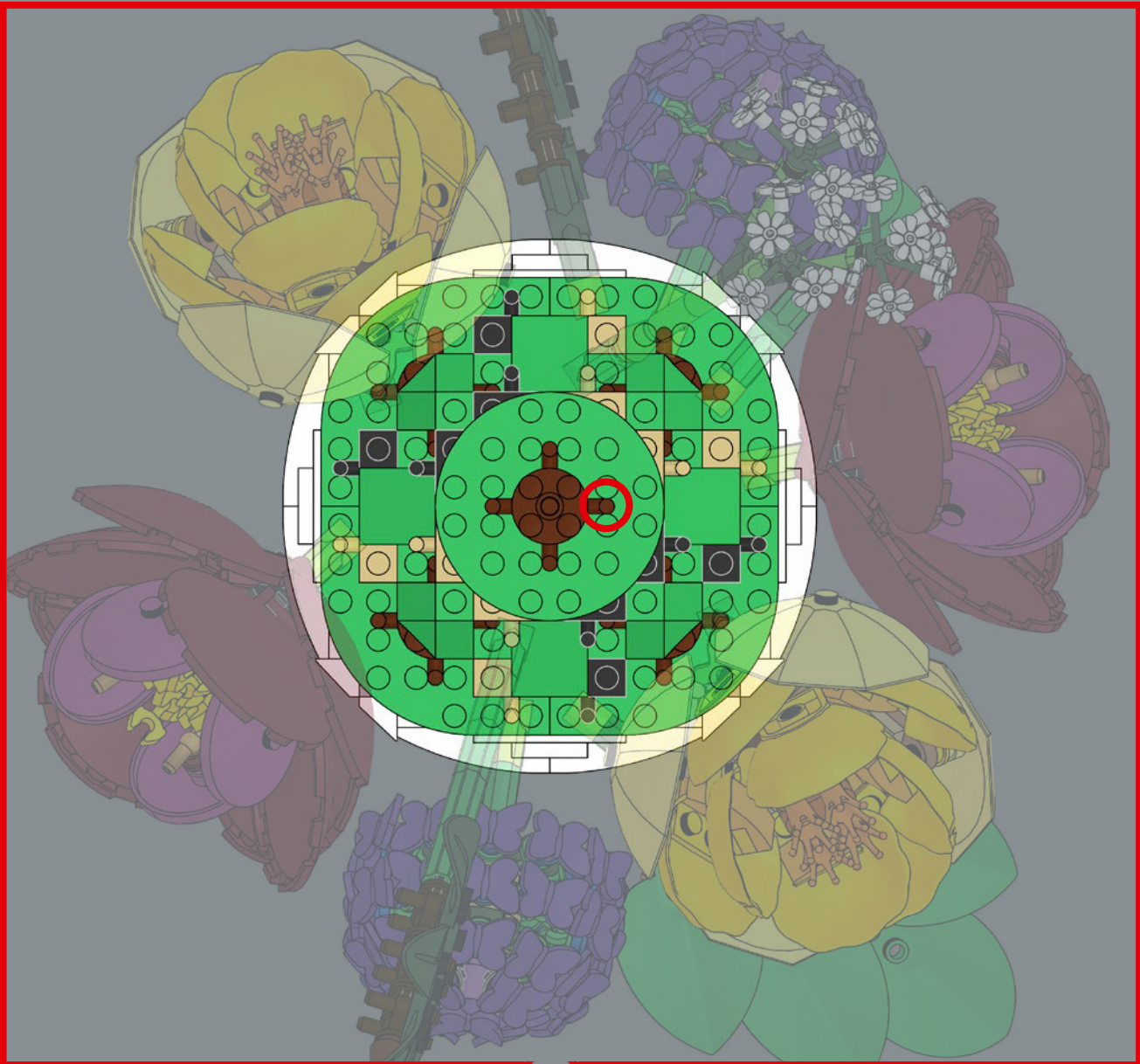

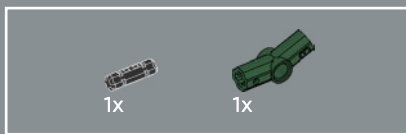
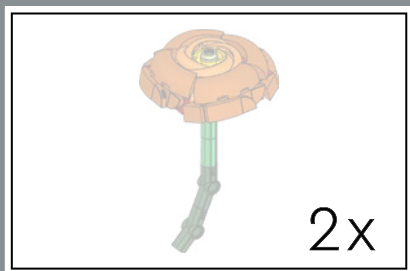

122

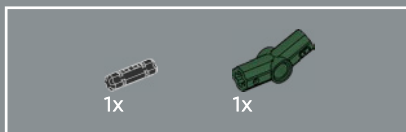

123

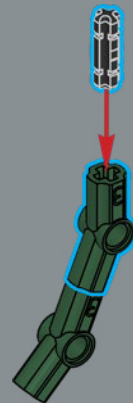



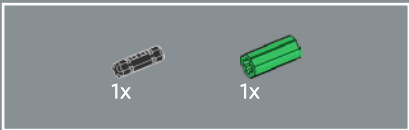

124

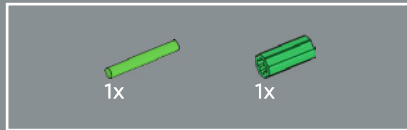
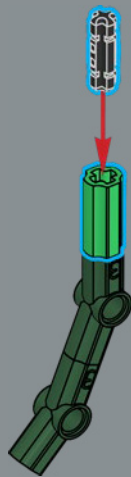

125

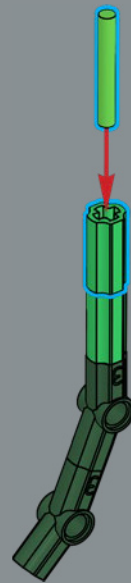

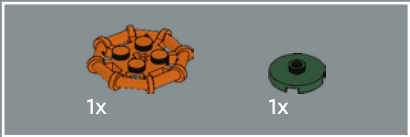

126

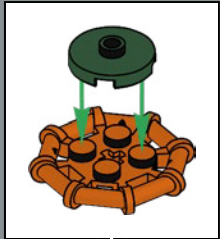

127



128



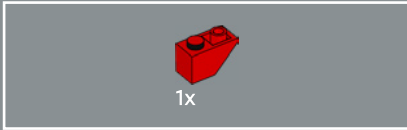

129

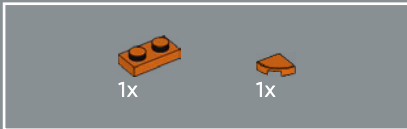
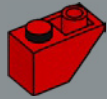

130

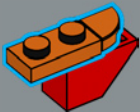

131

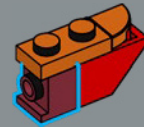

132

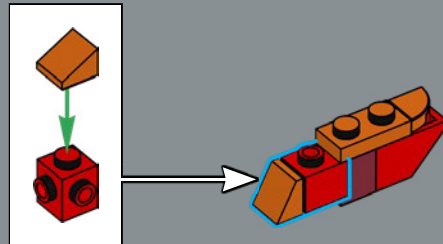

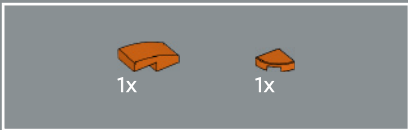

133

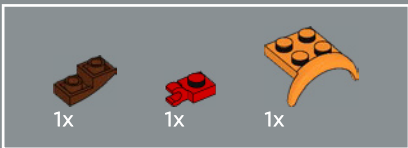
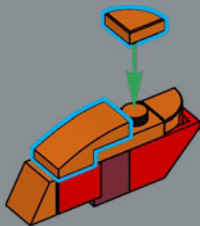

134

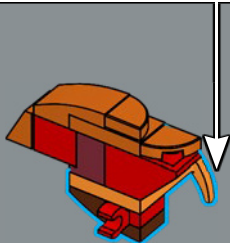
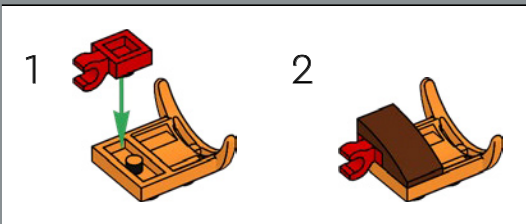

4x

Ranúnculo: Siempre se puede confiar en los elementos LEGO® que representan piezas de coches para reproducir un sinfín de detalles distintos. El centro de esta flor lleva cuatro guardabarros que hacen que los pétalos parezcan cerrados.

135

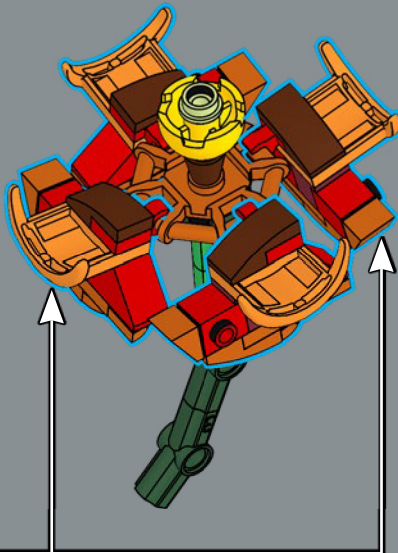

136

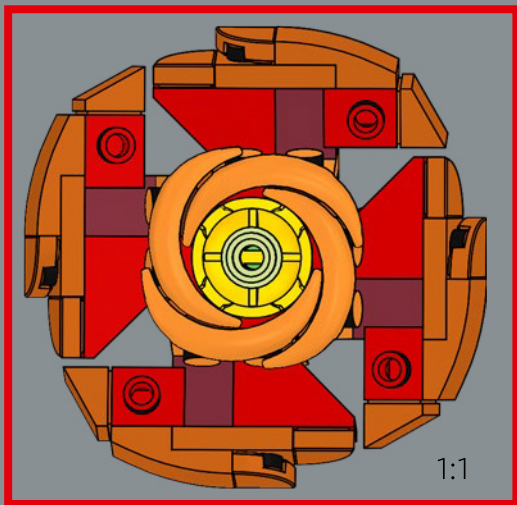
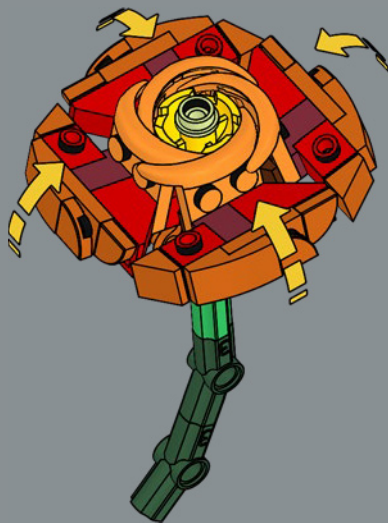

1:1

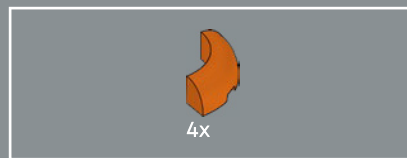

4x

137

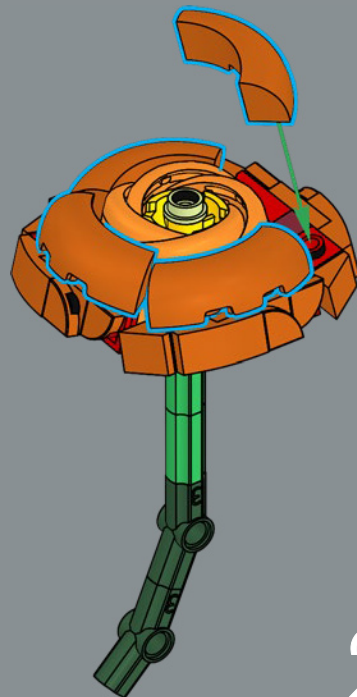

2x





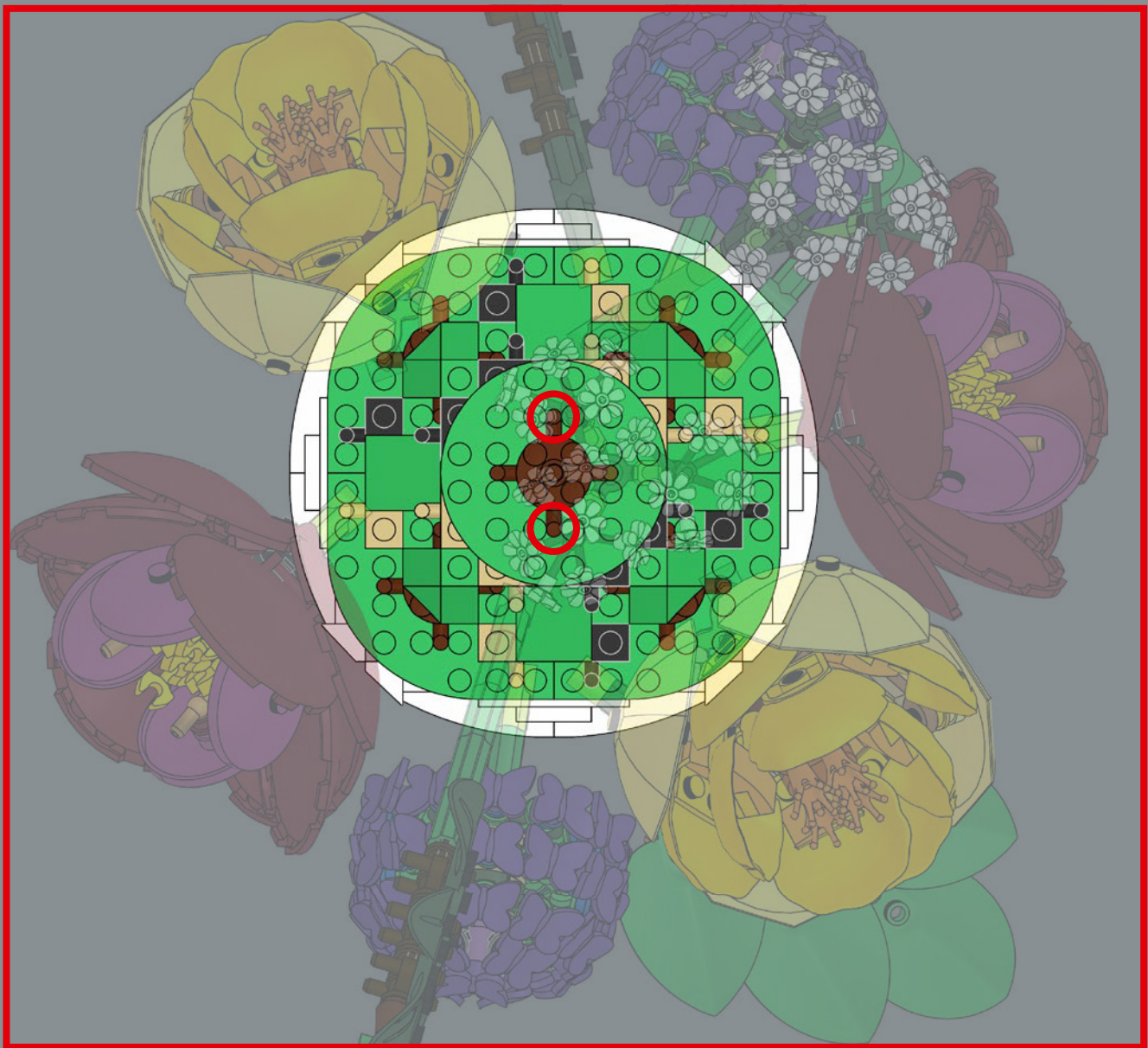

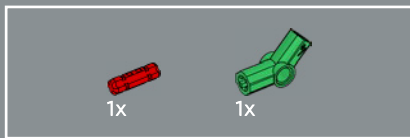
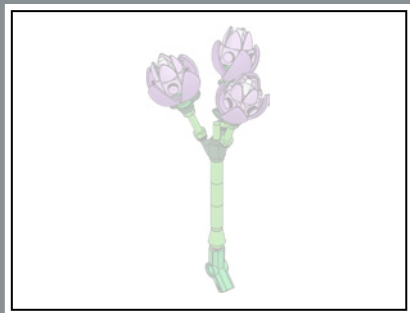

139

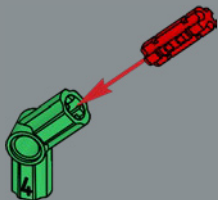

140

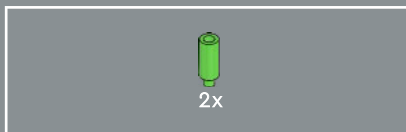

141

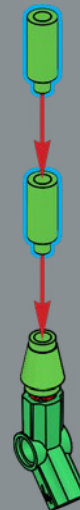



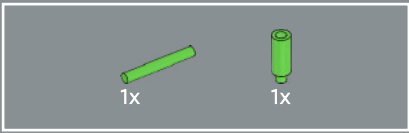

142

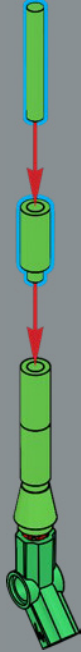

143

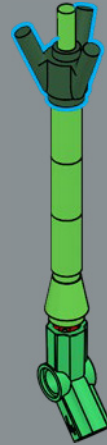



144

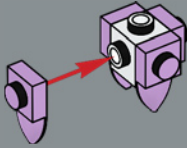

145



146

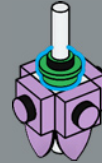

147

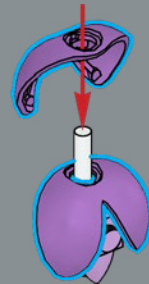

Flor de colibrí: Estas partes de la flor se diseñaron originalmente para crear las alas de una mariquita LEGO®.



148

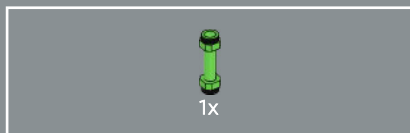
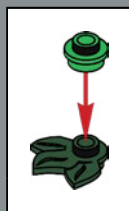

149

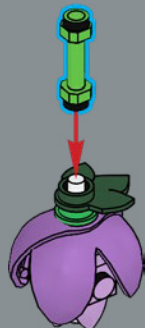

3x

150

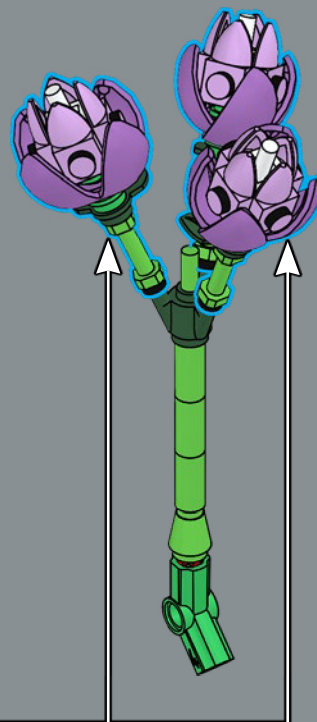





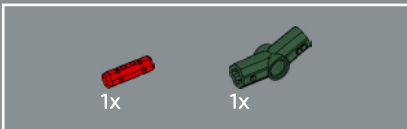
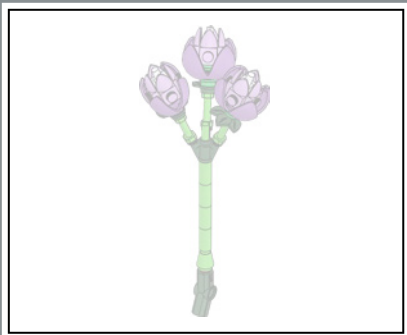

152



153

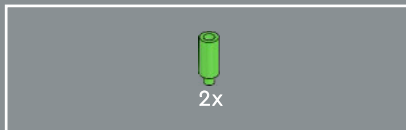

154





155

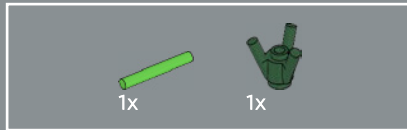

156

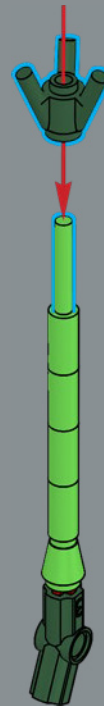

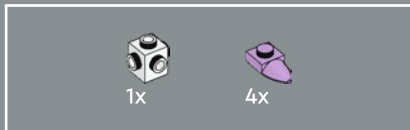

157

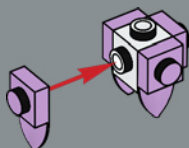

158

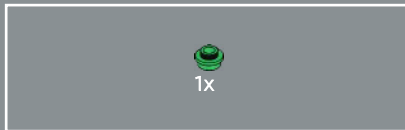

159

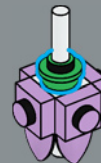

160

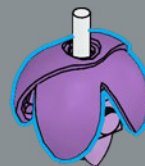





161

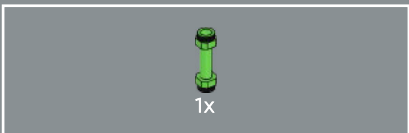
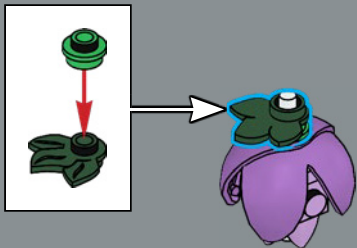

162

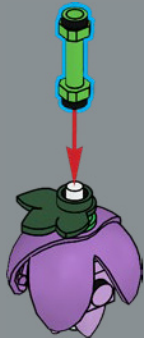

3x

163

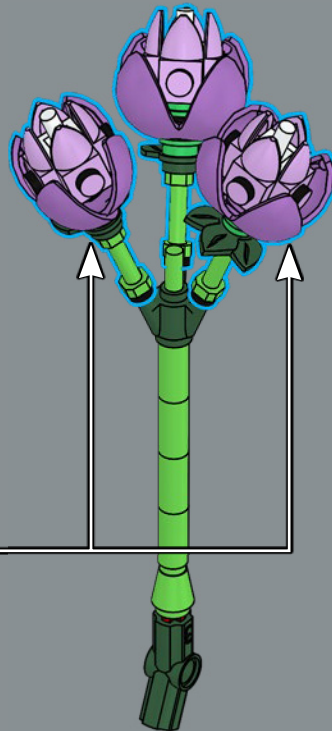



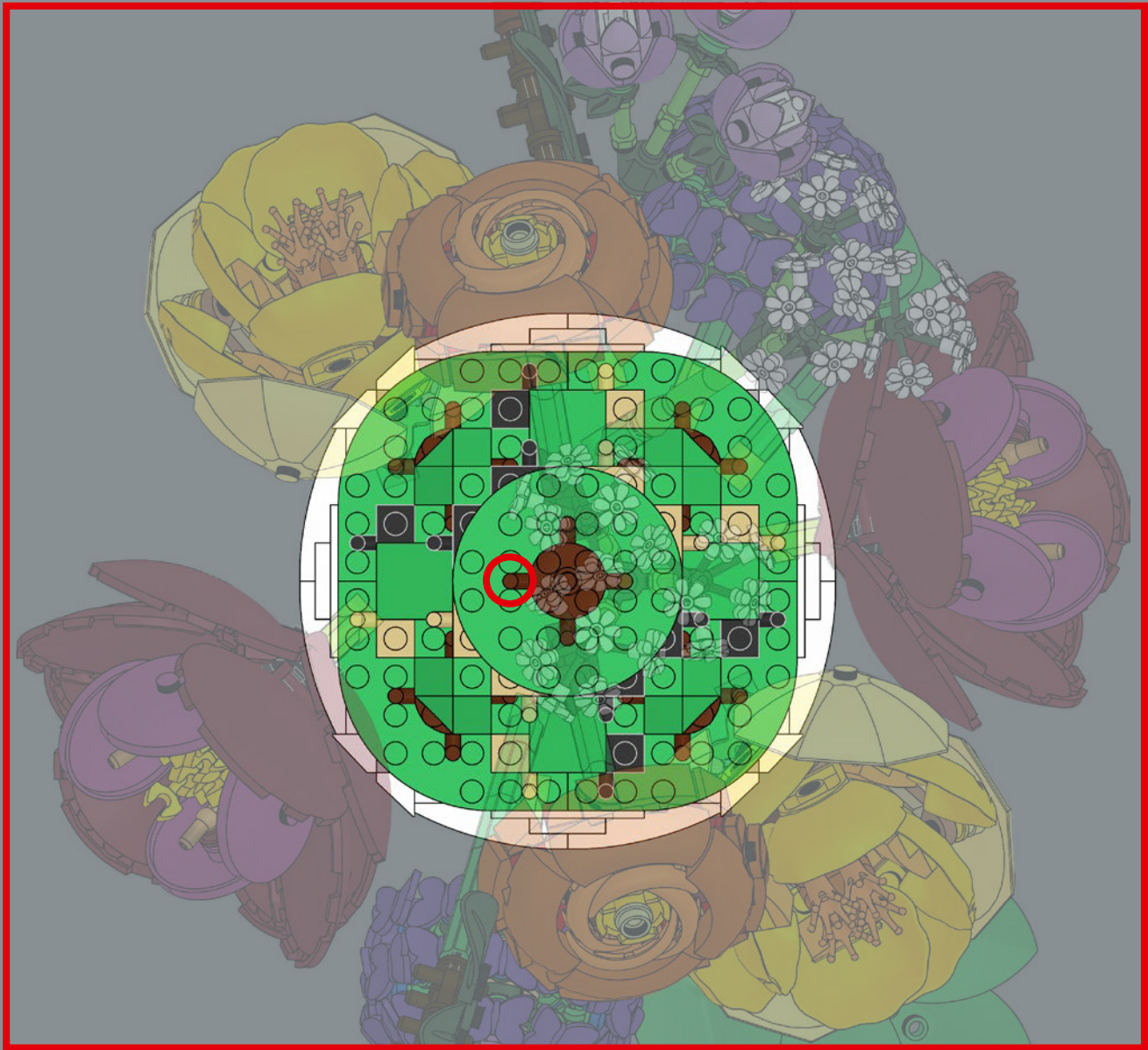

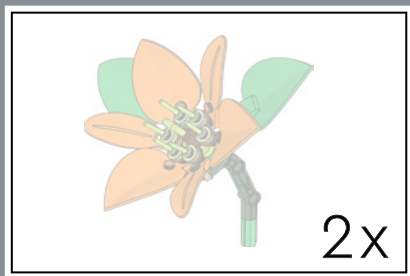

165

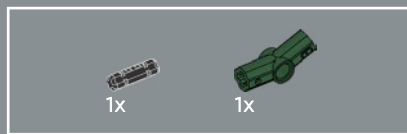

166

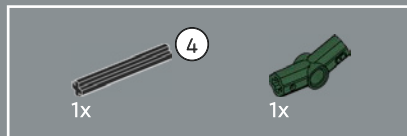
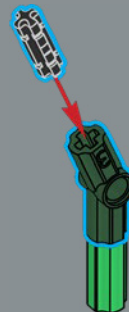

167

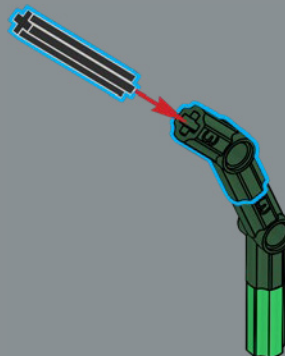

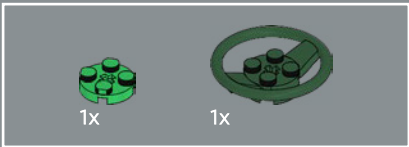

168

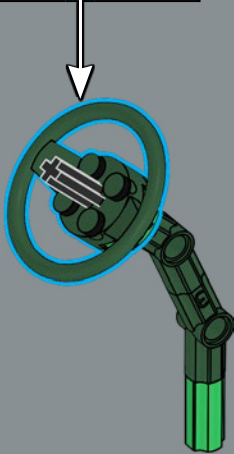
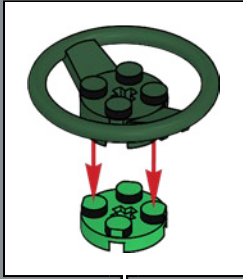

169

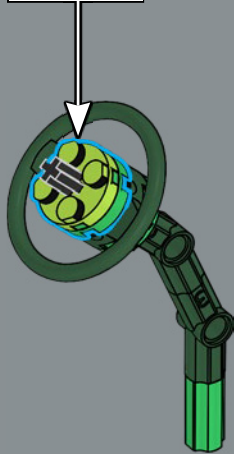
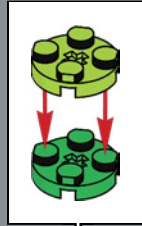



170

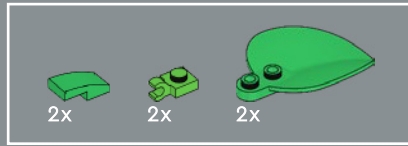
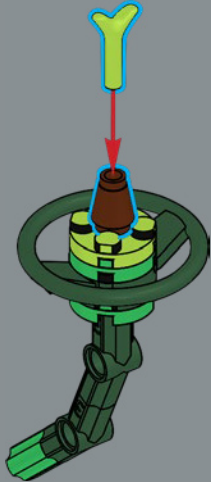

171

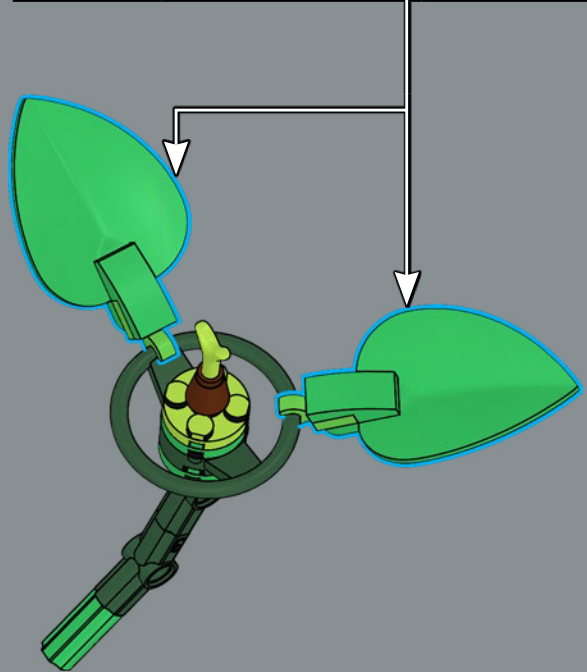
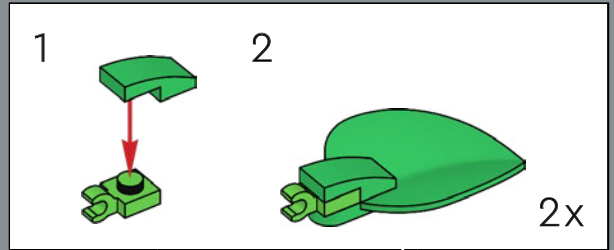

Azucena: ¡Cuidado, esta flor podría lanzarte un hechizo! Los estambres están hechos a partir de seis varitas LEGO®.



172

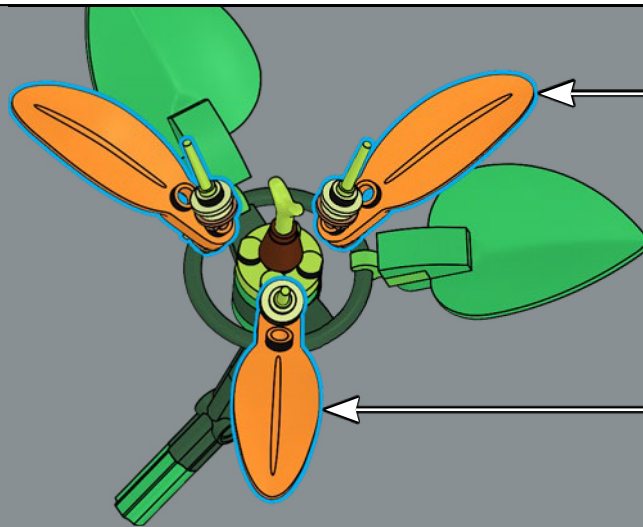
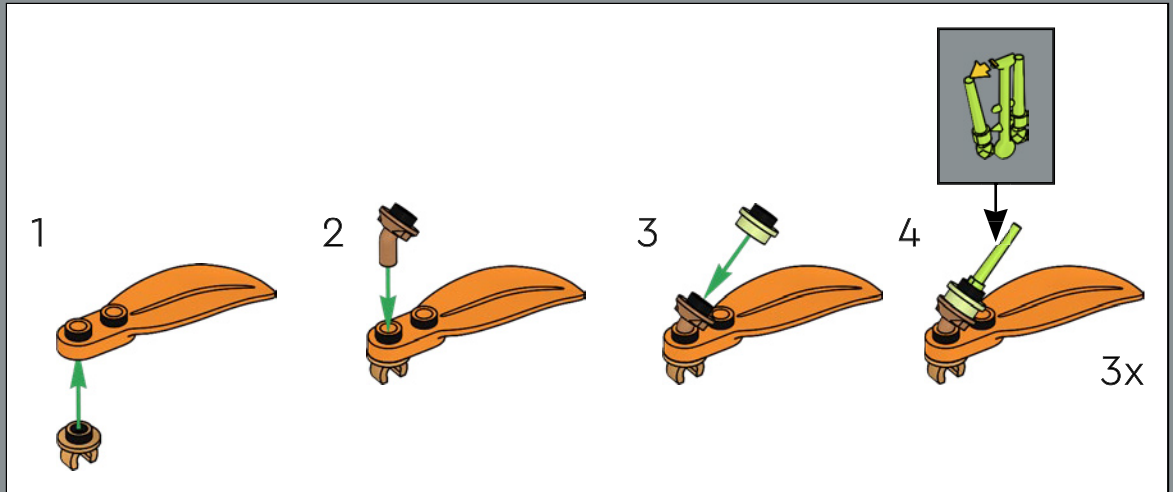



173

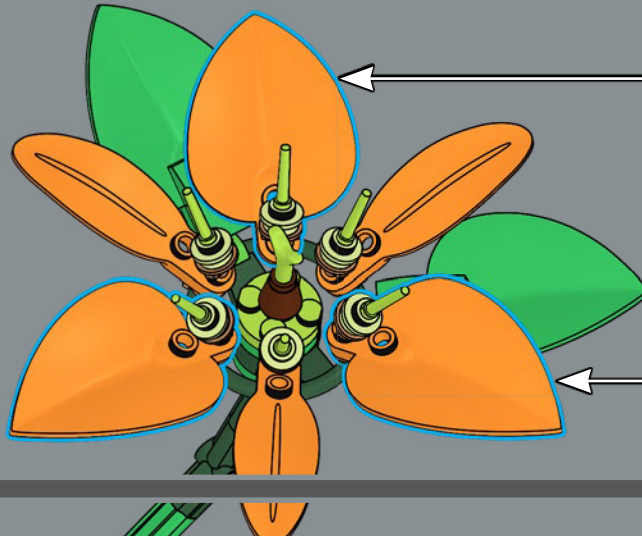
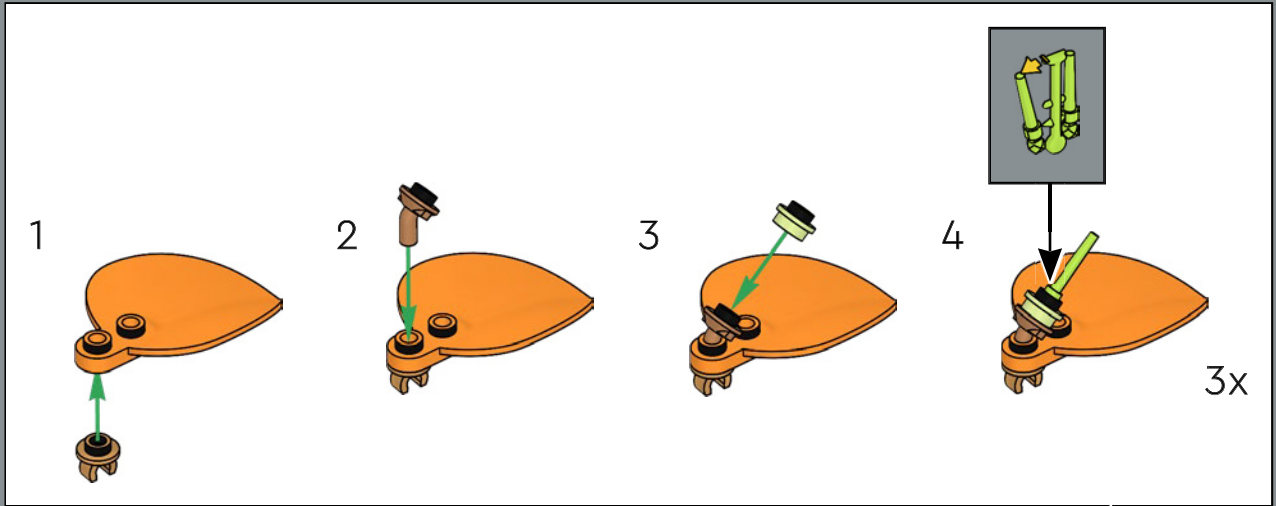



174

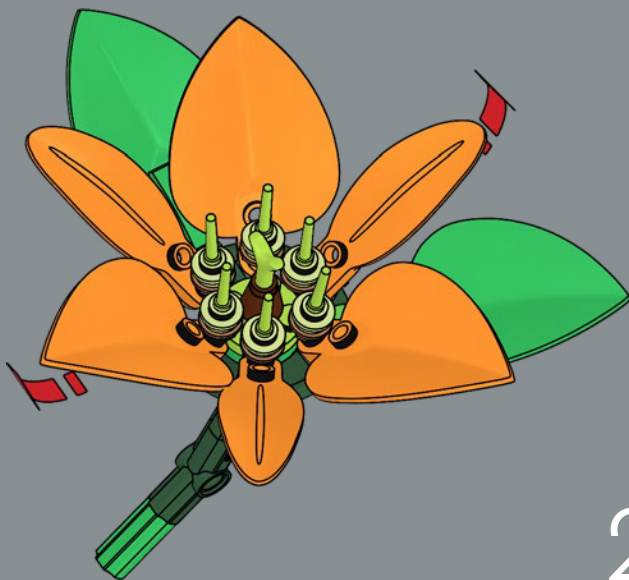

2x



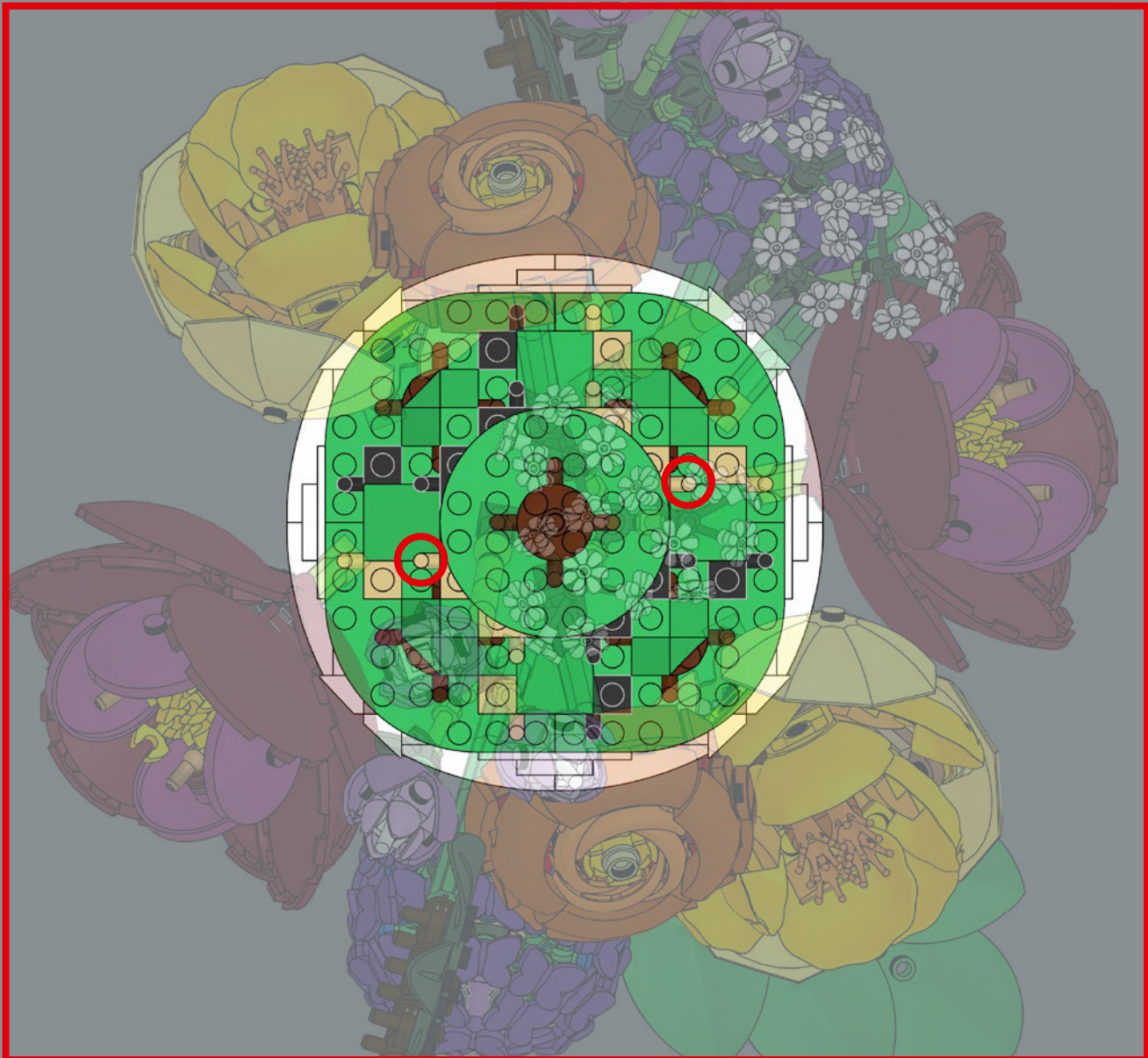



Descubre más consejos creativos  
con tu cuenta LEGO® Insiders en  
[LEGO.com/Botanicals-exclusive](https://LEGO.com/Botanicals-exclusive)





8x  
6527036

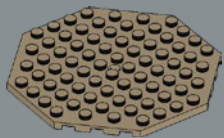

1x  
6288246



2x  
6392974



2x  
6512536



6x  
6400754



6x  
6398343



14x  
6510113



8x  
6329283



4x  
6525927



11x  
6344177



8x  
6348250



8x  
4539092



8x  
6168645



12x  
6212040



16x  
6527035



16x  
6099728



1x  
6365882



8x  
4529242



8x  
6172922



5x  
6313506



2x  
6092568



2x  
6170468



2x  
6459423



1x  
4531751



2x  
6316697



1x  
6135494



4x  
6301870



6x  
4211414



4x  
6258831



8x  
6313114



2x  
6093527



2x  
6116608



4x  
6469463



8x  
6231765



8x  
6527029



78x  
6468346



8x  
6212377



8x  
6252838



12x  
6520665



14x  
6452472



12x  
6265670



8x  
6492538



12x  
6510192



2x  
6482110



12x  
6534648



14x  
6256092



24x  
6468342



8x  
6527034



8x  
6473212



8x  
6468286



8x  
6466720



2x  
6510511



16x  
6492073



8x  
6527033

[LEGO.com/service](https://www.LEGO.com/service)



# YOU COULD WIN



## YOU COULD WIN

Your feedback will help shape the future development of this product series.

Visit:

## DU KÖNNTEST GEWINNEN

Dein Feedback trägt zur Weiterentwicklung dieser Produktreihe bei.

Geh auf:

## VOUS POURRIEZ GAGNER

Vos commentaires nous aideront à concevoir les futurs produits de cette gamme.

Visitez :

## POTRESTI VINCERE TU

La tua opinione ci aiuterà a migliorare la creazione futura di questa linea di prodotti.

Visita:

## PUEDES GANAR

Tu opinión contribuirá al futuro de esta serie de productos.

Visita:

## 轻松获奖

您的反馈将有助于我们在今后改进本产品系列。

请访问：

---

# LEGO.com/productfeedback

---

You also have the chance to win a LEGO® set.

Terms and conditions apply.\*

Außerdem hast du die Chance, ein LEGO® Set zu gewinnen.

Es gelten die Teilnahmebedingungen.\*

Vous pourriez également gagner un ensemble LEGO®.

Des conditions s'appliquent.\*

Hai anche la possibilità di vincere un set LEGO®.

Termini e condizioni sono applicabili.\*

También tienes la oportunidad de ganar un set LEGO®.

Aplican términos y condiciones.\*

您还有机会赢取乐高®套装。

条款和条件适用。\*

\*LEGO.com/productfeedback-terms



LEGO and the LEGO logo are trademarks of the LEGO Group.  
©2025 The LEGO Group.