



10342





LEGO.com/sustainable-packaging



FR
DONNEZ
OU
RECYCLEZ



OU



OU



ASSOCIATION

MAGASIN

DÉCHÈTERIE

Adresses sur quefairedemesdechets.fr



BUiLDER



Apple and the Apple logo are trademarks of Apple Inc., registered in the U.S. and other countries and regions. App Store is a service mark of Apple Inc. Google Play and the Google Play logo are trademarks of Google LLC. Tencent and the Tencent logo are trademarks of Tencent Inc.

Q LEGO.com/devicecheck

Q LEGO® Builder

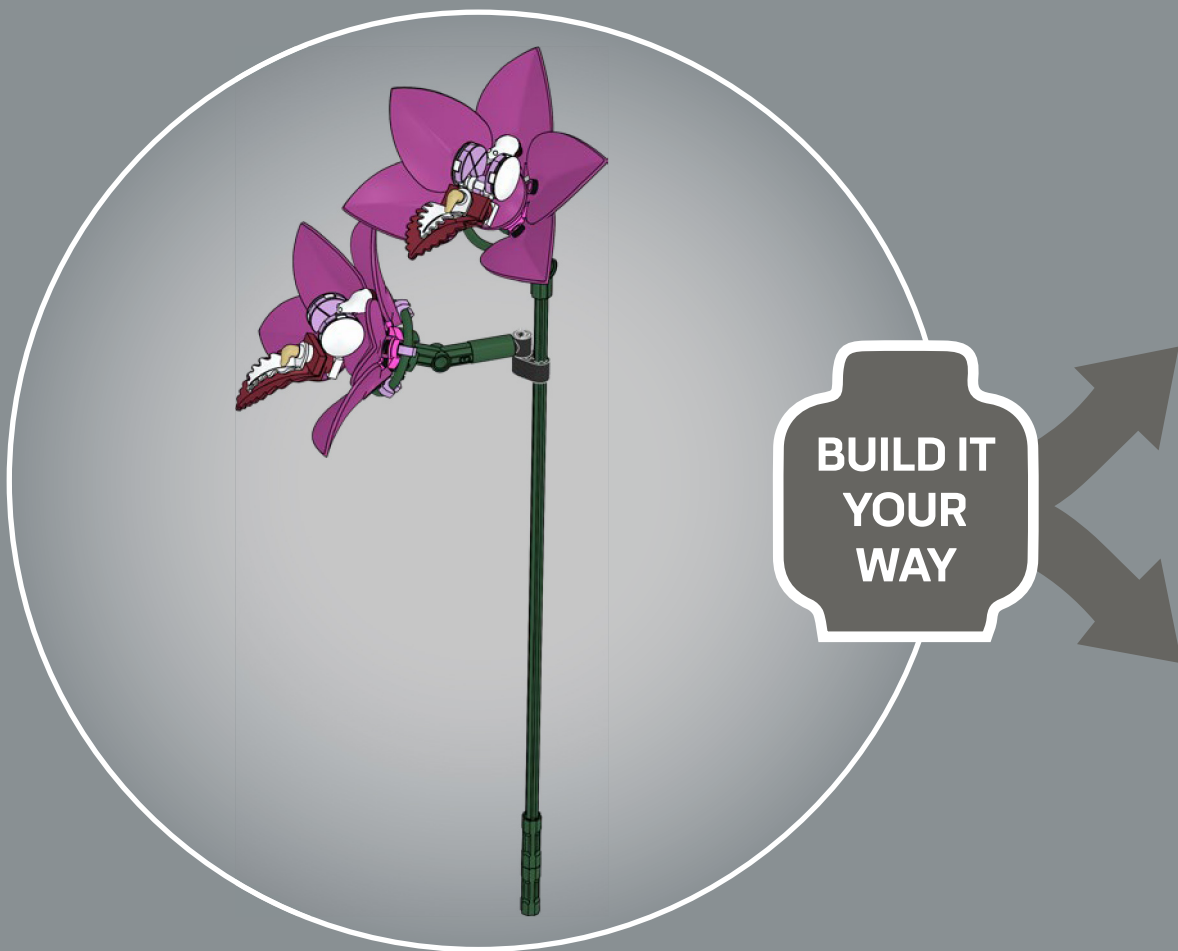

EN Build It Your Way | **DE** Bau, wie du willst | **FR** Construisez à votre façon | **IT** Costruiscilo come vuoi tu | **ES** Constrúyelo a tu manera
| **PT** Constrói à Tua Maneira | **ZH** 自由拼搭 | **PL** Zbuduj po swojemu | **CS** Postavte to po svém | **SK** Postavte to po svojom | **HU** Építs kedved szerint!
| **RO** Construięște așa cum dorești | **BG** Постройте го по своя начин | **LV** Būvē tieši tā, kā vēlies | **ET** Ehita enda moodi | **LT** Sukonstruokite savaip

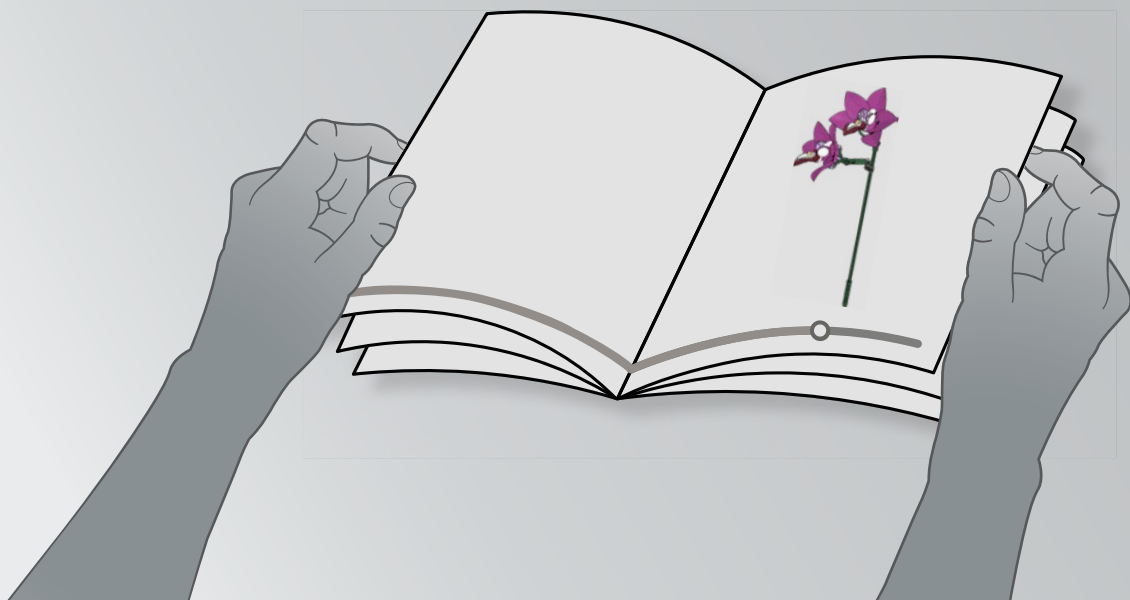
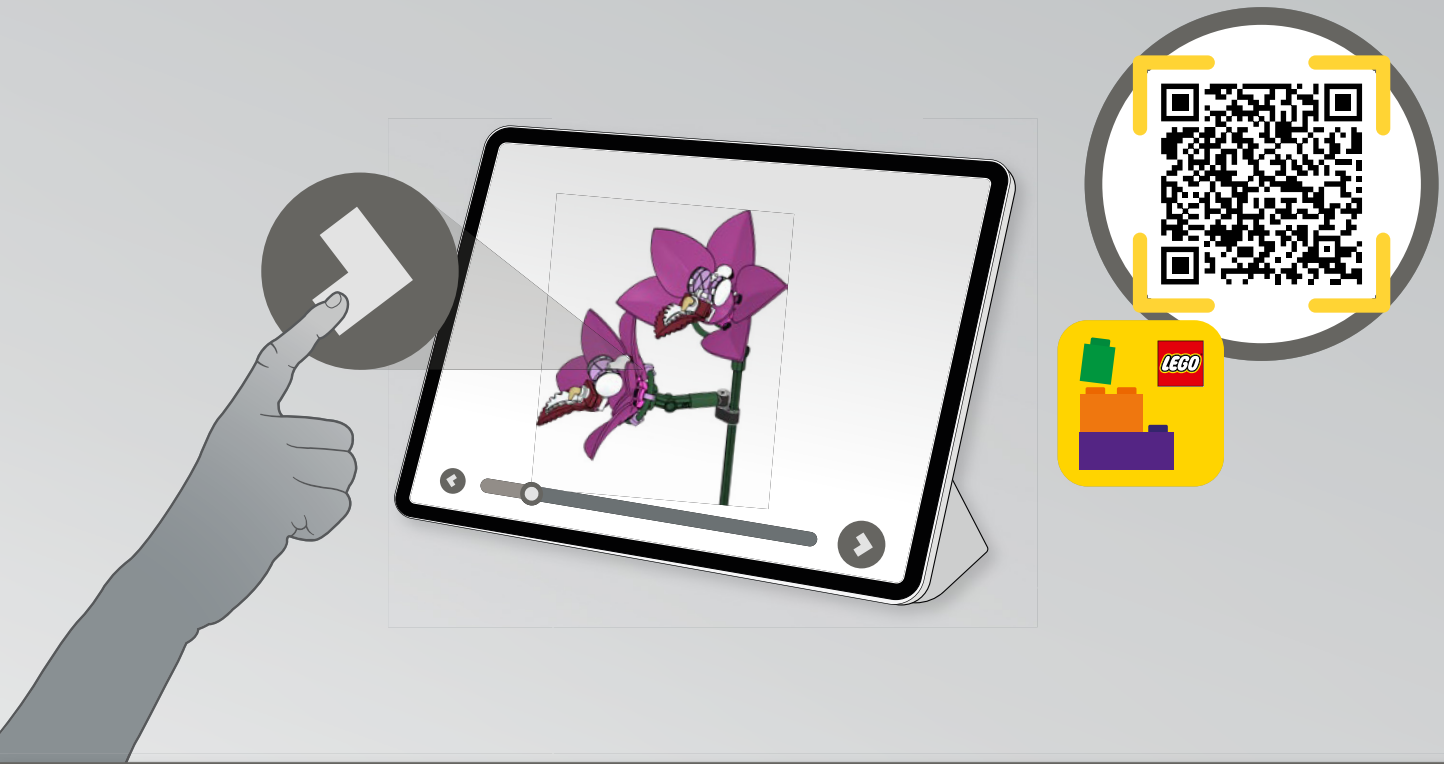



Élégance naturelle

Lorsque nous créons une composition florale LEGO®, nous pouvons nous inspirer de la profusion de couleurs, d'espèces végétales et de parfums que la nature nous offre. En combinant des fleurs aux tons pastel ou aux couleurs vives à des conifères au port majestueux, nous avons expérimenté de nouvelles techniques et utilisé des éléments LEGO de façon créative pour donner vie à ce somptueux bouquet. Chaque détail méticuleusement recréé est un hommage authentique et artistique aux multiples trésors de la nature.

L'équipe de design LEGO® Botanique

Autrefois considéré comme une mauvaise herbe et aujourd'hui souvent mis à l'honneur dans les bouquets, le bleuet est très présent en Europe et en Amérique du Nord et particulièrement apprécié des abeilles et des papillons.



(*Centauria cyanus*)

LE BLEUET



(*Eucalyptus pulverulenta*)

L'EUCALYPTUS « BABY BLUE »

Également connu sous le nom de gommier argenté de montagne, ce membre de la famille des eucalyptus agrmente souvent les bouquets de fleurs dans le monde entier.



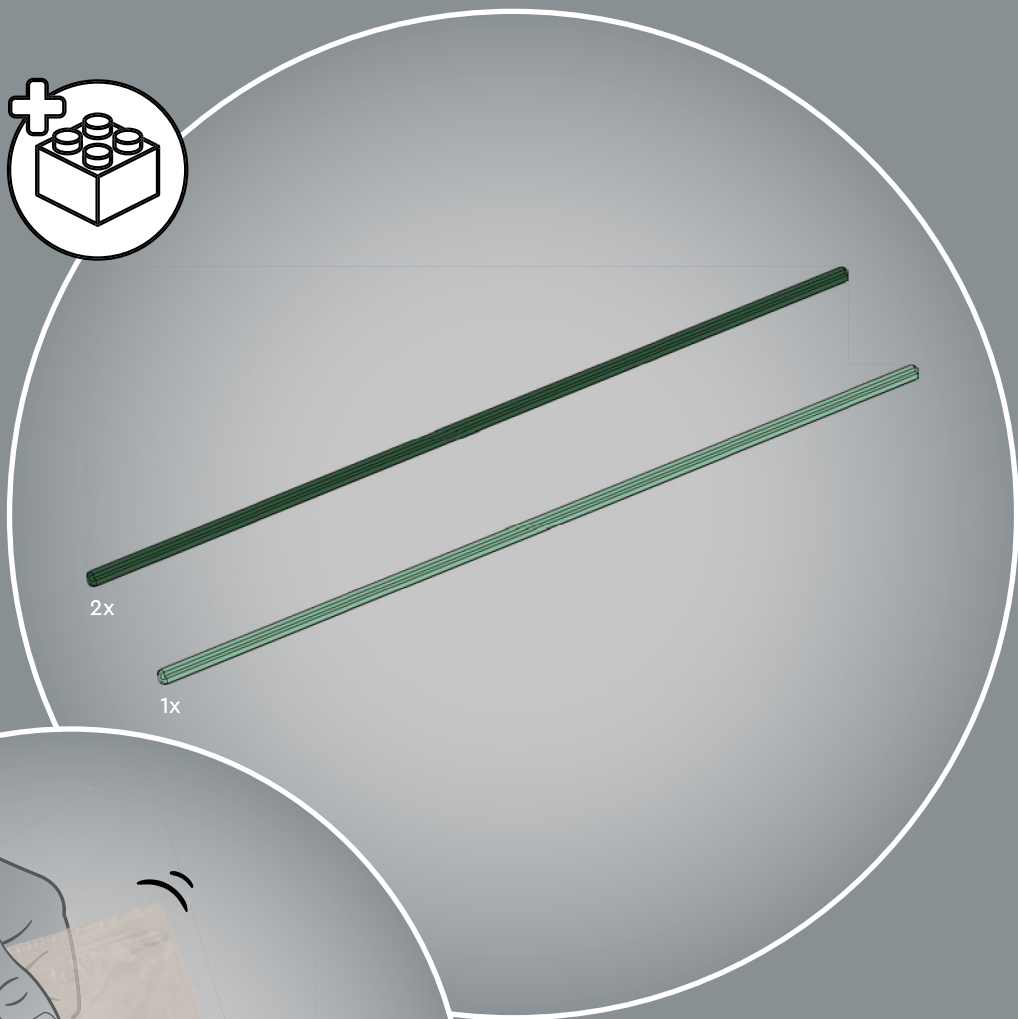
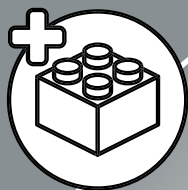

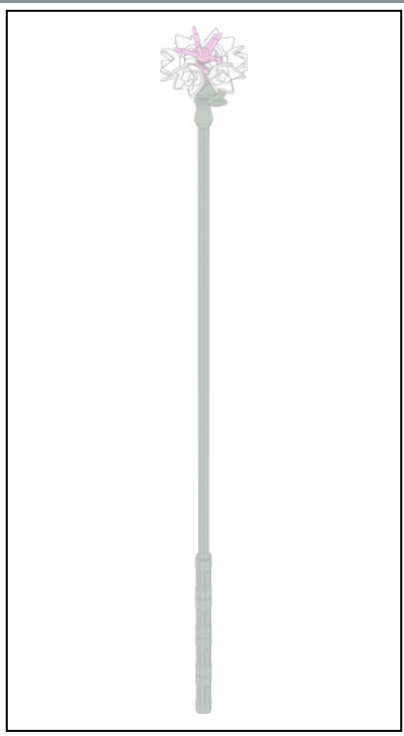

1

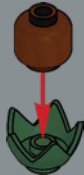

2



3

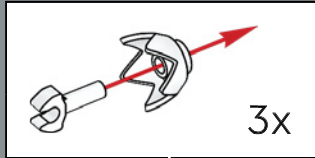

4

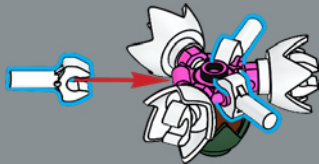

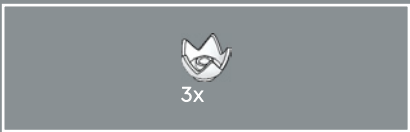

5

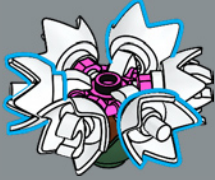

Ces petites briques LEGO® utilisées pour les pétales de bleuet sont en réalité des couronnes de minifigurines.



6

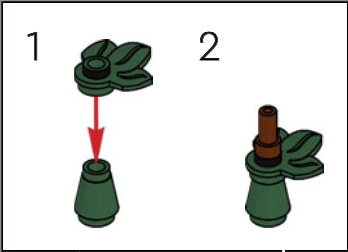

7



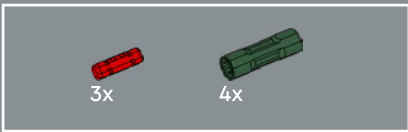

8

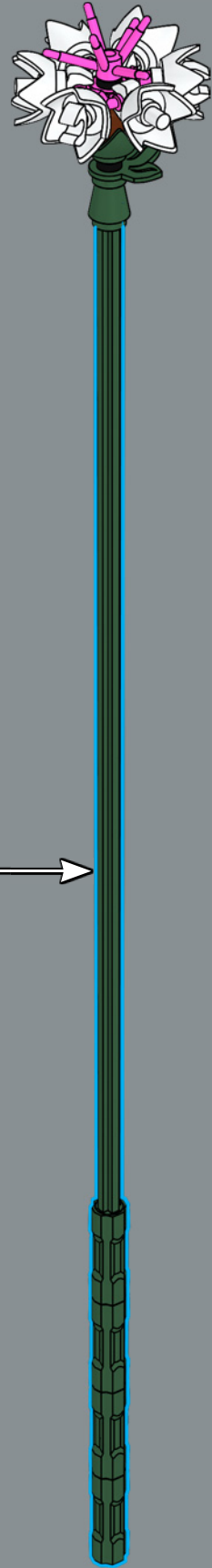
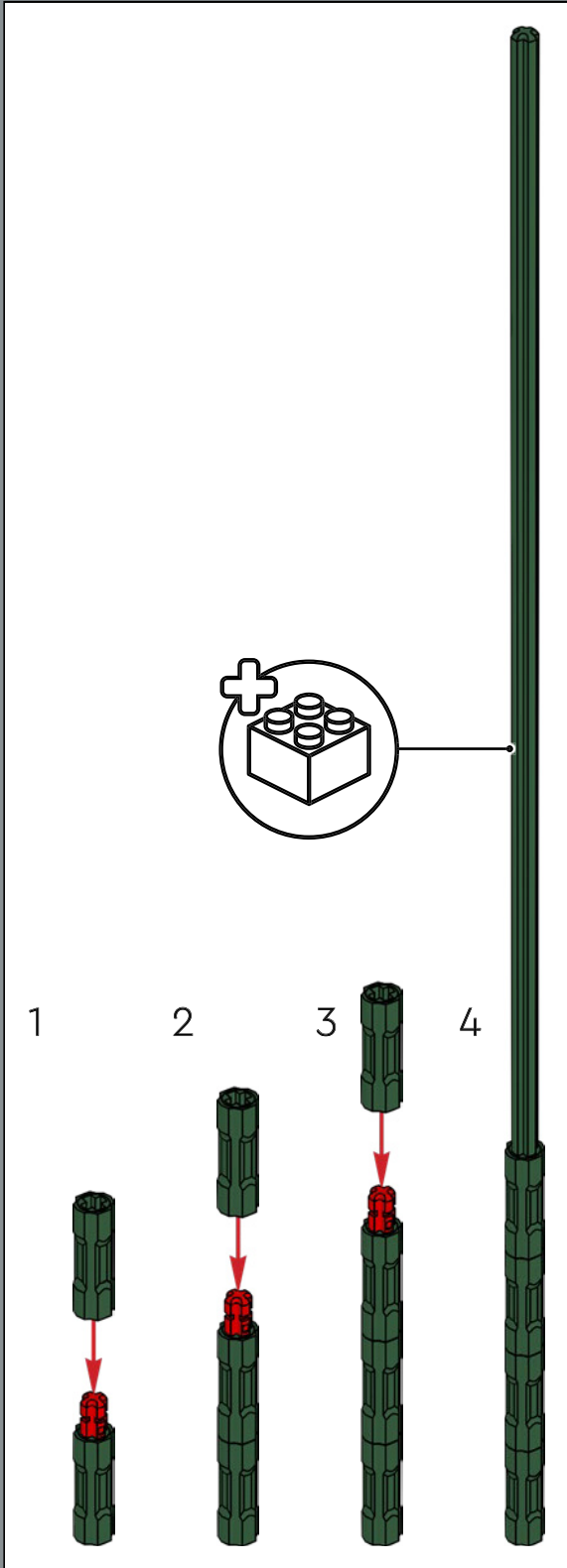

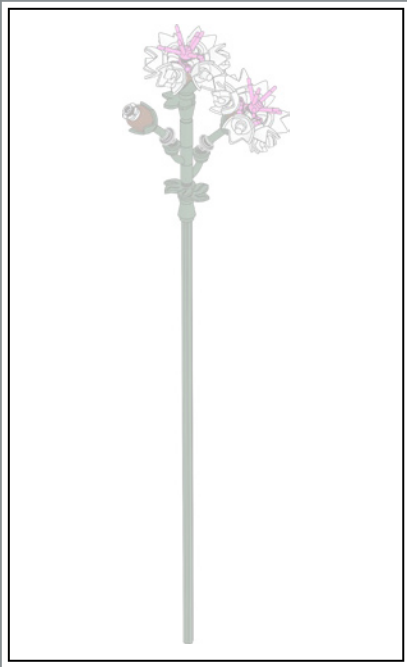

1

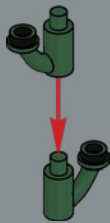

2

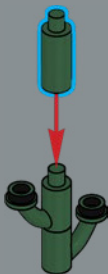

3

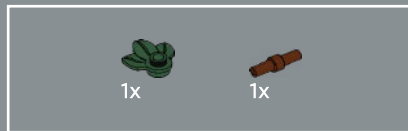
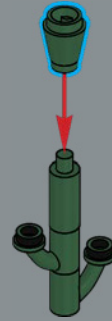

4





5



6

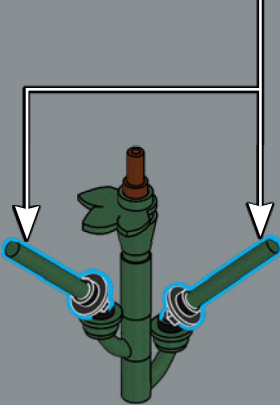
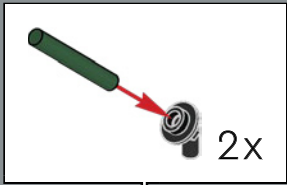

7

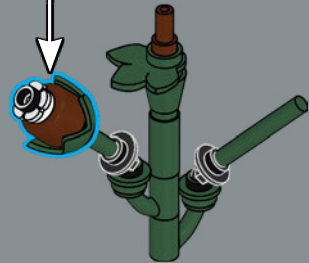
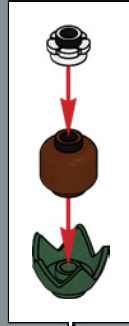



8

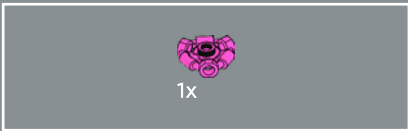
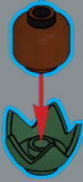

9



10

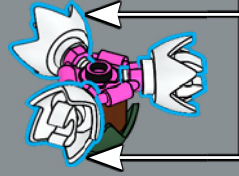
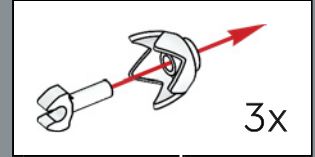

11

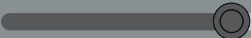
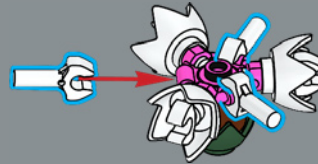

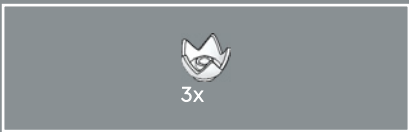

12

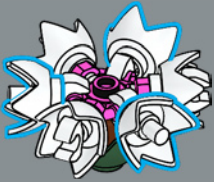

13



2x

14

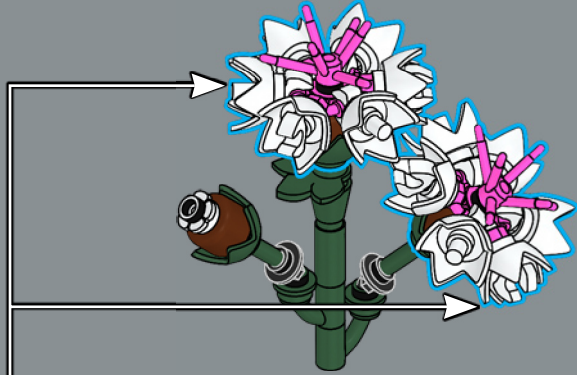

15

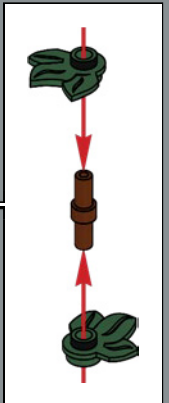
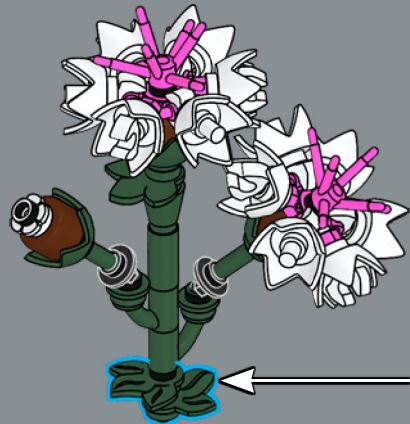



16

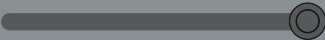
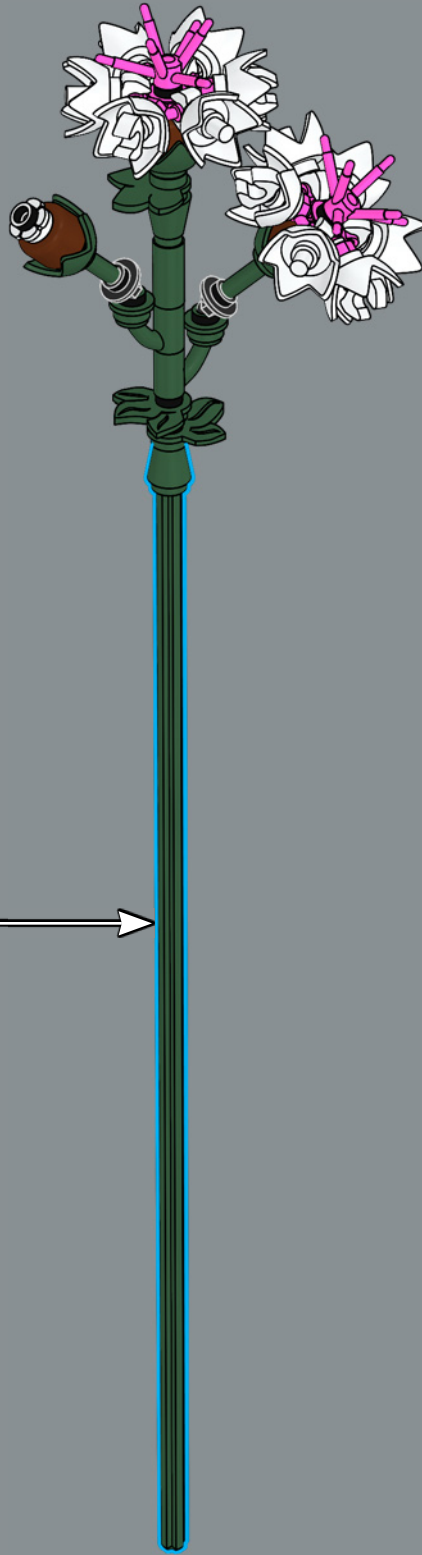
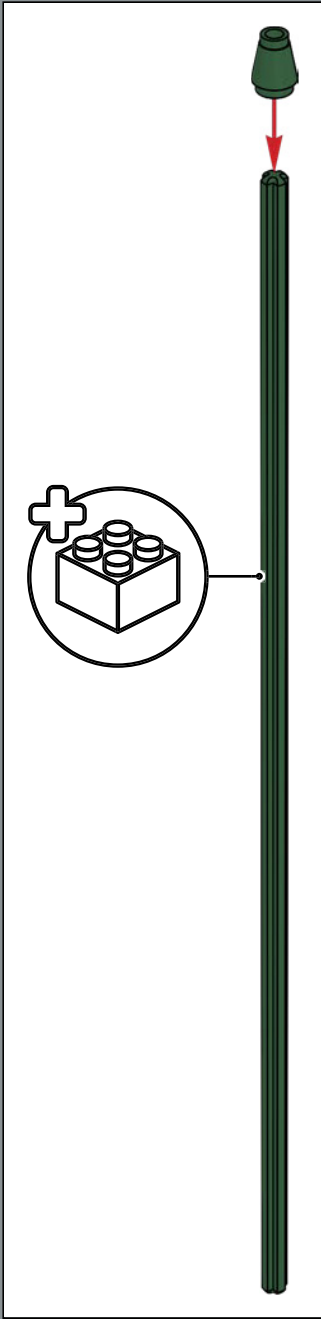

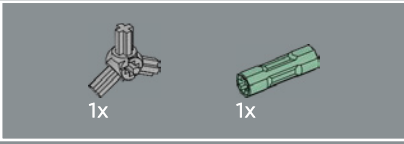

1

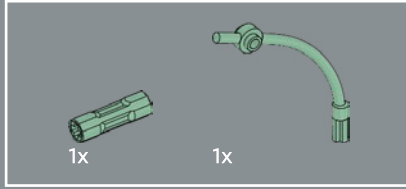
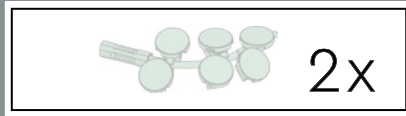
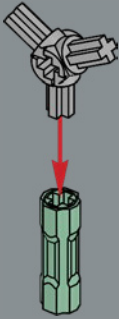

2

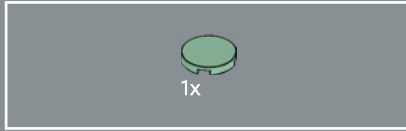
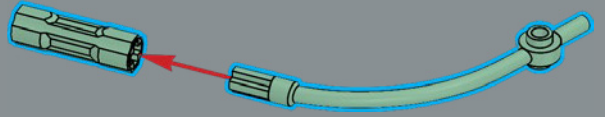

3

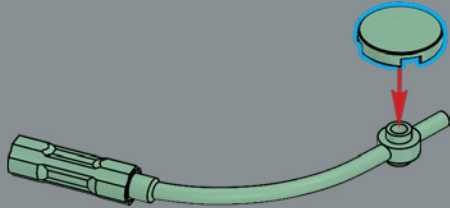



4

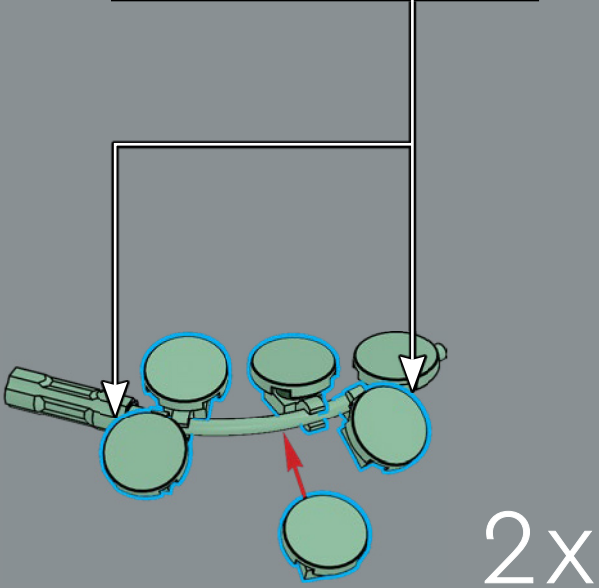
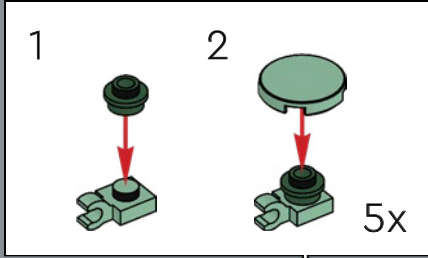

5

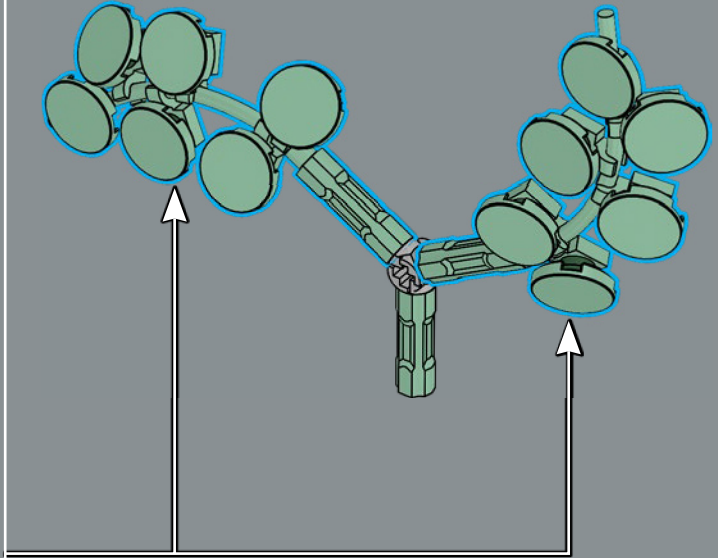



6

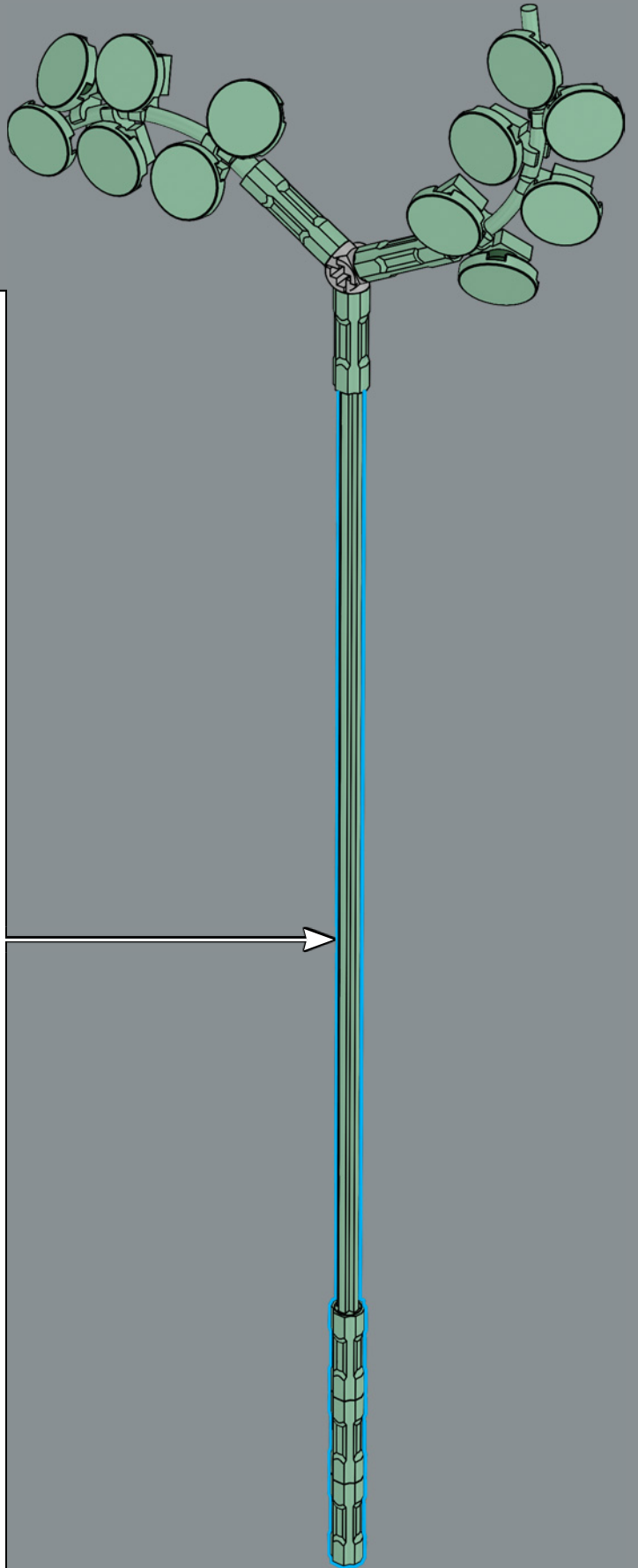
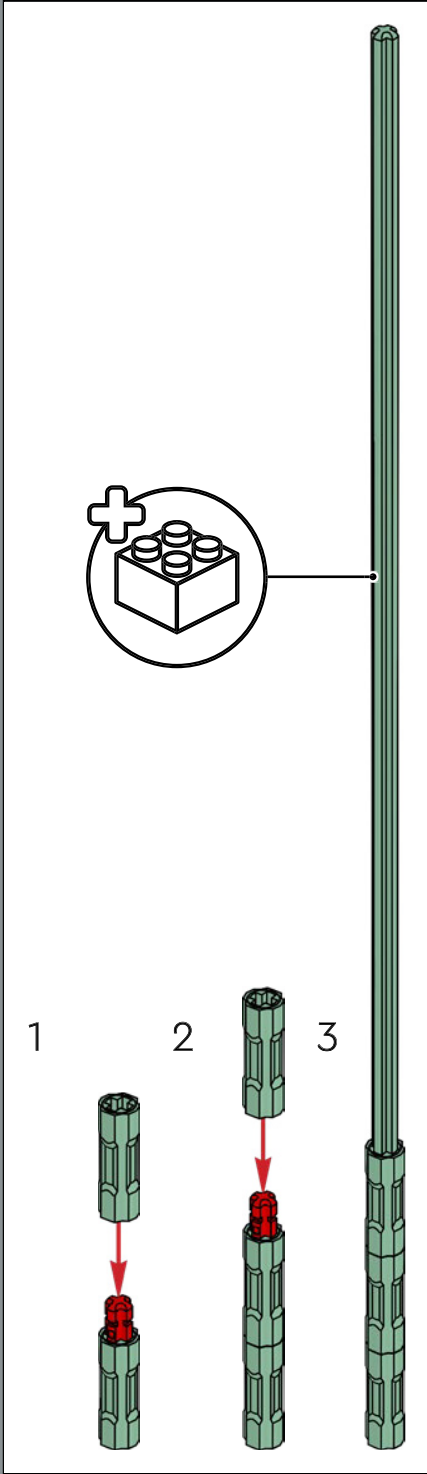



(Sambucus nigra)

LE SUREAU NOIR

Il existe différentes espèces de sureau à feuilles caduques à travers le monde, mais la plupart produisent de délicates fleurs blanches et des baies violet foncé. Les unes comme les autres sont très appréciées dans la préparation de mets et de boissons.

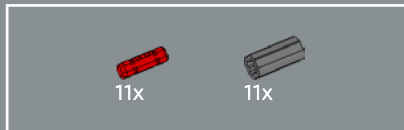

1

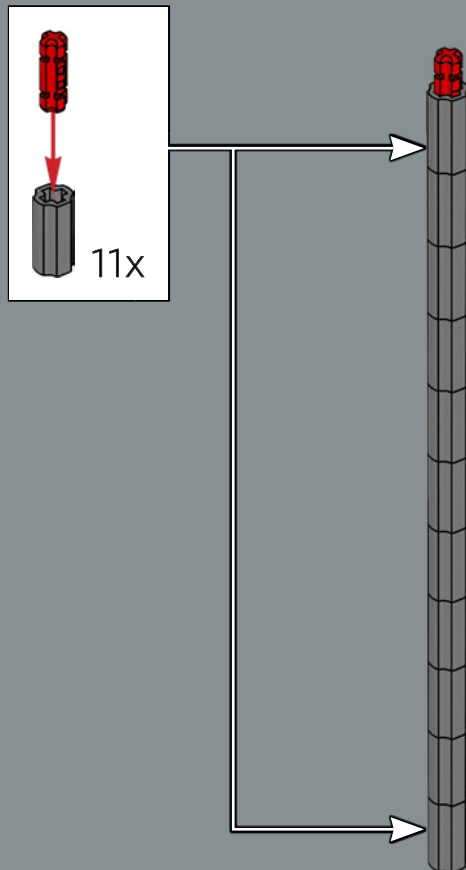

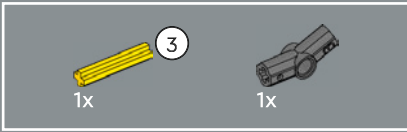
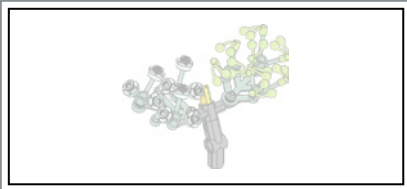

2

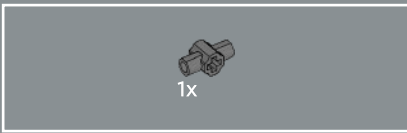
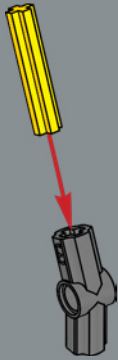

3

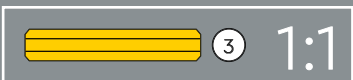
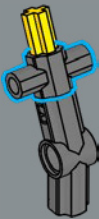

4

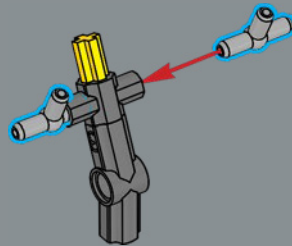

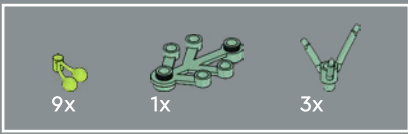

5

1



2

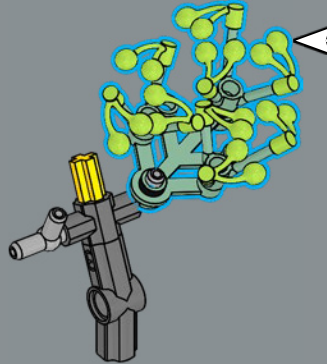
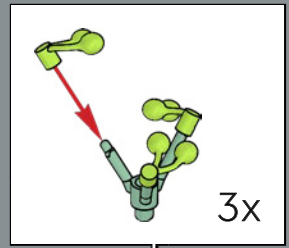
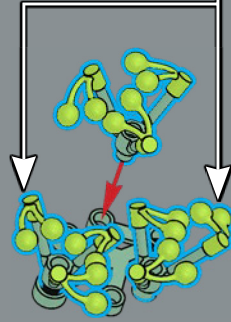

Ici, pour recréer les bourgeons de sureau non ouverts, nous avons utilisé des cerises de minifigurines LEGO® classiques.

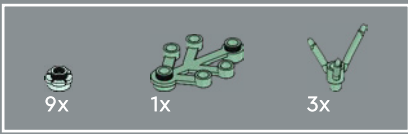

6

1



2

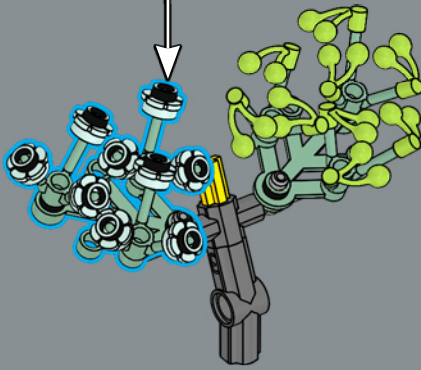
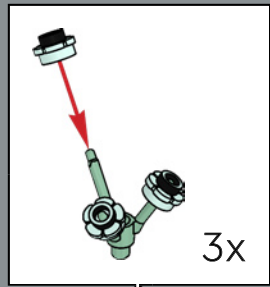
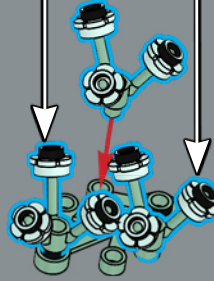

7

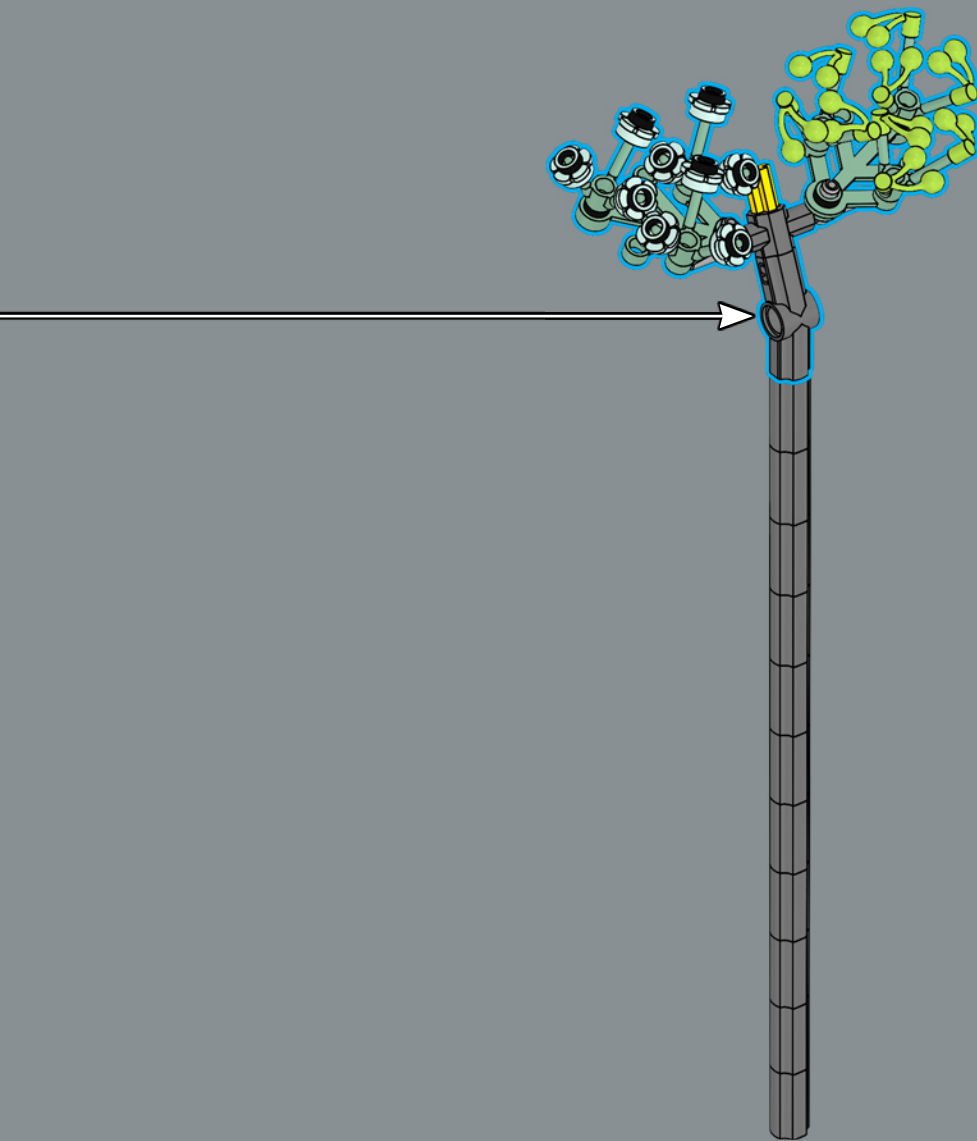

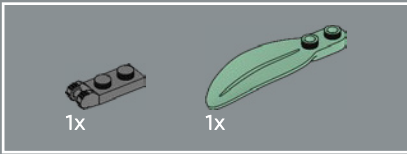
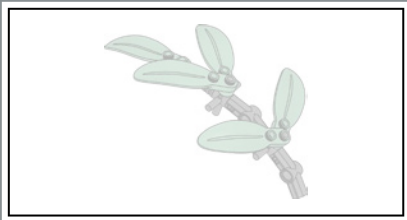

8

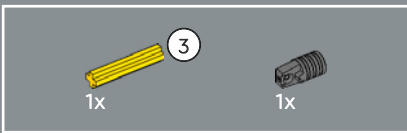
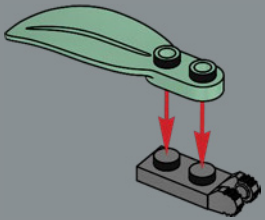

9

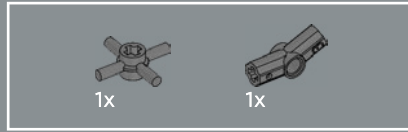
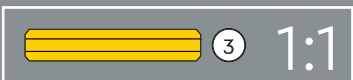
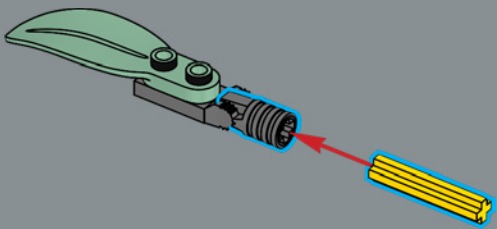

10

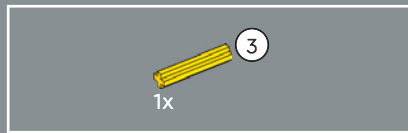
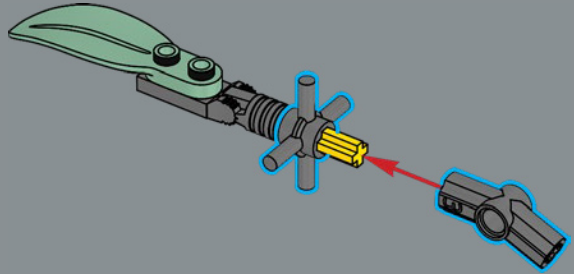

11

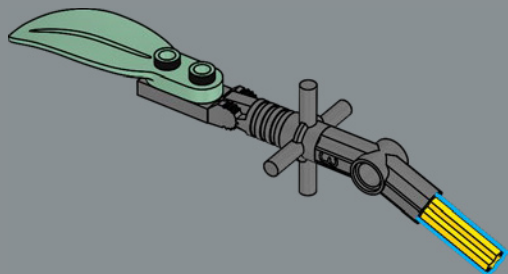



12

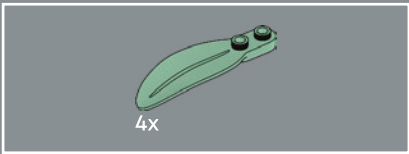
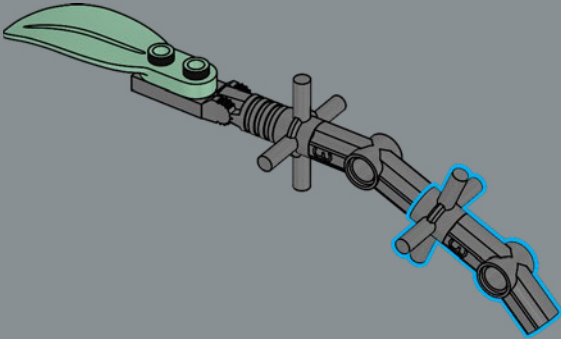

13

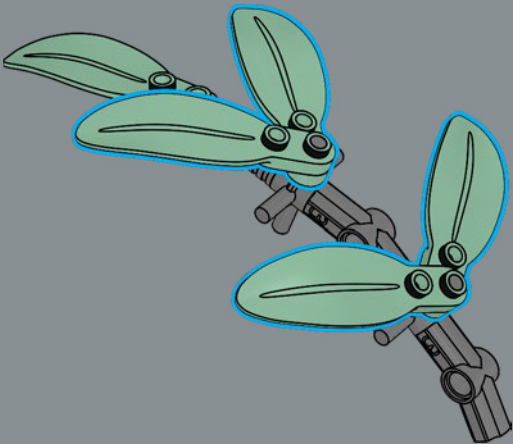

14

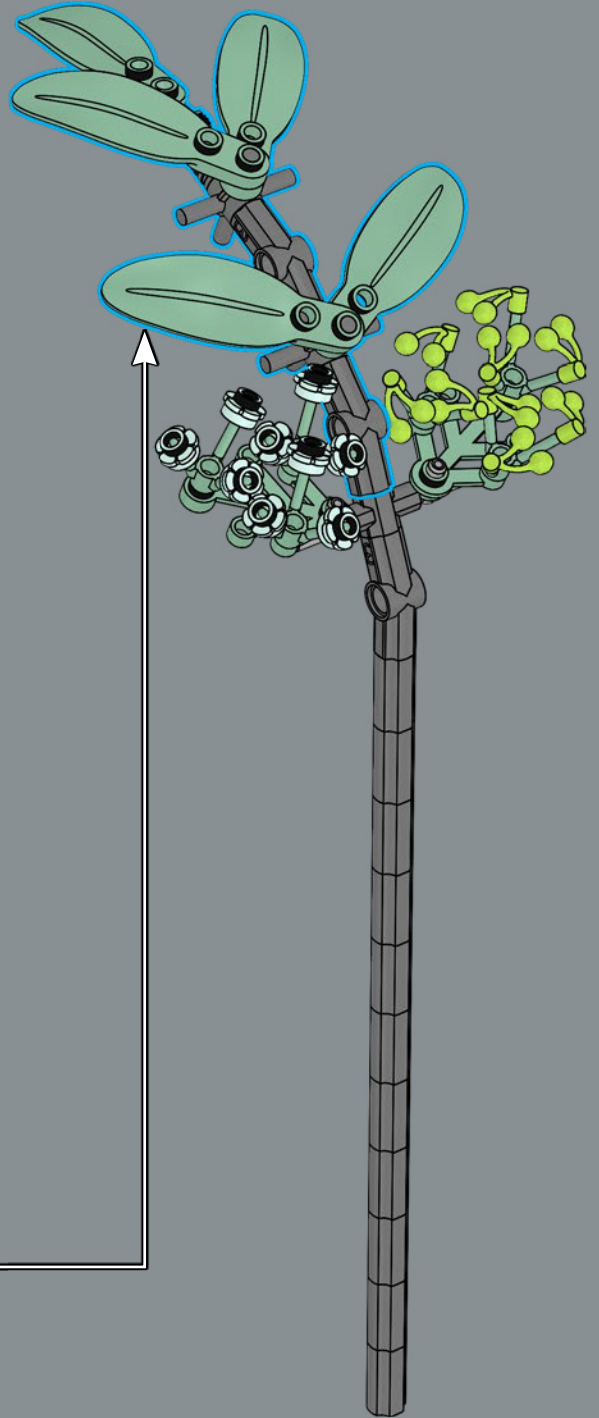

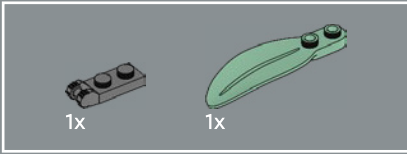
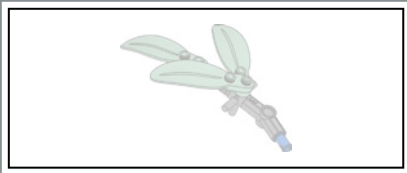

15

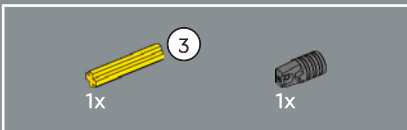
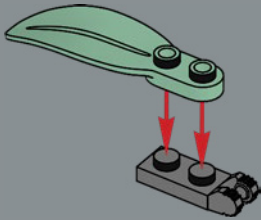

16

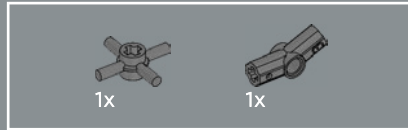
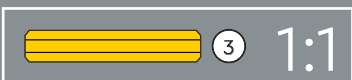
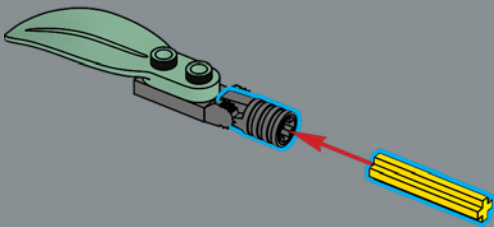

17

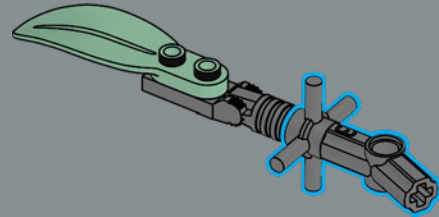

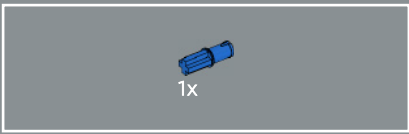

18

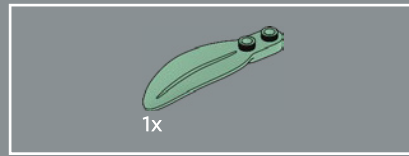
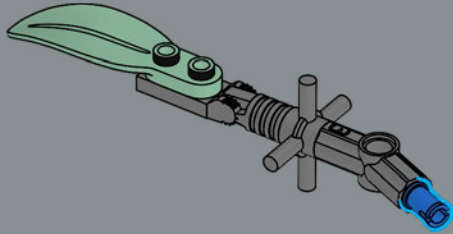

19

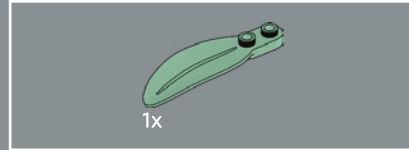
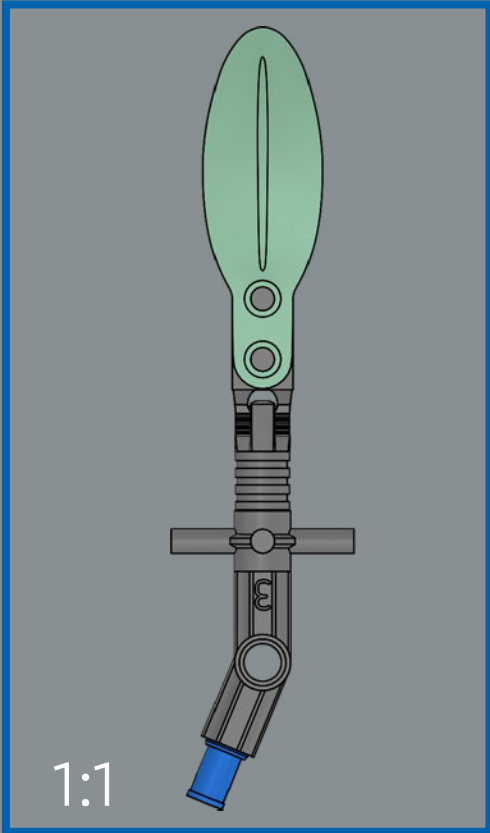
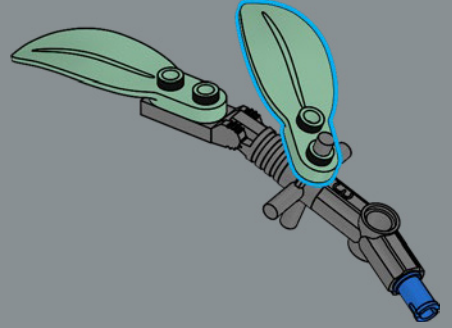

20

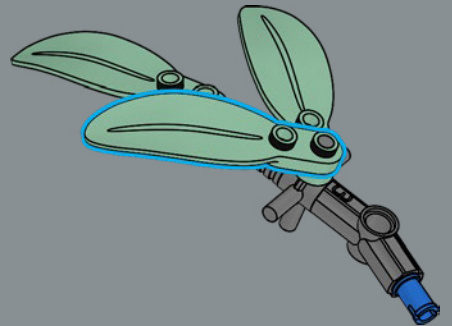

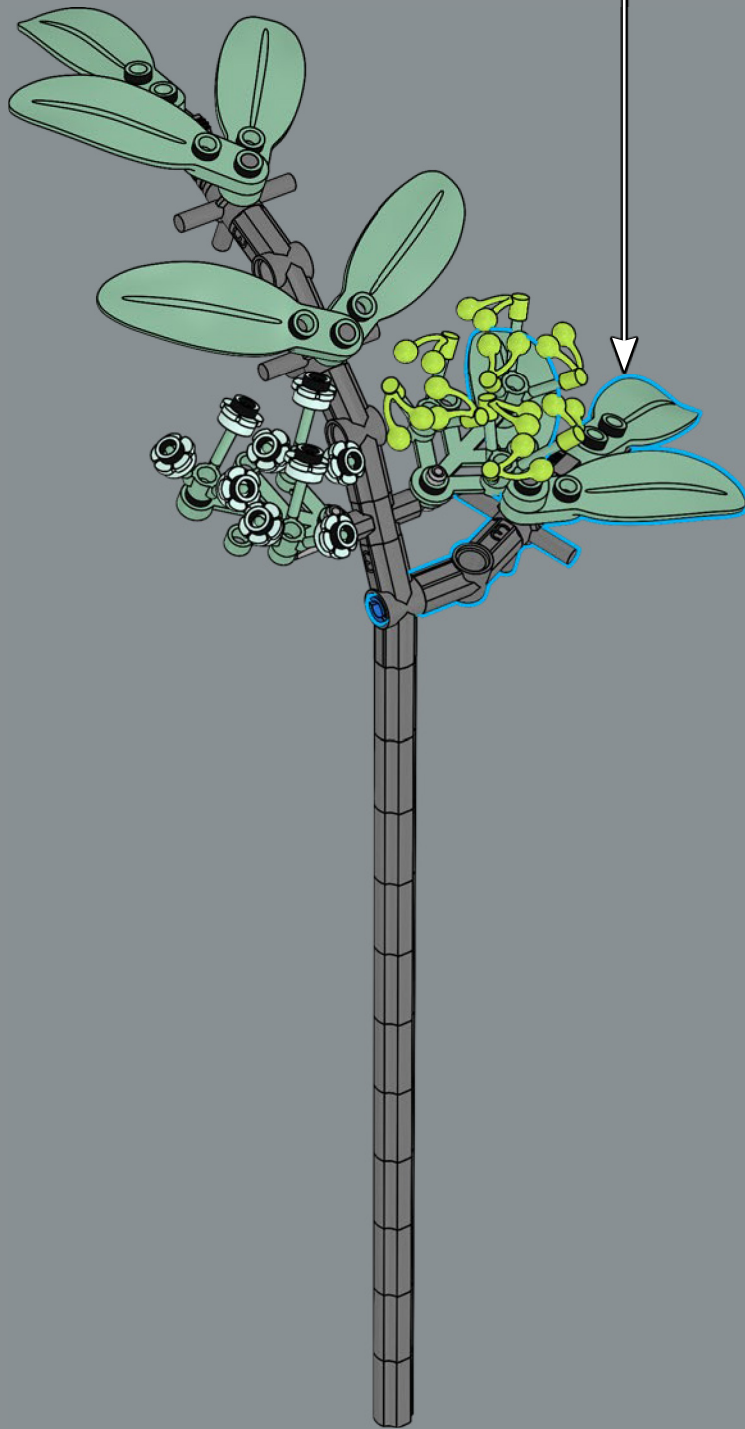

2x





(Rosa)

LA ROSE

Symbole d'amour et emblème de beauté depuis des siècles, la rose apporte de la grâce à tous les bouquets, et ce, quelle que soit sa couleur, qu'il s'agisse de fleurs véritables ou de modèles LEGO®.



(Felicia amelloides)

L'ASTER DU CAP

Commune en Europe et en Amérique du Nord, l'aster du Cap symbolise l'engagement et la confiance, ce qui en fait un cadeau parfait pour les personnes que vous chérissez.

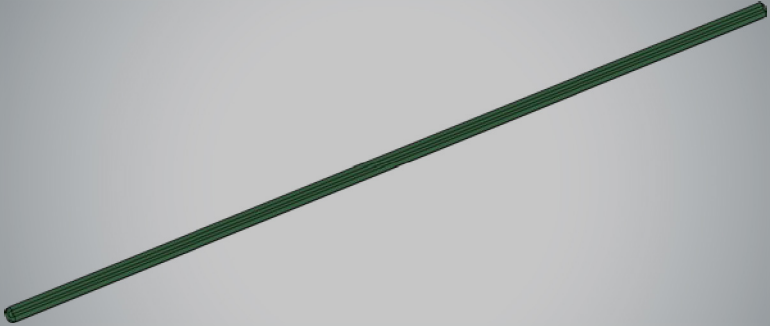
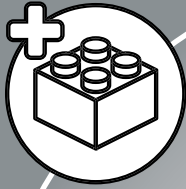

2x



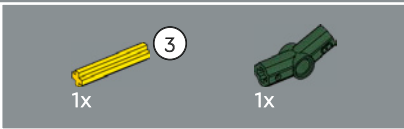
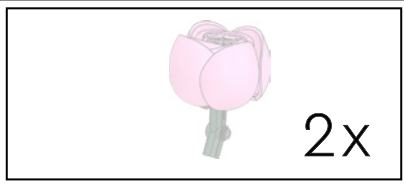
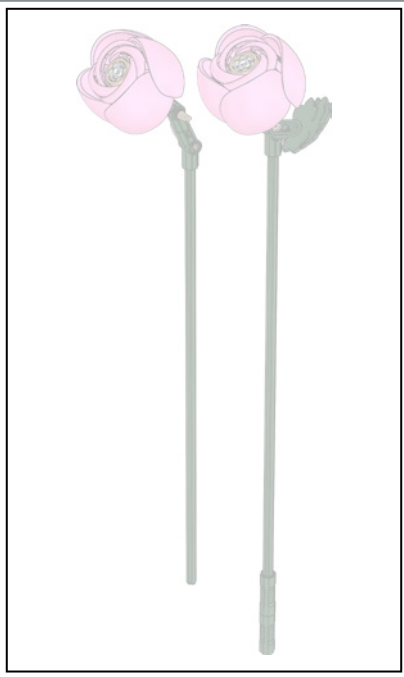

1

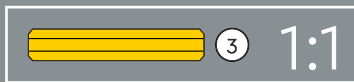
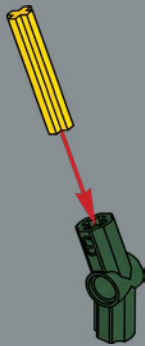

2

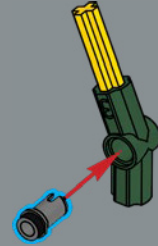

3





4



5



6

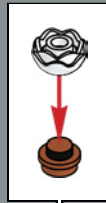

Nos minifigurines LEGO® aiment aussi les fleurs. Cette petite fleur, conçue à l'origine comme une petite pivoine, constitue aujourd'hui le centre d'une rose.

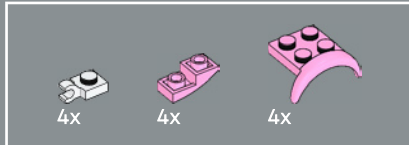

7

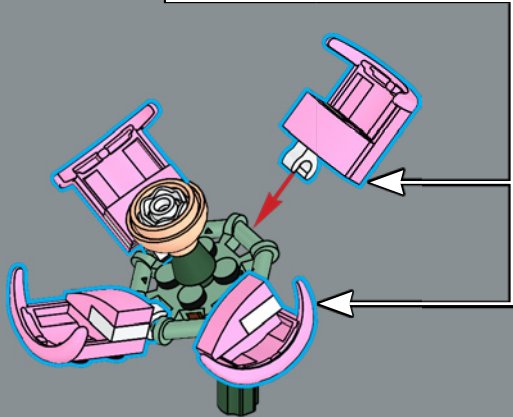
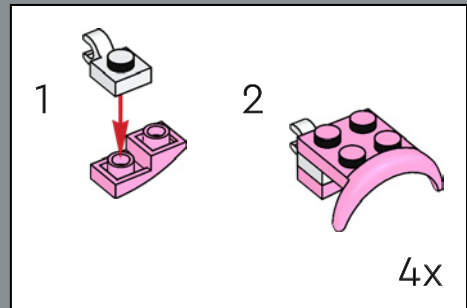

8

La spirale de pétales centrale de cette rose a été construite avec des passages de roue de voitures LEGO®.

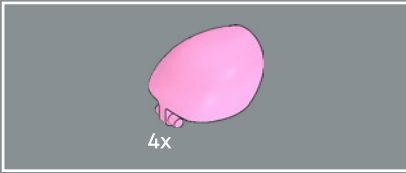
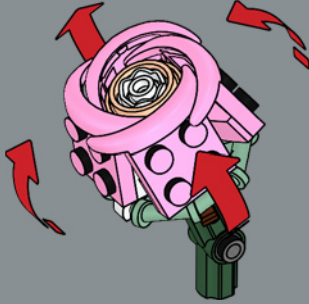

9

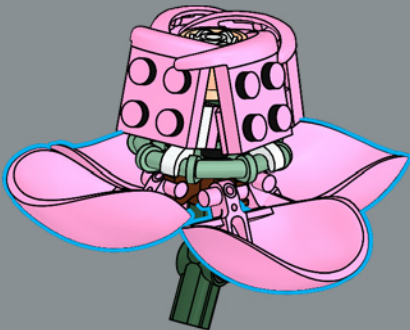

10

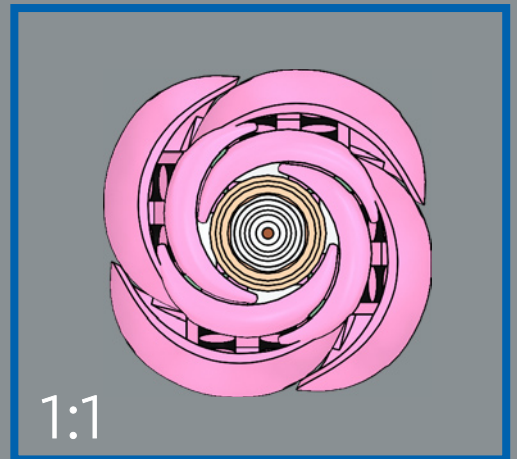
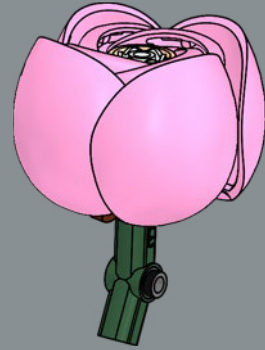

2x

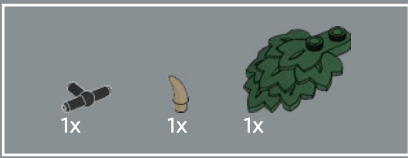

11

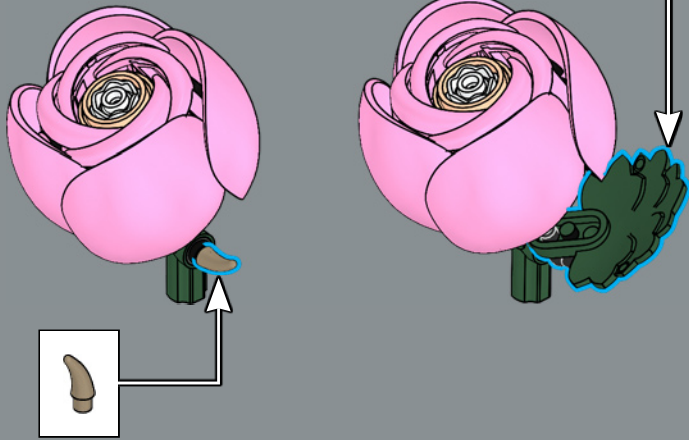
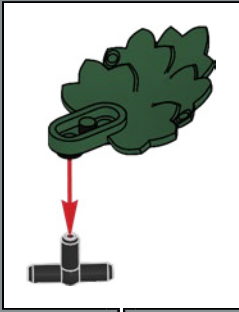

12

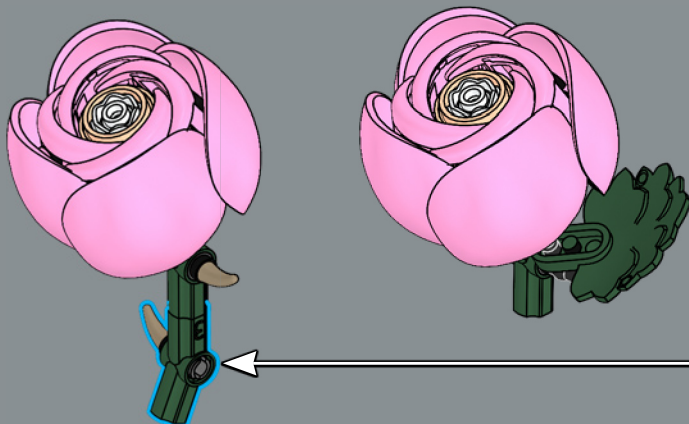
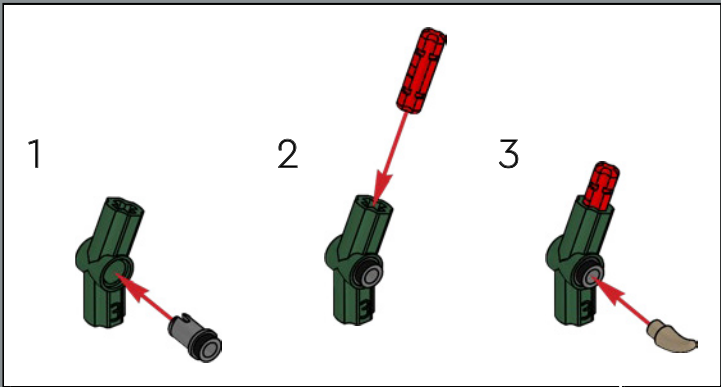

13

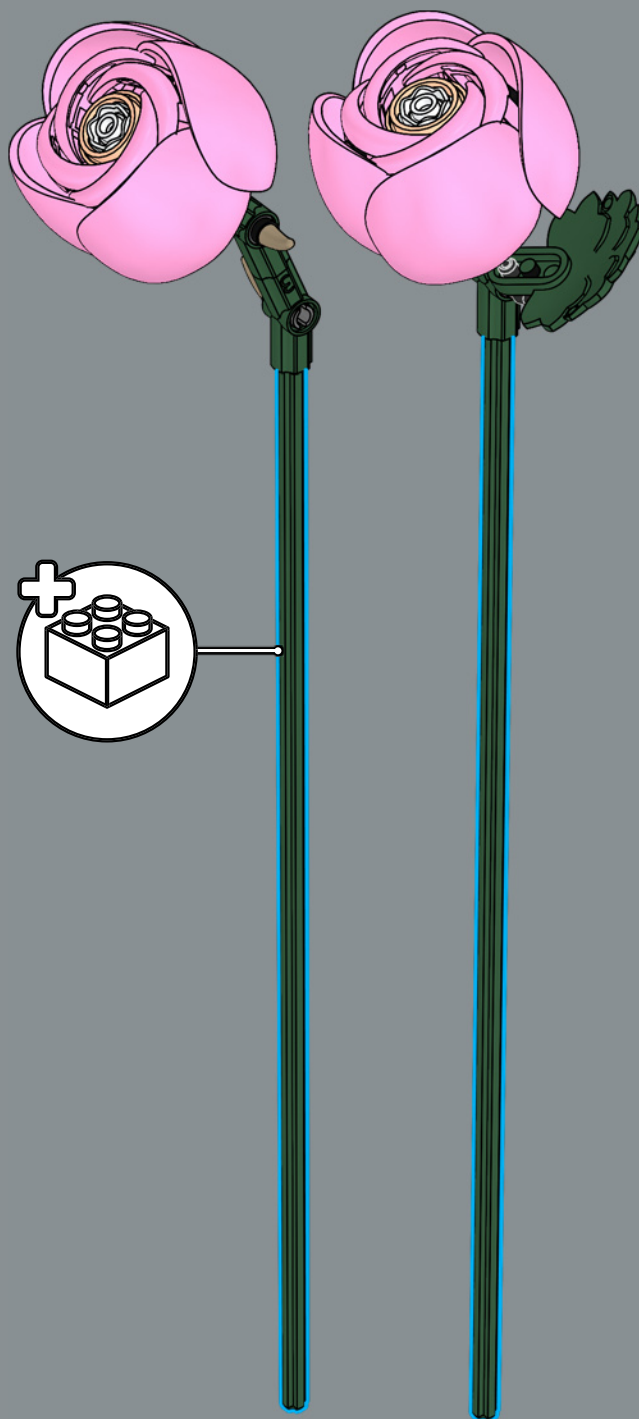

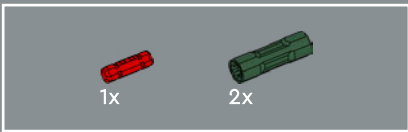

14

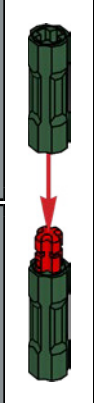

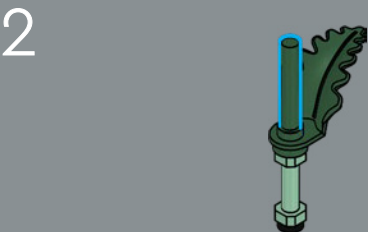
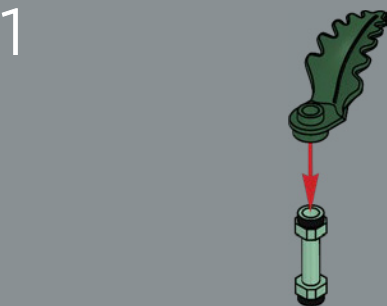
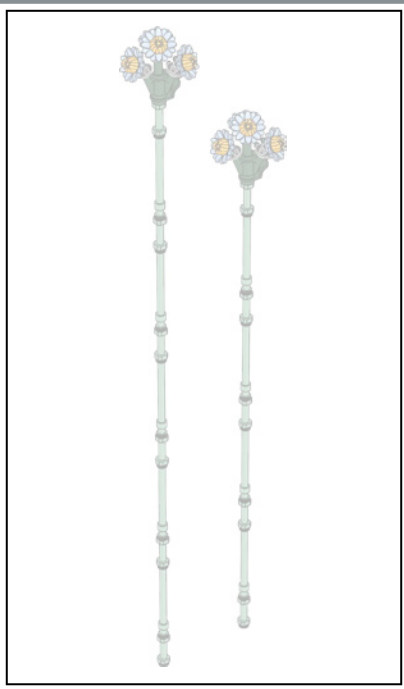

3

Ce petit trépied avait été conçu à l'origine pour aider les minifigurines LEGO® à stabiliser leur appareil photo. Il contient désormais un petit bouquet d'asters du Cap.

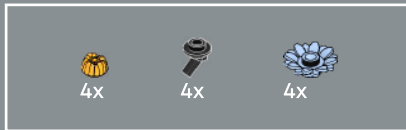
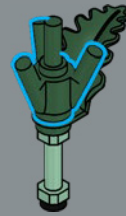

4

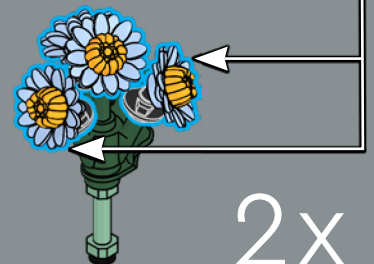
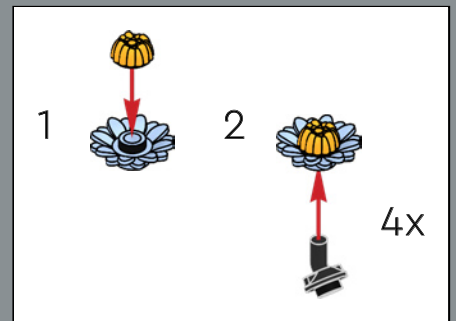

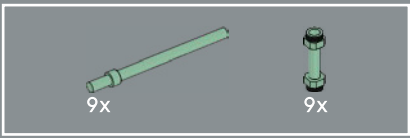

5

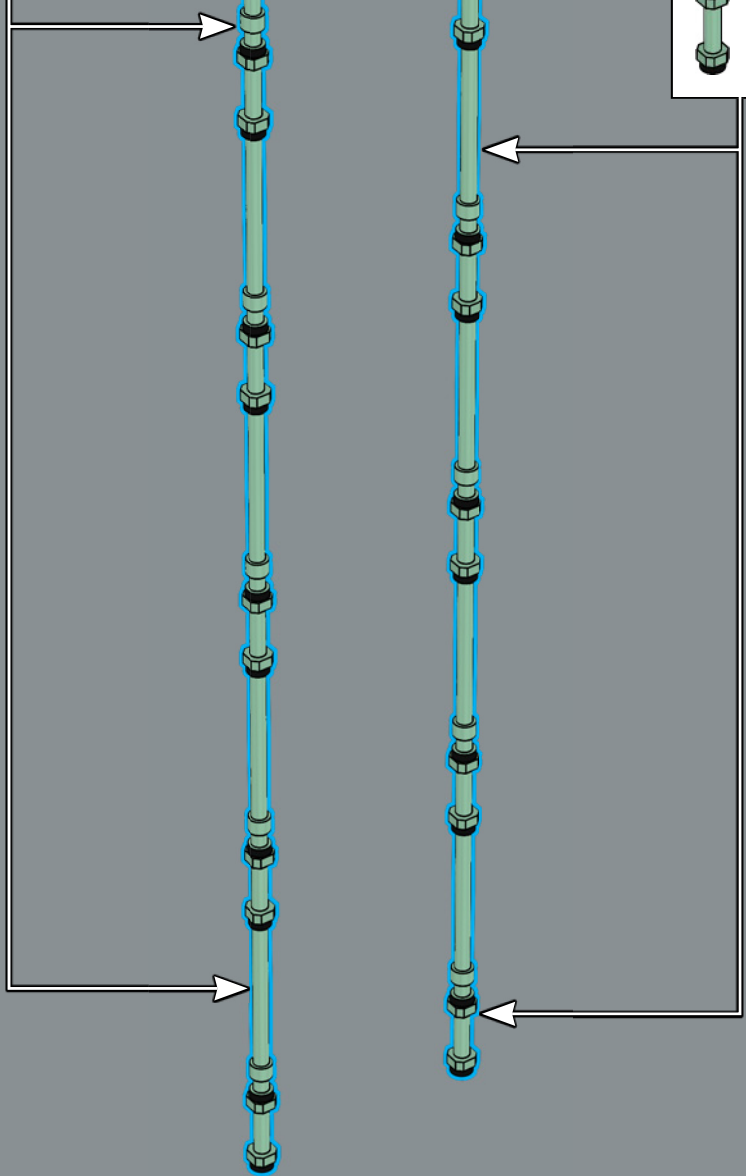
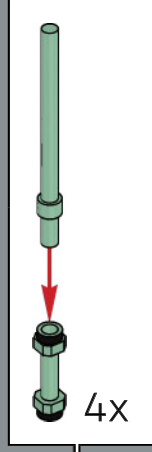
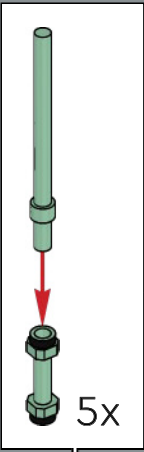



(Campanula medium)

LA CAMPANULE CARILLON

Plante bisannuelle originaire du sud de l'Europe, la campanule produit des fleurs en forme de calice ou de cloche, généralement dans des teintes de bleu, blanc ou rose tout au long de l'été.



(Ranunculus)

LA RENONCULE DES FLEURISTES

Originaire d'Europe, d'Amérique du Nord et d'Asie, la renoncule des fleuristes, avec ses couches complexes de pétales de couleur pastel, est toujours un élément apprécié dans les bouquets.



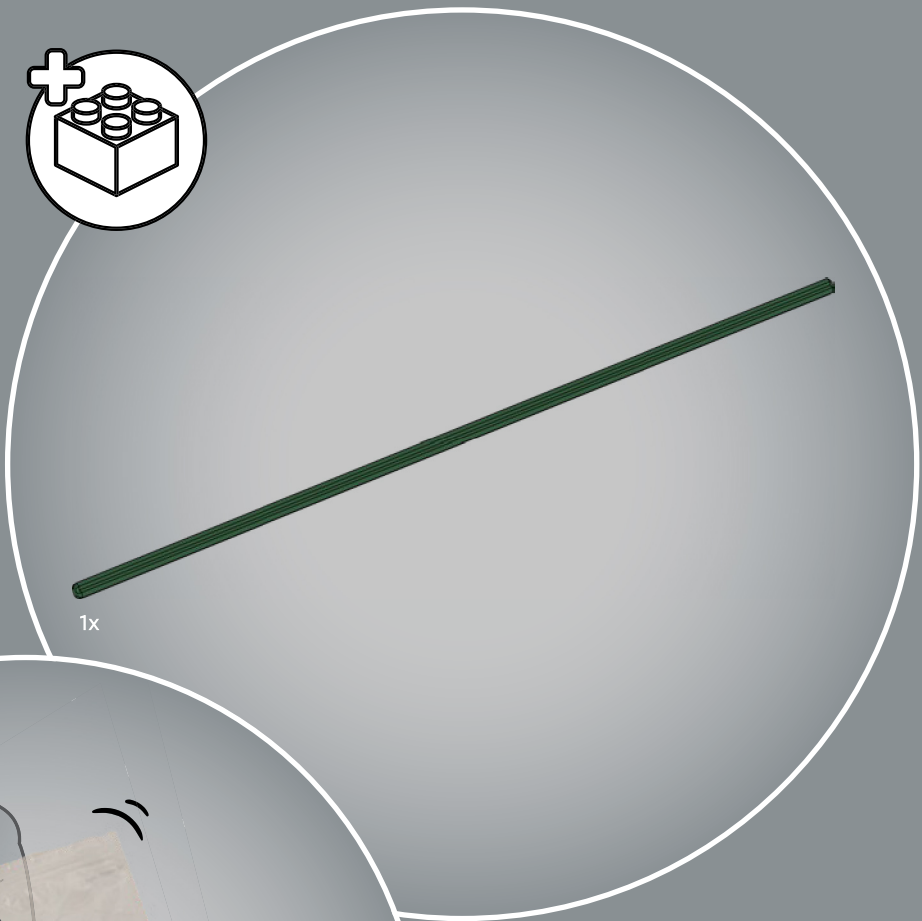
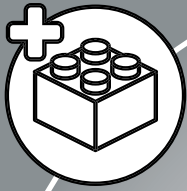

1x



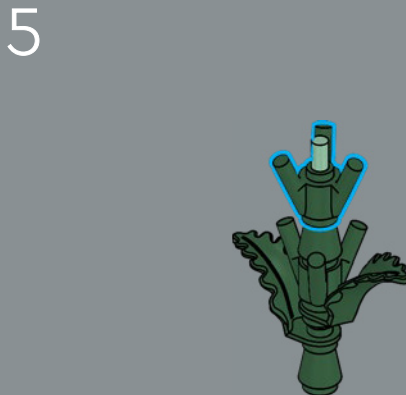
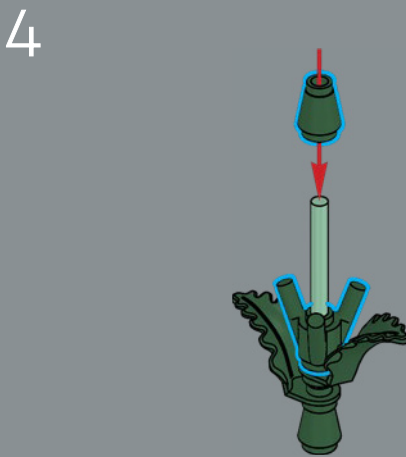
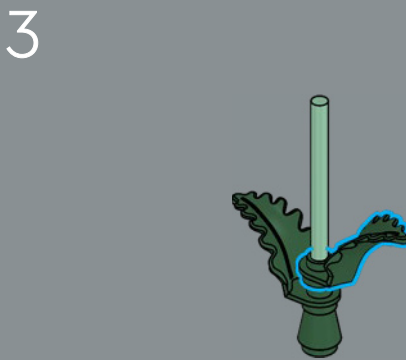
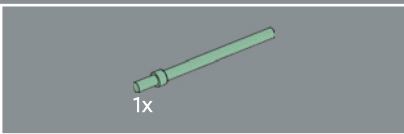
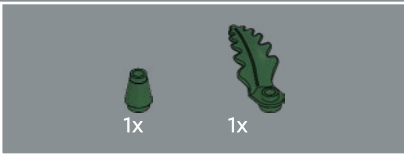
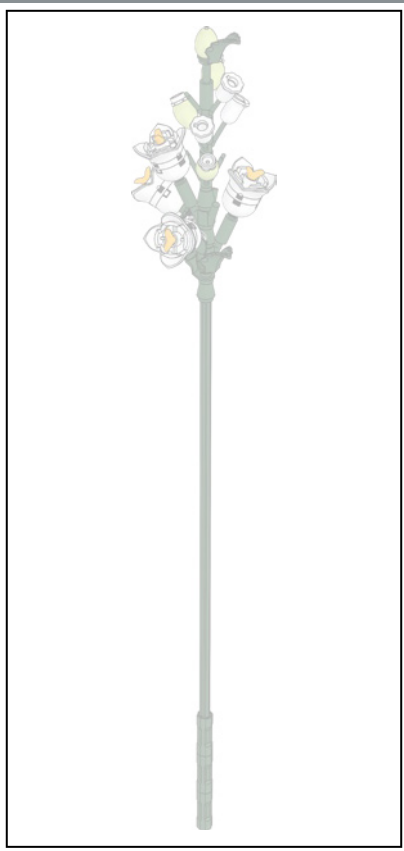

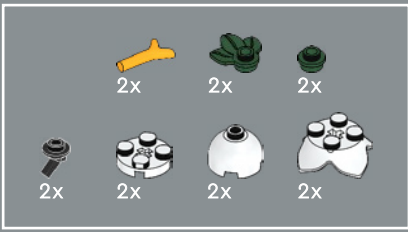

6

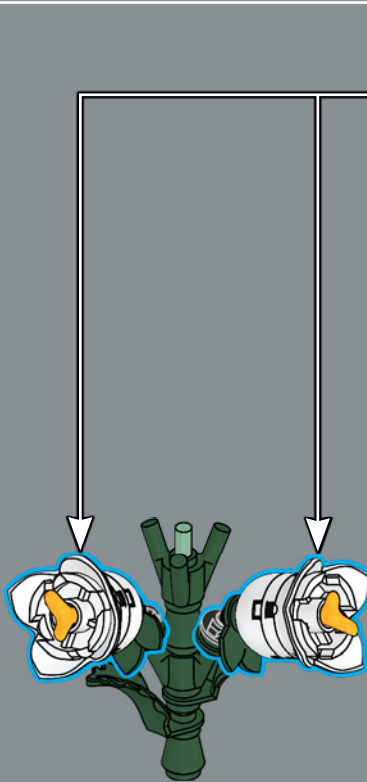
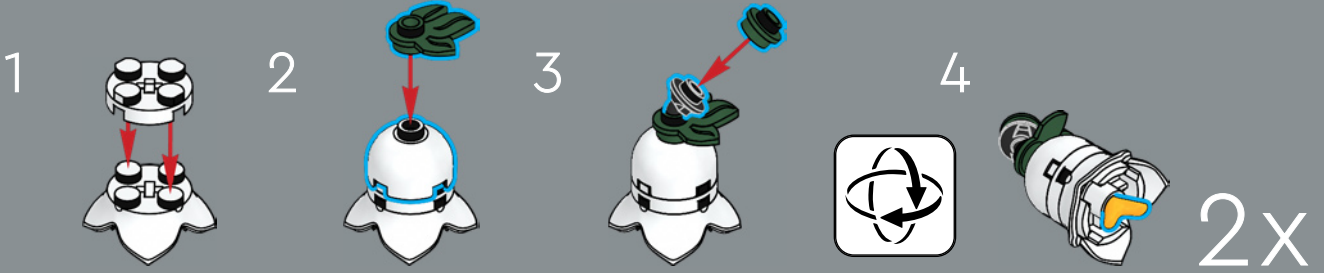



7

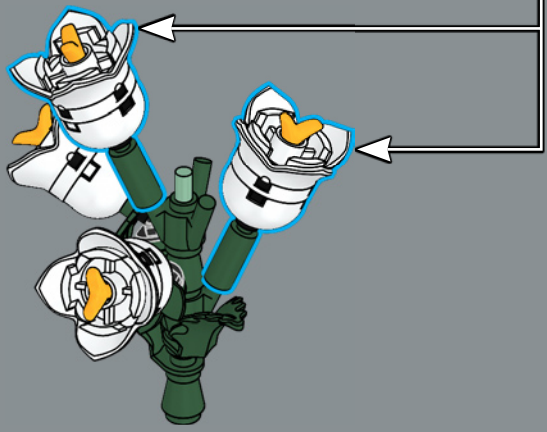
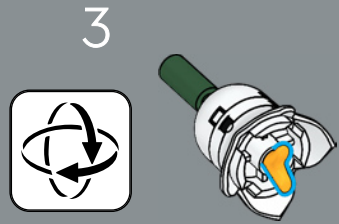
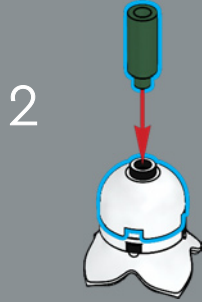

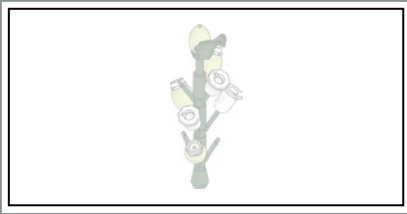

8

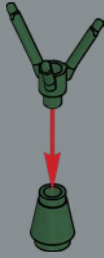

9

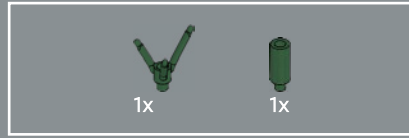
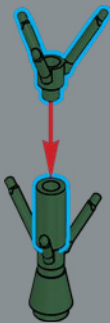

10

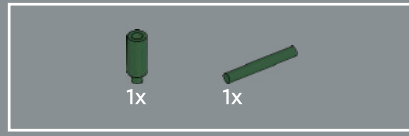
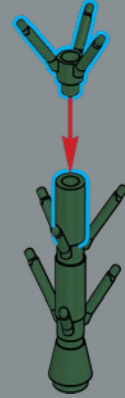

11

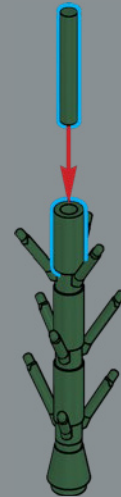



12

Ici, l'un de nos personnages de la gamme LEGO® DREAMZzz™ est utilisé pour représenter une petite fleur de campanule.

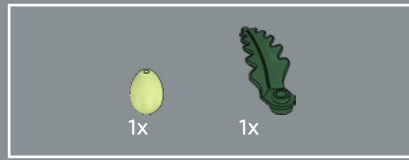
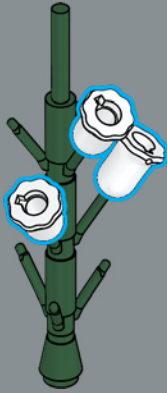

14

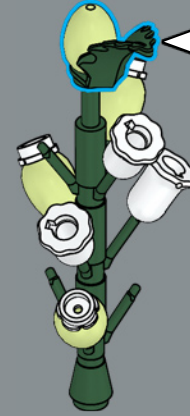
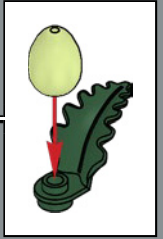

13

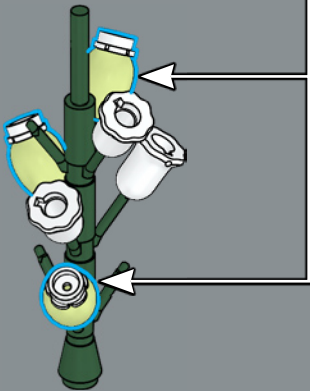
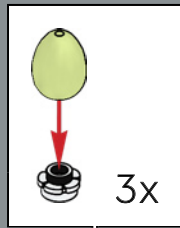

15

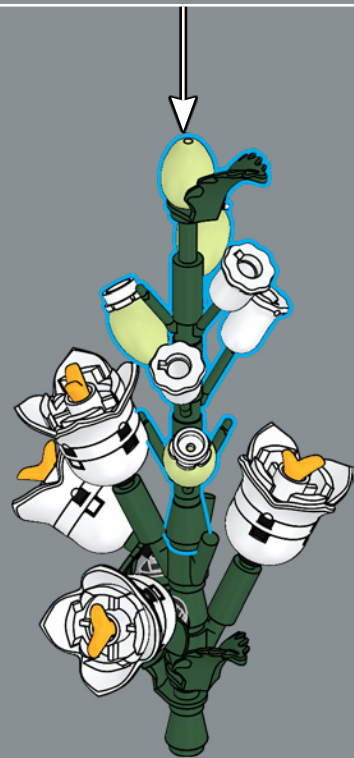

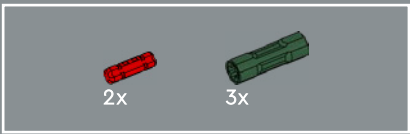

16

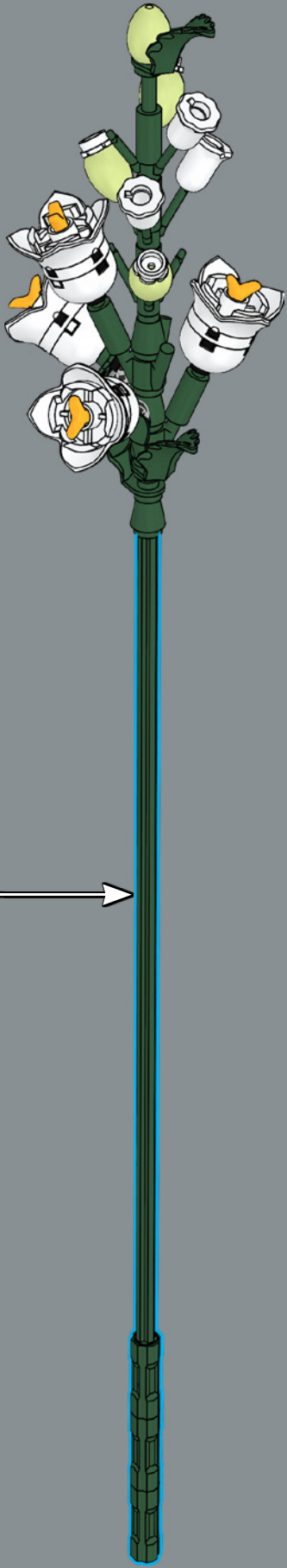
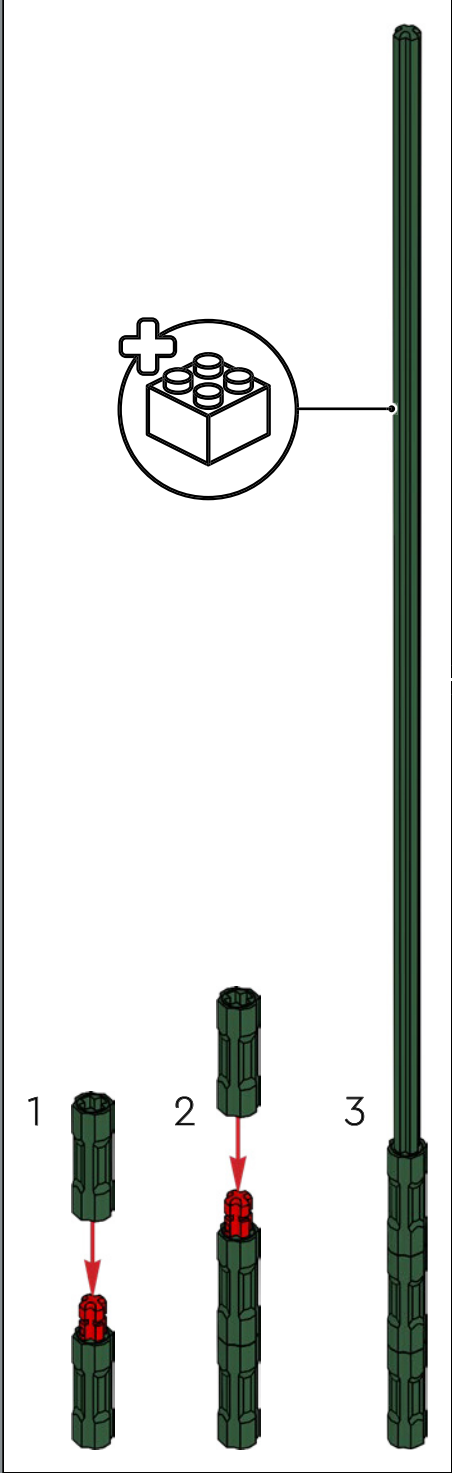

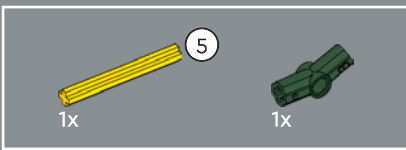

1

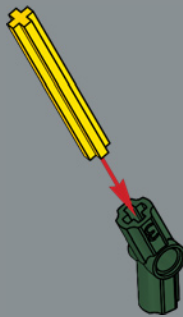

2

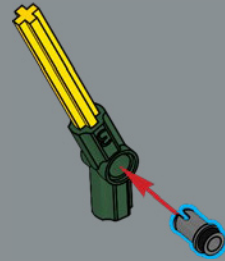

3

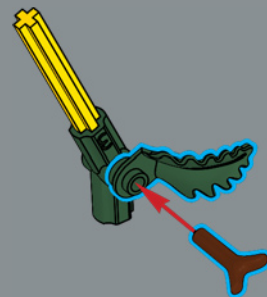

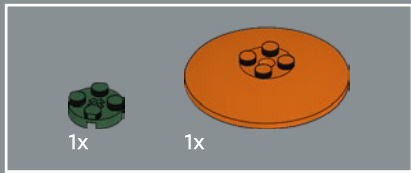

4

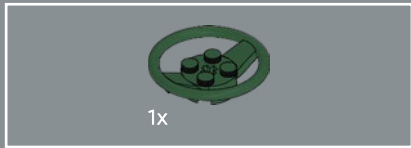
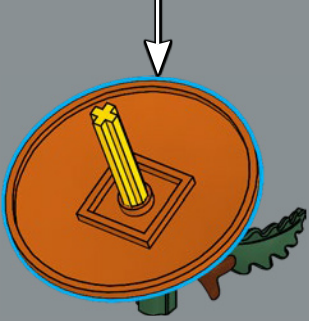
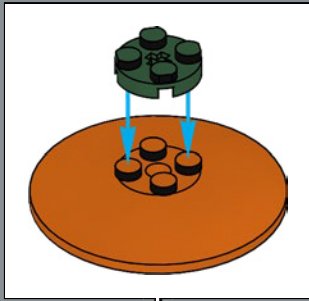

5

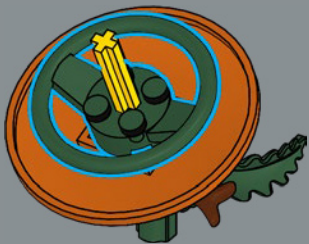

6

Conçu à l'origine pour de grands modèles LEGO® de voitures, ce volant constitue désormais le centre de nos fleurs LEGO. La tête de hache pour minifigurine est apparue en 2005 avec la gamme LEGO Vikings.

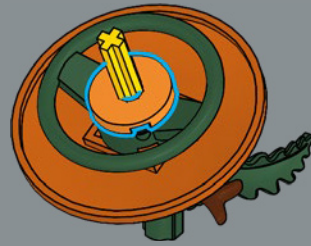

7

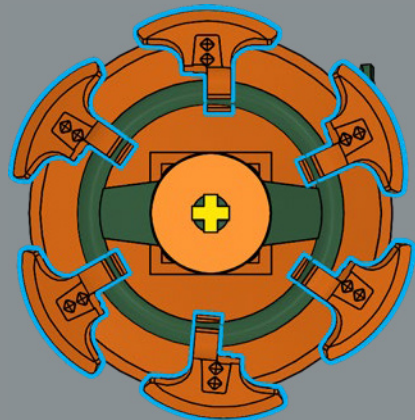



8

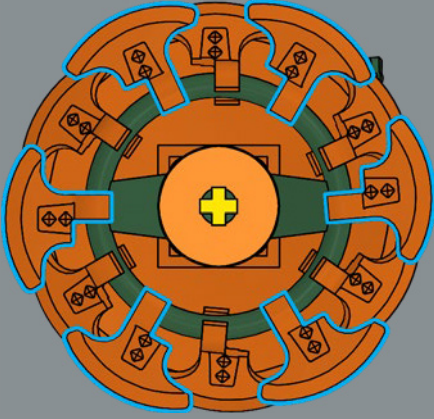

9

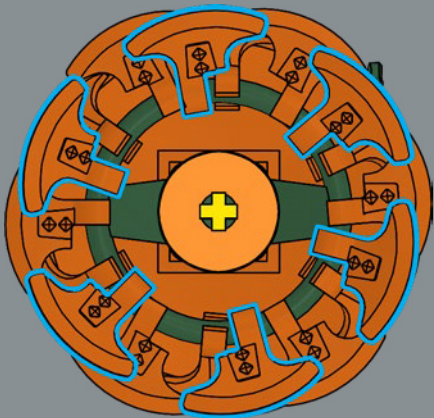

10

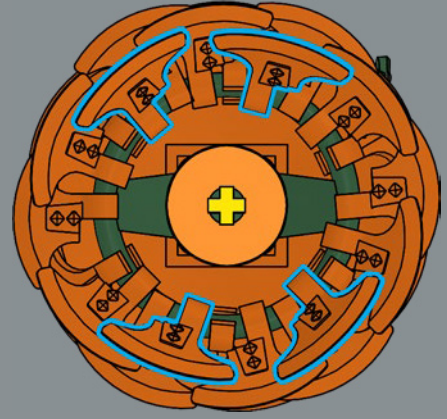

11

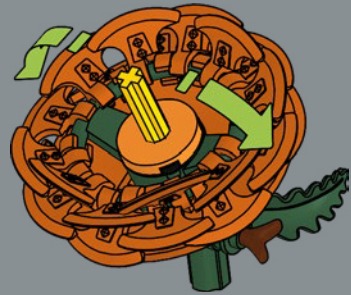

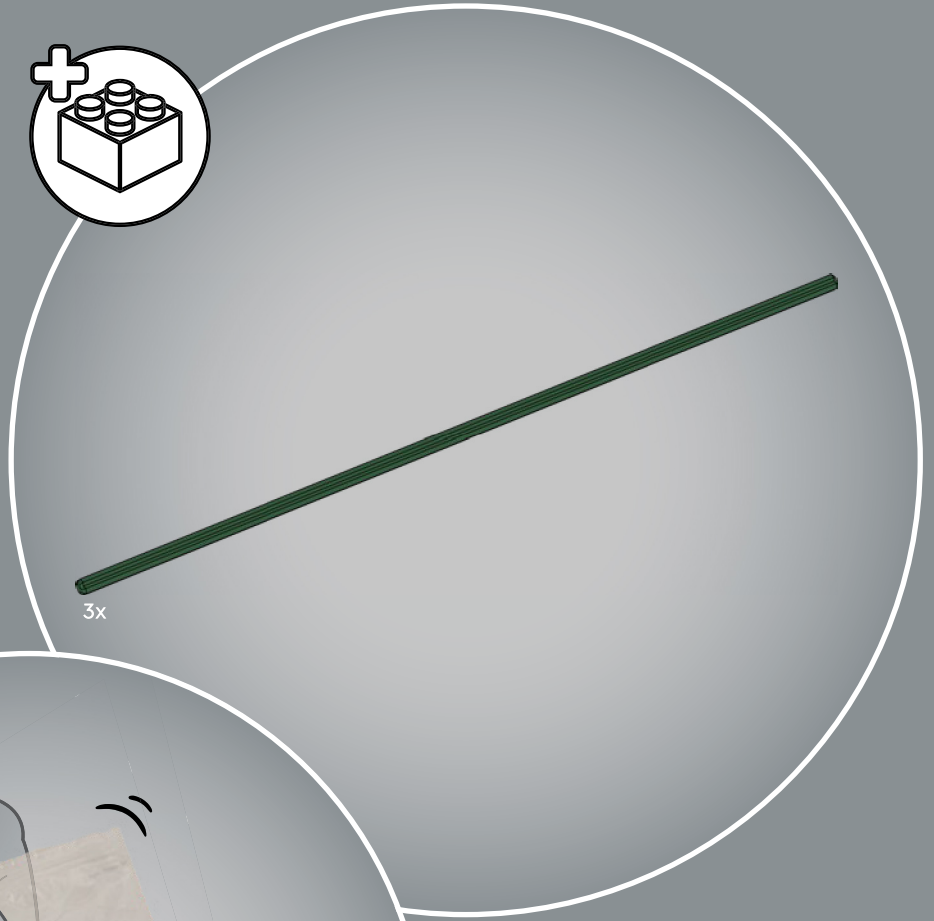
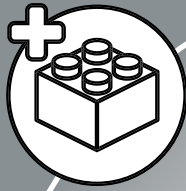

3x



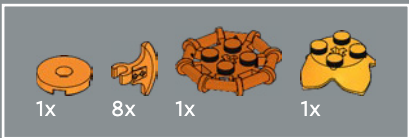

12

1

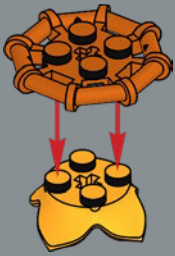

2

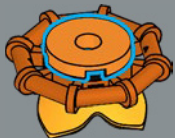

3

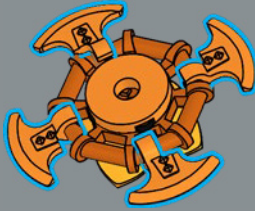

4

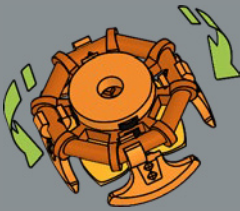

5

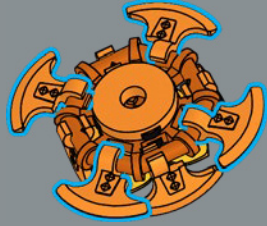

6

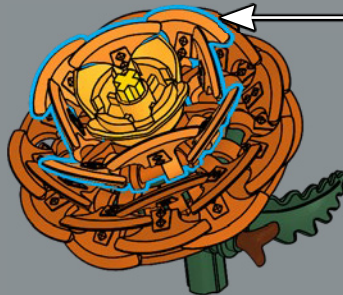
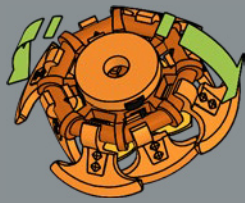

2x

On n'a probablement jamais utilisé autant de haches dans une fleur LEGO®.

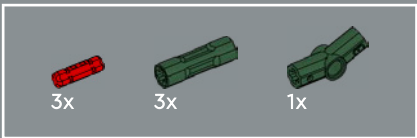

13

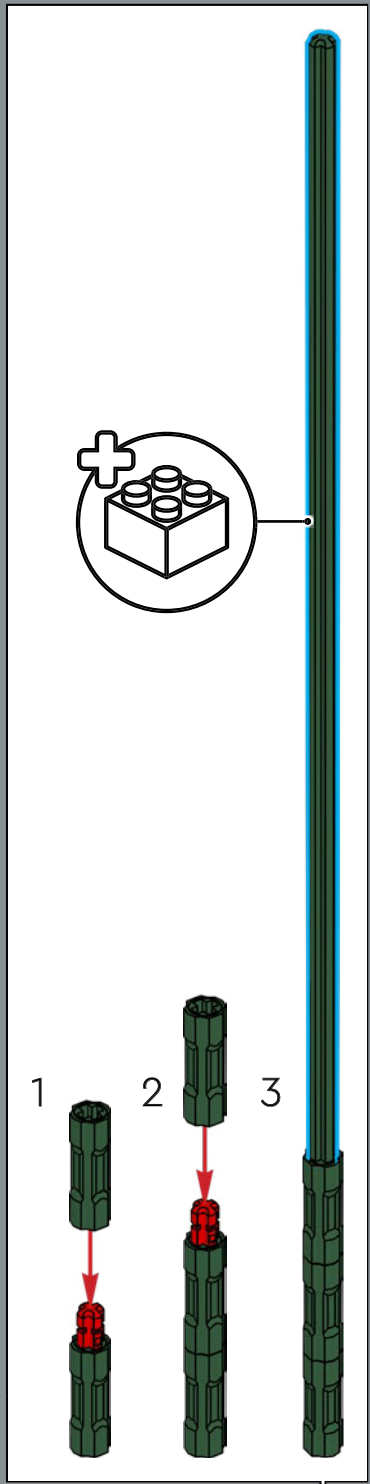
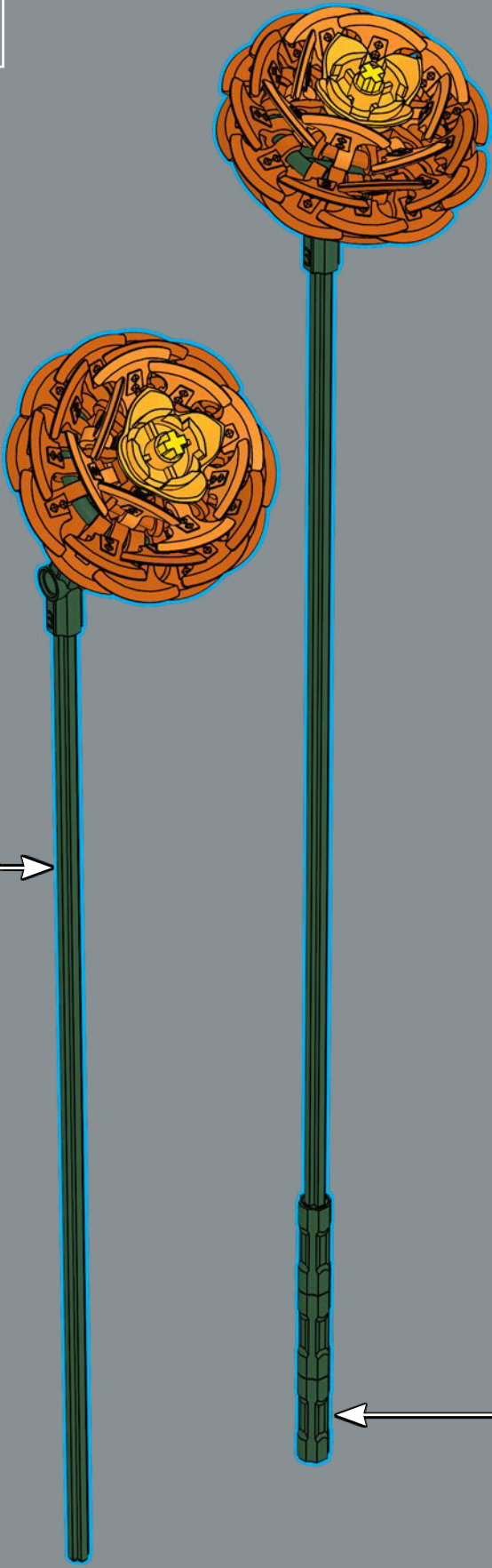
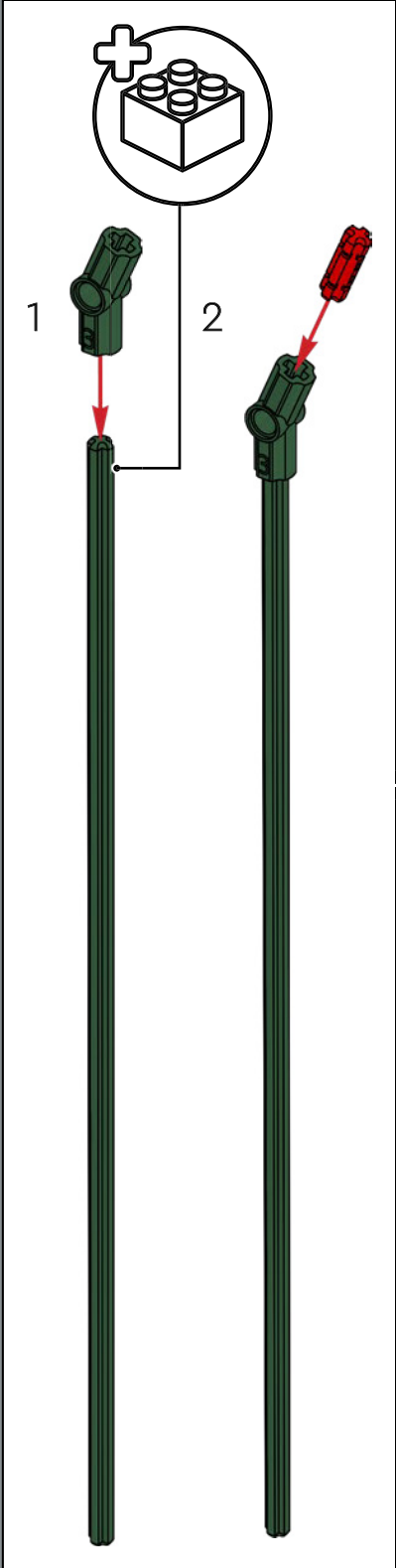



(Dahlia nymphaea)

LE DAHLIA NÉUPHAR

Symboles d'élégance et de grâce, les fleurs décoratives du dahlia néuphar se déploient comme un feu d'artifice somptueux.

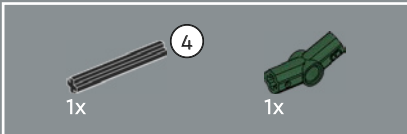
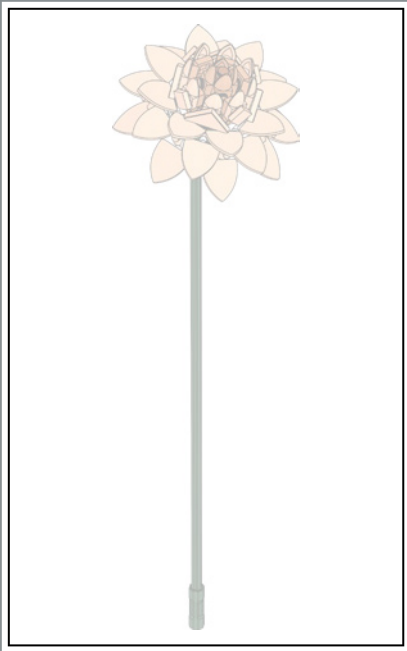

1

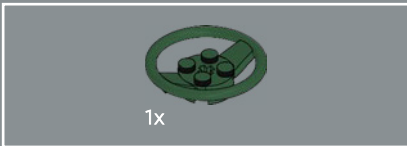
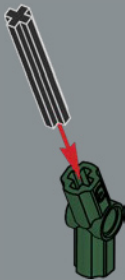

2

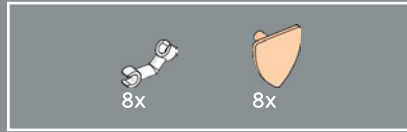
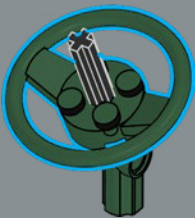

3

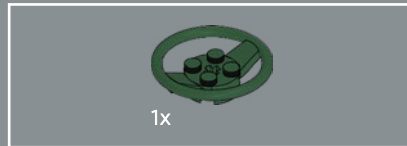
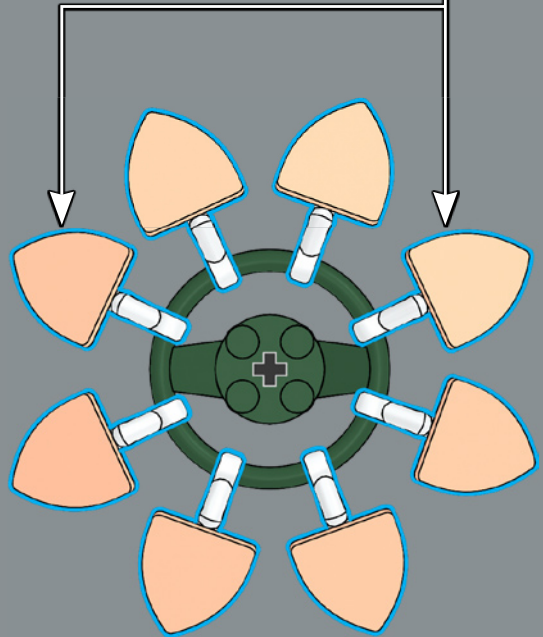
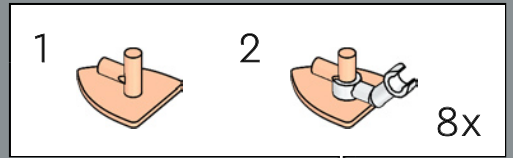

4

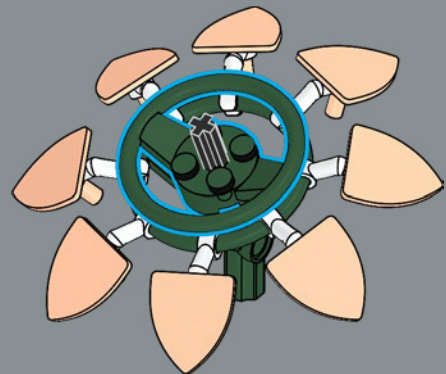

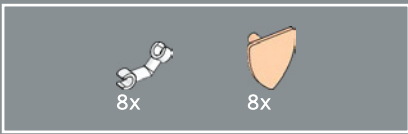

5

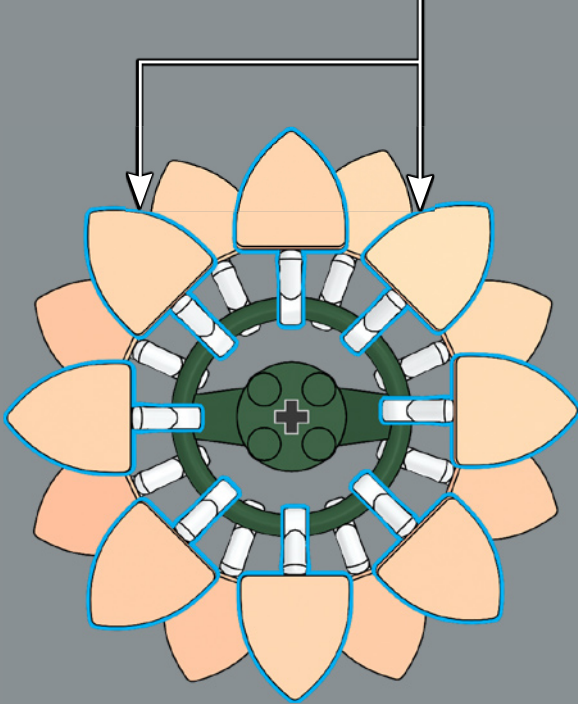
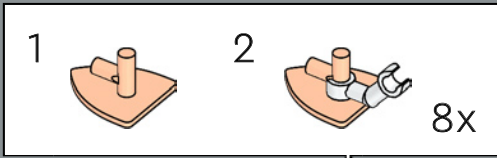

Félicitations ! Vous voici mieux équipé(e) que ne l'étaient nos chevaliers LEGO® lorsque ces boucliers ont été introduits en 1978 !

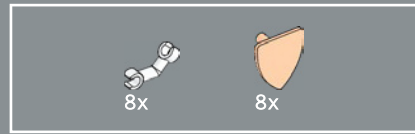

6

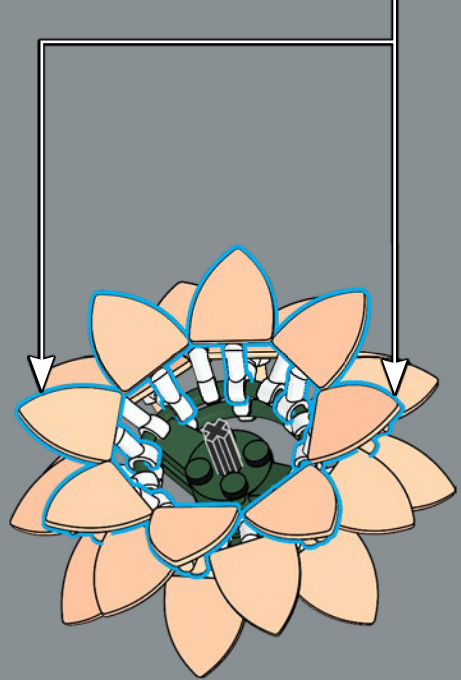
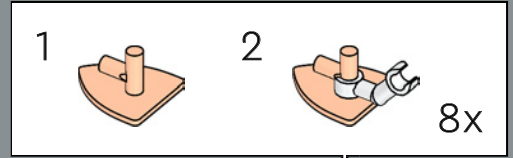

7

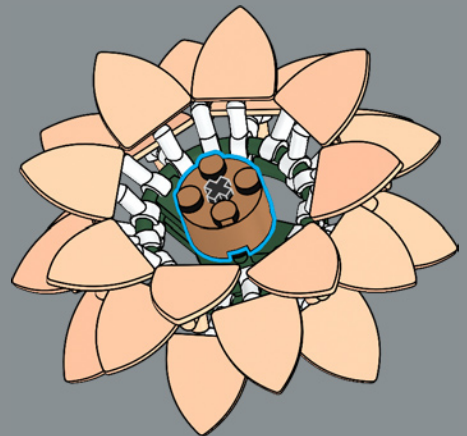

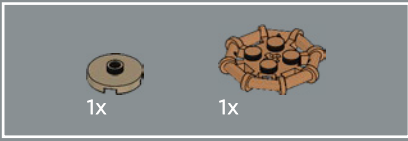

8

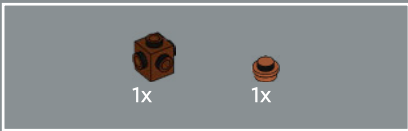
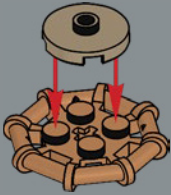

9

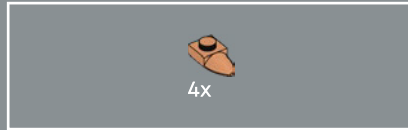
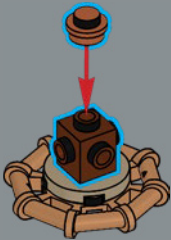

10

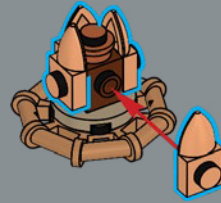

11

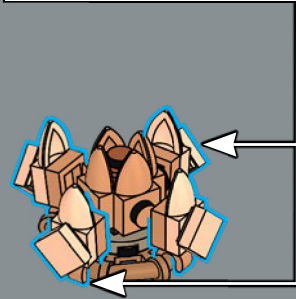
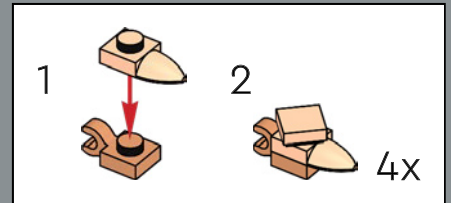



12

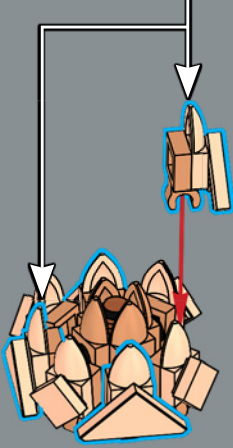
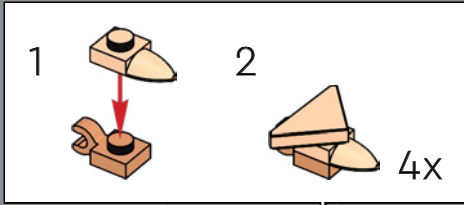

13

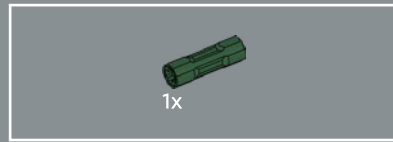
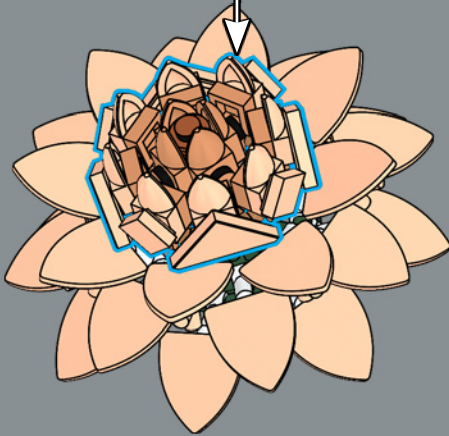

14

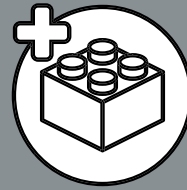
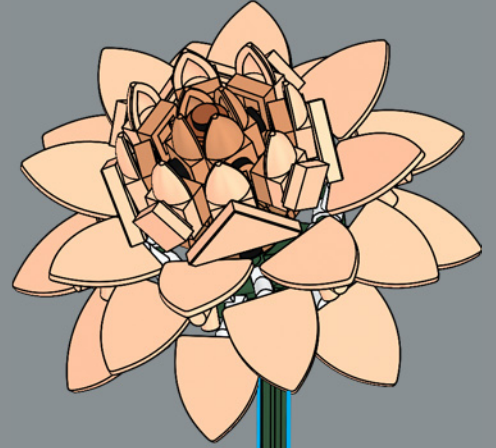



(Cymbidium)

L'ORCHIDÉE BATEAU

Documentée dans des textes anciens datant de l'époque de Confucius, vers 500 avant notre ère, l'orchidée bateau est la plus ancienne espèce d'orchidée cultivée connue.

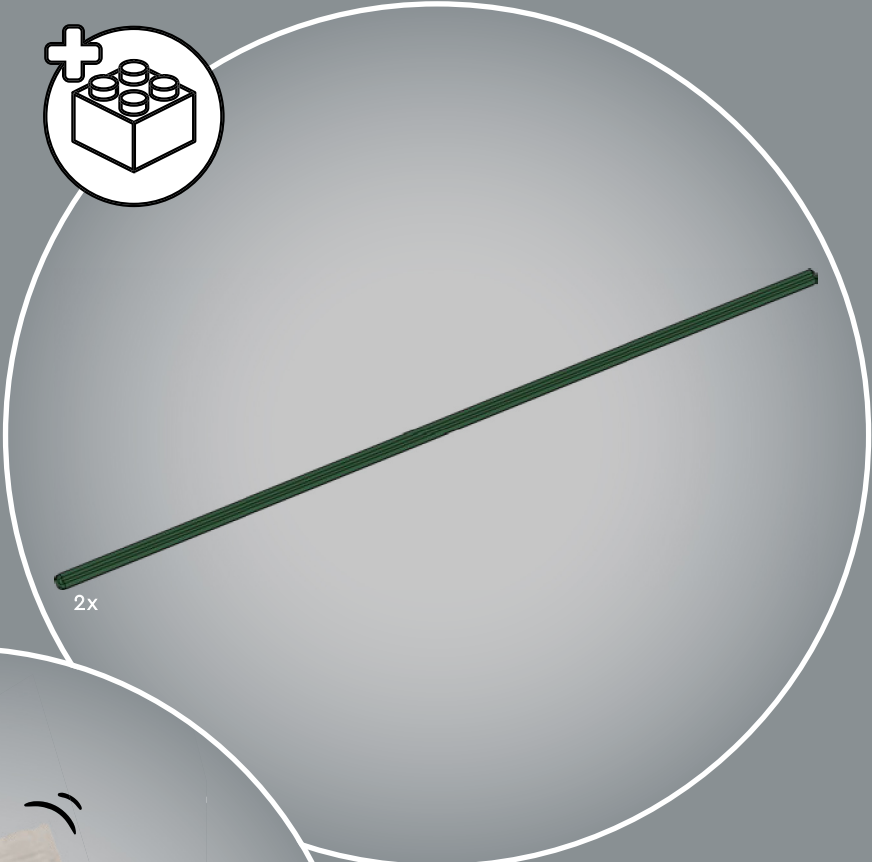
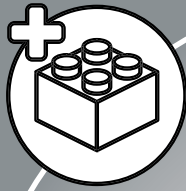

2x



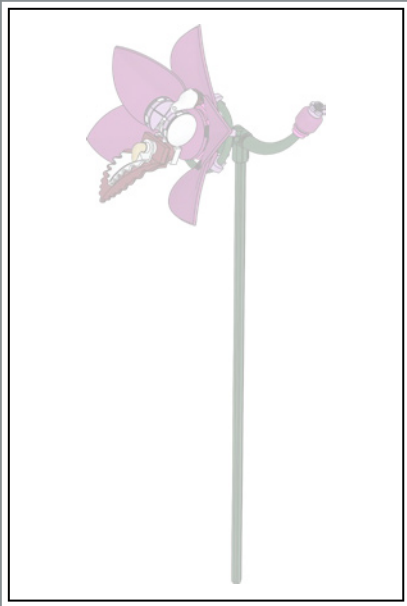

1

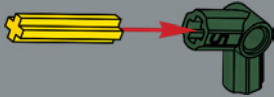

2

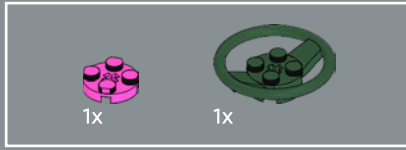
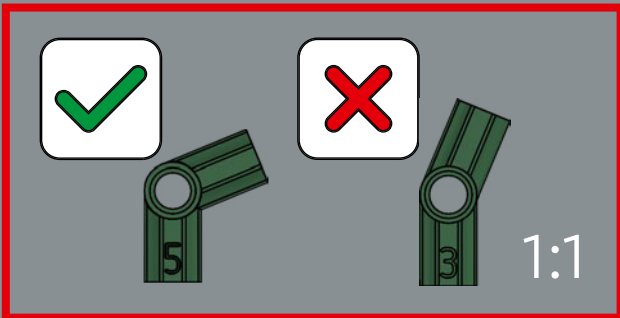
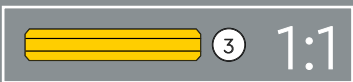
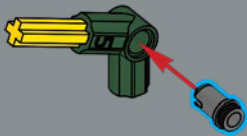

3

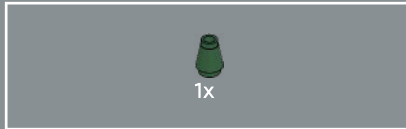
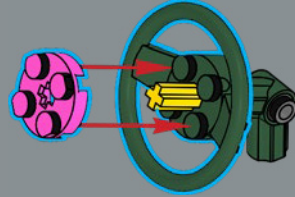

4

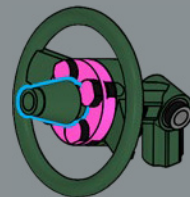

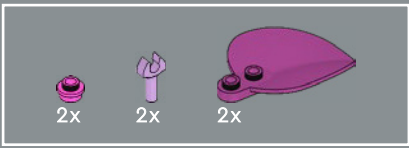

5

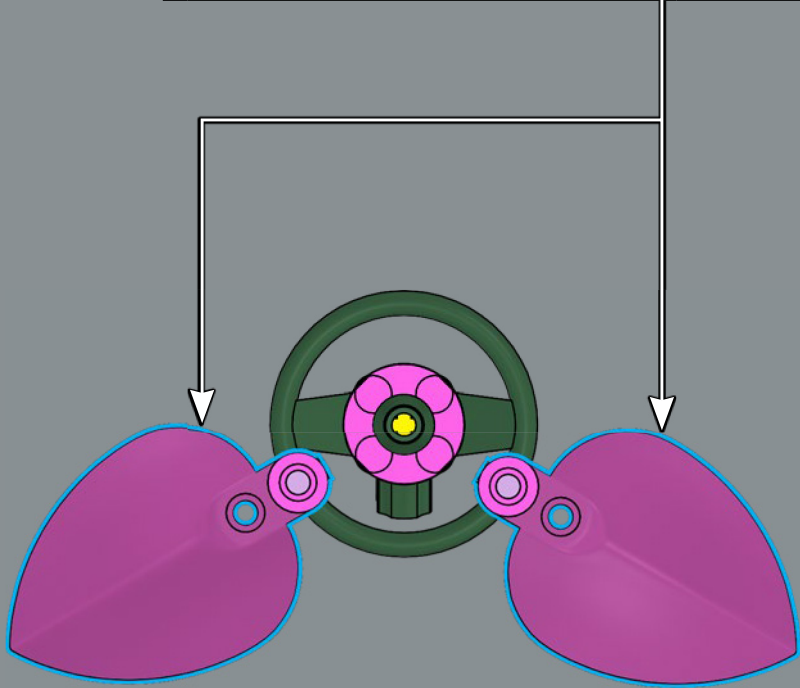
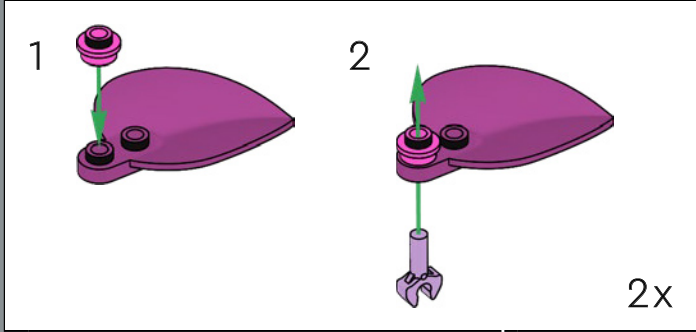



6

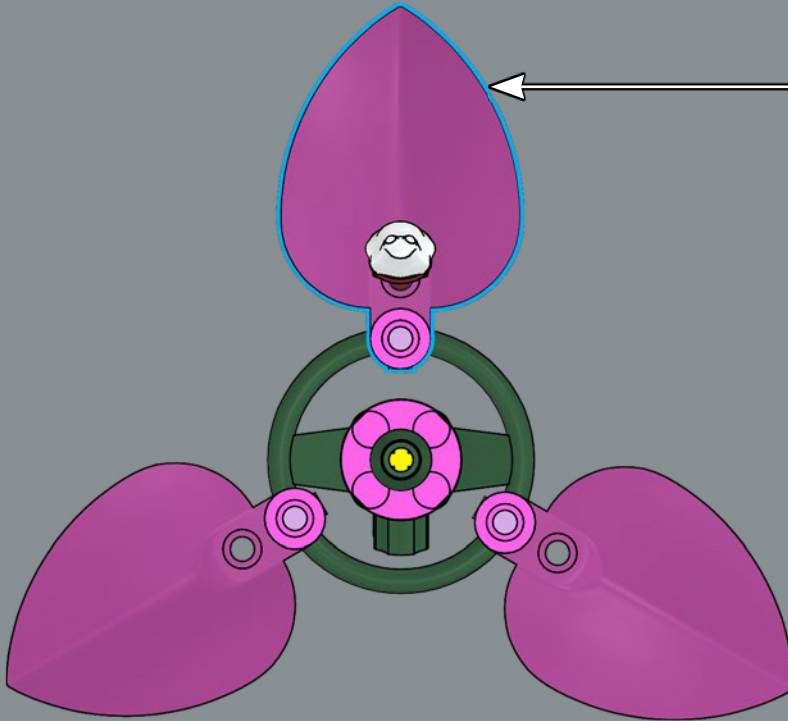
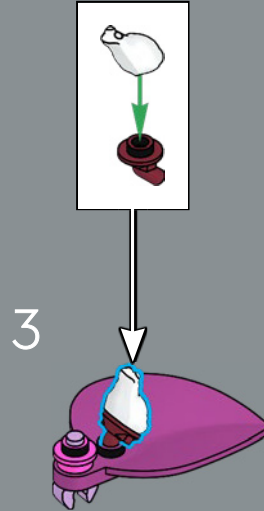
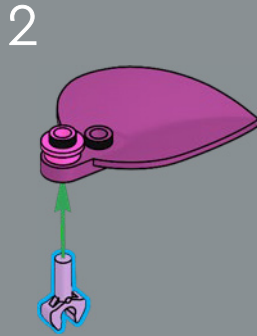
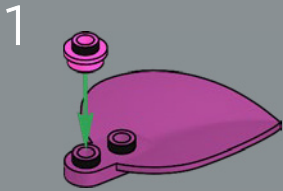

On peut même utiliser une grenouille LEGO® pour représenter une partie de la fleur !

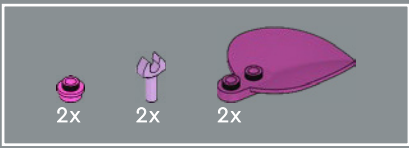

7

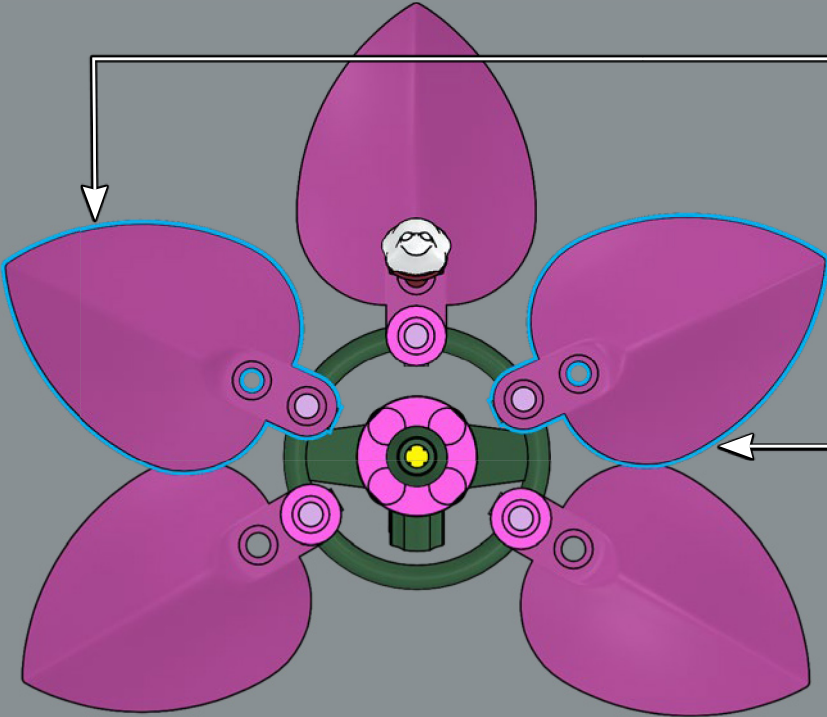
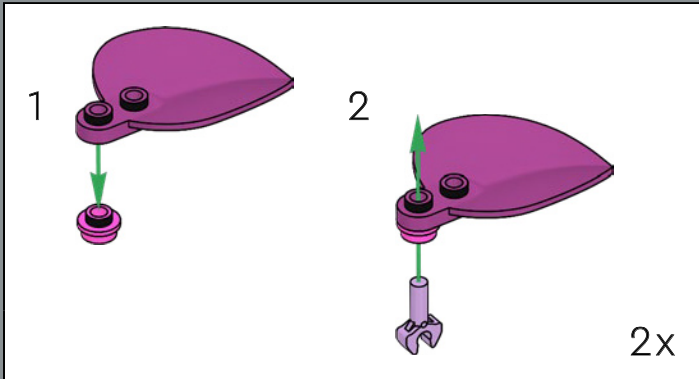

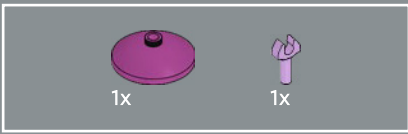

8

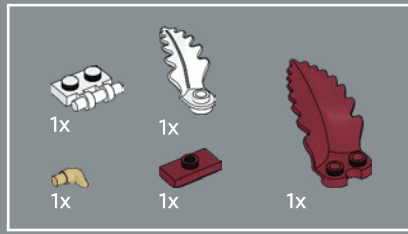
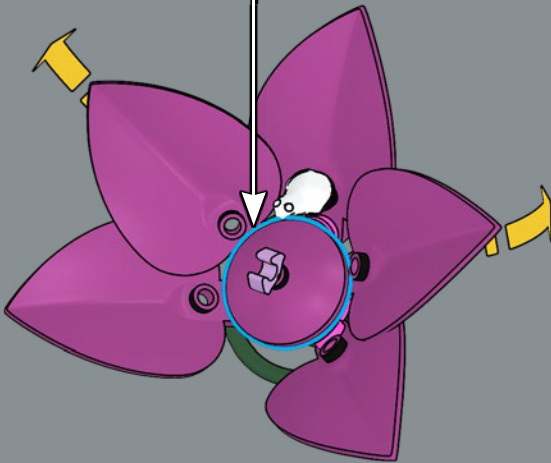
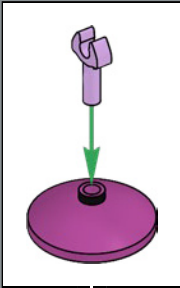

9

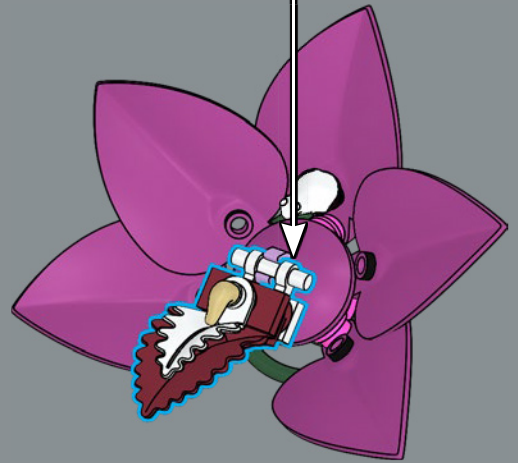
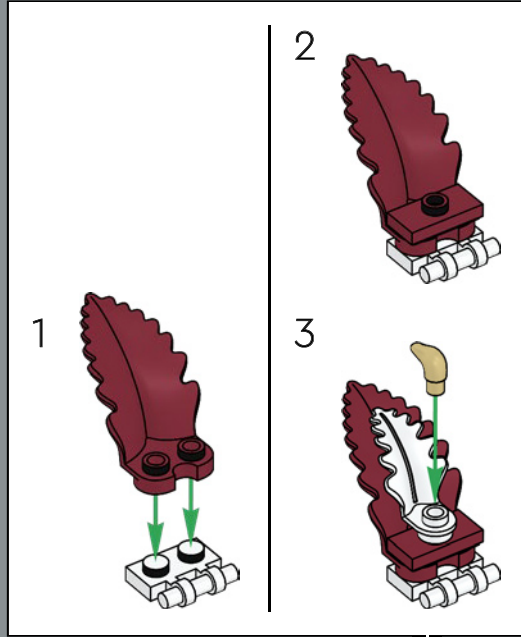



10

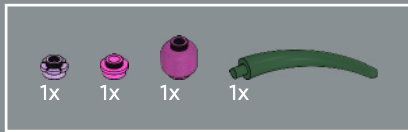
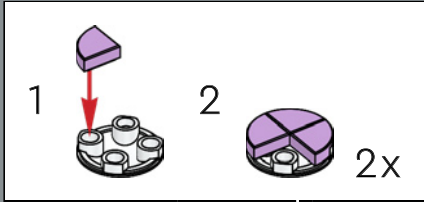

11

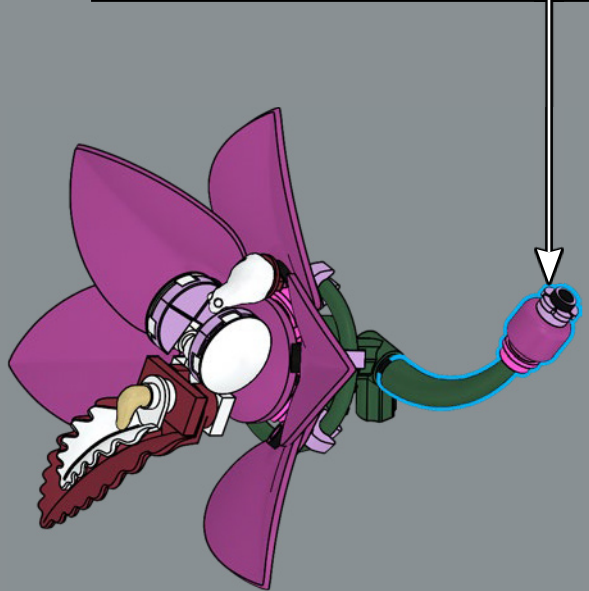
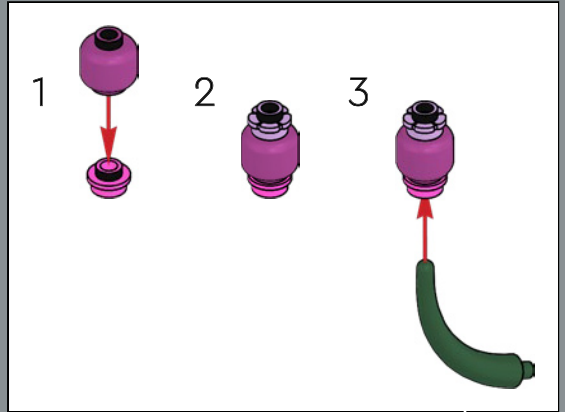

12

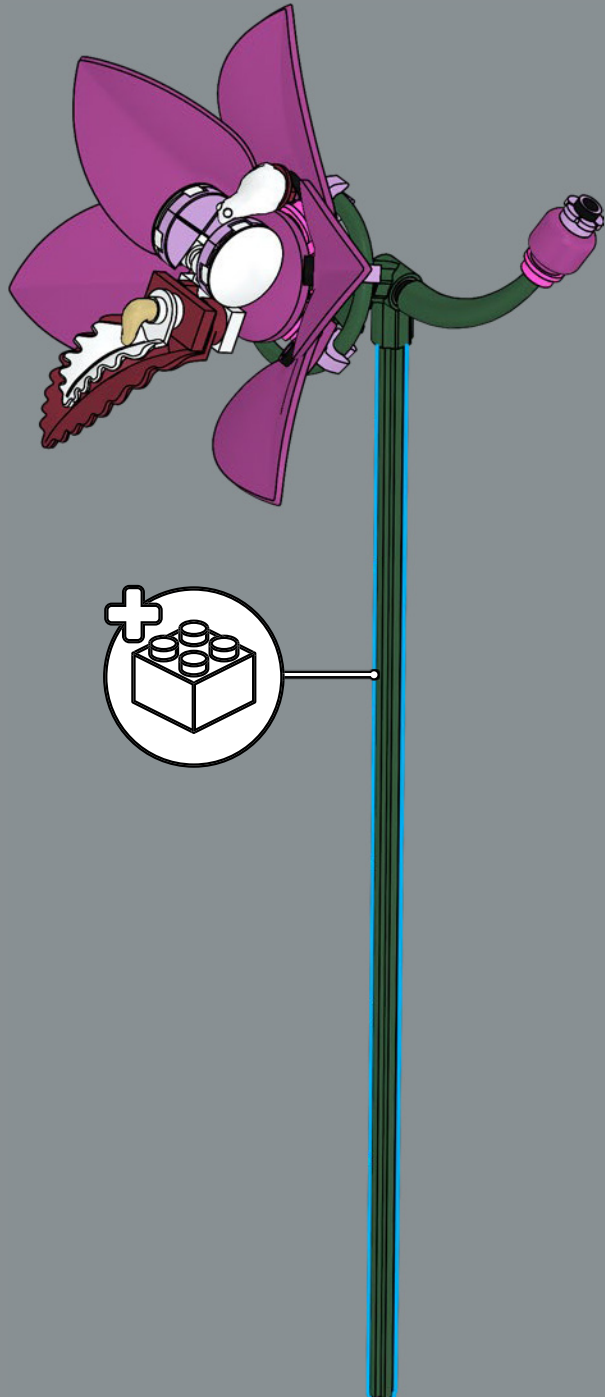

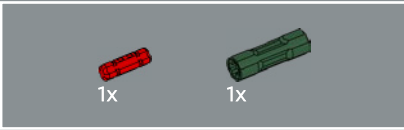
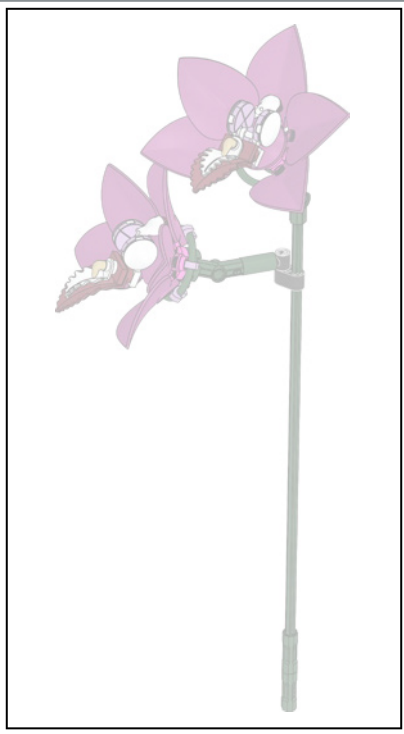

13



14



15

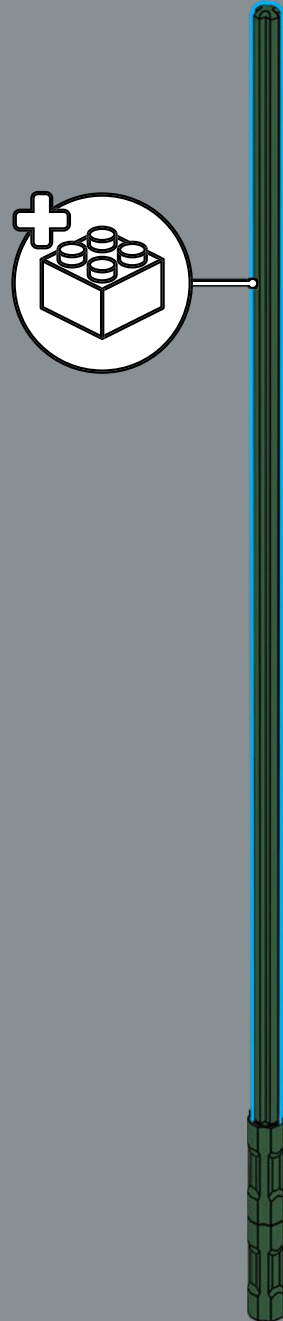

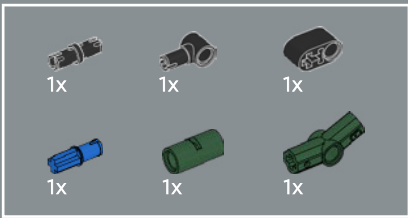

16

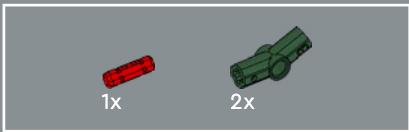
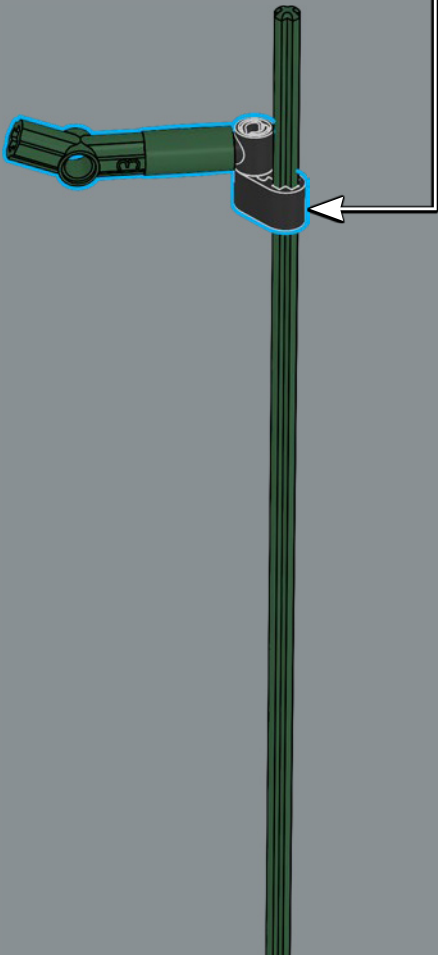
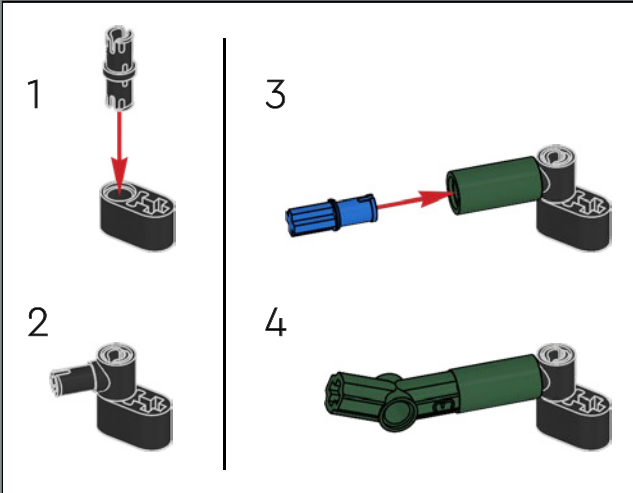

17

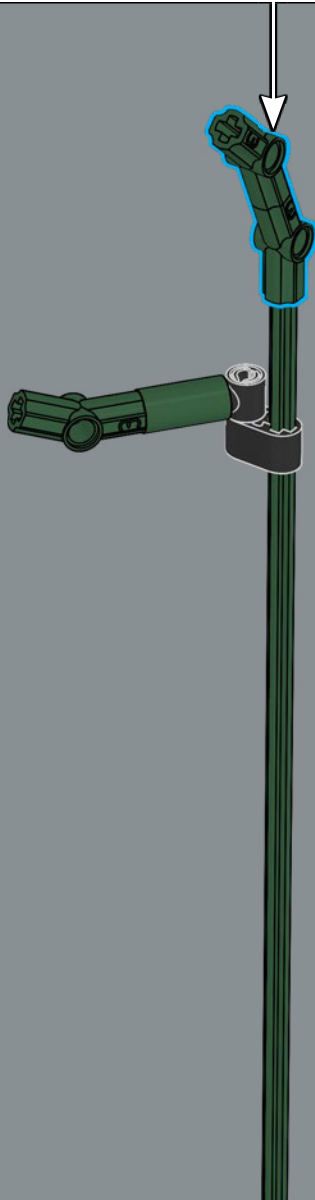
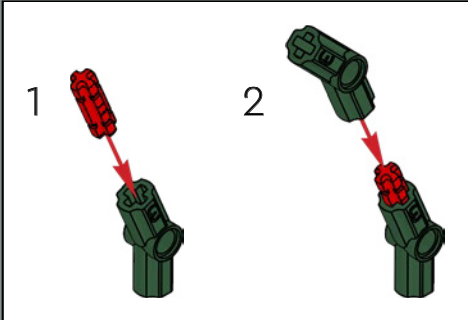

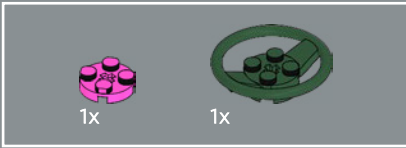
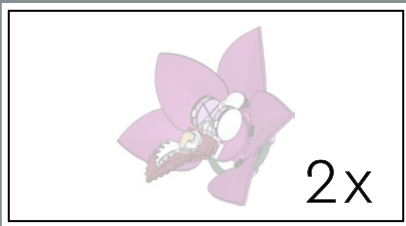

18

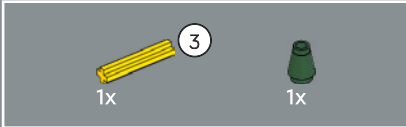
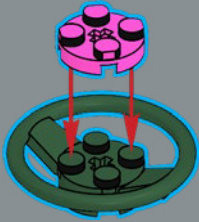

19

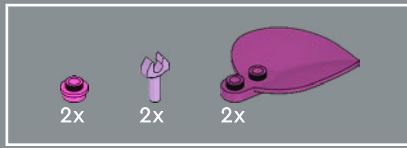
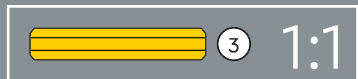
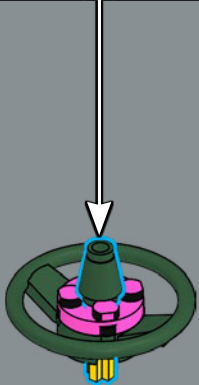
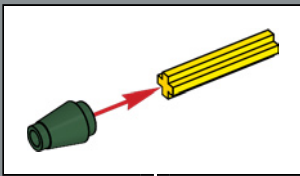

20

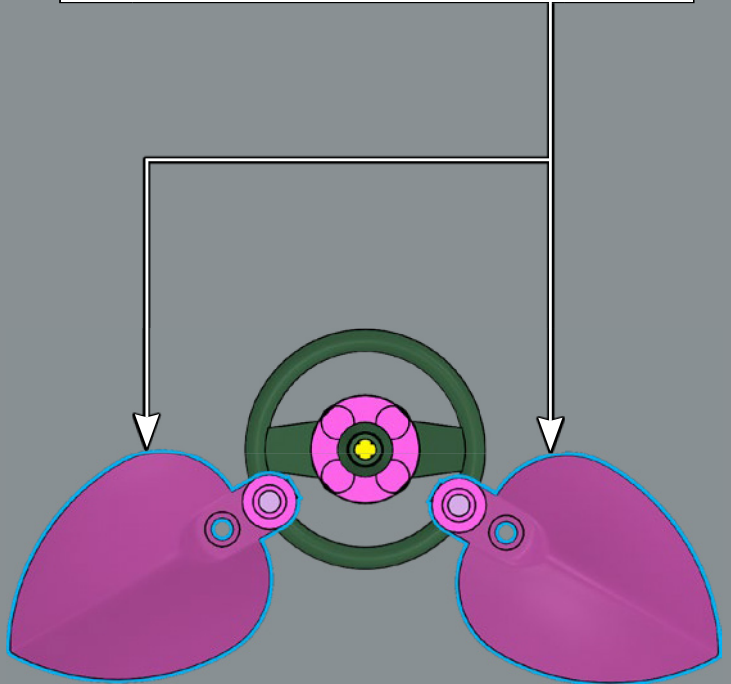
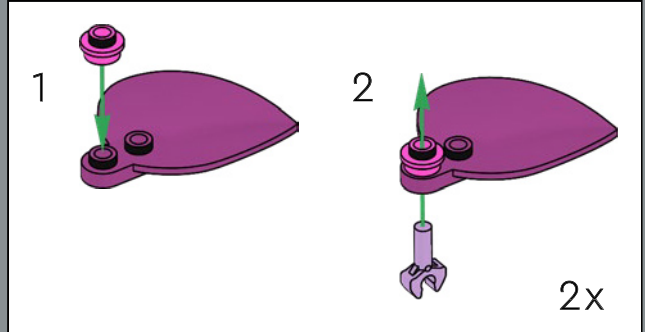



21

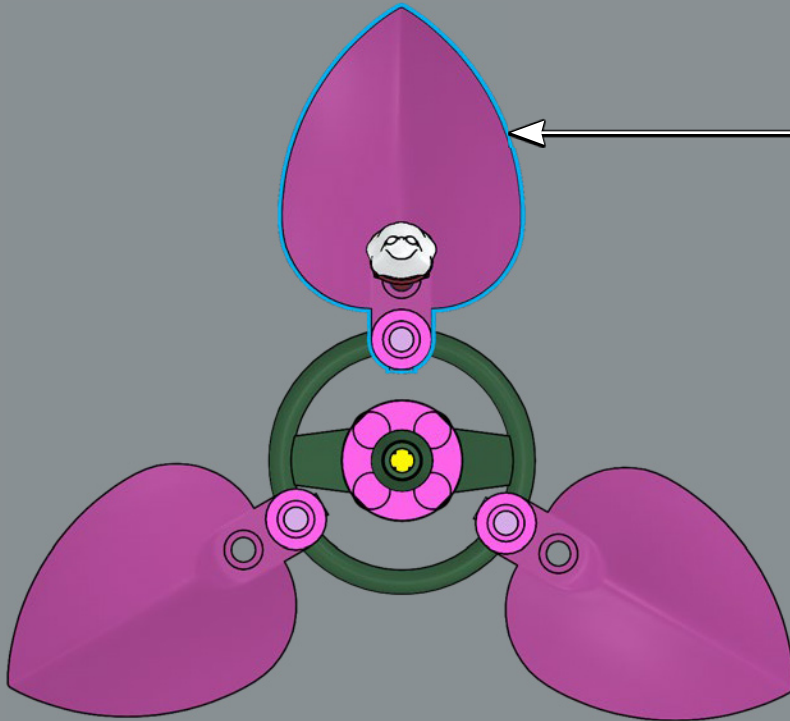
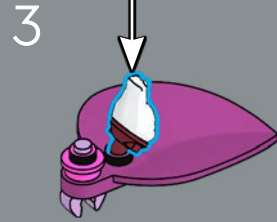
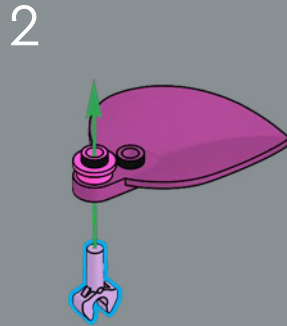
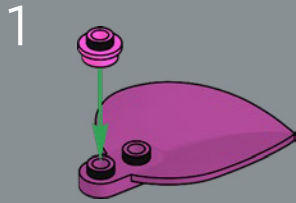

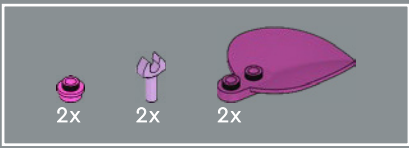

22

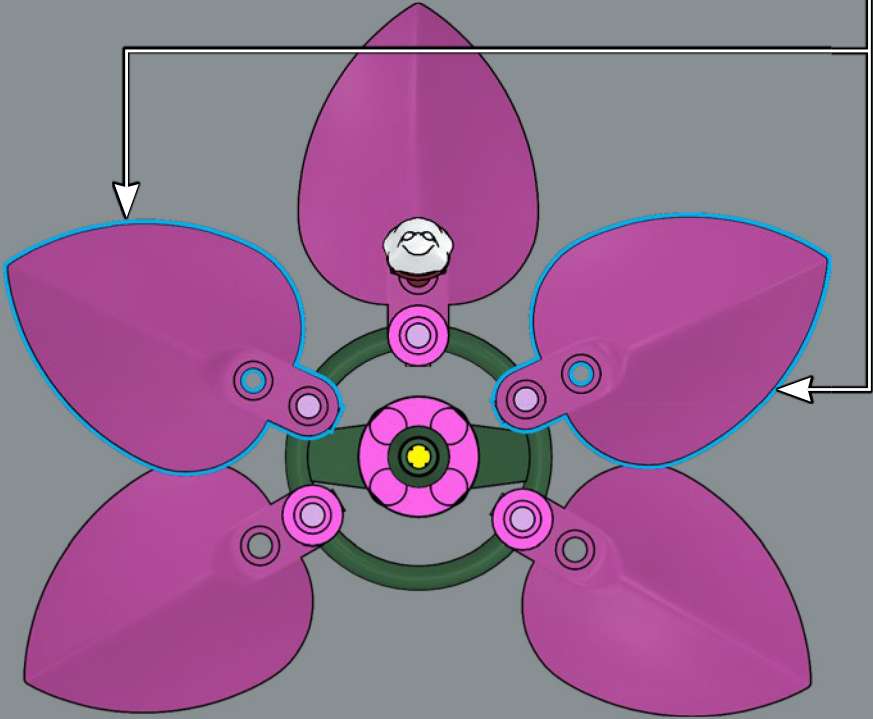
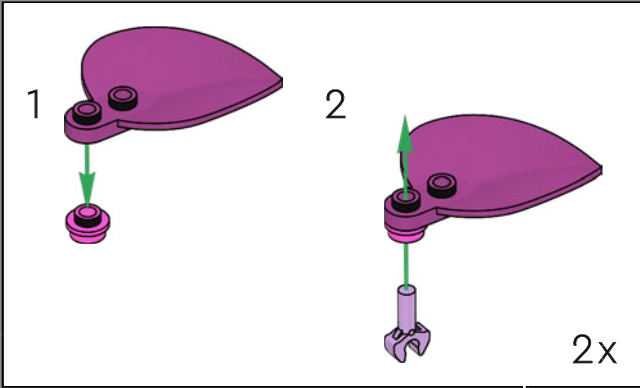

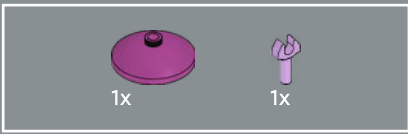

23

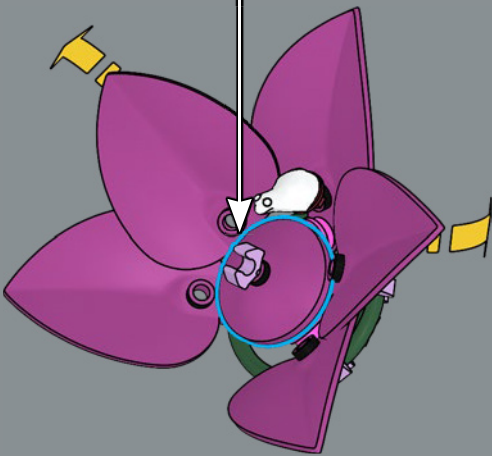
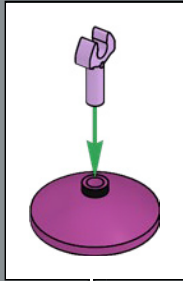

24

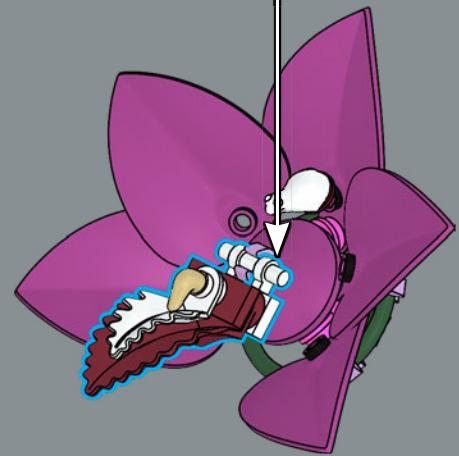
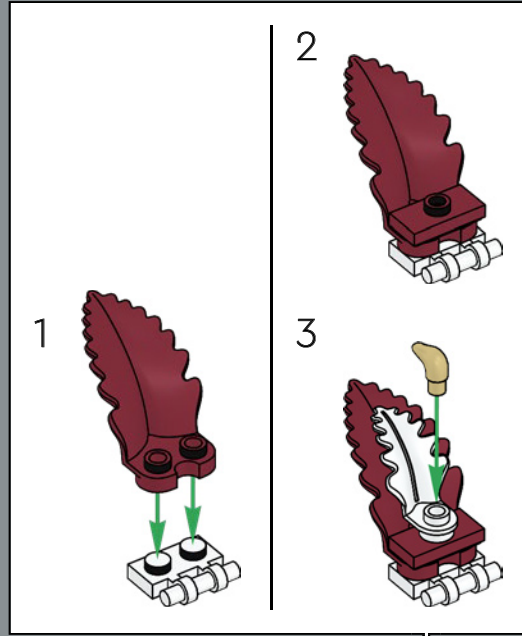

Une plante construite avec des plantes ? Le label de cette orchidée est composé de deux feuilles de fougère LEGO®.



25

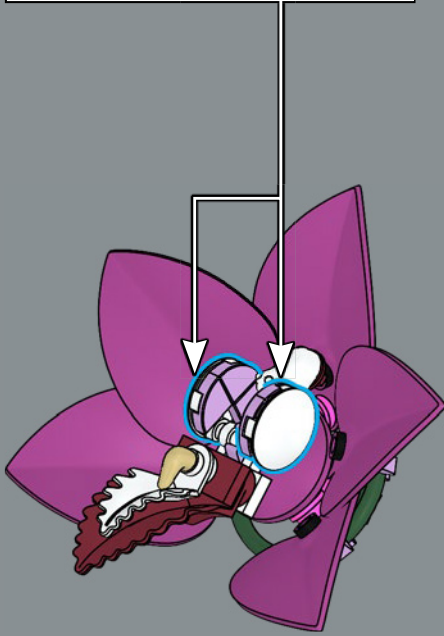
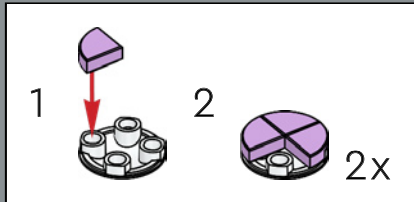

2x

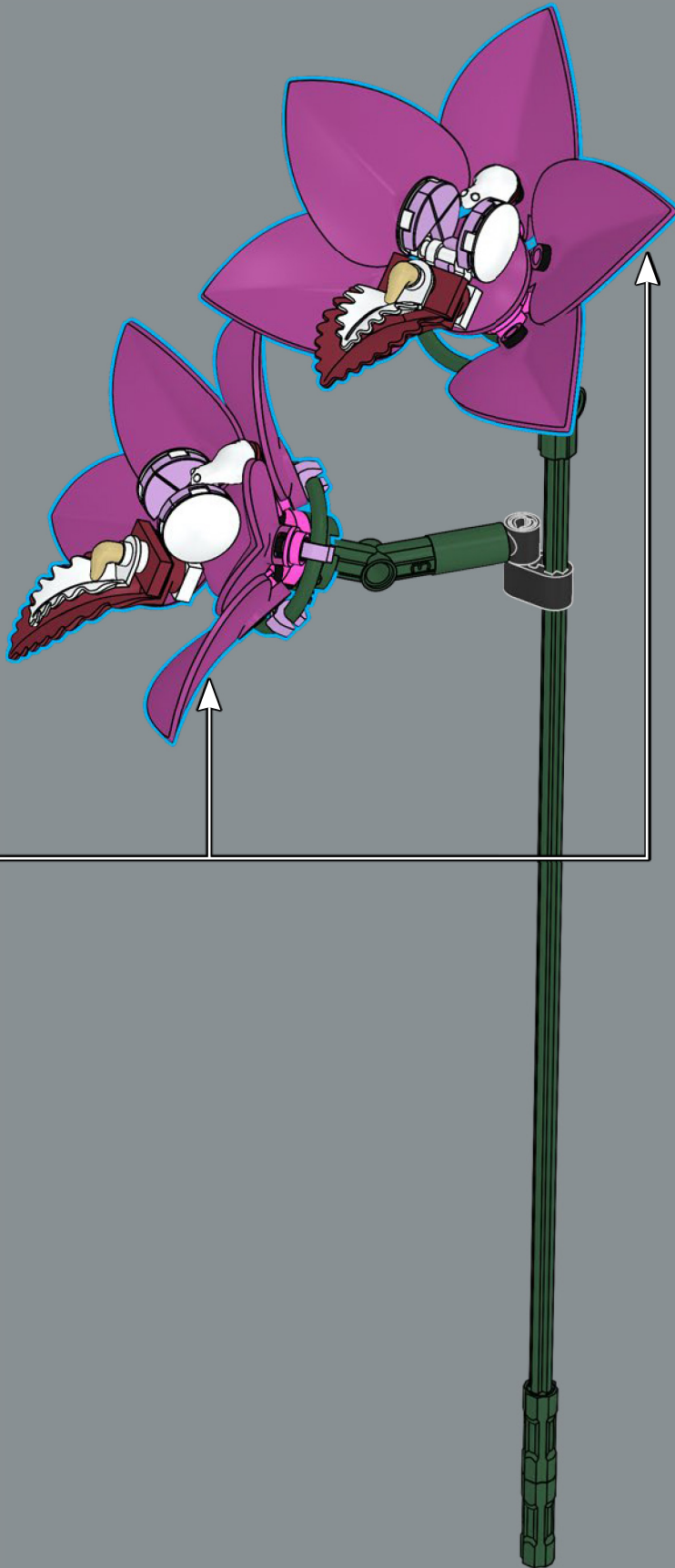

Enrichissez votre bouquet

Envie de découvrir de nouvelles espèces de fleurs LEGO® ?
Trouvez d'autres fleurs et plantes dans notre collection
Botanique et inspirez-vous-en pour réaliser vos propres
bouquets et compositions florales.



Découvrez d'autres astuces
créatives grâce à votre
compte LEGO® Insiders sur

LEGO.com/Botanicals-exclusive

- 4x 6206149
- 1x 6279875
- 3x 6498565
- 3x 6510194
- 44x 6525752
- 22x 4516546
- 4x 6398468
- 18x 6439046
- 1x 6282140
- 1x 6349342
- 3x 6092597
- 6x 6316692
- 18x 6240465
- 3x 6298930
- 1x 6265091
- 1x 6515241
- 3x 6529631
- 4x 6267047
- 4x 4211508
- 2x 6525773
- 1x 370526
- 5x 6525789
- 4x 6454729
- 8x 6366184
- 3x 6525849
- 1x 6315782
- 10x 6344177
- 4x 6454729
- 6x 6395635
- 18x 6259700
- 16x 6525753
- 15x 6330196
- 4x 6313765
- 4x 6265702
- 1x 4502595
- 8x 6347293
- 4x 6147052
- 1x 6507841
- 3x 6451002
- 4x 6265702
- 18x 6087084
- 24x 6252200
- 4x 6147052
- 2x 6078605
- 2x 6310174
- 8x 6525786
- 8x 6230582
- 6x 4278271
- 1x 6493246
- 7x 6329283
- 2x 6349130
- 3x 6326495
- 36x 4142865
- 4x 403201
- 3x 6217587
- 1x 6512537
- 2x 6349130
- 3x 6525769
- 3x 4206482
- 4x 6429053
- 15x 6519960
- 2x 6529632
- 16x 6525770
- 3x 6525790
- 13x 6130007
- 3x 6439714
- 2x 6270111
- 10x 6474602
- 4x 6480369
- 8x 6296041
- 2x 6130008
- 3x 4140583
- 1x 6132767
- 4x 6474604
- 1x 6454167
- 8x 6296041
- 8x 617912
- 4x 6468789
- 6x 6522274
- 4x 6525927
- 1x 6454167
- 8x 6456642
- 8x 617189
- 12x 6214235
- 4x 6096682
- 3x 6368620
- 14x 6230571
- 2x 6035029
- 1x 617189
- 8x 6456642
- 1x 6104209
- 4x 6525785
- 11x 6411591
- 7x 6447541
- 10x 6360112
- 12x 6468072
- 1x 6214235
- 4x 6096682
- 8x 6525787
- 8x 6525784
- 11x 6411591
- 7x 6447541
- 12x 6526753
- 6x 6348251
- 2x 6223219
- 2x 6525748
- 1x 6329299
- 1x 6523407
- 1x 6329299
- 10x 6523407

4

3

5



LEGO.com/service



YOU COULD WIN



YOU COULD WIN

Your feedback will help shape the future development of this product series.

Visit:

DU KÖNNTEST GEWINNEN

Dein Feedback trägt zur Weiterentwicklung dieser Produktreihe bei.

Geh auf:

VOUS POURRIEZ GAGNER

Vos commentaires nous aideront à concevoir les futurs produits de cette gamme.

Visitez :

POTRESTI VINCERE TU

La tua opinione ci aiuterà a migliorare la creazione futura di questa linea di prodotti.

Visita:

PUEDES GANAR

Tu opinión contribuirá al futuro de esta serie de productos.

Visita:

轻松获奖

您的反馈将有助于我们在今后改进本产品系列。

请访问:

LEGO.com/productfeedback

You also have the chance to win a LEGO® set.

Terms and conditions apply.*

Außerdem hast du die Chance, ein LEGO® Set zu gewinnen.

Es gelten die Teilnahmebedingungen.*

Vous pourriez également gagner un ensemble LEGO®.

Des conditions s'appliquent.*

Hai anche la possibilità di vincere un set LEGO®.

Termini e condizioni sono applicabili.*

También tienes la oportunidad de ganar un set LEGO®.

Aplican términos y condiciones.*

您还有机会赢取乐高®套装。

条款和条件适用。*

*LEGO.com/productfeedback-terms

