



10342





LEGO.com/sustainable-packaging



FR  
**DONNEZ**  
OU  
**RECYCLEZ**



OU



OU



ASSOCIATION    MAGASIN    DÉCHÈTERIE

Adresses sur [quefairedemesdechets.fr](http://quefairedemesdechets.fr)



# BUiLDER

Download on the  
**App Store**

GET IT ON  
**Google Play**

 **腾讯应用宝**  
安卓应用商店

Apple and the Apple logo are trademarks of Apple Inc., registered in the U.S. and other countries and regions. App Store is a service mark of Apple Inc. Google Play and the Google Play logo are trademarks of Google LLC. Tencent and the Tencent logo are trademarks of Tencent Inc.

 [LEGO.com/devicecheck](https://LEGO.com/devicecheck)

 **LEGO® Builder**

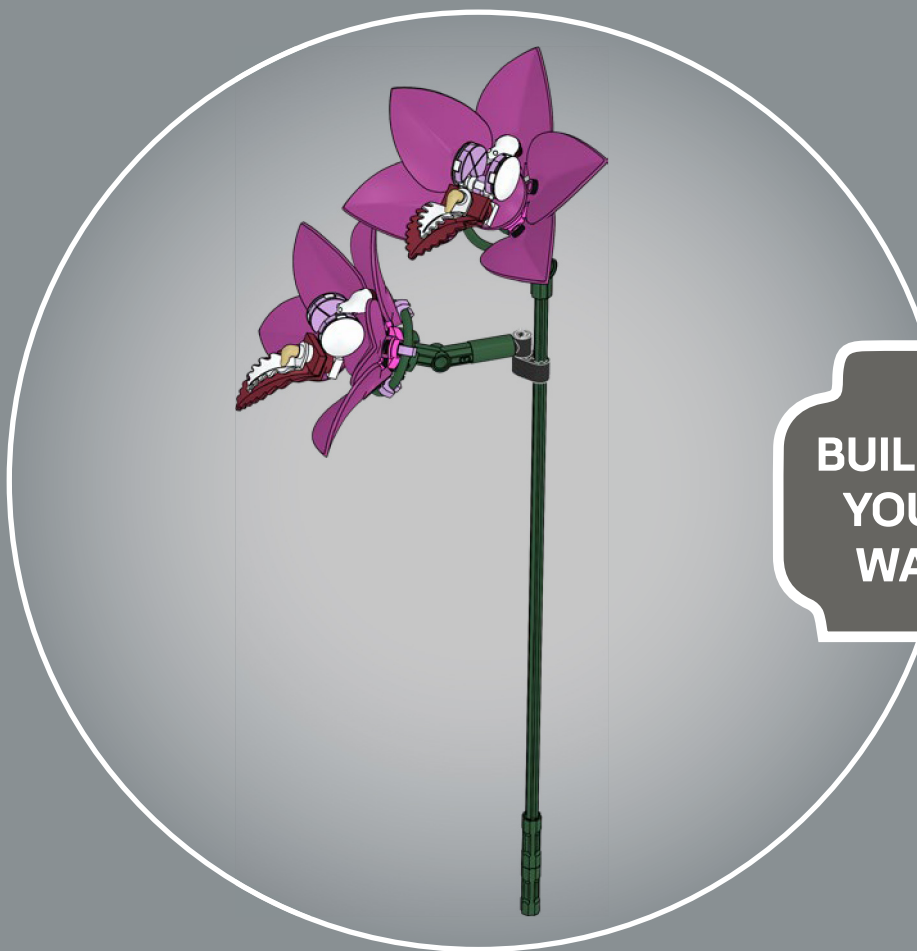

**BUILD IT  
YOUR  
WAY**



**EN** Build It Your Way | **DE** Bau, wie du willst | **FR** Construisez à votre façon | **IT** Costruiscilo come vuoi tu | **ES** Constrúyelo a tu manera | **PT** Constrói à Tua Maneira | **ZH** 自由拼搭 | **PL** Zbuduj po swojemu | **CS** Postavte to po svém | **SK** Postavte to po svojom | **HU** Építs kedved szerint! | **RO** Construięște așa cum dorești | **BG** Постройте го по своя начин | **LV** Būvē tieši tā, kā vēlies | **ET** Ehita enda moodi | **LT** Sukonstruokite savaip

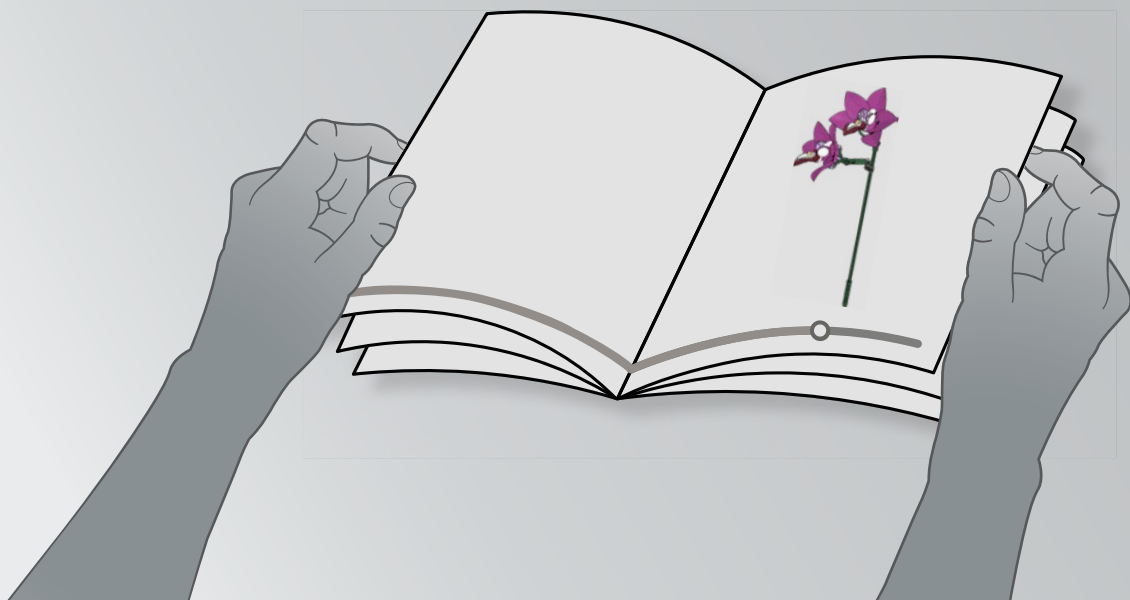
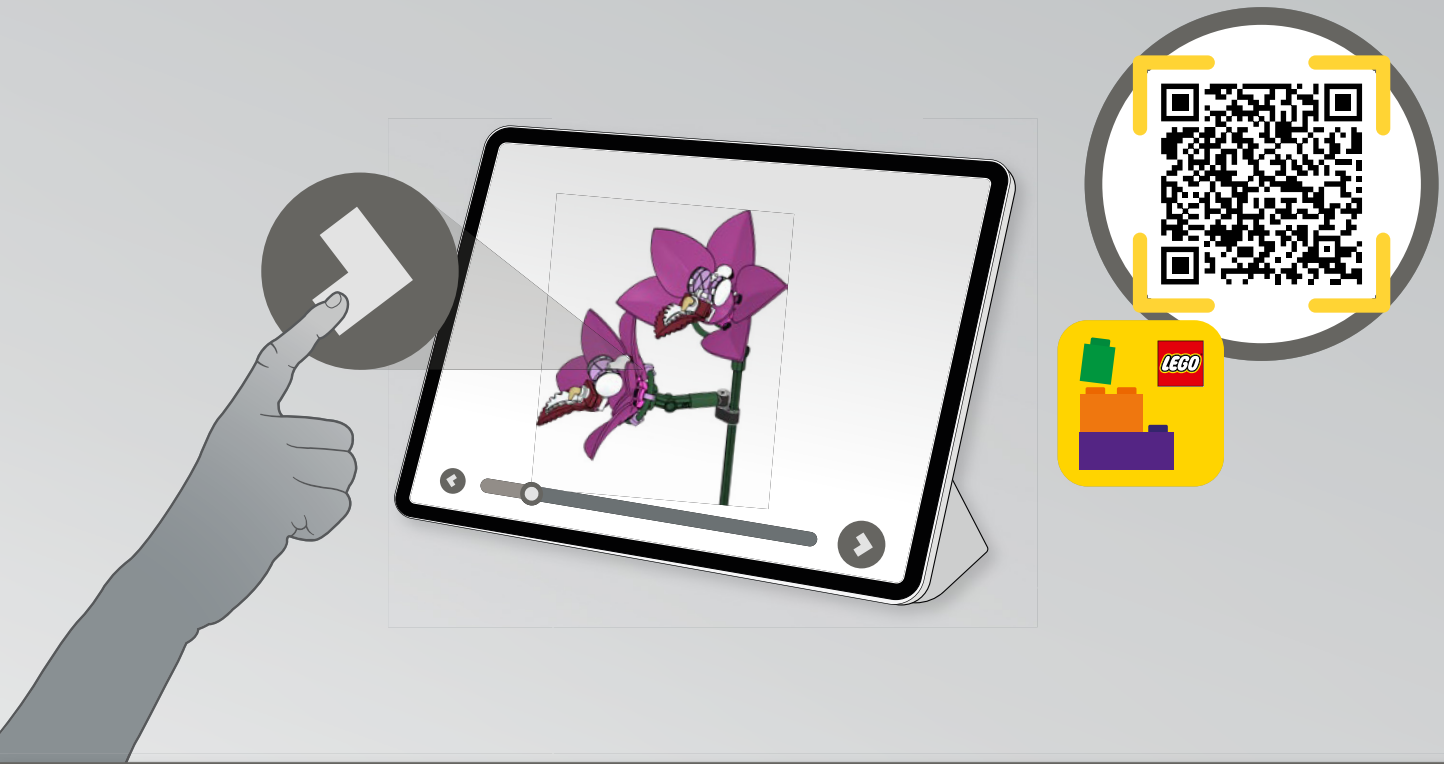

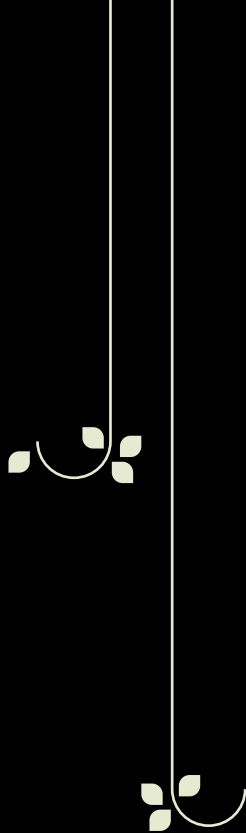

## Elegante por naturaleza

Cuando diseñamos un arreglo floral LEGO®, la naturaleza nos ofrece una enorme abundancia de colores, especies de plantas y olores como fuente de inspiración. Mientras combinamos flores en colores vibrantes y tonos pastel con elegantes hojas de un intenso verde, experimentamos con nuevas técnicas (y usos creativos de los elementos LEGO) para dar vida a este opulento ramo. Cada detalle se ha recreado meticulosamente para rendir un homenaje tan auténtico como artístico a los diversos tesoros de la naturaleza.

*El equipo de diseño de LEGO® Botanical*

De hierbajo rebelde a apreciada flor para ramos, esta belleza increíblemente popular entre las abejas y las mariposas crece con fuerza en Europa y Norteamérica.



(*Centaurea cyanus*)  
**ACIANO**



(*Eucalyptus pulverulenta*)

## EUCALIPTO AZUL

Conocido también como goma de montaña con hojas plateadas de Australia, este miembro de la especie de los eucaliptos es un clásico en los ramos de flores de todo el mundo.



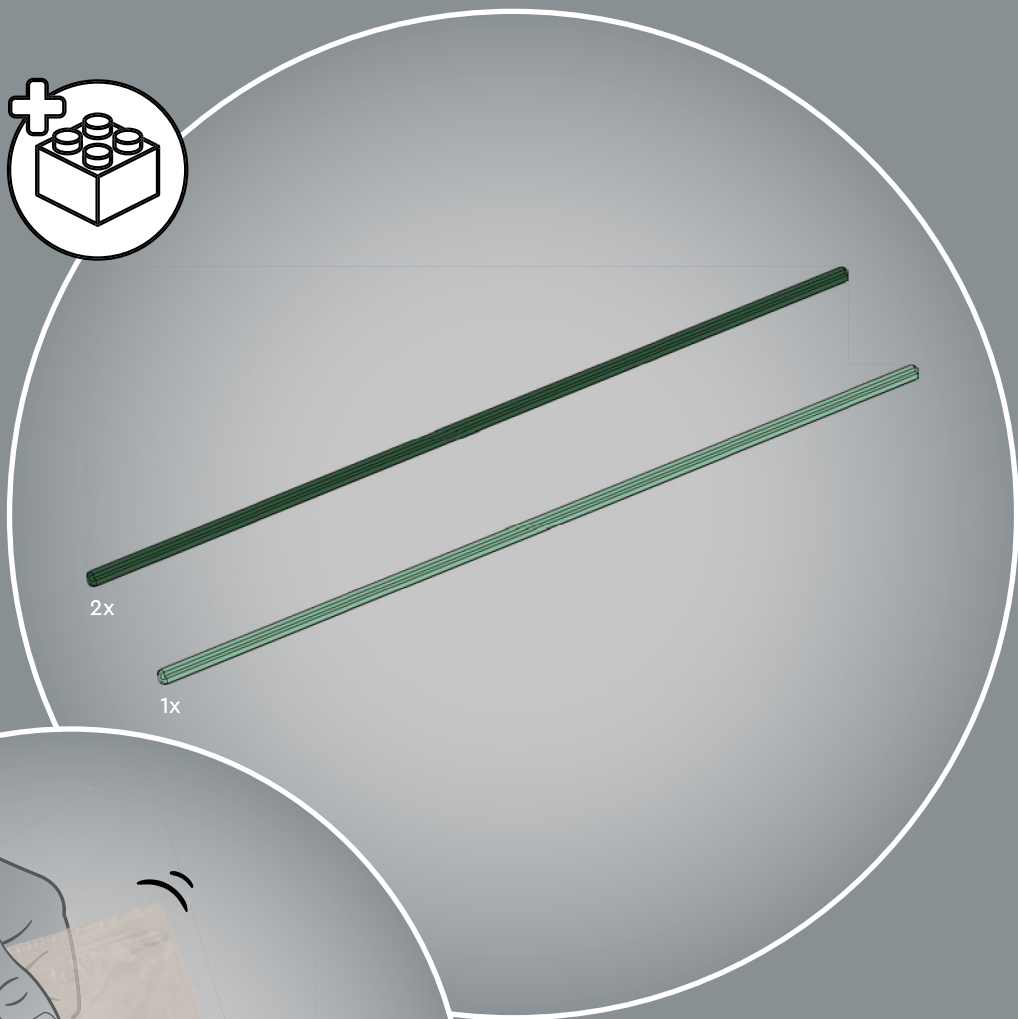
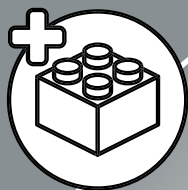



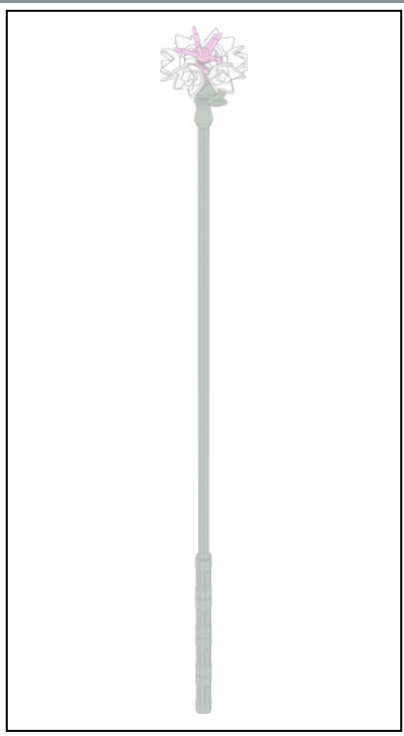

1

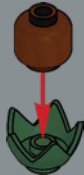

2



3

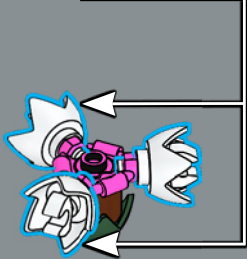
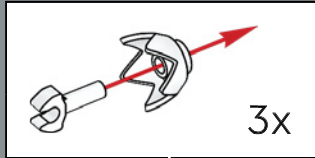

4

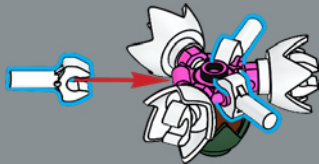

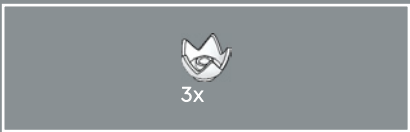

5

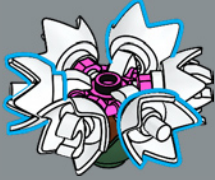

Estos pequeños ladrillos LEGO® usados para los pétalos del aciano son, en realidad, coronas para minifiguras.



6

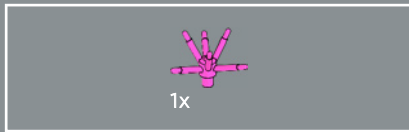
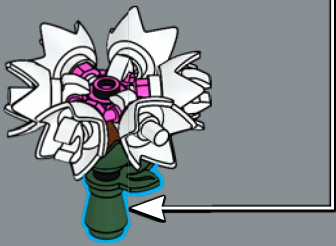
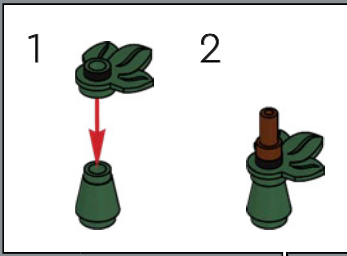

7

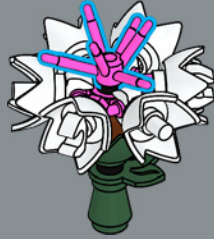

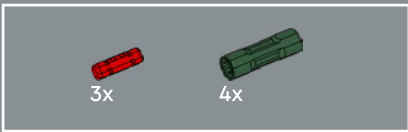

8

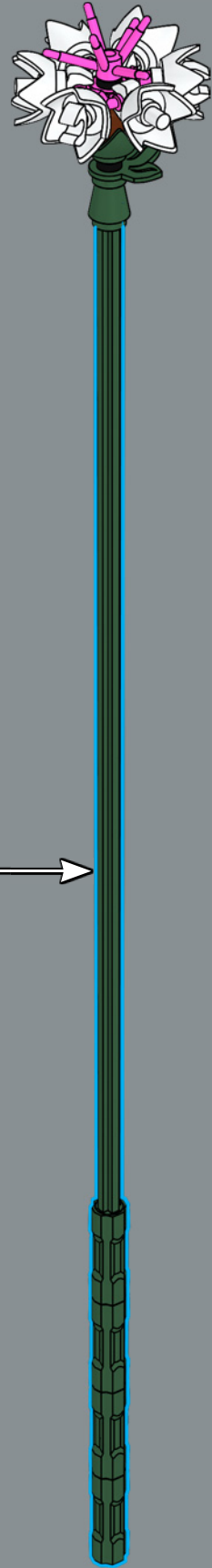
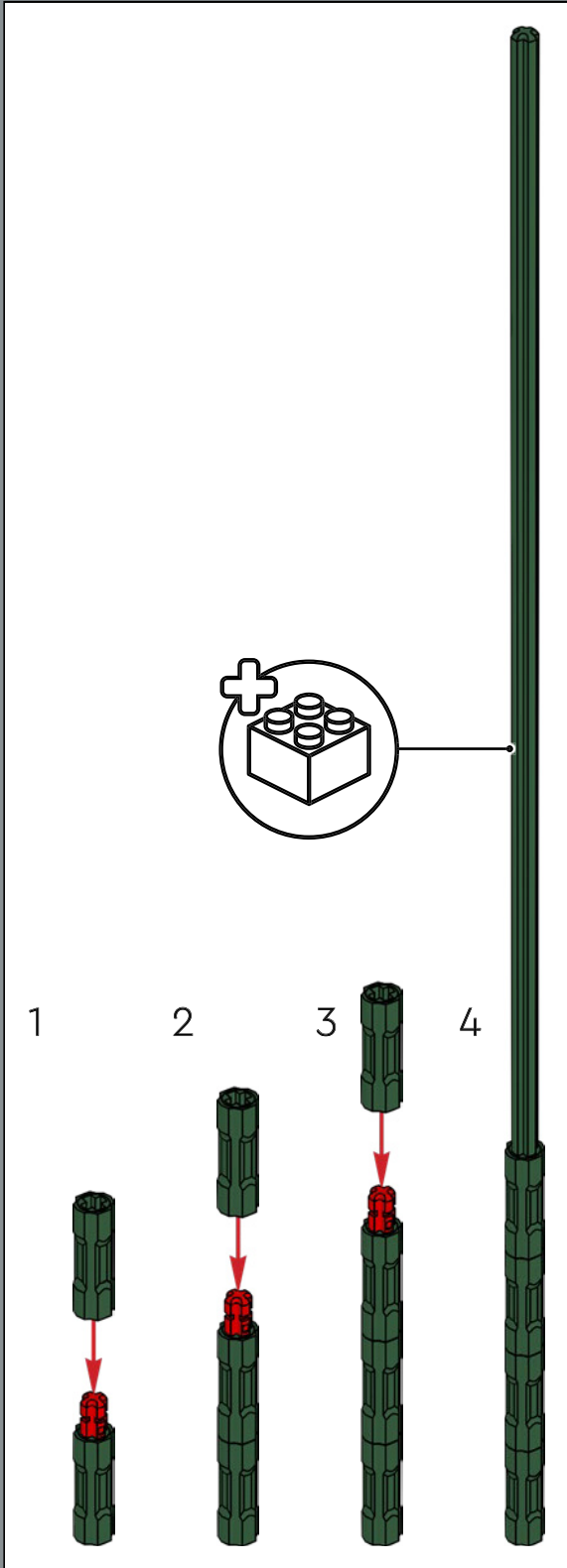

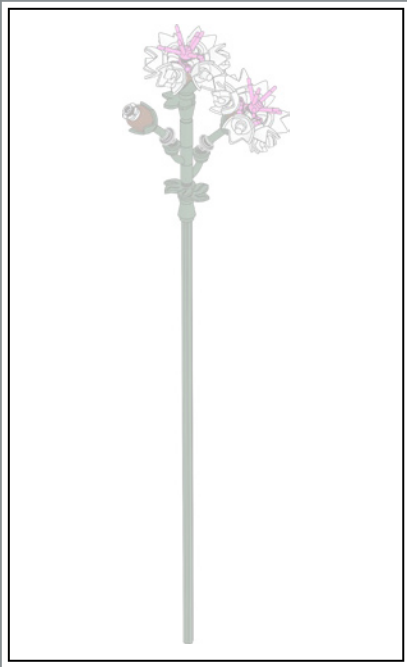

1

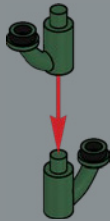

2

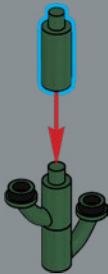

3

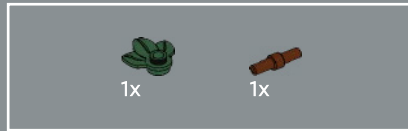
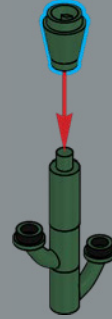

4





5



6

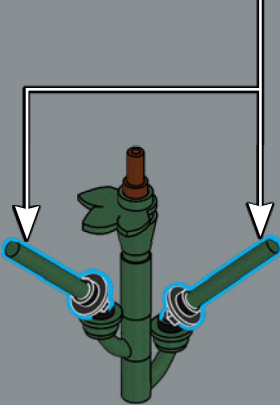
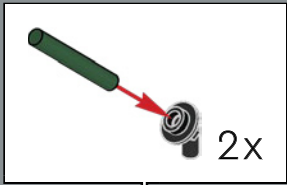

7

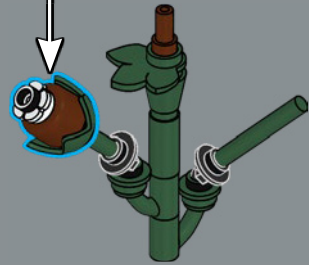
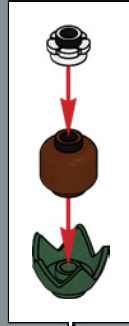



8

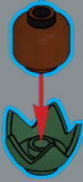

9



10

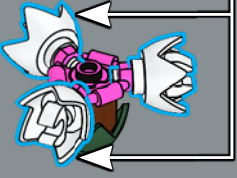
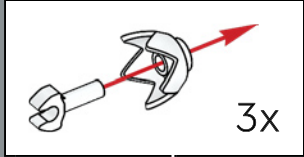

11

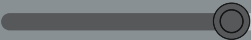
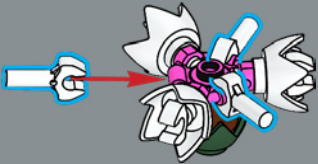

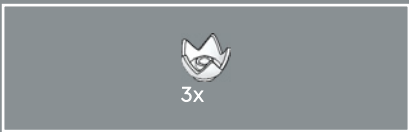

12

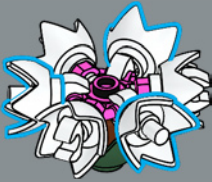

13



2x

14

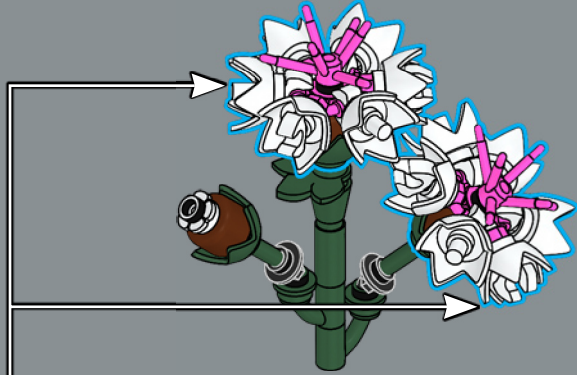

15

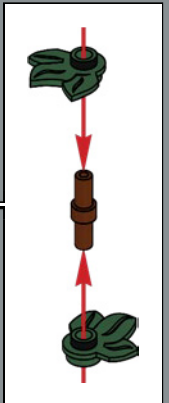
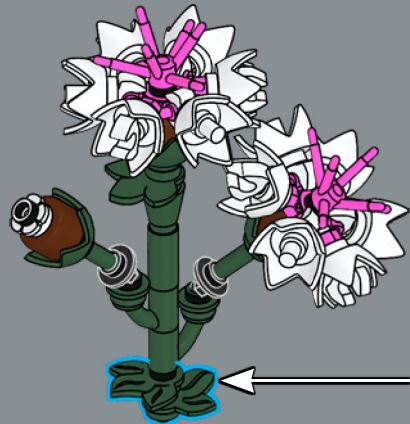



16

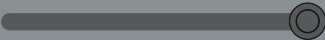
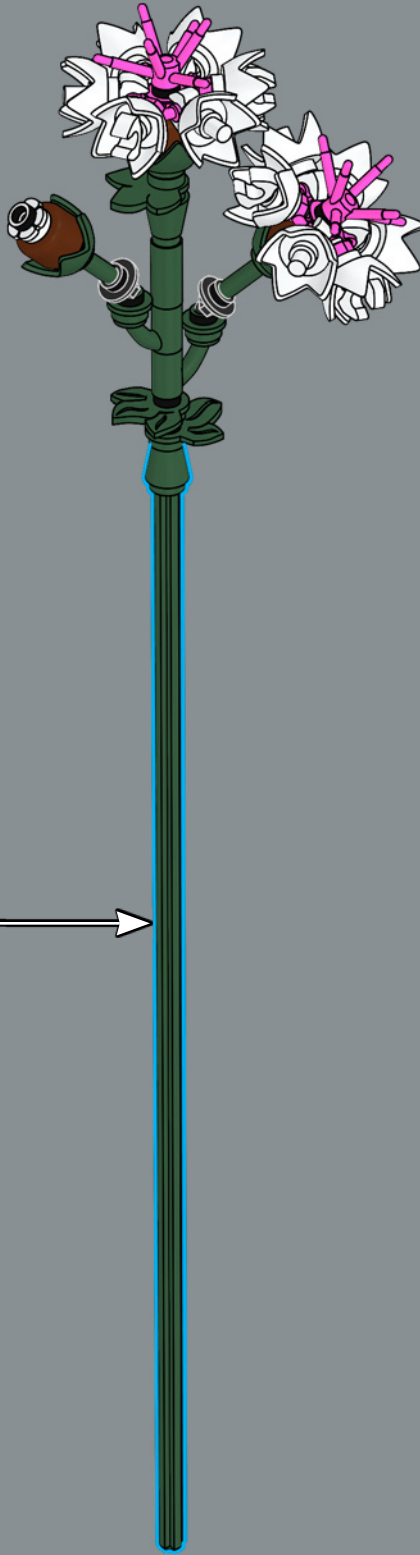
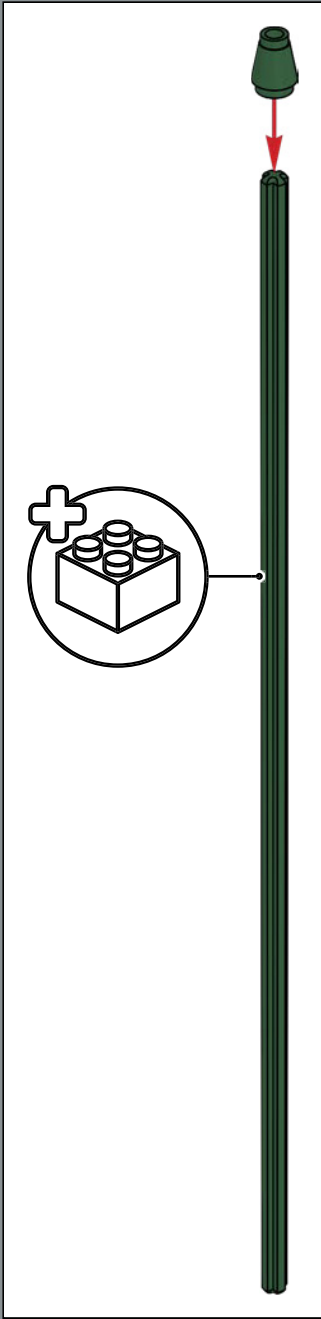



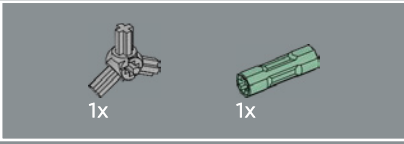

1

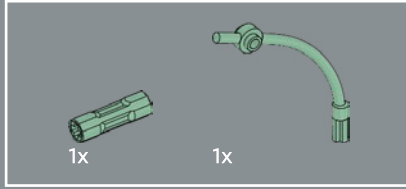
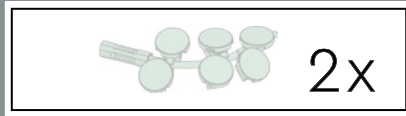
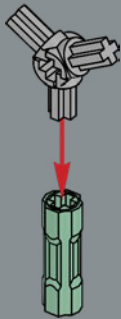

2

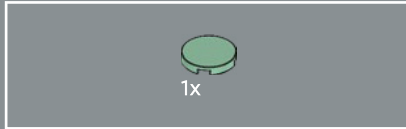
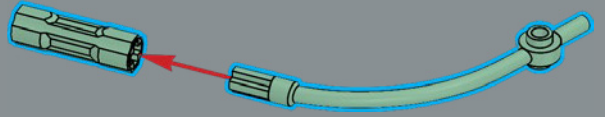

3

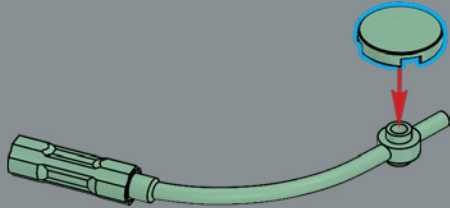



4

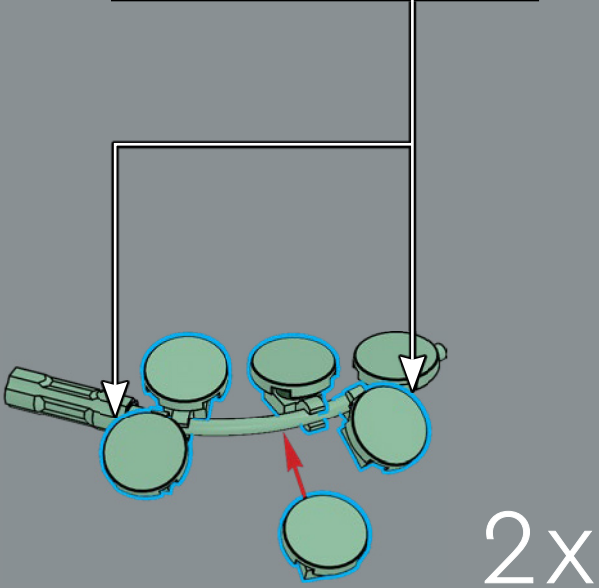
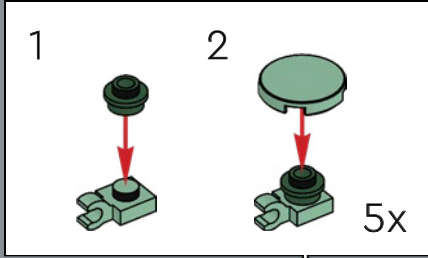

5

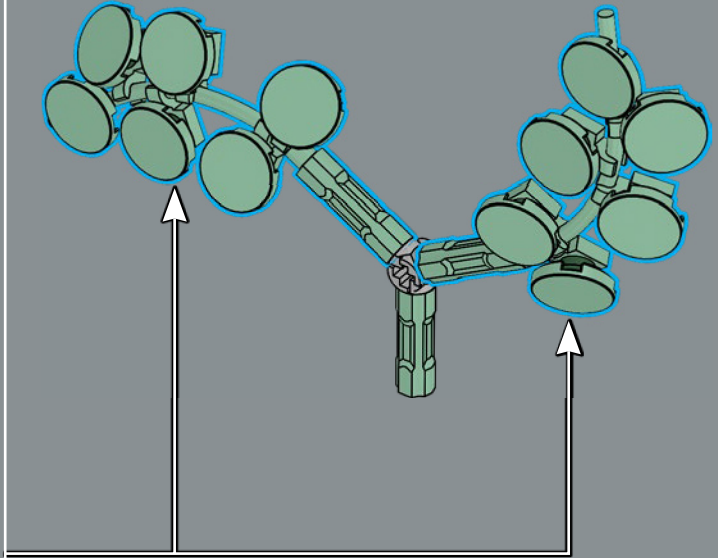



6

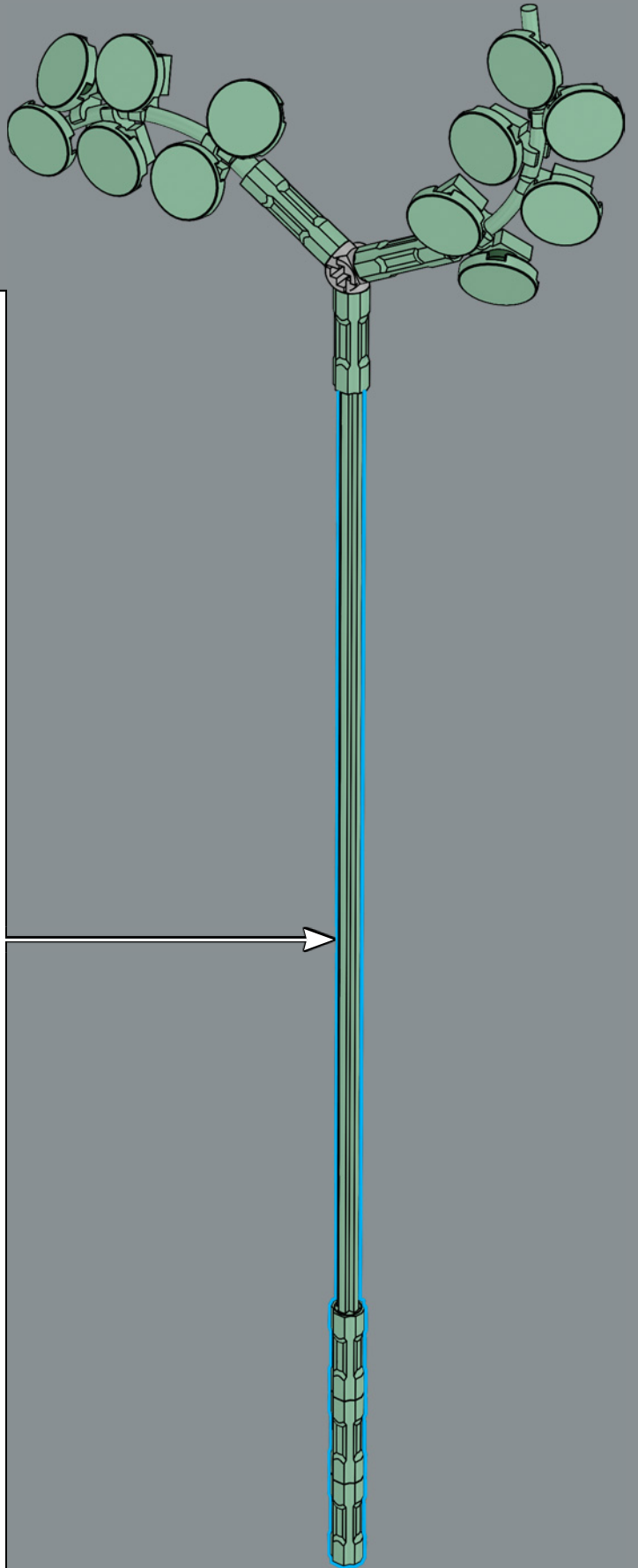
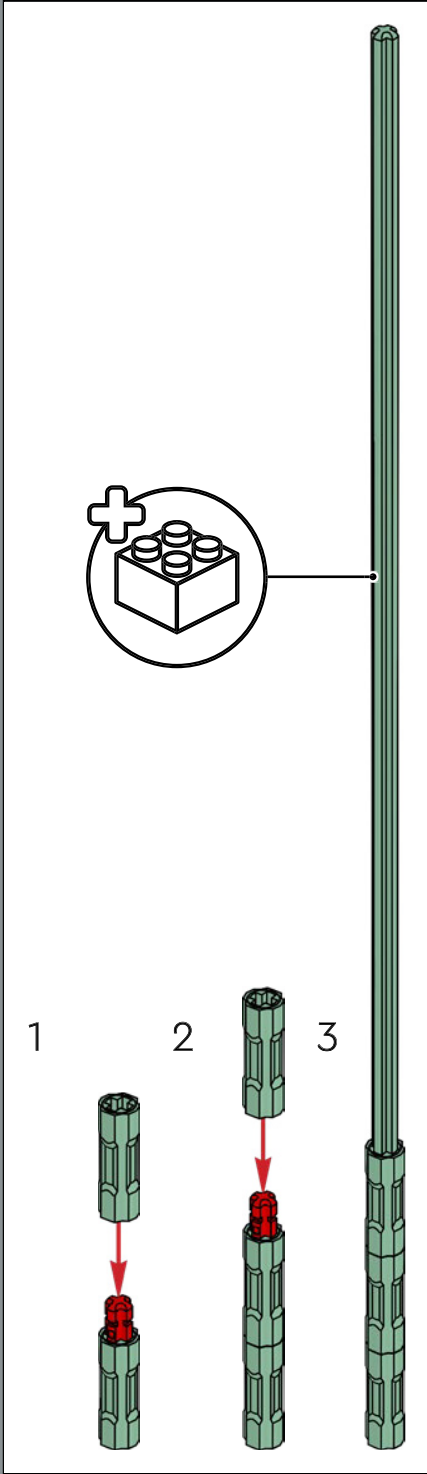



*(Sambucus nigra)*

## SAÚCO

Las especies de arbustos caducifolios de saúco varían en todo el mundo, pero la mayoría produce delicadas flores blancas y bayas de color púrpura oscuro. Ambas son sabores muy populares en platos y bebidas.

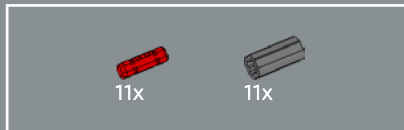

1

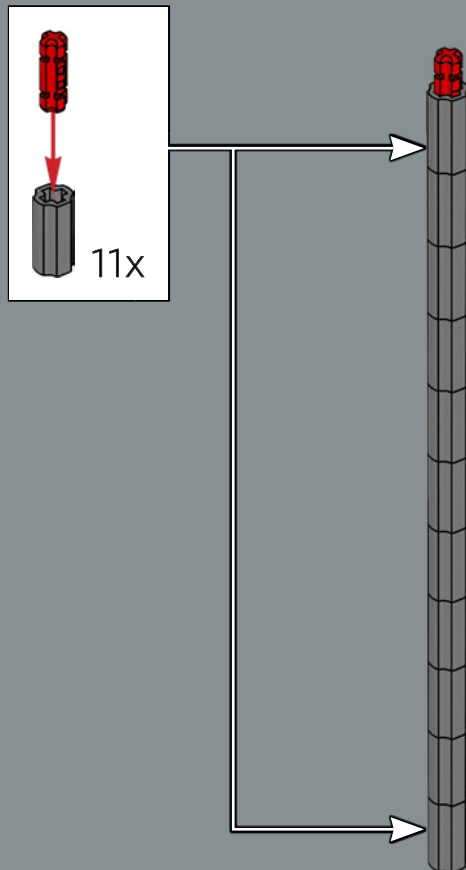

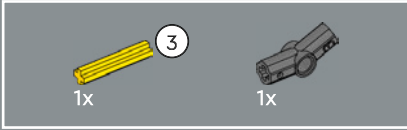
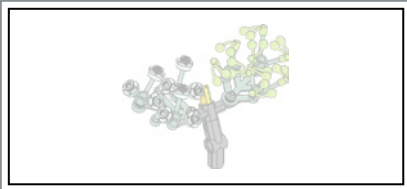

2

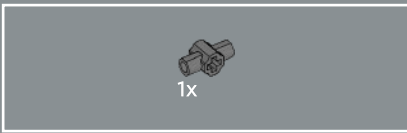
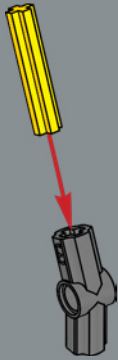

3

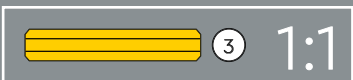
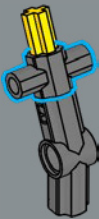

4

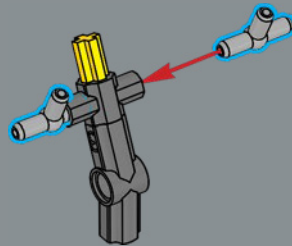

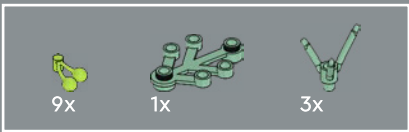

5

1



2

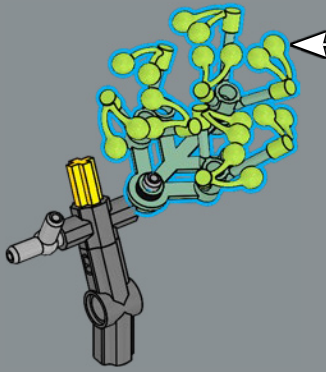
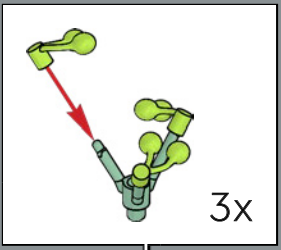
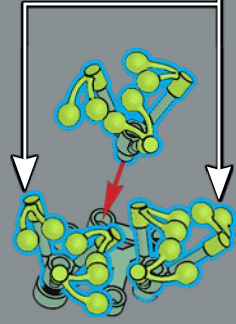

Estos capullos sin abrir de saúco se construyen con las clásicas cerezas para minifiguras LEGO®.

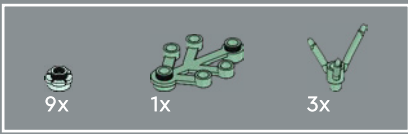

6

1



2

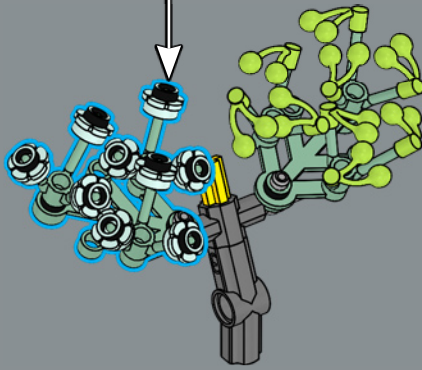
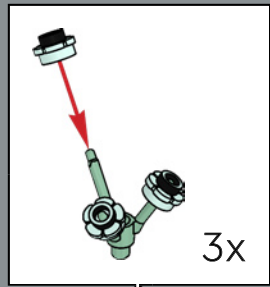
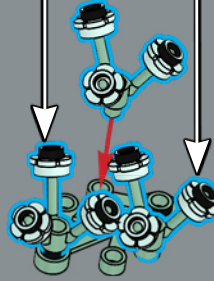



7

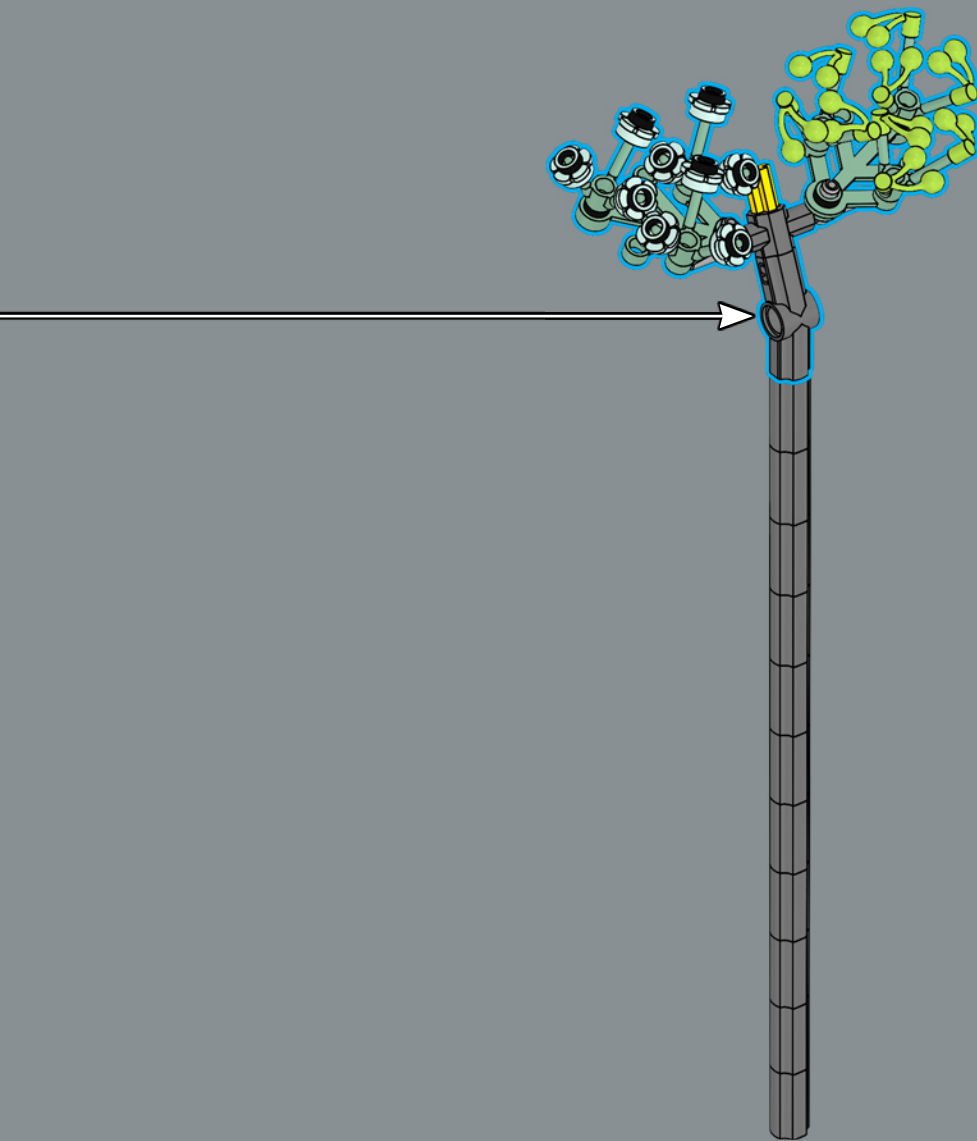

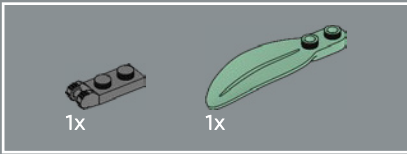
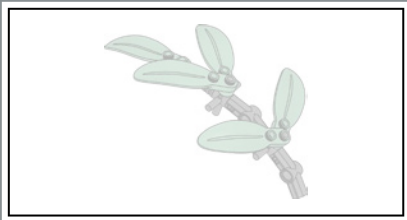

8

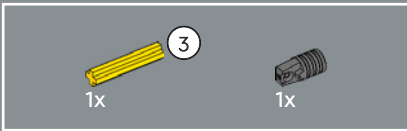
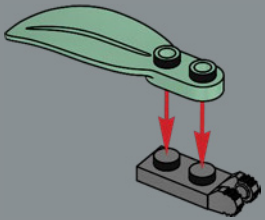

9

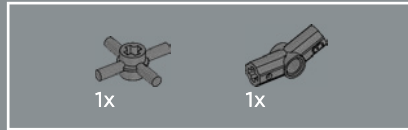
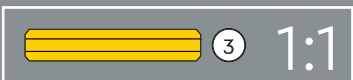
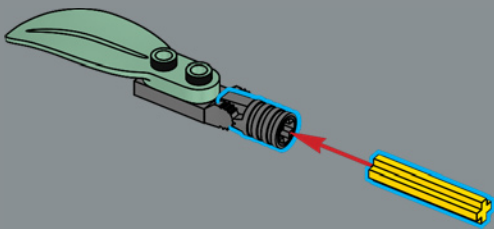

10

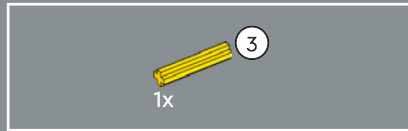
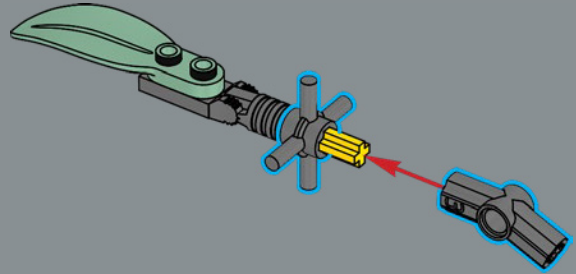

11

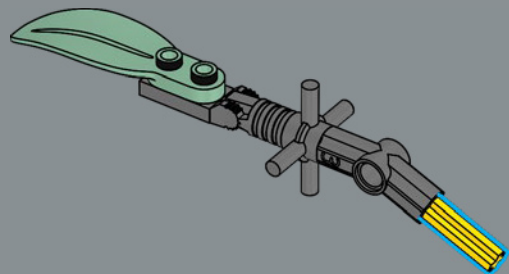



12

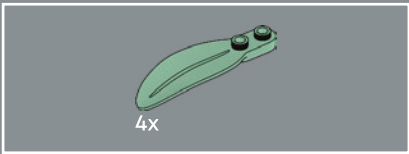
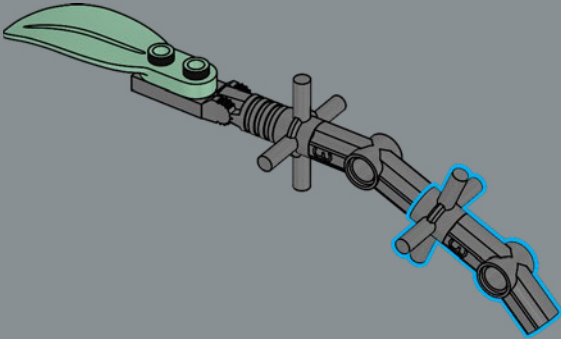

13

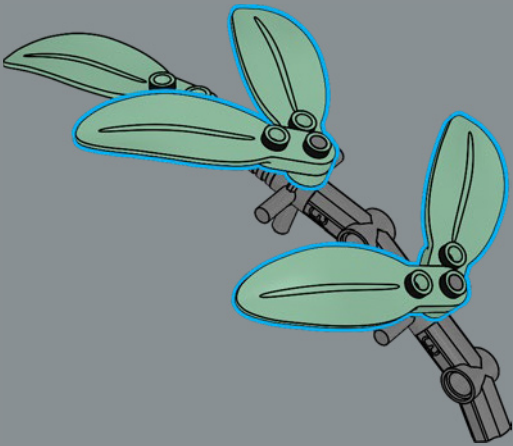

14

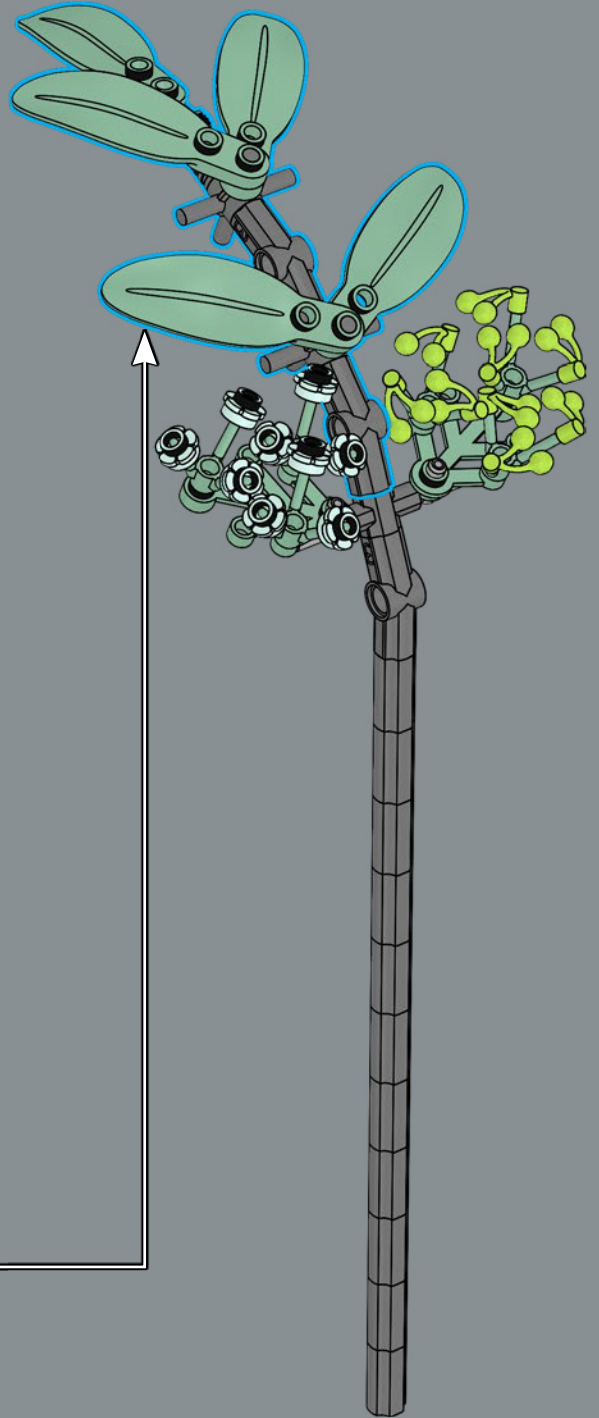

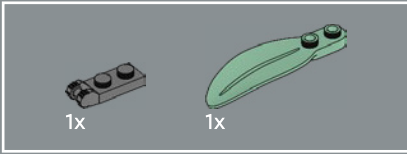
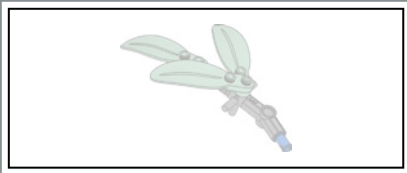

15

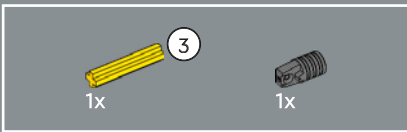
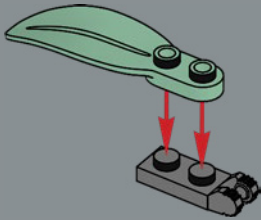

16

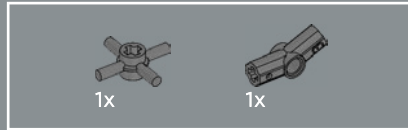
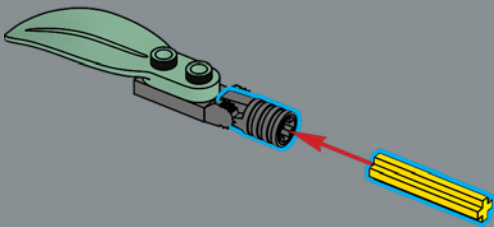

17

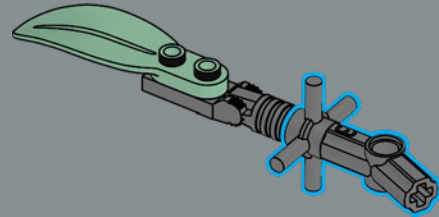

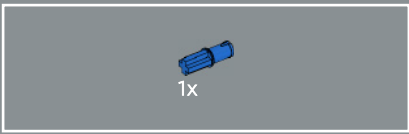

18

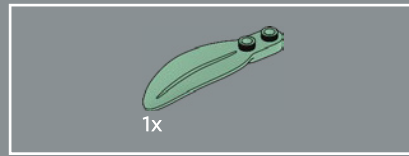
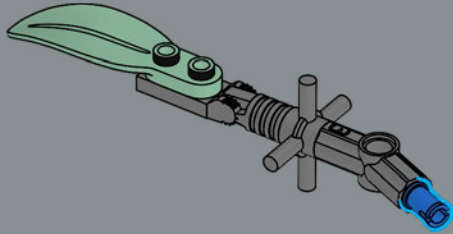

19

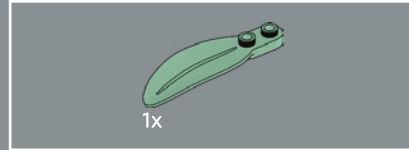
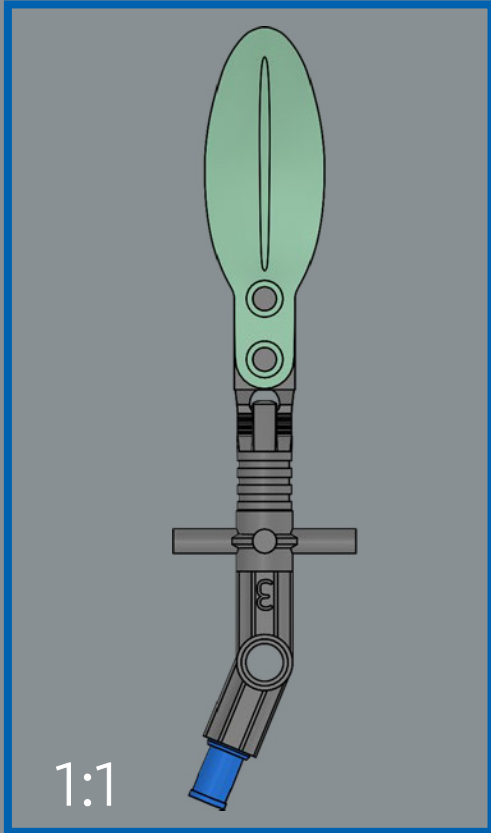
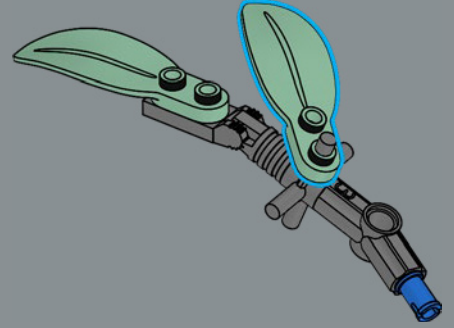

20

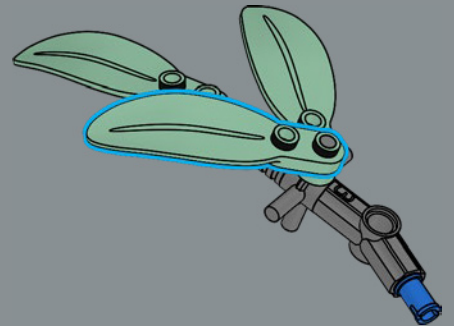

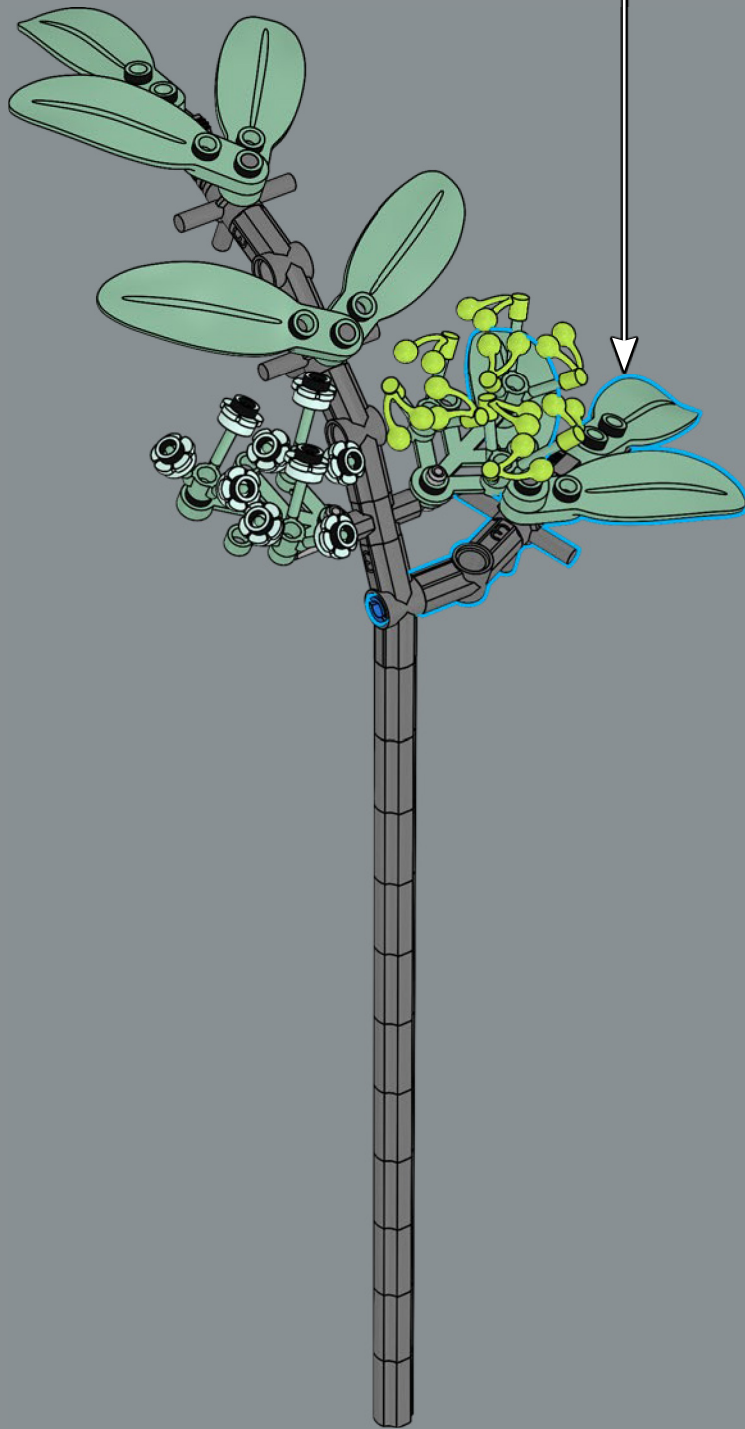

2x





*(Rosa)*

## ROSA

Las rosas, regaladas como símbolo de amor y belleza durante siglos, aportan gracia y elegancia a cualquier ramo (ya sean naturales o en formato LEGO®).



*(Felicja amelloides)*

## MARGARITA AZUL

Comunes en Europa y Norteamérica, las margaritas azules, símbolo del compromiso y la confianza, son el regalo perfecto para un ser querido.

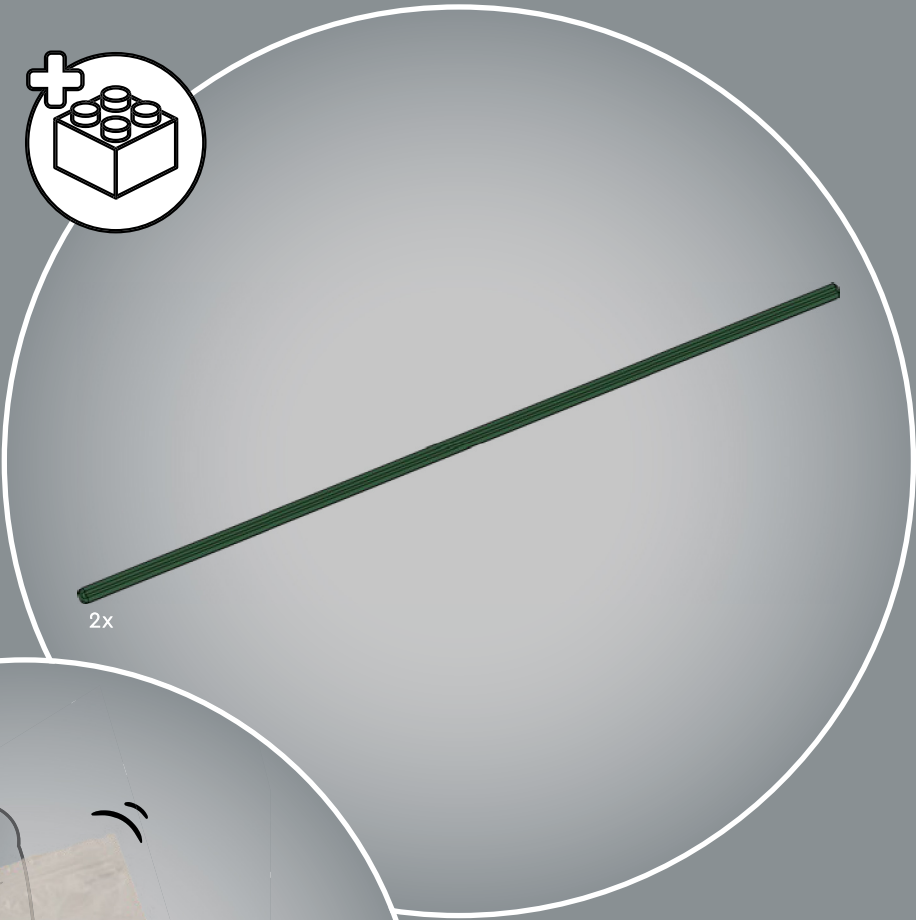
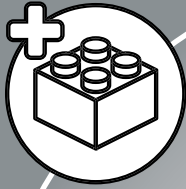

2x



3





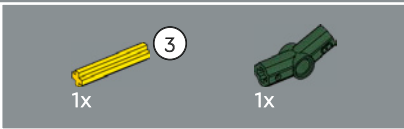
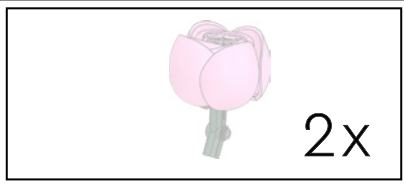
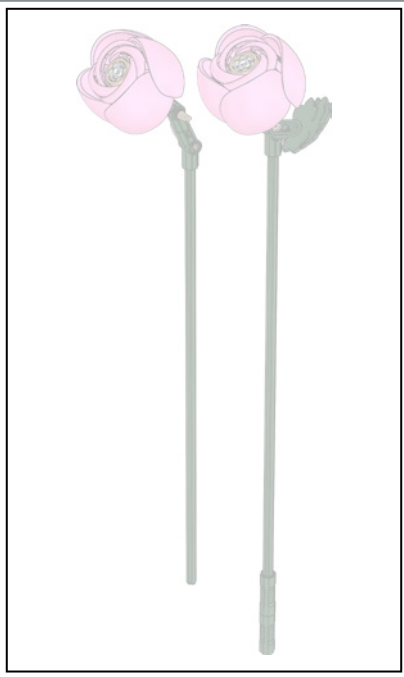

1

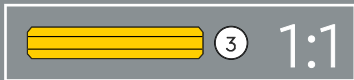
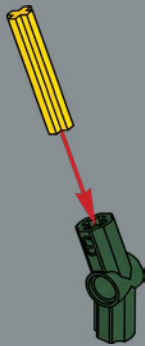

2

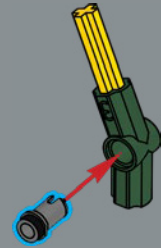

3





4



5



6

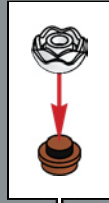

A nuestras minifiguras LEGO® también les gustan las flores. Esta florecilla fue originalmente una pequeña peonía y ahora forma el centro de una rosa.

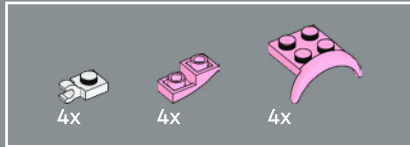

7

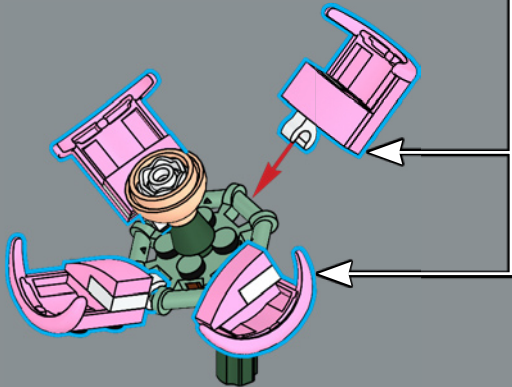
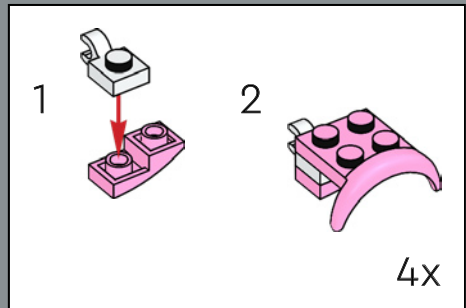

8

La espiral de pétalos del centro de esta rosa está creada a partir de guardabarros de coches LEGO®.

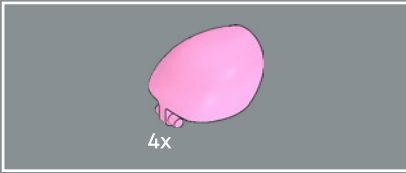
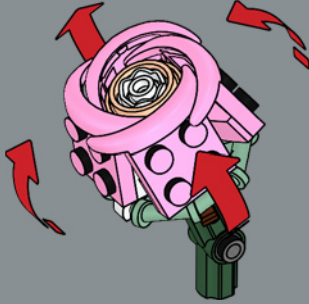

9

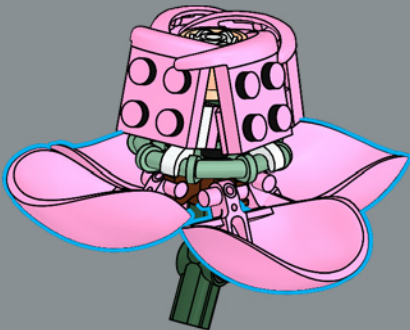

10

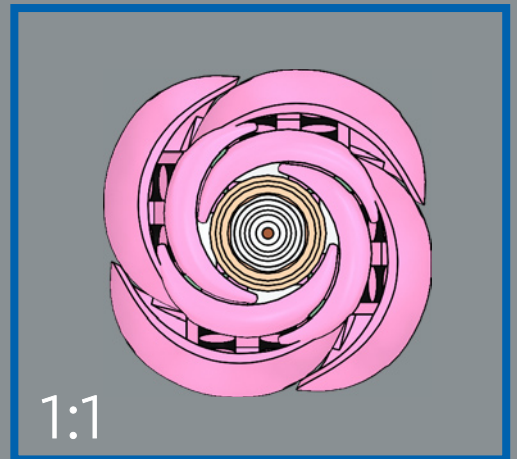
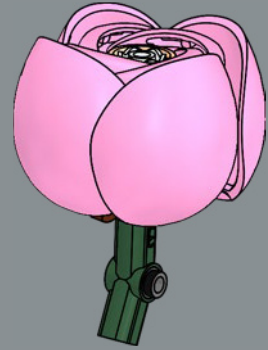

2x

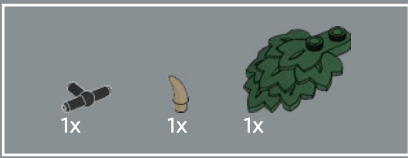

11

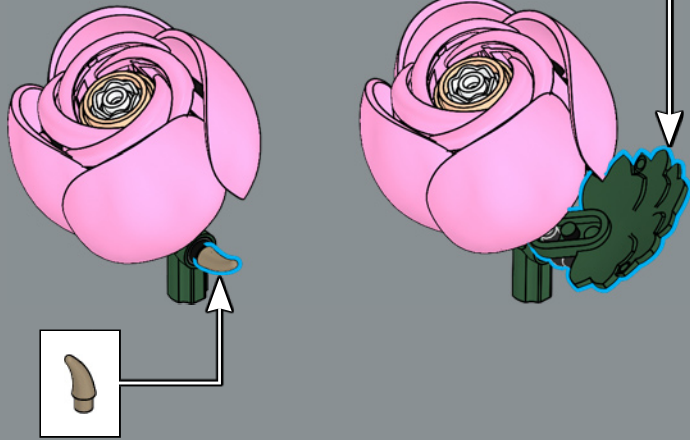
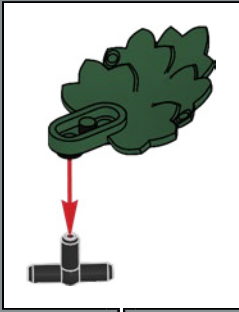

12

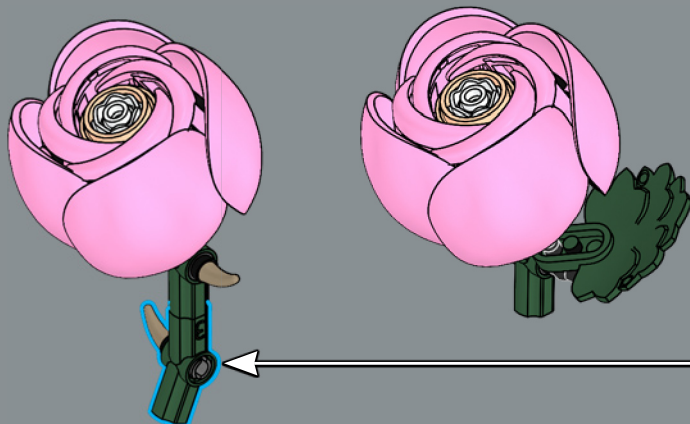
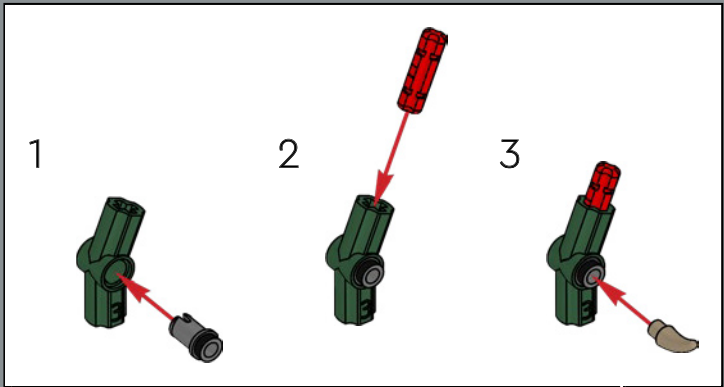

13

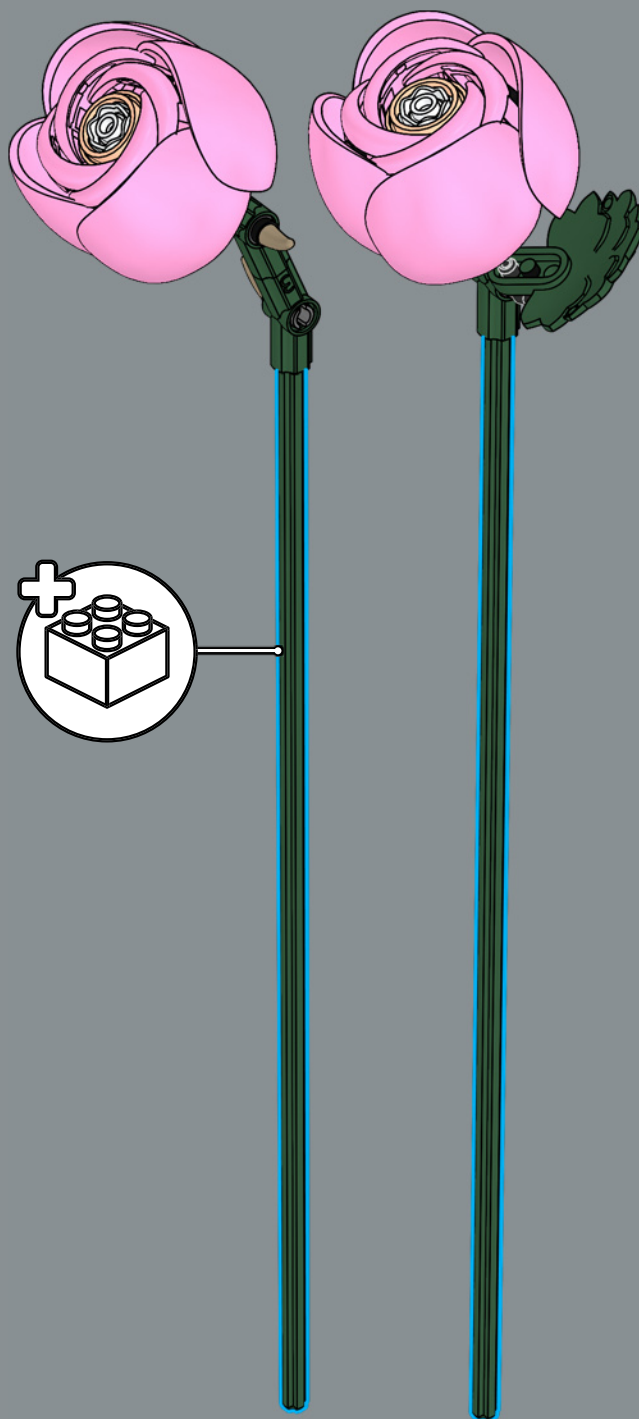

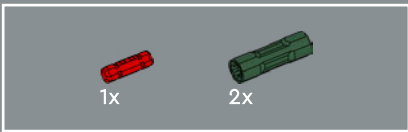

14

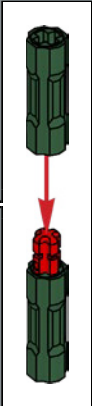

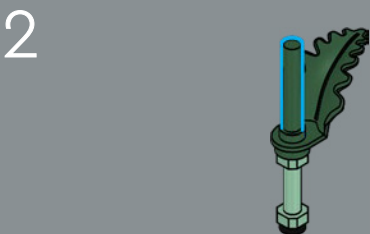
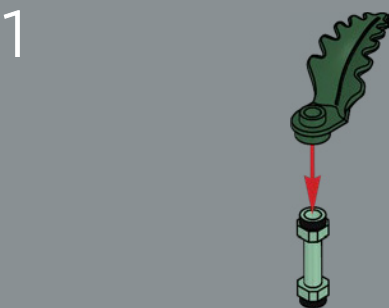
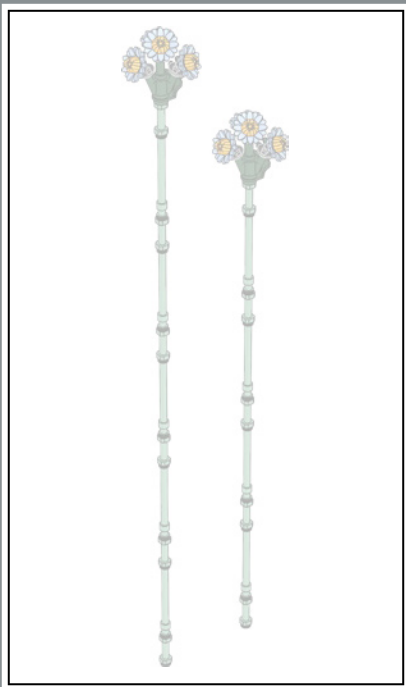

3

Este pequeño elemento que representa un trípode servía para ayudar a las minifiguras LEGO® a mantener firmes sus cámaras. Ahora sostiene un ramillete de margaritas azules.

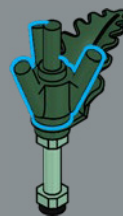

4

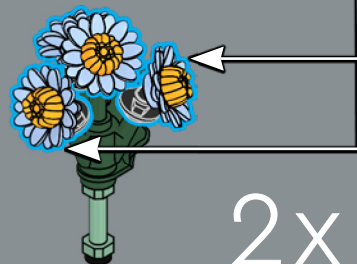
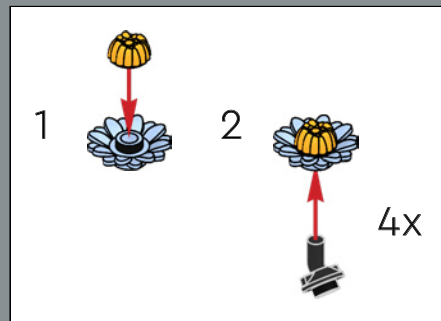

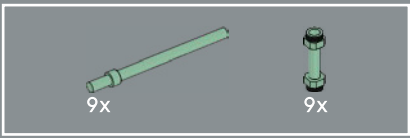

5

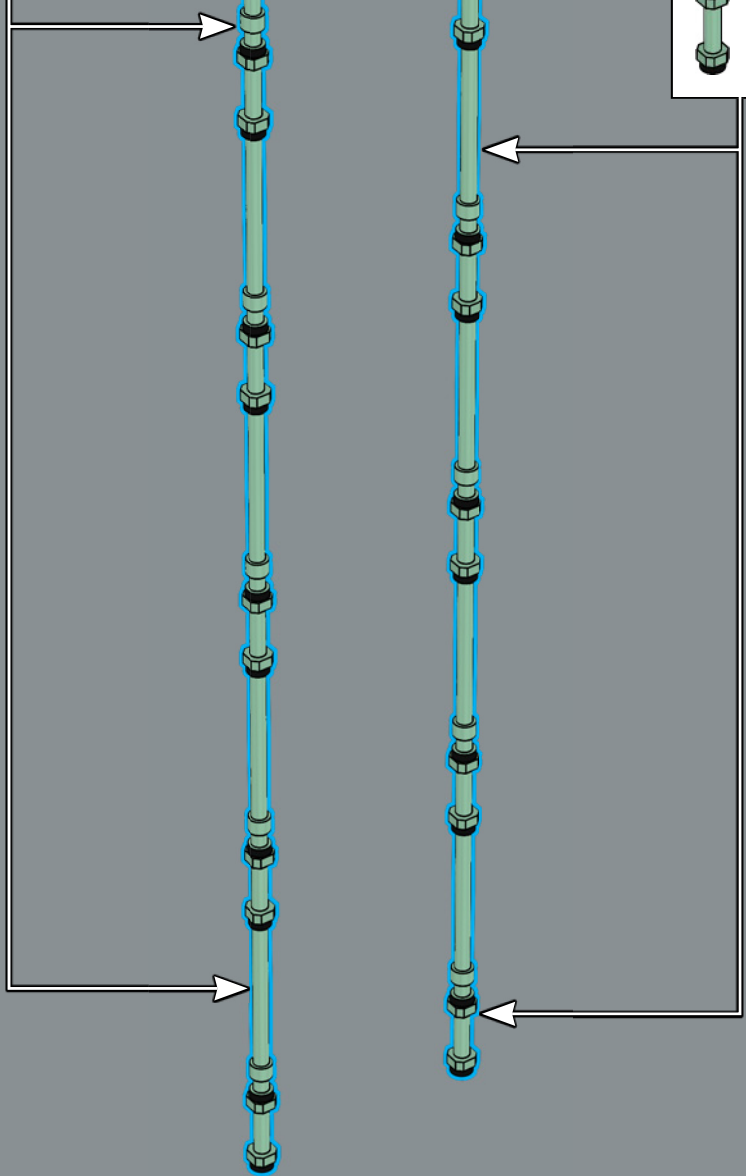
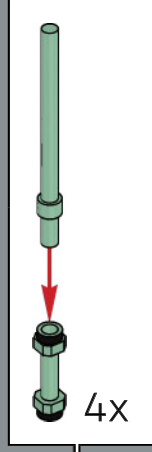
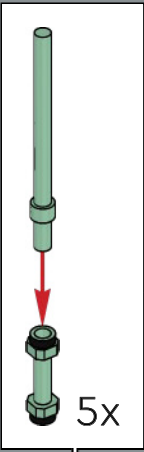





(*Campanula medium*)

## CAMPANILLA DE CANTERBURY

Los farolillos de la *Campanula*, una especie bienal de la flora del sur de Europa típica del verano, tienen forma de campana en tonos azules, blancos o rosas.



(*Ranunculus*)

## RANÚNCULO

Los ranúnculos, autóctonos de Europa, Norteamérica y Asia, con intrincadas capas de pétalos en colores pastel, siempre son una opción popular para los ramos de flores.

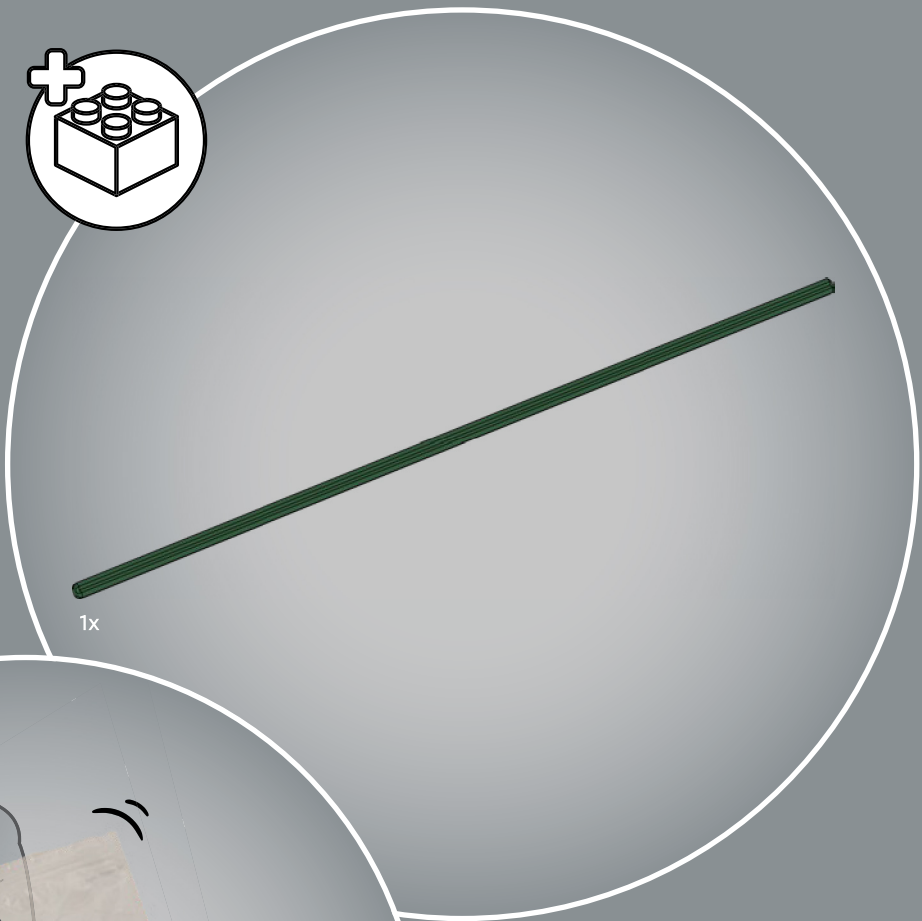
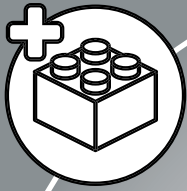

1x



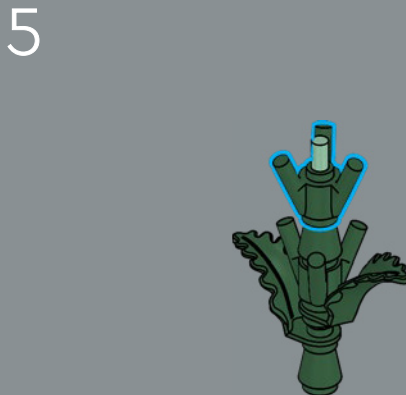
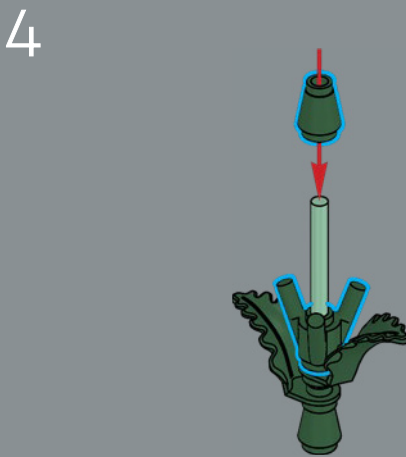
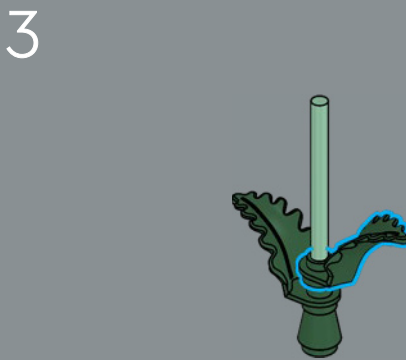
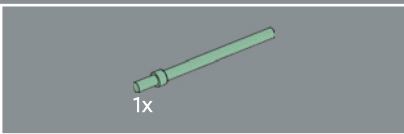
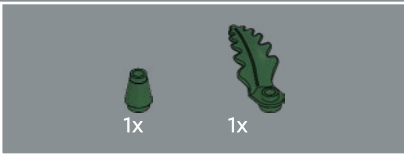
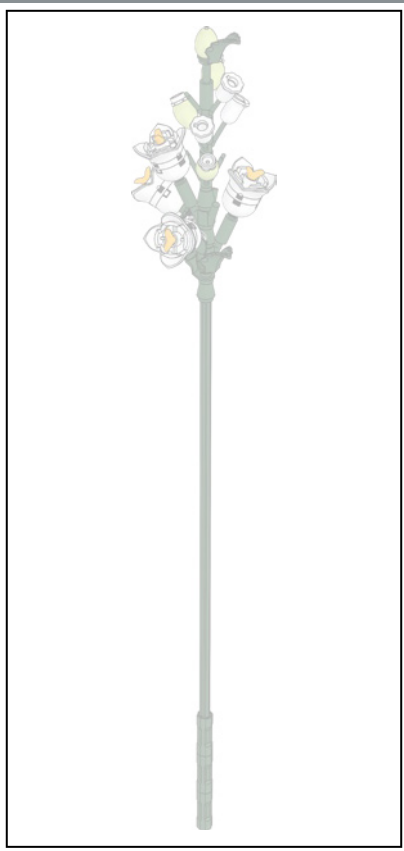

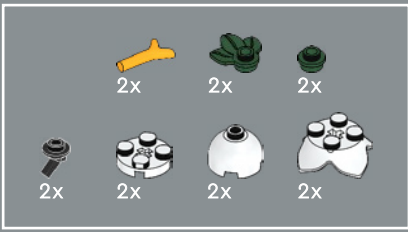

6

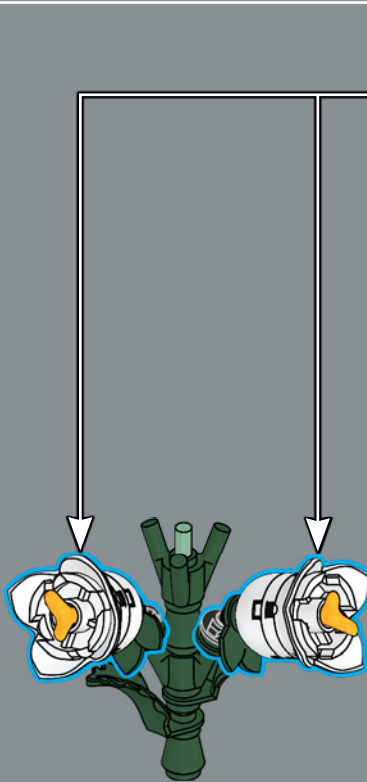
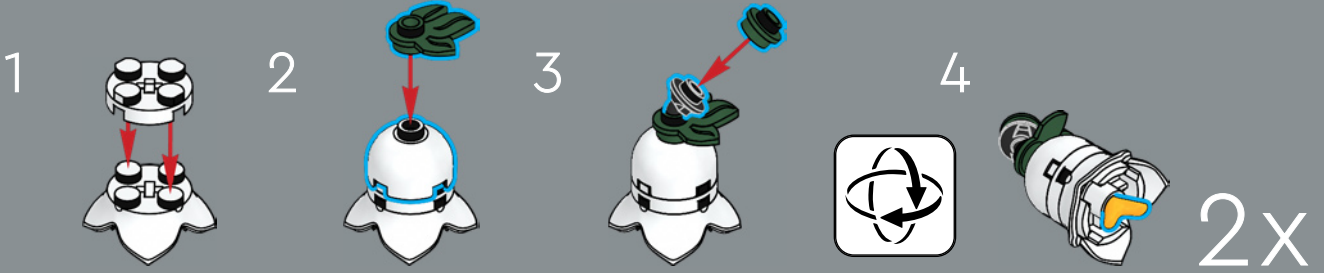



7

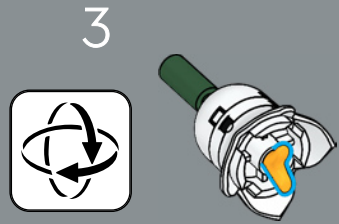
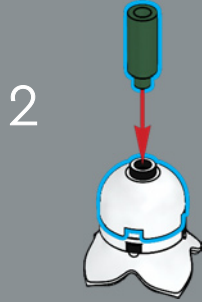

2x

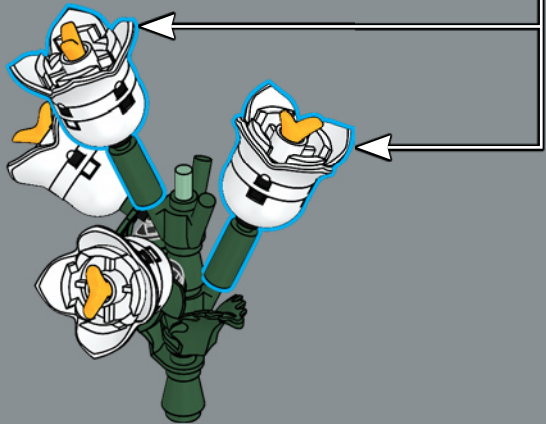

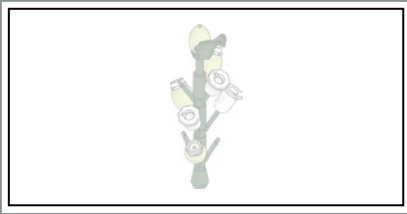

8

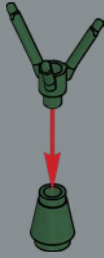

9

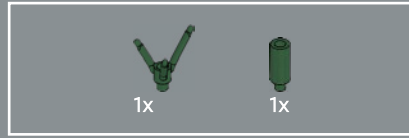
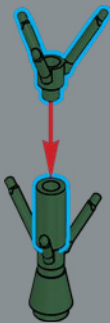

10

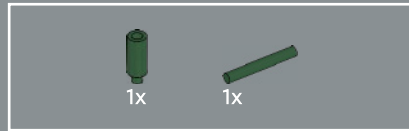
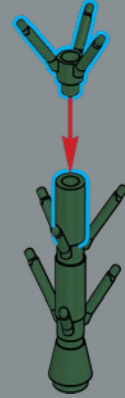

11

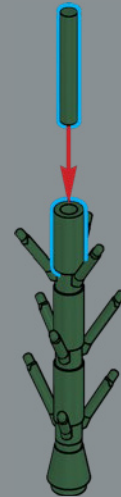



12

Uno de los personajes de nuestro tema LEGO® DREAMZZZ™ se ha usado aquí para representar una florecilla de *Campanula*.

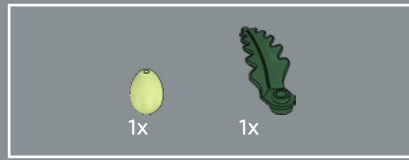
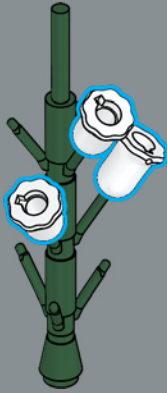

14

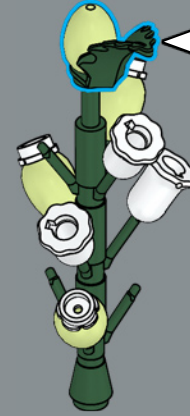
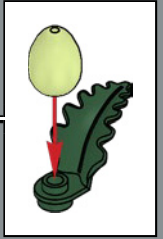

13

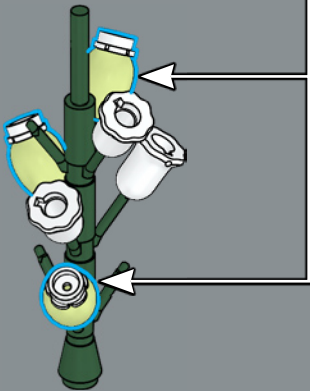
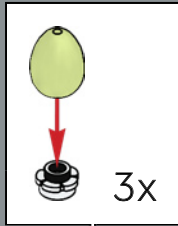

15

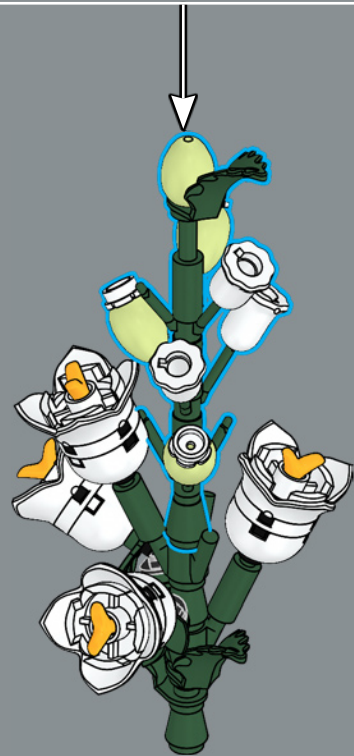

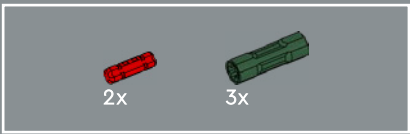

16

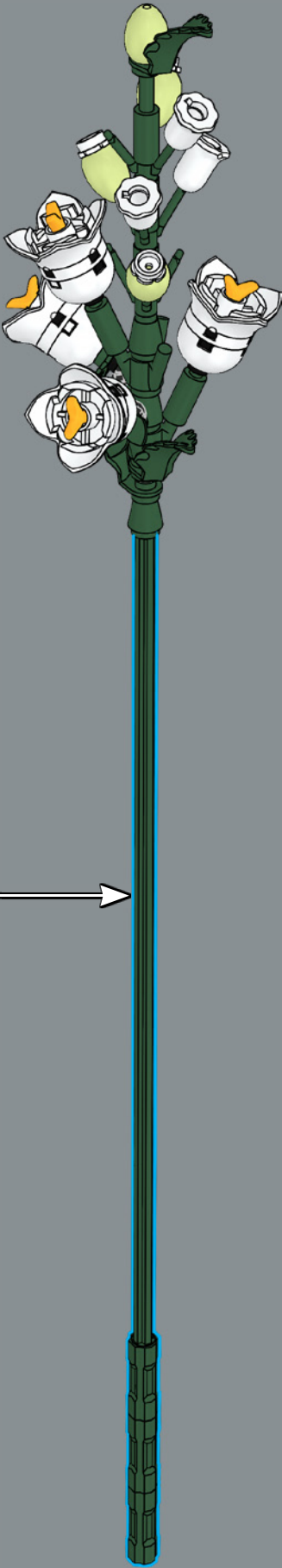
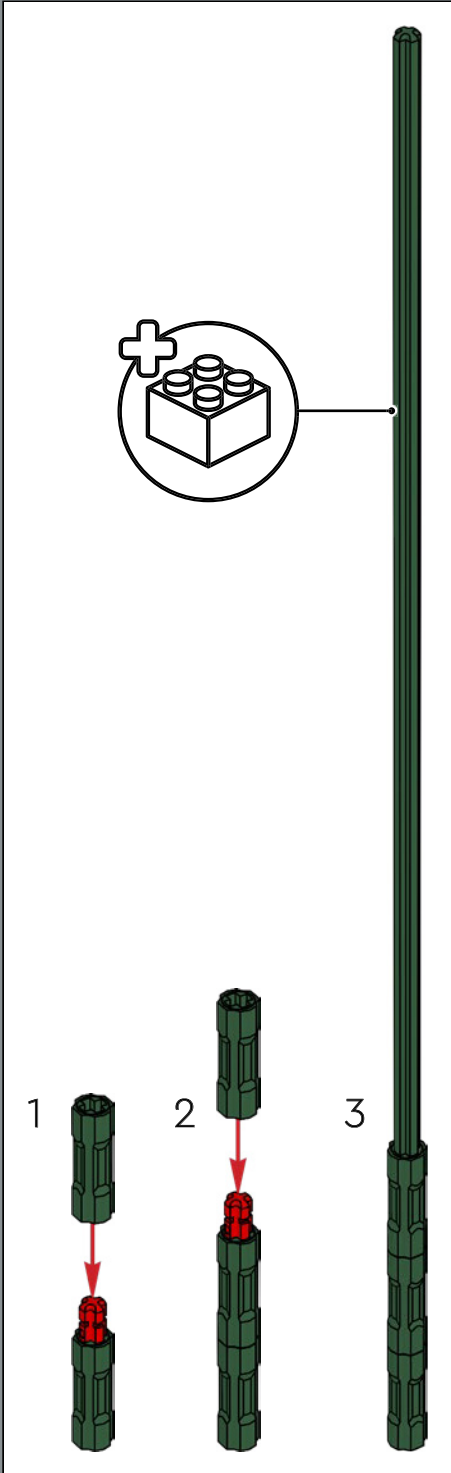



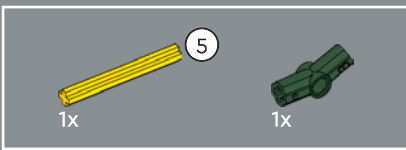

1

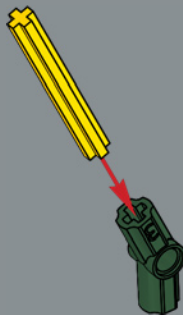

2

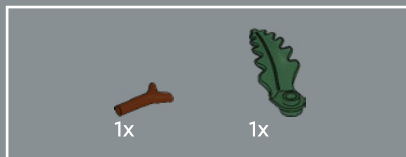
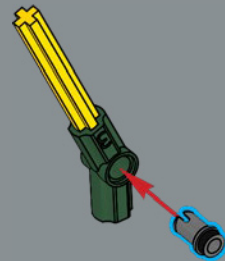

3

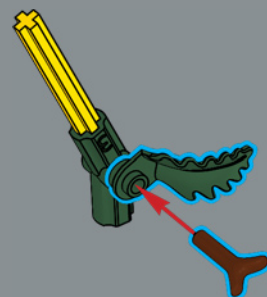

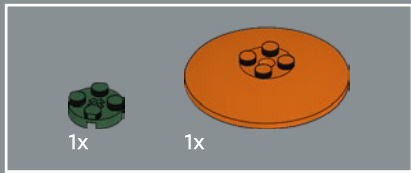

4

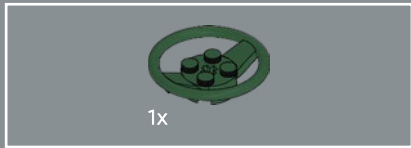
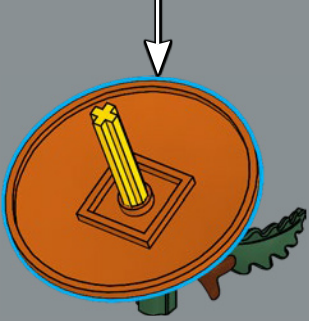
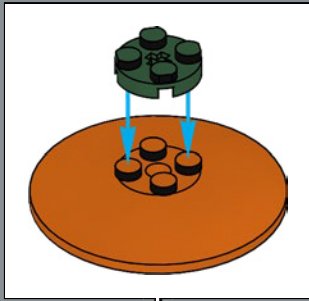

5

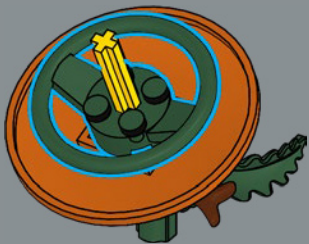

6

Este volante, diseñado para coches LEGO® a gran escala, ahora conforma el centro de nuestras flores LEGO. La cabeza de hacha para minifiguras se introdujo en 2005 para la gama LEGO Vikings.

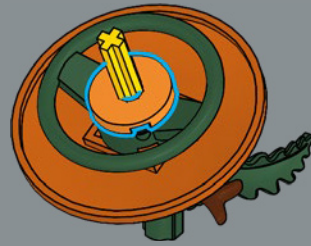

7

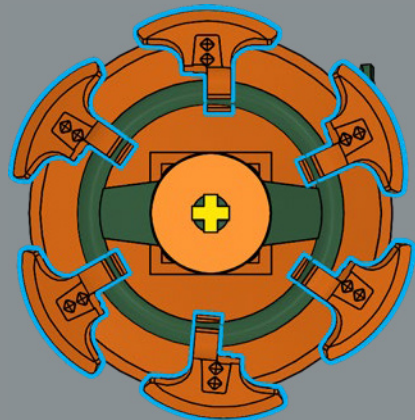



8

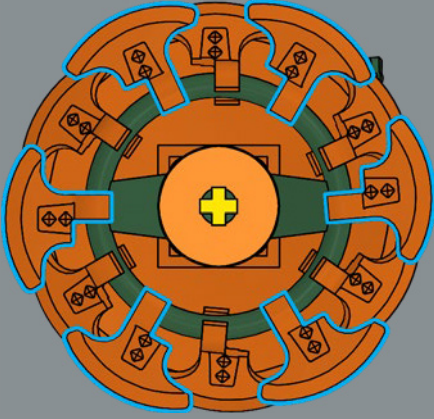

9

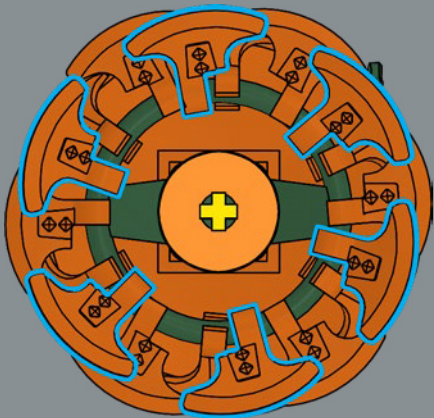

10

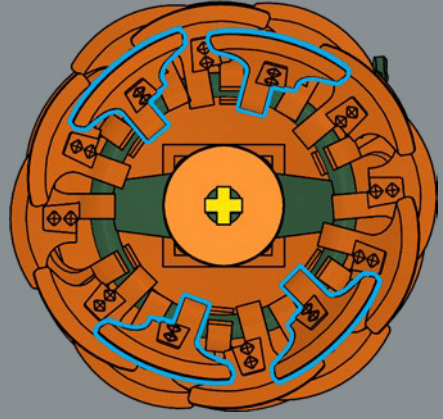

11

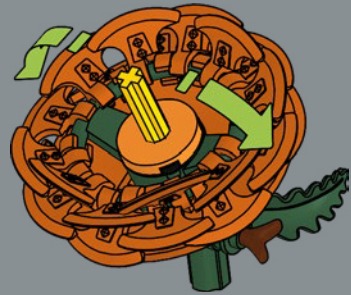

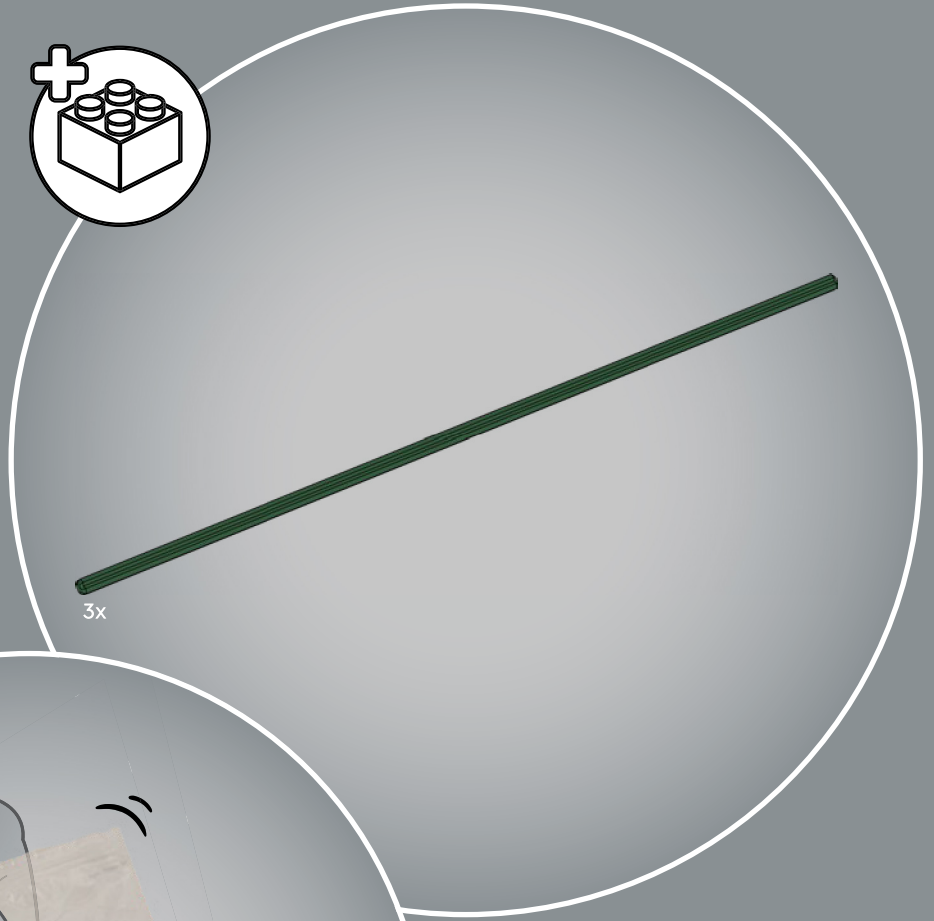
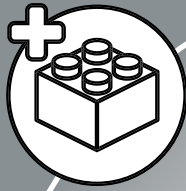

3x





# 12

1

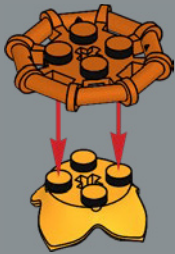

3

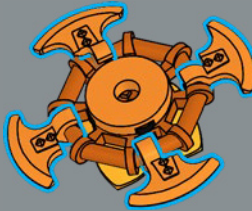

5

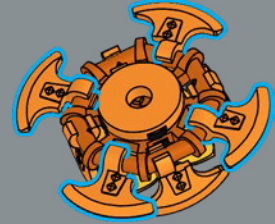

2

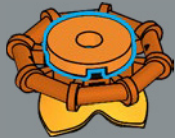

4

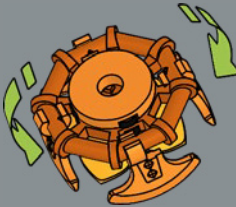

6

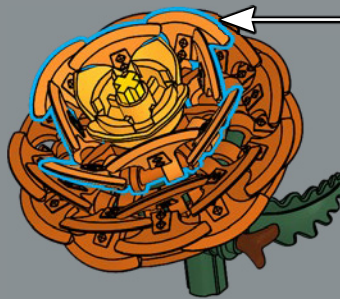
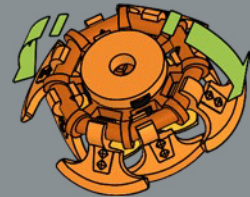

2x

Esta es, quizá, la flor LEGO® que más hachas tiene de todas las que hemos creado.

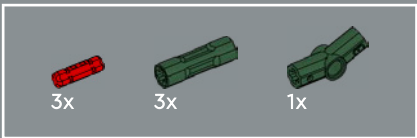

13

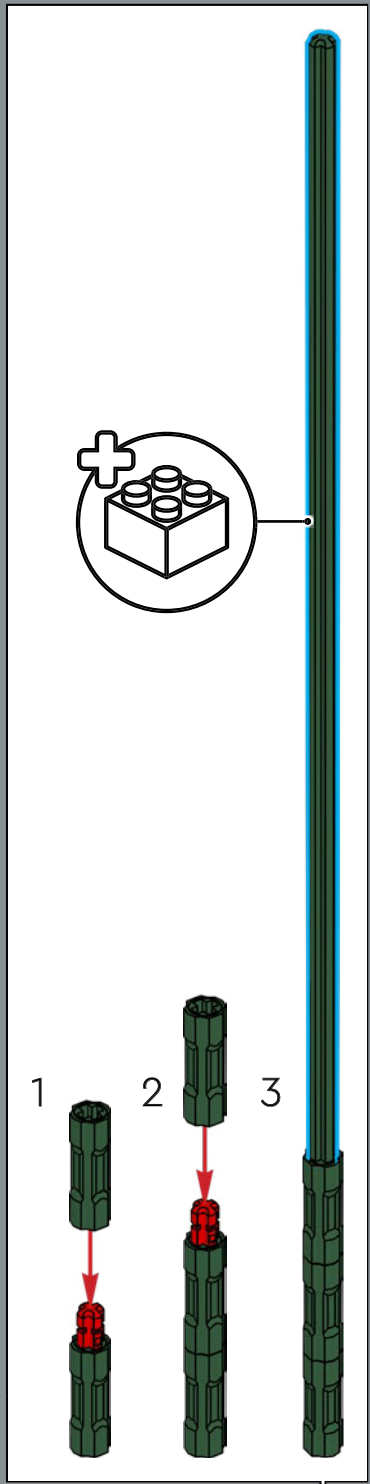
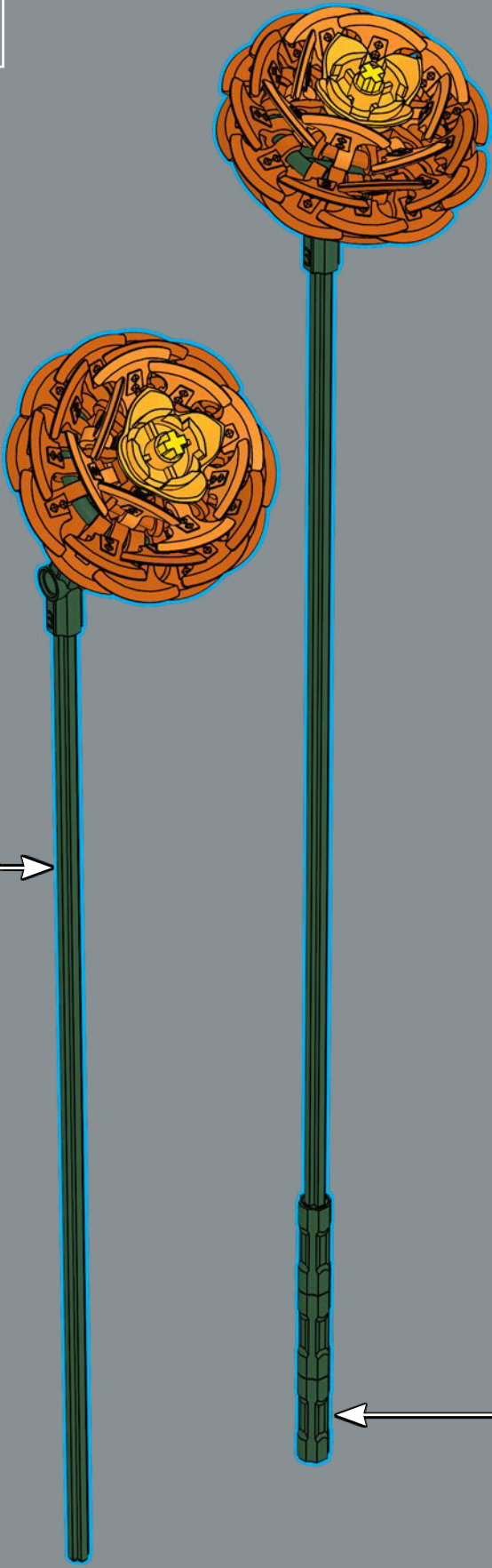
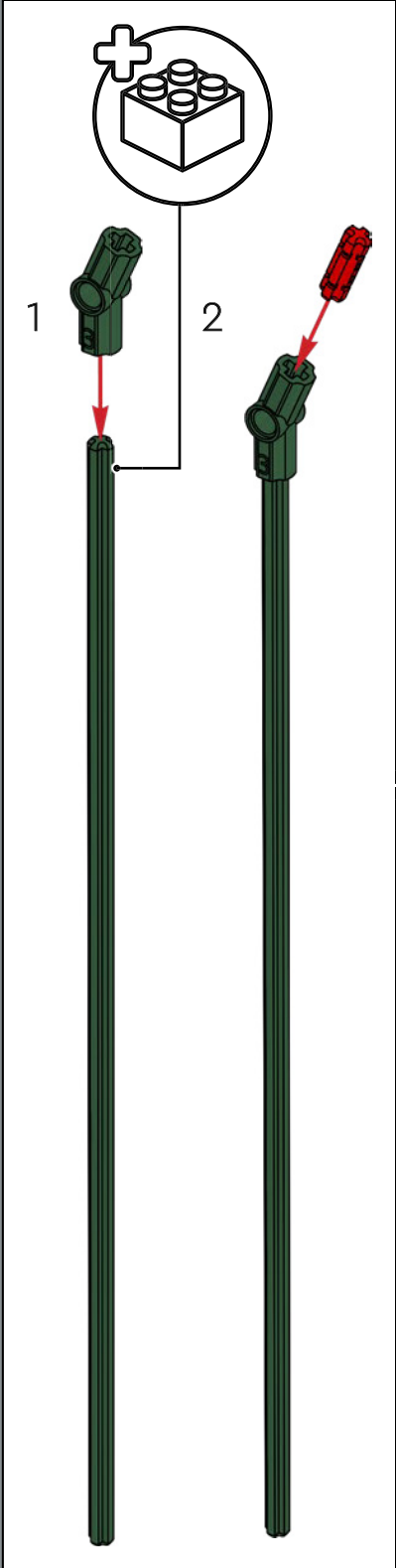

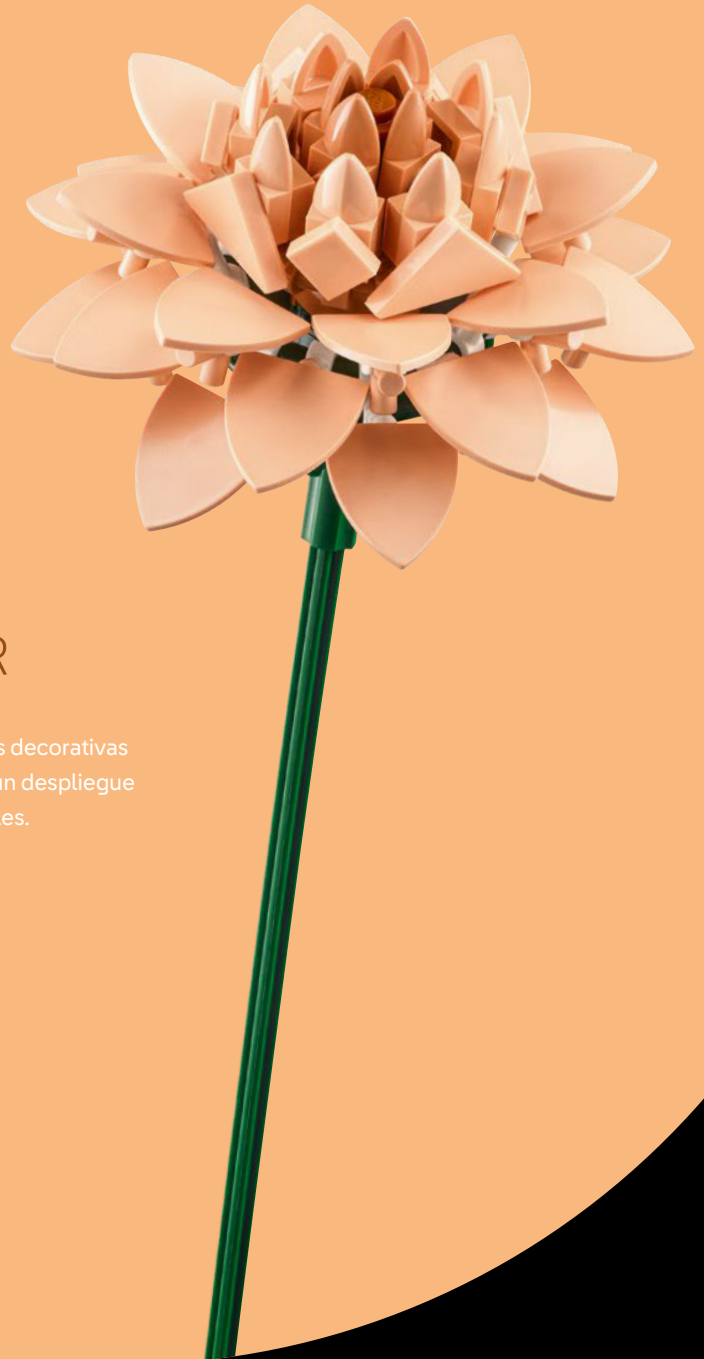

*(Dahlia nymphaea)*

## DALIA NENÚFAR

Símbolos de elegancia y gracilidad, las decorativas flores de la dalia nenúfar se abren en un despliegue semejante a fastuosos fuegos artificiales.

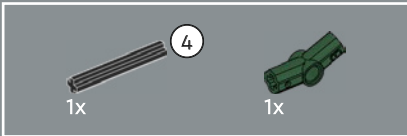
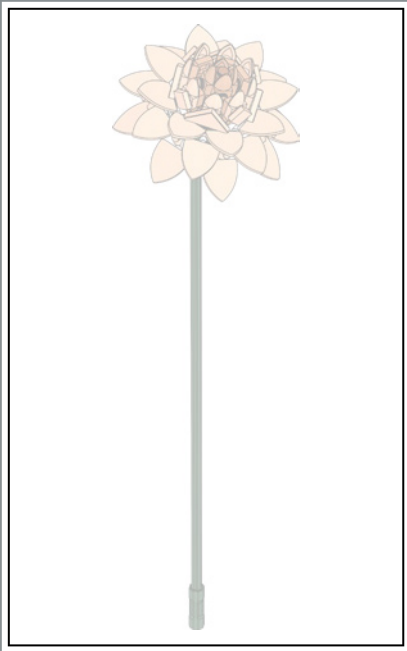

1

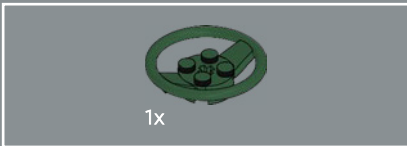

2

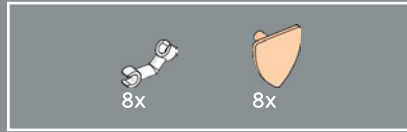
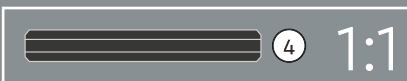
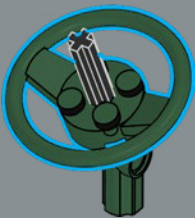

3

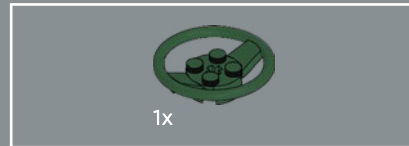
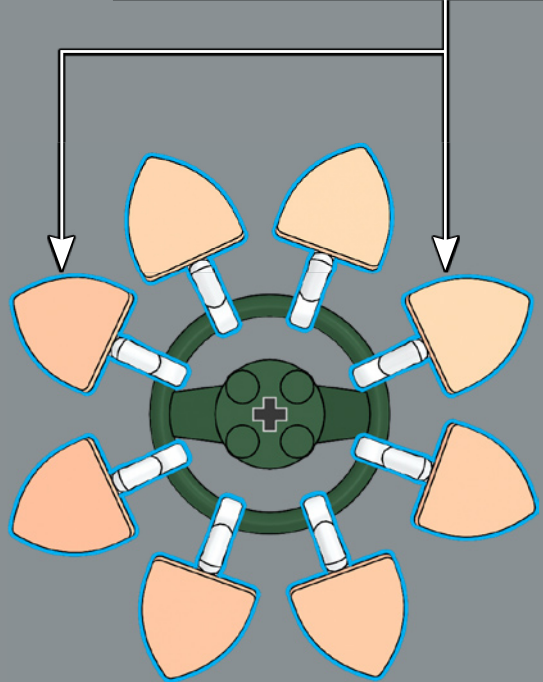
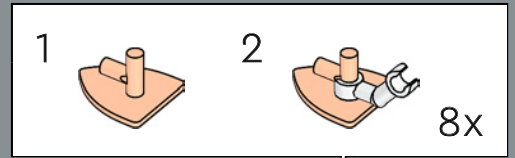

4

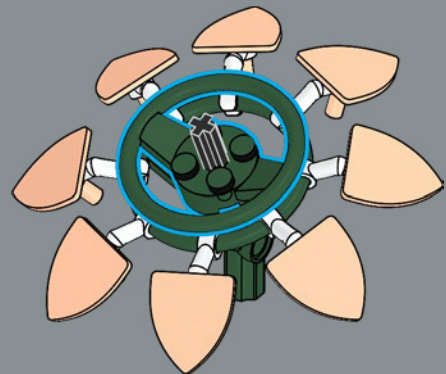



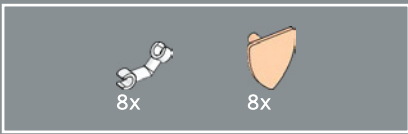

5

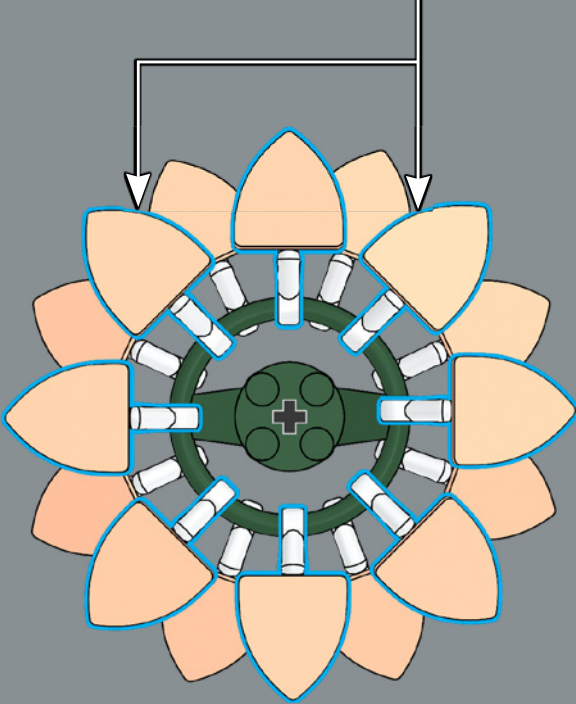
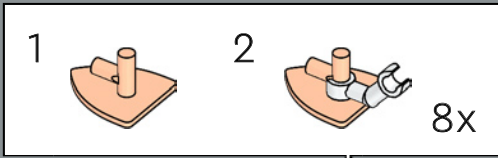

¡Enhorabuena! Ahora puedes cubrirte y resguardarte mejor que nuestros caballeros LEGO® antes de que se introdujeran estos escudos en 1978...

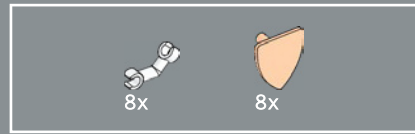

6

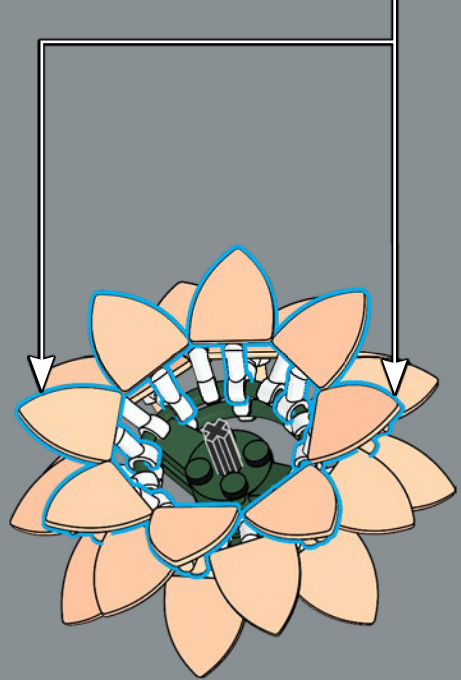
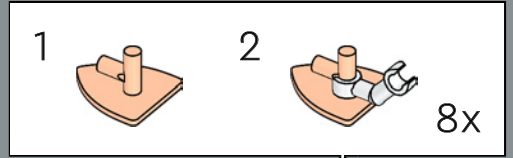

7

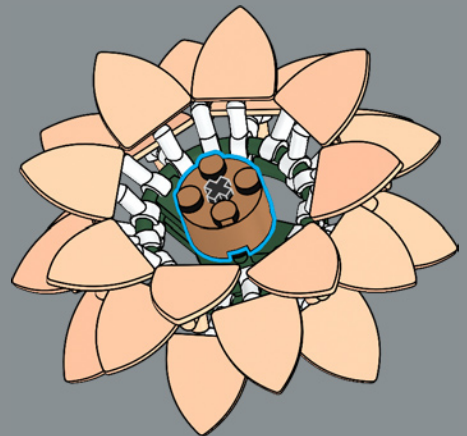

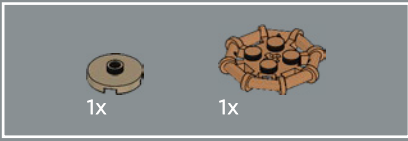

8

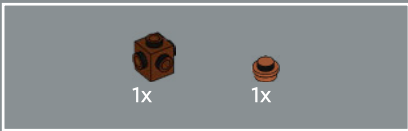
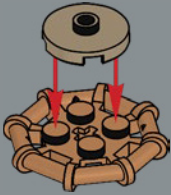

9

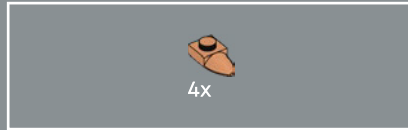
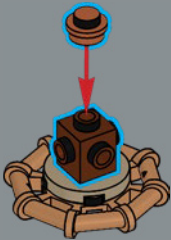

10

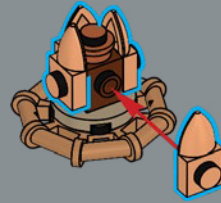

11

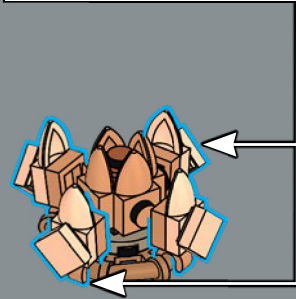
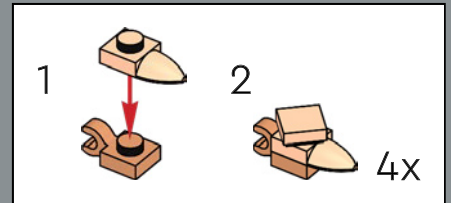



12

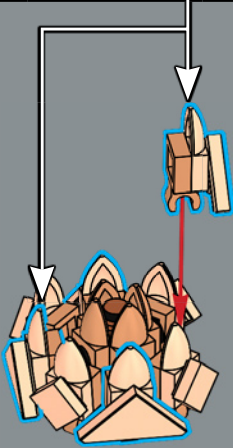
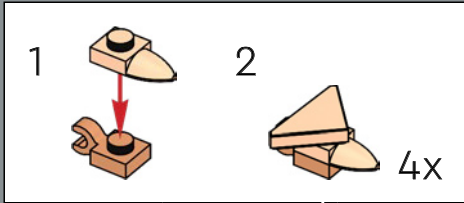

13

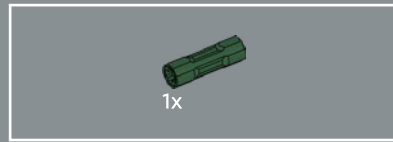
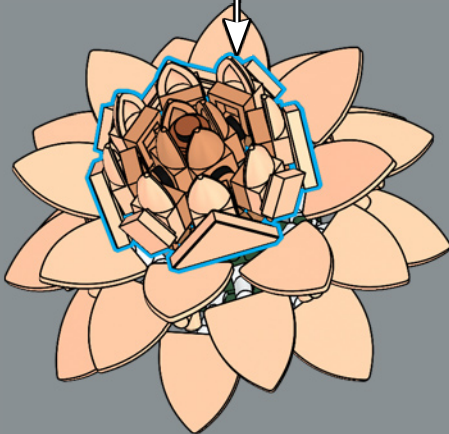

14

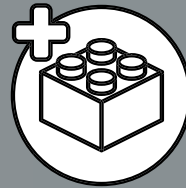
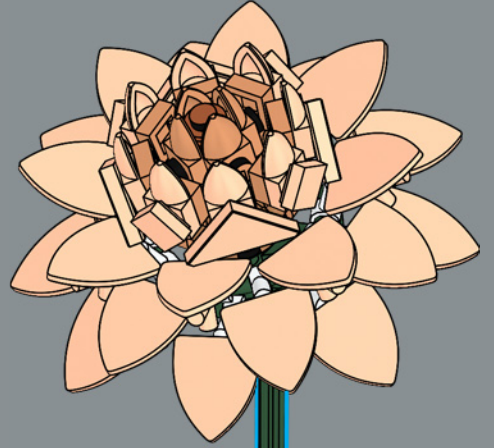



(*Cymbidium*)

## ORQUÍDEA BARCO

Las orquídeas *Cymbidium* aparecen documentadas en registros de la época de Confucio, alrededor del año 500 a. C., lo que las convierte en la especie de orquídea cultivada más antigua que conocemos.

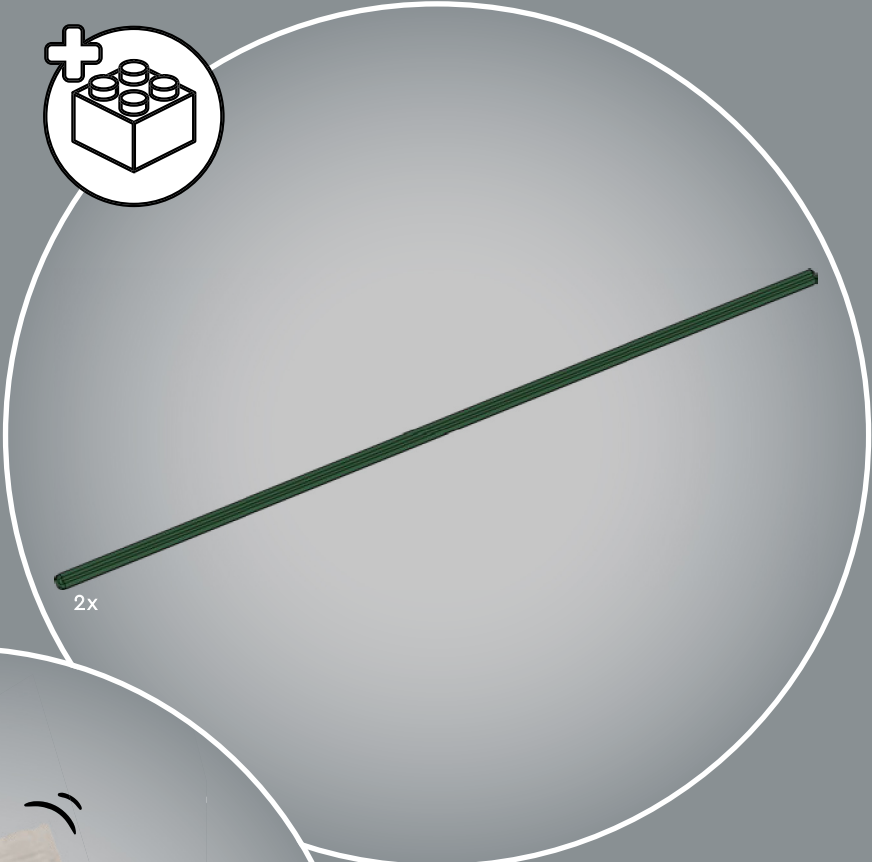
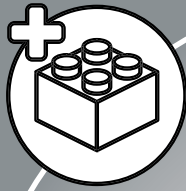

2x



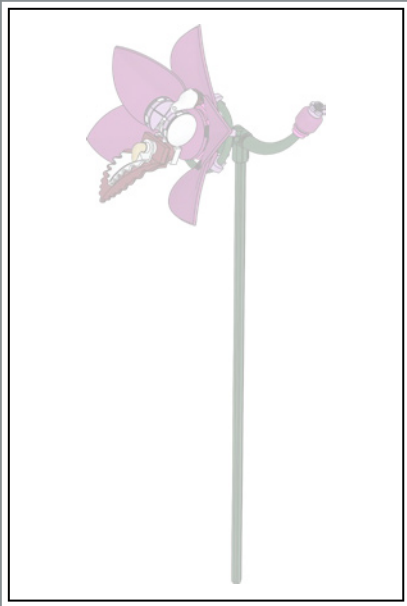

1

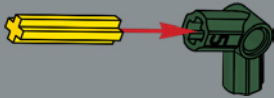

2

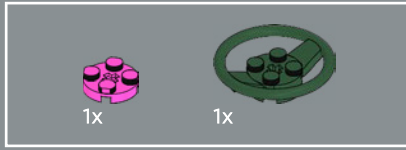
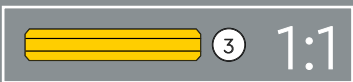
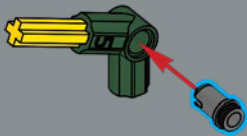

3

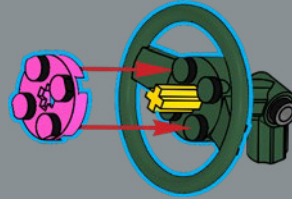

4

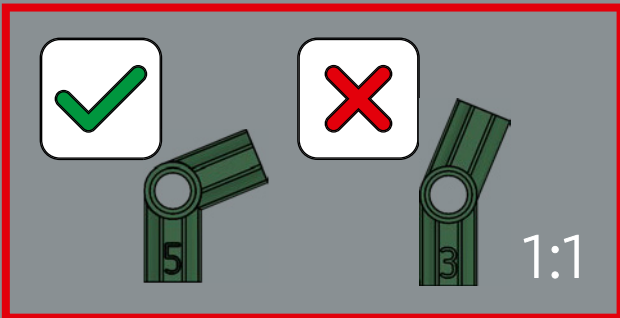
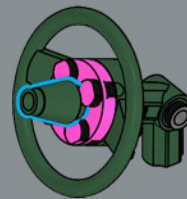
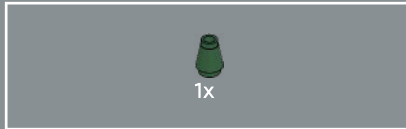

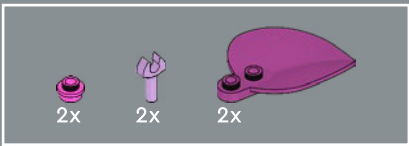

5

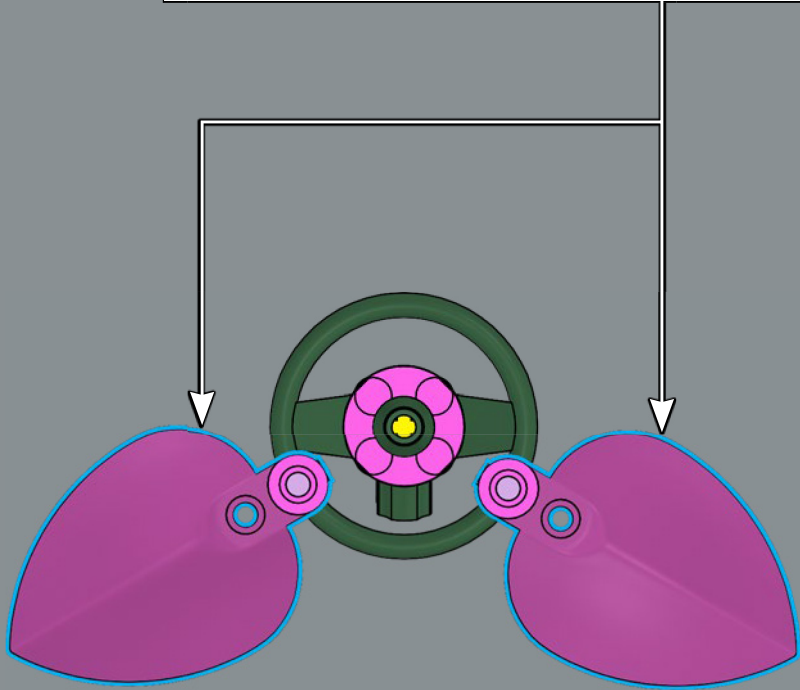
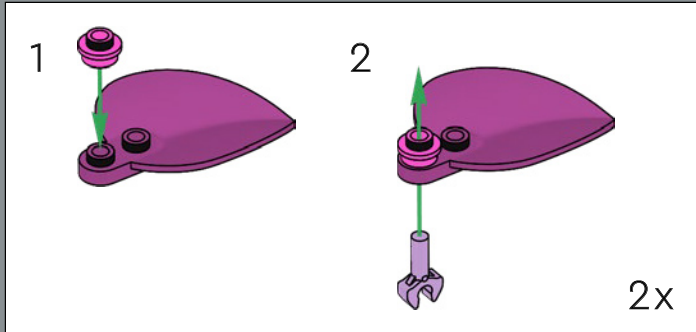



6

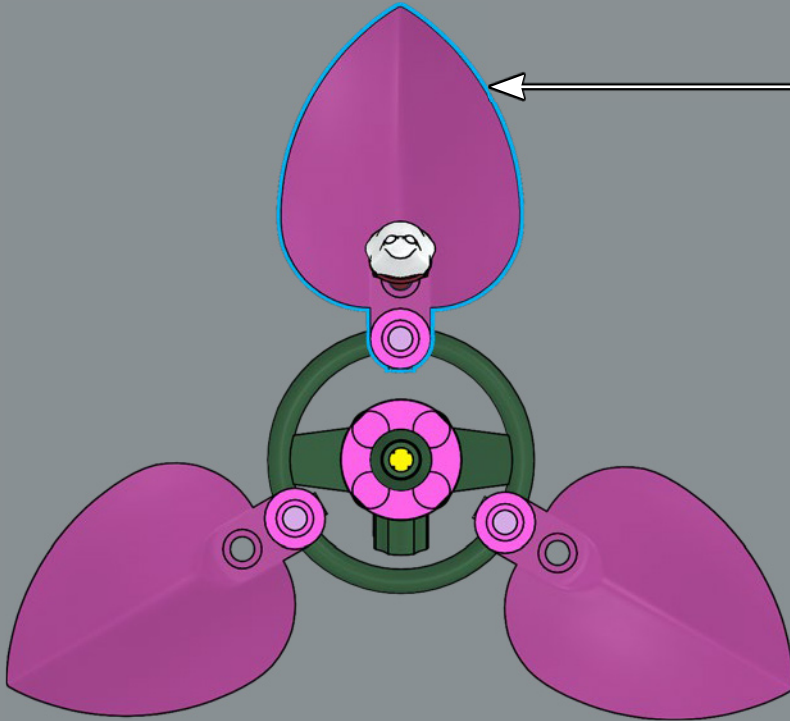
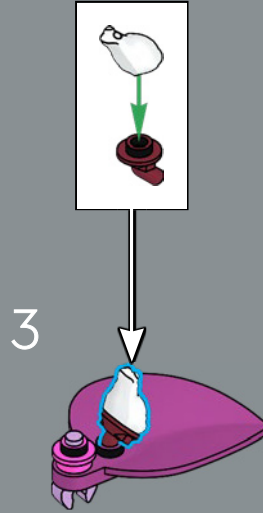
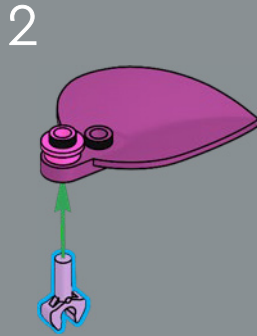
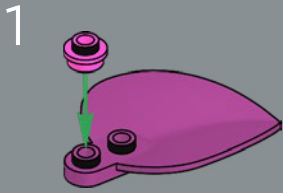

Para recrear partes de una flor puede usarse... ¡hasta una rana LEGO®!



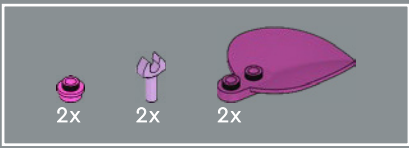

7

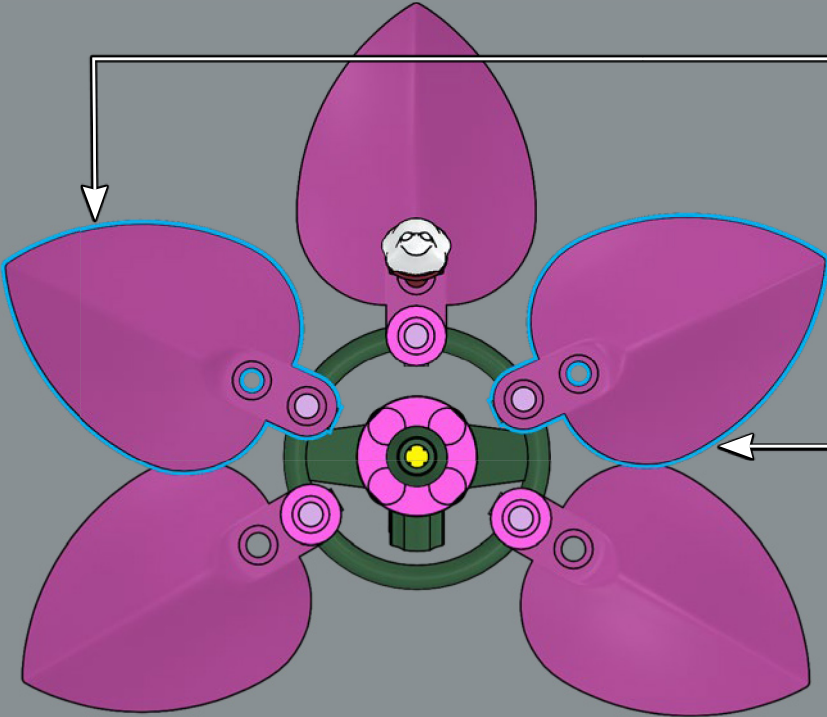
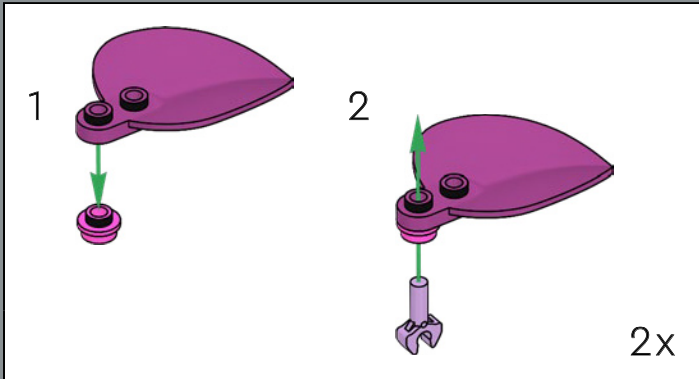

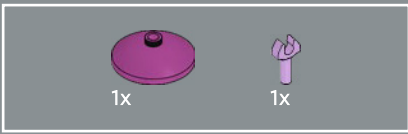

8

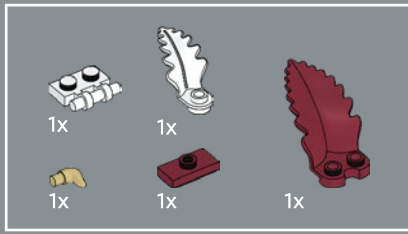
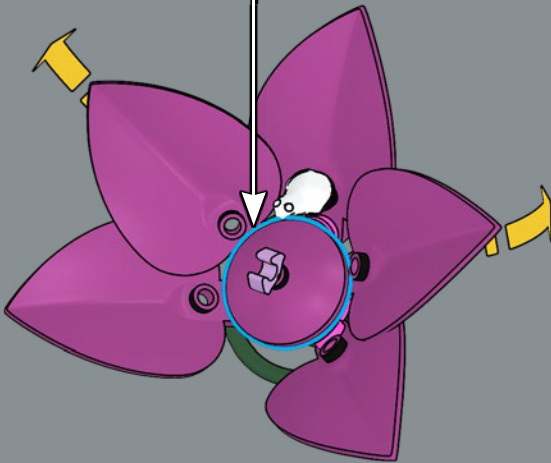
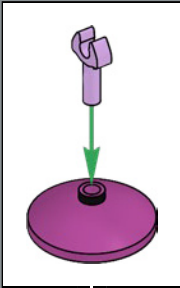

9

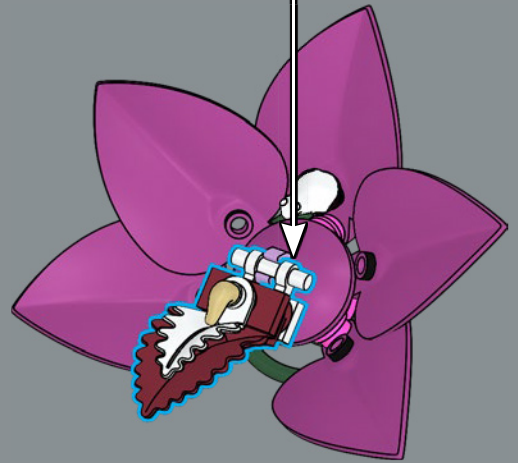
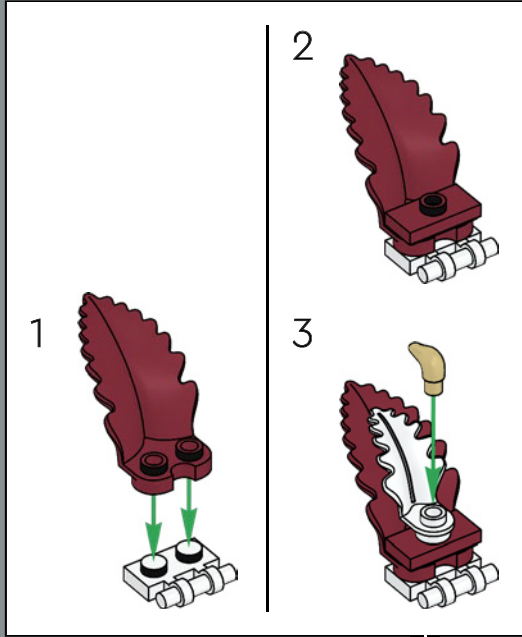



10

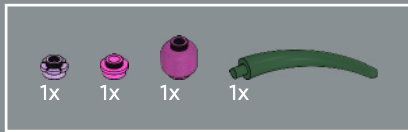
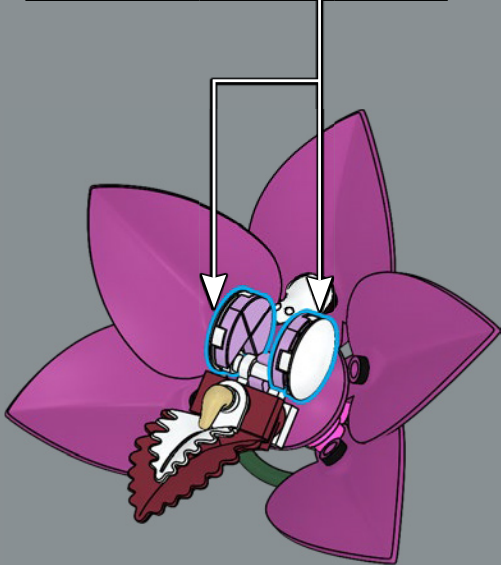
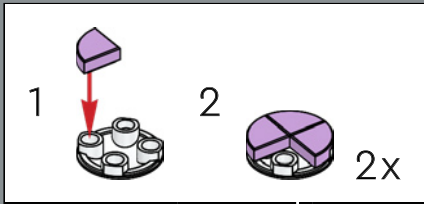

11

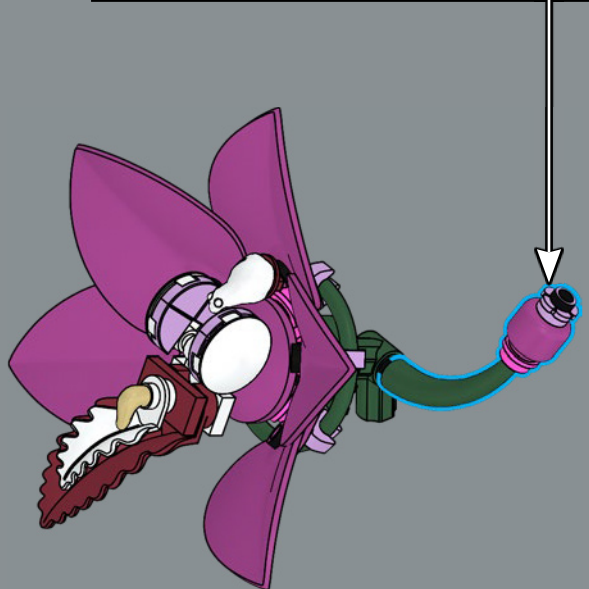
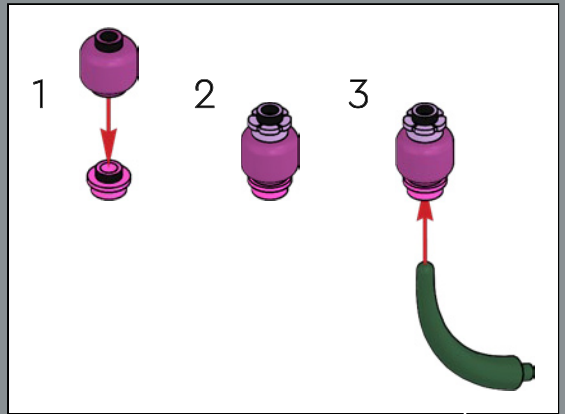

12

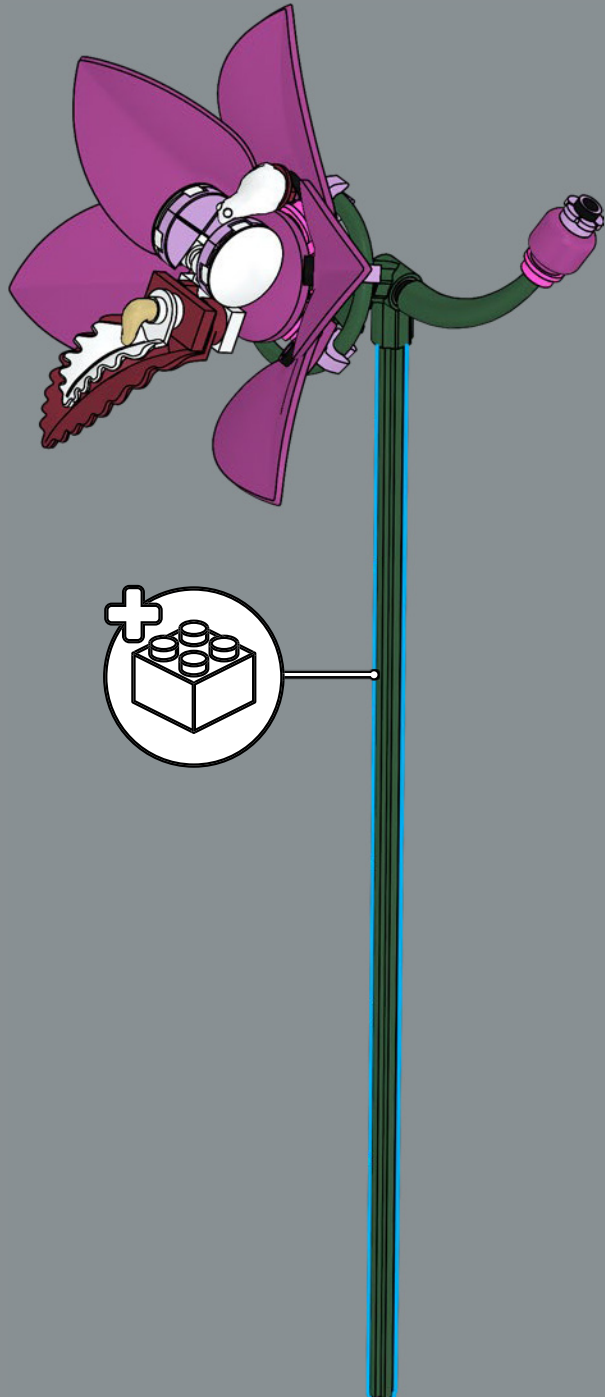

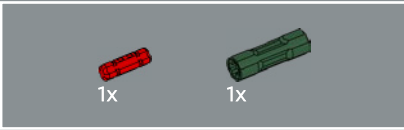
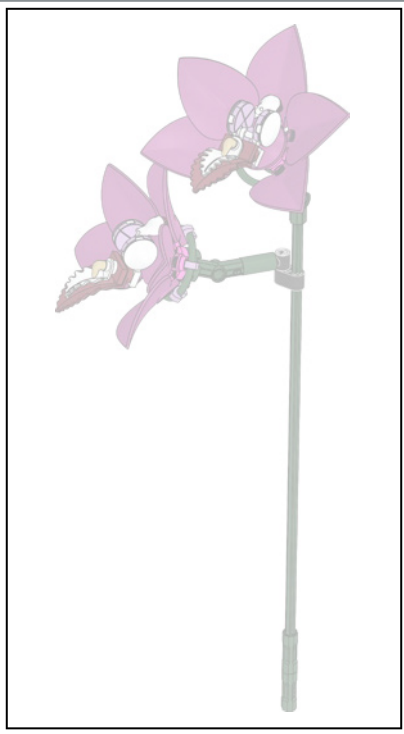

13



14



15



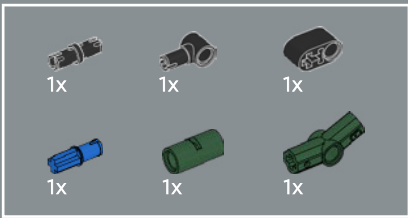

16

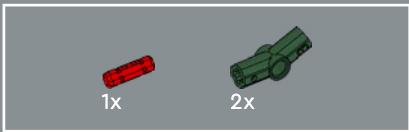
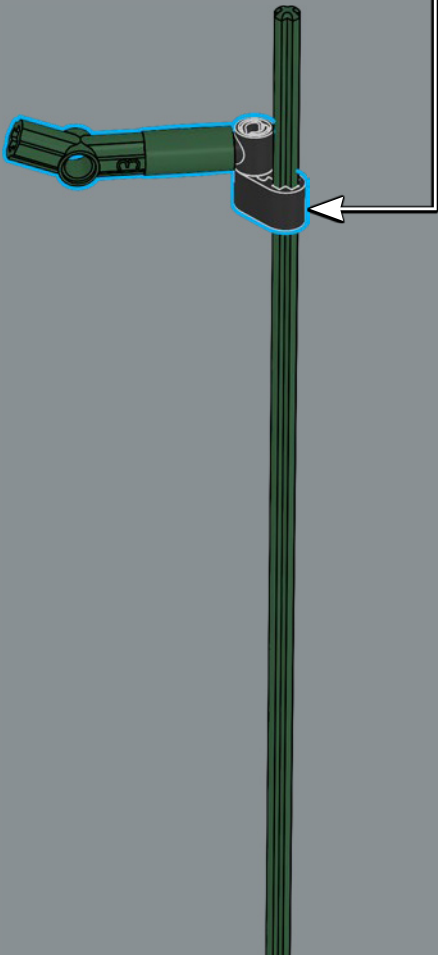
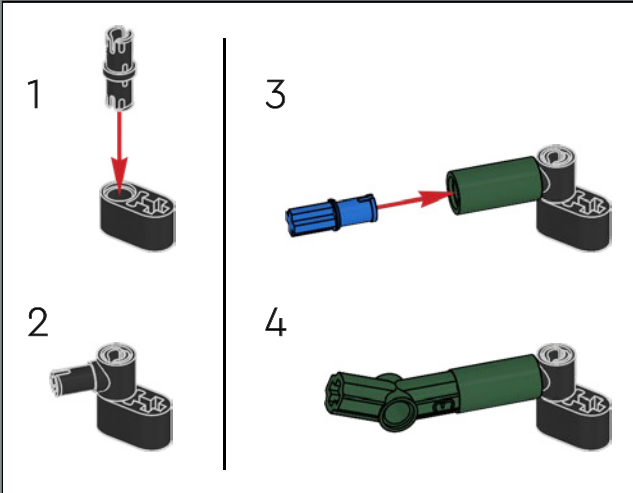

17

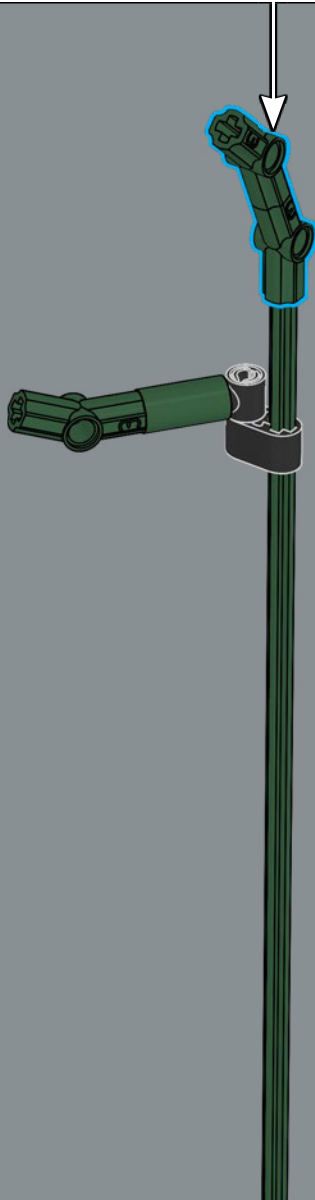
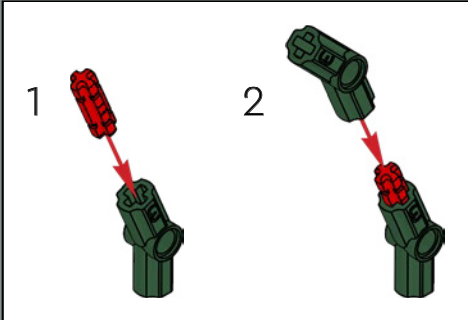

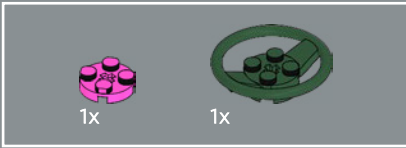
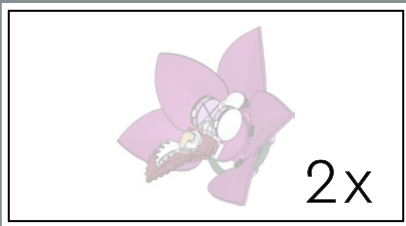

18

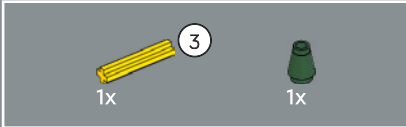
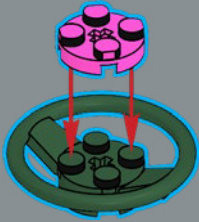

19

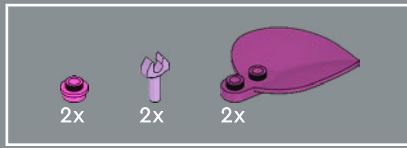
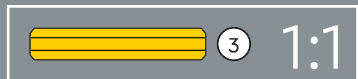
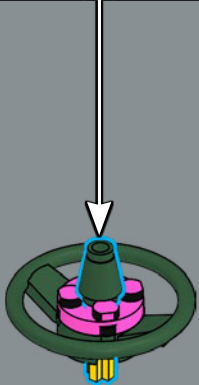
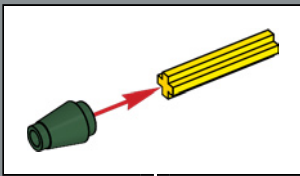

20

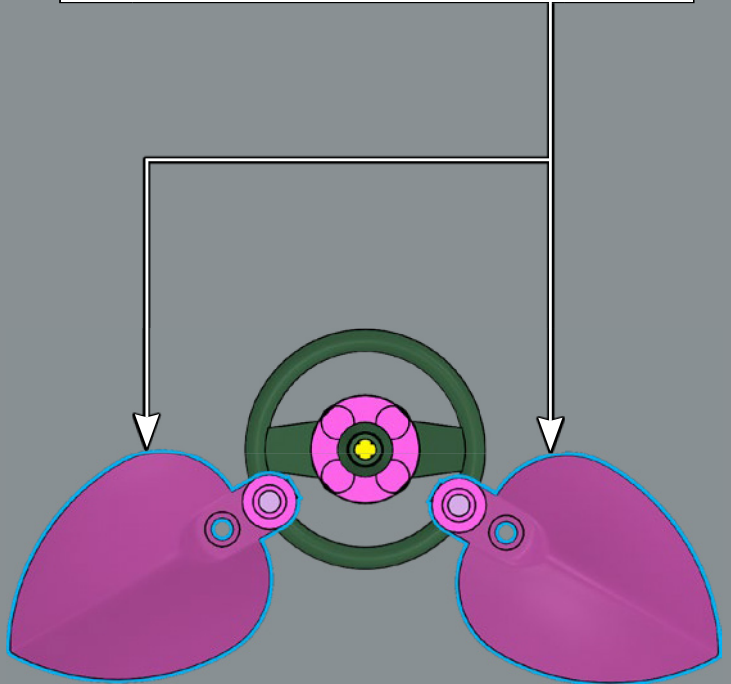
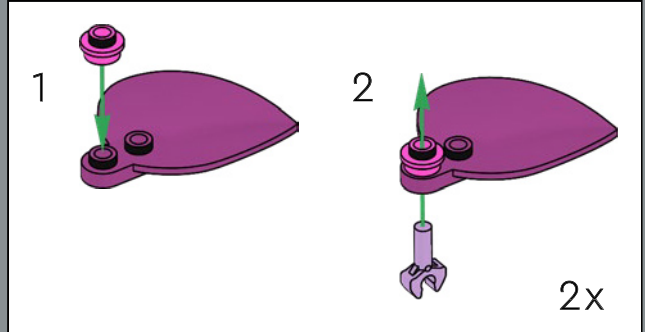



21

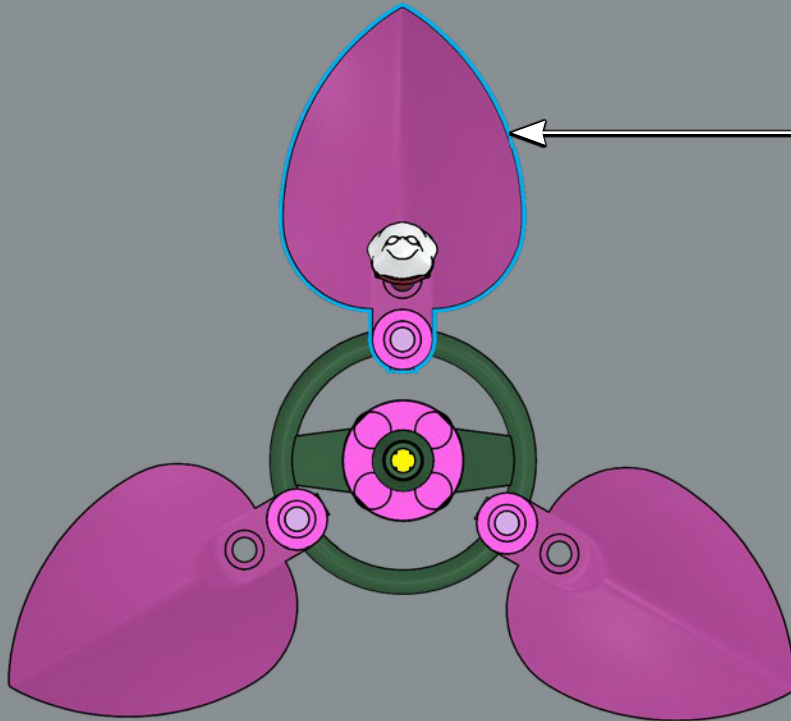
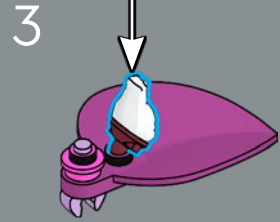
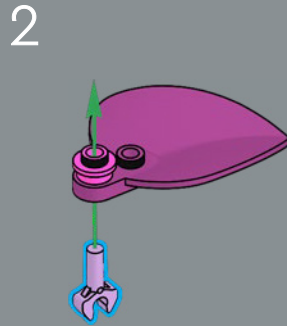
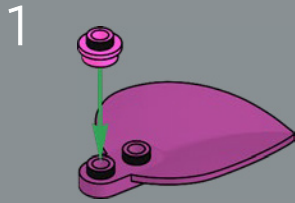
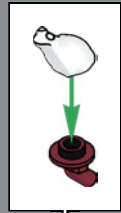



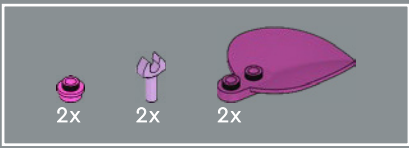

22

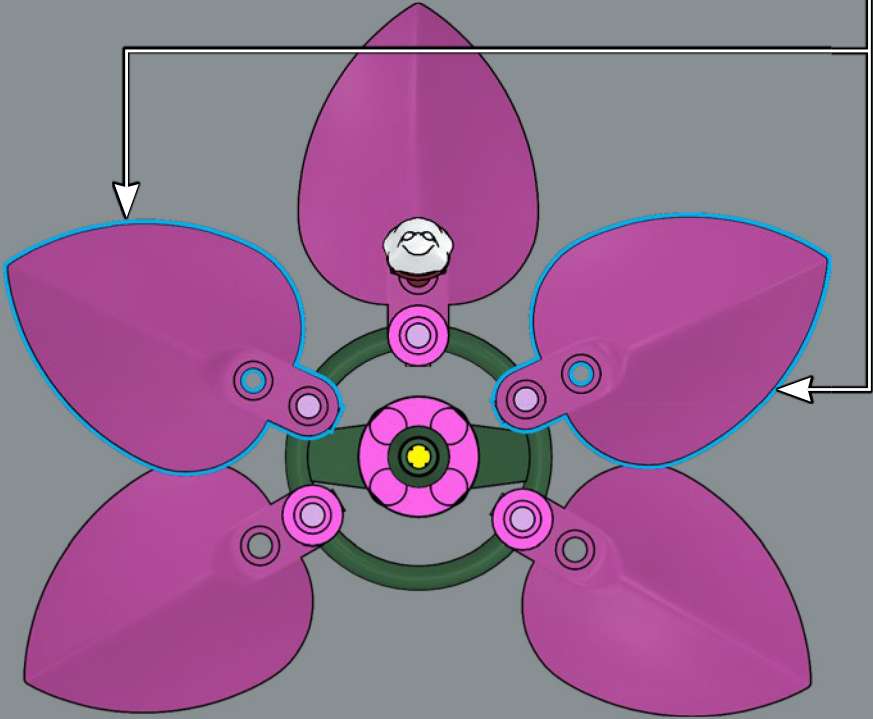
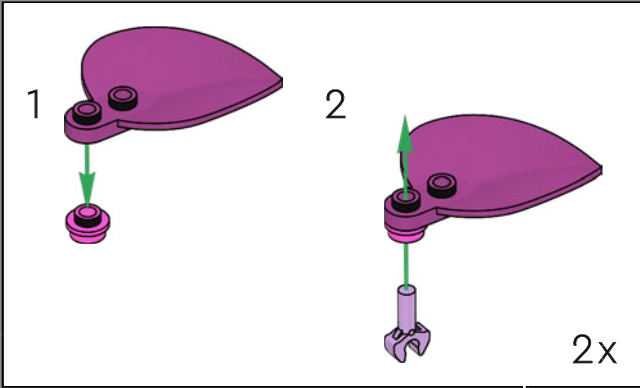

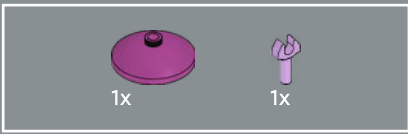

23

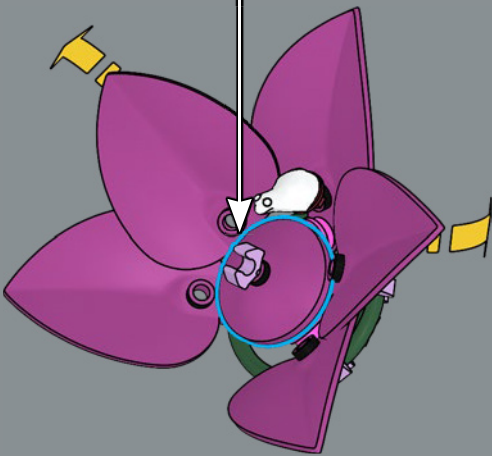
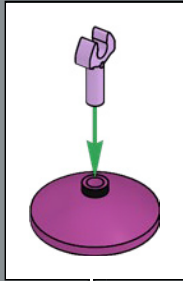

24

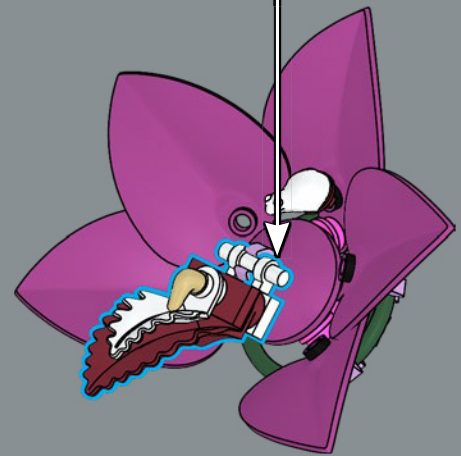
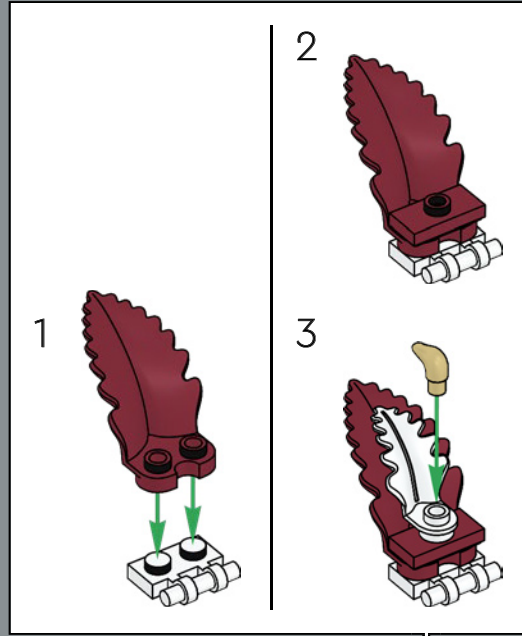

¿Una planta hecha con plantas?  
El labelo de esta orquídea se  
construyó usando dos hojas de  
helecho LEGO®.



25

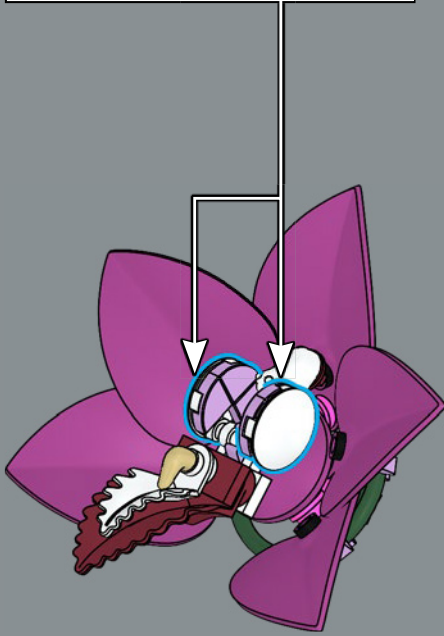
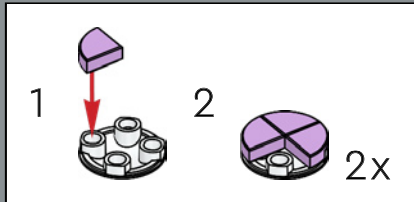

2x

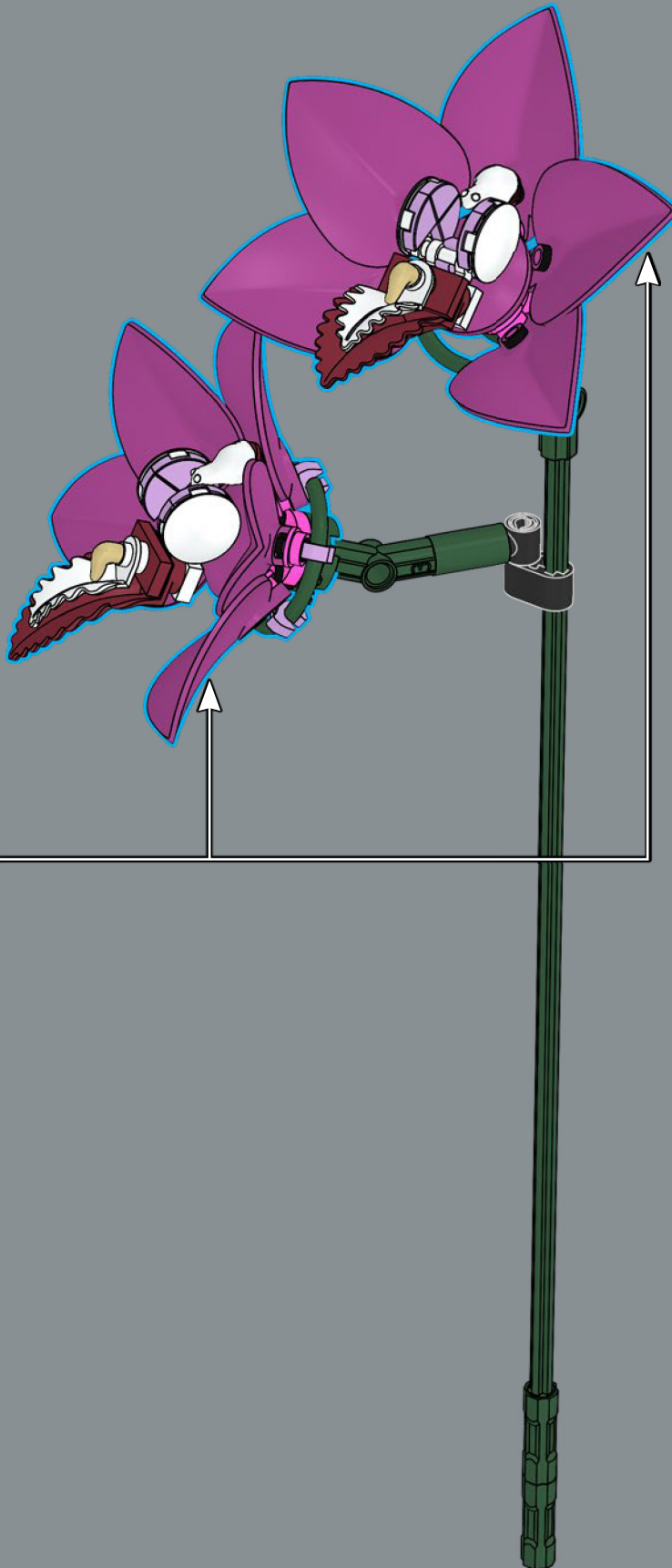

# ■ Crea ramos más grandes

¿Quieres descubrir nuevas especies de flores LEGO®?  
Encuentra más flores y plantas en nuestra colección  
Botanical y llénate de inspiración para crear tus  
propios ramos y arreglos florales.



Descubre más consejos  
creativos con tu cuenta  
LEGO® Insiders en

[LEGO.com/Botanicals-exclusive](https://LEGO.com/Botanicals-exclusive)

- 4x 6206149
- 1x 6279875
- 3x 6498565
- 3x 6510194
- 44x 6525752
- 22x 4516546
- 4x 6398468
- 18x 6439046
- 1x 6282140
- 1x 6349342
- 3x 6092597
- 6x 6316692
- 18x 6240465
- 3x 6298930
- 1x 6265091
- 1x 6515241
- 3x 6529631
- 2x 6510511
- 4x 6267047
- 4x 6211508
- 2x 6525773
- 1x 370526
- 5x 6525789
- 4x 6454729
- 8x 6366184
- 3x 6525849
- 1x 6315782
- 10x 6344177
- 4x 6454729
- 6x 6395635
- 18x 6259700
- 16x 6525753
- 15x 6330196
- 4x 6395635
- 4x 6265702
- 8x 6087084
- 8x 6347293
- 4x 6147052
- 1x 6507841
- 2x 6310174
- 18x 6259700
- 8x 6347293
- 4x 6480394
- 8x 6517933
- 16x 6230582
- 8x 6347293
- 24x 6252200
- 4x 6147052
- 7x 6329283
- 2x 6078605
- 8x 6525786
- 36x 4142865
- 6x 4278271
- 1x 6493246
- 2x 6349130
- 24x 6252200
- 3x 6525769
- 3x 6326495
- 8x 625783
- 6x 4278271
- 3x 6217587
- 1x 6512537
- 2x 6349130
- 3x 6525769
- 3x 6525769
- 36x 4142865
- 4x 403201
- 2x 6519960
- 2x 6529632
- 2x 6349130
- 3x 6525769
- 3x 6525769
- 3x 4206482
- 4x 6429053
- 15x 6519960
- 2x 6529632
- 16x 6525770
- 3x 6525790
- 13x 6130007
- 3x 6439714
- 2x 6270111
- 10x 6474602
- 4x 6480369
- 3x 6525790
- 13x 6130007
- 3x 6439714
- 2x 6270111
- 10x 6474602
- 4x 6480369
- 8x 6296041
- 2x 6130008
- 3x 4140583
- 1x 6132767
- 4x 6474604
- 1x 6454167
- 8x 6296041
- 2x 6130008
- 3x 4140583
- 1x 6132767
- 4x 6474604
- 1x 6454167
- 8x 6296041
- 2x 6130008
- 4x 6468789
- 6x 6522274
- 4x 6525927
- 1x 6177189
- 8x 6456642
- 12x 6510193
- 3x 6368620
- 14x 6230571
- 2x 6035029
- 1x 6177189
- 8x 6456642
- 12x 6510193
- 4x 6525785
- 11x 6411591
- 7x 6447541
- 10x 6360112
- 1x 6214235
- 4x 6096682
- 1x 6104209
- 8x 6525784
- 11x 6411591
- 7x 6447541
- 12x 6468072
- 1x 6214235
- 4x 6096682
- 1x 6104209
- 18x 6439052
- 2x 6525787
- 18x 6251854
- 12x 6526753
- 6x 6348251
- 2x 6223219
- 2x 6525748
- 1x 6329299
- 10x 6523407



 [LEGO.com/service](https://www.LEGO.com/service)



# YOU COULD WIN



## YOU COULD WIN

Your feedback will help shape the future development of this product series.

Visit:

## DU KÖNNTEST GEWINNEN

Dein Feedback trägt zur Weiterentwicklung dieser Produktreihe bei.

Geh auf:

## VOUS POURRIEZ GAGNER

Vos commentaires nous aideront à concevoir les futurs produits de cette gamme.

Visitez :

## POTRESTI VINCERE TU

La tua opinione ci aiuterà a migliorare la creazione futura di questa linea di prodotti.

Visita:

## PUEDES GANAR

Tu opinión contribuirá al futuro de esta serie de productos.

Visita:

## 轻松获奖

您的反馈将有助于我们在今后改进本产品系列。

请访问:

---

# LEGO.com/productfeedback

---

You also have the chance to win a LEGO® set.

Terms and conditions apply.\*

Außerdem hast du die Chance, ein LEGO® Set zu gewinnen.

Es gelten die Teilnahmebedingungen.\*

Vous pourriez également gagner un ensemble LEGO®.

Des conditions s'appliquent.\*

Hai anche la possibilità di vincere un set LEGO®.

Termini e condizioni sono applicabili.\*

También tienes la oportunidad de ganar un set LEGO®.

Aplican términos y condiciones.\*

您还有机会赢取乐高®套装。

条款和条件适用。\*

\*LEGO.com/productfeedback-terms

