



10342





LEGO.com/sustainable-packaging



FR
DONNEZ
OU
RECYCLEZ



OU



OU



ASSOCIATION MAGASIN DÉCHÈTERIE

Adresses sur quefairedemesdechets.fr



BUiLDER

Download on the
App Store

GET IT ON
Google Play

 **腾讯应用宝**
安卓应用商店

Apple and the Apple logo are trademarks of Apple Inc., registered in the U.S. and other countries and regions. App Store is a service mark of Apple Inc. Google Play and the Google Play logo are trademarks of Google LLC. Tencent and the Tencent logo are trademarks of Tencent Inc.

 LEGO.com/devicecheck



 **LEGO® Builder**



EN Build It Your Way | **DE** Bau, wie du willst | **FR** Construisez à votre façon | **IT** Costruiscilo come vuoi tu | **ES** Constrúyelo a tu manera
| **PT** Constrói à Tua Maneira | **ZH** 自由拼搭 | **PL** Zbuduj po swojemu | **CS** Postavte to po svém | **SK** Postavte to po svojom | **HU** Építs kedved szerint!
| **RO** Construięște așa cum dorești | **BG** Постройте го по своя начин | **LV** Būvē tieši tā, kā vēlies | **ET** Ehita enda moodi | **LT** Sukonstruokite savaip

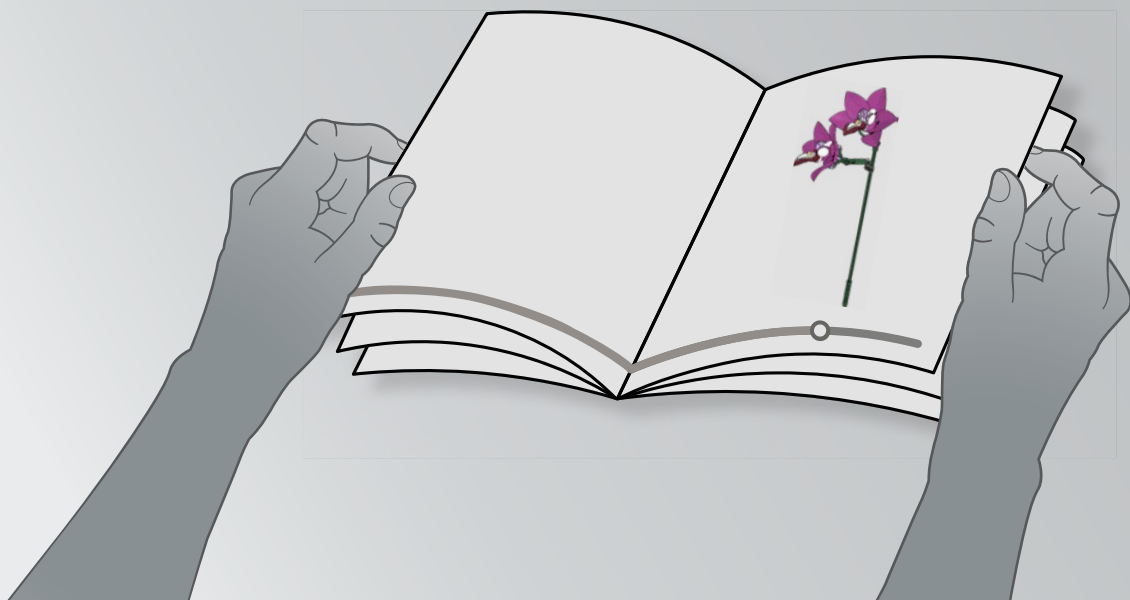
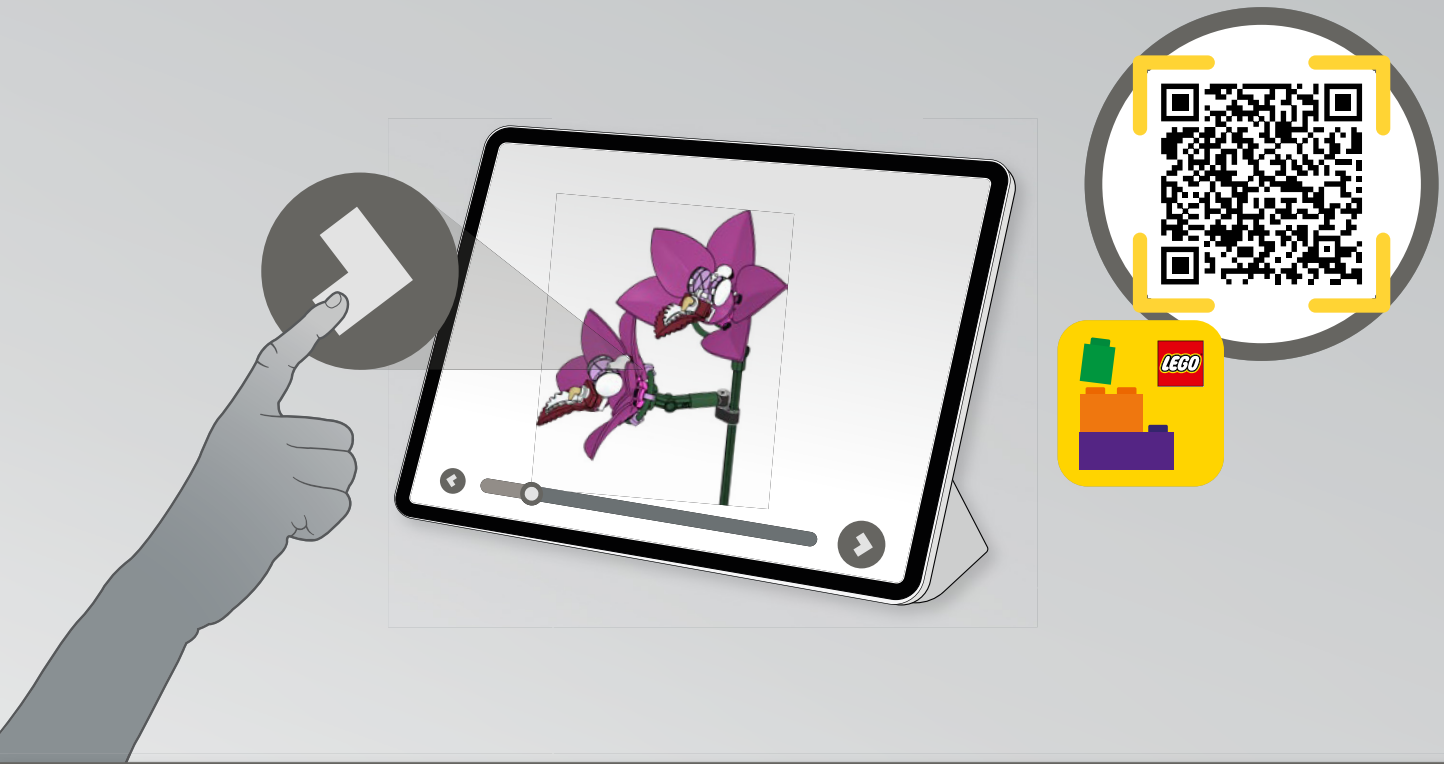



Von Natur aus elegant

Wenn wir ein LEGO® Blumenmodell entwerfen, liefert uns die Natur eine unfassbare Vielfalt an Farben, Pflanzenarten und Düften als Vorlage. Wir haben Blüten in Pastelltönen und kräftig leuchtenden Farben mit eleganten immergrünen Pflanzen kombiniert und dabei mit neuen Bautechniken und der kreativen „Zweckentfremdung“ bereits vorhandener LEGO Elemente experimentiert, um diesen üppigen Blumenstrauß zum Leben zu erwecken. Jedes Detail wurde akribisch nachgebildet, um eine möglichst authentische und kunstvolle Hommage an die diversen Schätze der Natur zu erschaffen.

Das LEGO® Botanicals Designteam

Diese bei Bienen und Schmetterlingen äußerst beliebte Schönheit gedeiht in Europa und Nordamerika. Einst galt sie eher als wehrhaftes Unkraut, doch heute schmückt sie so manchen Zierstrauß.



(Centaurea cyanus)

KORNBLUME



(Eucalyptus pulverulenta)

SILBERBLÄTTRIGER EUKALYPTUS

Dieser Vertreter der Eukalyptusart bereichert viele Blumensträuße rund um den Globus.



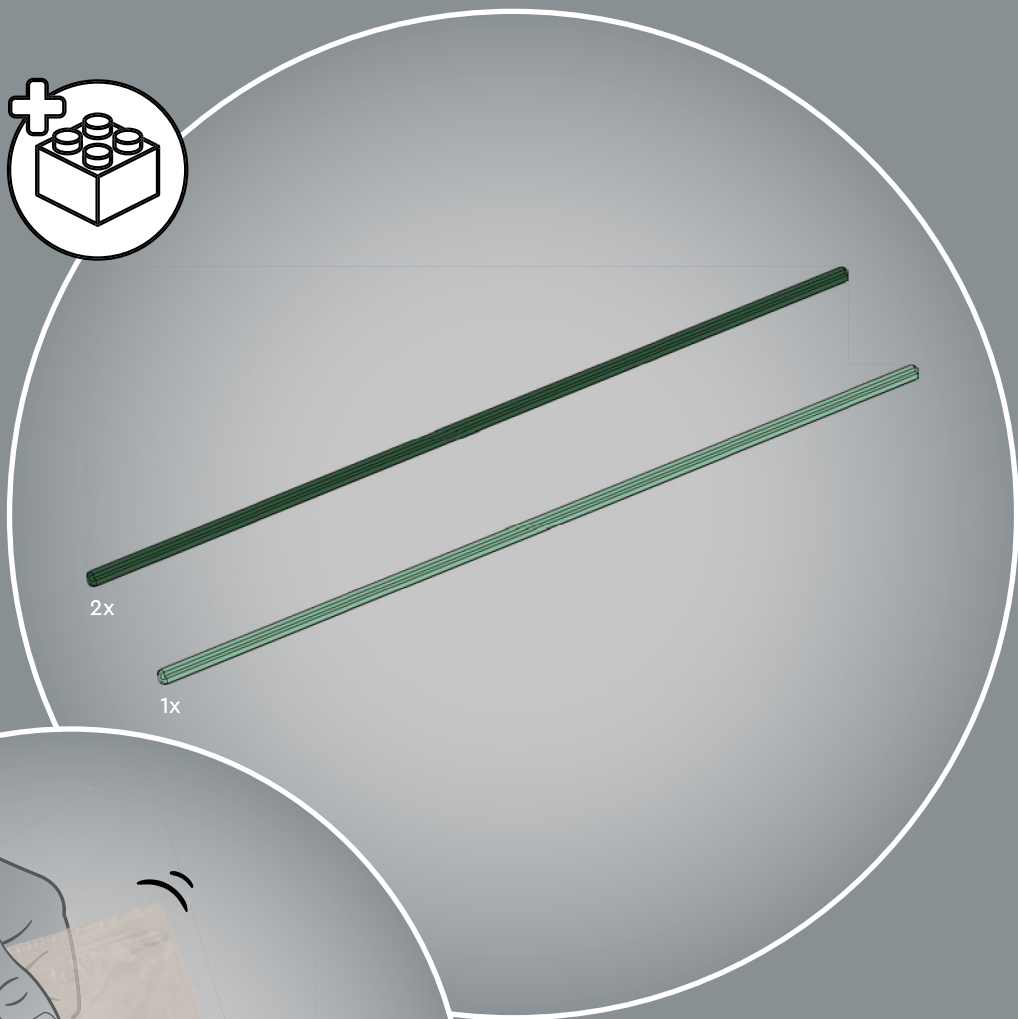
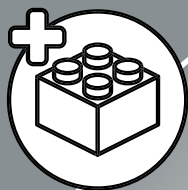

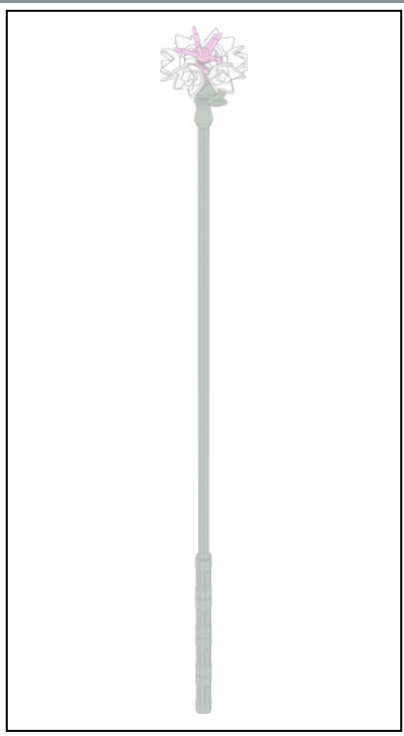

1

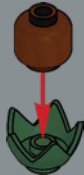

2



3

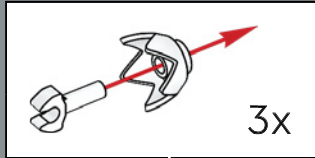

4

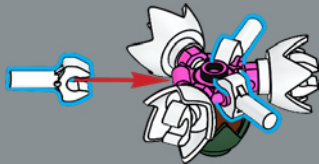

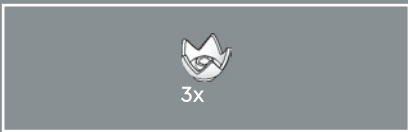

5

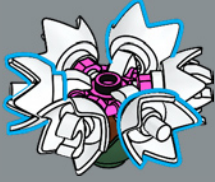

Die als Blütenblätter benutzten kleinen LEGO® Steine waren ursprünglich Kronen, die die Häupter von Minifiguren schmückten.



6

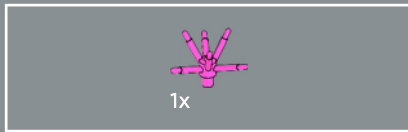
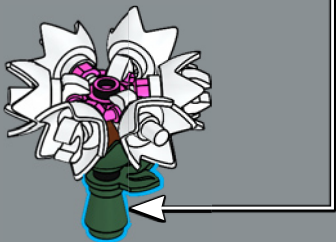
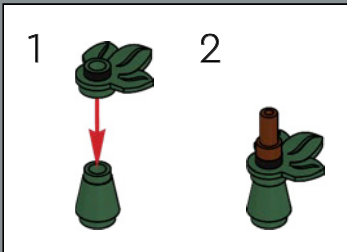

7

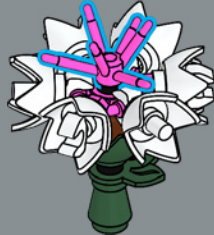

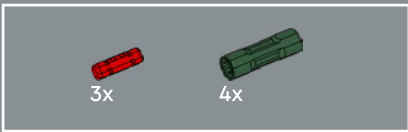

8

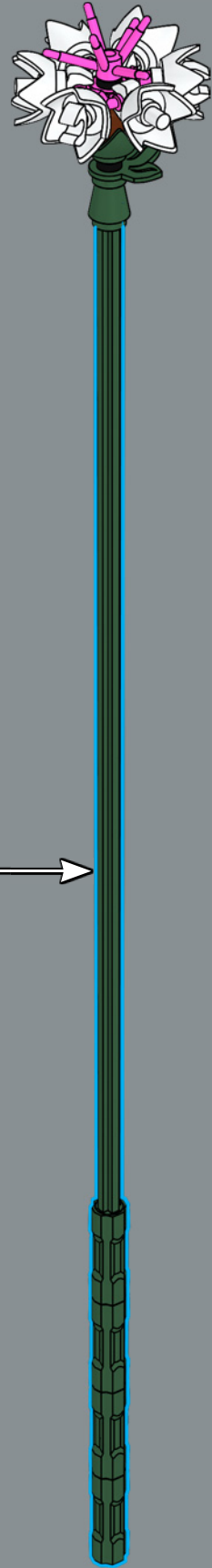
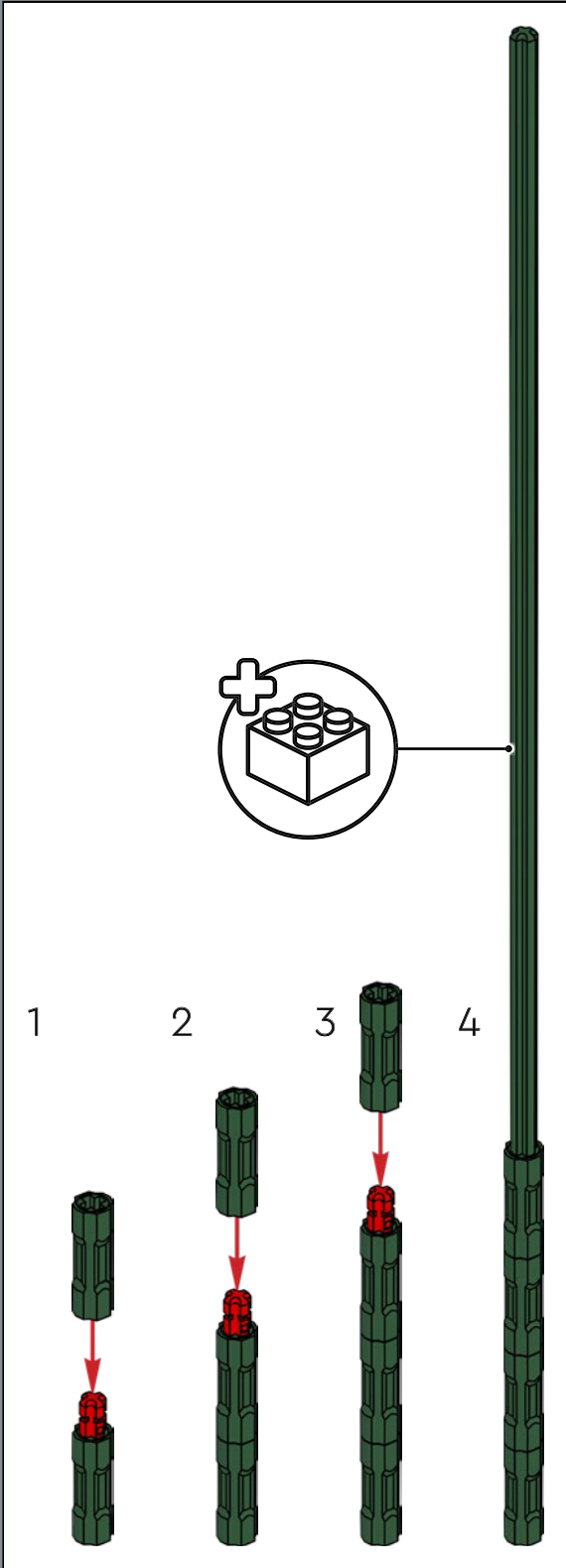

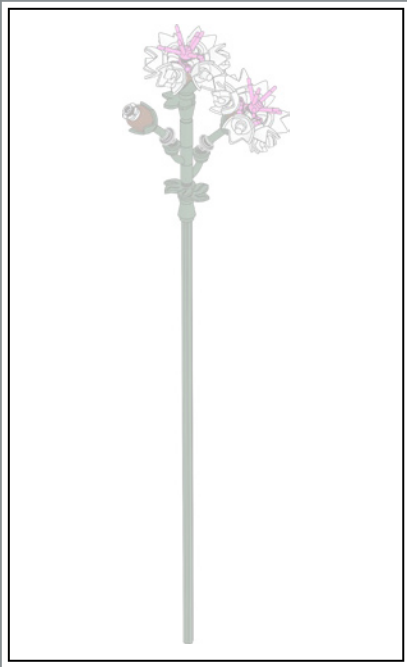

1

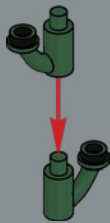

2

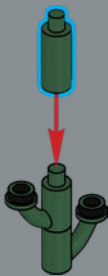

3

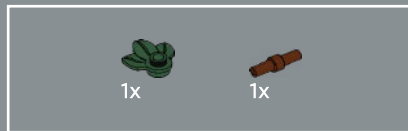
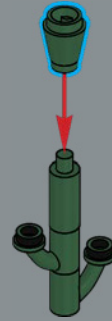

4





5



6

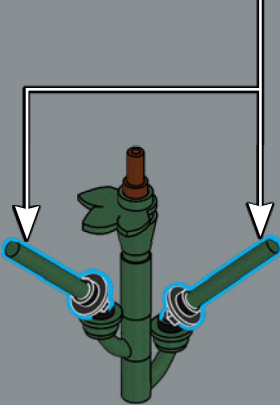
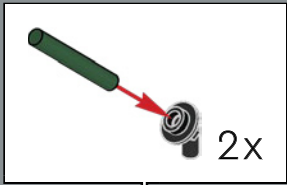

7

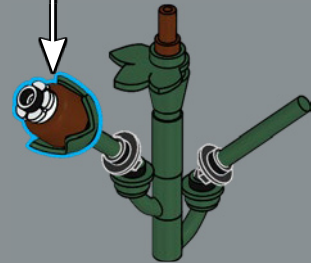
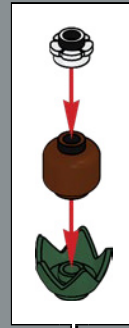



8

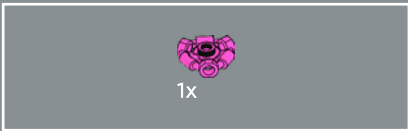
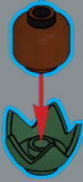

9



10

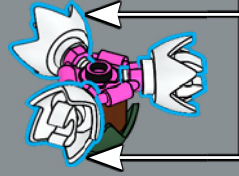
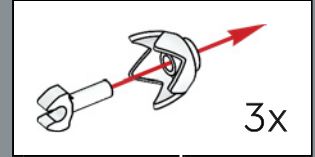

11

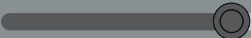
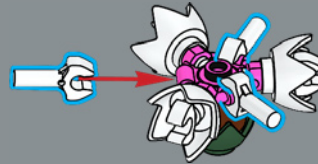

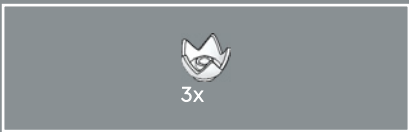

12

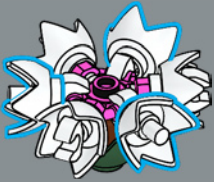

13



2x

14

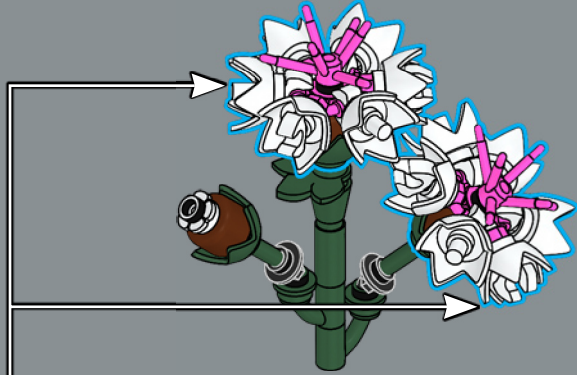

15

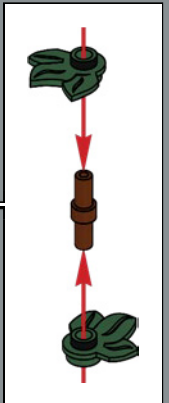
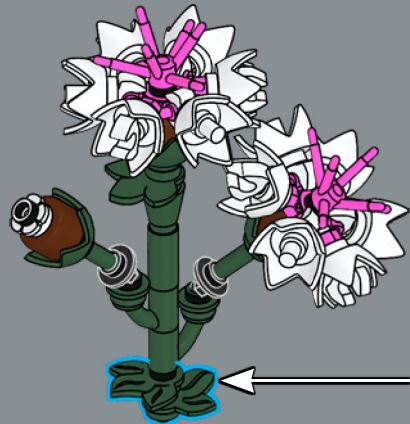



16

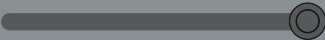
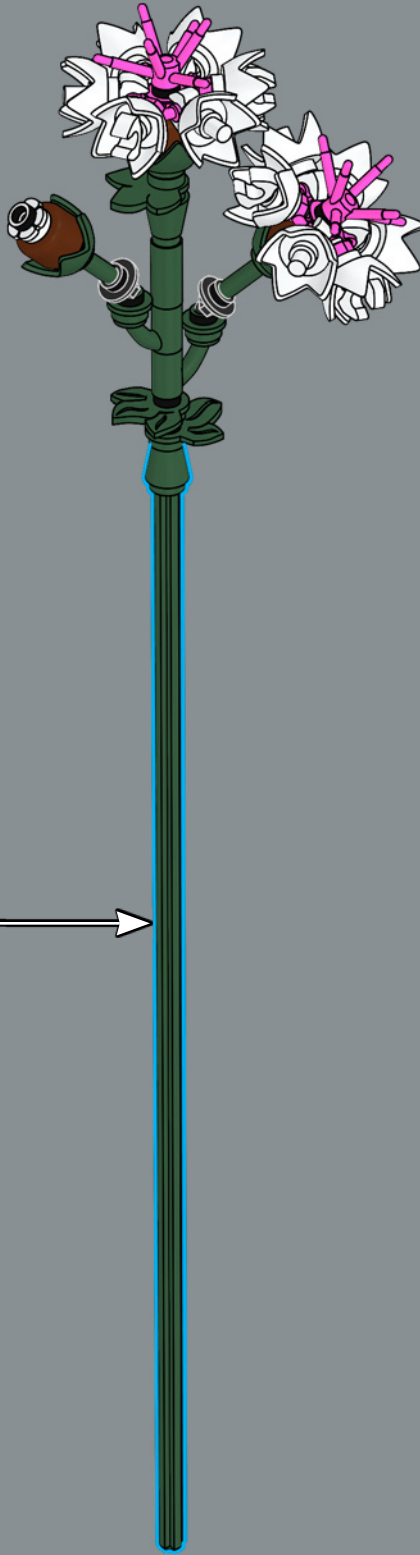
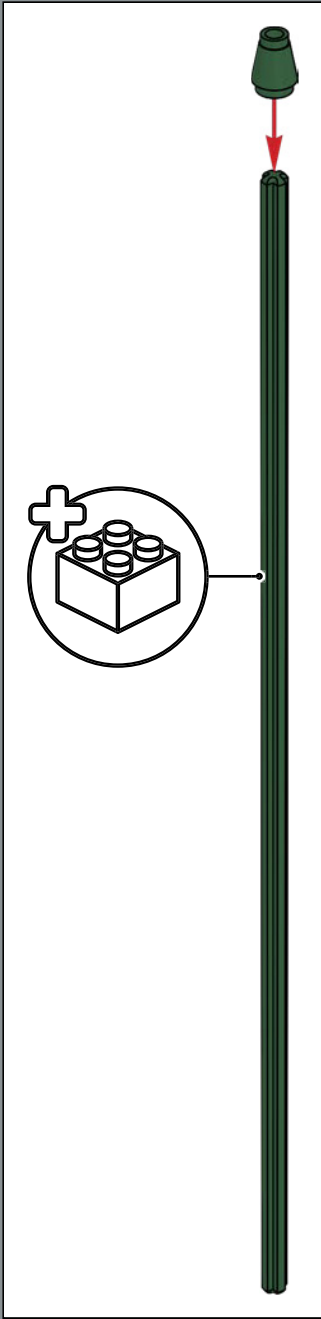

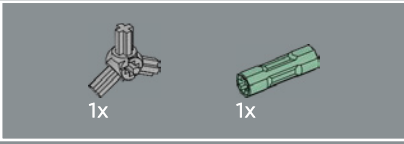

1

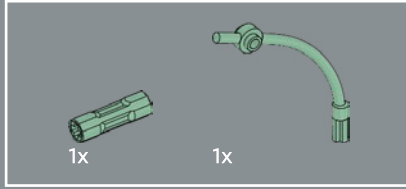
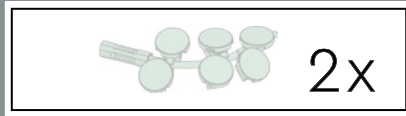
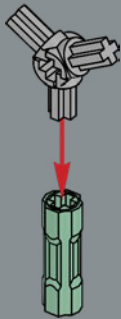

2

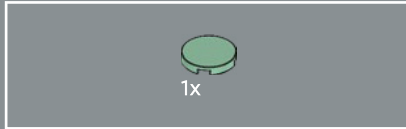
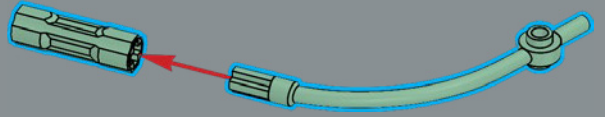

3

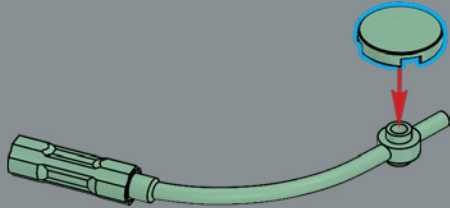



4

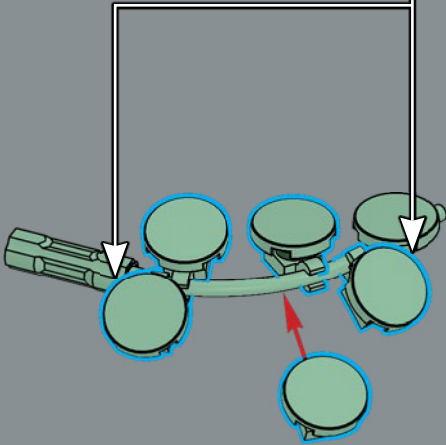
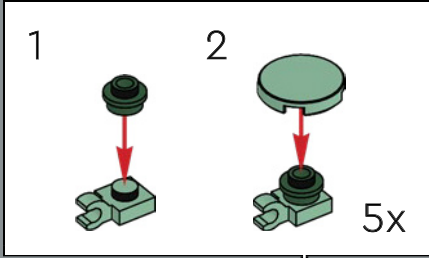

5

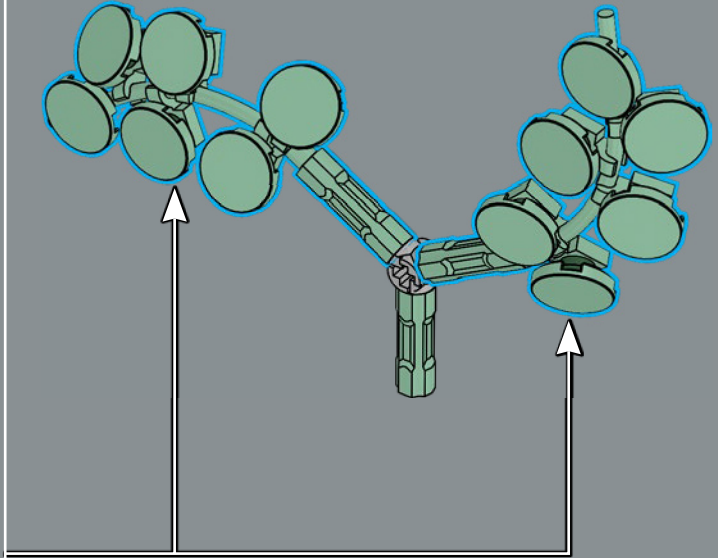



6

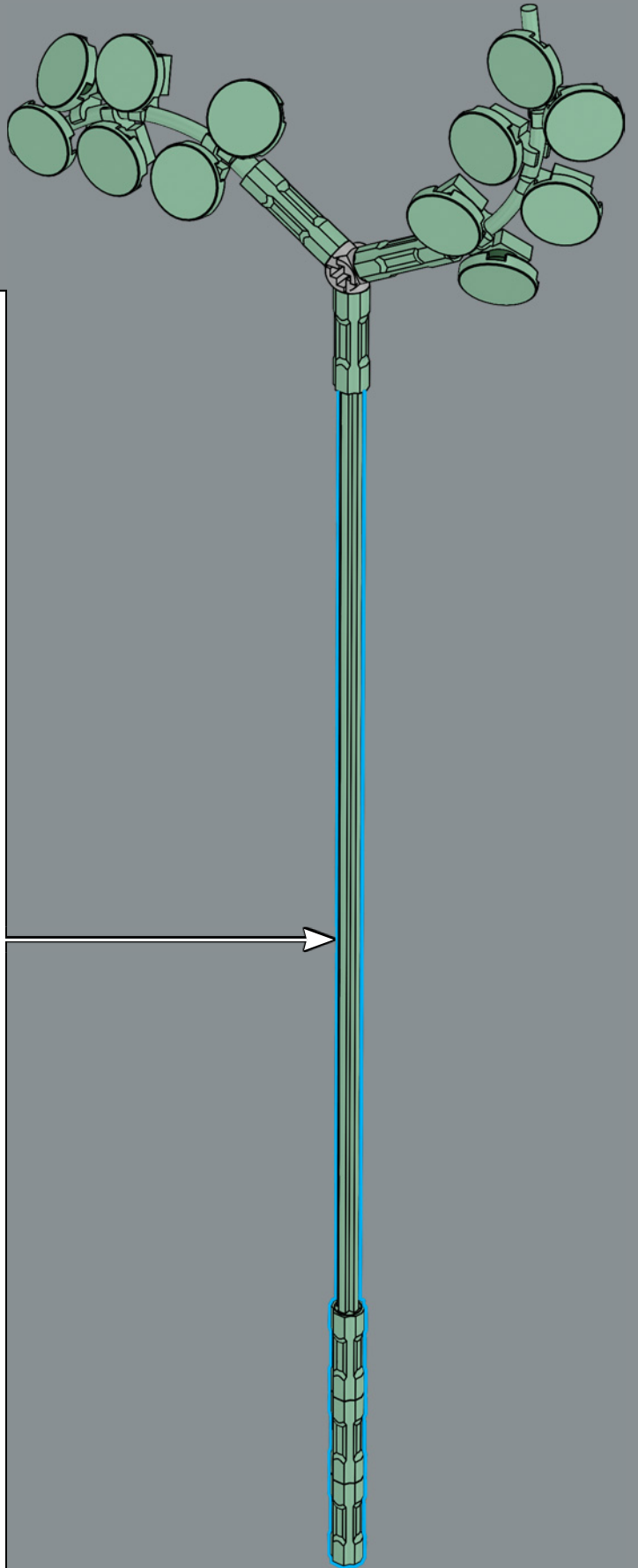
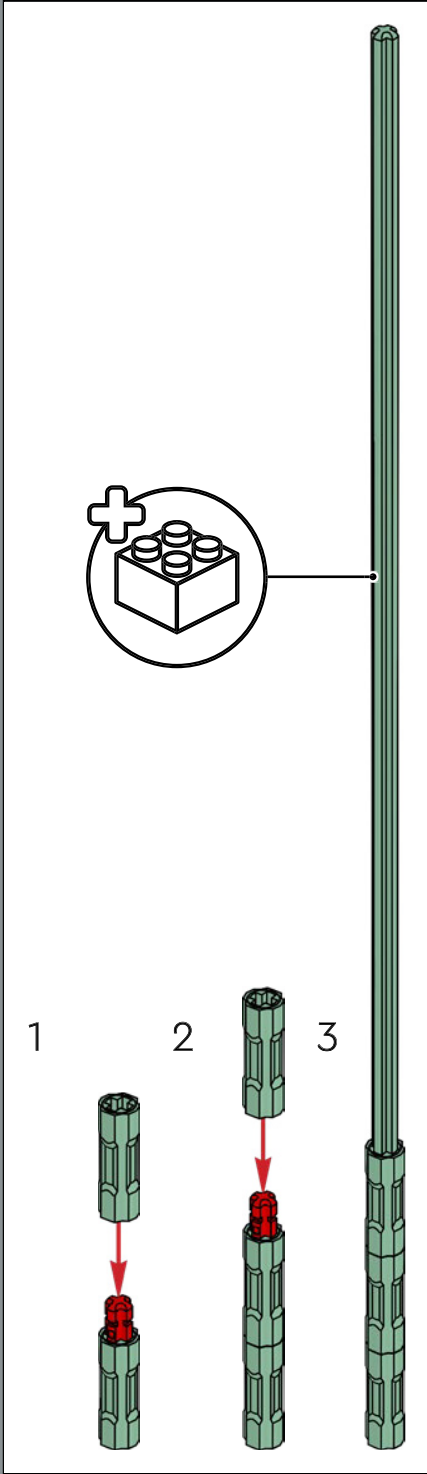



(Sambucus nigra)

HOLUNDER

Die laubabwerfenden Holunderstraucharten unterscheiden sich zwar von Kontinent zu Kontinent, doch die meisten von ihnen tragen weiße Blüten und dunkelviolette Beeren. Sowohl die Blüten als auch die Beeren verleihen beliebten Getränken ihren markanten Geschmack.

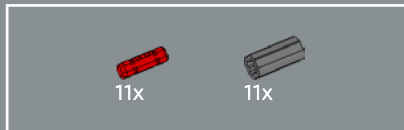

1

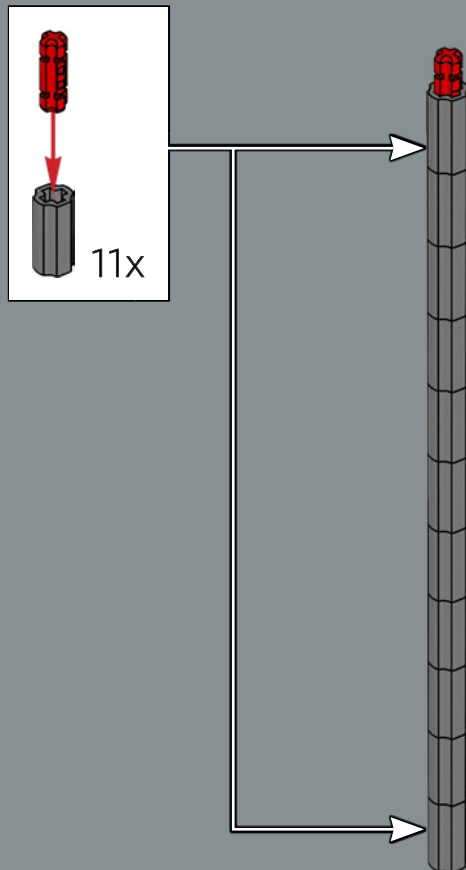

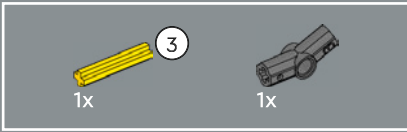
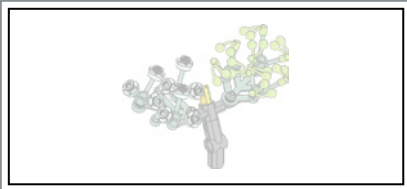

2

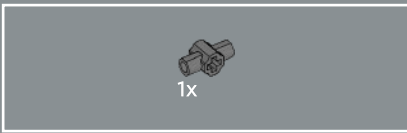
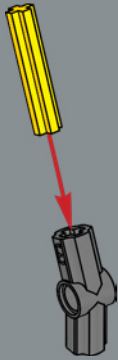

3

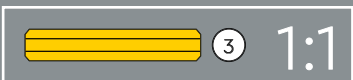
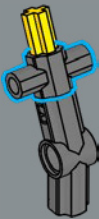

4



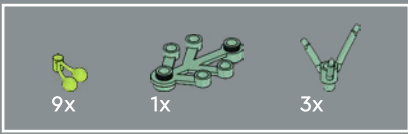

5

1



2

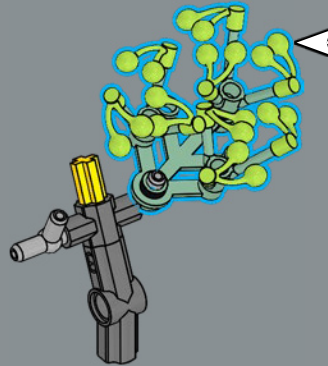
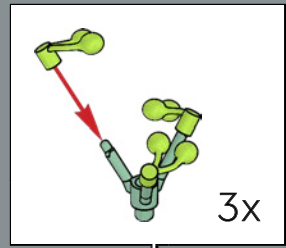
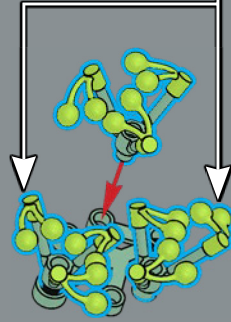

Diese geschlossenen Holunderknospen werden aus klassischen LEGO® Minifigur-Kirschen gebaut.

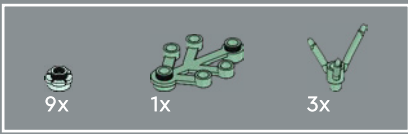

6

1



2

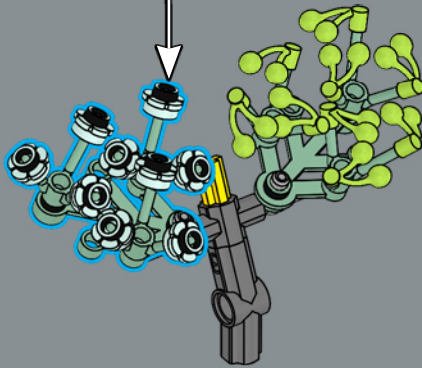
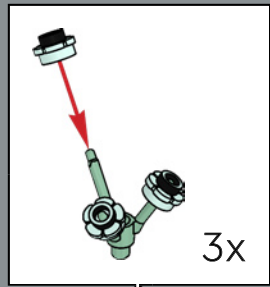
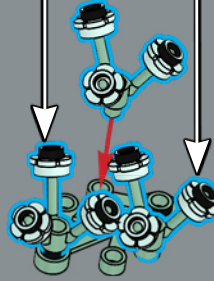

7

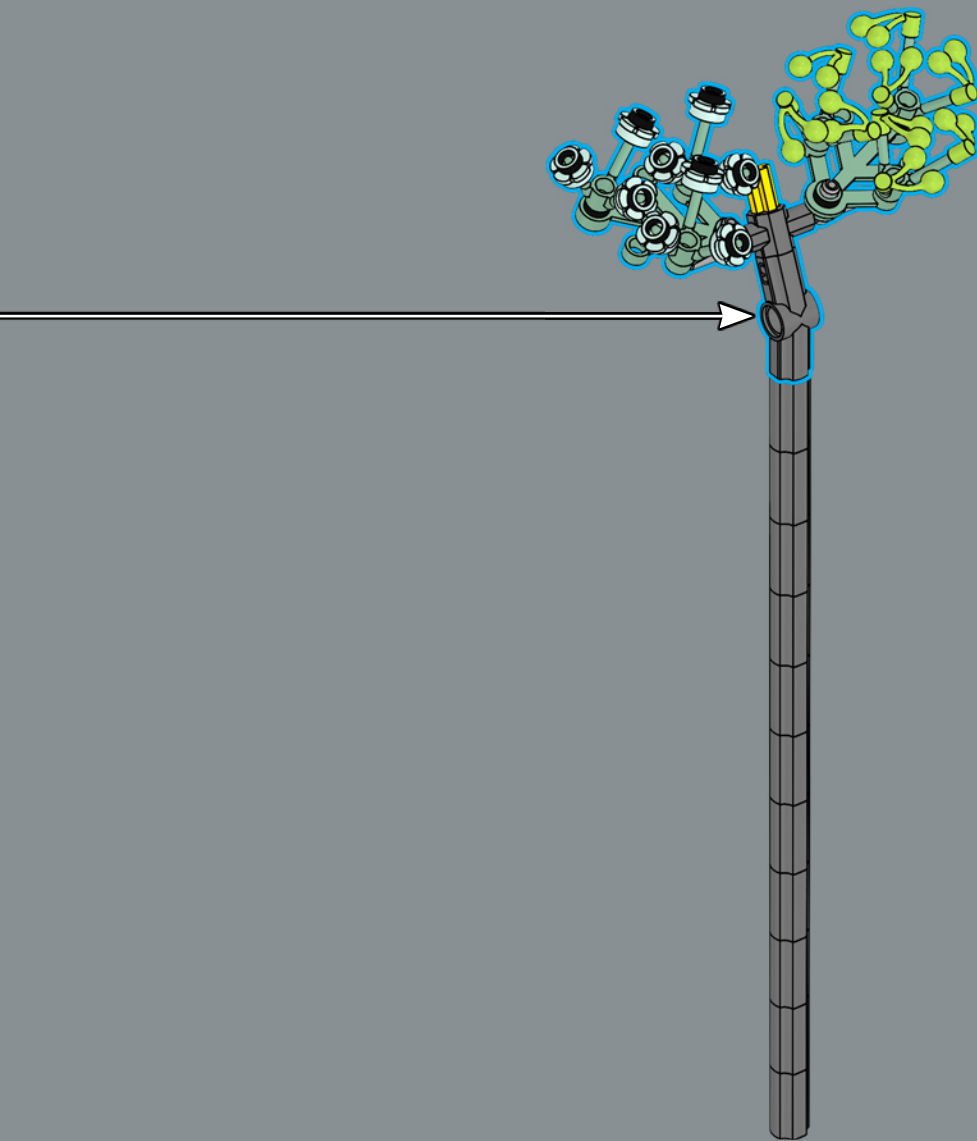

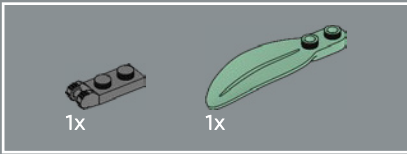
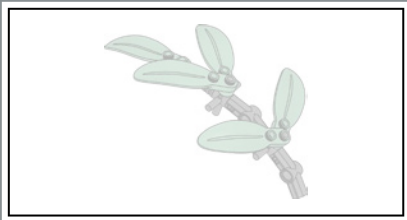

8

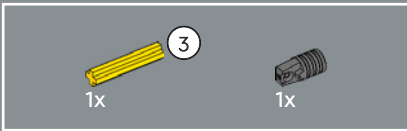
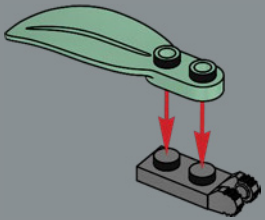

9

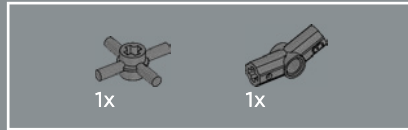
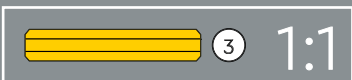
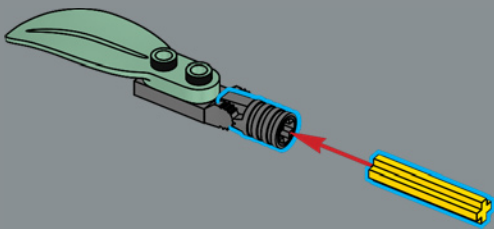

10

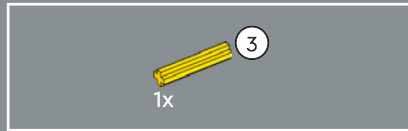
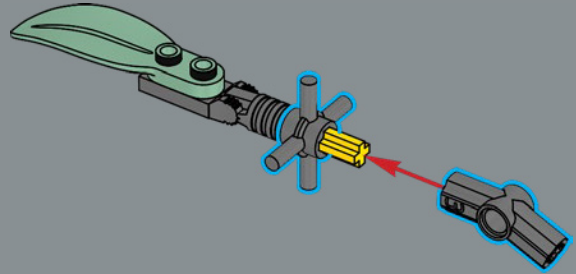

11

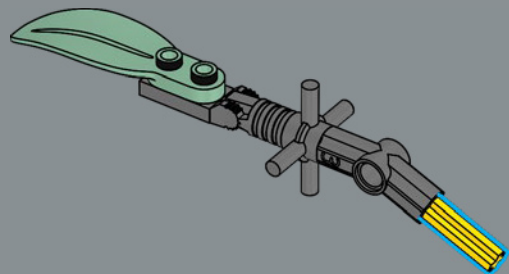

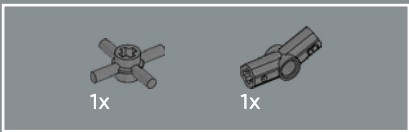

12

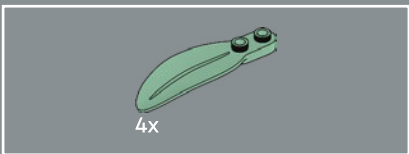
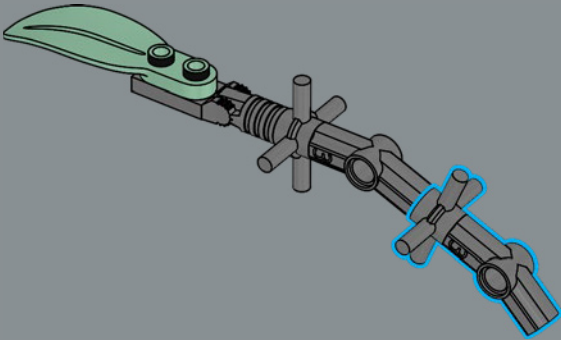

13

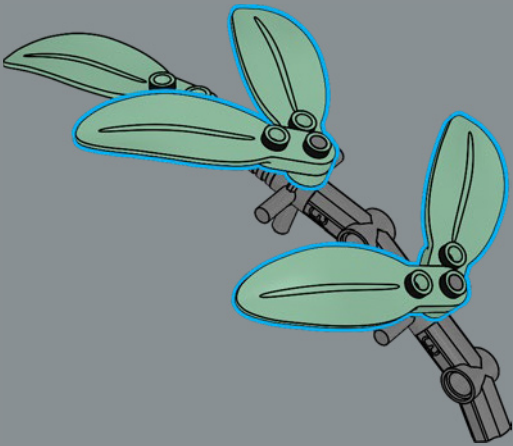

14

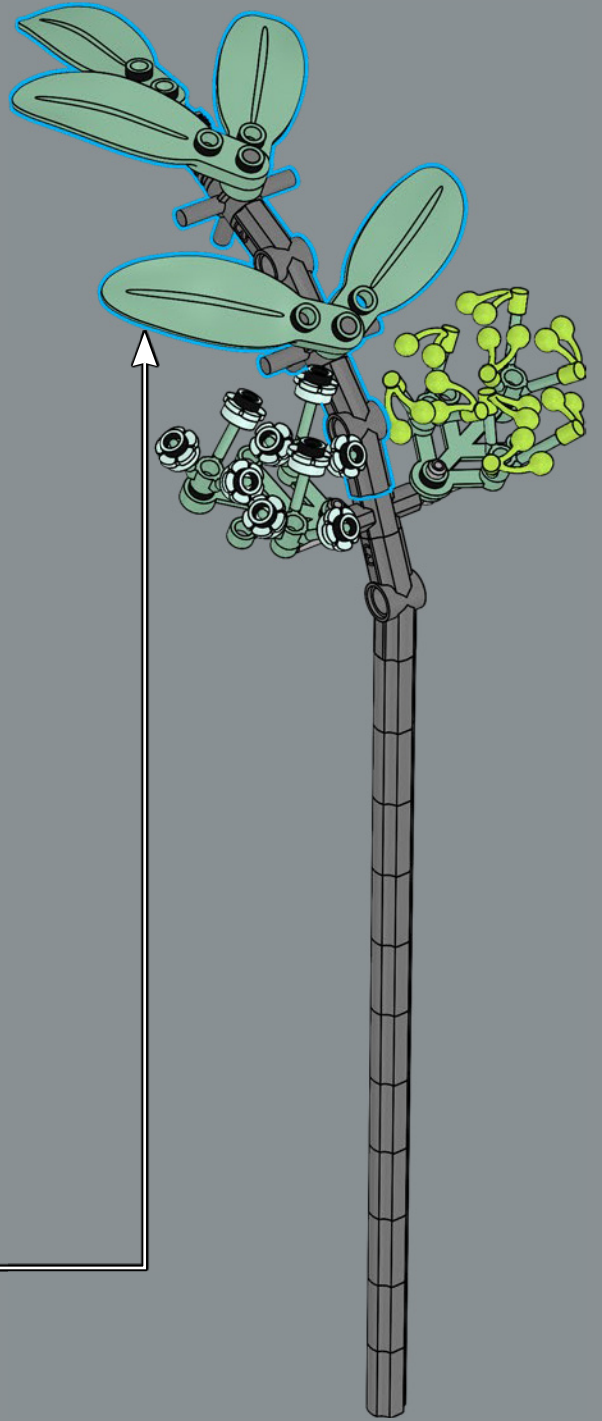

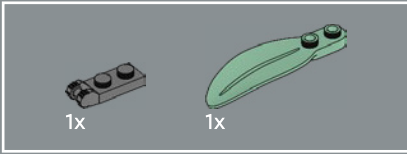
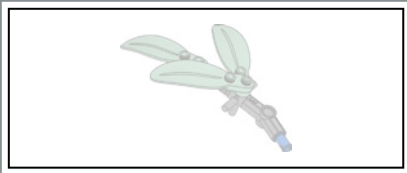

15

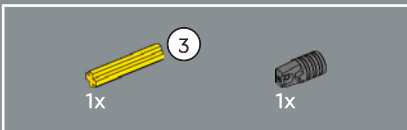
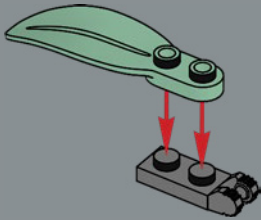

16

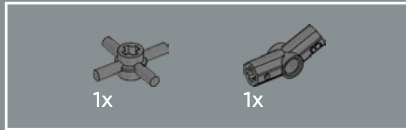
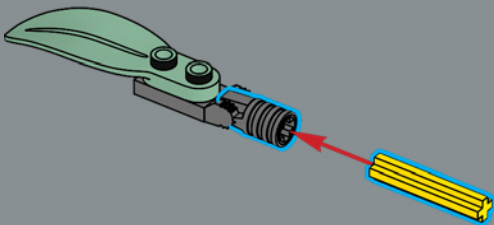

17

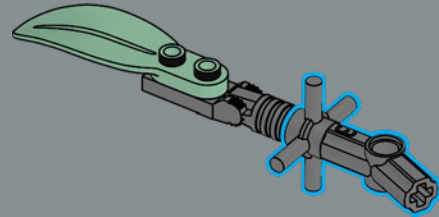

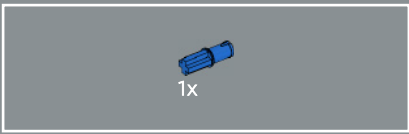

18

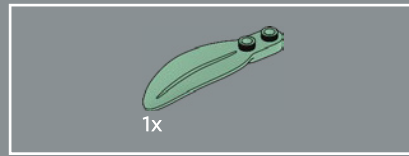
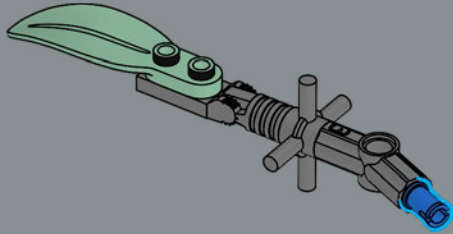

19

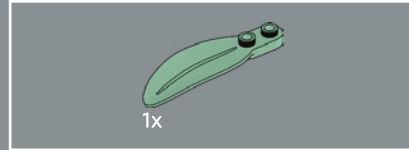
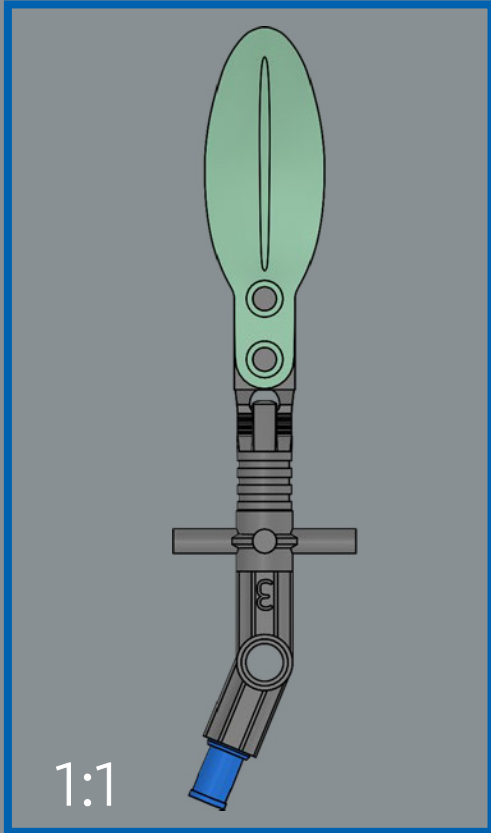
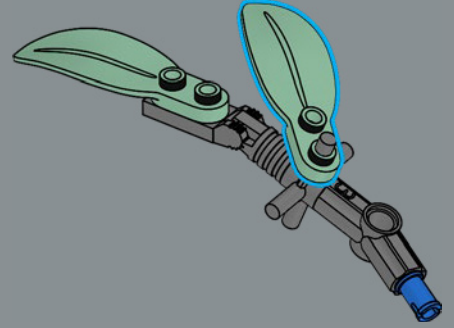

20

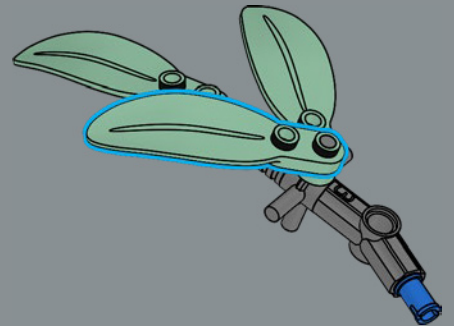

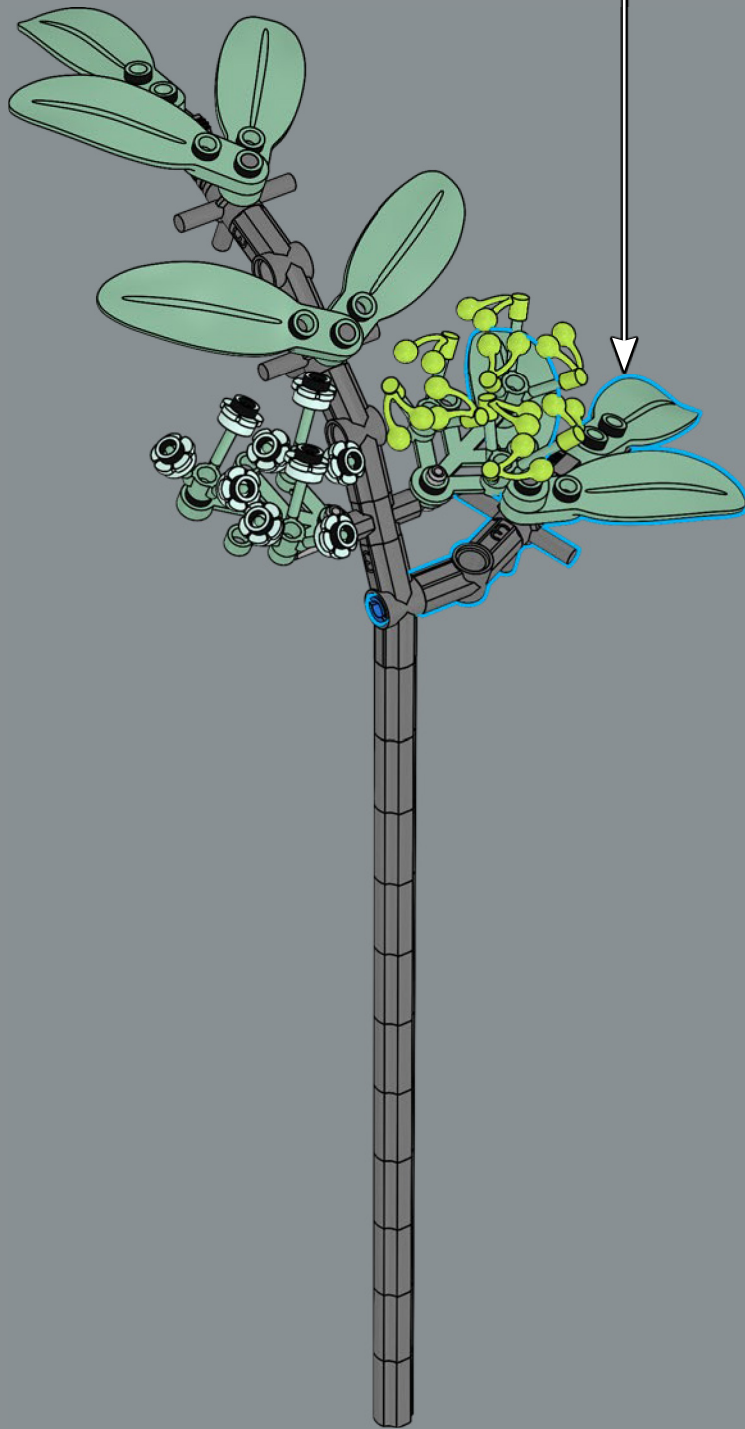

2x





(Rosa)

ROSE

Rosen werden schon seit Jahrhunderten als Symbole der Liebe und Zeichen der Schönheit verschenkt. In jedem Farbton verleihen sie sowohl echten Blumensträußen als auch allen LEGO® Arrangements eine anmutige Note.



(Felicia amelloides)

BLAUE KAPASTER

Die in Europa und Nordamerika weit verbreitete Blaue Kapaster symbolisiert Hingabe und Vertrauen. Deshalb ist sie das perfekte Geschenk für einen besonders geliebten Schatz.

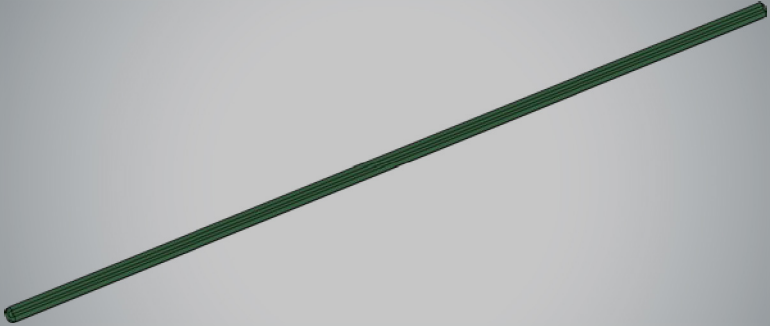
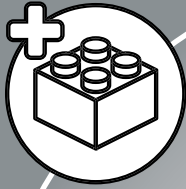

2x



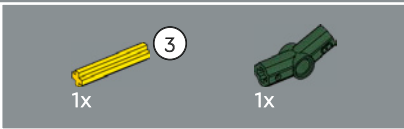
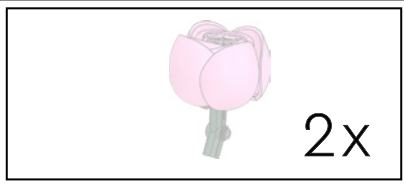
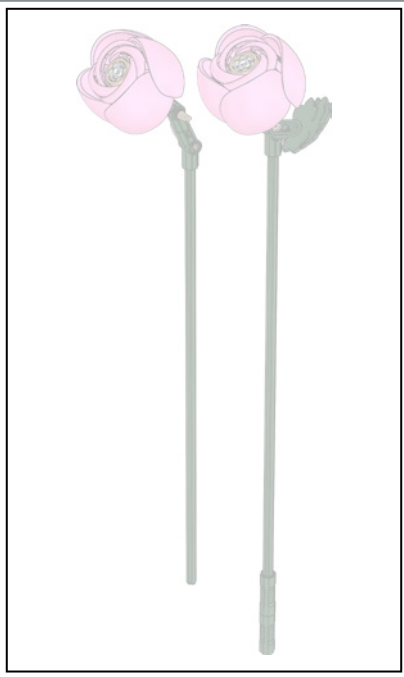

1

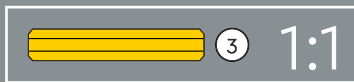
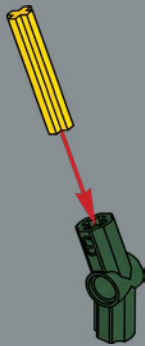

2

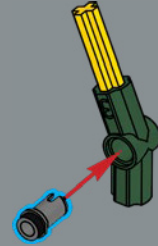

3





4



5



6

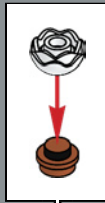

Auch unsere LEGO® Minifiguren mögen Blumen. Diese ursprünglich als kleine Pfingstrose konzipierte Blume bildet nun das Mittelstück einer Rose.

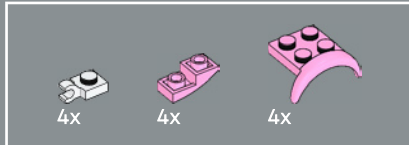

7

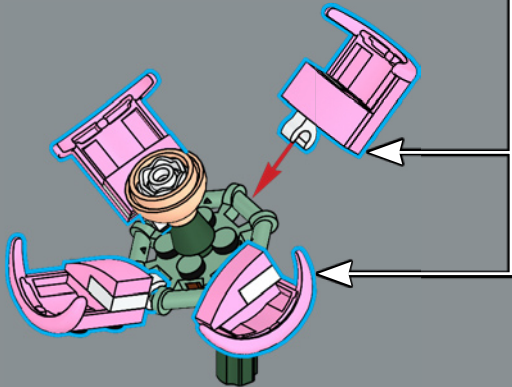
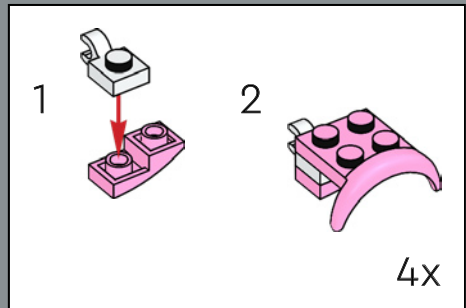

8

Die mittlere Spirale aus Blütenblättern wird aus den Radkästen von LEGO® Autos gebaut.

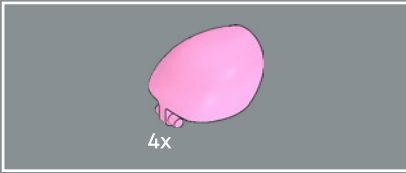
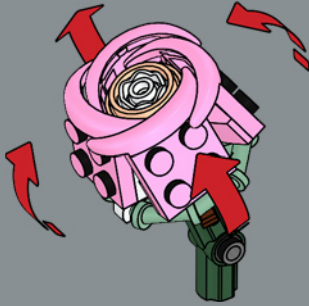

9

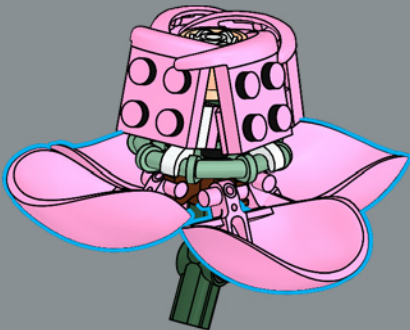

10

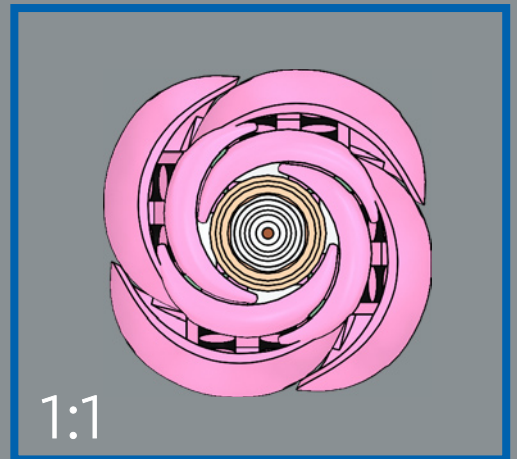
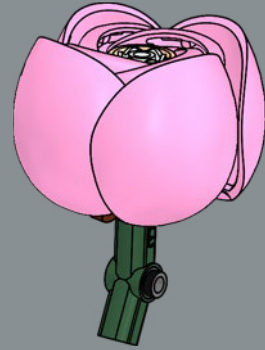

2x

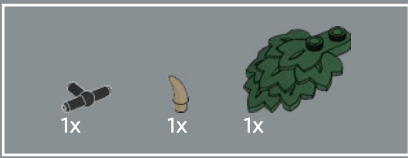

11

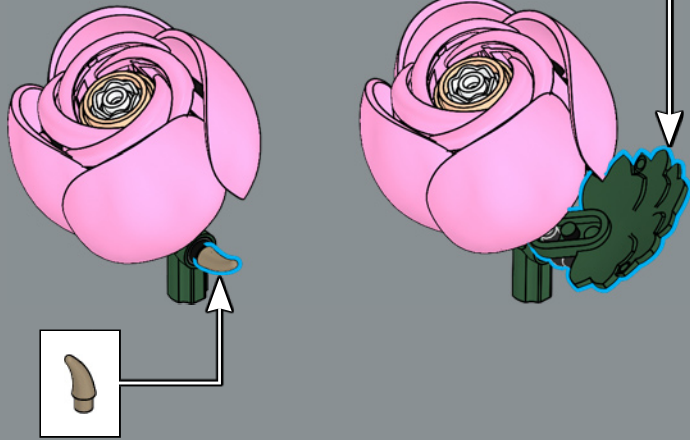
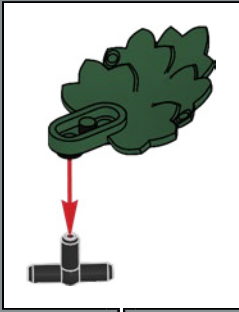

12

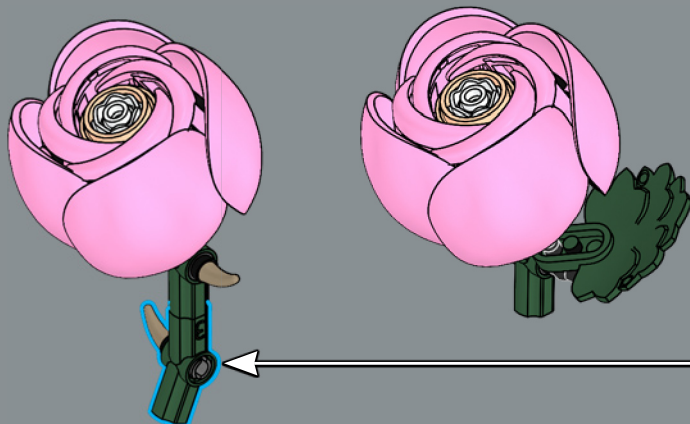
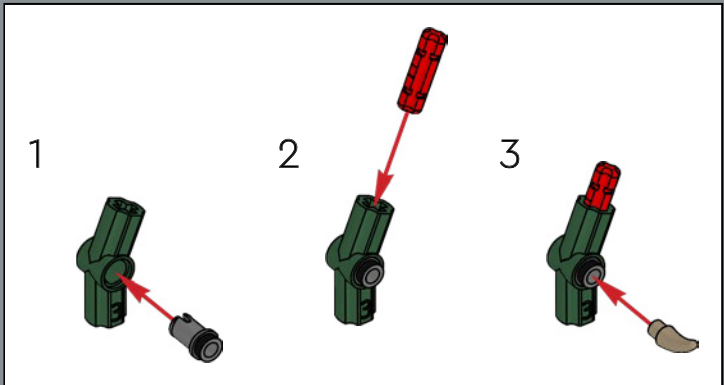

13

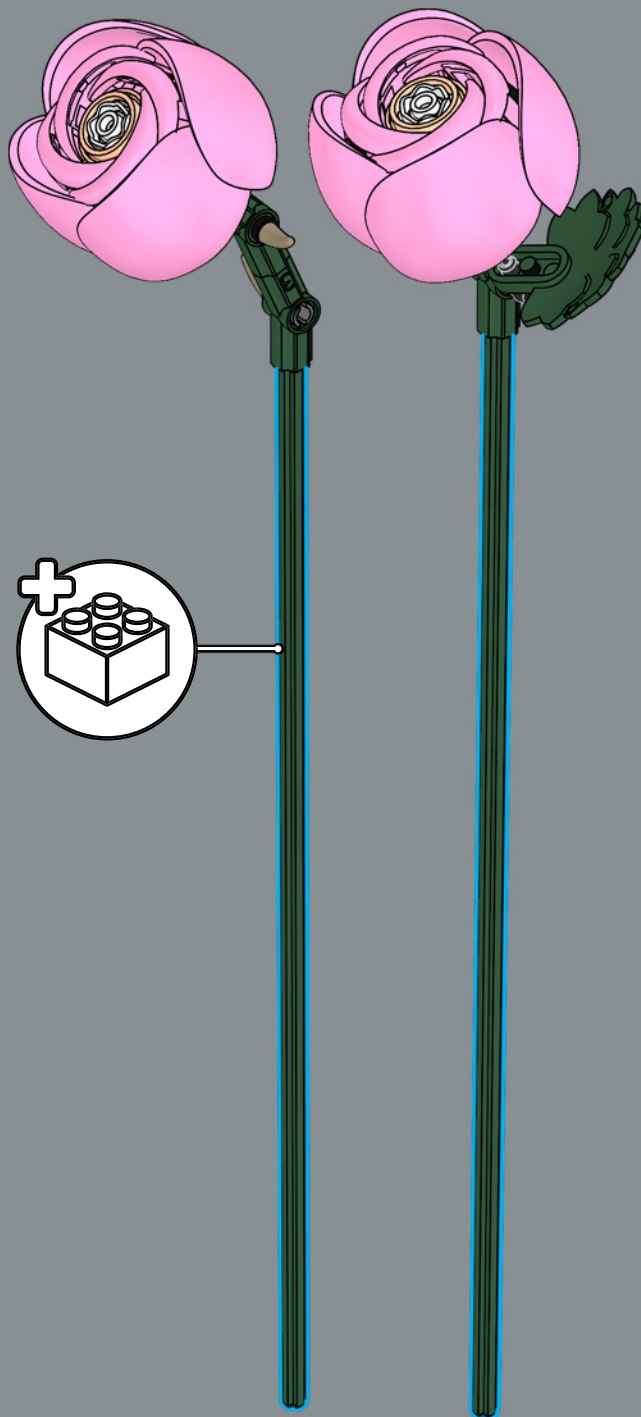



14

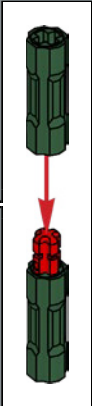

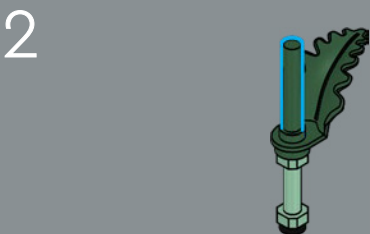
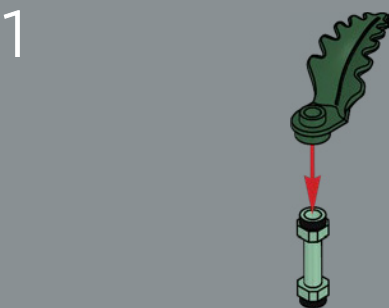
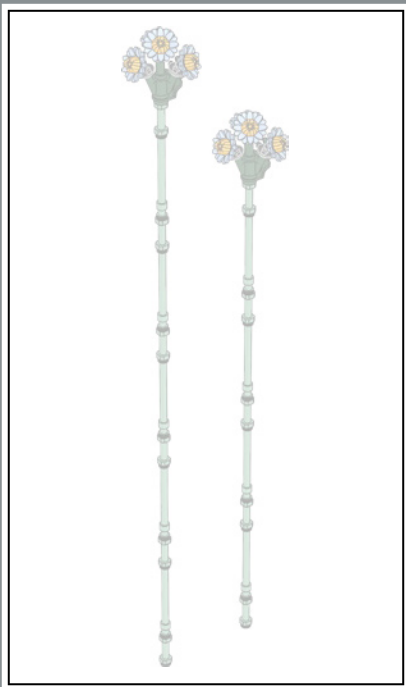

3

Dieses kleine Stativ sollte den Kameras von LEGO® Minifiguren einen festen Stand verleihen. Jetzt trägt es einige Blaue Kapaster.

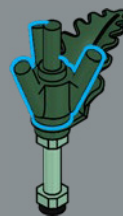

4

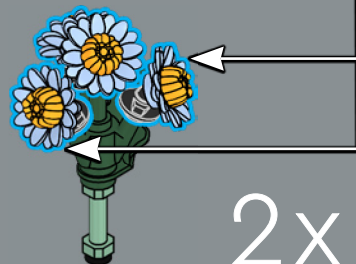
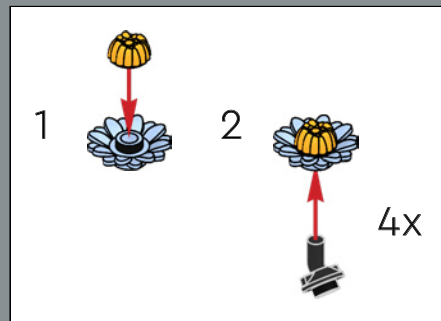

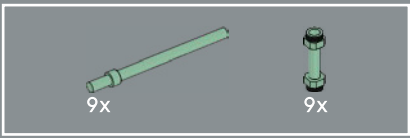

5

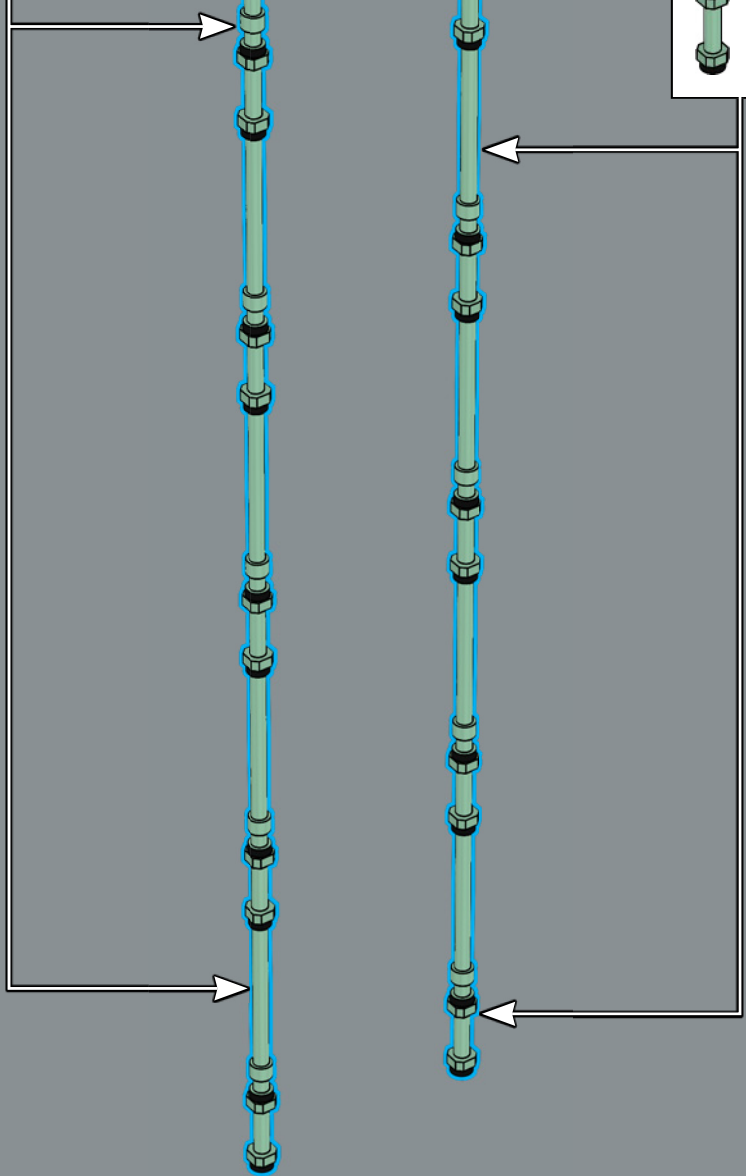
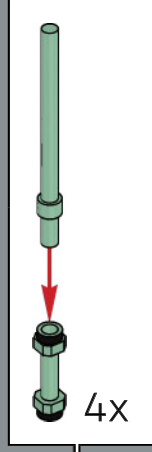
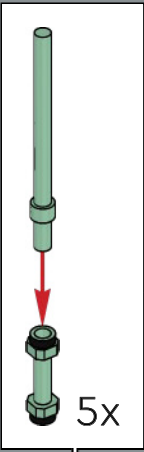



(Campanula medium)

MARIEN-GLOCKENBLUME

Diese zweijährige Schönheit aus Südeuropa trägt kelch- oder glockenförmige Blüten und ist den ganzen Sommer über in Blau-, Weiß- und Rosatönen zu sehen.



(Ranunculus)

RANUNKEL

Die auch als Asiatischer Hahnenfuß bezeichnete Ranunkel ist in Europa, Nordamerika und Asien beheimatet. Wegen ihrer verschachtelten pastellfarbenen Blütenblätter wird sie gerne für Blumensträuße verwendet.

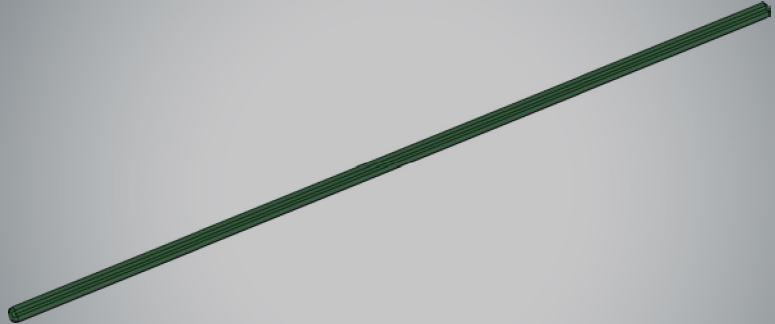
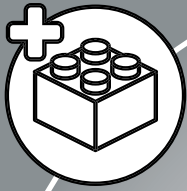

1x



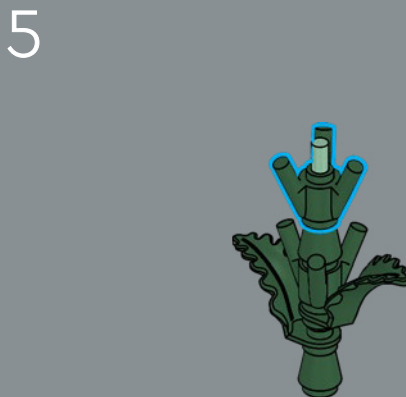
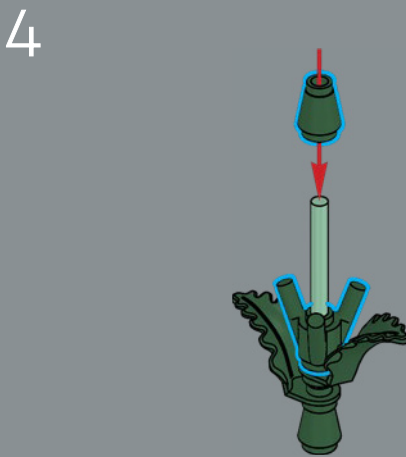
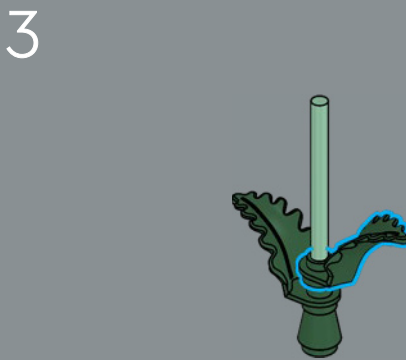
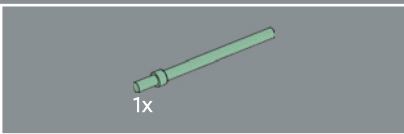
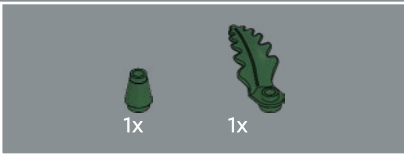
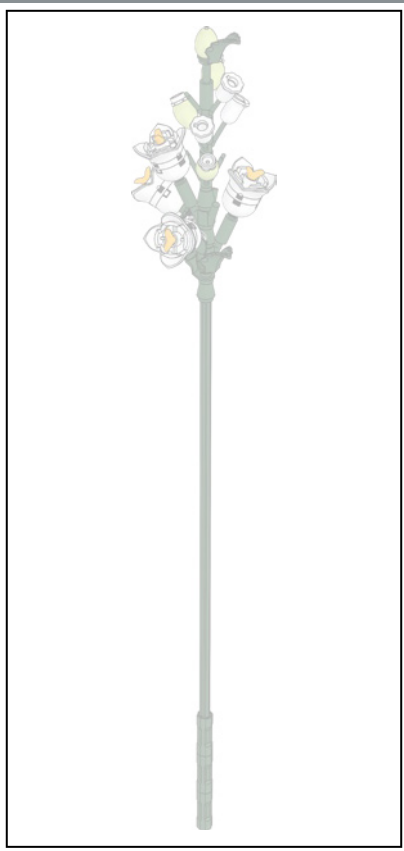

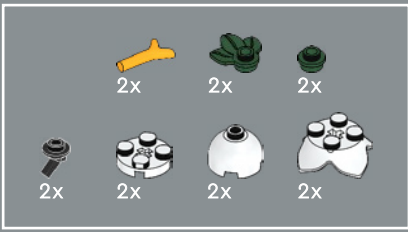

6

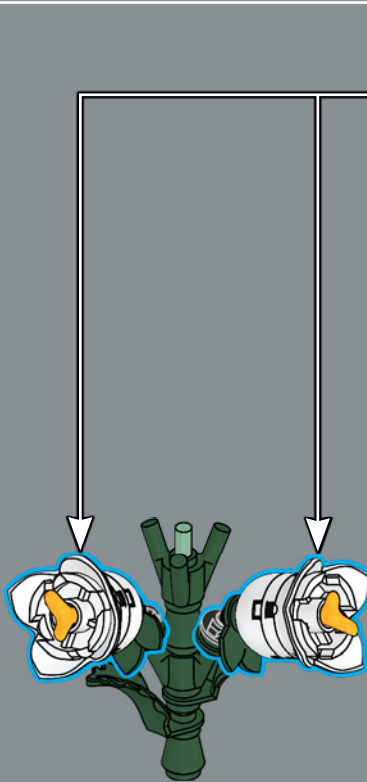
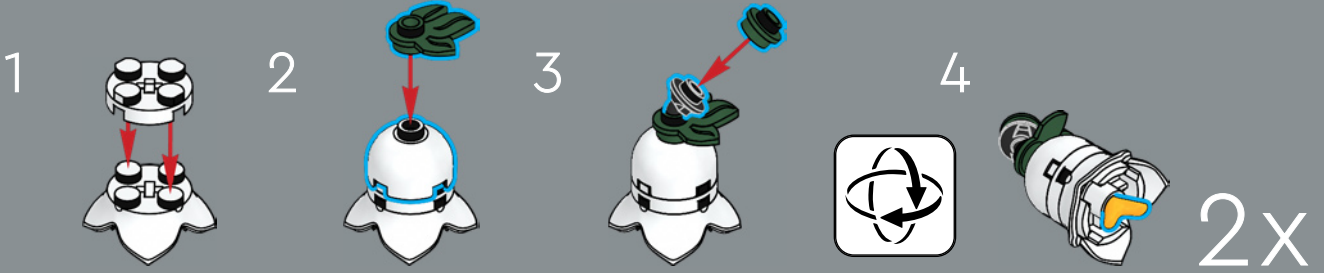



7

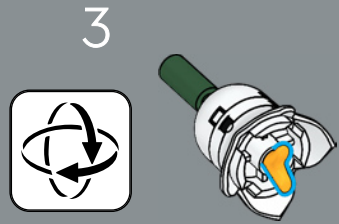
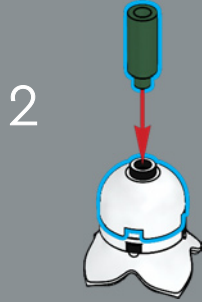

2x

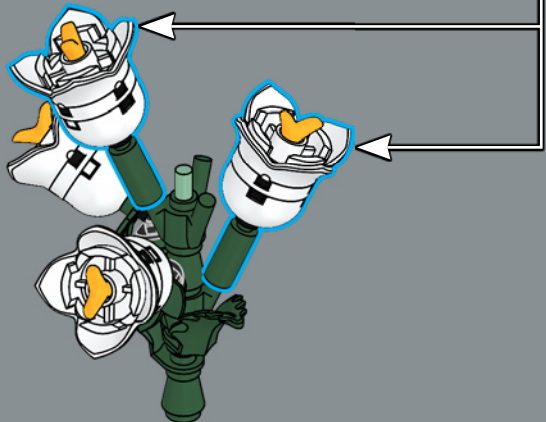

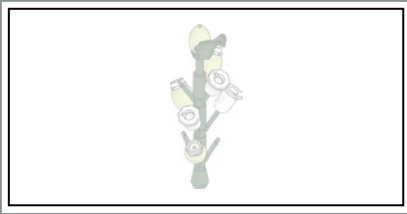

8

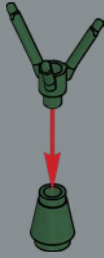

9

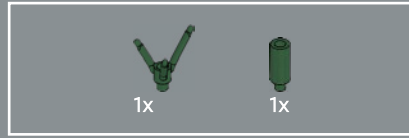
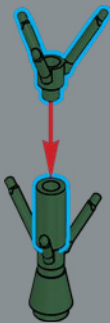

10

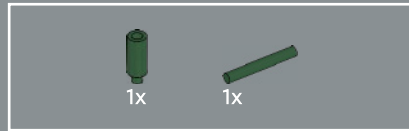
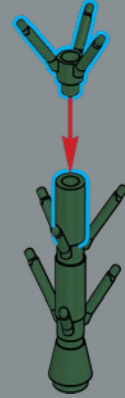

11

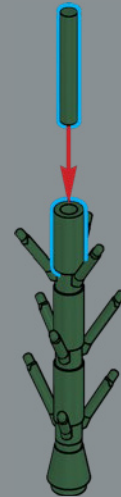



12

Einer der Charaktere aus unseren LEGO® DREAMZzz™ Sets stellt hier die Blüte einer Glockenblume dar.

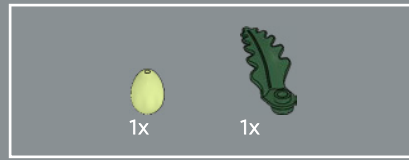
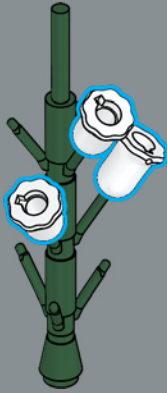

14

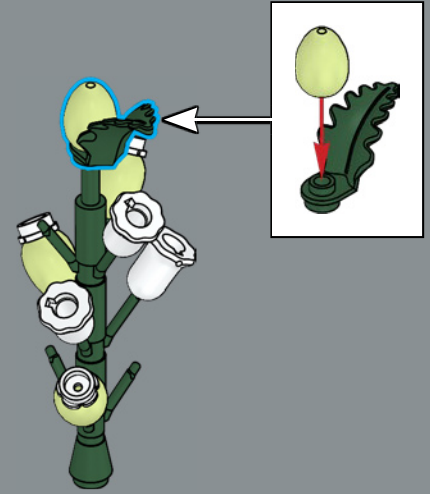

13

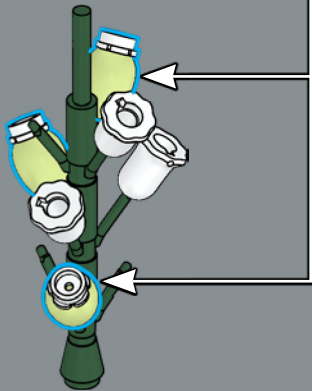
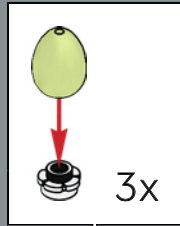

15

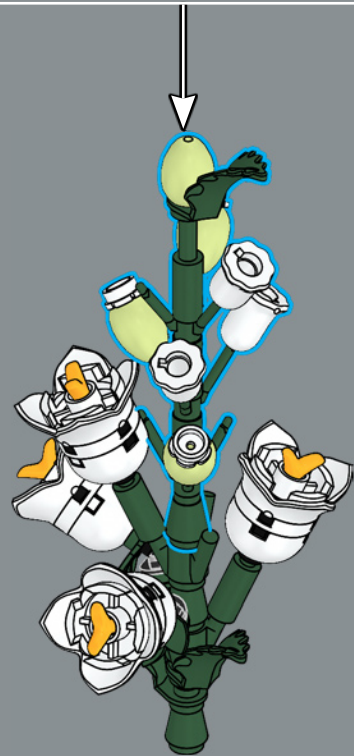

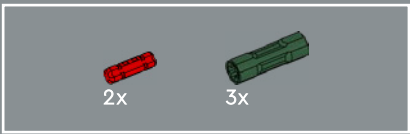

16

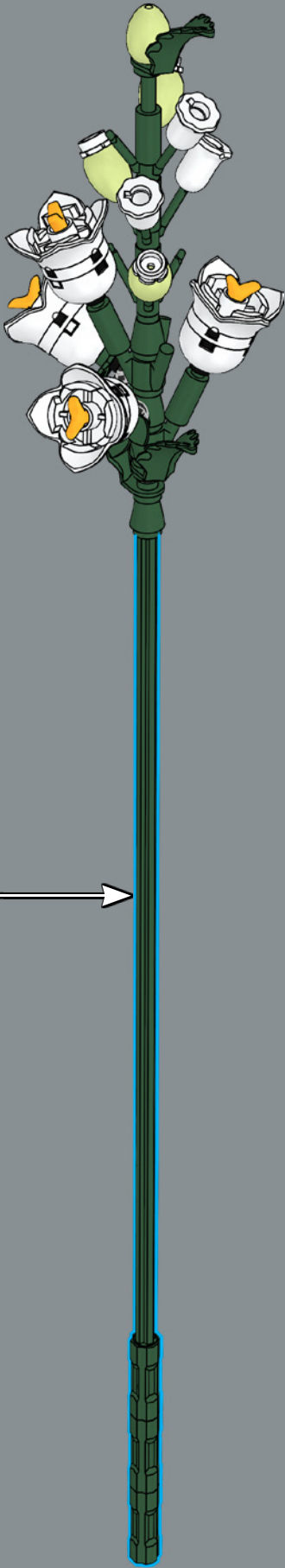
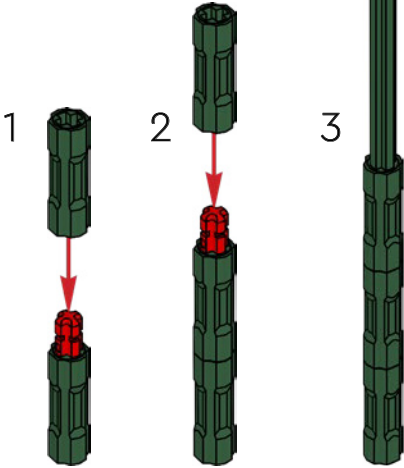
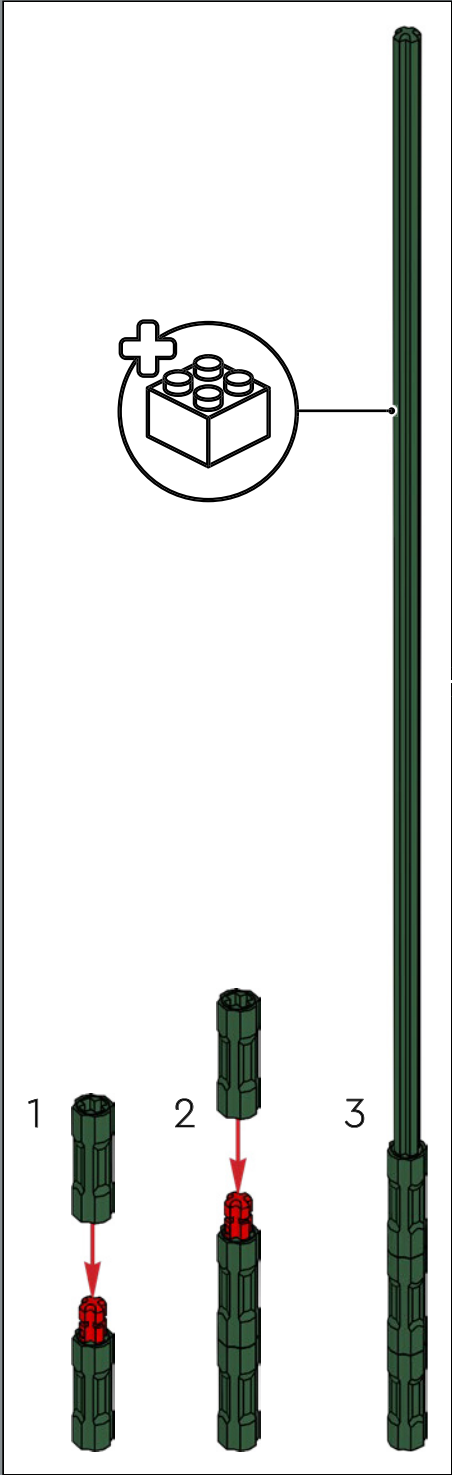

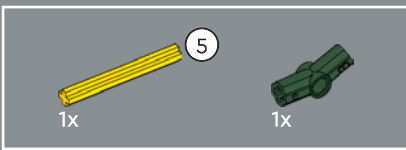

1

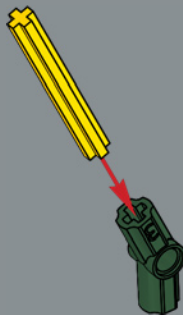

2

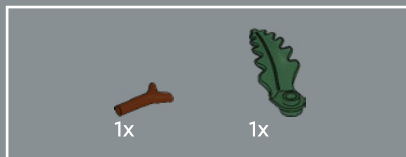
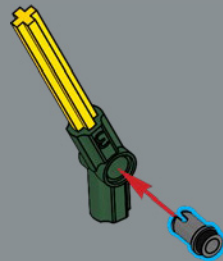

3

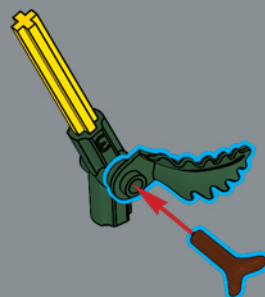

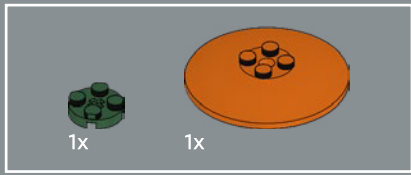

4

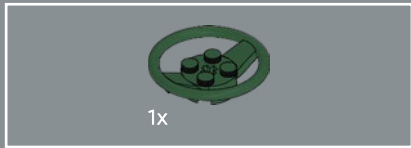
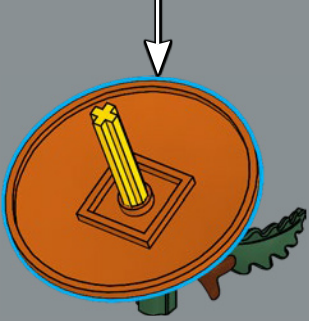
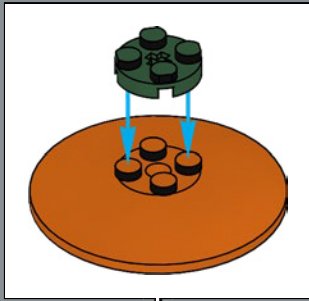

5

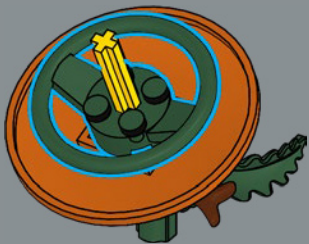

6

Das ursprünglich für größere LEGO® Autos entwickelte Lenkrad bildet nun das Zentrum unserer LEGO Blumen. Der Axtkopf kam im Jahr 2005 mit den LEGO Wikinger-Sets heraus und wurde von den enthaltenen Minifiguren benutzt.

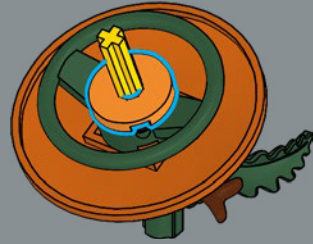

7

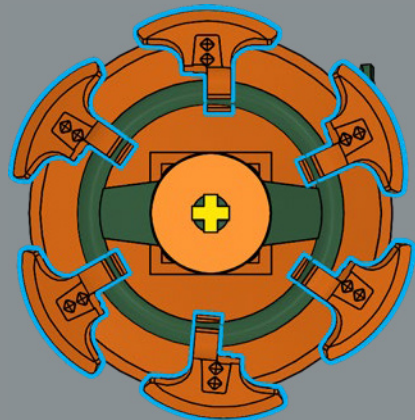



8

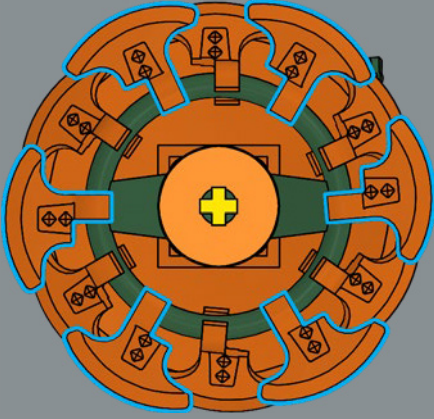

9

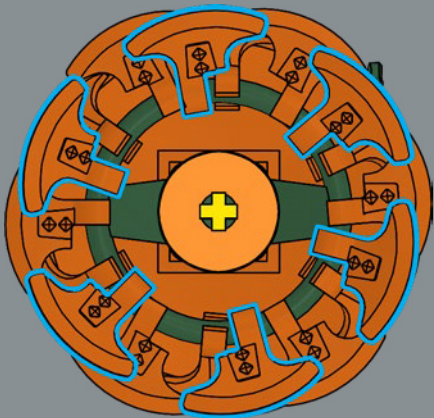

10

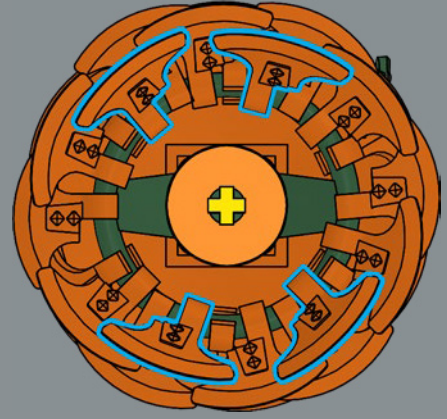

11

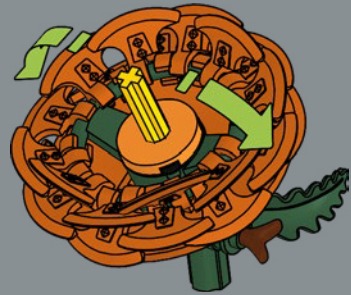

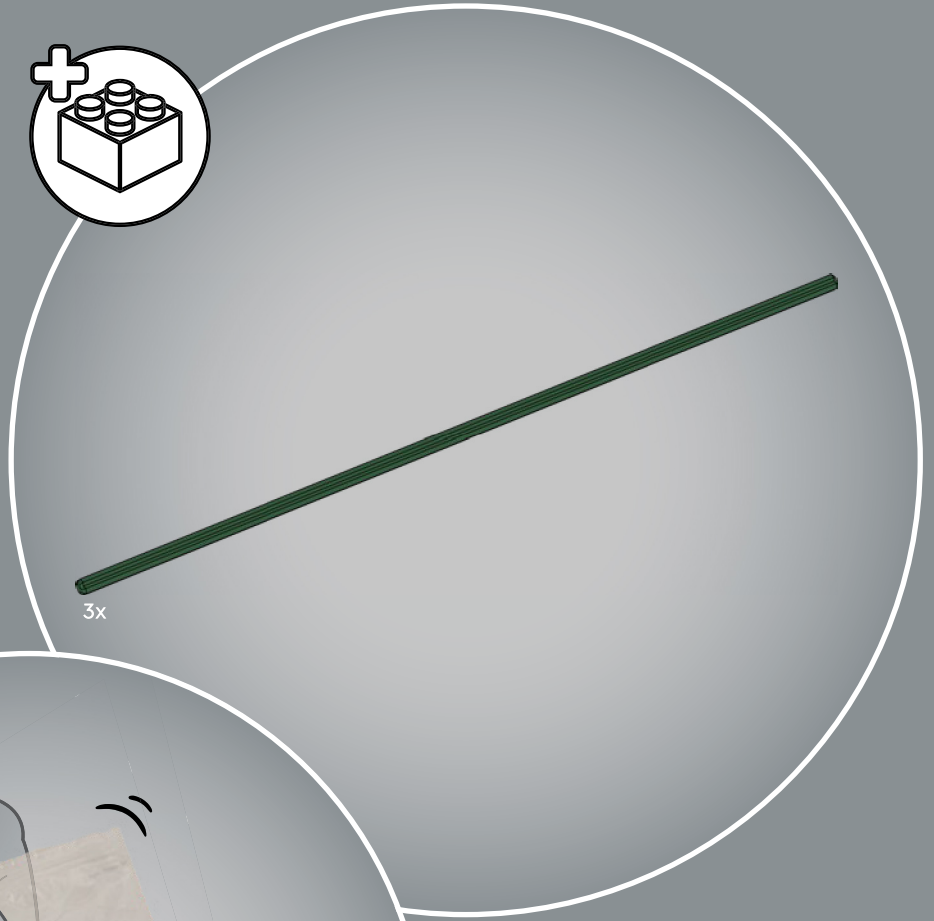
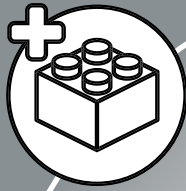

3x





12

1

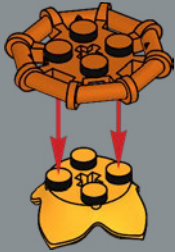

3

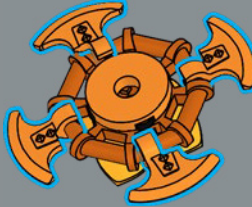

5

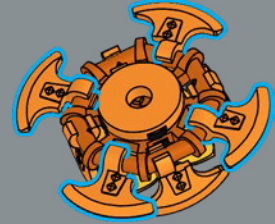

2

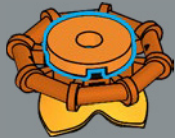

4

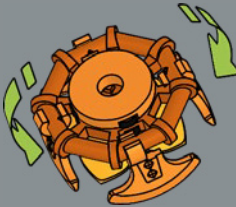

6

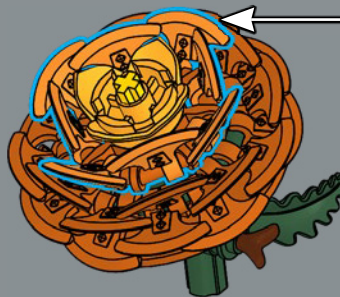
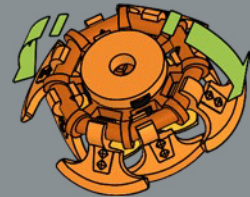

2x

Vermutlich wurden noch nie zuvor so viele Äxte in einer LEGO® Blume verwendet.

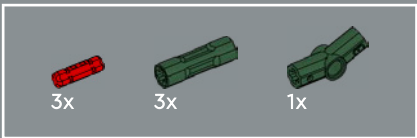

13

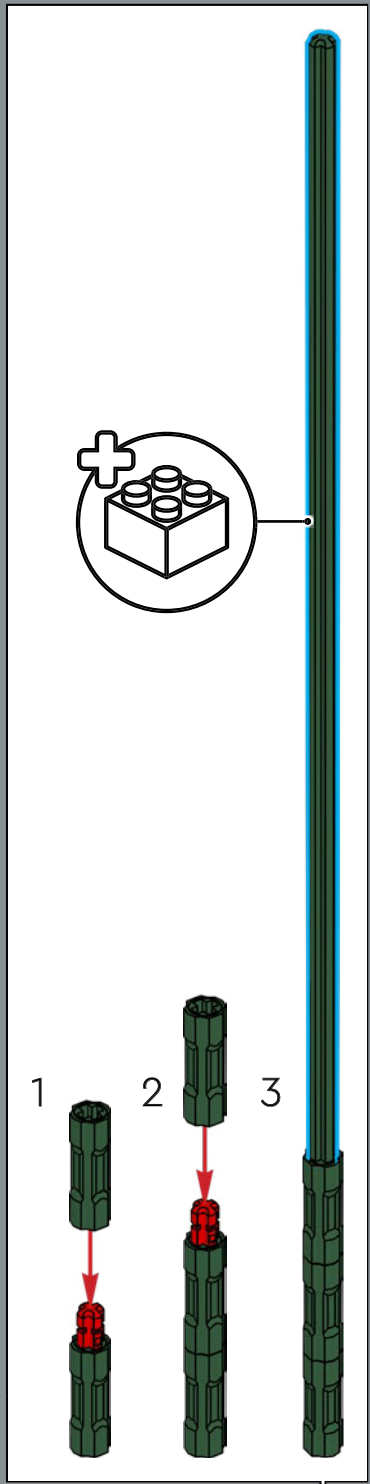
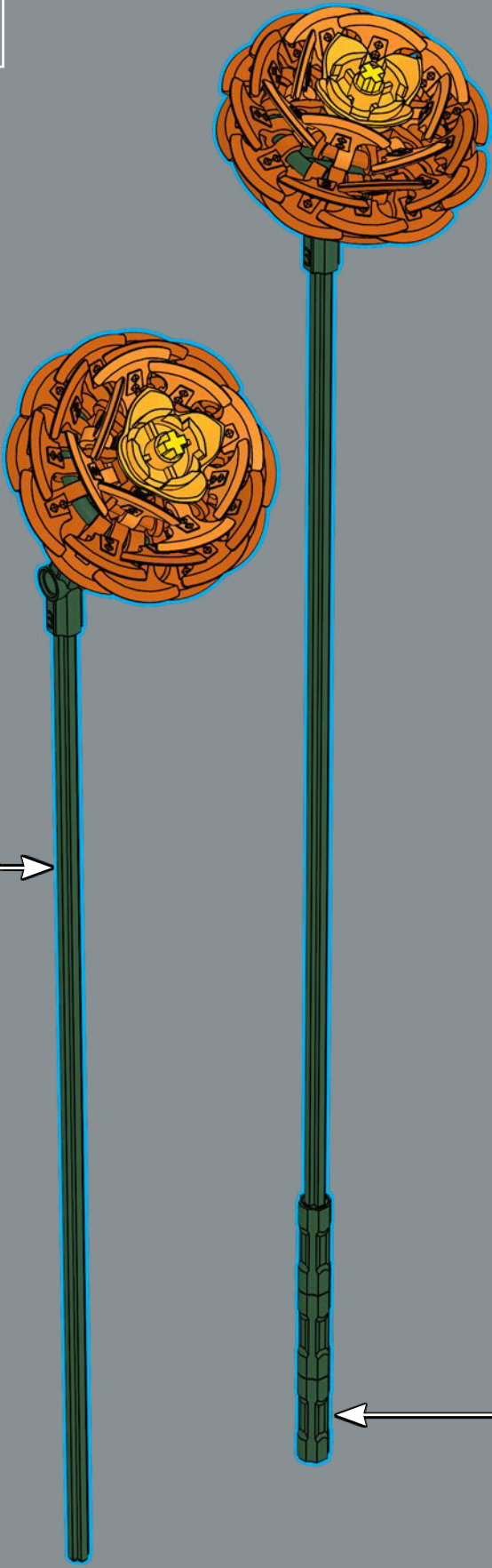
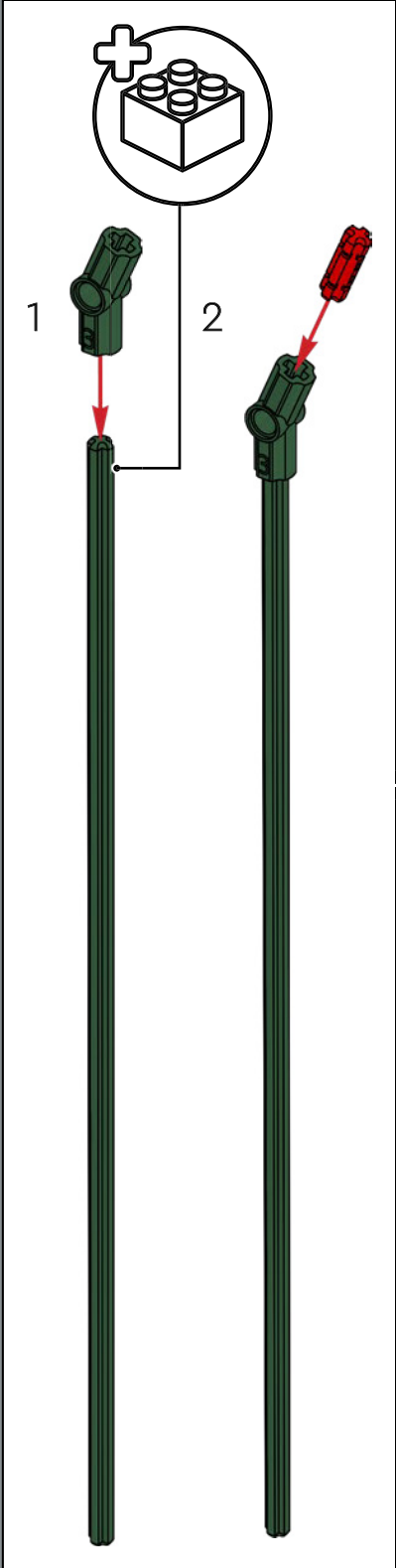

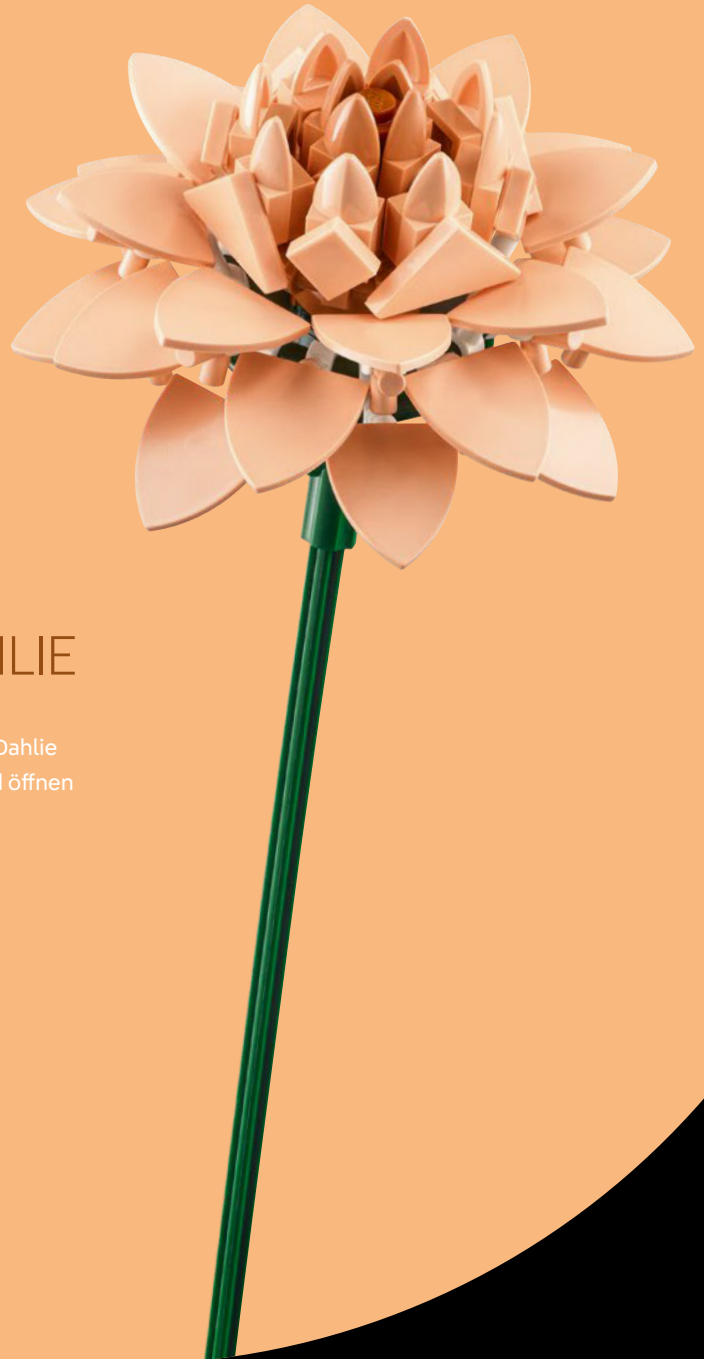

(Dahlia nymphaea)

SEEROSEN-DAHLIE

Die dekorativen Blüten der Seerosen-Dahlie symbolisieren Eleganz und Anmut und öffnen sich wie ein luxuriöses Feuerwerk.

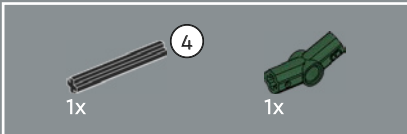
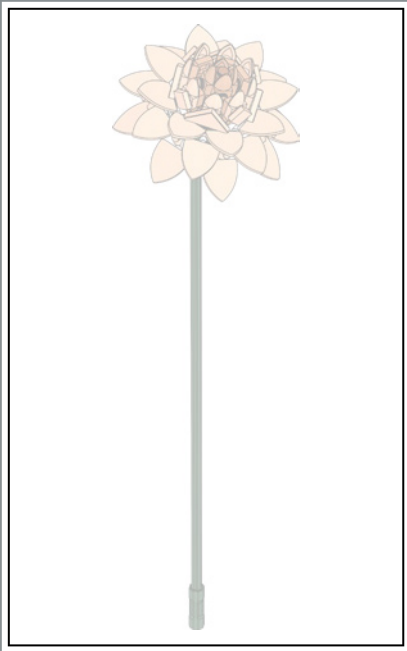

1

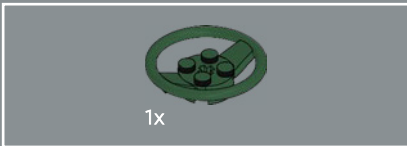

2

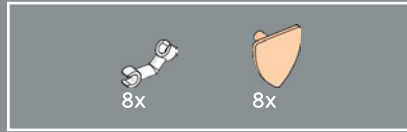
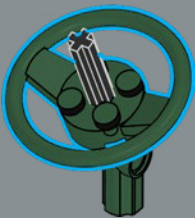

3

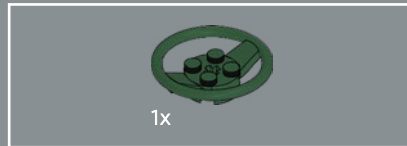
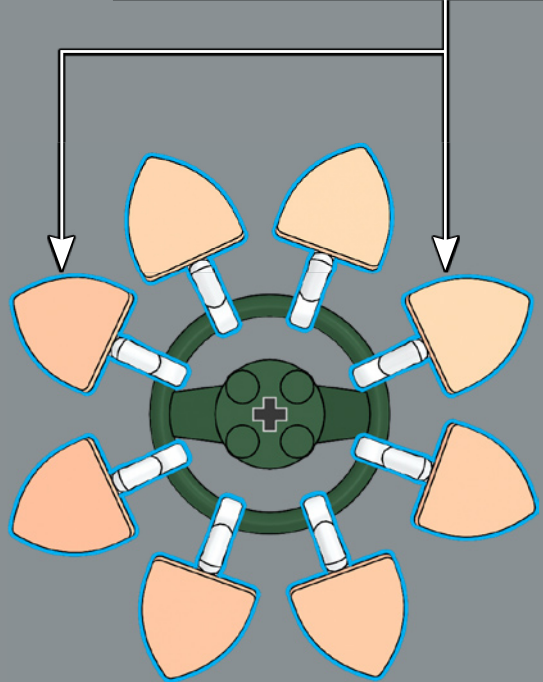
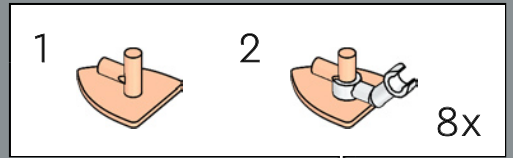

4

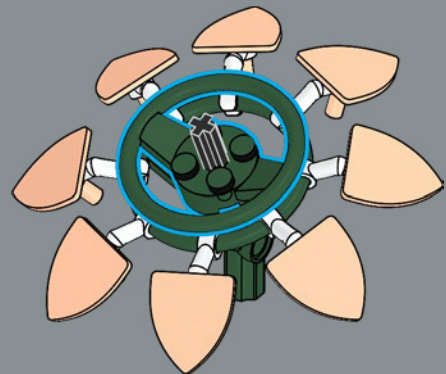

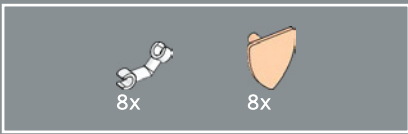

5

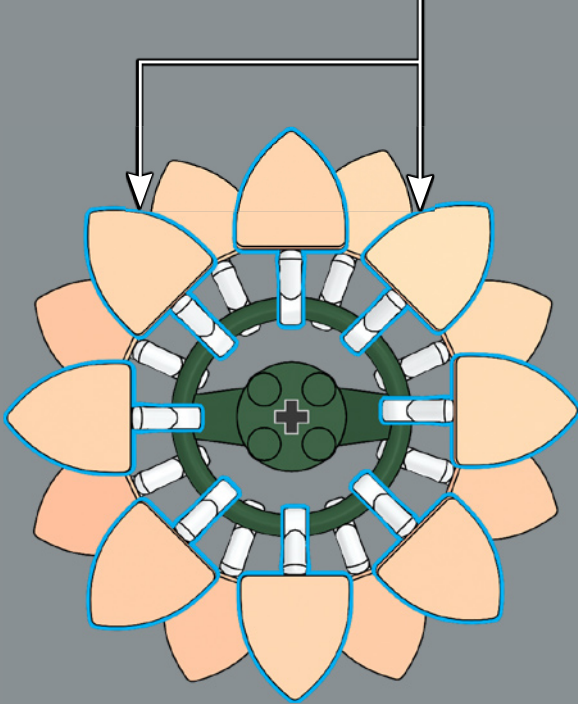
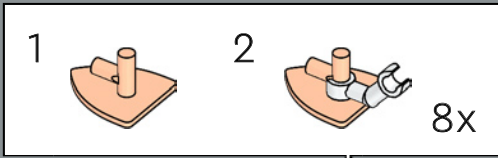

Herzlichen Glückwunsch! Mit diesen Schilden bist du jetzt besser ausgerüstet als unsere LEGO® Ritter, als sie 1978 auf den Markt kamen!

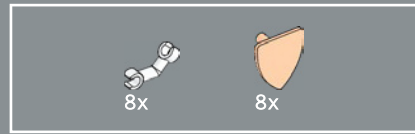

6

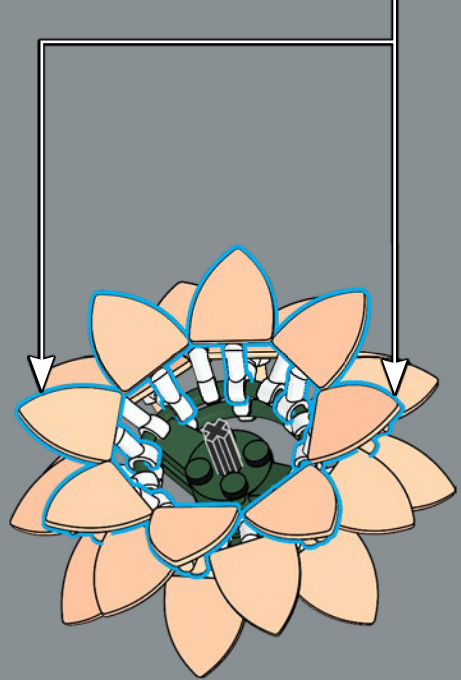
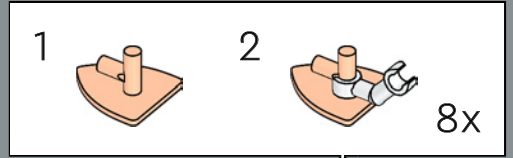

7

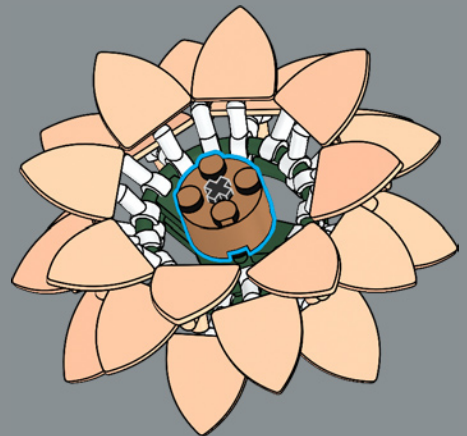

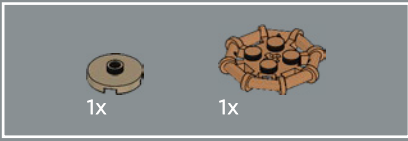

8

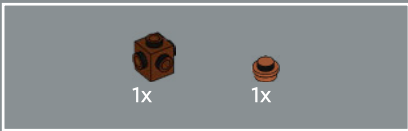
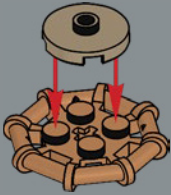

9

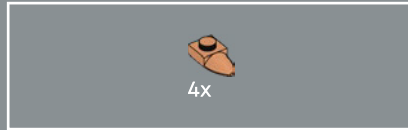
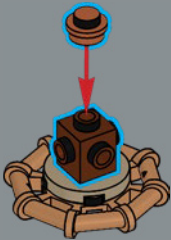

10

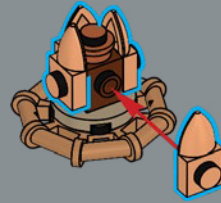

11

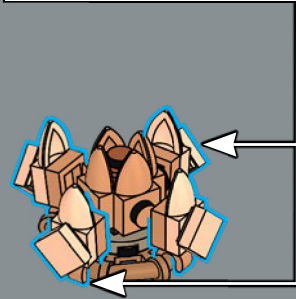
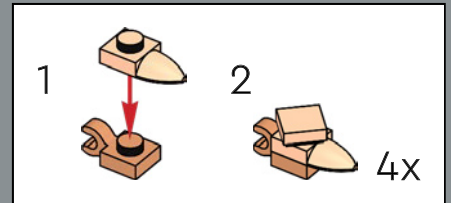



12

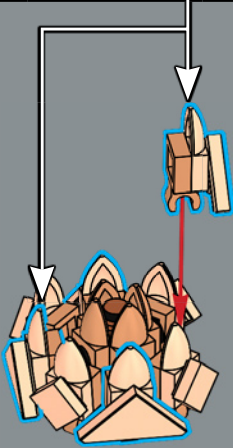
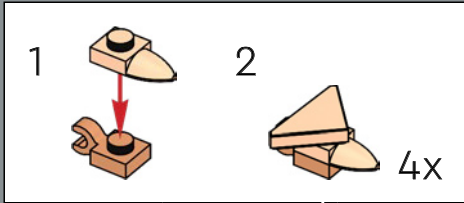

13

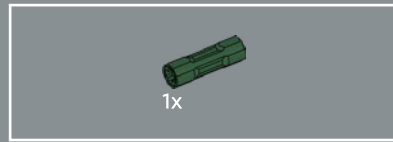
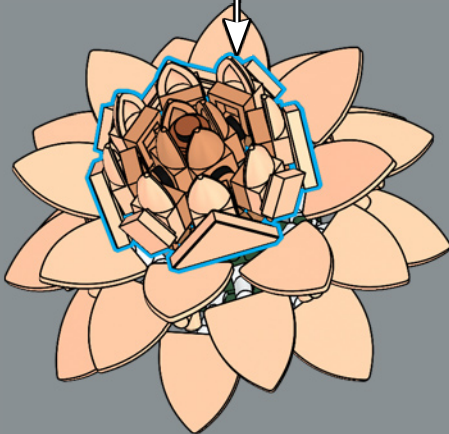

14

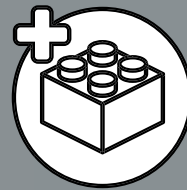
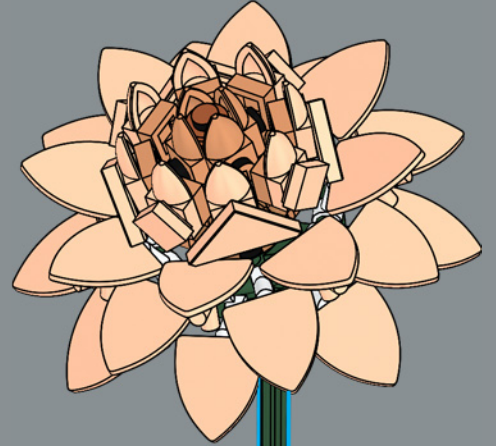



(Cymbidium)

KAHNORCHIS

Die Kahnorchis (auch Cymbidium- oder Kahnorchidee) ist schon seit der Zeit von Konfuzius rund 500 Jahre vor Christi Geburt dokumentiert. Das macht sie zur ältesten bekannten gezüchteten Orchideenart.

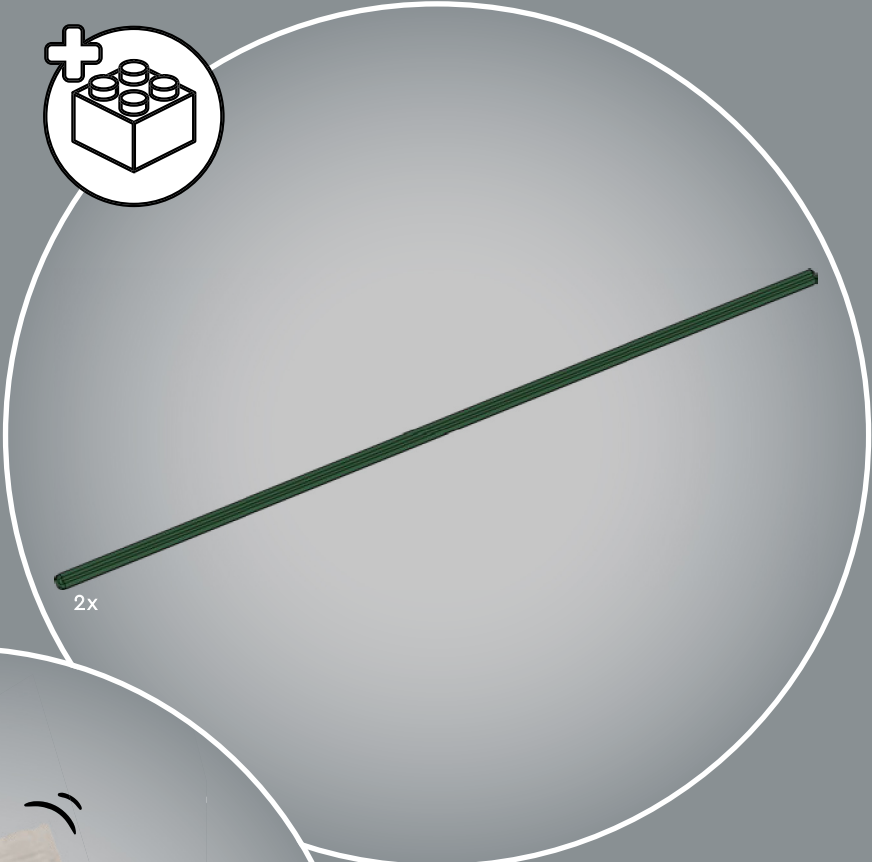
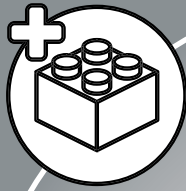

2x



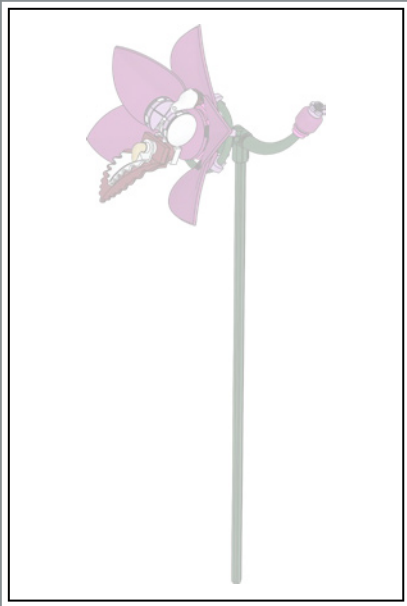

1

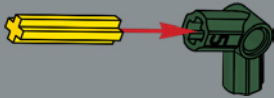

2

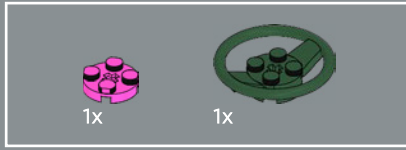
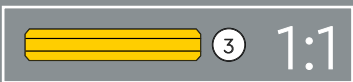
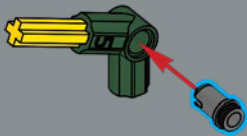

3

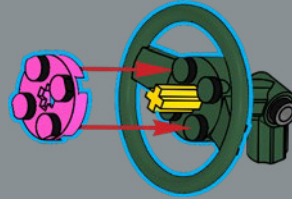

4

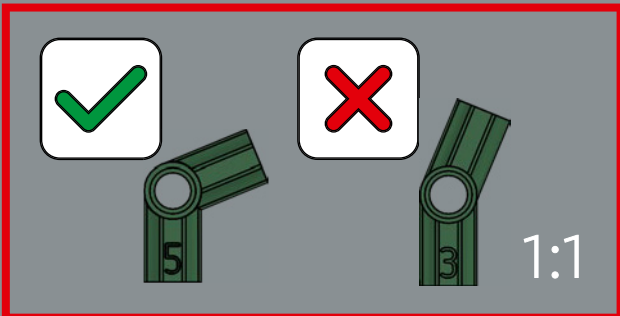
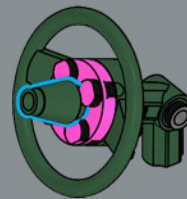

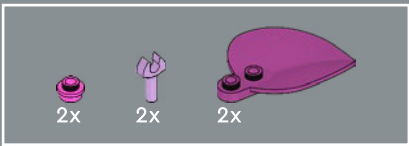

5

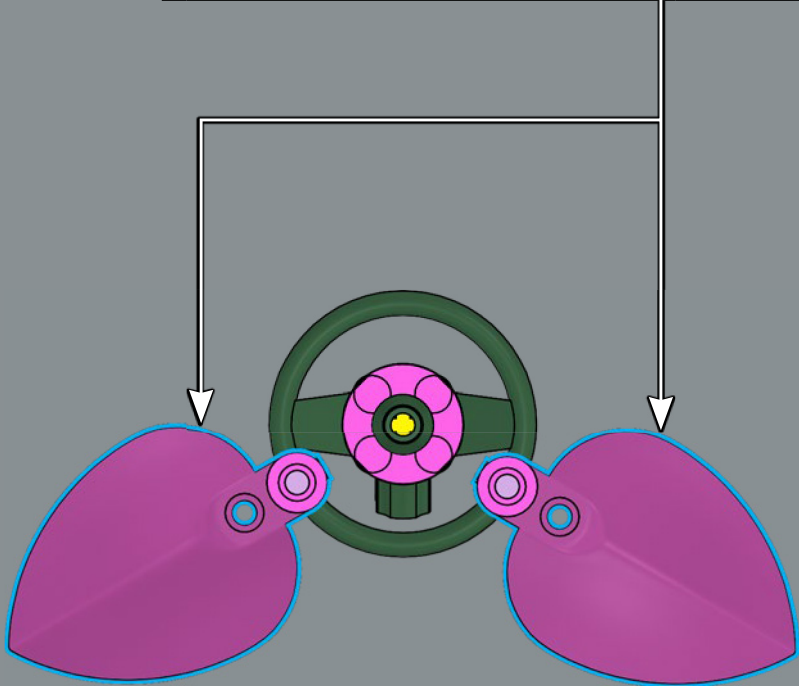
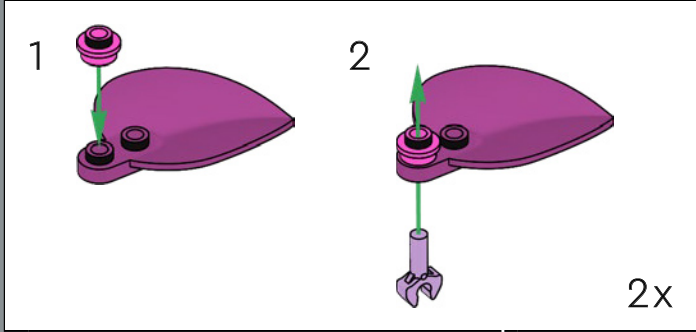



6

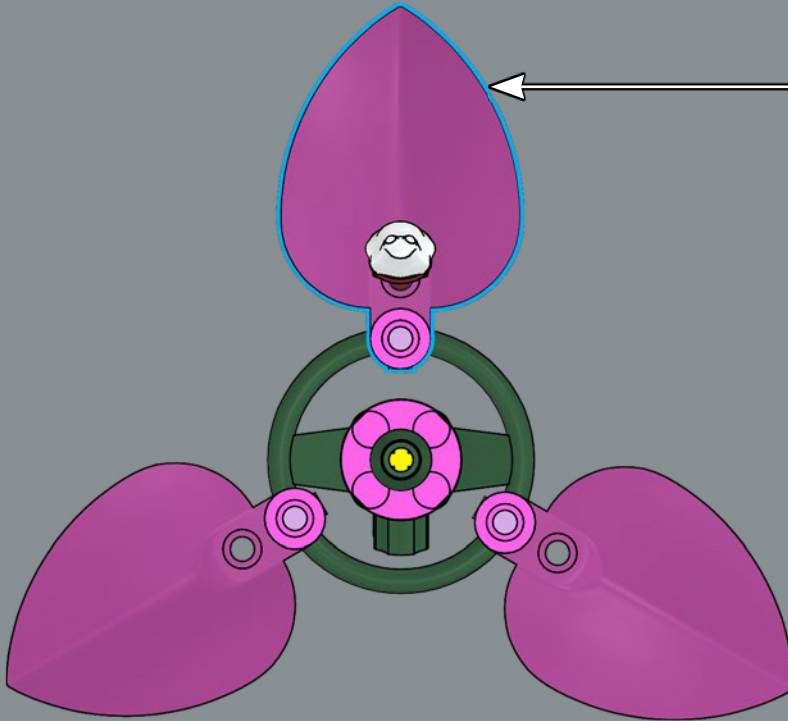
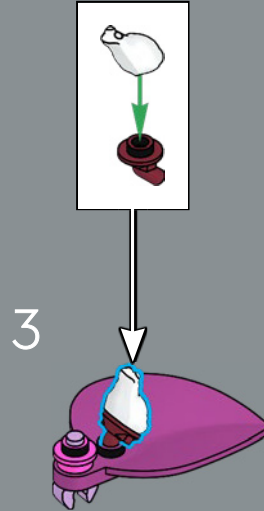
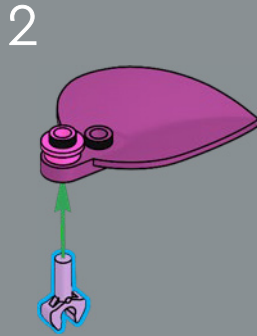
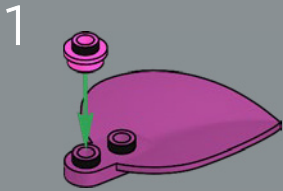

Sogar ein LEGO® Frosch kann umfunktioniert werden, um Teile einer Blume darzustellen.

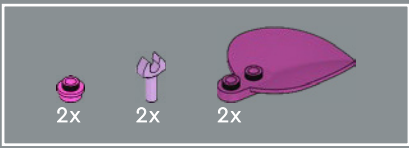

7

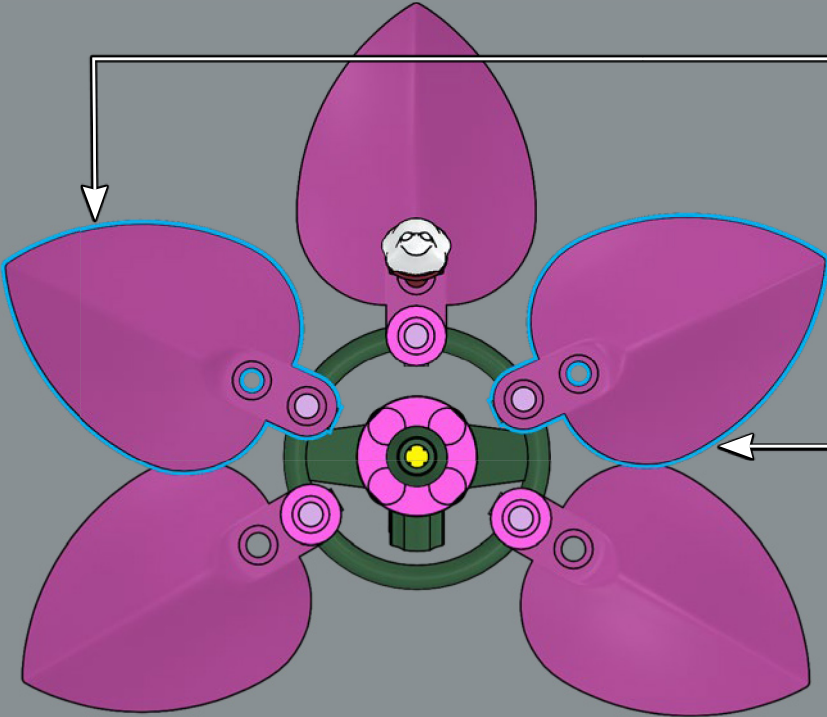
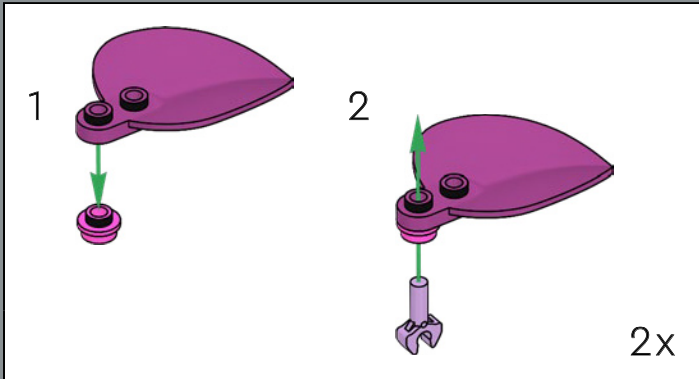

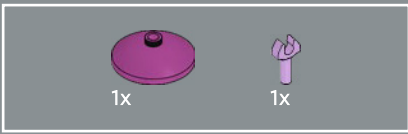

8

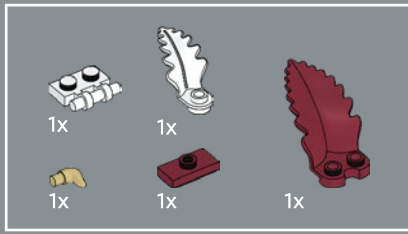
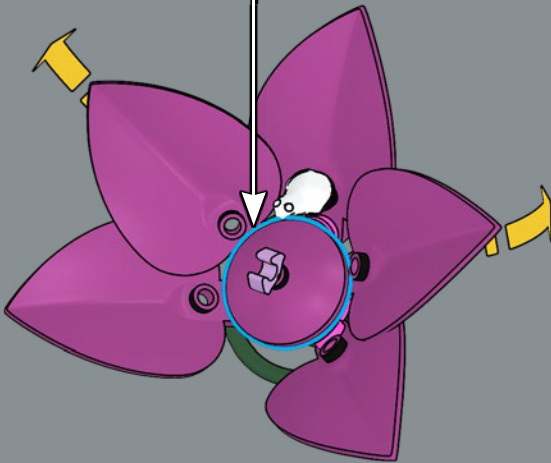
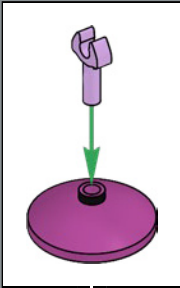

9

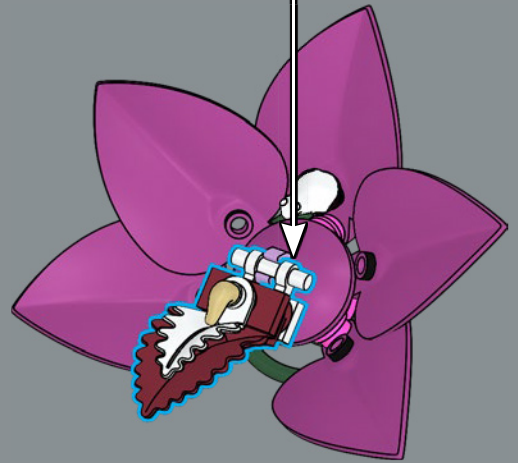
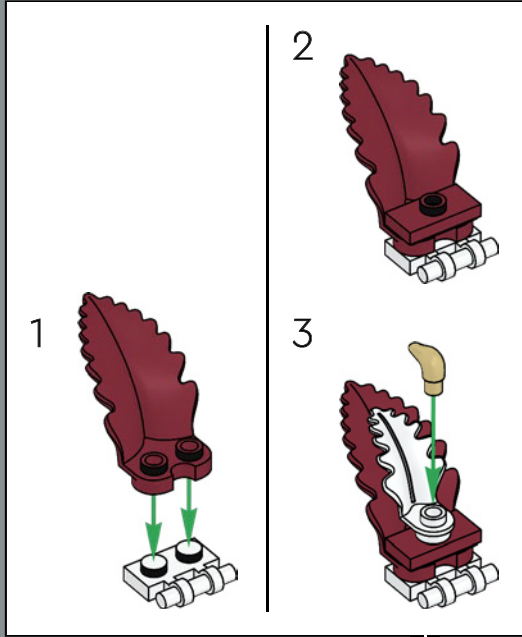



10

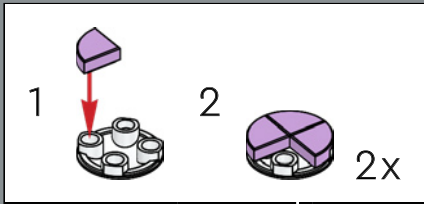

11

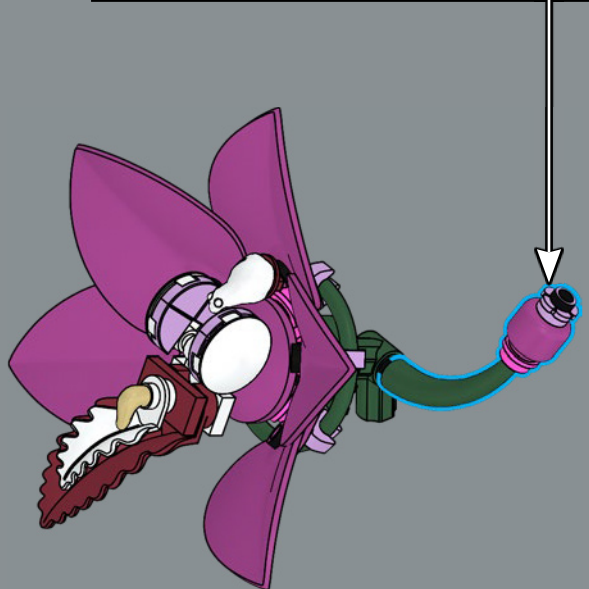
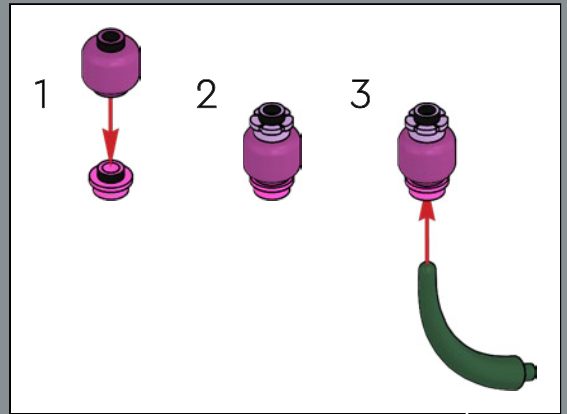

12

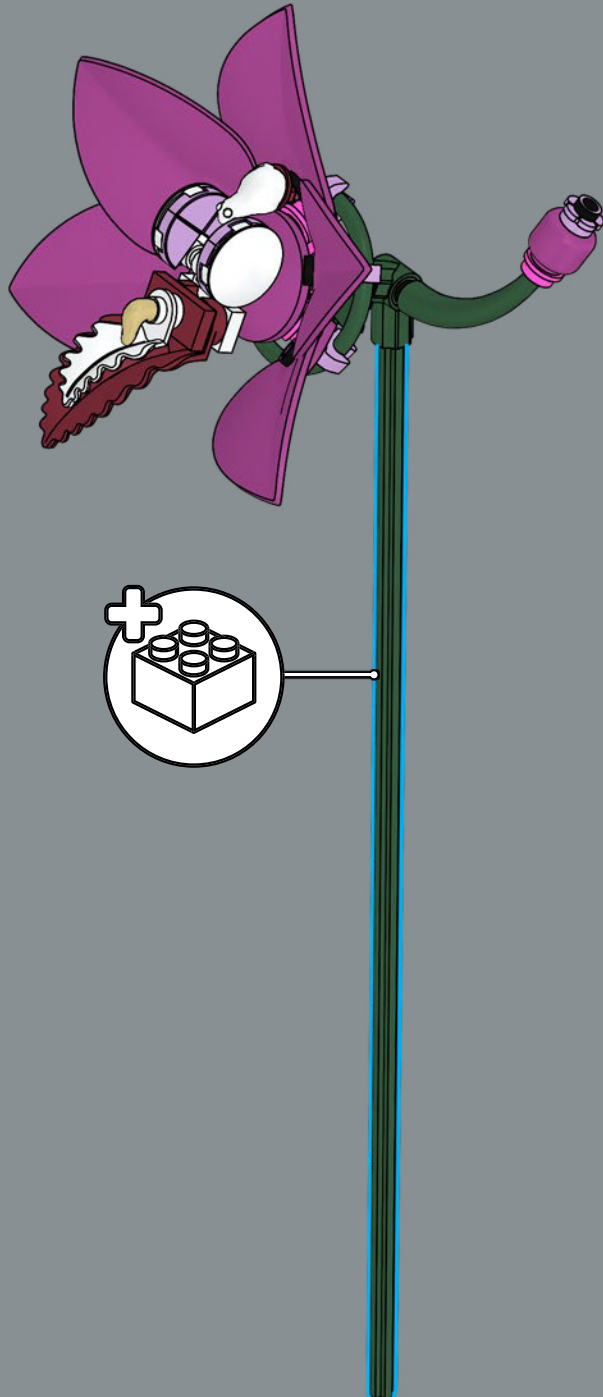

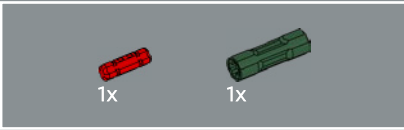
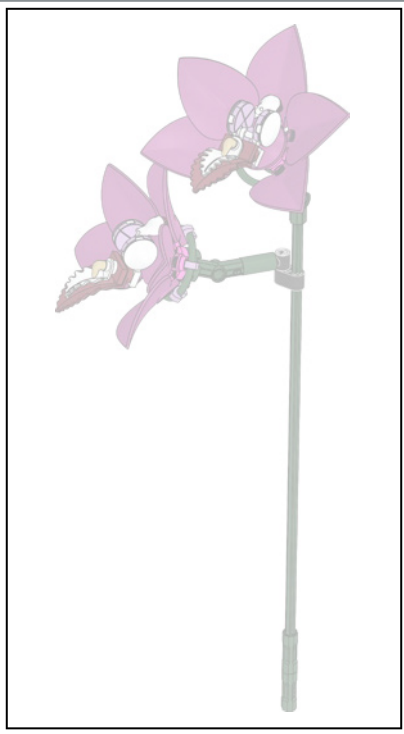

13



14



15

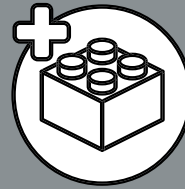

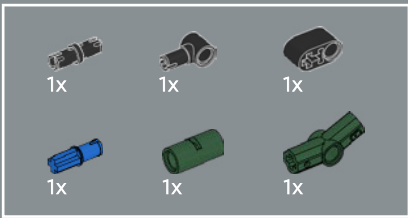

16

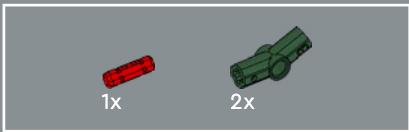
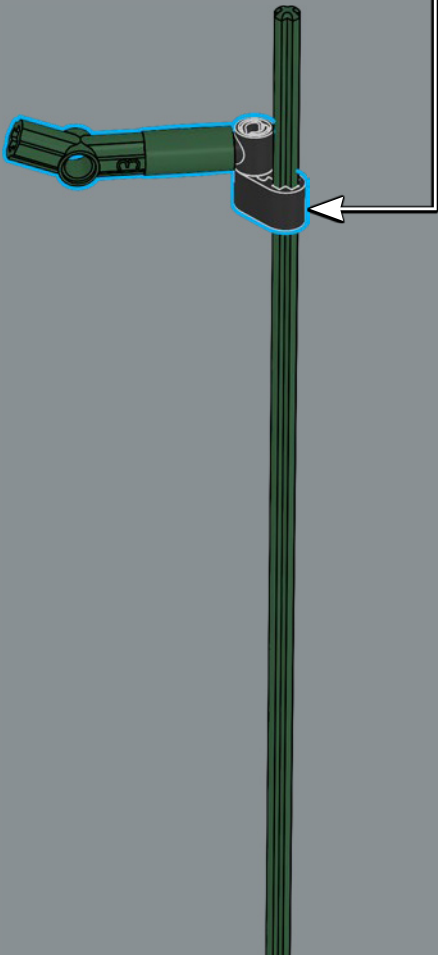
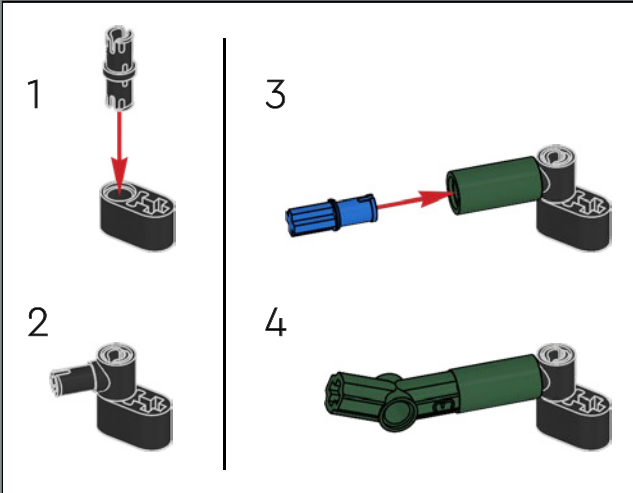

17

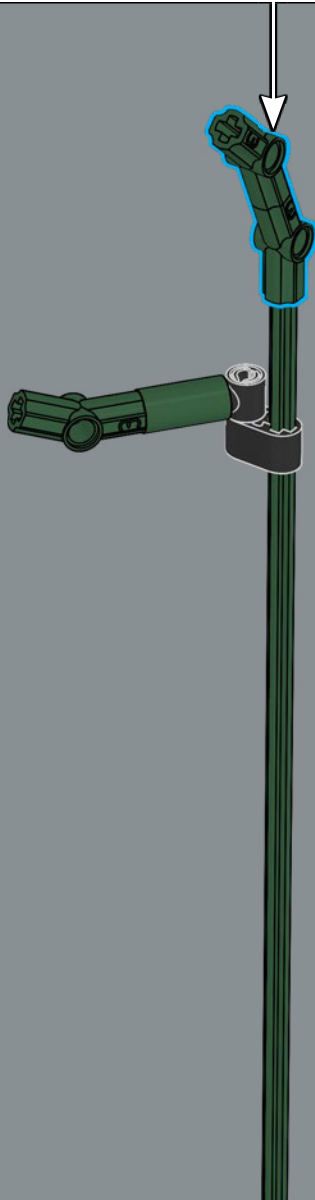
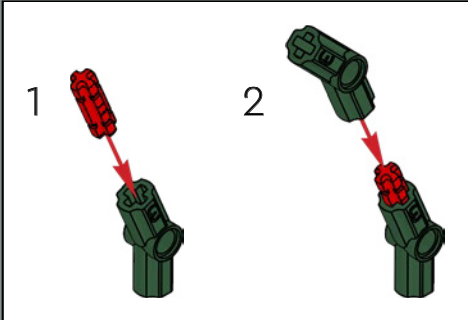

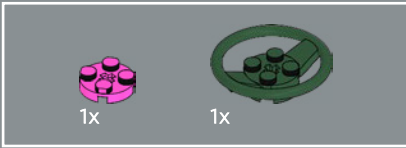
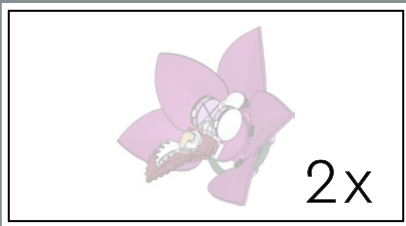

18

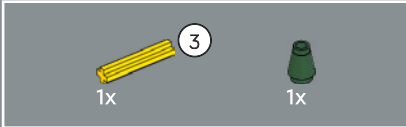
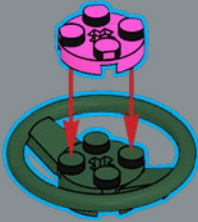

19

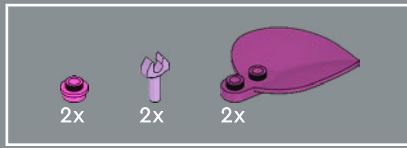
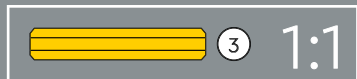
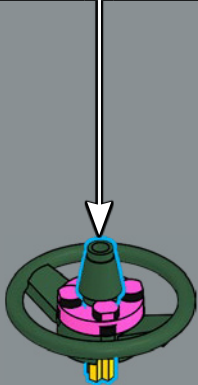
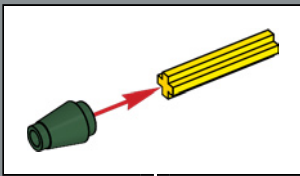

20

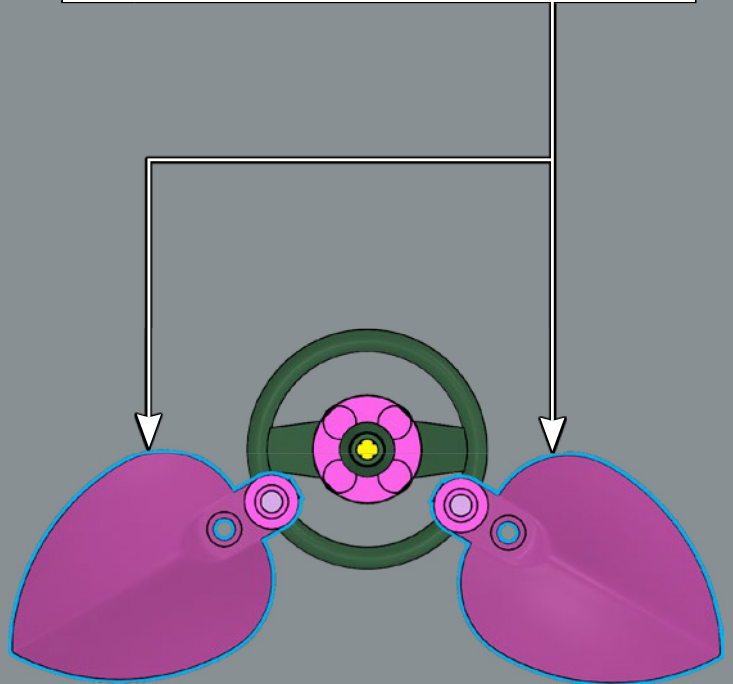
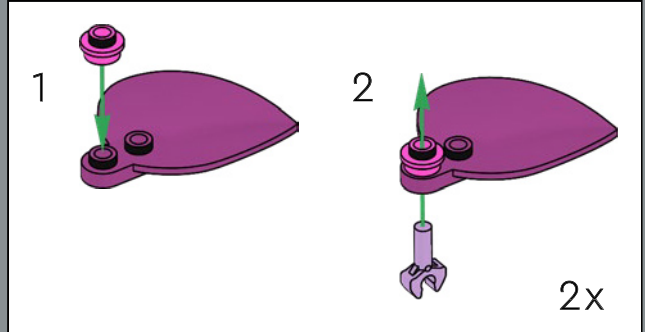



21

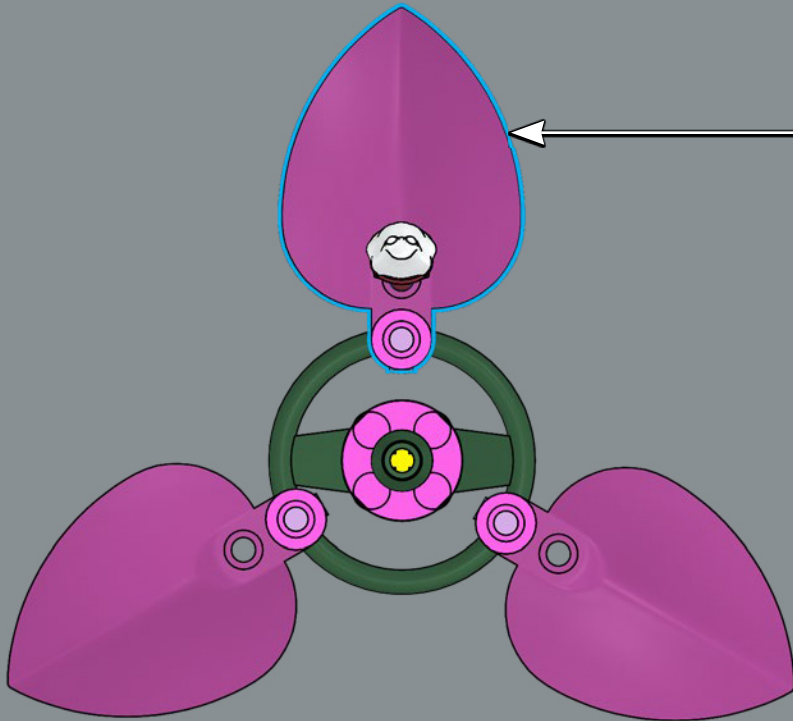
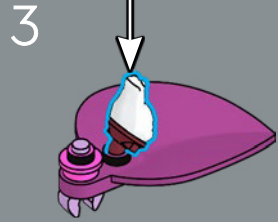
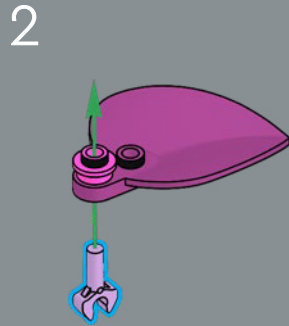
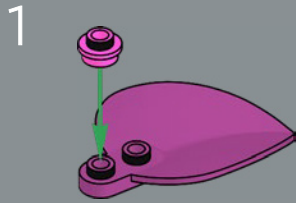
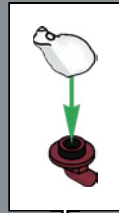

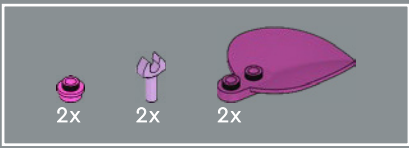

22

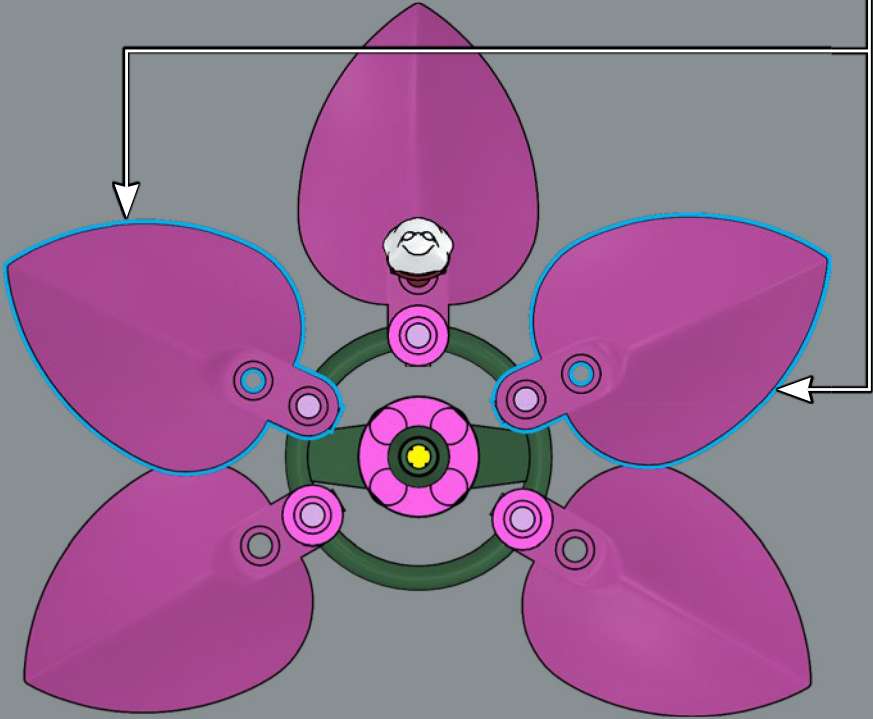
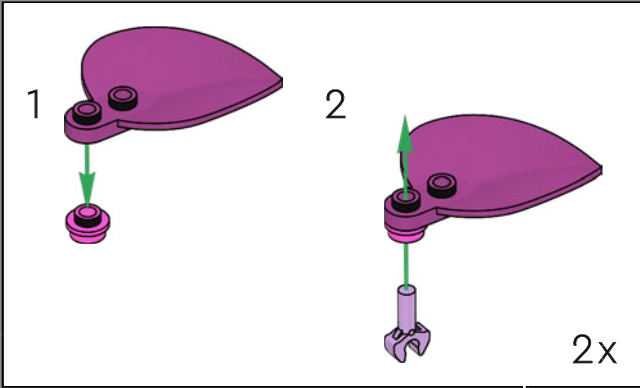

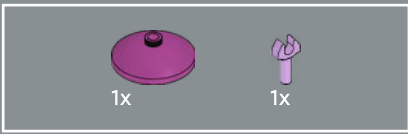

23

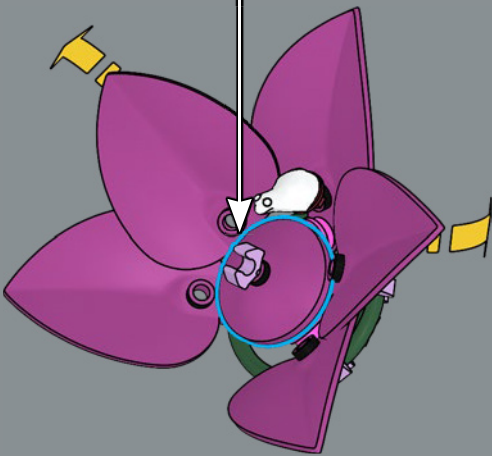
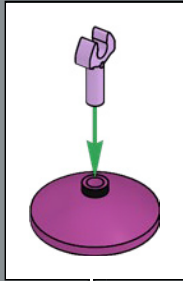

24

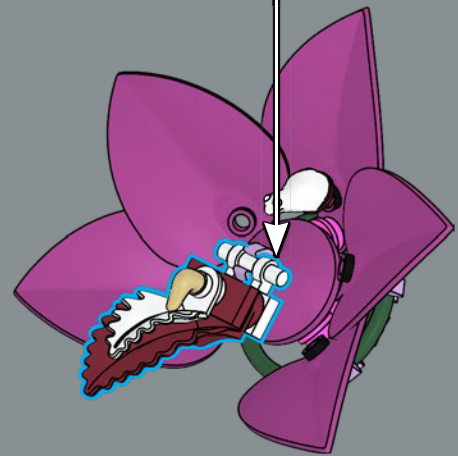
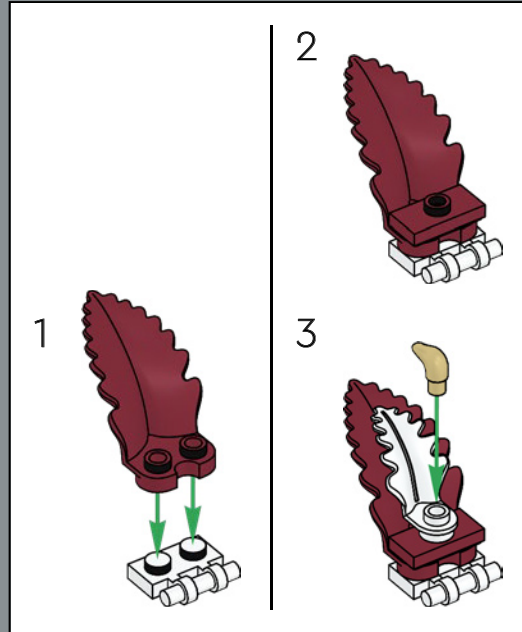

Eine aus Pflanzen erschaffene Pflanze? Das Labellum (die Lippe) dieser Orchidee wird aus 2 LEGO® Farnblättern gebaut.



25

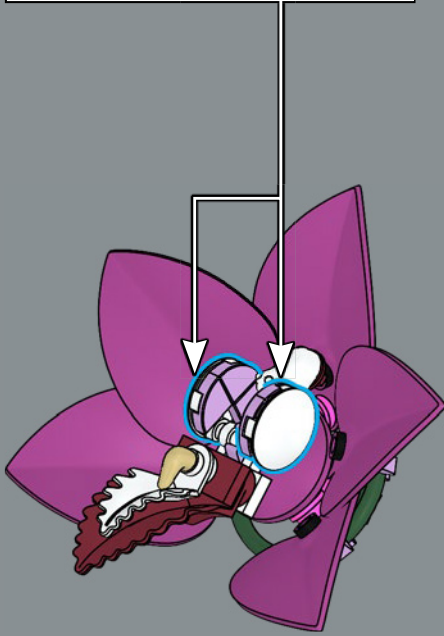
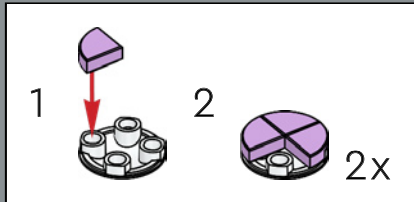

2x

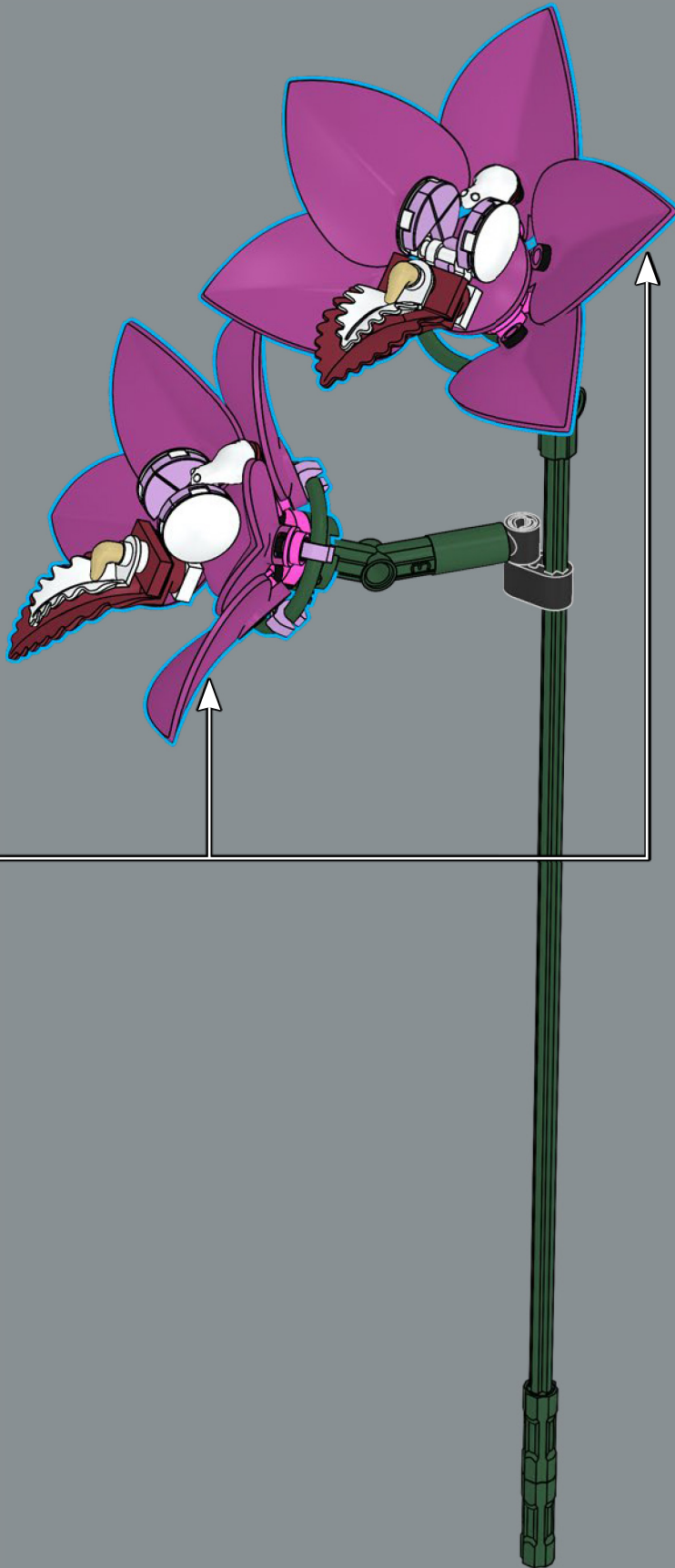

Erweitere deinen Blumenstrauß

Hast du Lust, neue LEGO® Blumenarten zu entdecken? In unserer Botanicals Reihe findest du noch weitere Blumen und Pflanzen. Lass dich von diesen Sets inspirieren, deine eigenen Blumensträuße und Gestecke zu kombinieren.



Weitere kreative Tipps
findest du in deinem
LEGO® Insiders-Konto auf

[LEGO.com/Botanicals-exclusive](https://www.lego.com/Botanicals-exclusive)

- 4x 6206149
- 1x 6279875
- 3x 6498565
- 3x 6510194
- 44x 6525752
- 22x 4516546
- 4x 6398468
- 18x 6439046
- 1x 6282140
- 1x 6349342
- 3x 6092597
- 6x 6316692
- 18x 6240465
- 3x 6298930
- 1x 6265091
- 1x 6515241
- 3x 6529631
- 4x 6267047
- 4x 4211508
- 2x 6525773
- 1x 370526
- 5x 6525789
- 8x 6366184
- 3x 6525849
- 1x 6315782
- 10x 6344177
- 4x 6395635
- 1x 4502595
- 18x 6259700
- 3x 6315782
- 10x 6344177
- 6x 6395635
- 18x 6087084
- 8x 6347293
- 16x 6525753
- 15x 6330196
- 4x 6265702
- 2x 6310174
- 24x 6252200
- 4x 6147052
- 1x 6507841
- 8x 6265702
- 16x 6230582
- 6x 4278271
- 1x 6493246
- 7x 6329283
- 3x 6326495
- 36x 4142865
- 4x 403201
- 3x 6217587
- 1x 6512537
- 3x 6525769
- 3x 4206482
- 4x 6429053
- 15x 6519960
- 2x 6529632
- 3x 6525790
- 13x 6130007
- 3x 6439714
- 2x 6270111
- 4x 6525766
- 8x 6296041
- 2x 6130008
- 3x 4140583
- 1x 6132767
- 6x 6400754
- 8x 6517912
- 12x 6510193
- 4x 6468789
- 6x 6522274
- 4x 6525927
- 8x 6456642
- 1x 6104209
- 3x 6368620
- 14x 6230571
- 2x 6035029
- 4x 6096682
- 1x 6251854
- 4x 6525785
- 11x 6411591
- 7x 6447541
- 10x 6360112
- 2x 6525787
- 8x 6525784
- 1x 6411591
- 7x 6447541
- 12x 6468072
- 12x 6526753
- 6x 6348251
- 2x 6223219
- 2x 6525748
- 1x 6329299
- 10x 6523407

4

3

5





YOU COULD WIN



YOU COULD WIN

Your feedback will help shape the future development of this product series.

Visit:

DU KÖNNTEST GEWINNEN

Dein Feedback trägt zur Weiterentwicklung dieser Produktreihe bei.

Geh auf:

VOUS POURRIEZ GAGNER

Vos commentaires nous aideront à concevoir les futurs produits de cette gamme.

Visitez :

POTRESTI VINCERE TU

La tua opinione ci aiuterà a migliorare la creazione futura di questa linea di prodotti.

Visita:

PUEDES GANAR

Tu opinión contribuirá al futuro de esta serie de productos.

Visita:

轻松获奖

您的反馈将有助于我们在今后改进本产品系列。

请访问:

LEGO.com/productfeedback

You also have the chance to win a LEGO® set.

Terms and conditions apply.*

Außerdem hast du die Chance, ein LEGO® Set zu gewinnen.

Es gelten die Teilnahmebedingungen.*

Vous pourriez également gagner un ensemble LEGO®.

Des conditions s'appliquent.*

Hai anche la possibilità di vincere un set LEGO®.

Termini e condizioni sono applicabili.*

También tienes la oportunidad de ganar un set LEGO®.

Aplican términos y condiciones.*

您还有机会赢取乐高®套装。

条款和条件适用。*

*LEGO.com/productfeedback-terms

