



10340







LEGO.com/sustainable-packaging



FR  
**DONNEZ  
OU  
RECYCLEZ**



OU



OU



ASSOCIATION    MAGASIN    DÉCHÈTERIE

Adresses sur [quefairedemesdechets.fr](http://quefairedemesdechets.fr)





# BUILDER



Apple and the Apple logo are trademarks of Apple Inc., registered in the U.S. and other countries and regions. App Store is a service mark of Apple Inc. Google Play and the Google Play logo are trademarks of Google LLC. Tencent and the Tencent logo are trademarks of Tencent Inc.

LEGO.com/devicecheck



LEGO® Builder









## Des moments chaleureux lorsque l'hiver s'installe

À l'arrivée de l'automne et de l'hiver, la nature semble nous inviter à jouer avec ses splendides couleurs et à apprécier ses précieux cadeaux. Les baies rouges embellissent les branches vertes, tandis que les feuilles semblent rayonner et diffuser des teintes chaudes lorsqu'elles tombent à vos pieds. Faites entrer la couleur et la joie chez vous avant le retour des beaux jours. Appréciez le processus créatif et la satisfaction d'assembler toutes les formes et couleurs qui vous inspirent, puis lâchez prise. Avec cette élégante couronne ou guirlande LEGO®, vous pouvez prolonger ce sentiment de joie et renouveler votre décoration tout au long de la saison hivernale.





## Des arômes évoquant les fêtes

Chaque saison possède ses attraits. Même les sombres journées d'hiver nous offrent de beaux moments de partage avec nos proches. Peu de choses éveillent des souvenirs aussi agréables que les doux parfums aromatiques des fêtes de fin d'année : les branches de sapin vivifiantes, les tranches d'orange acidulées, la délicieuse cannelle ou la sève de pin boisée. Lorsque vous construisez ce set, inspirez-vous de toutes ces odeurs et épices familières. Construisez une couronne décorative à accrocher au mur ou une guirlande festive pour votre table. Ajoutez votre touche créative et personnalisez votre modèle en fonction de l'occasion, de votre humeur ou de votre décoration intérieure. Que ce soit dans la forme ou dans les détails, en changeant les baies ou en reconfigurant les éléments décoratifs, expérimentez avec les différentes pièces pour créer un modèle totalement nouveau. Nous espérons que ce modèle vous apportera du réconfort durant les jours de froid et qu'il vous permettra de créer de précieux souvenirs à chérir pendant des années.

**KENYON ANDREW BRADY**  
*Model Designer LEGO®*







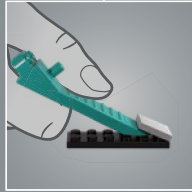
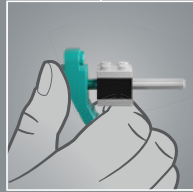
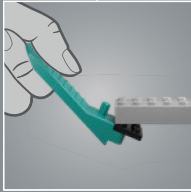
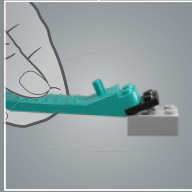
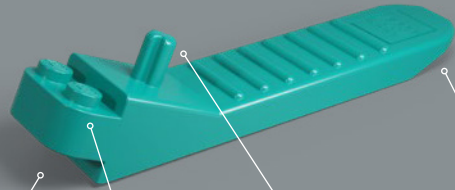



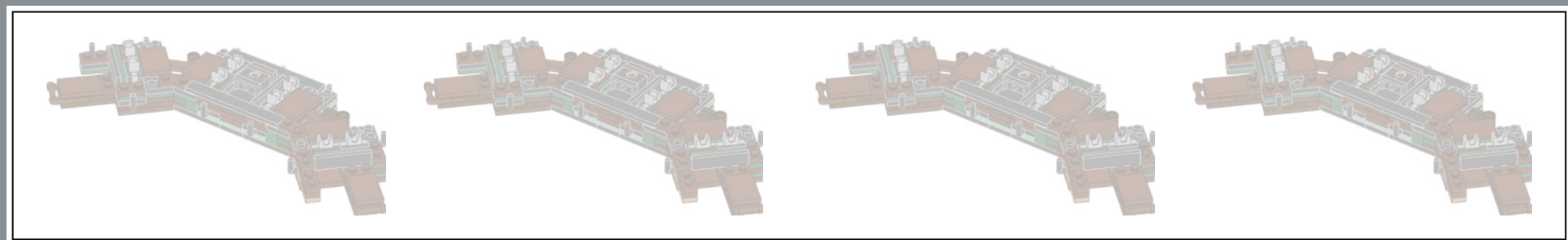





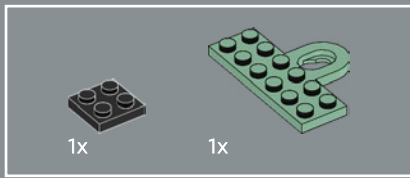

5

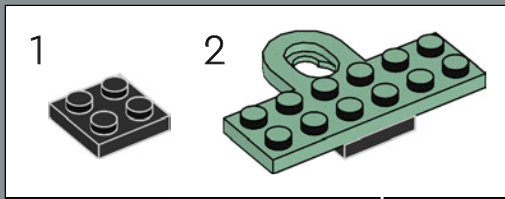
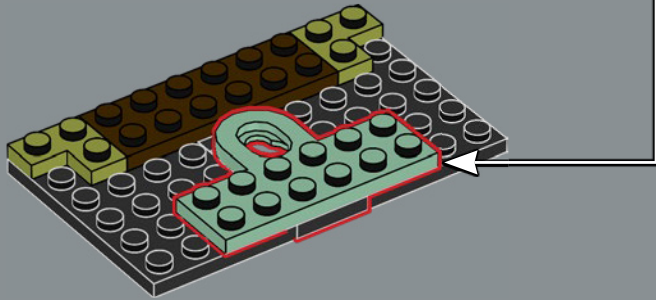

7

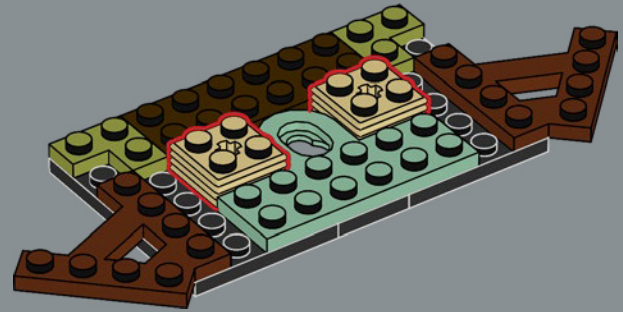

6

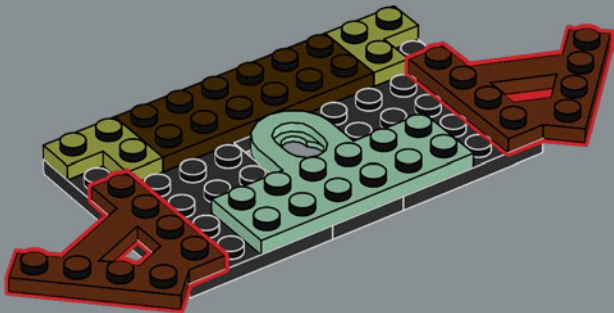

8

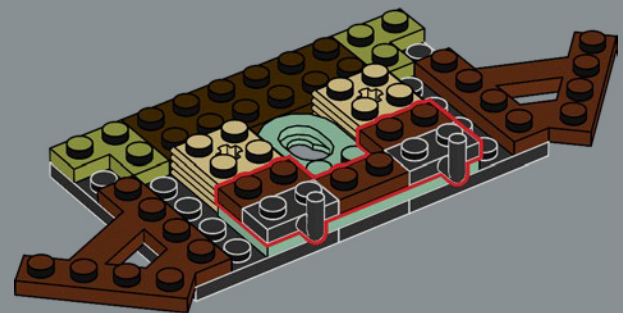

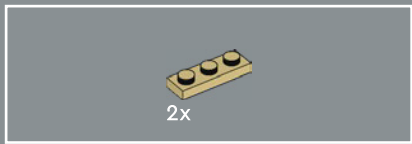

9

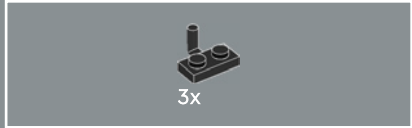
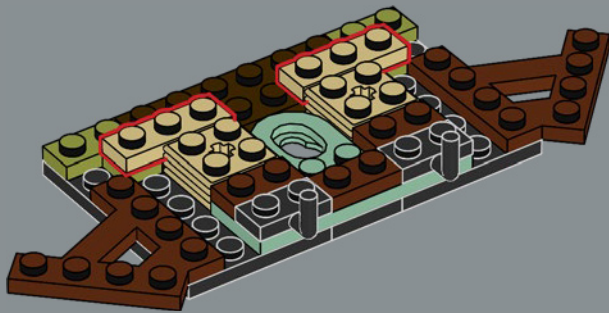

10

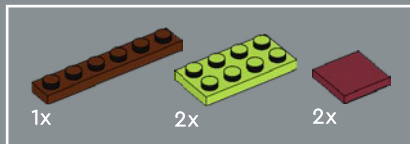
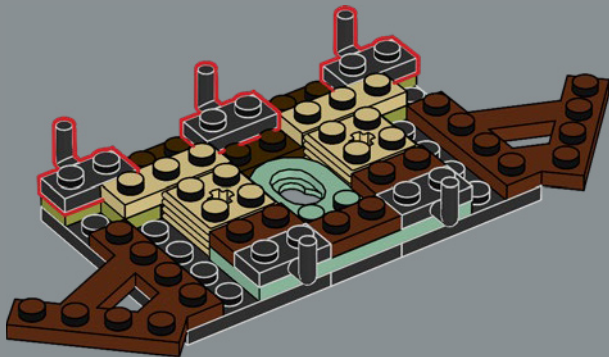

11

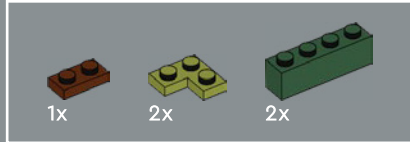
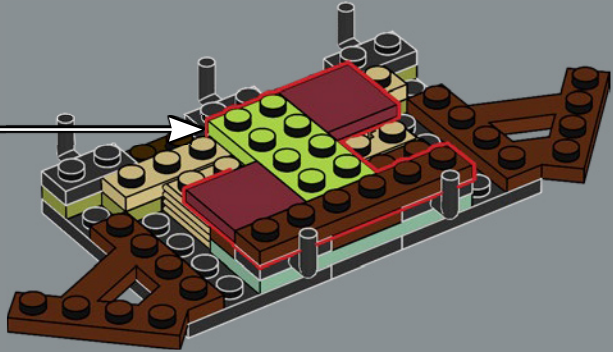
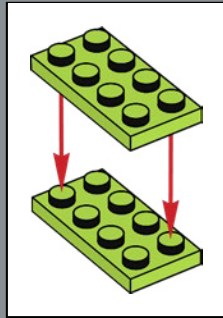

12

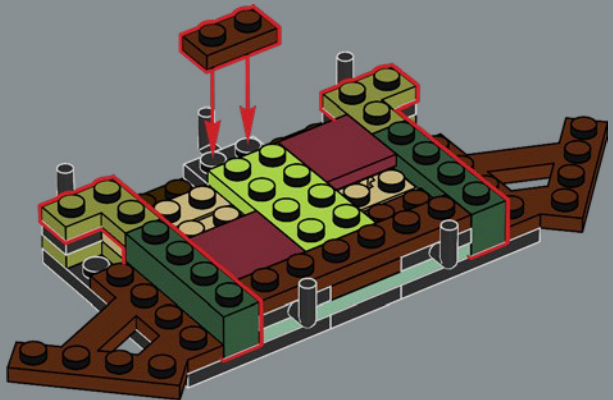





13

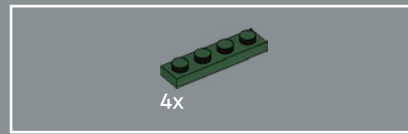
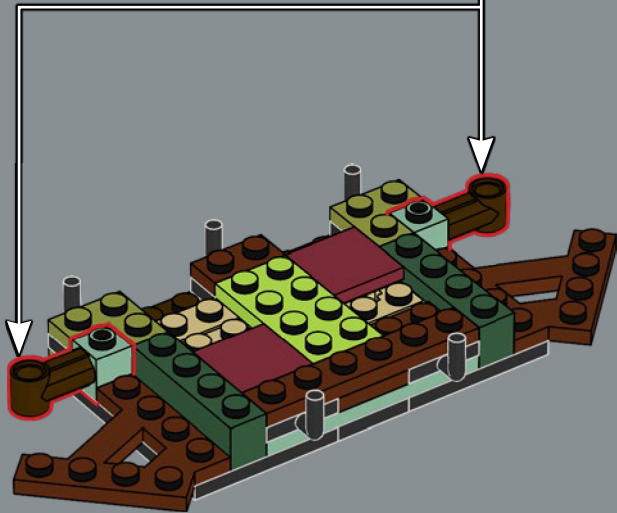
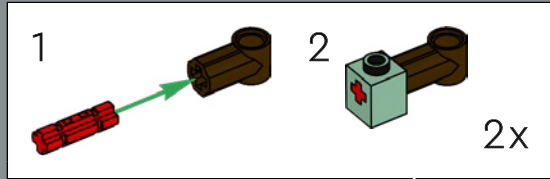

14

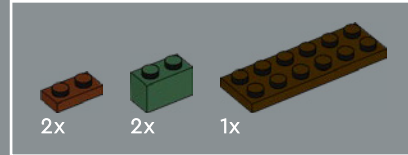
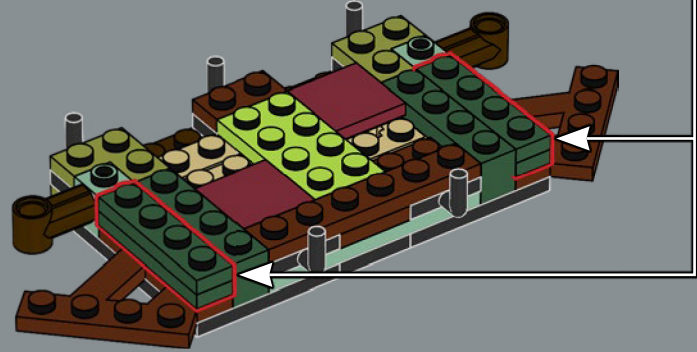
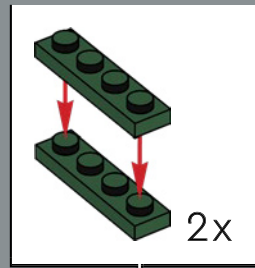

15

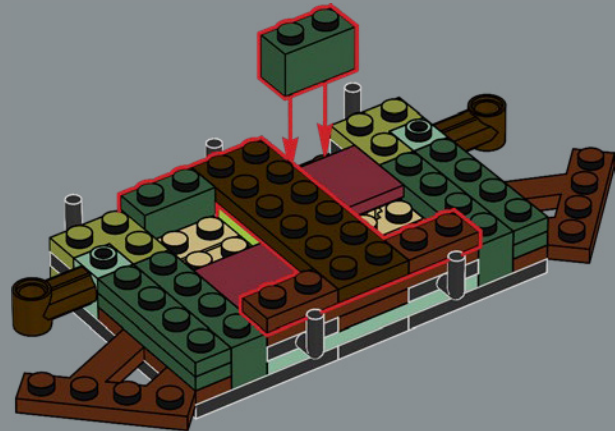

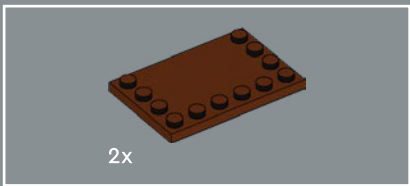

16

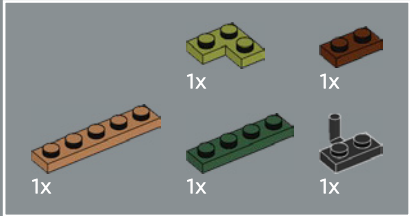
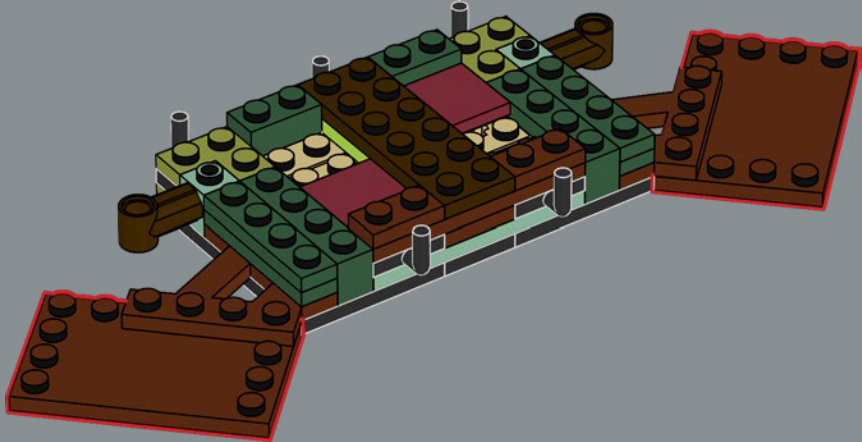

17

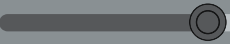
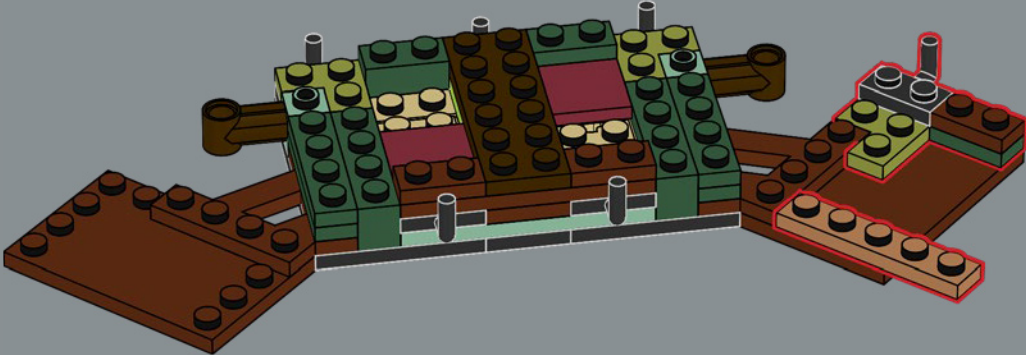
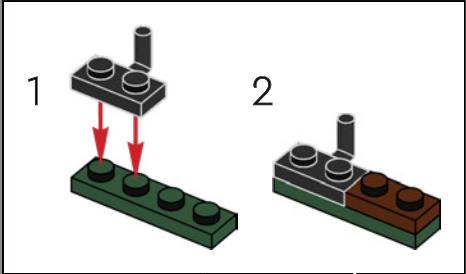



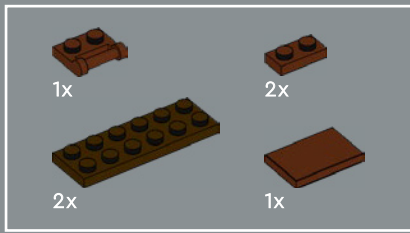

18

1

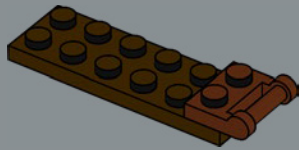

2

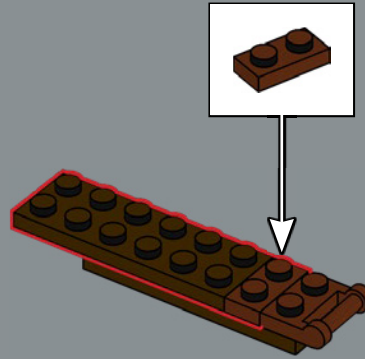

3

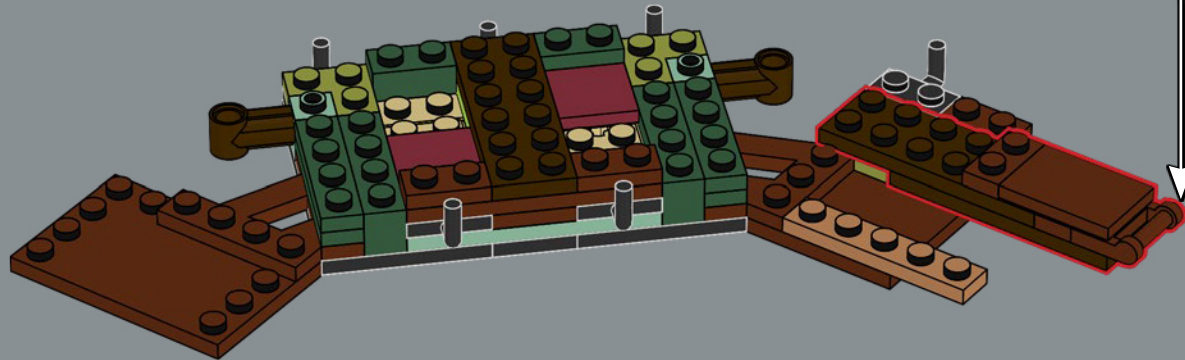
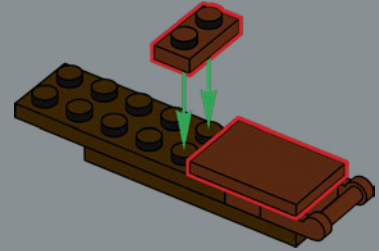

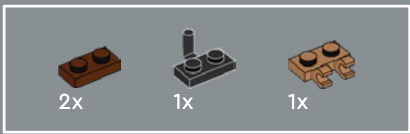

19

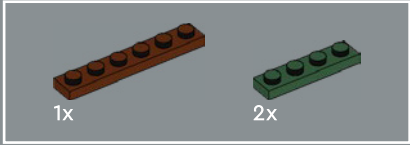
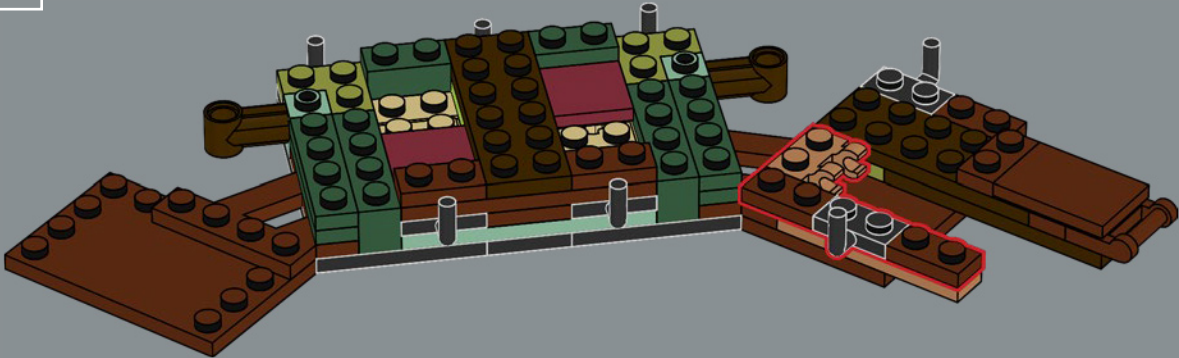

20

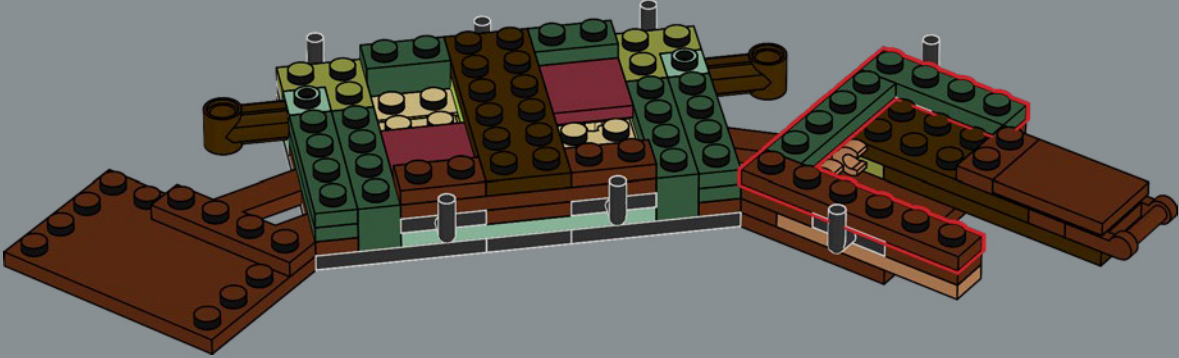



21

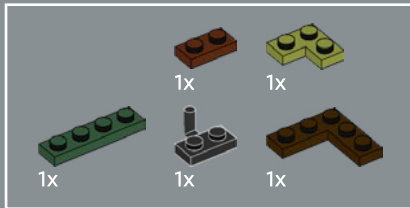
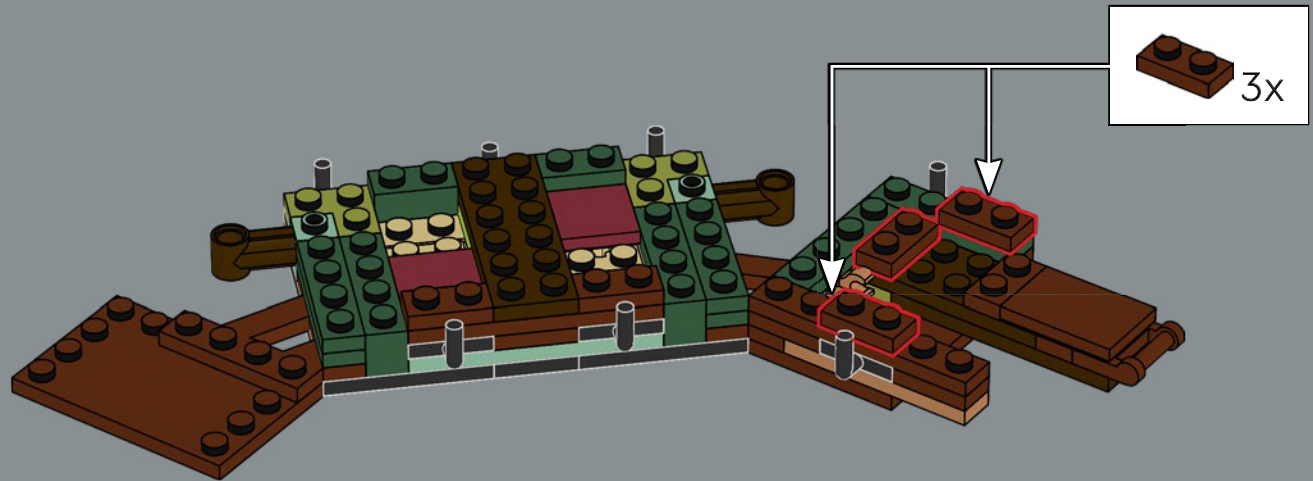

22

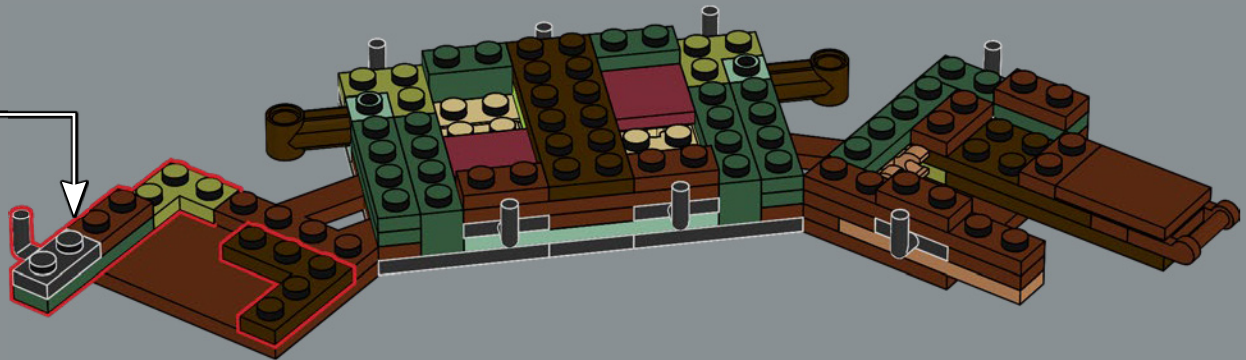
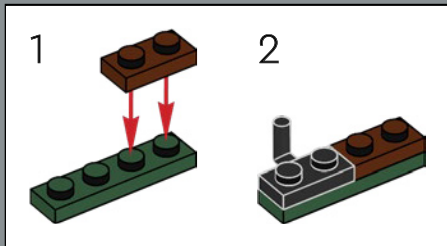



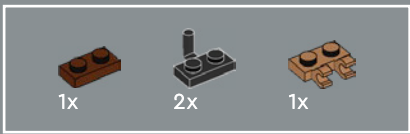

23

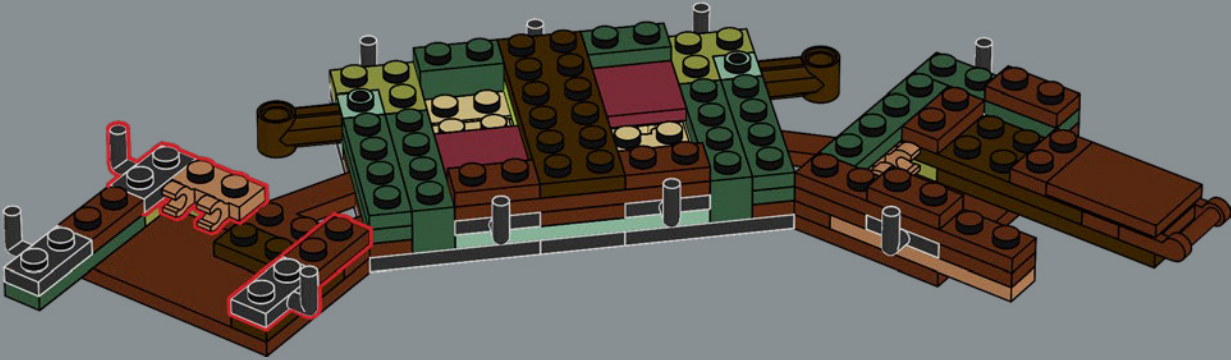

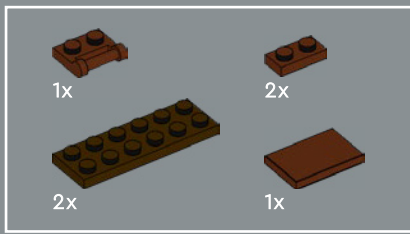

24

1

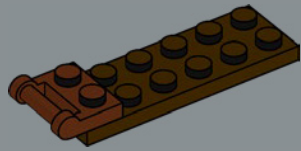

2

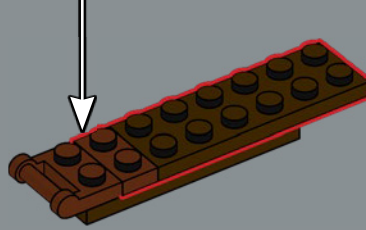

3

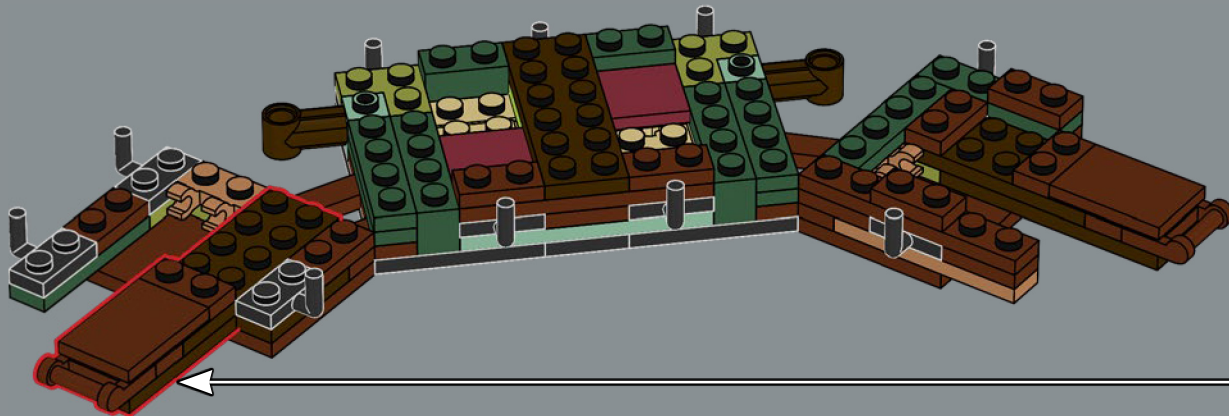
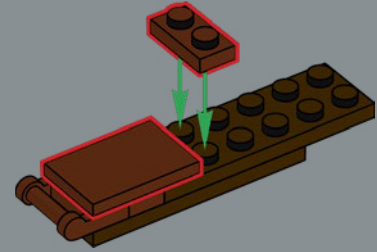

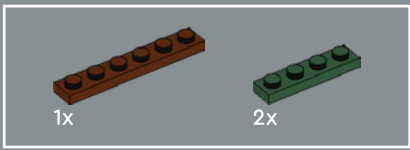

25

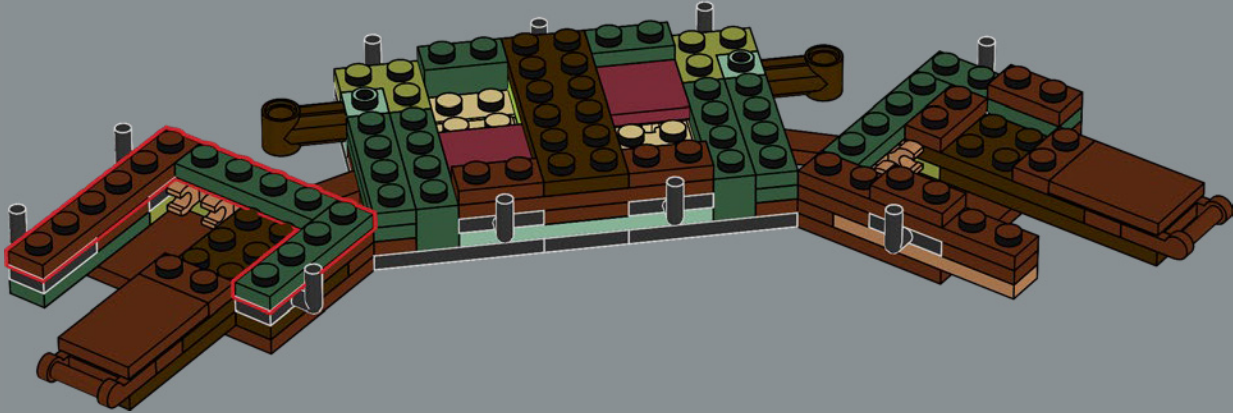

26





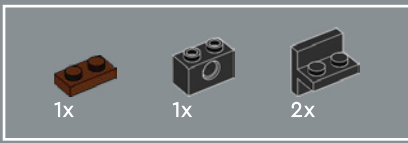

27

1

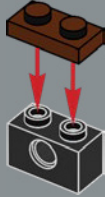

2

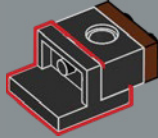

3

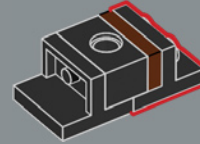

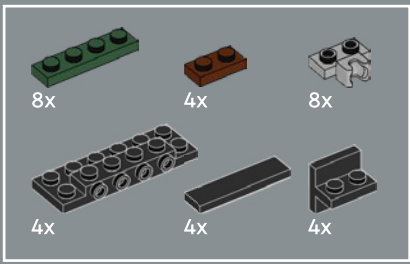

28

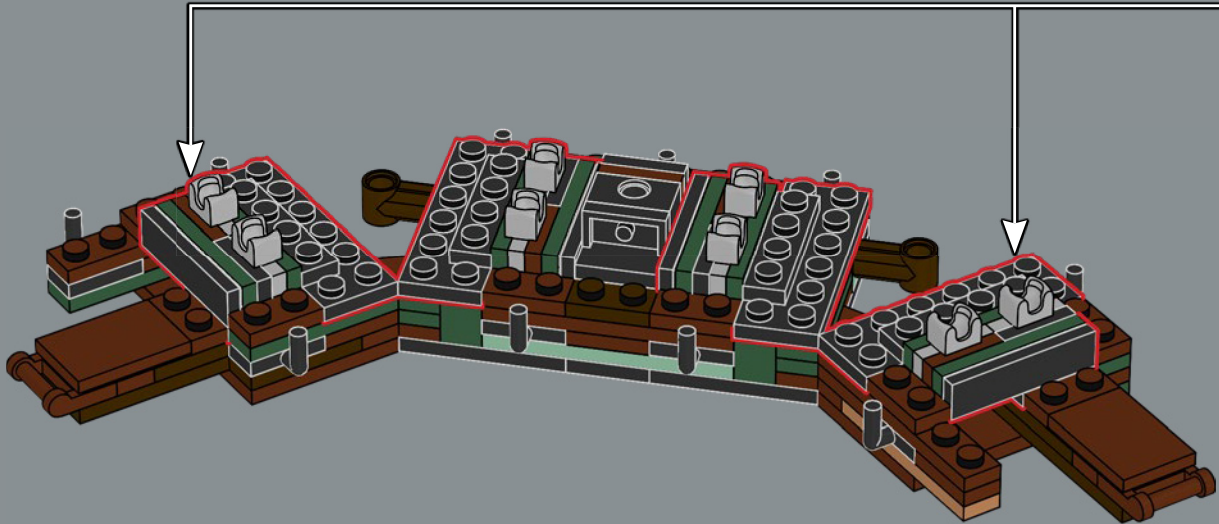
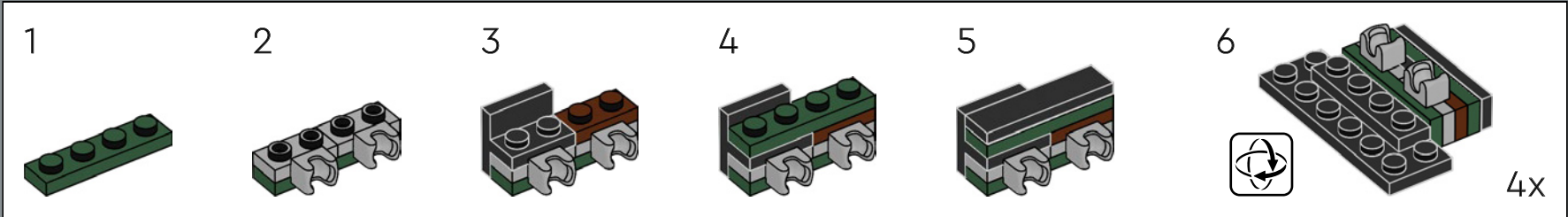





29

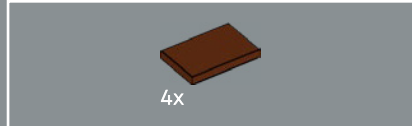
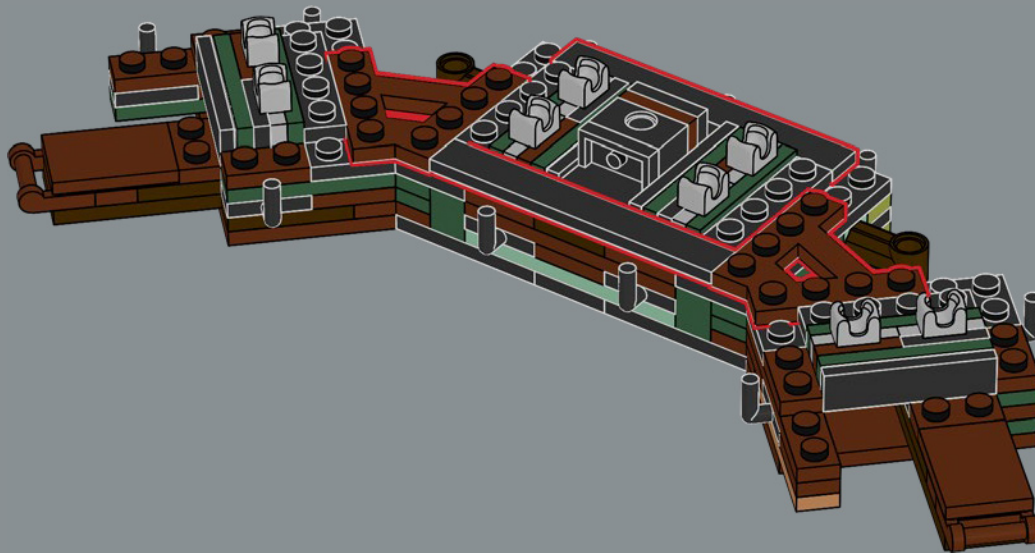

30

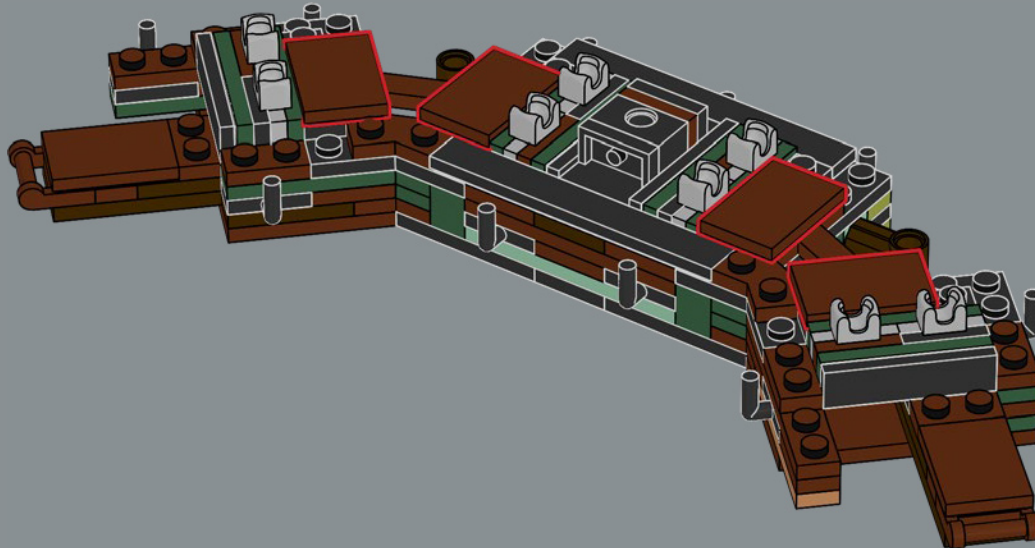

4x

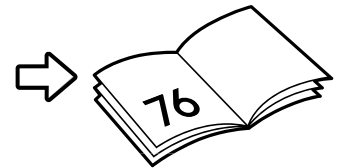
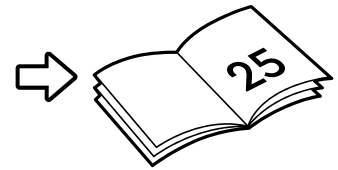





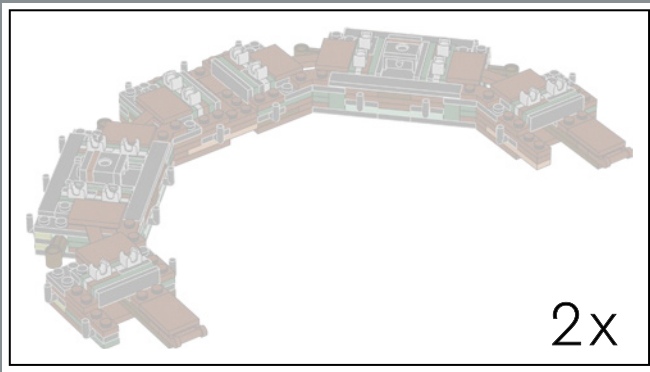

2x

31

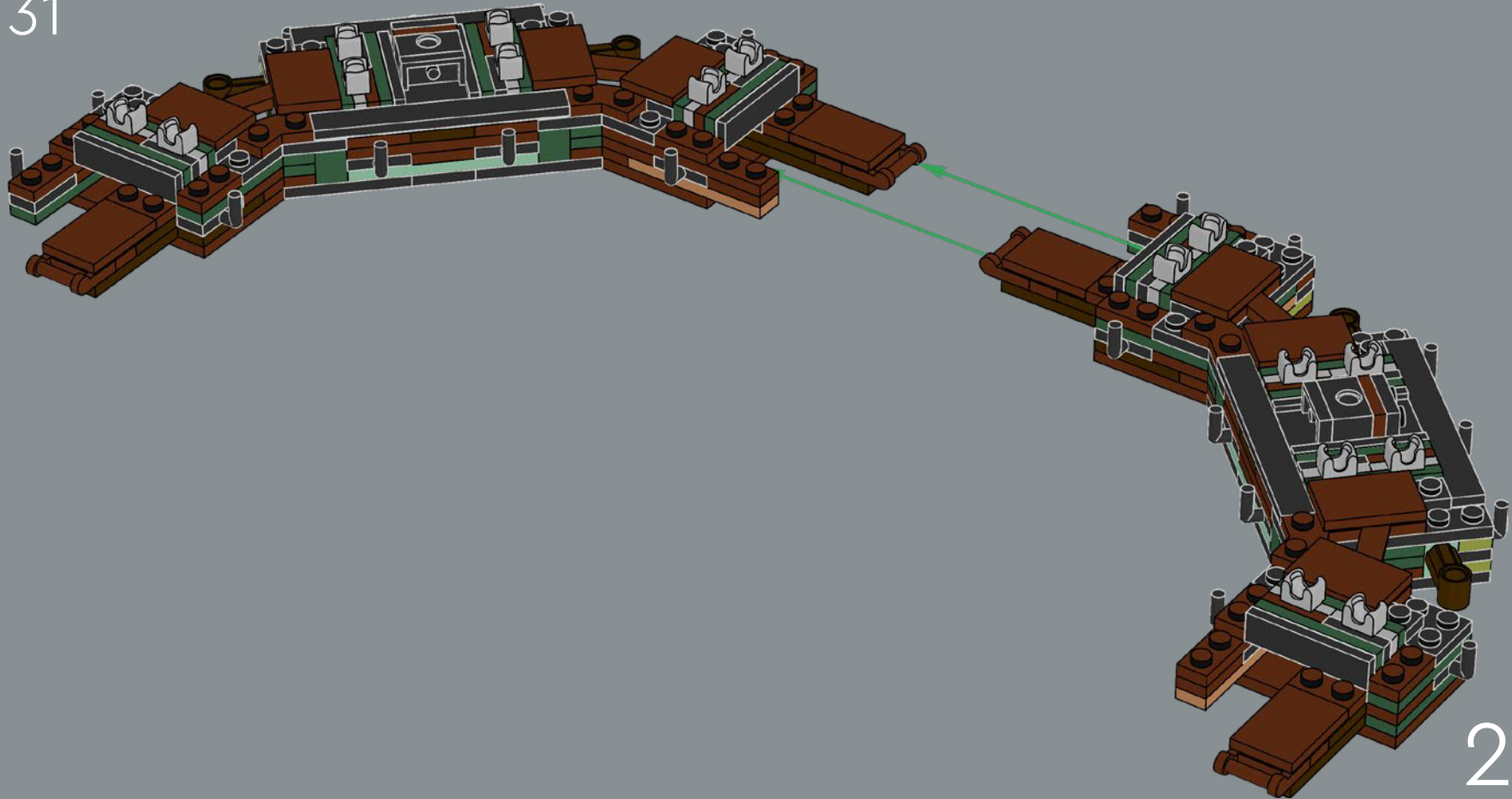

2x



32

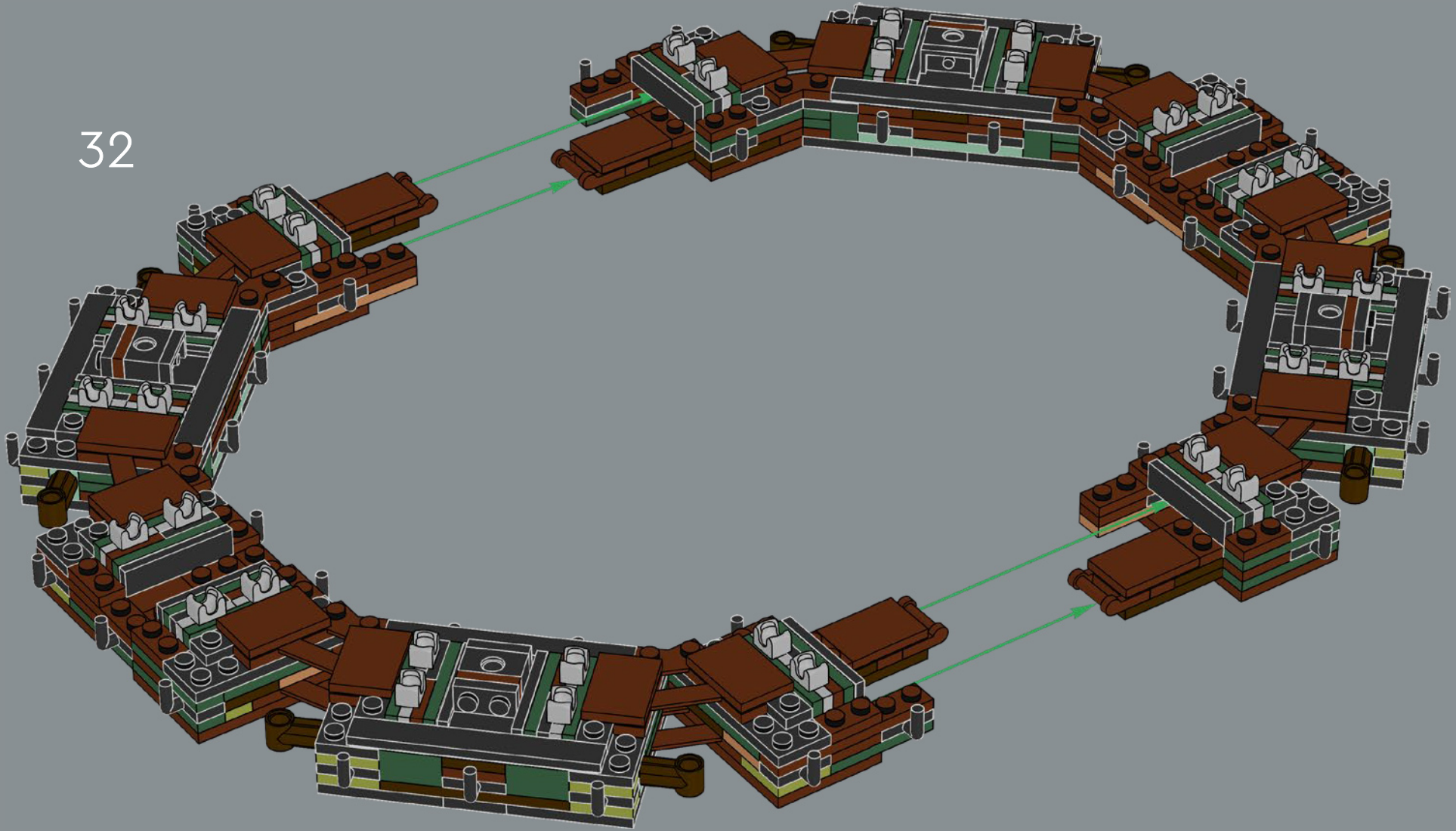





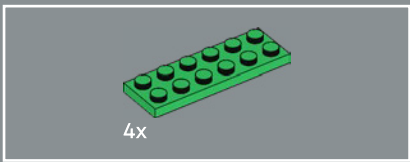

33



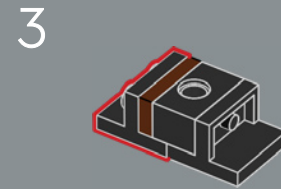
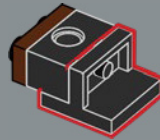
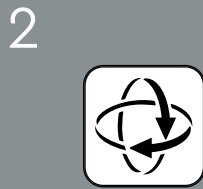
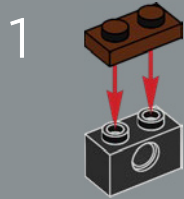
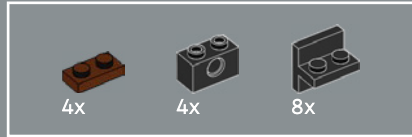
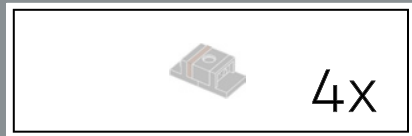

4x

34

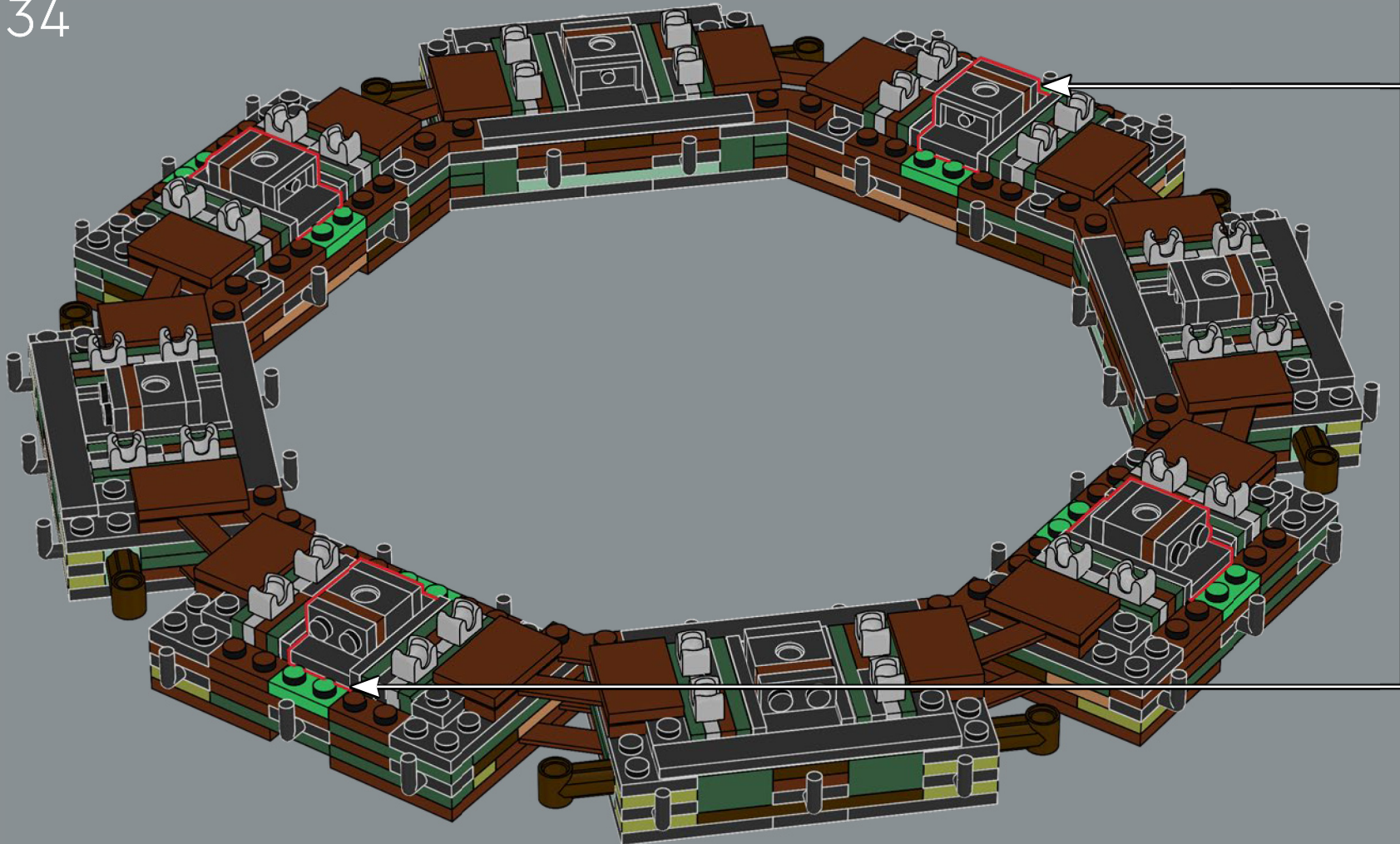



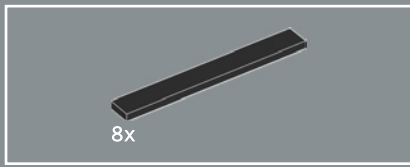

35

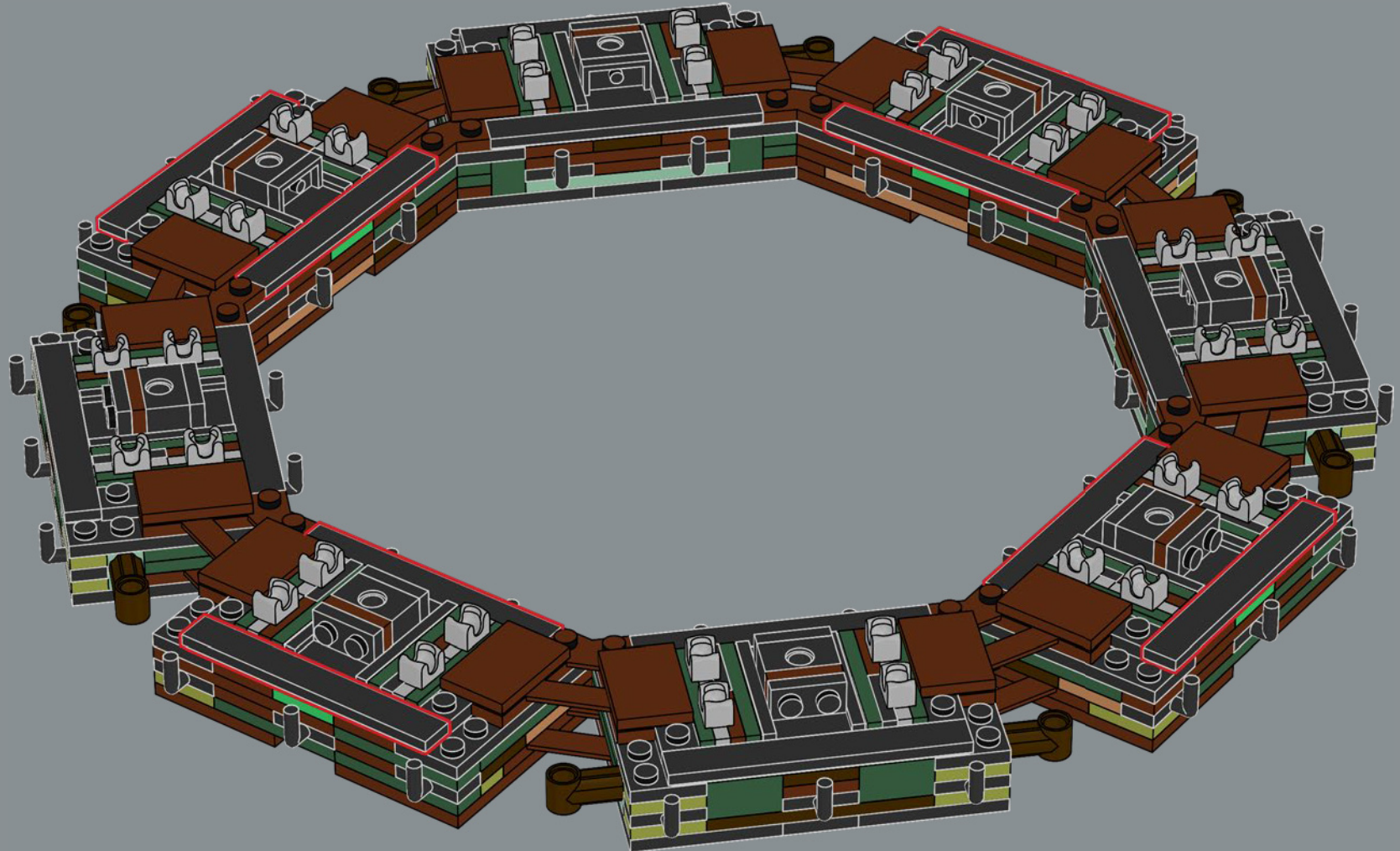



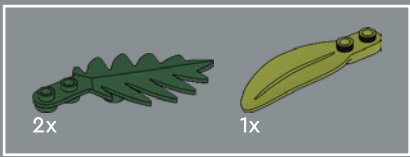

36



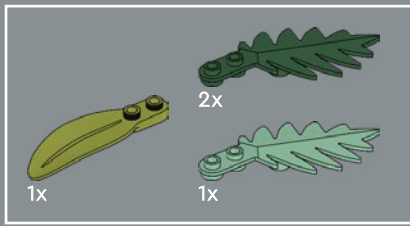

37





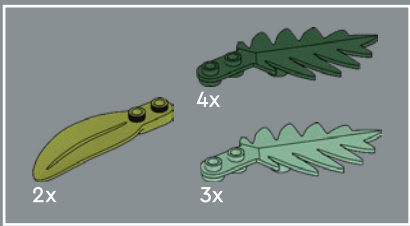

38







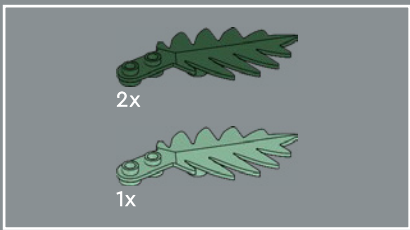

40





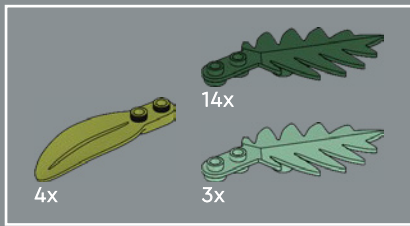

41







8x

42



8x





Lorsqu'elles sont assemblées en séquence, les tiges de fleurs LEGO® forment des aiguilles de sapin remarquablement pointues.

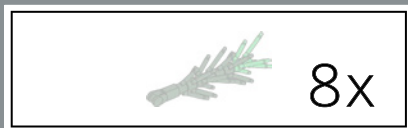

43

1

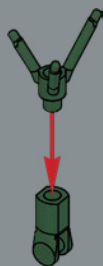

2

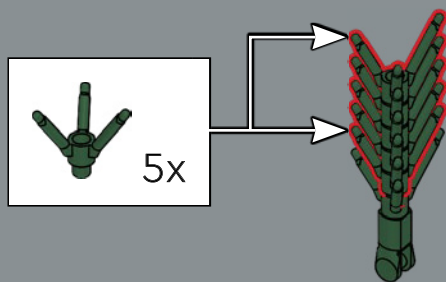

3



4

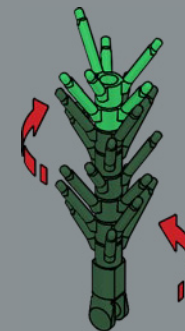

8x











Le dessous des aiguilles du sapin de Fraser a une teinte bleuâtre. Elle est ici représentée par des feuilles de palmier vert-de-gris, une nouvelle couleur pour cet élément LEGO® classique apparu pour la première fois en 1989.

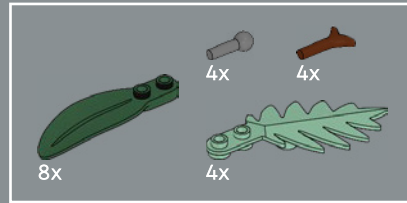
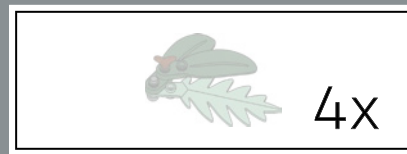

45

1

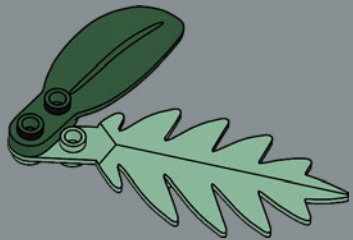

2

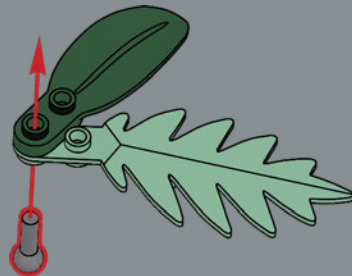

3

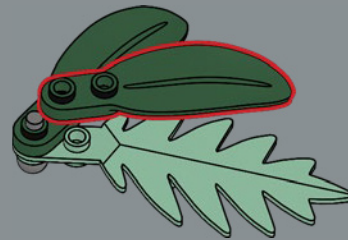

4

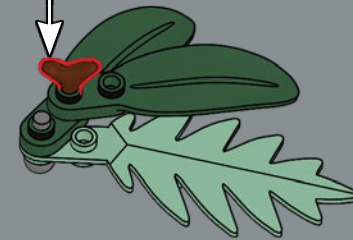

4x







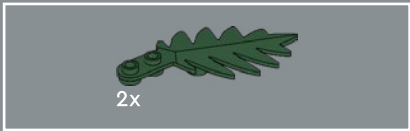
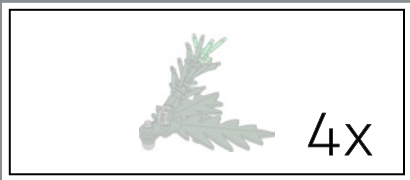

46

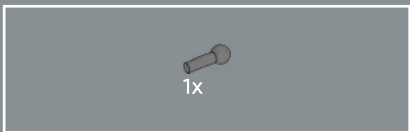
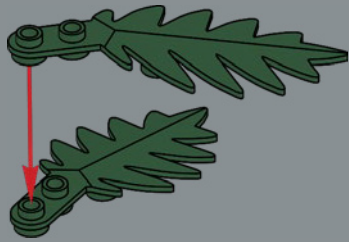

47

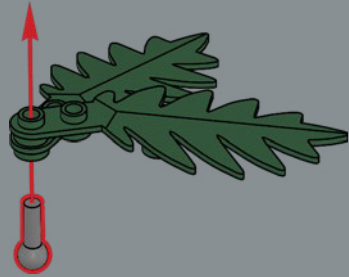

48

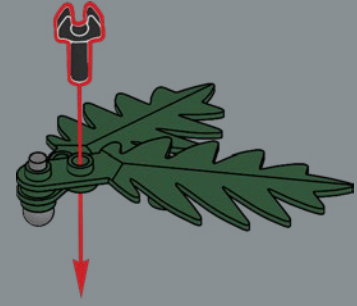



49

1

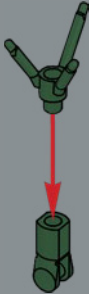

2

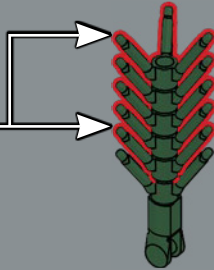
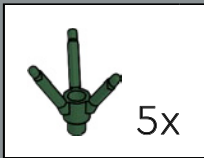

3



4

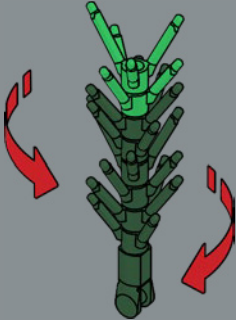



4x









Certaines espèces de magnolia ont un feuillage persistant, ce qui rend leurs feuilles parfaites pour être intégrées dans des compositions florales tout au long de l'année.

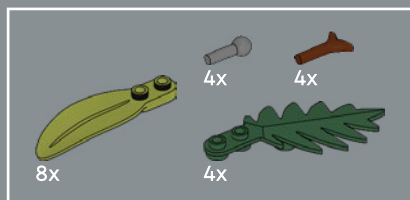

51

1

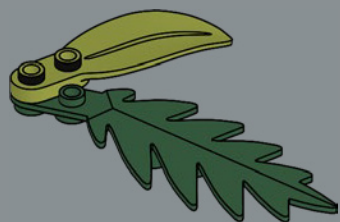

2

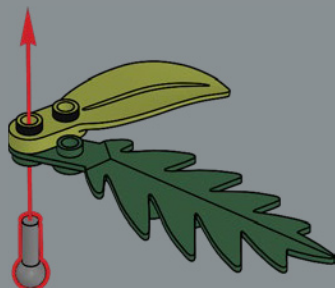

3

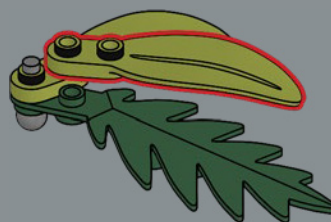

4

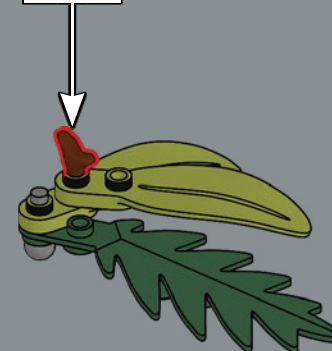
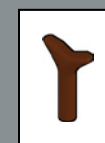

4x









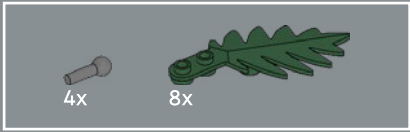
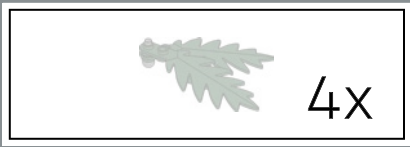

52

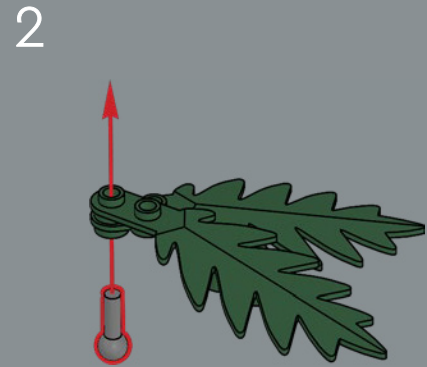
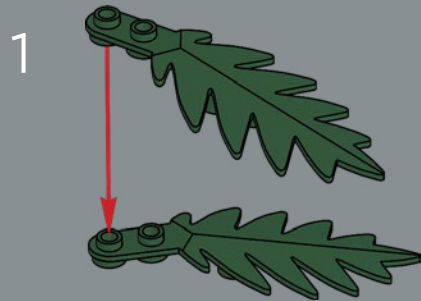

4x





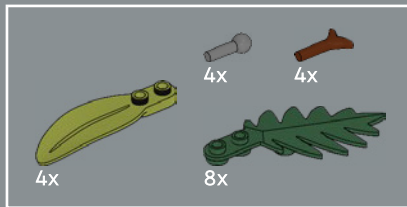

53

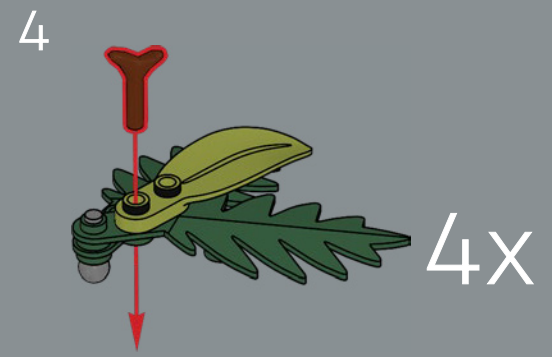
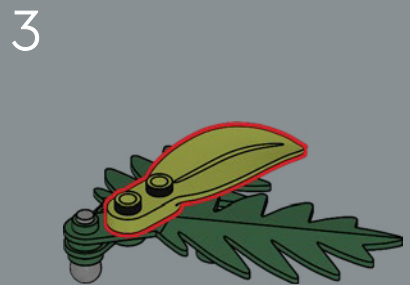
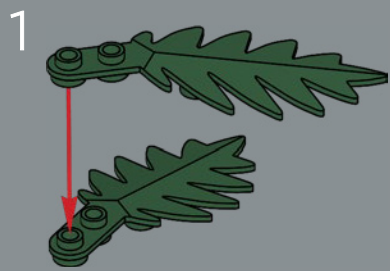





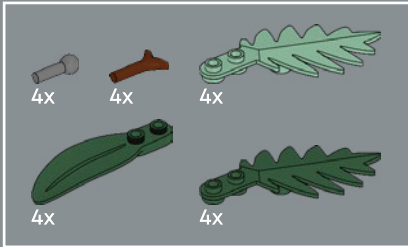

54

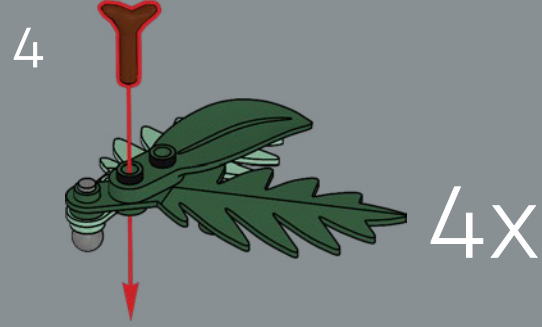
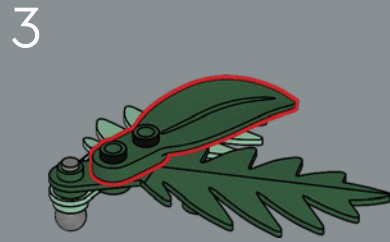
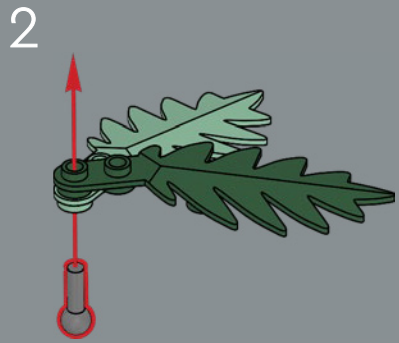









55

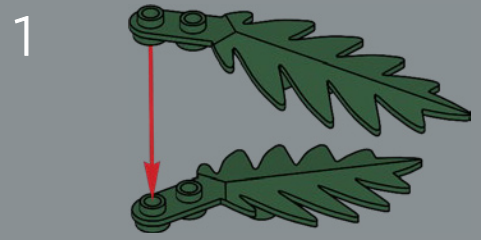







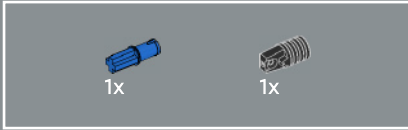

56



57

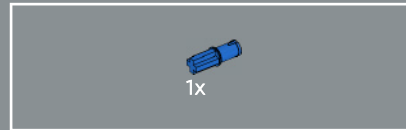

58

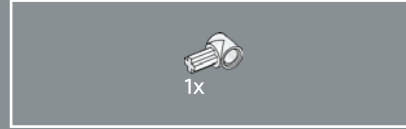

59



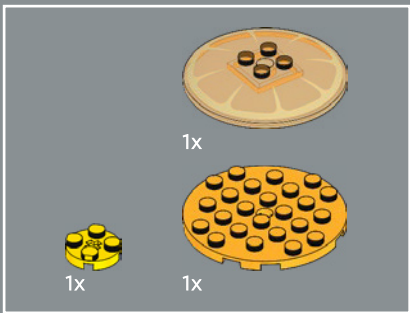

60

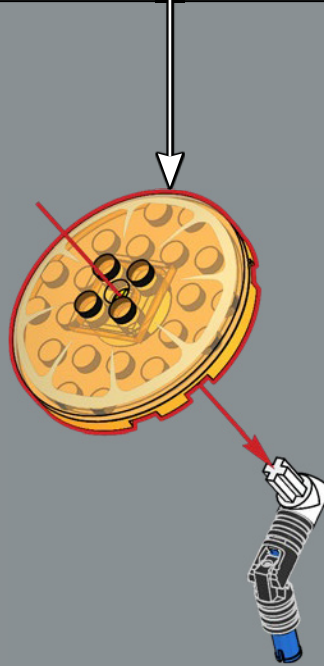
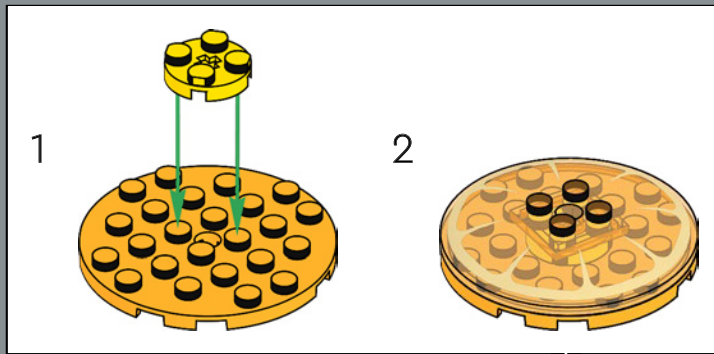

Les antennes paraboliques orange translucides imprimées reproduisent la transparence des tranches d'orange séchées.



61

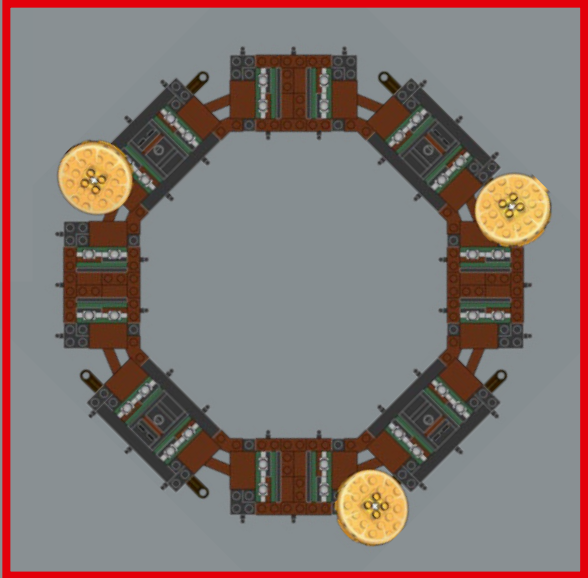





62



63

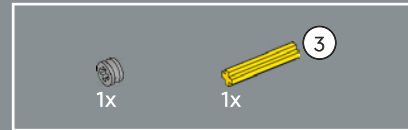

64



65





66



67

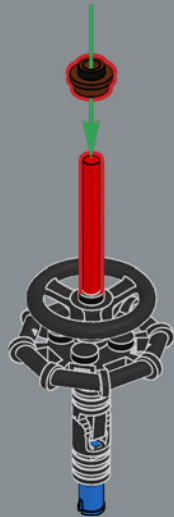

68

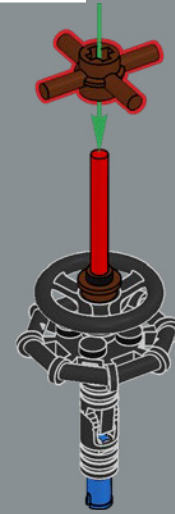

69

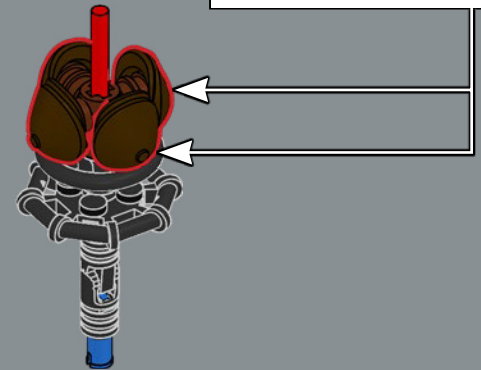
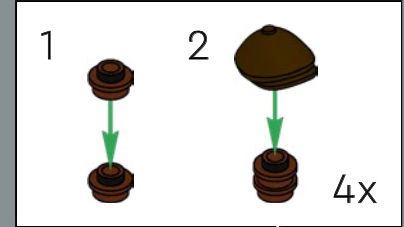



70

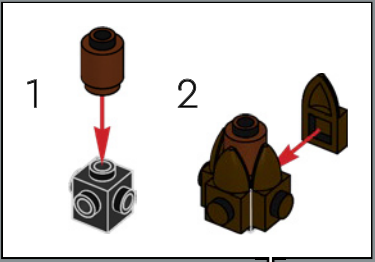

71

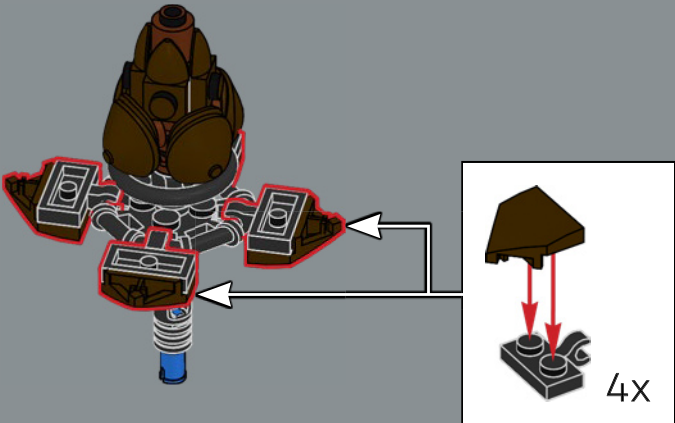

72

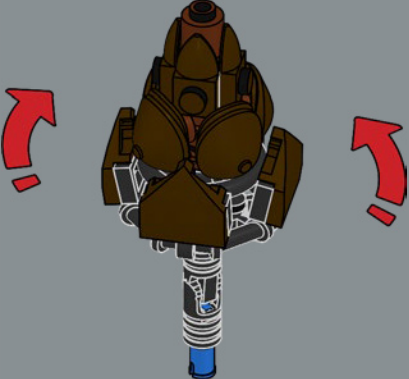

3x





73

Le cône du pin sylvestre dispose d'écaïlles qui présentent une petite protubérance ressemblant au bouton situé au sommet d'une casquette gavroche.

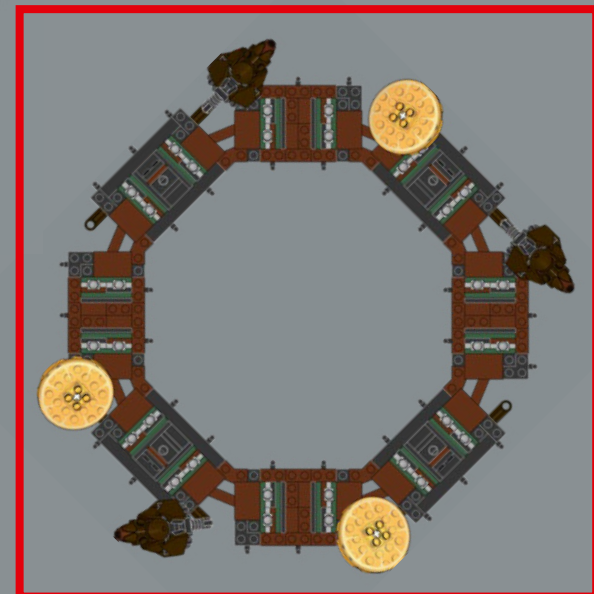

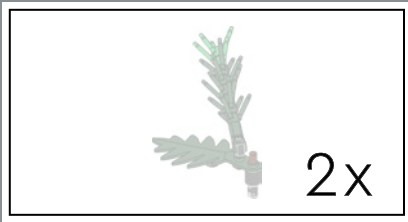

74

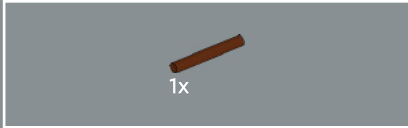

75

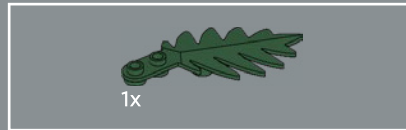

76

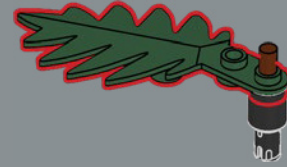

77

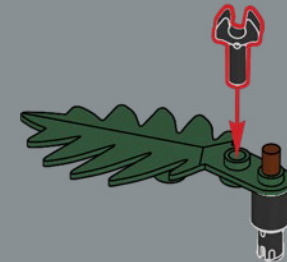



78

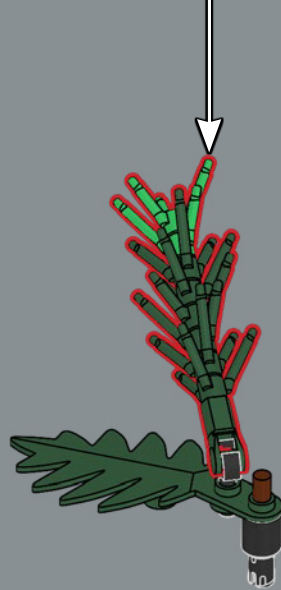
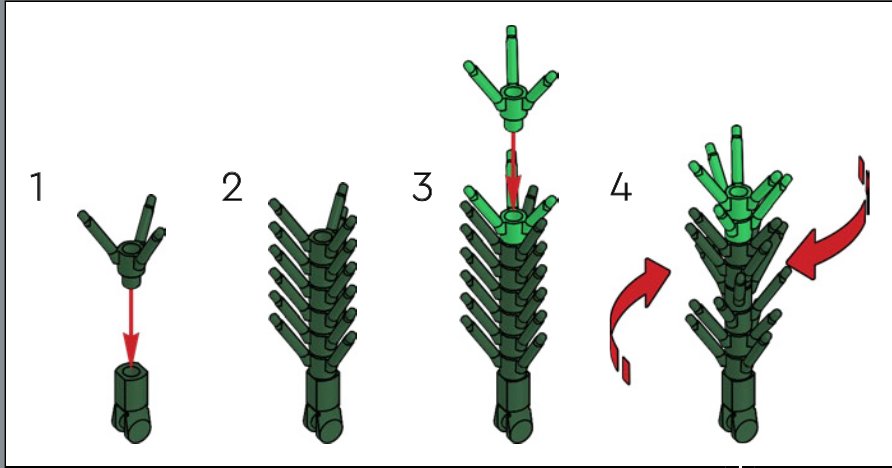

2x







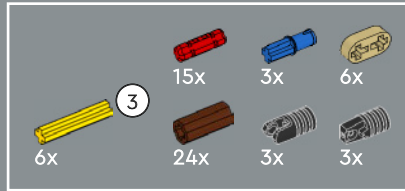
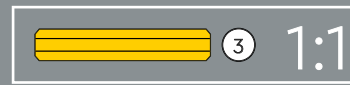
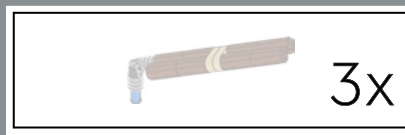

80

1



2



3



4





Le bâton de cannelle est issu de l'écorce interne séchée du cannelier. Autrefois, cette épice était considérée comme plus précieuse que l'or.

5



6

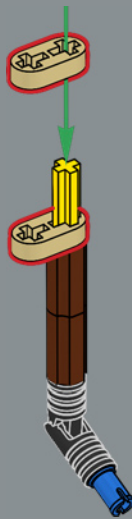

7

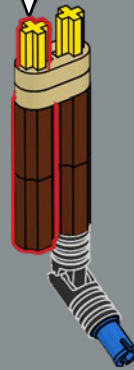

8

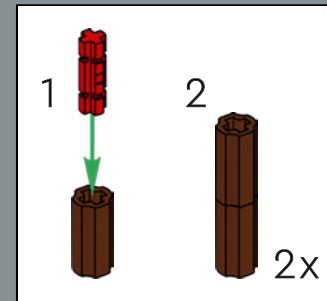
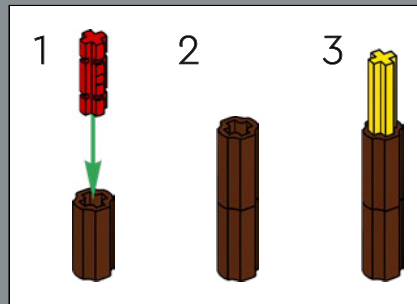
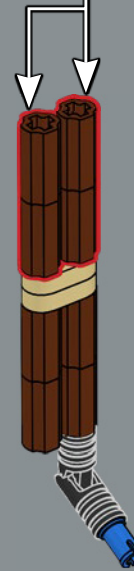

3x









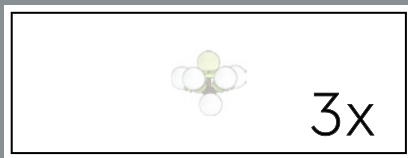

3x



82

1



2

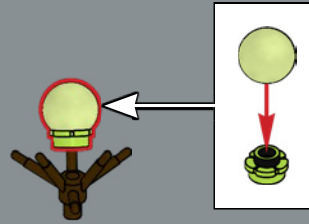

3

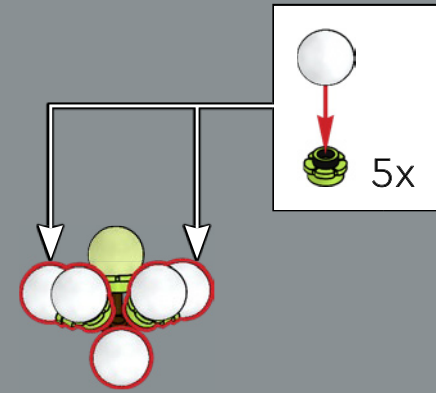

3x

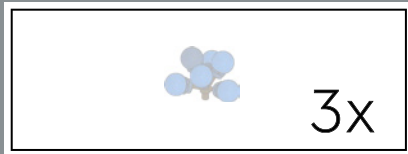

3x

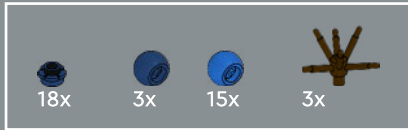

83

1



2

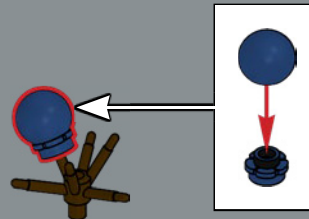

3

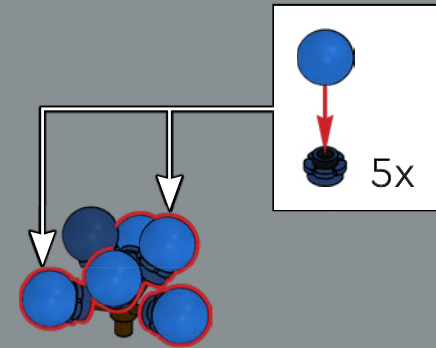

3x

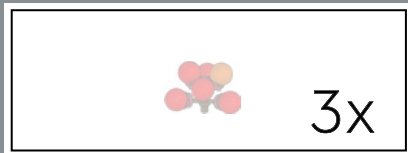

3x



84

1



2

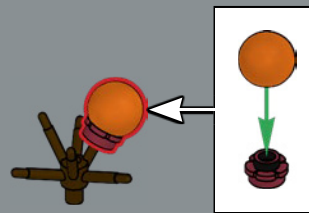

3

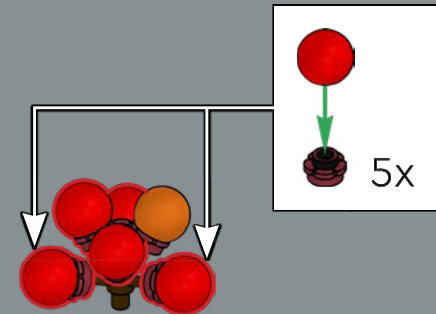

3x



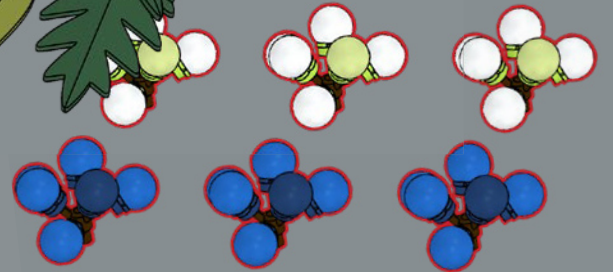
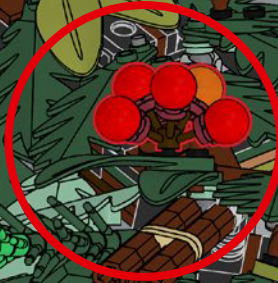
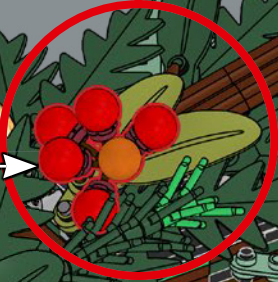
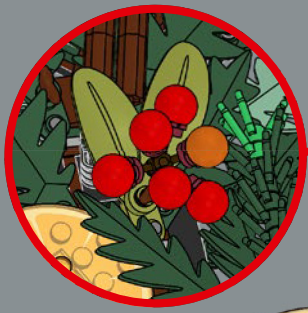





Les baies d'hiver rouge vif sont une ressource alimentaire cruciale pour les oiseaux durant la saison hivernale.







31

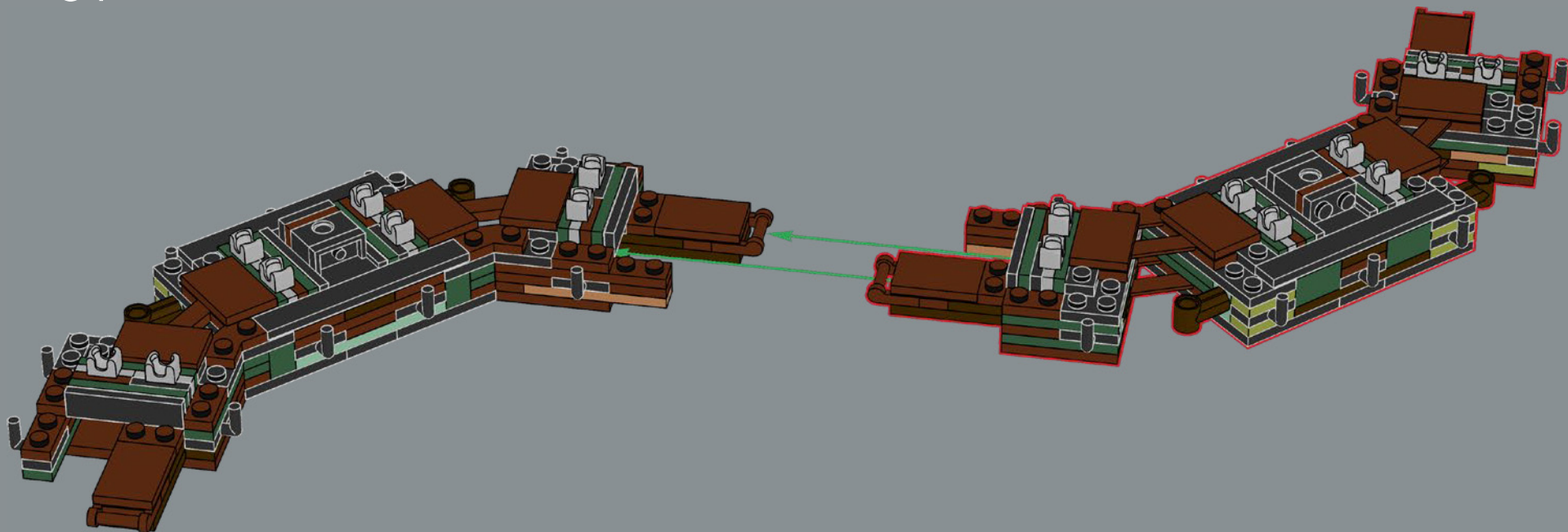

32

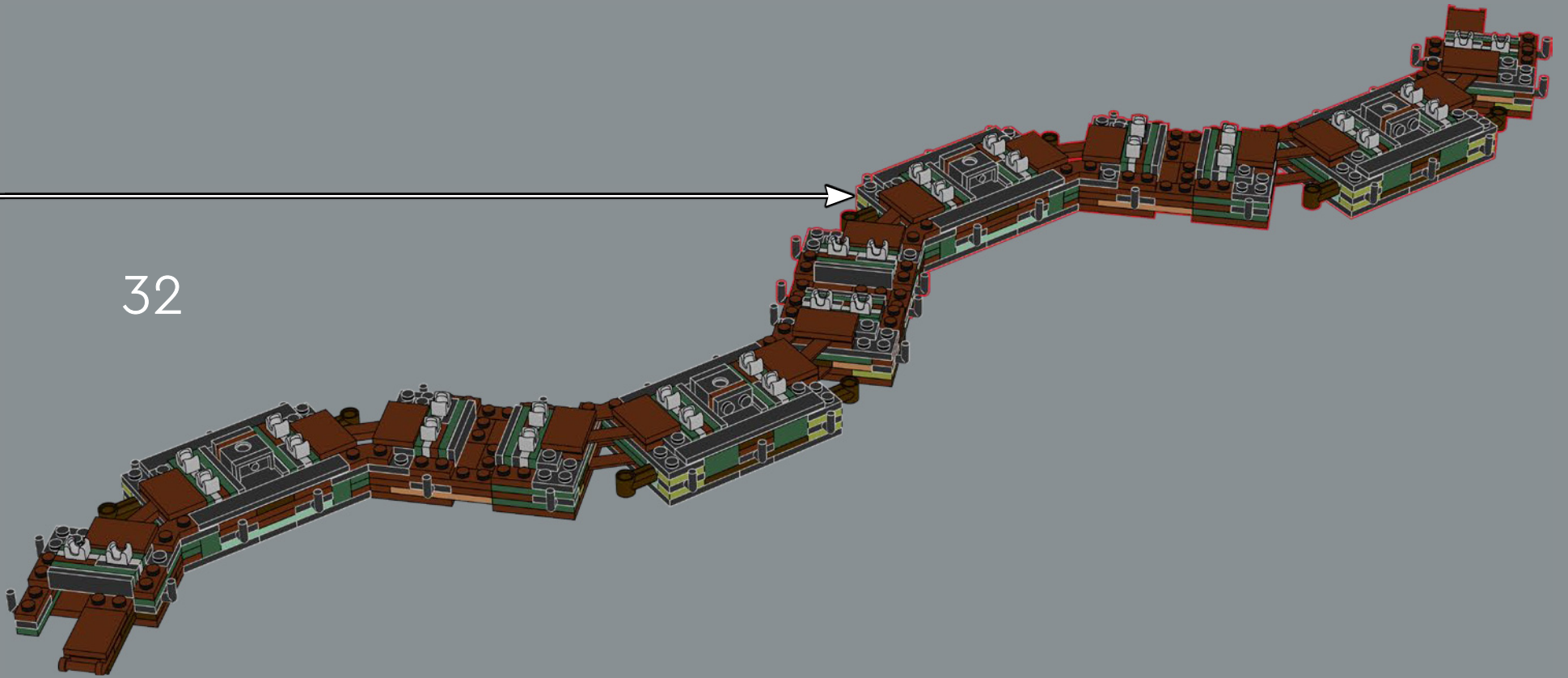

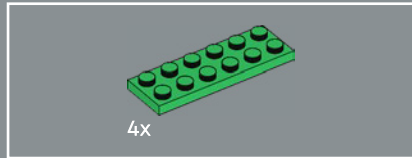

33





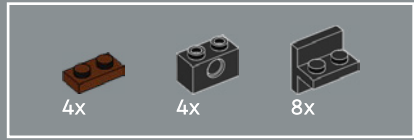
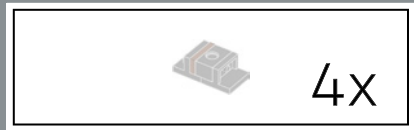

34

1

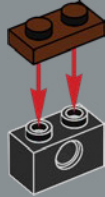

2



3

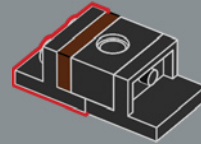

4x



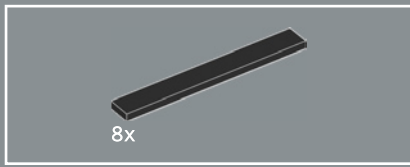

35

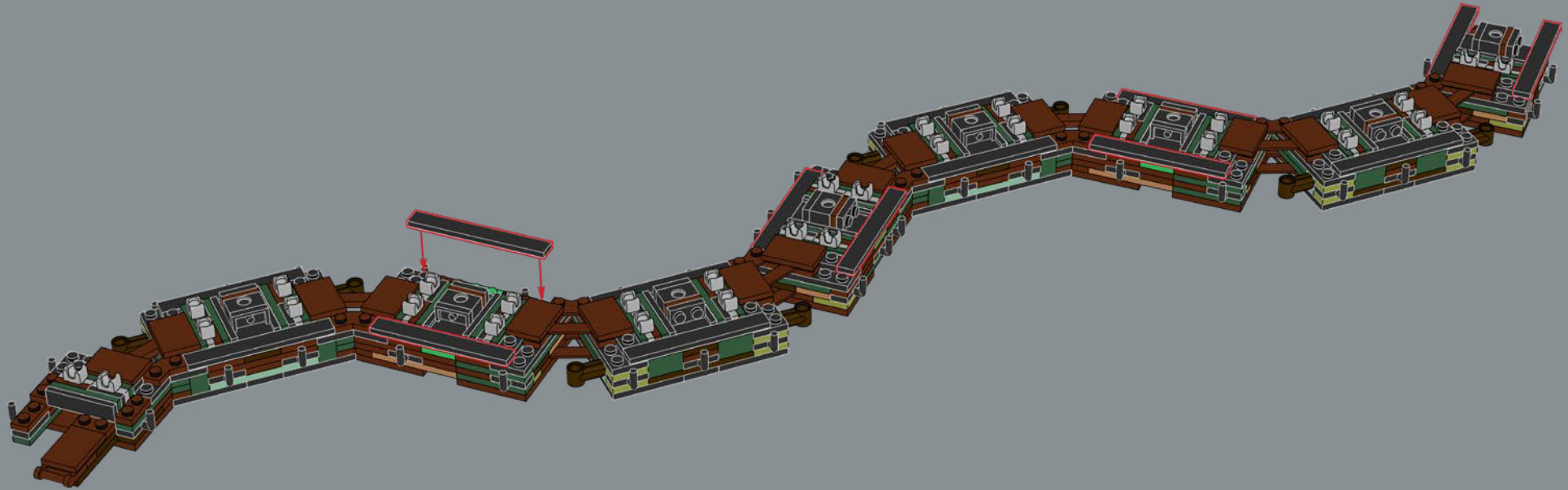

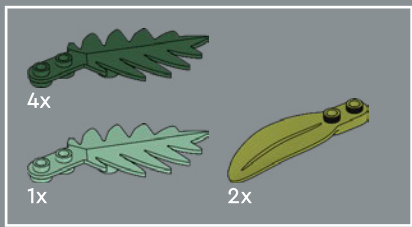

36

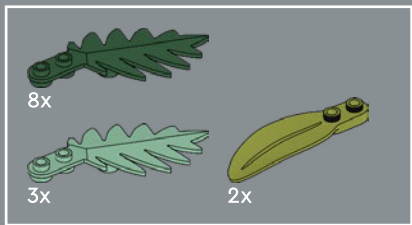
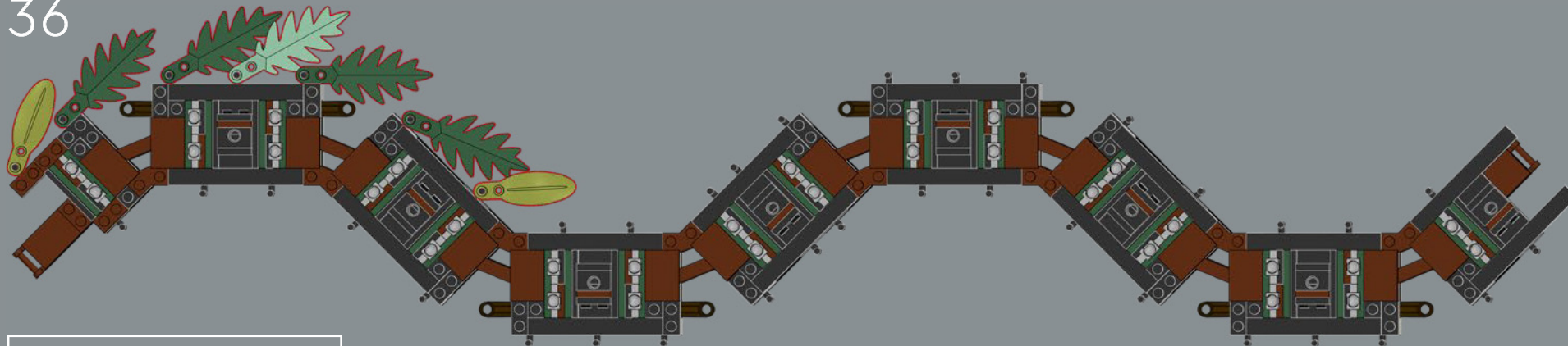

37

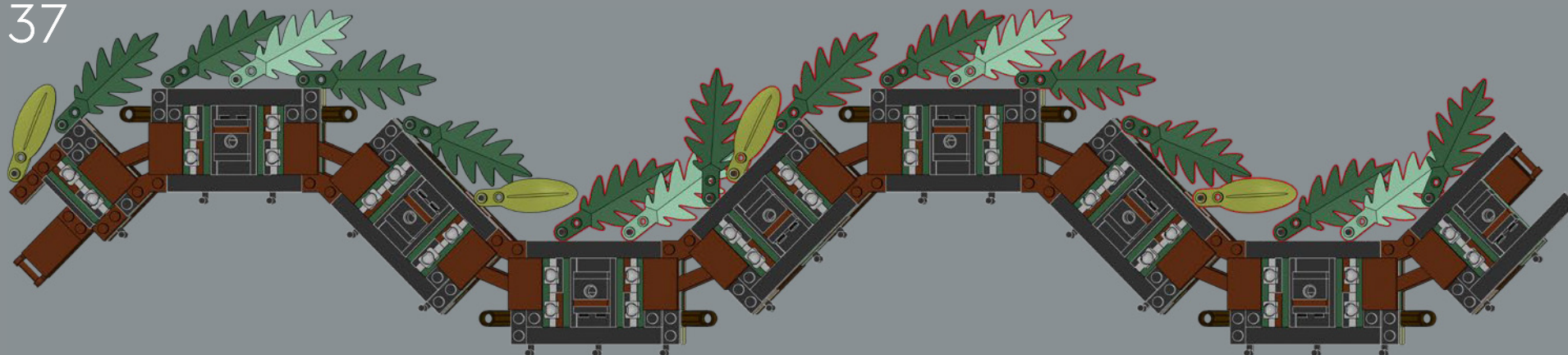



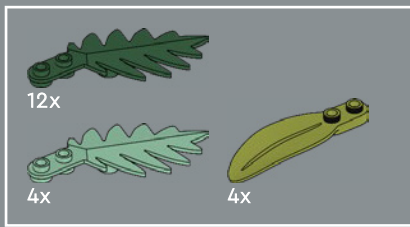

38

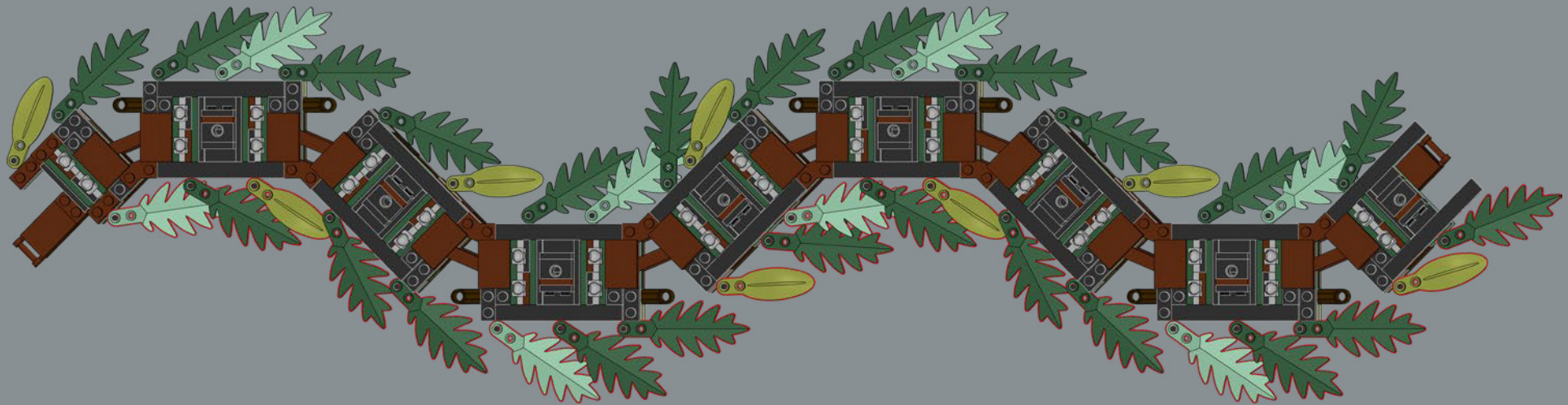



8x

39

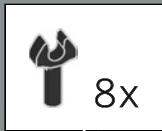
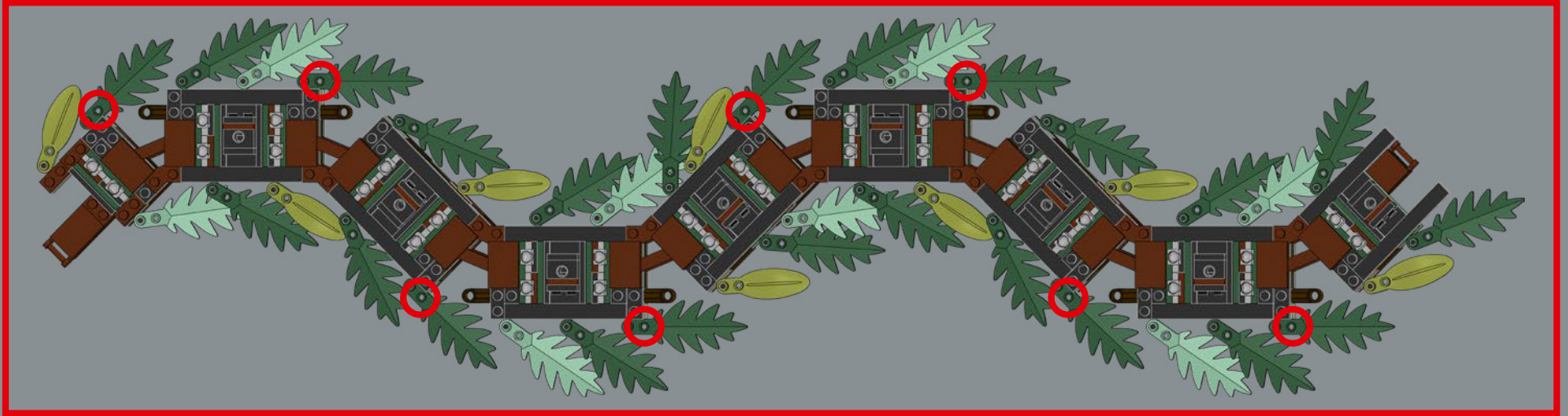

8x



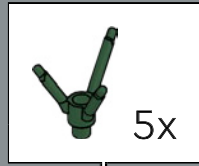
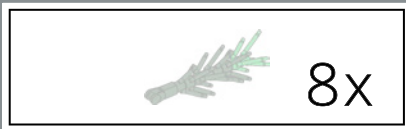

40

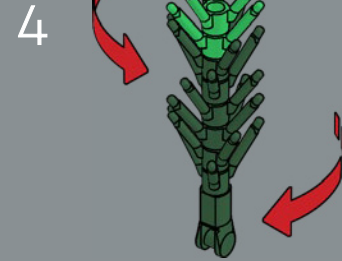
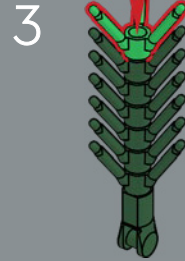
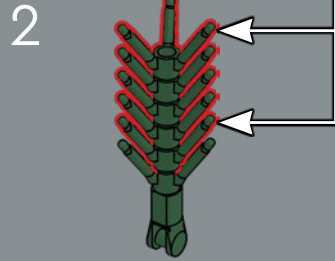
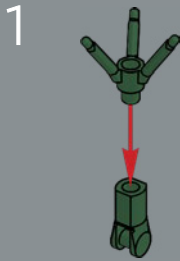

8x





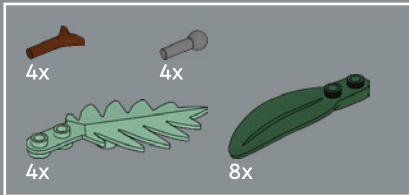

41

1

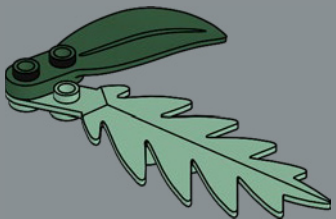

2

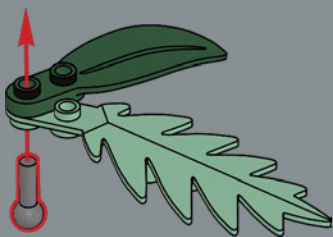

3

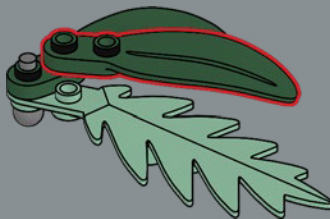

4

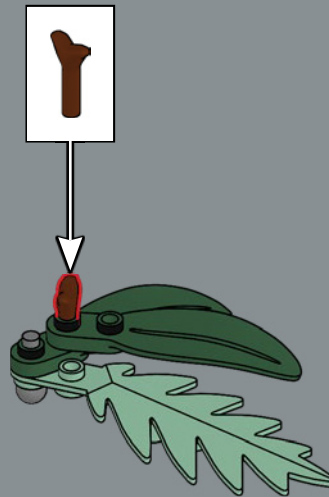

4x

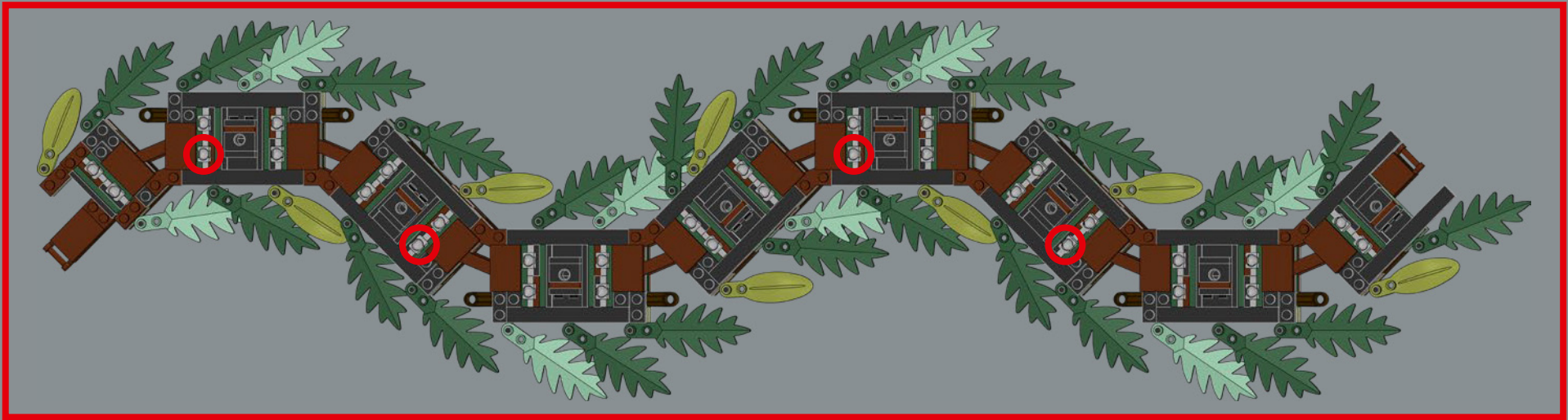

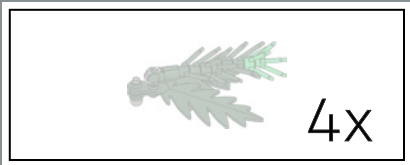

42

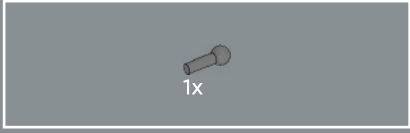
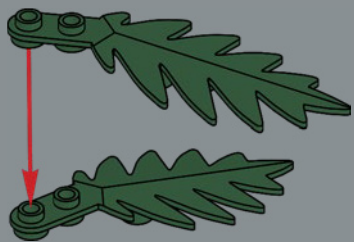

43

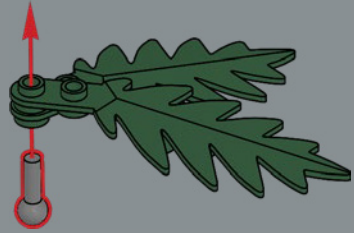

44

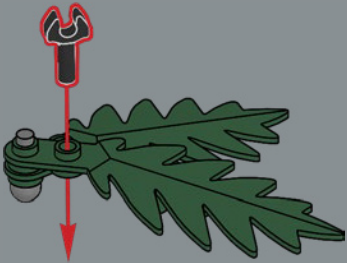





45

1

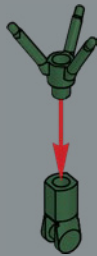

2

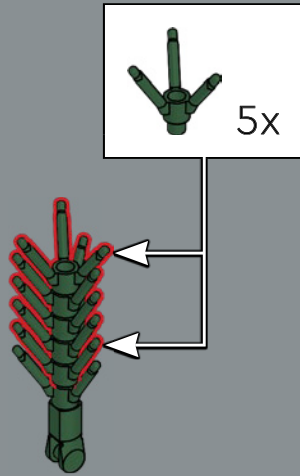

3

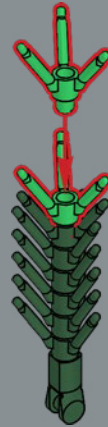

4

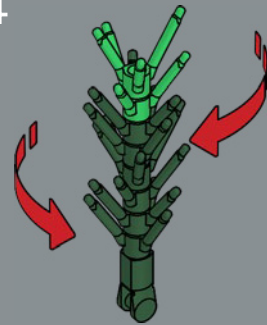

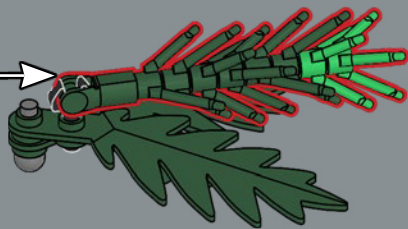

4x

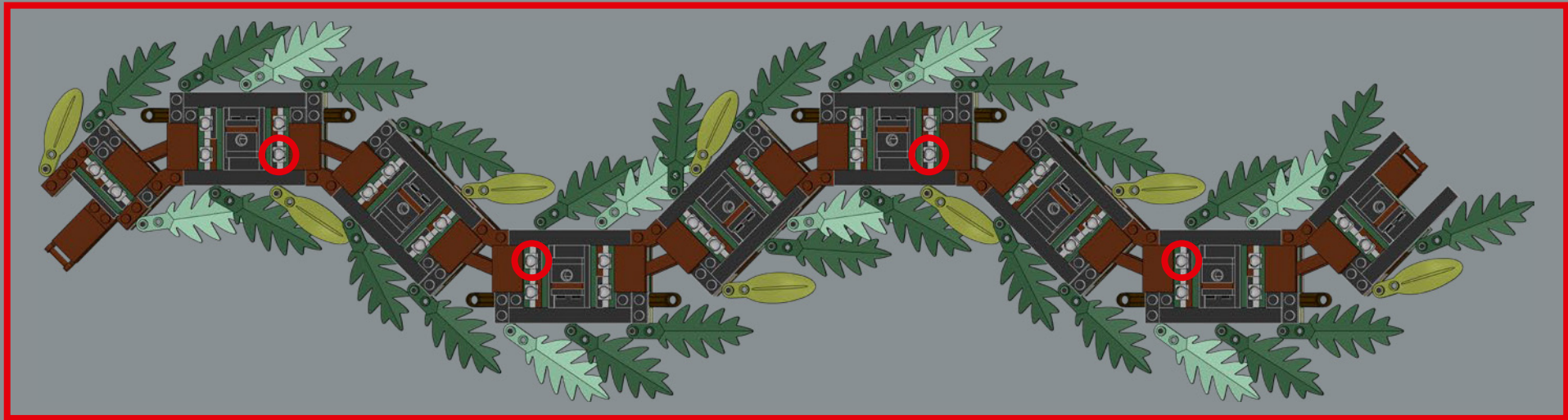



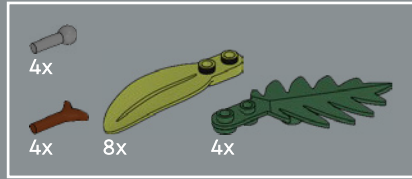
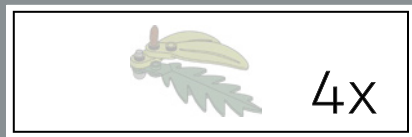

47

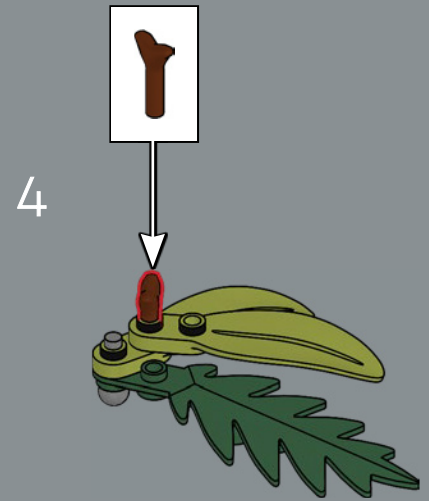
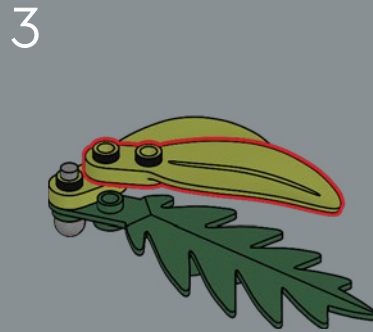
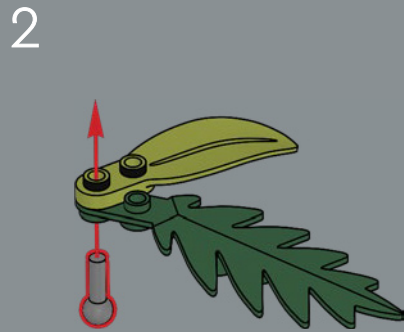
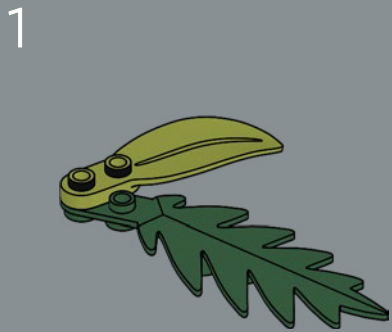

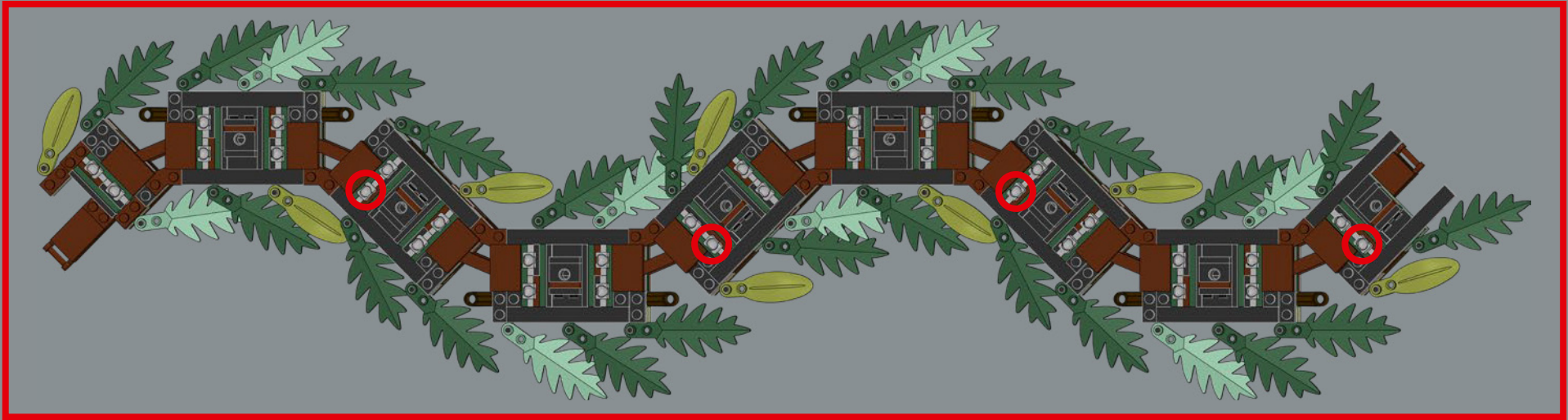

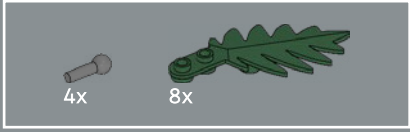
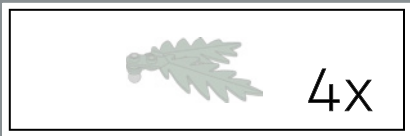

48

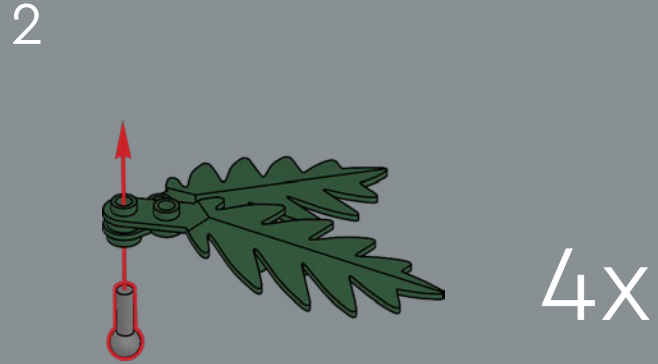
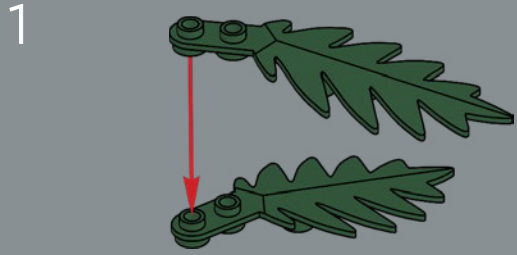



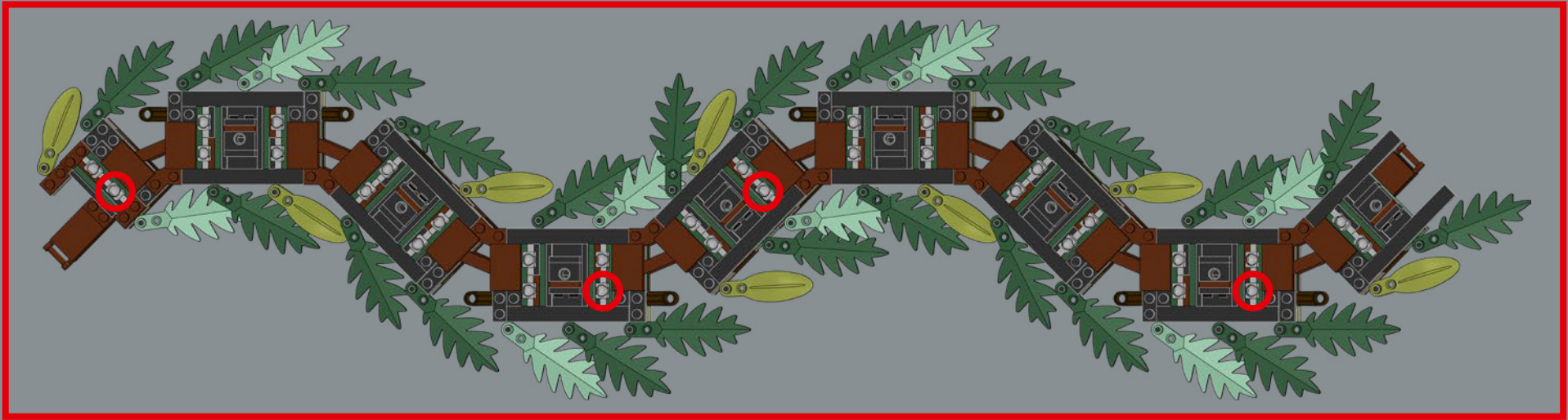

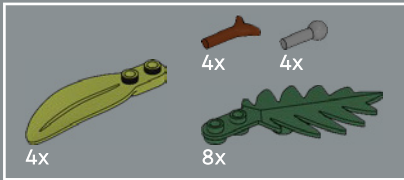

49

1

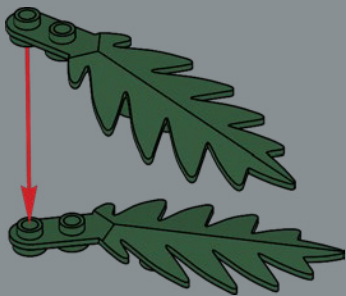

2

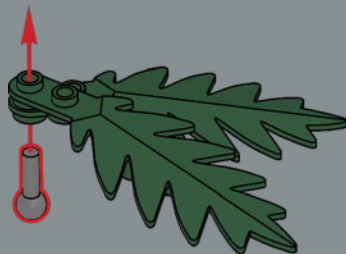

3

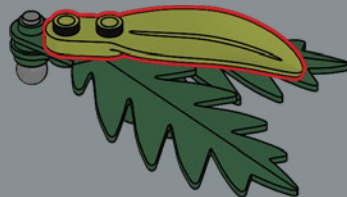

4

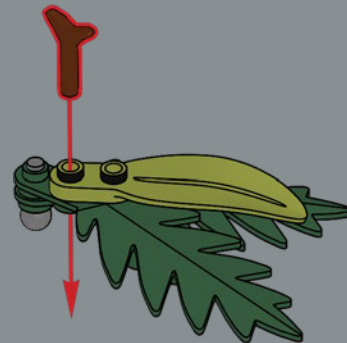

4X



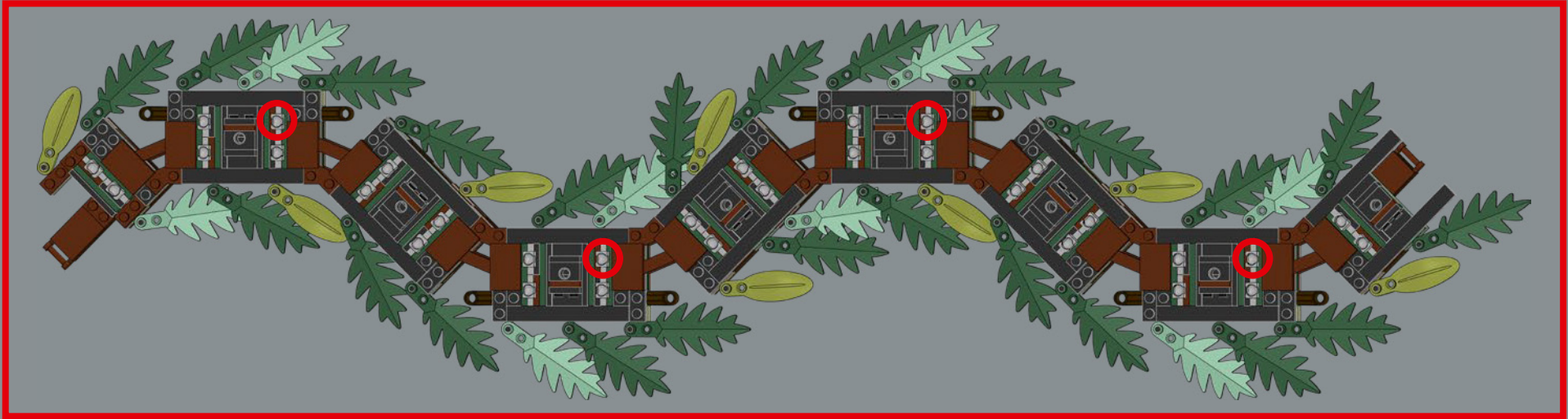



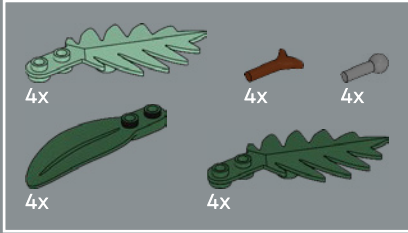
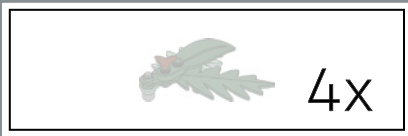

50

1



2

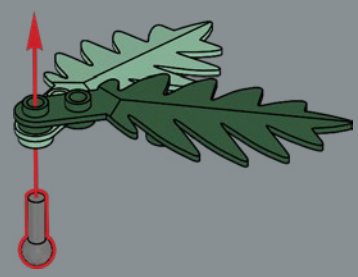

3

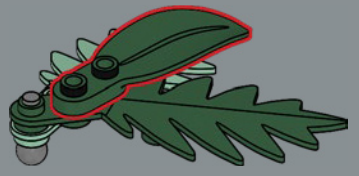

4



4x

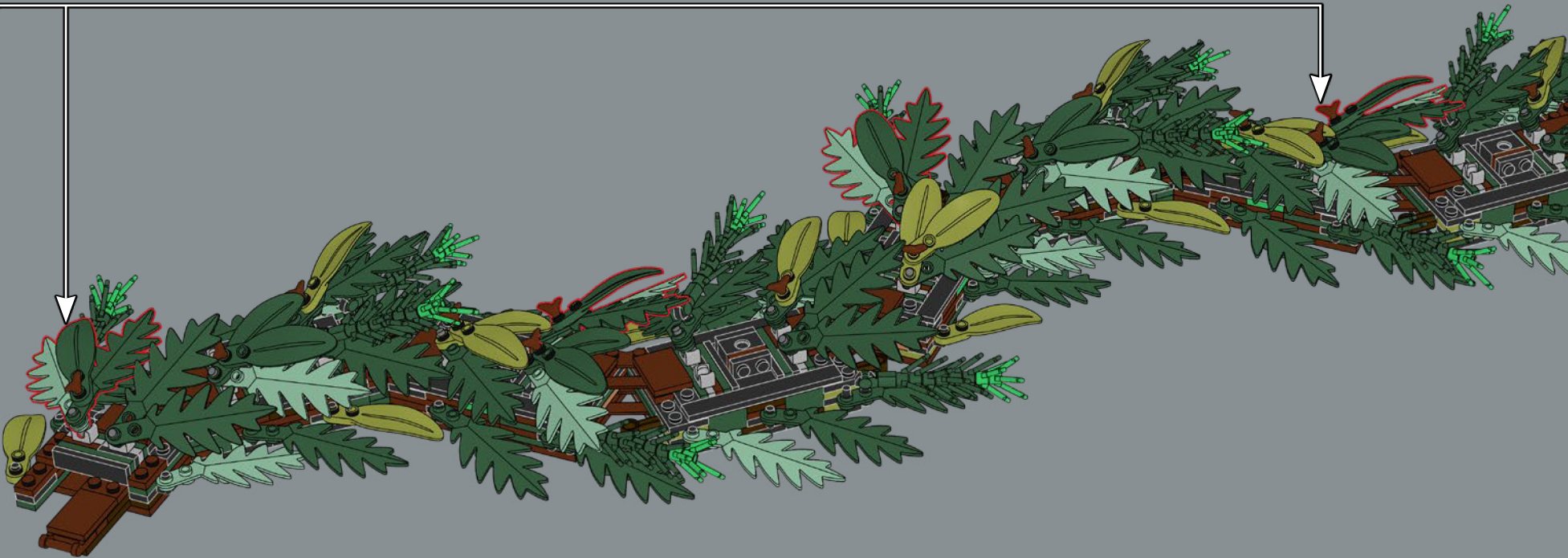
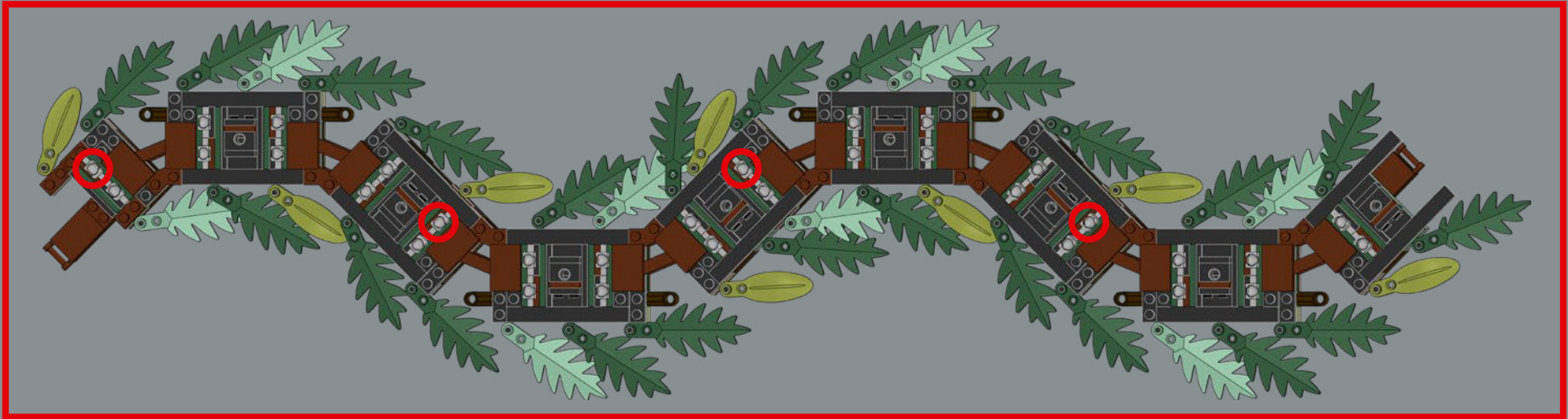

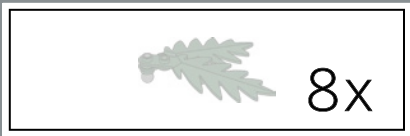

51

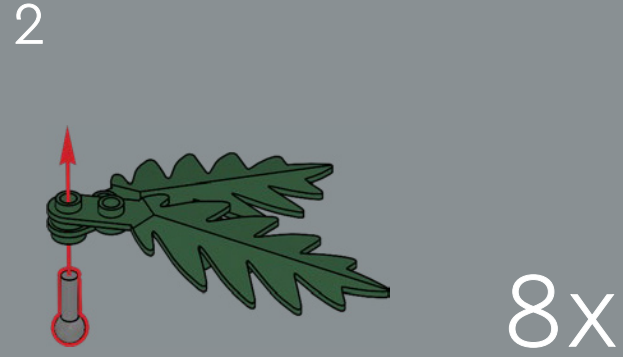
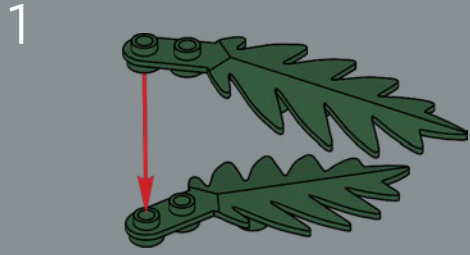



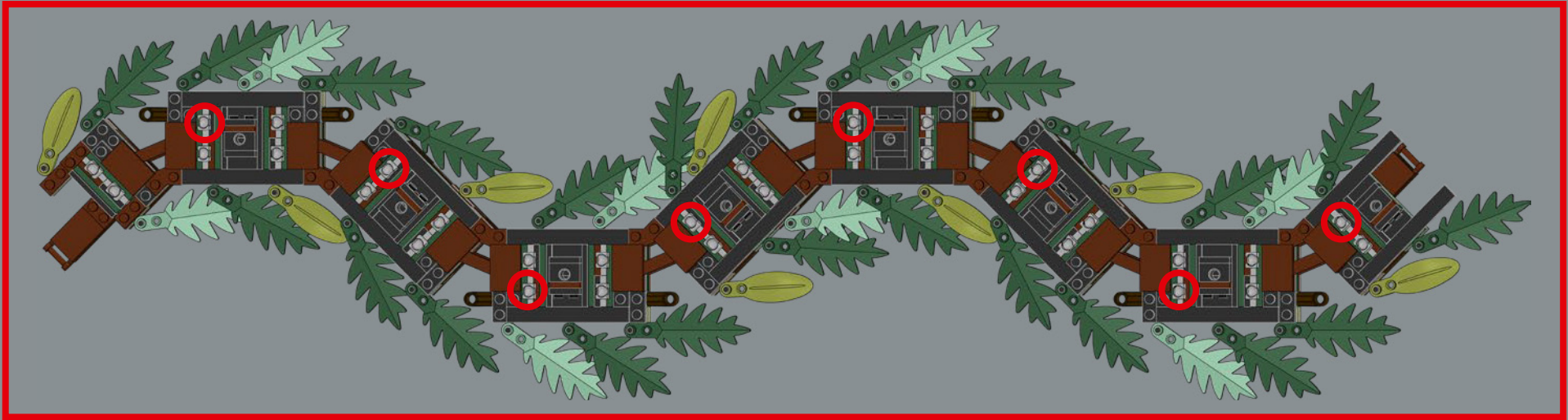

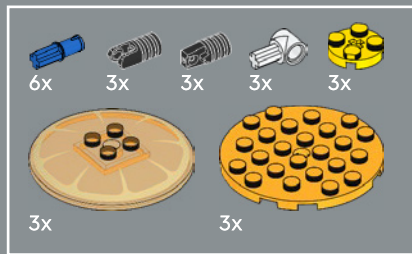

52

1



2



3



4

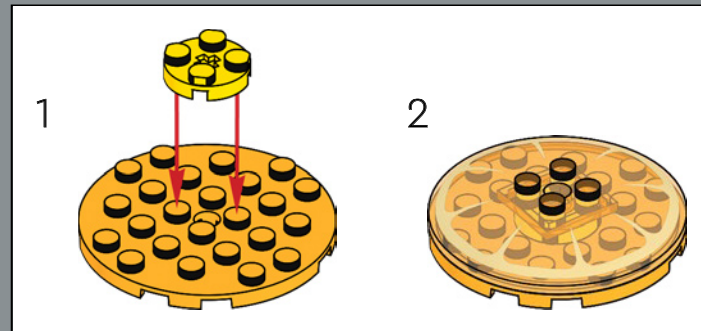
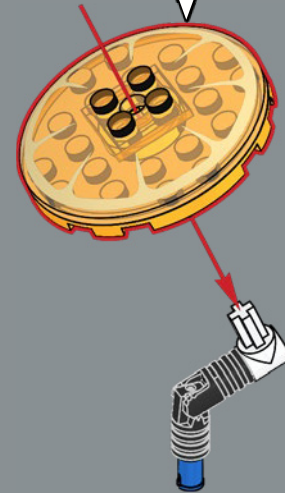



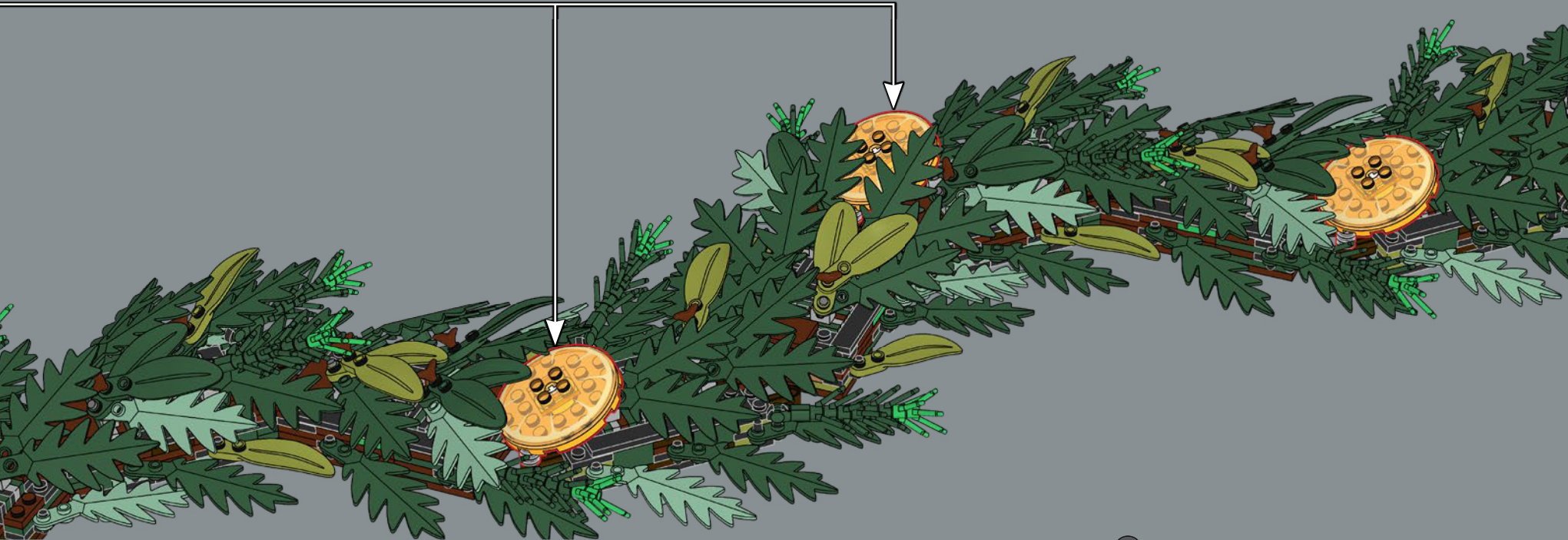
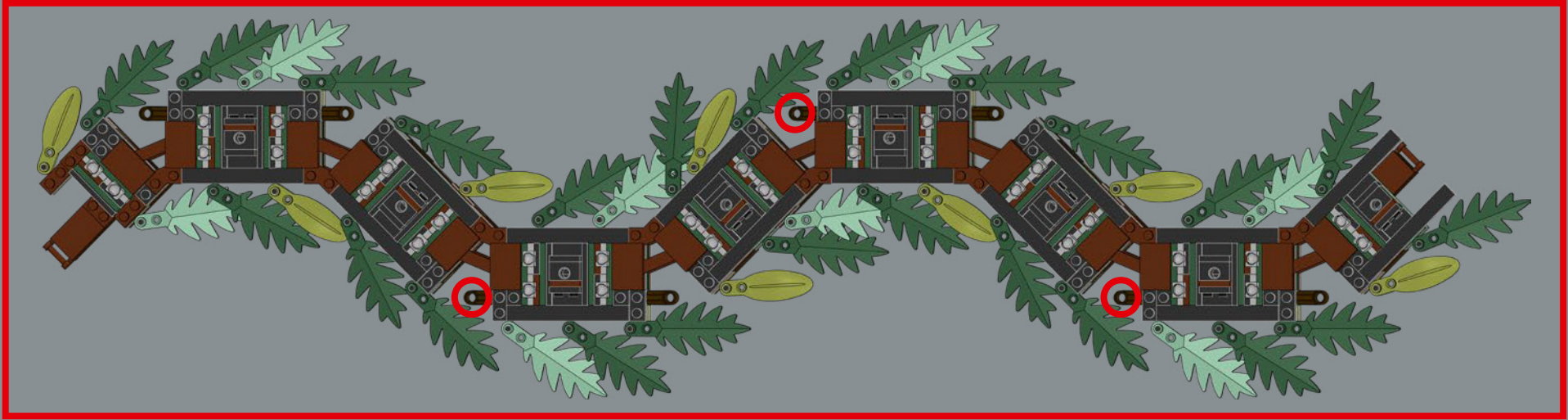



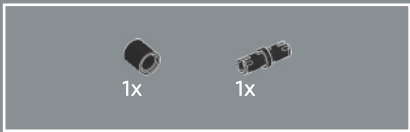
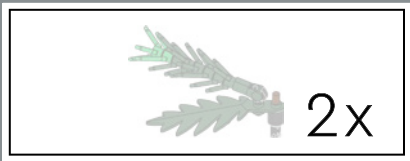

53



54

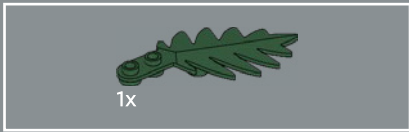

55



56

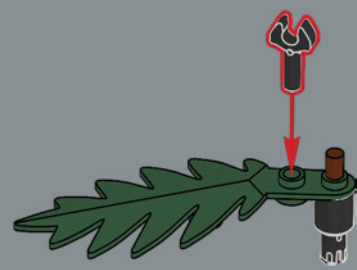



57

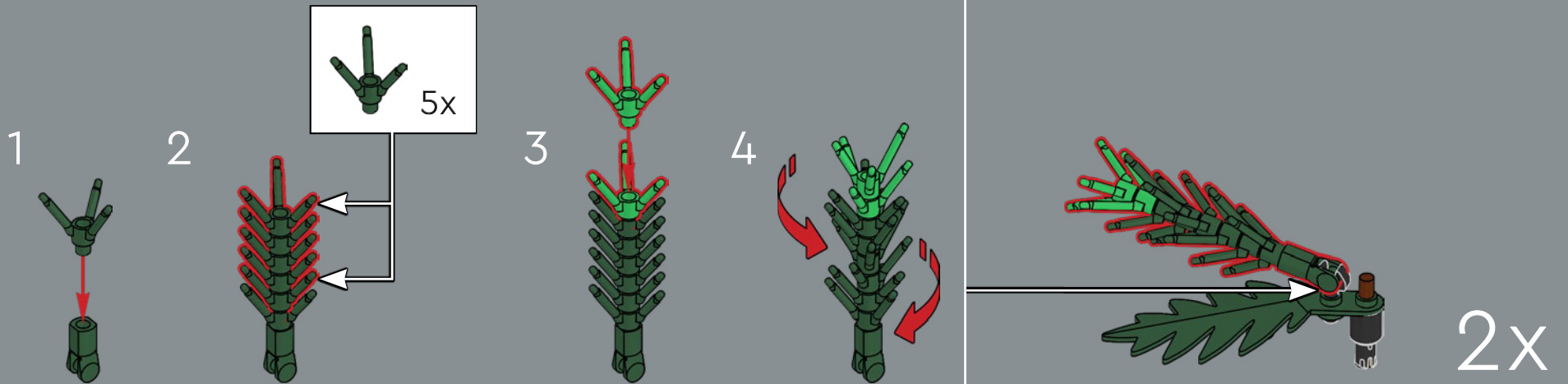

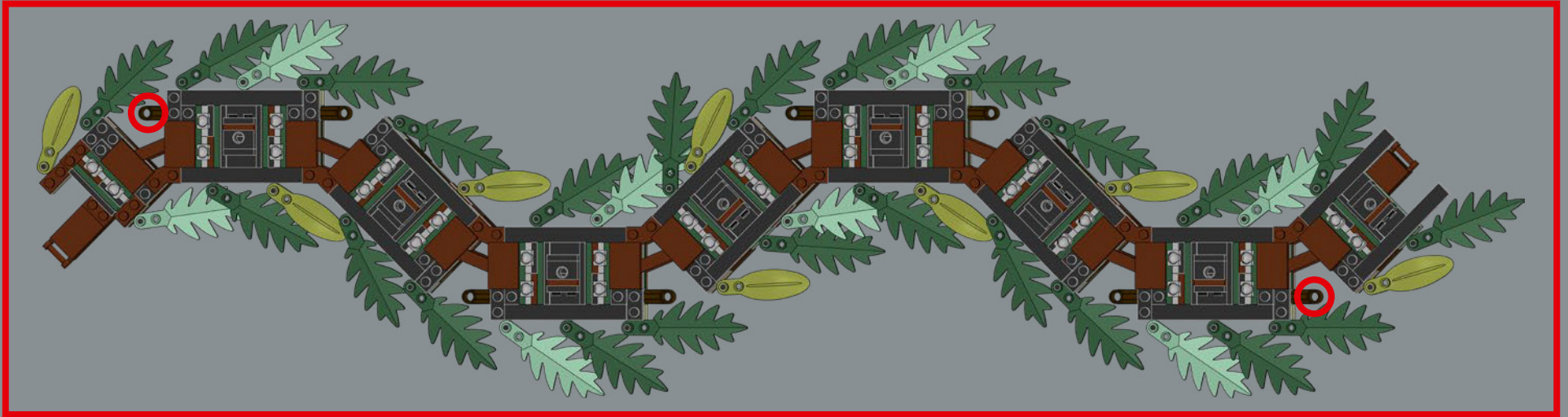



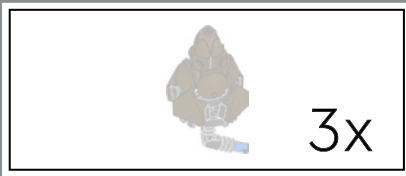

59



60

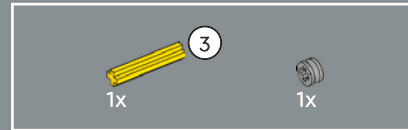

61



62





63

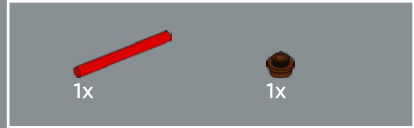

64

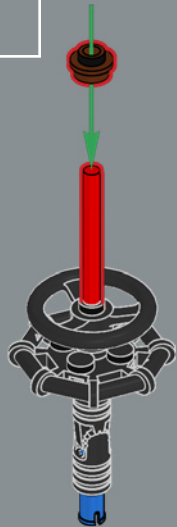

65



66

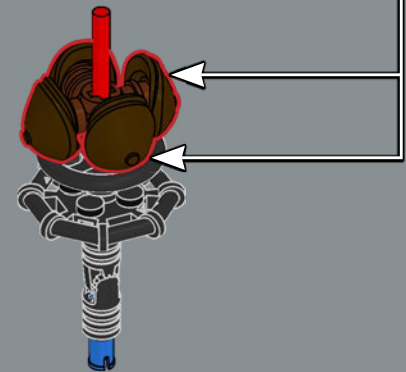
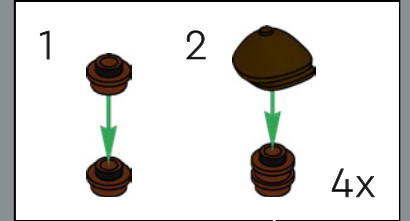



67

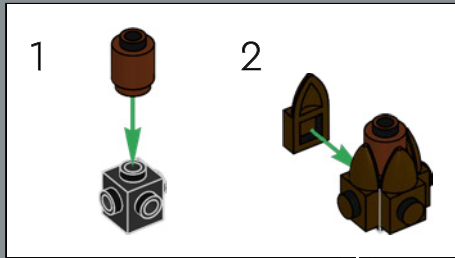

68

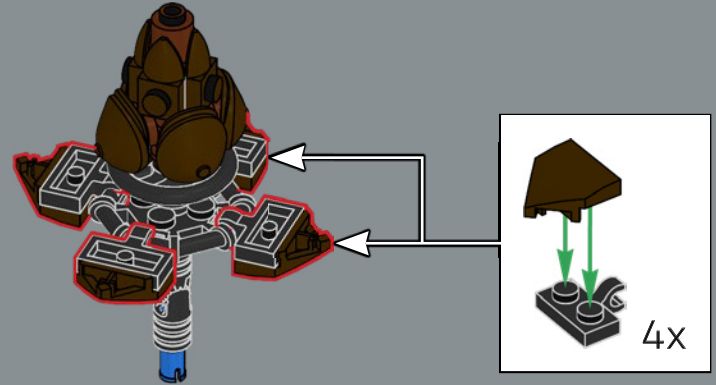

69

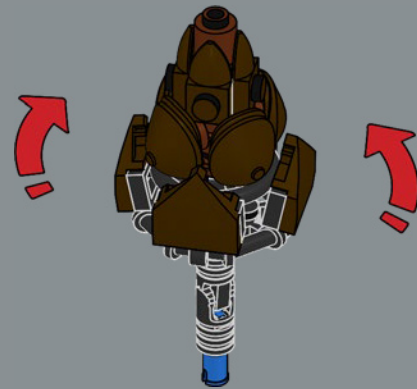

3x





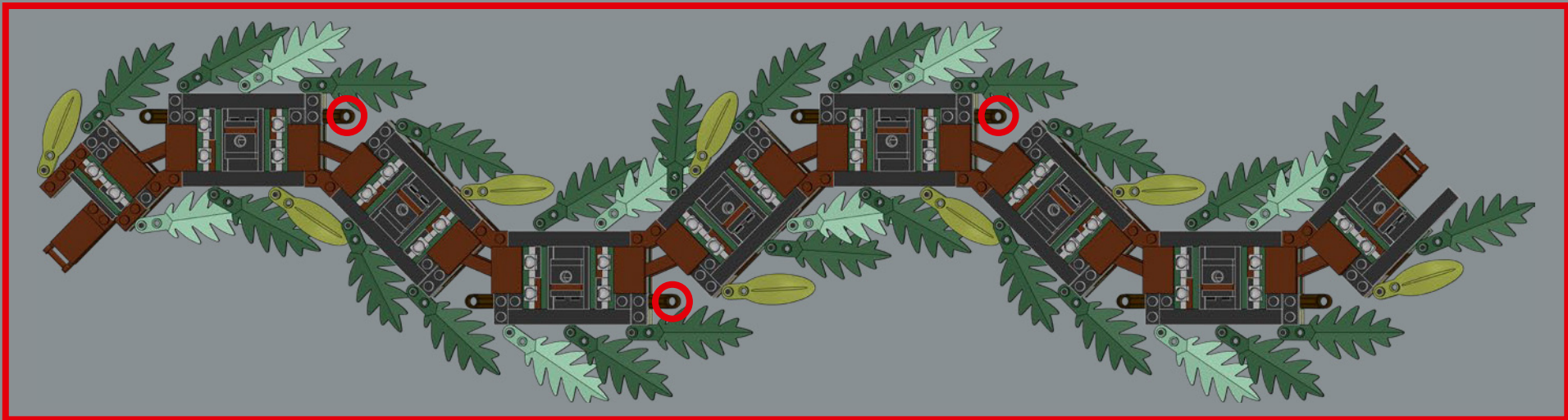

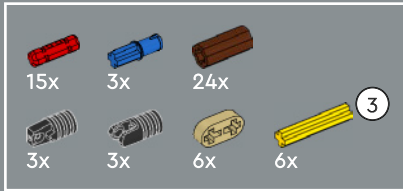
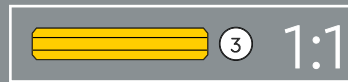
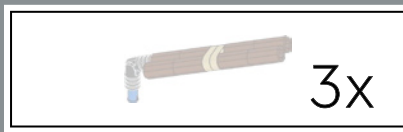

71

1



2



3



4



5



6

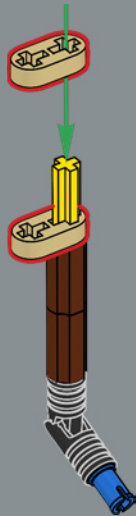

7

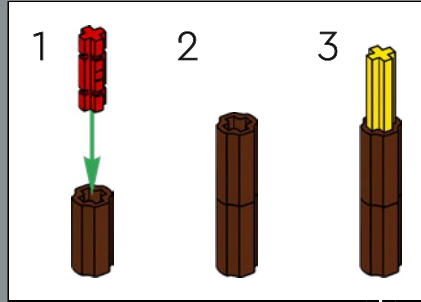
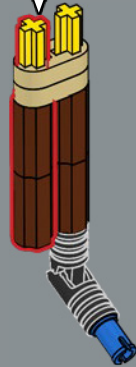

8

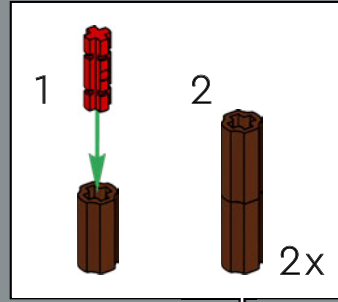

3x



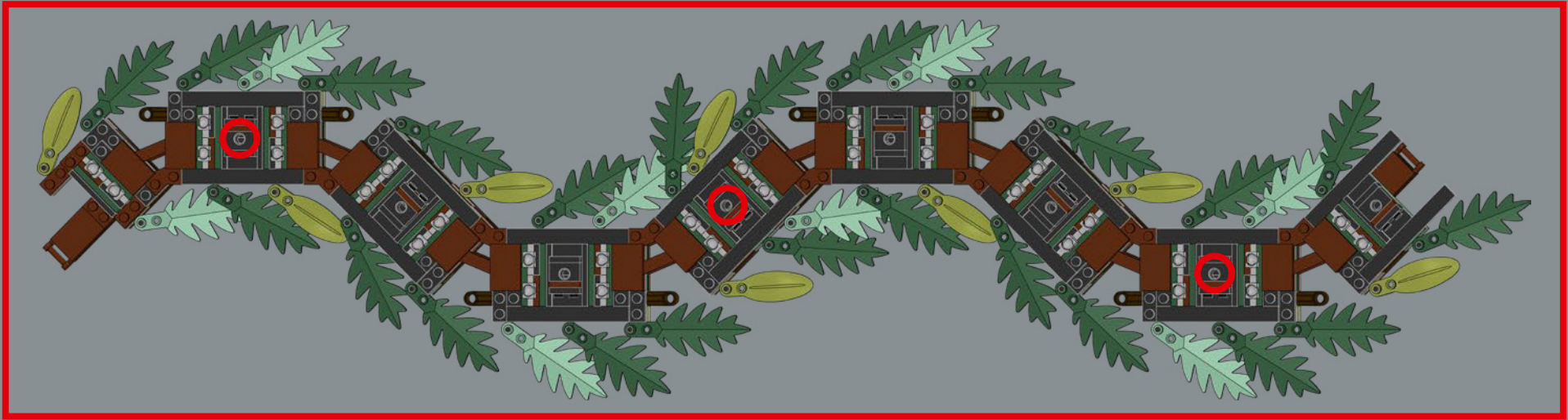

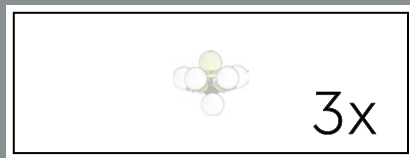

72

1



2

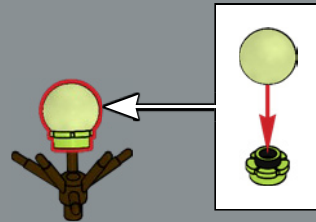

3

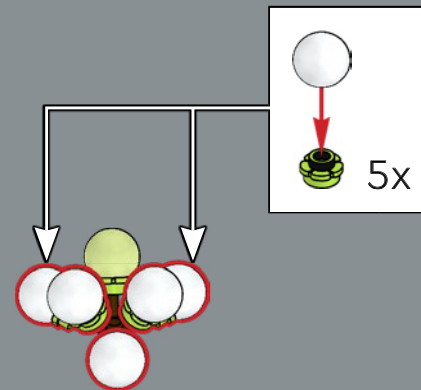

3x

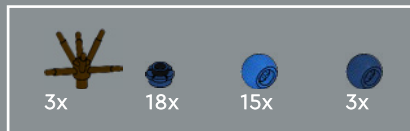
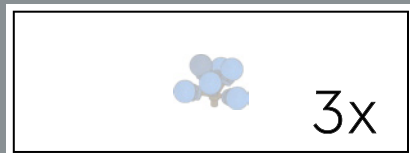

73

1



2

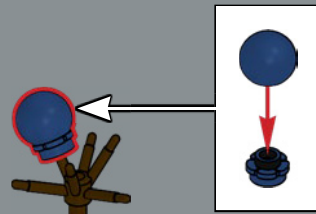

3

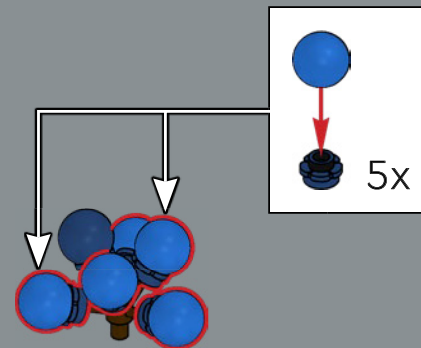

3x



74

1



2

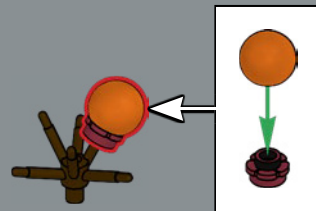

3

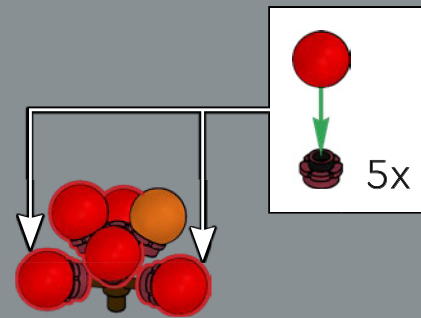

3x











15x  
6052864

3x  
6179606

6x  
6376461

8x  
6330903

8x  
4121921

15x  
4290714

23x  
4142865

3x  
6296954

15x  
6224247

12x  
4206482

3x  
403224

9x  
6130007

18x  
6495167

3x  
6498566

3x  
6495163

3x  
6491212

18x  
6209692

8x  
4537936

24x  
6473460

20x  
6495168

28x  
6269971

4x  
379528

3x  
6509614

3x  
6131694

8x  
6347306

4x  
6343854

14x  
6499873

84x  
6498565

8x  
4245570

72x  
6020923

8x  
4245571

12x  
6491214

74x  
6420219

8x  
6359069

16x  
6491215

4x  
6495166

1x  
6254100

3x  
6271165

32x  
6043656

3x  
4211183

27x  
6215659

16x  
6078605

24x  
4531751

108x  
4211150

8x  
6236915

2x  
6428805

3x  
6316697

24x  
6311441

16x  
6084573

12x  
4221590

8x  
6370000

18x  
6458394

8x  
4539105

32x  
6364352

12x  
6491211

8x  
6332586

12x  
6501311

12x  
6308903

9x  
6452882

4x  
6473454

24x  
4518687

14x  
6439039

9x  
6265699

9x  
6271535

2x  
6279875

2x  
6121485

3x  
473326

12x  
6313116

40x  
6261348

8x  
370026

32x  
6250020

8x  
302226

3x  
4580509

3x  
6018805

16x  
243126

16x  
6401209

16x  
416226

8x  
303226



LEGO.com/service





# YOU COULD WIN



## YOU COULD WIN

Your feedback will help shape the future development of this product series.

Visit:

## DU KÖNNTEST GEWINNEN

Dein Feedback trägt zur Weiterentwicklung dieser Produktreihe bei.

Geh auf:

## VOUS POURRIEZ GAGNER

Vos commentaires nous aideront à concevoir les futurs produits de cette gamme.

Visitez :

## POTRESTI VINCERE TU

La tua opinione ci aiuterà a migliorare la creazione futura di questa linea di prodotti.

Visita:

## PUEDES GANAR

Tu opinión contribuirá al futuro de esta serie de productos.

Visita:

## 轻松获奖

您的反馈将有助于我们在今后改进本产品系列。

请访问:

---

**[LEGO.com/productfeedback](https://LEGO.com/productfeedback)**

---

You also have the chance to win a LEGO® set.

Terms and conditions apply.\*

Außerdem hast du die Chance, ein LEGO® Set zu gewinnen.

Es gelten die Teilnahmebedingungen.\*

Vous pourriez également gagner un ensemble LEGO®.

Des conditions s'appliquent.\*

Hai anche la possibilità di vincere un set LEGO®.

Termini e condizioni sono applicabili.\*

También tienes la oportunidad de ganar un set LEGO®.

Aplican términos y condiciones.\*

您还有机会赢取乐高®套装。

条款和条件适用。\*

\*[LEGO.com/productfeedback-terms](https://LEGO.com/productfeedback-terms)

