



10340







LEGO.com/sustainable-packaging



FR  
**DONNEZ**  
OU  
**RECYCLEZ**



ASSOCIATION

OU



MAGASIN

OU



DÉCHÈTERIE

Adresses sur [quefairedemesdechets.fr](http://quefairedemesdechets.fr)





# BUILDER



Apple and the Apple logo are trademarks of Apple Inc., registered in the U.S. and other countries and regions. App Store is a service mark of Apple Inc. Google Play and the Google Play logo are trademarks of Google LLC. Tencent and the Tencent logo are trademarks of Tencent Inc.

LEGO.com/devicecheck



LEGO® Builder









# Ein Gefühl der Wärme an kalten Tagen

Wenn die ersten Vorboten von Herbst und Winter eintreffen, lädt uns die Natur zum Spielen ein – mit all ihren herbstlichen und winterlichen Farben und Schätzen. Leuchtende Beeren fügen sich wunderbar in die immergrünen Zweige ein, und die Blätter, die dir vor die Füße fallen, verbreiten mit ihren sanften Farbtönen wohlige Wärme. Hol dir diese prächtigen Farbbündel in die eigenen vier Wände und erzeuge ein gemütliches Ambiente, in dem wir uns bis zum Frühling sehr wohl fühlen werden. Außerdem wird dir dieser kreative Prozess ein wunderbares Erfolgsgefühl vermitteln, wenn du all die inspirierenden Formen und Farben zusammenfügst. Ganz nebenbei verschafft dir das Modell auch eine perfekte Entschuldigung, dich einzukuscheln und deine Sinne zu verwöhnen. Mit diesem eleganten LEGO® Kranz (beziehungsweise mit dieser Girlande) kannst du deine Wohn-Deko den ganzen Winter lang so verändern, dass die freudige Stimmung nicht so schnell verebbt.





# Weihnachtliche Aromen

Jeder Jahreszeit wohnt ein eigener Zauber inne. Sogar an dunklen Wintertagen erleben wir erhellende Momente, die wir mit unseren Lieben teilen können. Nichts weckt in uns so schöne Erinnerungen wie die süßlich-würzigen Düfte der Weihnachtszeit, beispielsweise der belebende Duft von Tannennadeln, würzigen Orangescheiben, warmem Zimt oder erdigem Kiefernharz. Wenn du Platz nimmst, um dieses Set zu bauen, kannst du dich von all diesen vertrauten Düften und Gewürzen inspirieren lassen. Baue einen dekorativen Kranz zum Aufhängen an der Wand oder das spektakuläre Mittelstück einer Weihnachtsgirlande. Verleih deinem Modell deine eigene kreative Note und gestalte den Kranz so, dass er deine Stimmung widerspiegelt oder sich perfekt in deine Einrichtung einfügt. Du kannst nicht nur die Form, sondern auch die winzigen Details des Arrangements verändern. Tausche einfach die Beeren aus, ordne die Zierelemente anders an und experimentiere mit den Elementen, um einen neuen Ausdruck zu erzielen. Hoffentlich spürst du beim Bauen an kalten Tagen wohlige Wärme und erlebst tolle Momente, an die du dich noch lange erinnern wirst.

**KENYON ANDREW BRADY**

LEGO® Modelldesigner







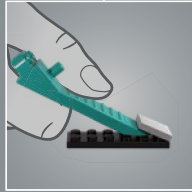
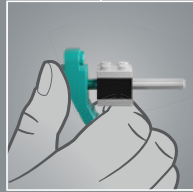
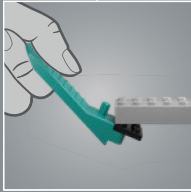
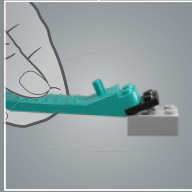
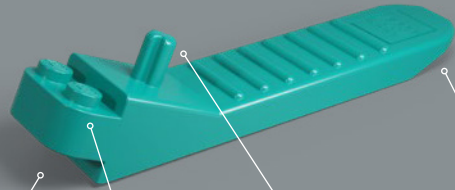



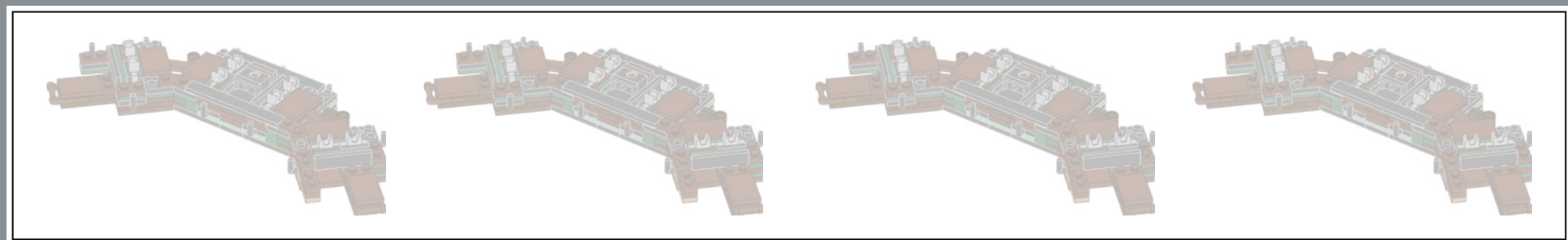





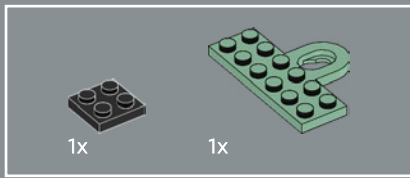

5

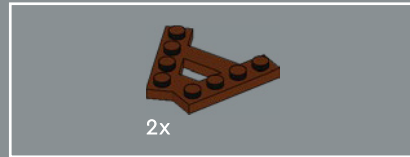
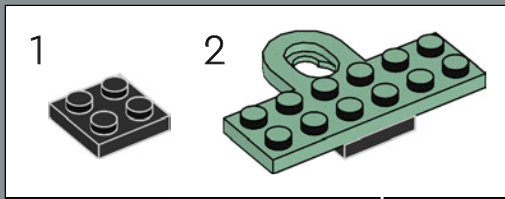
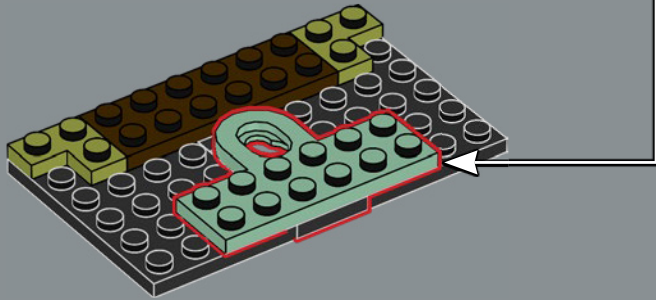

6

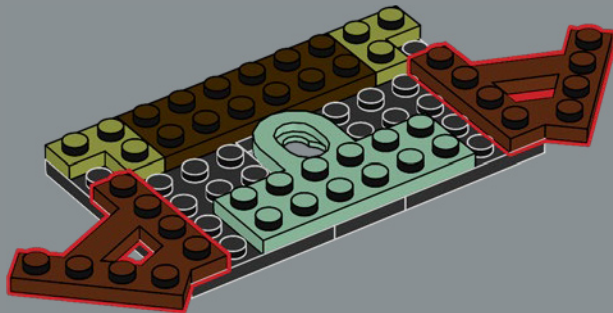

7

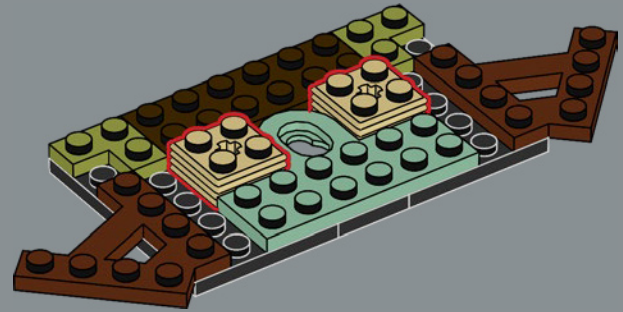

8

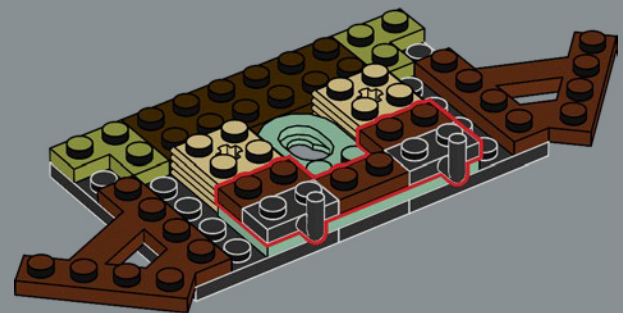

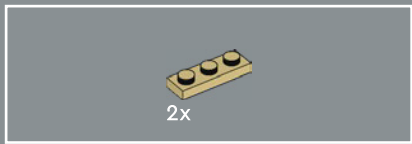

9

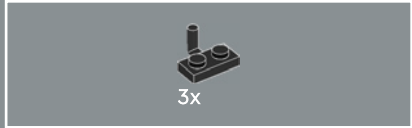
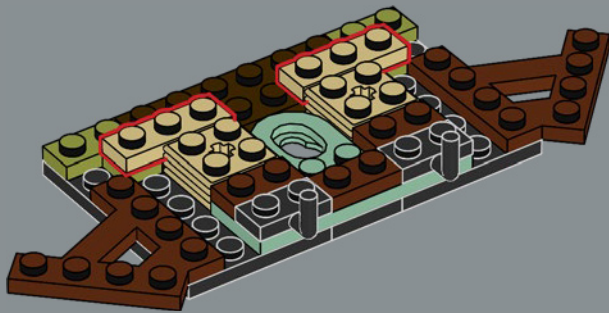

10

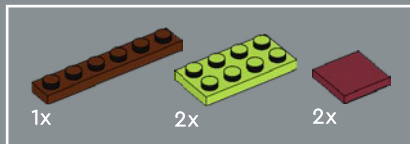
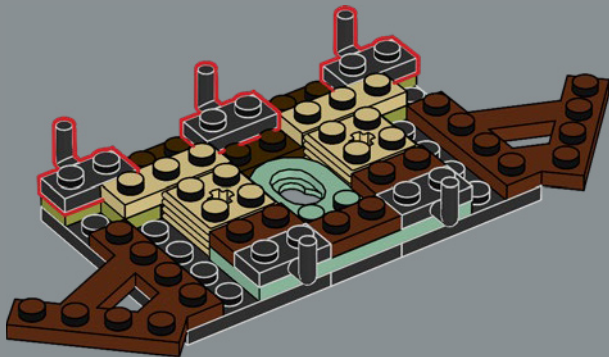

11

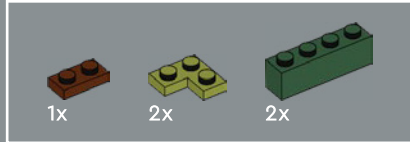
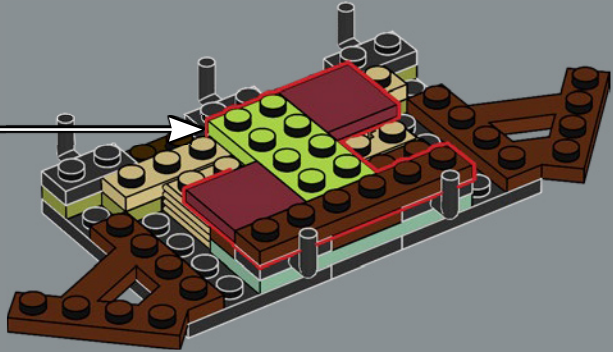
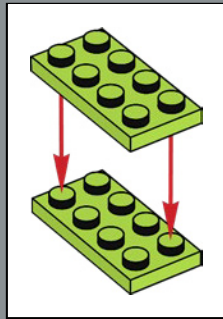

12

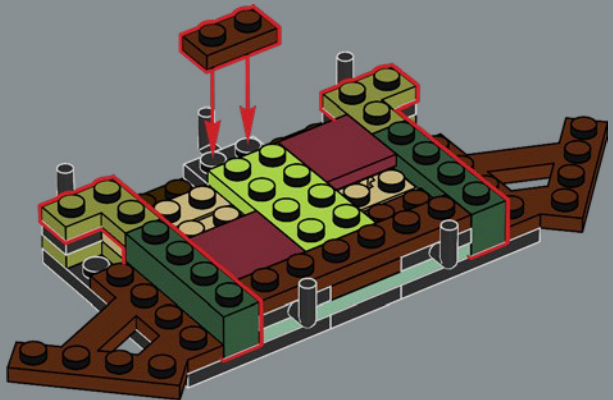





13

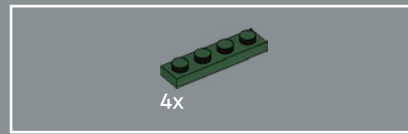
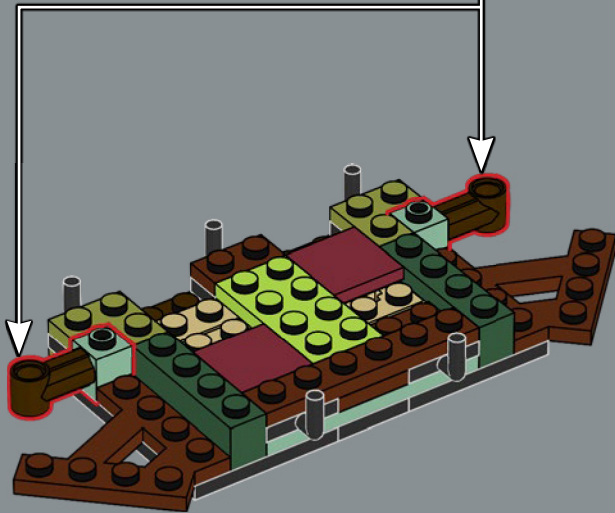
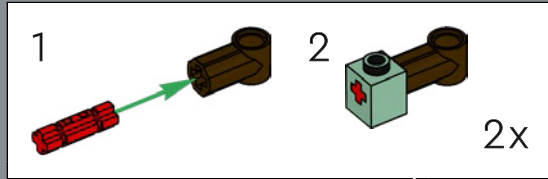

14

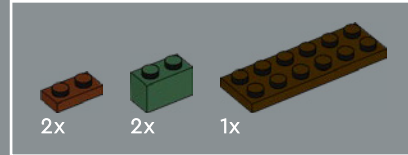
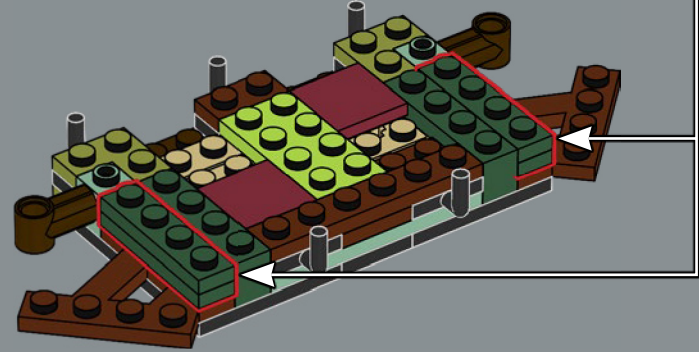
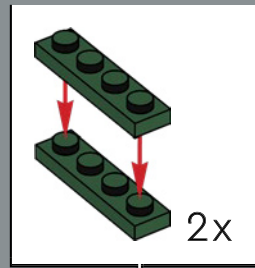

15

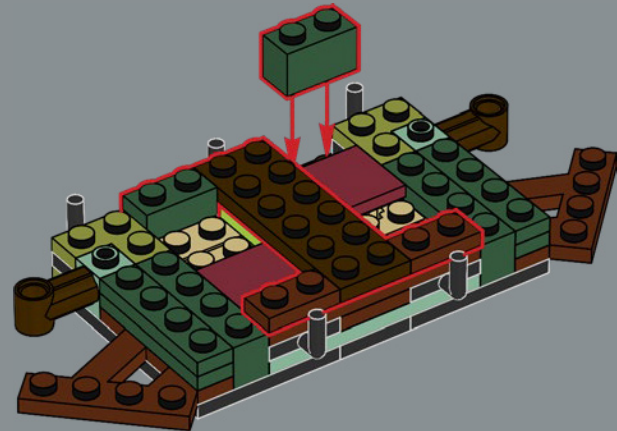

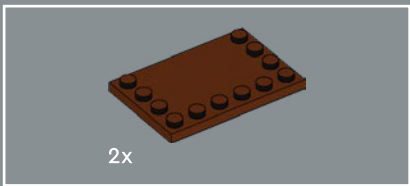

16

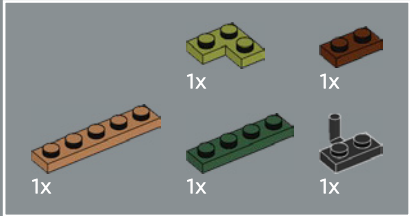
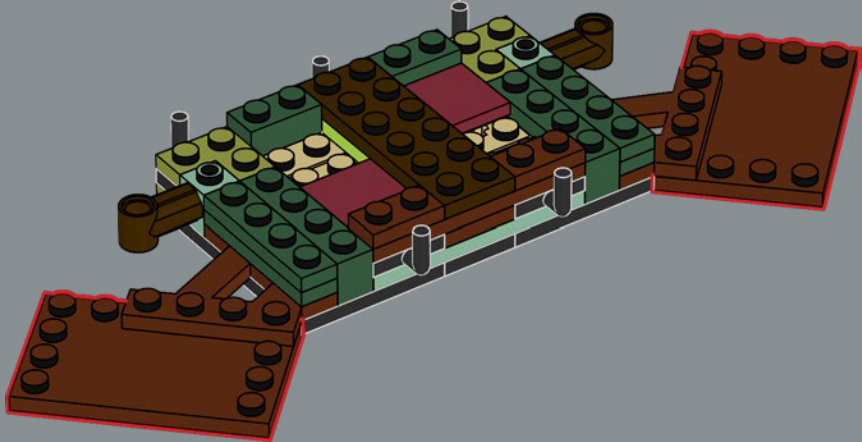

17

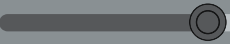
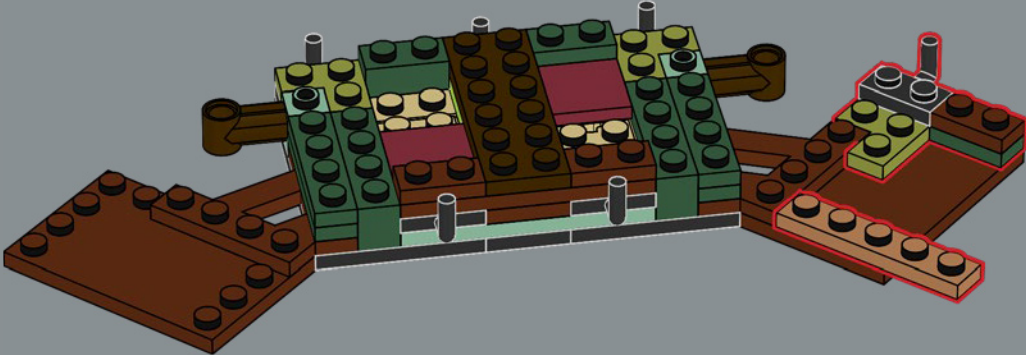
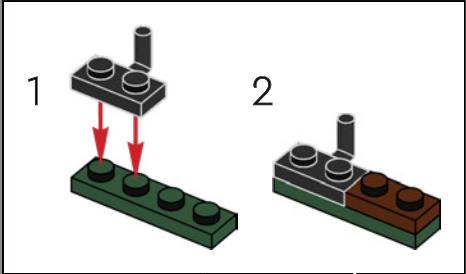



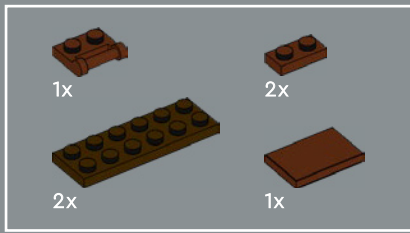

18

1

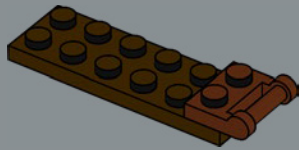

2

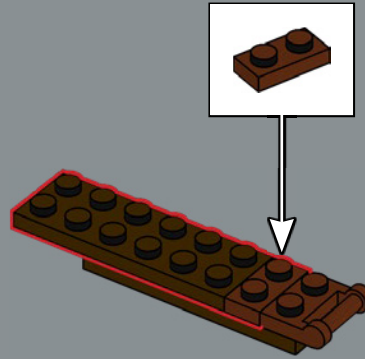

3

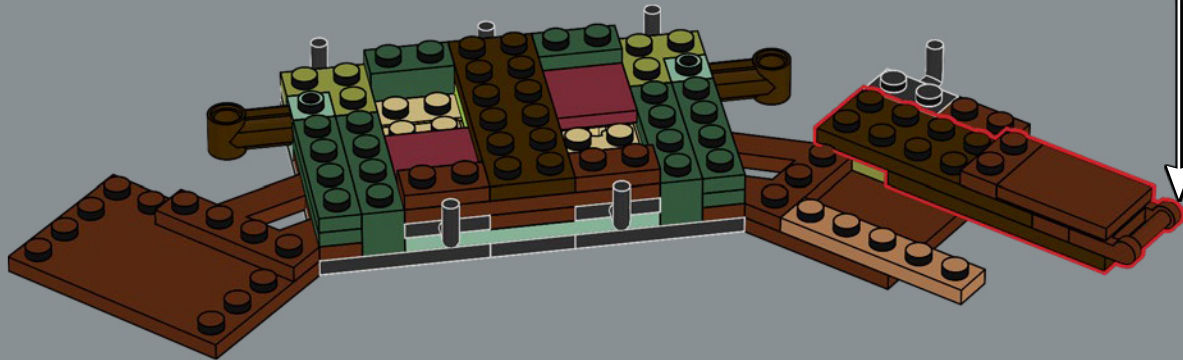
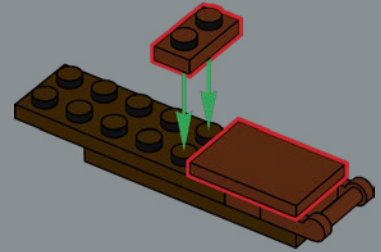

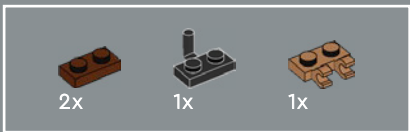

19

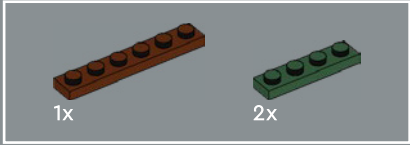
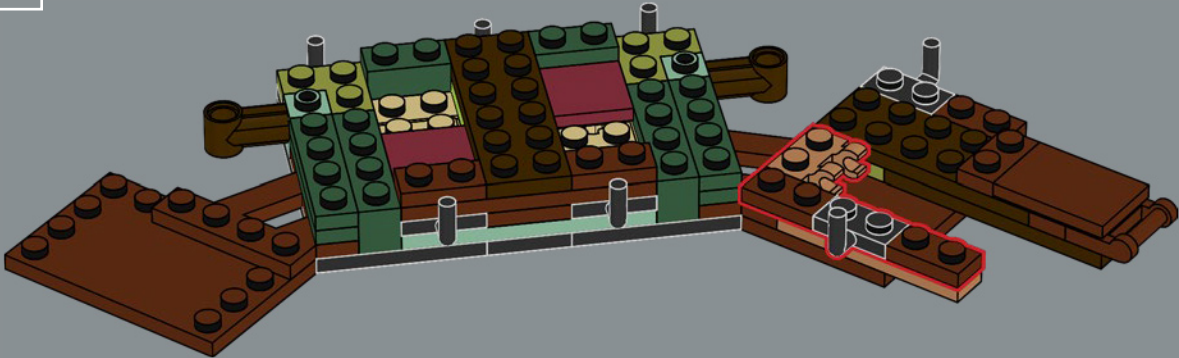

20

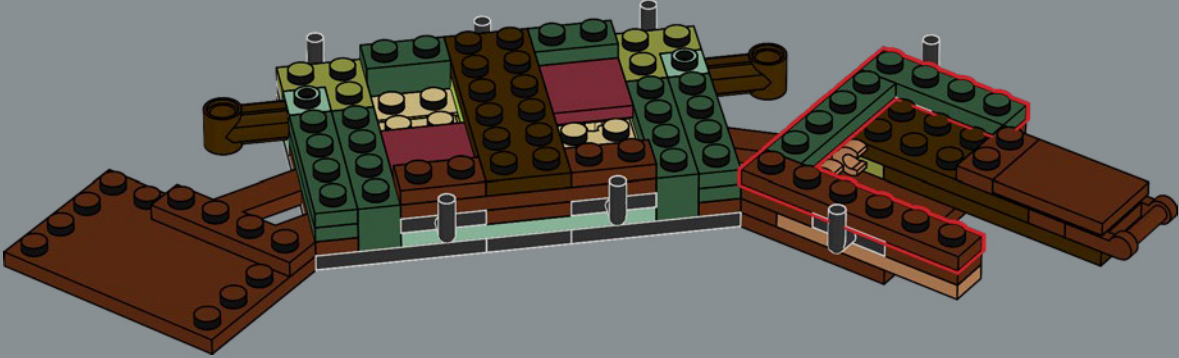





21

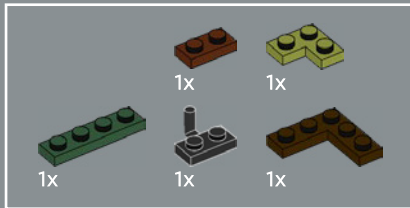
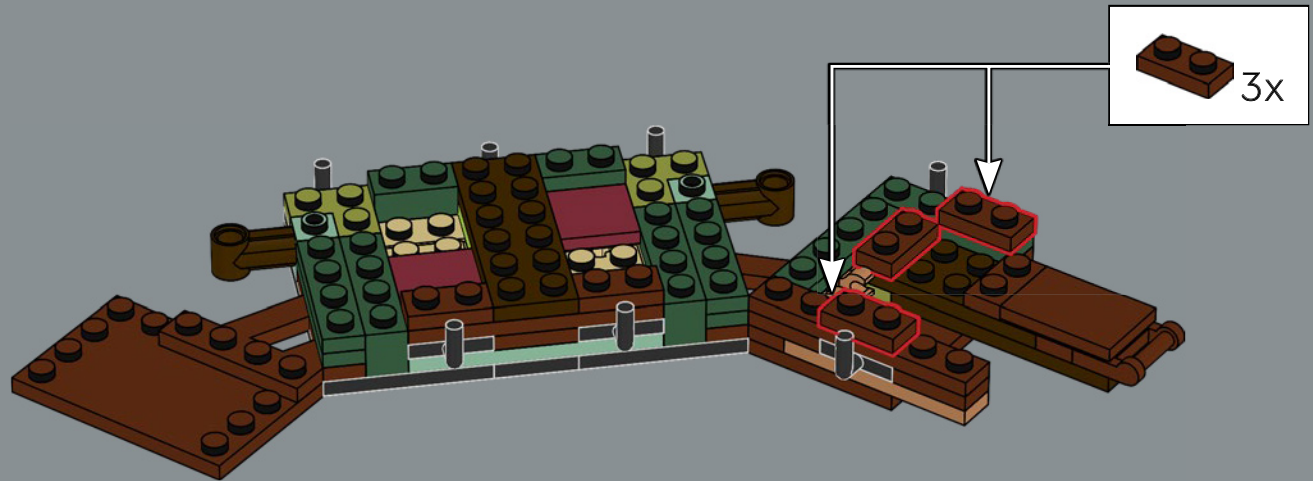

22

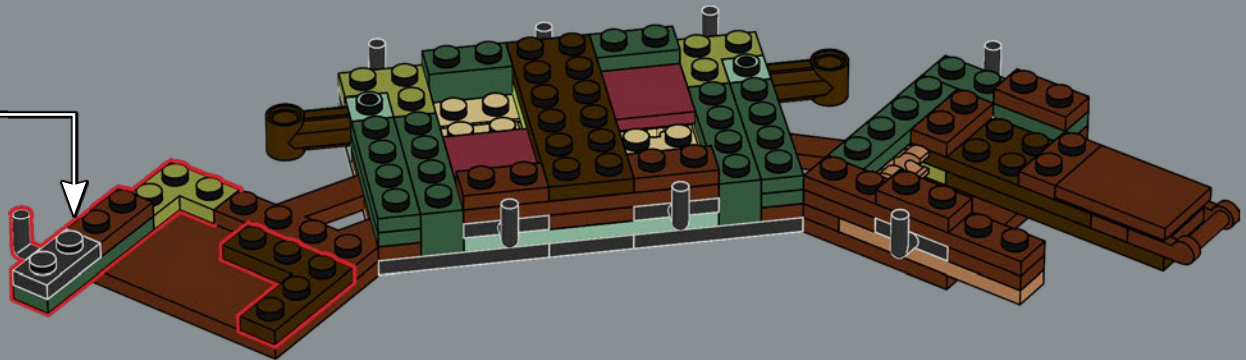
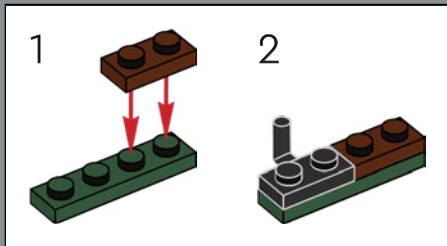

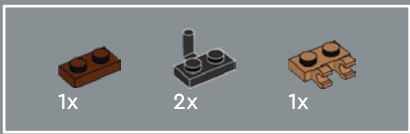

23

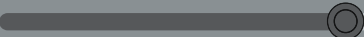
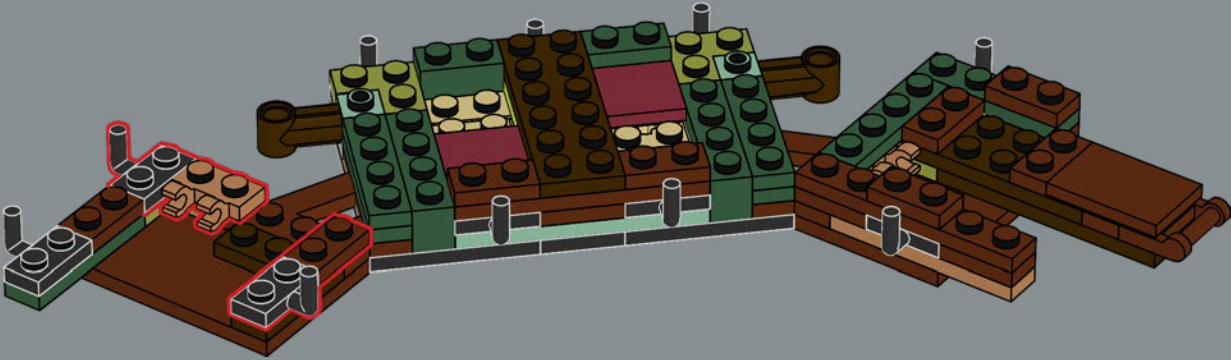



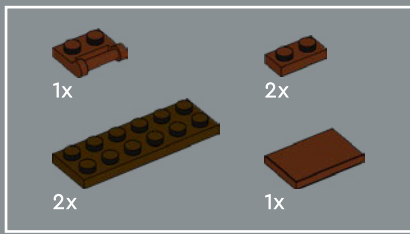

24

1

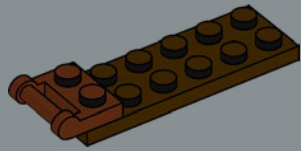

2



3

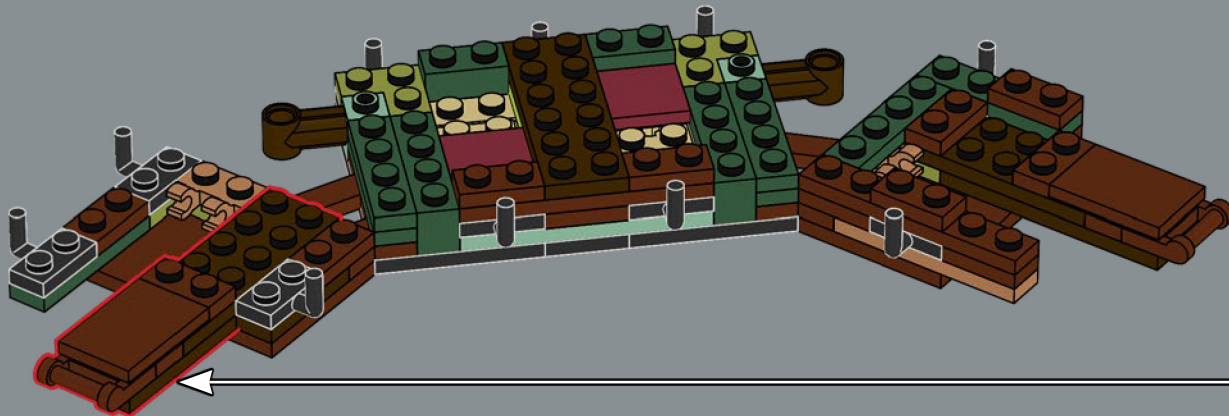
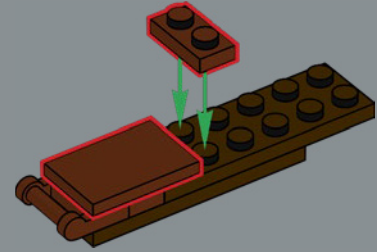

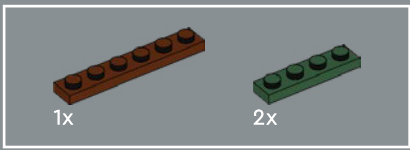

25

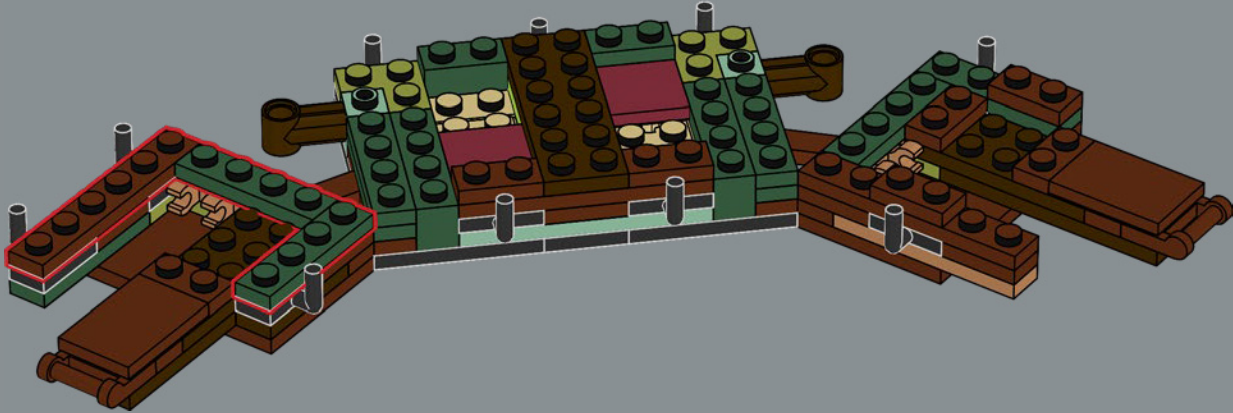

26

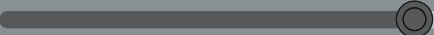
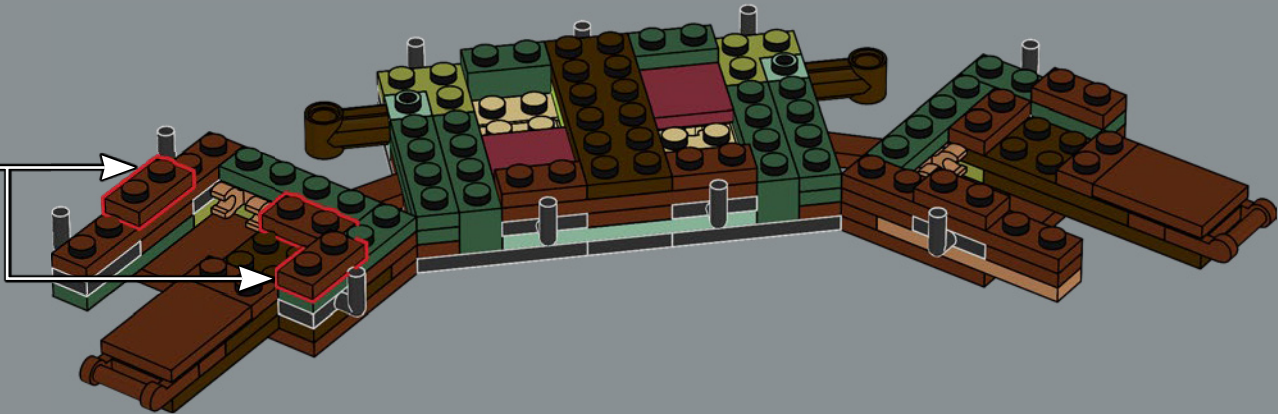



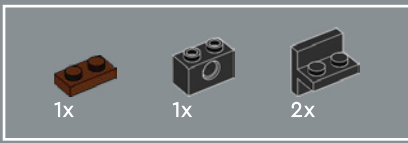

27

1

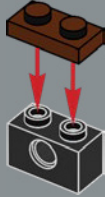

2

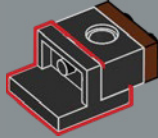

3

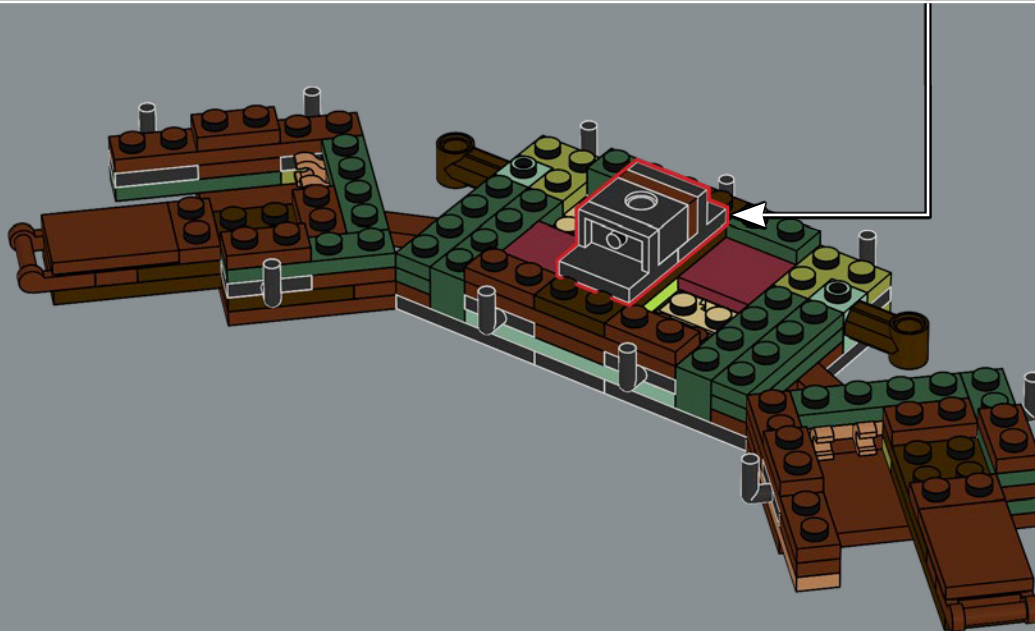
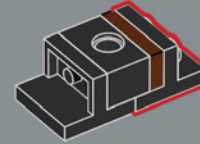

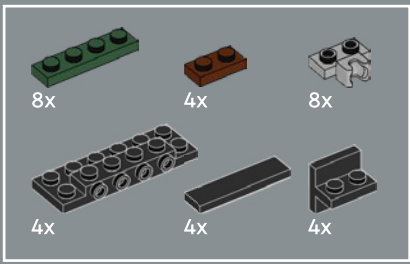

28

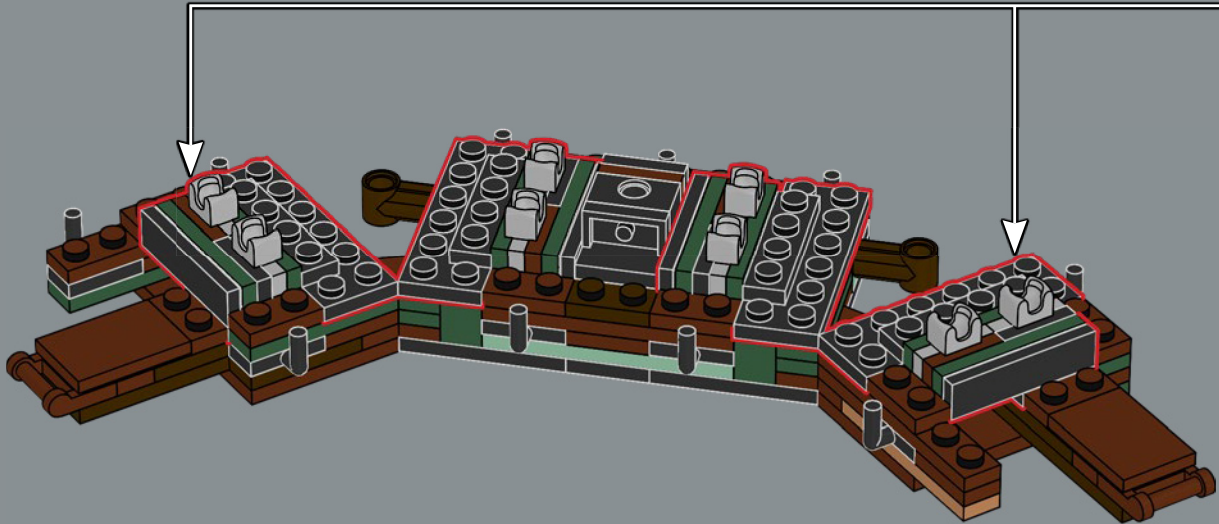
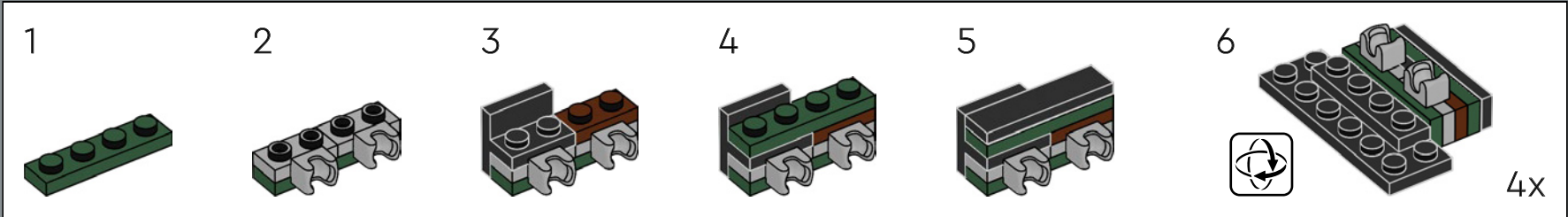



29

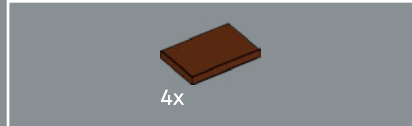
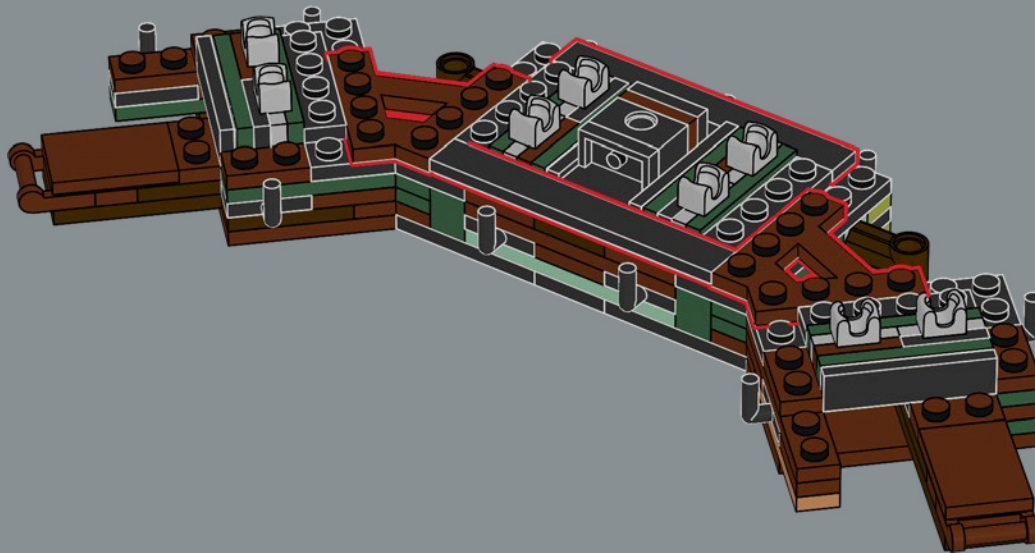

30

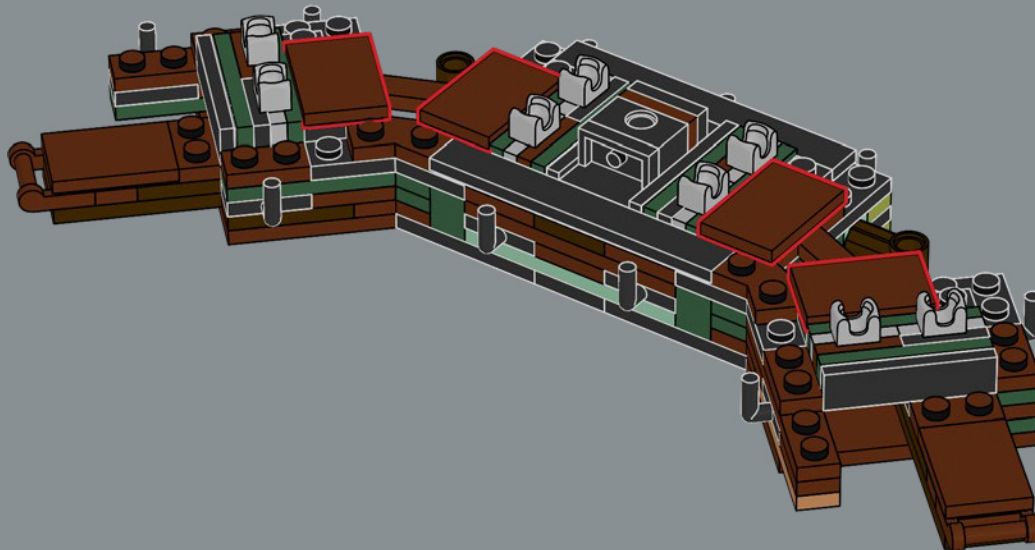

4x



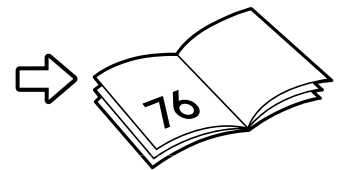



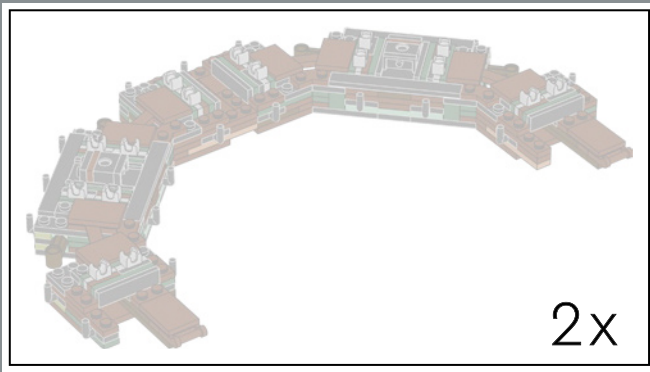

2x

31

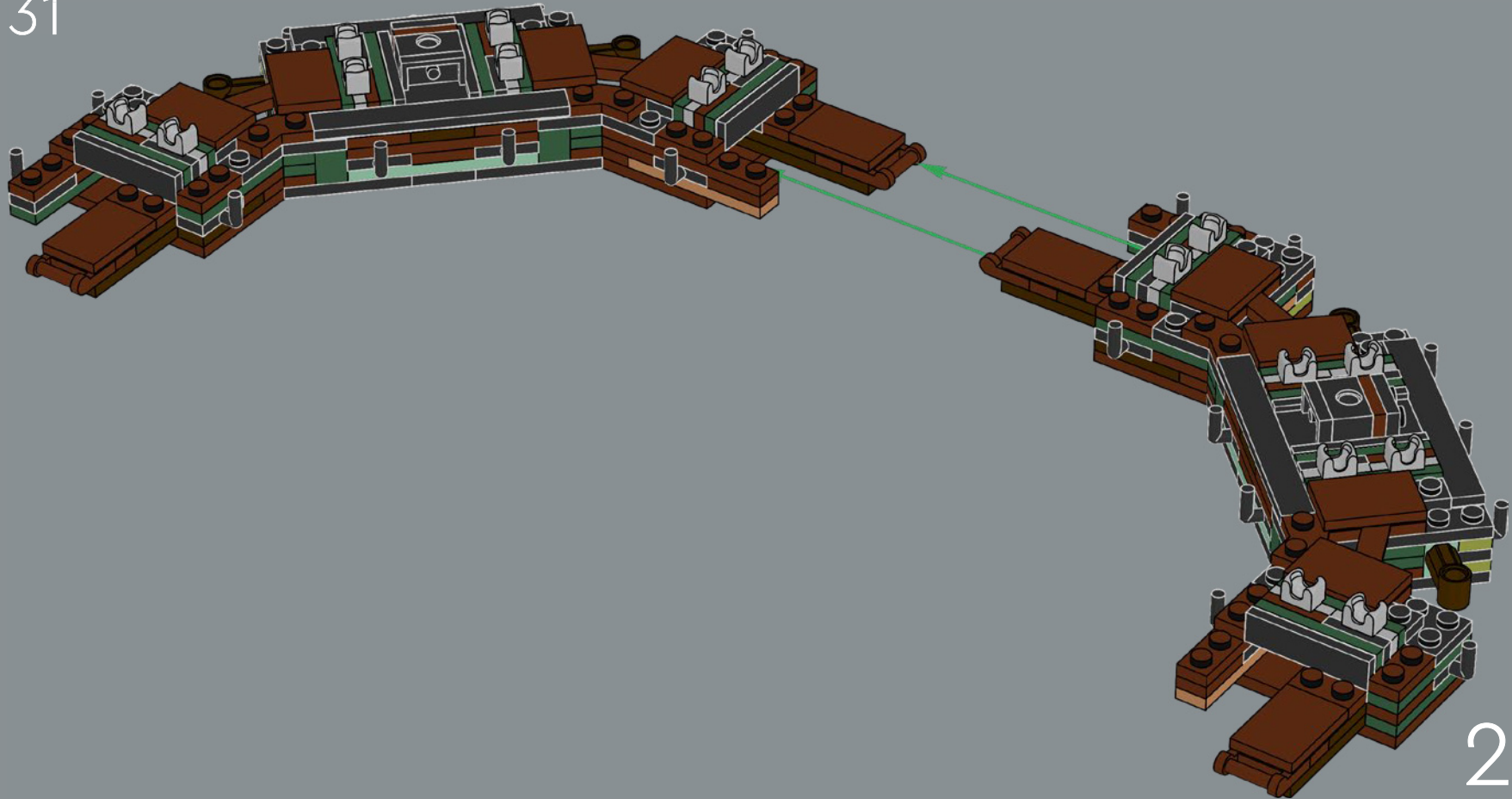

2x





32

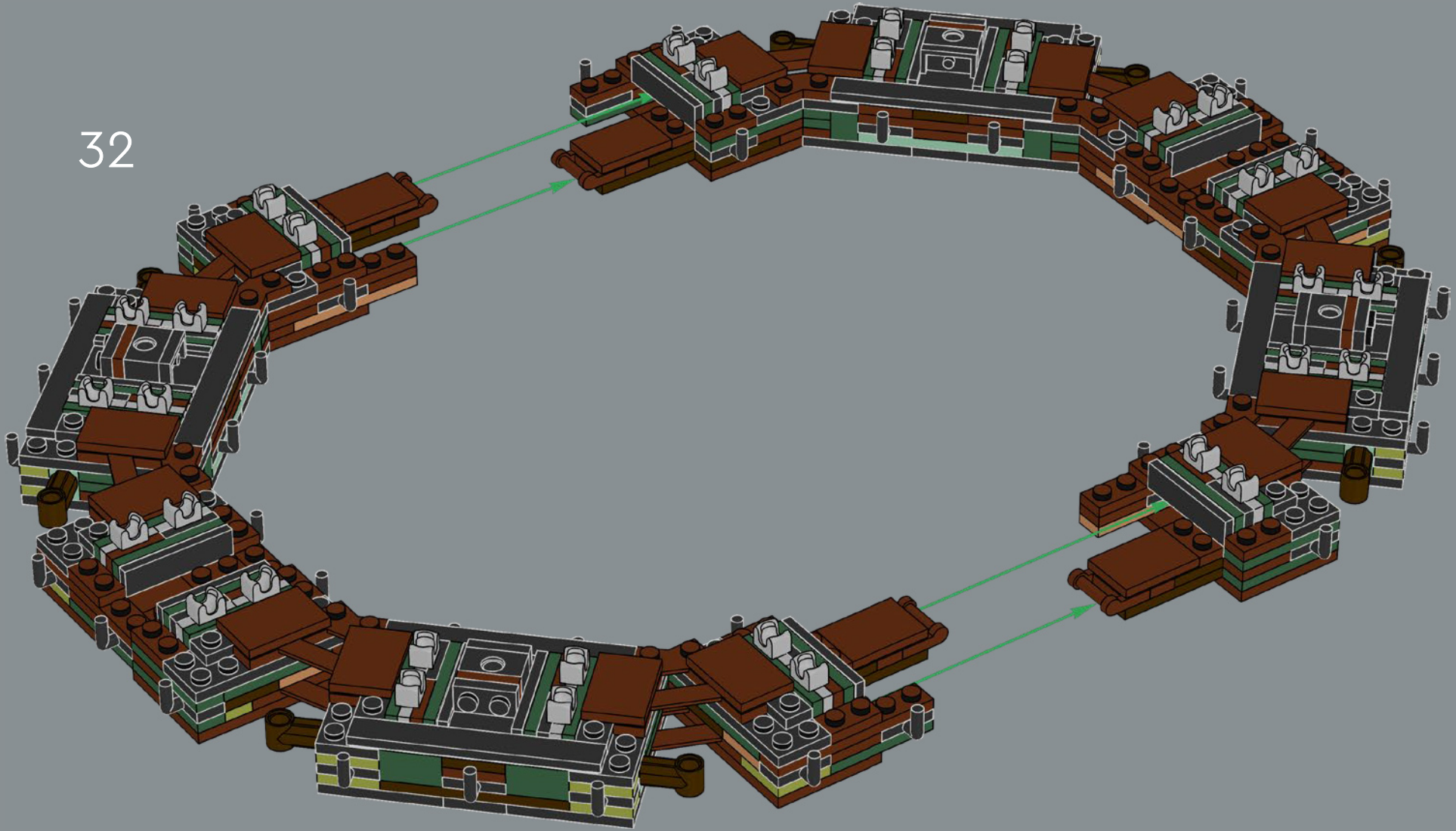



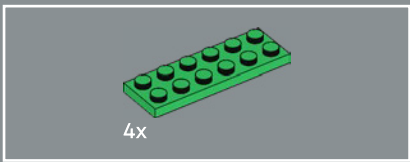

33





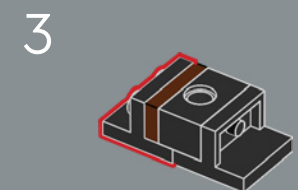
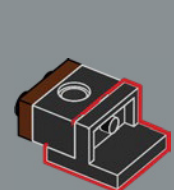
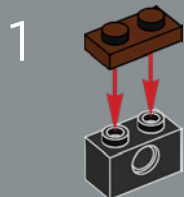
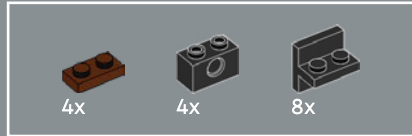
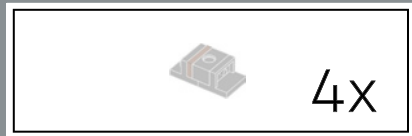

4x

34

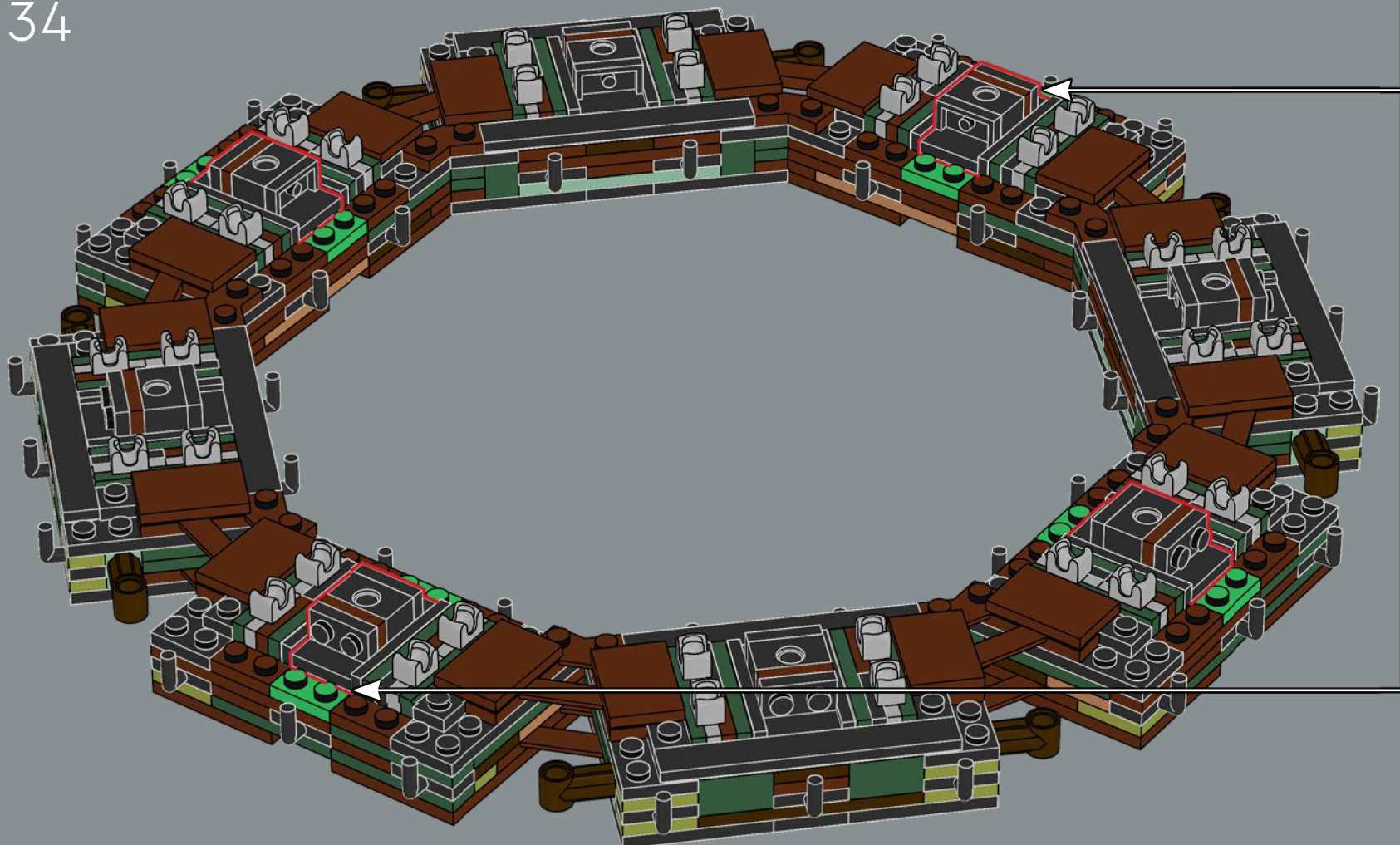

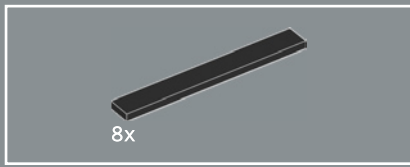

35

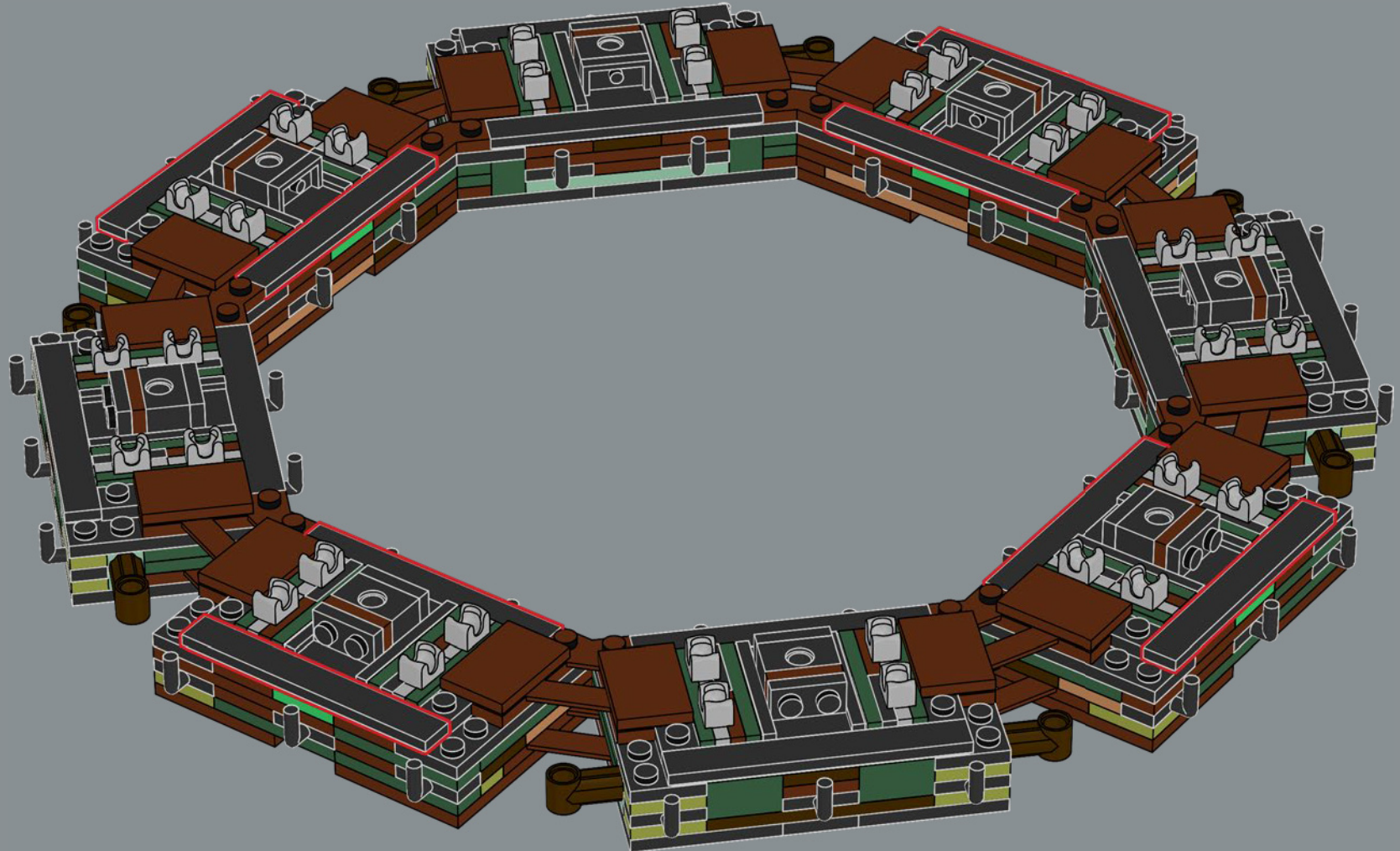



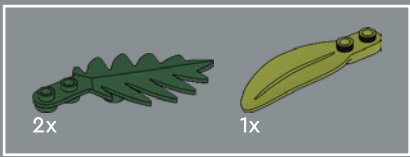

36





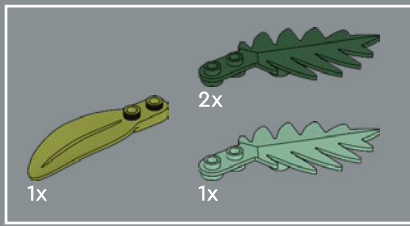

37



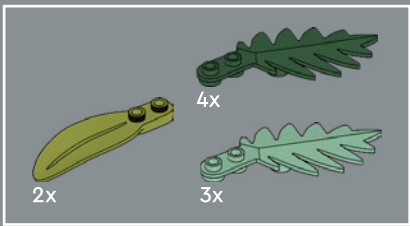

38









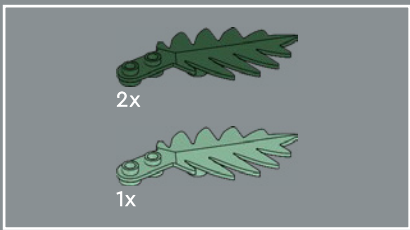

40



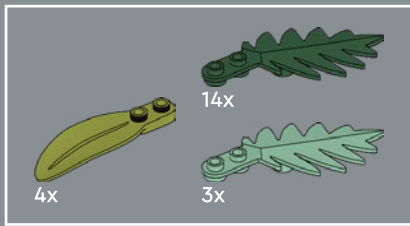

41







8x

42



8x







Wenn man LEGO® Blumenstängel nacheinander aufsteckt,  
kann man Zweige mit spitzen Kiefernadeln erschaffen.

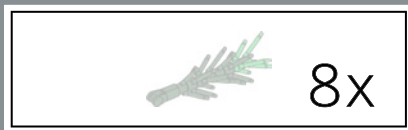

43

1

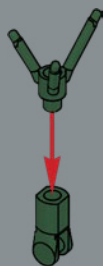

2

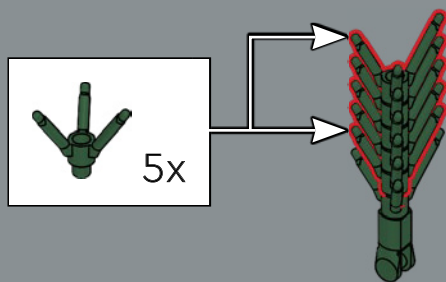

3



4

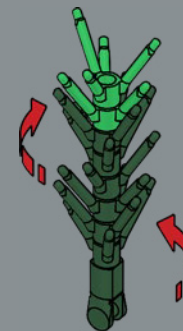

8x











Die Unterseite der Fraser-Tannennadeln hat einen leichten Blaustich, den wir hier mit sandgrünen Palmblättern darstellen. Das ist ein völlig neuer Farbton für dieses klassische LEGO® Element, das 1989 seine Premiere feierte.

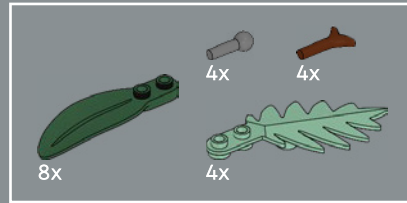
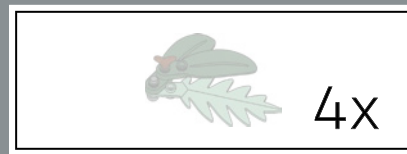

45

1

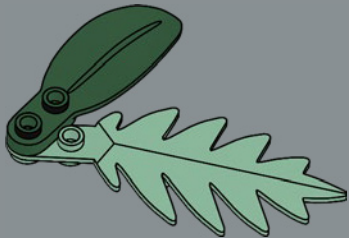

2

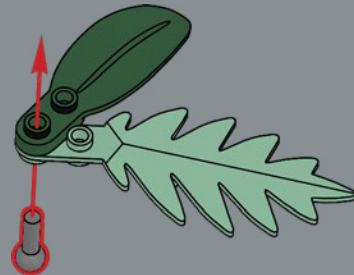

3

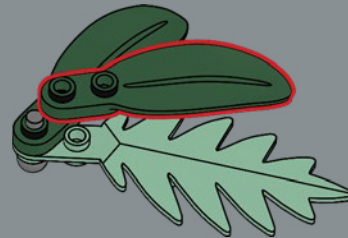

4

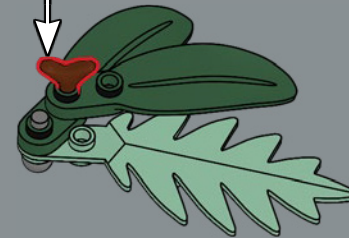

4x



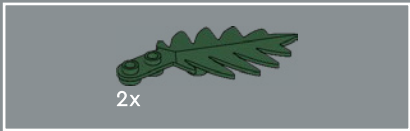
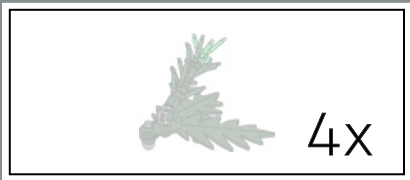

46

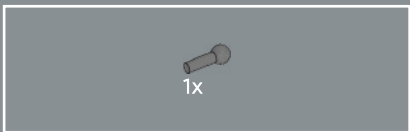
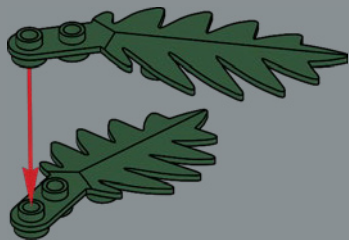

47

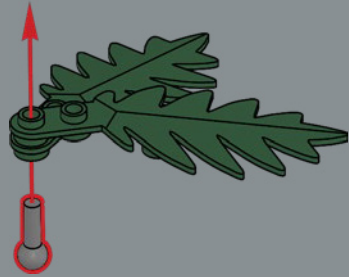

48

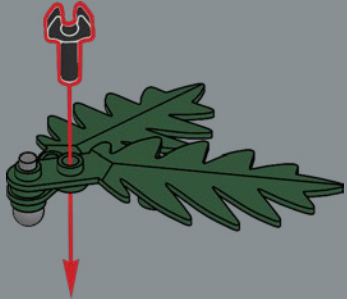





49

1

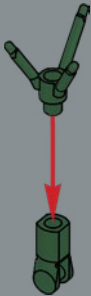

2

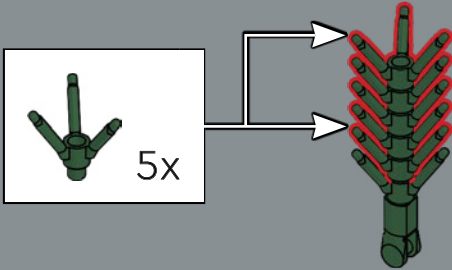

3



4

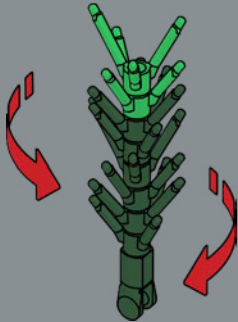



4x









Einige Magnolienarten sind immergrün,  
deshalb eignen sich ihre Blätter für Ganzjahresgestecke.

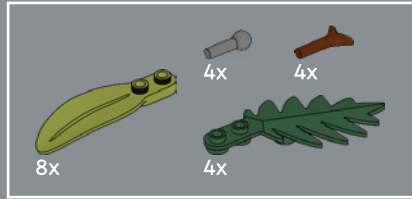

51

1

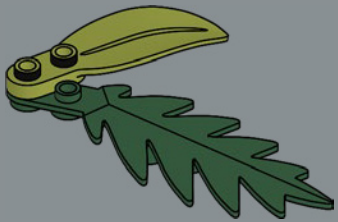

2

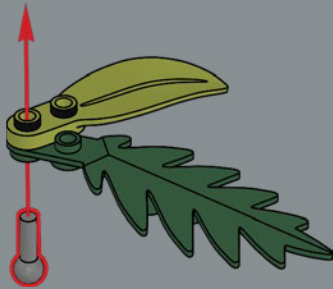

3

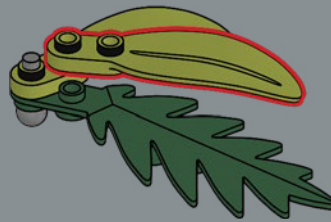

4

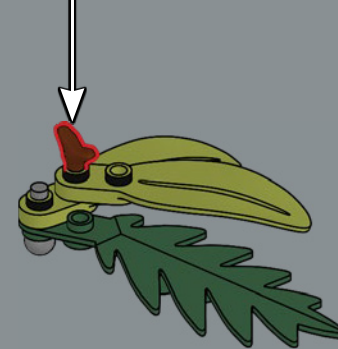
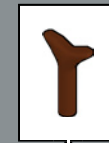

4x





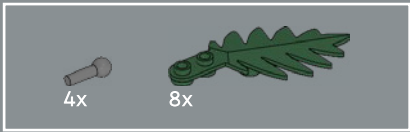
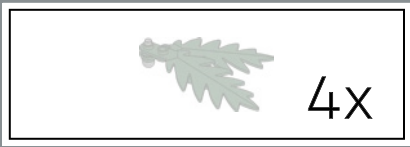

52

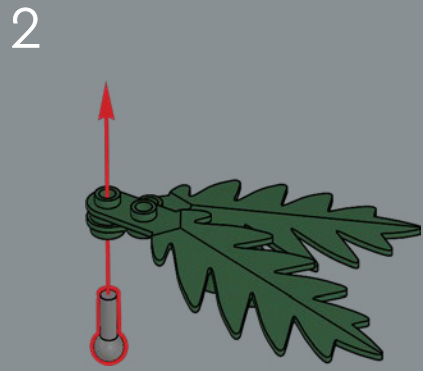
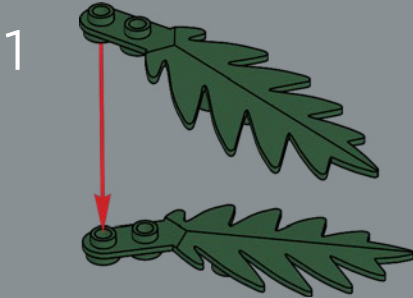

4x







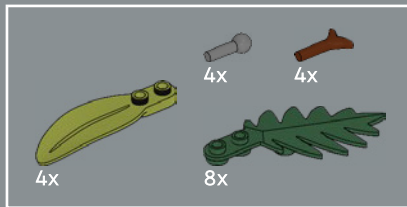

53

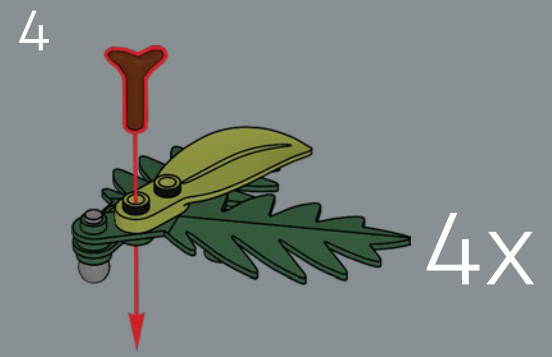
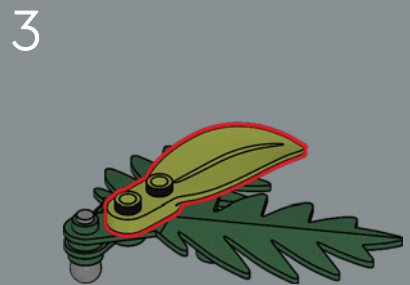
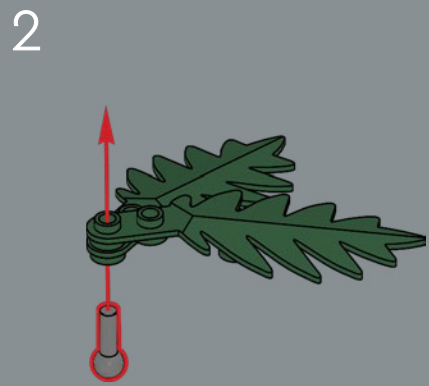
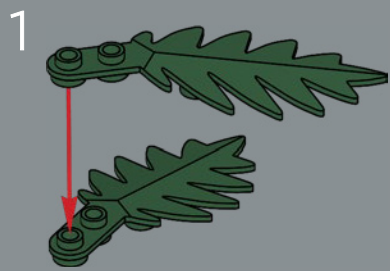







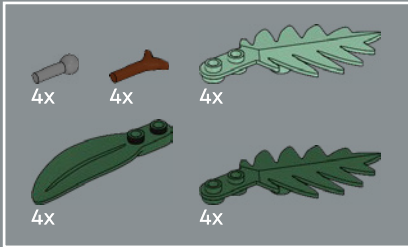

54

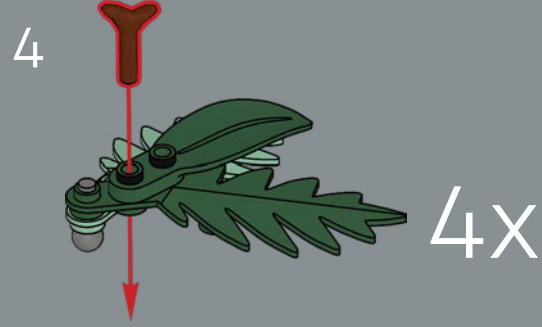
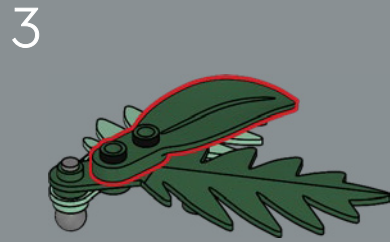
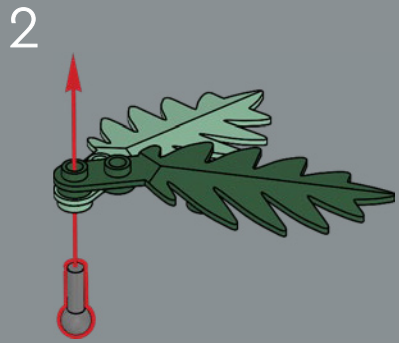





55

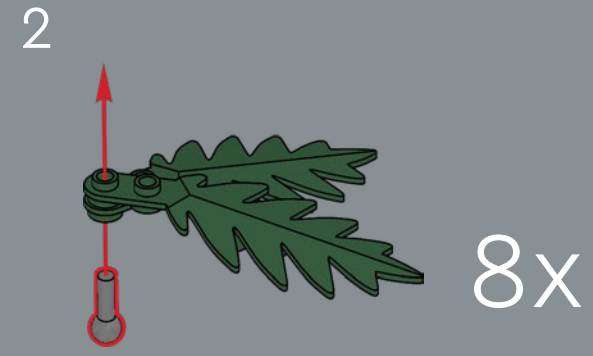
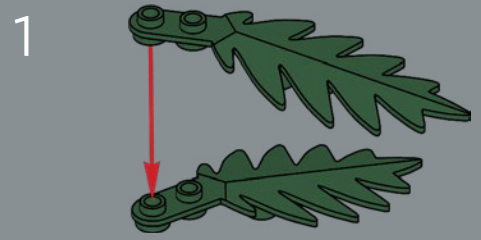







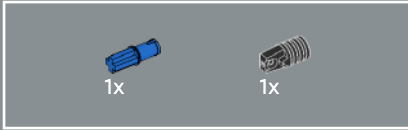

56

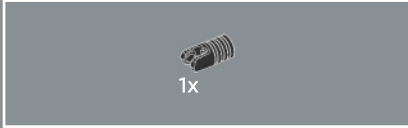

57

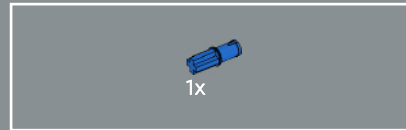

58



59





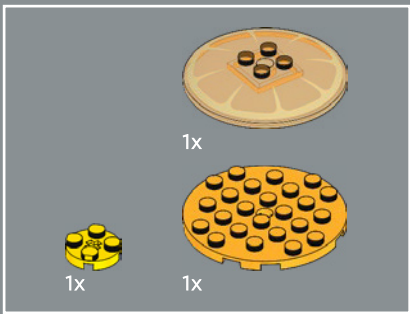

60

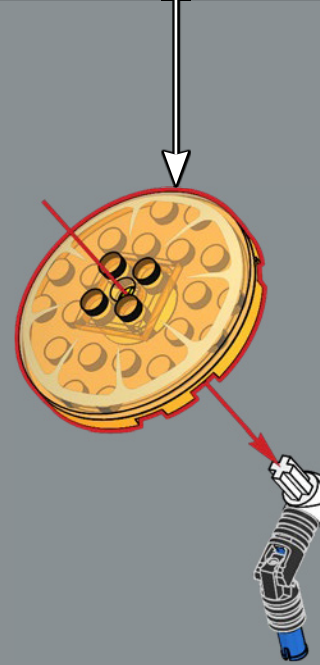
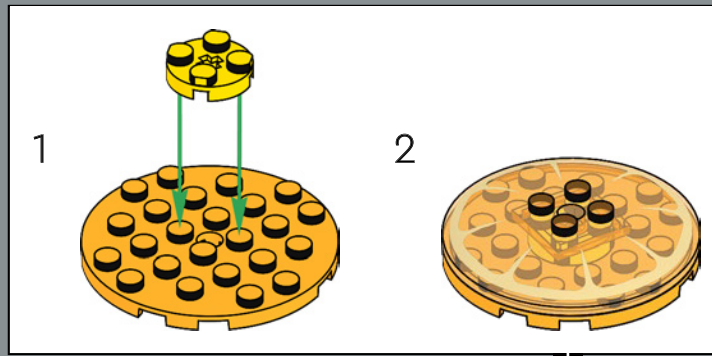

3x



Bedruckte durchsichtig-orange Satellitenschüsseln stellen durchscheinende Orangenscheiben dar.



61

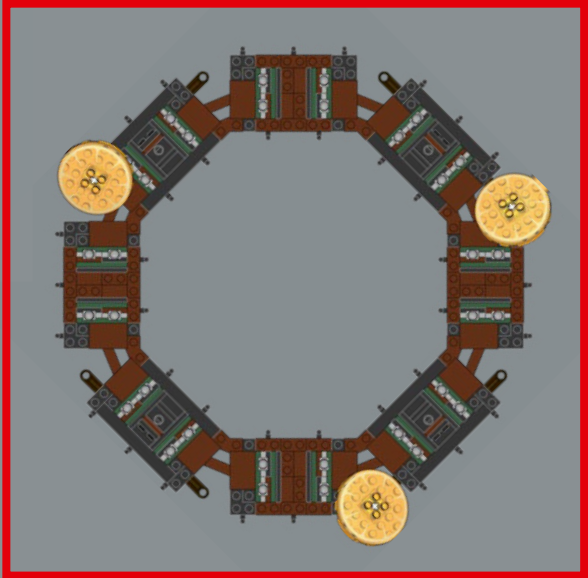



62



63

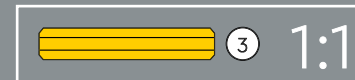
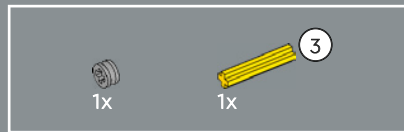

64



65







66



67

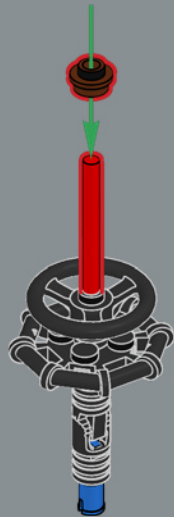

68

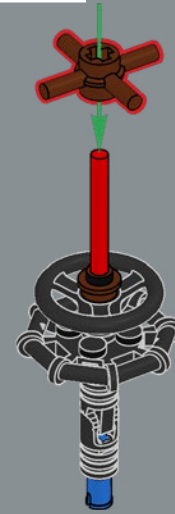

69

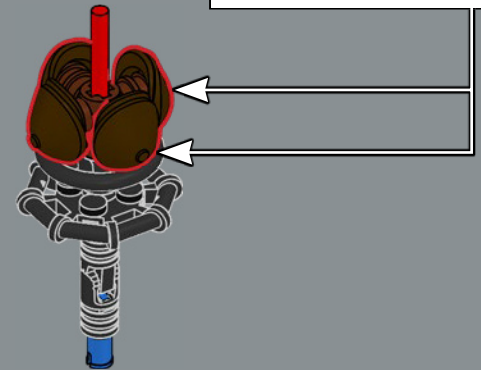
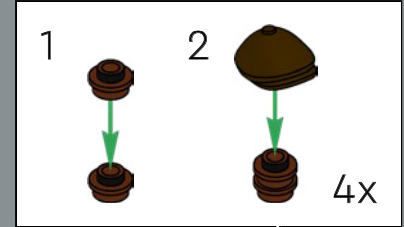



70

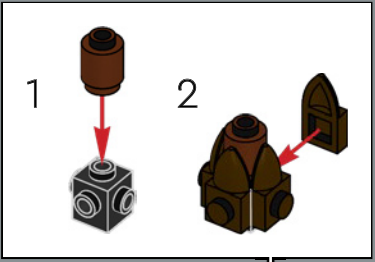

71

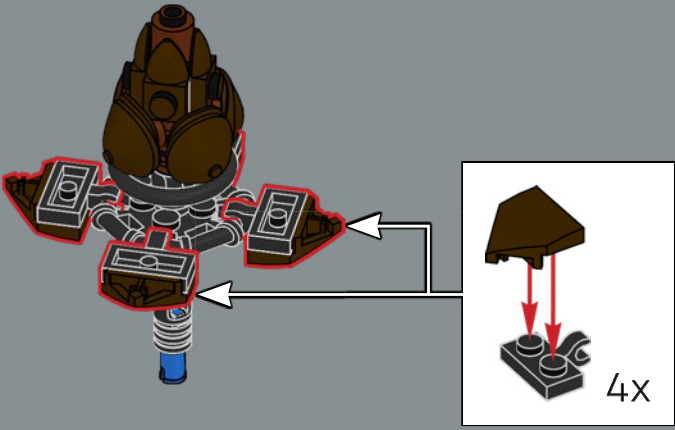

72

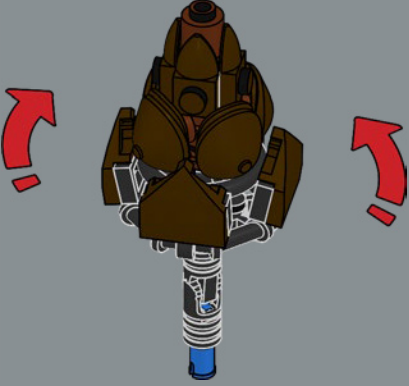

3x



73

Die Kiefernzapfen der Waldkiefer haben Schuppen mit kleinen Auswüchsen, die dem Knopf auf der Kappe des Zeitungsjungen ähneln.

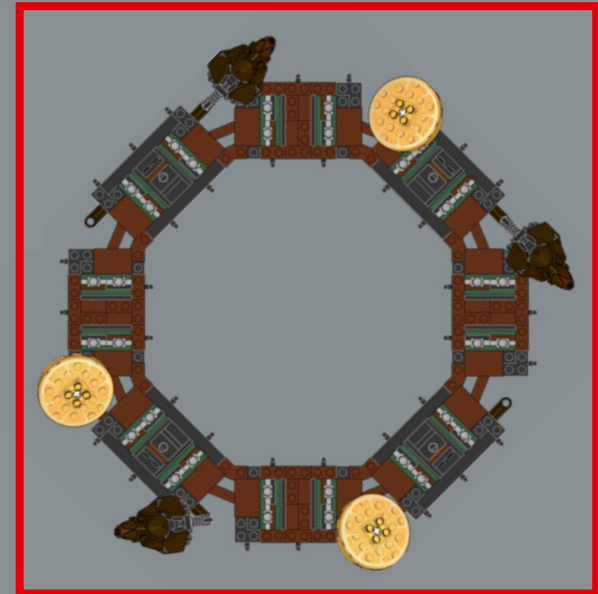



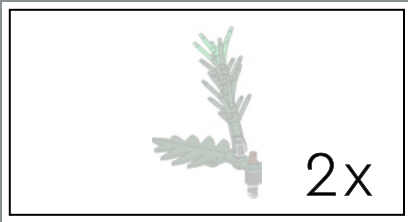

74

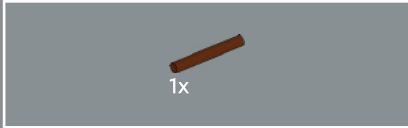

75

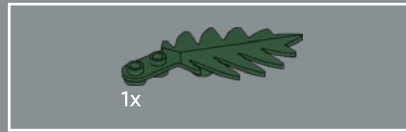

76

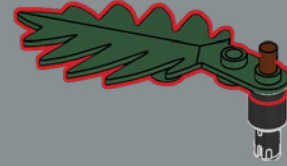

77

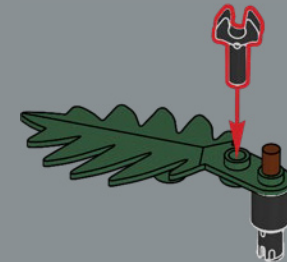



78

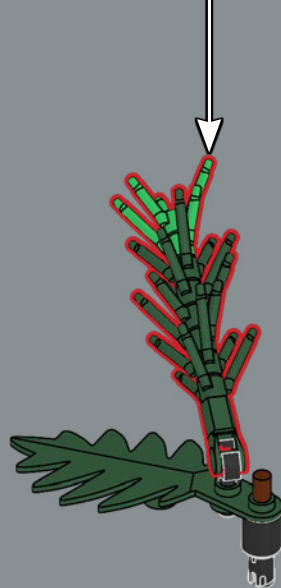
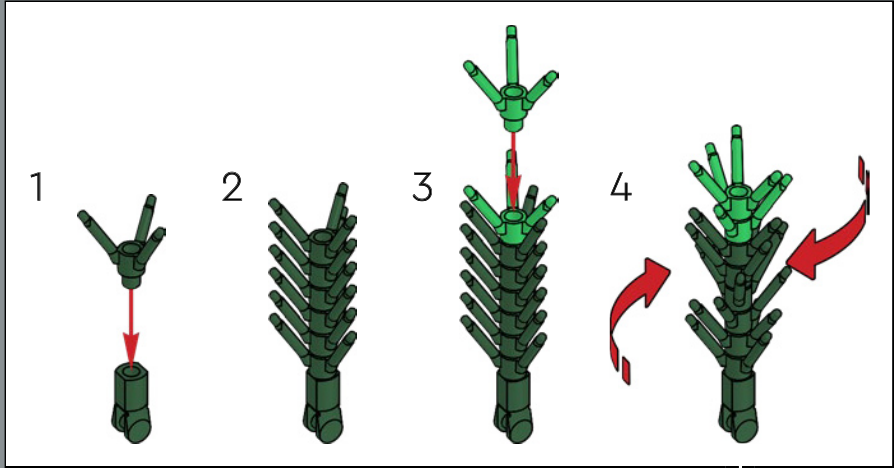

2x







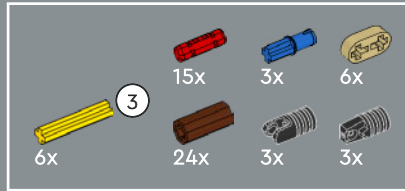
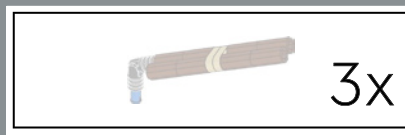

80

1



2



3



4





Zimtstangen stammen aus der getrockneten inneren Rinde eines Zimtbaums. In der Antike war das Gewürz wertvoller als Gold.

5



6

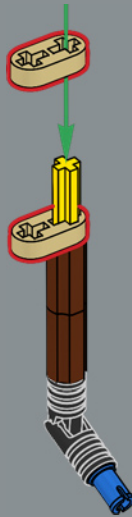

7

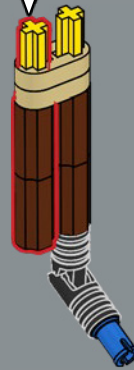

8

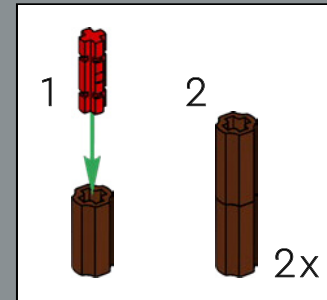
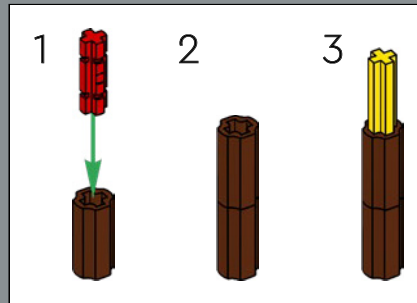
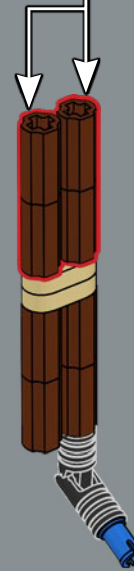

3x







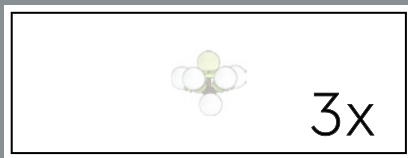

3x



82

1



2

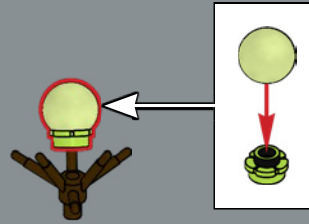

3

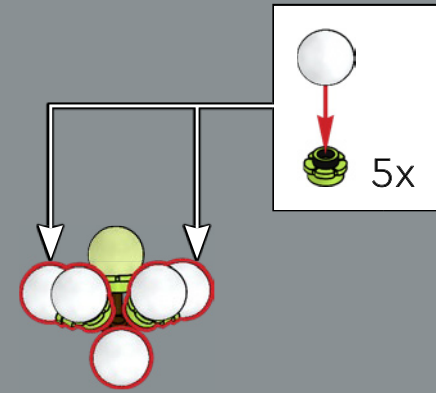

3x

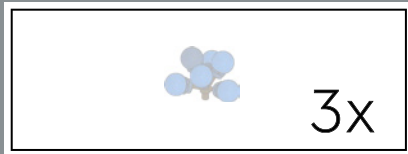

3x

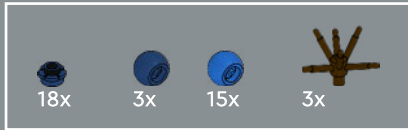

83

1



2

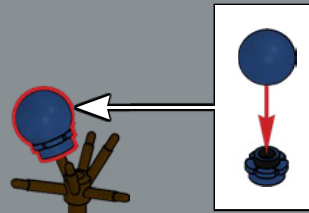

3

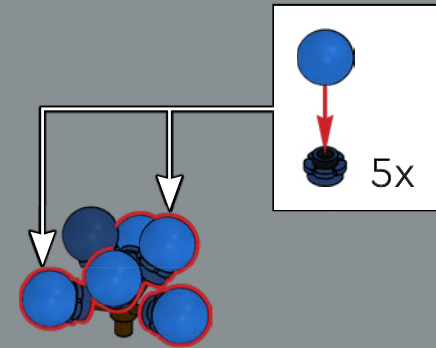

3x

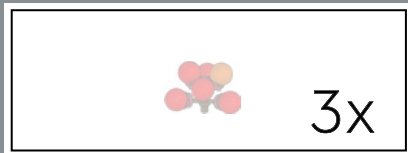

3x



84

1



2

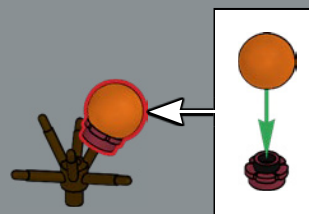

3

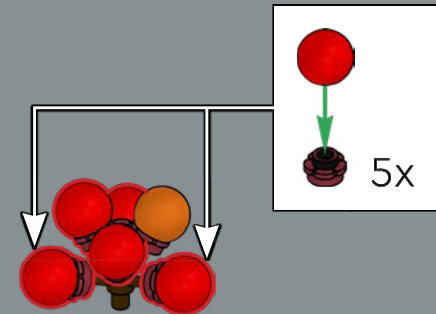

3x



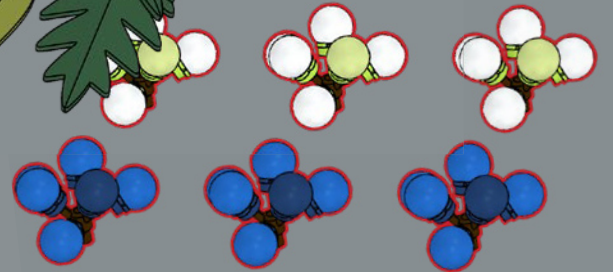
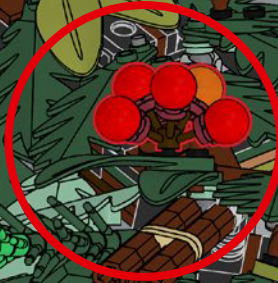
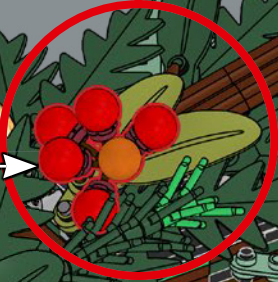
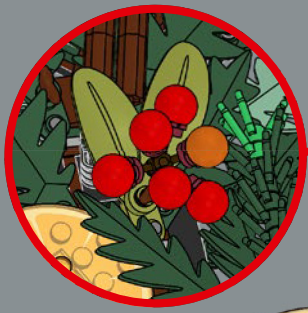





Leuchtend-rote Winterbeeren sind im Winter eine wichtige Nahrungsquelle für Vögel.





31

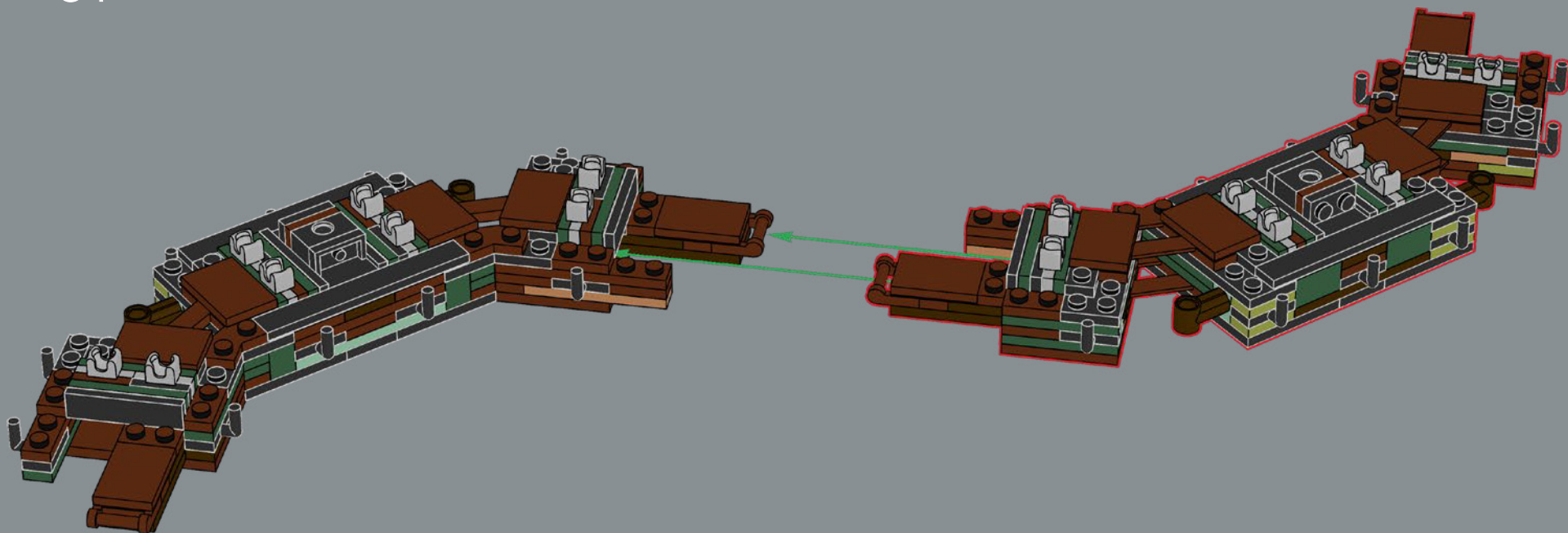



32

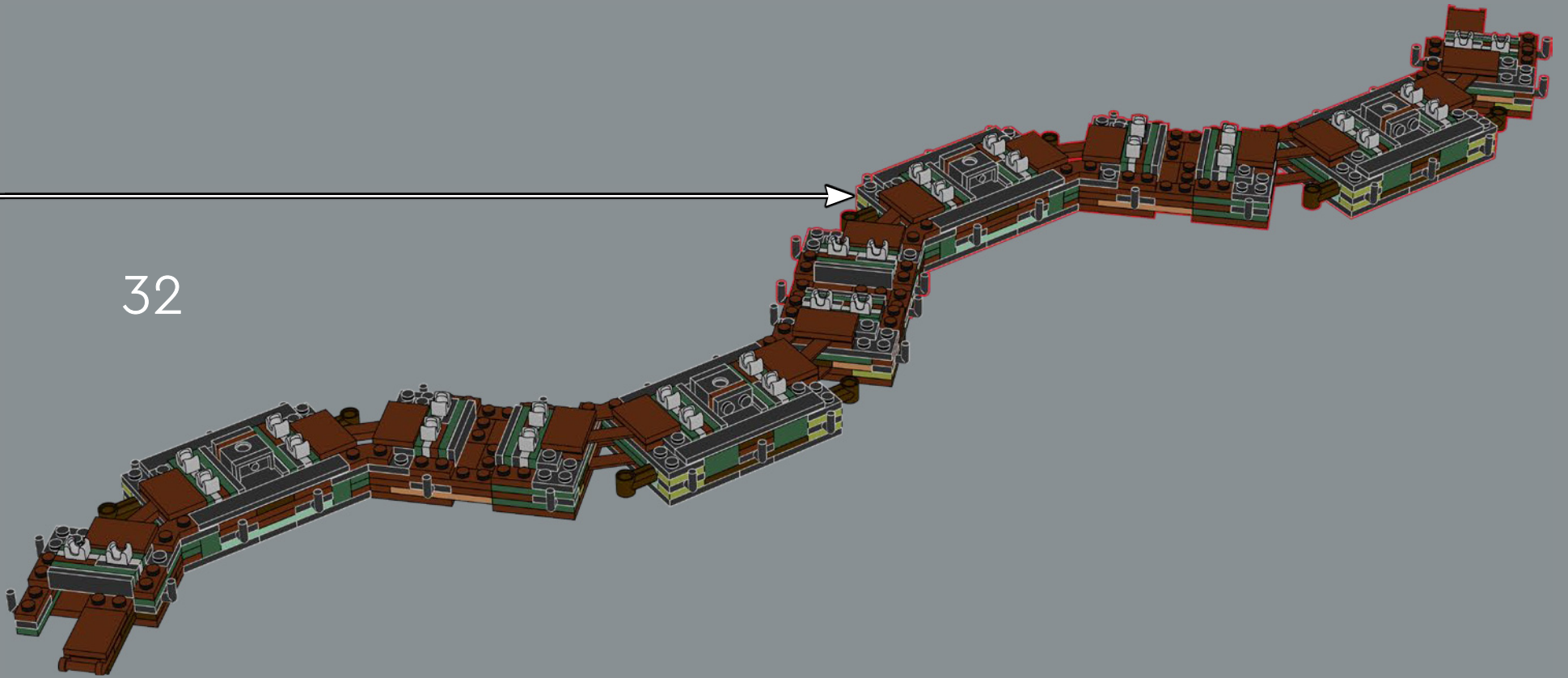

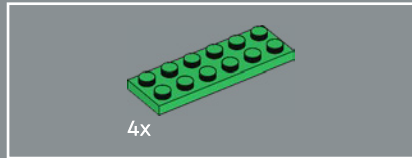

33

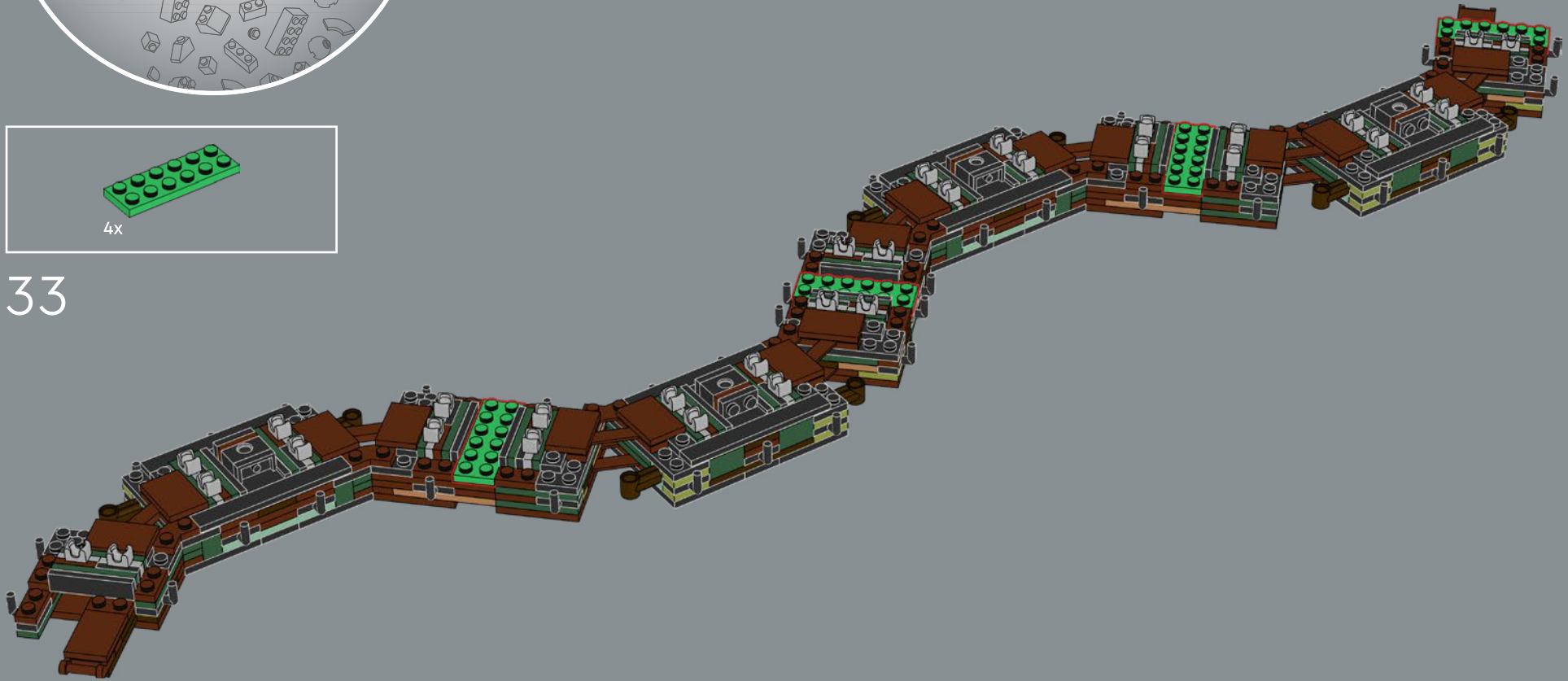

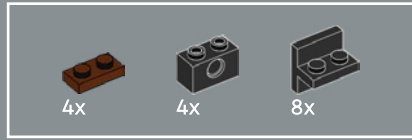
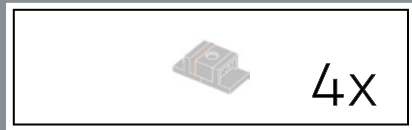

34

1

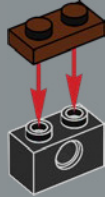

2

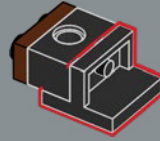

3

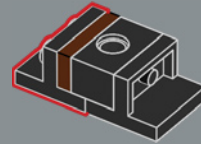

4x





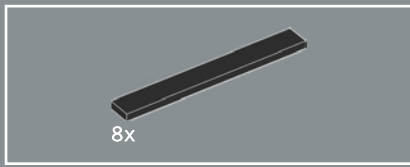

35

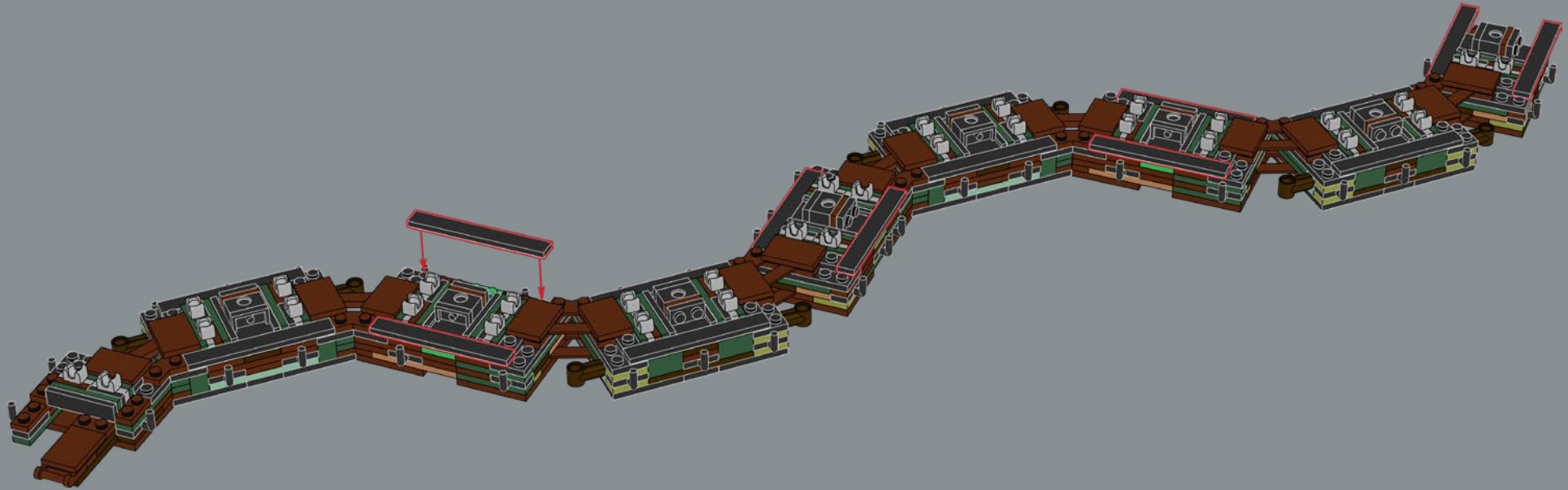

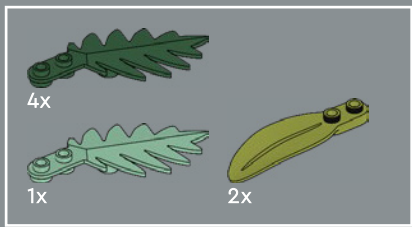

36

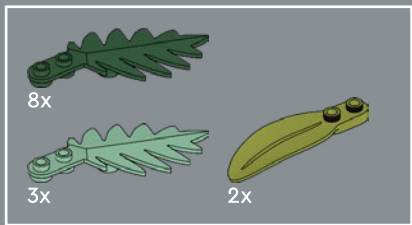
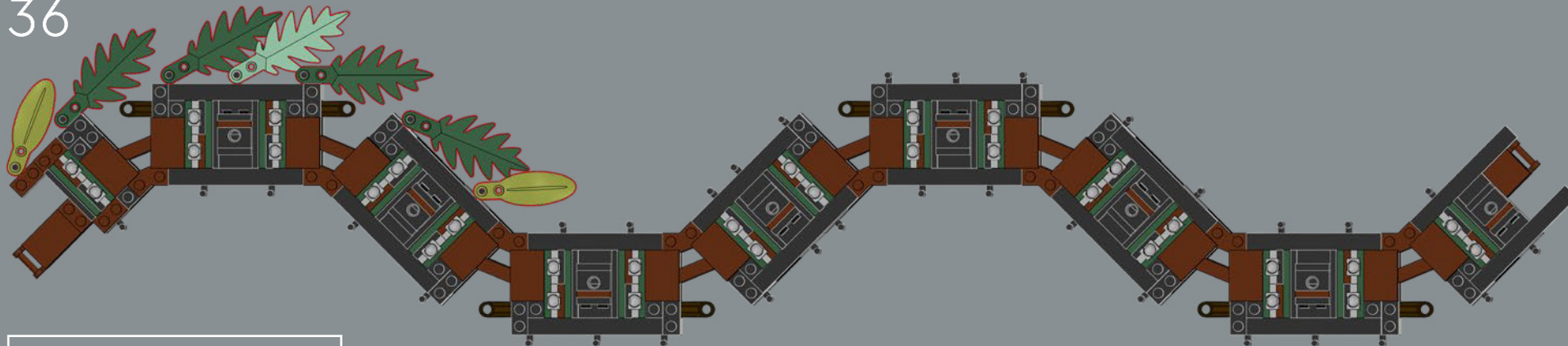

37

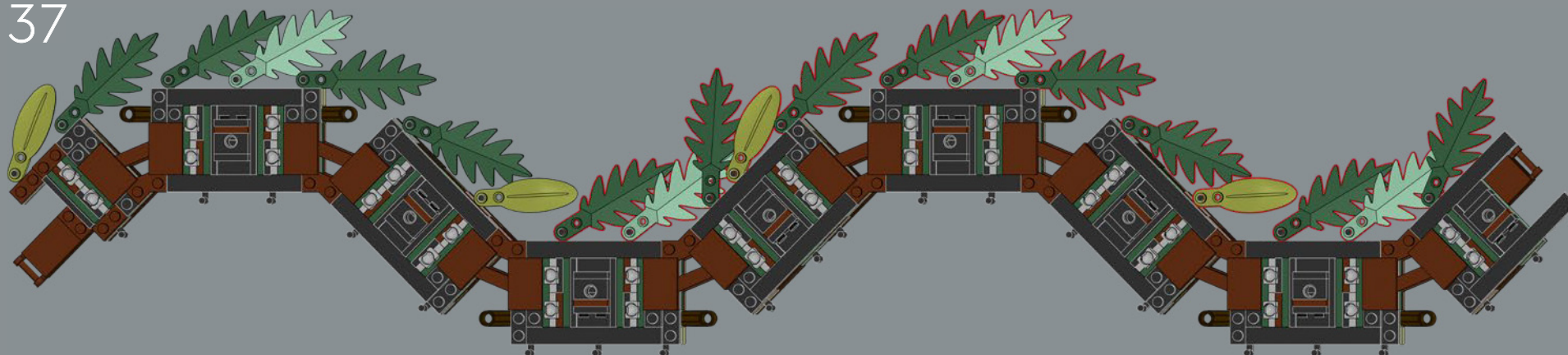

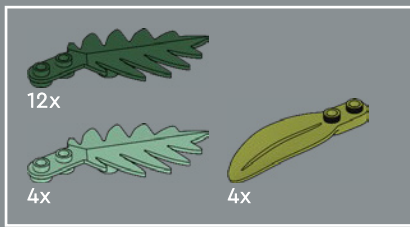

38

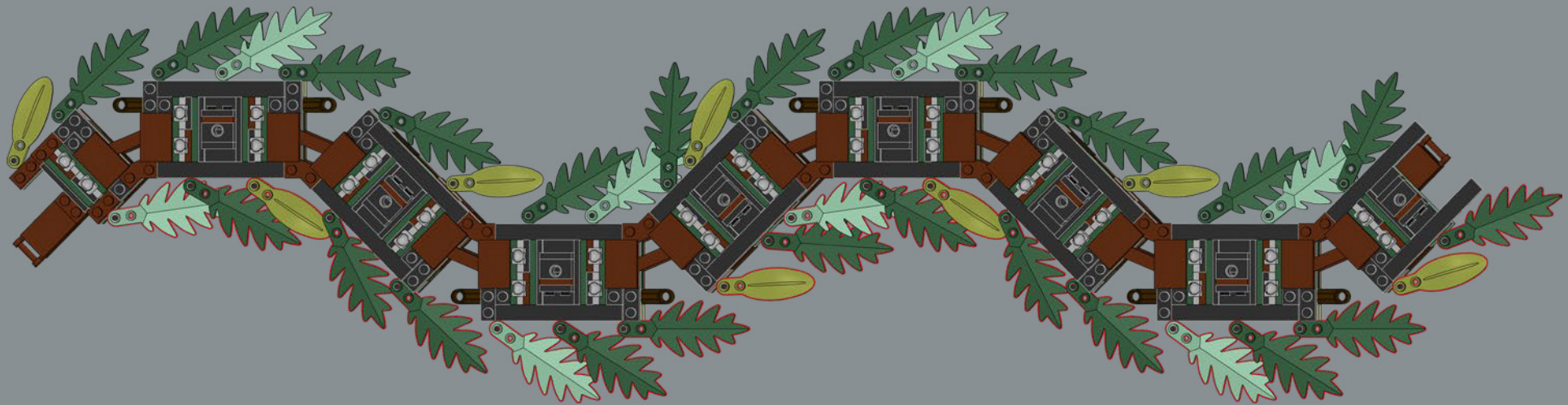





8x

39

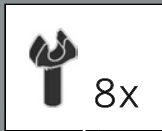
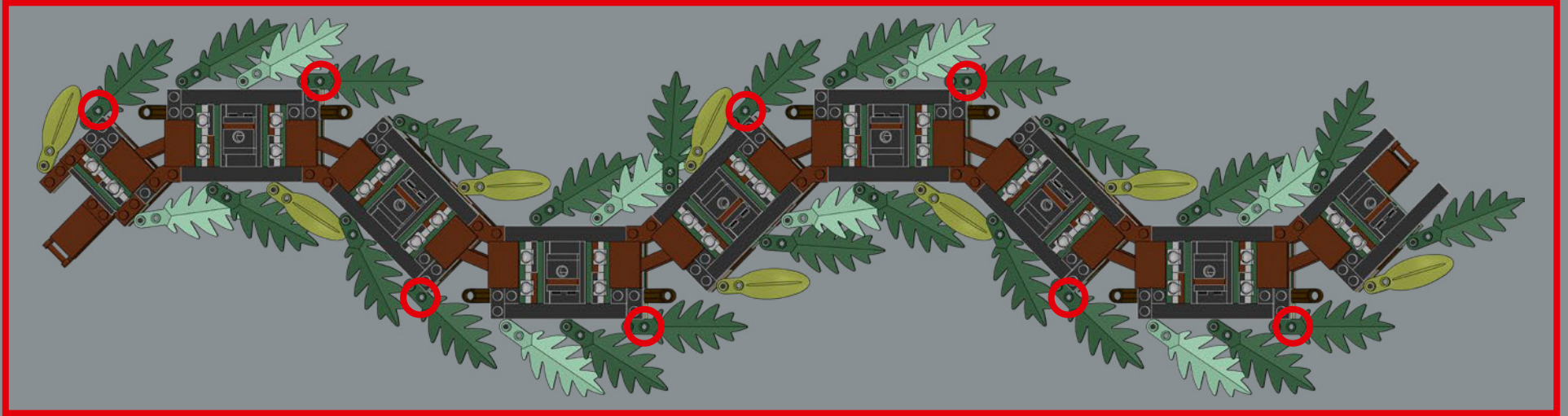

8x



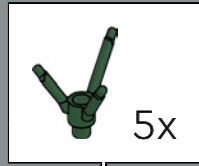
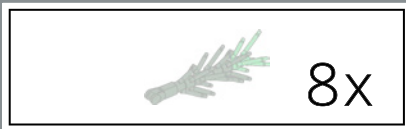

40

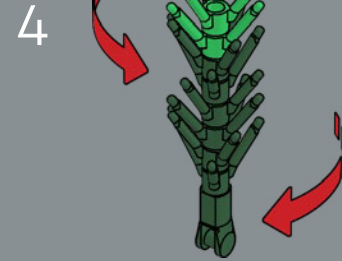
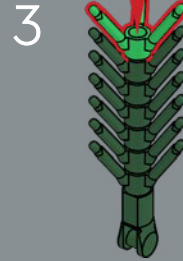
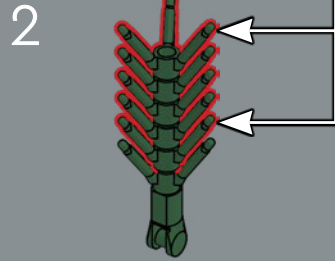
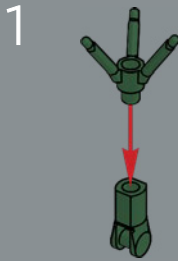

8x



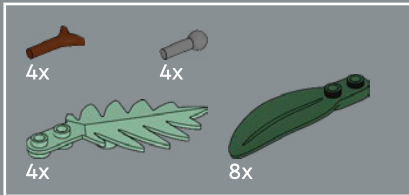

41

1

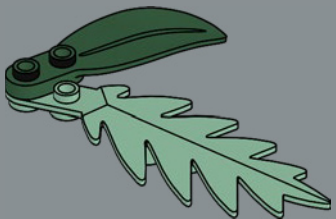

2

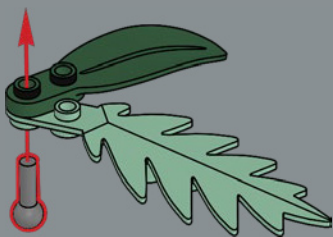

3

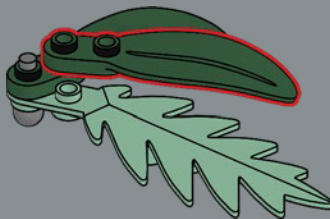

4

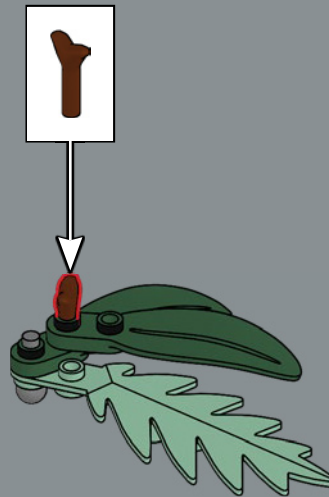

4x



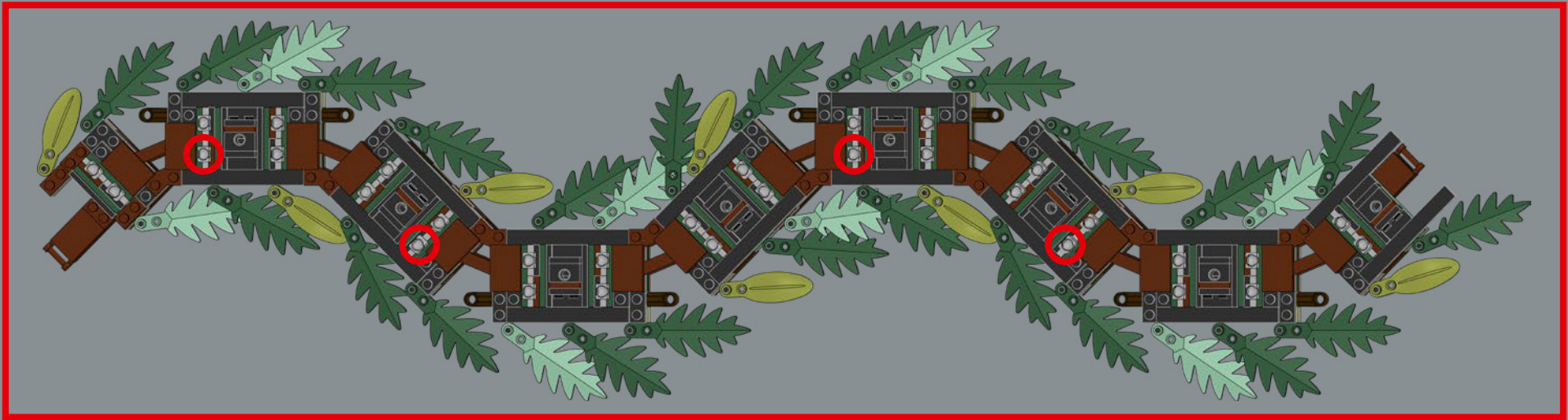

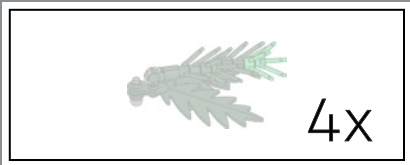

42

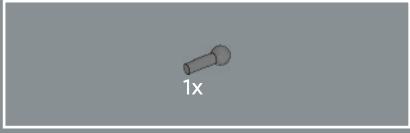
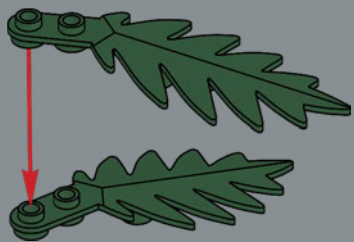

43

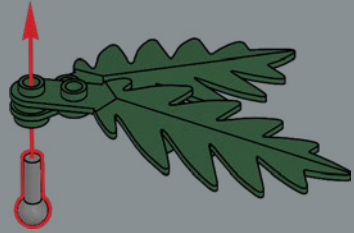

44

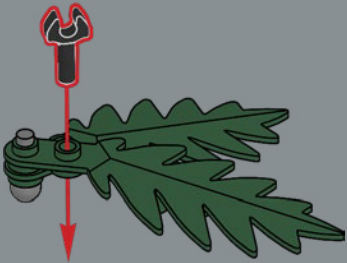



45

1

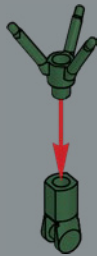

2

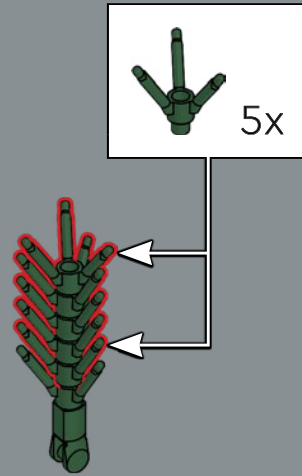

3



4

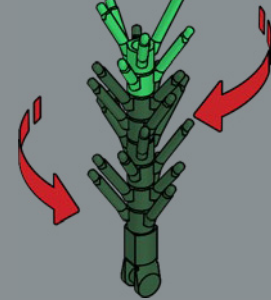



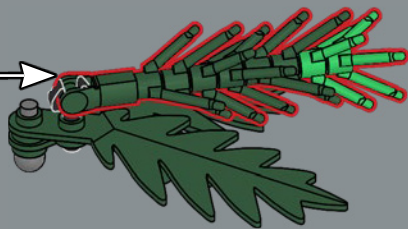

4x

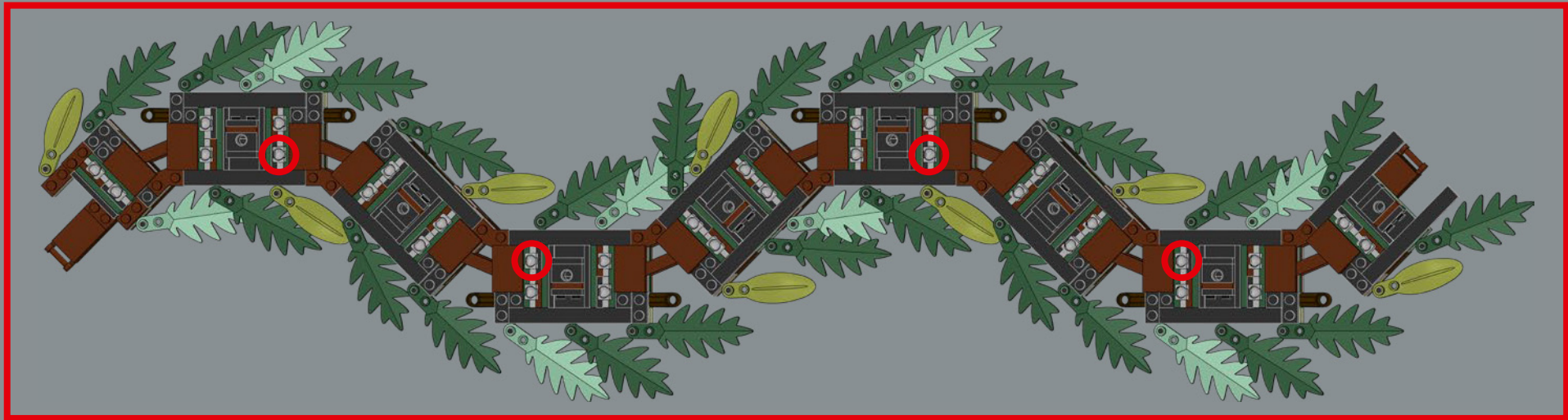

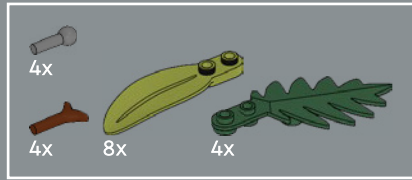
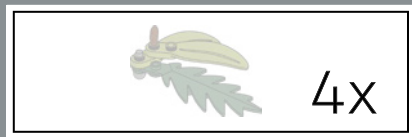

47

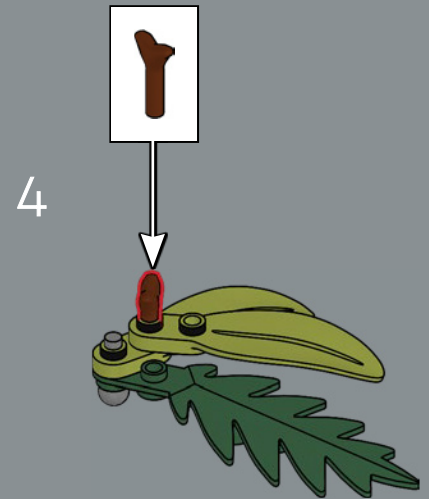
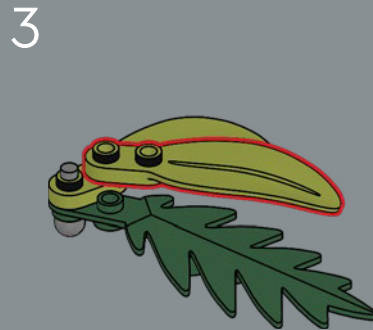
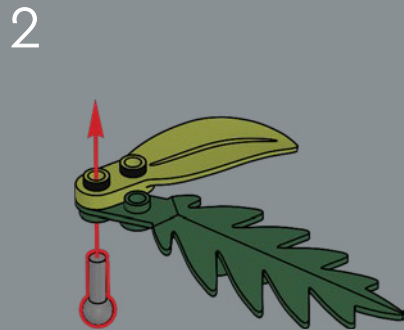
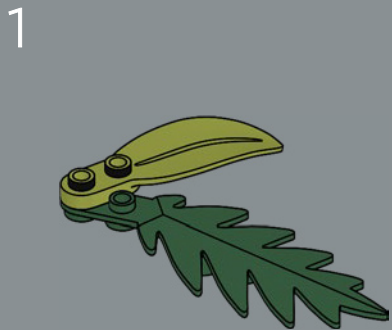



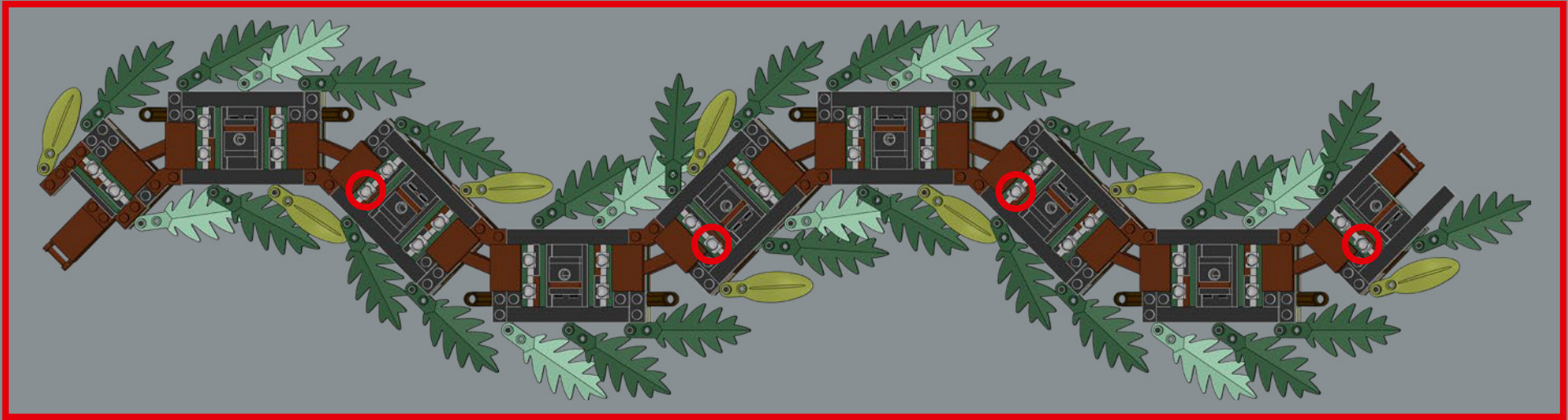

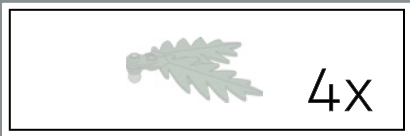

48

1

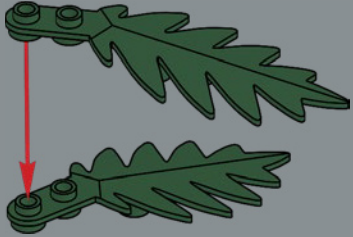

2

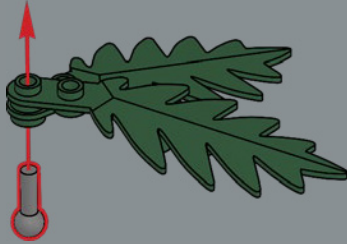

4x

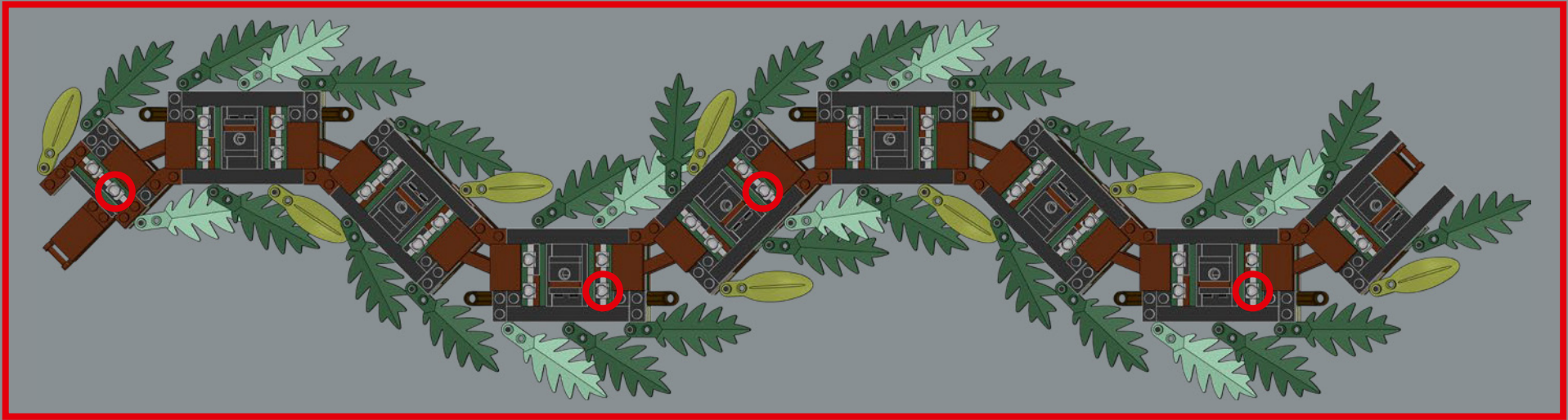



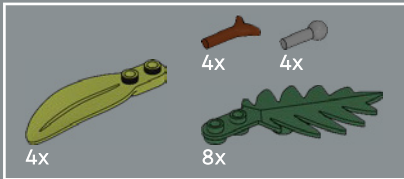

49

1

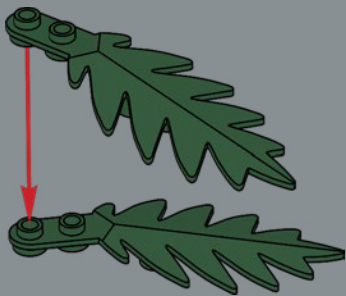

2



3

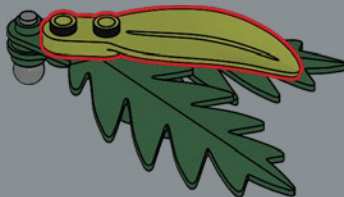

4

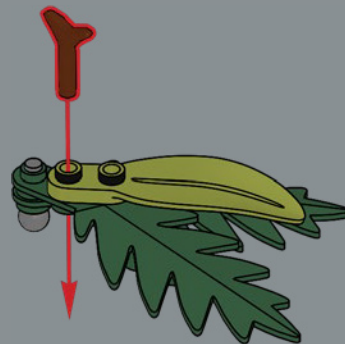

4x

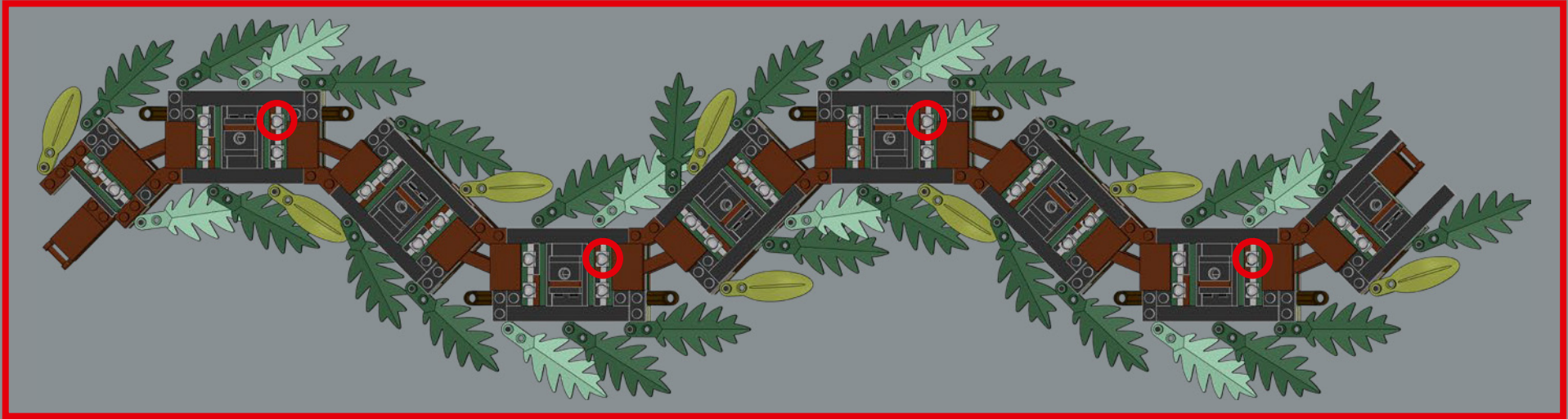

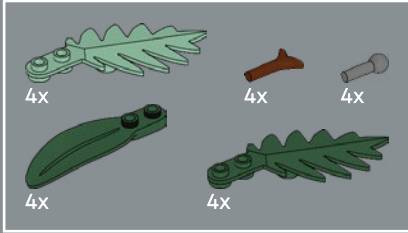
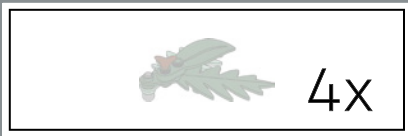

50

1



2

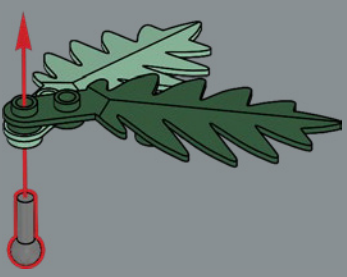

3



4



4x



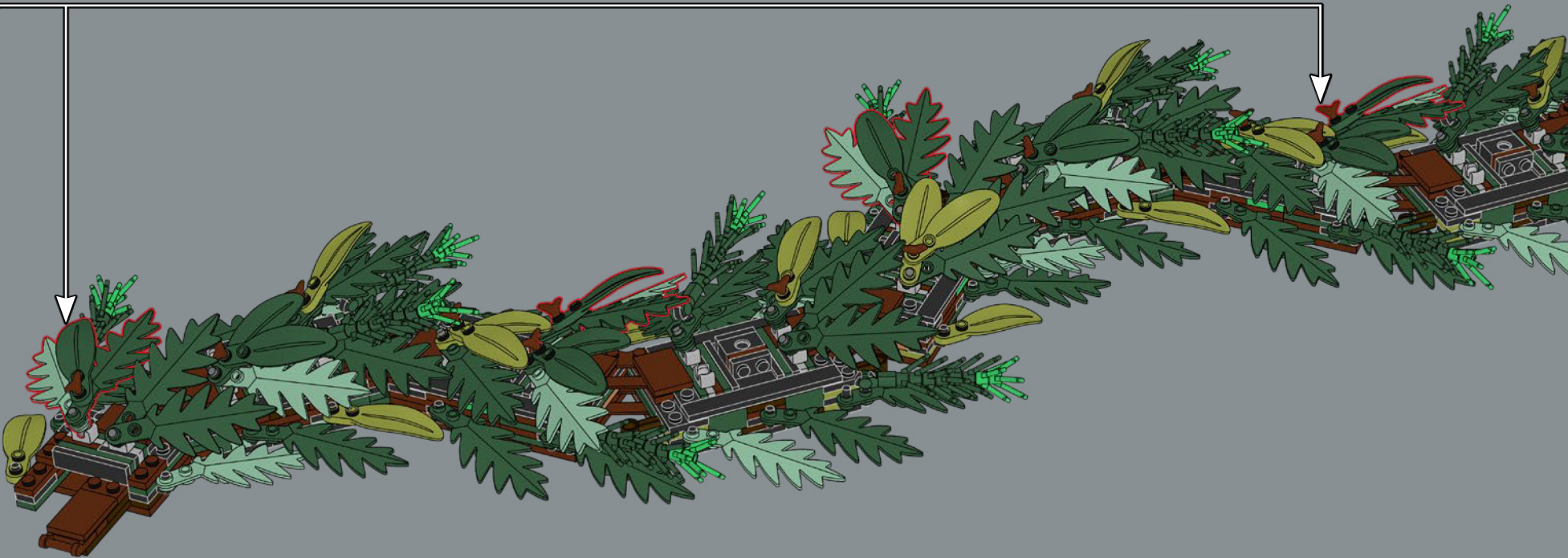
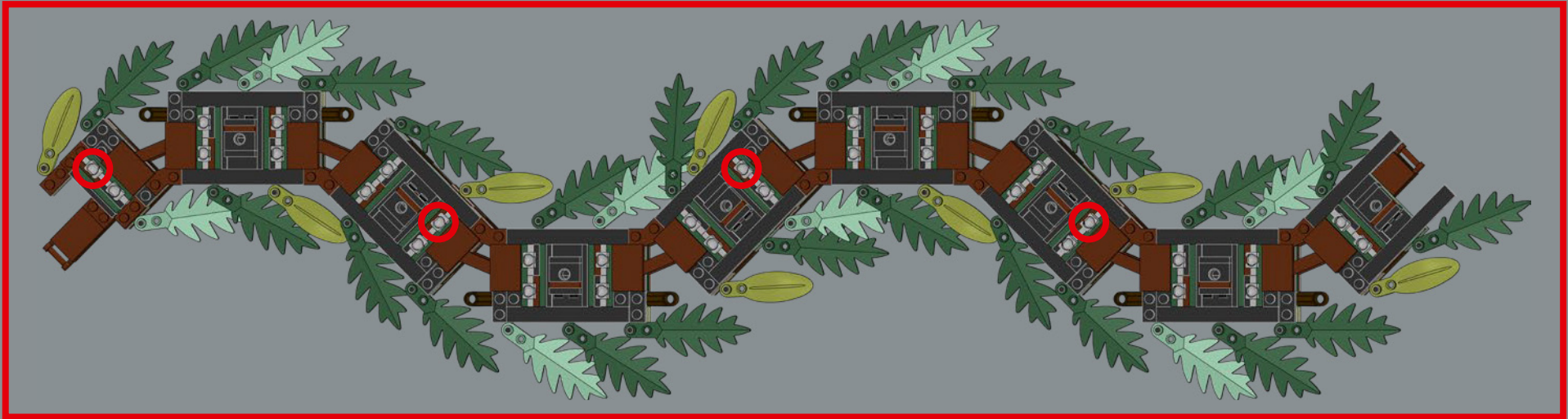

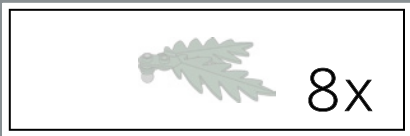

51

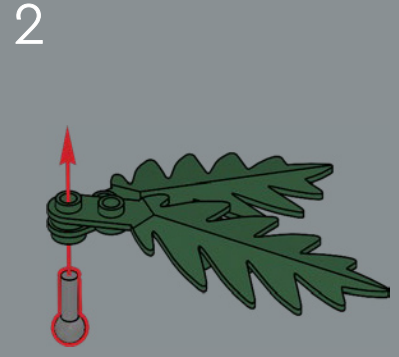
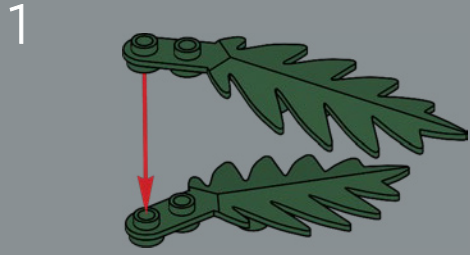

8x



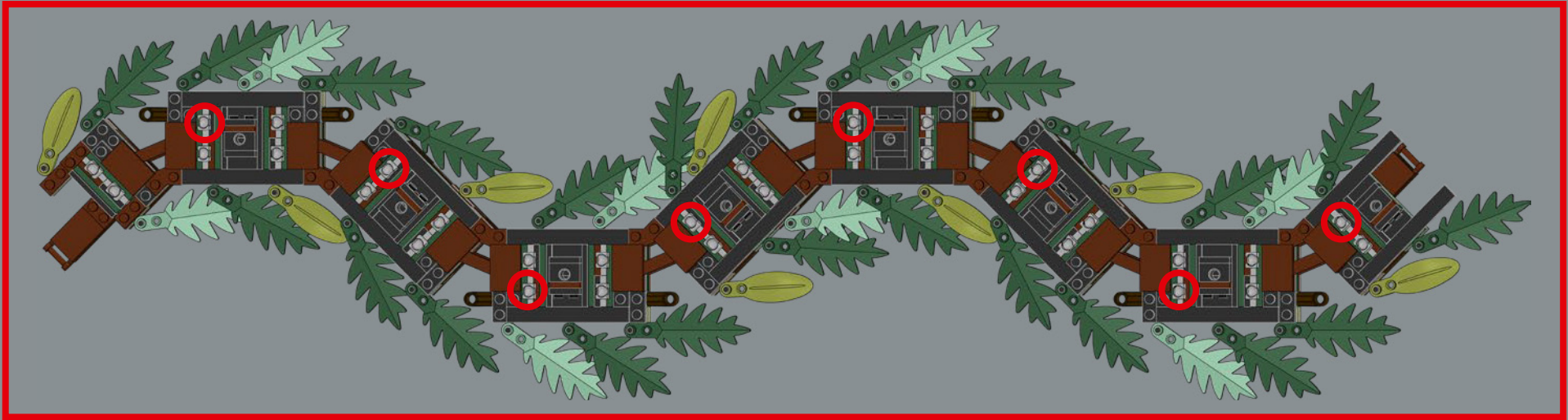



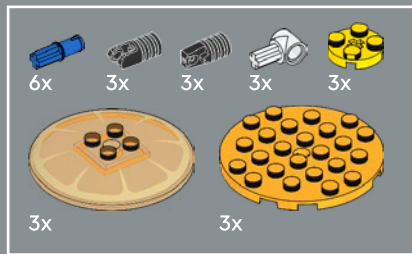

52

1



2



3



4

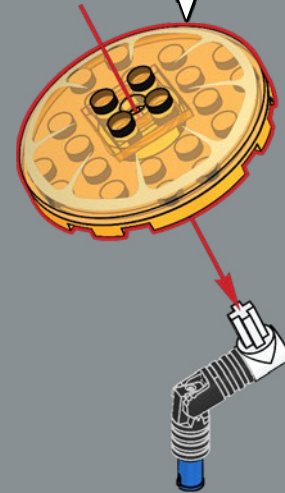

3x

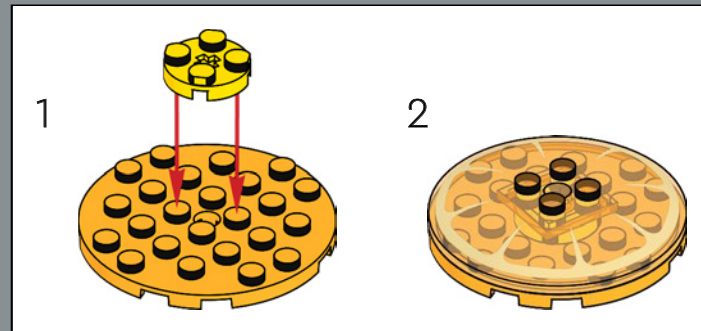

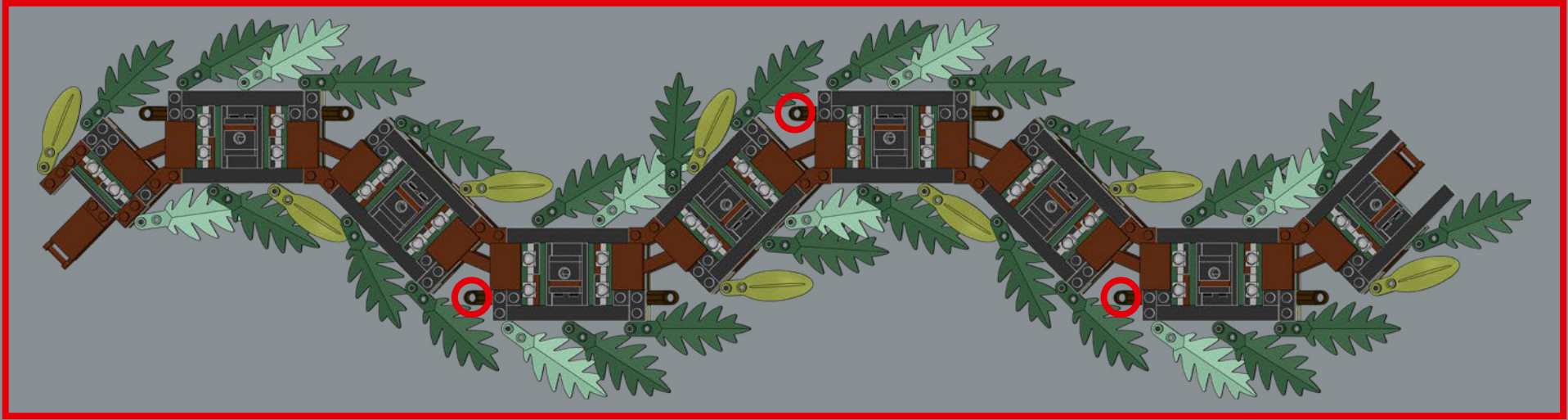

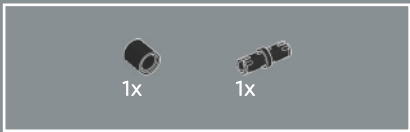
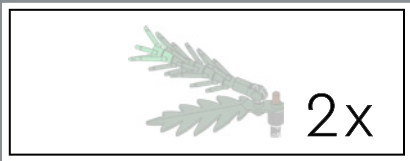

53



54



55



56

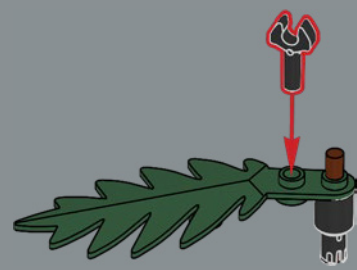





57

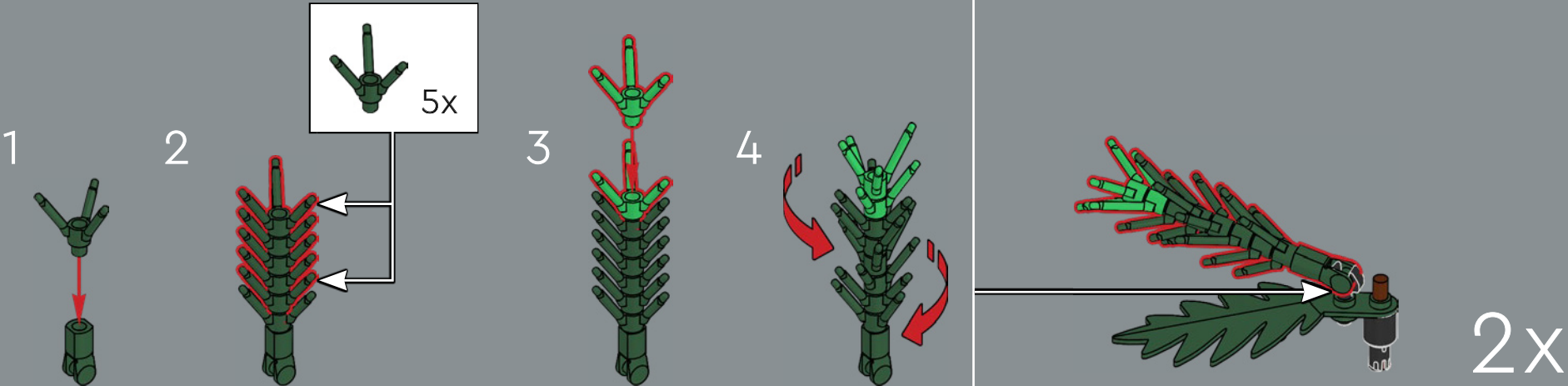

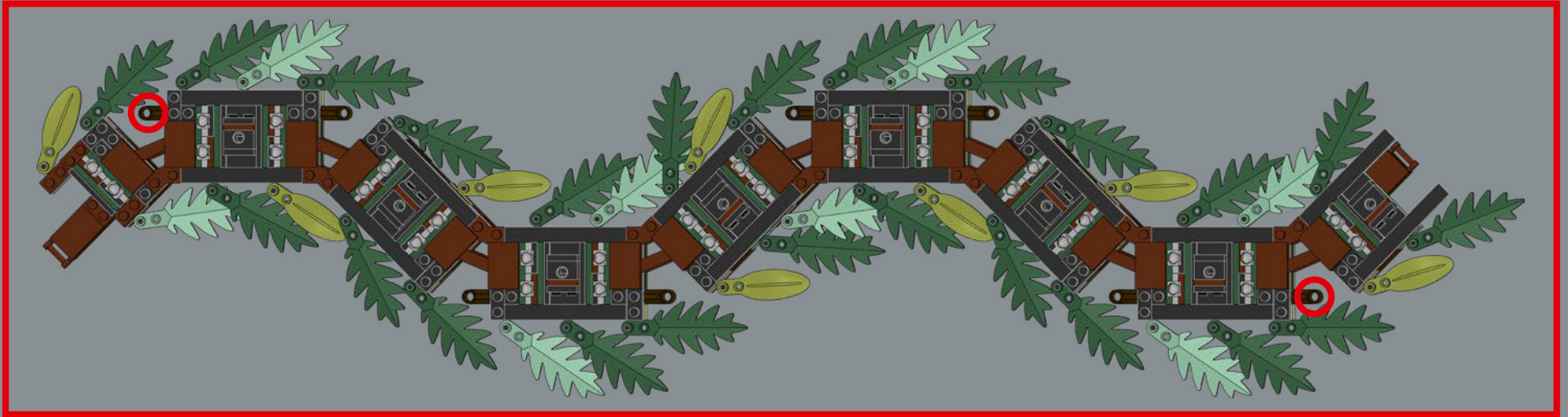

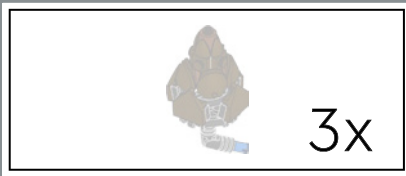

59



60

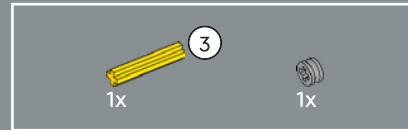

61



62







63

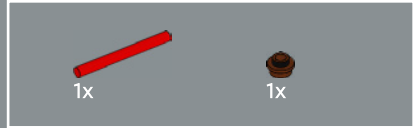

64

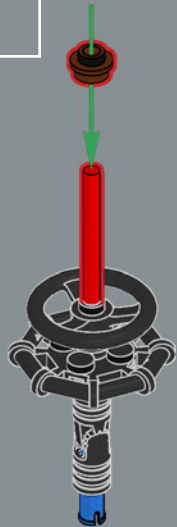

65



66

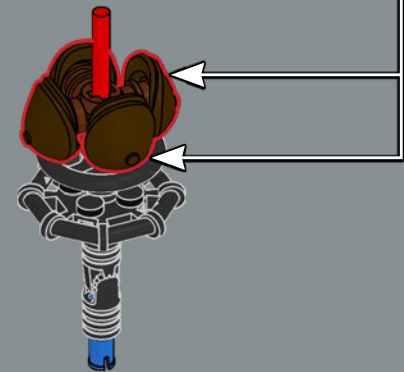
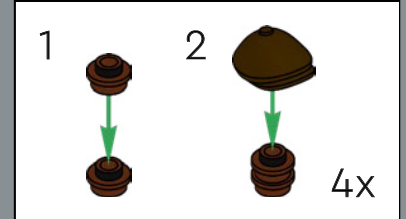



67

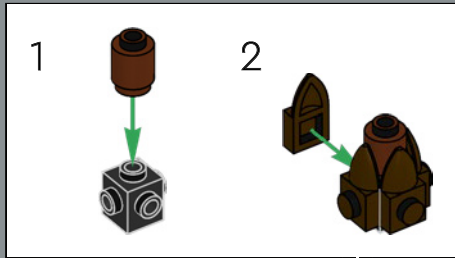

68

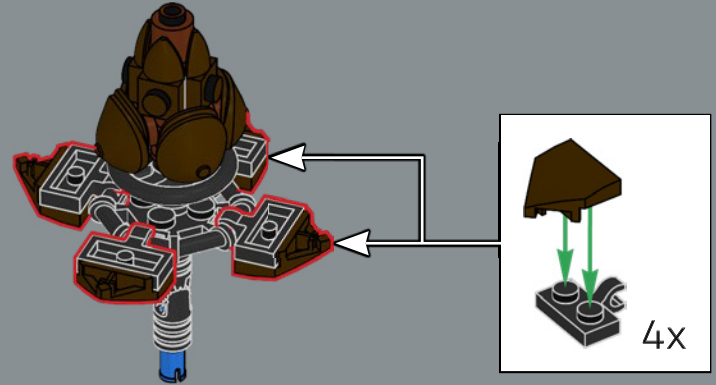

69

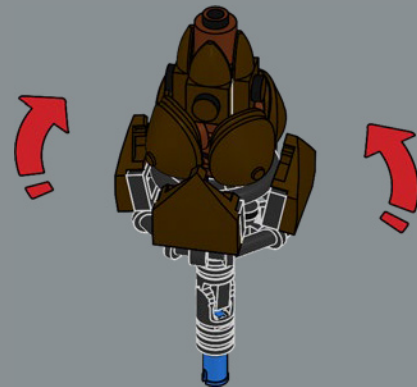

3x

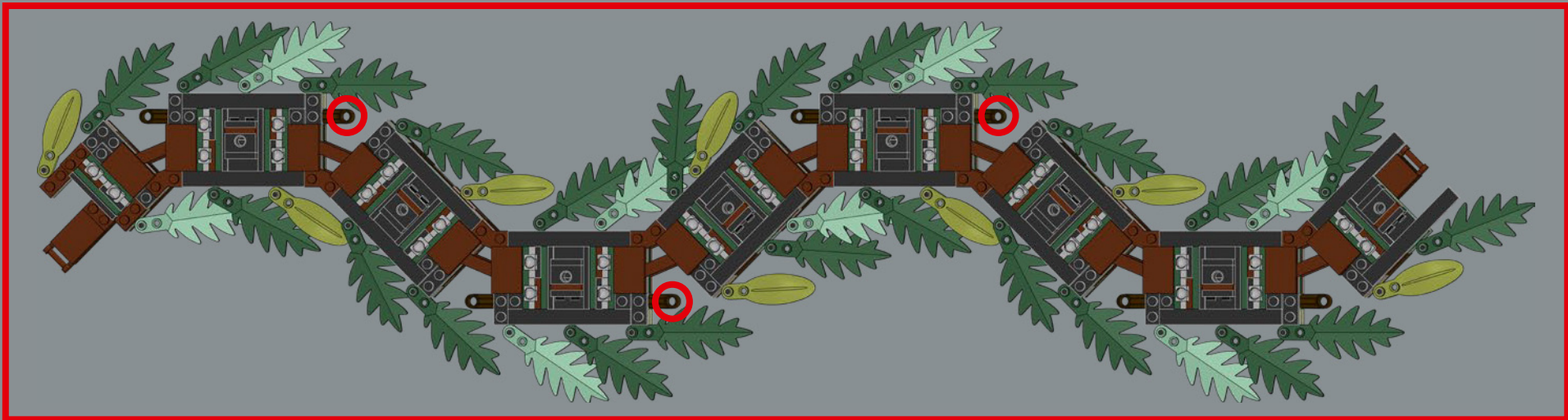



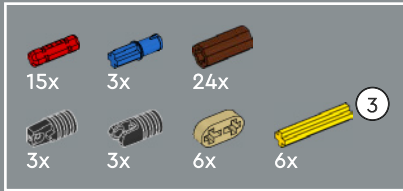
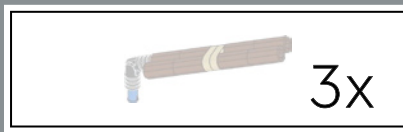

71

1



2



3



4



5



6

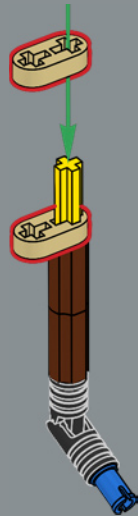

7

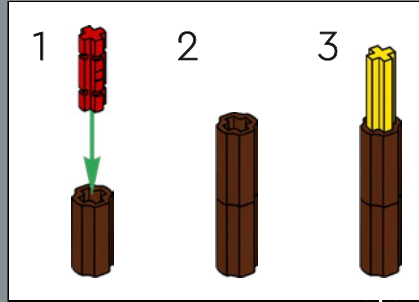
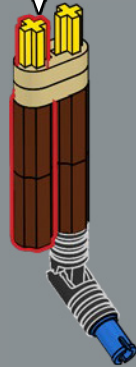

8

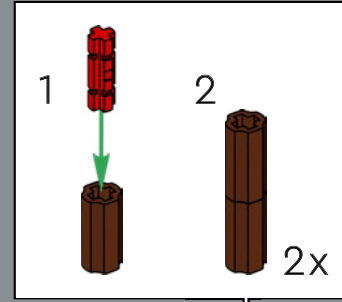
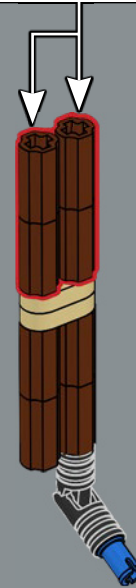

3x

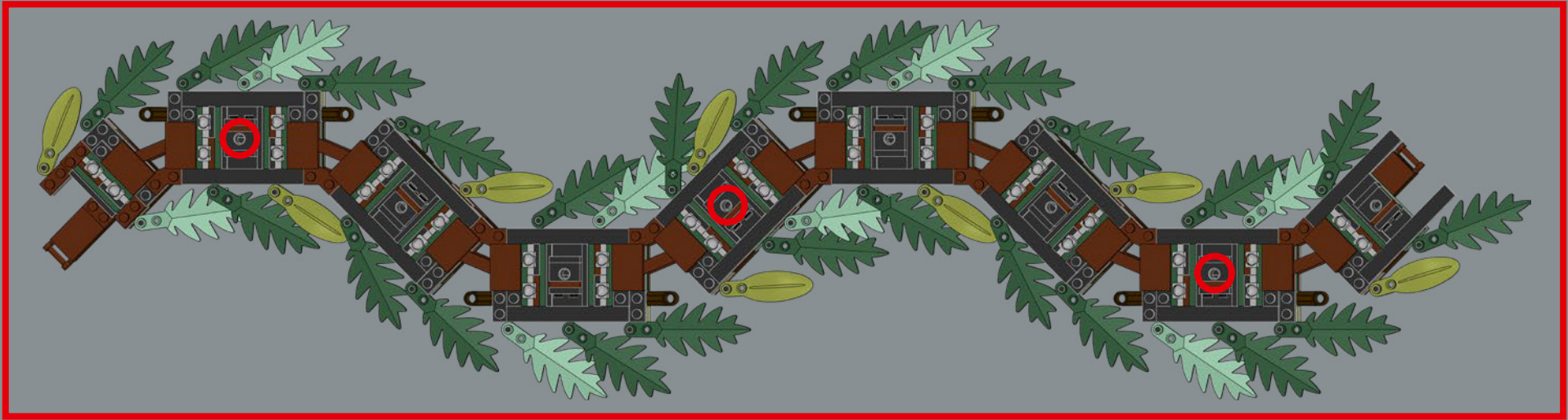



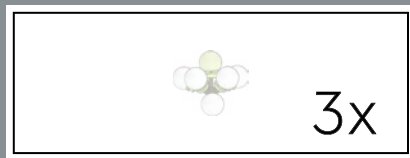

72

1



2

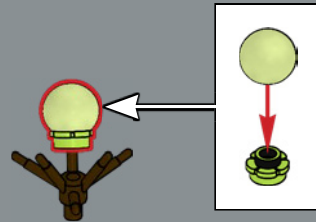

3

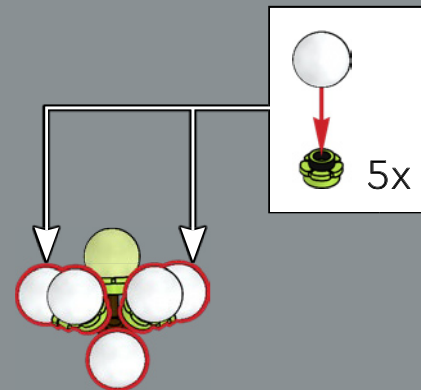

3x

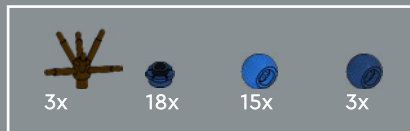
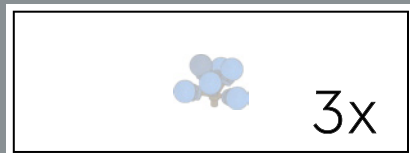

73

1



2

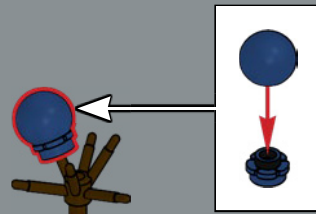

3

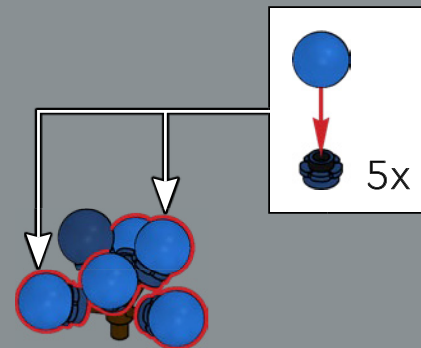

3x



74

1



2

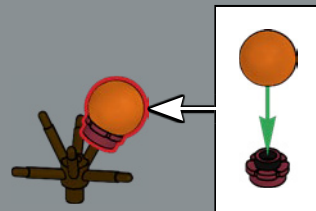

3

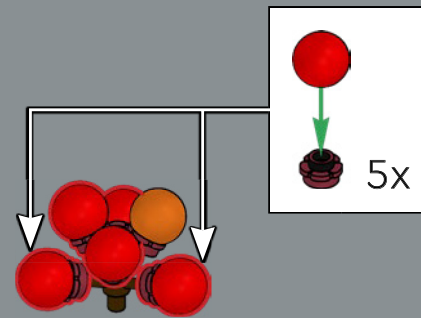

3x









15x  
6052864

3x  
6179606

6x  
6376461

8x  
6330903

8x  
4121921

15x  
4290714

23x  
4142865

3x  
6296954

15x  
6224247

12x  
4206482

3x  
403224

9x  
6130007

18x  
6495167

3x  
6498566

3x  
6495163

3x  
6491212

18x  
6209692

8x  
4537936

24x  
6473460

20x  
6495168

28x  
6269971

4x  
379528

3x  
6509614

3x  
6131694

8x  
6347306

4x  
6343854

14x  
6499873

84x  
6498565

8x  
4245570

72x  
6020923

8x  
4245571

12x  
6491214

74x  
6420219

8x  
6359069

16x  
6491215

4x  
6495166

1x  
6254100

3x  
6271165

32x  
6043656

3x  
4211183

27x  
6215659

16x  
6078605

24x  
4531751

108x  
4211150

8x  
6236915

2x  
6428805

3x  
6316697

24x  
6311441

16x  
6084573

12x  
4221590

8x  
6370000

18x  
6458394

8x  
4539105

32x  
6364352

12x  
6491211

8x  
6332586

12x  
6501311

12x  
6308903

9x  
6452882

4x  
6473454

24x  
4518687

14x  
6439039

9x  
6265699

9x  
6271535

2x  
6279875

2x  
6121485

3x  
473326

12x  
6313116

40x  
6261348

8x  
370026

32x  
6250020

8x  
302226

3x  
4580509

3x  
6018805

16x  
243126

16x  
6401209

16x  
416226

8x  
303226



LEGO.com/service



# YOU COULD WIN



## YOU COULD WIN

Your feedback will help shape the future development of this product series.

Visit:

## DU KÖNNTEST GEWINNEN

Dein Feedback trägt zur Weiterentwicklung dieser Produktreihe bei.

Geh auf:

## VOUS POURRIEZ GAGNER

Vos commentaires nous aideront à concevoir les futurs produits de cette gamme.

Visitez :

## POTRESTI VINCERE TU

La tua opinione ci aiuterà a migliorare la creazione futura di questa linea di prodotti.

Visita:

## PUEDES GANAR

Tu opinión contribuirá al futuro de esta serie de productos.

Visita:

## 轻松获奖

您的反馈将有助于我们在今后改进本产品系列。

请访问:

---

[LEGO.com/productfeedback](https://www.lego.com/productfeedback)

---

You also have the chance to win a LEGO® set.

Terms and conditions apply.\*

Außerdem hast du die Chance, ein LEGO® Set zu gewinnen.

Es gelten die Teilnahmebedingungen.\*

Vous pourriez également gagner un ensemble LEGO®.

Des conditions s'appliquent.\*

Hai anche la possibilità di vincere un set LEGO®.

Termini e condizioni sono applicabili.\*

También tienes la oportunidad de ganar un set LEGO®.

Aplican términos y condiciones.\*

您还有机会赢取乐高®套装。

条款和条件适用。\*

\*[LEGO.com/productfeedback-terms](https://www.lego.com/productfeedback-terms)



