



10337





LEGO.com/sustainable-packaging



FR
**DONNEZ
OU
RECYCLEZ**



OU



OU



ASSOCIATION MAGASIN DÉCHÈTERIE

Adresses sur quefairedemesdechets.fr



BUILDER



Apple and the Apple logo are trademarks of Apple Inc., registered in the U.S. and other countries and regions. App Store is a service mark of Apple Inc. Google Play and the Google Play logo are trademarks of Google LLC. Tencent and the Tencent logo are trademarks of Tencent Inc.

LEGO.com/devicecheck



LEGO® Builder

LAMBORGHINI



完美的比例



如果你是 20 世纪 80 年代的青少年，那么你很可能会从一英里外认出 Lamborghini Countach 的轮廓。你甚至可能还在某处藏着它的一张海报（或自豪地展示着）。从 1971 年推出第一台 LP500 原型车到今天，Countach 拥有 50 多年的历史，它的一切都是颠覆性的。引人注目的低矮轮廓、鲜明棱角和剪刀门，以及 V-12 发动机的轰鸣声，巩固了 Countach 作为 20 世纪 80 年代和 90 年代典型代表的地位，并定义了当时超级跑车的风格。它具有开创性的未来派设计融入了时代精神和流行文化，就像一件经典的艺术品一样，拥有永恒的吸引力。它的故事、外形和亮丽的色彩使其成为乐高® Icons 系列无可争议的候选者。

Lamborghini Countach 的演变过程

几十年来，Lamborghini Countach 随着创新技术和风格的涌现而不断演变。这款乐高®模型的设计灵感源自 Lamborghini Countach 5000 Quattrovalvole (1985 年 - 1988 年)，同时向其杰出的前辈致敬。



1971 年 LP500

在日内瓦车展上展示的原型车成为所有未来版本的基础。



1973 年 COUNTACH LP400

LP400 根据原型车的经验进行了修改，是 Countach 的第一款量产车型。



1978 年 COUNTACH LP400 S

更新后的外观设计包括新式轮拱延伸和可选的 V 形尾翼。



1983 年 COUNTACH LP500 S

虽然外观设计基本保持不变，但内饰进行了改进，更强大的发动机令性能更加出色。



1985 年 COUNTACH 5000 QUATTROVALVOLE

美国和欧洲最畅销的 Lamborghini Countach，是超级跑车爱好者梦寐以求的瑰宝。



2021 年 COUNTACH LPI 800-4

为 Countach 诞生 50 周年而发布的混合动力限量版。





乐高®设计 团队感言

“Lamborghini Countach 的神奇光环至今仍然留在汽车爱好者的中心，使其非常适合成为一款乐高®模型。虽然直线似乎是乐高组件的自然形态，但浅角度是我们的拼搭系统最具挑战性的塑造任务之一。我们为这款模型开发了几个新的组件和先进的拼搭技术，其中包括标志性的深碟形轮辋和轮拱，以重现这种未来派意大利设计中特有的微妙角度、外形和比例。与兰博基尼 (Automobili Lamborghini S.p.A.) 合作是一段激动人心的旅程，我们将这款模型以乐高形式呈现，并配以可以工作的转向装置、可以打开的车门和发动机盖。”

SVEN FRANIC,
乐高®高级模型设计师

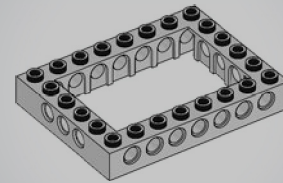
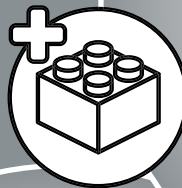
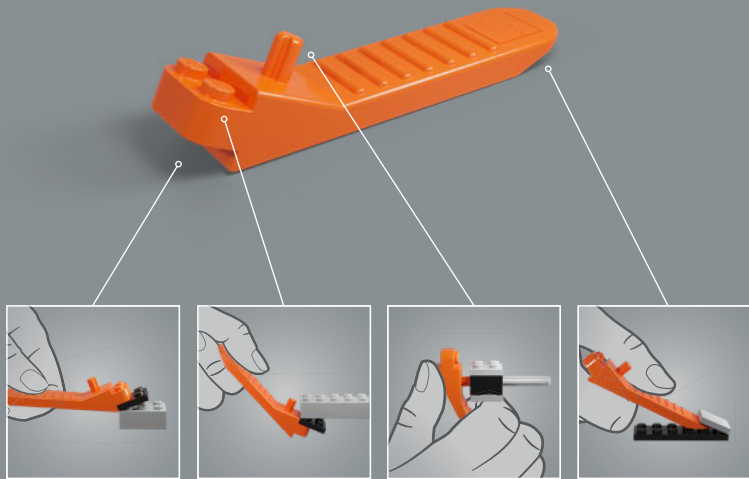

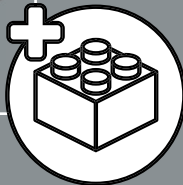
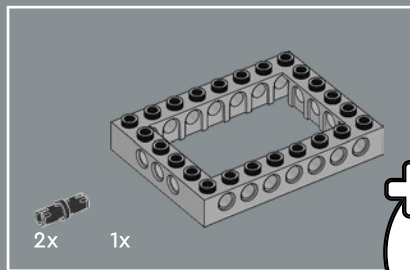

1

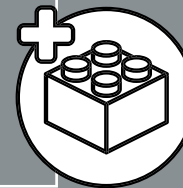
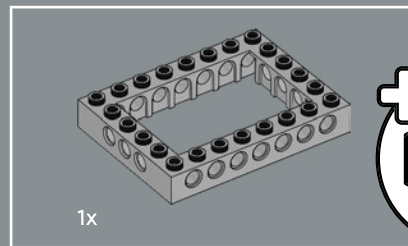
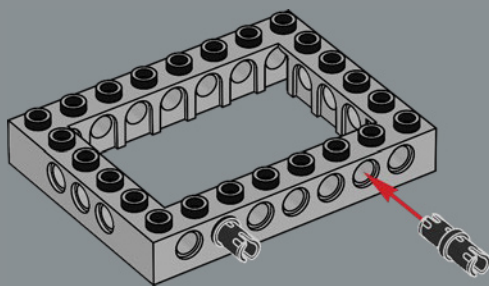

2

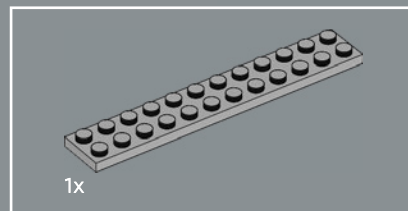
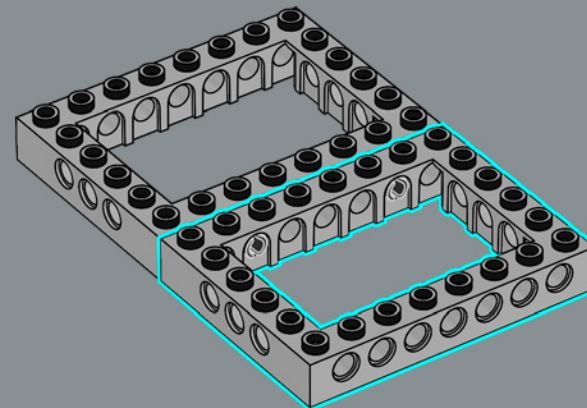

3

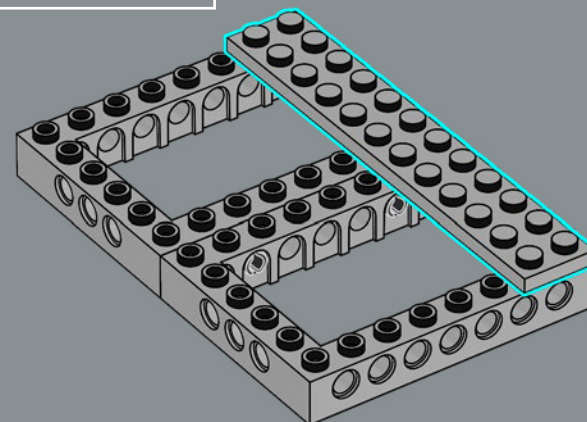

6x

4

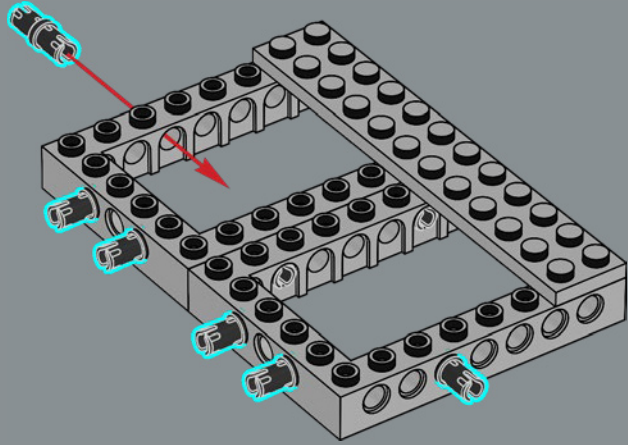

1x

2x

5

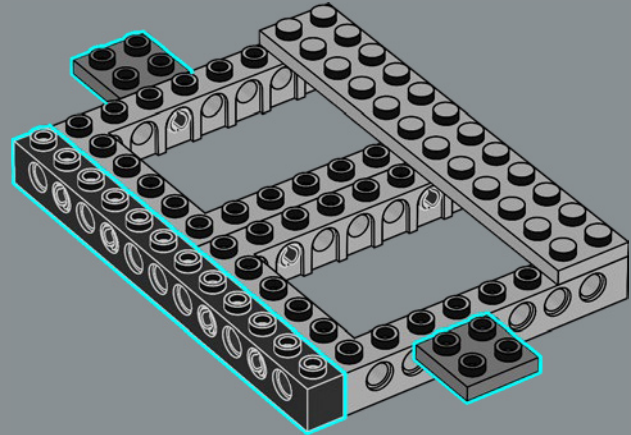

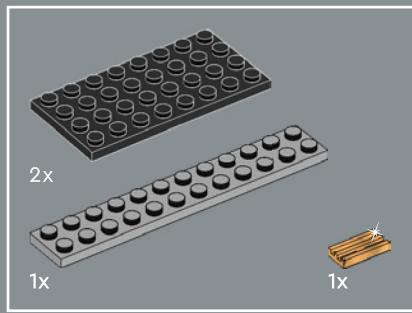

6

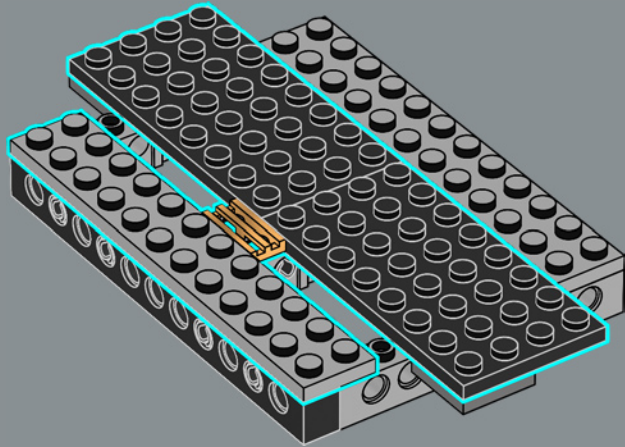

7

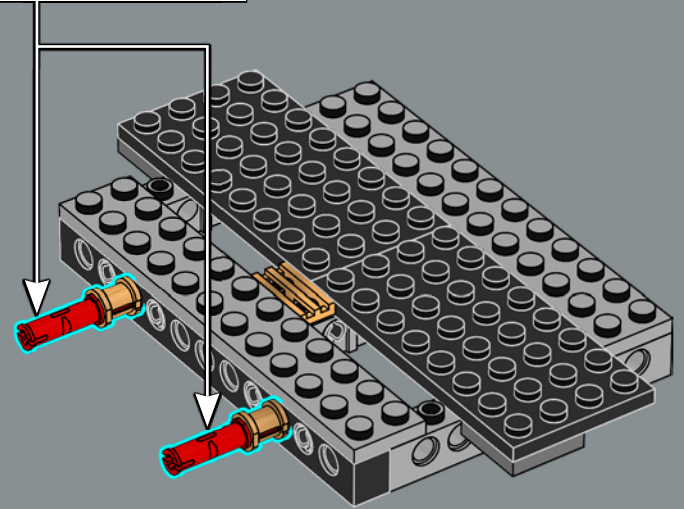
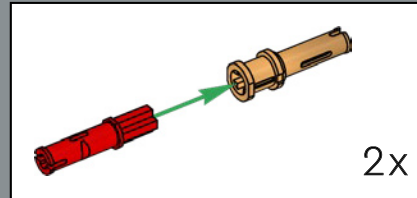

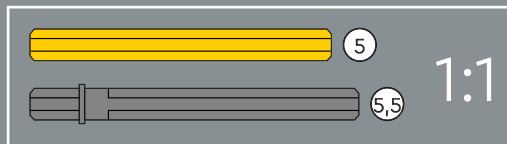
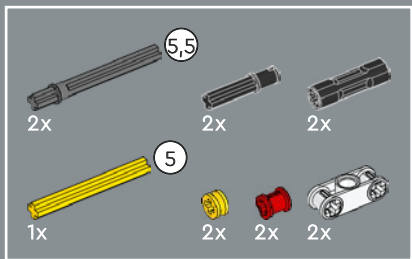

8

1

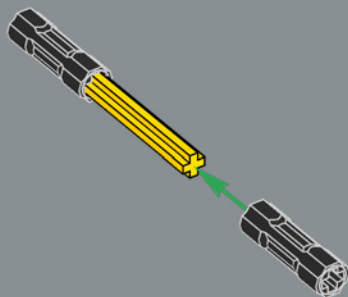

2

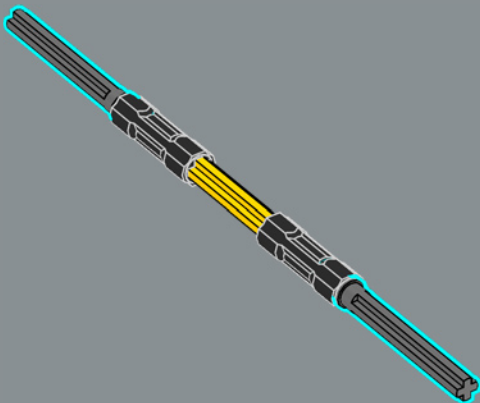

3

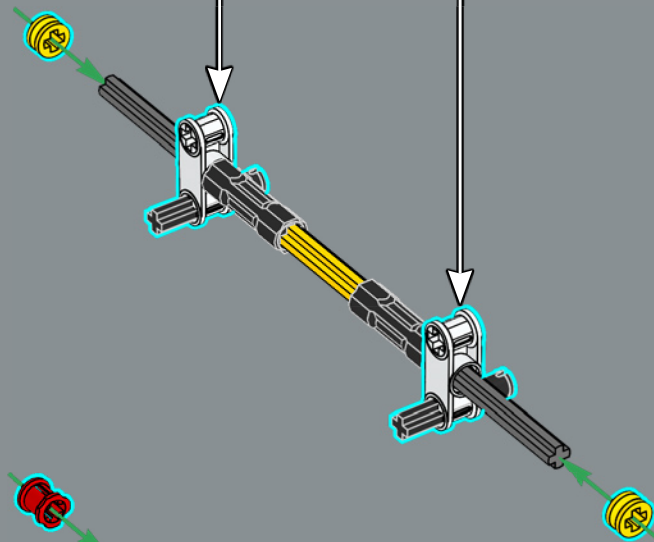

4

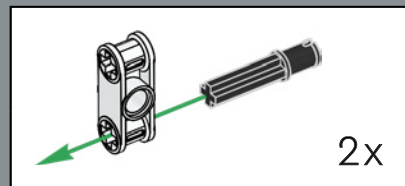
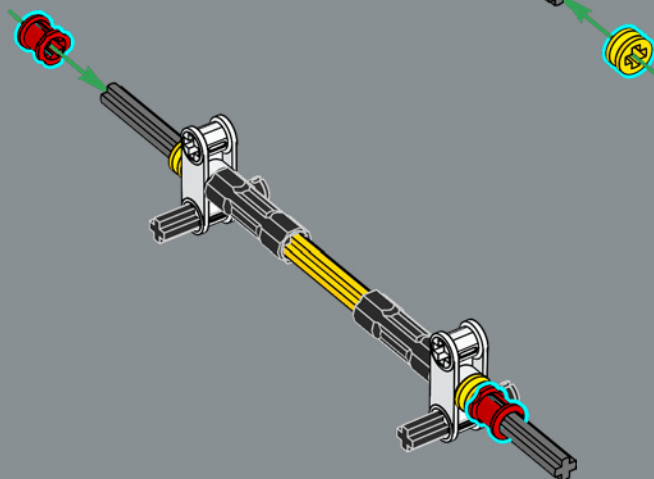

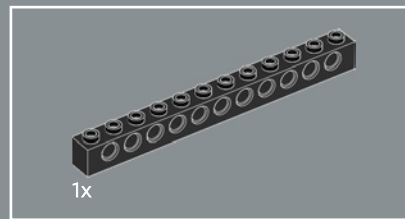
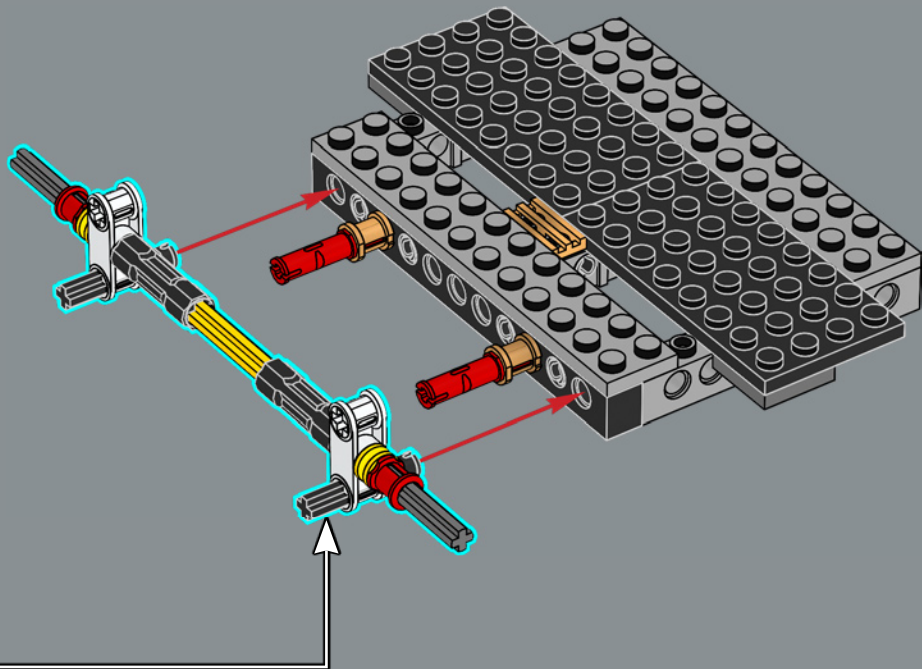

9

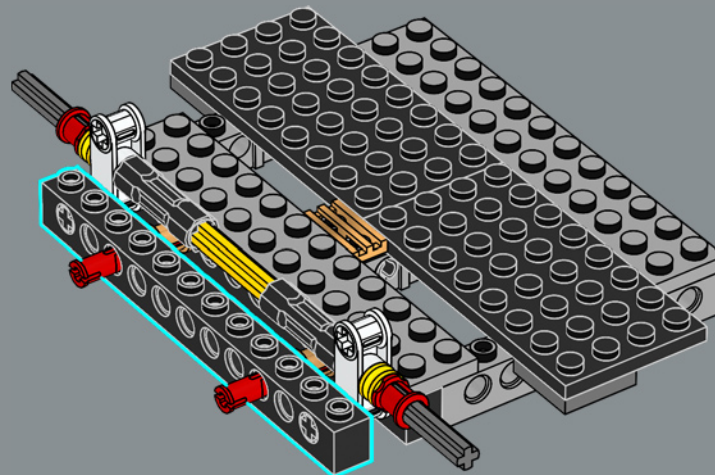



10

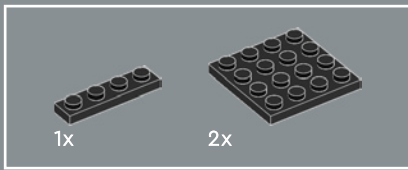
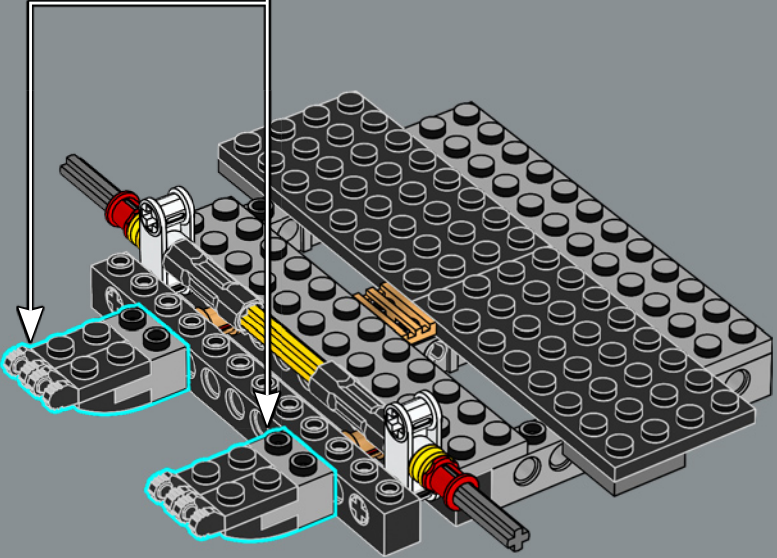
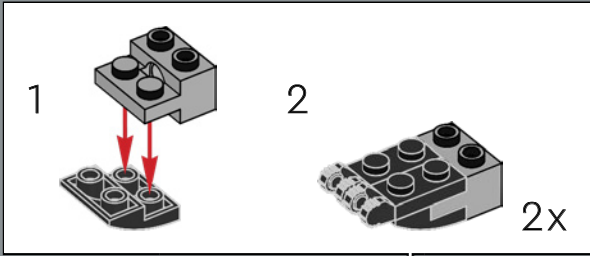

11

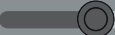
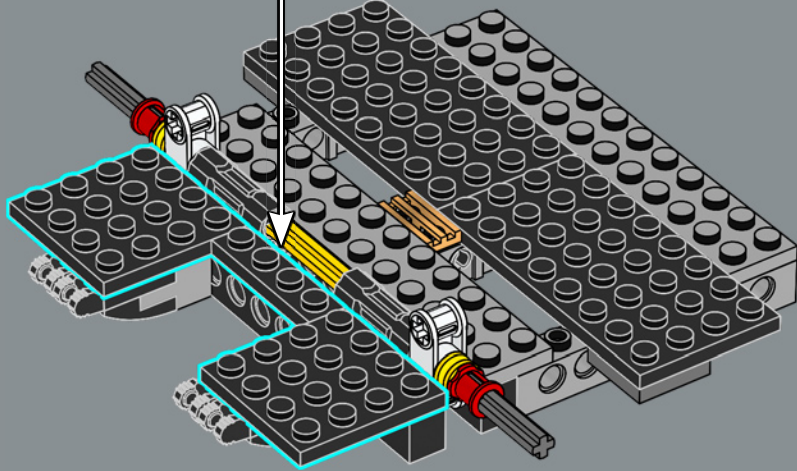
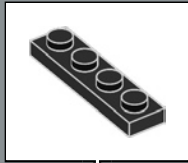

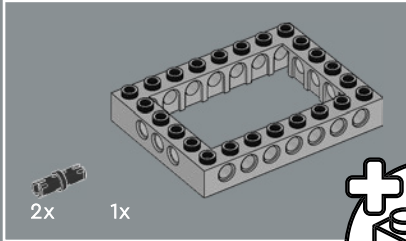
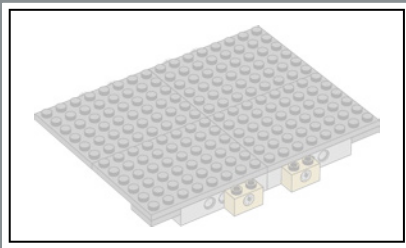

12

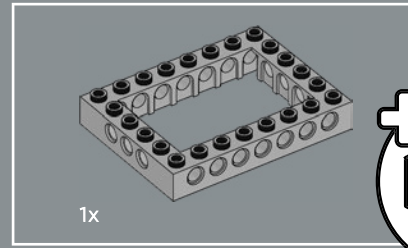
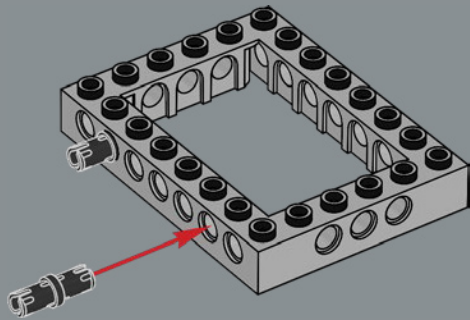
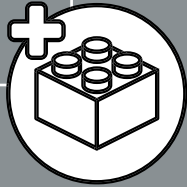

13

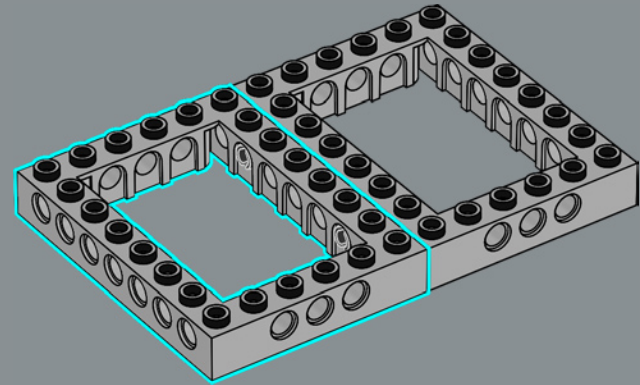
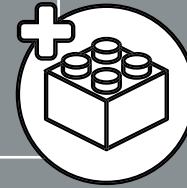

14

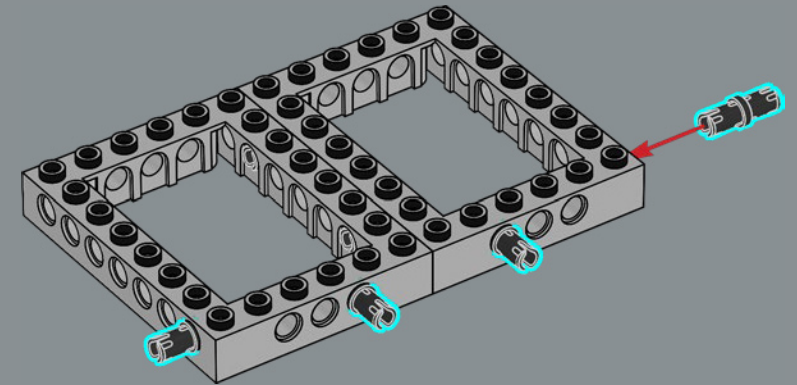

4x

15

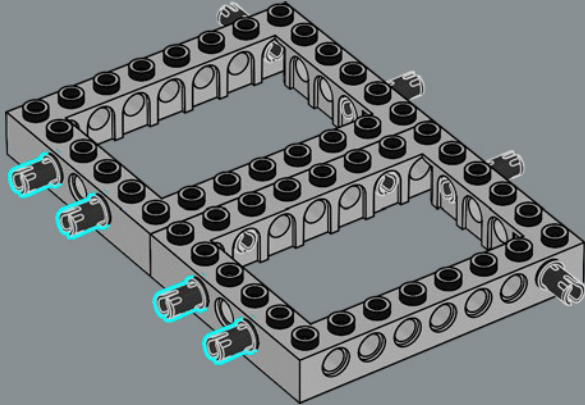

2x

16

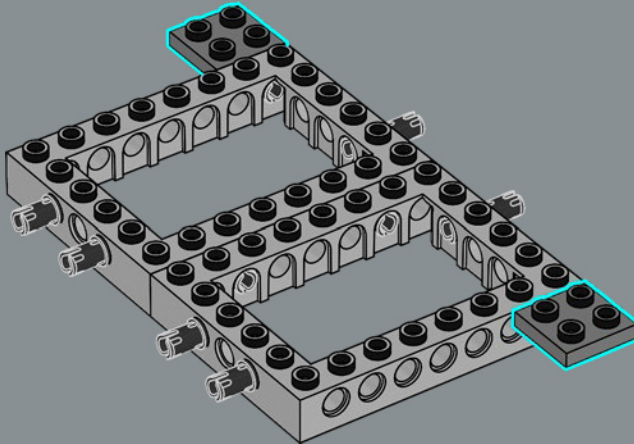

2x

17

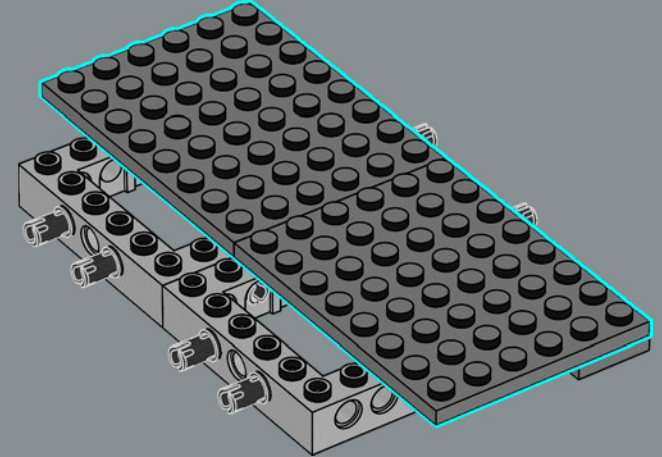

2x

18

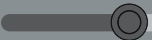
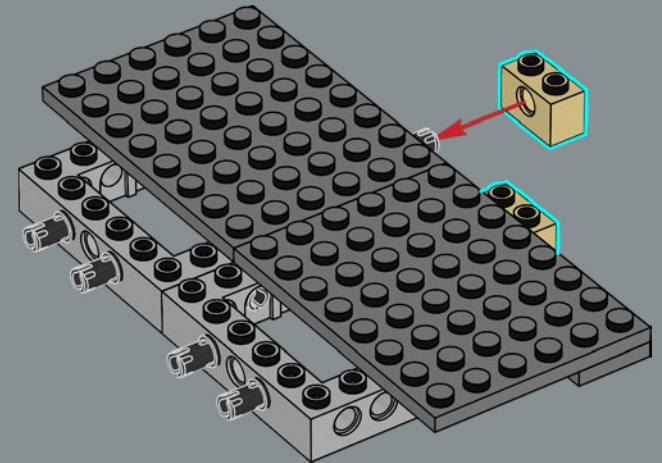

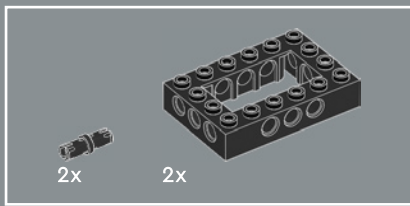

19

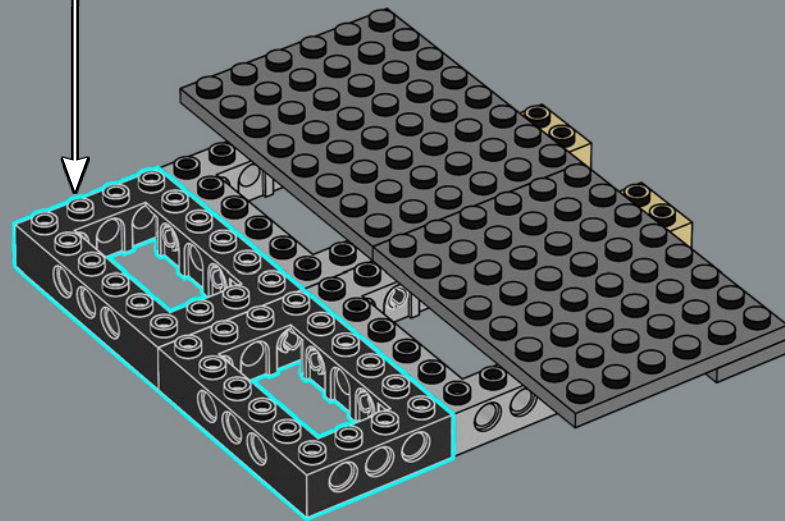
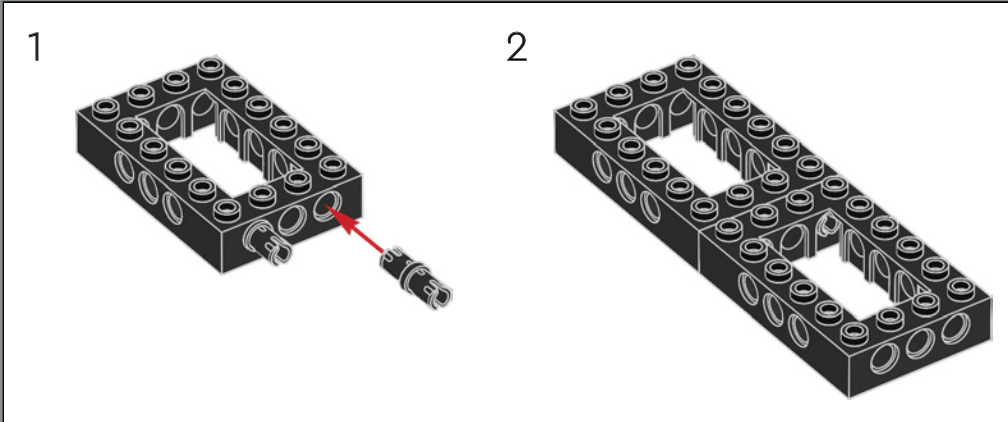

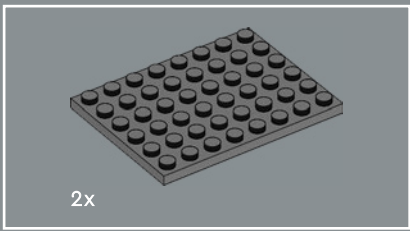

20

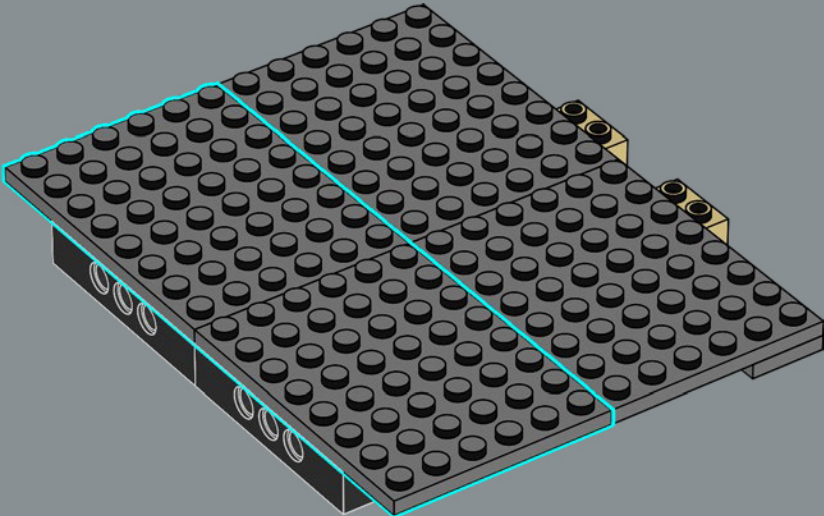

21

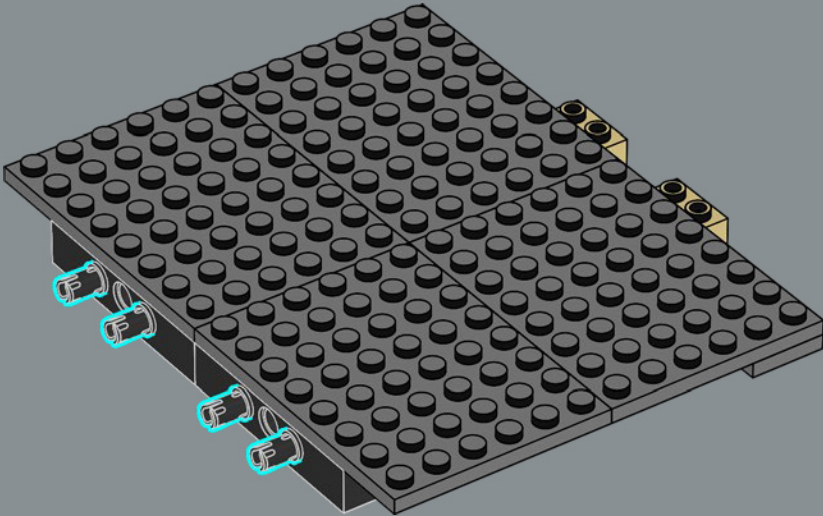



Lamborghini Countach 以其在整个 20 世纪 80 年代的经典电视剧和主要大片中令人难忘的亮相而闻名。

22

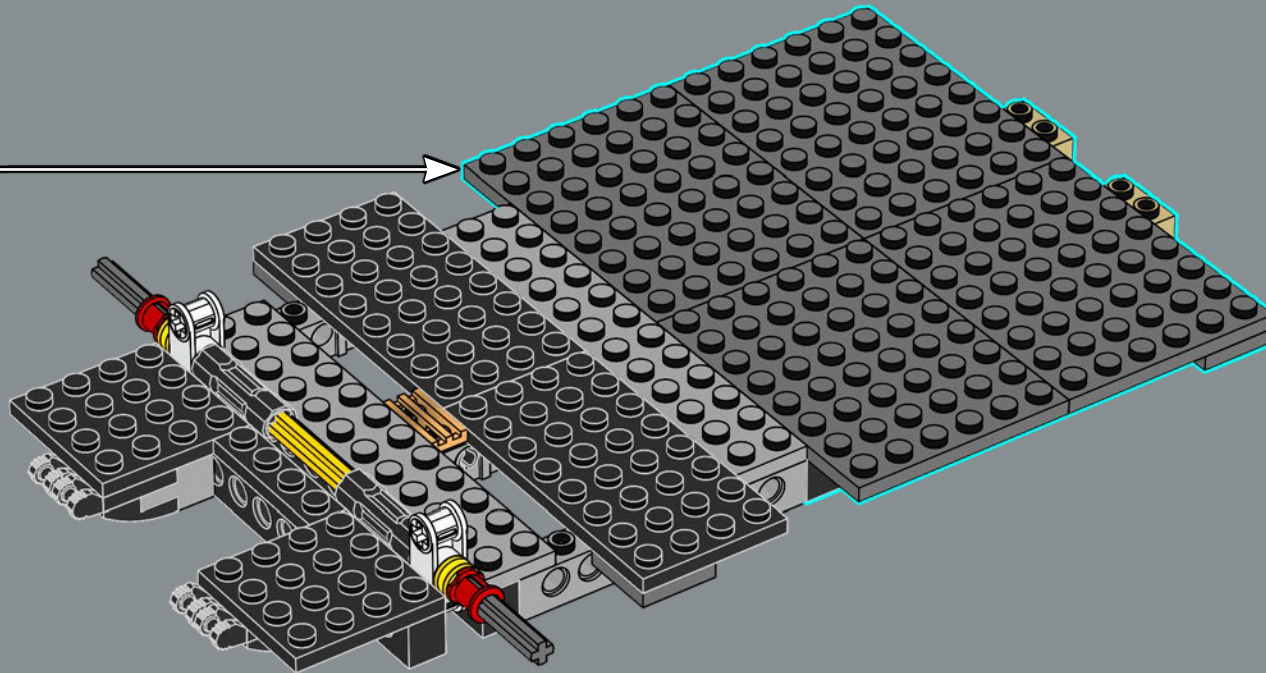

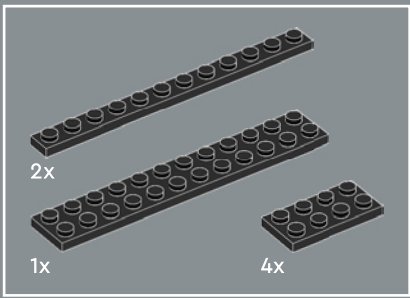

23

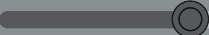
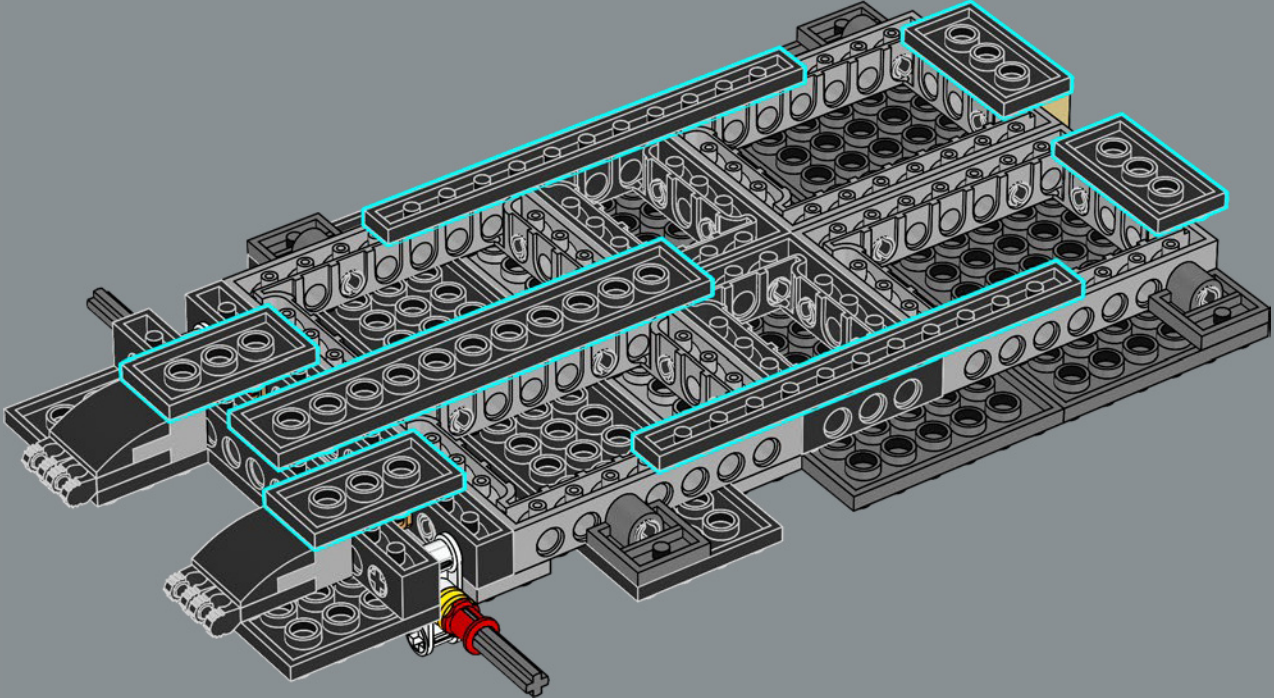

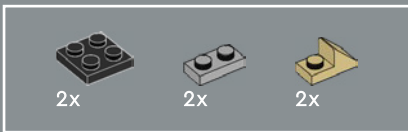

24

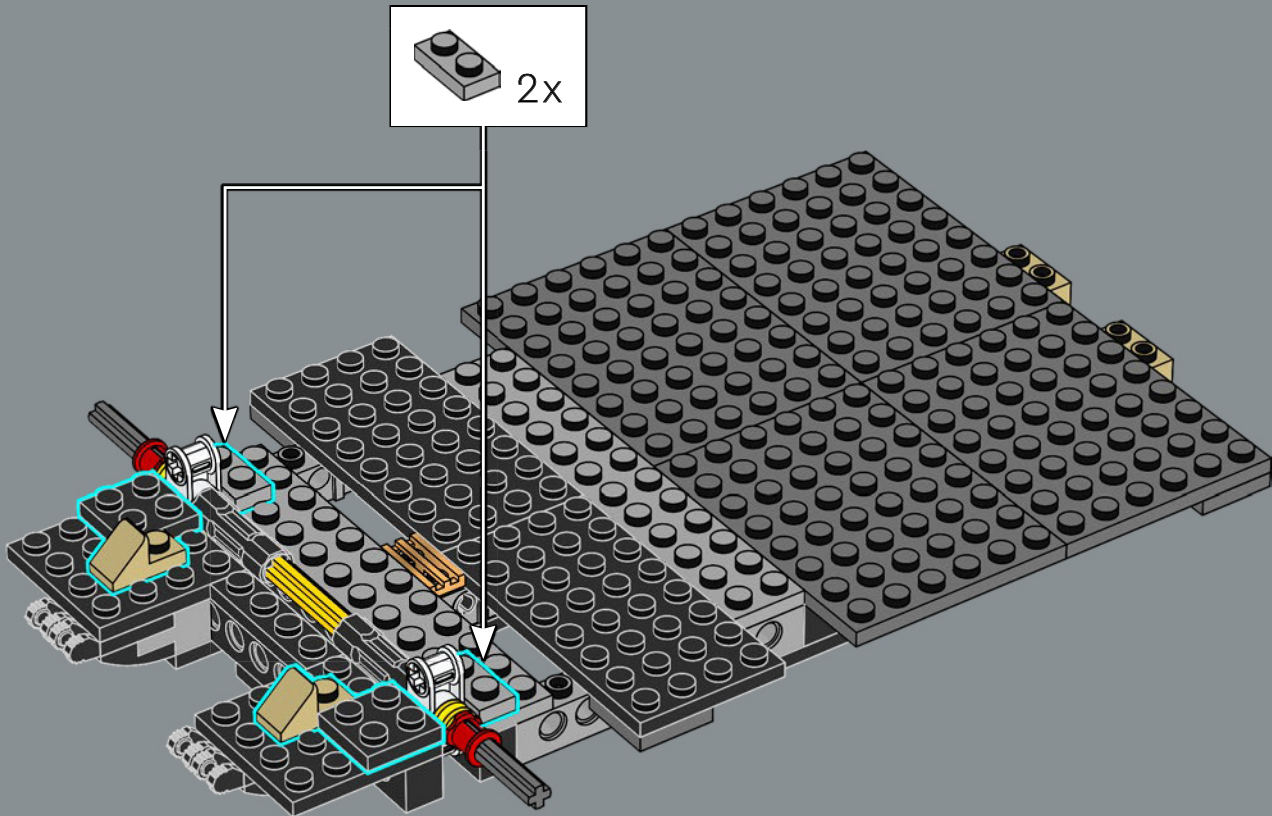

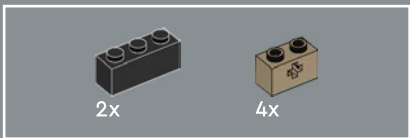

25

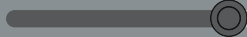
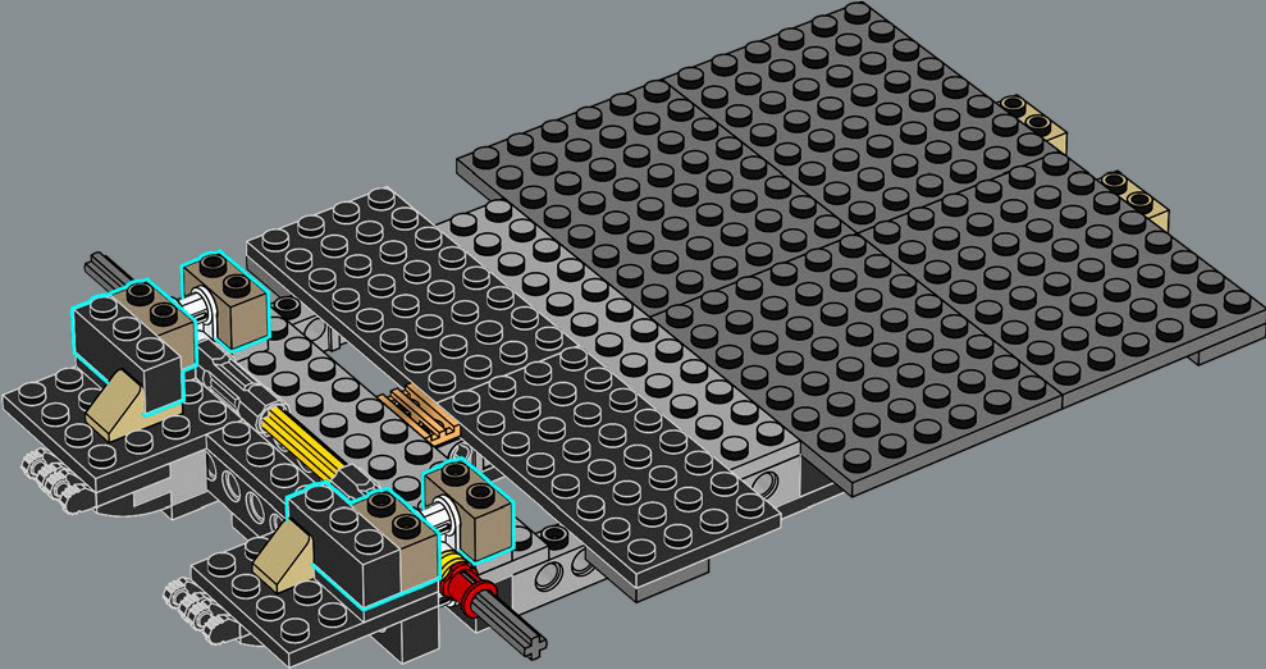

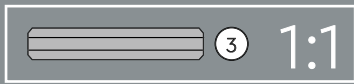
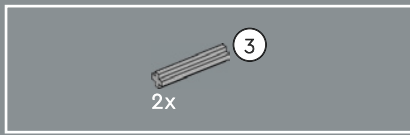

26

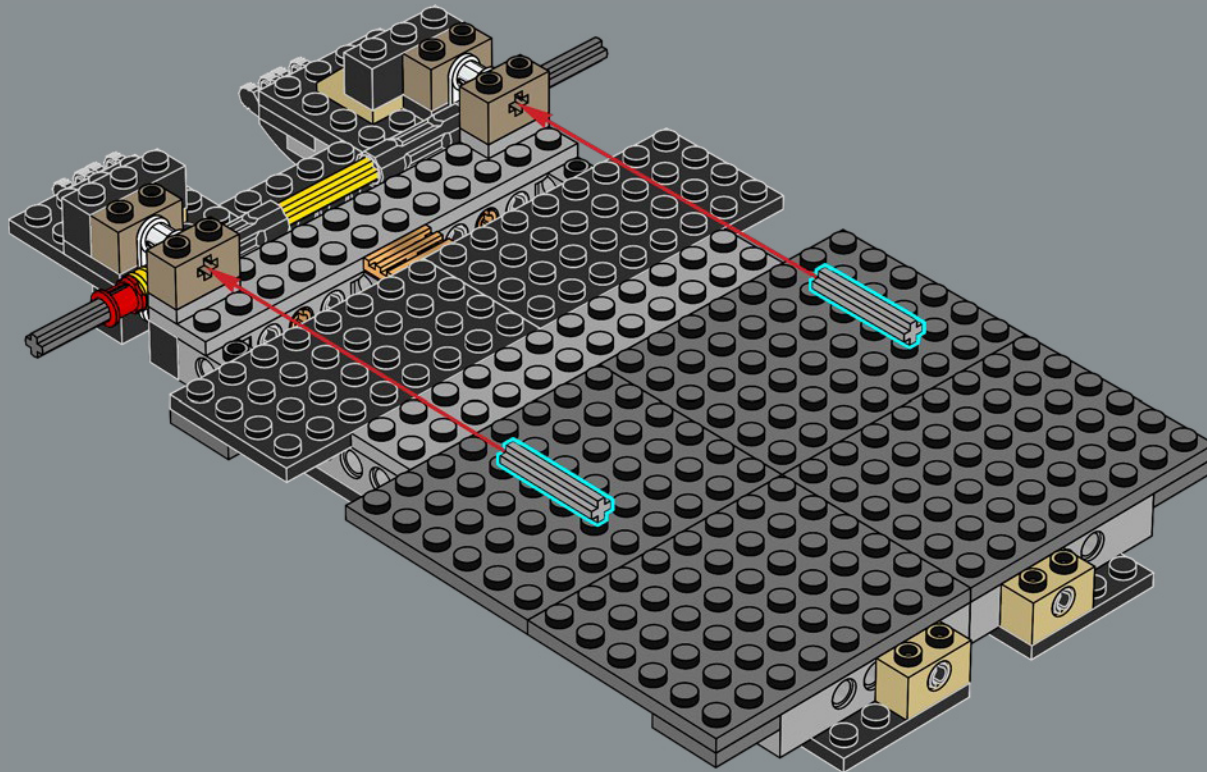

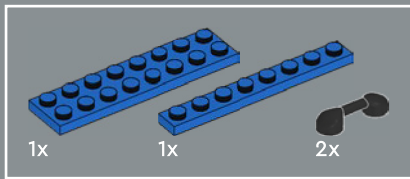

28

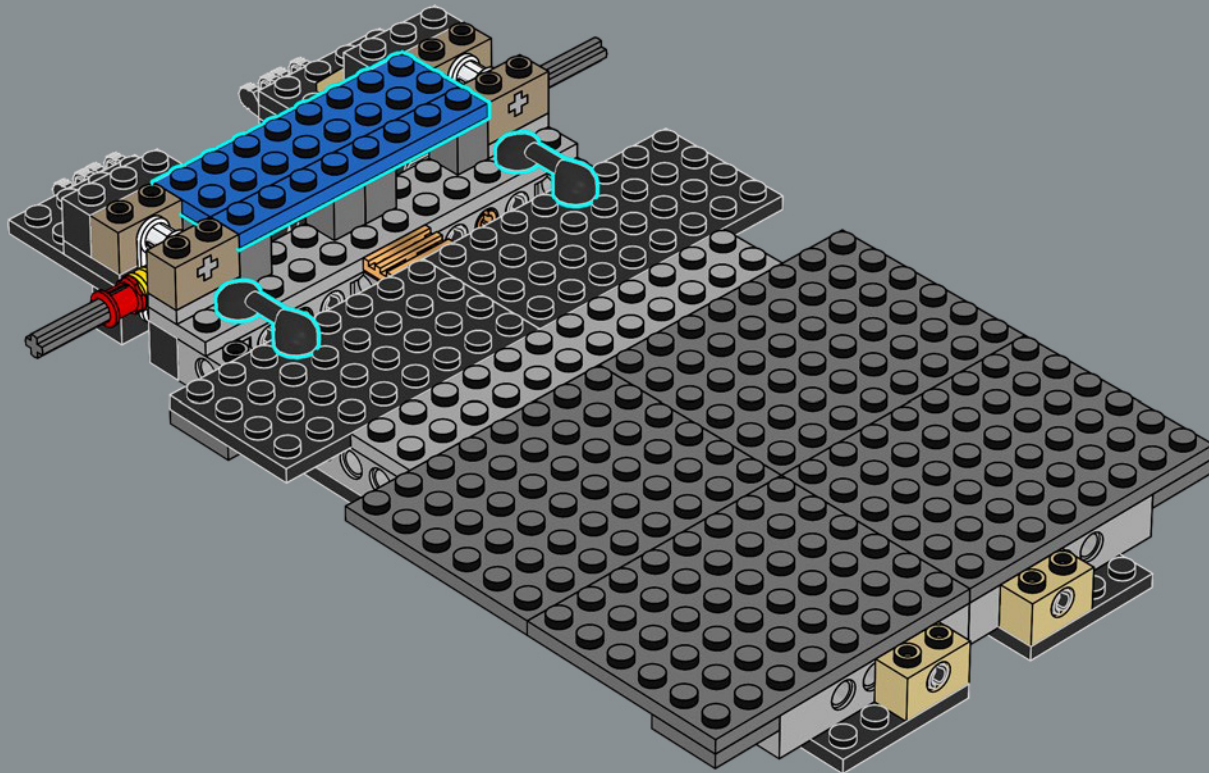

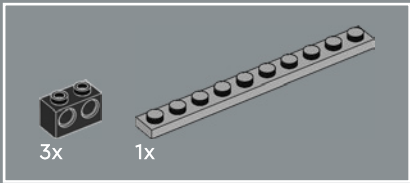

29

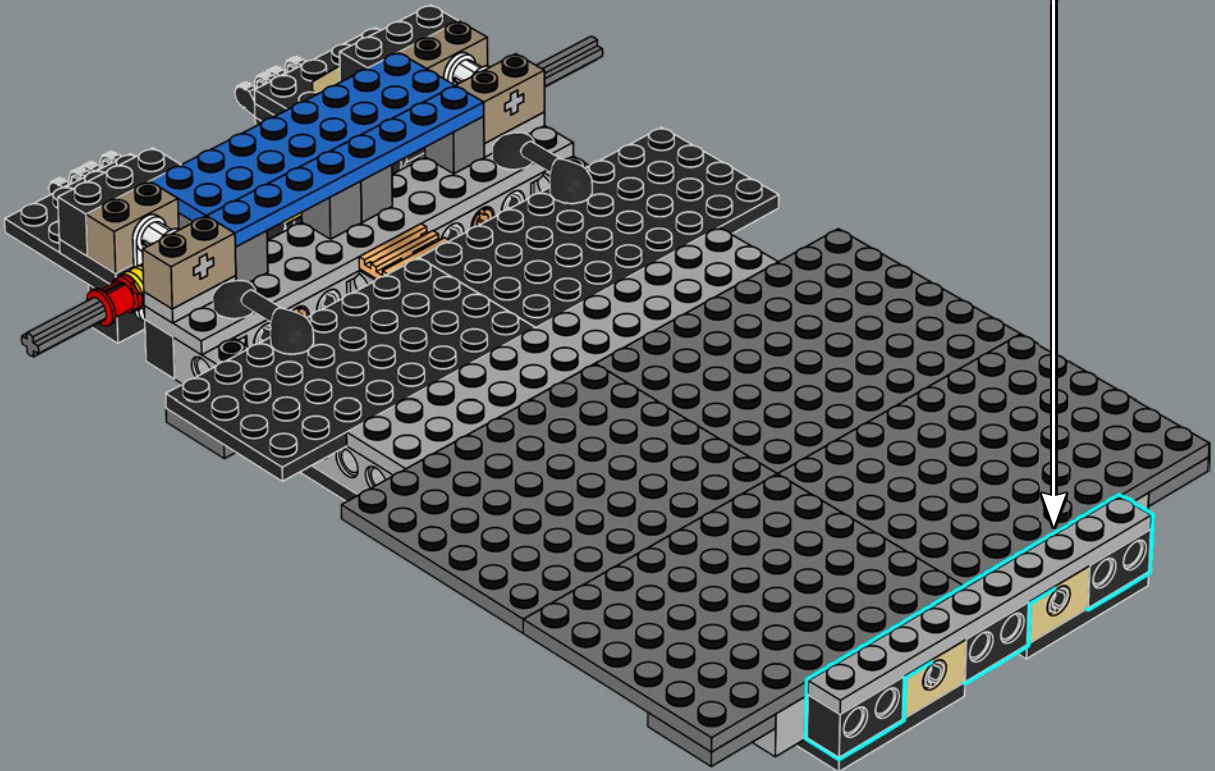
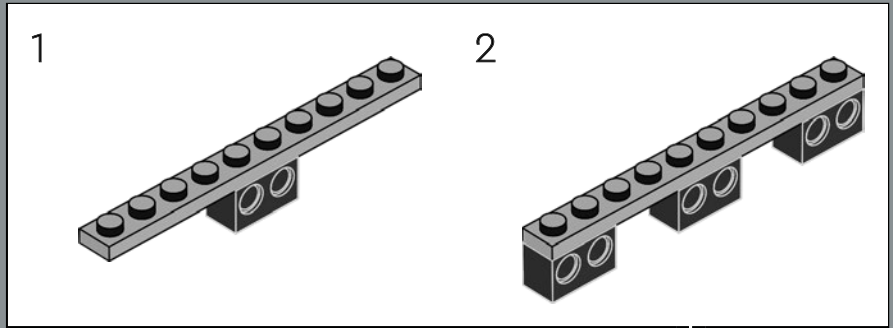

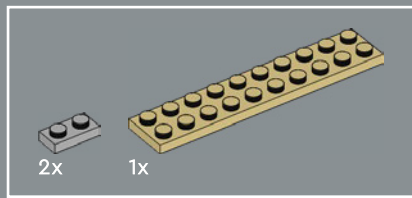

30

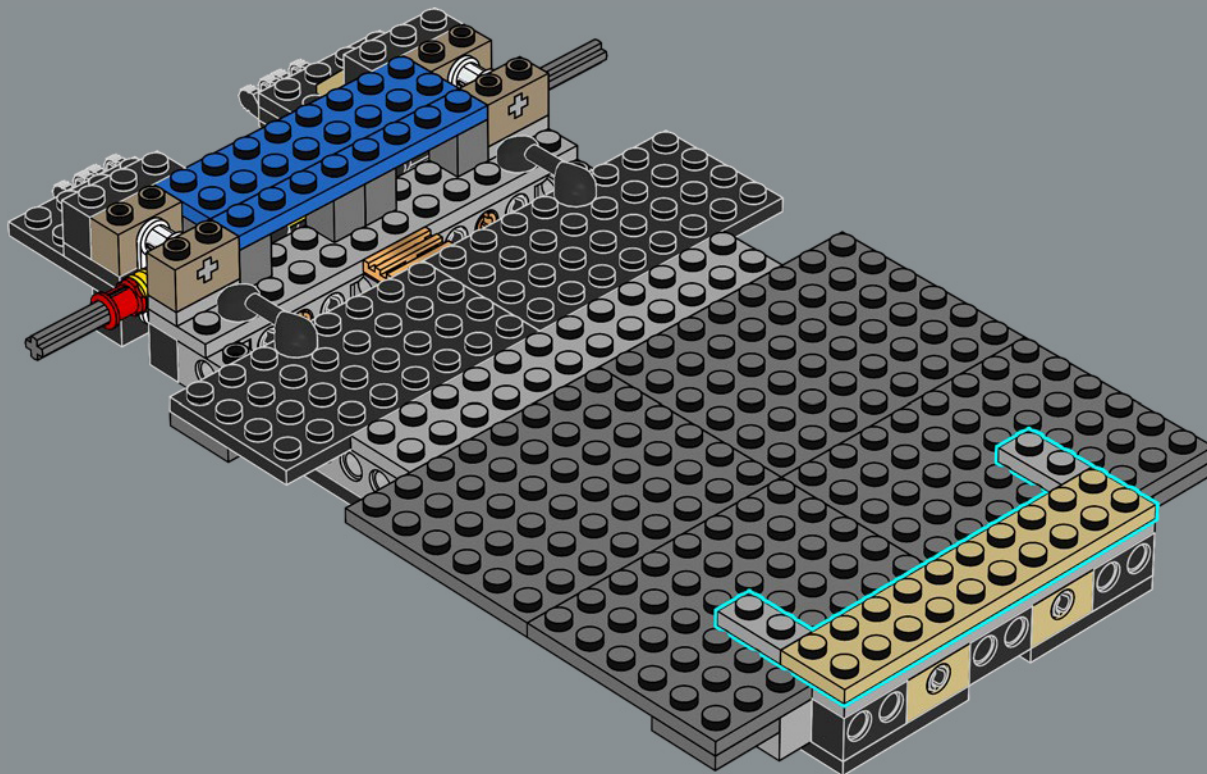

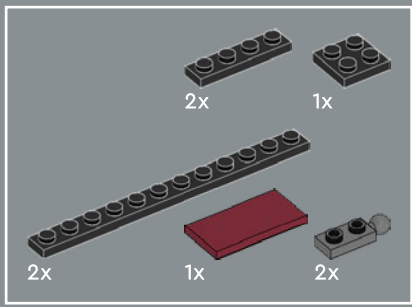

31

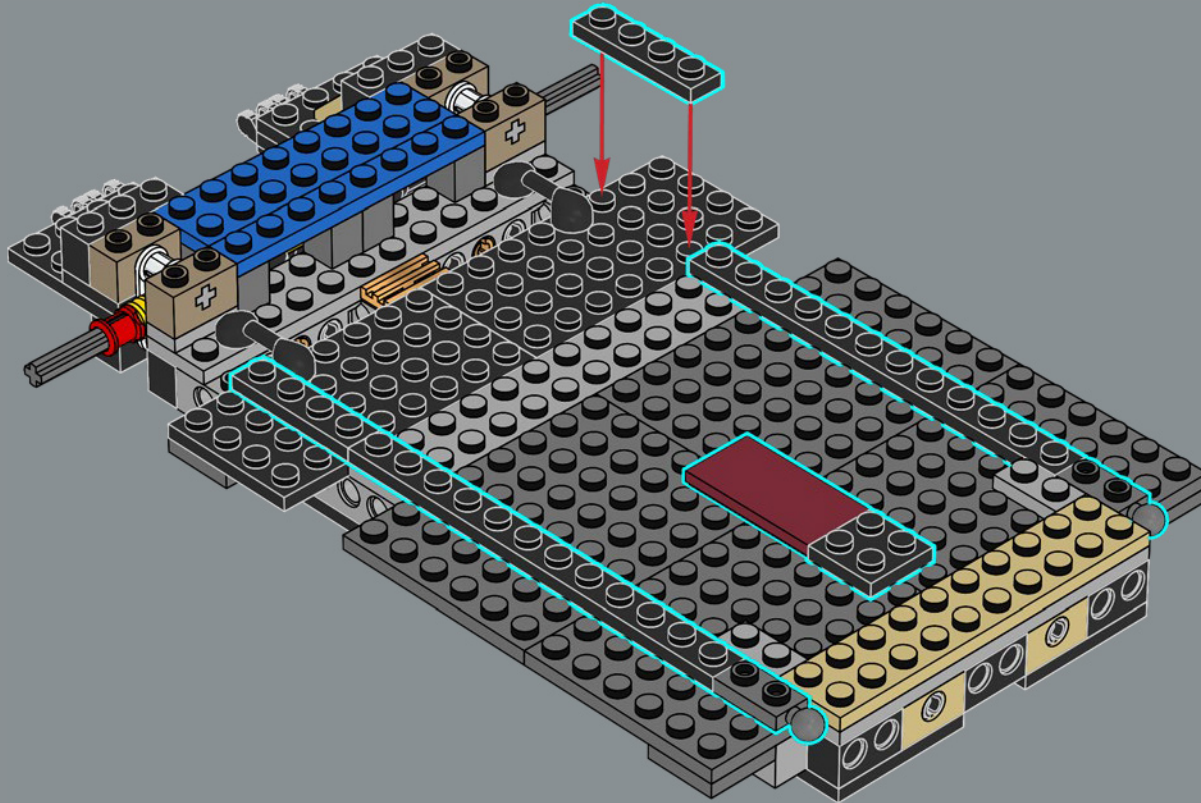

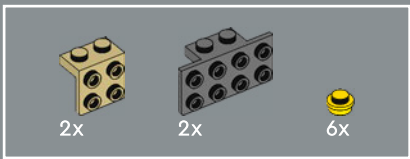

33

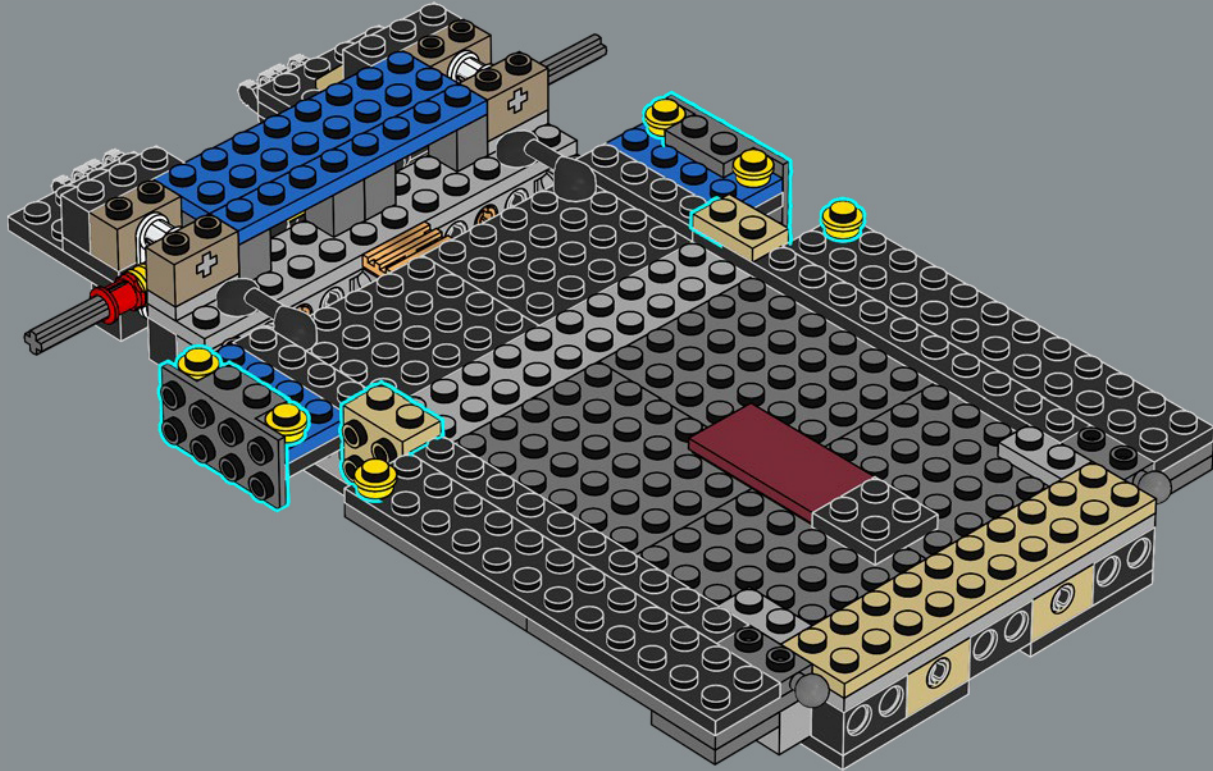

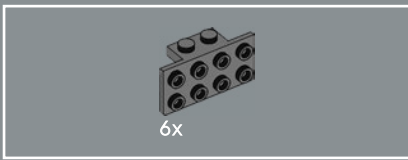

最初的 Lamborghini Countach 由
Carrozzeria Bertone 设计。

34

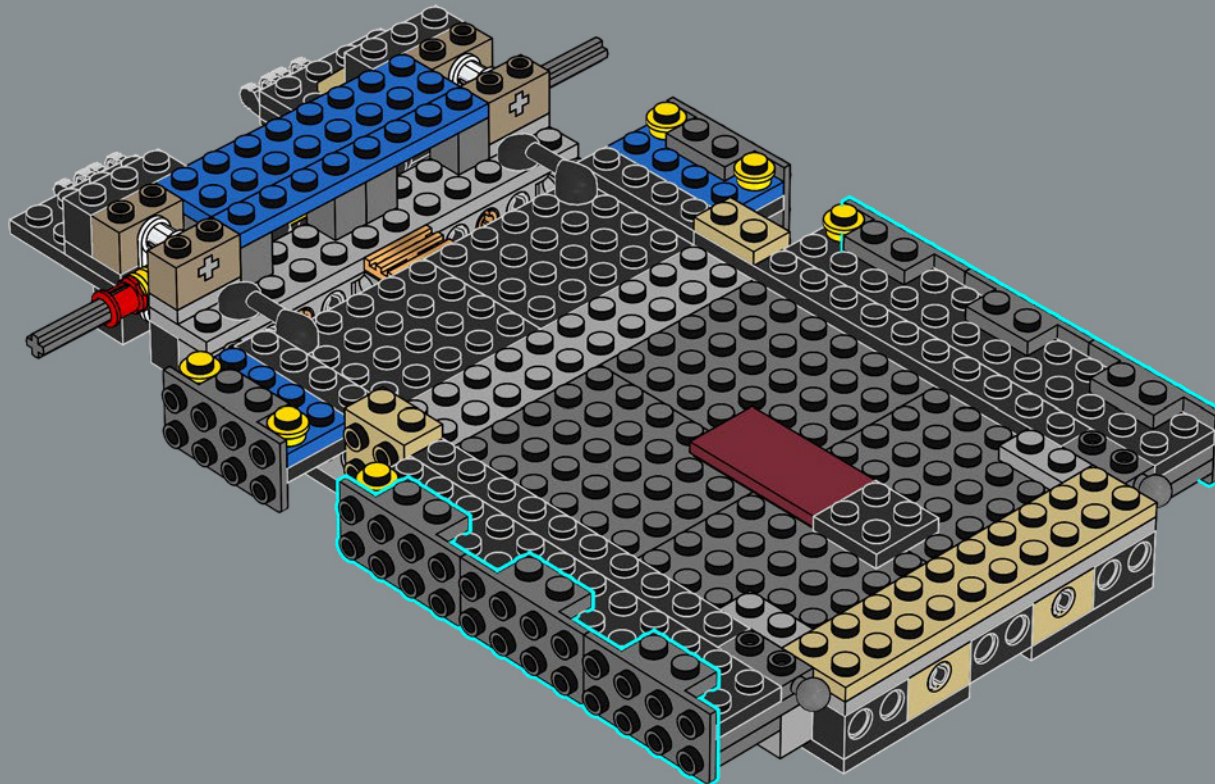

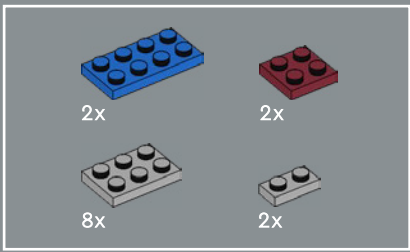

35

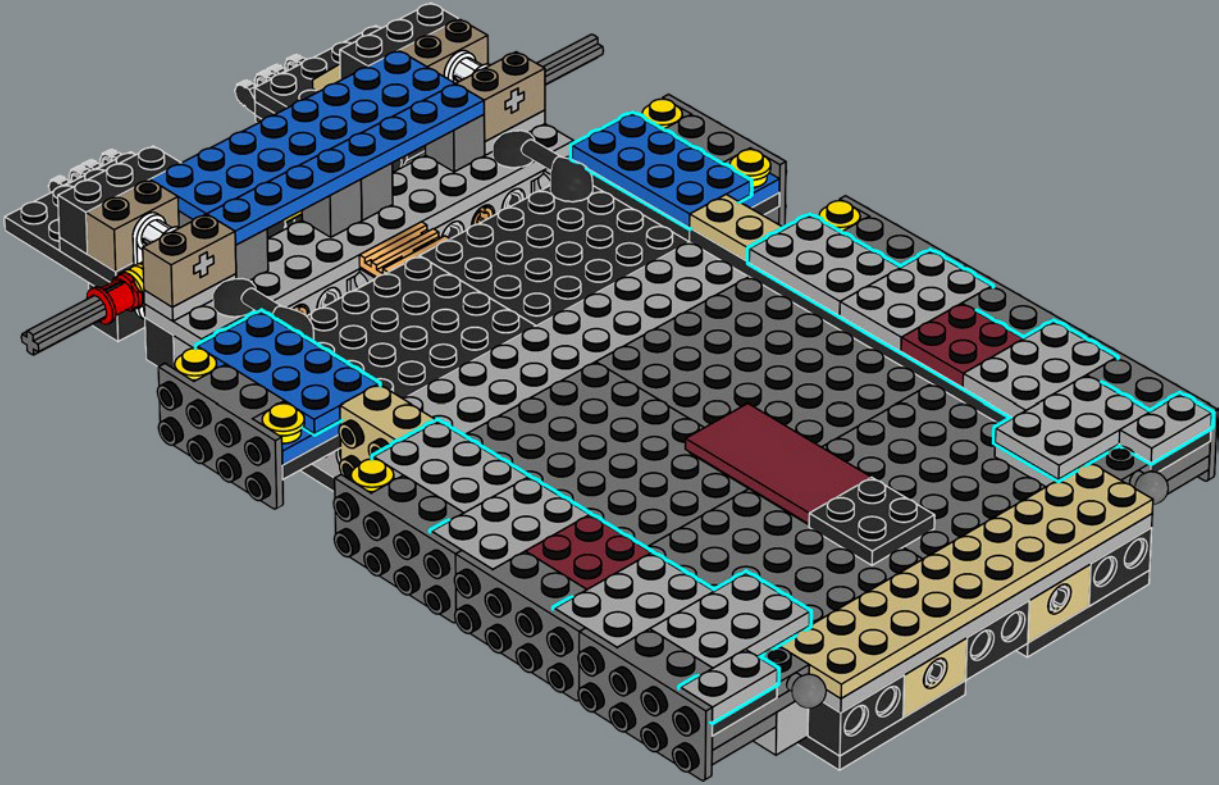

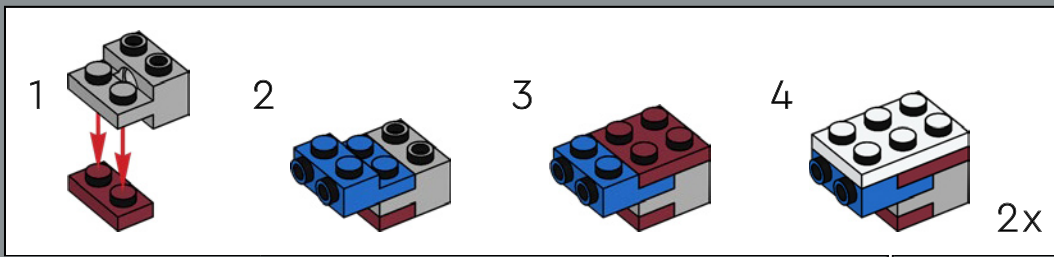
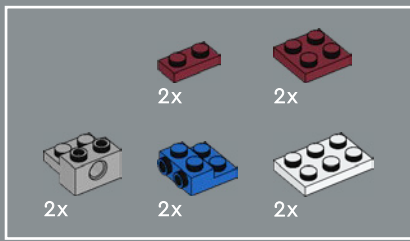

36

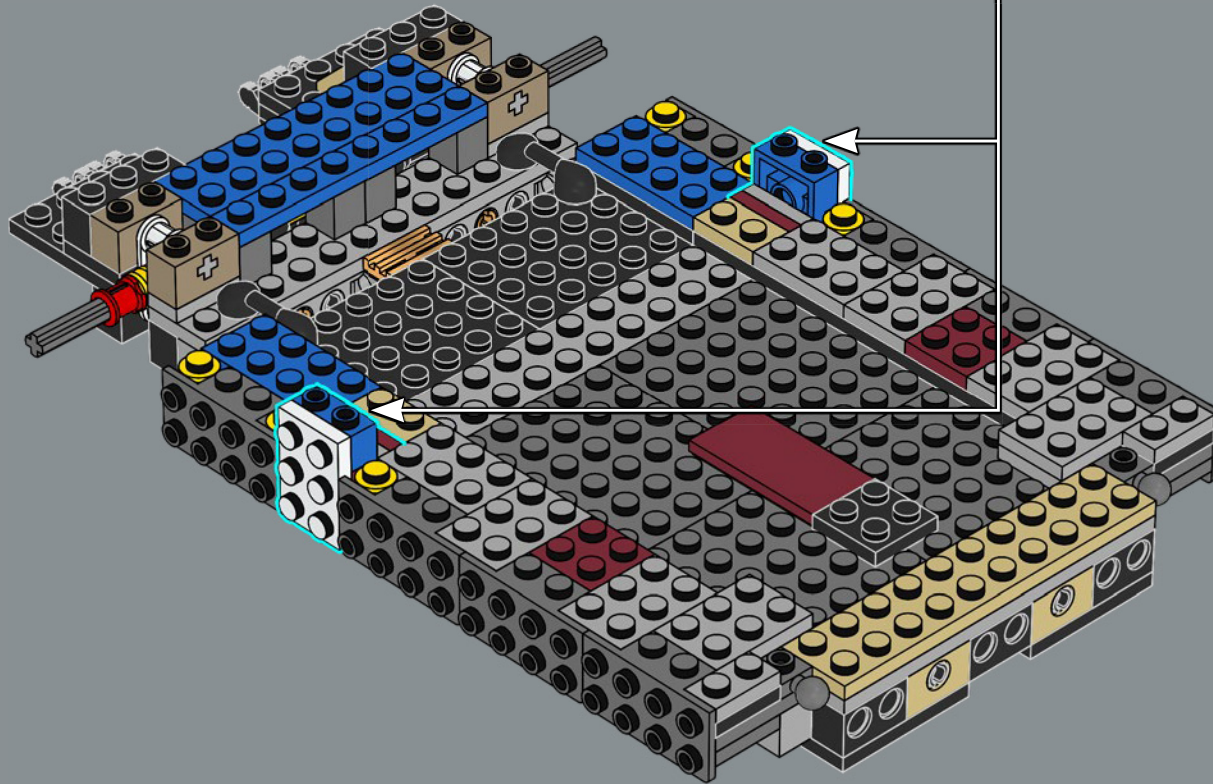

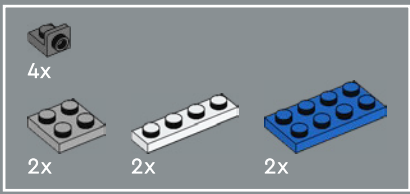

37

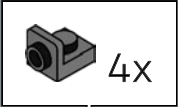
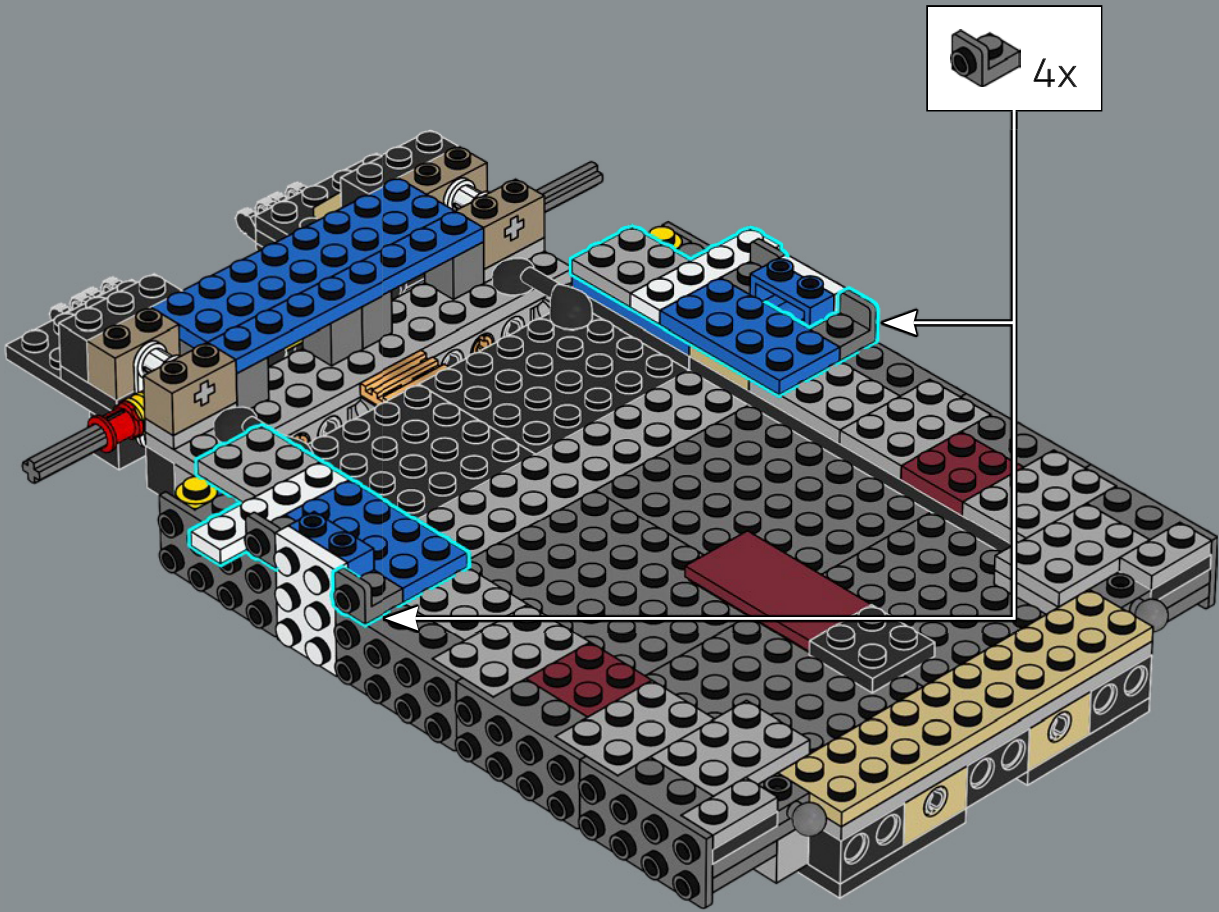



38

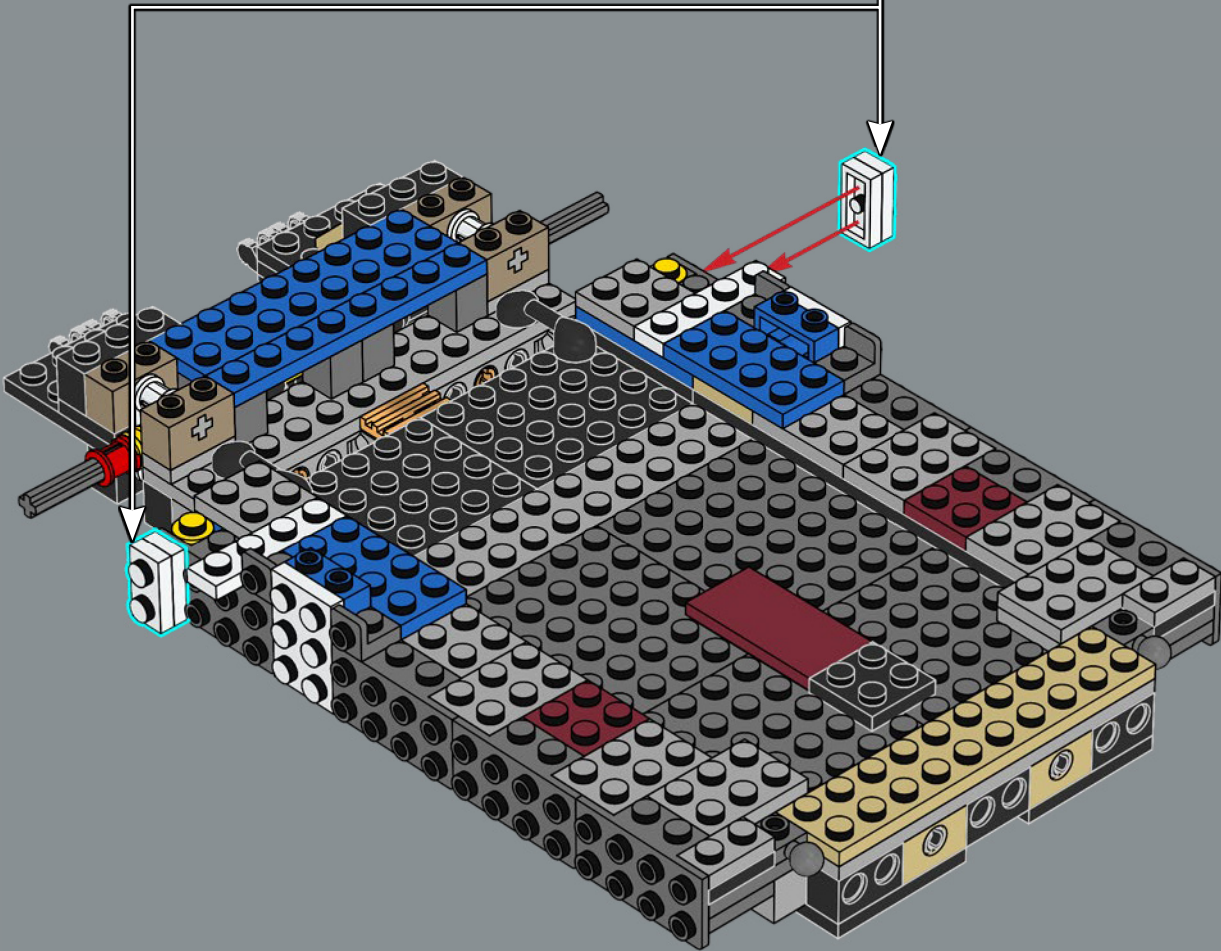
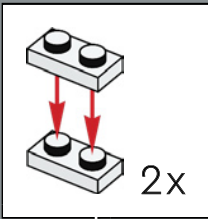

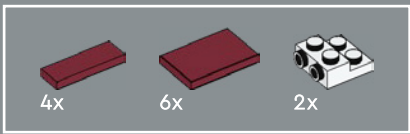

39

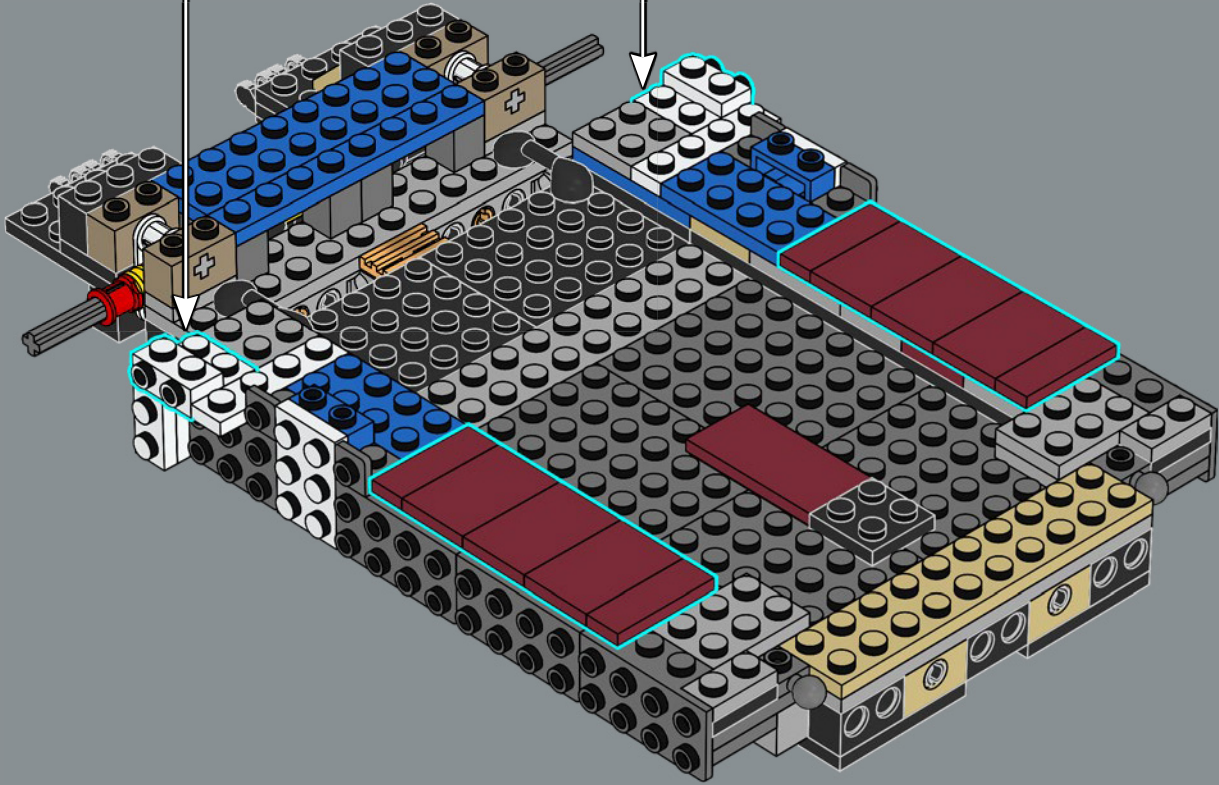
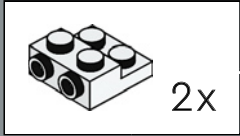

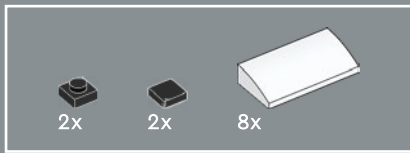

40

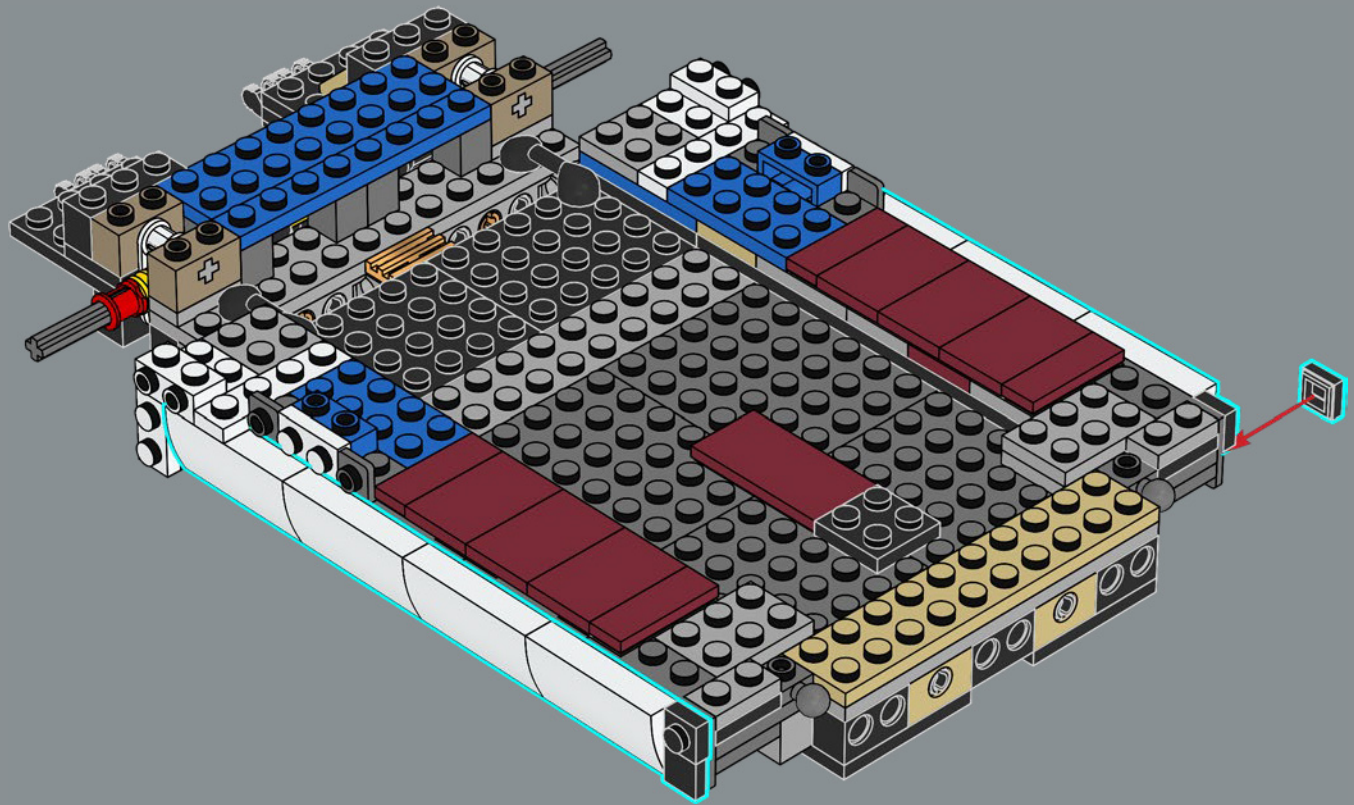

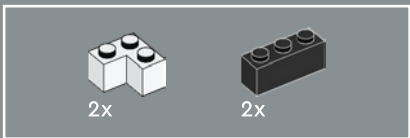

41

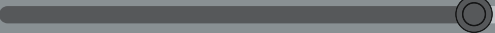
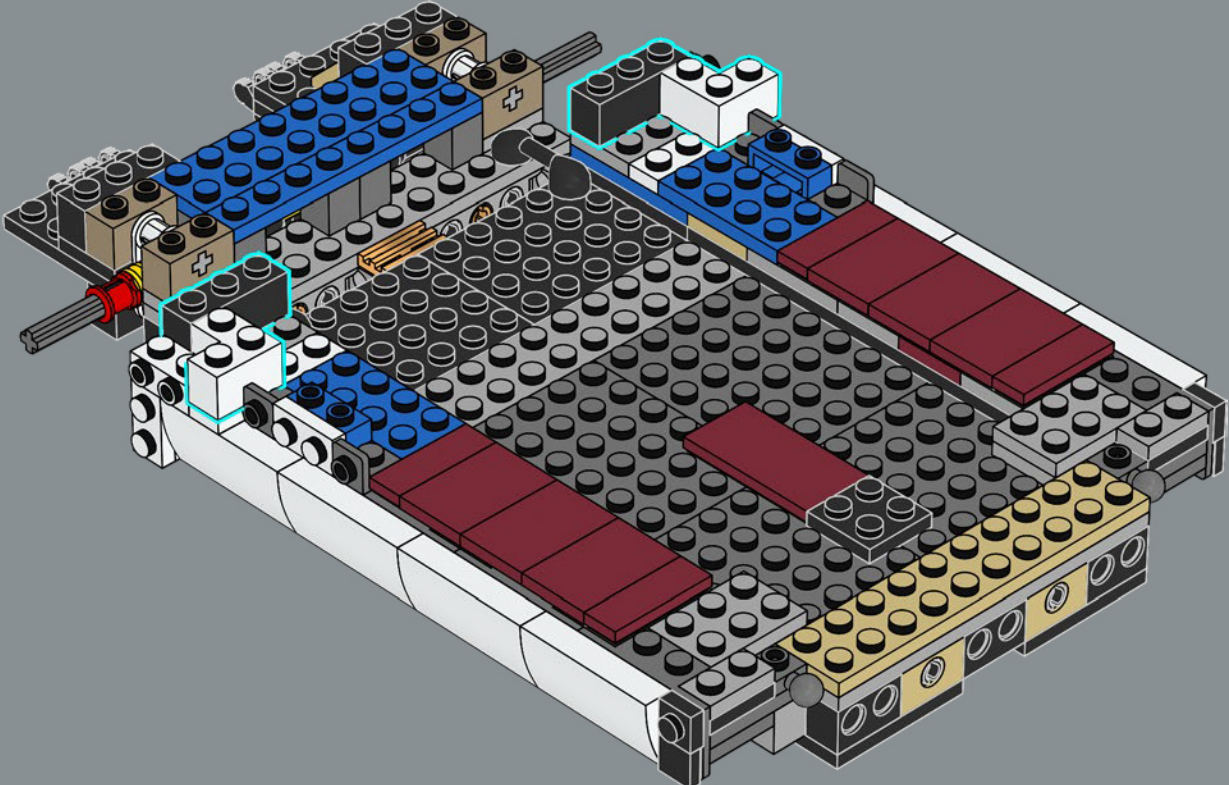

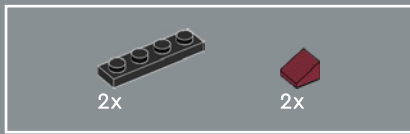

42

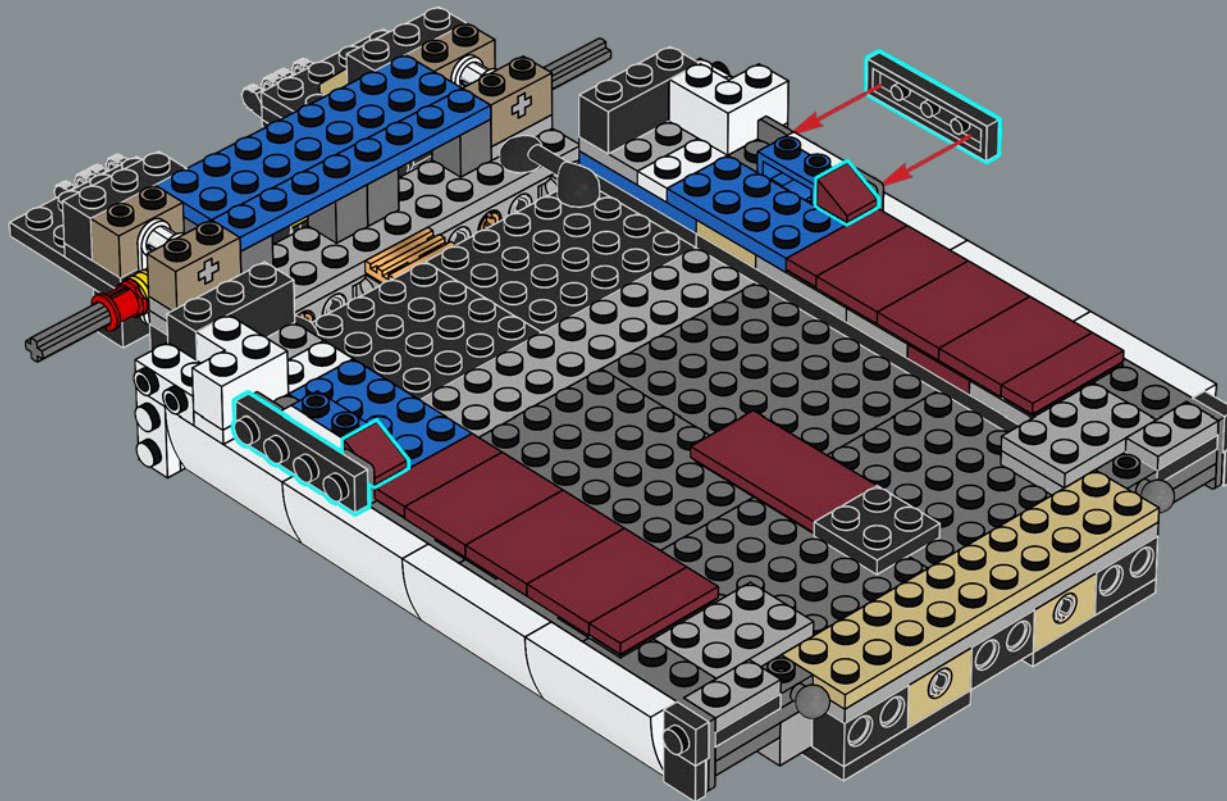



4x

43

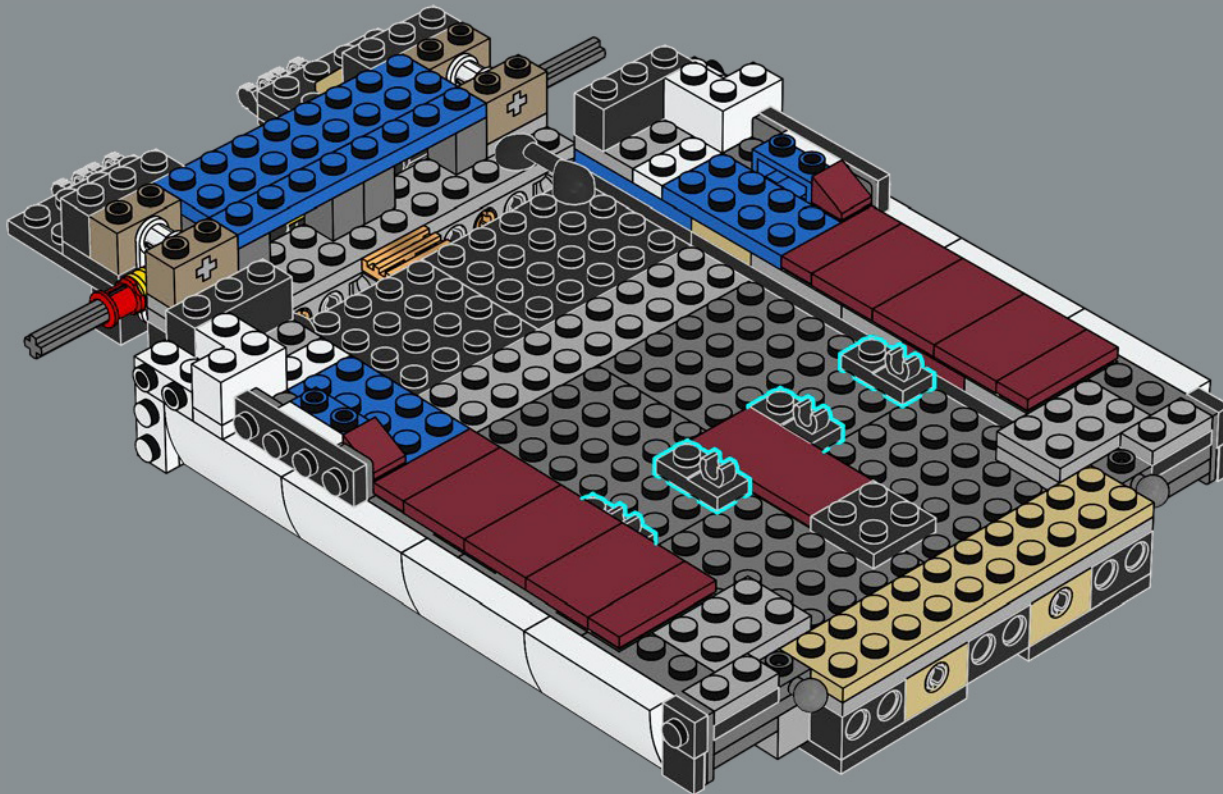

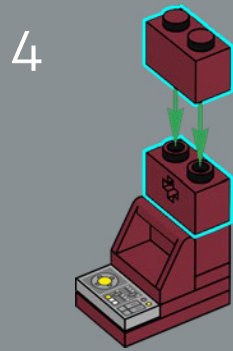
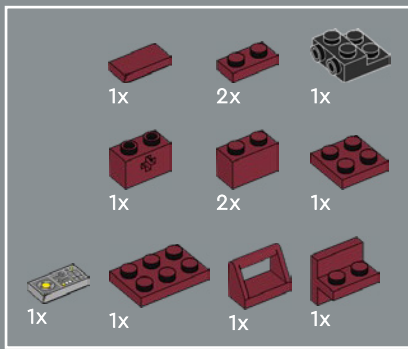

7

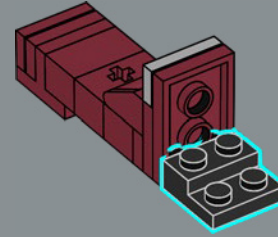

44

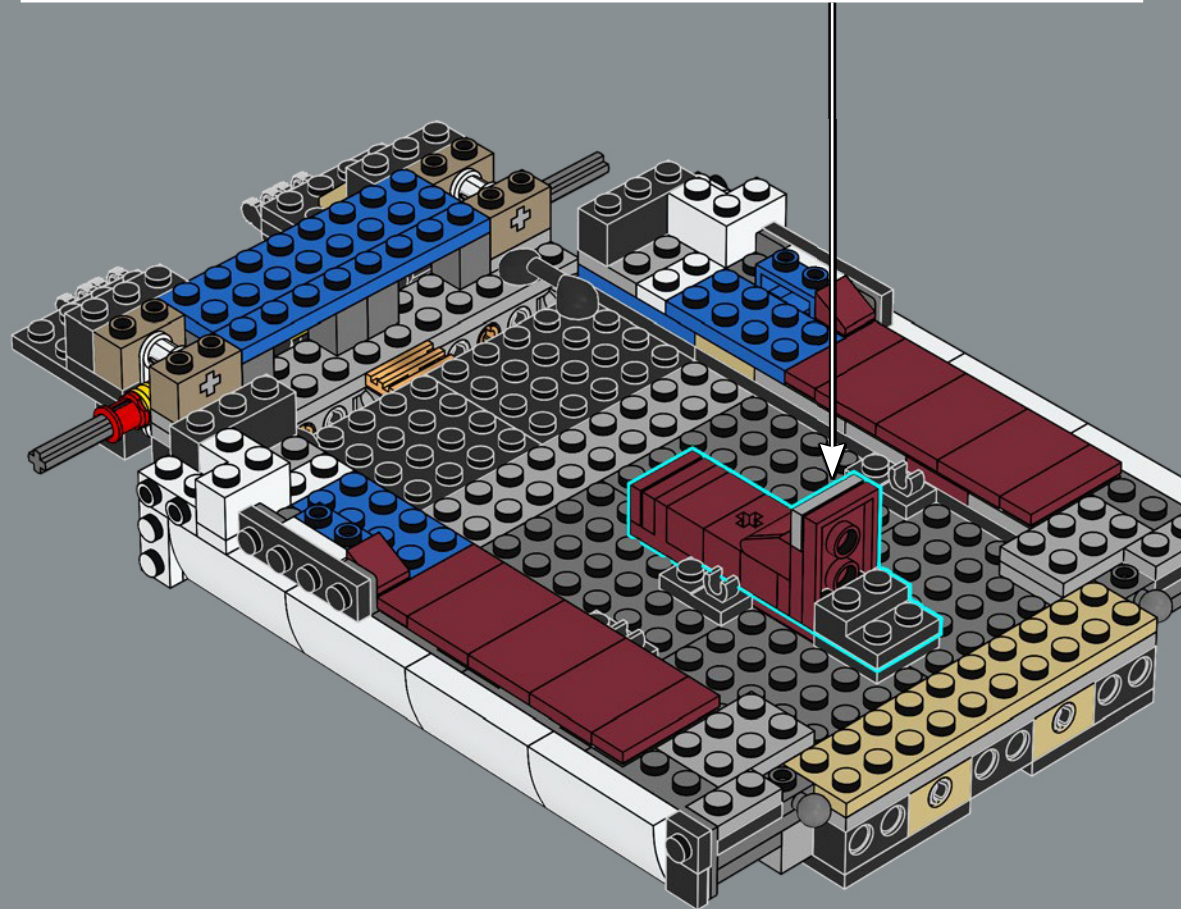
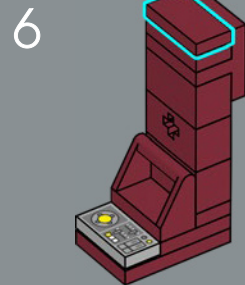
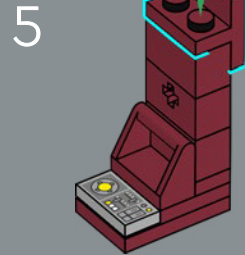
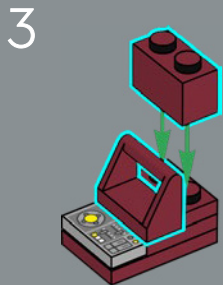
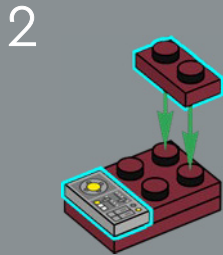
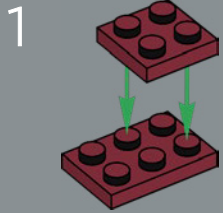



45

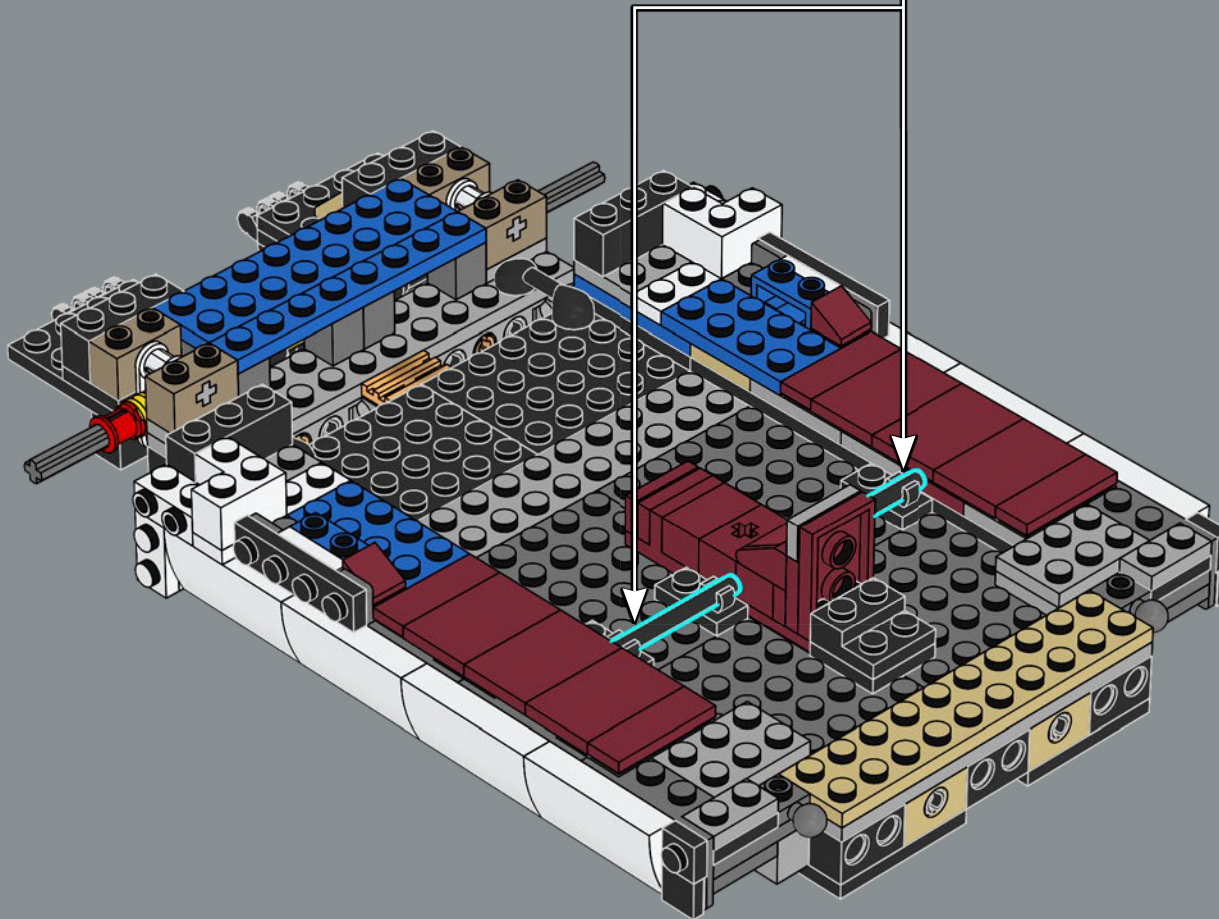
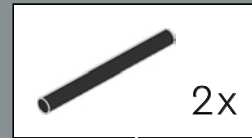

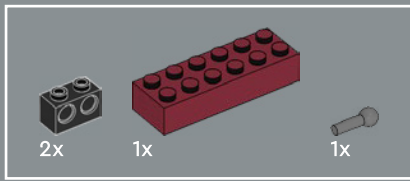

46

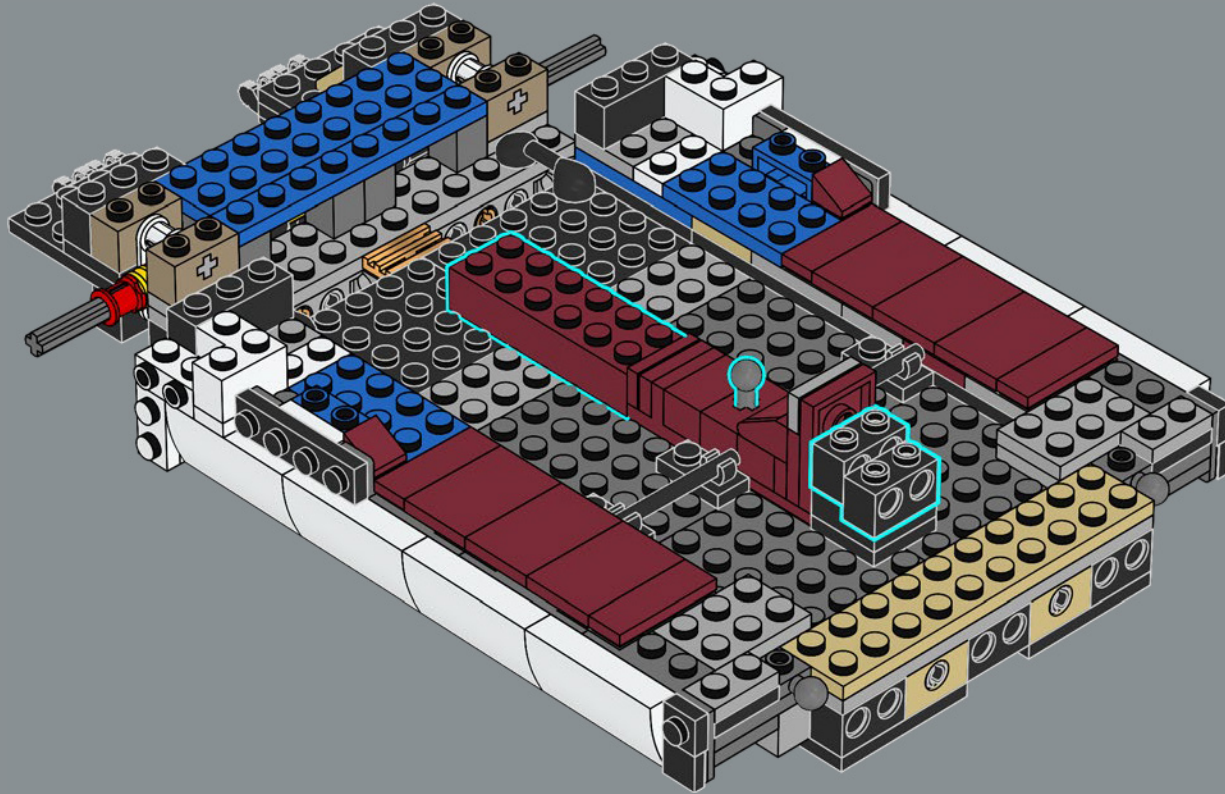

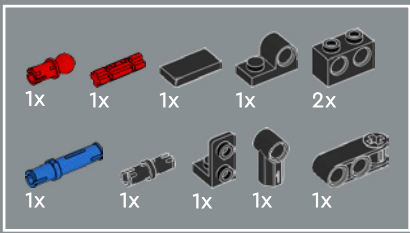

47

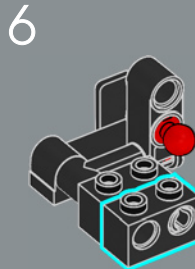
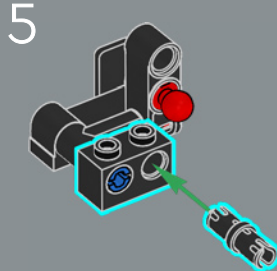
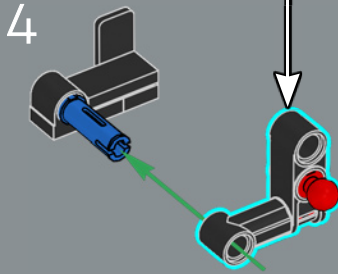
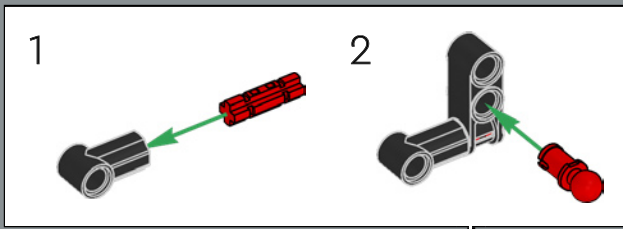
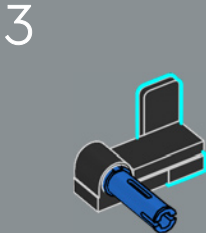
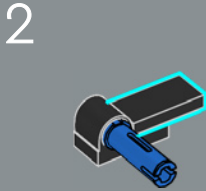
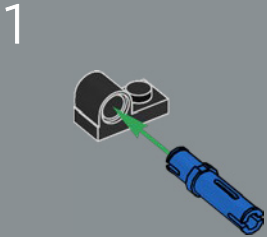

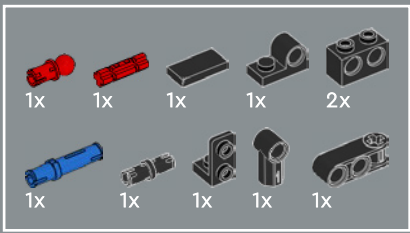

48

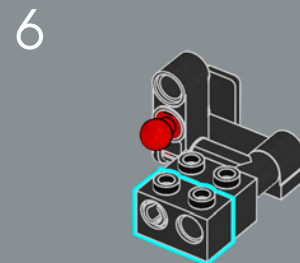
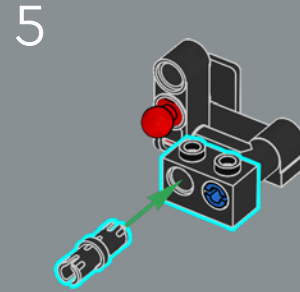
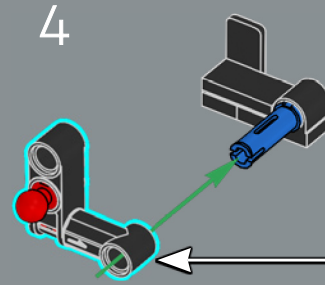
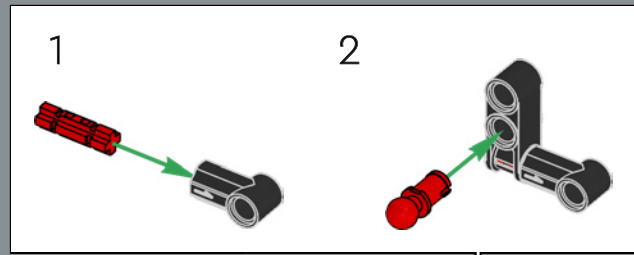
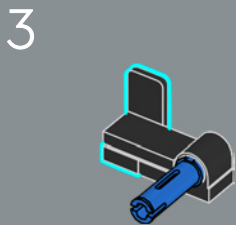
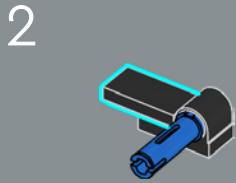
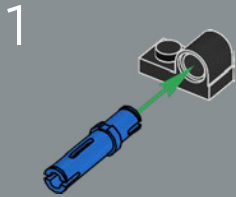

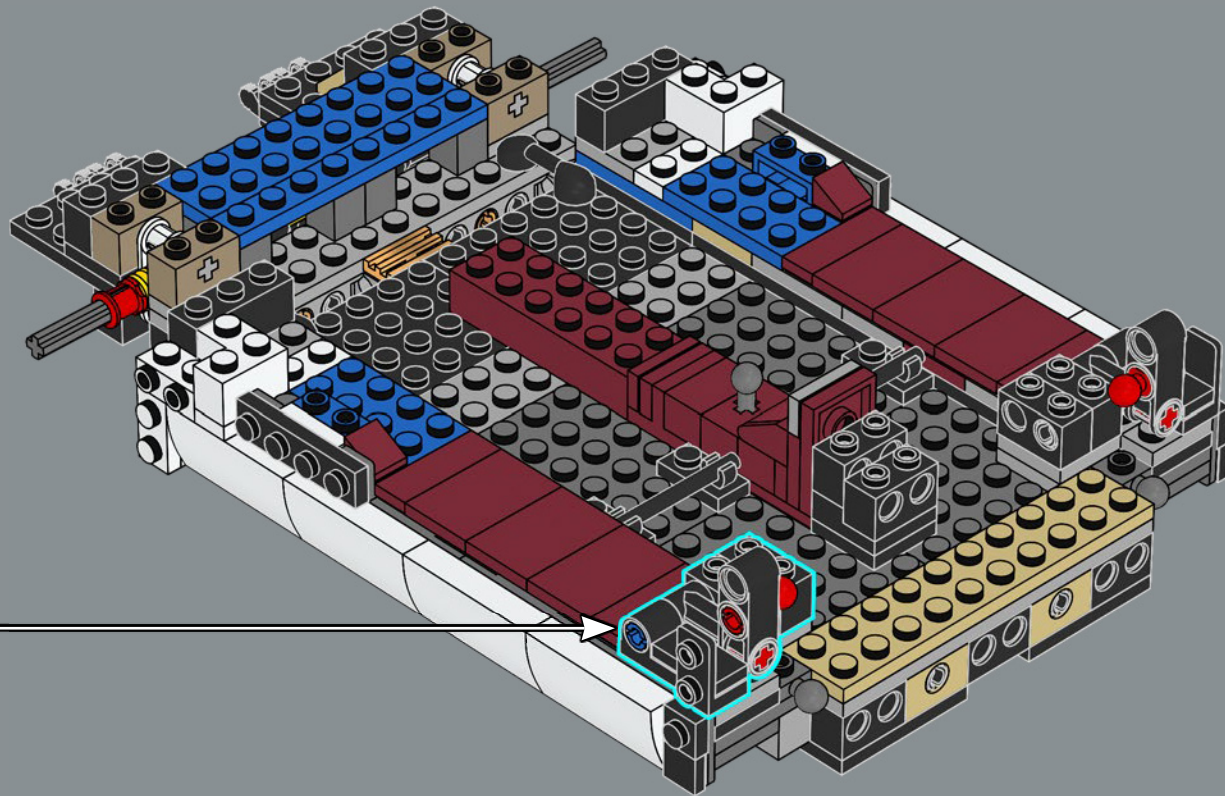

0
2x

49

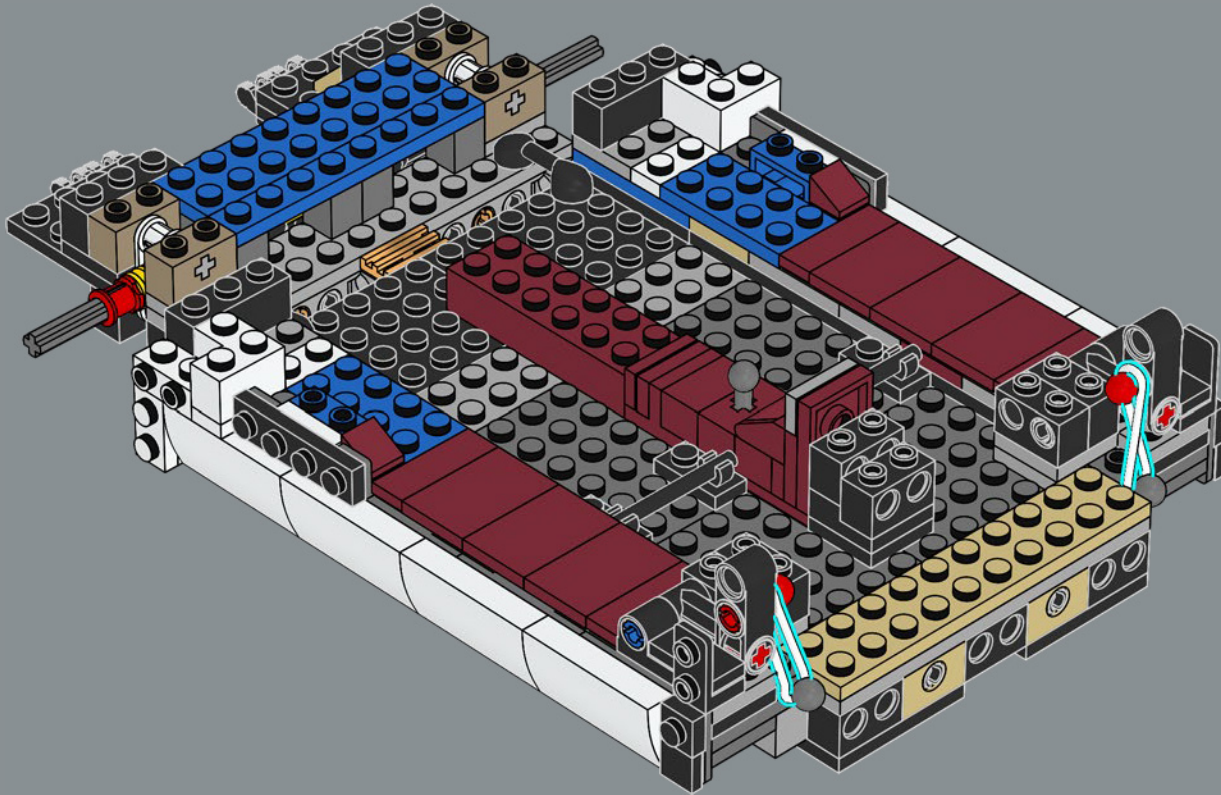

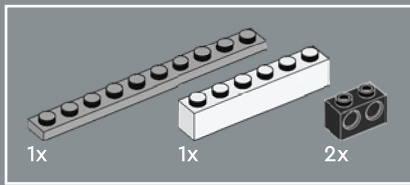

50

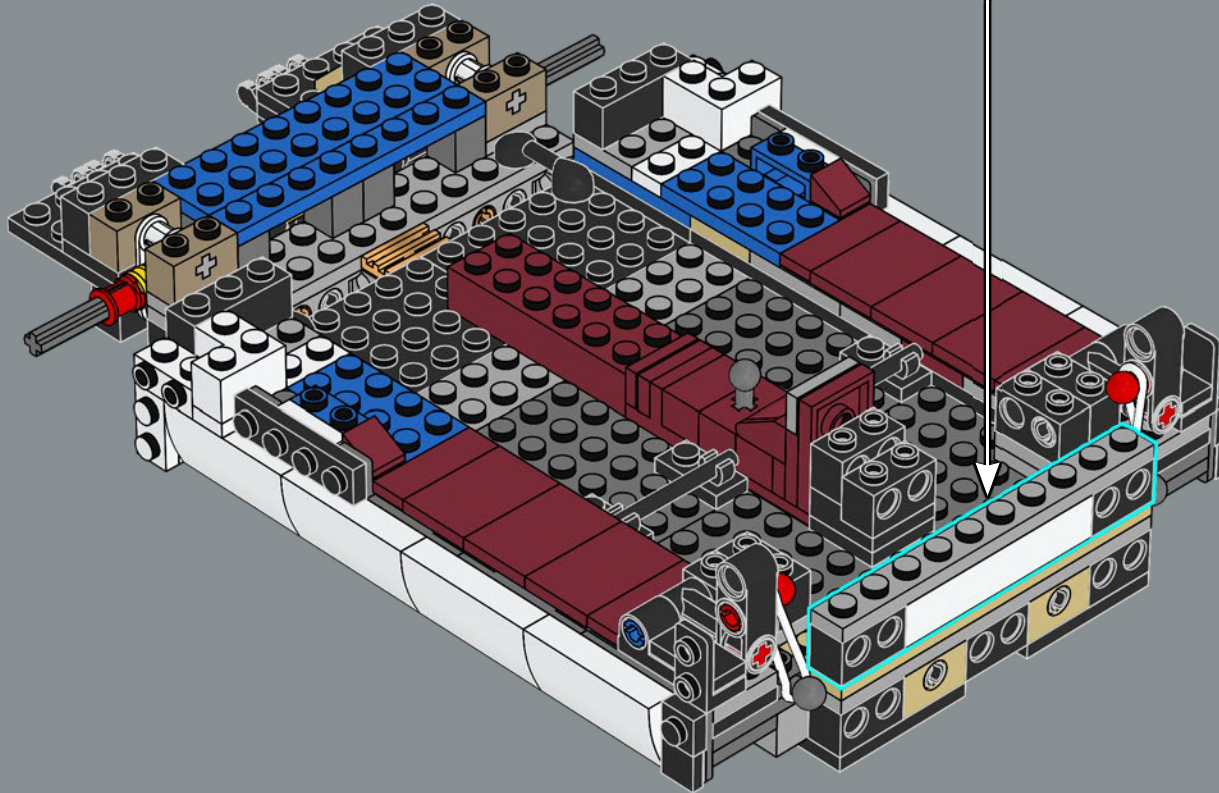
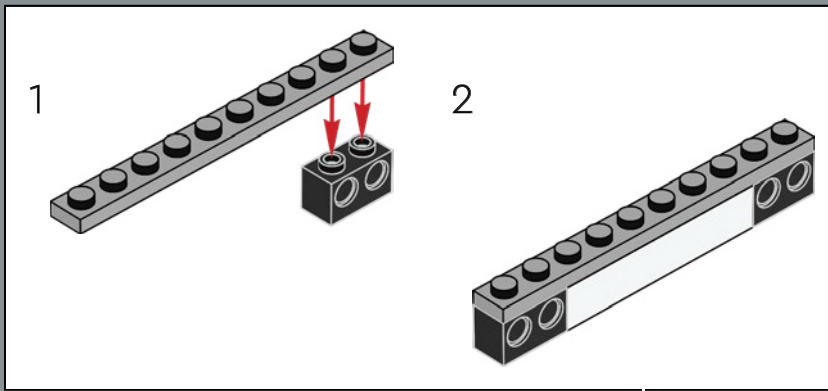

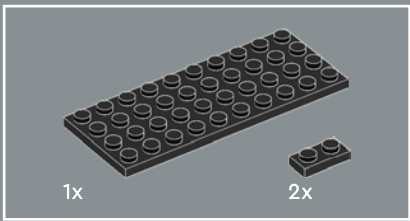

51

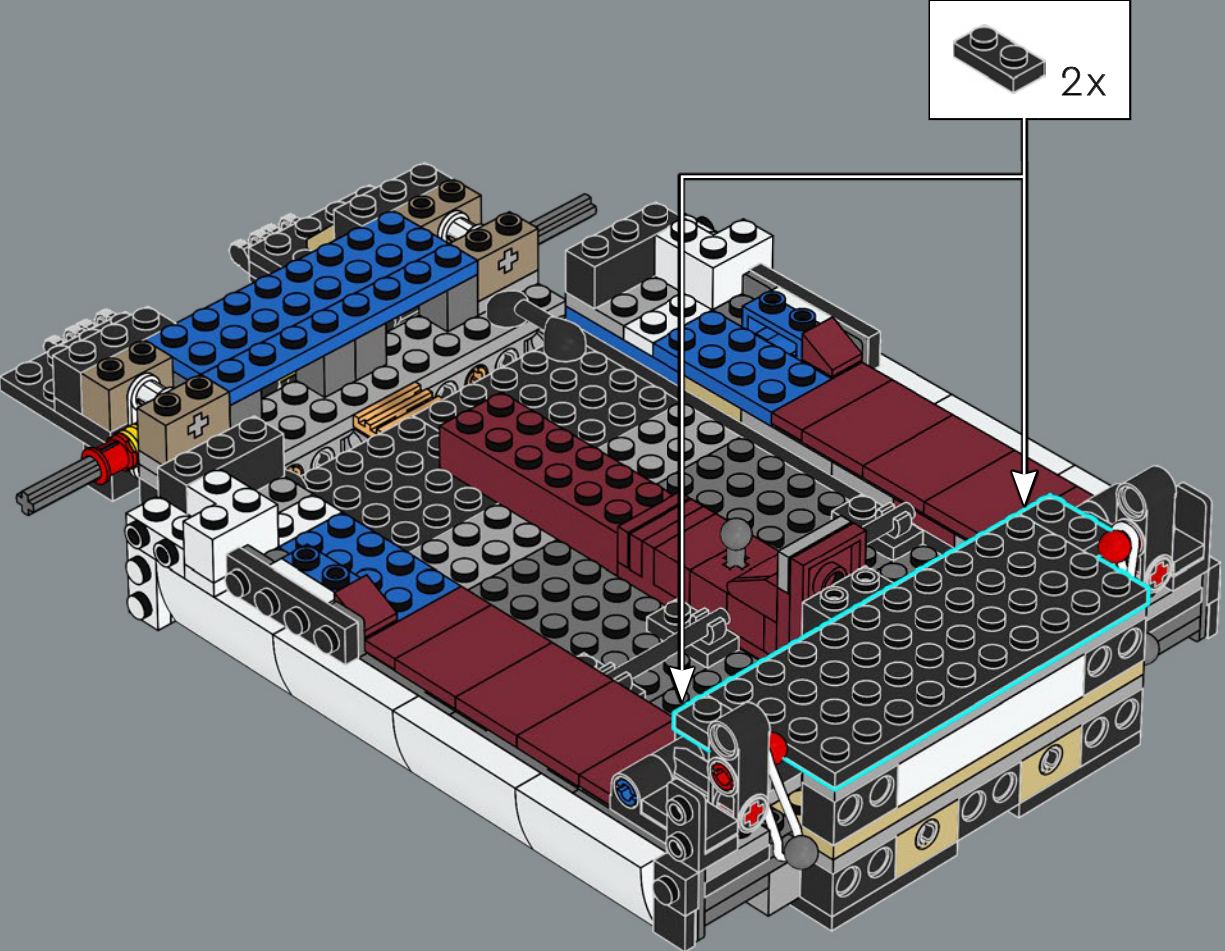

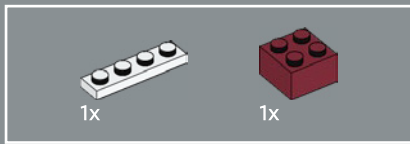

52

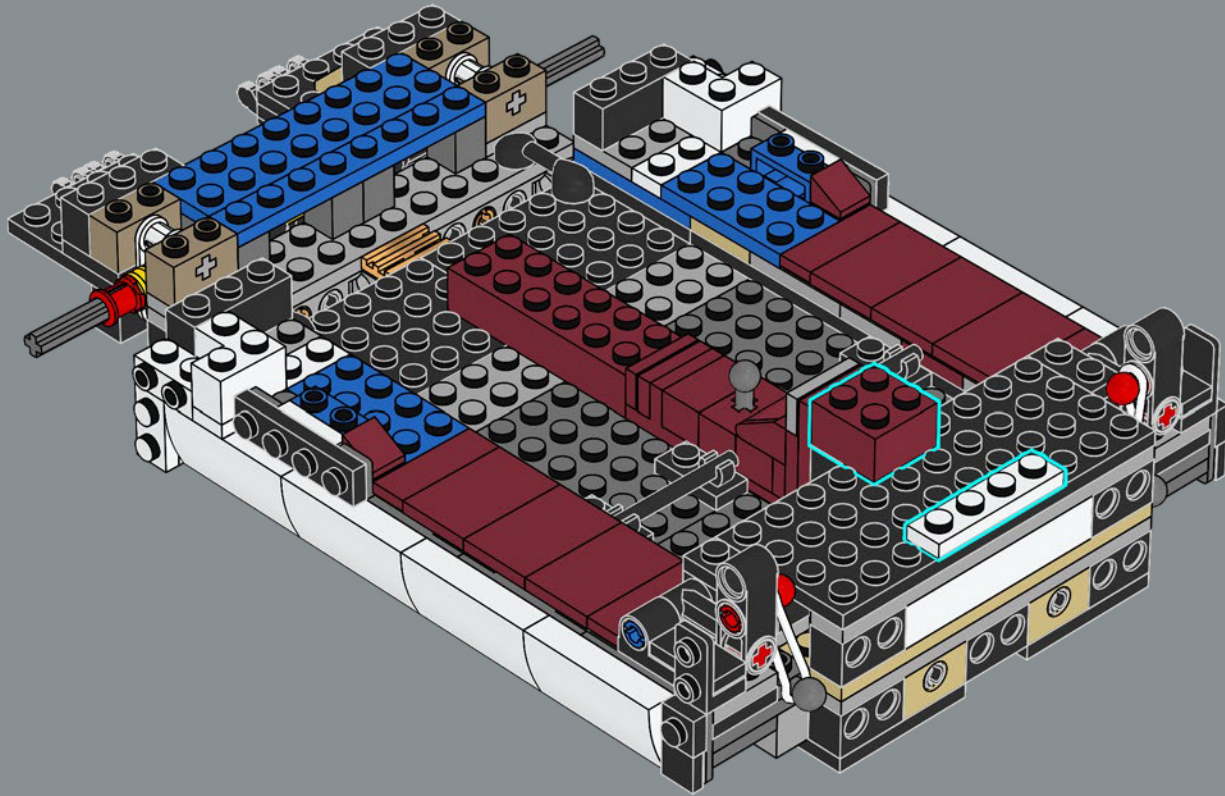

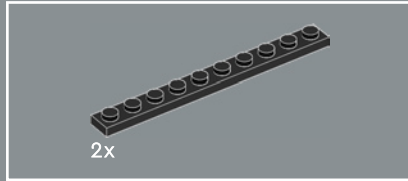
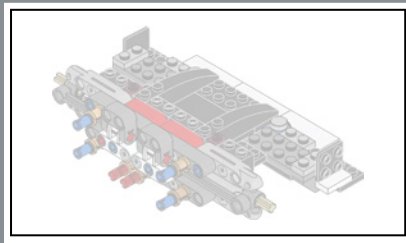

53

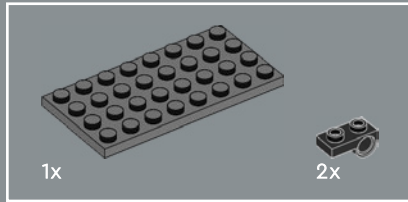
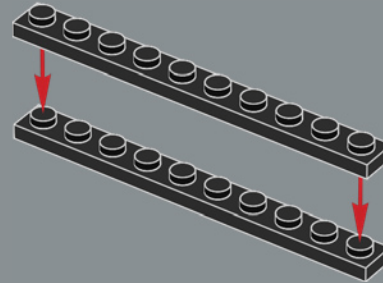

54

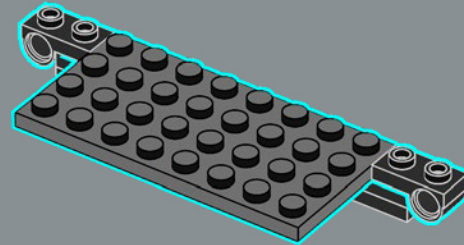

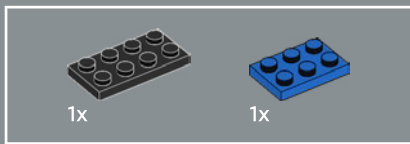

55

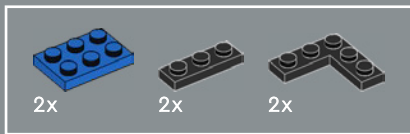
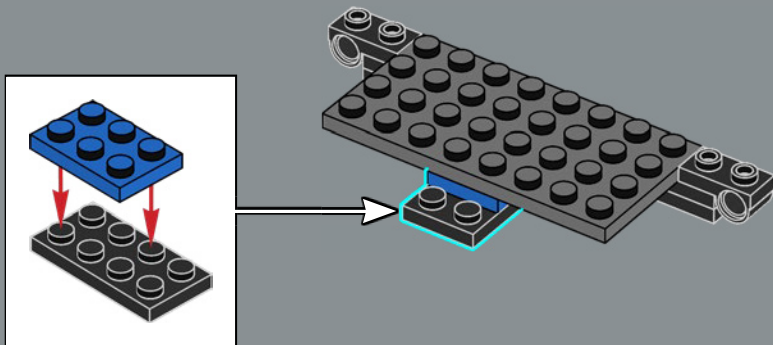

56

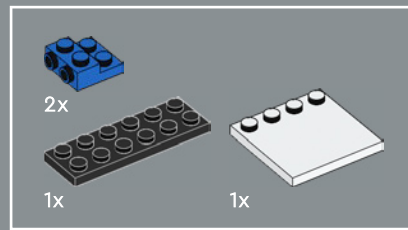
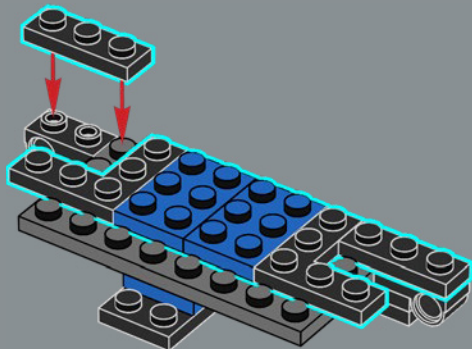

57

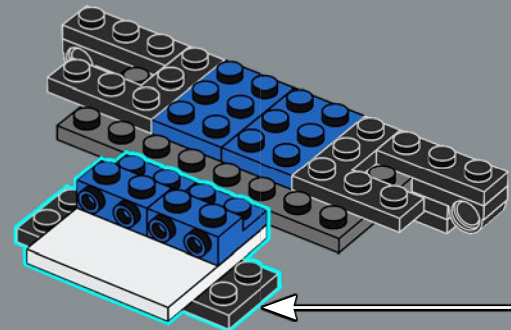
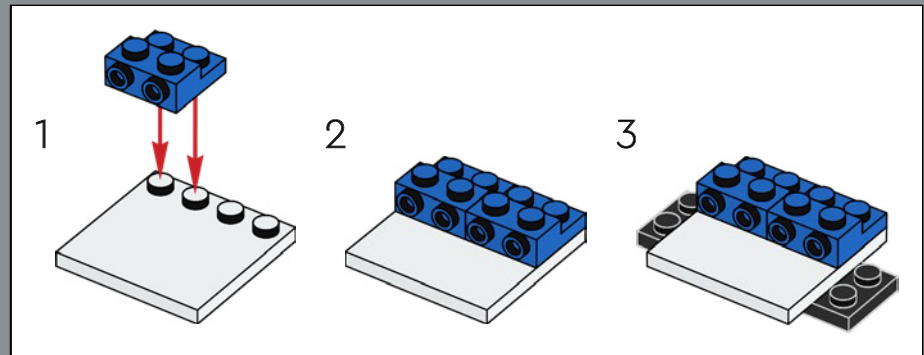

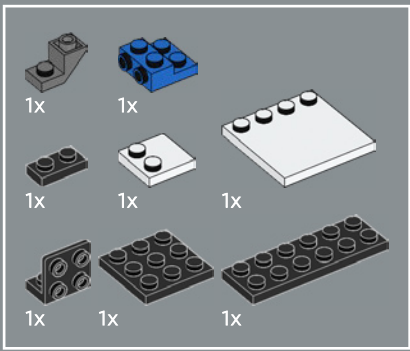

58

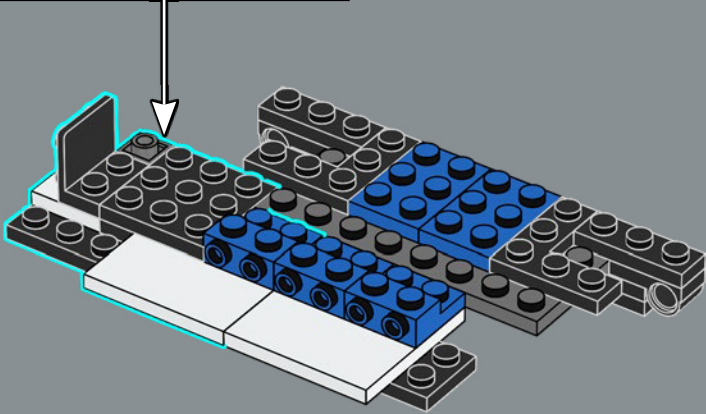
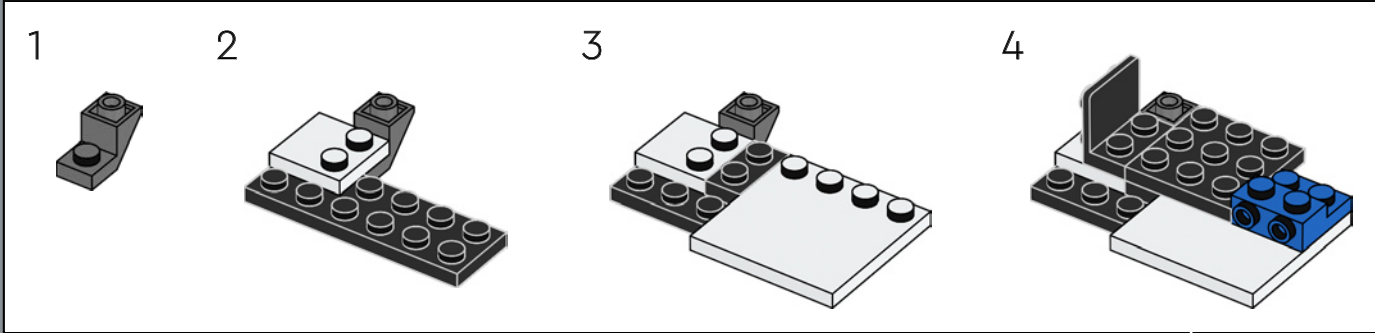

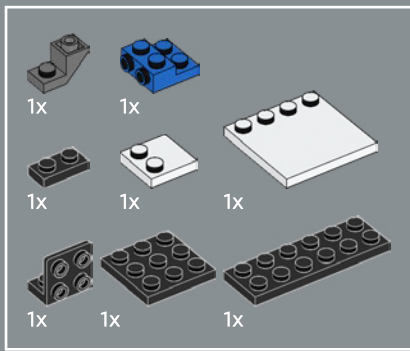

59

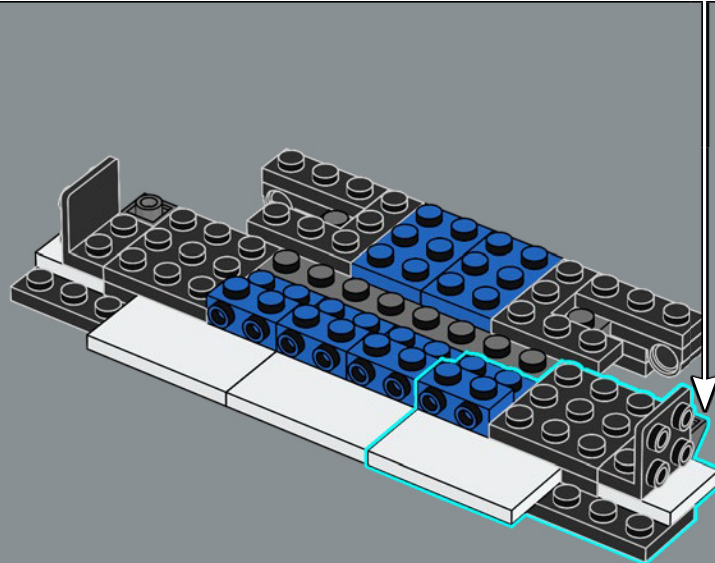
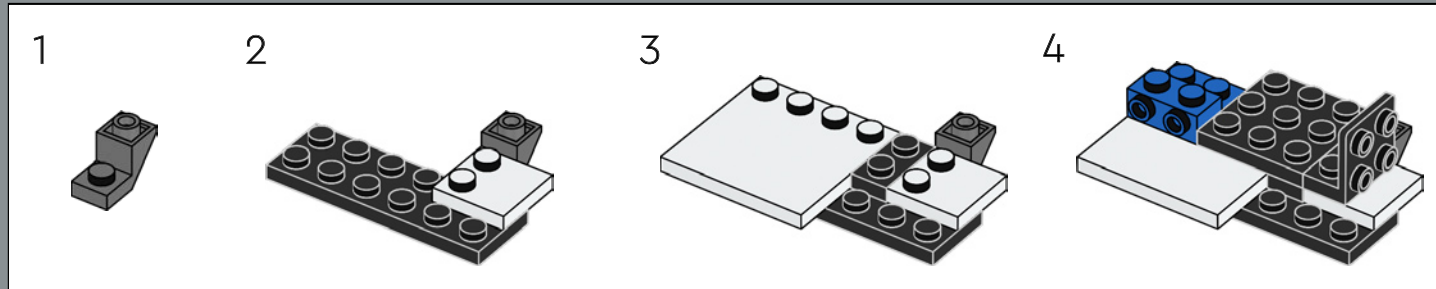

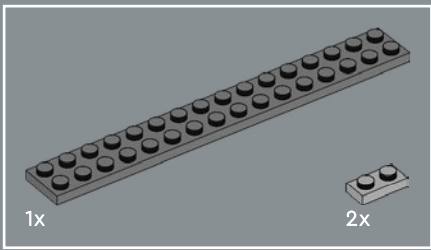

60

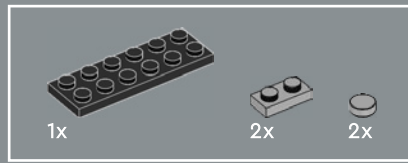
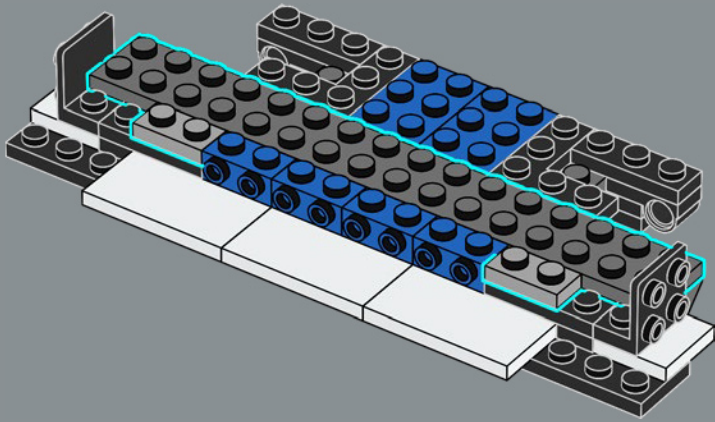

61

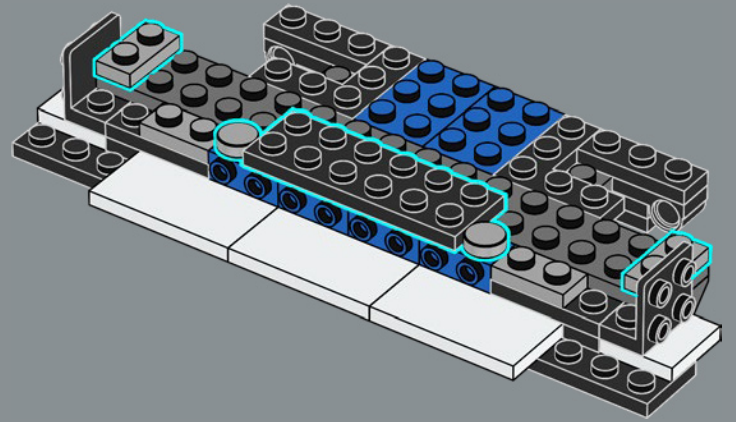

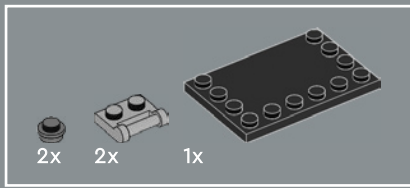

62

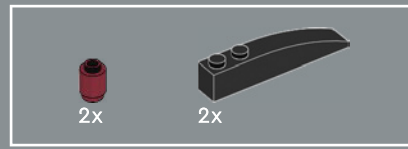
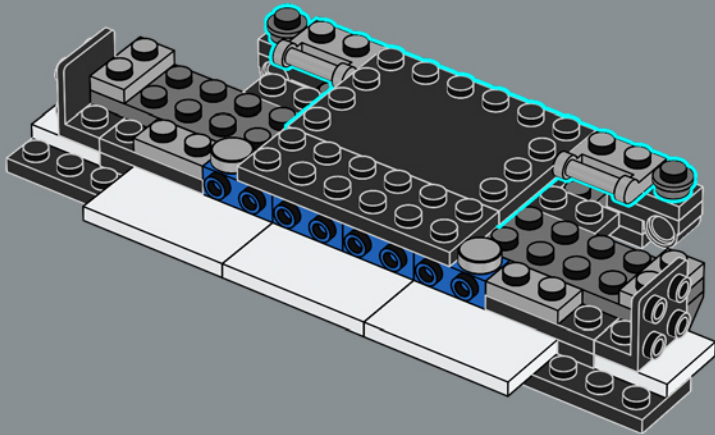

63

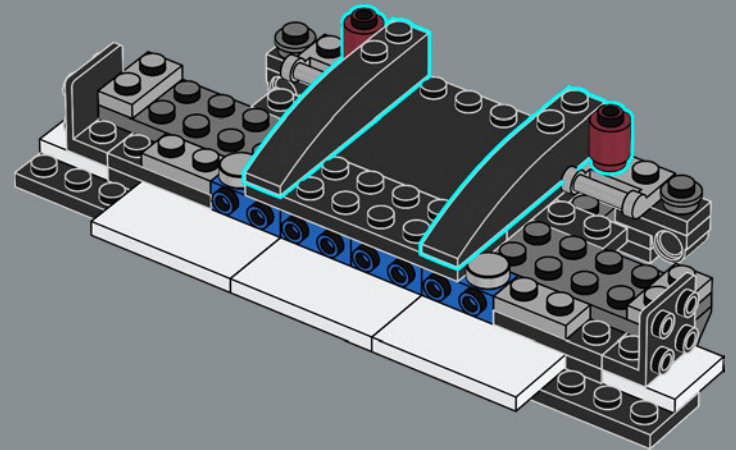

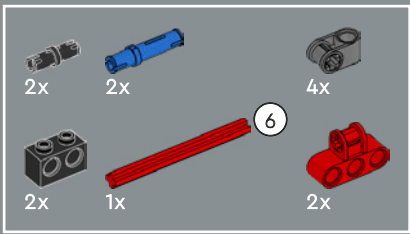

64

1

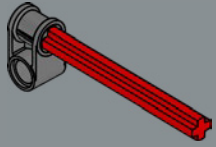

2

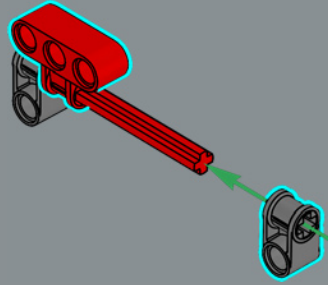

3

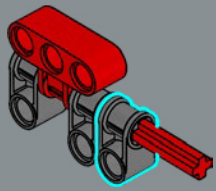

4

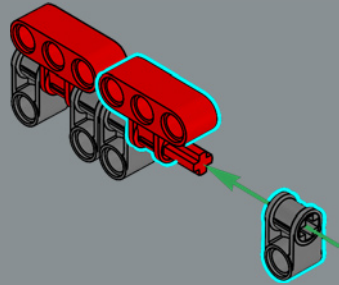

5

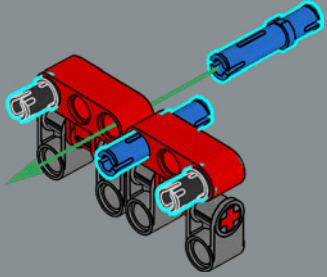

6

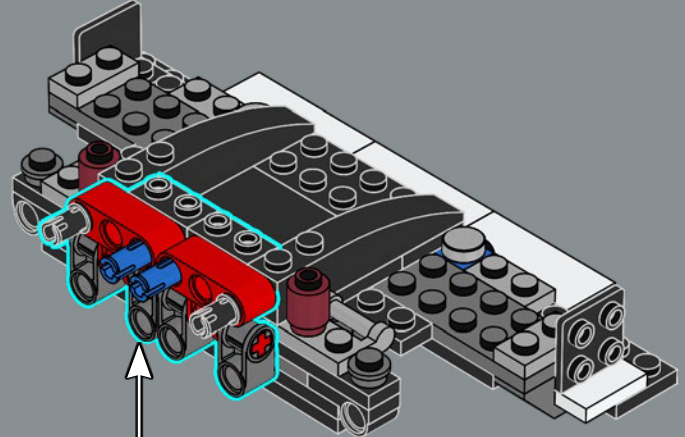
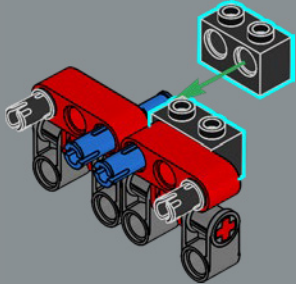

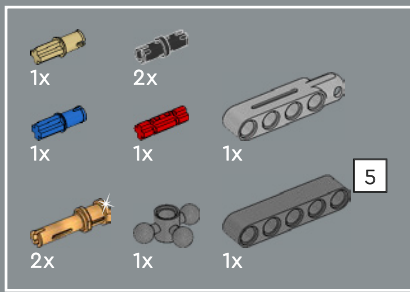

65

1

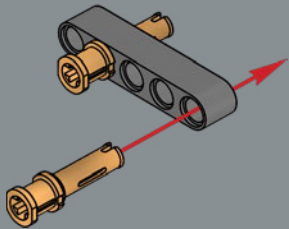

2

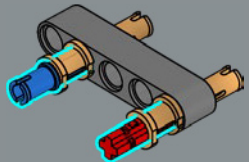

3

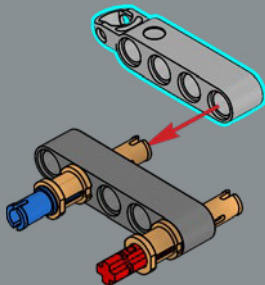

4

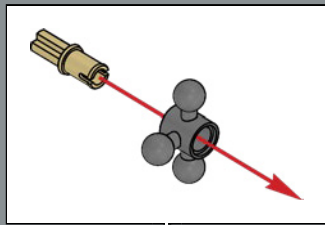
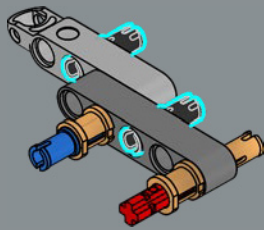

5

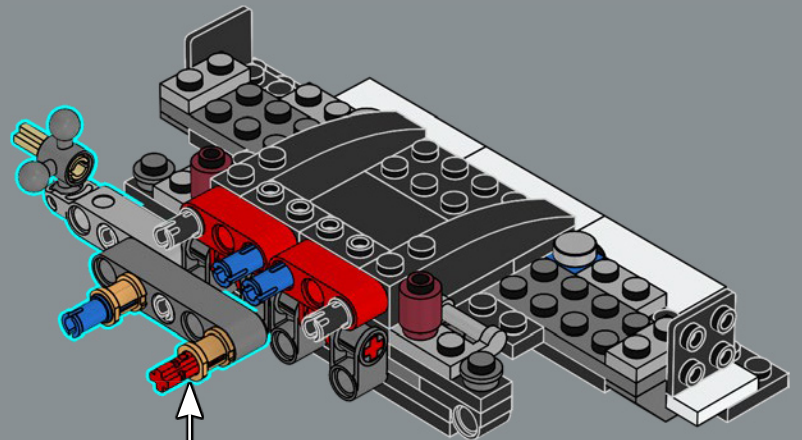
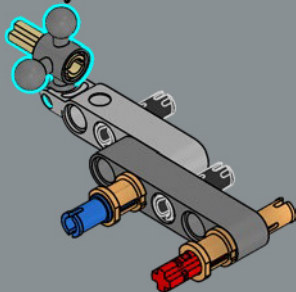

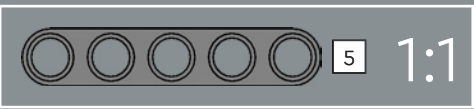
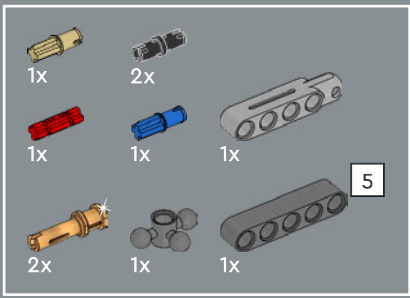

66

1

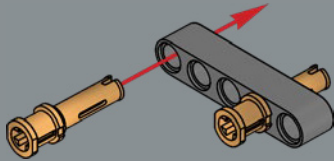

2

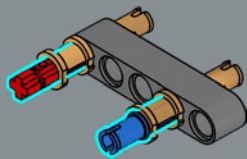

3

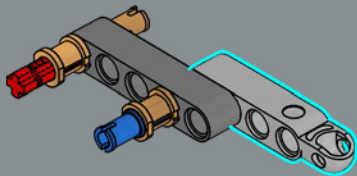

4

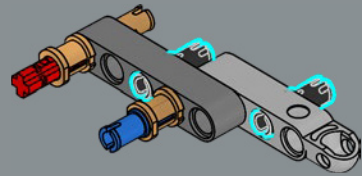

5

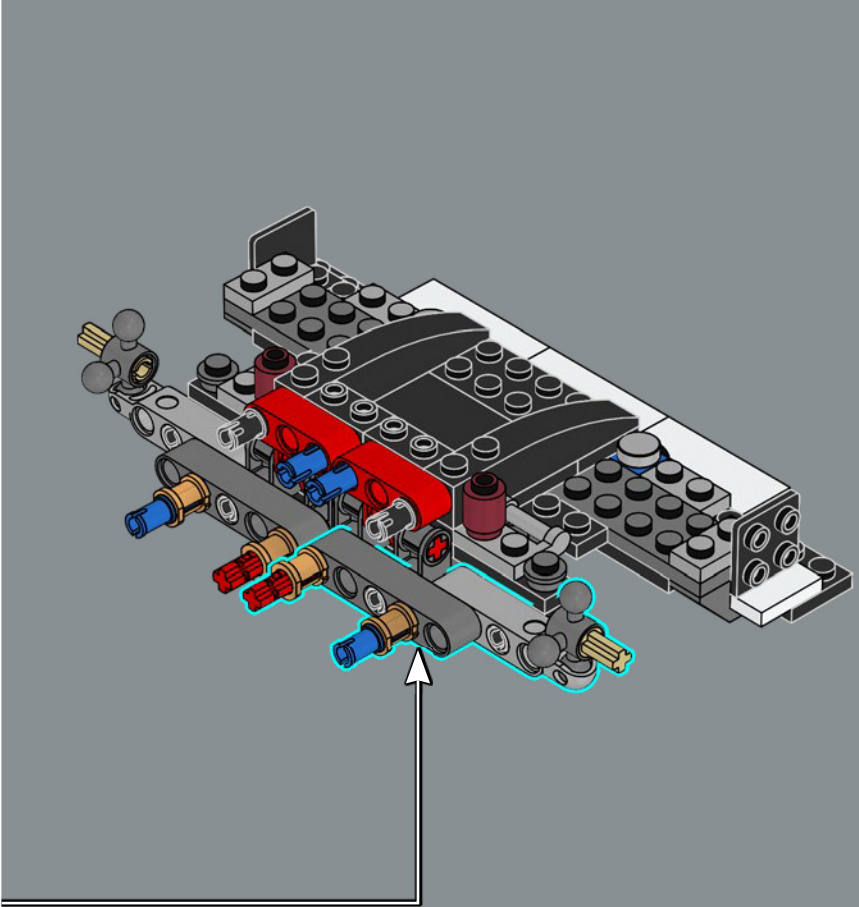
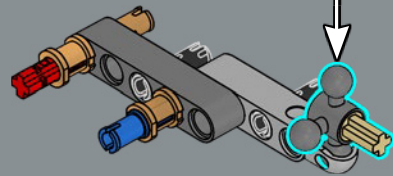

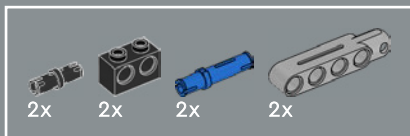

67

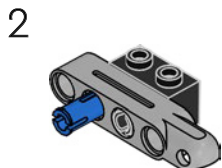
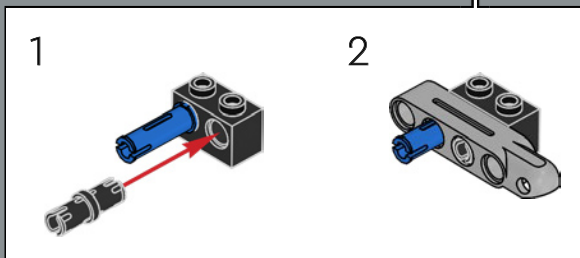
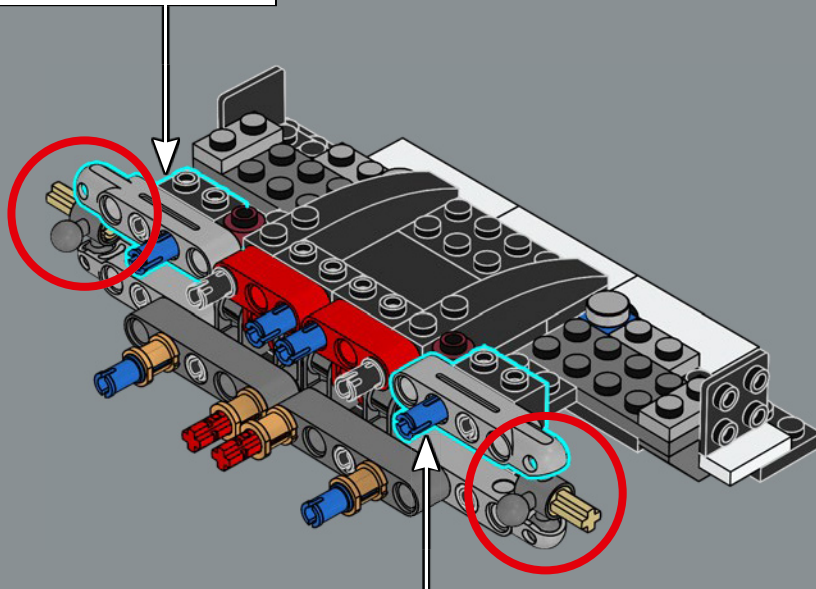
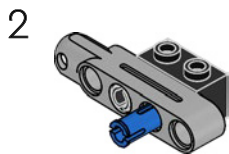
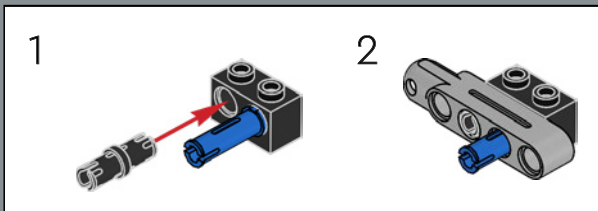

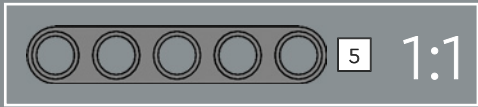
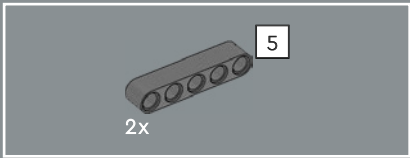

68

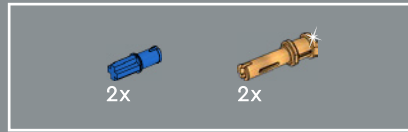
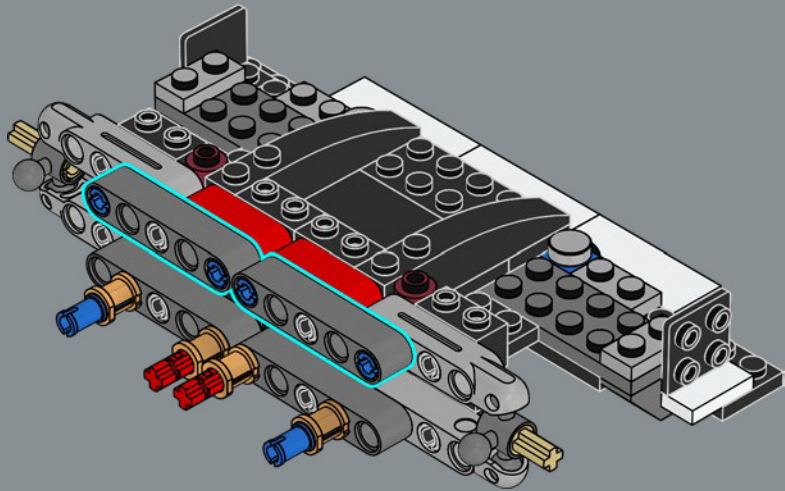

69

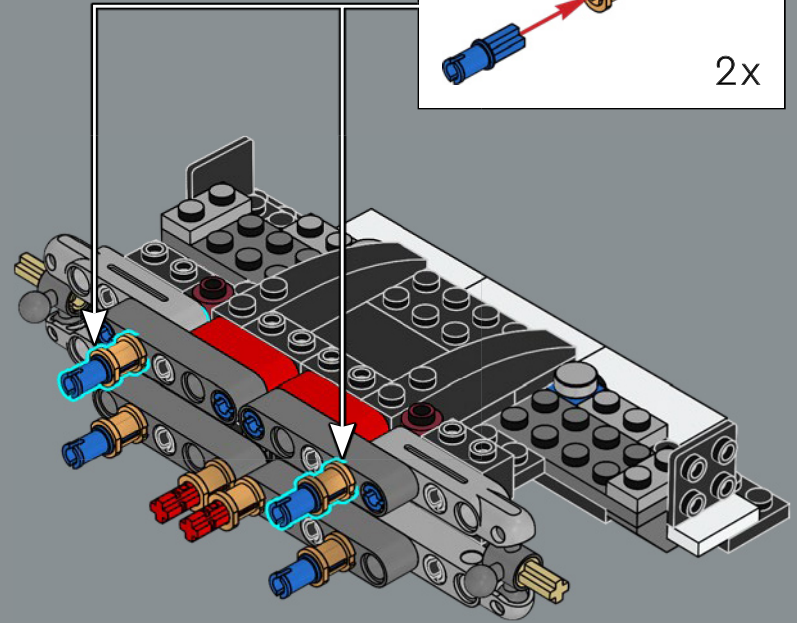
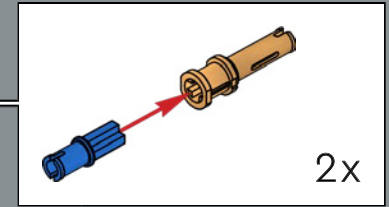

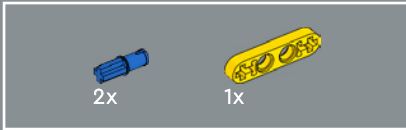
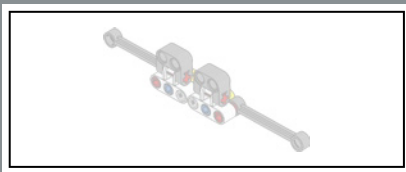

2x

1x

70

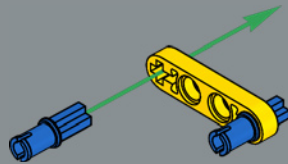

1x

71

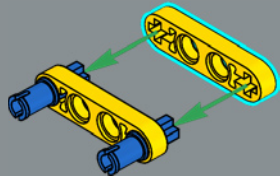

2x

72

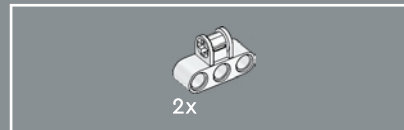
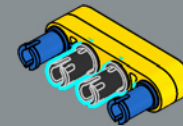

2x

73

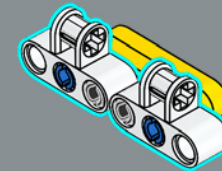

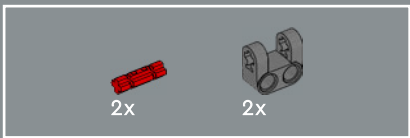

74

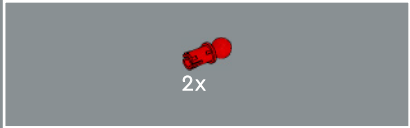
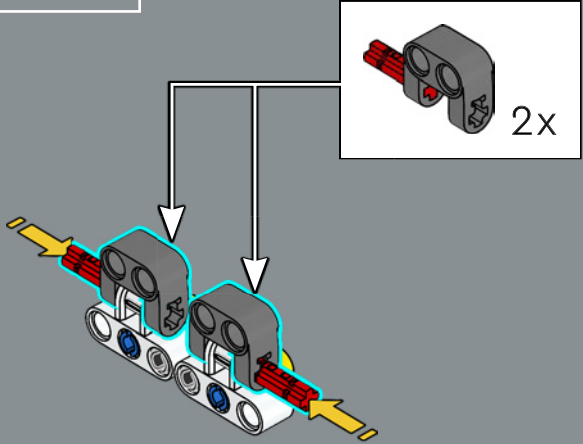

75

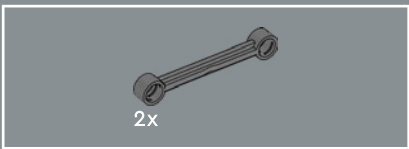
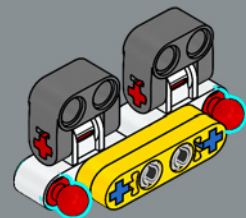

76

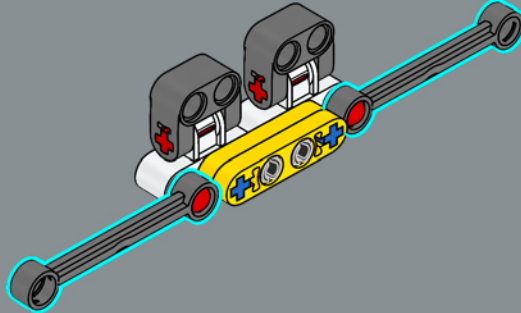

77

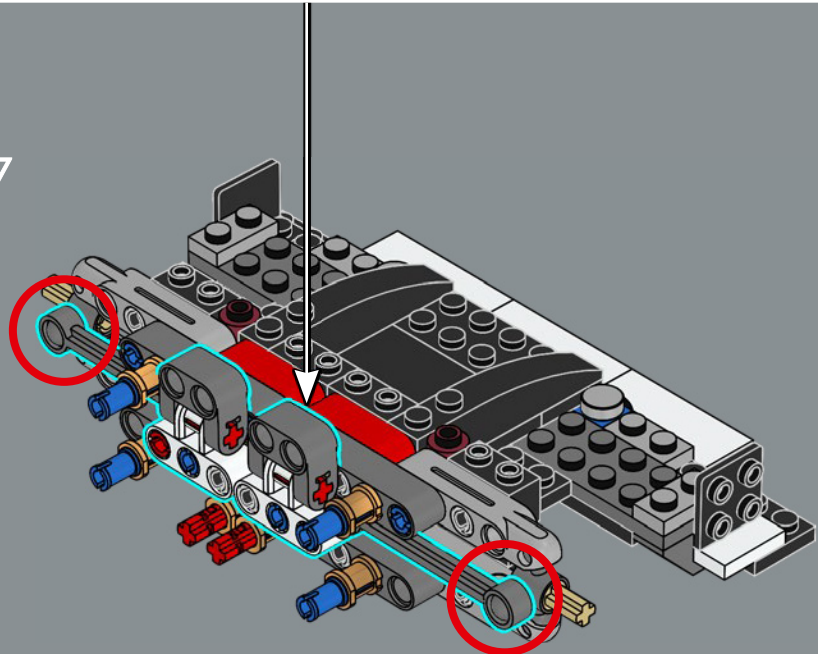

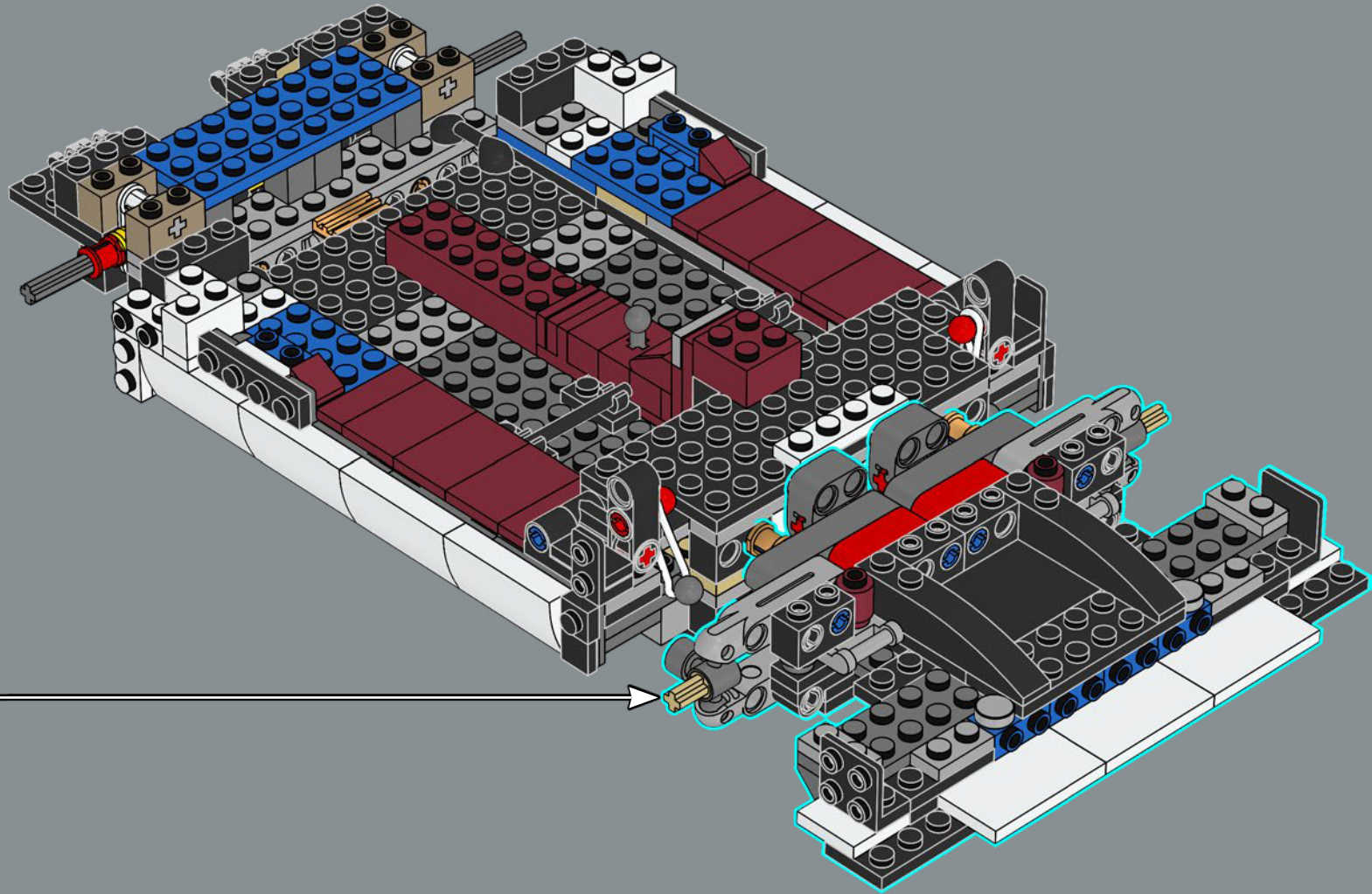

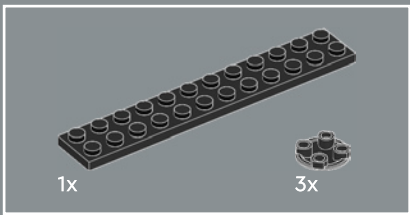

79

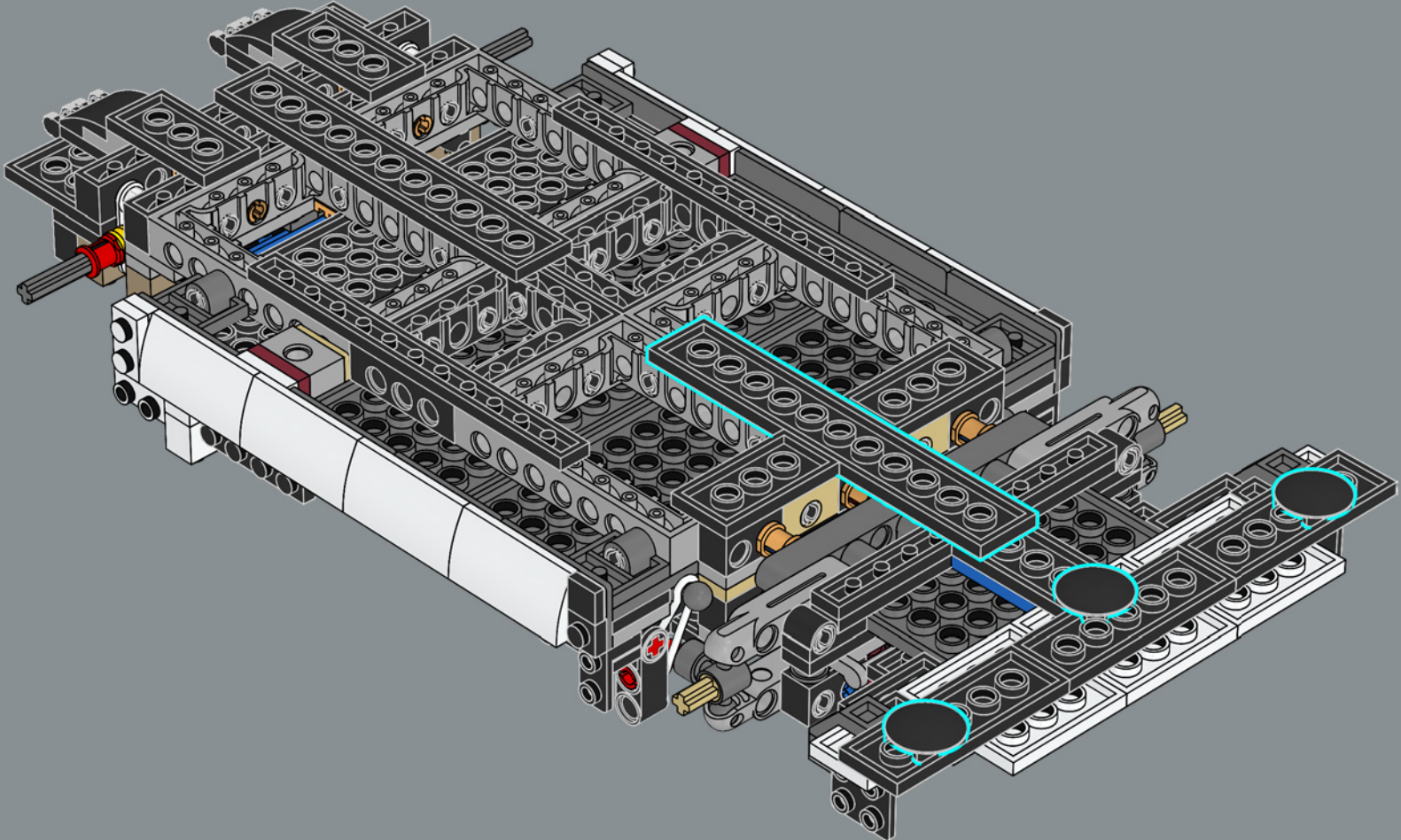

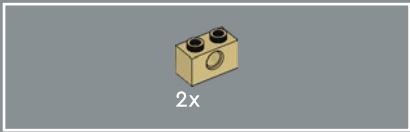

80

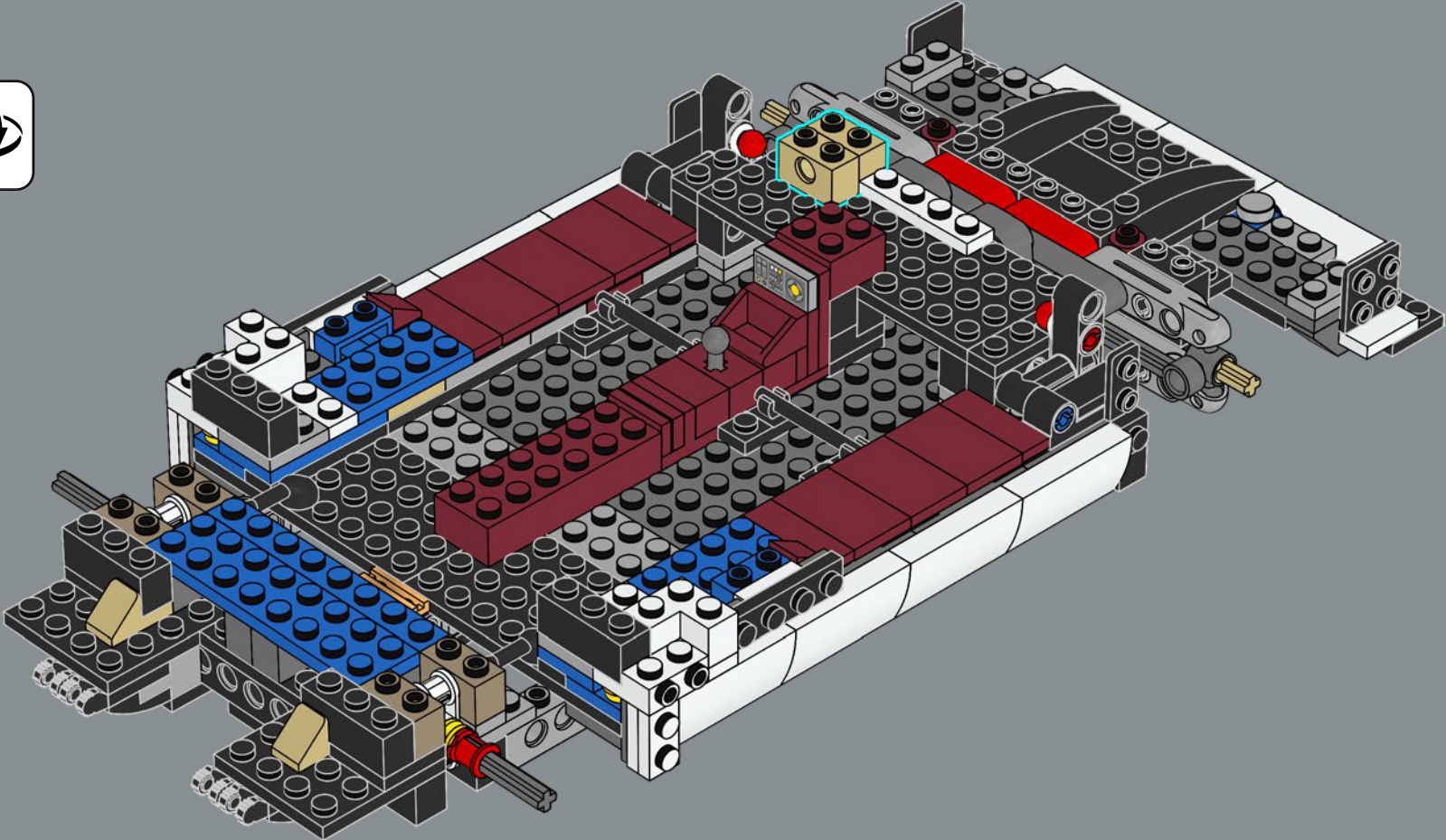

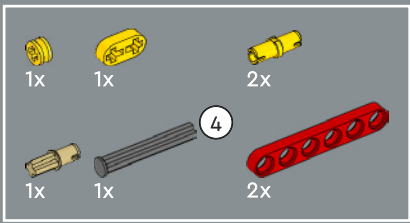

81

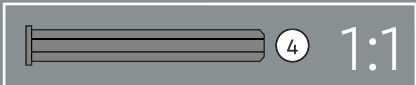
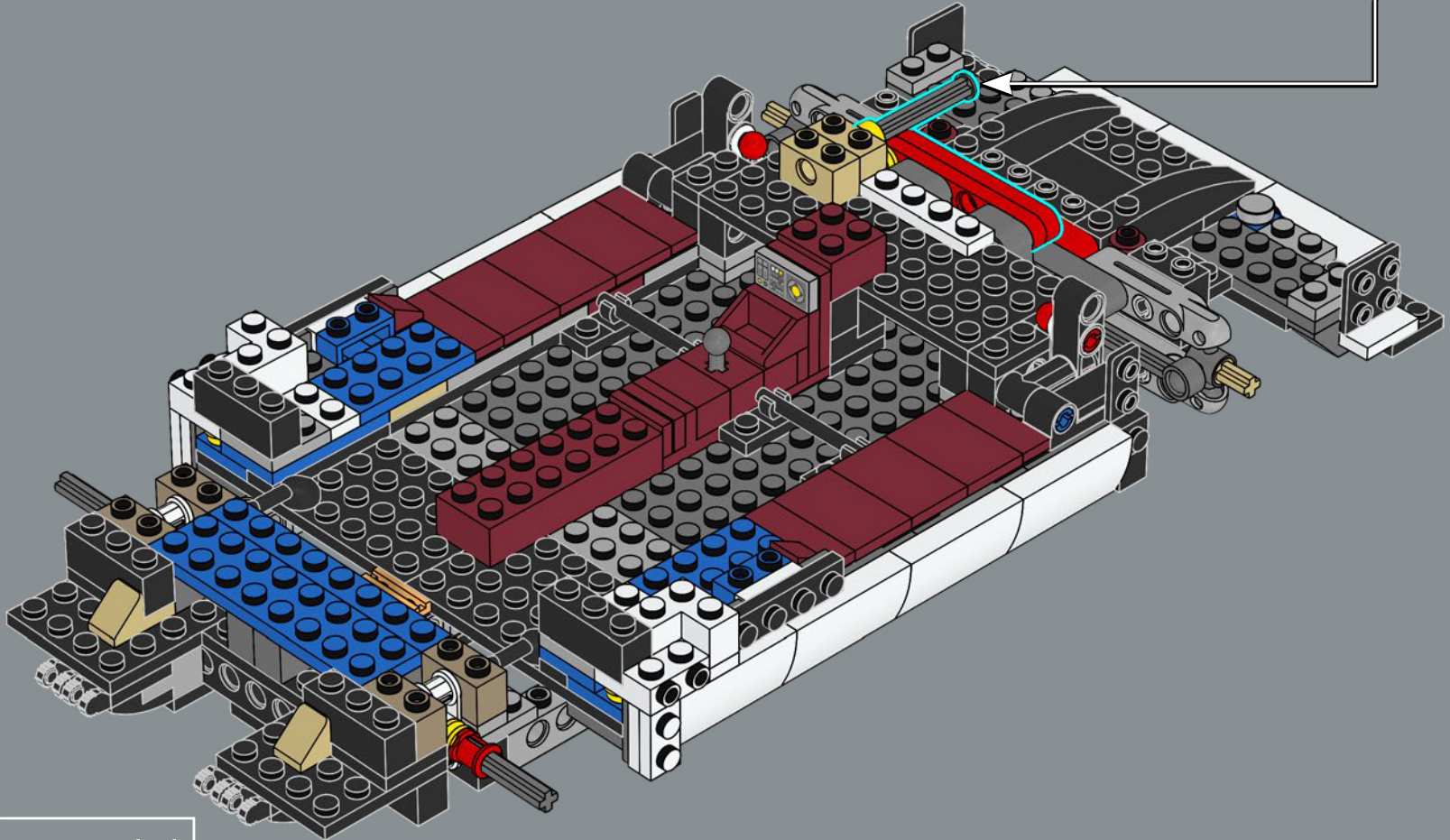
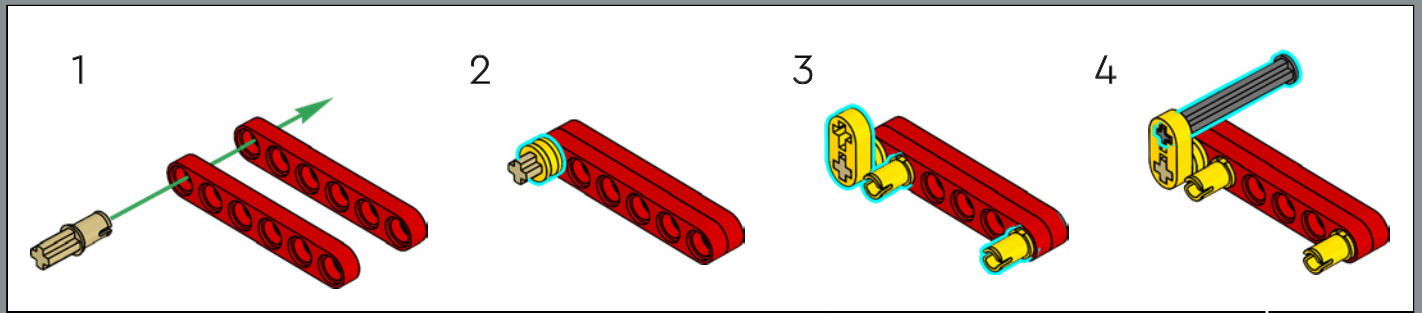



1x

82

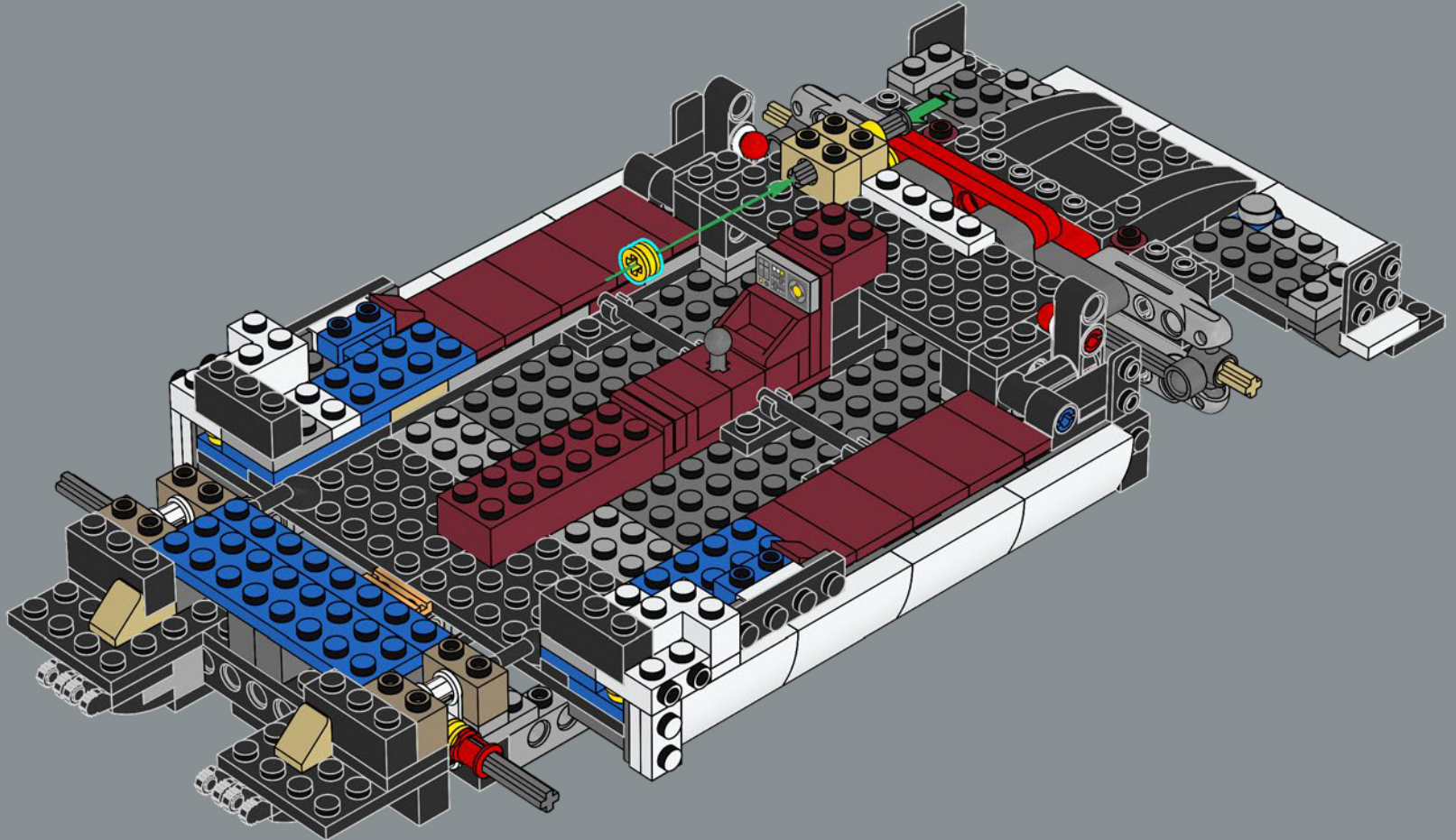

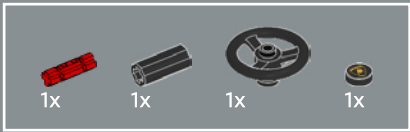

83

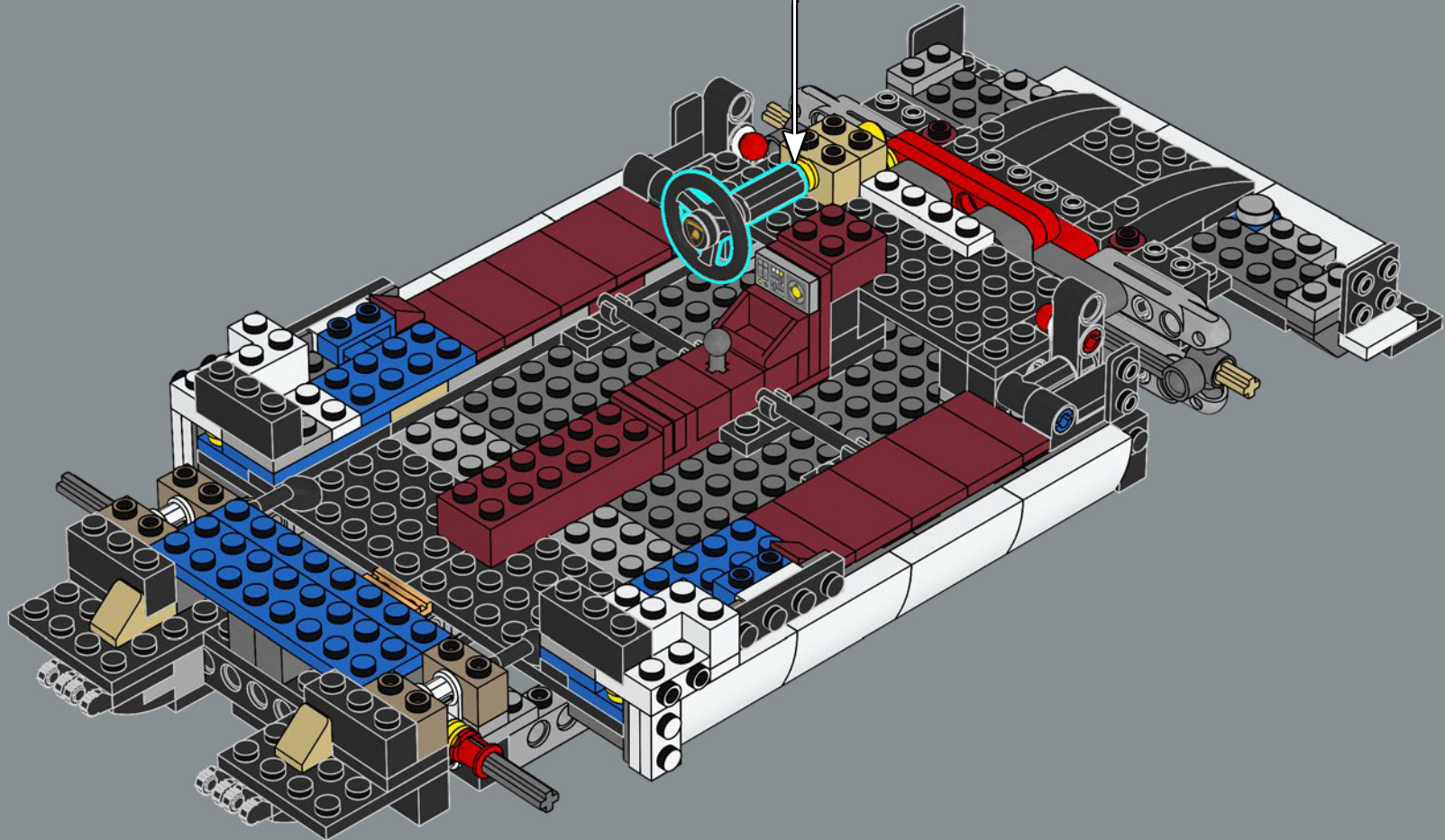
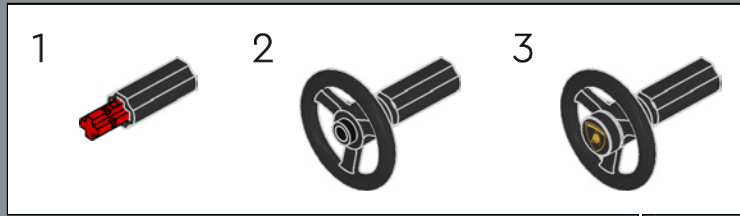

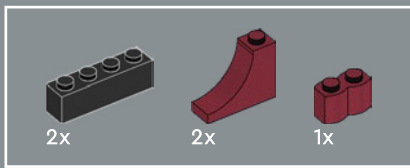

84

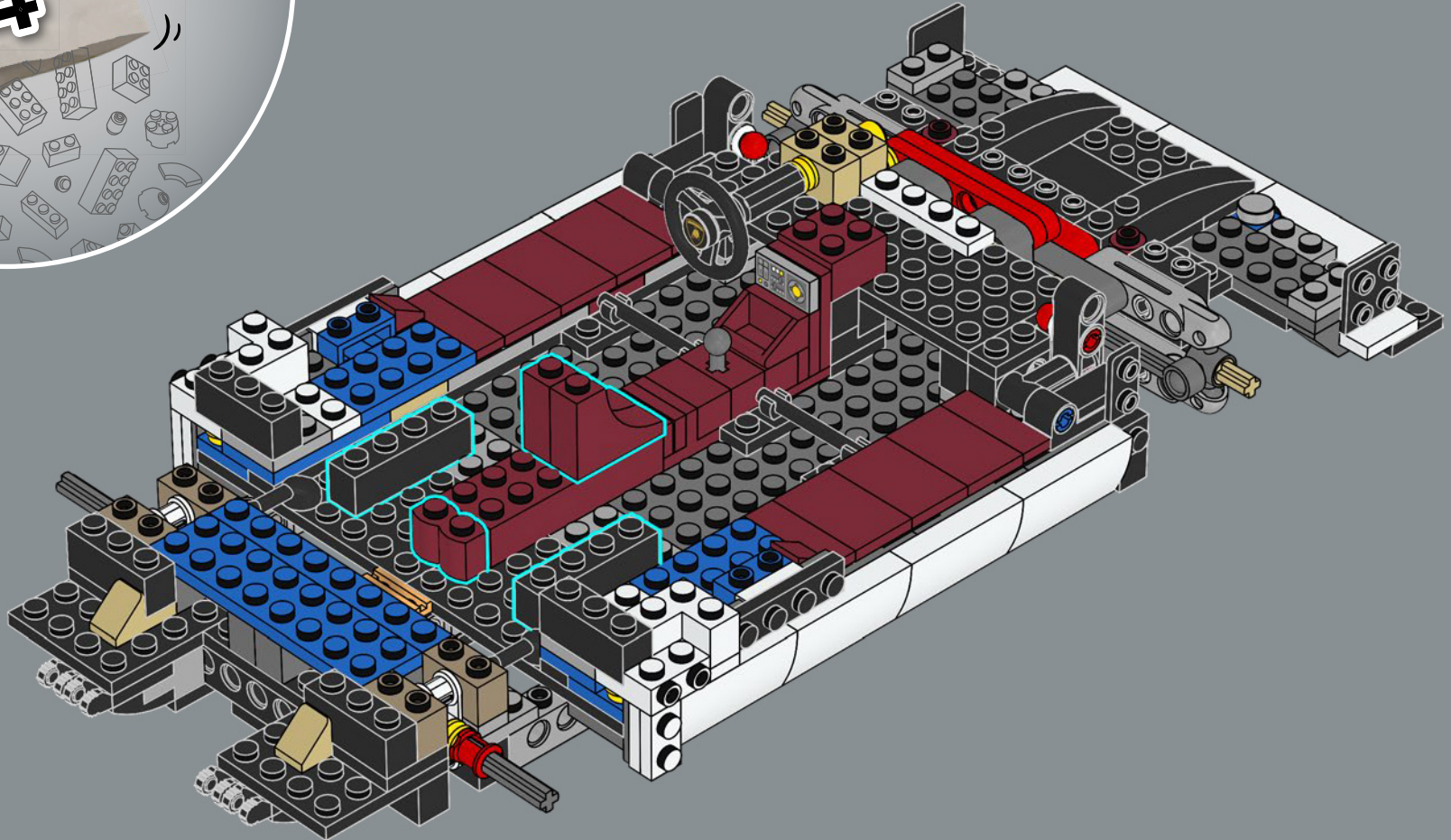

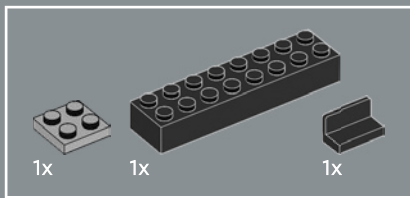

85

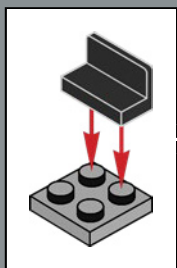
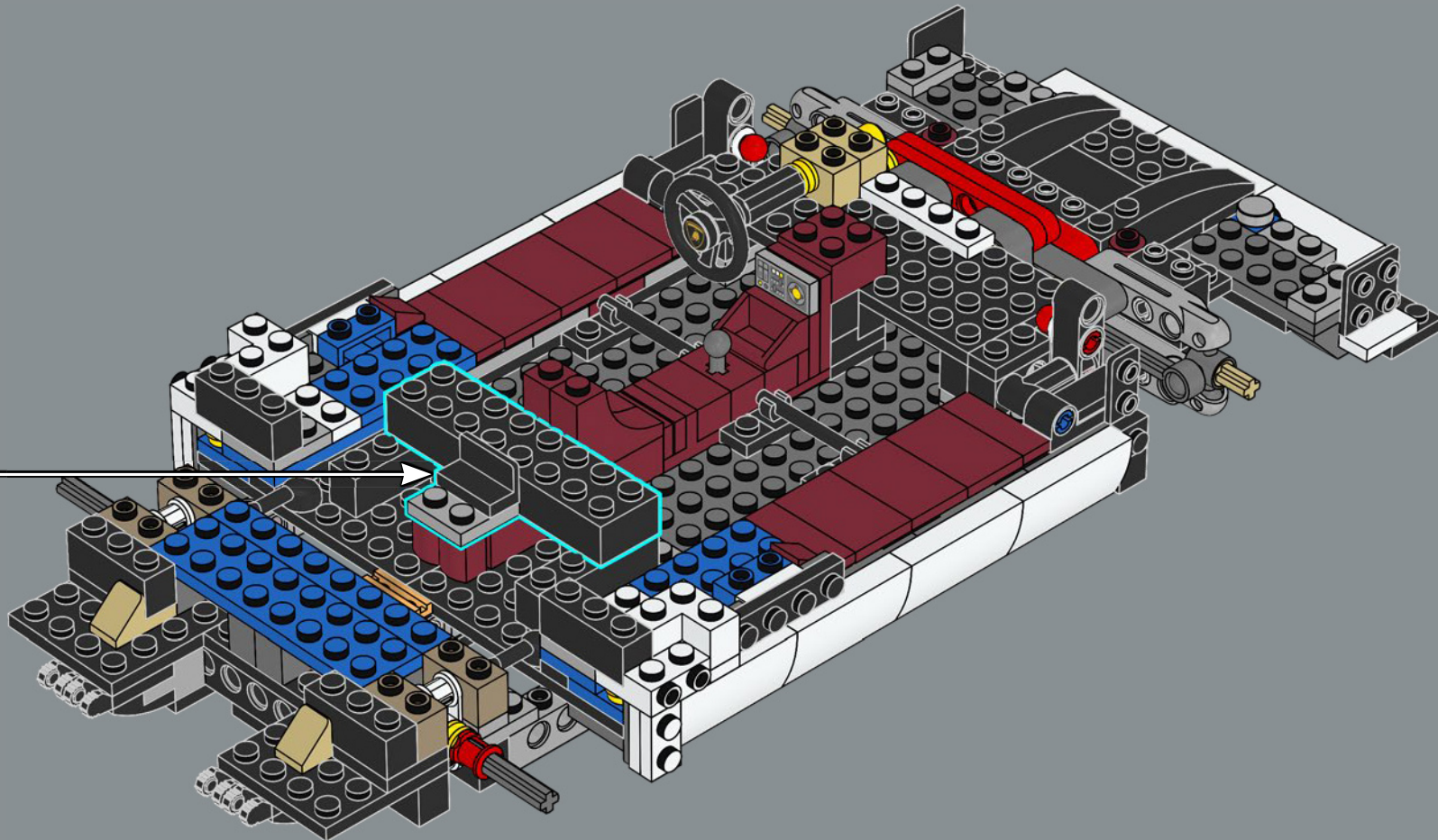

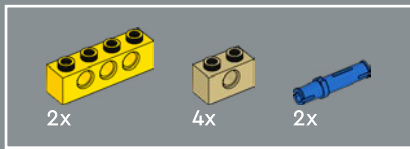

86

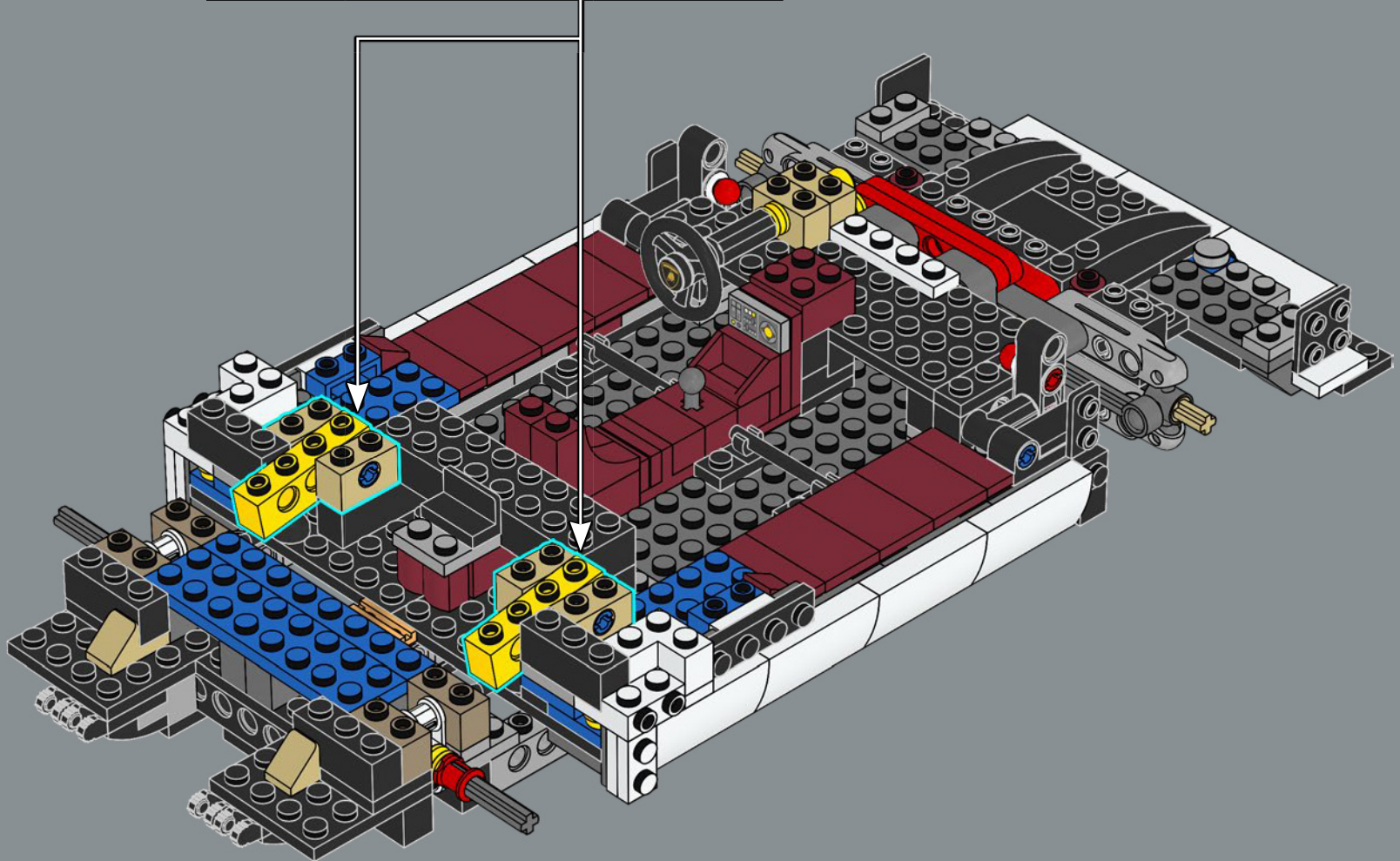
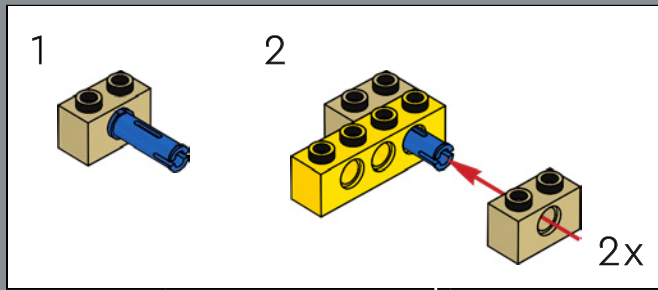

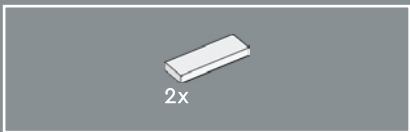

87

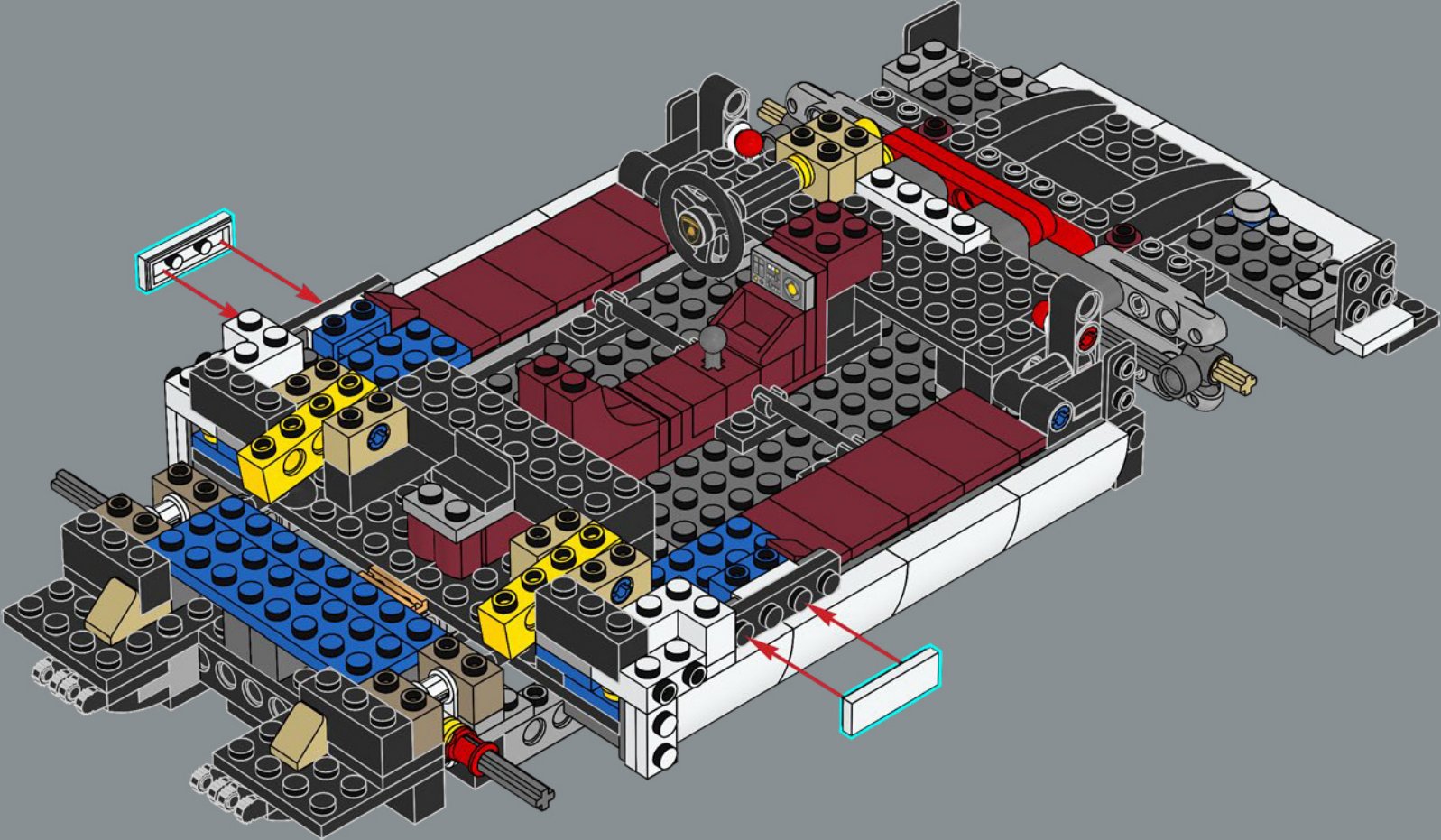

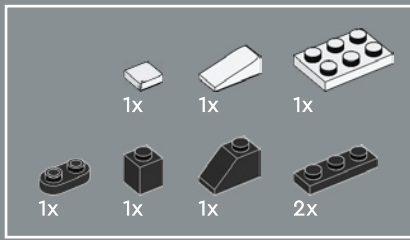

88

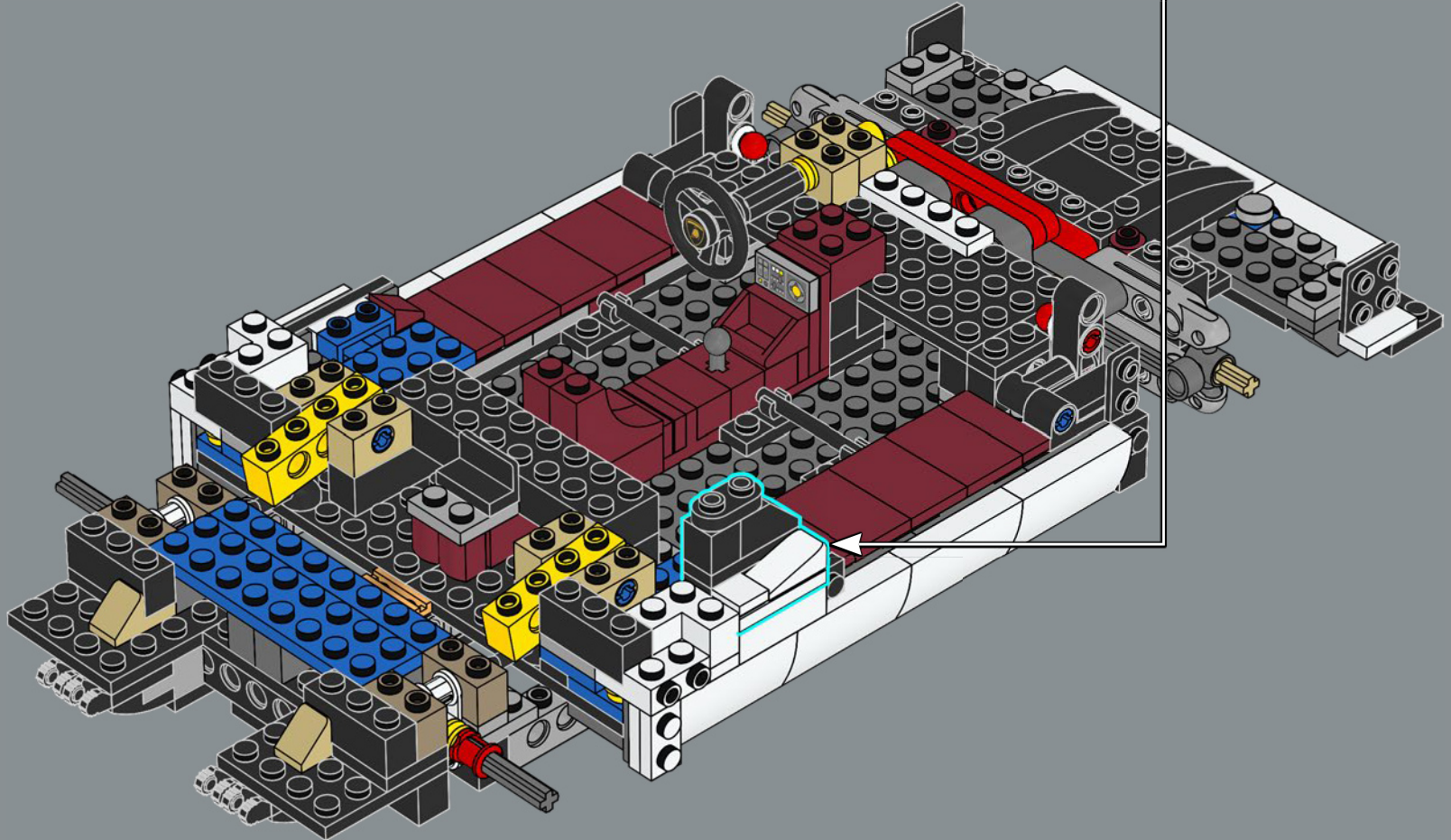
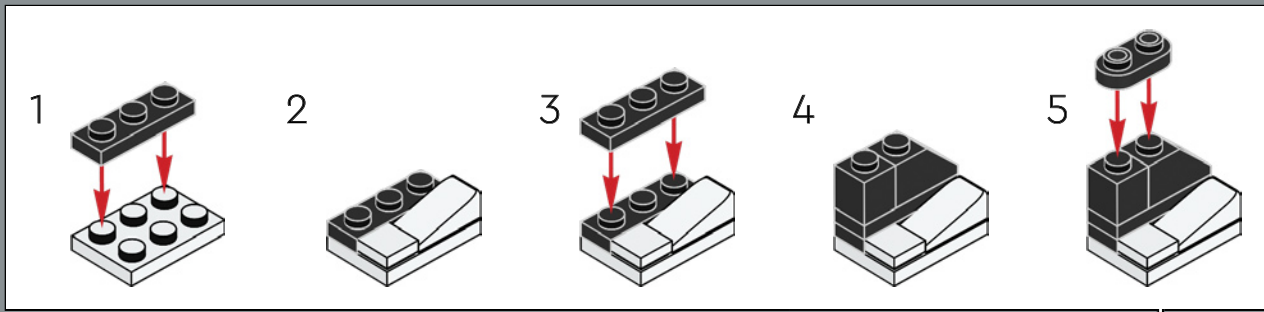

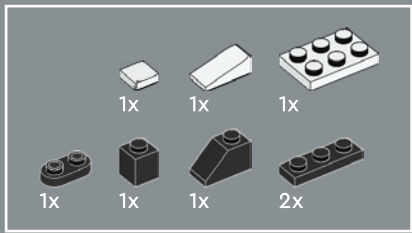

89

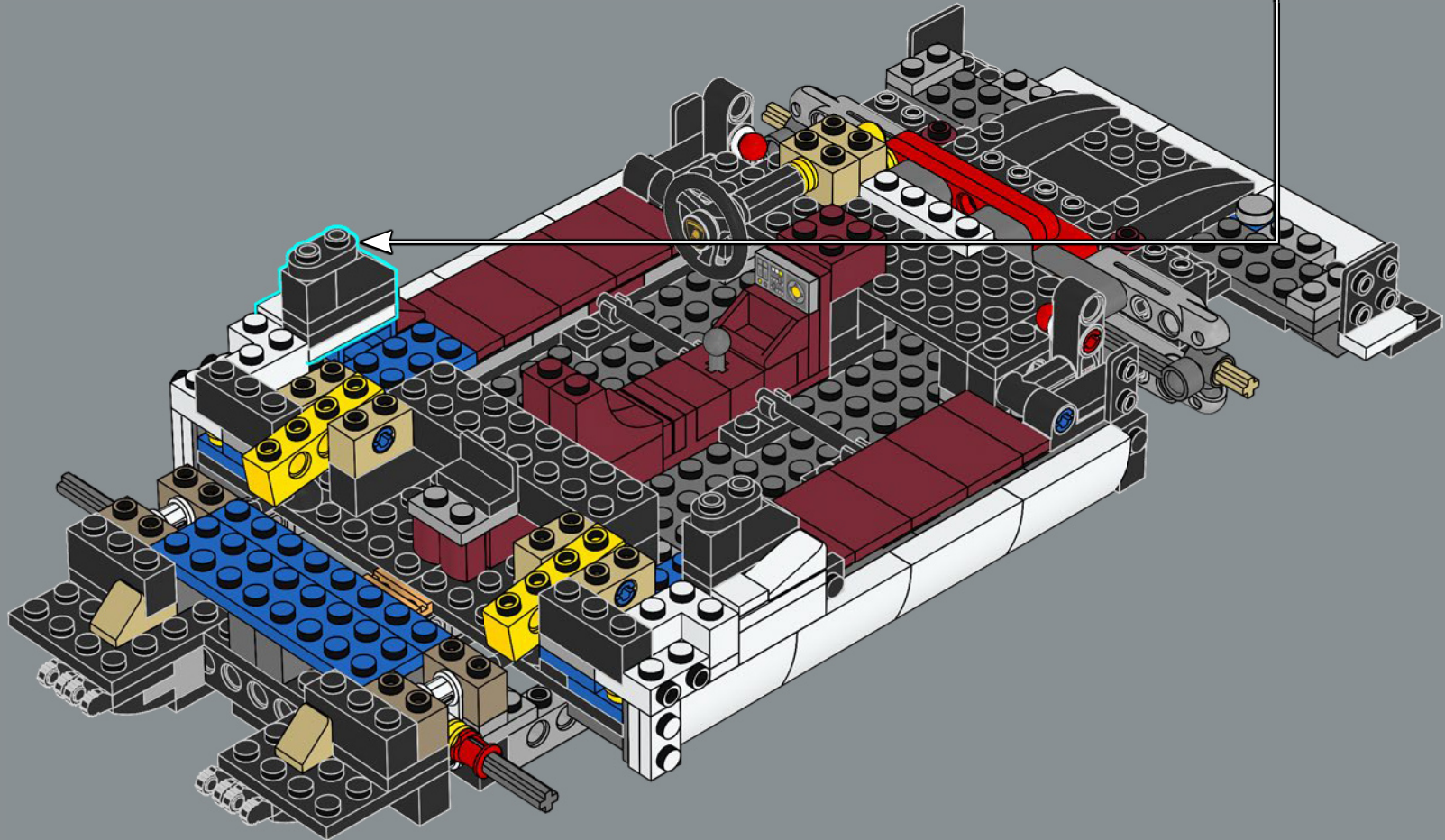
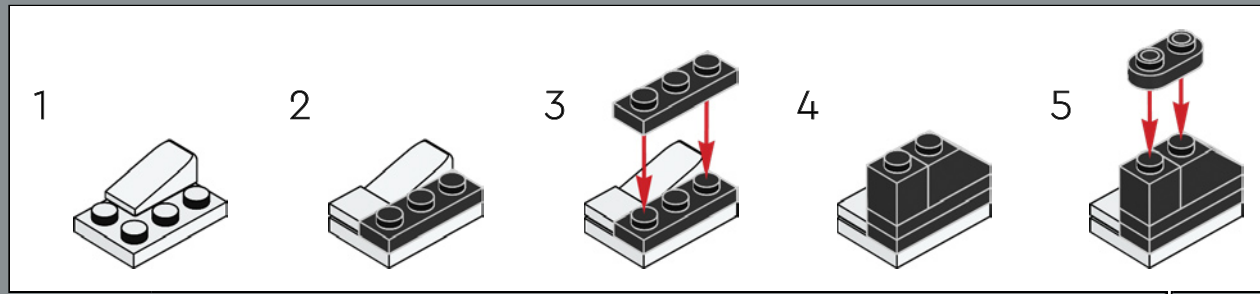

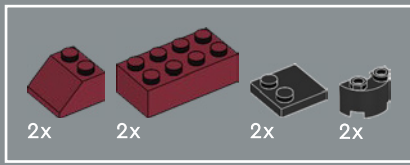

90

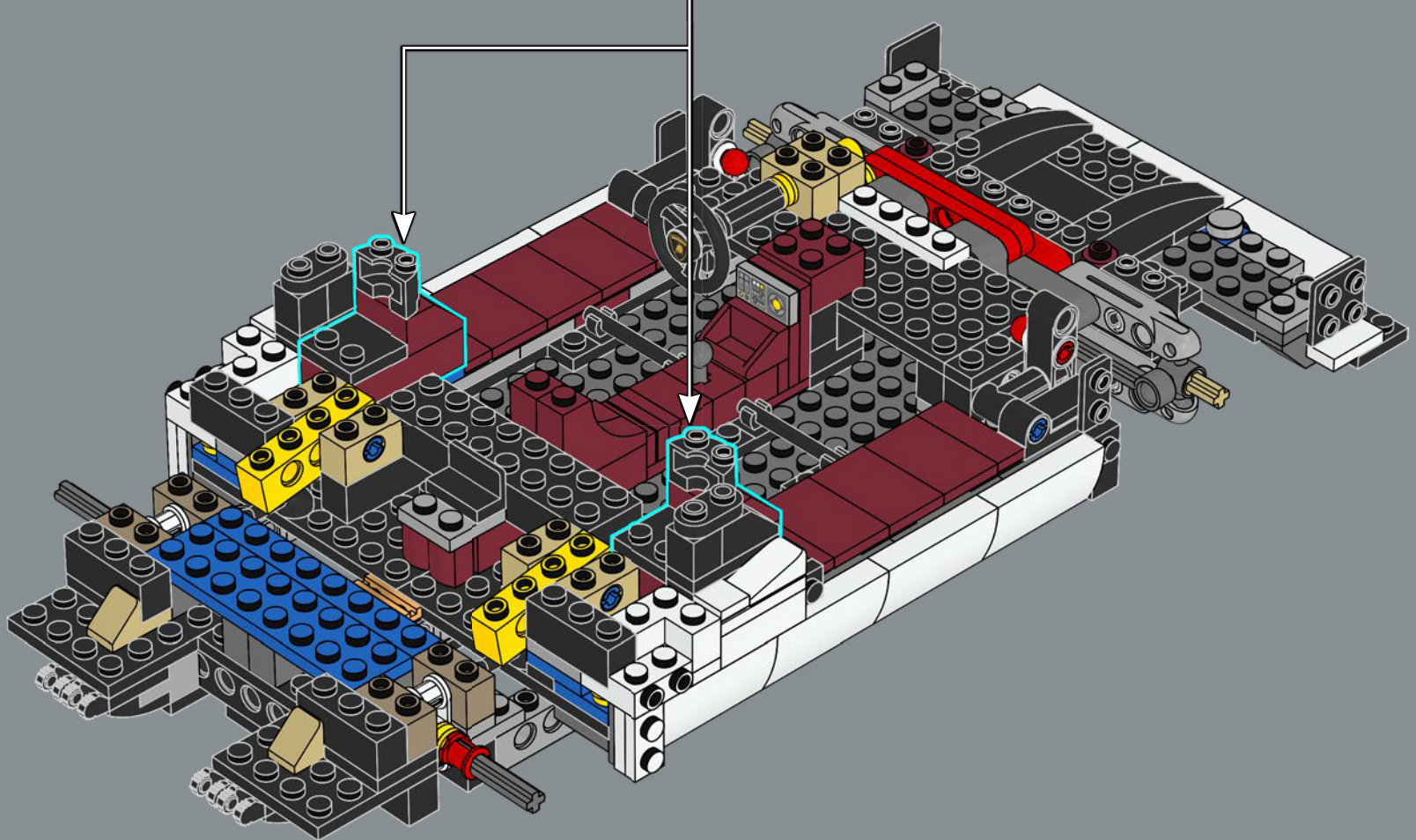
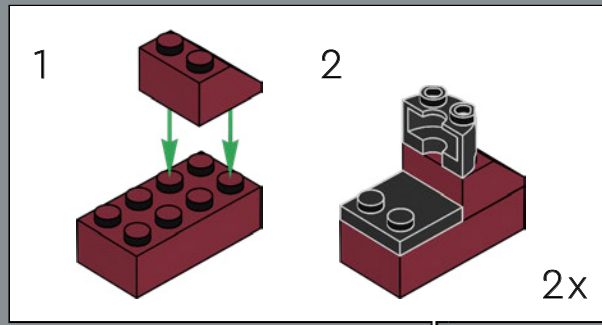

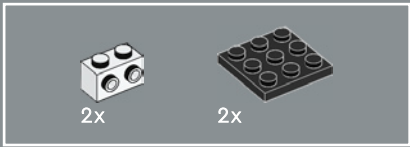

91

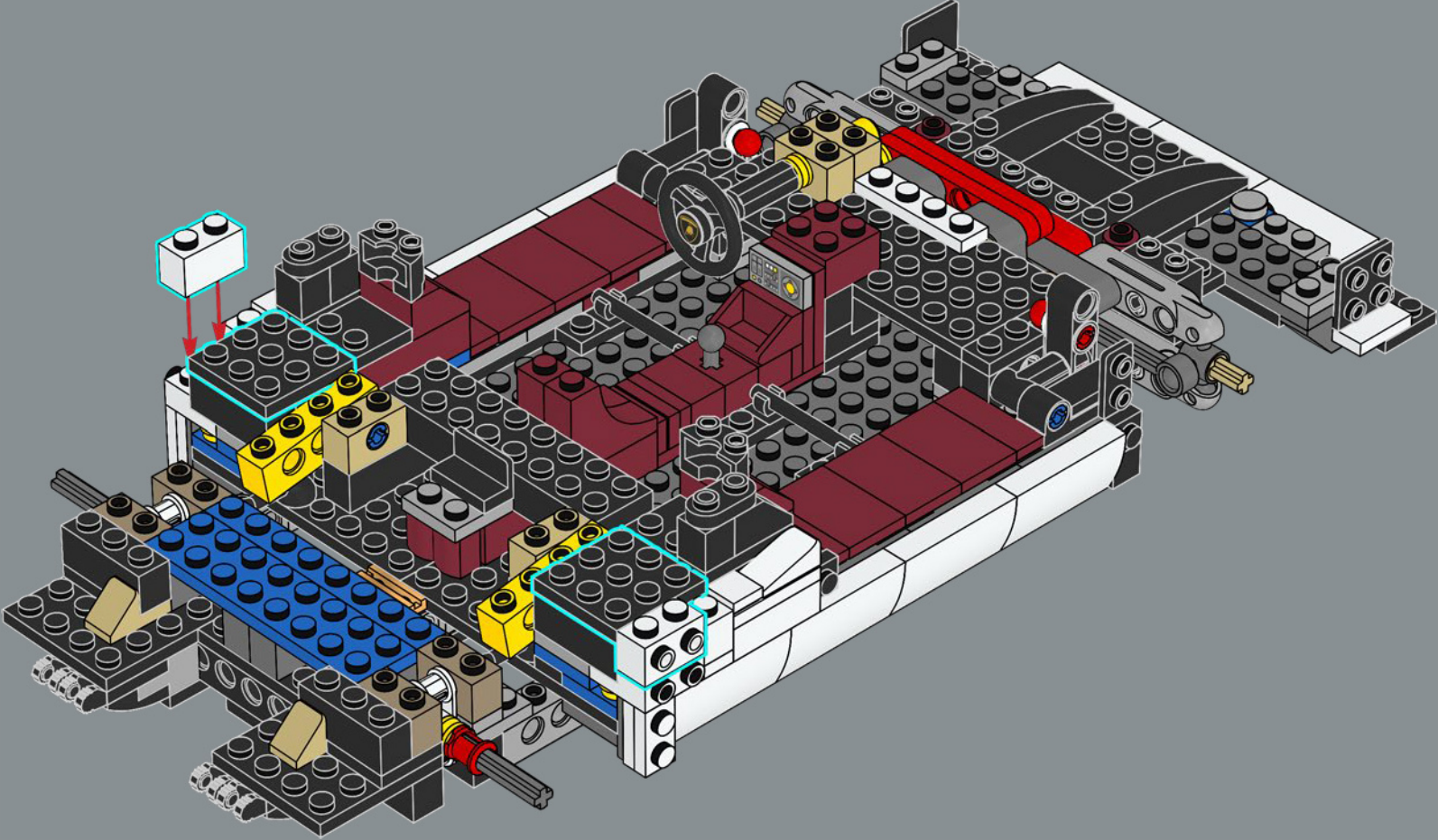

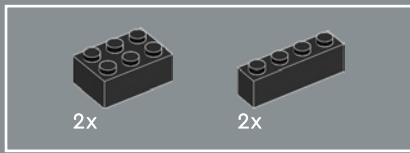

92

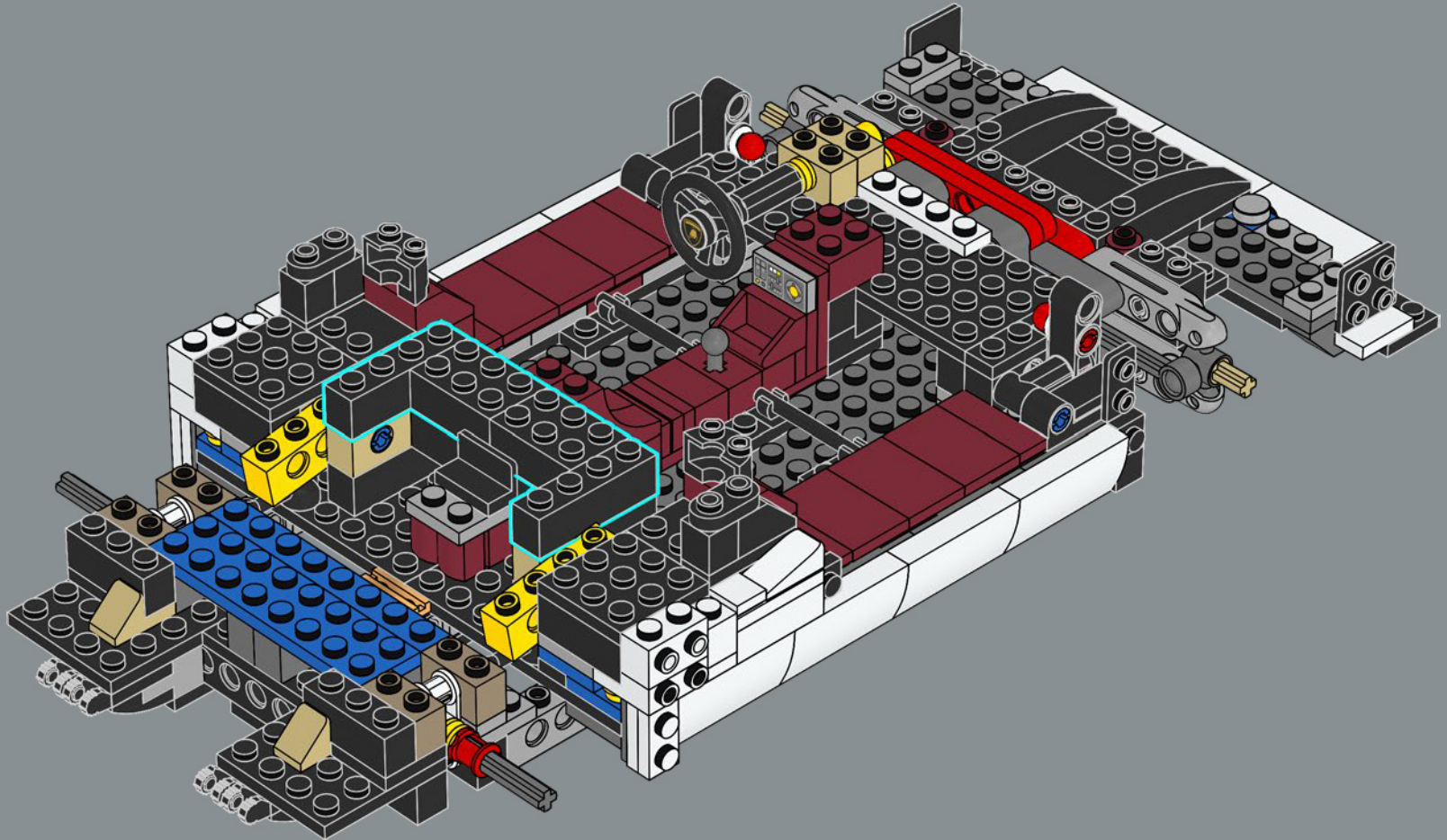

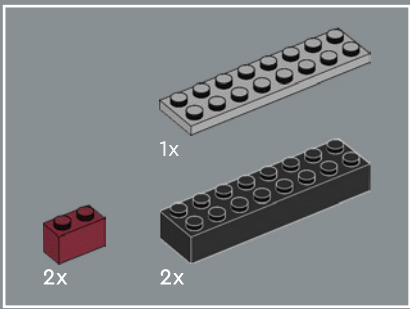

93

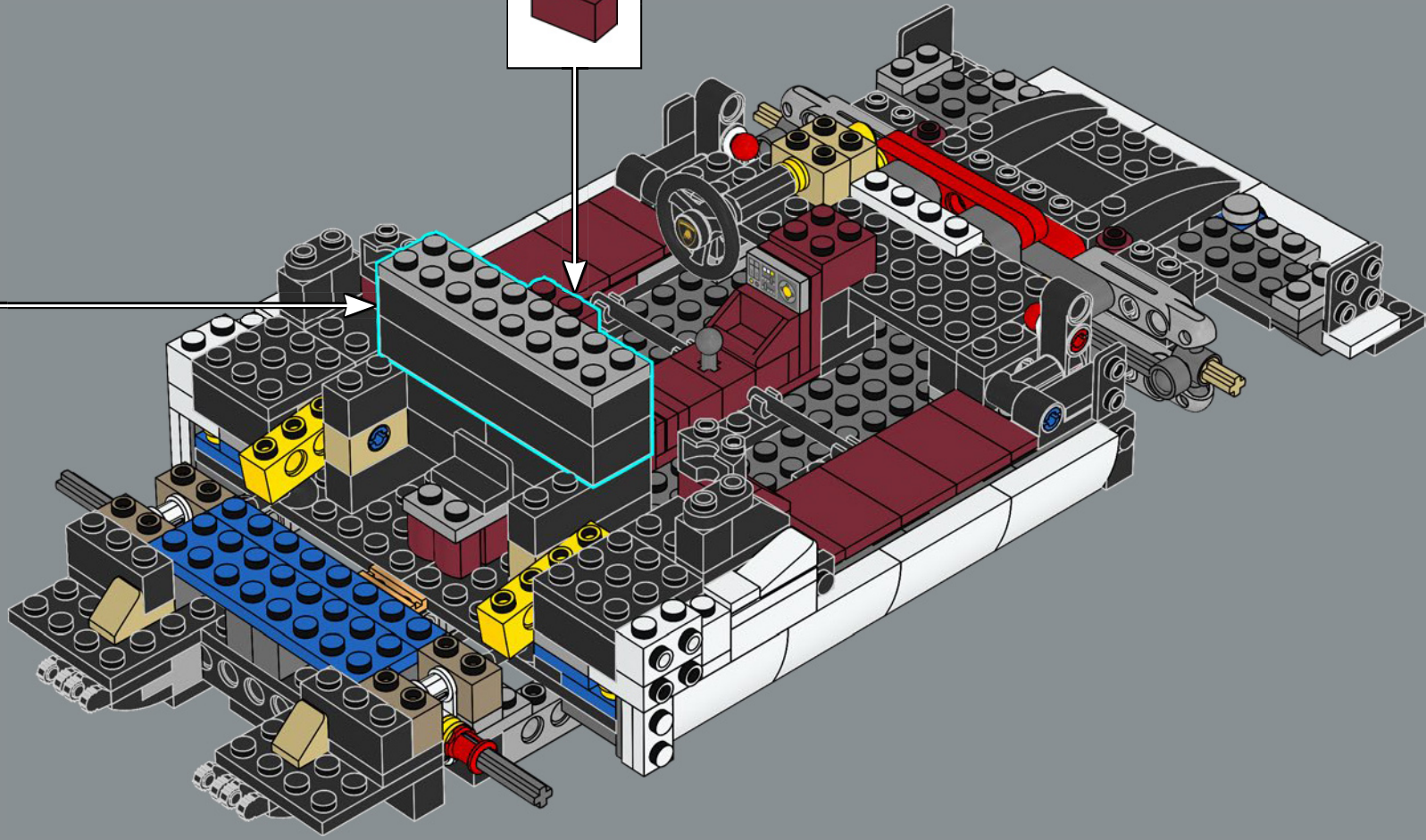
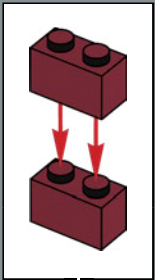
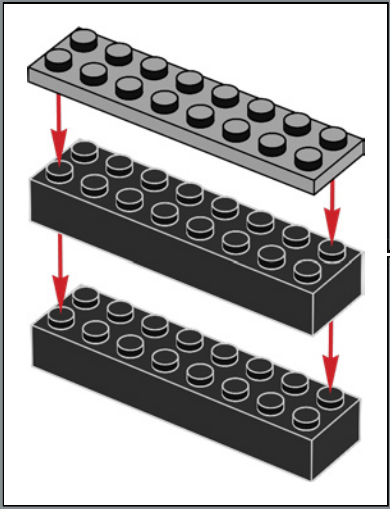

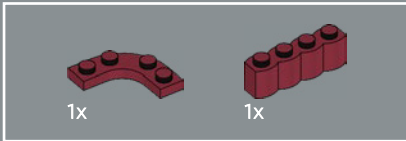
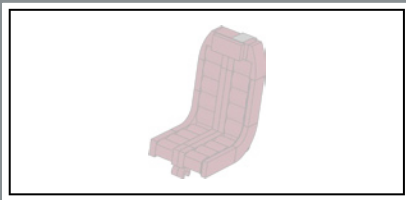

94

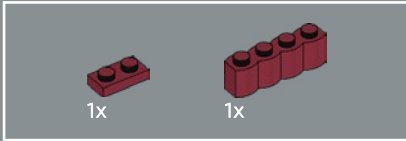
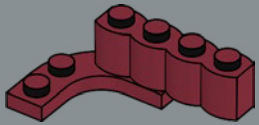

95

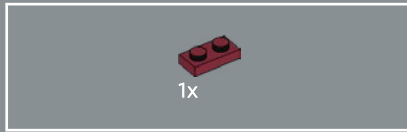
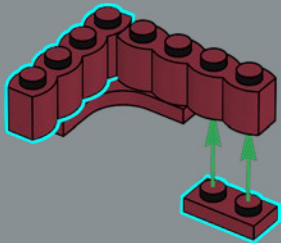

96

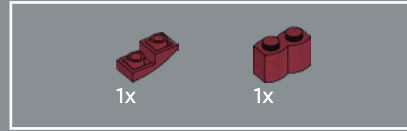
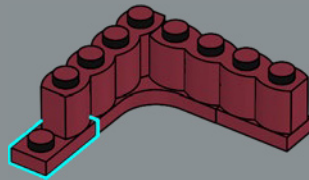

97

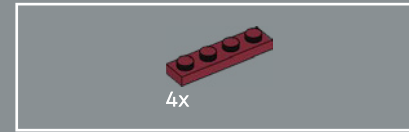
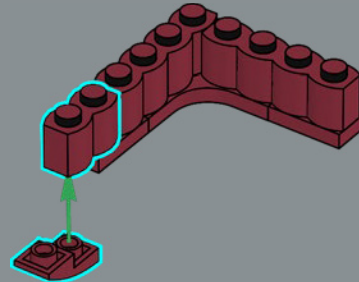

98

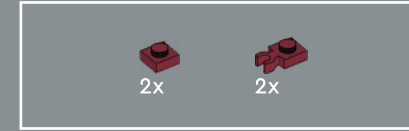
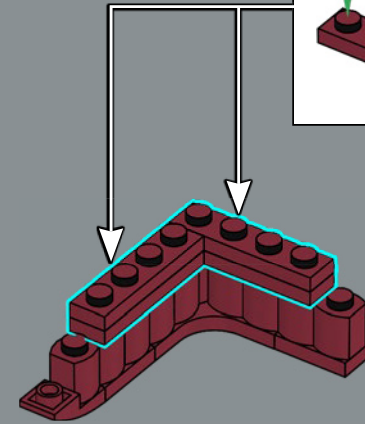
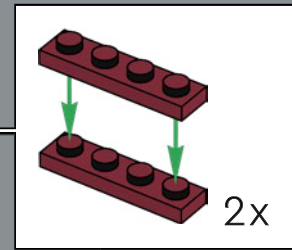

99

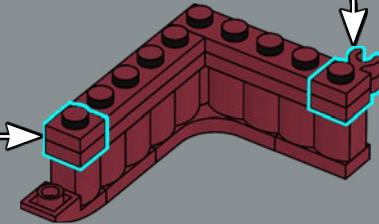
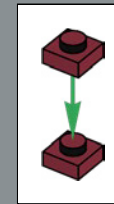
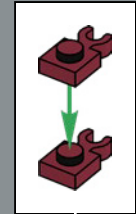

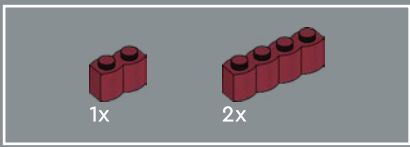

100

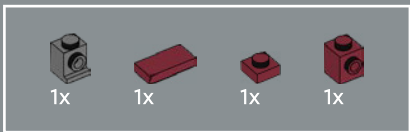
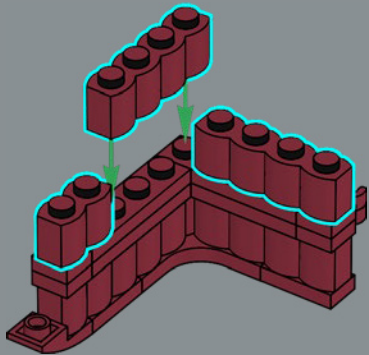

101

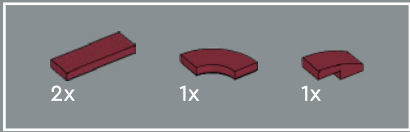
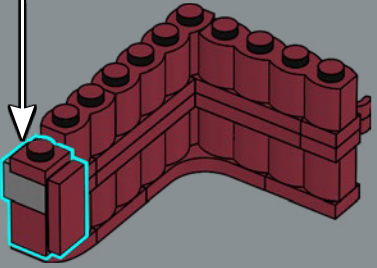
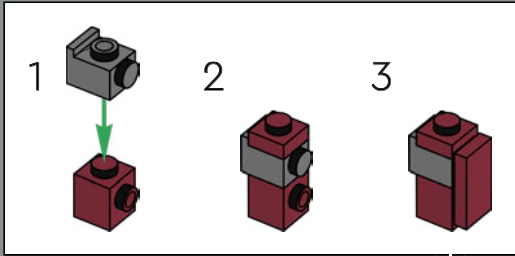

102

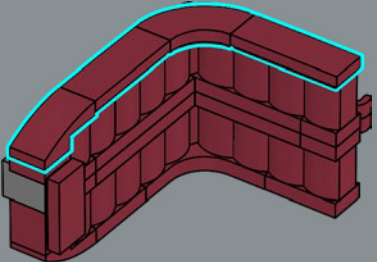

103

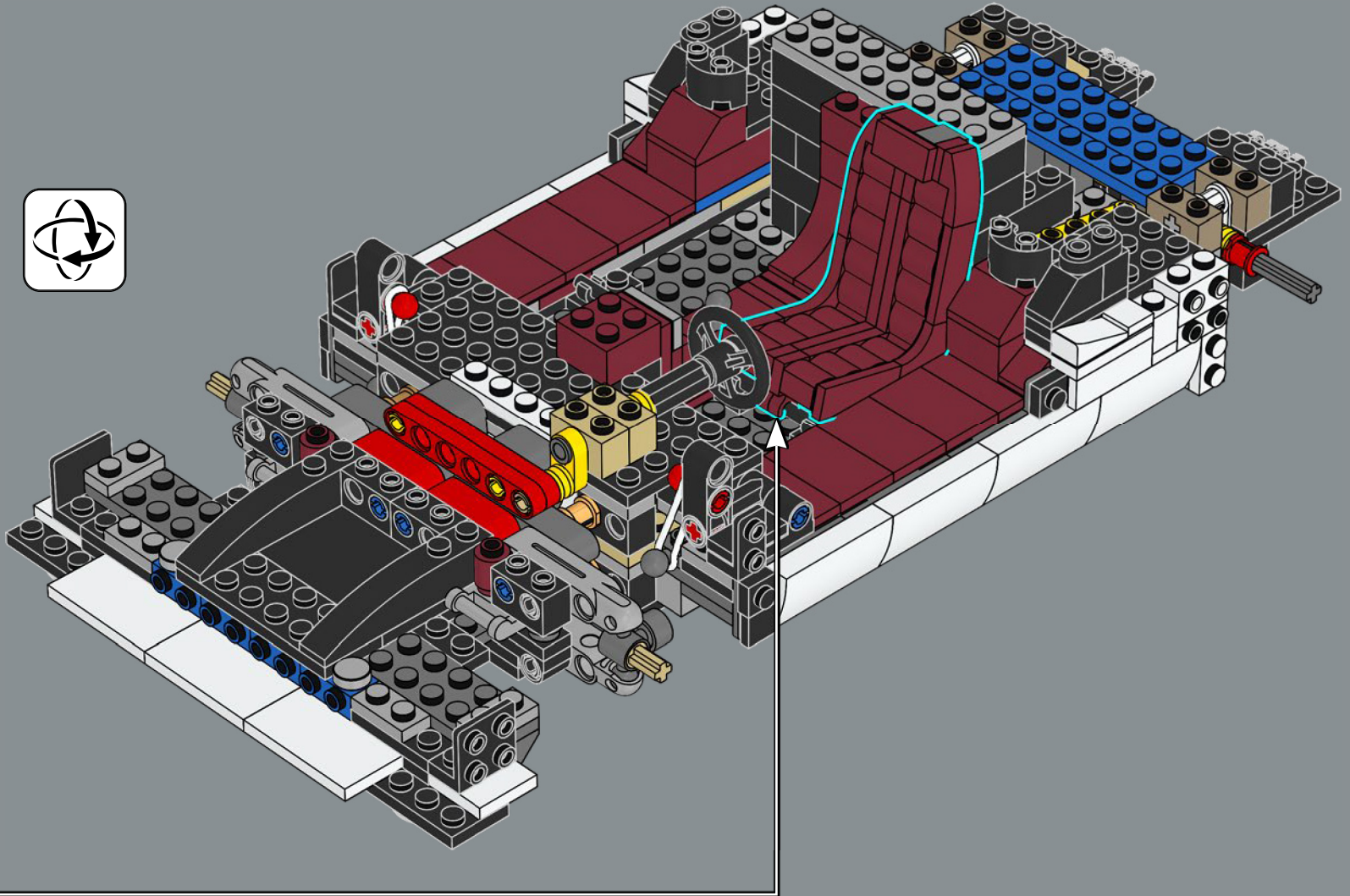

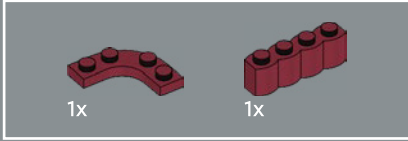

104

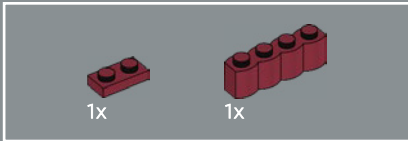
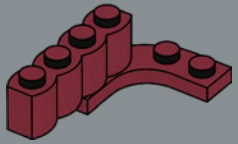

105

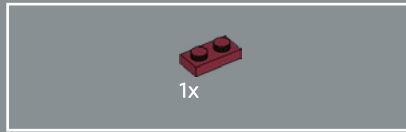
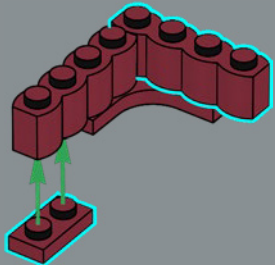

106

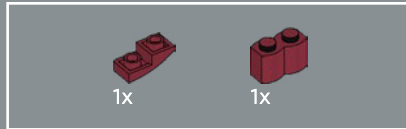
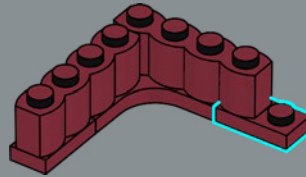

107

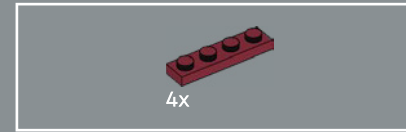
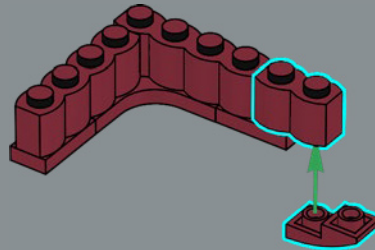

108

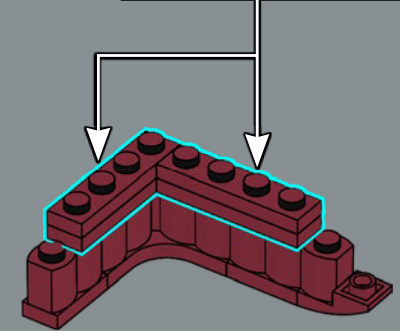
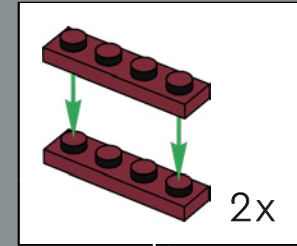



109

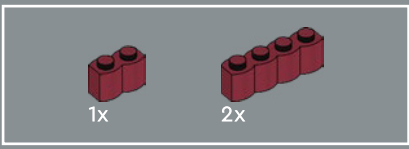
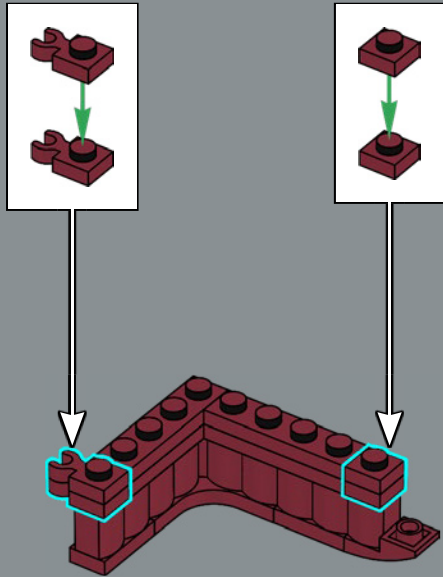

110

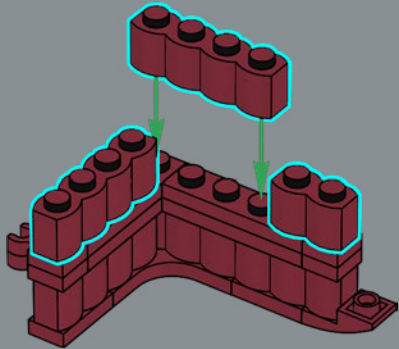

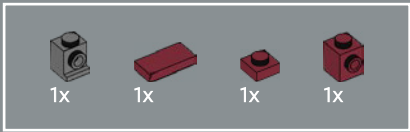

111

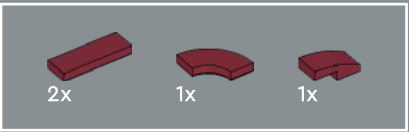
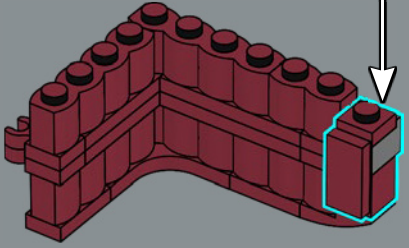
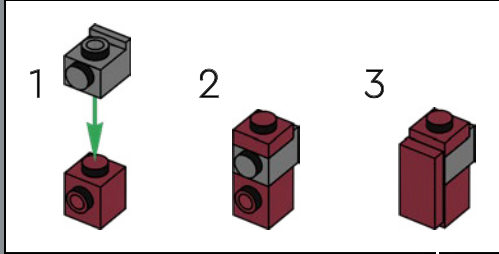

112

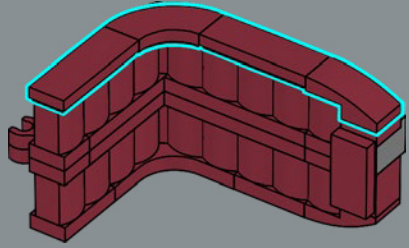

113

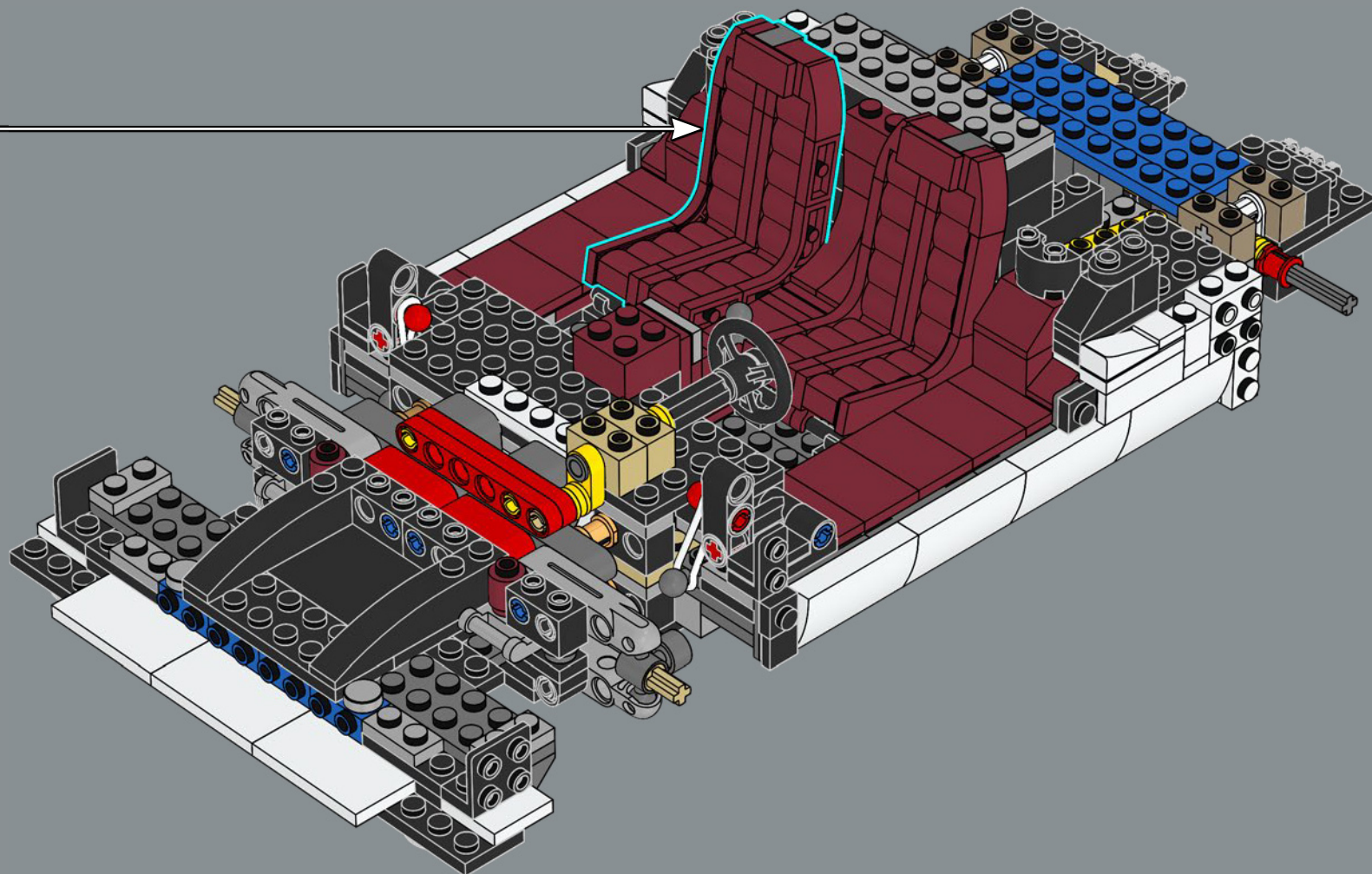

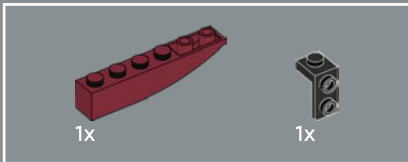
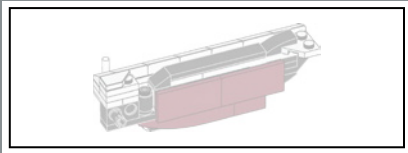

114

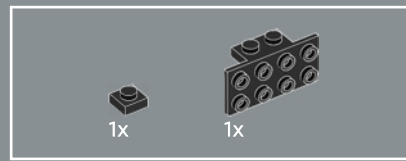
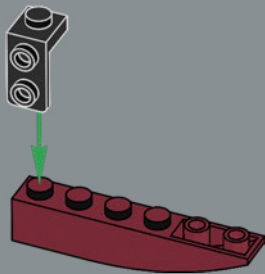

115

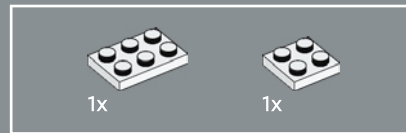
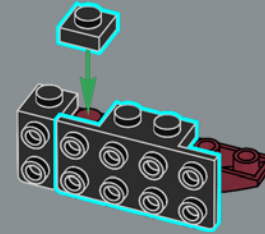

116

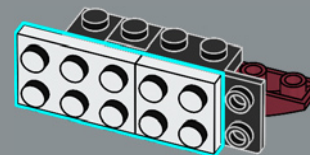

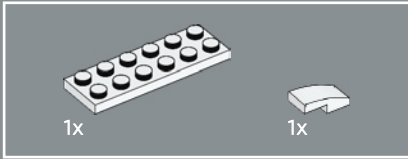
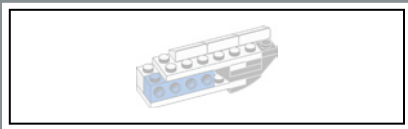

121

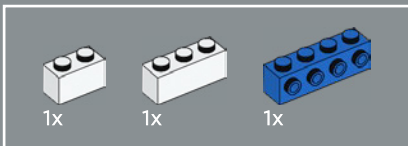
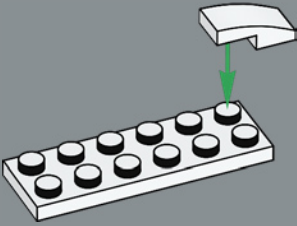

122

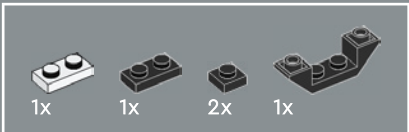
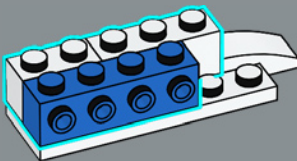

123

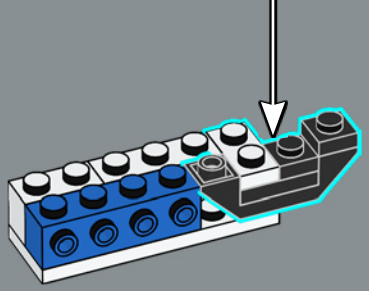
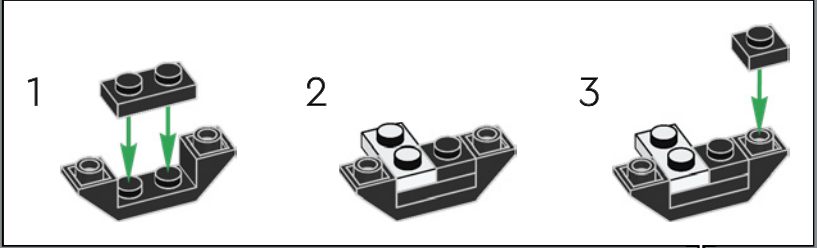

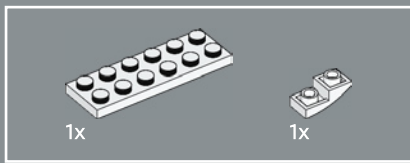

124

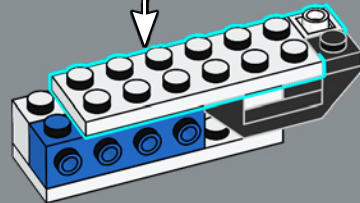
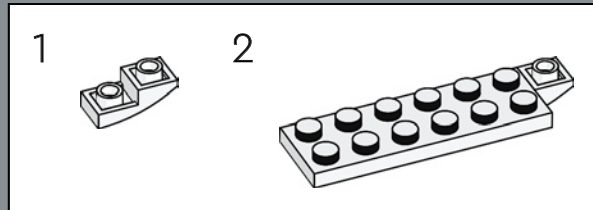

125

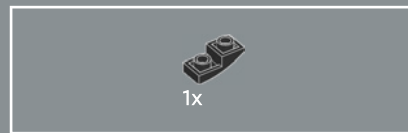
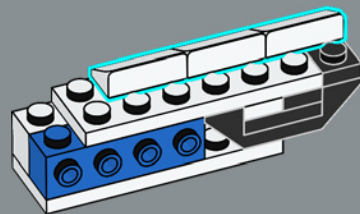

126

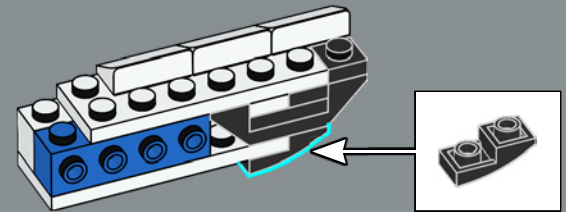

127

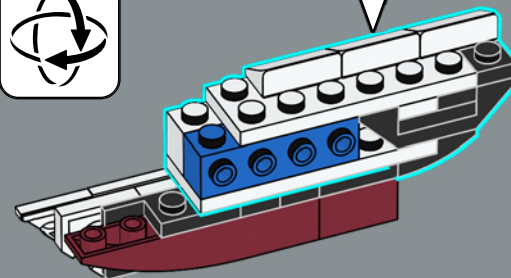

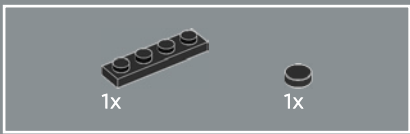

128

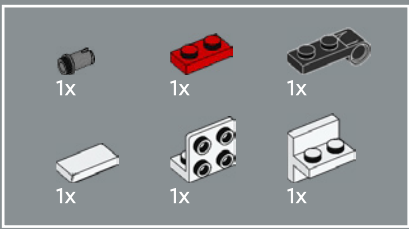
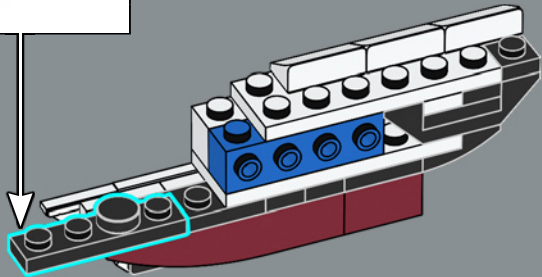
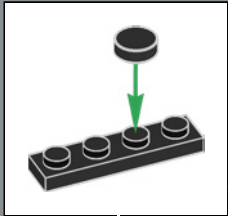

129

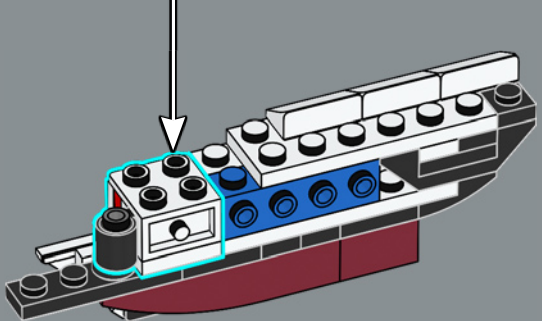
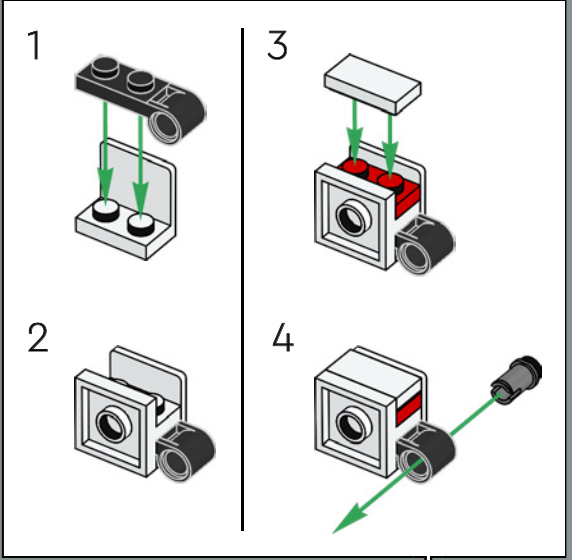

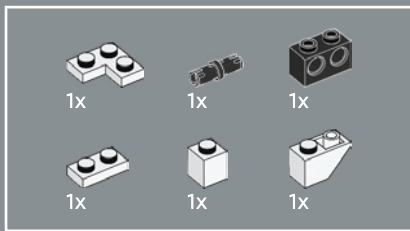

130

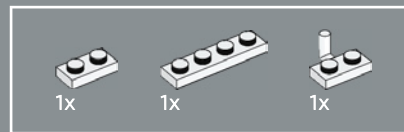
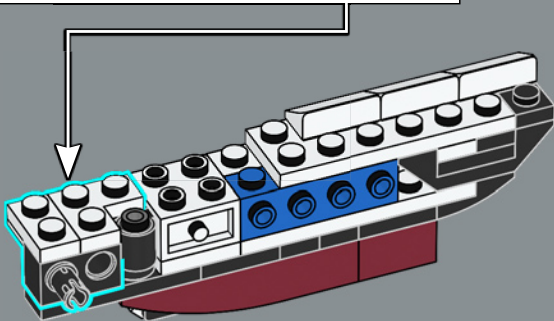
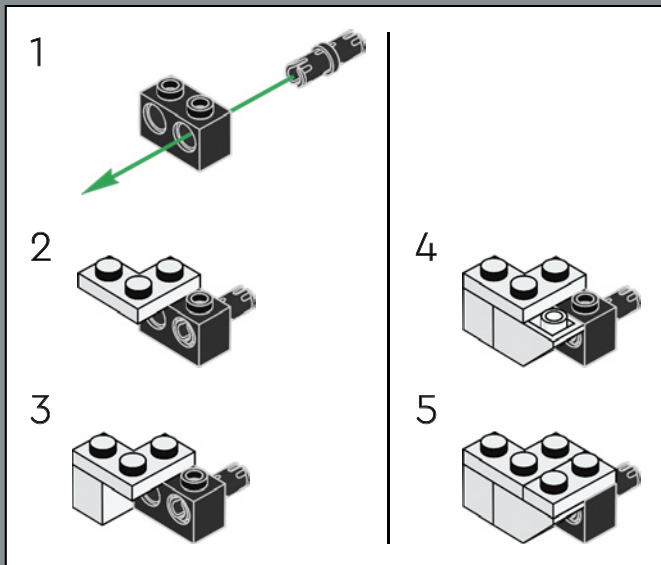

131

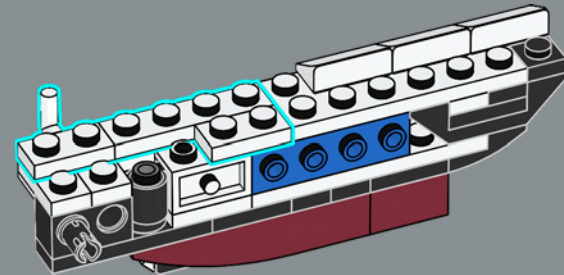

132

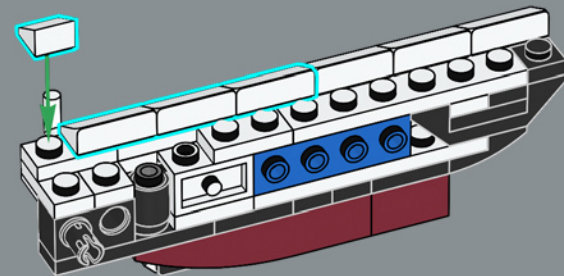



133

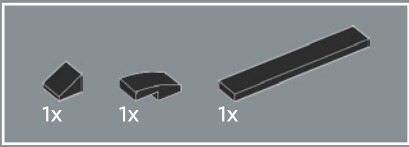
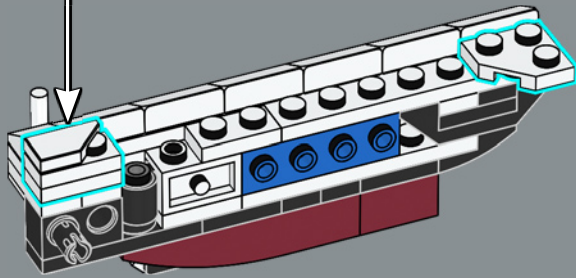
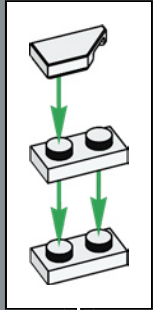

134

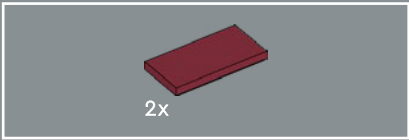
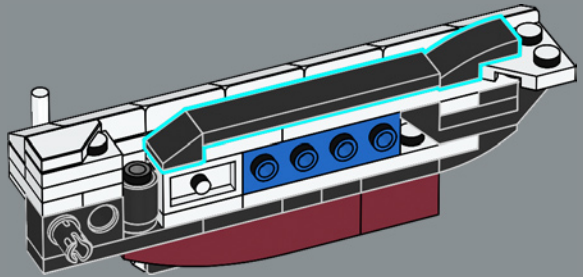

135

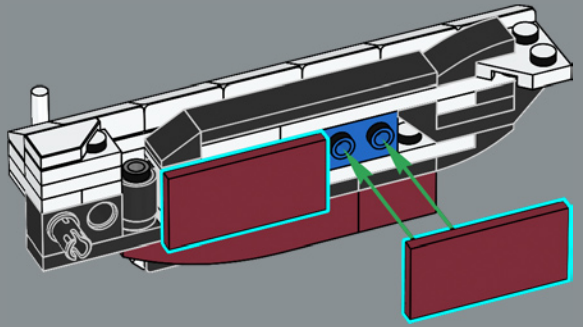

136

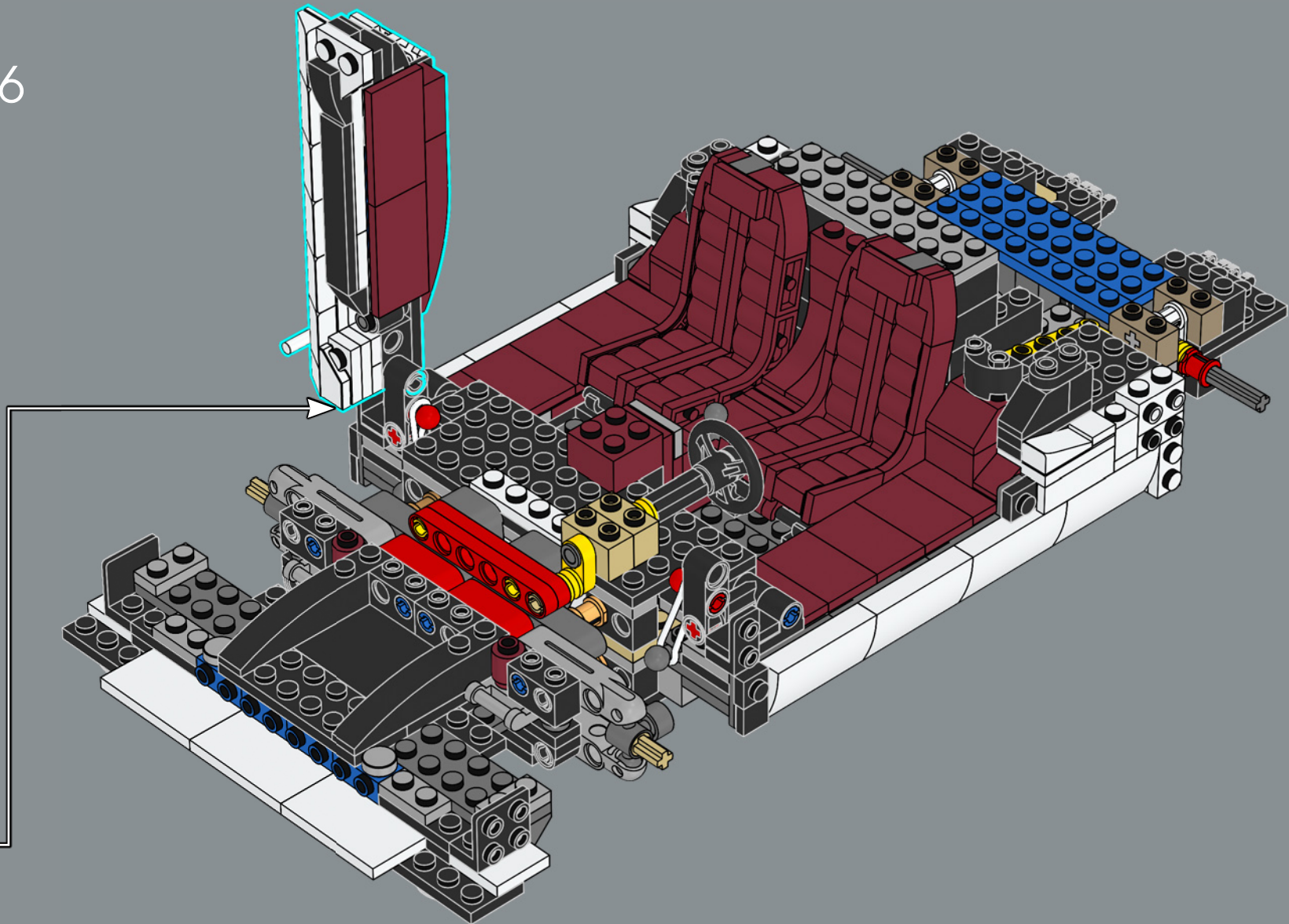

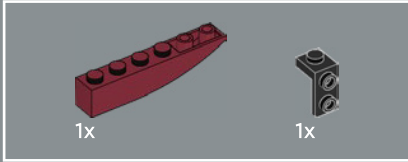
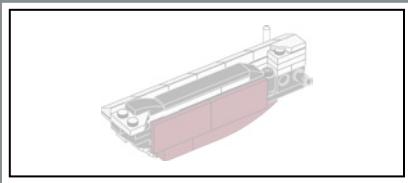

137

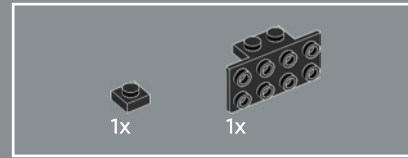
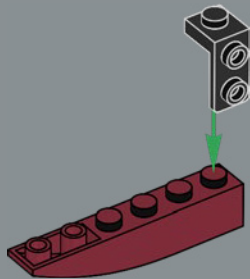

138

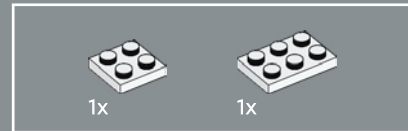
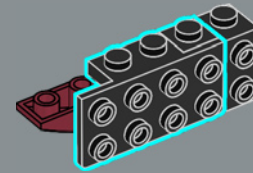

139

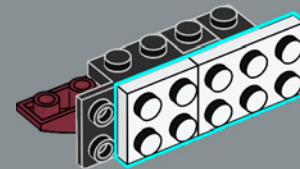

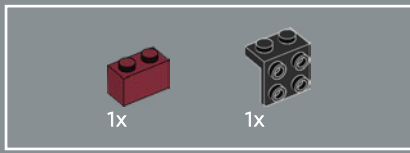

140

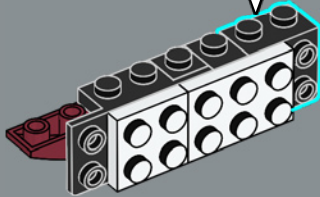
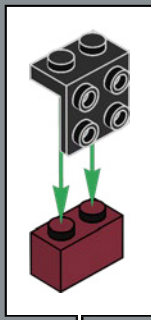

141

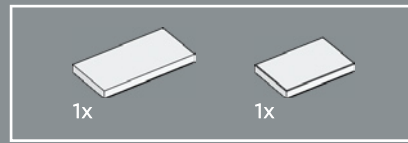
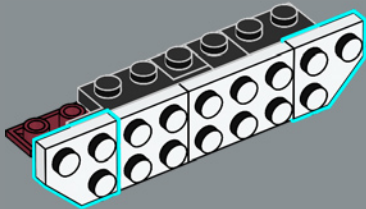

142

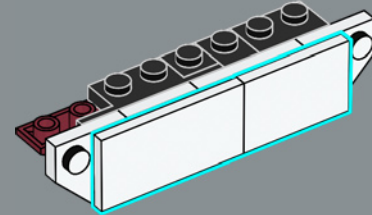

143

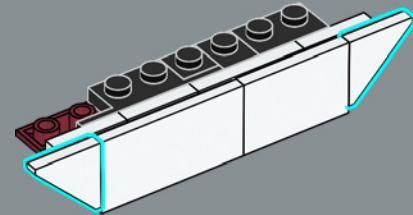

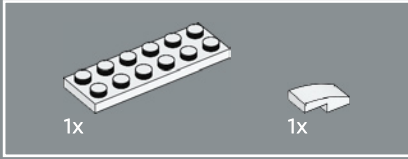
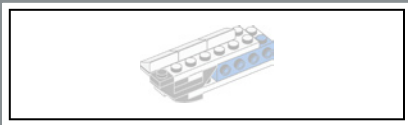

144

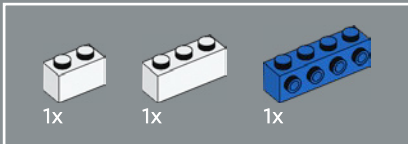
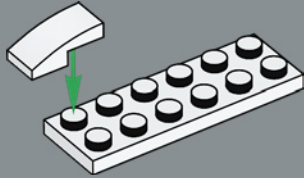

145

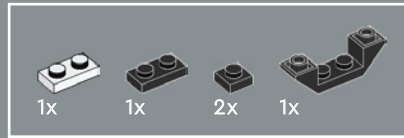
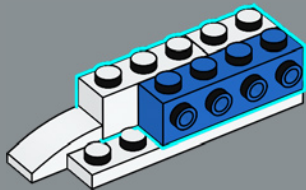

146

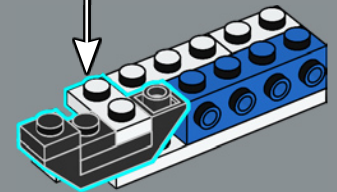
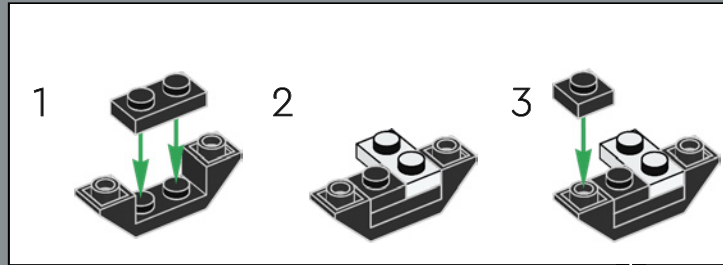

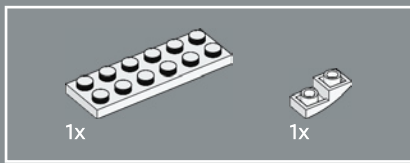

147

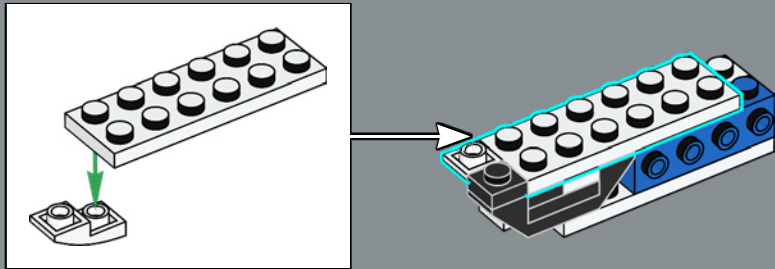

148

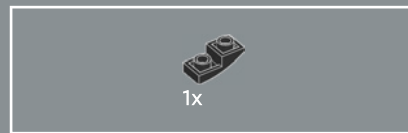
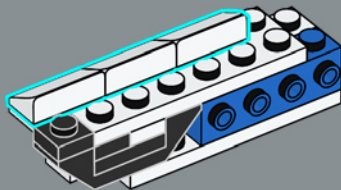

149

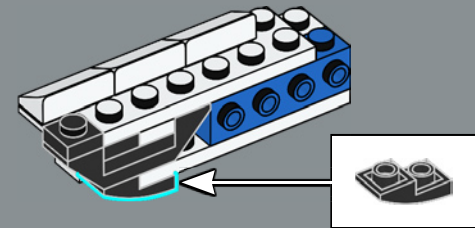

150

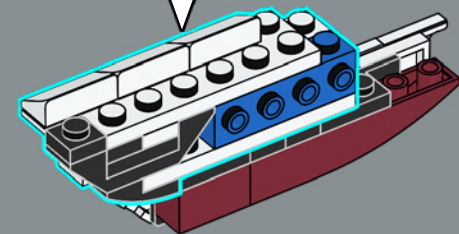

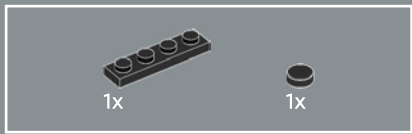

151

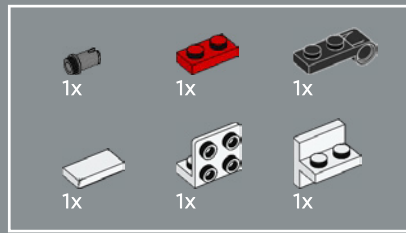
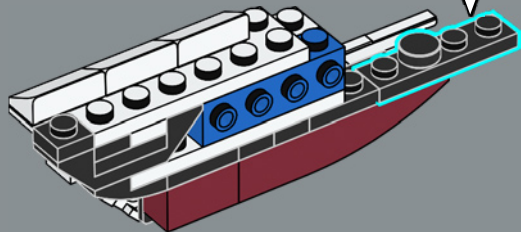
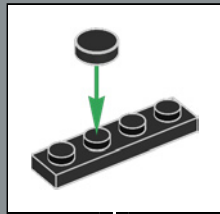

152

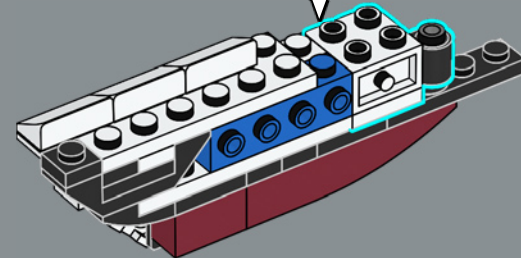
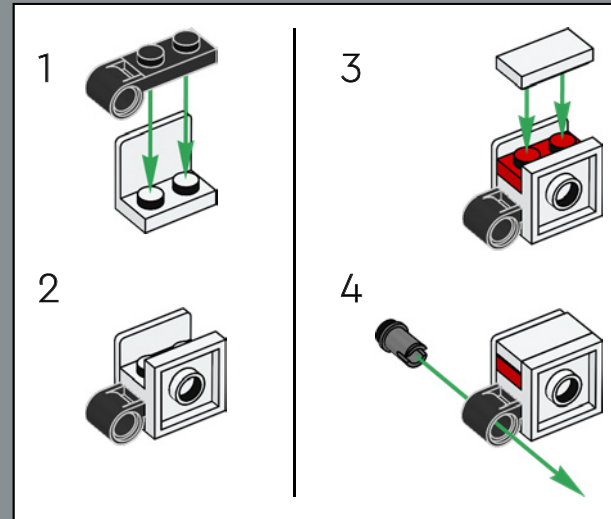

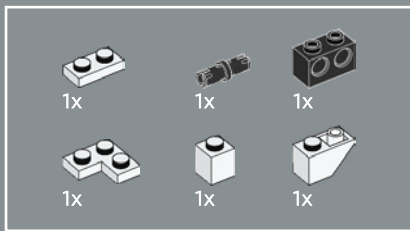

153

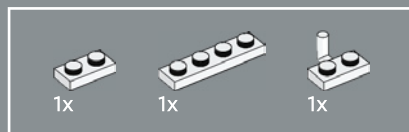
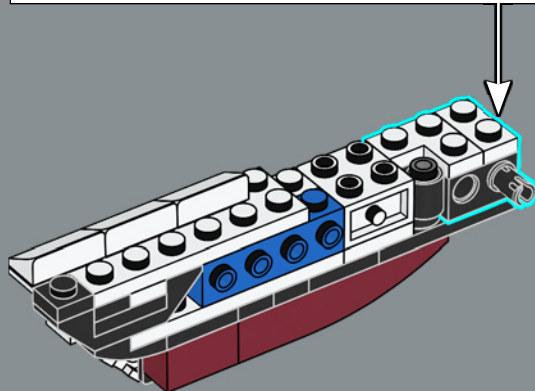
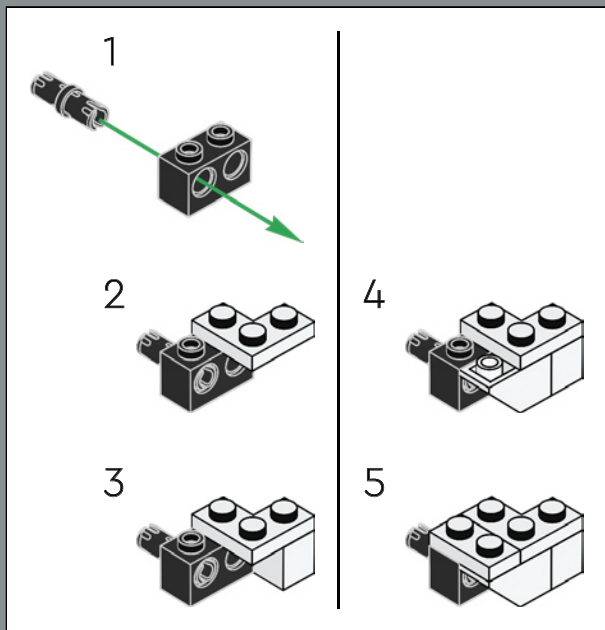

154

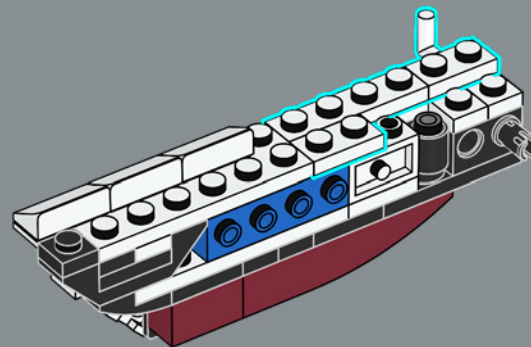



155

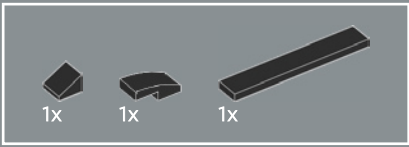
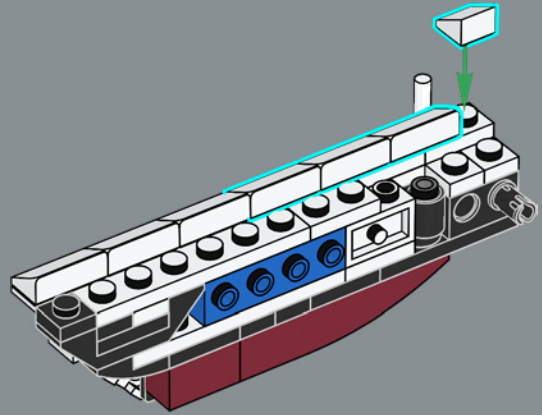

157

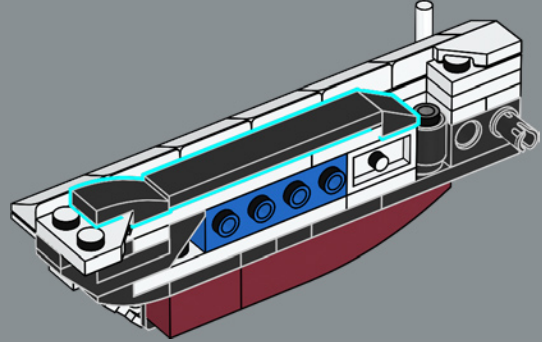

156

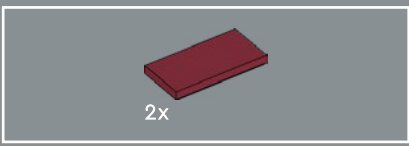
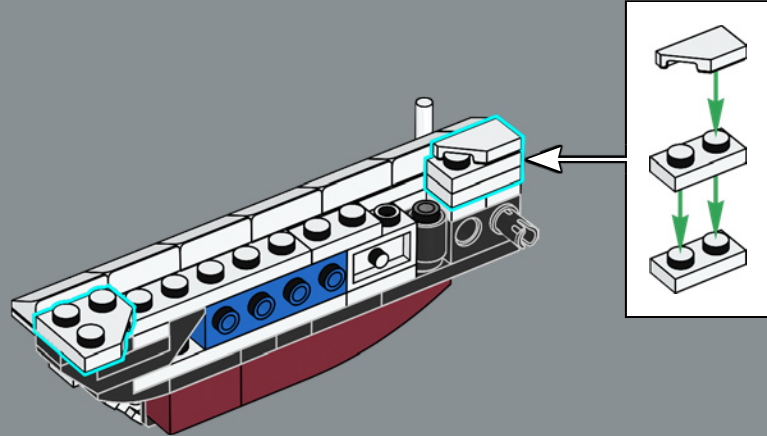

158

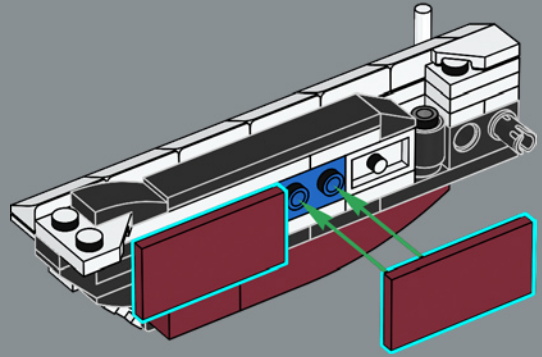



向上打开的车门通常被称为“剪刀门”。

159

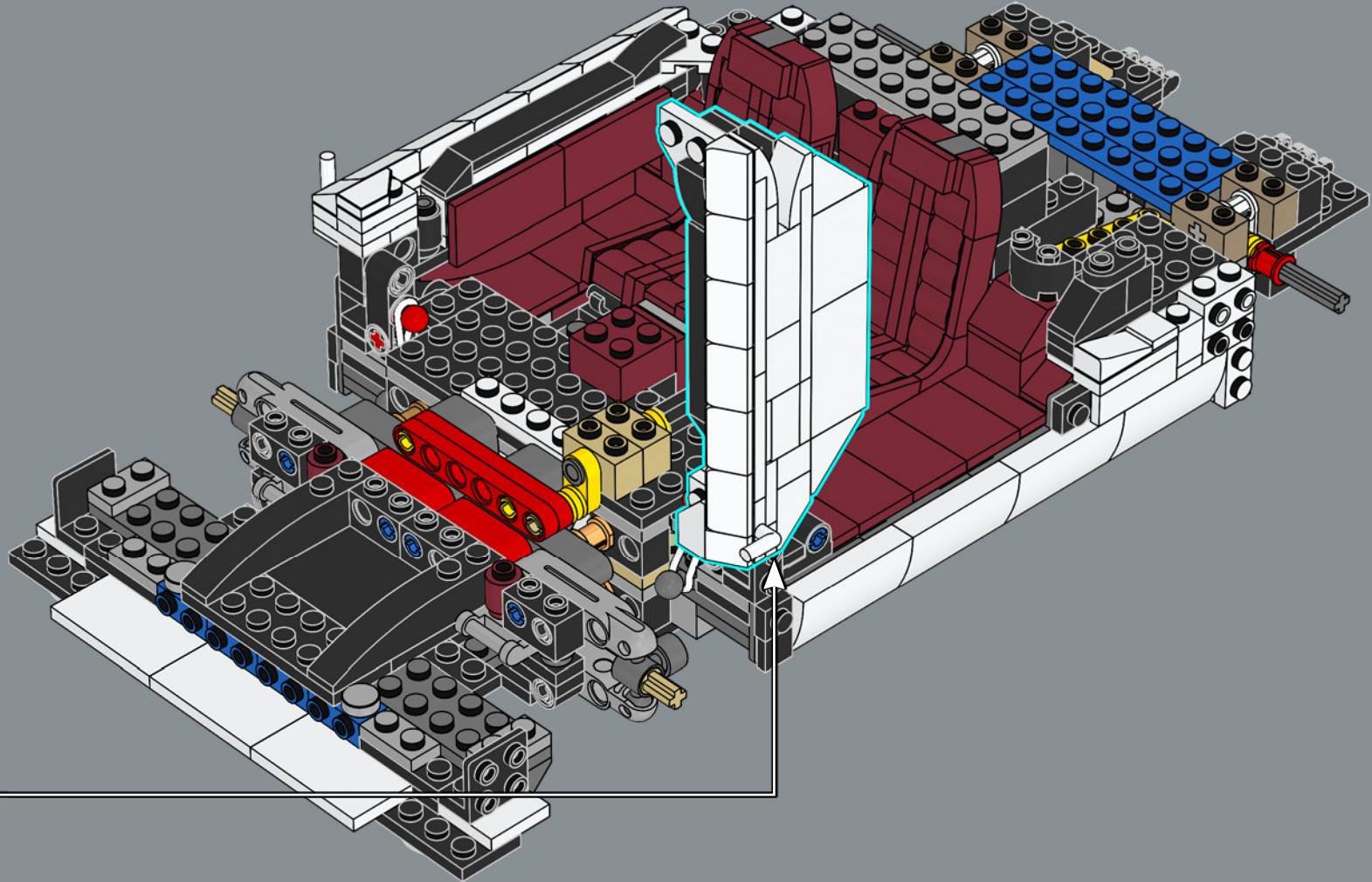

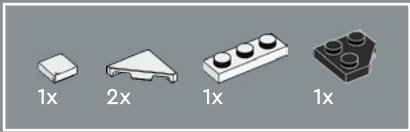

160

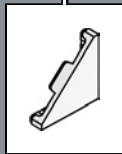
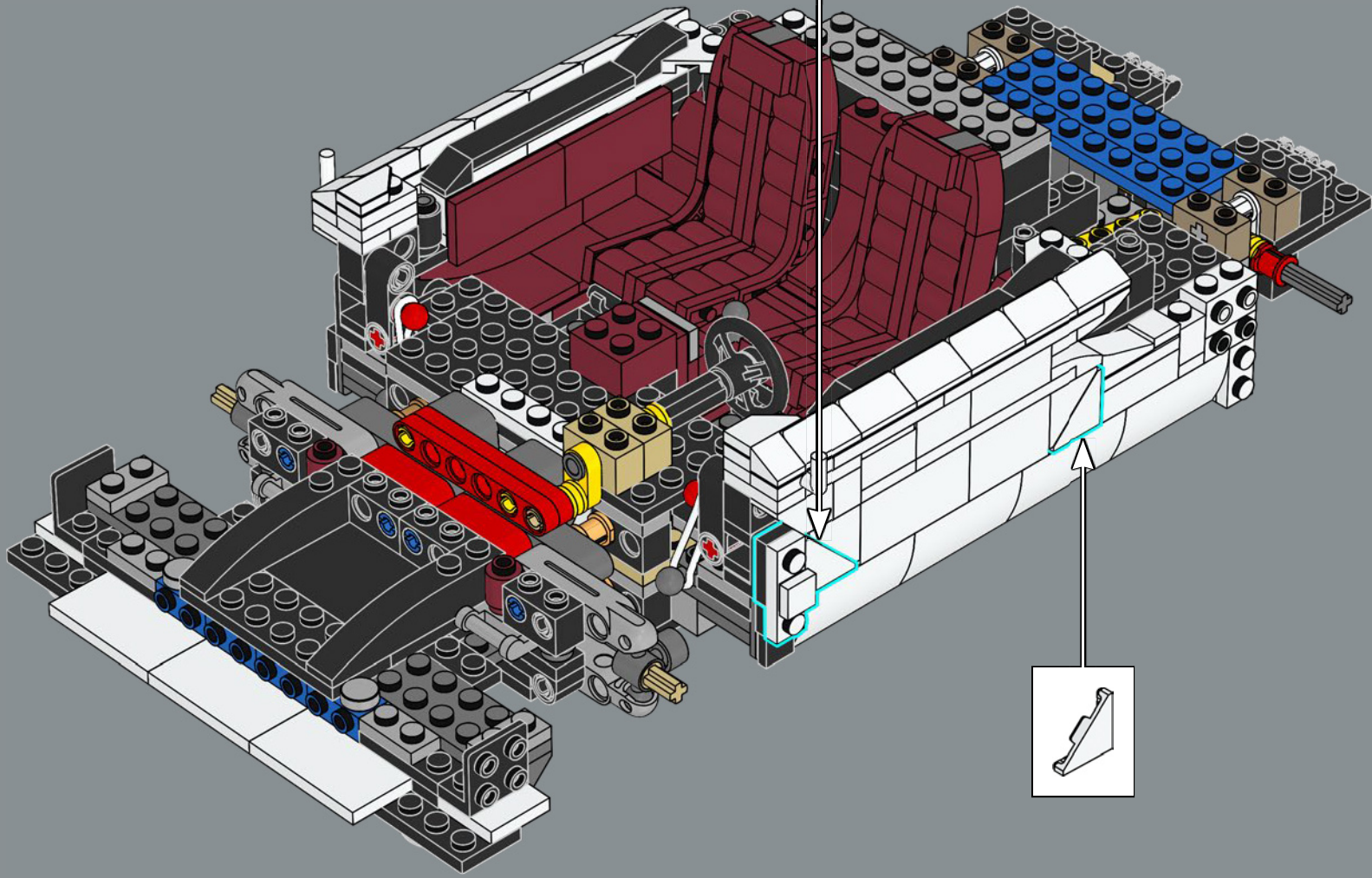
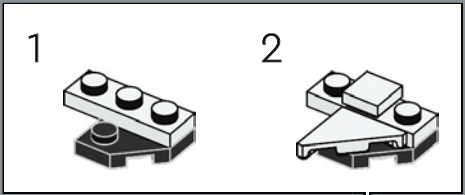

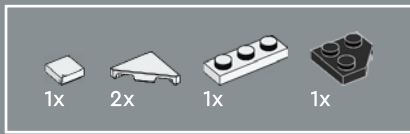

161

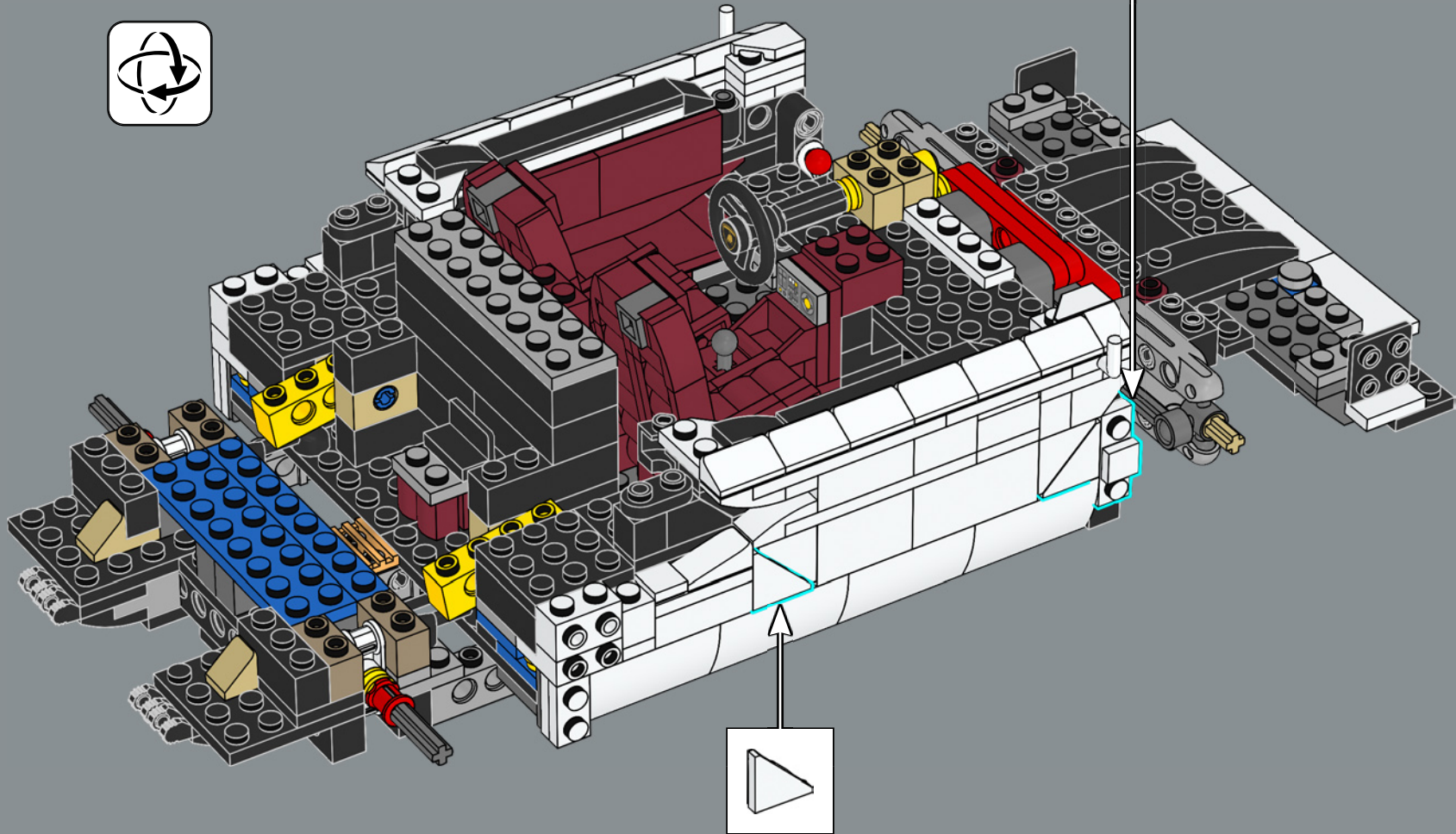
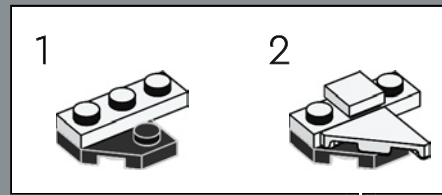

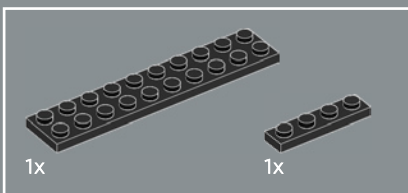
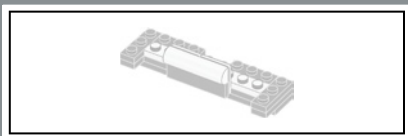

162

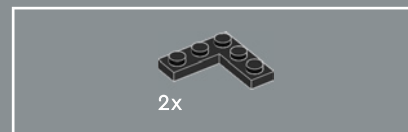
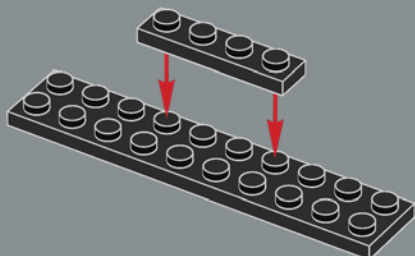

163

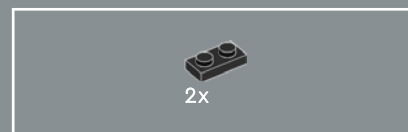
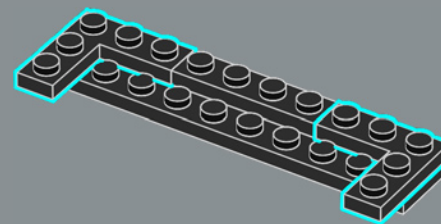

164

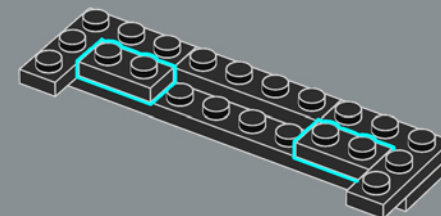



165

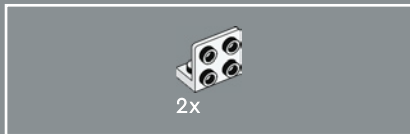
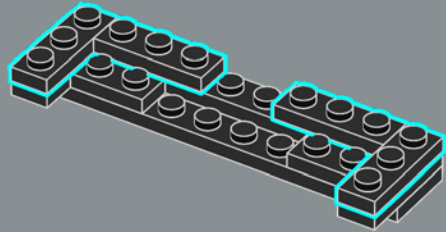

166

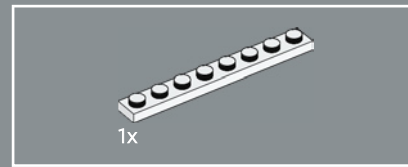
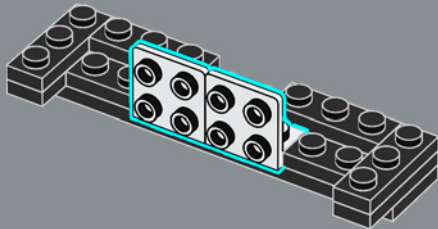

167

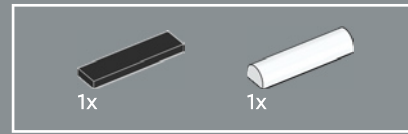
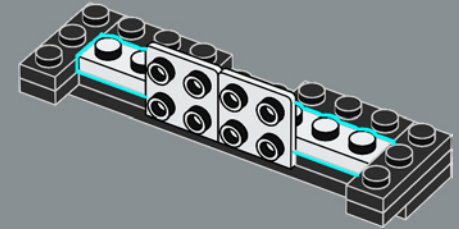

168

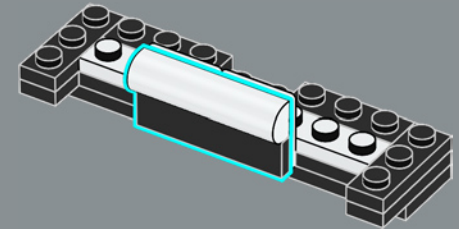

169

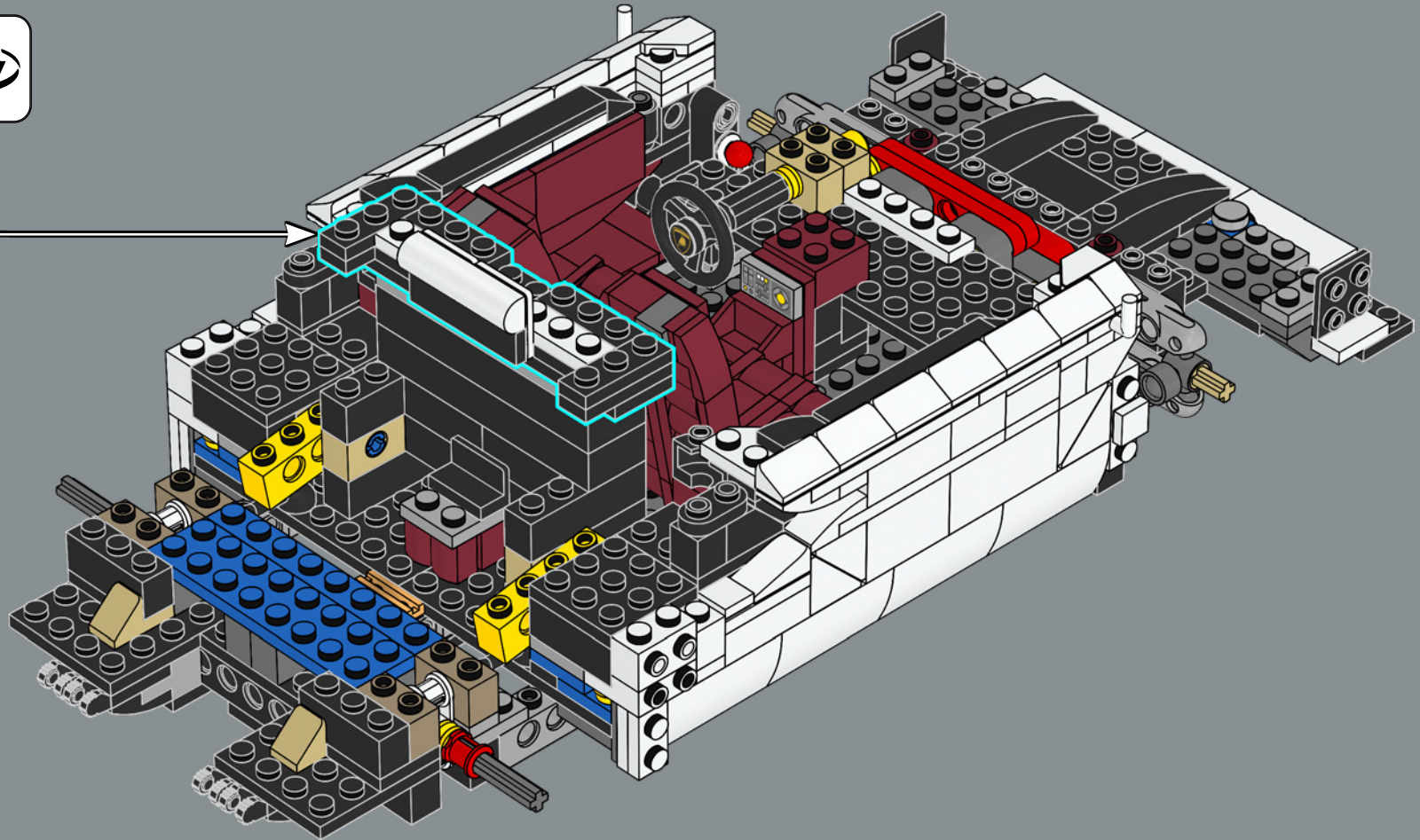

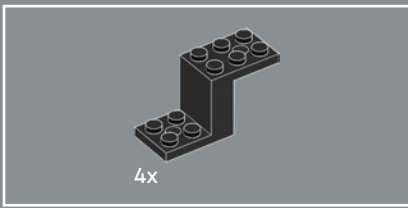

170

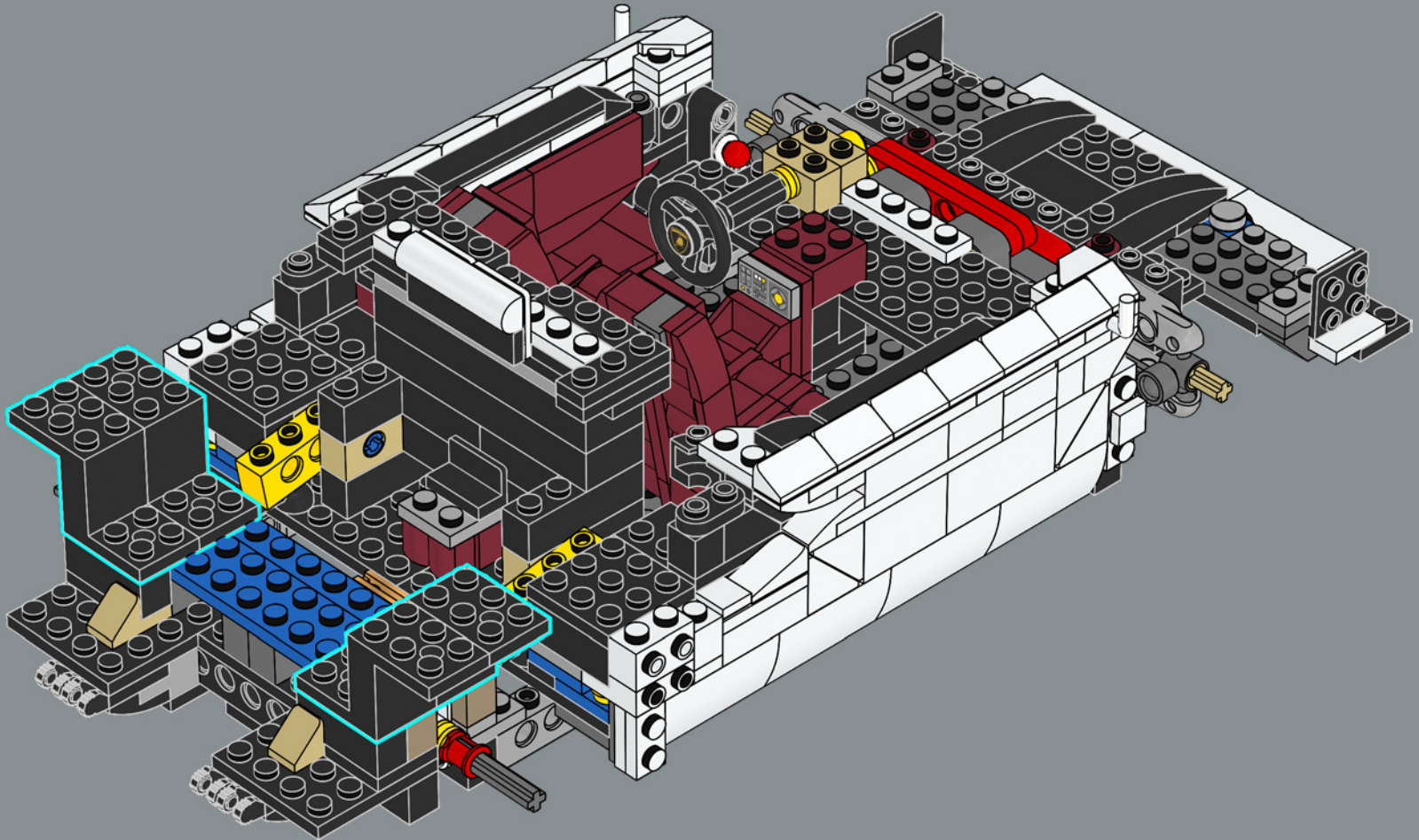

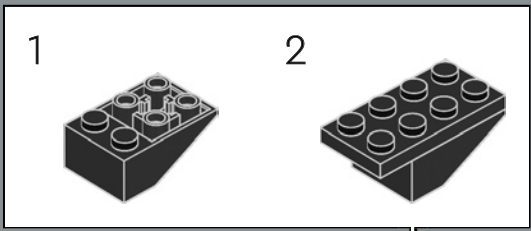
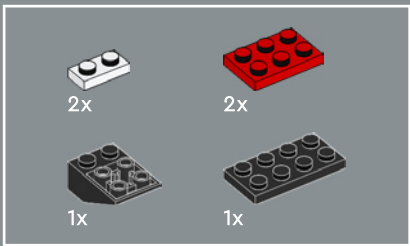

171

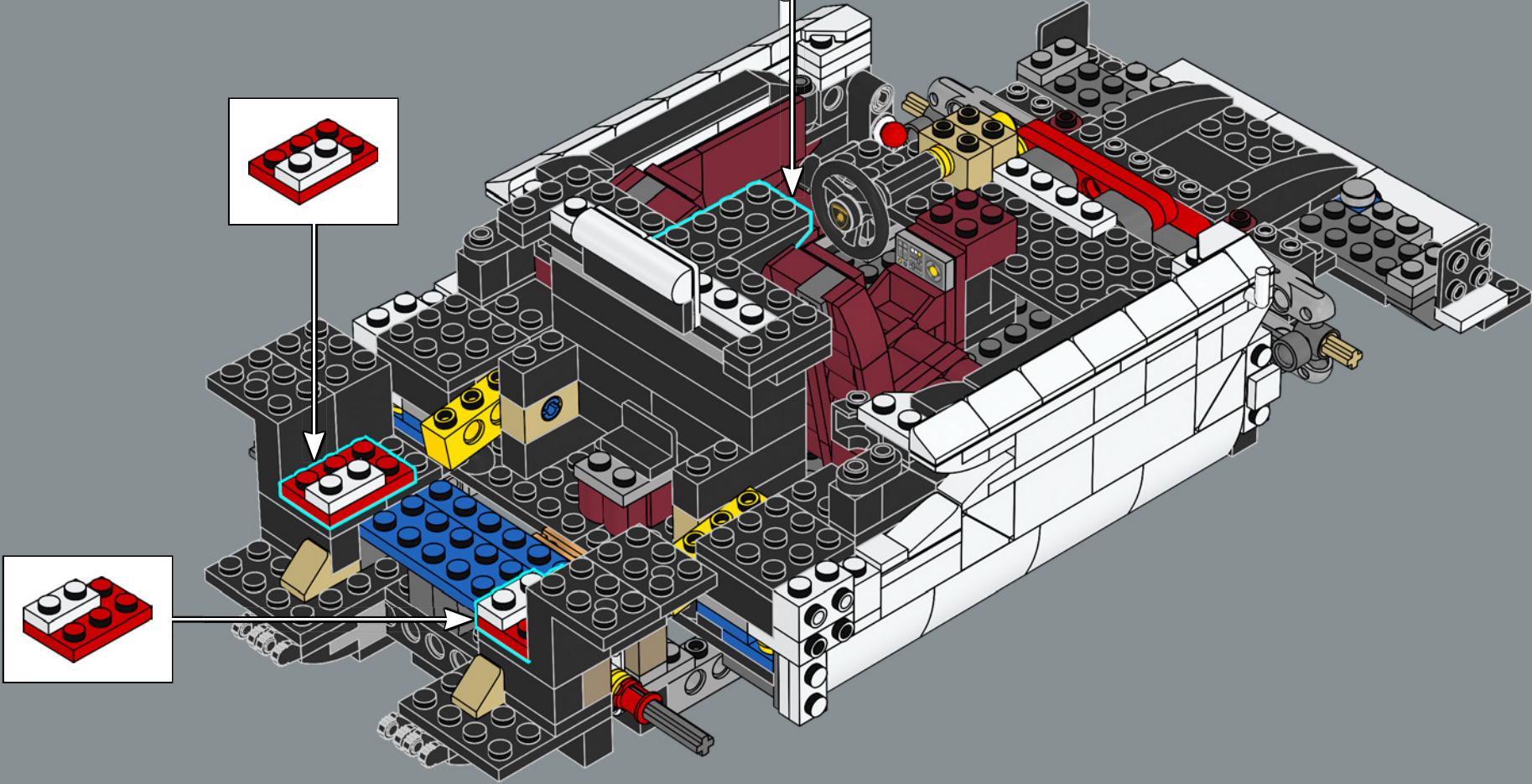

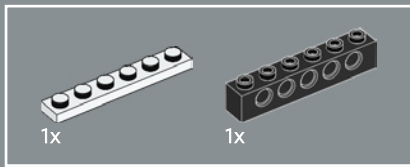

172

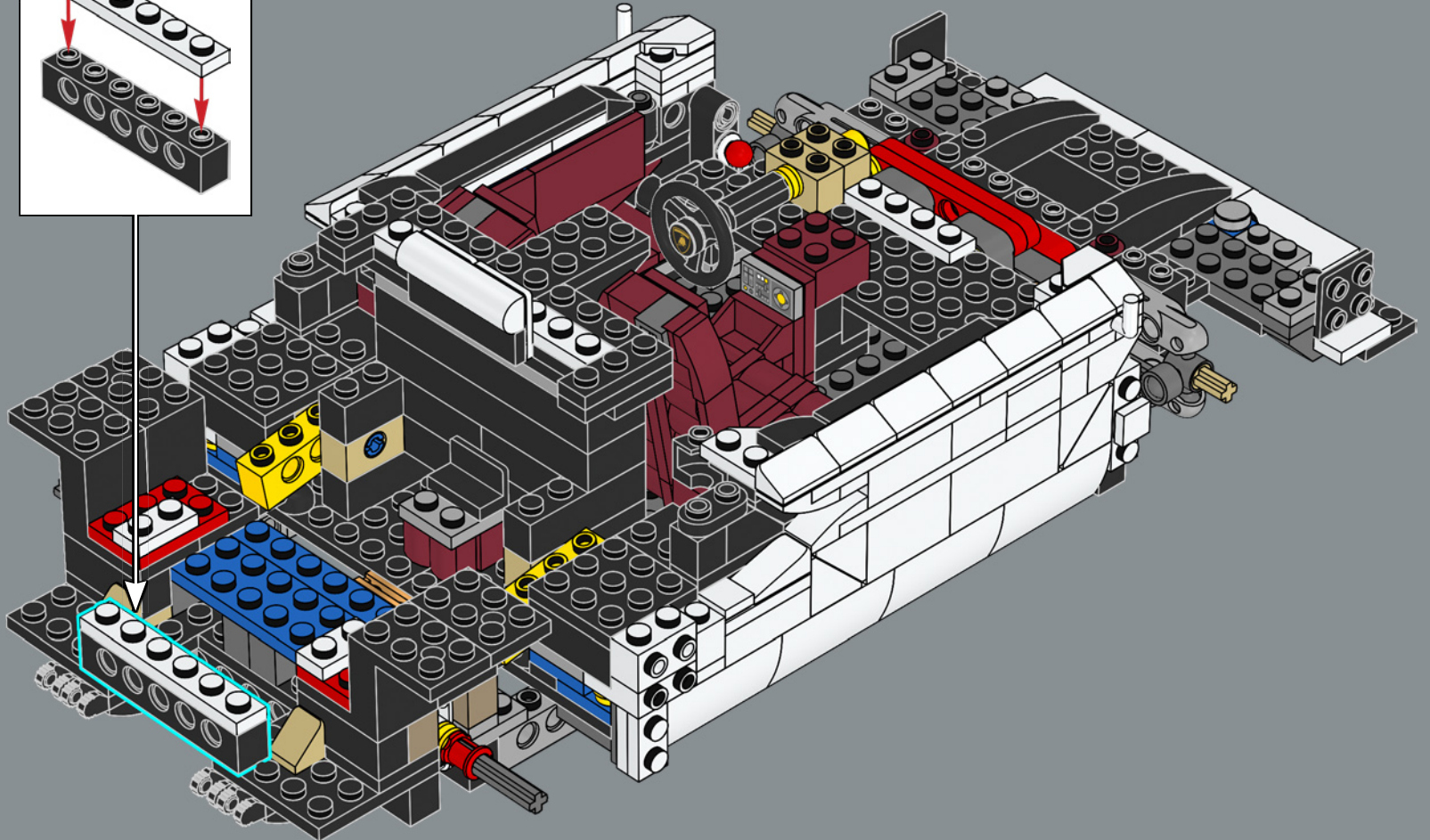
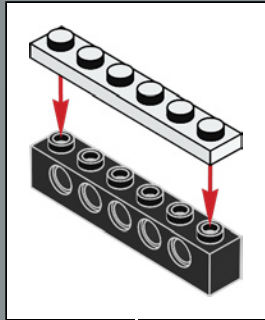

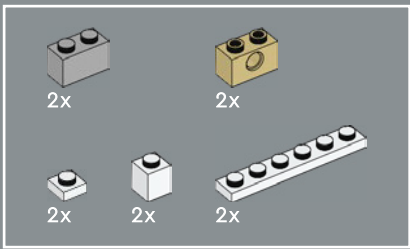

173

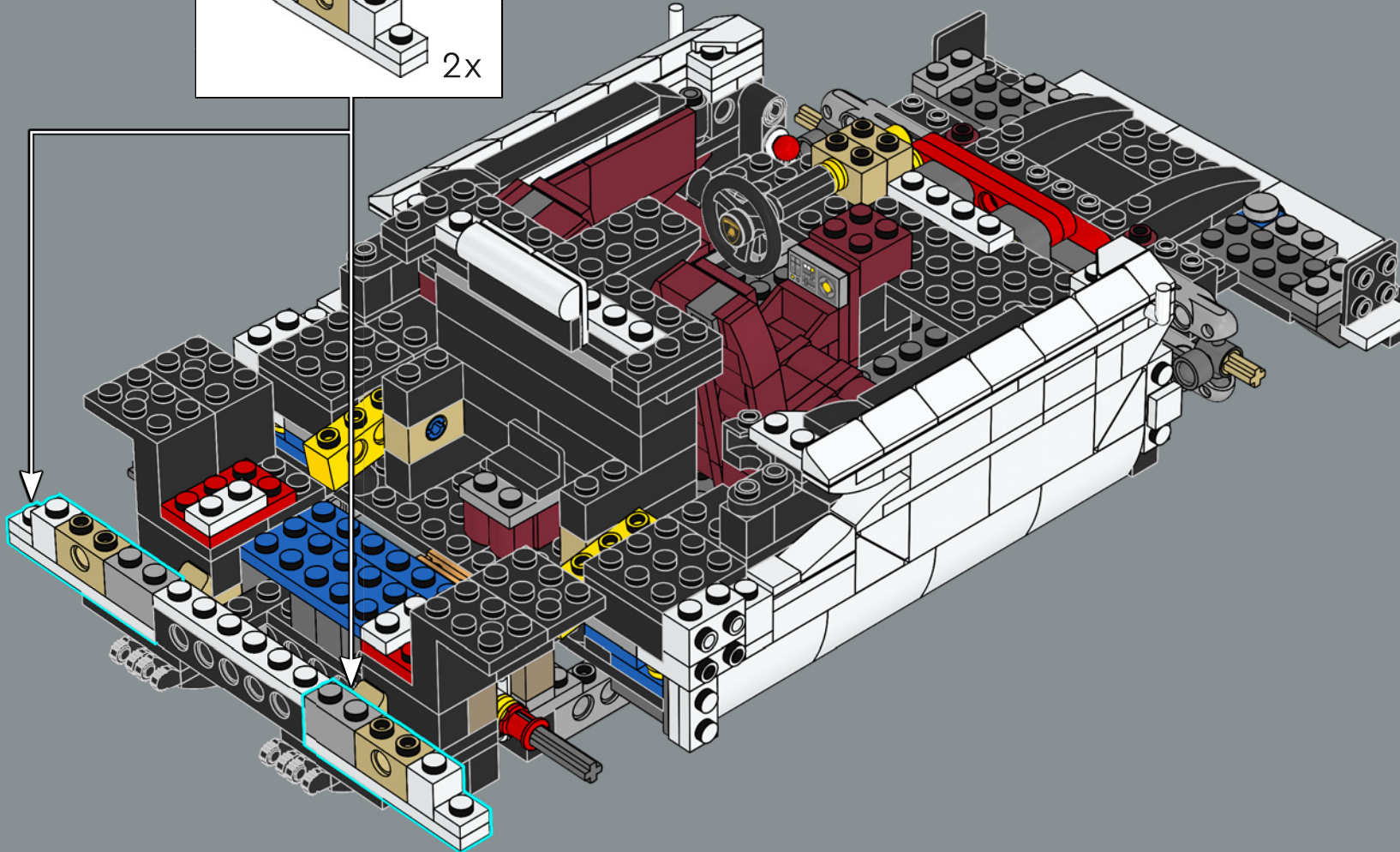
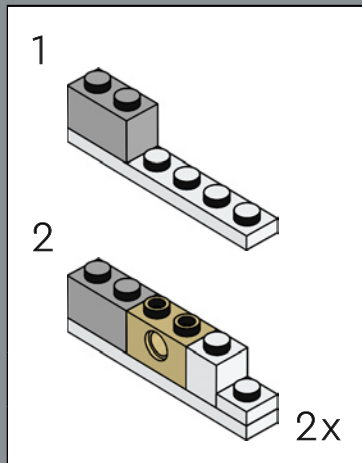

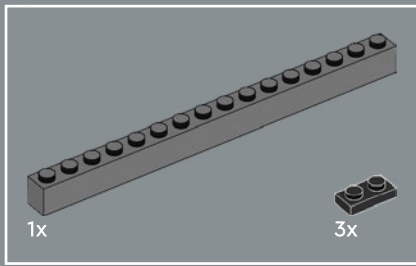

174

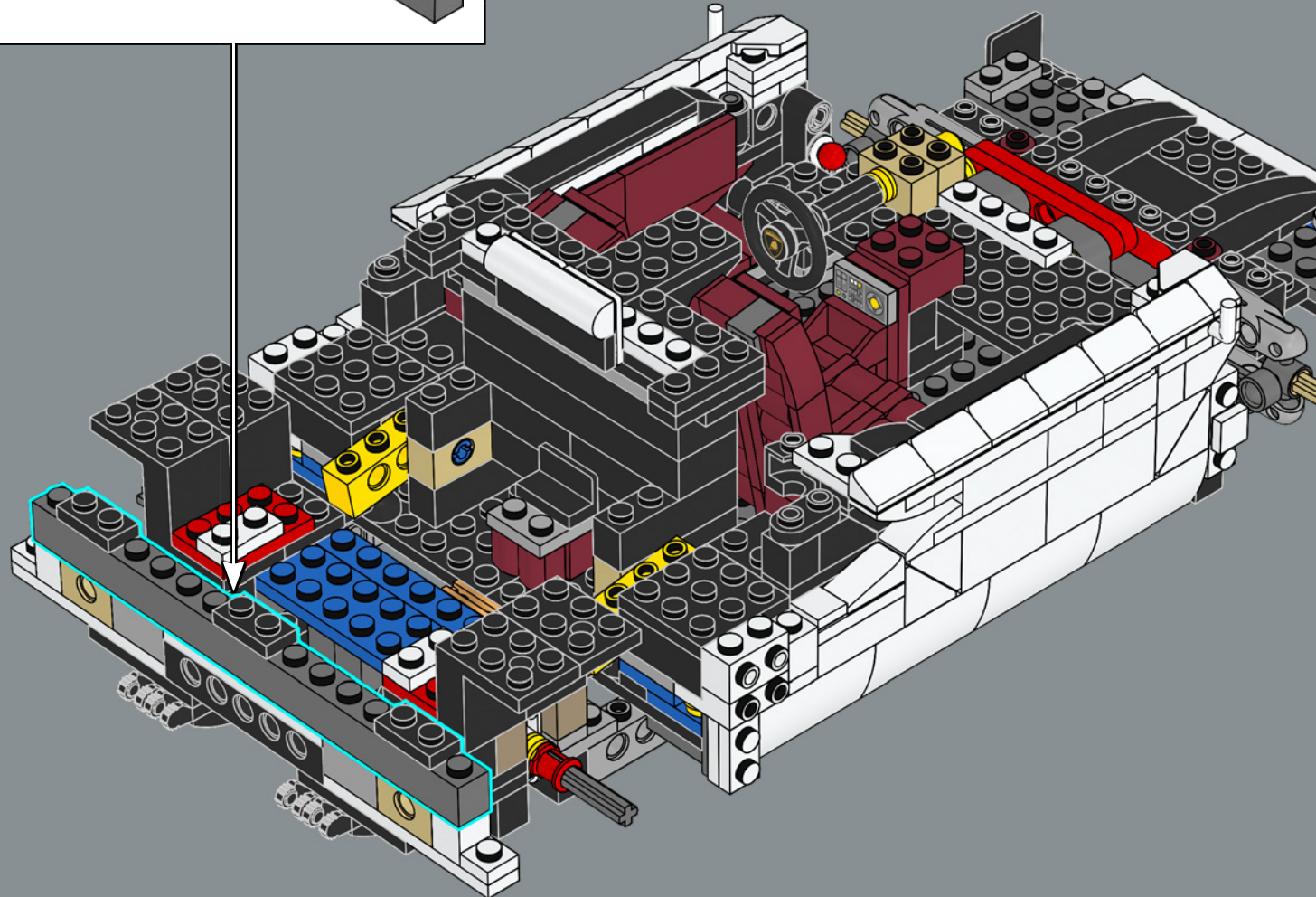
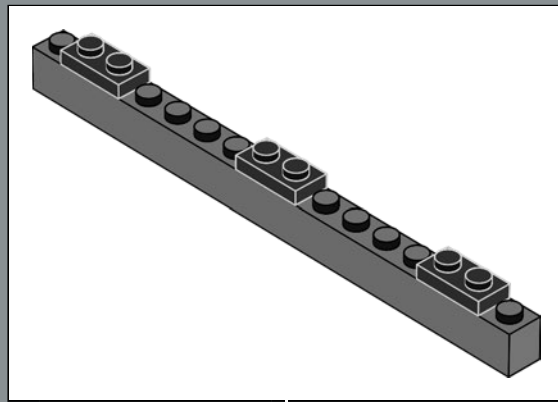

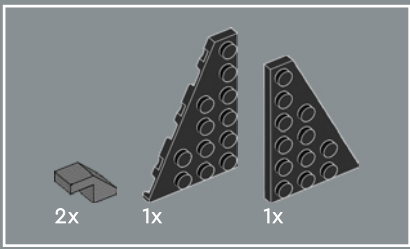

175

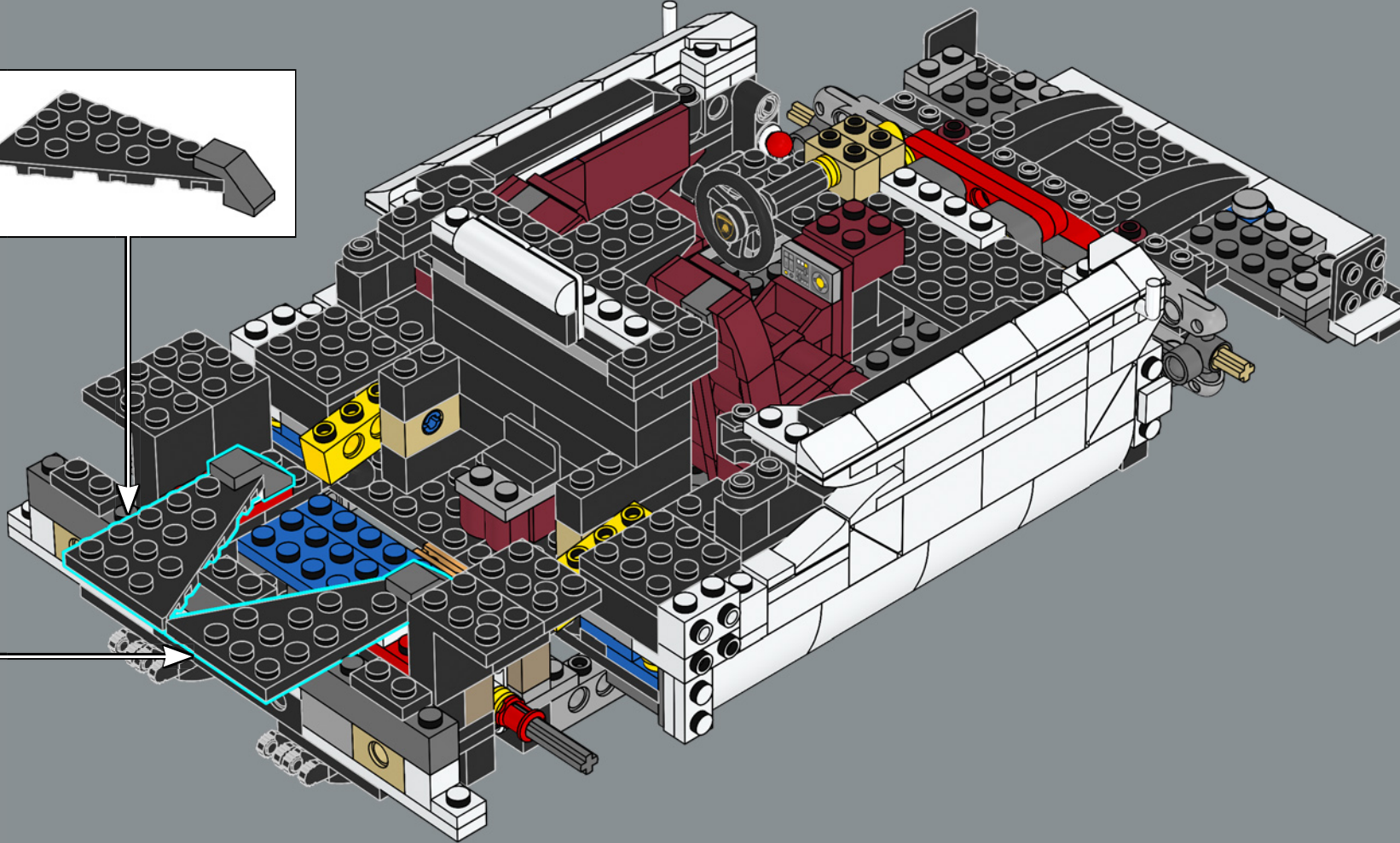
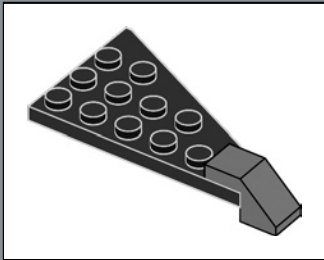
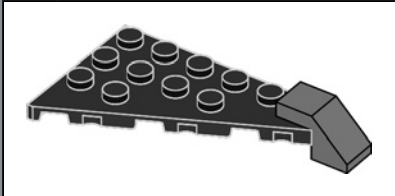

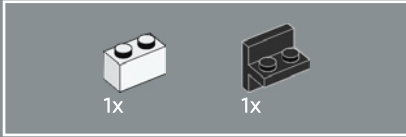
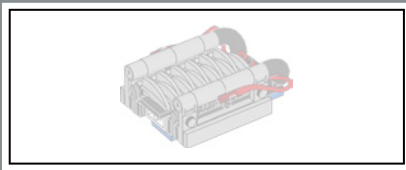

176

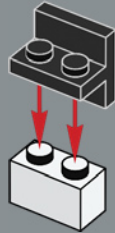

177

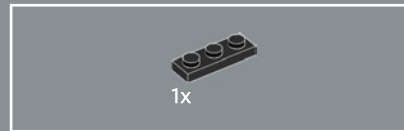
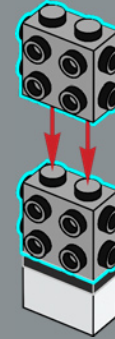

178



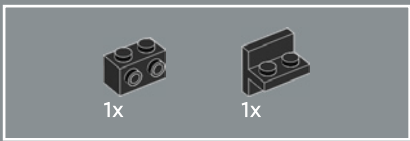

179

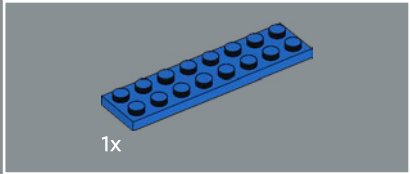
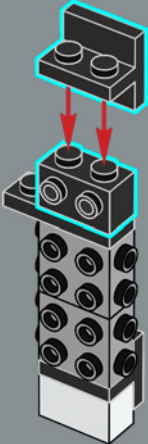

180

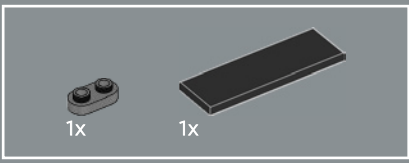
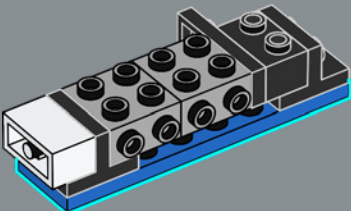

181

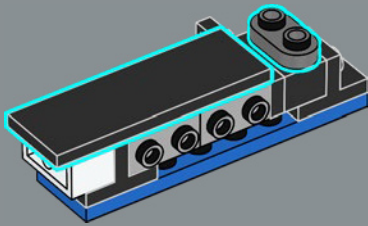

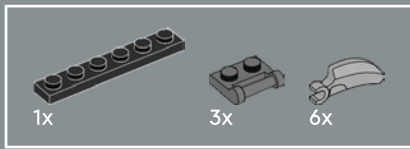

182

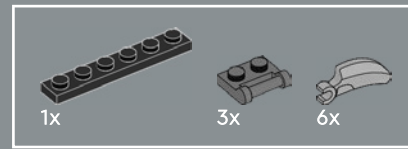
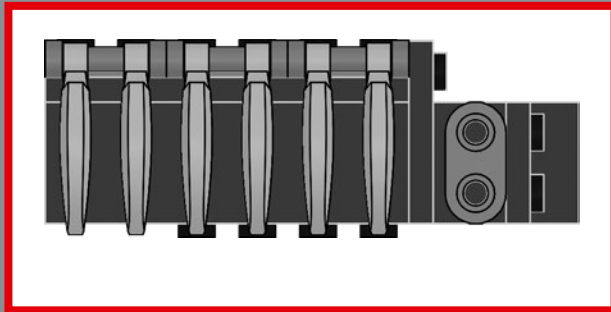
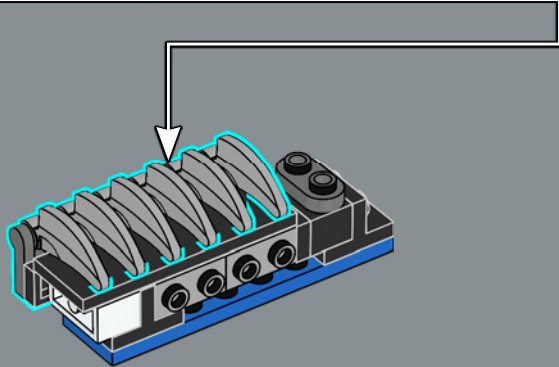
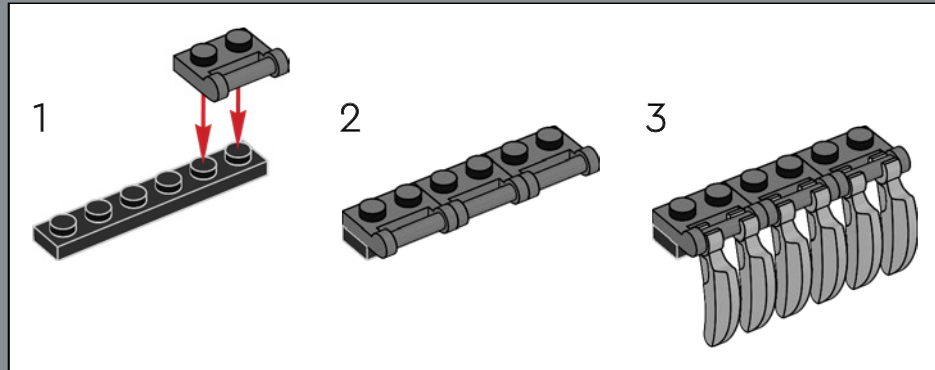

183

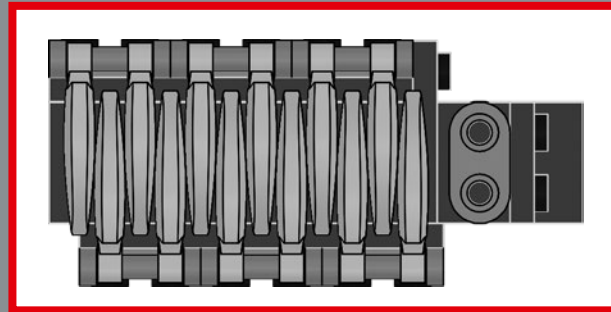
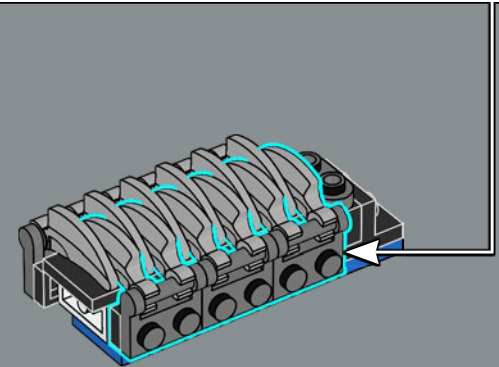
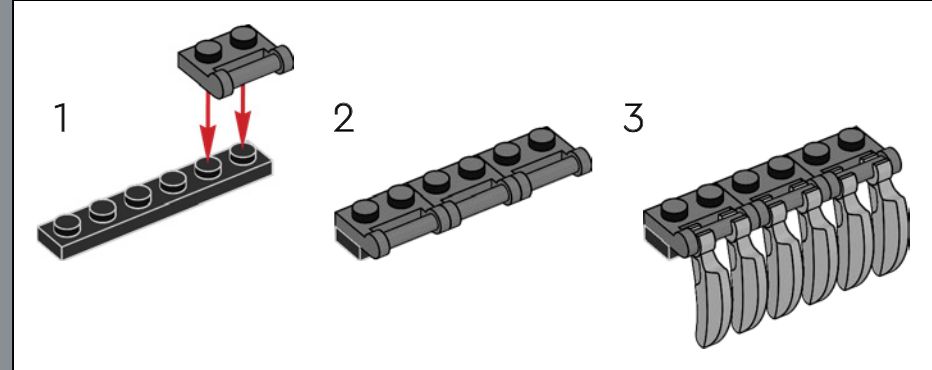

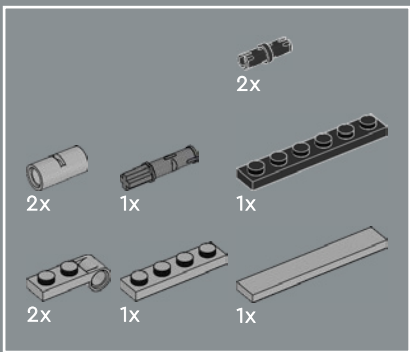

184

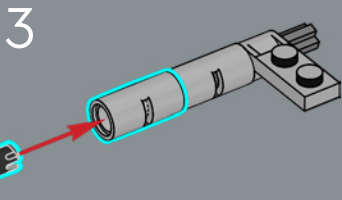
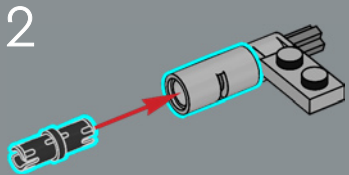
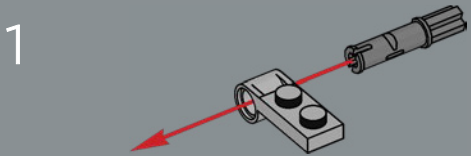

4

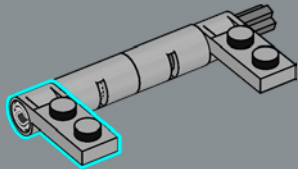

5

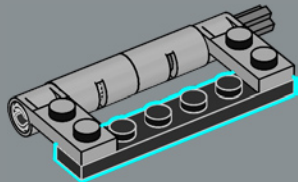

6

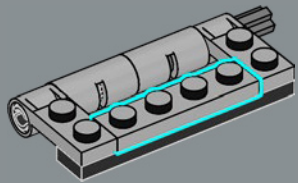

7

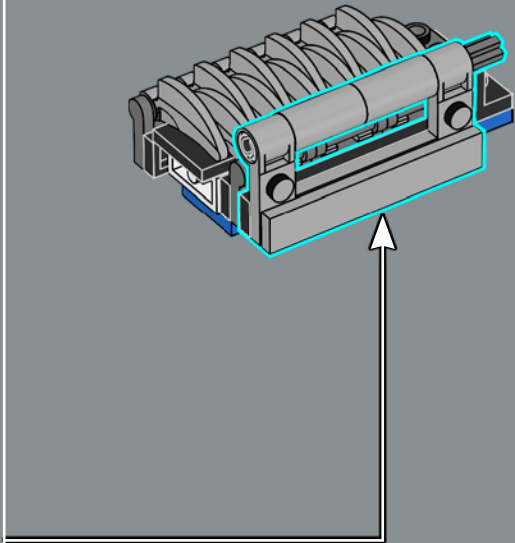
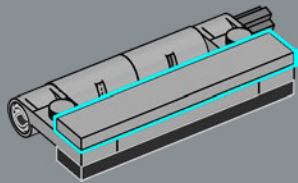

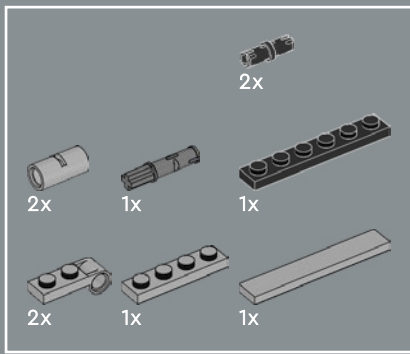

185

1

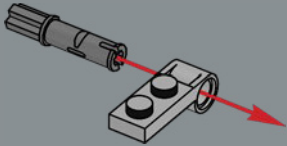

2

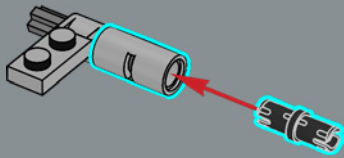

3

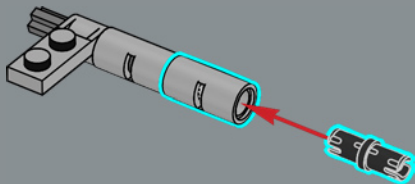

4

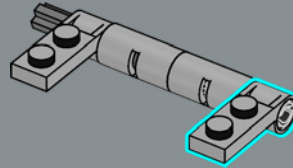

5

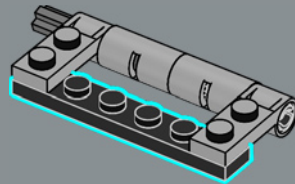

6

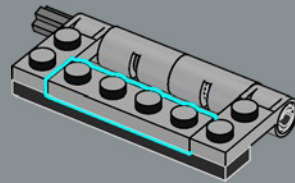

7

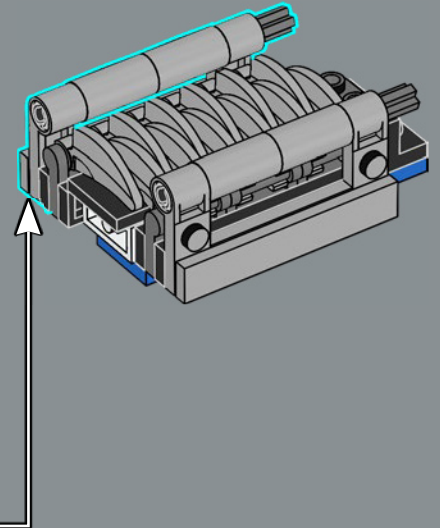
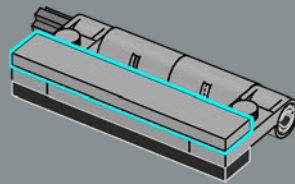

2x

186

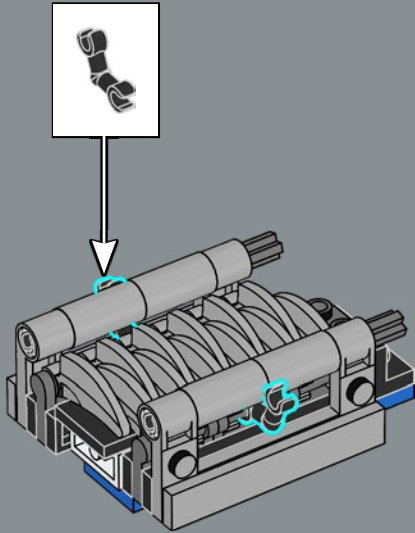

2x

187

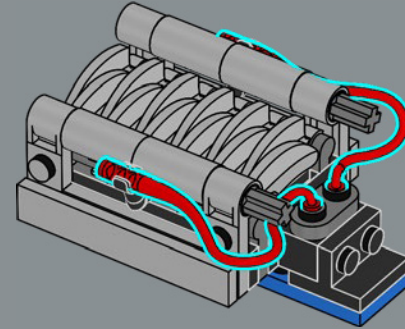

2x

188

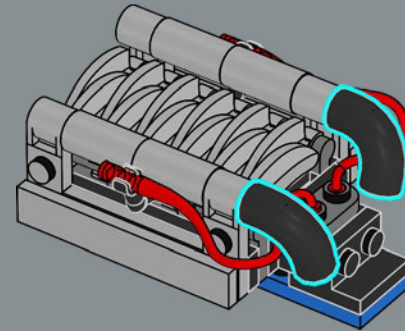



Countach 名称中的 LP 代表 Longitudinale Posteriore
(英语意为纵向后置)，是发动机的放置方式。

189

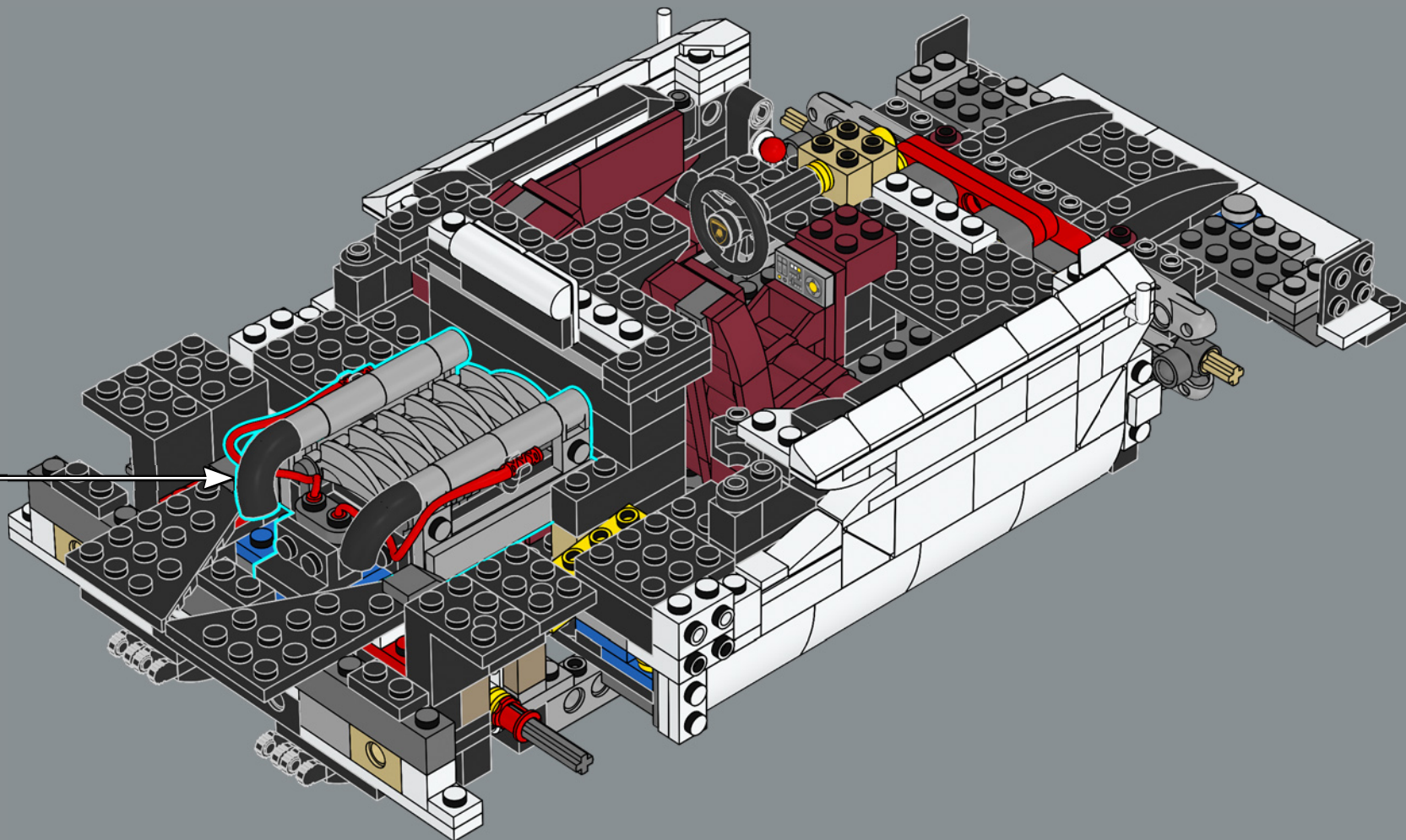

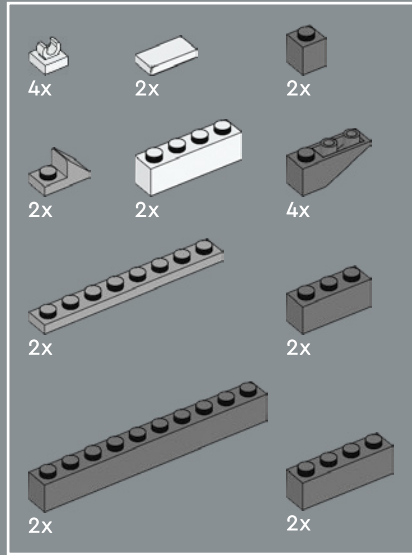
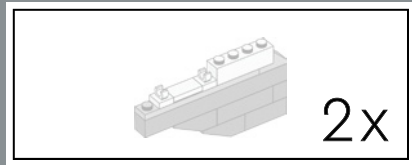

190

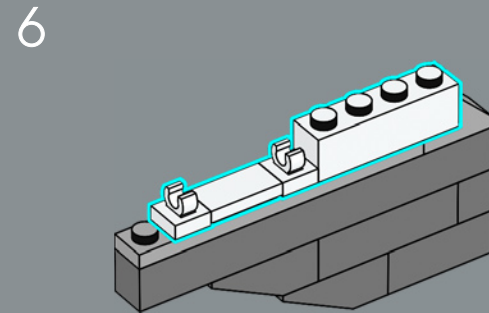
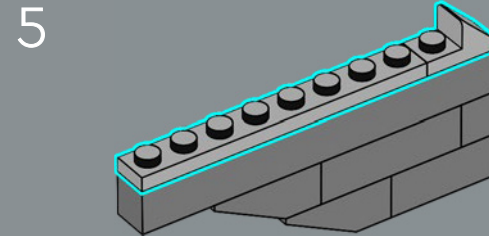
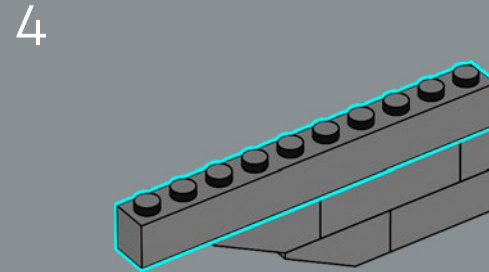
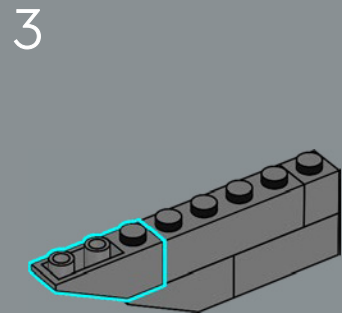
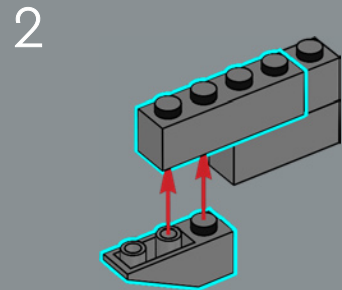
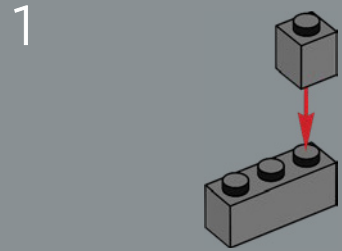

2x

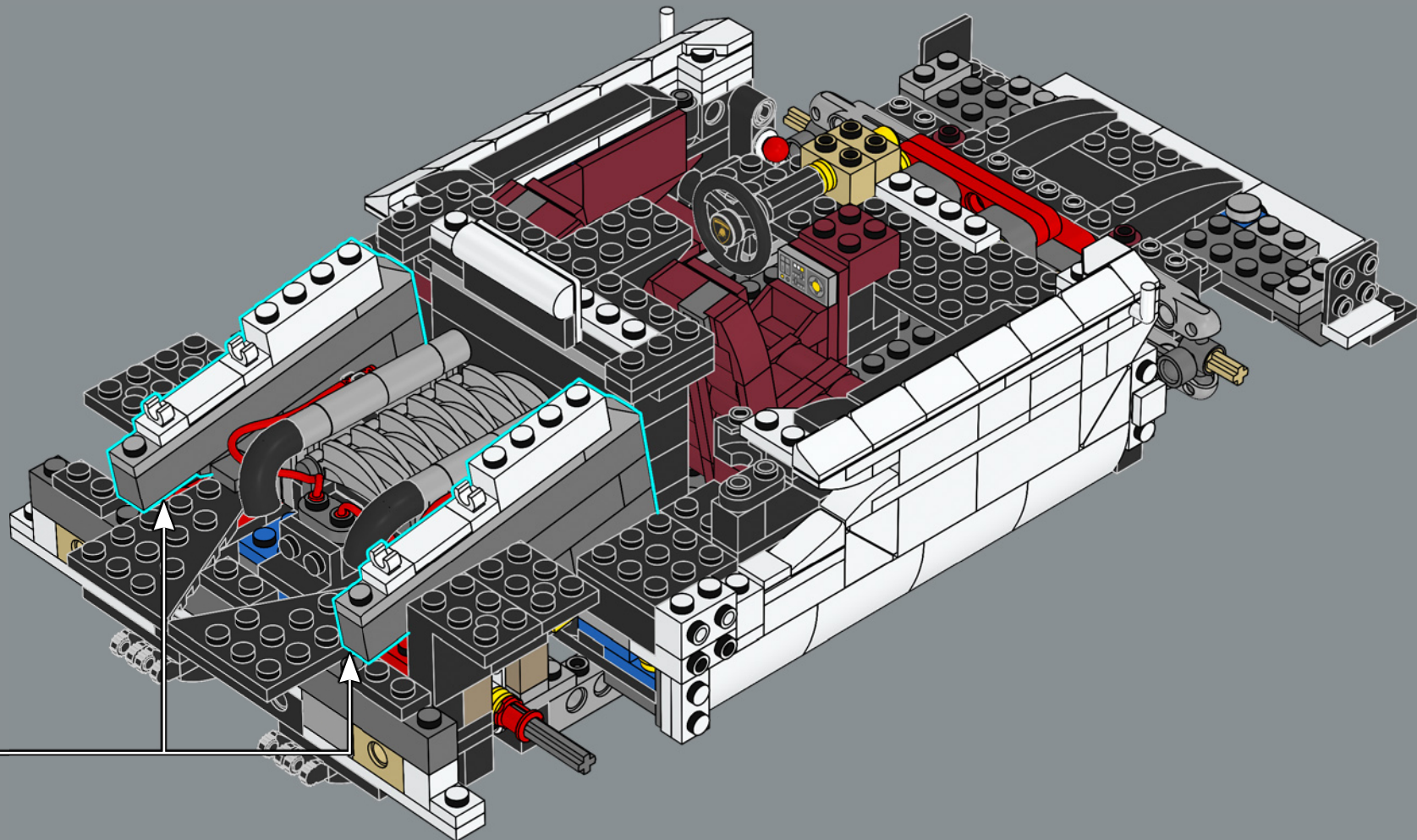

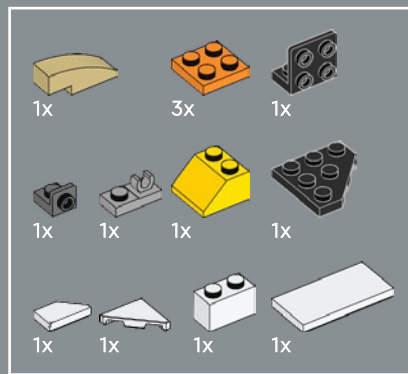

191

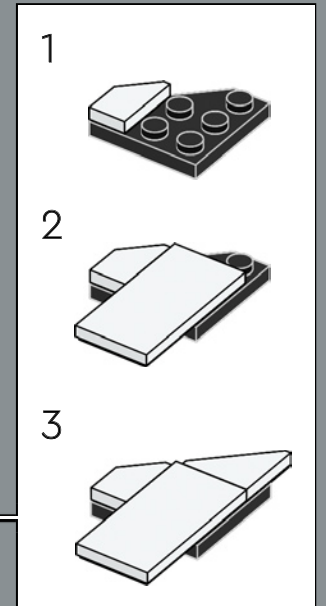
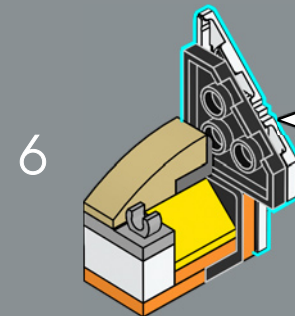
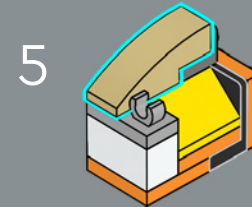
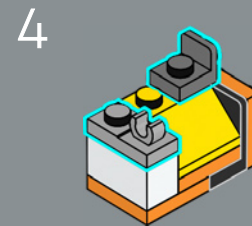
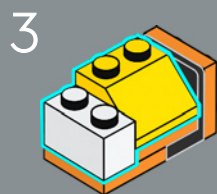
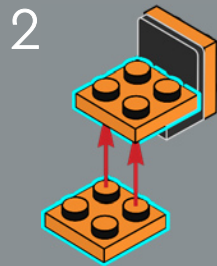
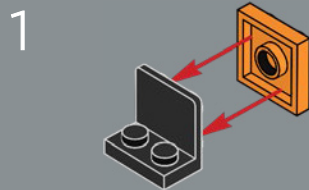

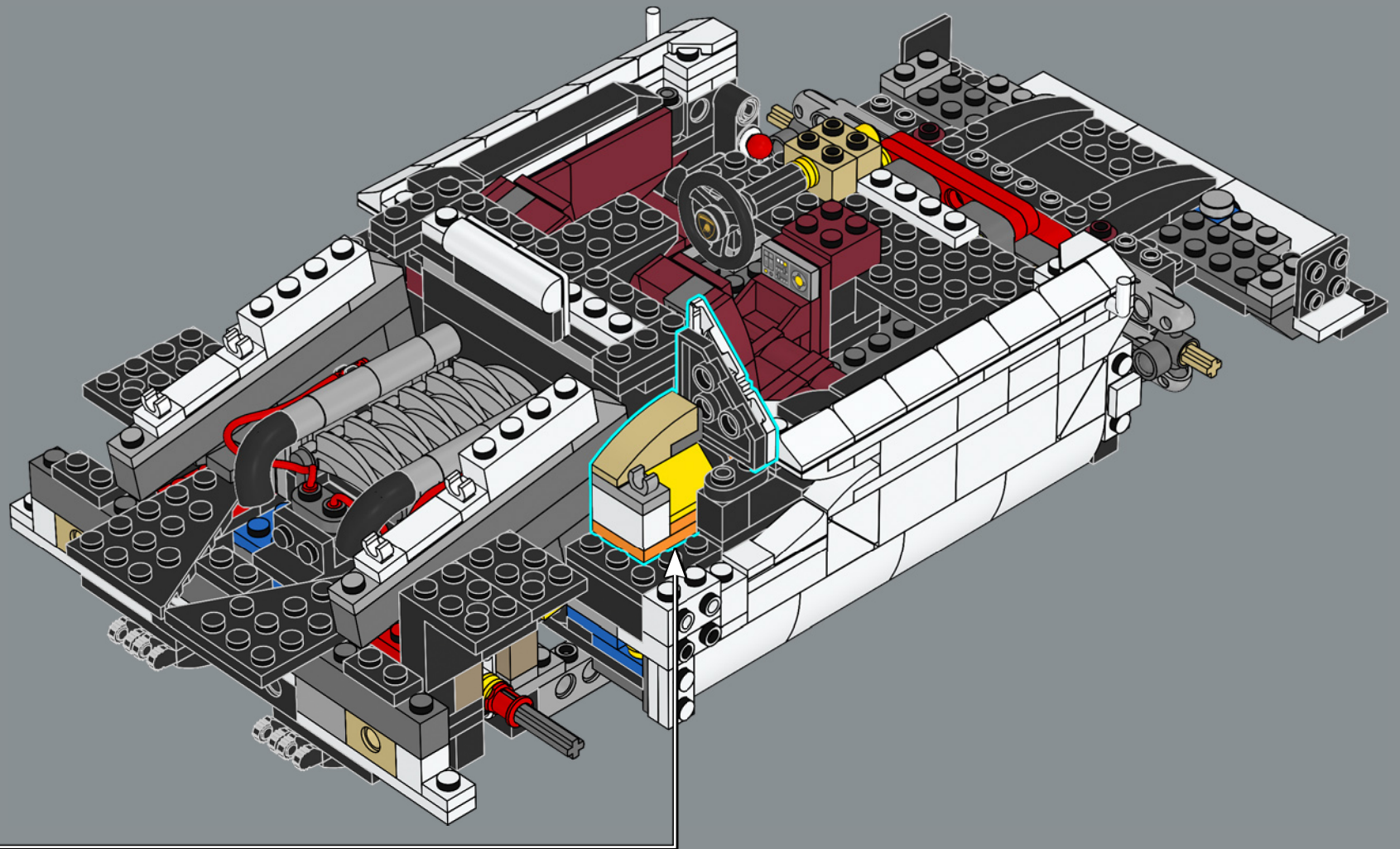

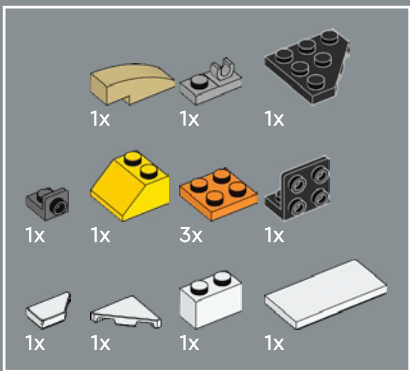

192

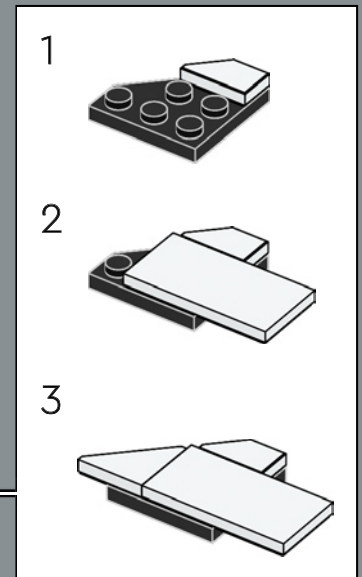
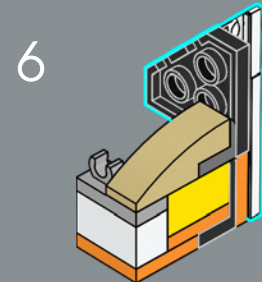
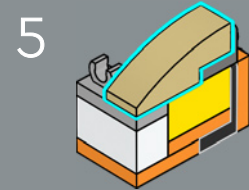
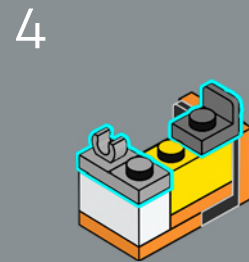
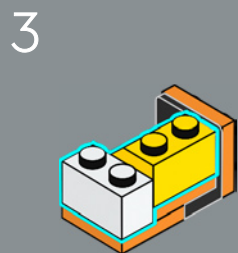
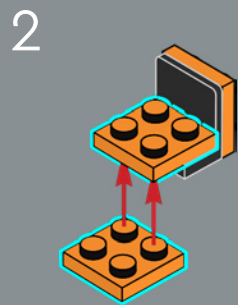
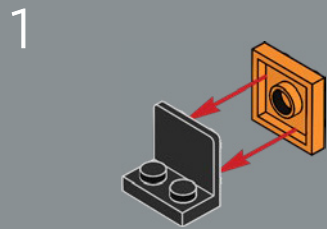

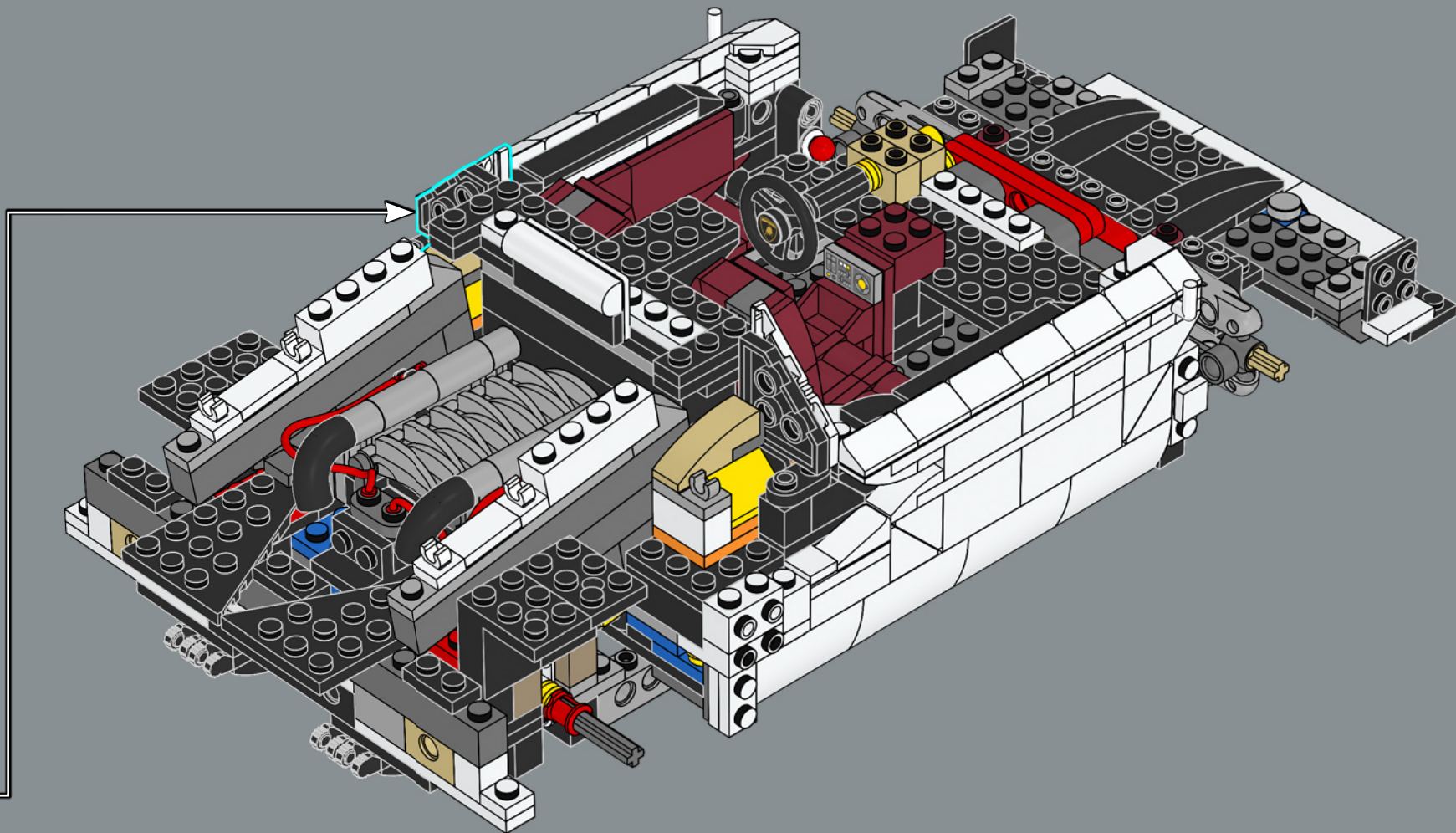

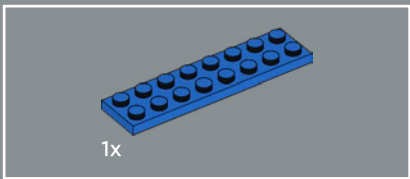

193

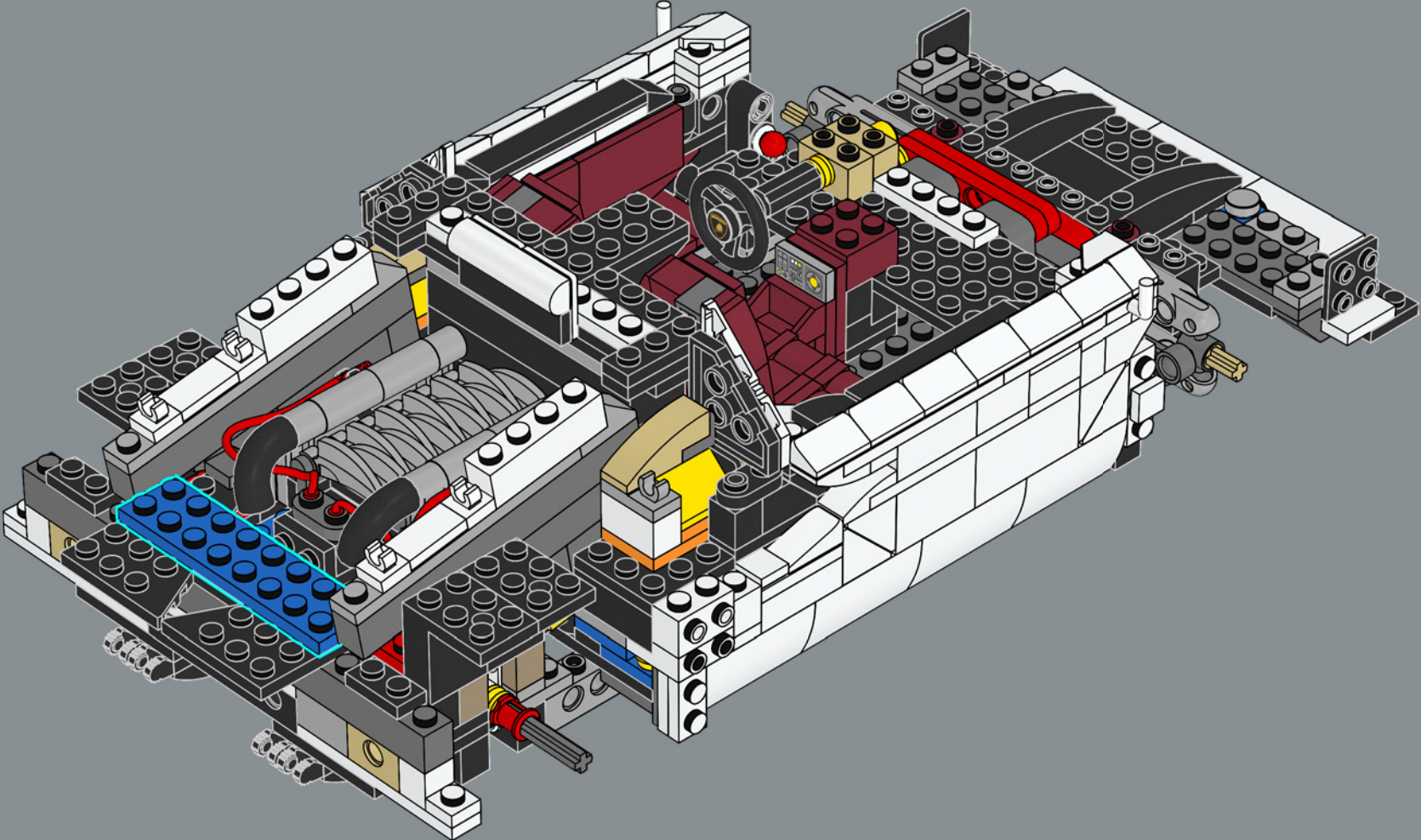

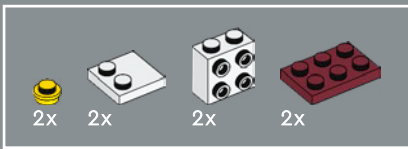

194

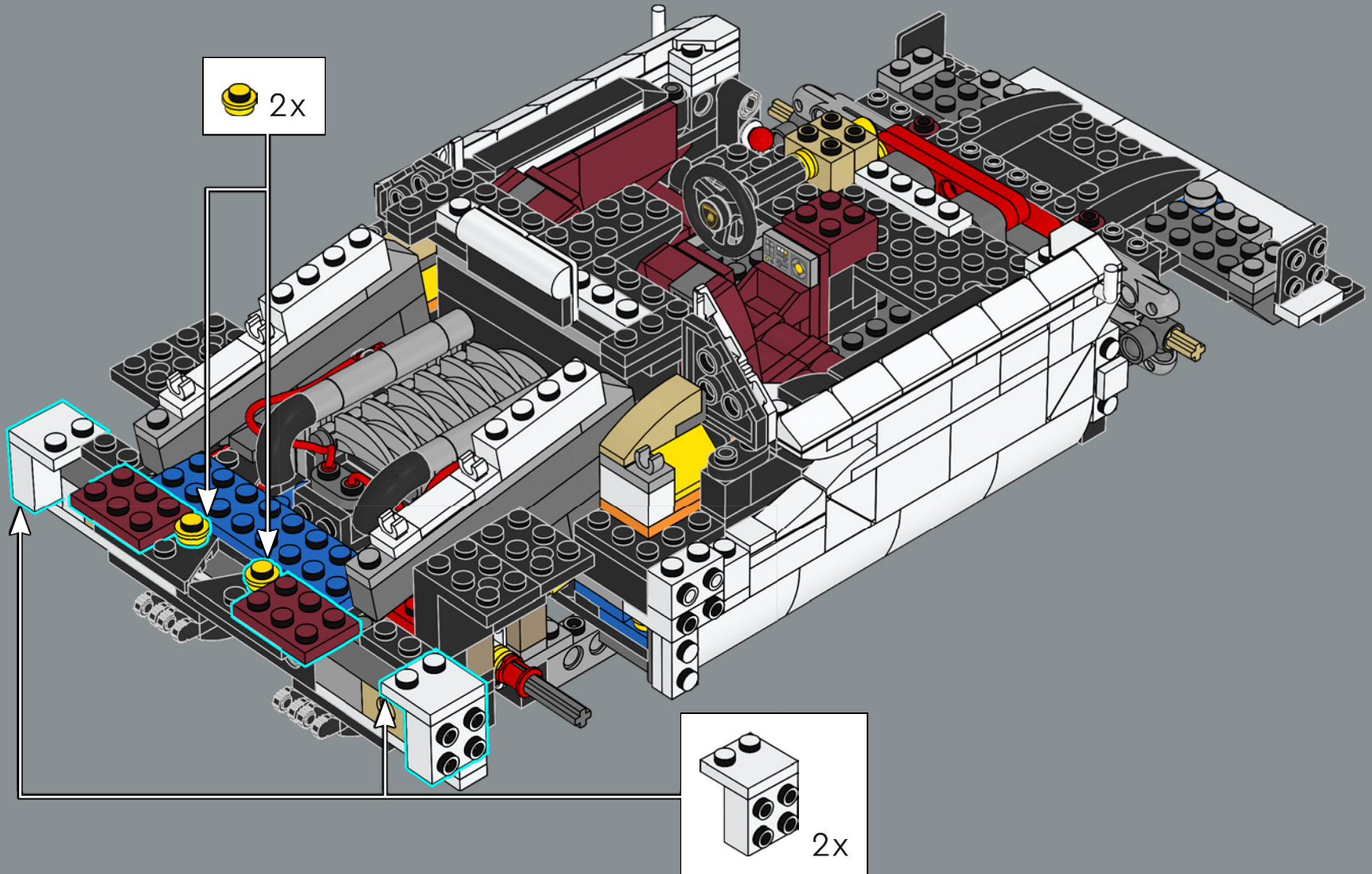



2x

195

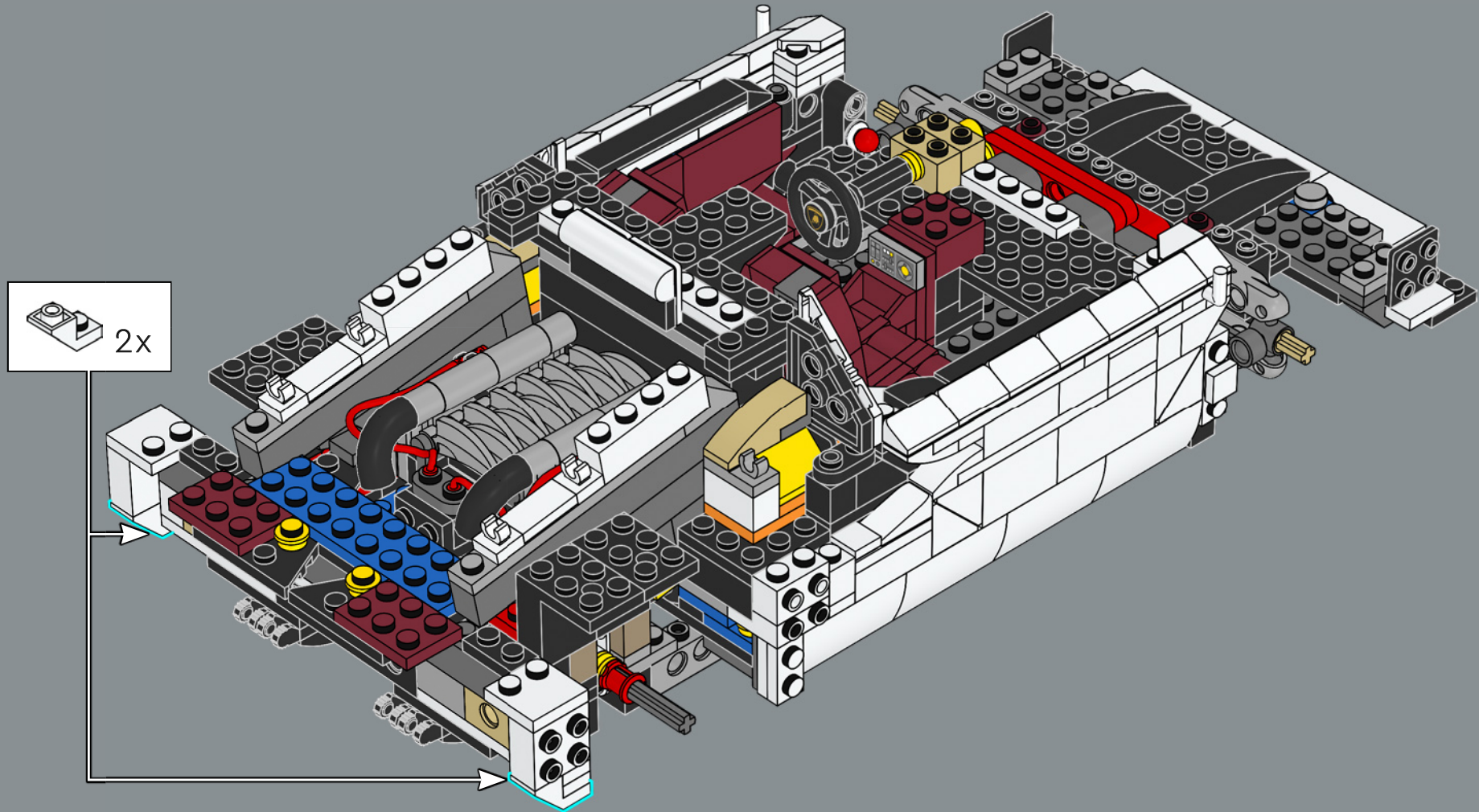

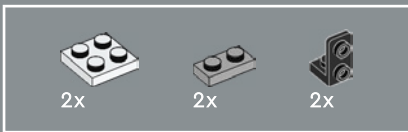

196

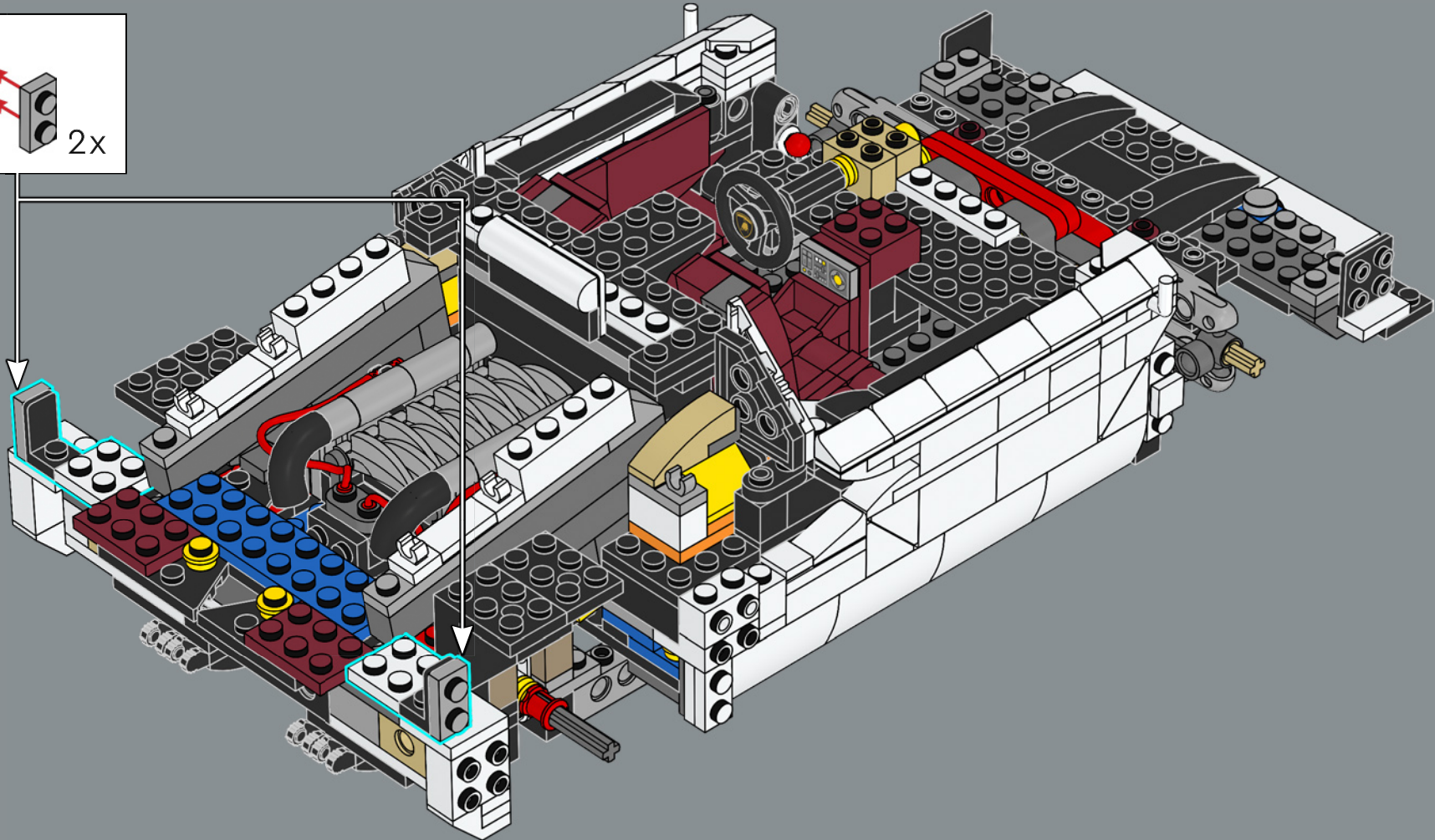
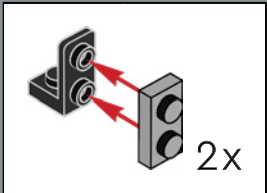

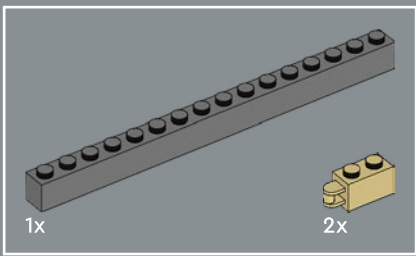

197

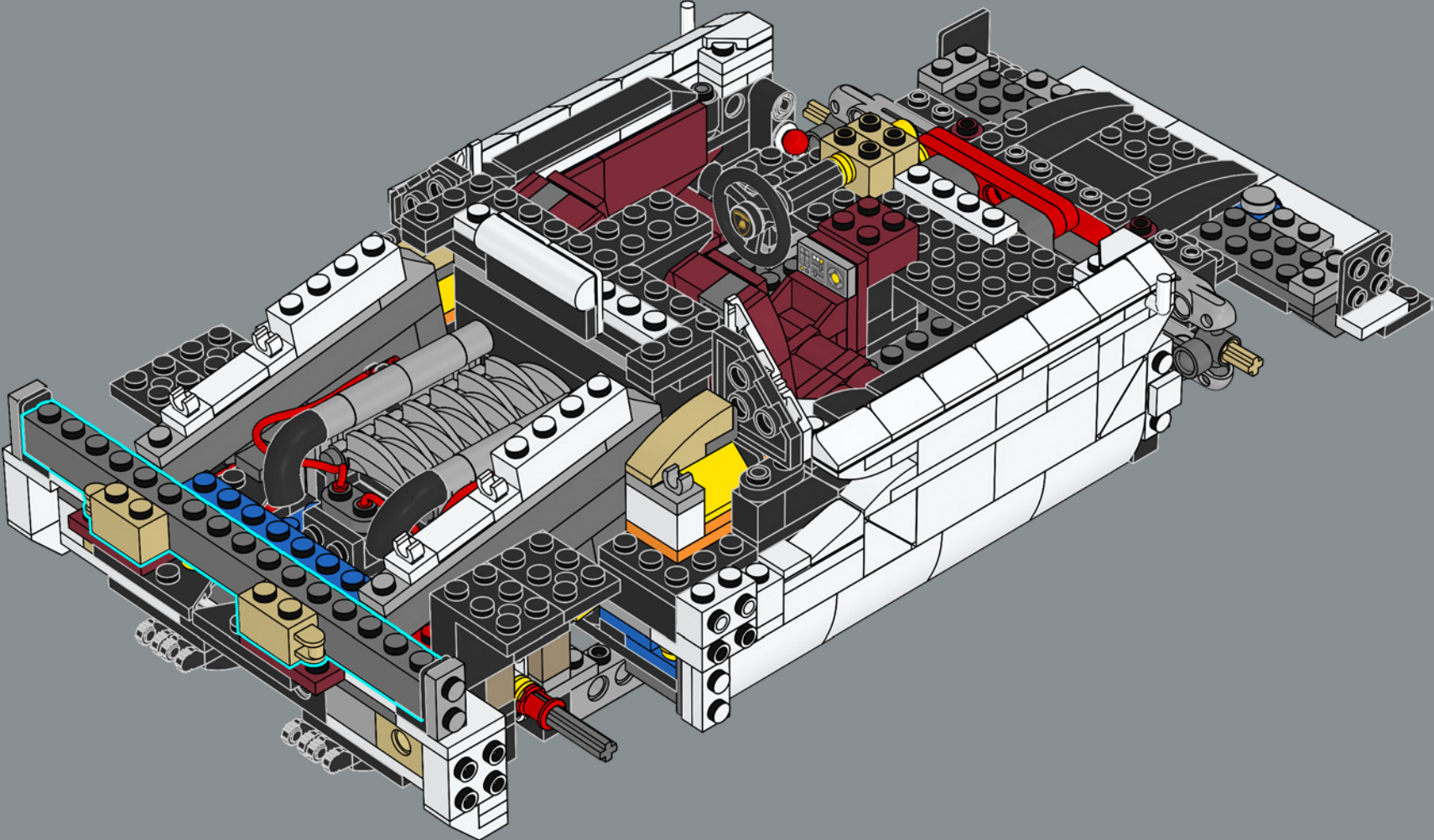

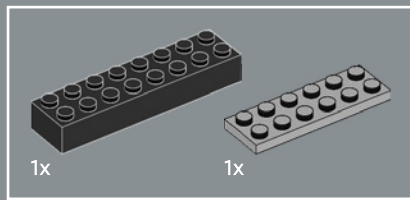

198

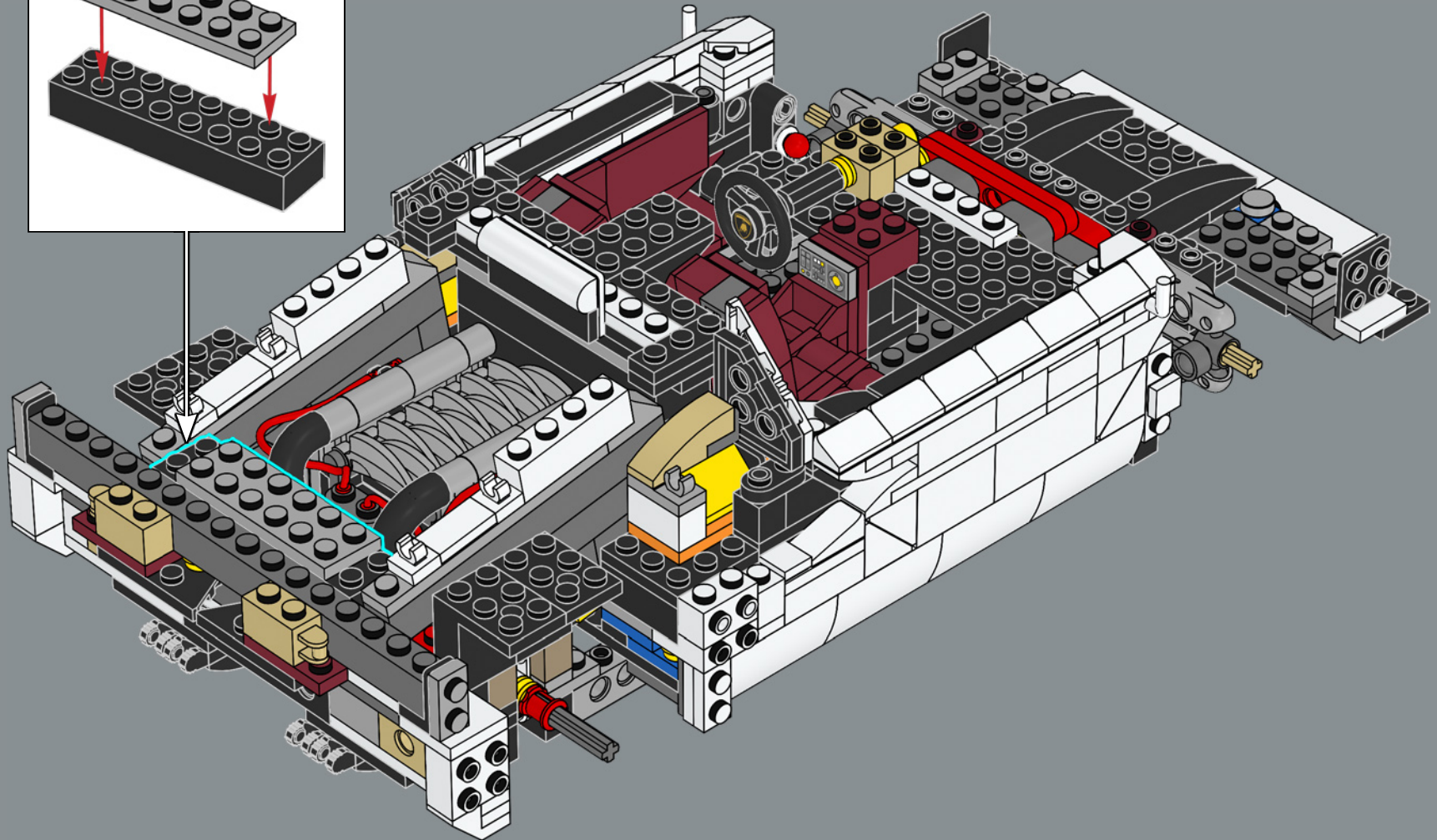
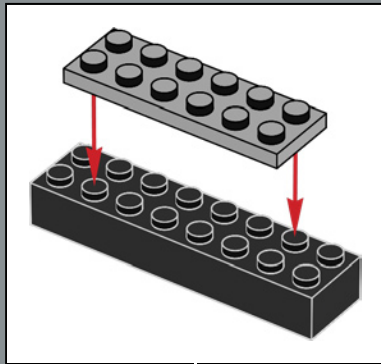

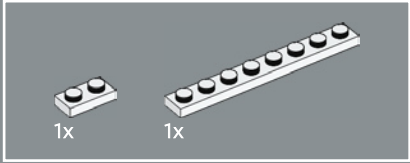
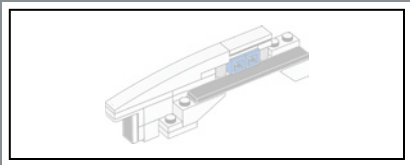

199

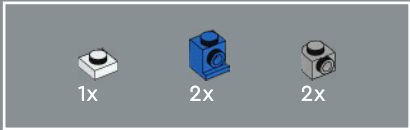
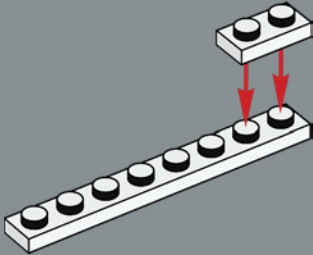

200

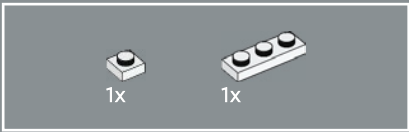
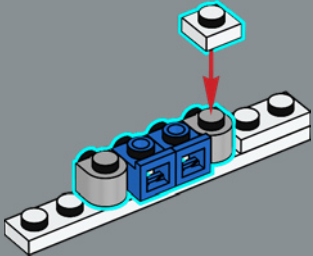

201

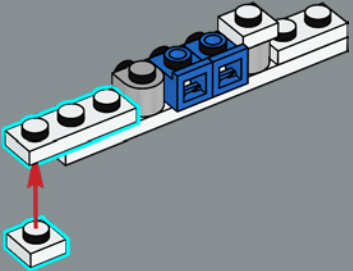

202

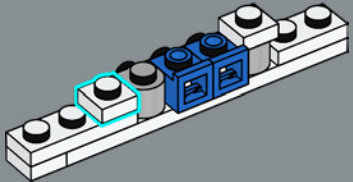

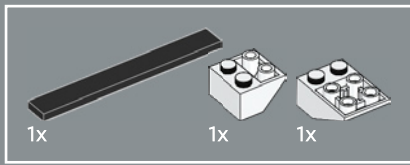

203

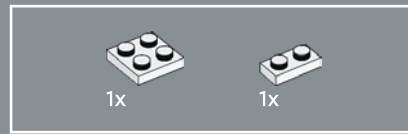
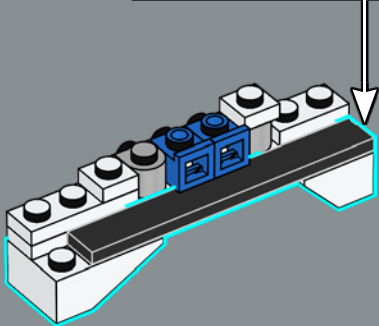
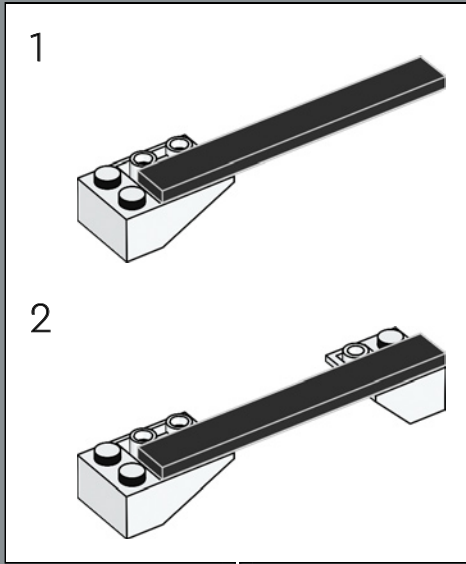

204

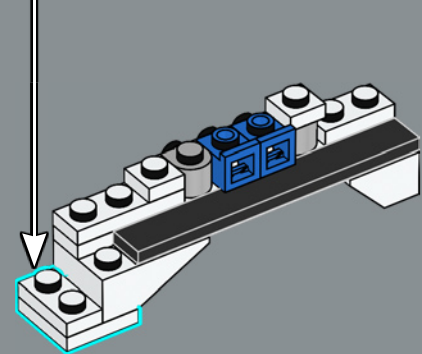
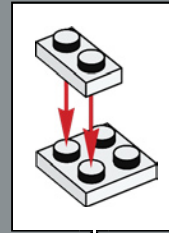

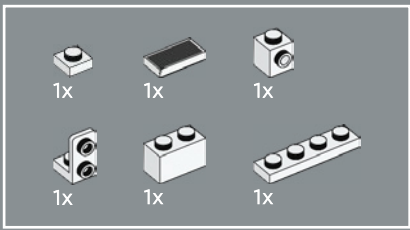

205

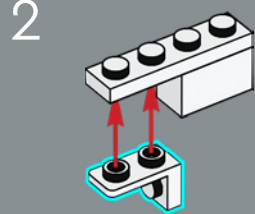
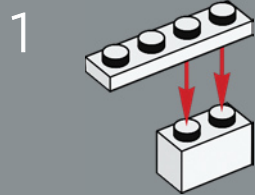

3

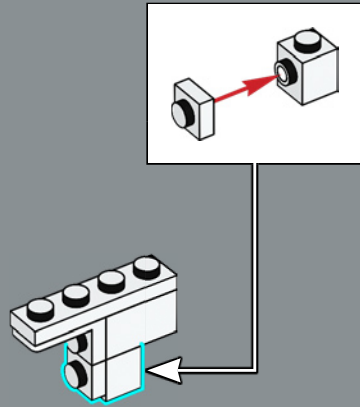

4

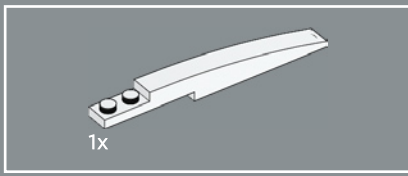
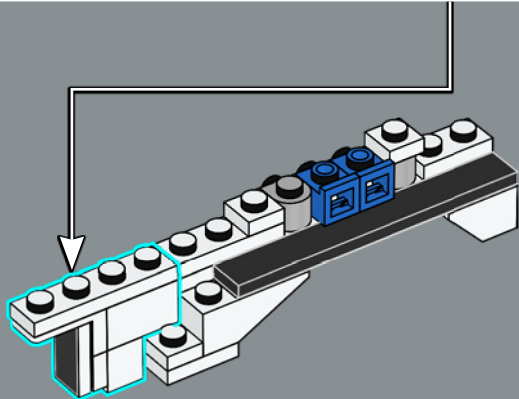
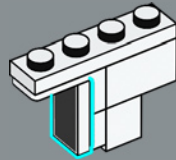

206

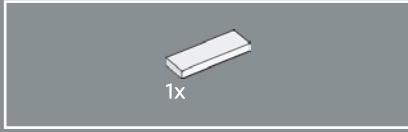
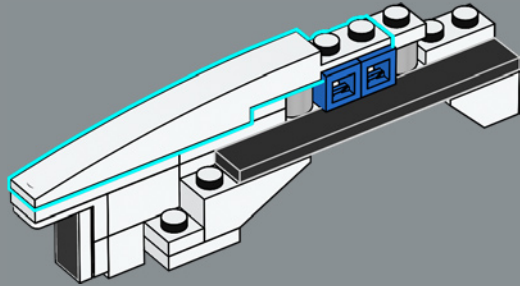

207

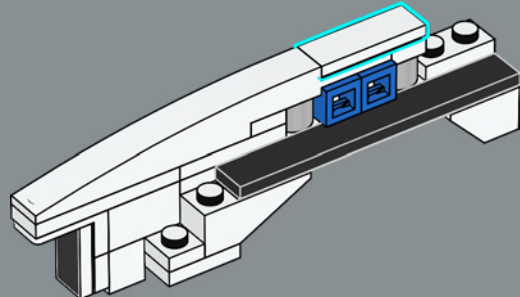

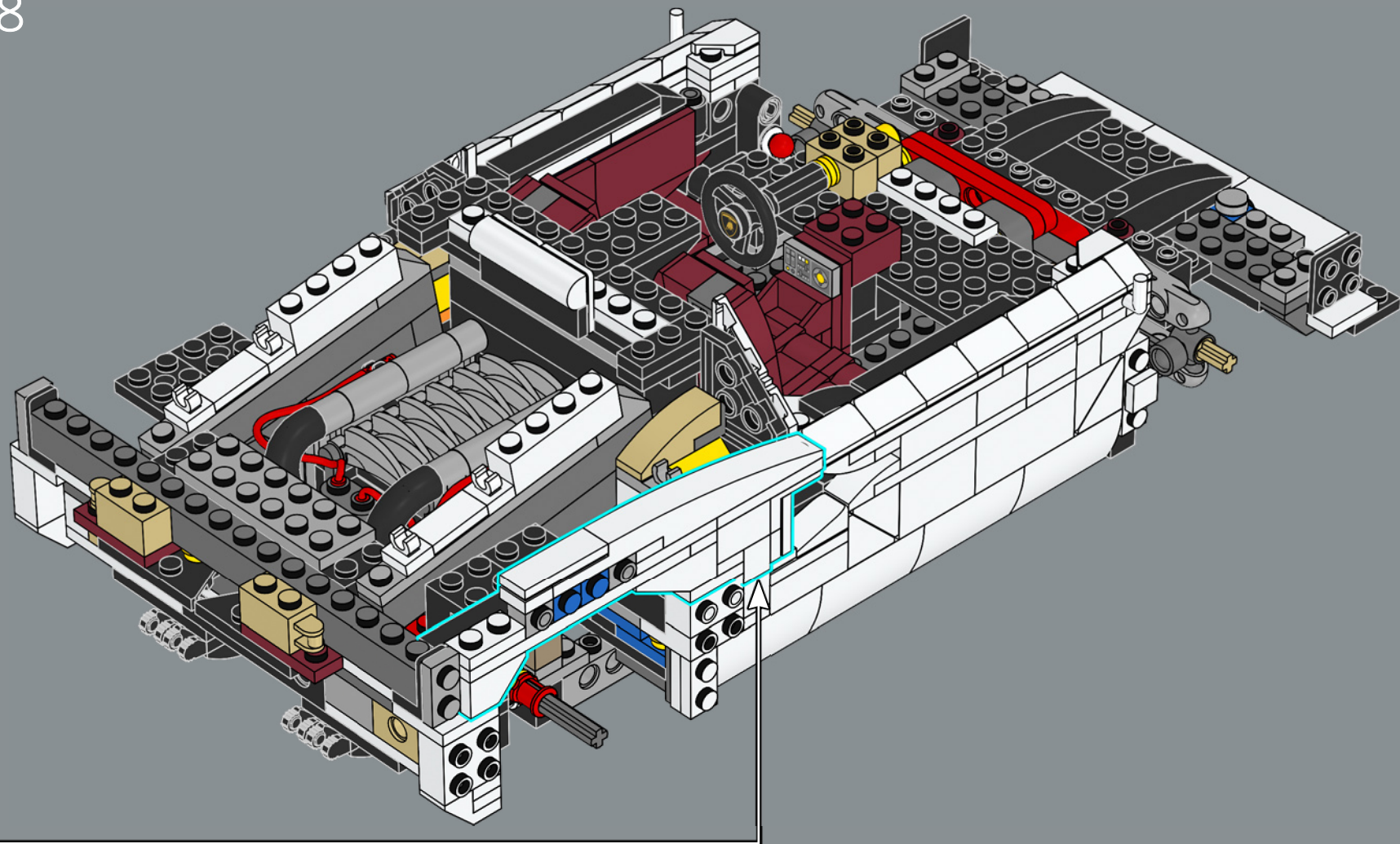

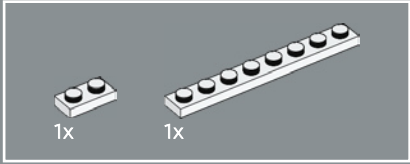
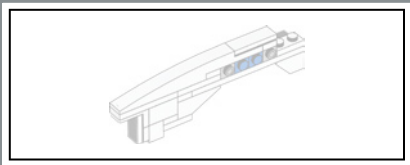

209

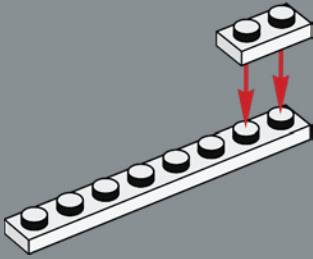

210

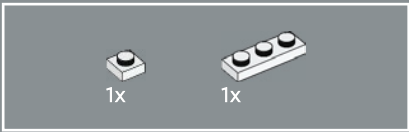
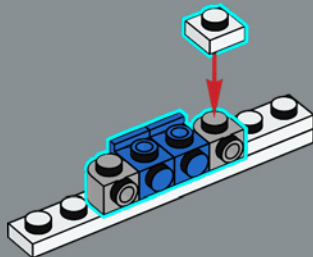

211

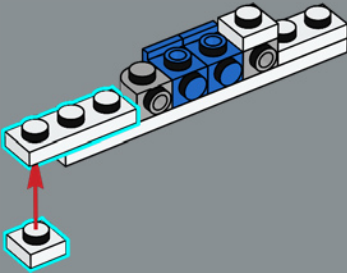

212

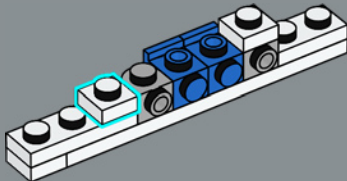

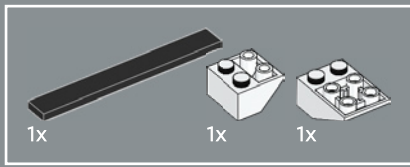

213

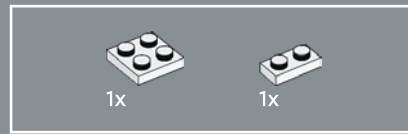
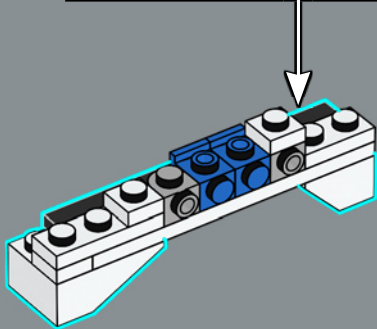
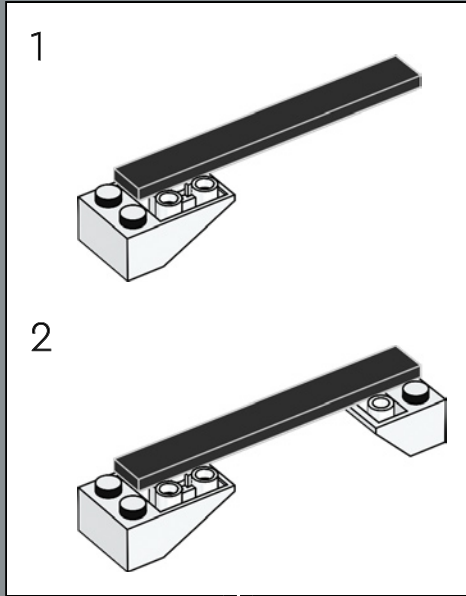

214

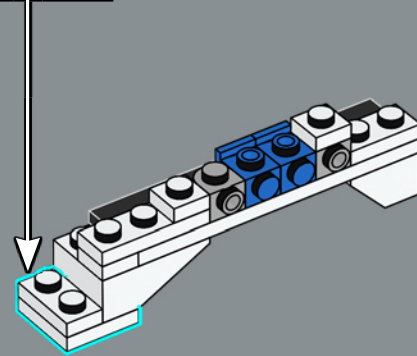
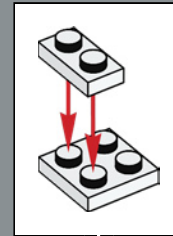

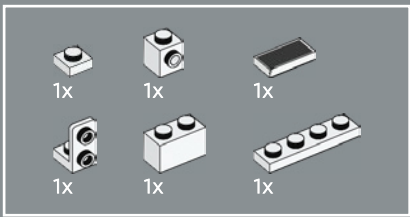

215

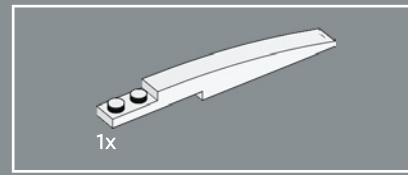
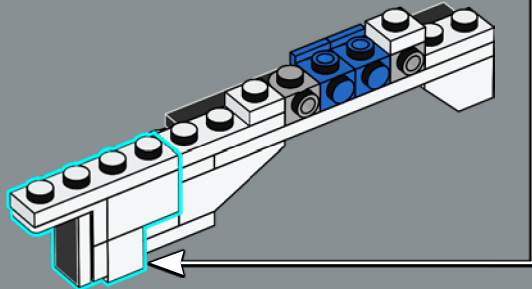
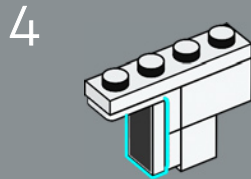
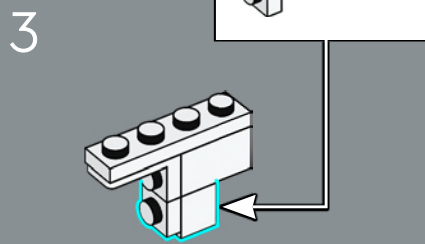
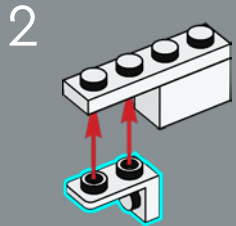
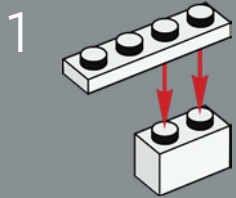

216

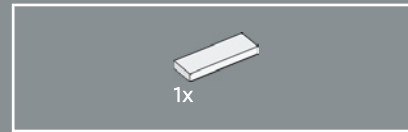
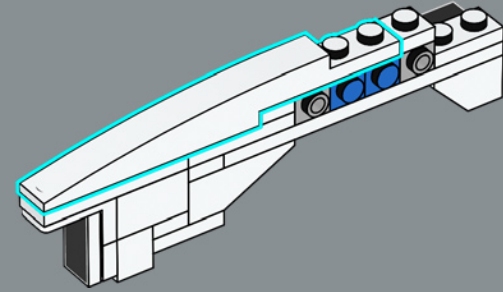

217

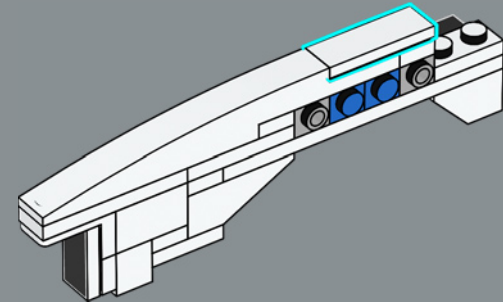

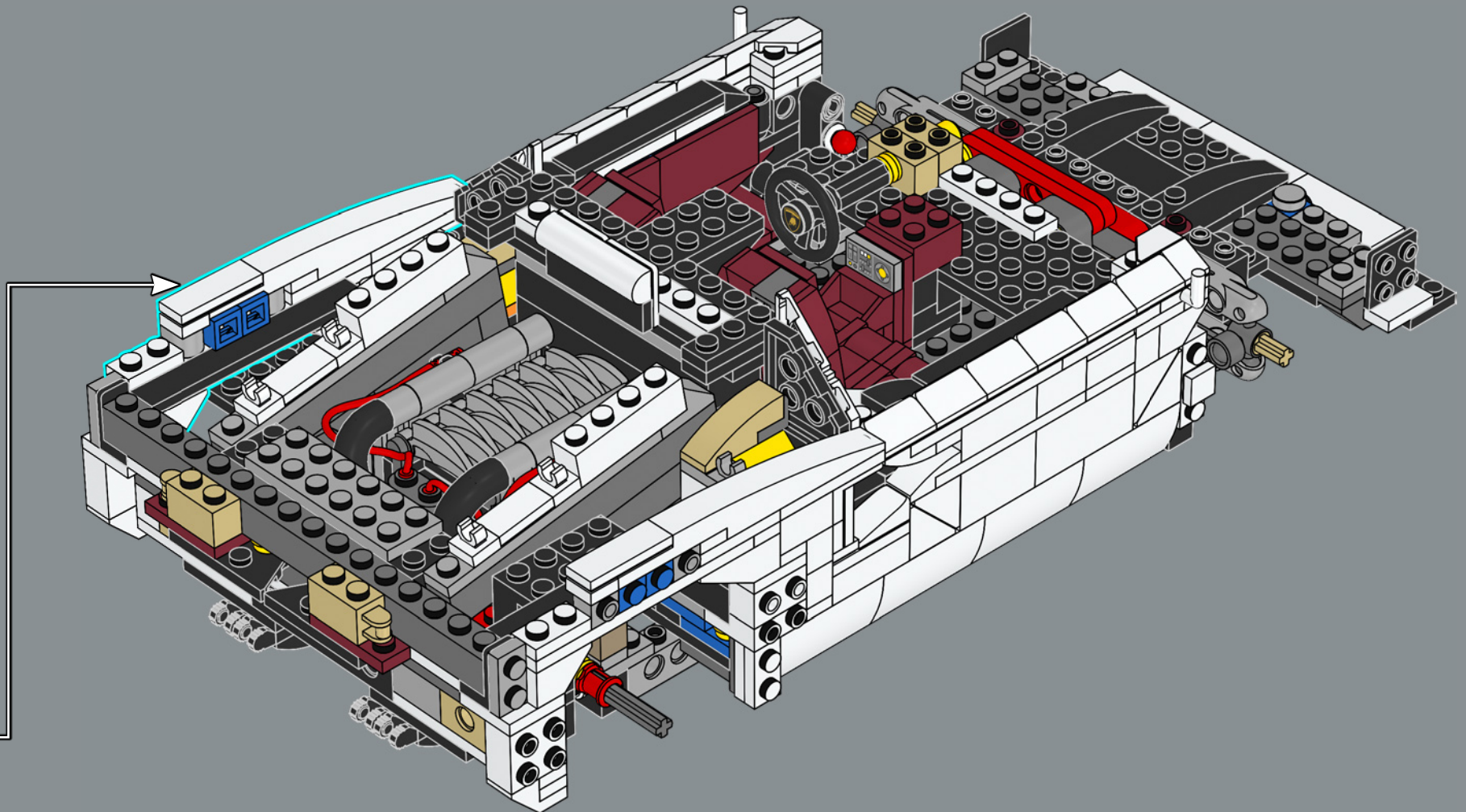

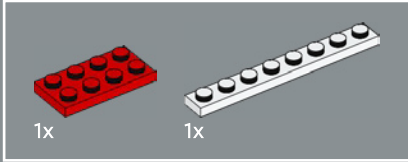
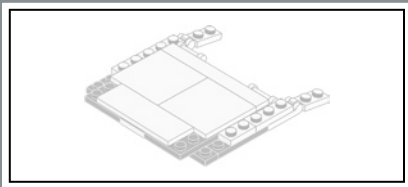

219

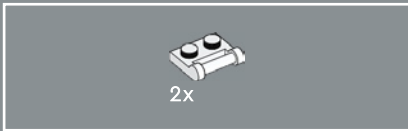
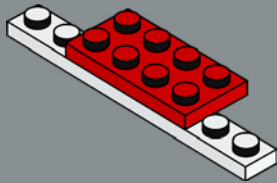

220

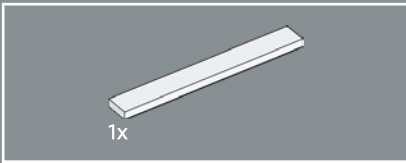
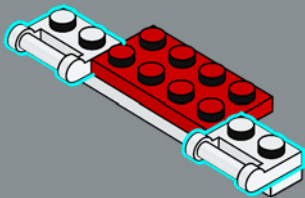

221

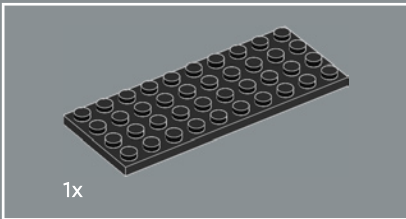
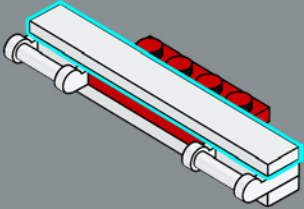

222

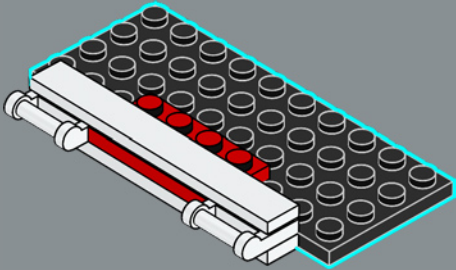

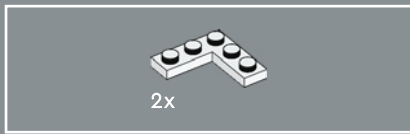

223

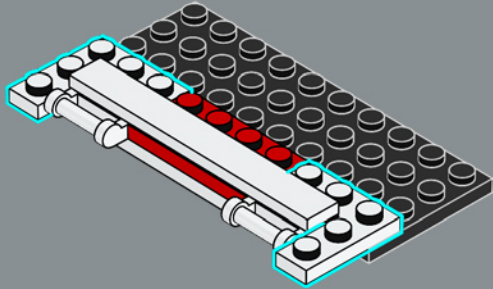

224

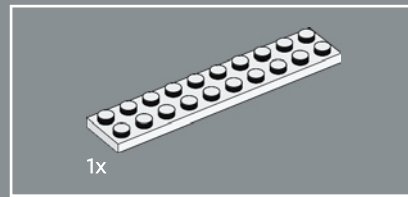
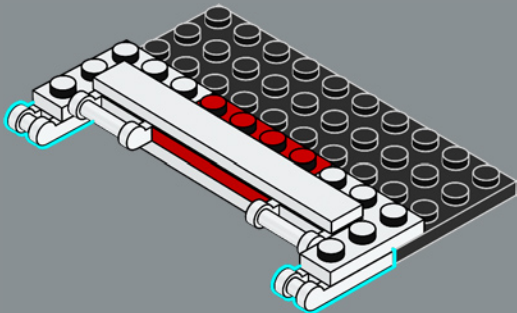

225

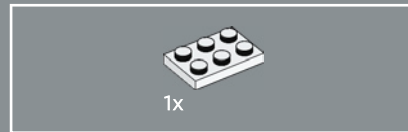
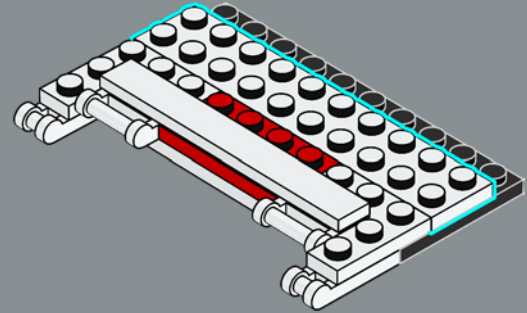

226

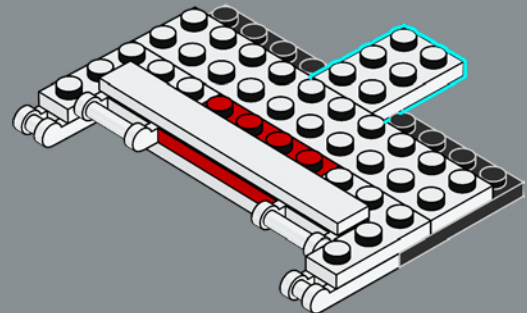

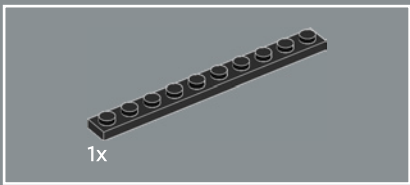

227

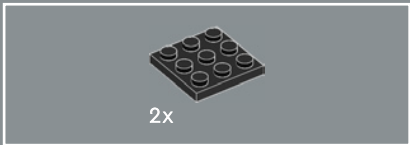
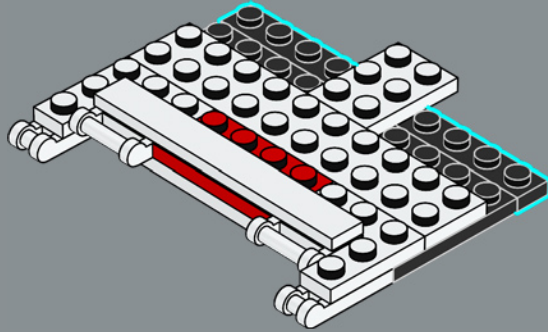

228

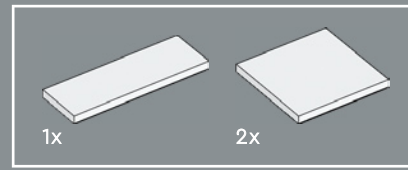
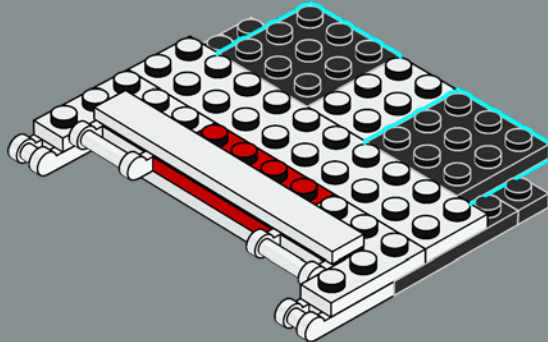

229

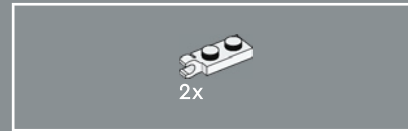
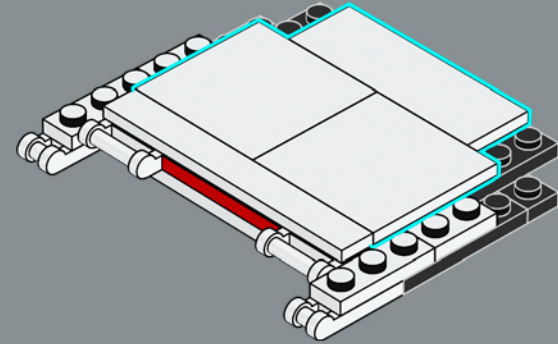

230

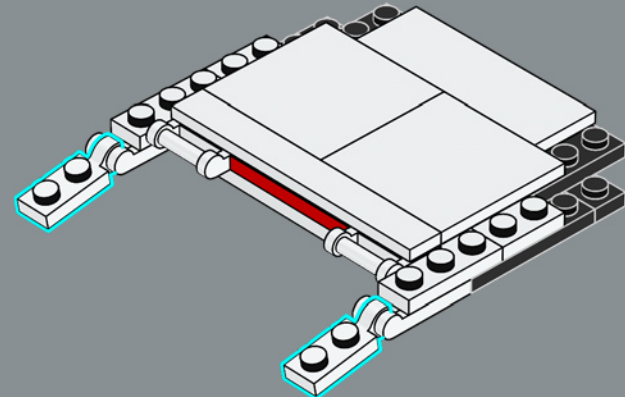

231

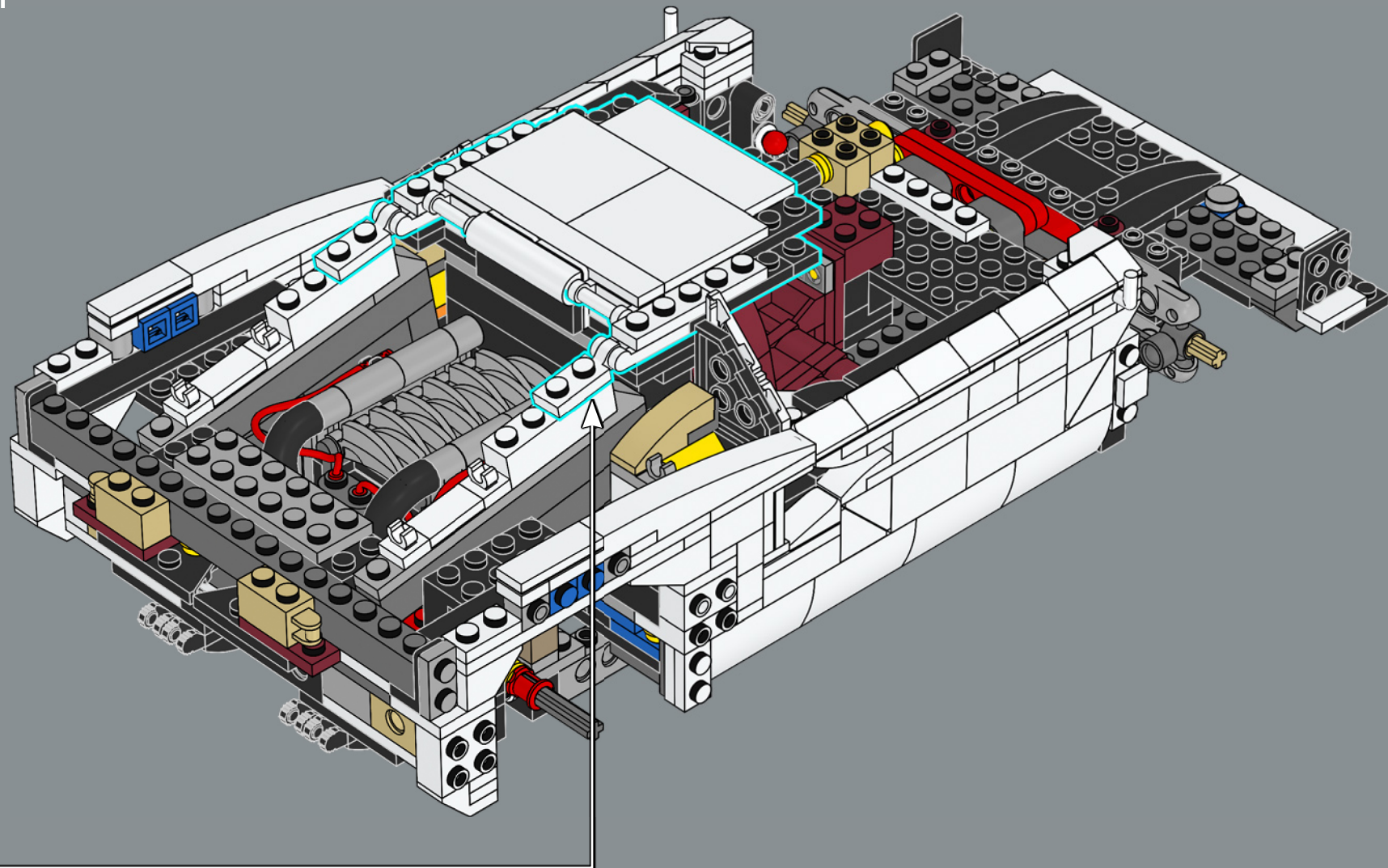

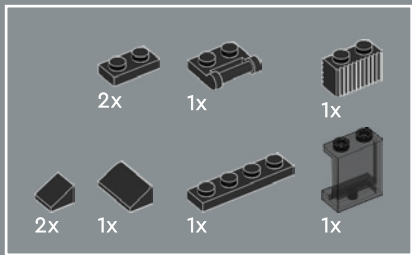

232

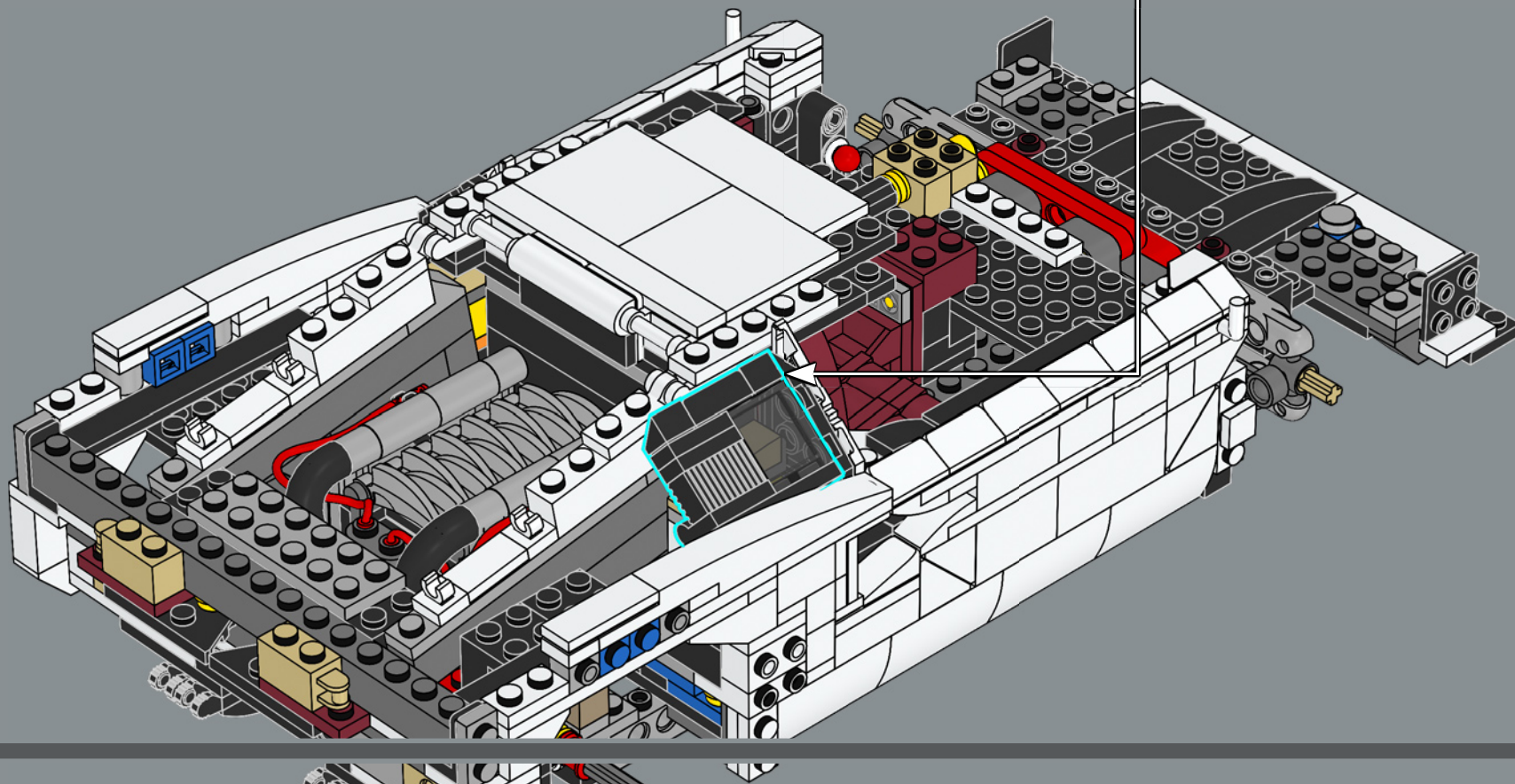
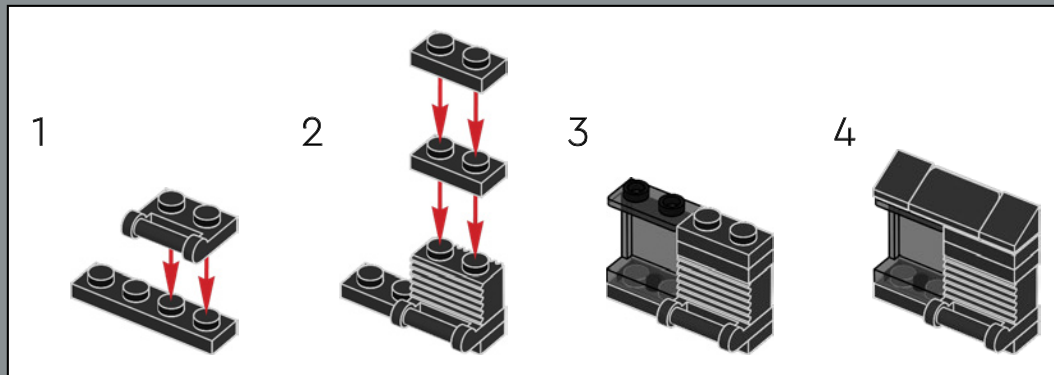

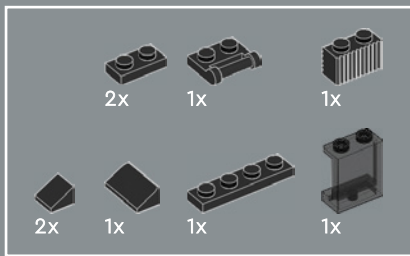

233

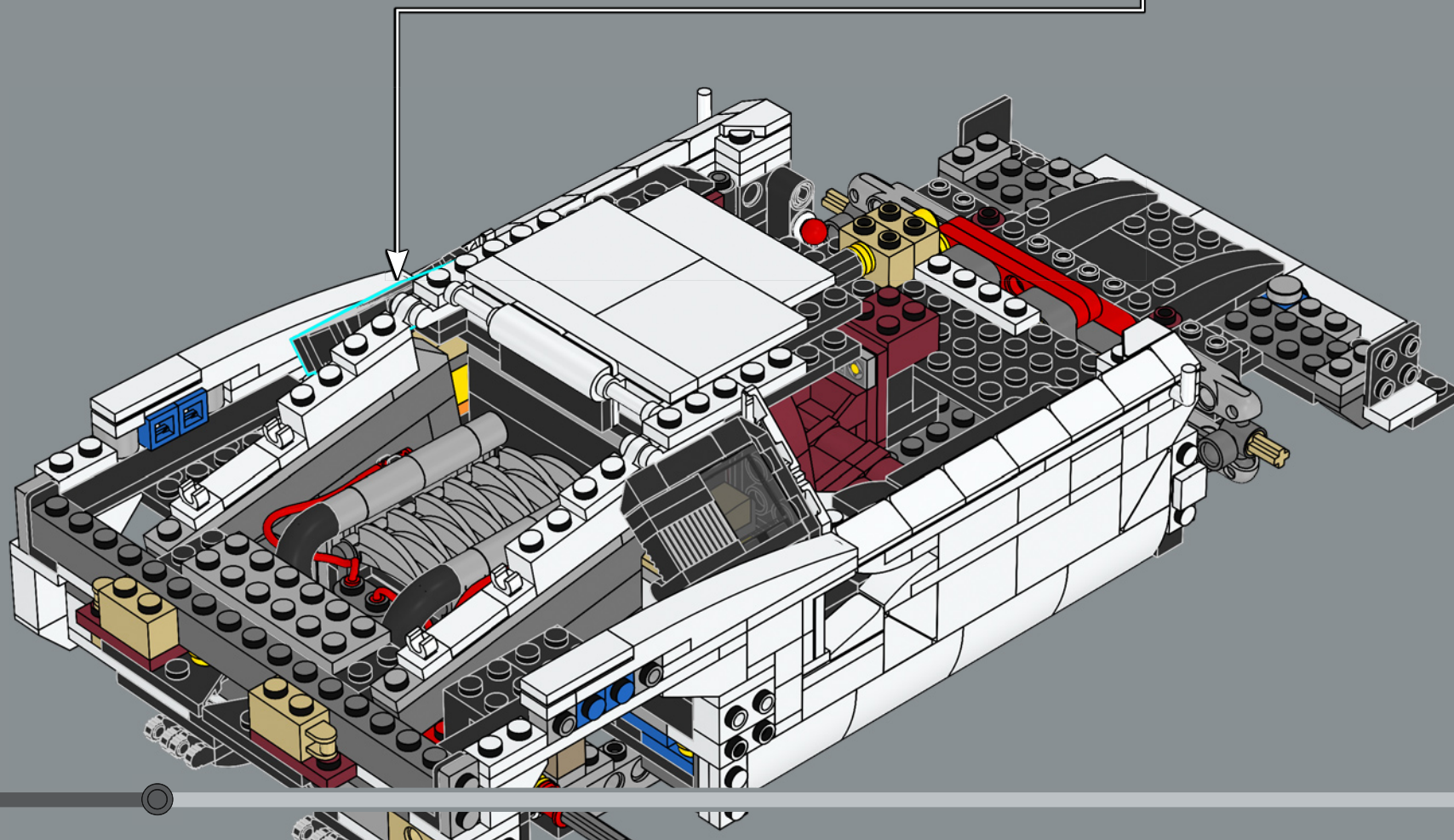
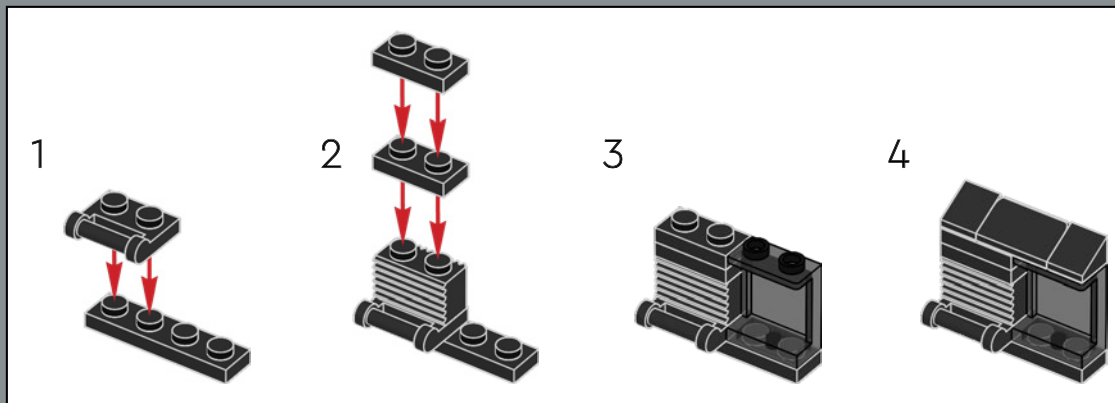

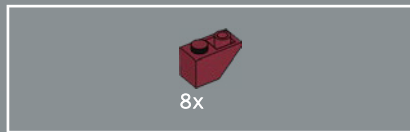

234

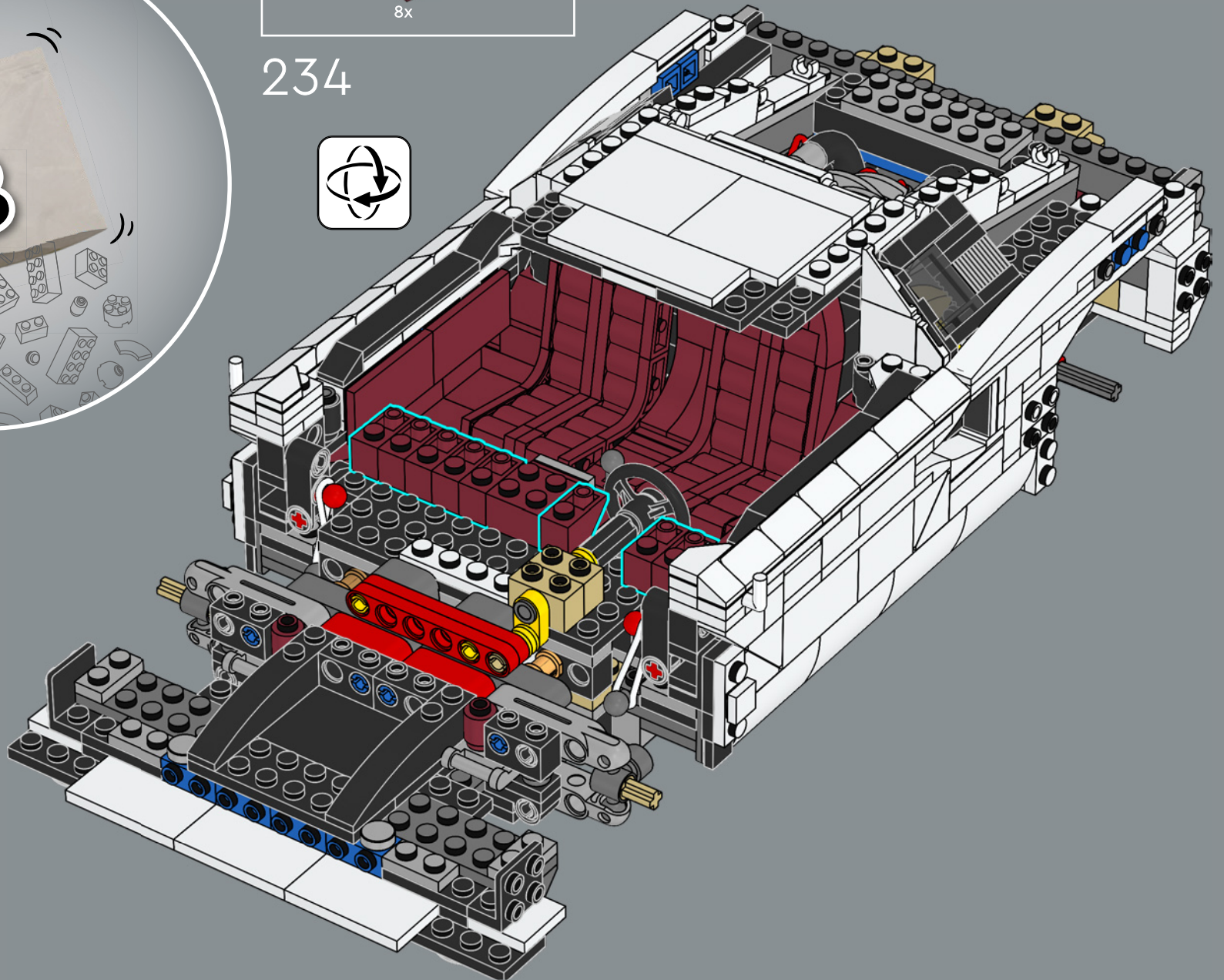

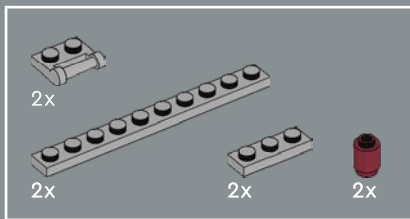

235

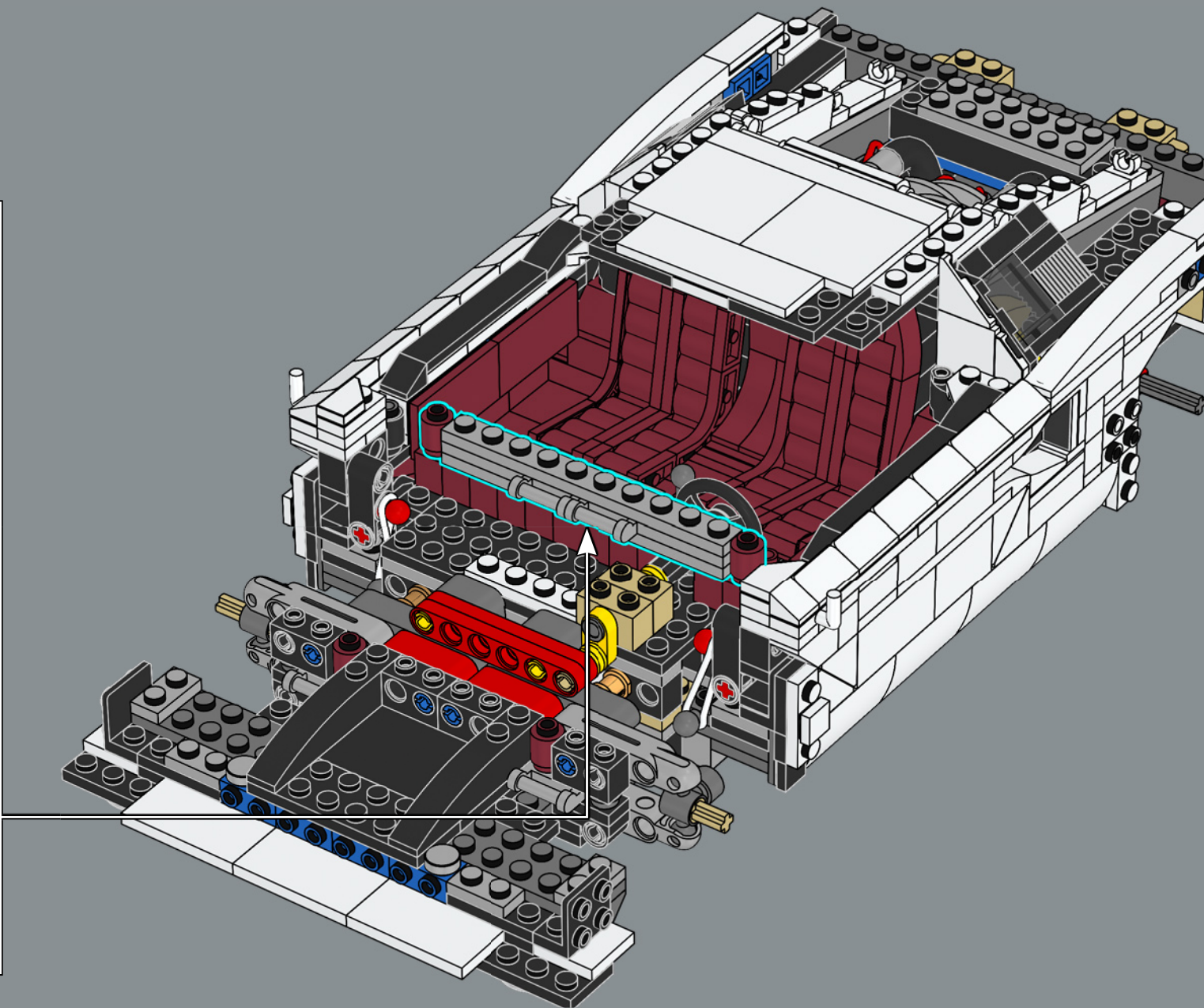
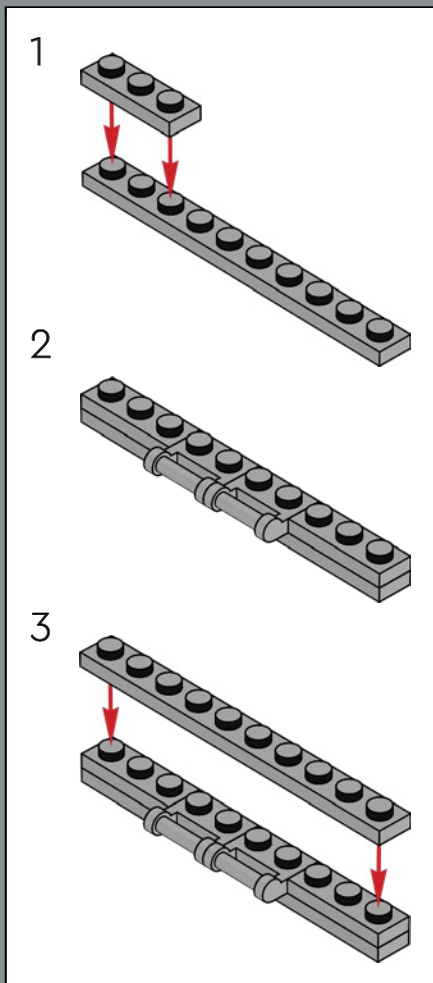

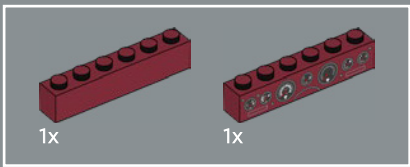

236

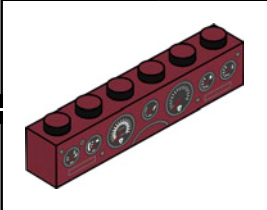
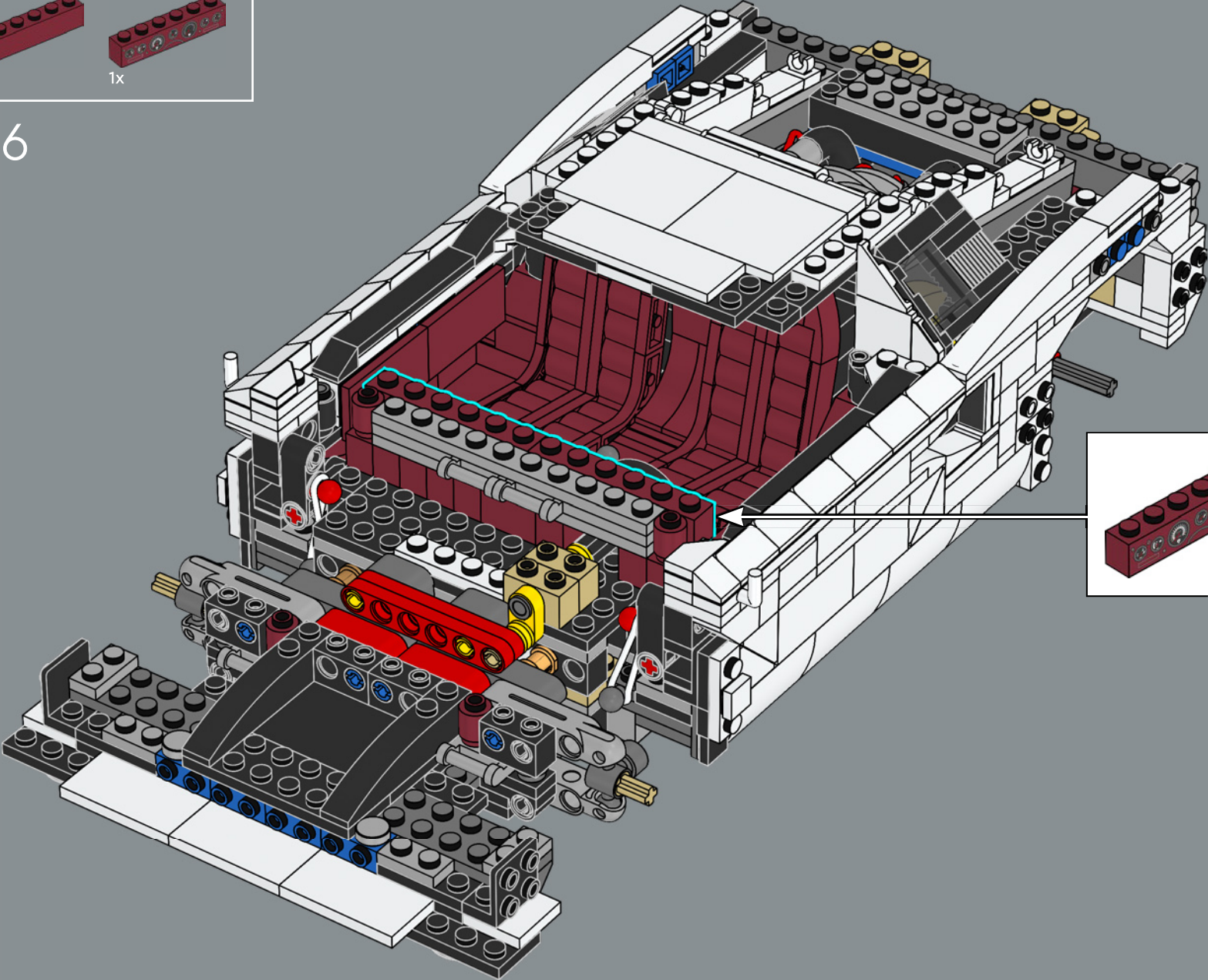

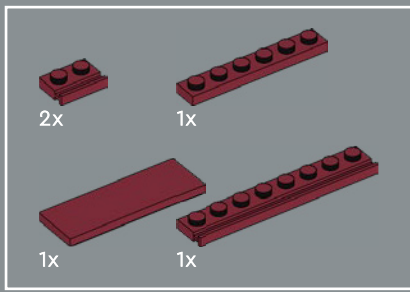

237

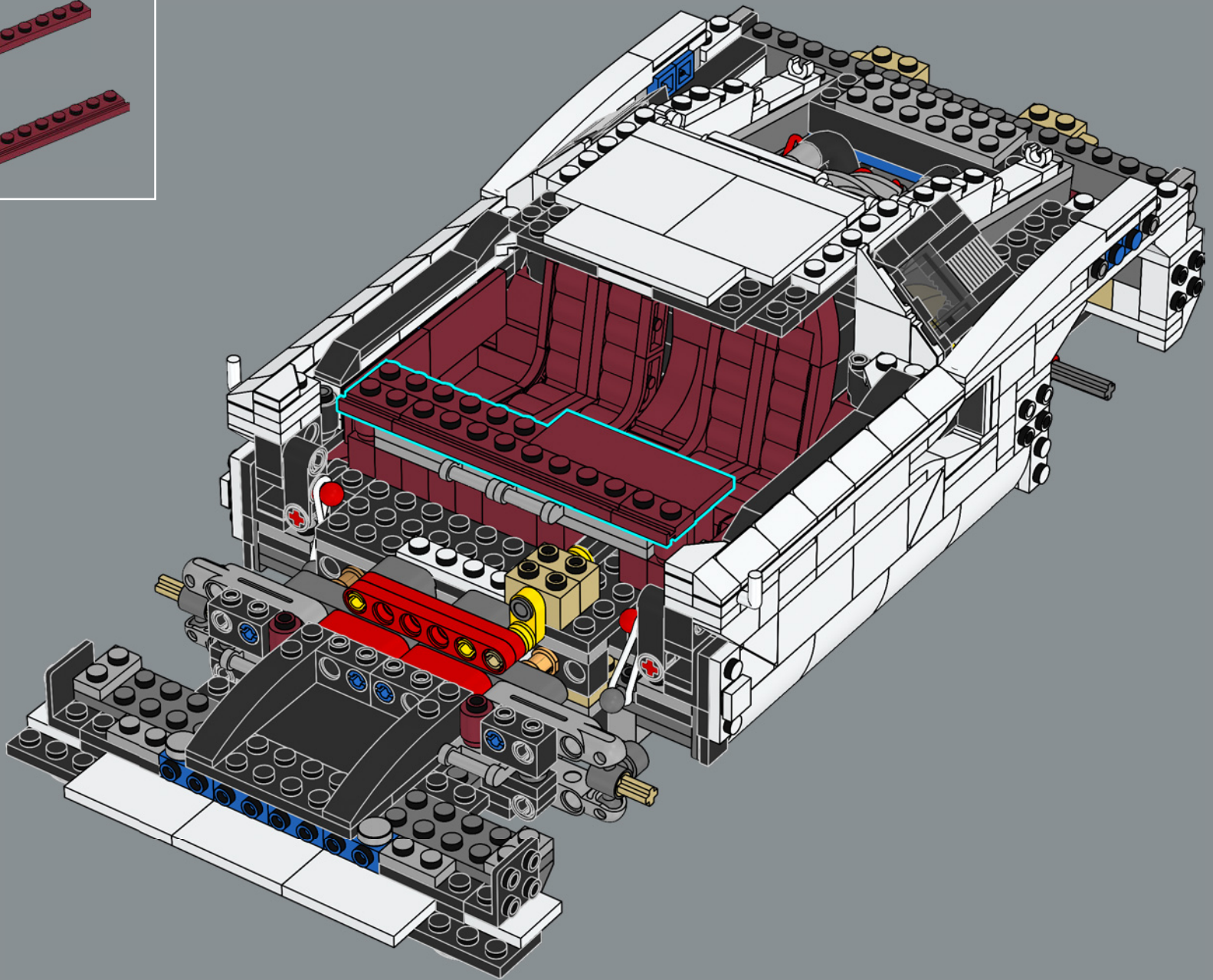



238

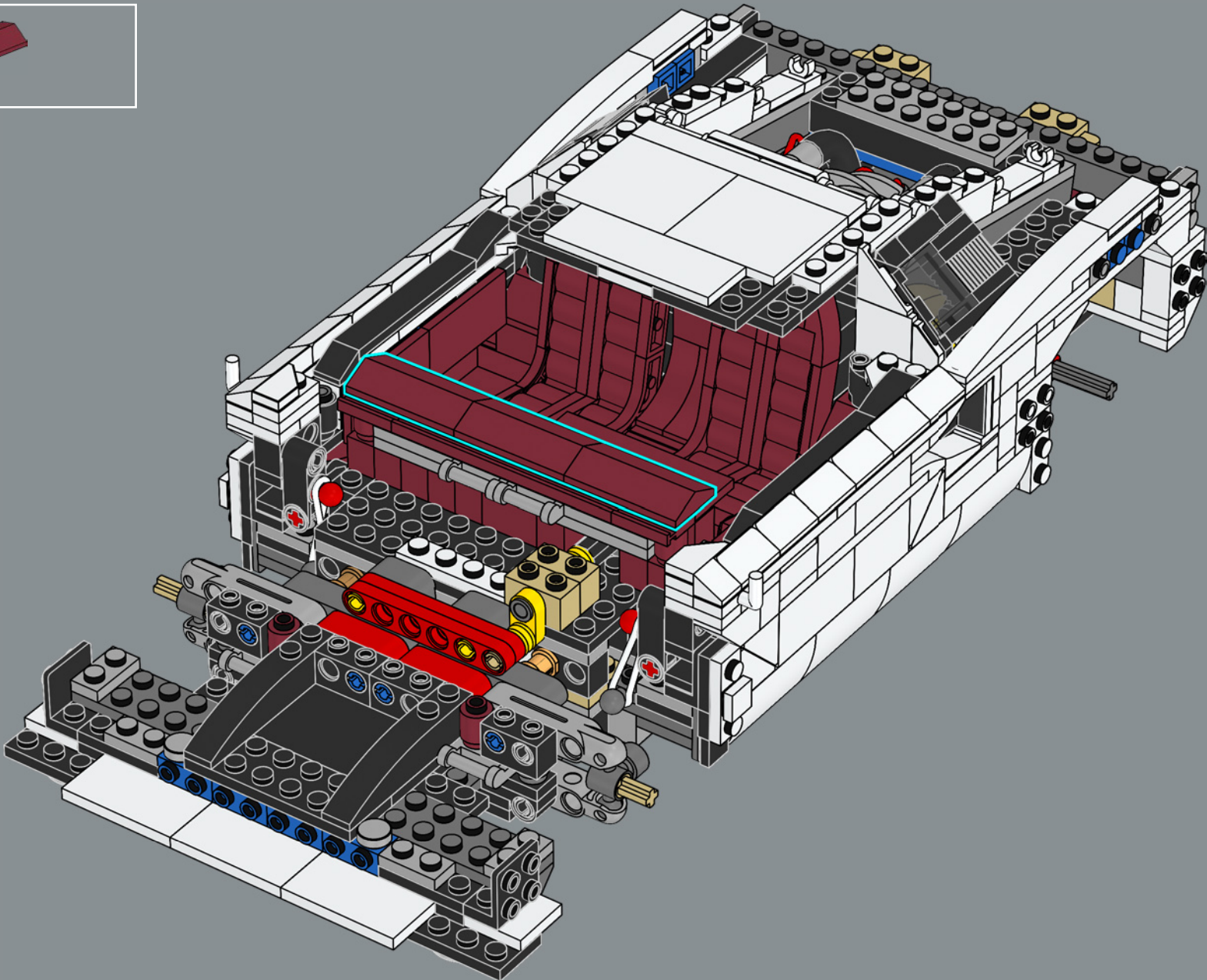

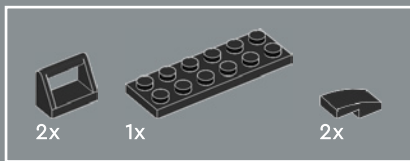

239

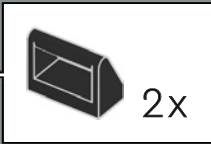
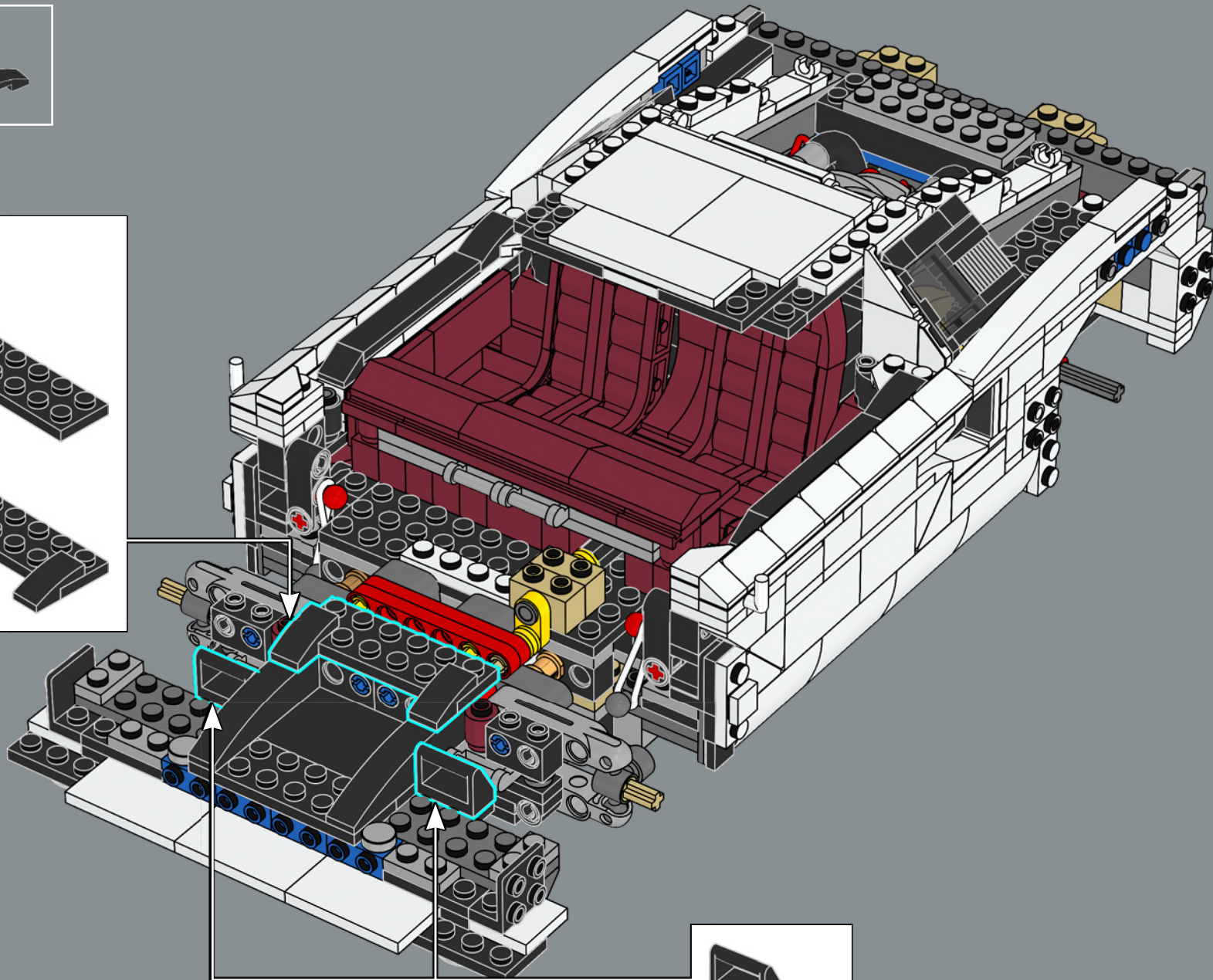
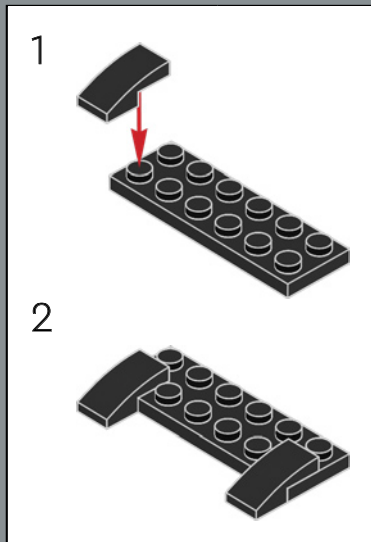

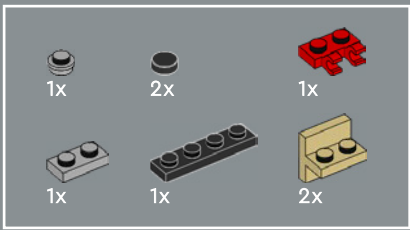

240

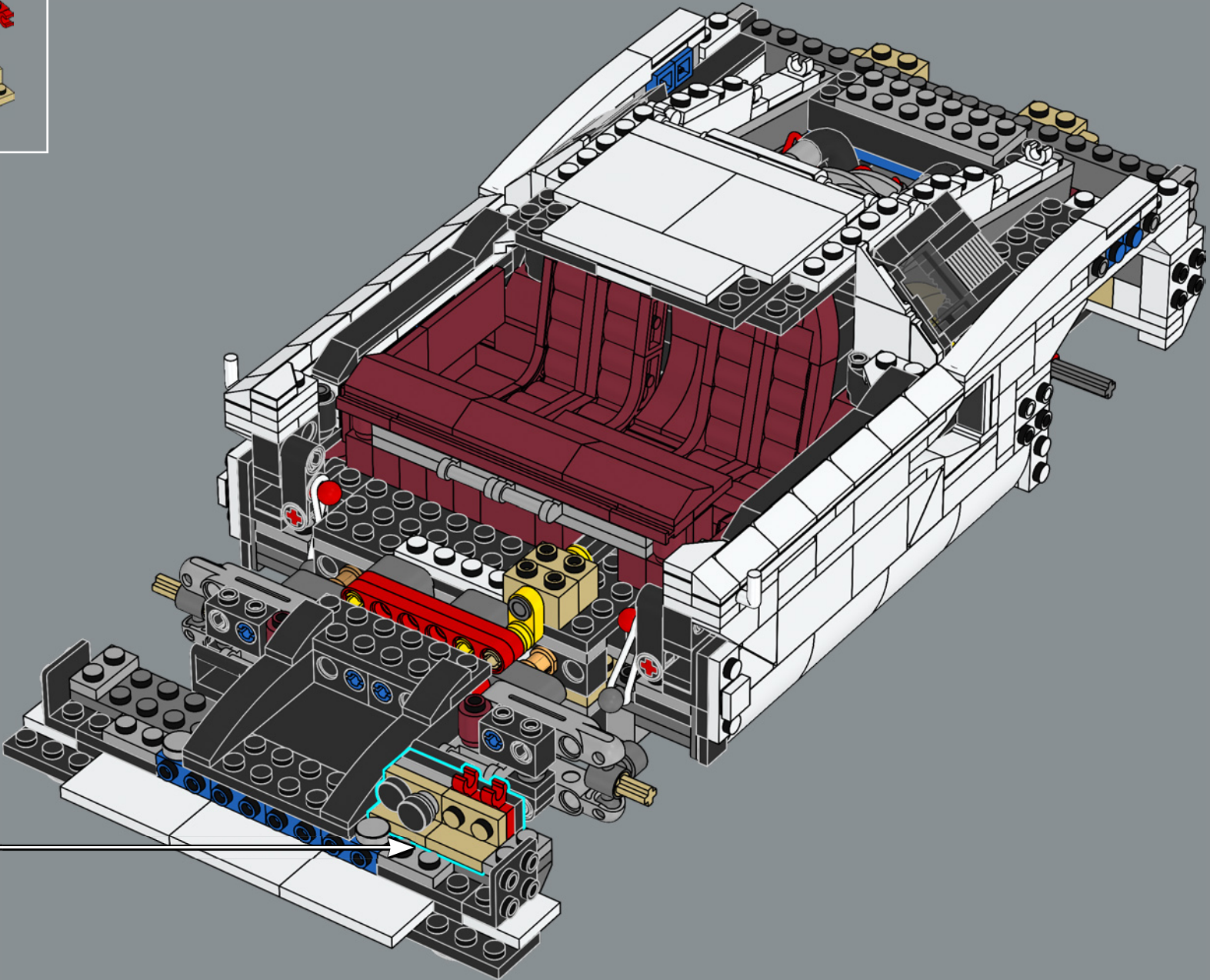
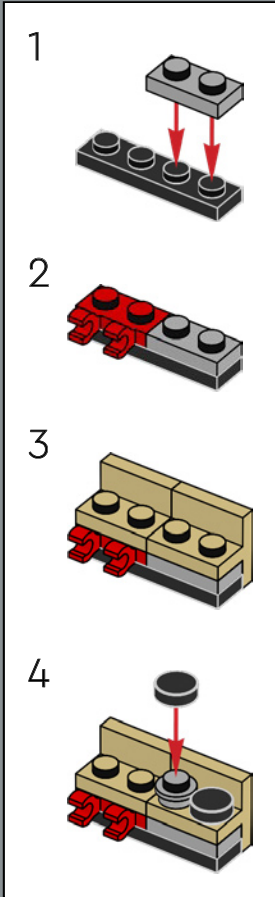

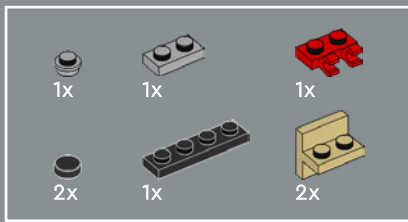

241

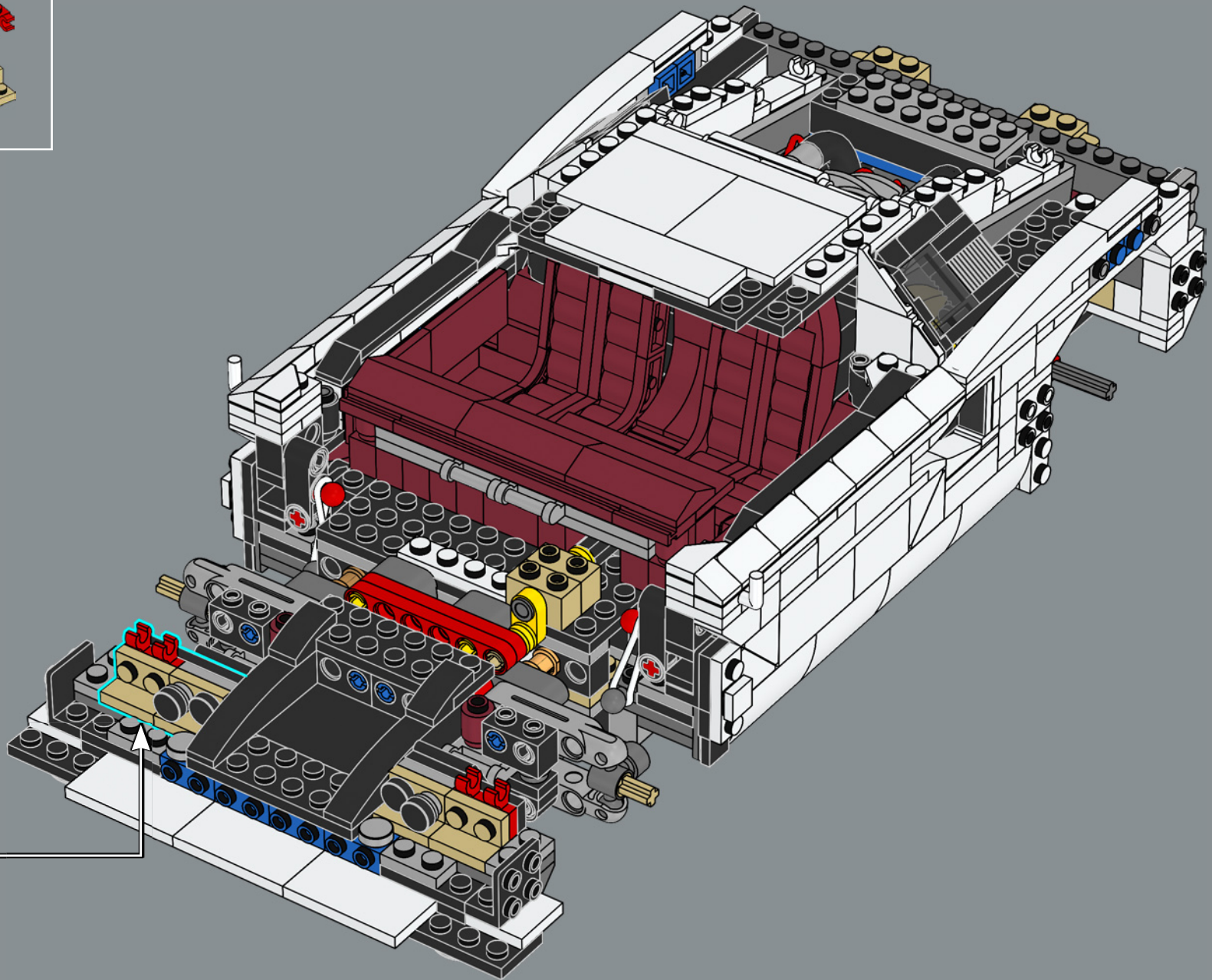
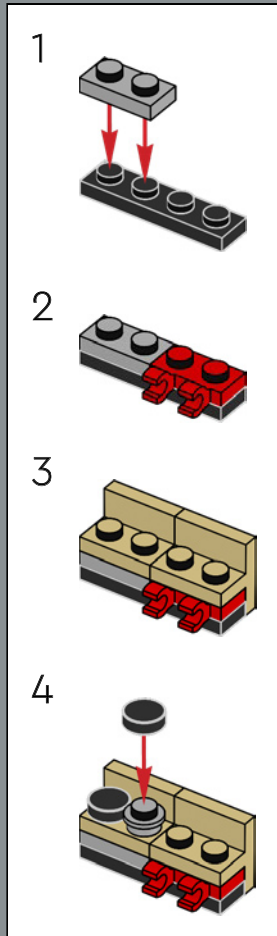



2x

242

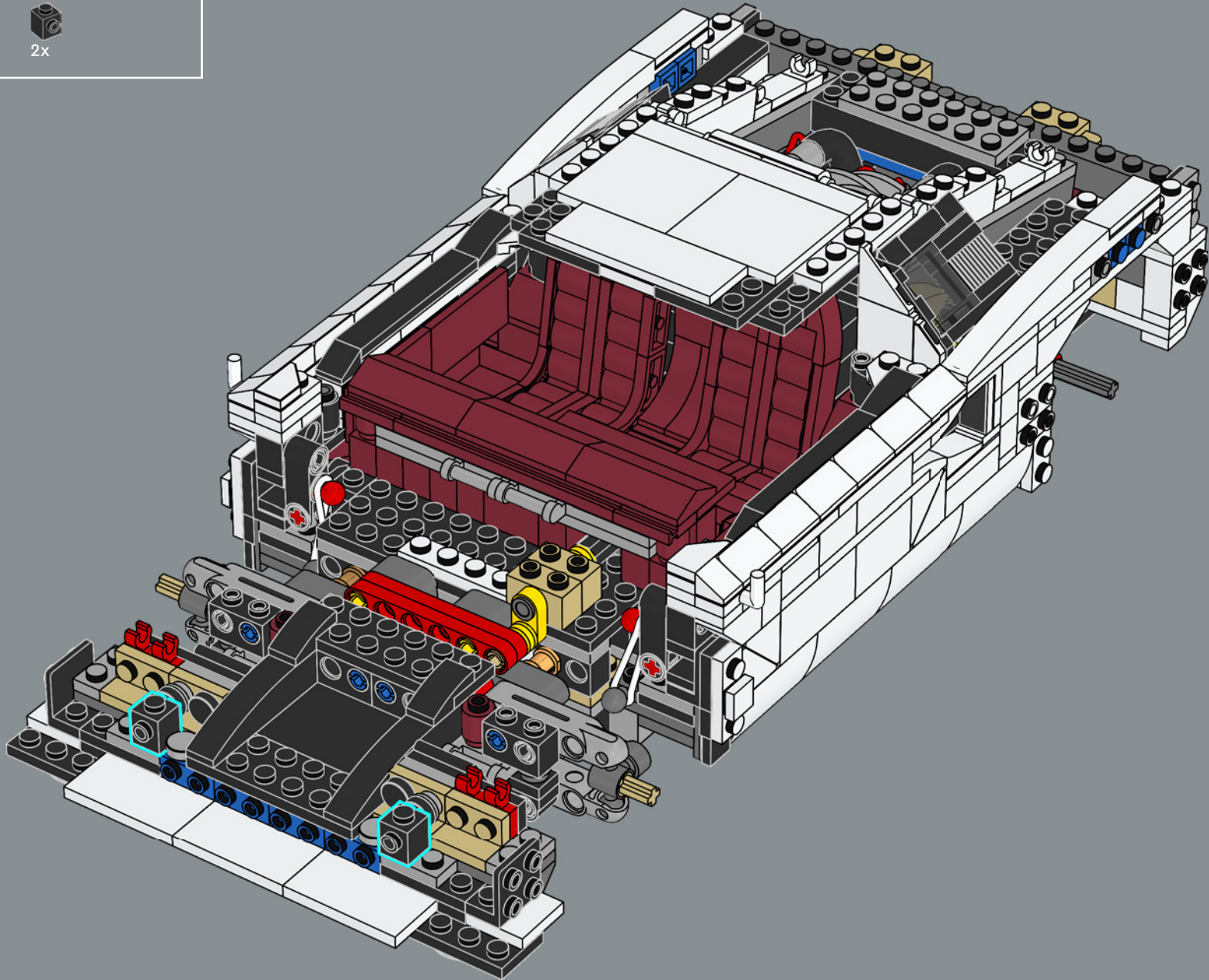

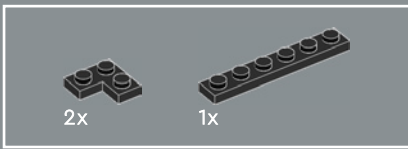

243

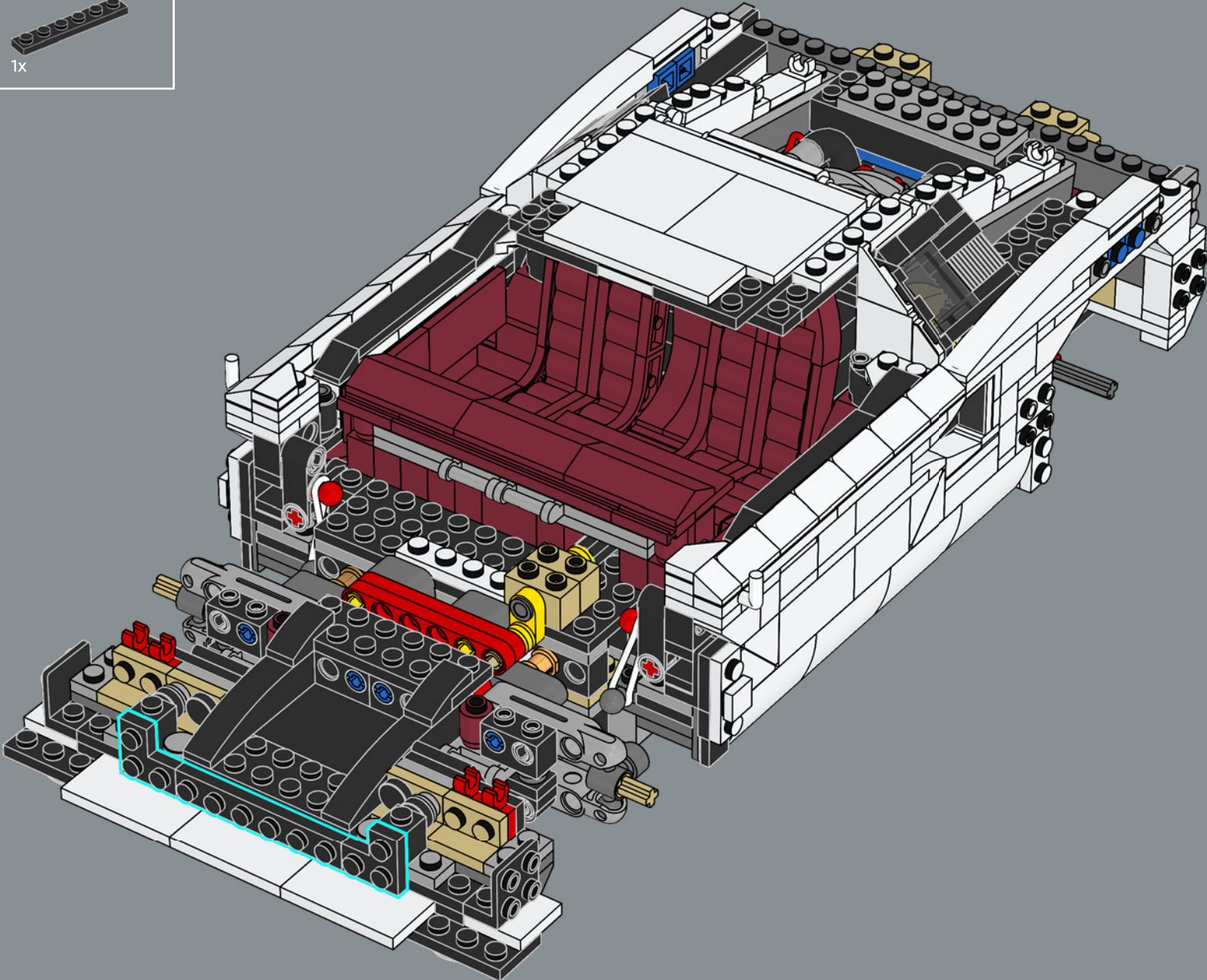



244

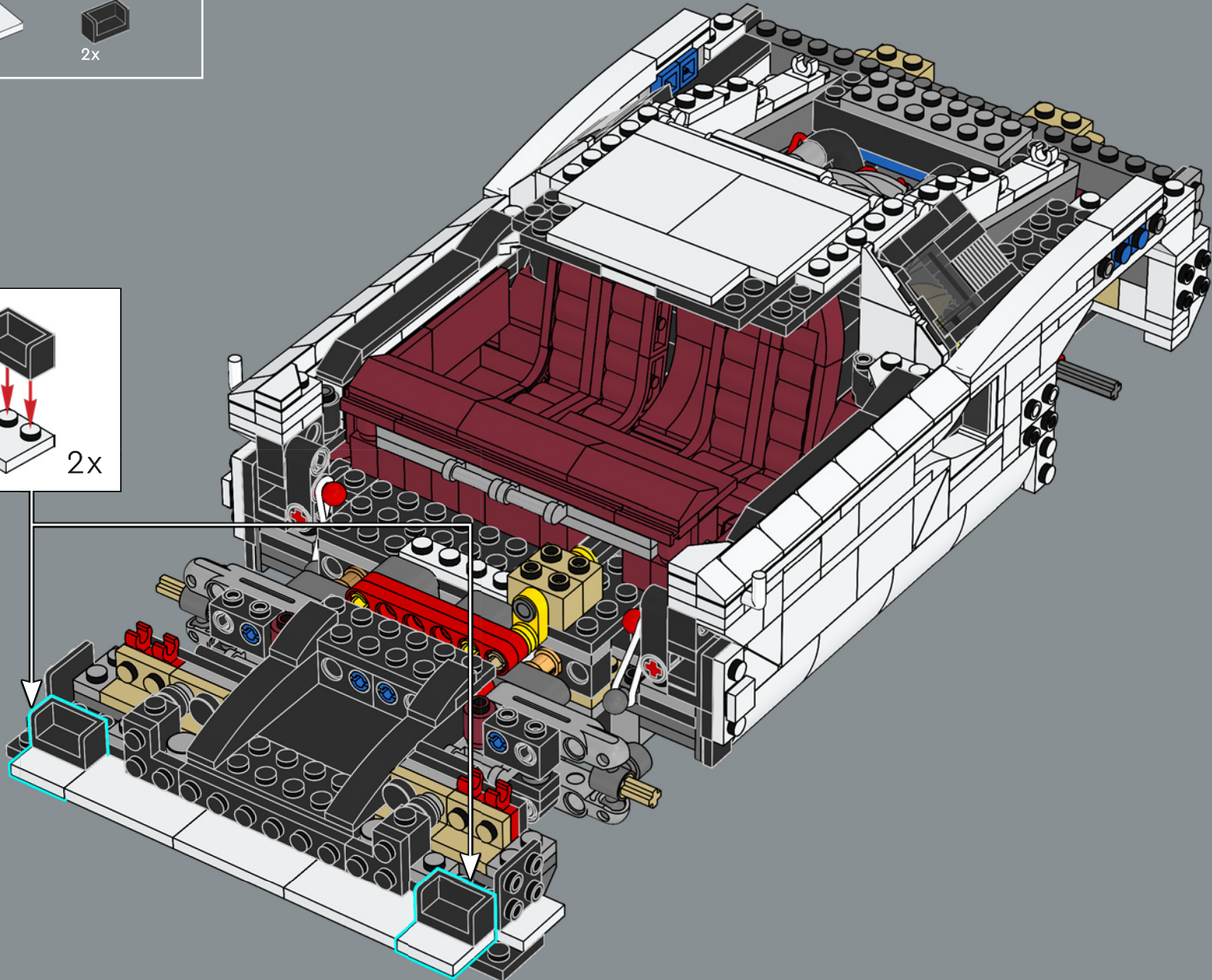
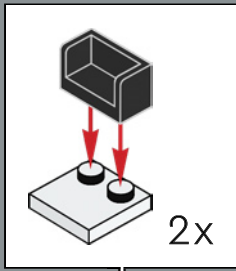

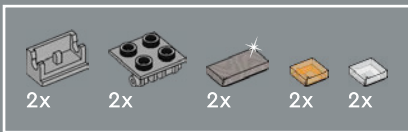

245

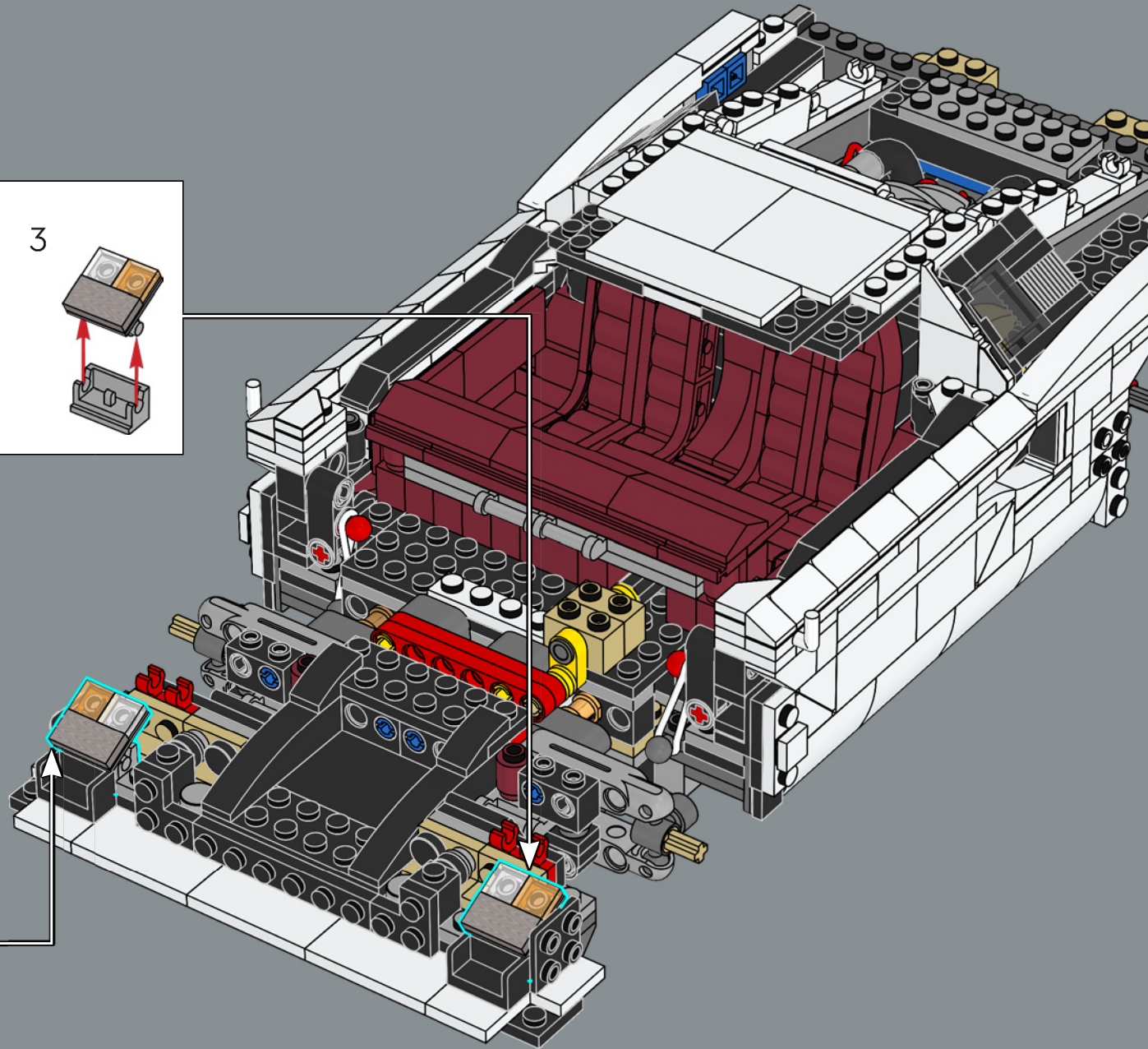
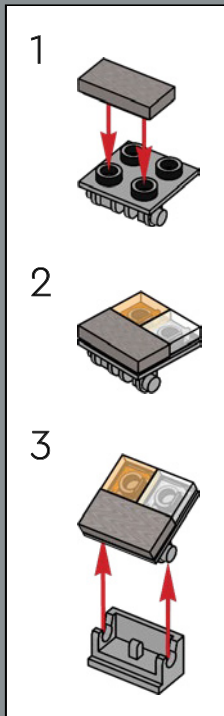
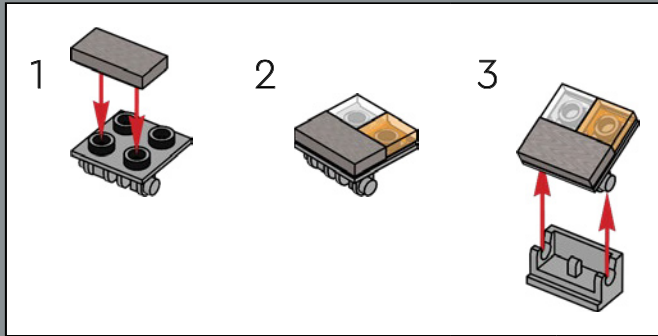

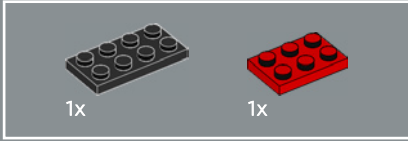
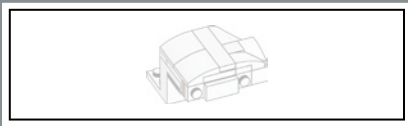

246

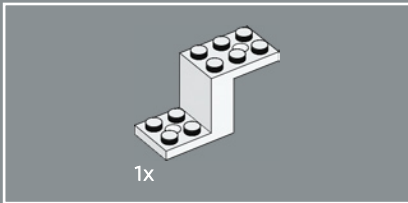
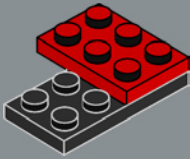

247

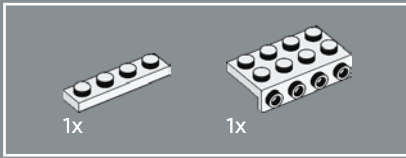
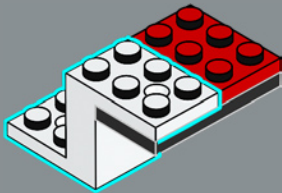

248

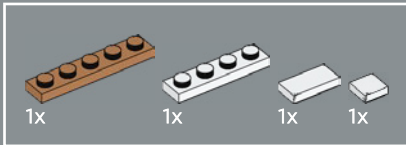
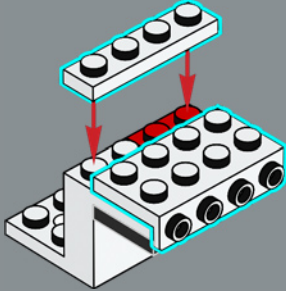

249

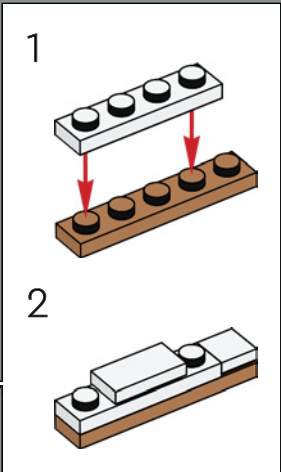
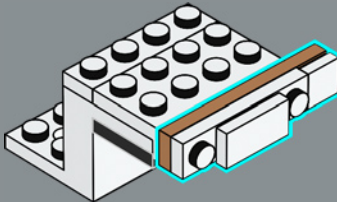



250

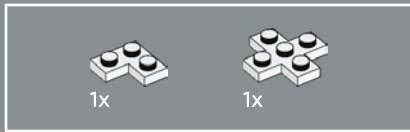
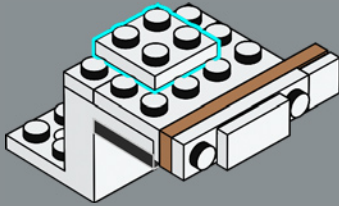

251

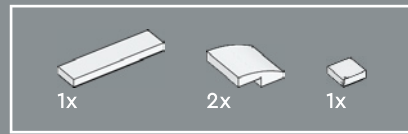
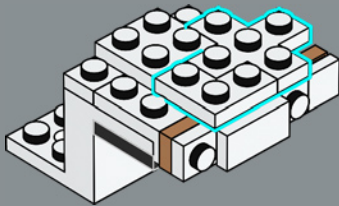

252

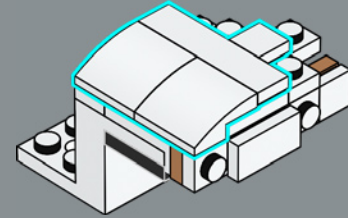

253

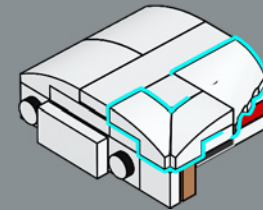

254

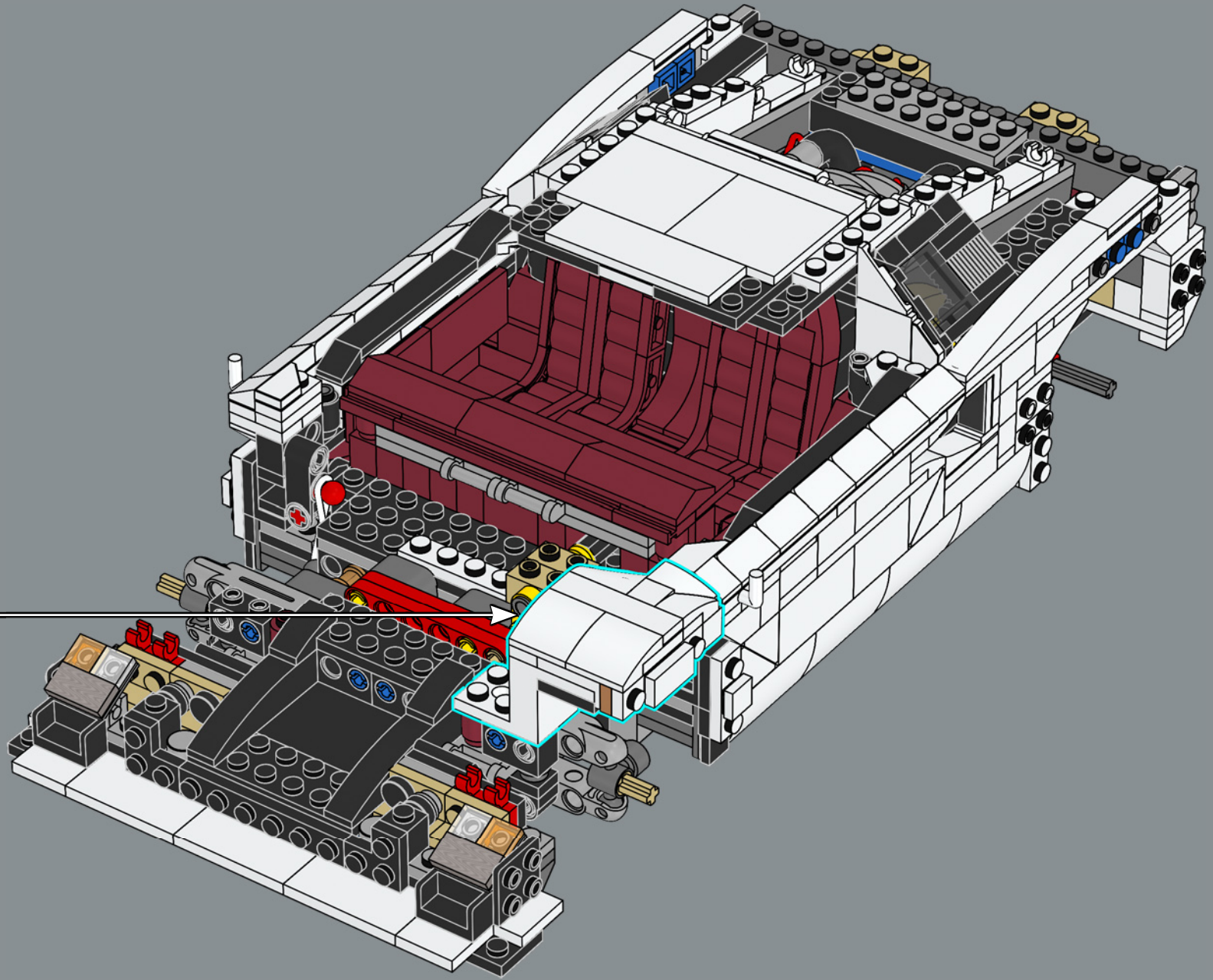

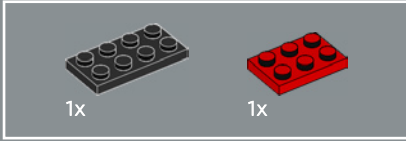
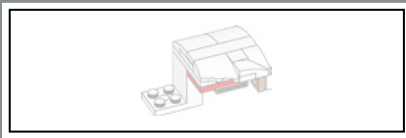

255

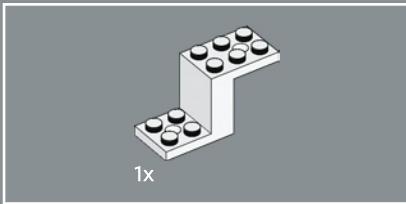
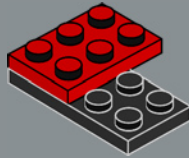

256

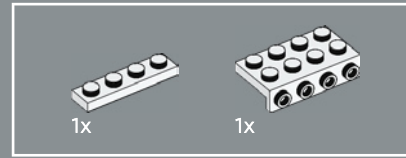
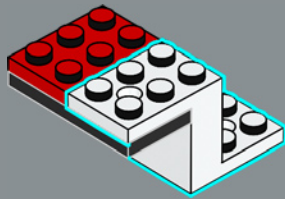

257

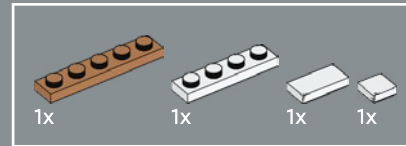
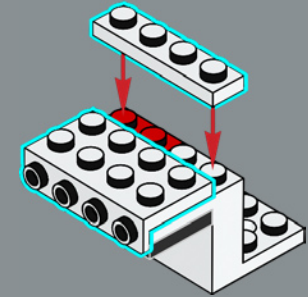

258

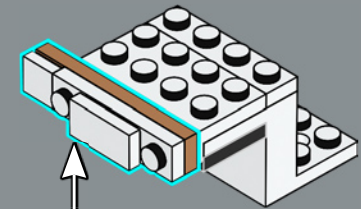
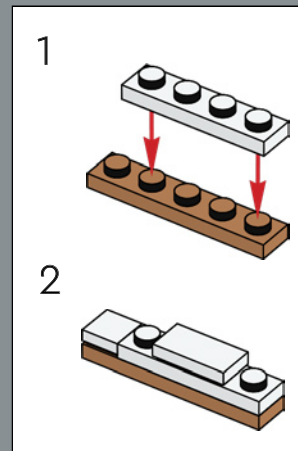



259

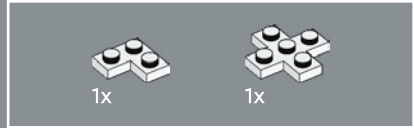
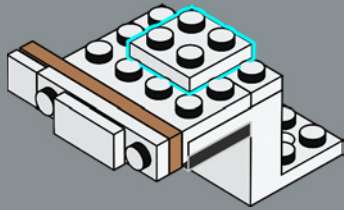

260

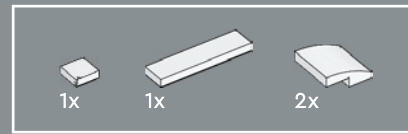
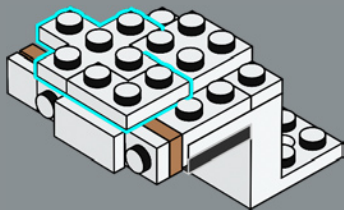

261

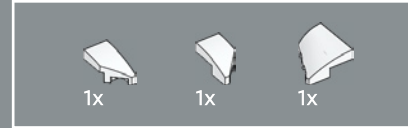
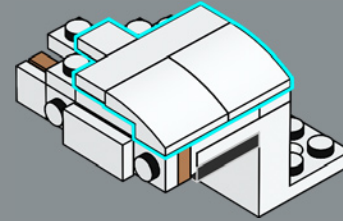

262

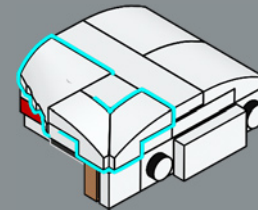

263

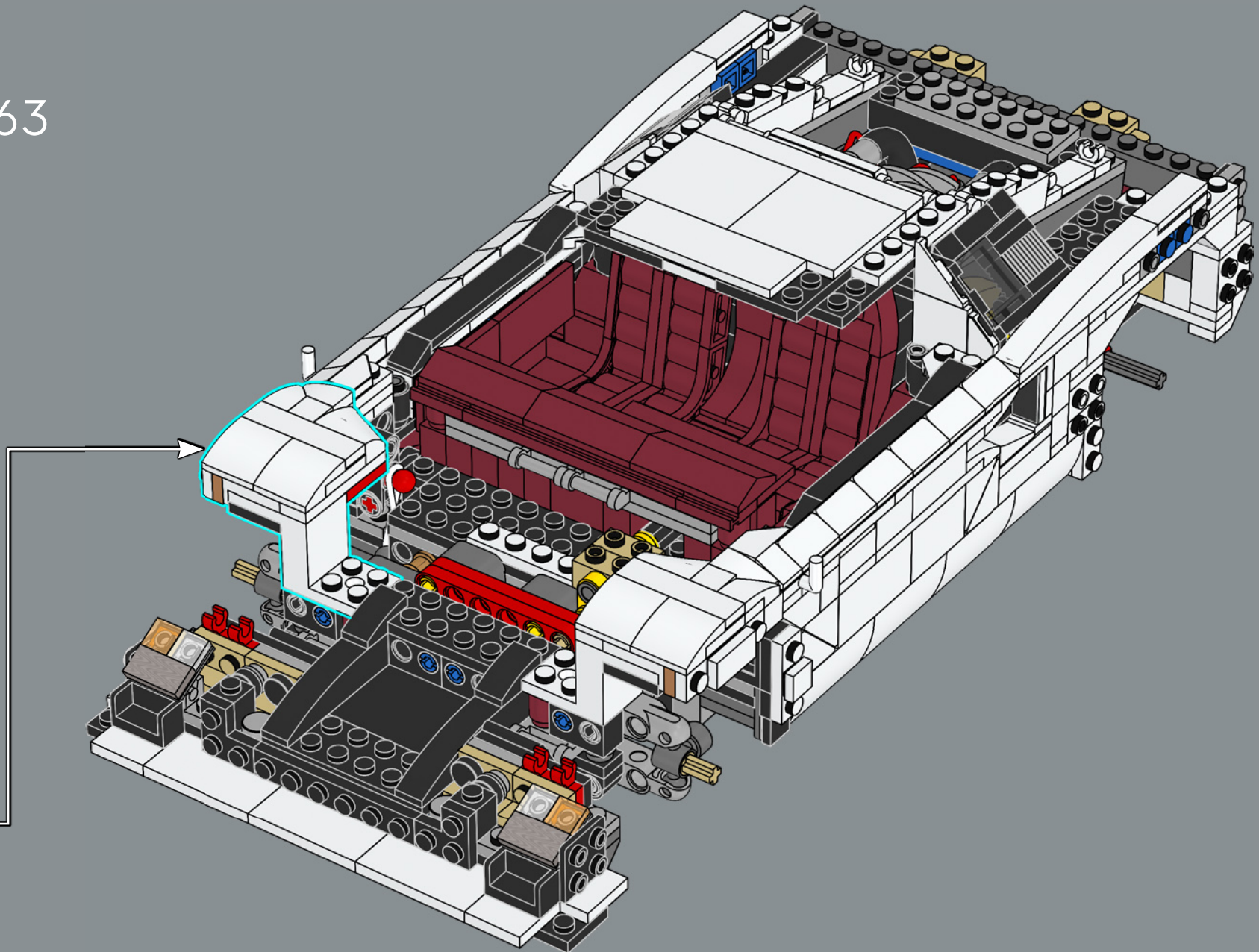

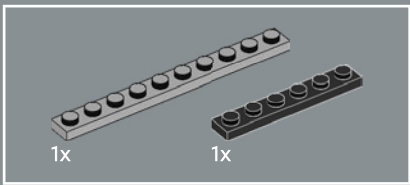

264

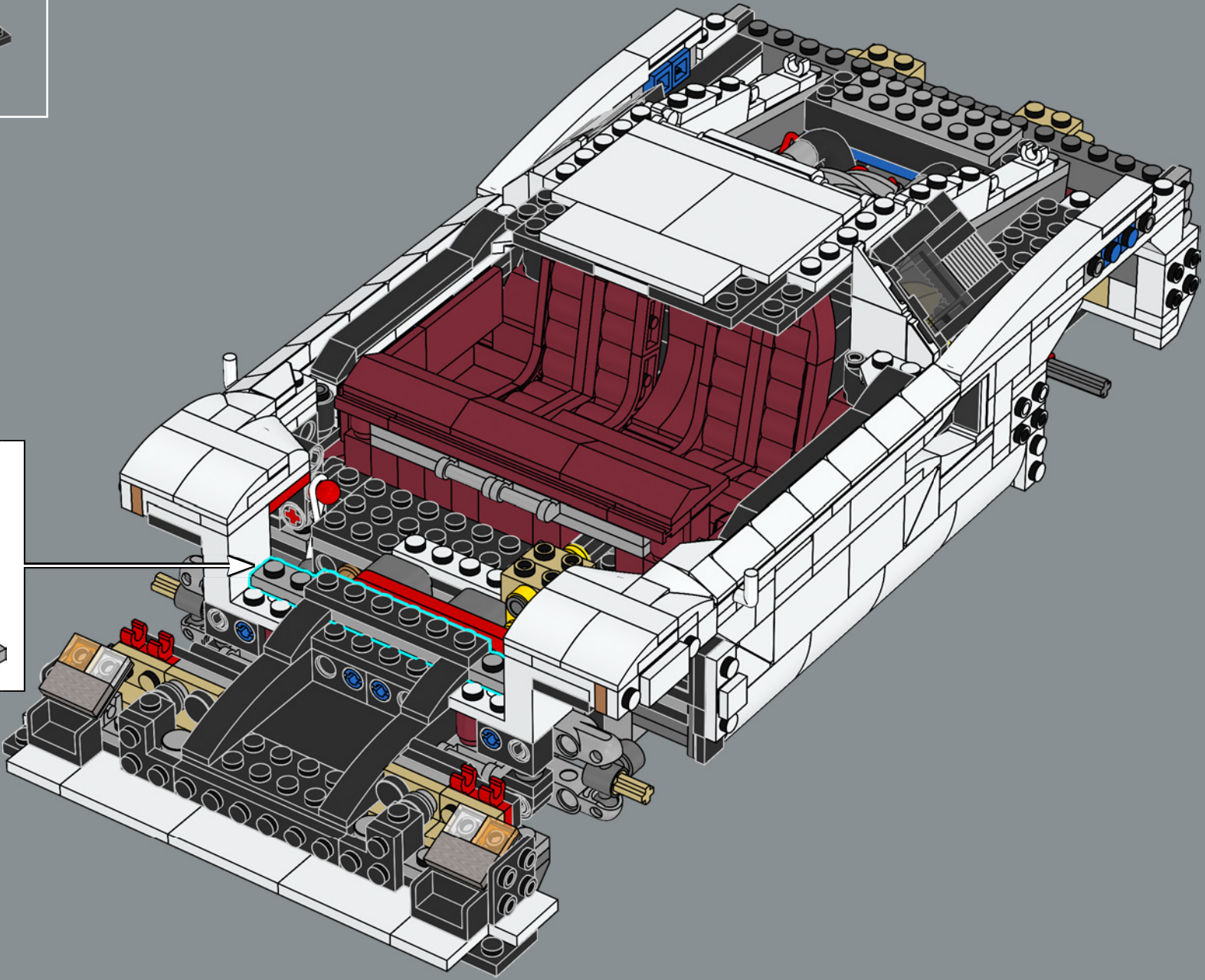
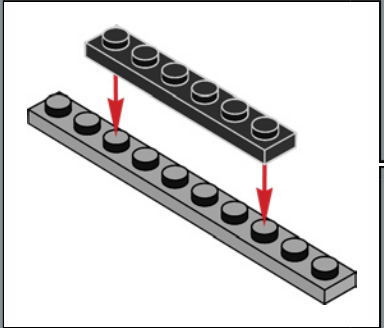

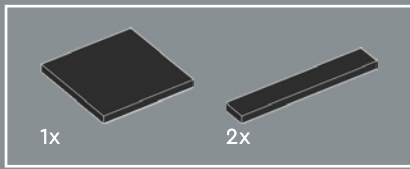

265

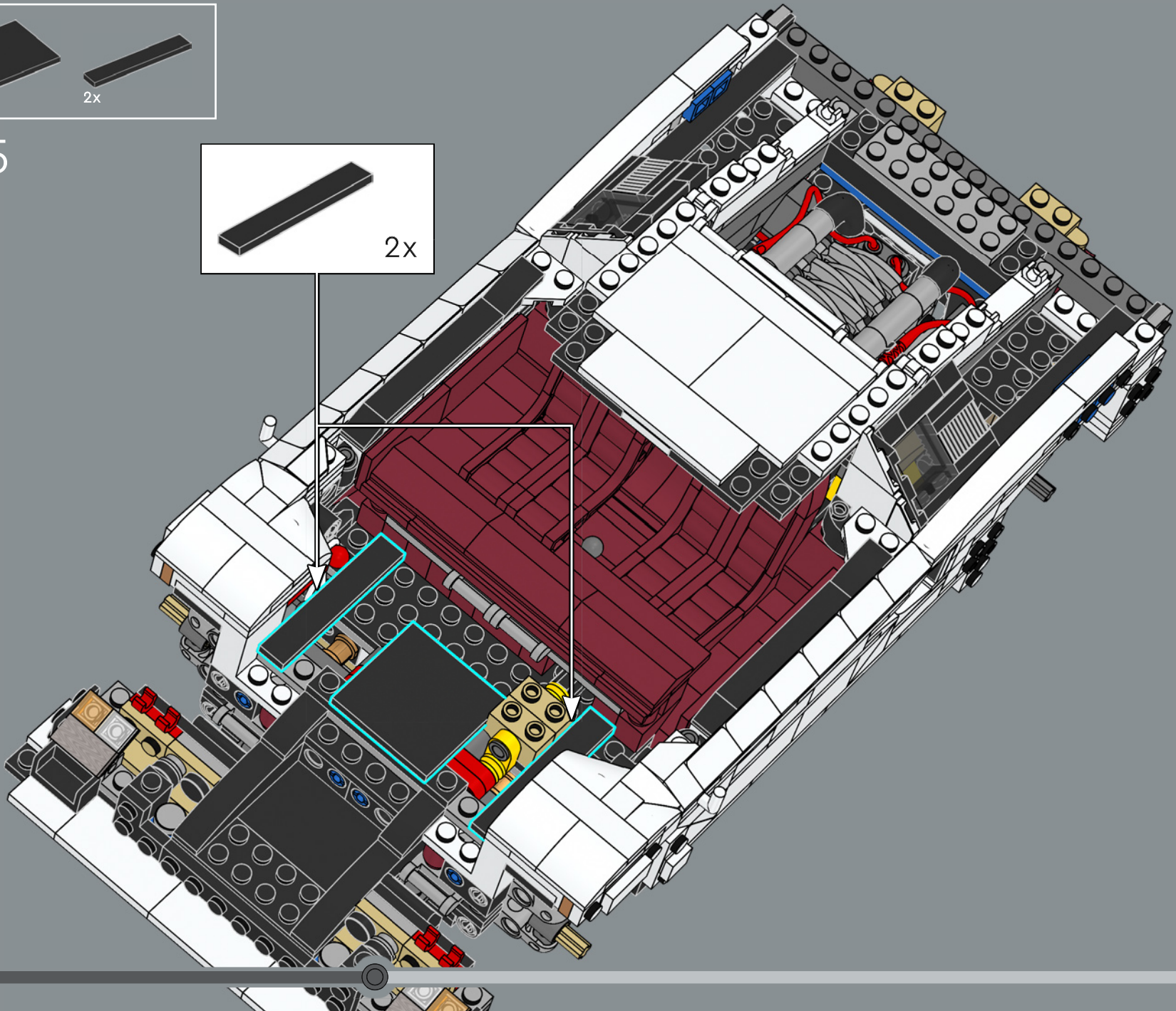
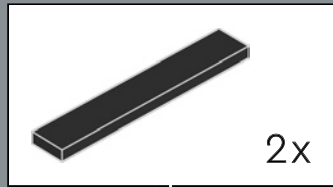

-  2x
-  2x
-  6x
-  2x

266

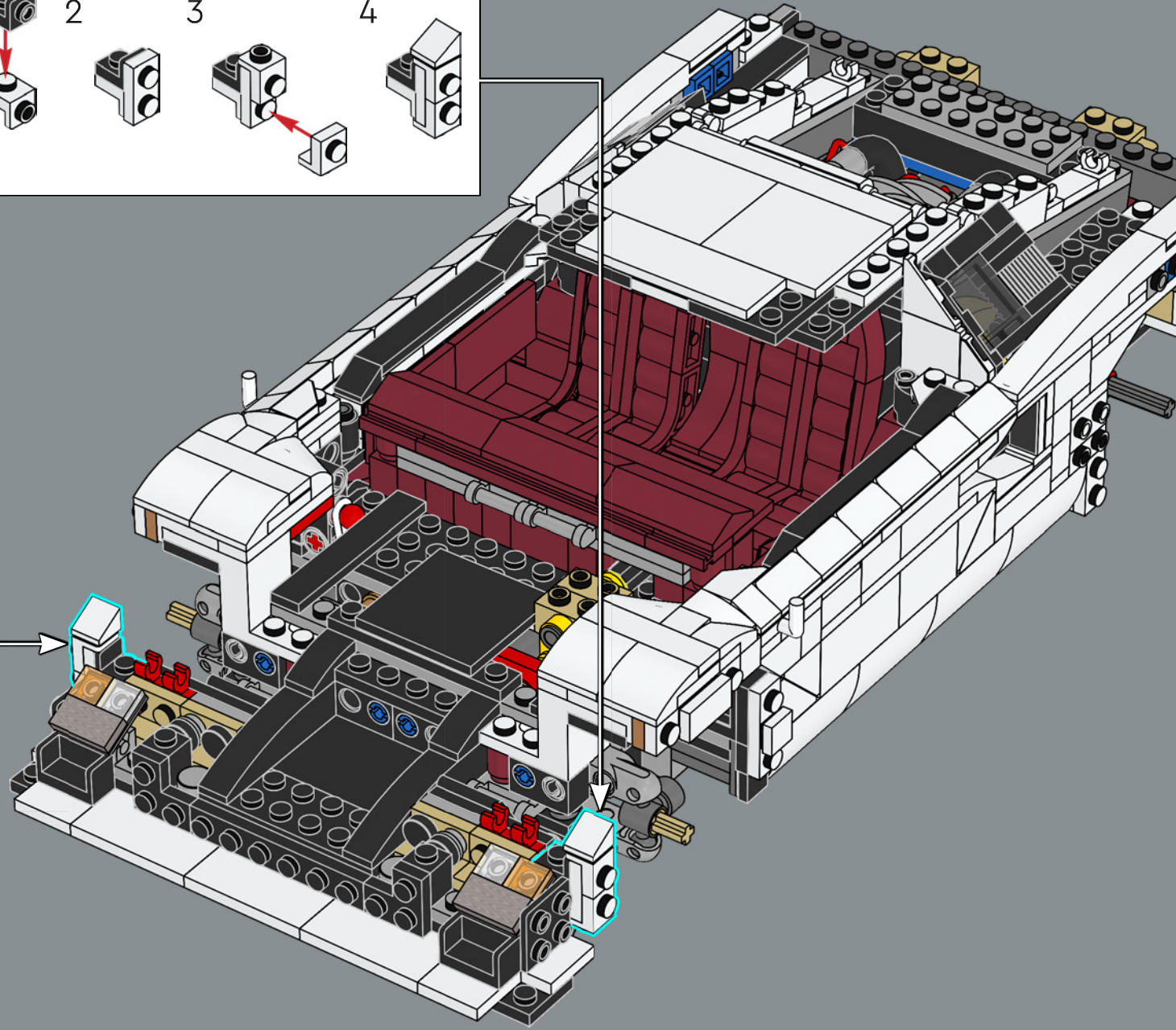
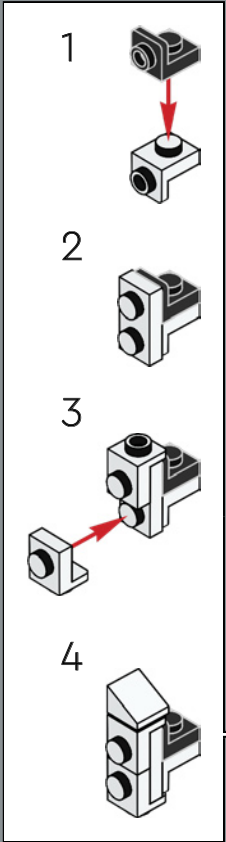
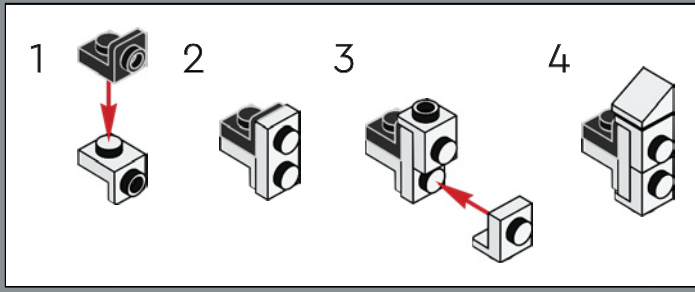



2x

267



2x

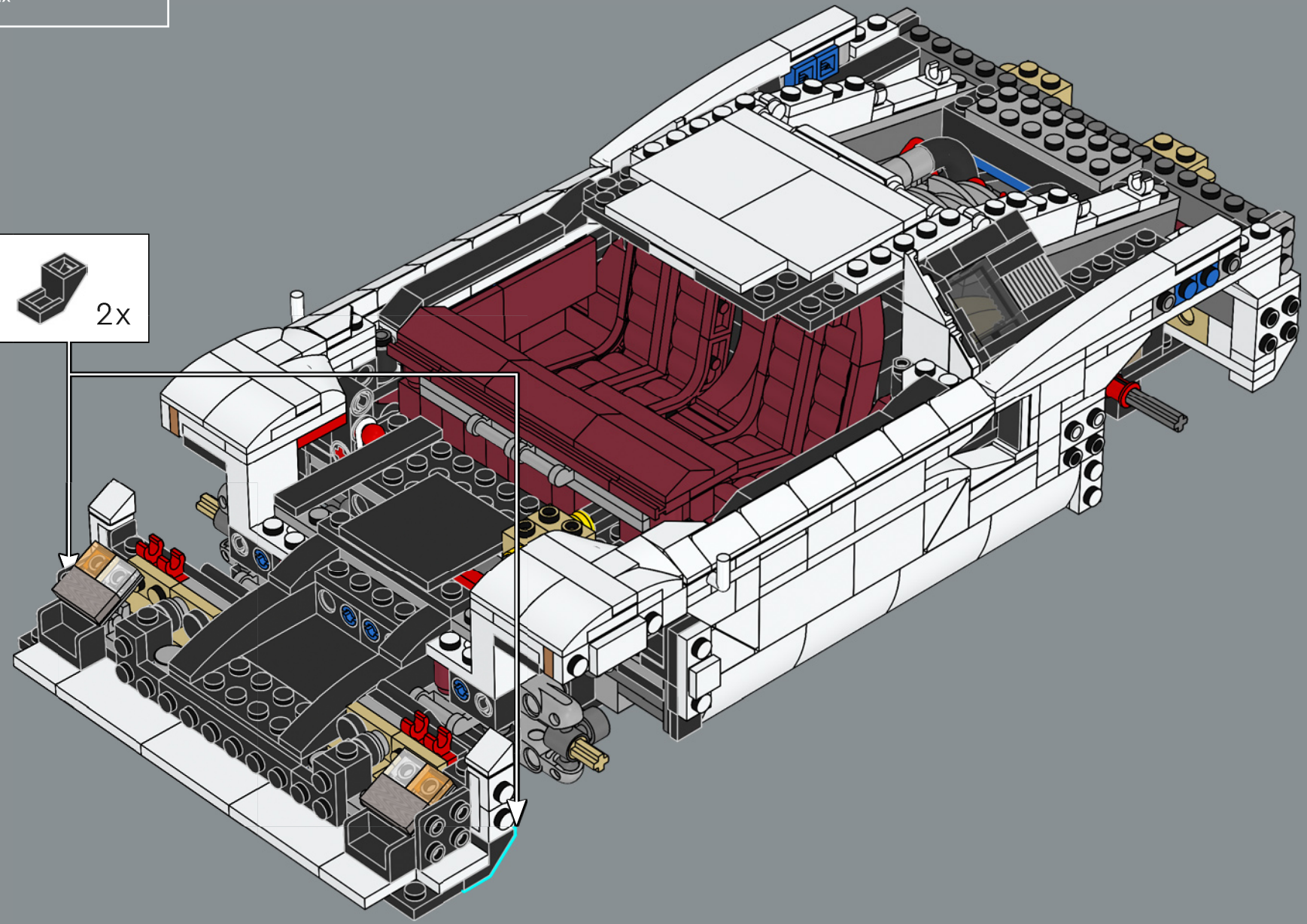

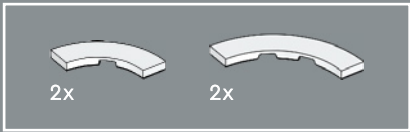

268

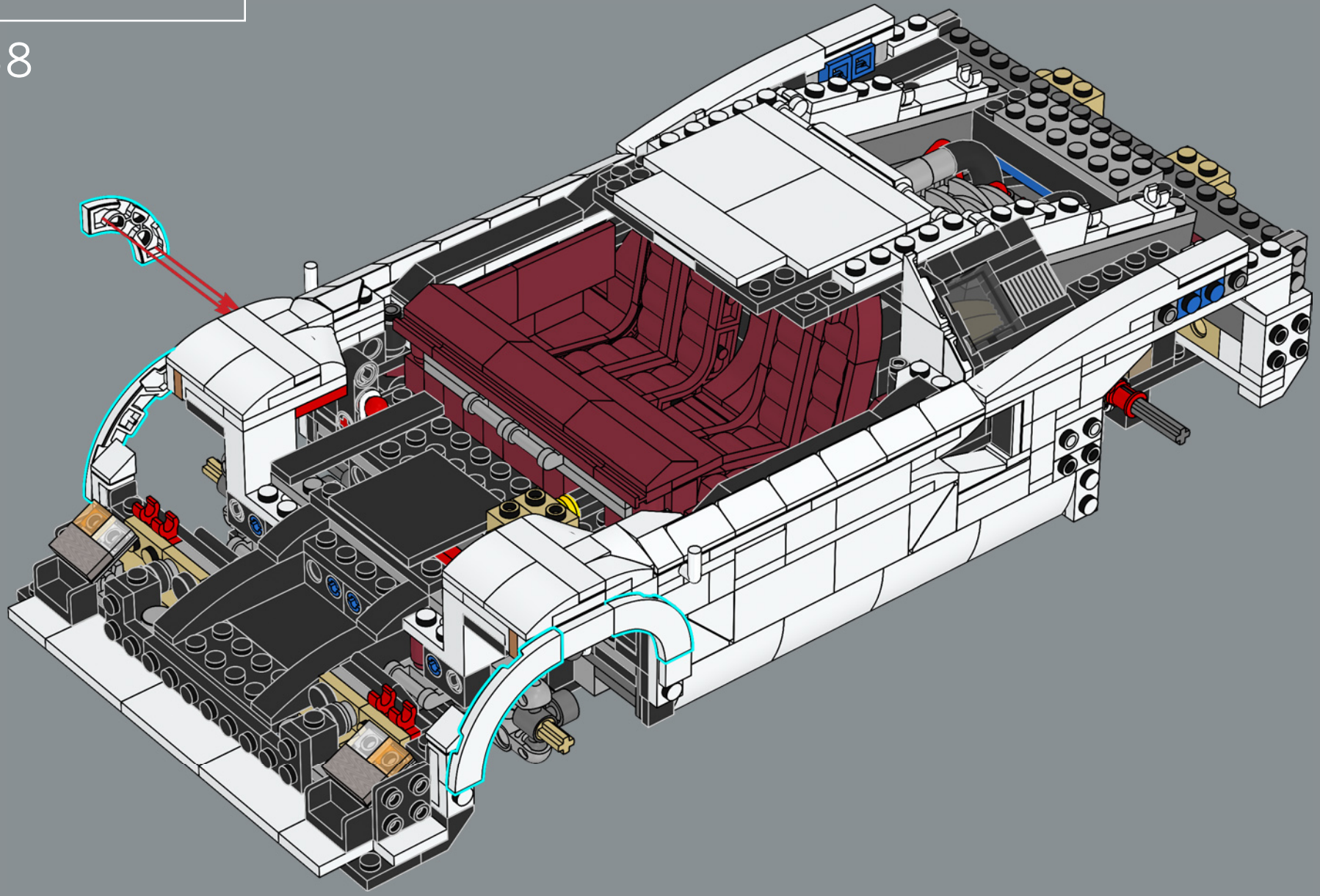

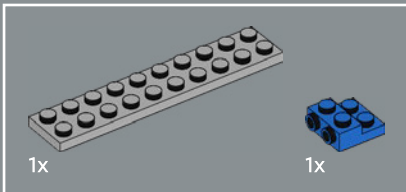
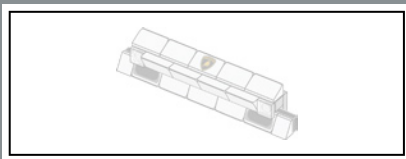

269

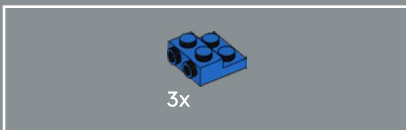
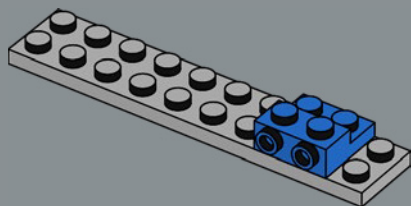

270

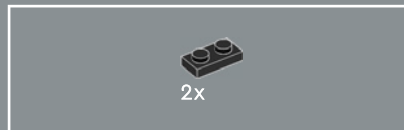
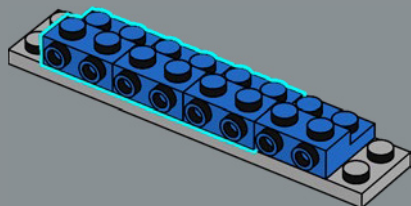

271

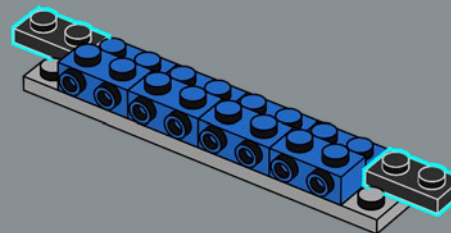

272

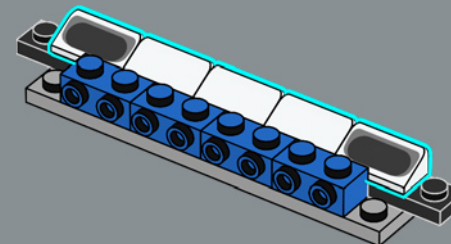



2x

273

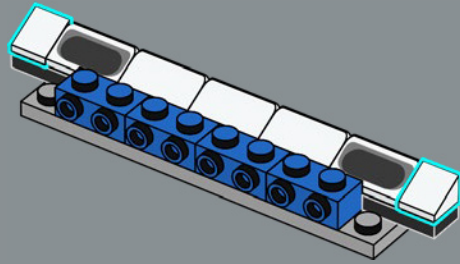

4x

274

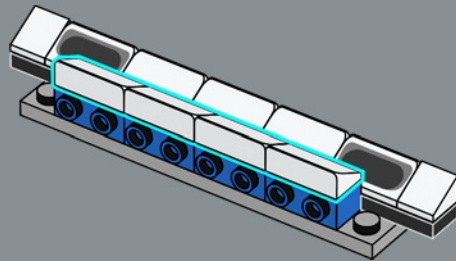

2x



2x

275

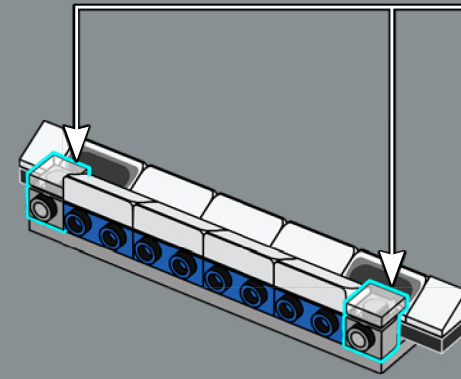

2x



4x



1x

276

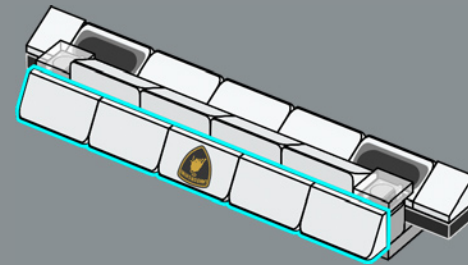

277

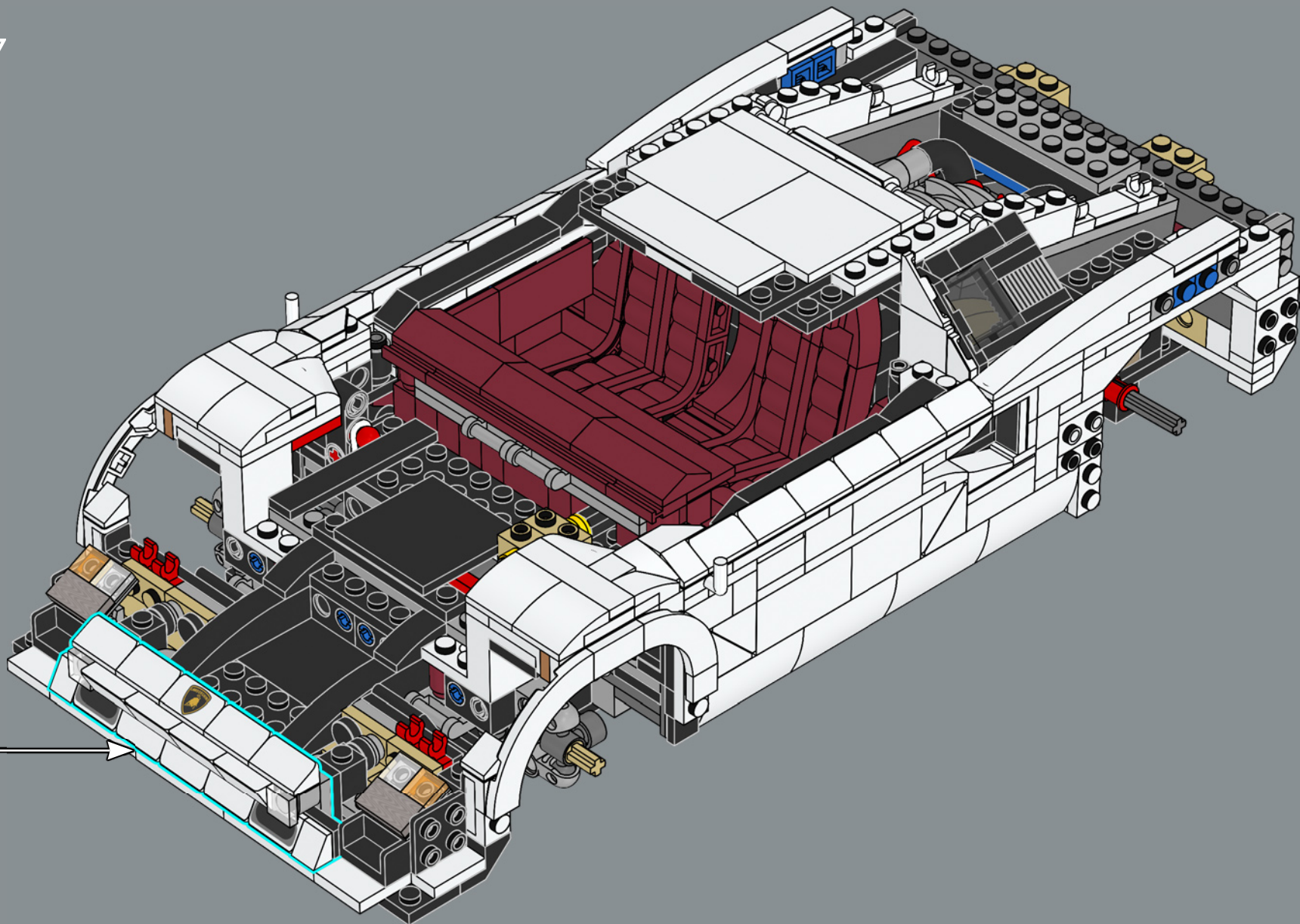

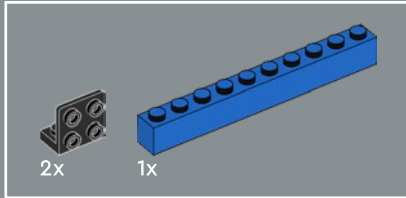
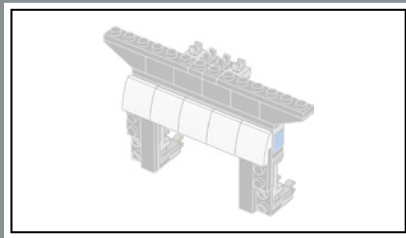

278

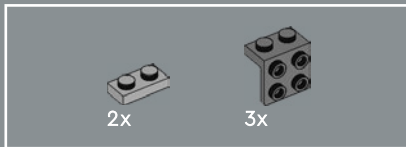
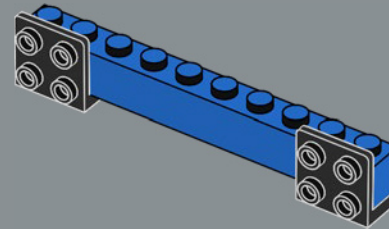

279

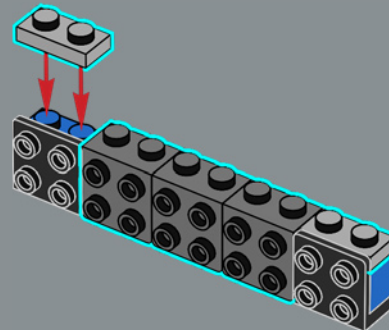

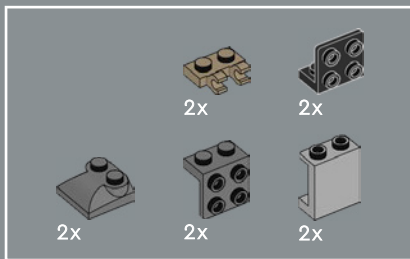

280

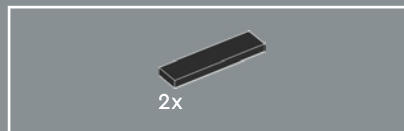
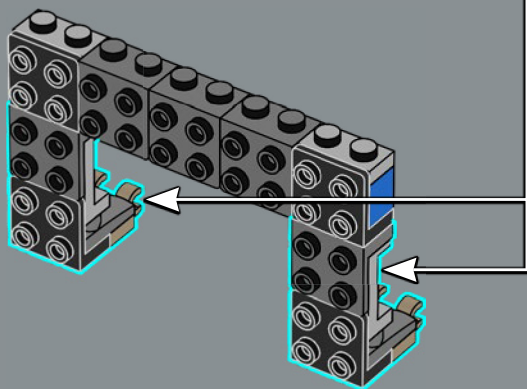
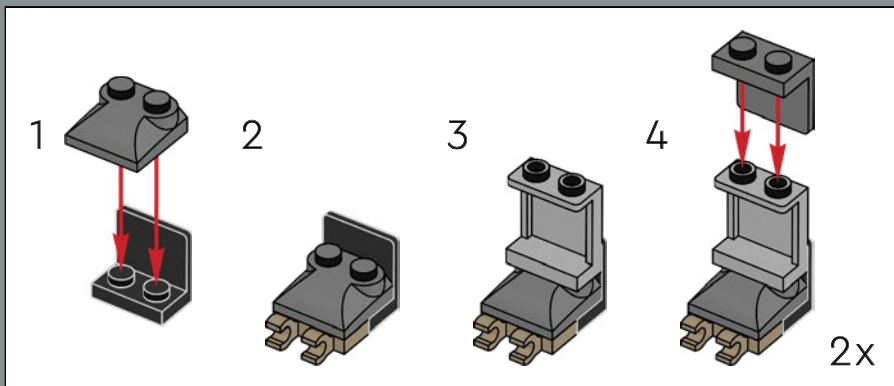

281

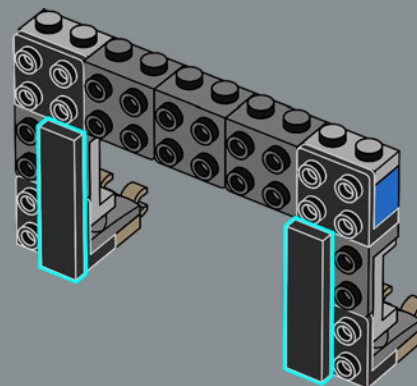

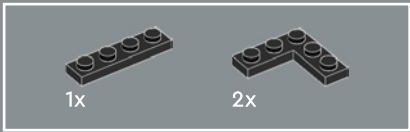

282

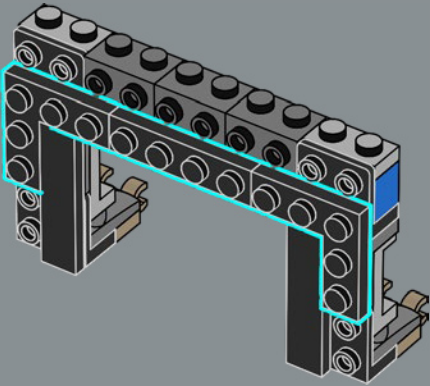

283

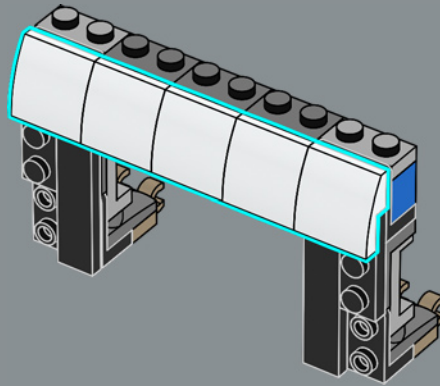

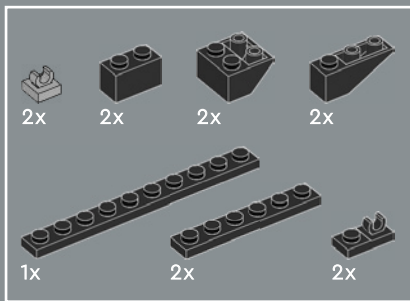

284

1

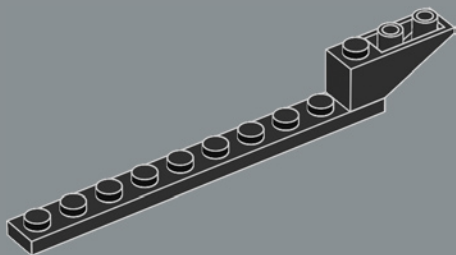

2

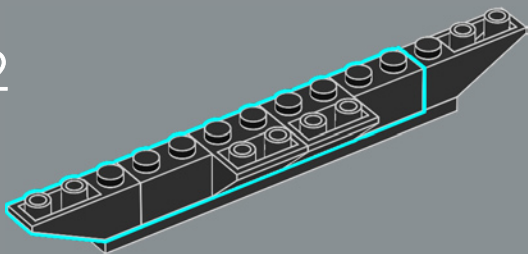

3

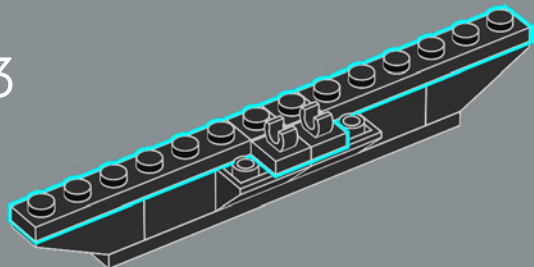

4

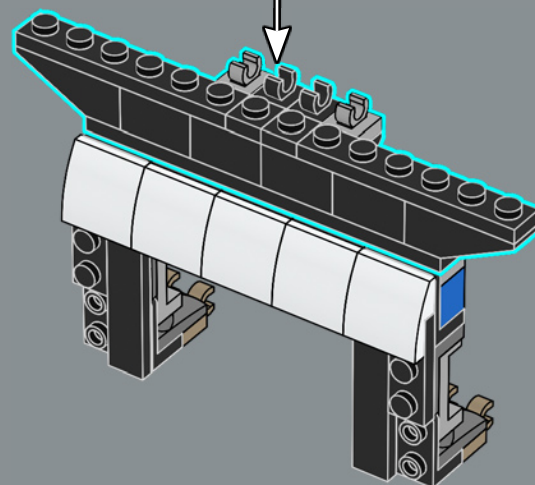
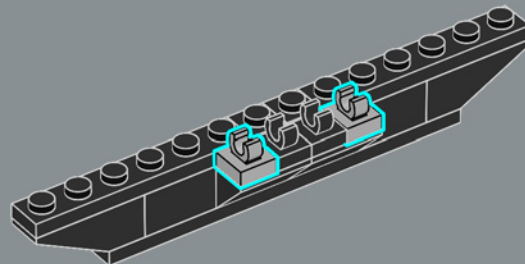

285

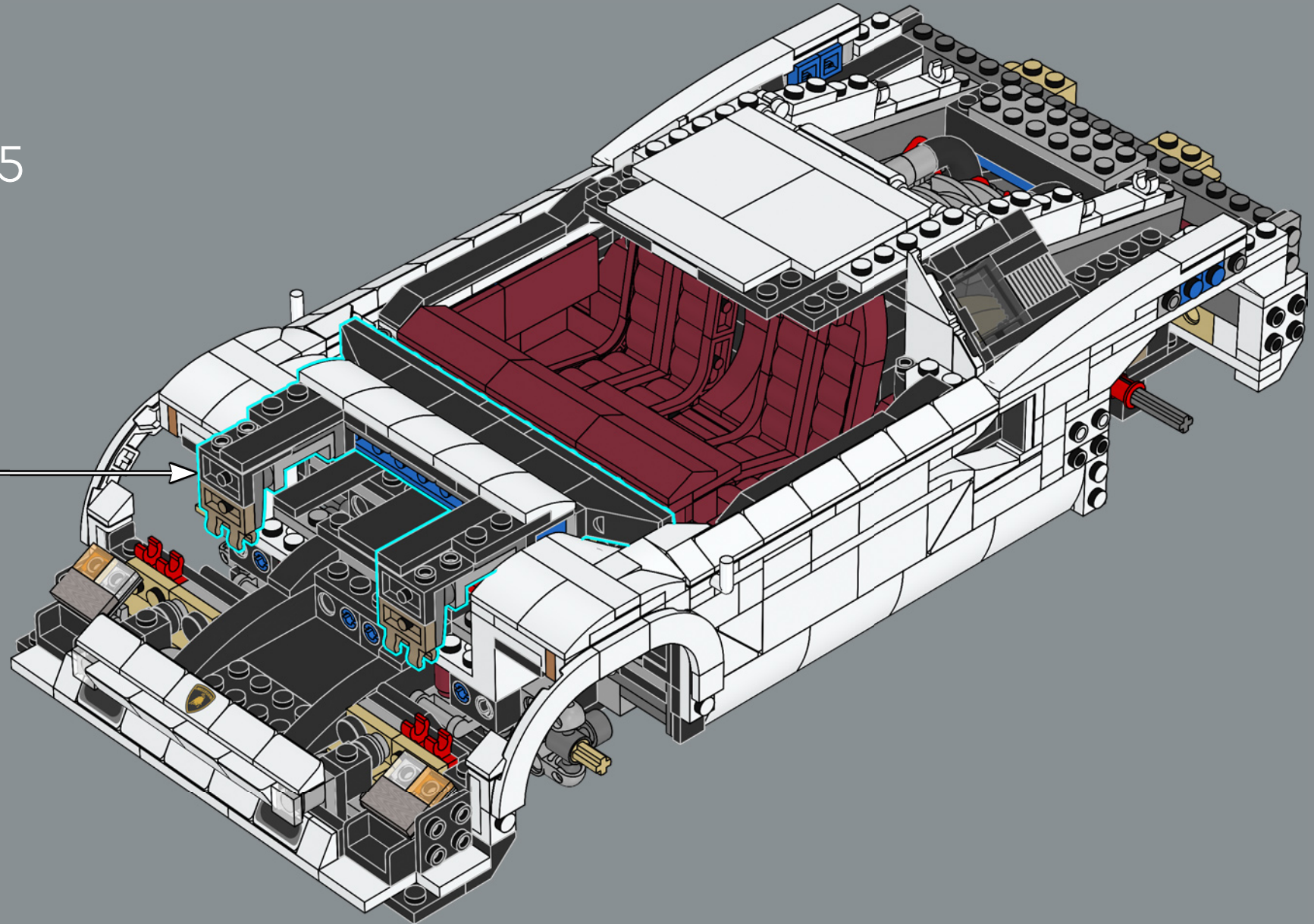

286

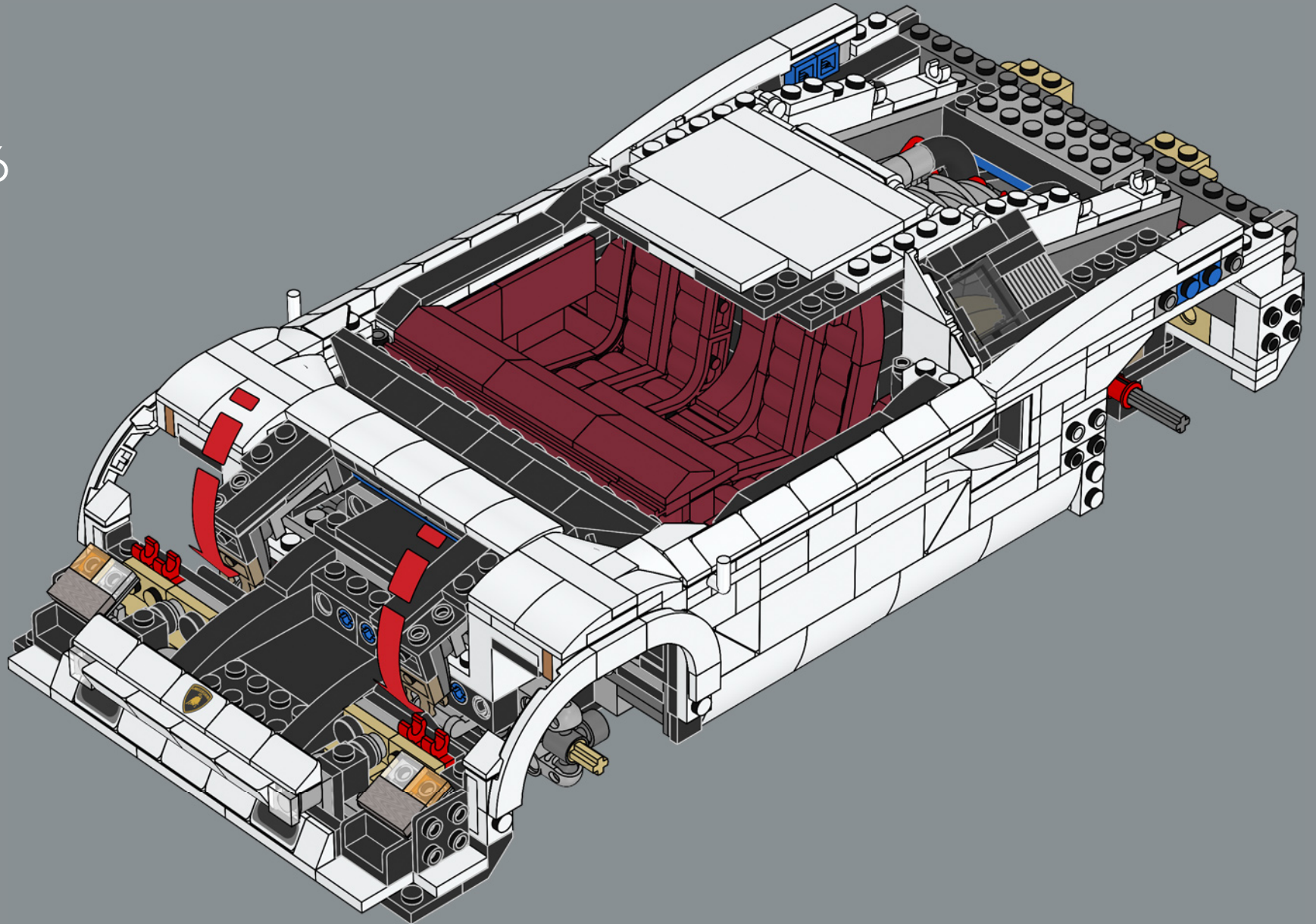



287

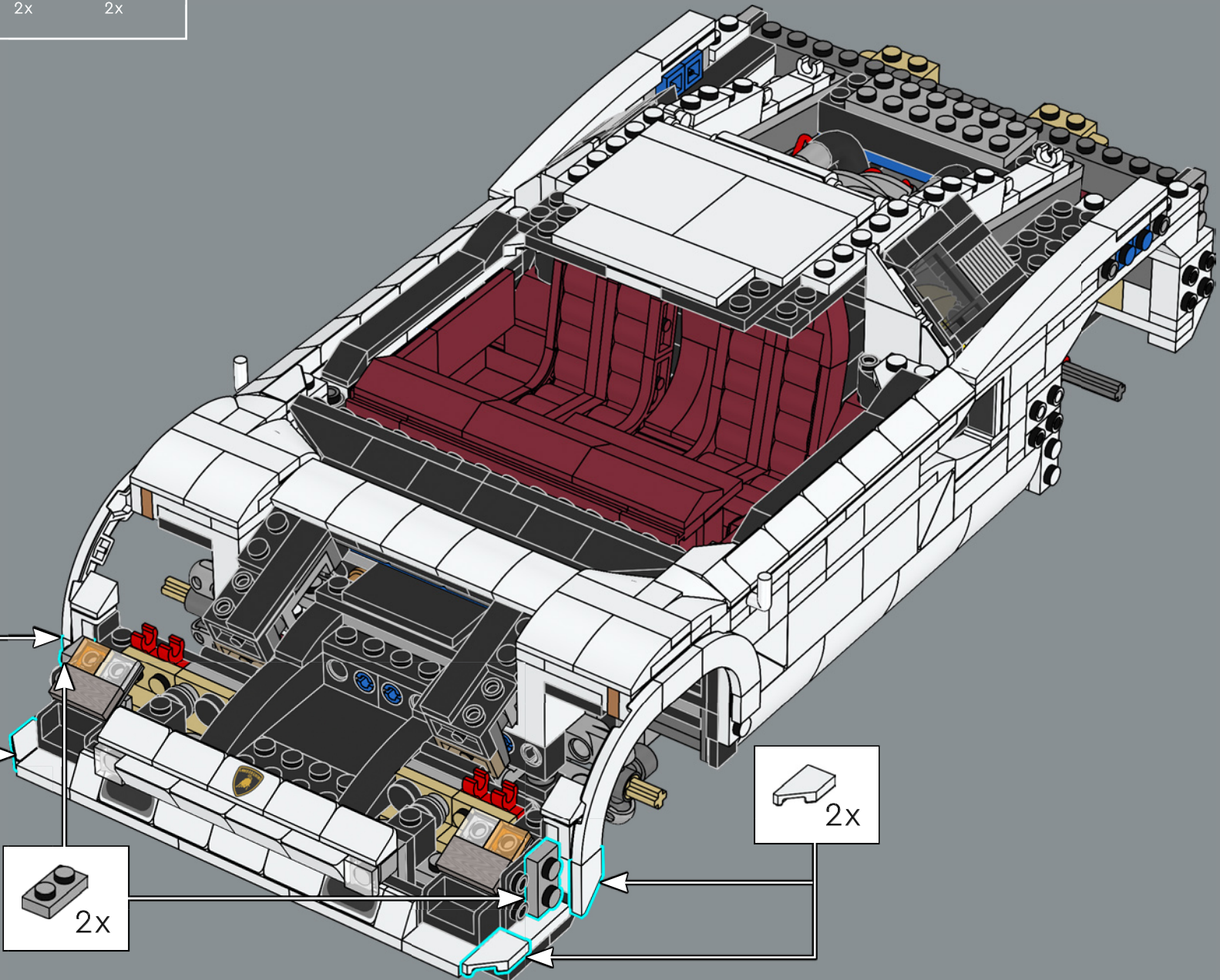
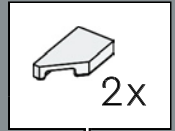
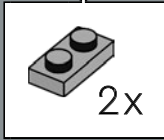
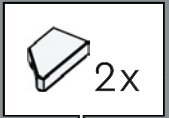



2x

288

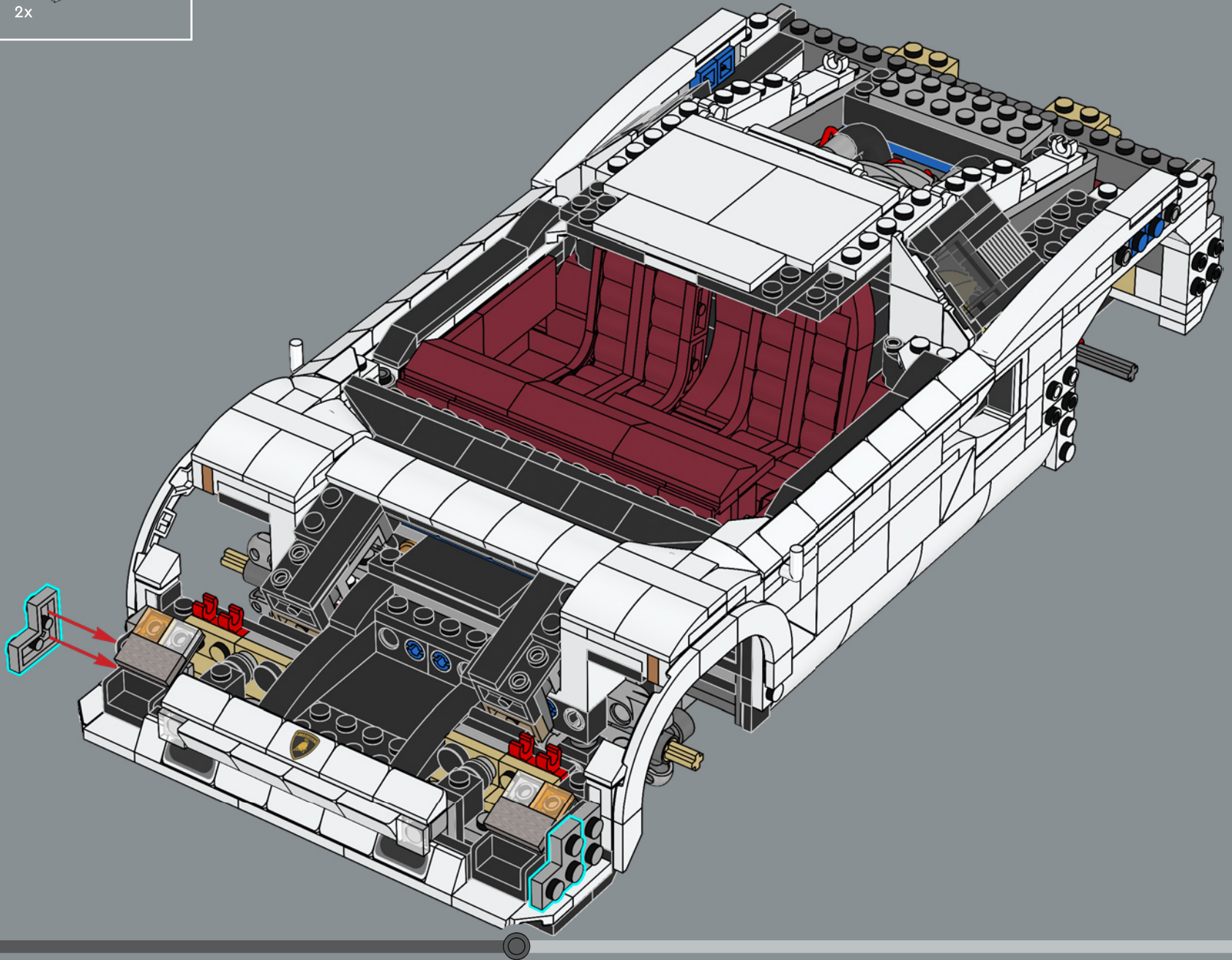

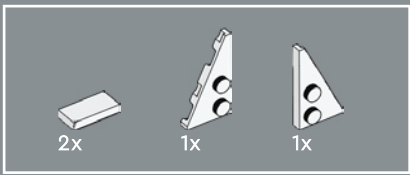

289

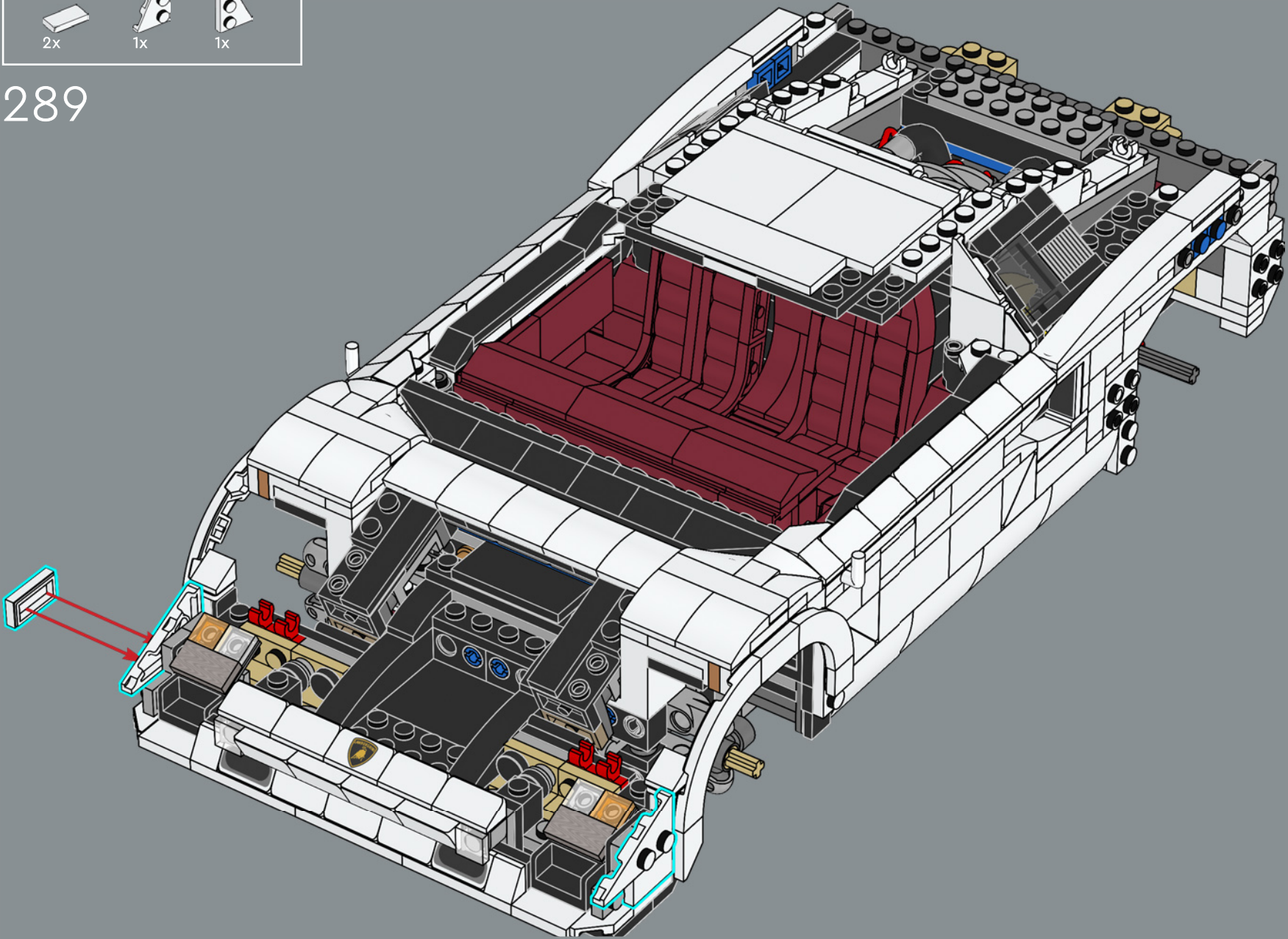

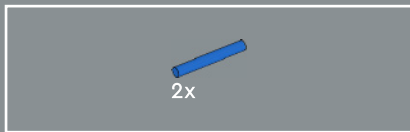

290

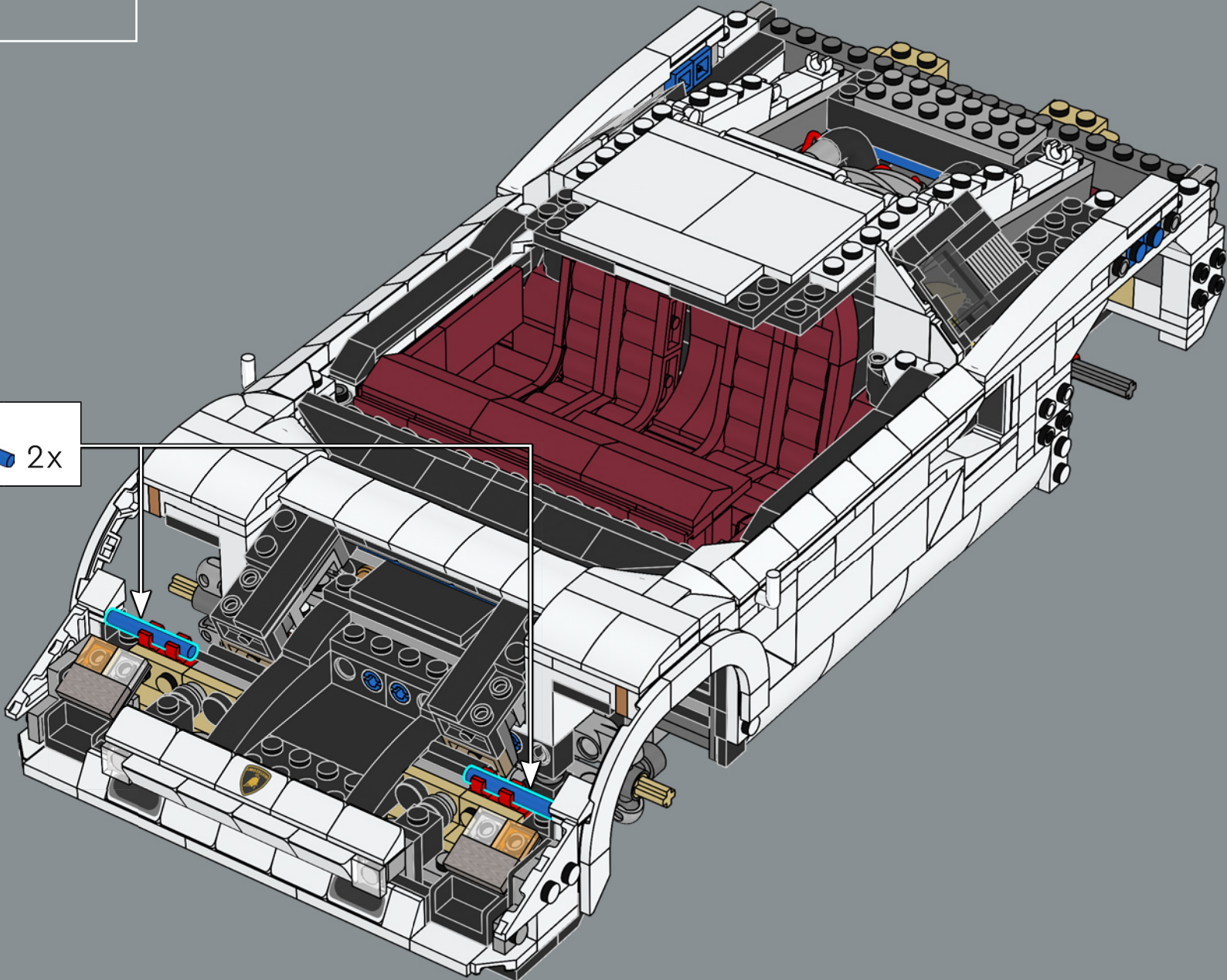

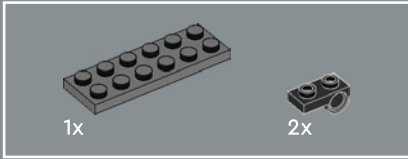
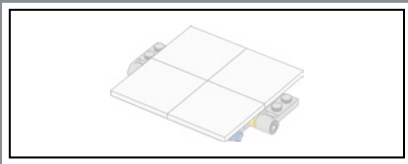

291

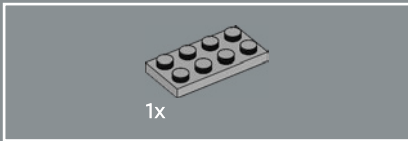
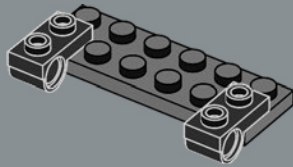

292

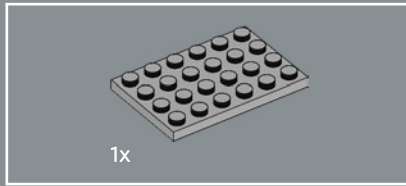
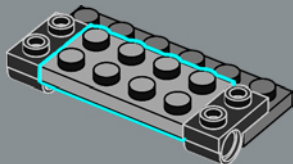

1x

293

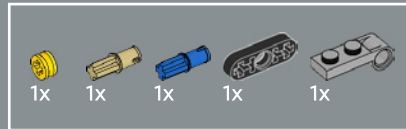
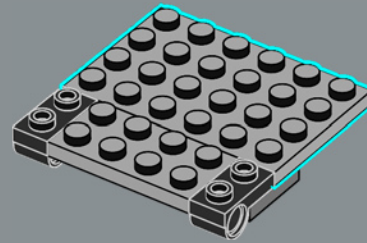

294

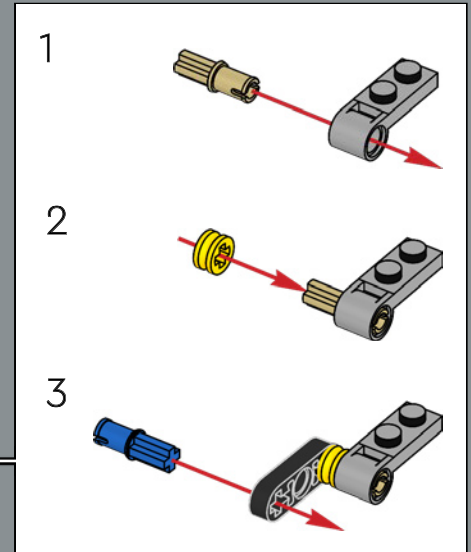
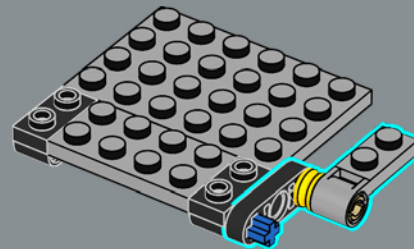



295

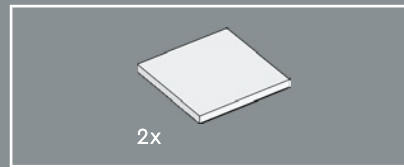
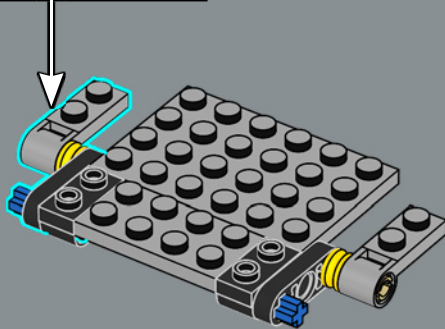
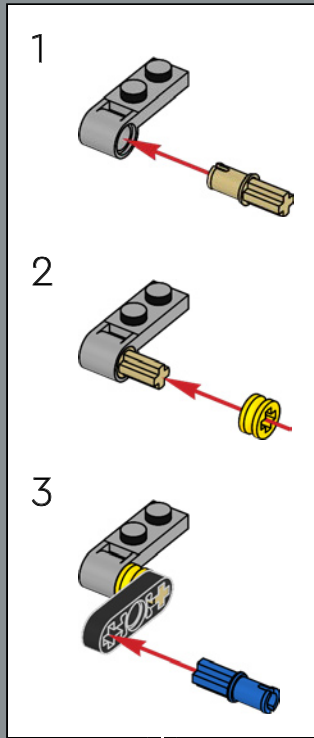

296

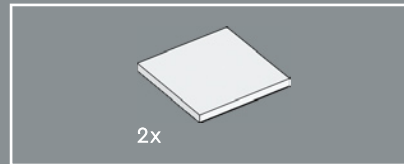
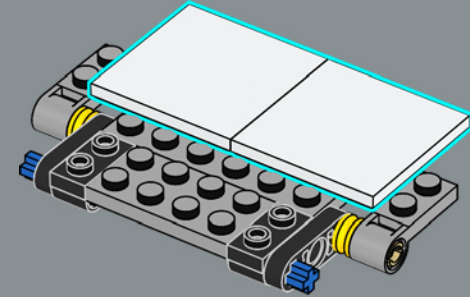

297

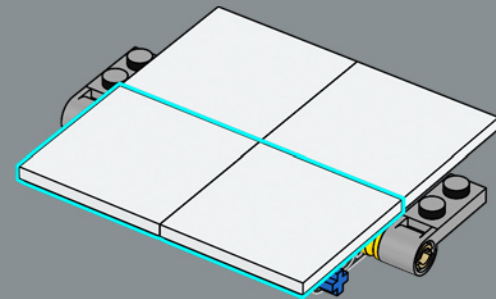

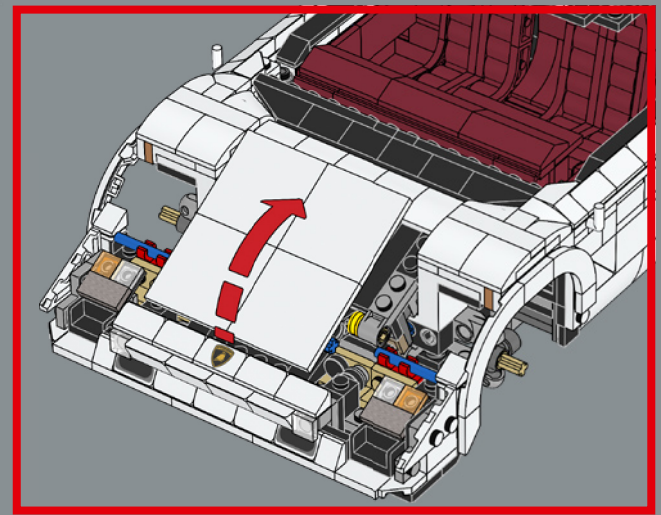
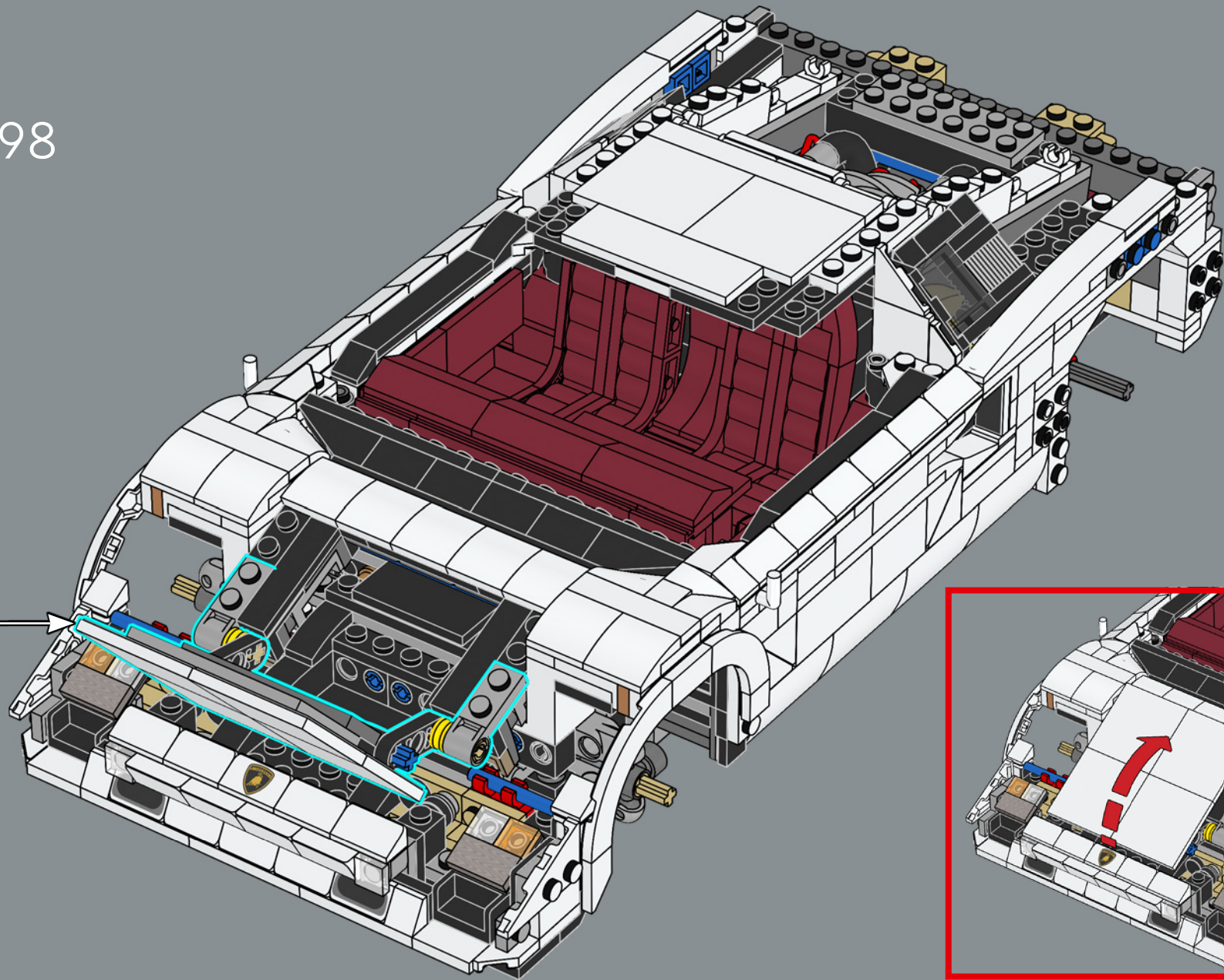

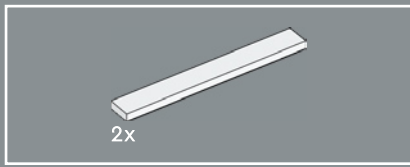

299

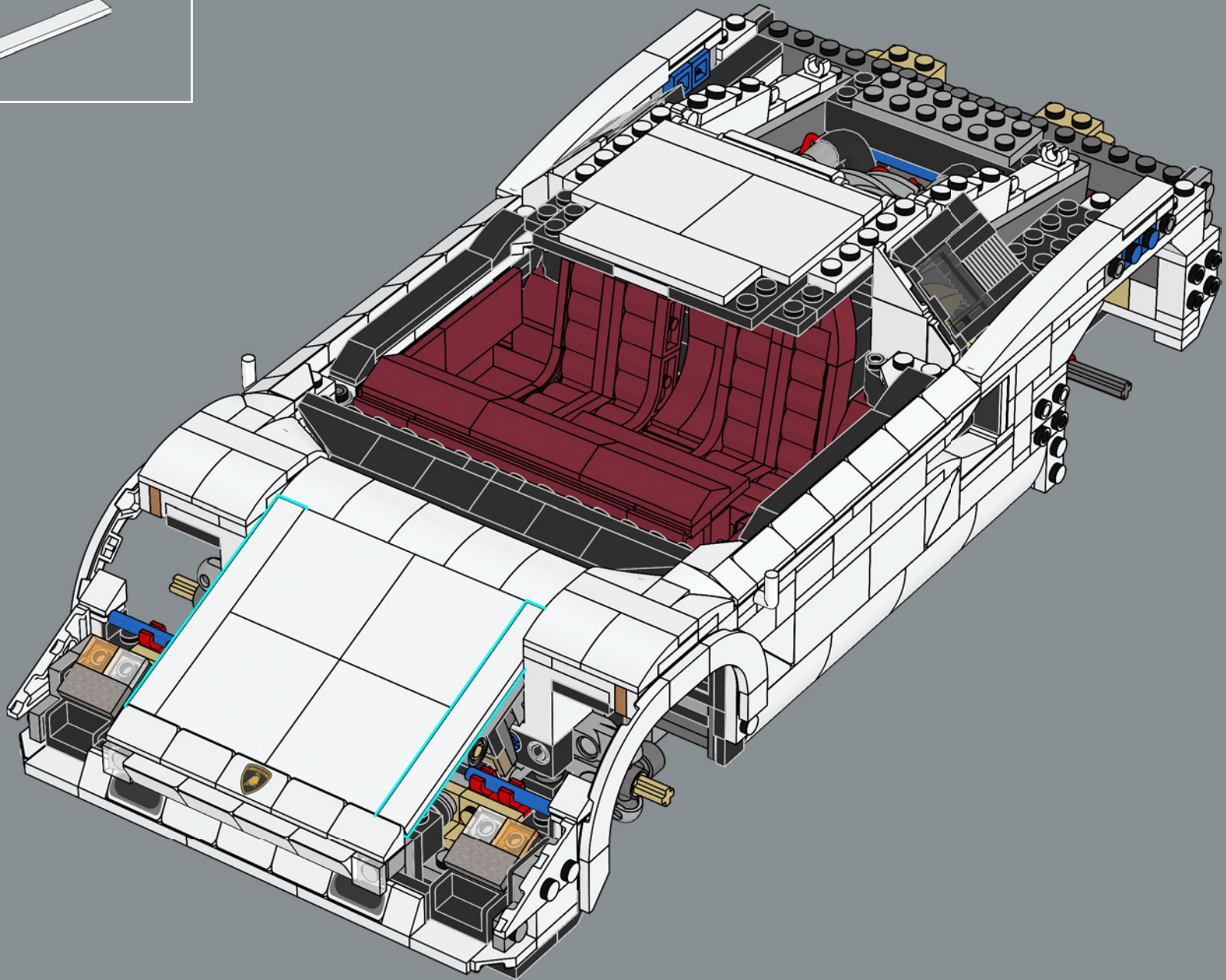

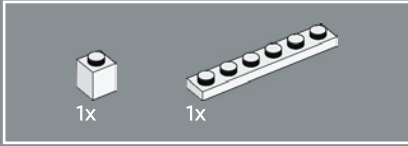
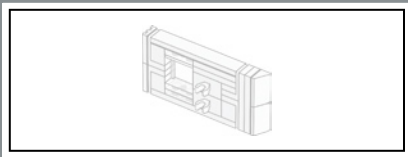

300

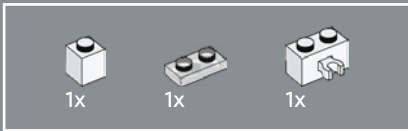
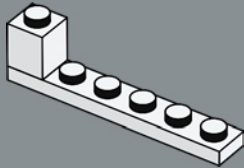

301

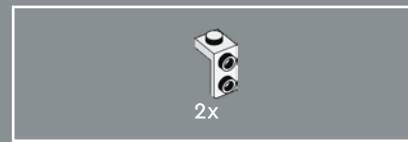
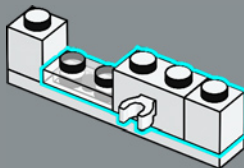

302

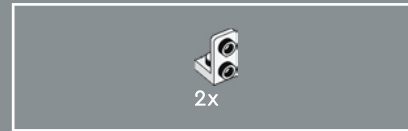
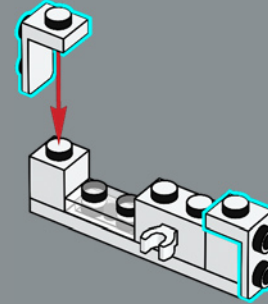

303

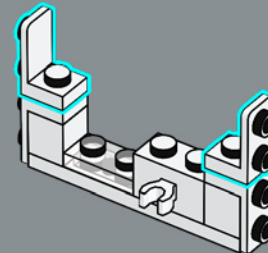

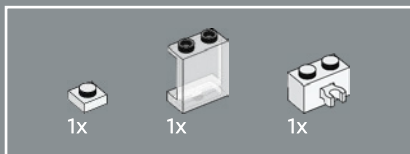

304

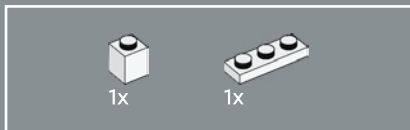
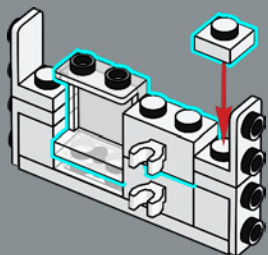

305

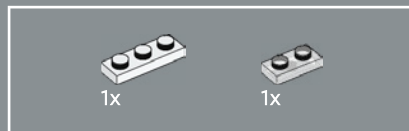
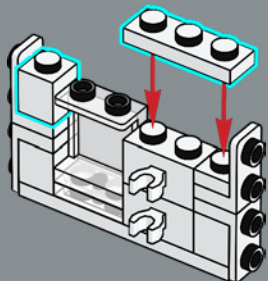

306

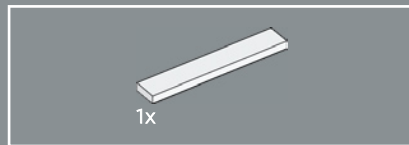
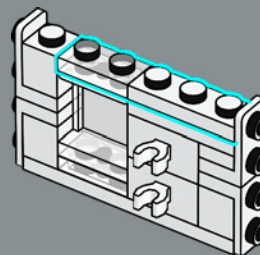

307

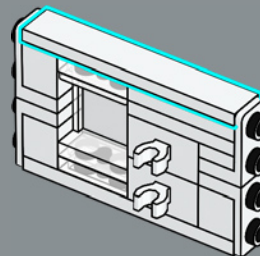



2x

308

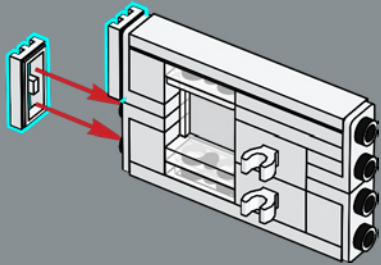

2x



2x

309

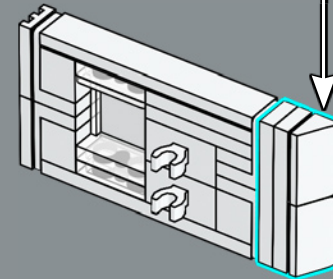
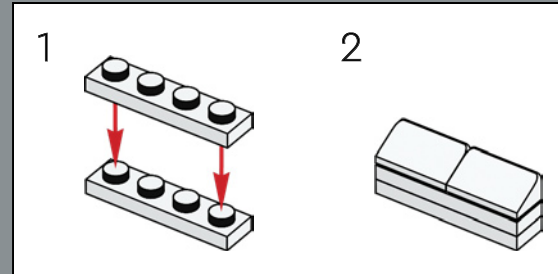

310

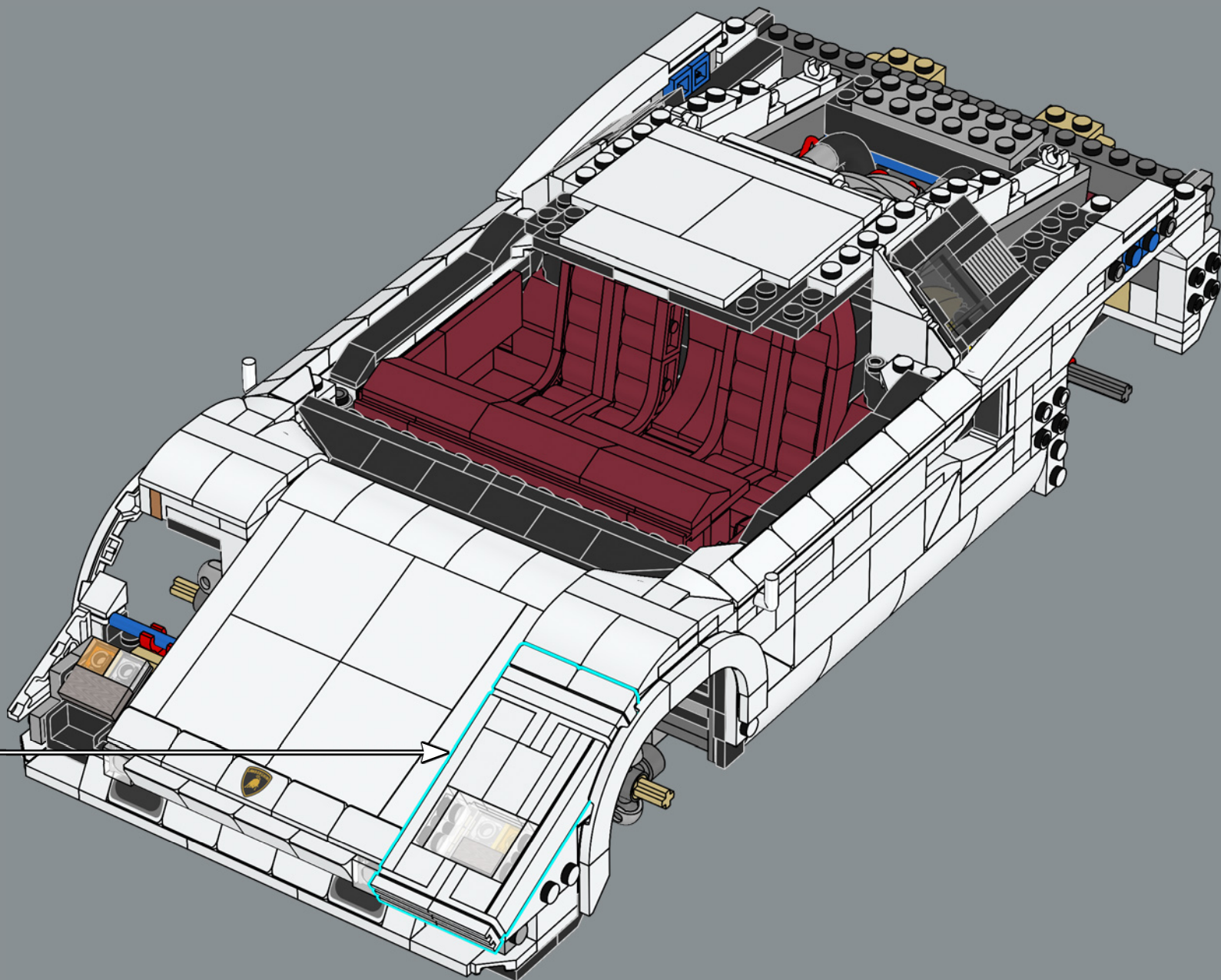

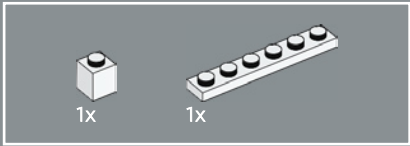
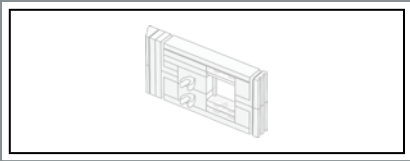

311

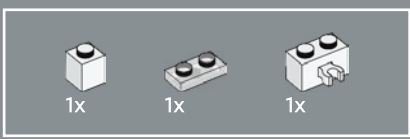
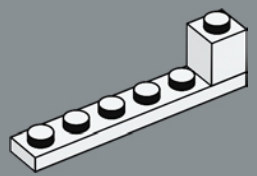

312

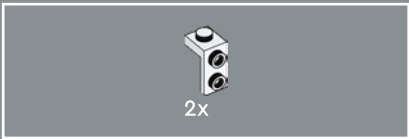
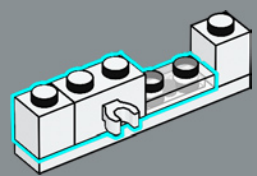

313

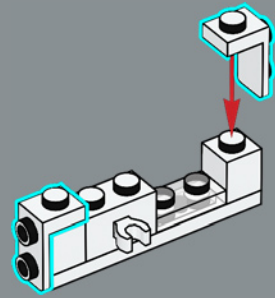

314

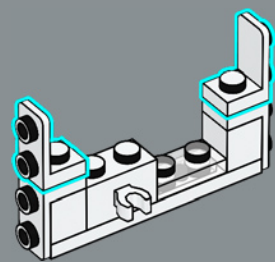

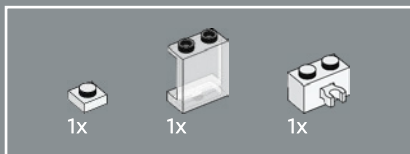

315

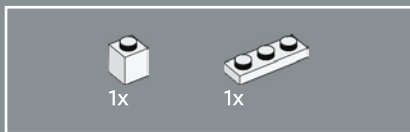
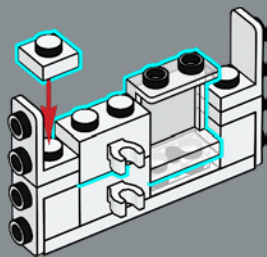

316

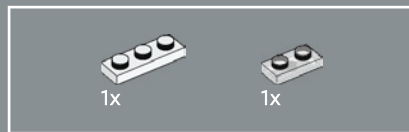
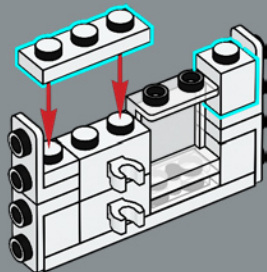

317

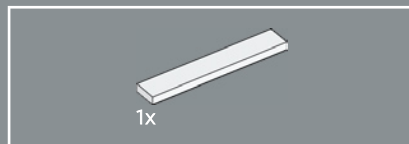
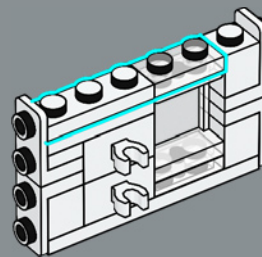

318

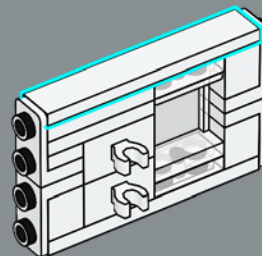



2x

319

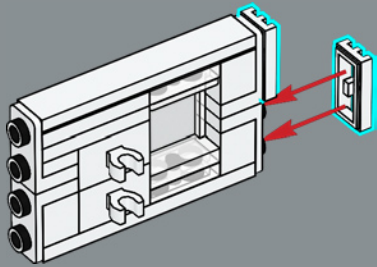

2x



2x

320

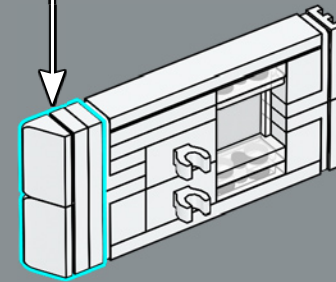
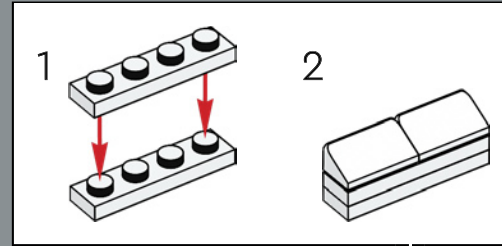

321

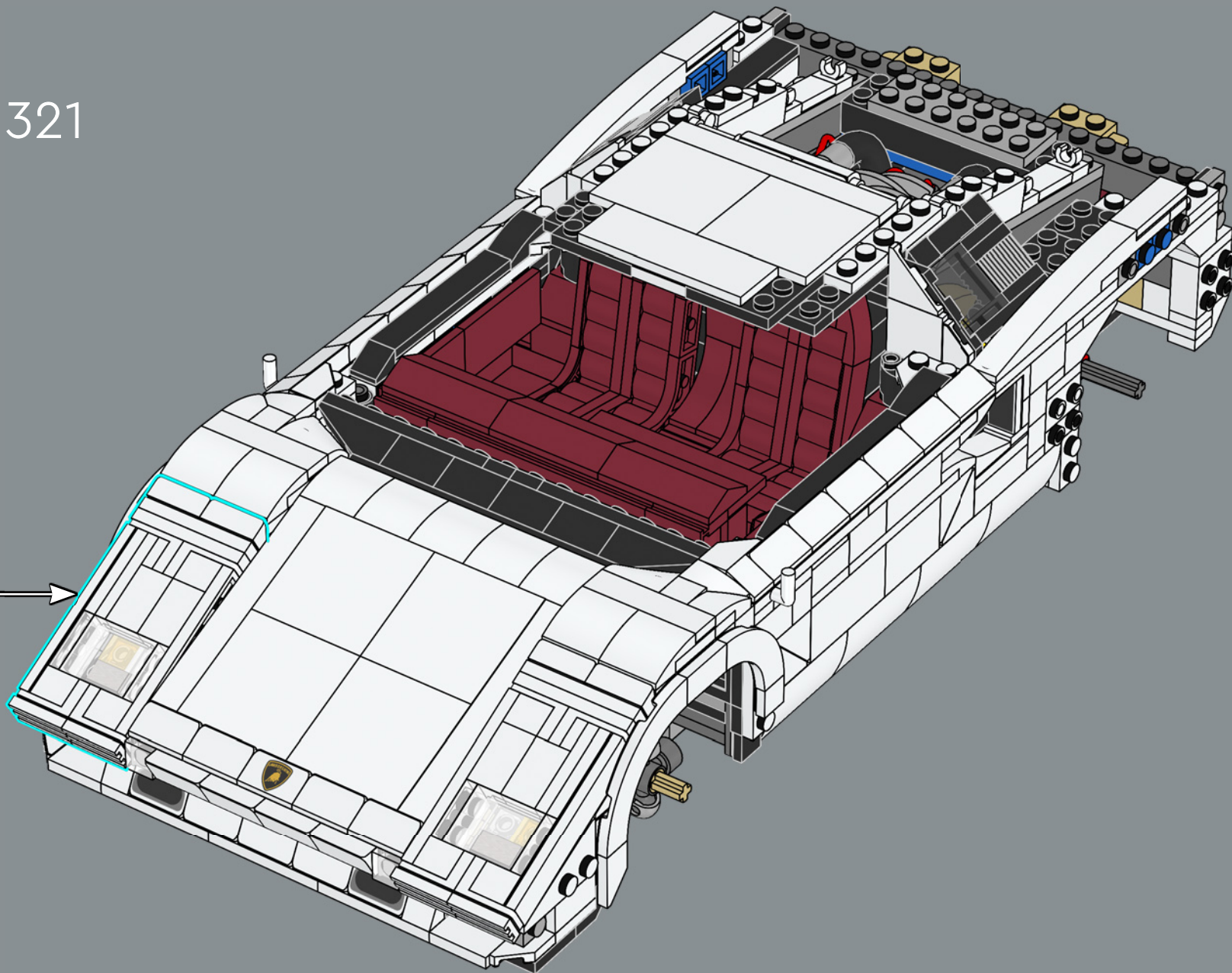

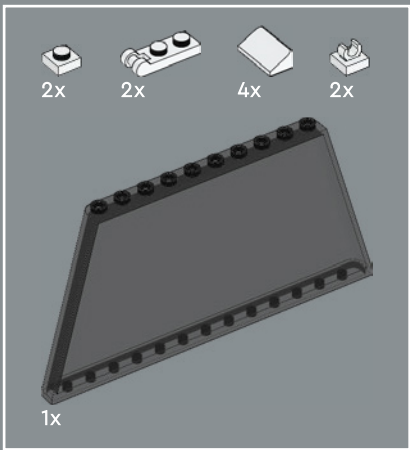

322

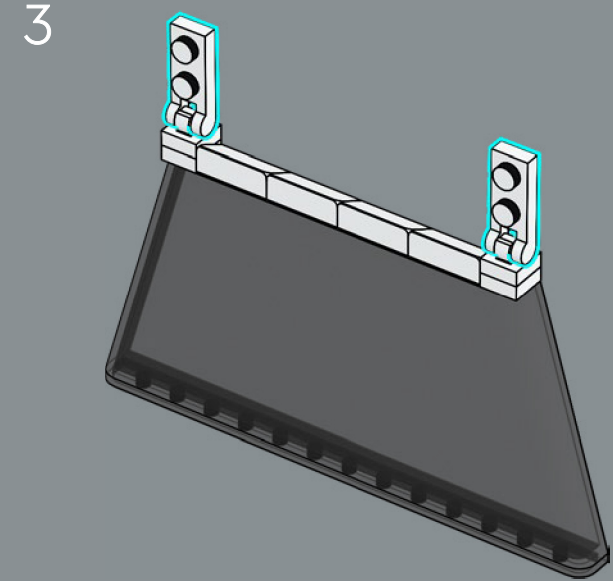
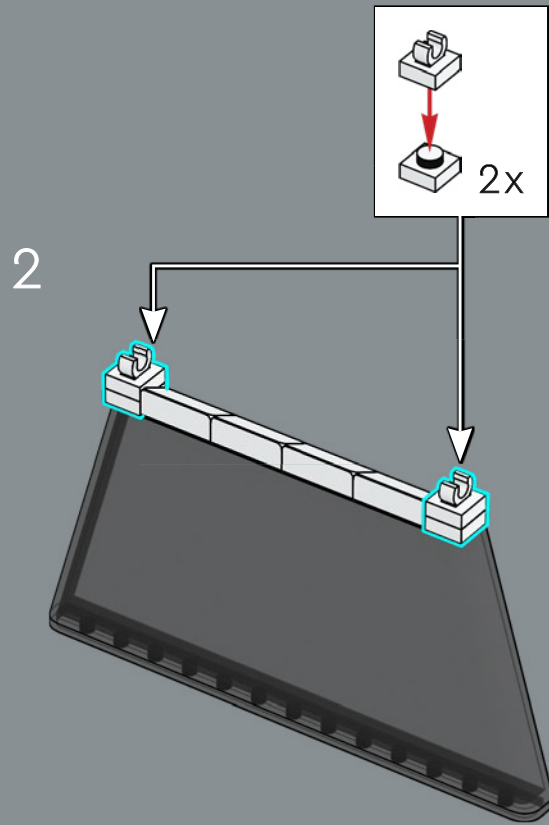
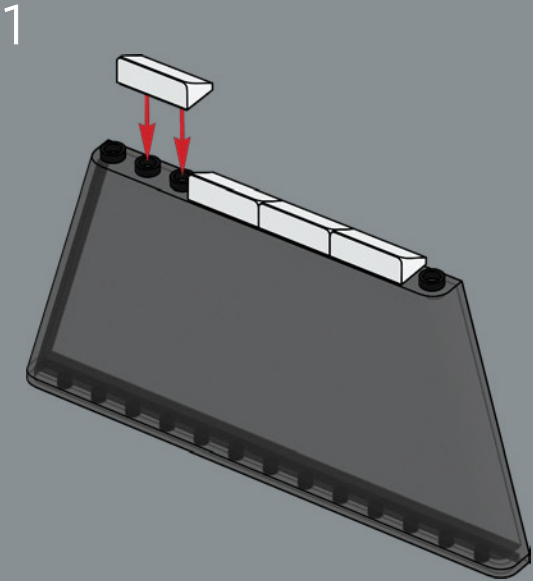

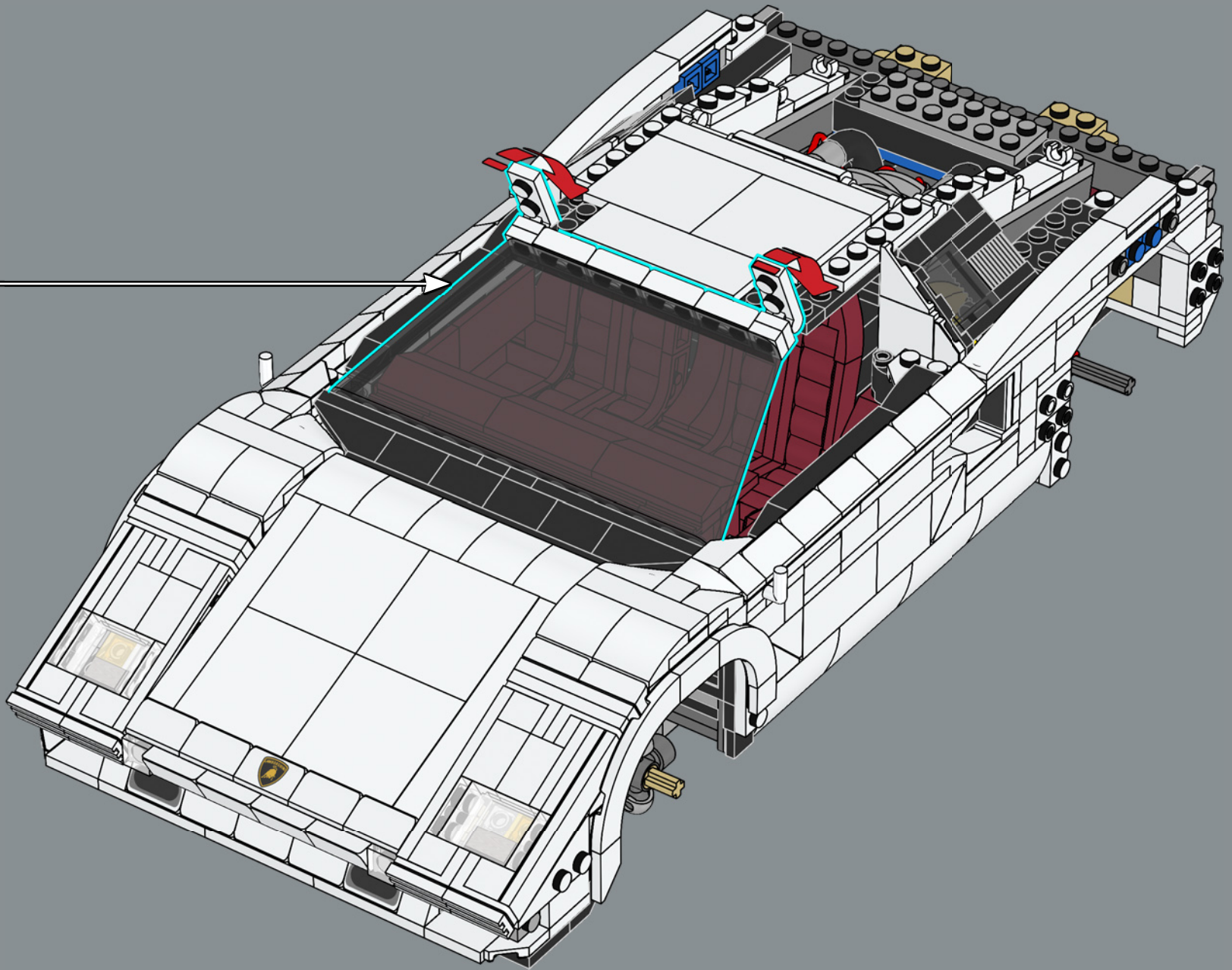

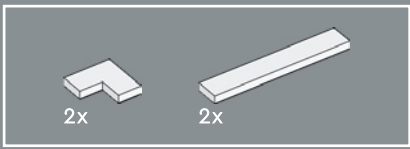

323

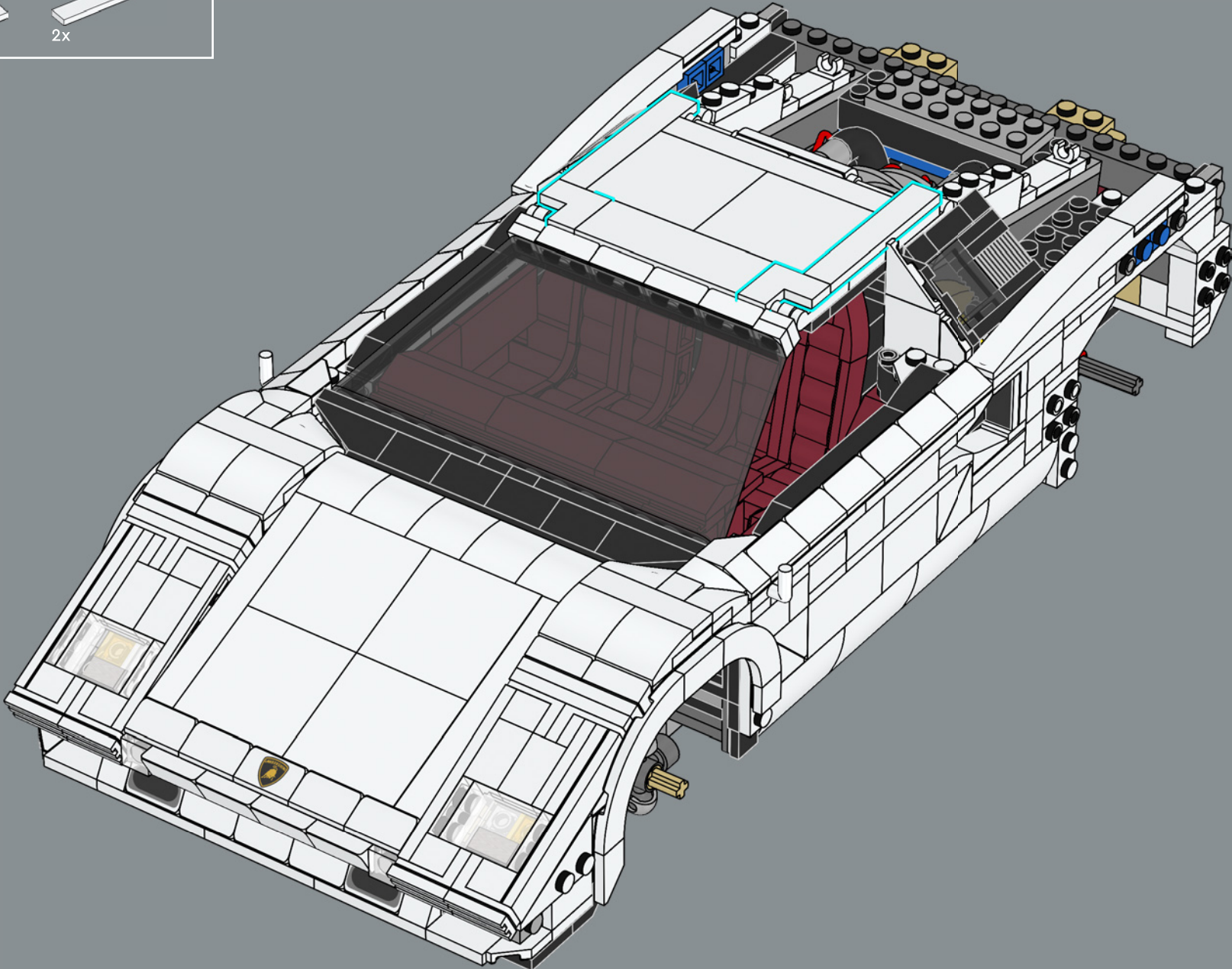

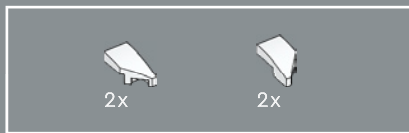

324

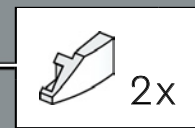
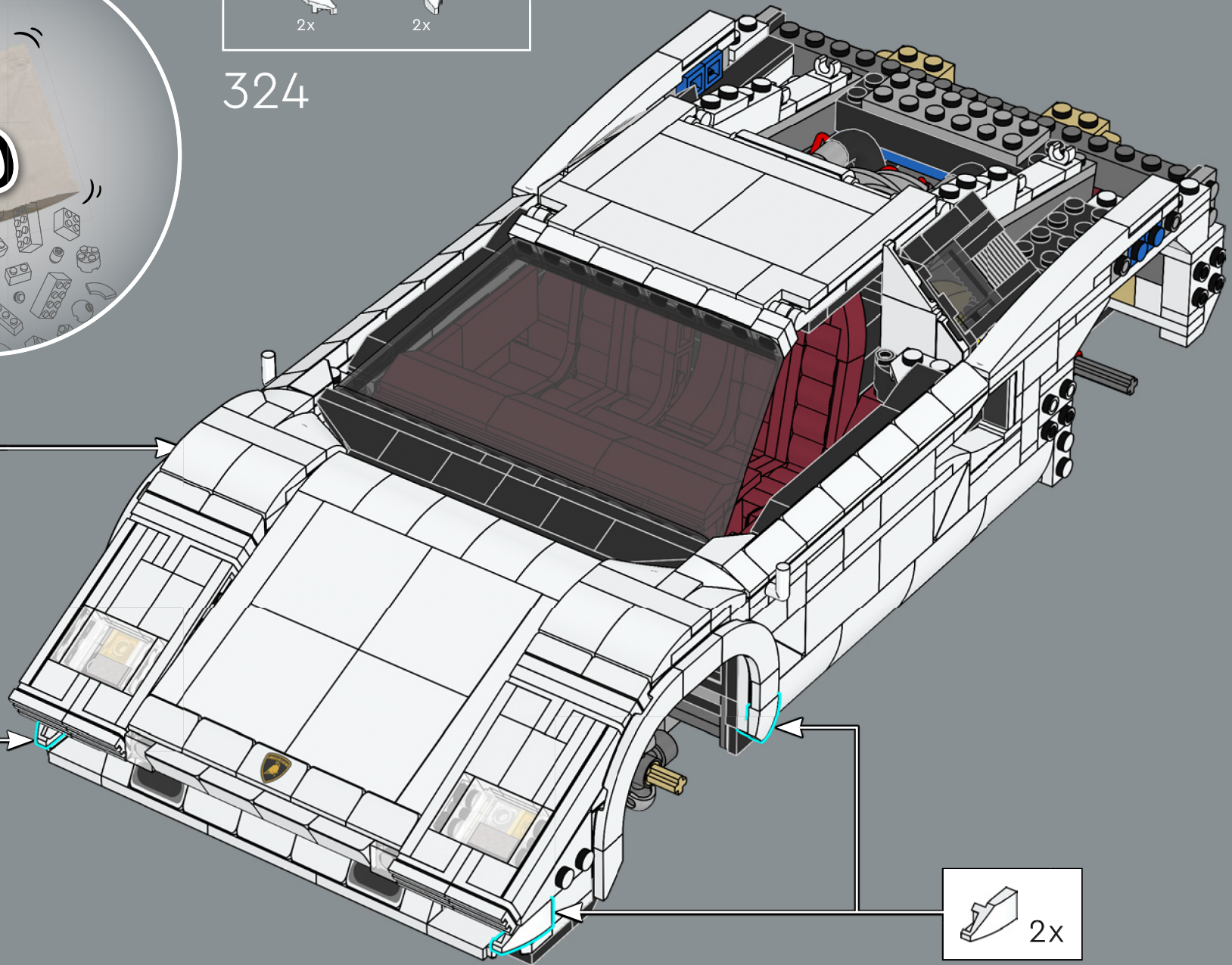

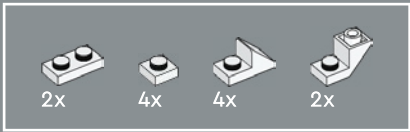

325

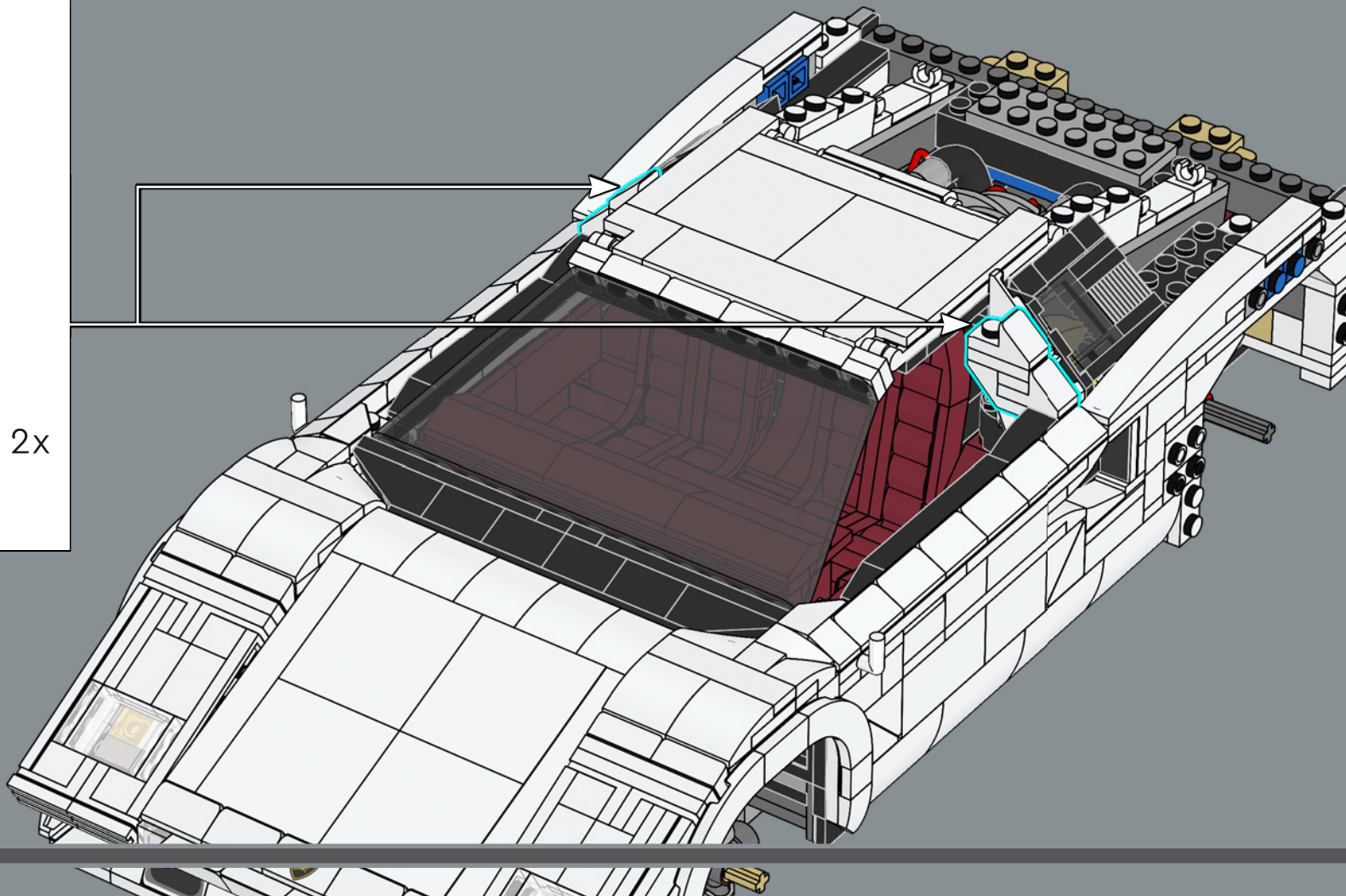
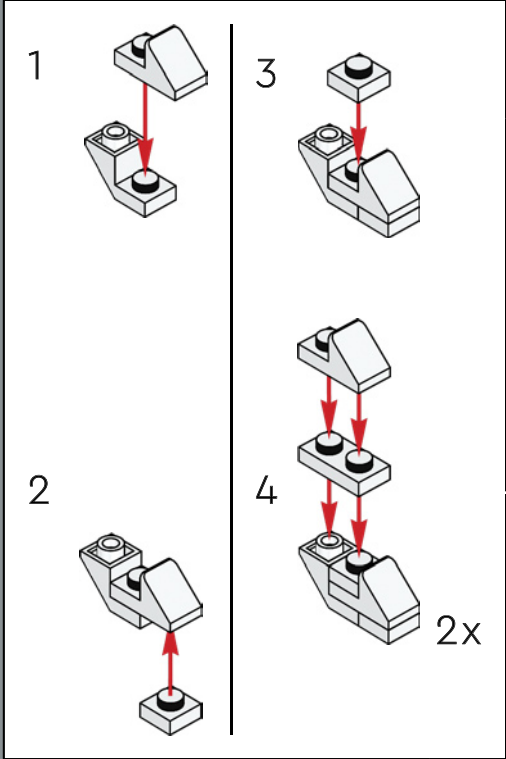

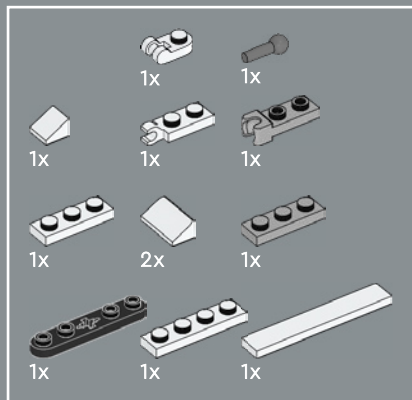

326

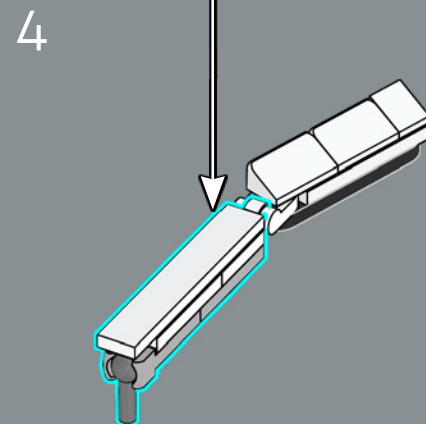
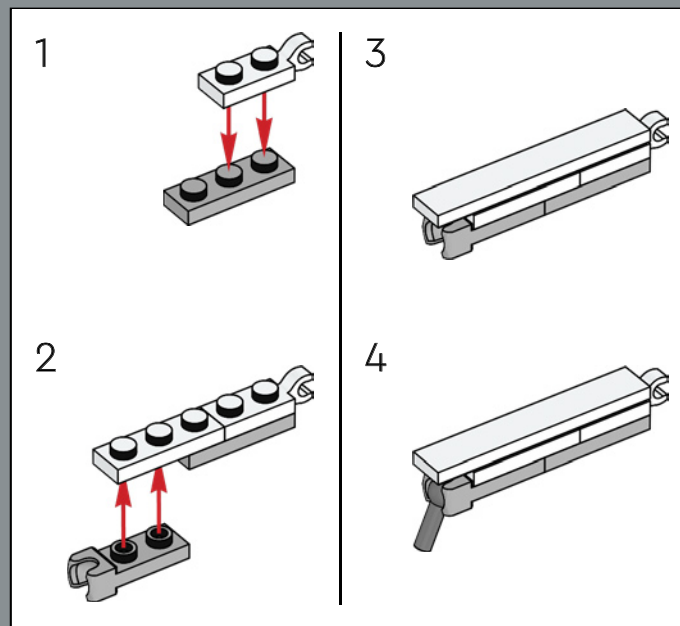
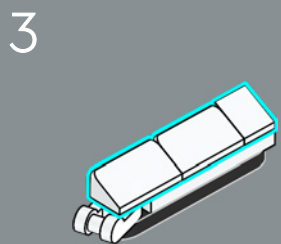
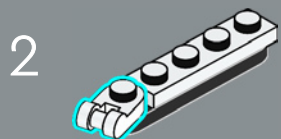
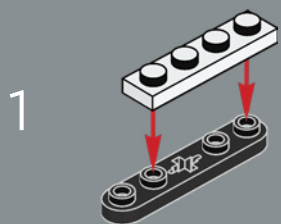

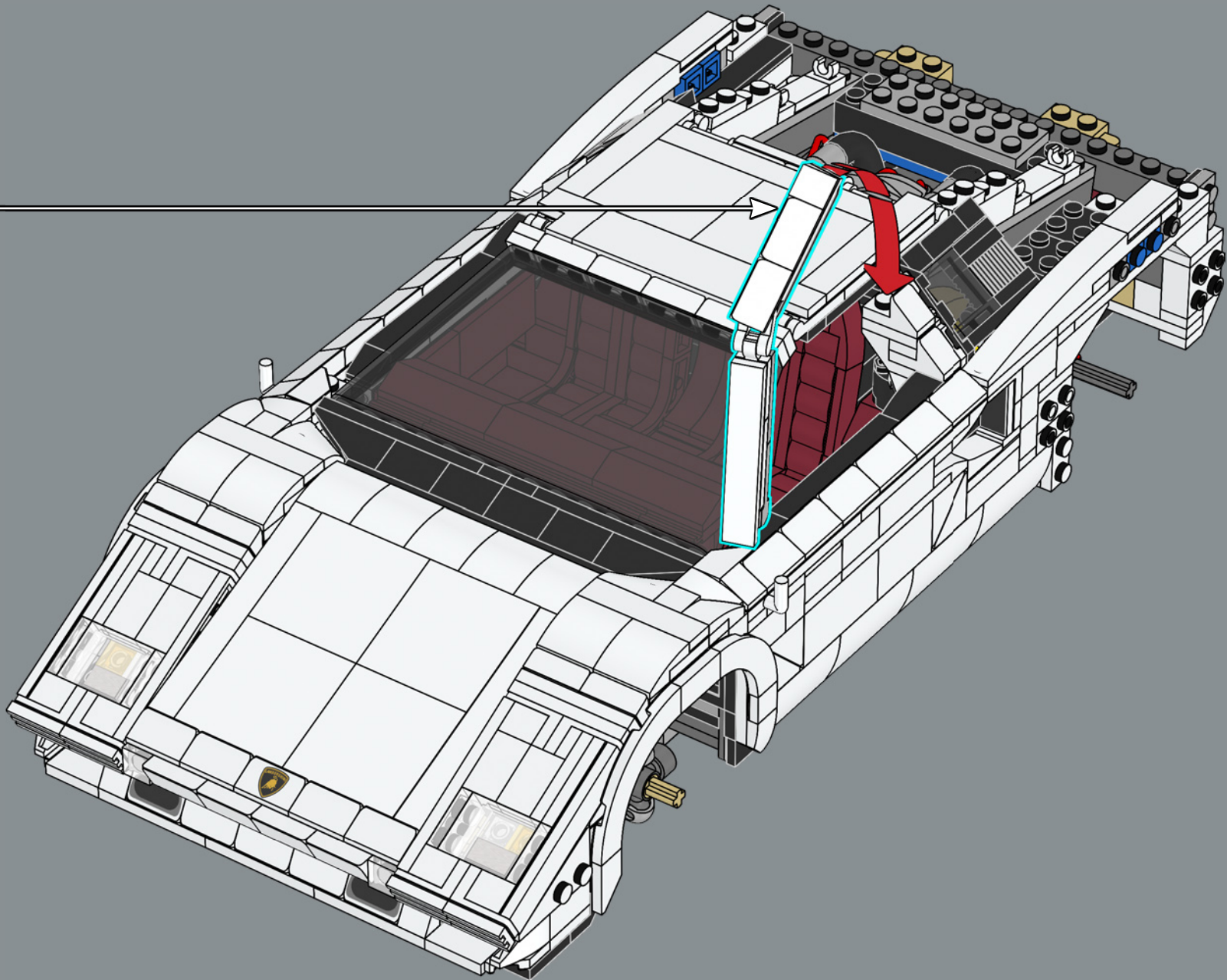

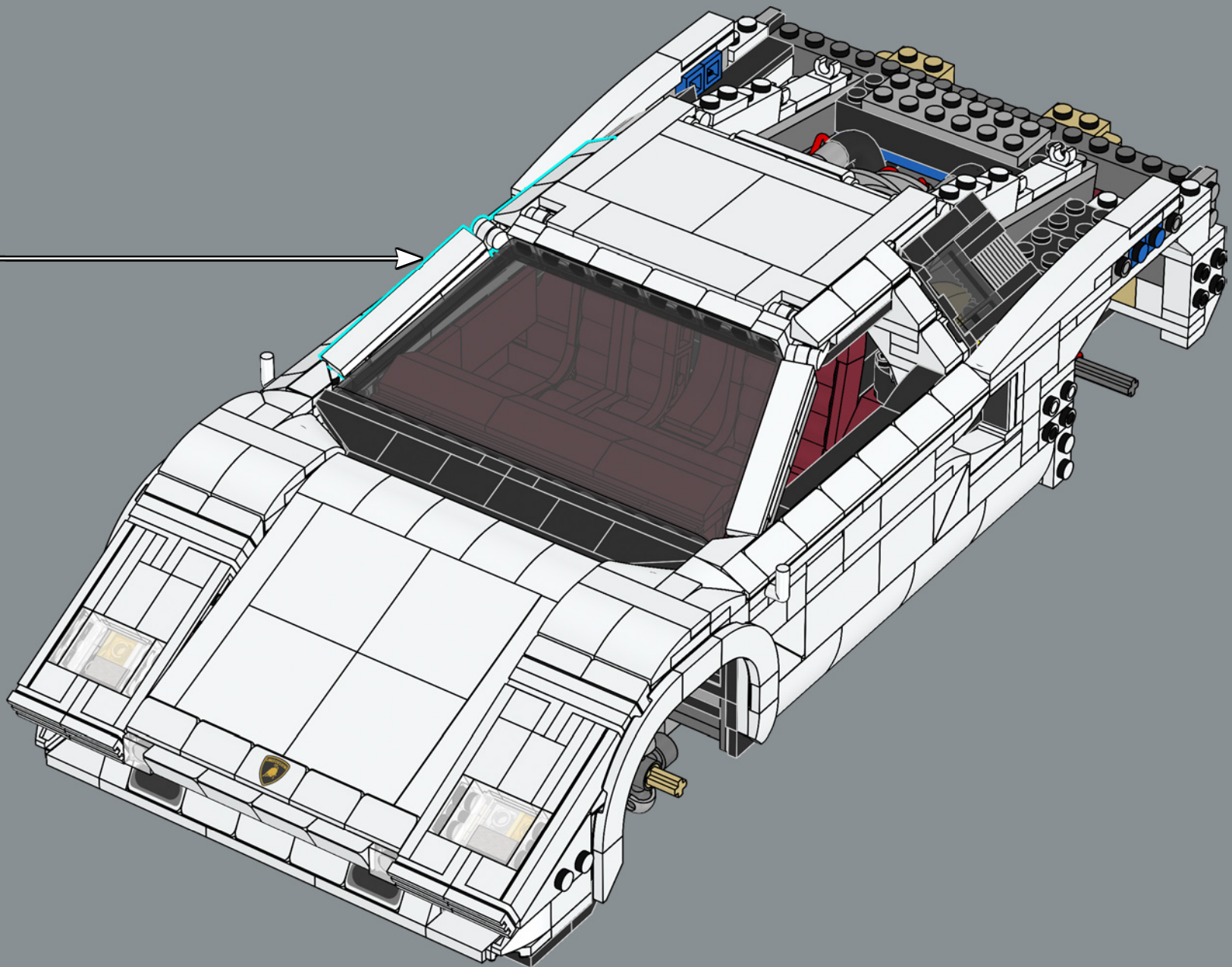

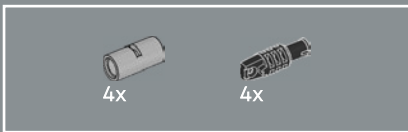

328

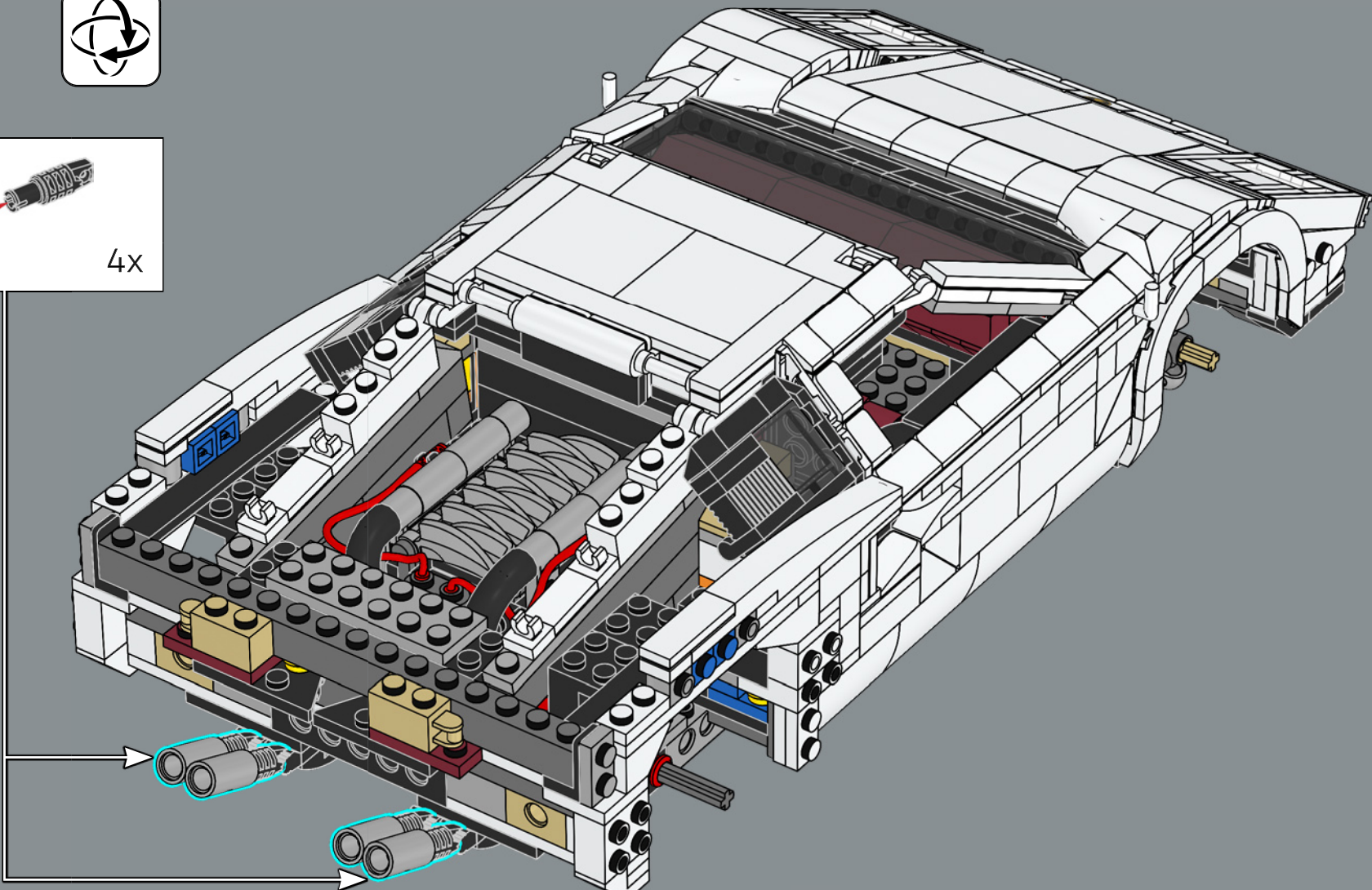
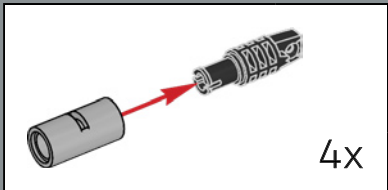

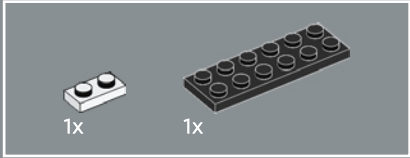
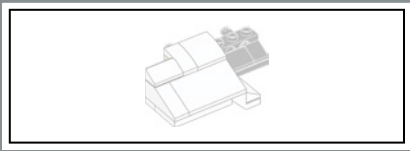

329

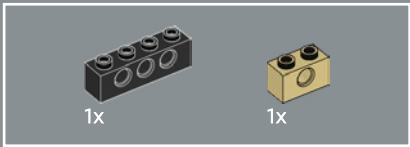
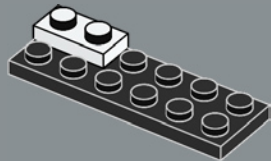

330

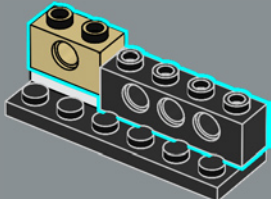

331

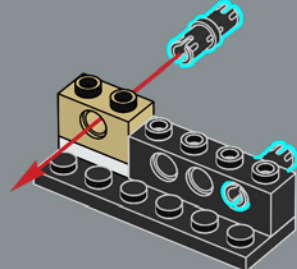

332

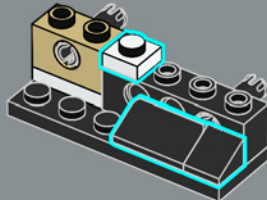

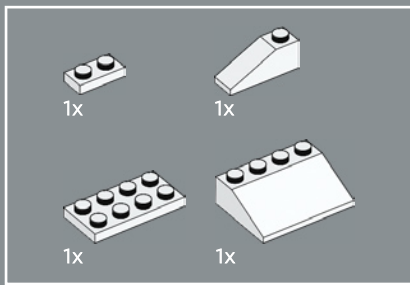

333

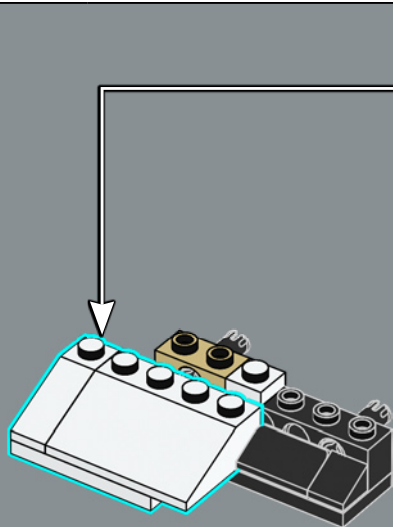
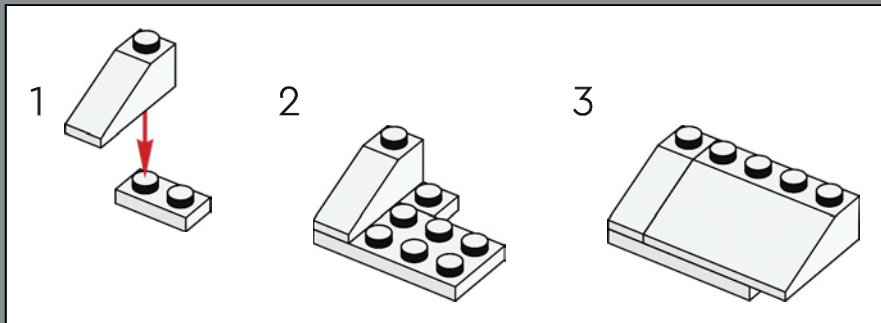

334

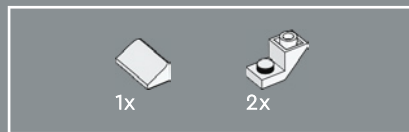
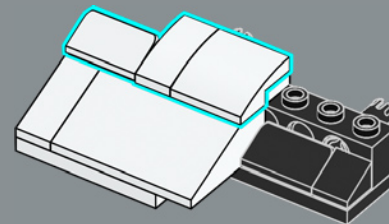

335

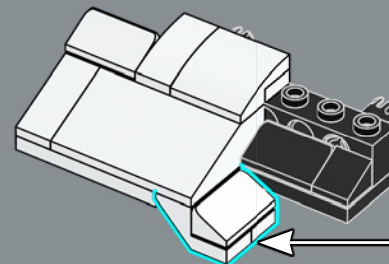
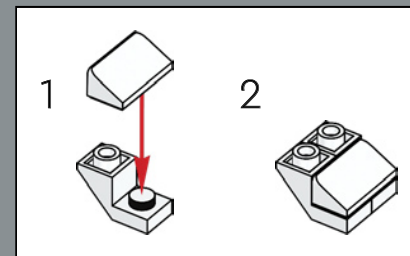

336

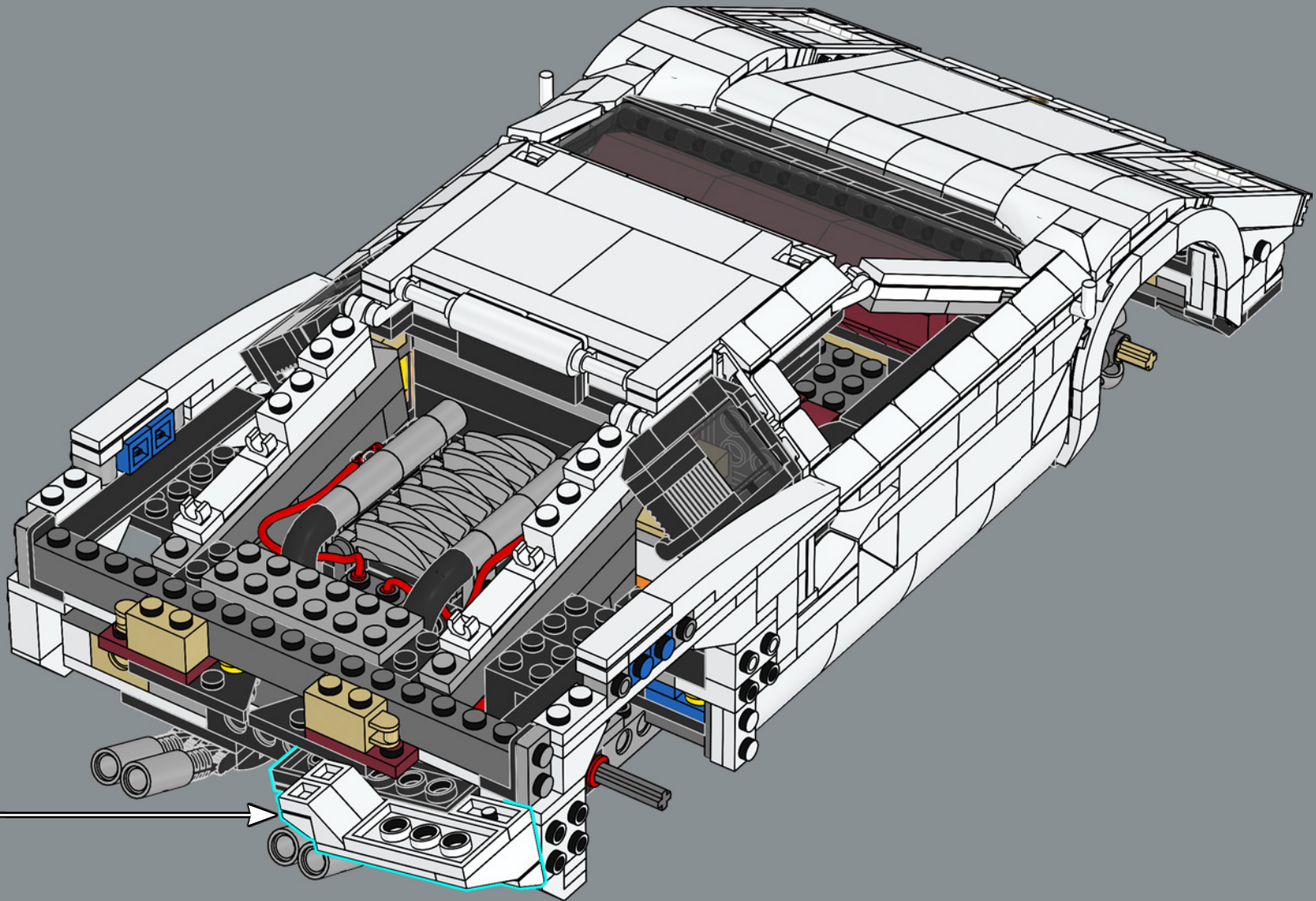

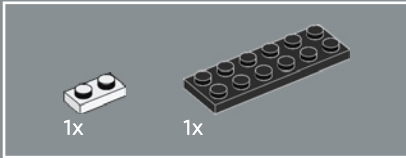
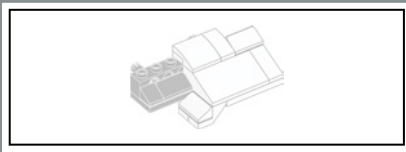

337

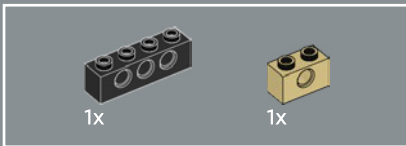
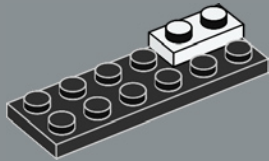

338

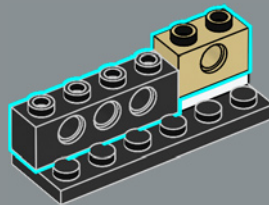

339

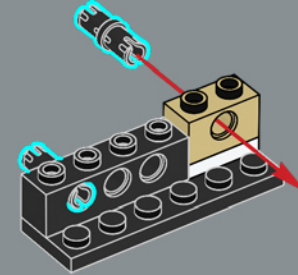

340

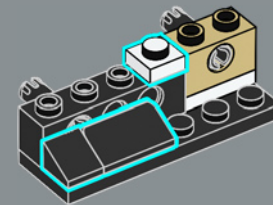

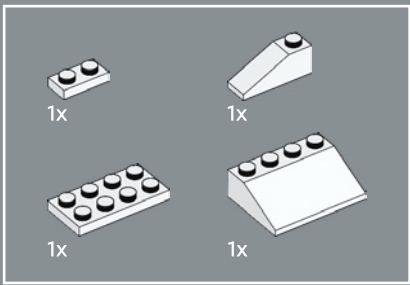

341

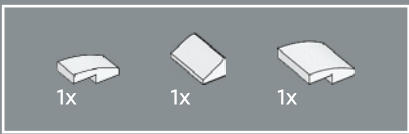
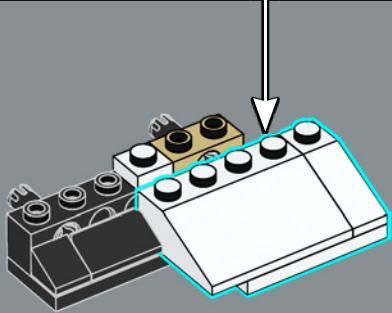
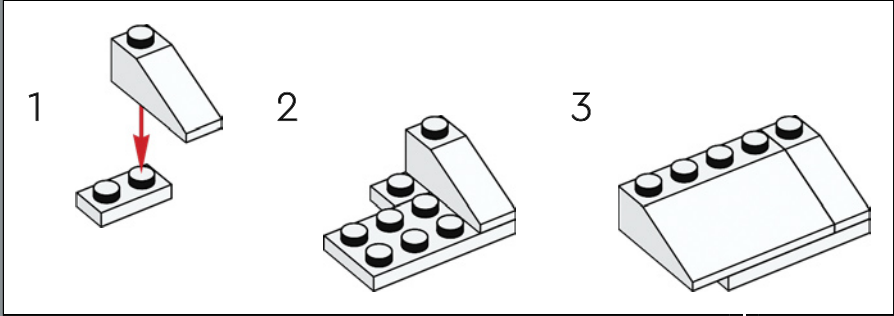

342

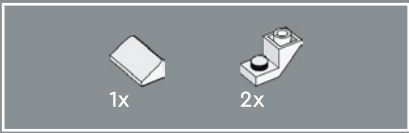
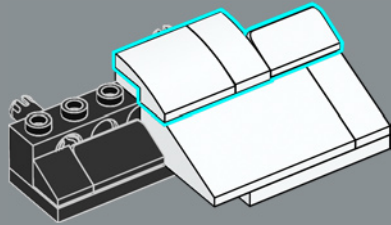

343

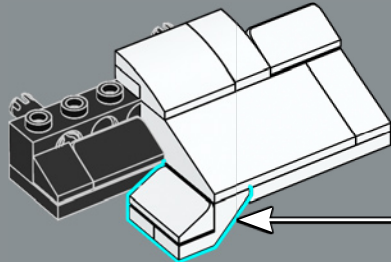
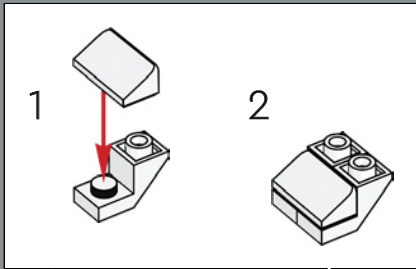

344

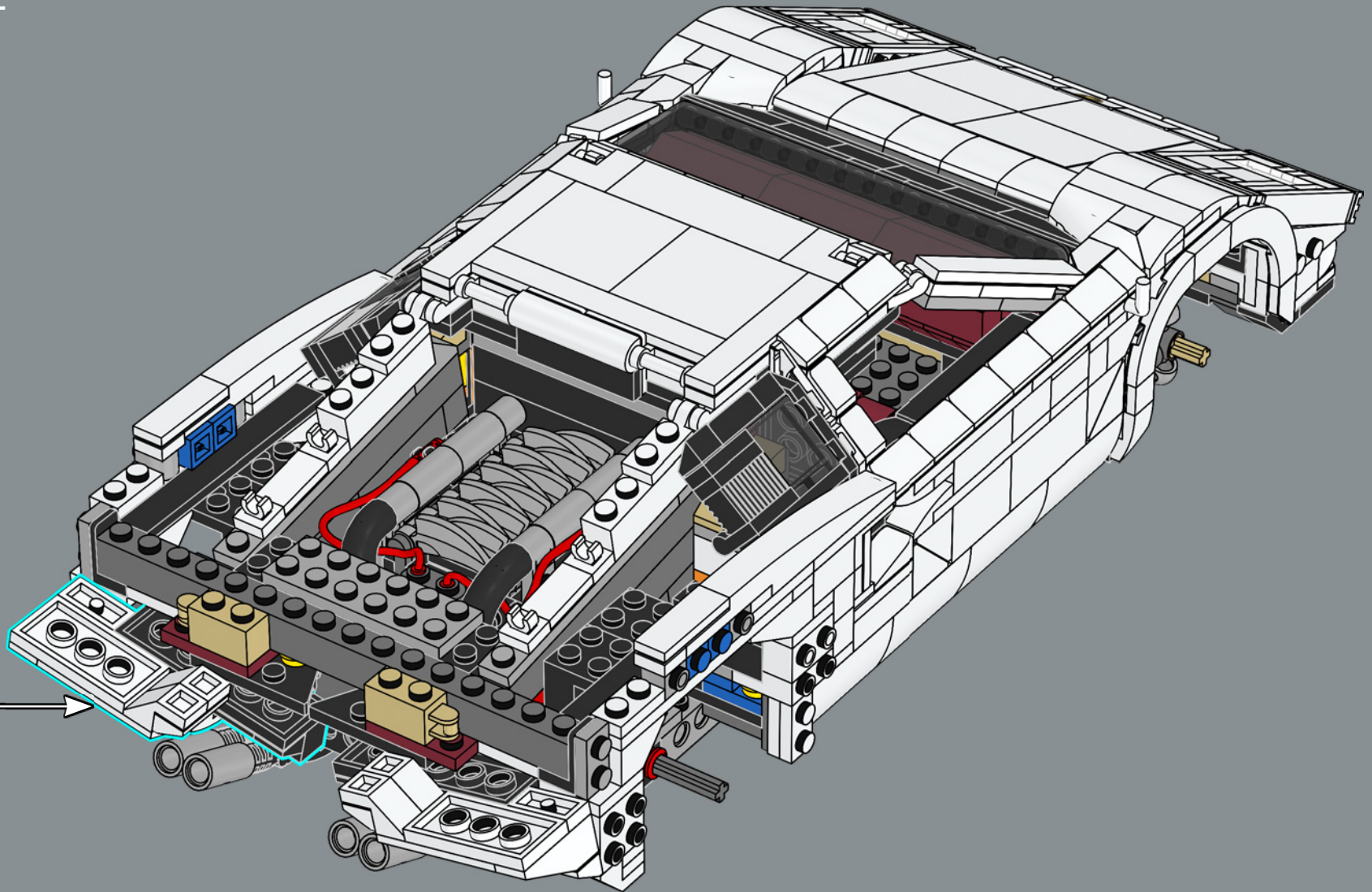

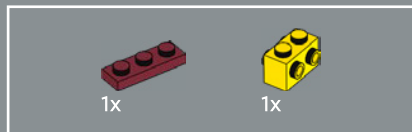
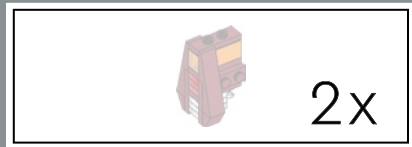

345

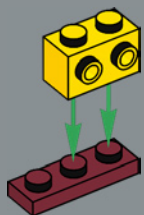

346

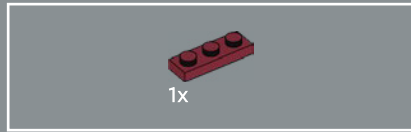
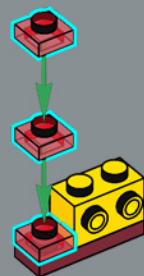

347

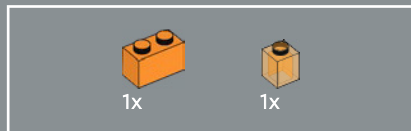
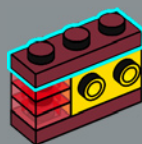

348

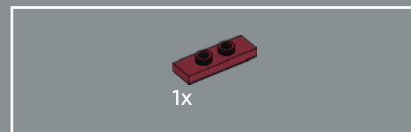

349

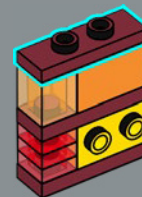

350

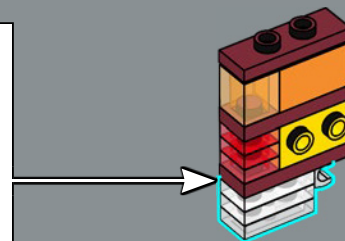
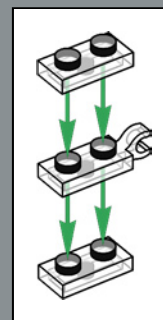
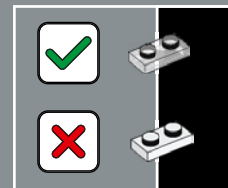

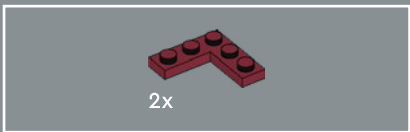

351

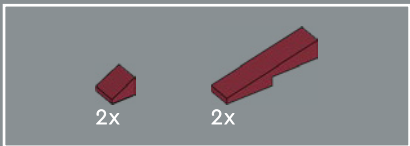
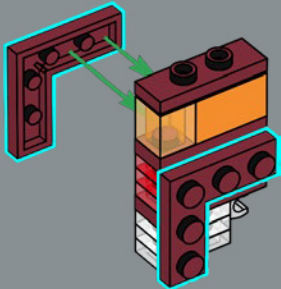

352

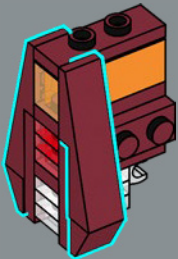

2x

353

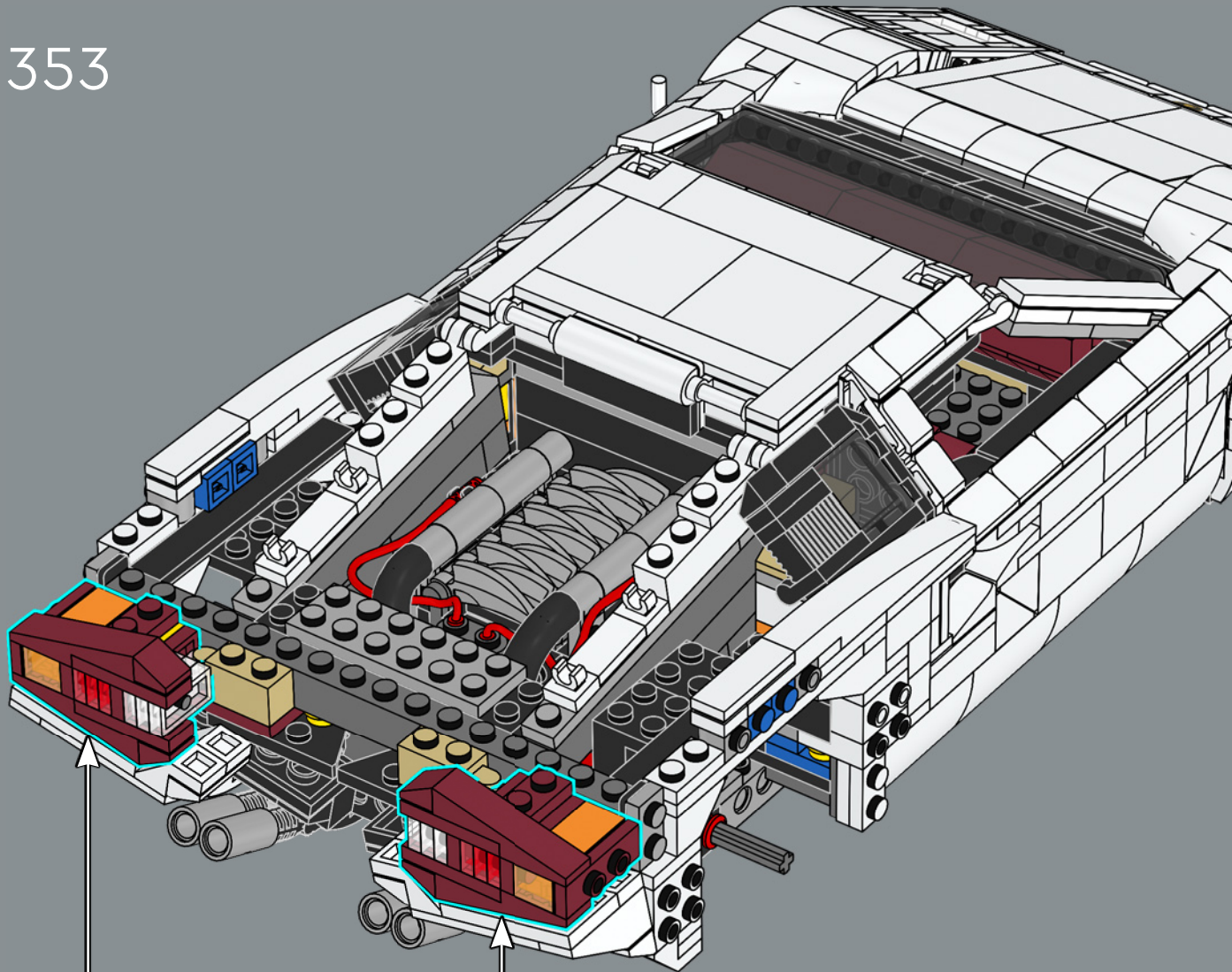

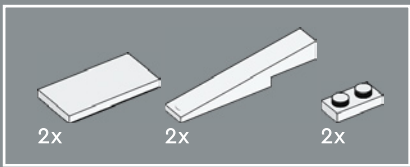

354

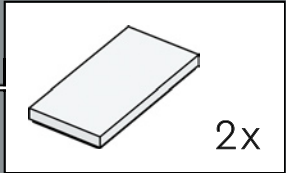
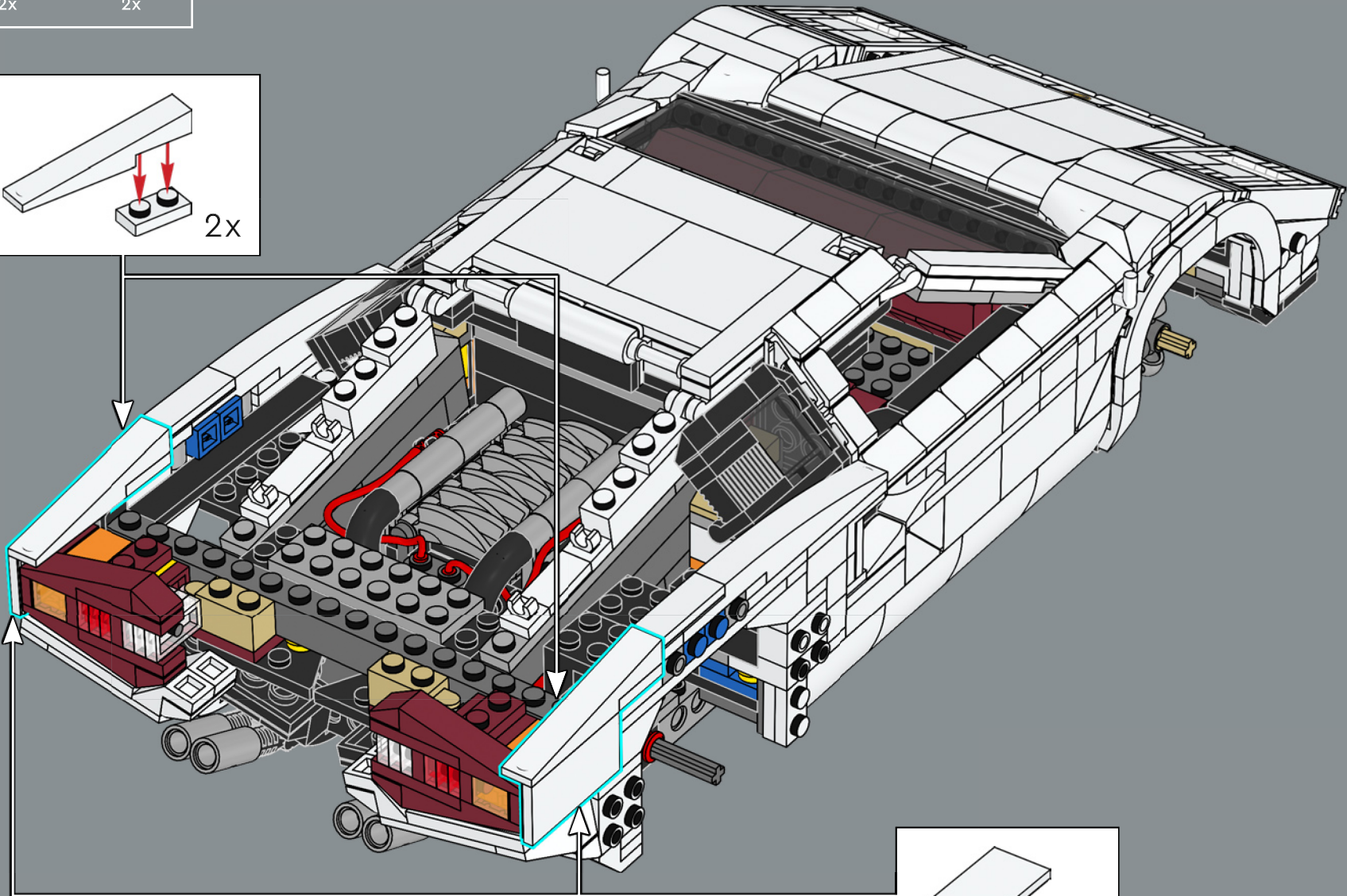
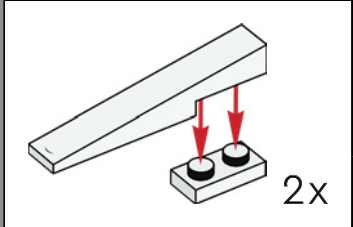

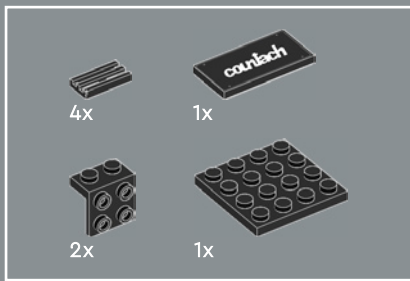

355

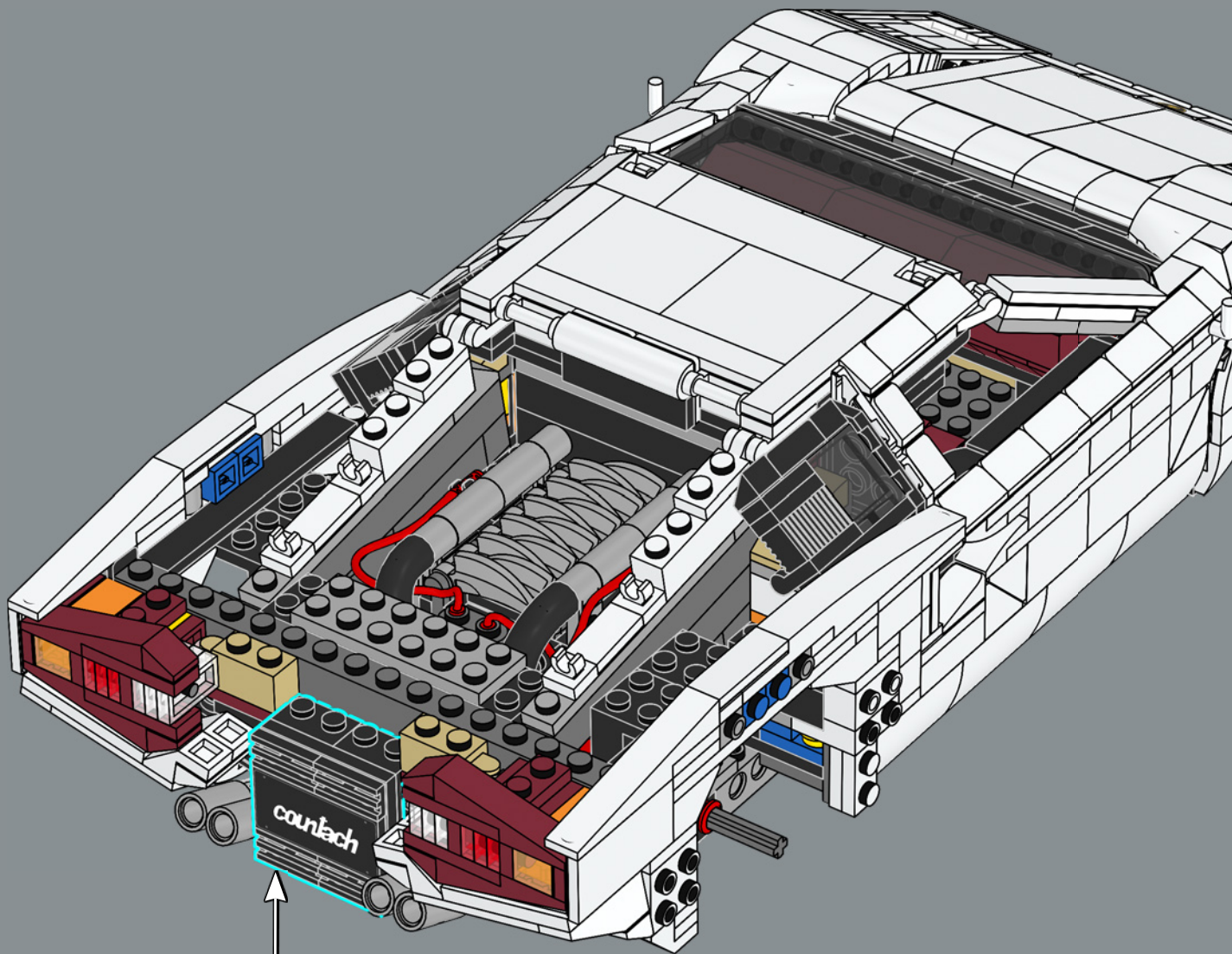
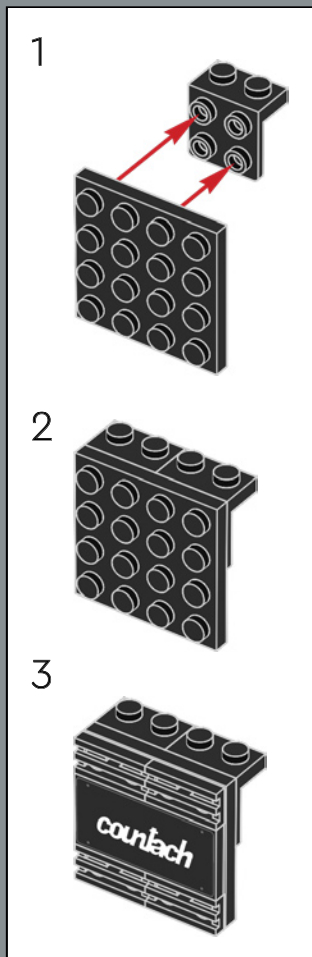

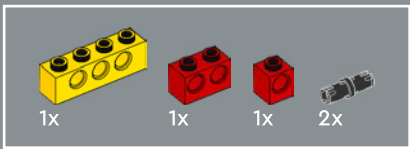

356

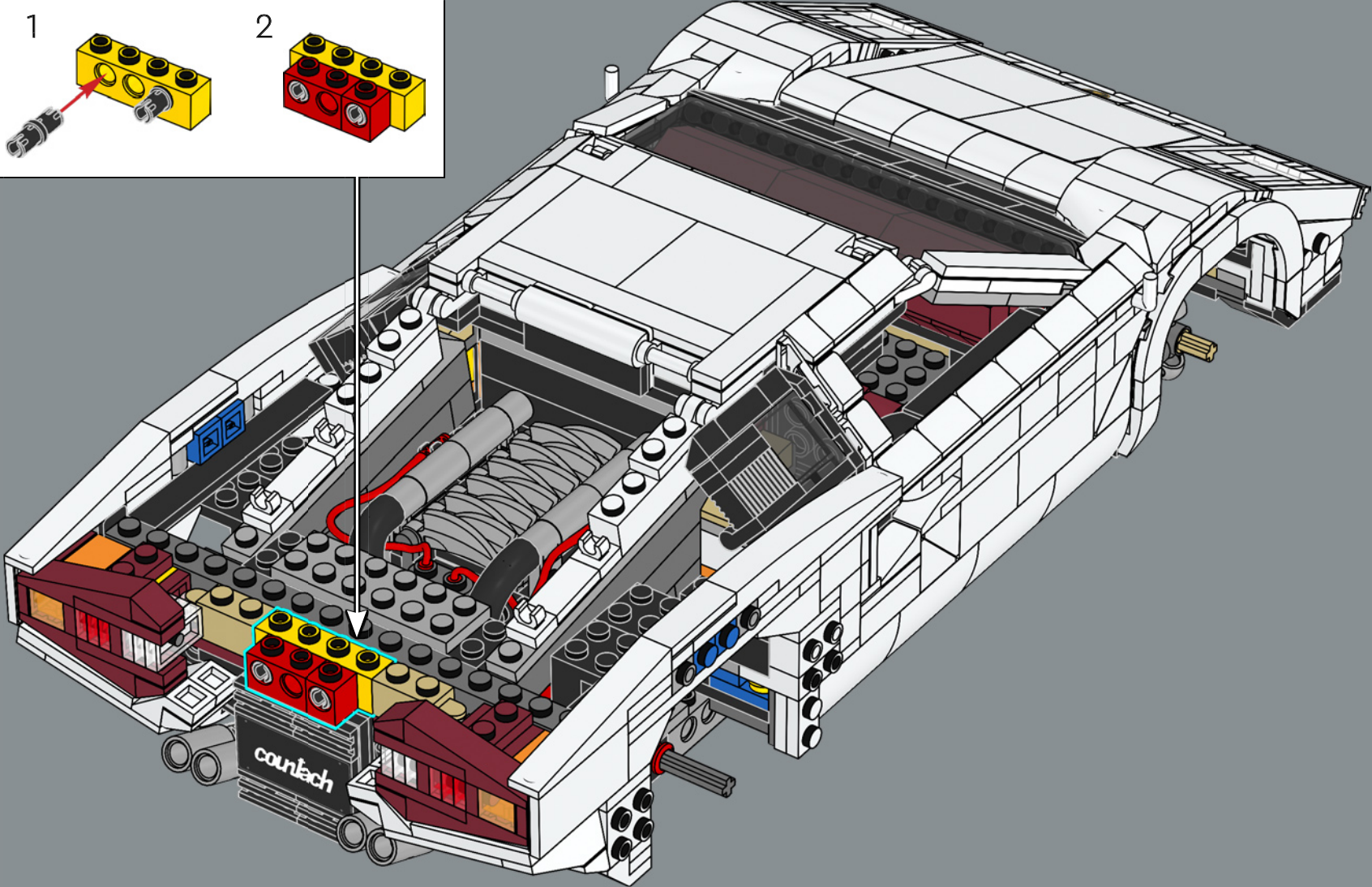
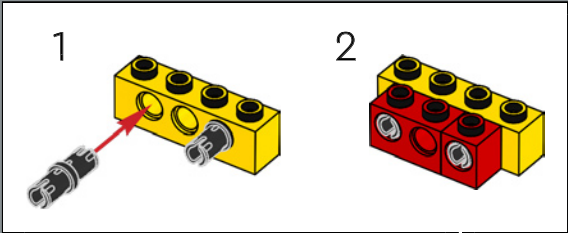

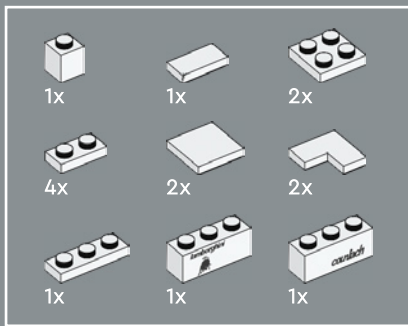

4

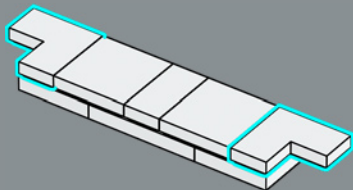

357

1

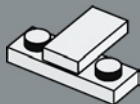

2

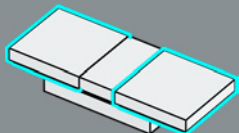

3

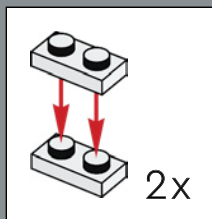
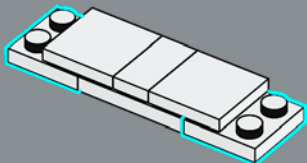

2x

5

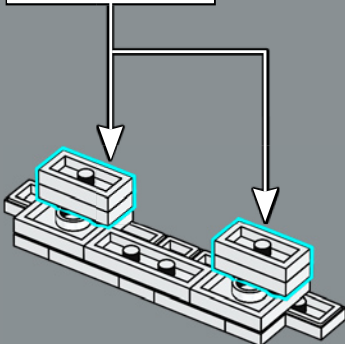

6

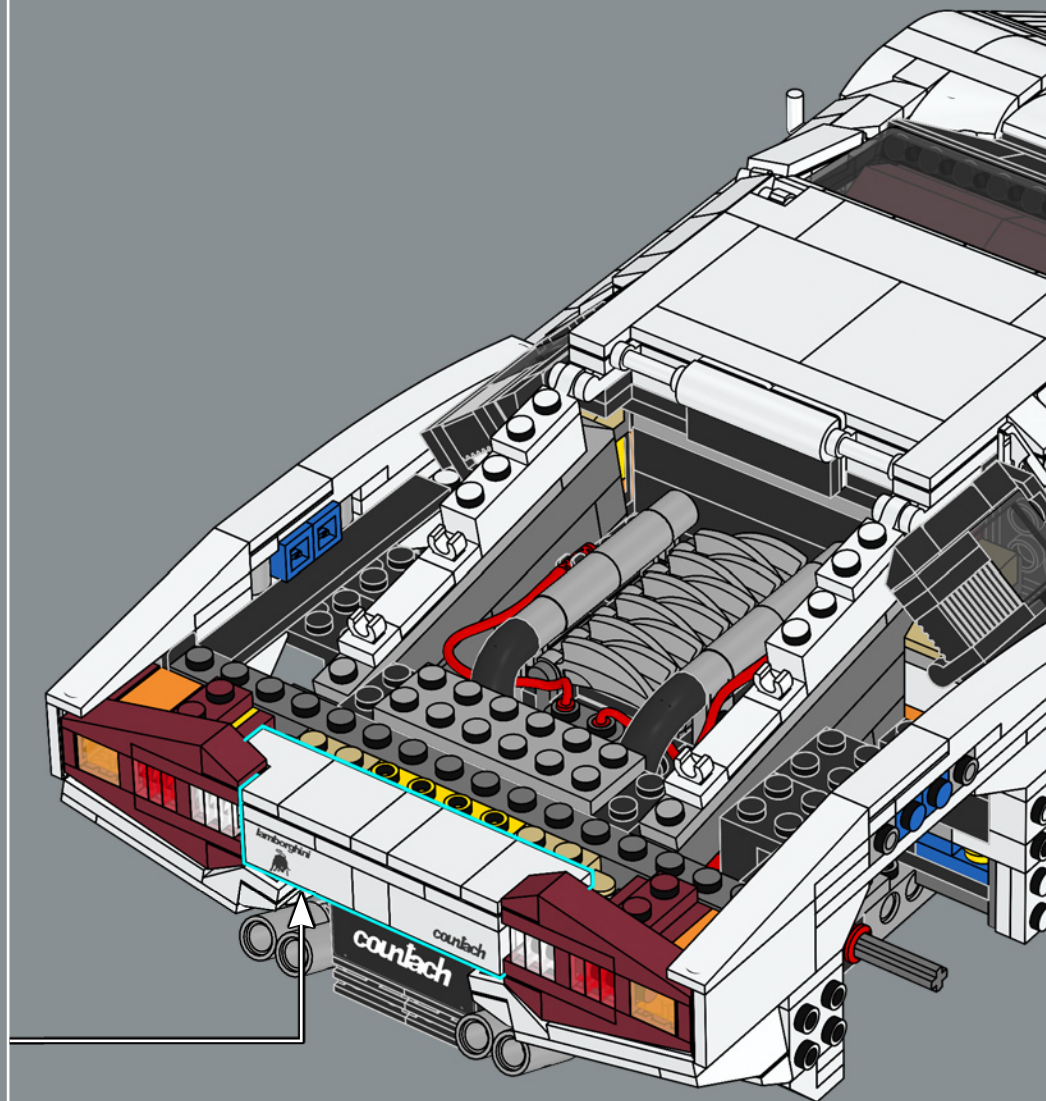
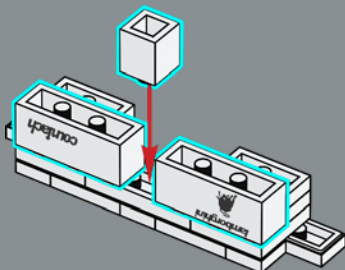

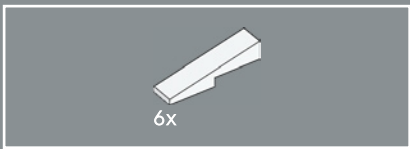

358



新式乐高®斜坡组件有助于在标志性设计中重现短而浅的角度。

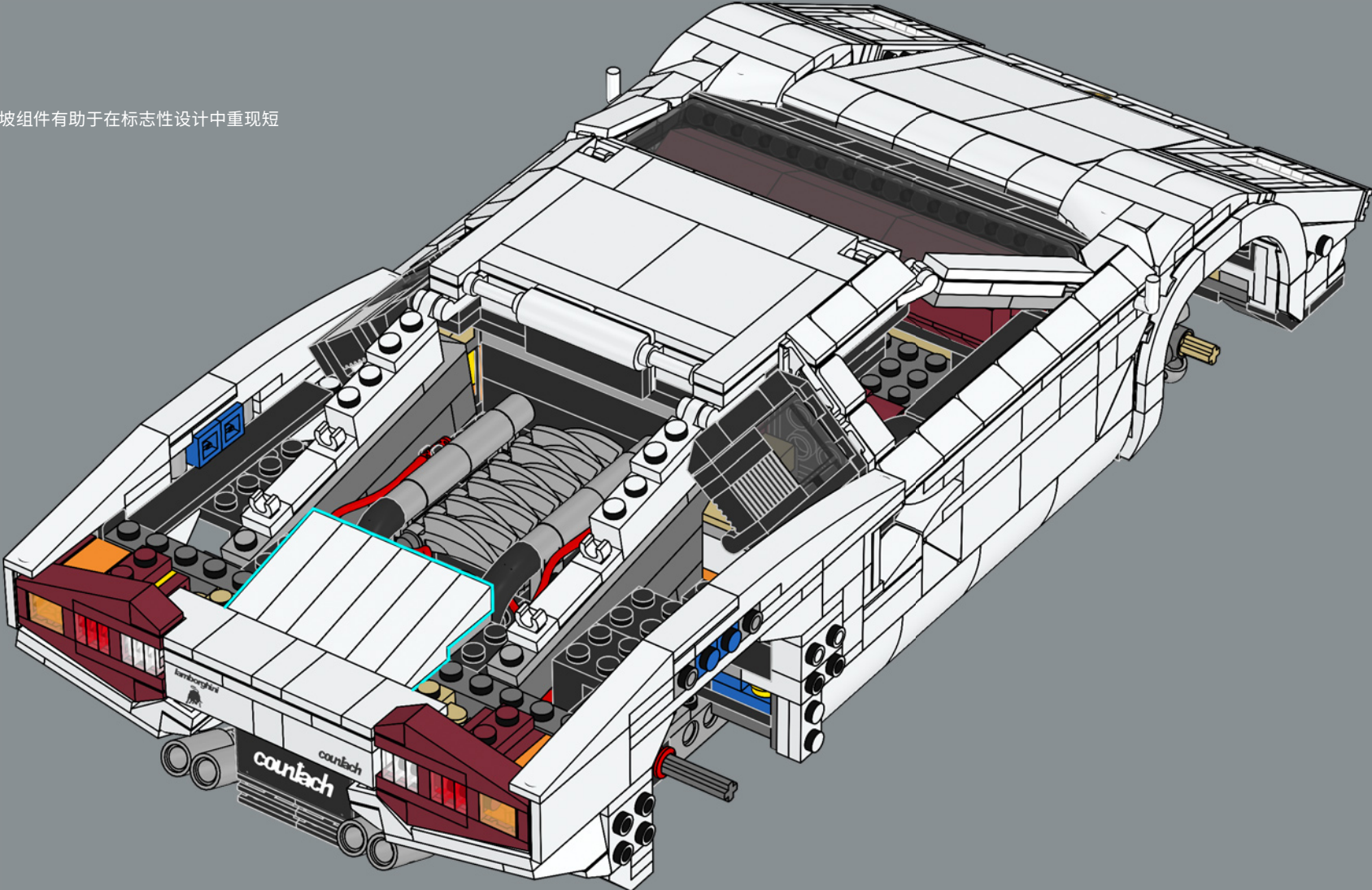

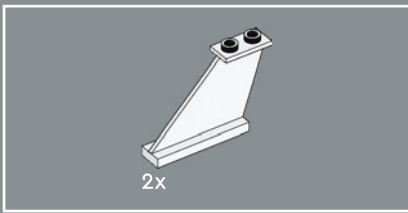

359

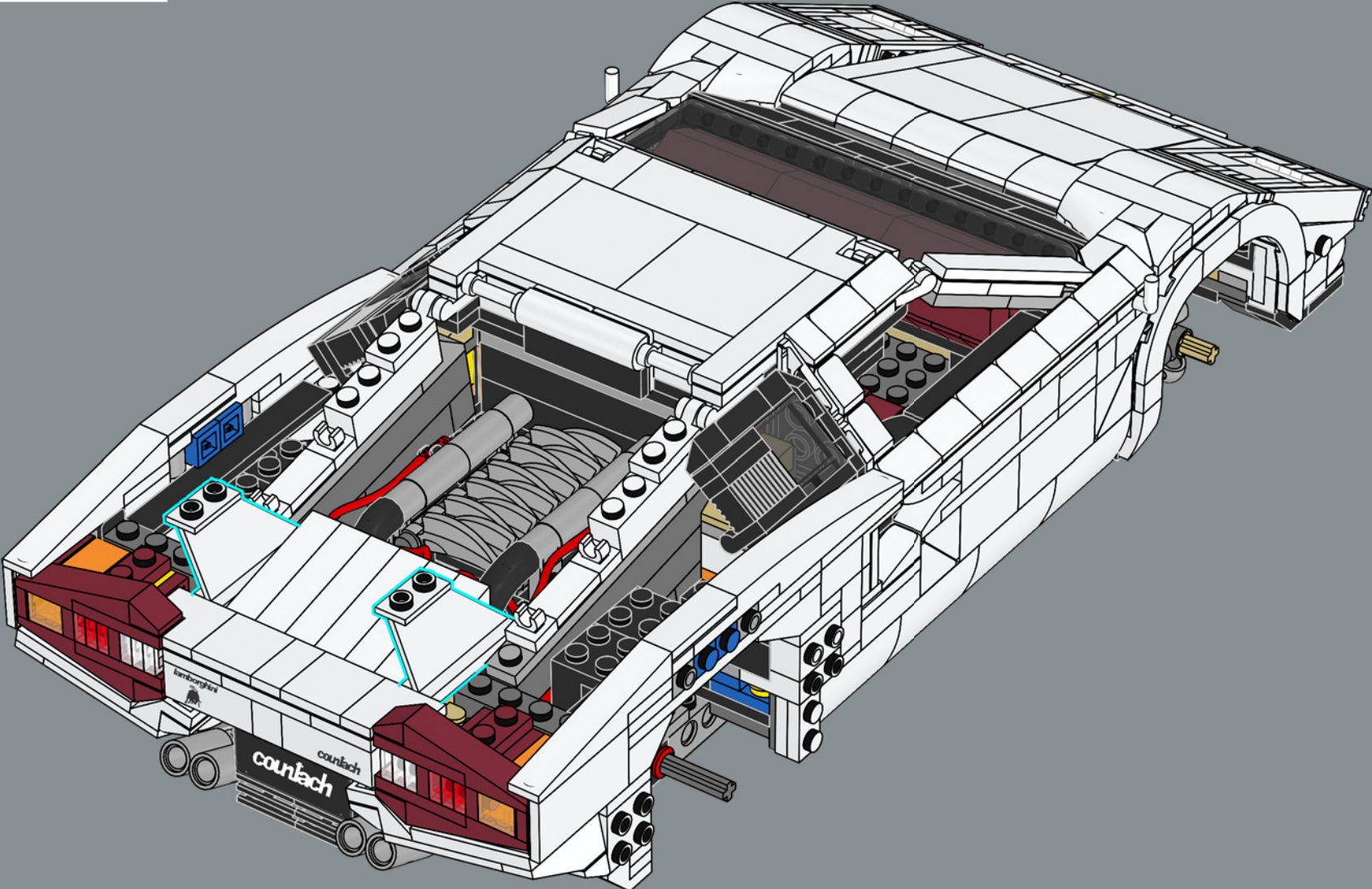

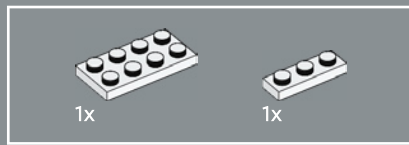
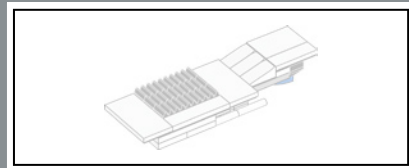

360

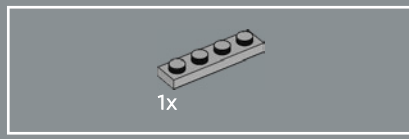
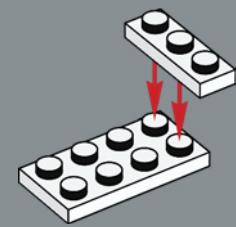

361

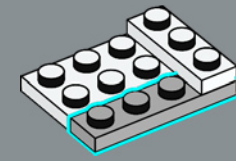



362

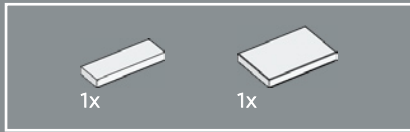
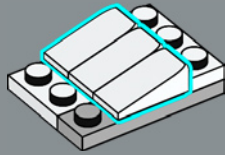

363

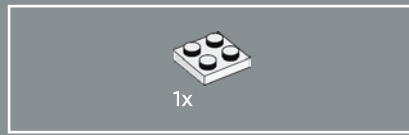
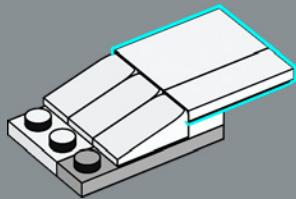
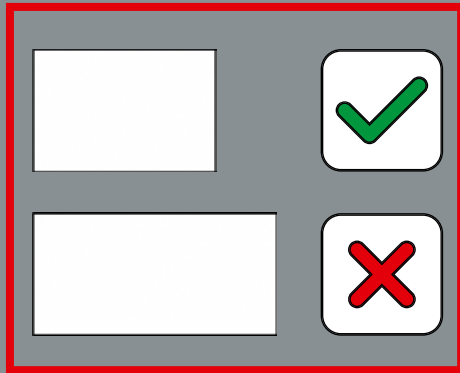

364

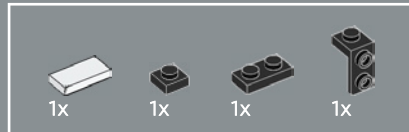
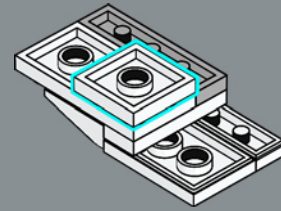

365

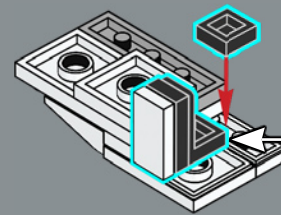
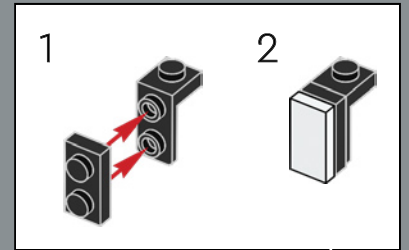



366

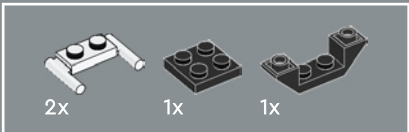
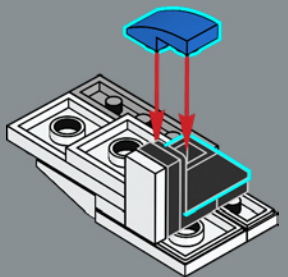

367

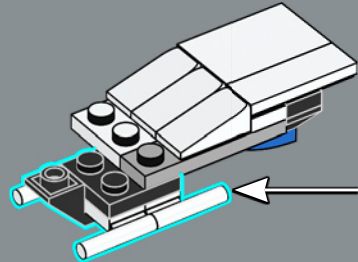
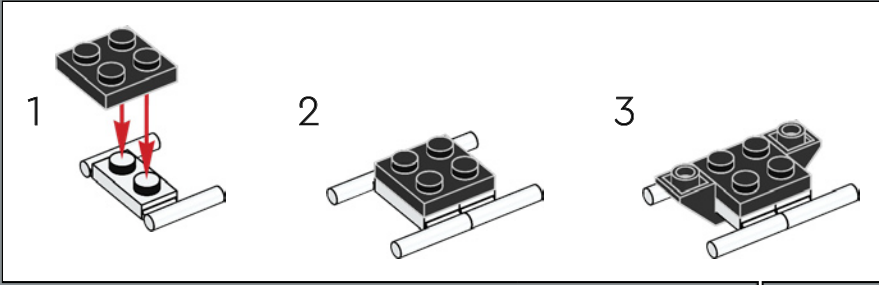

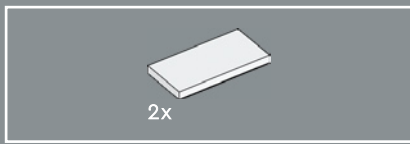

369

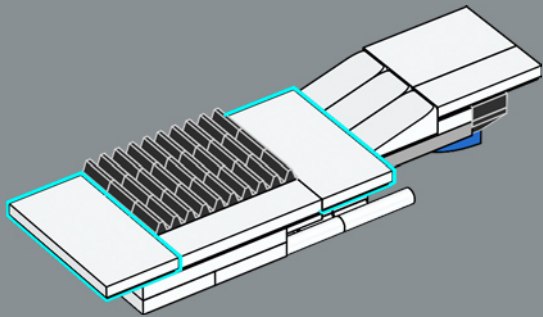
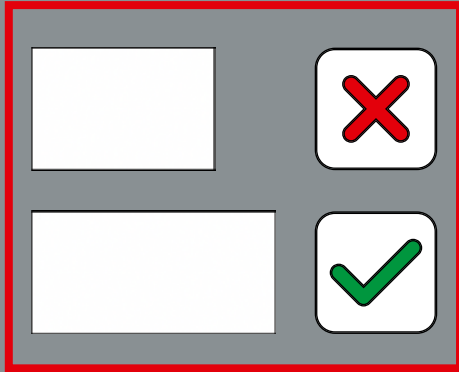

370

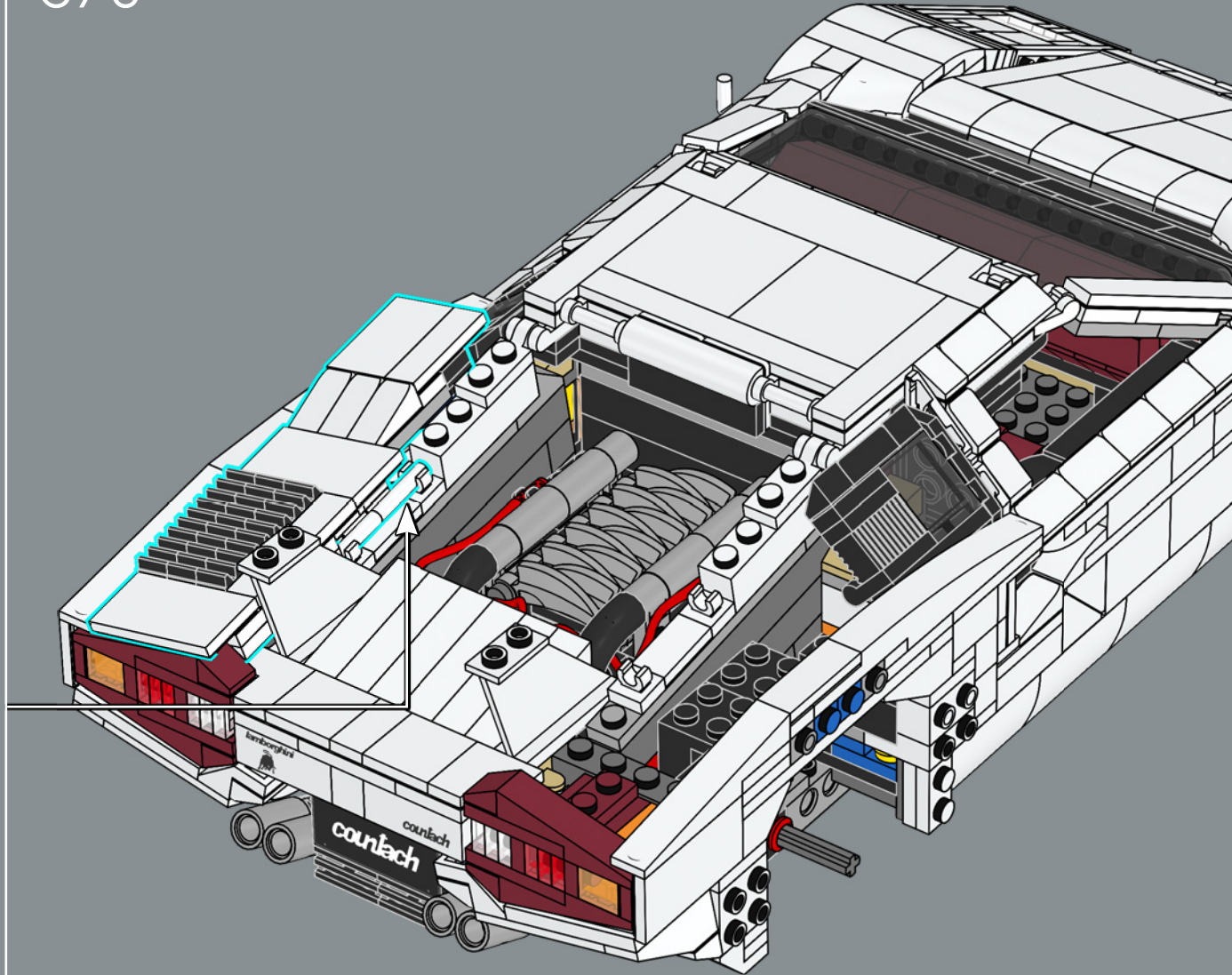

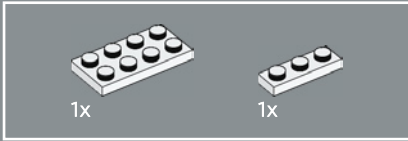
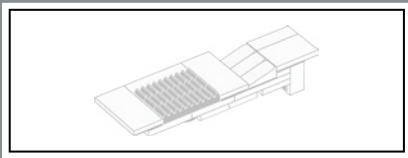

371

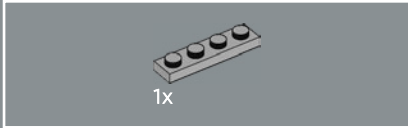
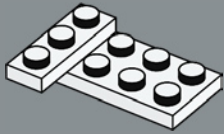

372

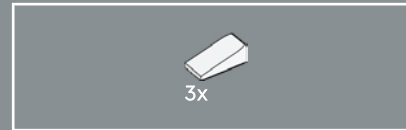
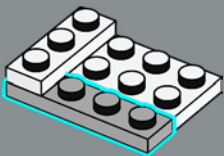

373

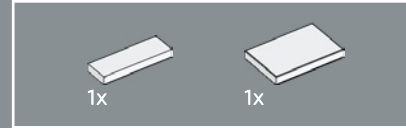
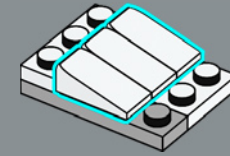

374

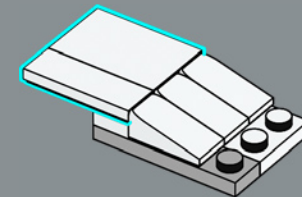
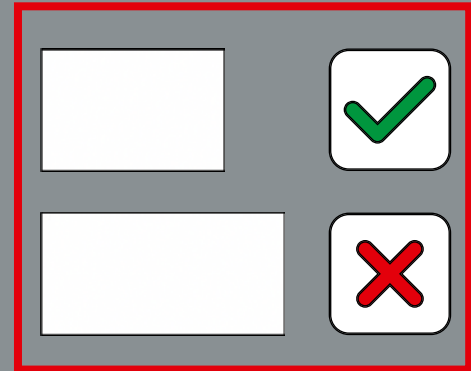

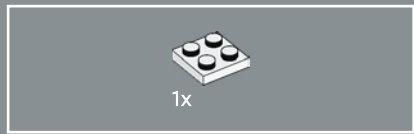

375

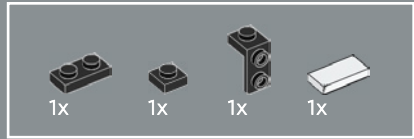
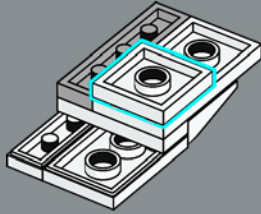

376

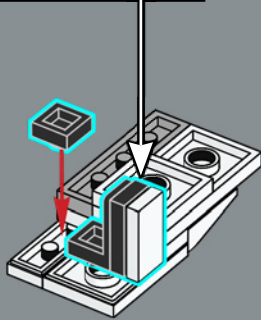
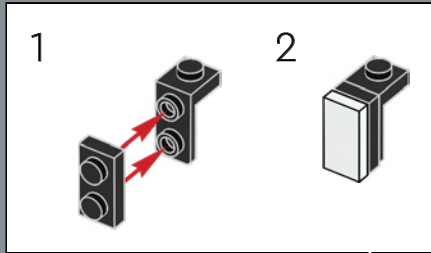

377

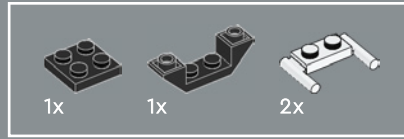
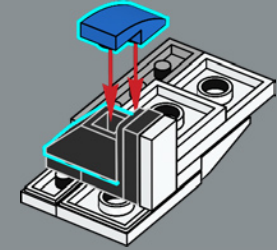

378

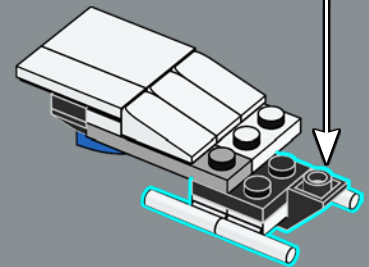
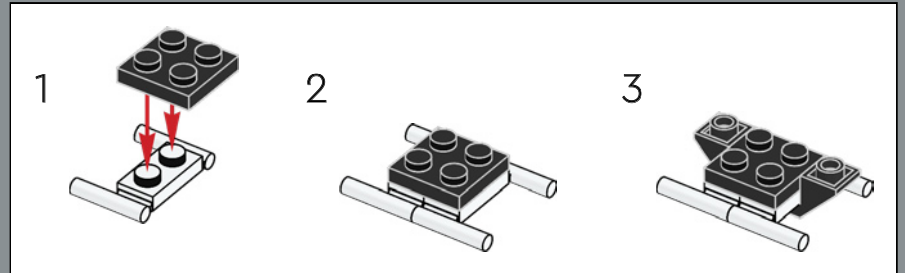

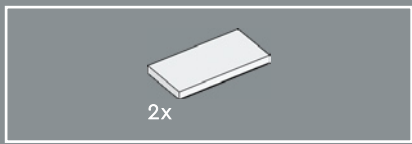

380

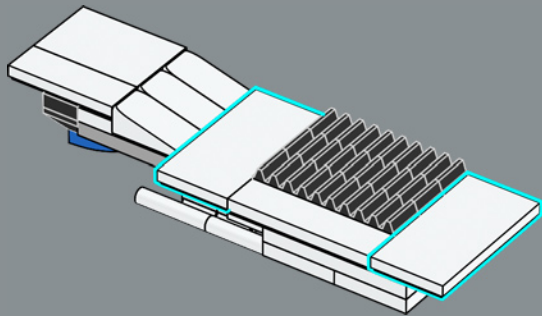
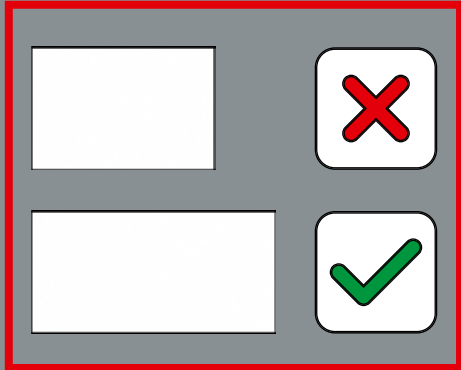

381

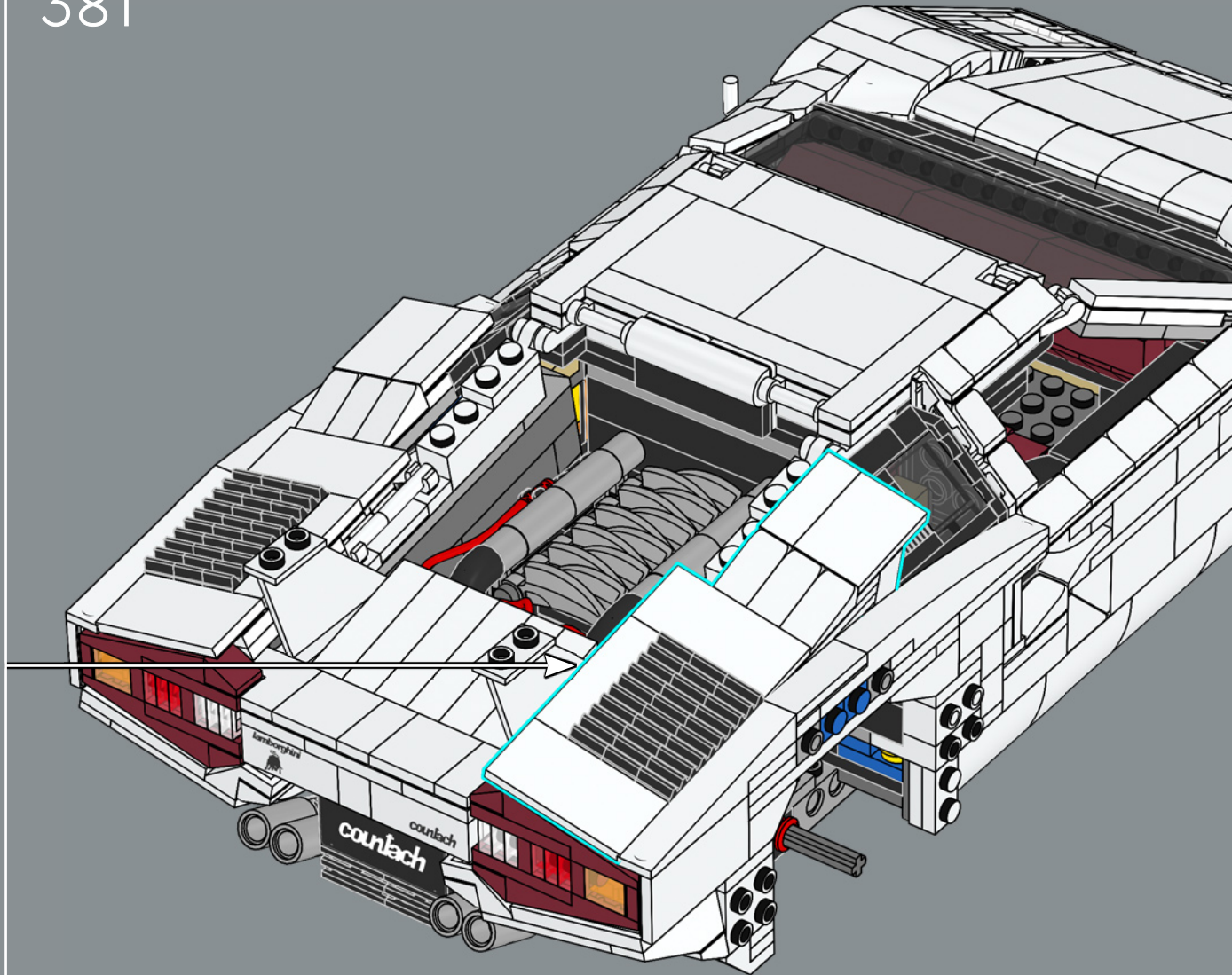

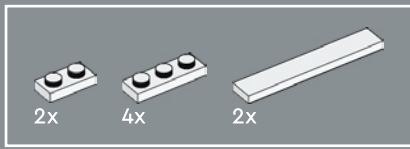

382

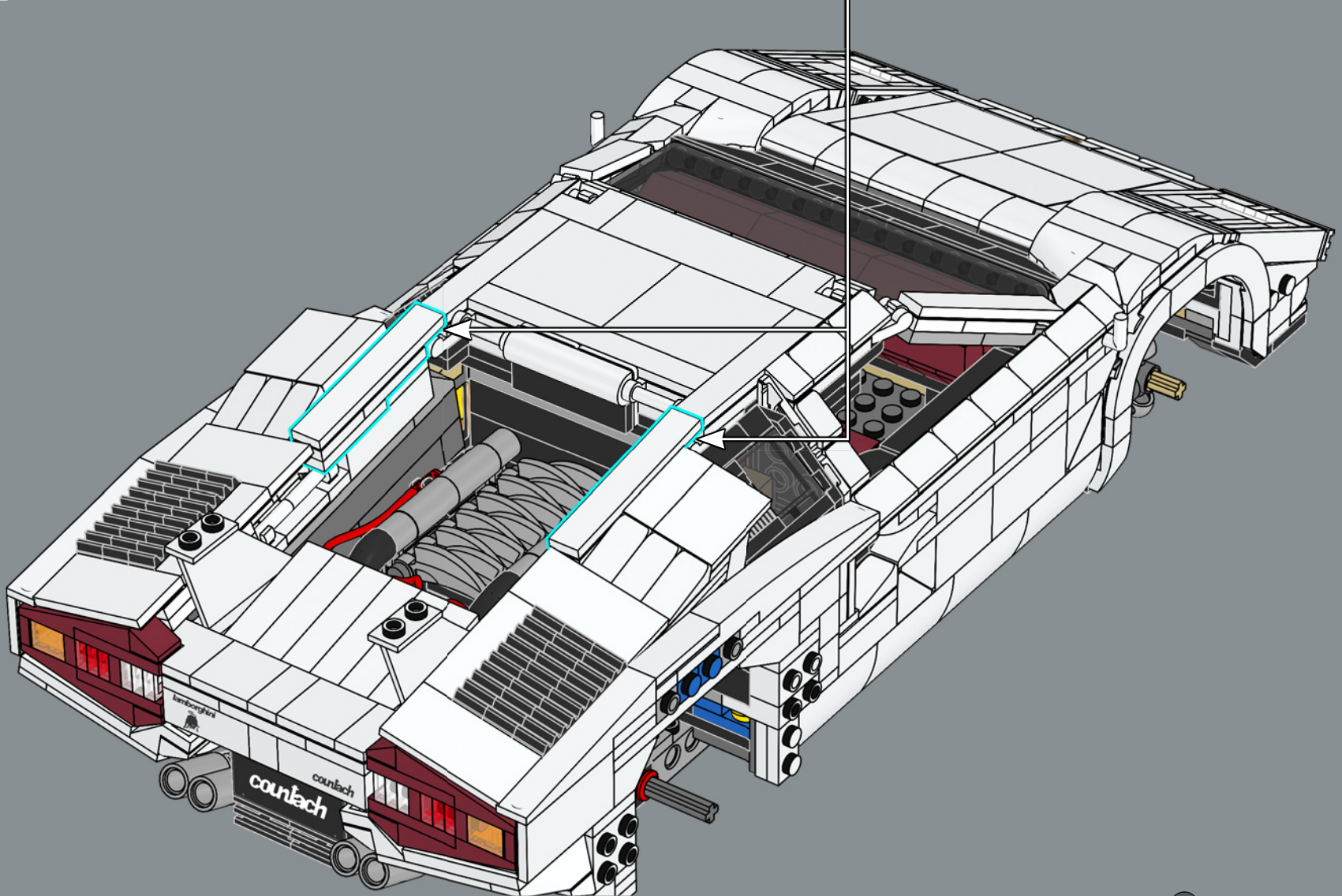
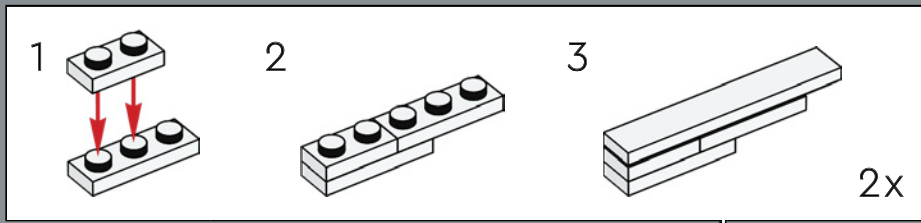

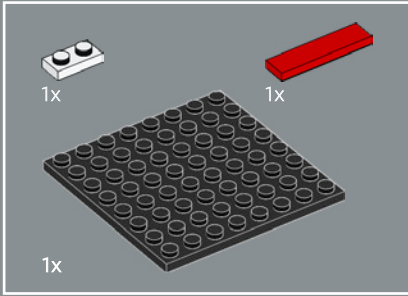
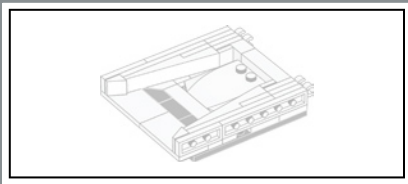

383

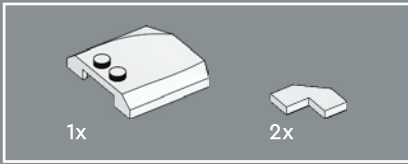
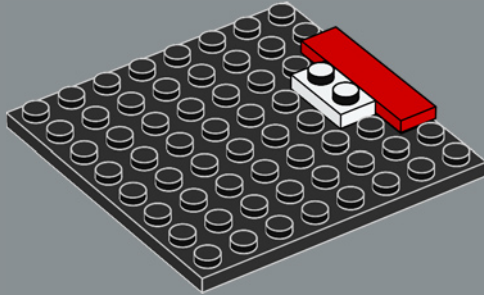

384

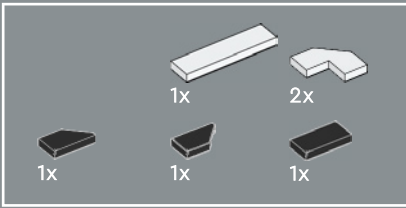
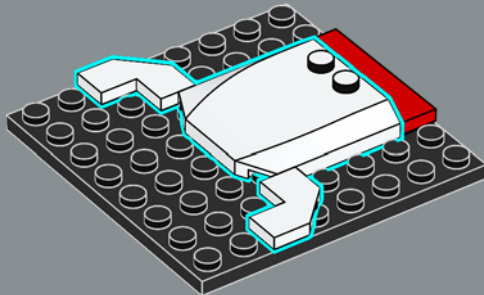

385

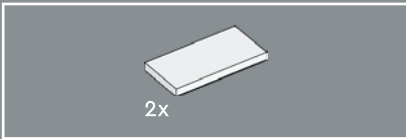
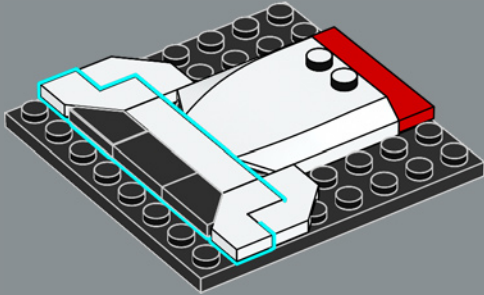

386

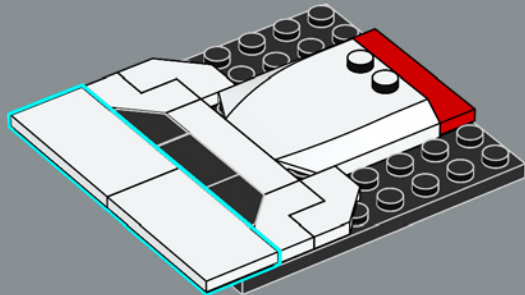

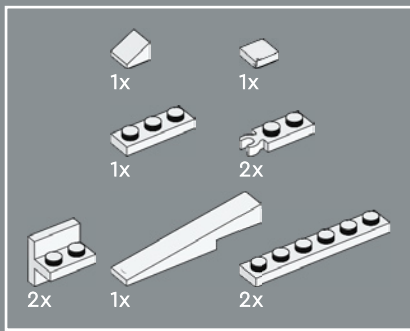

387

1

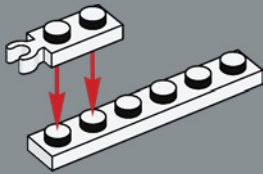

2

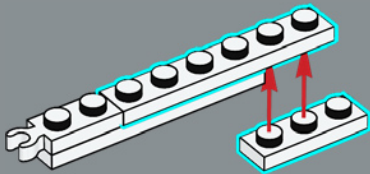

3

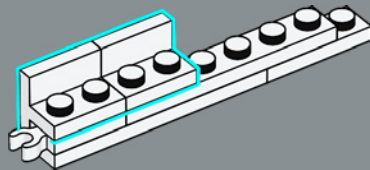

4

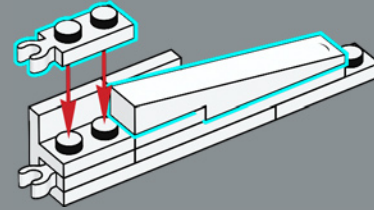

5

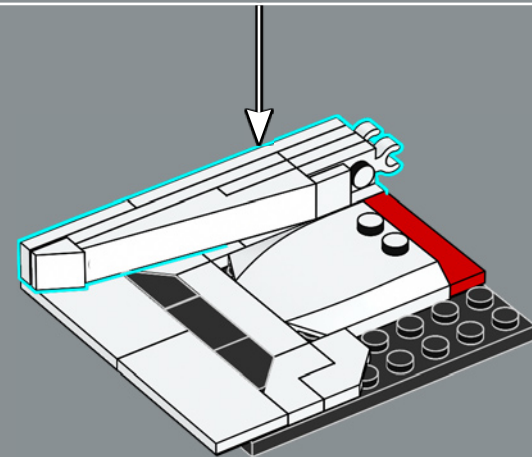
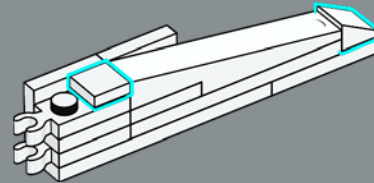

389

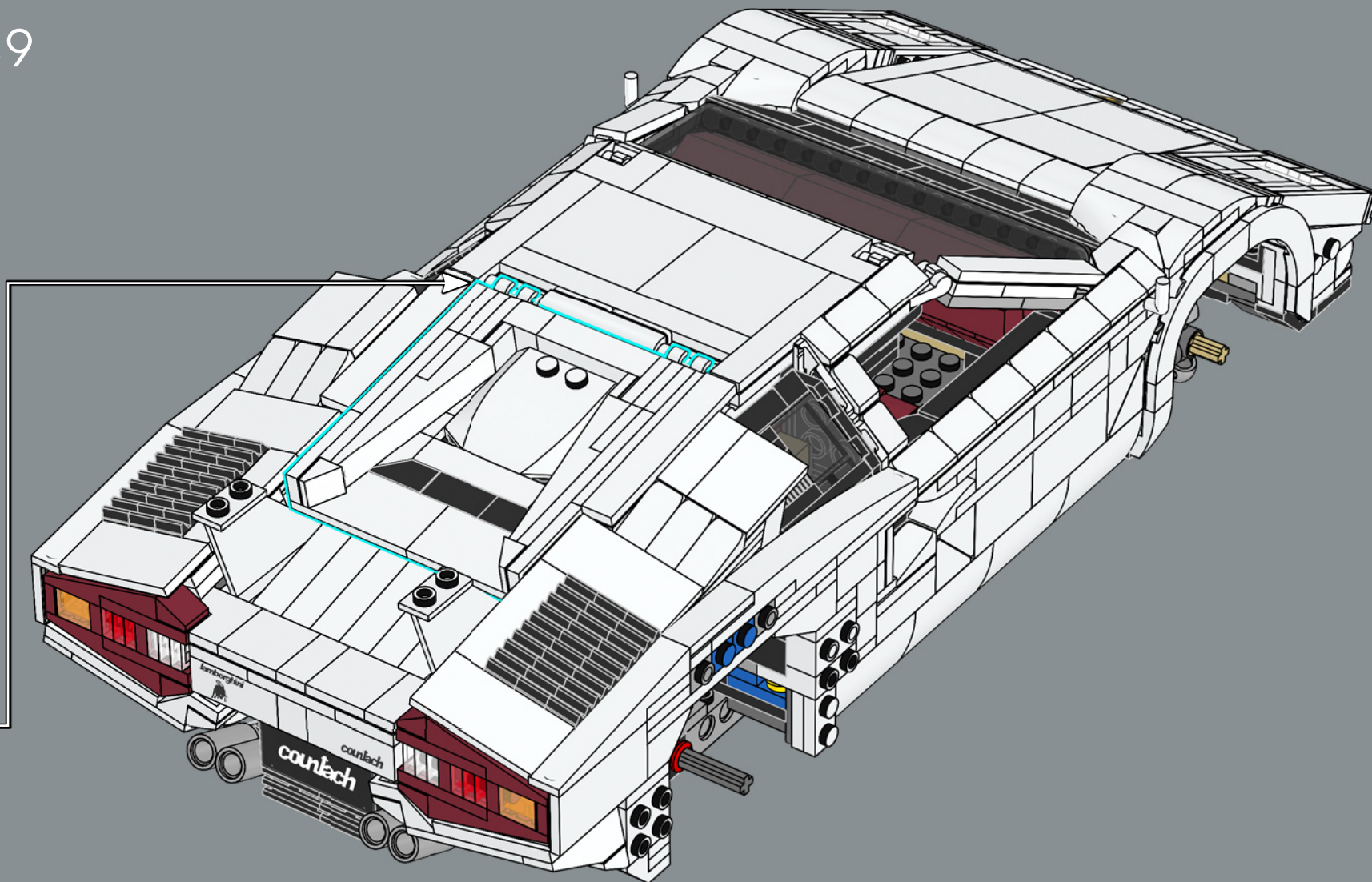

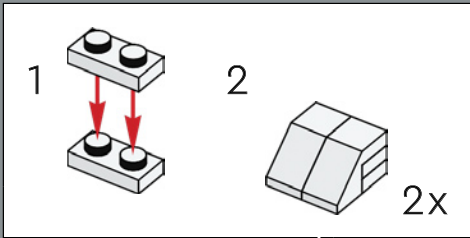
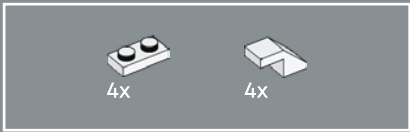

390

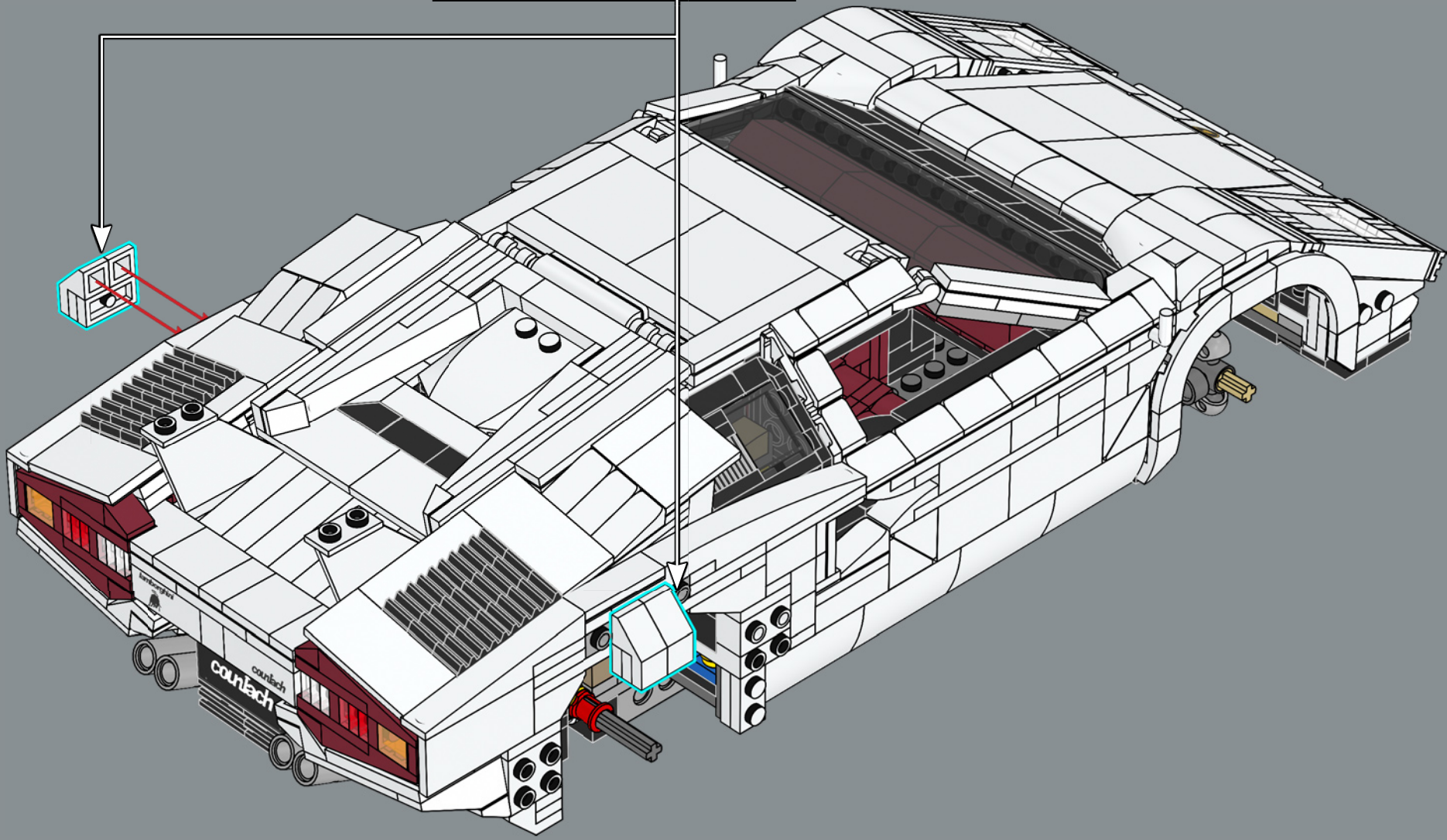



新式锥形乐高®组件有助于重现独特的尾翼。

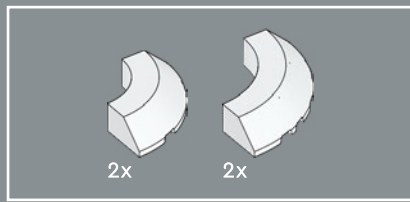

391

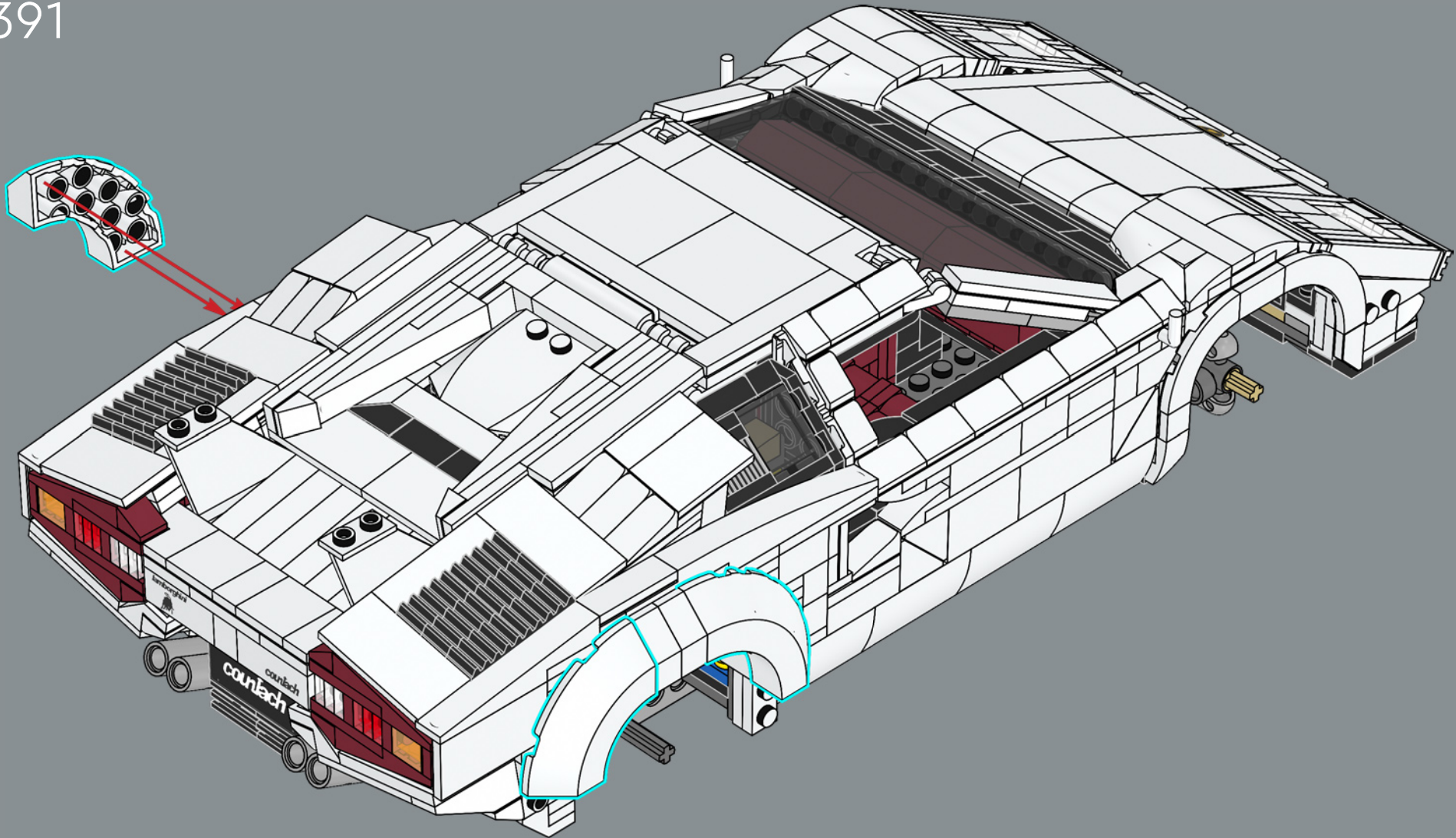



392

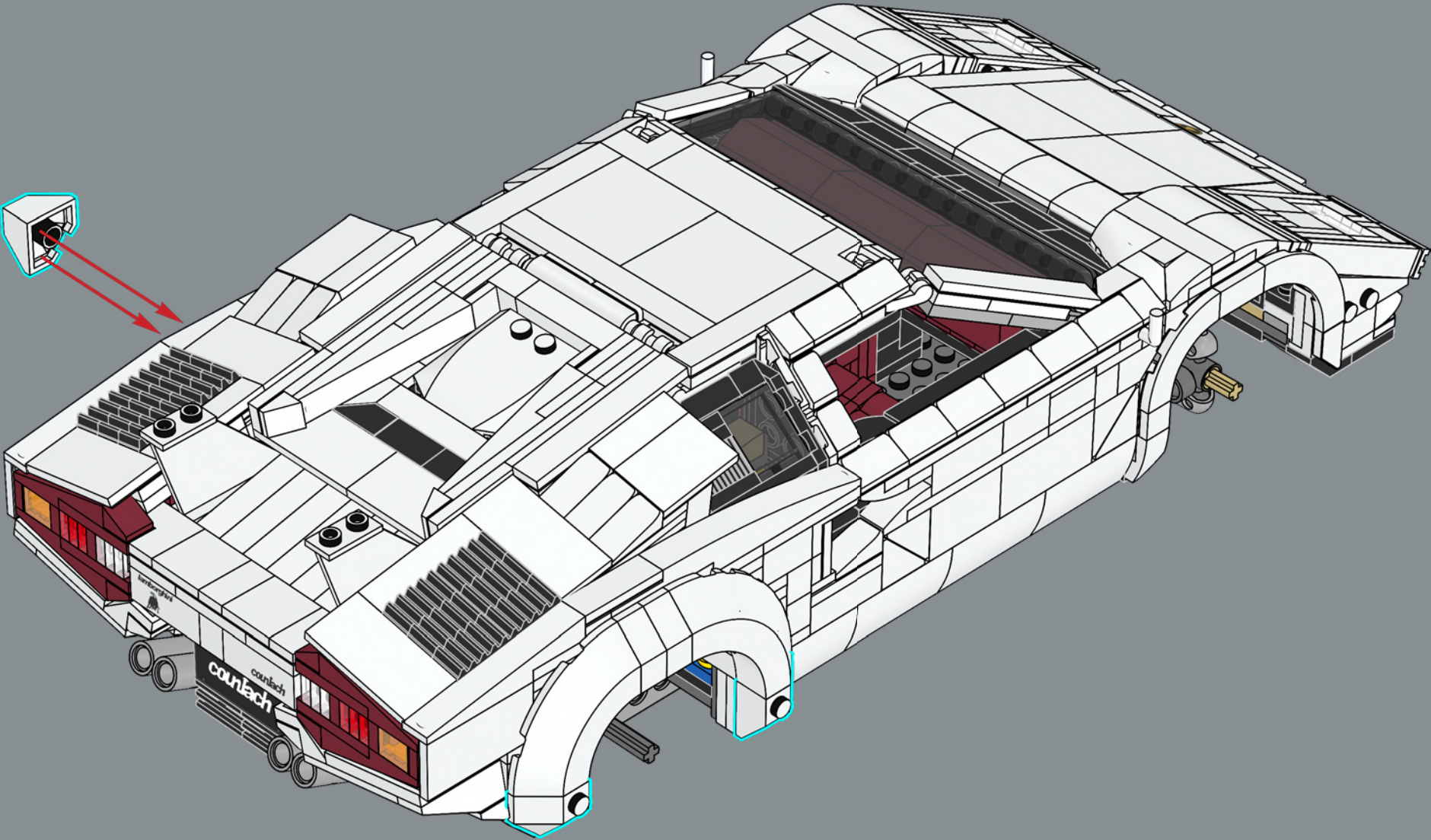

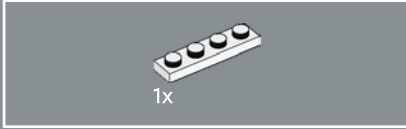
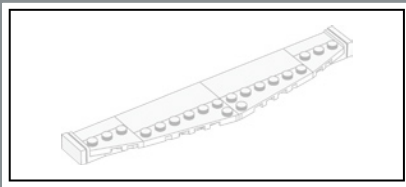

393

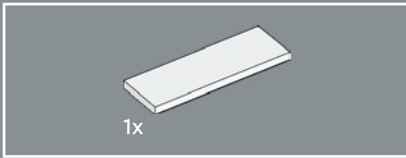

394

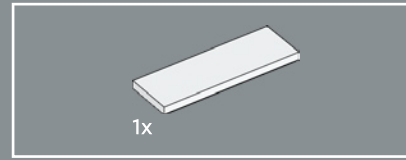
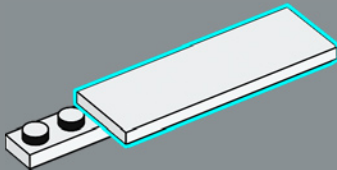

395

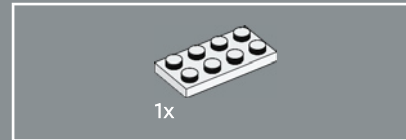
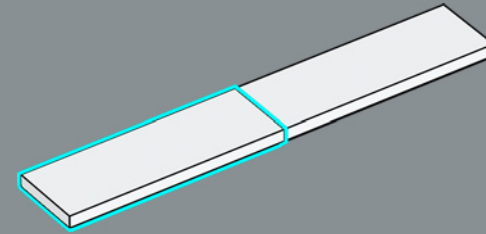

396

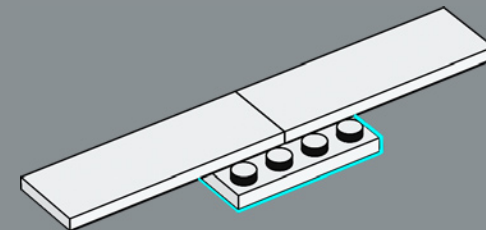

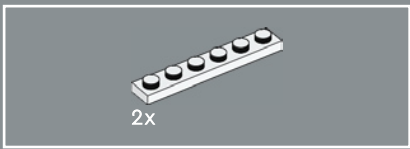

397

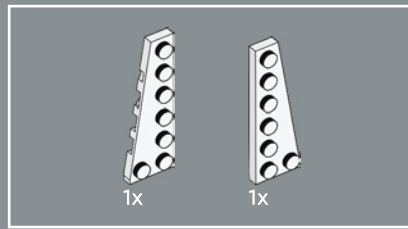
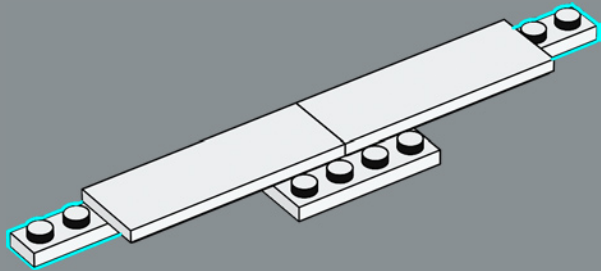

398

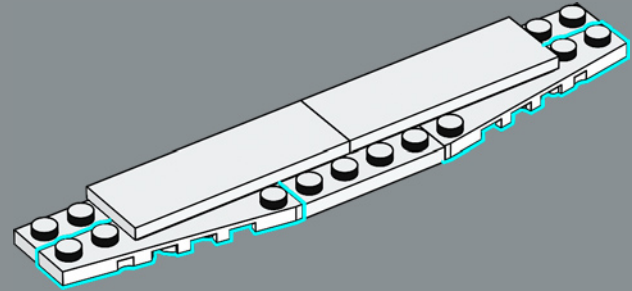

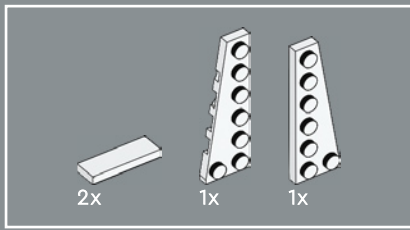

399

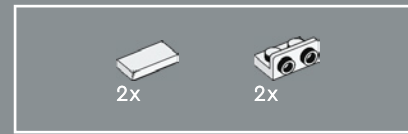
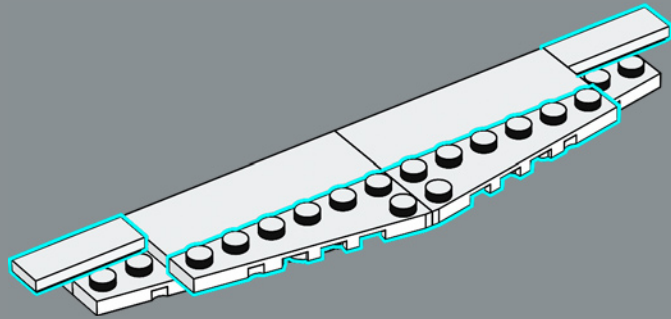

400

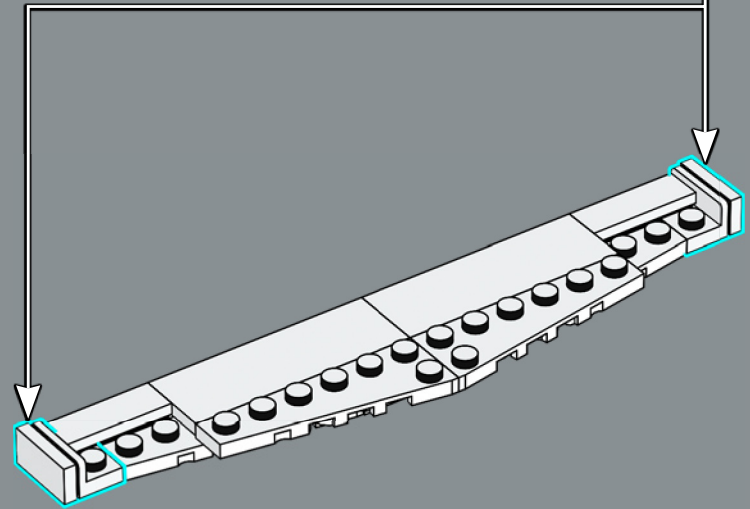
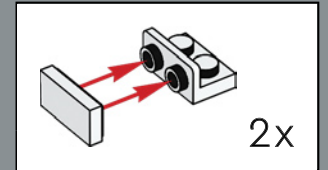

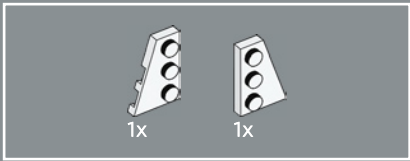

401

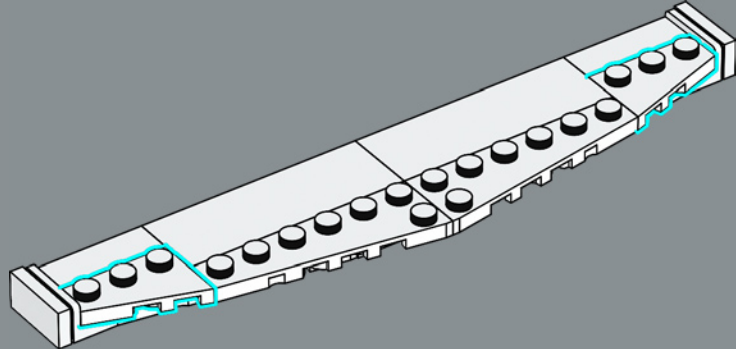

402

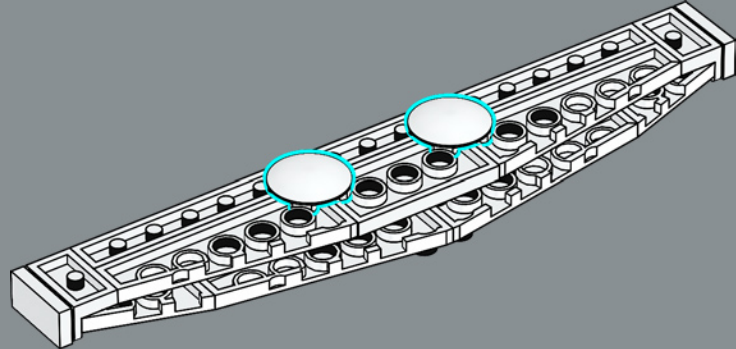

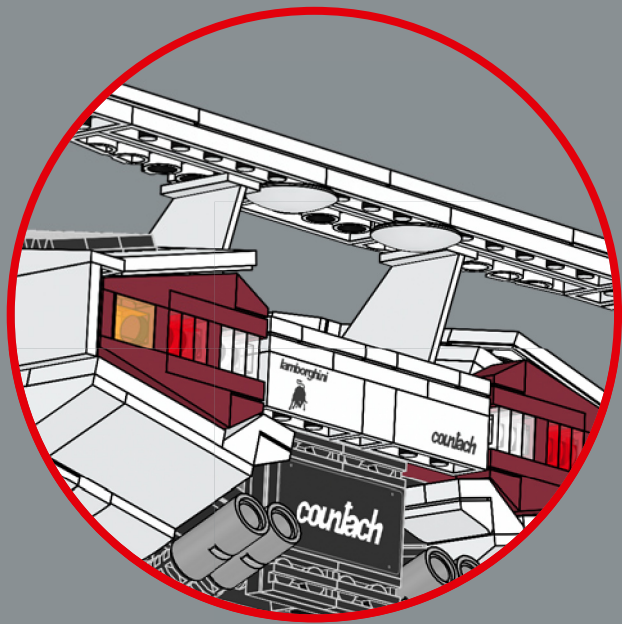

403

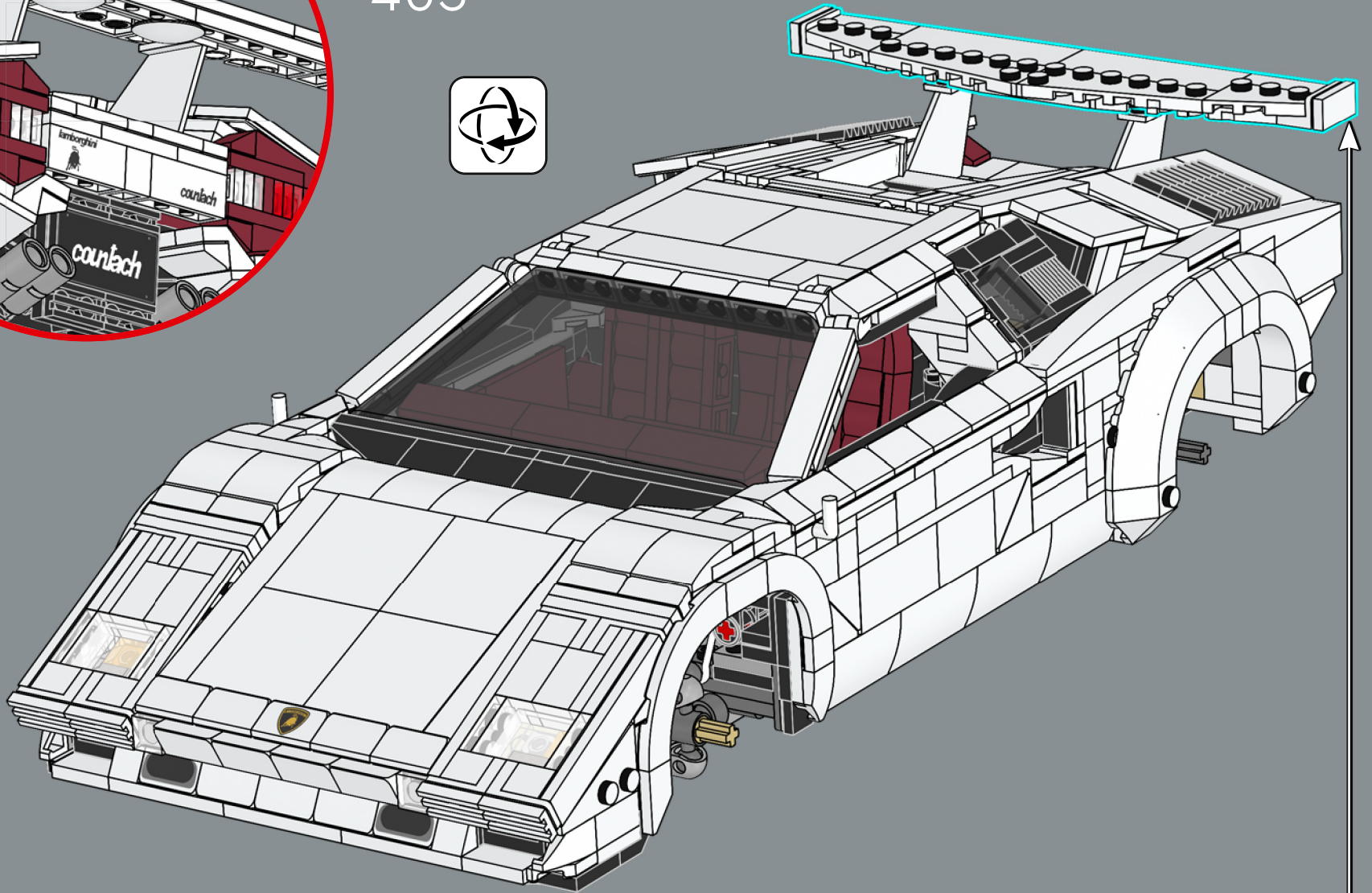

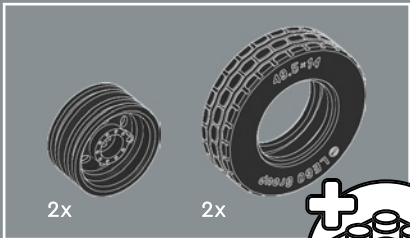

404

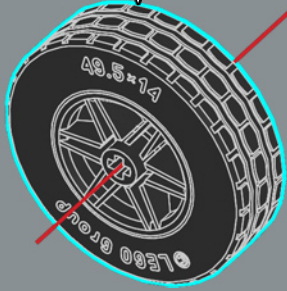
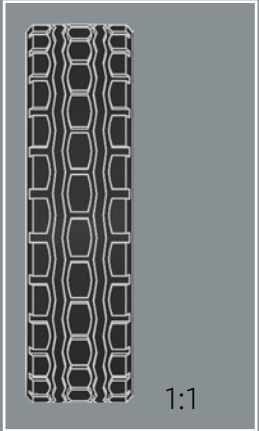
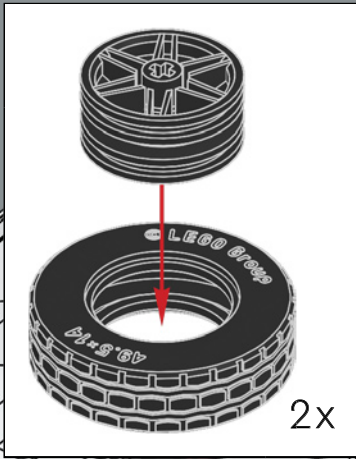
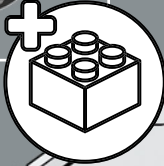

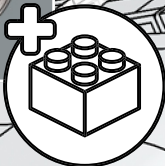
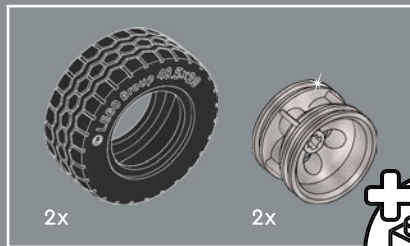

405

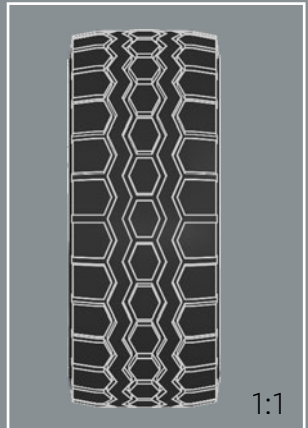
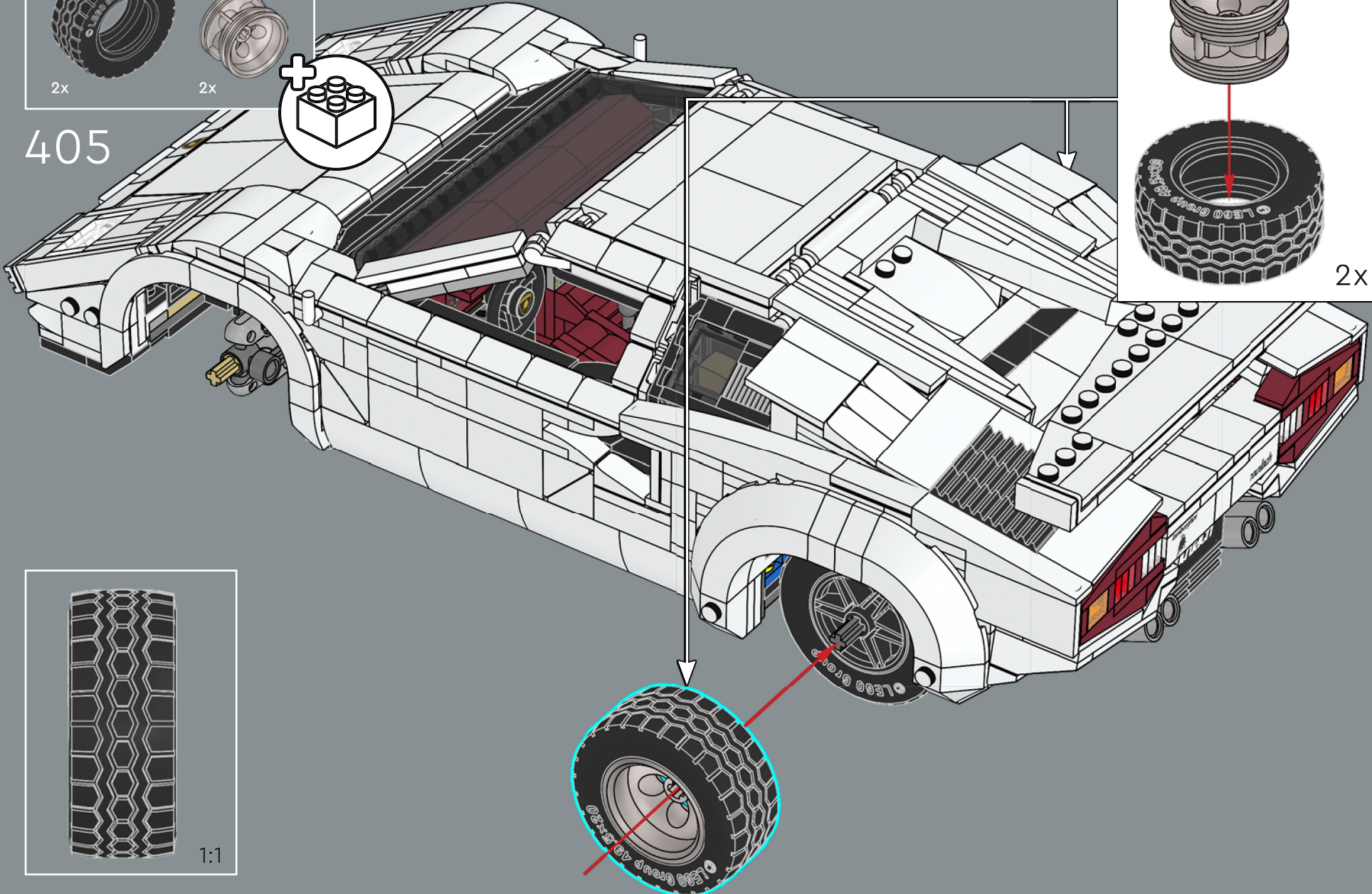
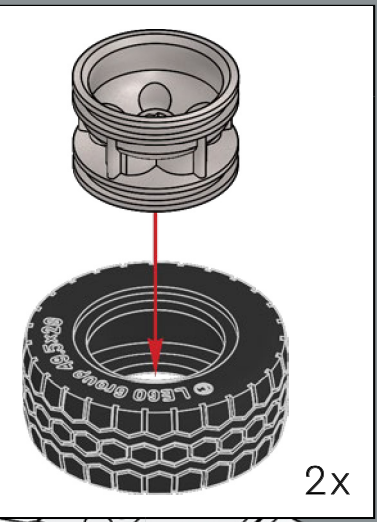



新式轮辋可以适应转向装置和后轮的
深轮廓。

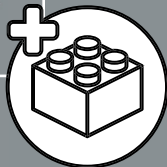
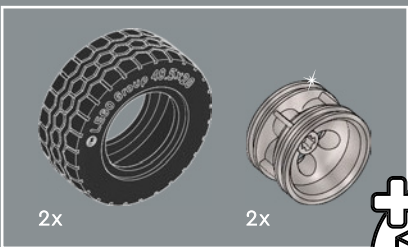

406

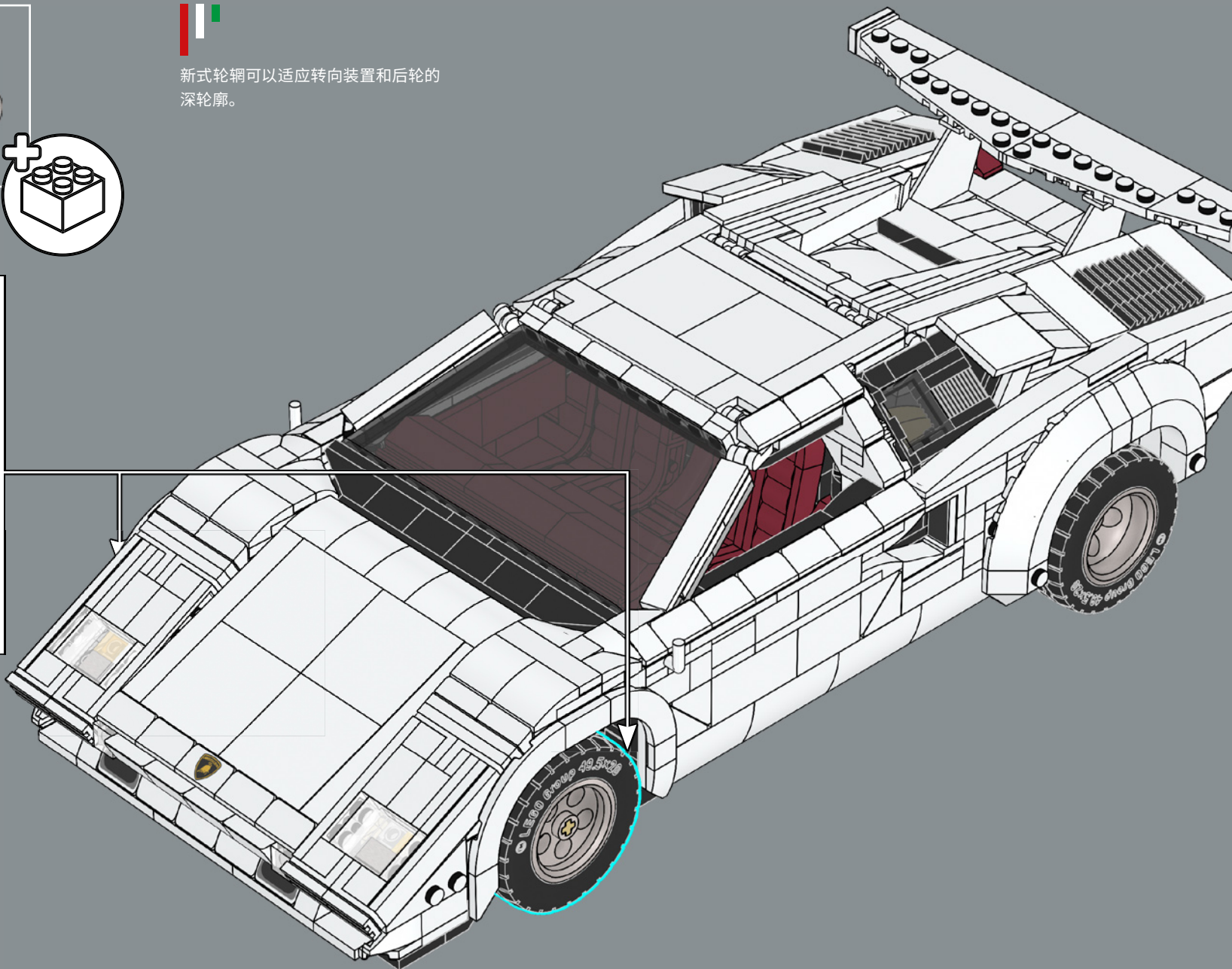
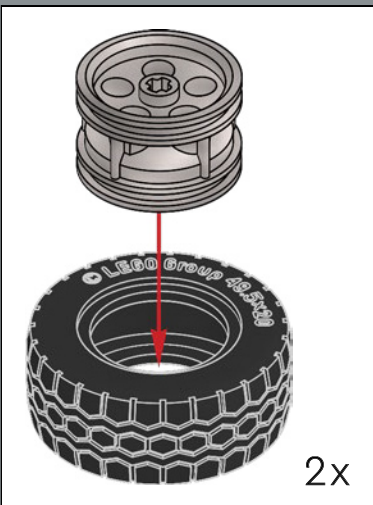

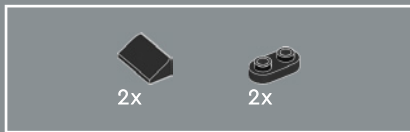

407

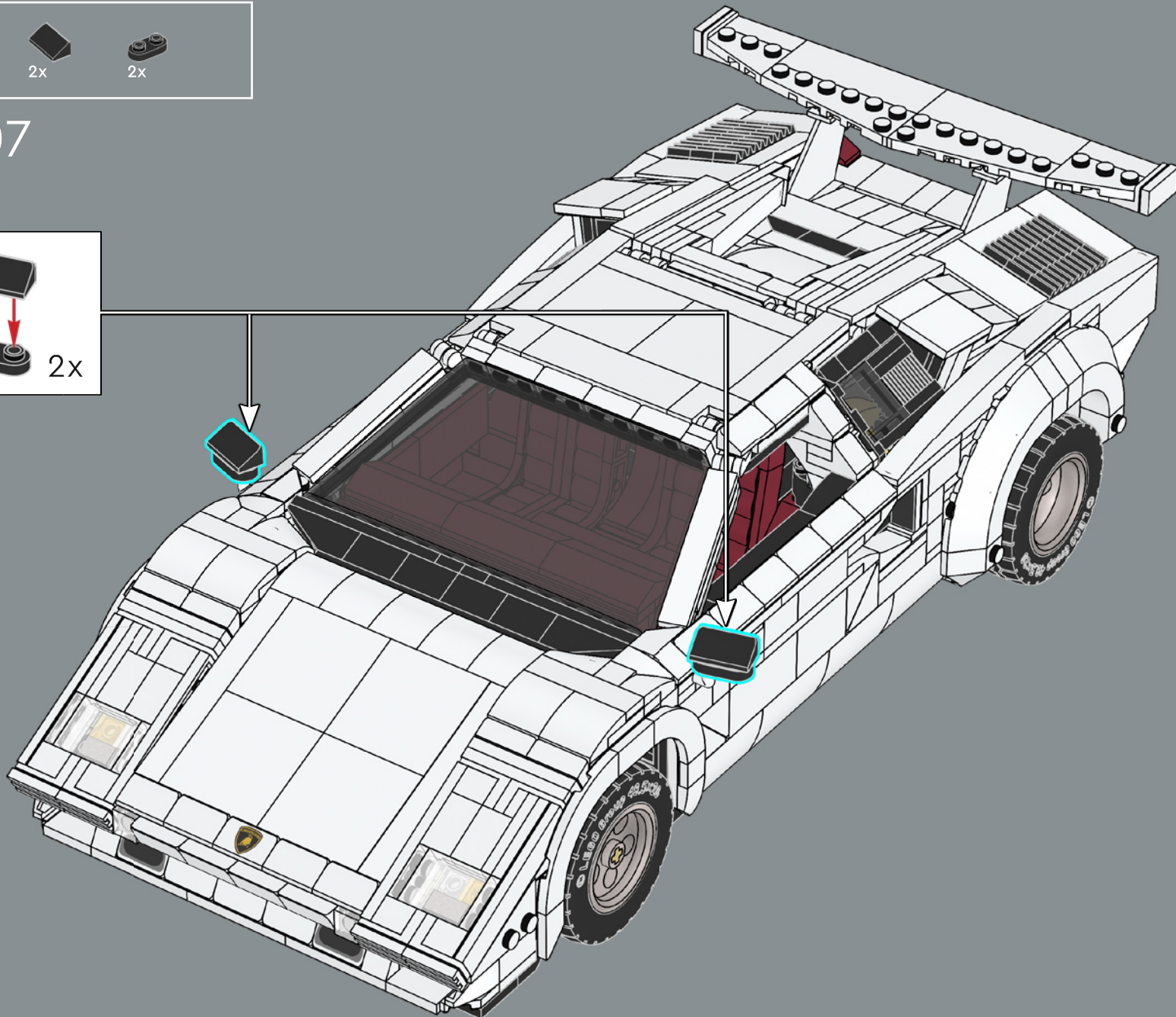
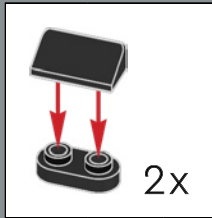

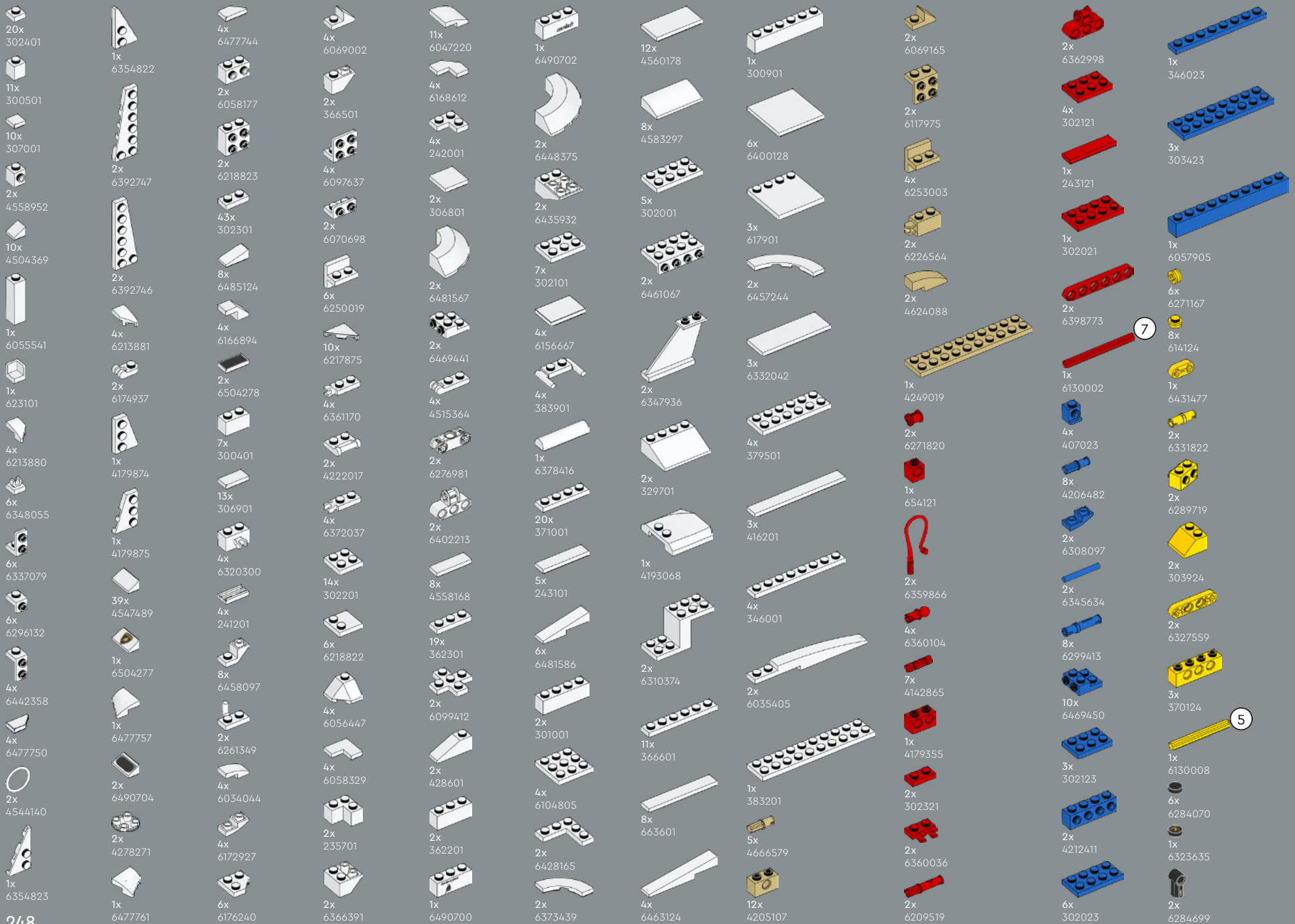



6x
64448793

2x
6284071

2x
6308012

2x
4211525

2x
4278273

8x
6173127

18x
4211398

2x
4211388

2x
6326078

1x
6329662

2x
4593679



LEGO.com/service

2x
4211469

2x
6093859

2x
6301870

4x
4244627

12x
6359723

4x
6326478

3x
4211397

2x
4211353

2x
4211815

2x
4211881

3

2x
6043639

6x
6438836

4x
4211429

8x
4211396

4x
4211445

4x
6247352

1x
4211395

2x
4211549

1x
4211452

2x
4211425

1x
4211404

1x
4211406

5x
4251149

1x
4211462

4x
6421513

2x
4211360

1x
6376639

2x
6240550

2x
6254252

1x
4490599

8x
6287672

2x
6343854

4x
6481570

2x
6217492

2x
6469858

2x
4210633

2x
6395635

2x
4211044

2x
4211098

6x
6225494

1x
6221607

4x
6261374

2x
6349479

2x
6168776

2x
6435267

5x
6117972

2x
6359227

6x
6146321

2x
6123814

2x
4218696

4x
6047417

3x
6364352

2x
6015356

4x
4652259

4x
4211068

2x
4211104

8x
6118832

1x
6083620

2x
4211103

4x
4210686

2x
4629920

4

2x
4508553

1x
4211002

2x
4211107

1x
4211061

4x
4210794

2x
4210783

1x
4210796

1x
6490496



YOU COULD WIN



YOU COULD WIN

Your feedback will help shape the future development of this product series.

Visit:

DU KÖNNTEST GEWINNEN

Dein Feedback trägt zur Weiterentwicklung dieser Produktreihe bei.

Geh auf:

VOUS POURRIEZ GAGNER

Vos commentaires nous aideront à concevoir les futurs produits de cette gamme.

Visitez :

POTRESTI VINCERE TU

La tua opinione ci aiuterà a migliorare la creazione futura di questa linea di prodotti.

Visita:

PUEDES GANAR

Tu opinión contribuirá al futuro de esta serie de productos.

Visita:

轻松获奖

您的反馈将有助于我们在今后改进本产品系列。

请访问:

[LEGO.com/productfeedback](https://www.lego.com/productfeedback)

You also have the chance to win a LEGO® set.

Terms and conditions apply.*

Außerdem hast du die Chance, ein LEGO® Set zu gewinnen.

Es gelten die Teilnahmebedingungen.*

Vous pourriez également gagner un ensemble LEGO®.

Des conditions s'appliquent.*

Hai anche la possibilità di vincere un set LEGO®.

Termini e condizioni sono applicabili.*

También tienes la oportunidad de ganar un set LEGO®.

Aplican términos y condiciones.*

您还有机会赢取乐高®套装。

条款和条件适用。*

*[LEGO.com/productfeedback-terms](https://www.lego.com/productfeedback-terms)

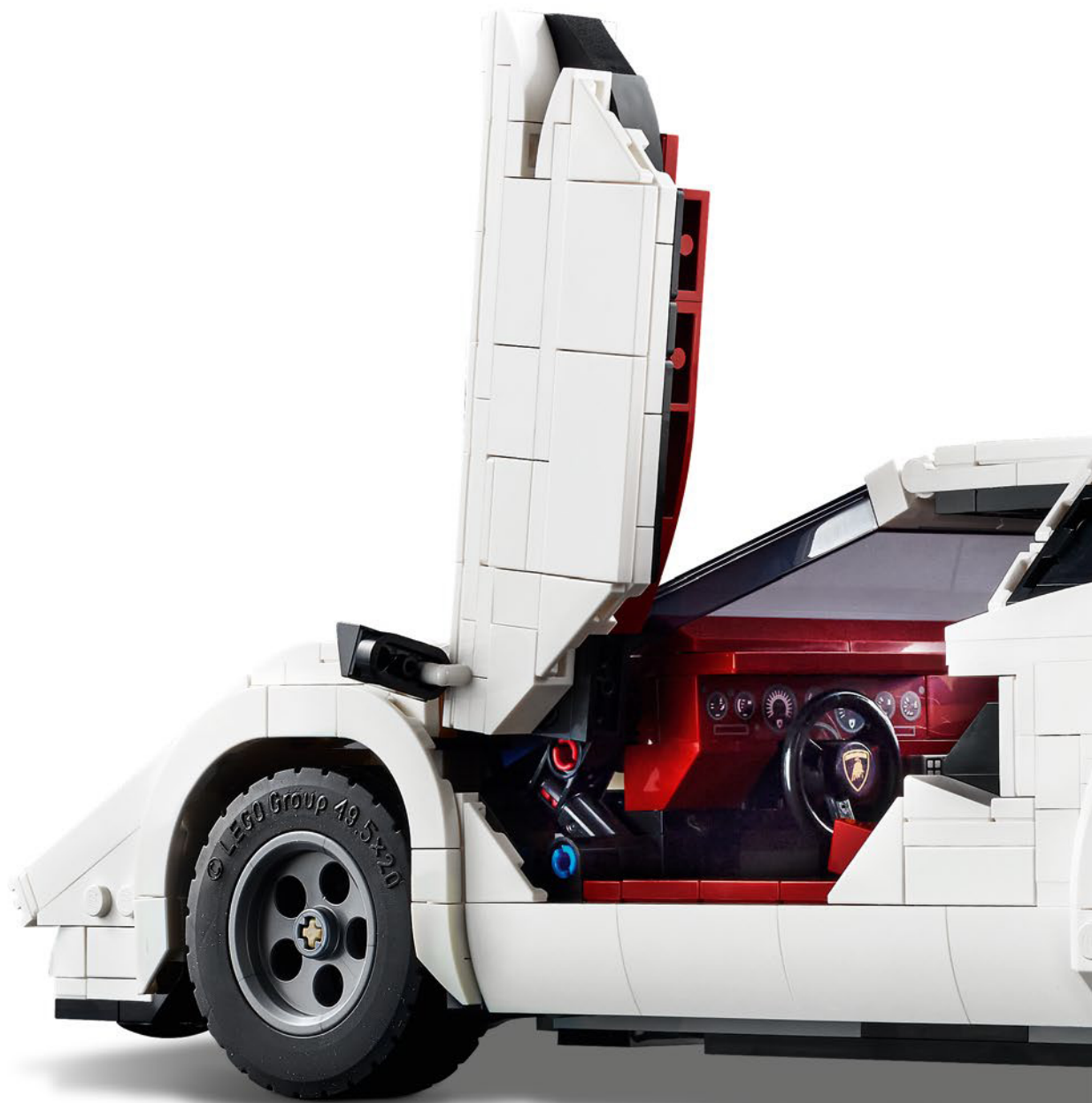

LEGO and the LEGO logo are trademarks of the LEGO Group. ©2024 The LEGO Group.
The "Lamborghini" and "Lamborghini Bull and Shield" trademarks, copyrights, designs and models are used under license from Automobili Lamborghini S.p.A, Italy.