



10337





LEGO.com/sustainable-packaging



FR
DONNEZ
OU
RECYCLEZ



OU



OU



ASSOCIATION MAGASIN DÉCHÈTERIE

Adresses sur quefairedemesdechets.fr



BUILDER



Apple and the Apple logo are trademarks of Apple Inc., registered in the U.S. and other countries and regions. App Store is a service mark of Apple Inc. Google Play and the Google Play logo are trademarks of Google LLC. Tencent and the Tencent logo are trademarks of Tencent Inc.

LEGO.com/devicecheck



LEGO® Builder

LAMBORGHINI



Proporzioni perfette



Se sei stato un adolescente negli anni '80, probabilmente riconoscerai subito la silhouette della Lamborghini Countach. E magari forse hai anche un poster nascosto da qualche parte (oppure l'hai esposto con orgoglio). Con una storia di oltre 50 anni – dal primo prototipo LP500 presentato nel 1971 fino a oggi – la Countach è sempre uscita dagli schemi. La silhouette sorprendentemente bassa, con angoli acuti e portiere a forbice, e l'inconfondibile rombo del motore V 12 hanno consolidato la Countach come un vero e proprio manifesto degli anni '80 e '90, definendo il genere delle auto super sportive del suo tempo. Il suo design innovativo e futuristico rispecchia fedelmente lo spirito del tempo e della cultura pop e, come un'opera d'arte classica, il suo fascino è senza tempo. Grazie alla sua storia, alla sua forma e ai suoi colori vivaci, è stata un'ovvia candidata per la piattaforma LEGO® Icons.

L'evoluzione della Lamborghini Countach

Nel corso dei decenni, la Lamborghini Countach si è evoluta con tecnologie e stili innovativi. Questo modello LEGO® è ispirato alla Lamborghini Countach 5000 Quattrovalvole (1985-1988), con riferimenti ai suoi illustri predecessori.



1971 LP500

Il prototipo presentato al Motor Show di Ginevra è diventato la base di tutte le edizioni future.



1973 COUNTACH LP400

Modificata sulla base dei dati ottenuti con il prototipo, la LP400 è stato il primo modello di produzione Countach.



1978 COUNTACH LP400 S

Il design esterno aggiornato includeva nuove estensioni dei passaruota e un'ala posteriore a forma di V (opzionale).



1983 COUNTACH LP500 S

Mentre il design esterno è rimasto sostanzialmente invariato, gli interni sono stati rinnovati e un motore più potente ha migliorato le prestazioni.



1985 COUNTACH 5000 QUATTROVALVOLE

La Lamborghini Countach più venduta sia negli Stati Uniti sia in Europa e un gioiello ambito dagli appassionati di auto super sportive.



2021 COUNTACH LPI 800-4

Un'edizione limitata ibrida-elettrica lanciata per il cinquantesimo anniversario della Countach.





Il Design Team LEGO®

"L'aura magica che avvolge la Lamborghini Countach è ancora presente oggi tra gli appassionati di auto, rendendola un match perfetto per un modello LEGO®. Mentre le linee rette sembrano una forma naturale per gli elementi LEGO, gli angoli poco profondi sono molto più impegnativi da realizzare con il nostro sistema di costruzione. Abbiamo sviluppato diversi nuovi elementi e tecniche di costruzione avanzate per questo modello, inclusi gli iconici cerchi bombati e i passaruota per ricreare gli angoli sottili, le forme e le proporzioni caratteristici di questo futuristico design italiano. È stata un'esperienza esaltante lavorare con Automobili Lamborghini S.p.A. per dare vita a questo modello in formato LEGO, completo di sterzo funzionante, portiere e cofano apribili".

SVEN FRANIC,
LEGO® Senior Model Designer

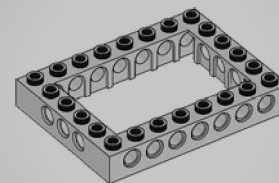
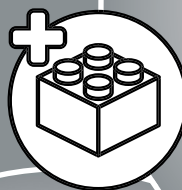
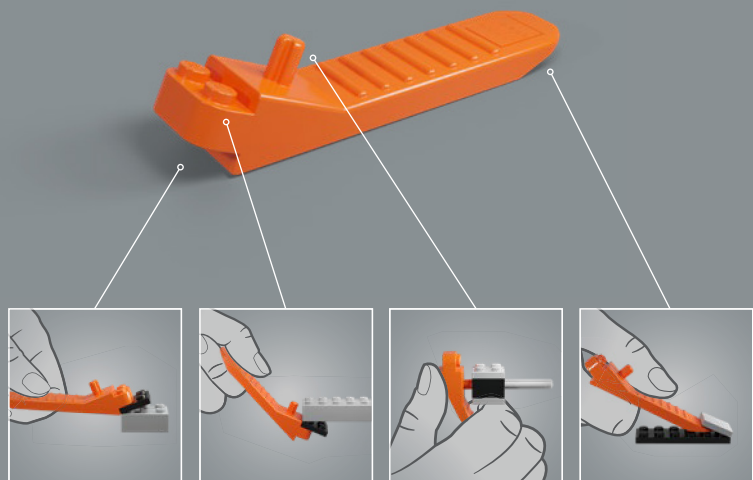

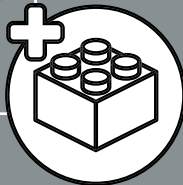
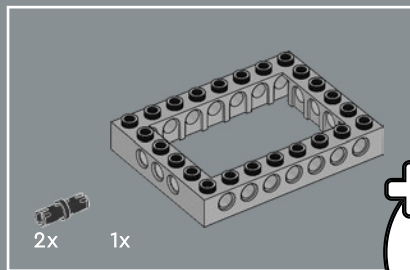

1

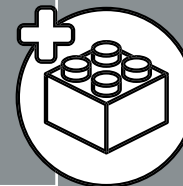
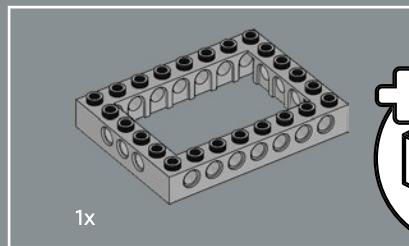
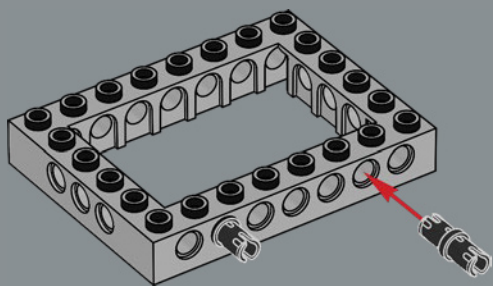

2

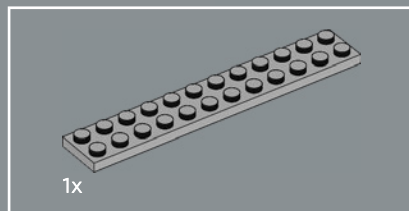
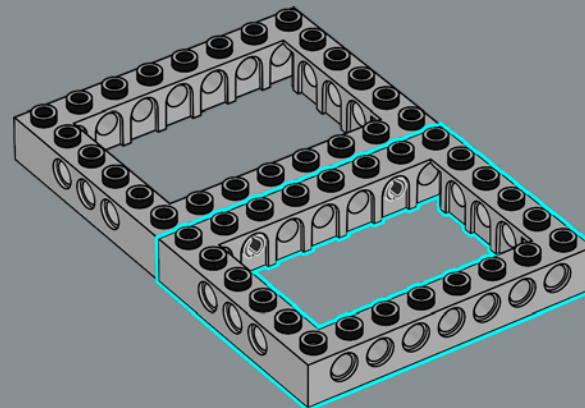

3

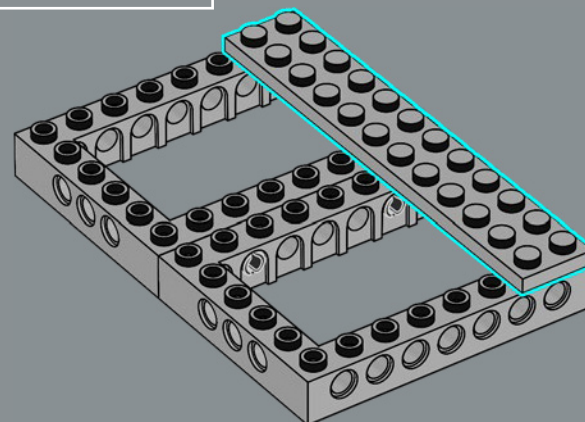

6x

4

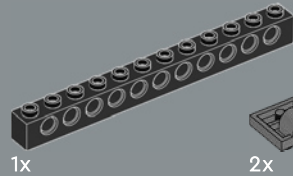
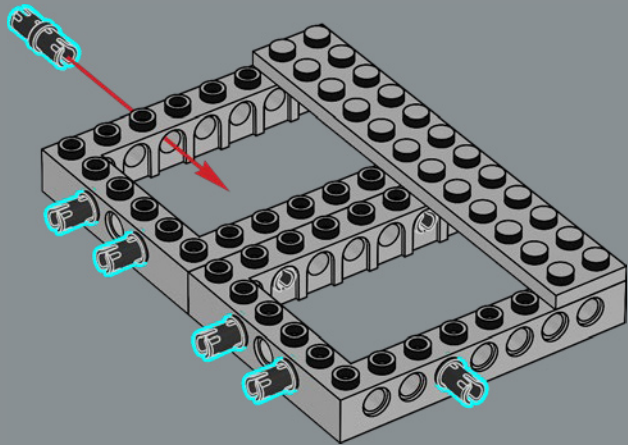

1x

2x

5

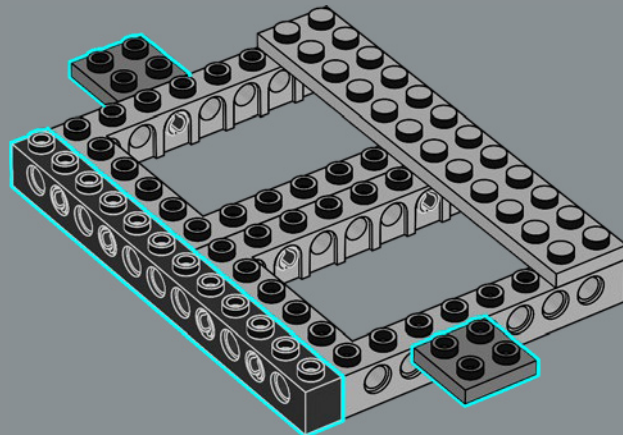

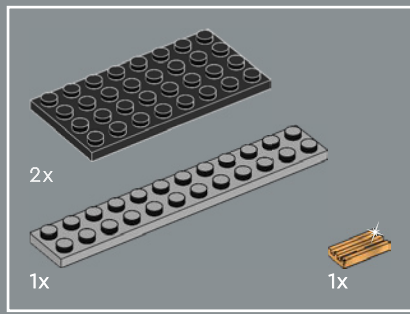

6

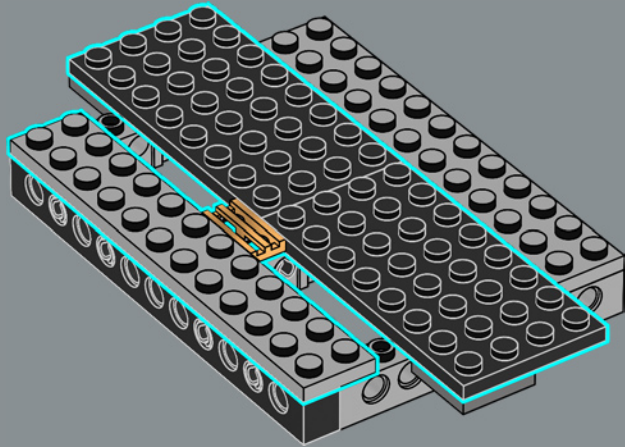

7

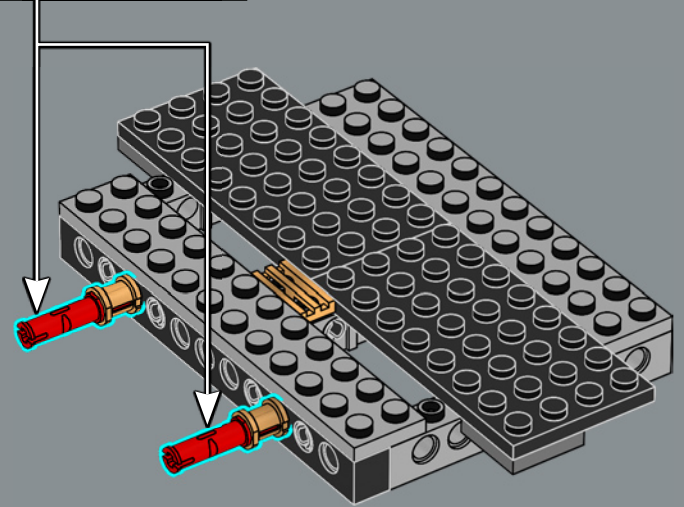
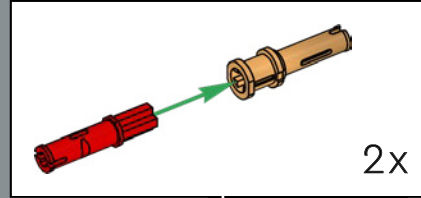

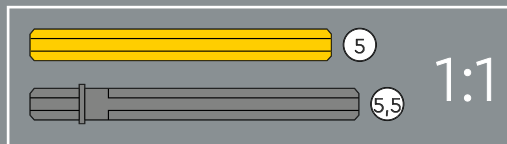
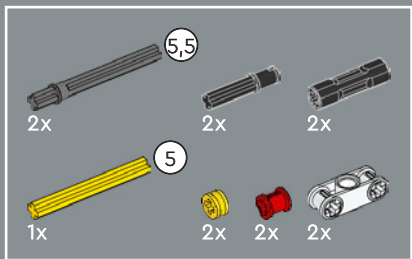

8

1

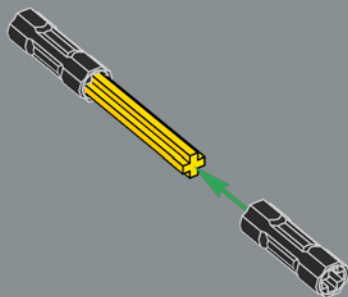

2

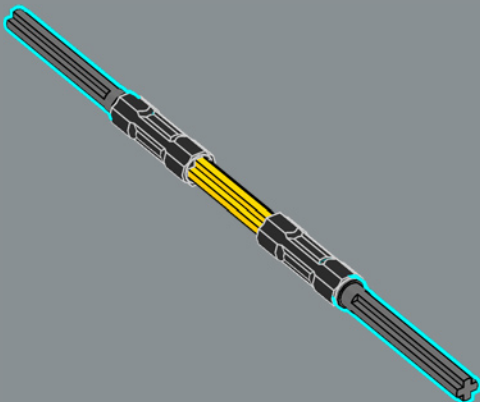

3

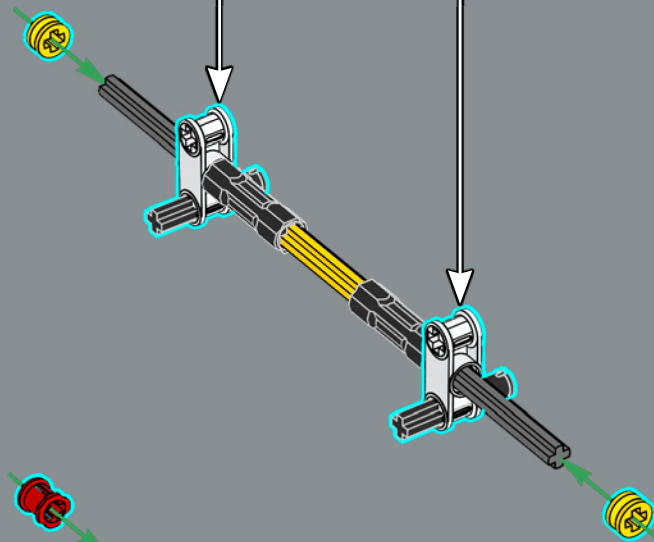

4

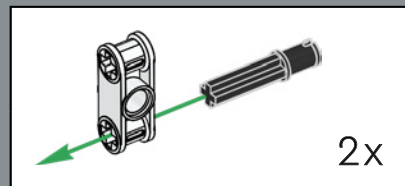
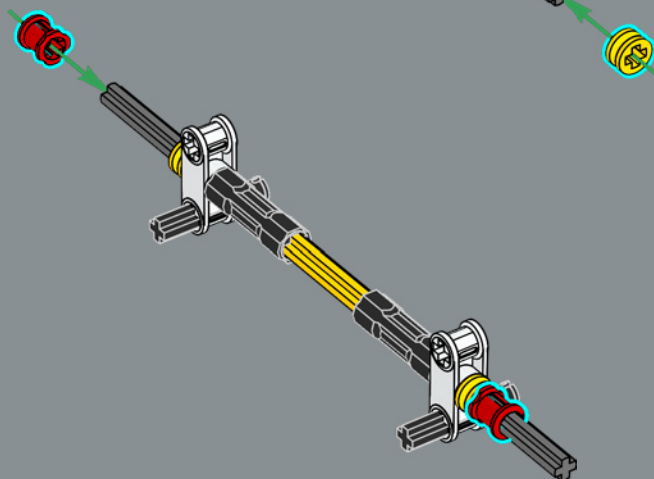

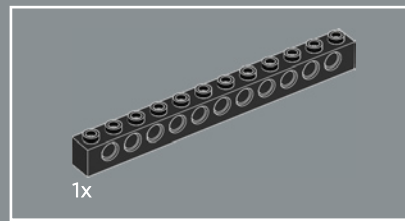
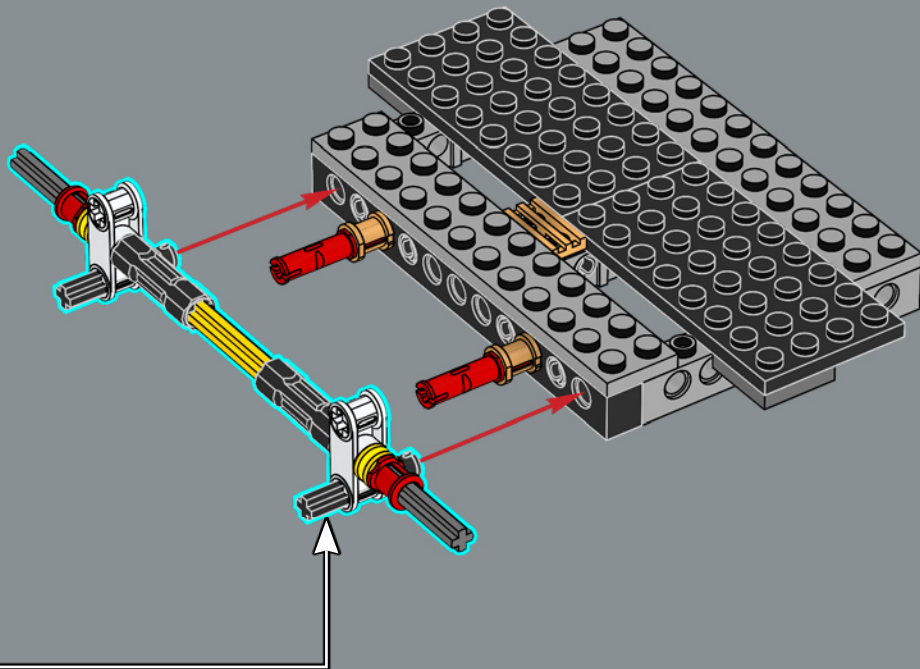

9

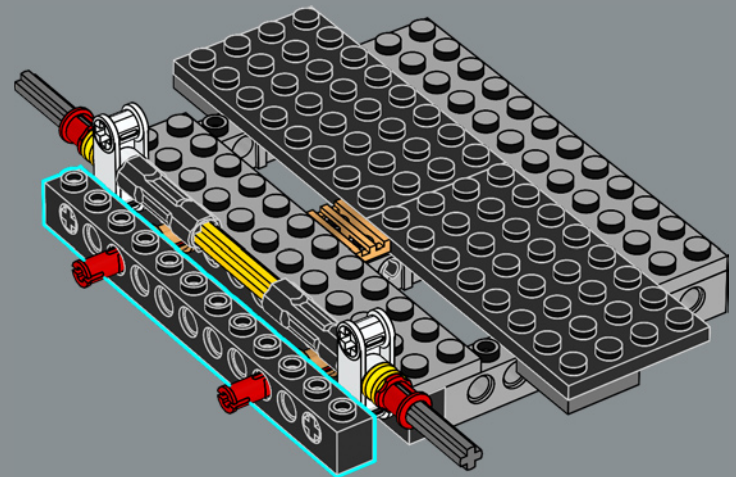



10

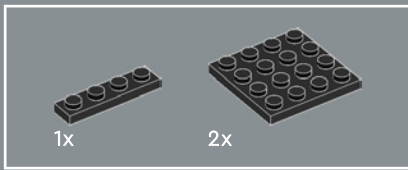
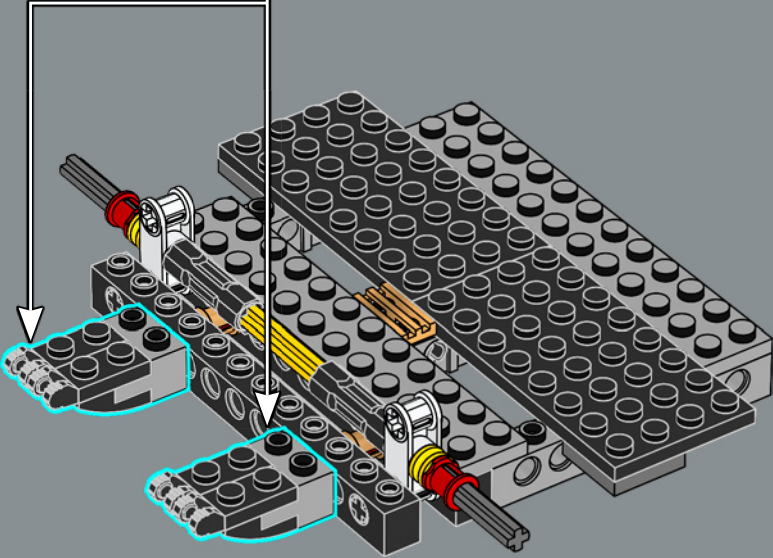
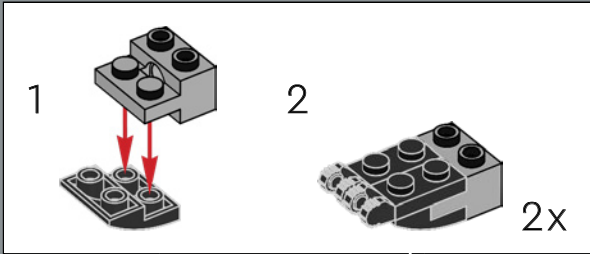

11

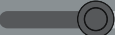
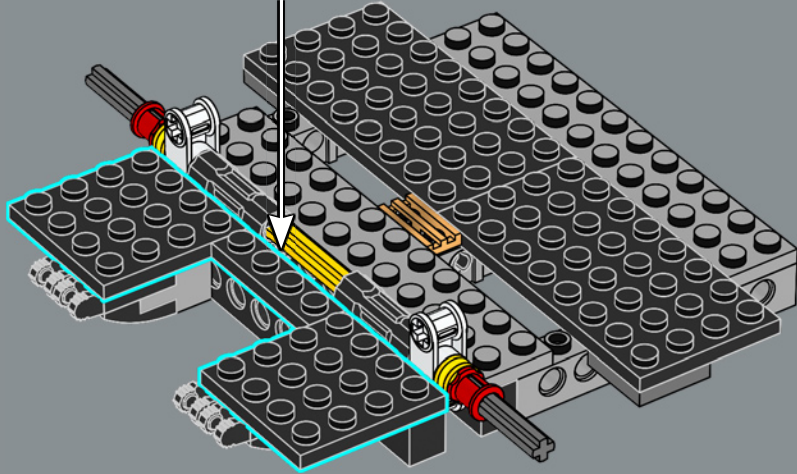
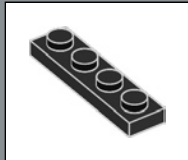

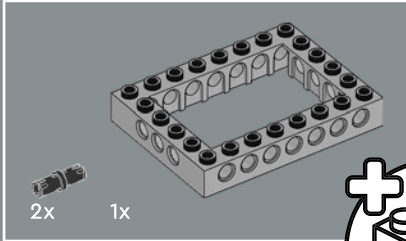
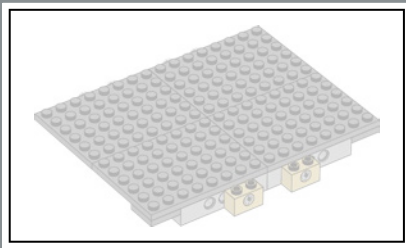

12

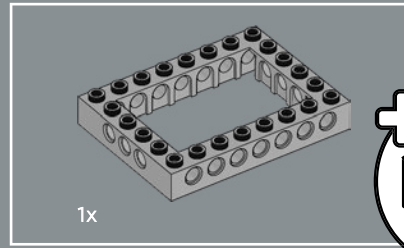
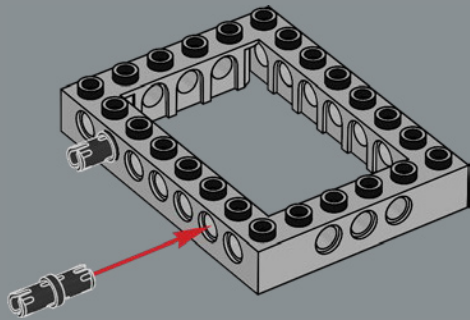
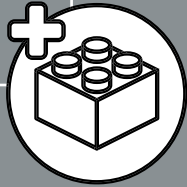

13

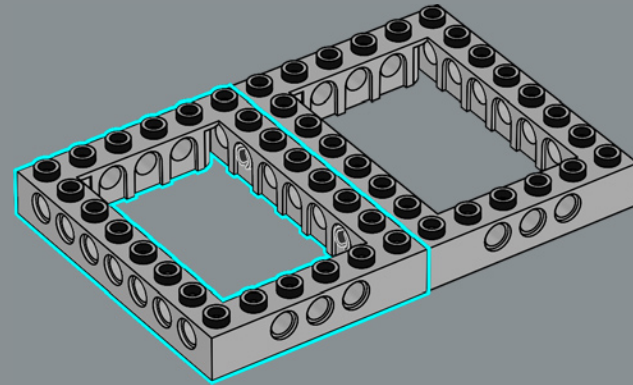
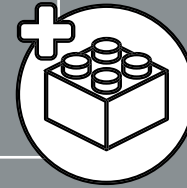

14

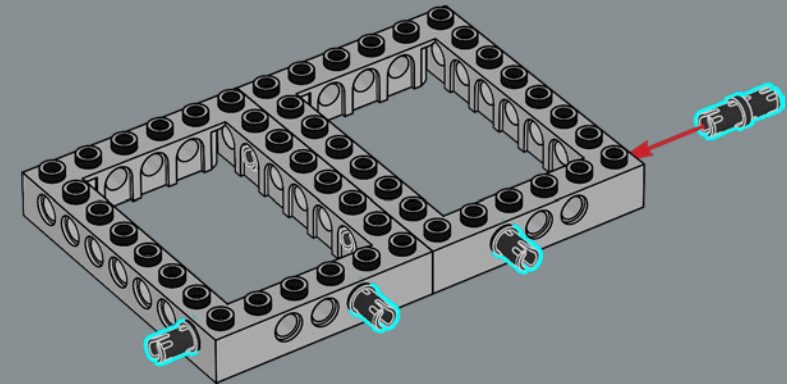

4x

15

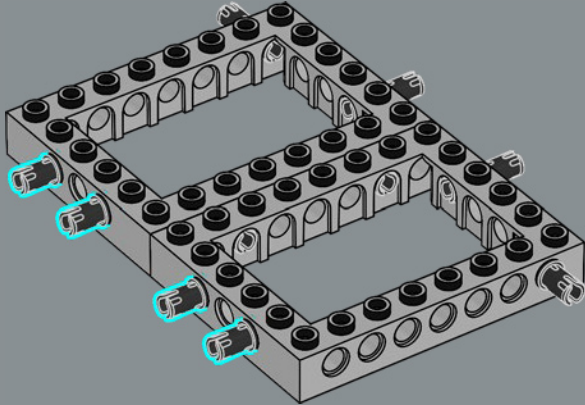

2x

16

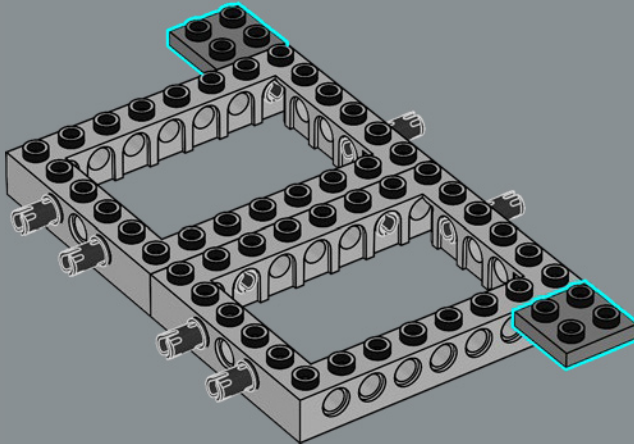

2x

17

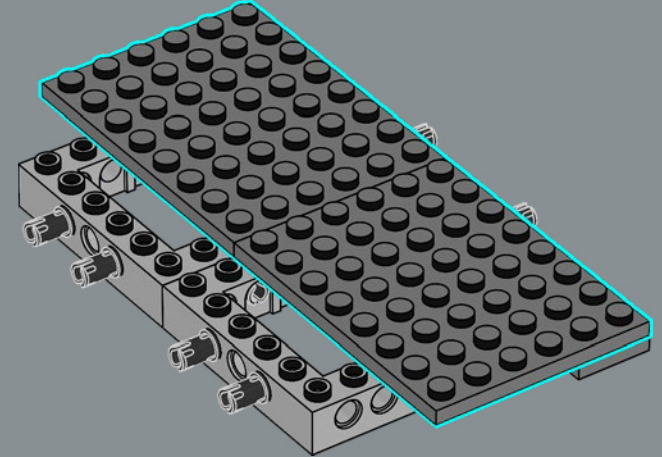

2x

18

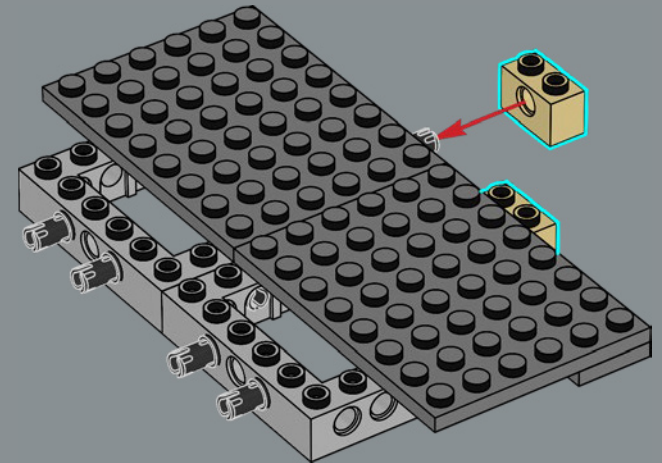

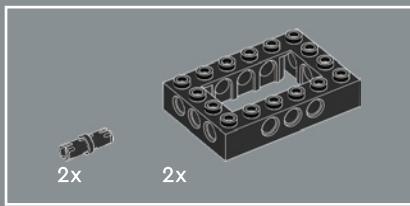

19

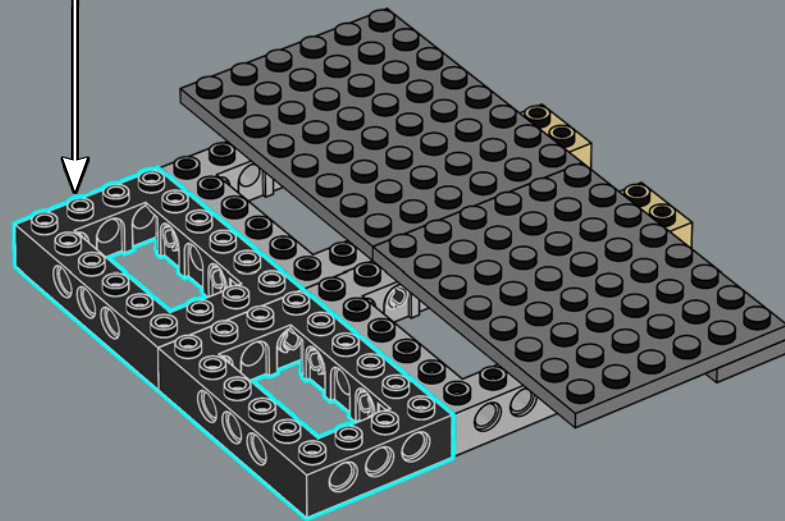
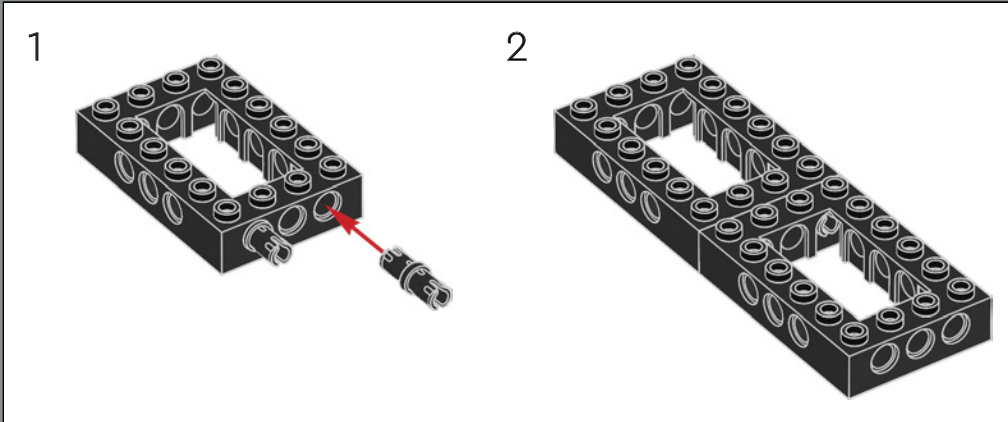

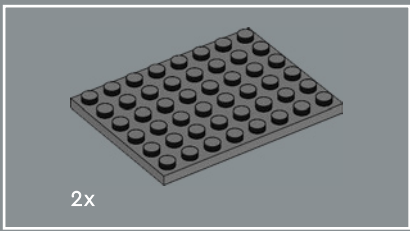

20

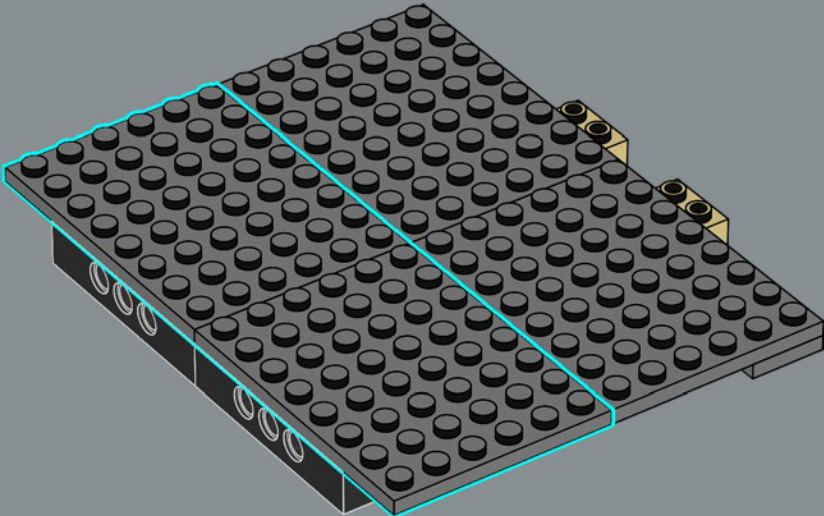

21

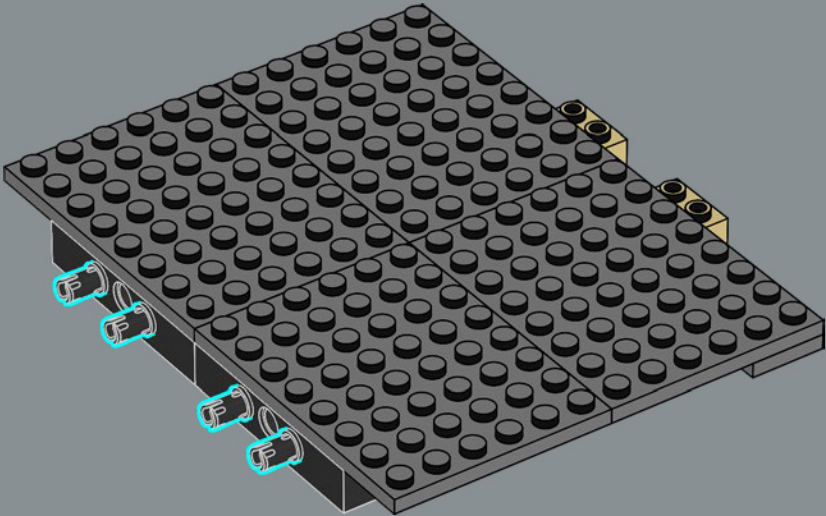



La Lamborghini Countach è nota per le sue apparizioni memorabili nelle serie TV classiche e nei film di maggior successo degli anni '80.

22

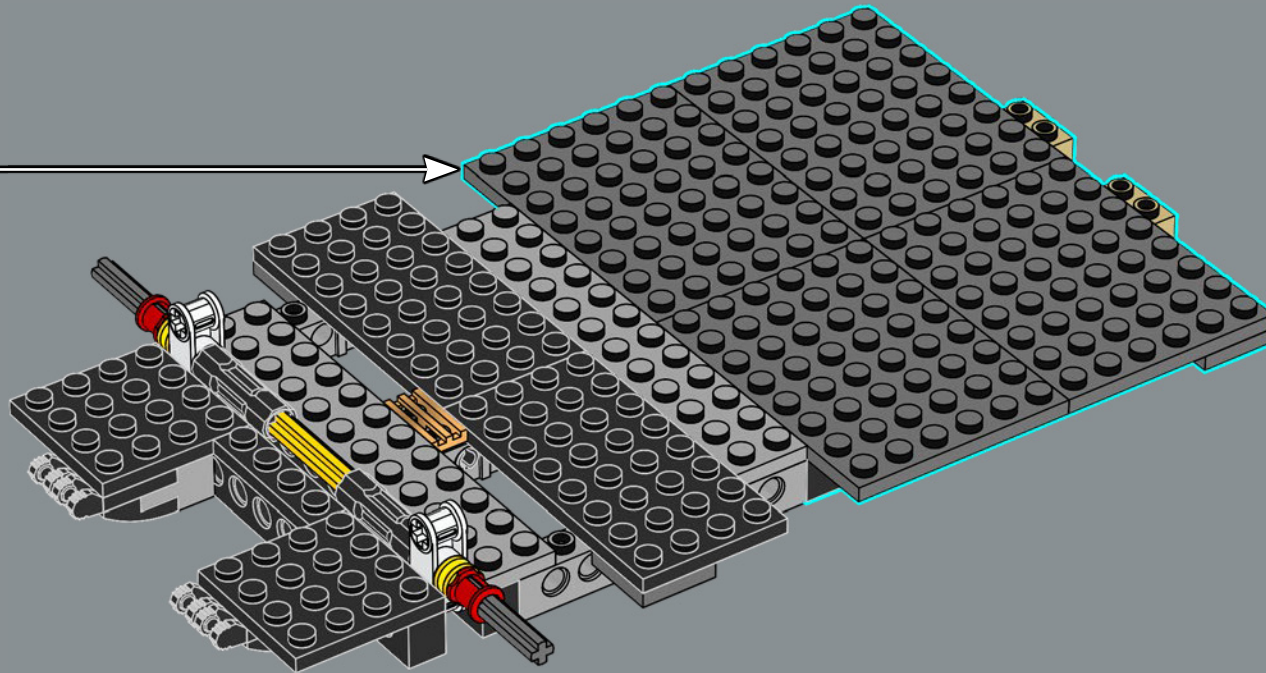

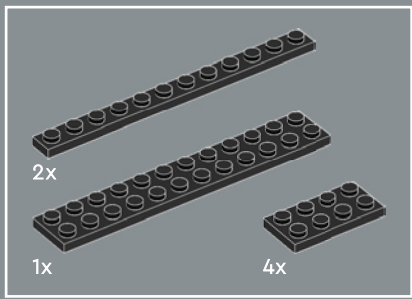

23

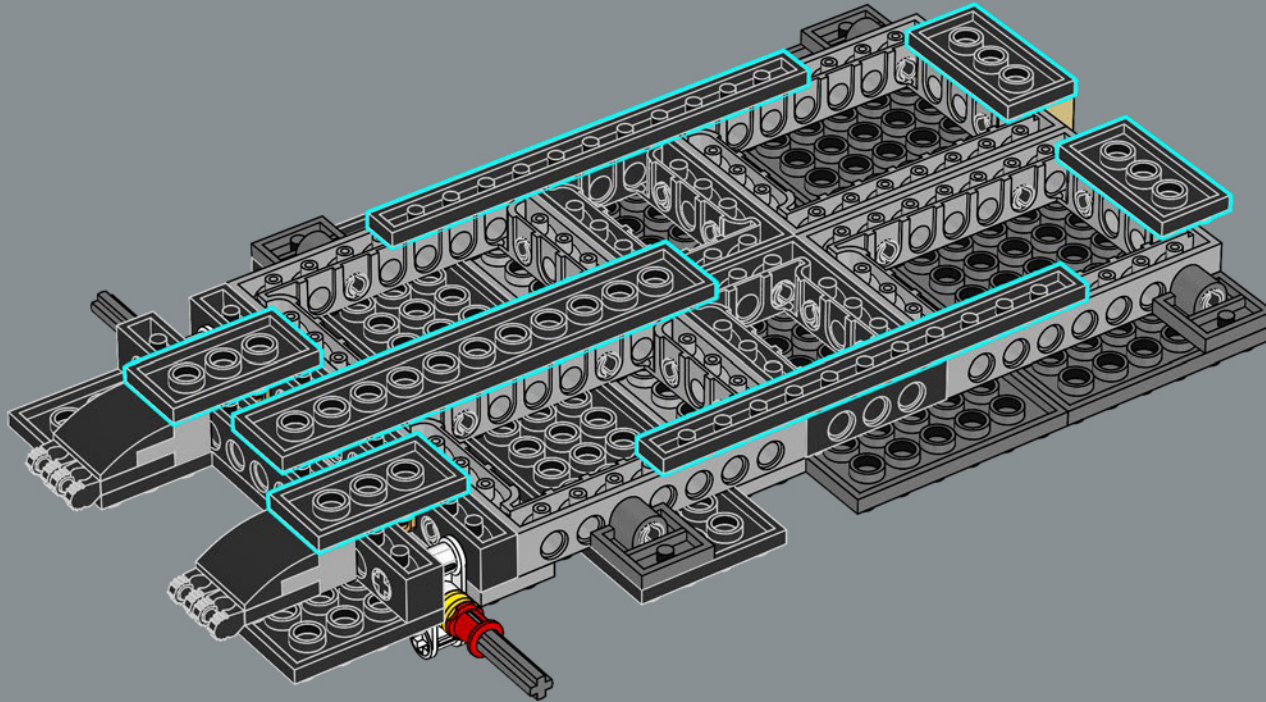

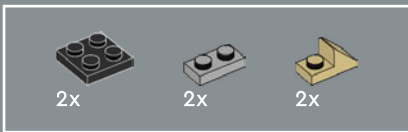

24

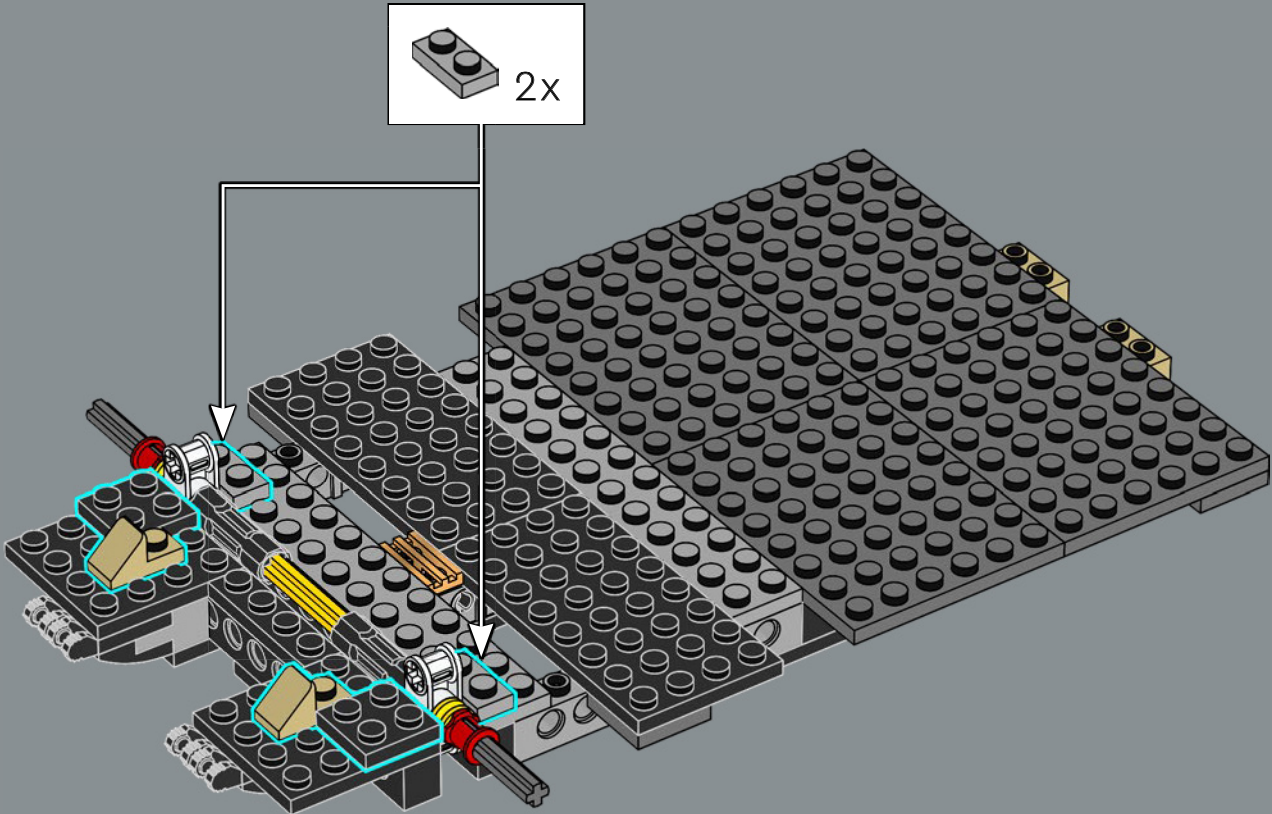

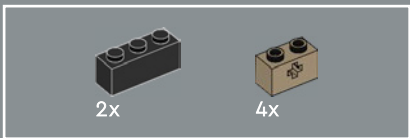

25

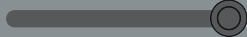
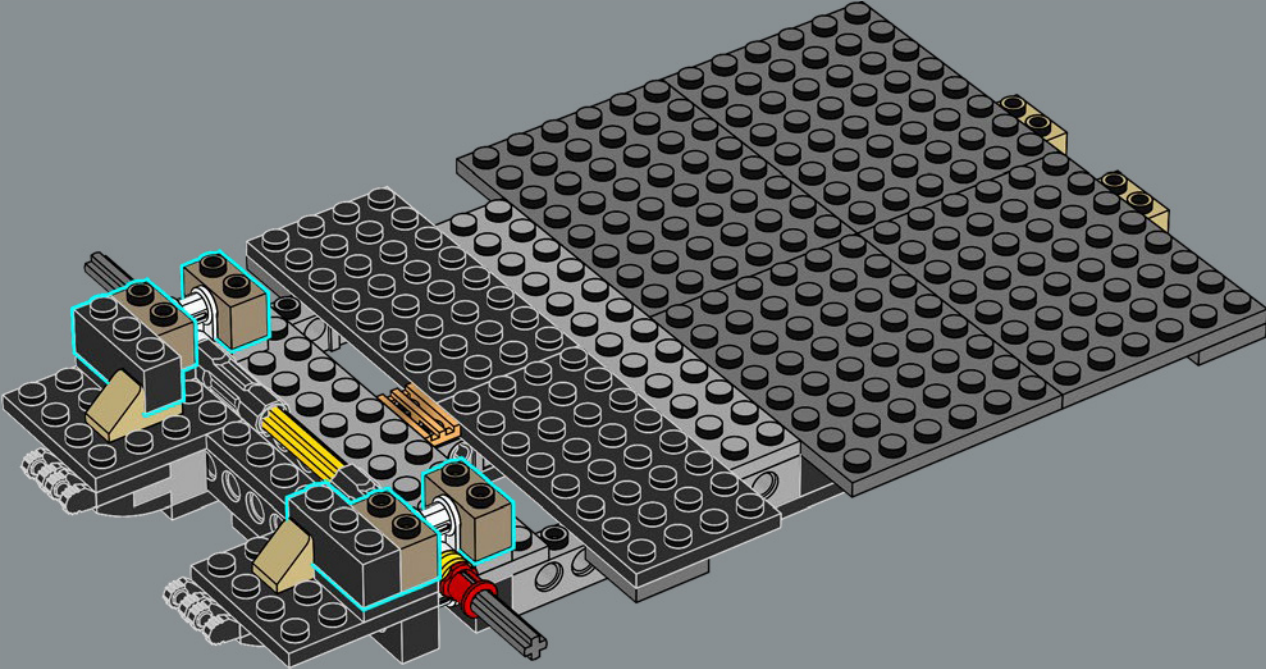

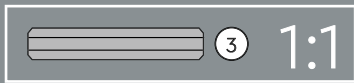
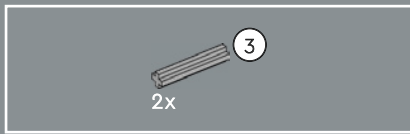

26

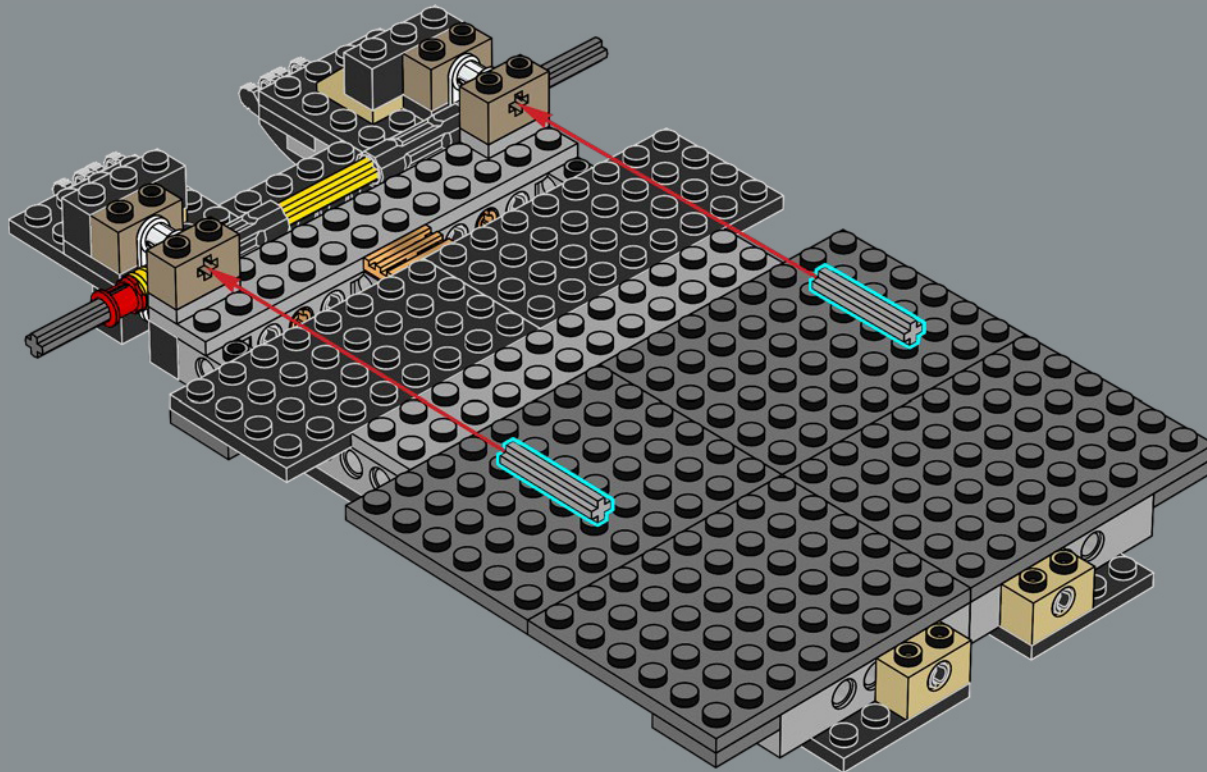

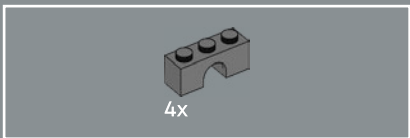

27

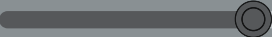
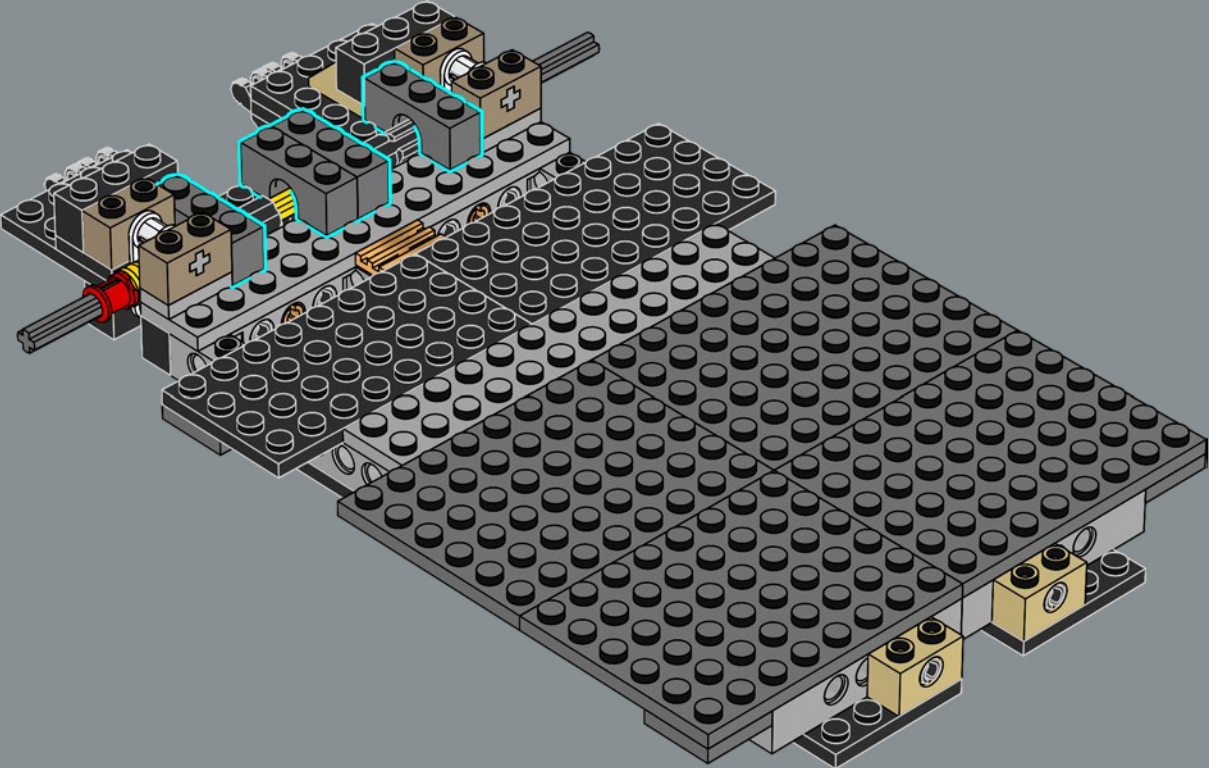

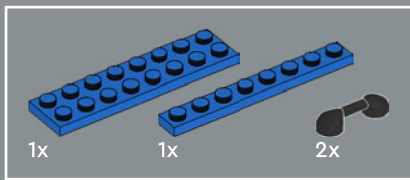

28

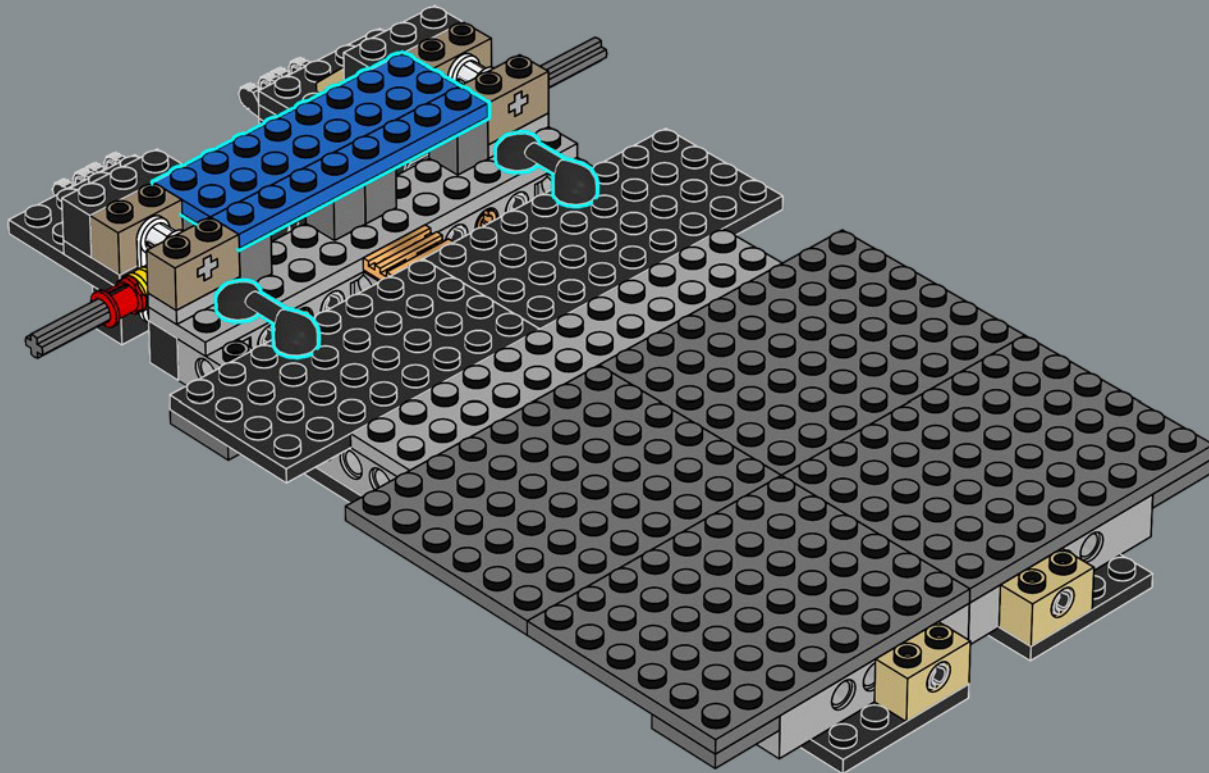

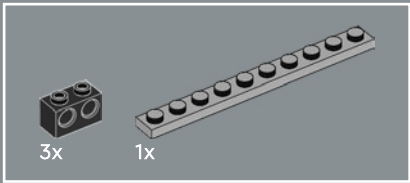

29

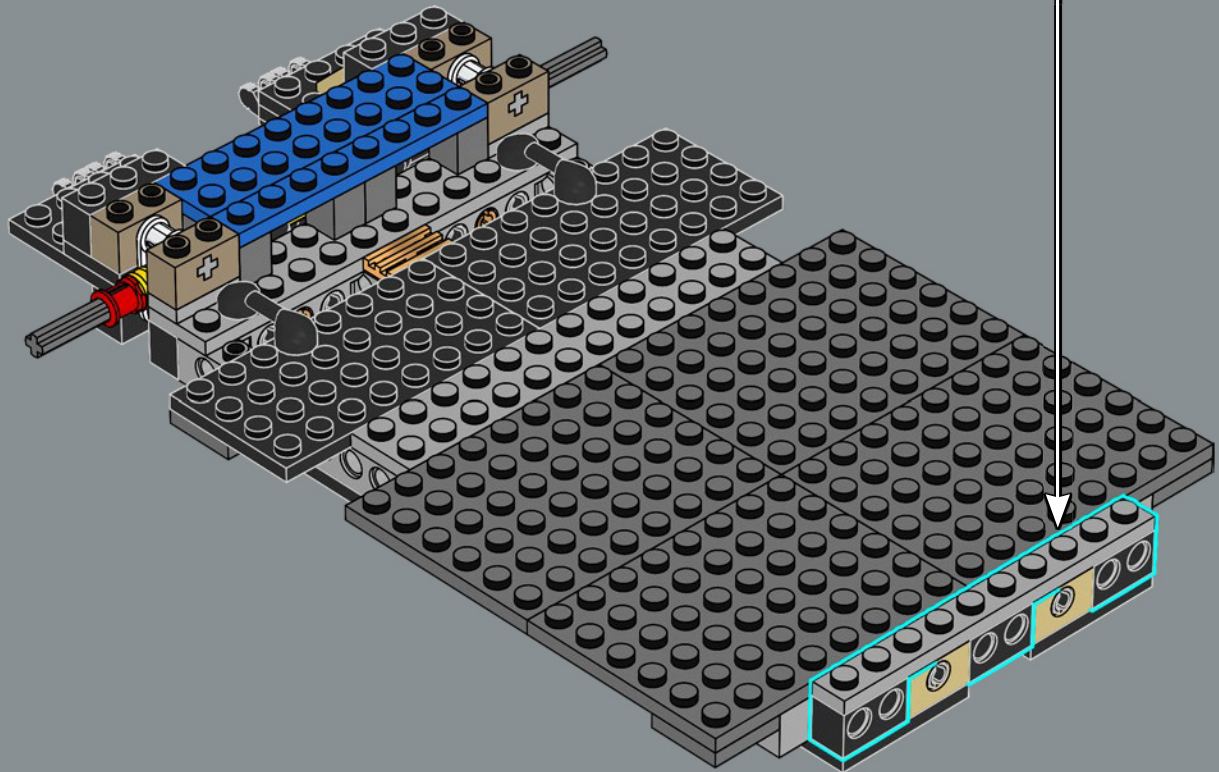
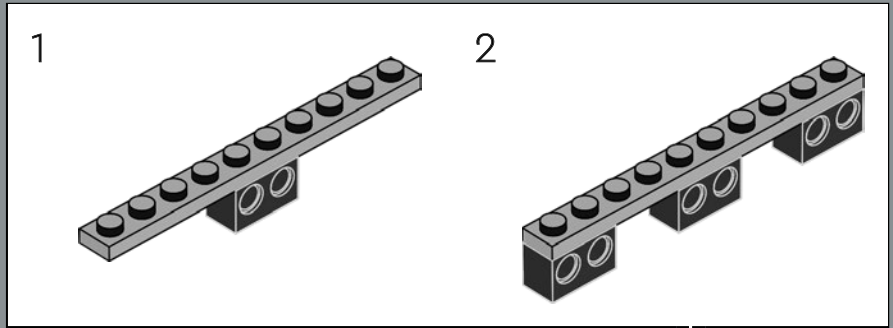

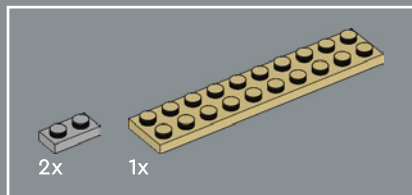

30

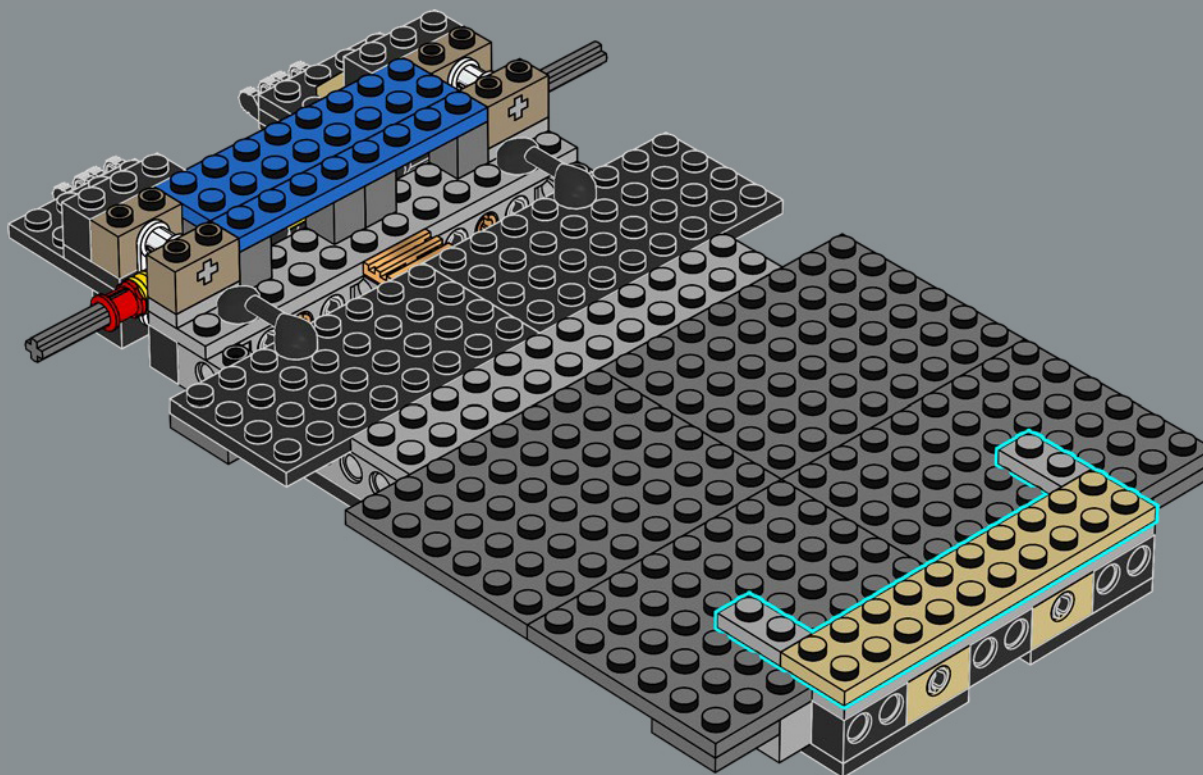

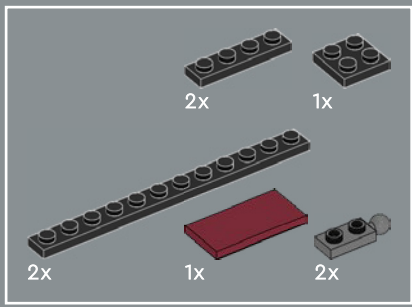

31

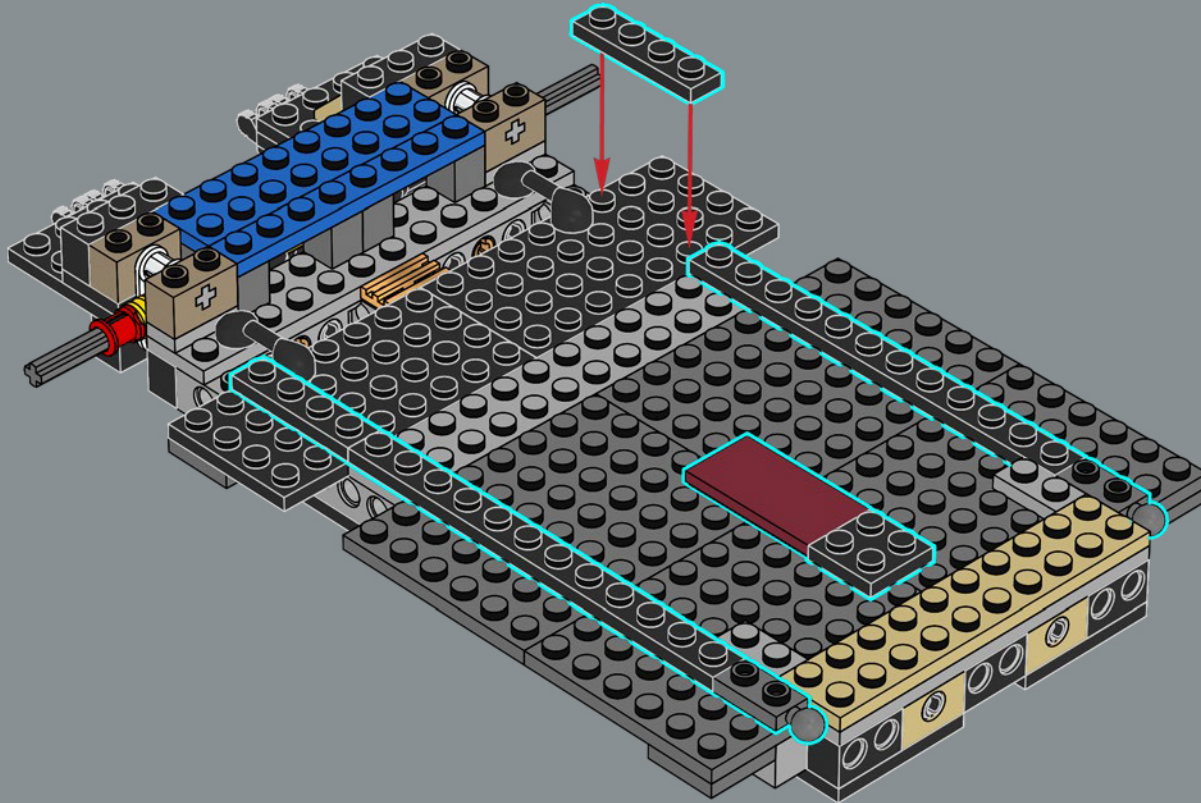

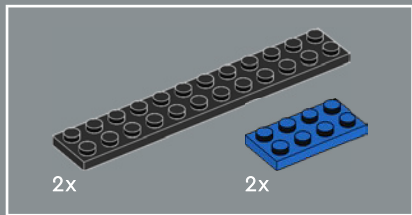

32

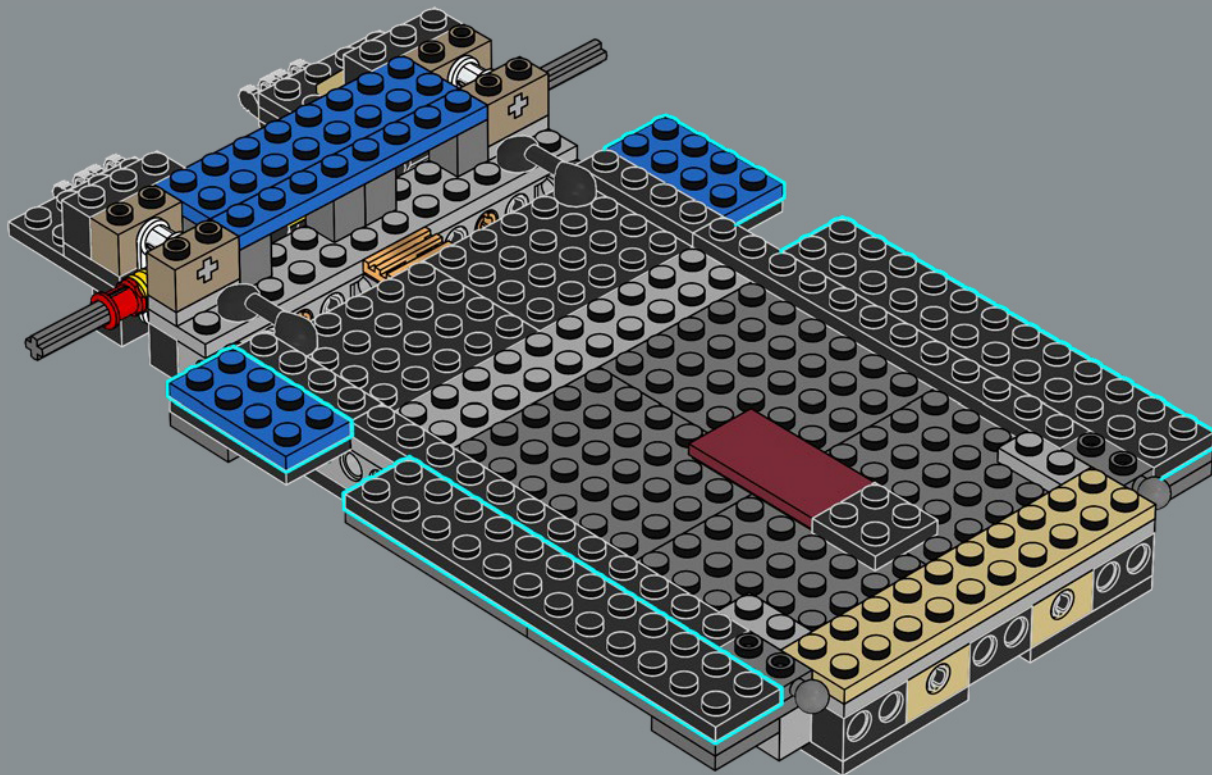

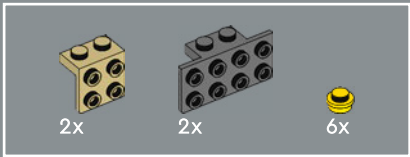

33

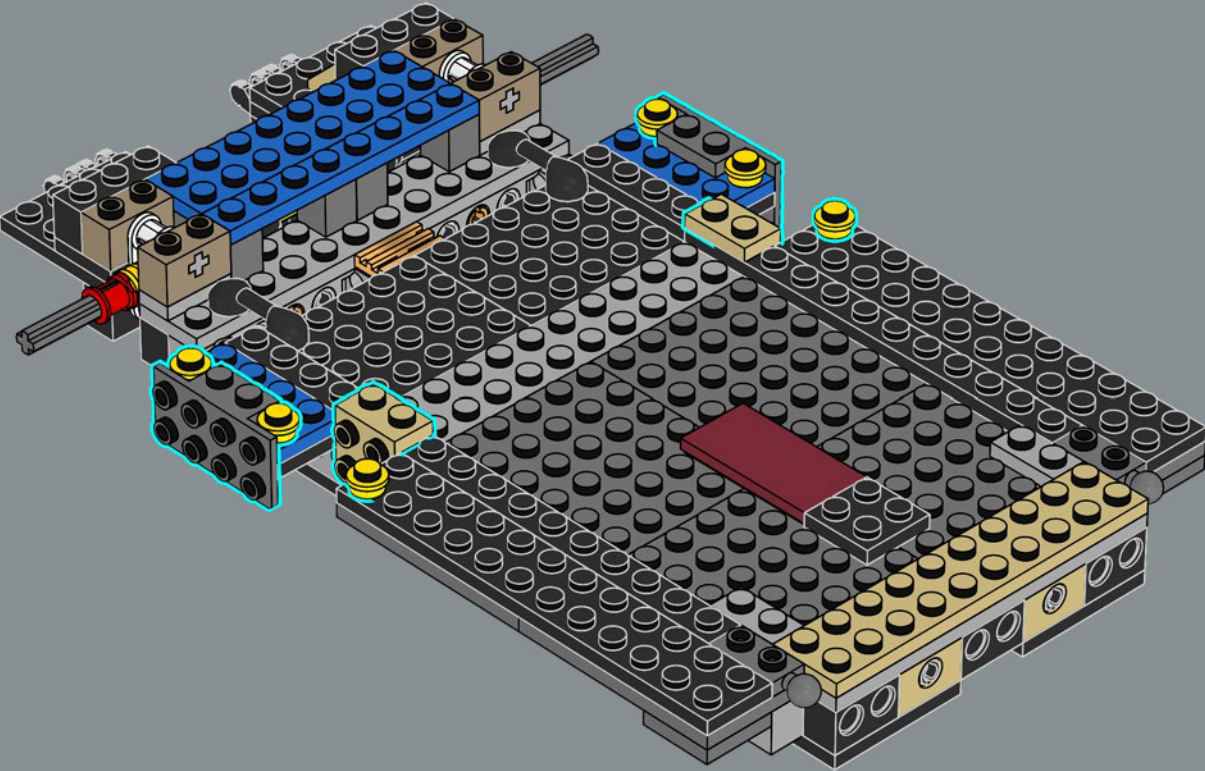

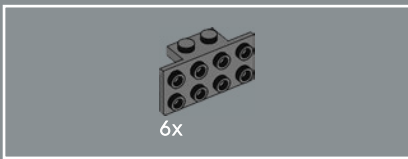

La Lamborghini Countach originale è stata progettata da Carrozzeria Bertone.

34

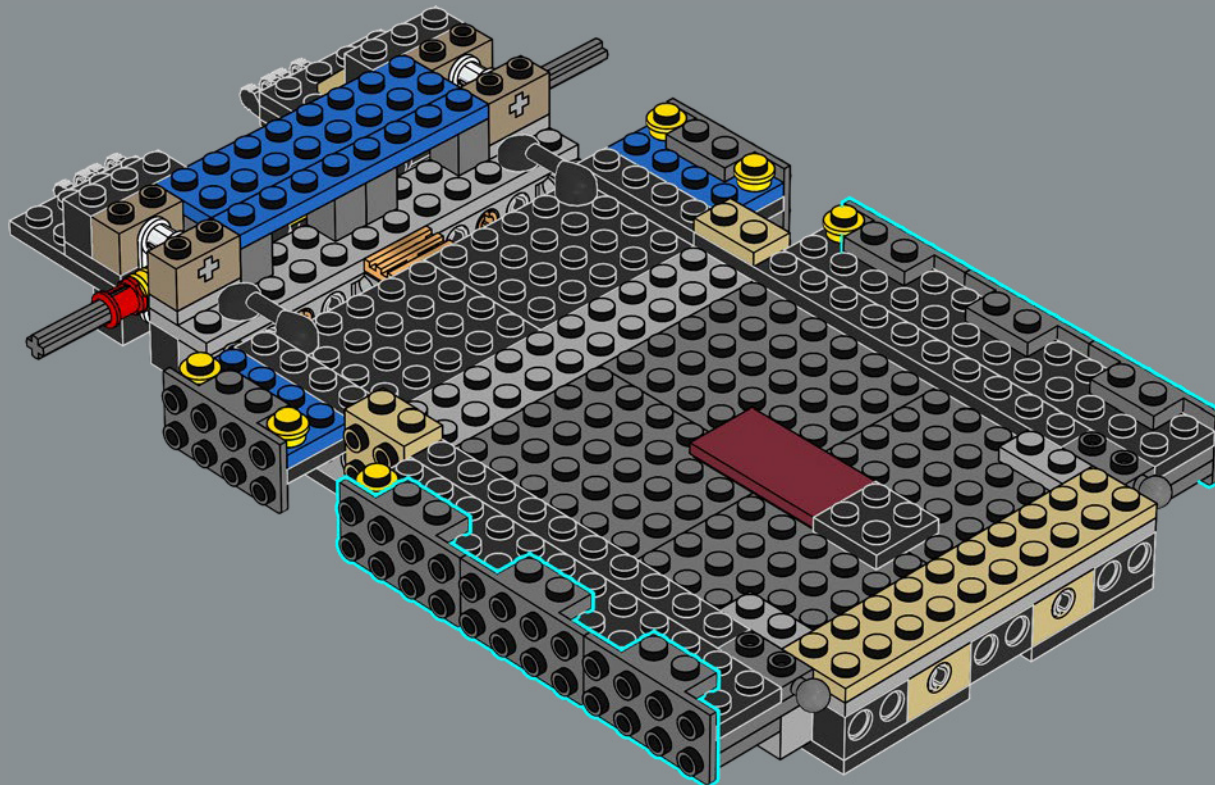

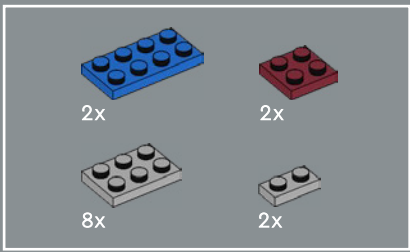

35

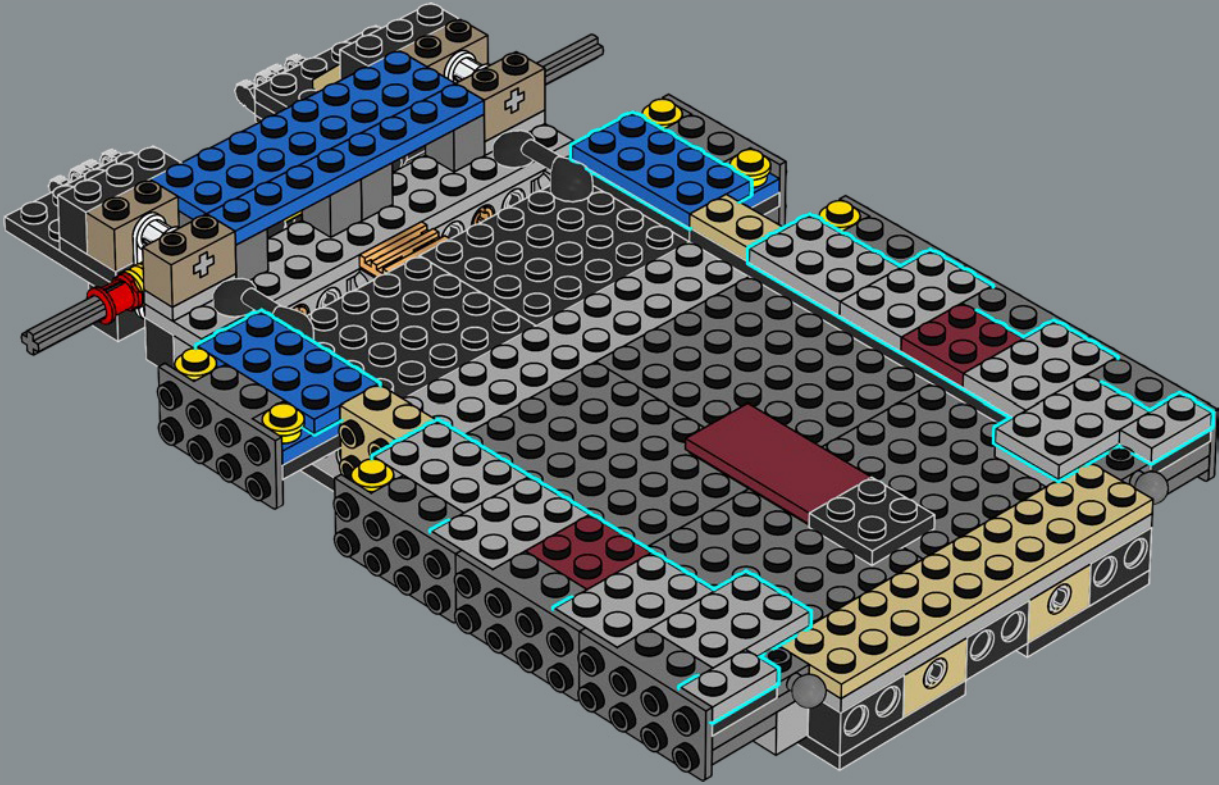

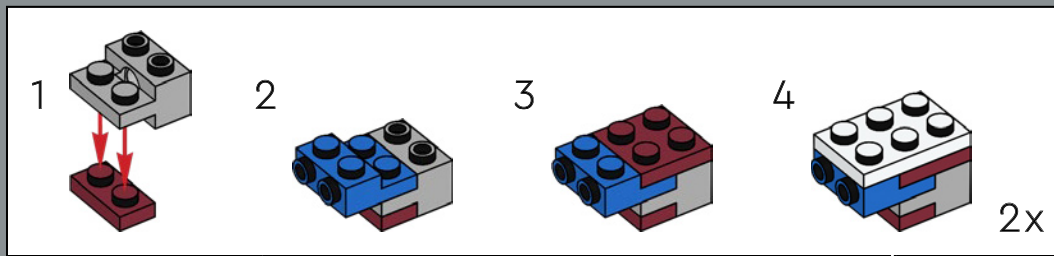
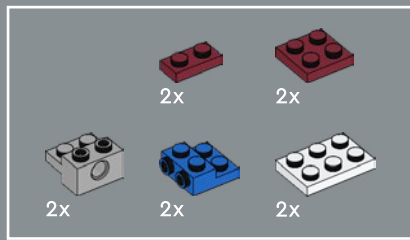

36

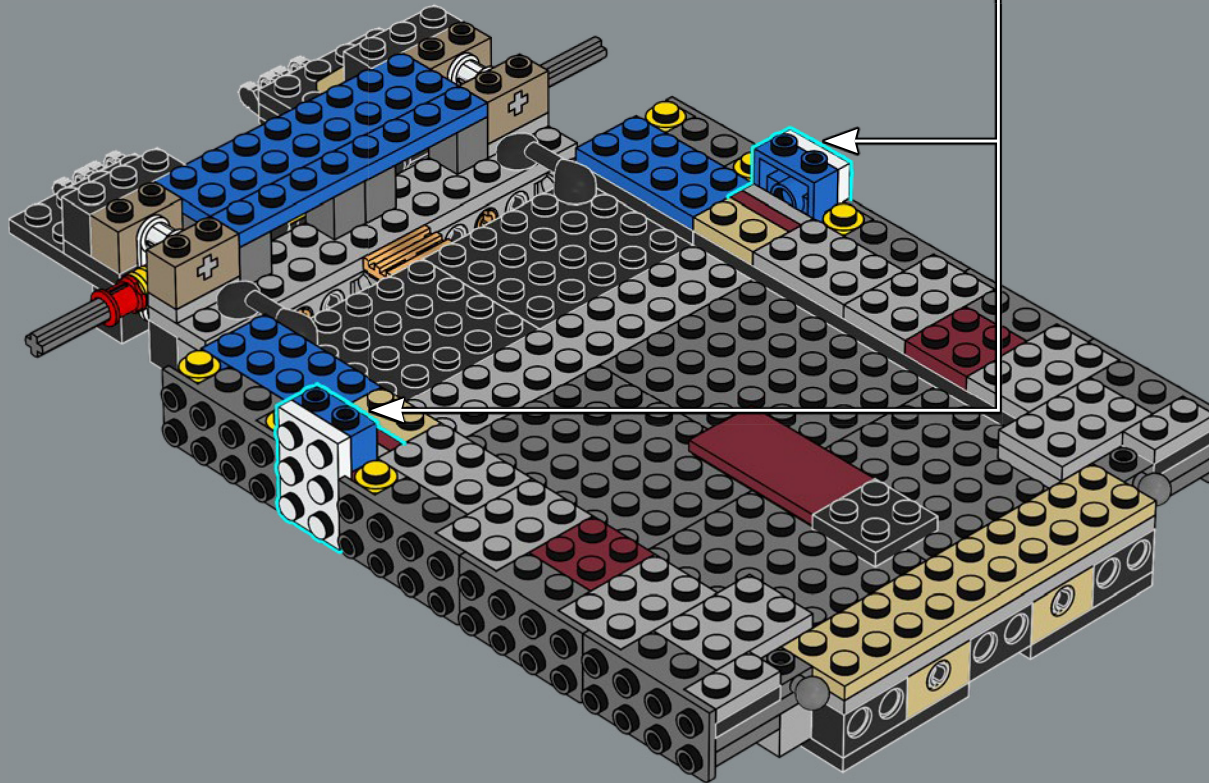

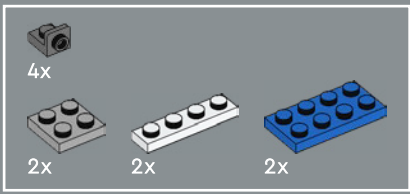

37

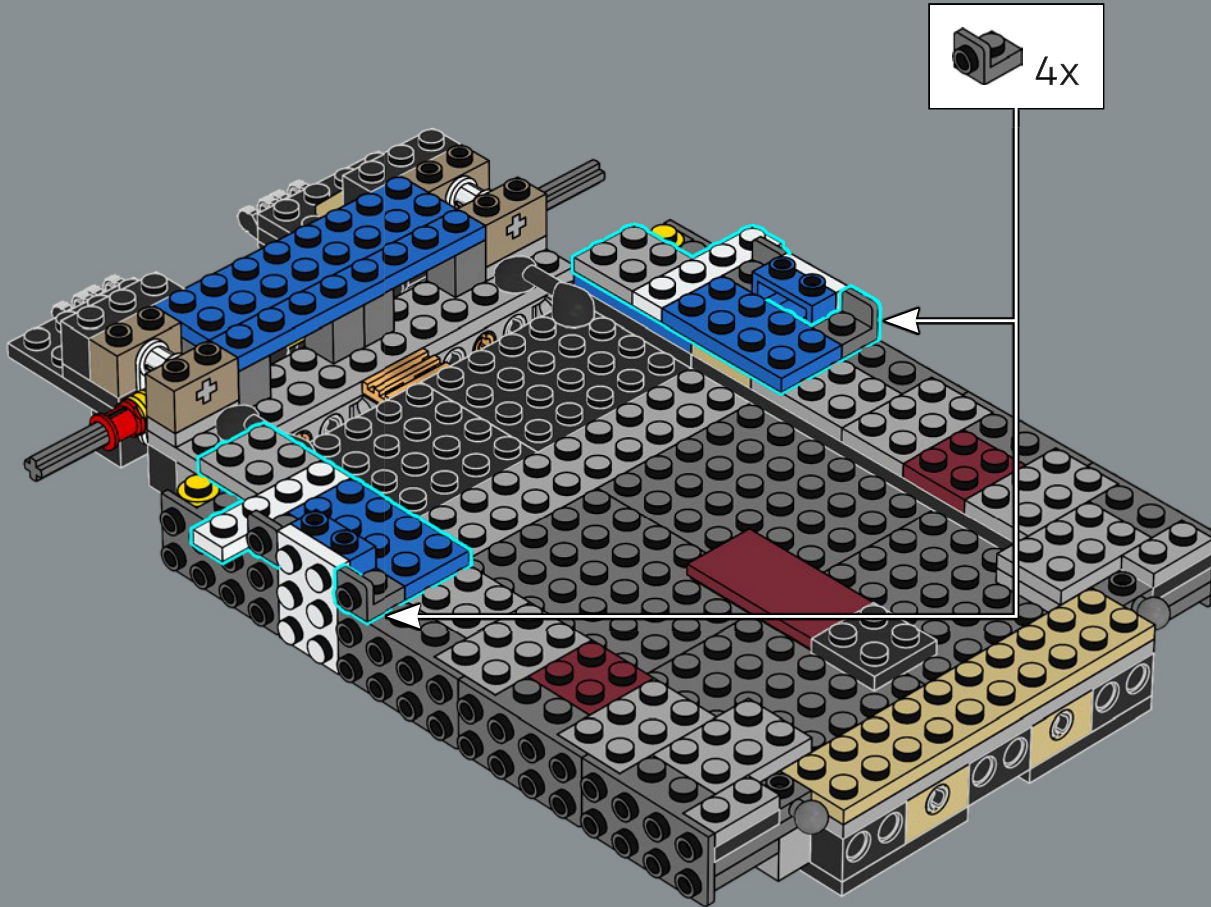



38

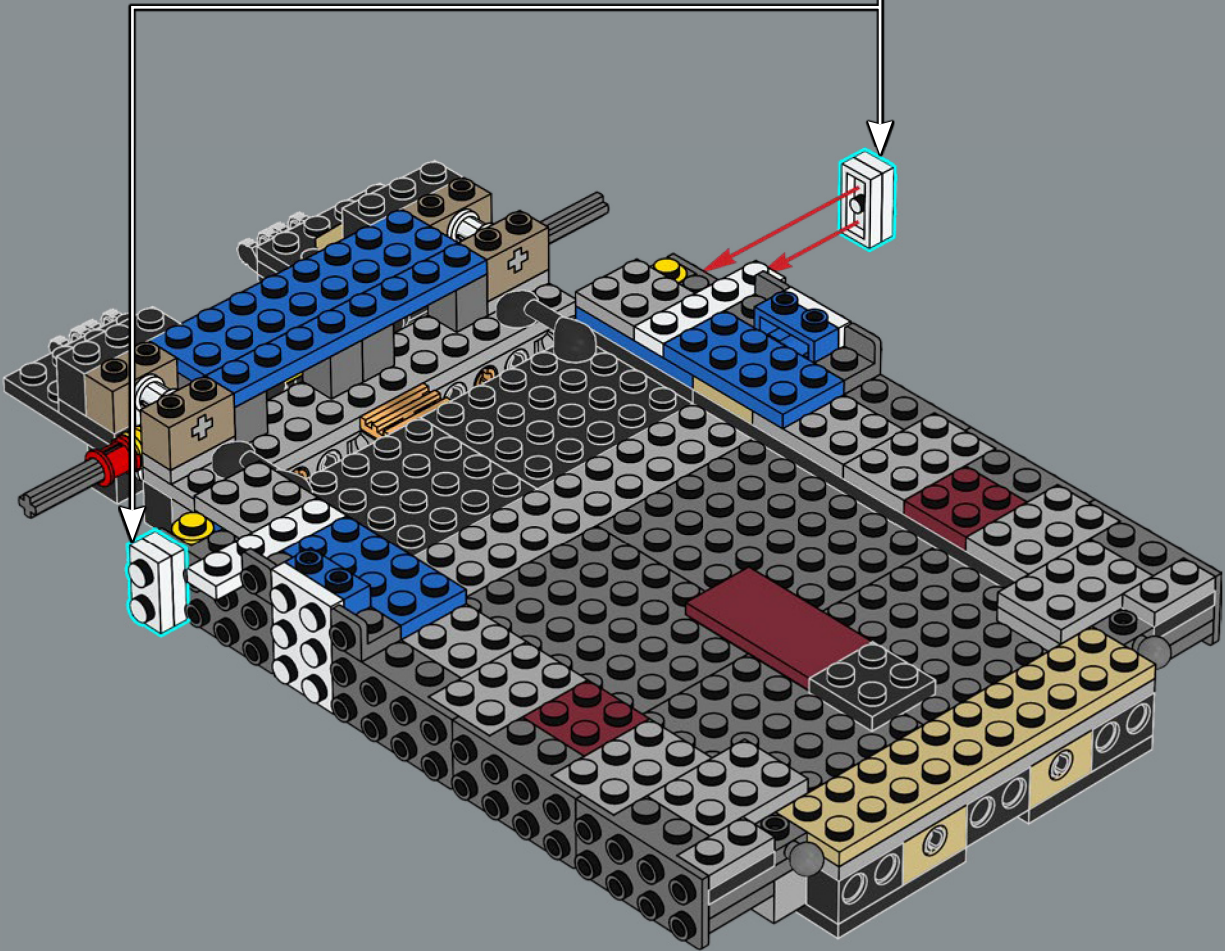
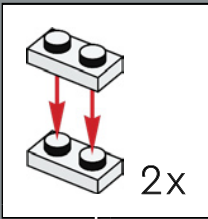

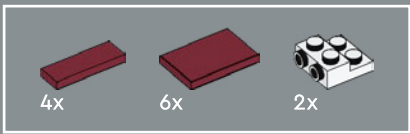

39

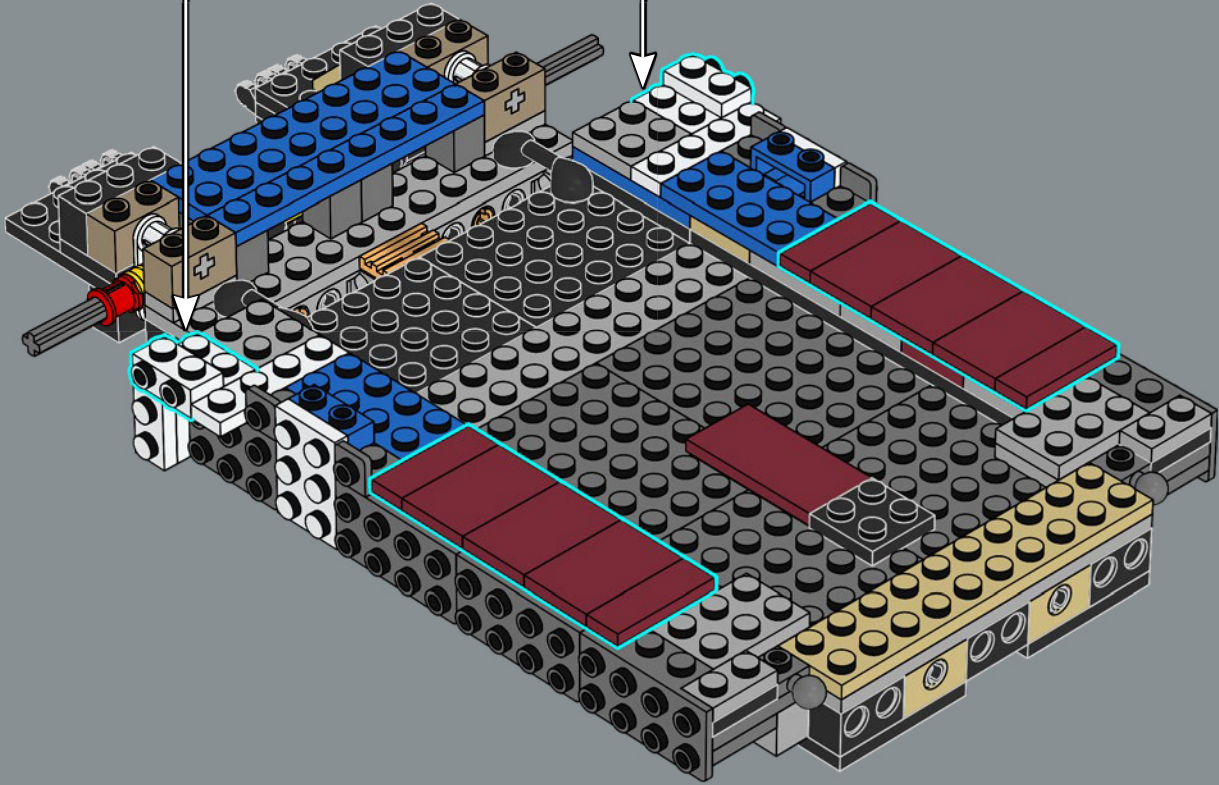
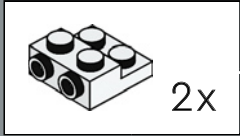



40

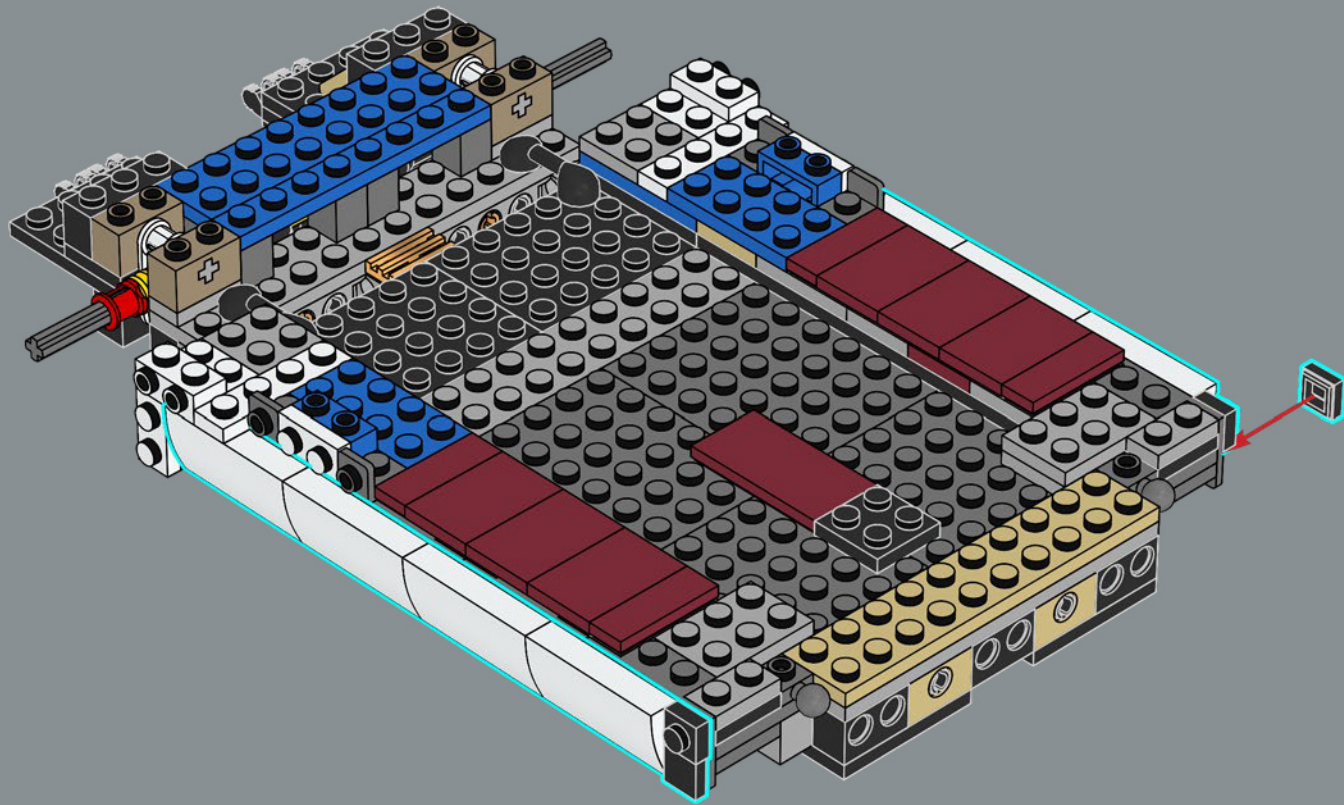

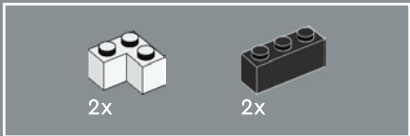

41

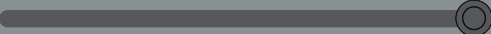
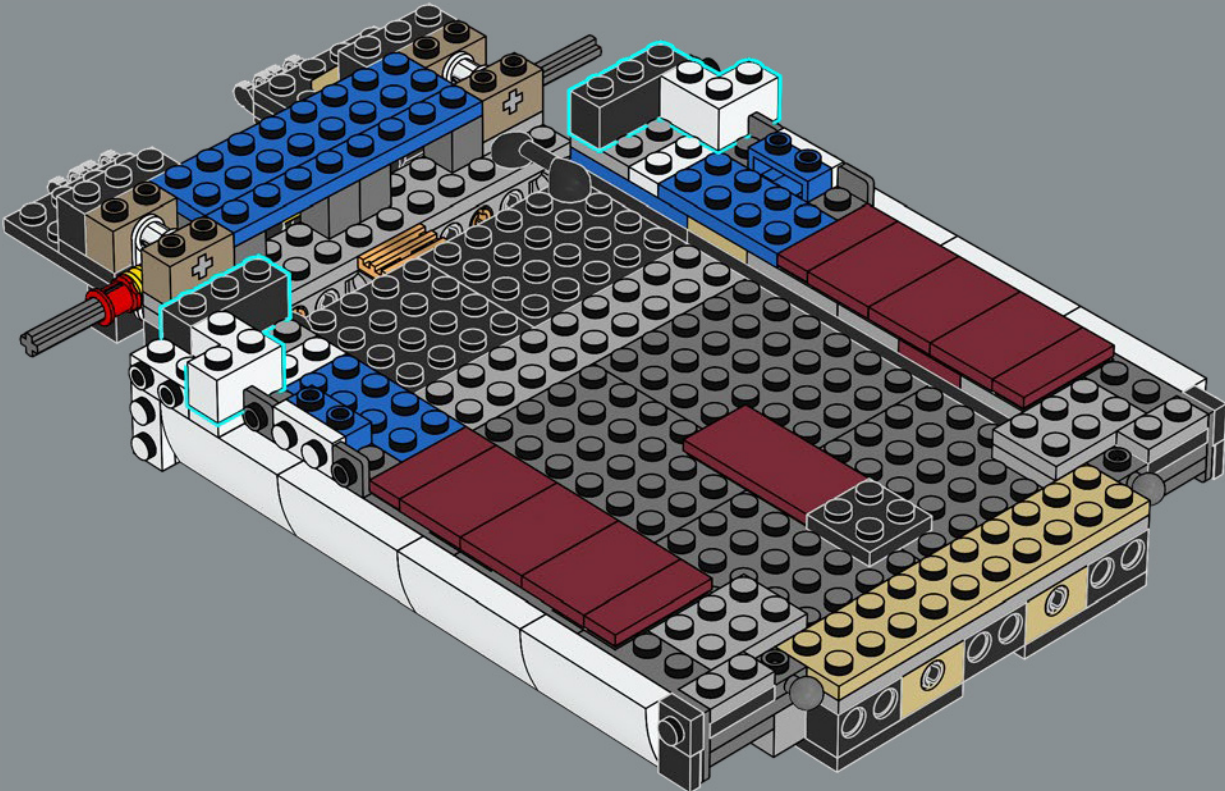

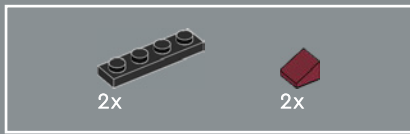

42

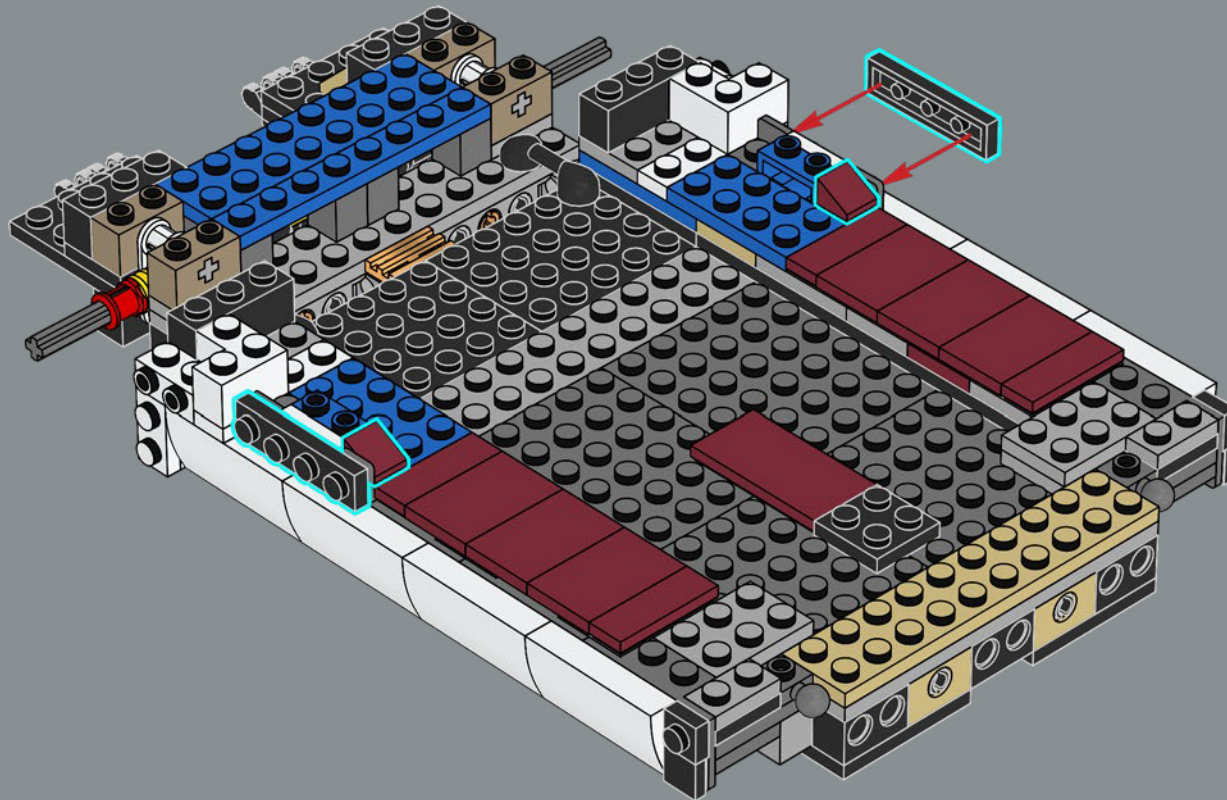



4x

43

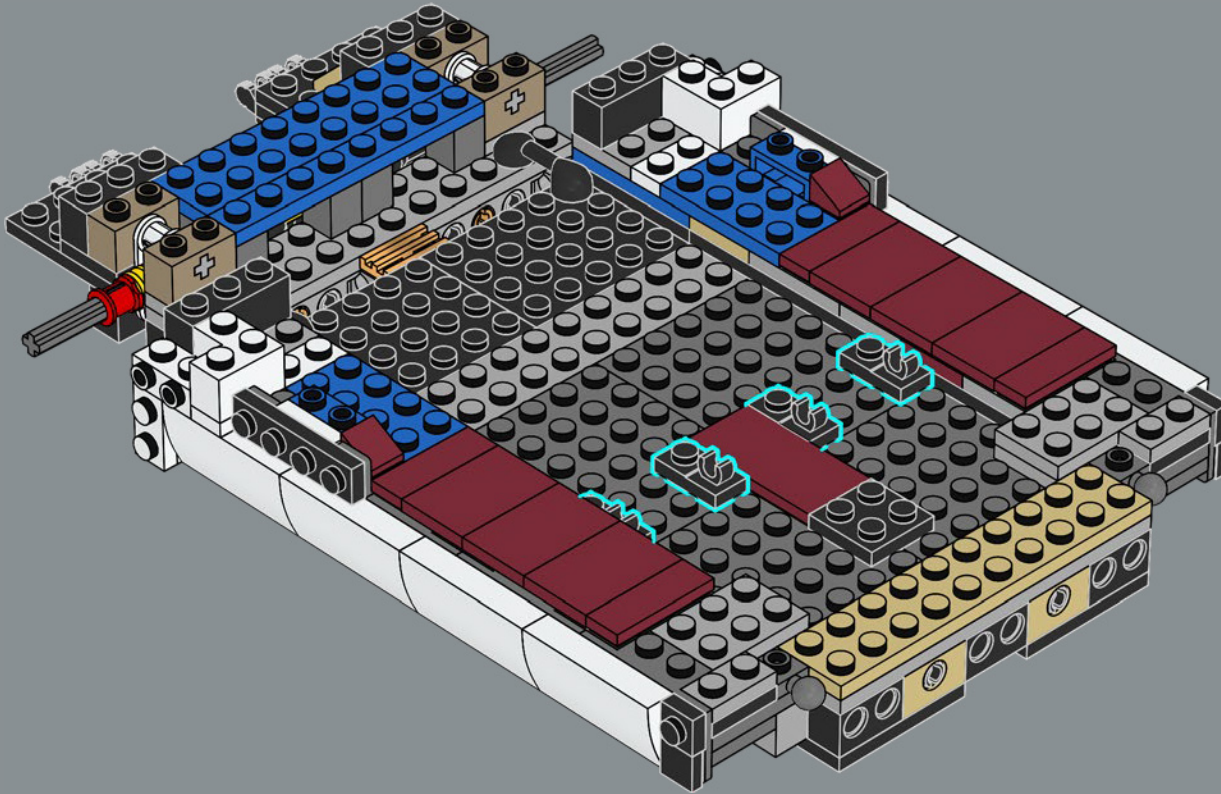

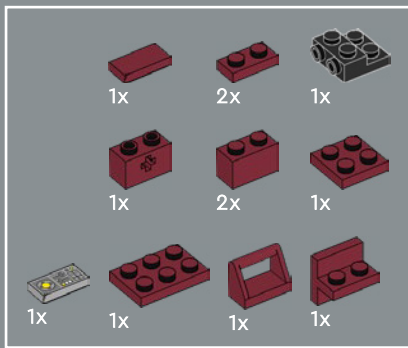

4

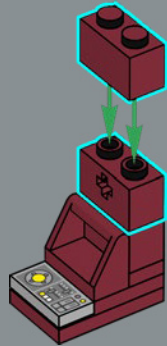

7

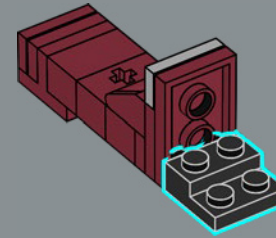

44

1

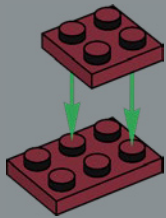

2

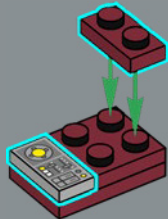

3

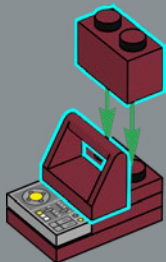

5

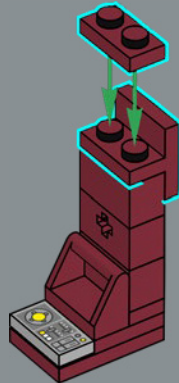

6

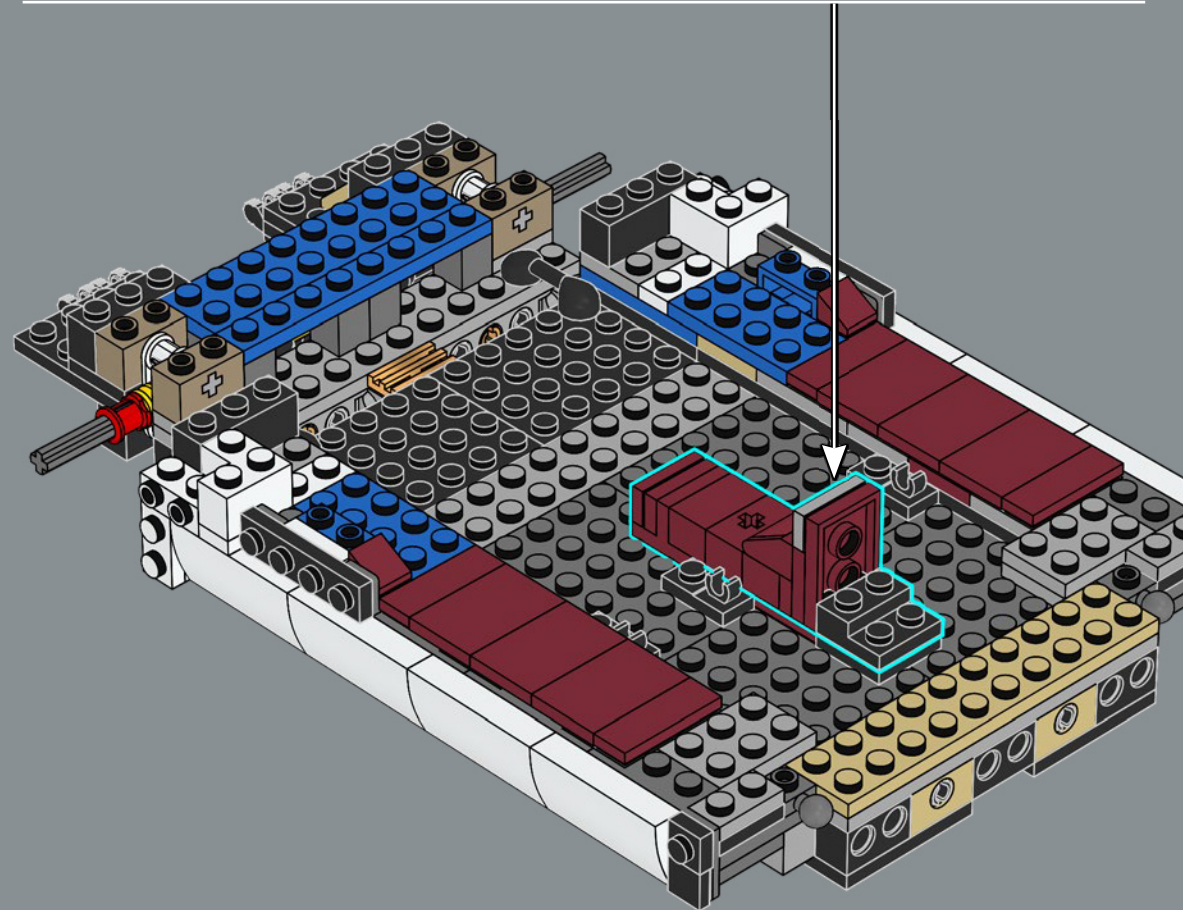
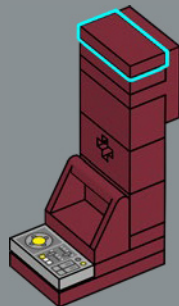



45

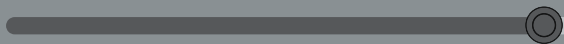
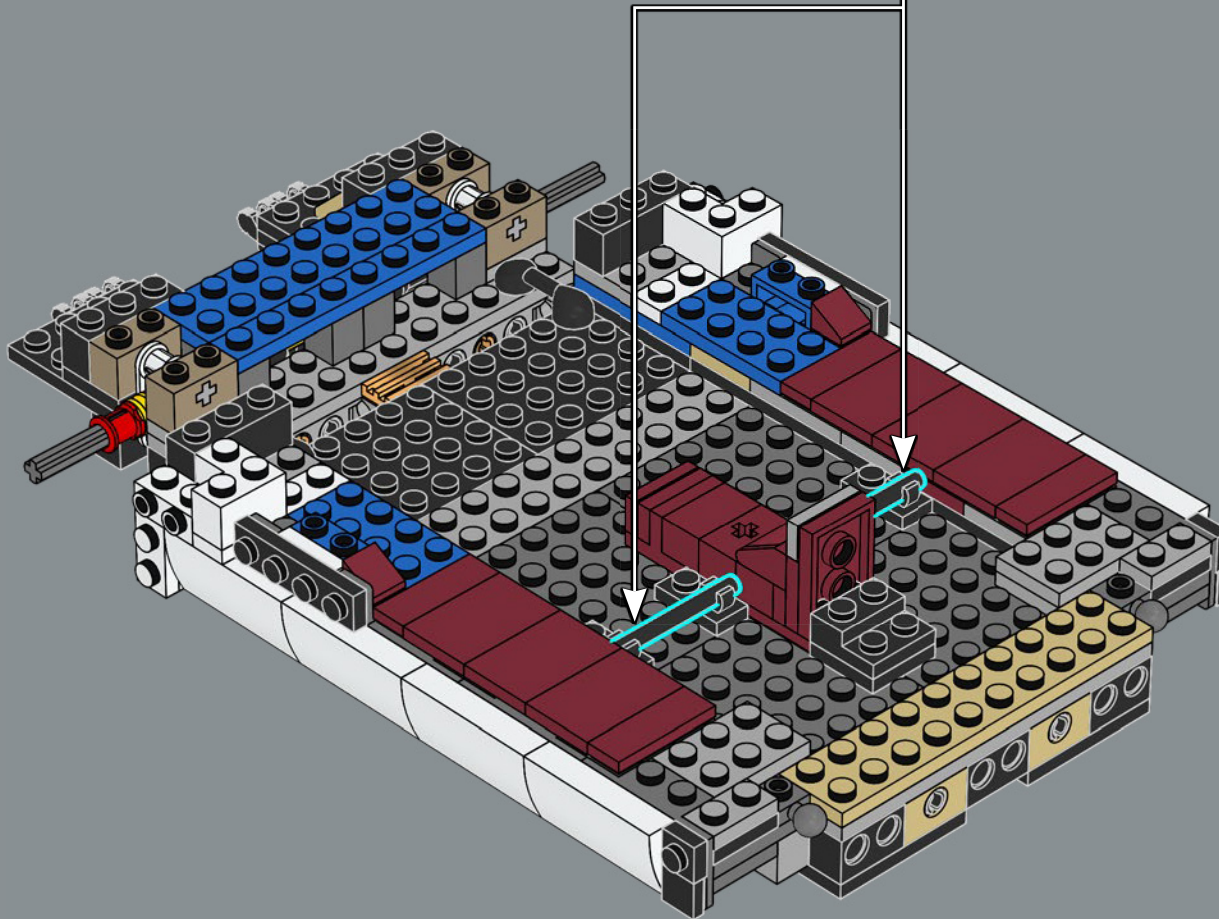

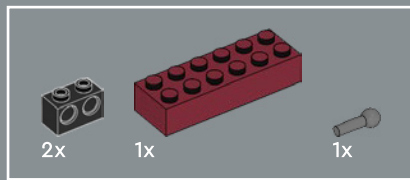

46

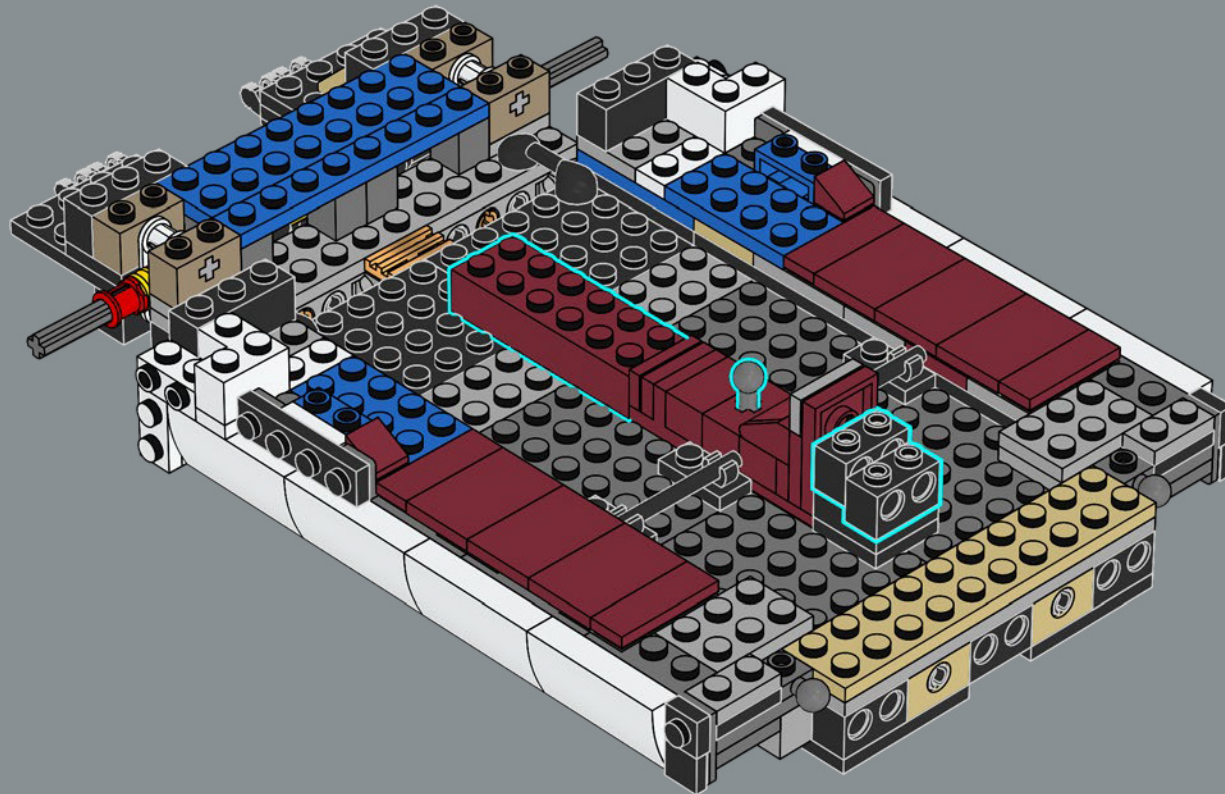

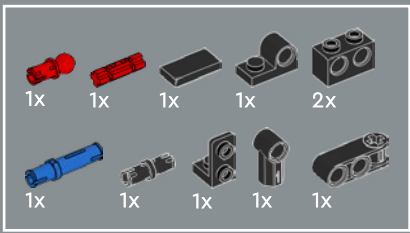

47

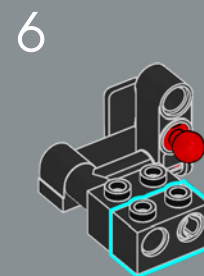
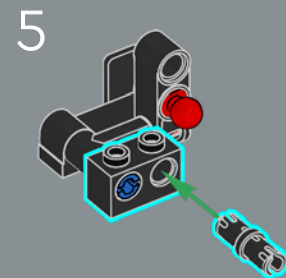
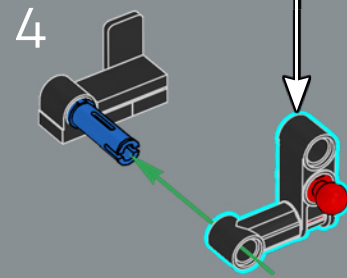
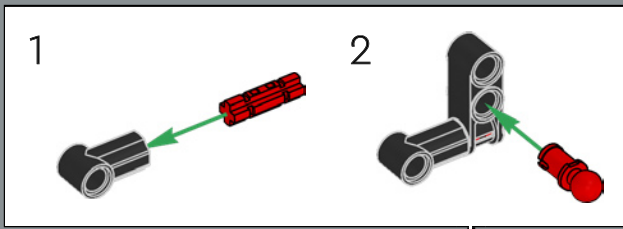
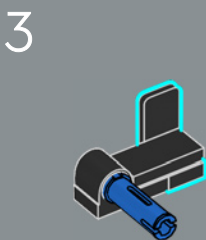
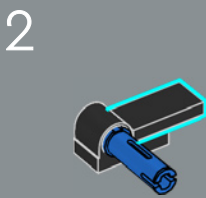
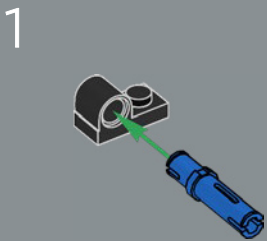

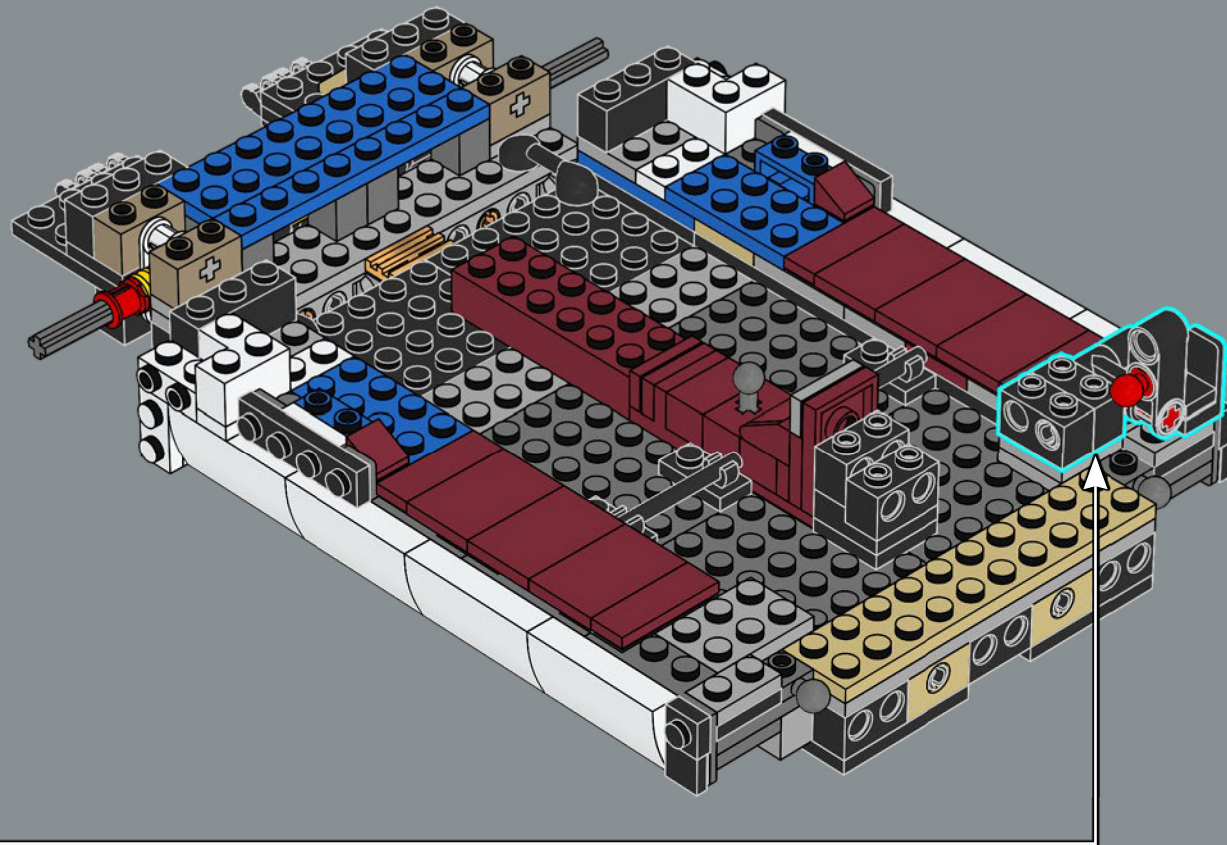

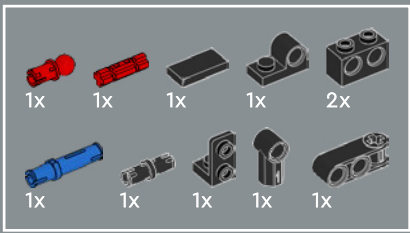

48

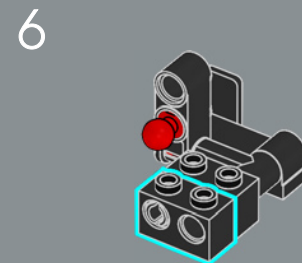
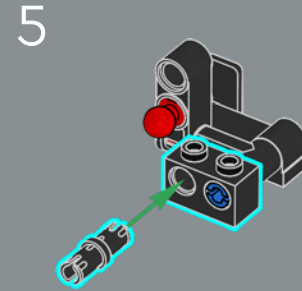
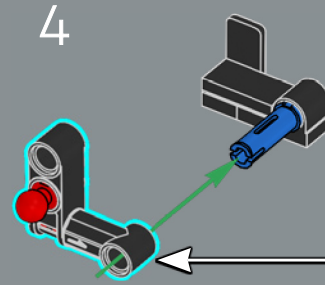
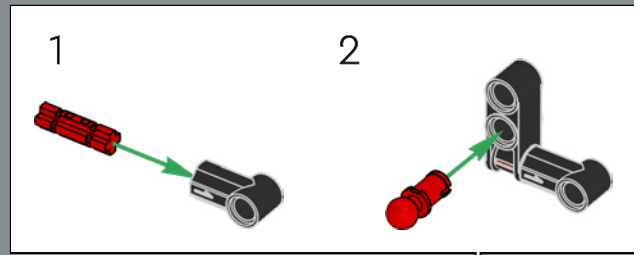
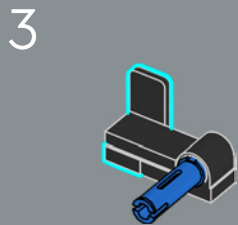
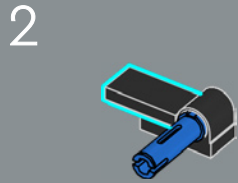
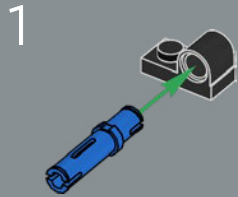

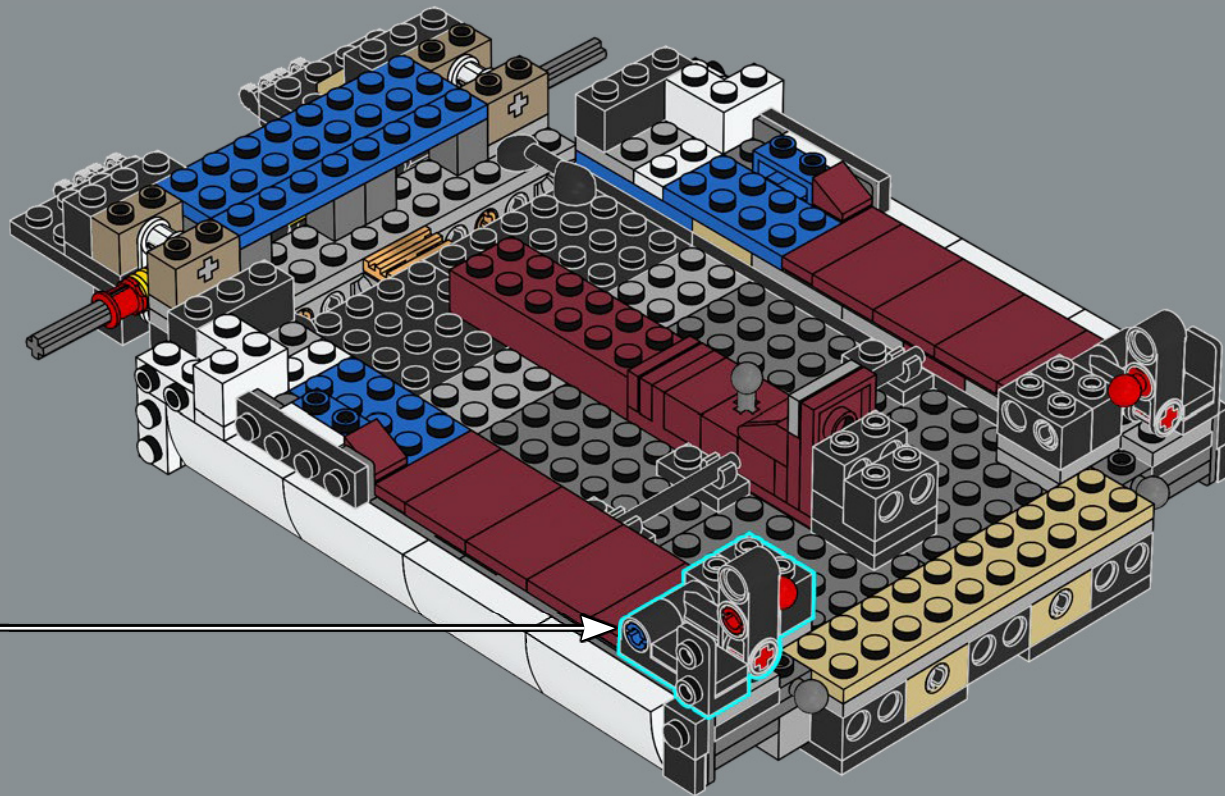

0
2x

49

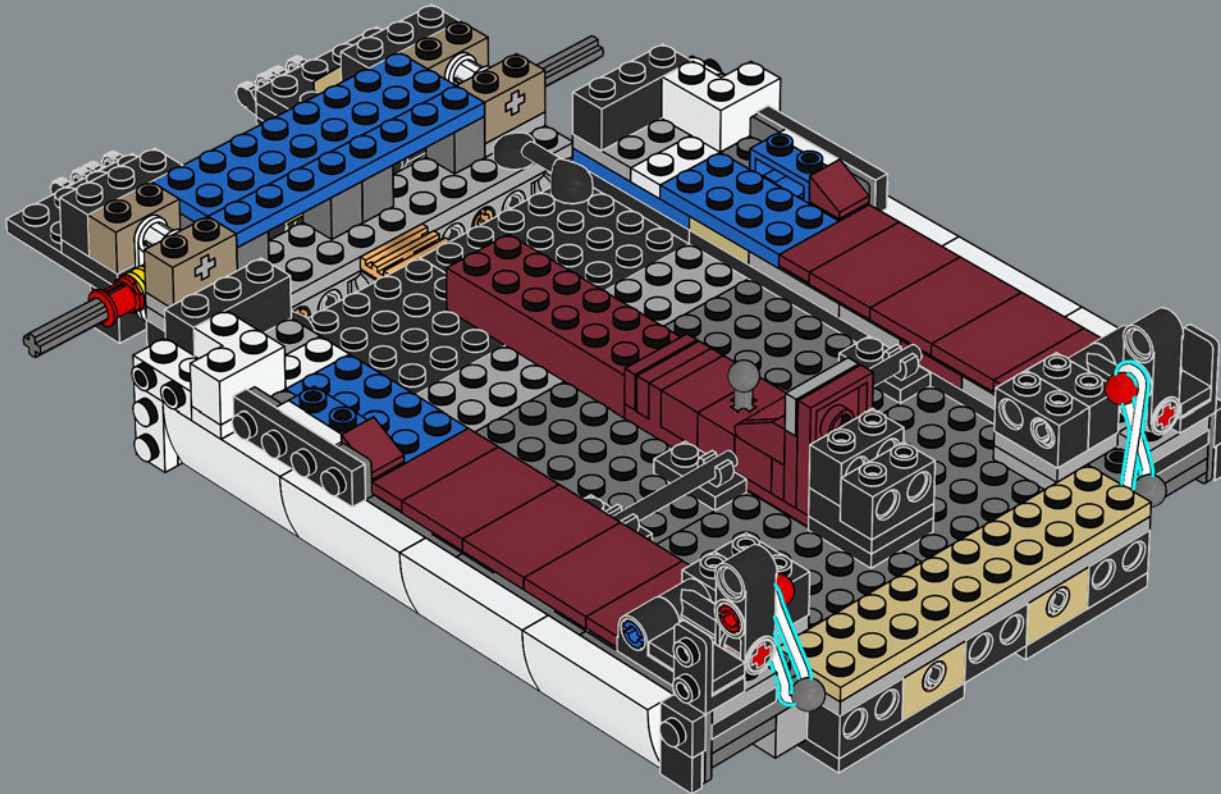

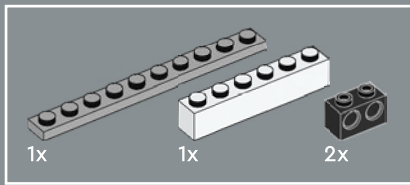

50

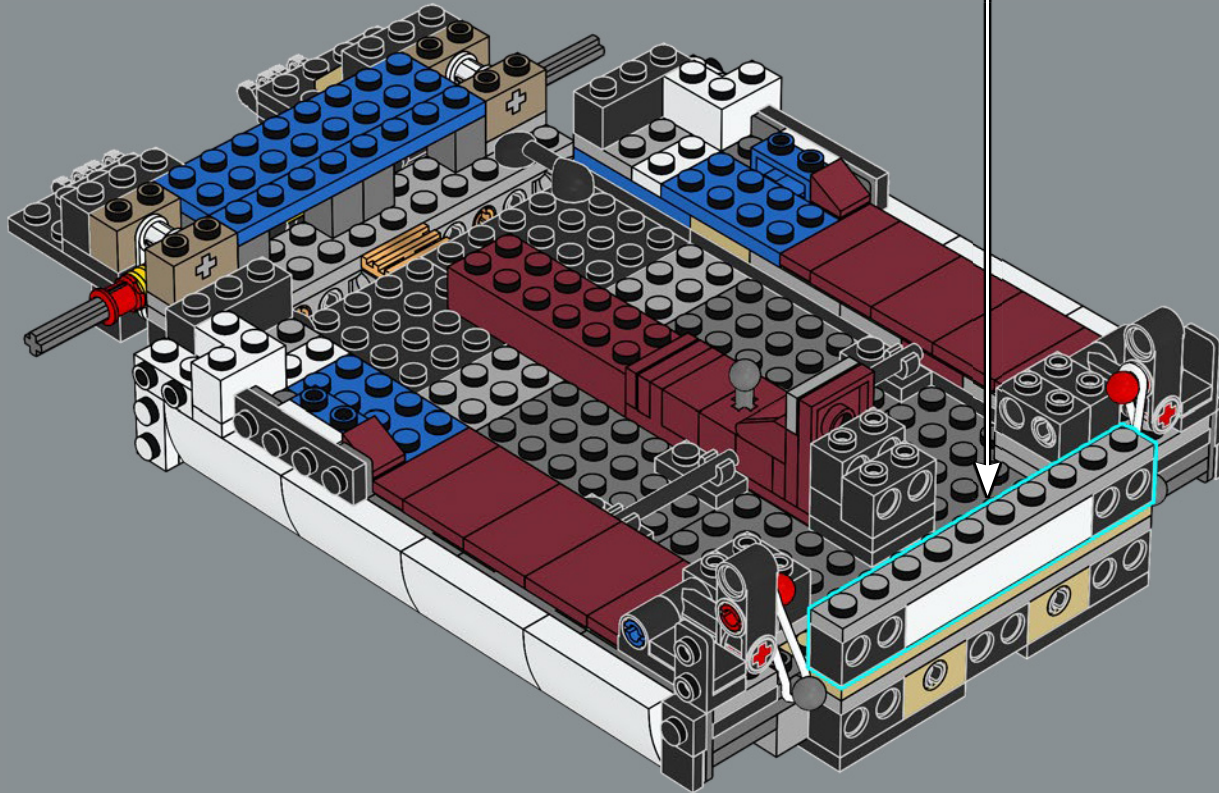
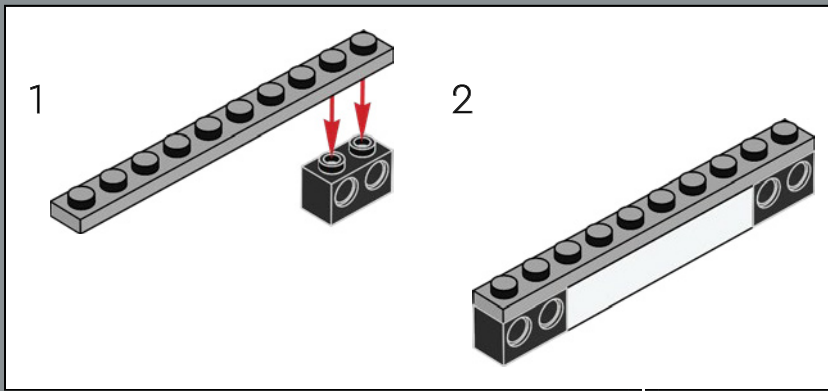

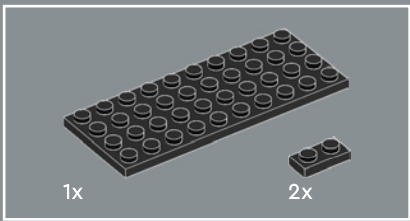

51

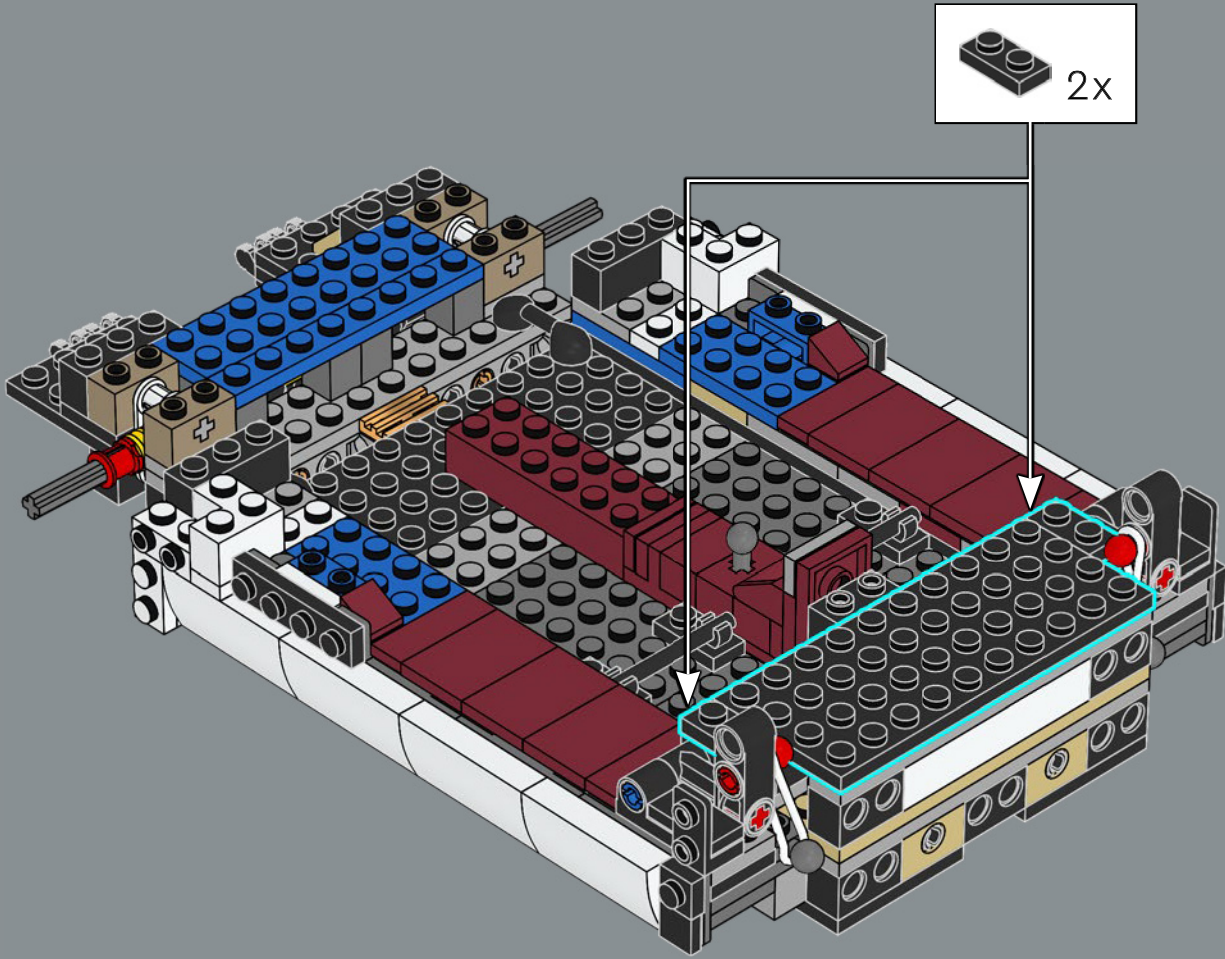

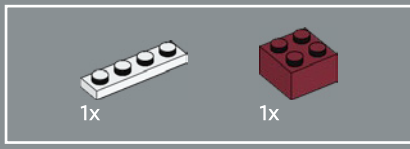

52

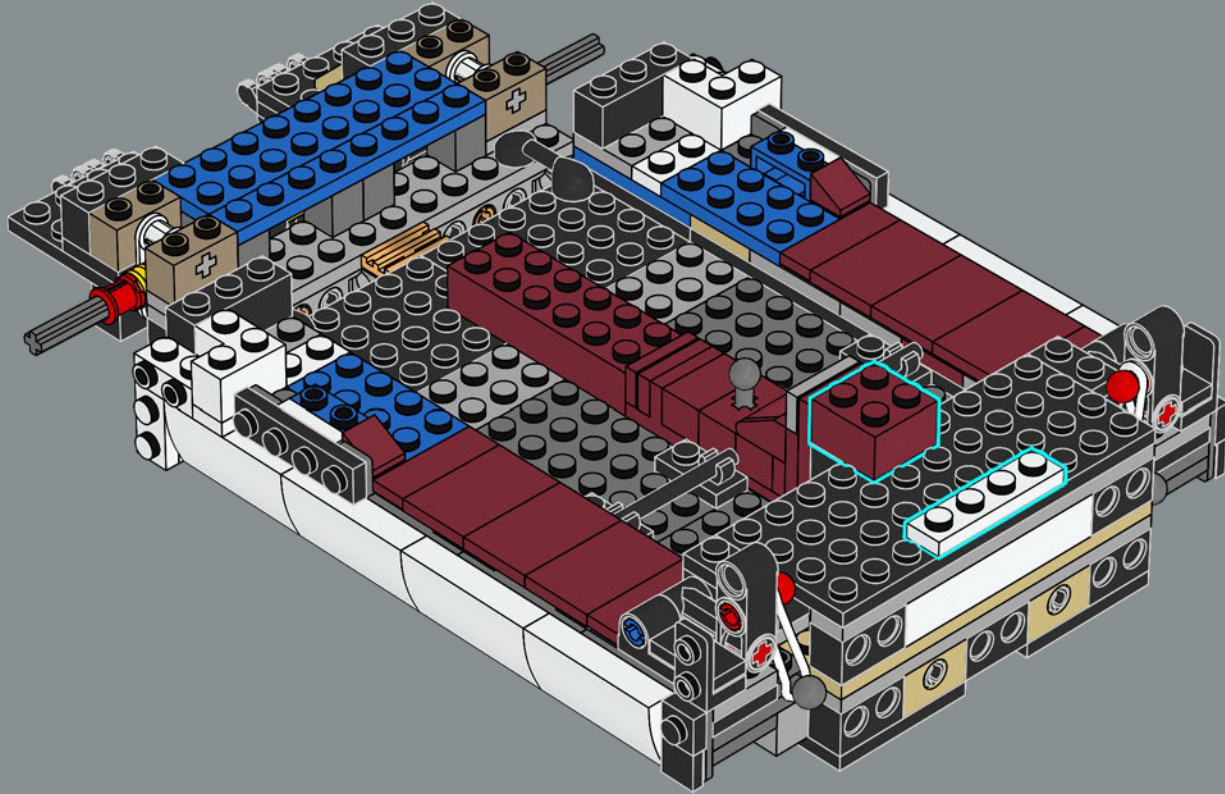

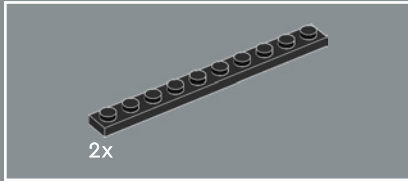
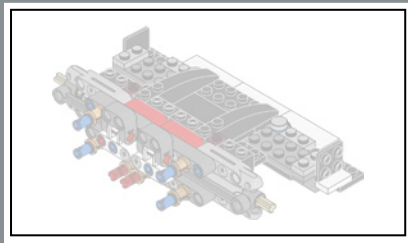

53

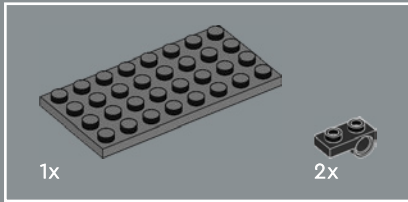
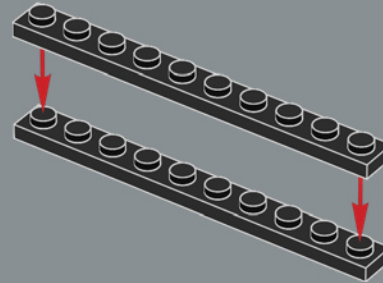

54

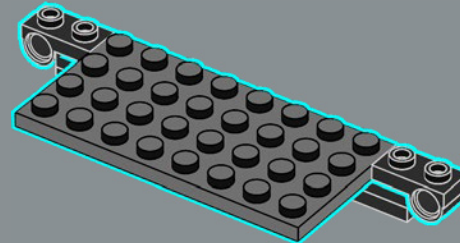

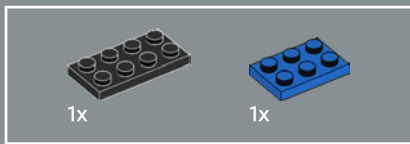

55

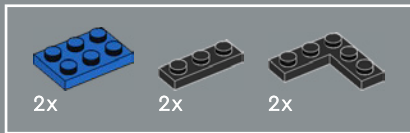
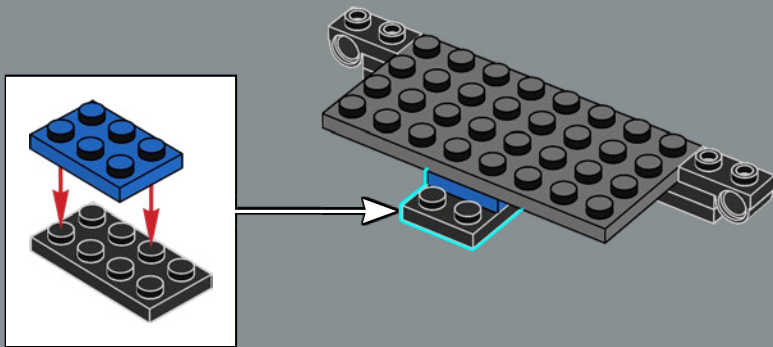

56

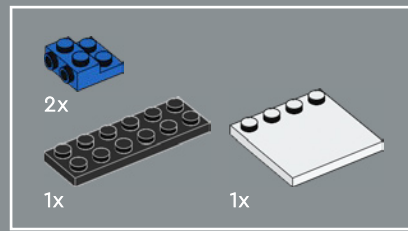
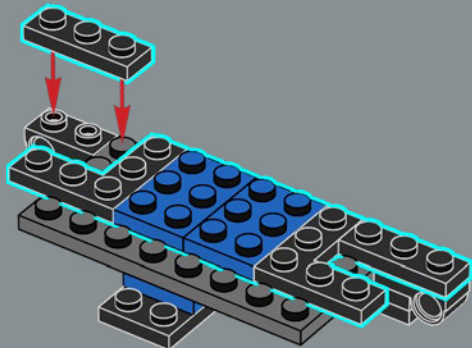

57

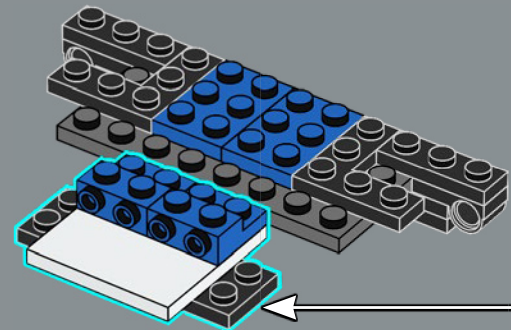
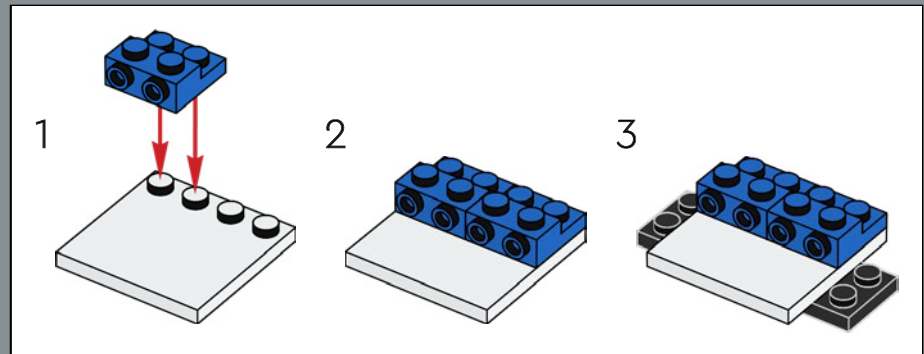

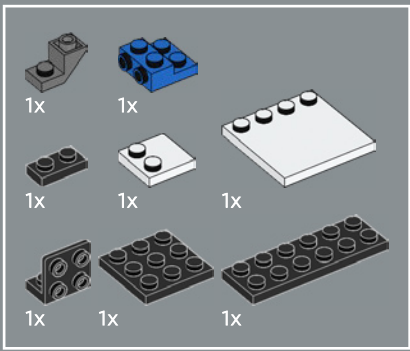

58

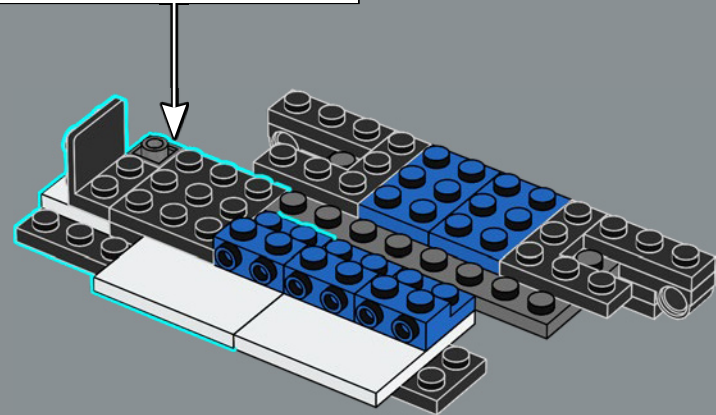
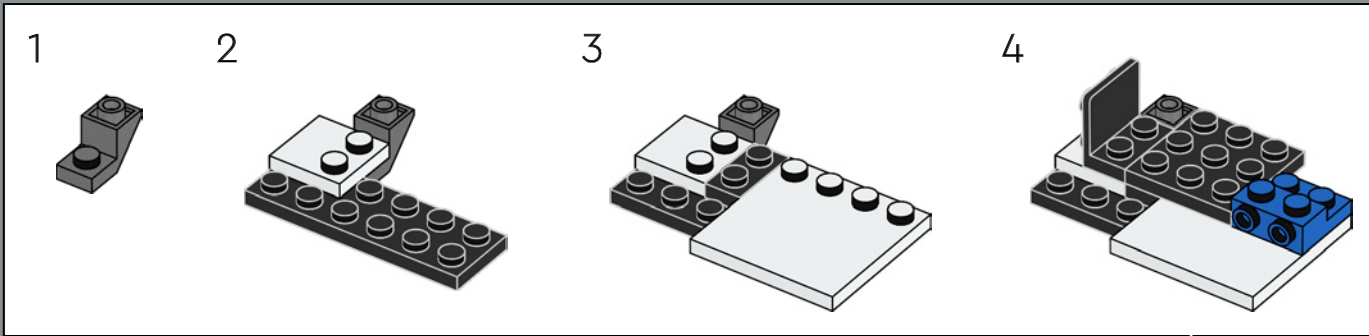

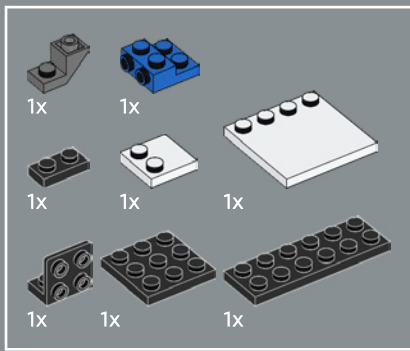

59

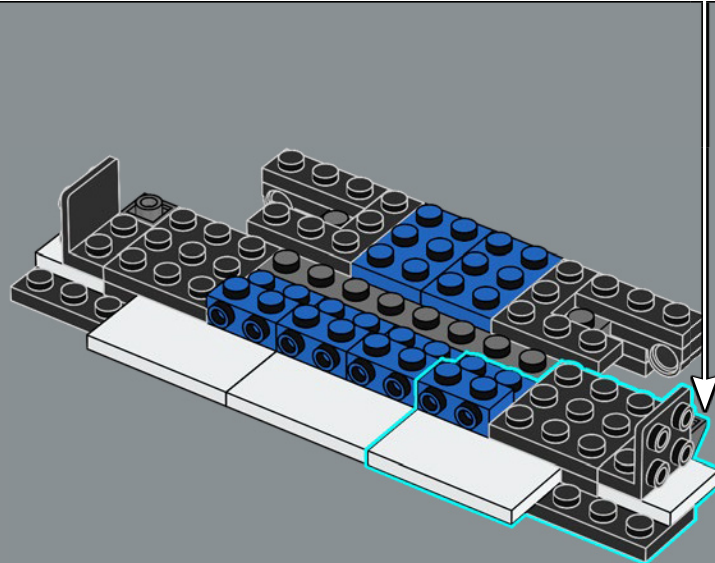
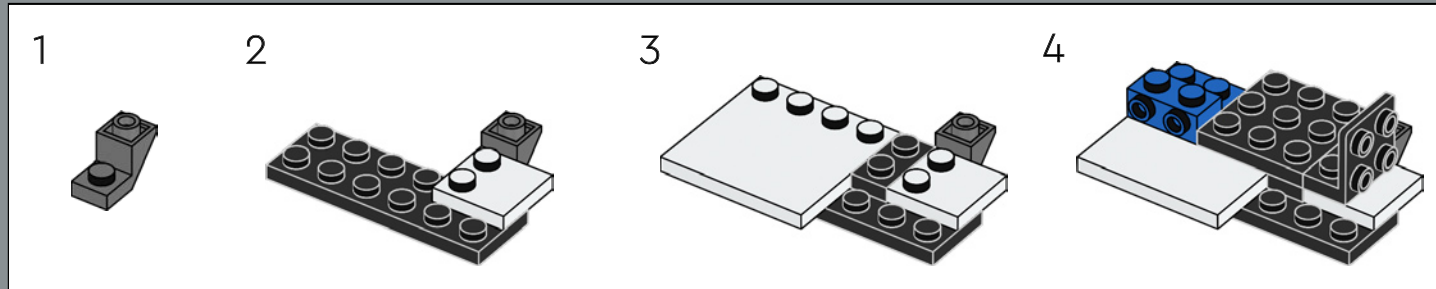

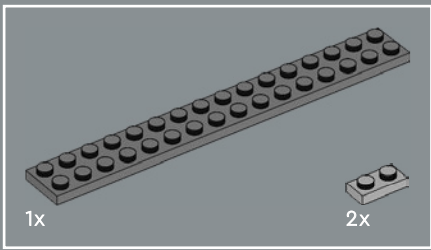

60

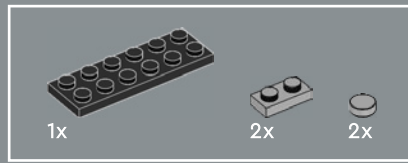
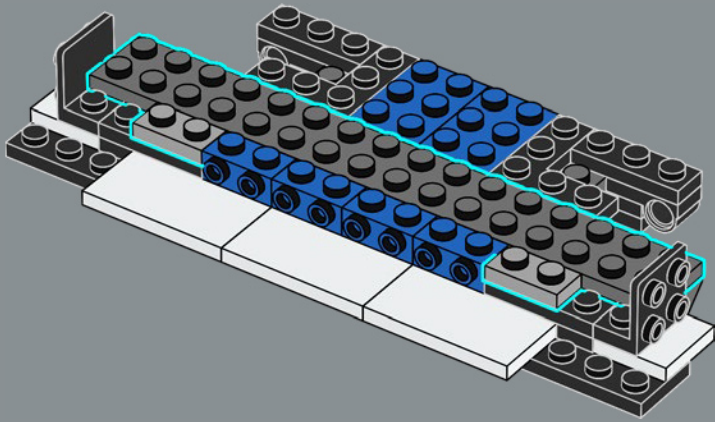

61

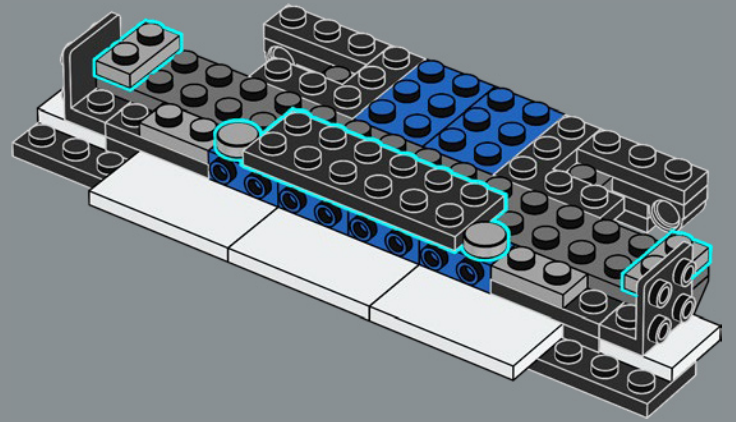

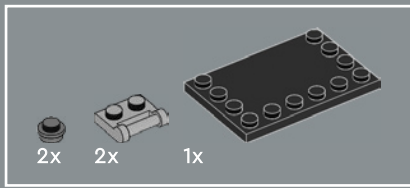

62

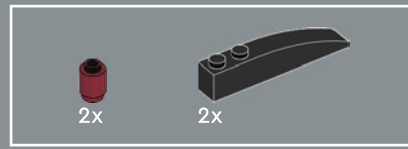
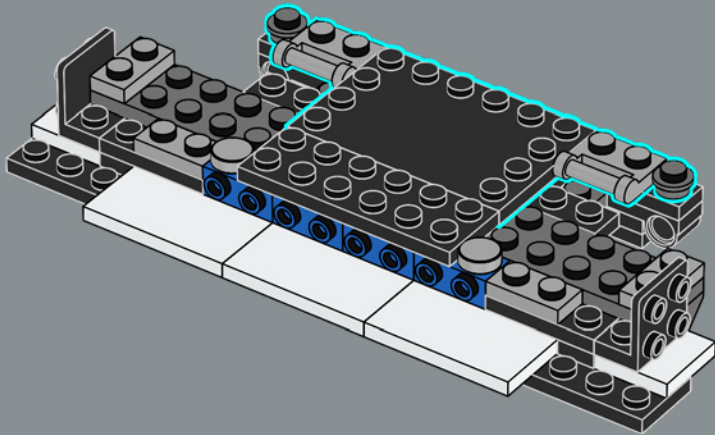

63

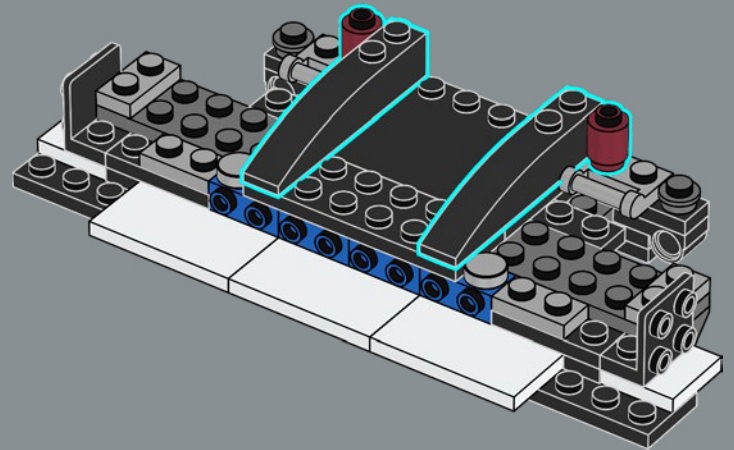

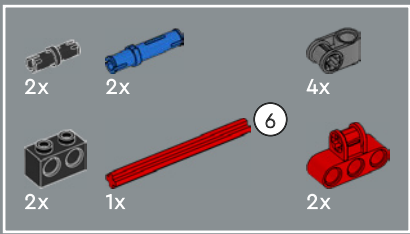

64

1

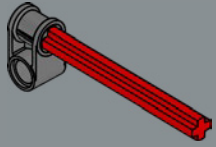

2

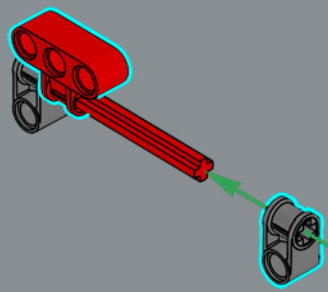

3

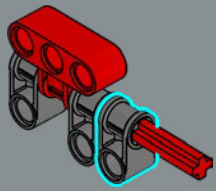

4

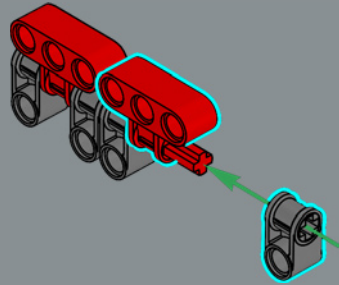

5

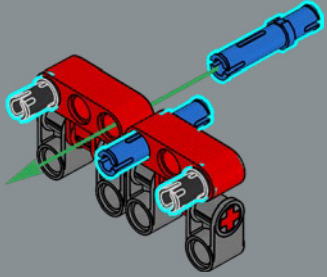

6

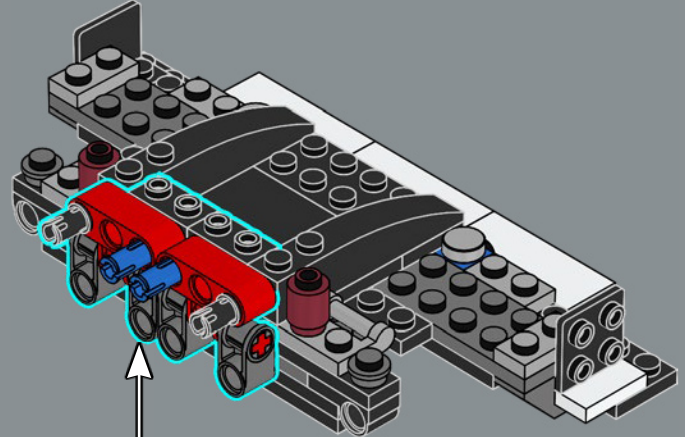
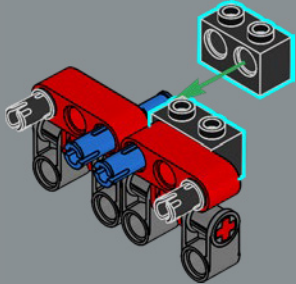

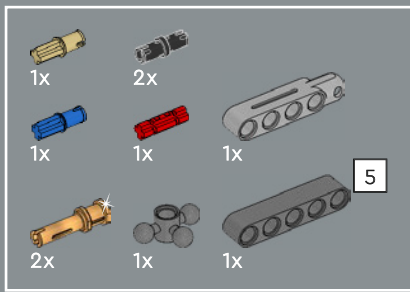

65

1

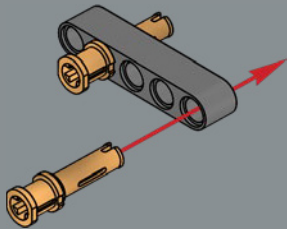

2

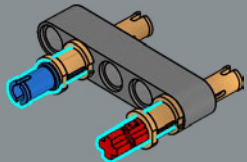

3

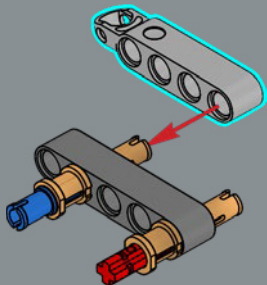

4

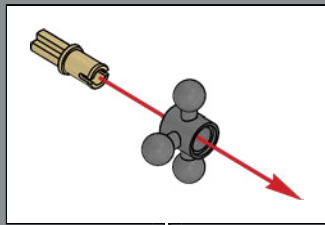
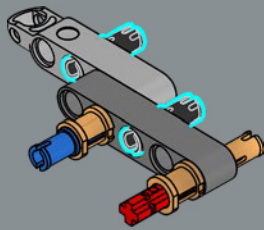

5

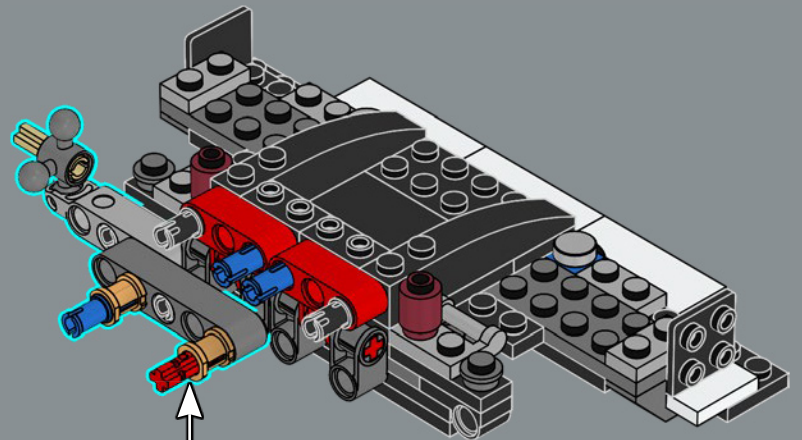
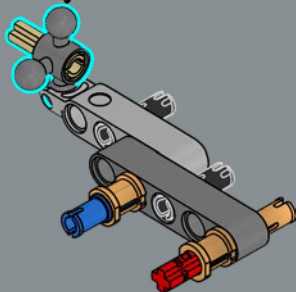

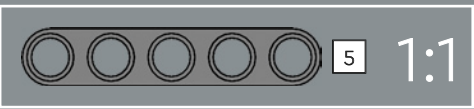
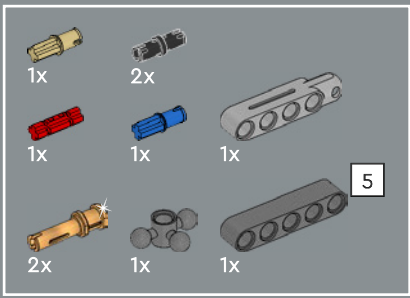

66

1

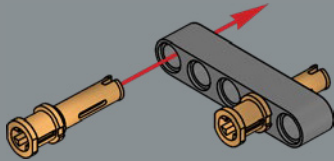

2

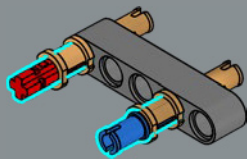

3

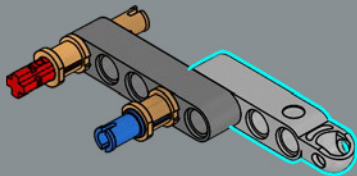

4

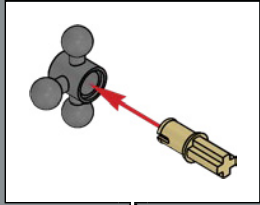
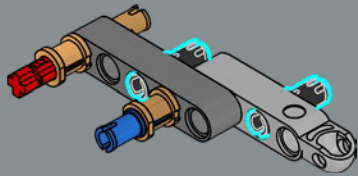

5

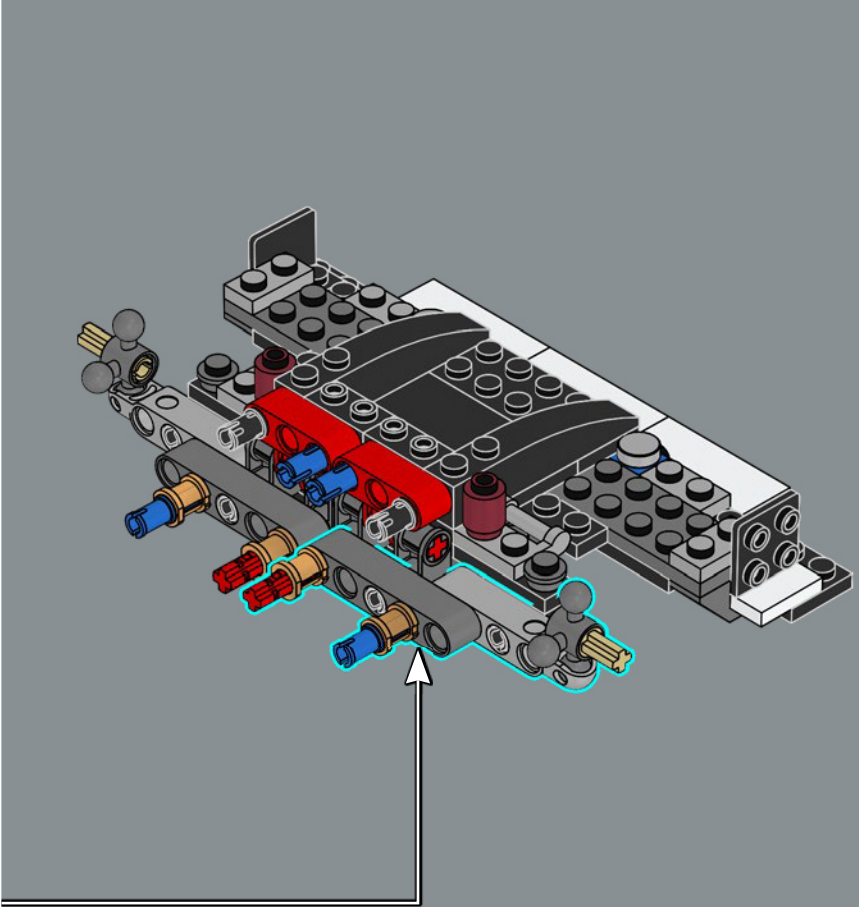
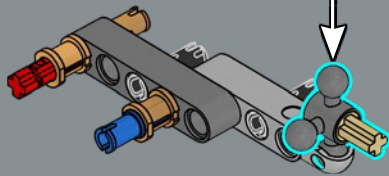

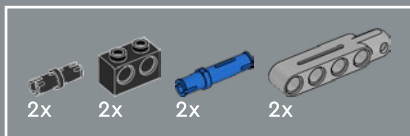

67

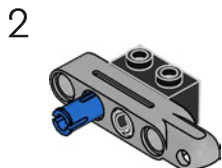
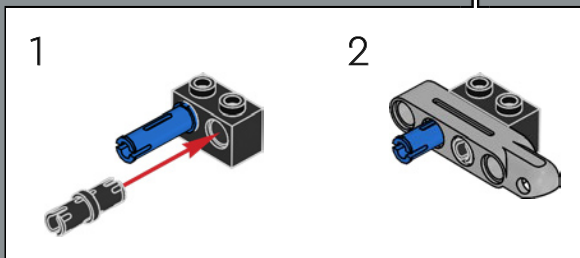
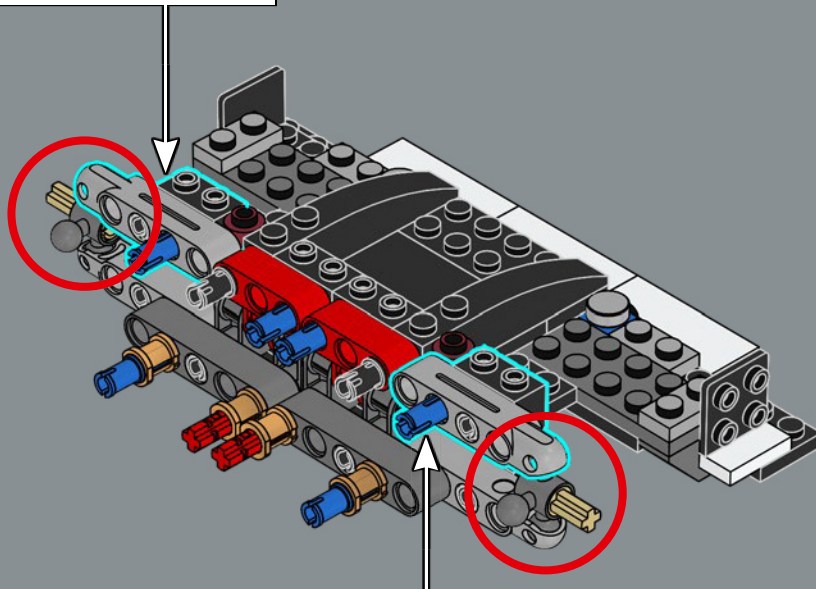
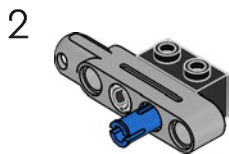
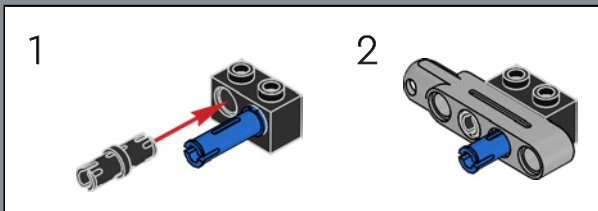

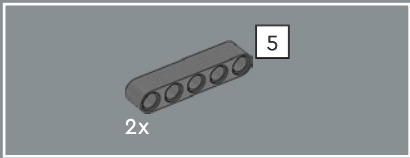

68

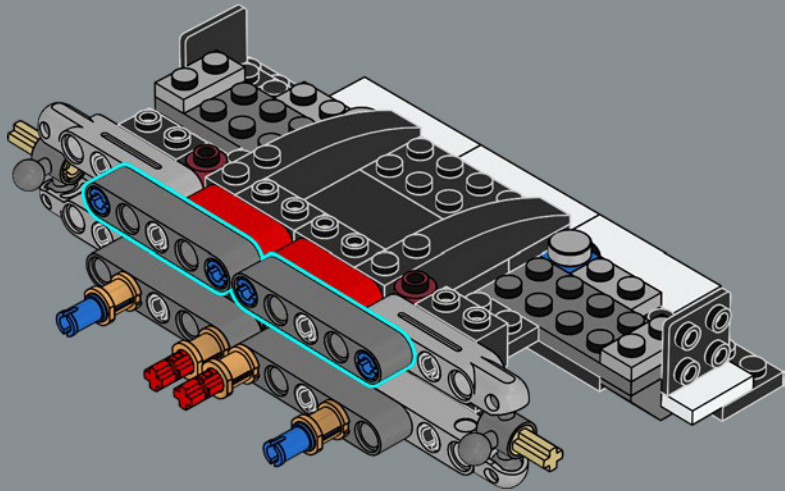

69

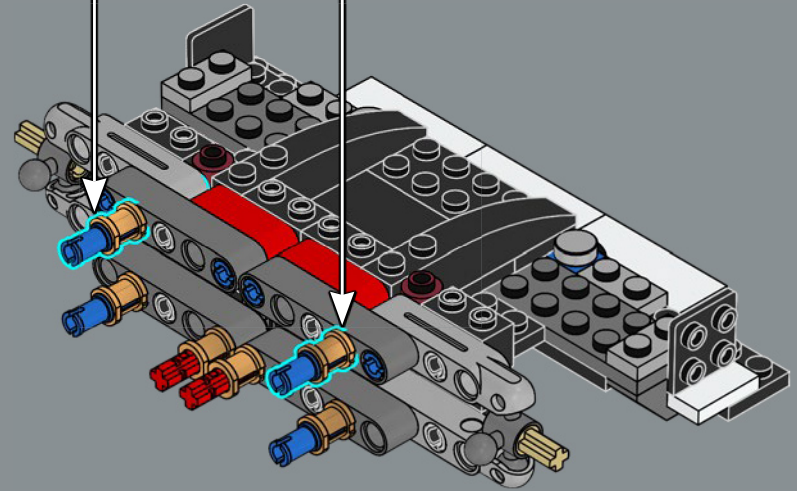
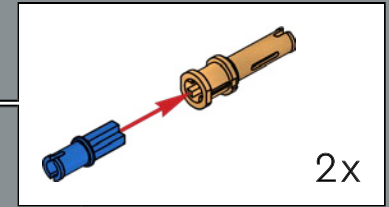

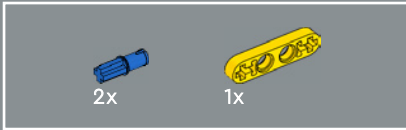
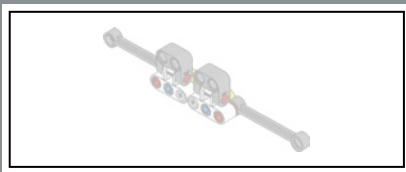

70

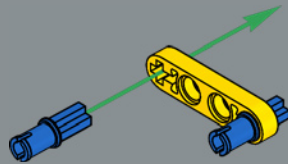

71

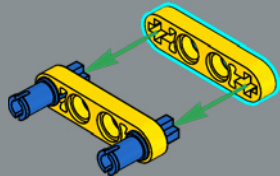

72

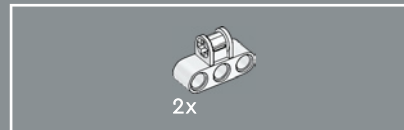
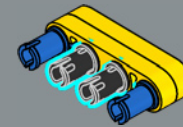

73

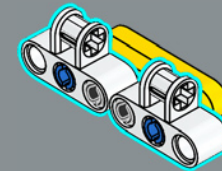

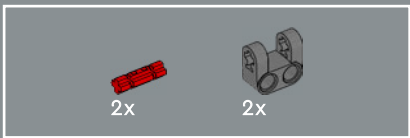

74

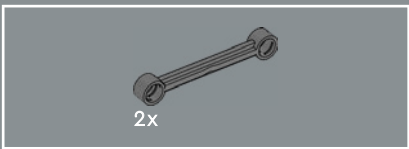
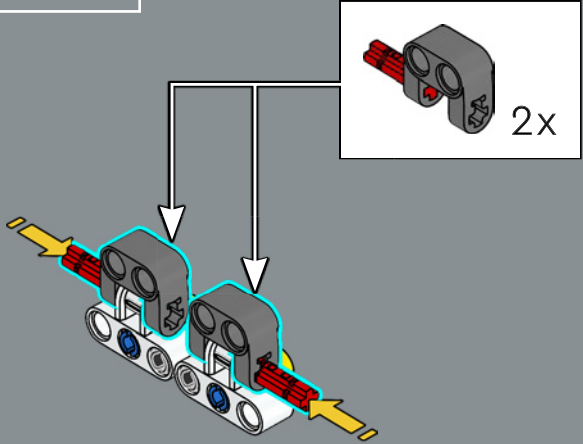

76

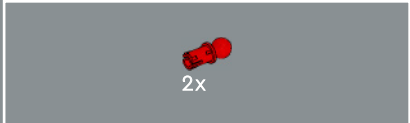
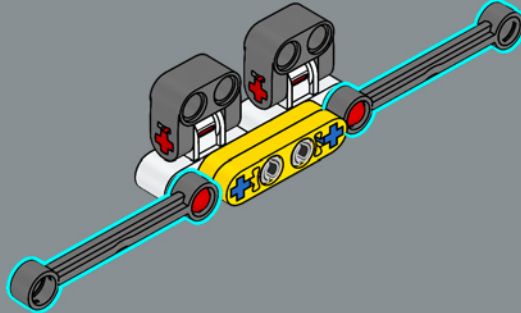

75

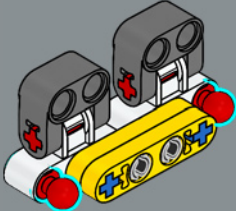

77

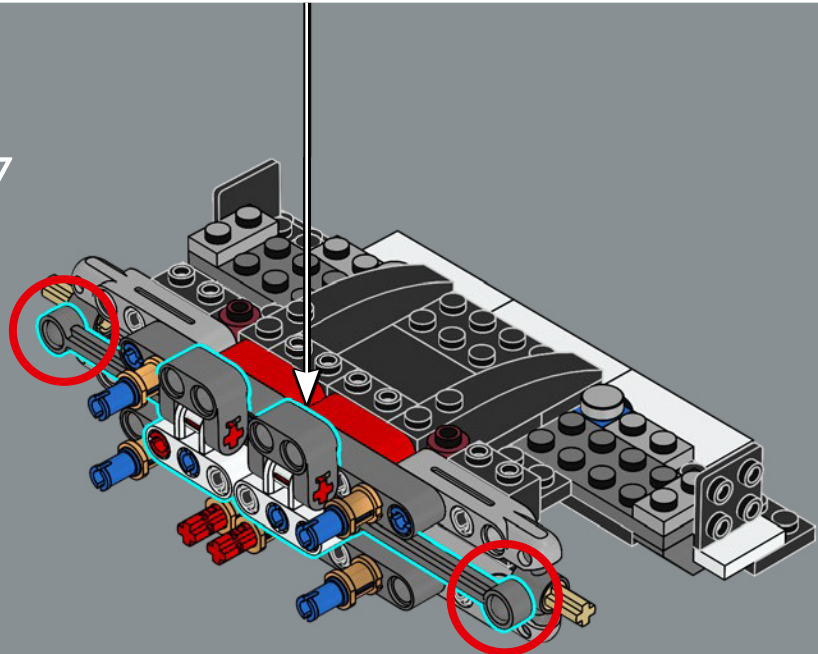

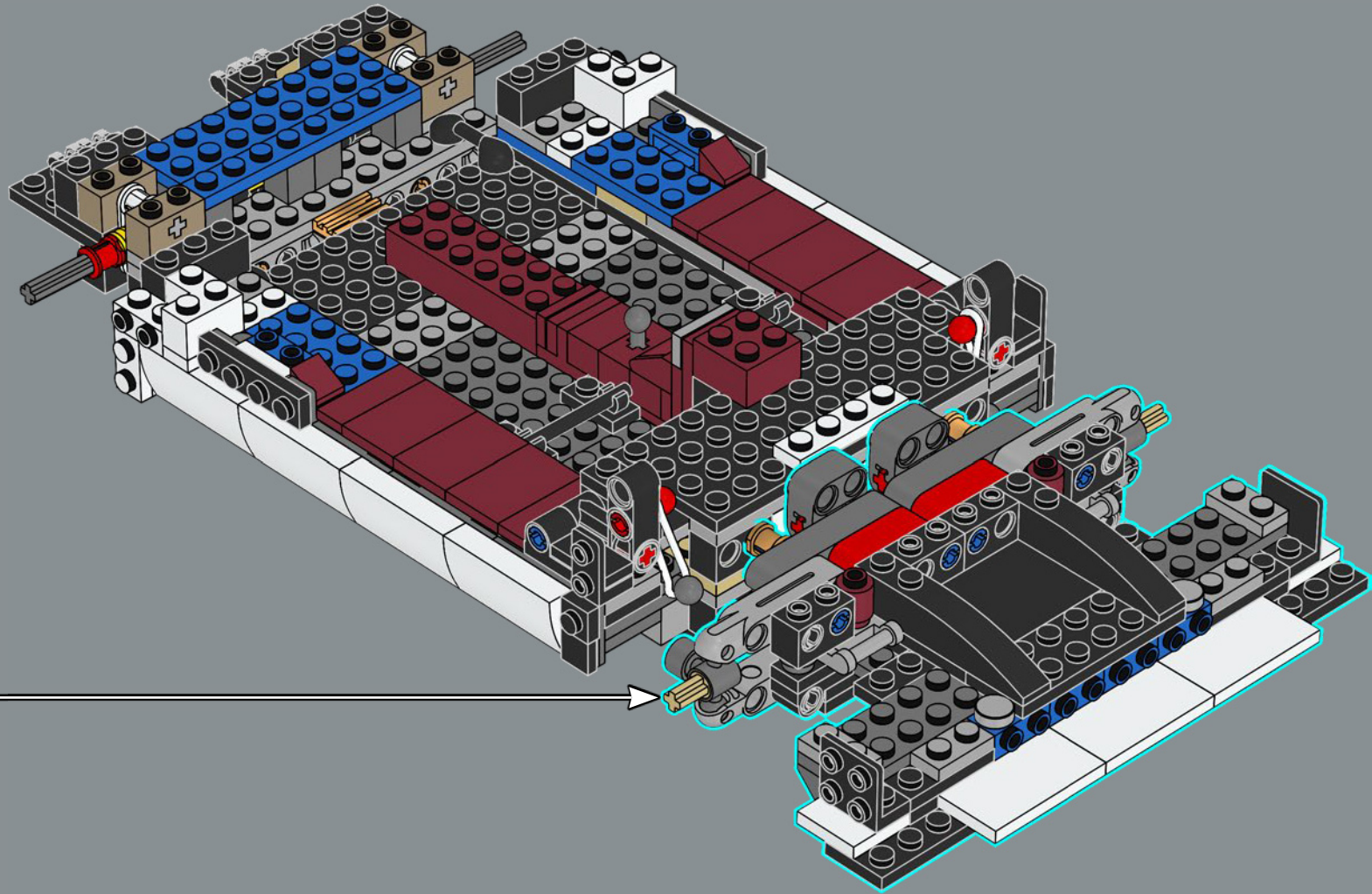

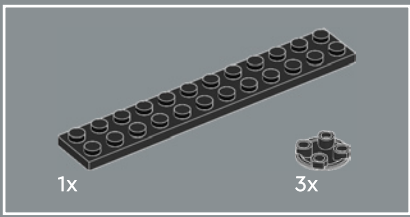

79

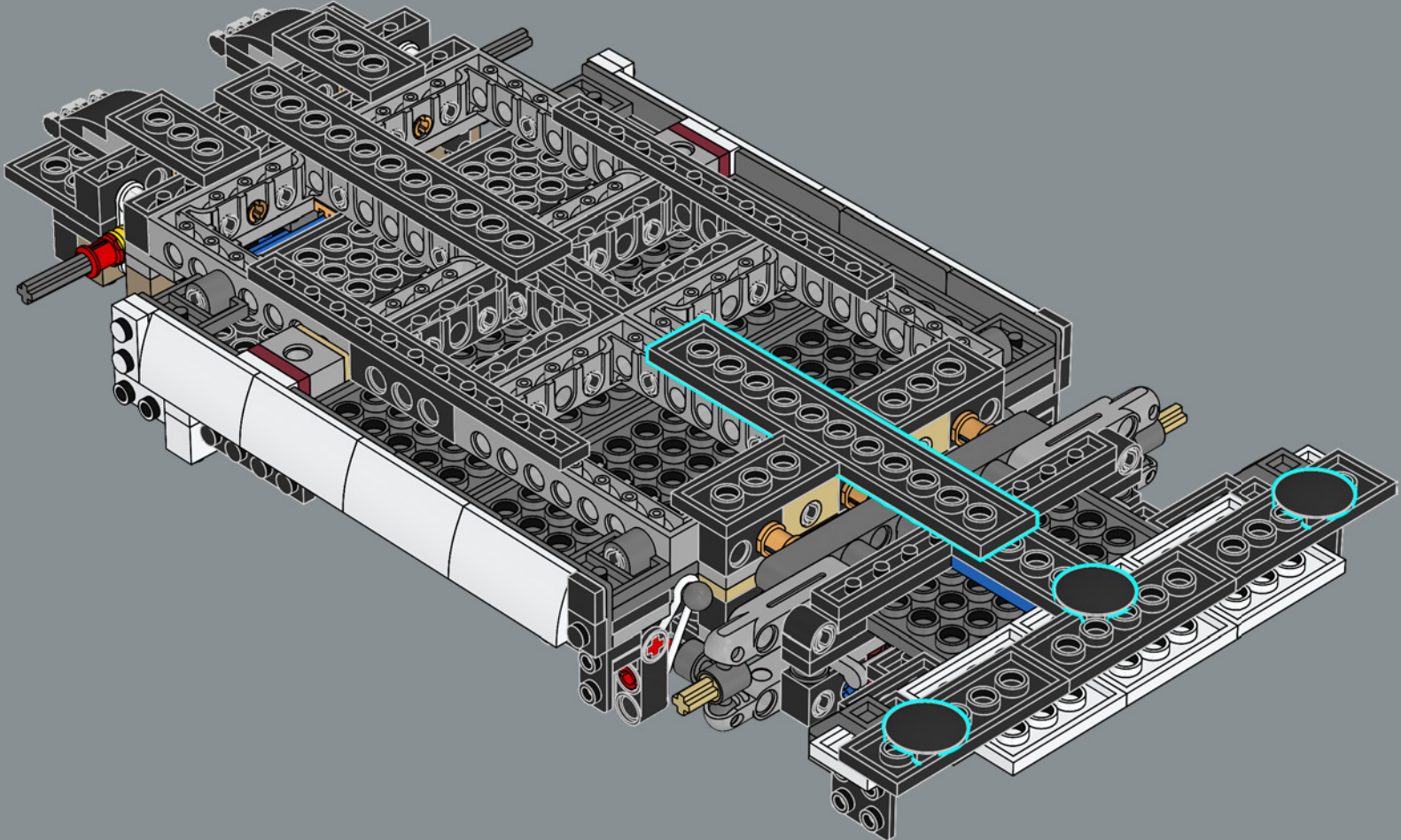

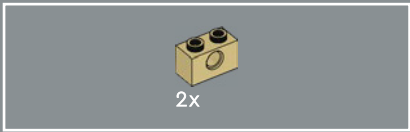

80

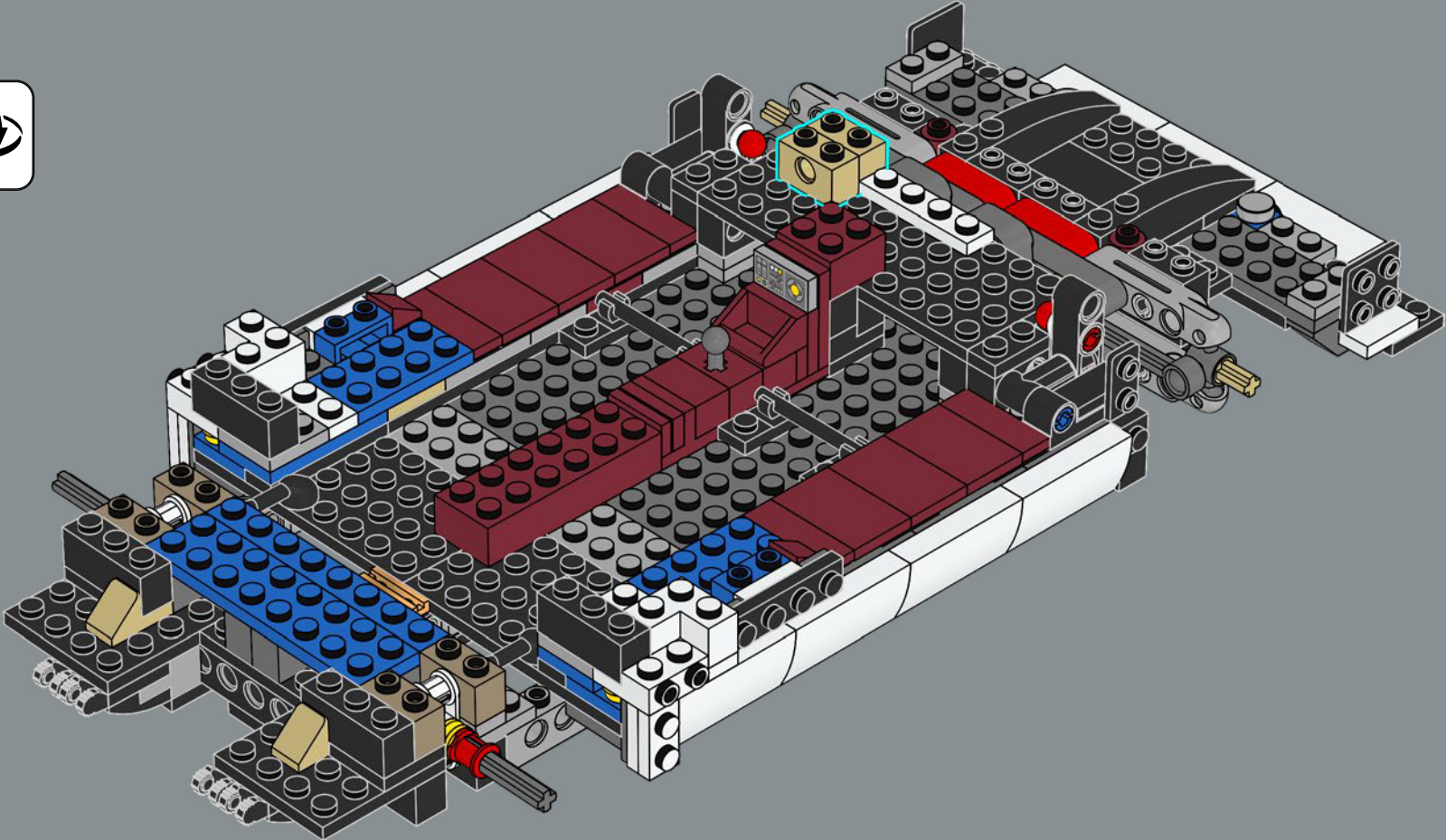

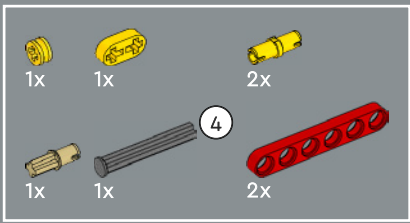

81

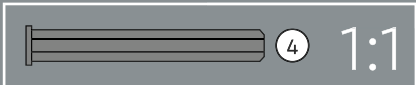
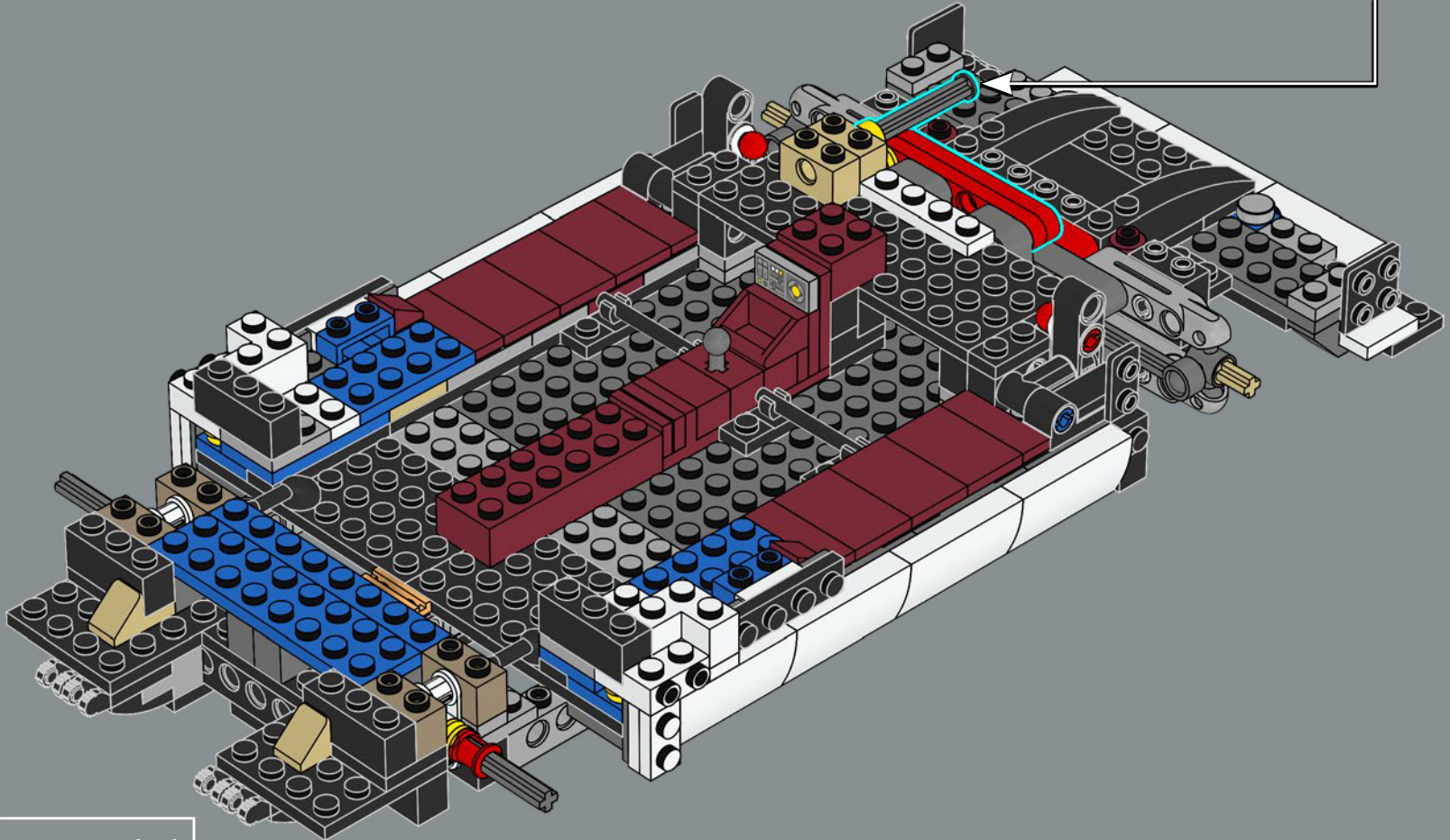
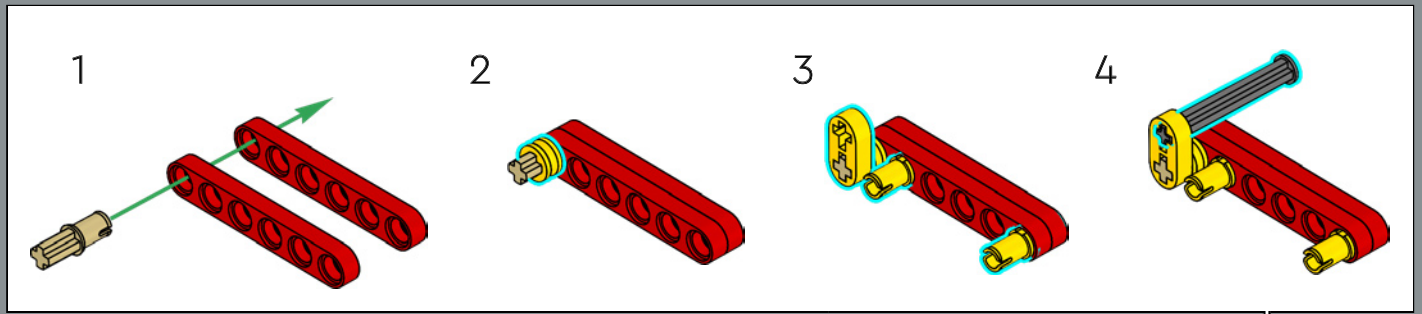



1x

82

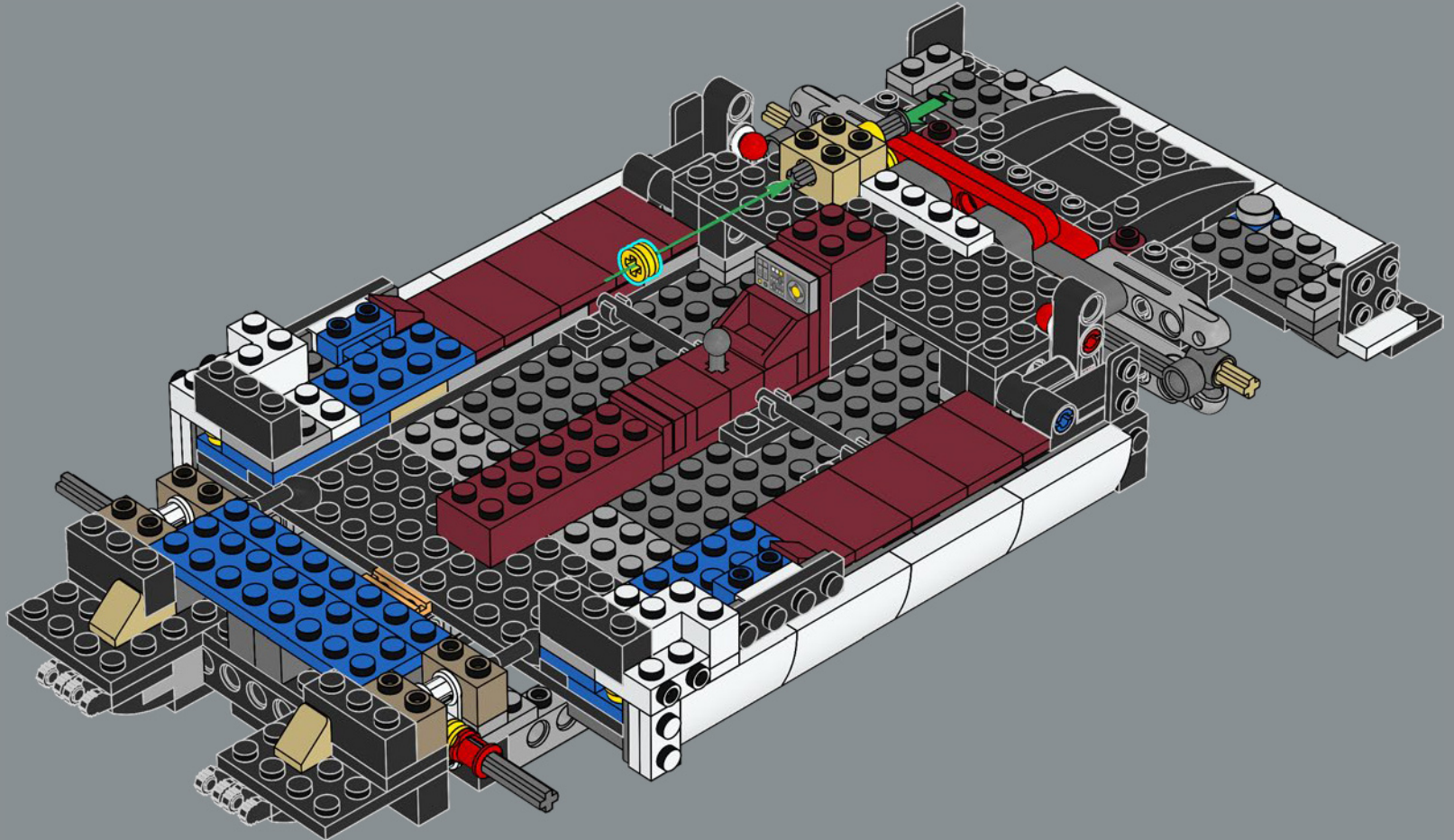

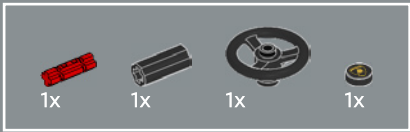

83

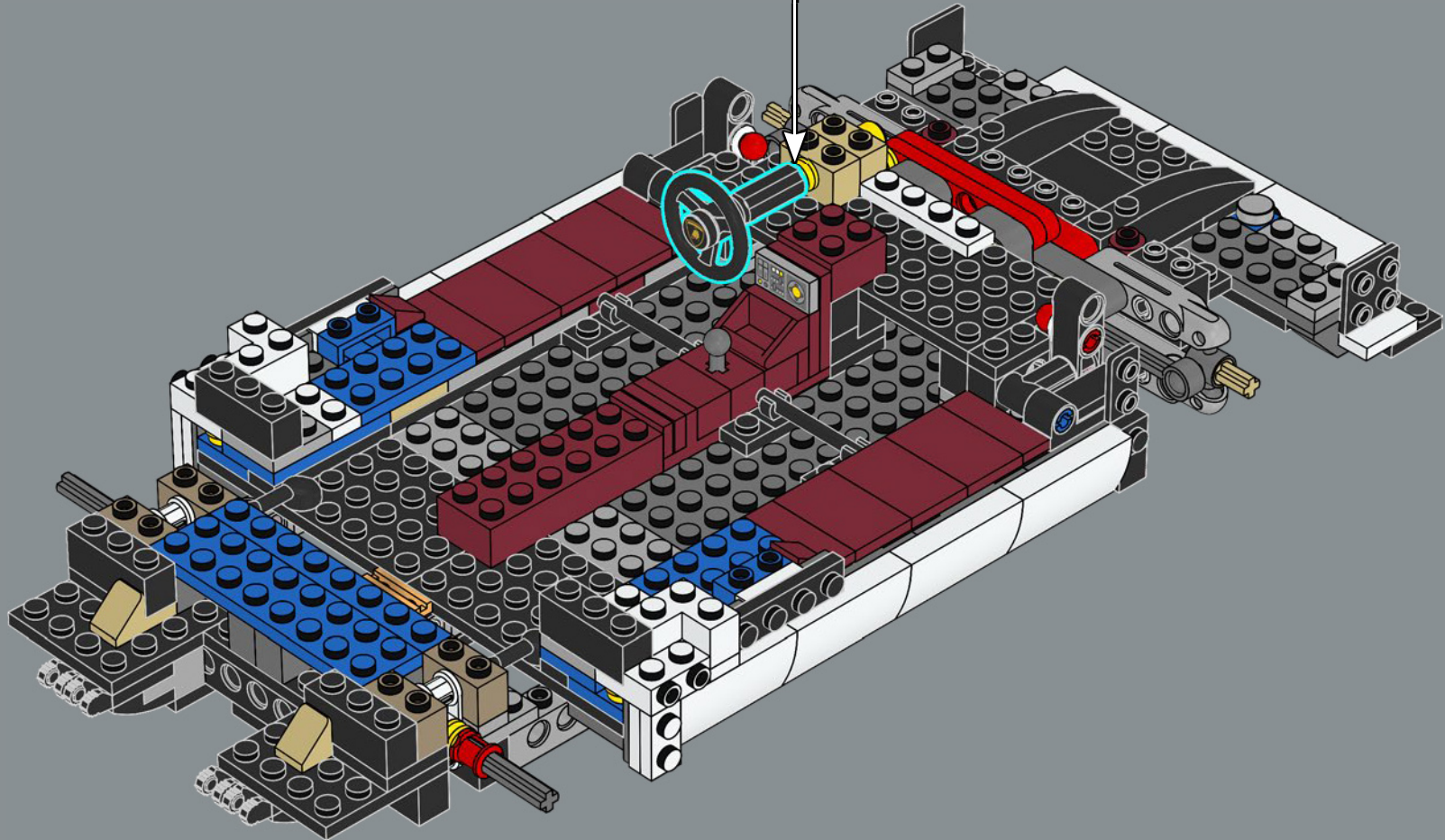
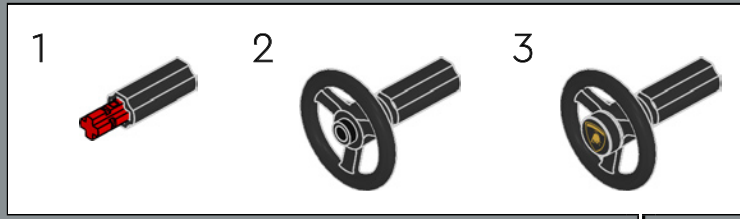

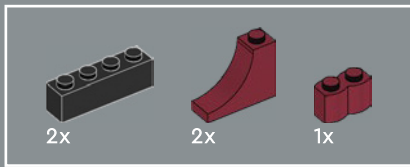

84

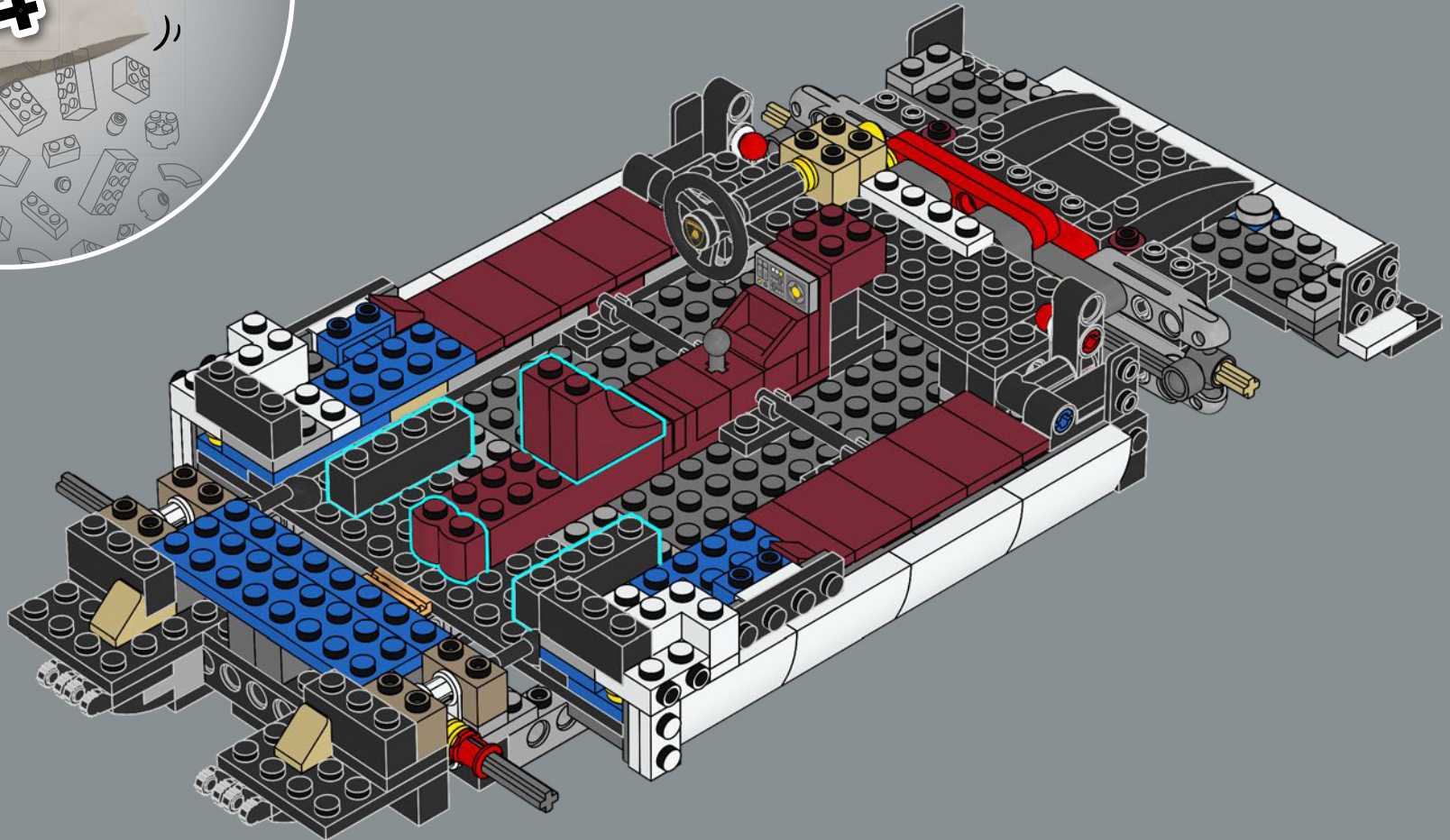

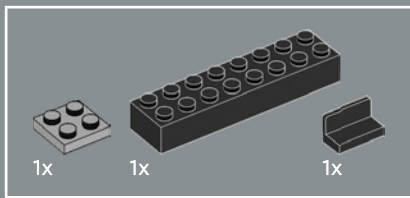

85

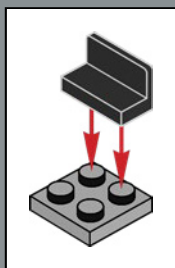
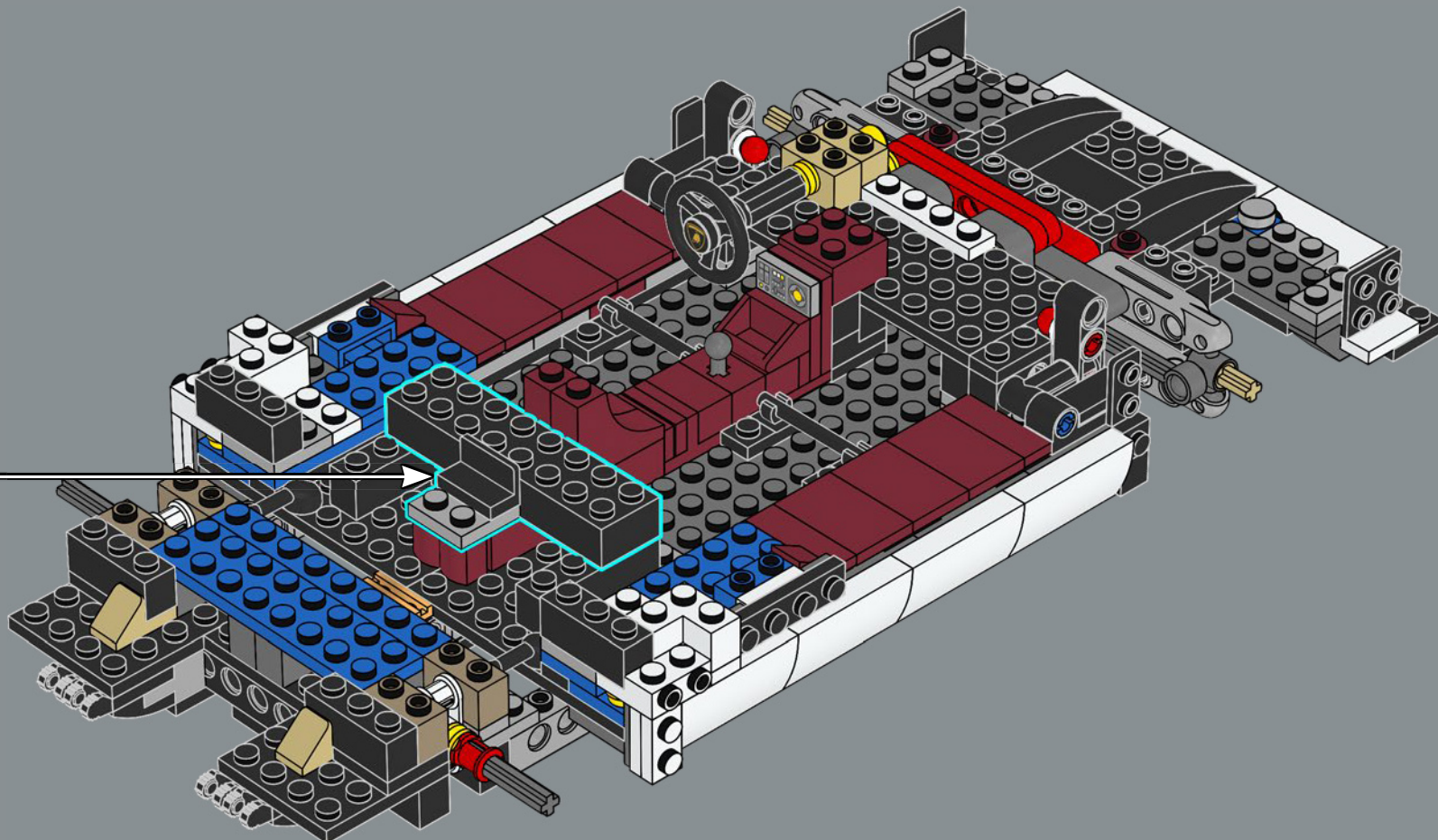

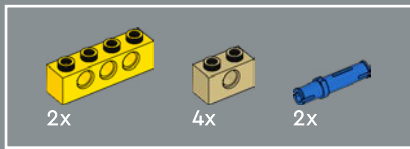

86

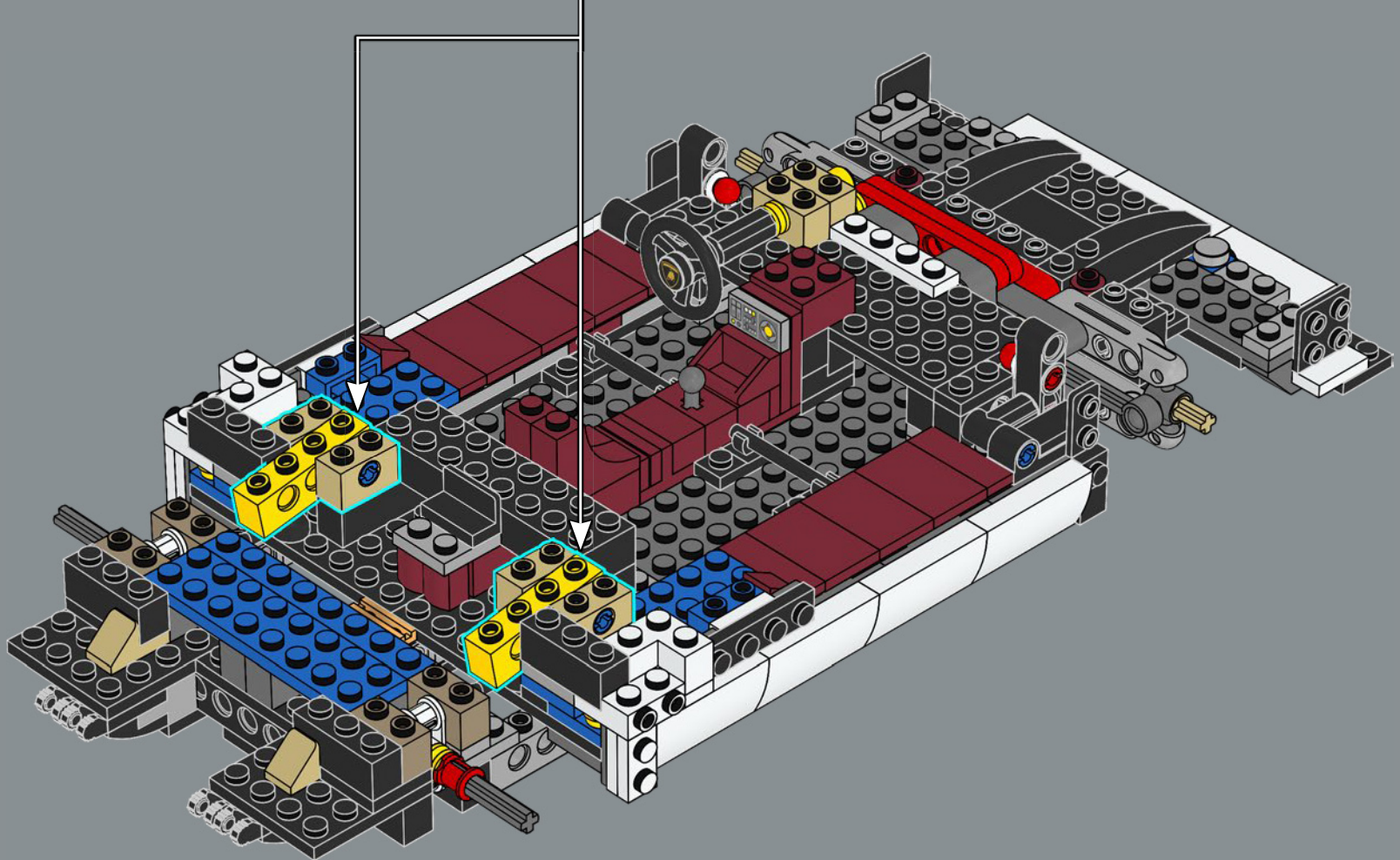
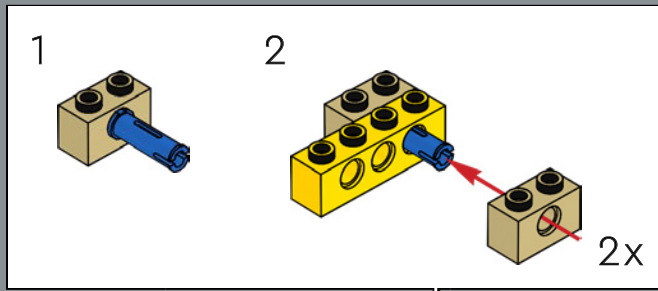

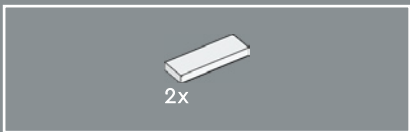

87

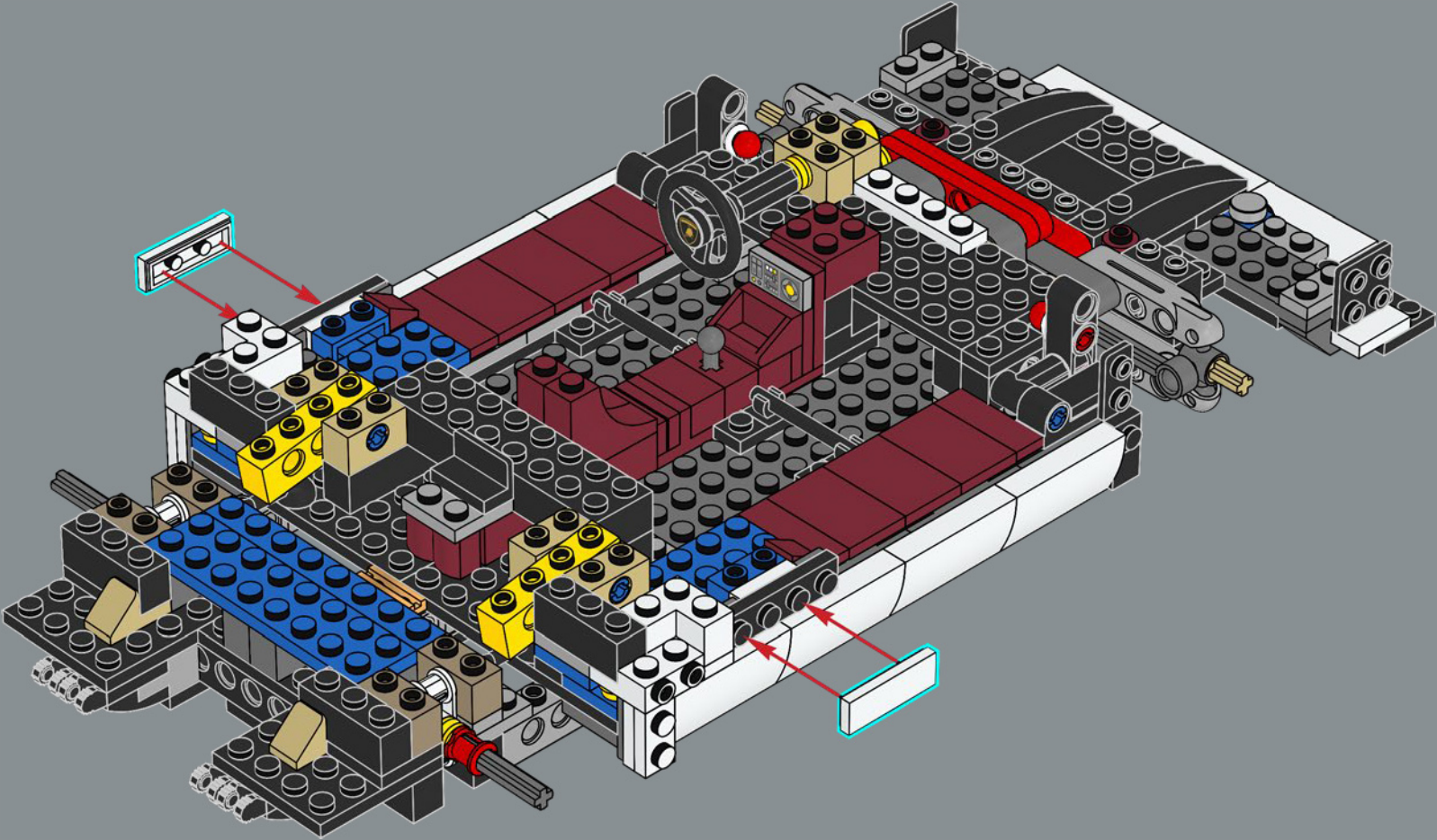

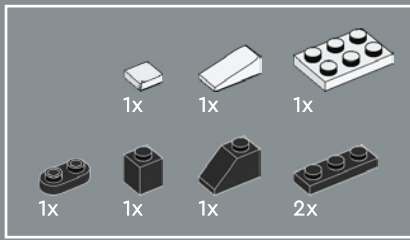

88

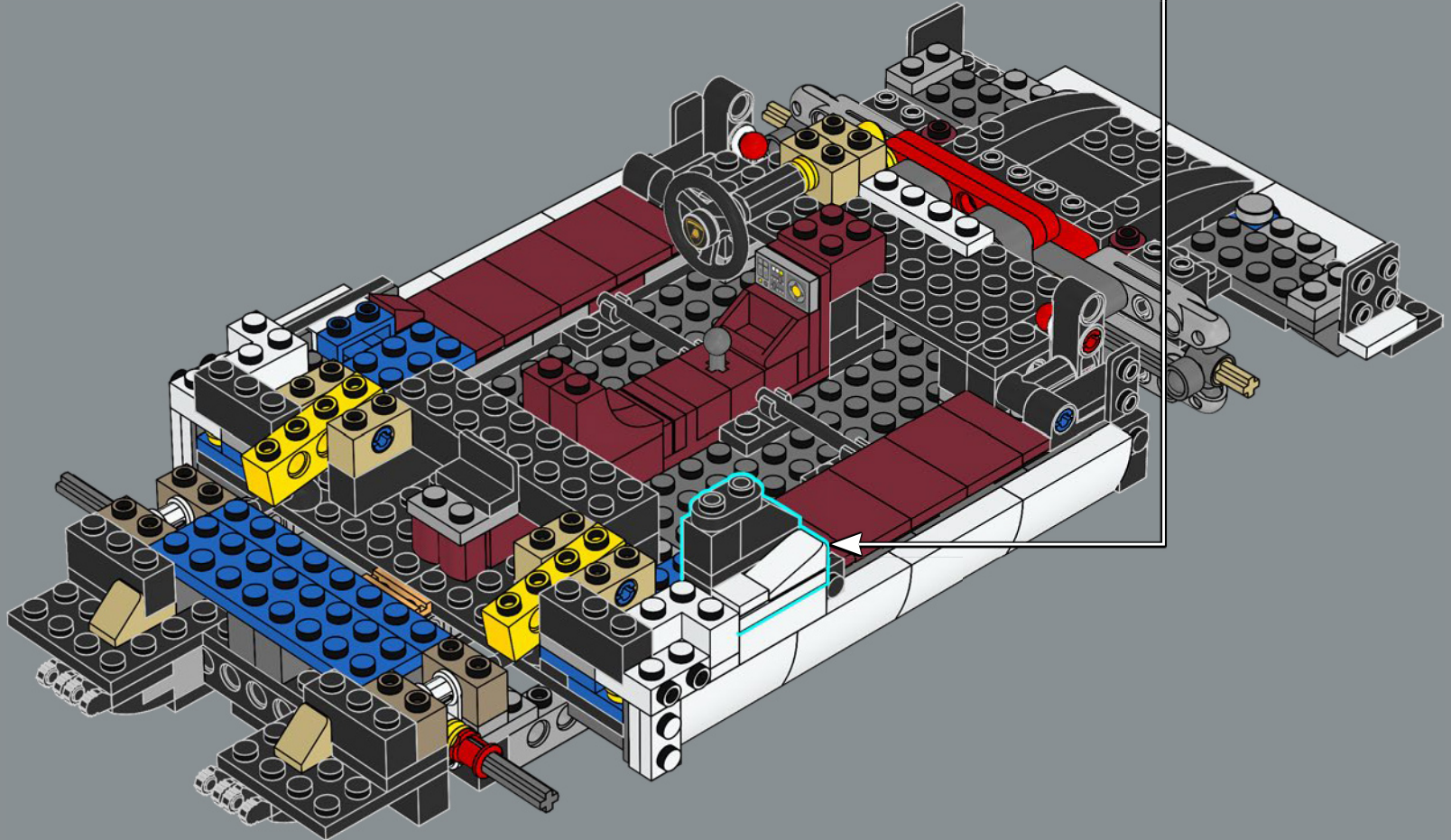
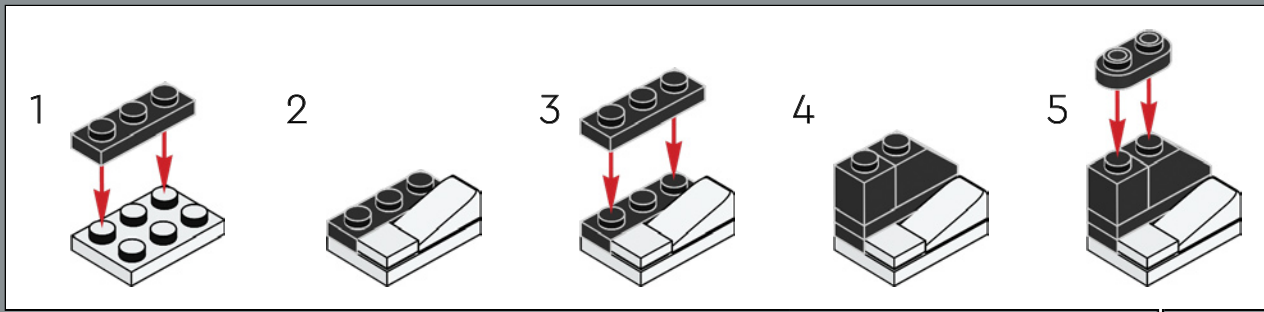

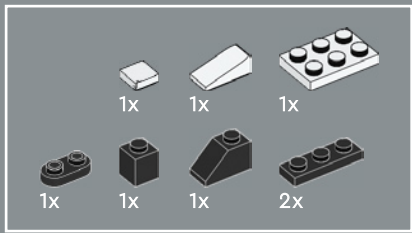

89

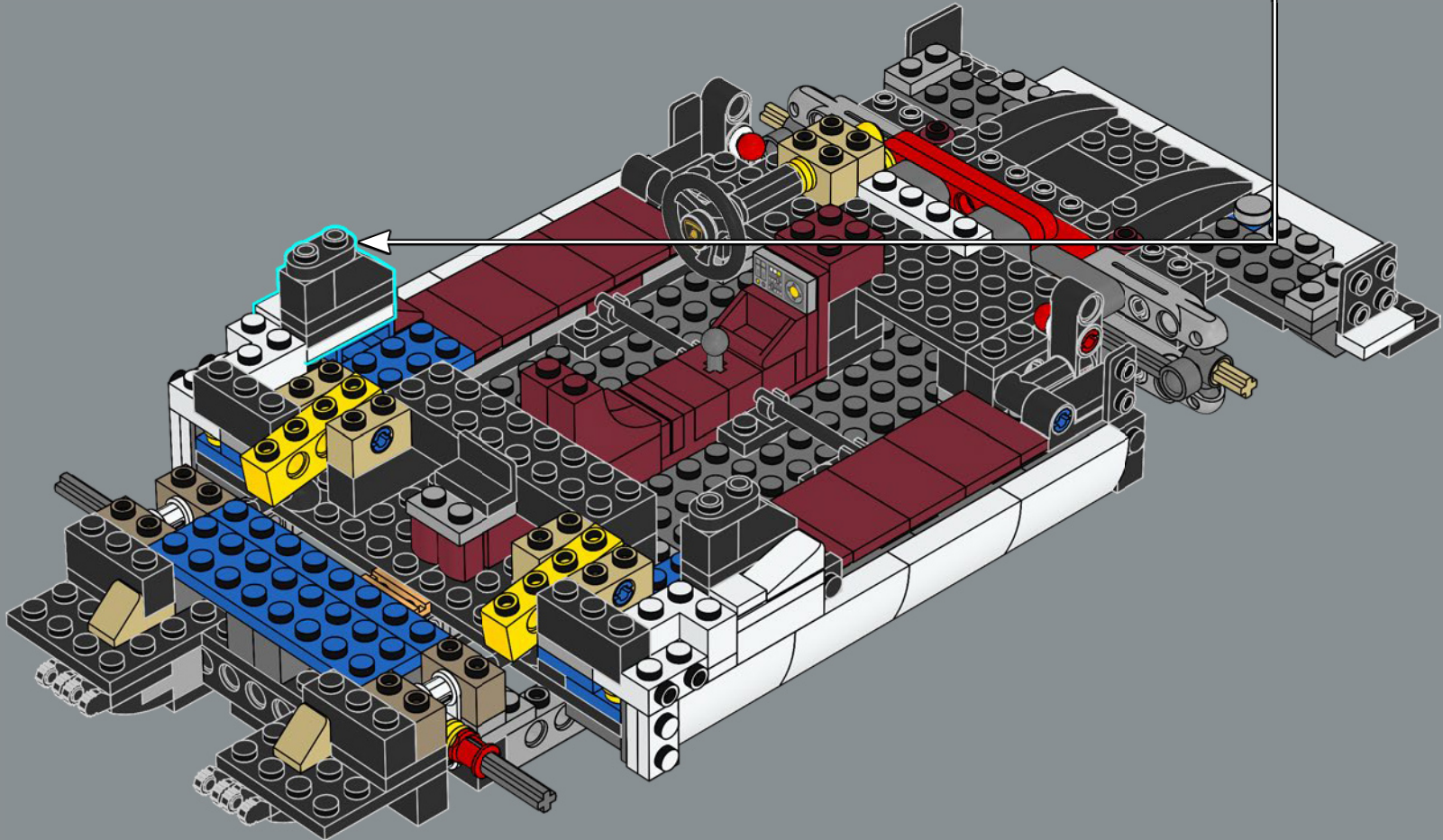
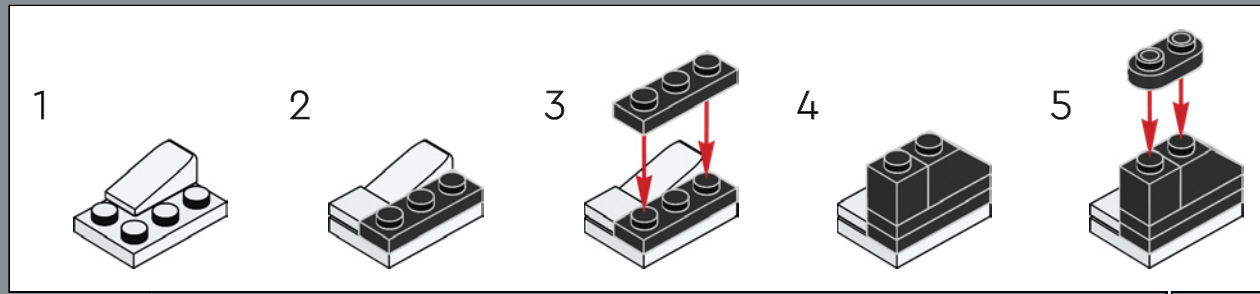

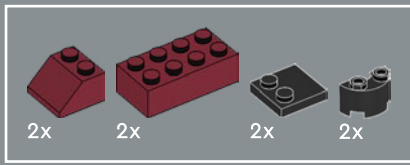

90

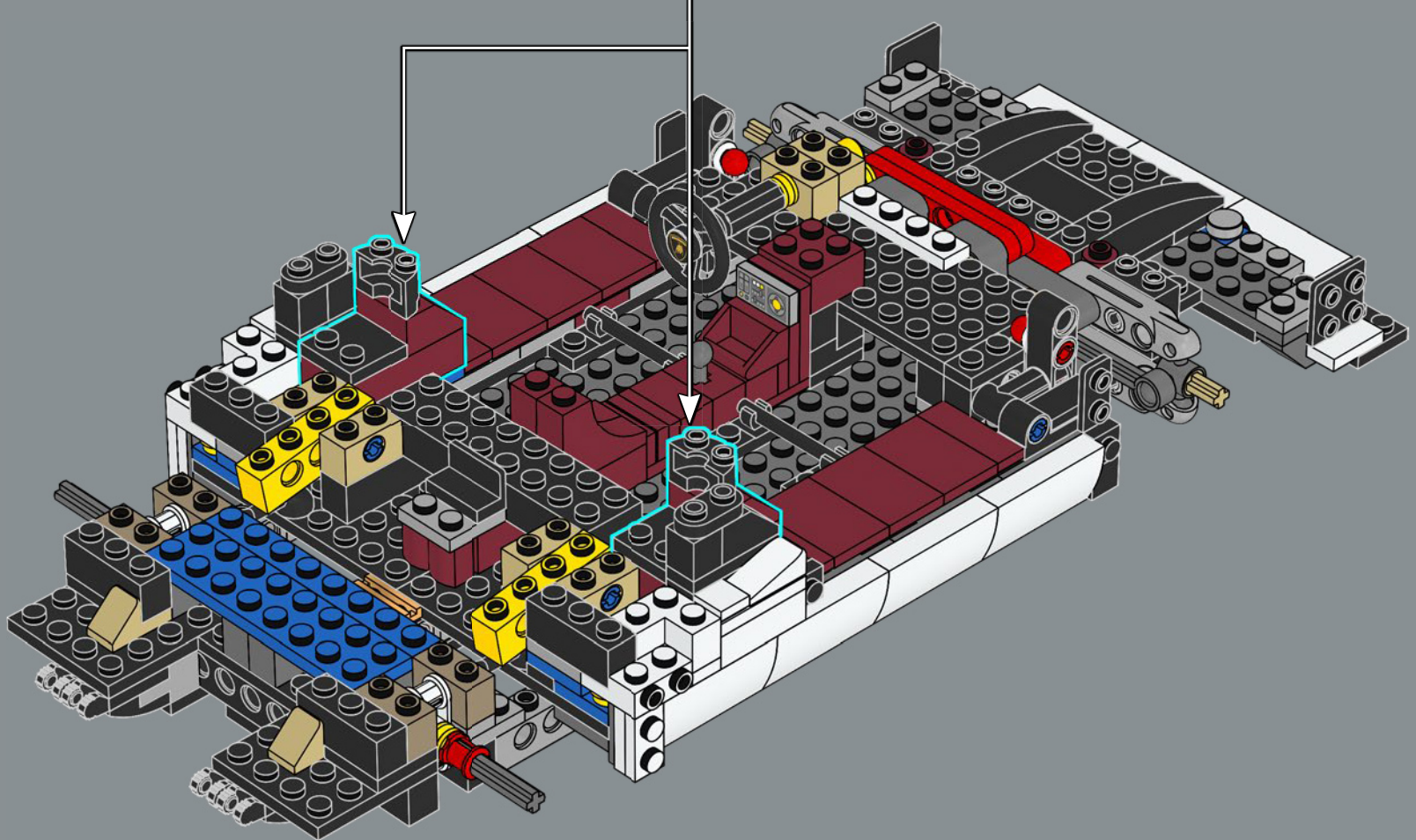
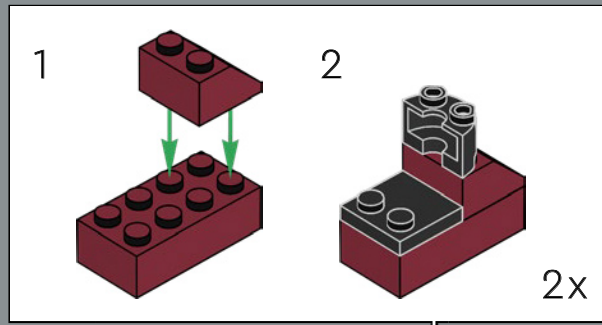



2x

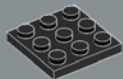

2x

91

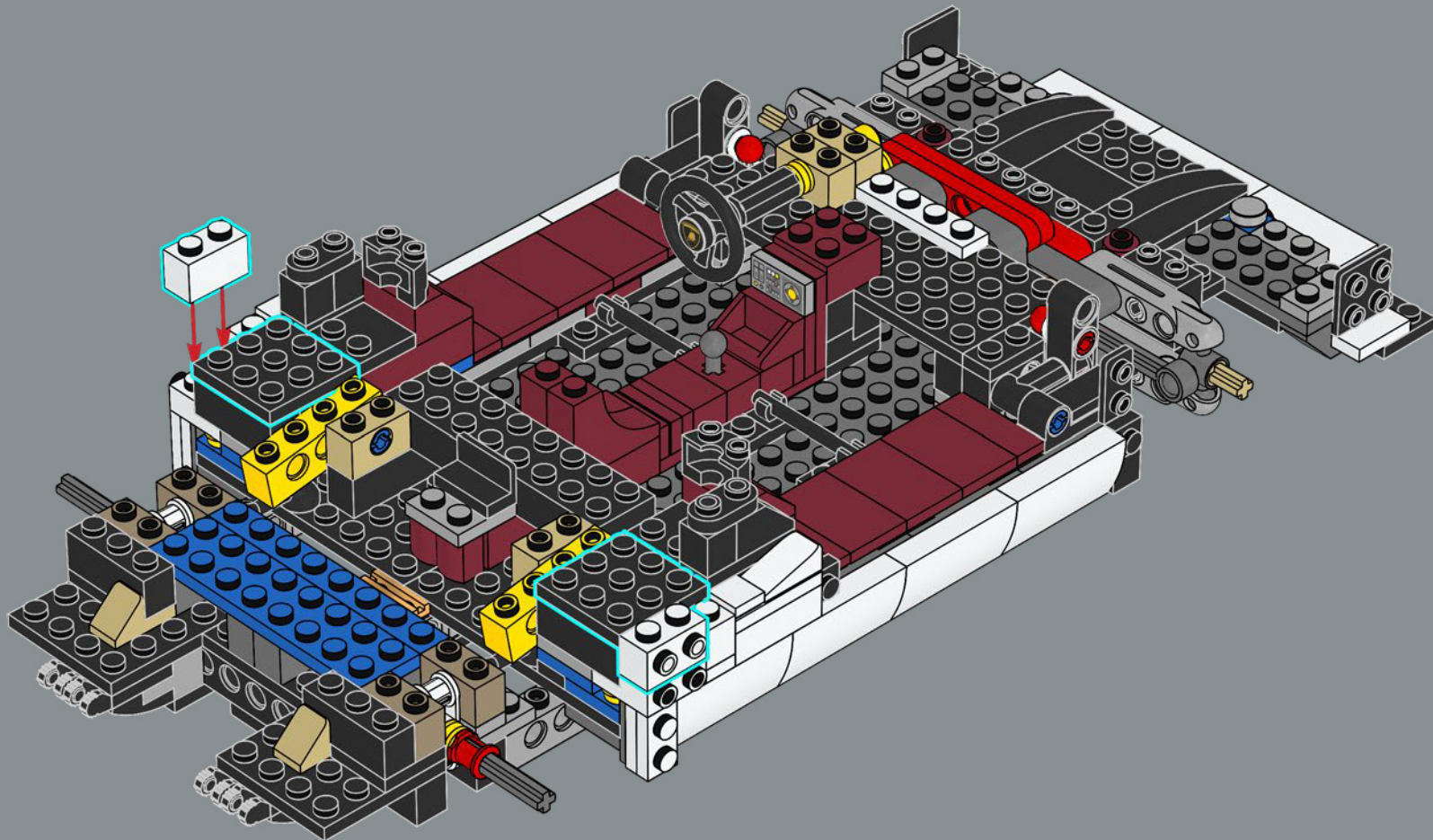

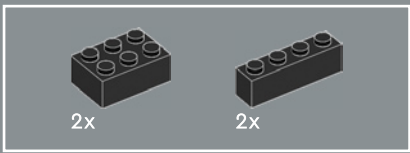

92

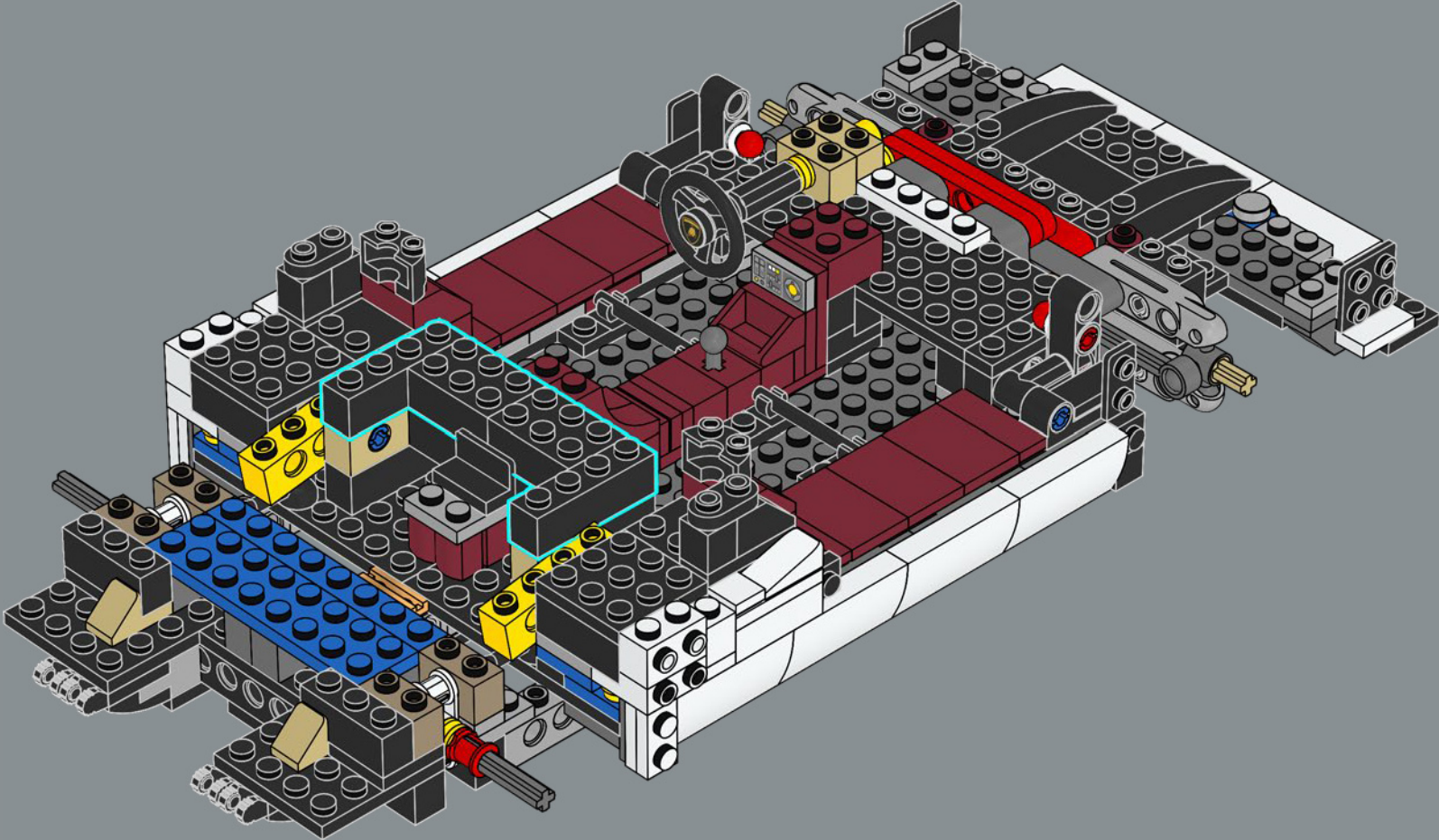

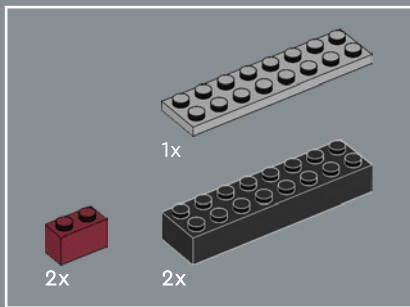

93

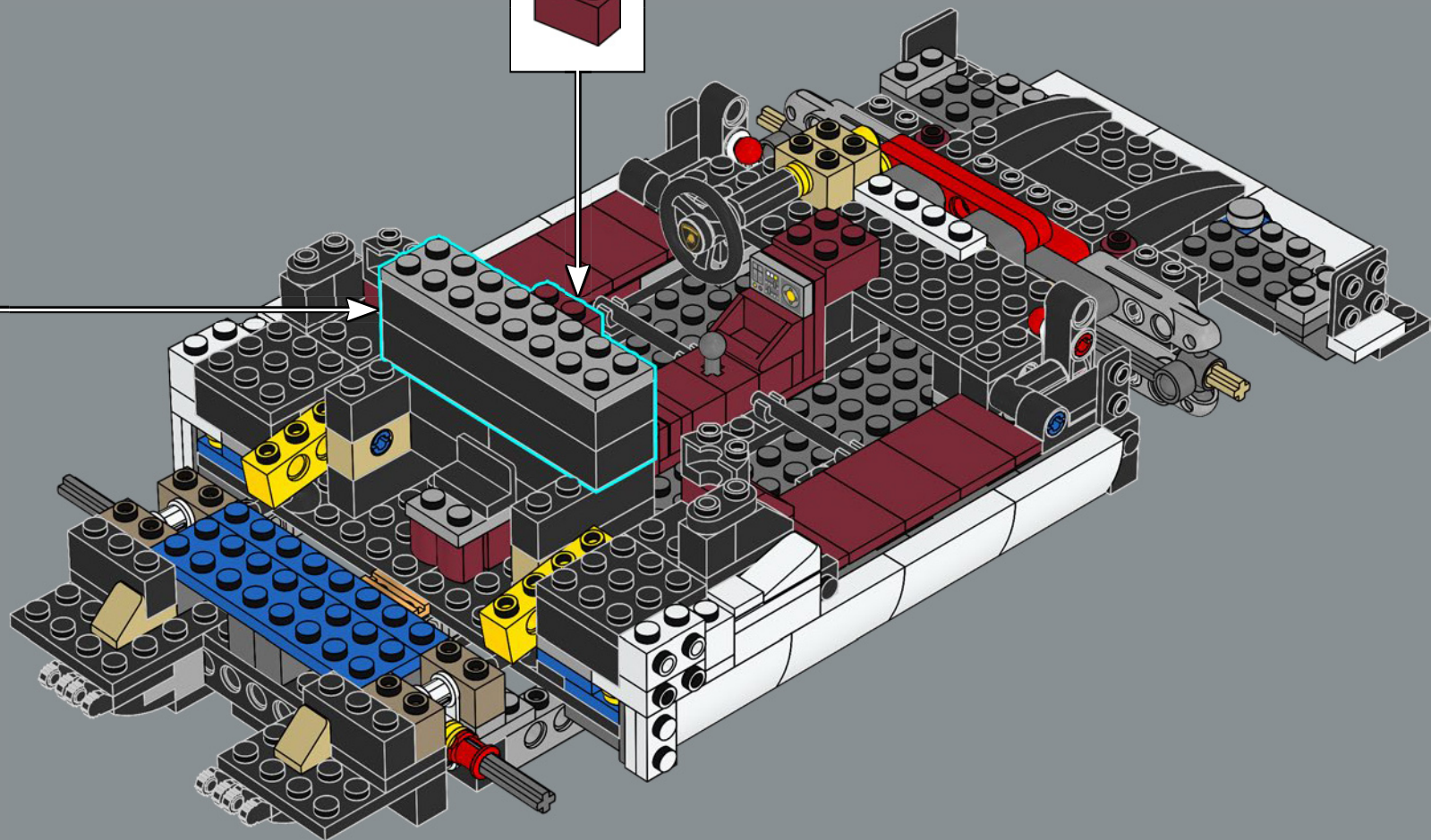
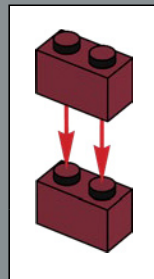
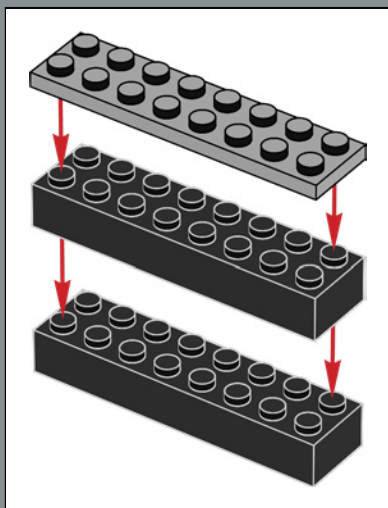

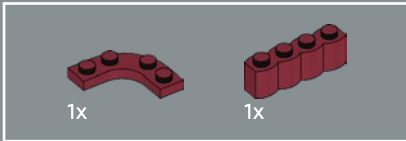
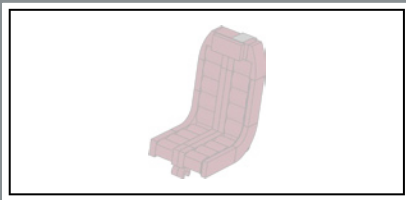

94

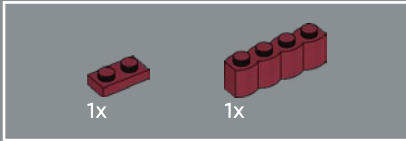
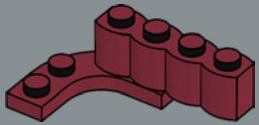

95

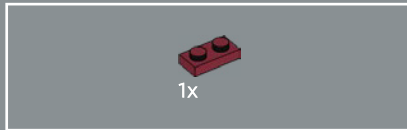
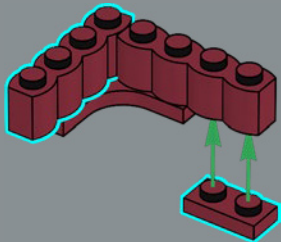

96

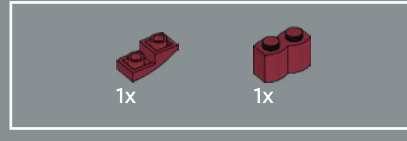
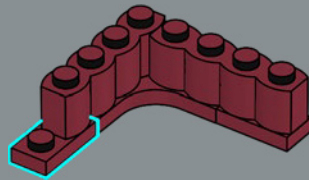

97

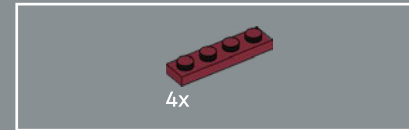
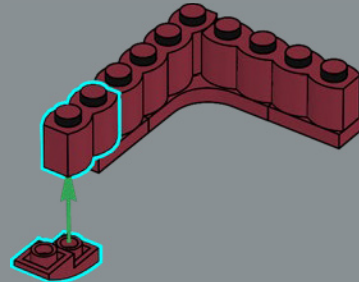

98

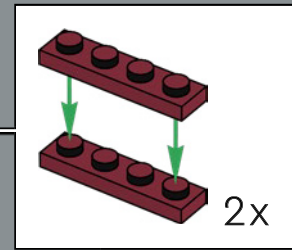
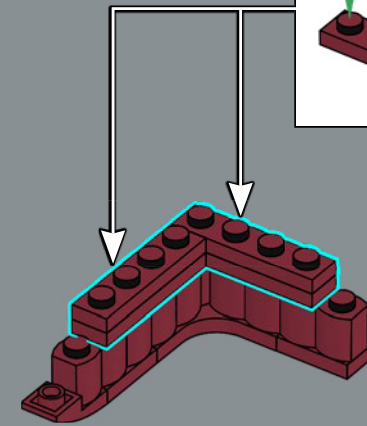

99

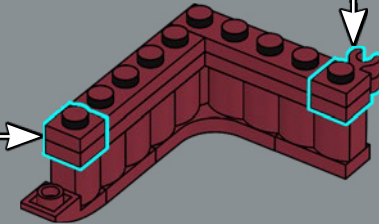
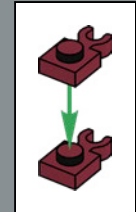
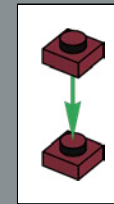

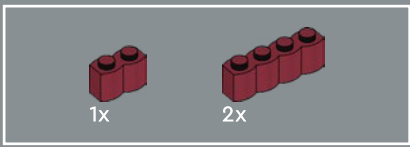

100

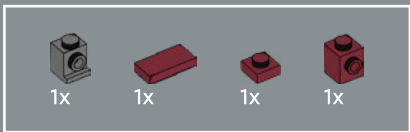
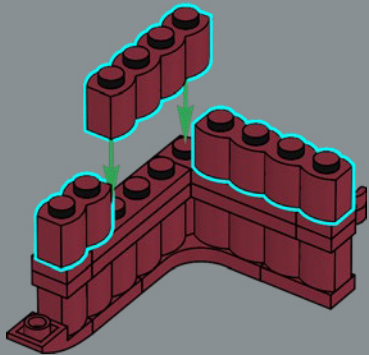

101

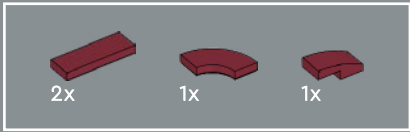
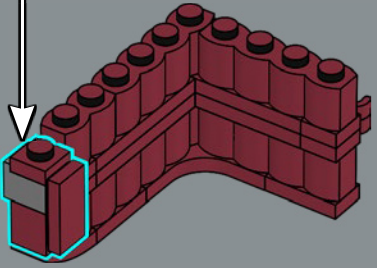
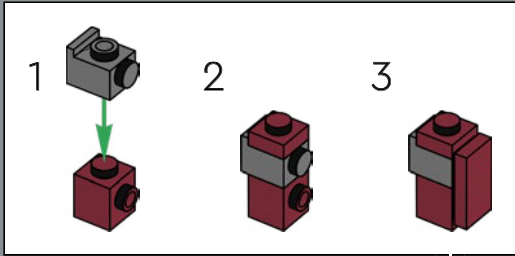

102

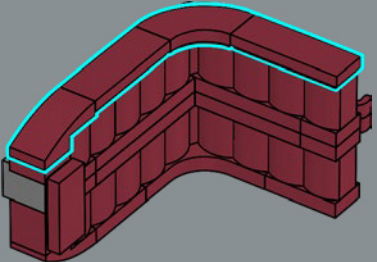

103

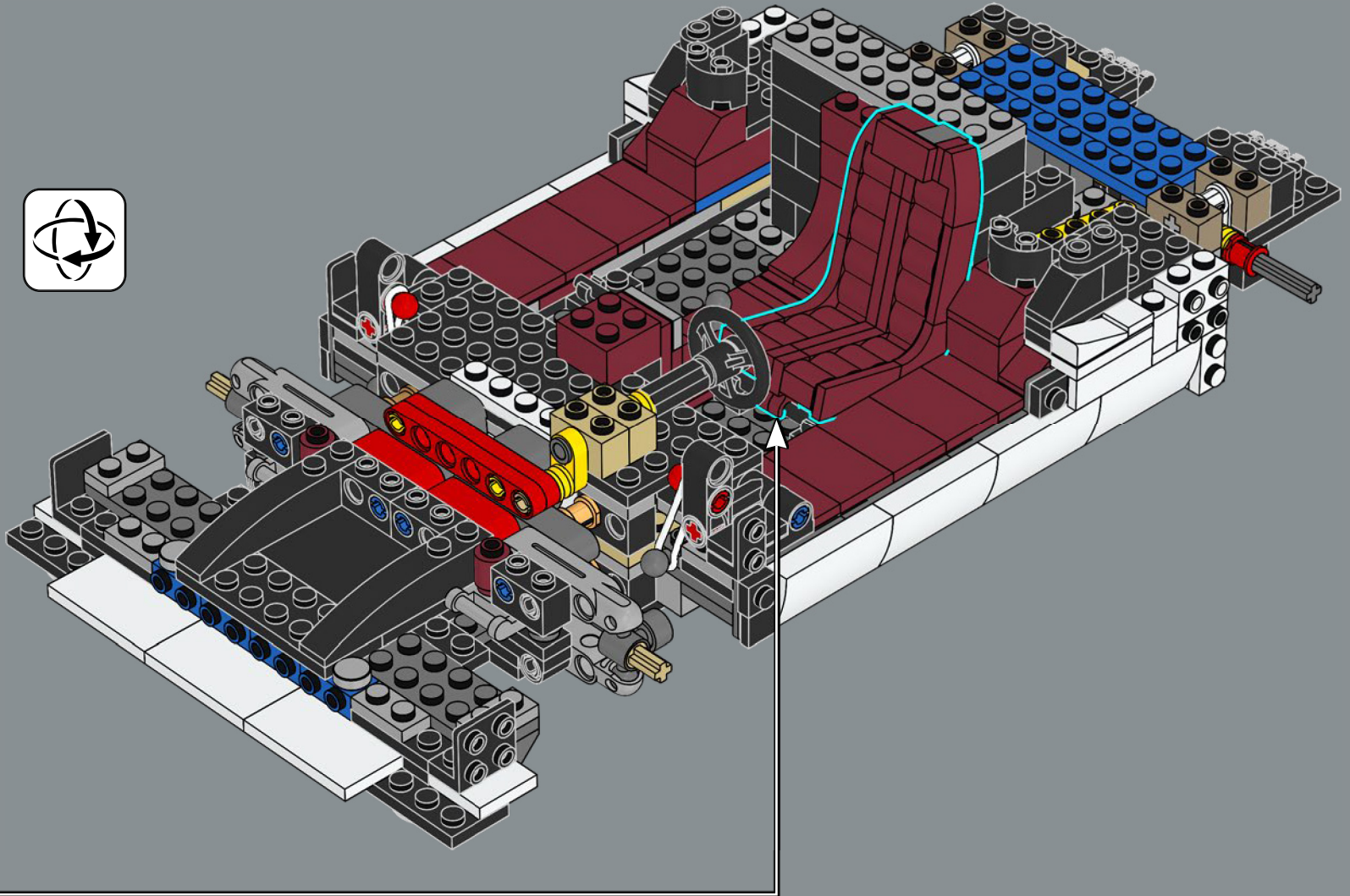

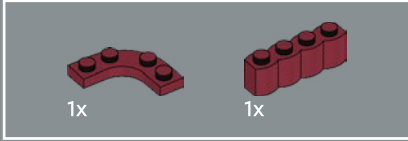

104

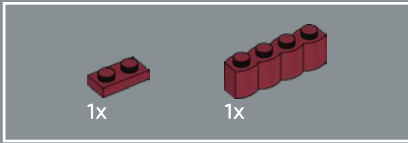
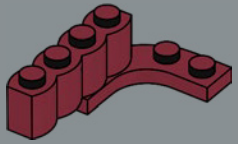

105

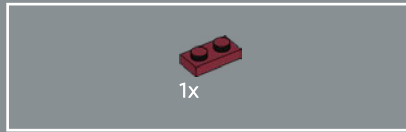
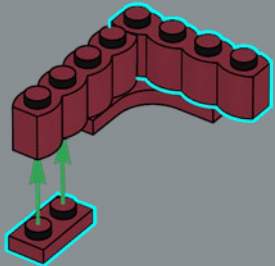

106

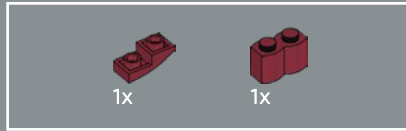
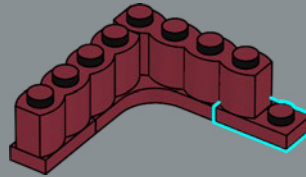

107

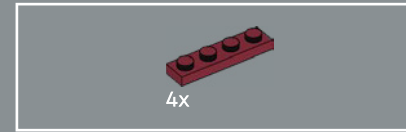
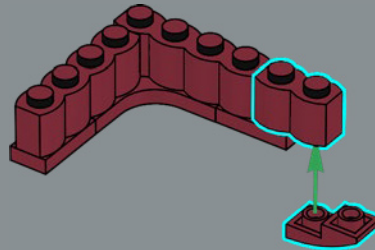

108

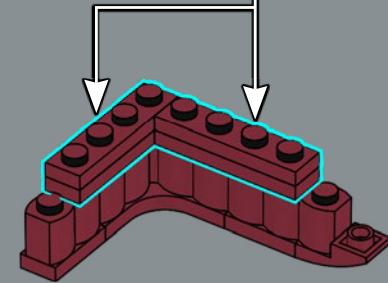
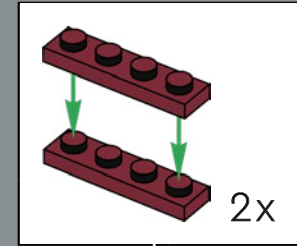



109

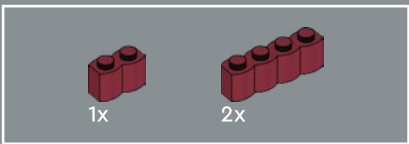
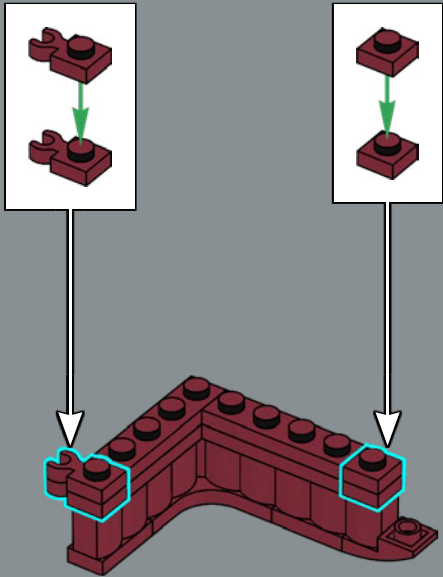

110

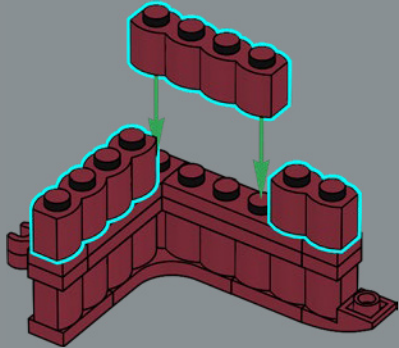

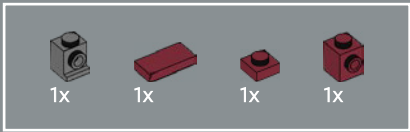

111

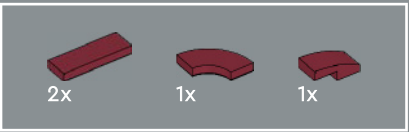
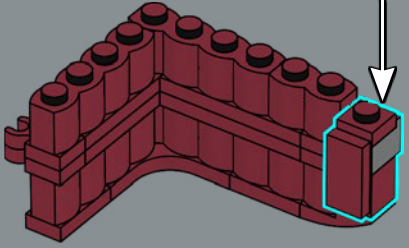
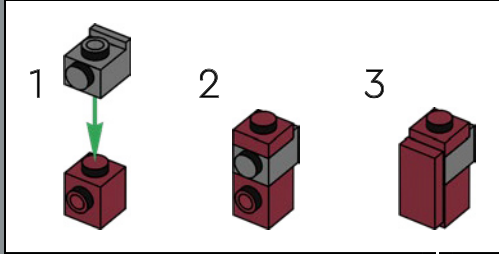

112

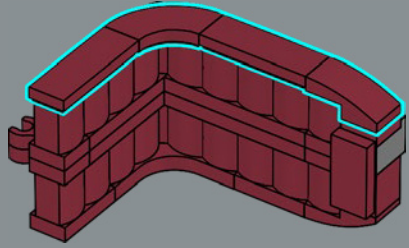

113

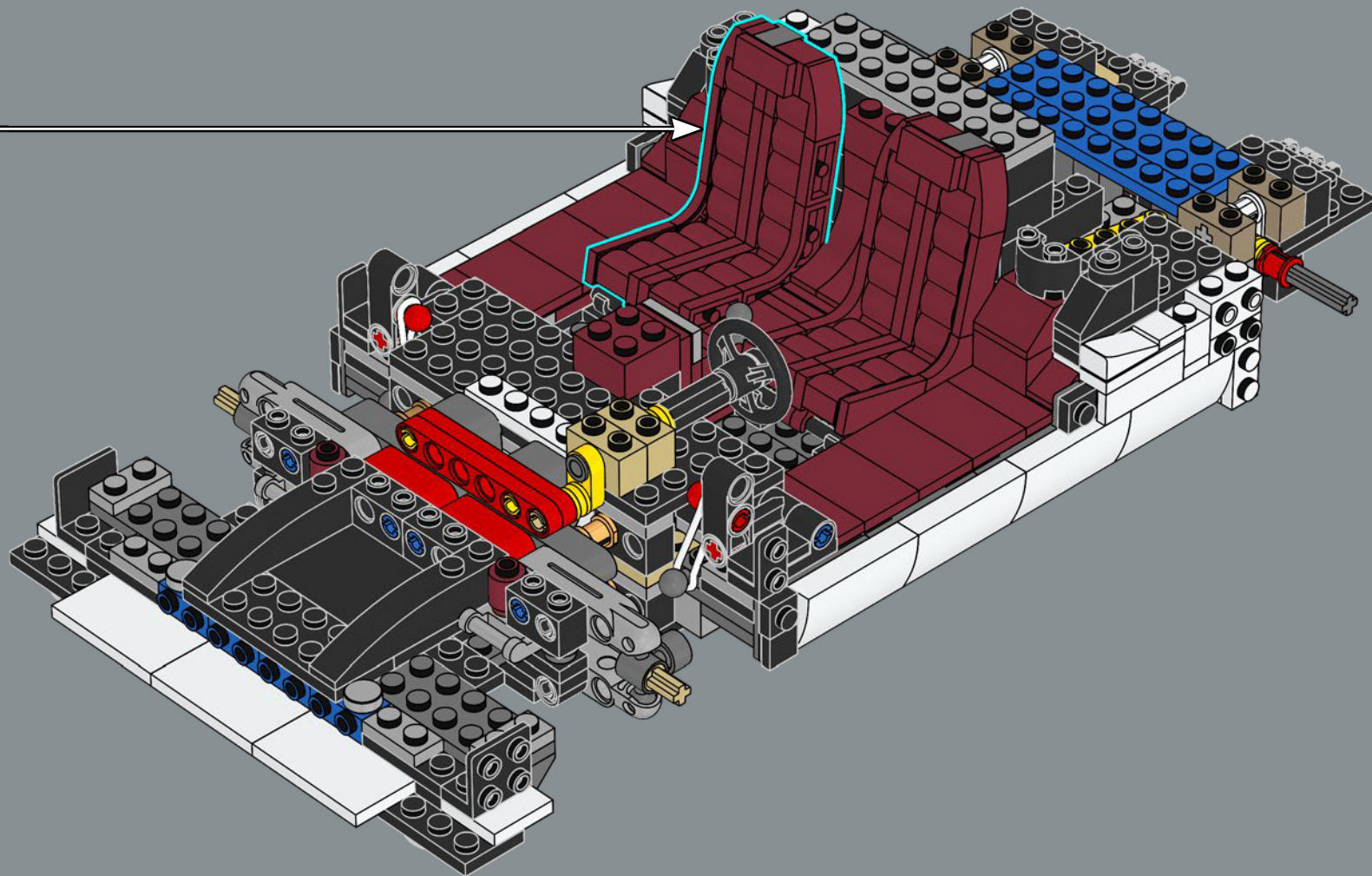

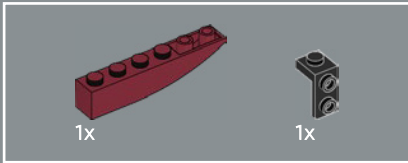
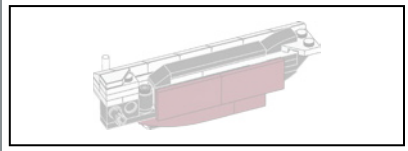

114

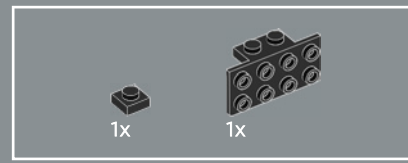
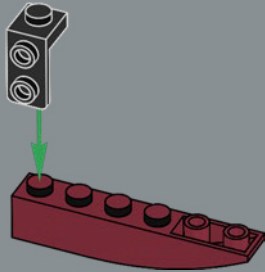

115

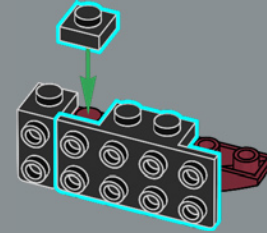

116

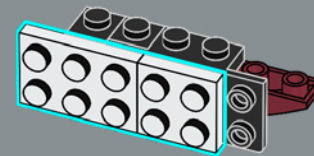

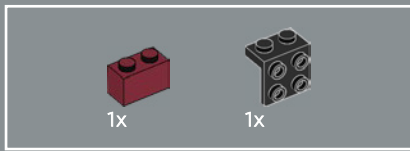

117

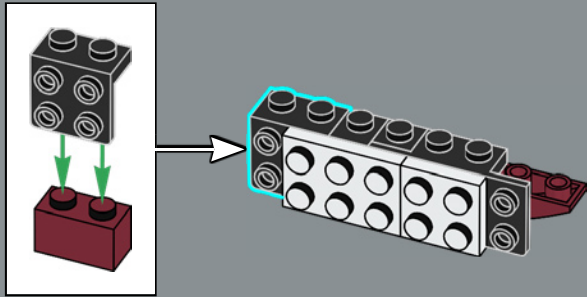

118

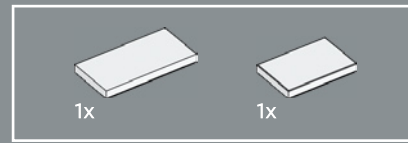
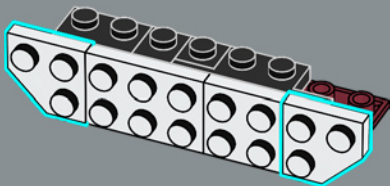

119

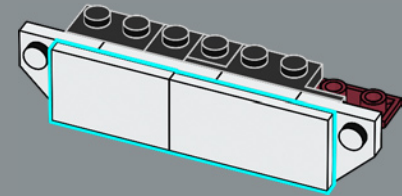

120

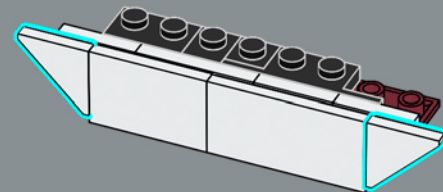

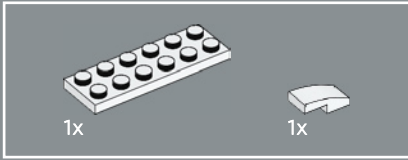
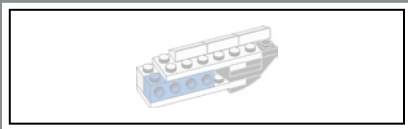

121

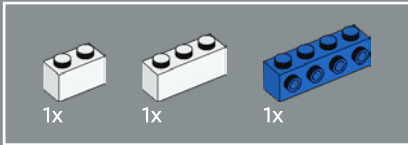
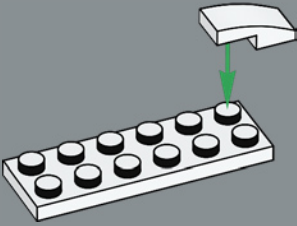

122

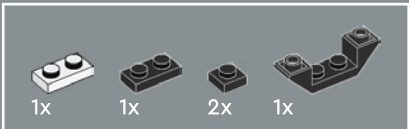
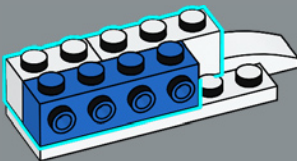

123

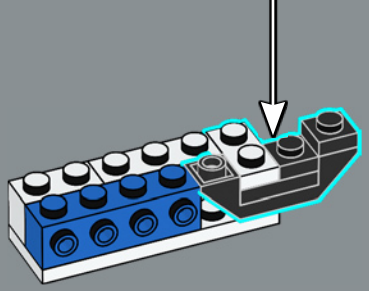
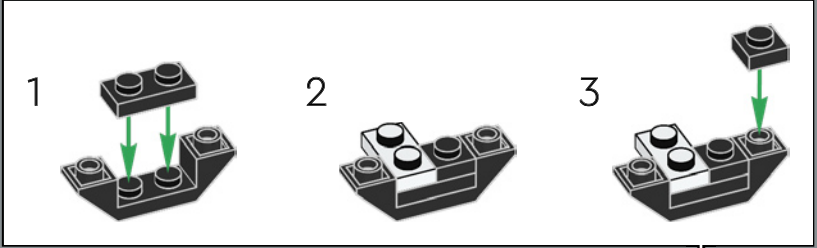

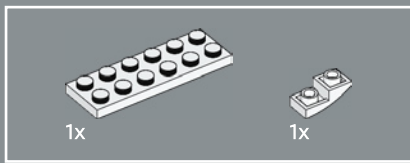

124

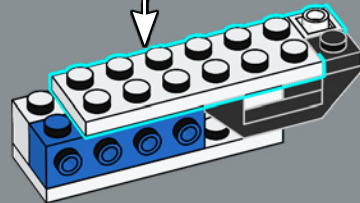
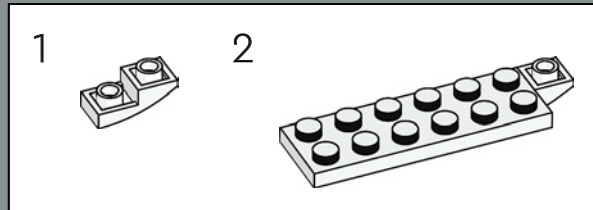

125

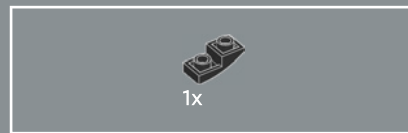
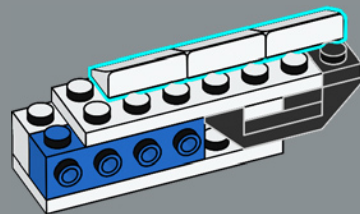

126

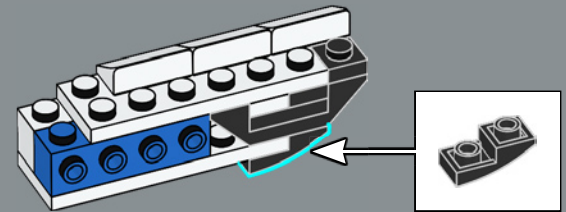

127

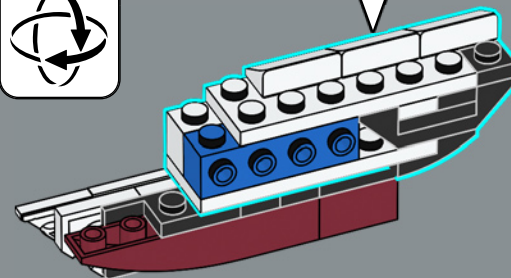

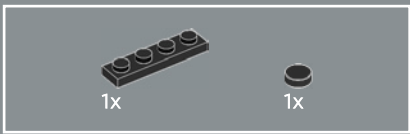

128

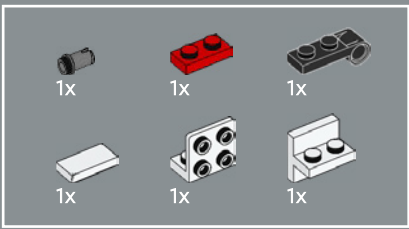
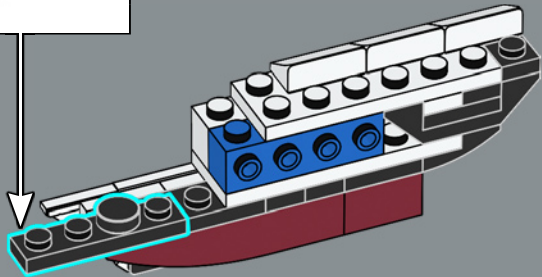
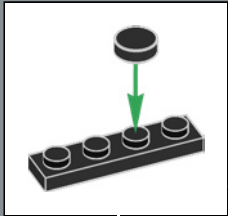

129

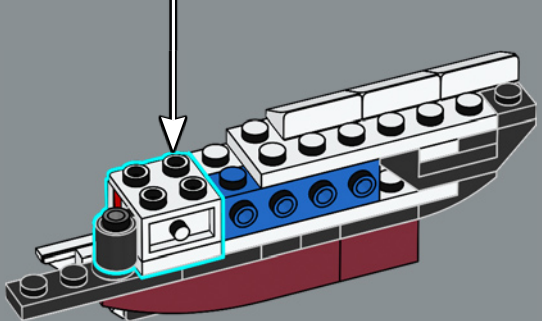
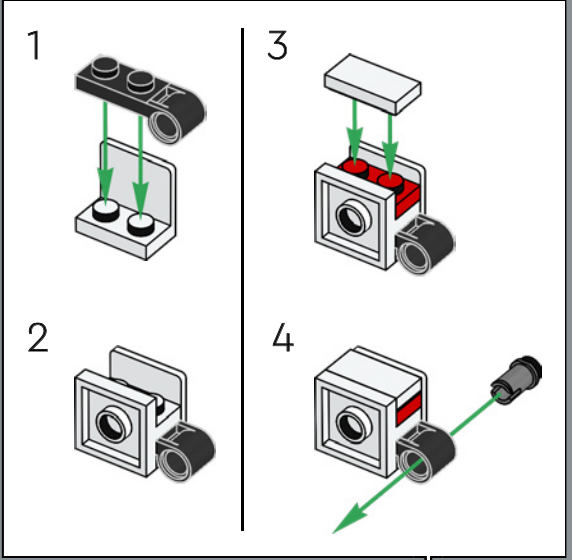

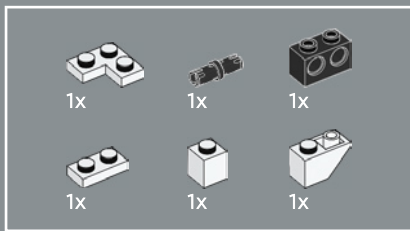

130

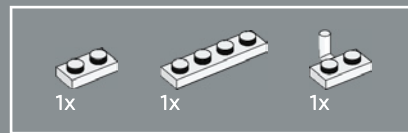
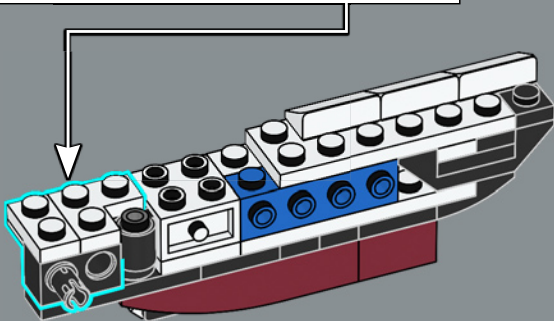
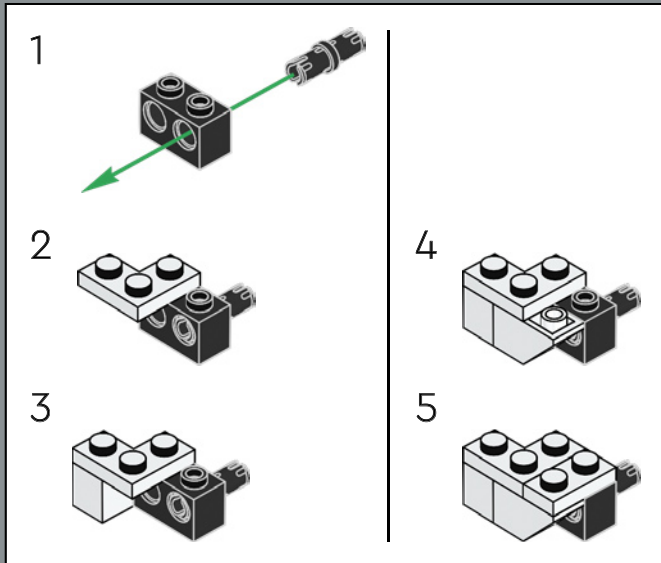

131

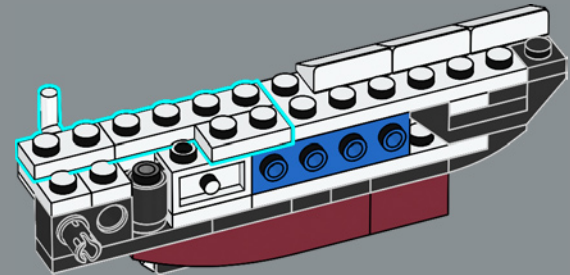

132

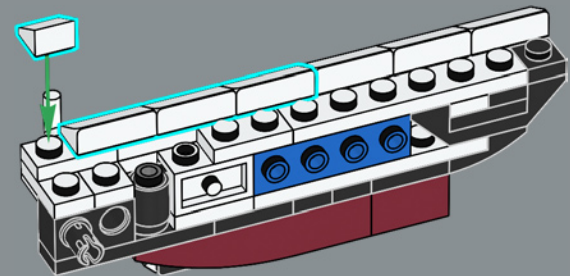



133

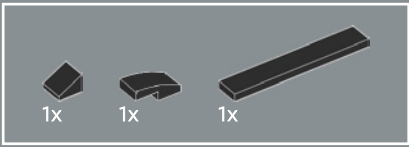
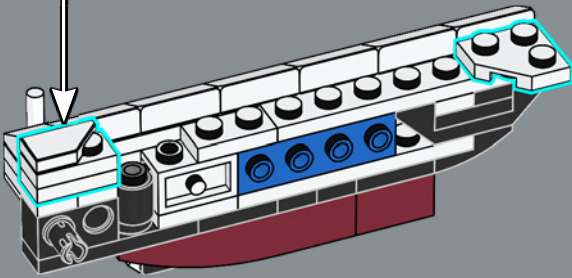
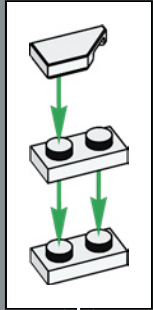

134

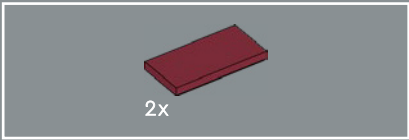
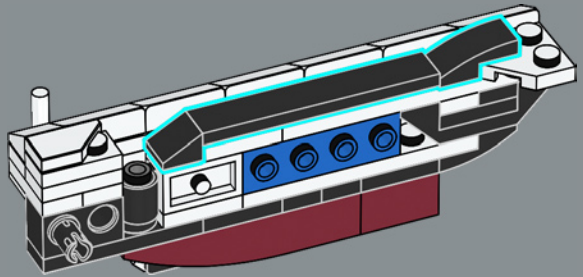

135

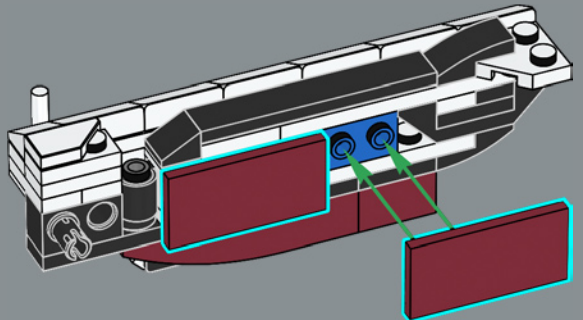

136

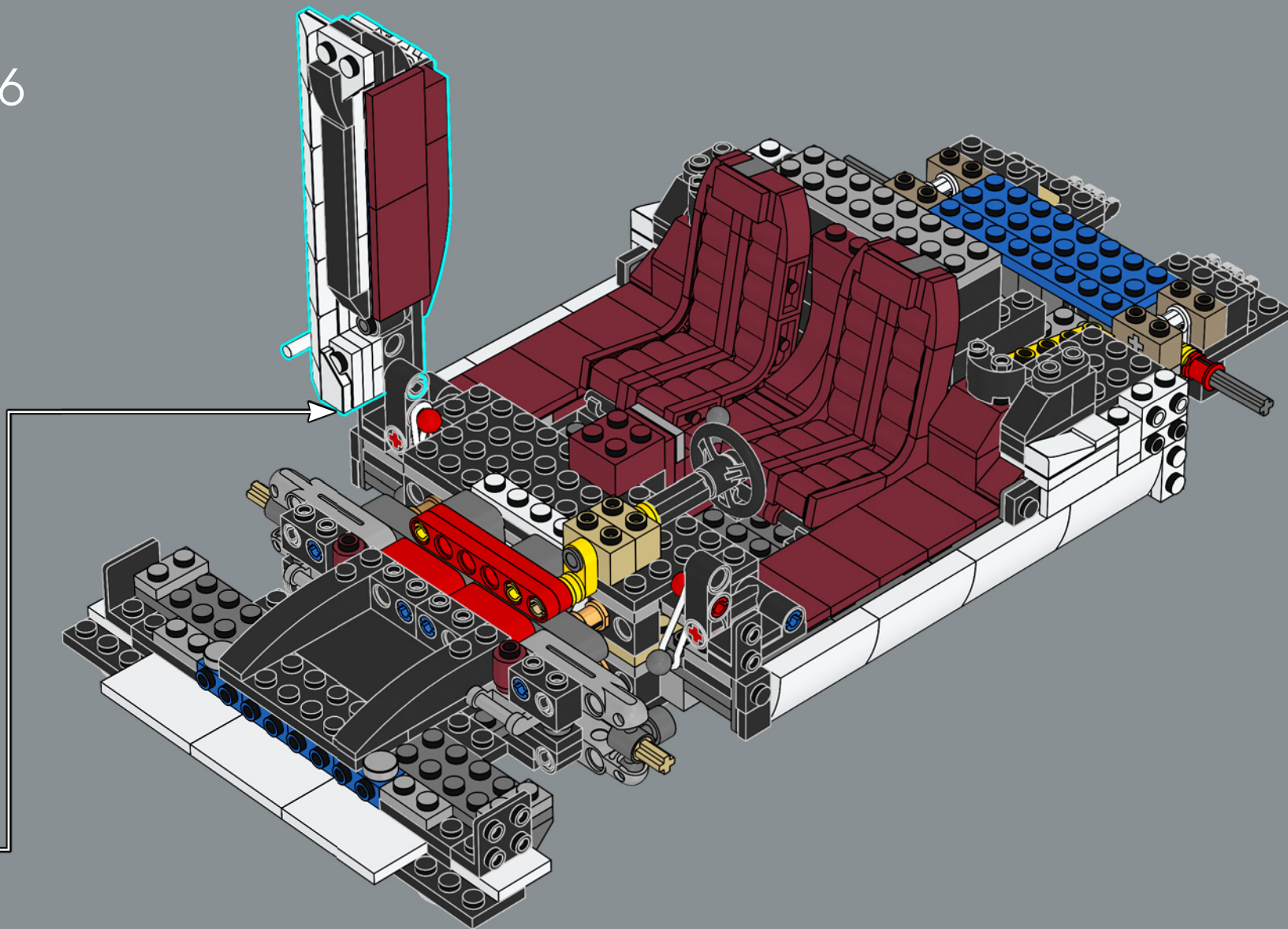

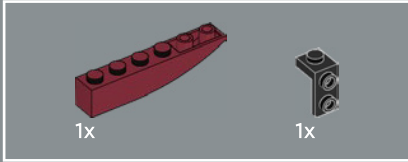
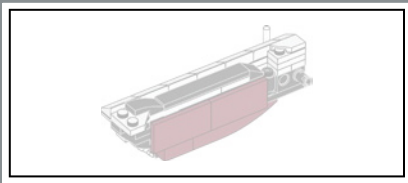

137

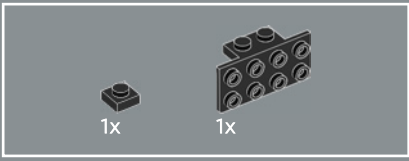
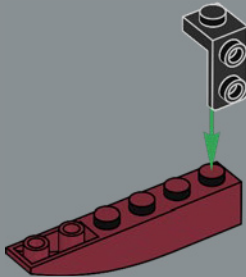

138

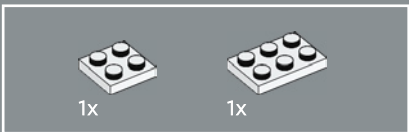
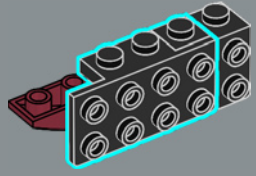

139

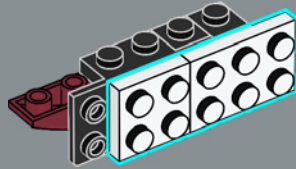

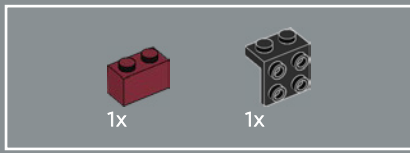

140

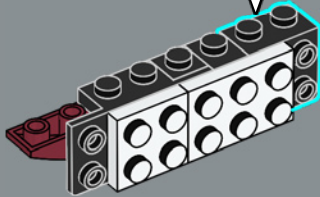
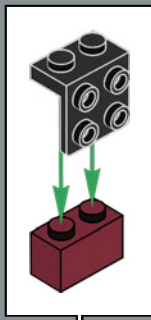

141

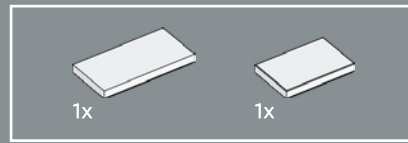
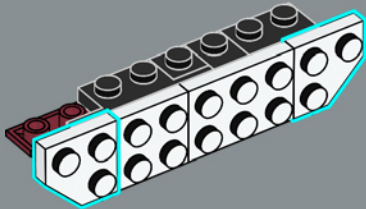

142

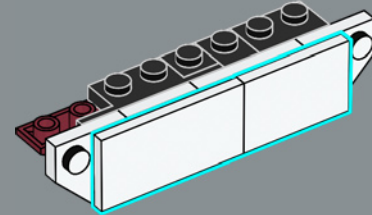

143

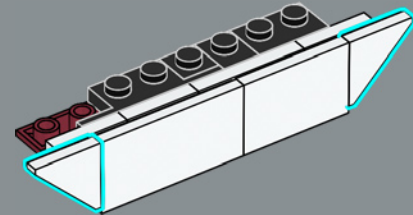

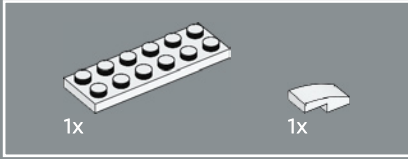
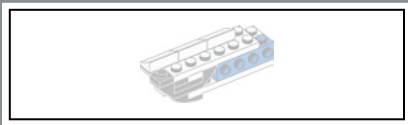

144

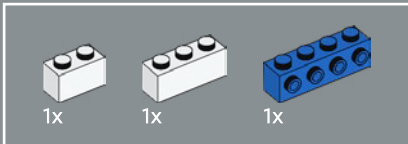
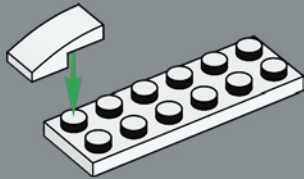

145

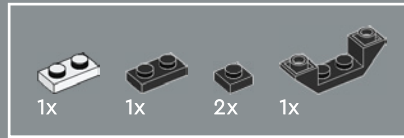
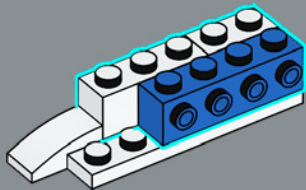

146

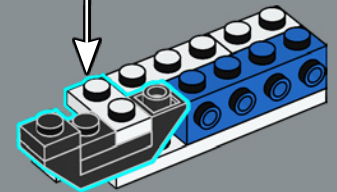
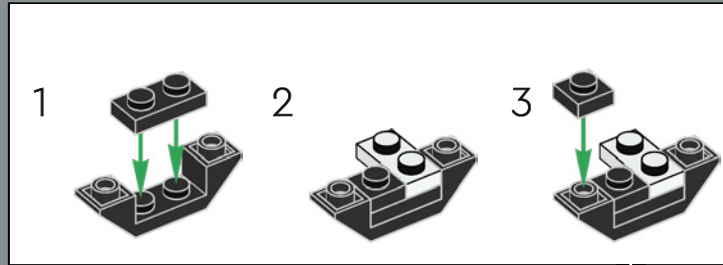

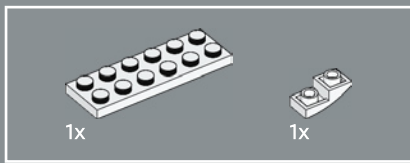

147

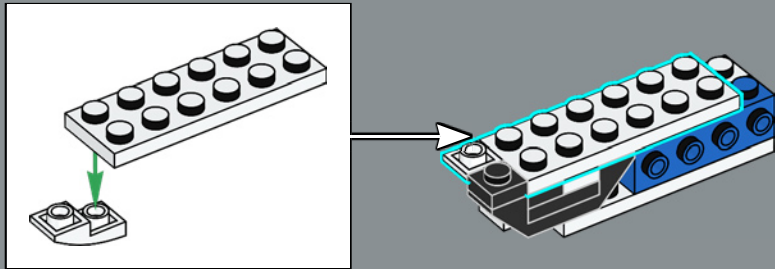

148

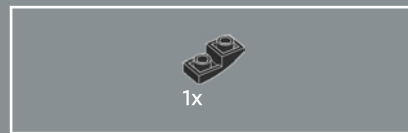
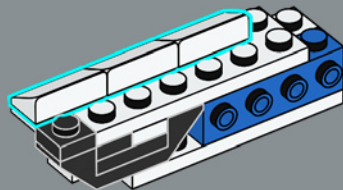

149

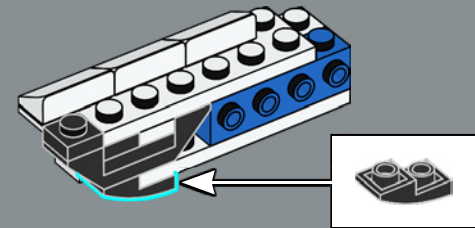

150

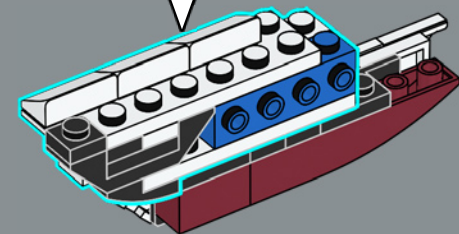

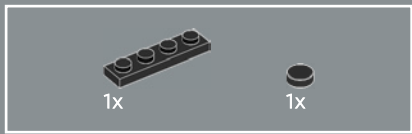

151

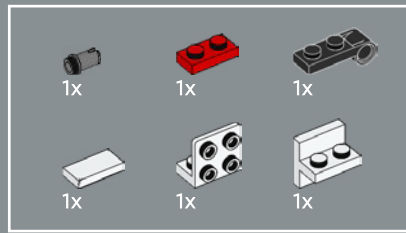
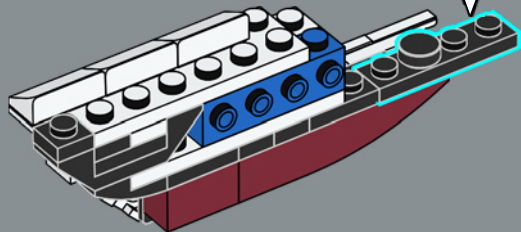
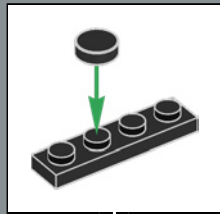

152

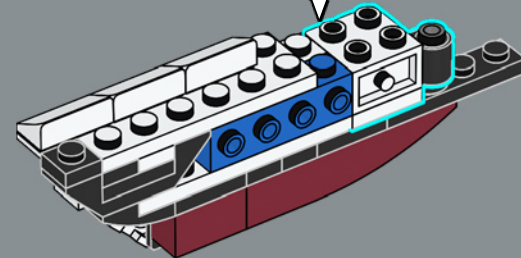
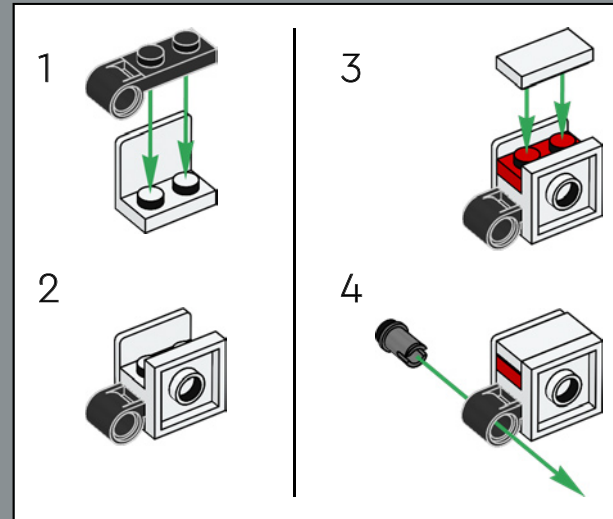

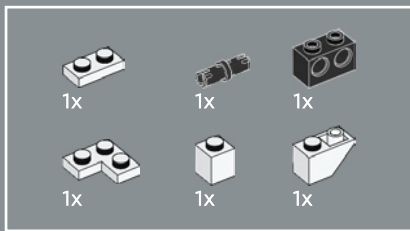

153

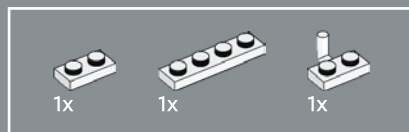
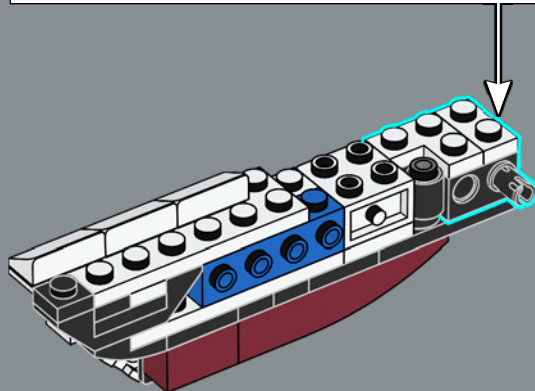
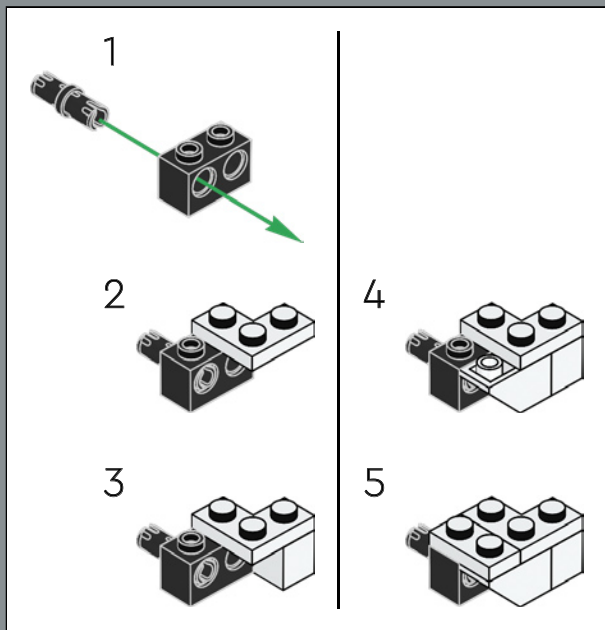

154

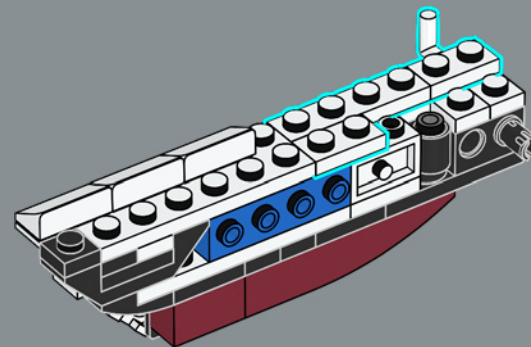



155

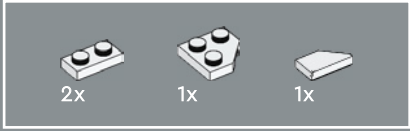
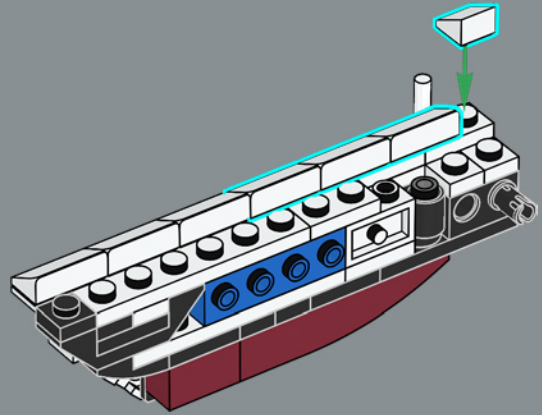

156

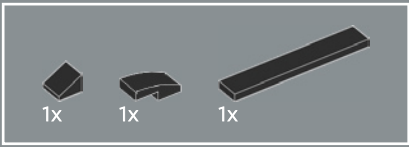
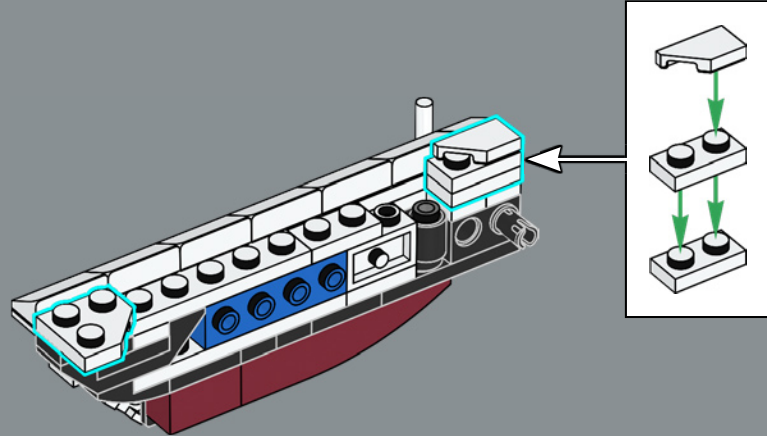

157

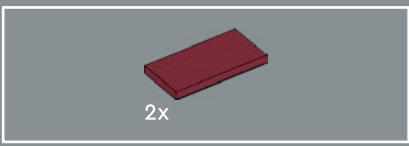
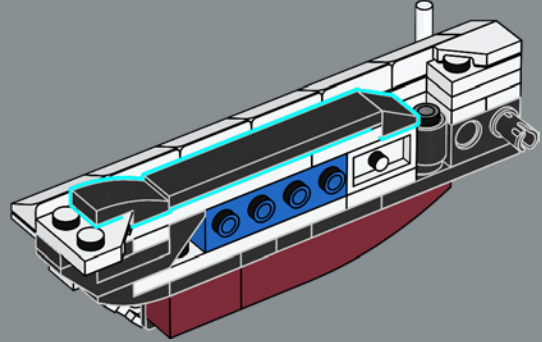

158

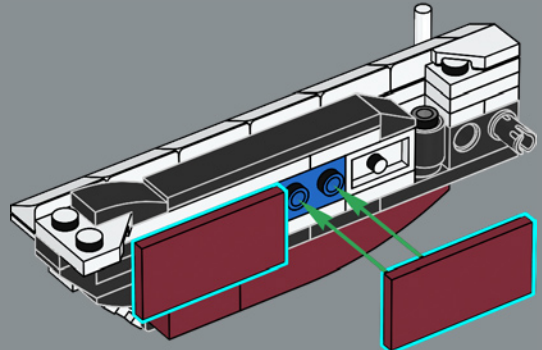



Le porte con apertura verso l'alto sono comunemente dette "portiere a forbice" o ad ala di gabbiano

159

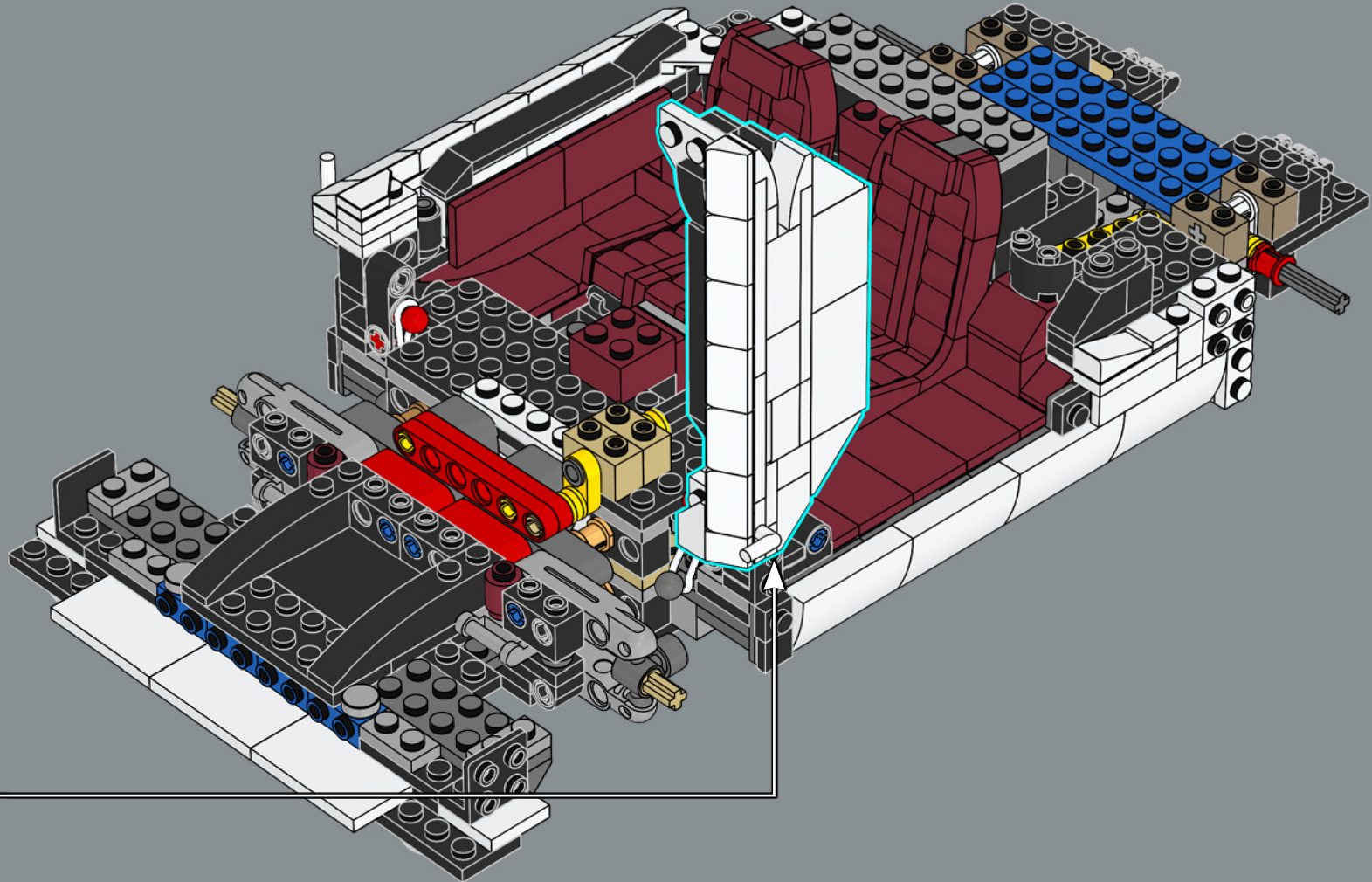

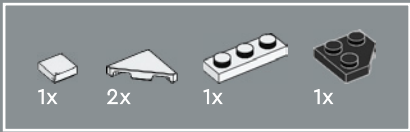

160

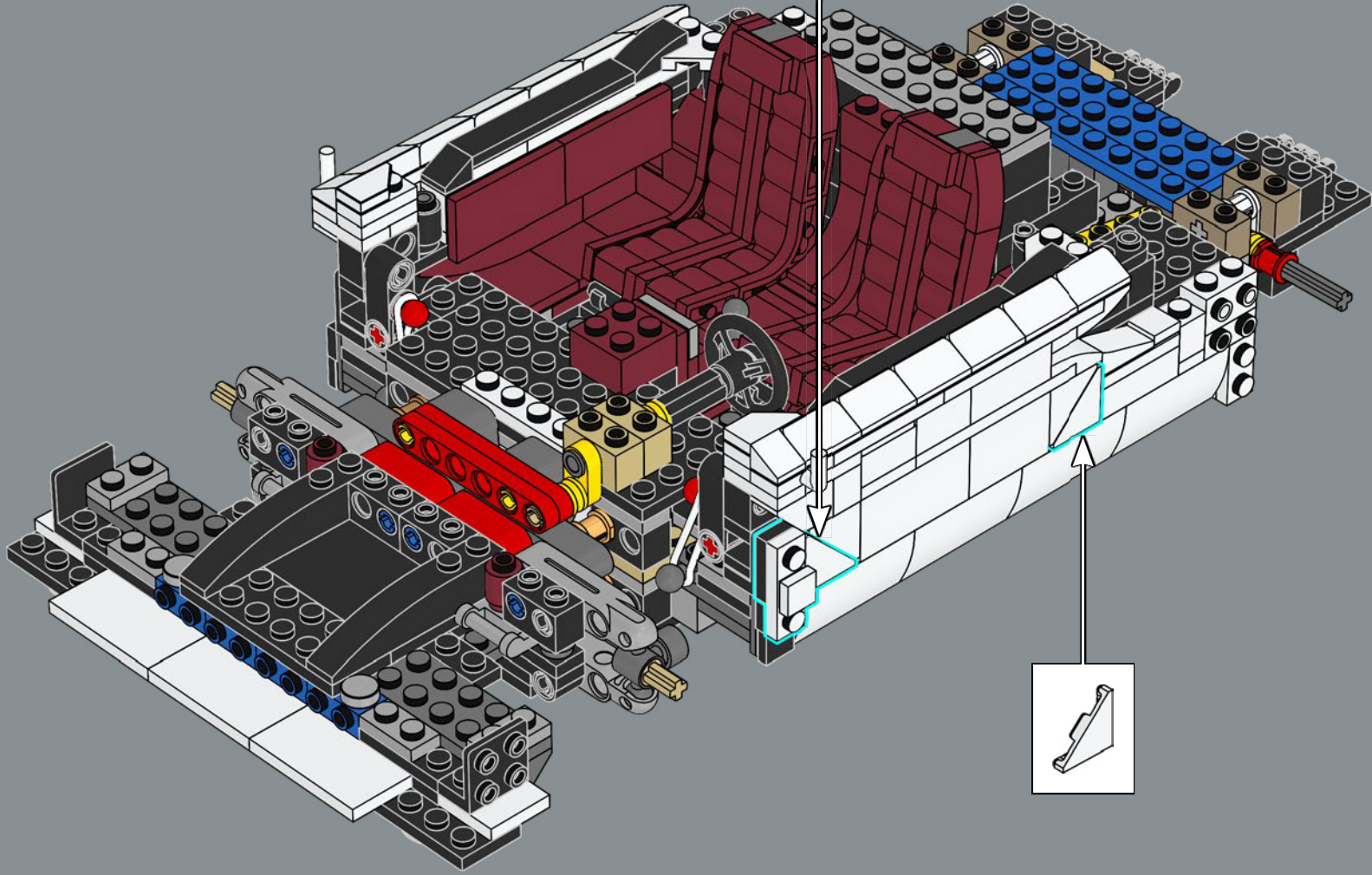
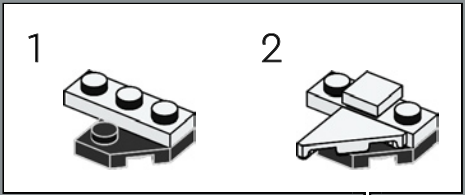

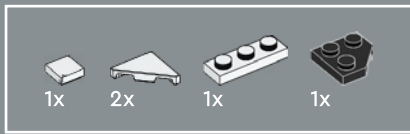

161

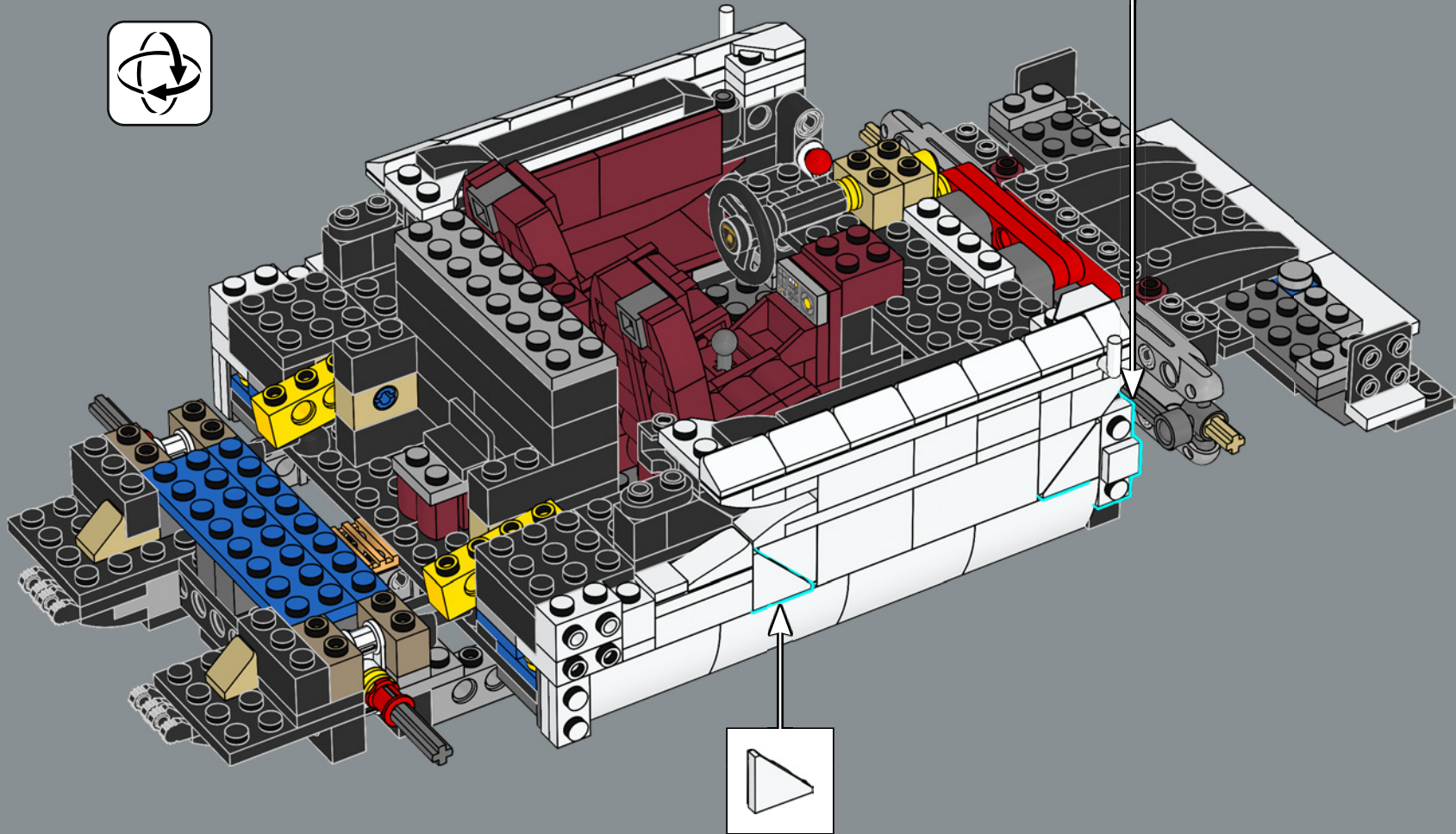
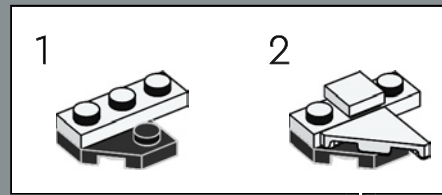

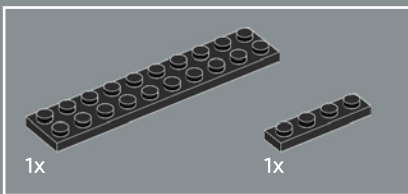
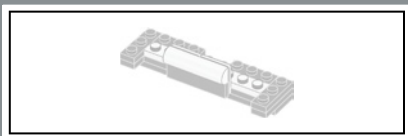

162

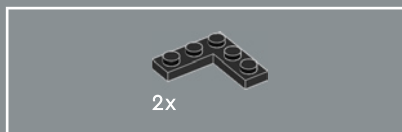
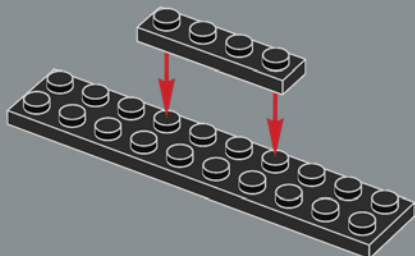

163

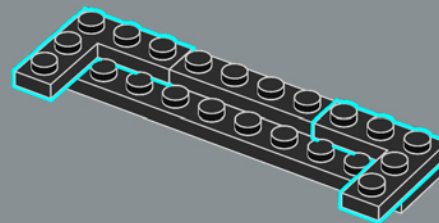

164

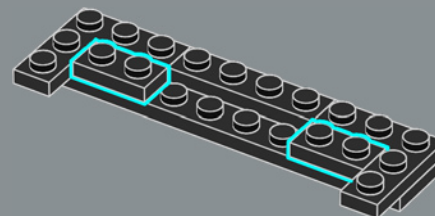



165

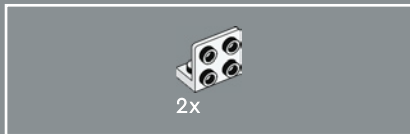
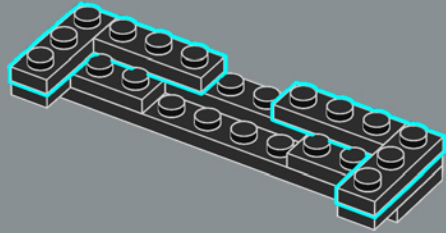

166

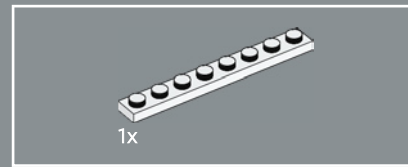
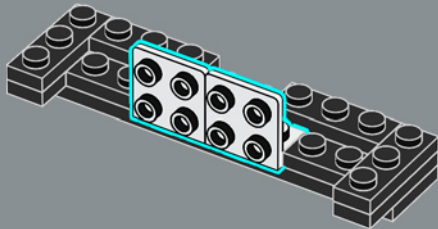

167

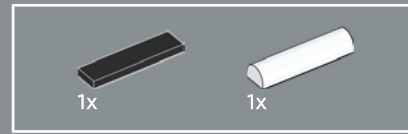
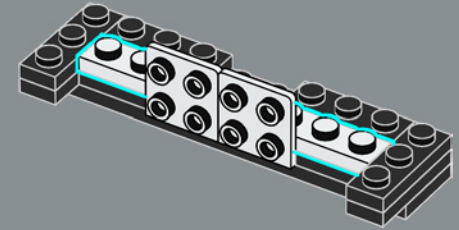

168

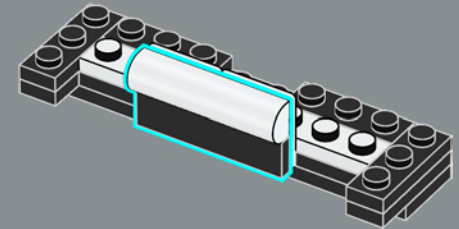

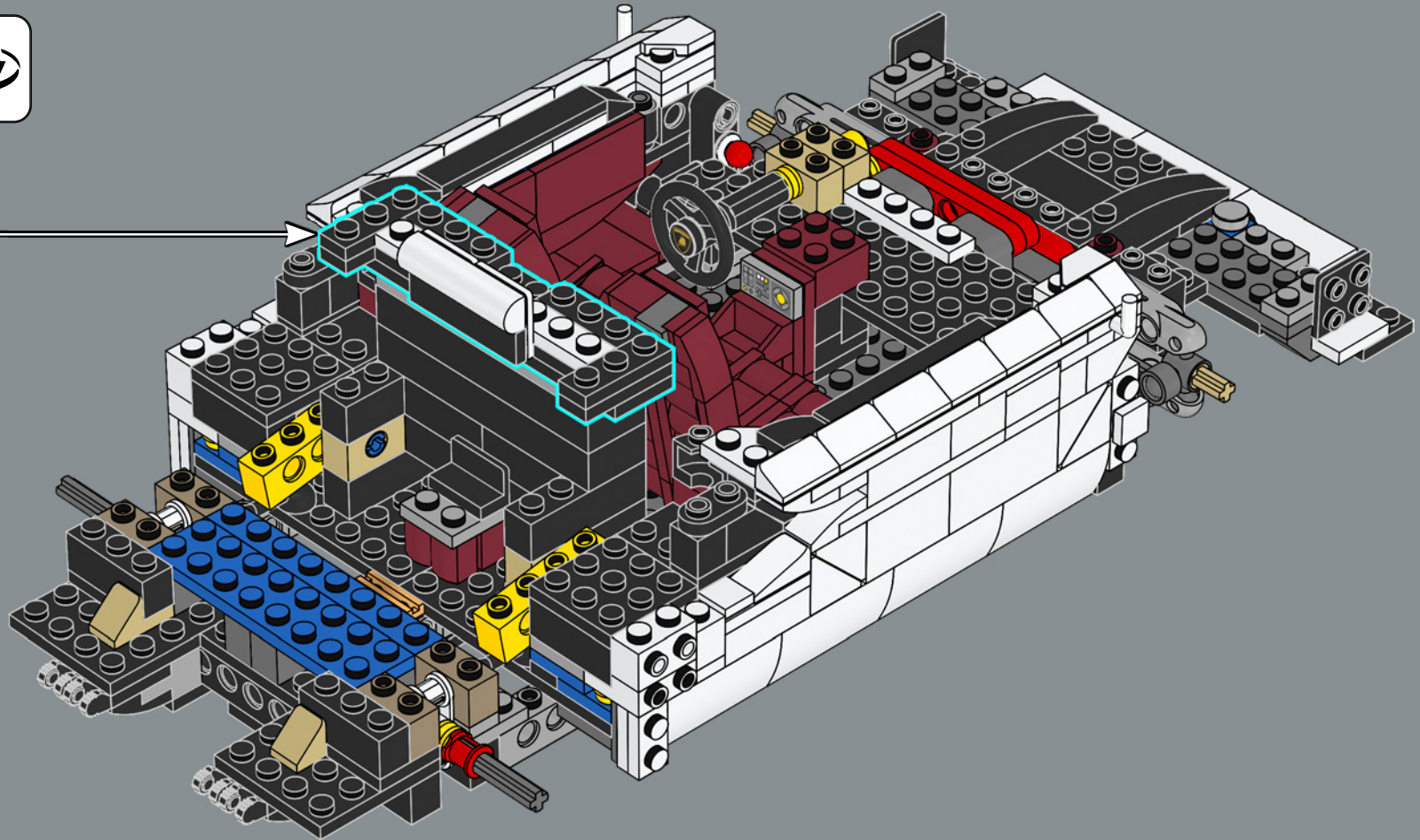

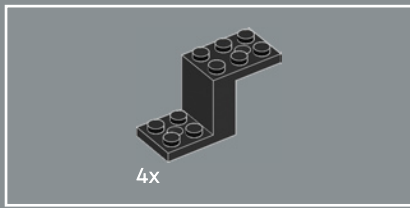

170

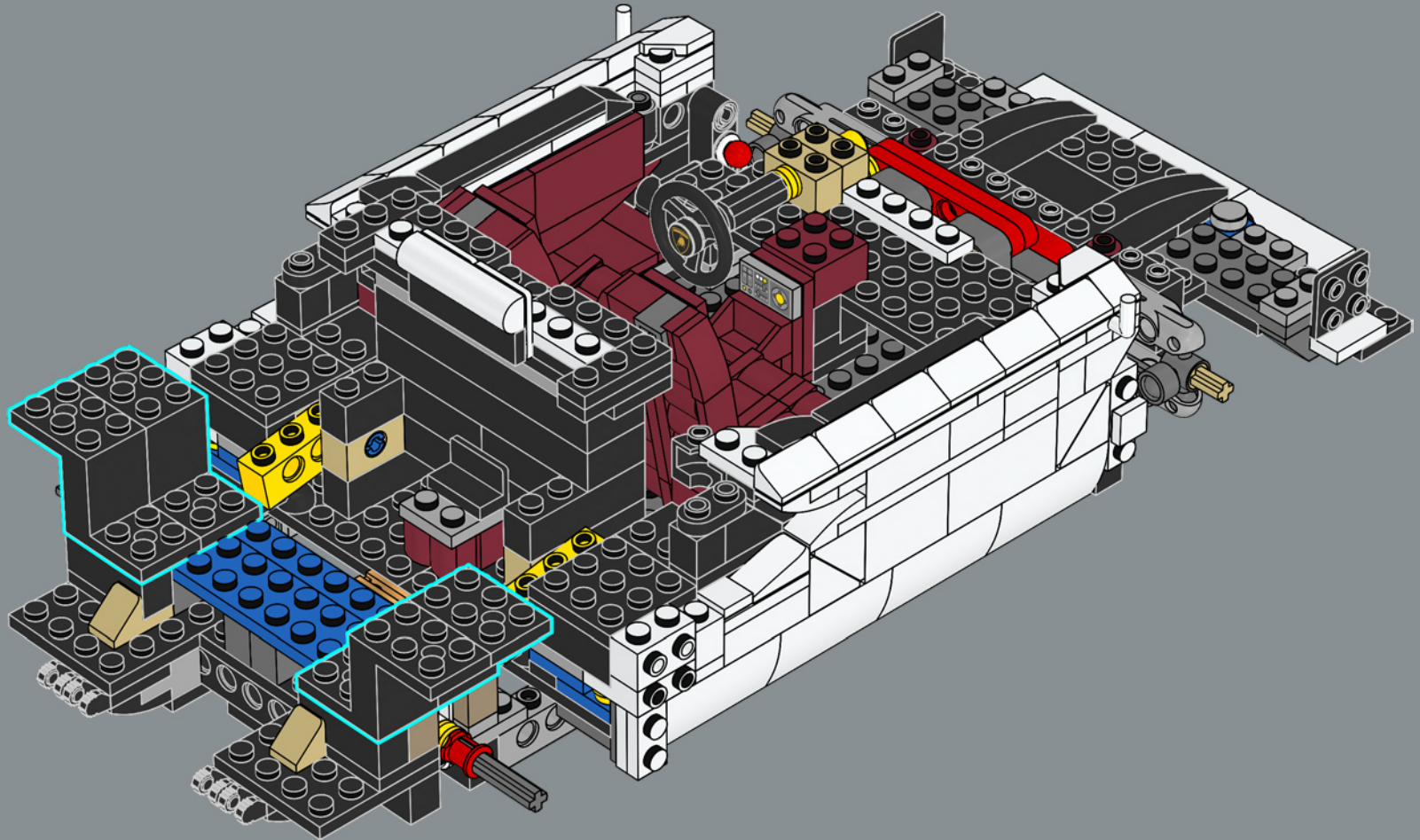

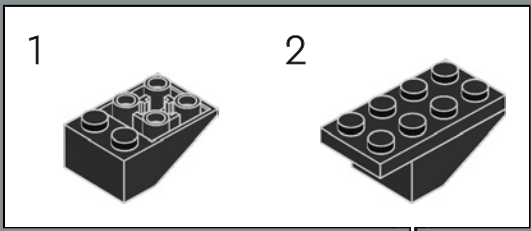
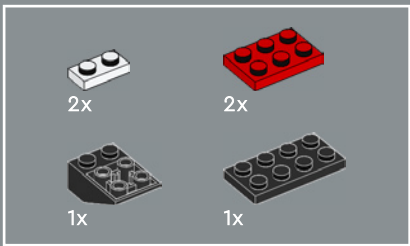

171

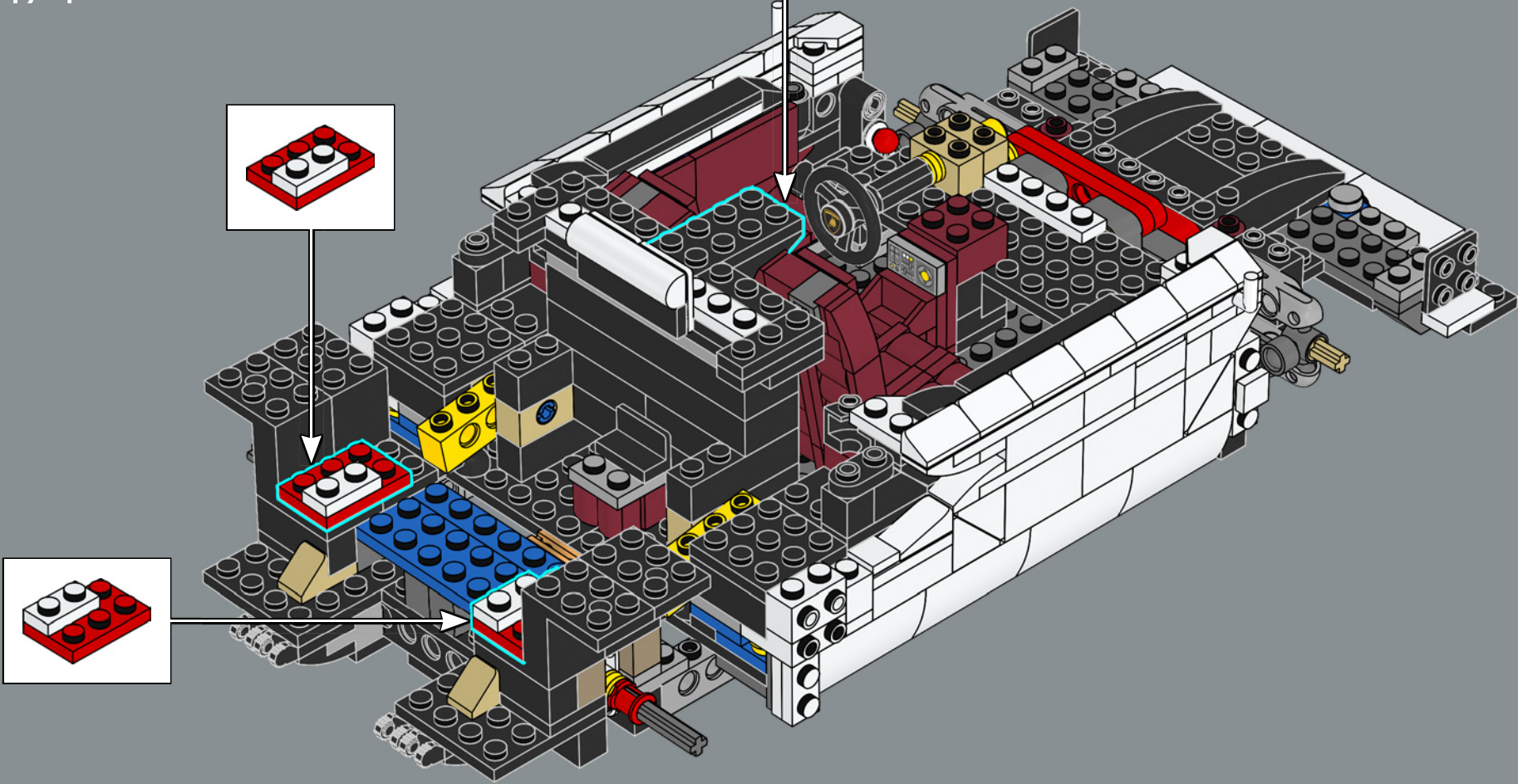

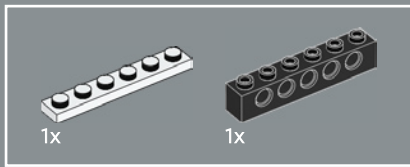

172

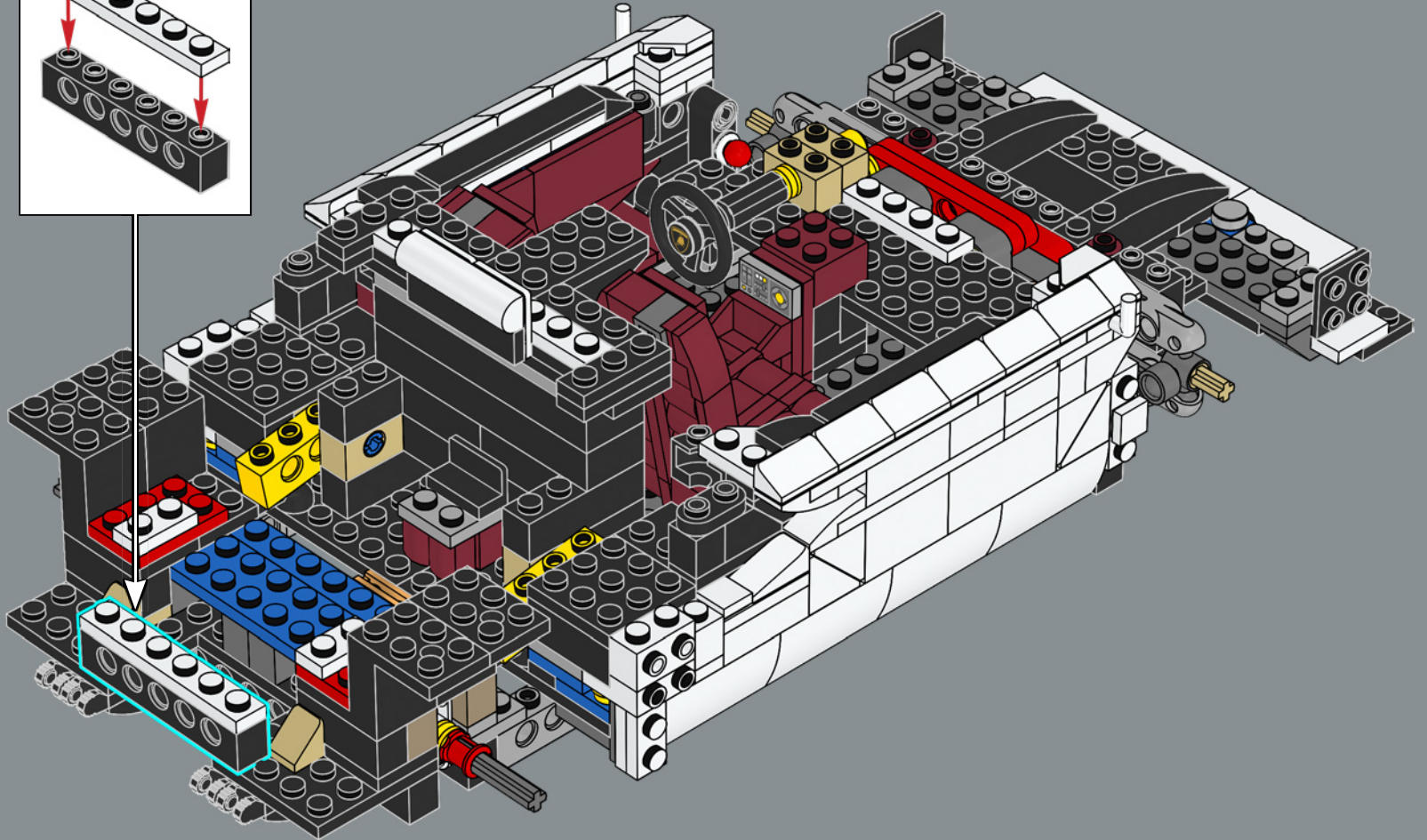
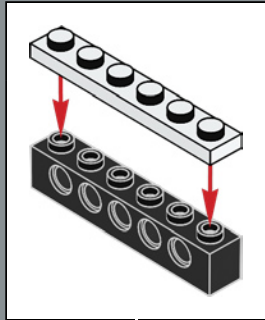

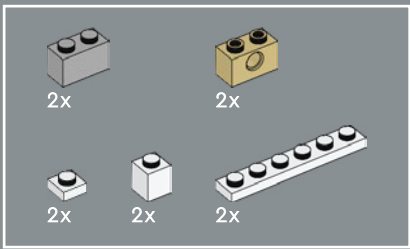

173

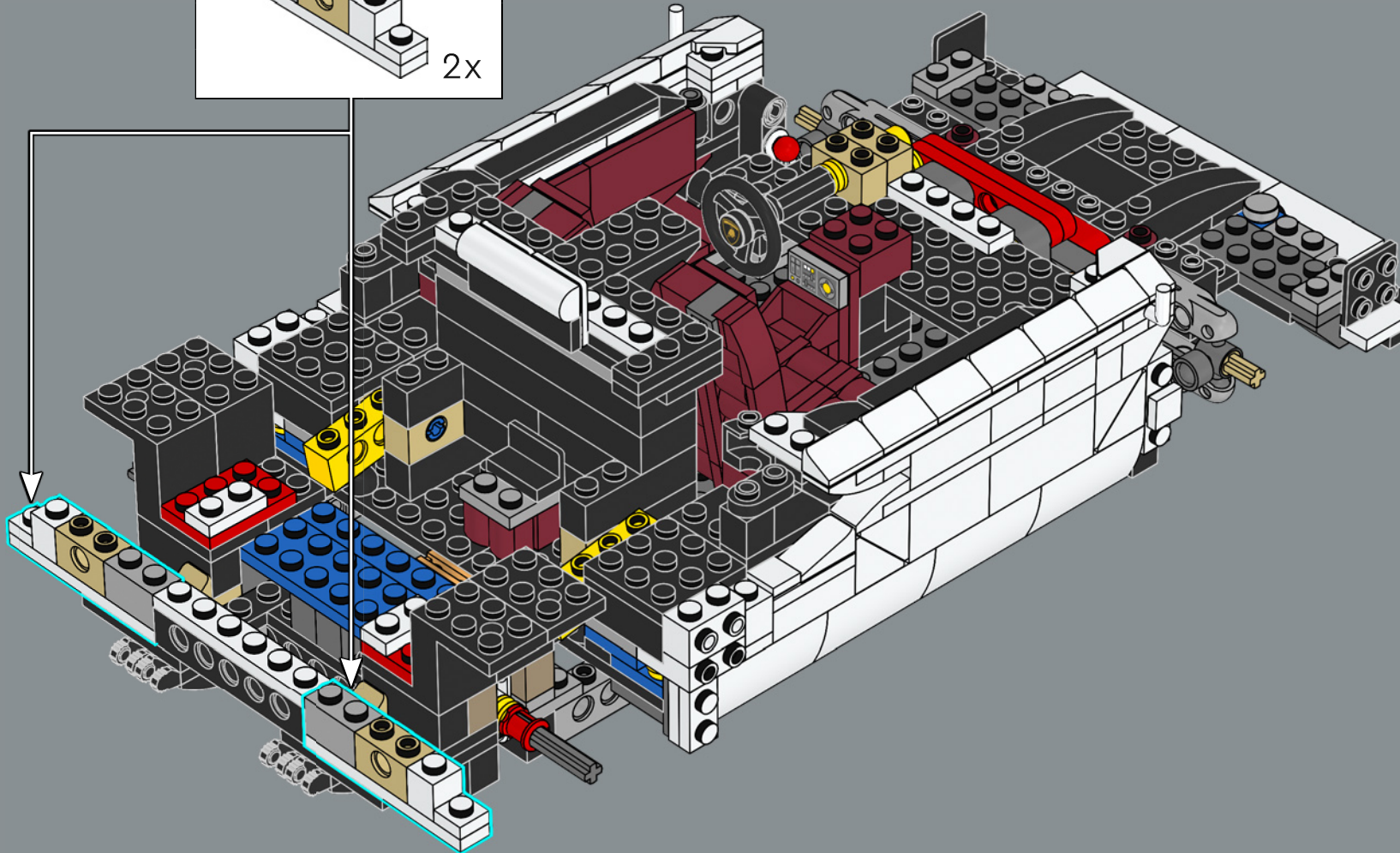
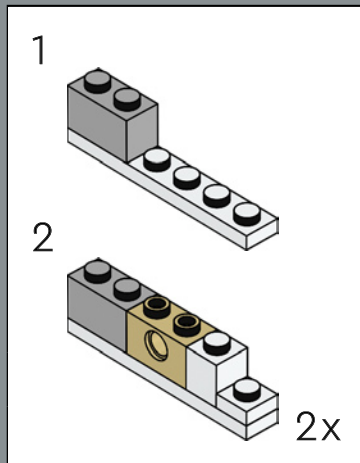

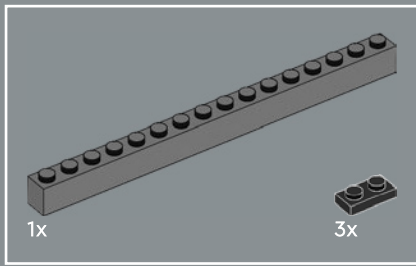

174

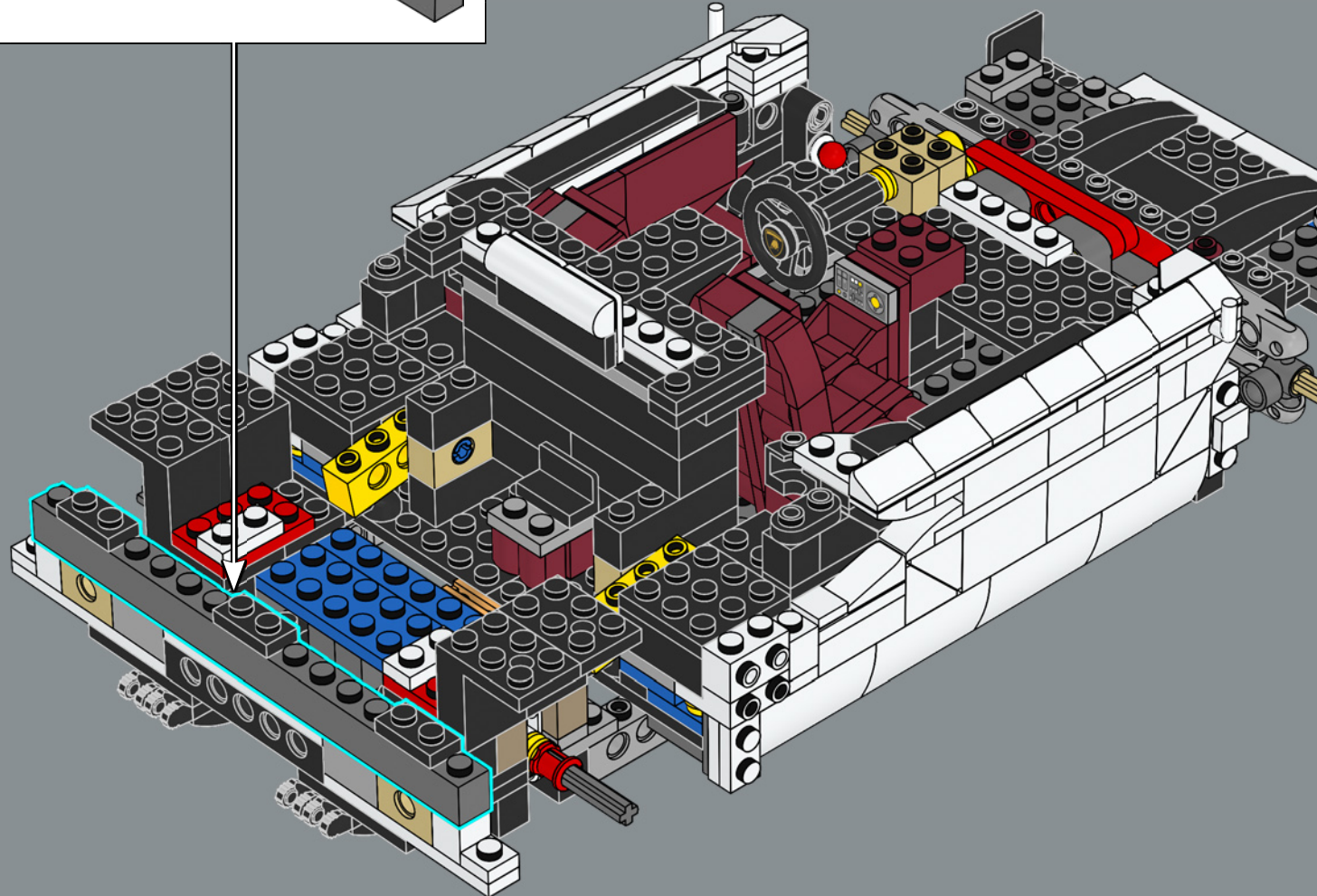
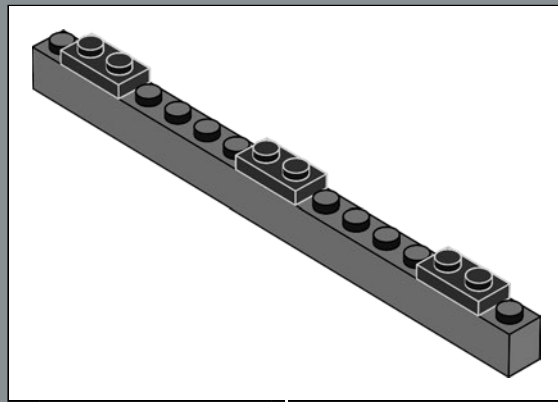

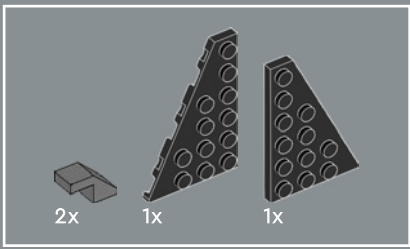

175

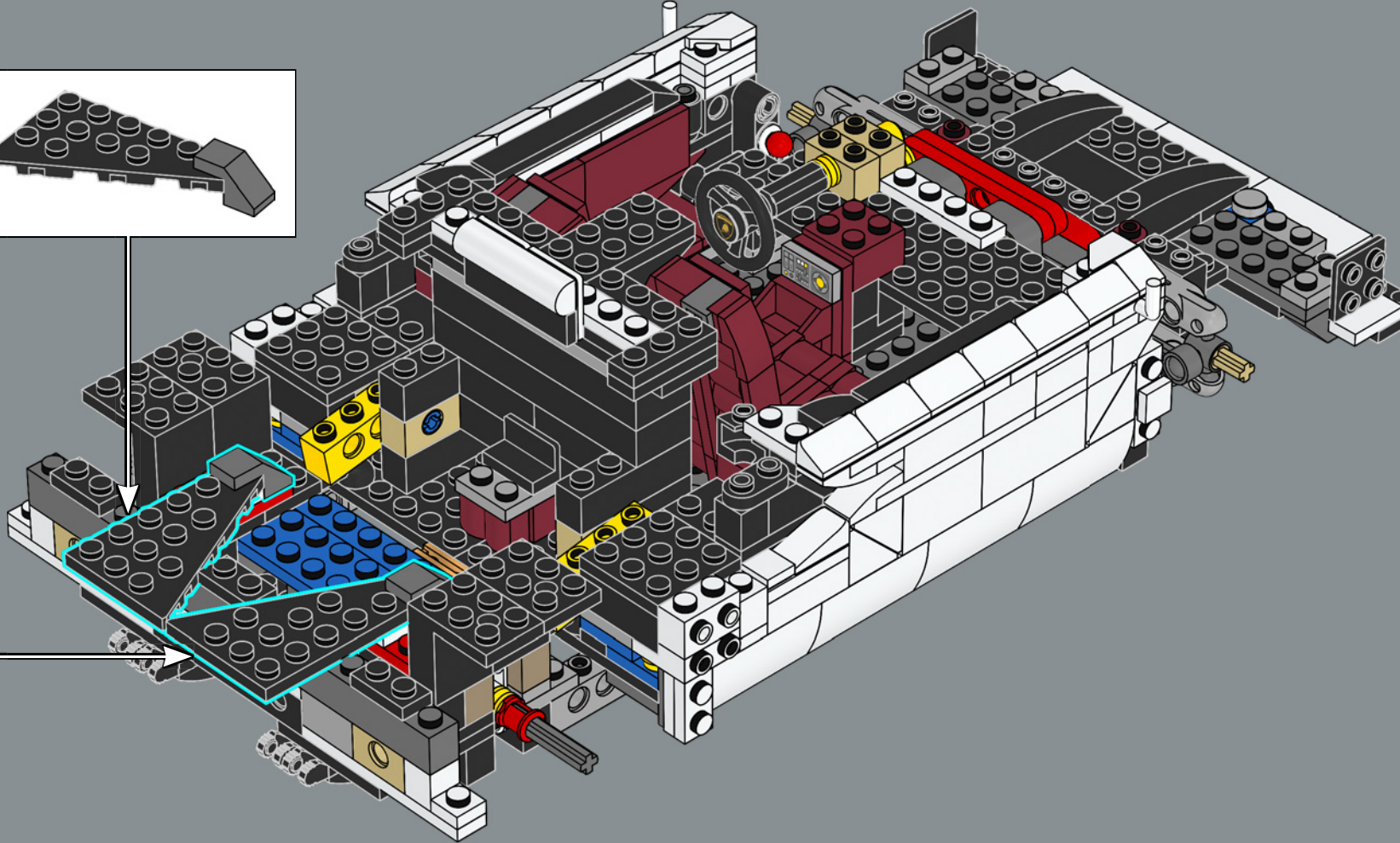
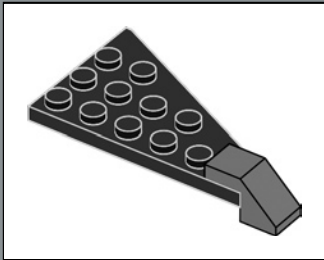
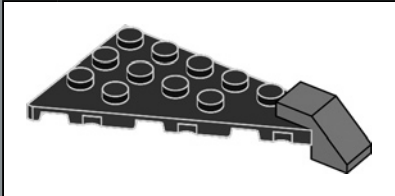

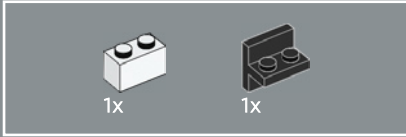
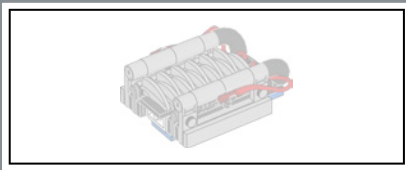

176

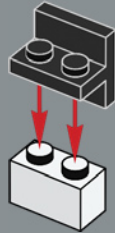

177

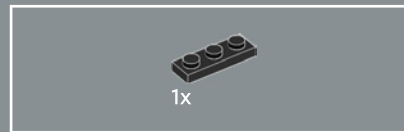
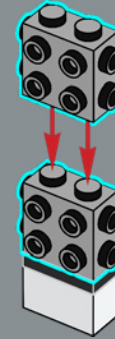

178



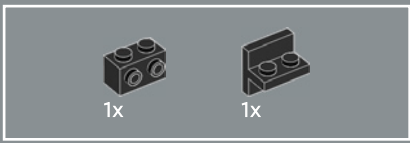

179

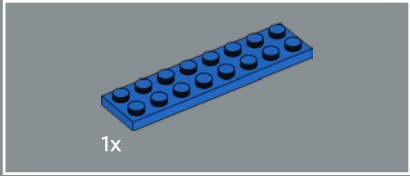
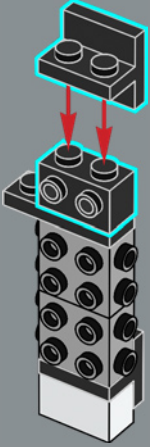

180

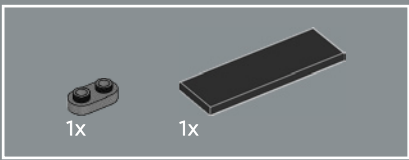
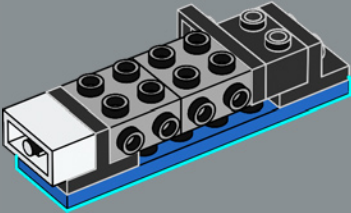

181

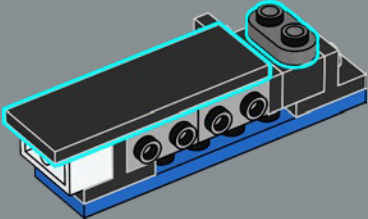

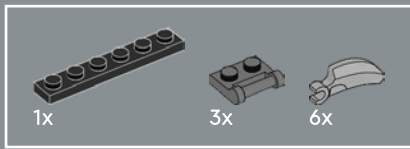

182

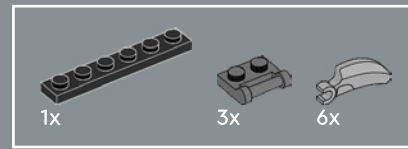
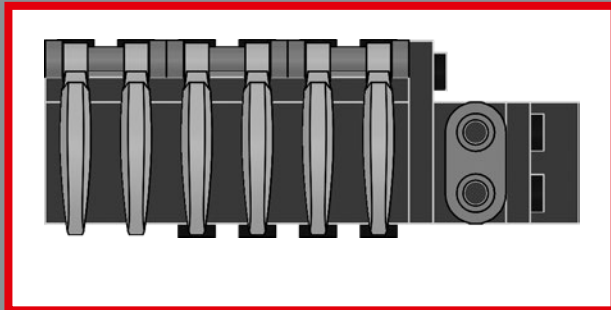
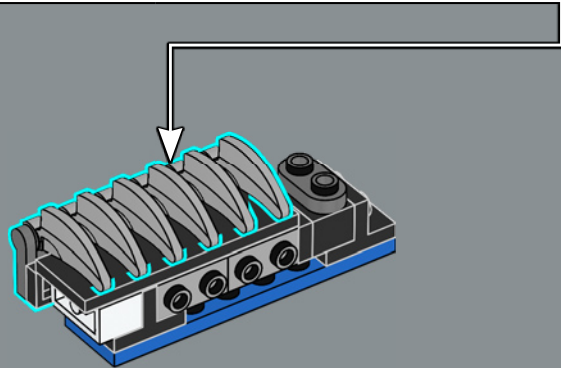
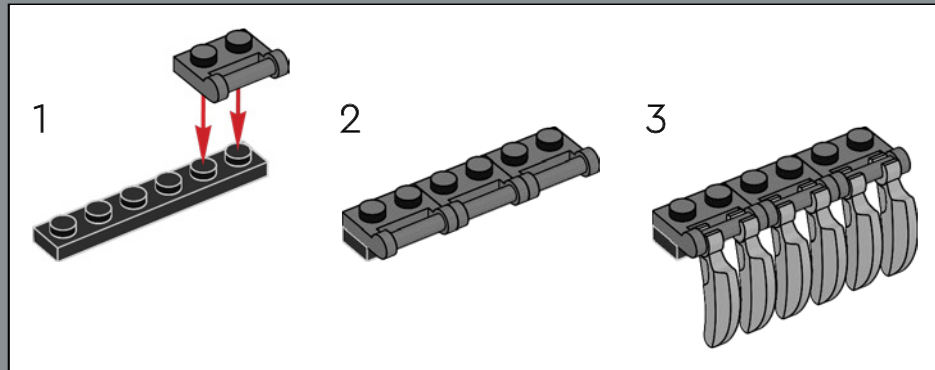

183

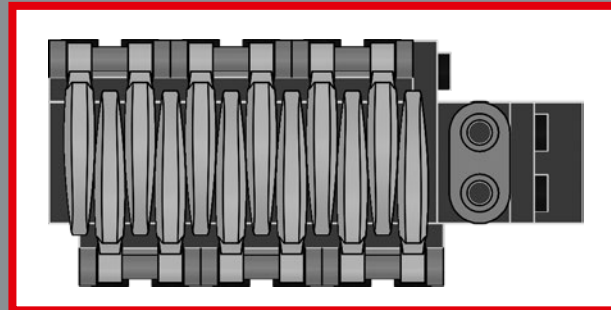
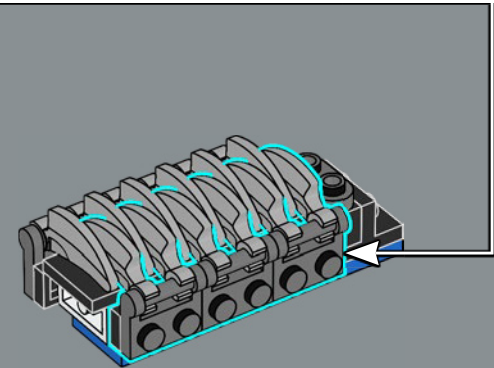
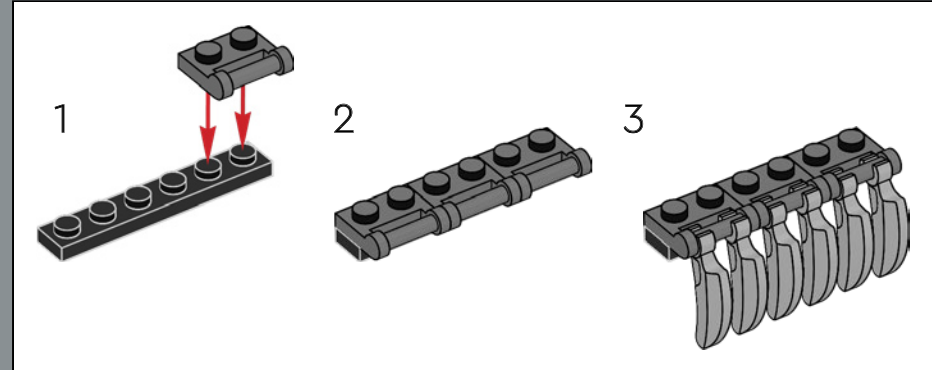

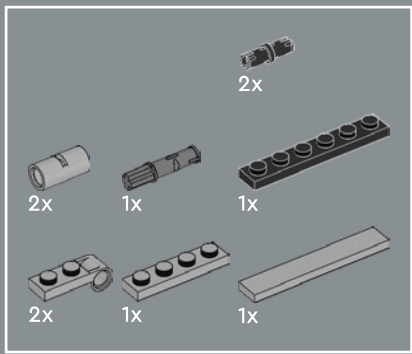

184

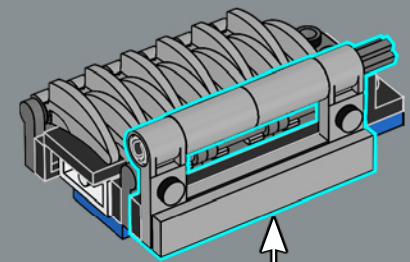
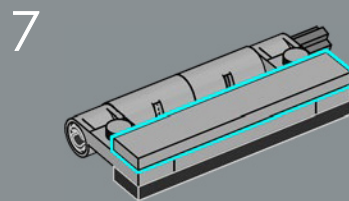
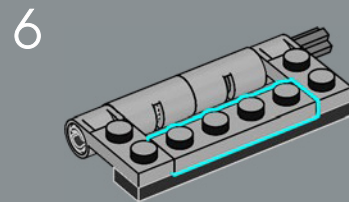
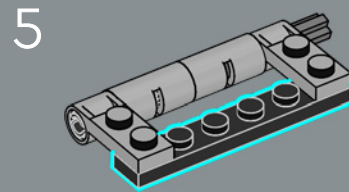
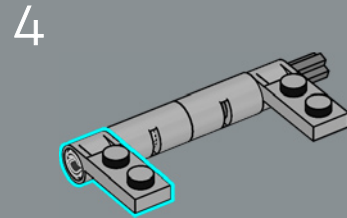
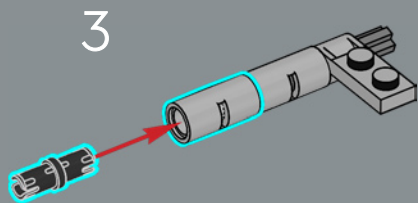
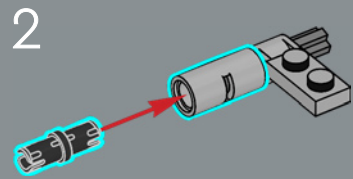
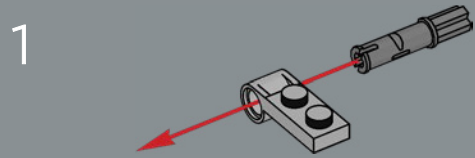

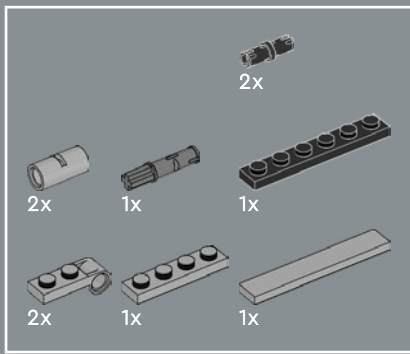

185

1

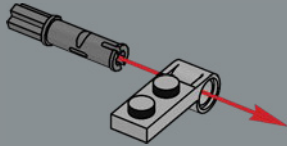

2

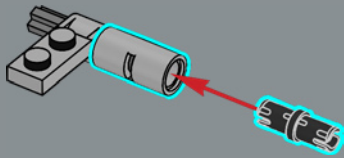

3

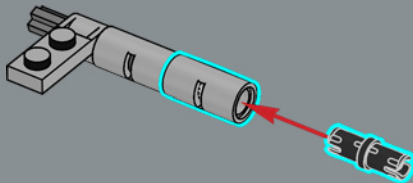

4

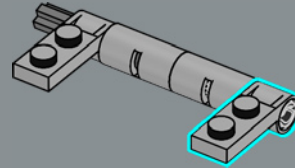

5

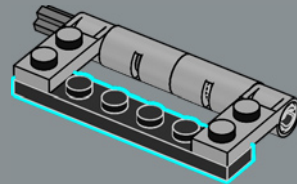

6

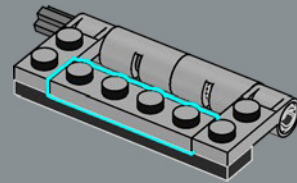

7

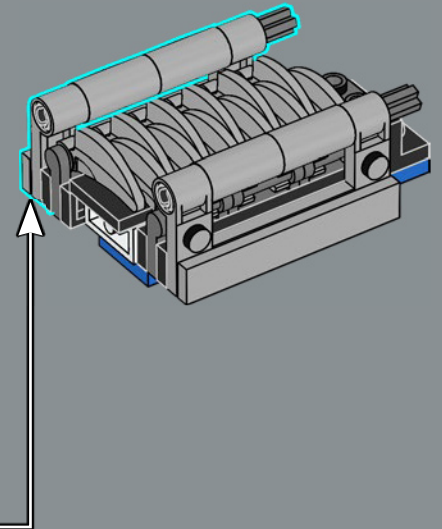
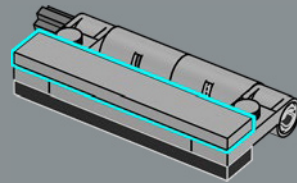

2x

186

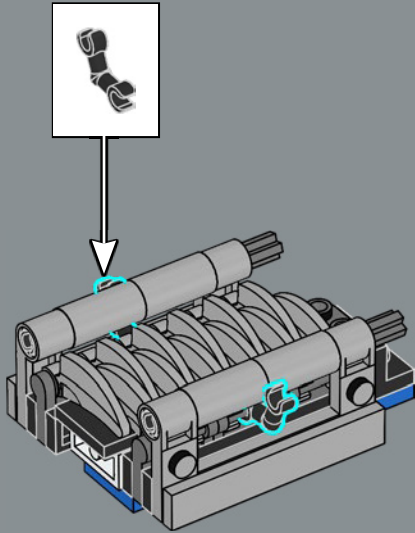

2x

187

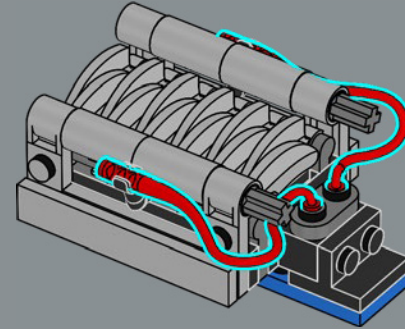

2x

188

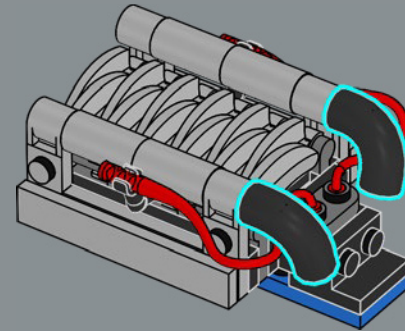



La sigla LP nei nomi Countach sta per Longitudinale Posteriore, poiché quella è la posizione del motore.

189

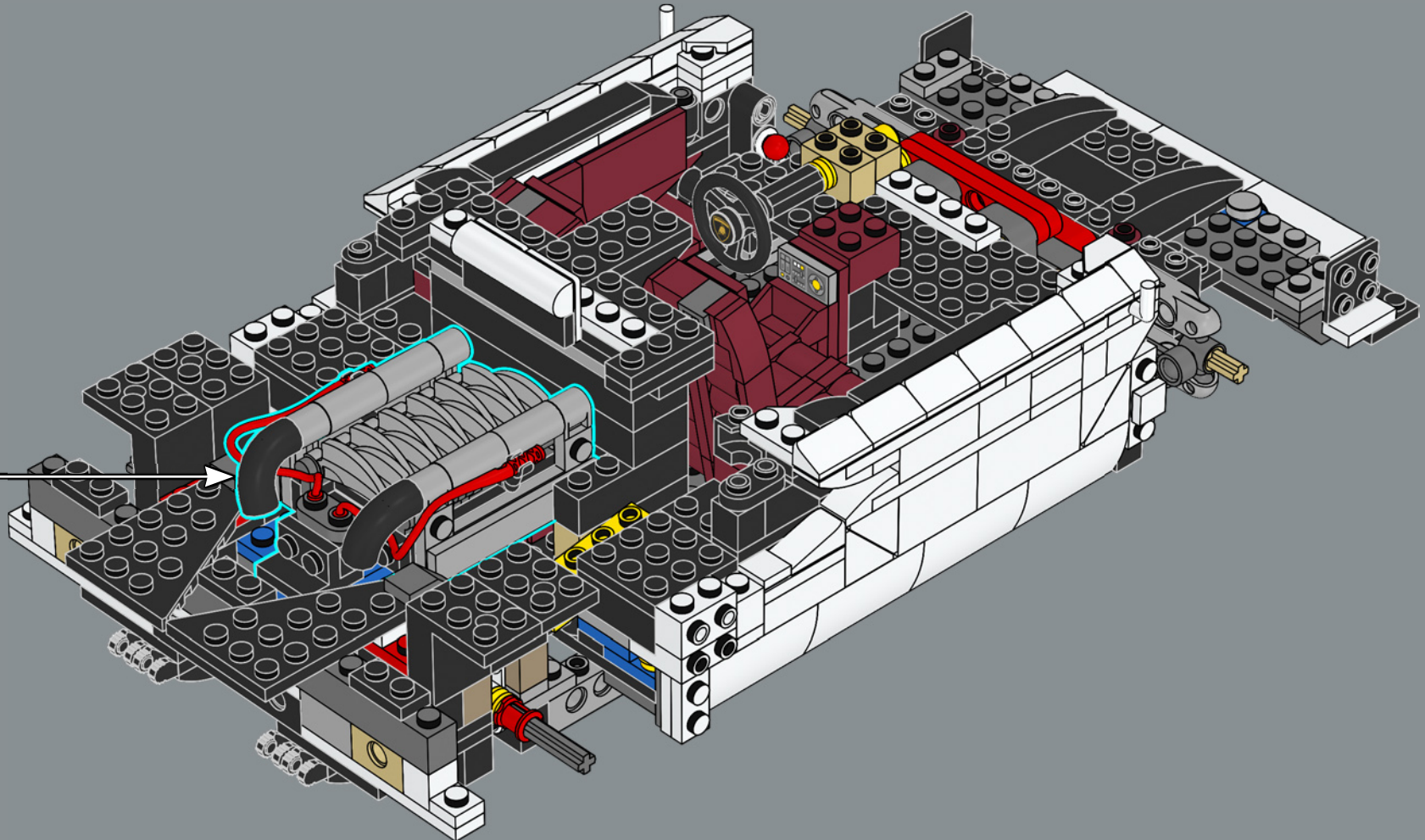

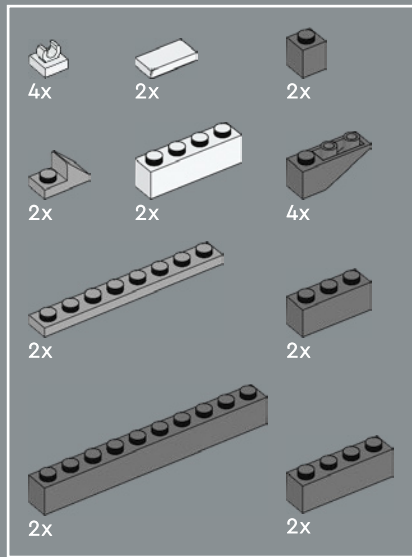
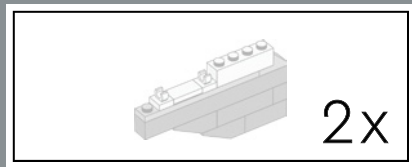

190

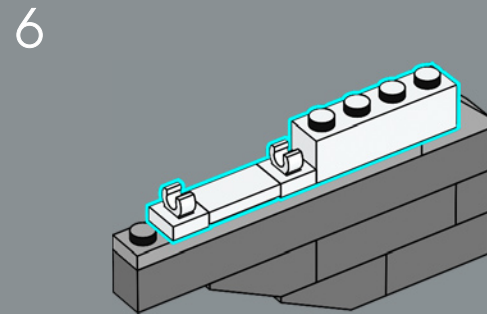
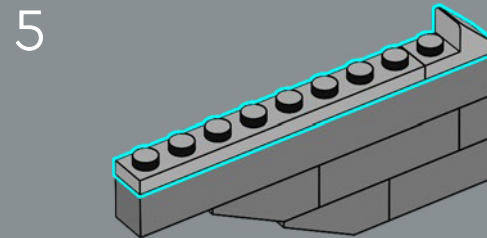
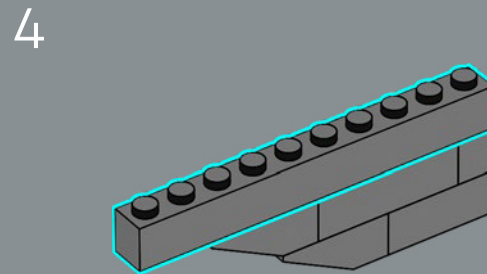
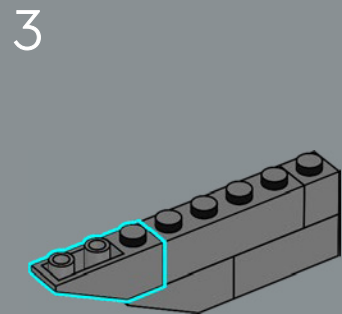
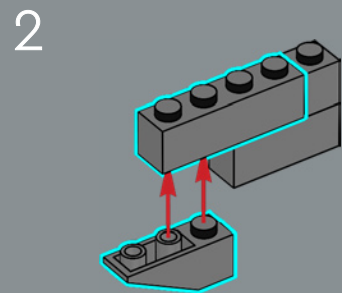
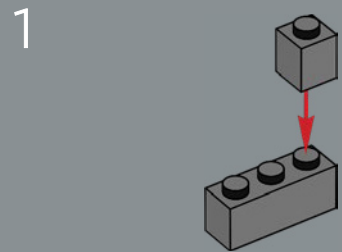

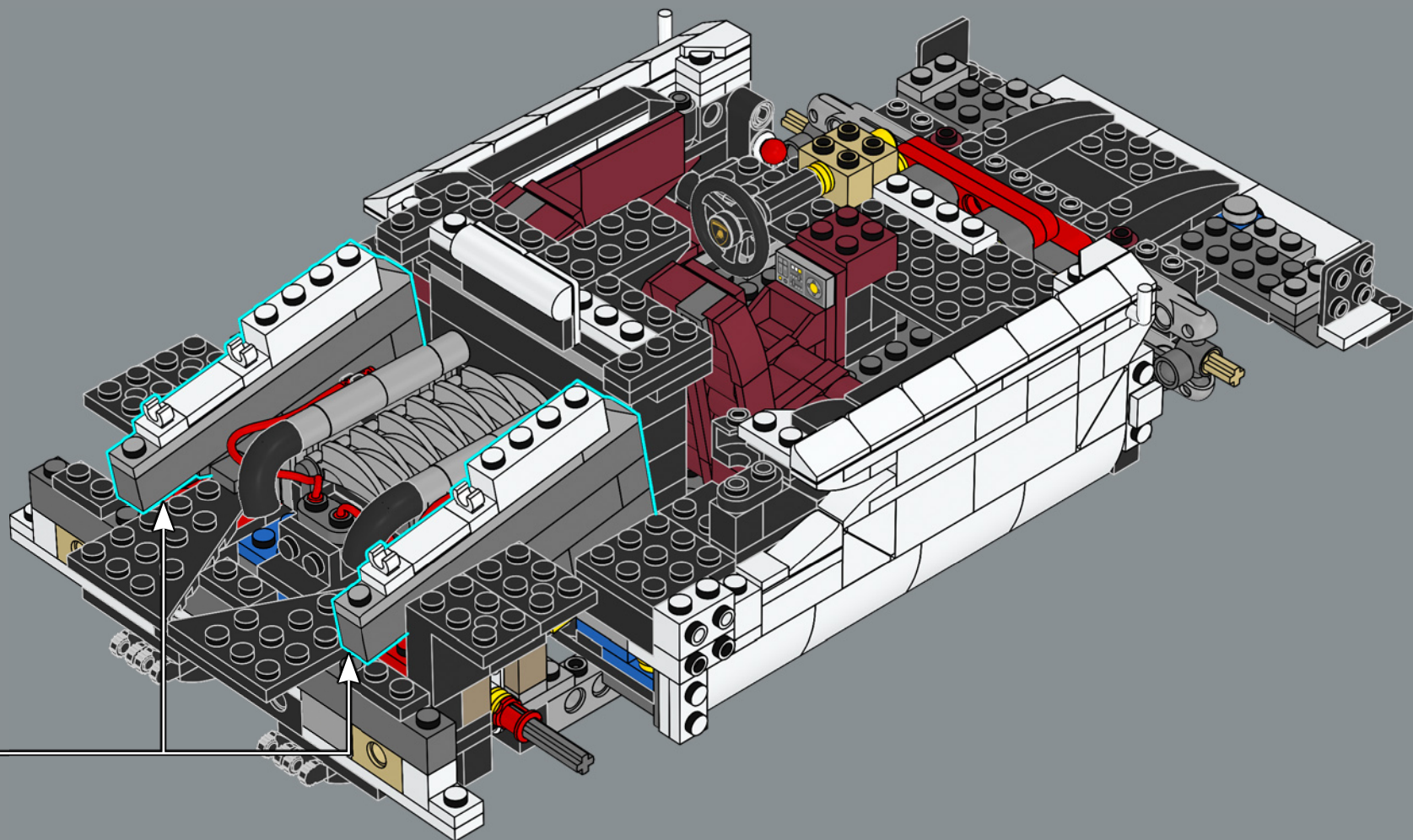

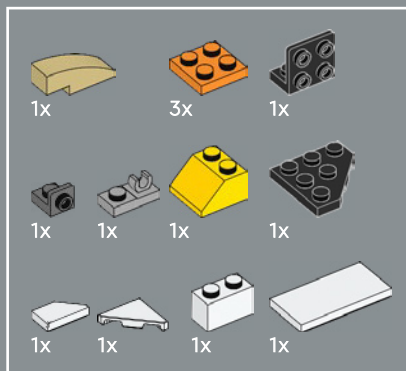

191

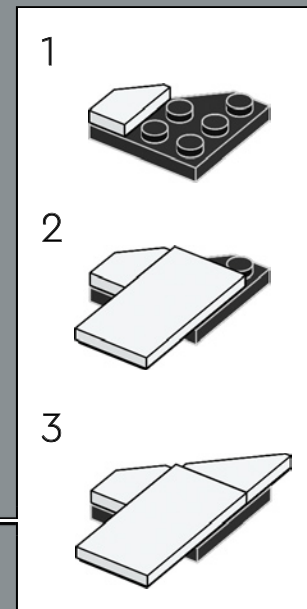
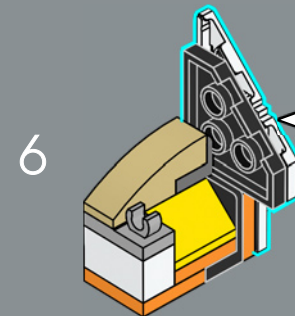
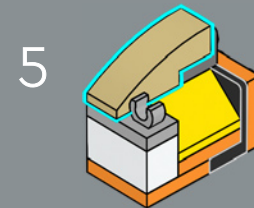
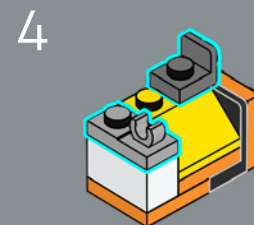
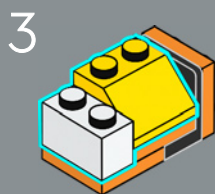
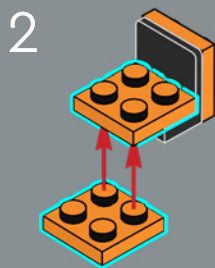
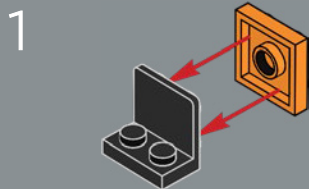

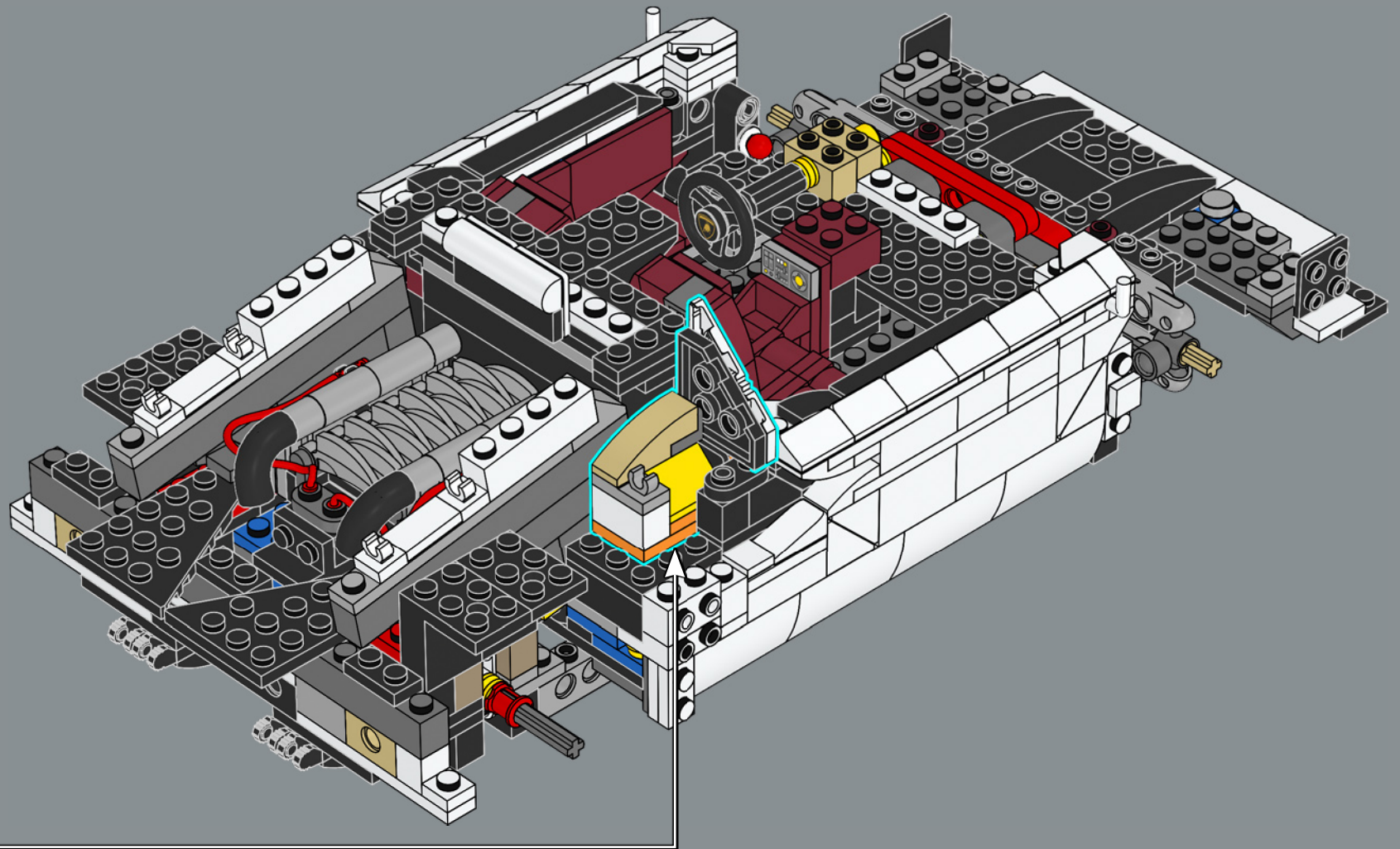

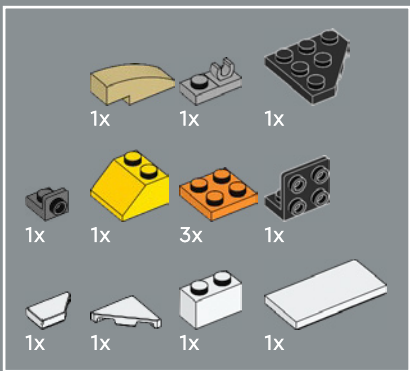

192

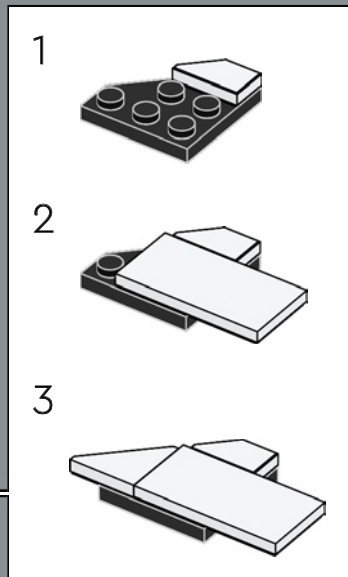
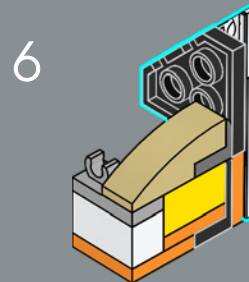
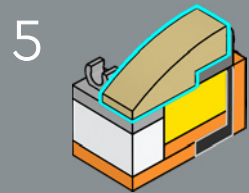
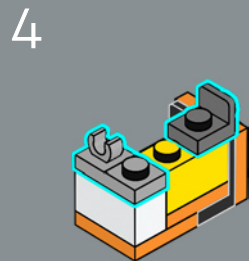
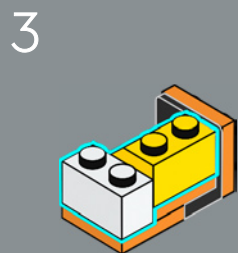
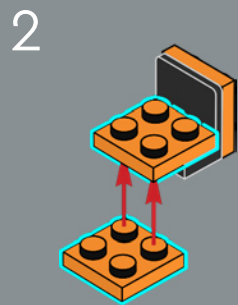
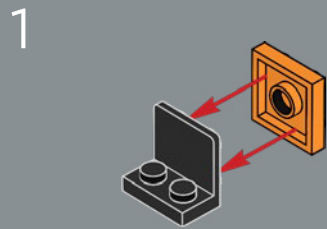

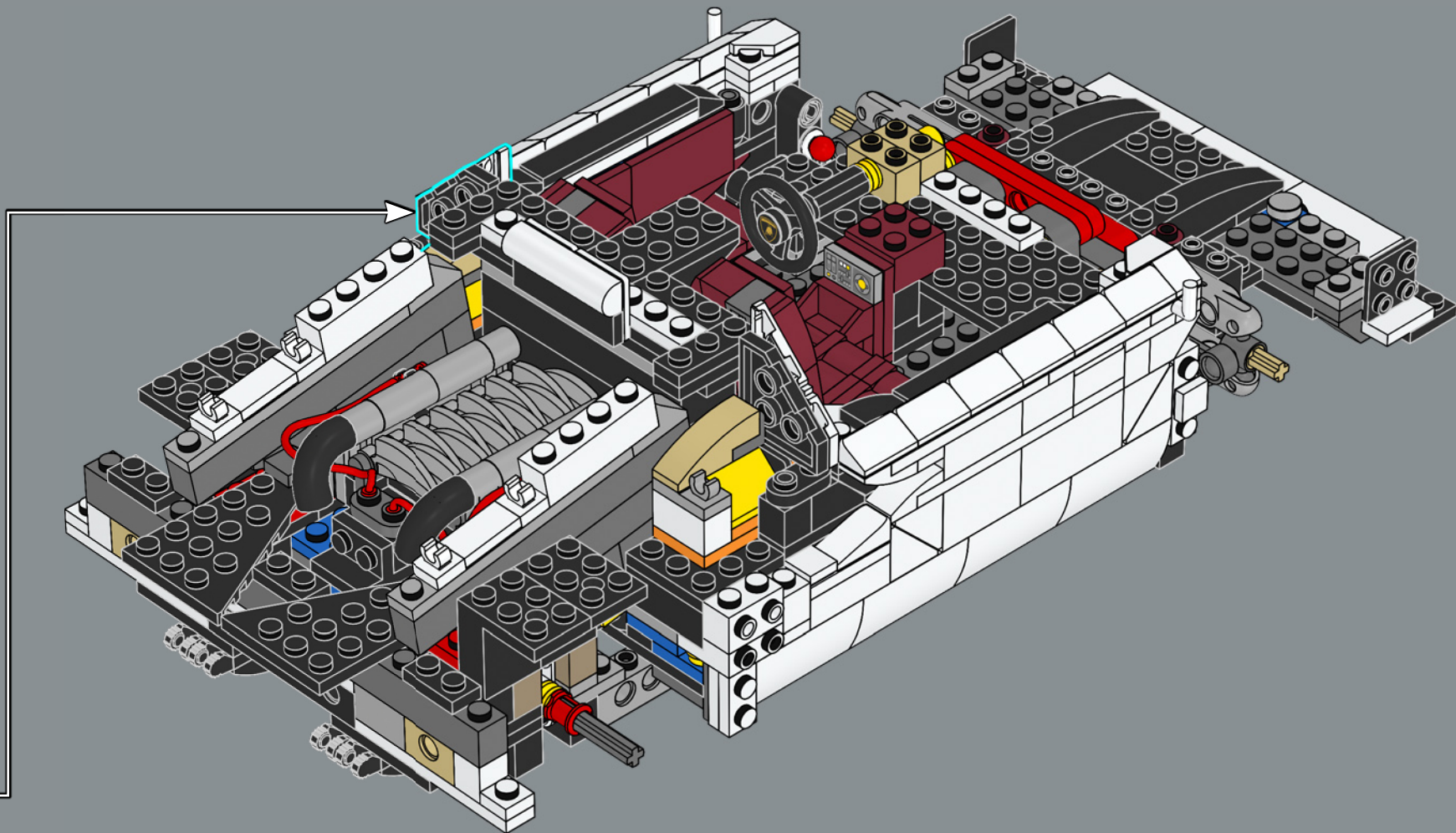

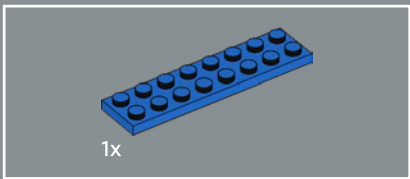

193

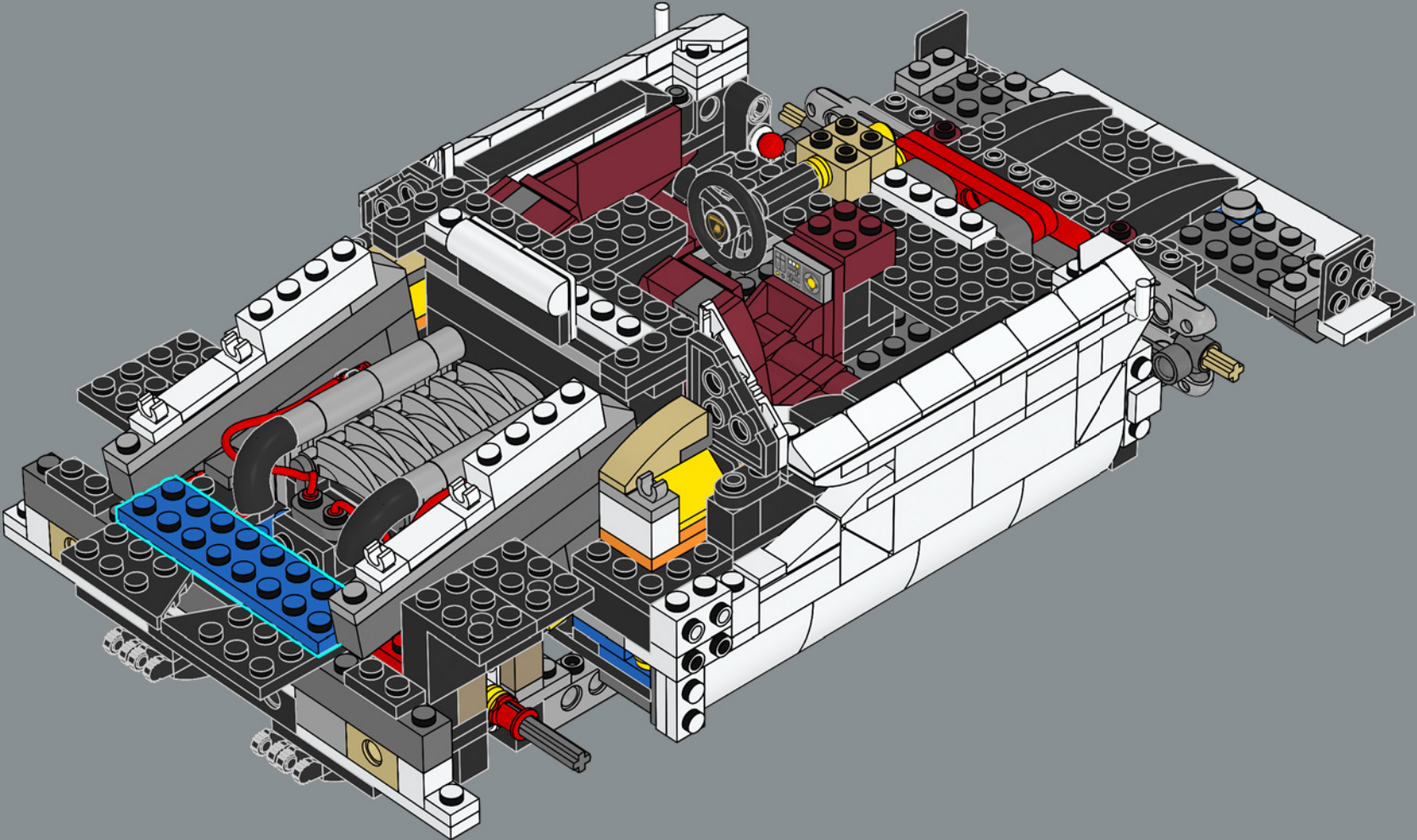

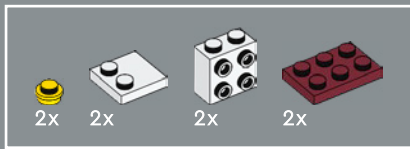

194

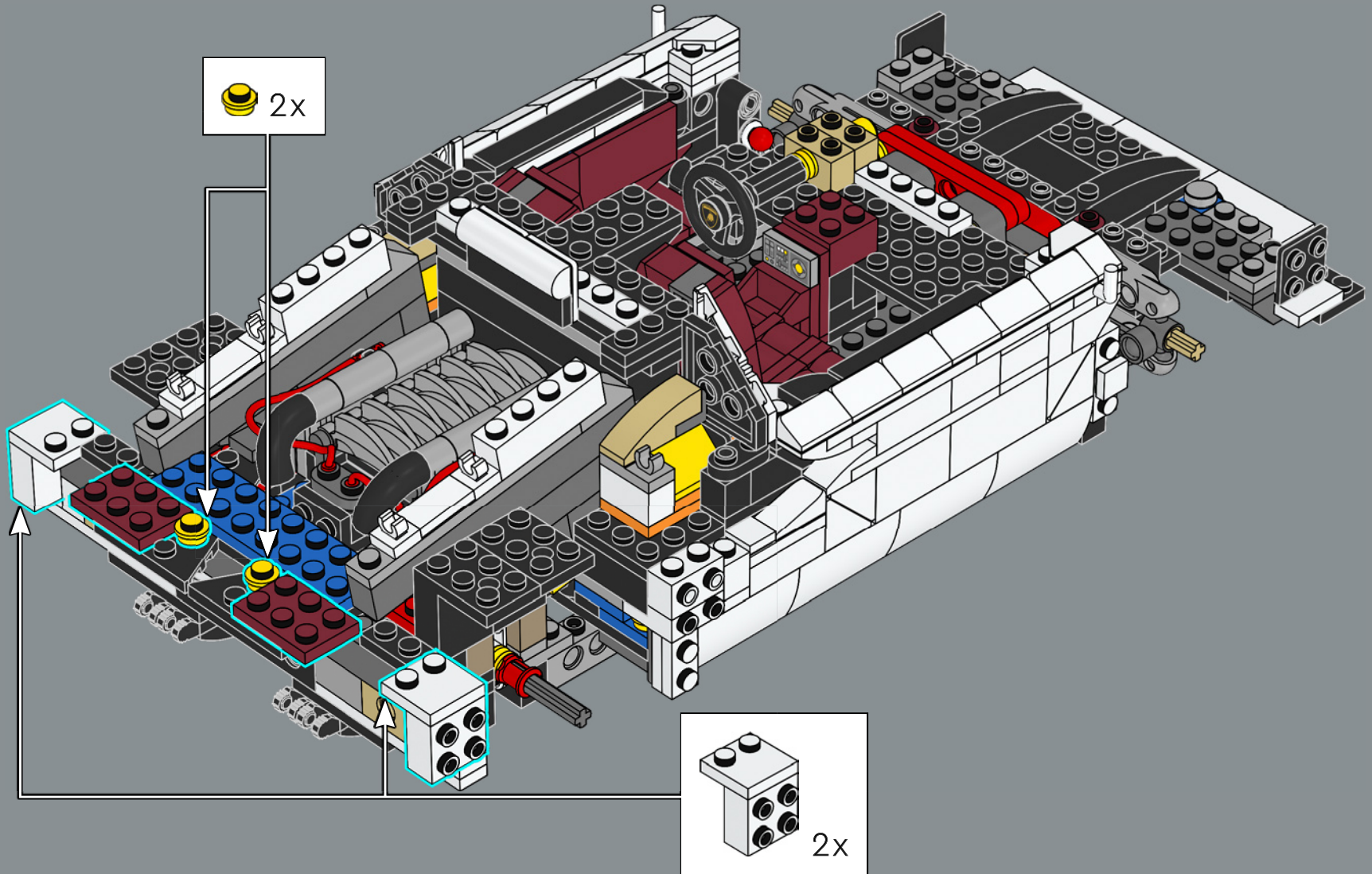



2x

195

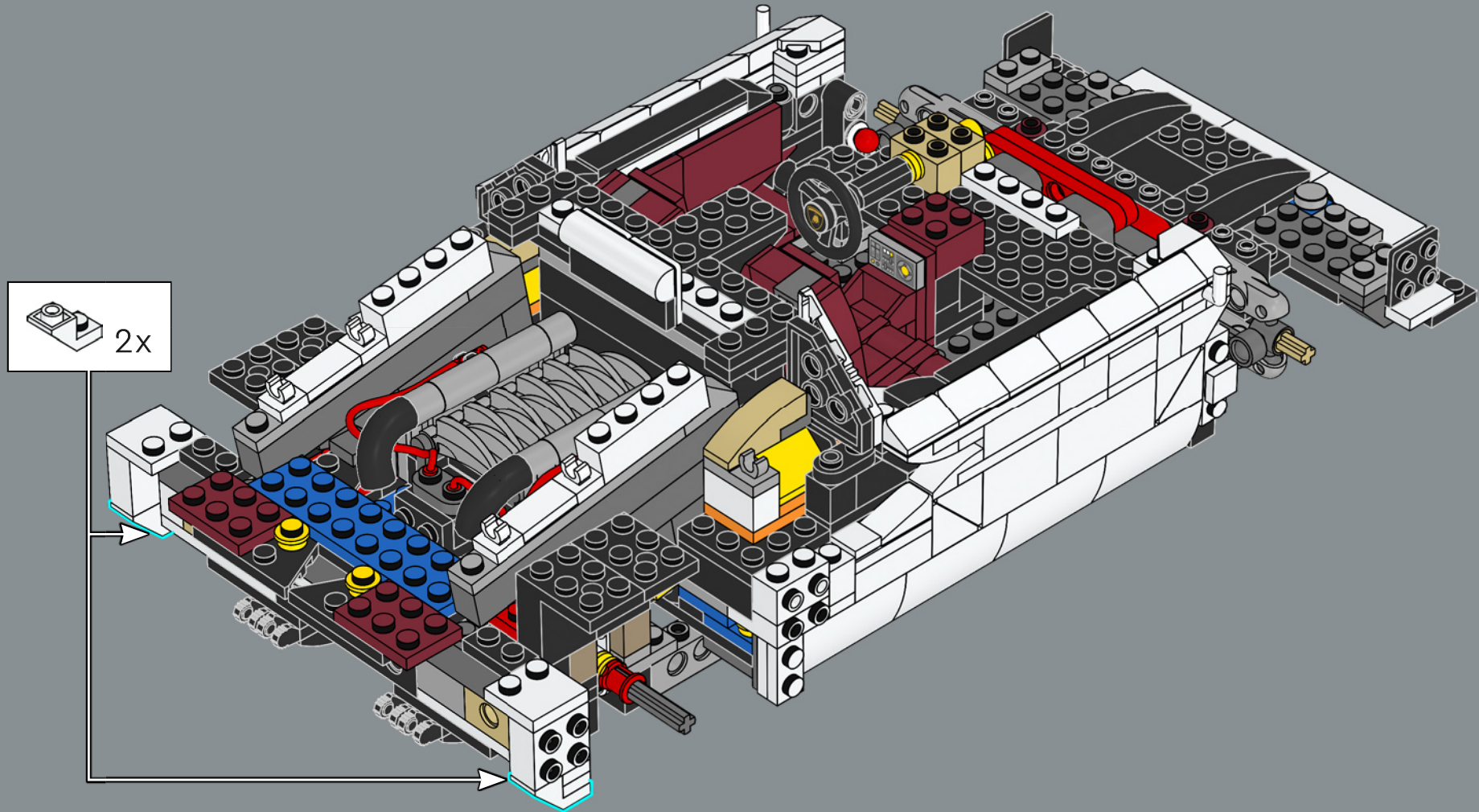

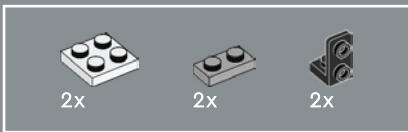

196

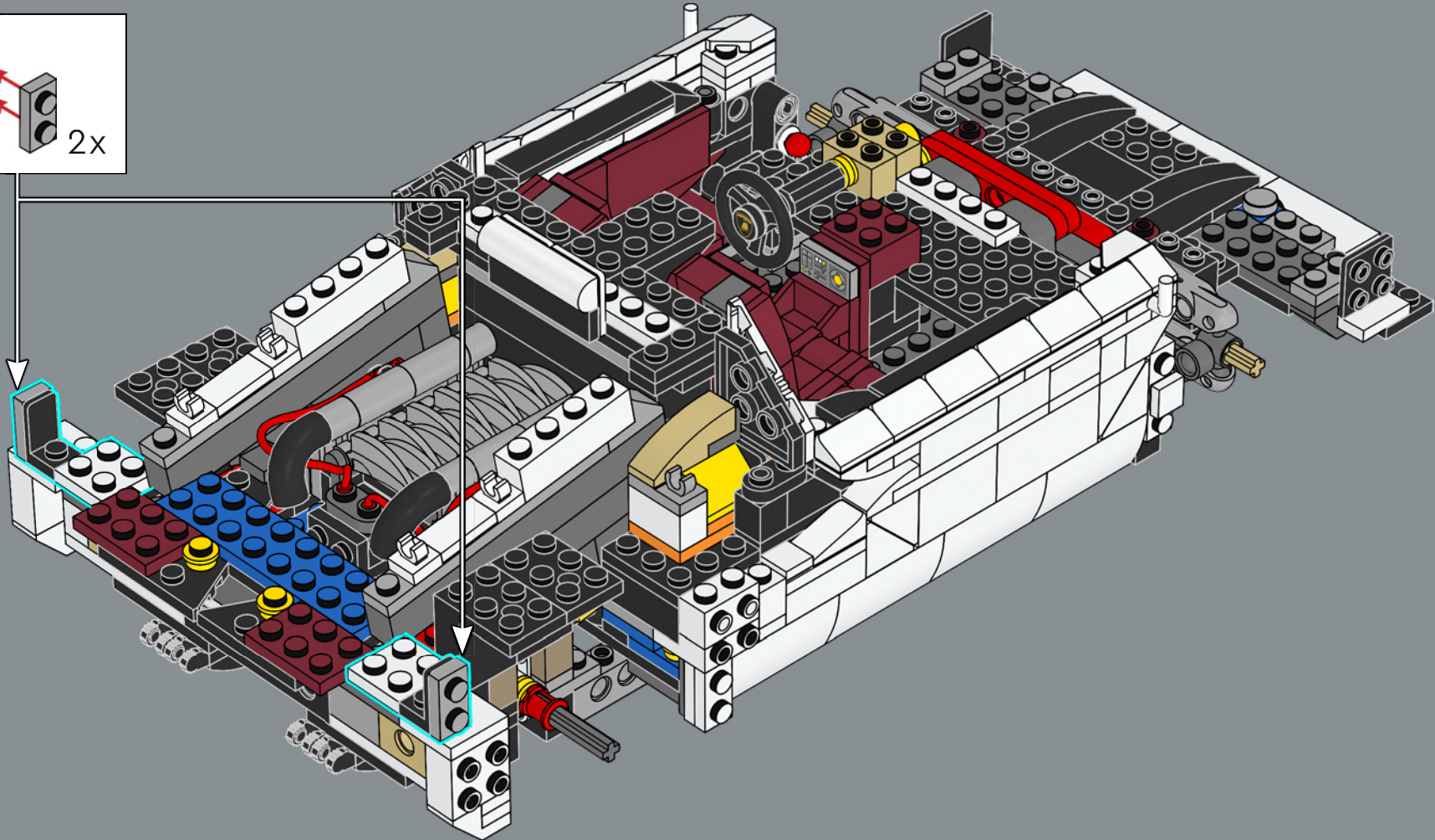
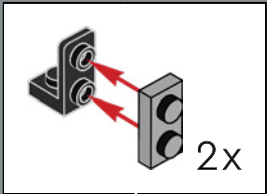

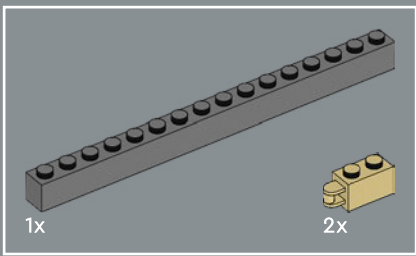

197

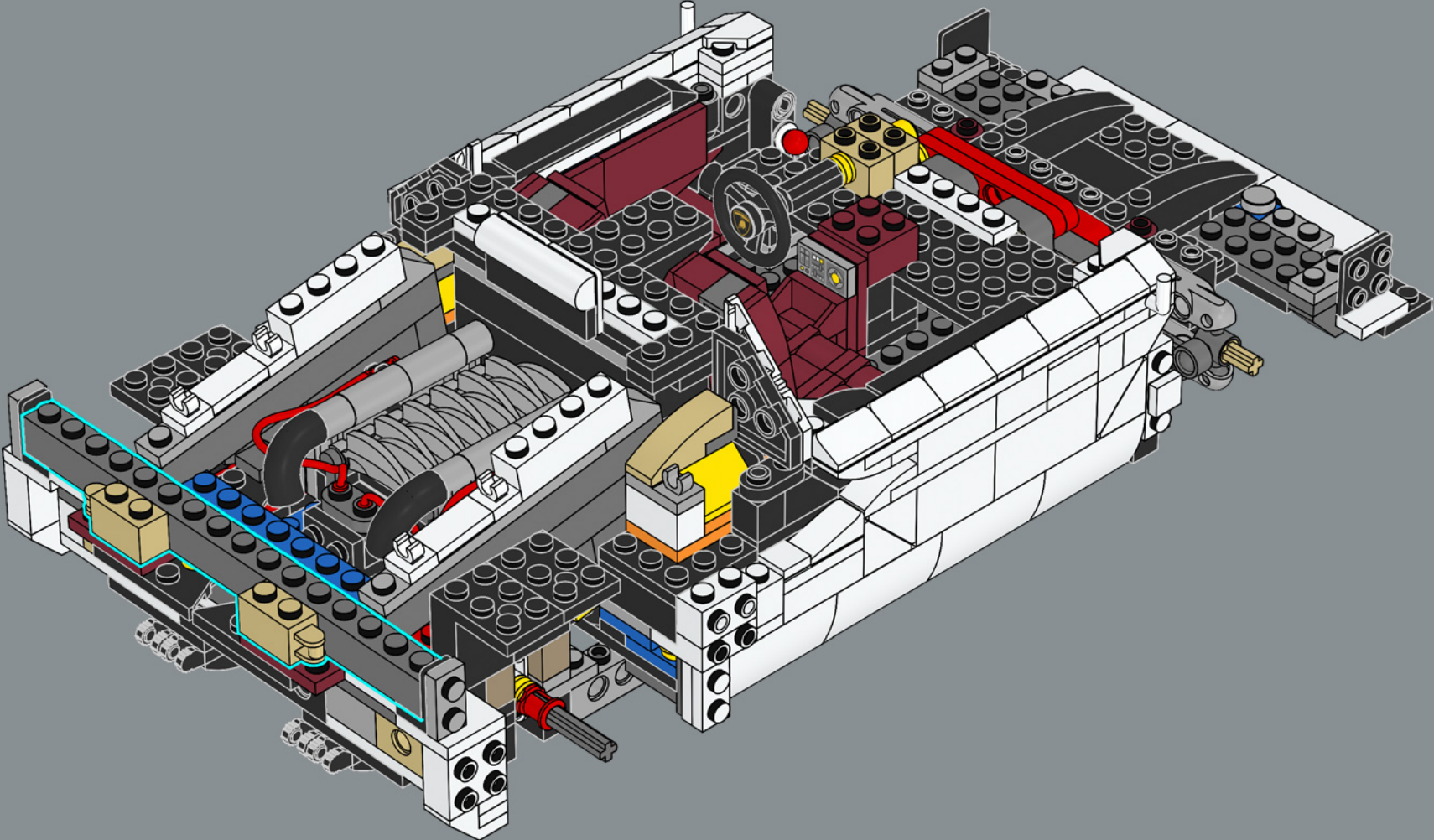

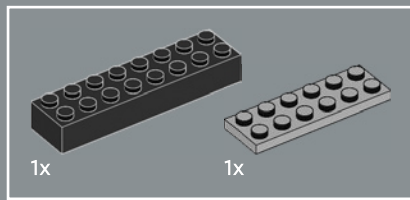

198

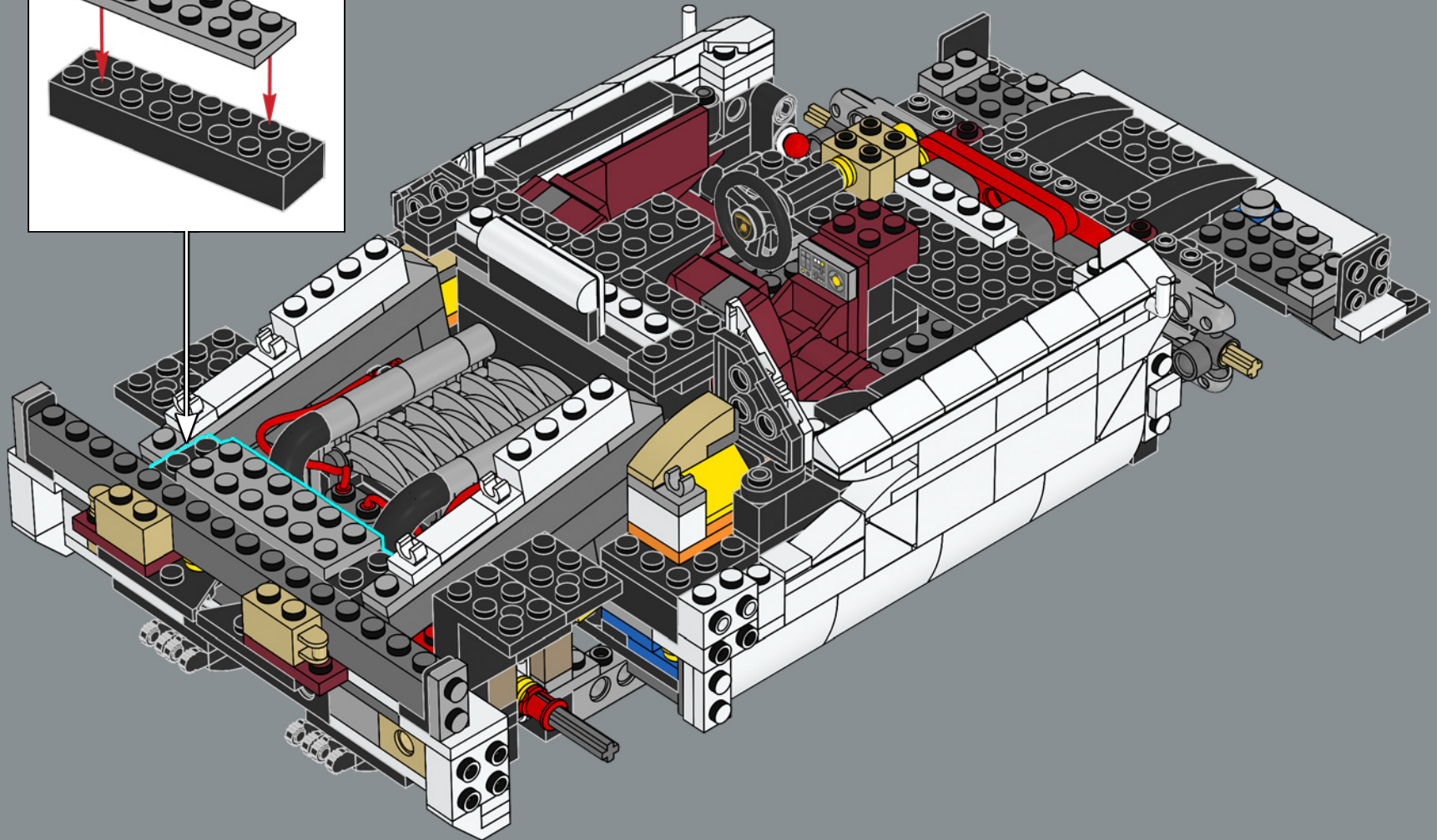
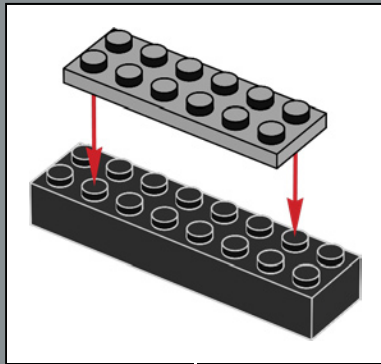

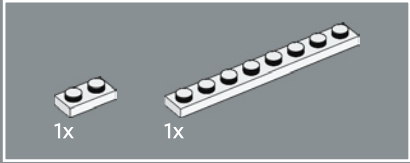
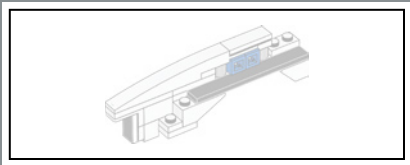

199

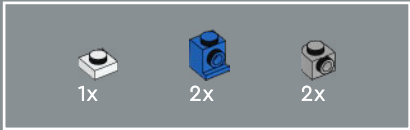
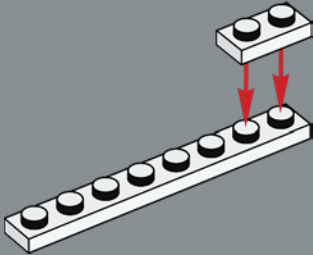

200

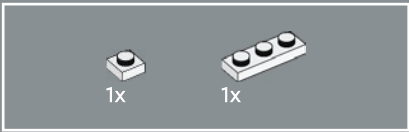
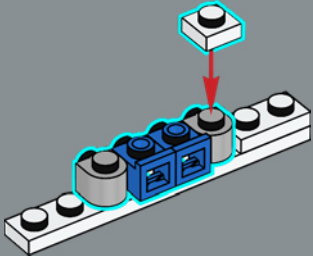

201

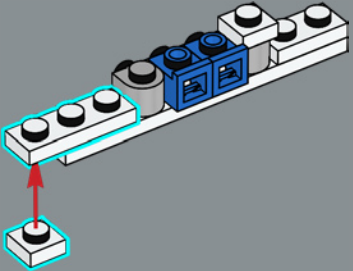

202

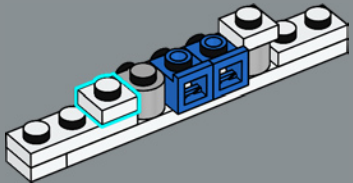

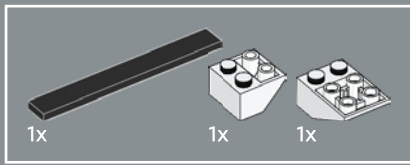

203

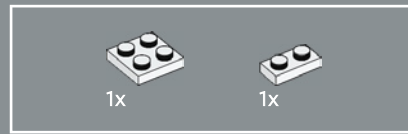
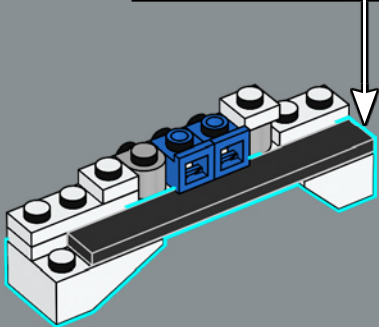
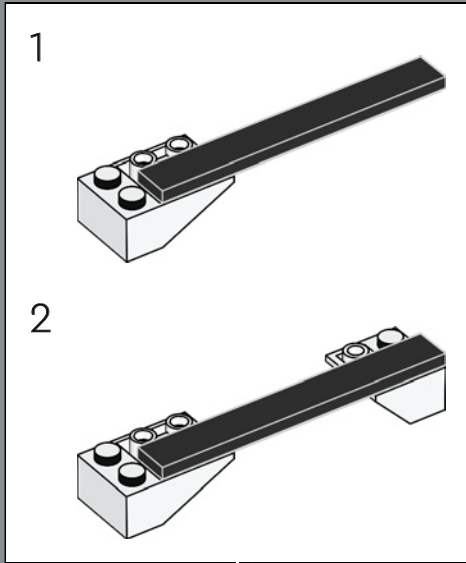

204

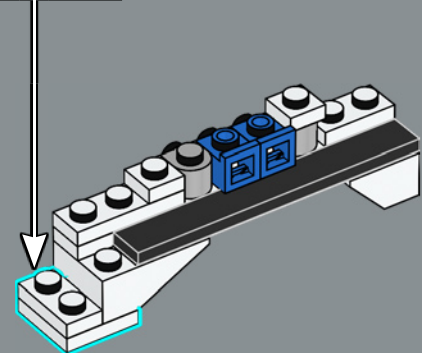
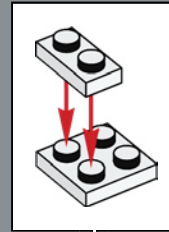

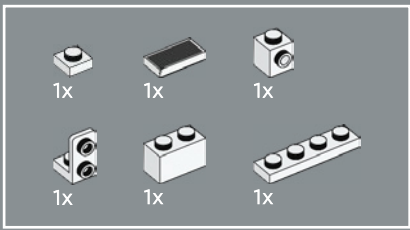

205

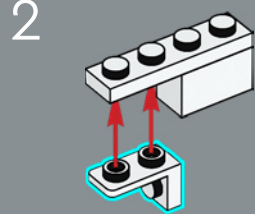
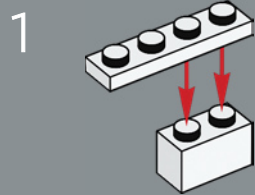

3

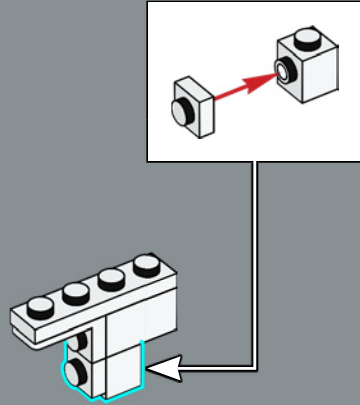

4

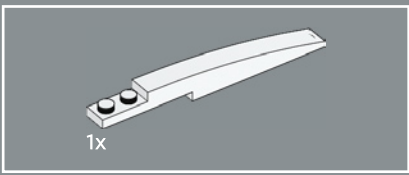
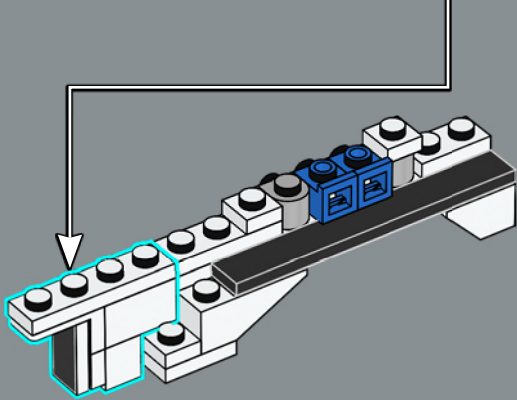
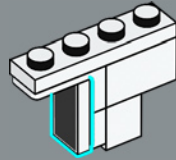

206

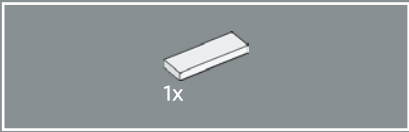
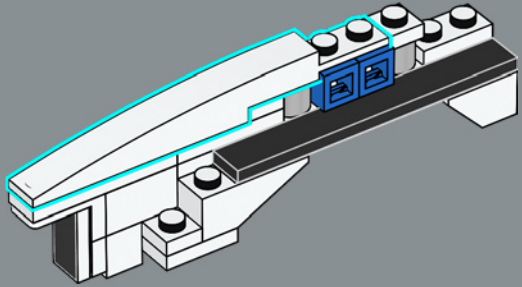

207

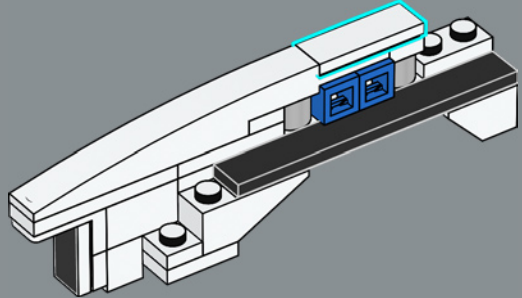

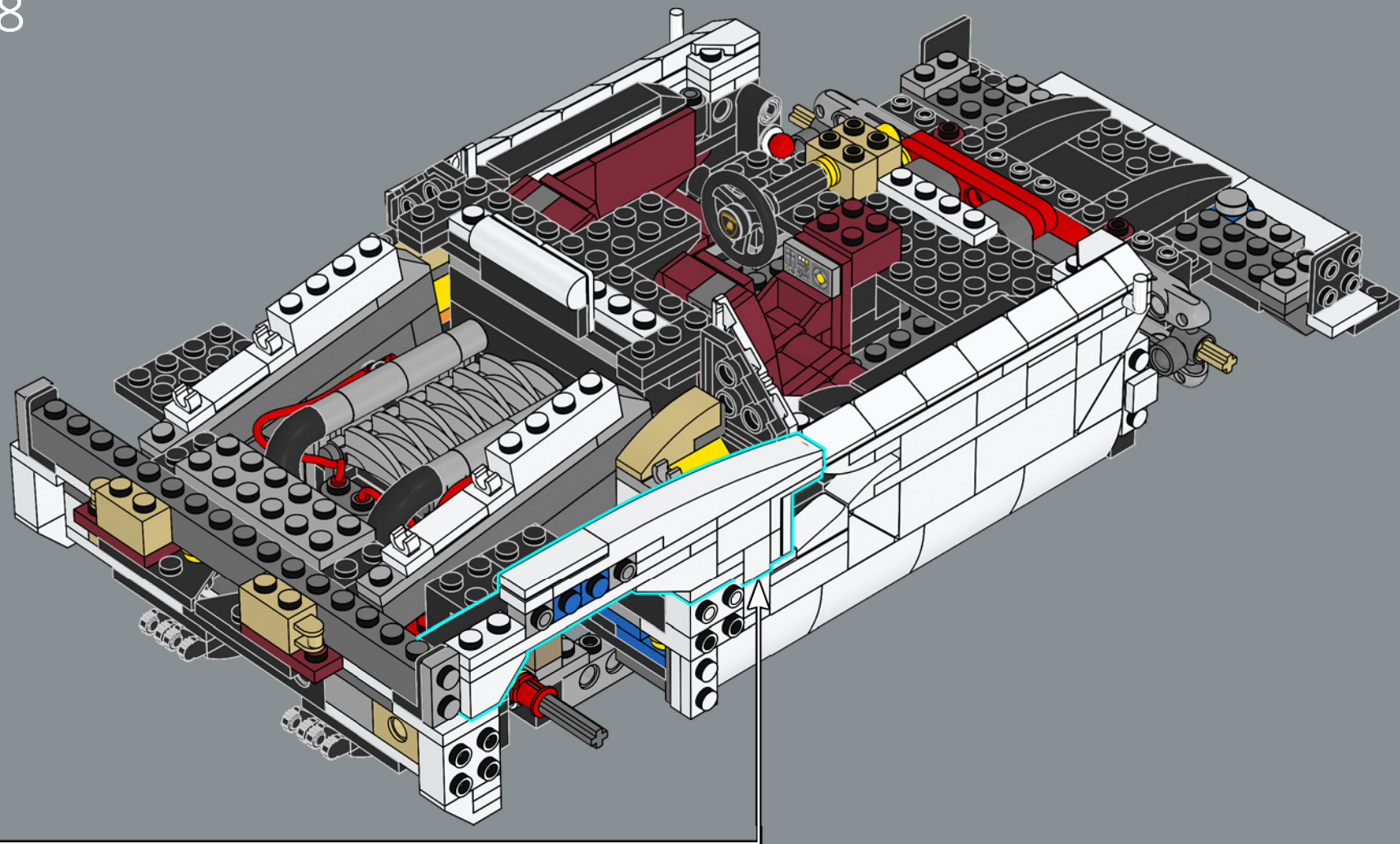

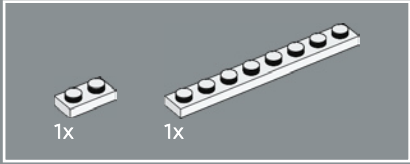
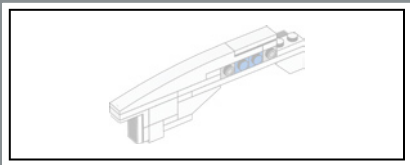

209

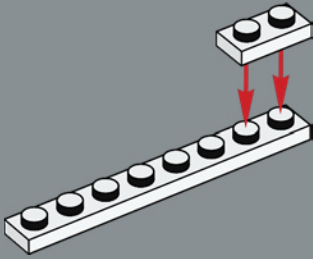

210

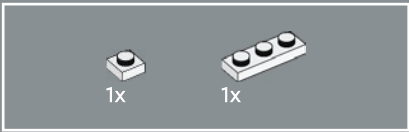
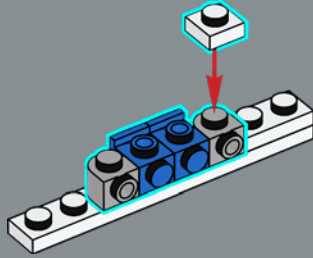

211

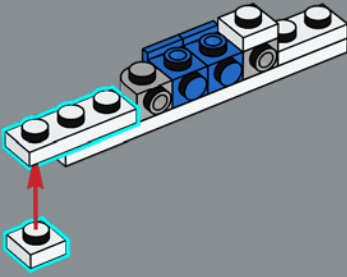

212

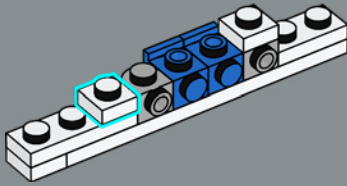

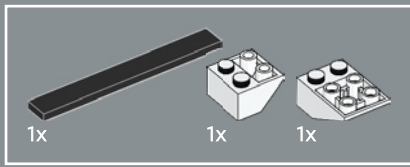

213

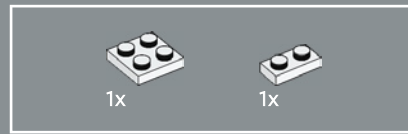
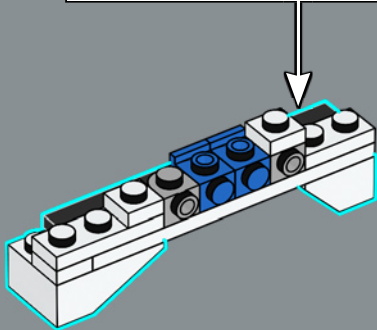
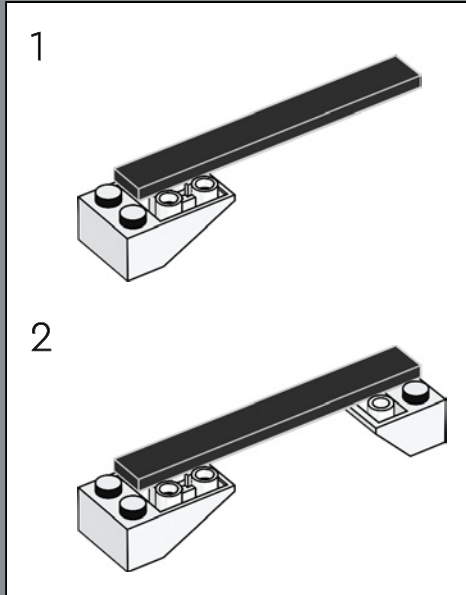

214

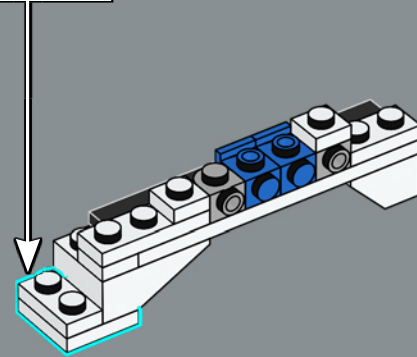
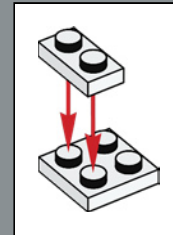

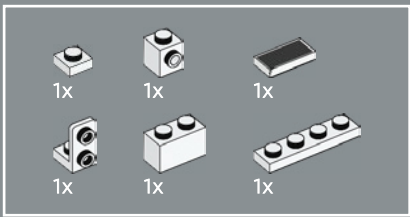

215

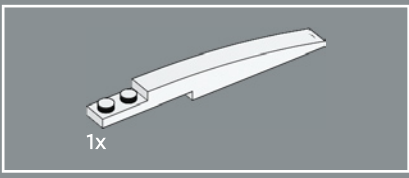
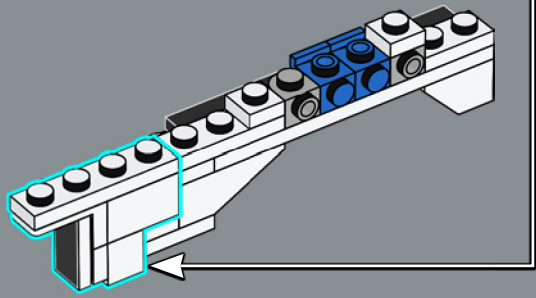
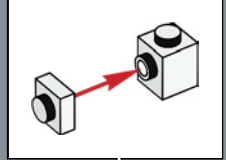
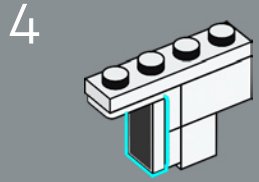
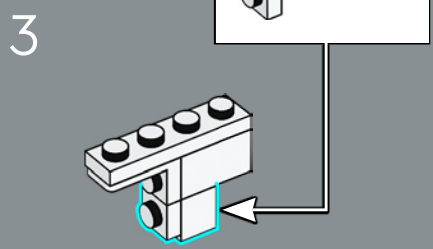
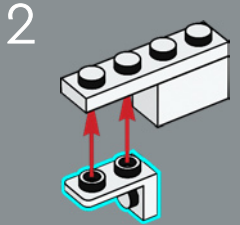
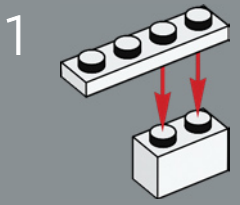

216

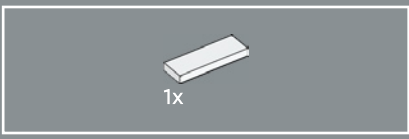
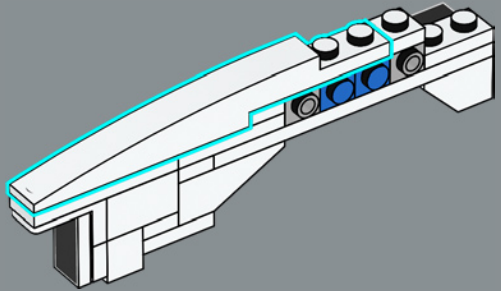

217

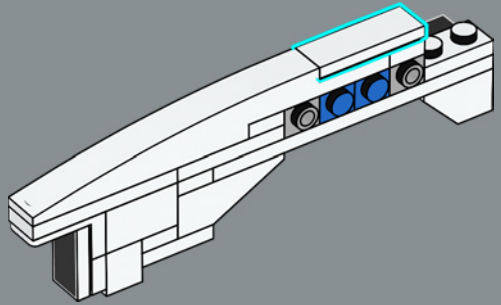

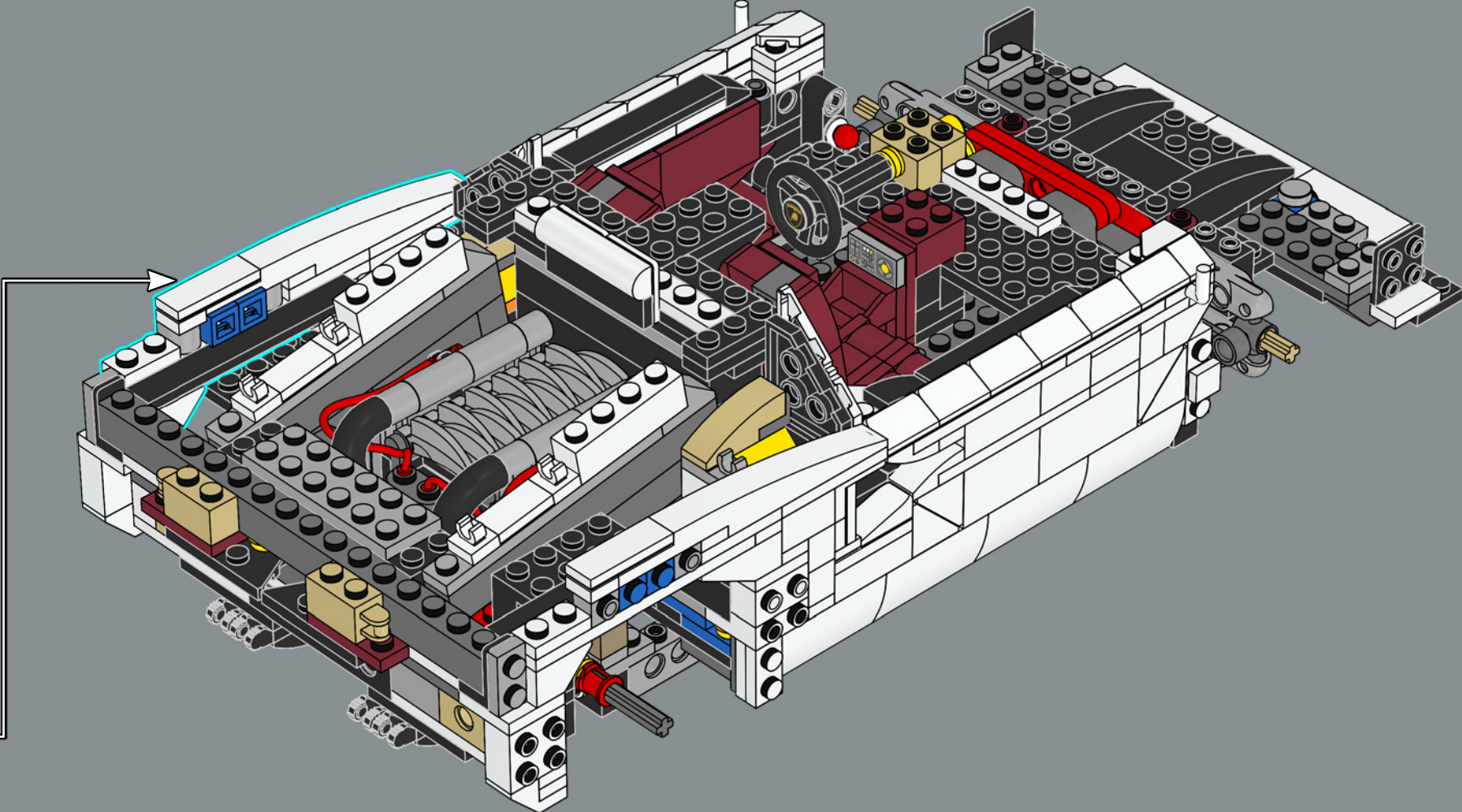

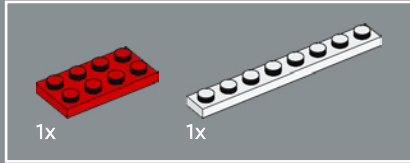
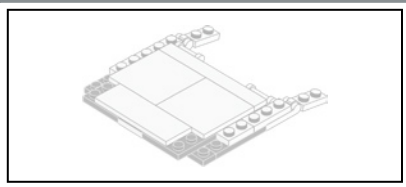

219

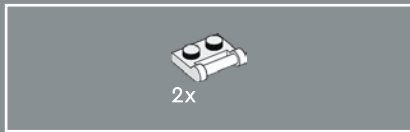
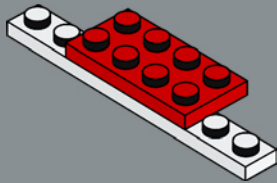

220

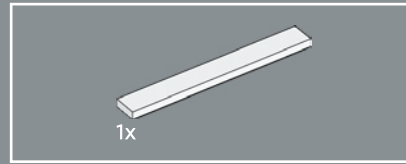
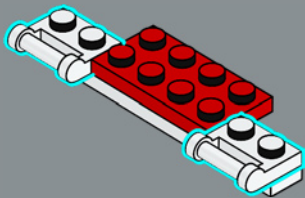

221

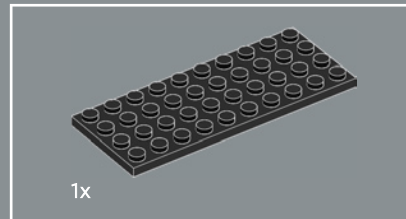
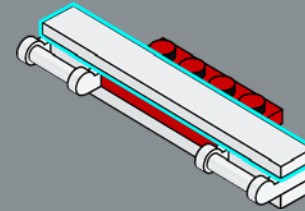

222

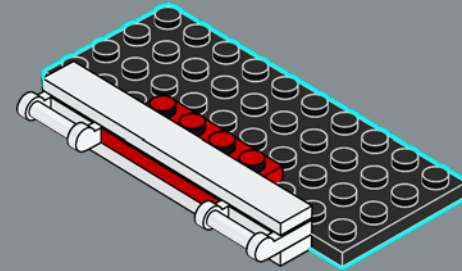

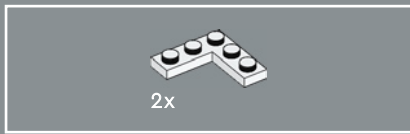

223

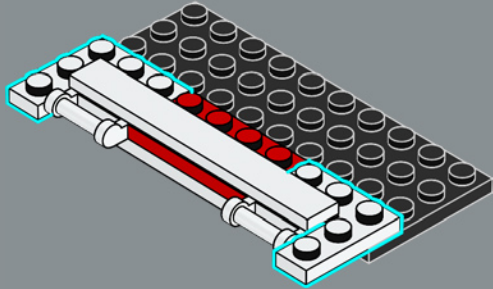

224

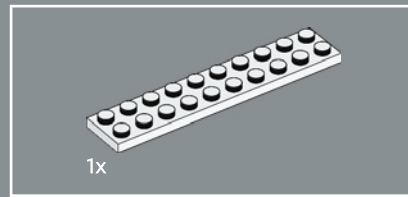
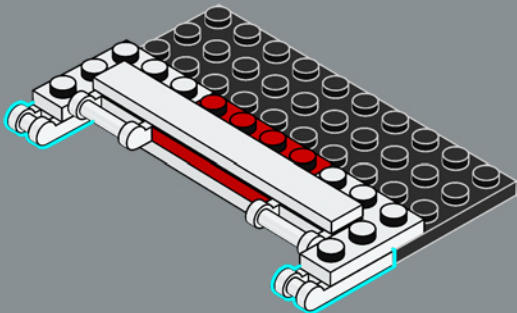

225

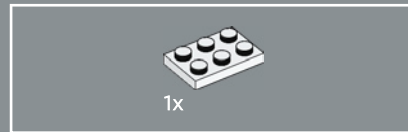
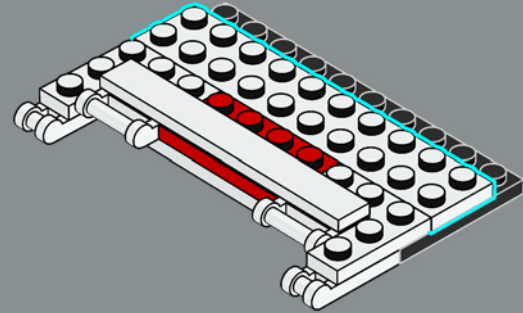

226

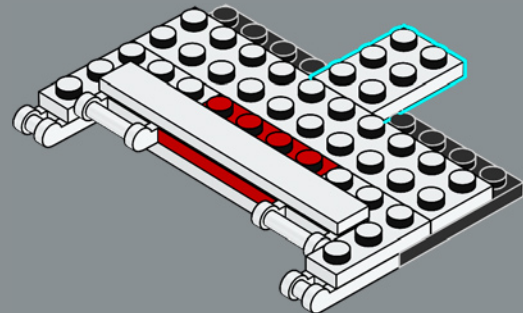

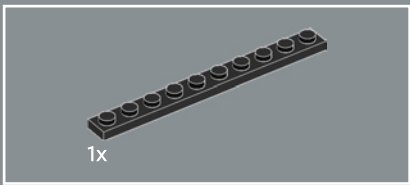

227

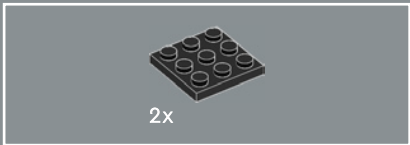
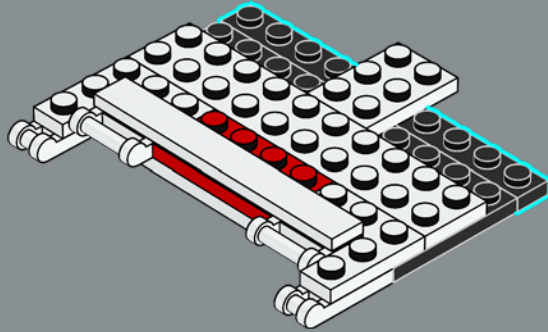

228

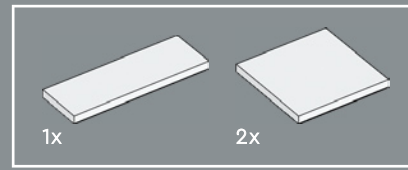
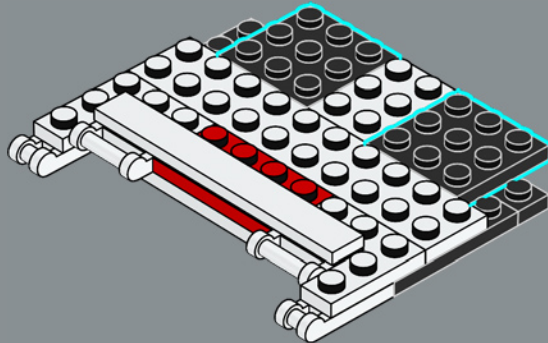

229

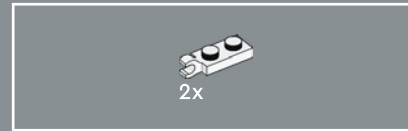
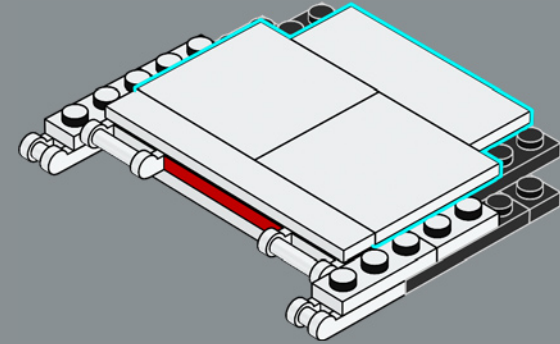

230

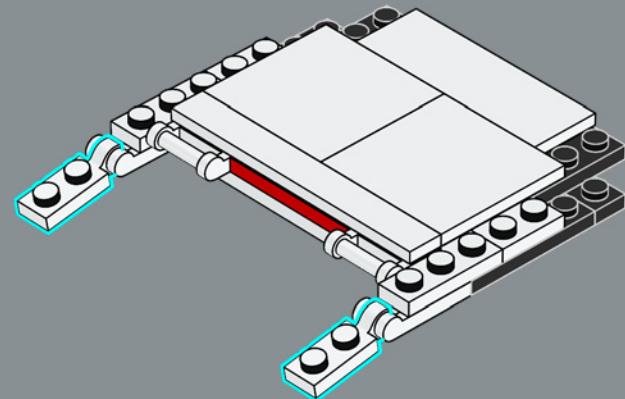

231

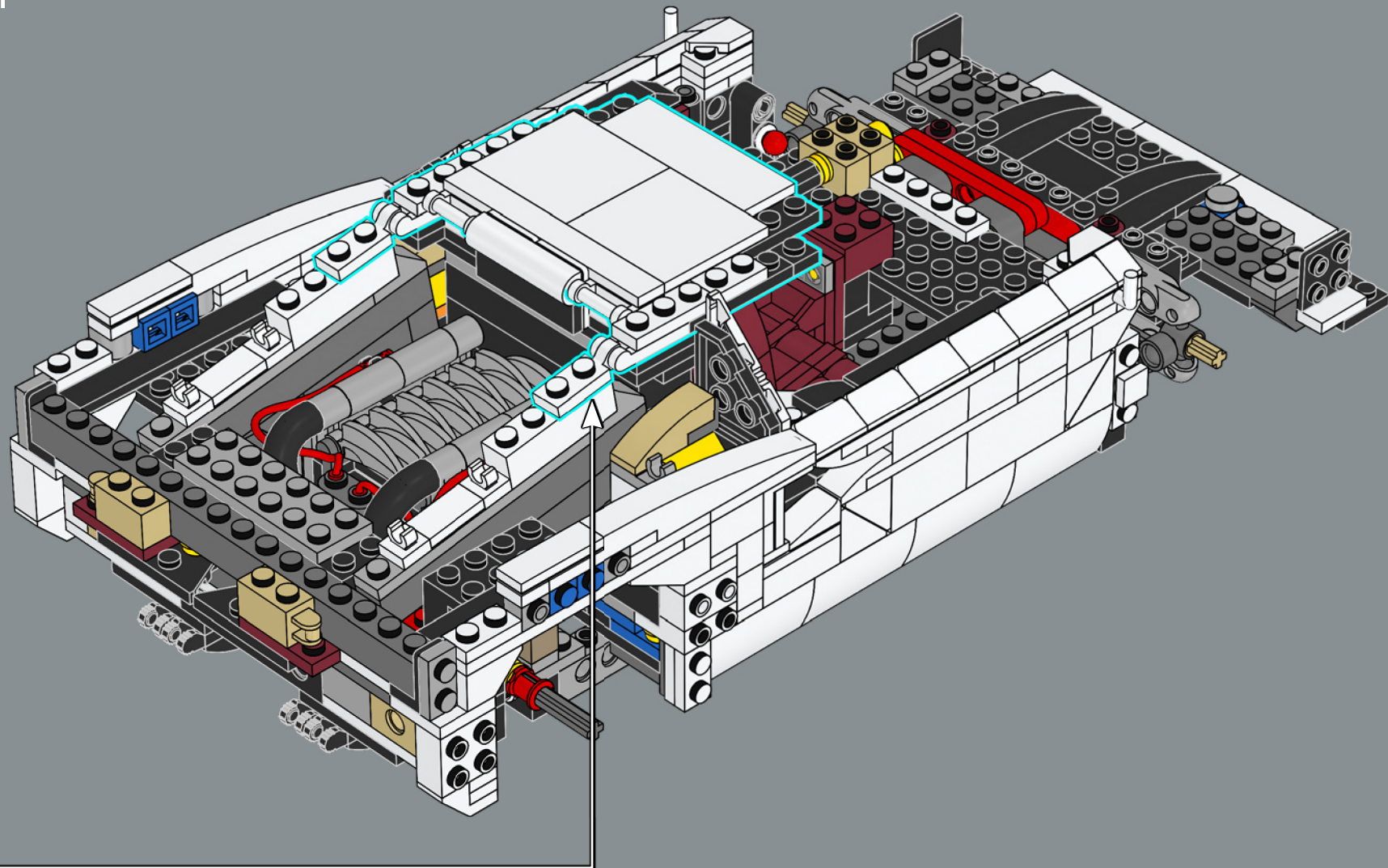

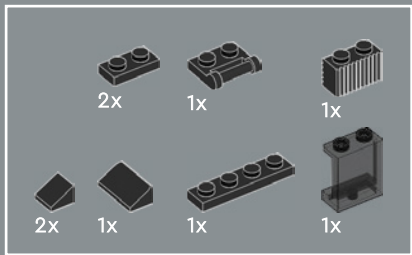

232

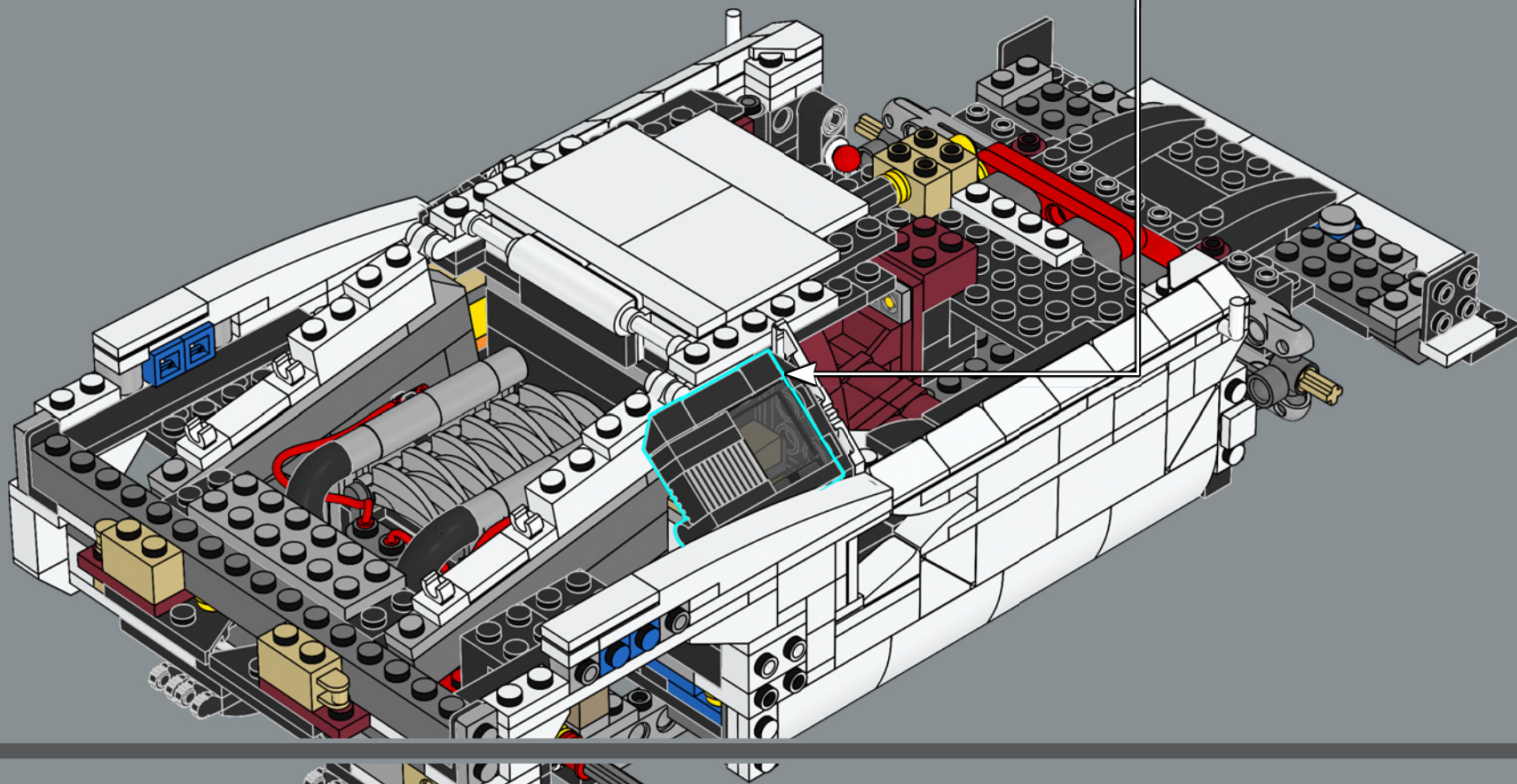
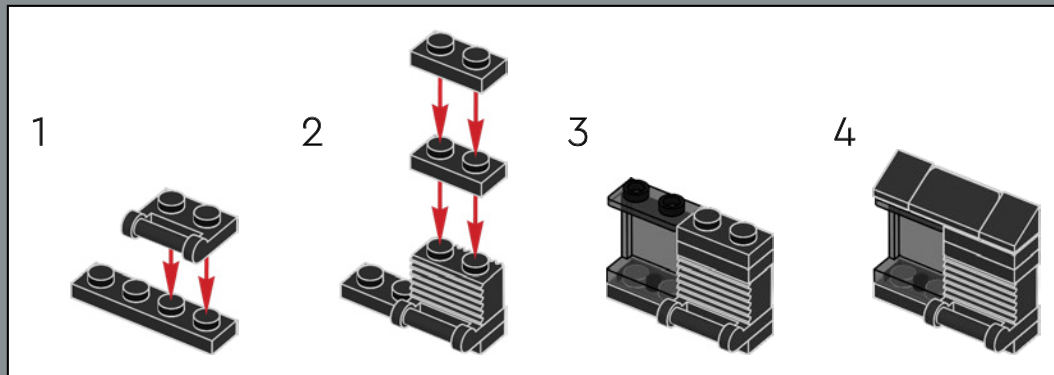

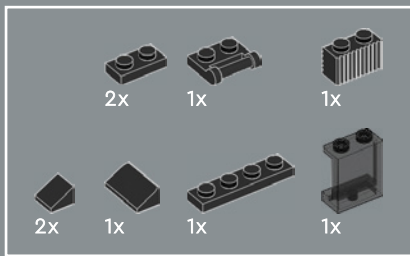

233

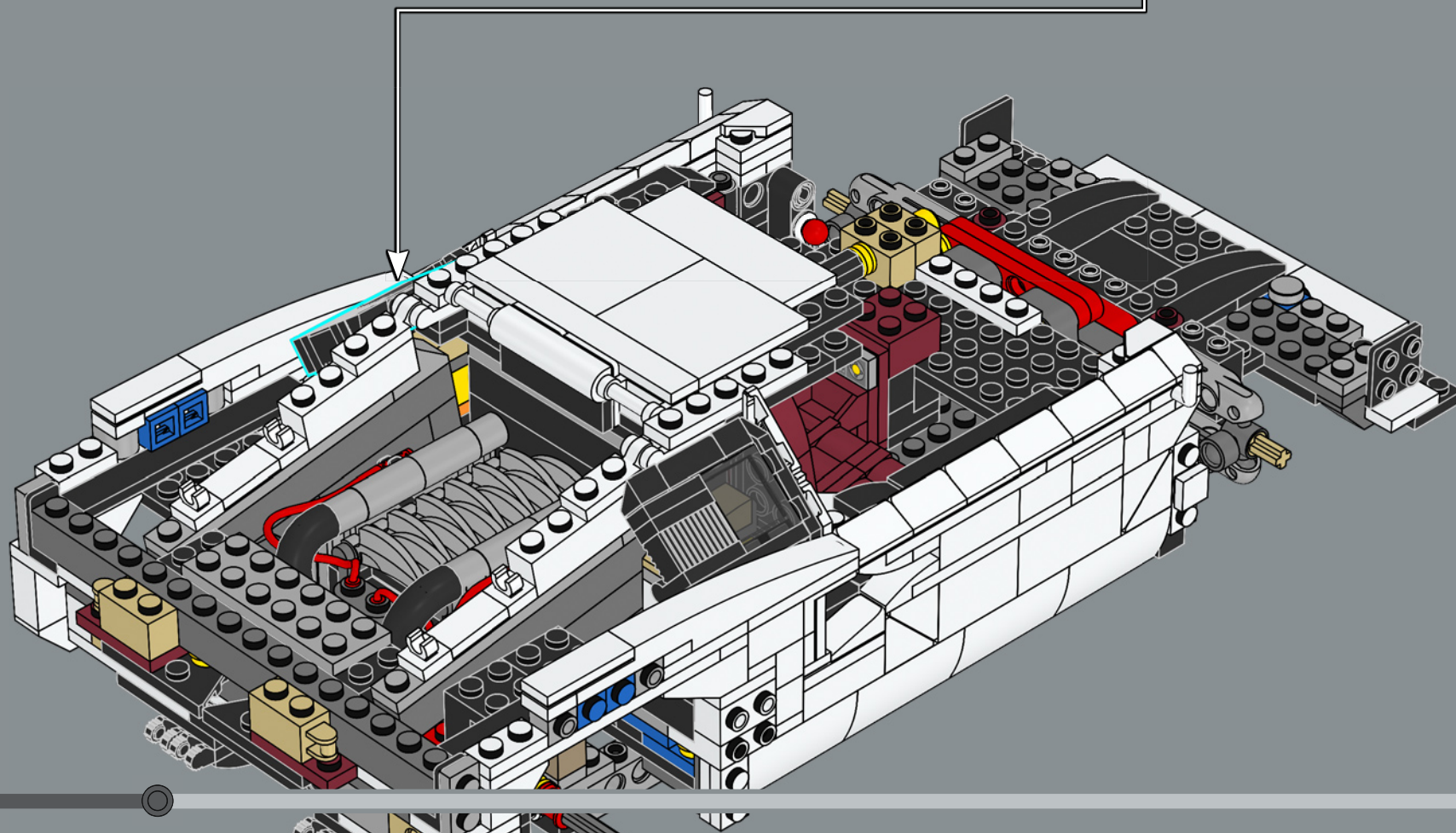
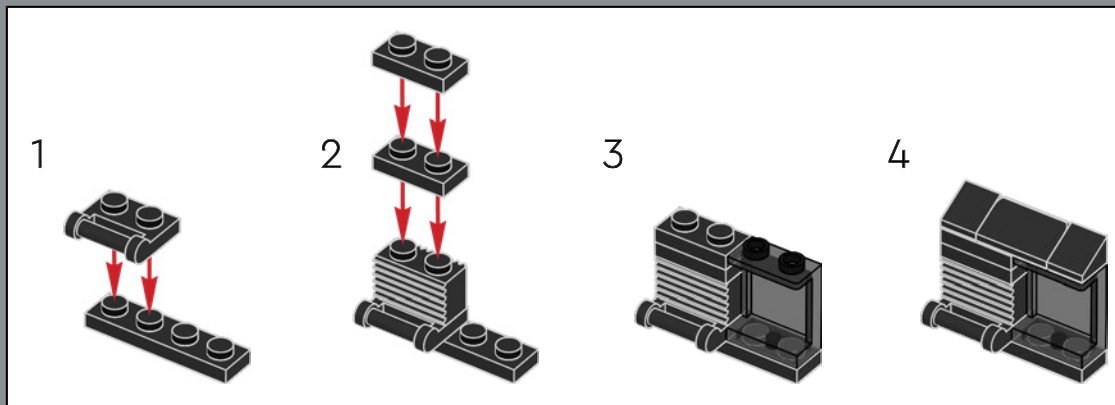

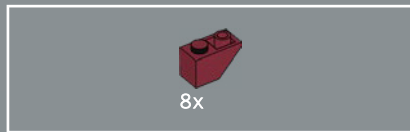

234

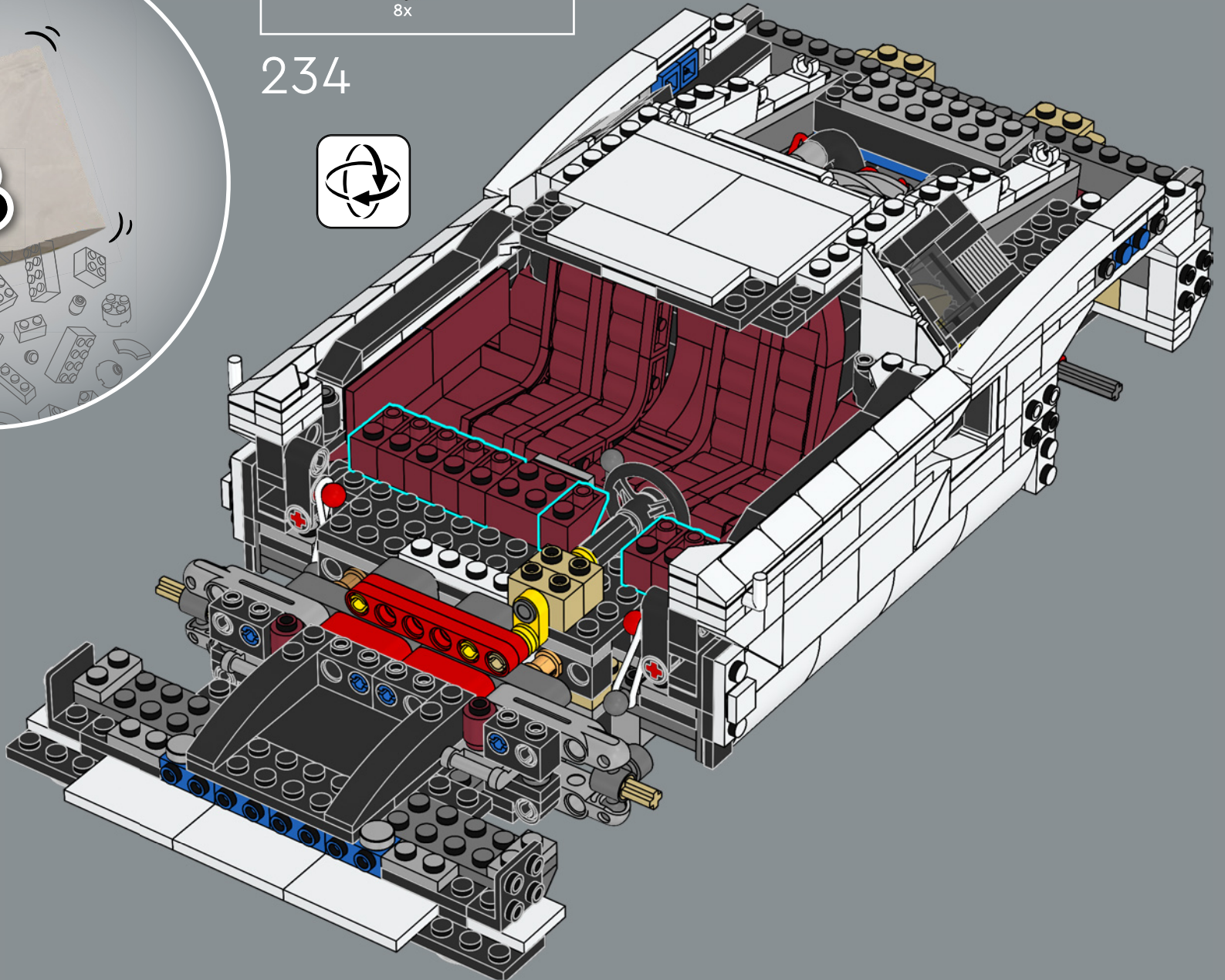

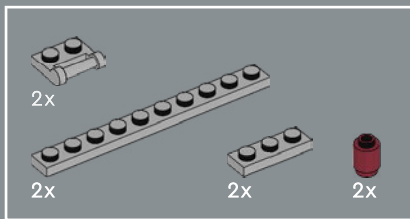

235

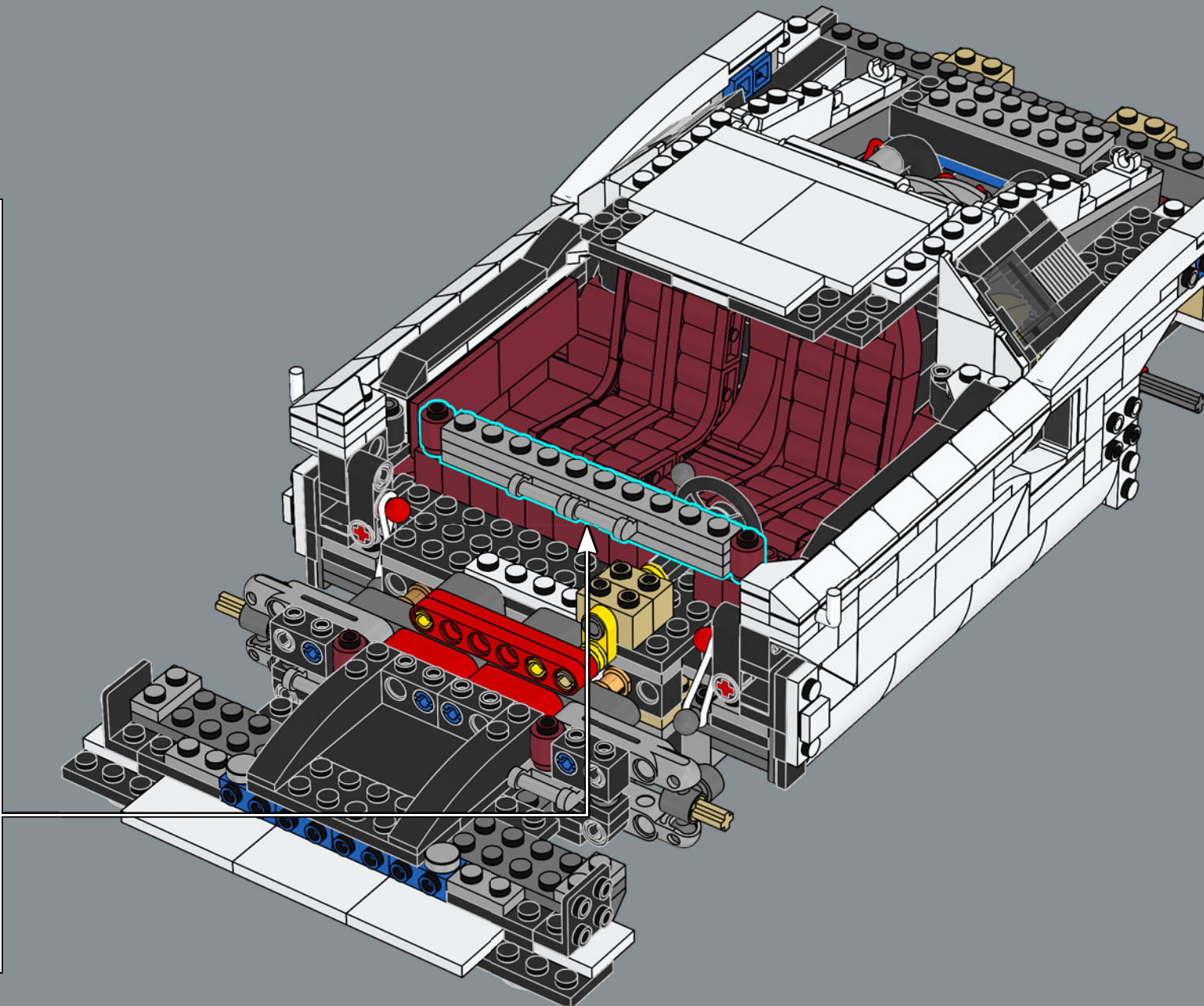
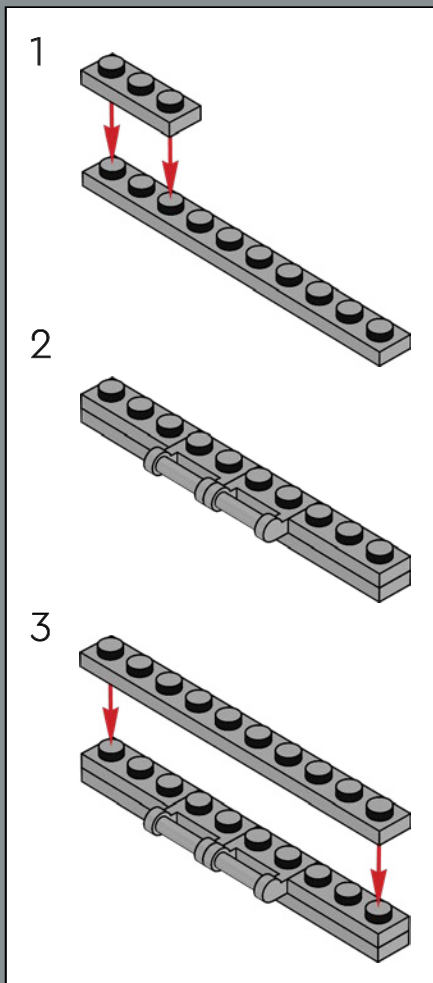

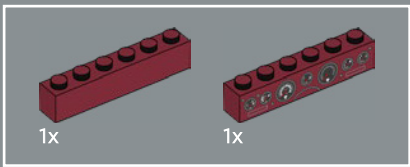

236

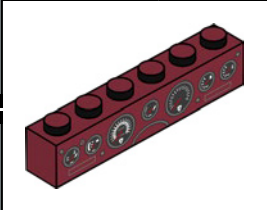
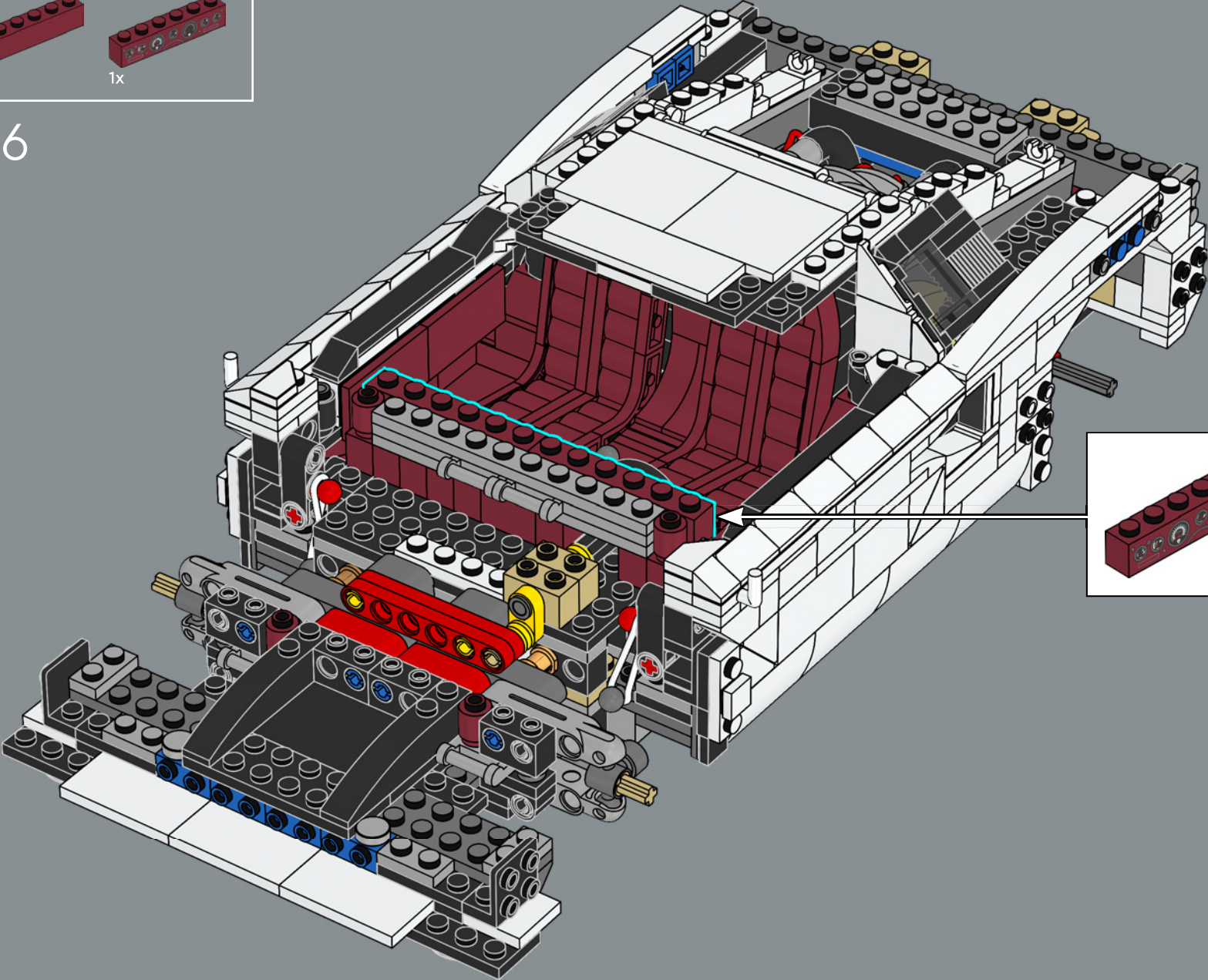

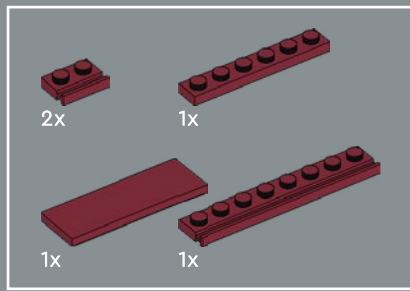

237

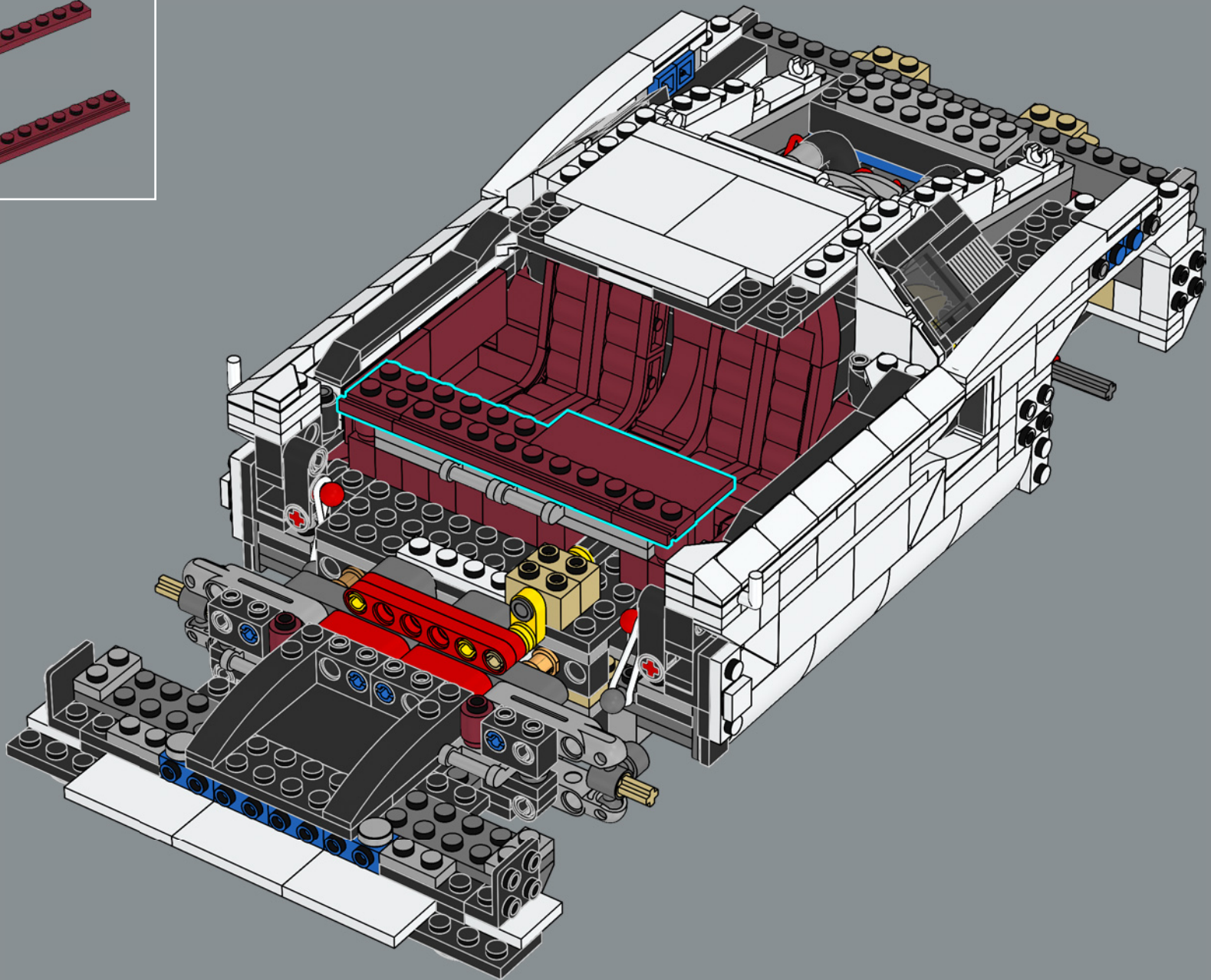



238

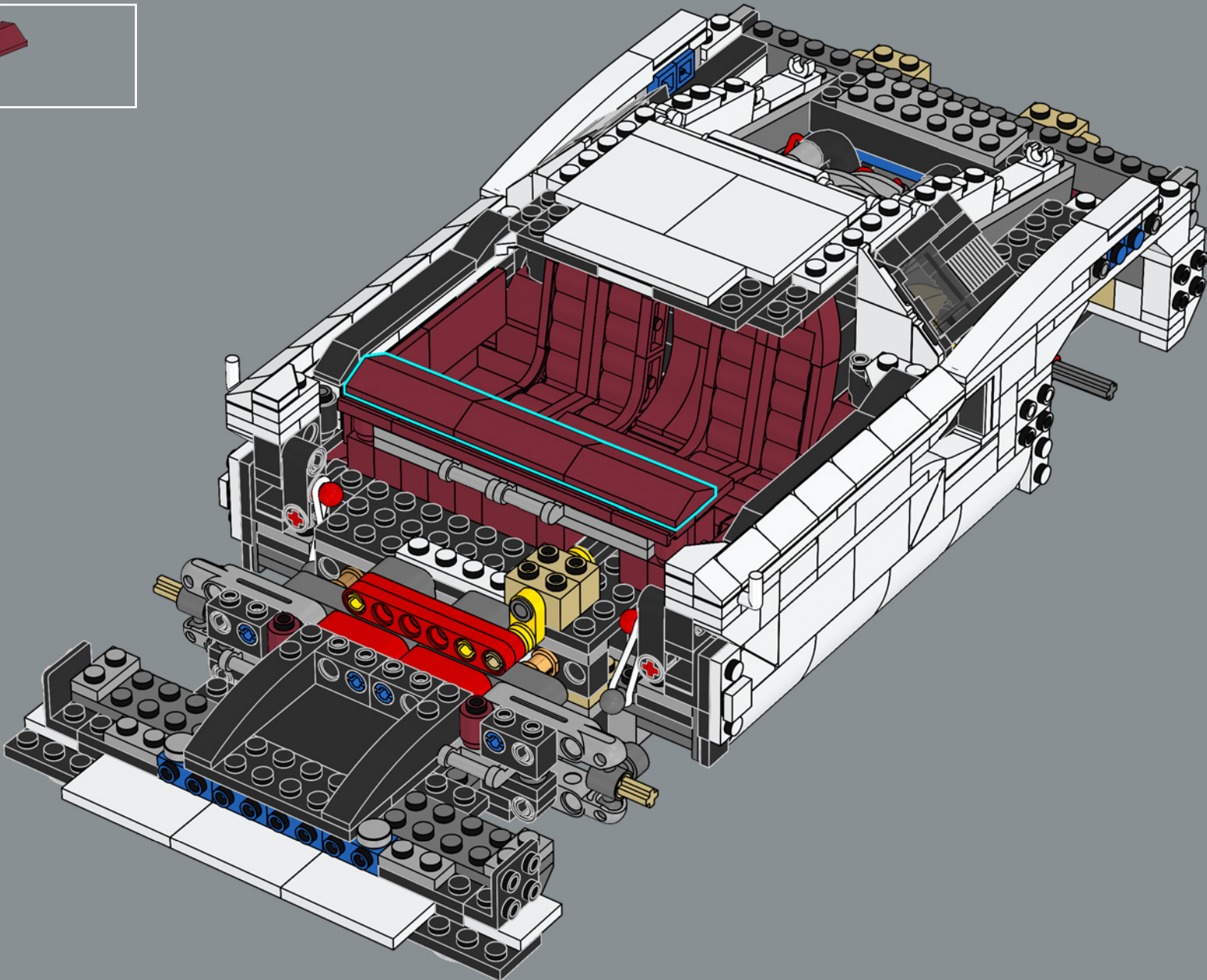

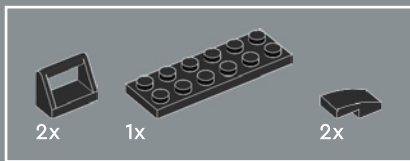

239

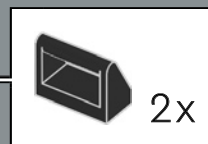
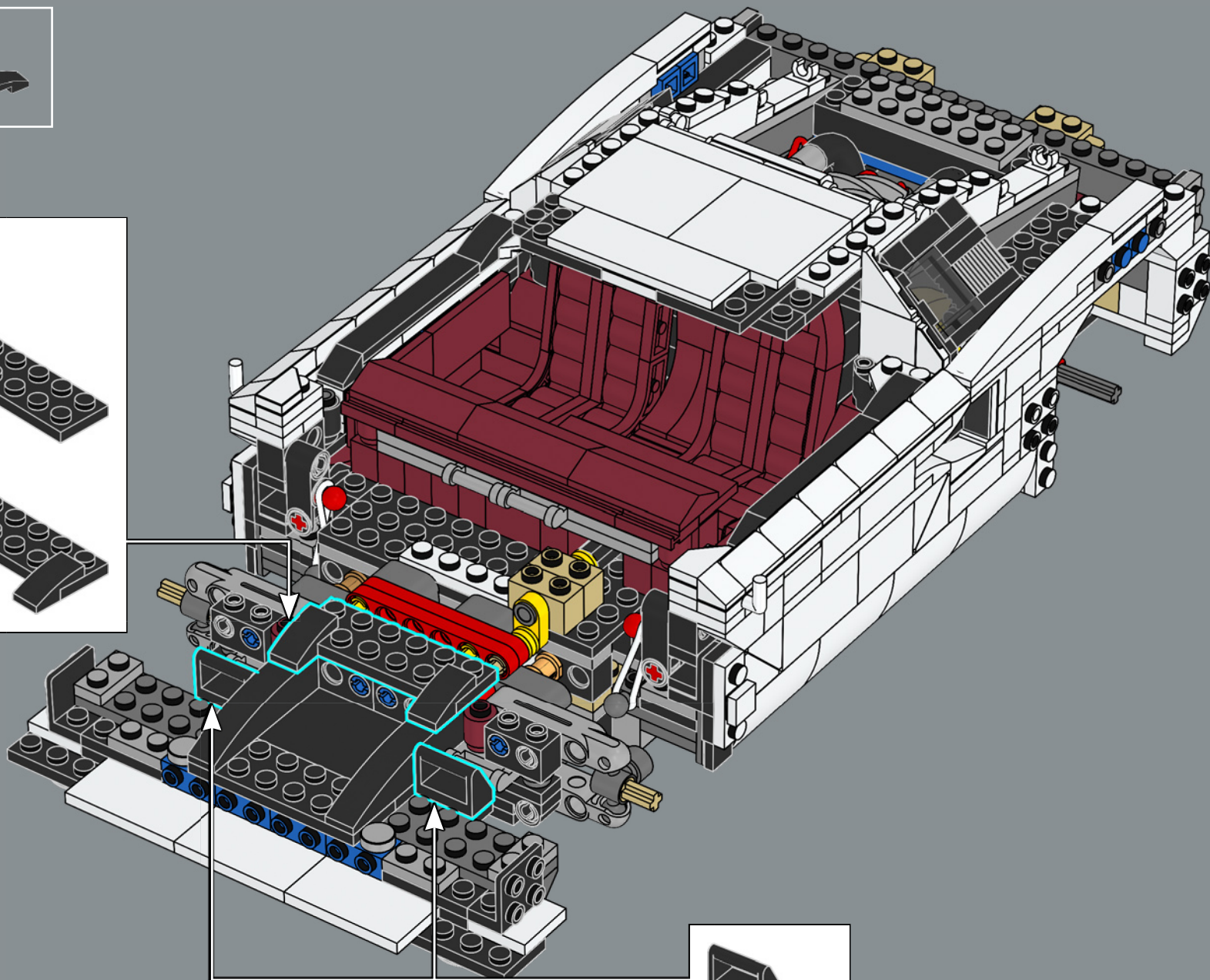
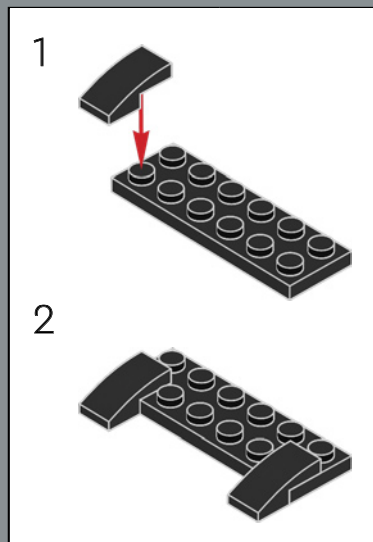

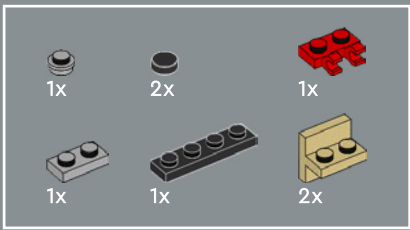

240

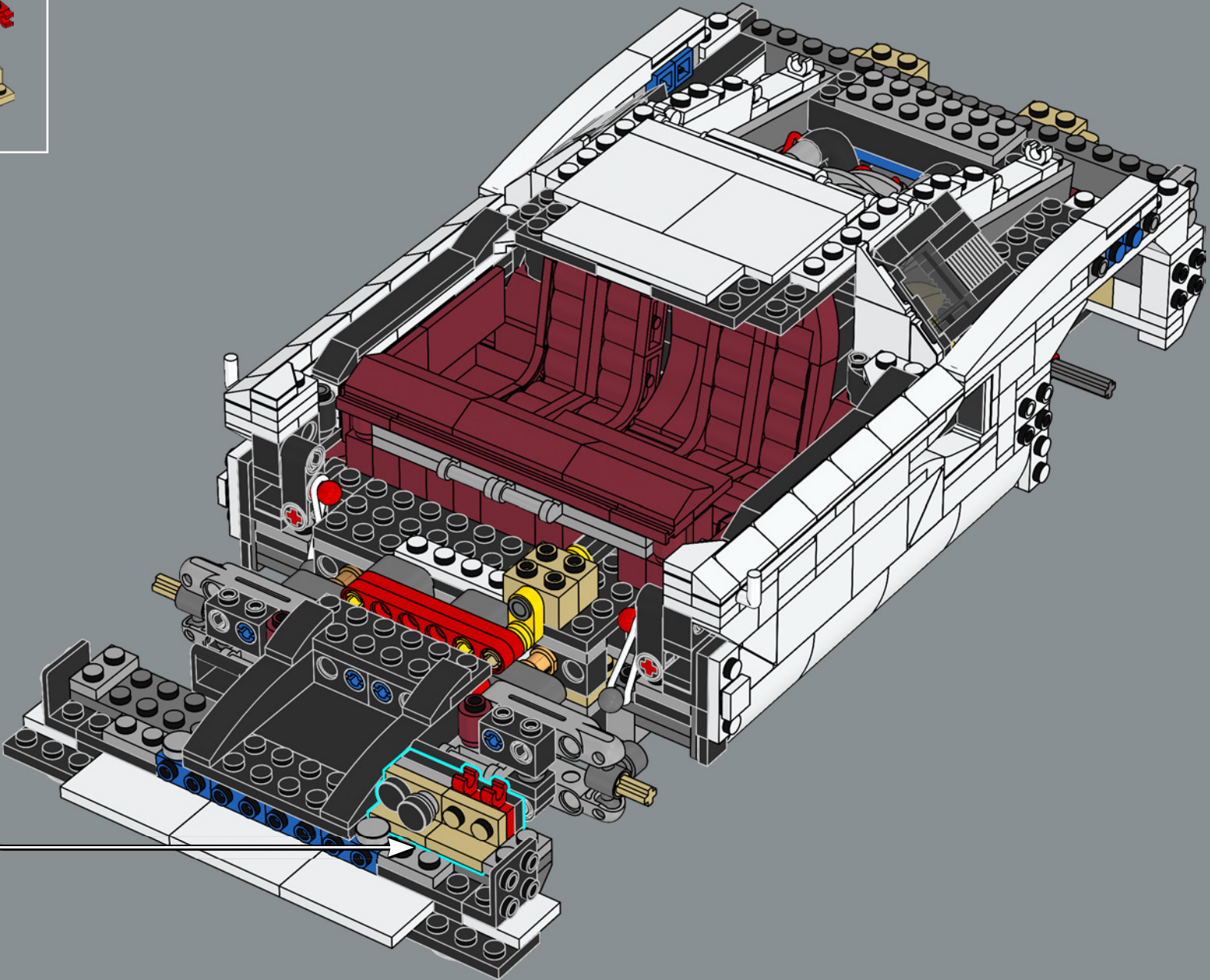
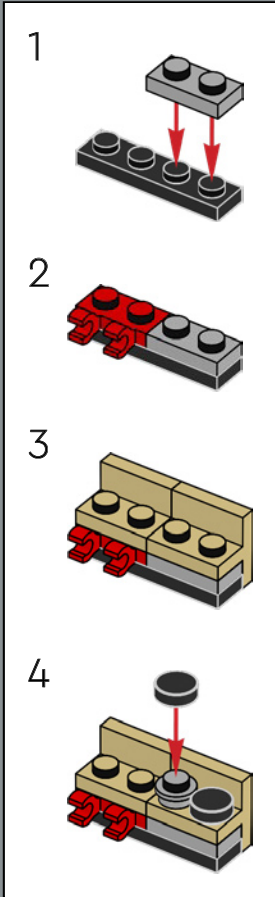

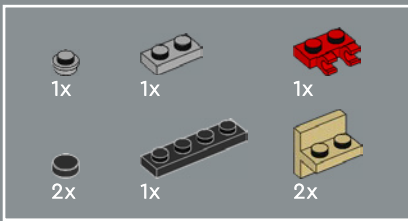

241

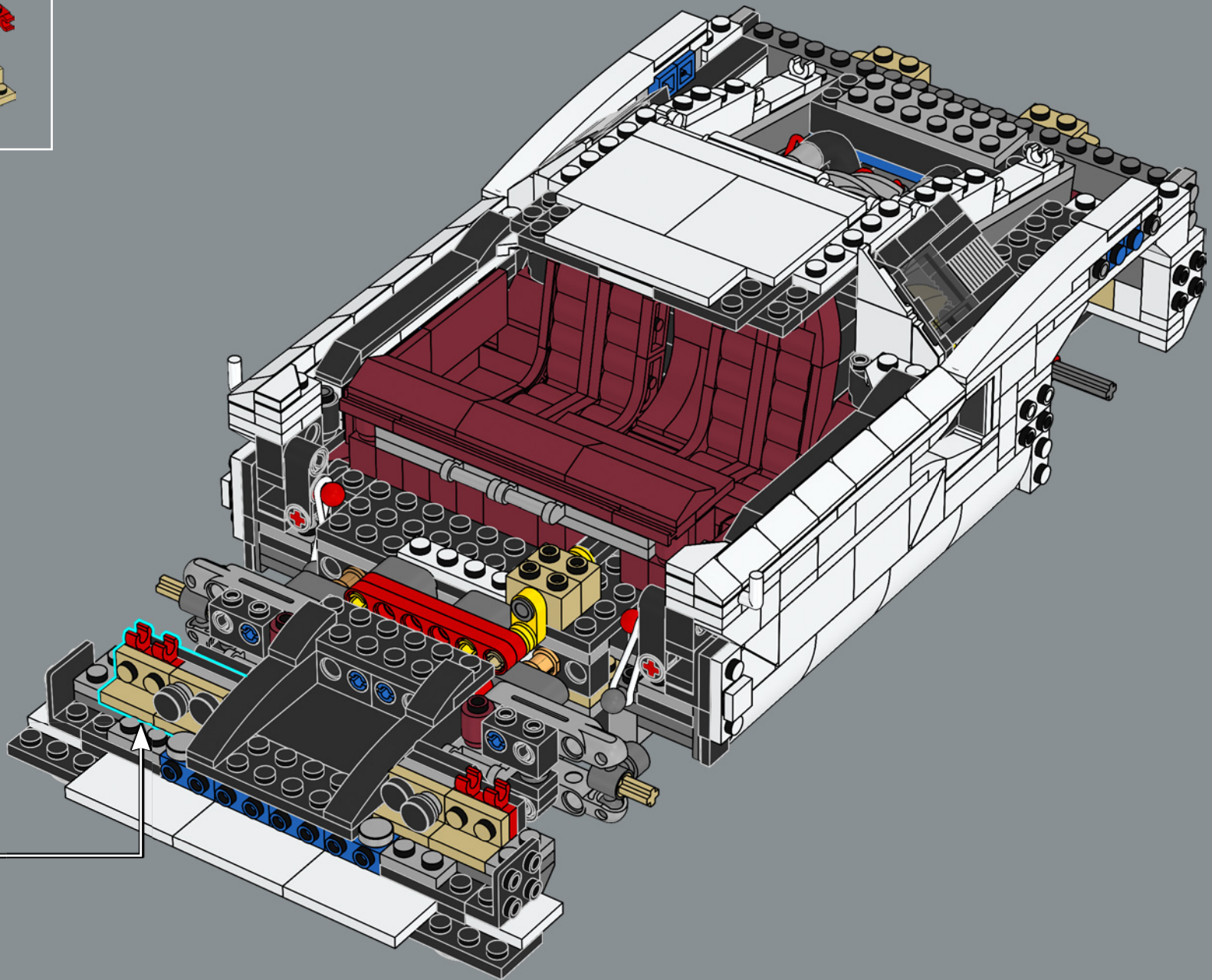
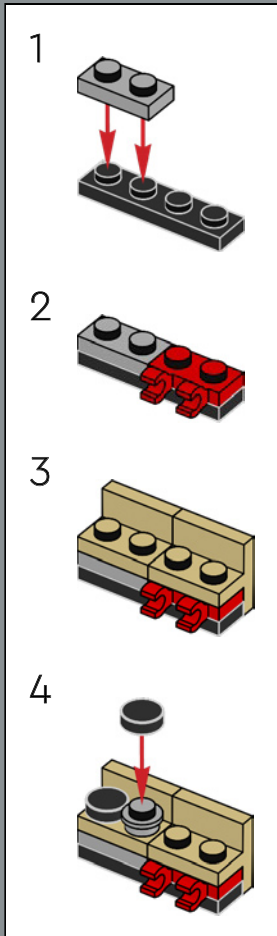



2x

242

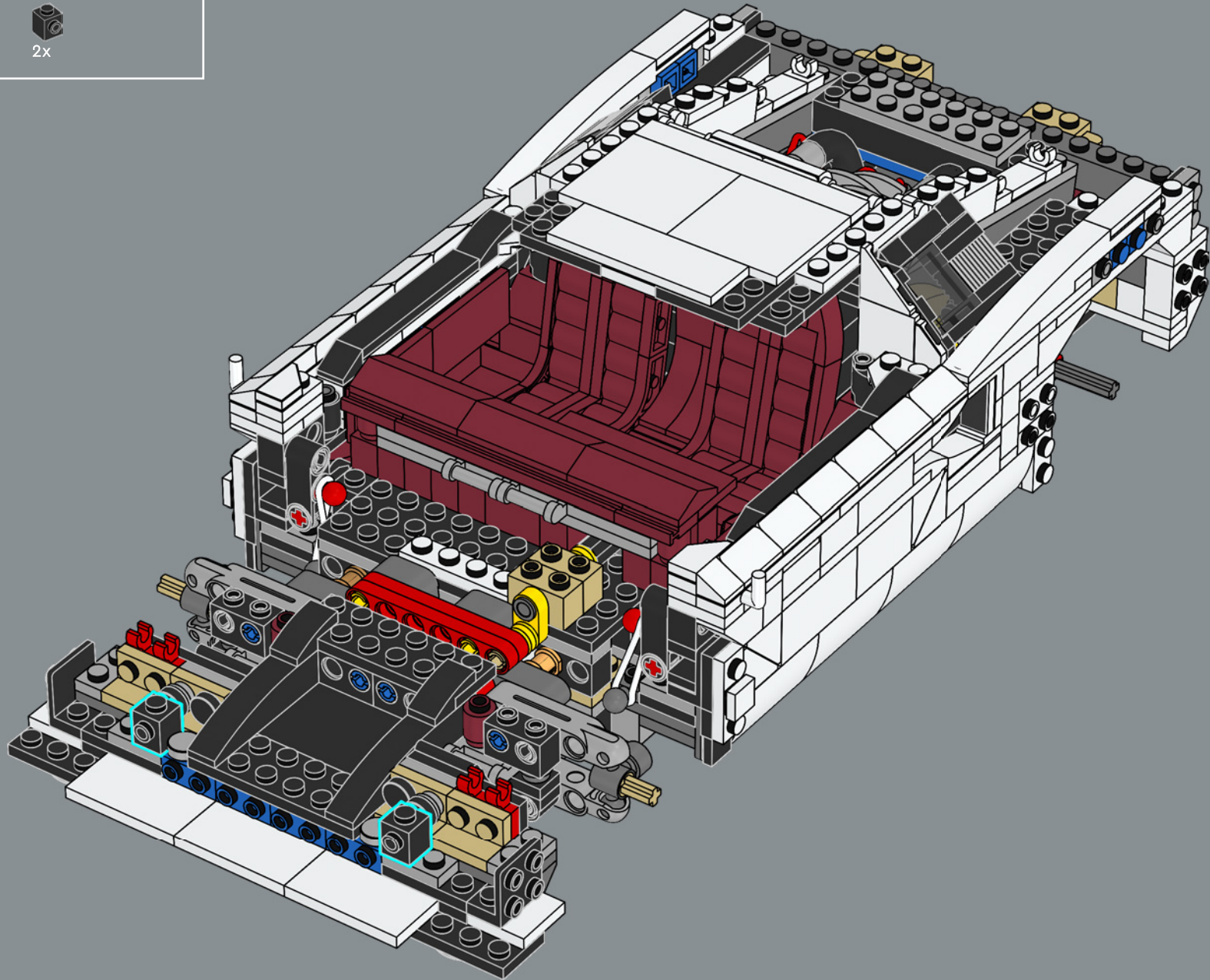

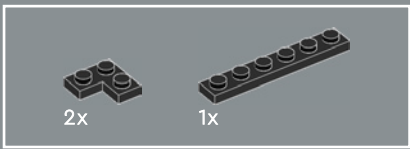

243

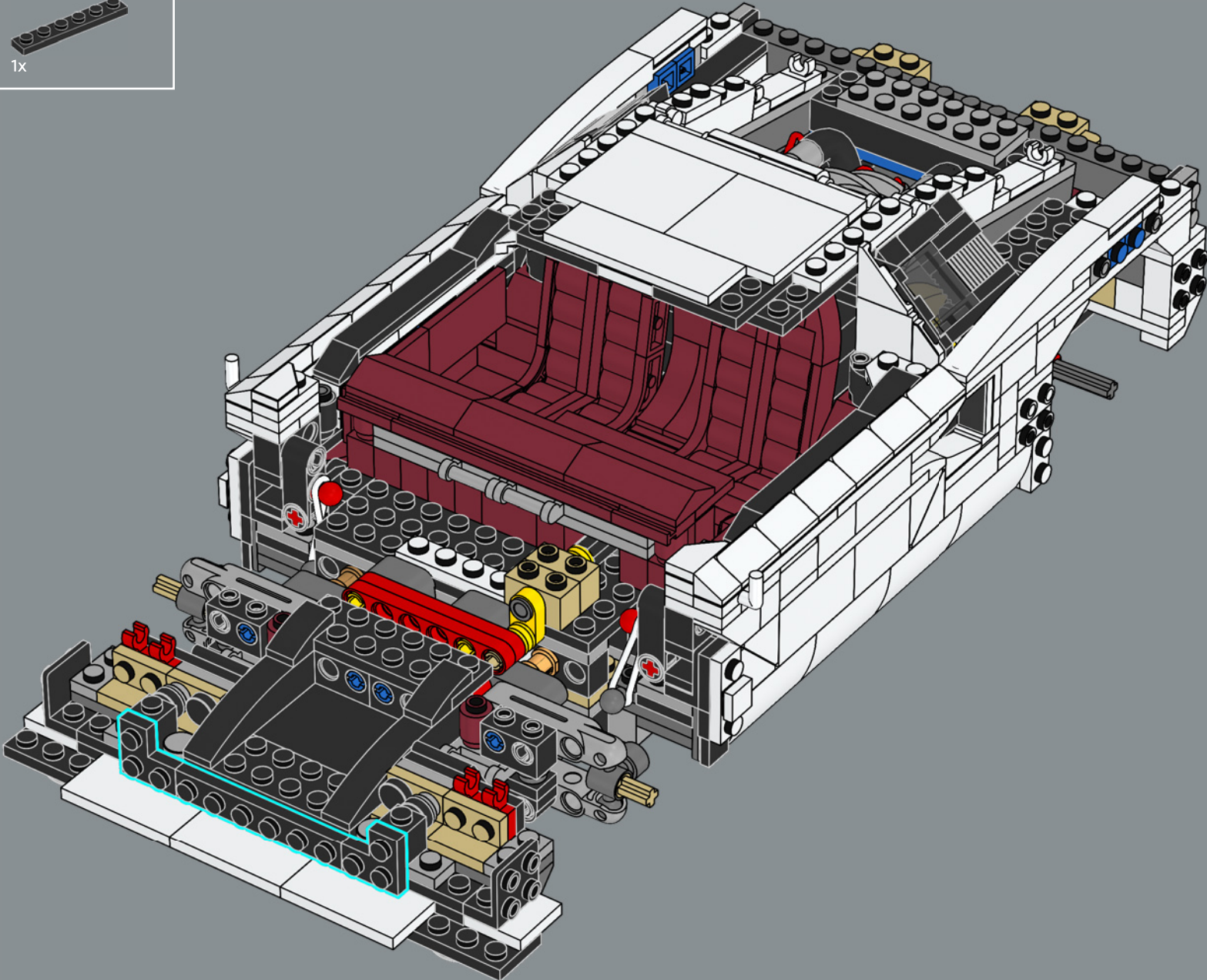



244

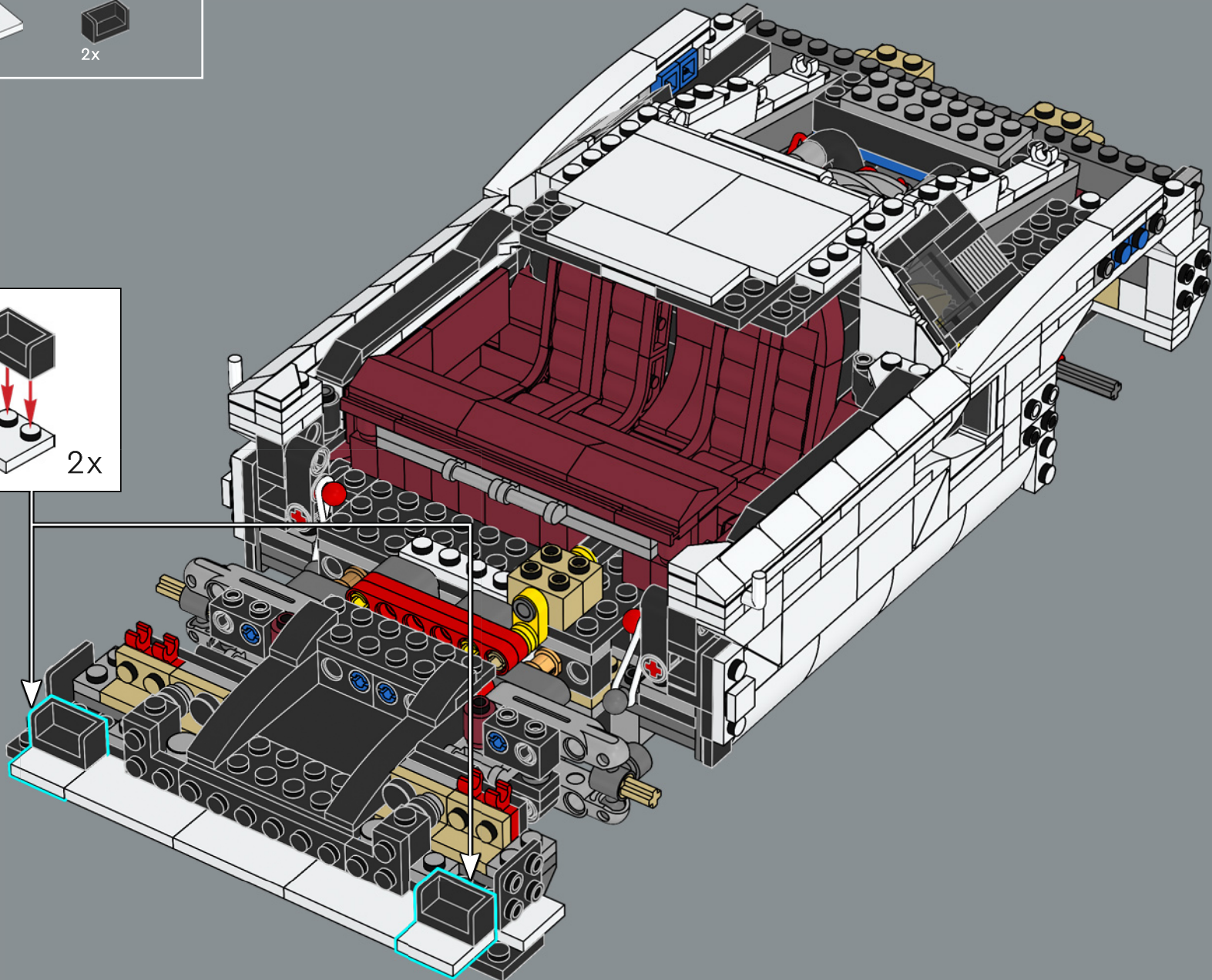
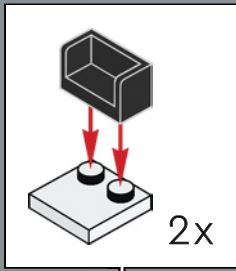

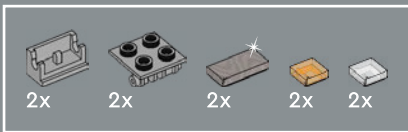

245

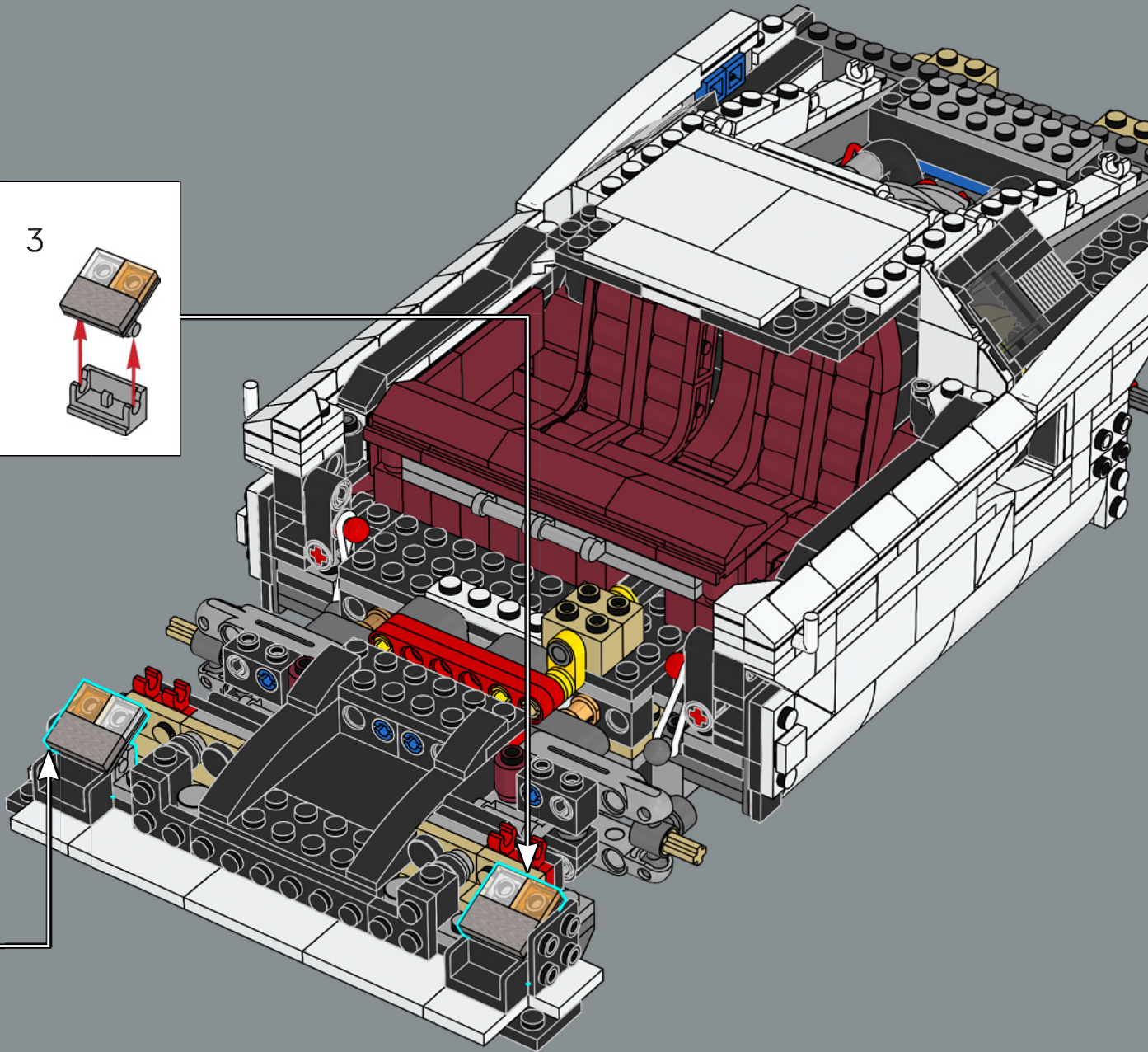
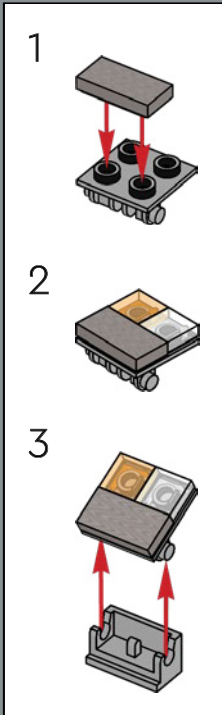
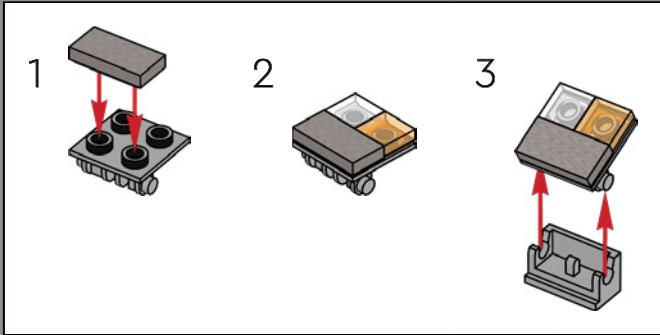

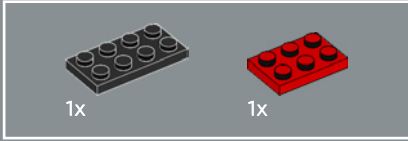
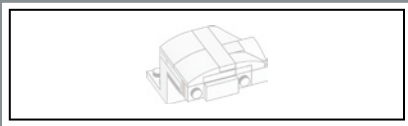

246

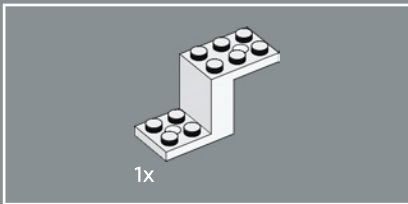
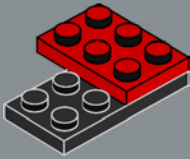

247

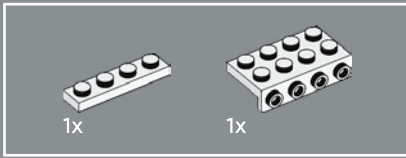
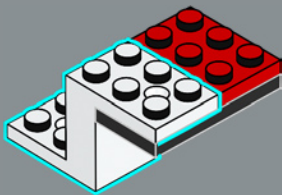

248

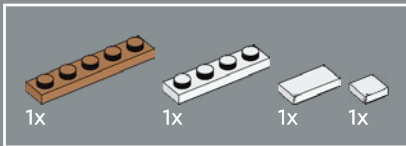
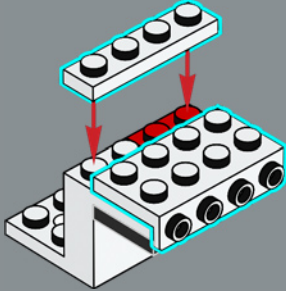

249

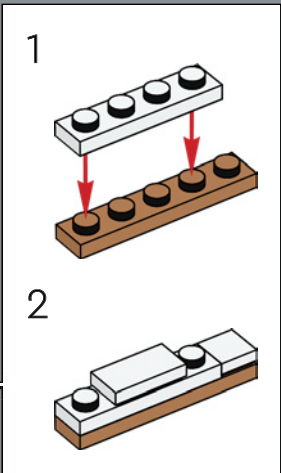
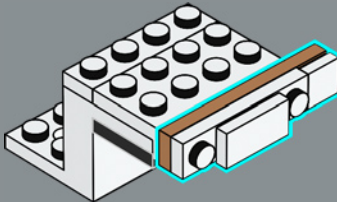

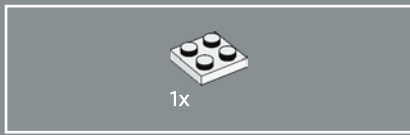

250

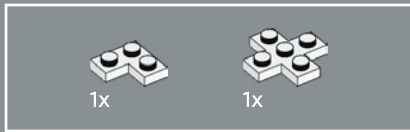
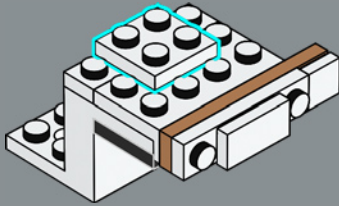

251

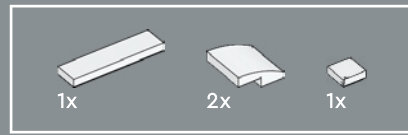
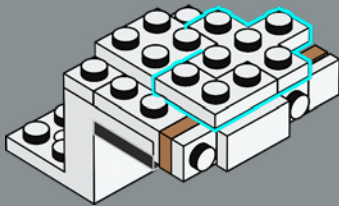

252

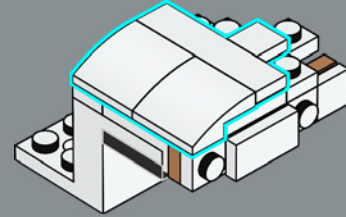

253

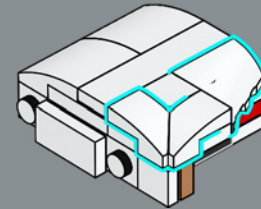

254

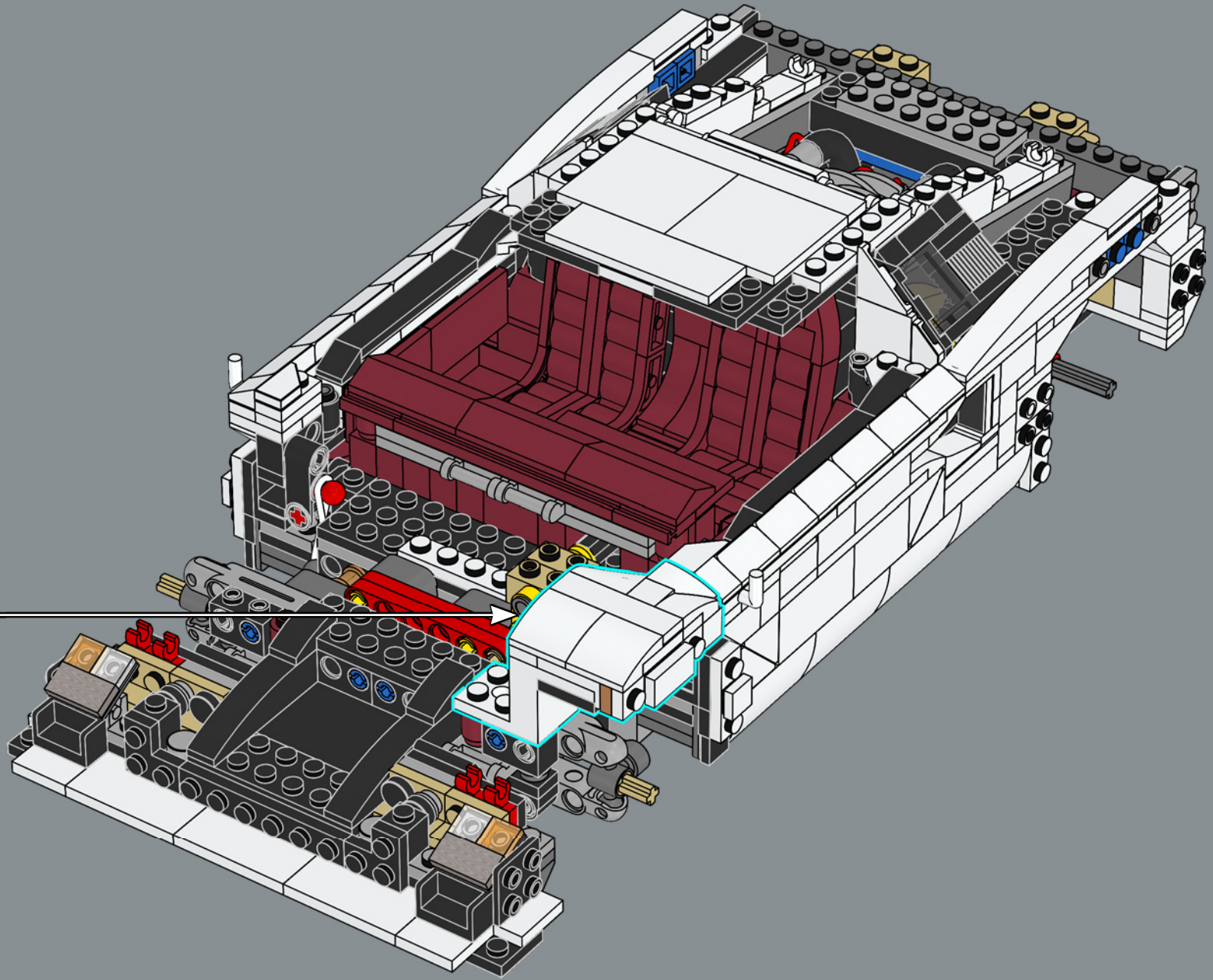

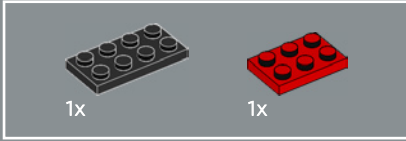
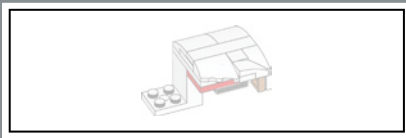

255

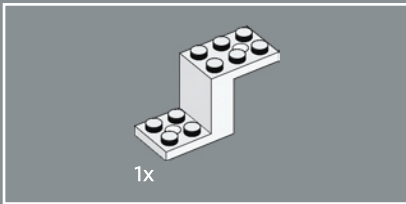
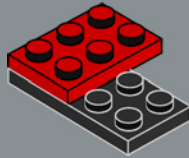

256

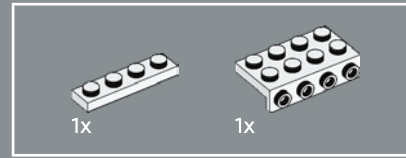
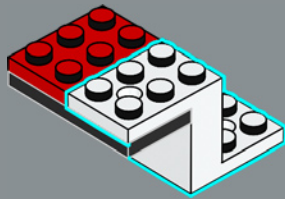

257

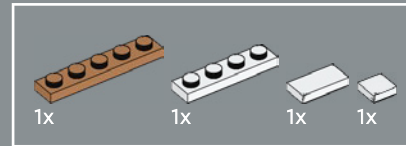
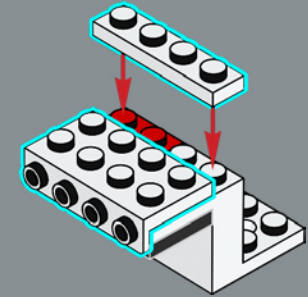

258

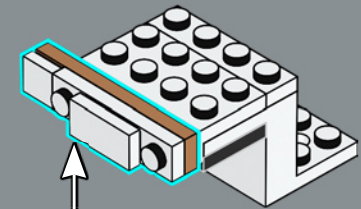
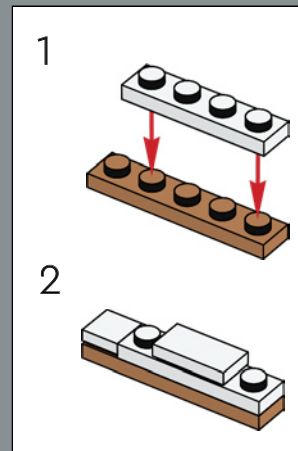

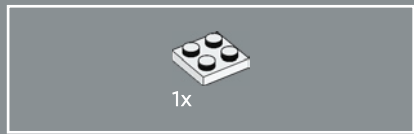

259

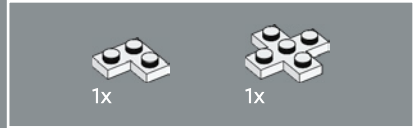
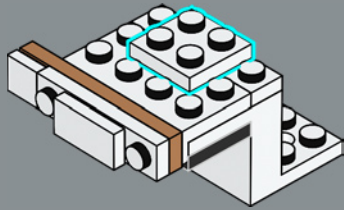

260

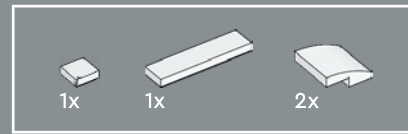
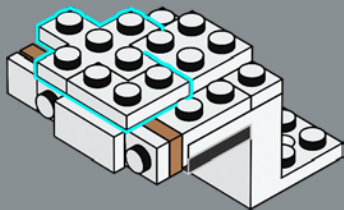

261

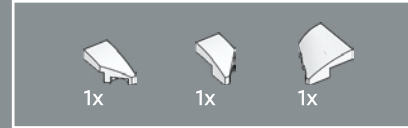
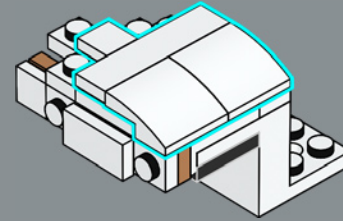

262

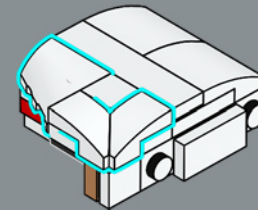

263

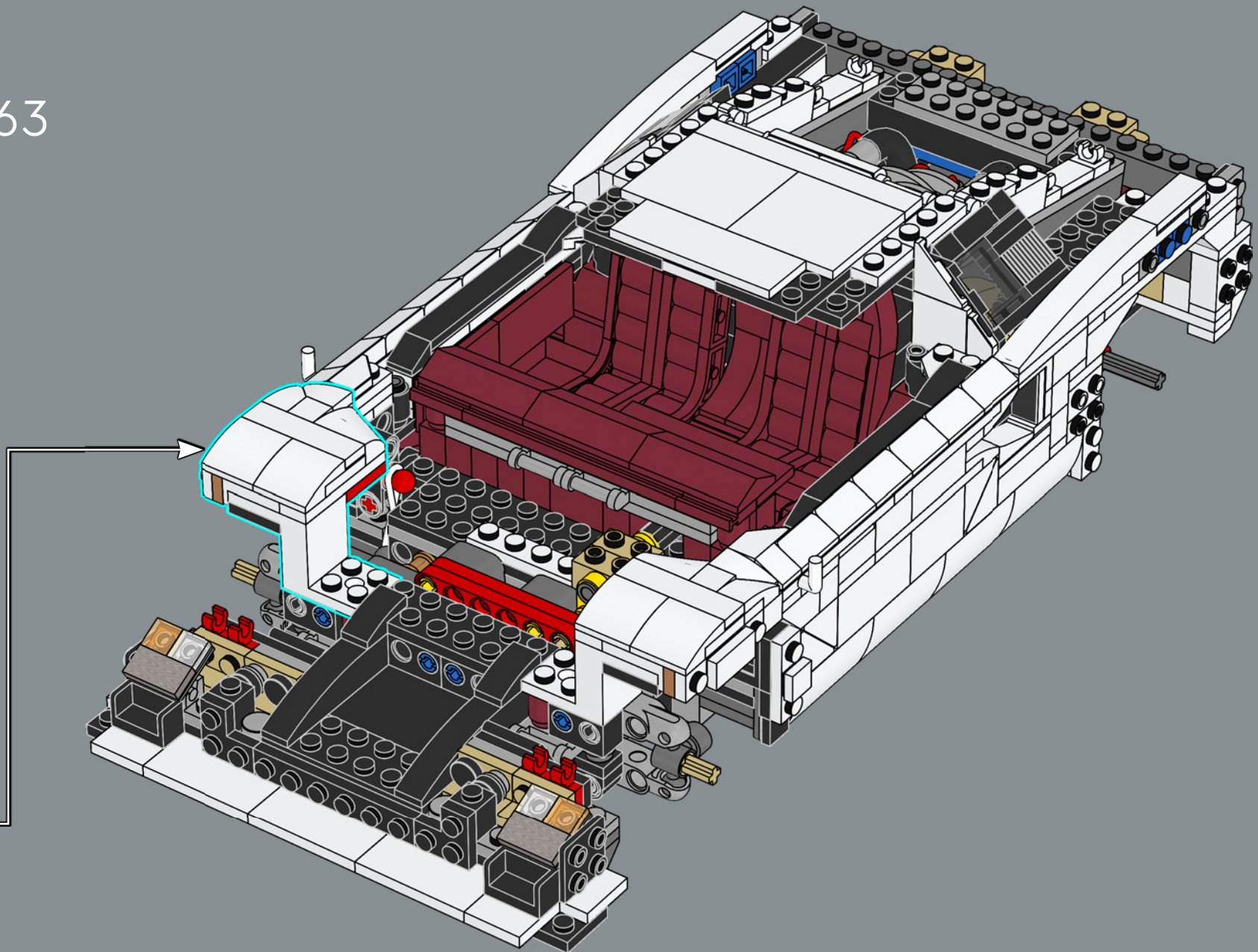

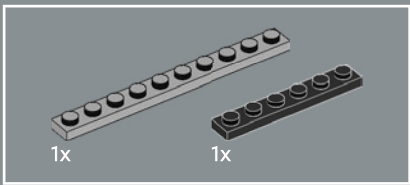

264

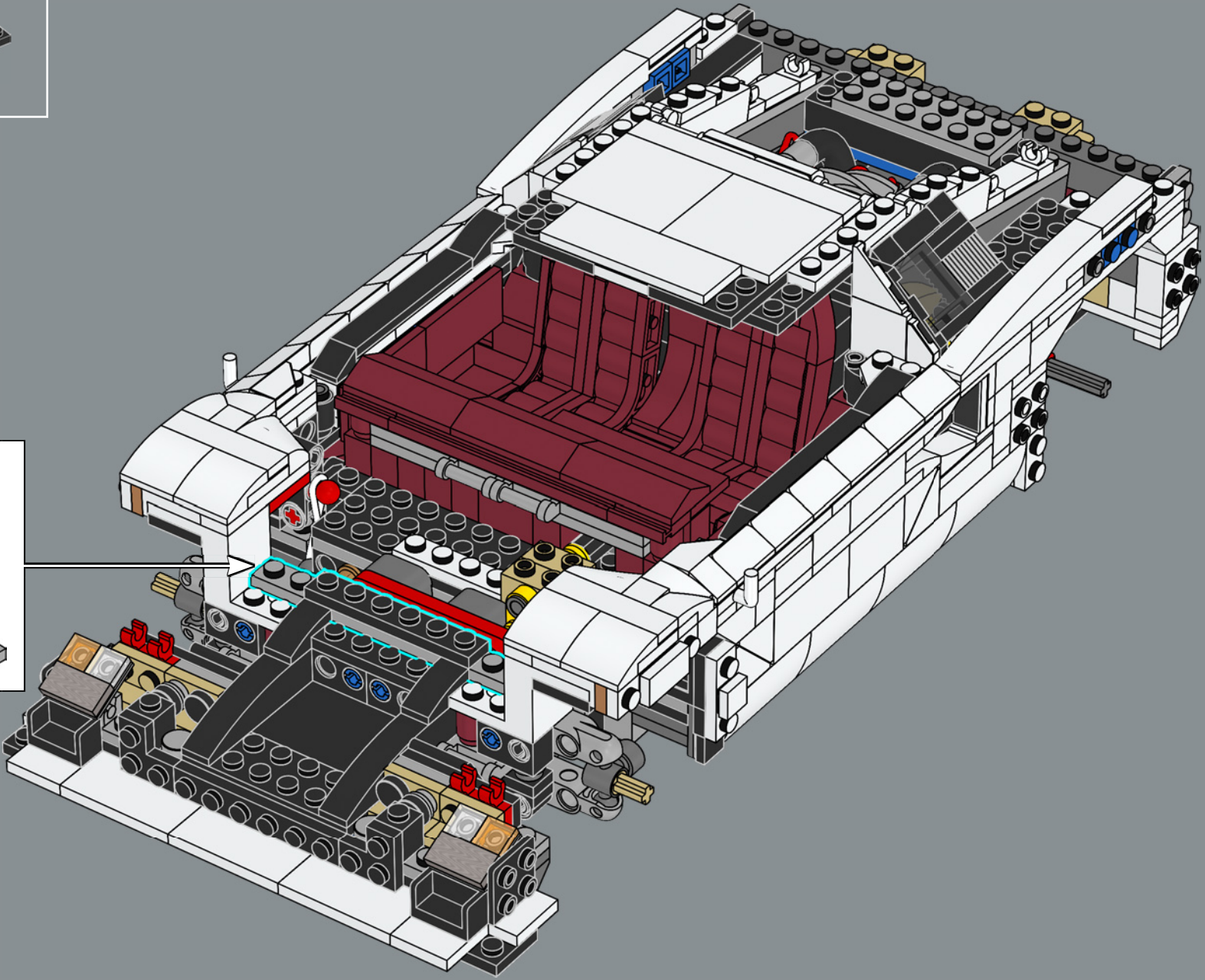
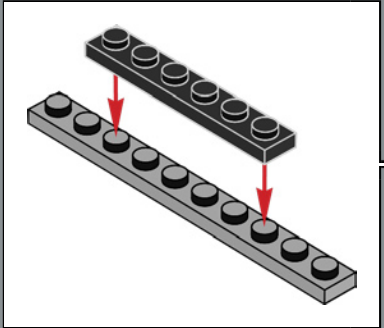

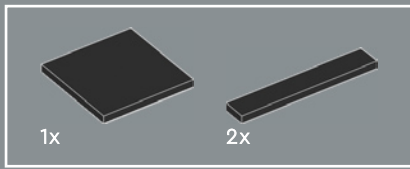

265

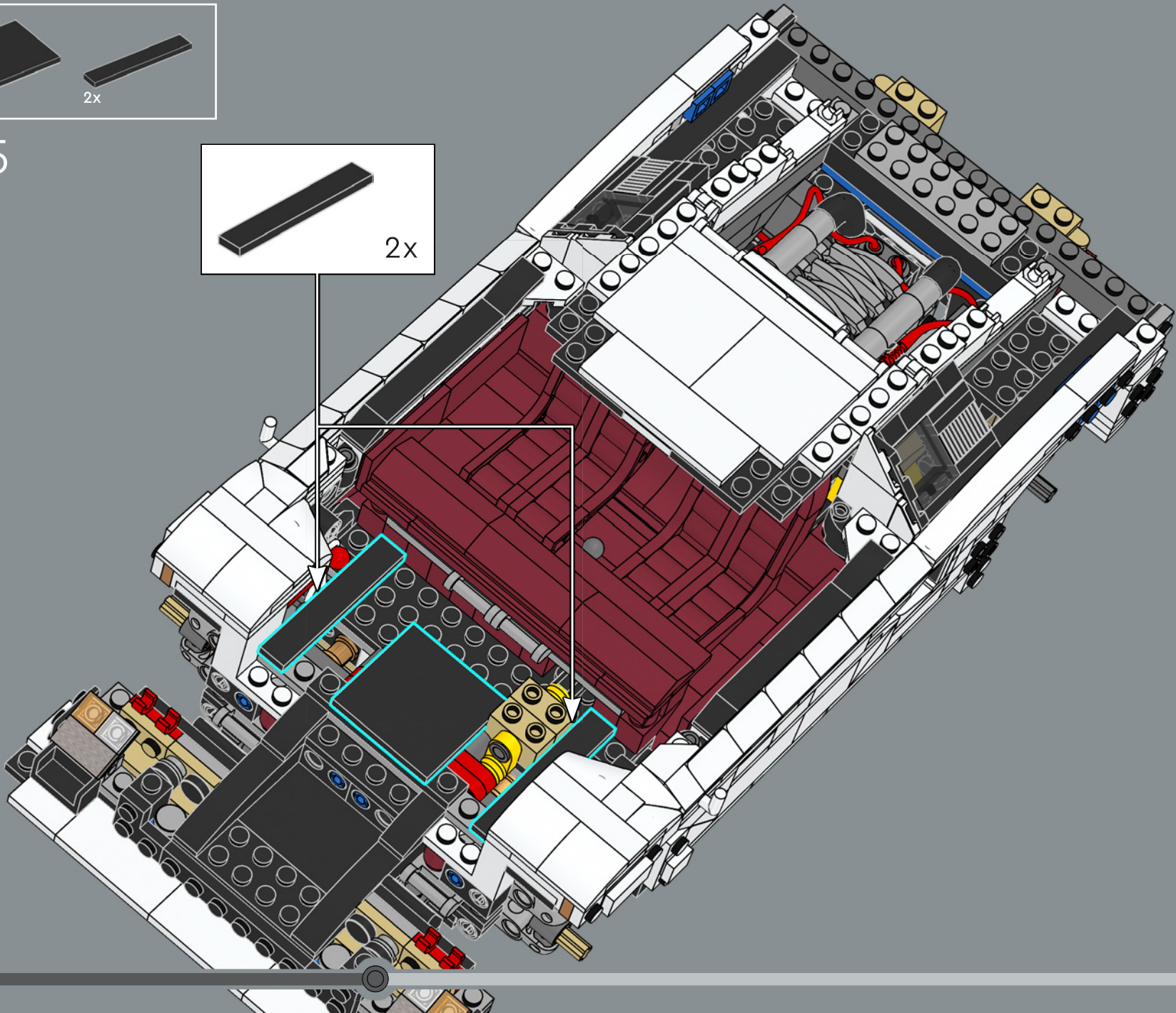
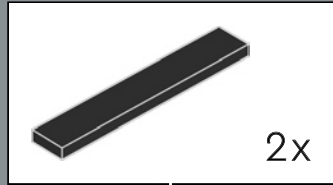

-  2x
-  2x
-  6x
-  2x

266

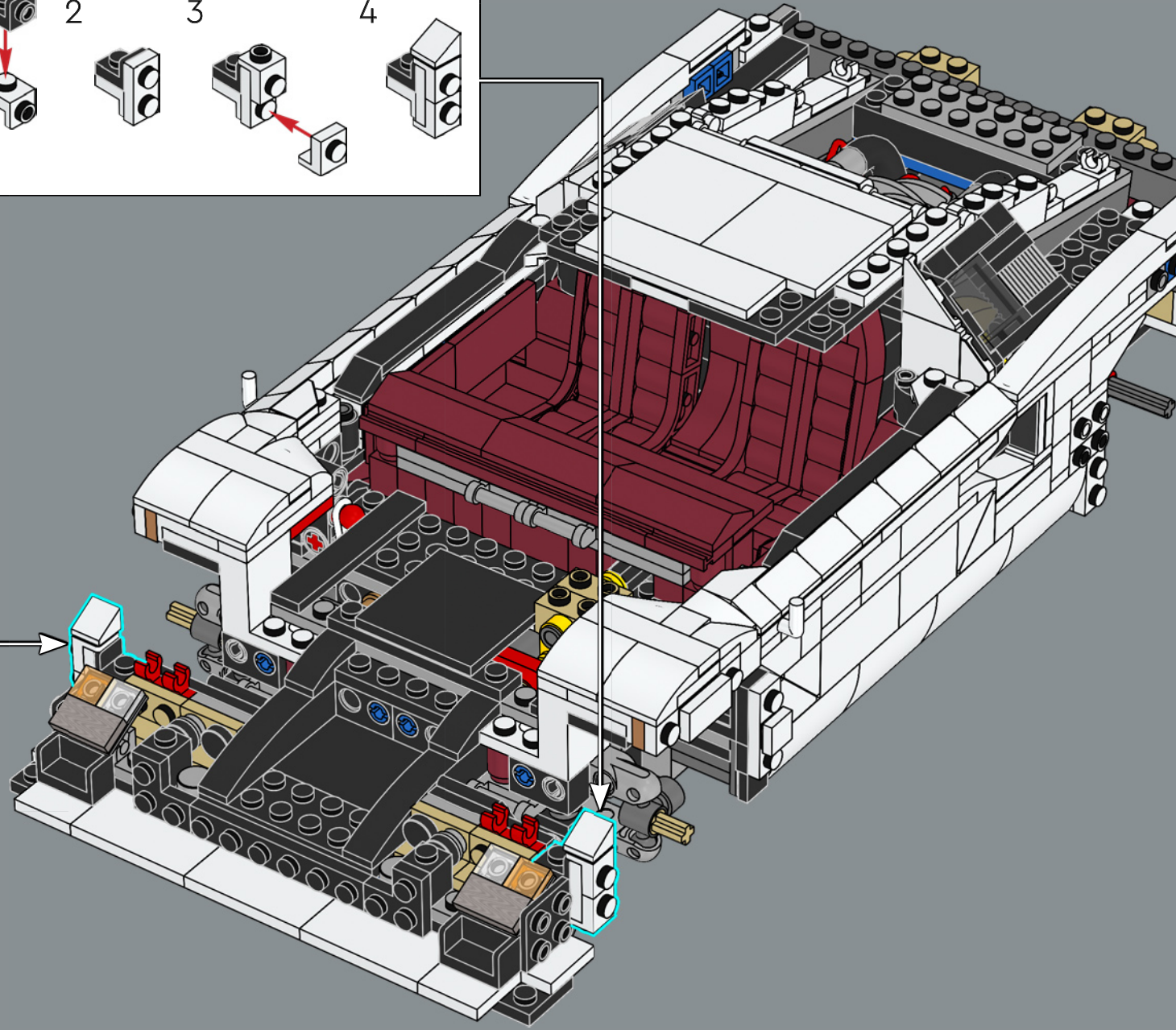
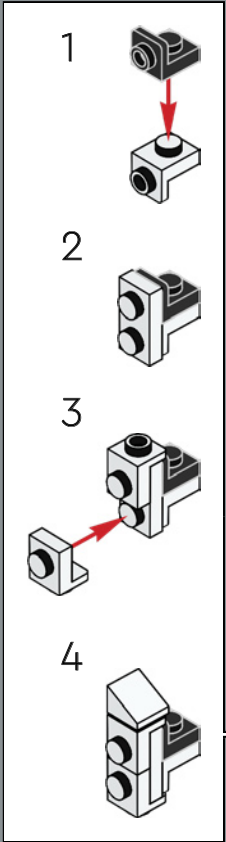
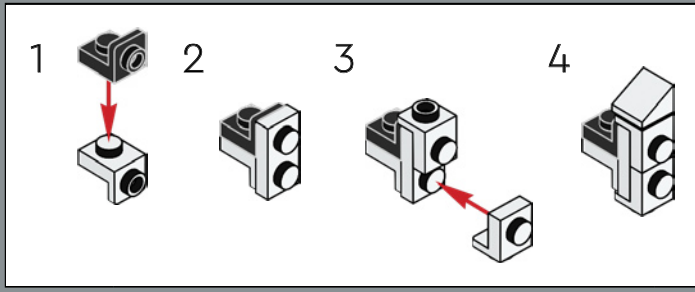



2x

267



2x

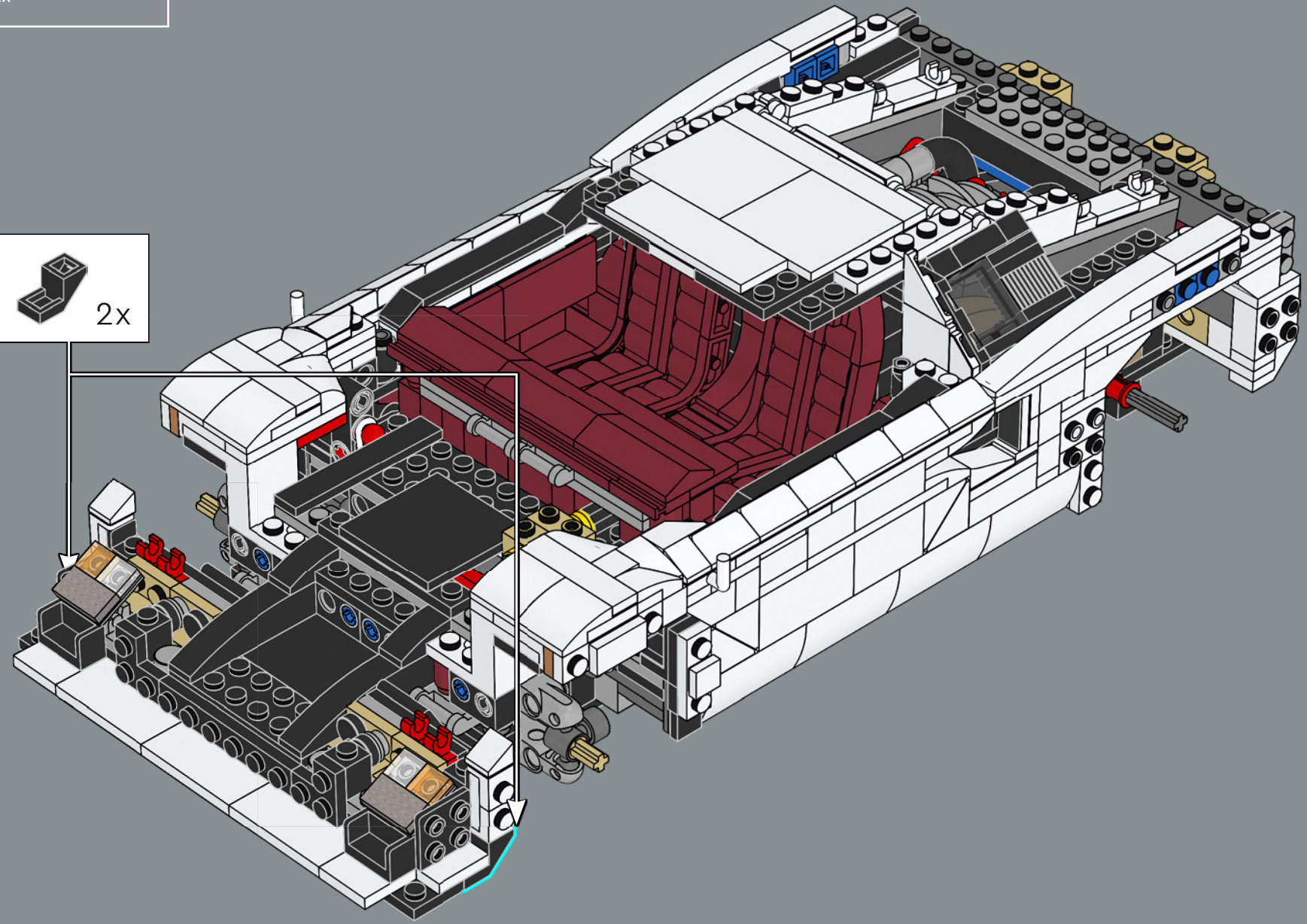

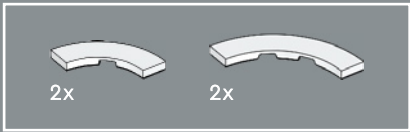

268

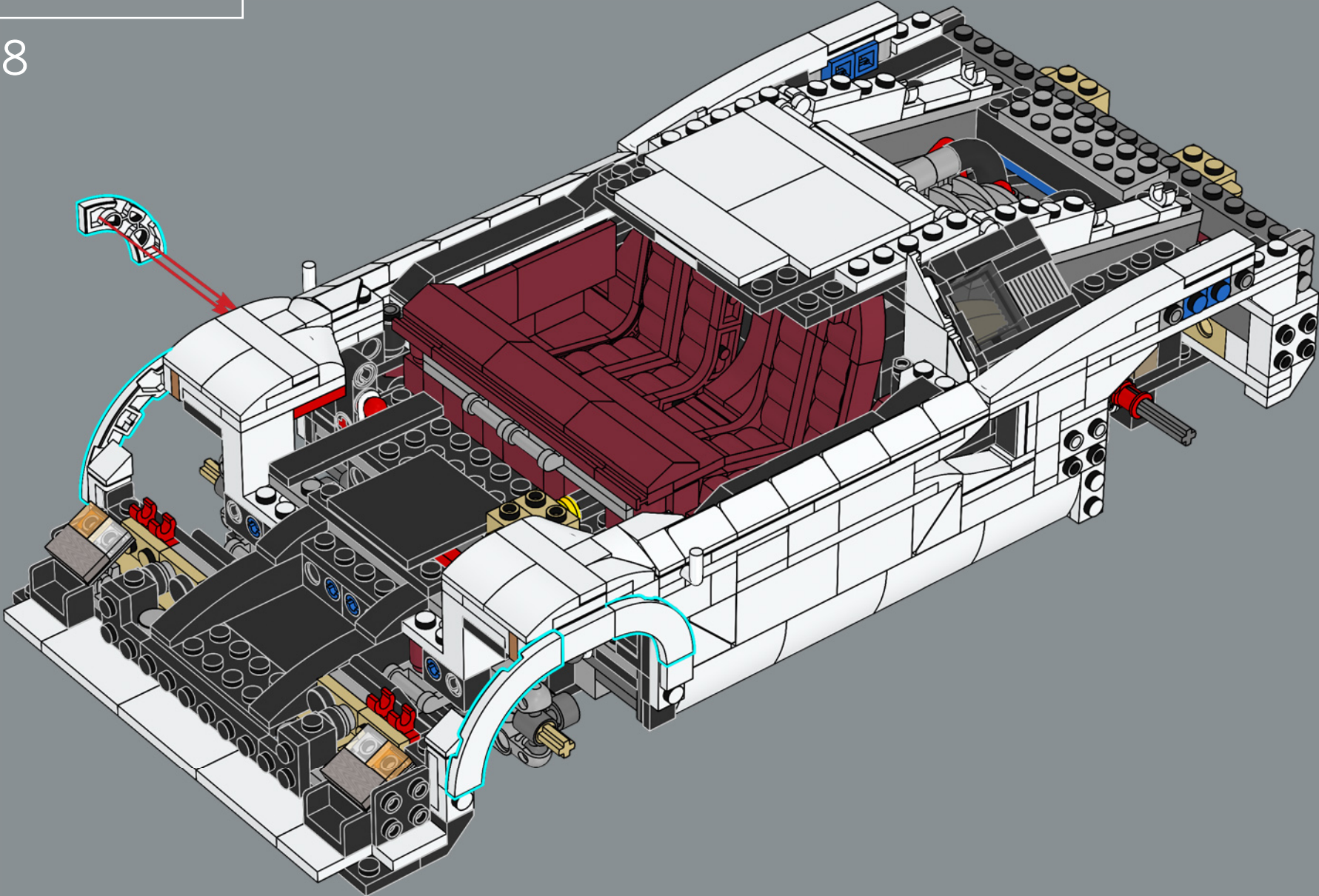

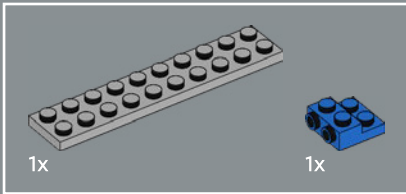
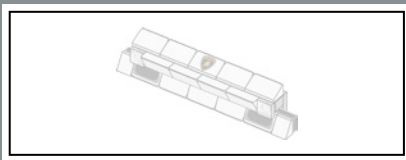

269

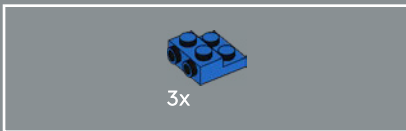
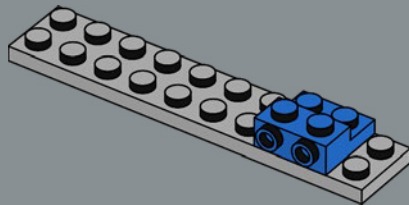

270

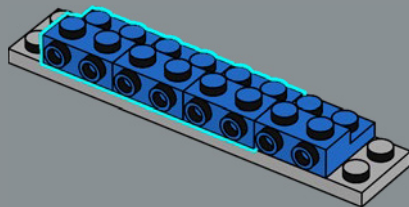

271

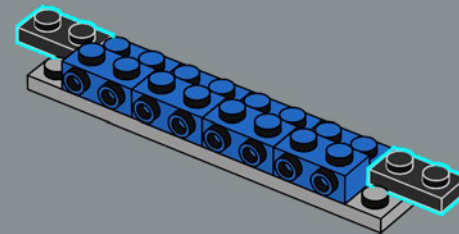

272

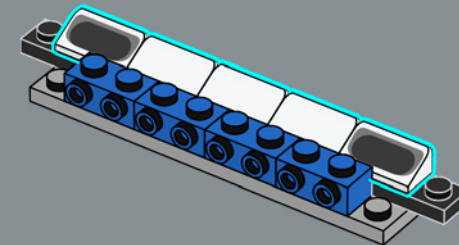



2x

273

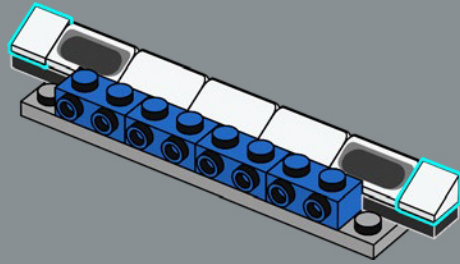

4x

274

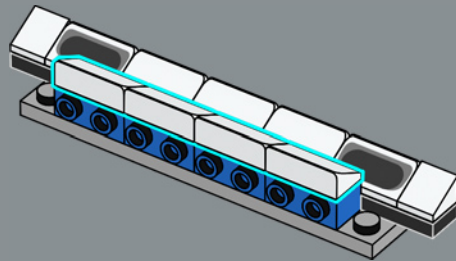

2x



2x

275

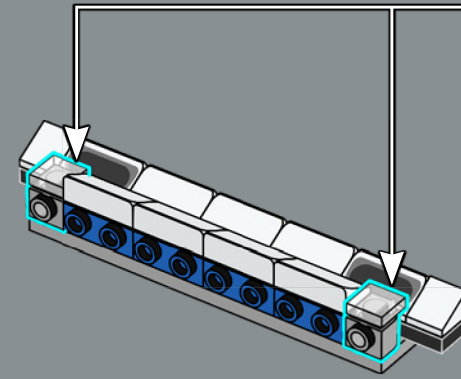

2x



4x



1x

276

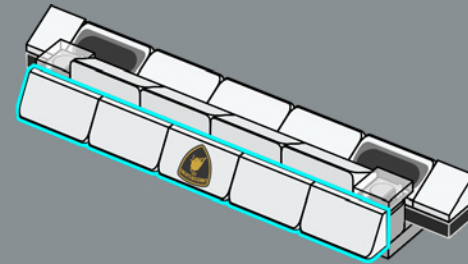

277

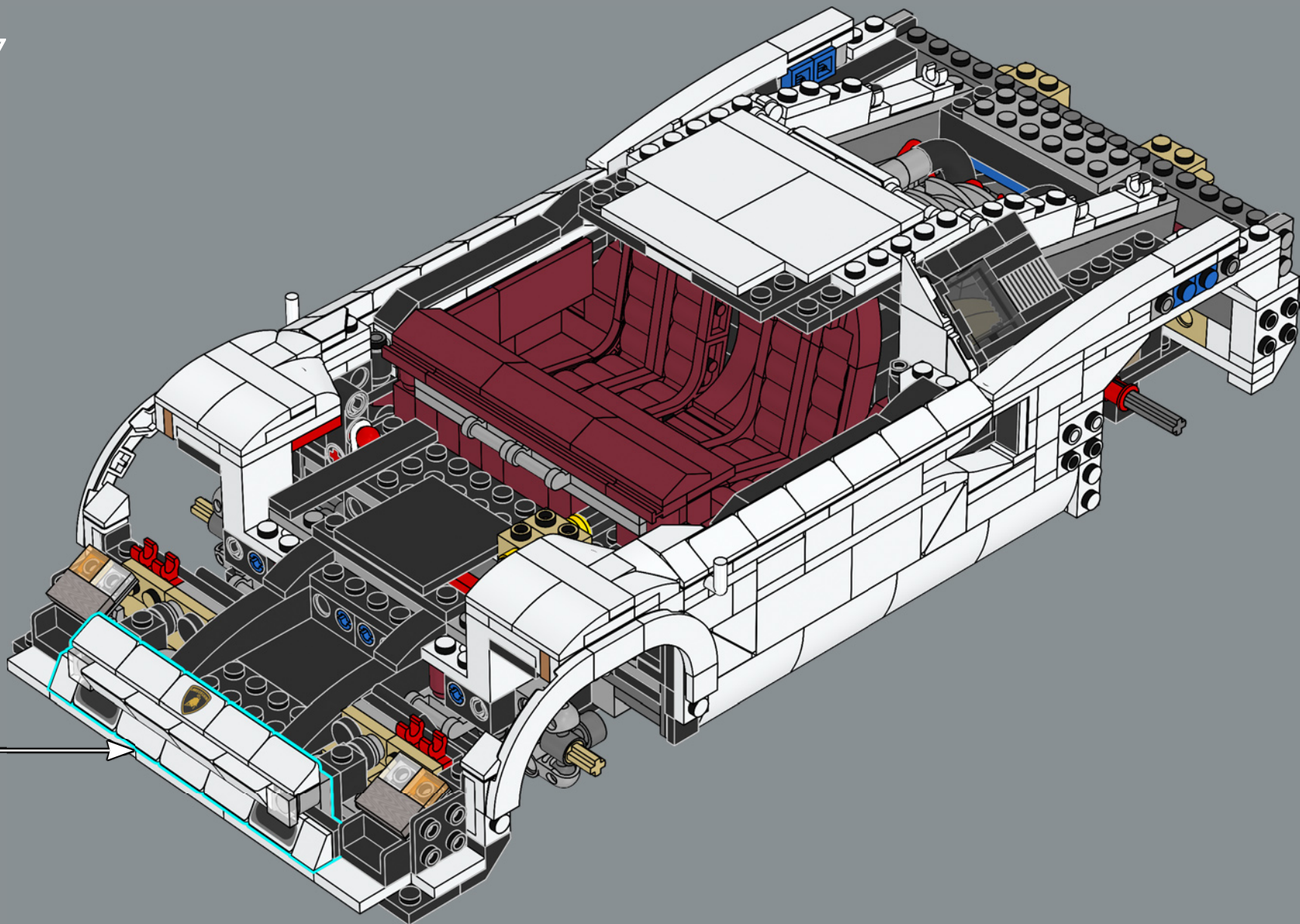

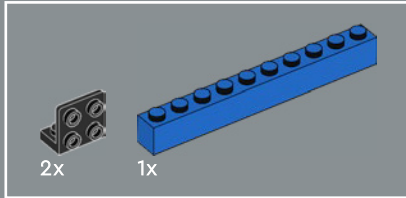
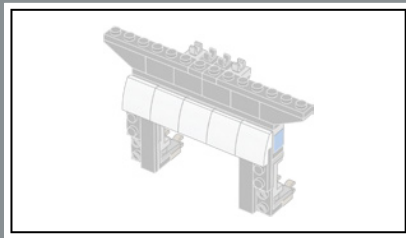

278

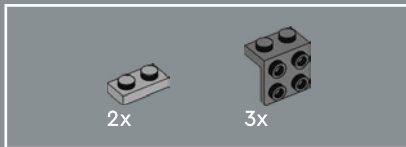
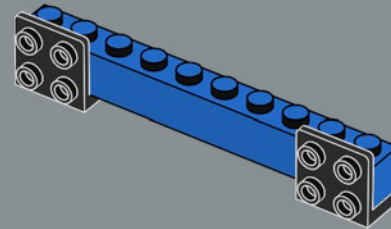

279

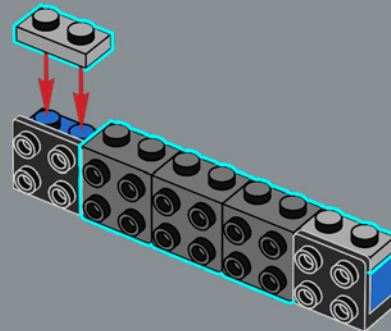

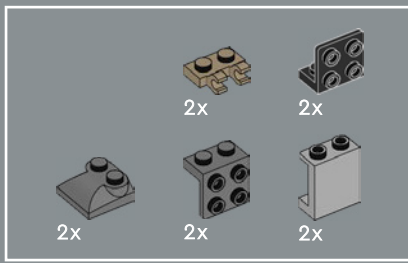

280

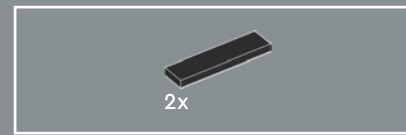
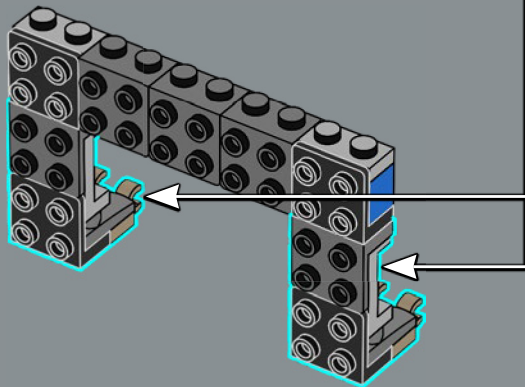
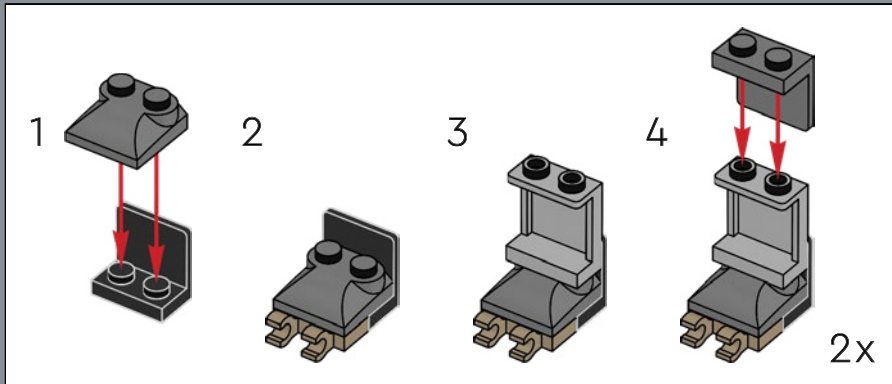

281

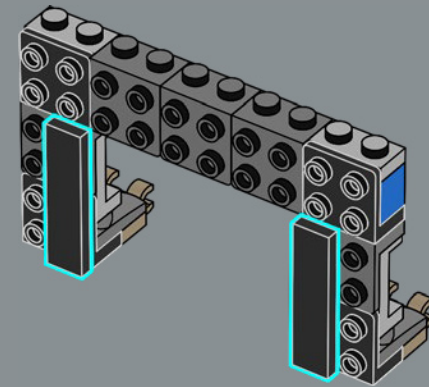

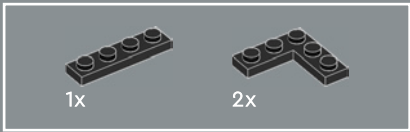

282

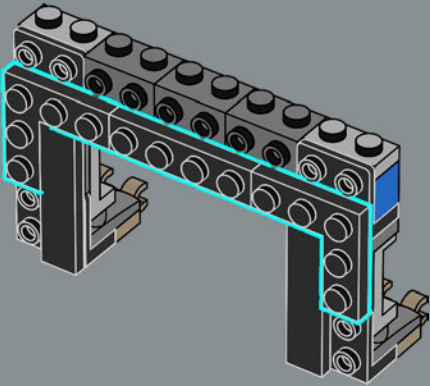

283

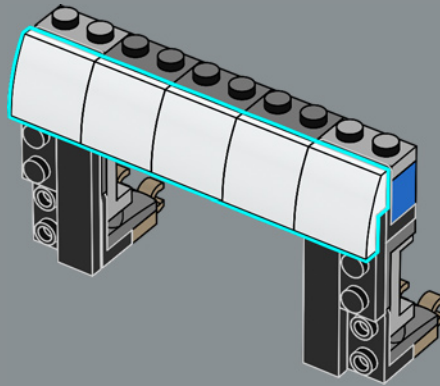

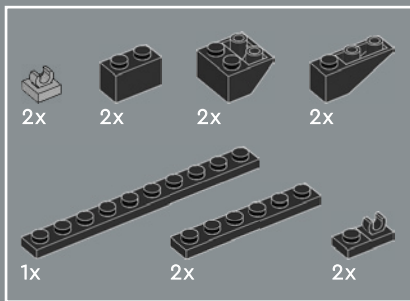

284

1

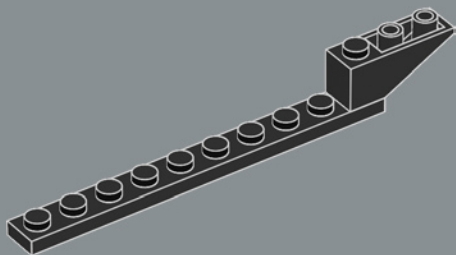

2

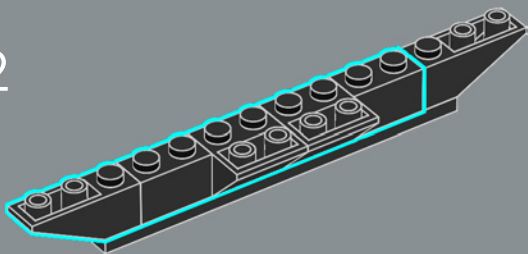

3

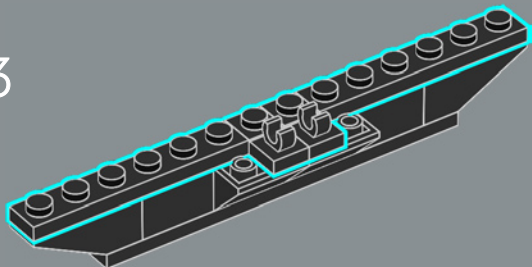

4

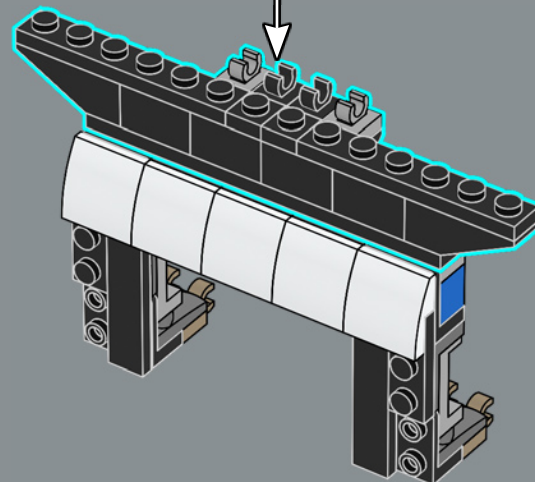
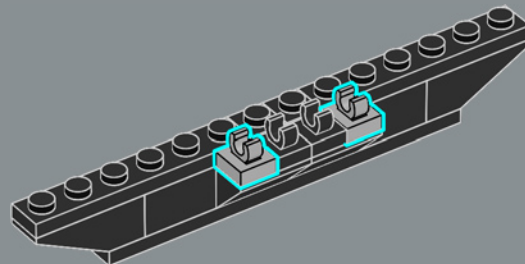

285

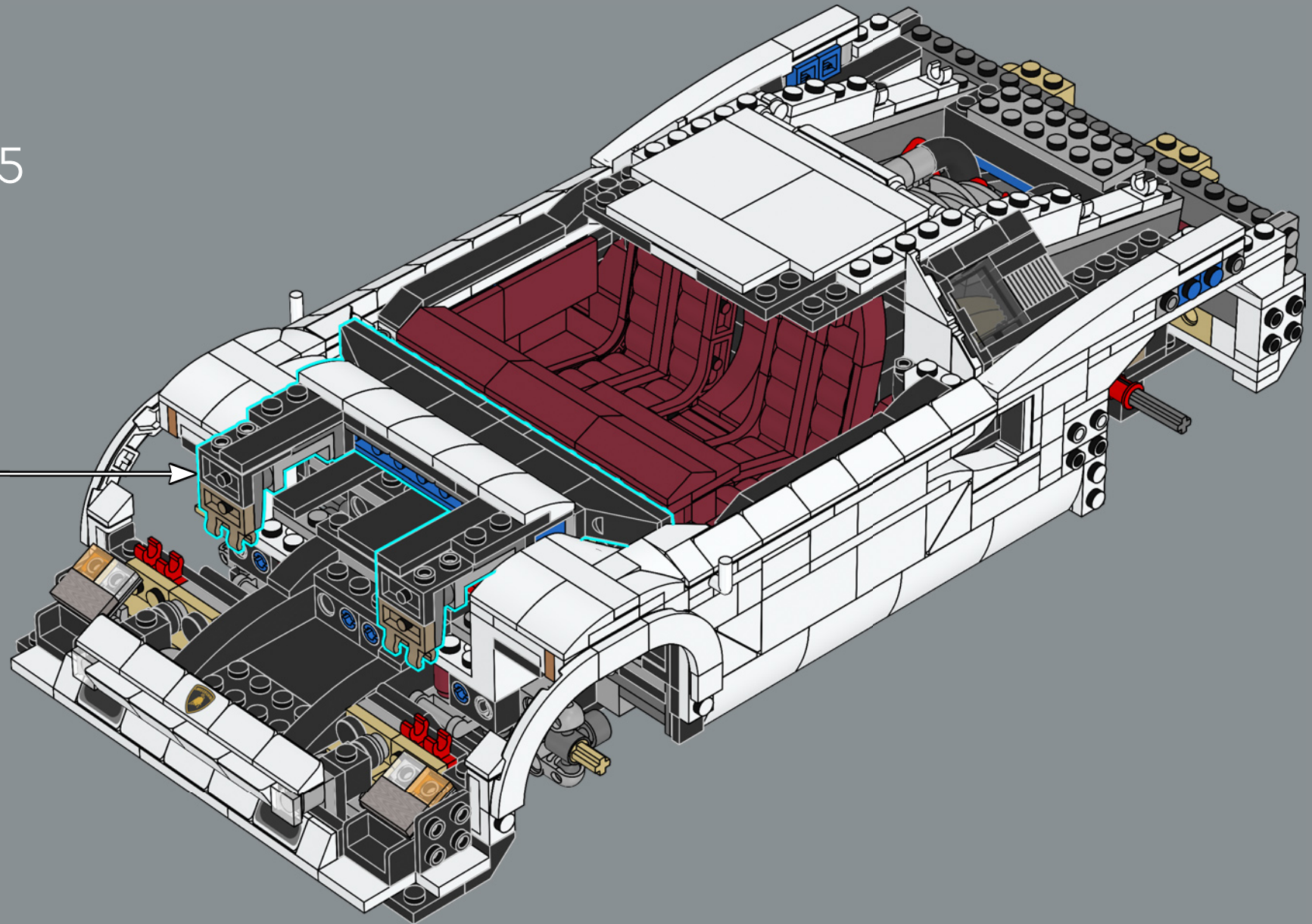

286

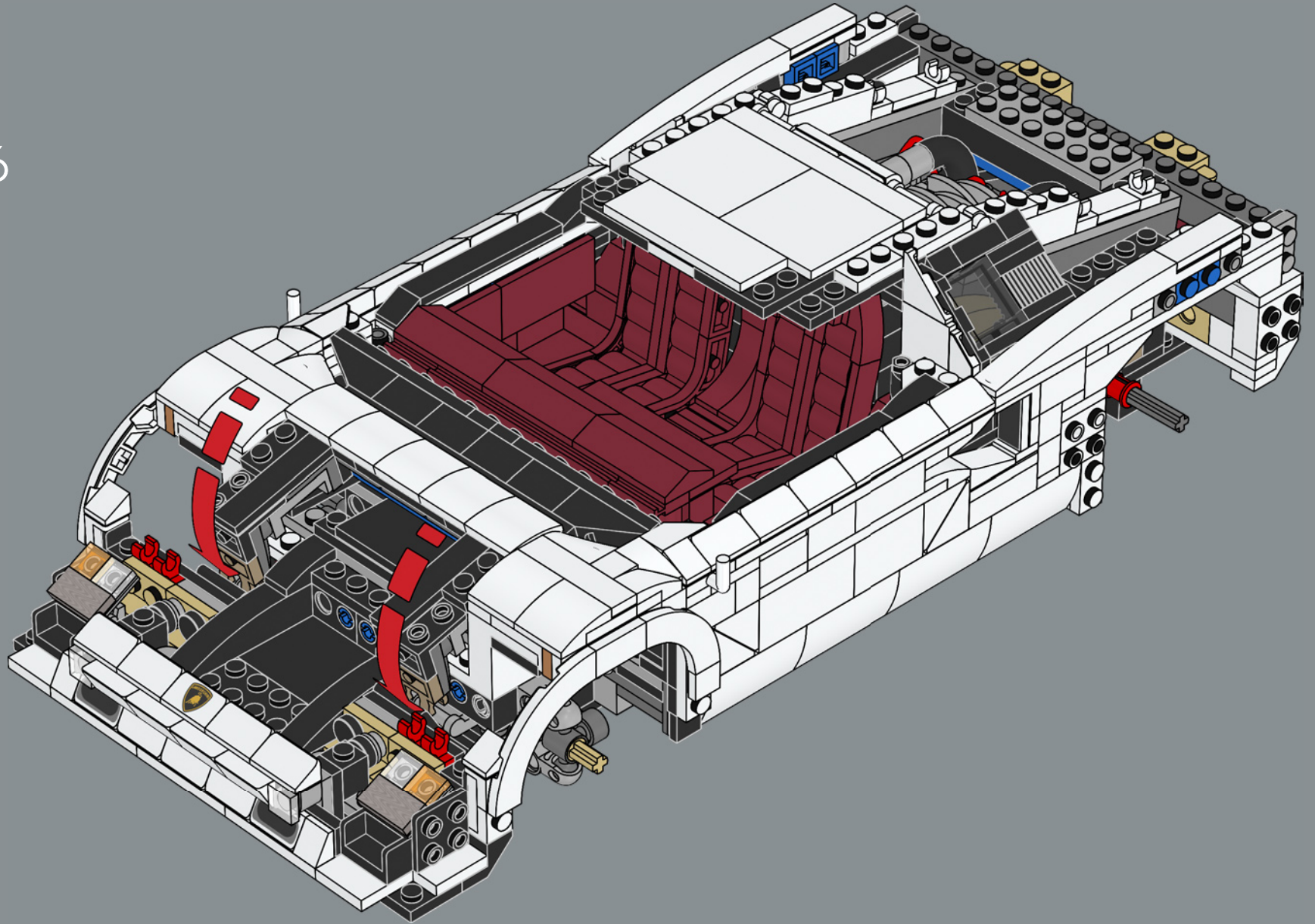



287

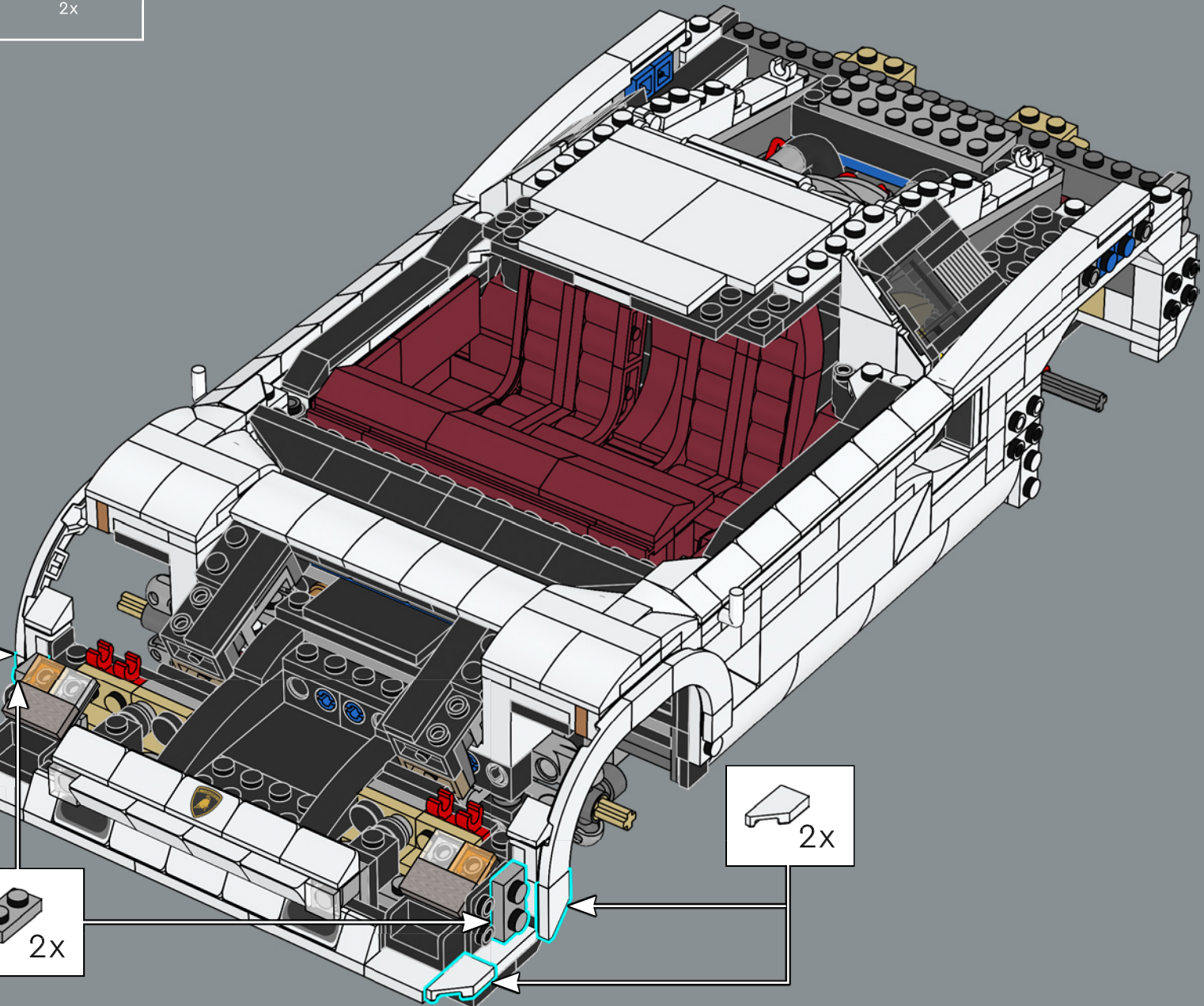
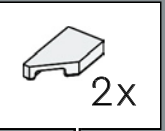
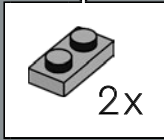
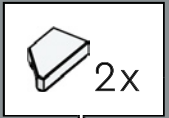



2x

288

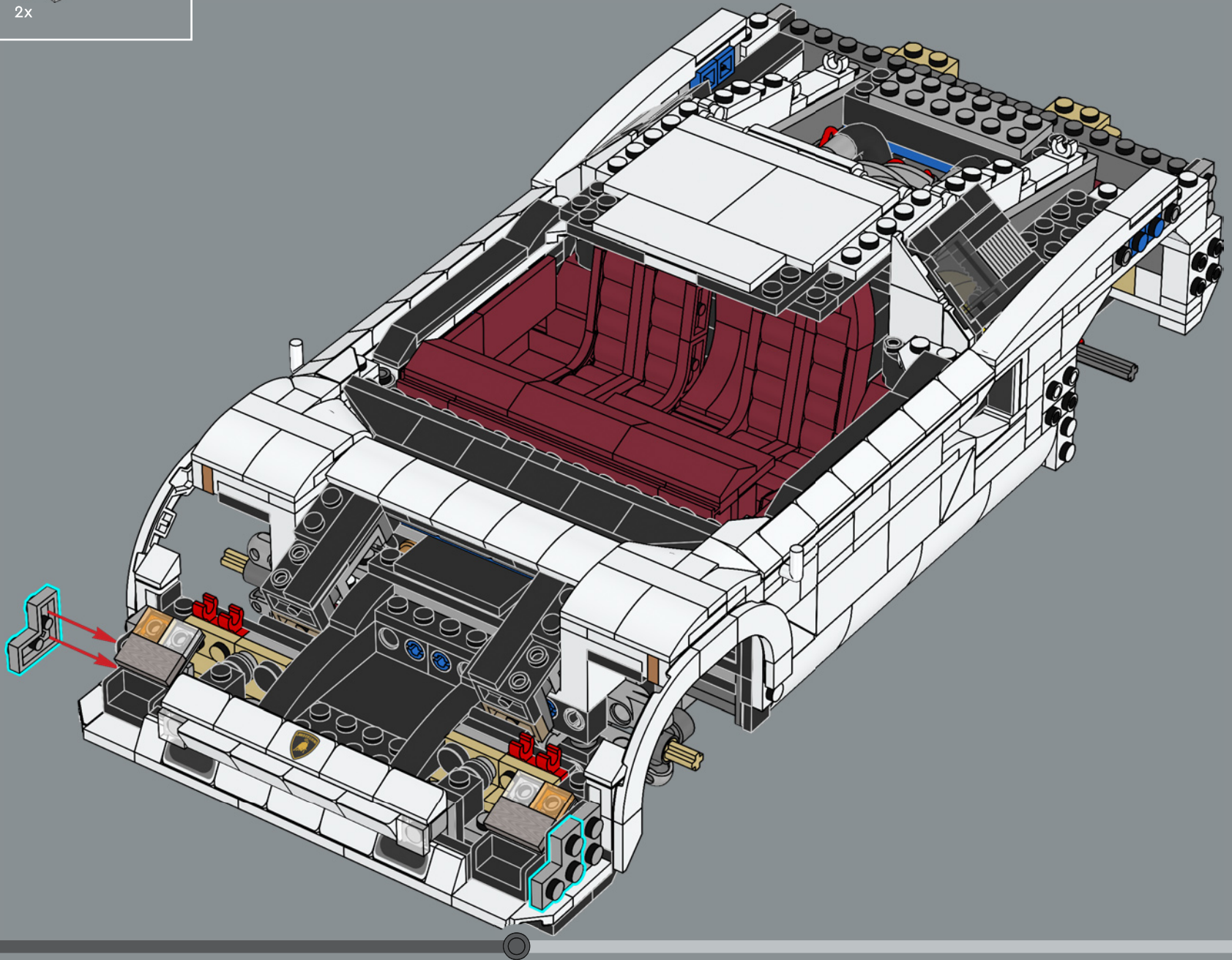

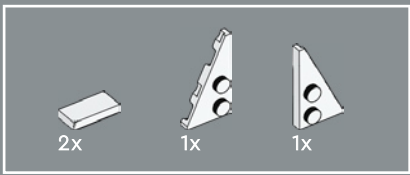

289

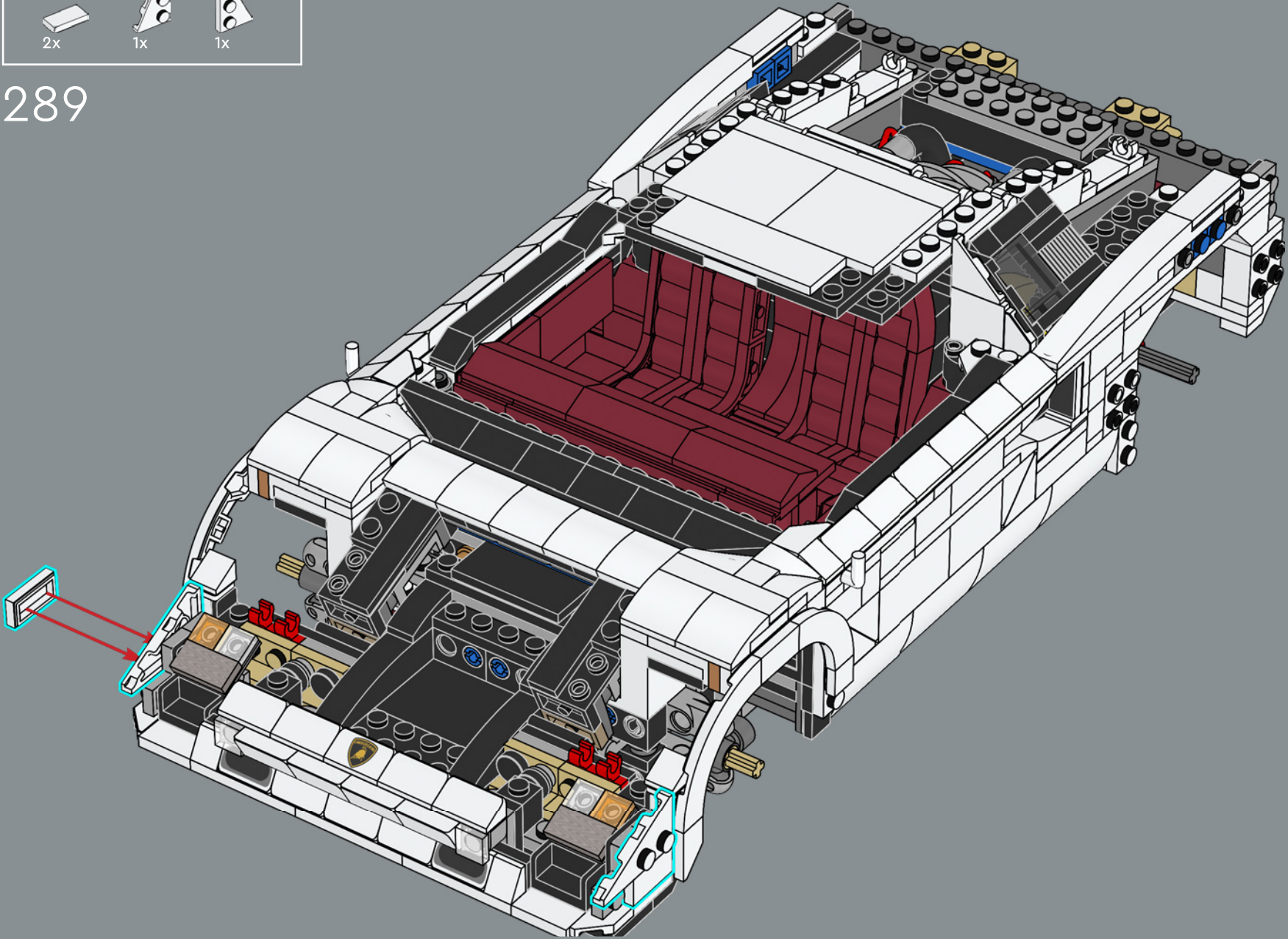



290

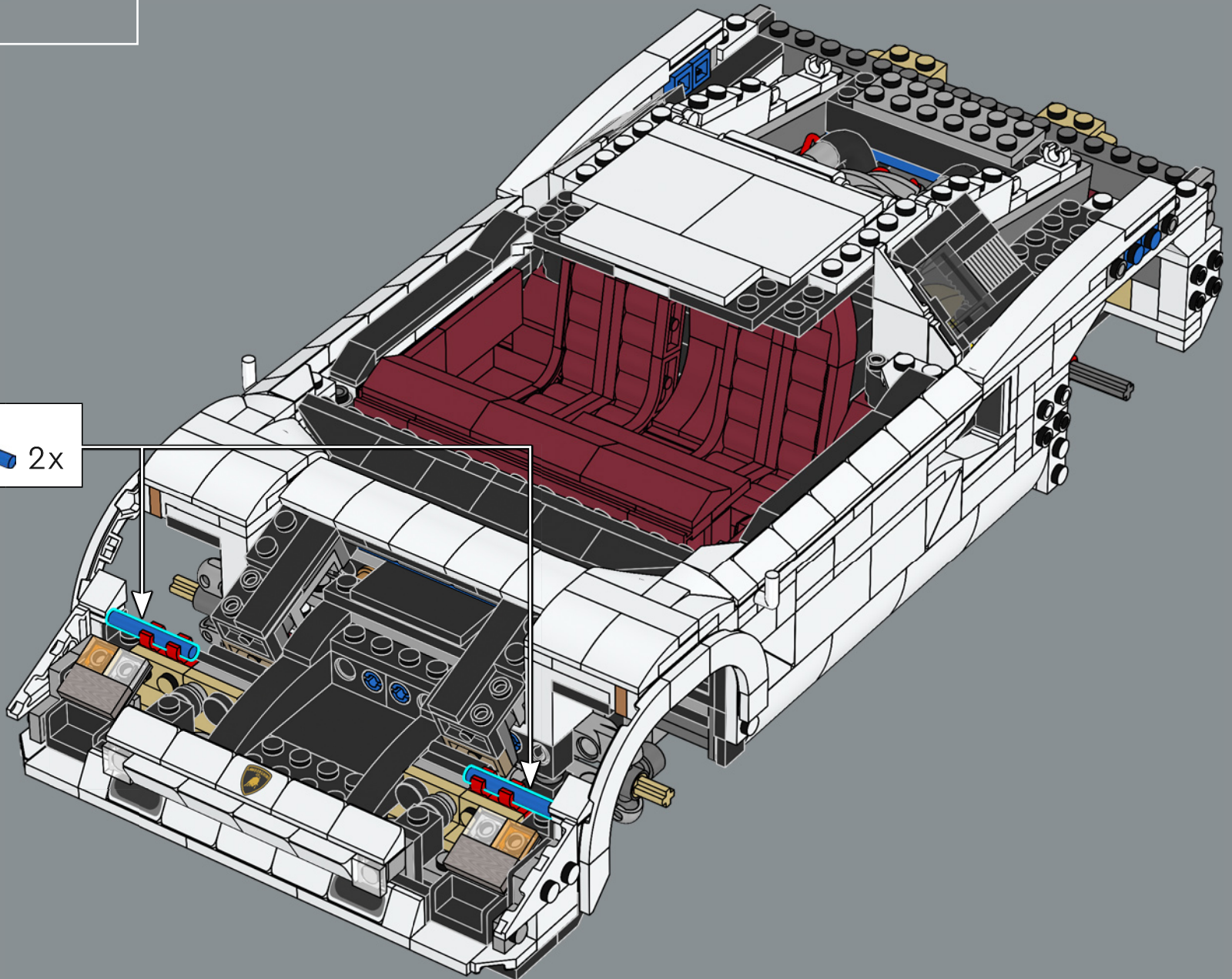
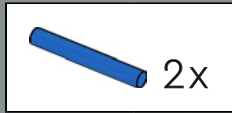

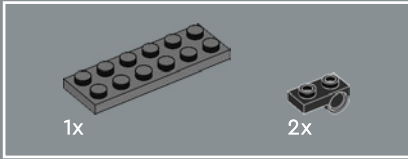
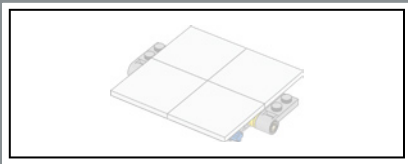

291

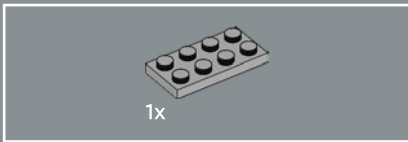
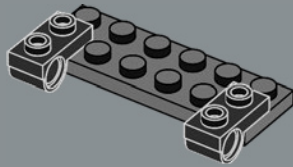

292

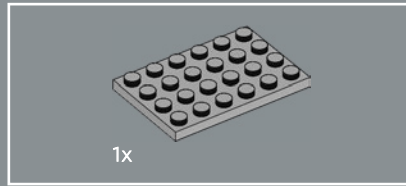
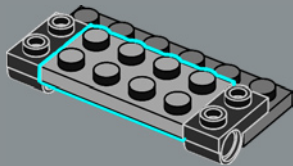

293

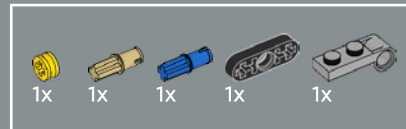
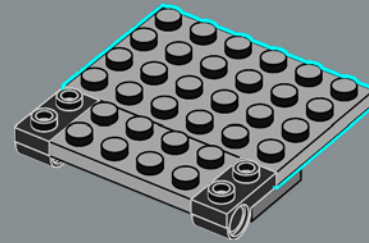

294

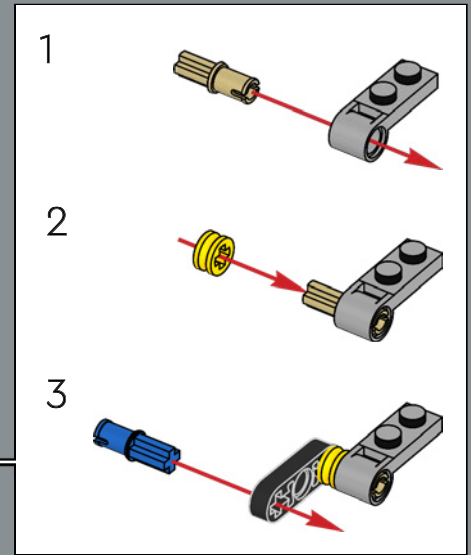
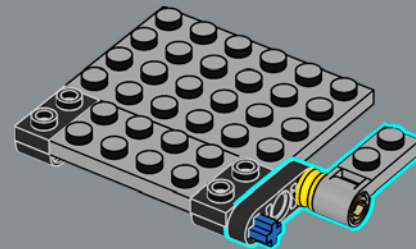



295

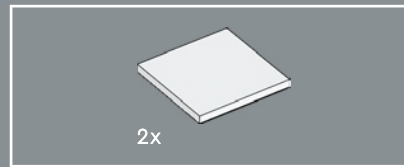
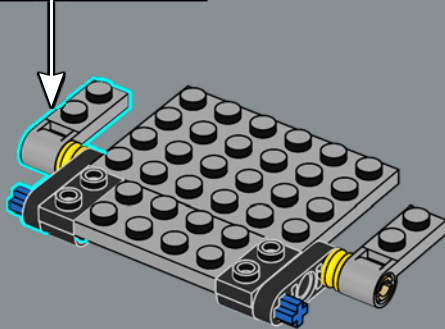
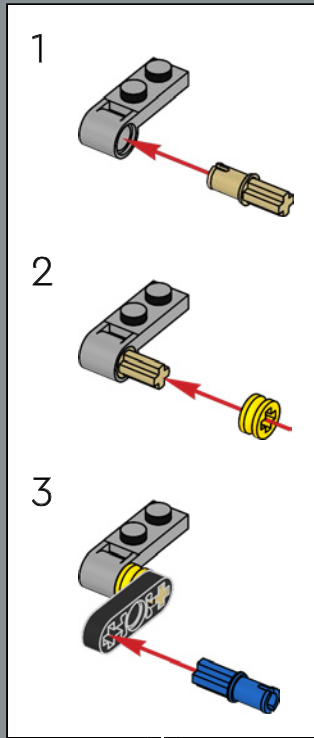

296

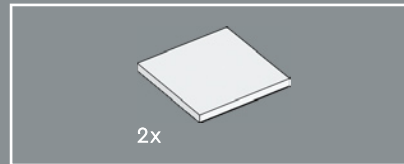
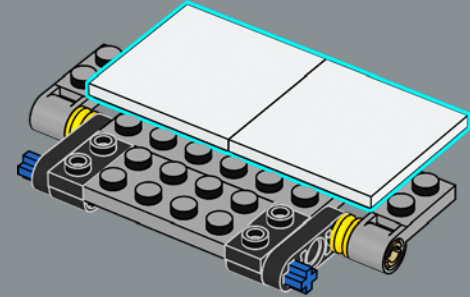

297

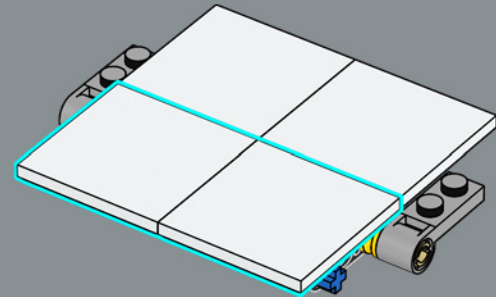

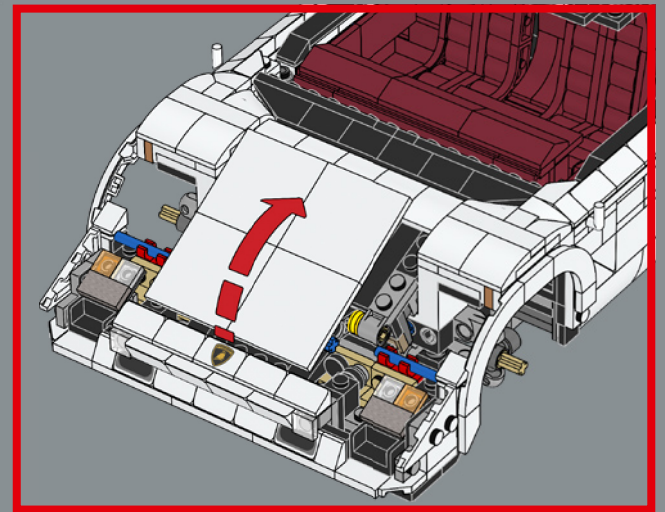
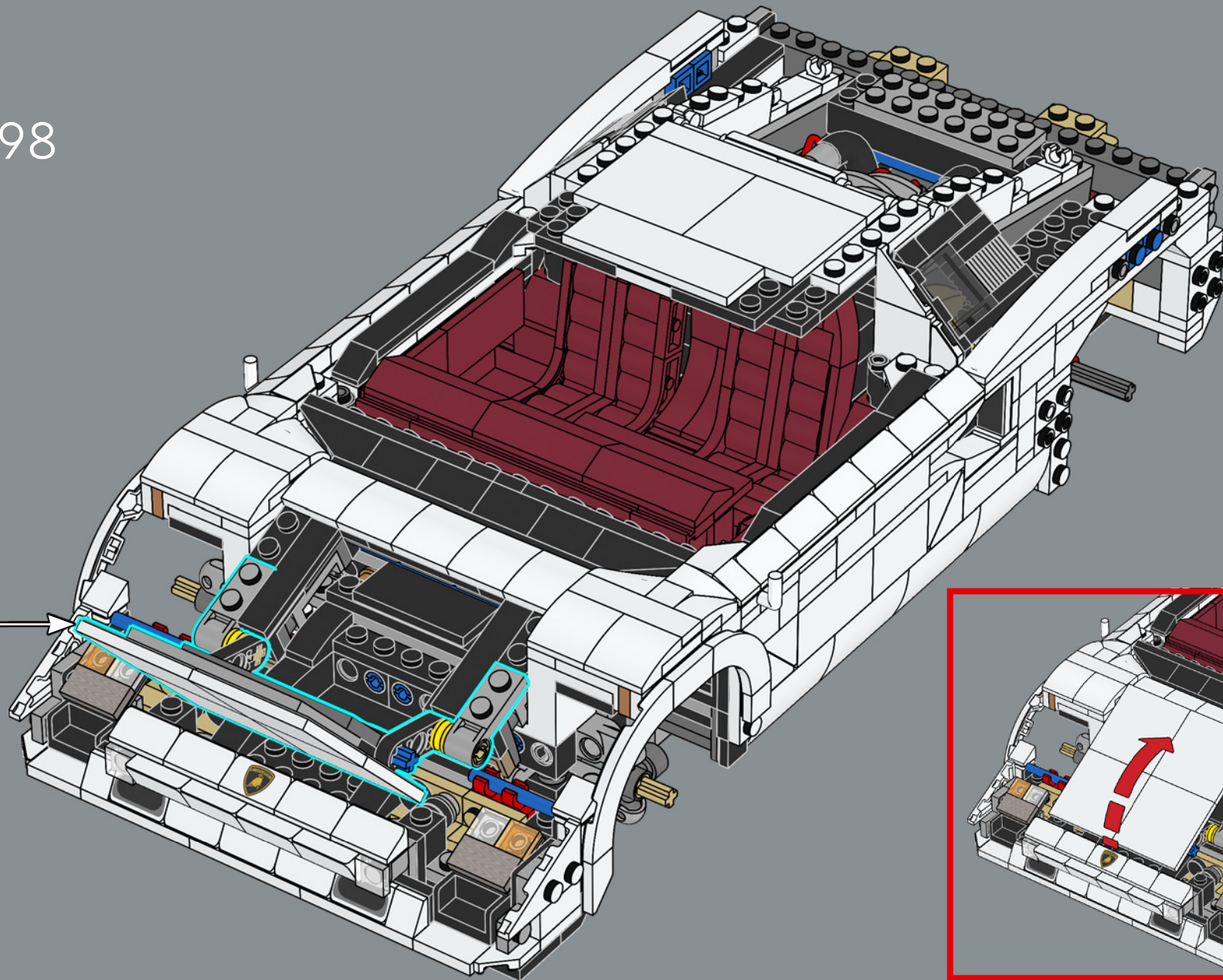

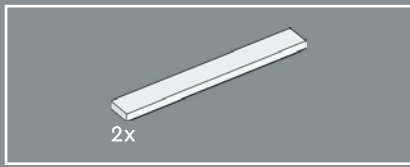

299

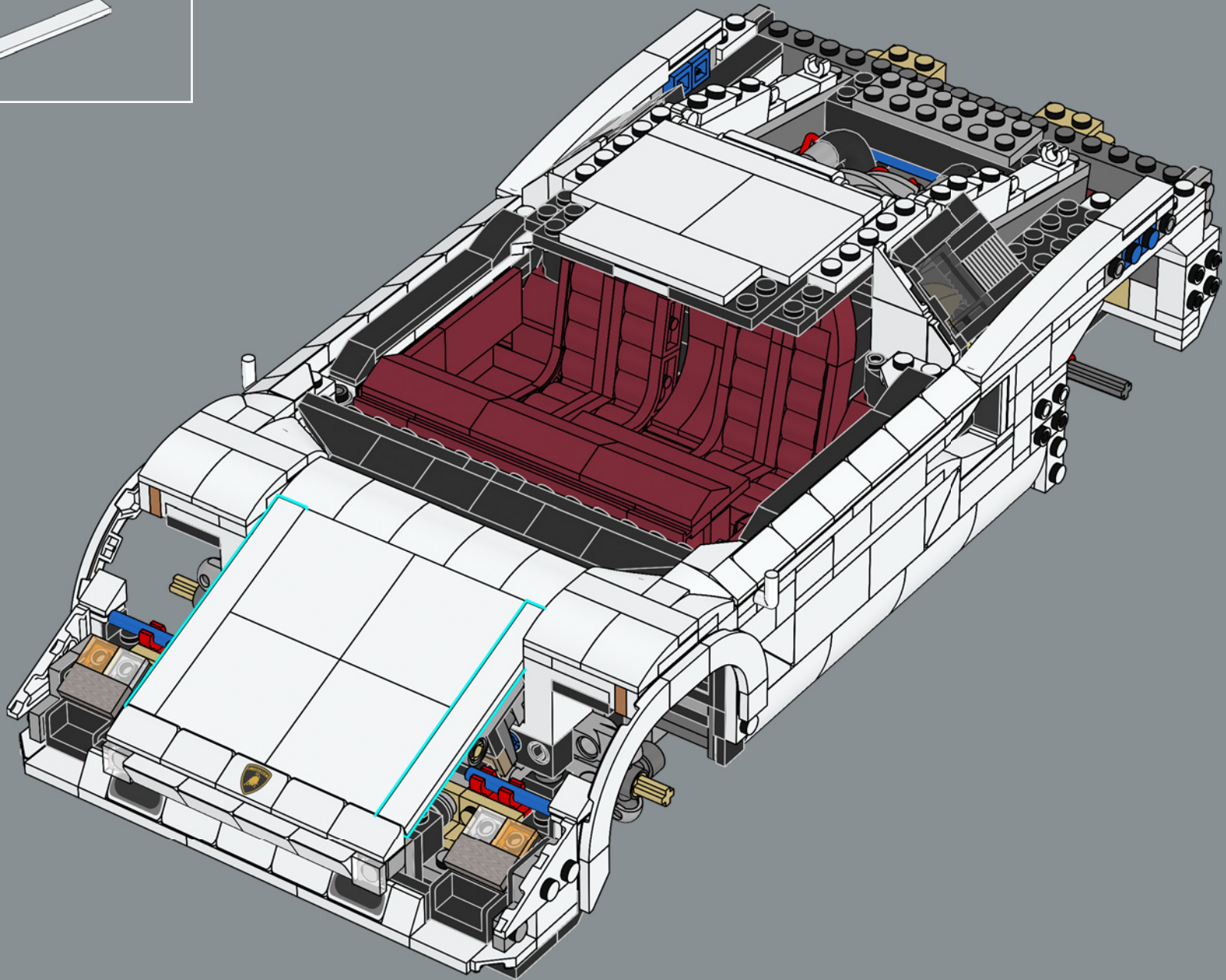

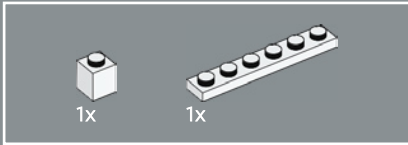
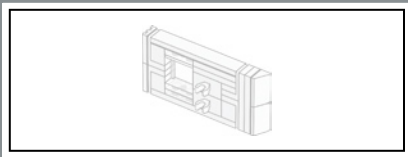

300

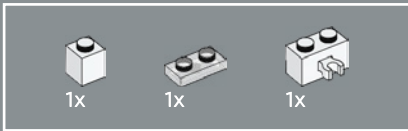
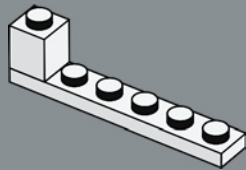

301

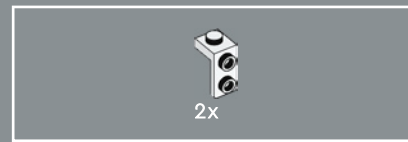
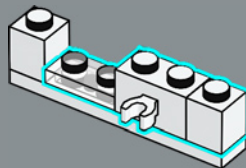

302

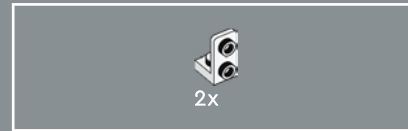
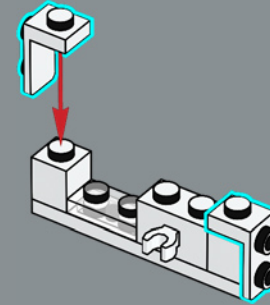

303

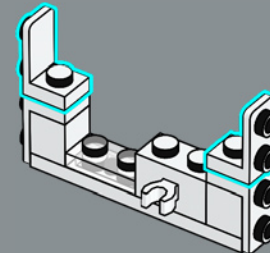

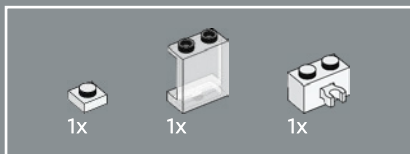

304

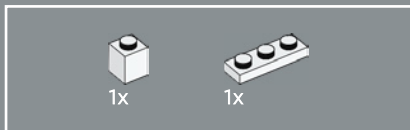
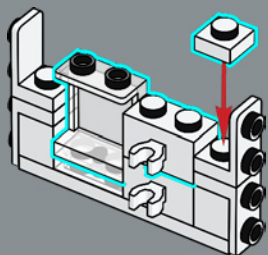

305

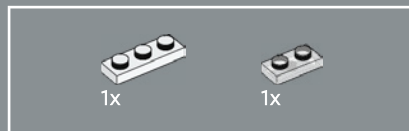
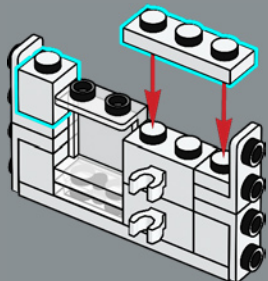

306

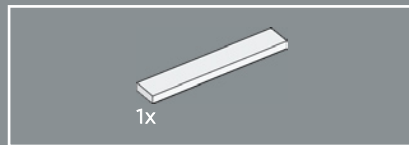
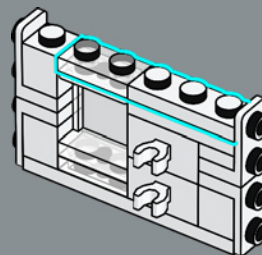

307

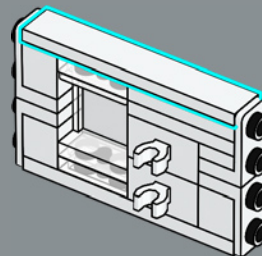



2x

308

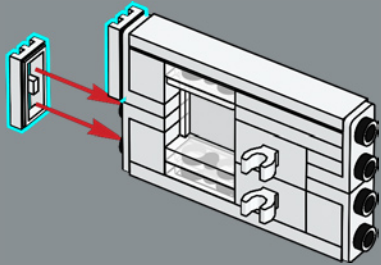

2x



2x

309

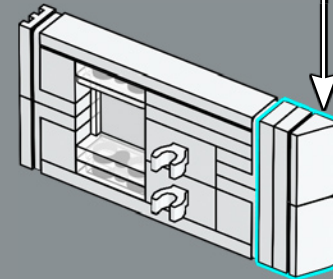
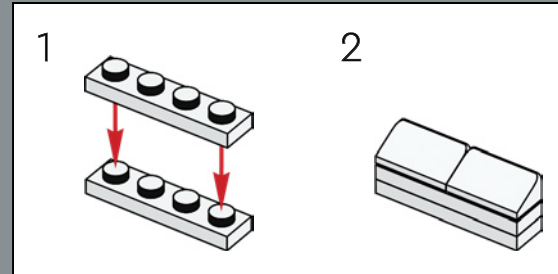

310

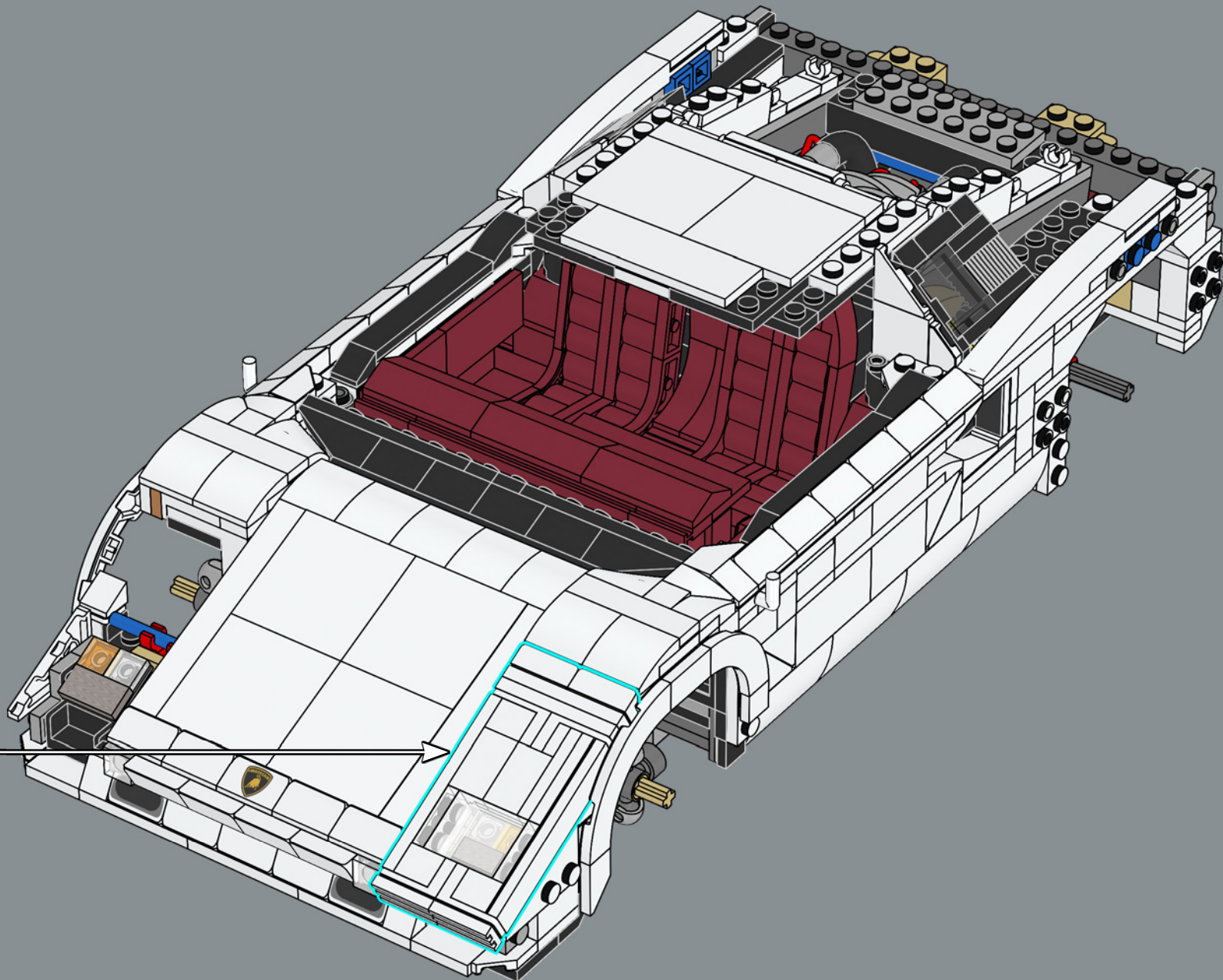

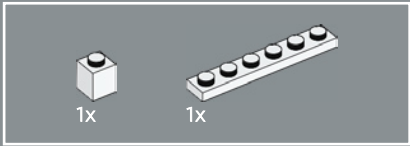
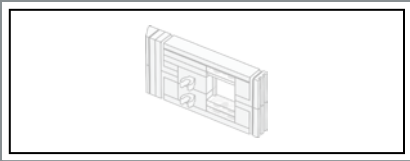

311

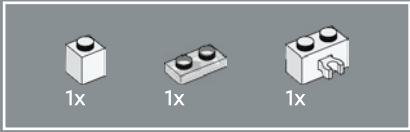
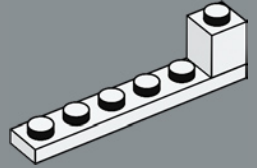

312

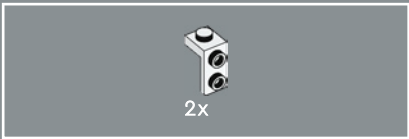
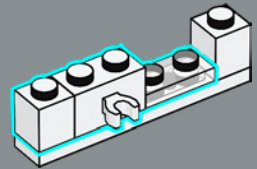

313

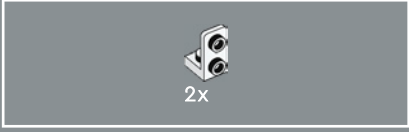
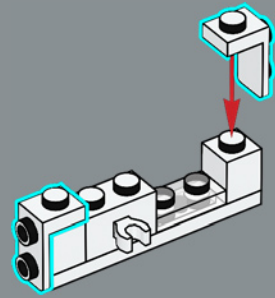

314

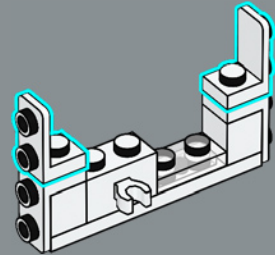

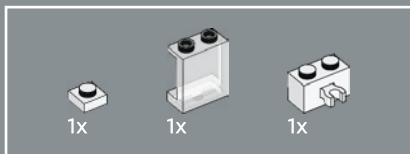

315

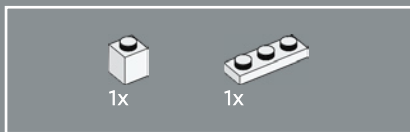
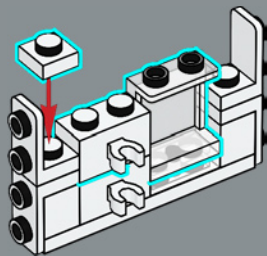

316

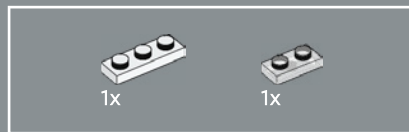
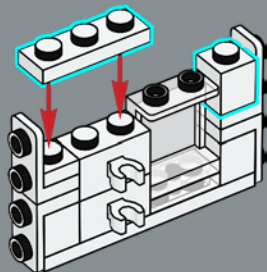

317

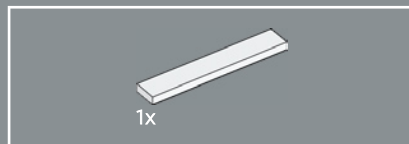
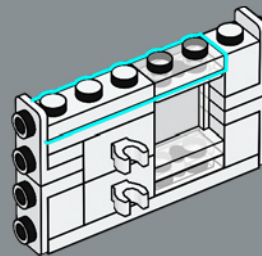

318

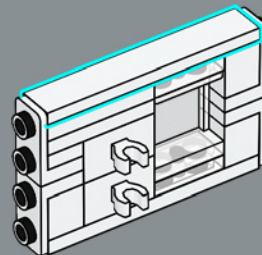



2x

319

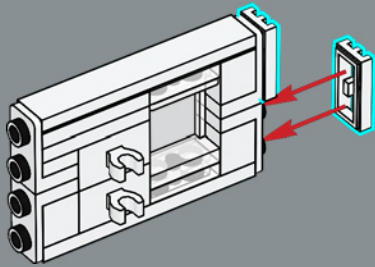

2x



2x

320

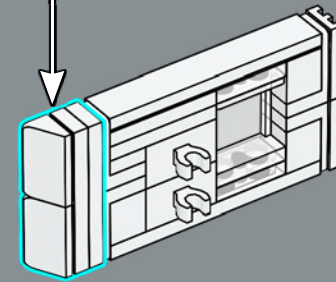
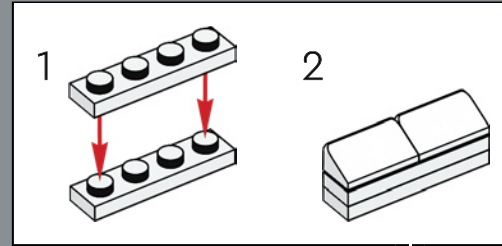

321

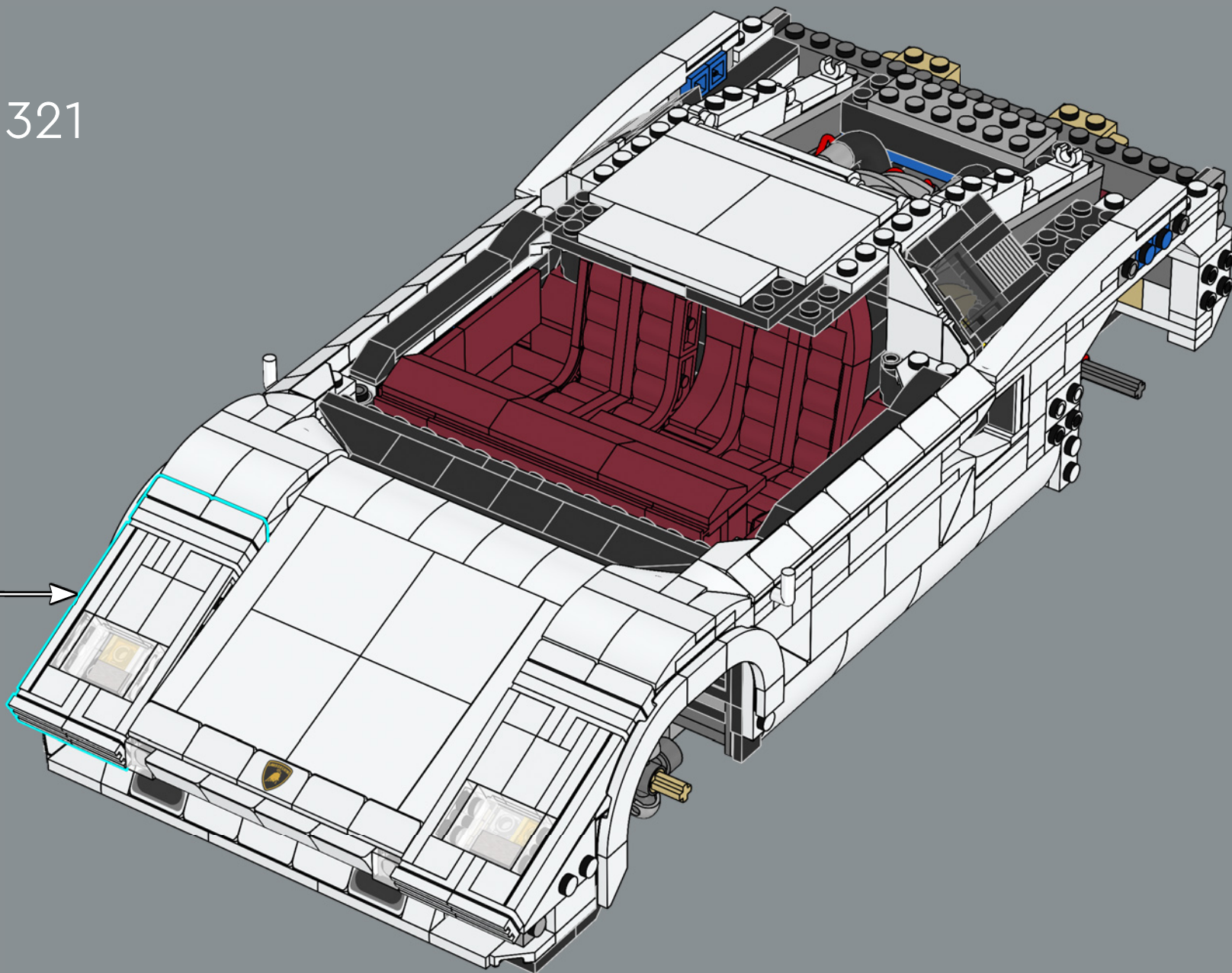

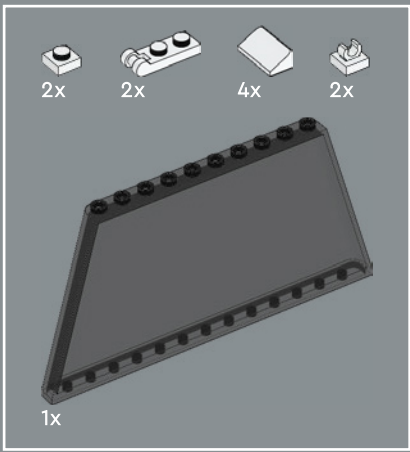

322

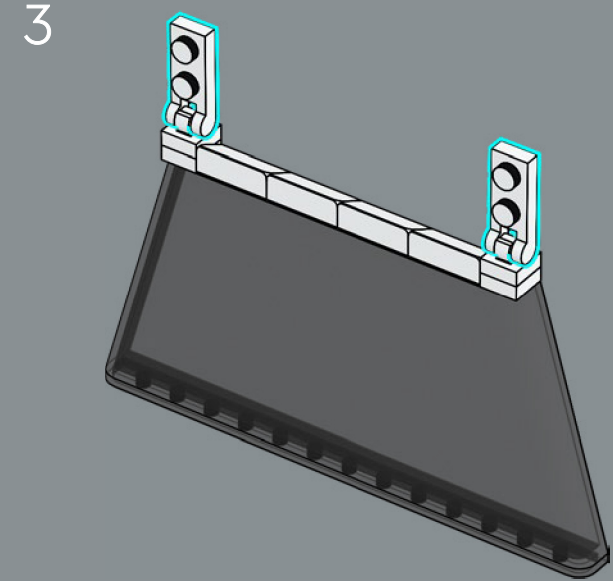
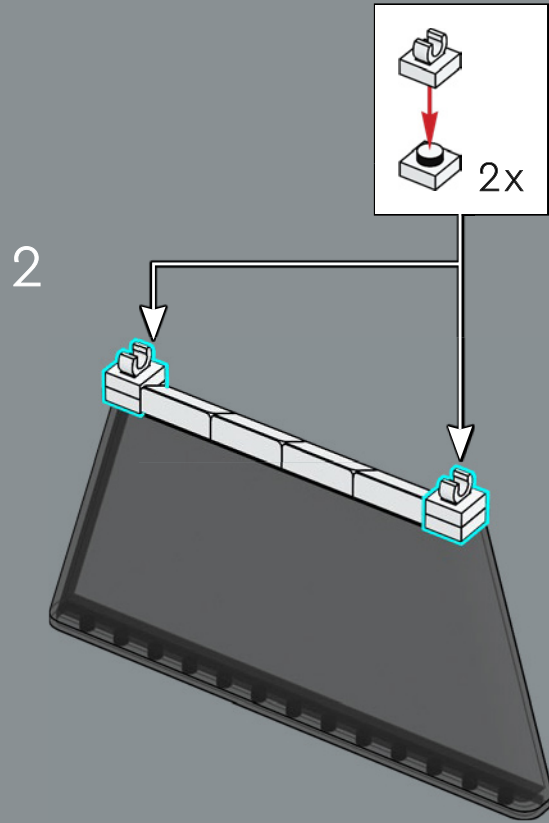
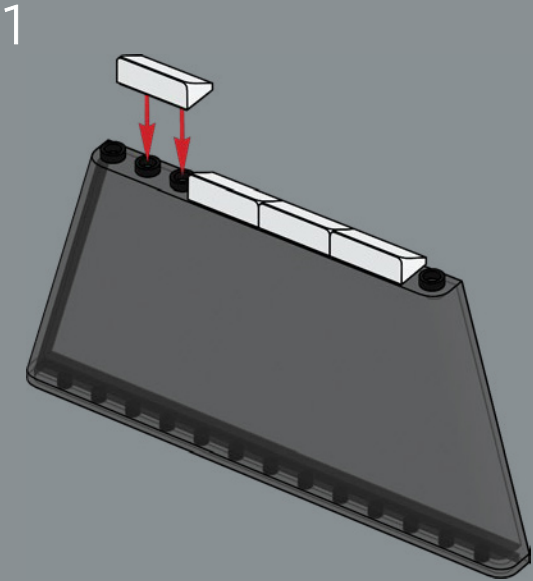

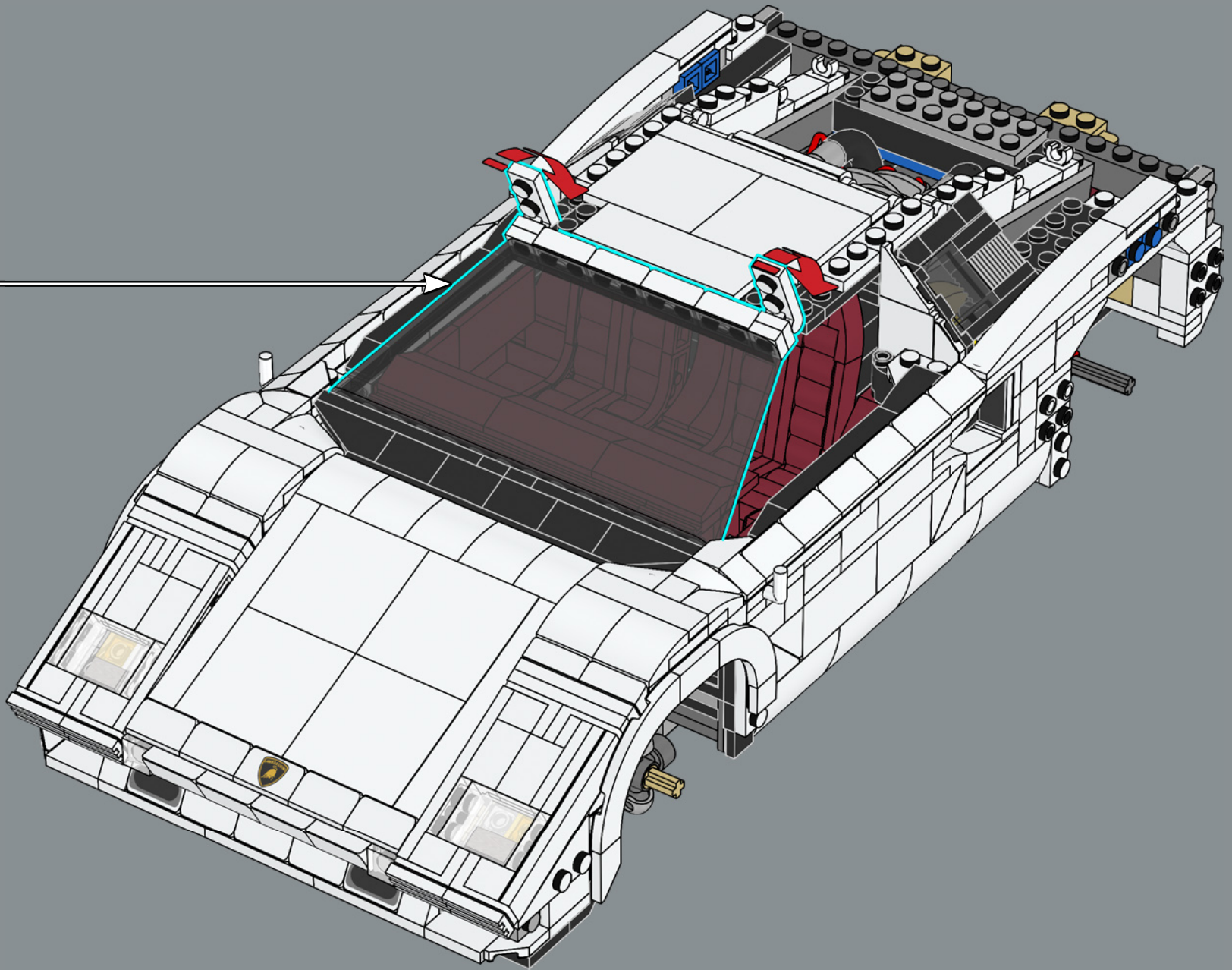

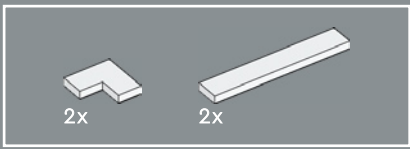

323

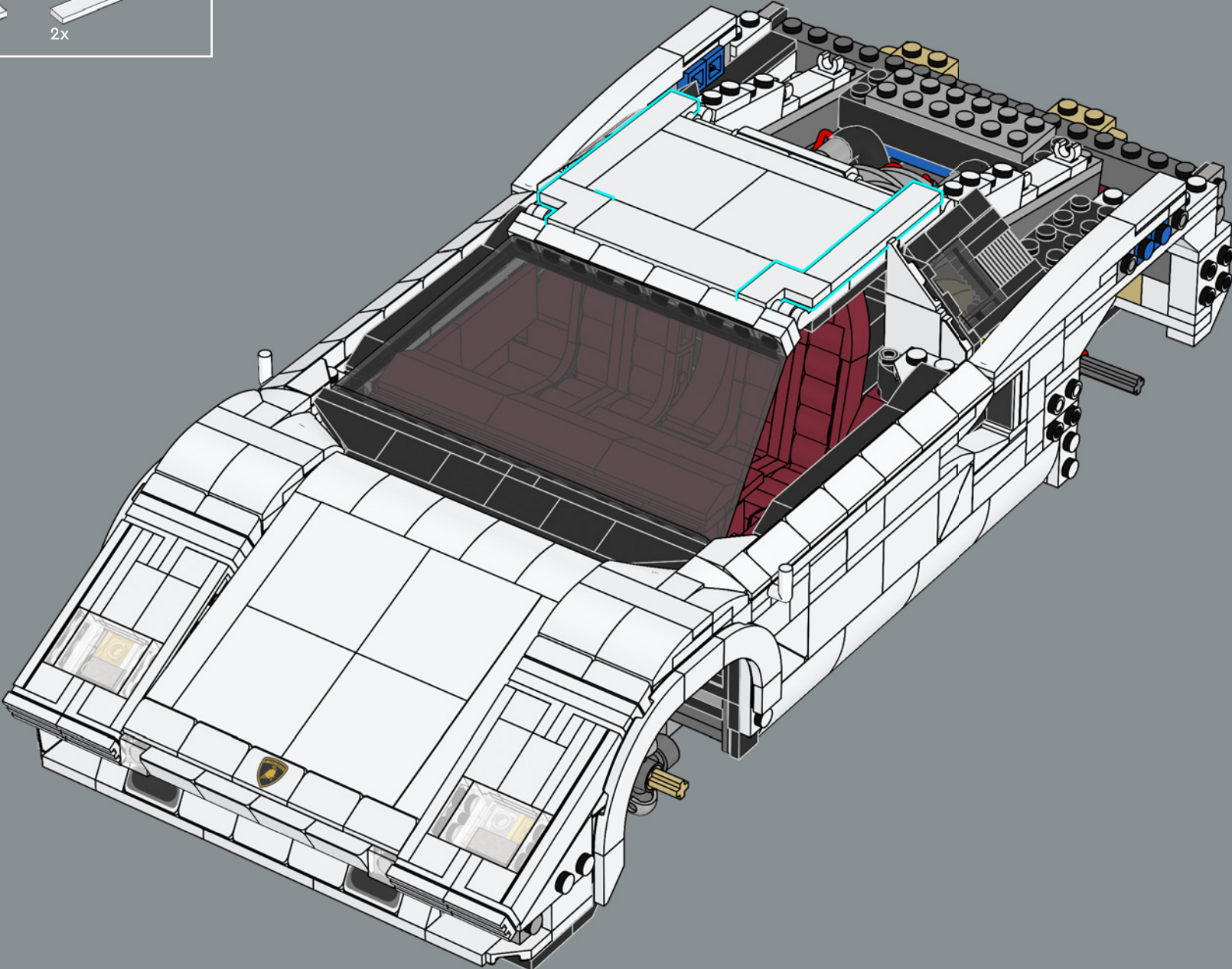

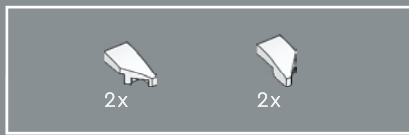

324

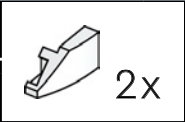
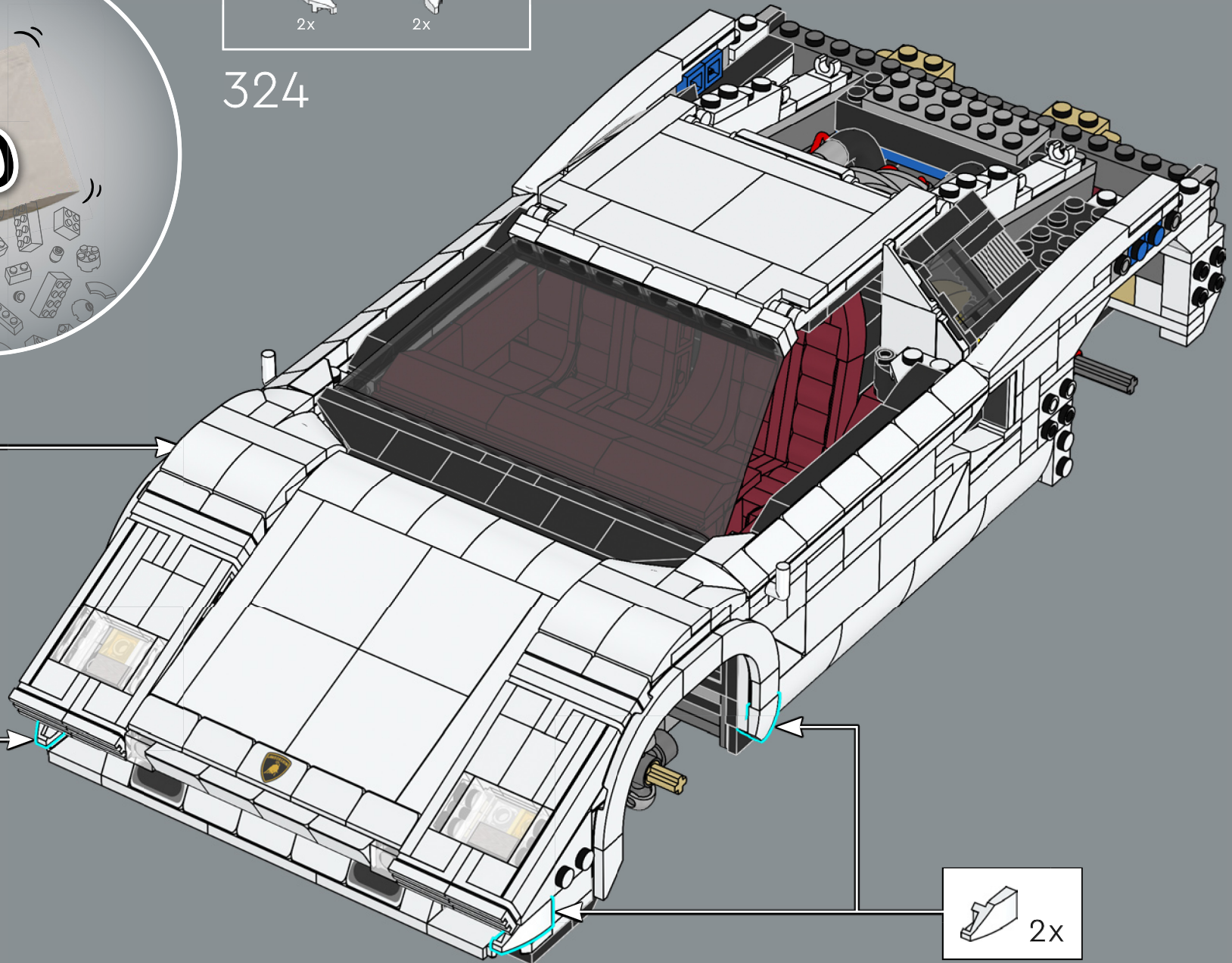

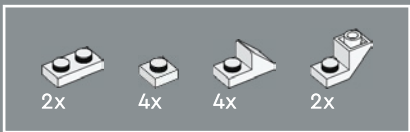

325

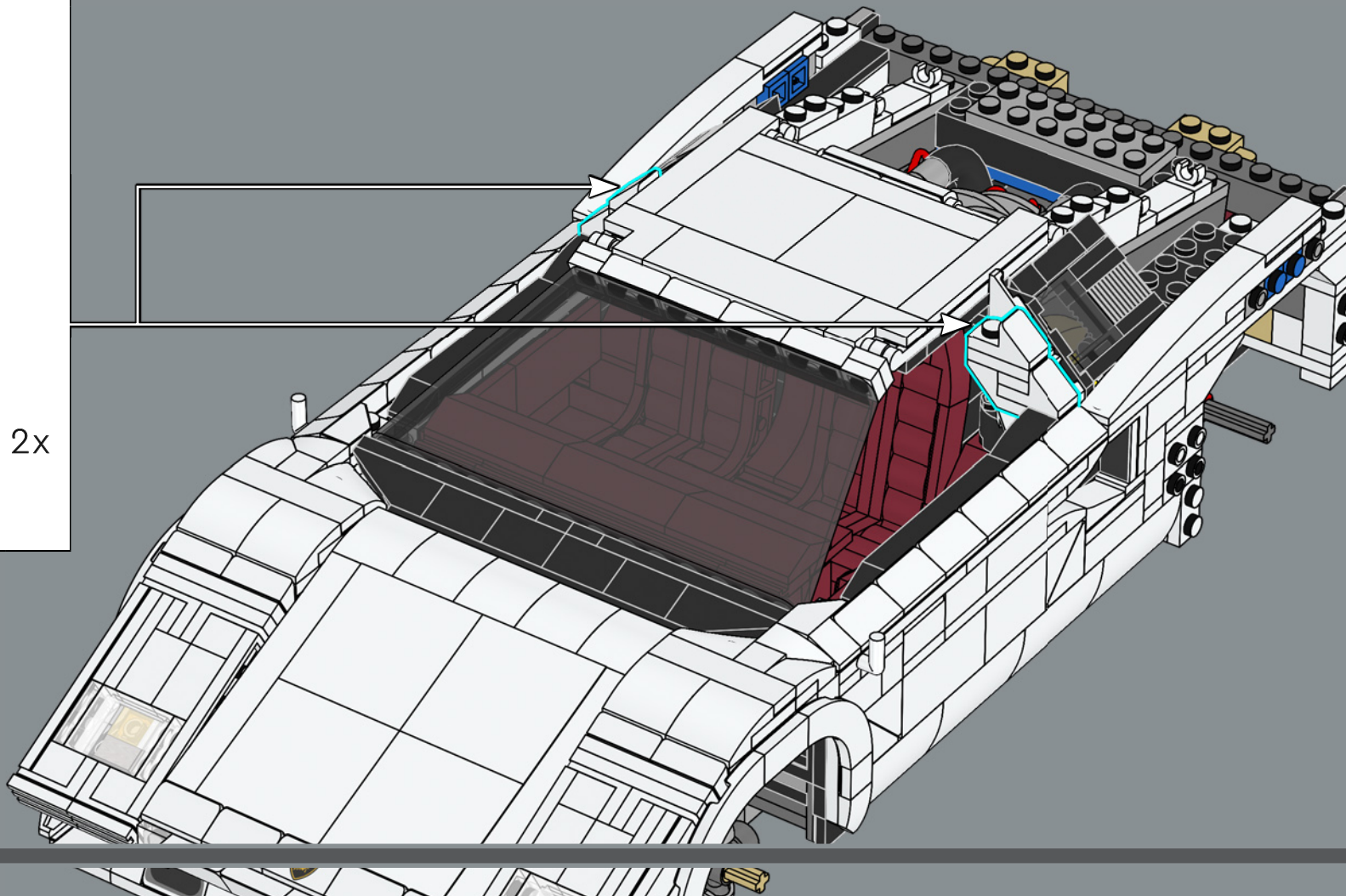
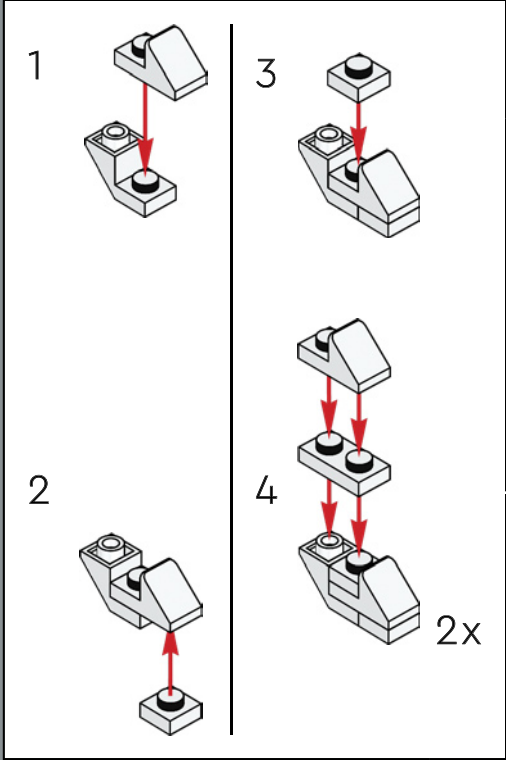

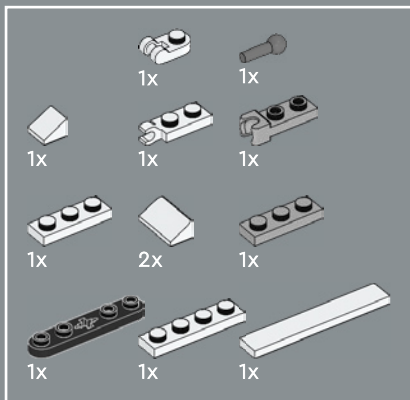

326

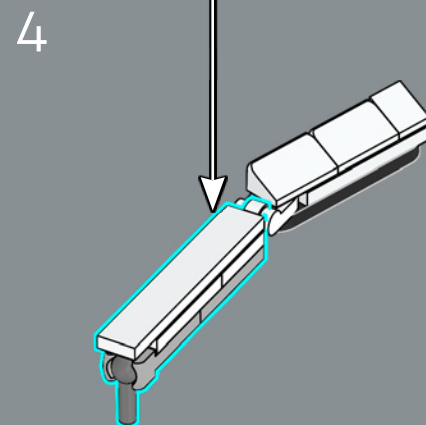
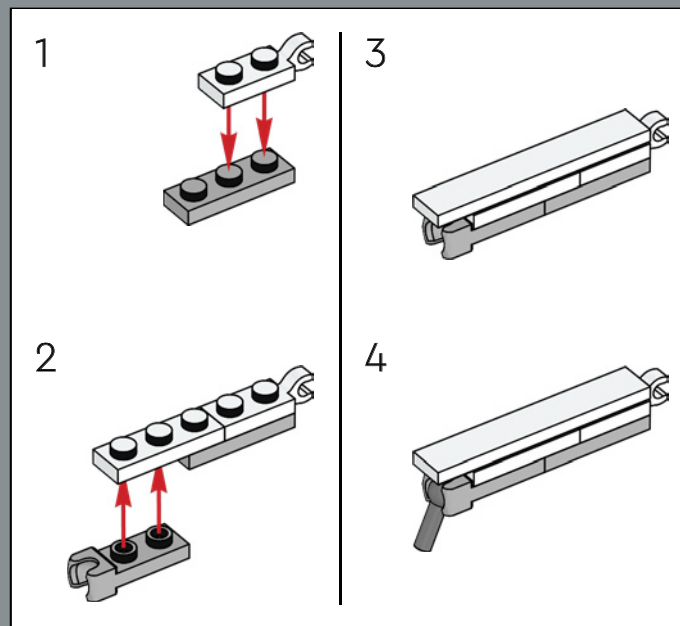
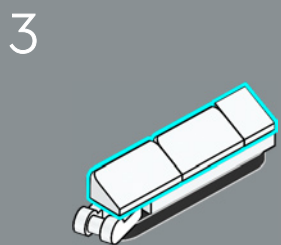
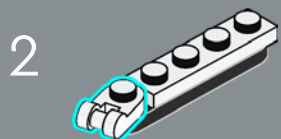
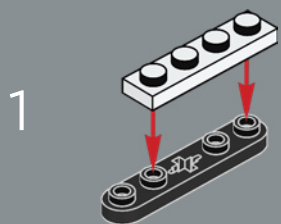

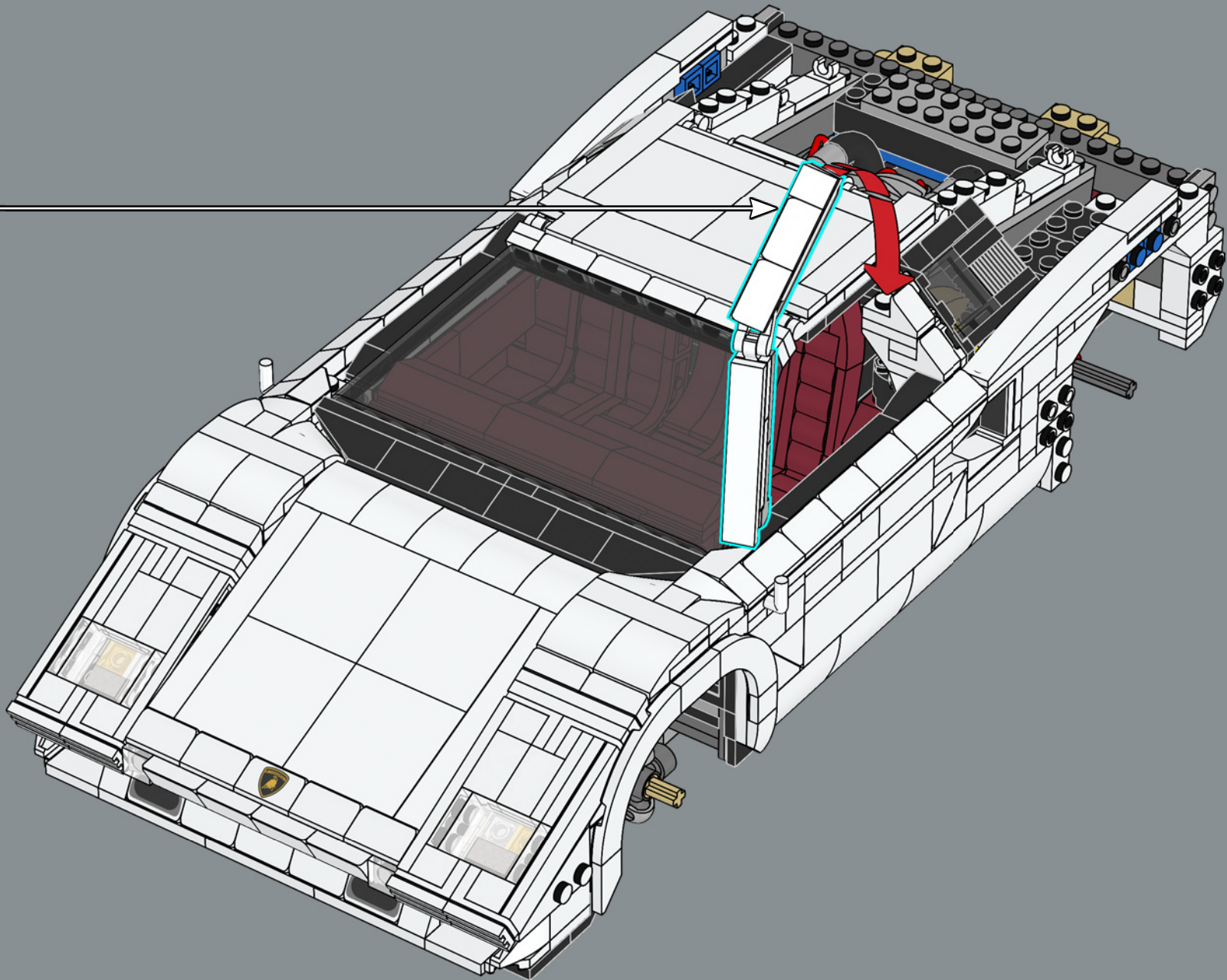

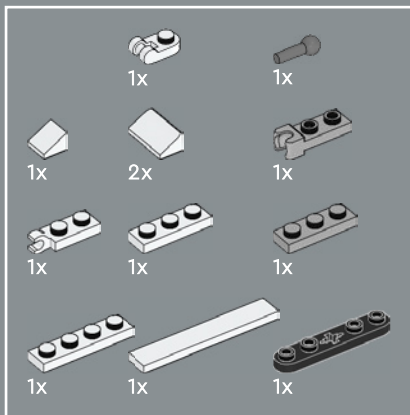

327

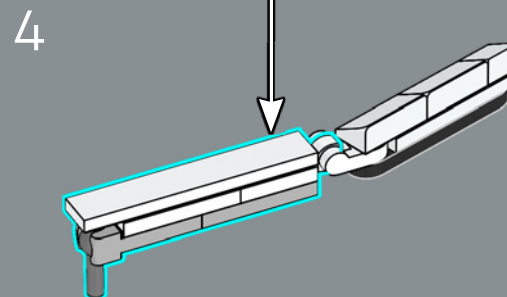
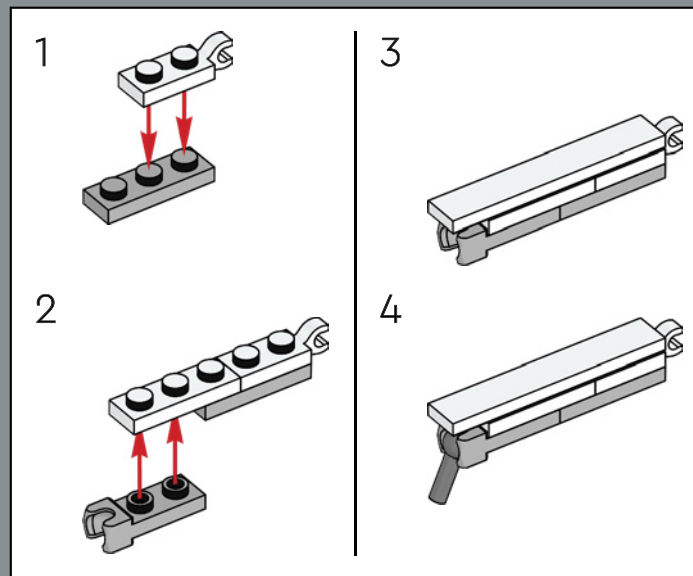
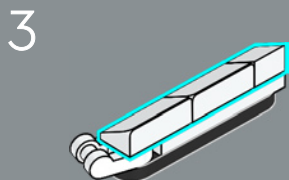
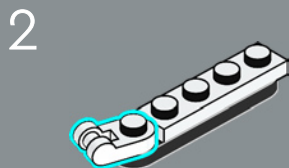
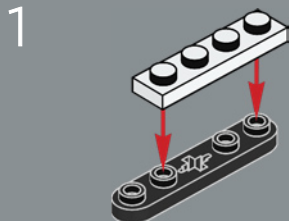

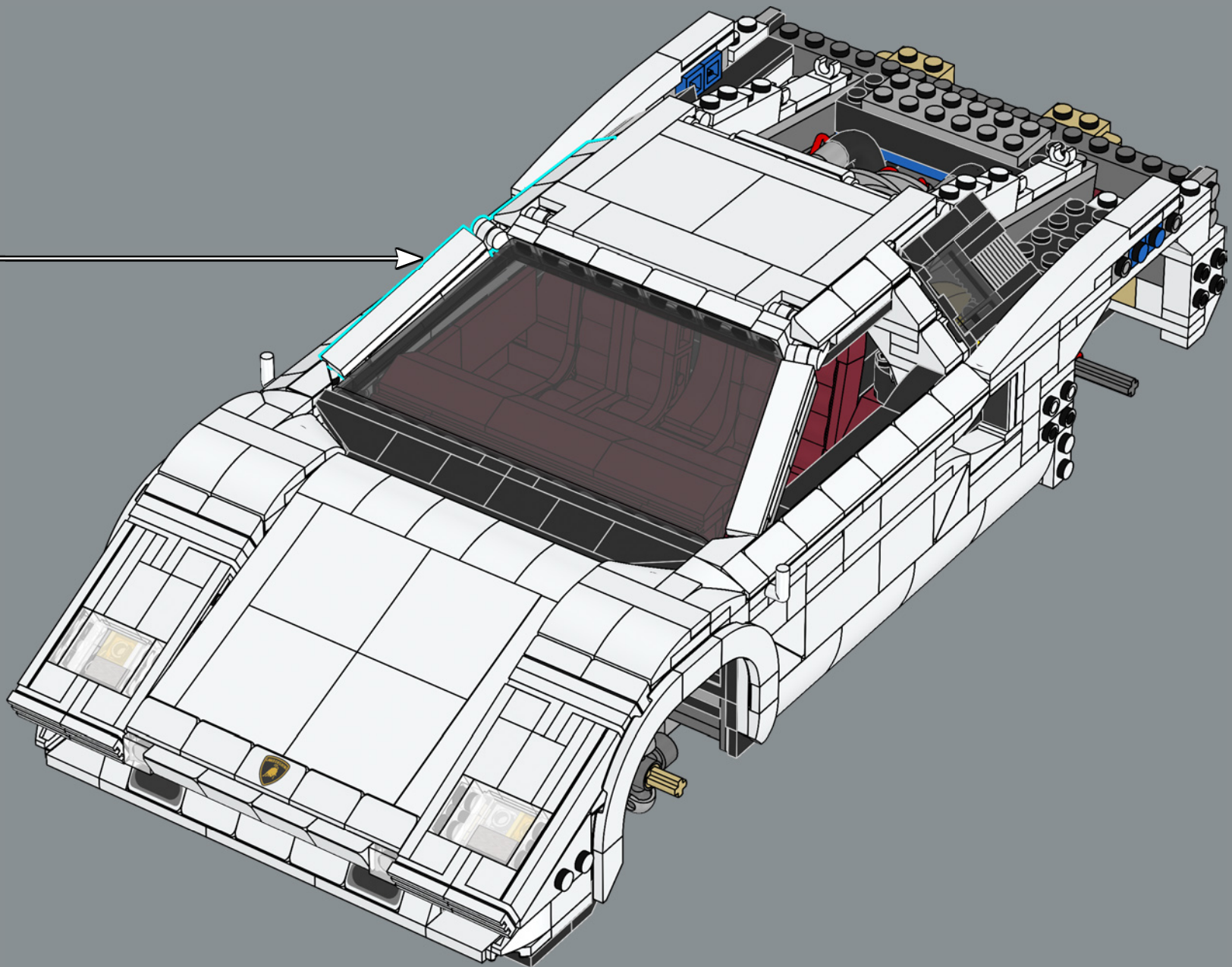

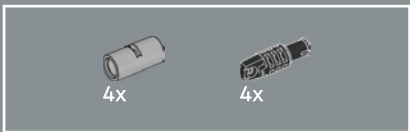

328

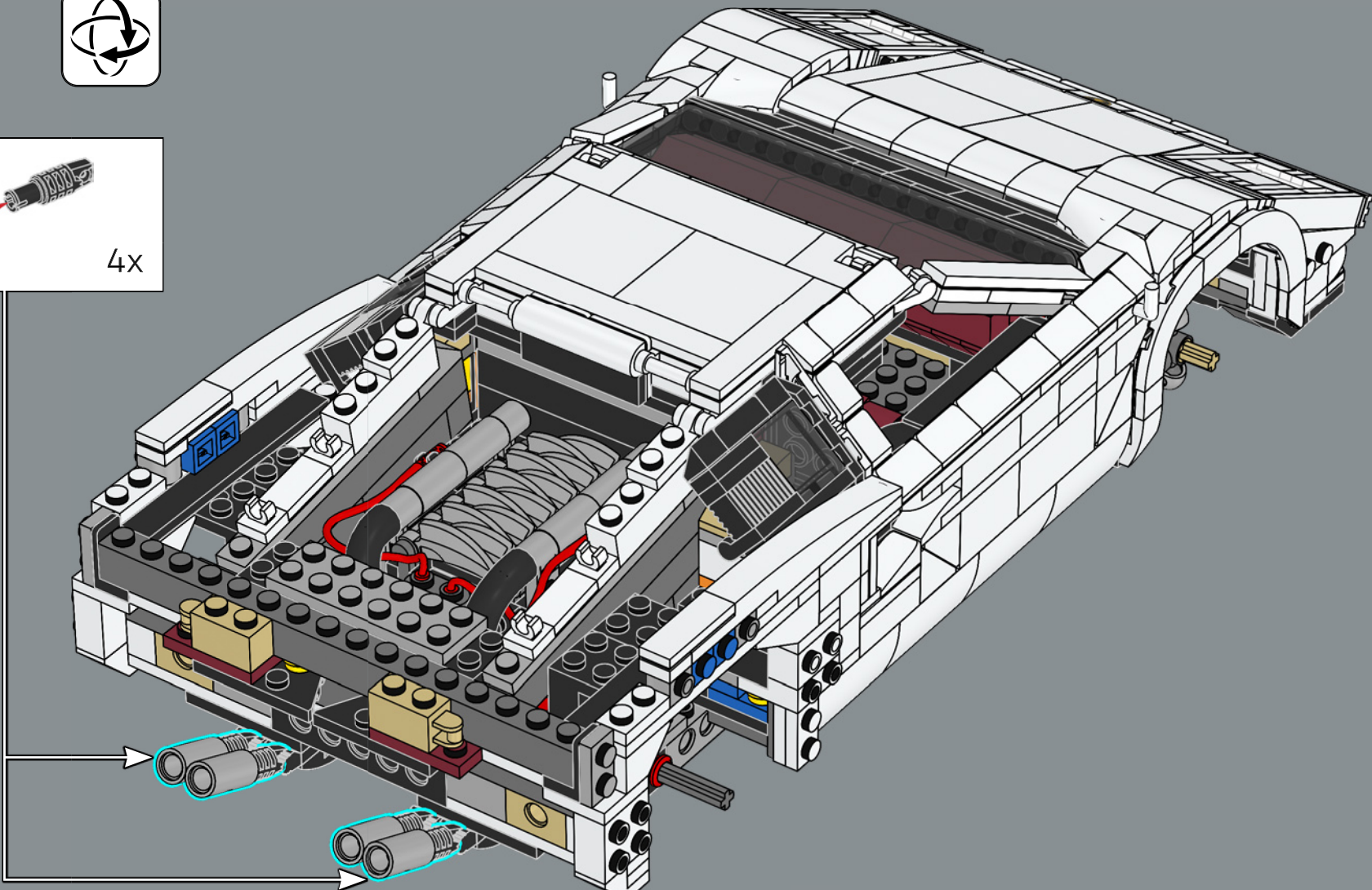
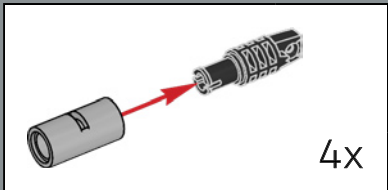

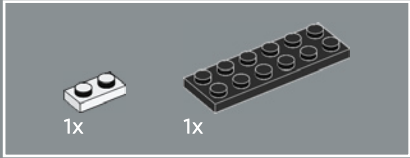
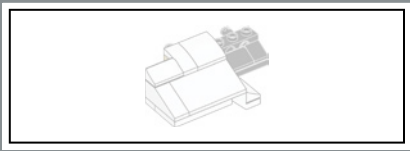

329

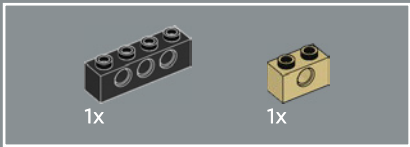
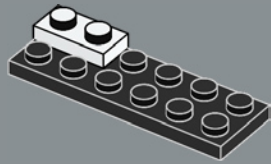

330

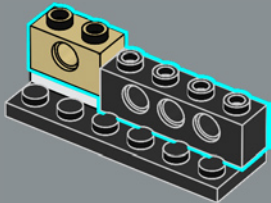

331

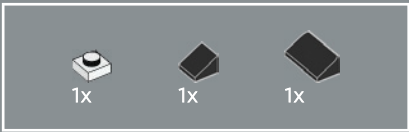
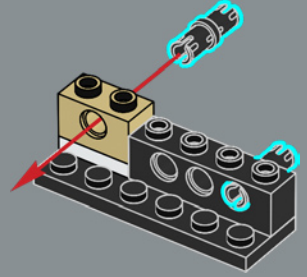

332

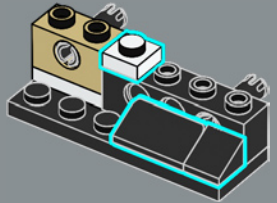

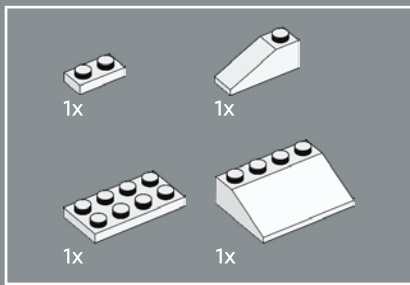

333

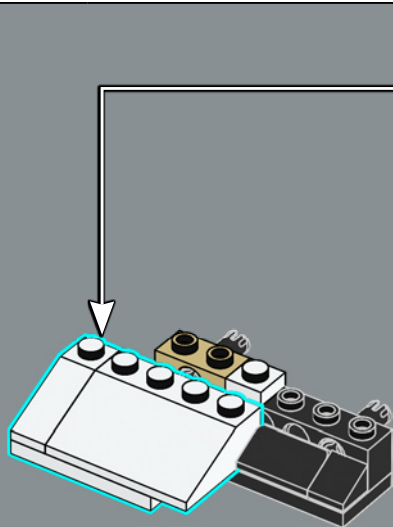
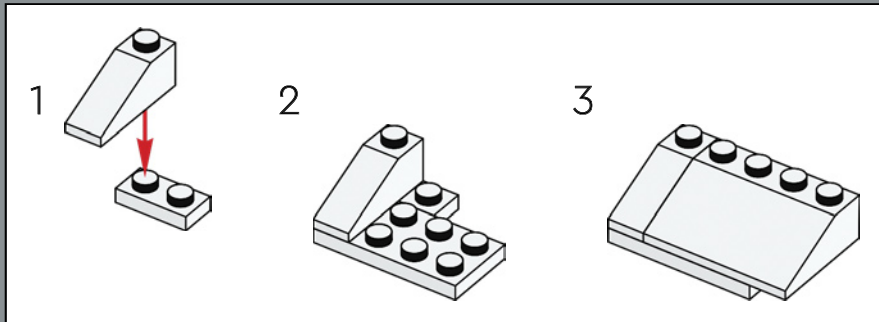

334

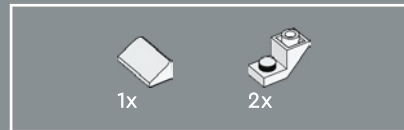
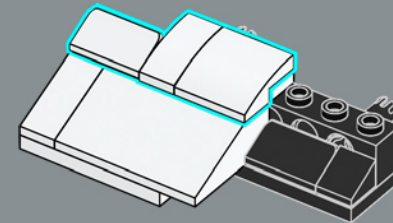

335

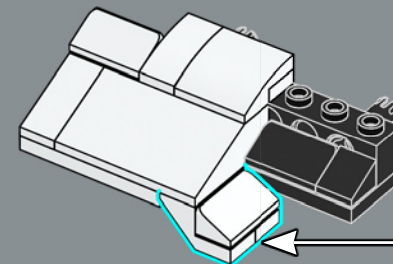
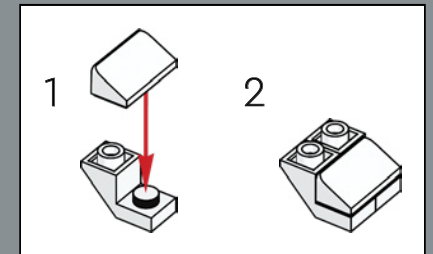

336

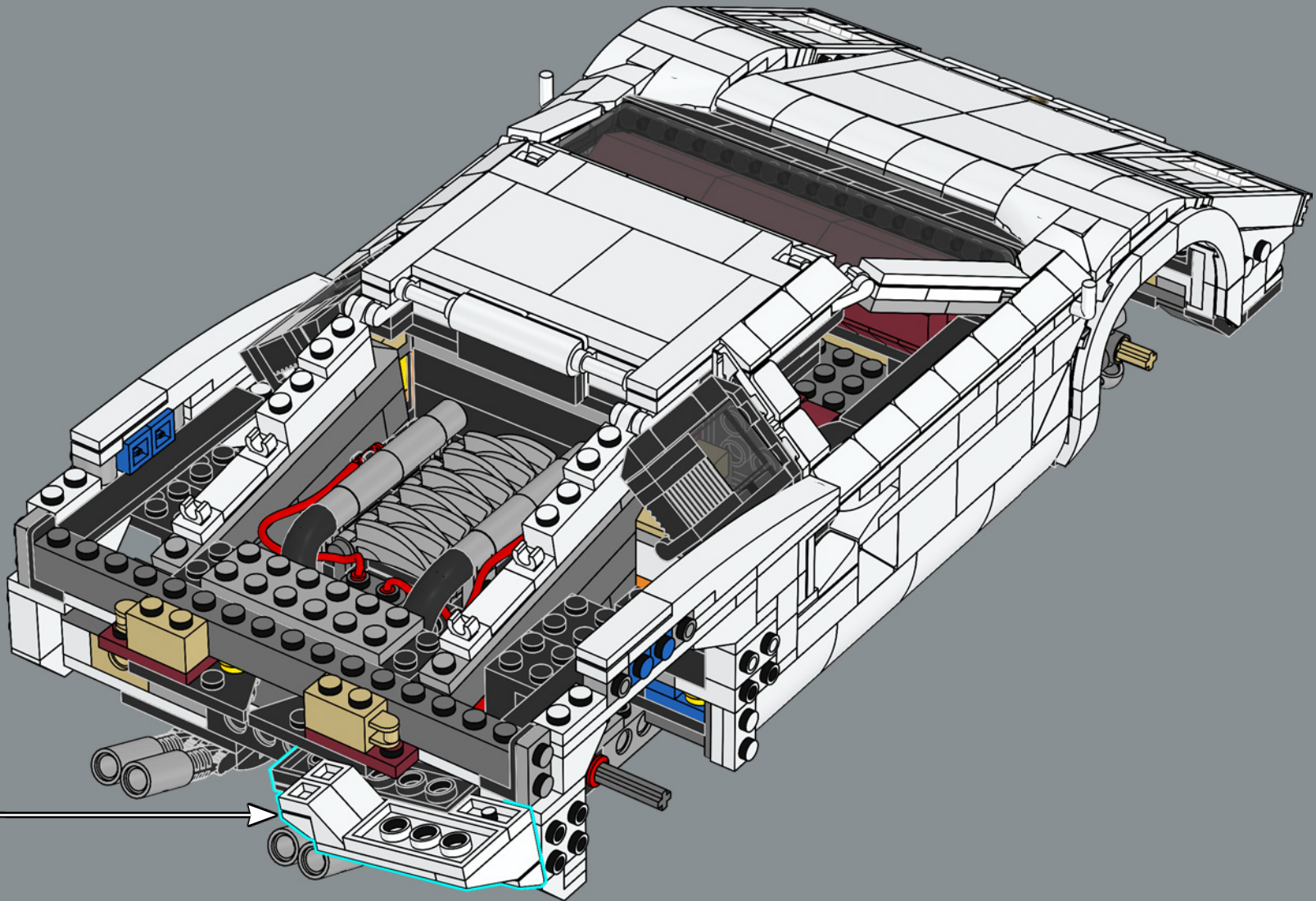

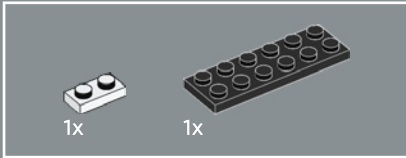
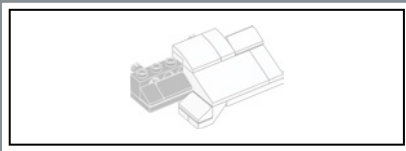

337

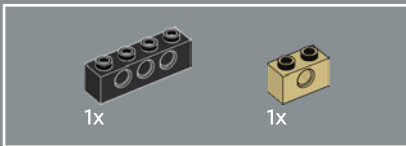
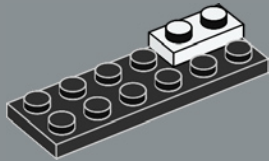

338

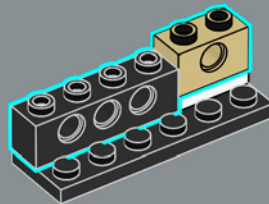

339

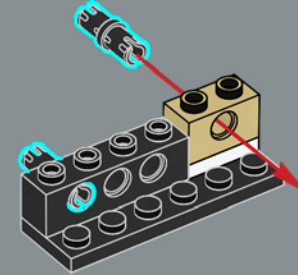

340

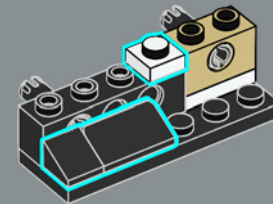

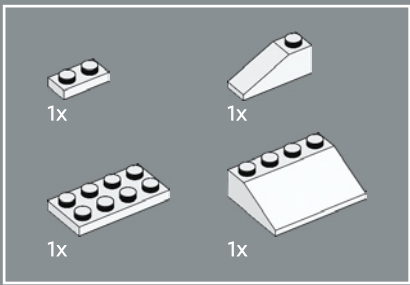

341

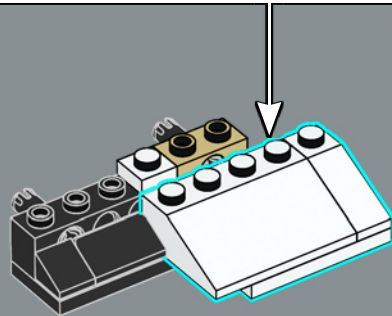
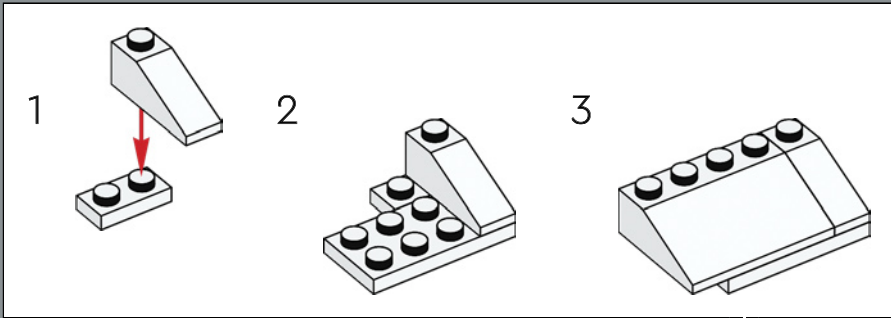

342

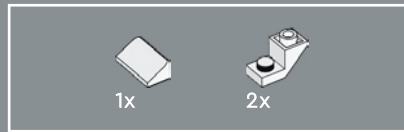
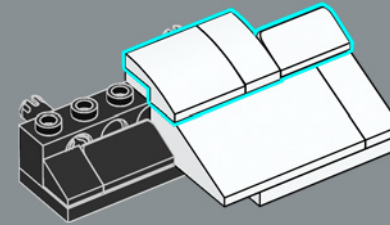

343

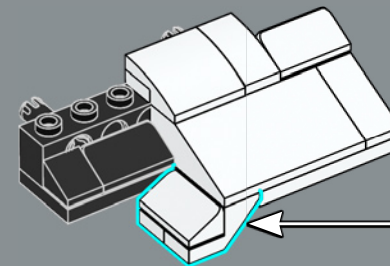
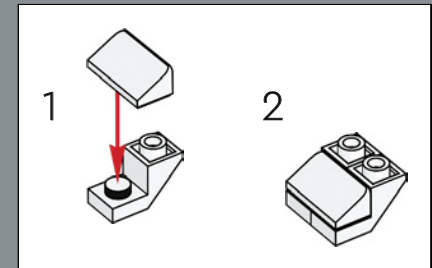

344

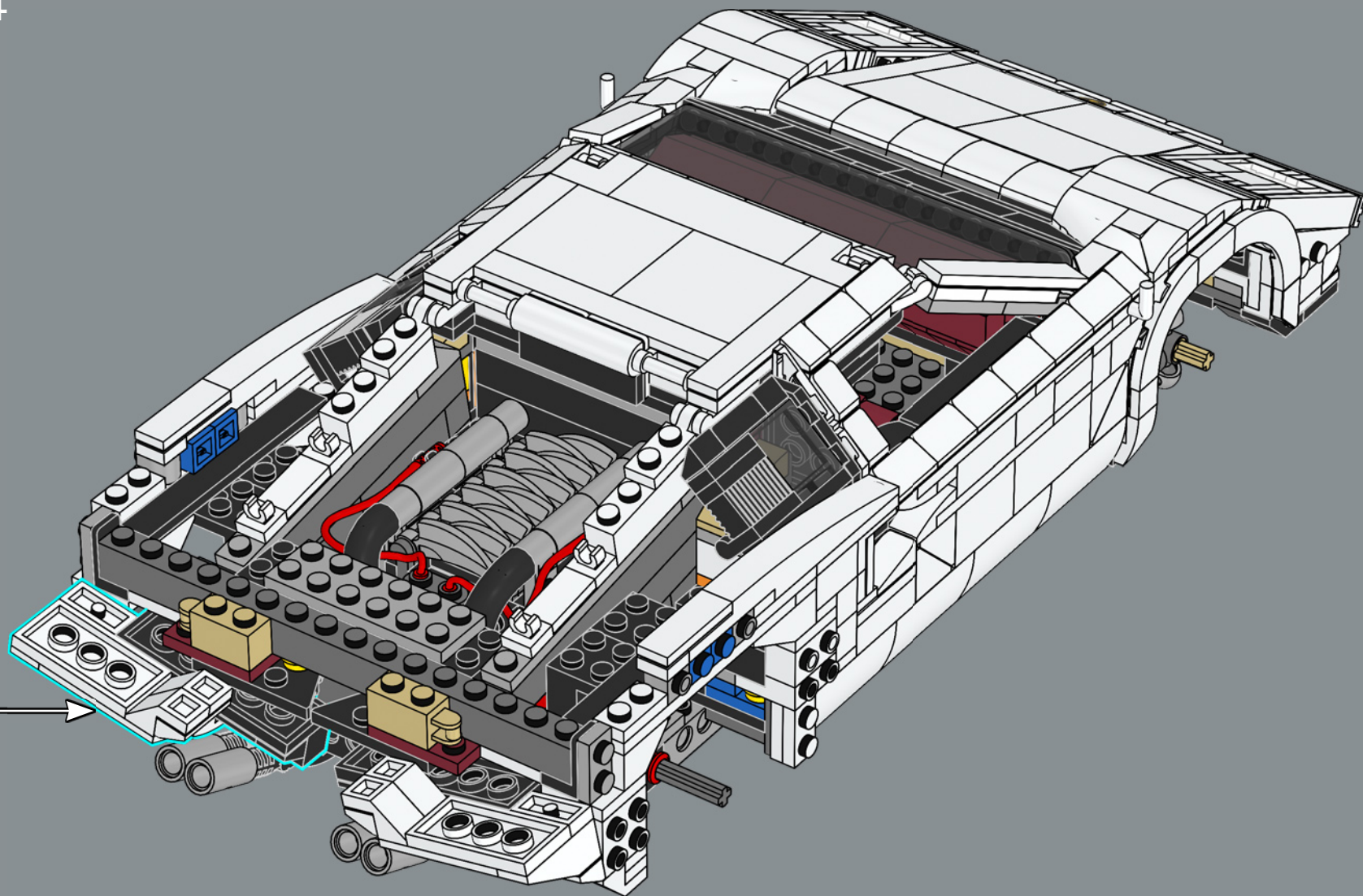

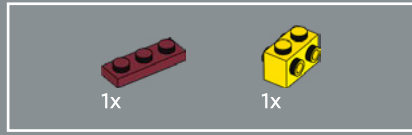
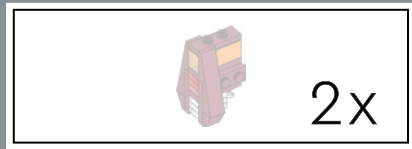

345

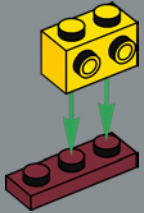

346

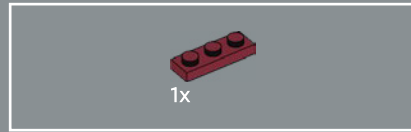
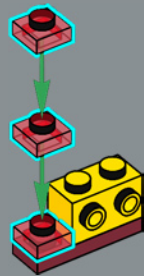

347

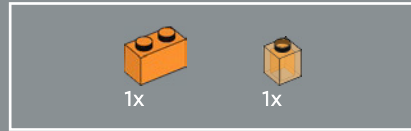
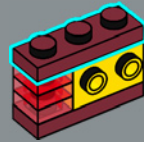

348

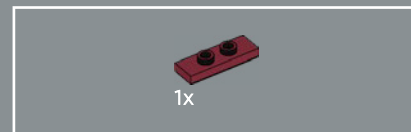

349

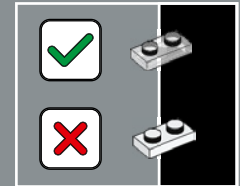
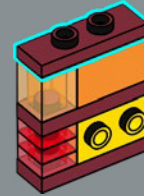

350

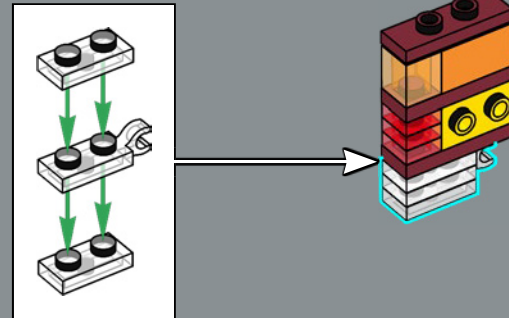

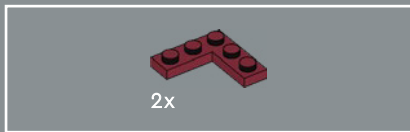

351

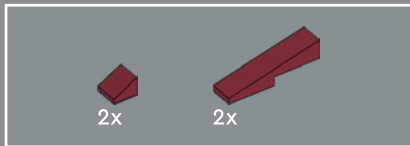
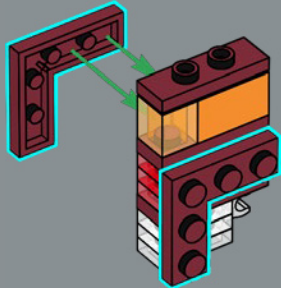

352

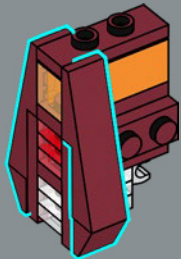

2x

353

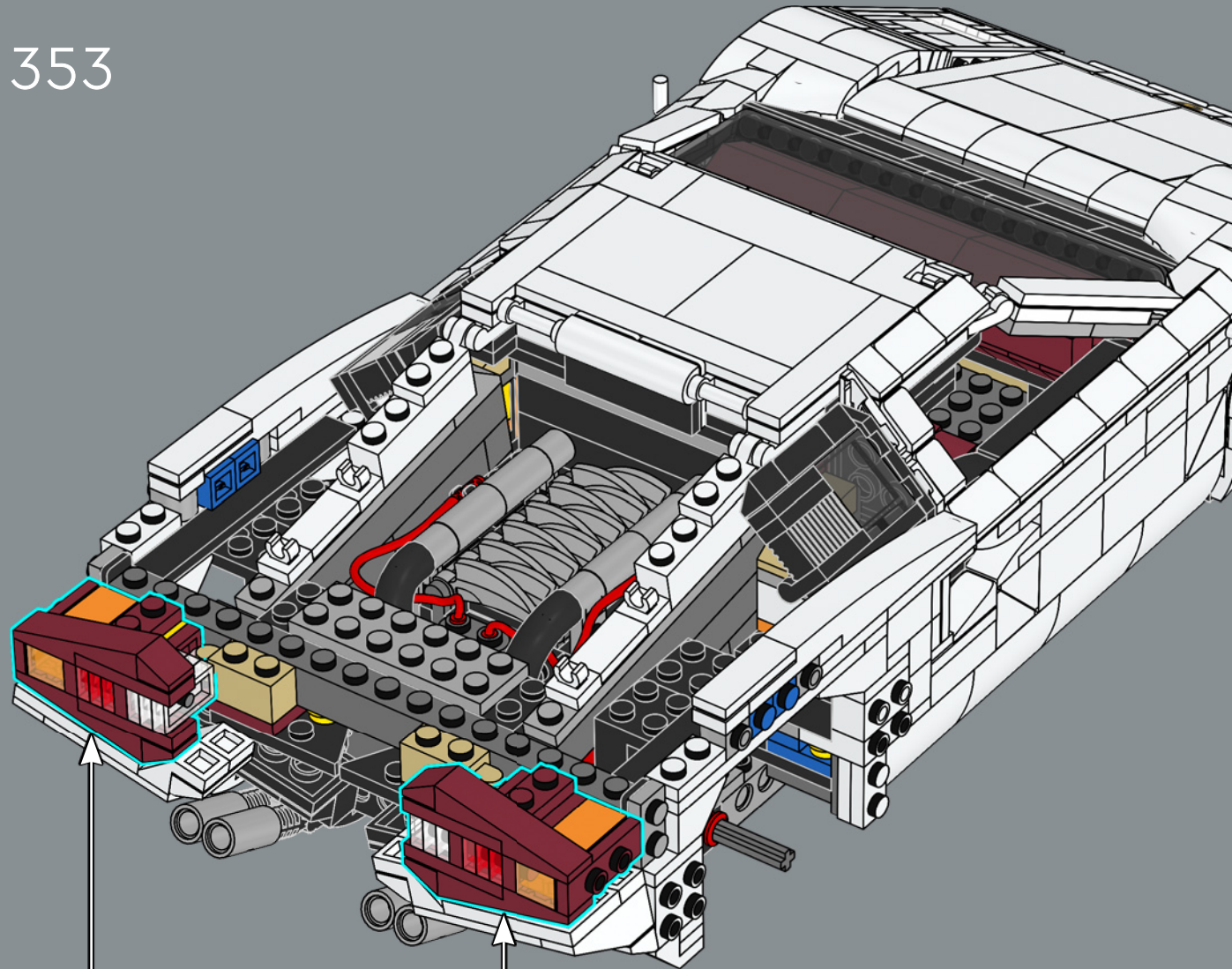

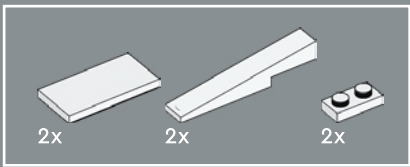

354

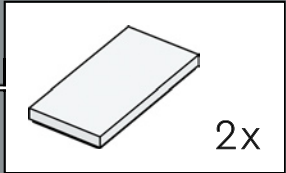
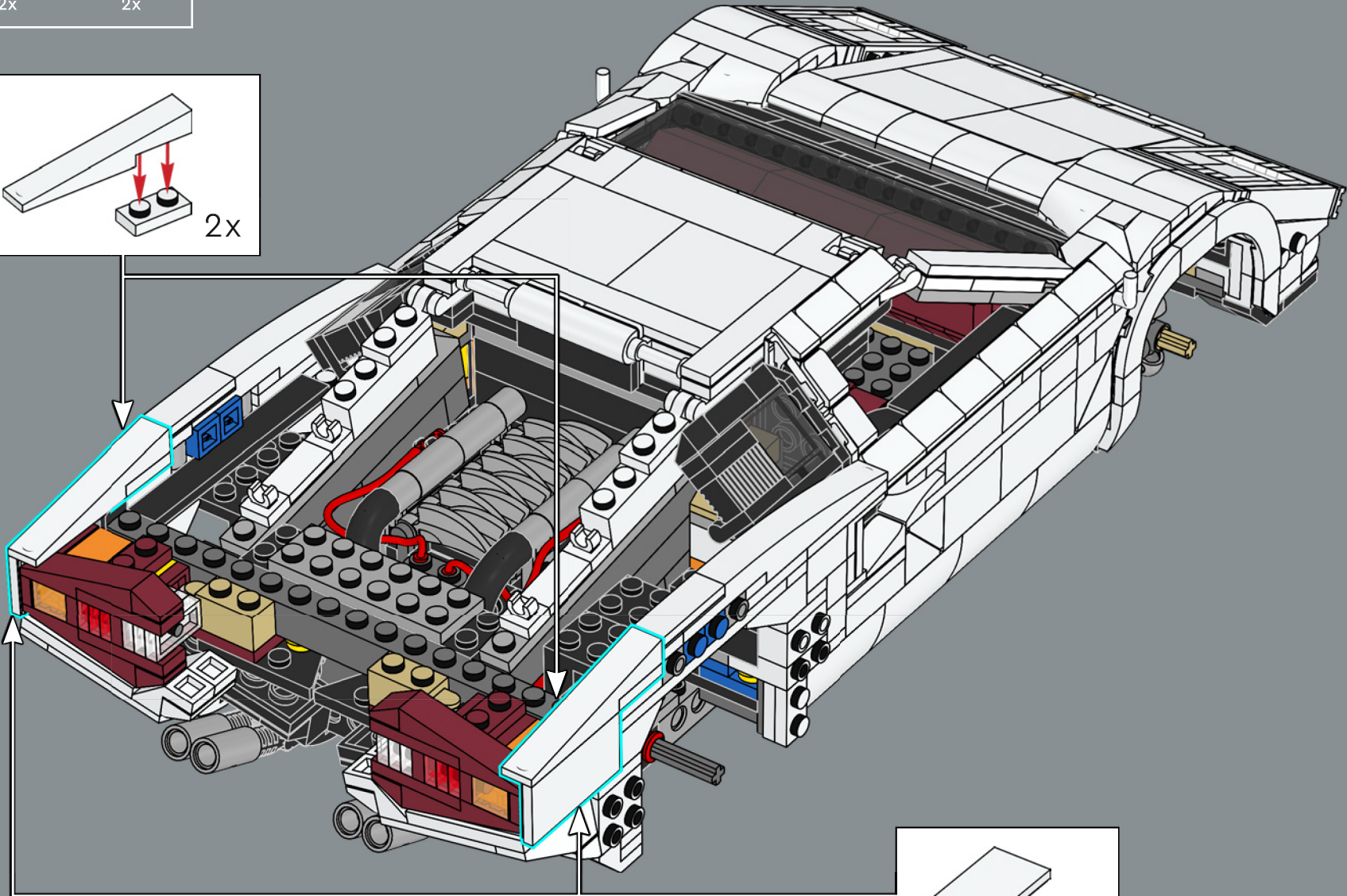
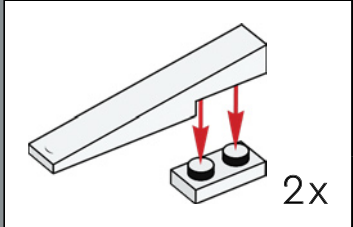

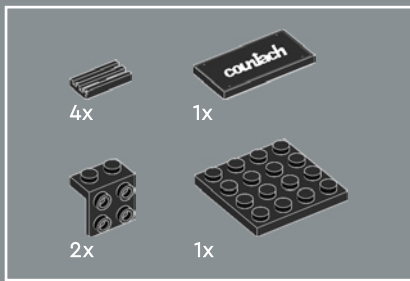

355

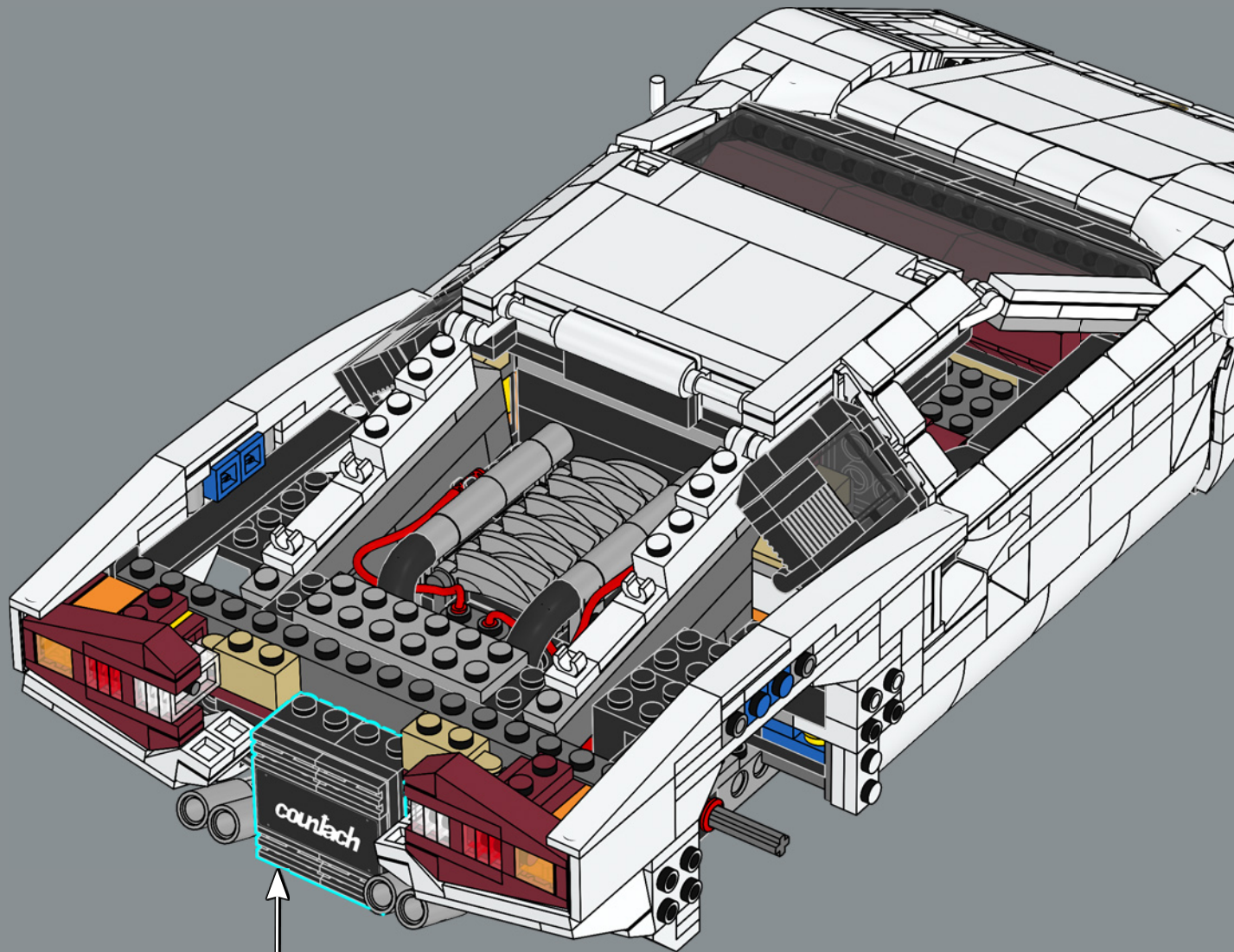
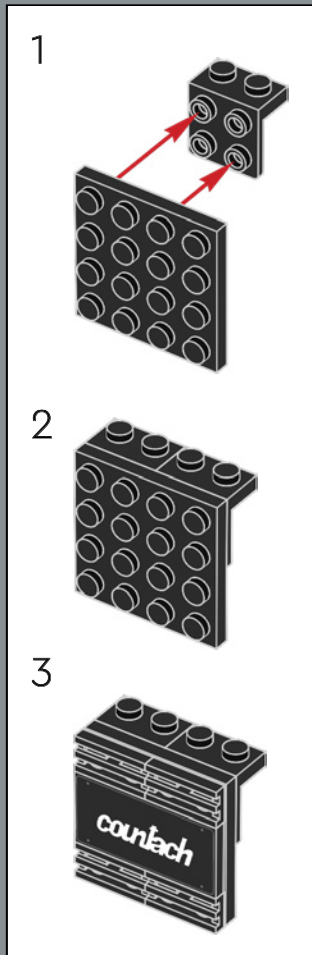

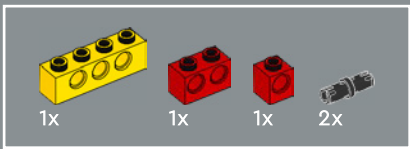

356

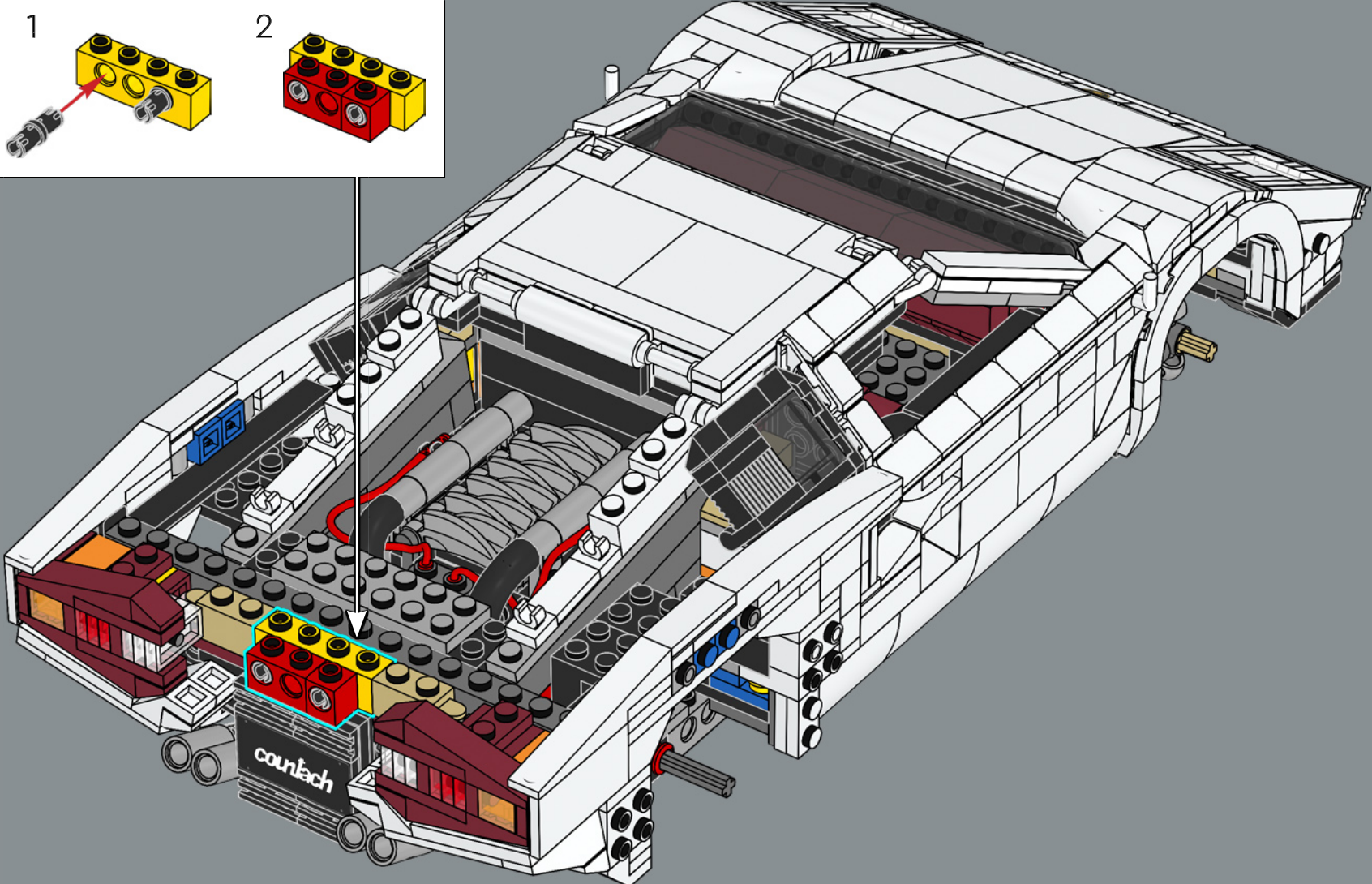
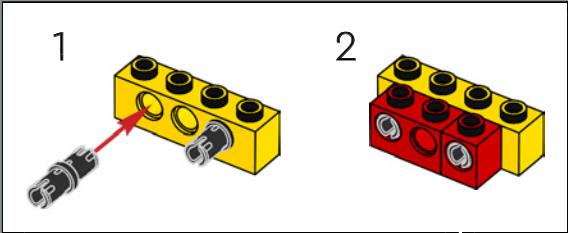

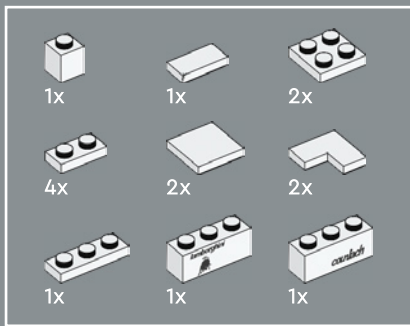

4

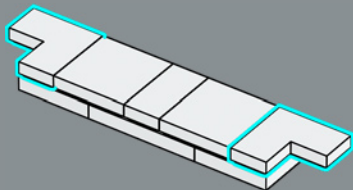

357

1

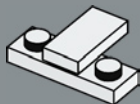

2

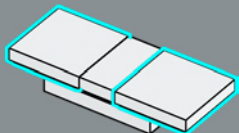

3

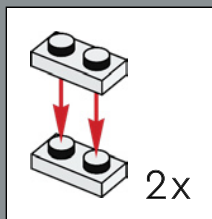
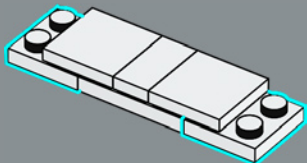

5

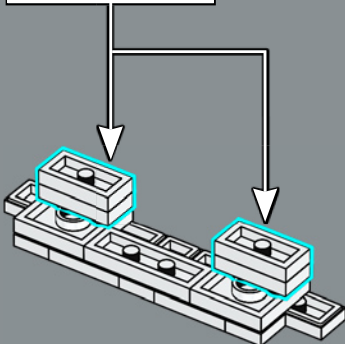

6

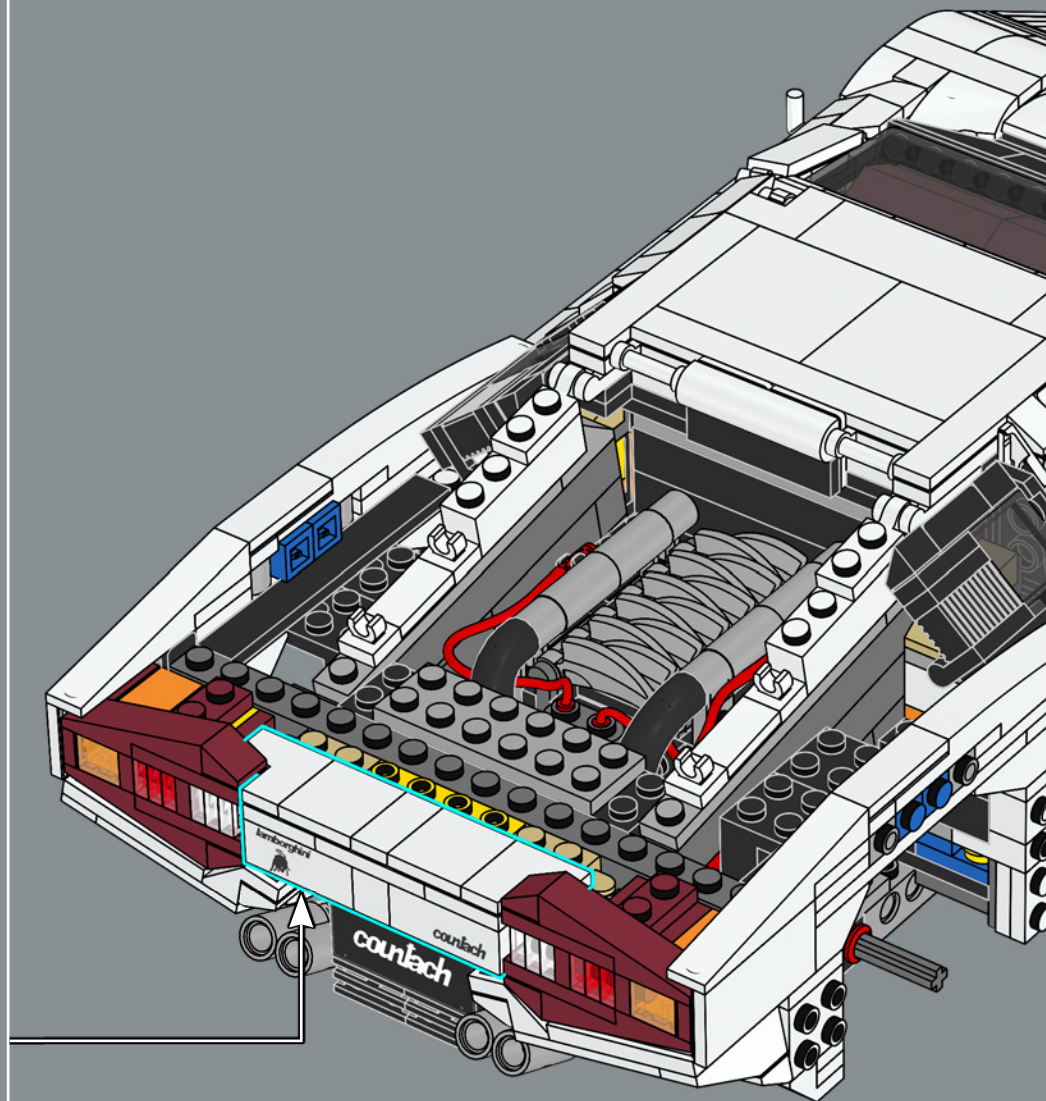
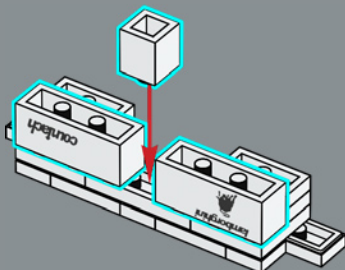

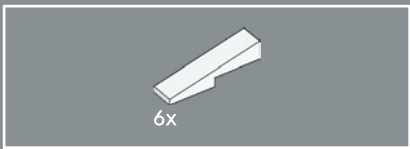

358



Un nuovo elemento slope LEGO® aiuta a ricreare angoli brevi e poco profondi nel design iconico.

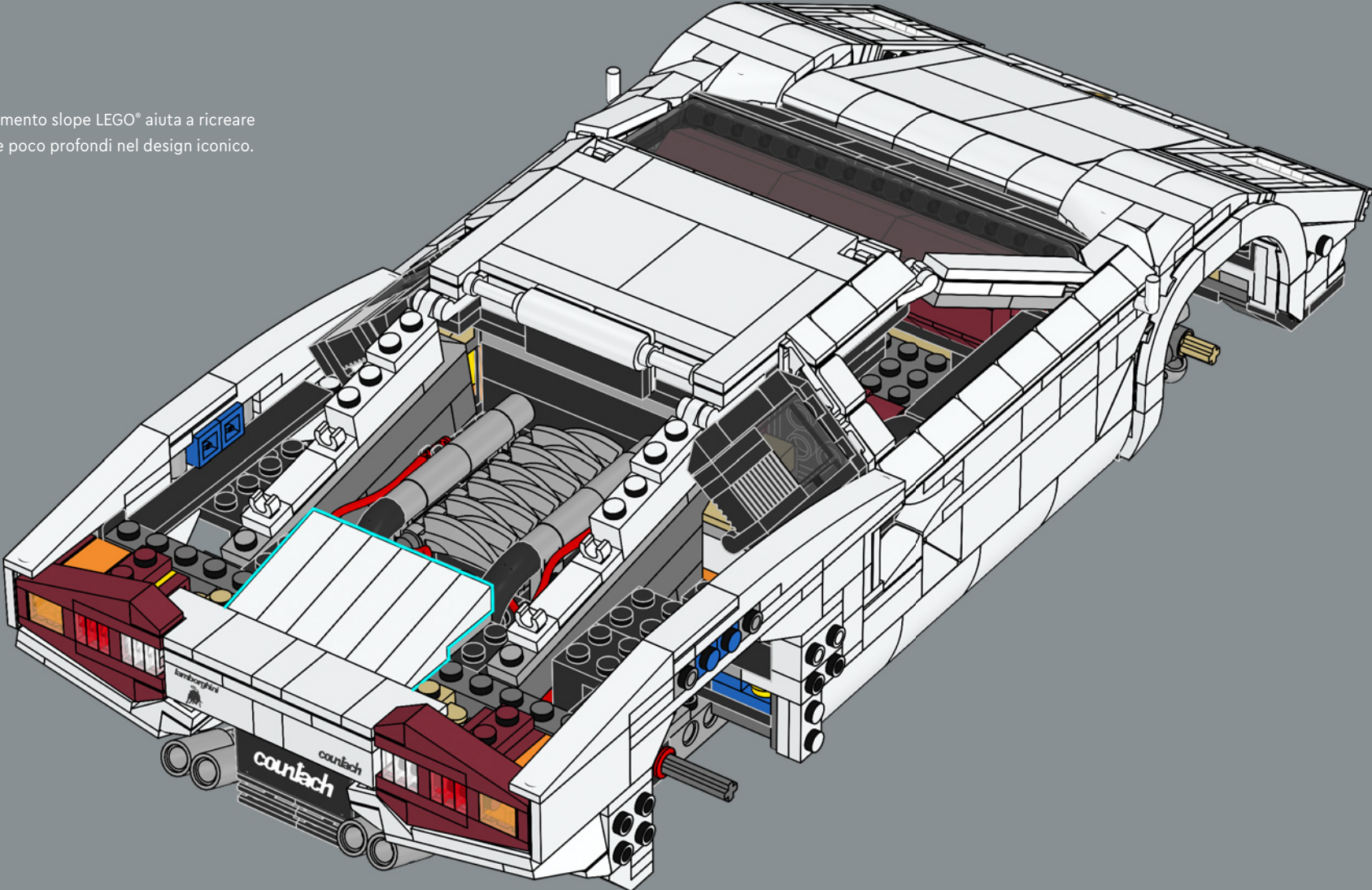

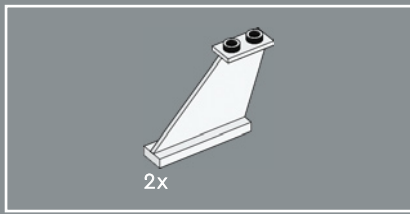

359

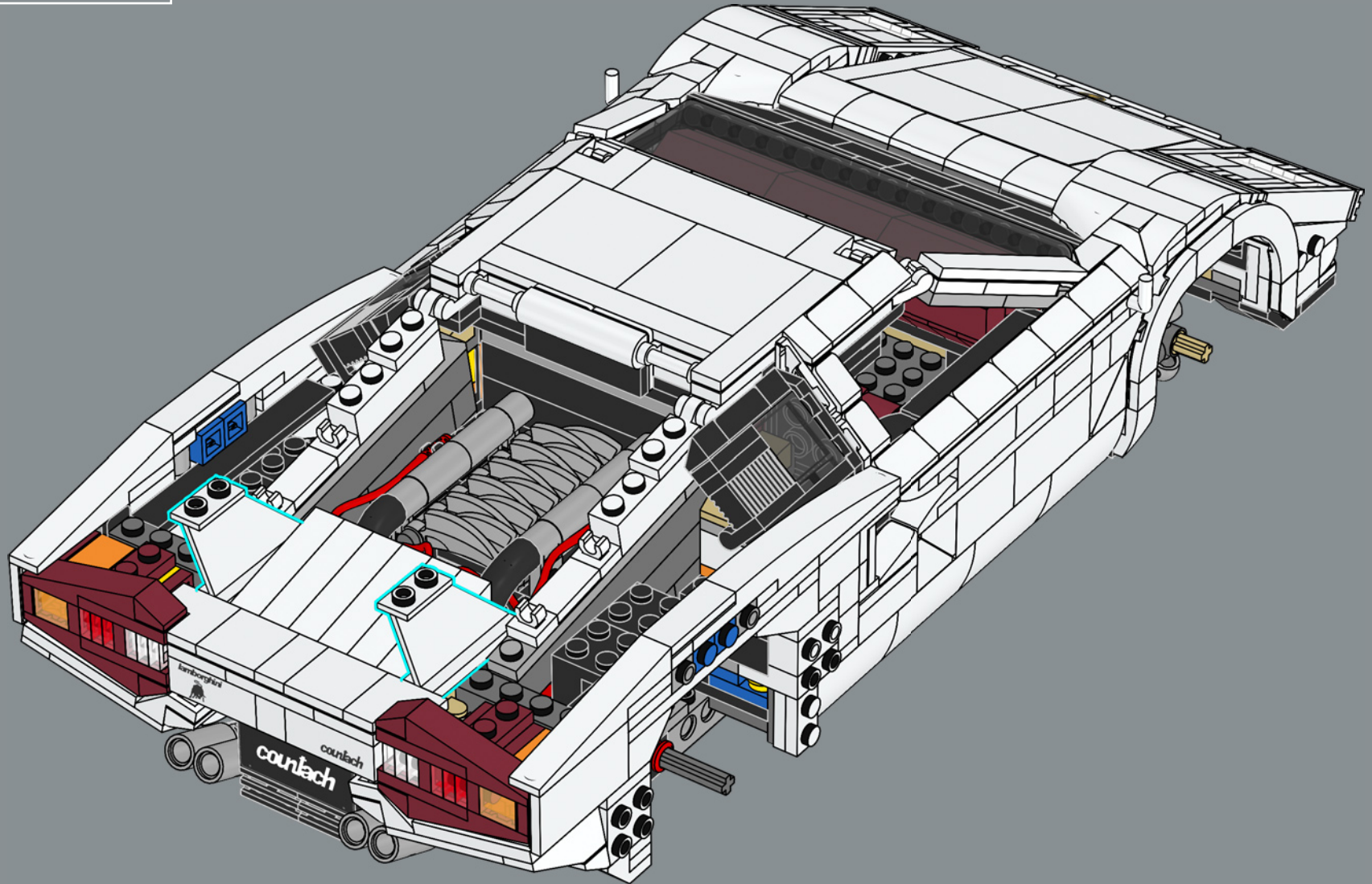

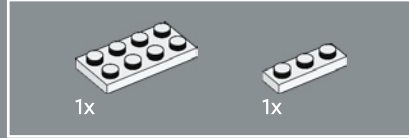
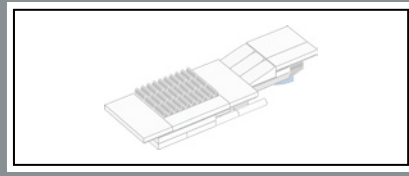
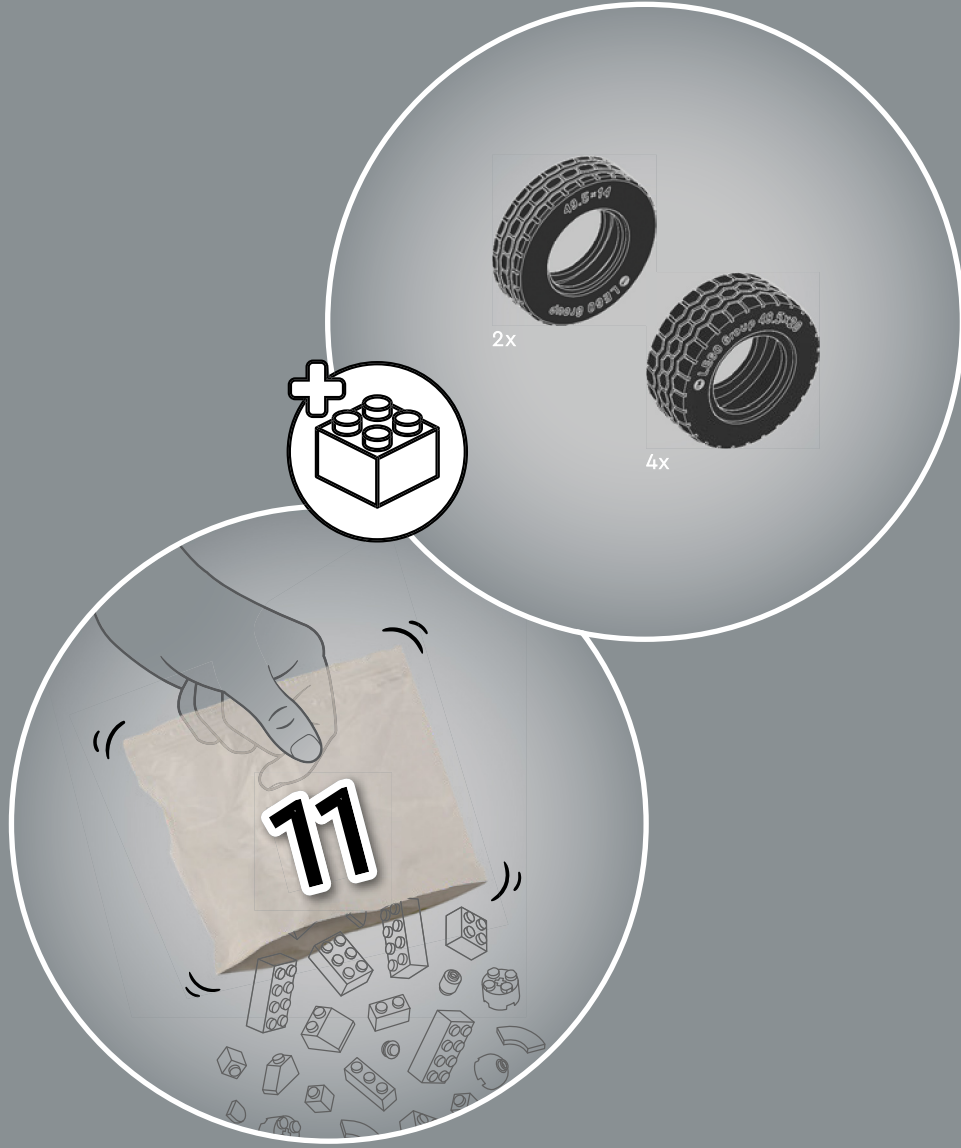

360

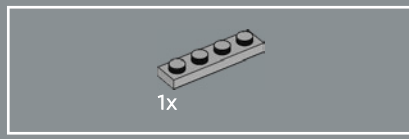
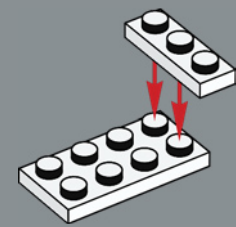

361

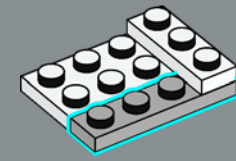



362

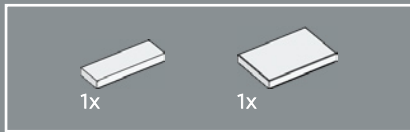
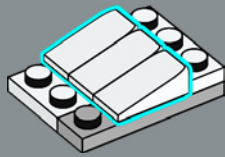

363

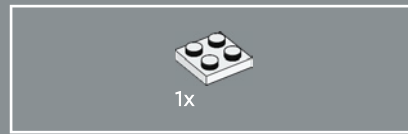
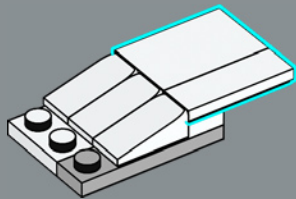
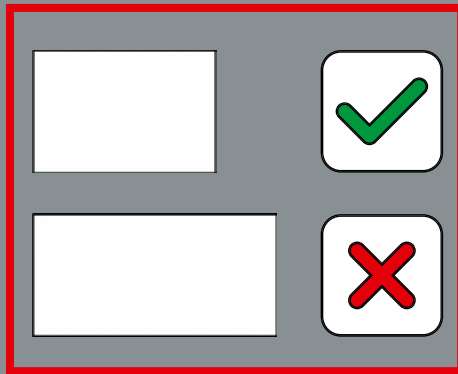

364

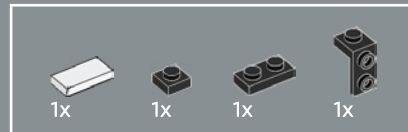
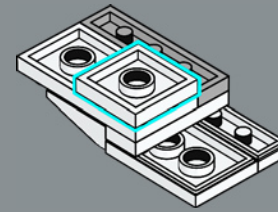

365

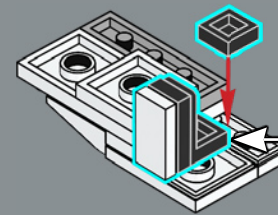
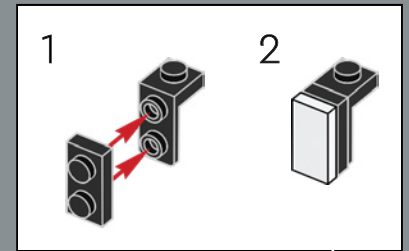



366

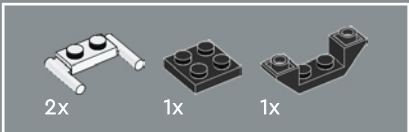
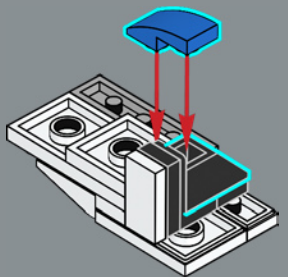

367

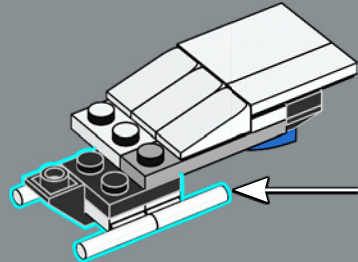
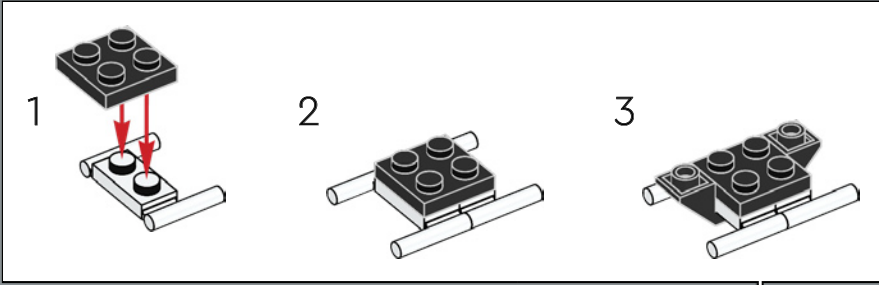

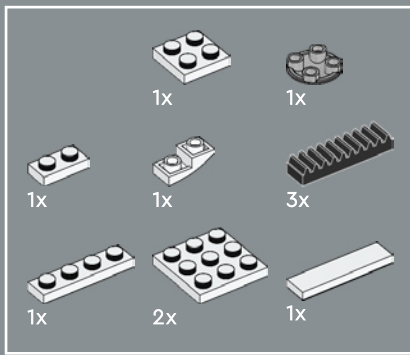

368

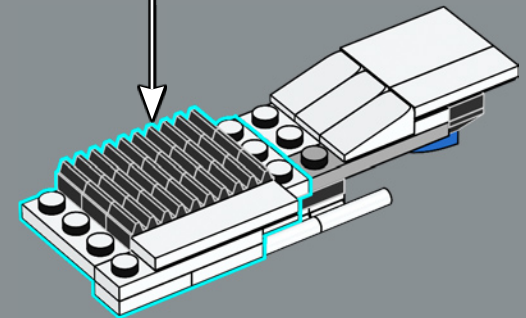
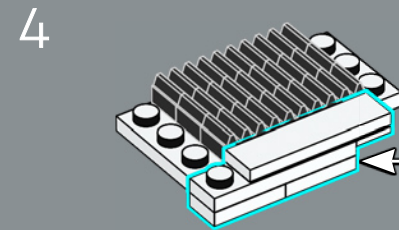
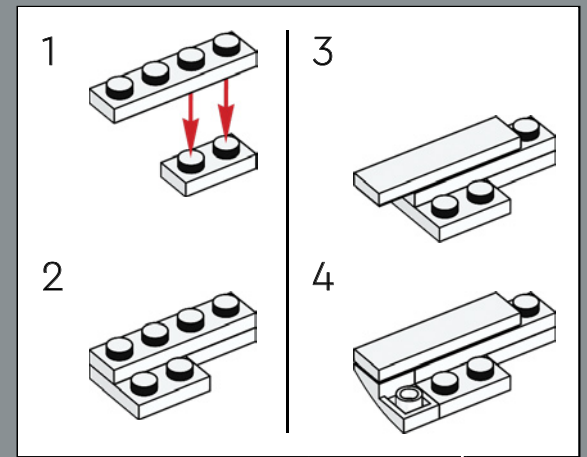
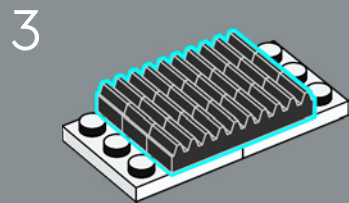
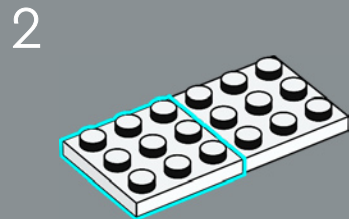
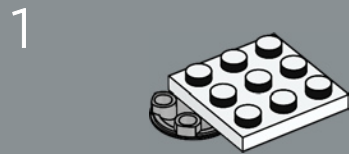

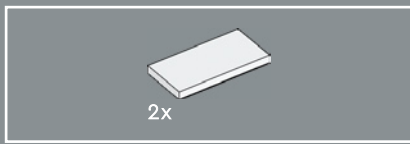

369

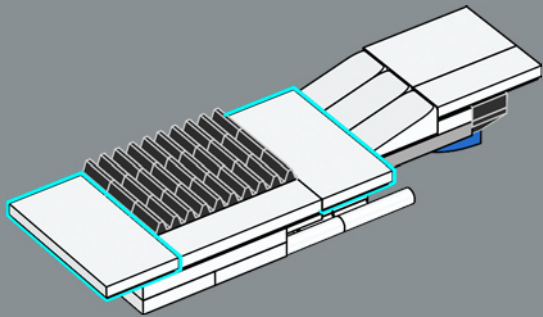
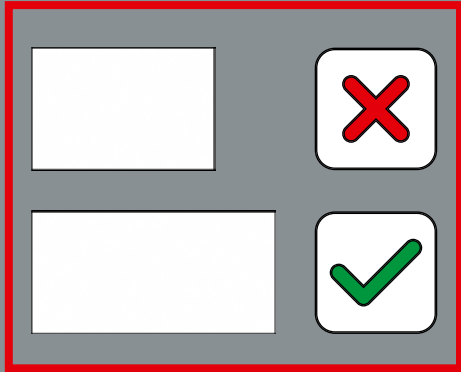

370

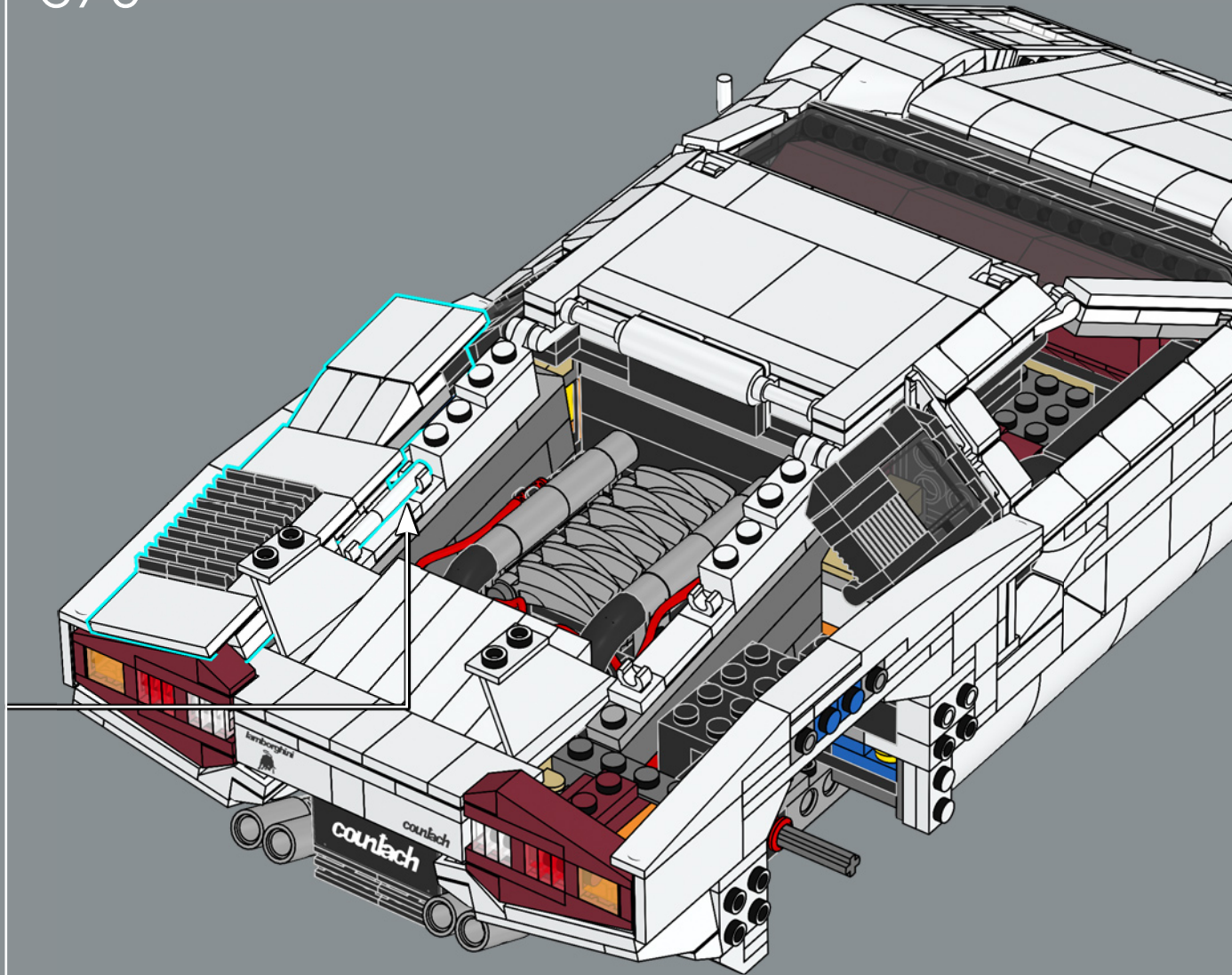

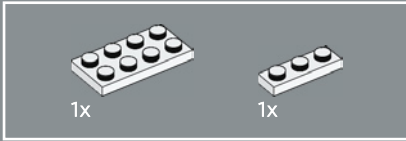
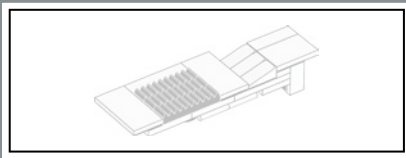

371

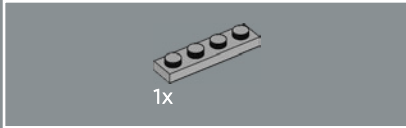
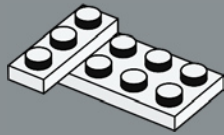

372

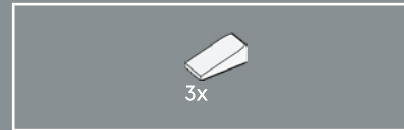
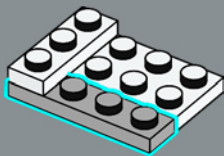

373

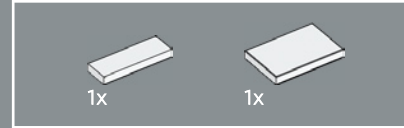
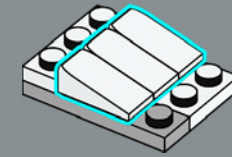

374

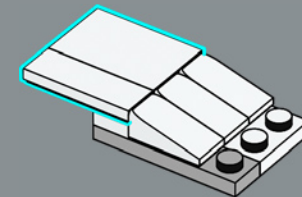
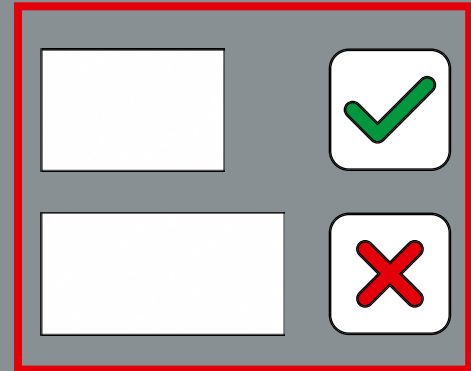

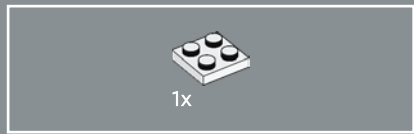

375

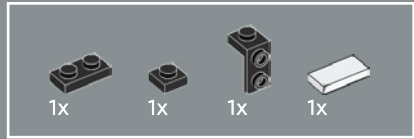
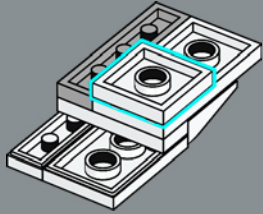

376

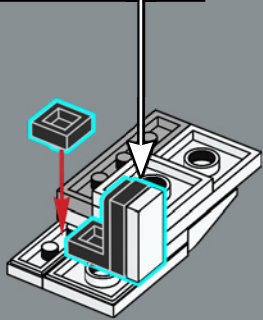
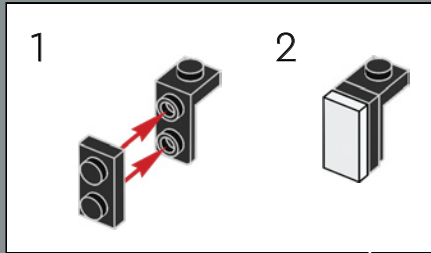

377

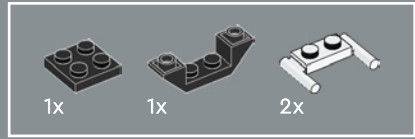
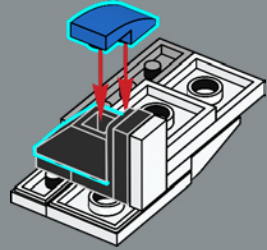

378

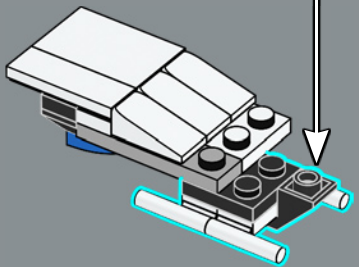
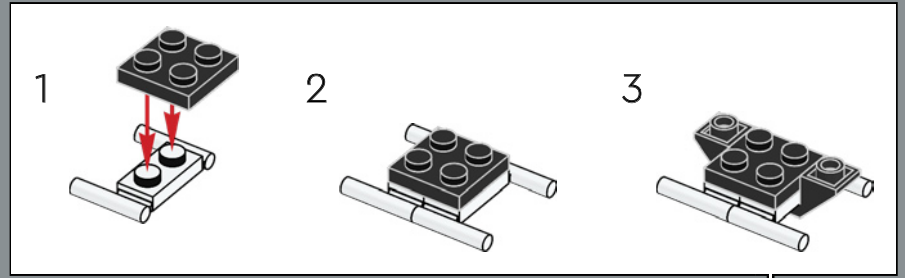

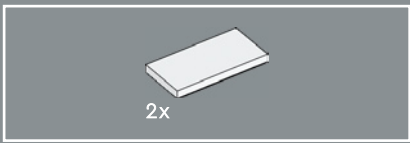

380

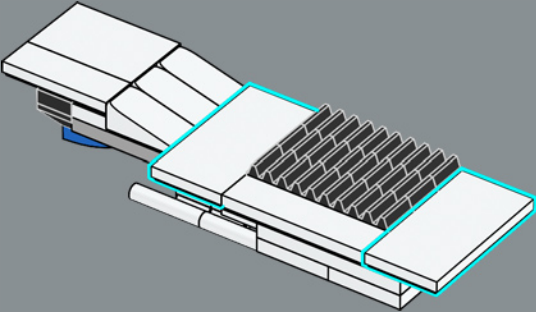
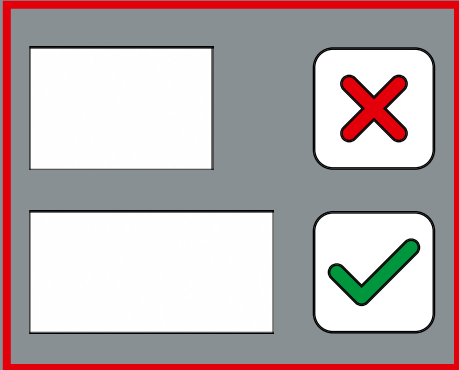

381

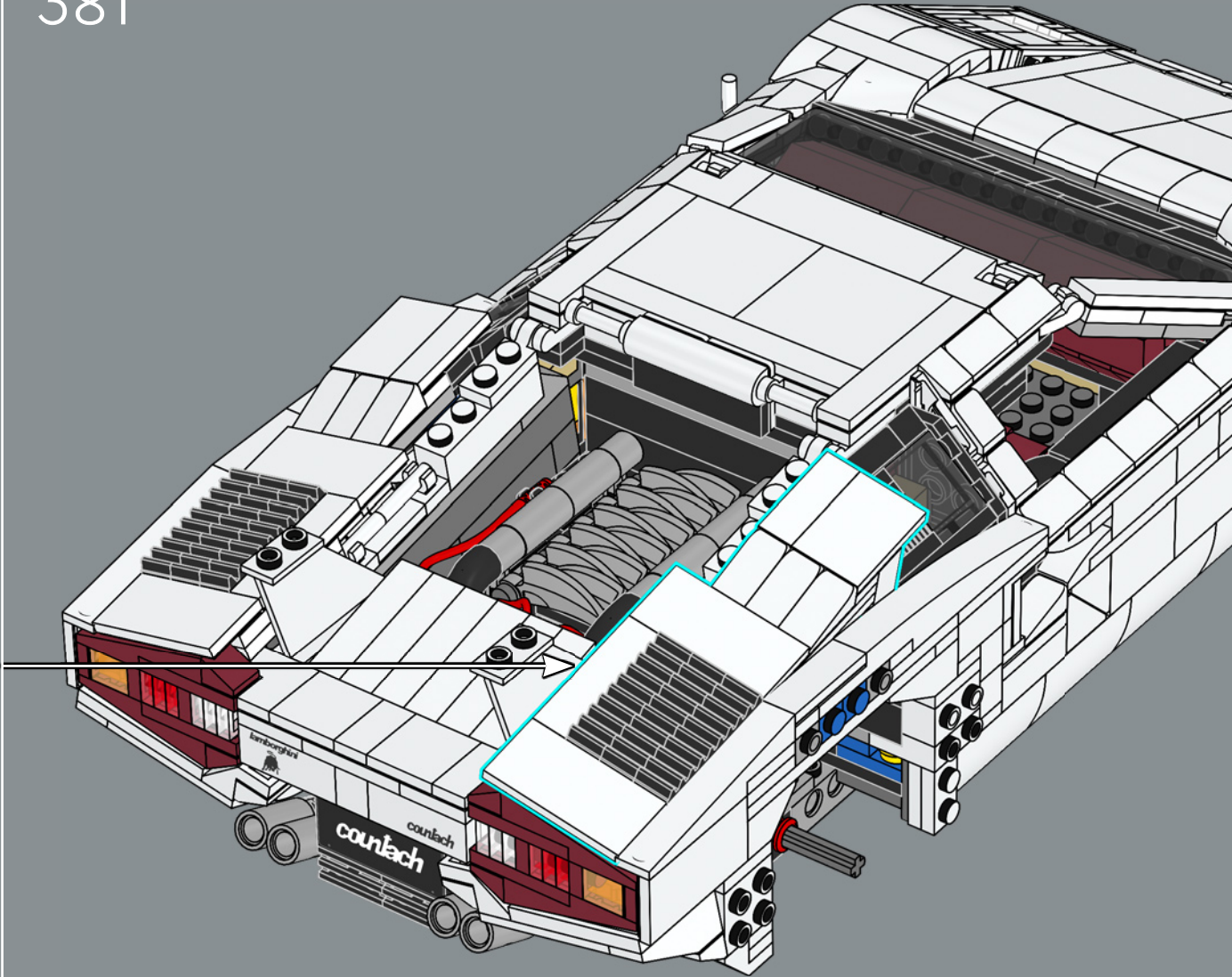

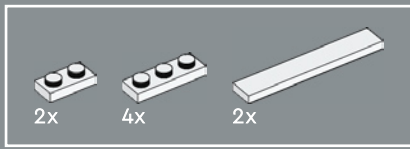

382

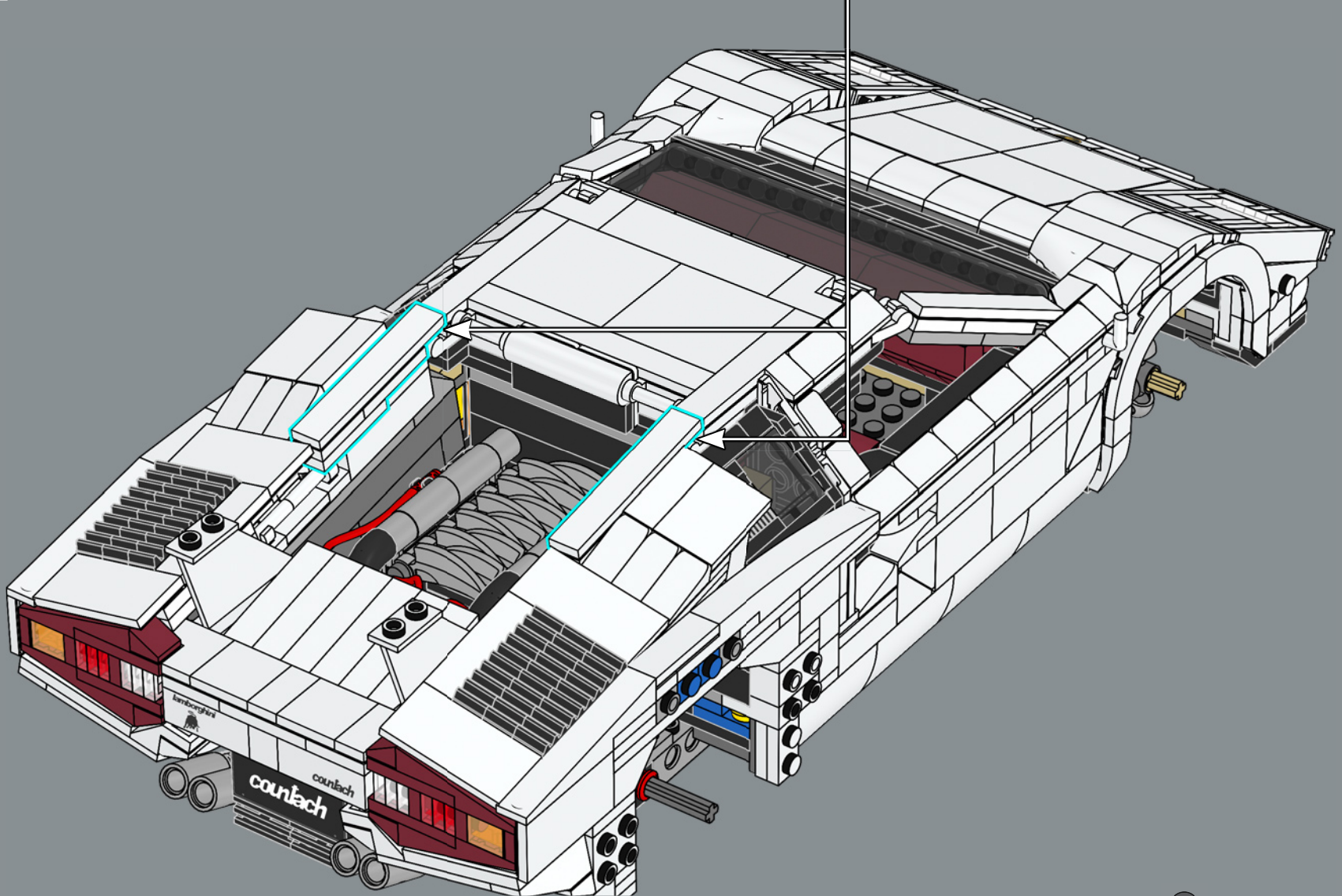
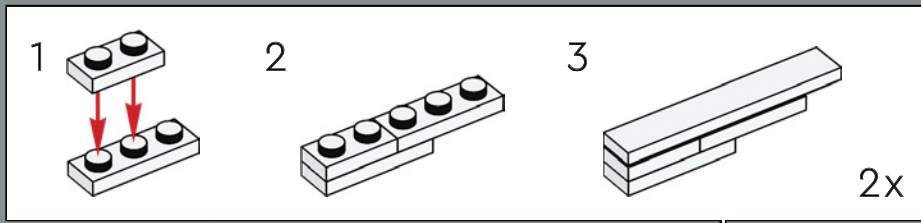

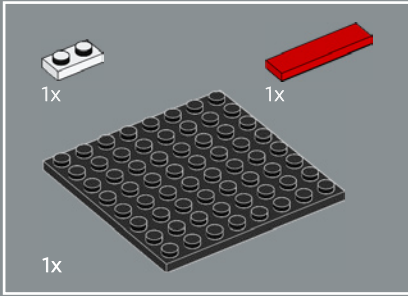
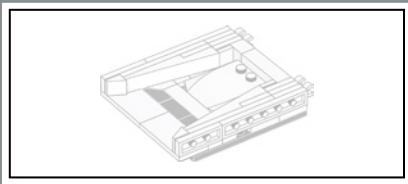

383

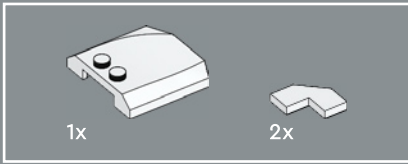
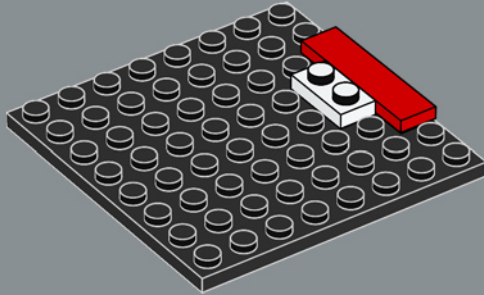

384

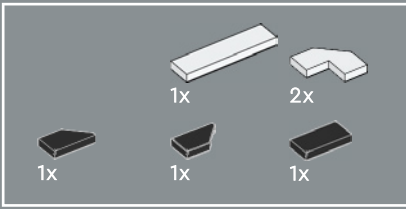
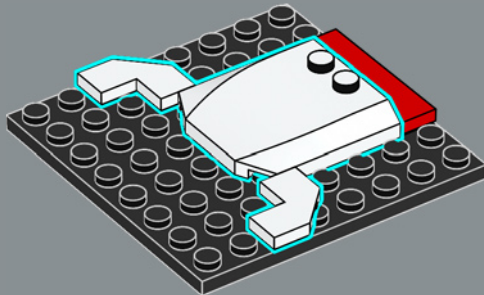

385

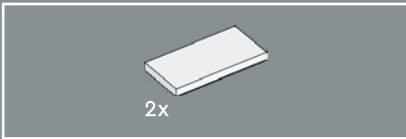
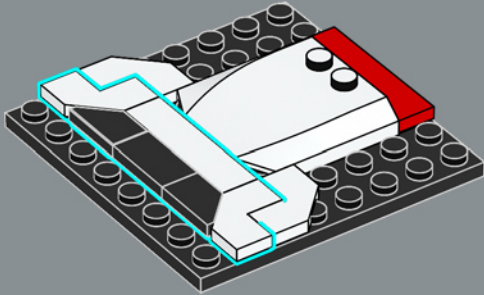

386

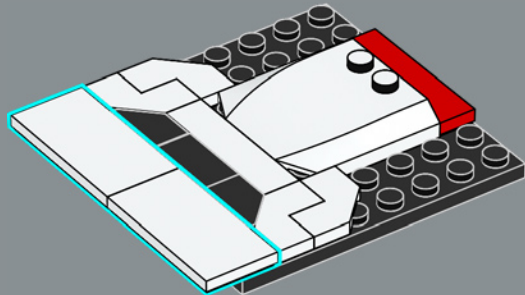

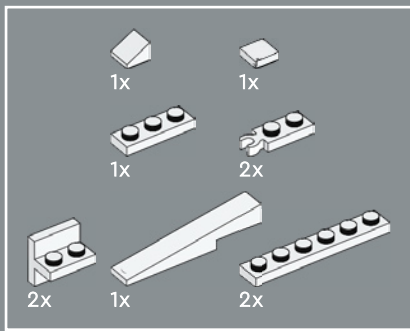

387

1

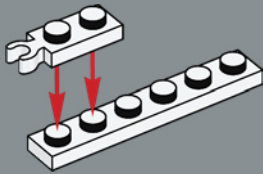

2

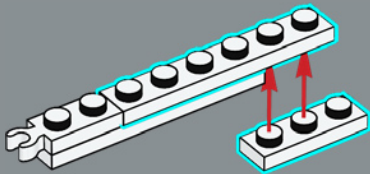

3

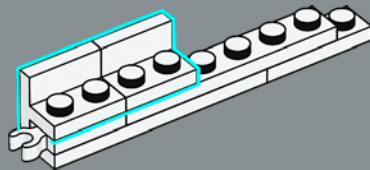

4

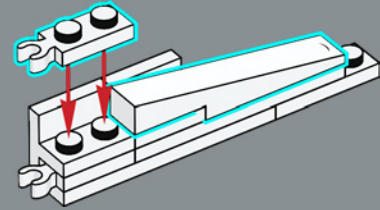

5

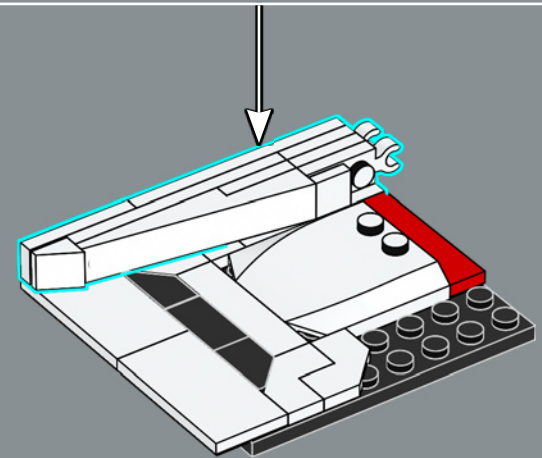
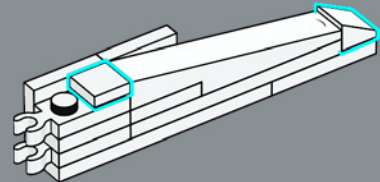

389

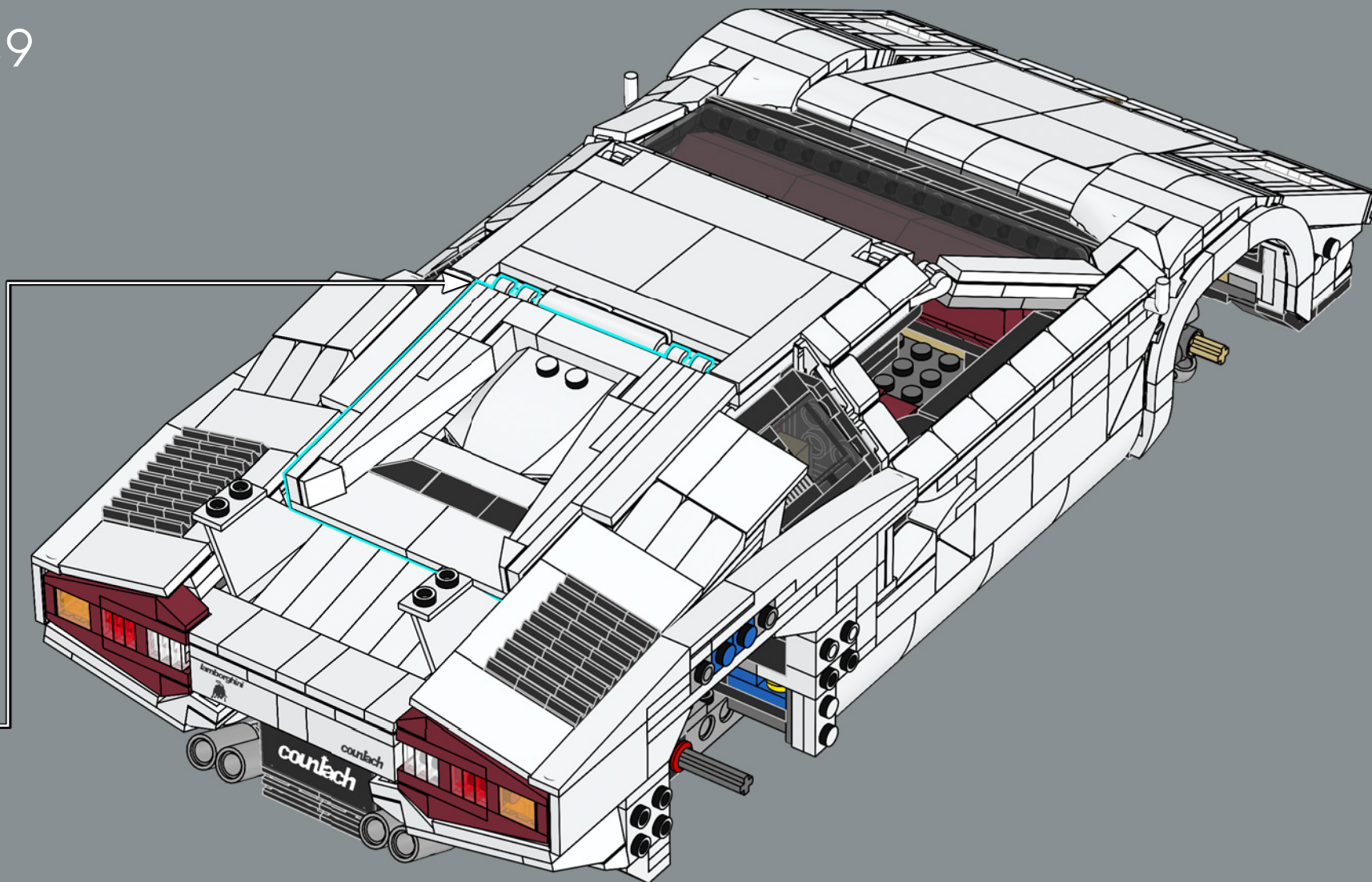

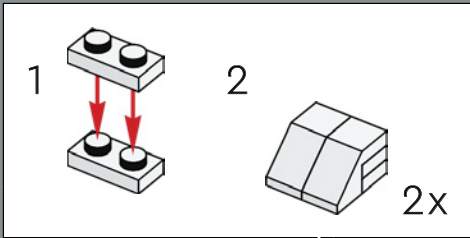
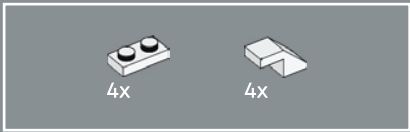

390

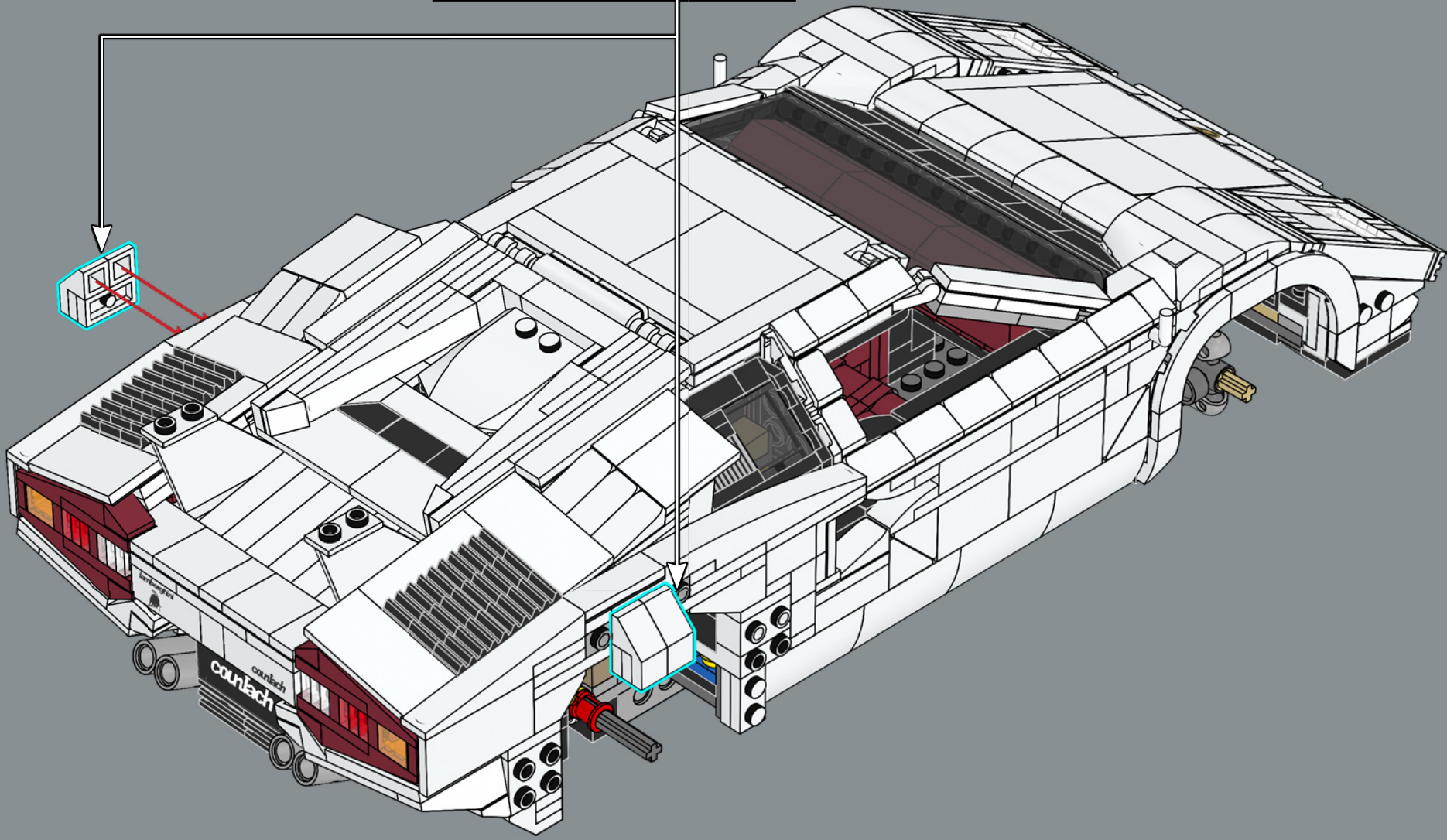



Un nuovo elemento LEGO® a forma di cono aiuta a ricreare la caratteristica ala.

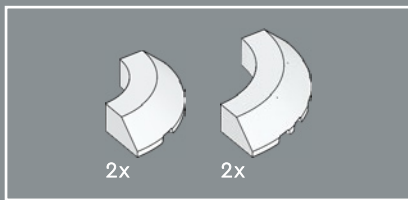

391

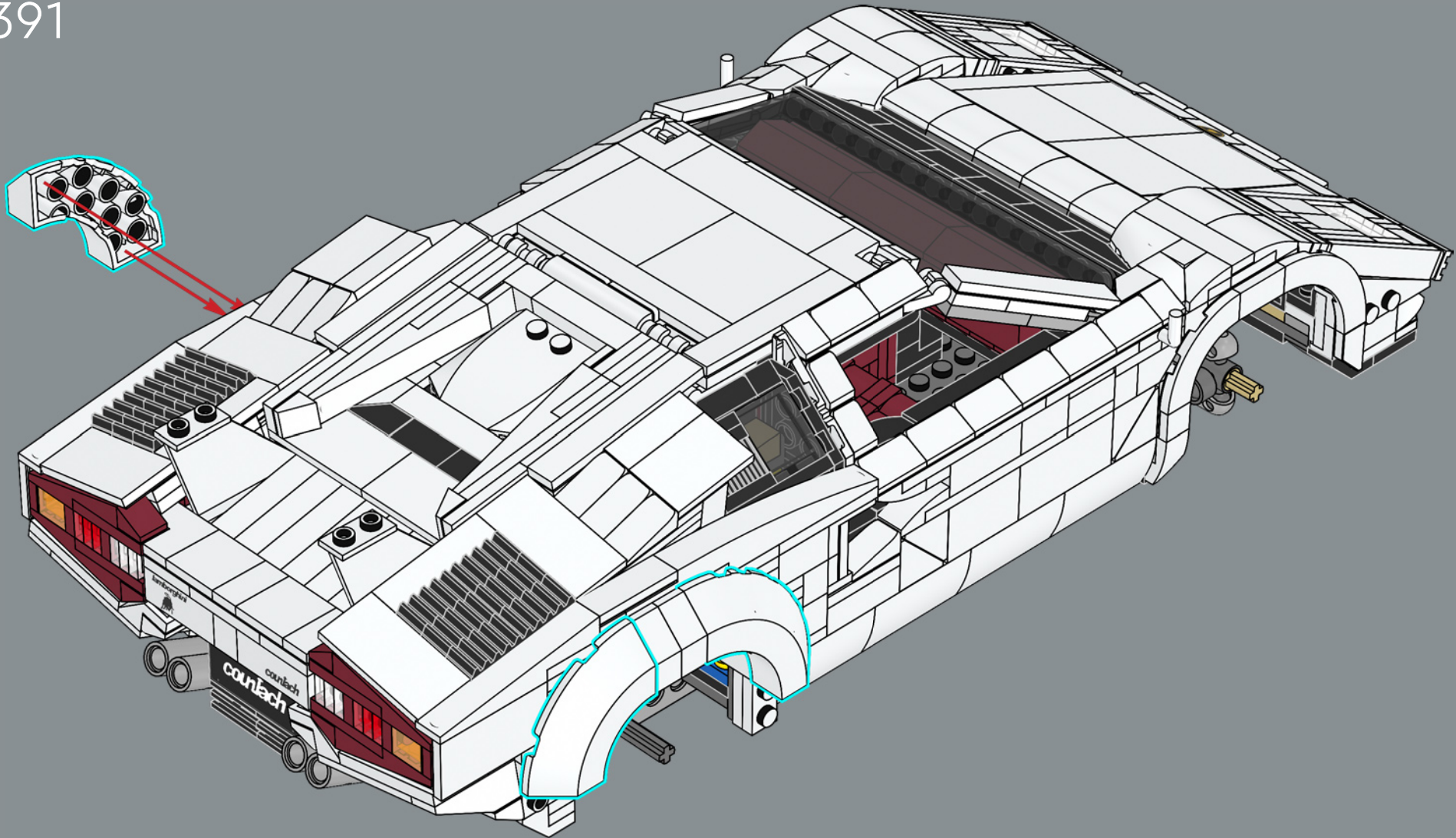



392

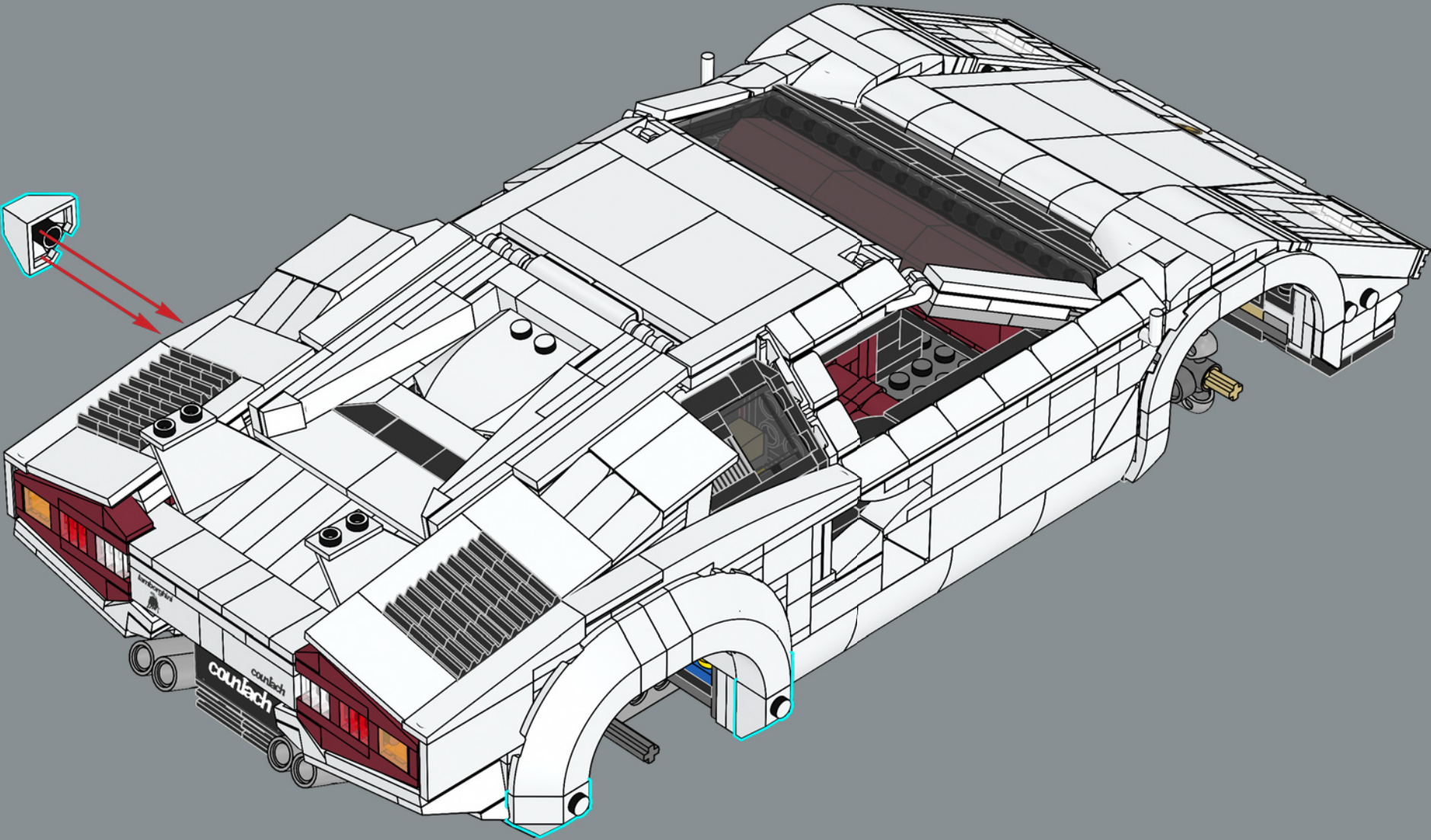

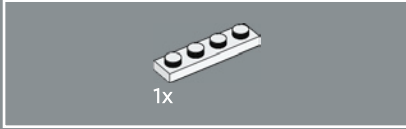
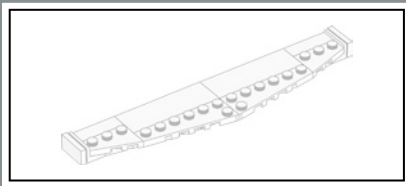

393

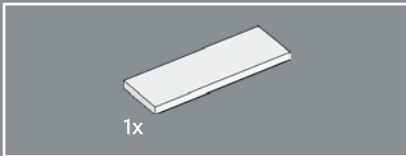

394

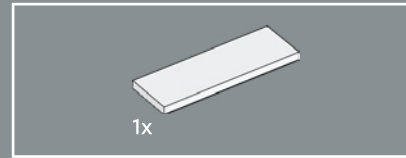
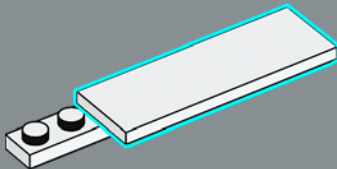

395

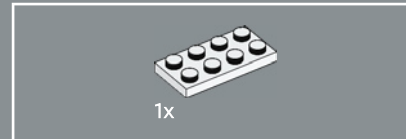
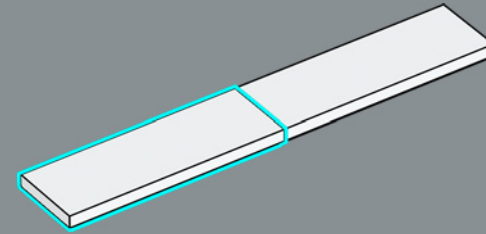

396

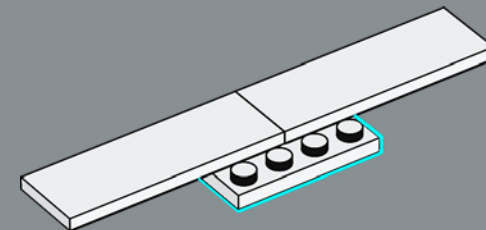

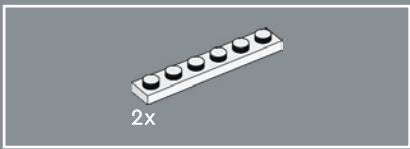

397

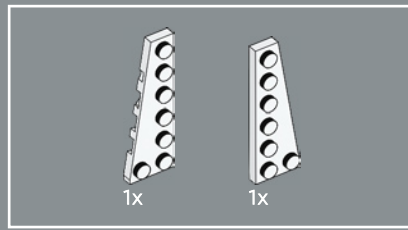
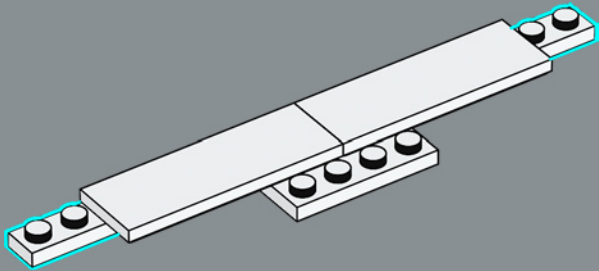

398

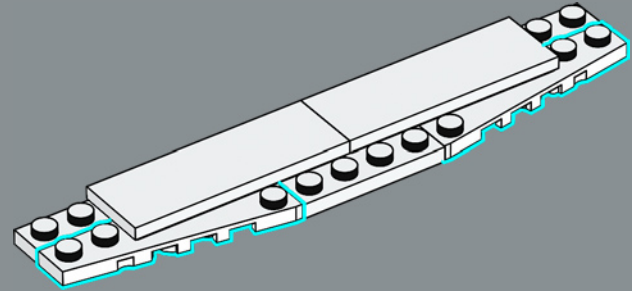

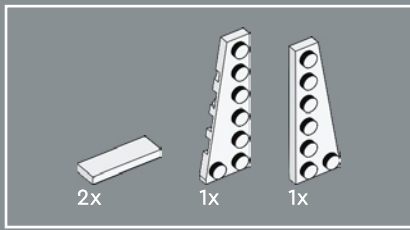

399

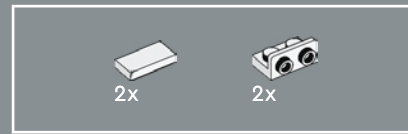
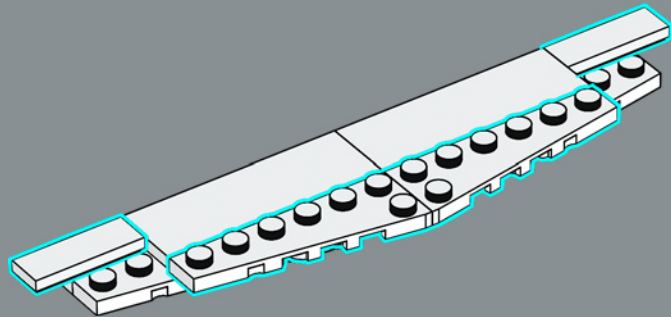

400

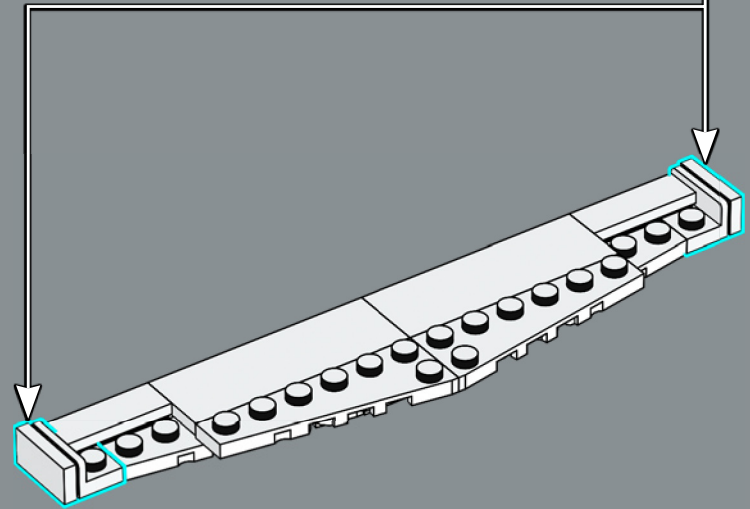
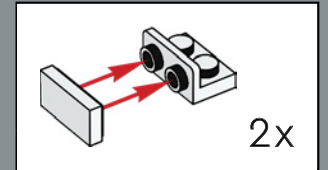

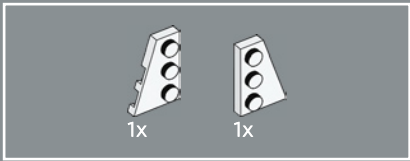

401

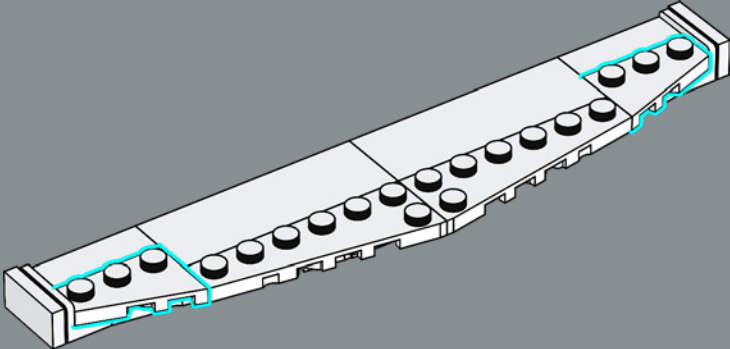

402

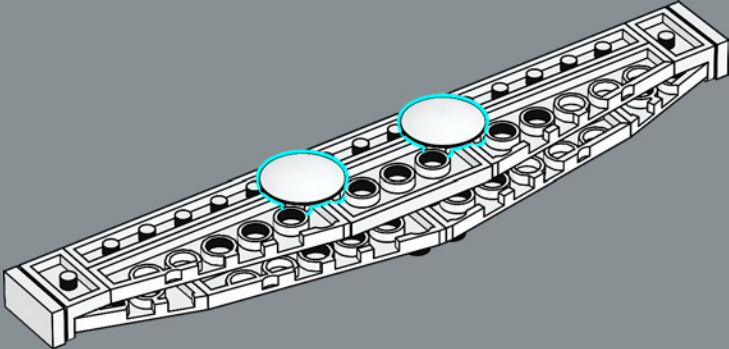

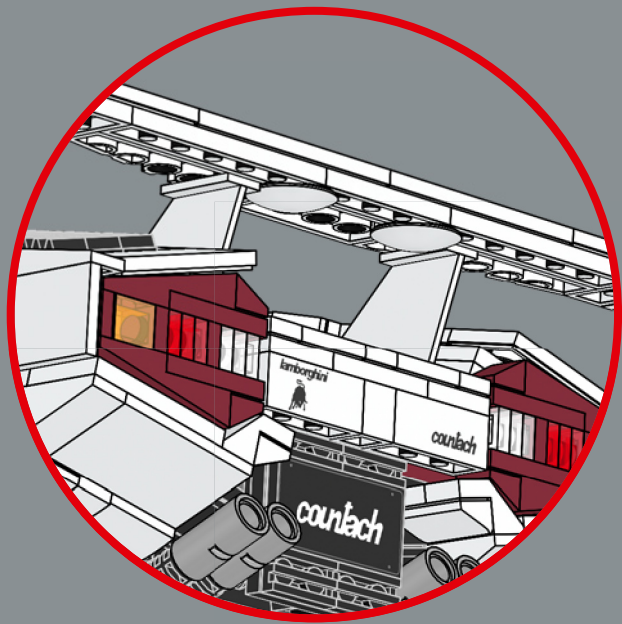

403

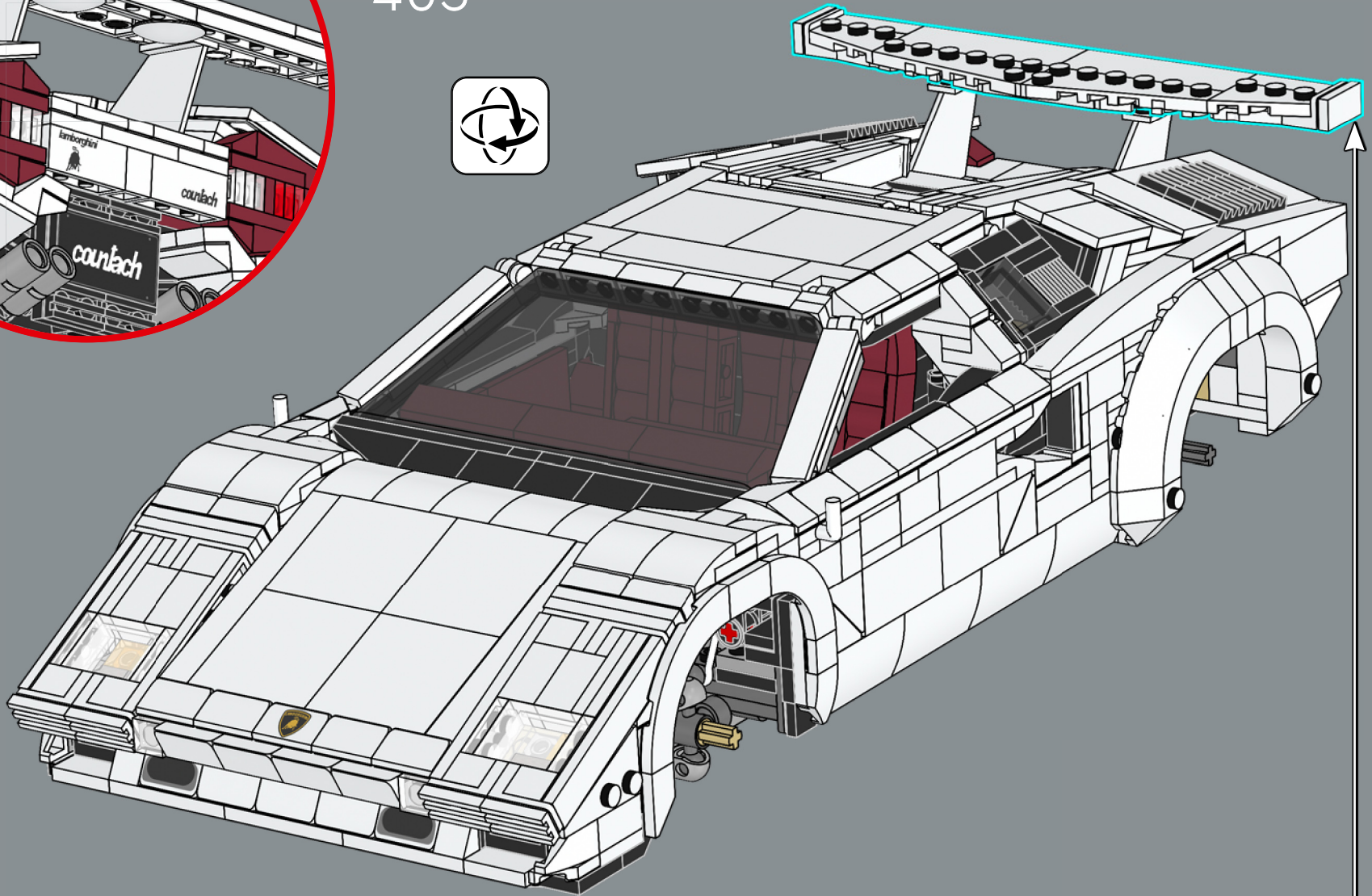

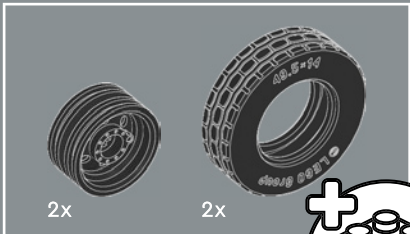

404

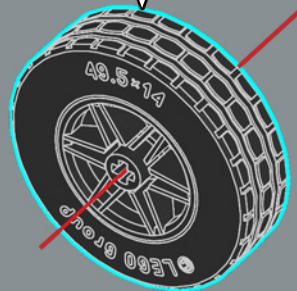
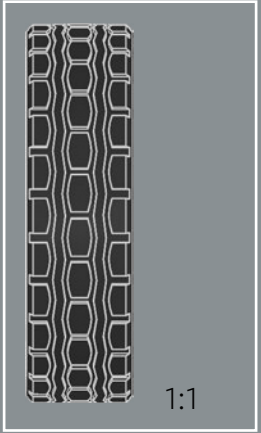
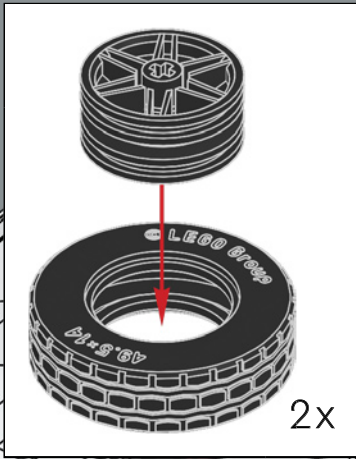
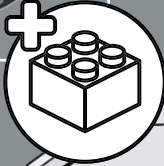

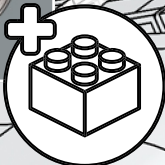
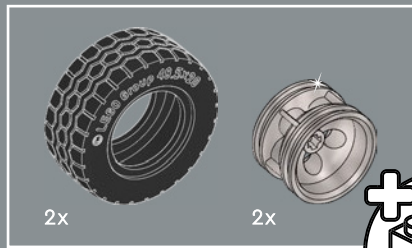

405

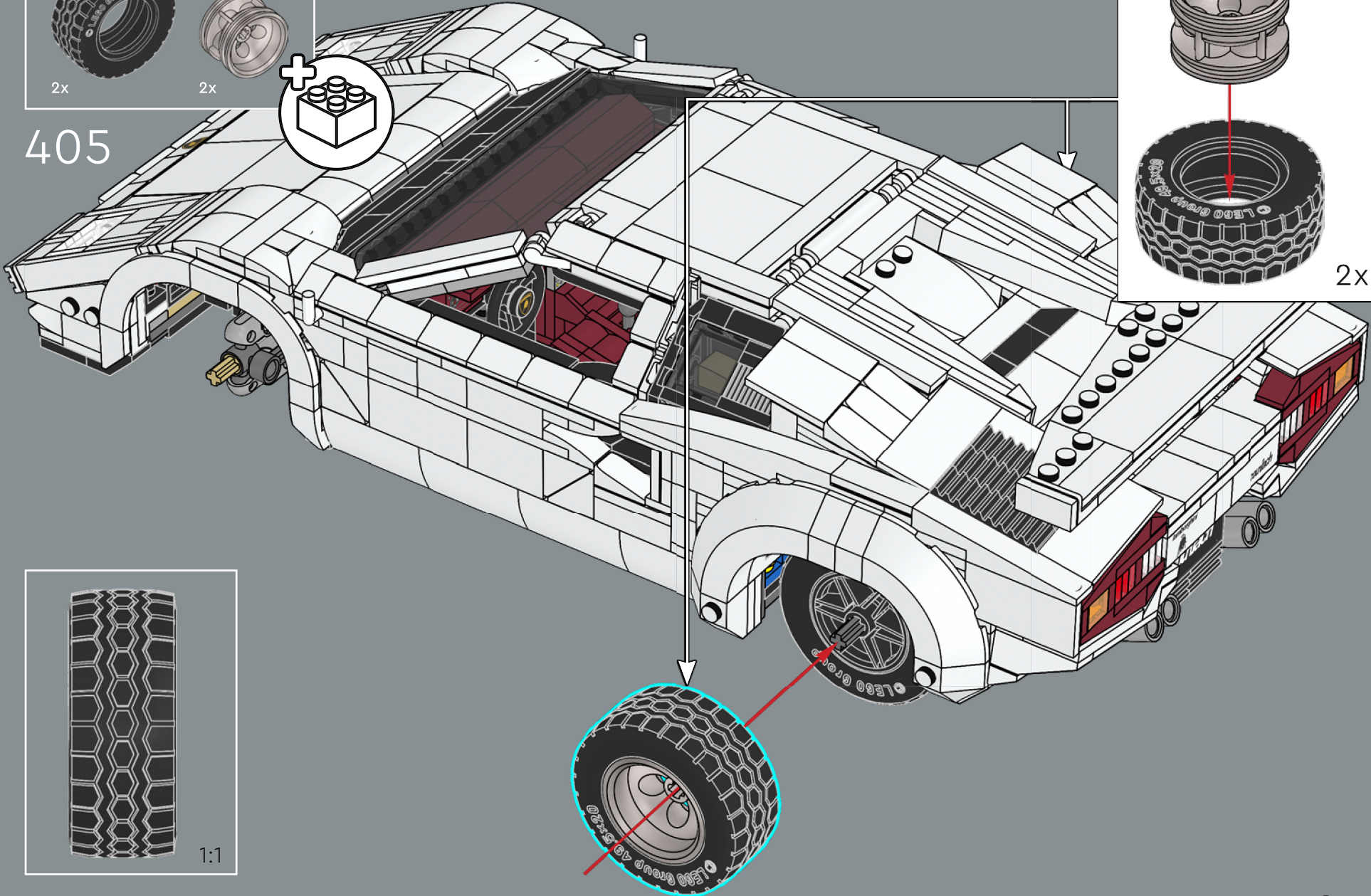
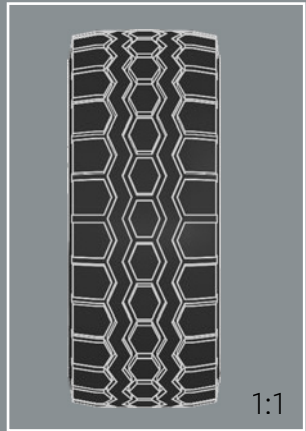
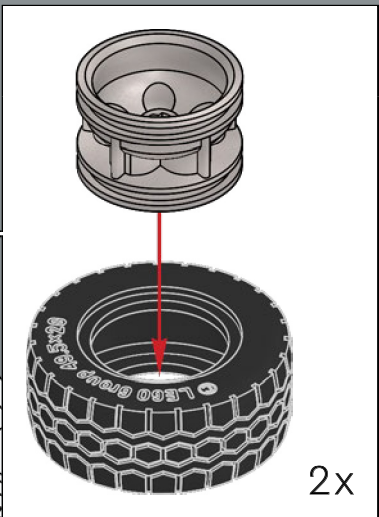



Un nuovo cerchio consente di applicare la funzione sterzante e un profilo più profondo delle ruote posteriori.



2x



2x

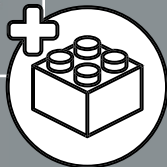

406



2x

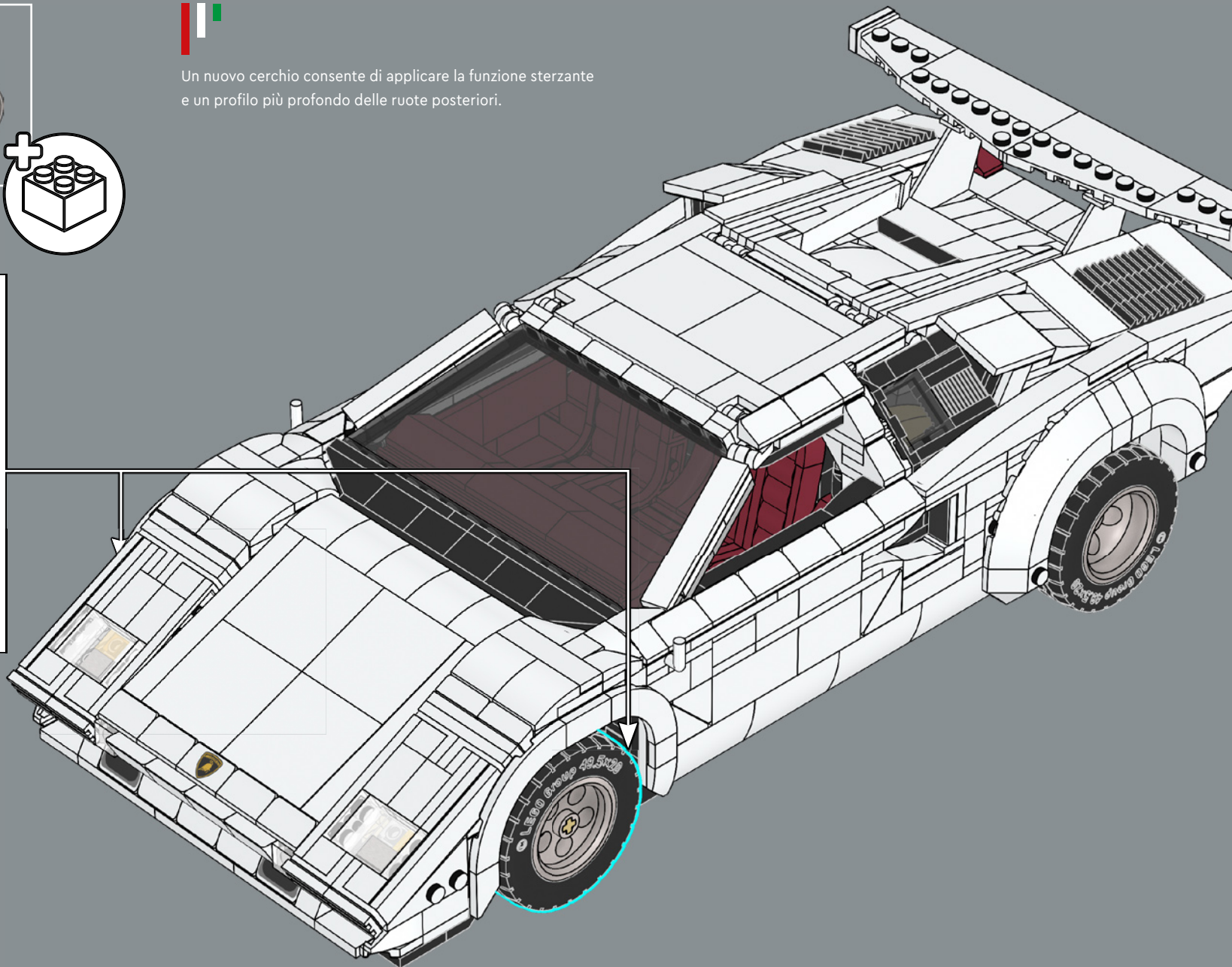

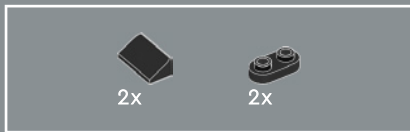

407

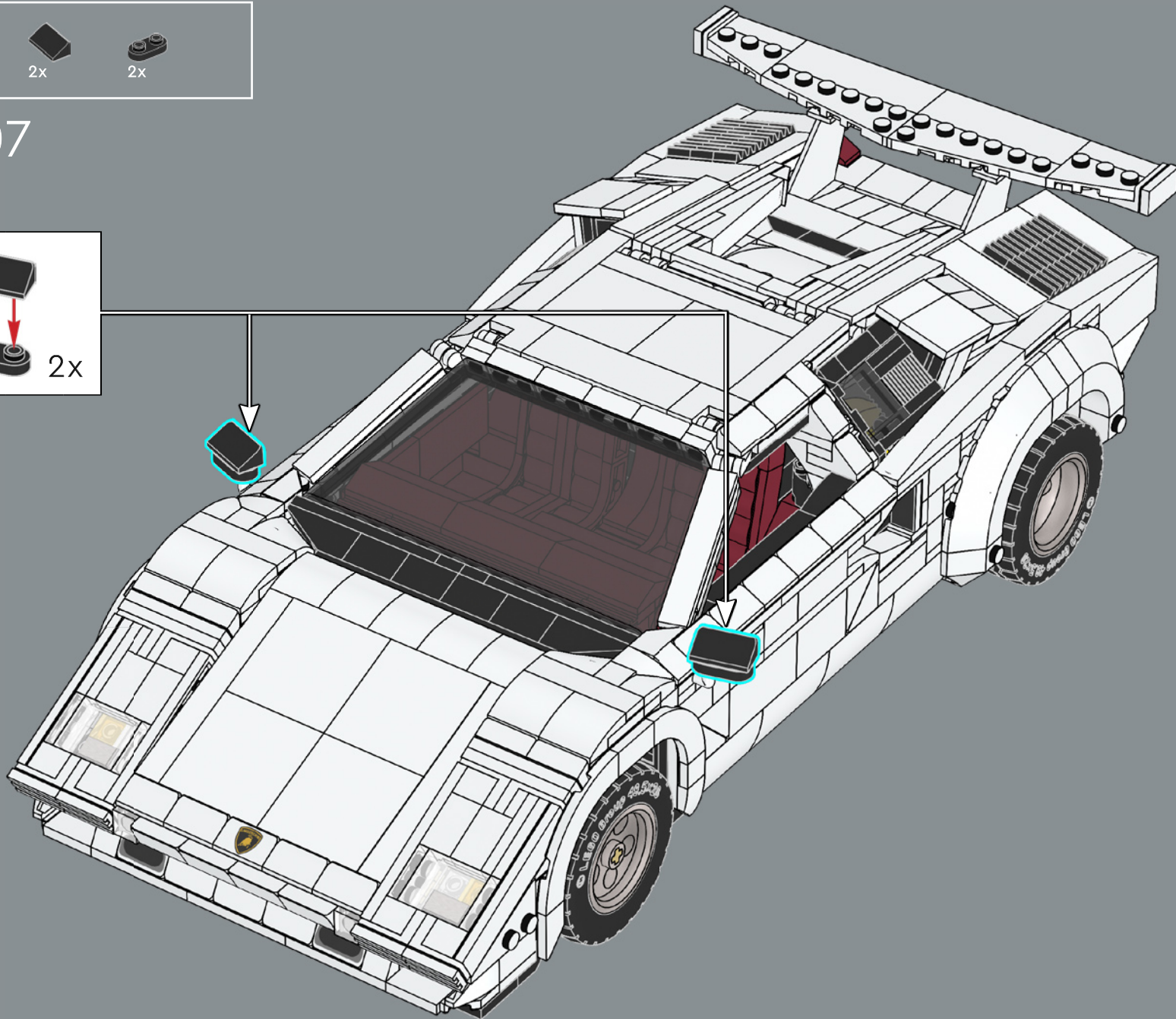
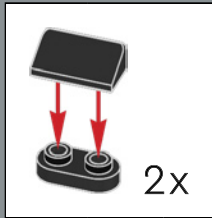

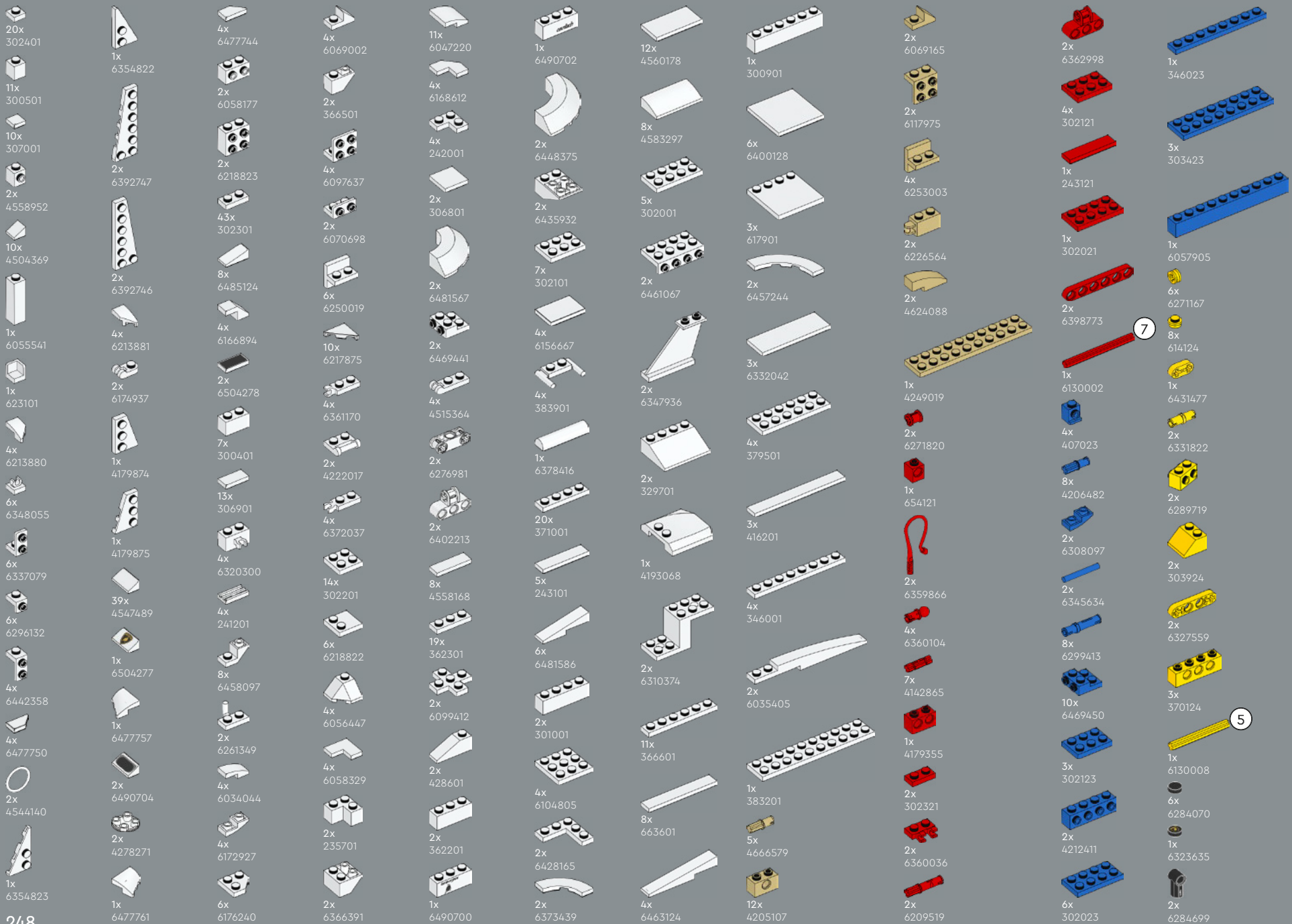



6x
64448793

2x
6284071

2x
6308012

2x
4211525

2x
4278273

8x
6173127

18x
4211398

2x
4211388

2x
6326078

1x
6329662

2x
4593679



[LEGO.com/service](https://www.LEGO.com/service)

2x
4211469

2x
6093859

2x
6301870

4x
4244627

12x
6359723

4x
6326478

3x
4211397

2x
4211353

2x
4211815

2x
4211881

3

2x
6043639

6x
6438836

4x
4211429

8x
4211396

4x
4211445

4x
6247352

1x
4211395

2x
4211549

1x
4211452

2x
4211425

1x
4211404

1x
4211406

5x
4251149

1x
4211462

4x
6421513

2x
4211360

1x
6335319

1x
6376639

2x
6240550

2x
6254252

1x
4490599

8x
6287672

2x
6343854

4x
6481570

2x
6217492

2x
6469858

2x
4210633

2x
6395635

2x
4211044

2x
4211098

6x
6225494

1x
6221607

4x
6261374

2x
6349479

2x
6168776

2x
6435267

5x
6117972

2x
6359227

6x
6146321

2x
6123814

2x
4218696

4x
6047417

3x
6364352

2x
6015356

4x
4652259

4x
4211068

2x
4211104

8x
6118832

1x
6083620

2x
4211103

4x
4210686

2x
4629920

4

2x
4508553

1x
4211002

2x
4211107

1x
4211061

4x
4210794

2x
4210783

1x
4210796

1x
6490496



YOU COULD WIN



YOU COULD WIN

Your feedback will help shape the future development of this product series.

Visit:

DU KÖNNTEST GEWINNEN

Dein Feedback trägt zur Weiterentwicklung dieser Produktreihe bei.

Geh auf:

VOUS POURRIEZ GAGNER

Vos commentaires nous aideront à concevoir les futurs produits de cette gamme.

Visitez :

POTRESTI VINCERE TU

La tua opinione ci aiuterà a migliorare la creazione futura di questa linea di prodotti.

Visita:

PUEDES GANAR

Tu opinión contribuirá al futuro de esta serie de productos.

Visita:

轻松获奖

您的反馈将有助于我们在今后改进本产品系列。

请访问:

LEGO.com/productfeedback

You also have the chance to win a LEGO® set.

Terms and conditions apply.*

Außerdem hast du die Chance, ein LEGO® Set zu gewinnen.

Es gelten die Teilnahmebedingungen.*

Vous pourriez également gagner un ensemble LEGO®.

Des conditions s'appliquent.*

Hai anche la possibilità di vincere un set LEGO®.

Termini e condizioni sono applicabili.*

También tienes la oportunidad de ganar un set LEGO®.

Aplican términos y condiciones.*

您还有机会赢取乐高®套装。

条款和条件适用。*

*LEGO.com/productfeedback-terms



LEGO and the LEGO logo are trademarks of the LEGO Group. ©2024 The LEGO Group.
The "Lamborghini" and "Lamborghini Bull and Shield" trademarks, copyrights, designs and models are used under license from Automobili Lamborghini S.p.A, Italy.