



10337





LEGO.com/sustainable-packaging



FR
DONNEZ
OU
RECYCLEZ



ASSOCIATION

OU



MAGASIN

OU



DÉCHÈTERIE

Adresses sur quefairedemesdechets.fr



BUILDER



Apple and the Apple logo are trademarks of Apple Inc., registered in the U.S. and other countries and regions. App Store is a service mark of Apple Inc. Google Play and the Google Play logo are trademarks of Google LLC. Tencent and the Tencent logo are trademarks of Tencent Inc.

LEGO.com/devicecheck



LEGO® Builder

LAMBORGHINI



Les proportions idéales



Si vous avez grandi dans les années 1980, vous reconnaîtrez probablement la silhouette de la Lamborghini Countach au premier coup d'œil. Vous avez peut-être même encore un poster la représentant quelque part (ou trônant encore fièrement sur vos murs). Comptant plus de 50 ans d'histoire, du premier prototype LP500 dévoilé en 1971 à nos jours, la Countach est un modèle profondément révolutionnaire. Avec ses angles vifs et ses portes en élytre, la silhouette remarquablement basse du modèle ainsi que le rugissement plein de fougue du moteur V-12 ont contribué à faire de la Countach un véritable emblème des années 1980 et d'une bonne partie des années 1990, jusqu'à devenir l'incarnation même de la supercar de l'époque. Son design futuriste et avant-gardiste était parfaitement en phase avec son époque et la culture populaire. Et comme toute œuvre d'art classique, son charme est intemporel. De par son histoire, sa forme et ses couleurs vives, ce modèle a toute sa place dans la gamme LEGO® Icons.

L'évolution de la Lamborghini Countach

La Lamborghini Countach a évolué au fil du temps en adoptant des technologies et des styles innovants. Ce modèle LEGO® est inspiré de la Lamborghini Countach 5000 Quattrovalvole (1985-1988), avec quelques clins d'œil à ses vénérables prédécesseurs.



1971 LP500

Le prototype dévoilé lors du salon de l'automobile de Genève a jeté les bases de toutes les versions ultérieures.



1973 COUNTACH LP400

Modifiée selon les enseignements tirés du prototype, la LP400 a été le premier modèle de série de la Countach.



1978 COUNTACH LP400 S

Le design extérieur réactualisé comprenait des élargisseurs de passages de roue et une aile arrière en forme de V en option.



1983 COUNTACH LP500 S

Si le design extérieur reste en grande partie inchangé, l'intérieur a été repensé et la performance améliorée grâce à un moteur plus puissant.



1985 COUNTACH 5000 QUATTROVALVOLE

Le modèle le plus vendu de la Lamborghini Countach, aussi bien en Europe qu'aux États-Unis, et un bijou très convoité par les amateurs de supercars.



2021 COUNTACH LPI 800-4

Une édition limitée électrique hybride a été lancée à l'occasion du 50^e anniversaire de la Countach.





Le message de l'équipe de design LEGO®

« Compte tenu de l'aura extraordinaire dont bénéficie encore aujourd'hui la Lamborghini Countach parmi les fans d'automobile, elle était la candidate idéale pour devenir un modèle LEGO®. Bien que les lignes droites semblent naturelles pour les éléments LEGO, les angles peu profonds comptent parmi les formes les plus difficiles à obtenir avec notre système de construction. Nous avons mis au point plusieurs nouveaux éléments et des techniques de construction avancées pour ce modèle, notamment pour les jantes Deep Dish et les passages de roue emblématiques, afin de reproduire les formes, les proportions et les angles subtils propres à ce design italien futuriste. Le chemin parcouru avec Automobili Lamborghini S.p.A. pour que la version LEGO de ce modèle voie le jour, avec une direction fonctionnelle ainsi que des portes et un capot qui s'ouvrent, a été particulièrement stimulant. »

SVEN FRANIC,
Senior Model Designer LEGO®

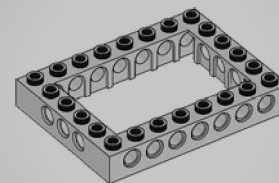
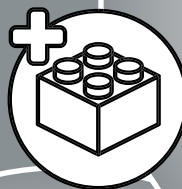
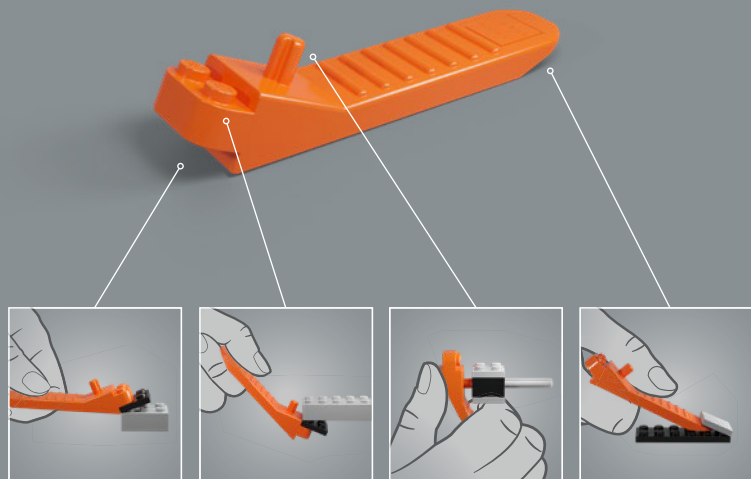

4x



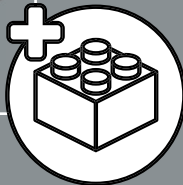
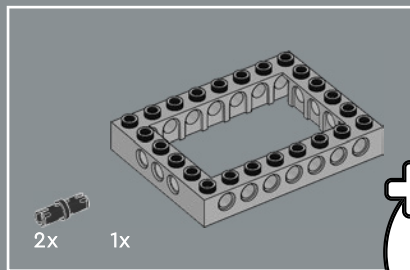

1

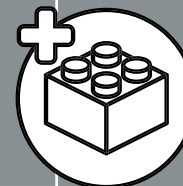
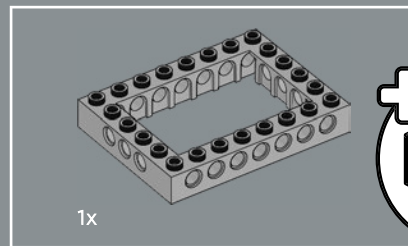
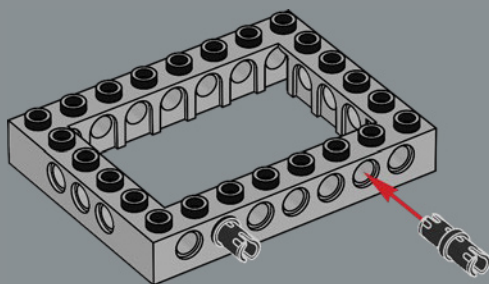

2

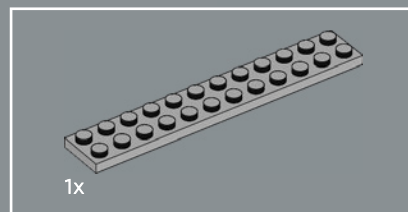
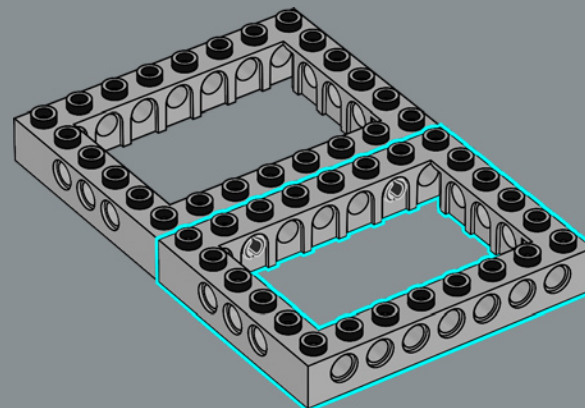

3

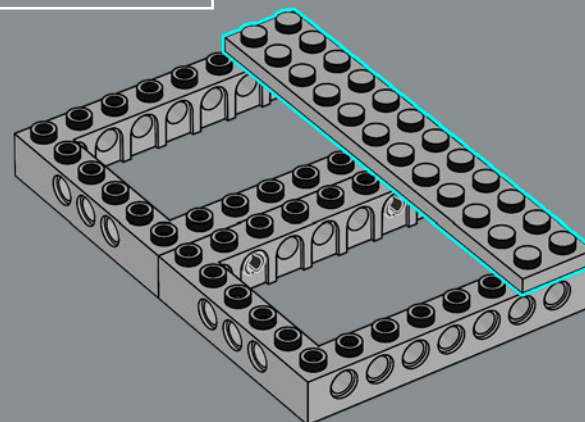

6x

4

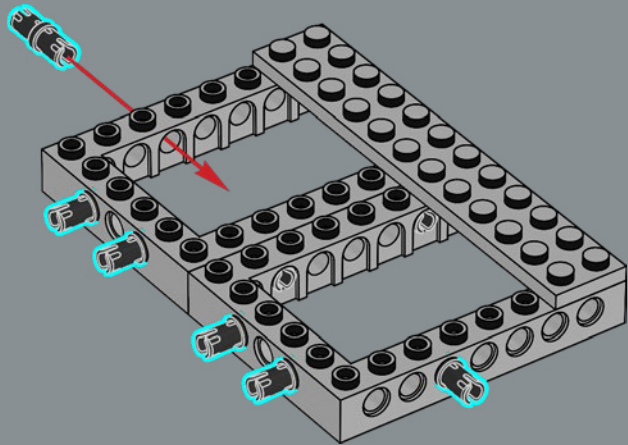

1x

2x

5

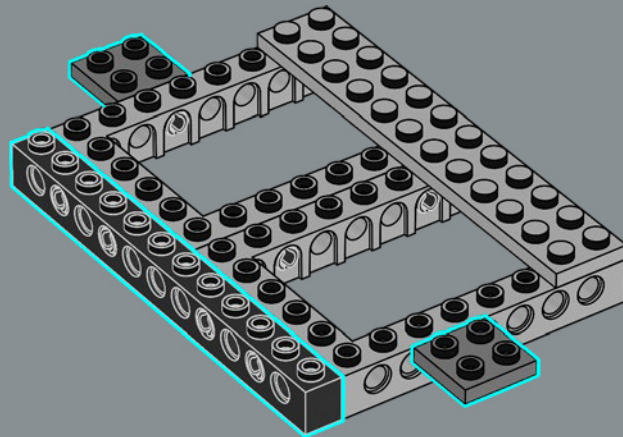

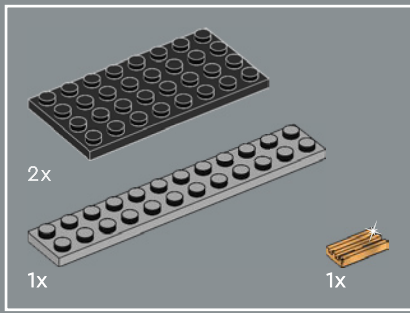

6

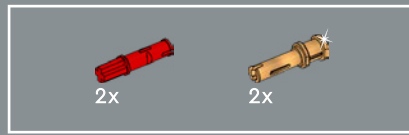
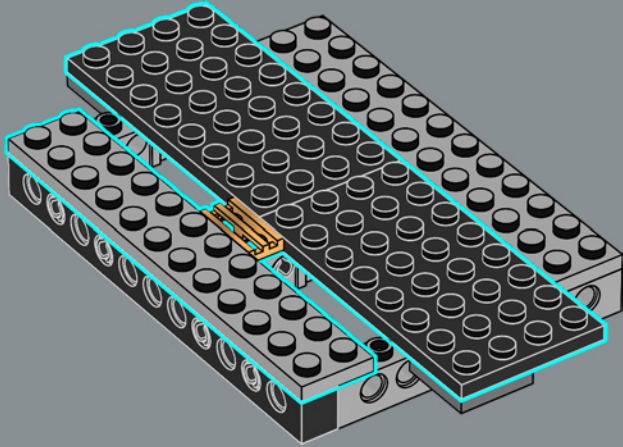

7

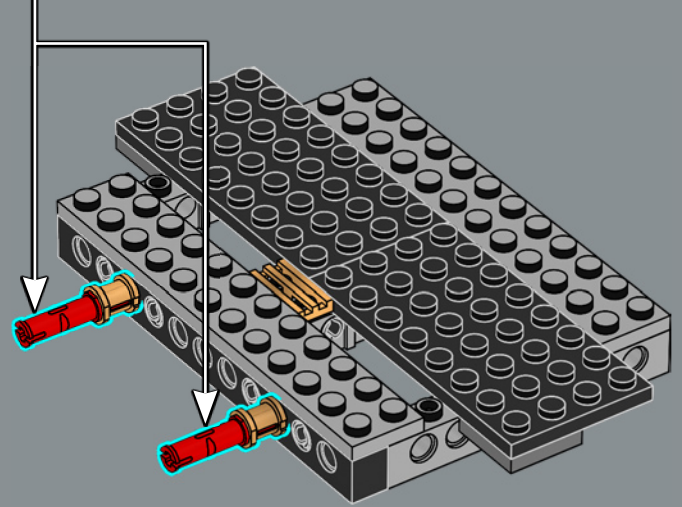
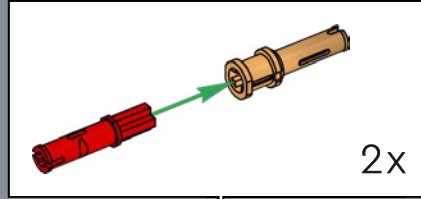

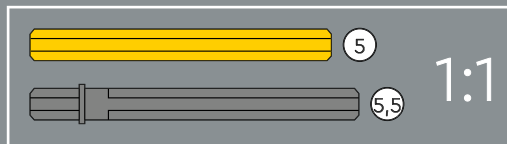
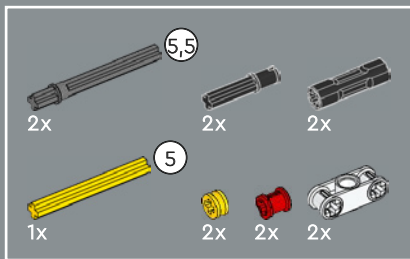

8

1

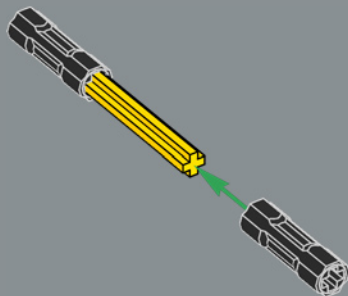

2

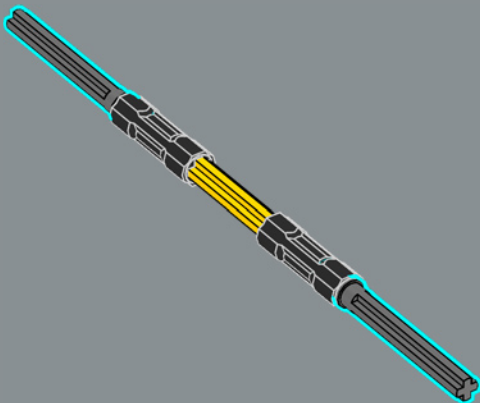

3

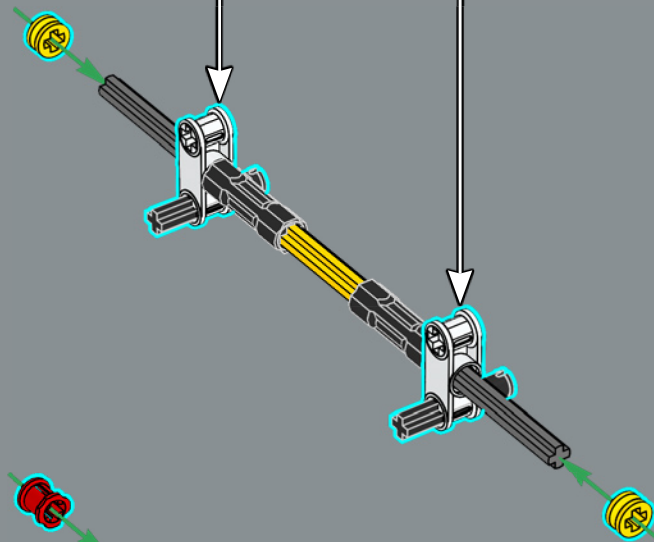

4

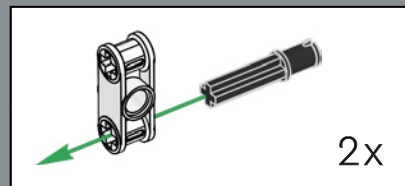
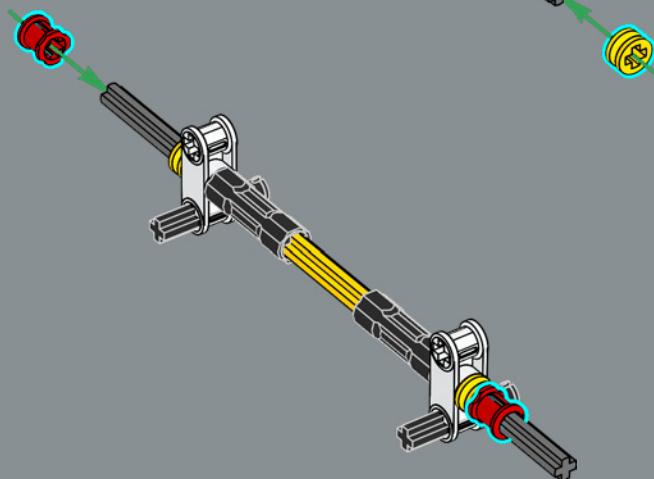

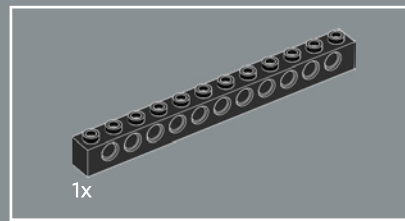
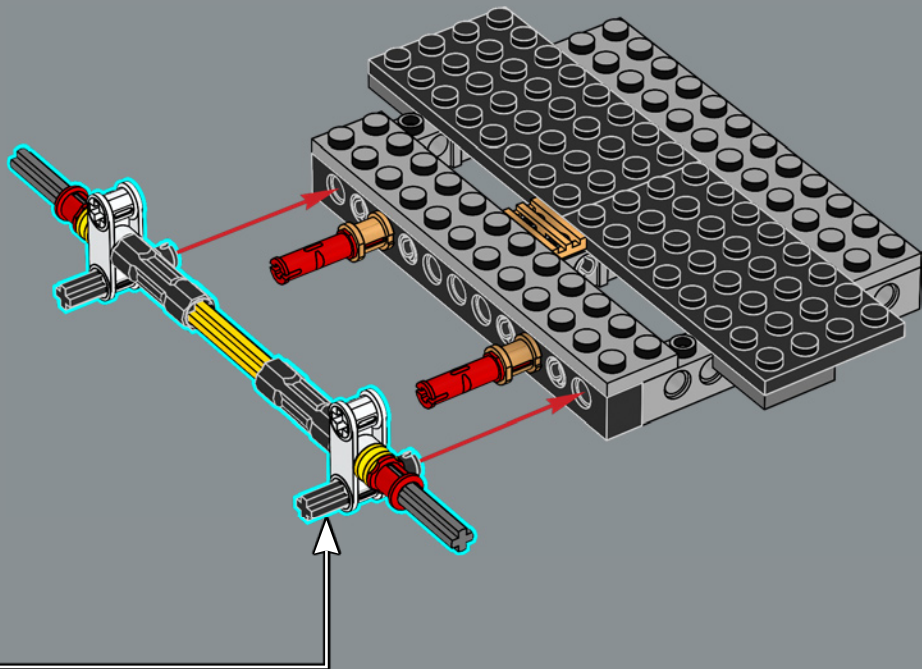

9

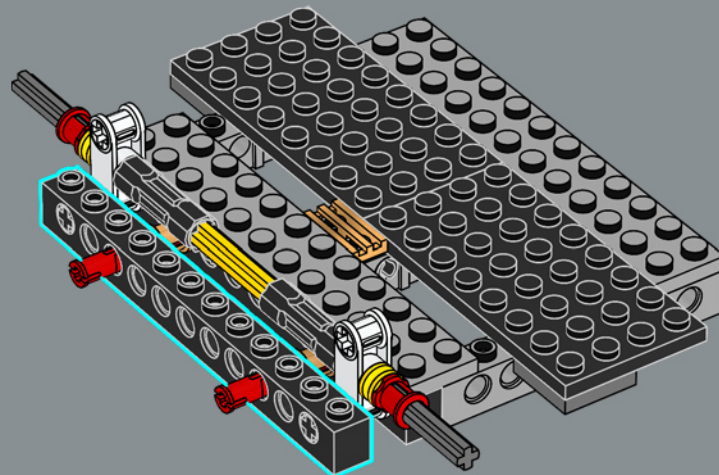



10

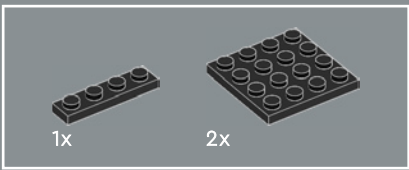
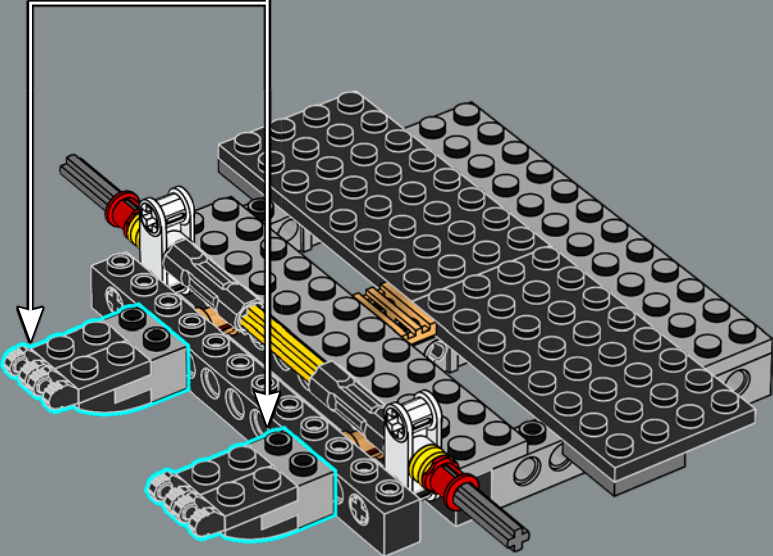
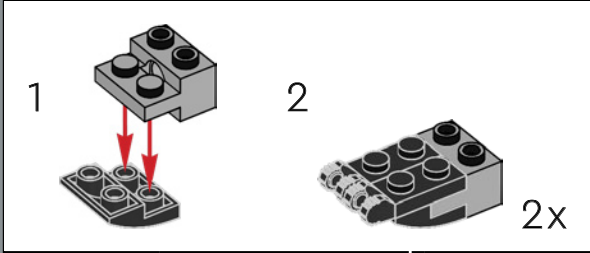

11

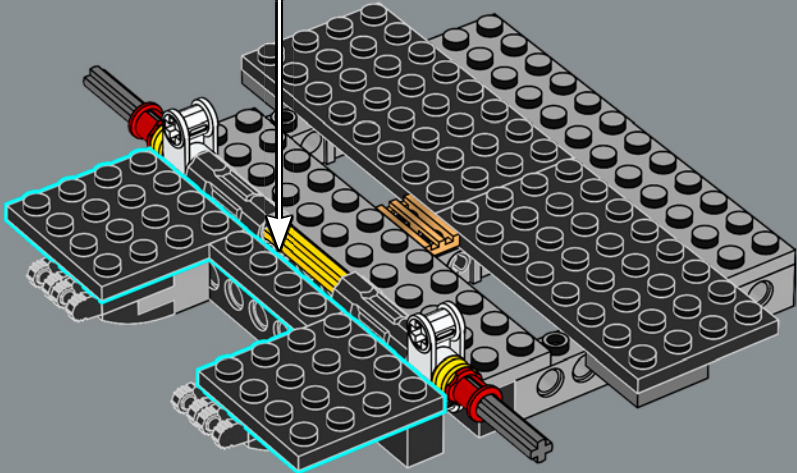
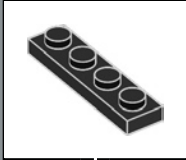

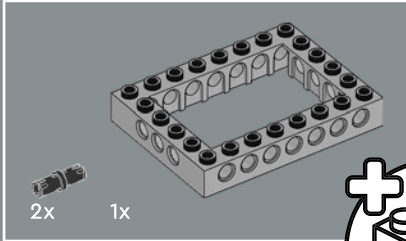
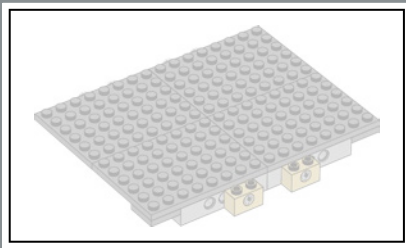

12

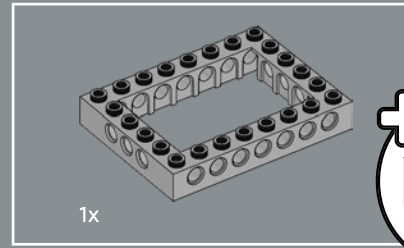
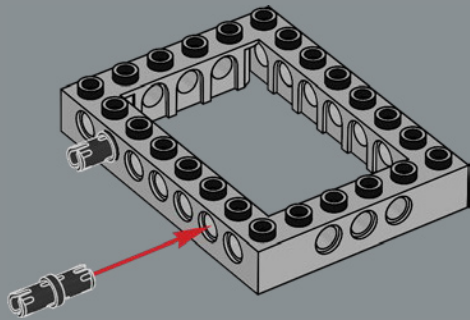

13

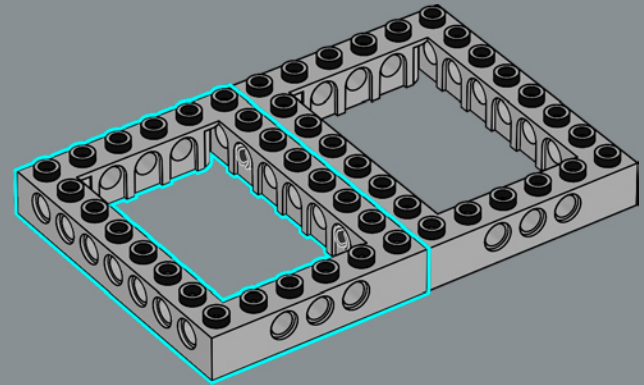

14

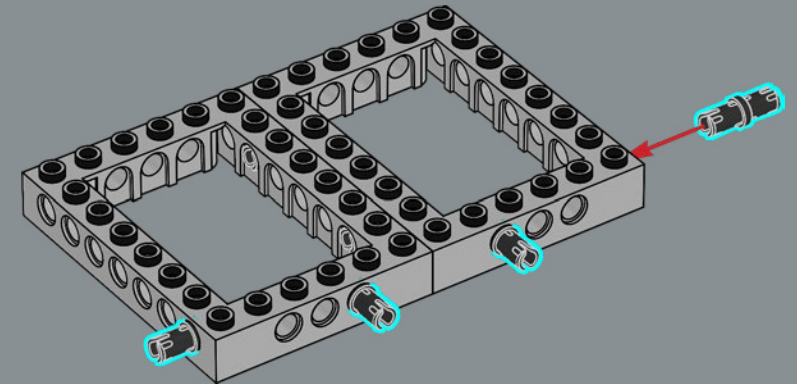

4x

15

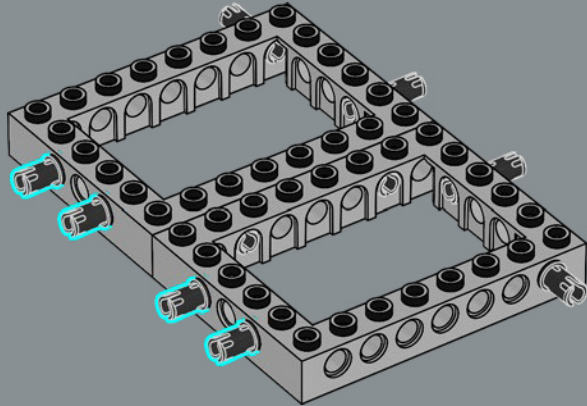

2x

16

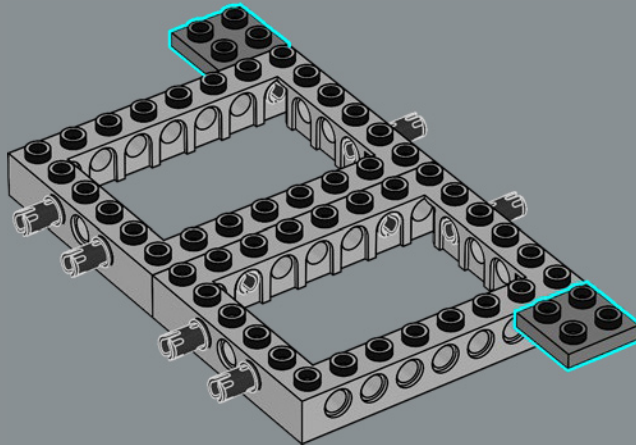

2x

17

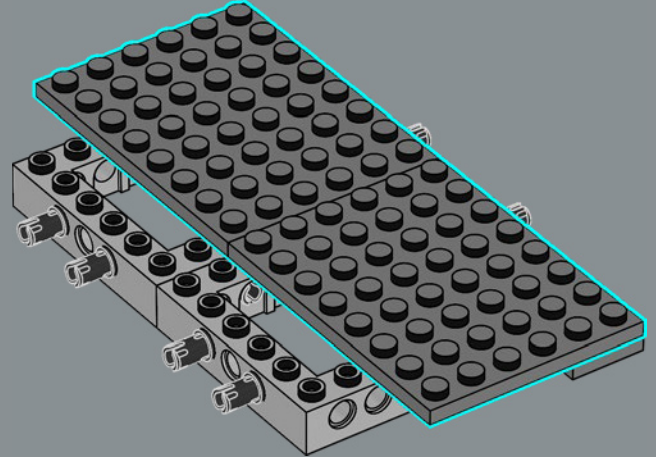

2x

18

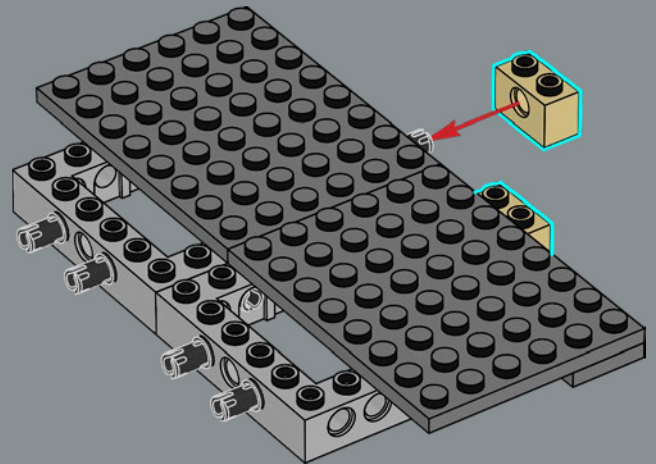

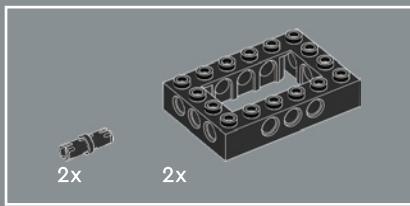

19

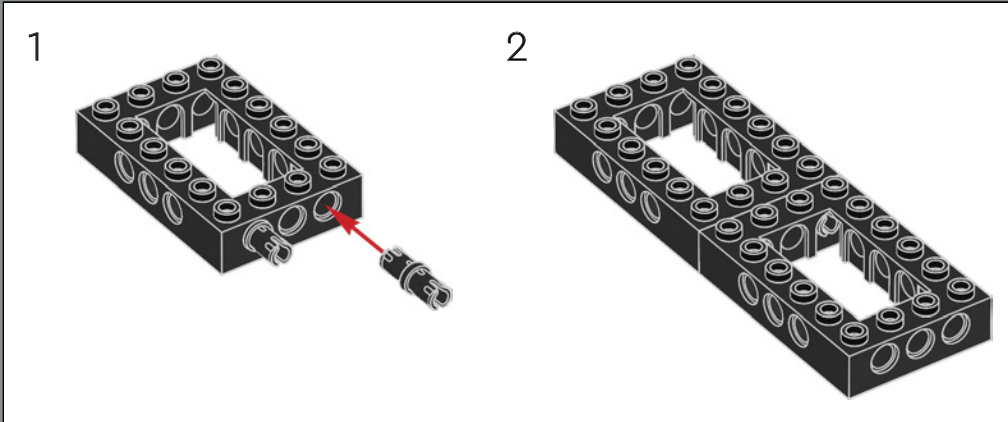

2

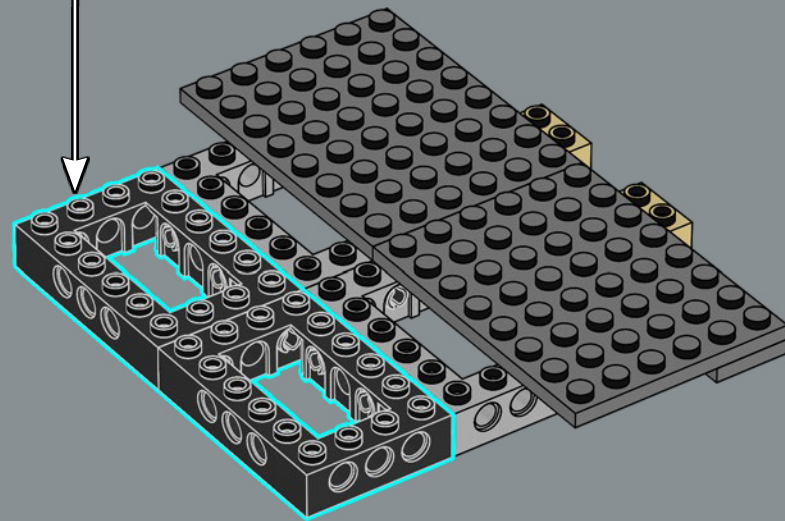
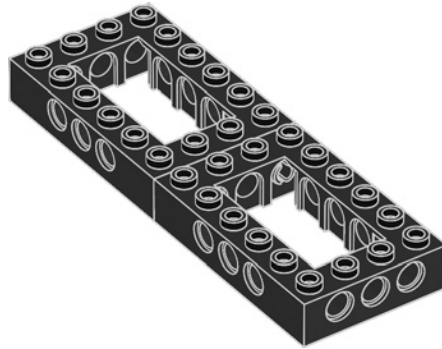

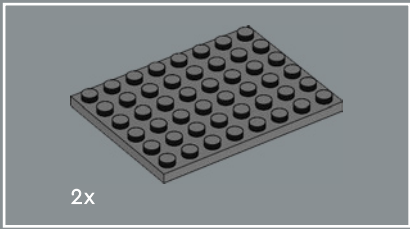

20

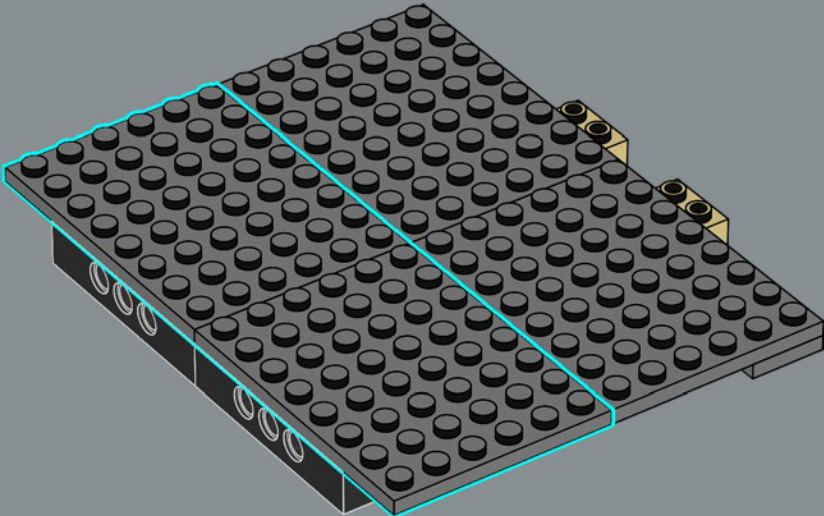

21

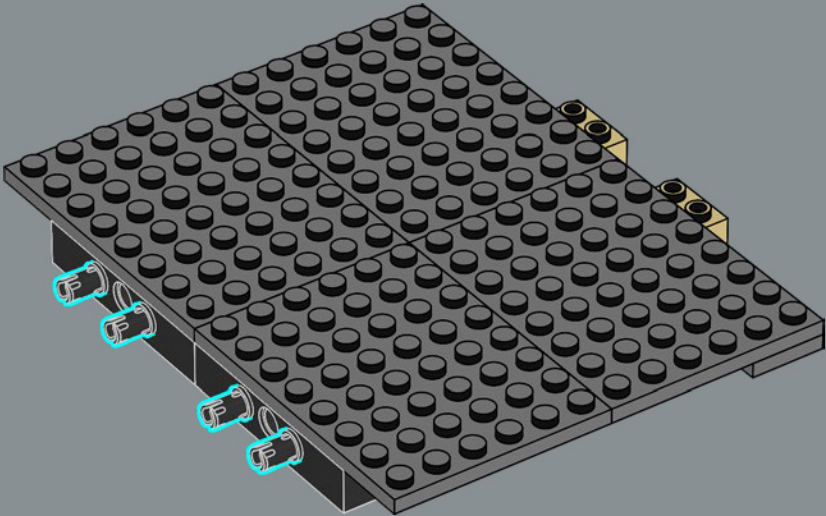



La Lamborghini Countach est célèbre pour ses apparitions mémorables dans des séries télévisées classiques et des films à succès tout au long des années 1980.

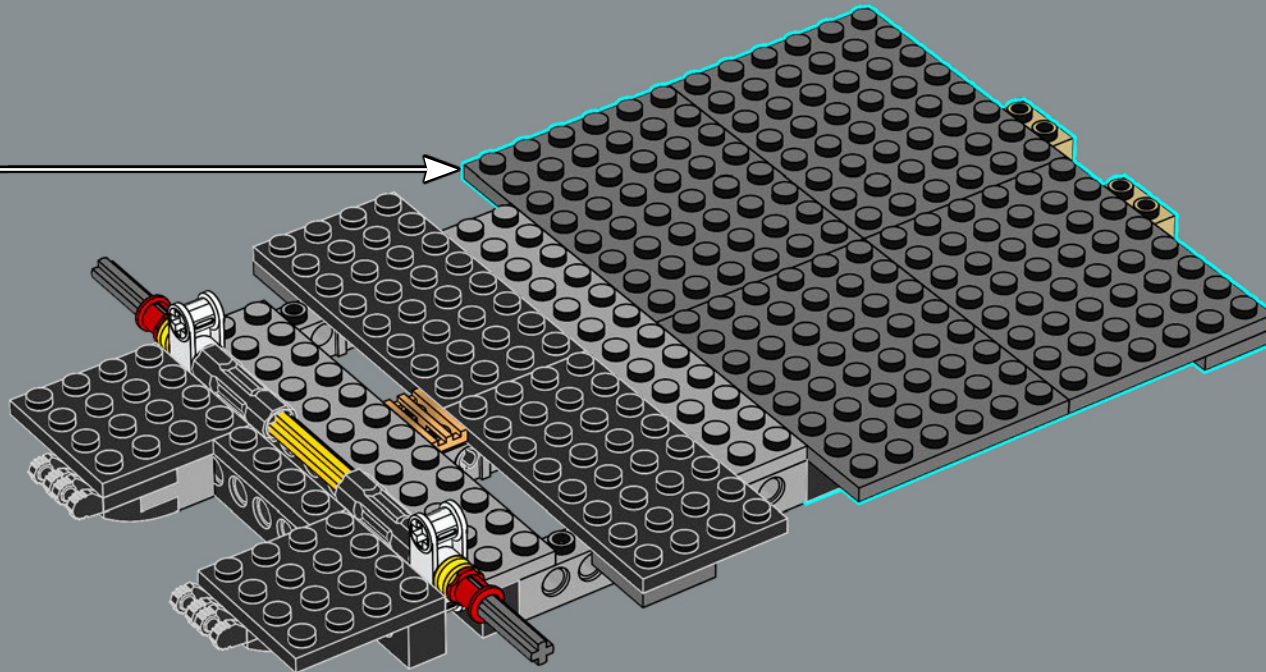

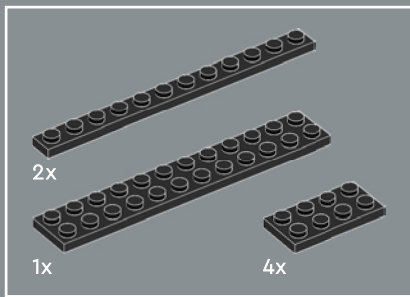

23

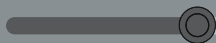
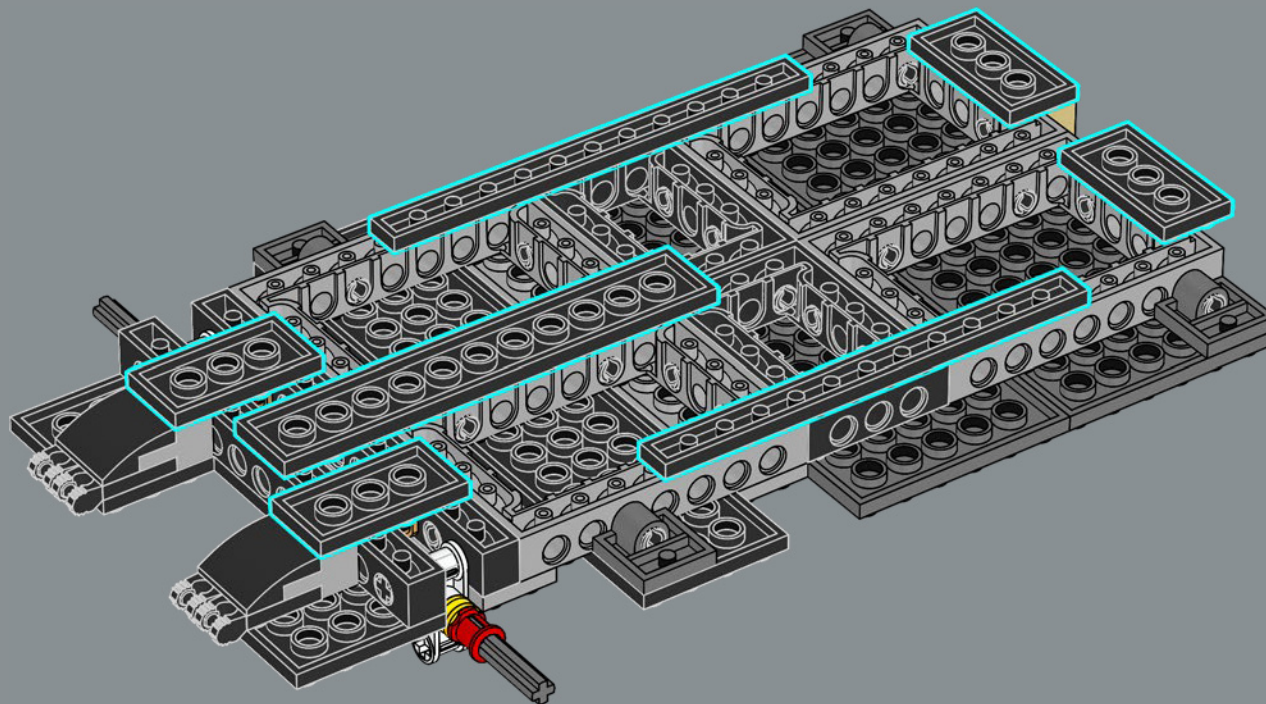

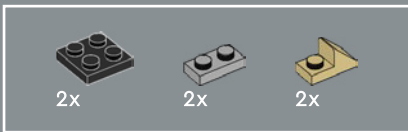

24

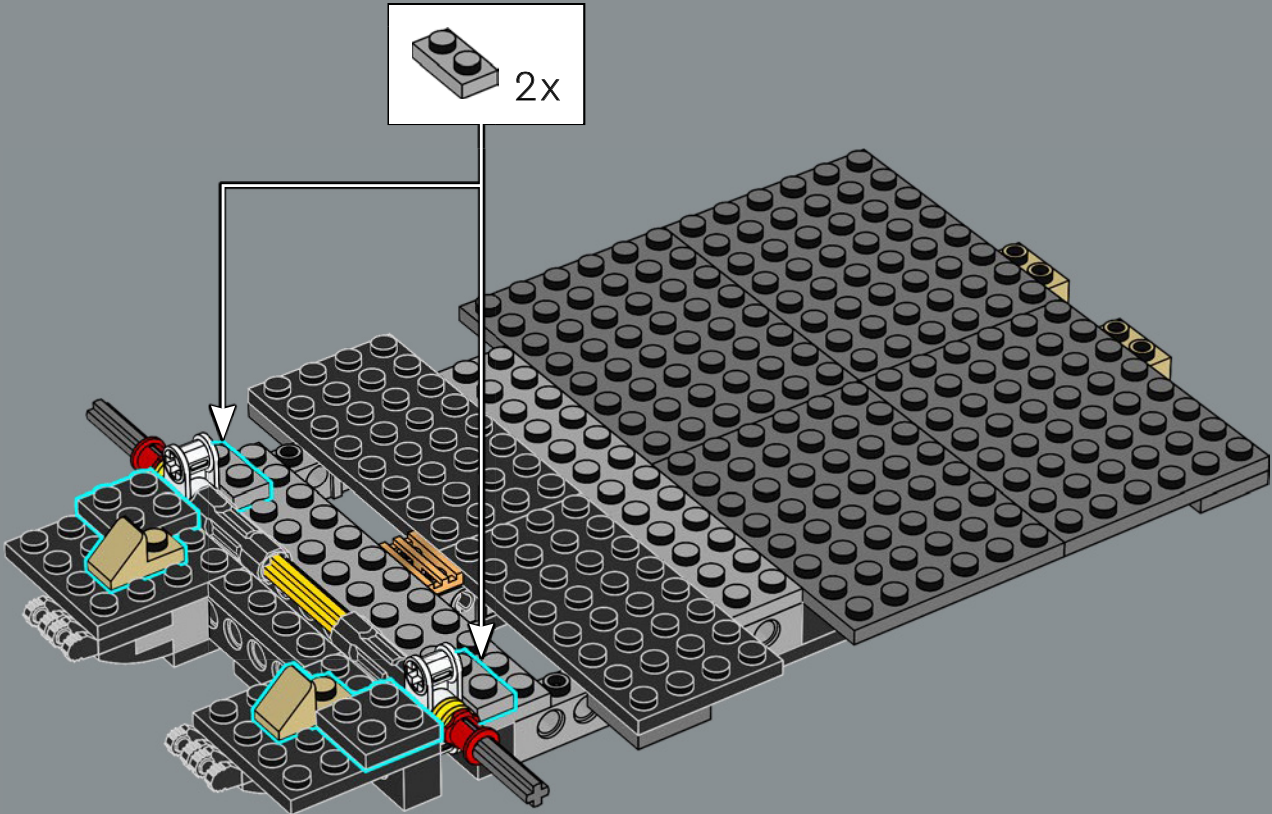

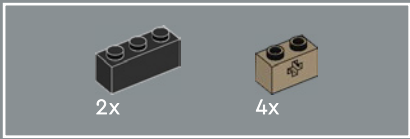

25

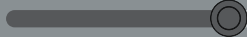
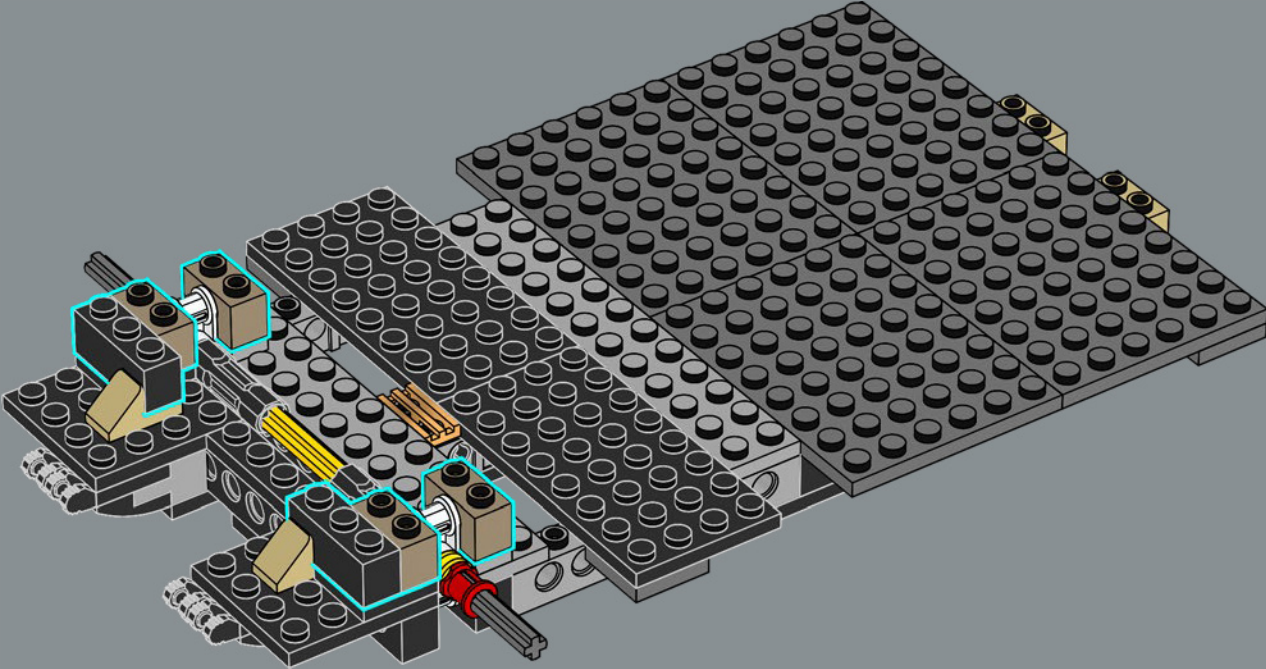

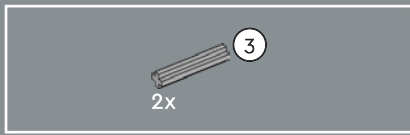

26

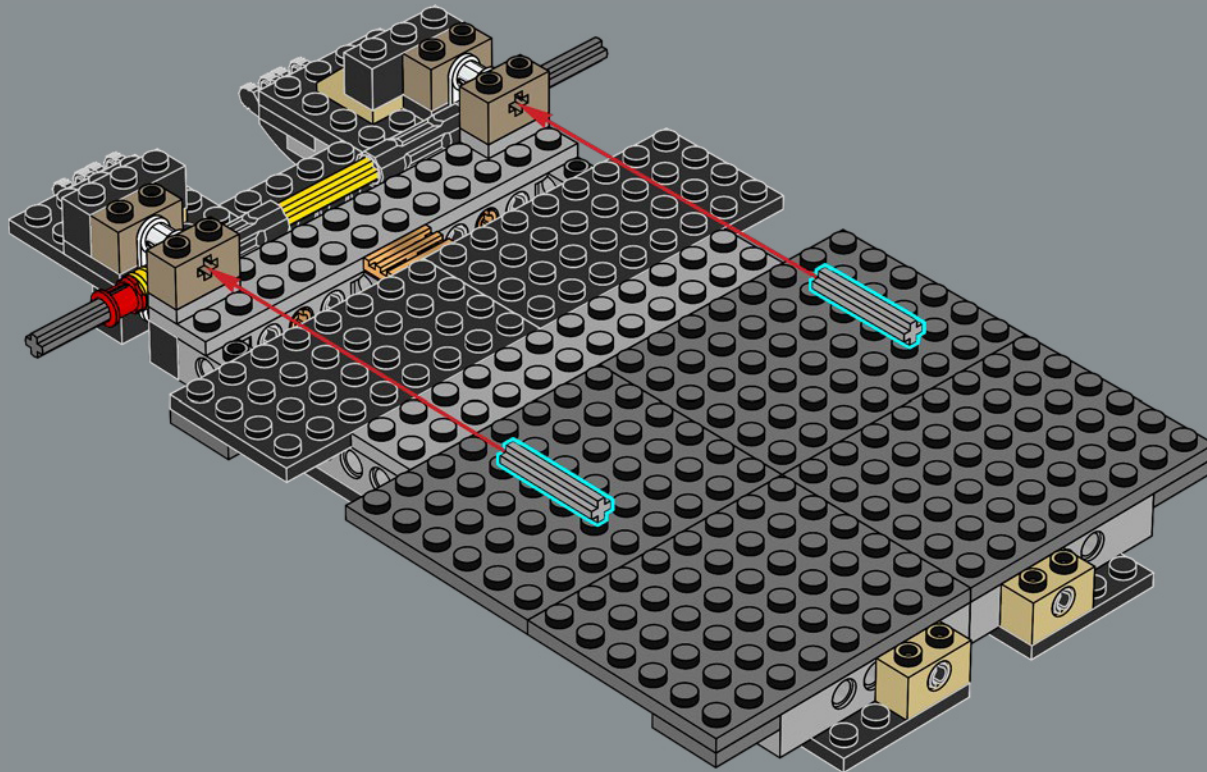

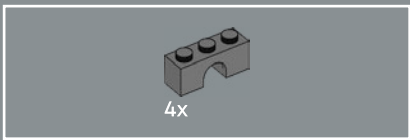

27

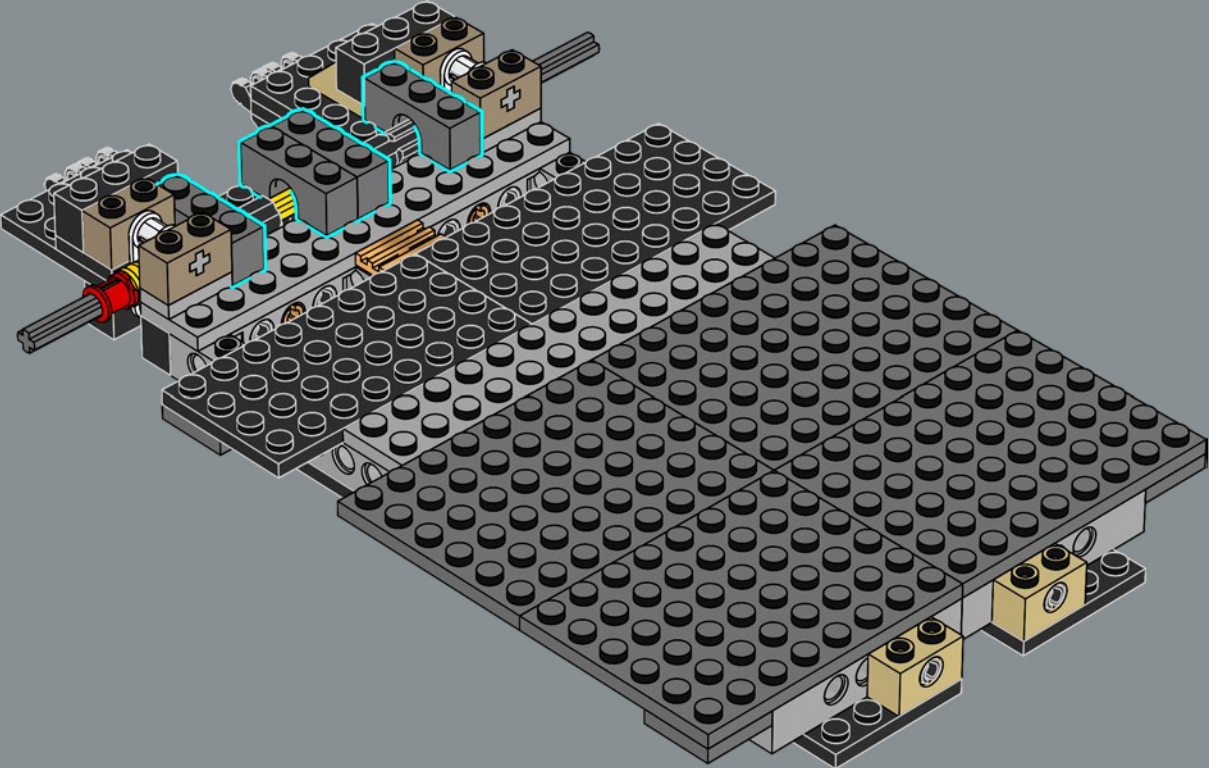

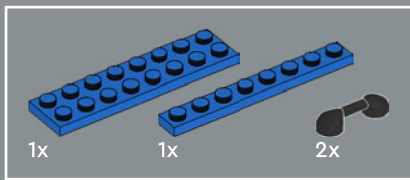

28

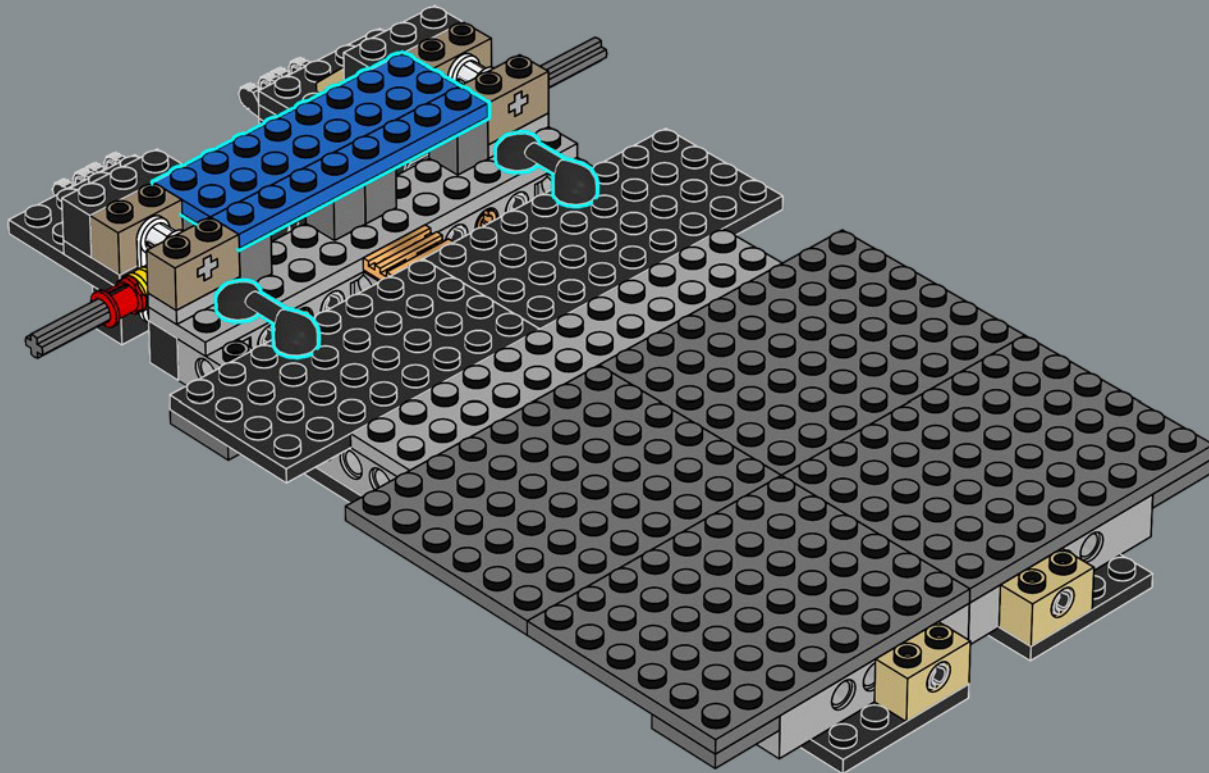

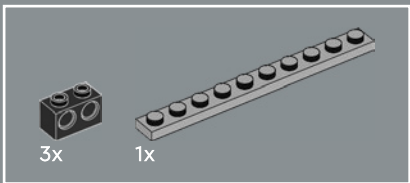

29

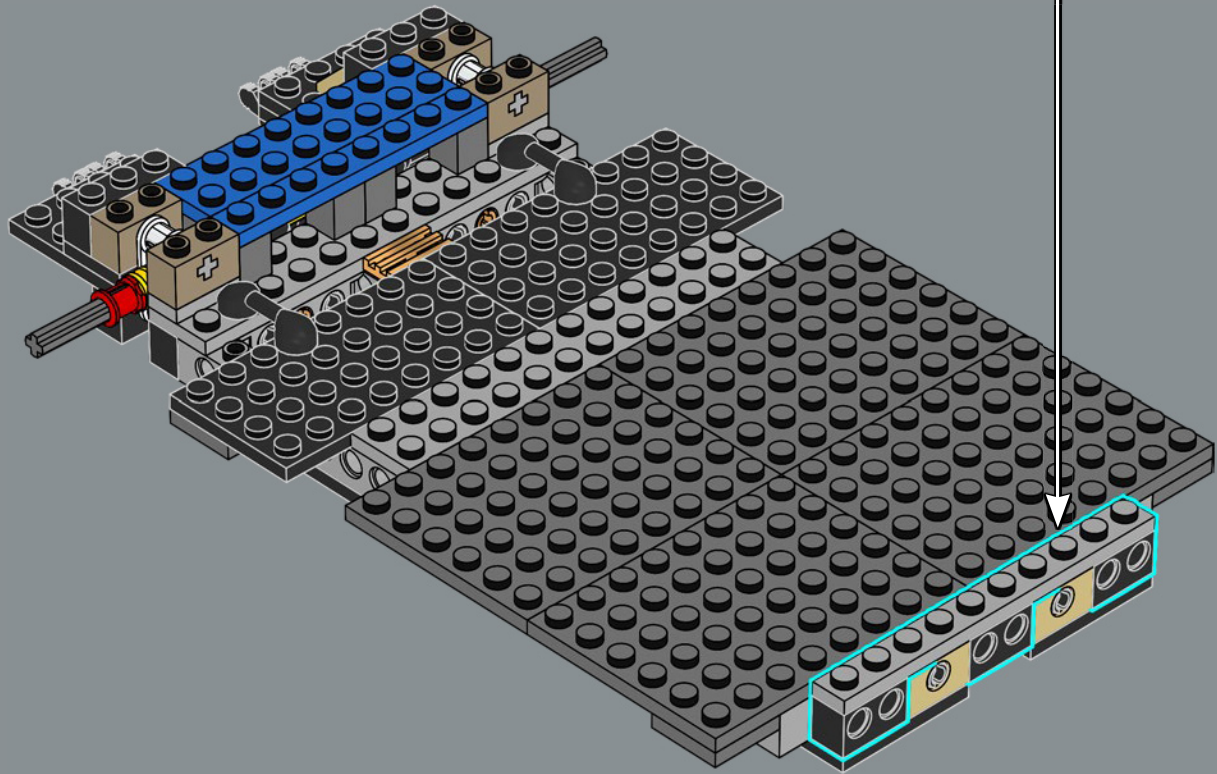
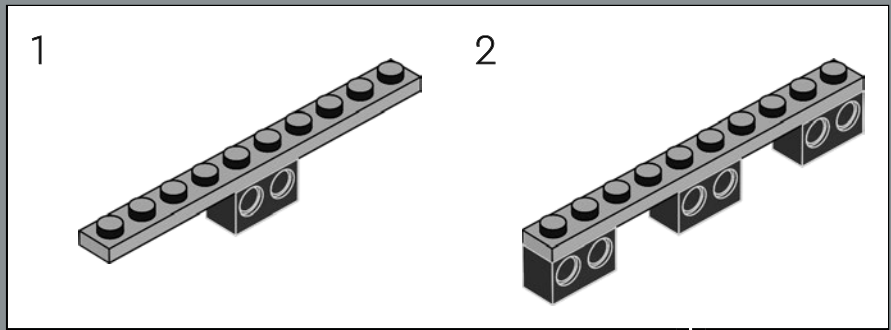

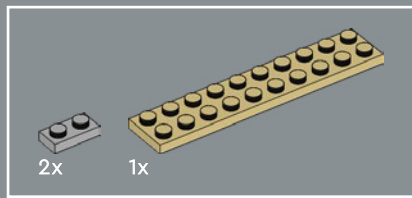

30

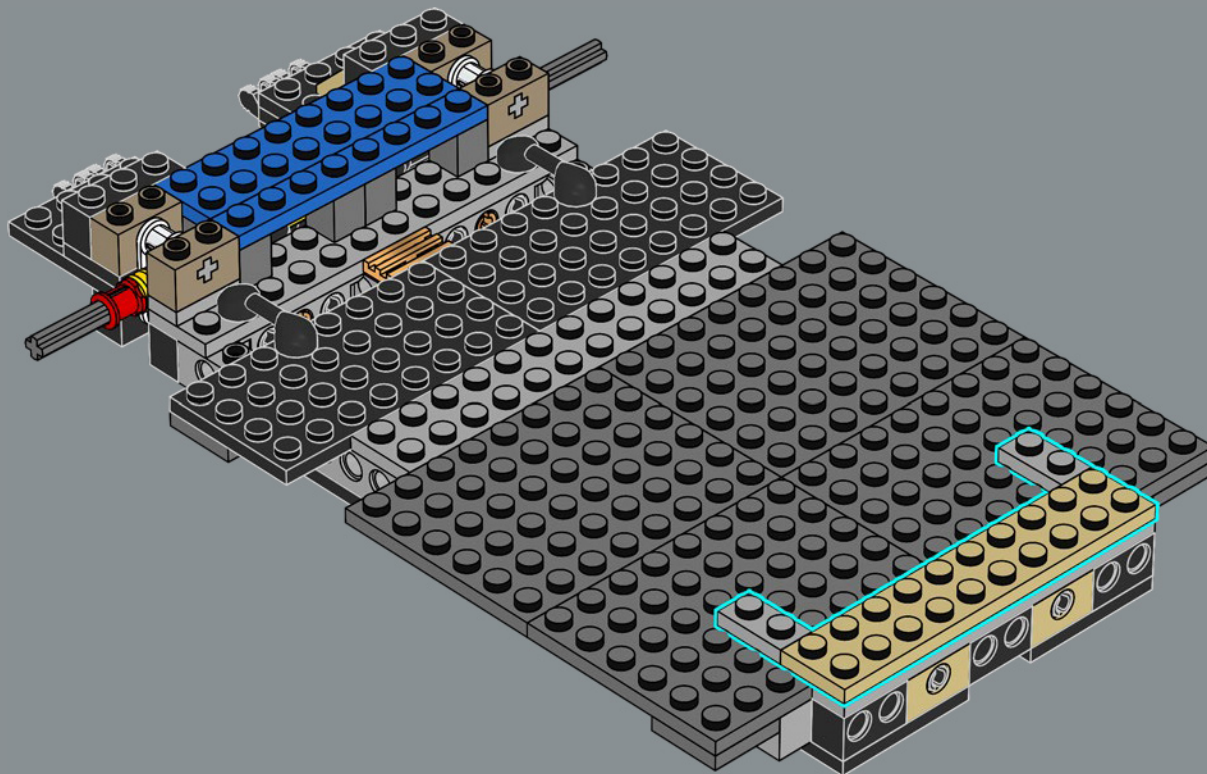

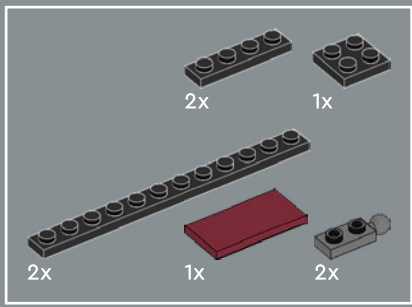

31

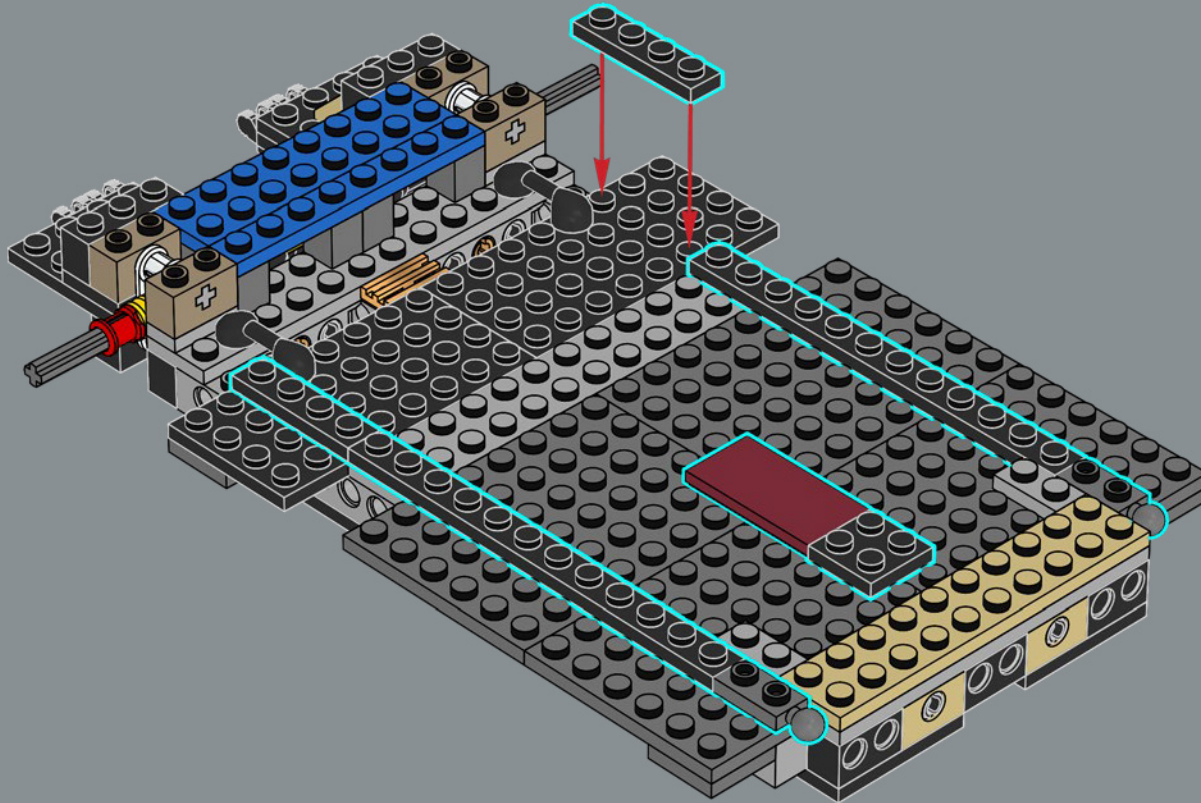

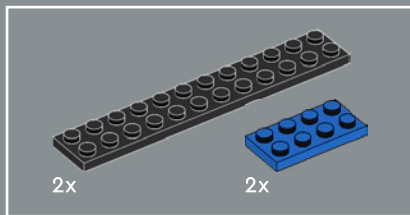

32

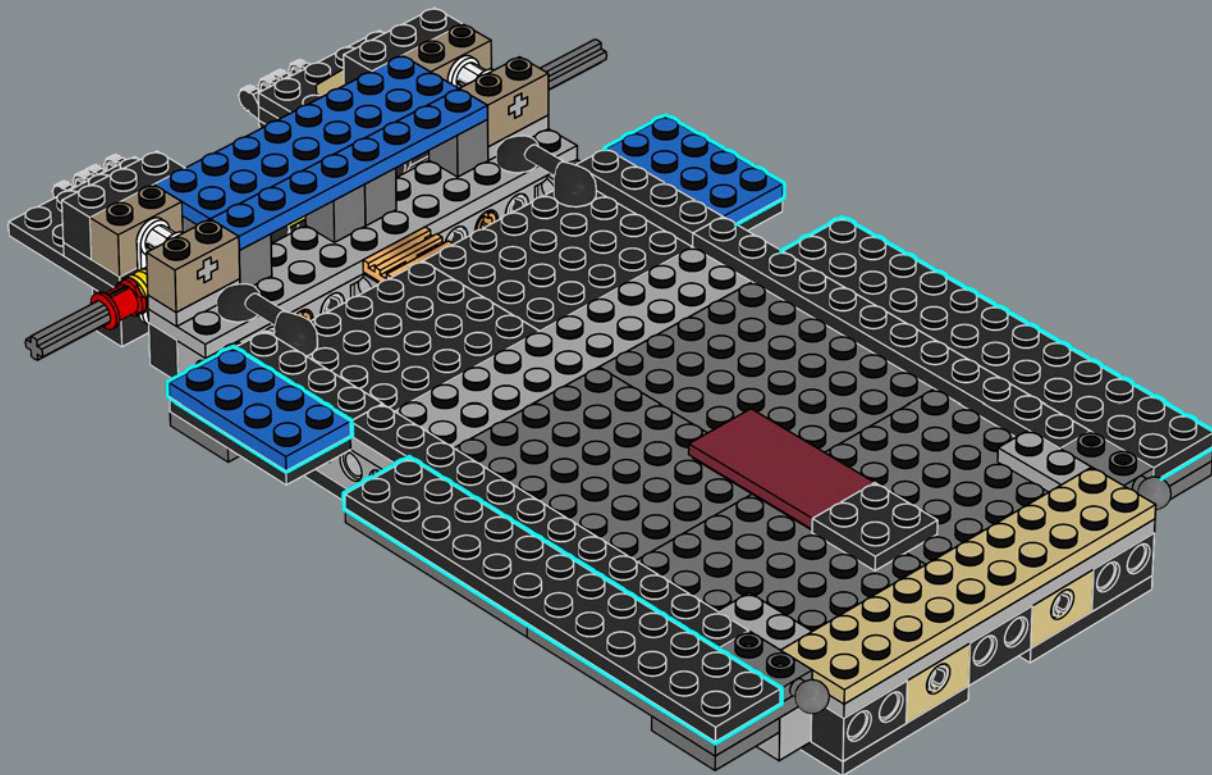

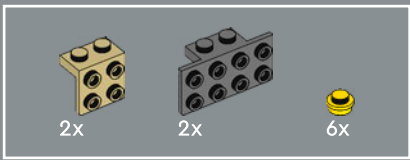

33

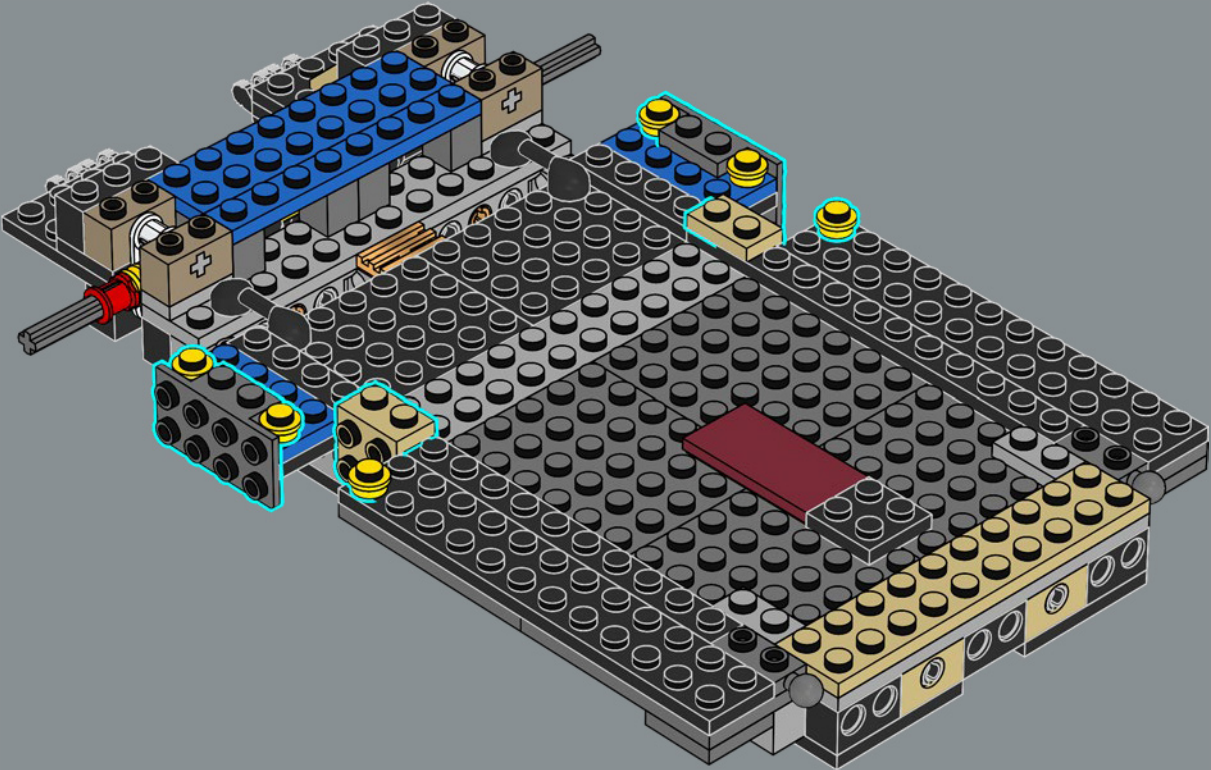

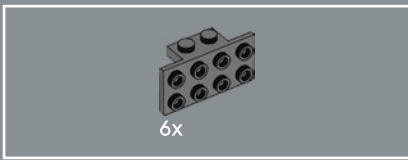

La première Lamborghini Countach a été
conçue par Carrozzeria Bertone.

34

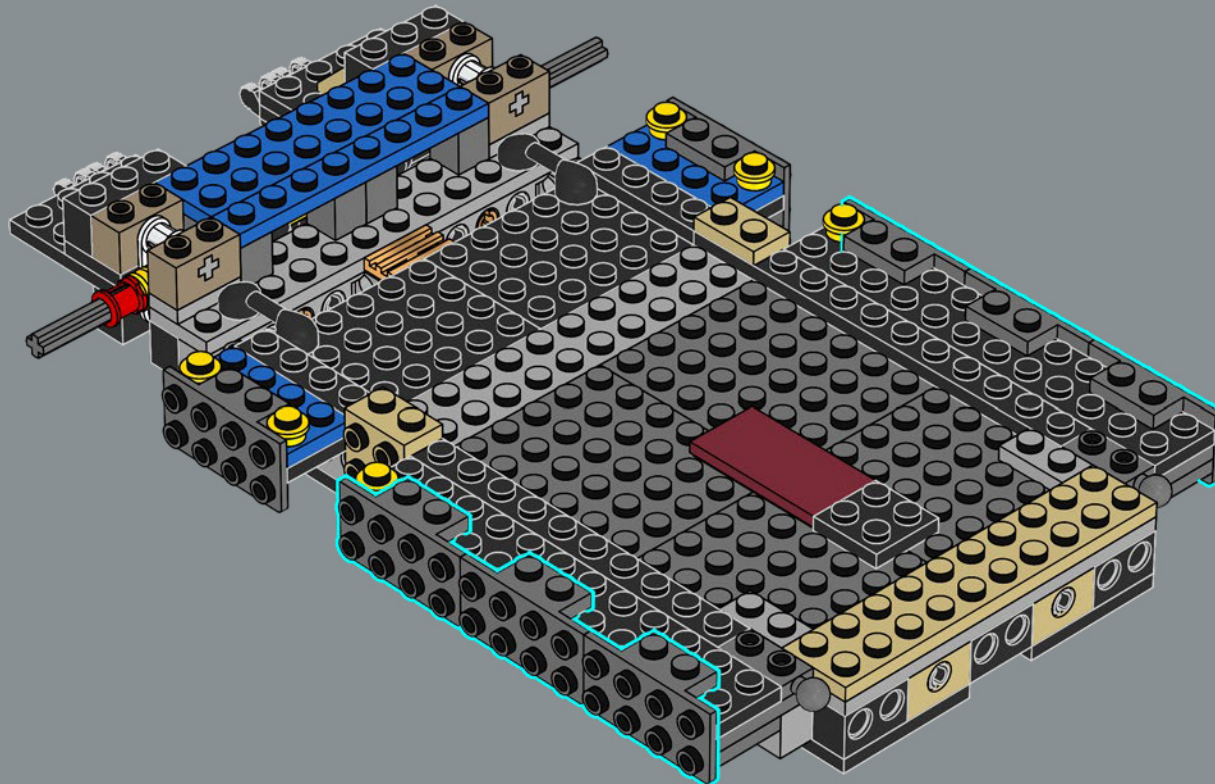

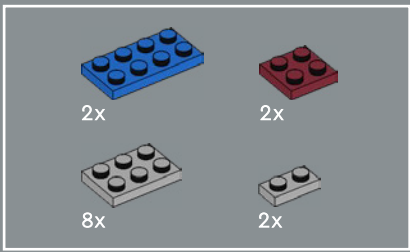

35

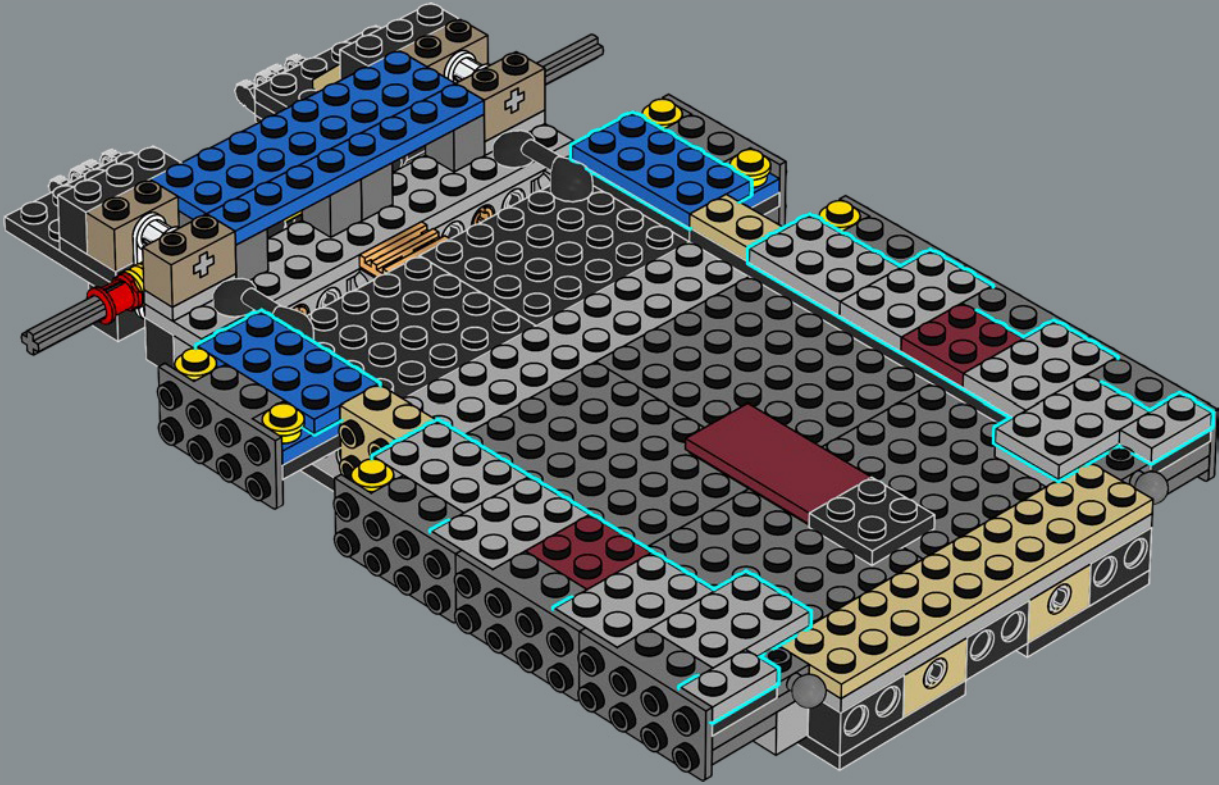

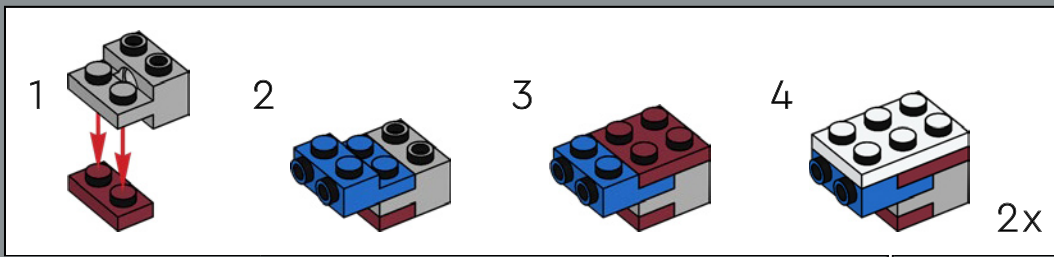
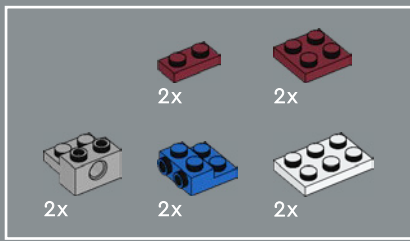

36

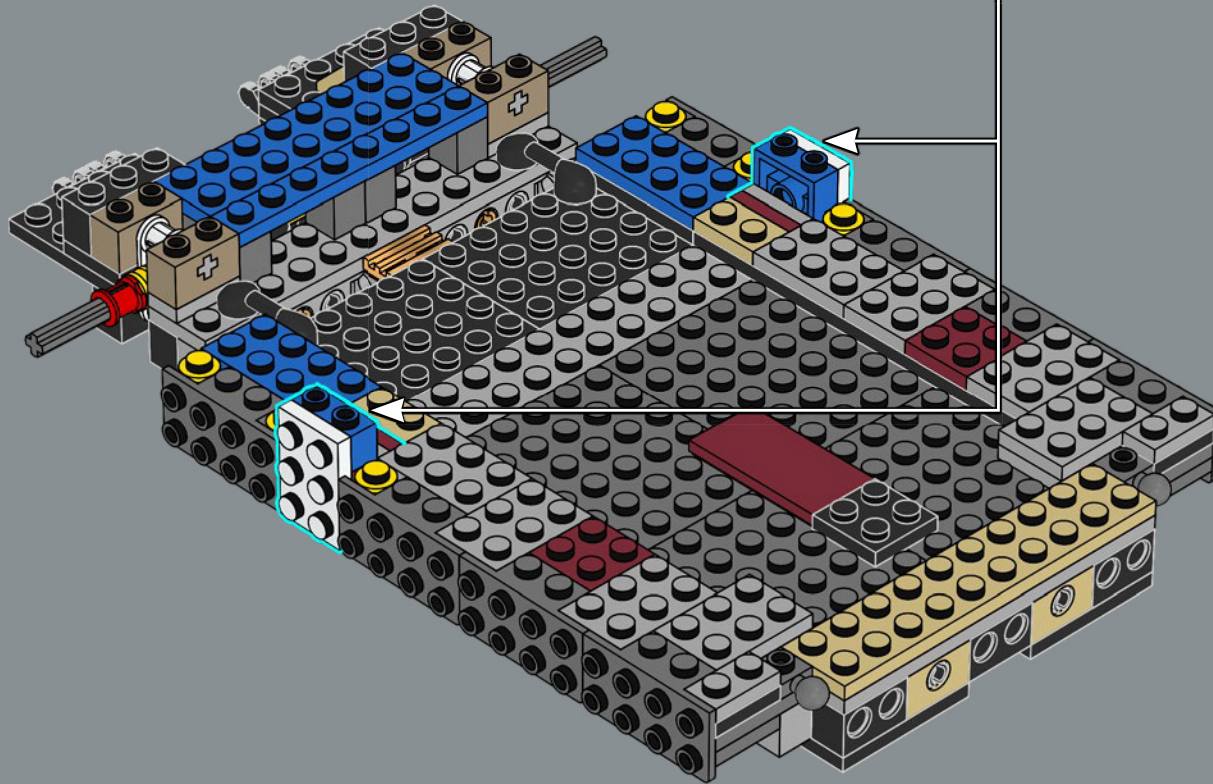

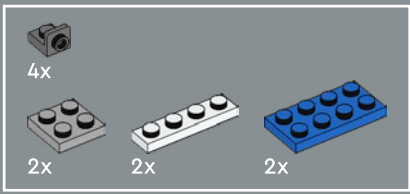

37

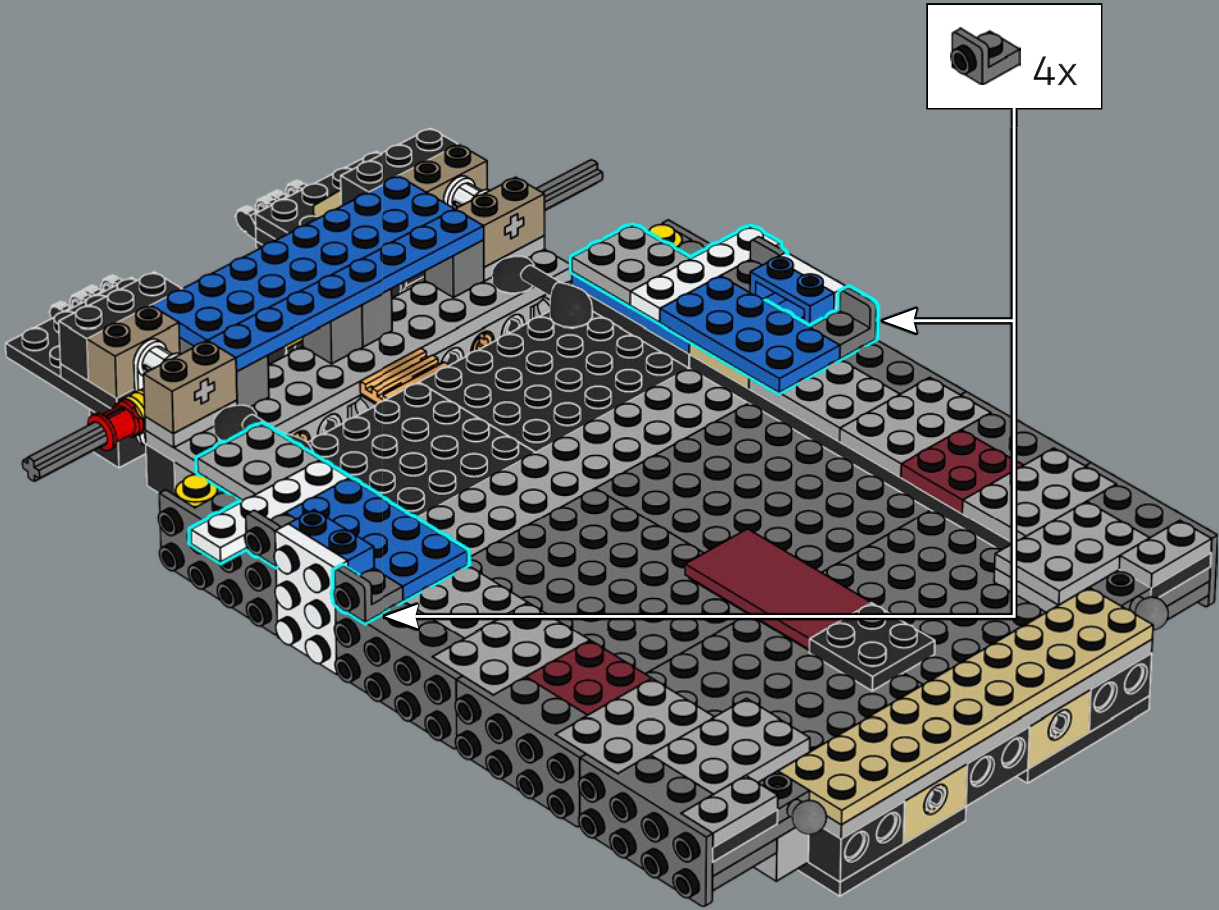



38

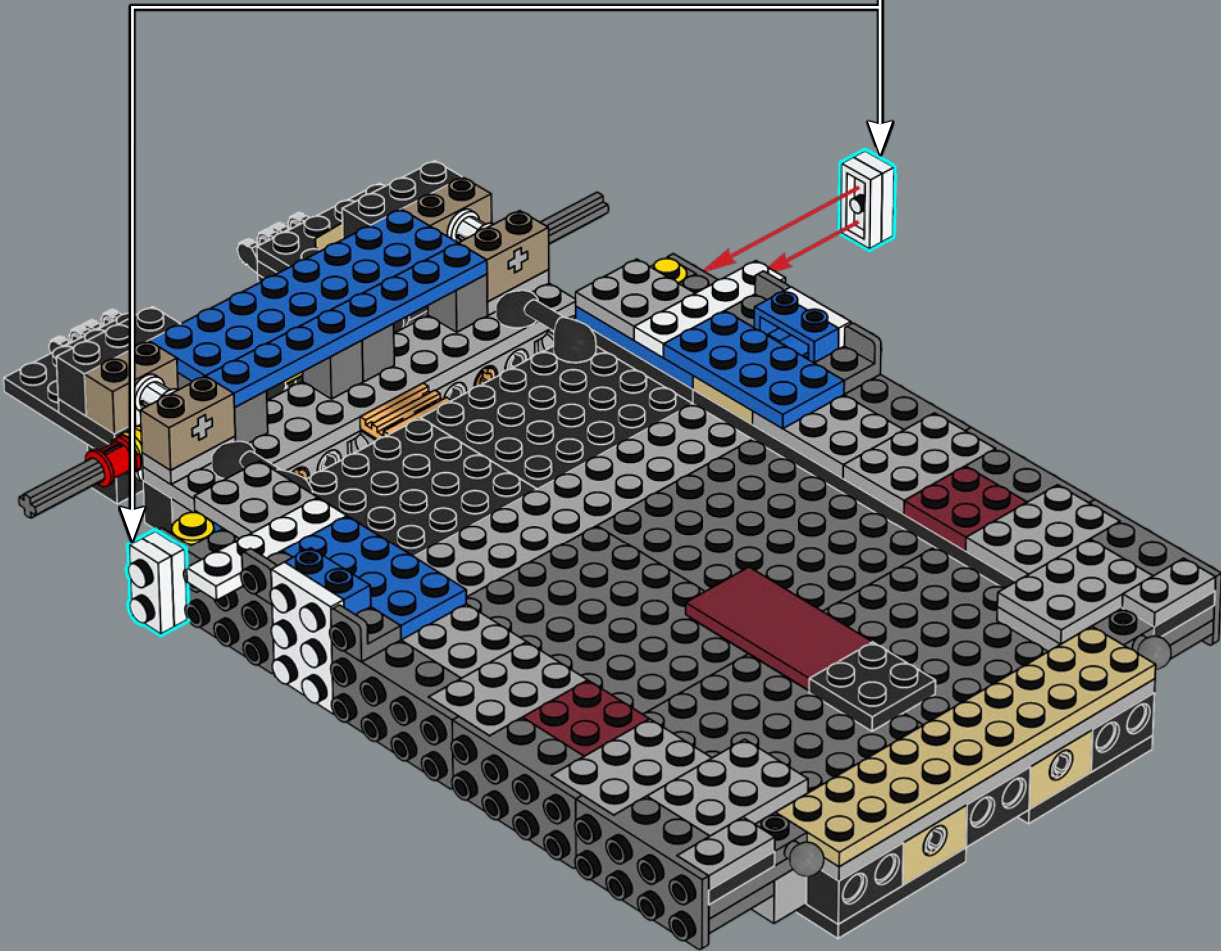
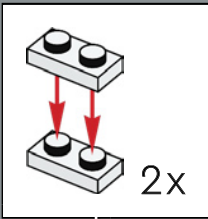

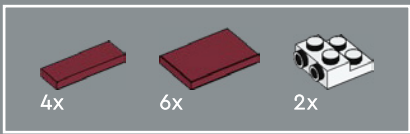

39

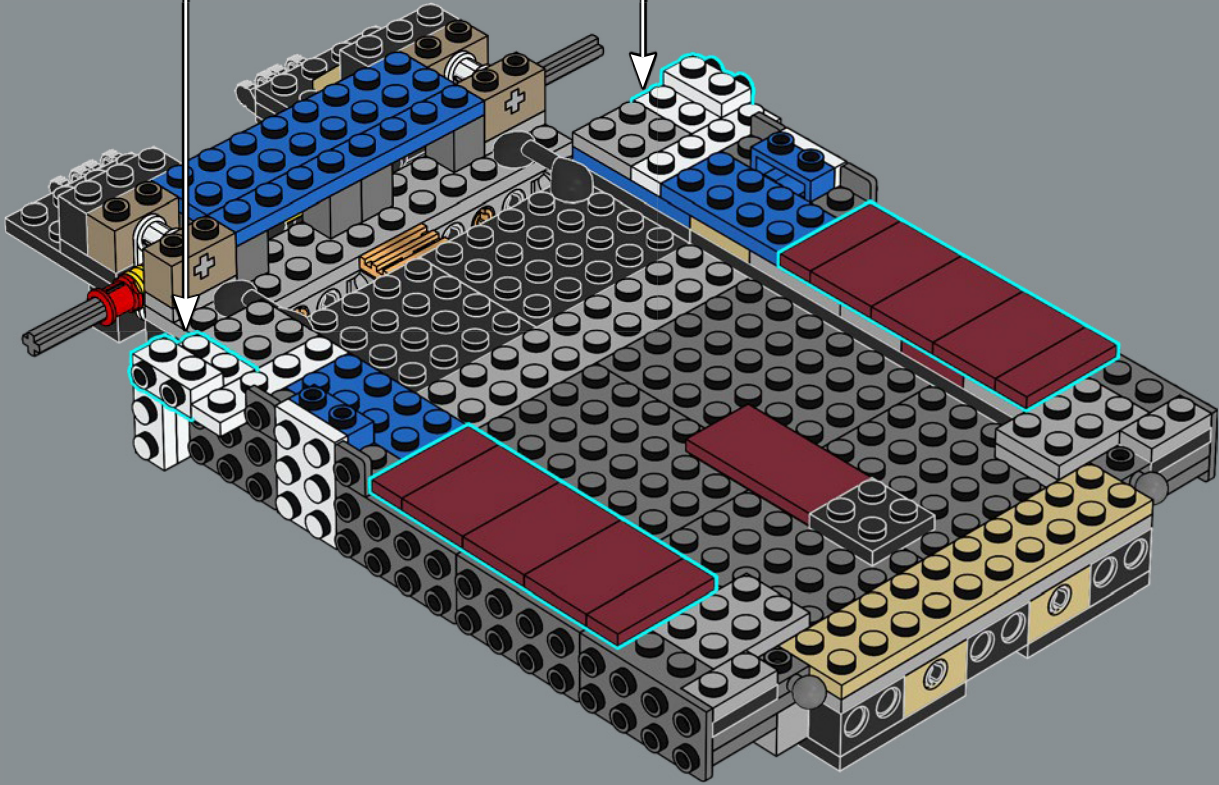
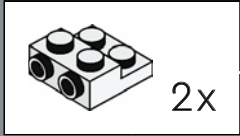

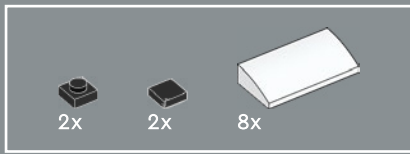

40

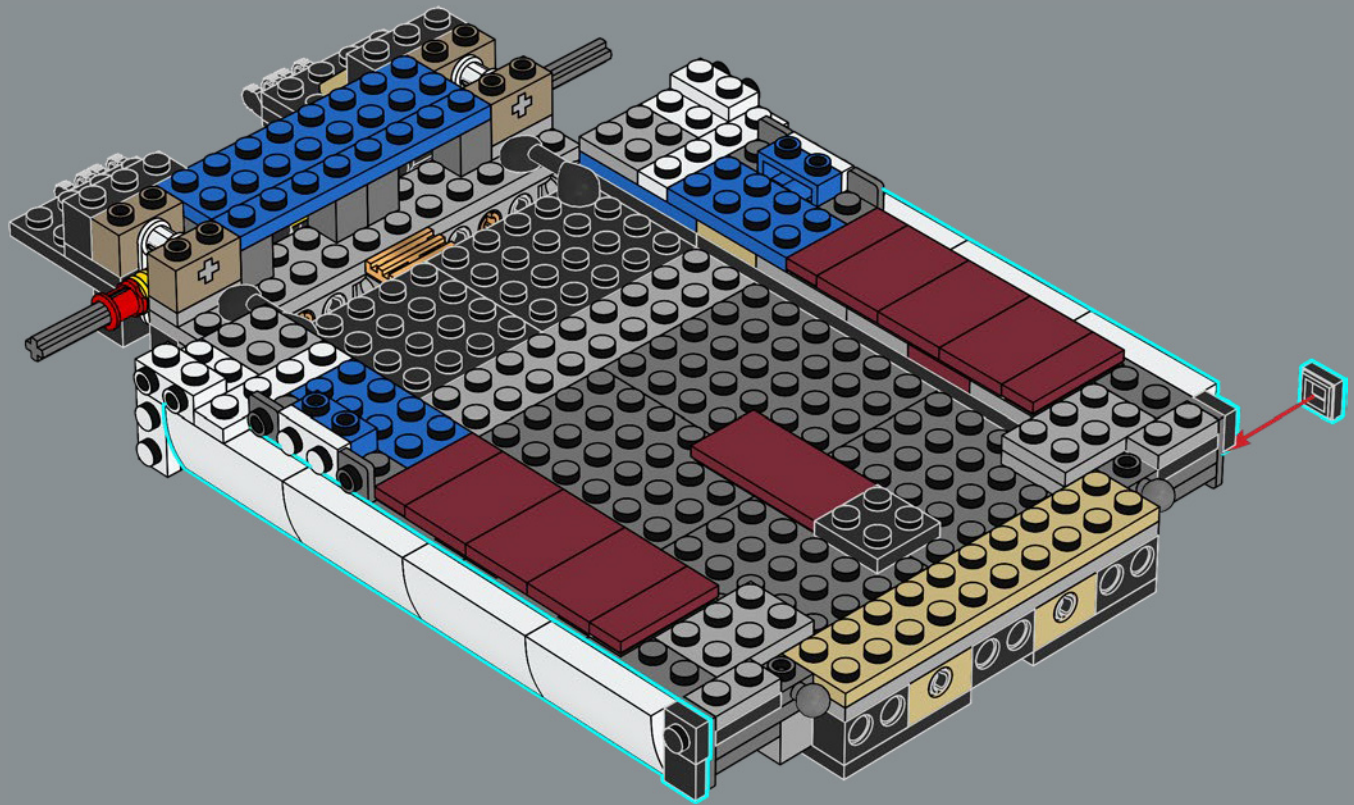

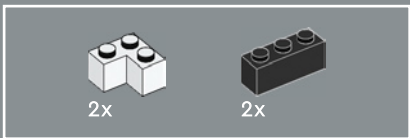

41

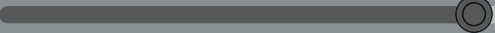
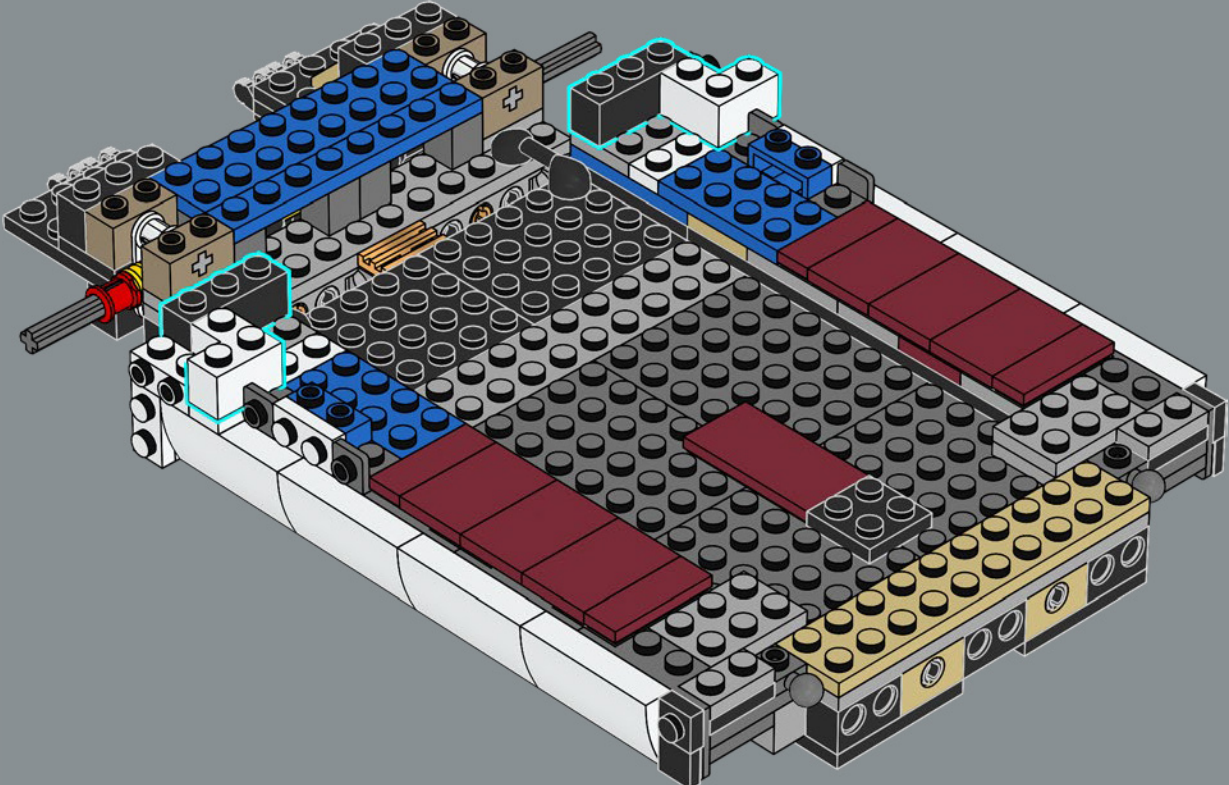

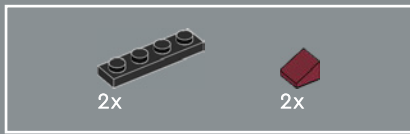

42

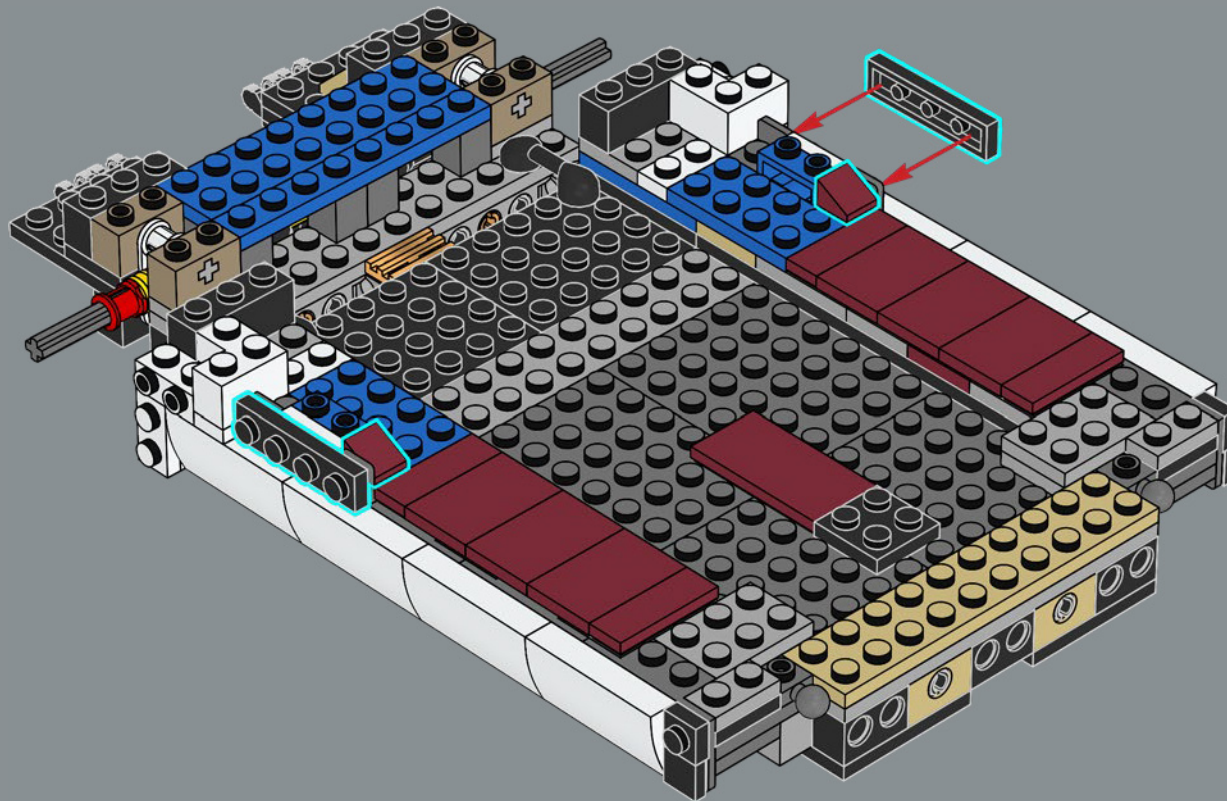



4x

43

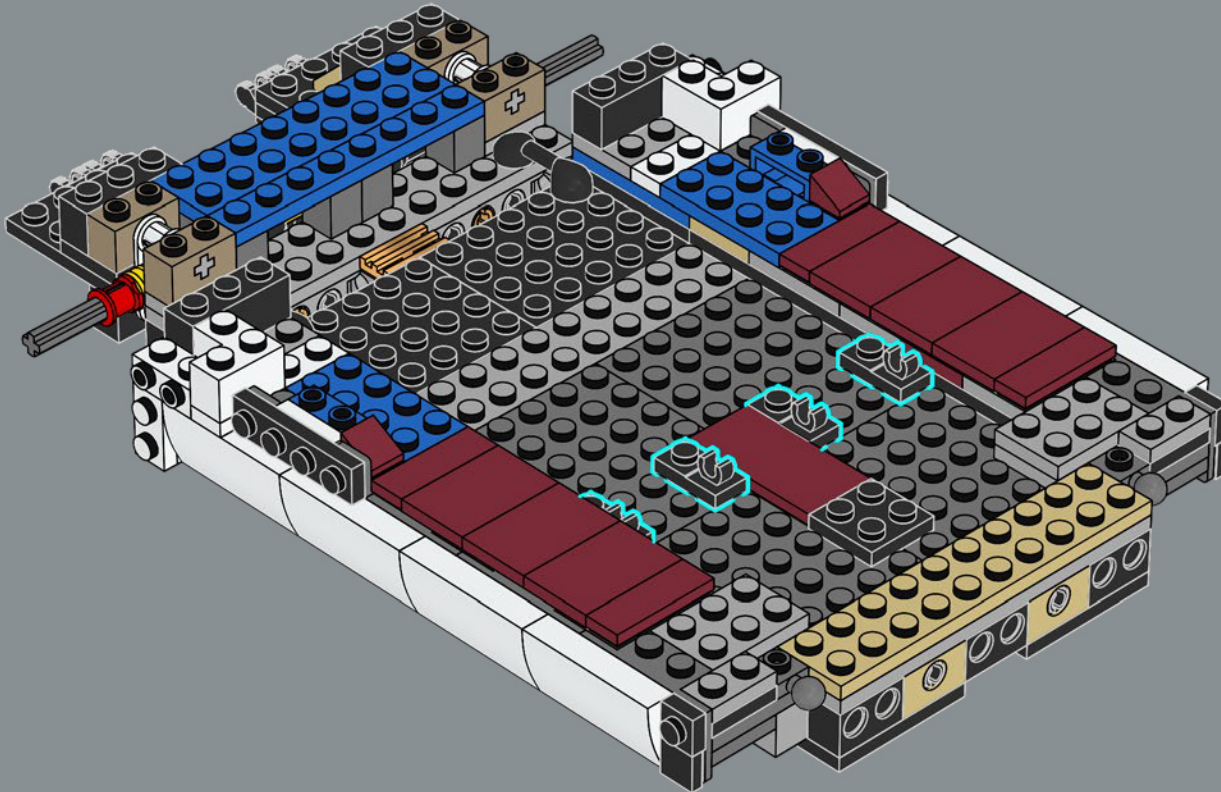

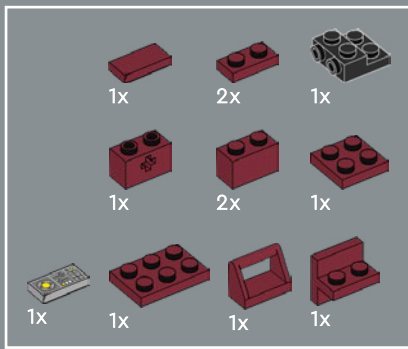

4

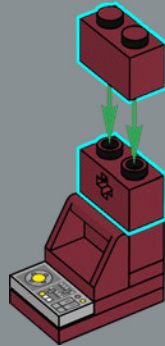

7

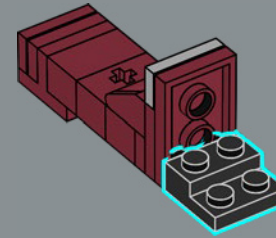

44

1

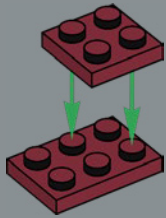

2

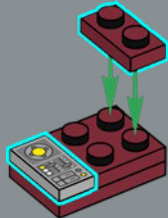

3

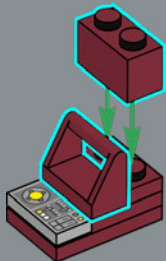

5

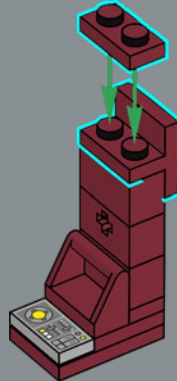

6

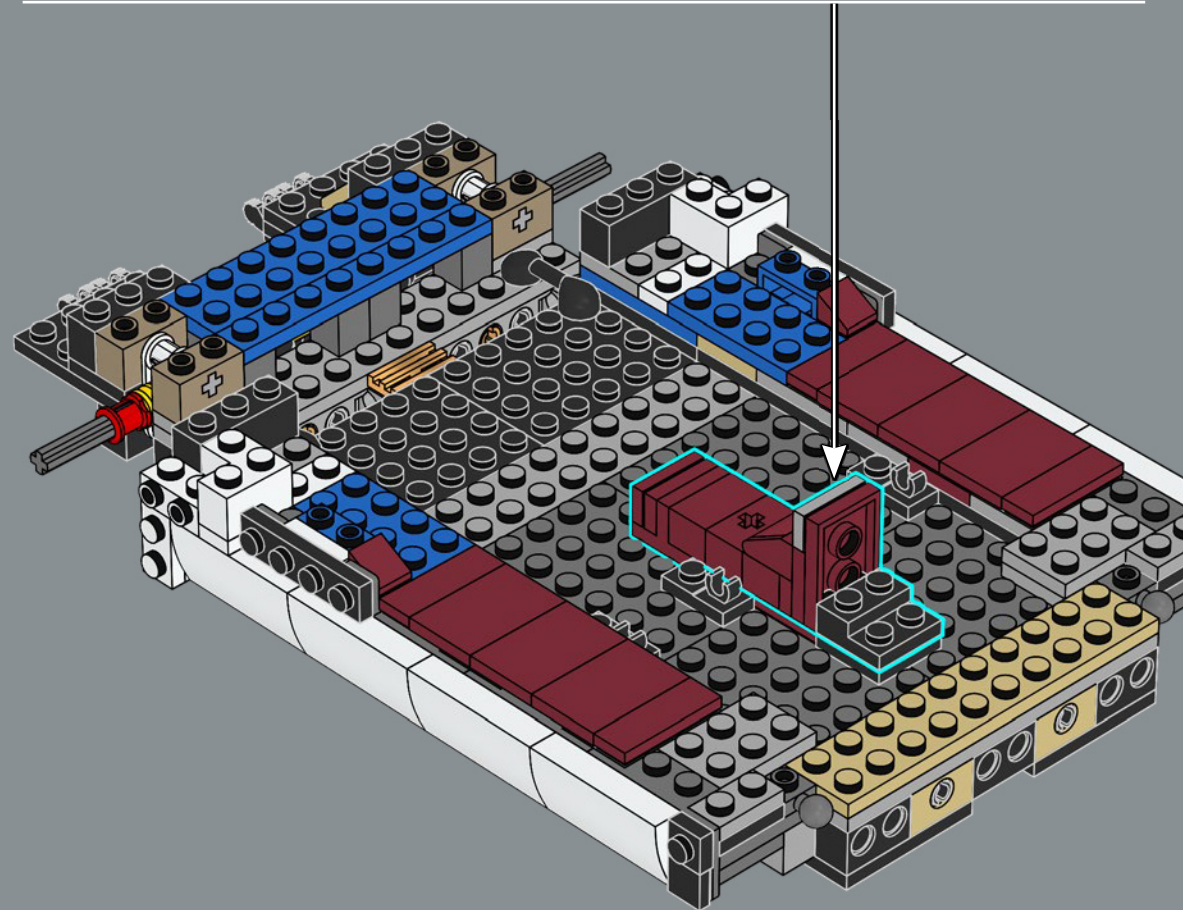
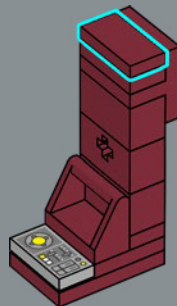



45

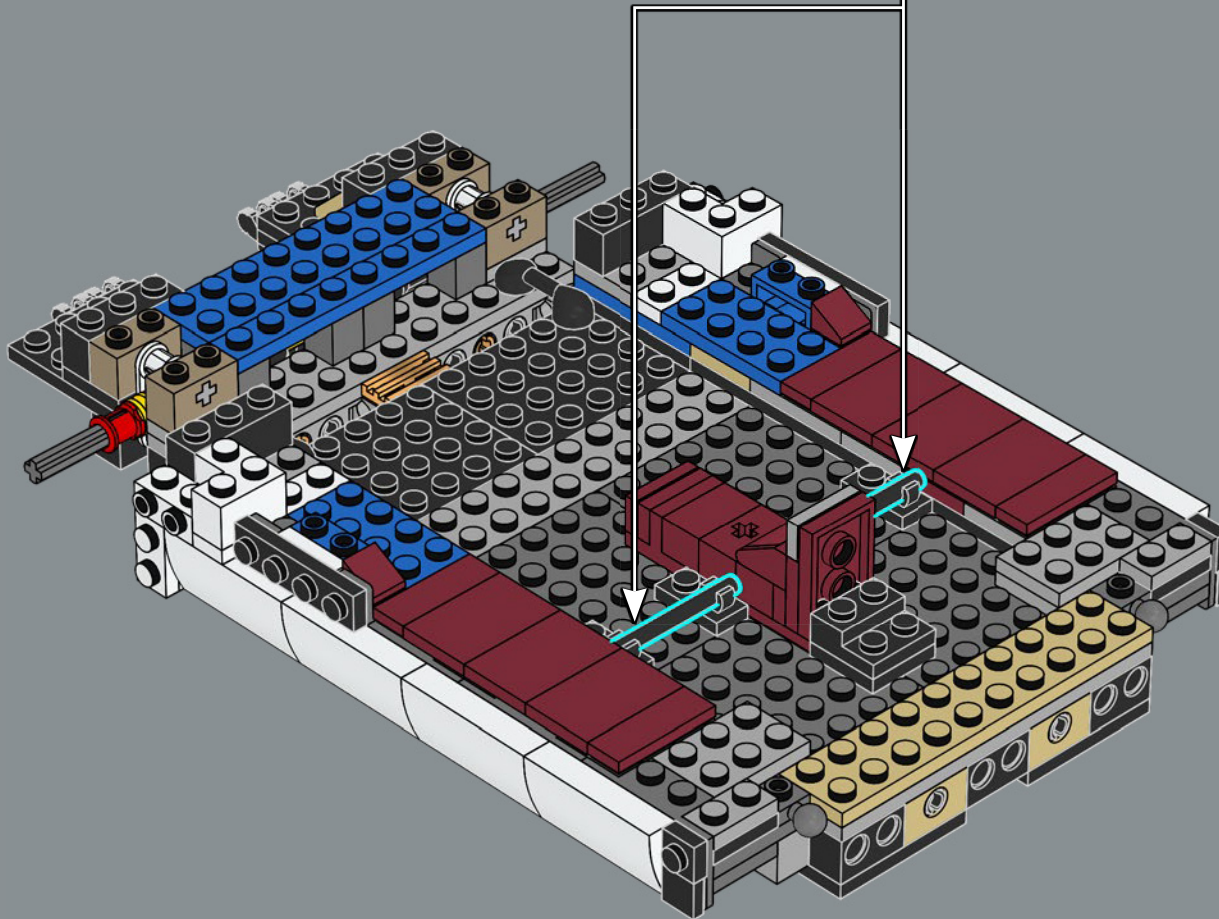
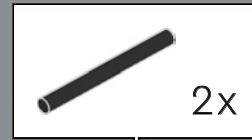

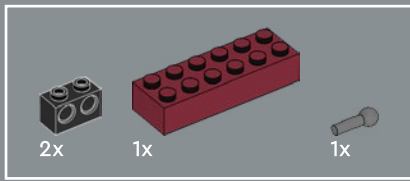

46

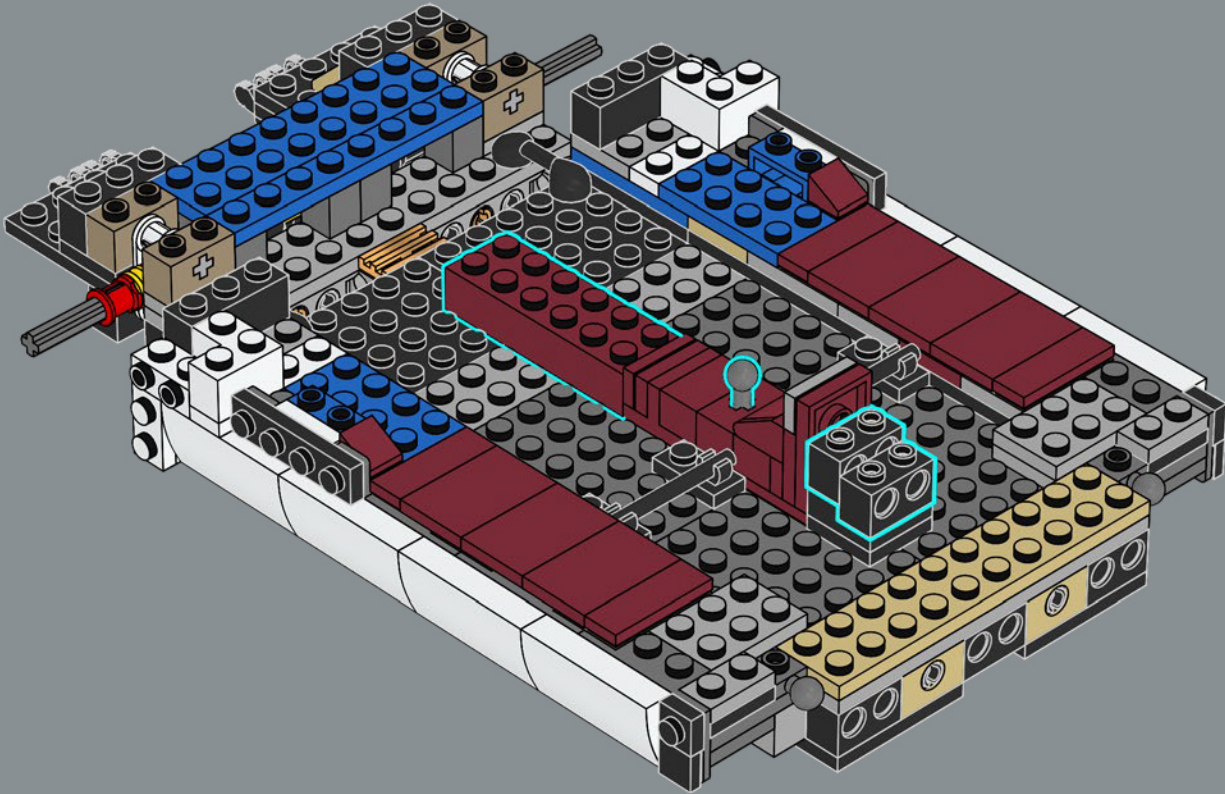

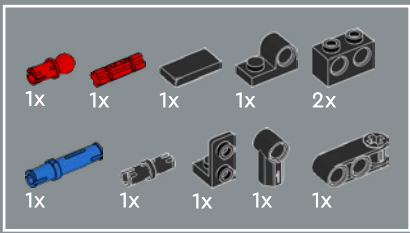

47

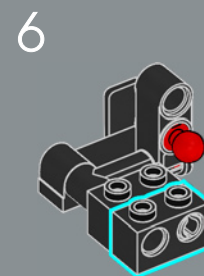
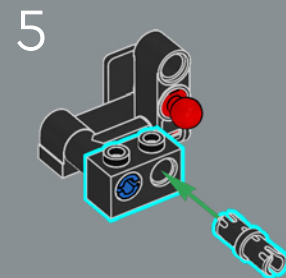
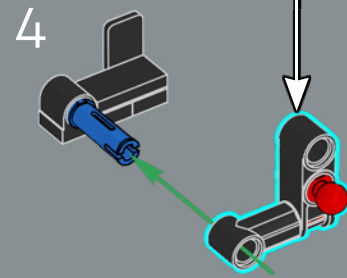
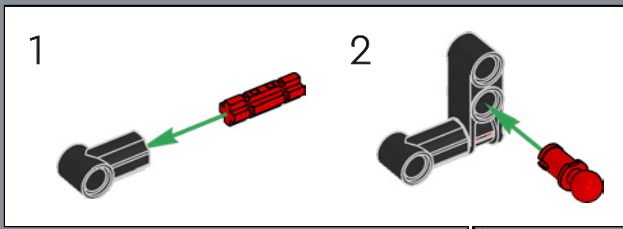
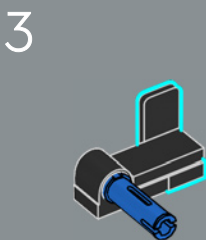
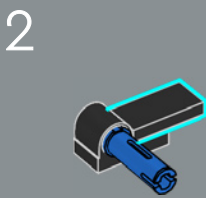
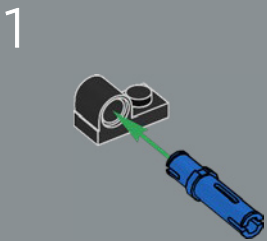

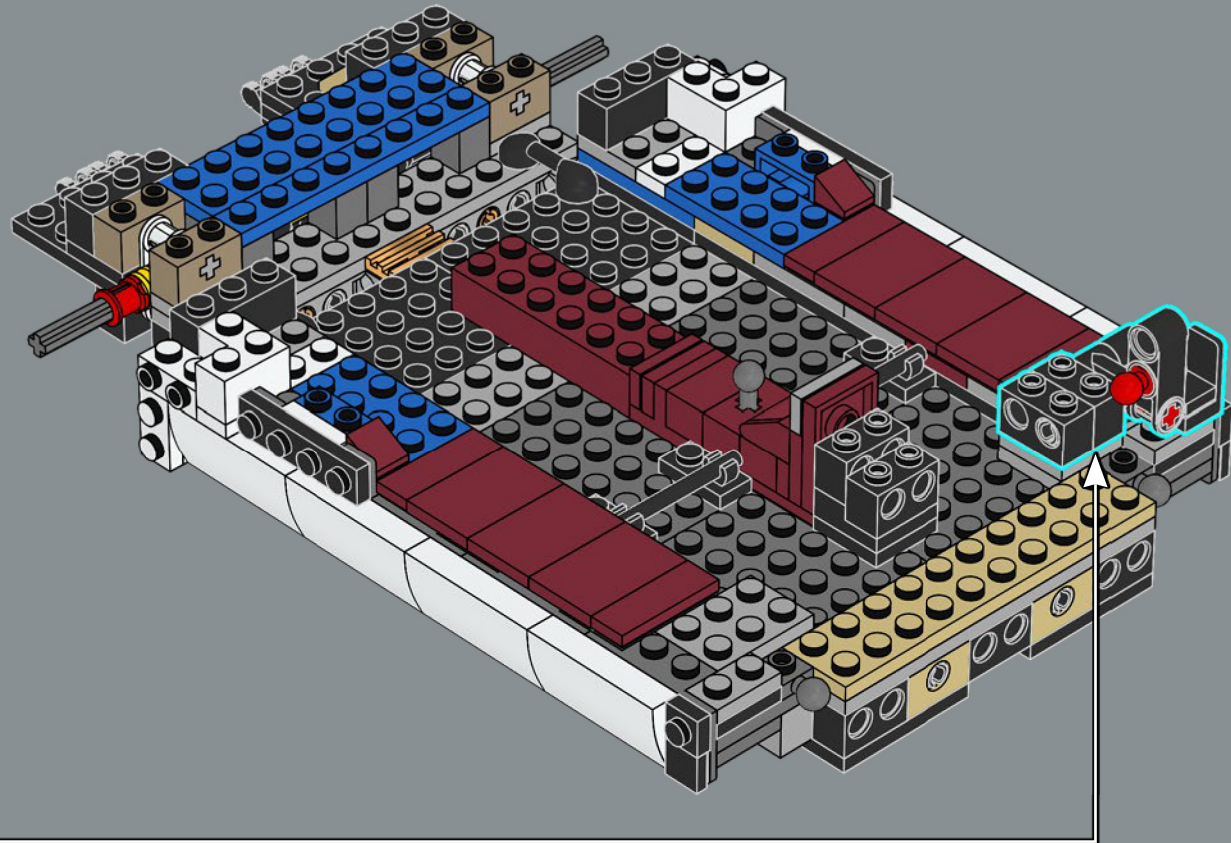

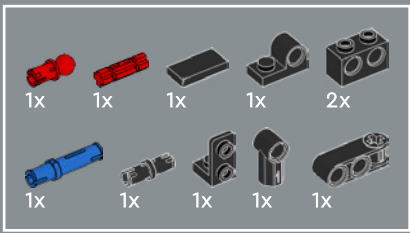

48

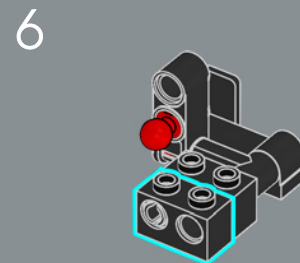
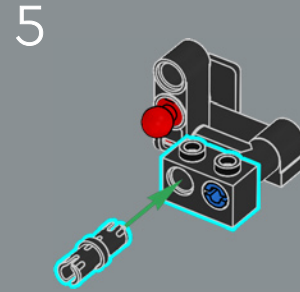
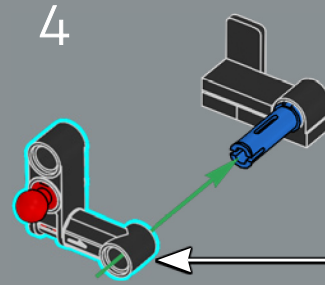
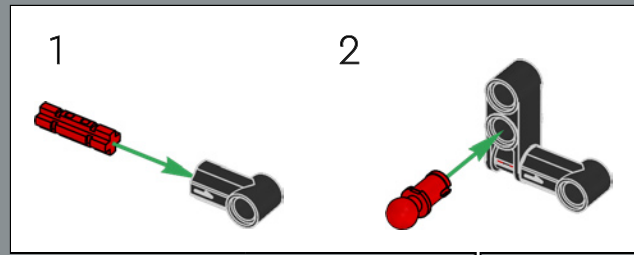
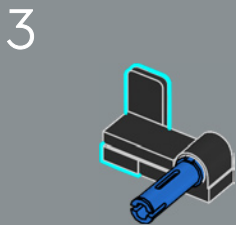
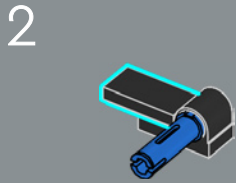
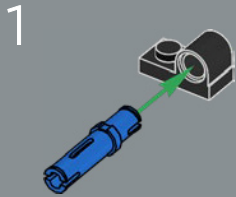

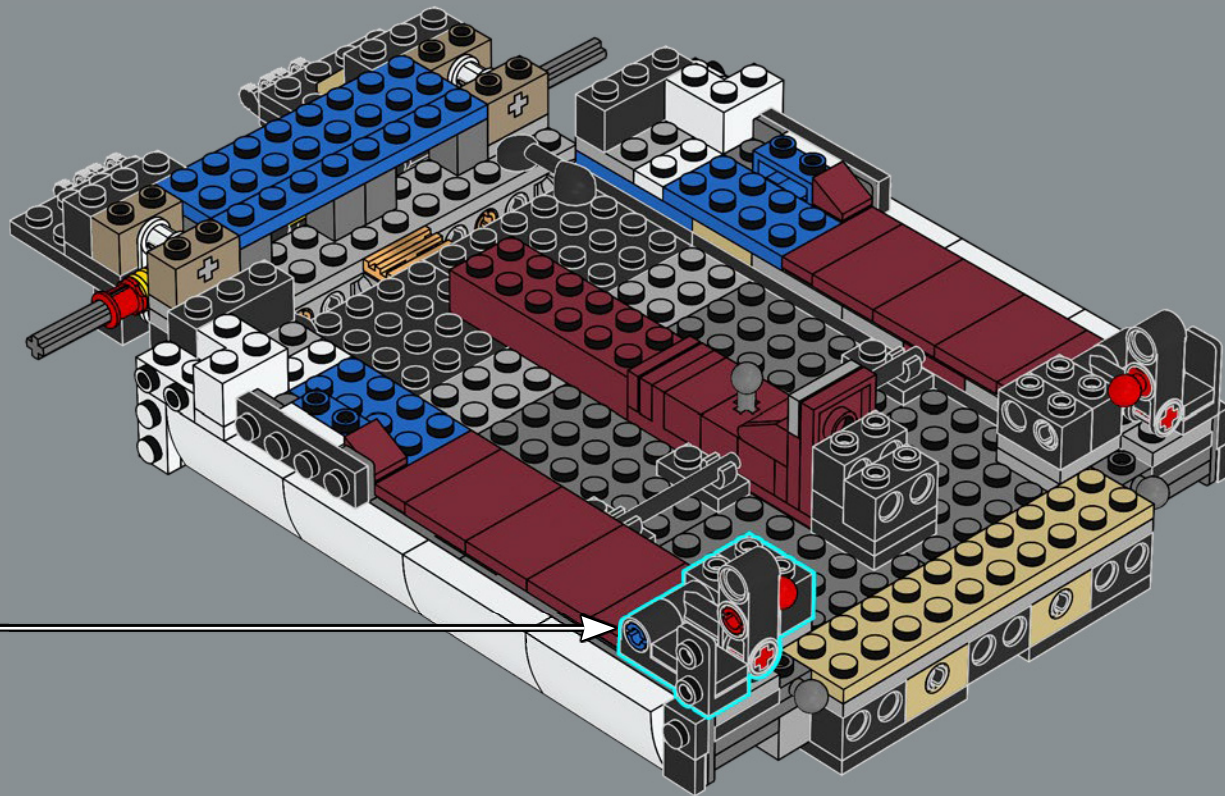

0
2x

49

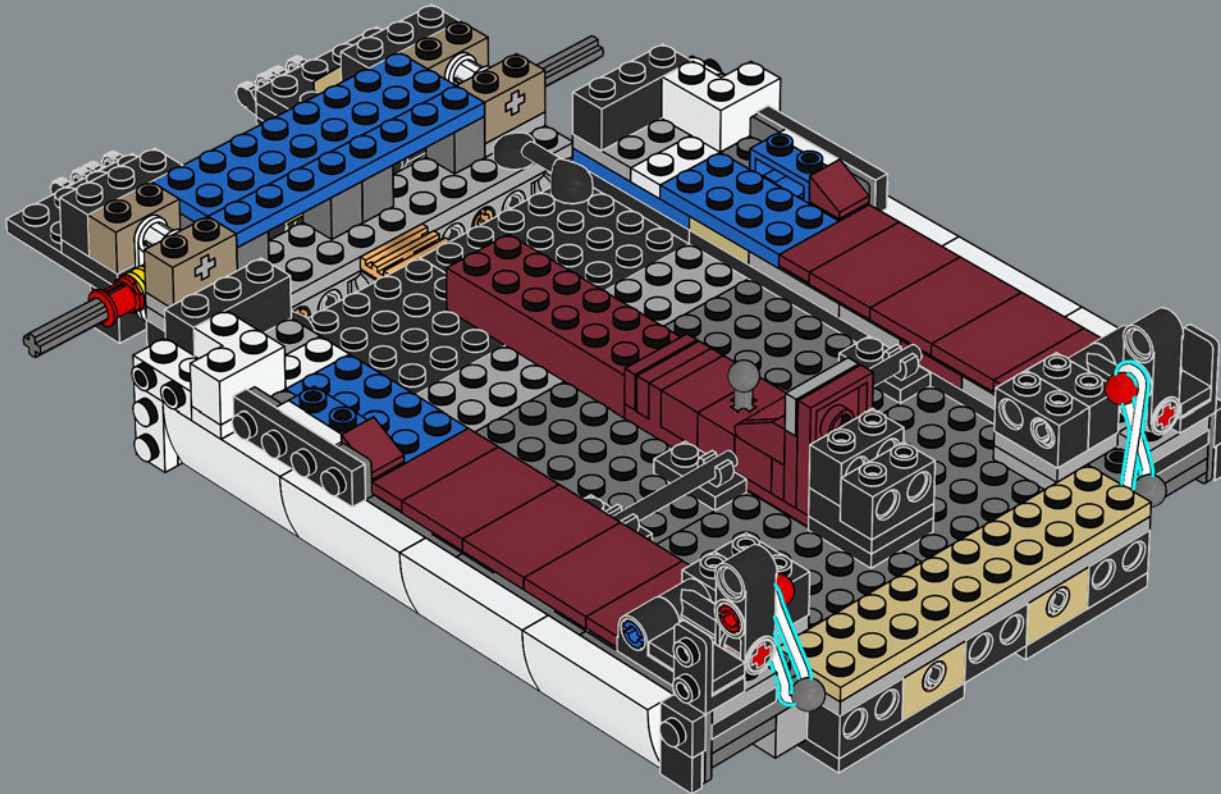

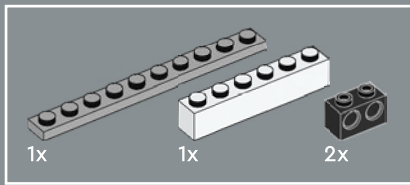

50

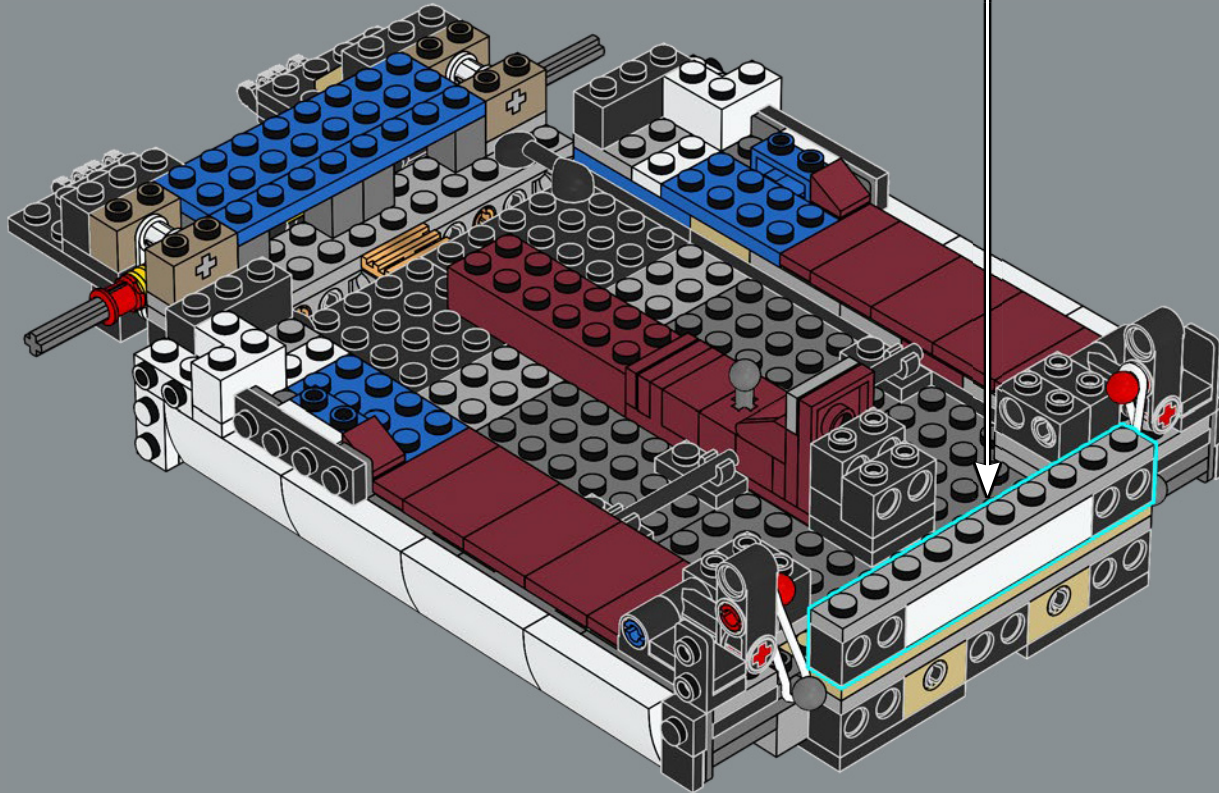
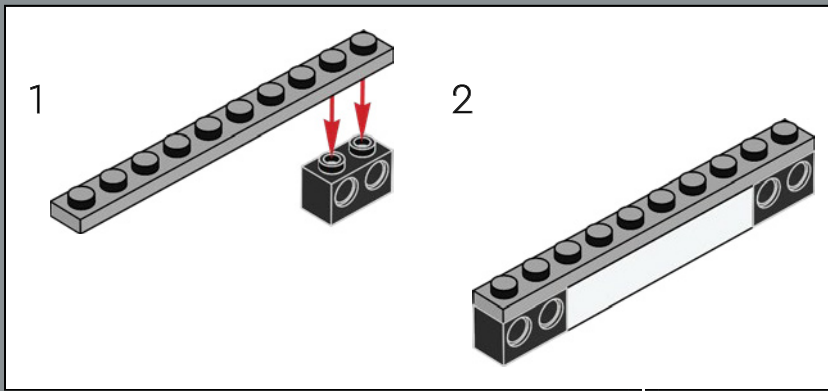

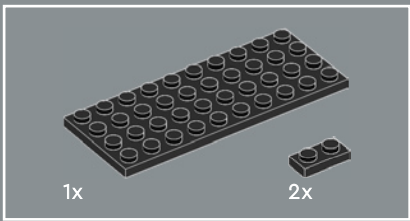

51

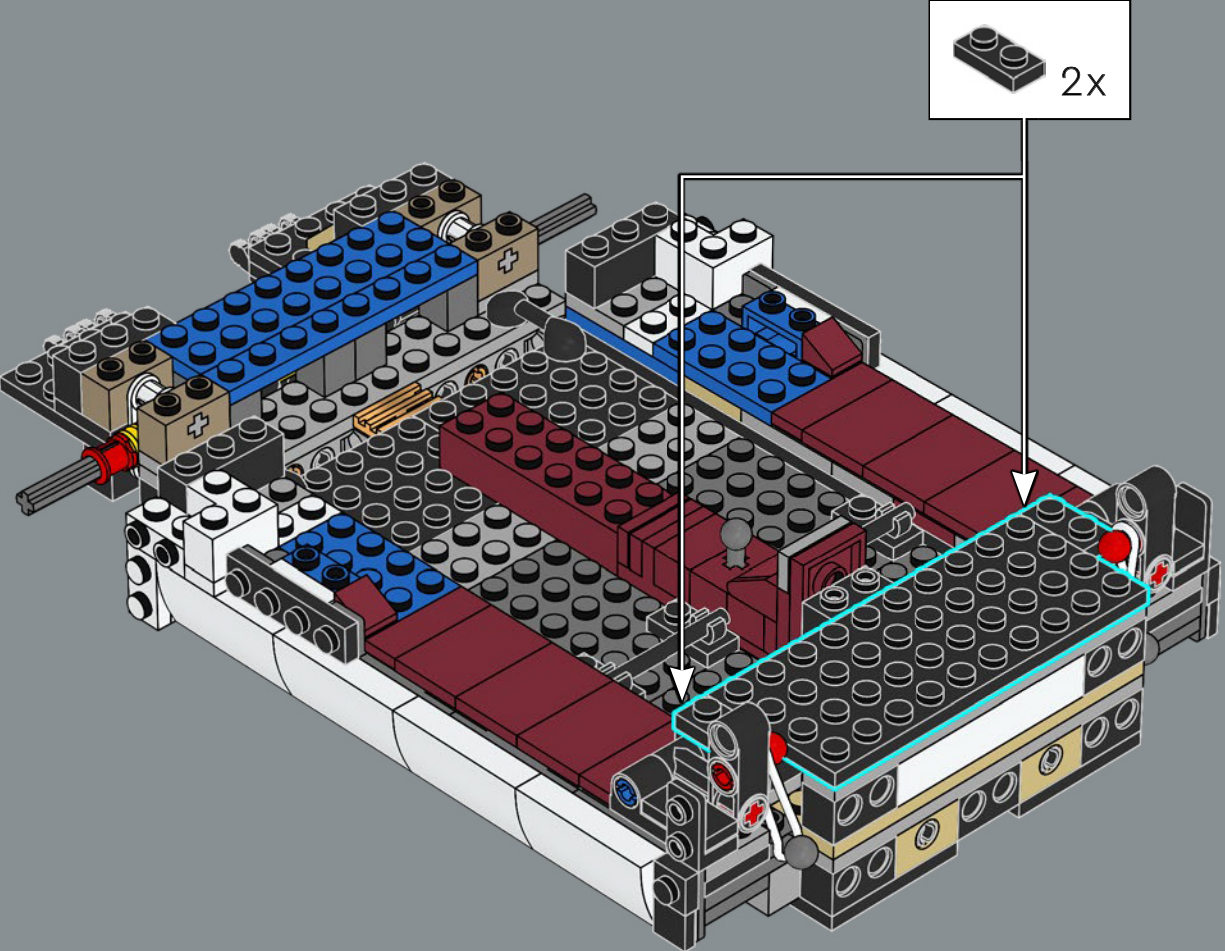

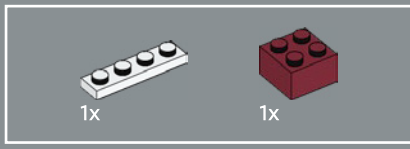

52

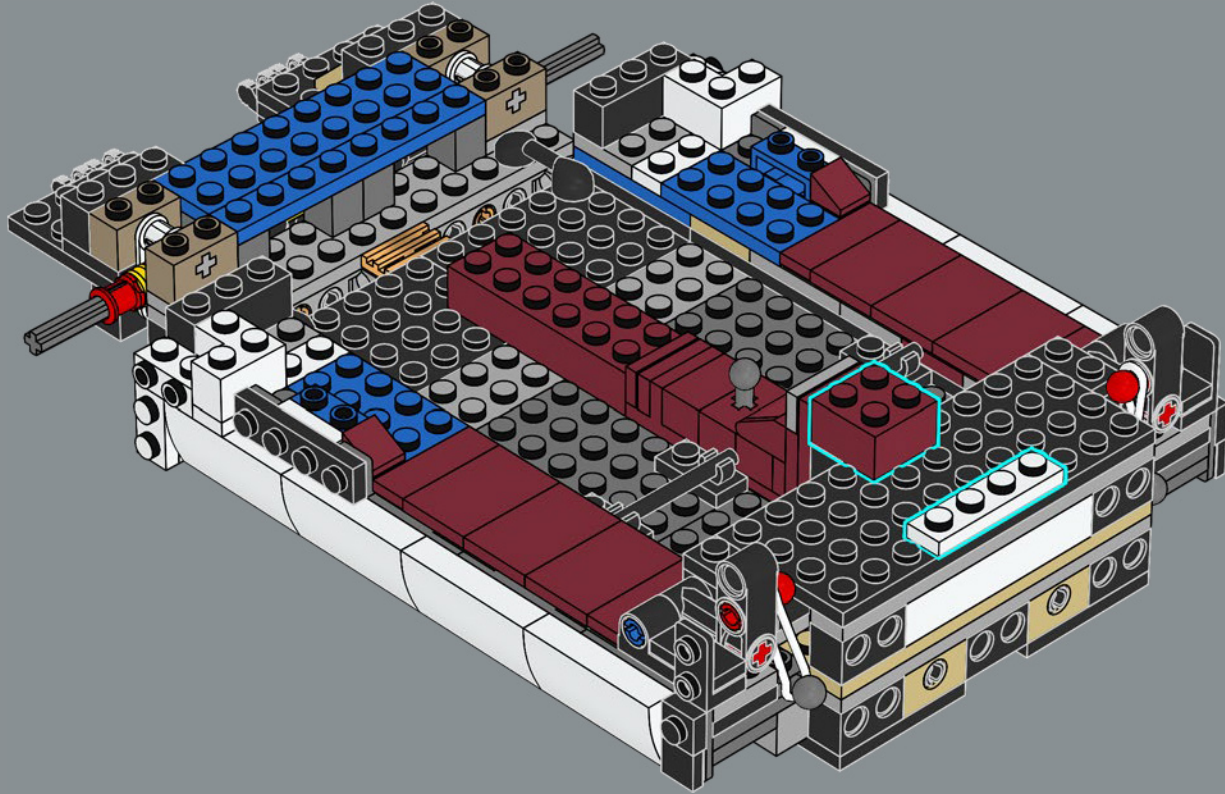

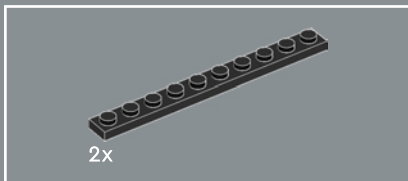
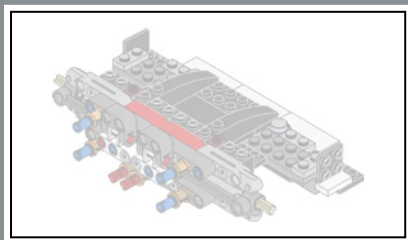

53

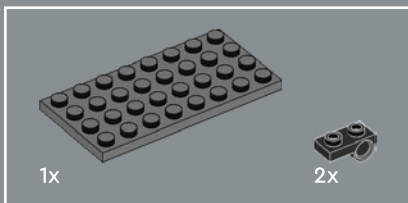
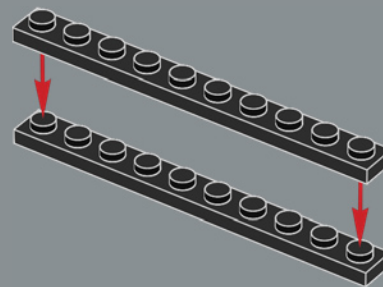

54

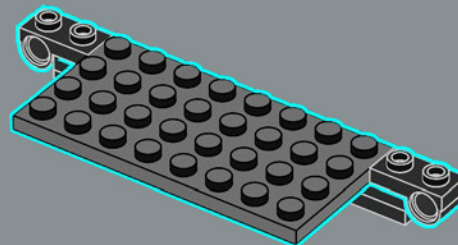

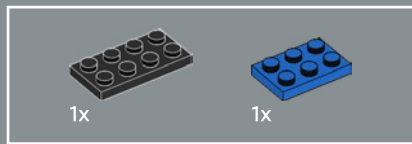

55

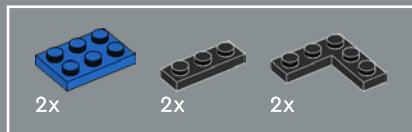
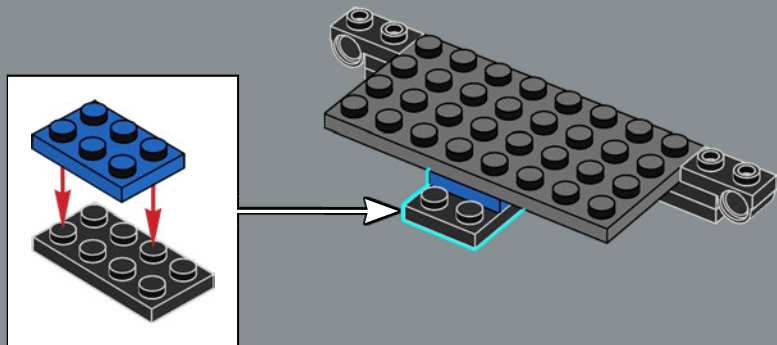

56

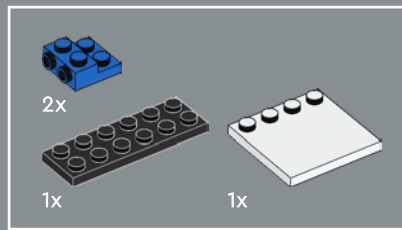
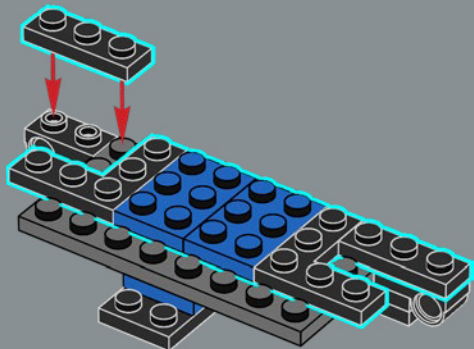

57

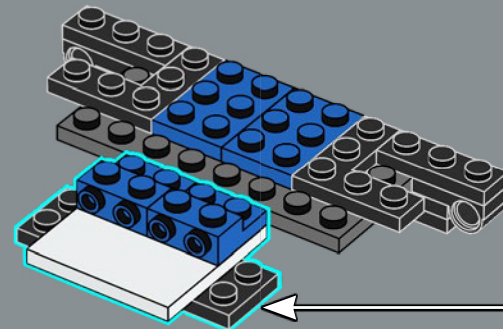
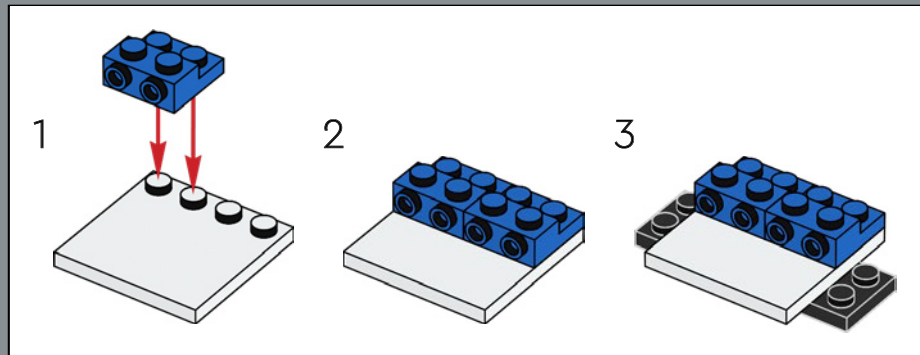

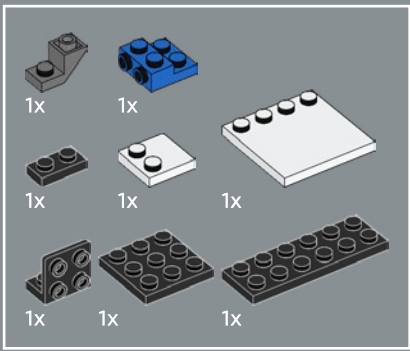

58

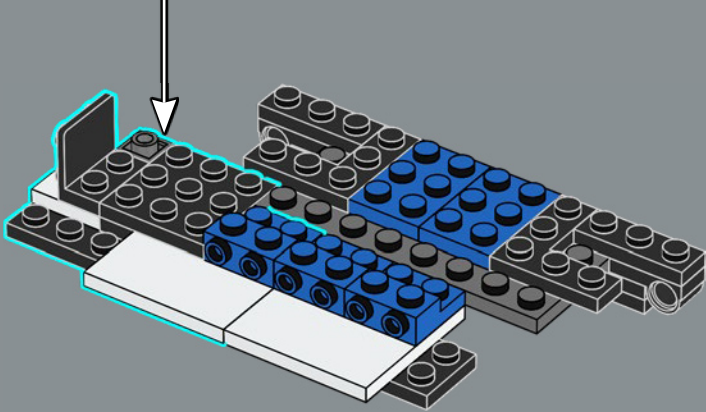
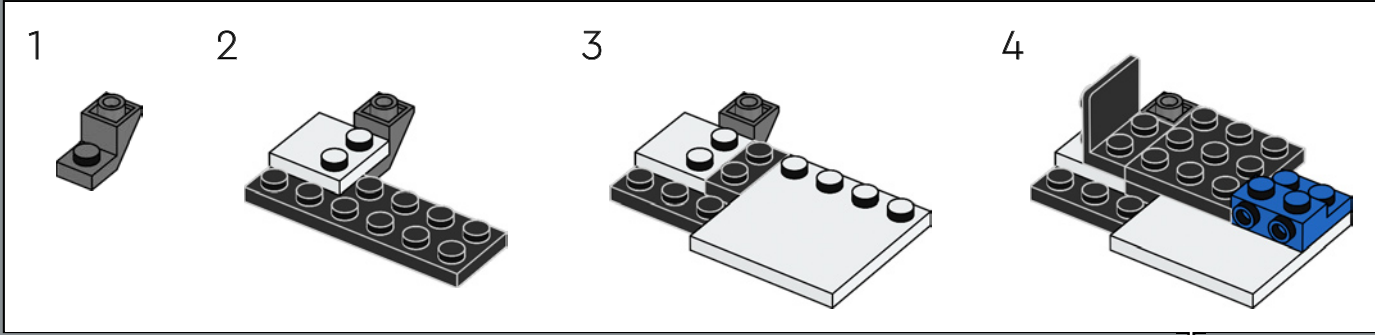

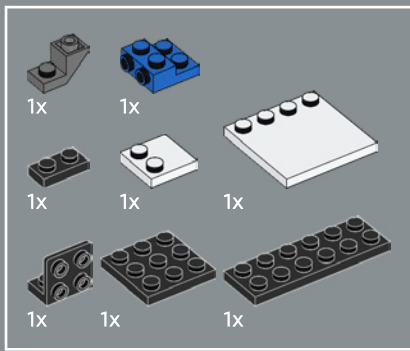

59

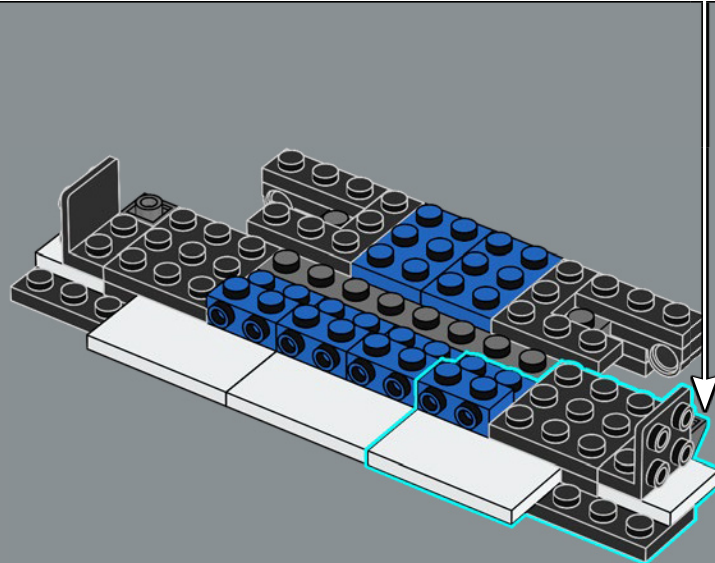
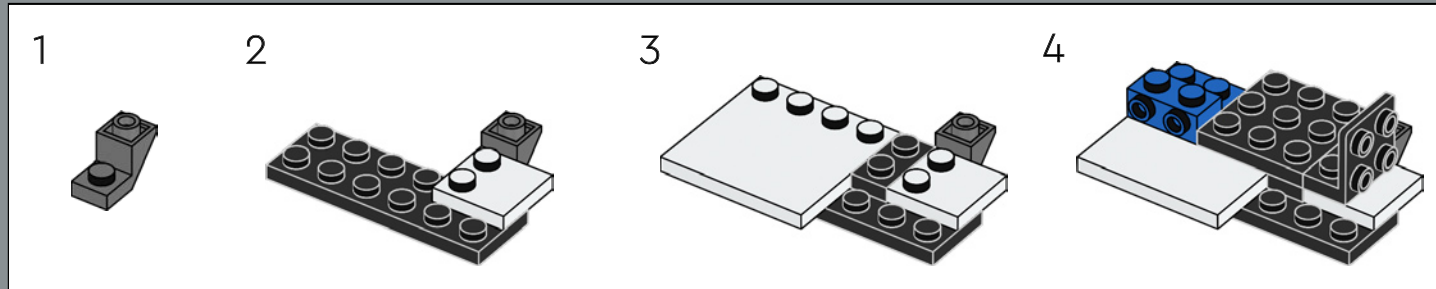

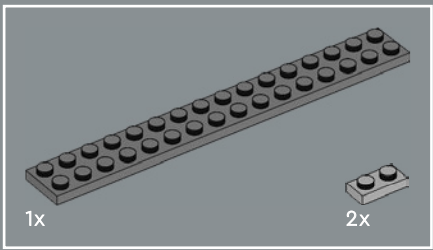

60

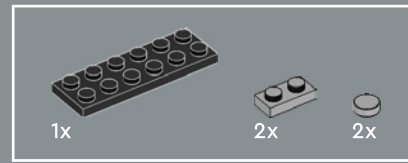
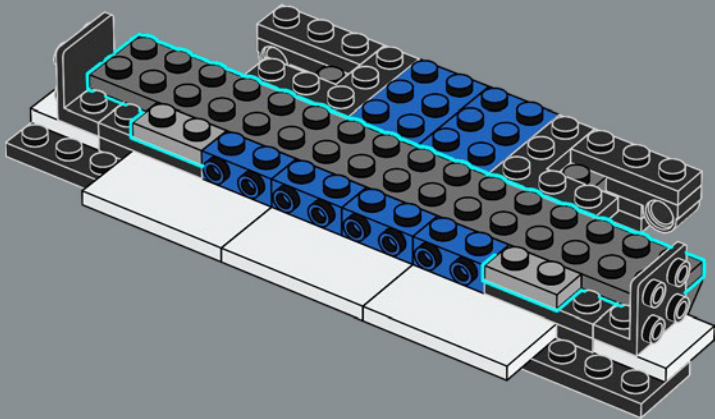

61

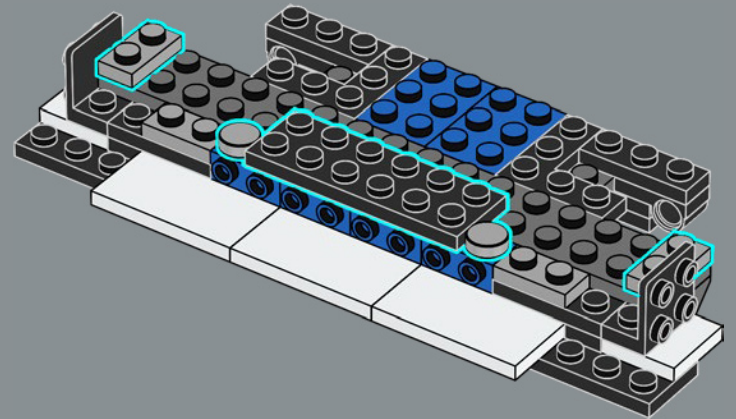

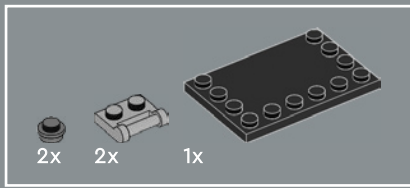

62

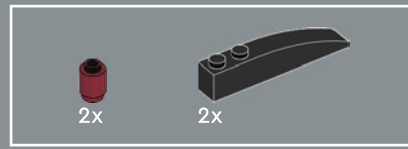
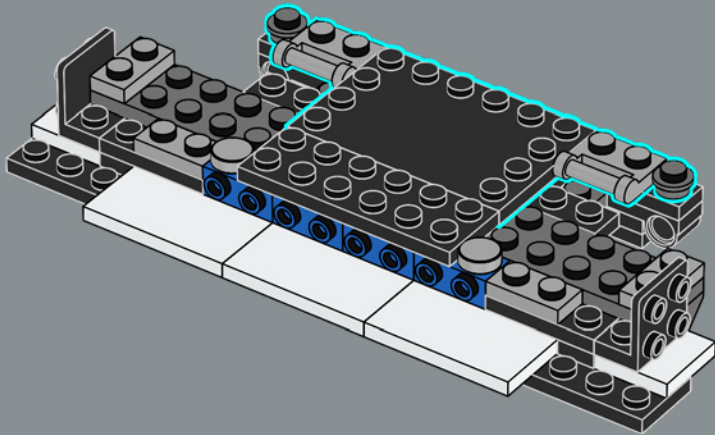

63

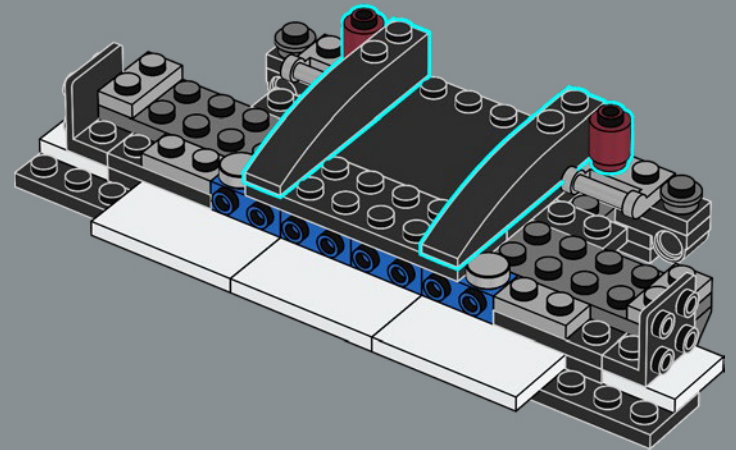

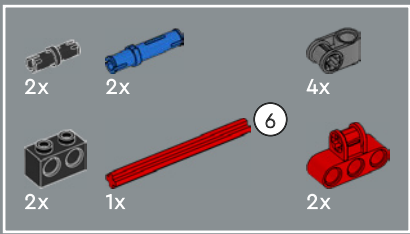

64

1

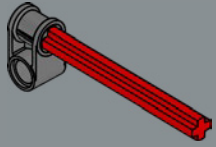

2

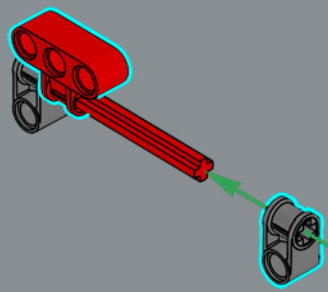

3

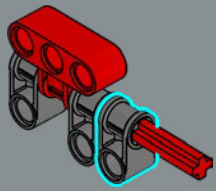

4

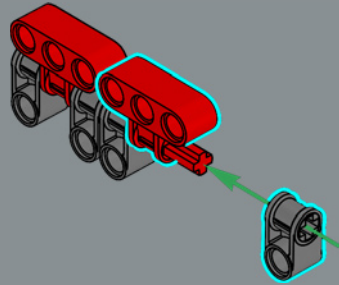

5

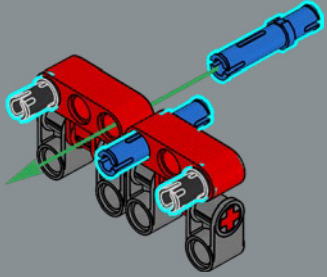

6

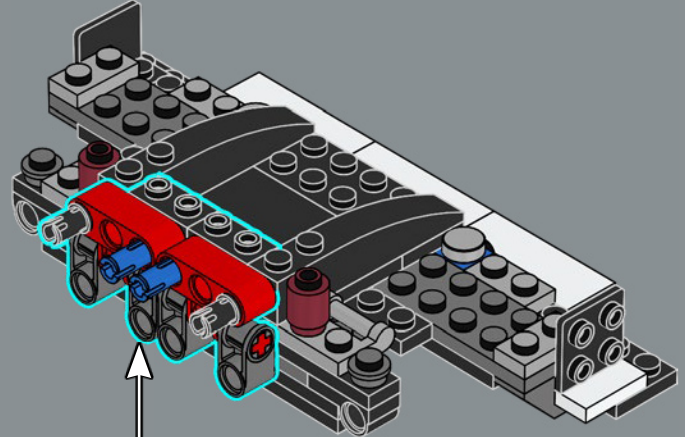
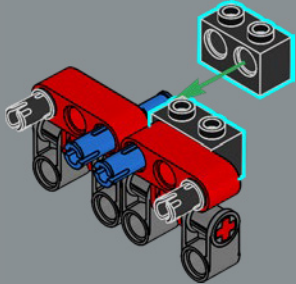

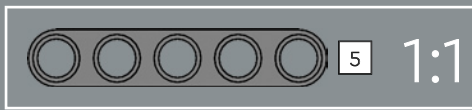
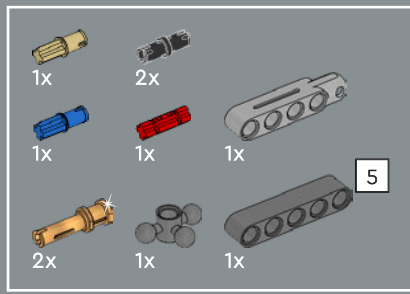

65

1

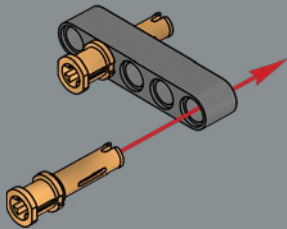

2

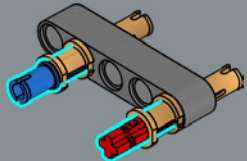

3

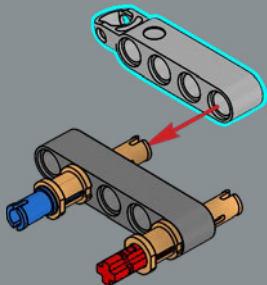

4

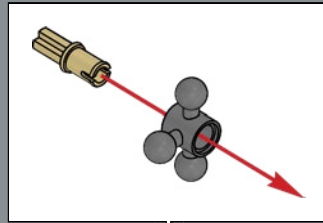
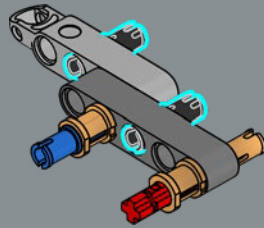

5

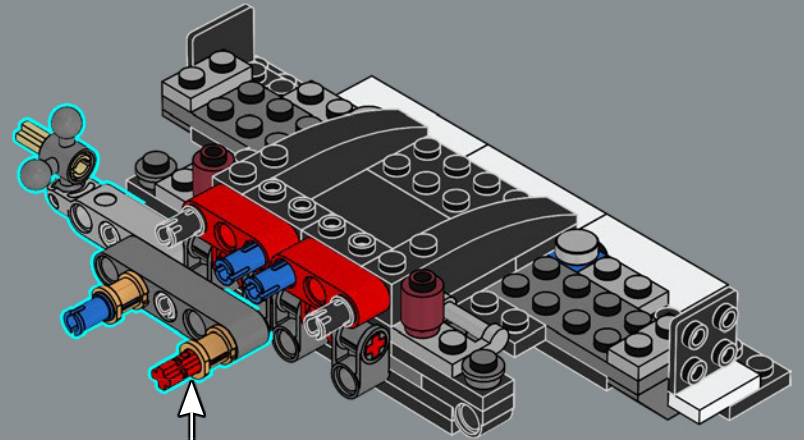
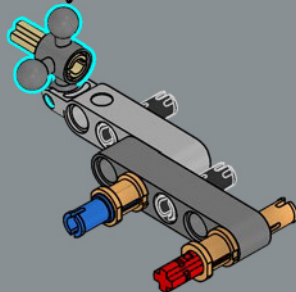

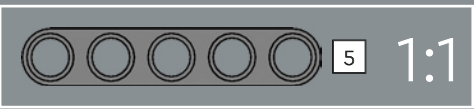
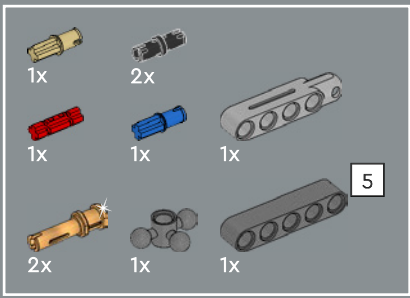

66

1

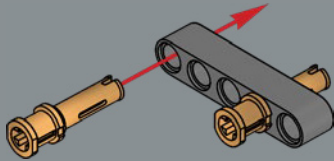

2

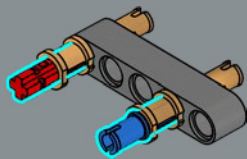

3

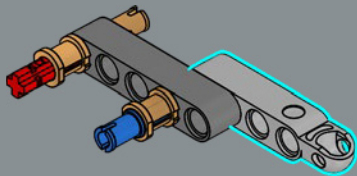

4

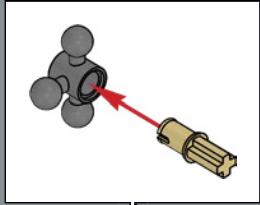
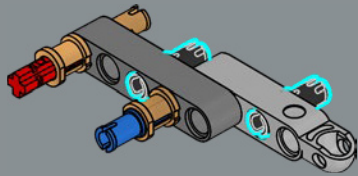

5

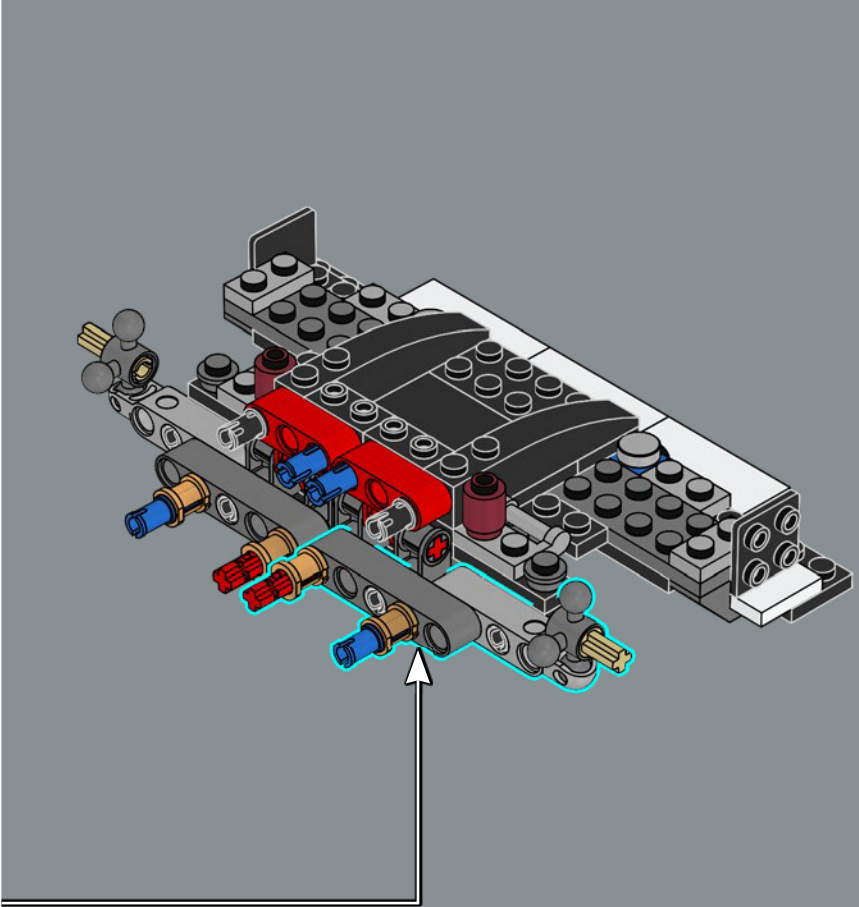
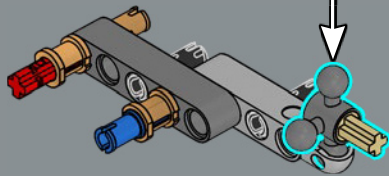

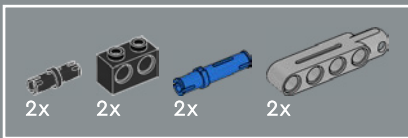

67

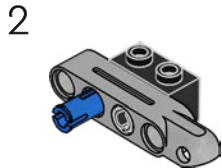
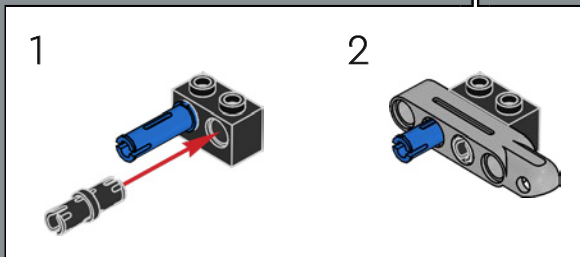
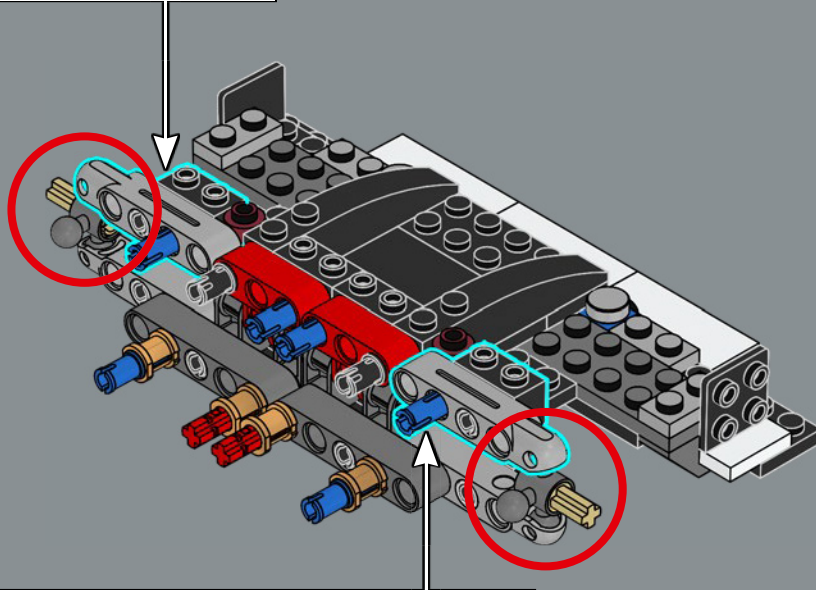
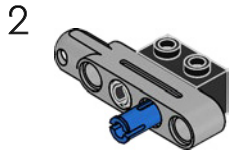
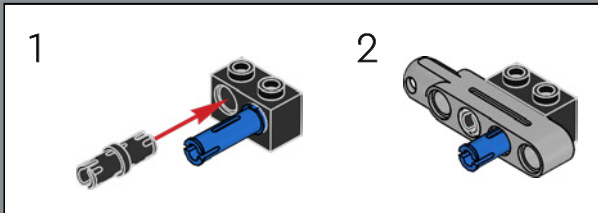

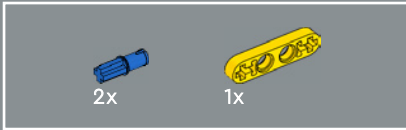
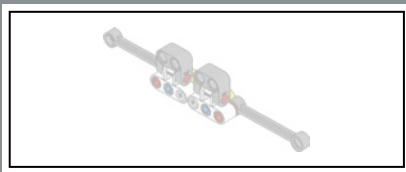

70

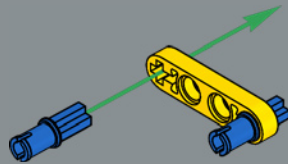

71

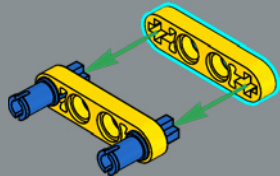

72

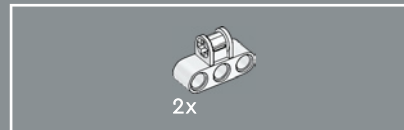
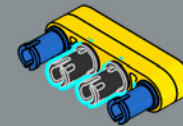

73

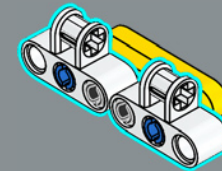

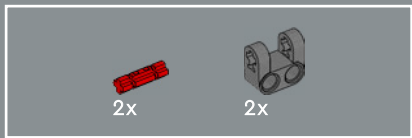

74

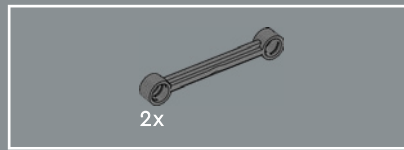
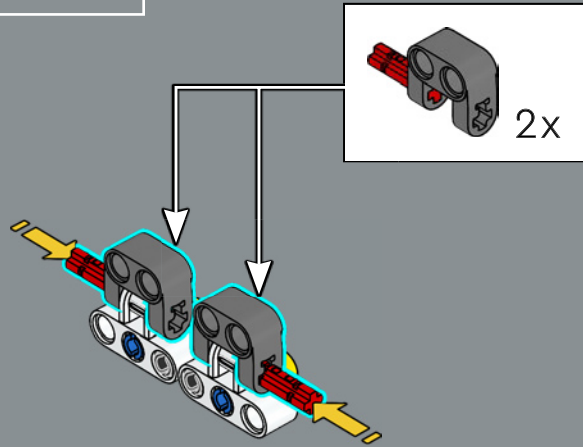

76

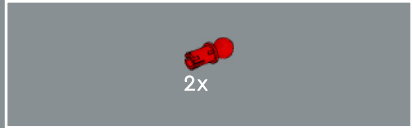
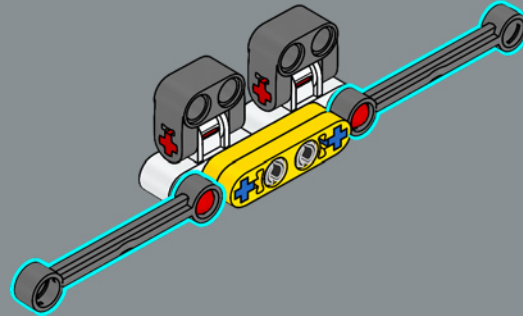

75

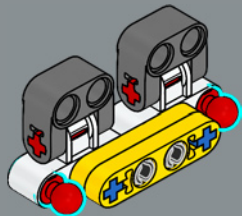

77

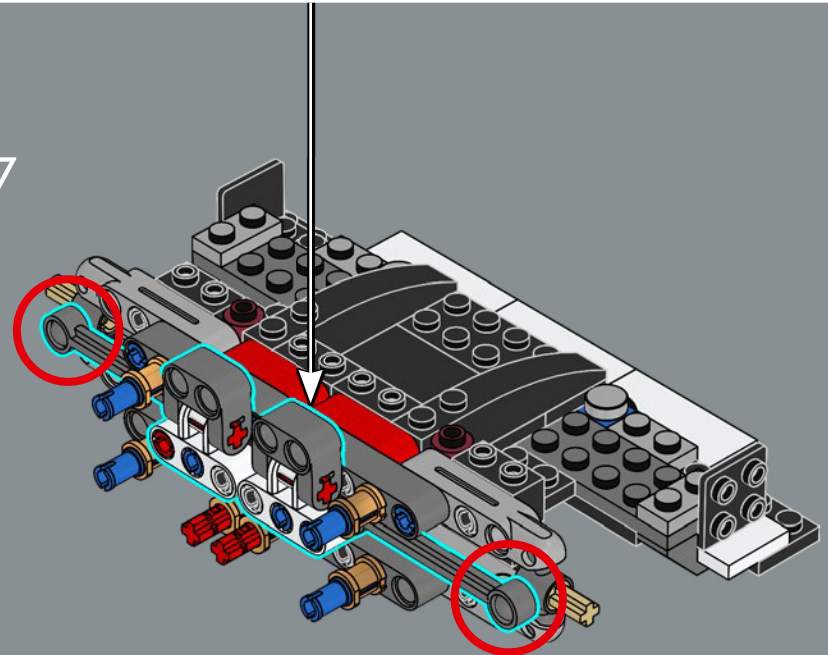

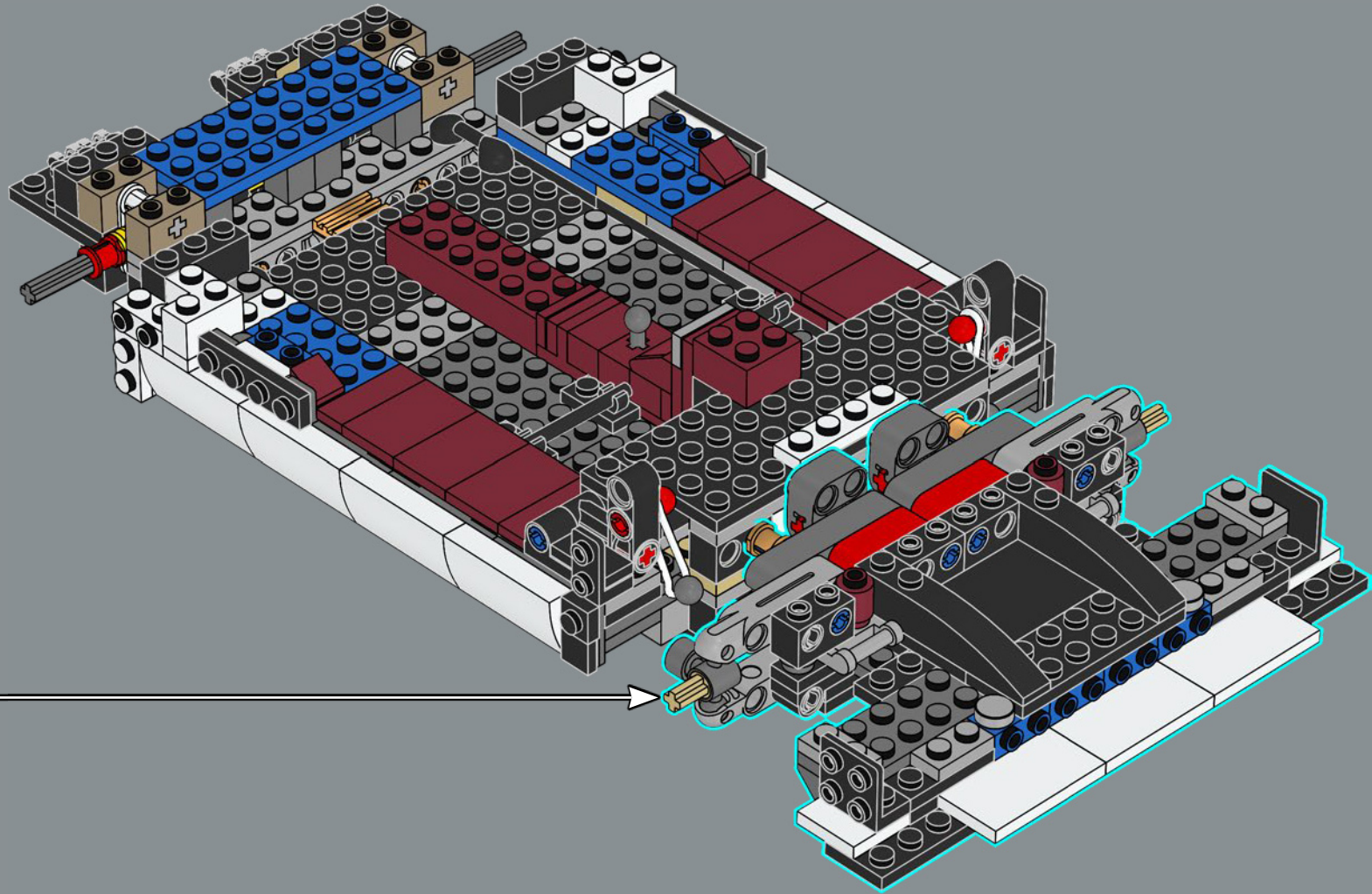

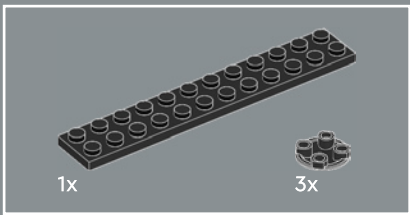

79

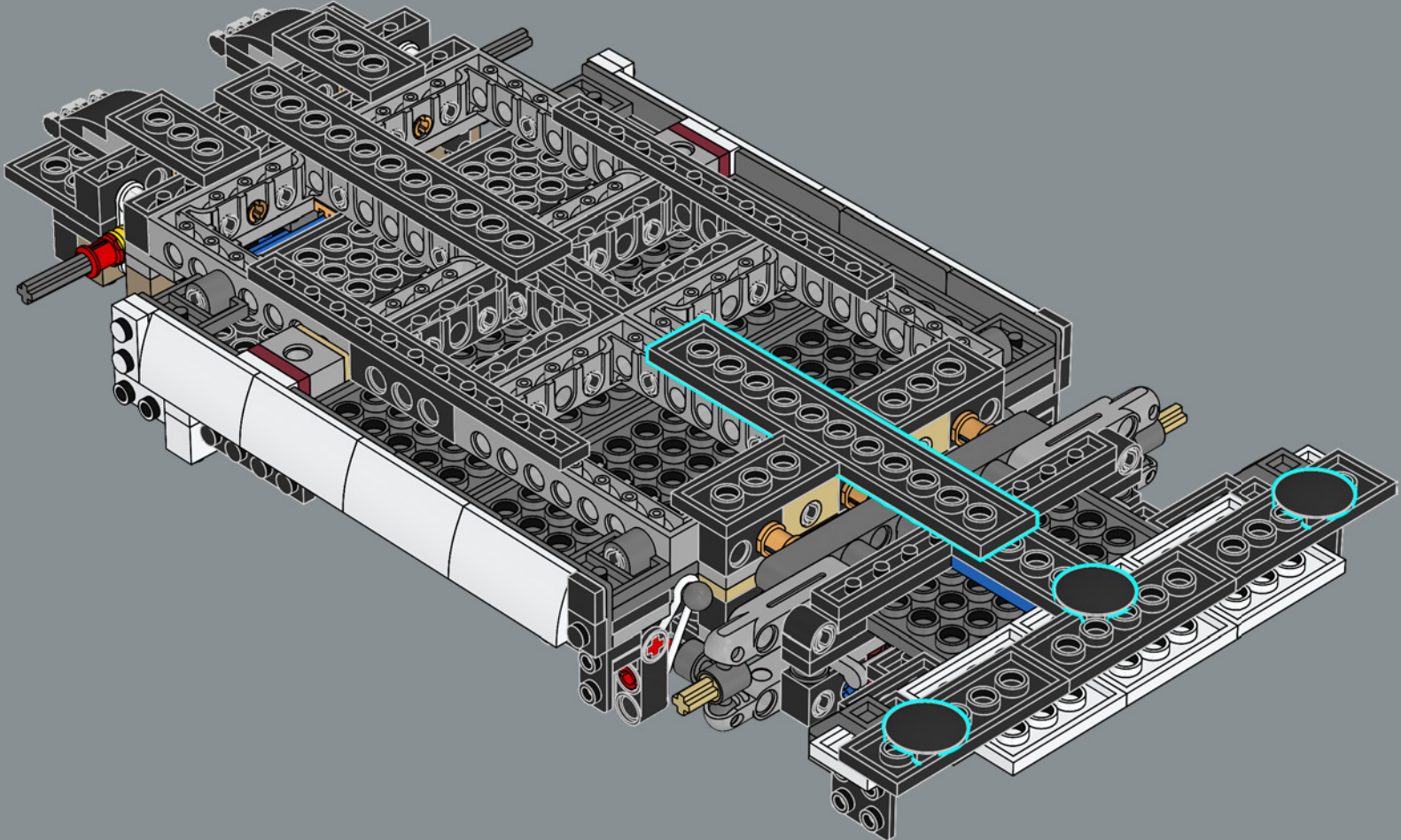

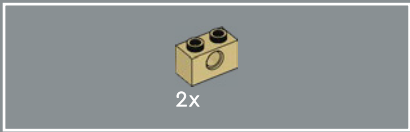

80

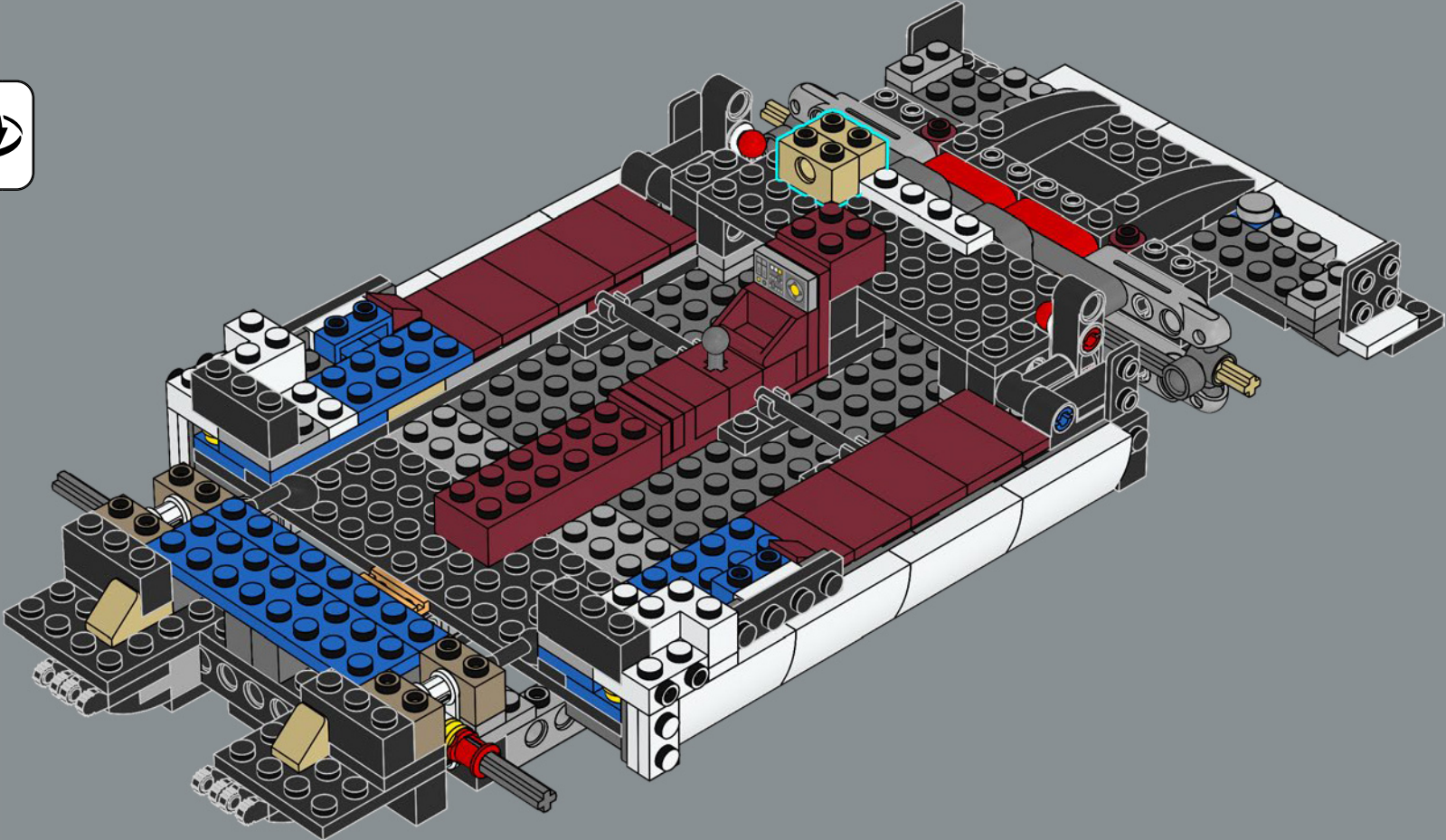

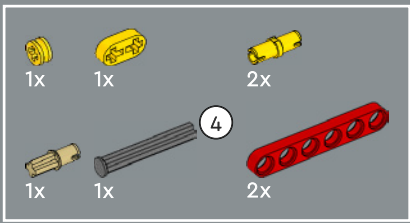

81

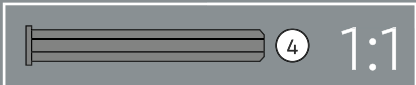
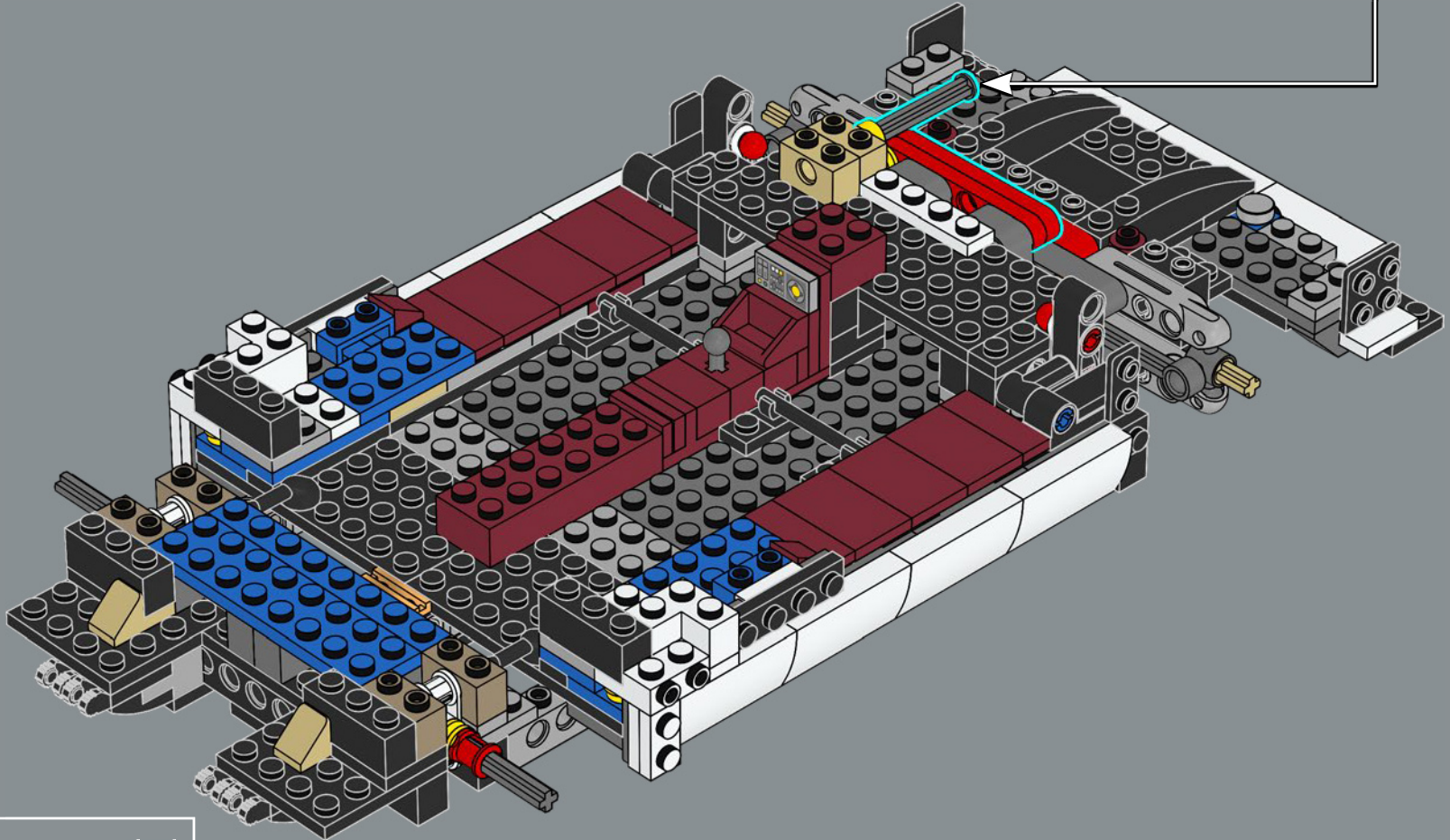
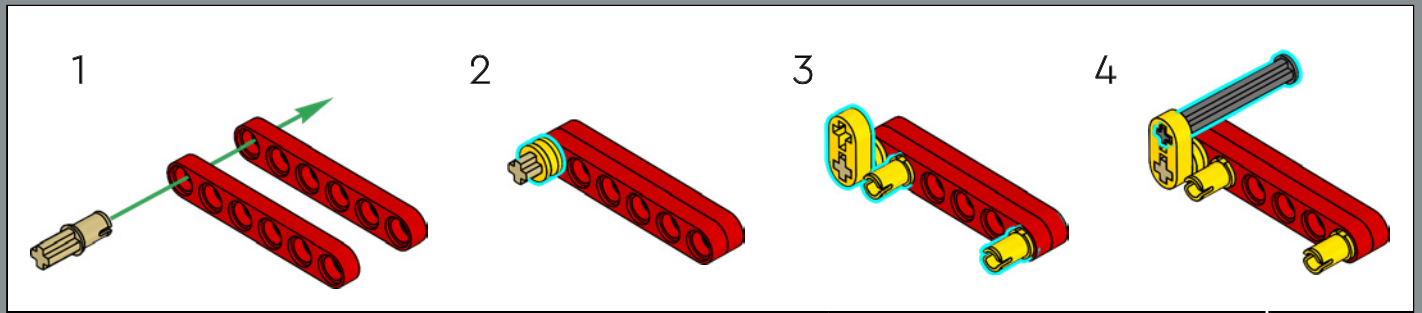



1x

82

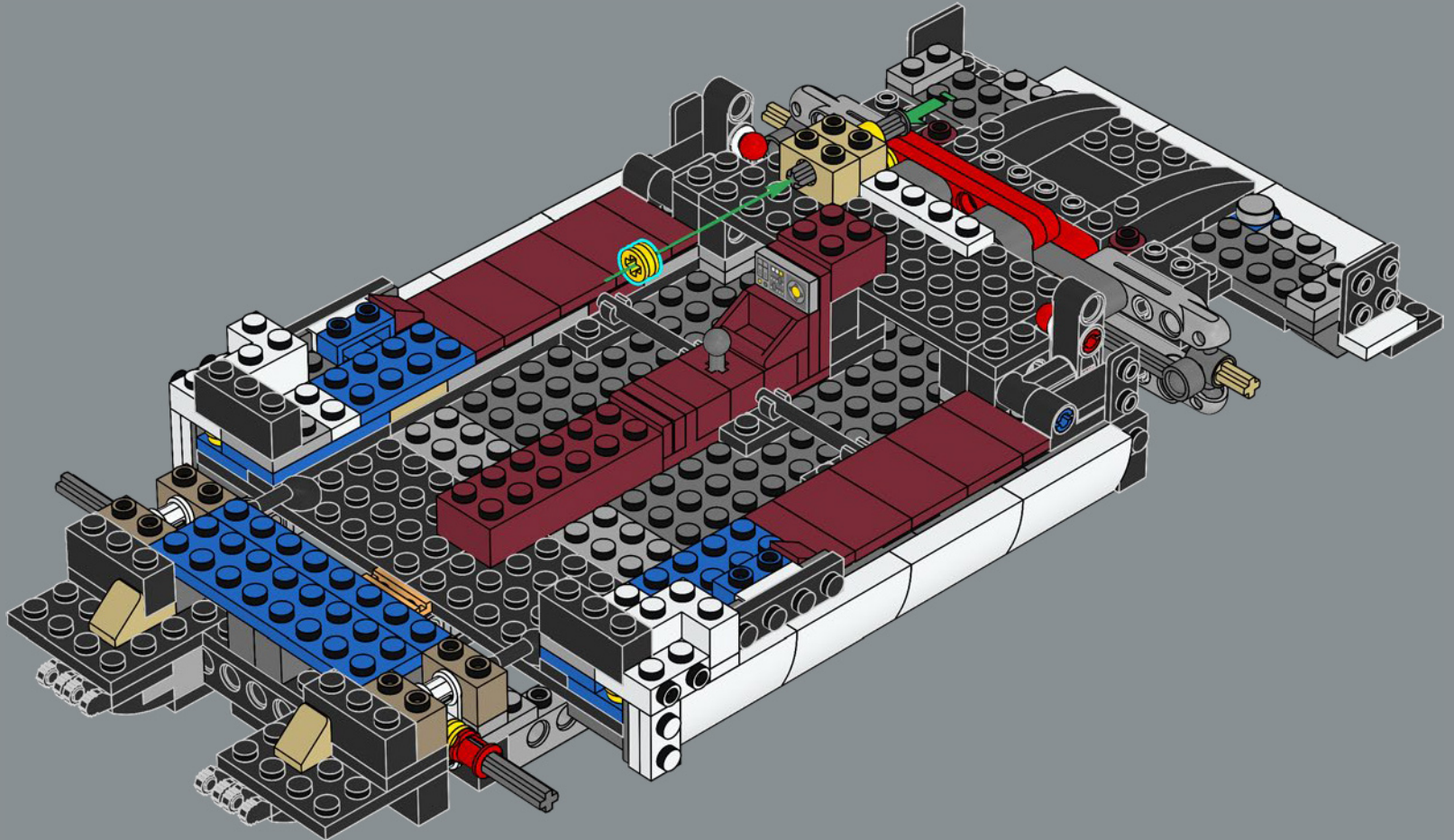

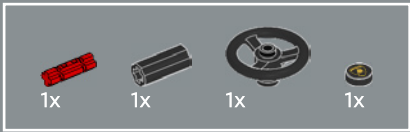

83

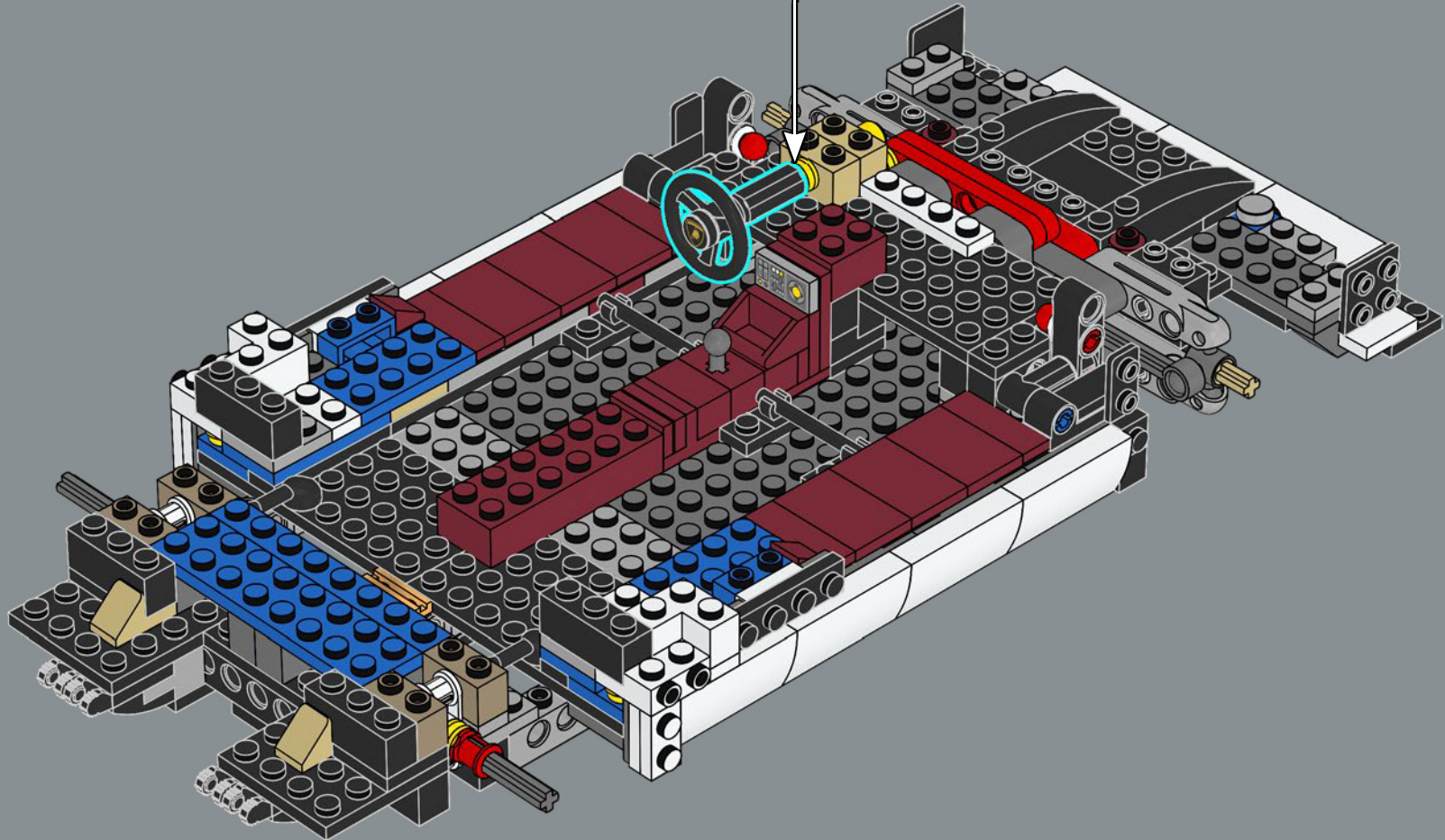
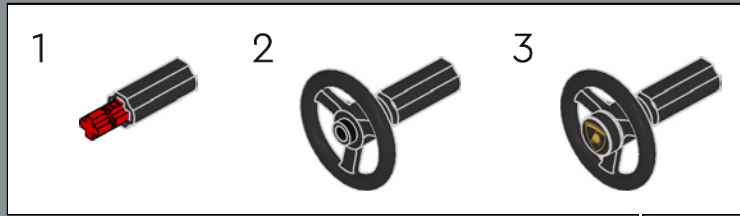

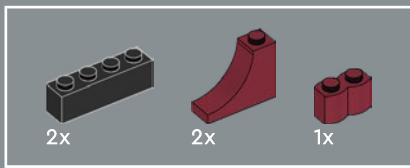

84

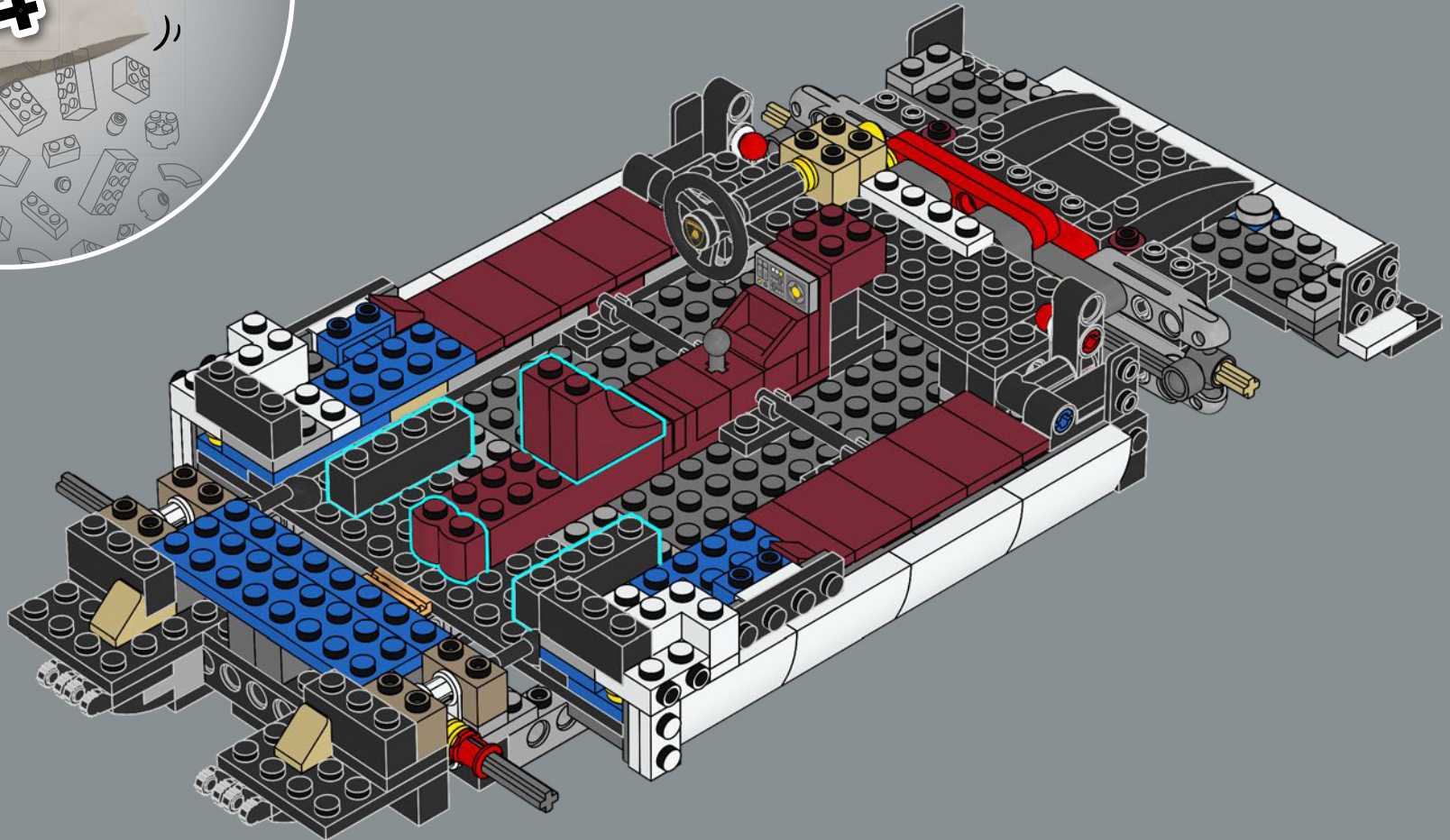

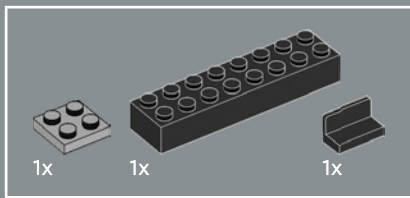

85

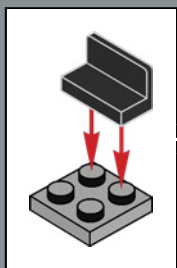
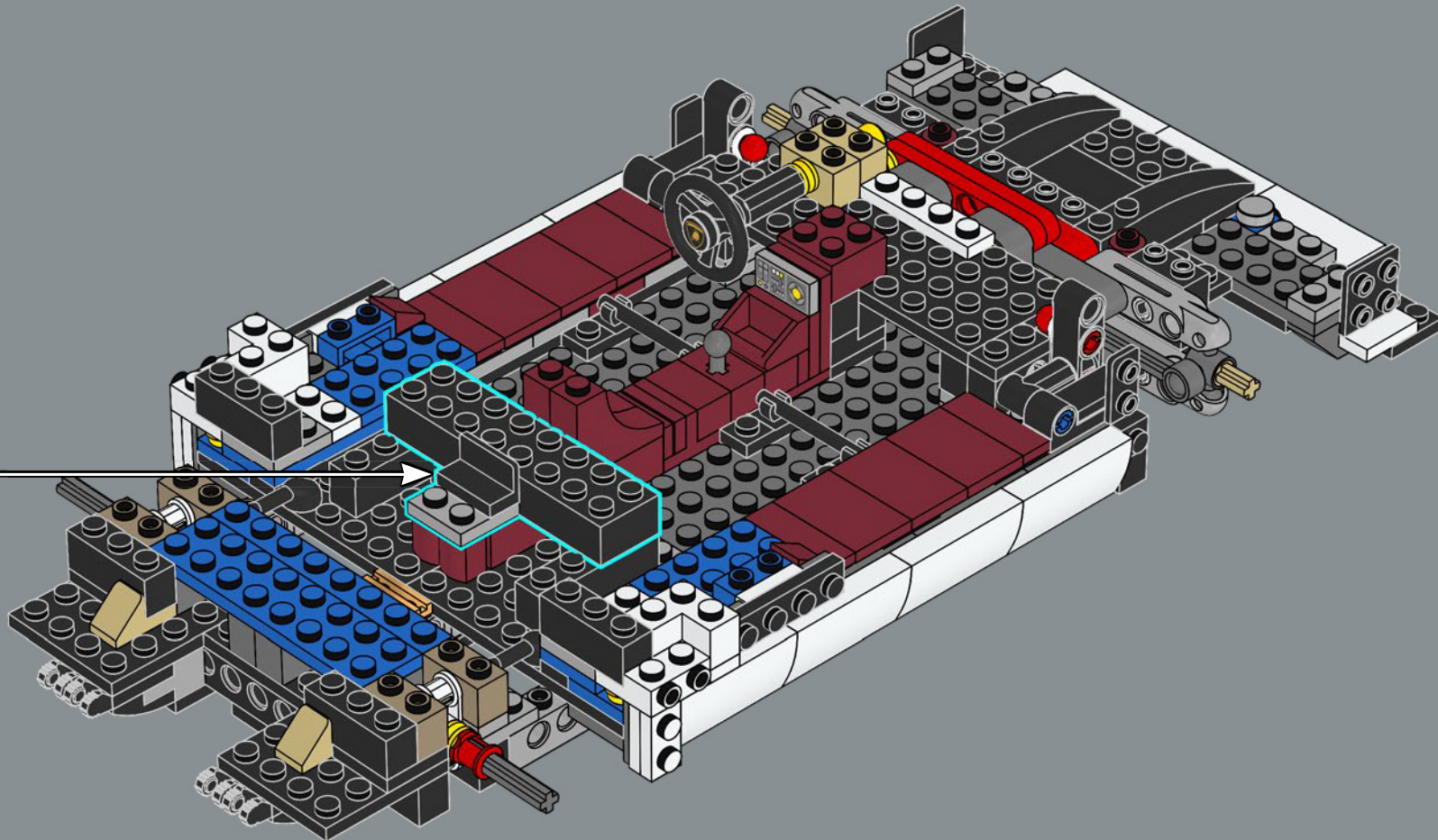

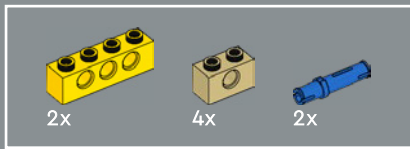

86

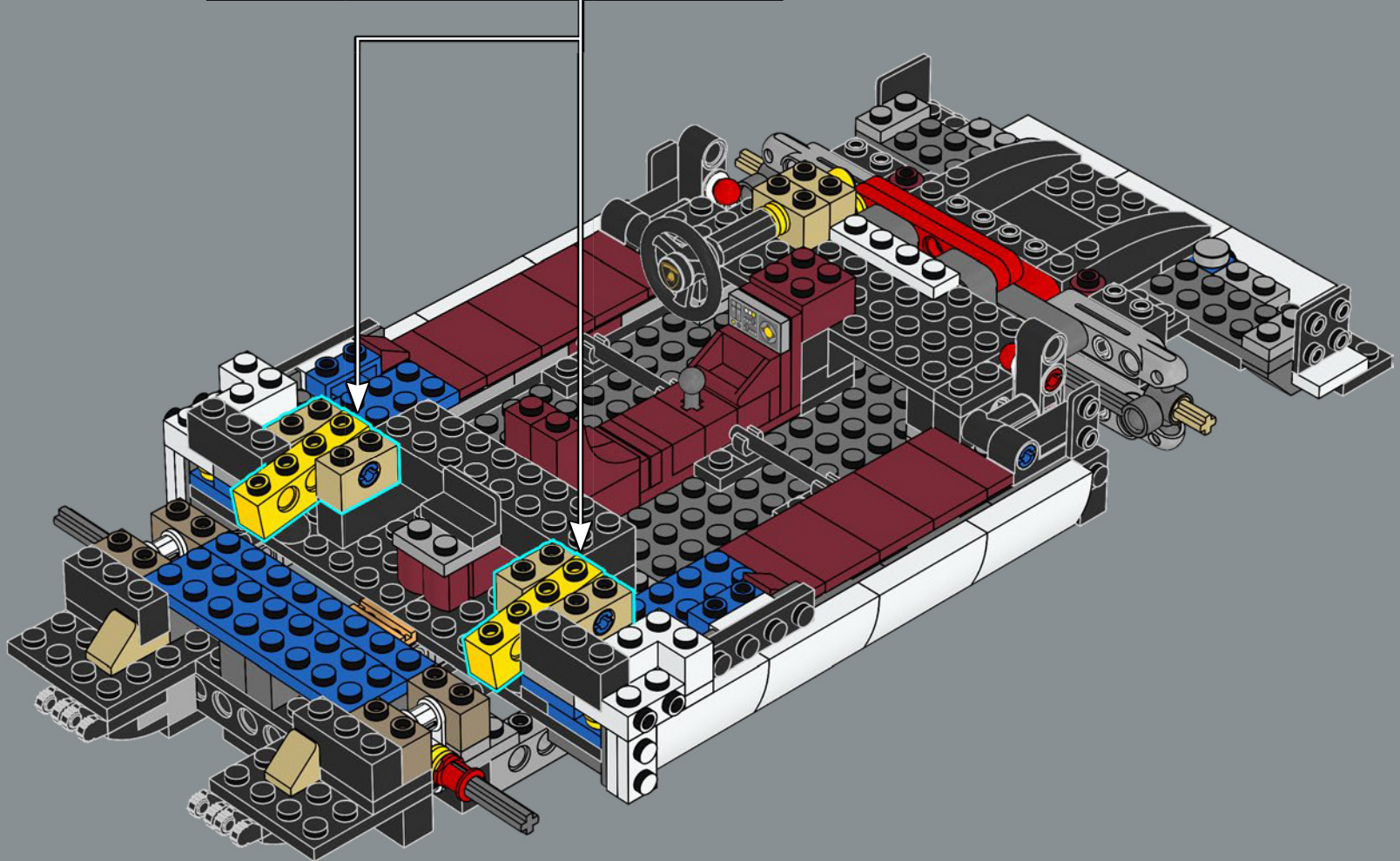
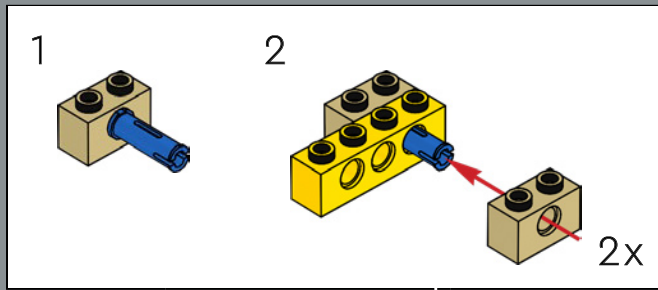

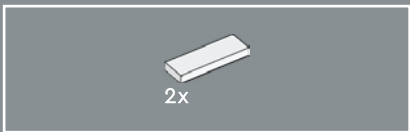

87

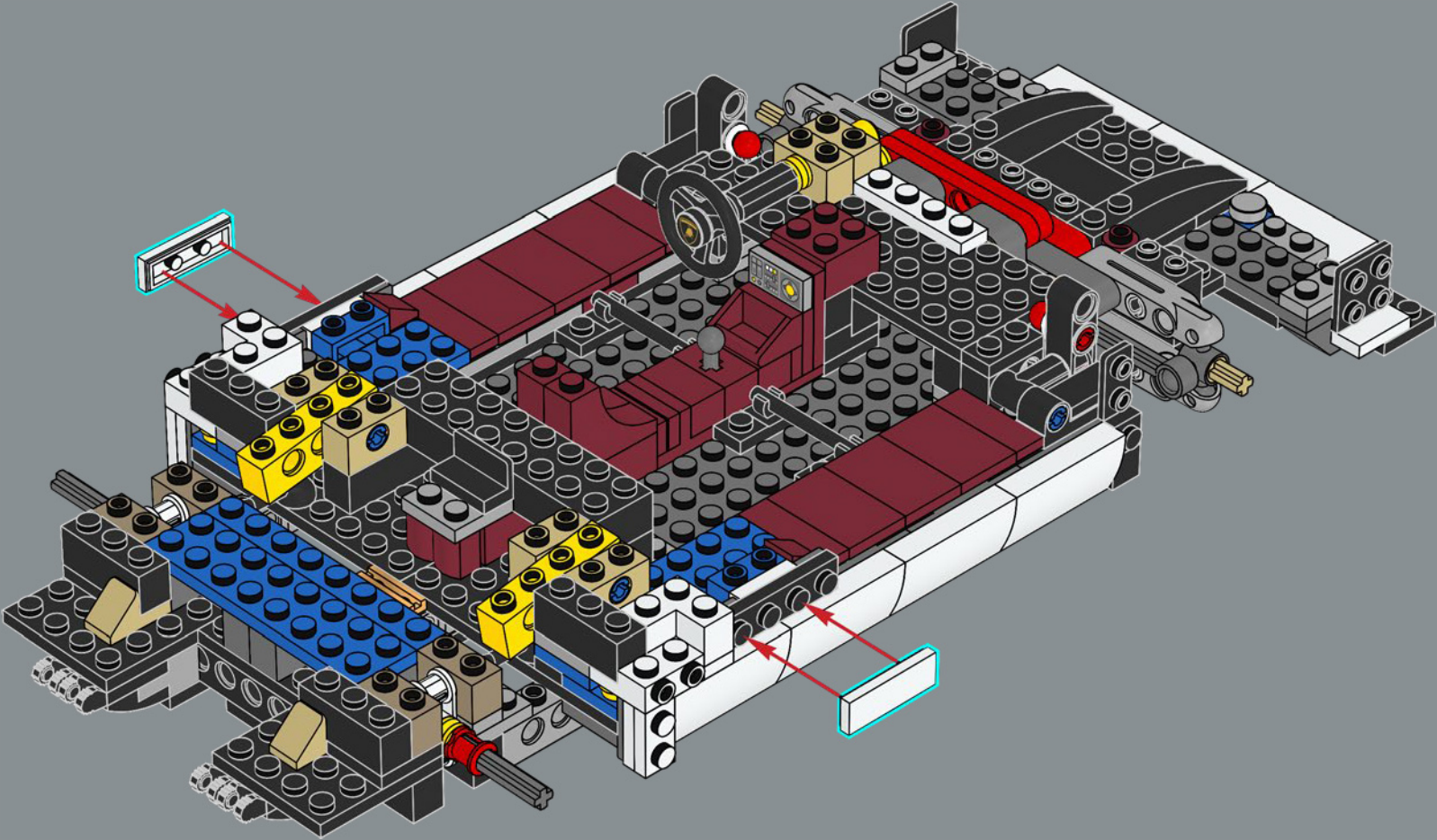

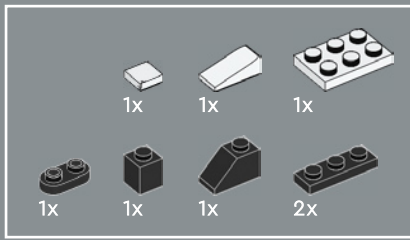

88

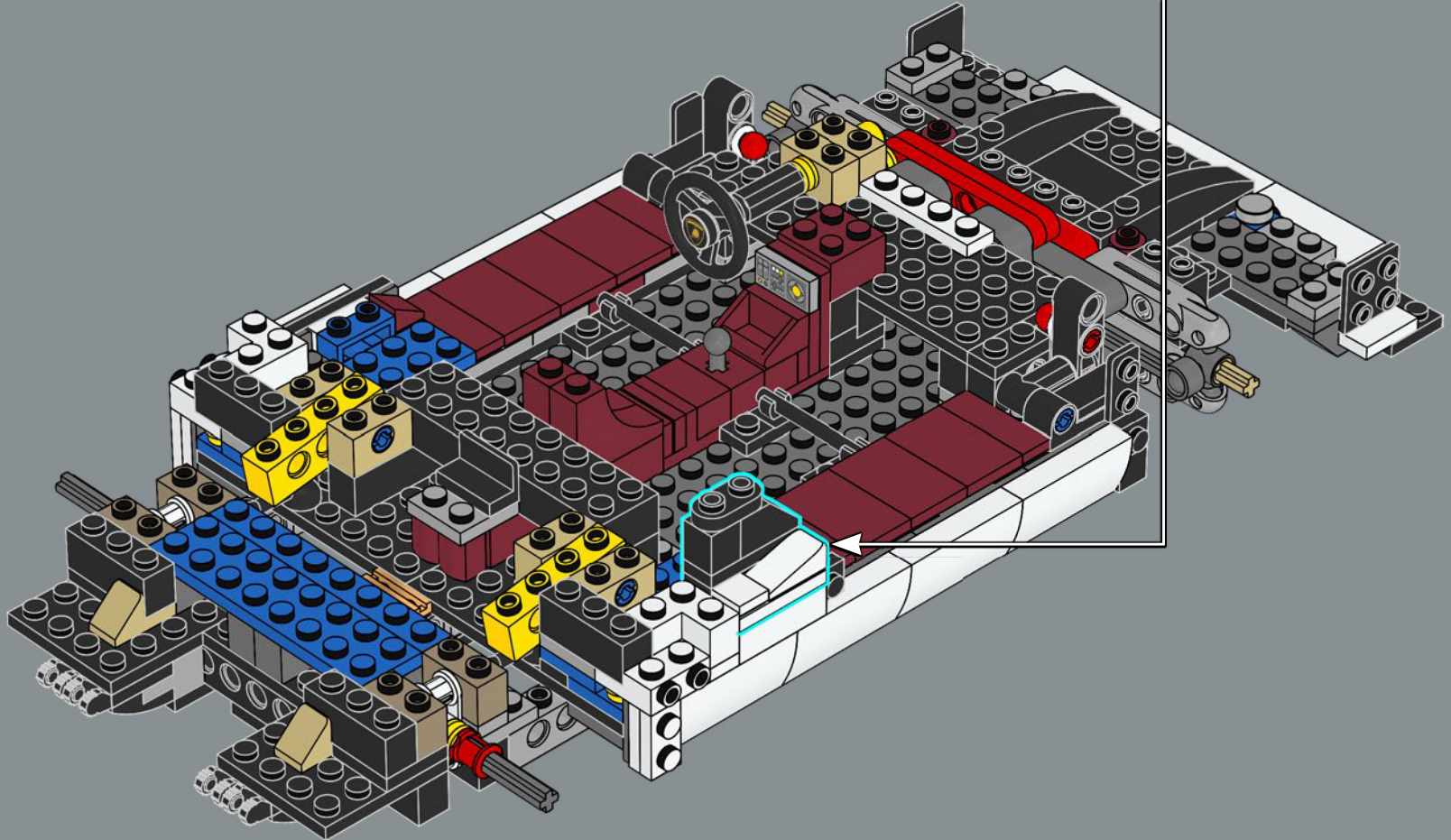
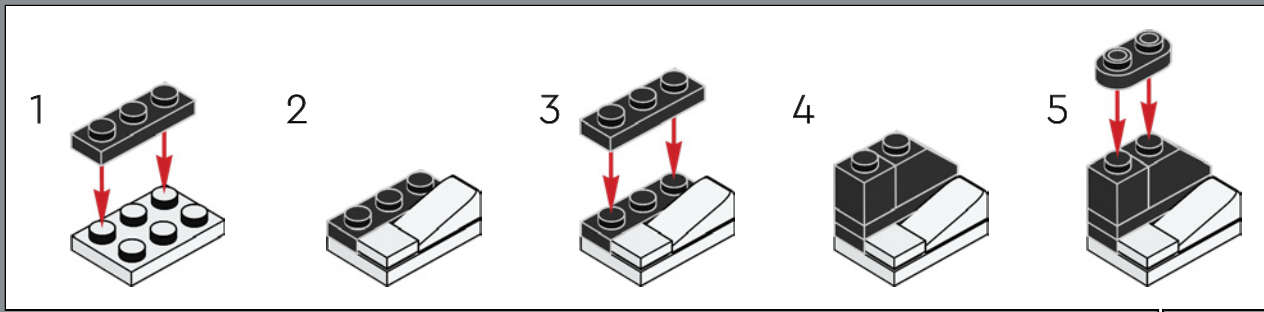

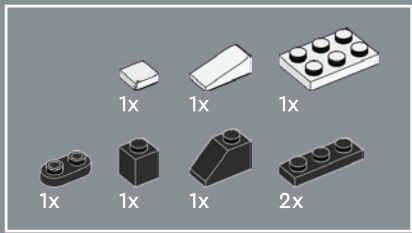

89

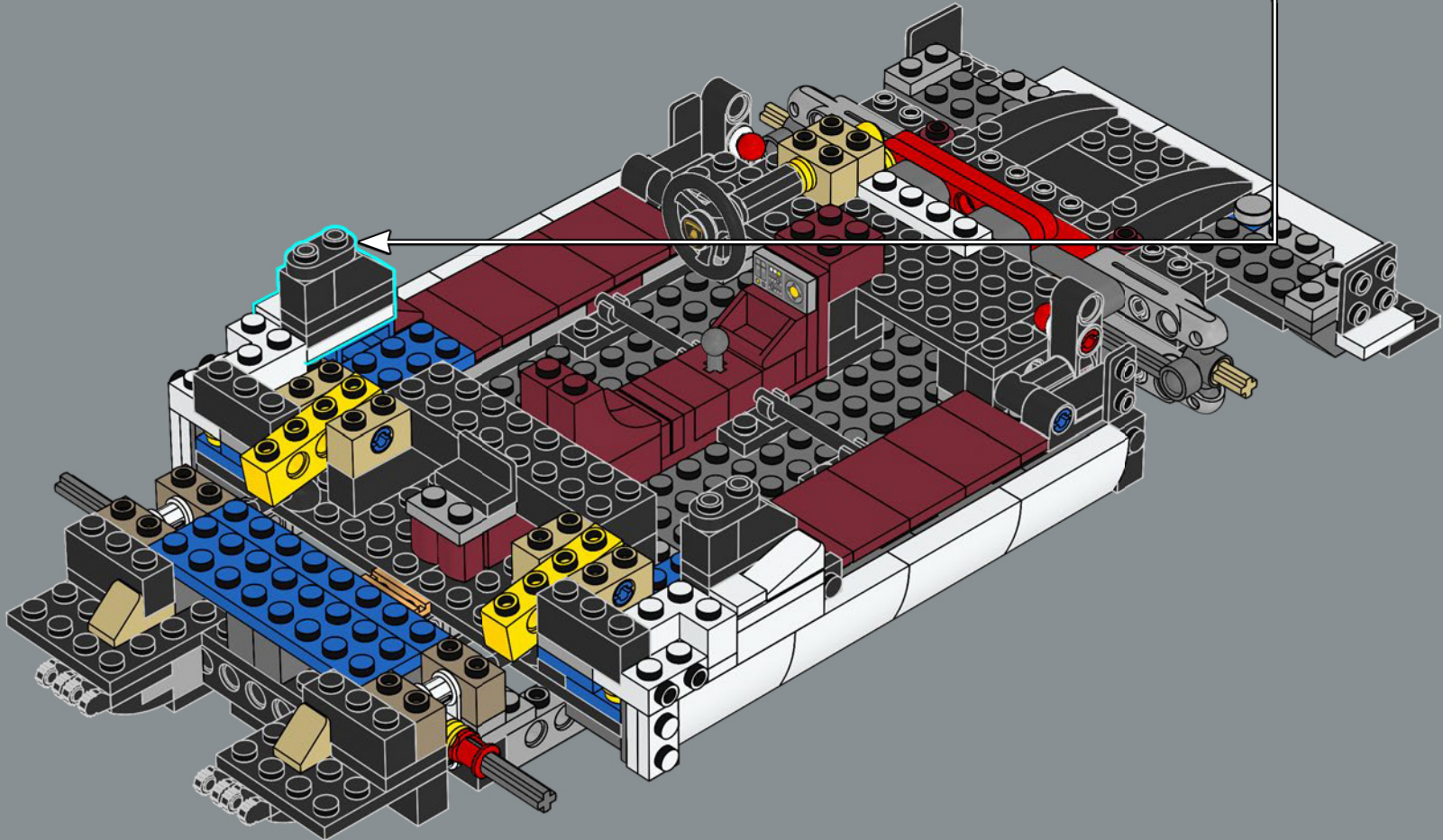
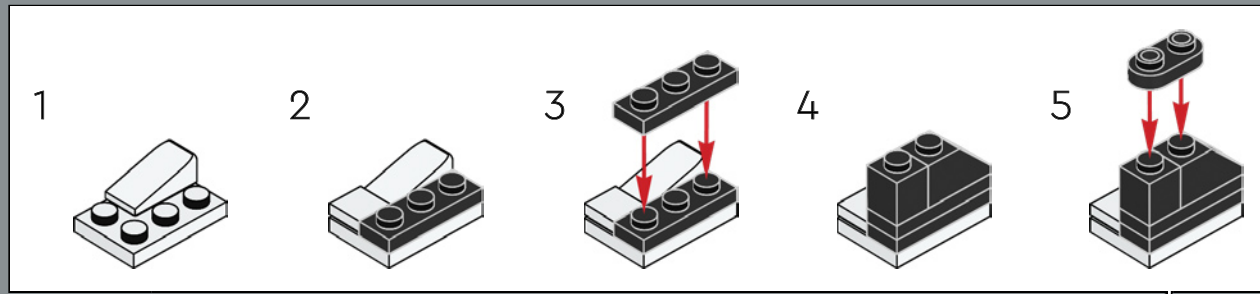

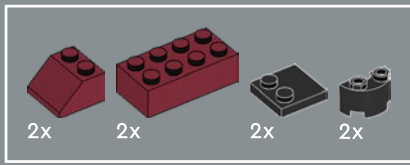

90

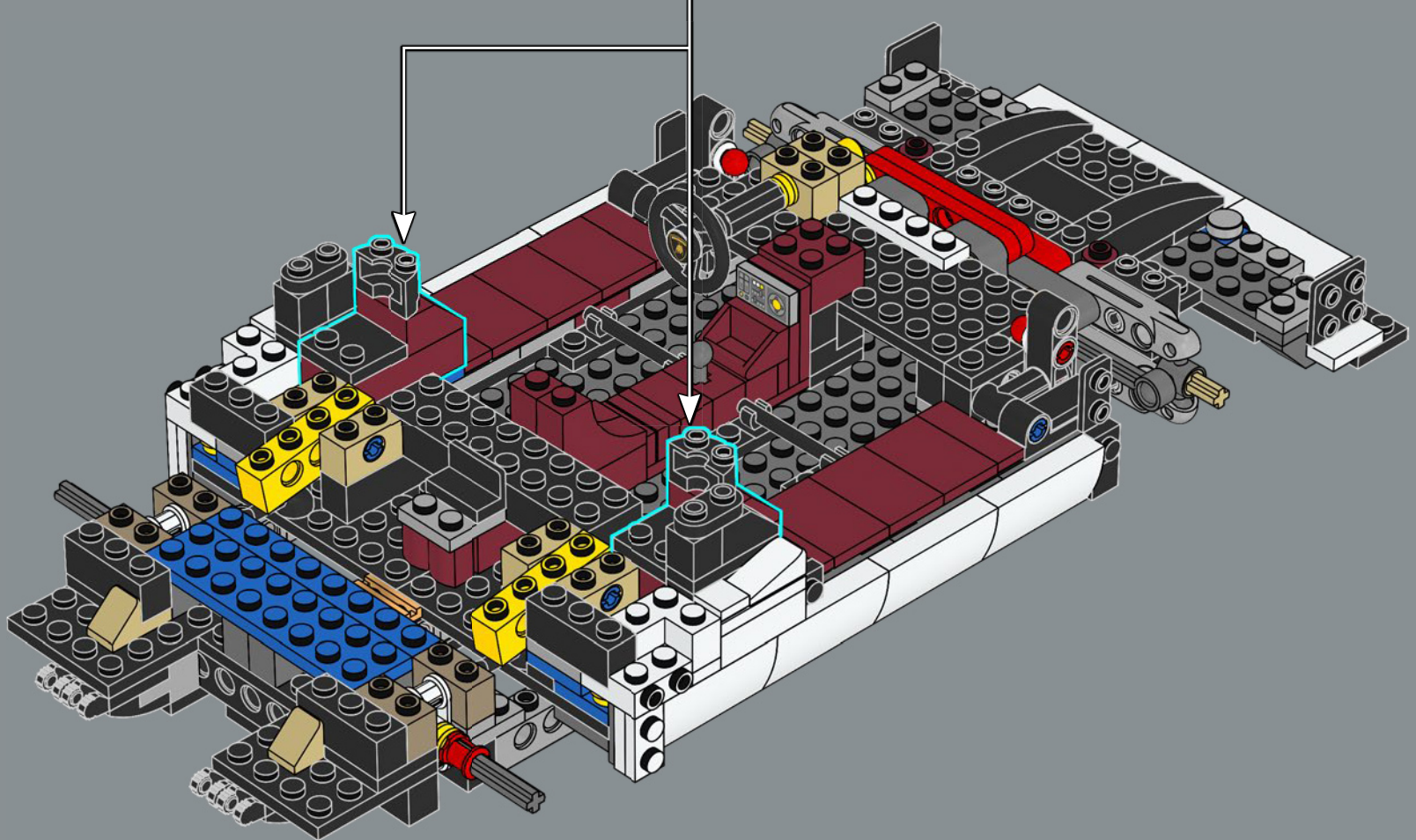
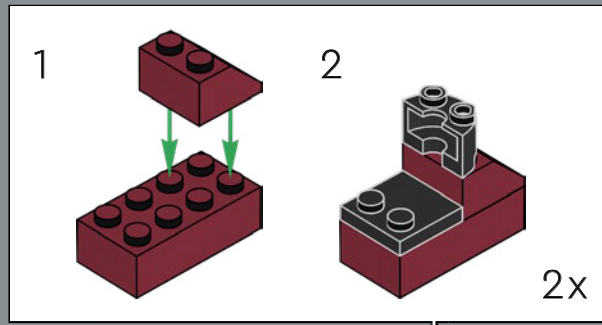

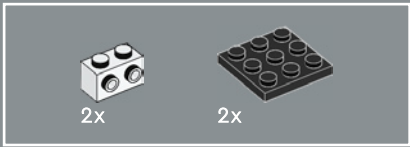

91

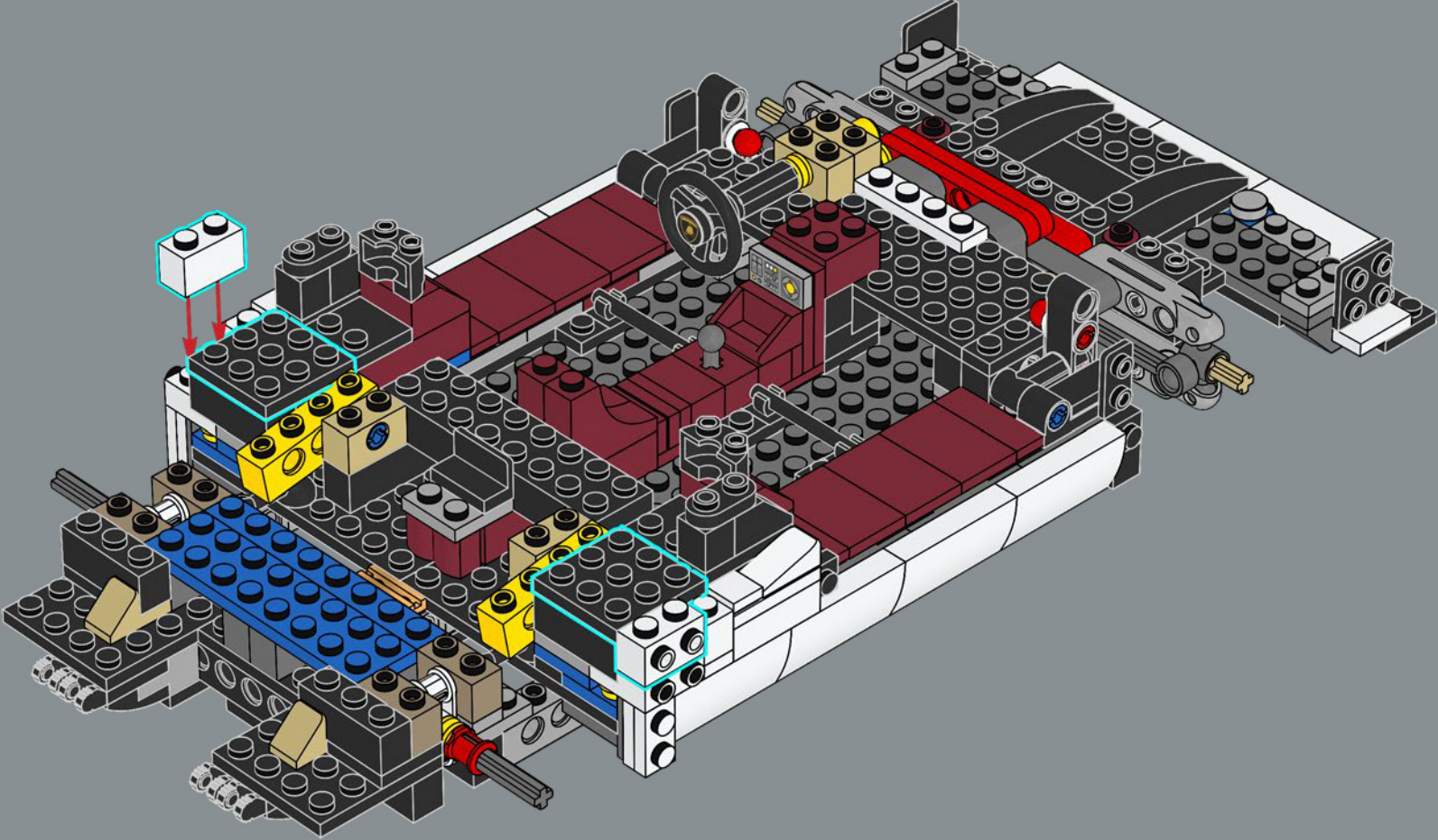

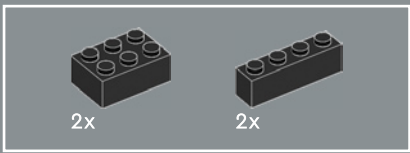

92

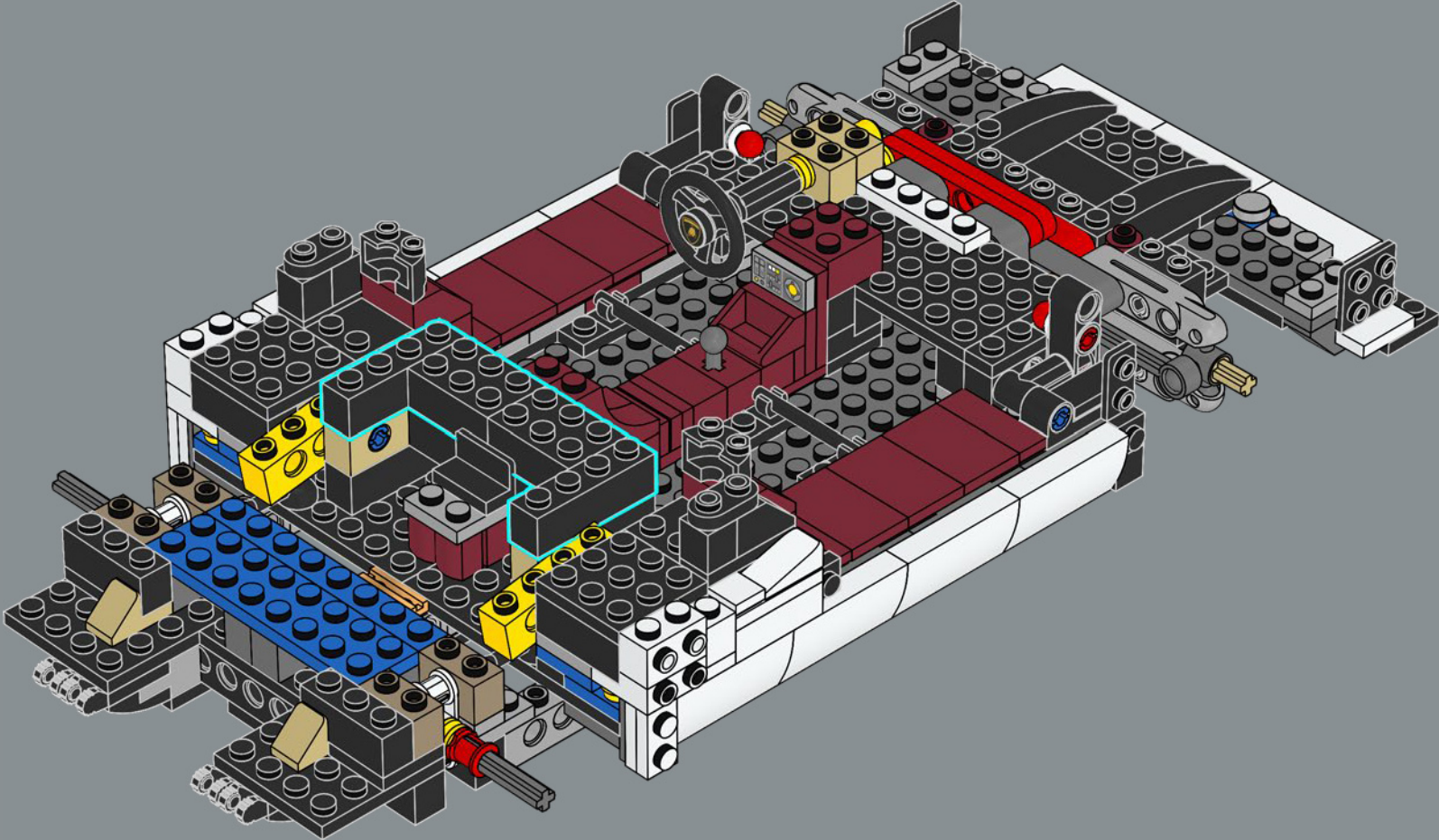

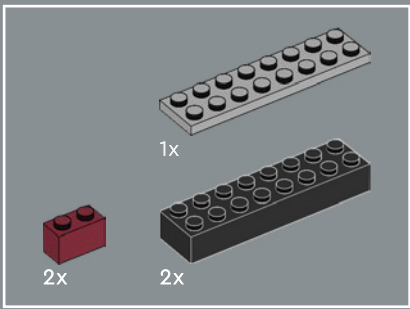

93

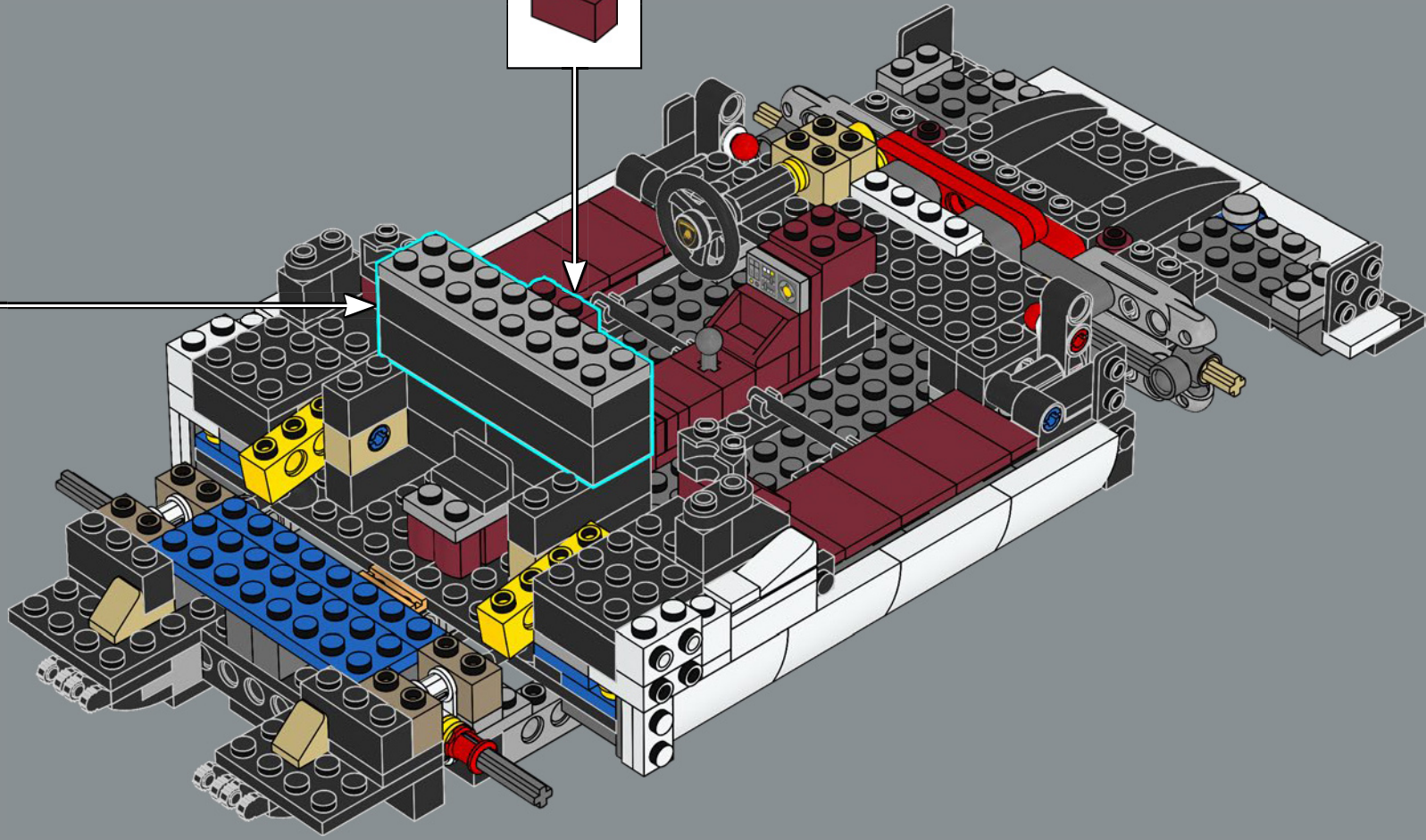
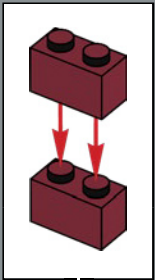
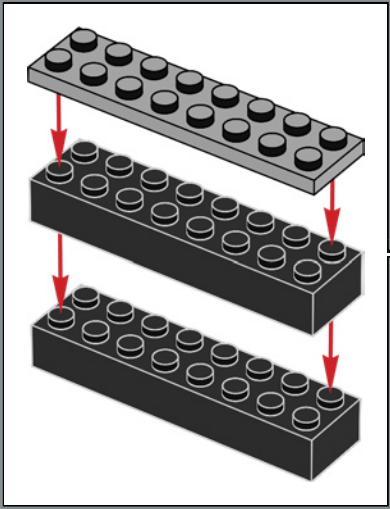

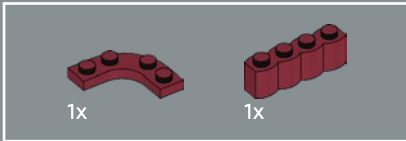

94

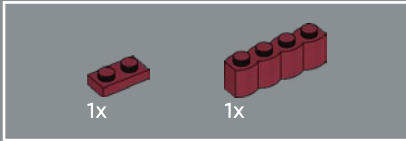
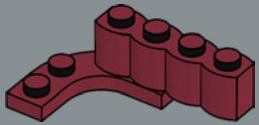

95

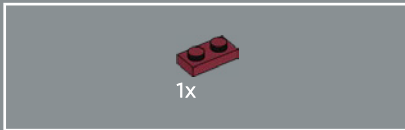
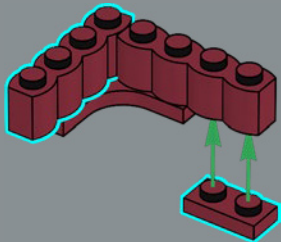

96

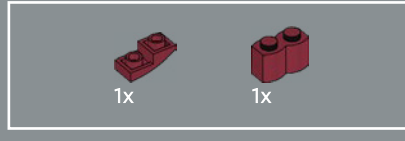
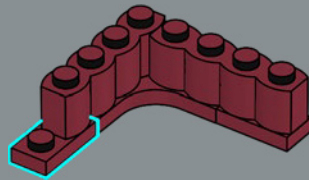

97

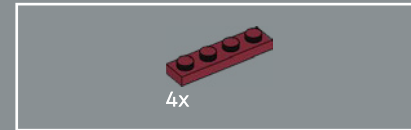
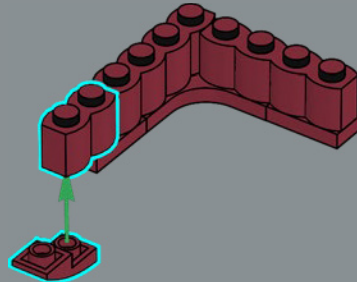

98

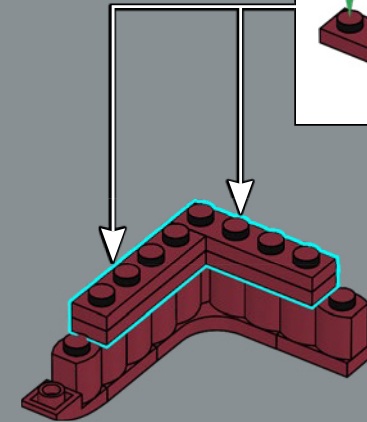
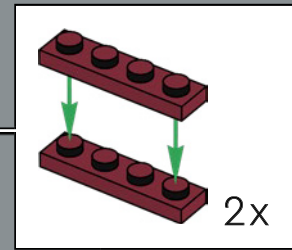

99

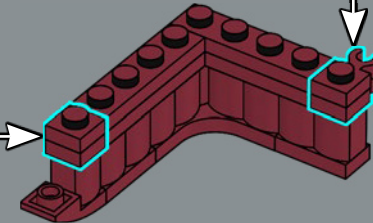
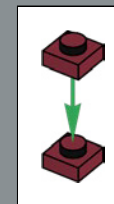
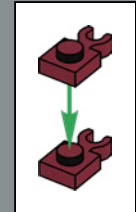

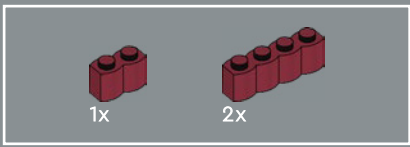

100

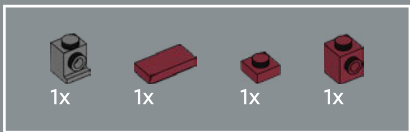
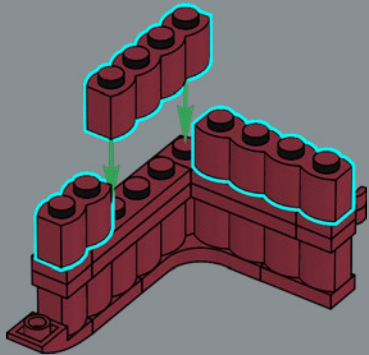

101

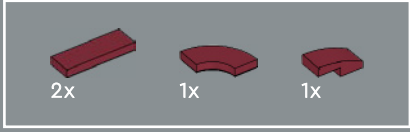
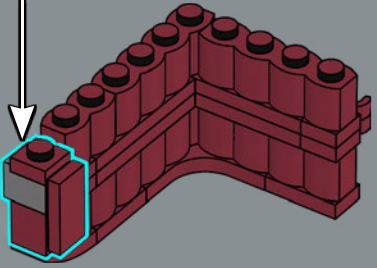
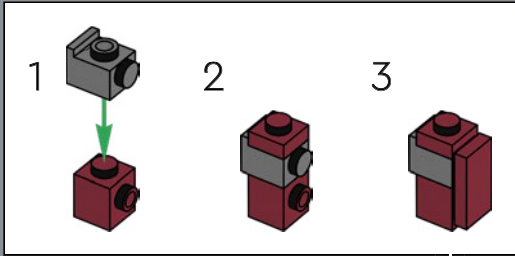

102

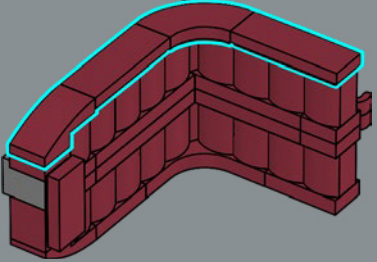

103

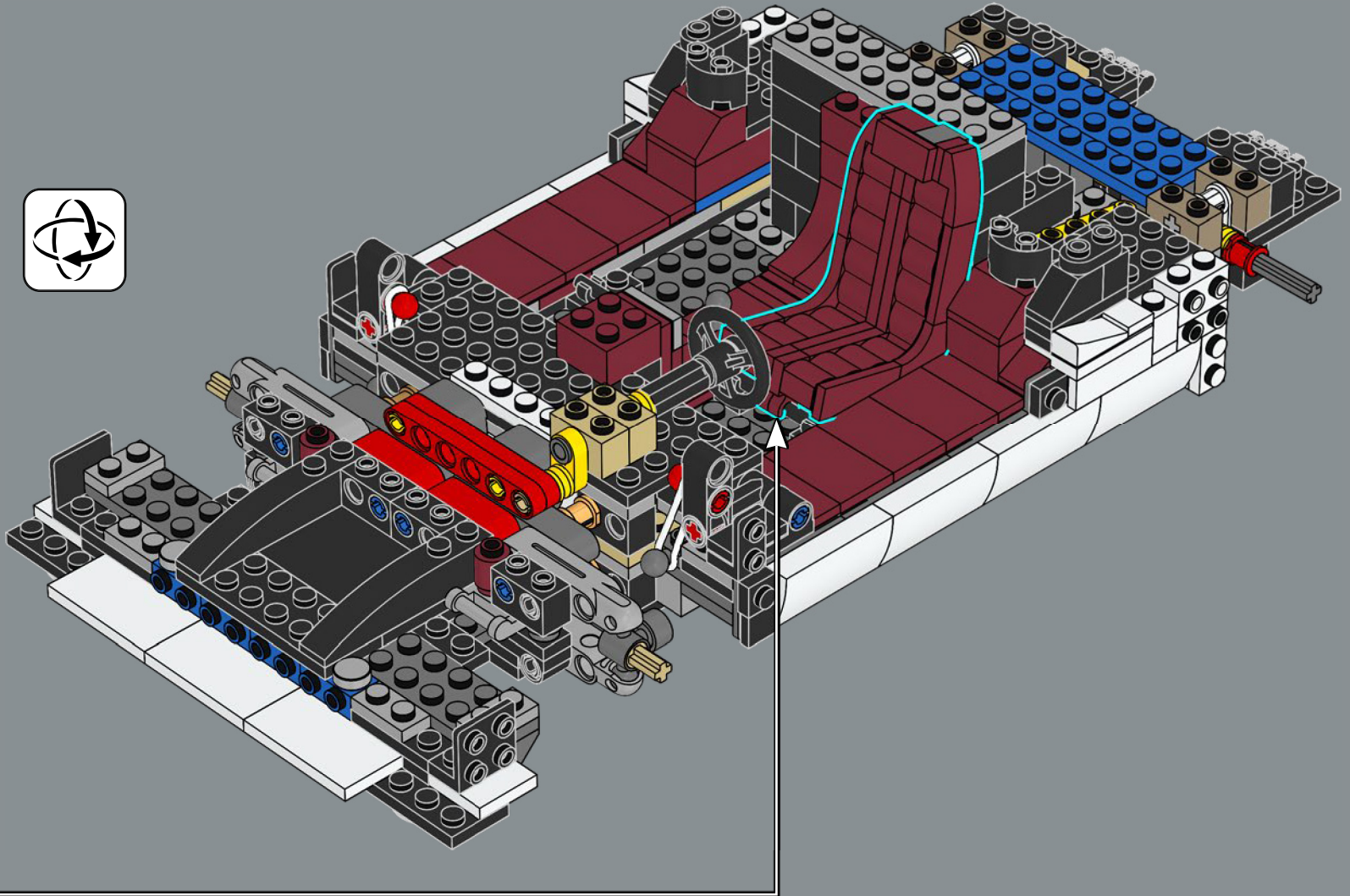

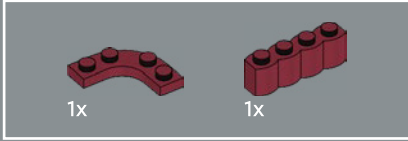

104

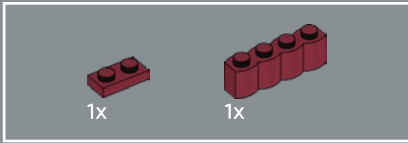
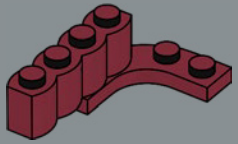

105

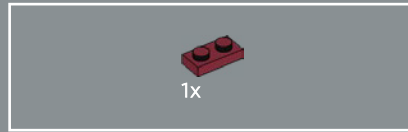
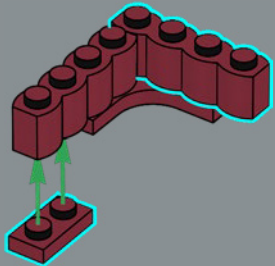

106

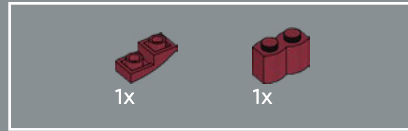
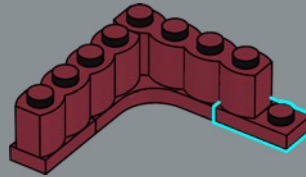

107

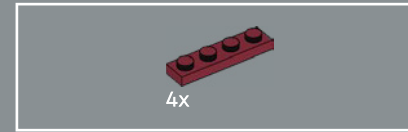
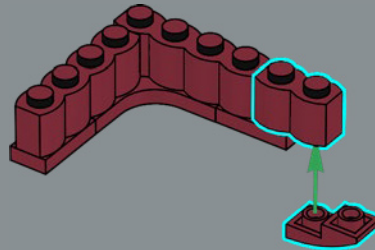

108

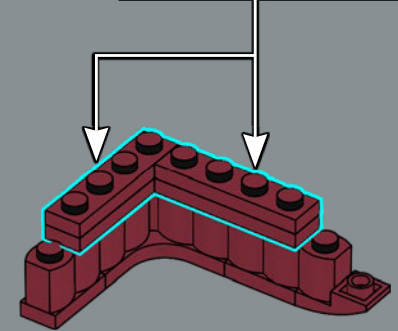
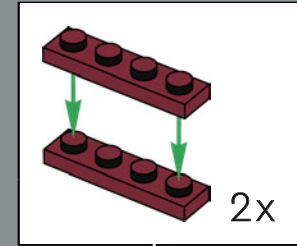



109

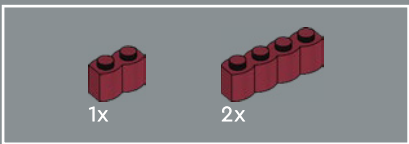
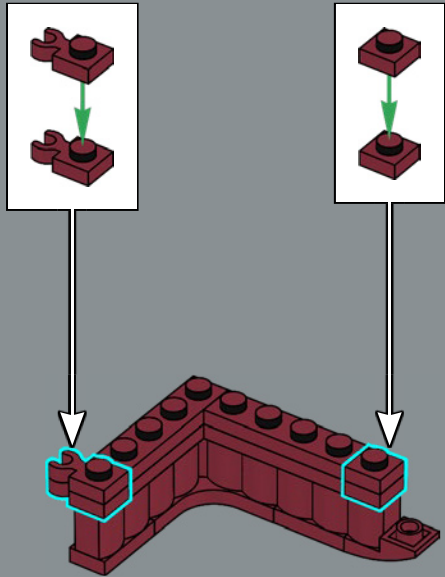

110

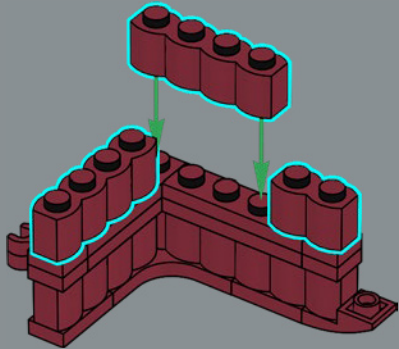

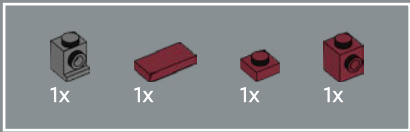

111

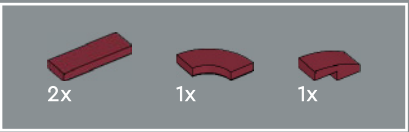
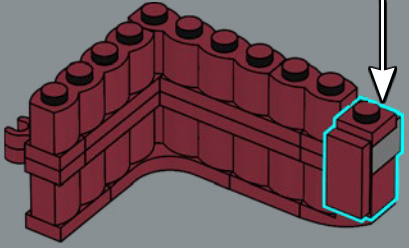
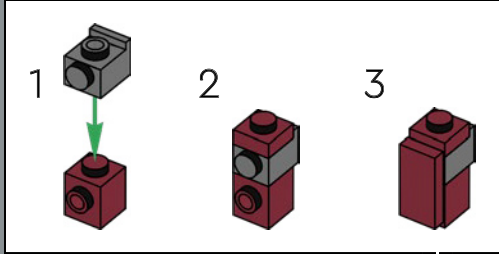

112

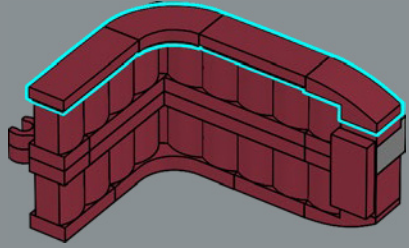

113

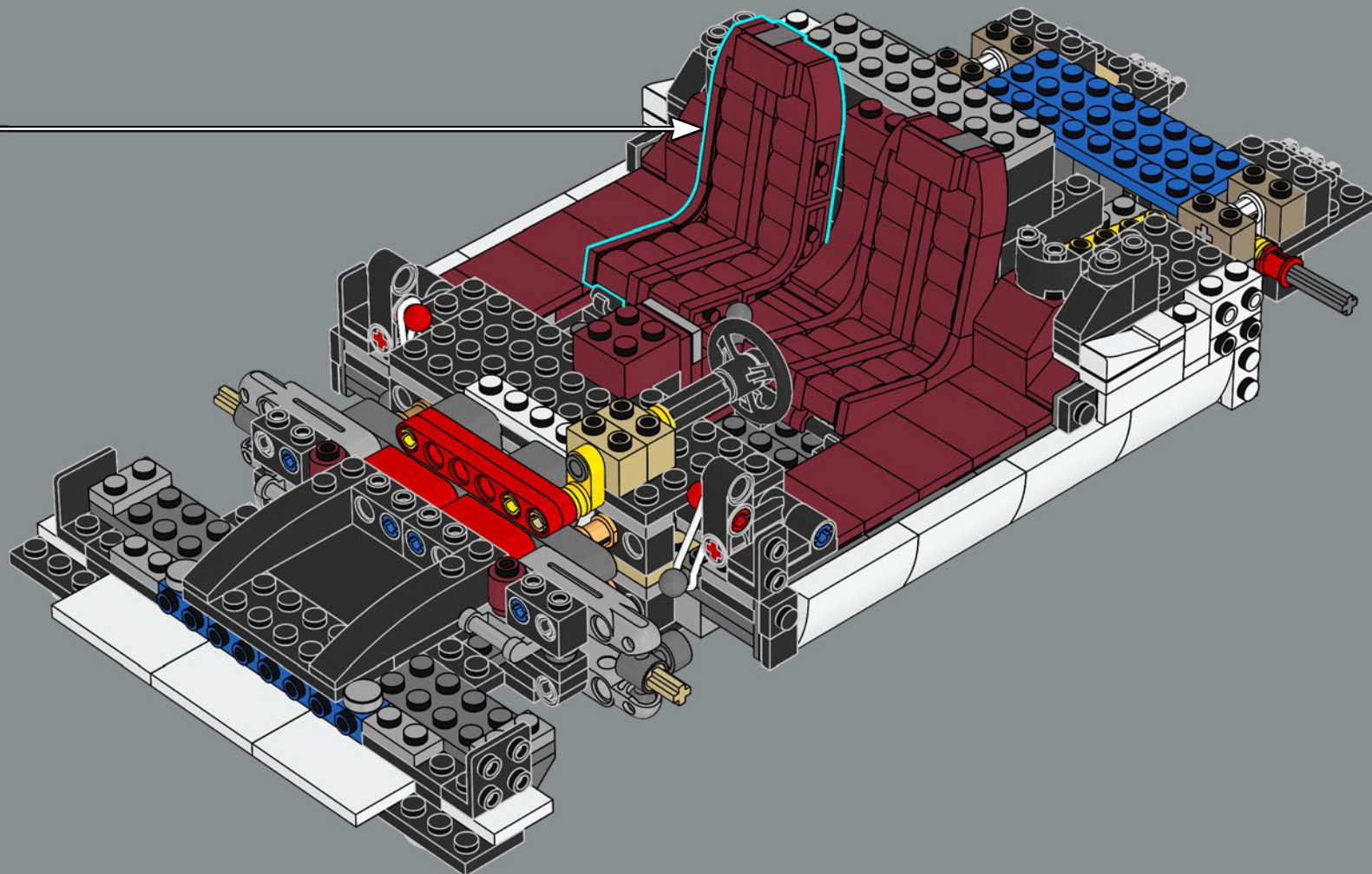

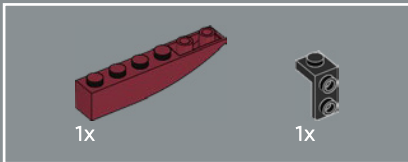
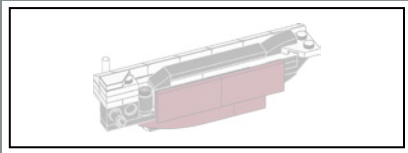

114

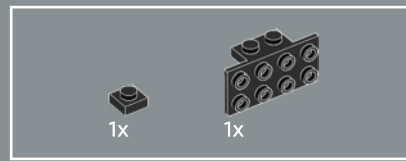
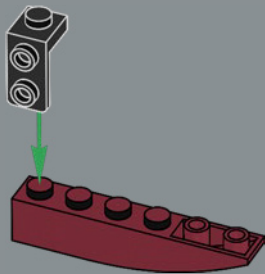

115

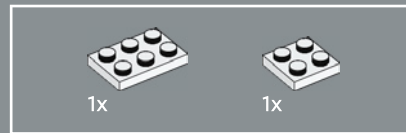
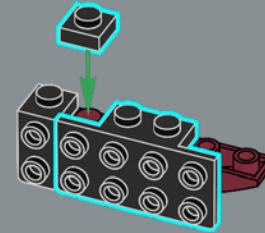

116

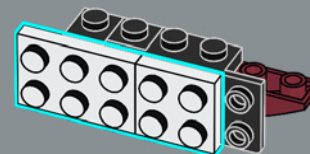

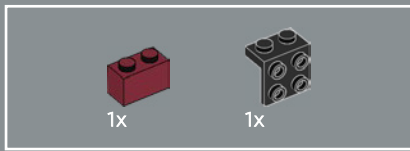

117

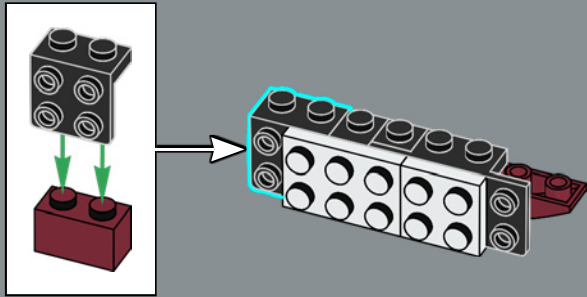

118

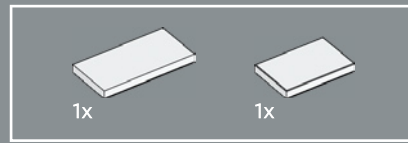
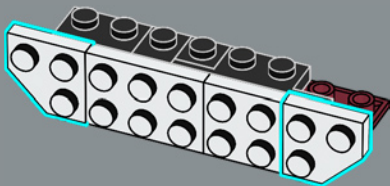

119

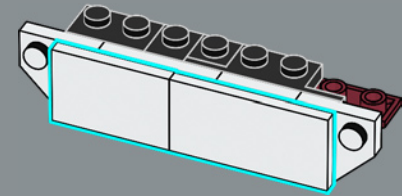

120

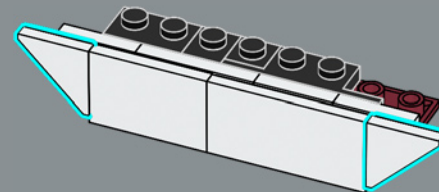

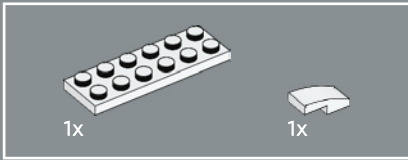
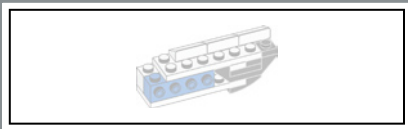

121

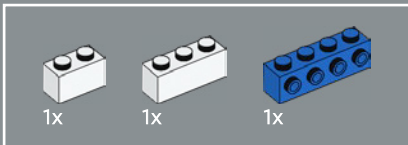
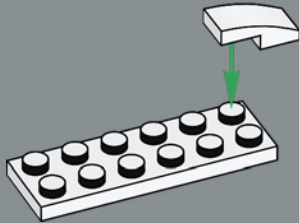

122

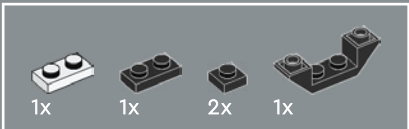
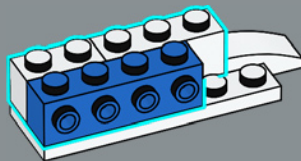

123

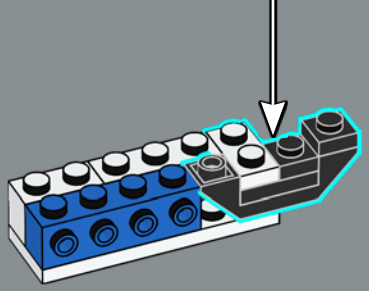
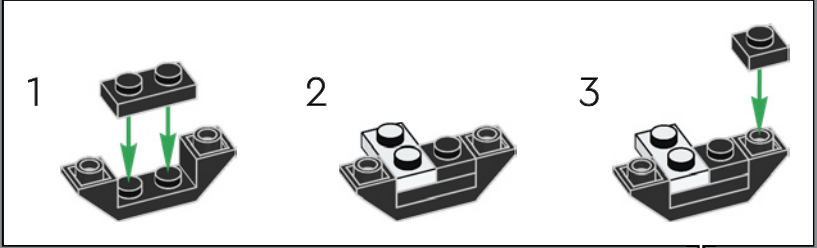

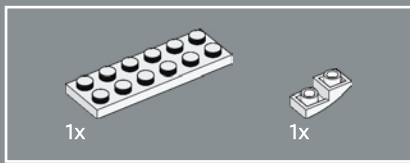

124

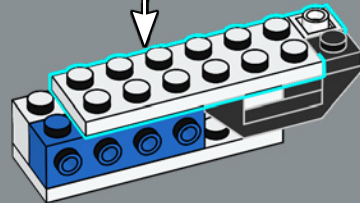
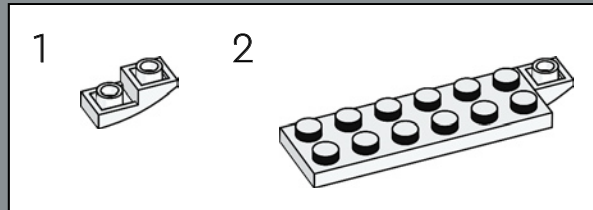

125

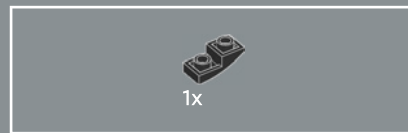
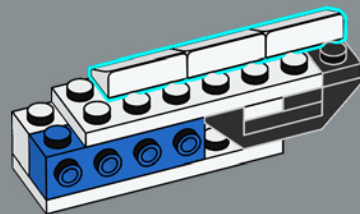

126

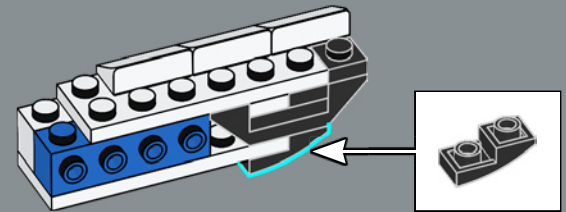

127

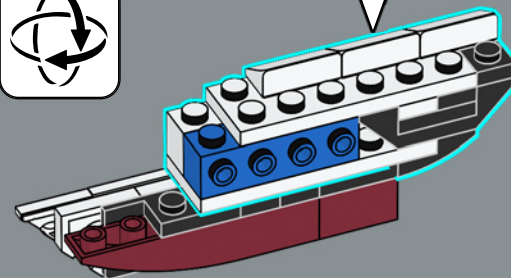

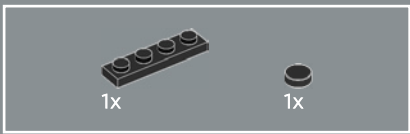

128

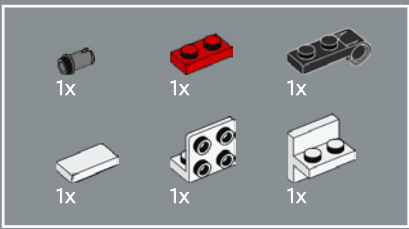
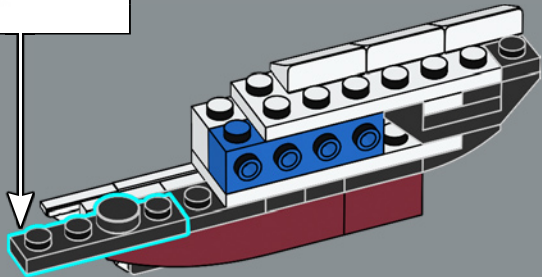
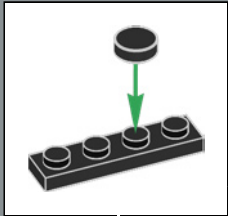

129

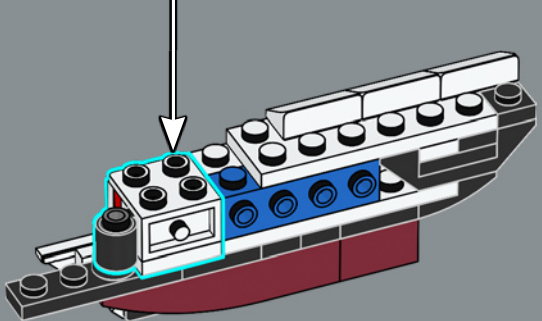
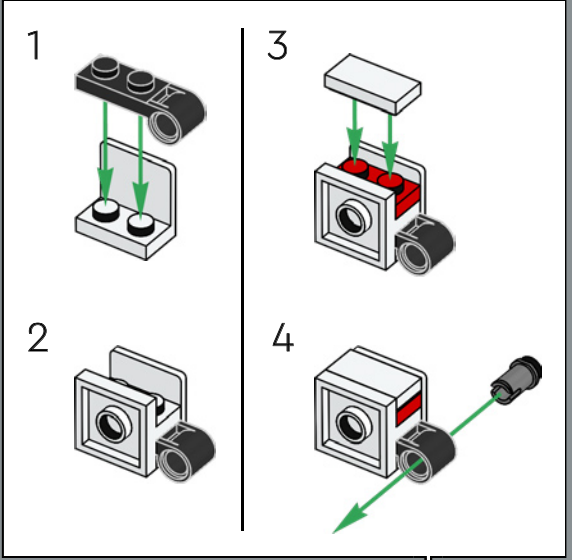

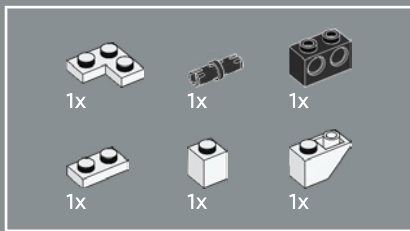

130

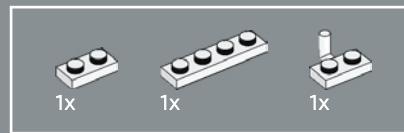
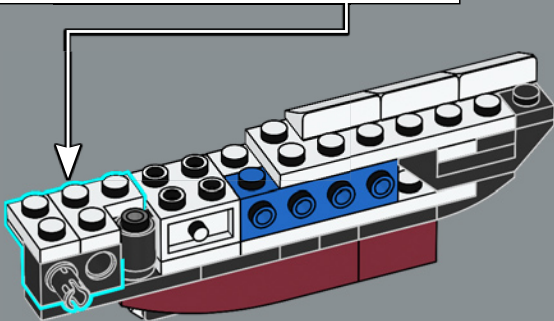
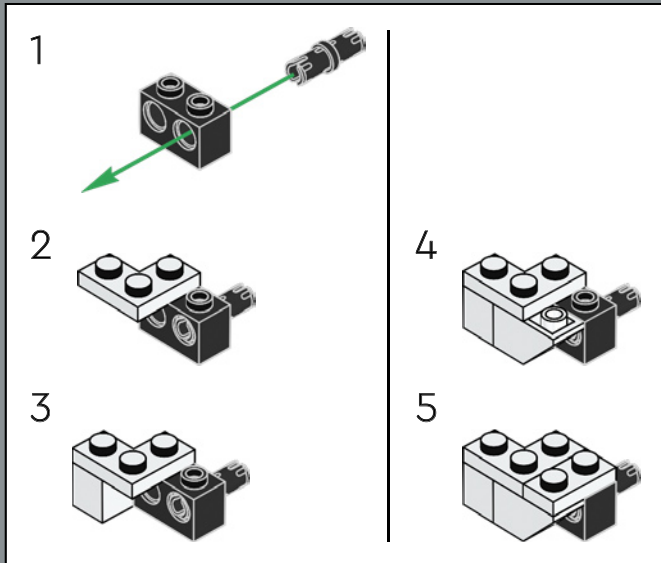

131

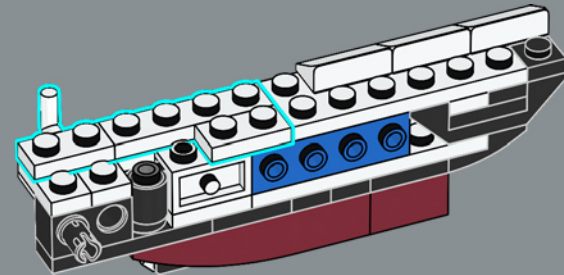

132

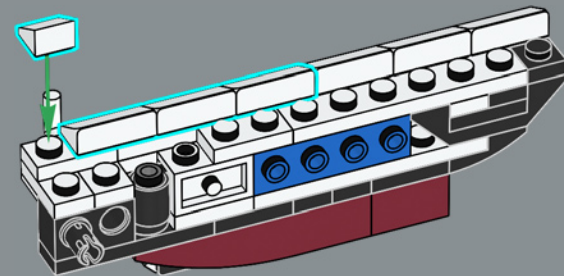



133

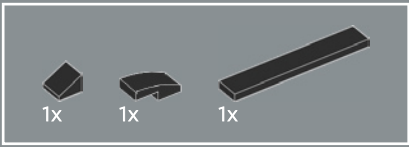
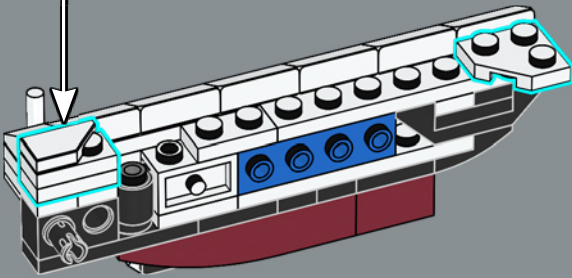
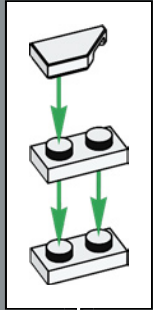

134

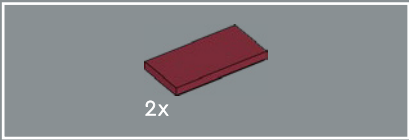
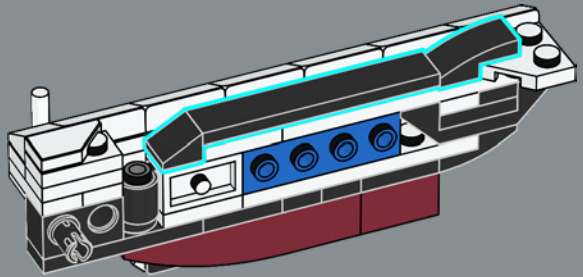

135

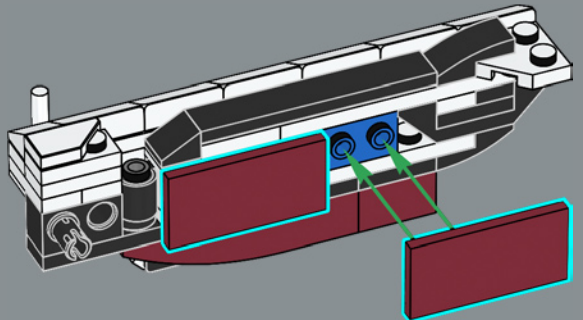

136

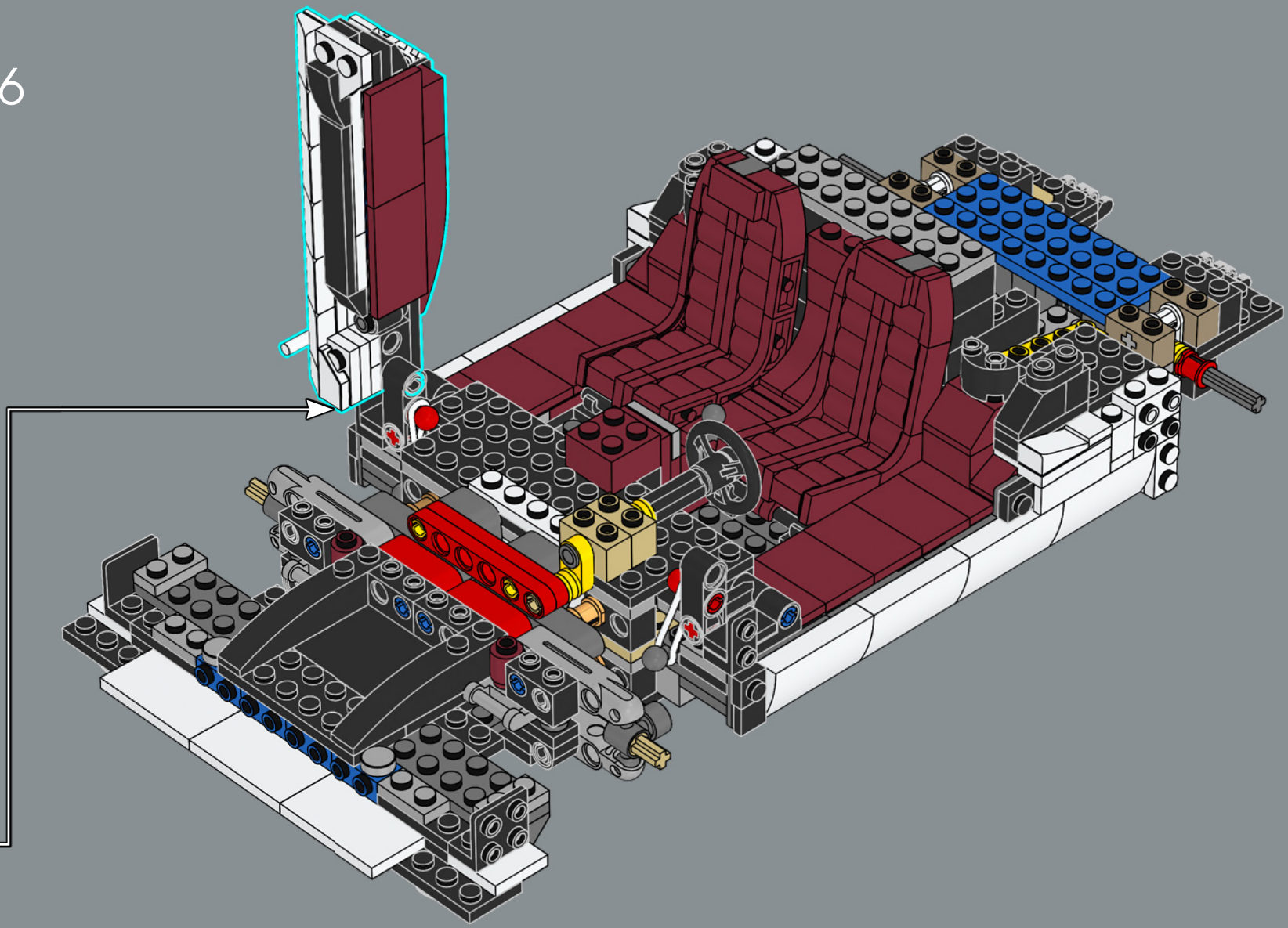

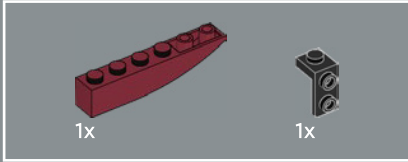
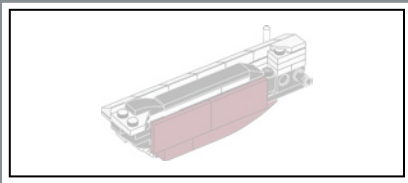

137

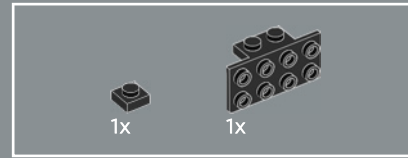
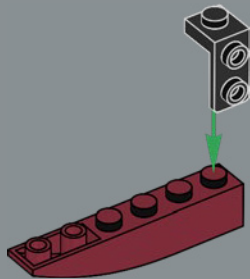

138

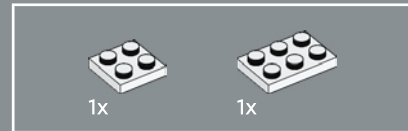
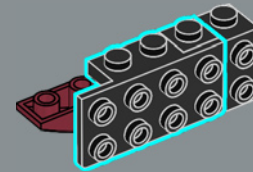

139

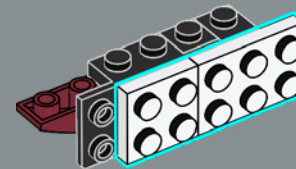

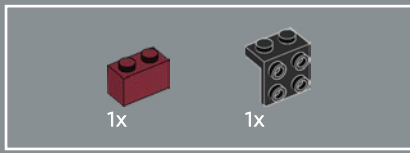

140

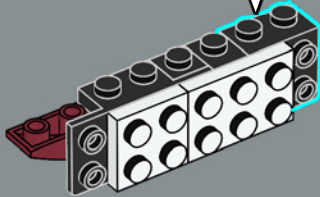
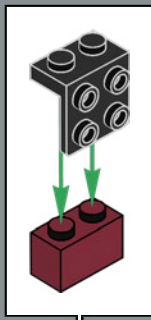

141

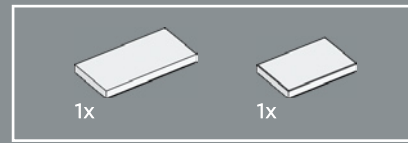
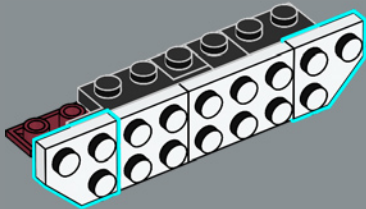

142

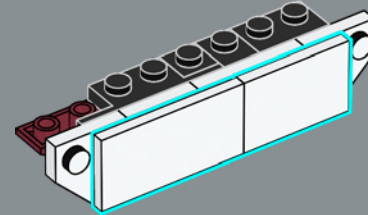

143

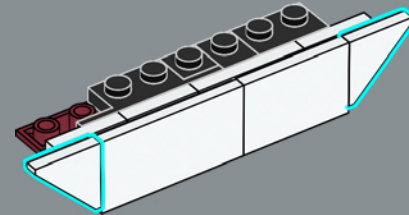

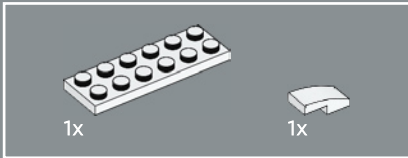
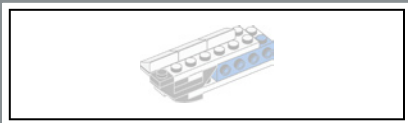

144

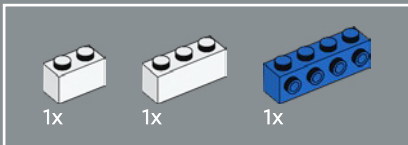
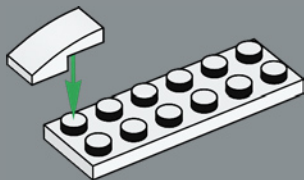

145

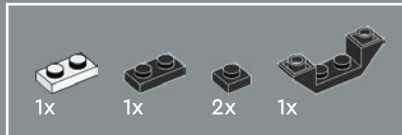
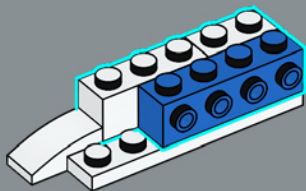

146

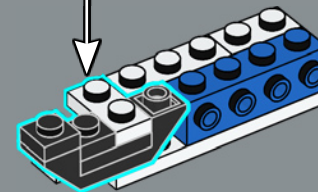
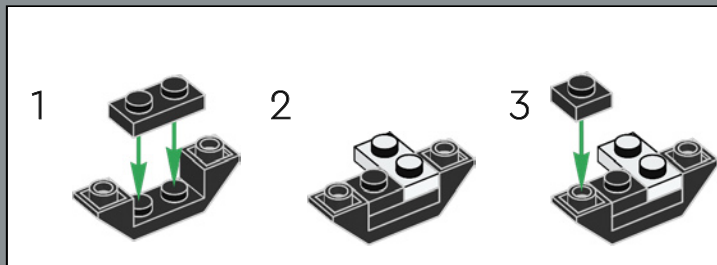

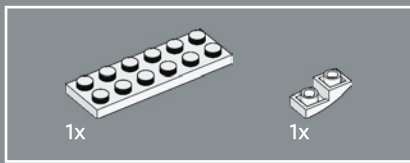

147

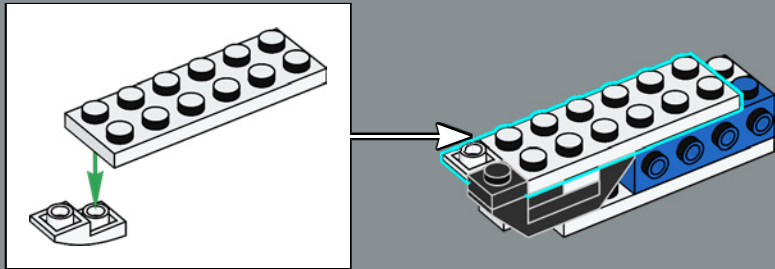

148

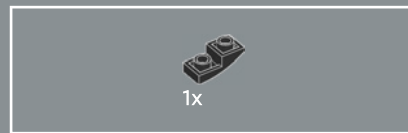
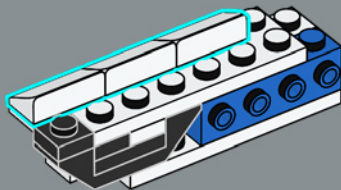

149

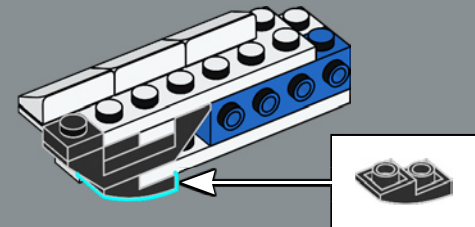

150

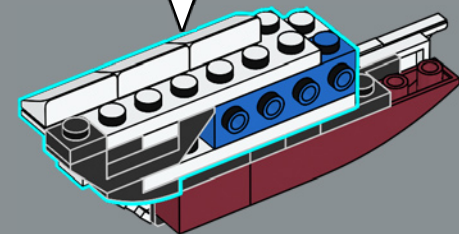

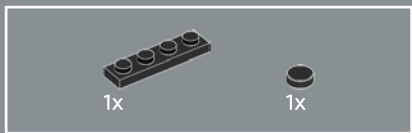

151

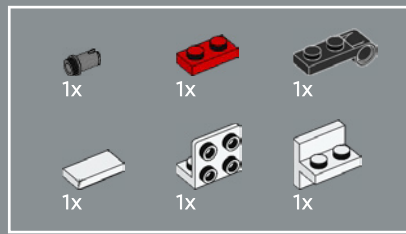
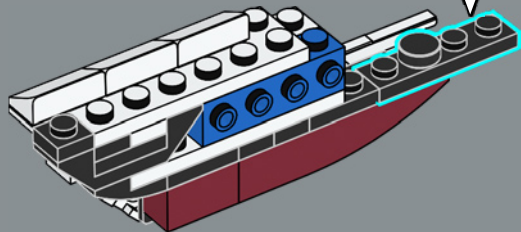
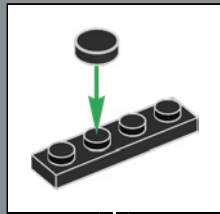

152

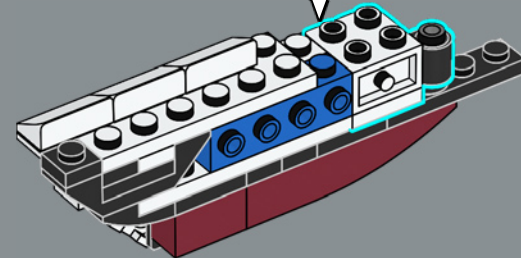
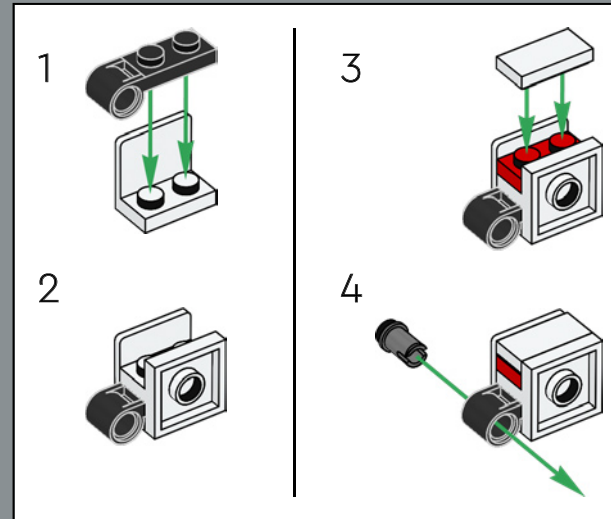

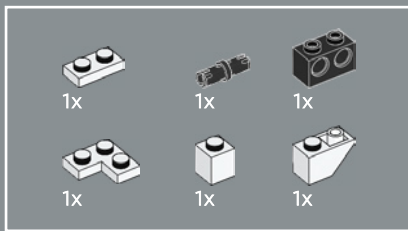

153

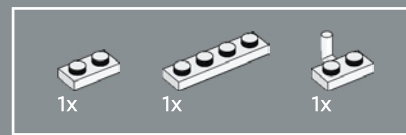
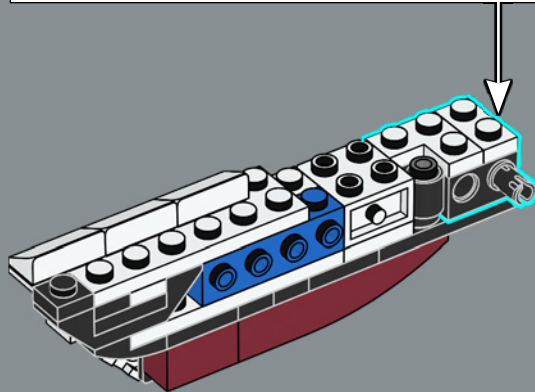
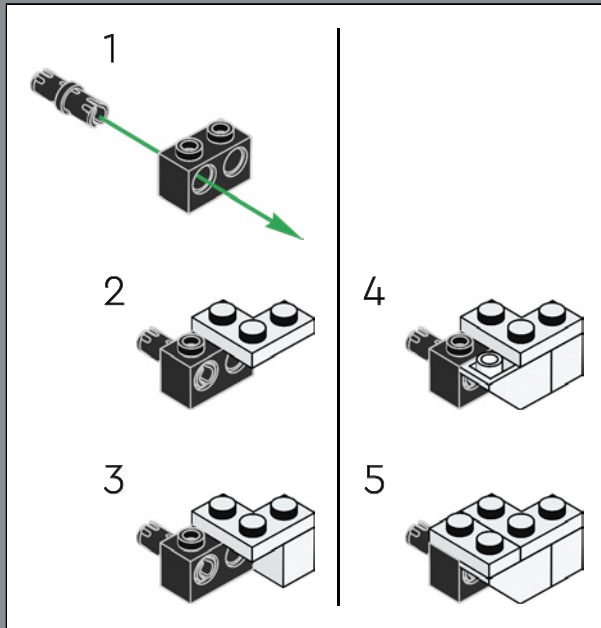

154

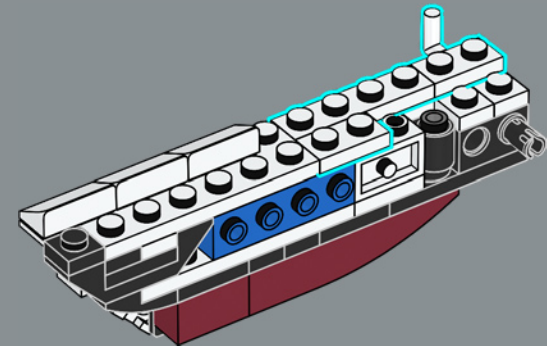



155

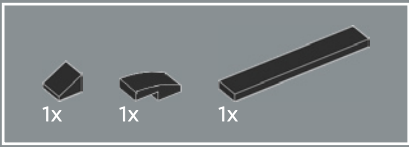
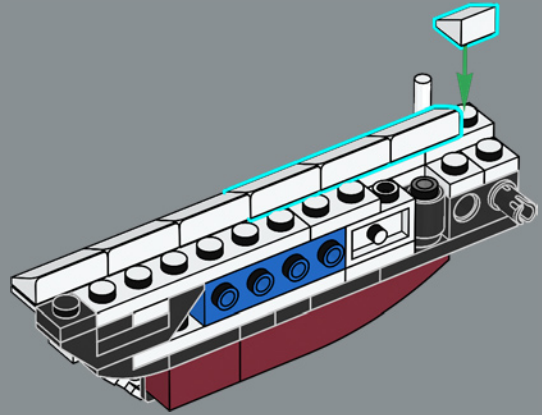

157

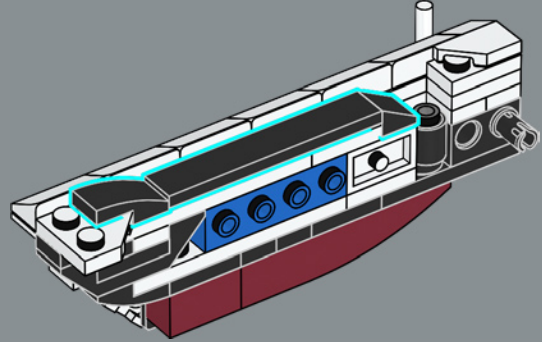

156

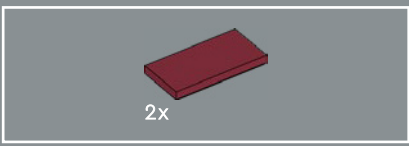
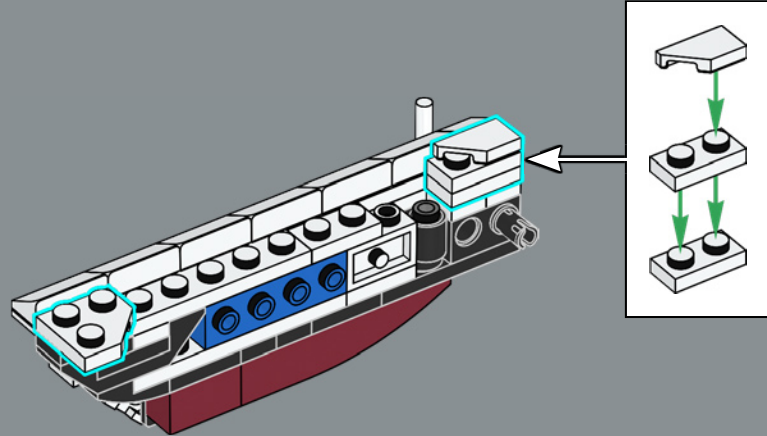

158

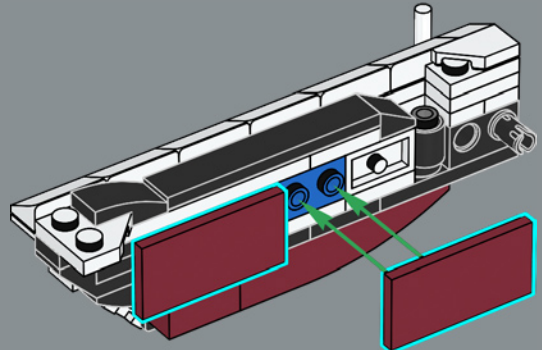



Les portes à ouverture vers le haut sont communément appelées « portes en élytre ».

159

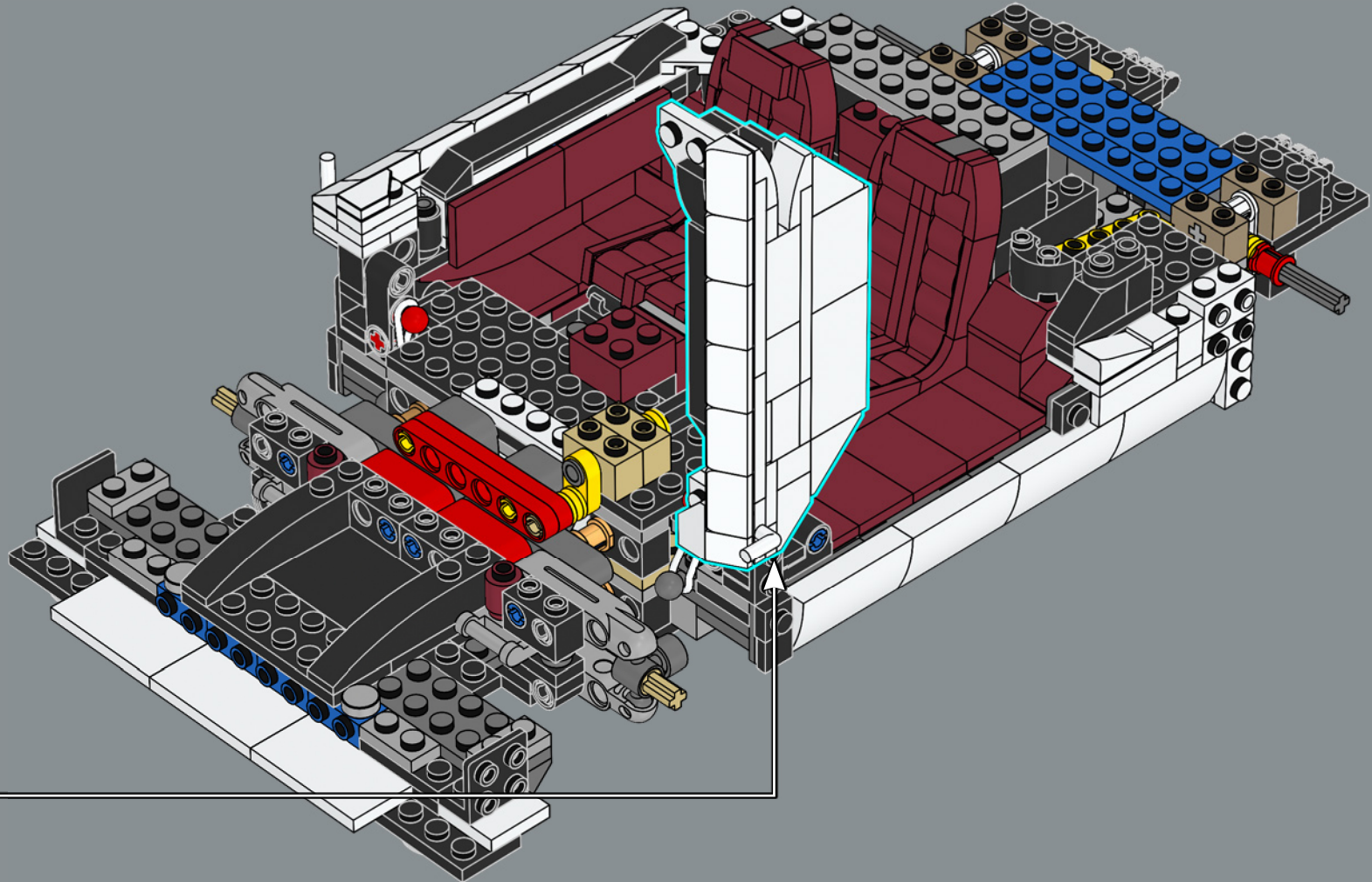

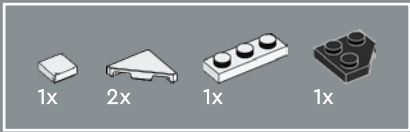

160

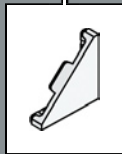
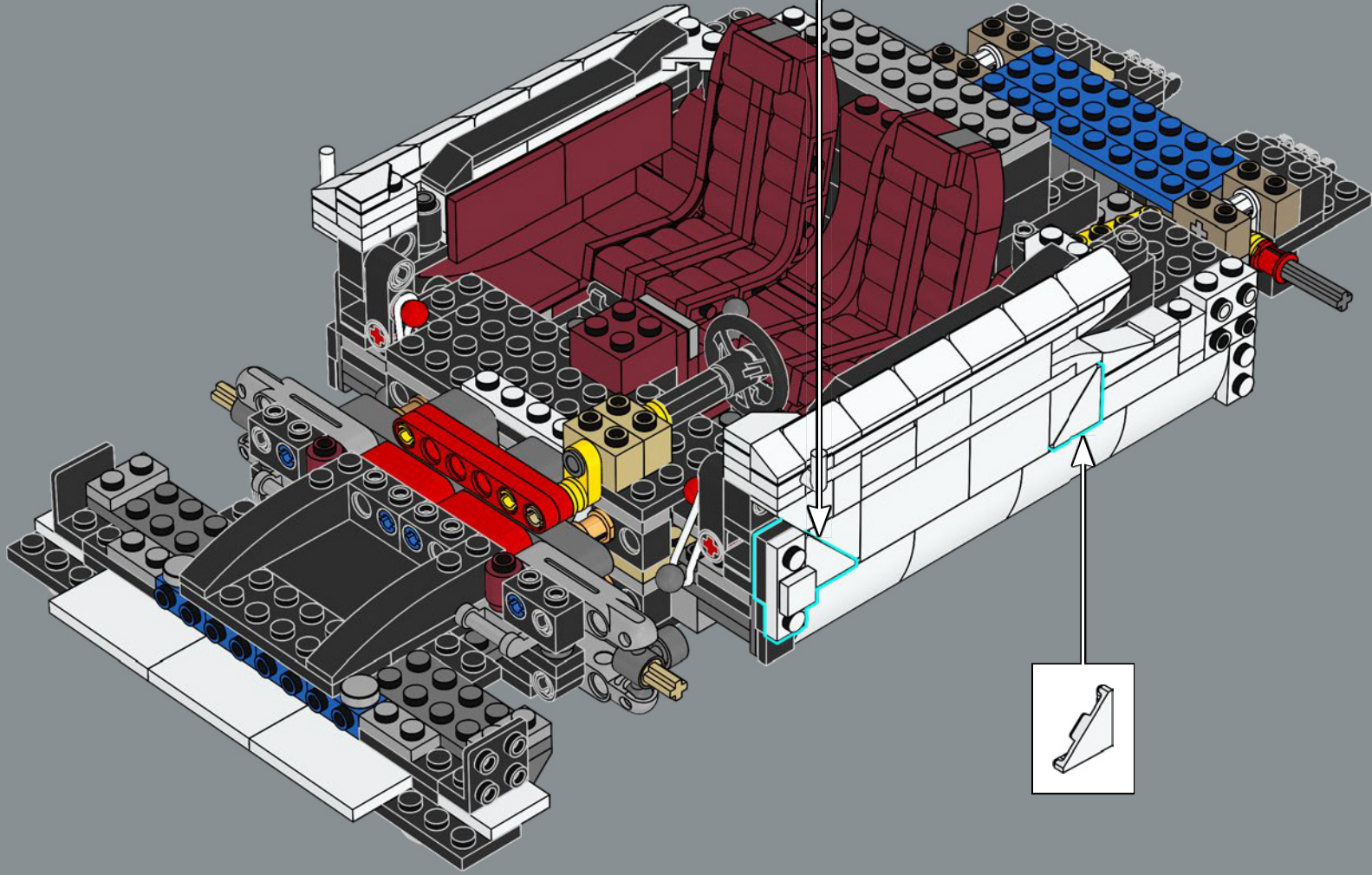
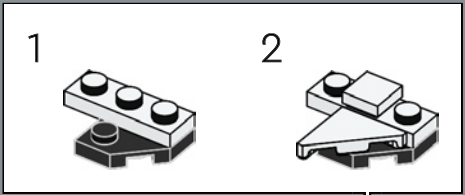

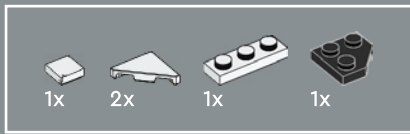

161

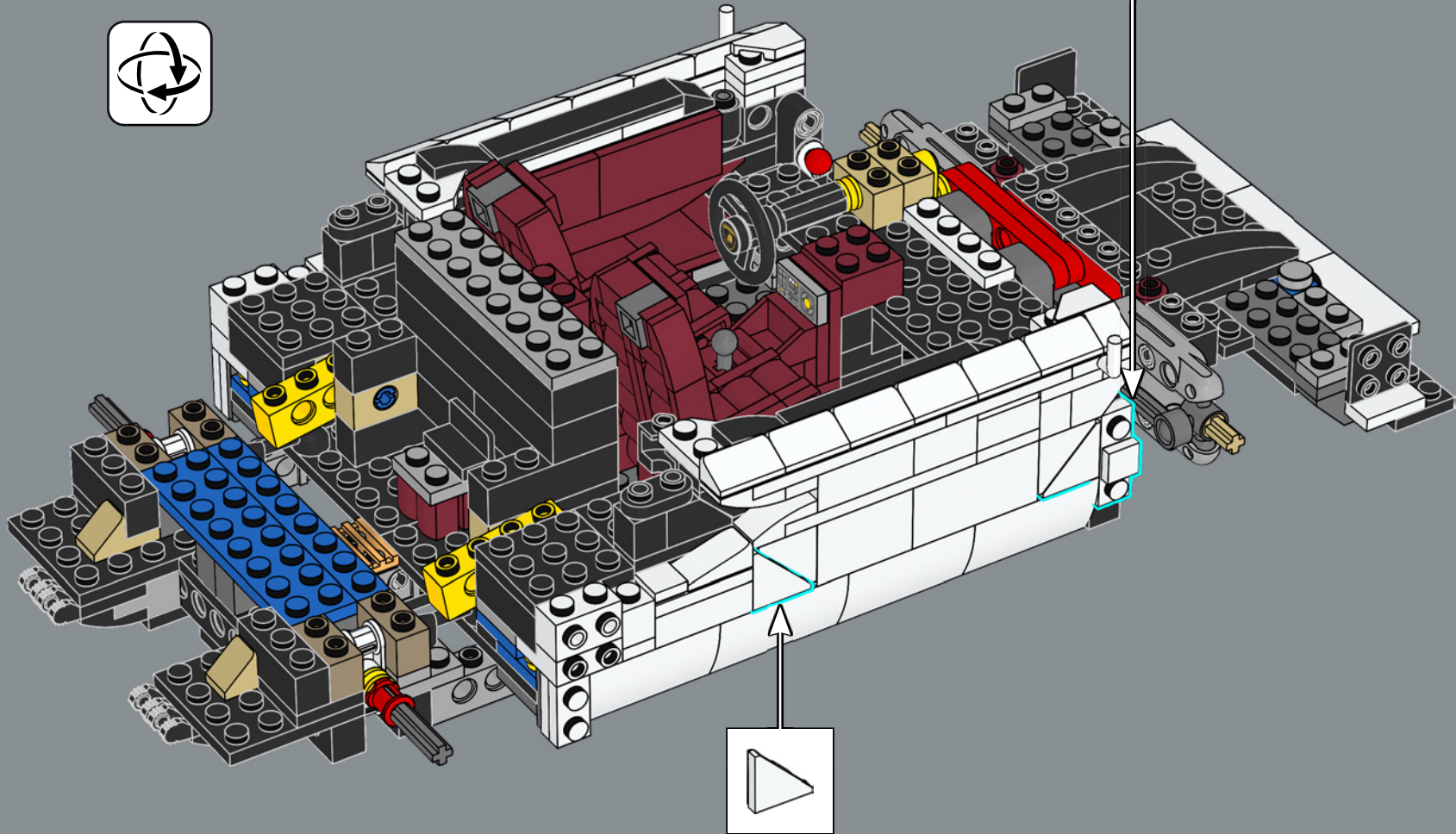
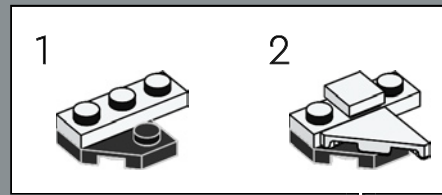

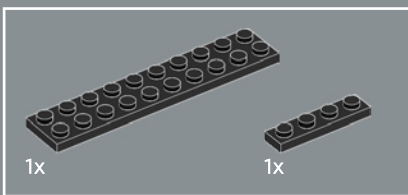
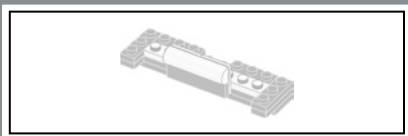

162

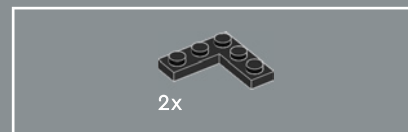
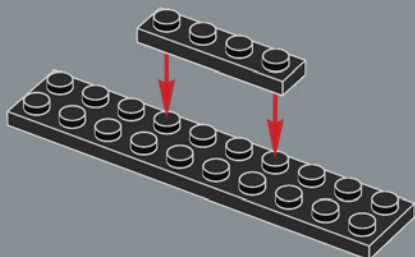

163

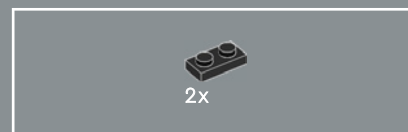
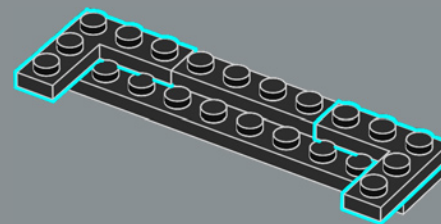

164

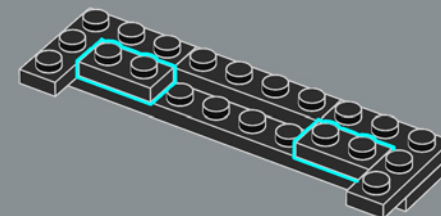

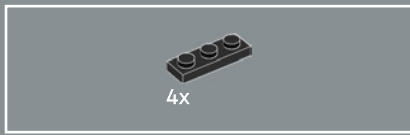

165

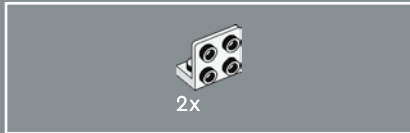
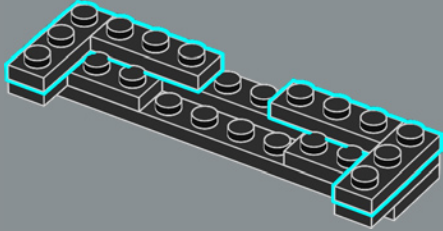

166

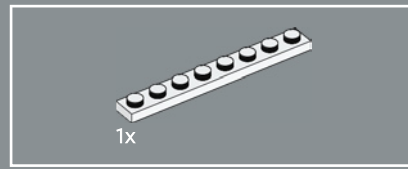
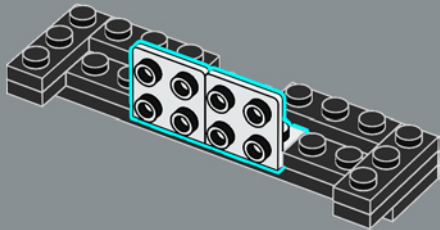

167

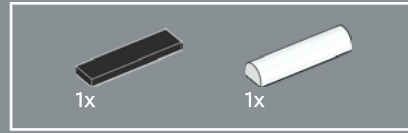
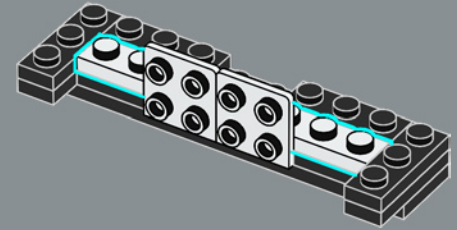

168

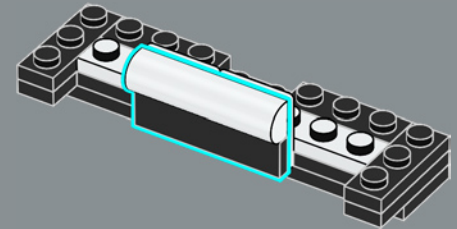

169

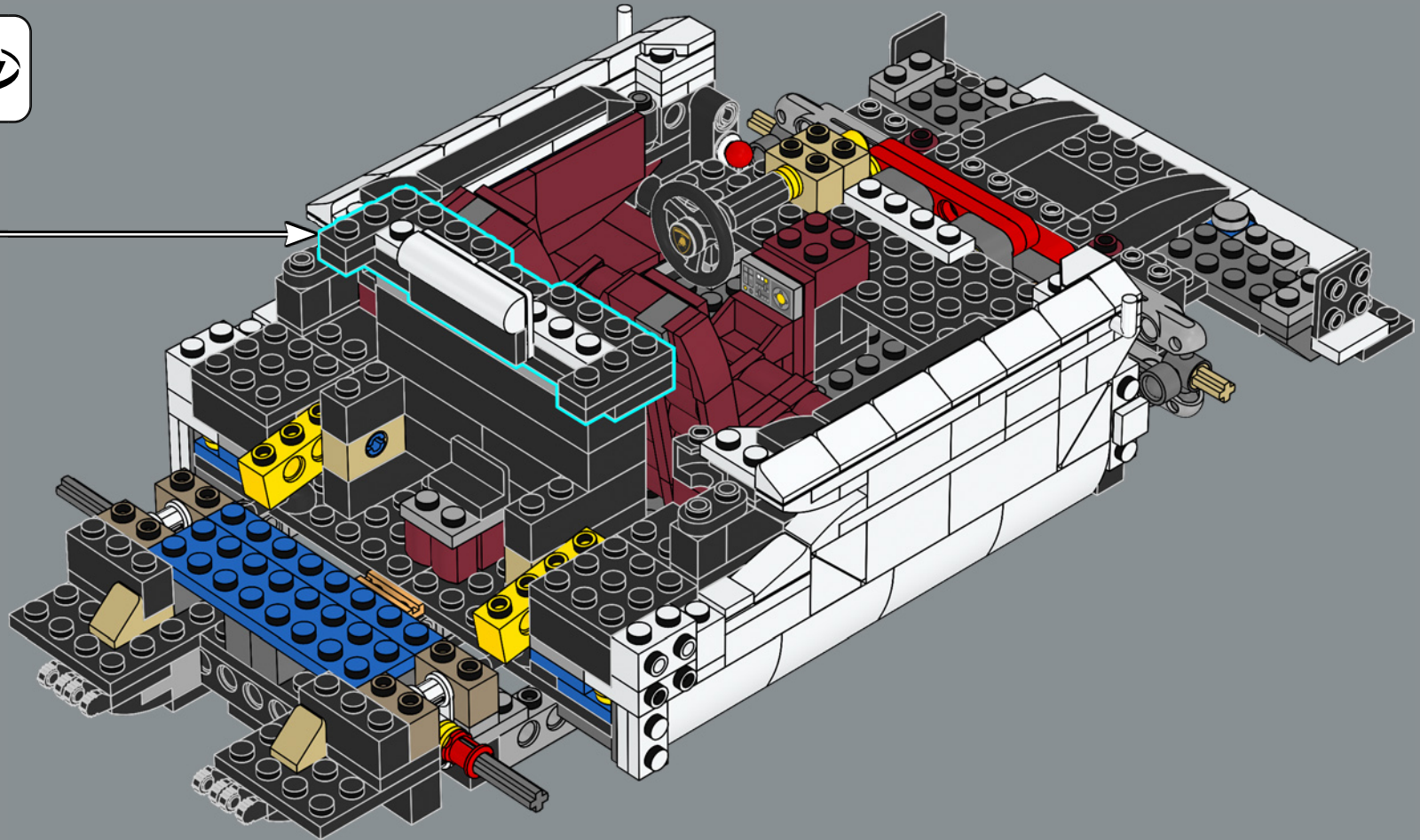

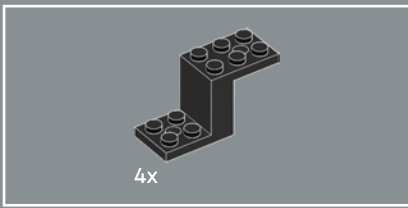

170

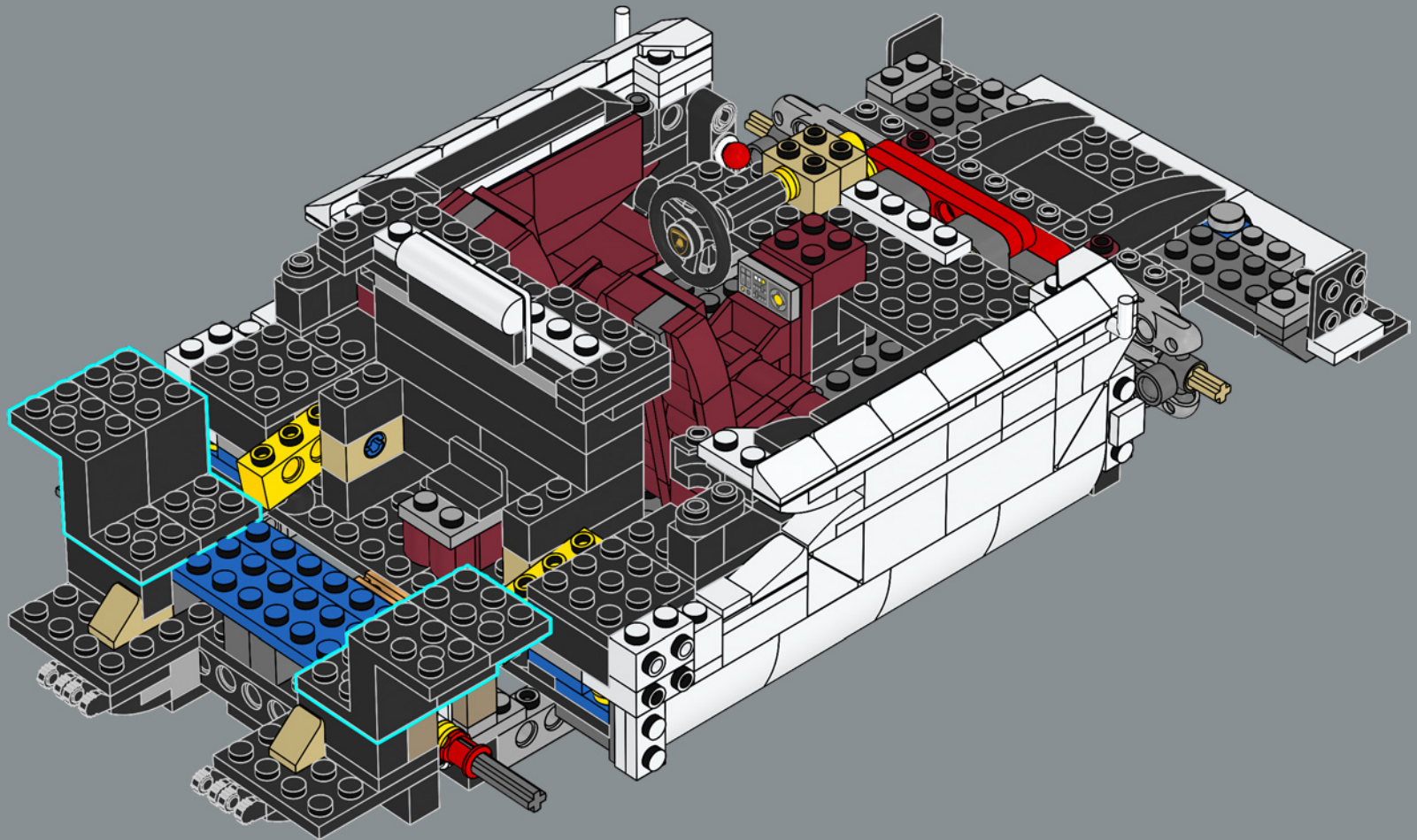

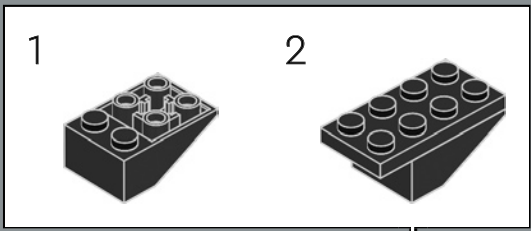
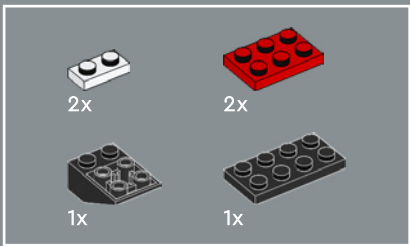

171

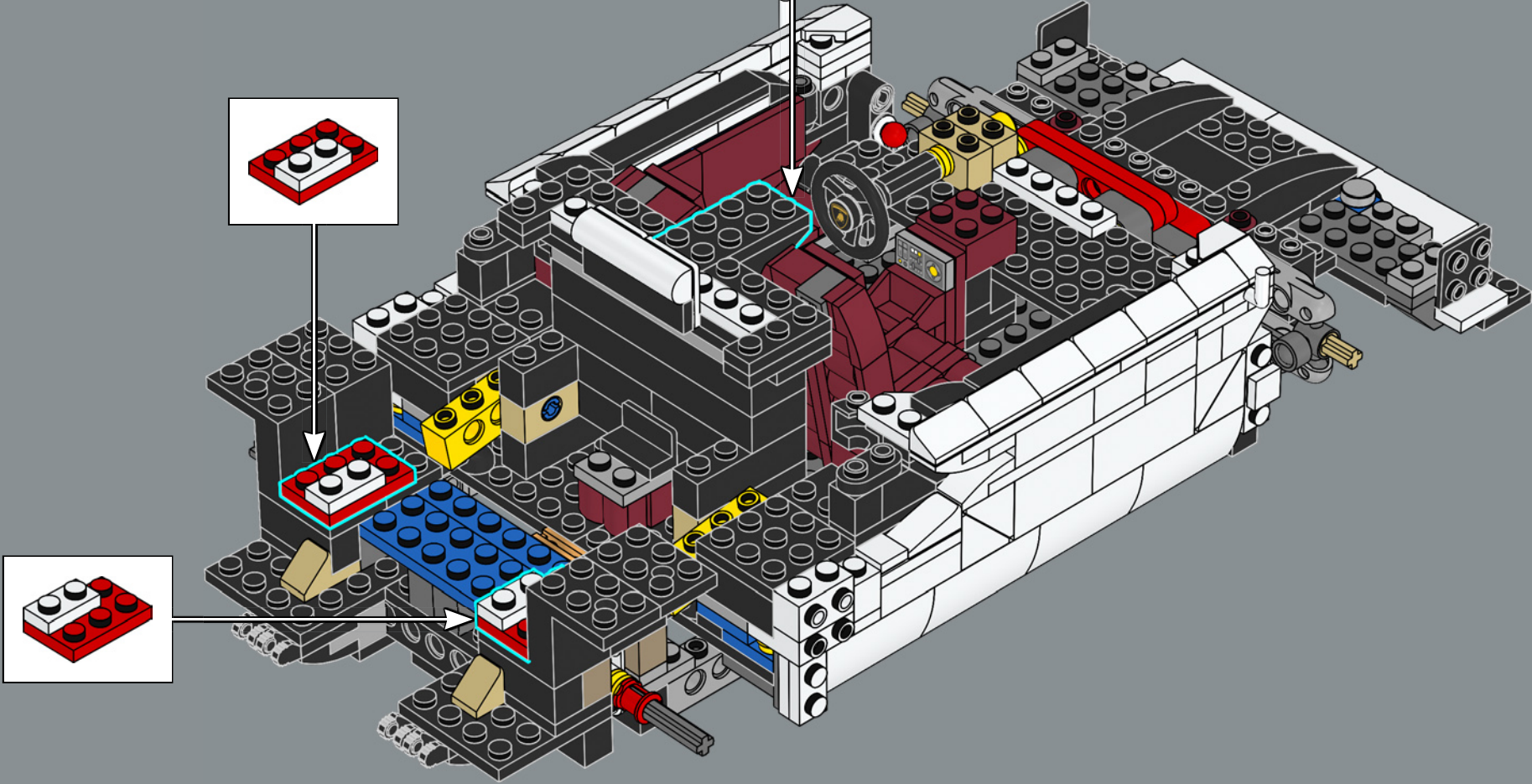

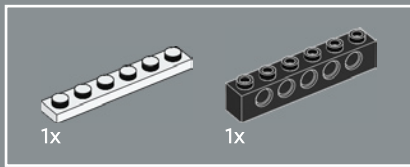

172

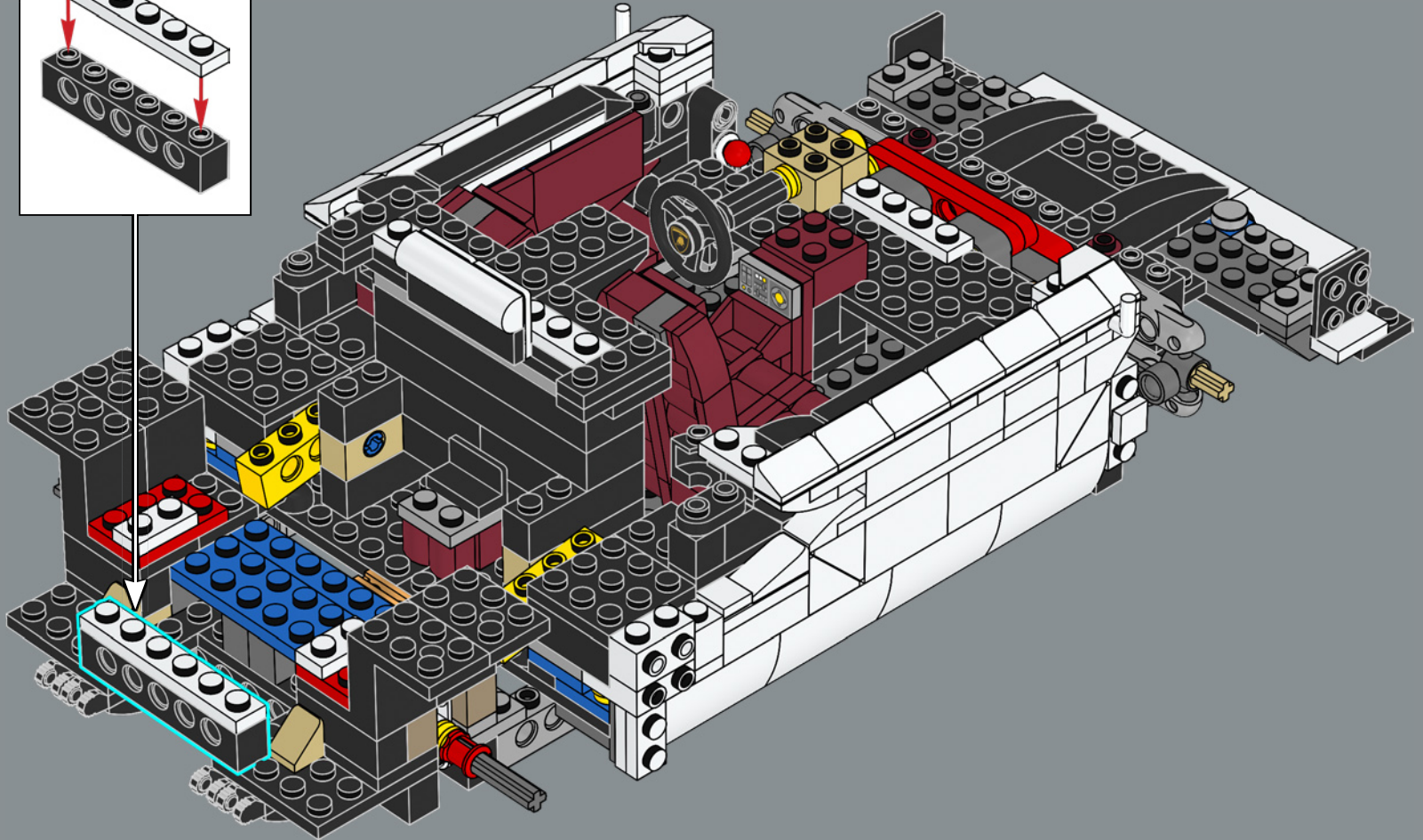
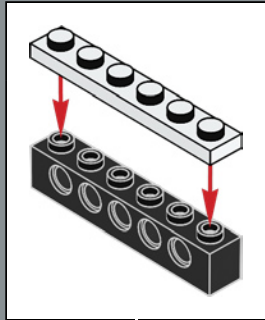

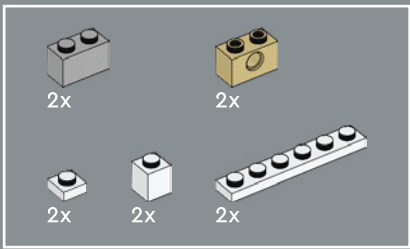

173

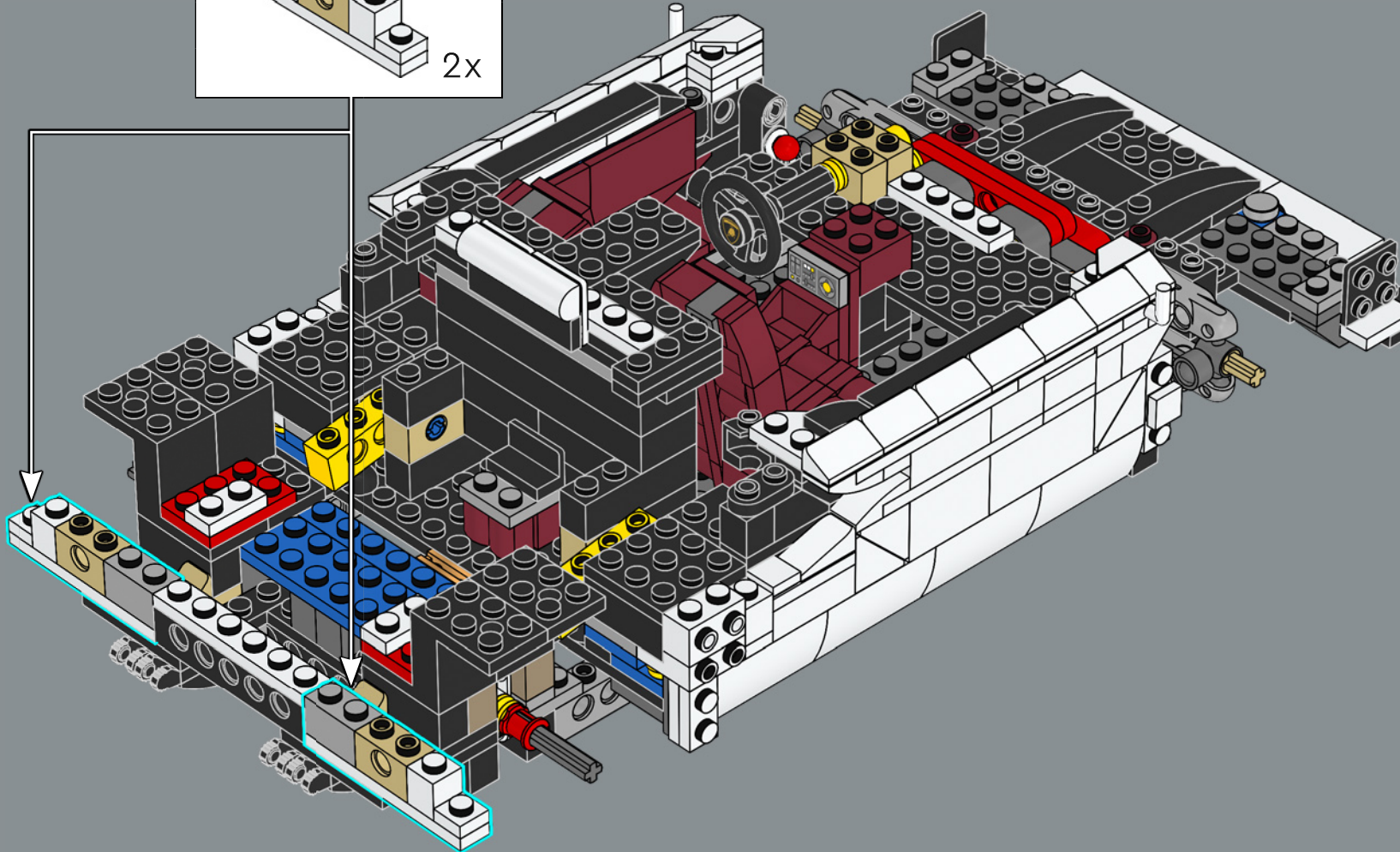
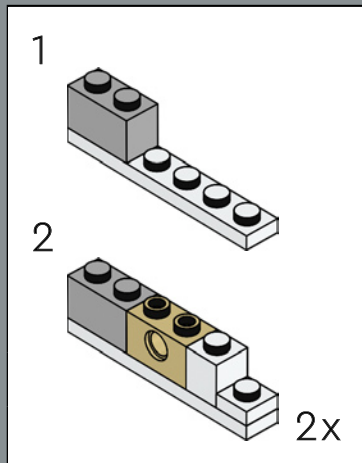

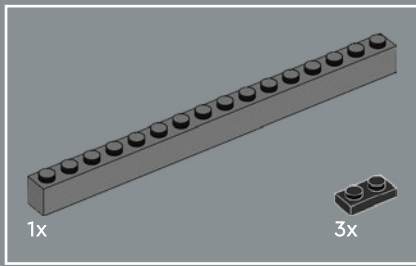

174

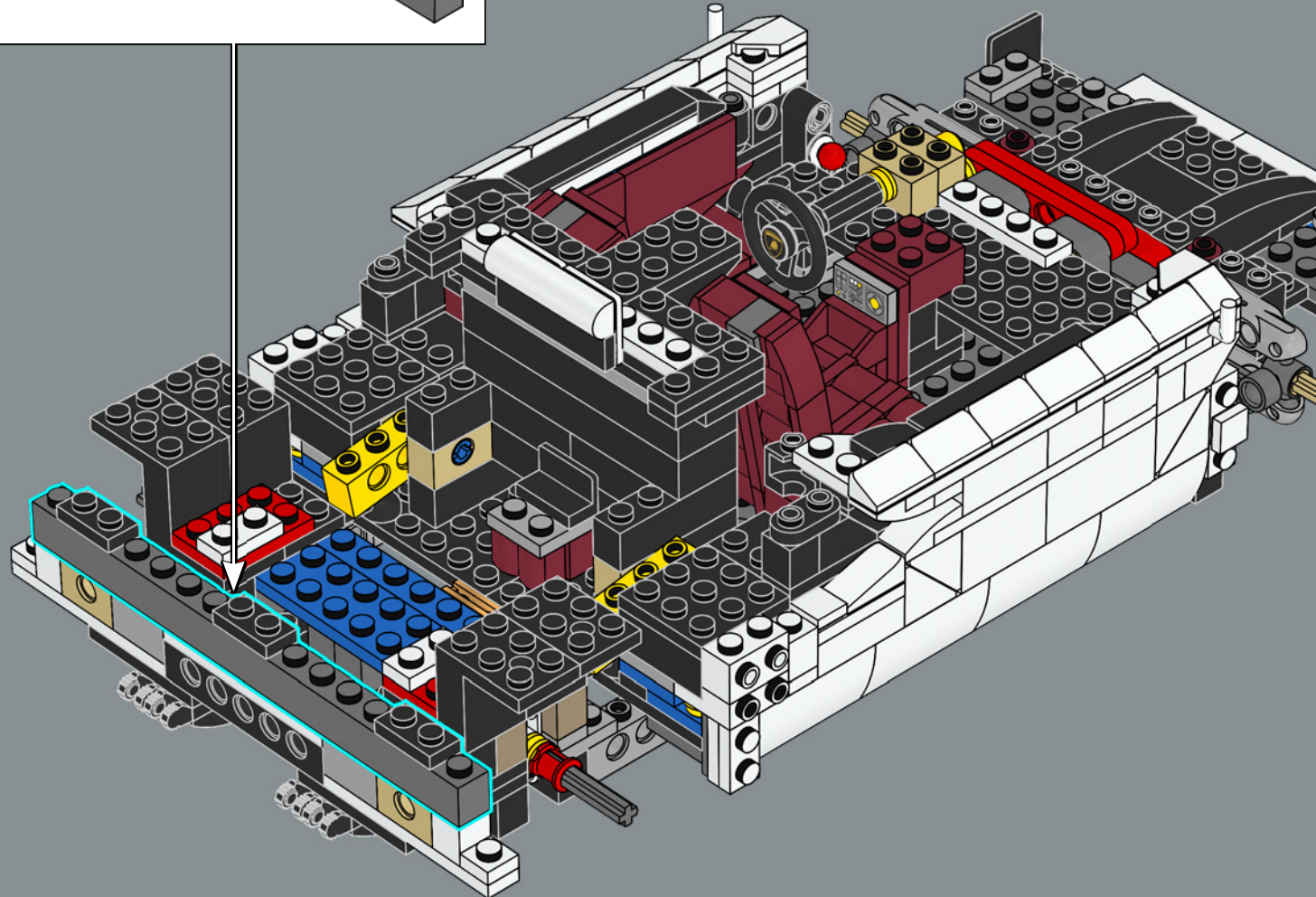
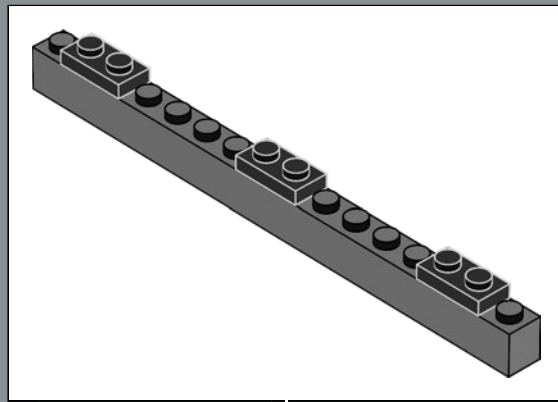

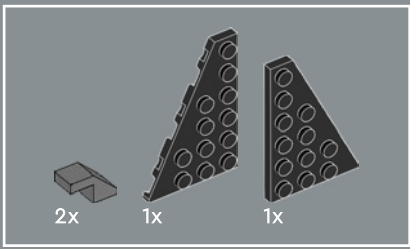

175

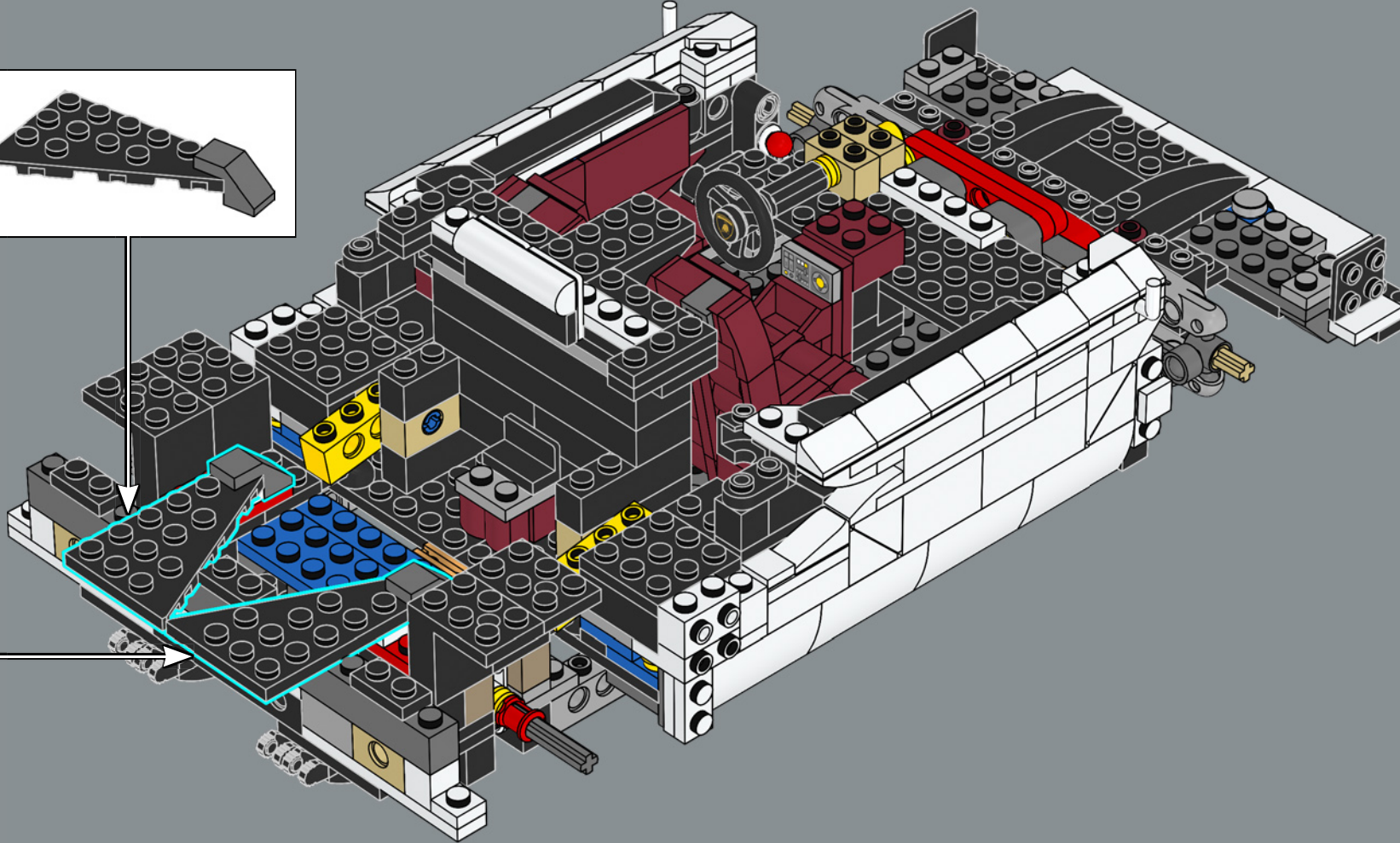
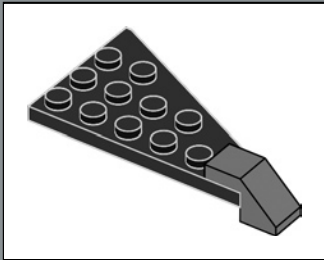
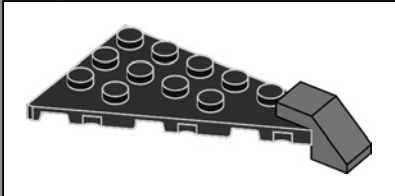

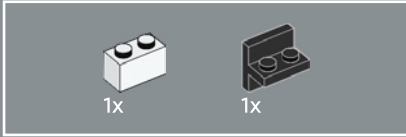
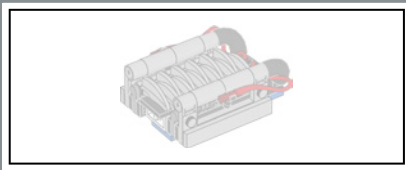

176

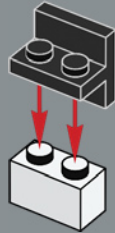

177

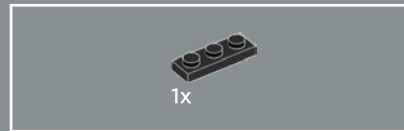
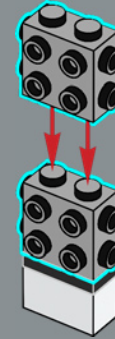

178



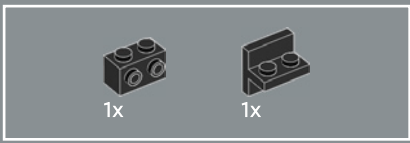

179

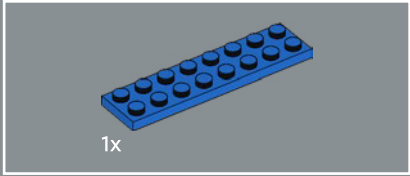
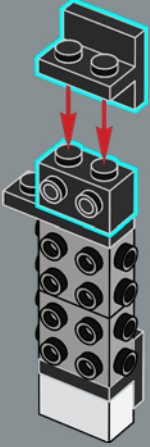

180

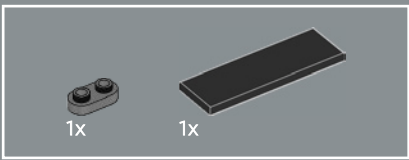
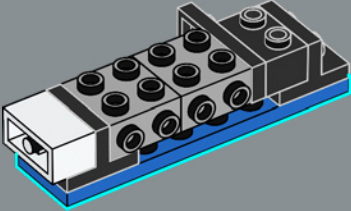

181

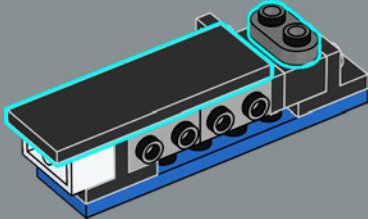

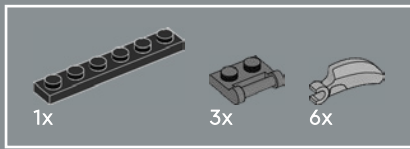

182

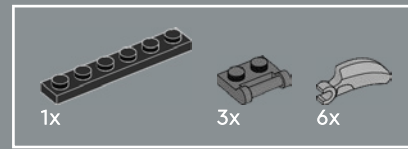
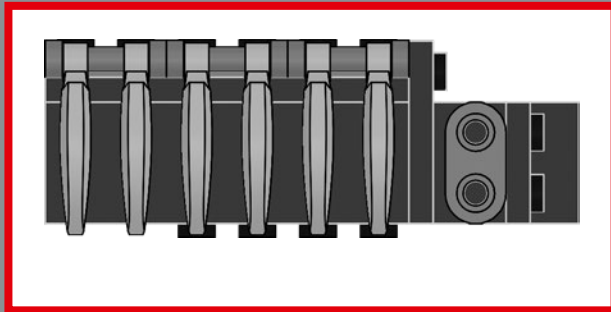
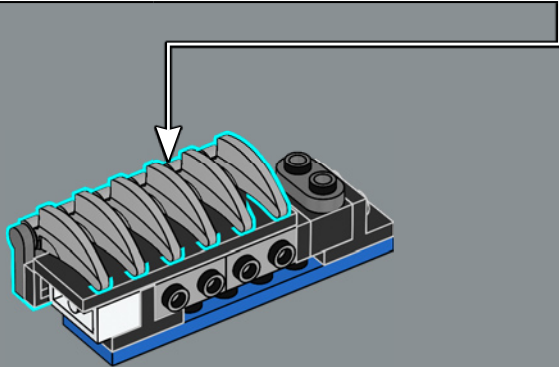
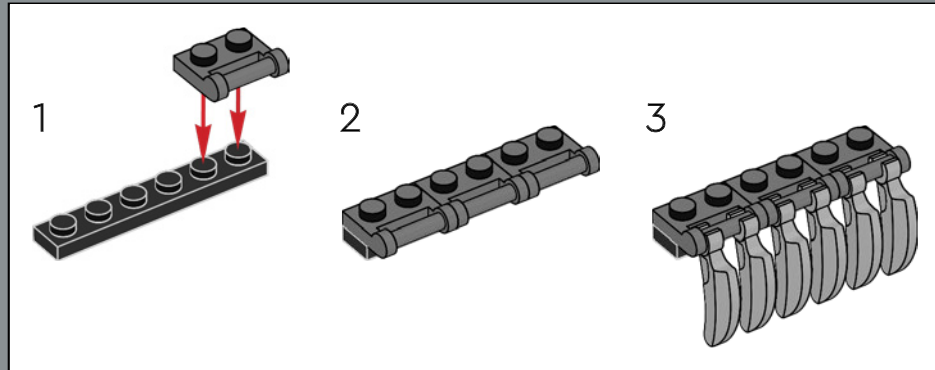

183

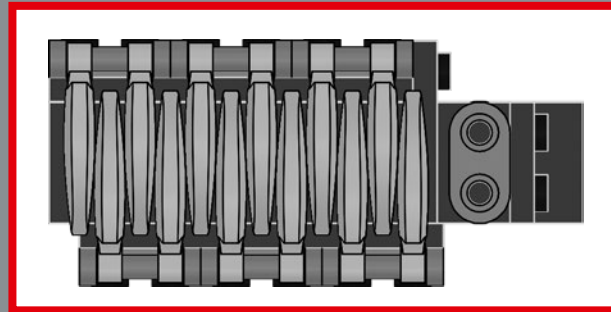
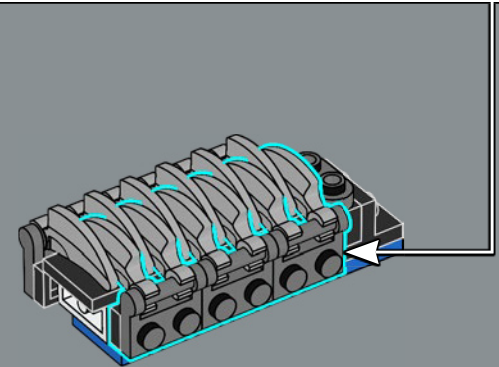
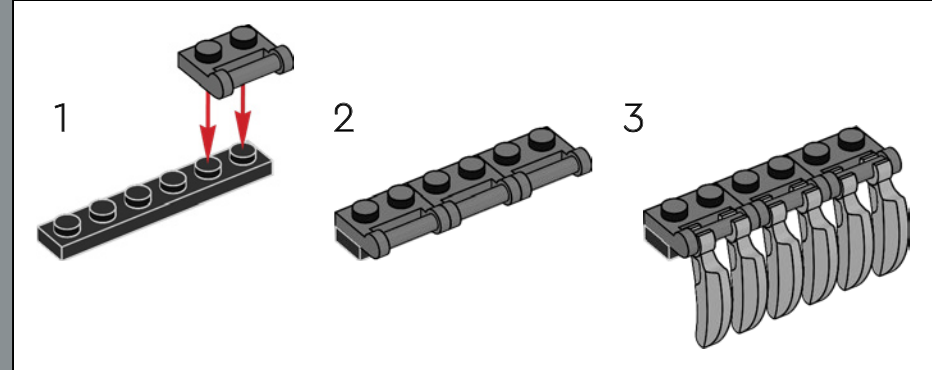

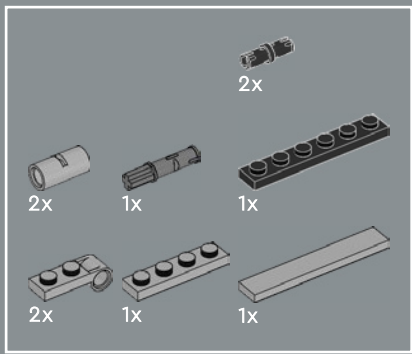

184

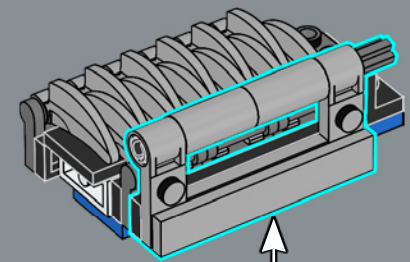
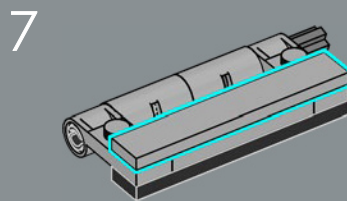
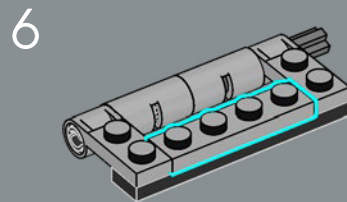
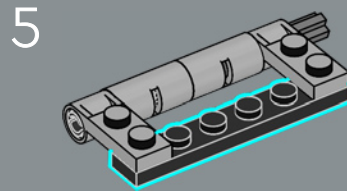
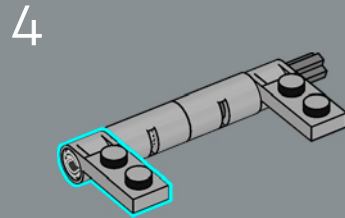
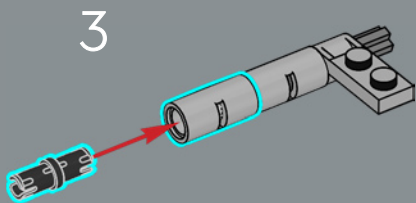
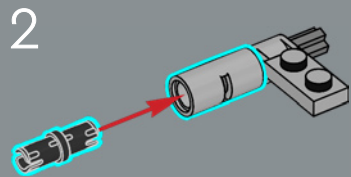
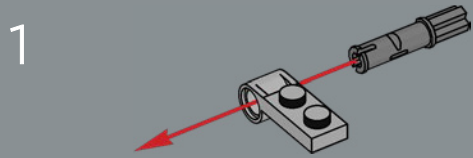

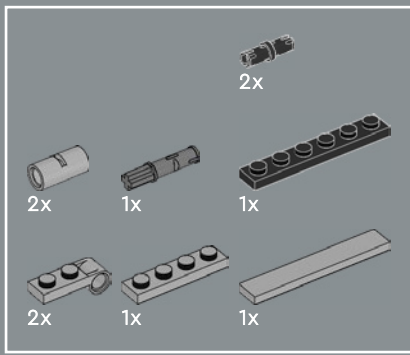

185

1

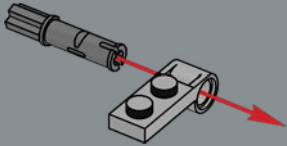

2

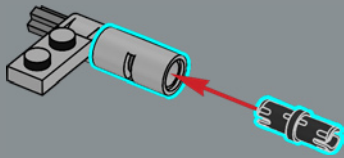

3

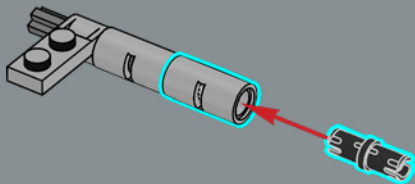

4

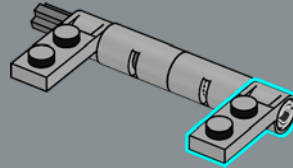

5

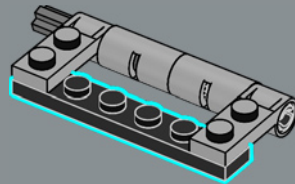

6

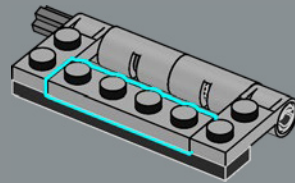

7

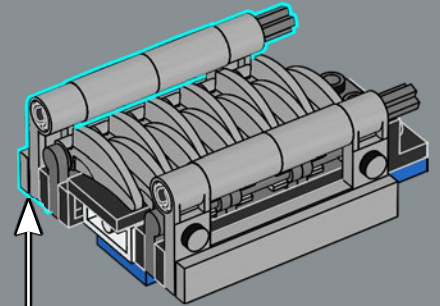
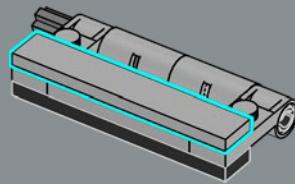

2x

186

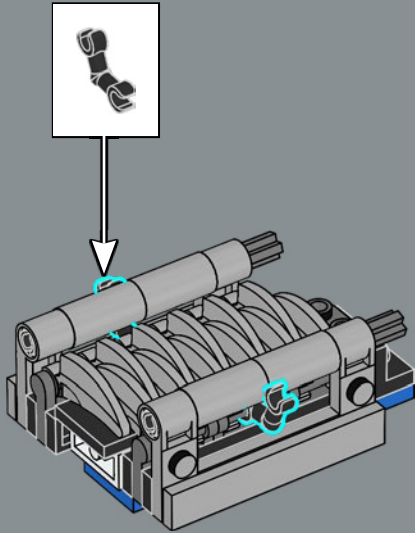

2x

187

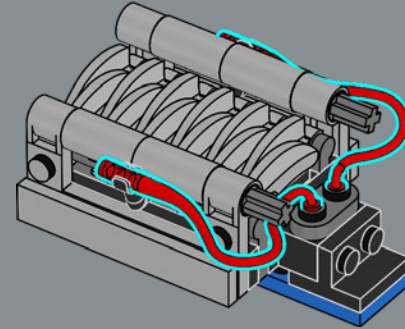

2x

188

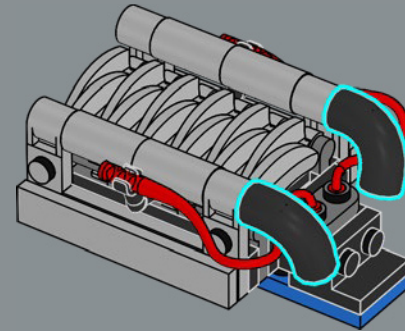



La mention « LP » qui apparaît dans les noms de la Countach signifie Longitudinale Posteriore (Longitudinal arrière en français), ce qui correspond à l'emplacement du moteur.

189

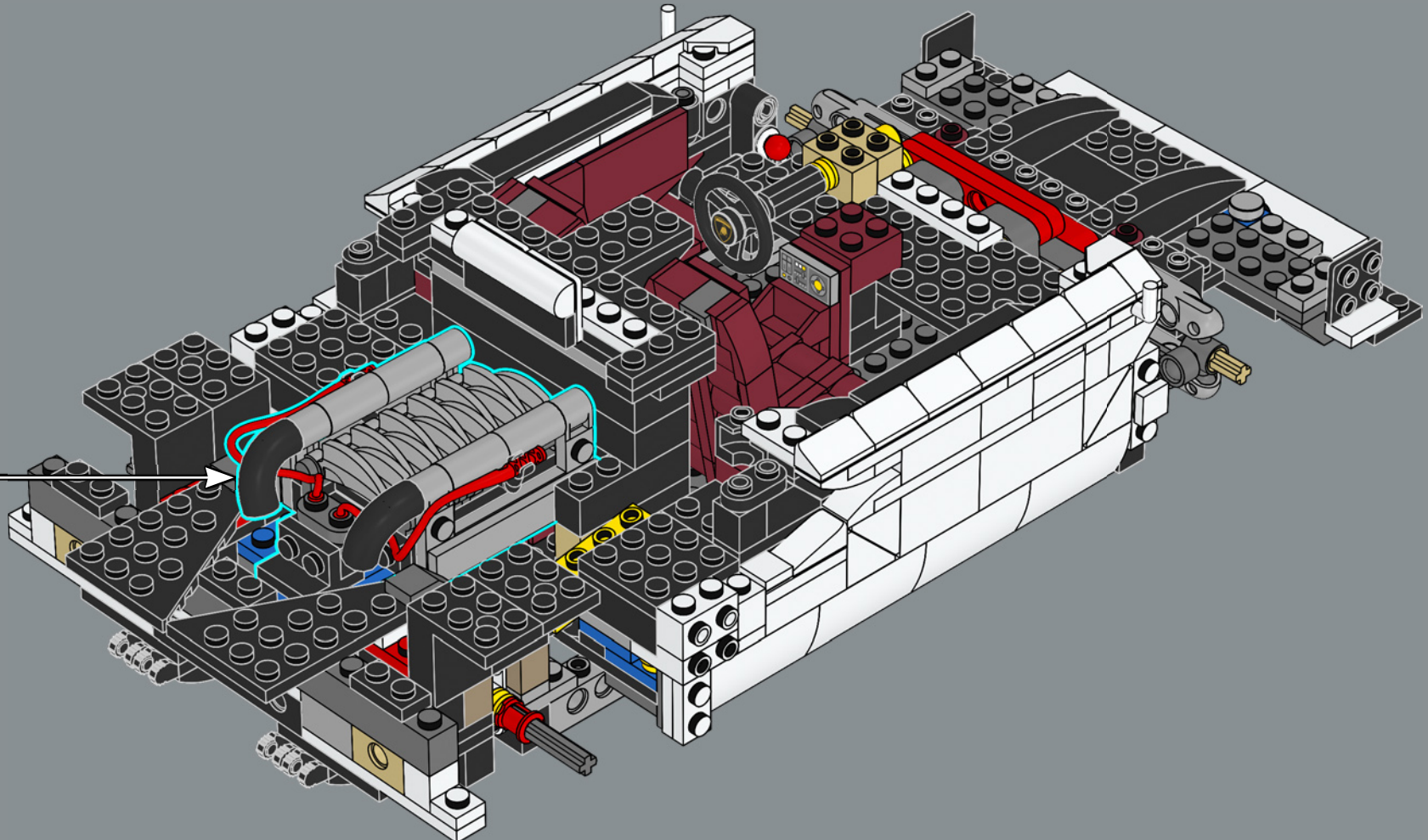

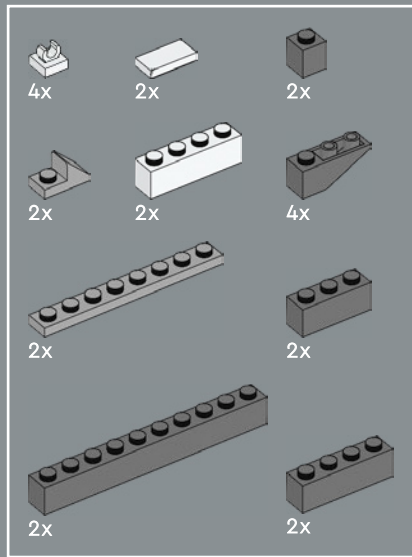
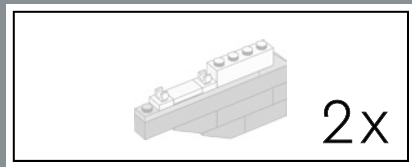

190

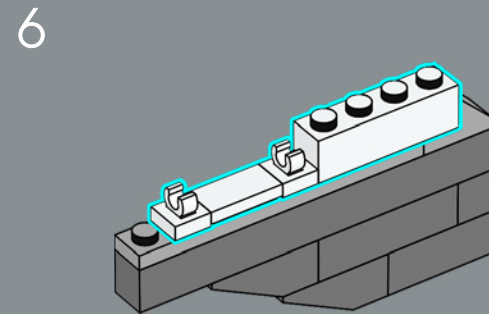
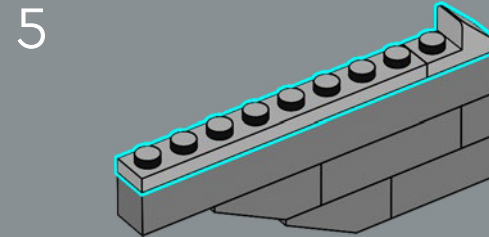
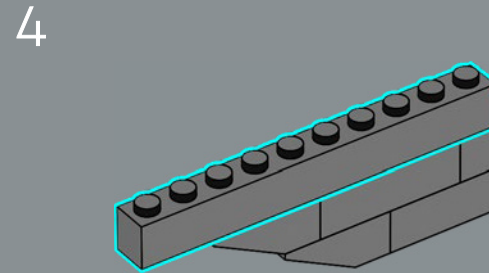
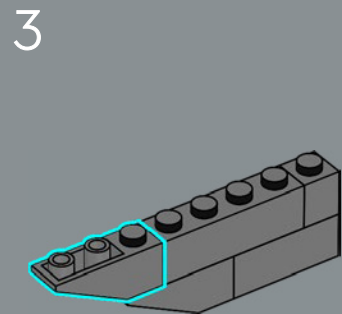
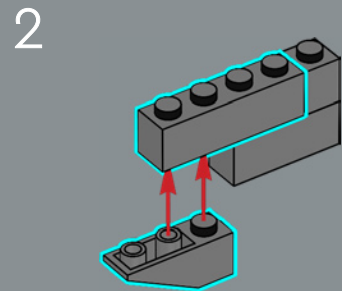
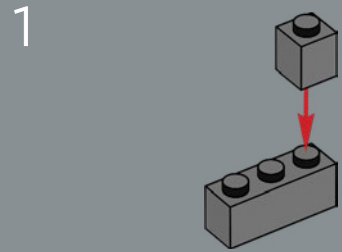

2x

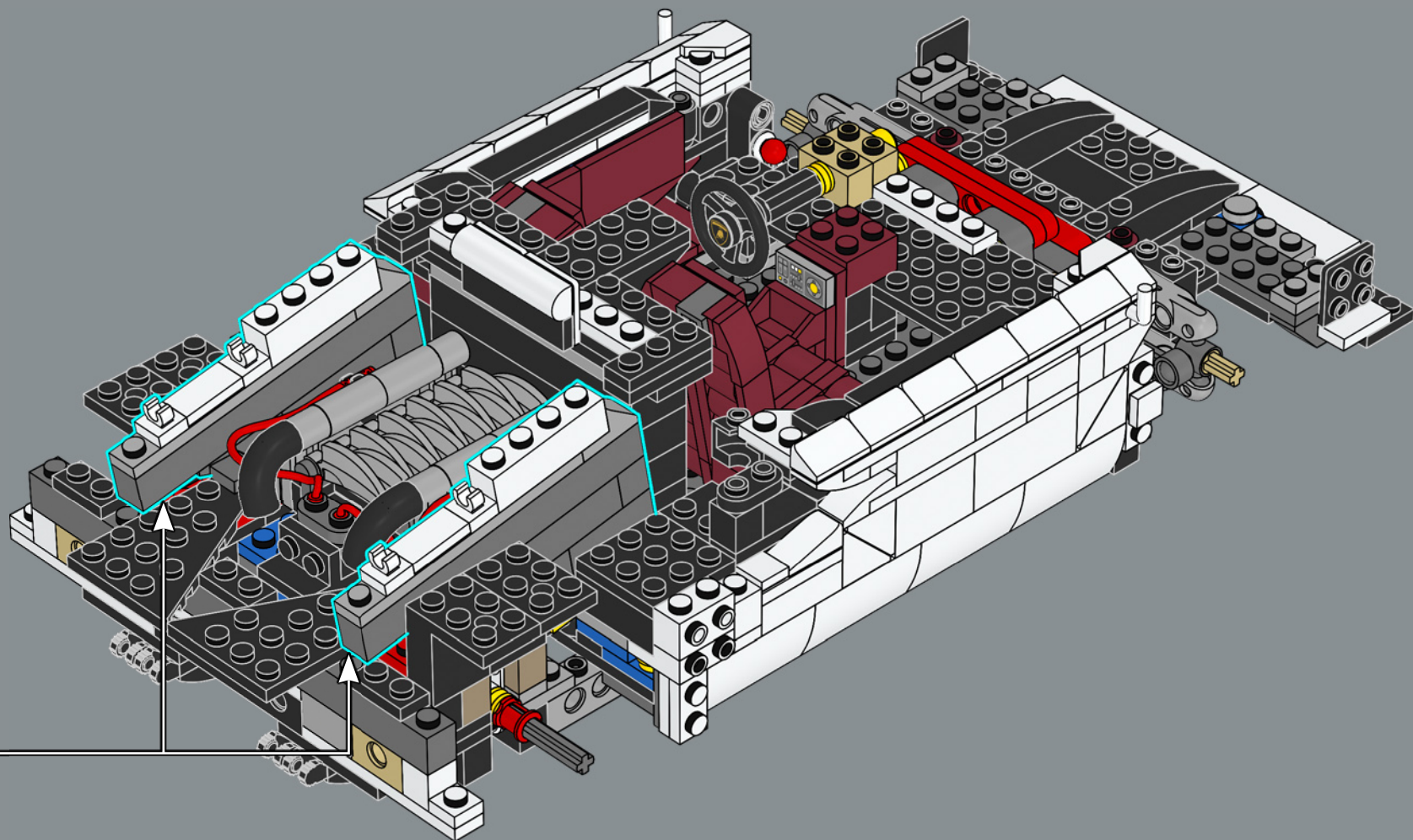

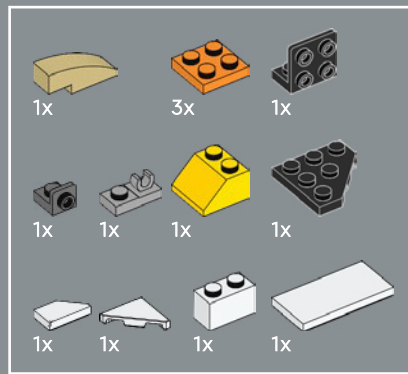

191

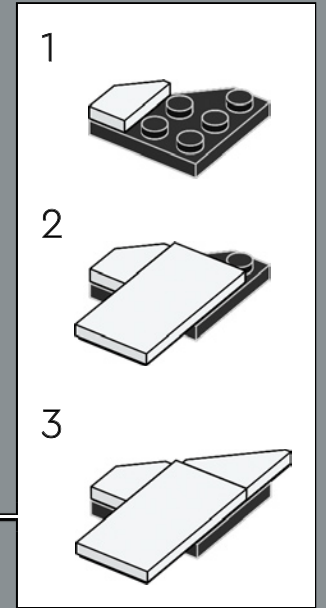
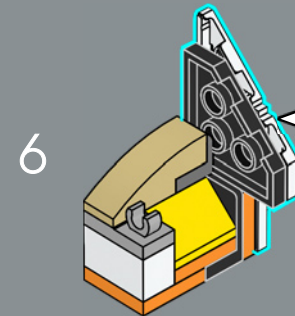
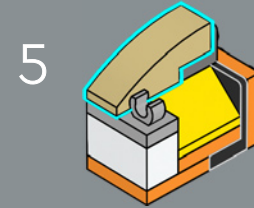
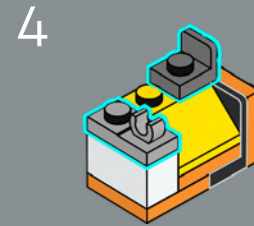
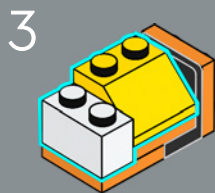
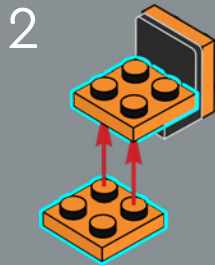
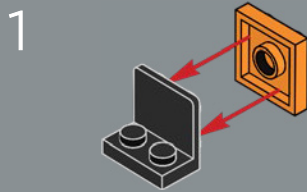

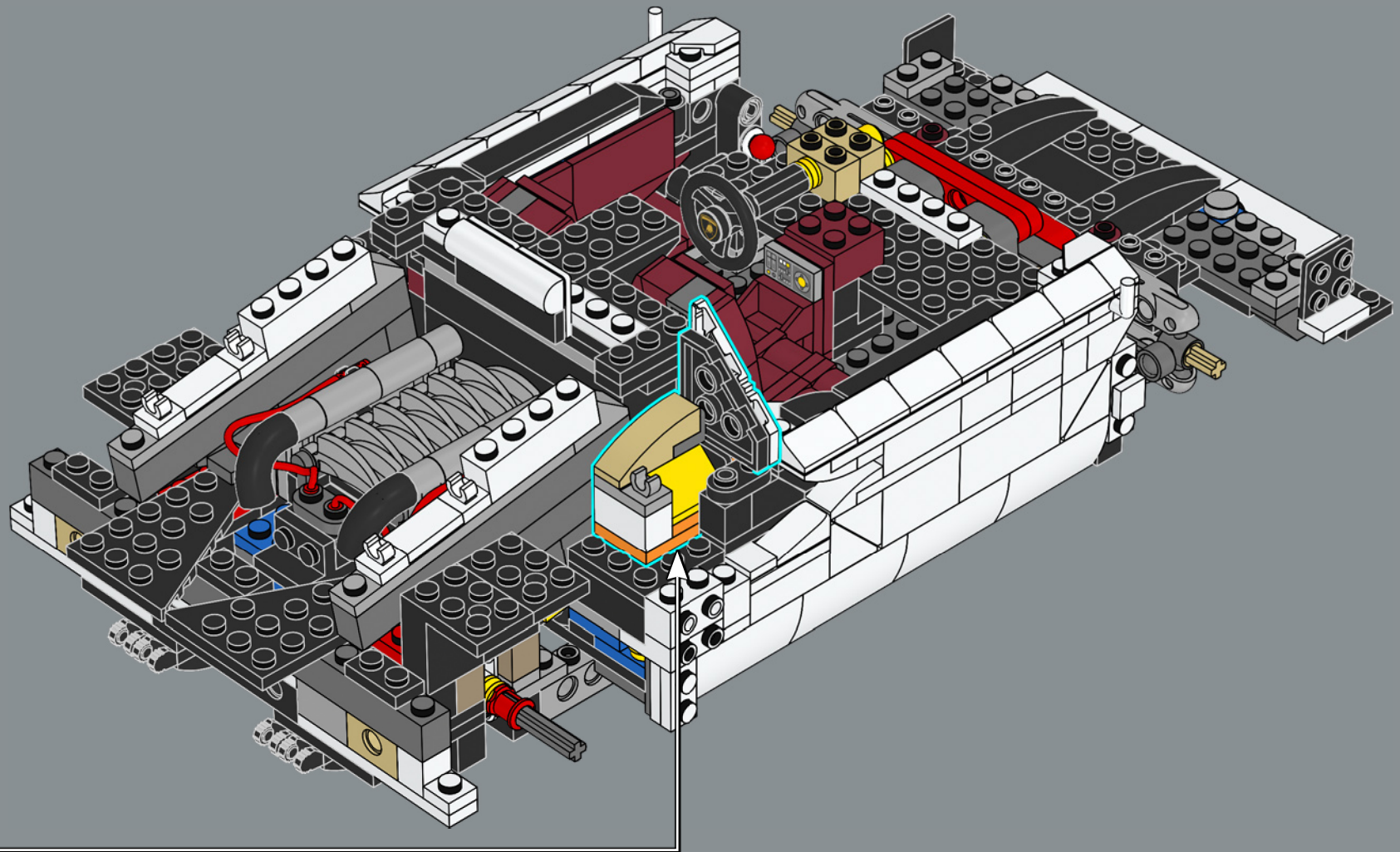

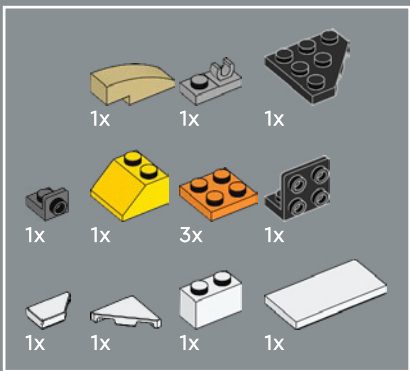

192

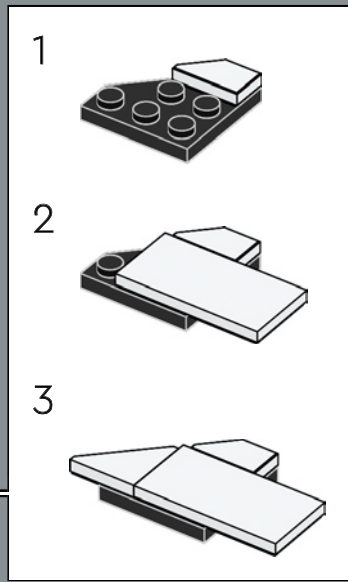
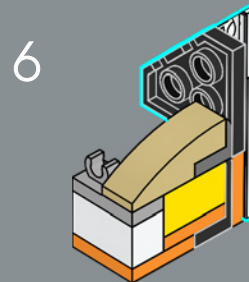
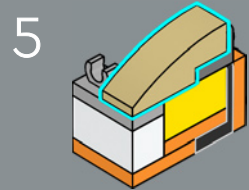
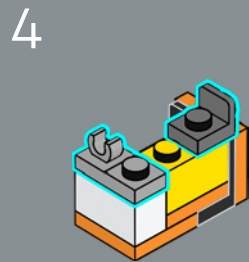
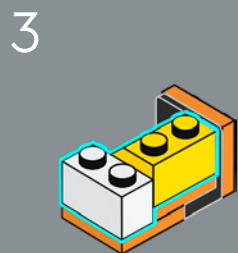
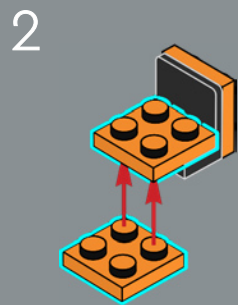
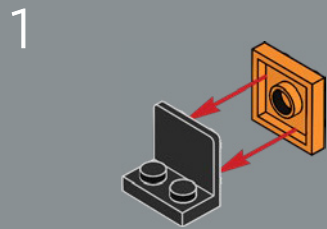

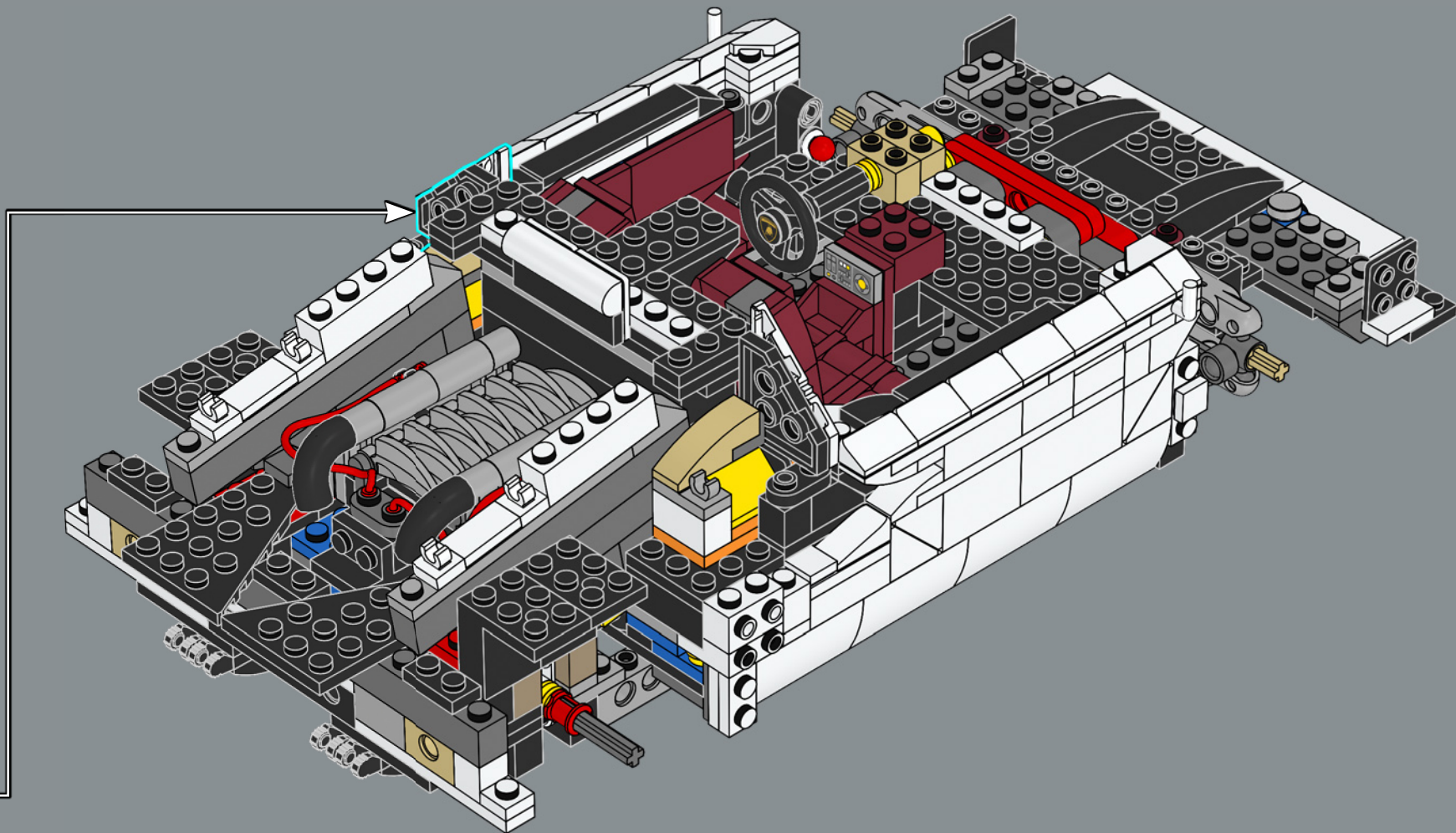

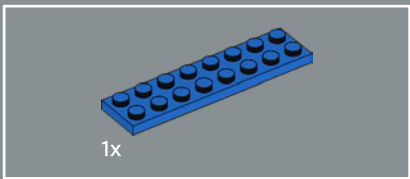

193

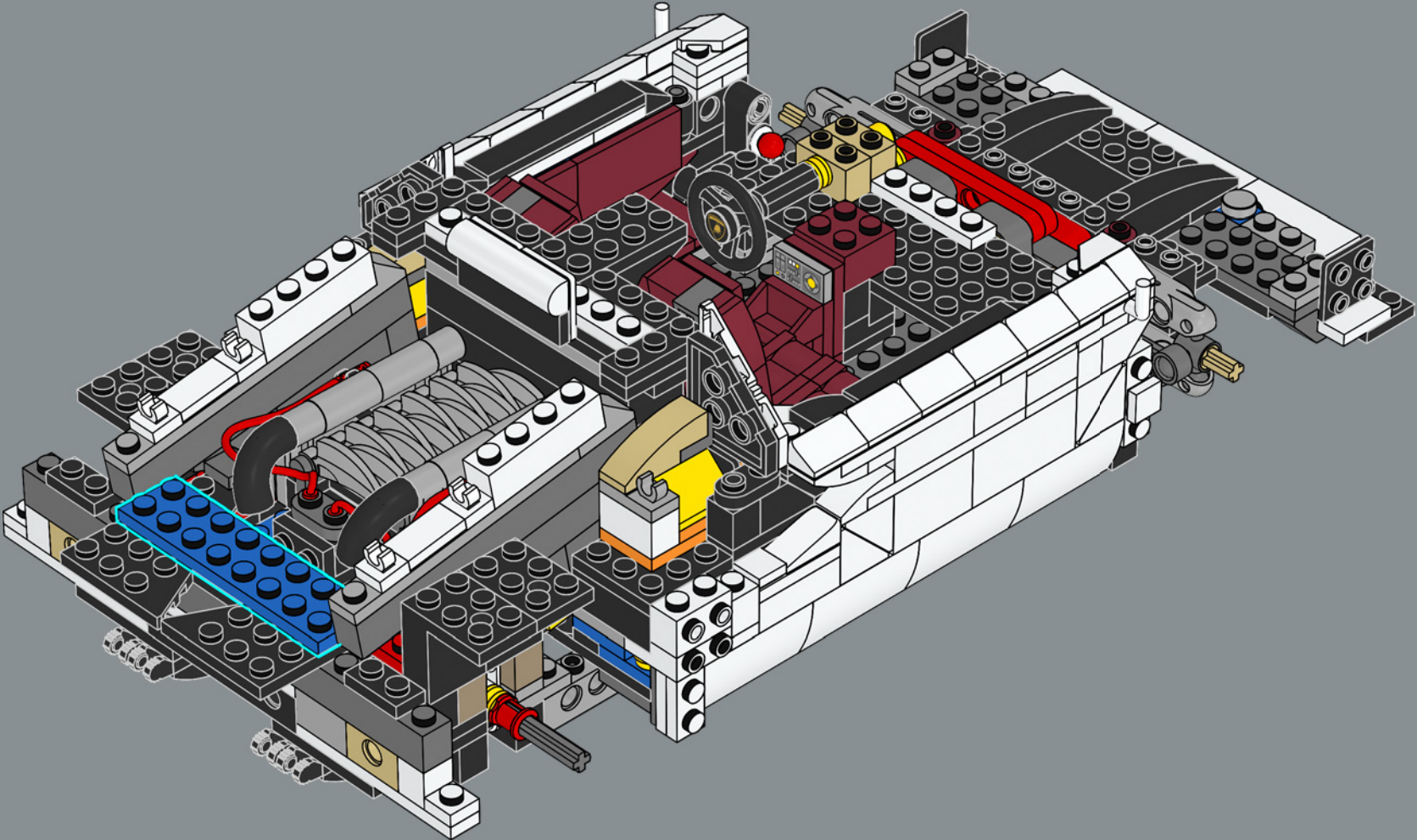

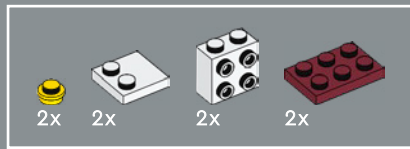

194

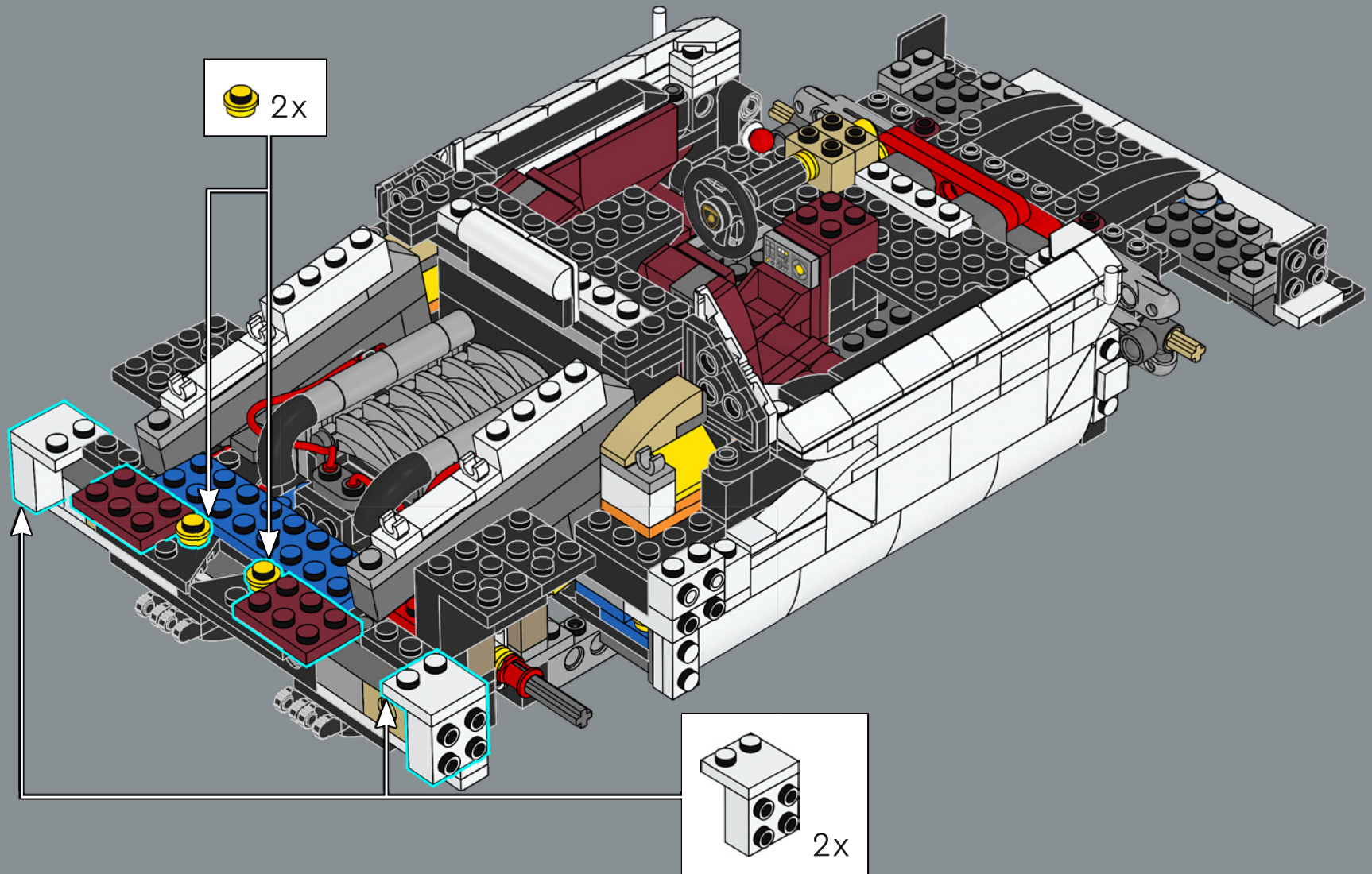



2x

195

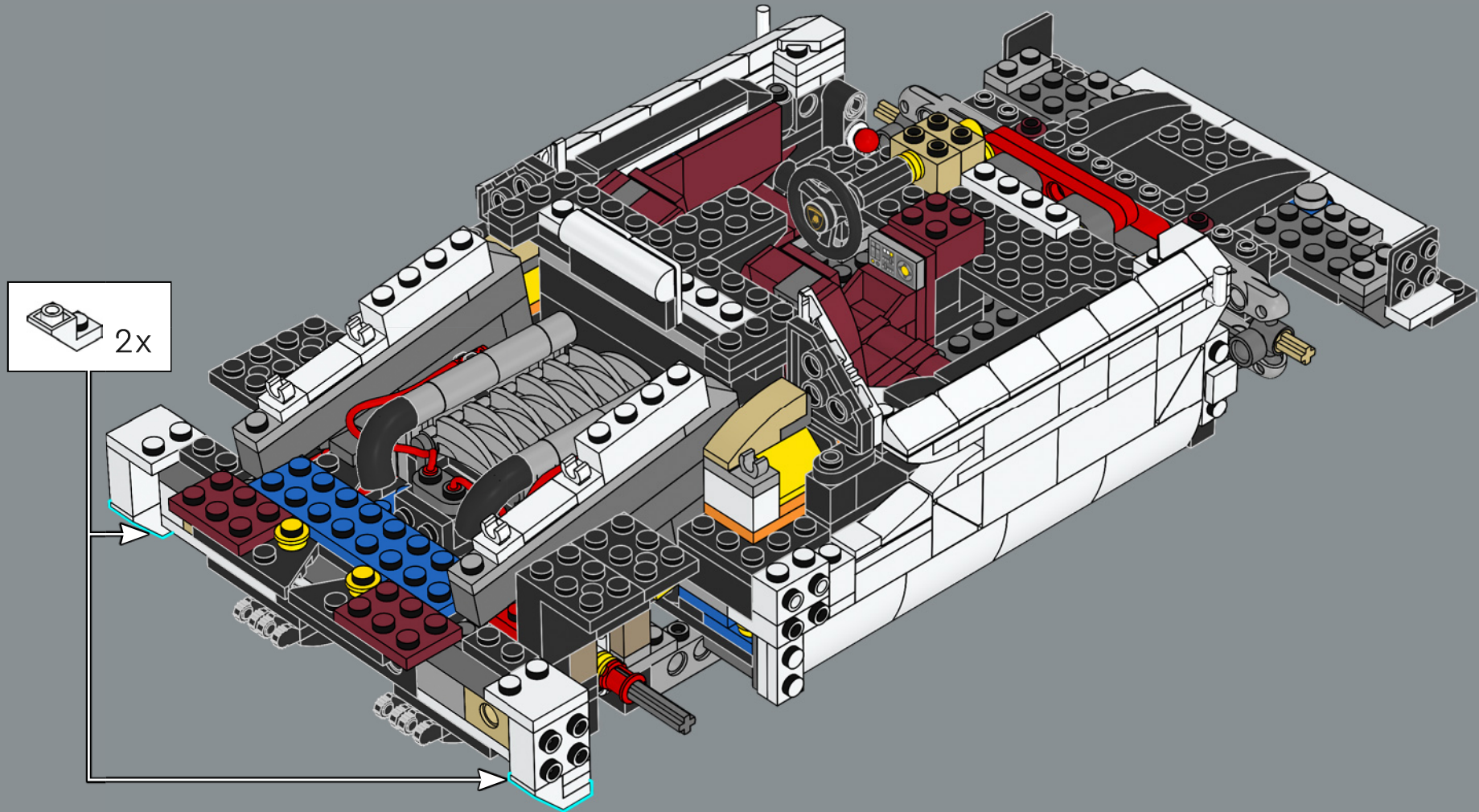

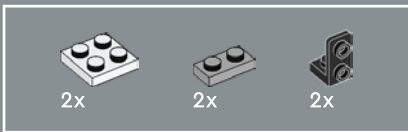

196

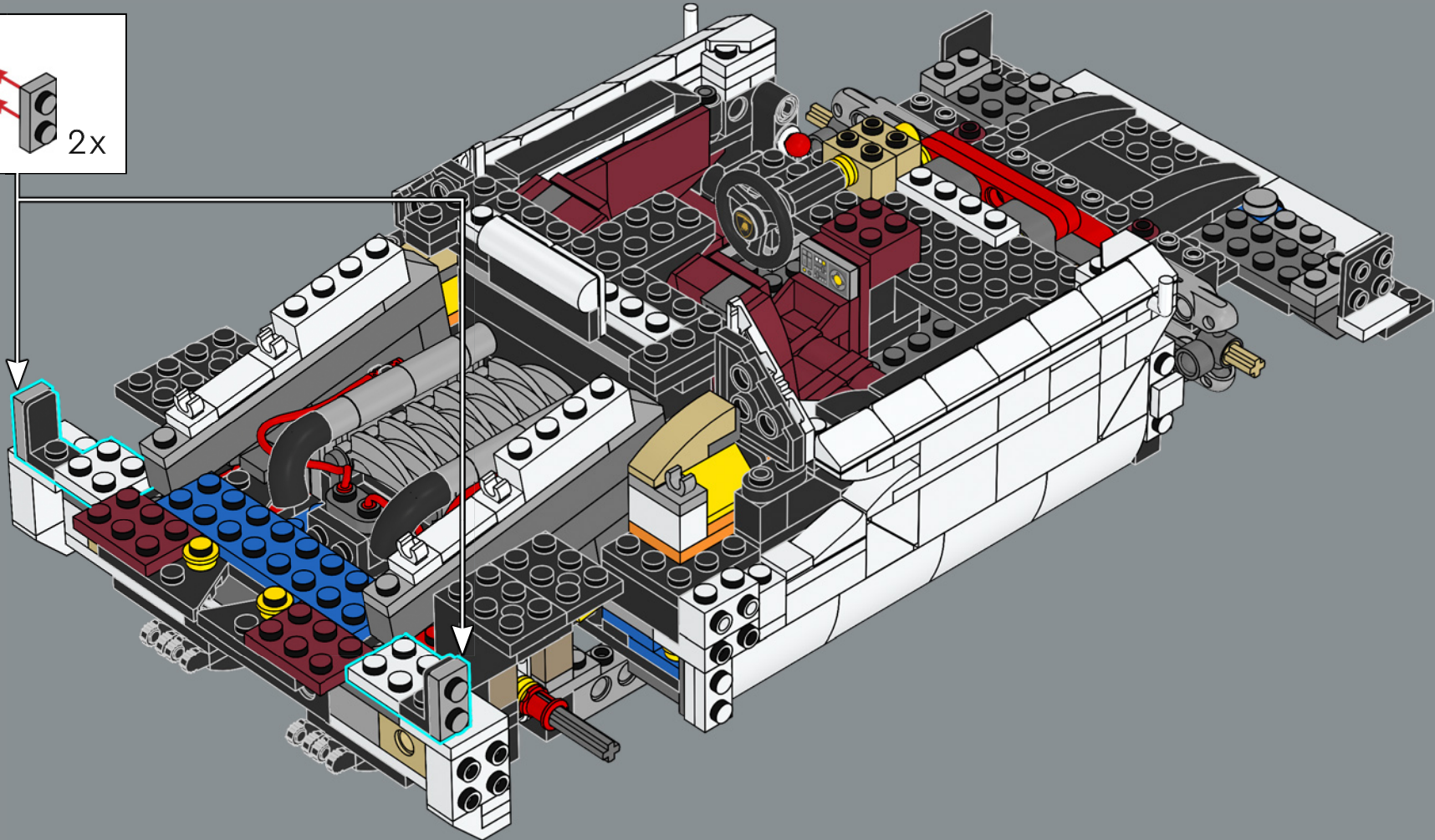
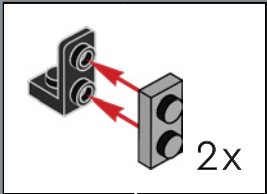

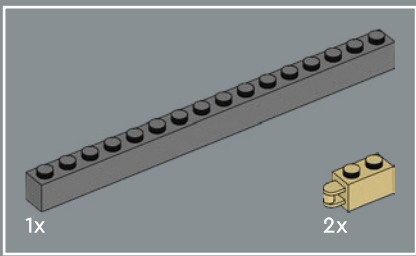

197

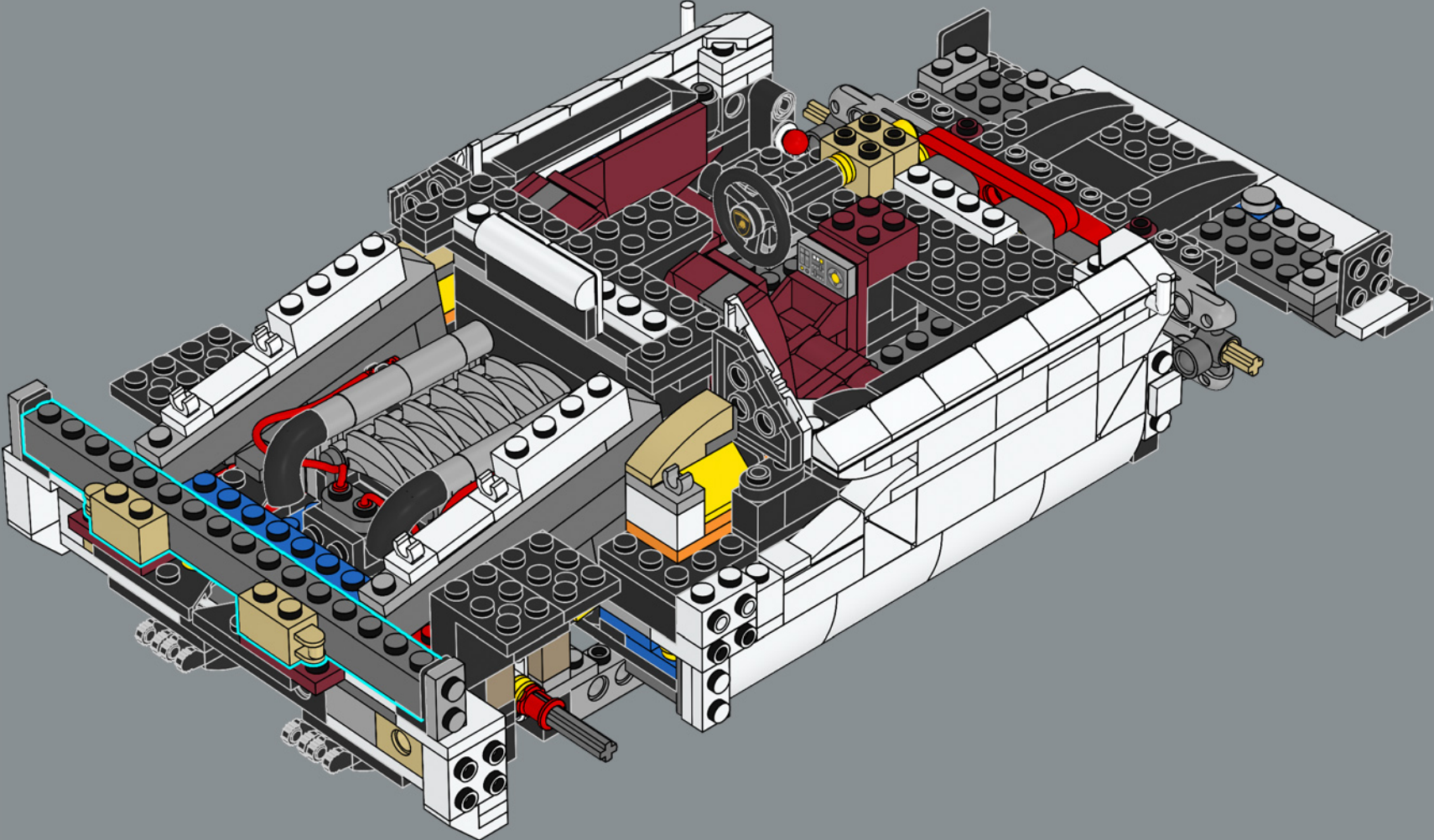

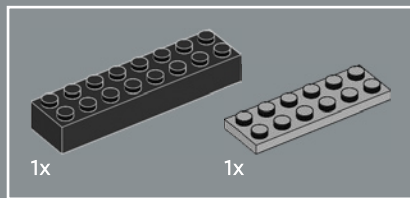

198

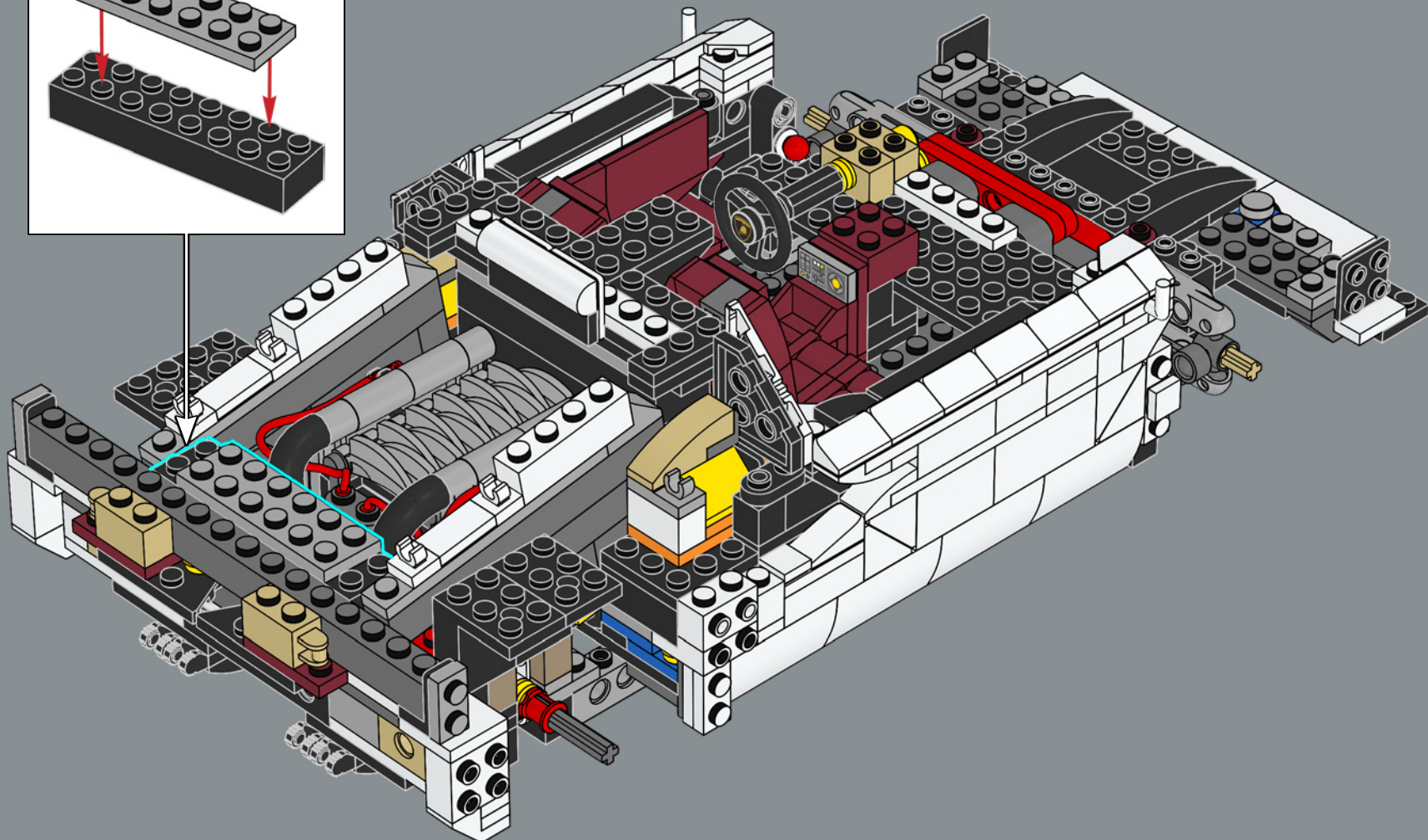
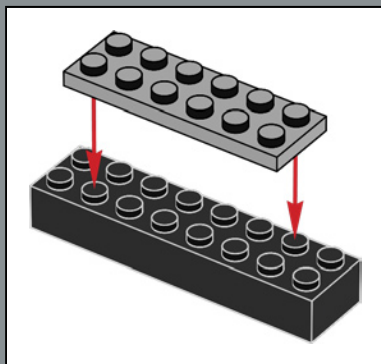

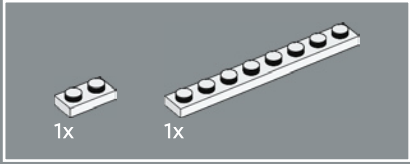
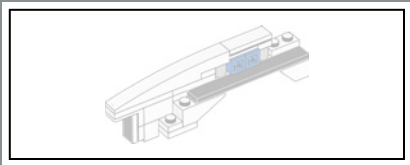

199

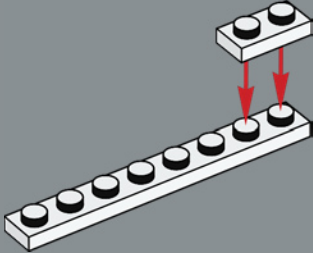

200

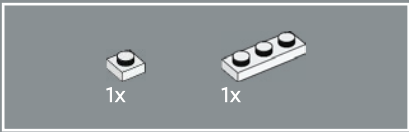
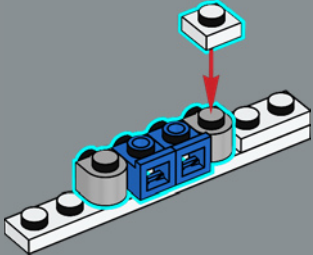

201

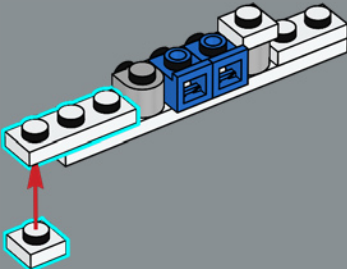

202

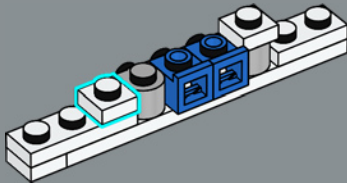

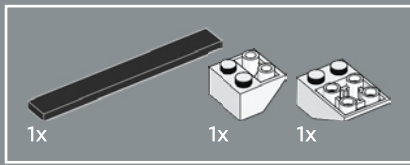

203

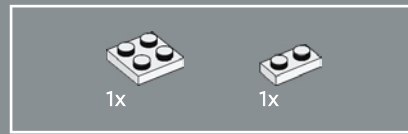
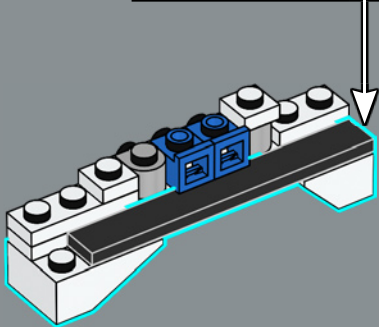
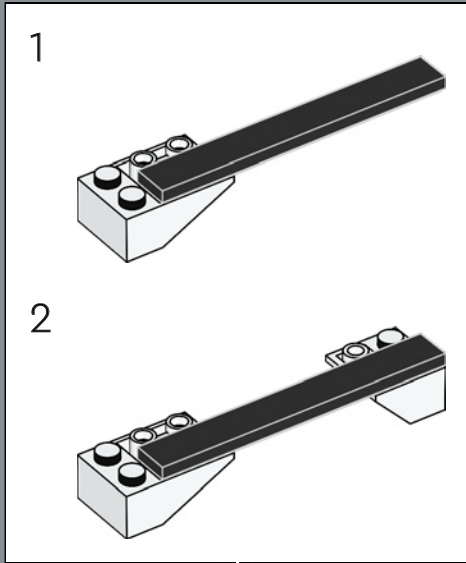

204

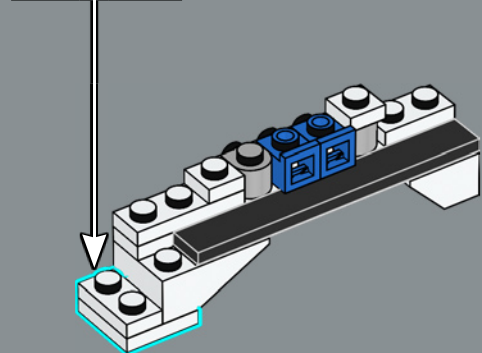
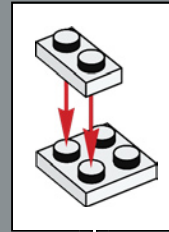

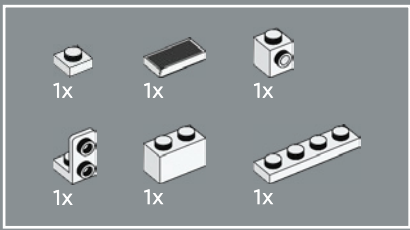

205

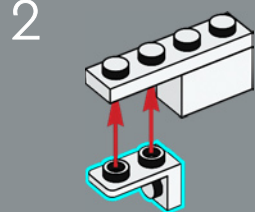
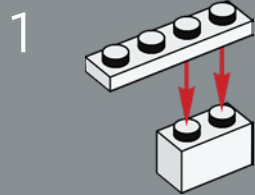

3

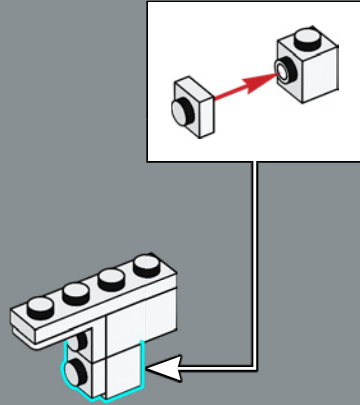

4

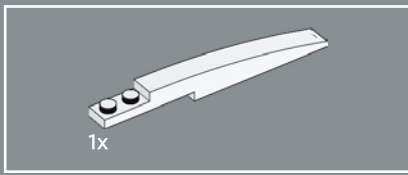
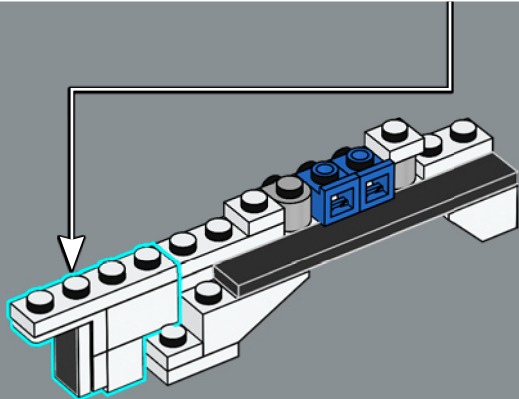
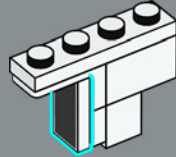

206

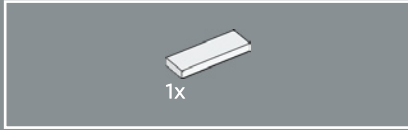
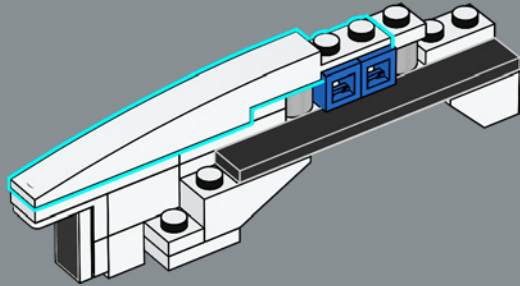

207

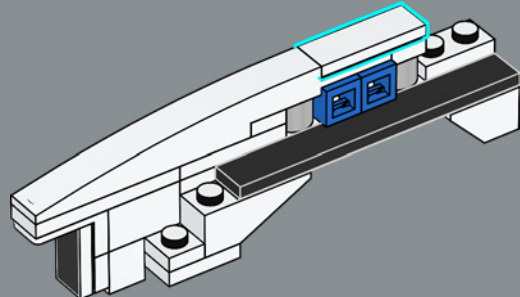

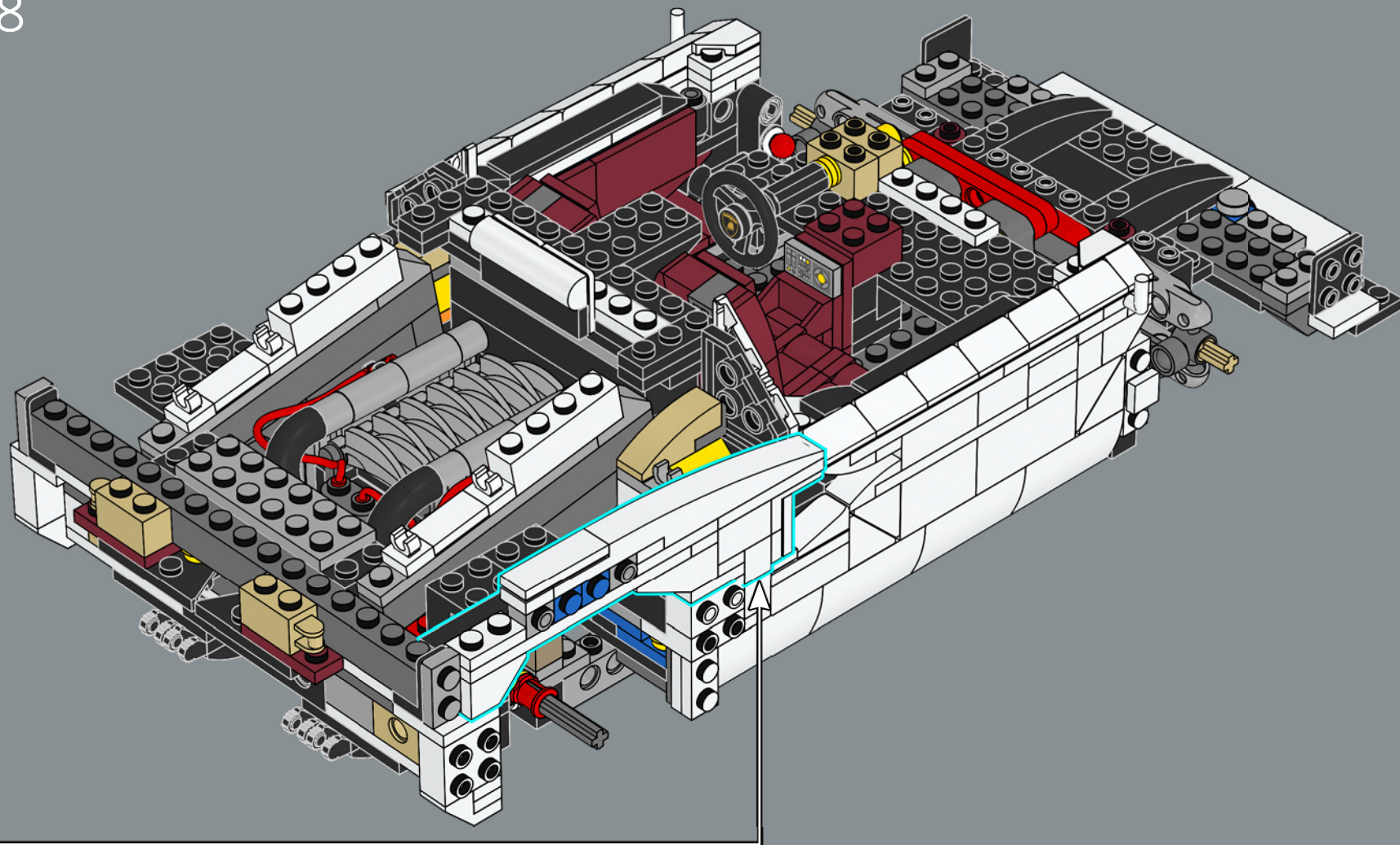

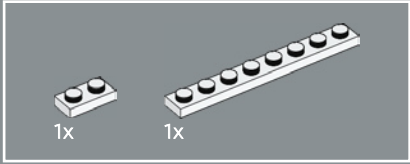
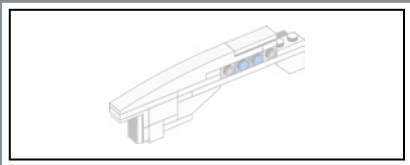

209

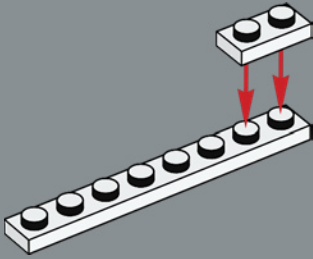

210

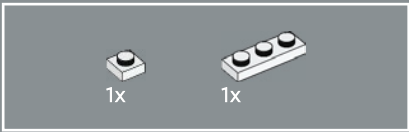
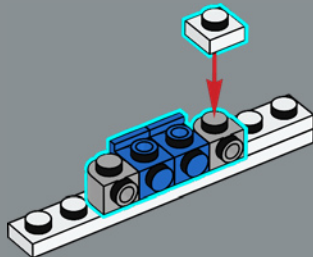

211

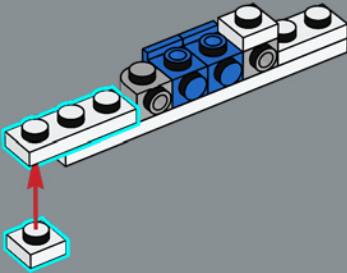

212

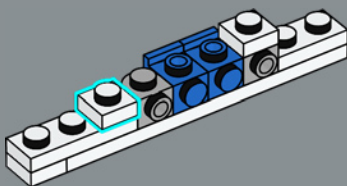

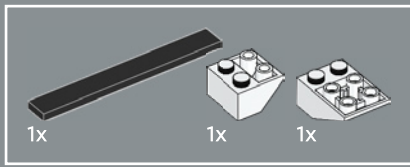

213

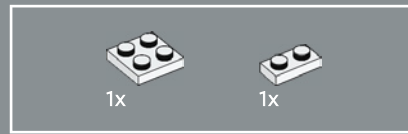
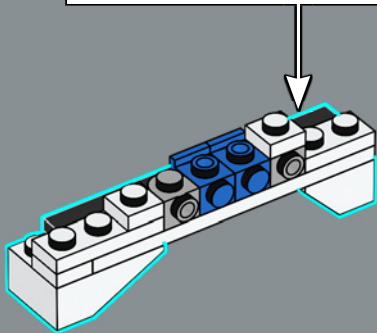
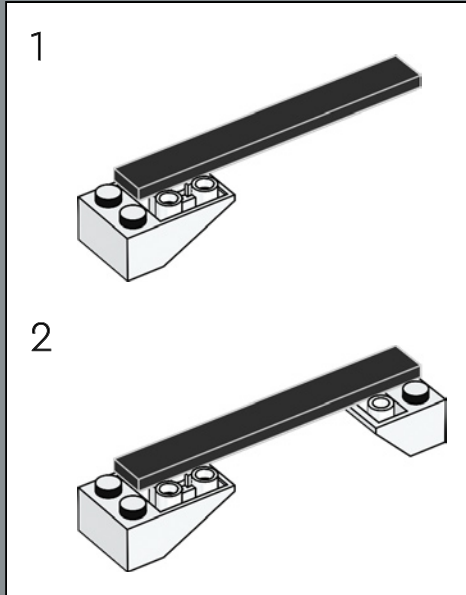

214

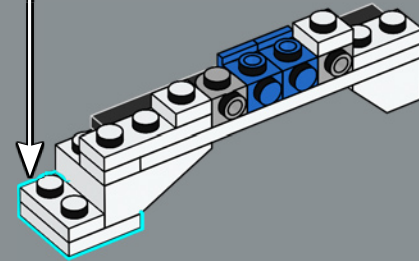
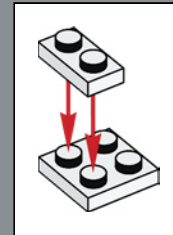

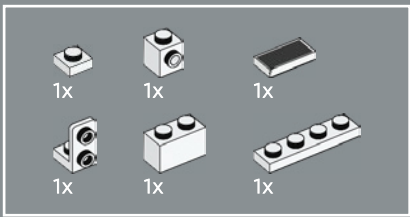

215

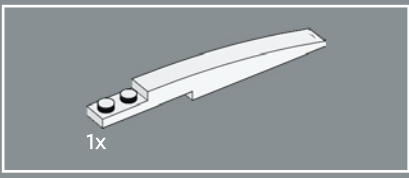
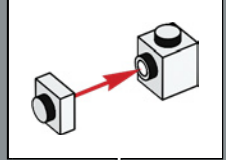
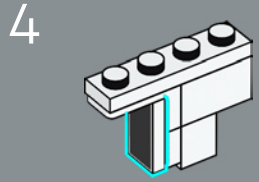
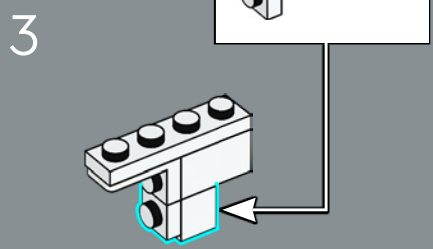
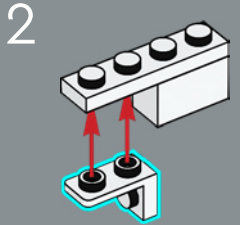
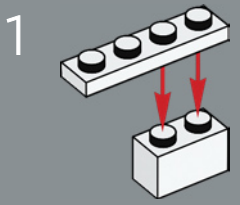

216

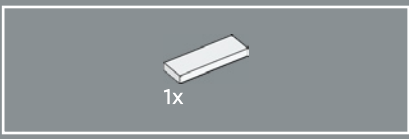
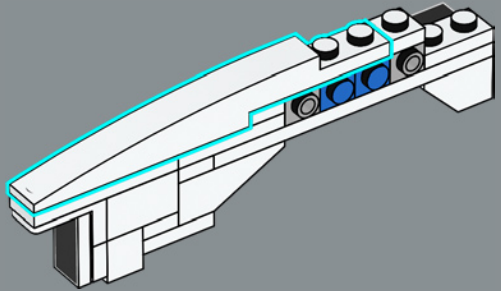

217

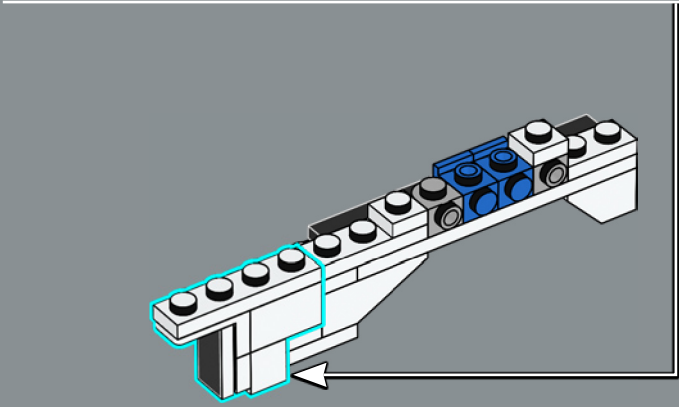
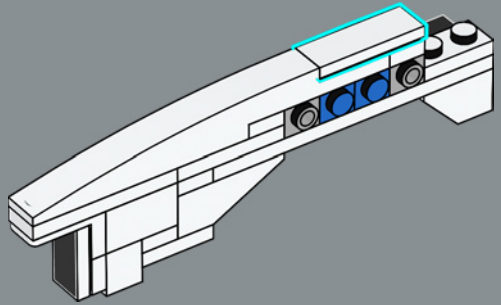

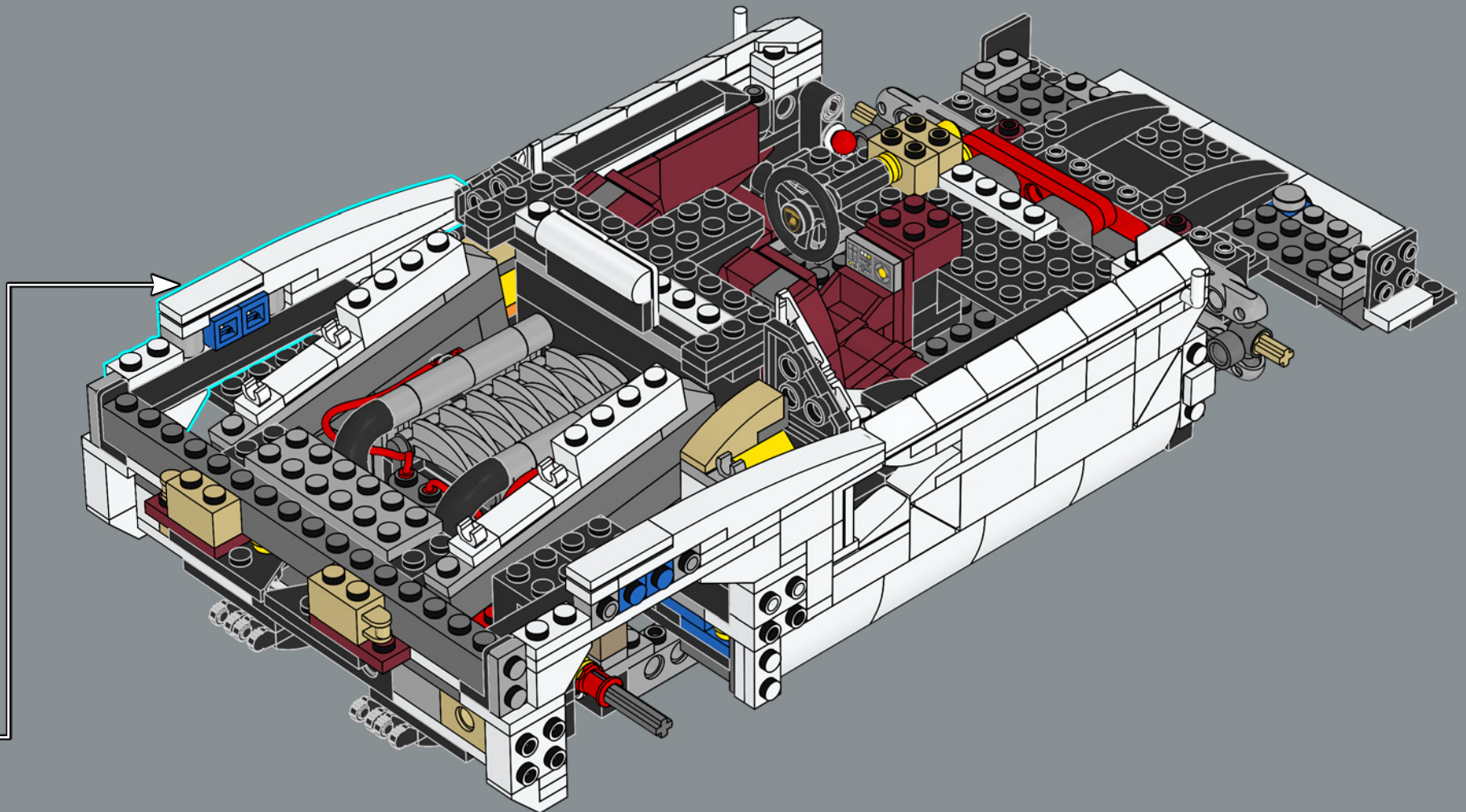

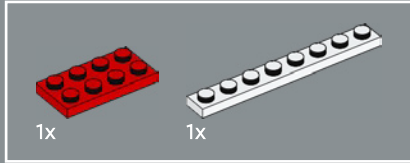
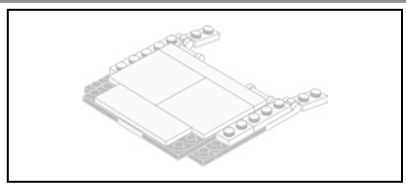

219

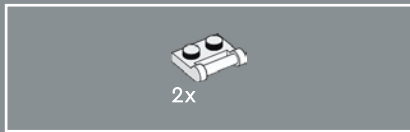
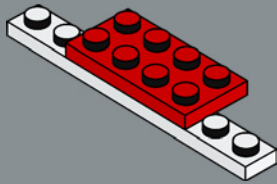

220

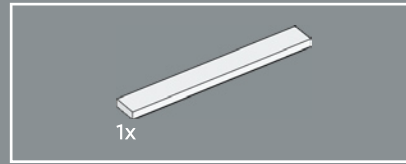
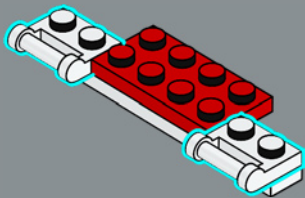

221

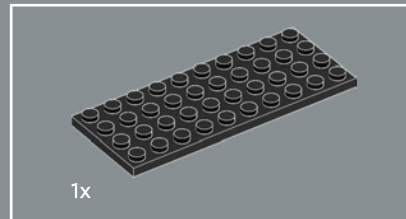
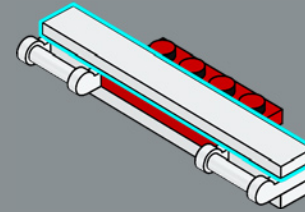

222

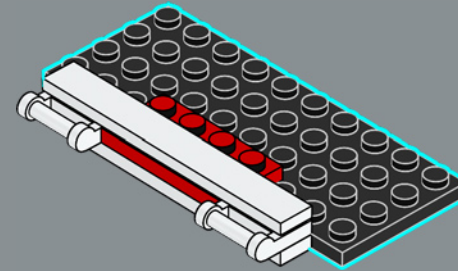

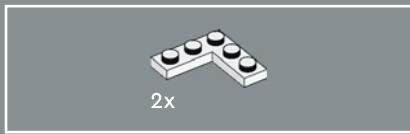

223

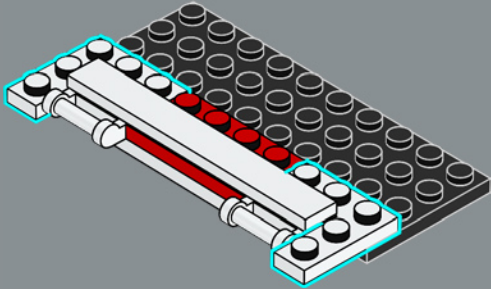

224

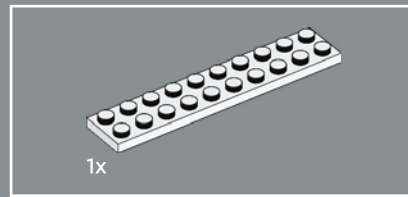
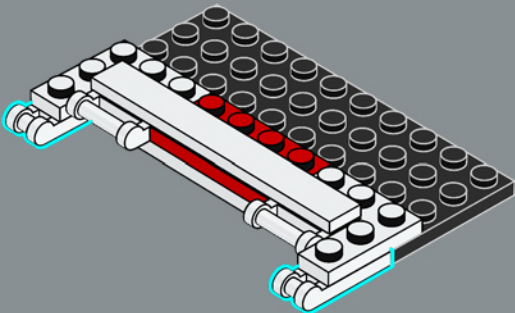

225

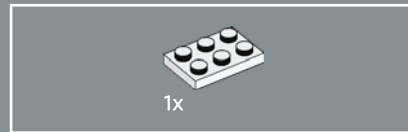
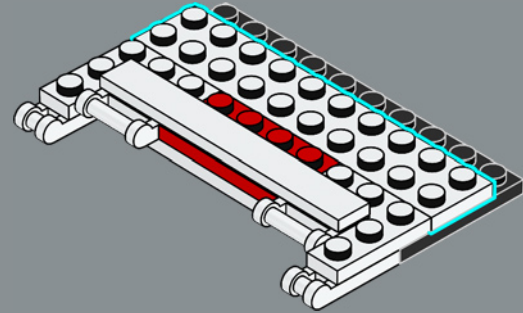

226

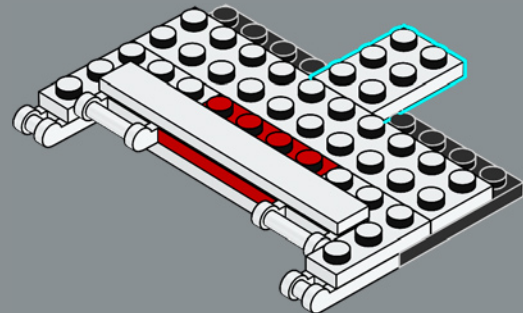

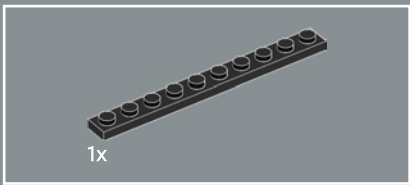

227

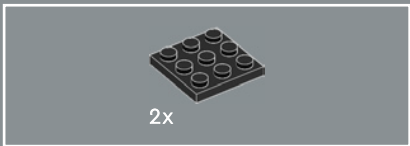
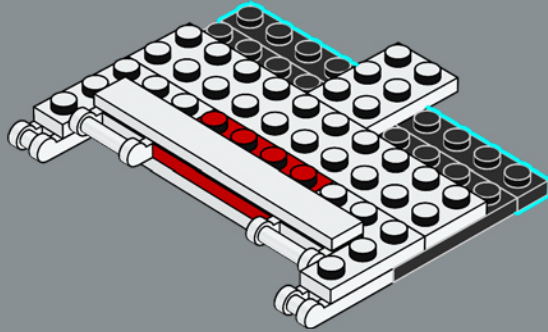

228

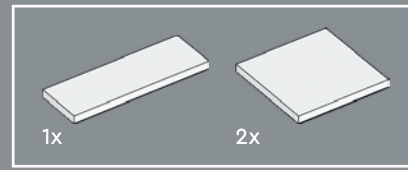
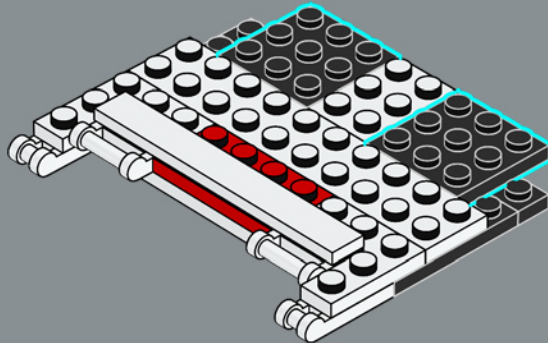

229

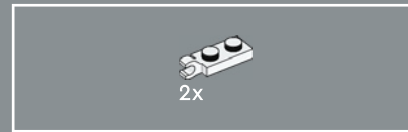
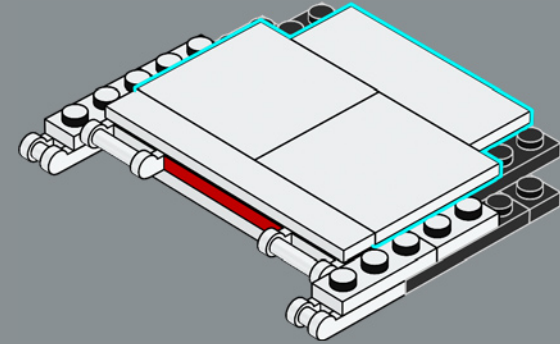

230

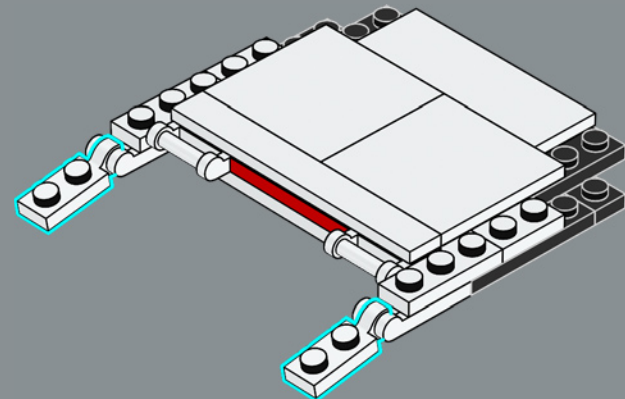

231

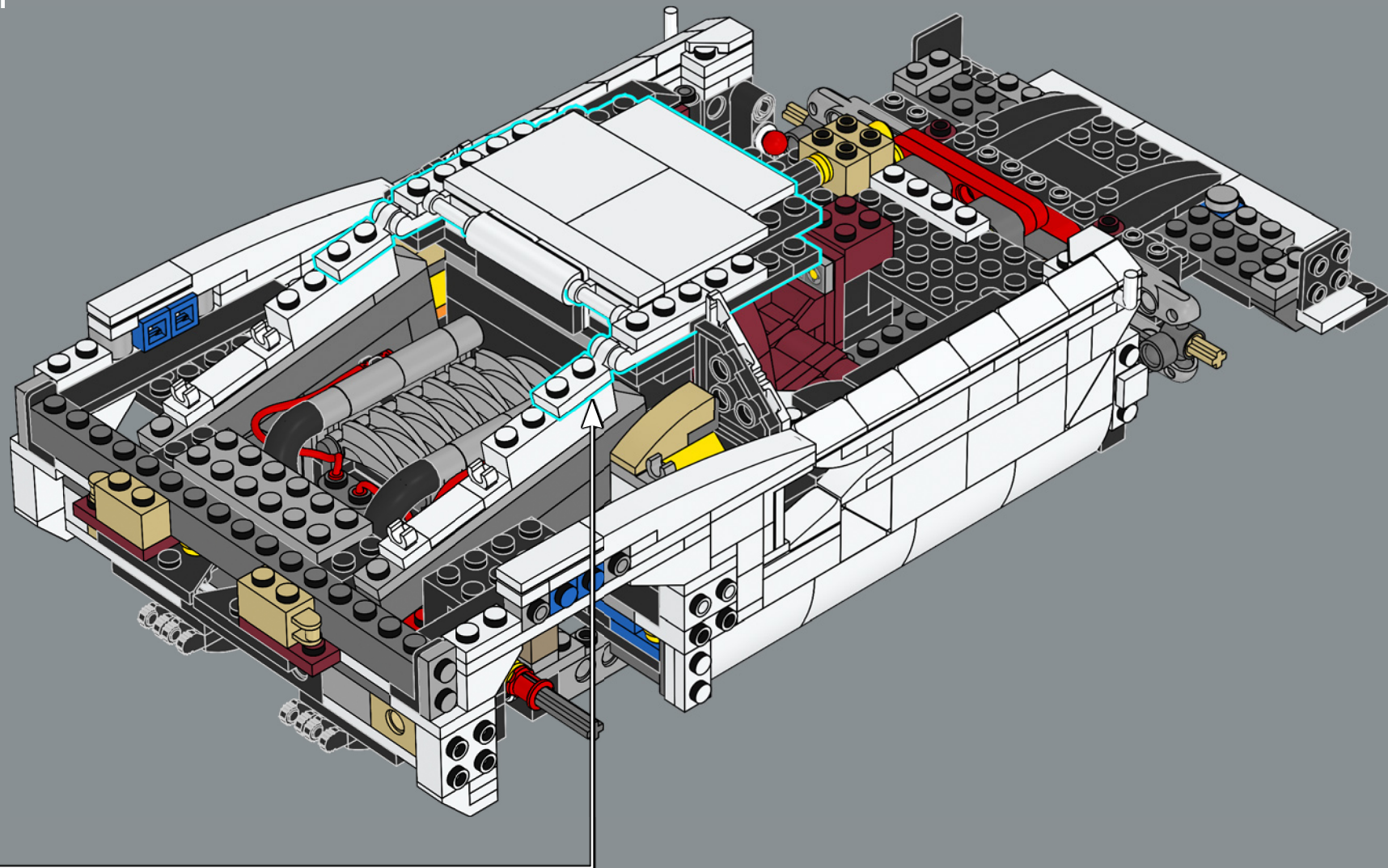

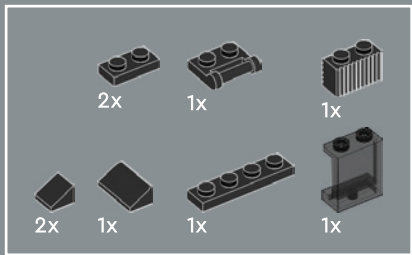

232

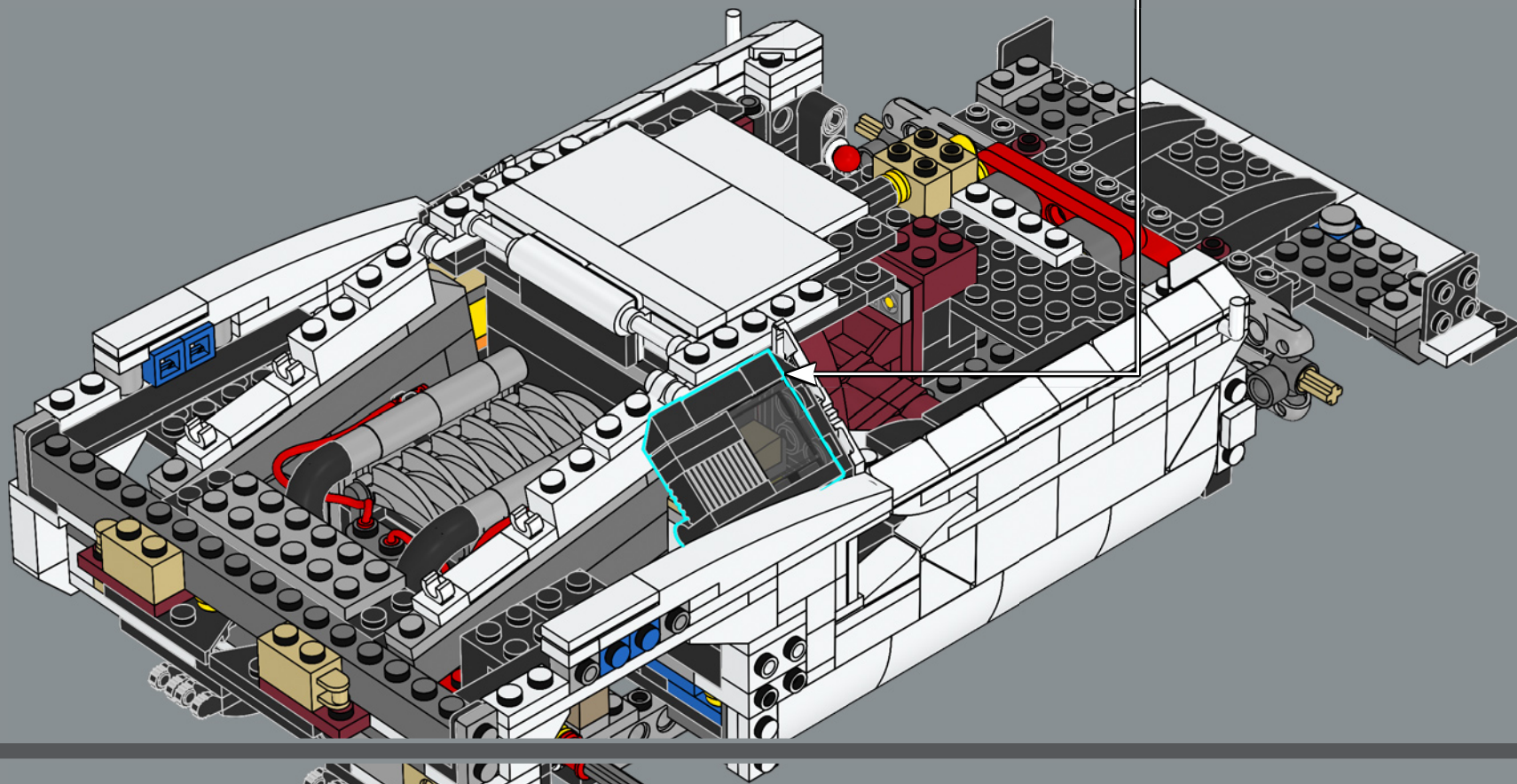
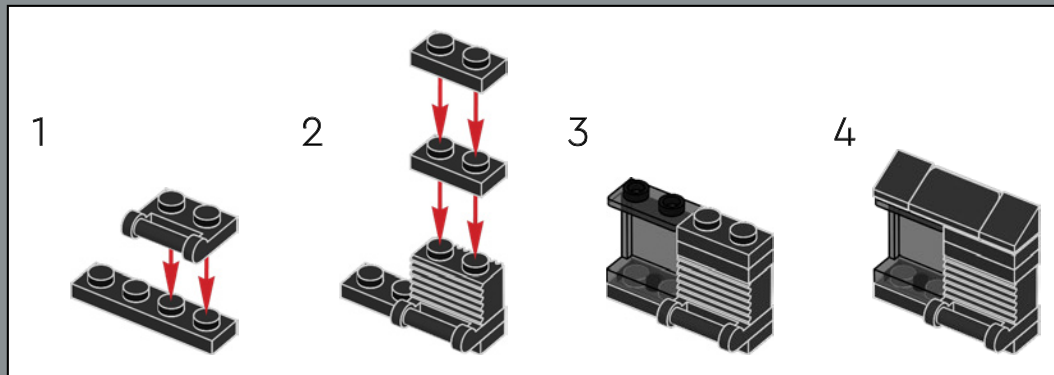

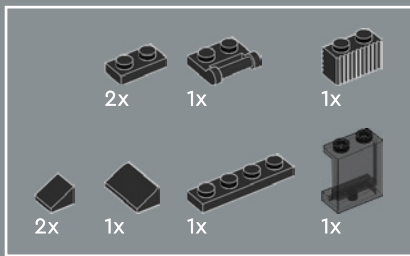

233

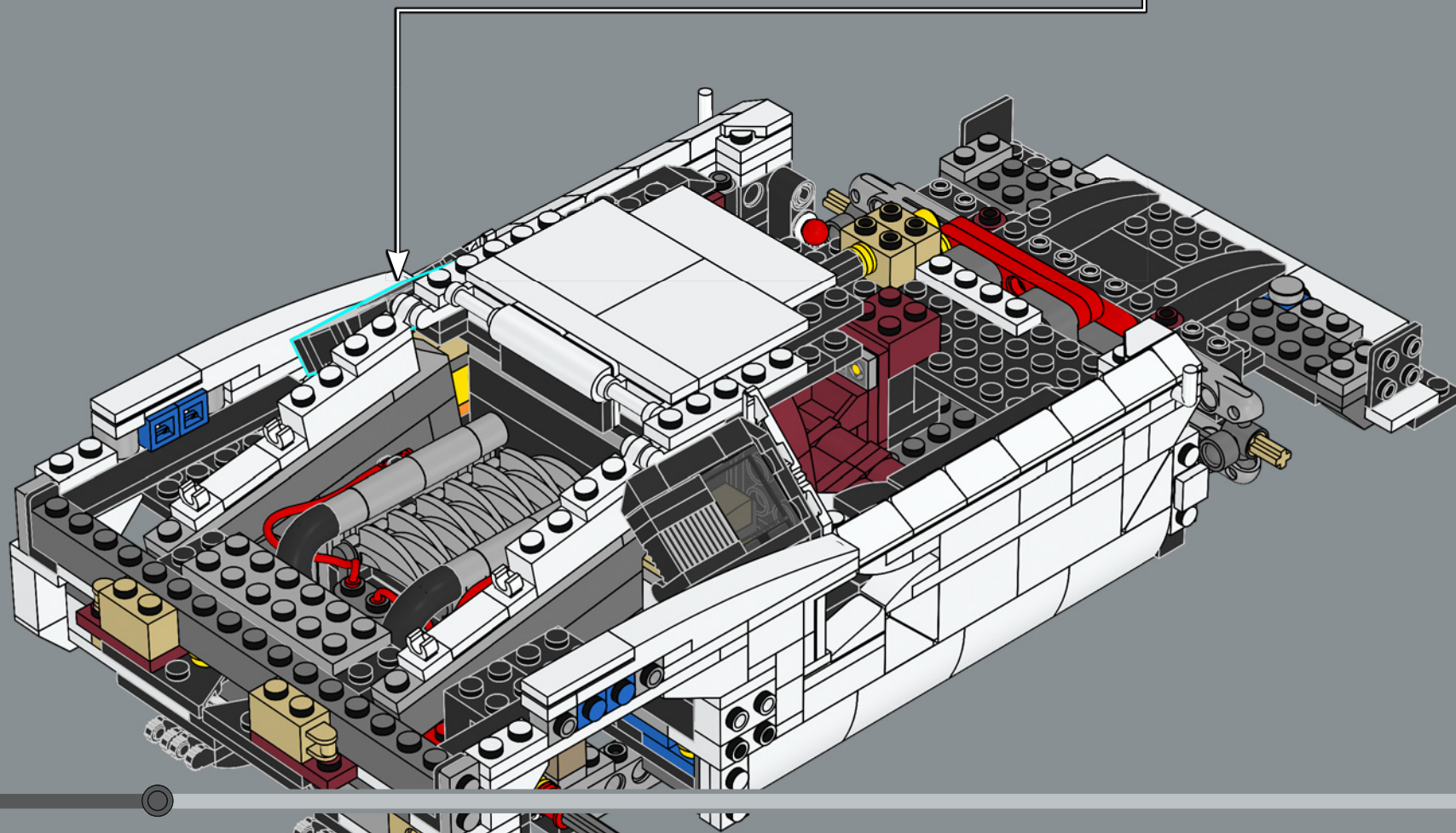
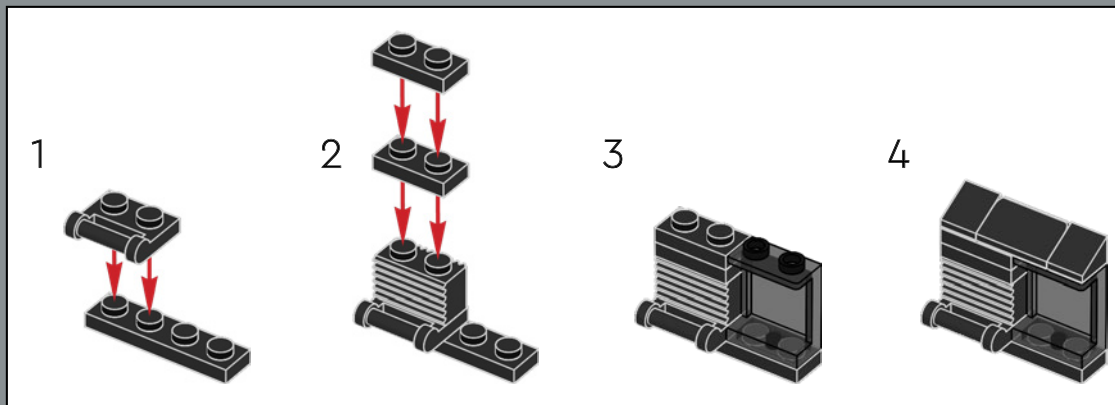

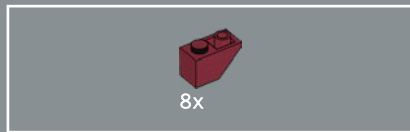

234

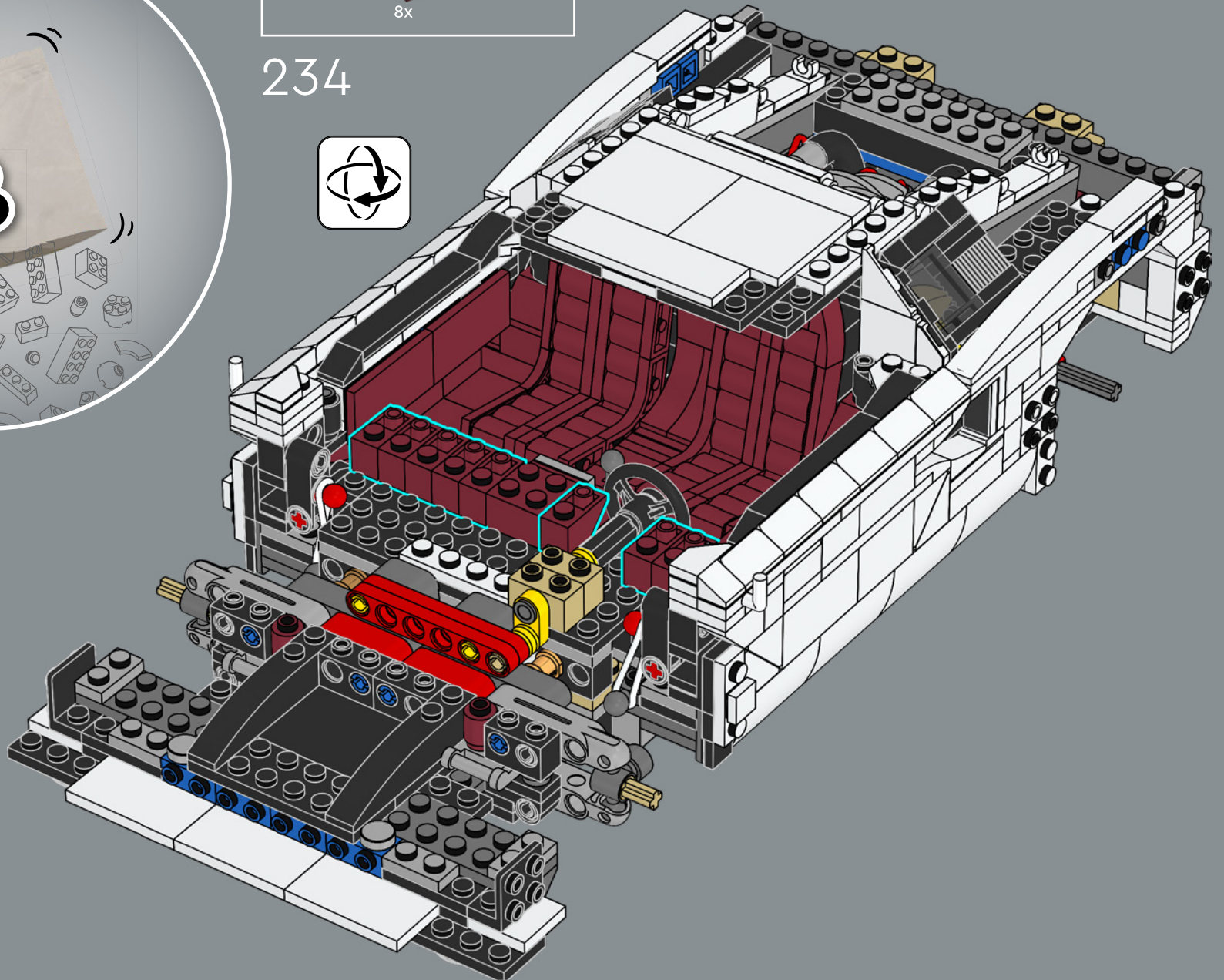

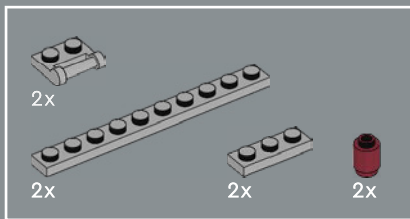

235

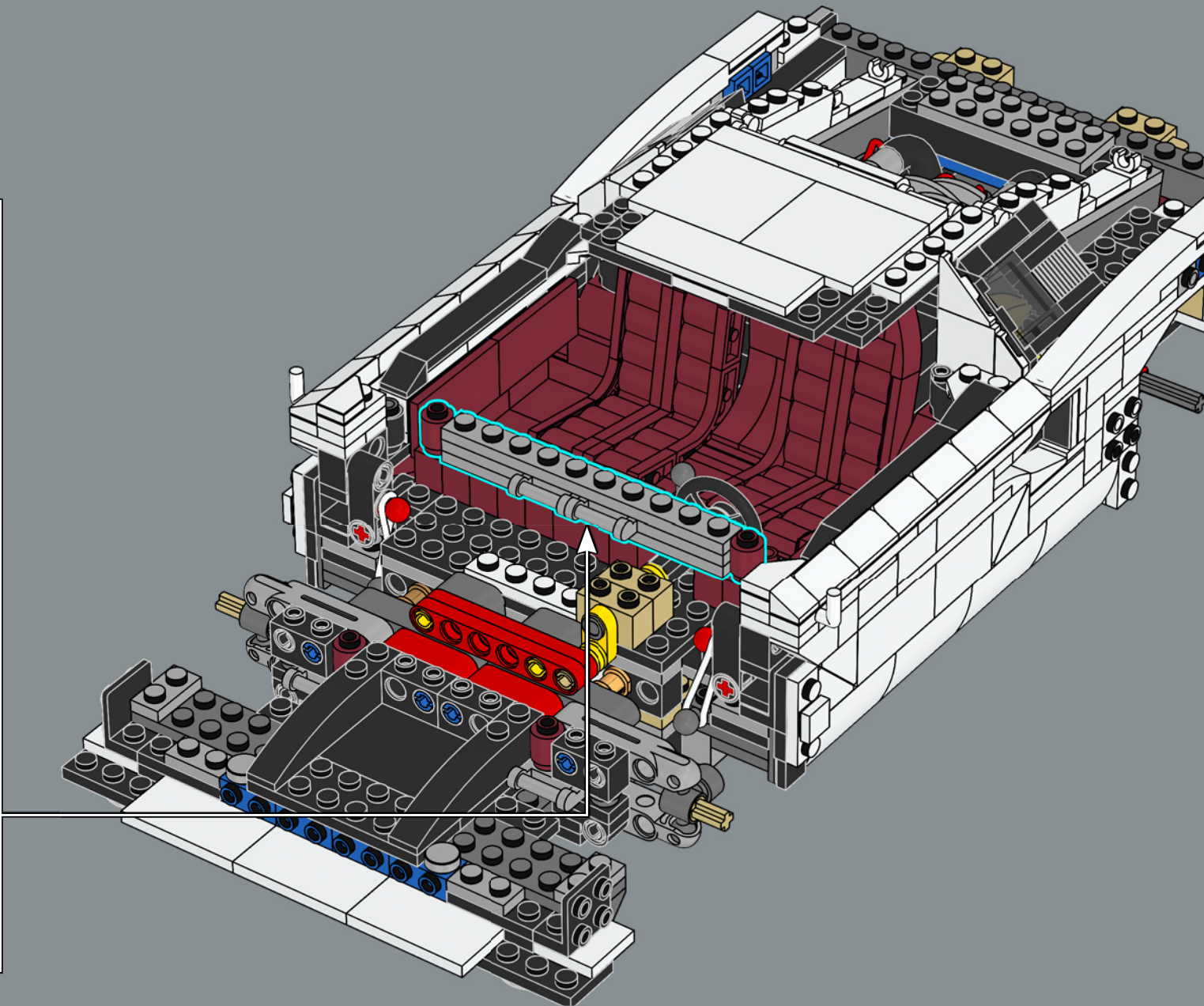
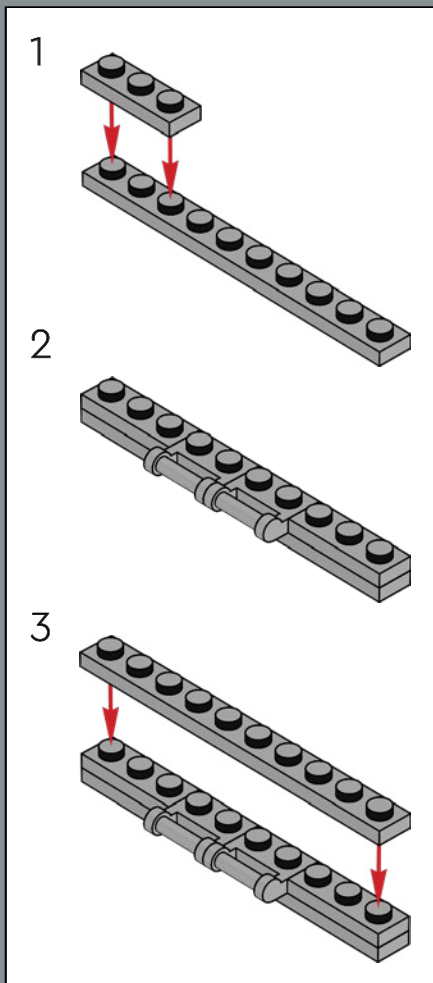

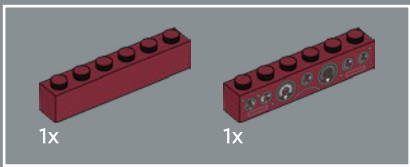

236

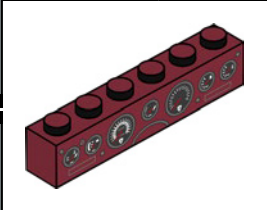
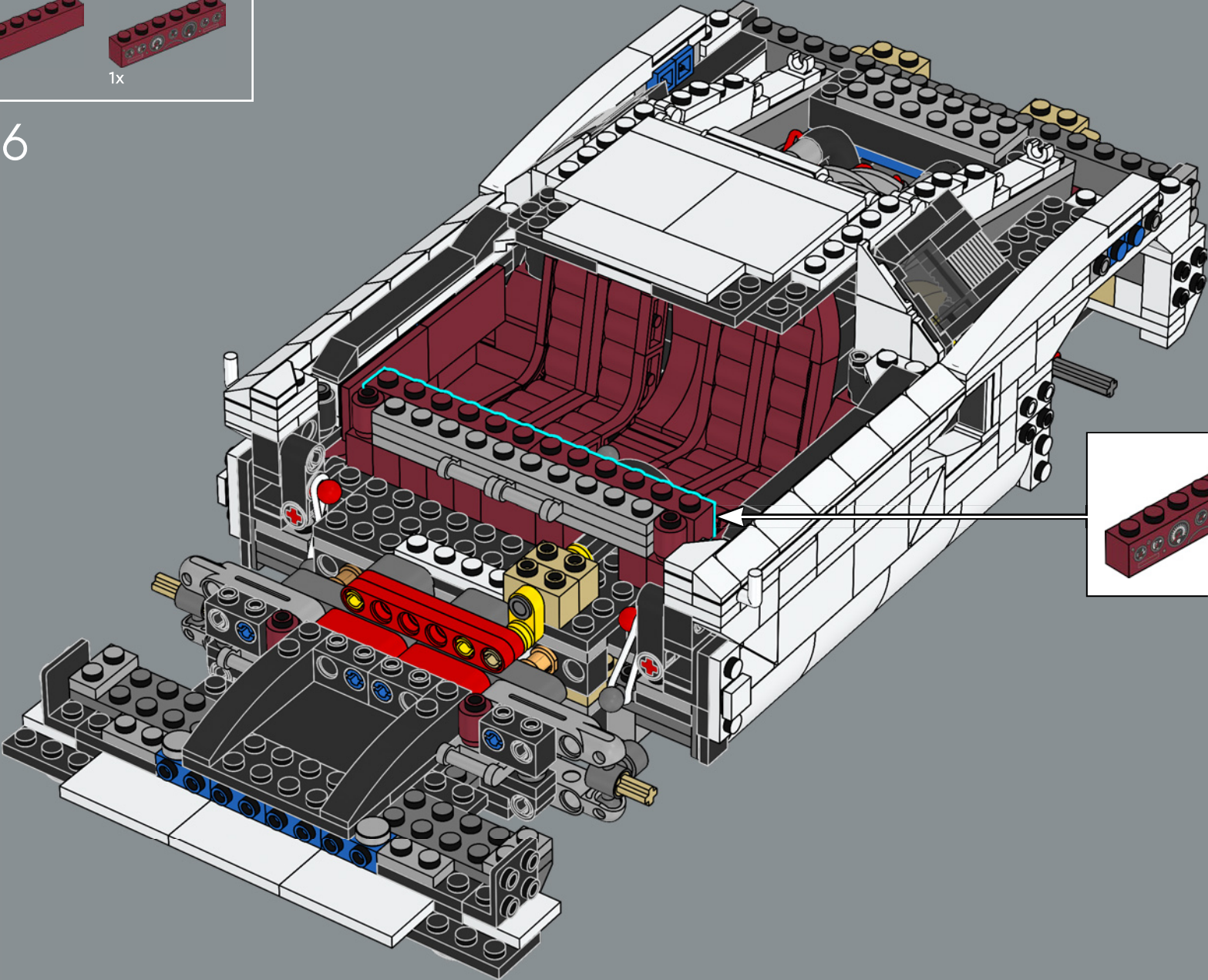

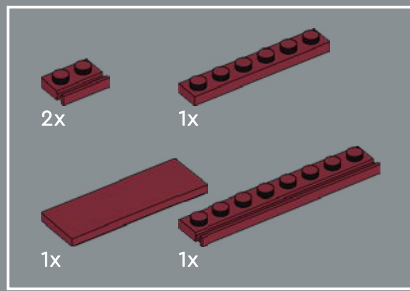

237

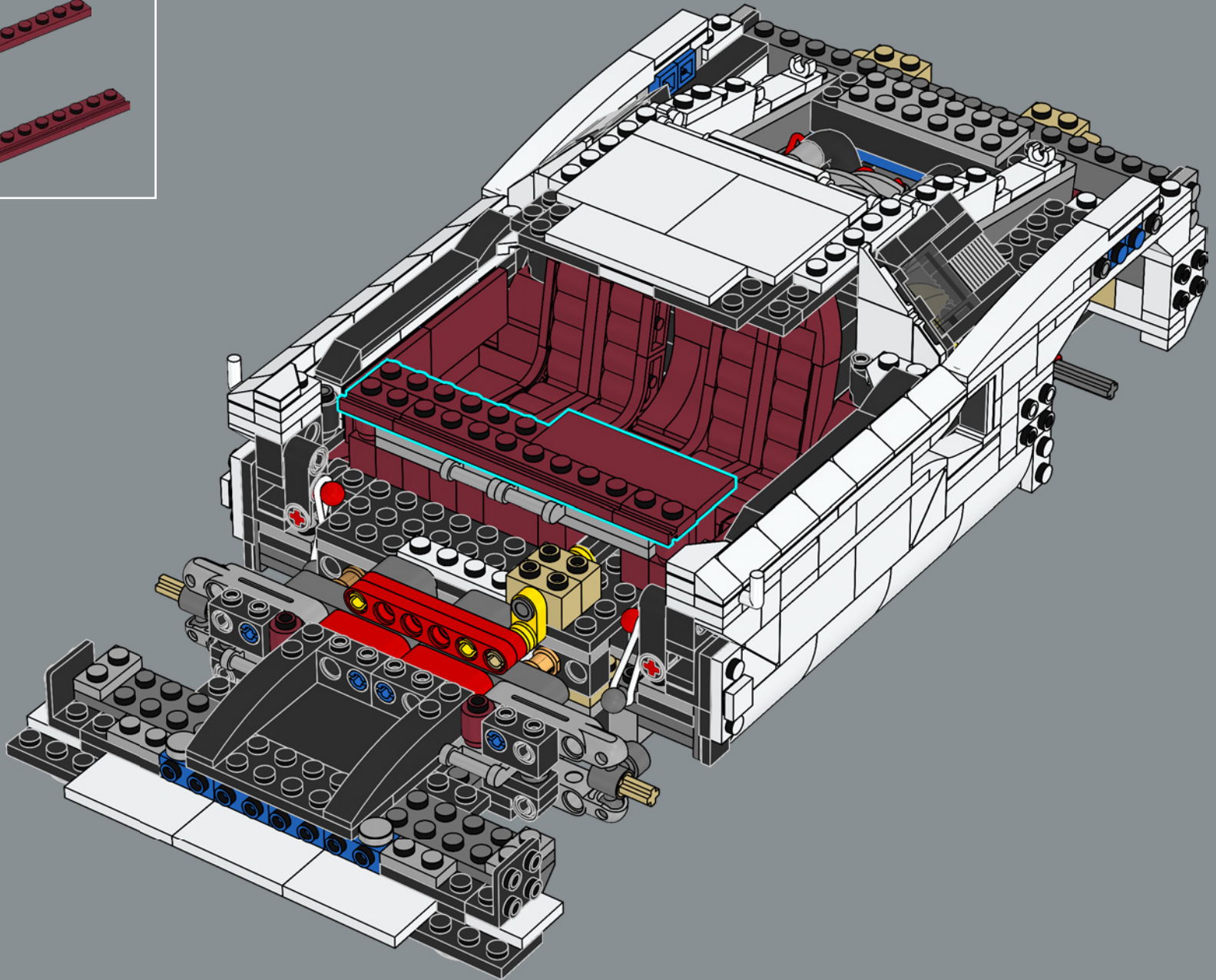

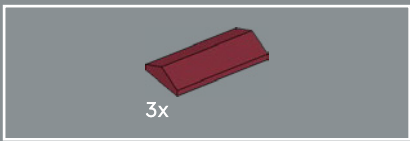

238

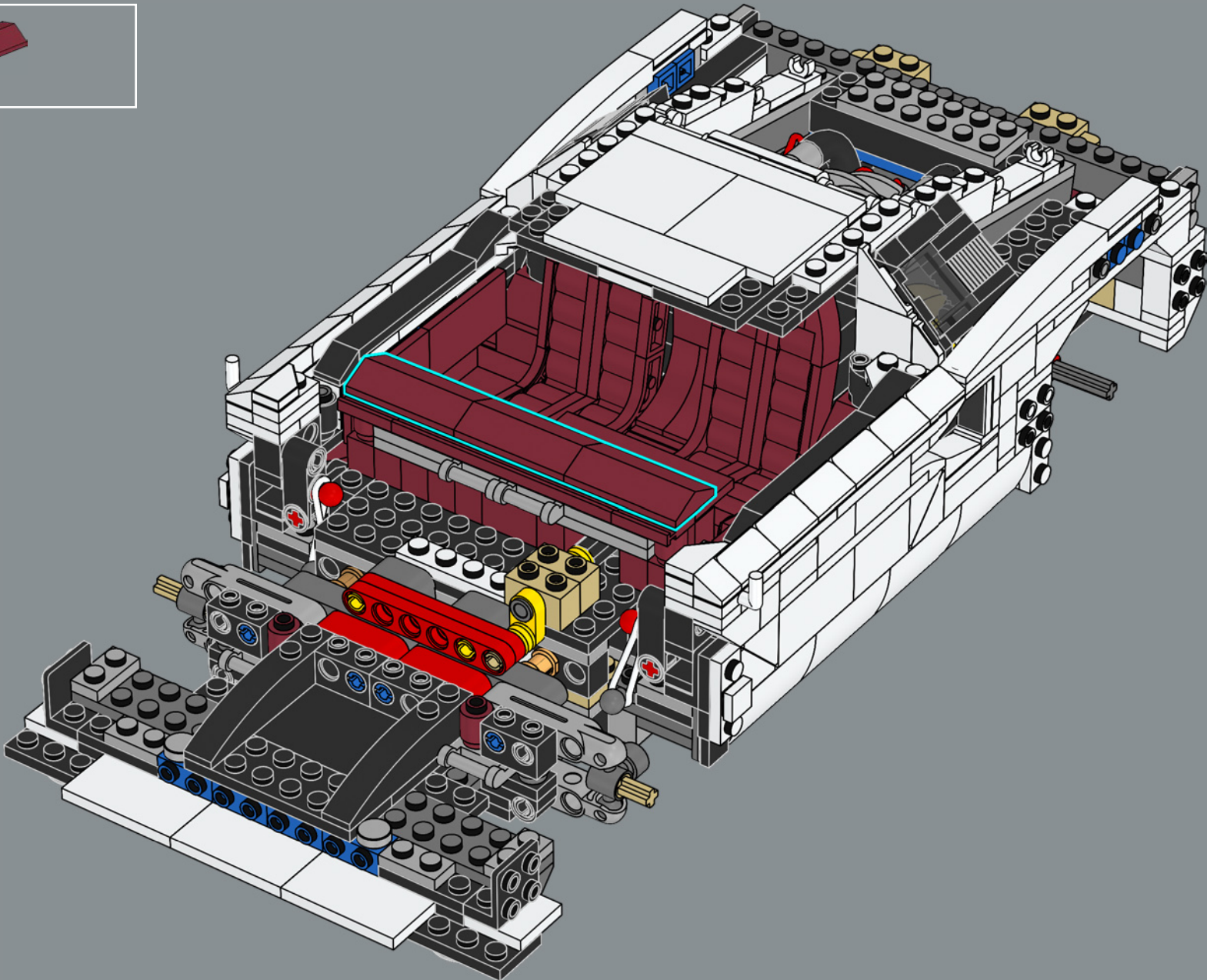

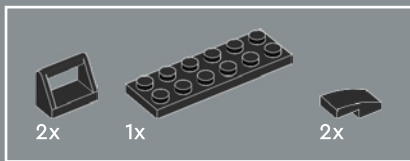

239

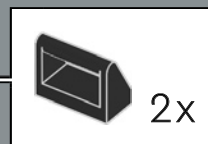
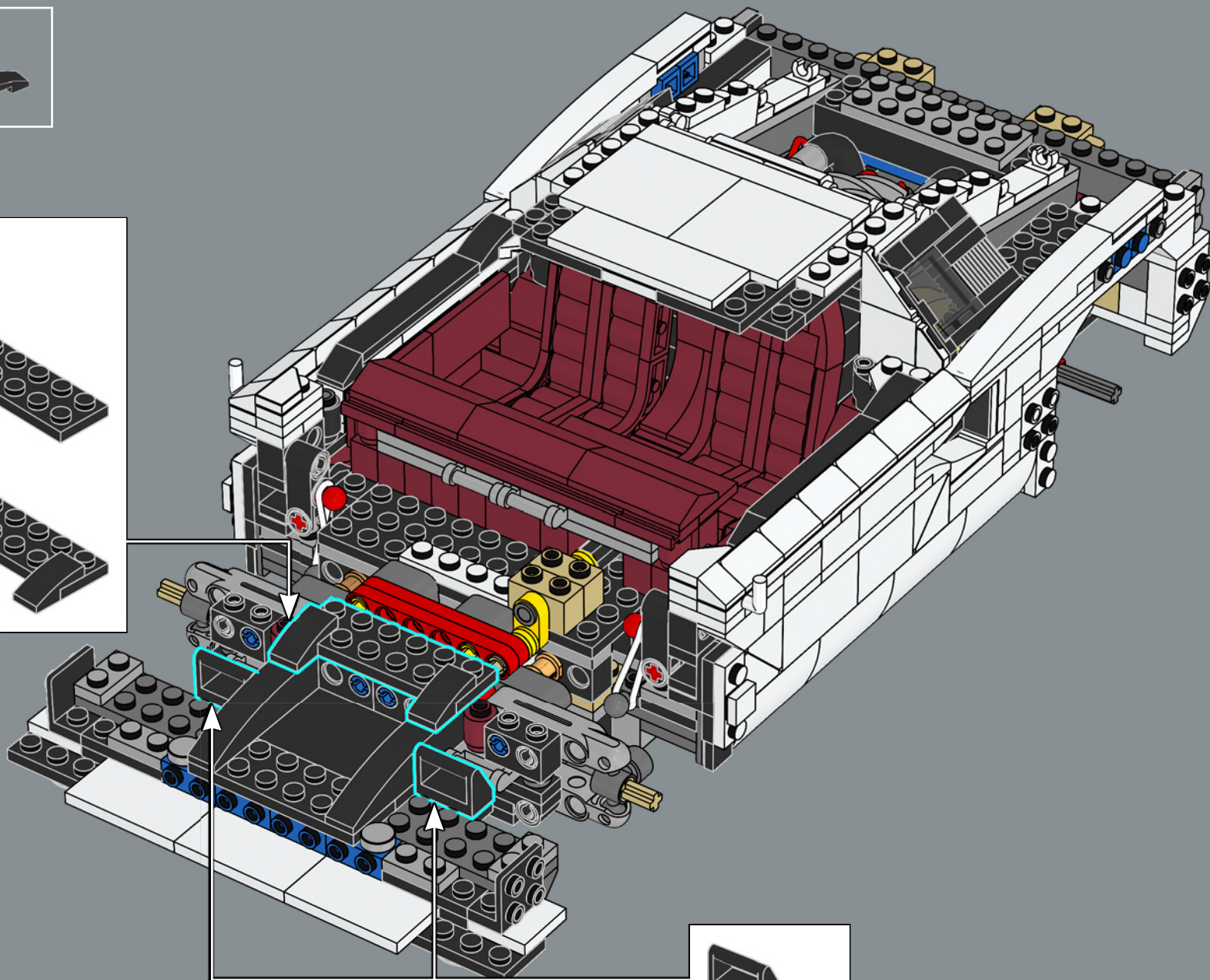
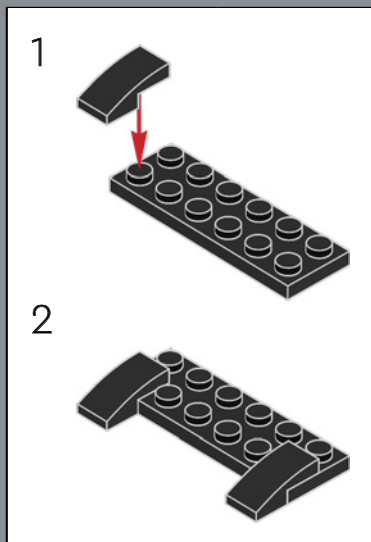

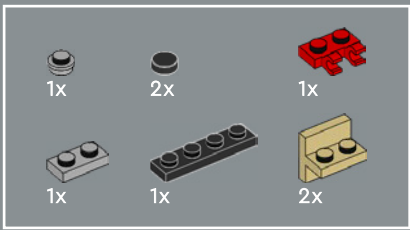

240

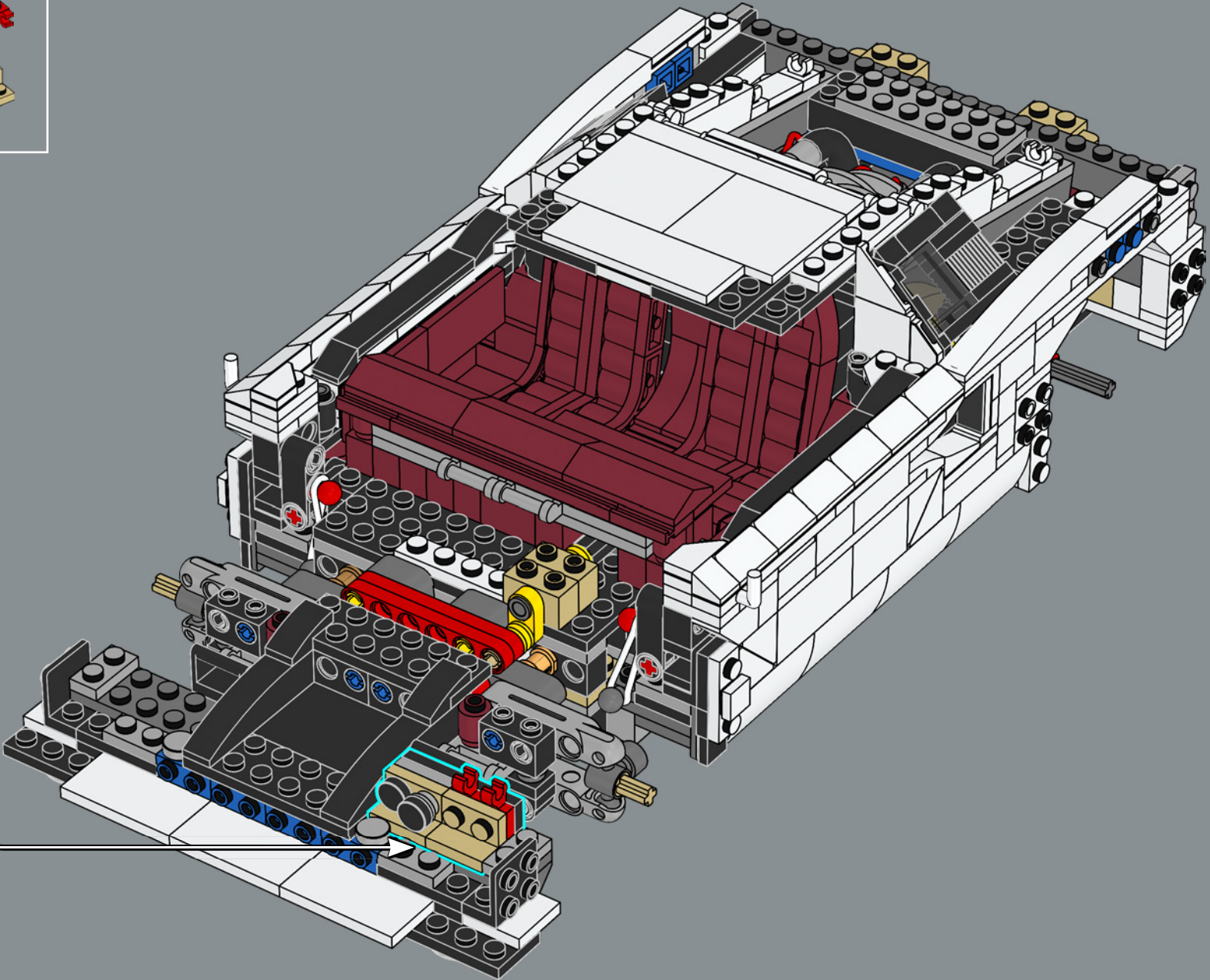
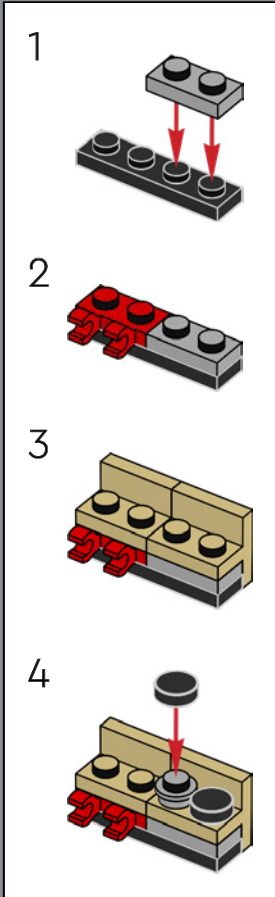

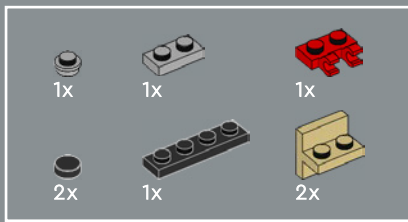

241

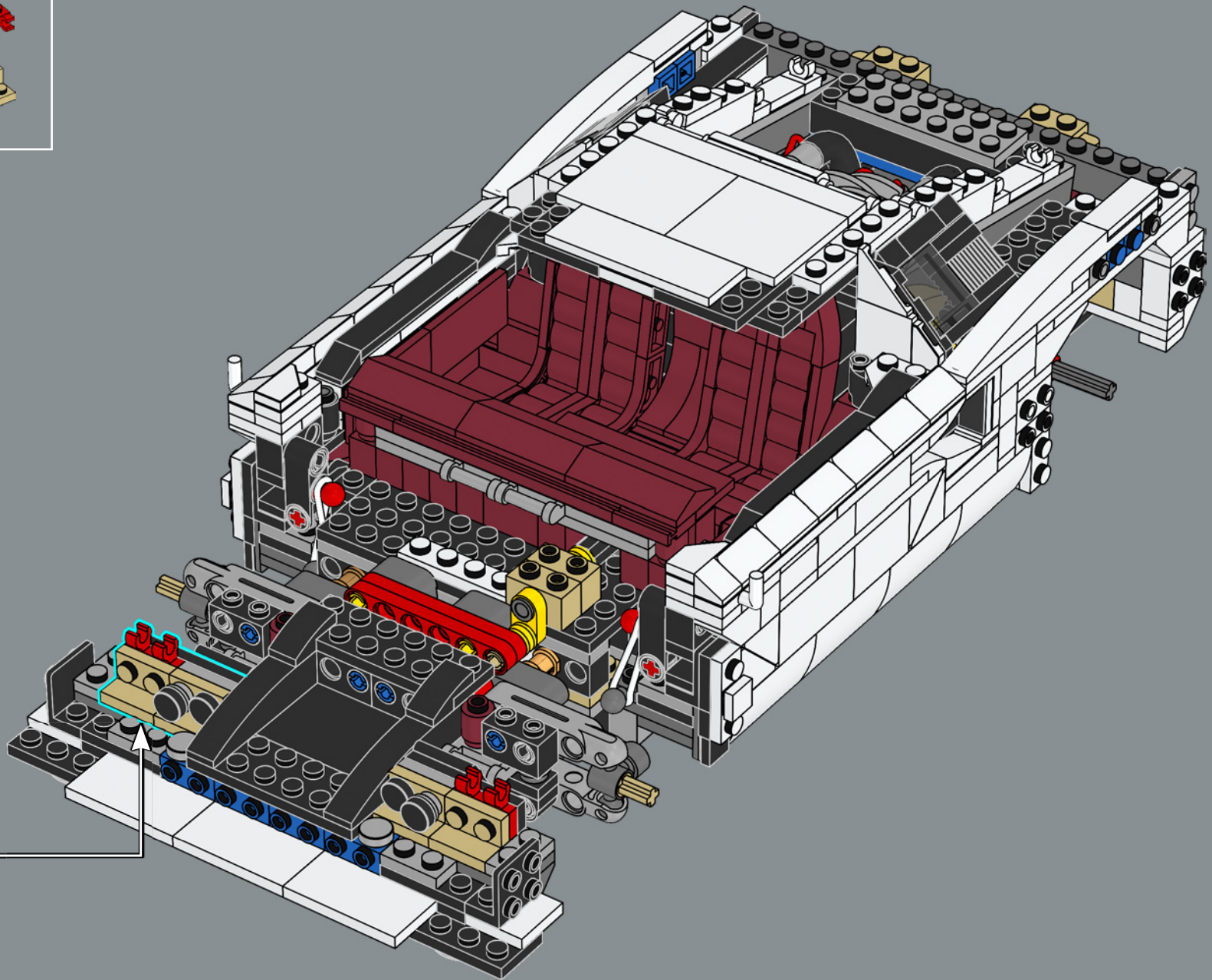
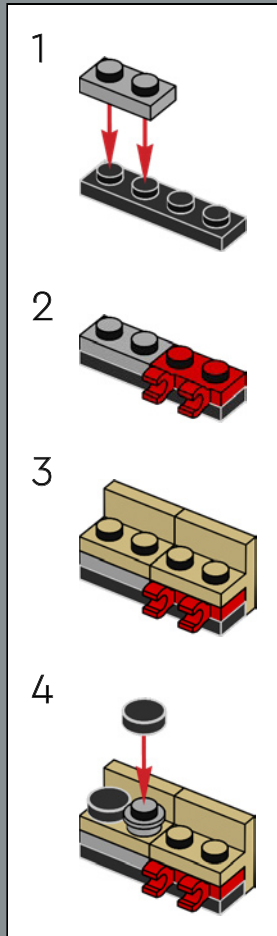



2x

242

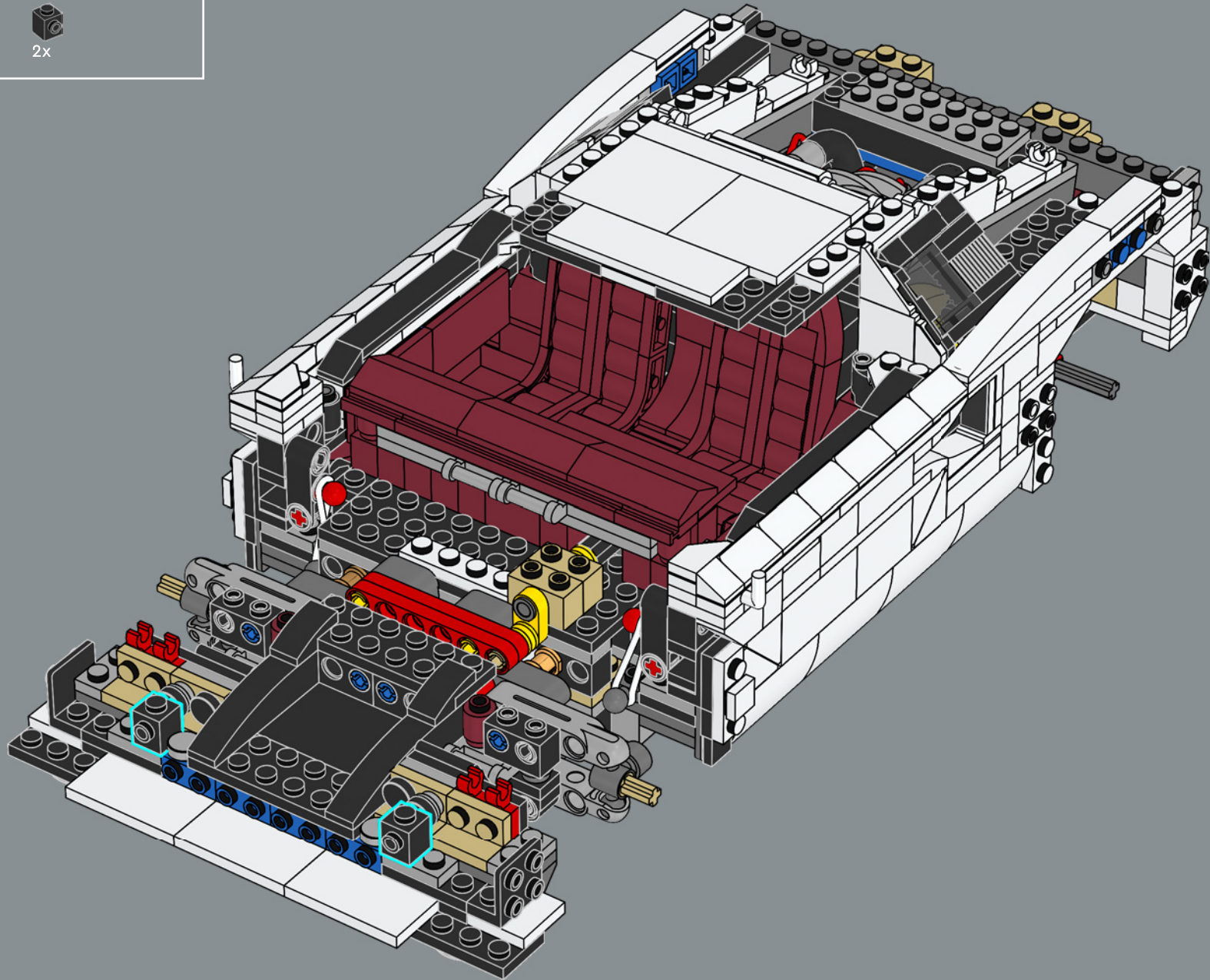

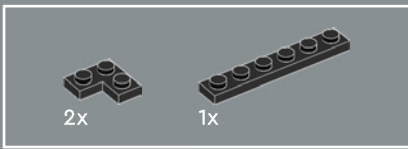

243

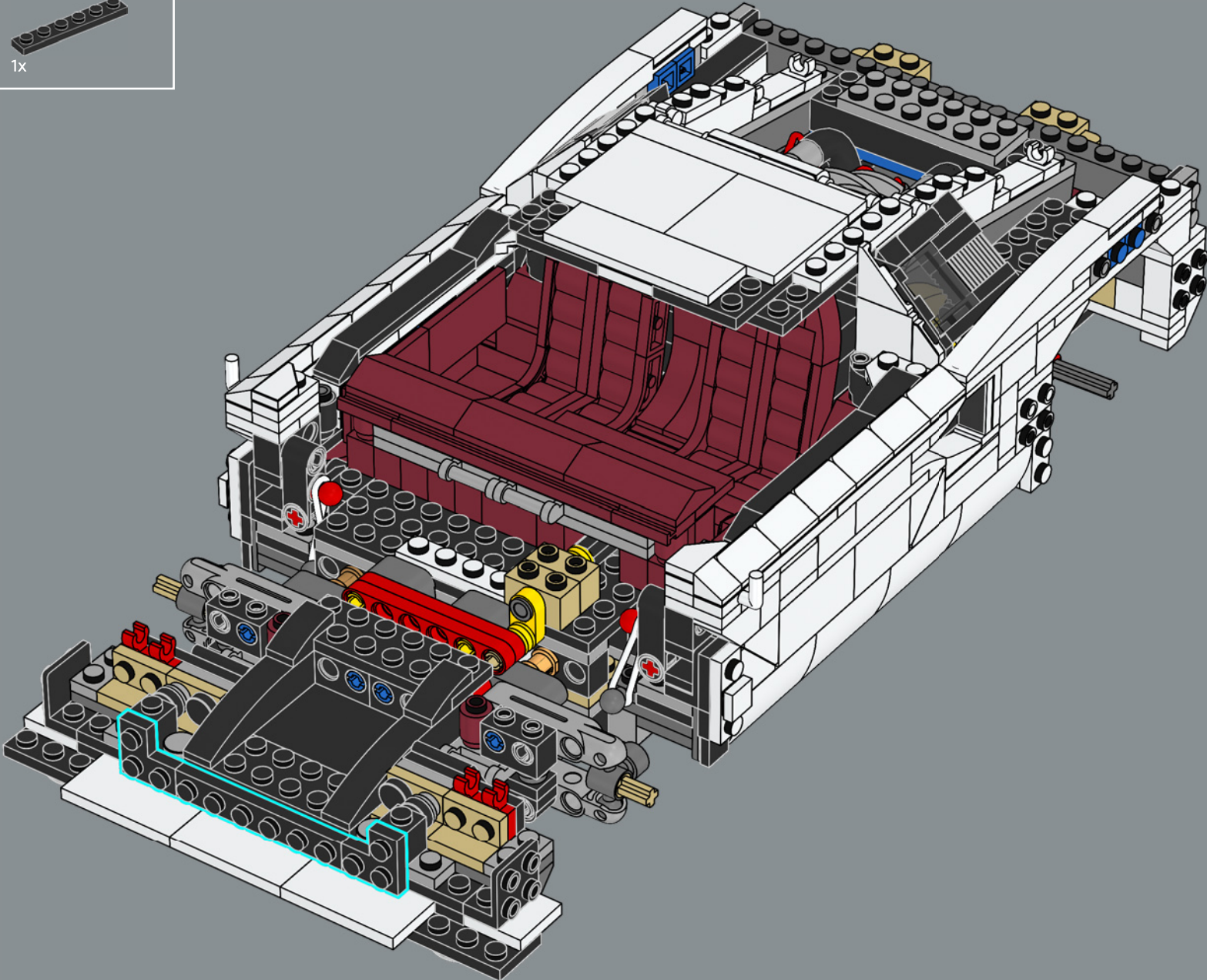



244

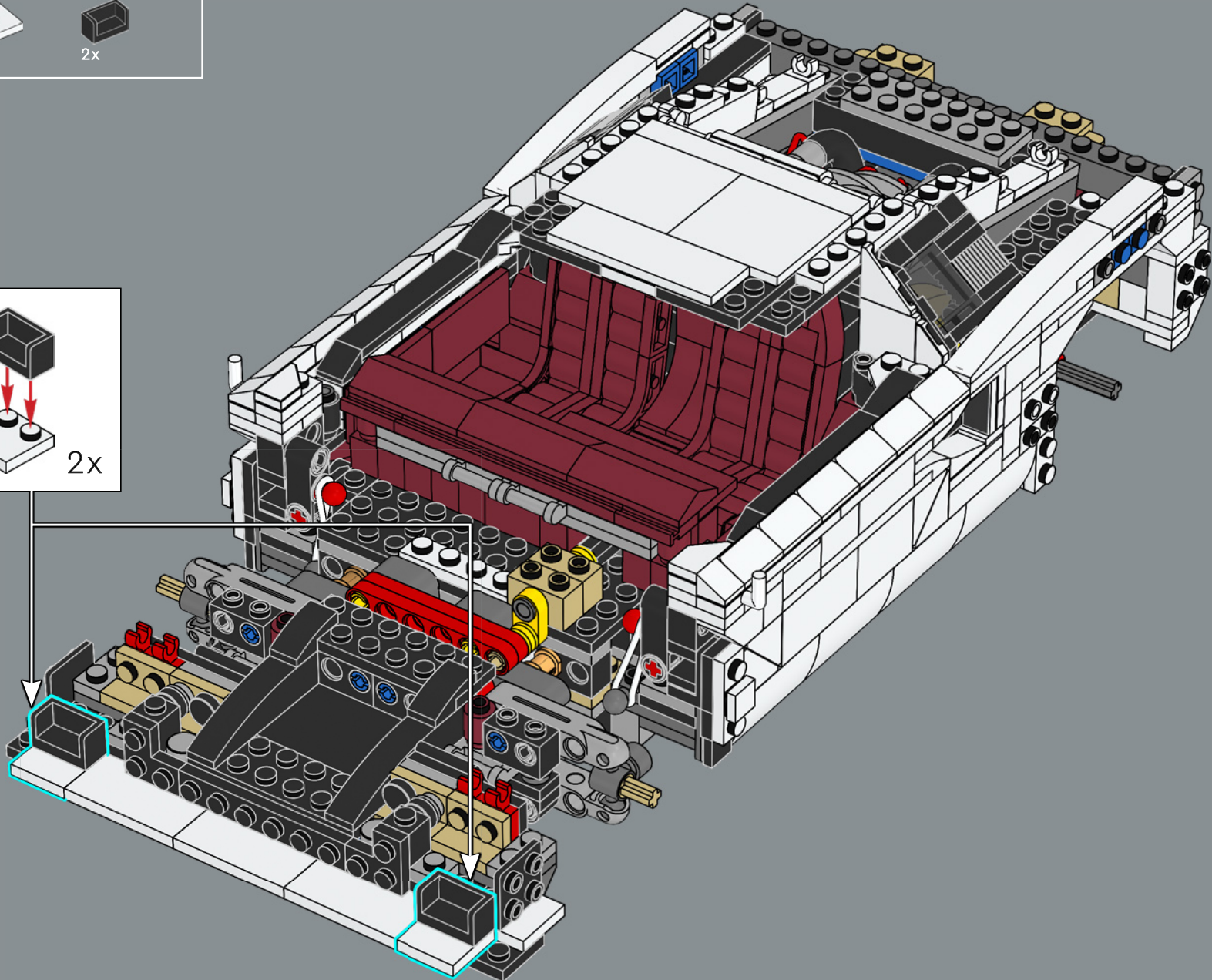
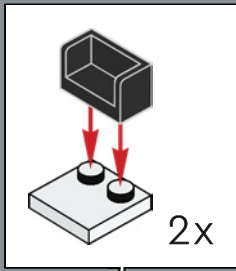

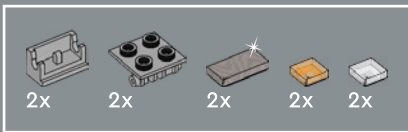

245

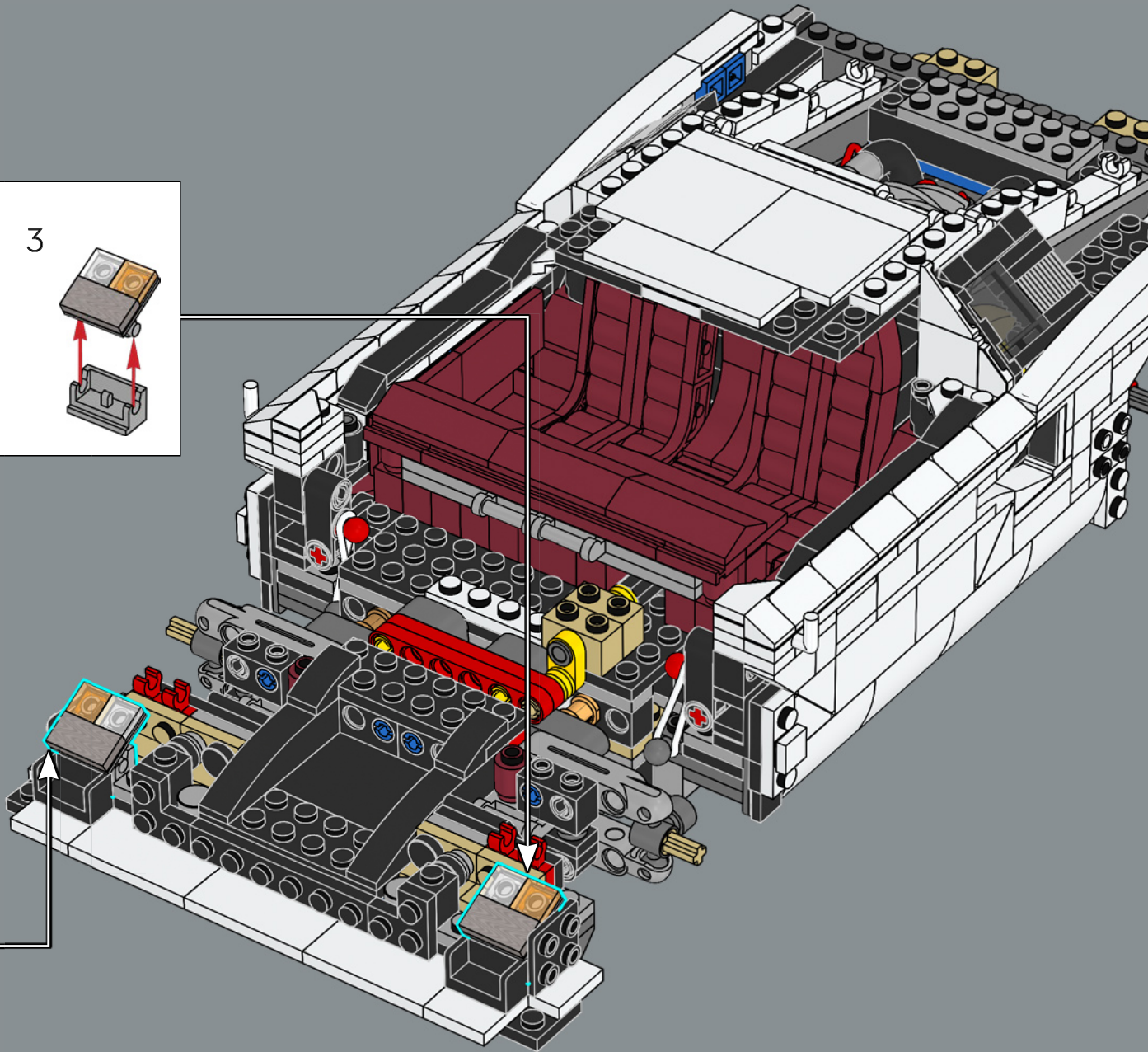
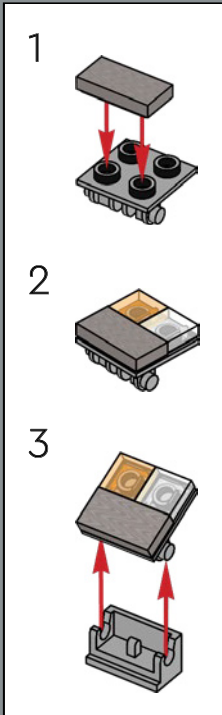
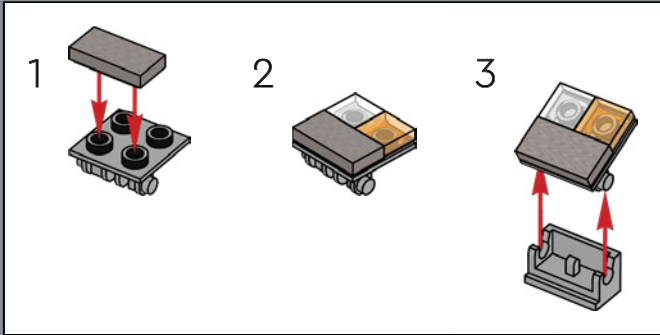

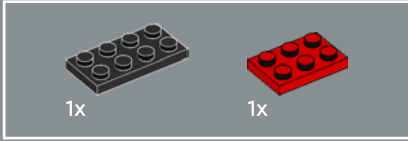
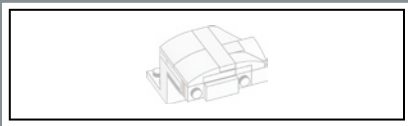

246

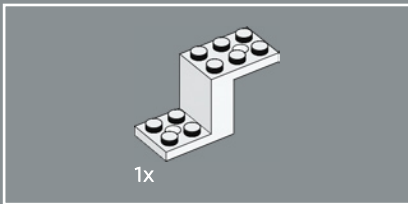
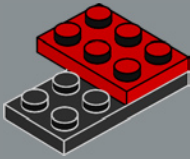

247

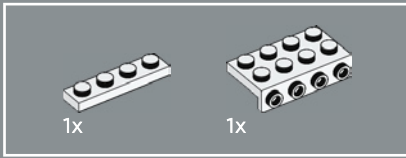
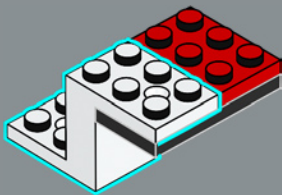

248

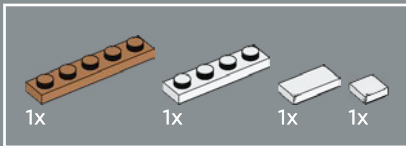
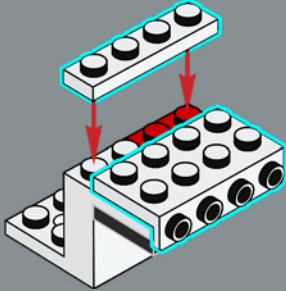

249

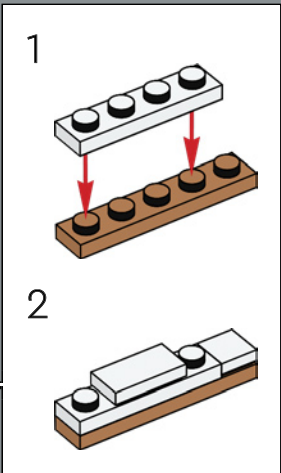
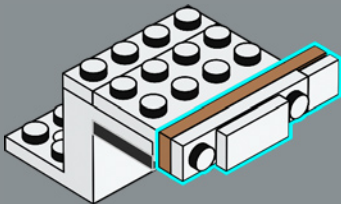



250

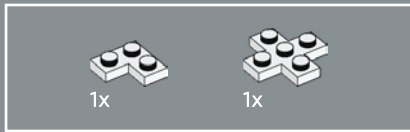
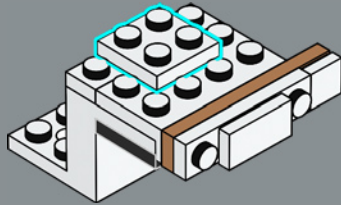

251

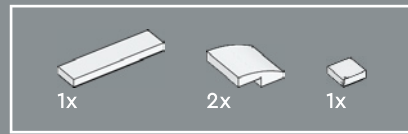
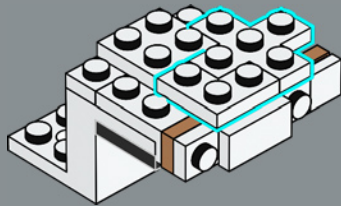

252

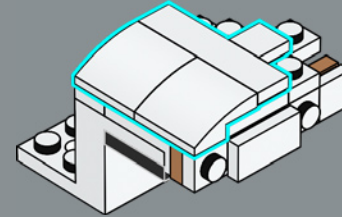

253

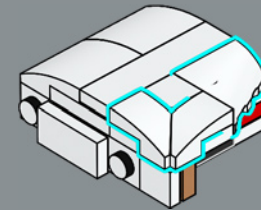

254

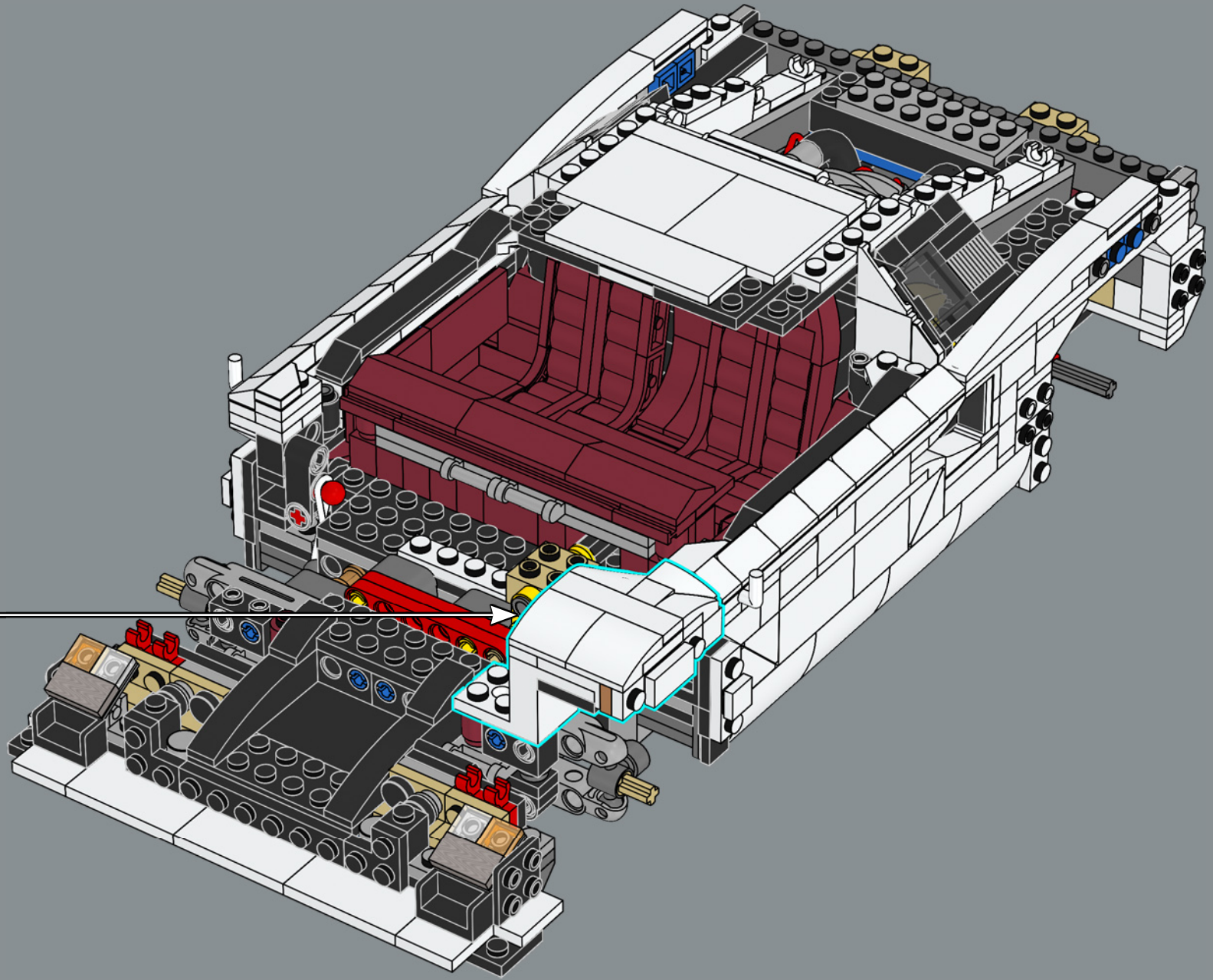

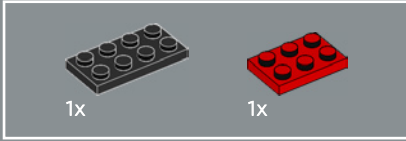
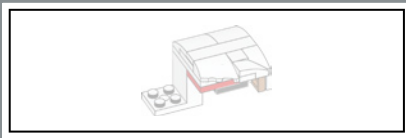

255

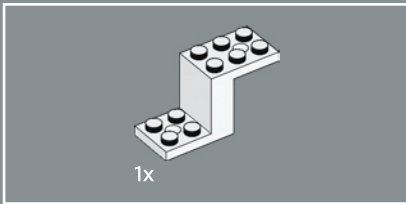
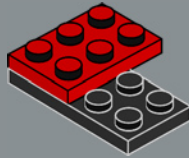

256

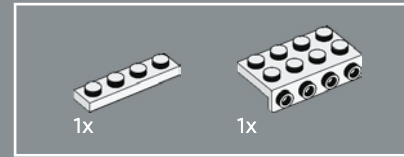
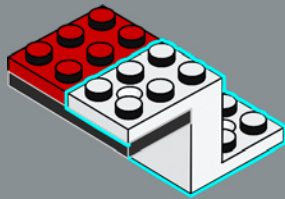

257

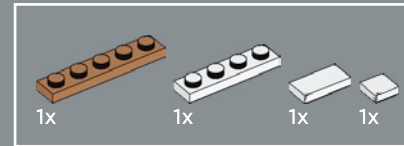
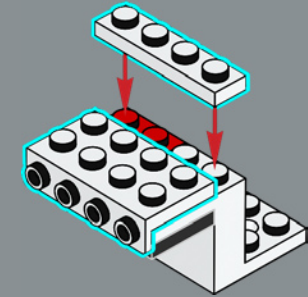

258

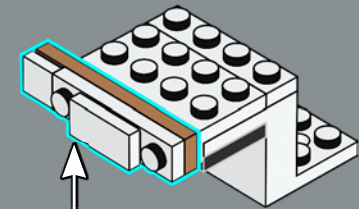
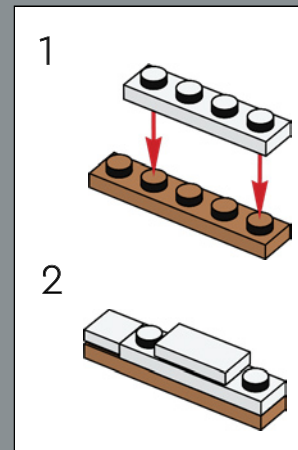

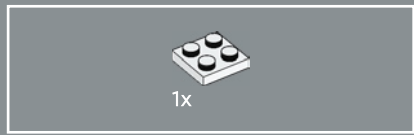

259

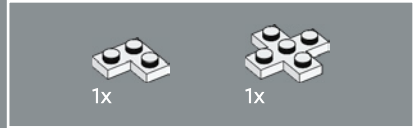
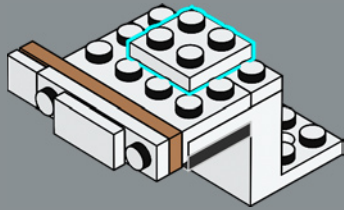

260

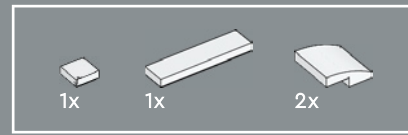
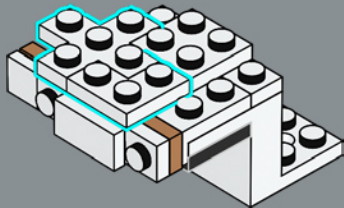

261

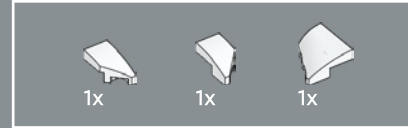
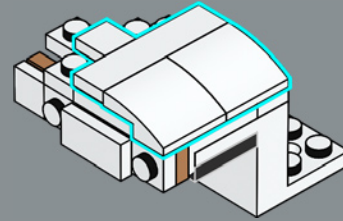

262

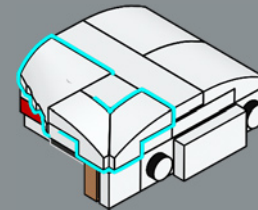

263

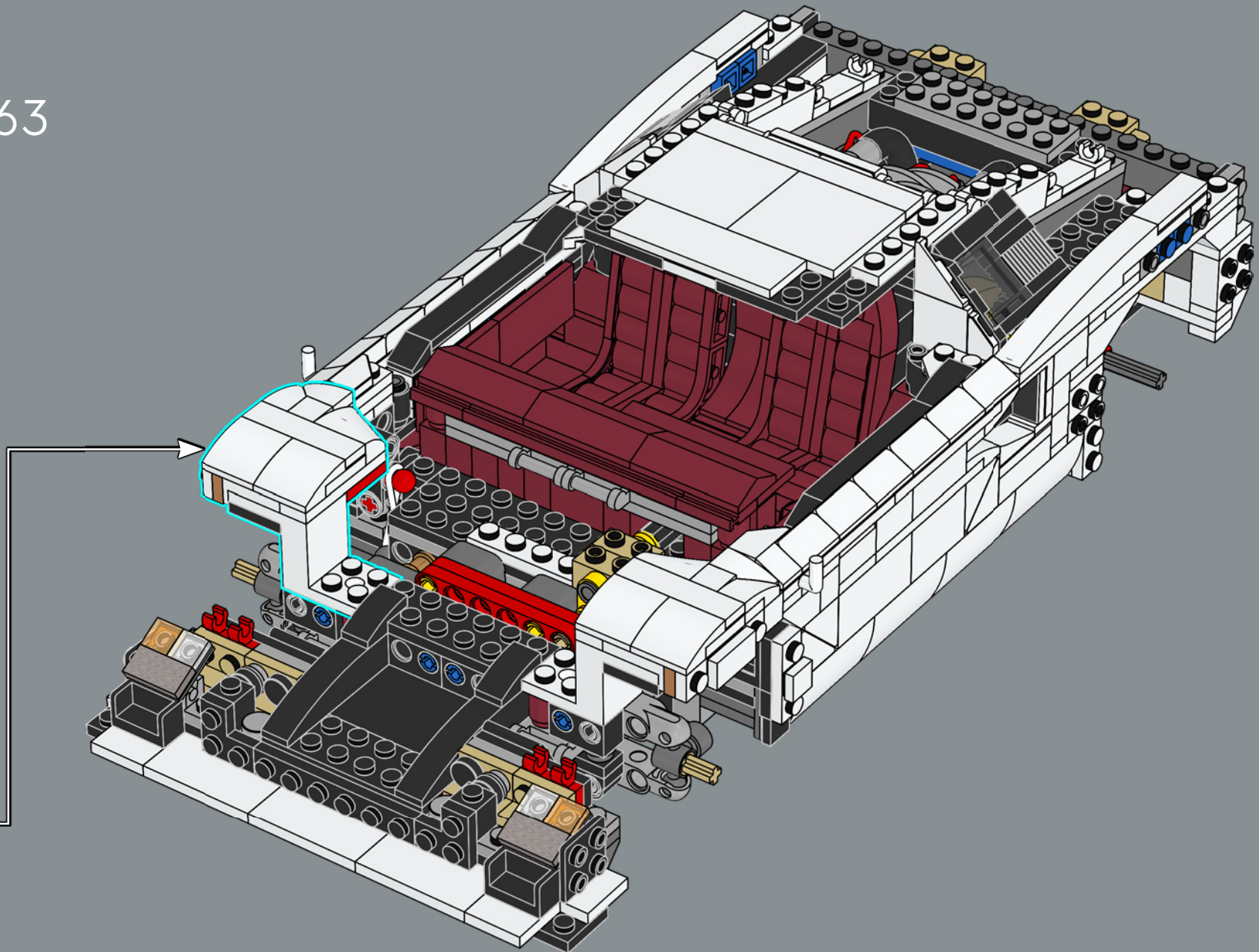

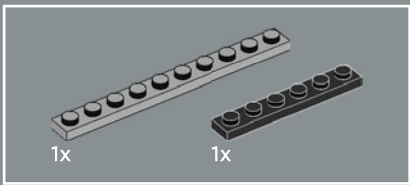

264

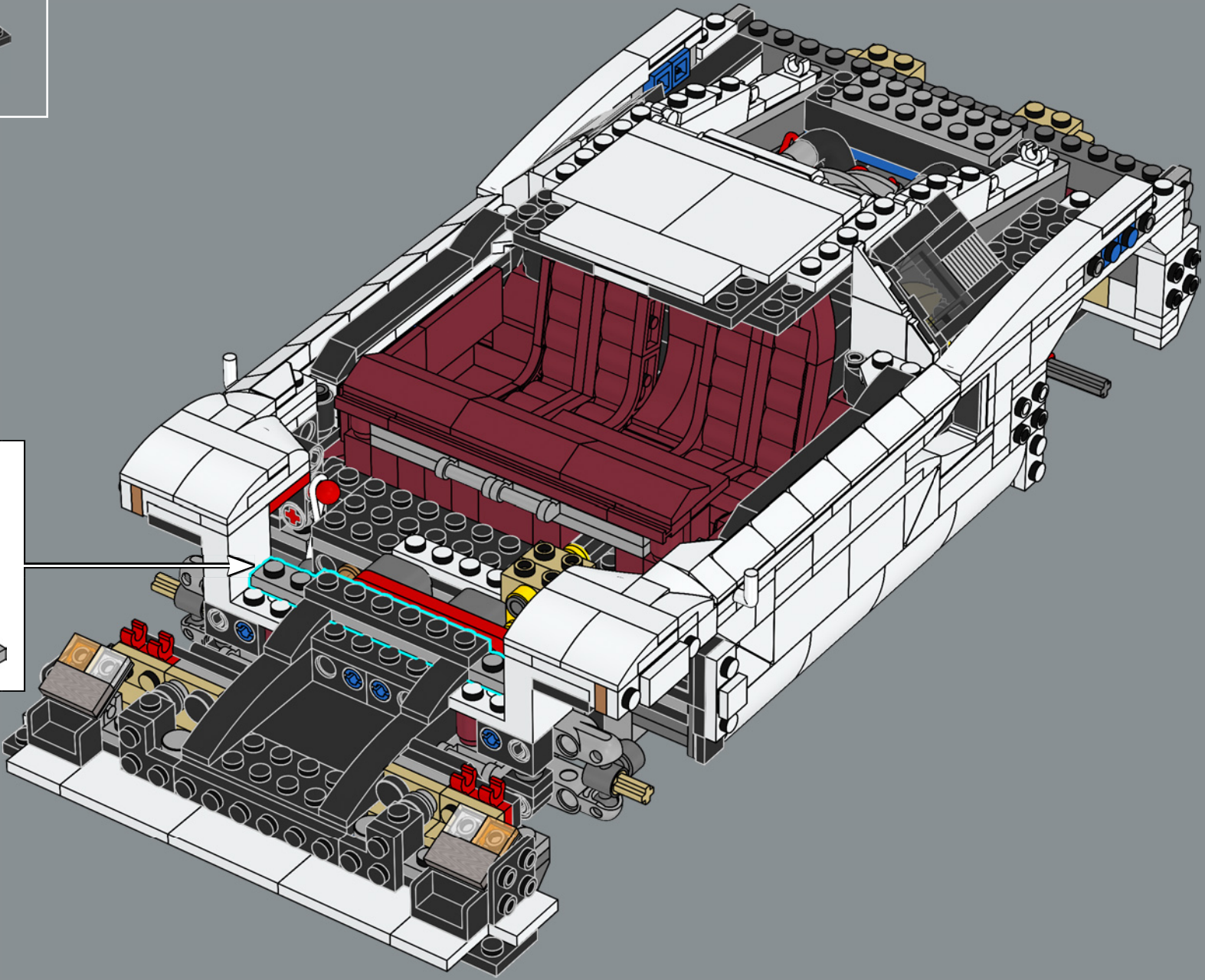
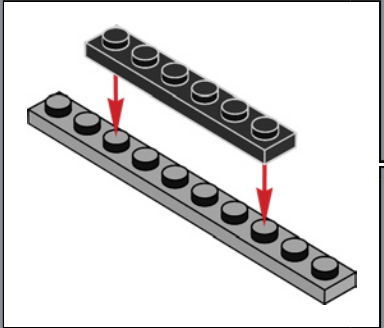

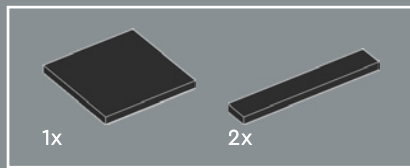

265

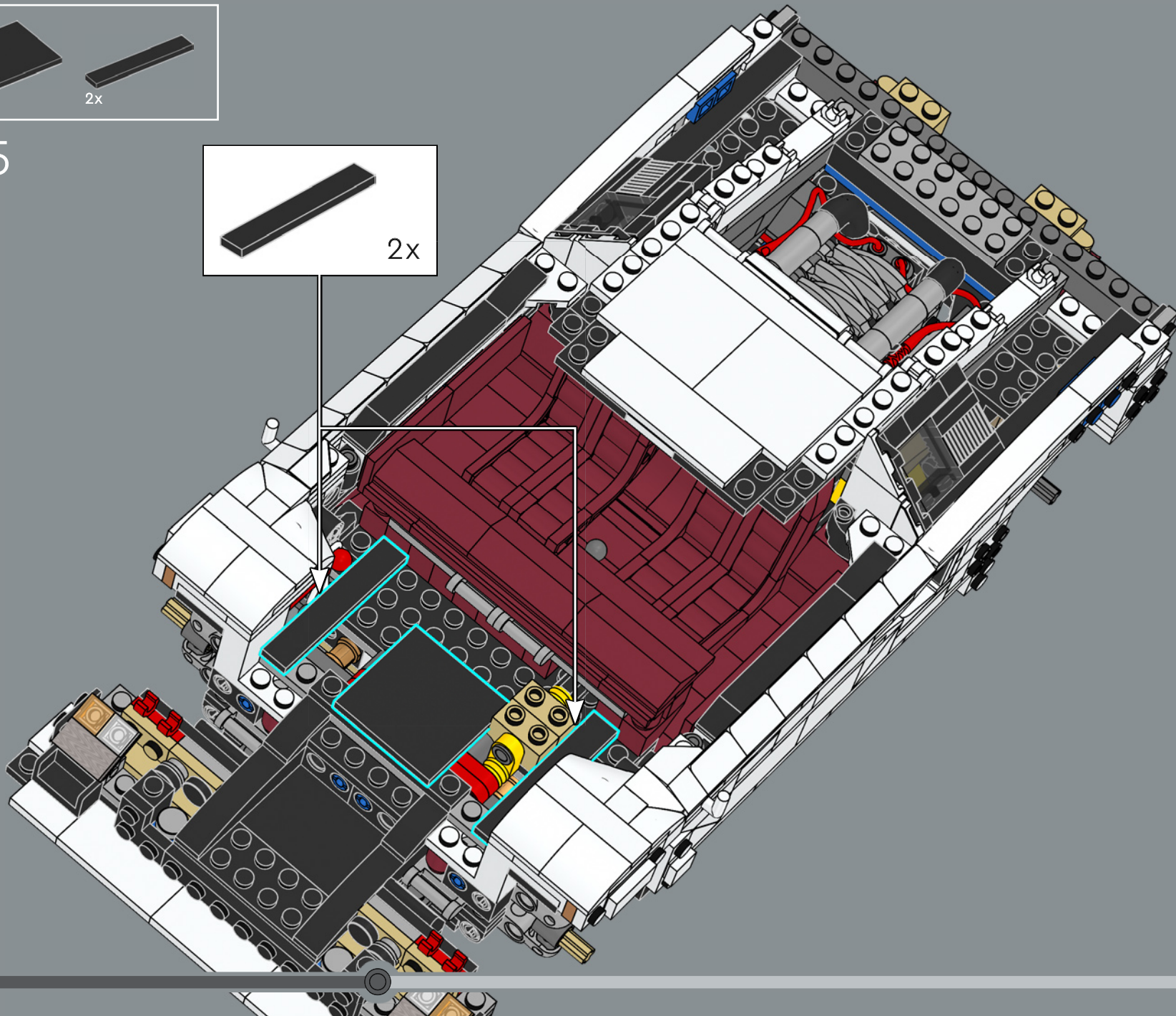
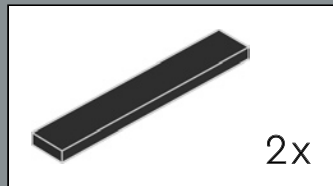

-  2x
-  2x
-  6x
-  2x

266

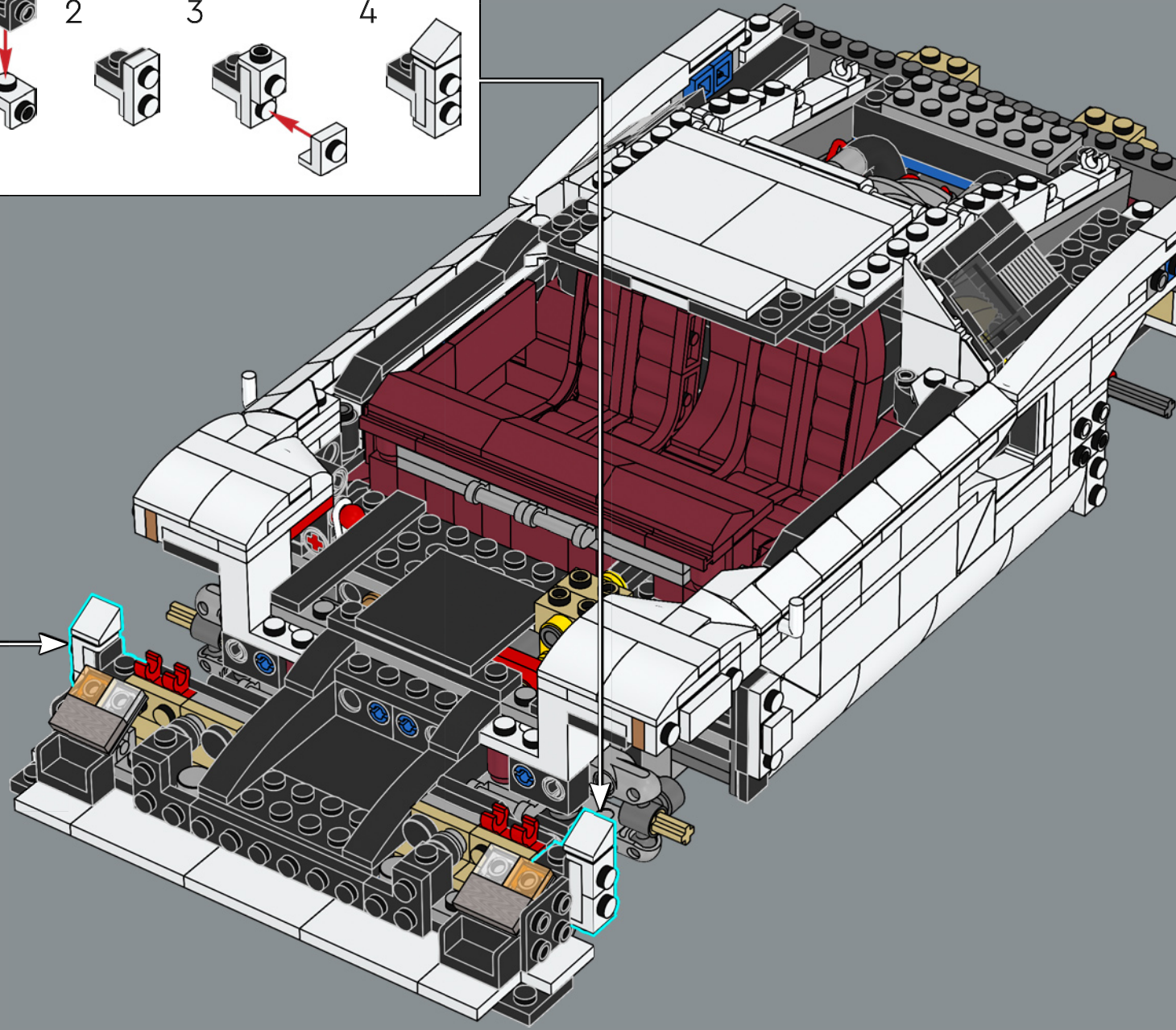
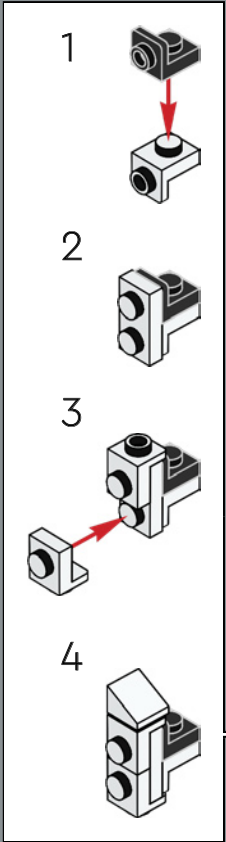
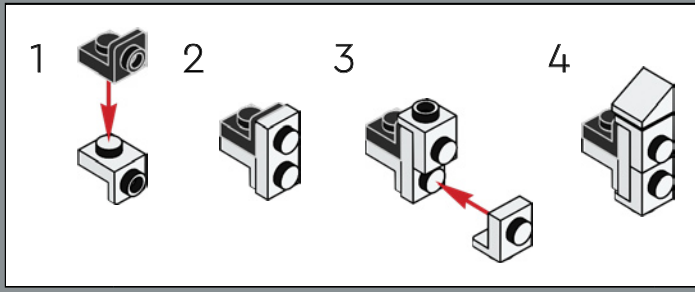



2x

267



2x

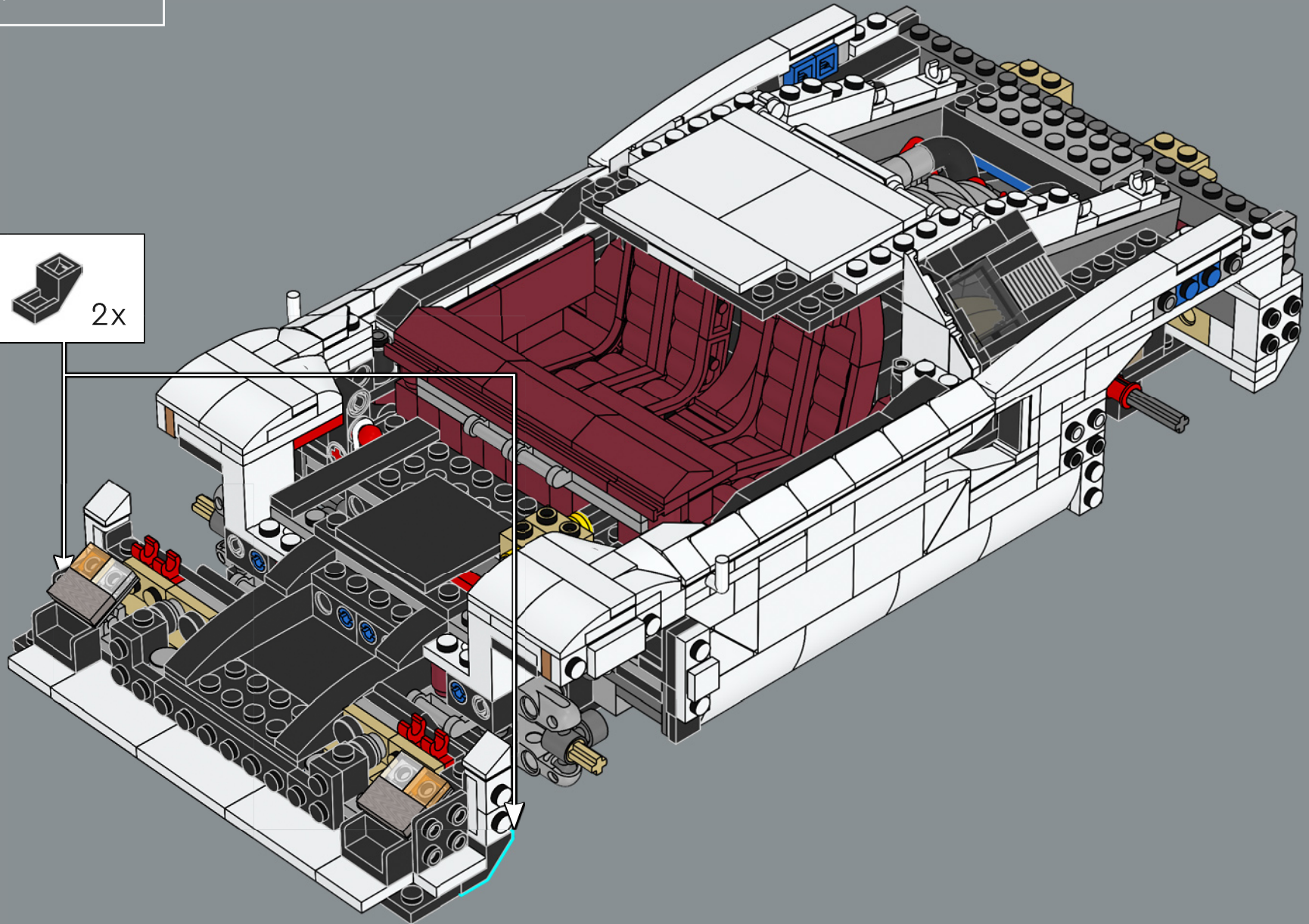

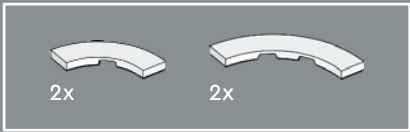

268

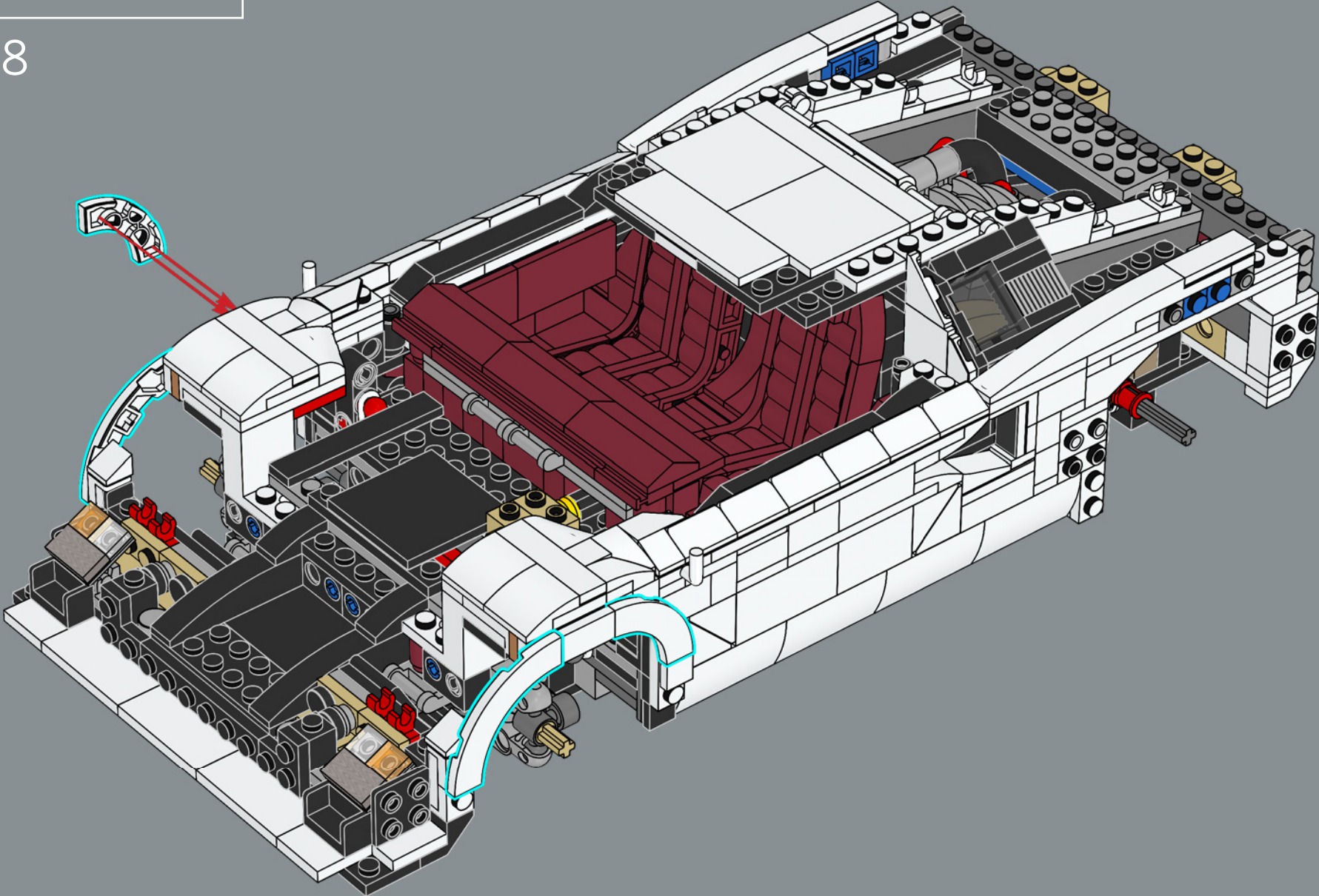

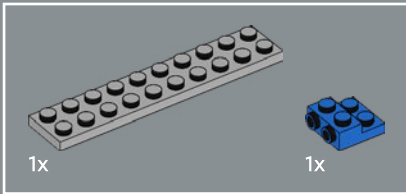
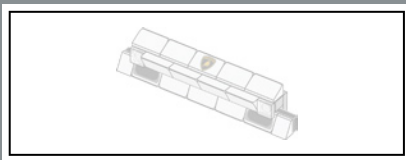

269

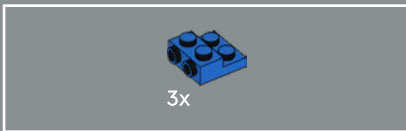
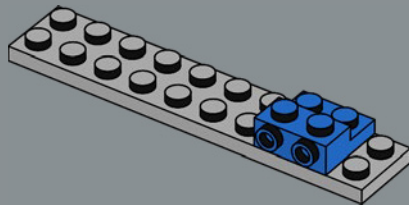

270

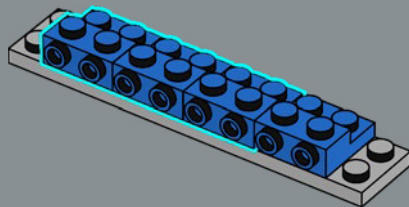

271

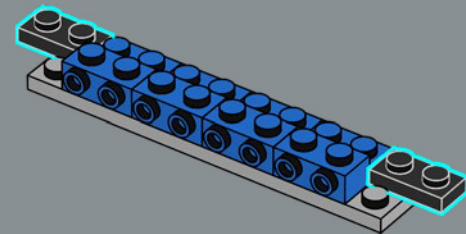

272

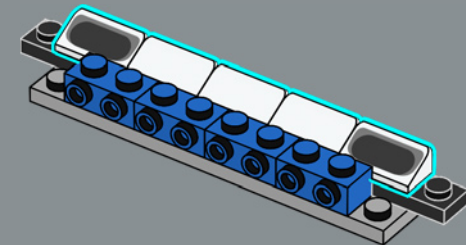



2x

273

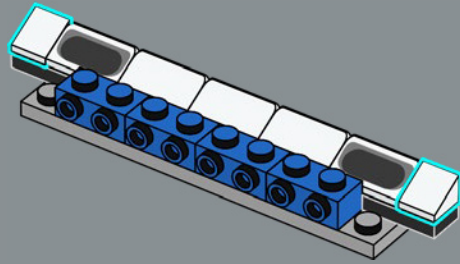

4x

274

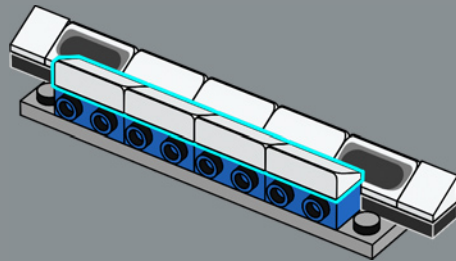

2x



2x

275

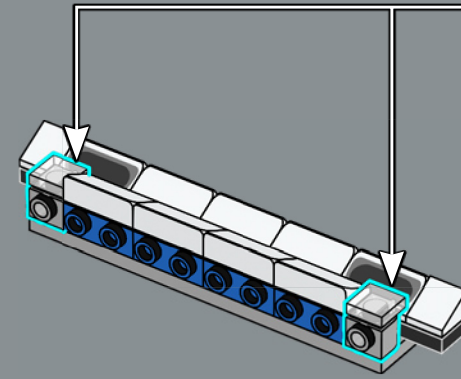

2x



4x



1x

276

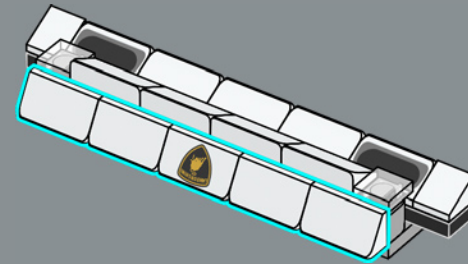

277

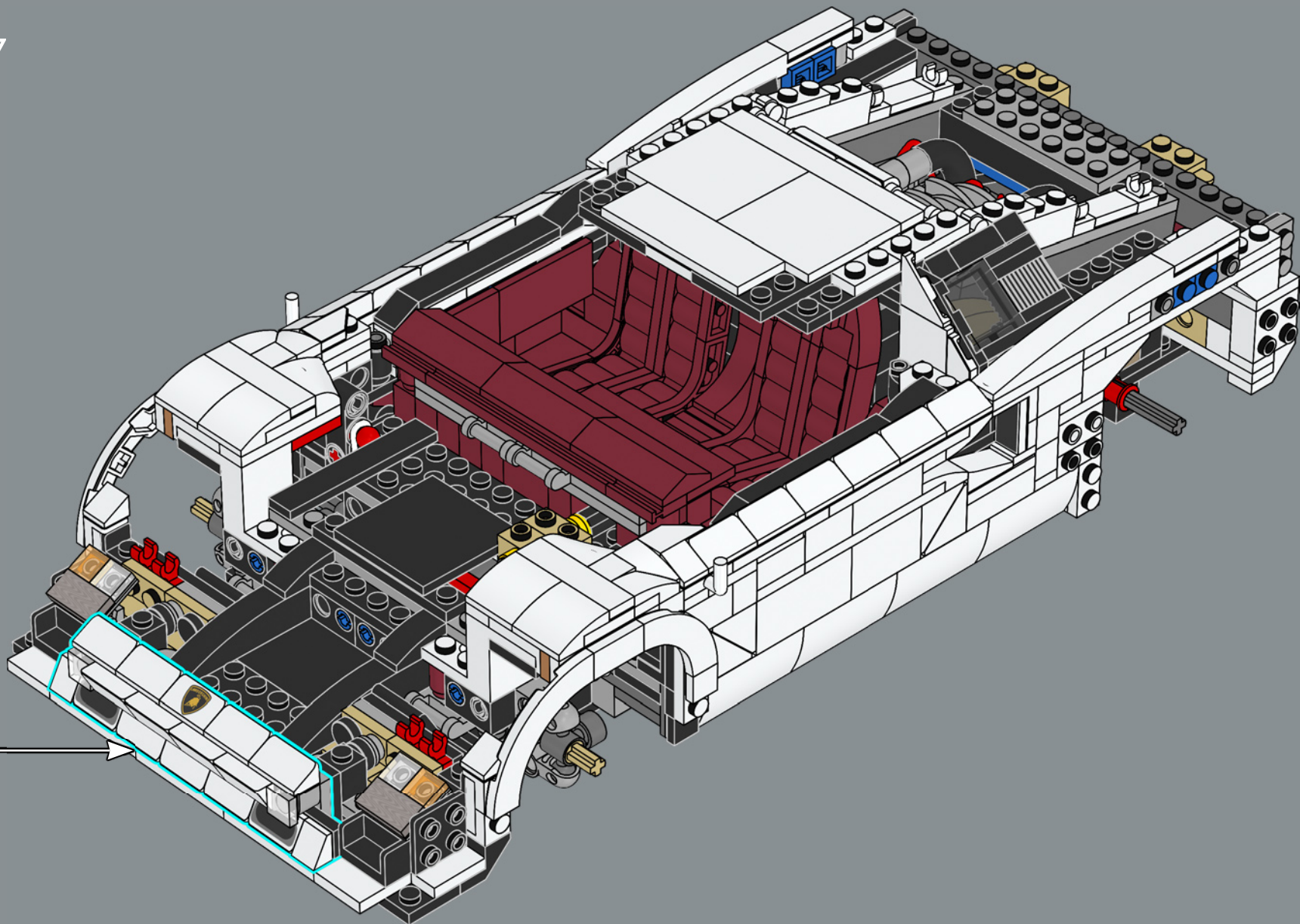

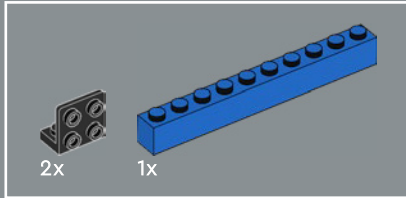
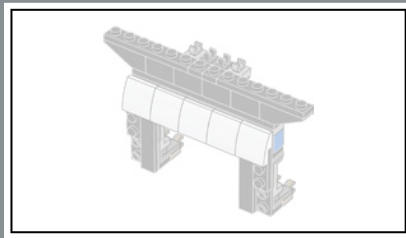

278

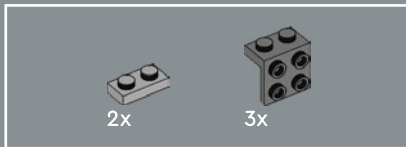
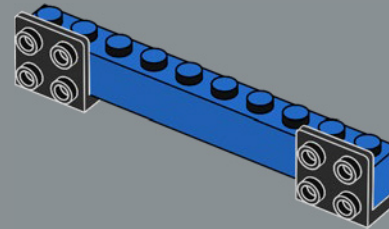

279

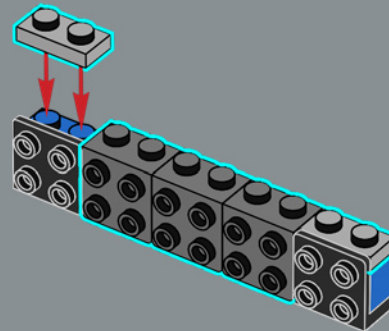

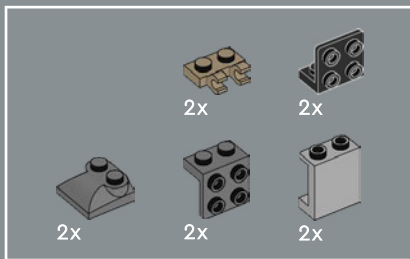

280

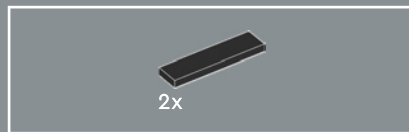
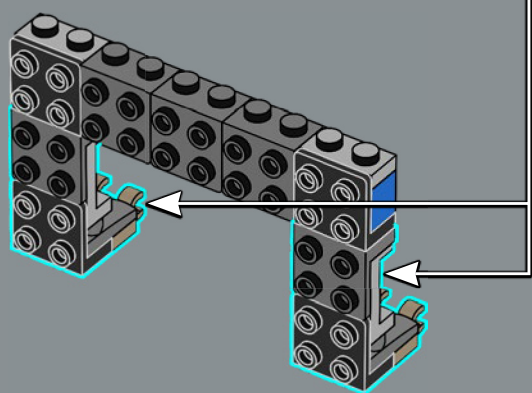
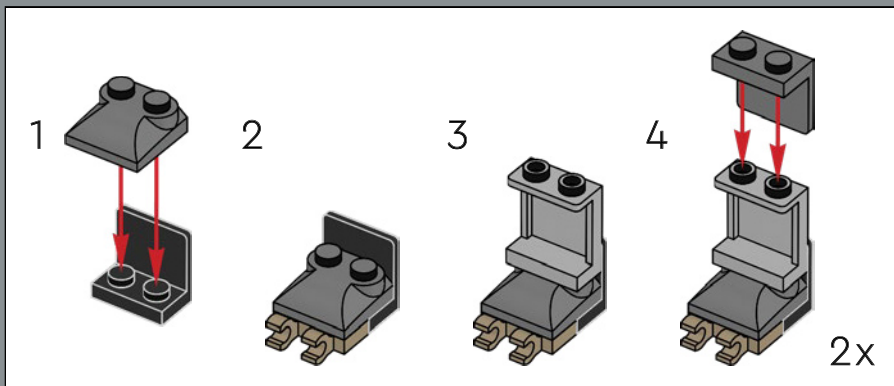

281

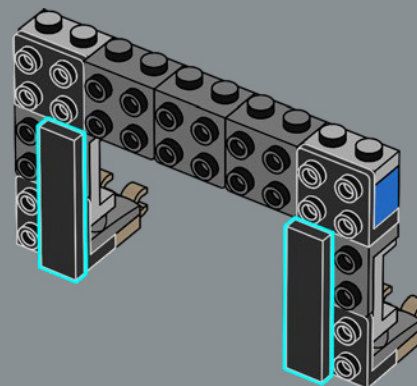

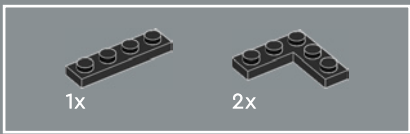

282

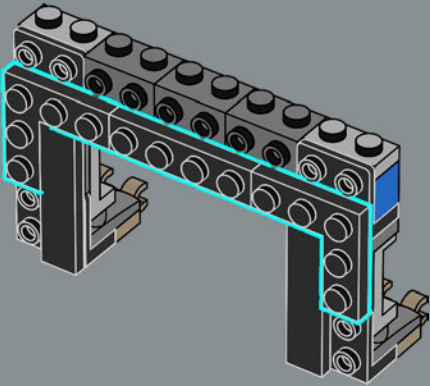

283

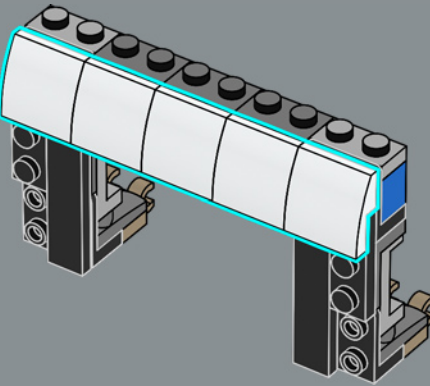

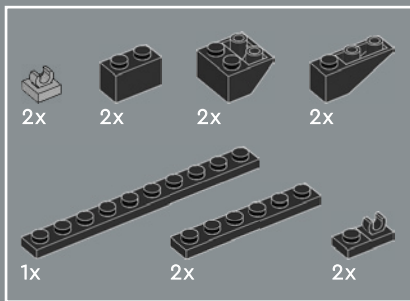

284

1

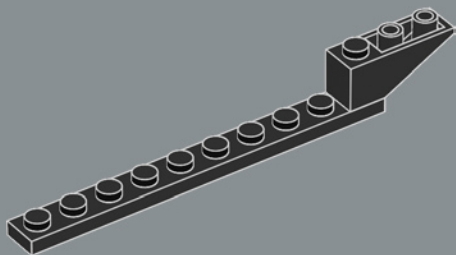

2

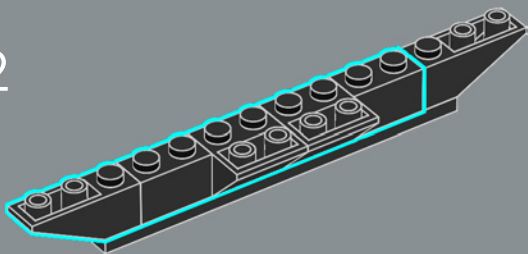

3

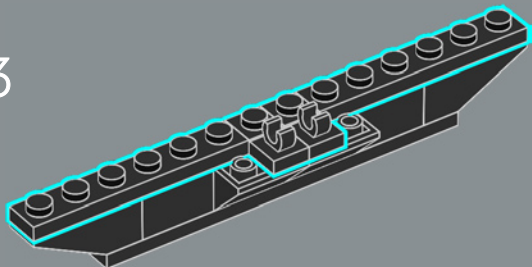

4

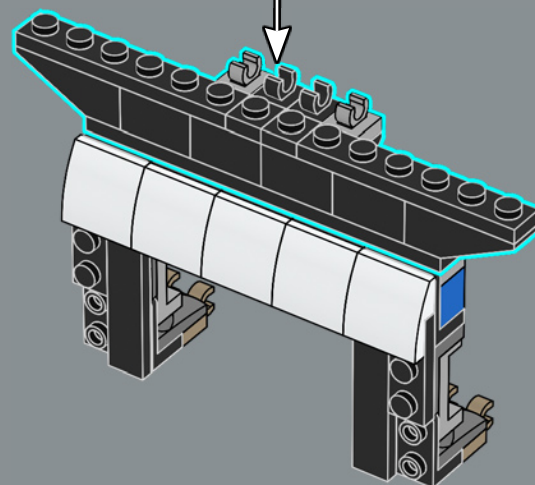
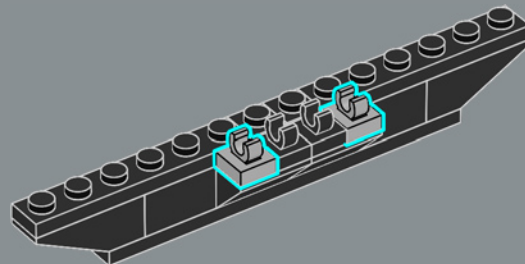

285

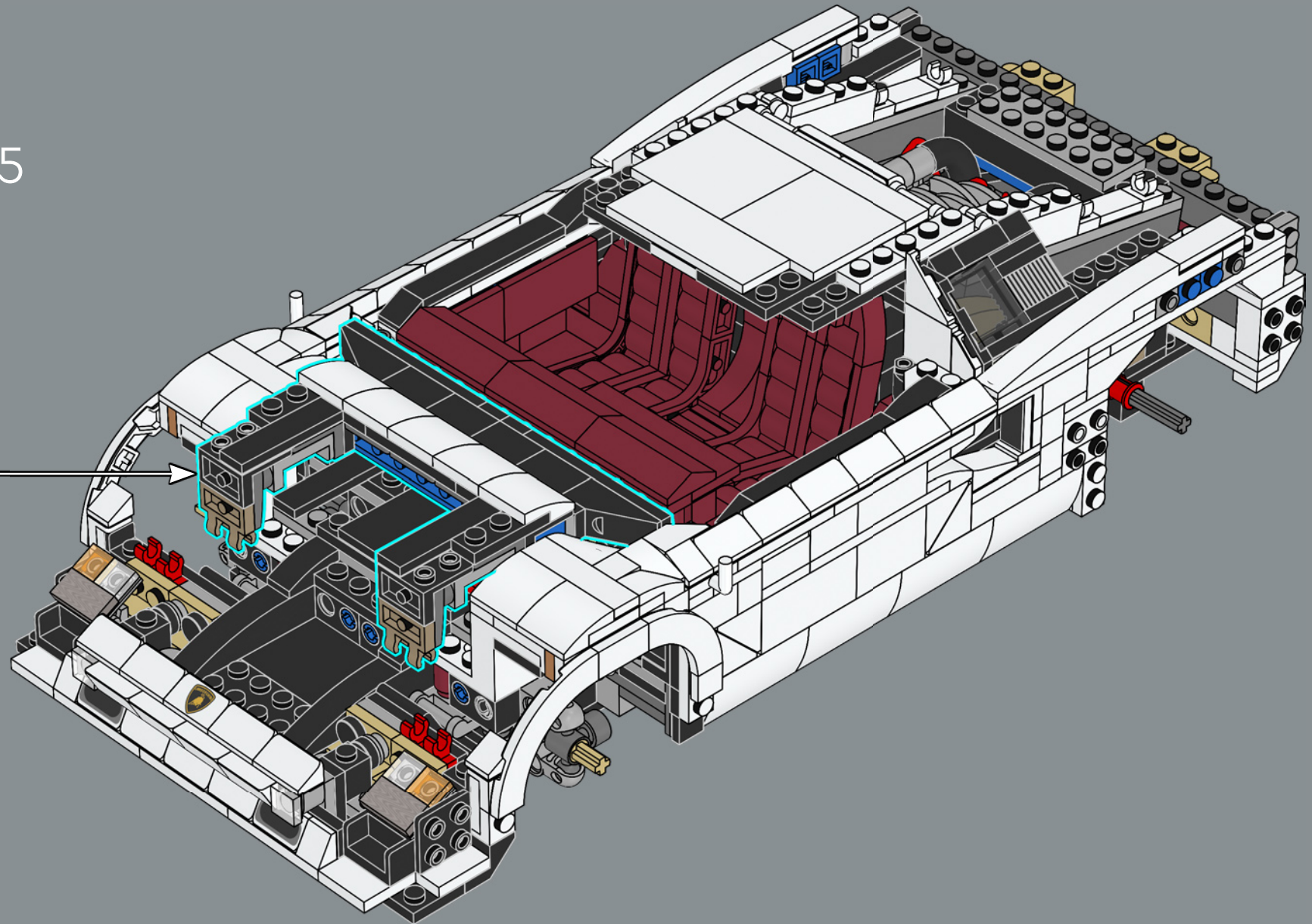

286

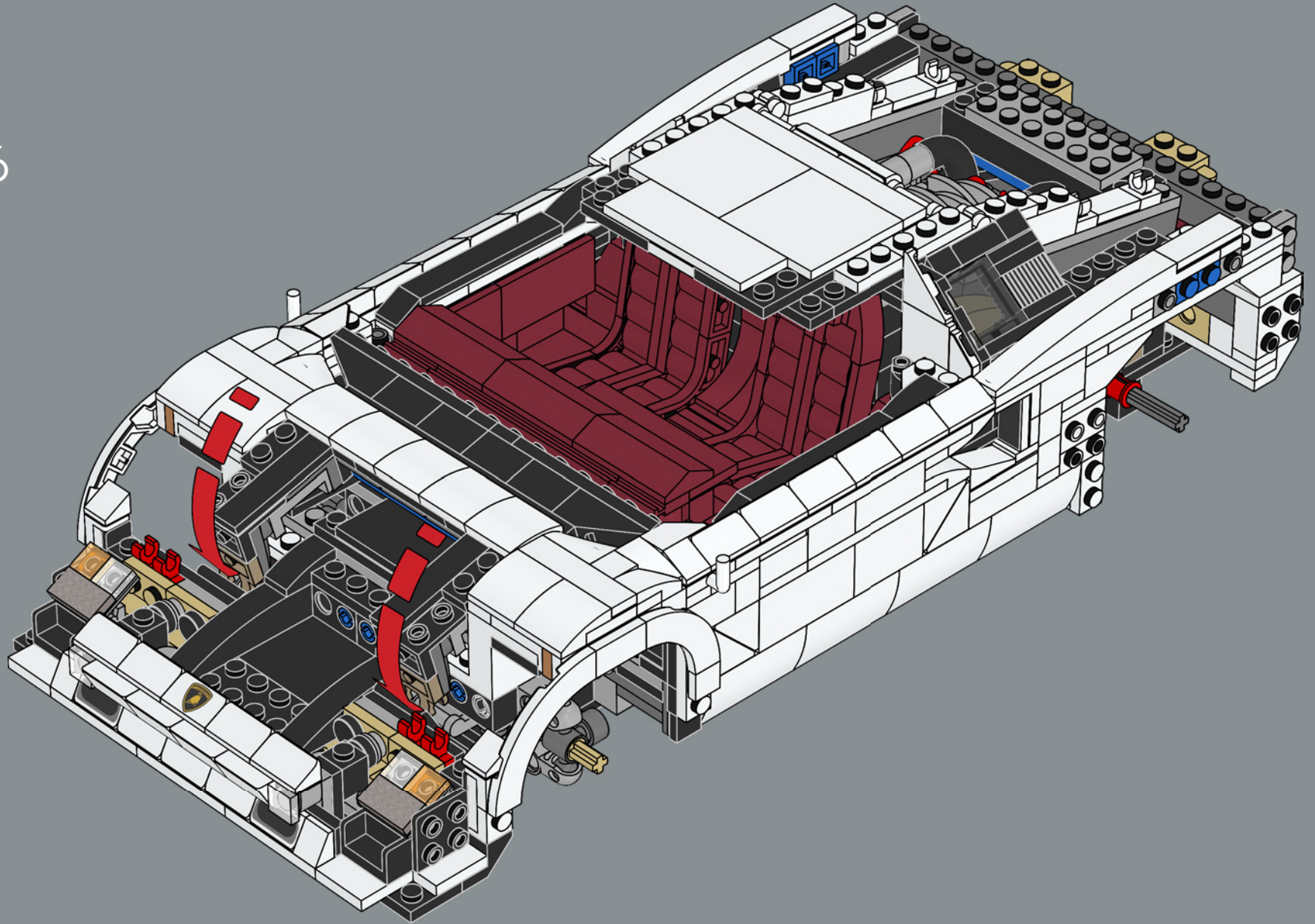



287

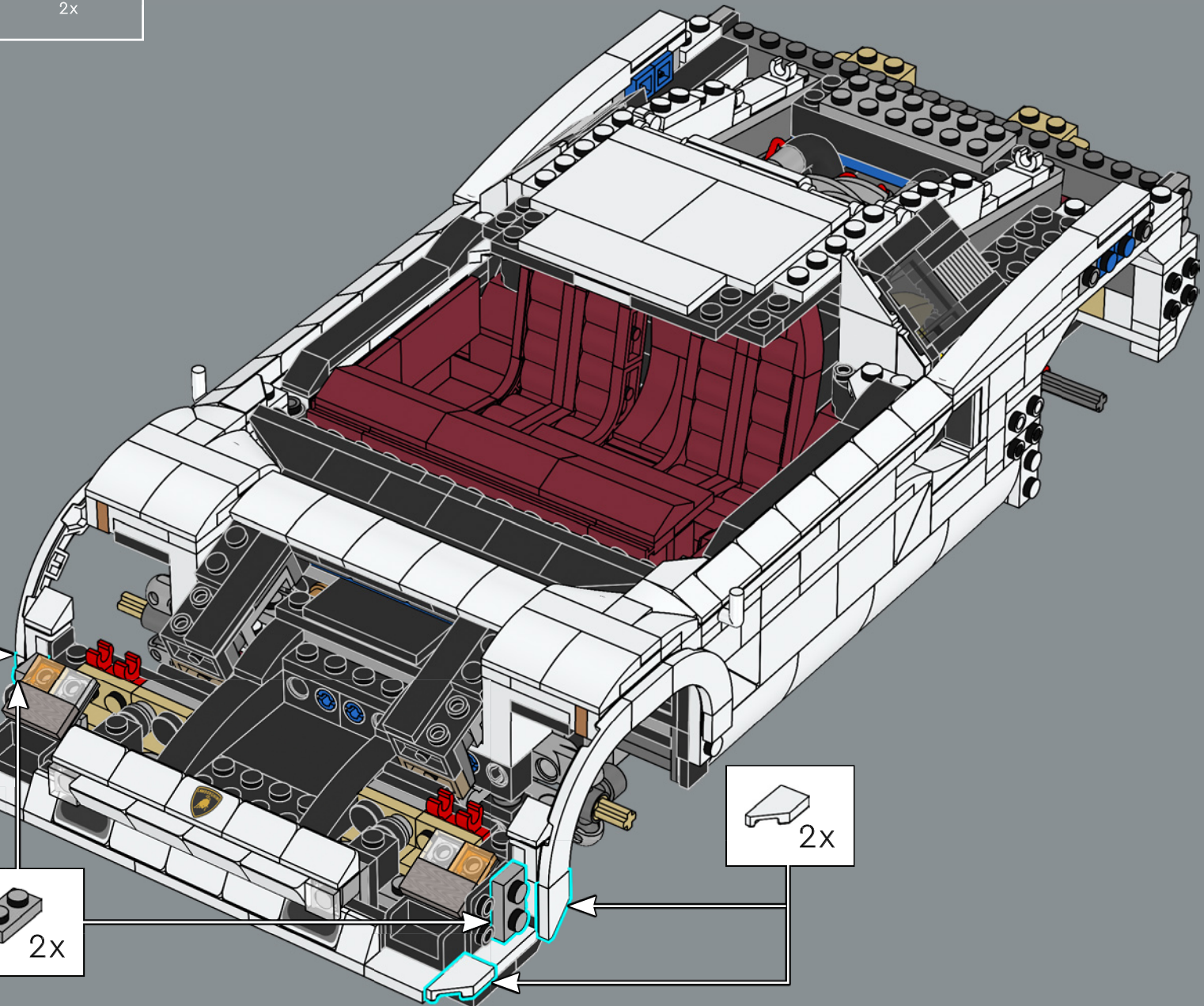
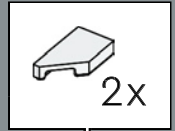
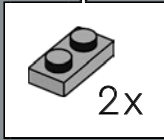
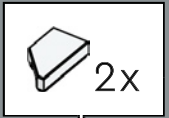



2x

288

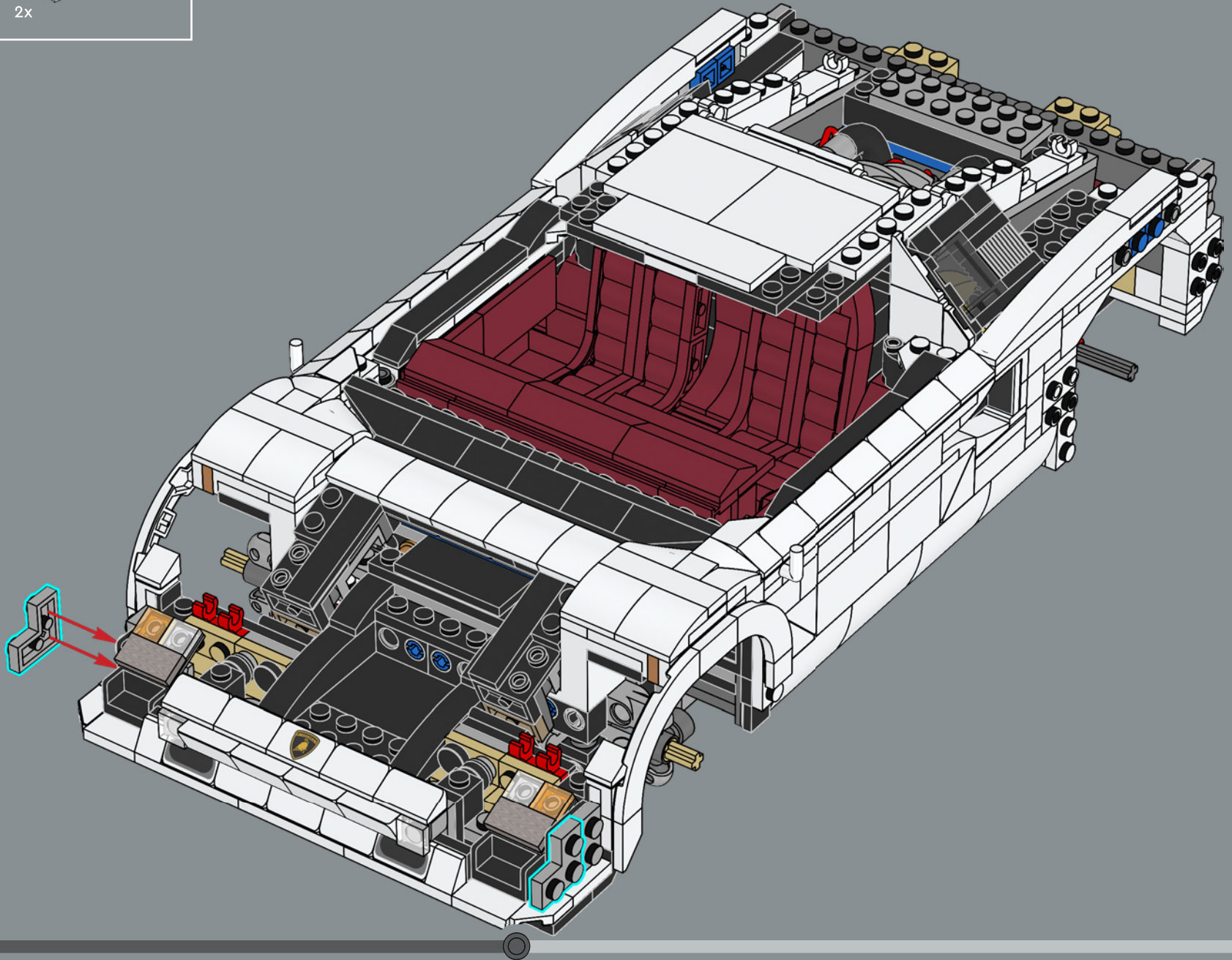

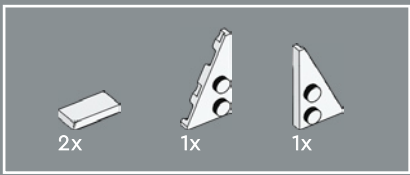

289

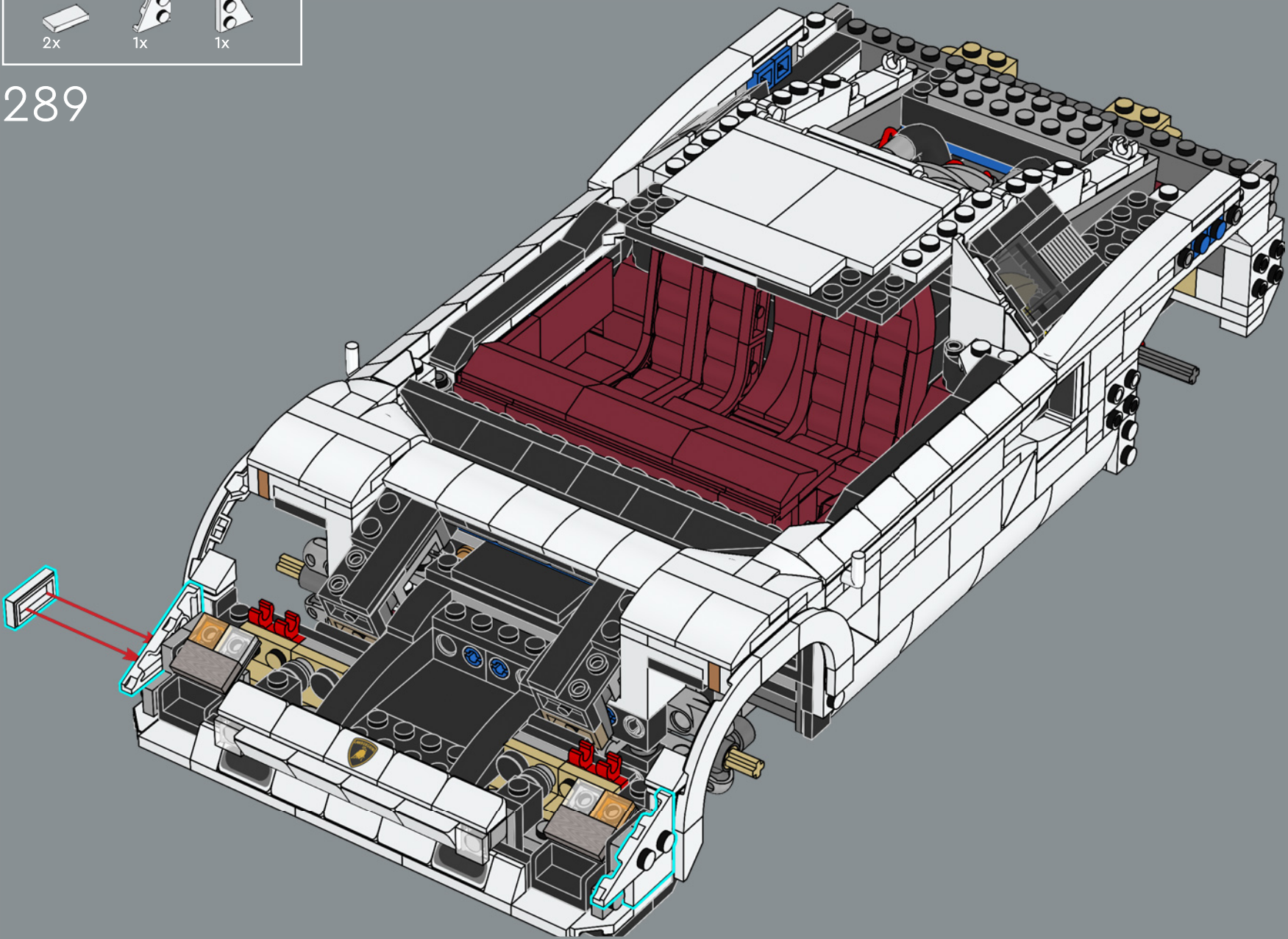



290

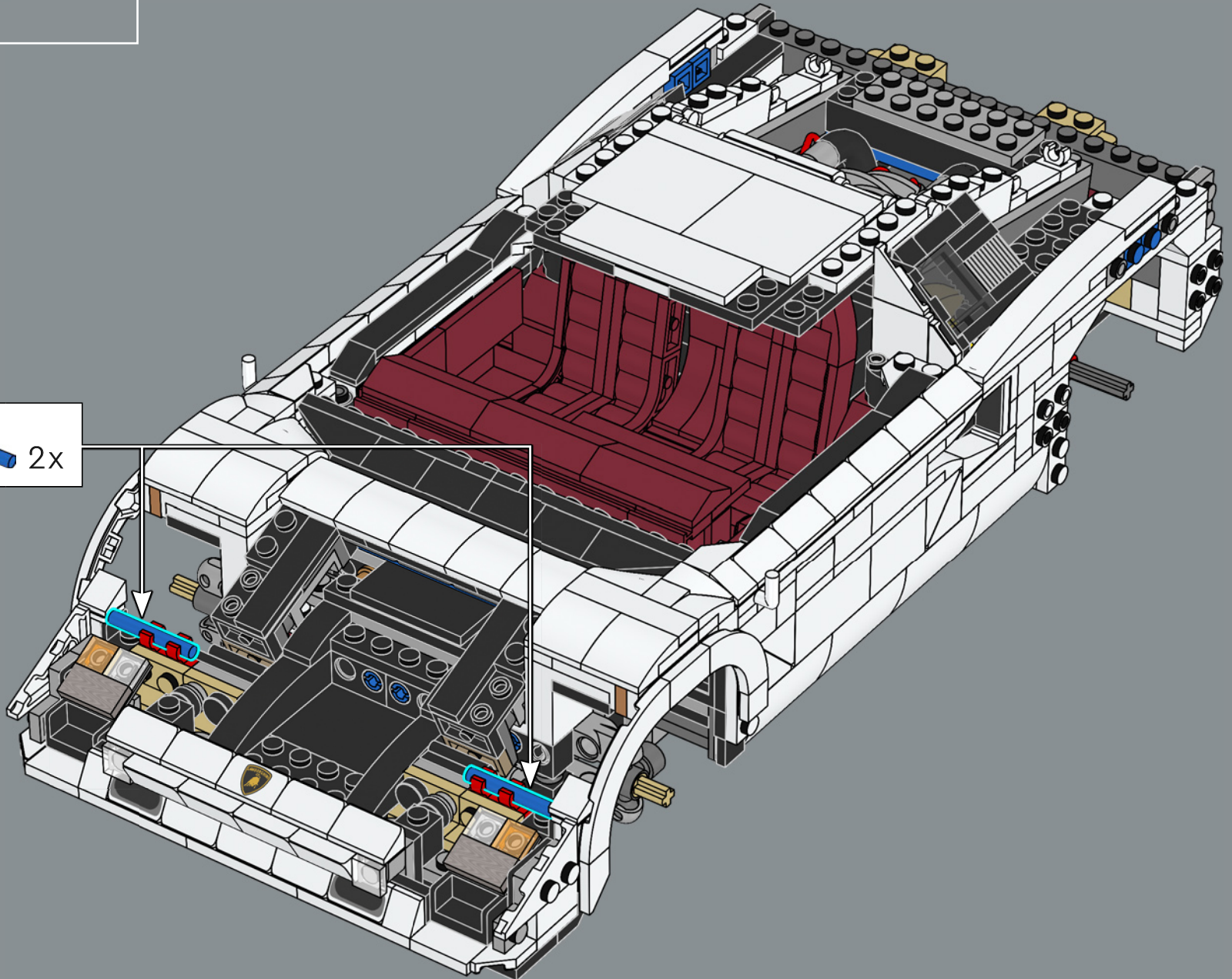
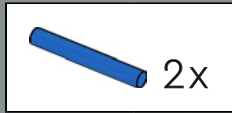

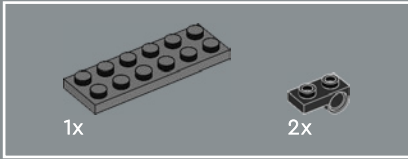
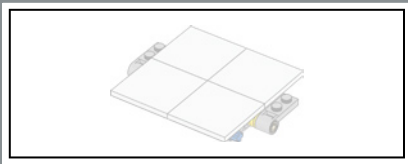

291

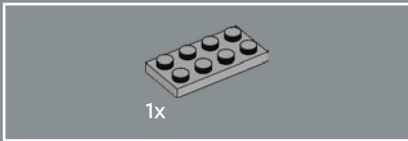
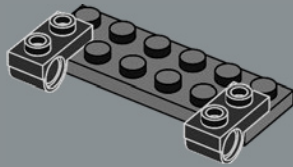

292

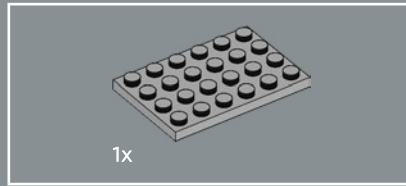
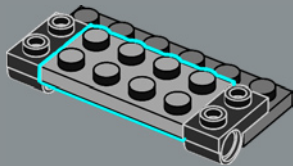

293

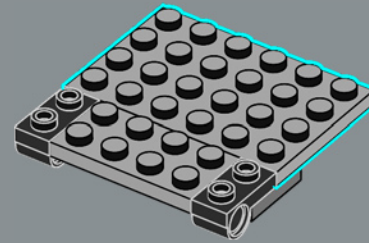

294

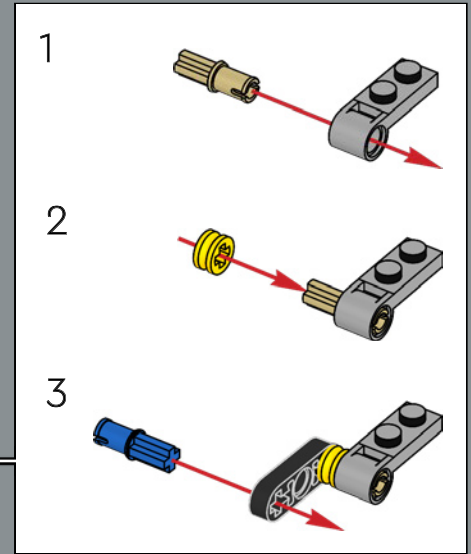
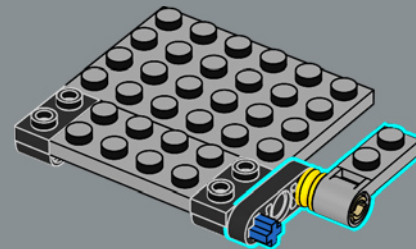



295

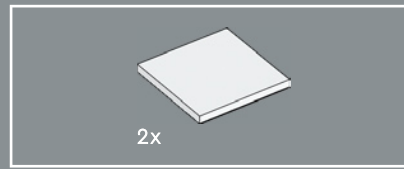
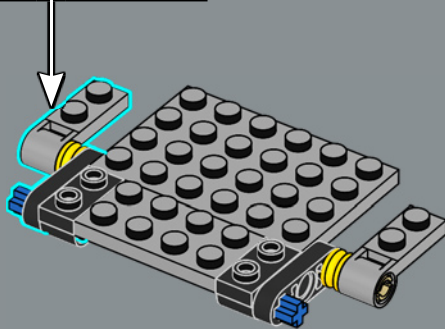
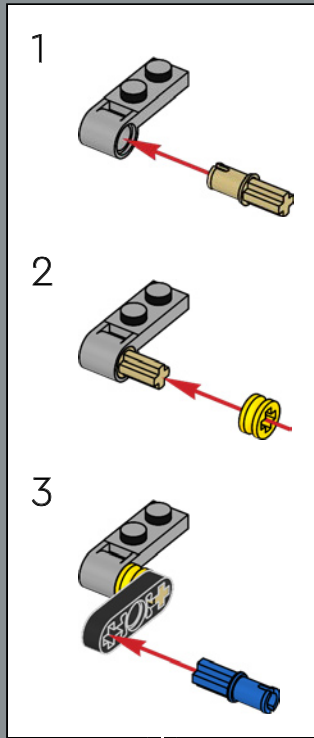

296

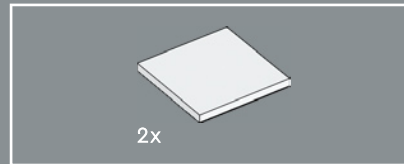
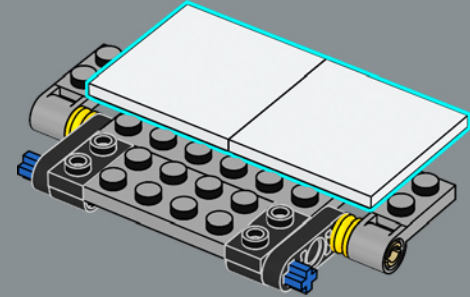

297

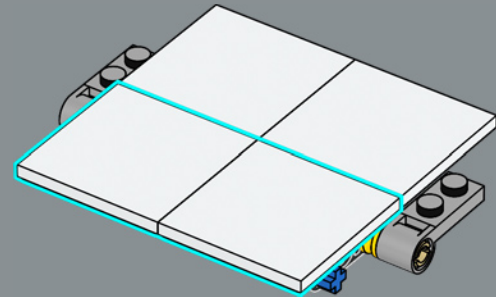

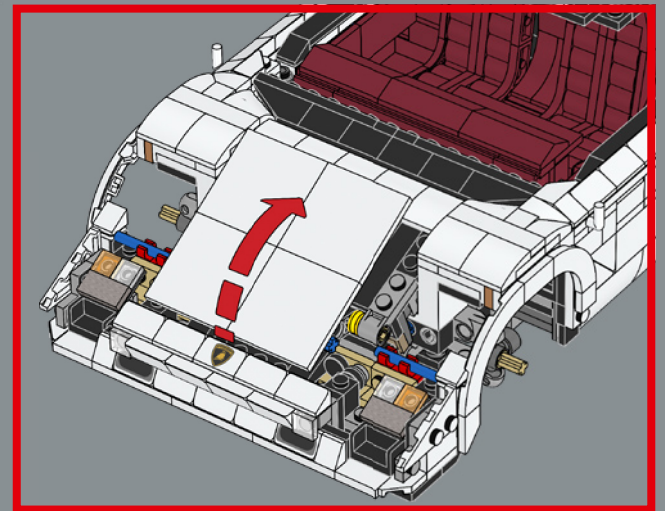
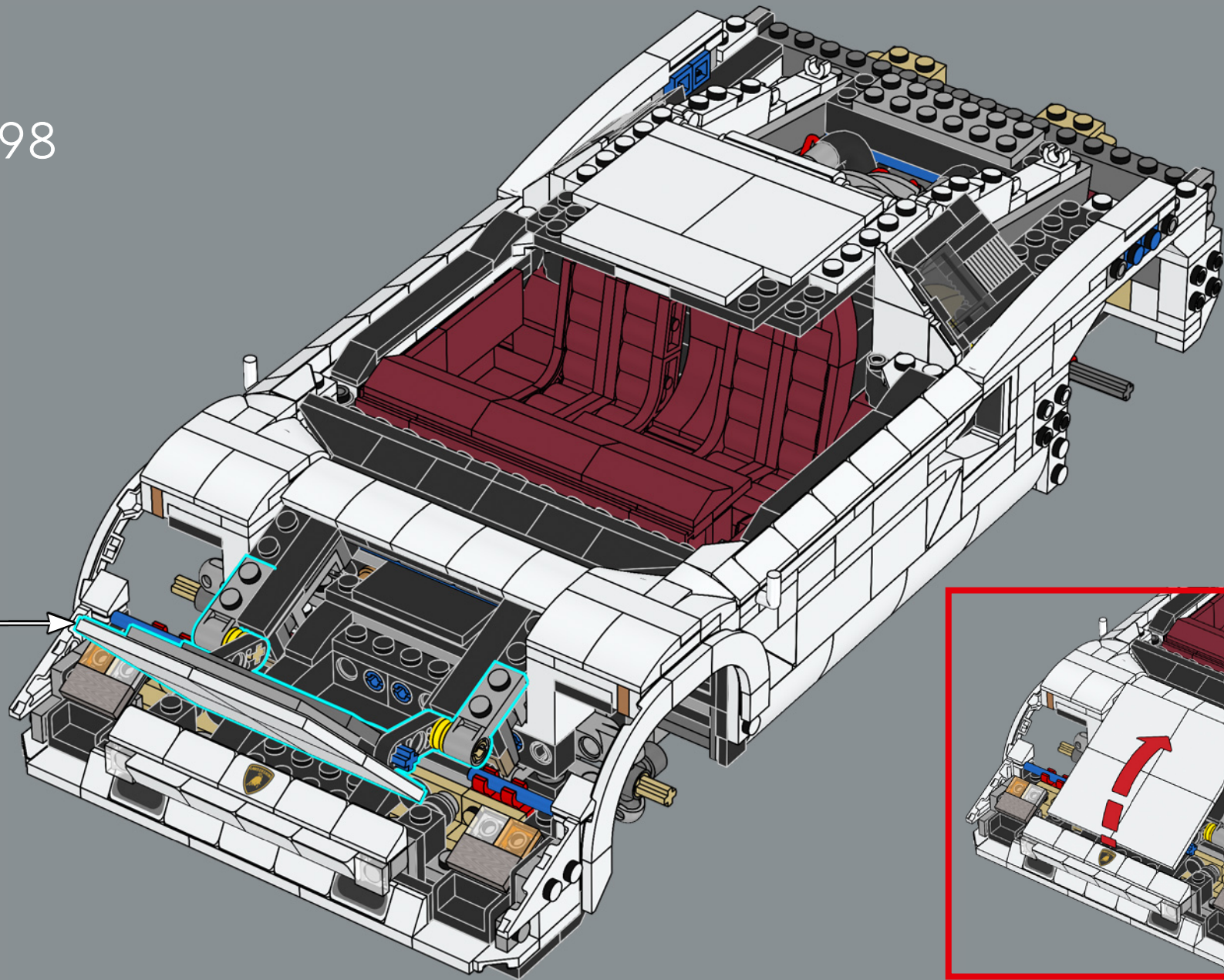

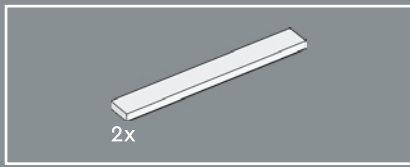

299

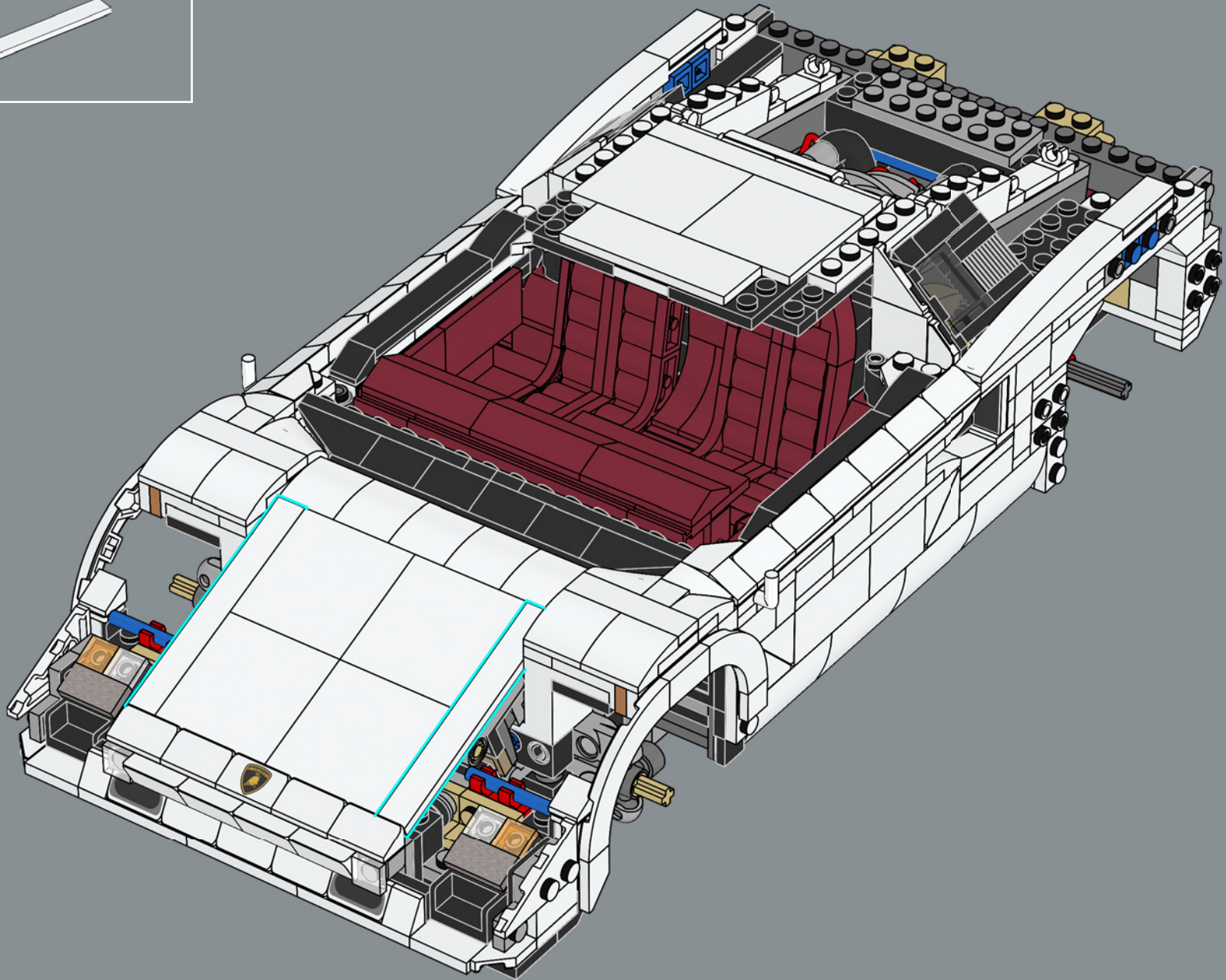

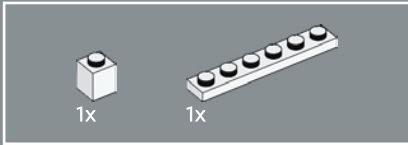
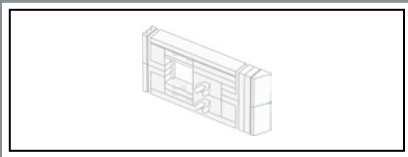

300

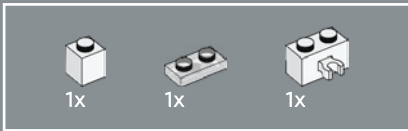
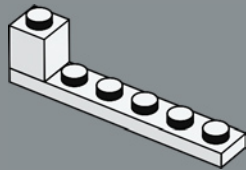

301

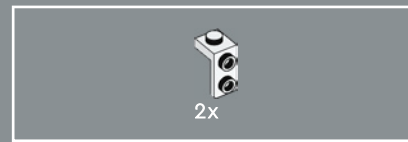
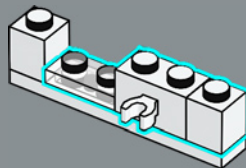

302

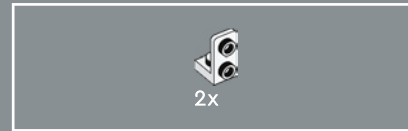
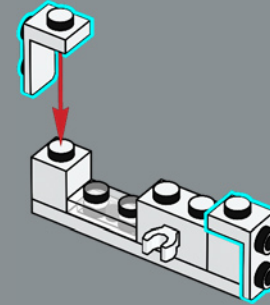

303

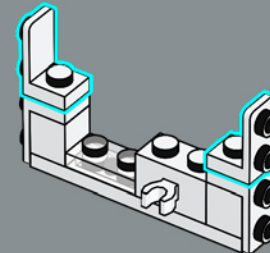

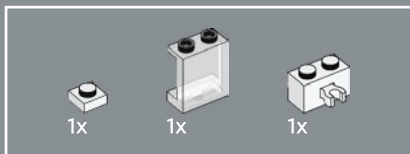

304

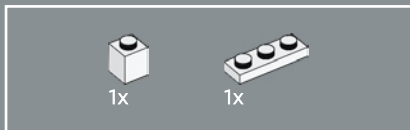
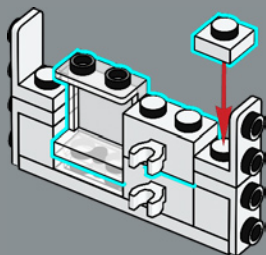

305

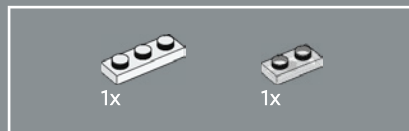
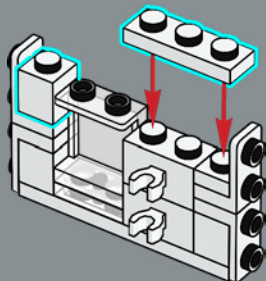

306

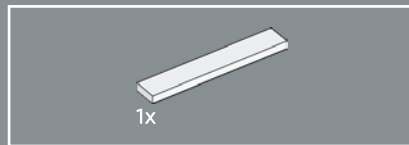
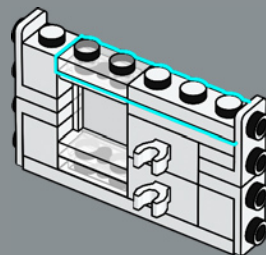

307

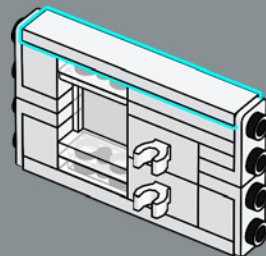



2x

308

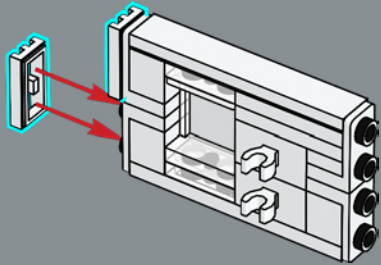

2x



2x

309

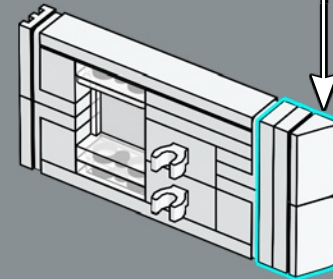
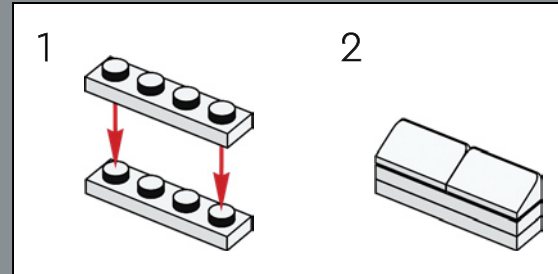

310

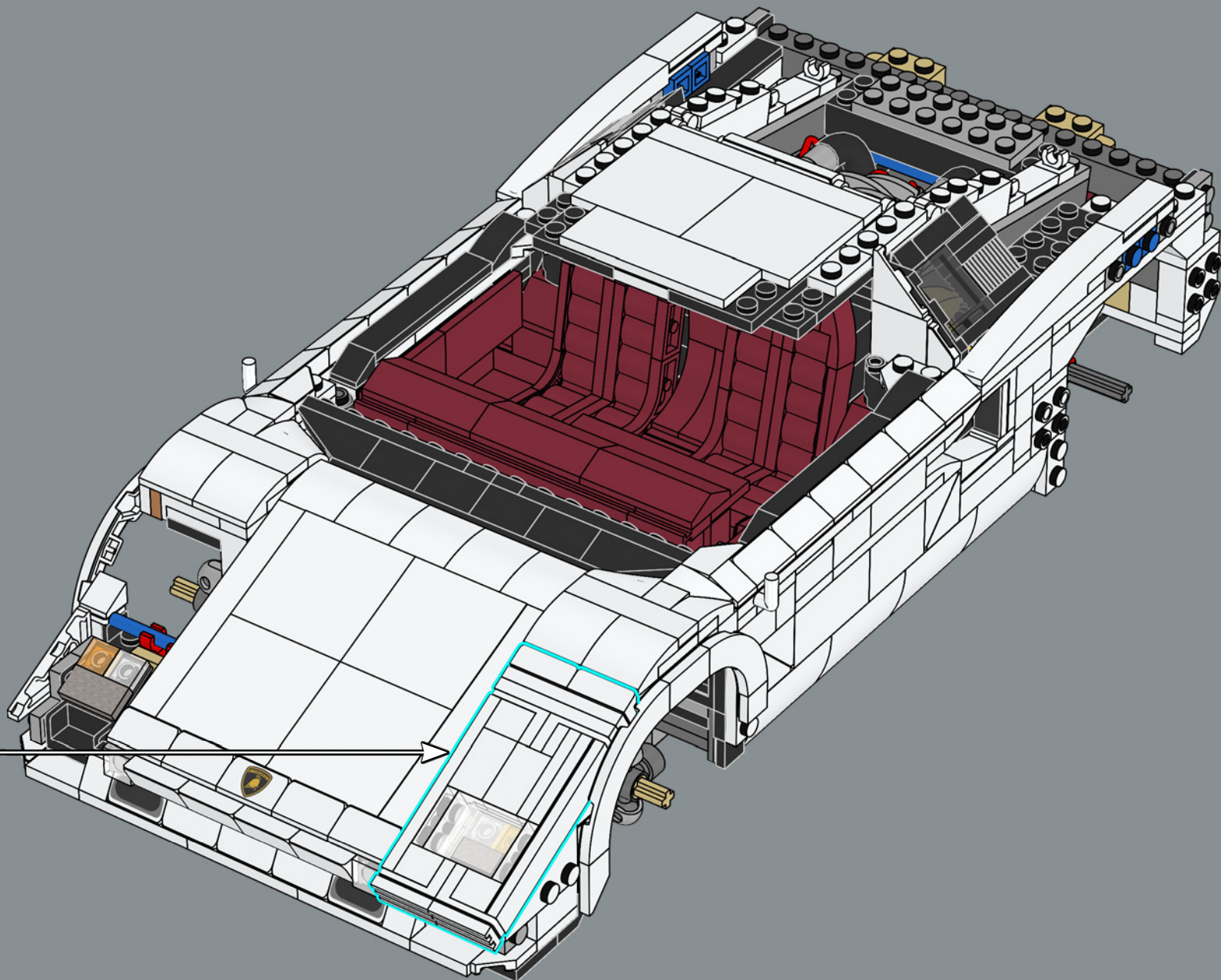

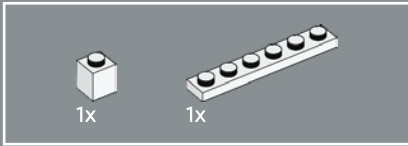
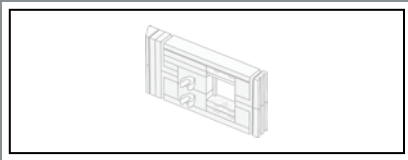

311

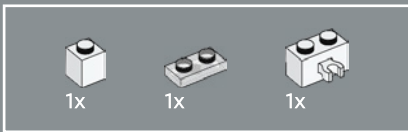
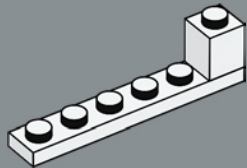

312

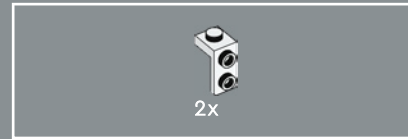
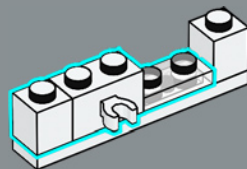

2x

313

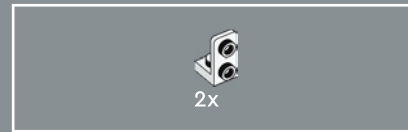
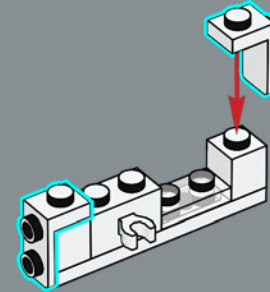

2x

314

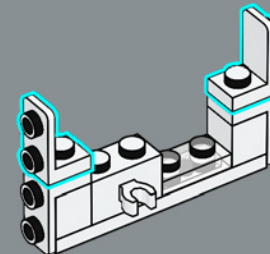

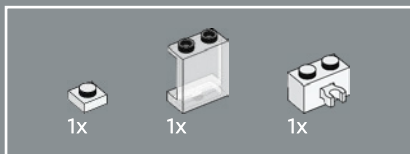

315

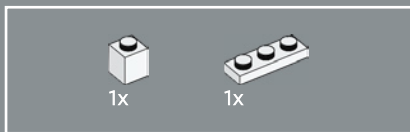
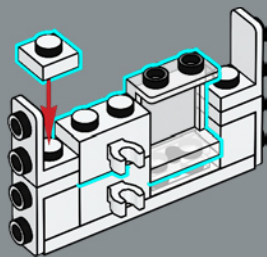

316

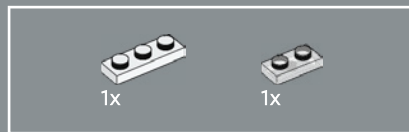
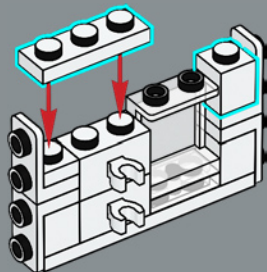

317

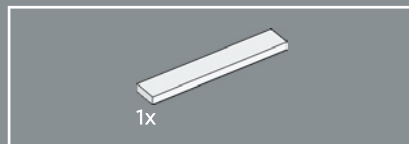
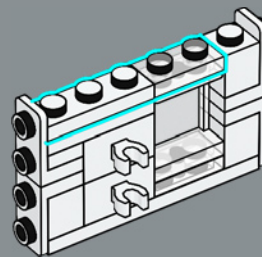

318

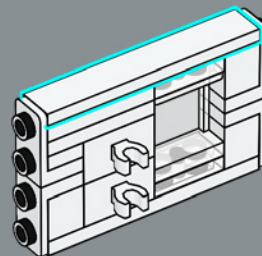



2x

319

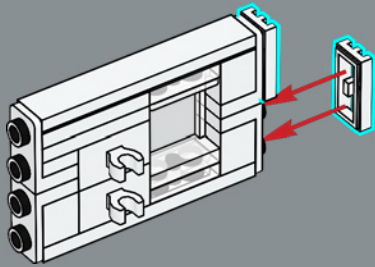

2x



2x

320

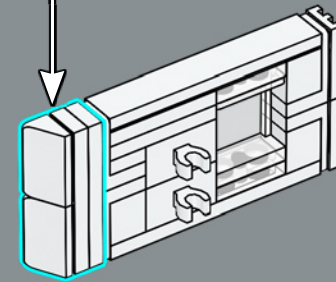
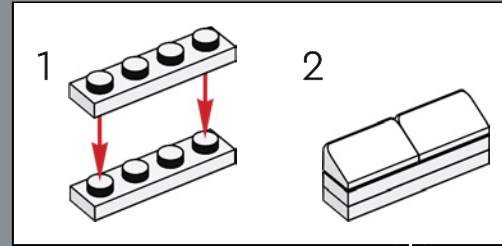

321

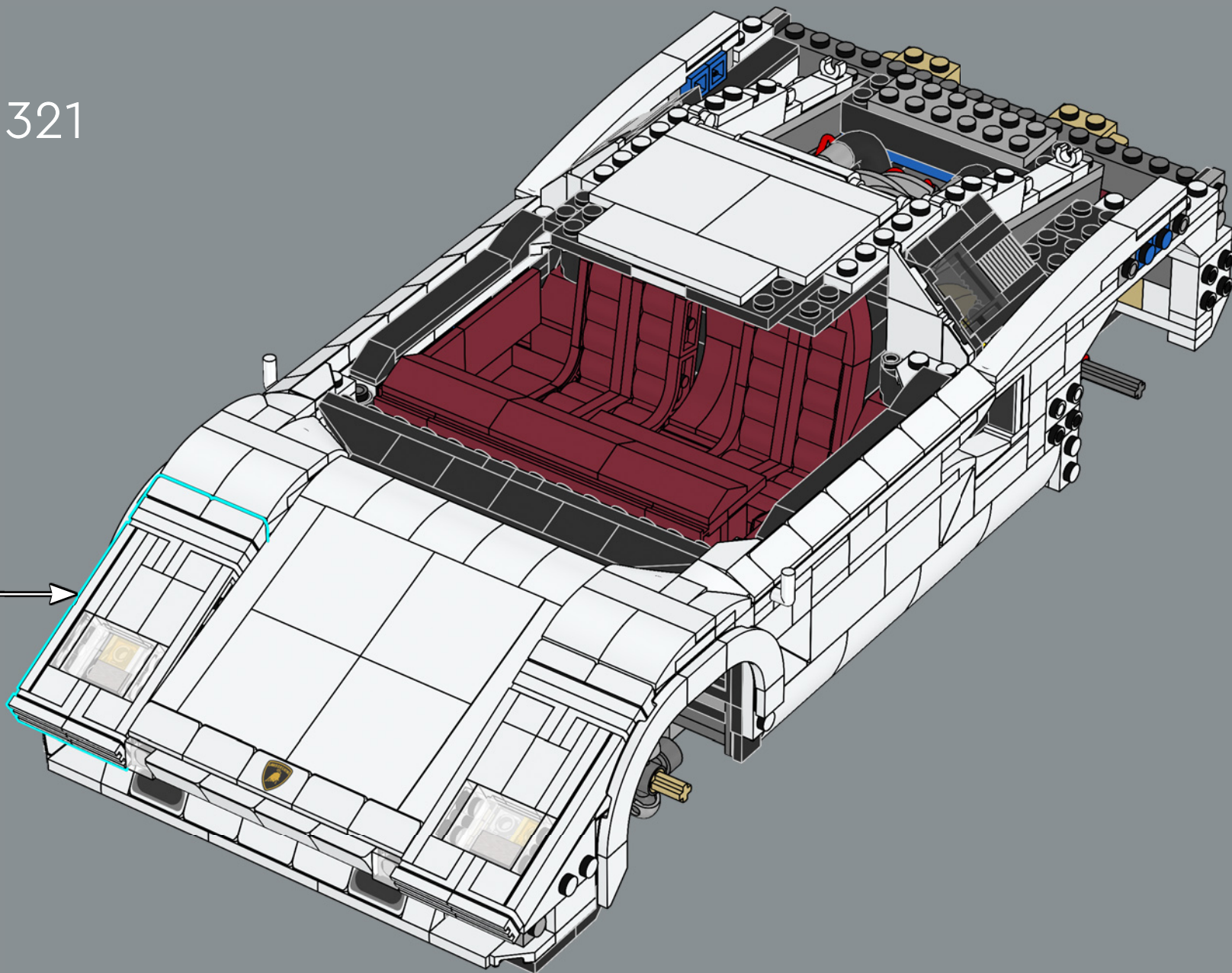

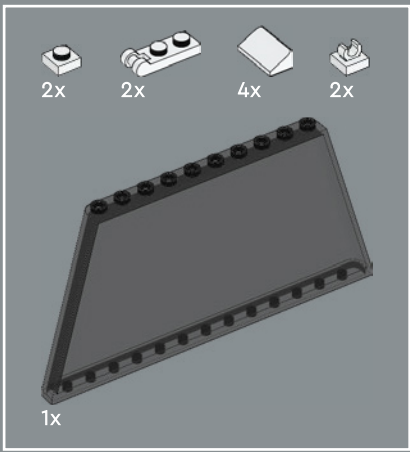

322

1

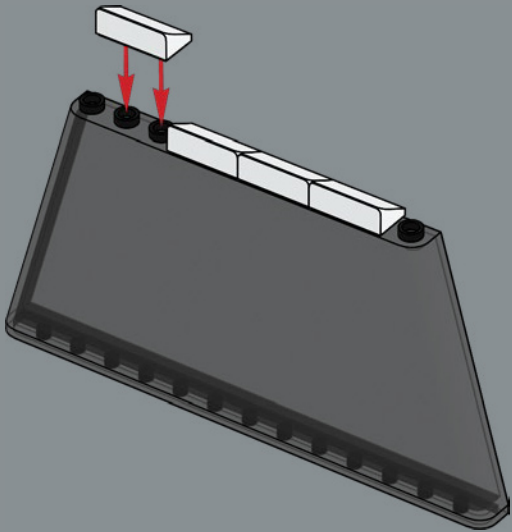

2

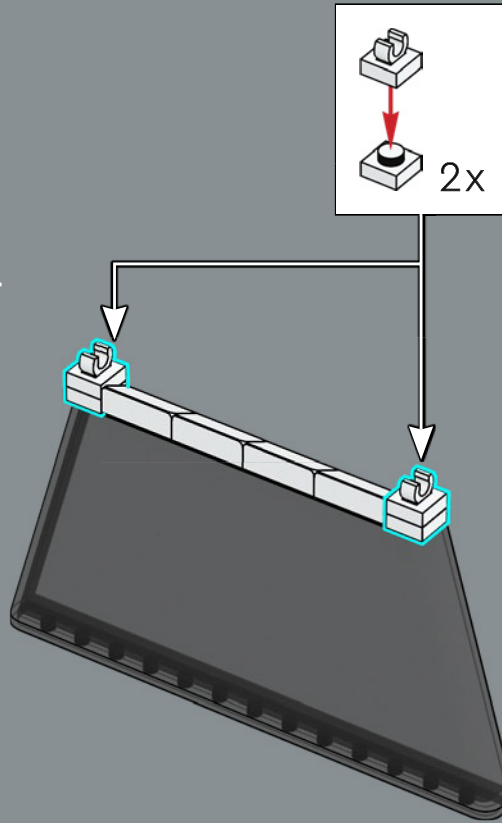

3

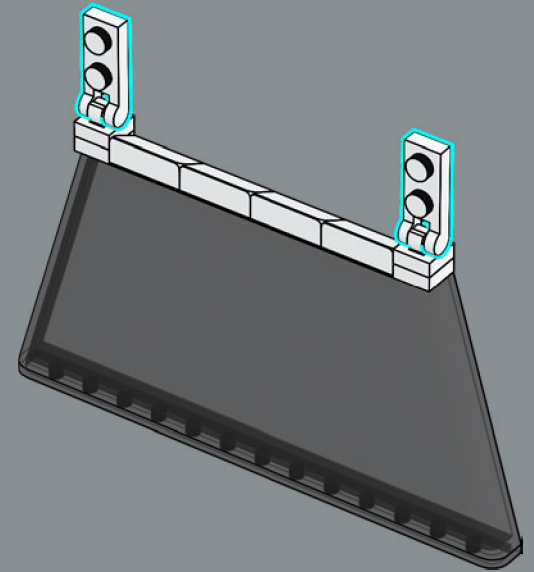

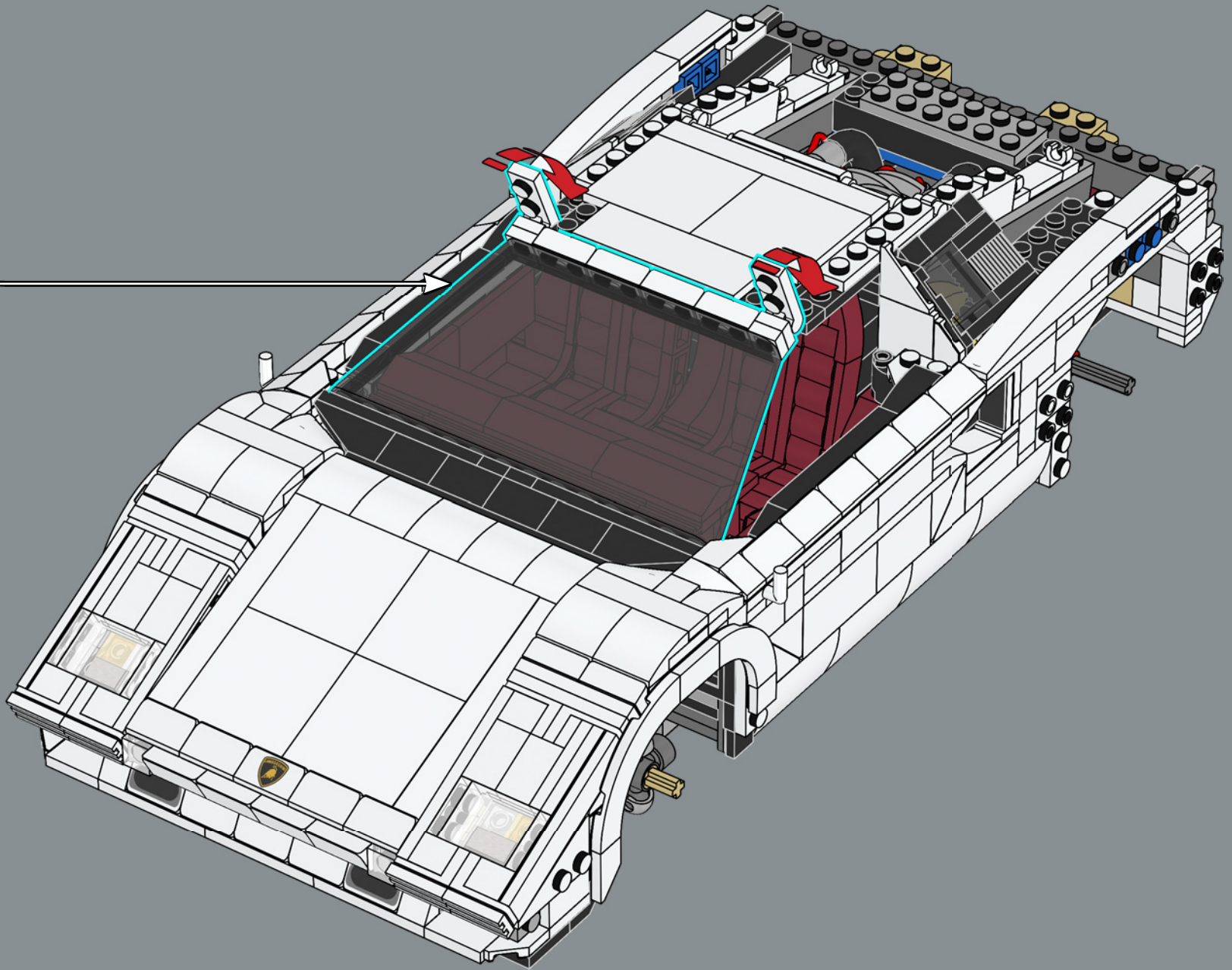

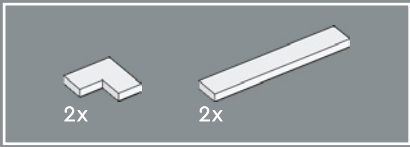

323

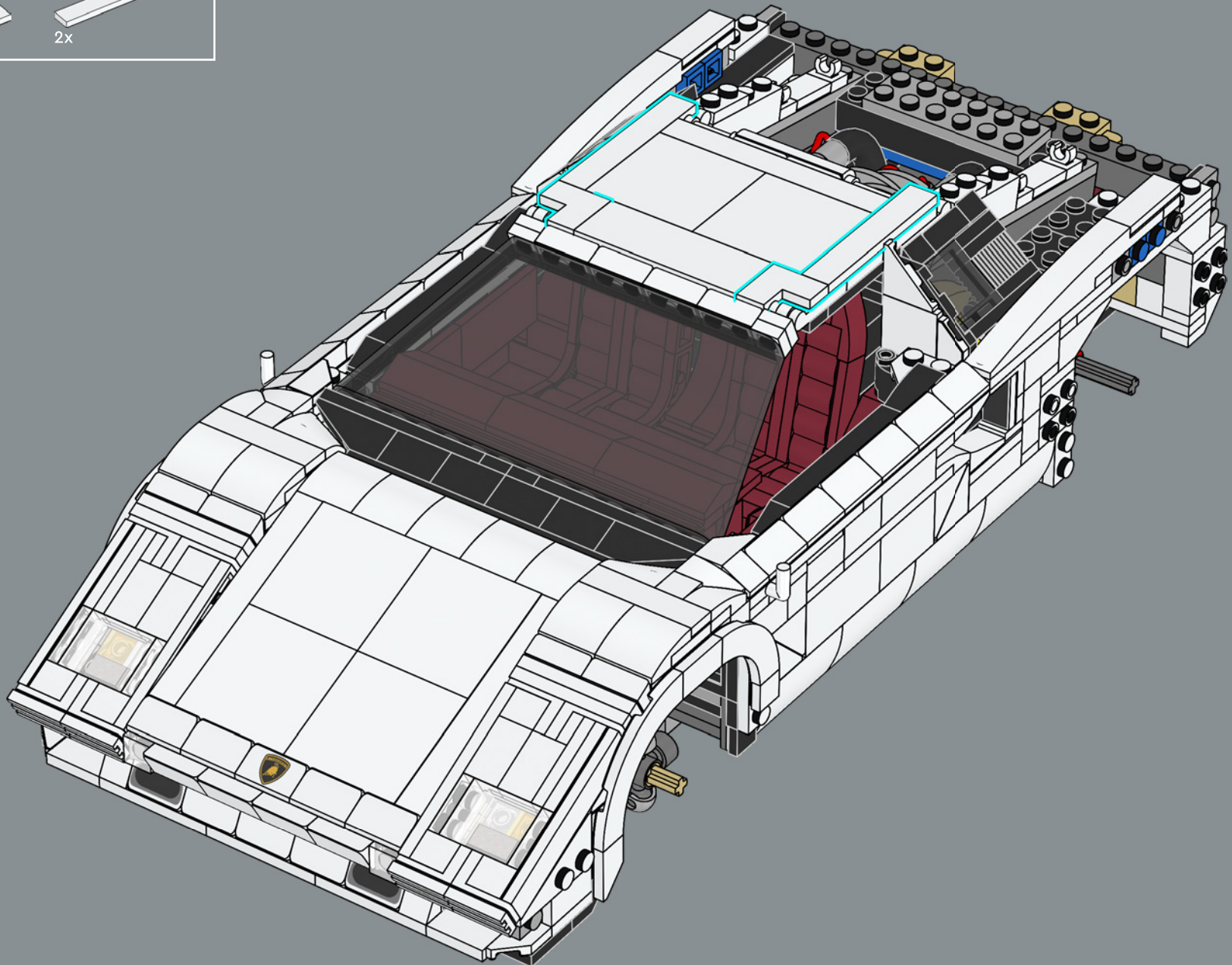

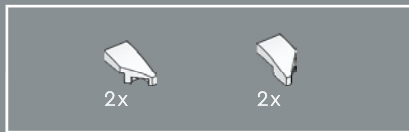

324

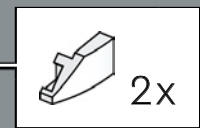
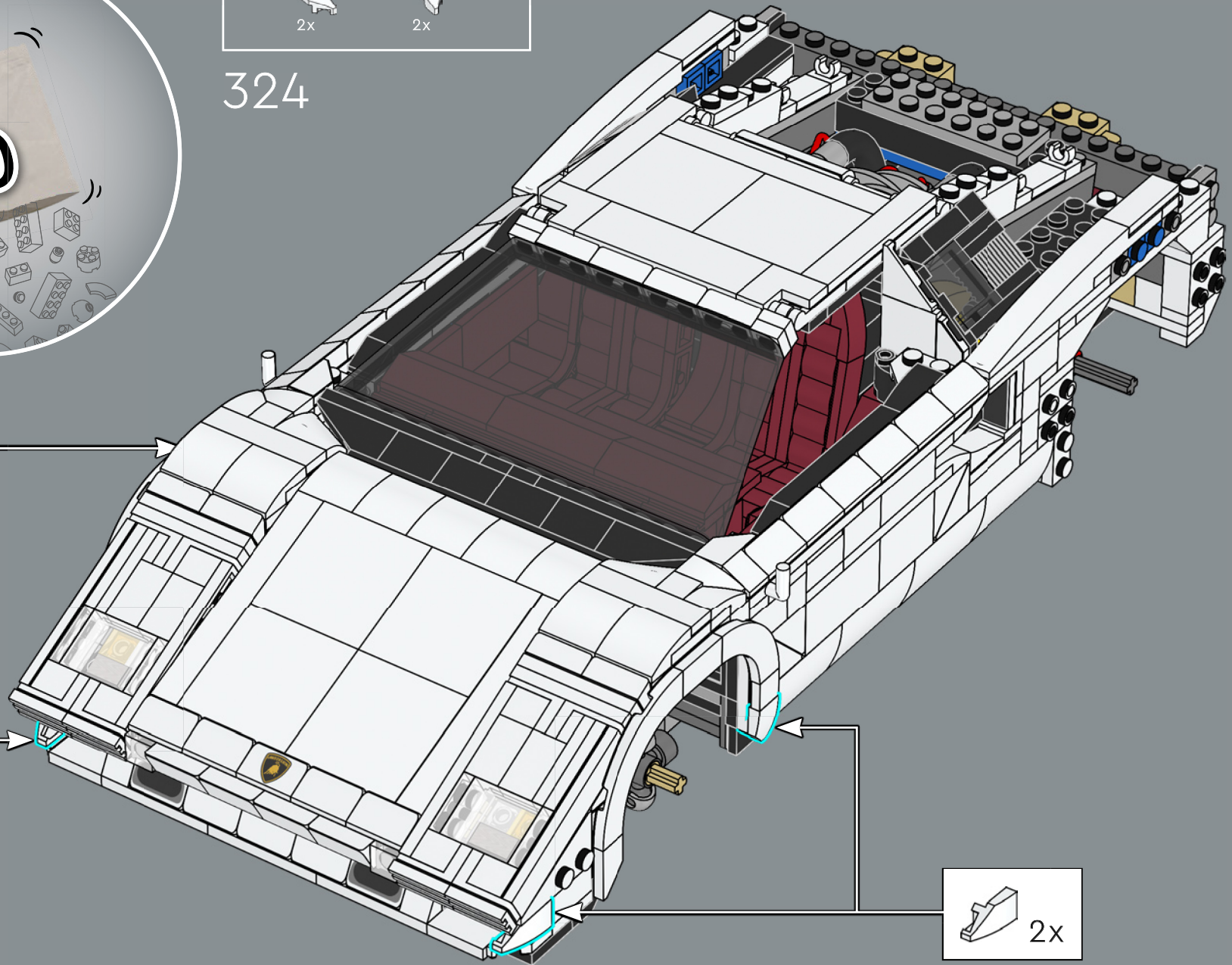

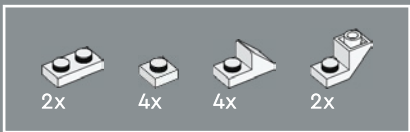

325

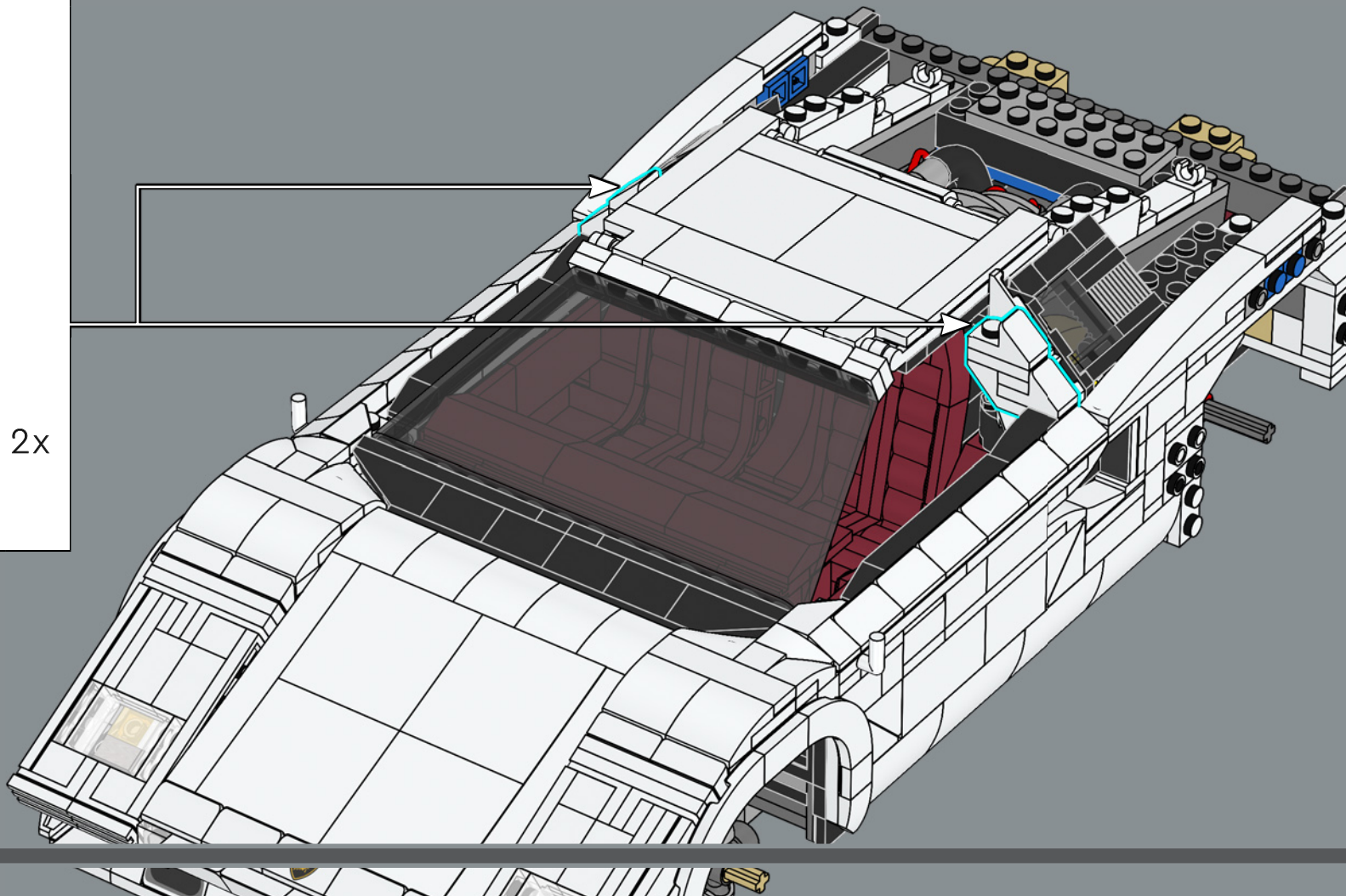
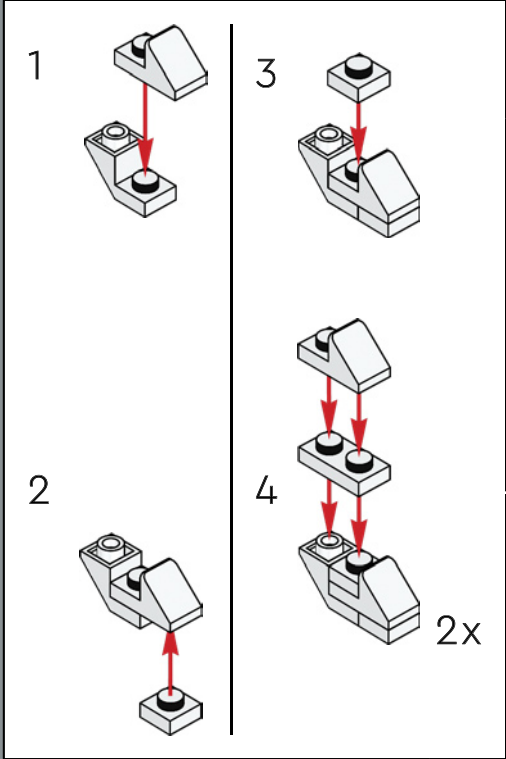

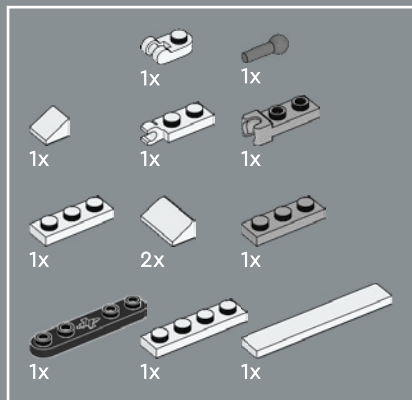

326

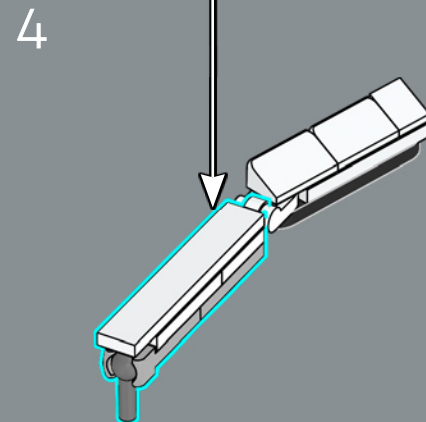
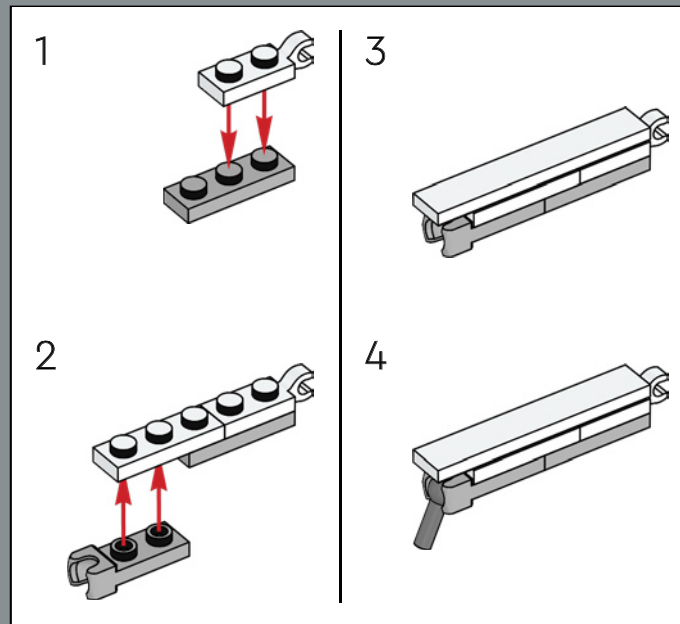
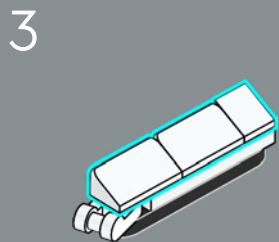
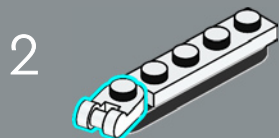
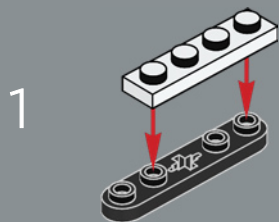

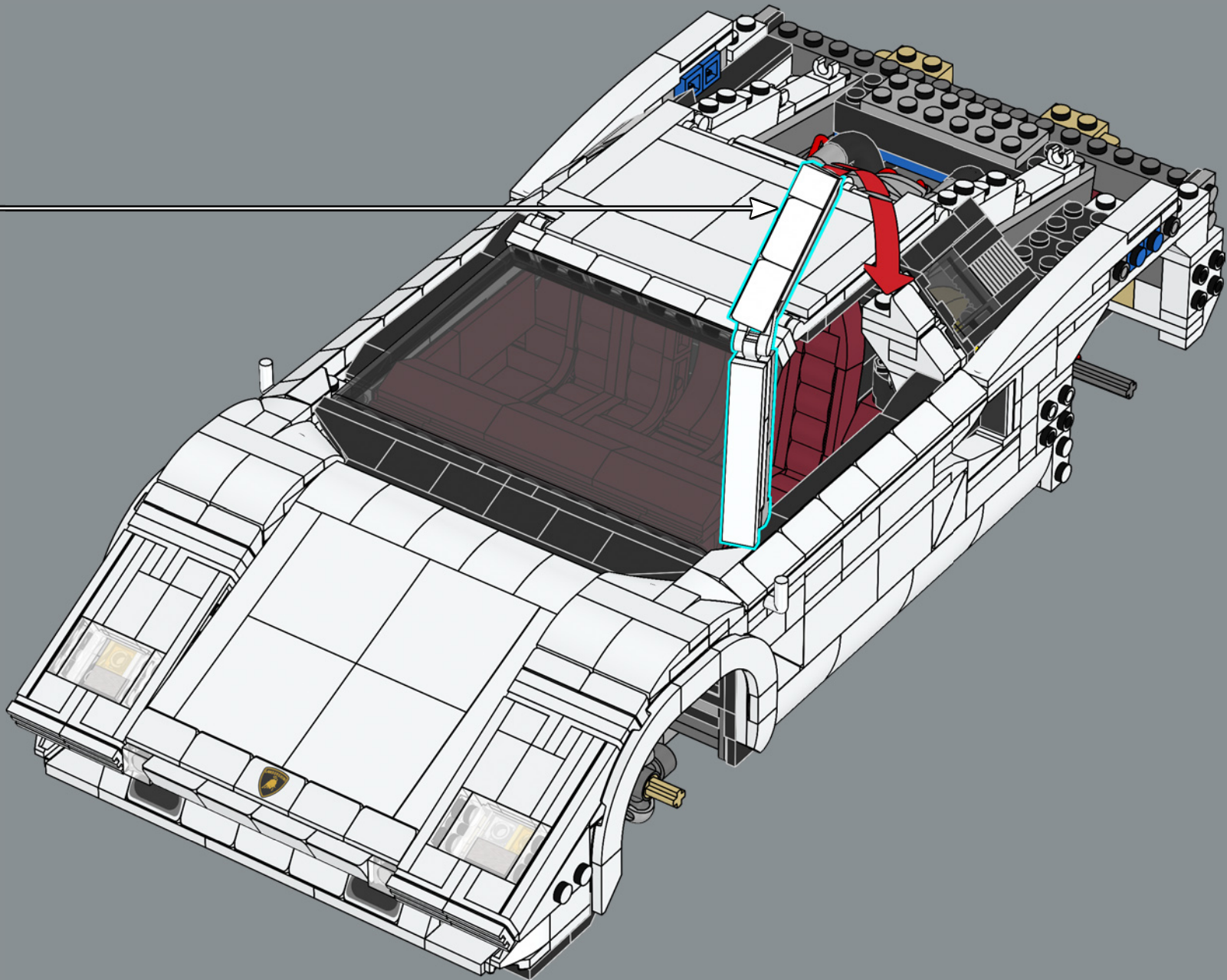

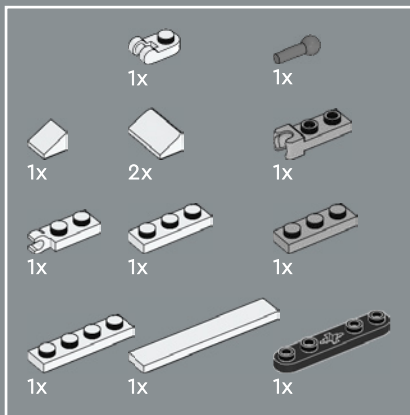

327

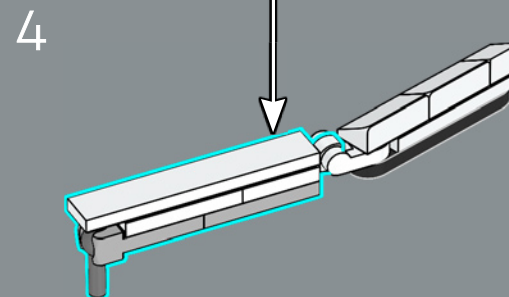
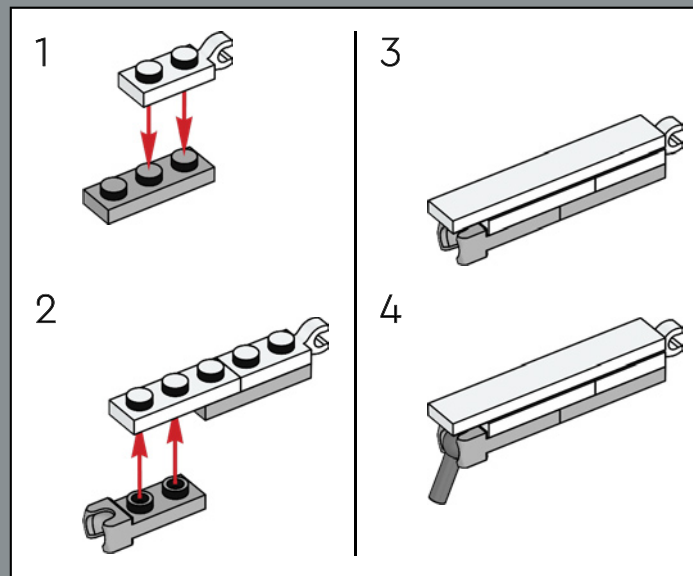
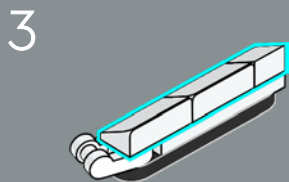
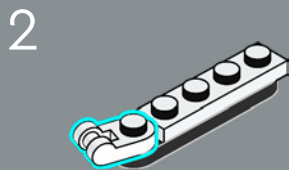
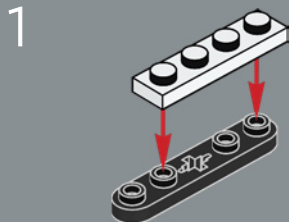

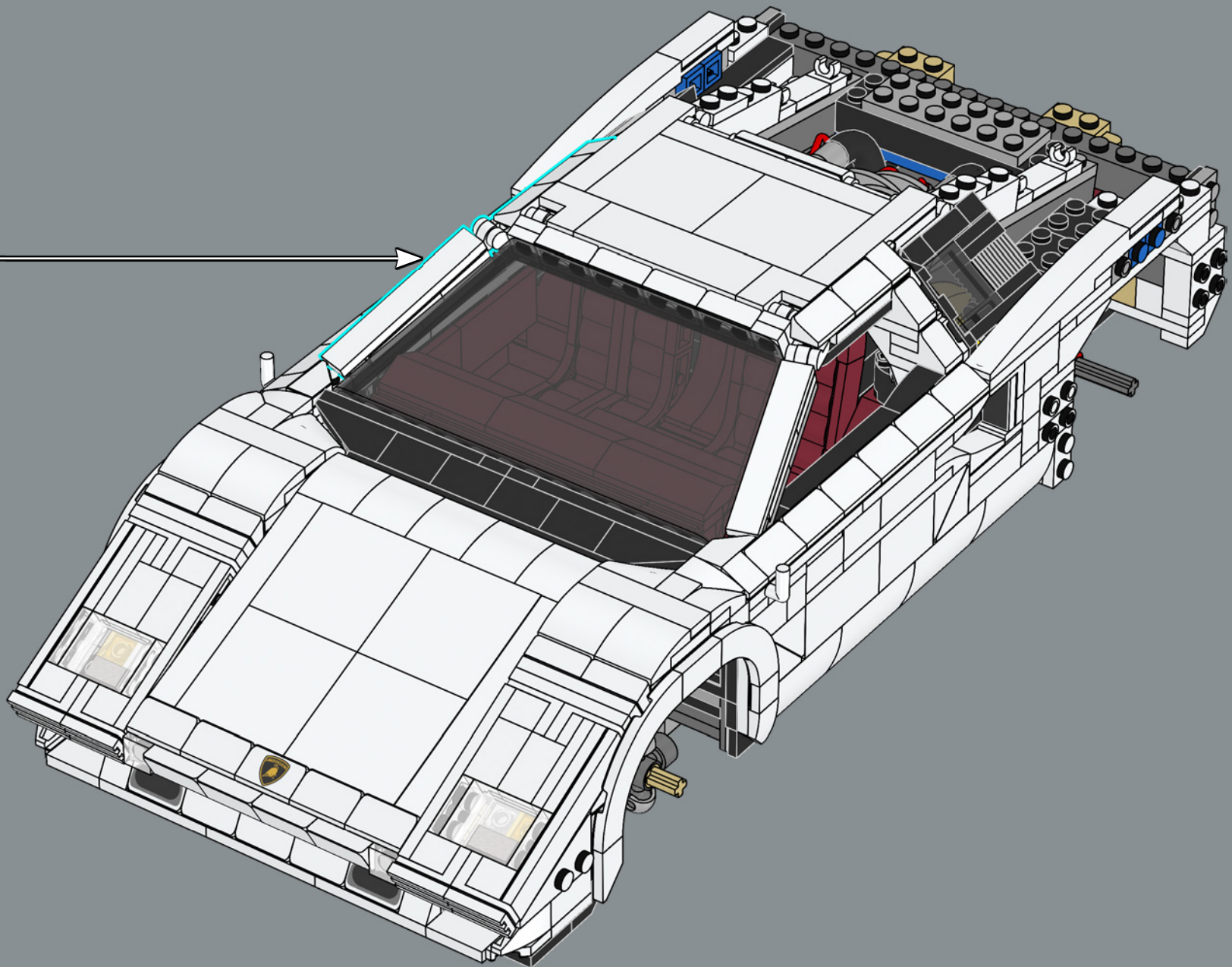

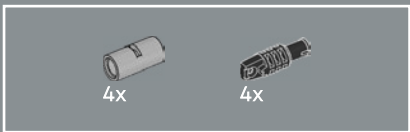

328

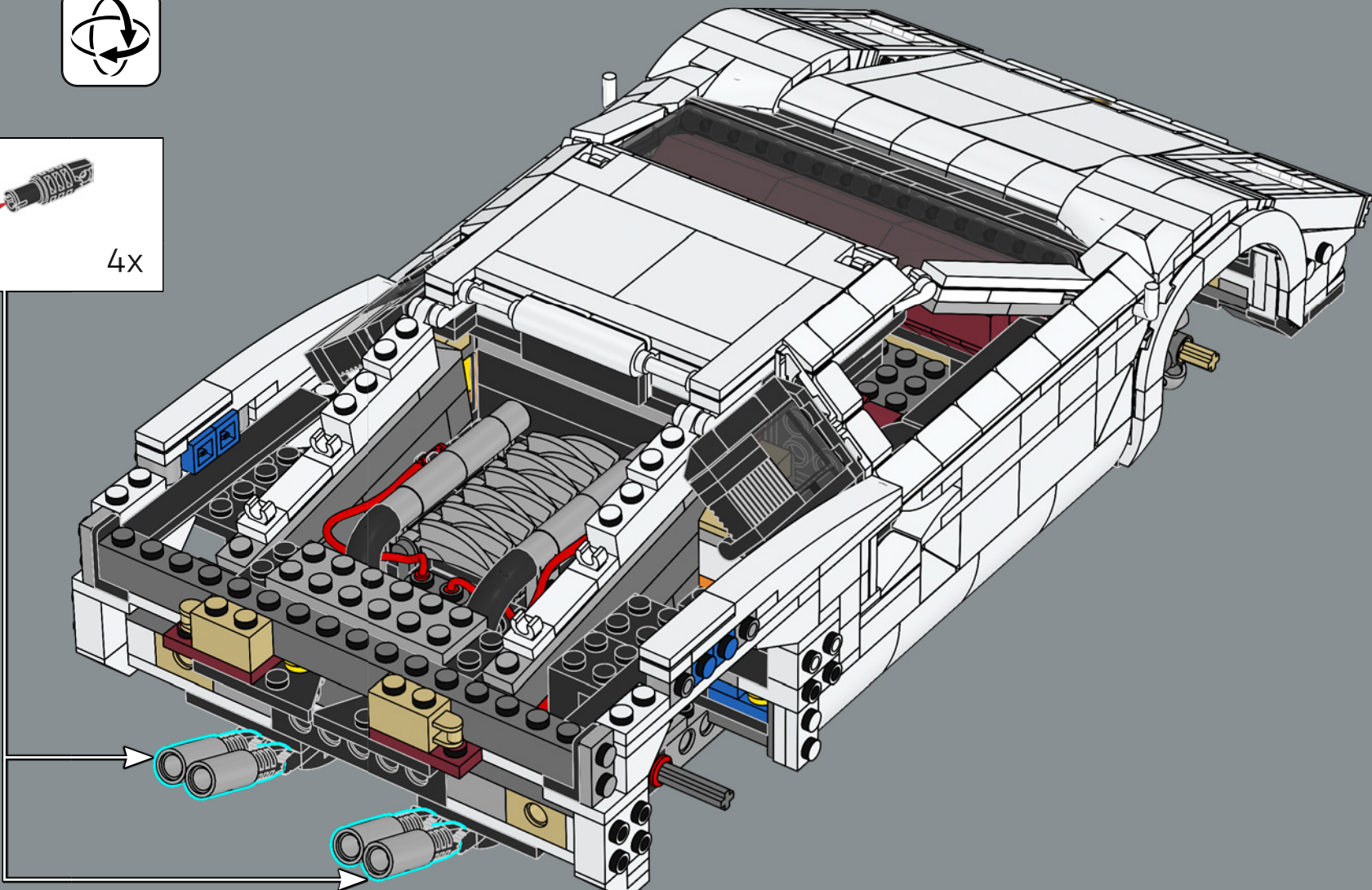
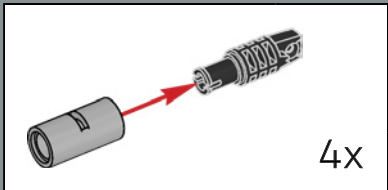

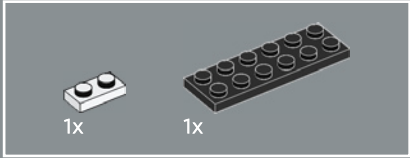
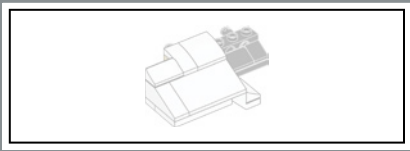

329

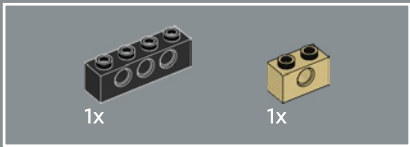
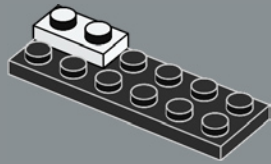

330

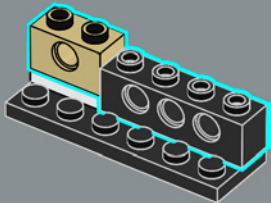

331

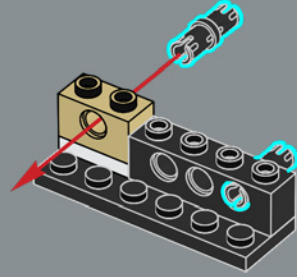

332

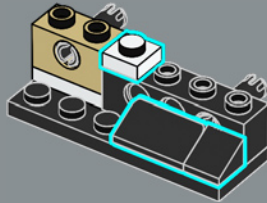

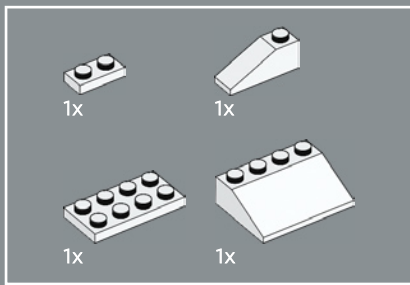

333

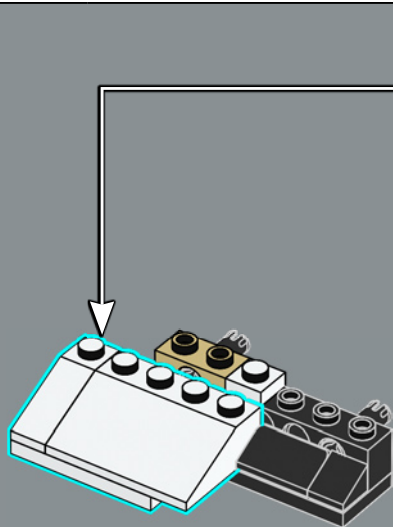
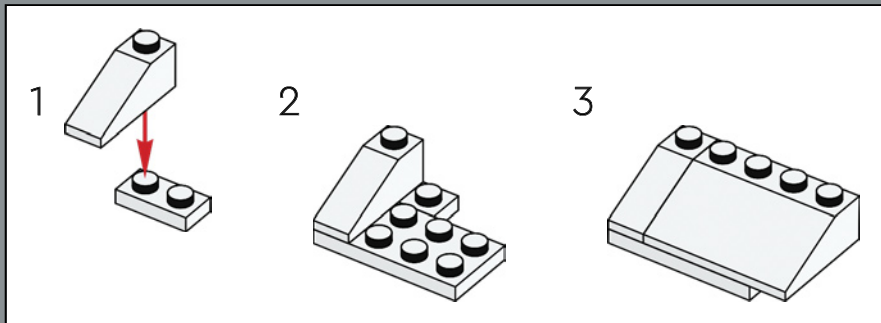

334

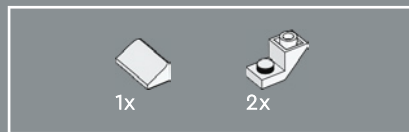
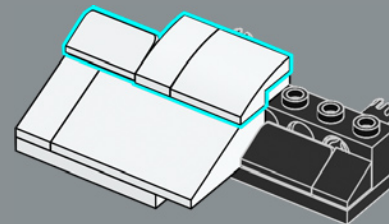

335

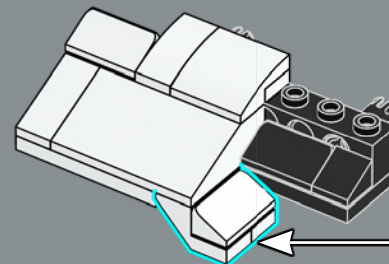
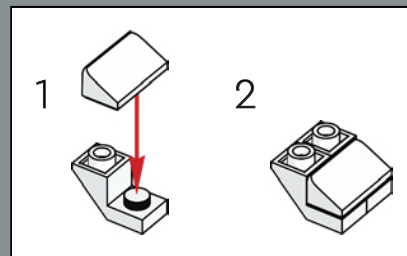

336

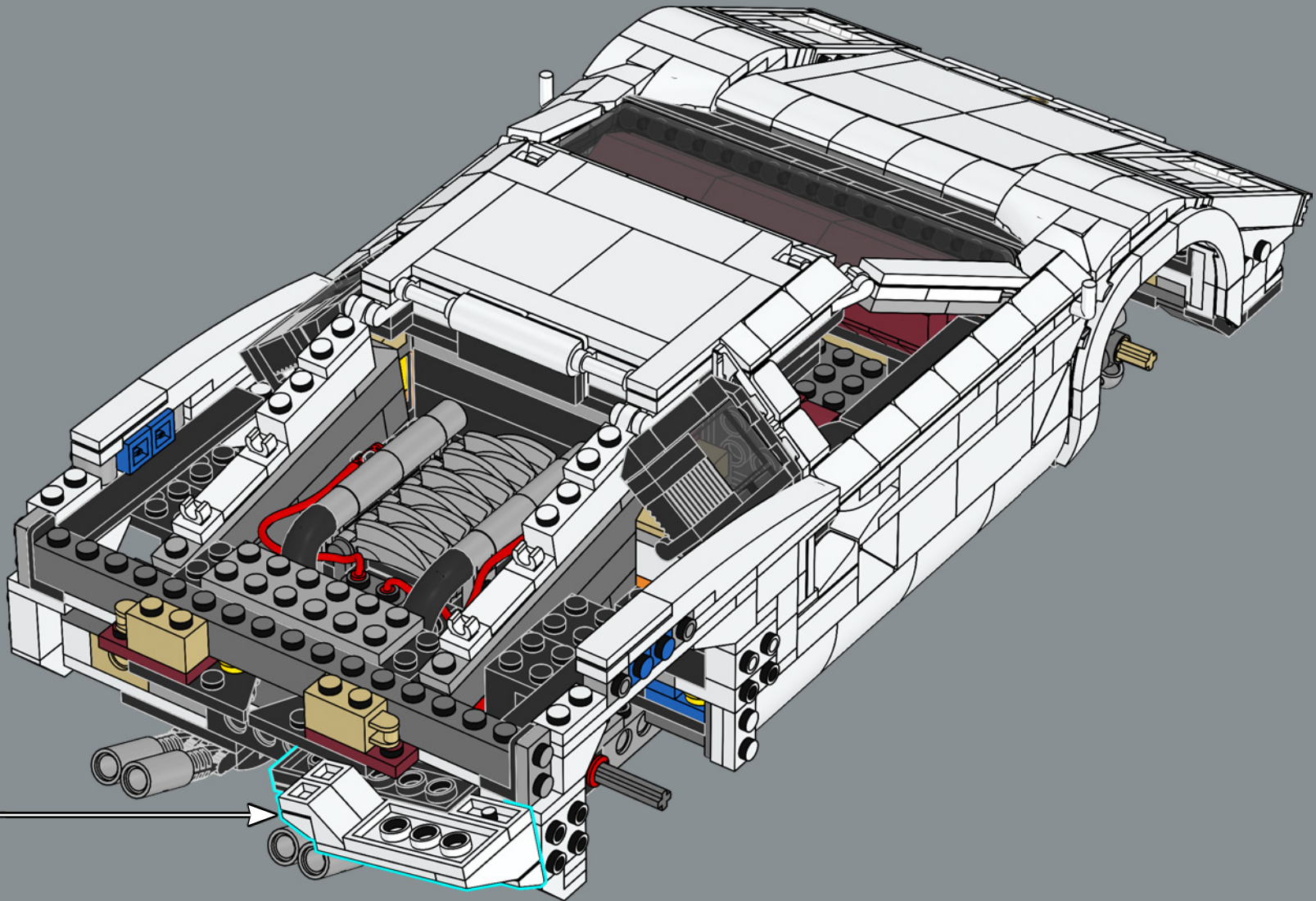

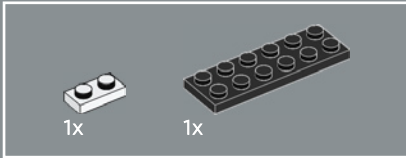
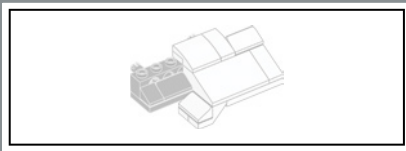

337

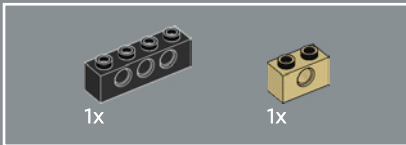
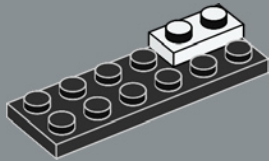

338

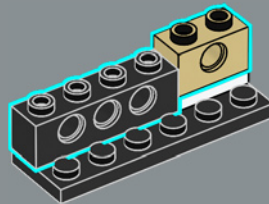

339

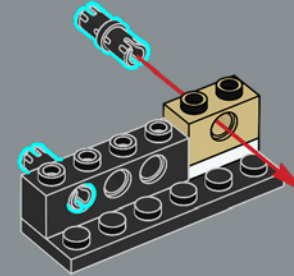

340

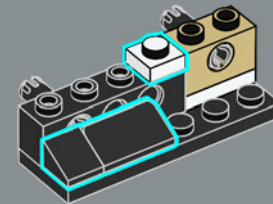

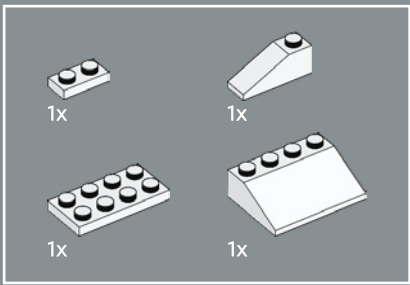

341

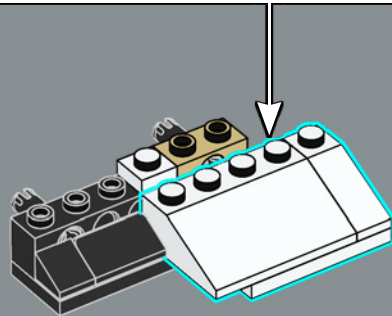
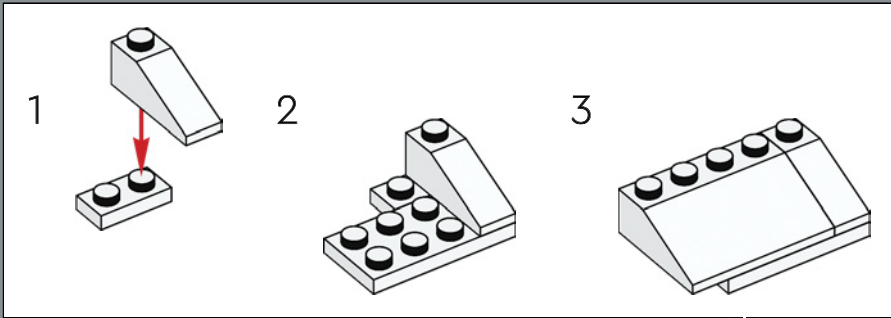

342

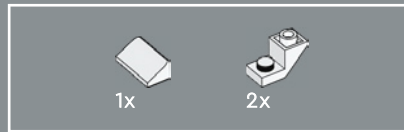
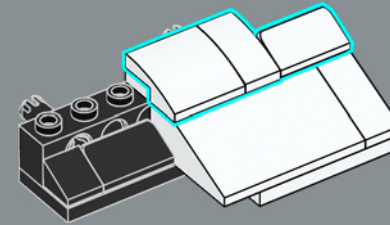

343

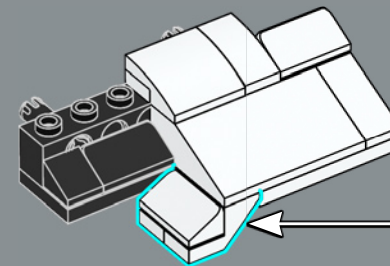
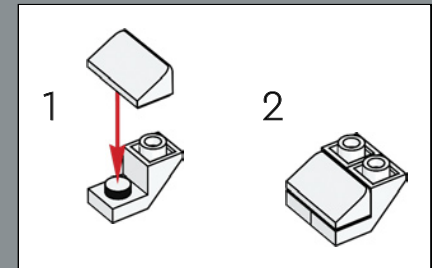

344

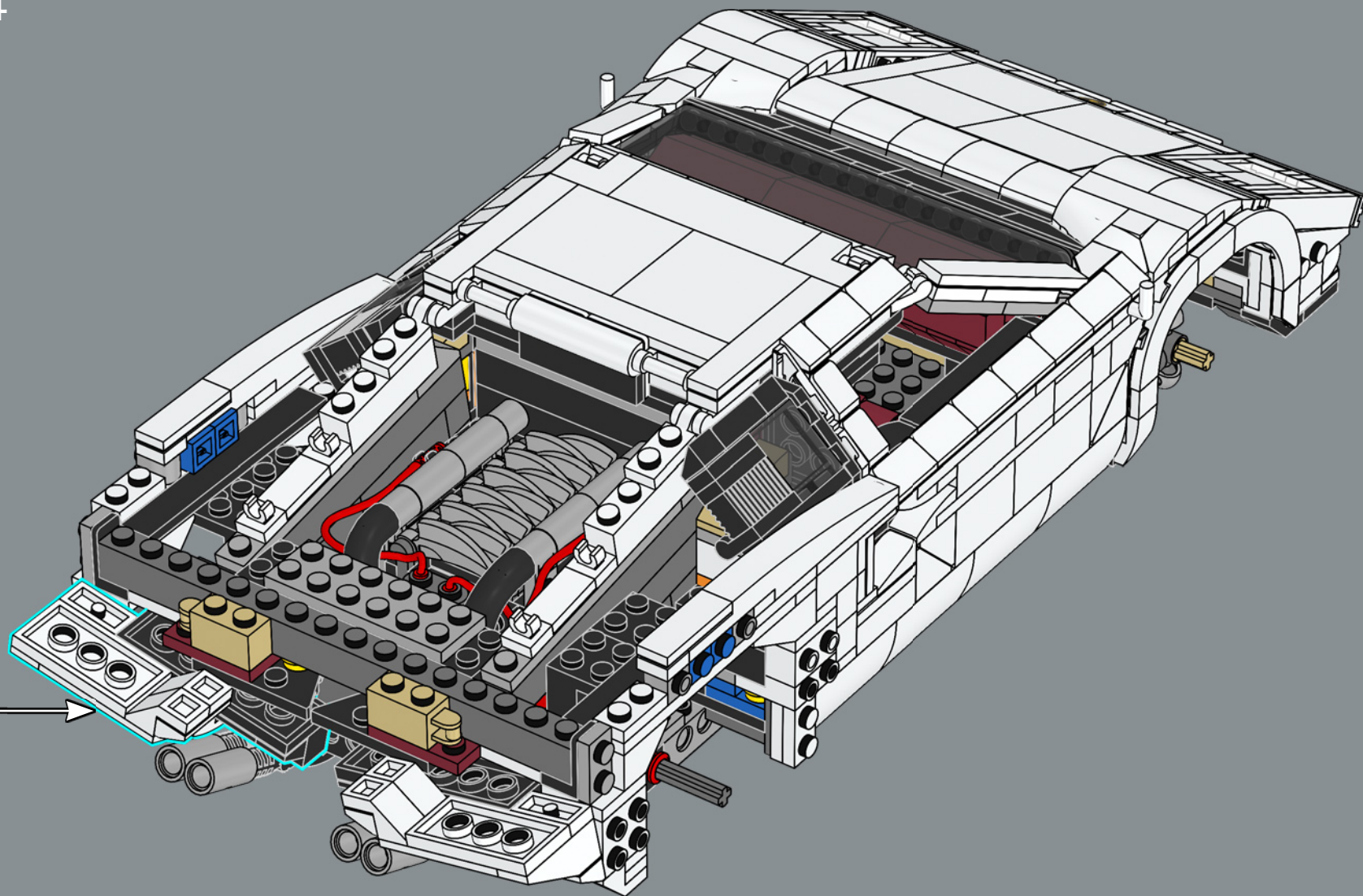

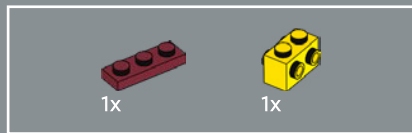
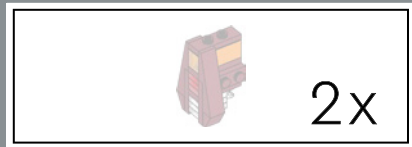

345

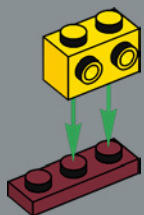

346

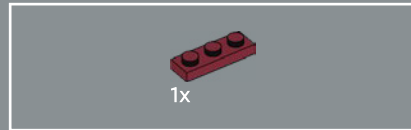
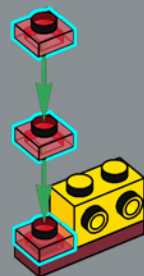

347

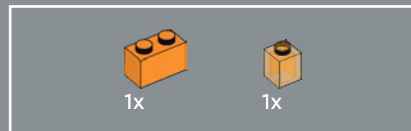
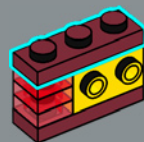

348

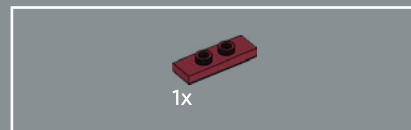

349

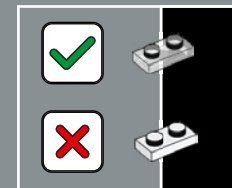
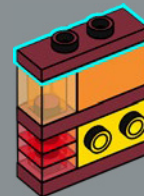

350

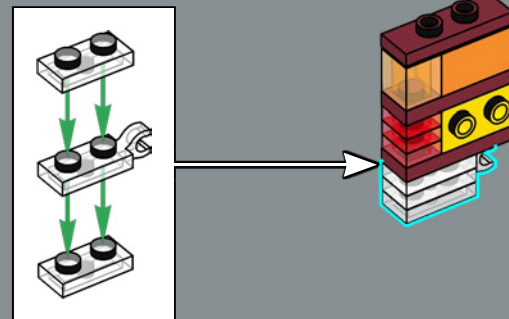

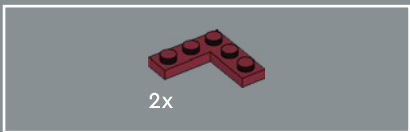

351

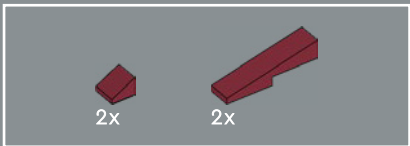
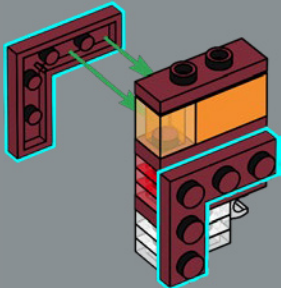

352

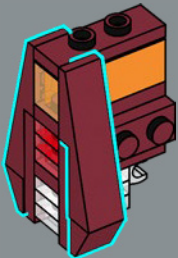

2x

353

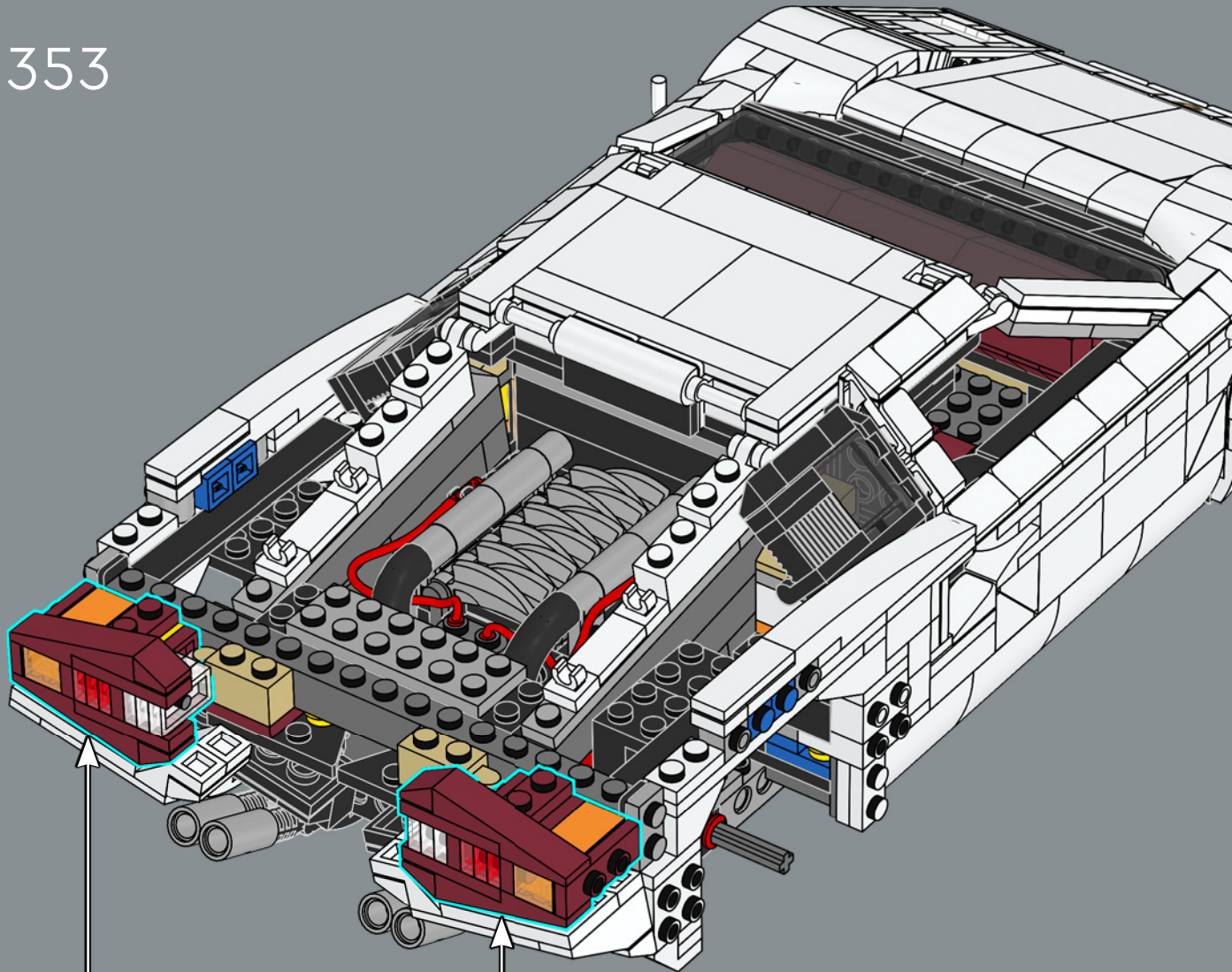

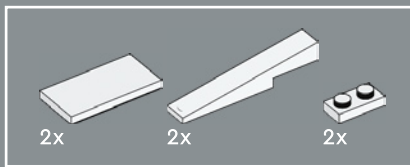

354

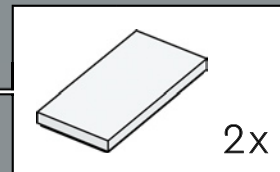
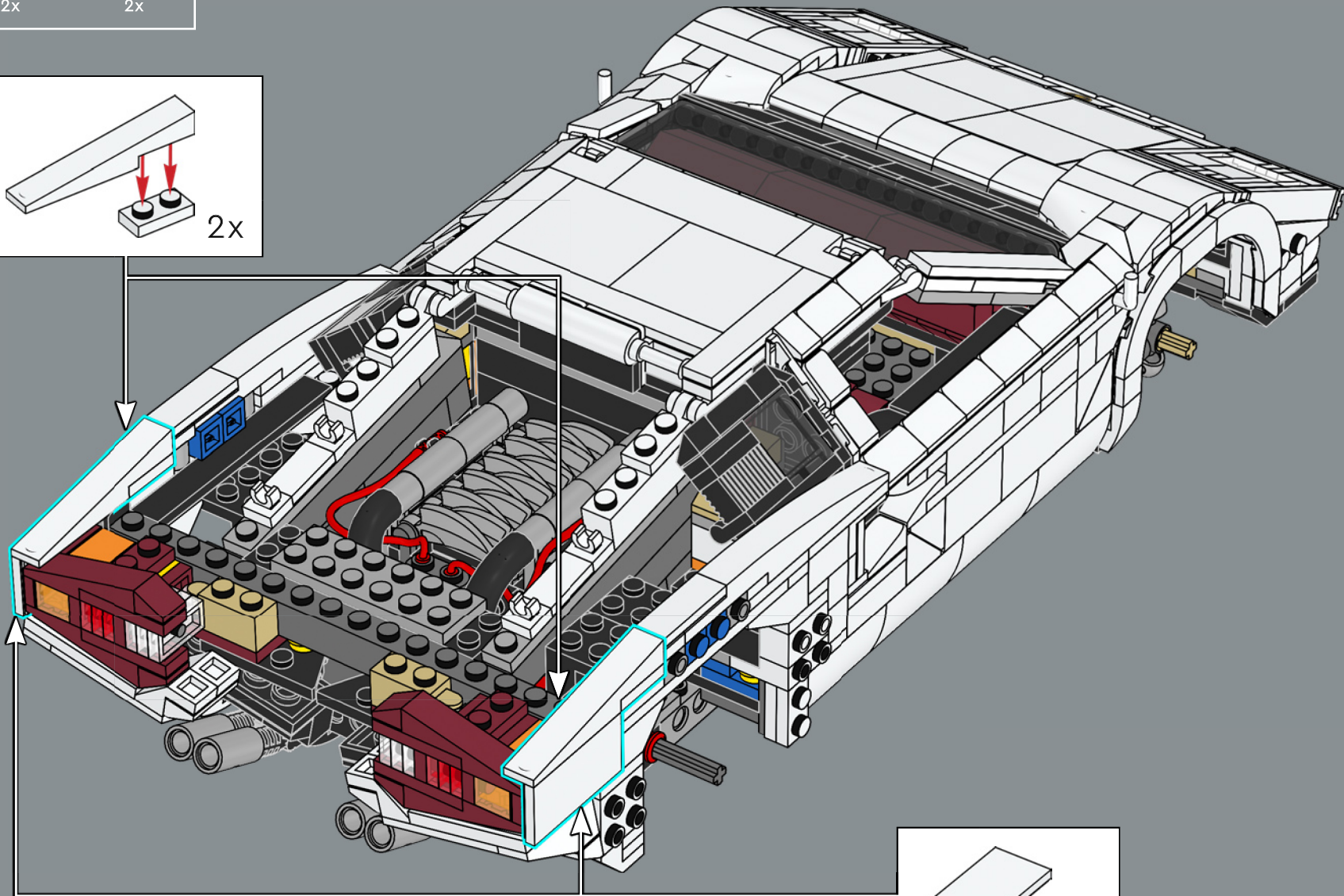
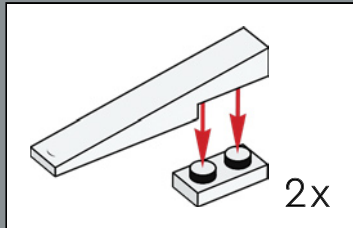

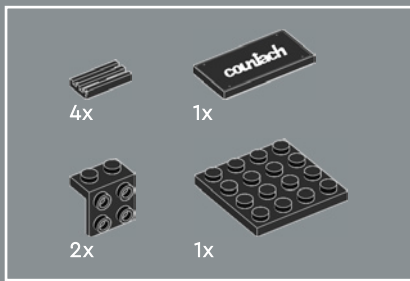

355

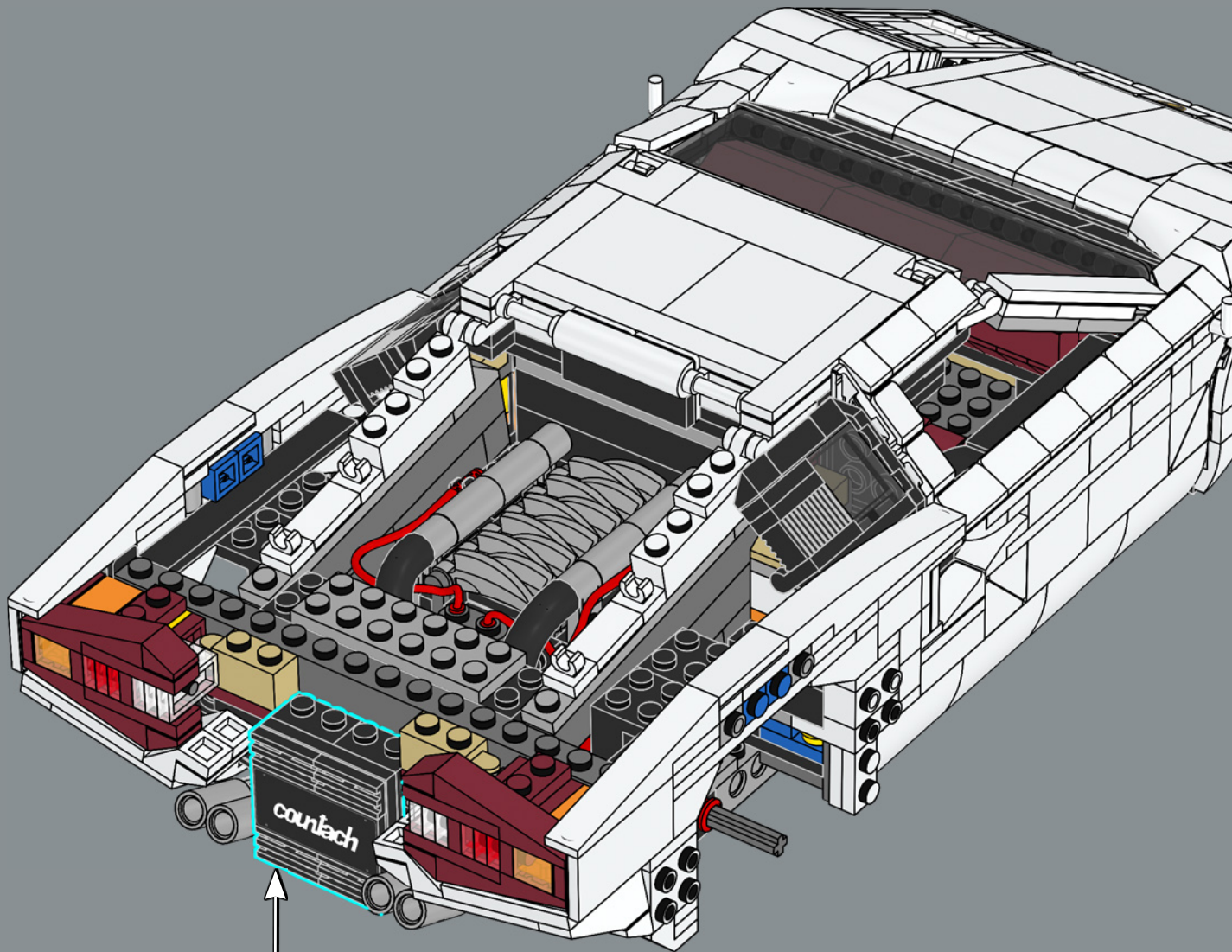
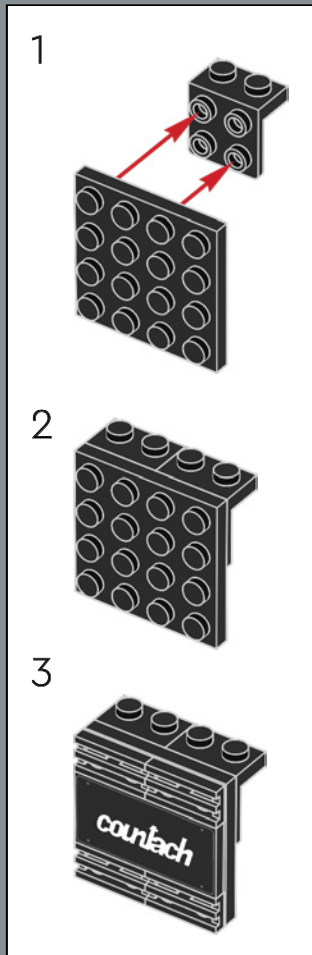

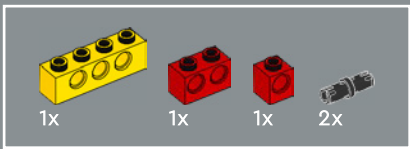

356

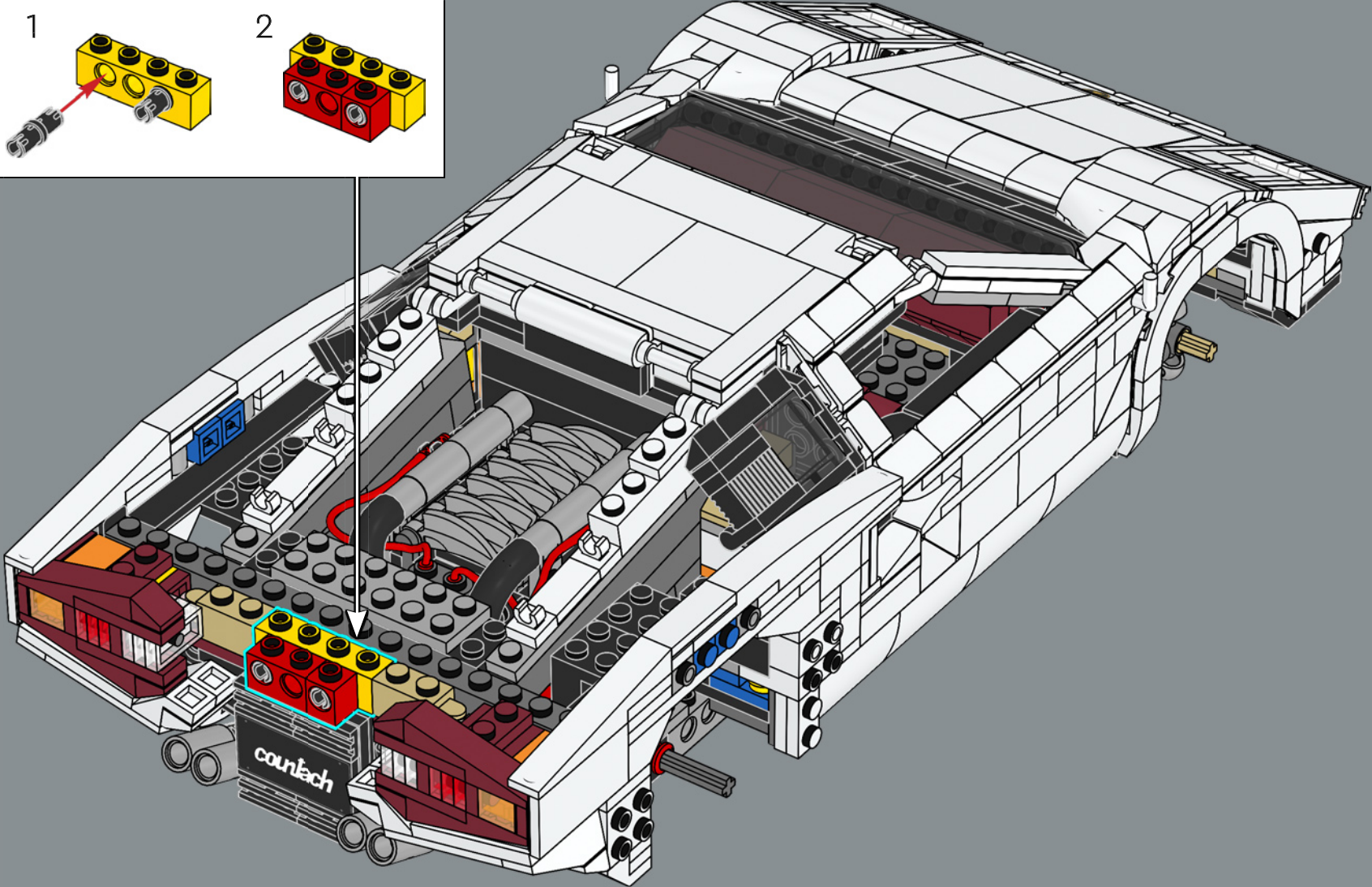
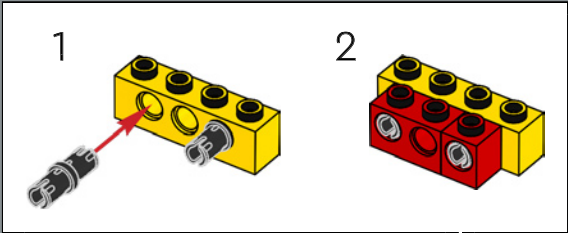

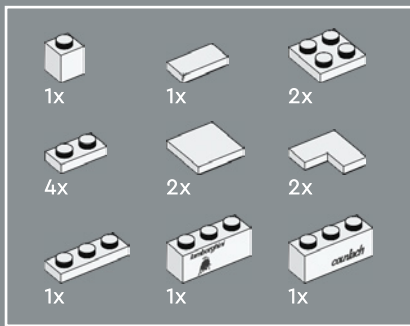

4

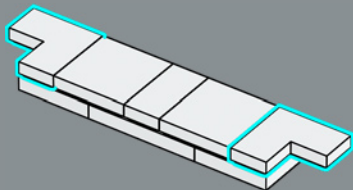

357

1

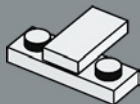

2

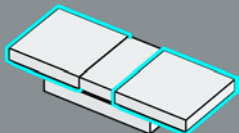

3

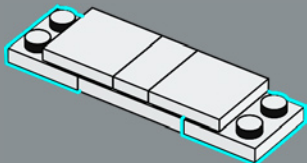

5

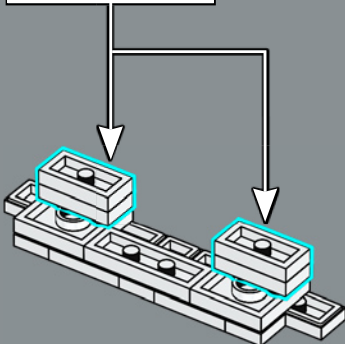
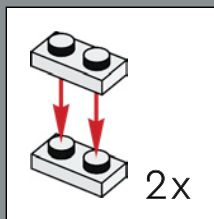

6

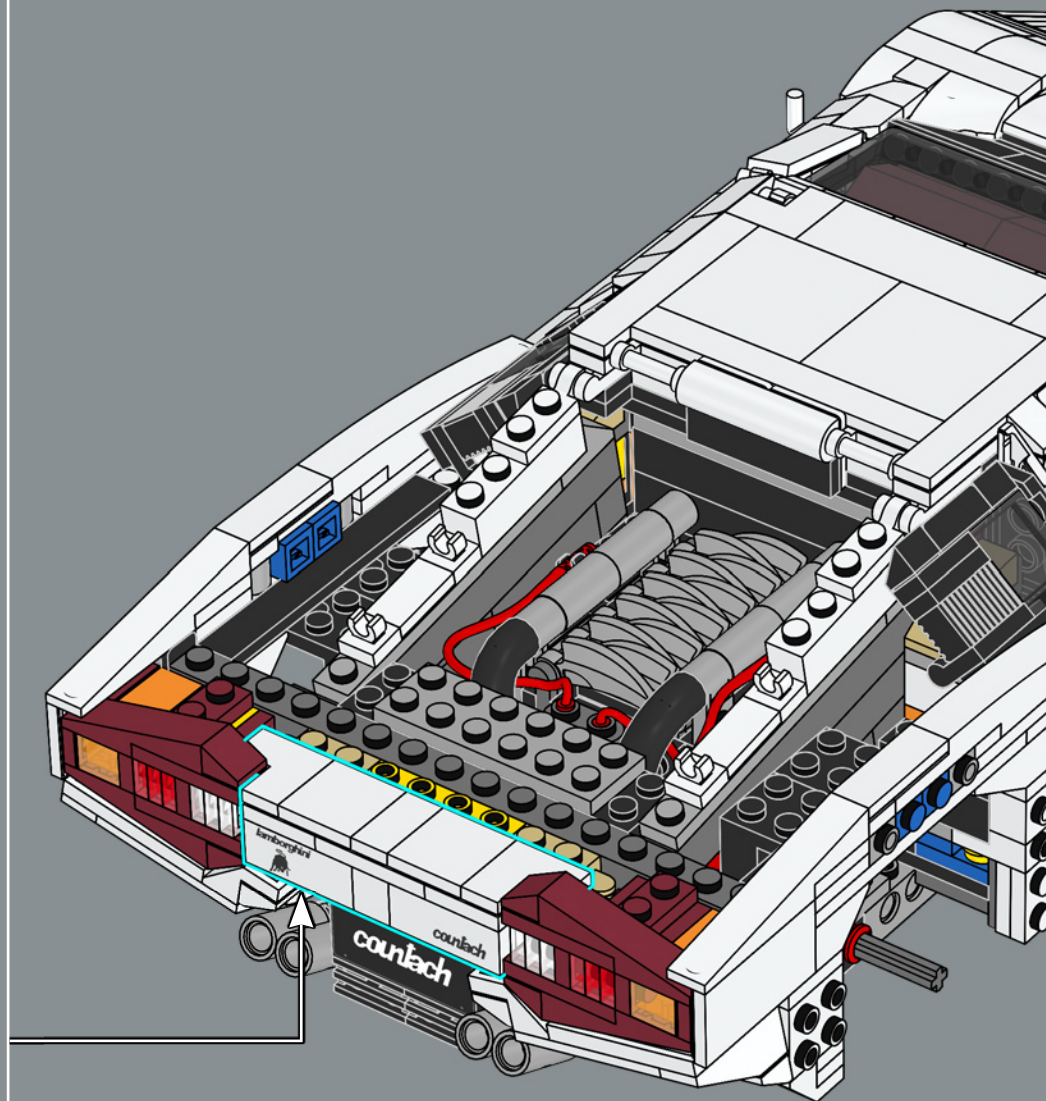
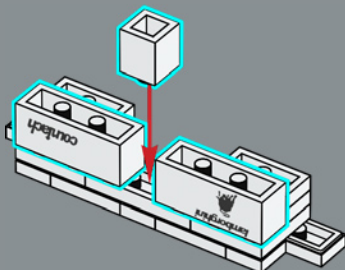

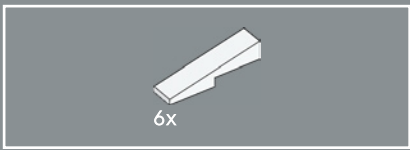

358



Un nouvel élément LEGO® incliné permet de recréer les angles courts et peu profonds du modèle légendaire.

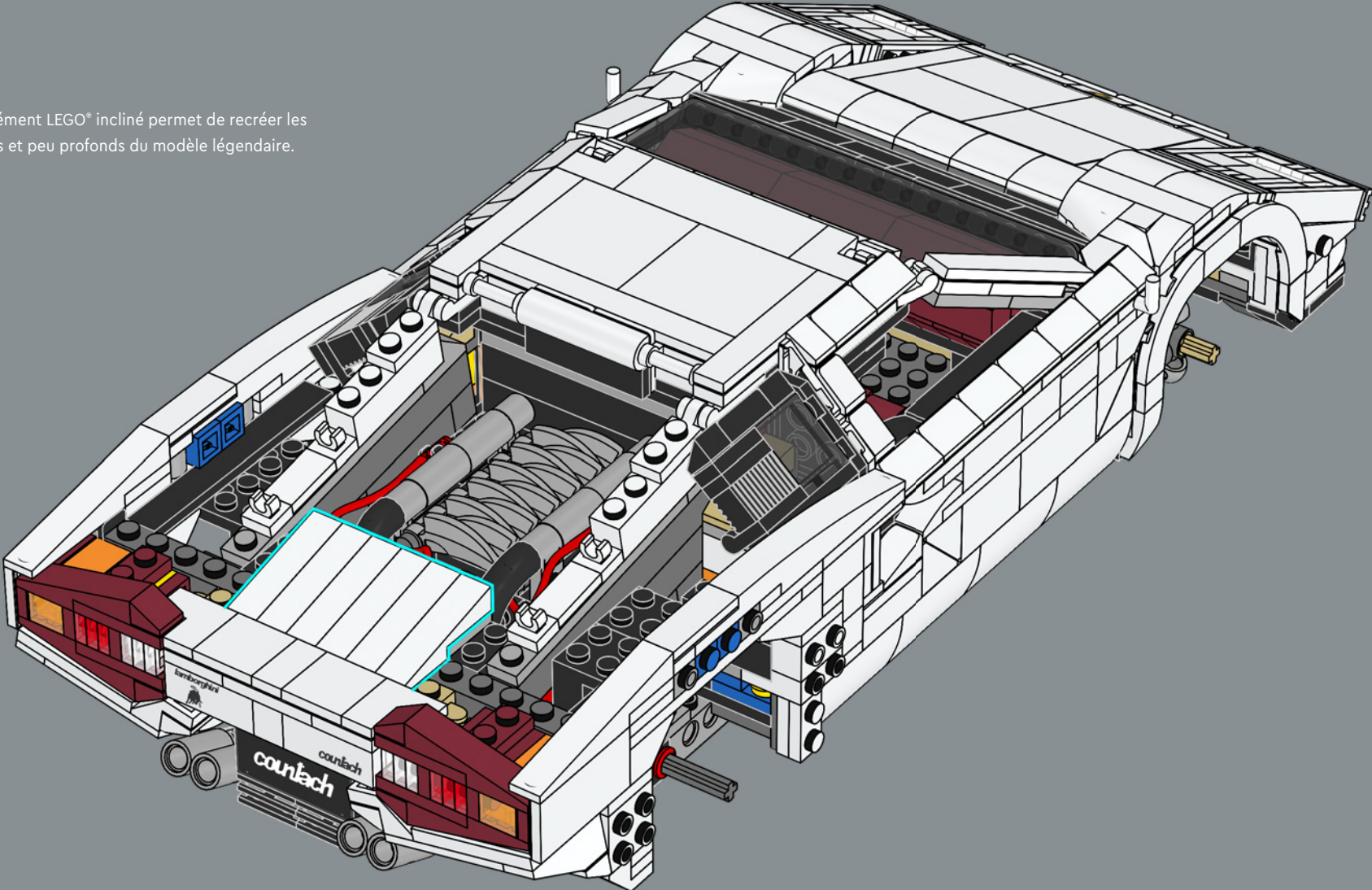

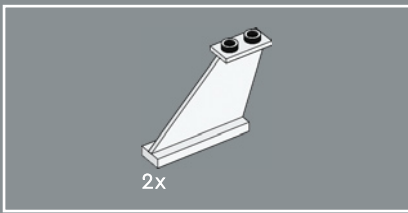

359

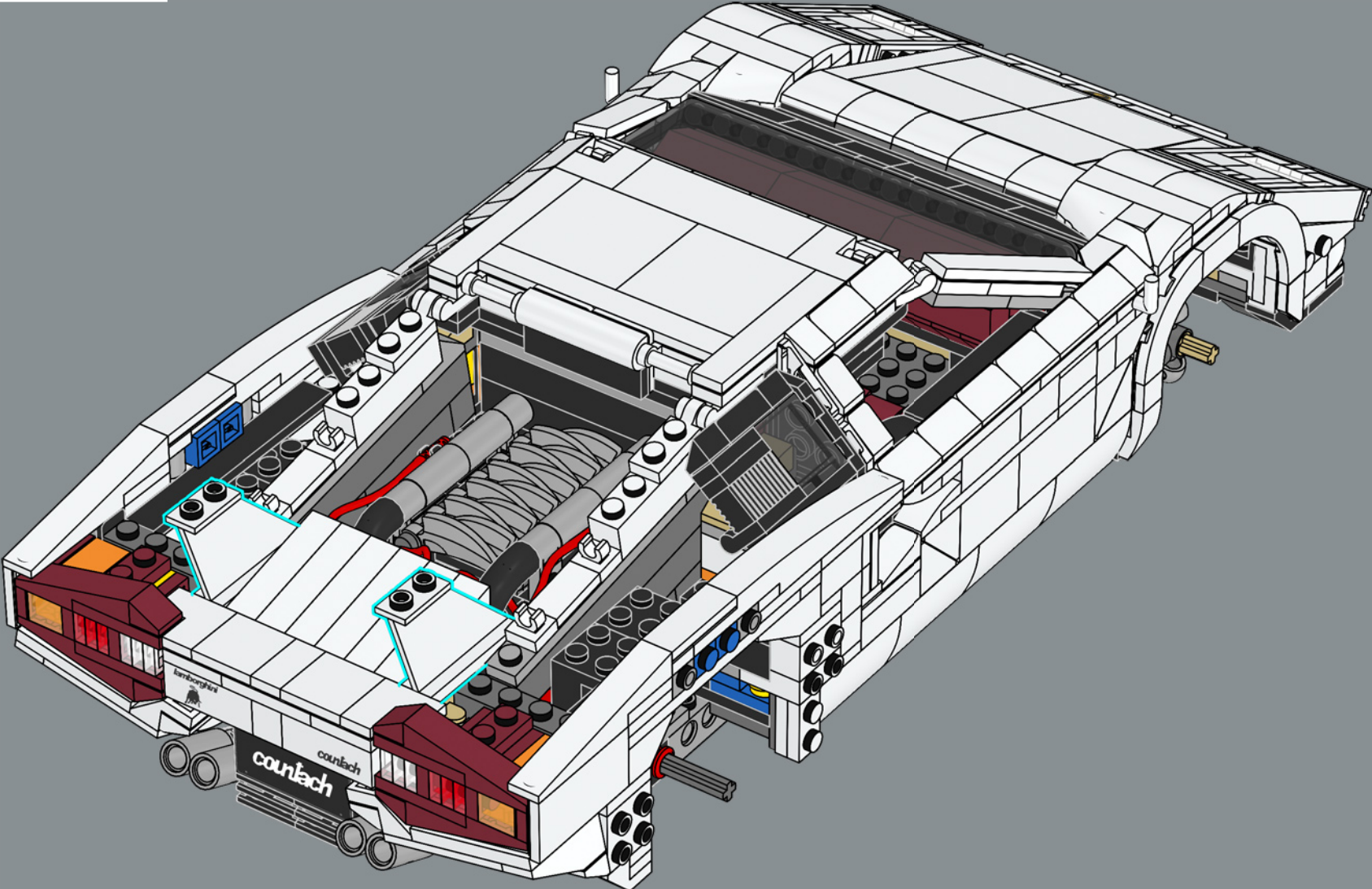

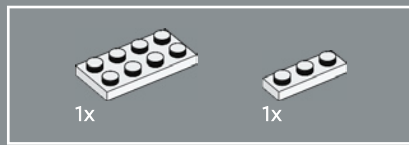
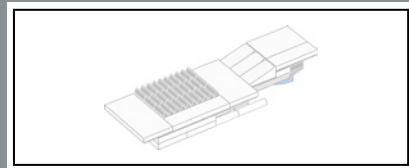
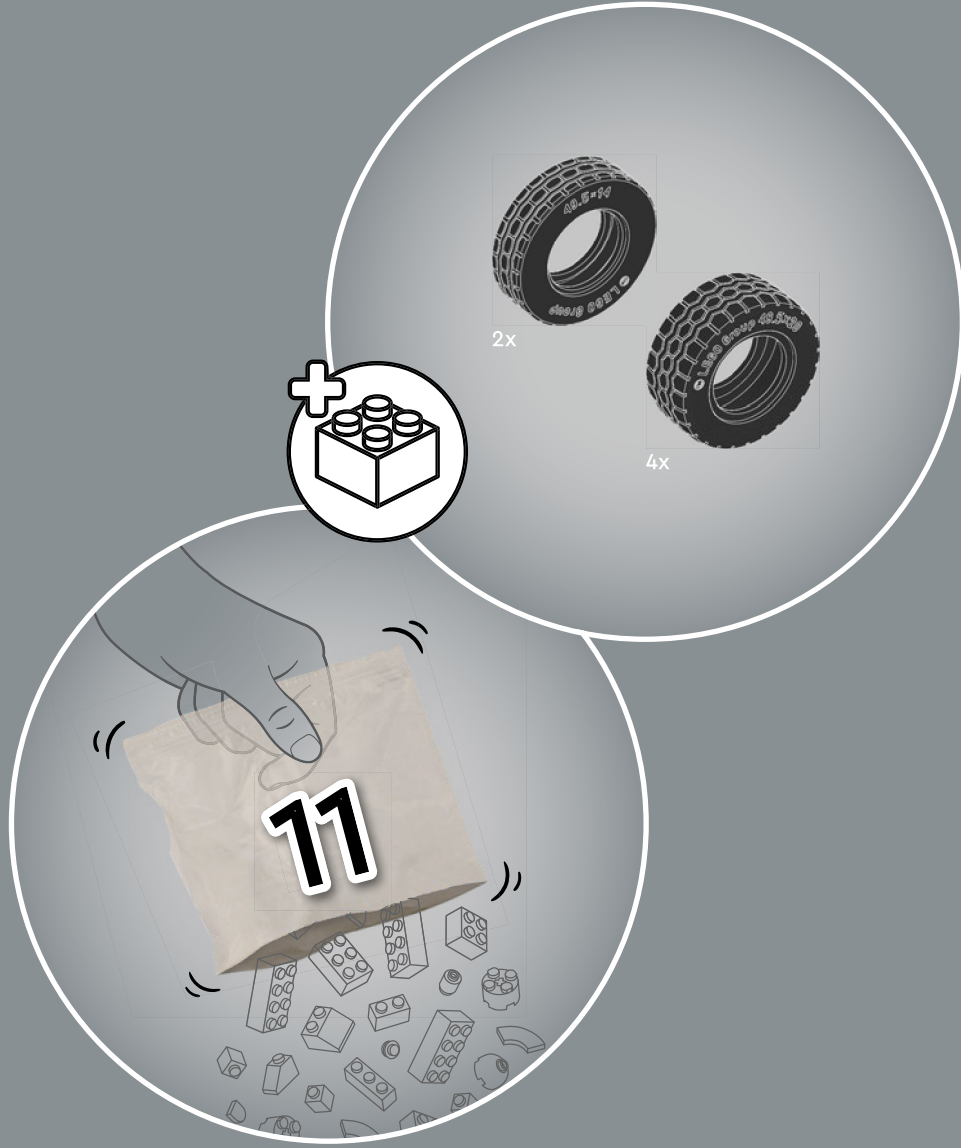

360

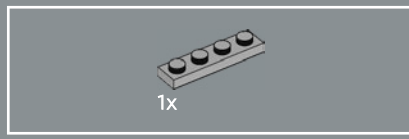
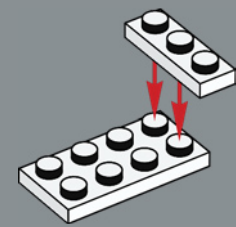

361

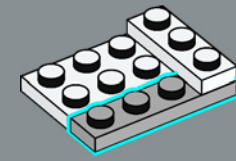



362

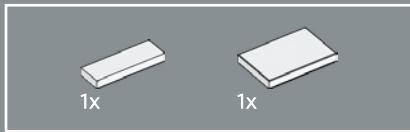
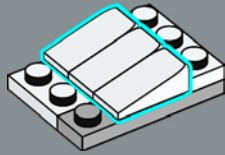

363

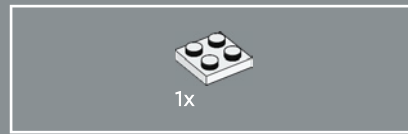
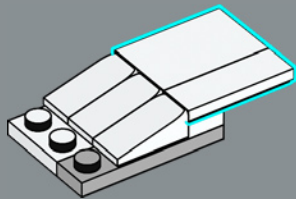
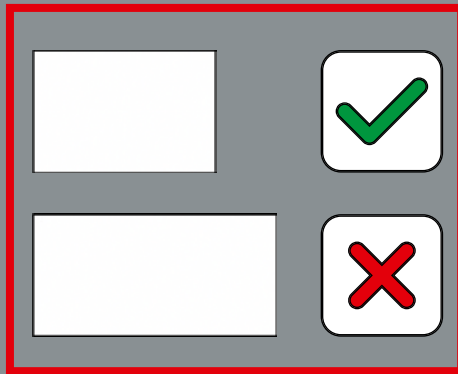

364

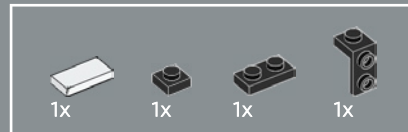
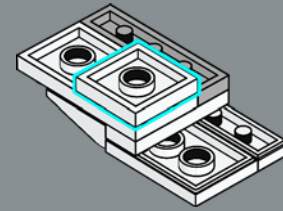

365

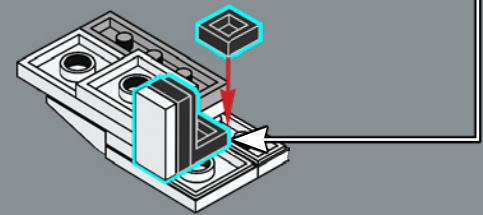
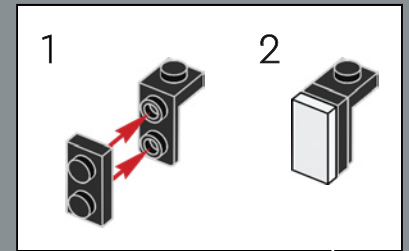



366

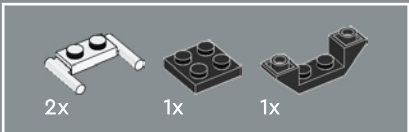
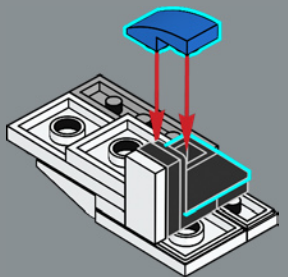

367

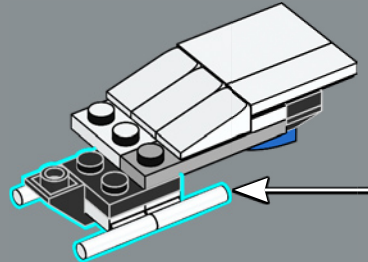
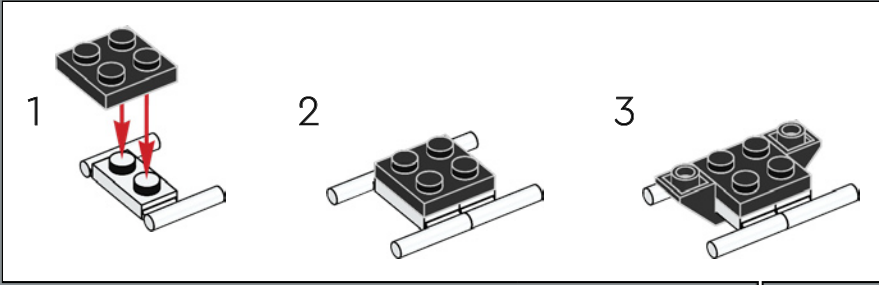

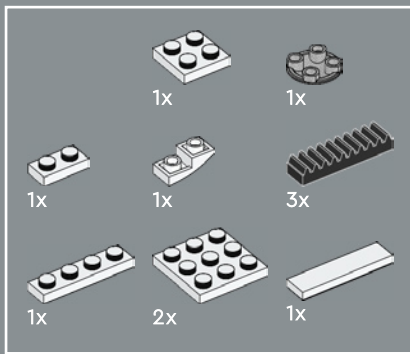

368

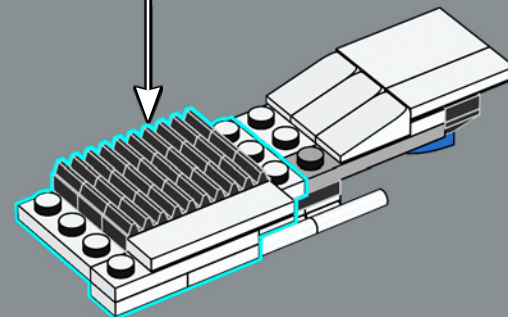
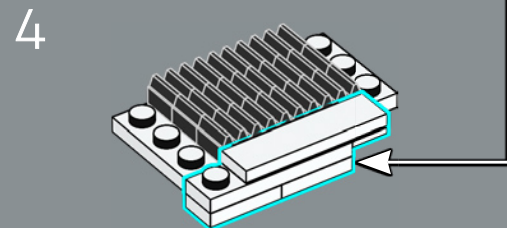
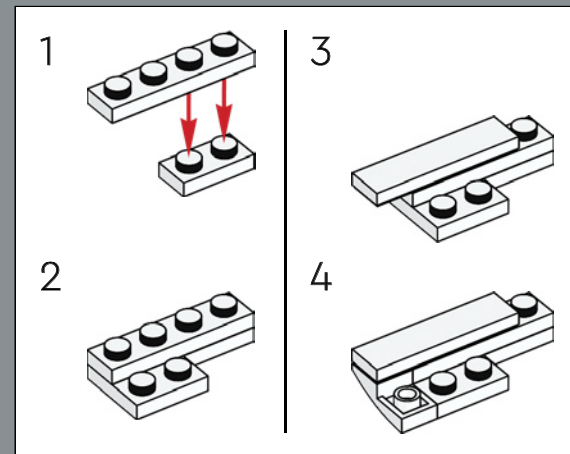
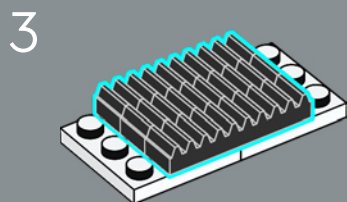
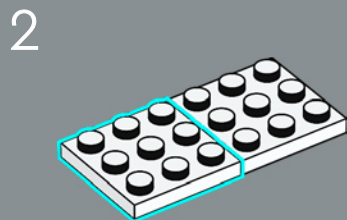
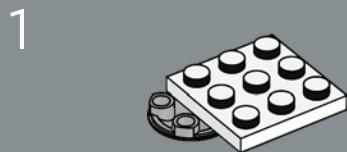

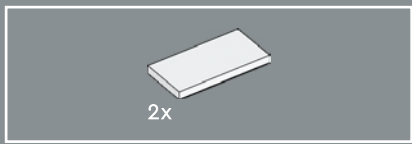

369

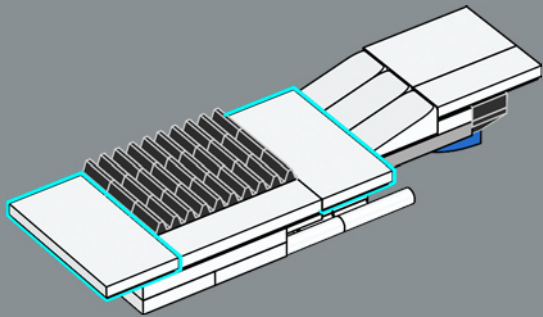
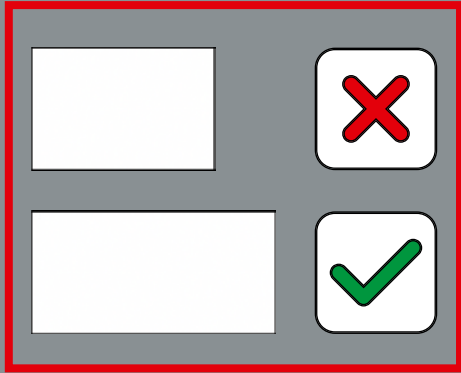

370

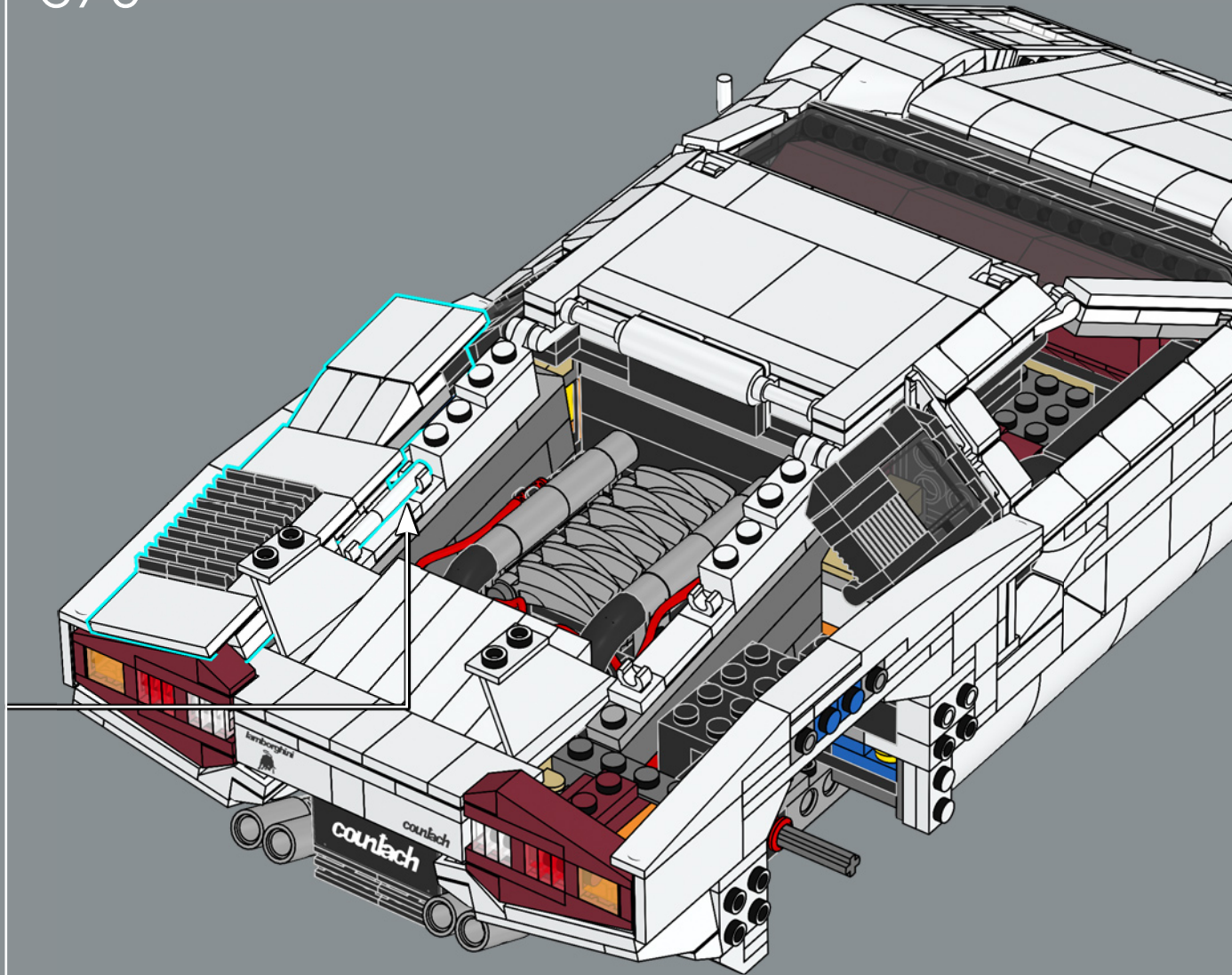

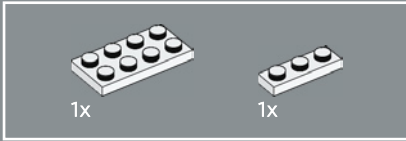
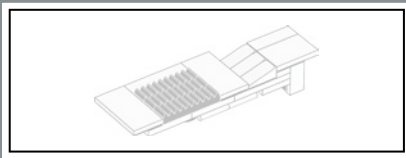

371

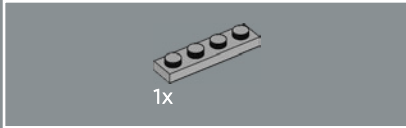
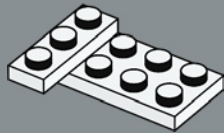

372

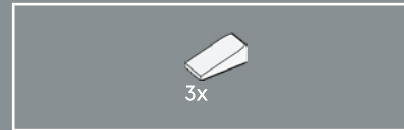
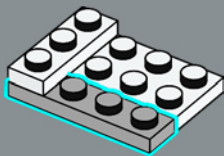

373

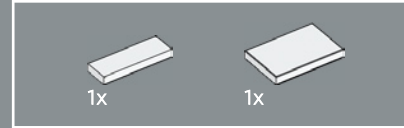
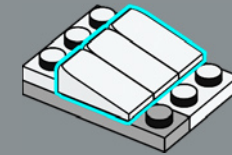

374

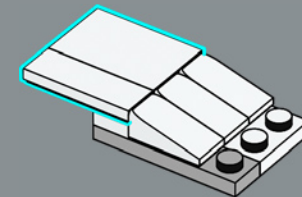
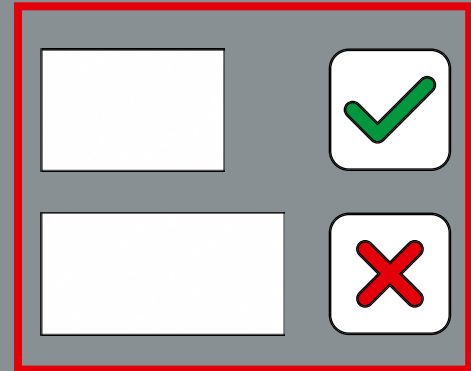

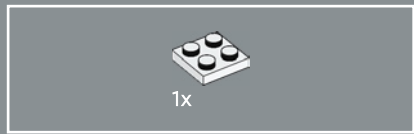

375

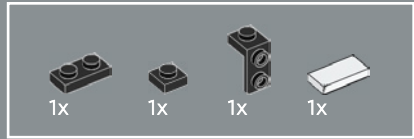
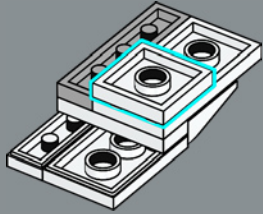

376

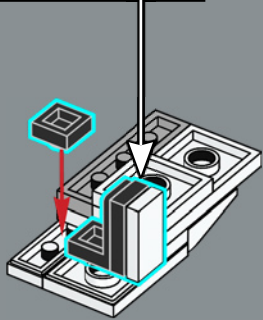
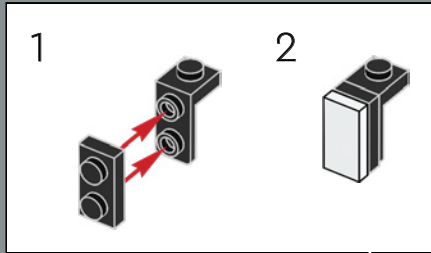

377

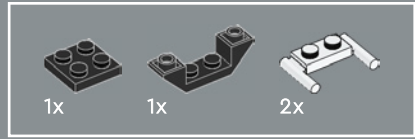
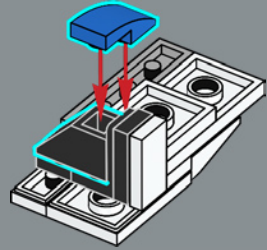

378

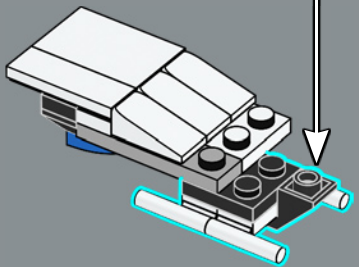
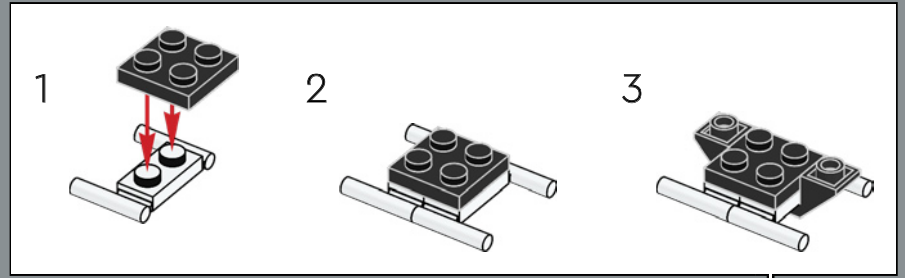

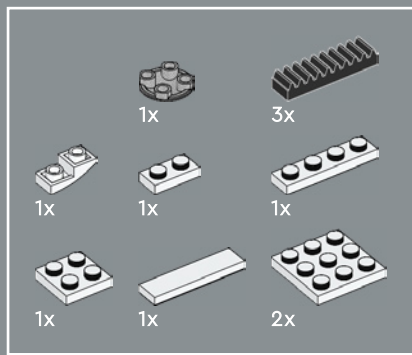

379

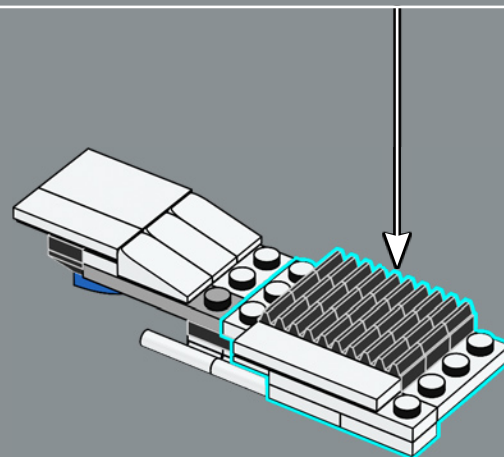
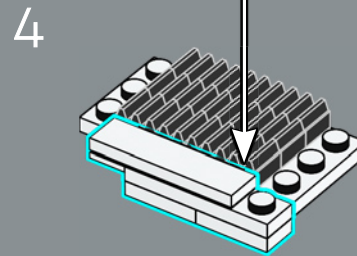
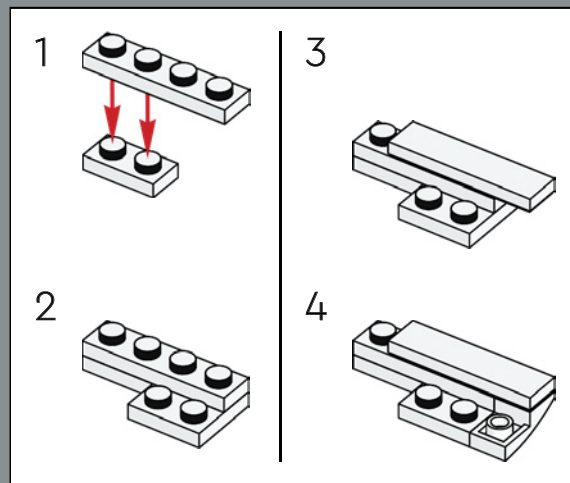
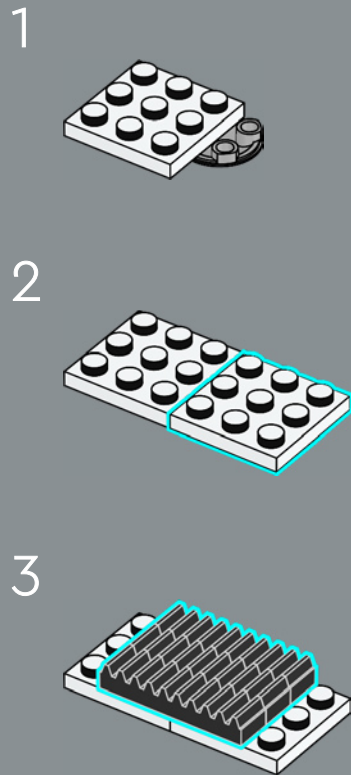

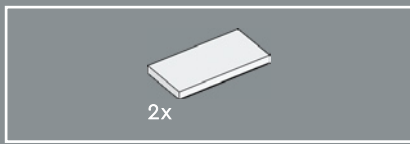

380

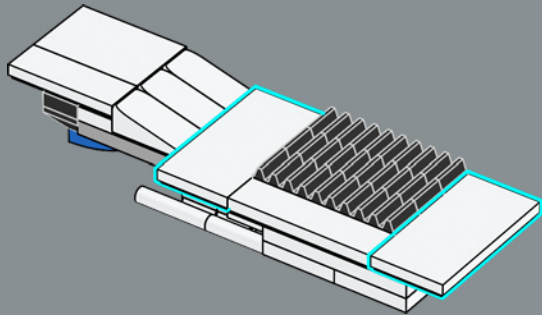
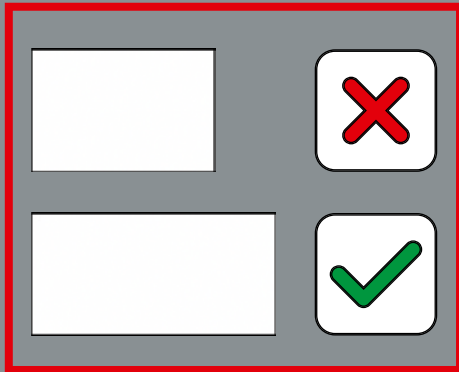

381

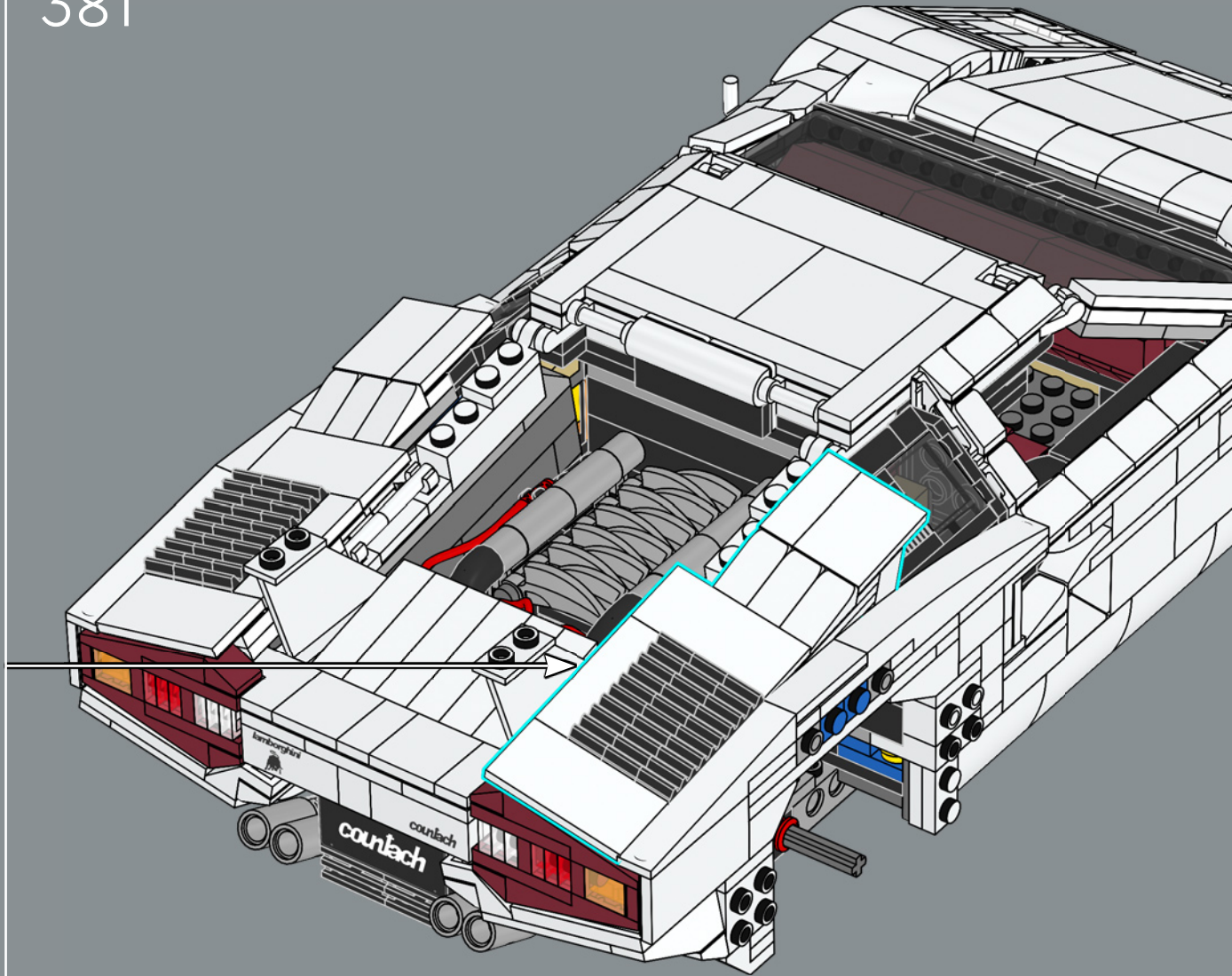

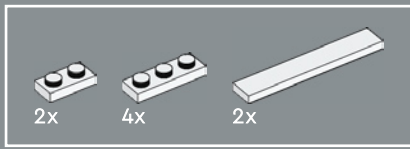

382

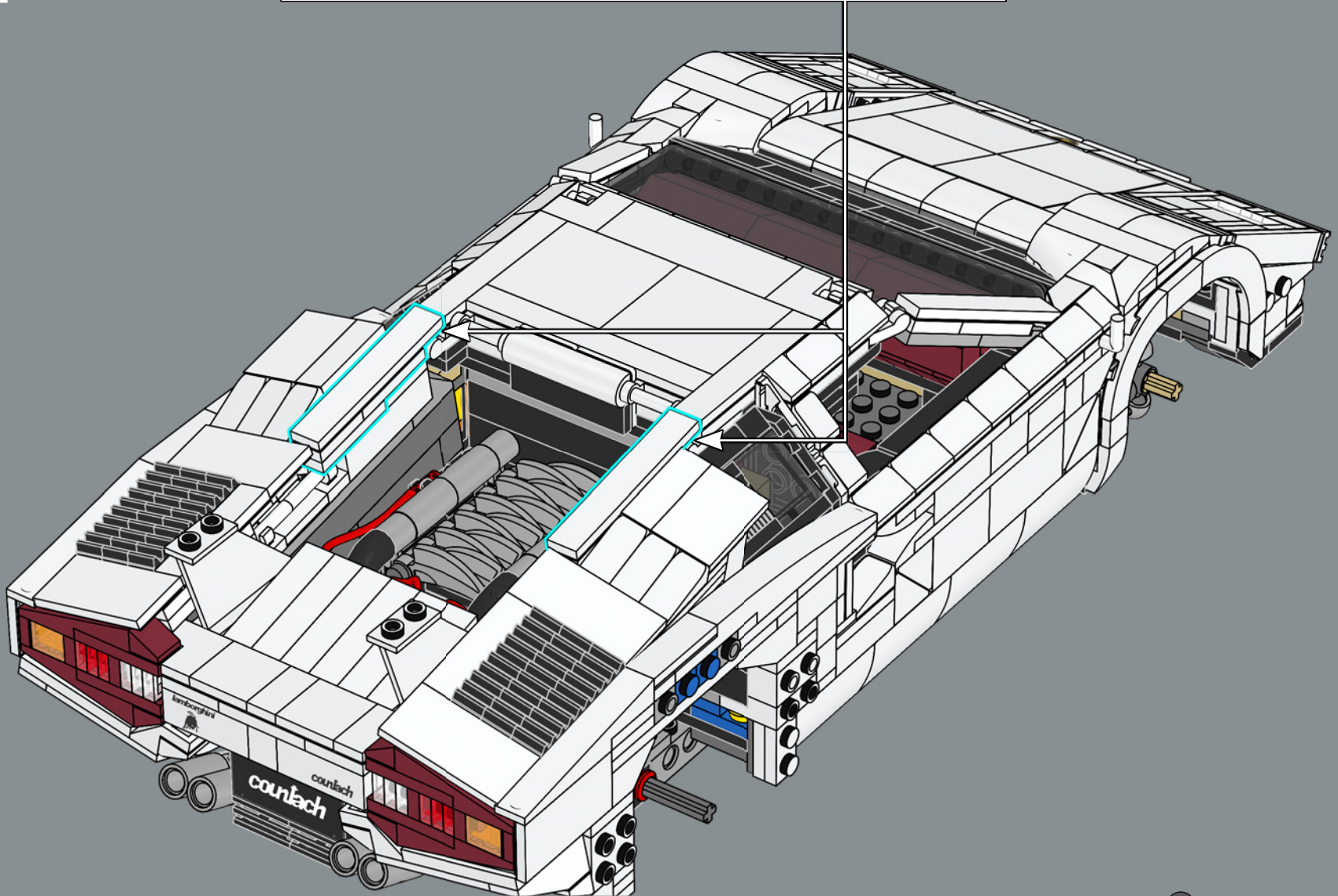
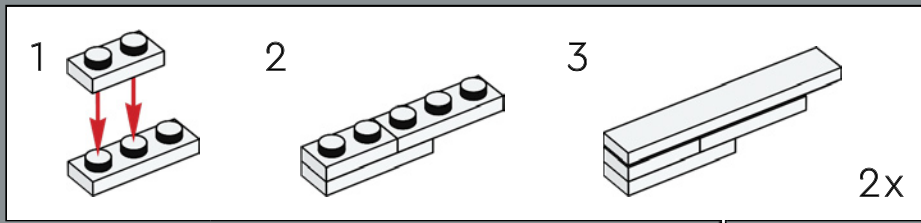

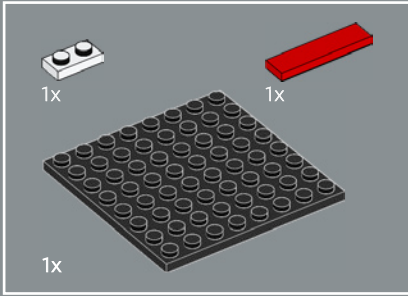
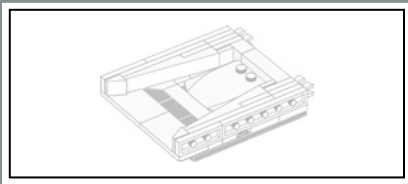

383

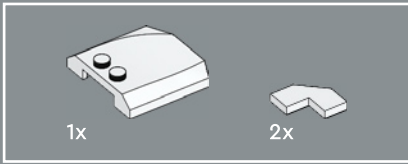
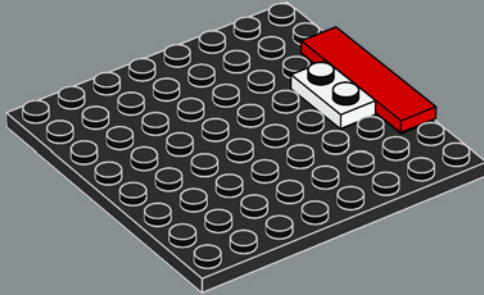

384

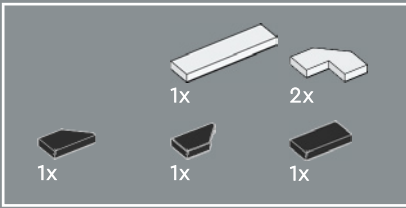
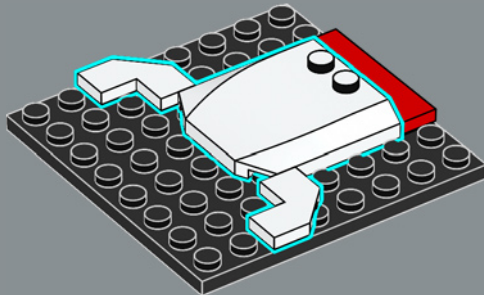

385

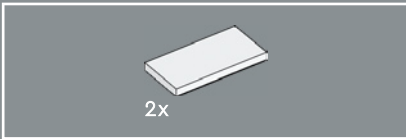
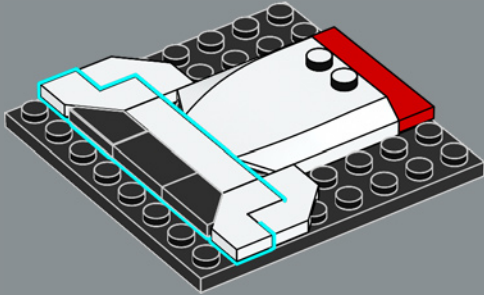

386

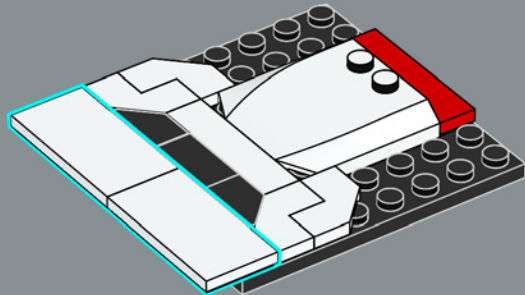

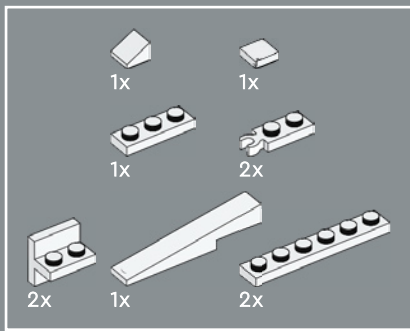

387

1

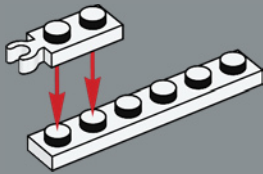

2

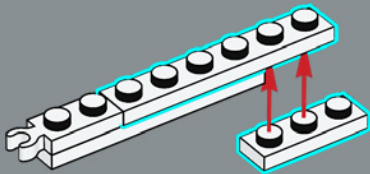

3

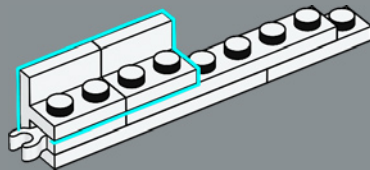

4

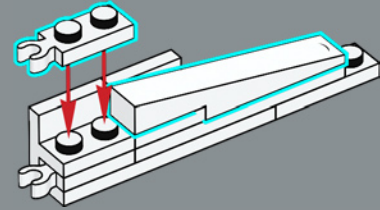

5

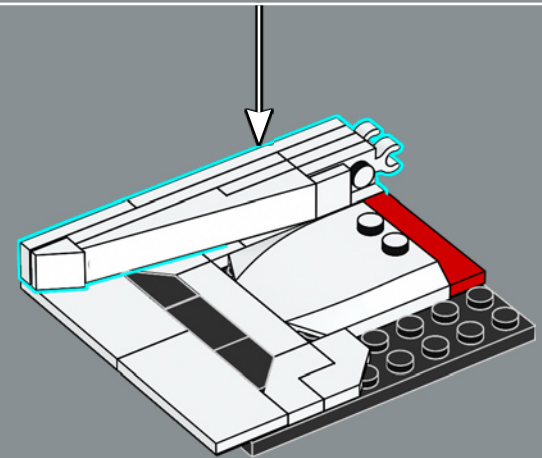
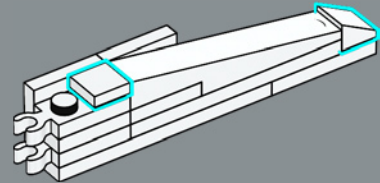

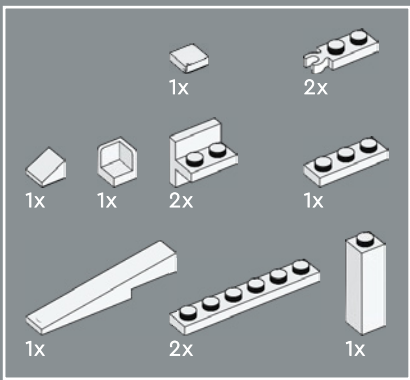

388

1

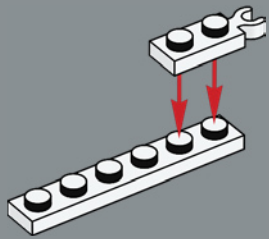

2

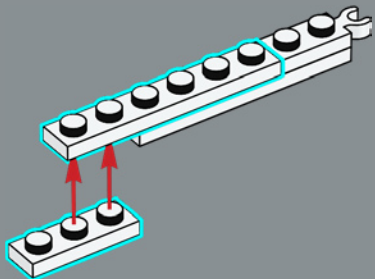

3

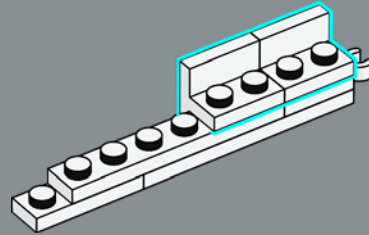

4

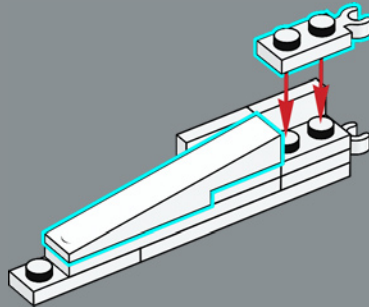

5

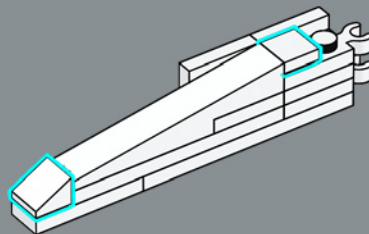

6

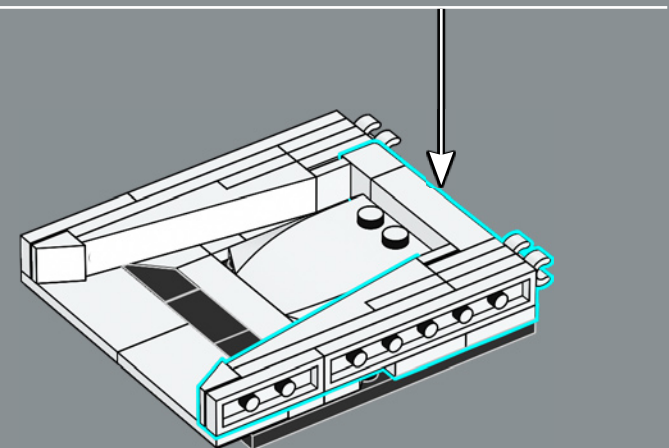
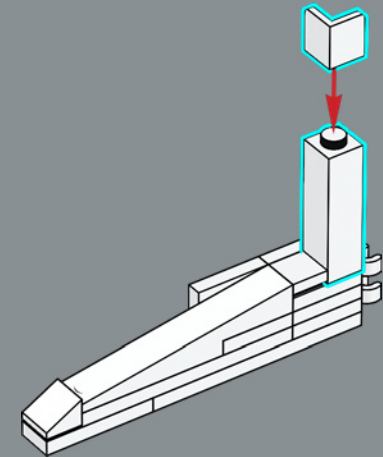

389

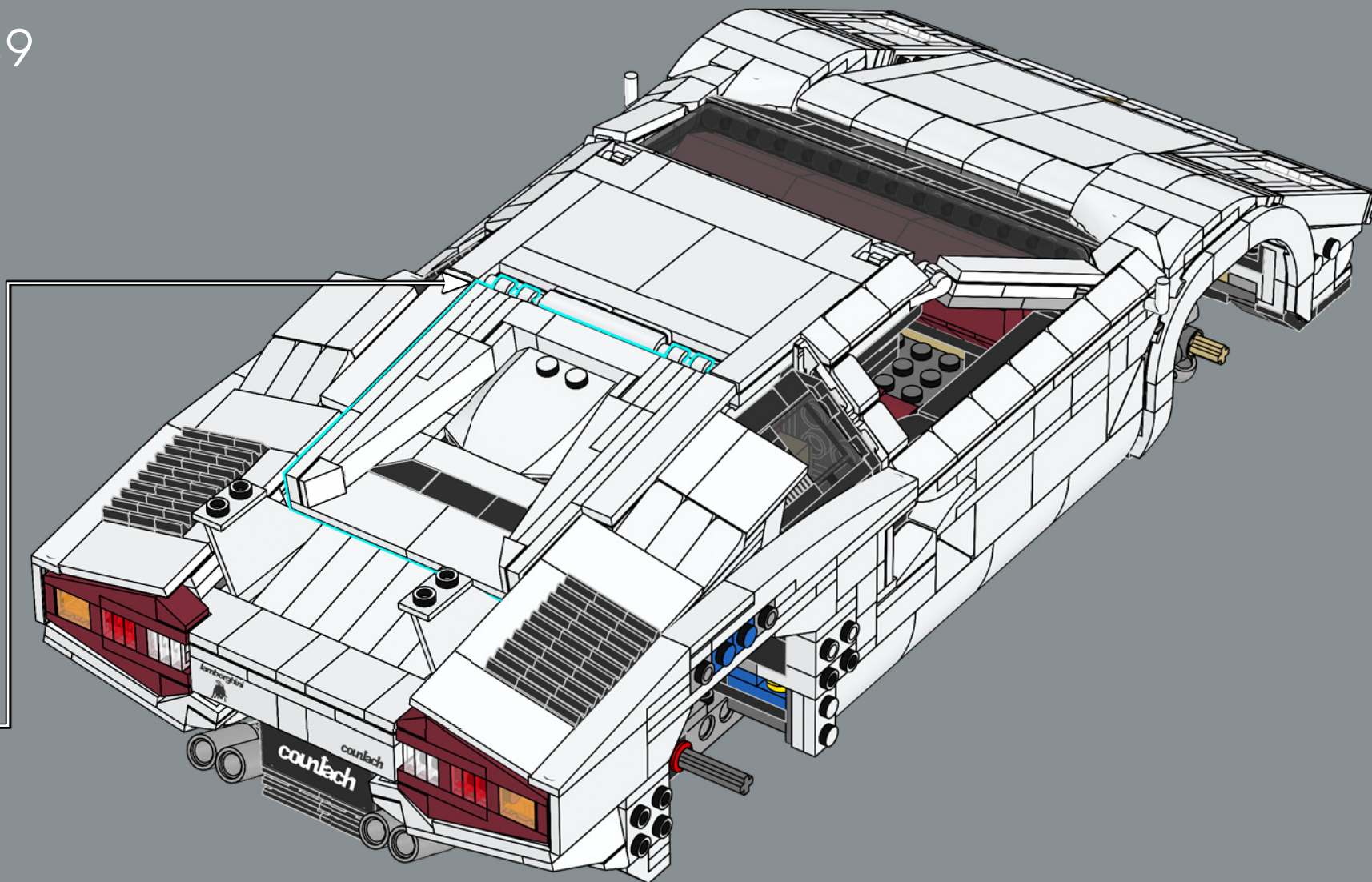

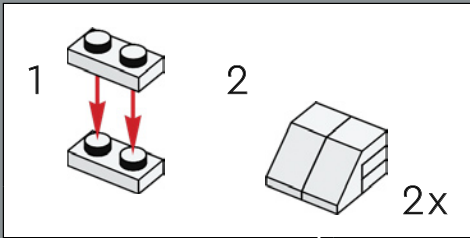
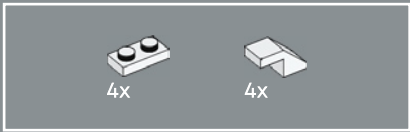

390

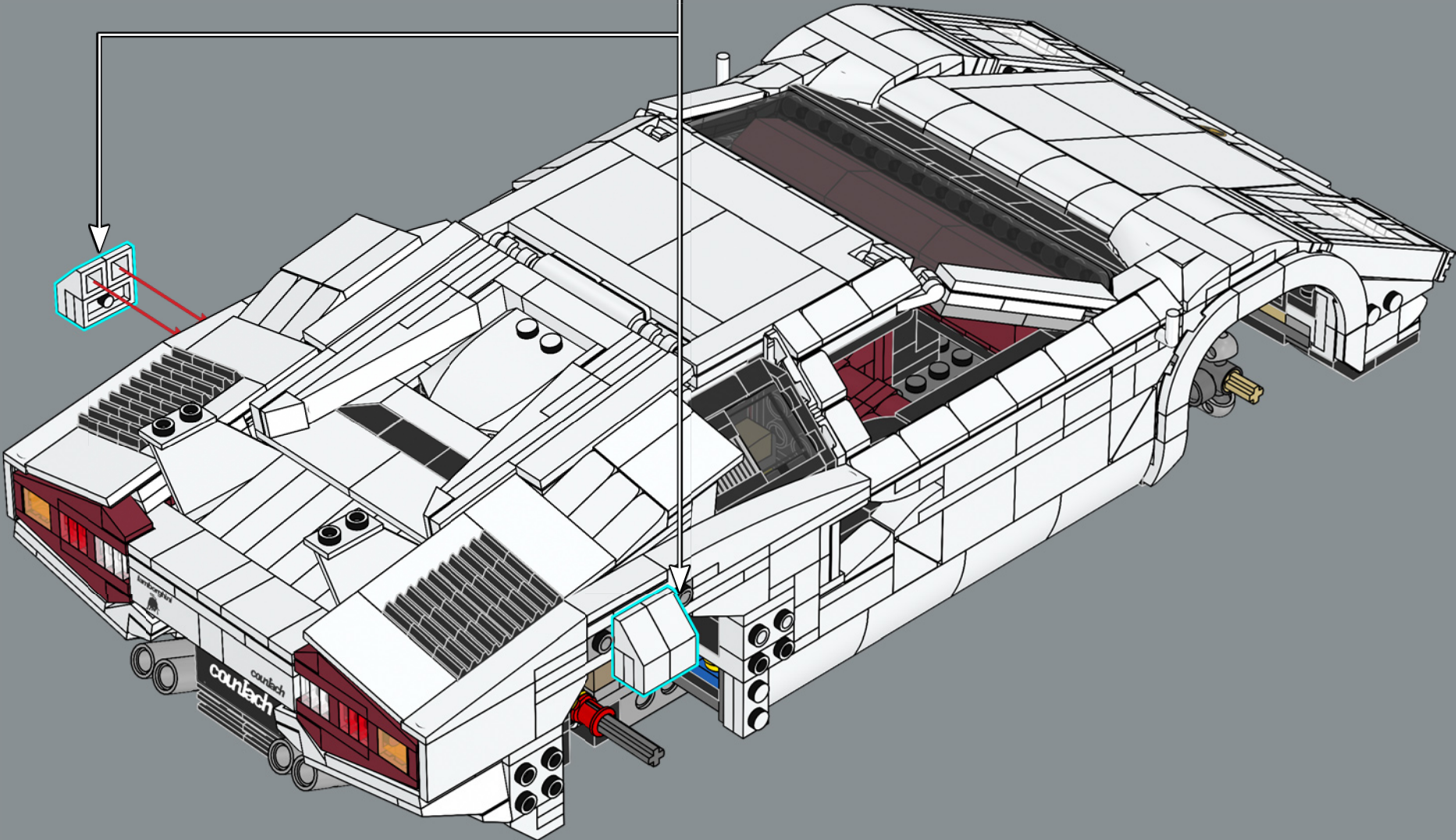



L'aile caractéristique a été reproduite à l'aide d'un nouvel élément LEGO® conique.

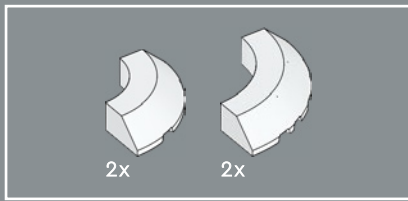

391

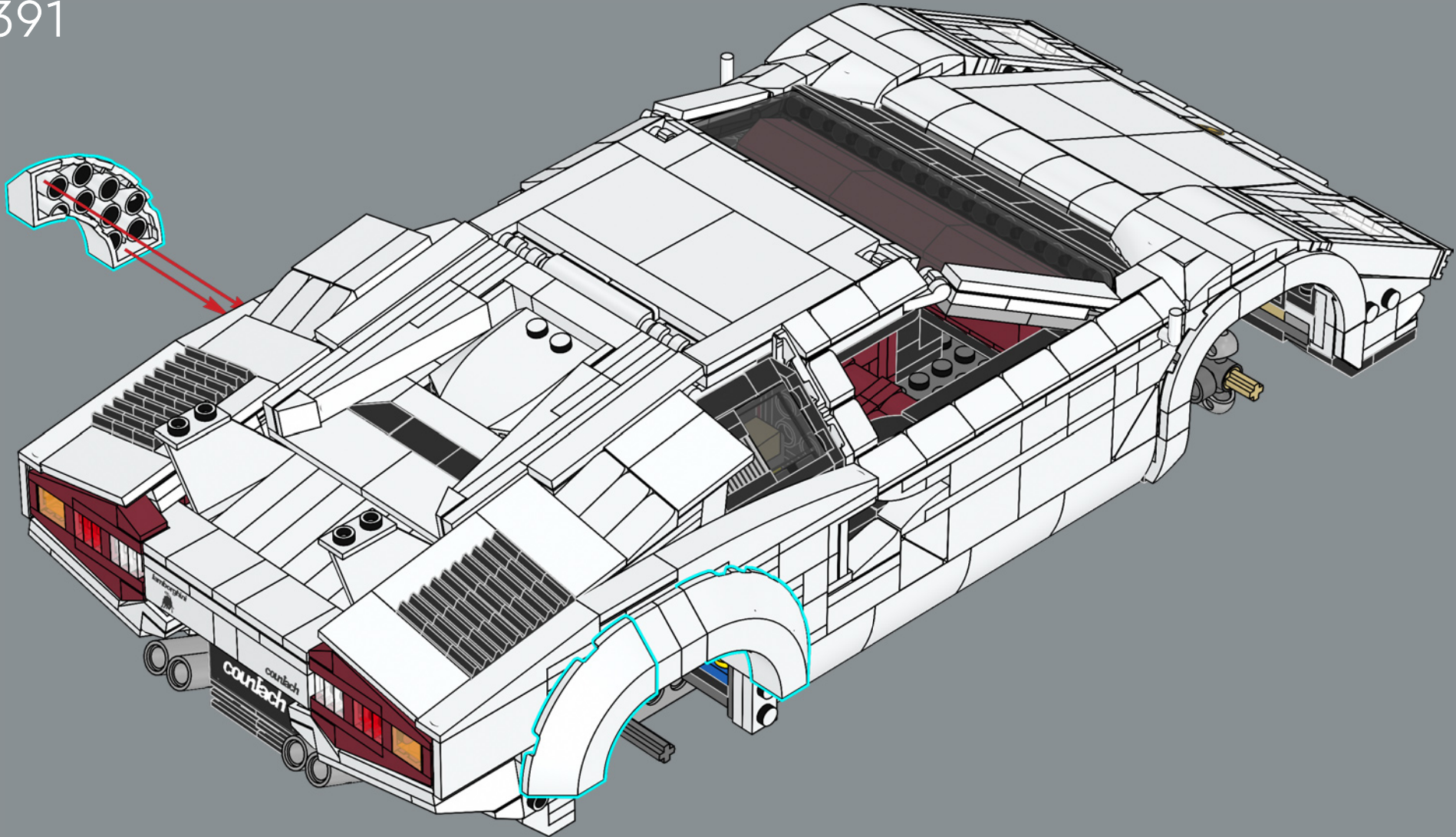



392

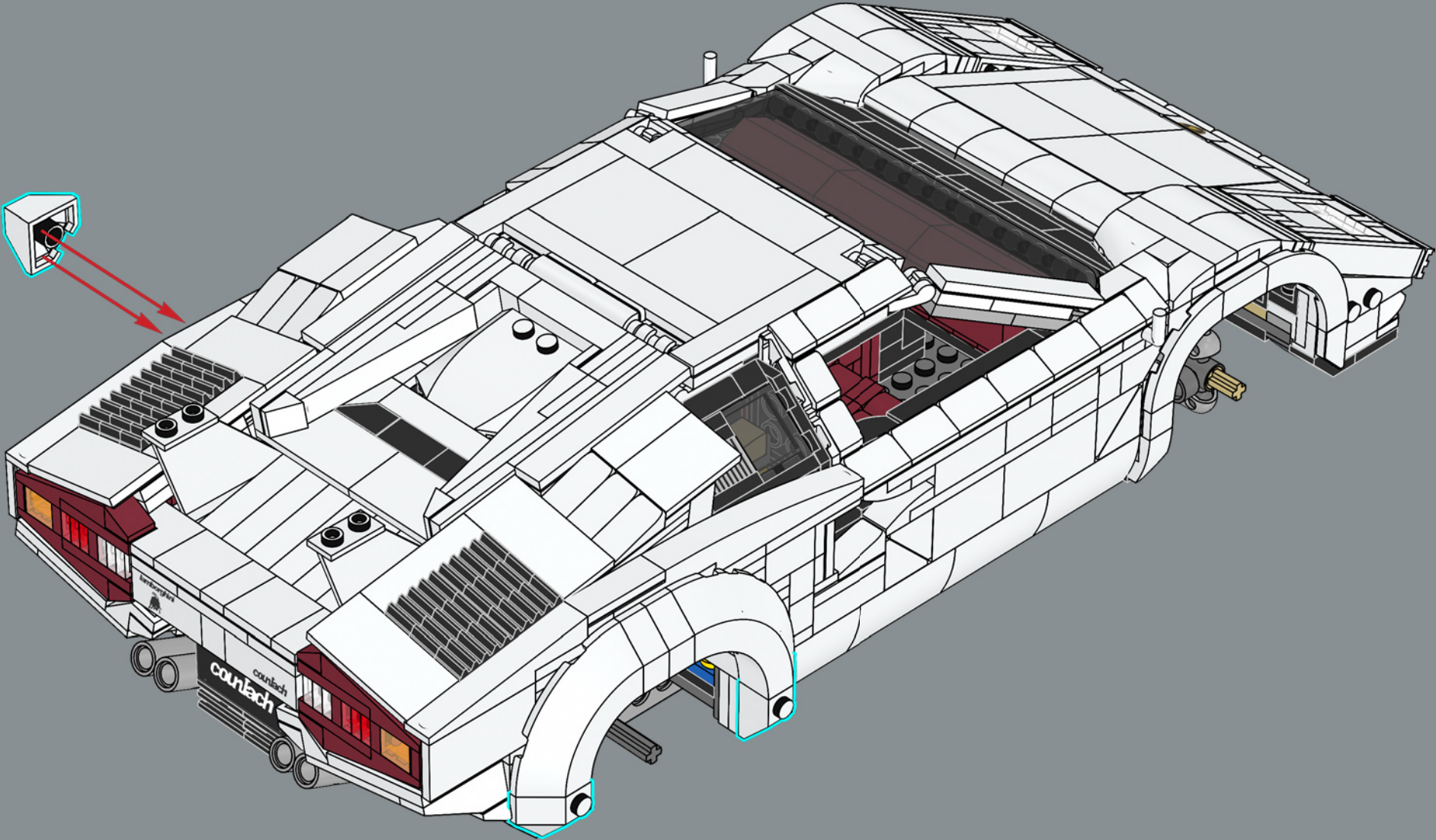

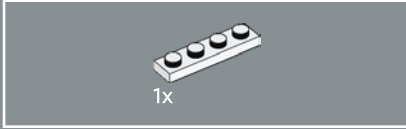
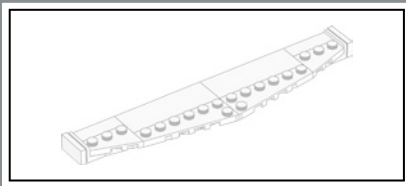

393

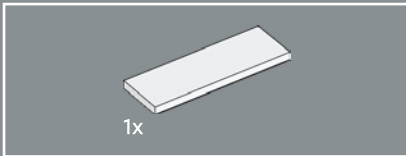

394

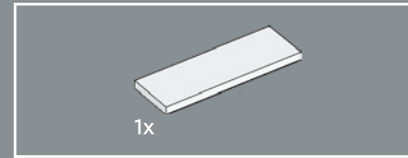
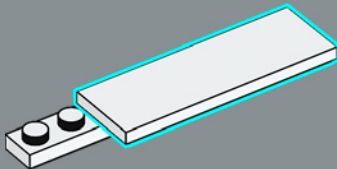

395

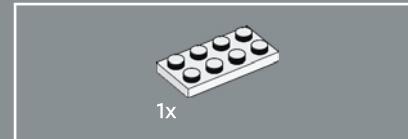
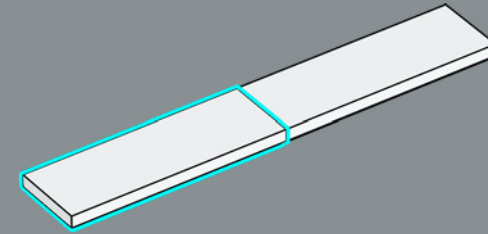

396

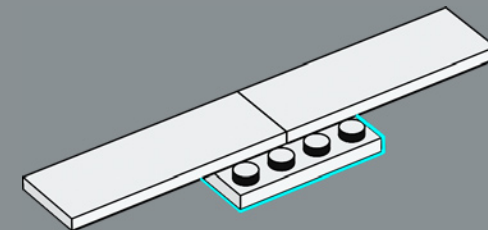

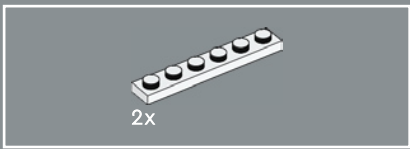

397

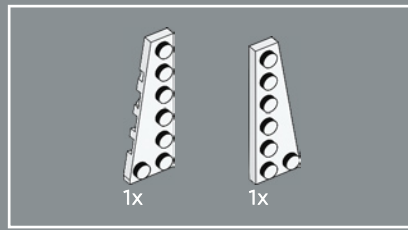
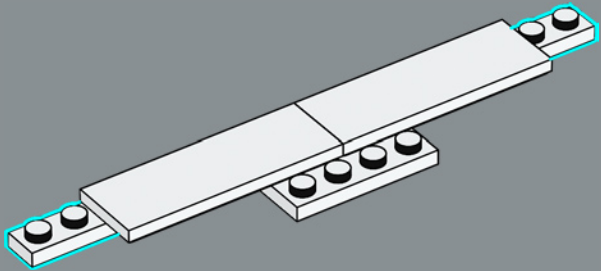

398

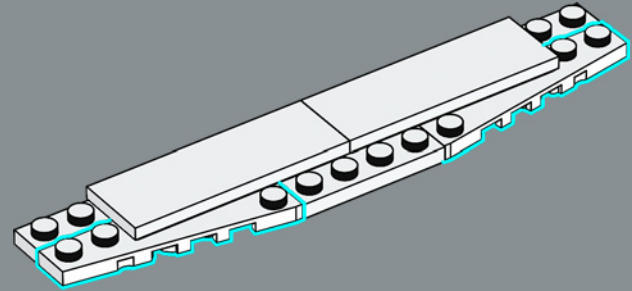

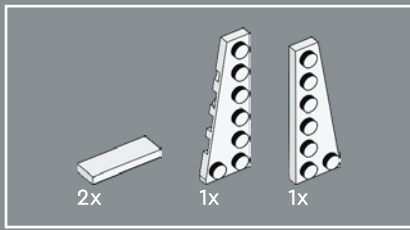

399

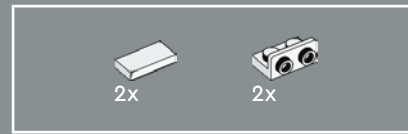
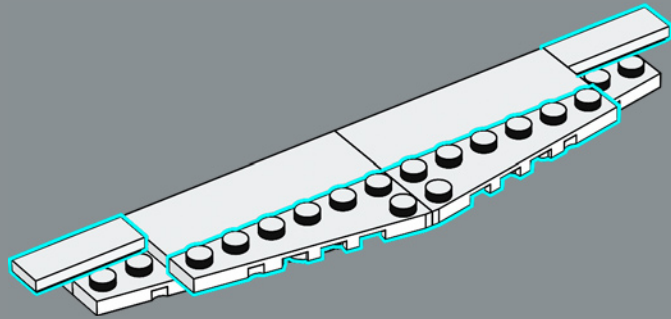

400

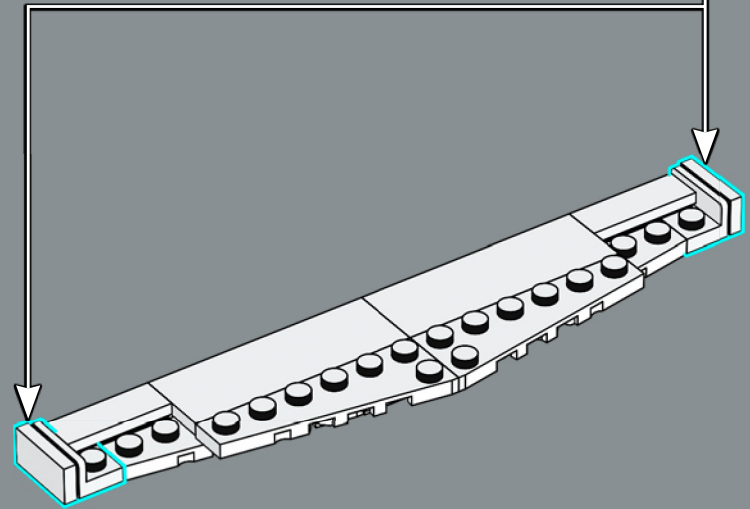
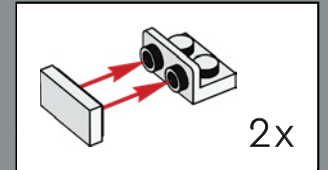

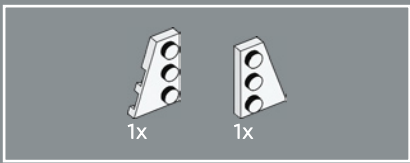

401

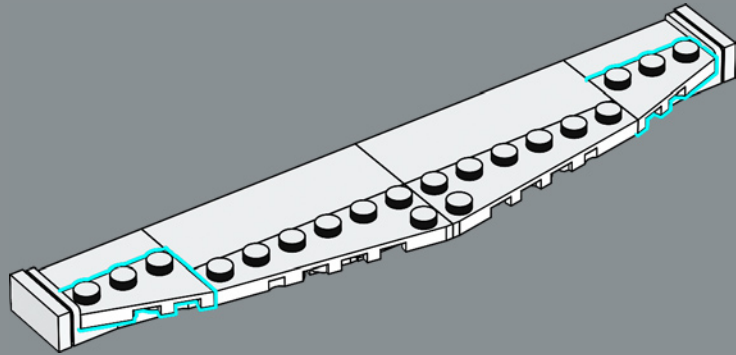

402

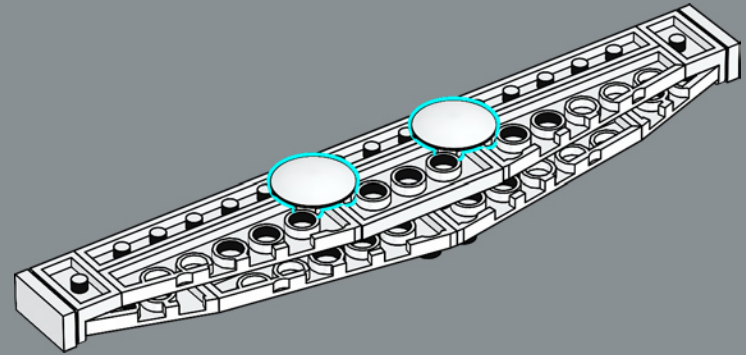

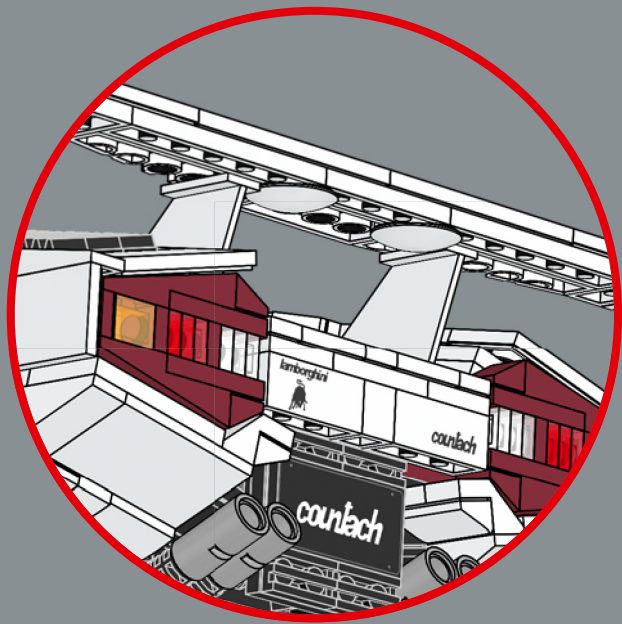

403

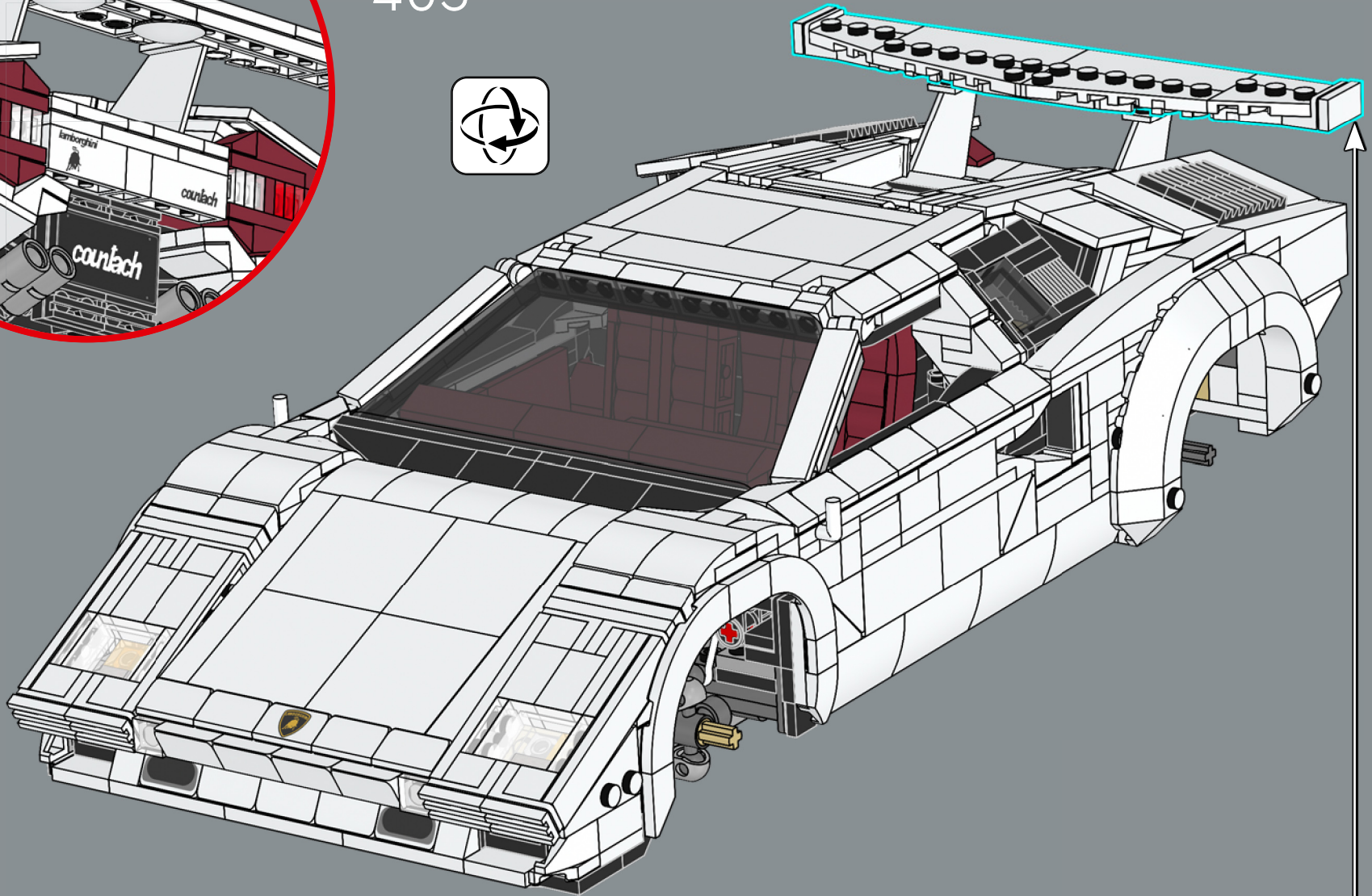

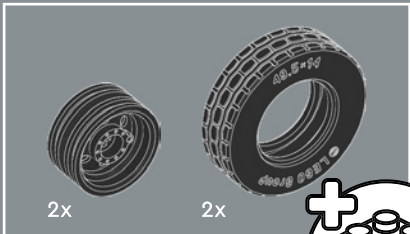

404

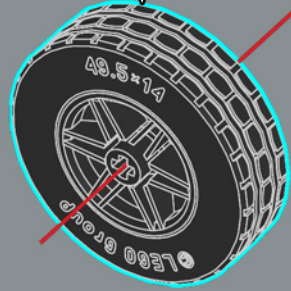
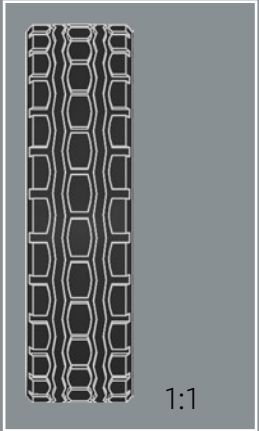
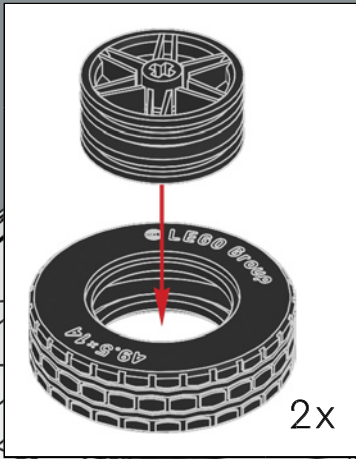
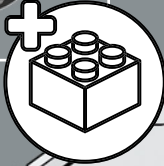

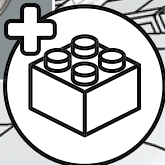
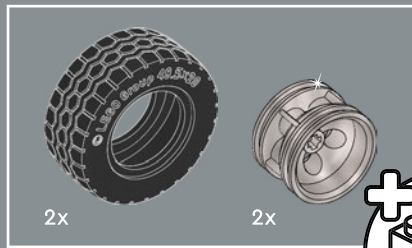

405

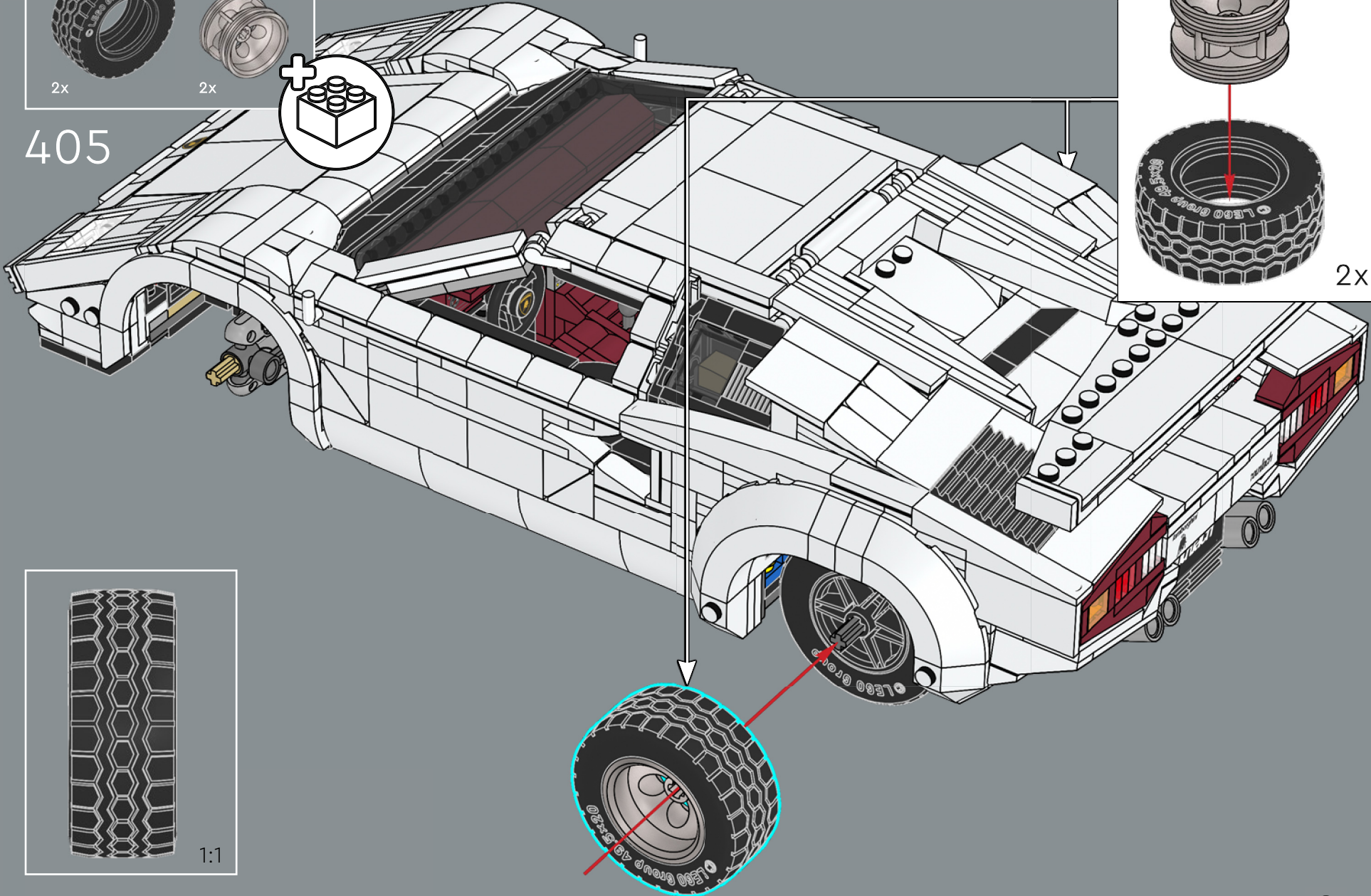
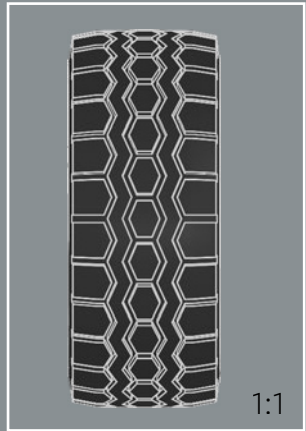
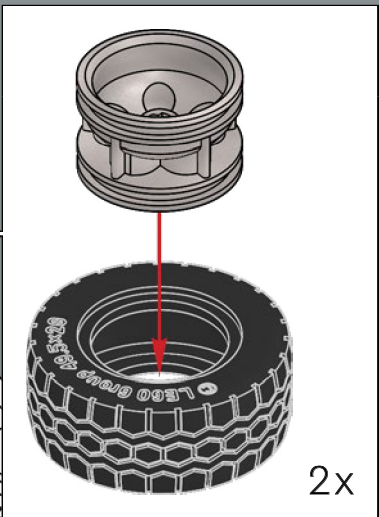



Une nouvelle jante accueille la direction et un contour profond sur les roues arrière.



2x

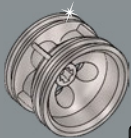

2x

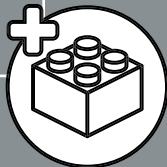

406

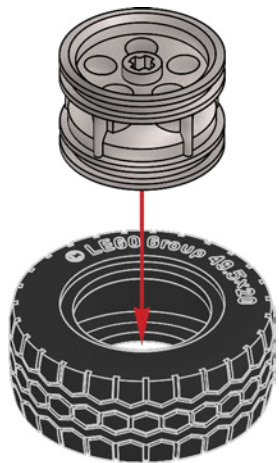

2x

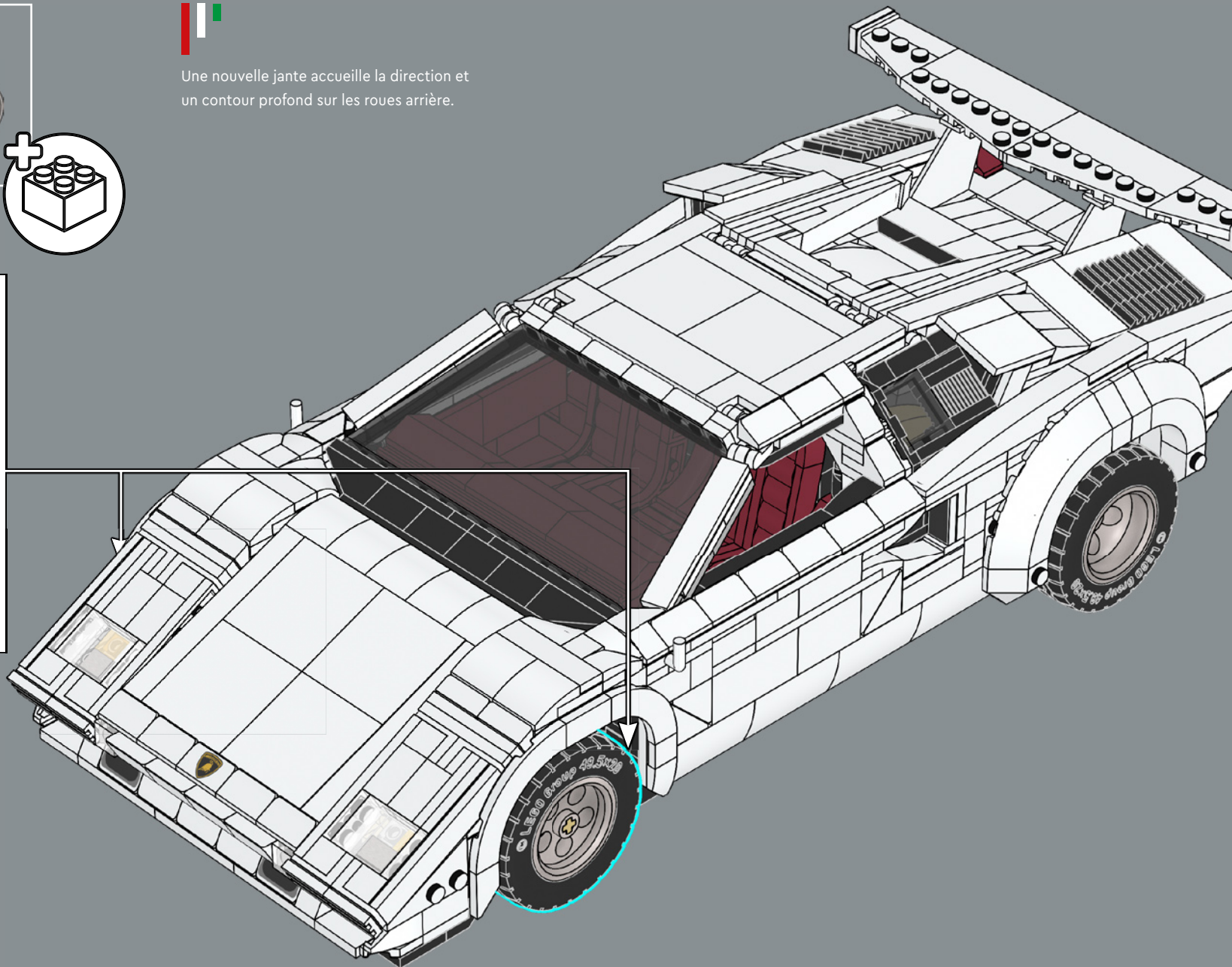

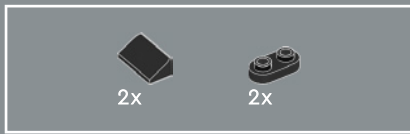

407

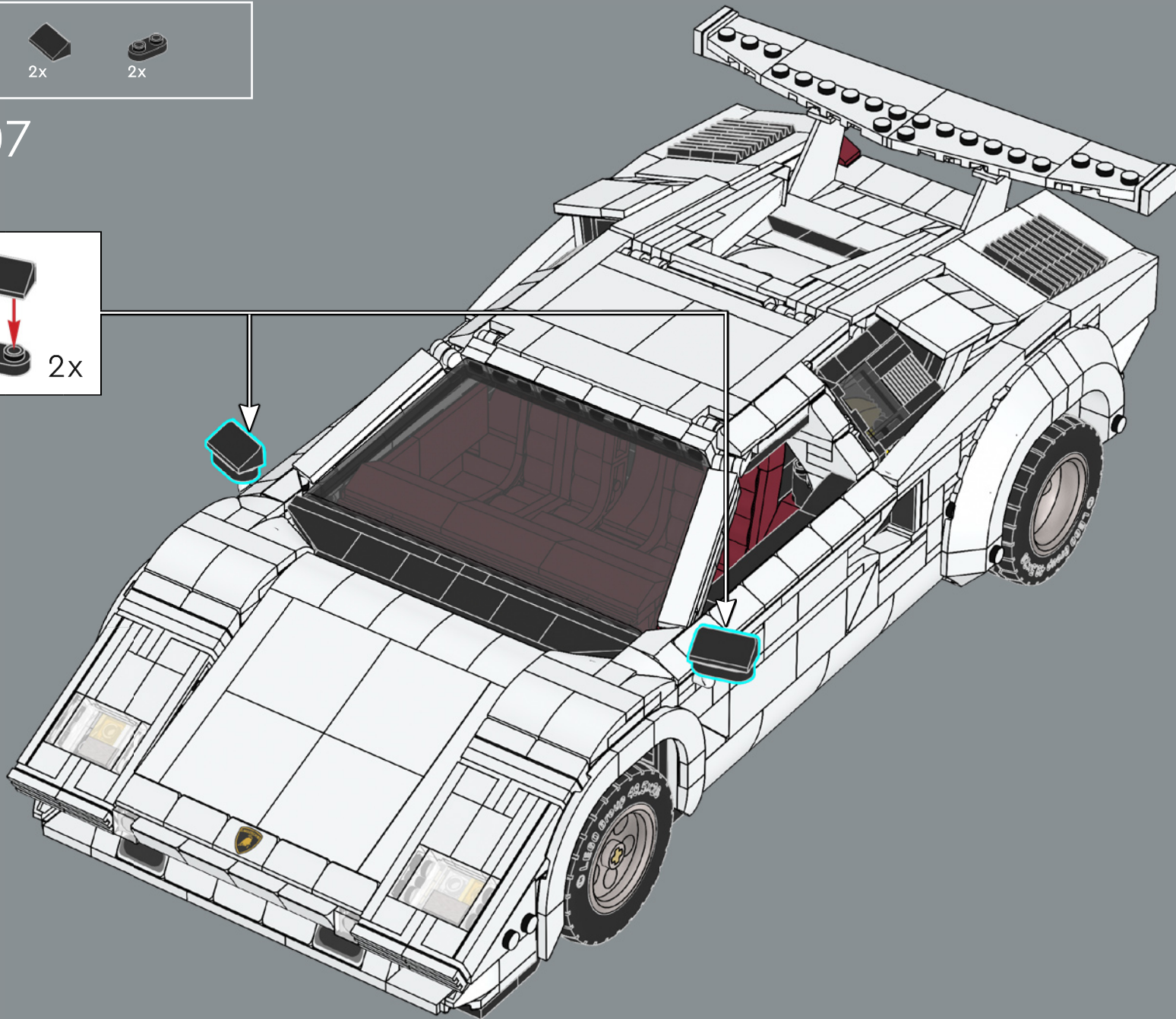
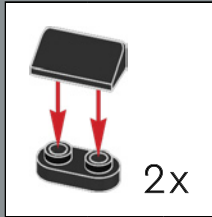

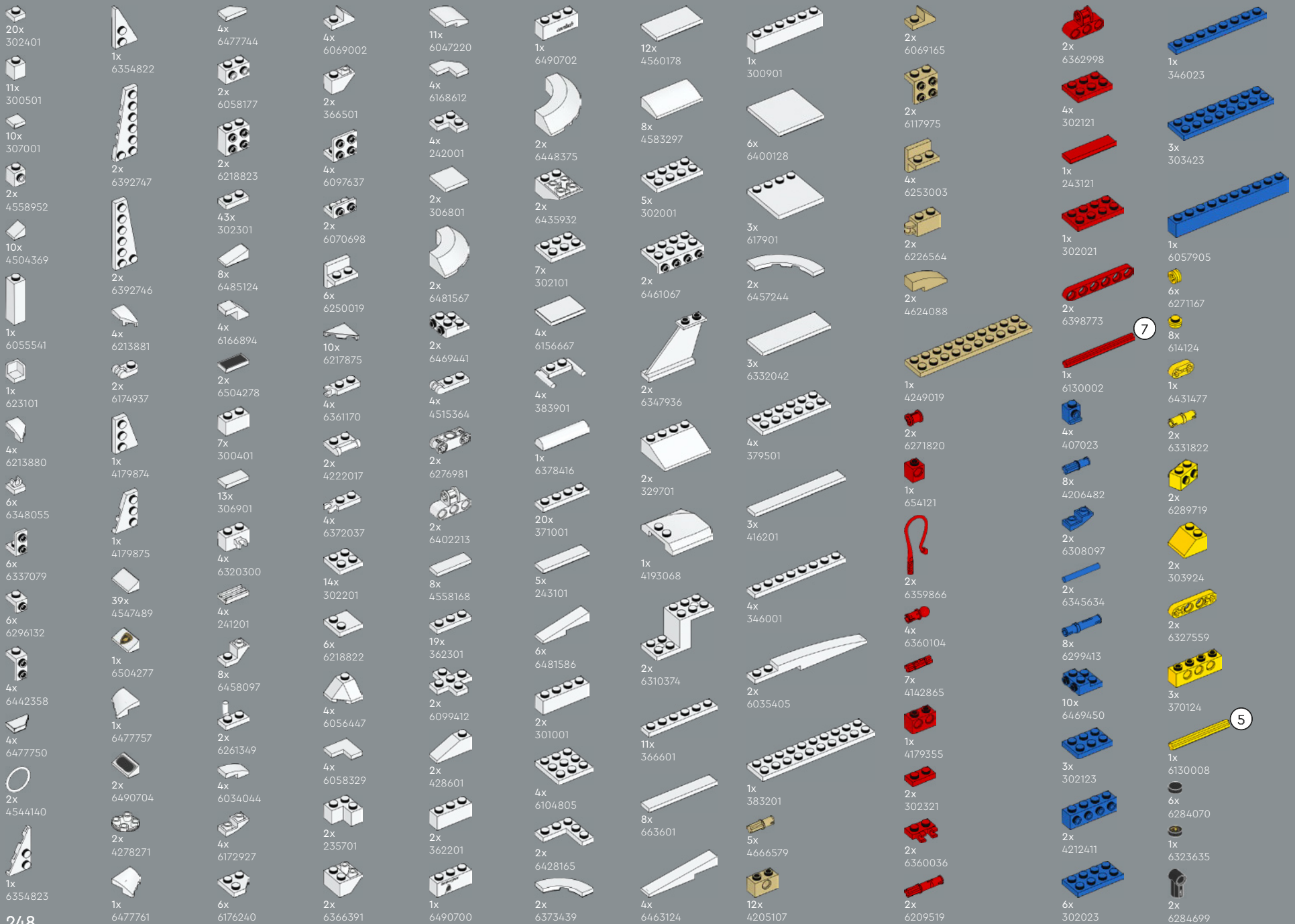



6x
64448793

2x
6284071

2x
6308012

2x
4211525

2x
4278273

8x
6173127

18x
4211398

2x
4211388

2x
6326078

1x
6329662

2x
4593679



LEGO.com/service

2x
4211469

2x
6093859

2x
6301870

4x
4244627

12x
6359723

4x
6326478

3x
4211397

2x
4211353

2x
4211815

2x
4211881

3

2x
6043639

6x
6438836

4x
4211429

8x
4211396

4x
4211445

4x
6247352

1x
4211395

2x
4211549

1x
4211452

2x
4211425

1x
4211404

1x
4211406

5x
4251149

1x
4211462

4x
6421513

1x
6335319

1x
6376639

2x
6240550

2x
6254252

1x
4490599

8x
6287672

2x
6343854

4x
6481570

2x
6217492

2x
6469858

2x
4210633

2x
6395635

2x
4211044

2x
4211098

6x
6225494

1x
6221607

4x
6261374

2x
6349479

2x
6168776

2x
6435267

5x
6117972

2x
6359227

6x
6146321

2x
6123814

2x
4218696

4x
6047417

3x
6364352

2x
6015356

4x
4652259

4x
4211068

2x
4211104

8x
6118832

1x
6083620

2x
4211103

4x
4210686

2x
4629920

4

2x
4508553

1x
4211002

2x
4211107

1x
4211061

4x
4210794

2x
4210783

1x
4210796

1x
6490496



YOU COULD WIN



YOU COULD WIN

Your feedback will help shape the future development of this product series.

Visit:

DU KÖNNTEST GEWINNEN

Dein Feedback trägt zur Weiterentwicklung dieser Produktreihe bei.

Geh auf:

VOUS POURRIEZ GAGNER

Vos commentaires nous aideront à concevoir les futurs produits de cette gamme.

Visitez :

POTRESTI VINCERE TU

La tua opinione ci aiuterà a migliorare la creazione futura di questa linea di prodotti.

Visita:

PUEDES GANAR

Tu opinión contribuirá al futuro de esta serie de productos.

Visita:

轻松获奖

您的反馈将有助于我们在今后改进本产品系列。

请访问:

[LEGO.com/productfeedback](https://www.lego.com/productfeedback)

You also have the chance to win a LEGO® set.

Terms and conditions apply.*

Außerdem hast du die Chance, ein LEGO® Set zu gewinnen.

Es gelten die Teilnahmebedingungen.*

Vous pourriez également gagner un ensemble LEGO®.

Des conditions s'appliquent.*

Hai anche la possibilità di vincere un set LEGO®.

Termini e condizioni sono applicabili.*

También tienes la oportunidad de ganar un set LEGO®.

Aplican términos y condiciones.*

您还有机会赢取乐高®套装。

条款和条件适用。*

*[LEGO.com/productfeedback-terms](https://www.lego.com/productfeedback-terms)



LEGO and the LEGO logo are trademarks of the LEGO Group. ©2024 The LEGO Group.
The "Lamborghini" and "Lamborghini Bull and Shield" trademarks, copyrights, designs and models are used under license from Automobili Lamborghini S.p.A, Italy.