



10337





LEGO.com/sustainable-packaging



FR
DONNEZ
OU
RECYCLEZ



OU



OU



ASSOCIATION MAGASIN DÉCHÈTERIE

Adresses sur quefairedemesdechets.fr



BUILDER



Apple and the Apple logo are trademarks of Apple Inc., registered in the U.S. and other countries and regions. App Store is a service mark of Apple Inc. Google Play and the Google Play logo are trademarks of Google LLC. Tencent and the Tencent logo are trademarks of Tencent Inc.

LEGO.com/devicecheck



LEGO® Builder

LAMBORGHINI



Perfekte Proportionen



Du hast die 1980er-Jahre als Teenager erlebt? Dann würdest du die Silhouette des Lamborghini Countach schon aus einem Kilometer Entfernung erkennen. Dann hast du vermutlich auch noch irgendwo ein Poster des Flitzers aufgehoben oder vielleicht sogar bei dir im Büro hängen. Die Geschichte des legendären Autos reicht mittlerweile mehr als 50 Jahre zurück. 1971 wurde der erste Prototyp des LP500 enthüllt. Und wirklich alles am Countach gilt bis heute als revolutionär. Die markante niedrige Silhouette, die scharfen Kanten, die Scherentüren und der brüllende V12-Motor haben den Countach zum Aushängeschild der 1980er-Jahre gemacht. Bis weit in die 1990er-Jahre war er der Inbegriff eines Supersportwagens. Sein bahnbrechend futuristisches Design entsprach dem Zeitgeist und passte perfekt in die damalige Popkultur. Doch genau wie ein klassisches Kunstwerk versprüht er einen zeitlosen Zauber. Seine Geschichte, seine Form und seine hellen Farben machen ihn zu einem unumstrittenen Kandidaten für die LEGO® Icons Reihe.

Die Evolution des Lamborghini Countach

Im Laufe der Jahrzehnte hat sich der Lamborghini Countach in puncto innovativer Technologie und Style immer weiter entwickelt. Dieses LEGO® Modell ist dem Lamborghini Countach 5000 Quattrovalvole (1985-1988) nachempfunden. Manche Elemente sind jedoch auch eine Hommage an seine erlesenen Vorgänger.



1971 LP500

Dieser auf dem Genfer Autosalon enthüllte Prototyp war das Fundament für alle künftigen Ausführungen.



1973 COUNTACH LP400

Die mit dem Prototyp gewonnenen Erkenntnisse flossen in den LP400 ein, der entsprechend modifiziert und zum ersten Serienmodell des Countach wurde.



1978 COUNTACH LP400 S

Das Außendesign wurde überarbeitet und umfasste unter anderem neue verbreiterte Radläufe und einen optionalen V-förmigen Heckflügel.



1983 COUNTACH LP500 S

Das Außendesign blieb zwar weitgehend unverändert, doch das Interieur wurde aufgemotzt. Und ein leistungsstärkerer Motor sorgte für eine bessere Performance.



1985 COUNTACH 5000 QUATTROVALVOLE

Der sowohl in den USA als auch in Europa meistverkaufte Lamborghini Countach war ein echtes Juwel, das jeder Supersportwagenfan beehrte.



2021 COUNTACH LPI 800-4

Zum 50-jährigen Jubiläum des Countach kam dieses Hybrid-Elektromodell in limitierter Auflage heraus.

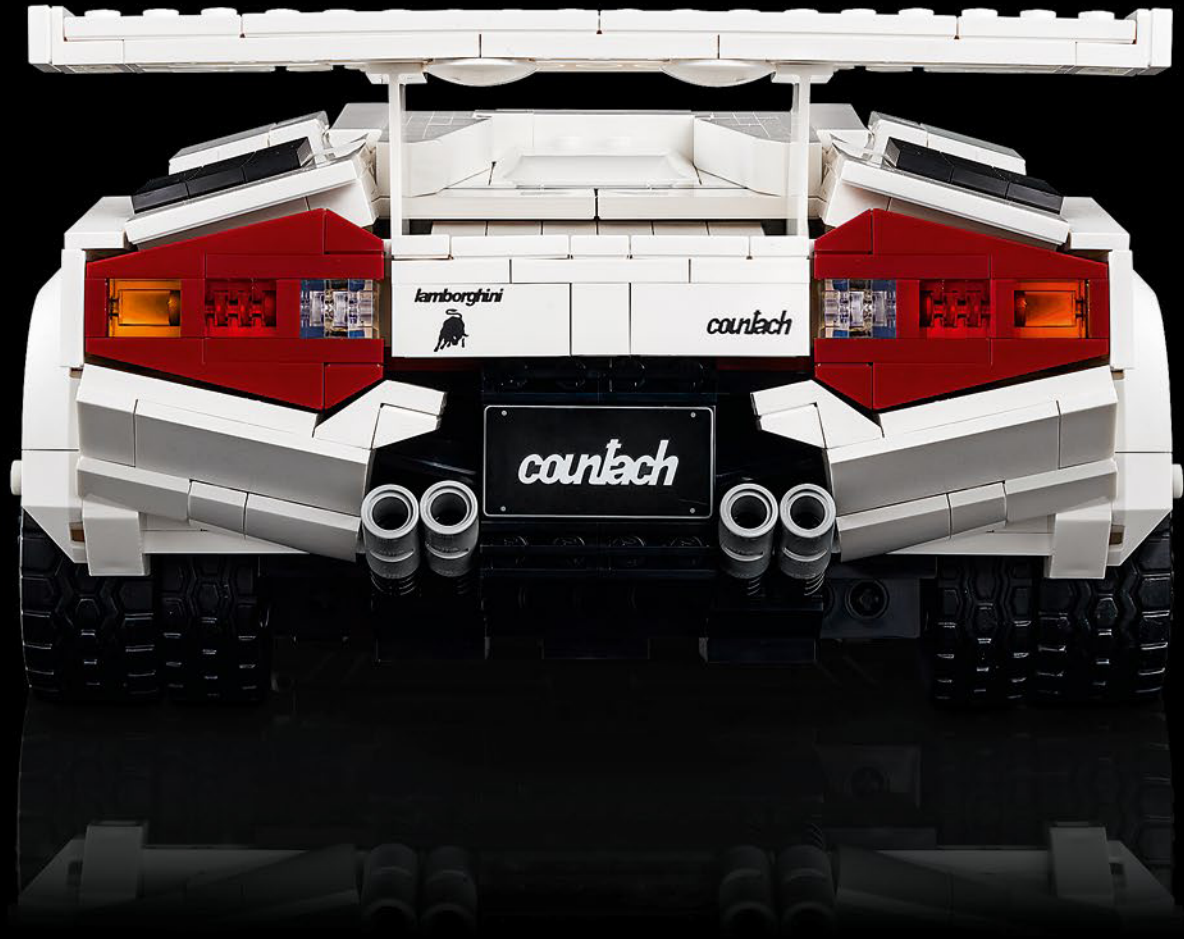



Anmerkungen des LEGO® Designteams

„Die magische Aura, die den Lamborghini Countach umgibt, fasziniert Autoliebhaber bis heute. Deshalb schreit das Auto förmlich danach, als LEGO® Modell nachgebildet zu werden. Am besten lassen sich mit LEGO Elementen natürlich gerade Linien nachbilden. Flache Winkel stellen uns mit unserem Bausystem dagegen vor richtig knifflige Herausforderungen. Deshalb haben wir für dieses Modell einige neue Elemente und komplexere Bautechniken entwickelt, darunter auch die legendären Deep-Dish-Felgen und die breiten Radläufe, um die typischen subtilen Winkel, Formen und Proportionen dieses futuristischen italienischen Designs richtig hinzubekommen. Dank der anregenden Zusammenarbeit mit Automobili Lamborghini S.p.A. konnten wir dieses Modell in LEGO Form zum Leben erwecken – inklusive funktionierender Lenkung. Und die Türen und die Motorhaube kann man natürlich aufklappen.“

SVEN FRANIC,
LEGO® Senior Model Designer

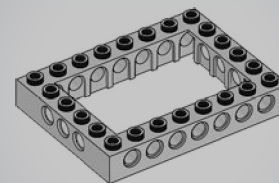
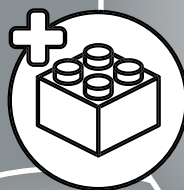
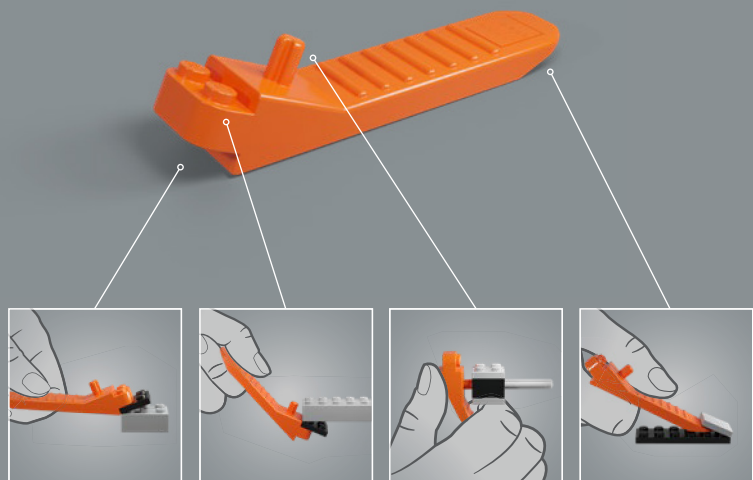

4x



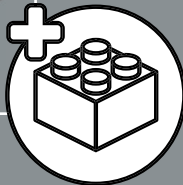
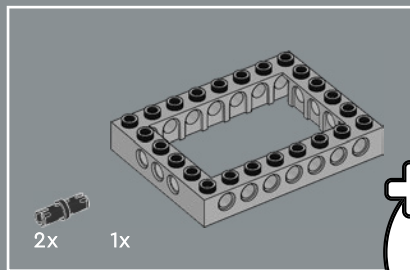

1

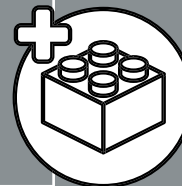
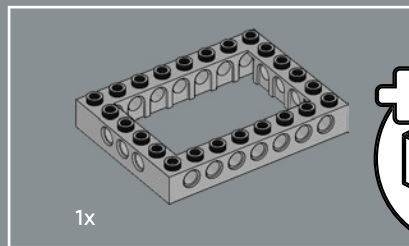
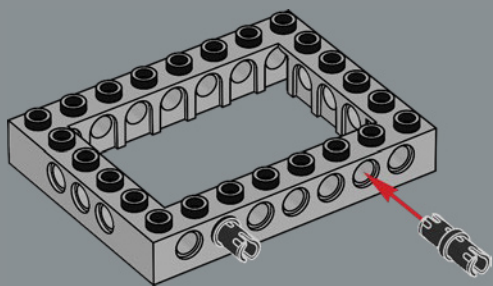

2

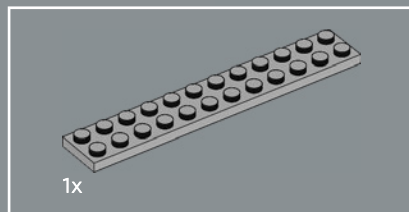
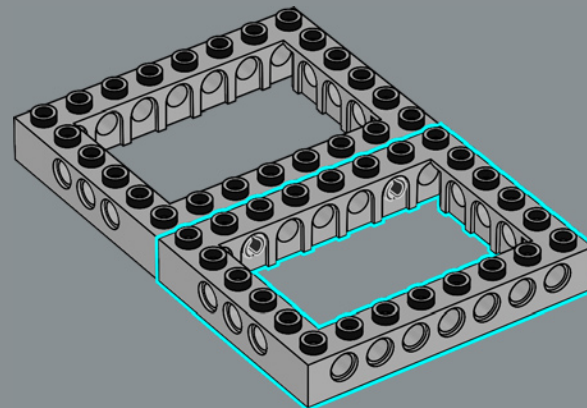

3

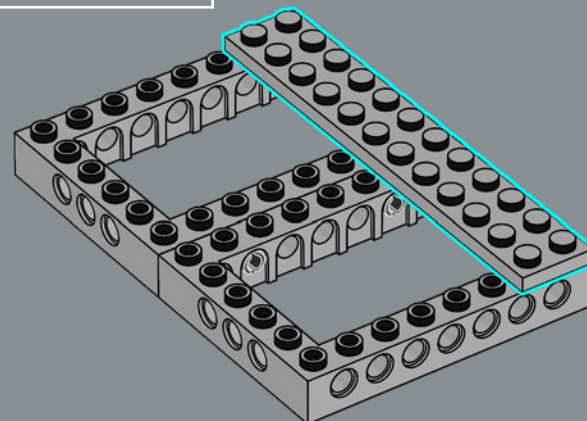

6x

4

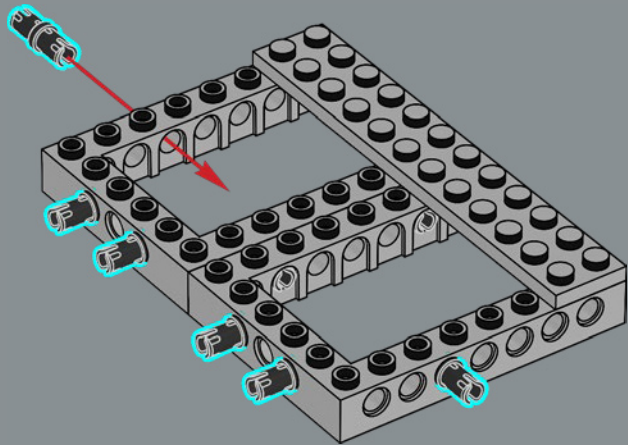

1x

2x

5

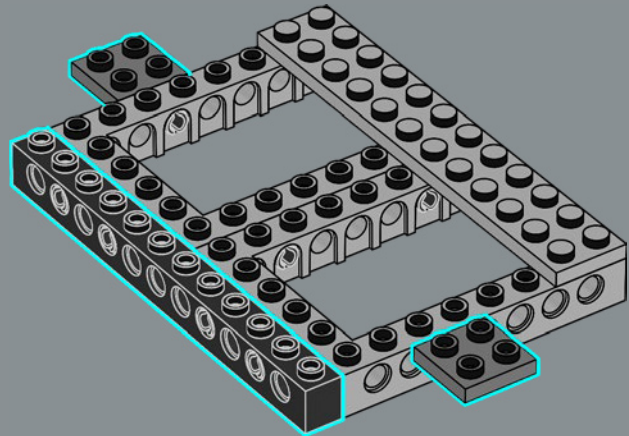

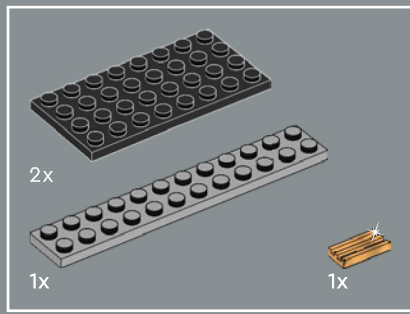

6

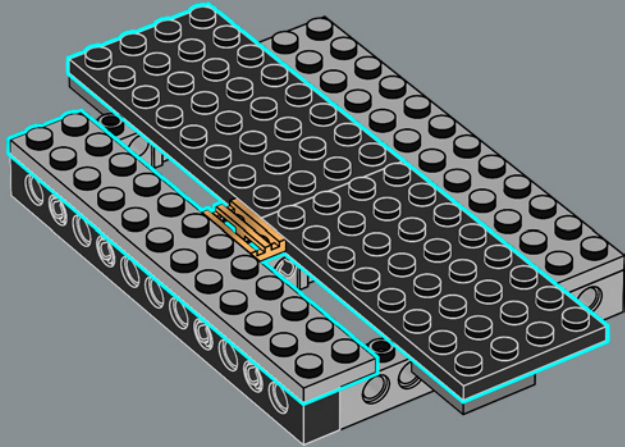

7

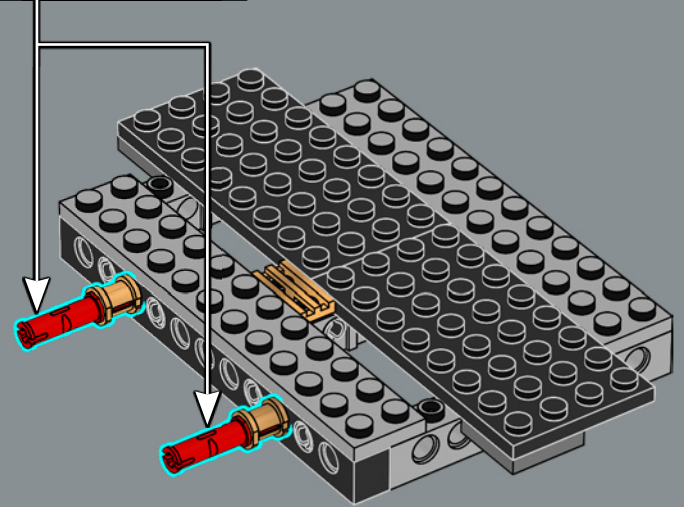
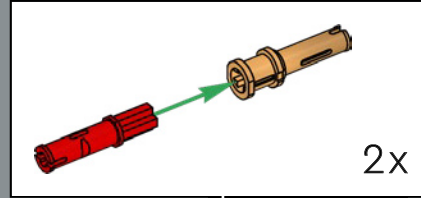

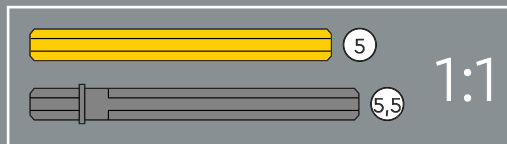
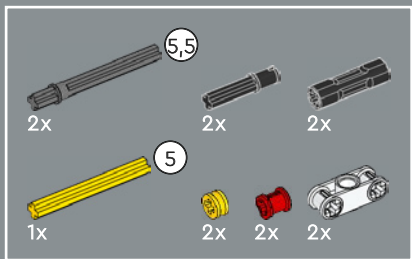

8

1

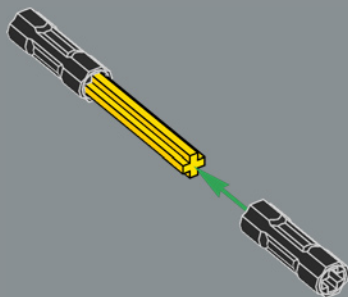

2

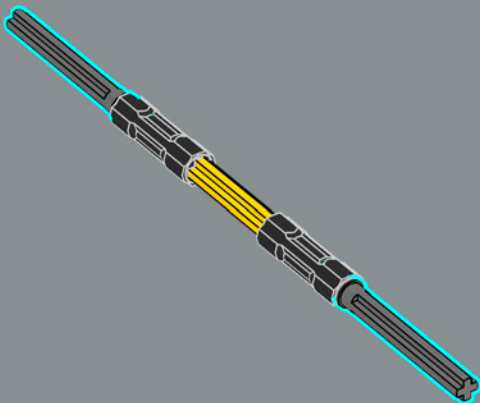

3

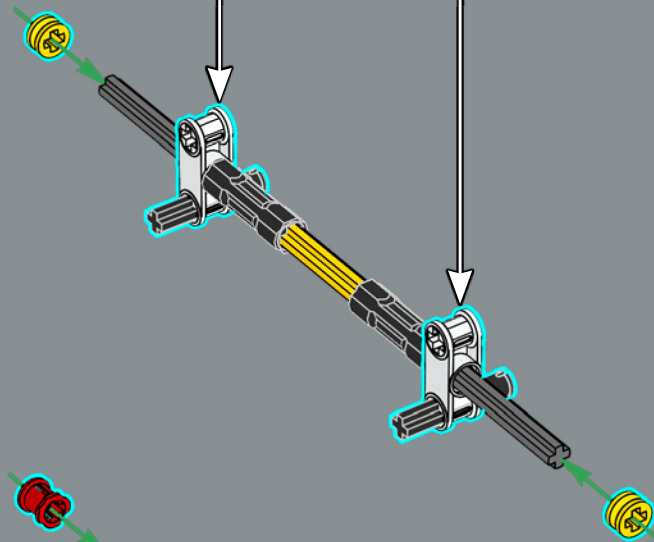

4

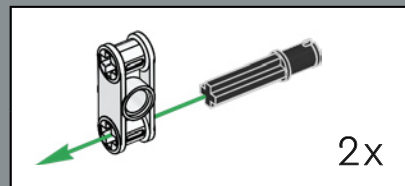
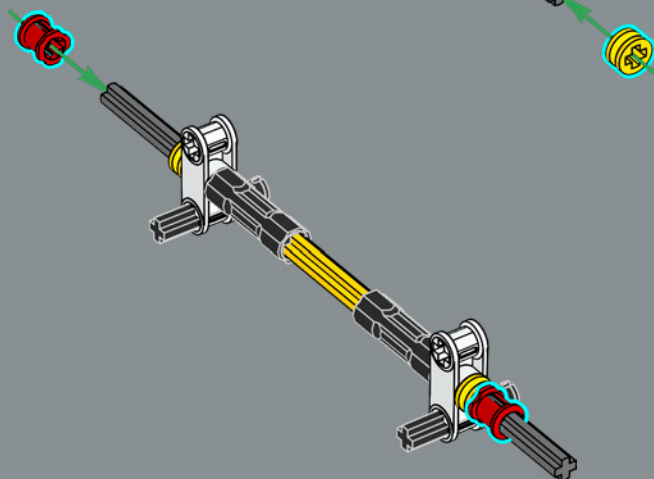

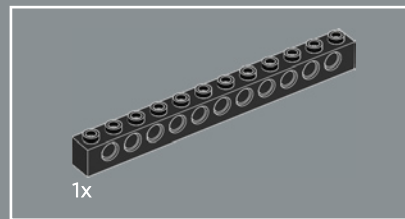
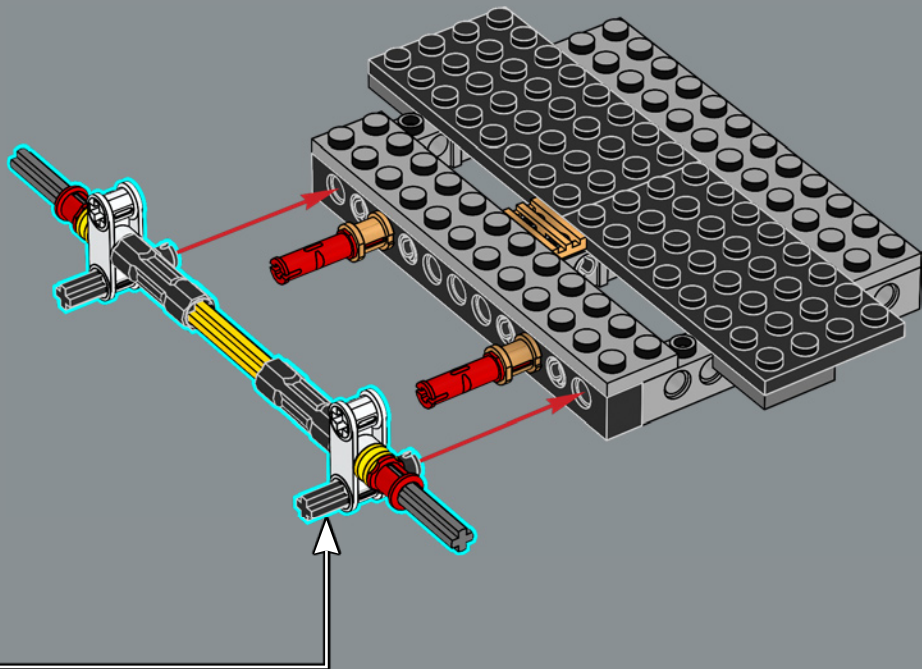

9

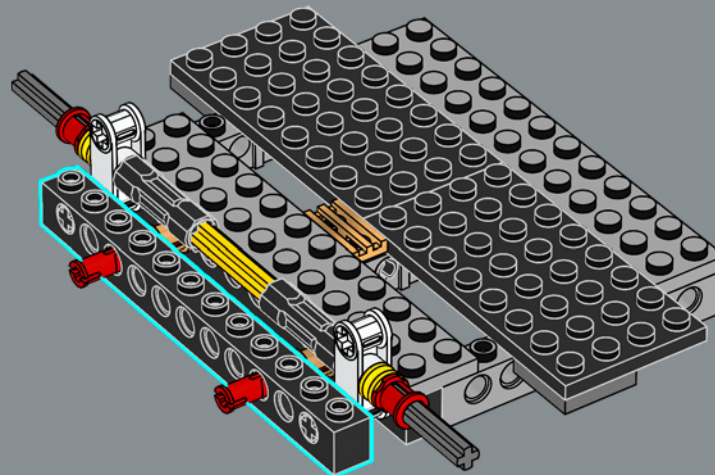



10

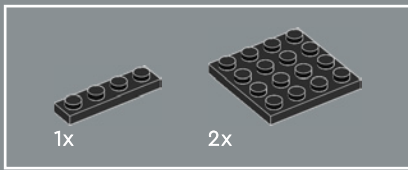
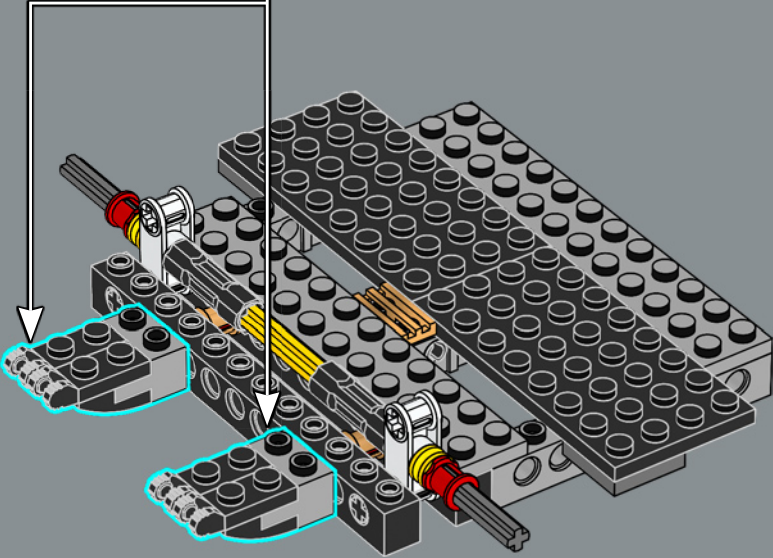
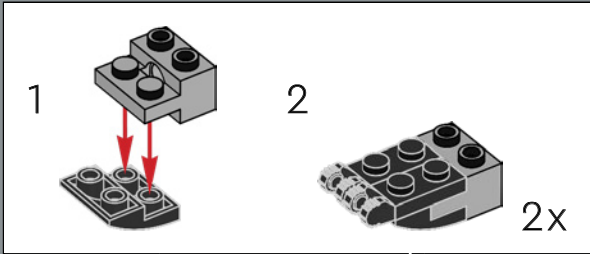

11

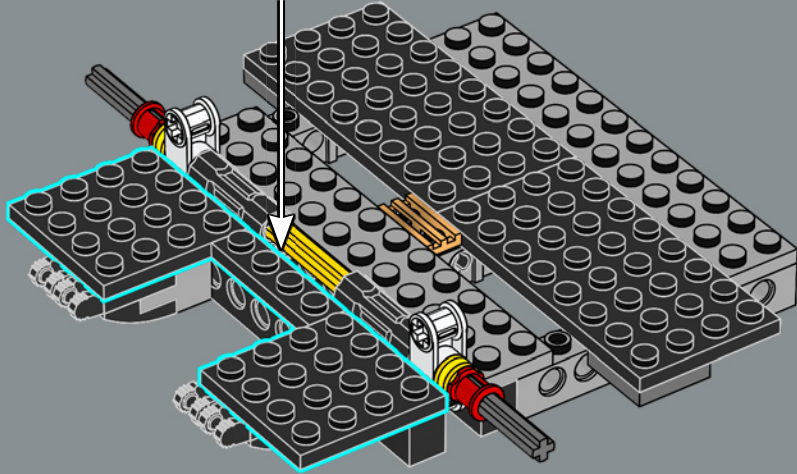
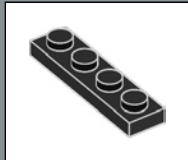

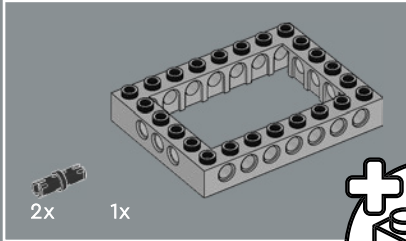
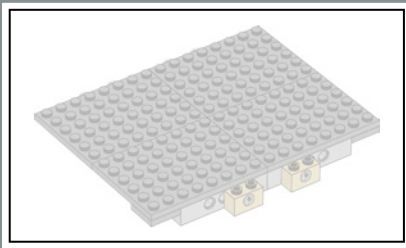

12

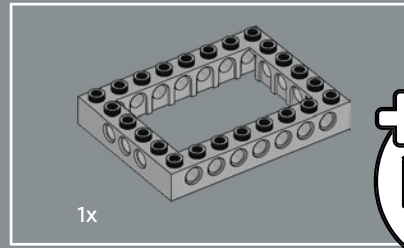
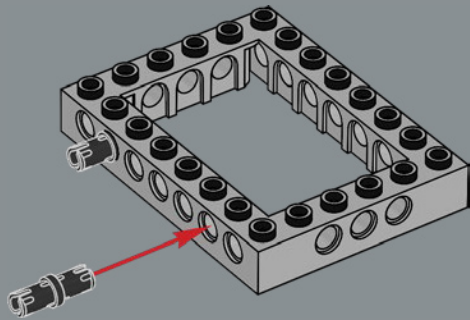
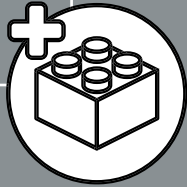

13

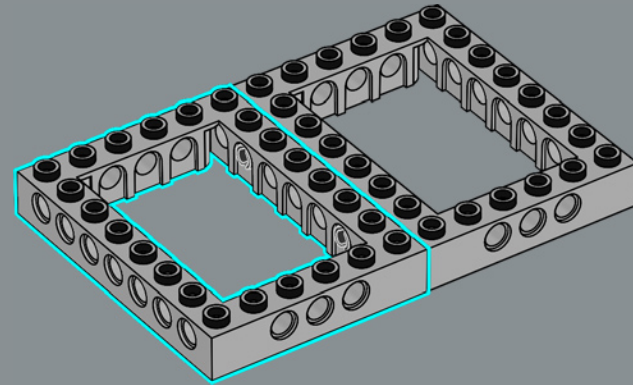
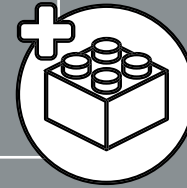

14

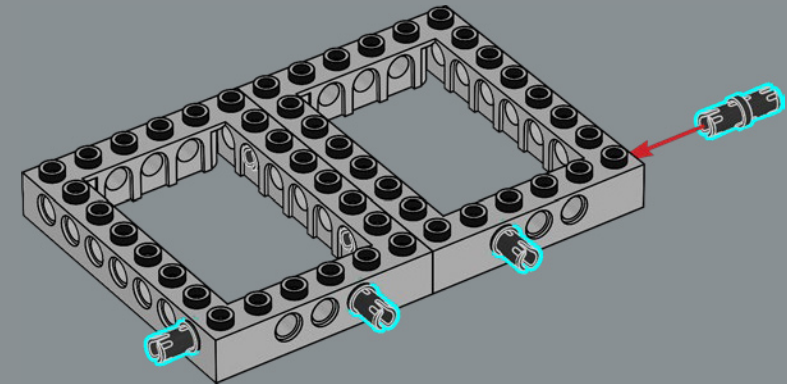

4x

15

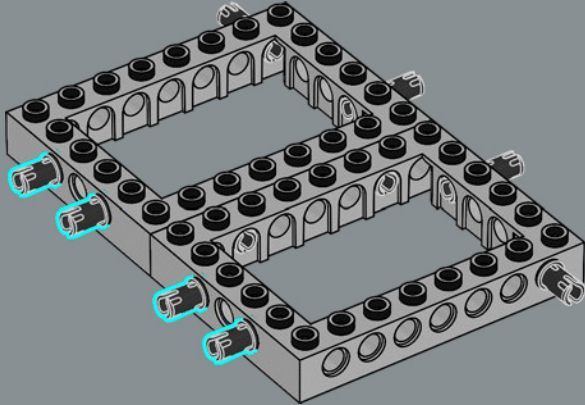

2x

16

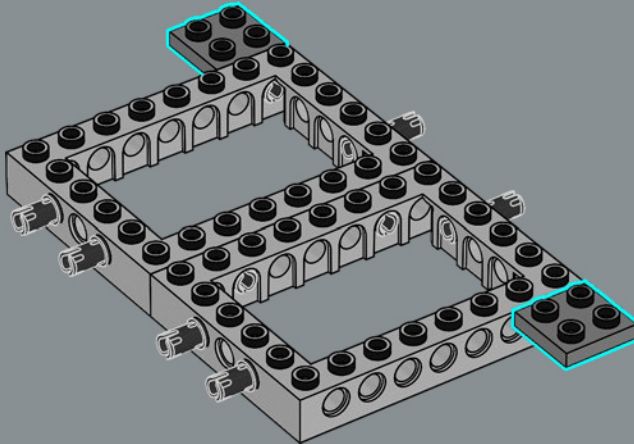

2x

17

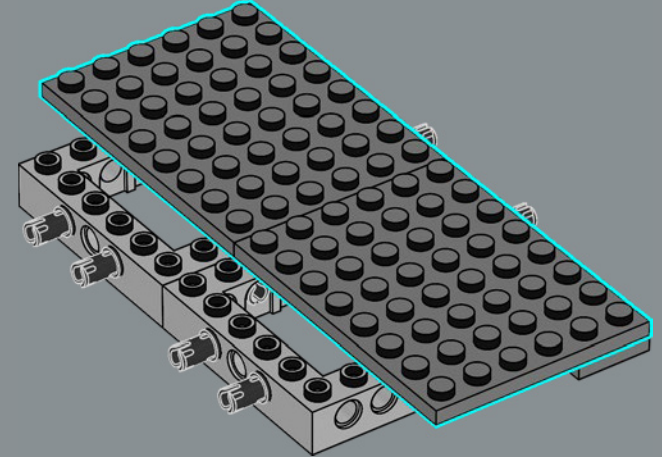

2x

18

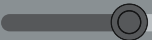
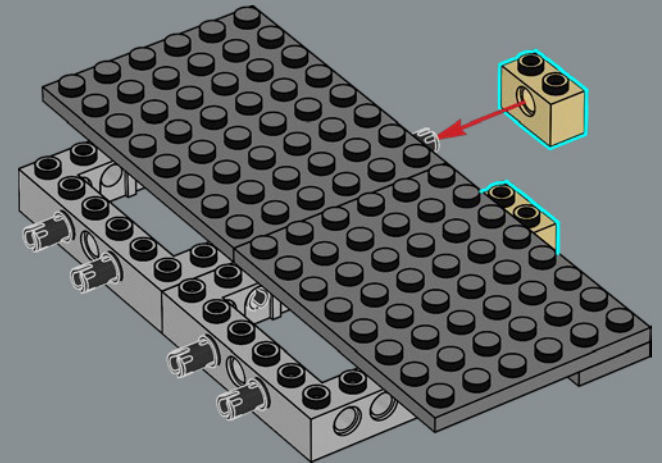

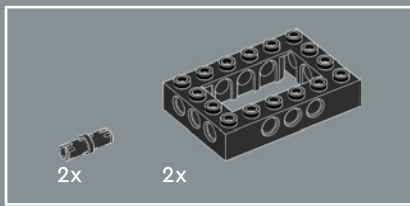

19

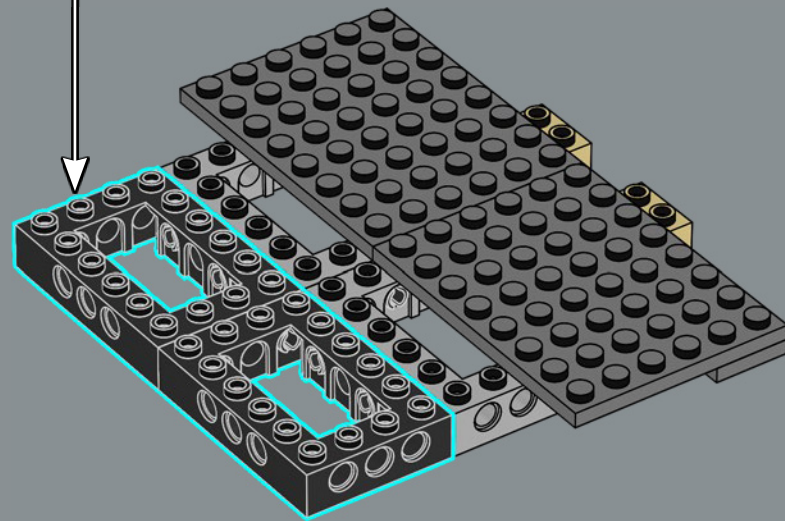
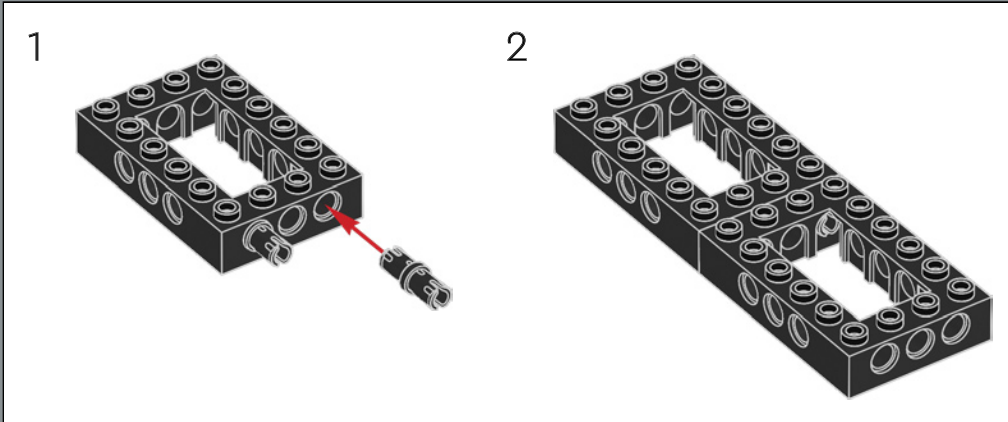

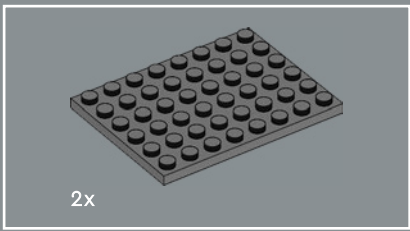

20

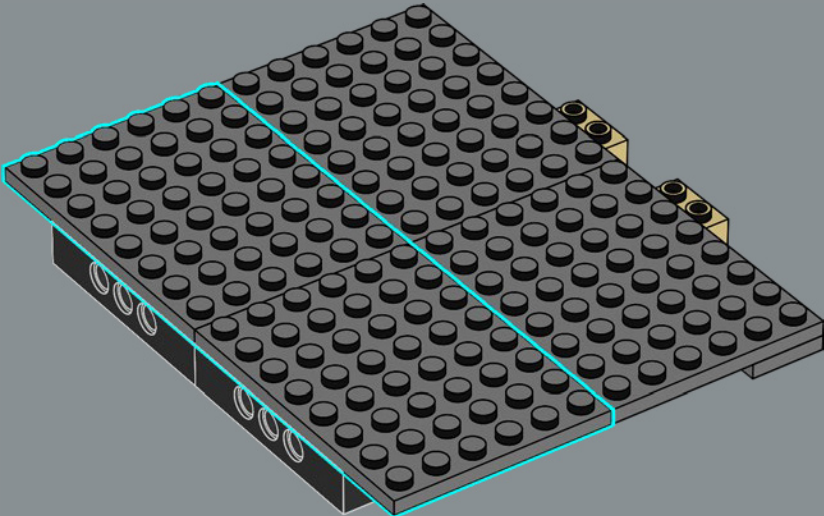

21

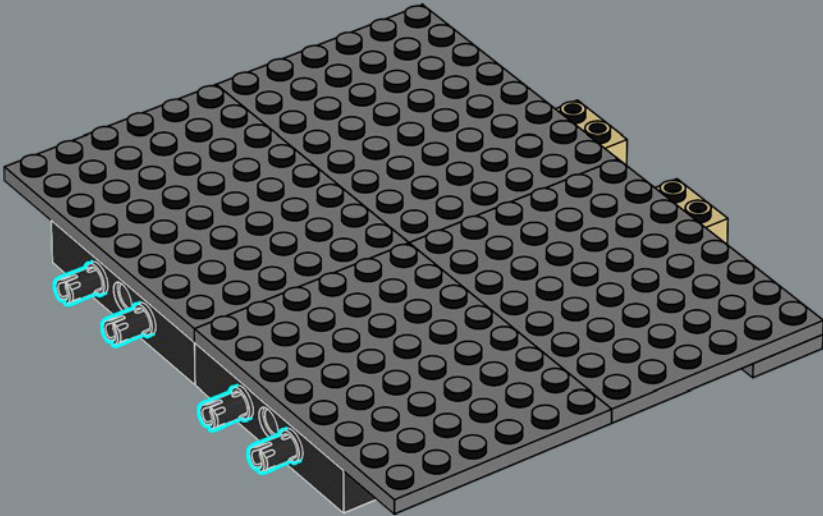



Der Lamborghini Countach hatte unvergessliche Auftritte in TV-Serien und großen Kinoerfolgen in den 1980er-Jahren.

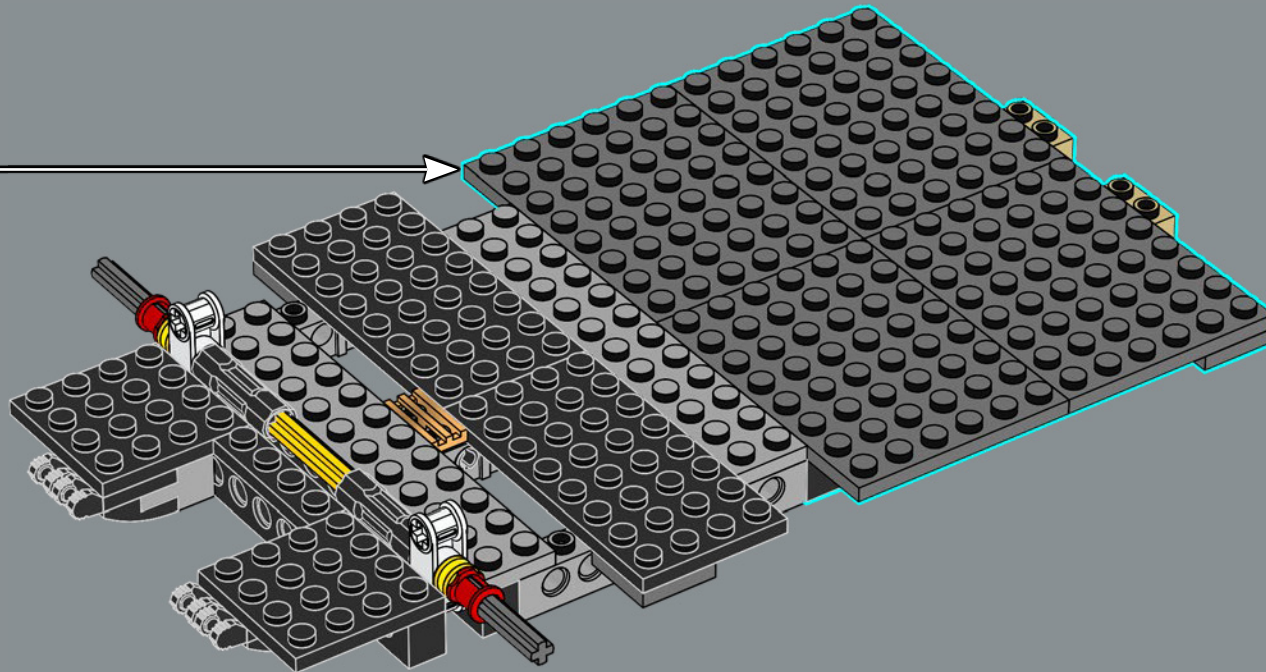

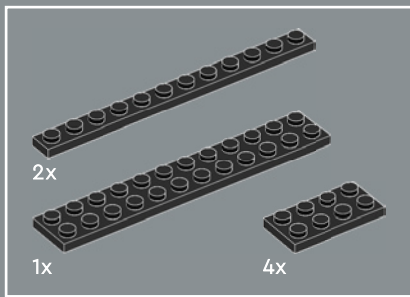

23

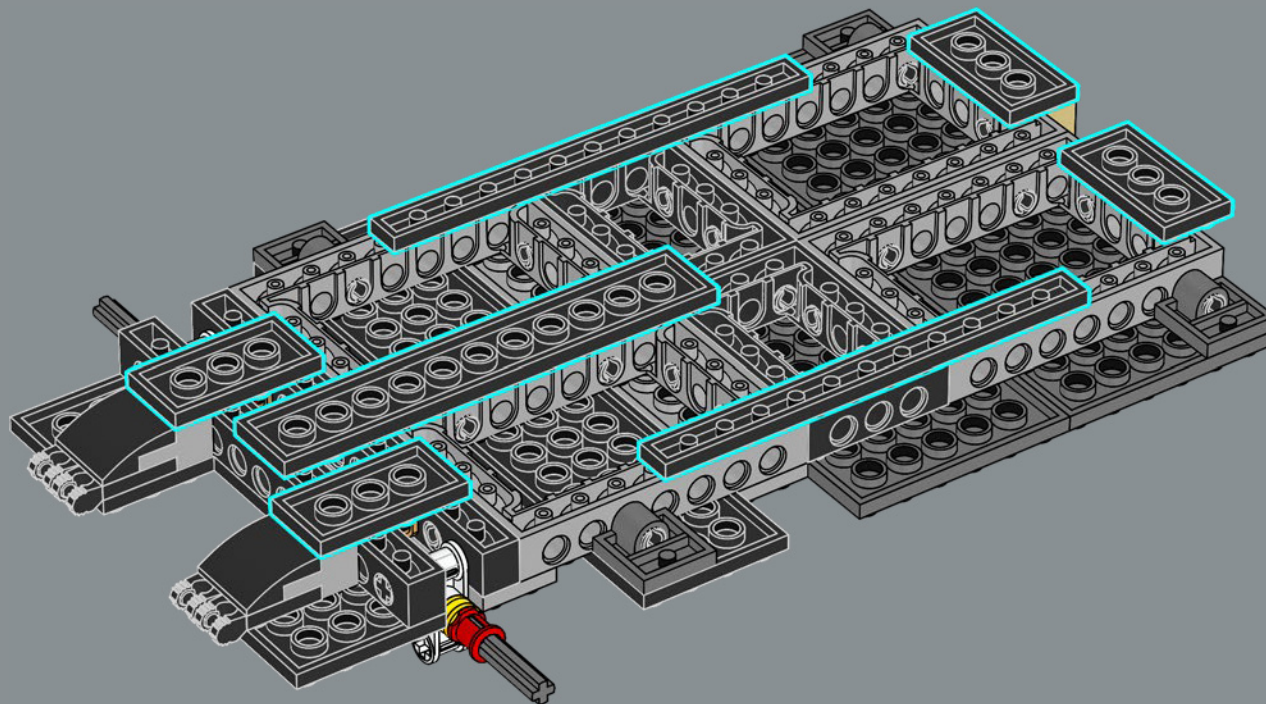

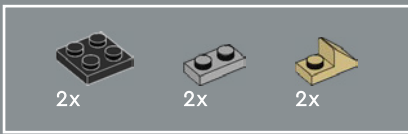

24

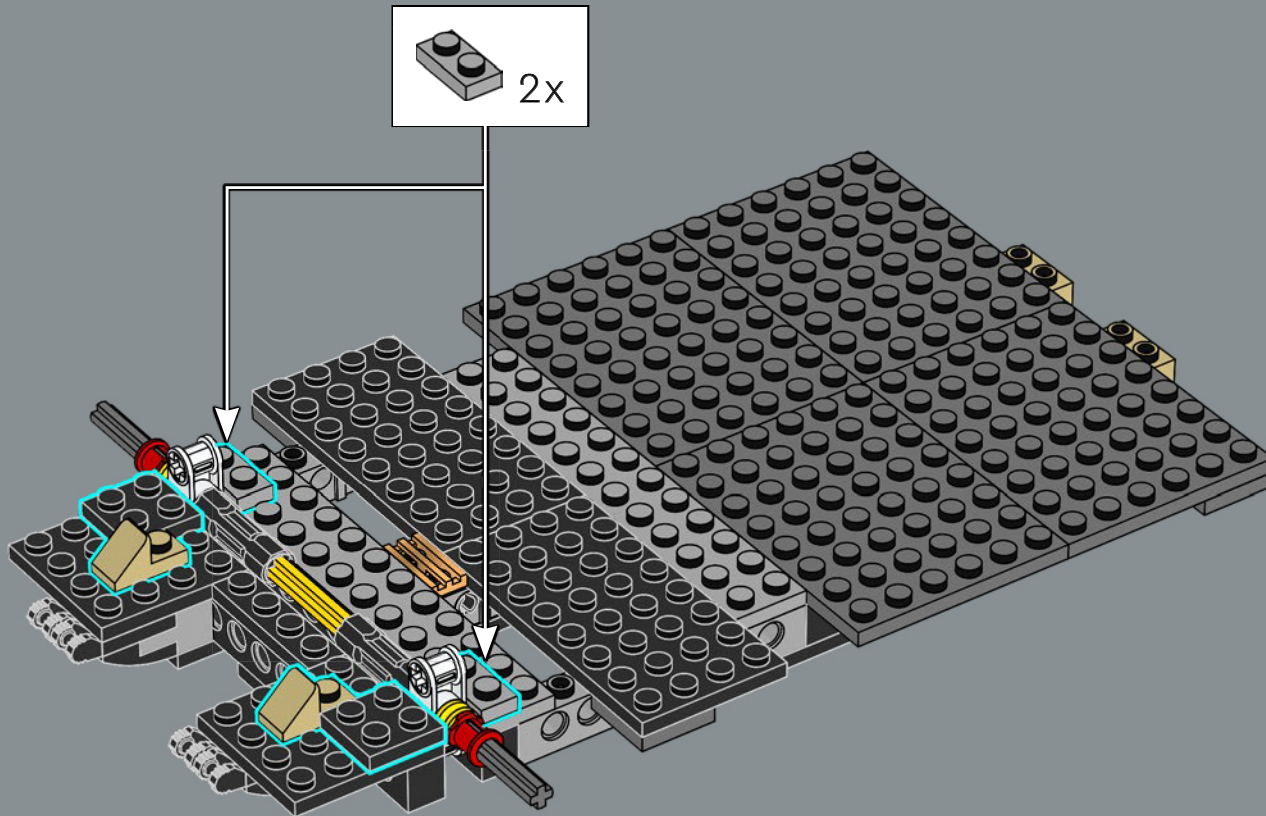

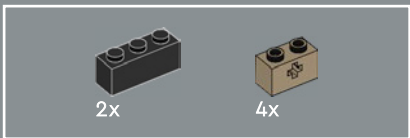

25

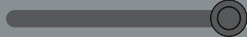
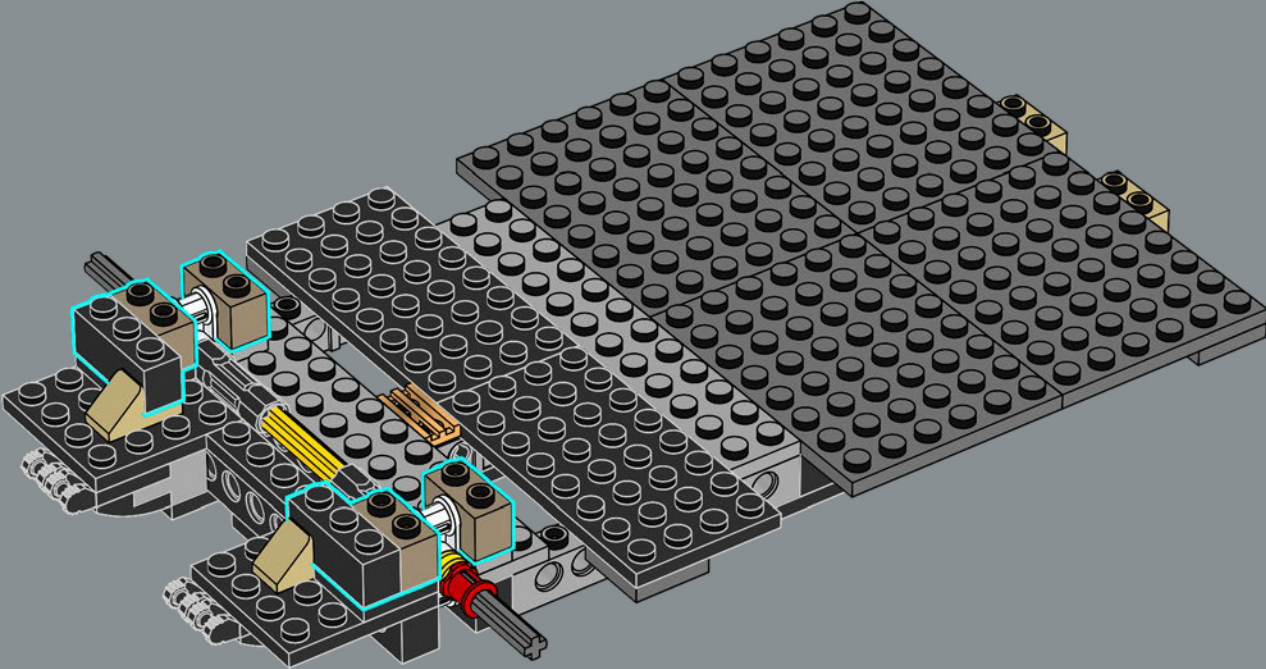

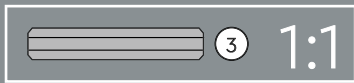
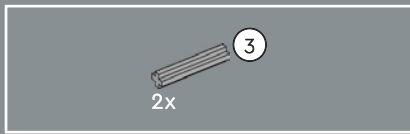

26

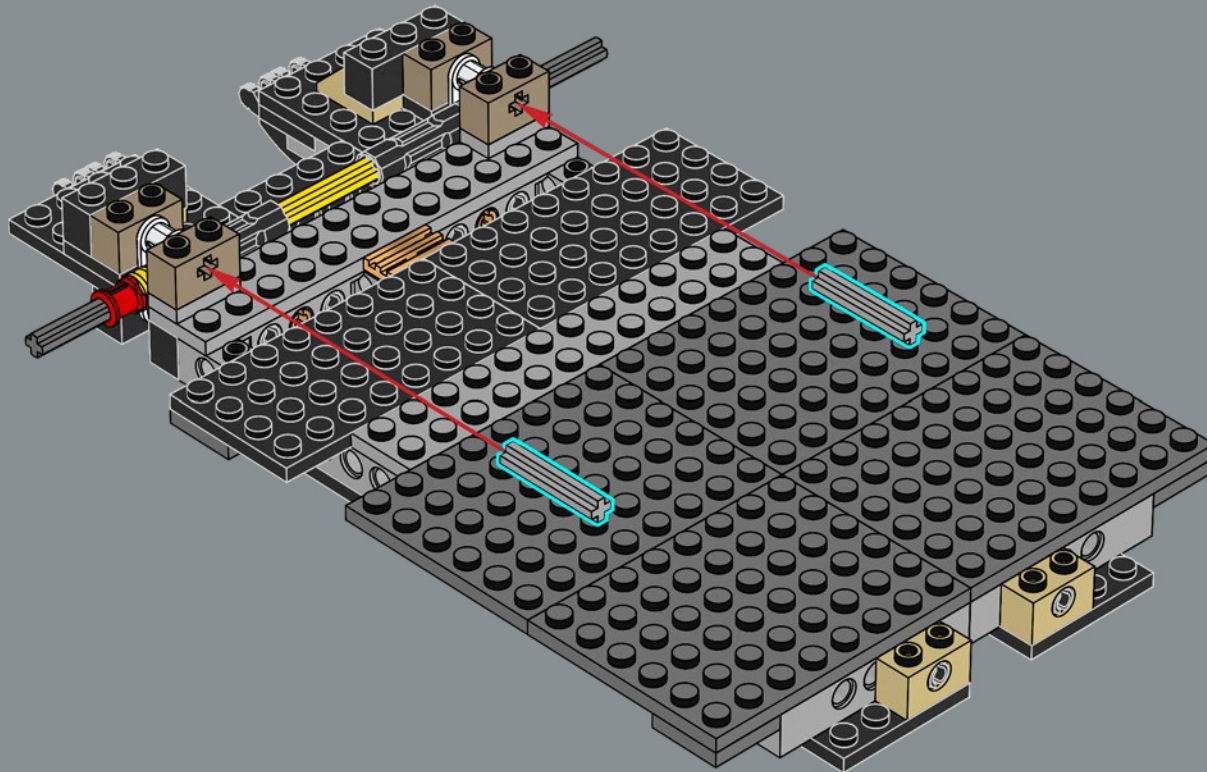

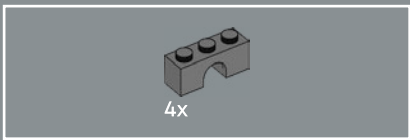

27

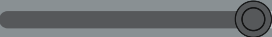
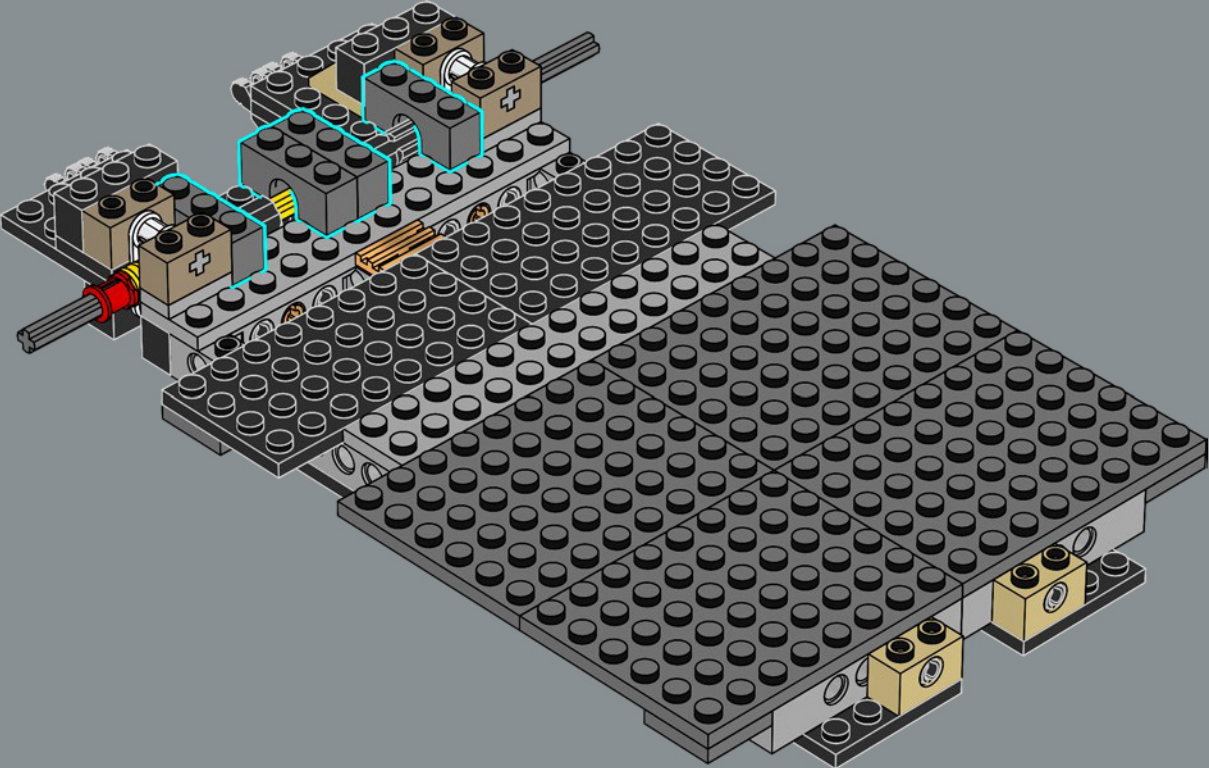

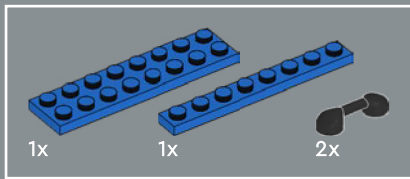

28

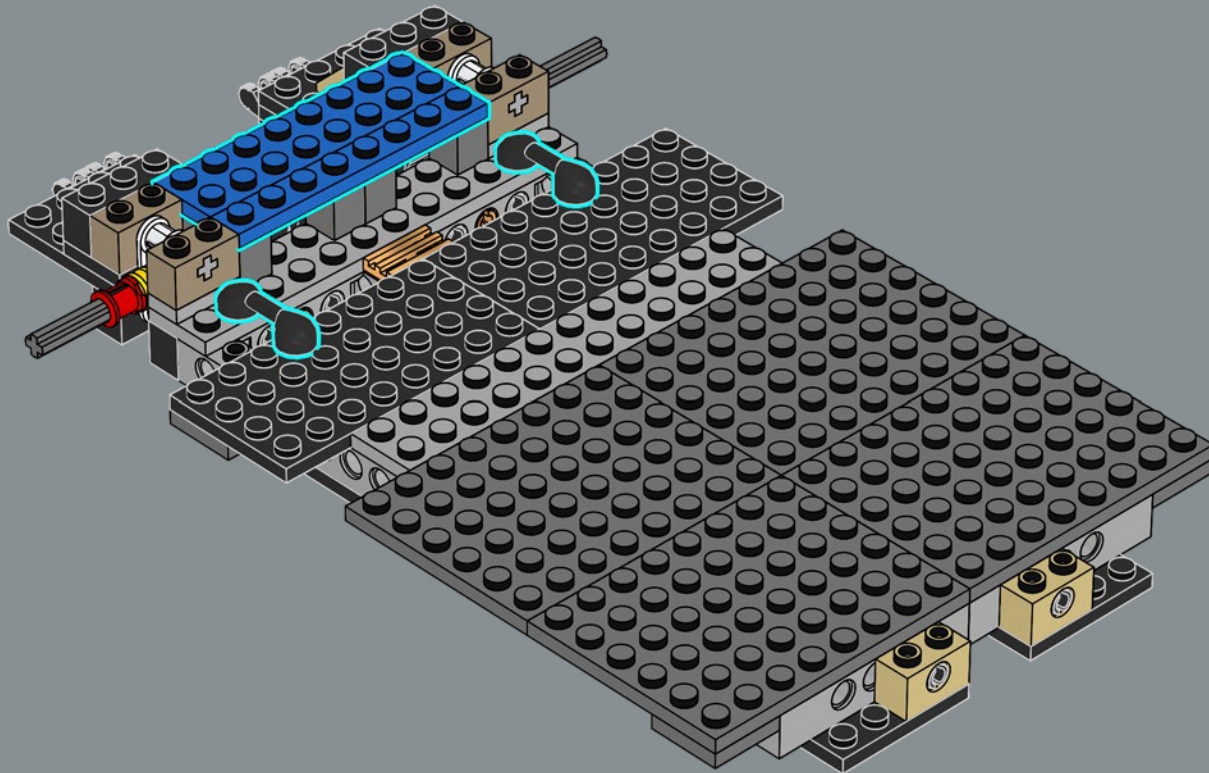

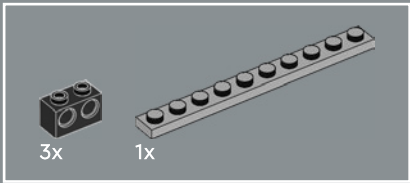

29

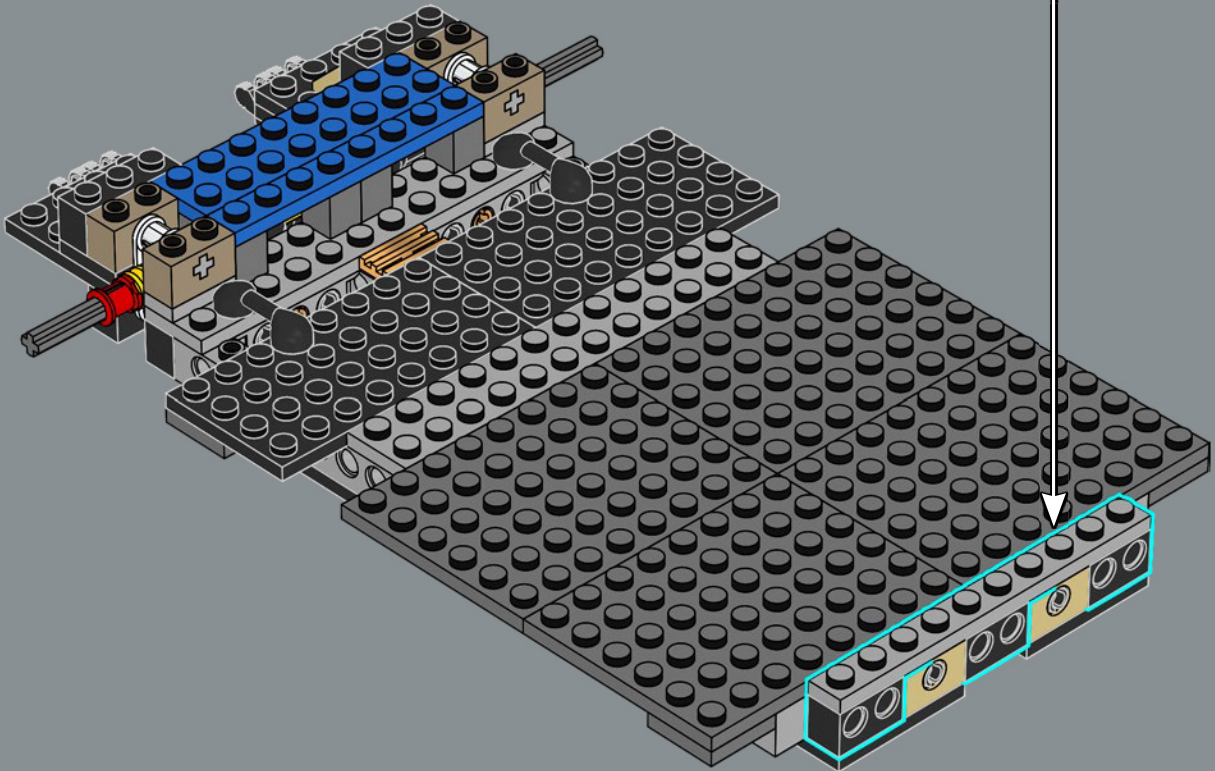
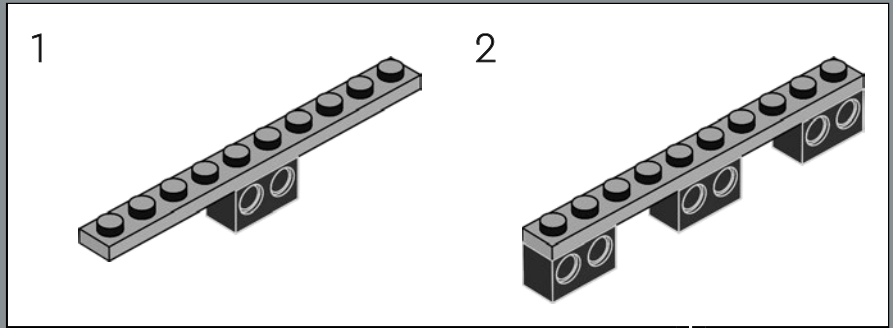

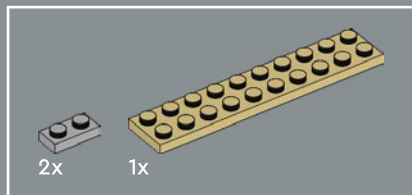

30

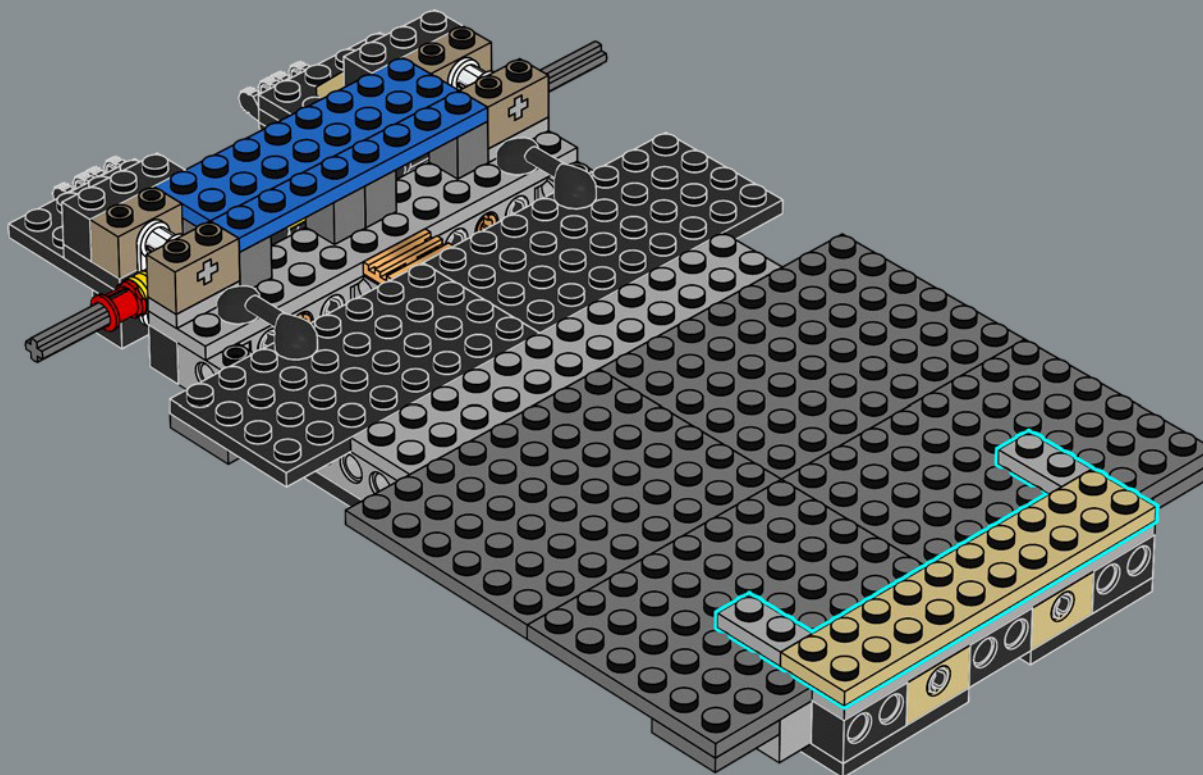

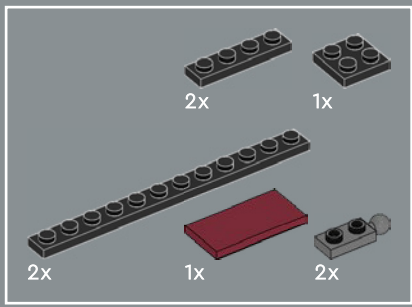

31

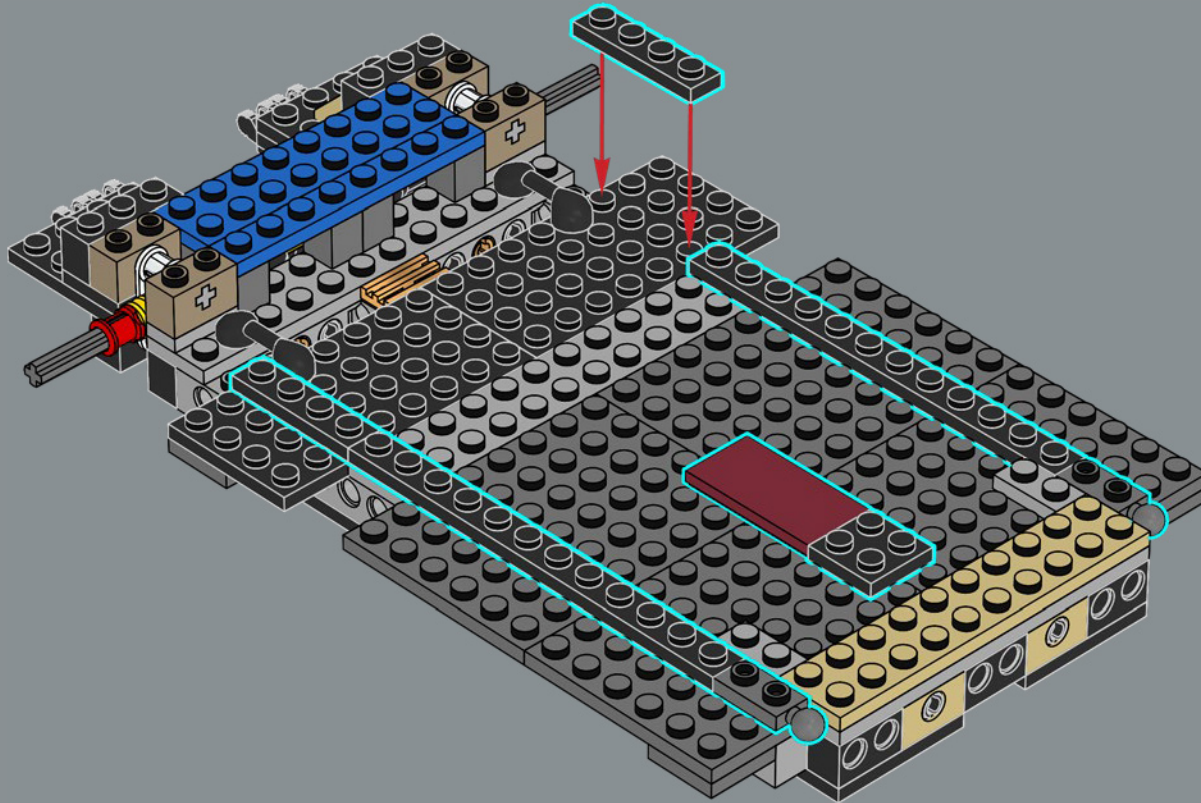

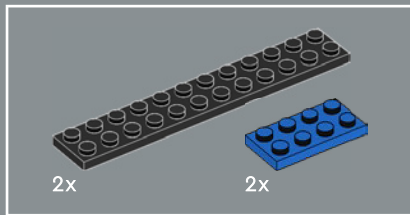

32

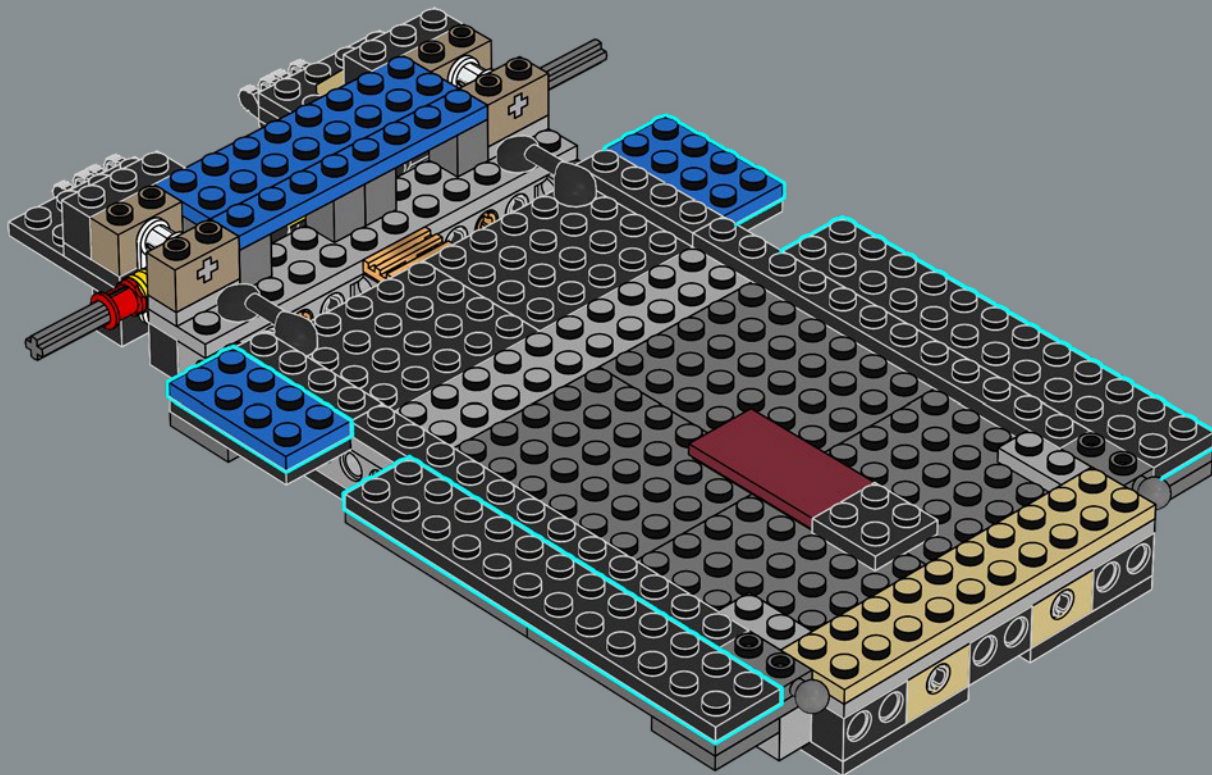

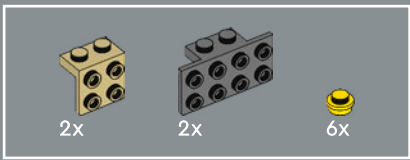

33

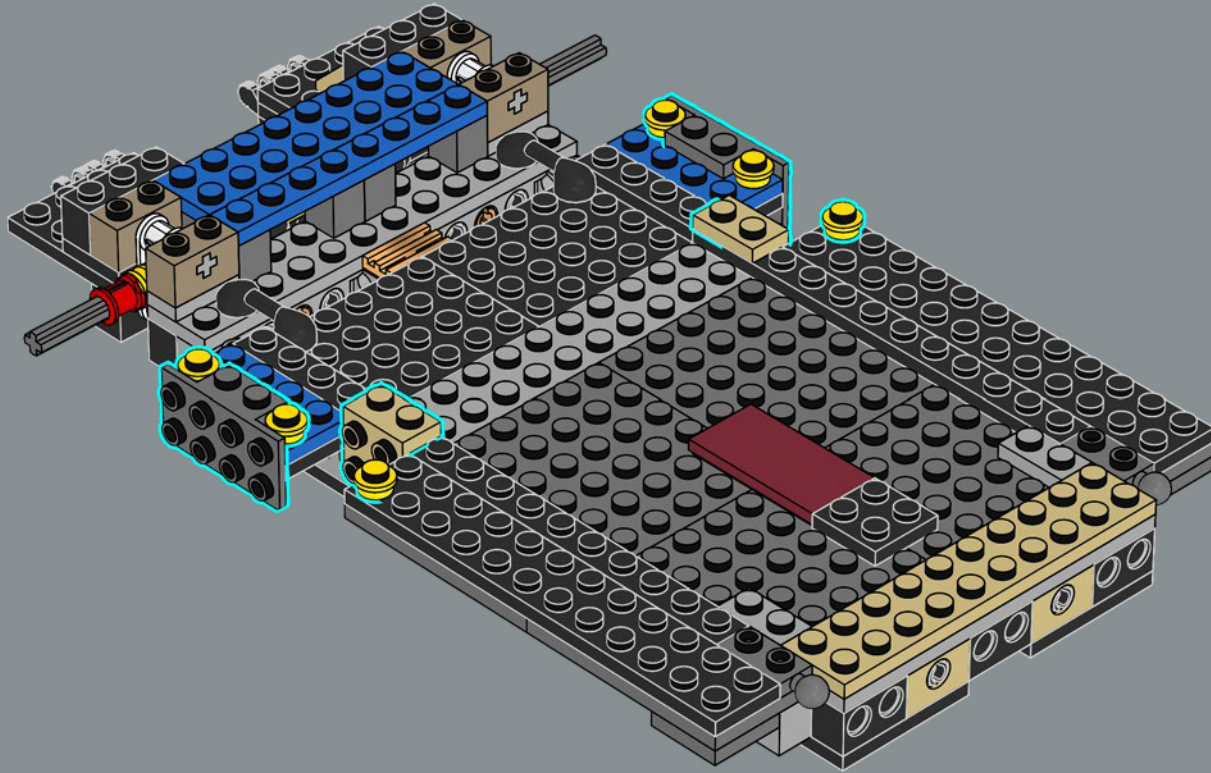

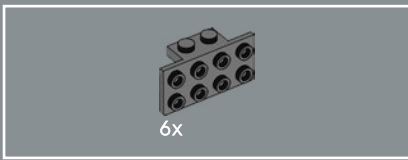

Das Design des ursprünglichen
Lamborghini Countach stammte von
Carrozzeria Bertone.

34

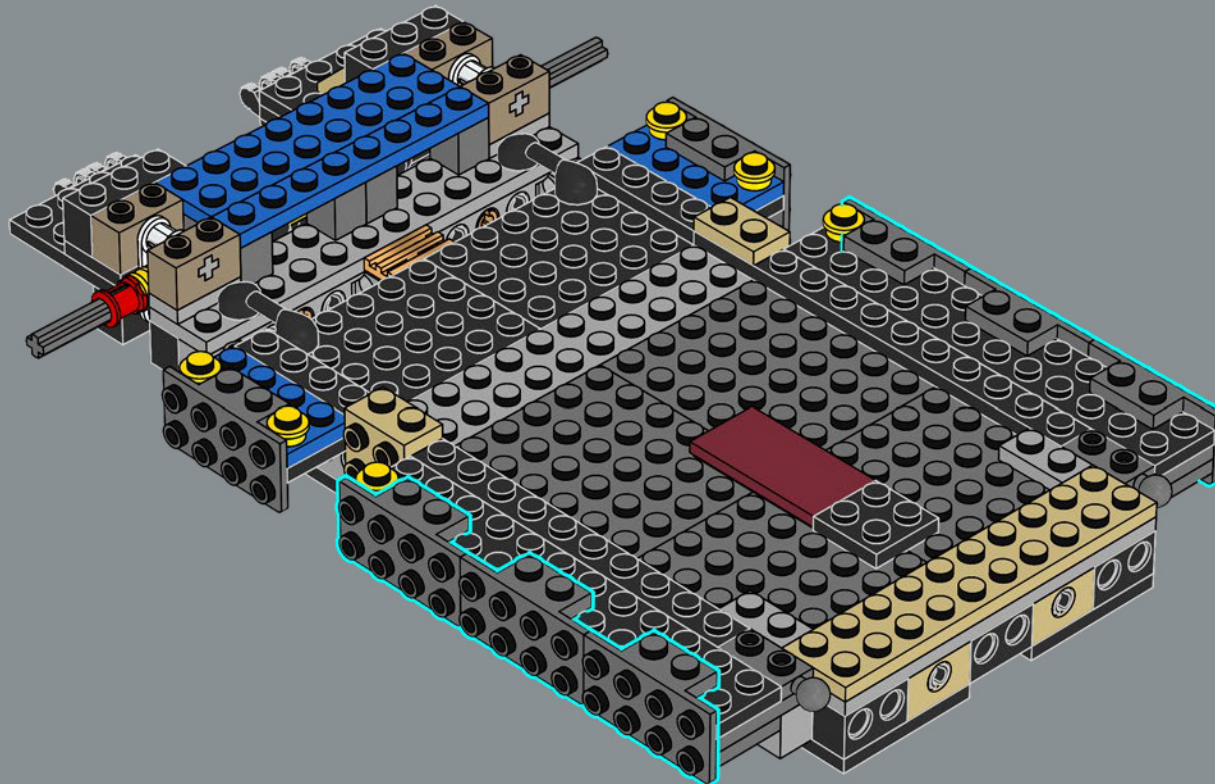

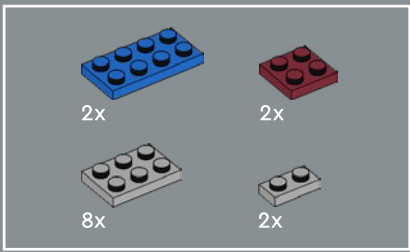

35

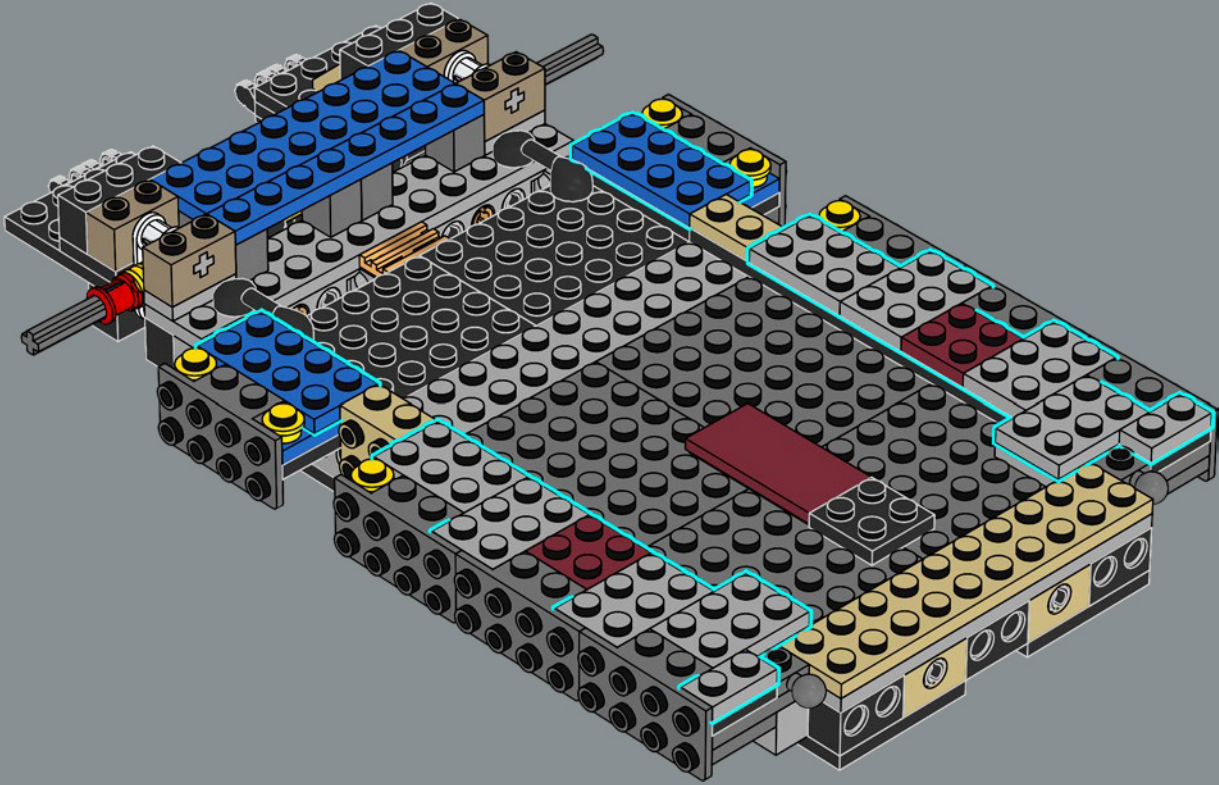

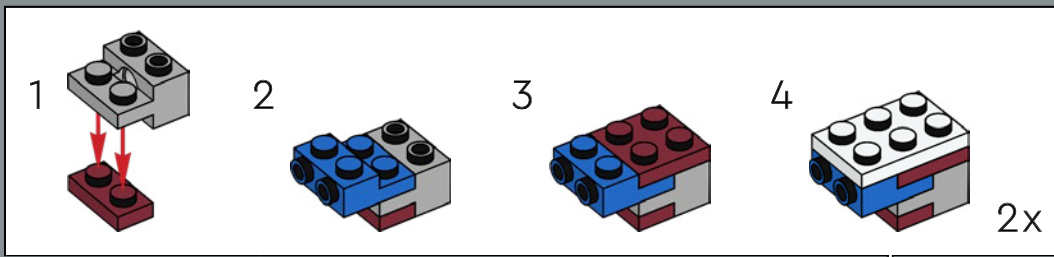
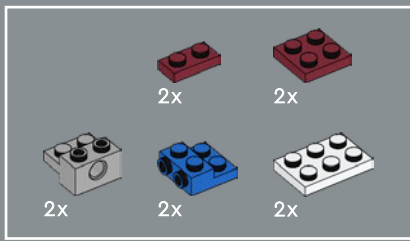

36

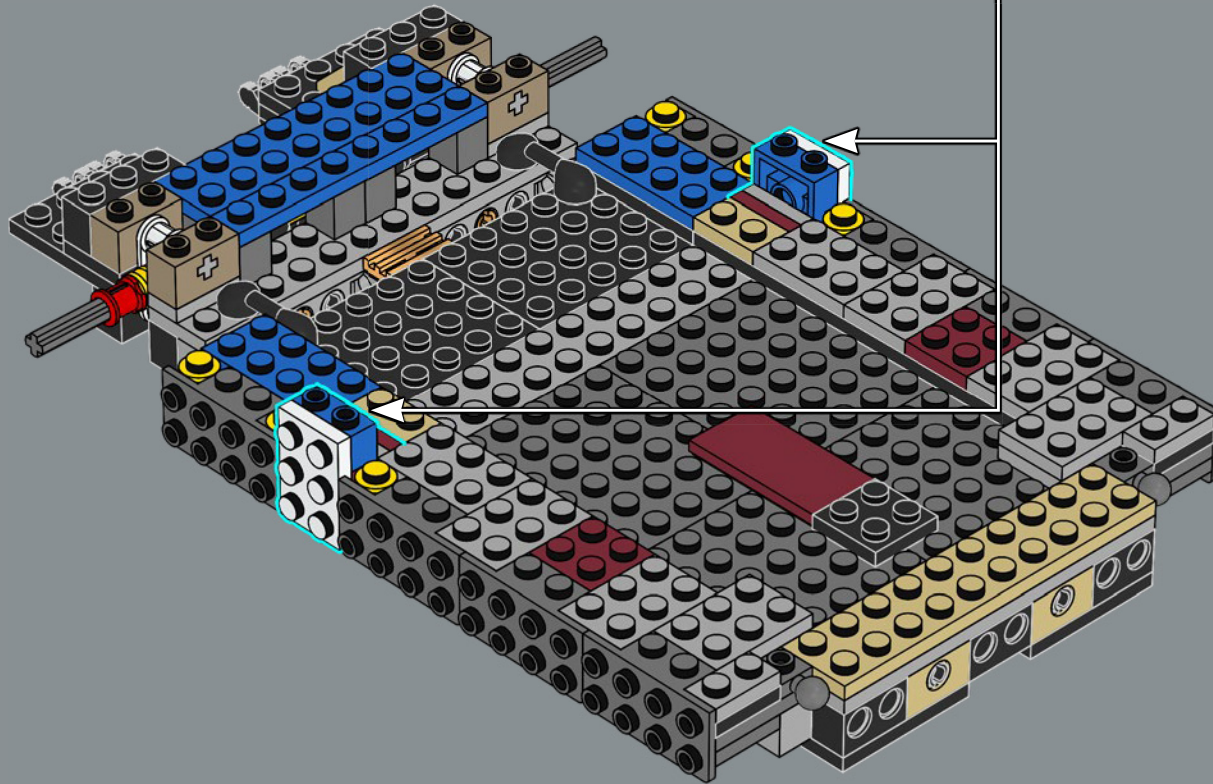

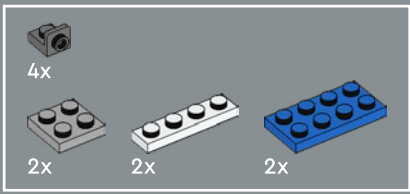

37

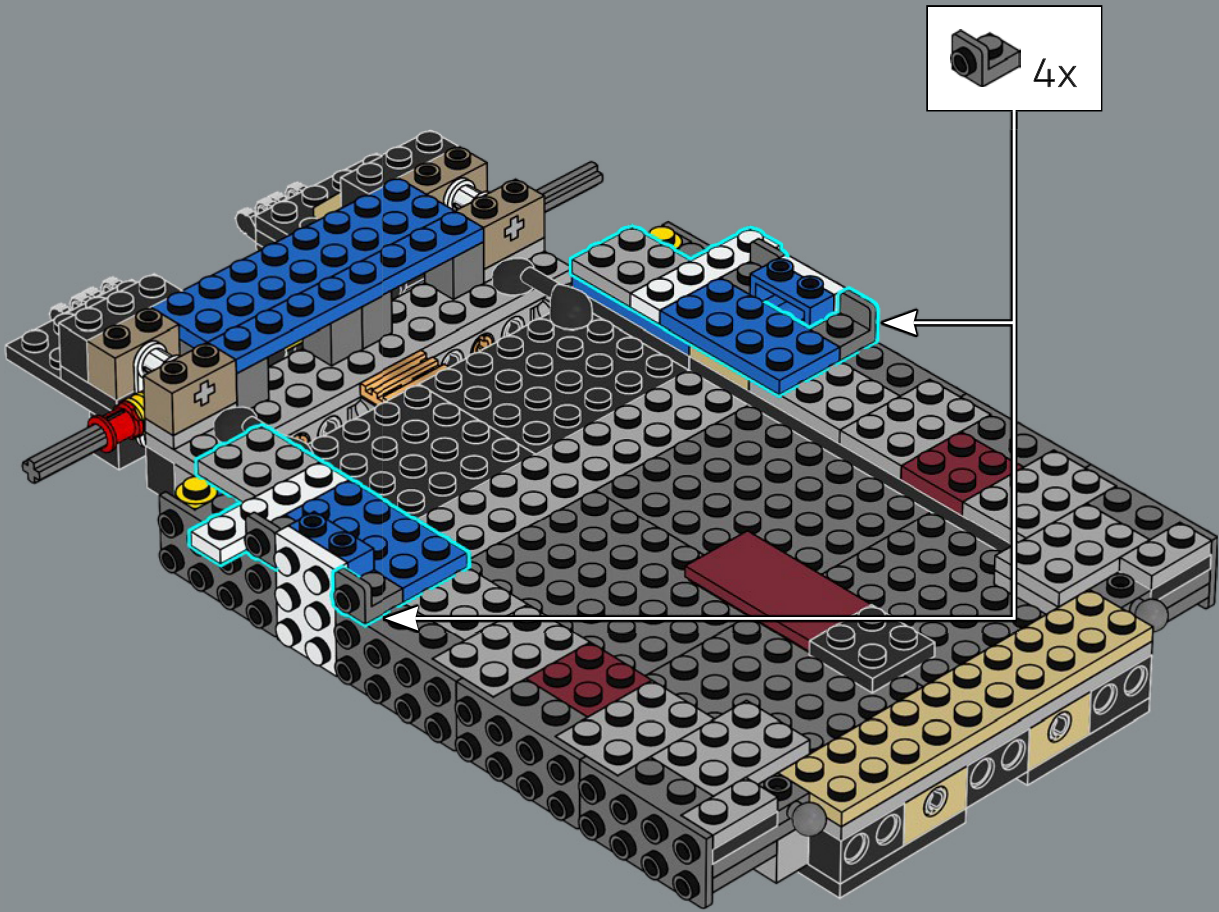



38

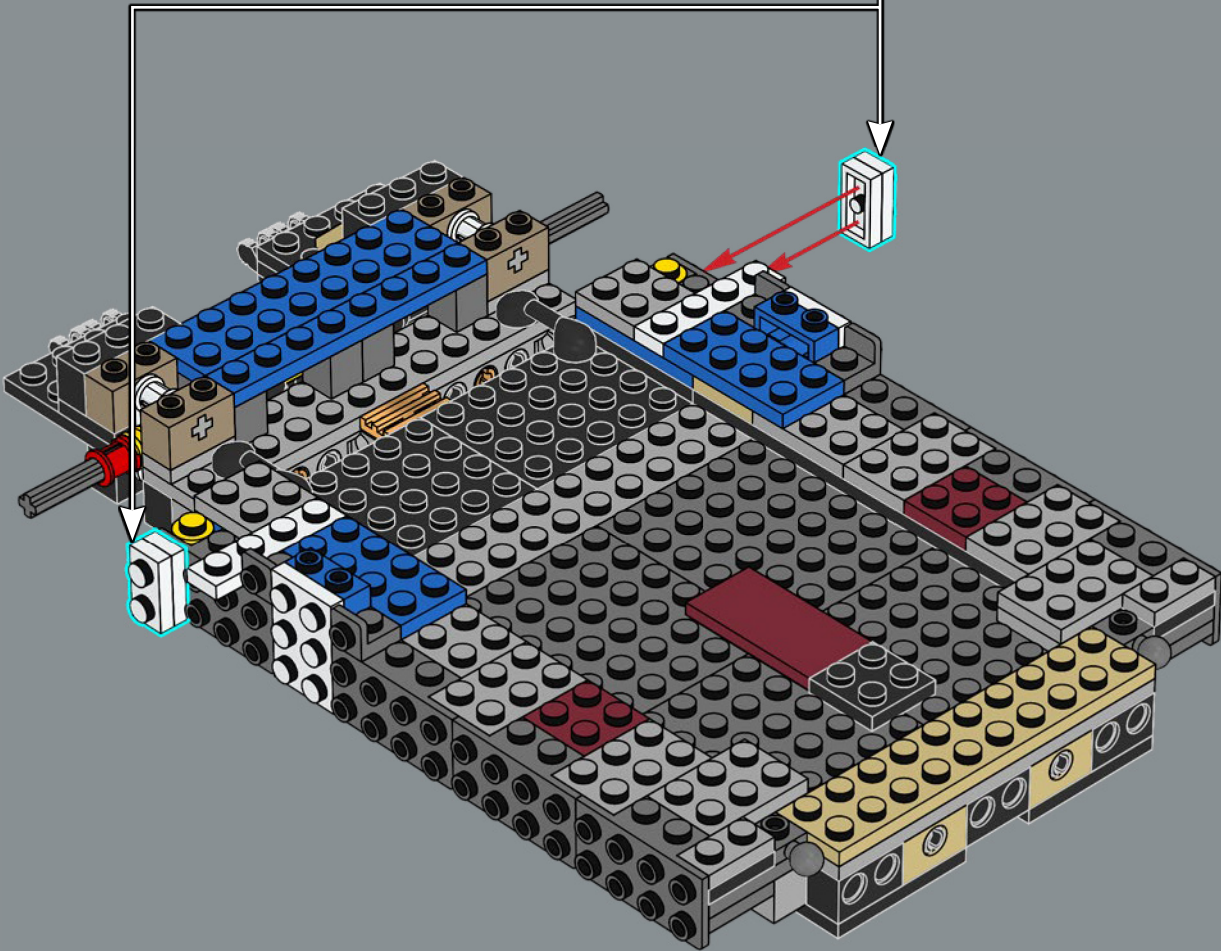
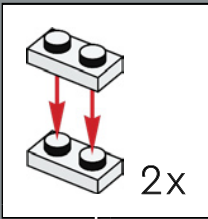

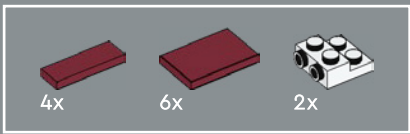

39

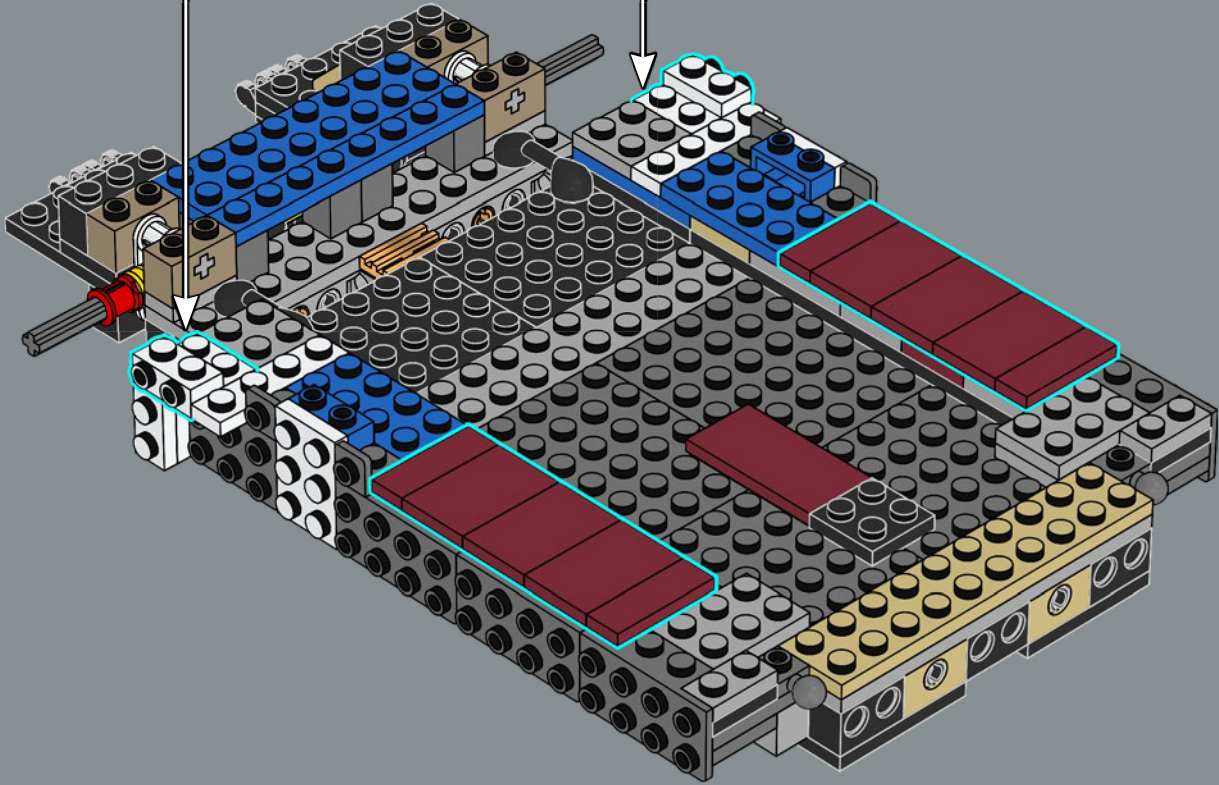
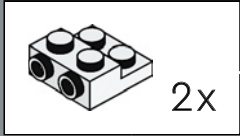



40

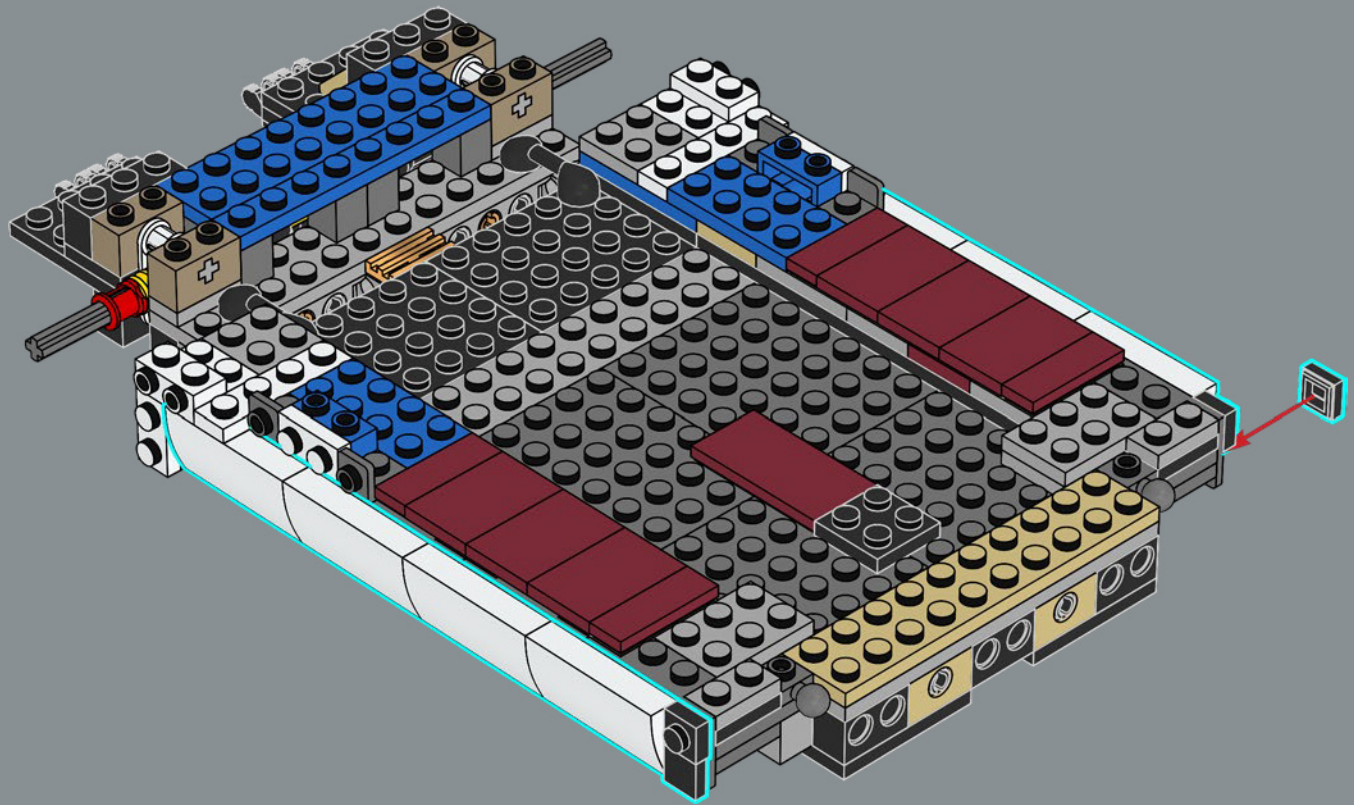

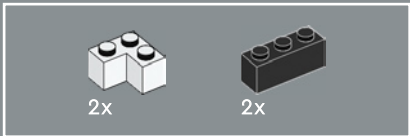

41

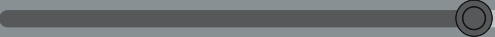
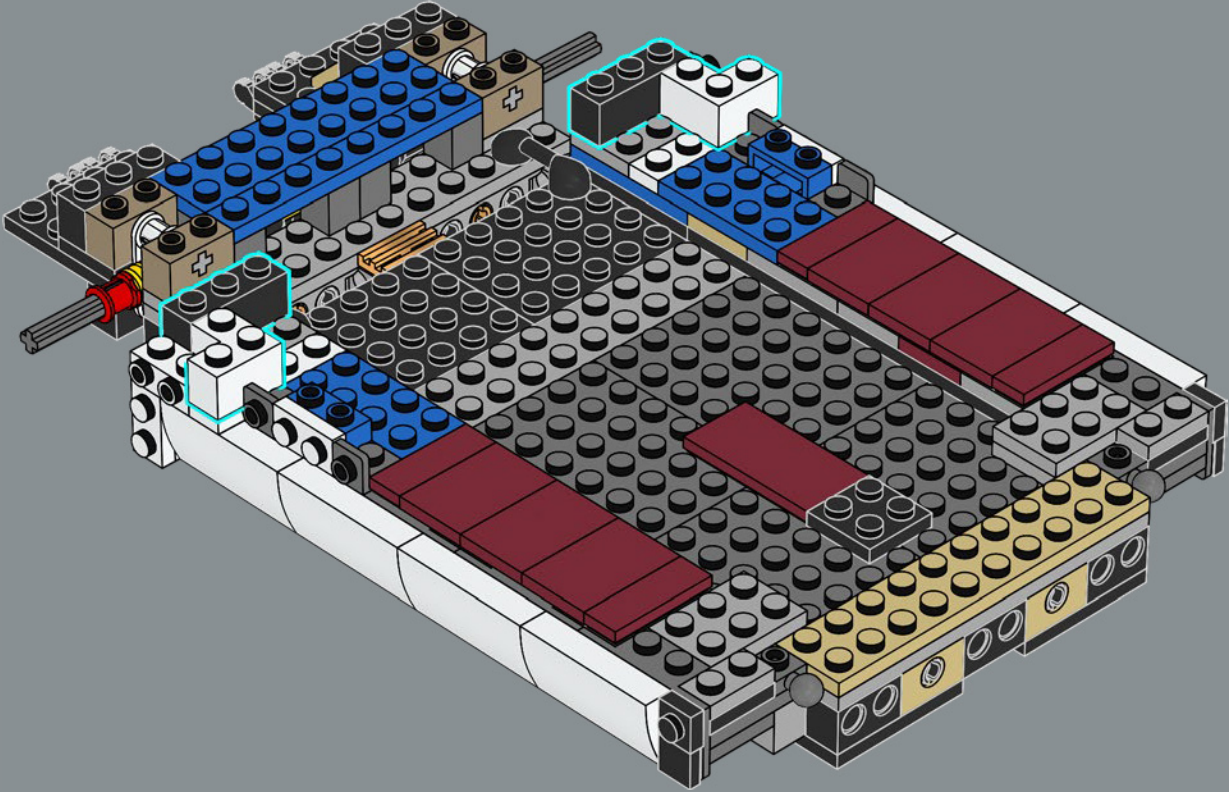

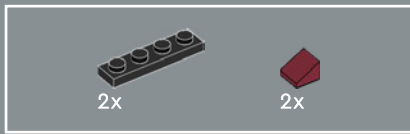

42

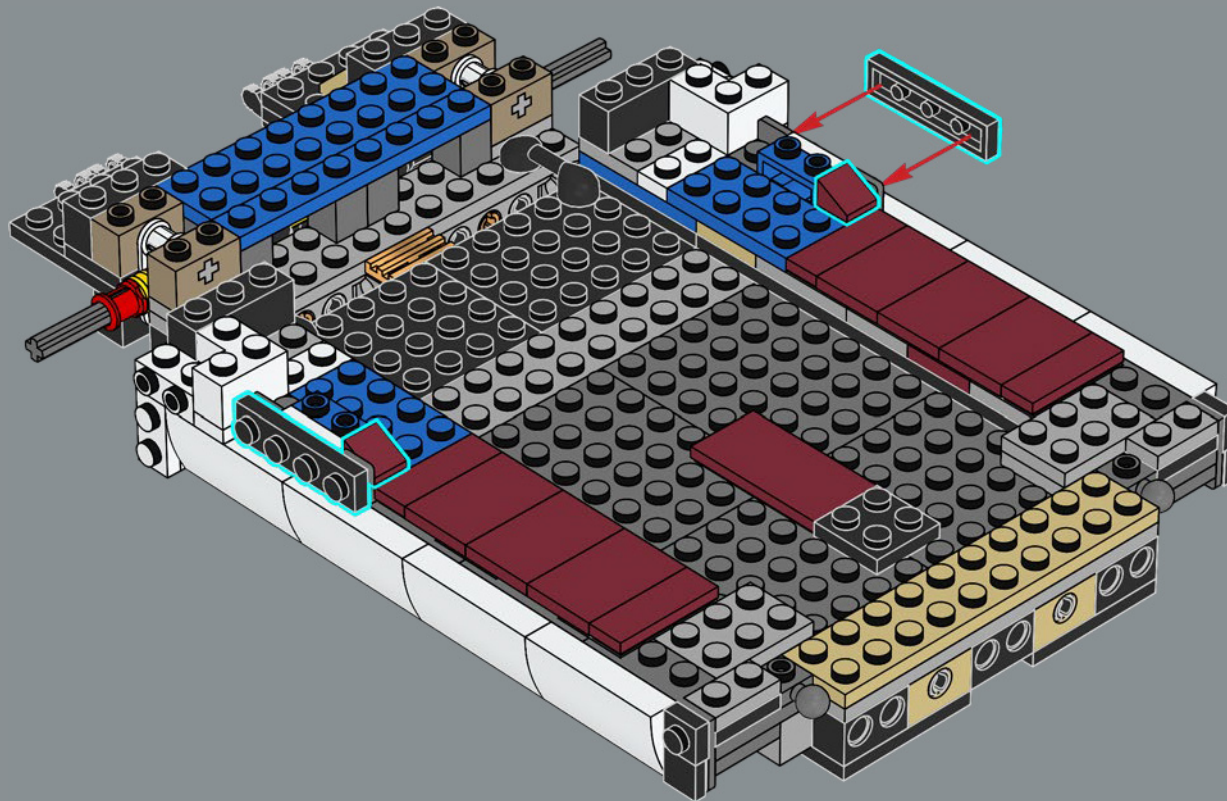

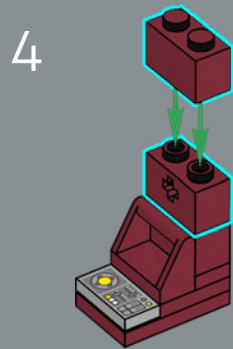
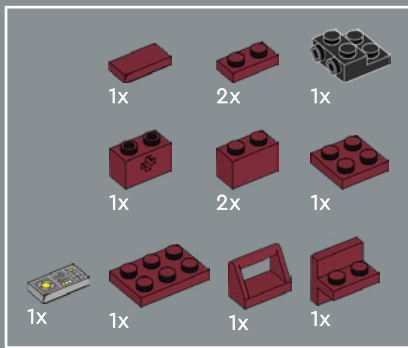

7

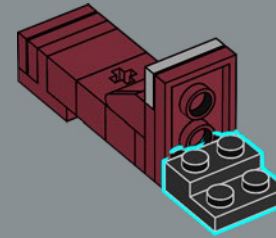

44

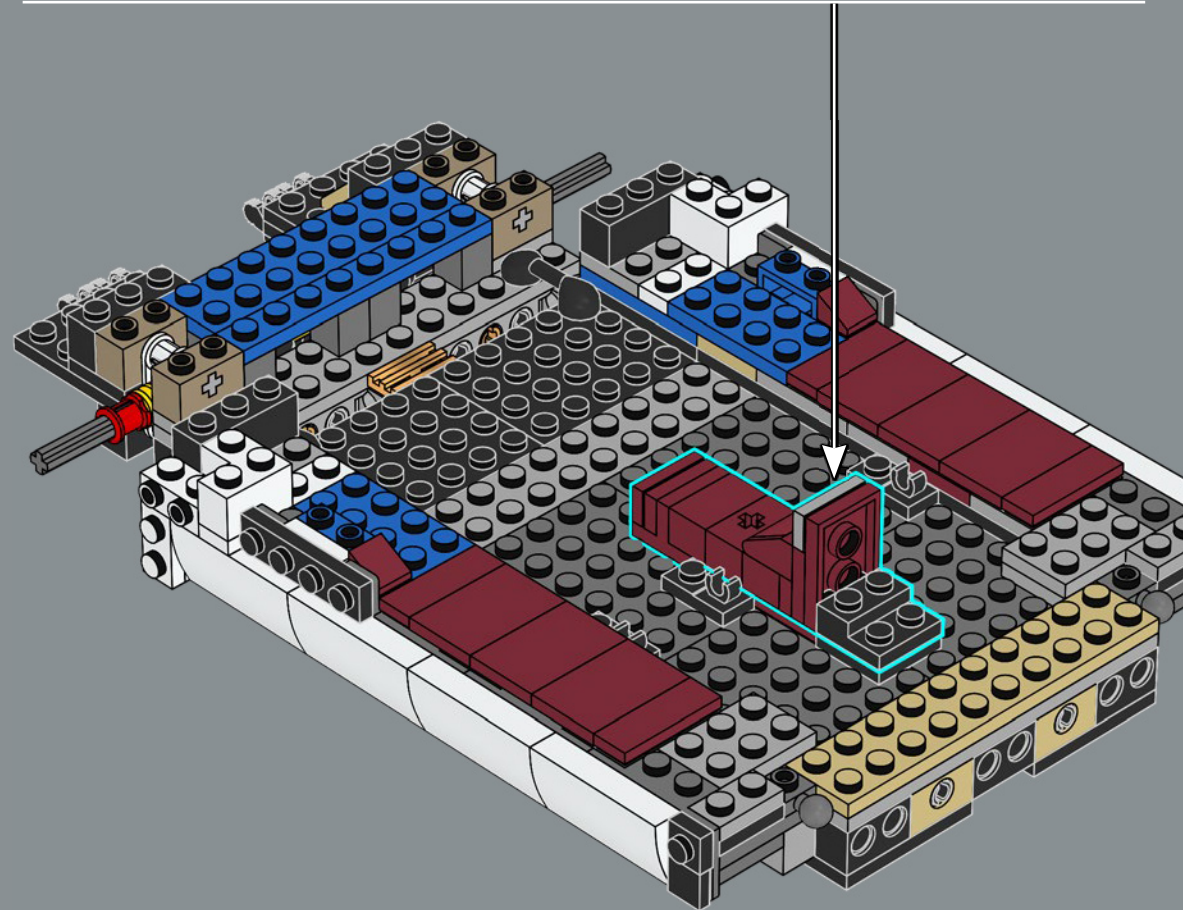
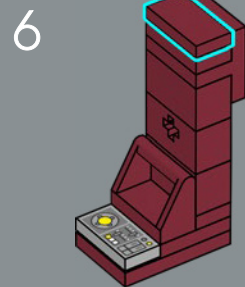
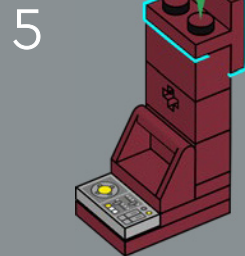
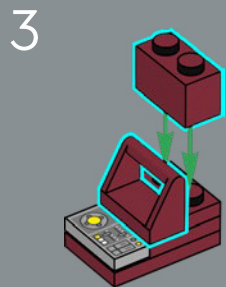
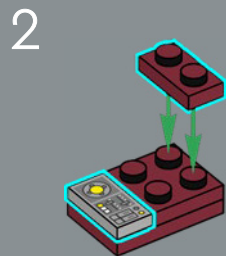
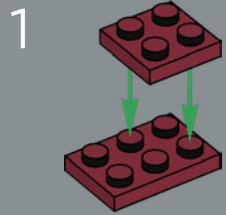



45

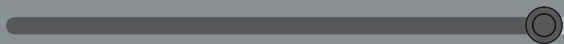
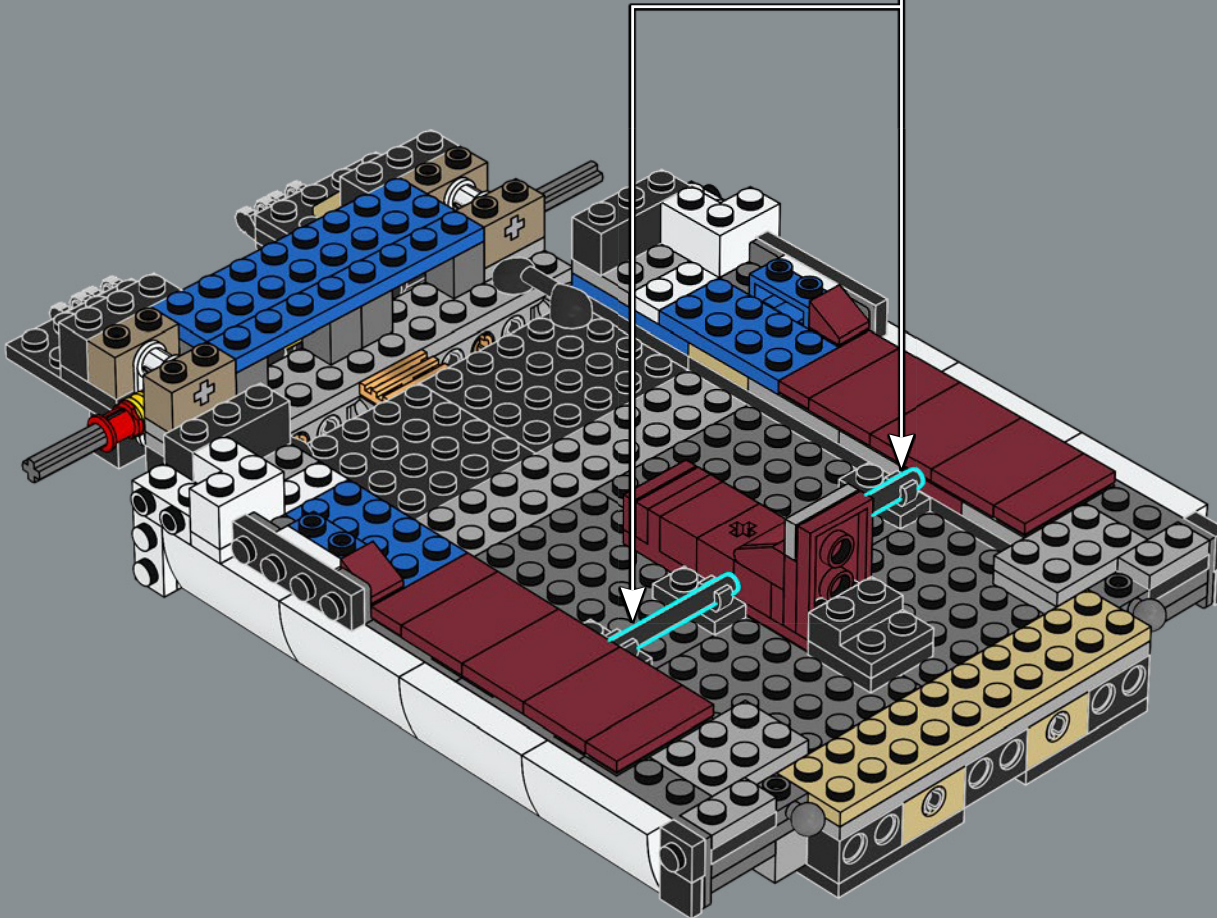

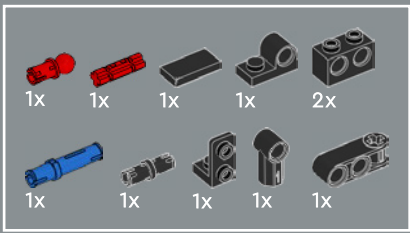

47

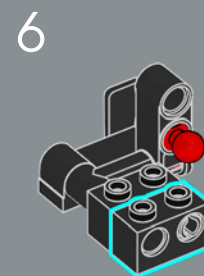
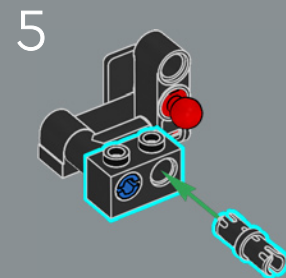
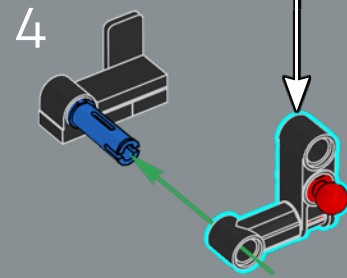
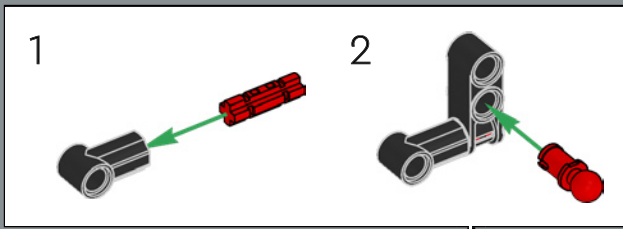
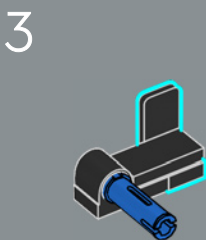
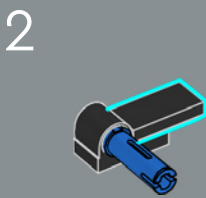
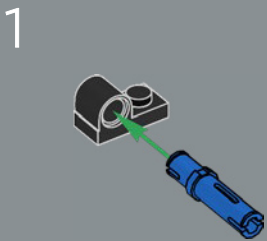

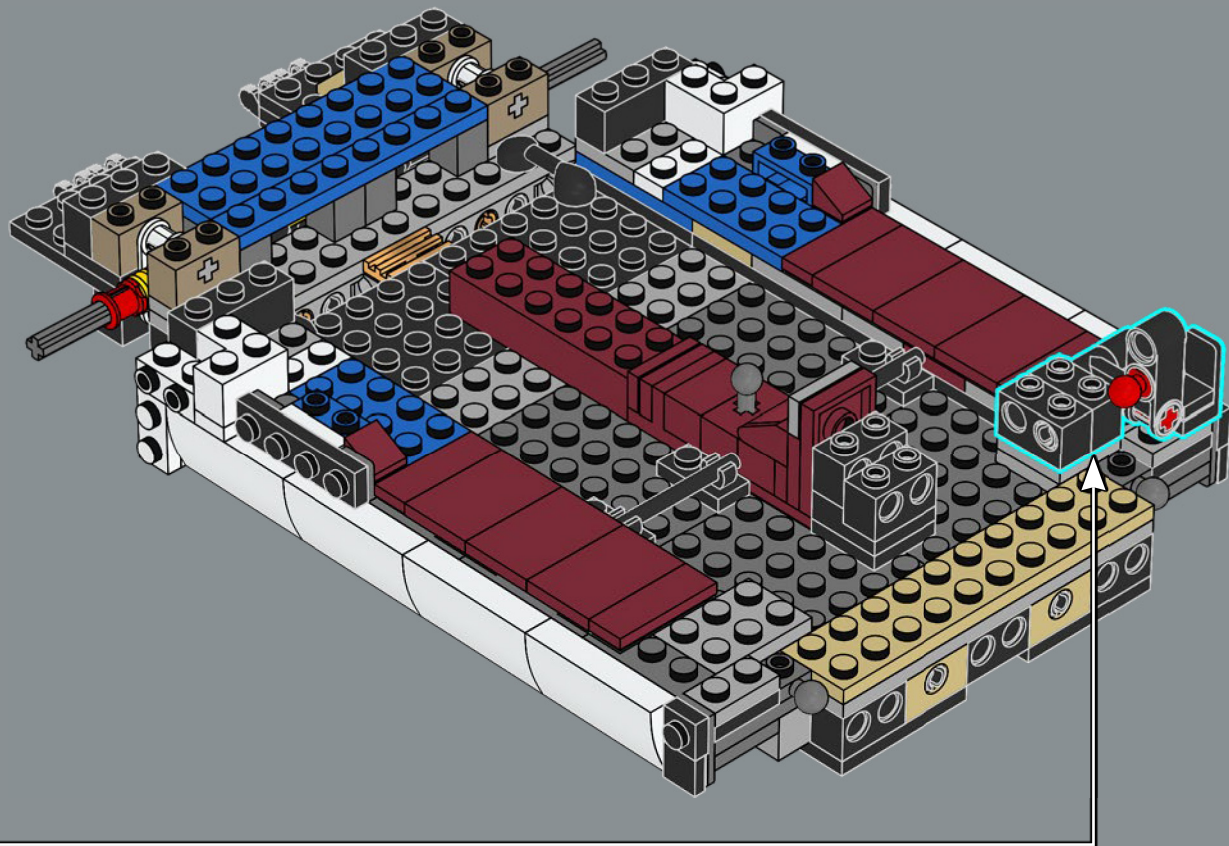

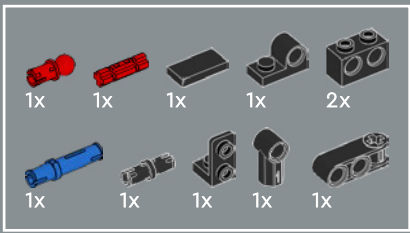

48

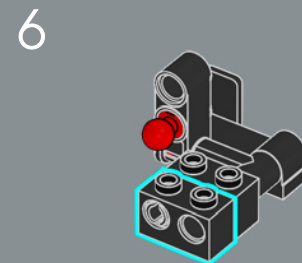
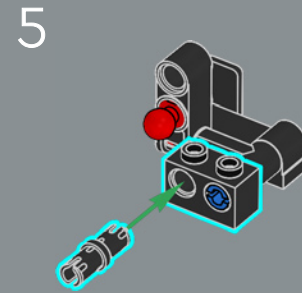
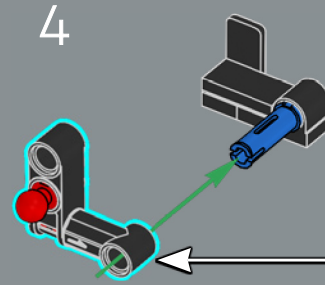
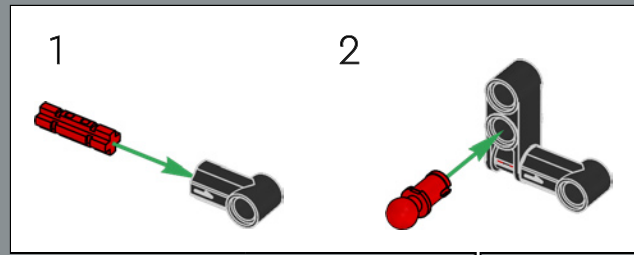
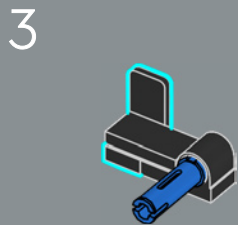
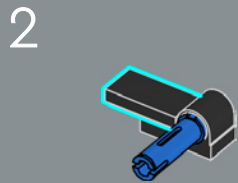
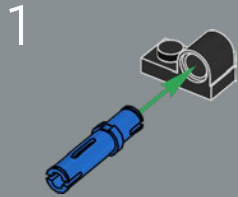

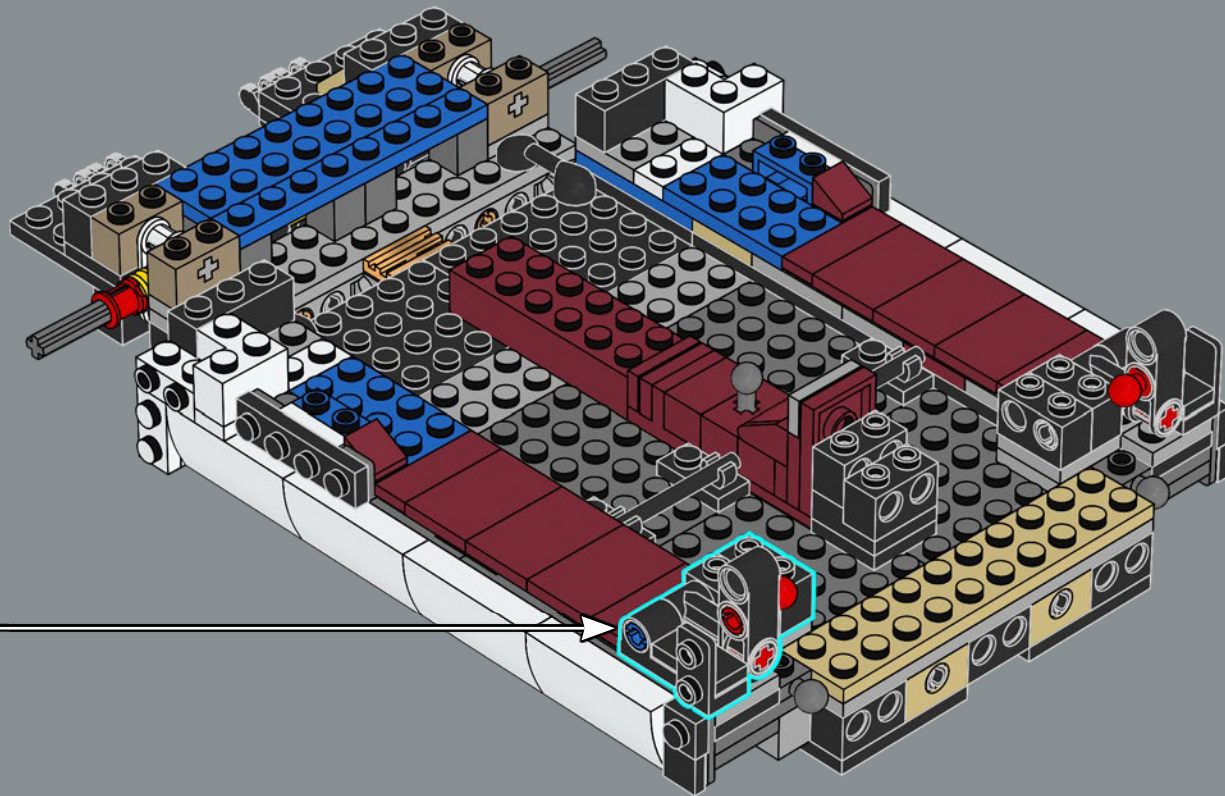

○
2x

49

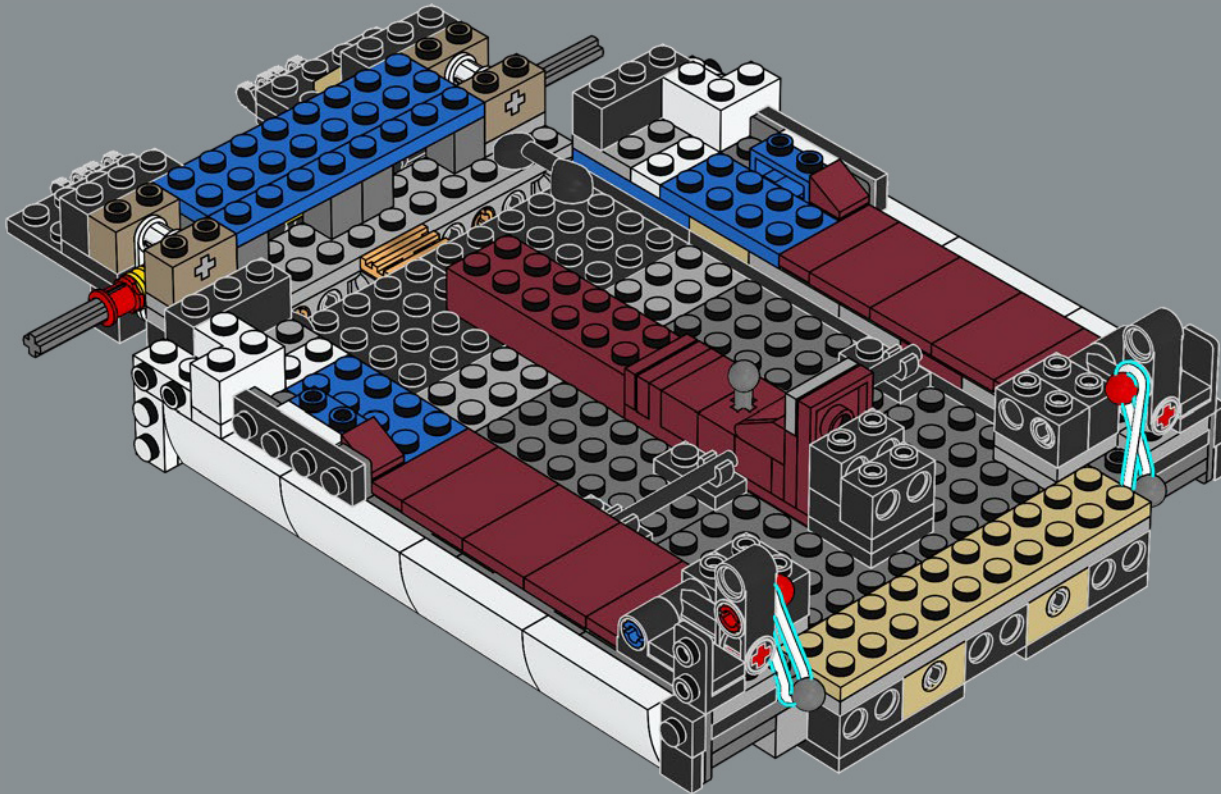

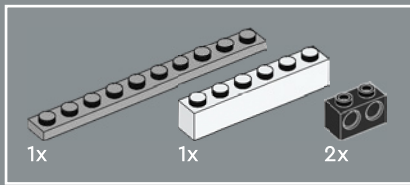

50

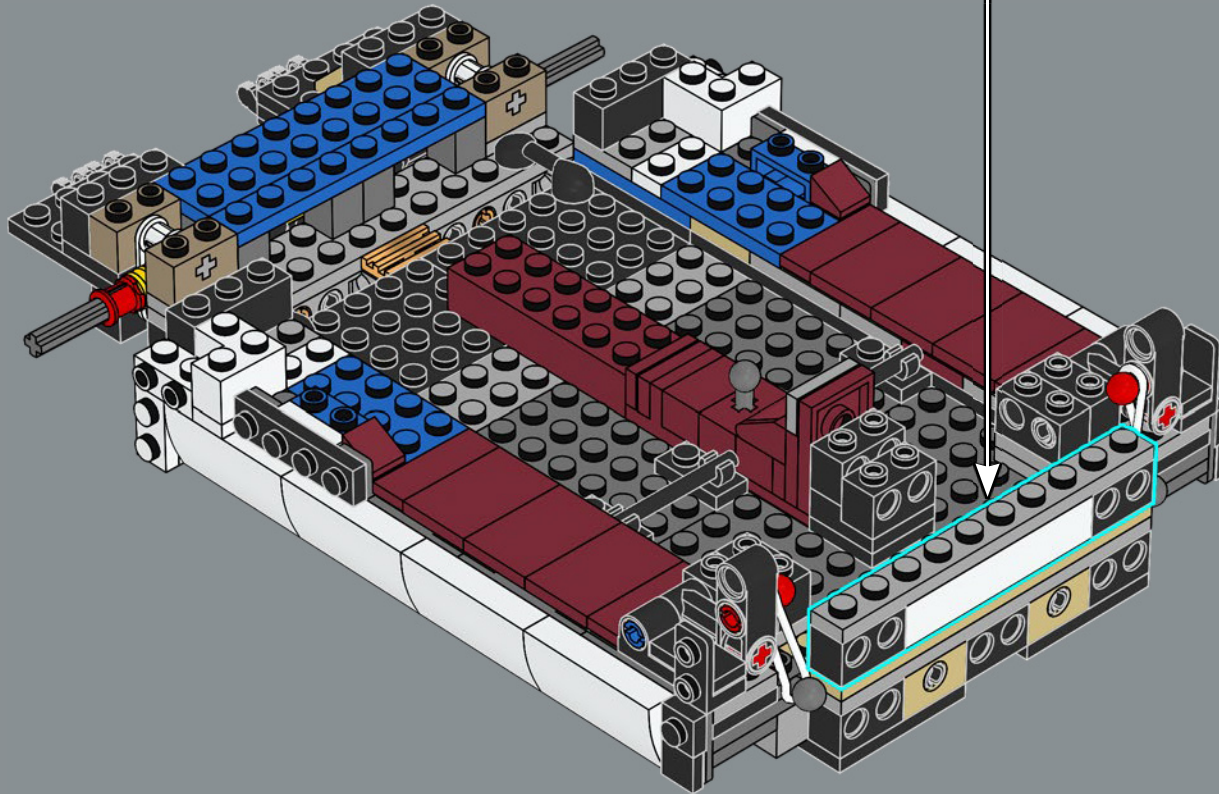
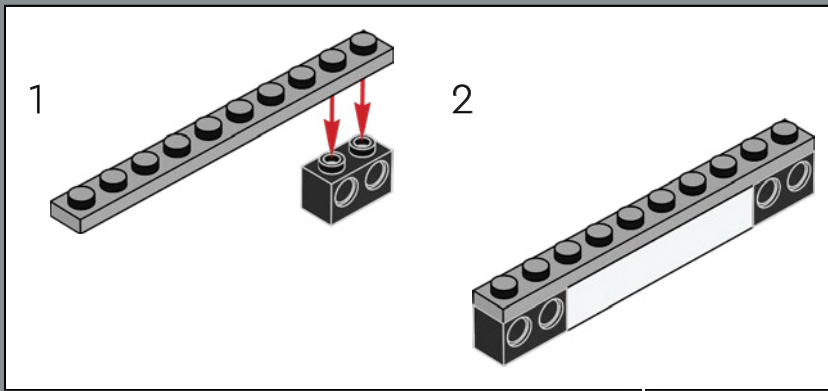

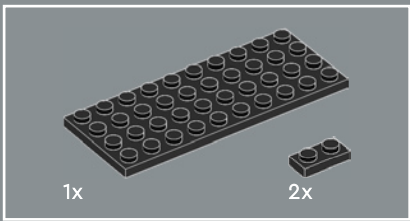

51

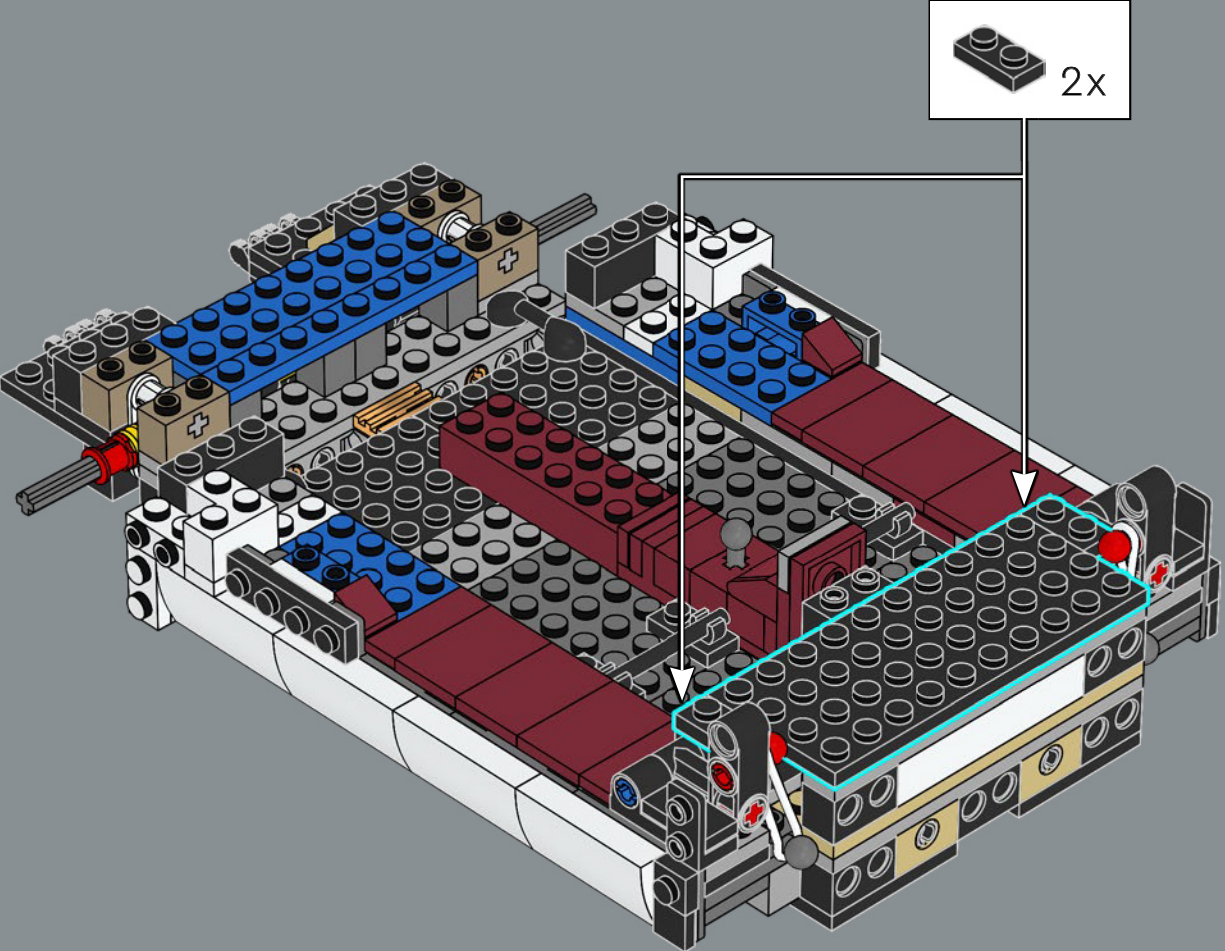

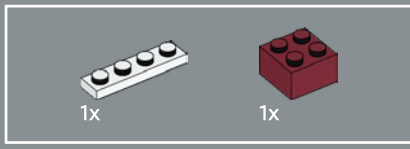

52

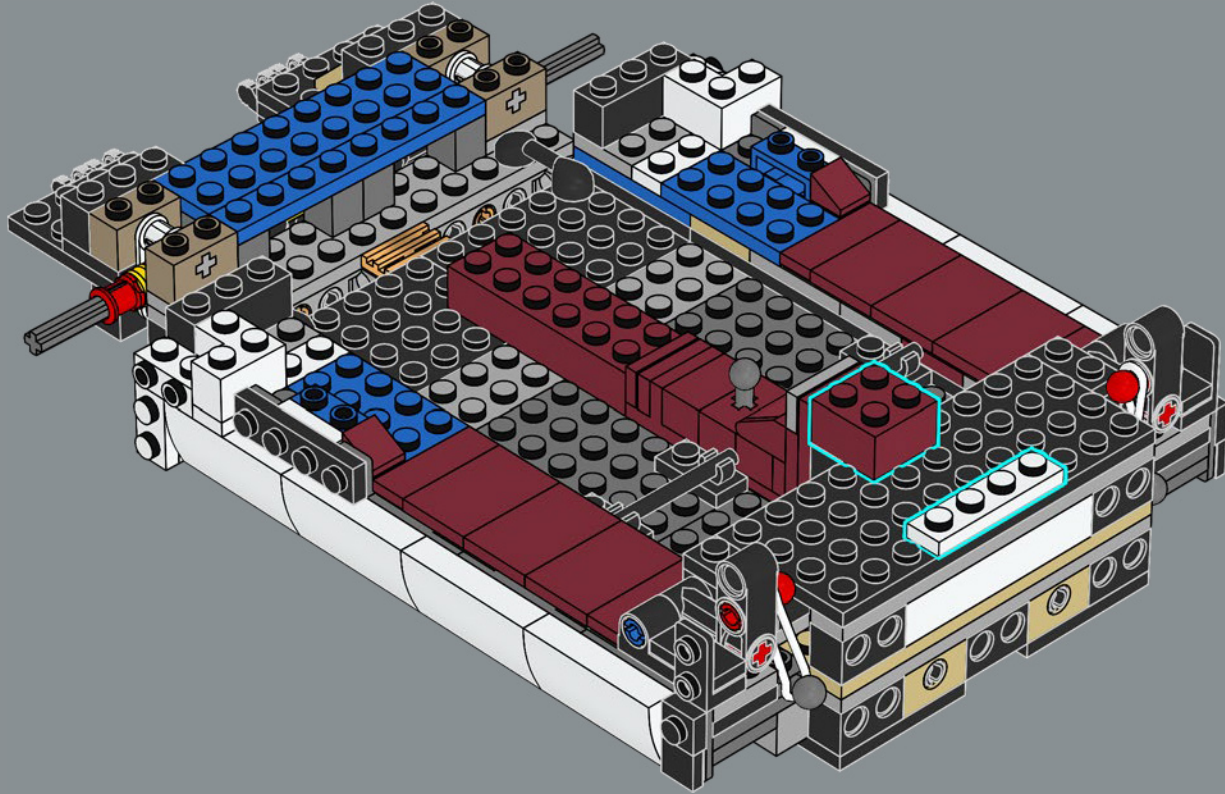

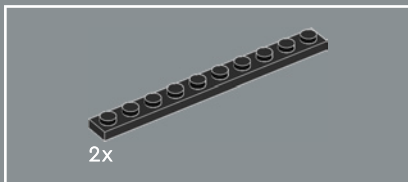
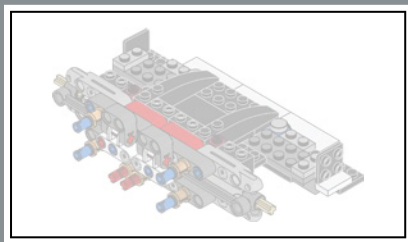

53

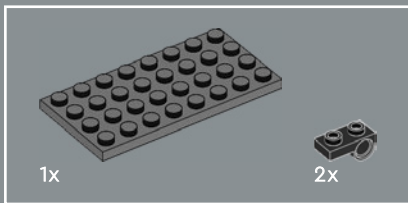
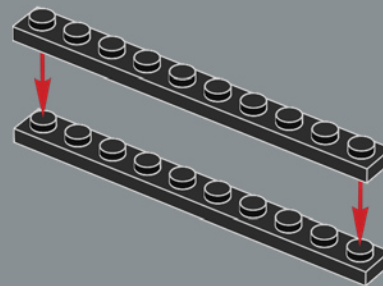

54

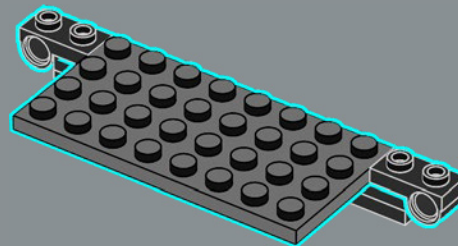

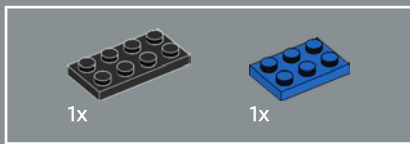

55

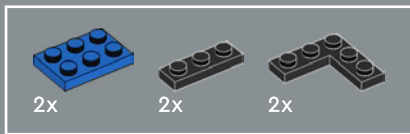
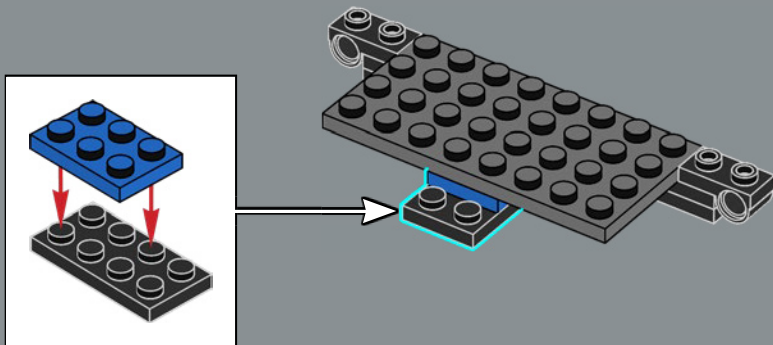

56

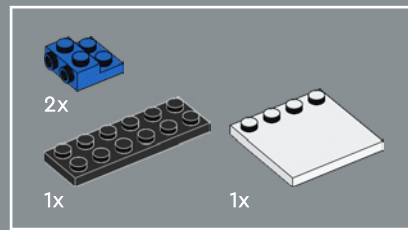
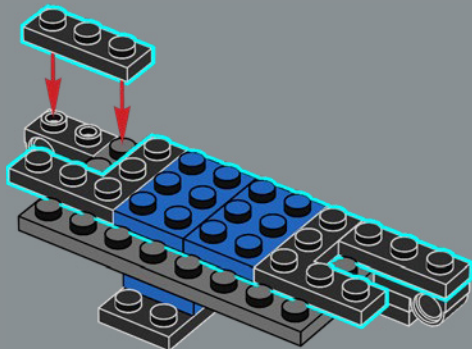

57

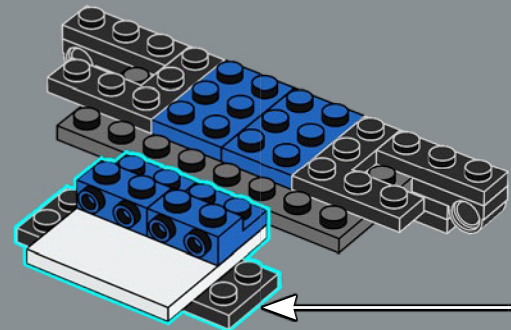
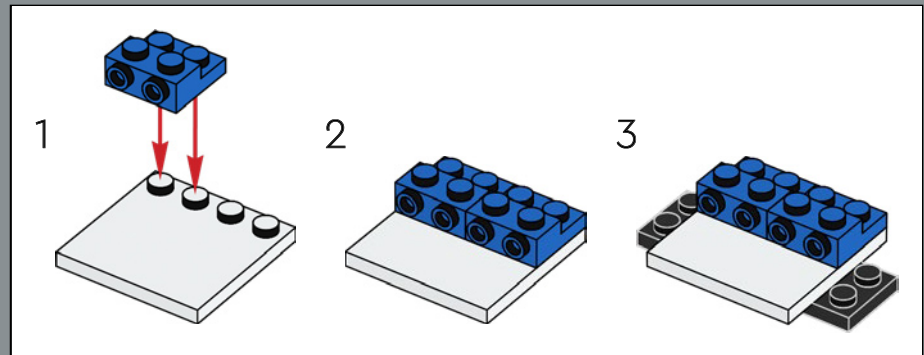

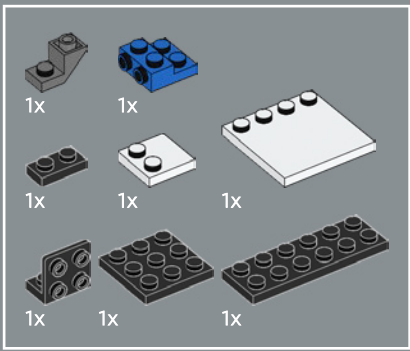

58

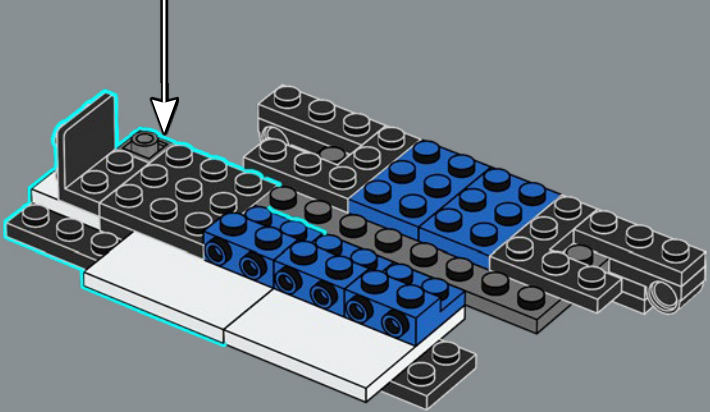
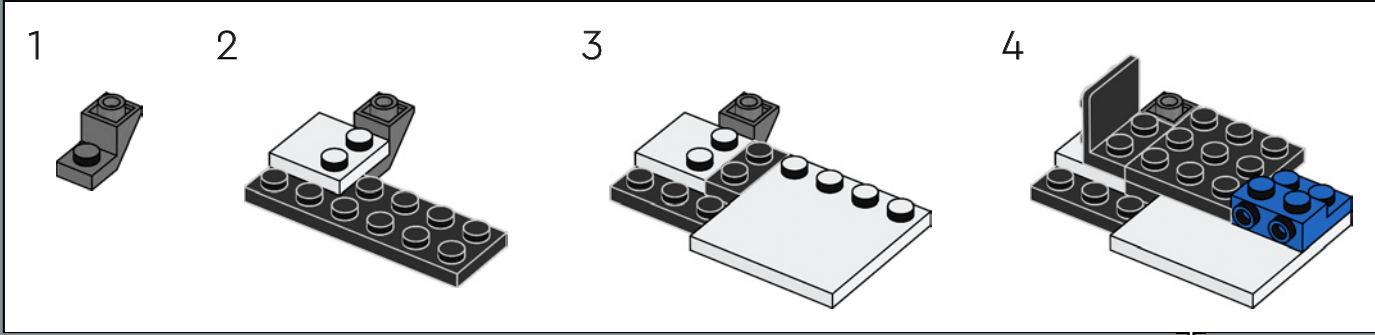

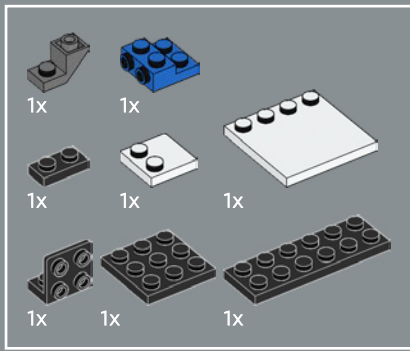

59

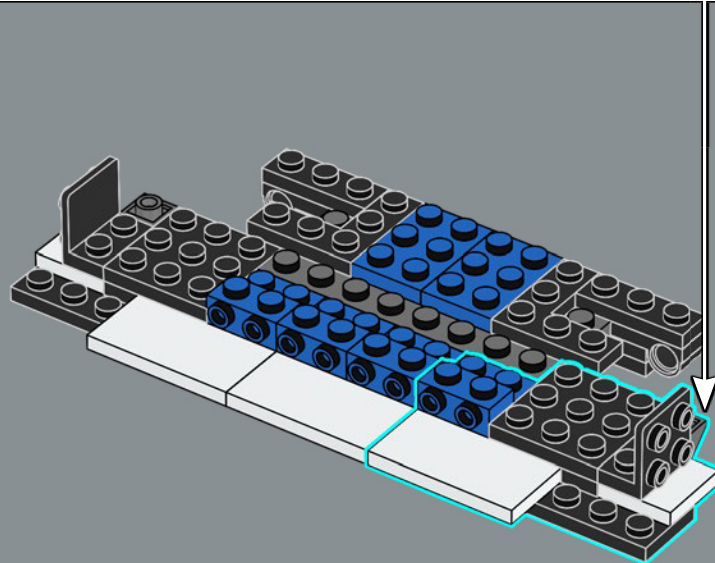
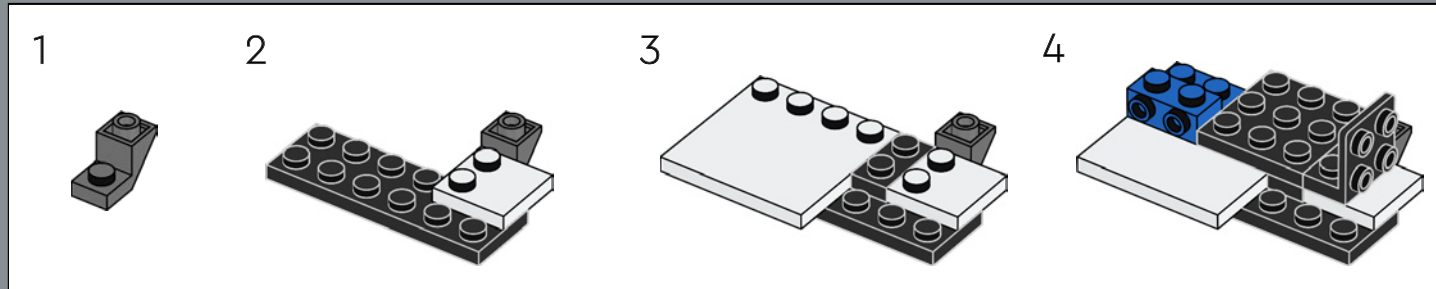

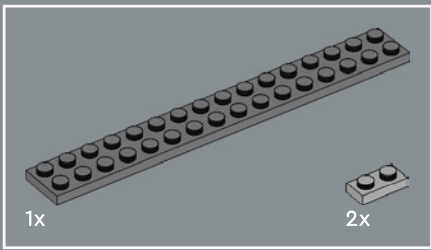

60

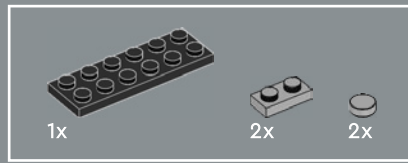
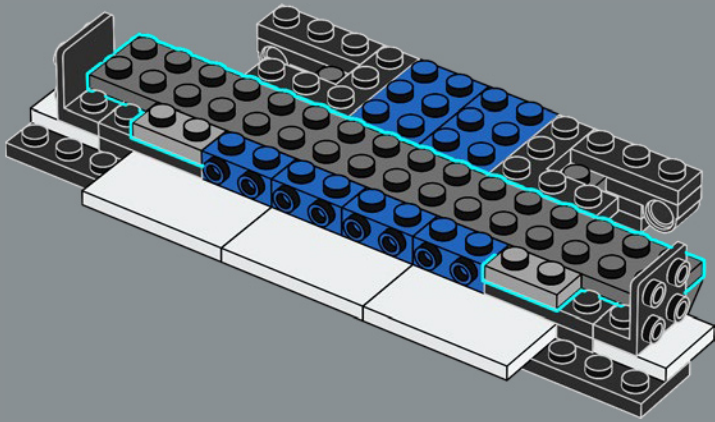

61

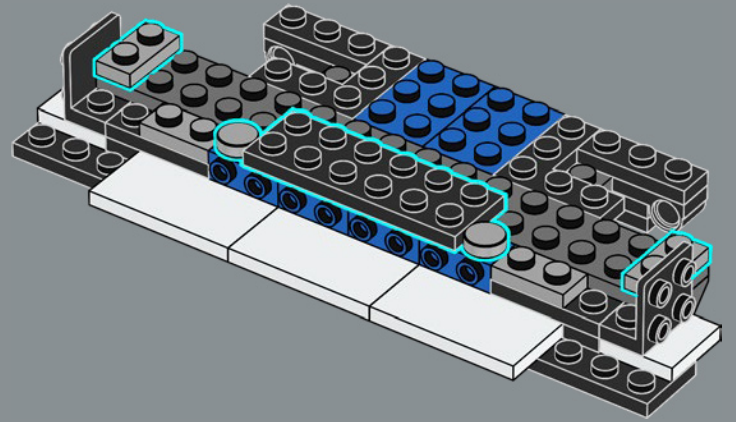

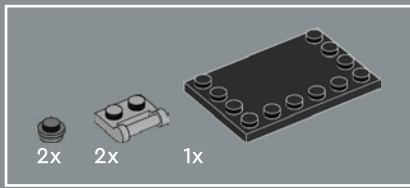

62

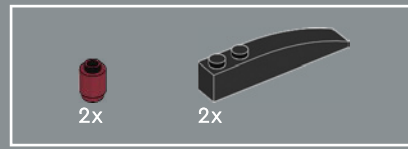
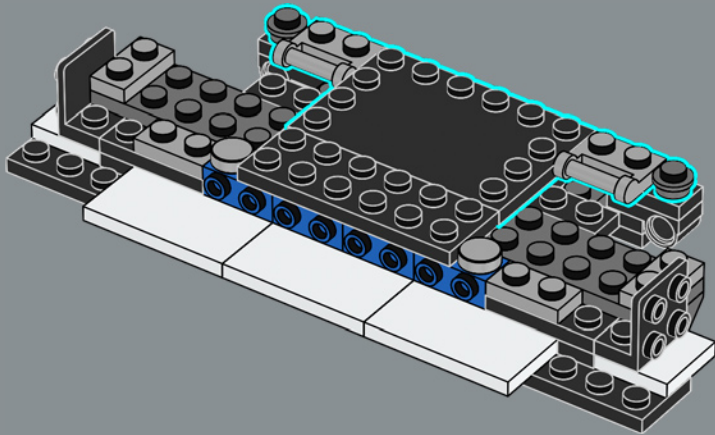

63

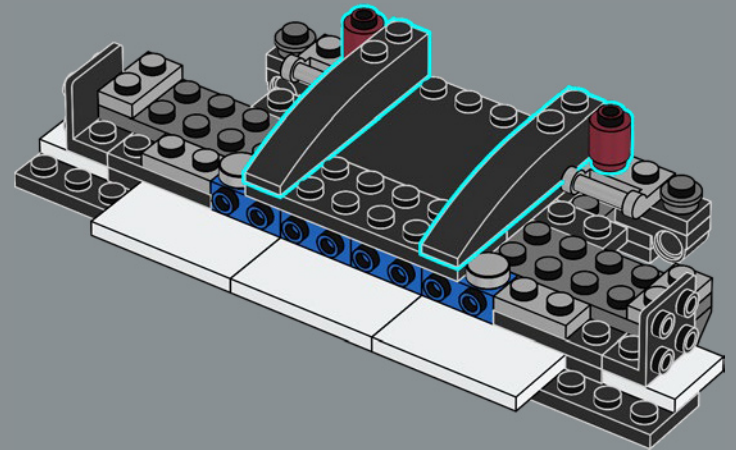

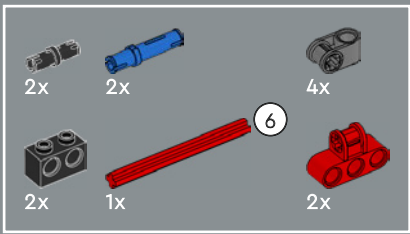

64

1

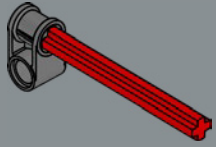

2

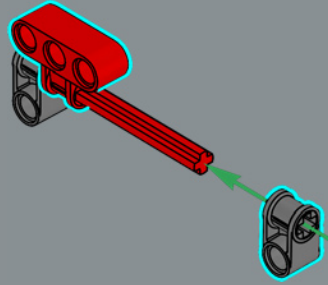

3

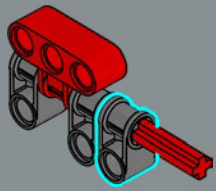

4

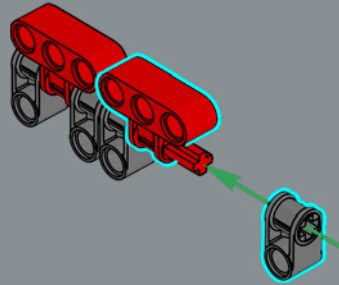

5

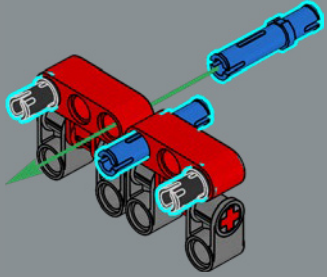

6

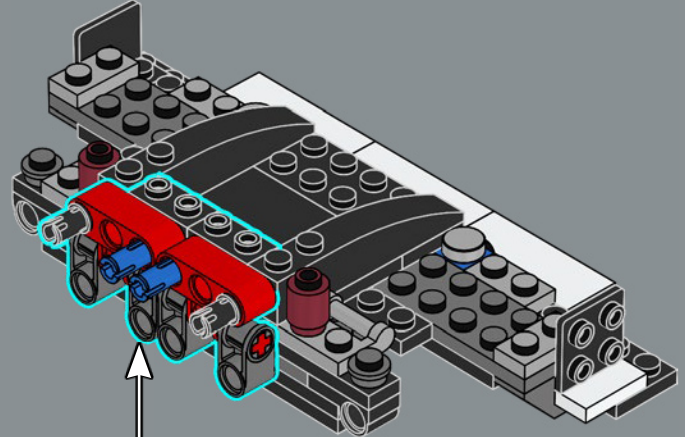
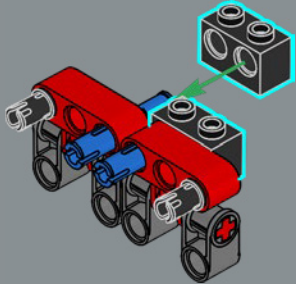

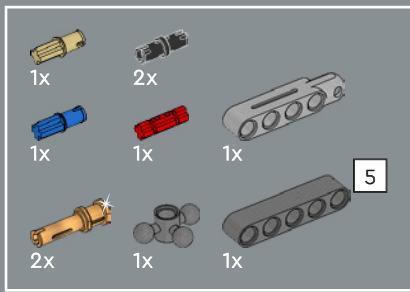

65

1

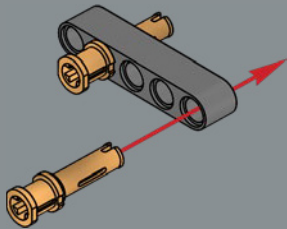

2

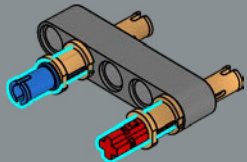

3

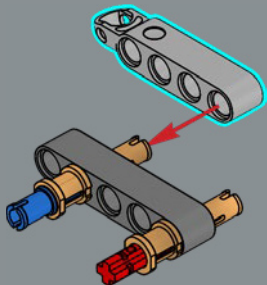

4

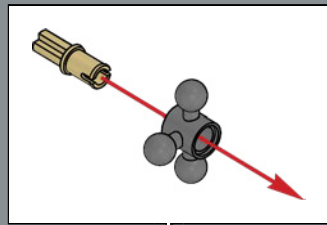
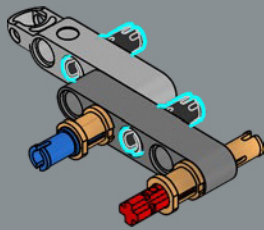

5

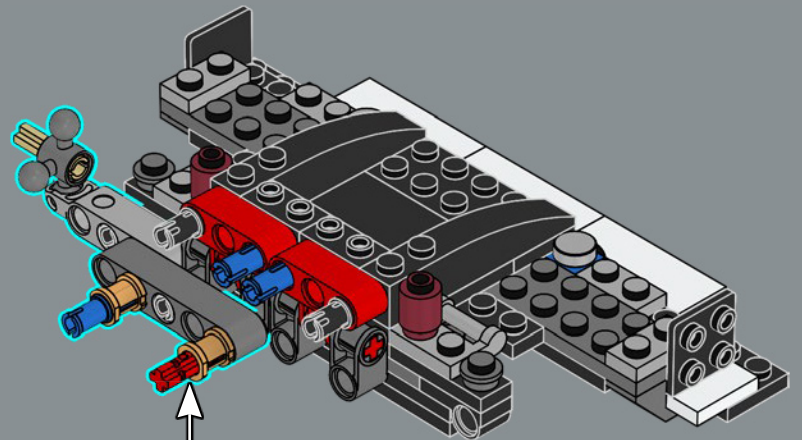
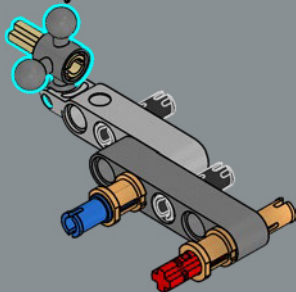

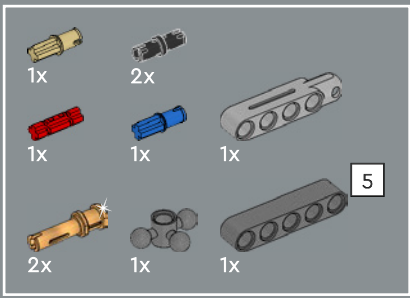

66

1

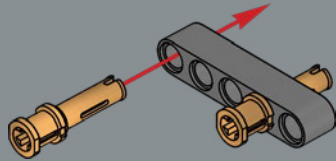

2

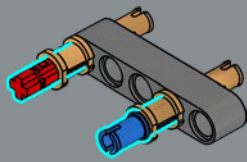

3

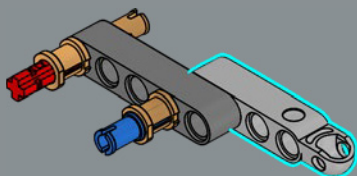

4

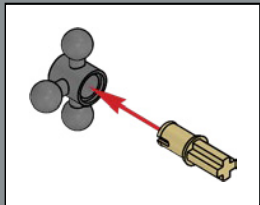
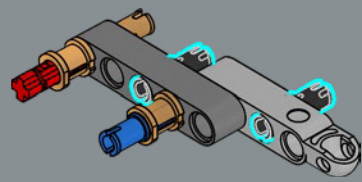

5

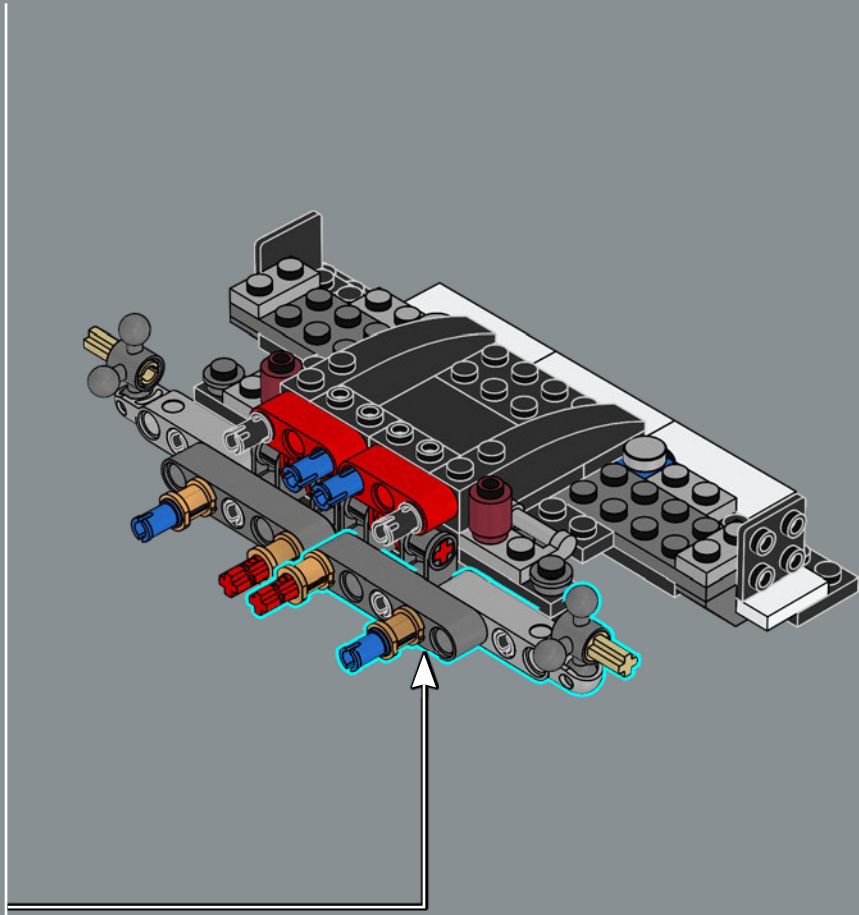
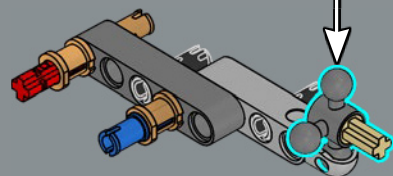

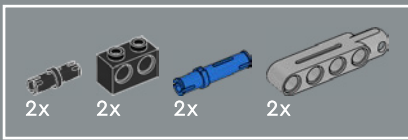

67

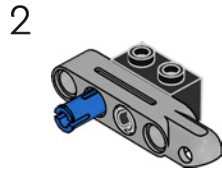
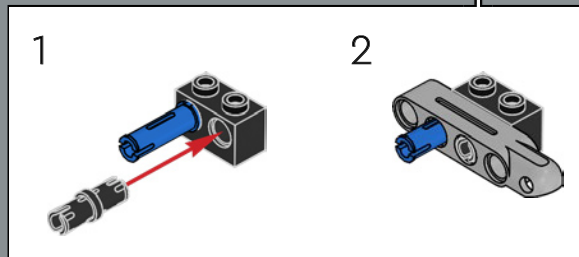
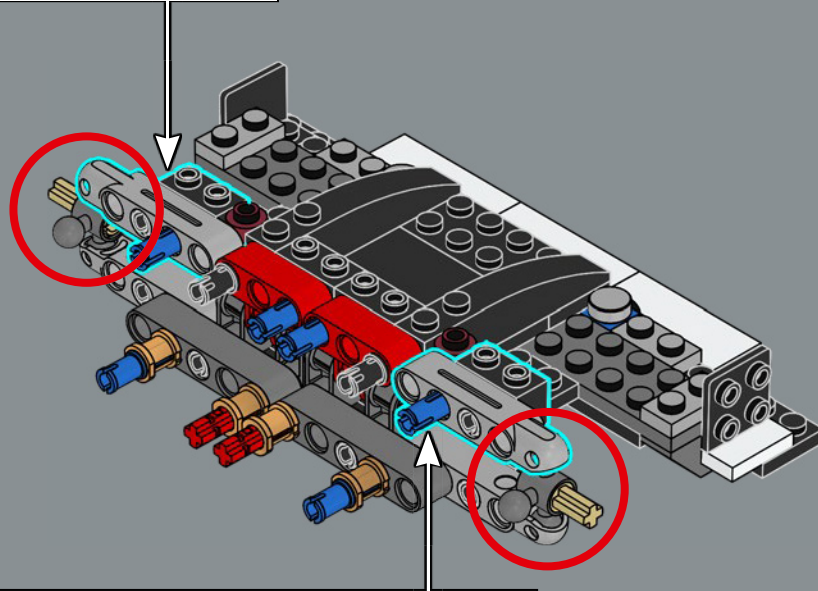
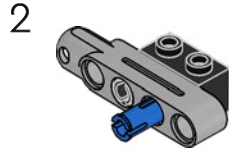
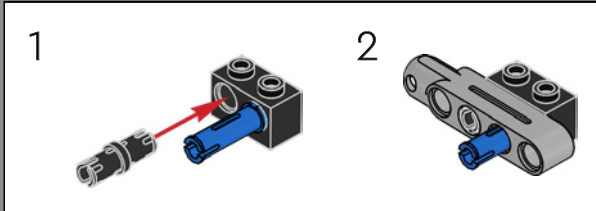

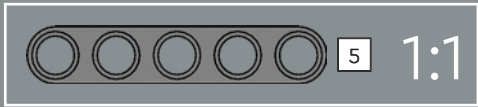
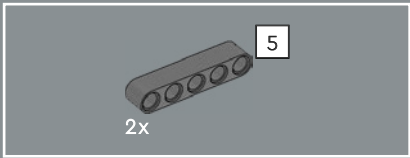

68

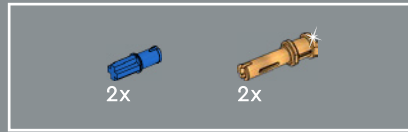
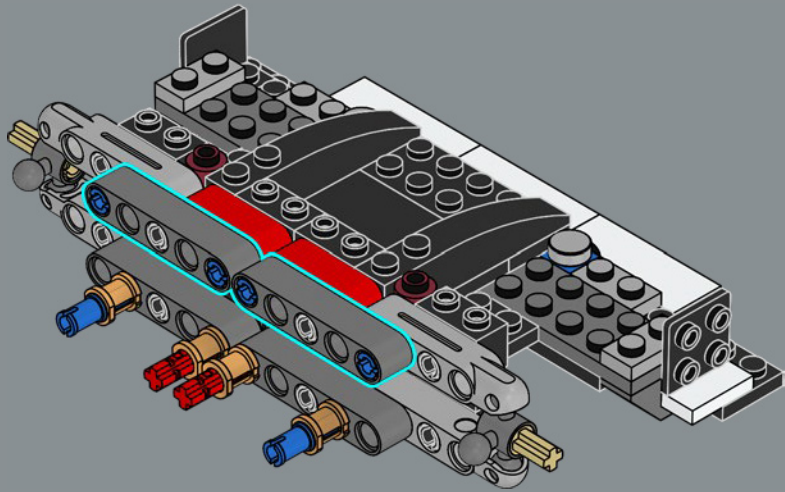

69

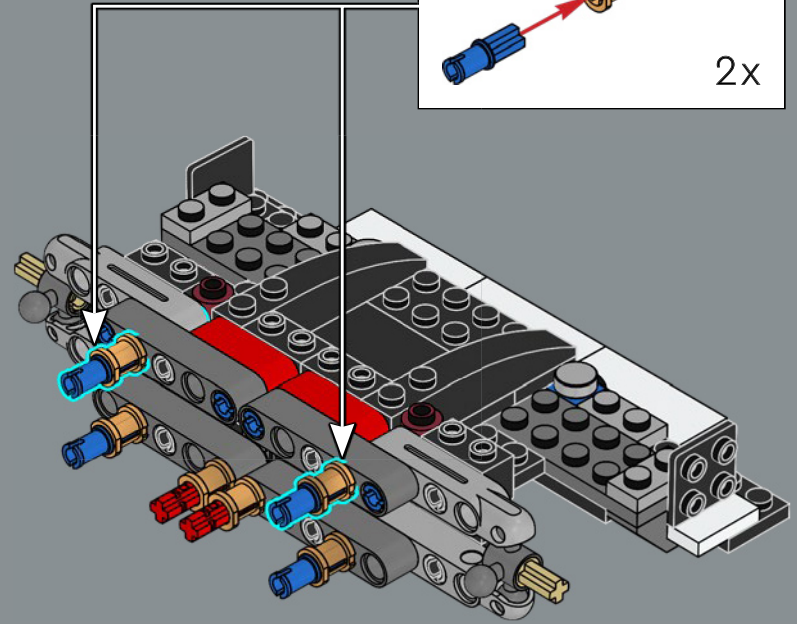
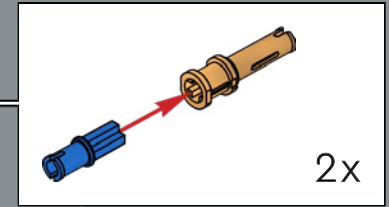

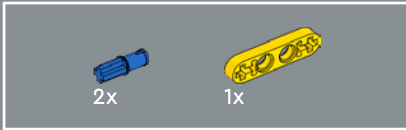
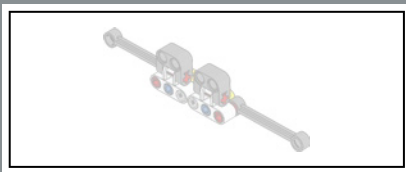

70

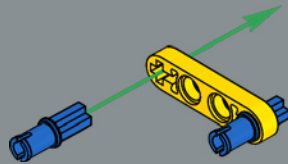

71

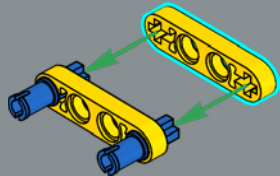

72

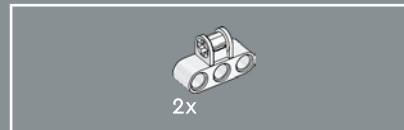
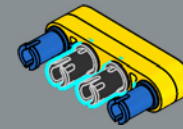

73

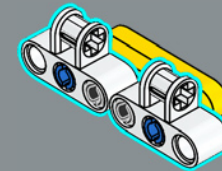

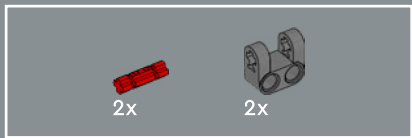

74

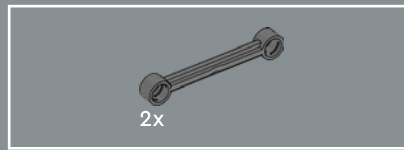
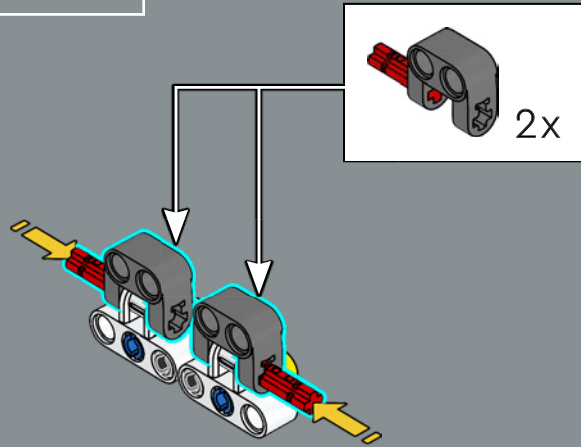

76

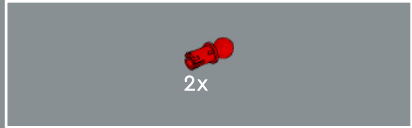
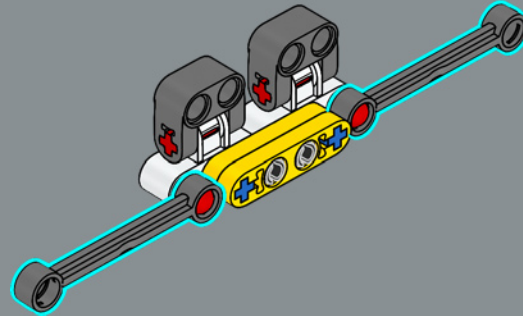

75

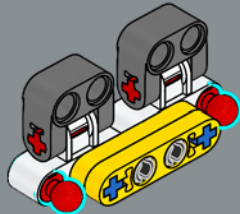

77

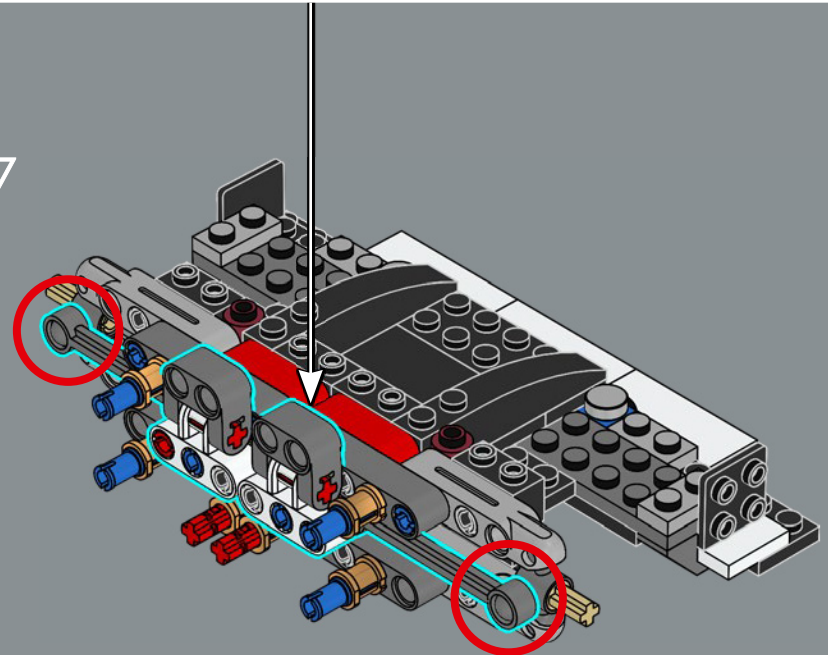

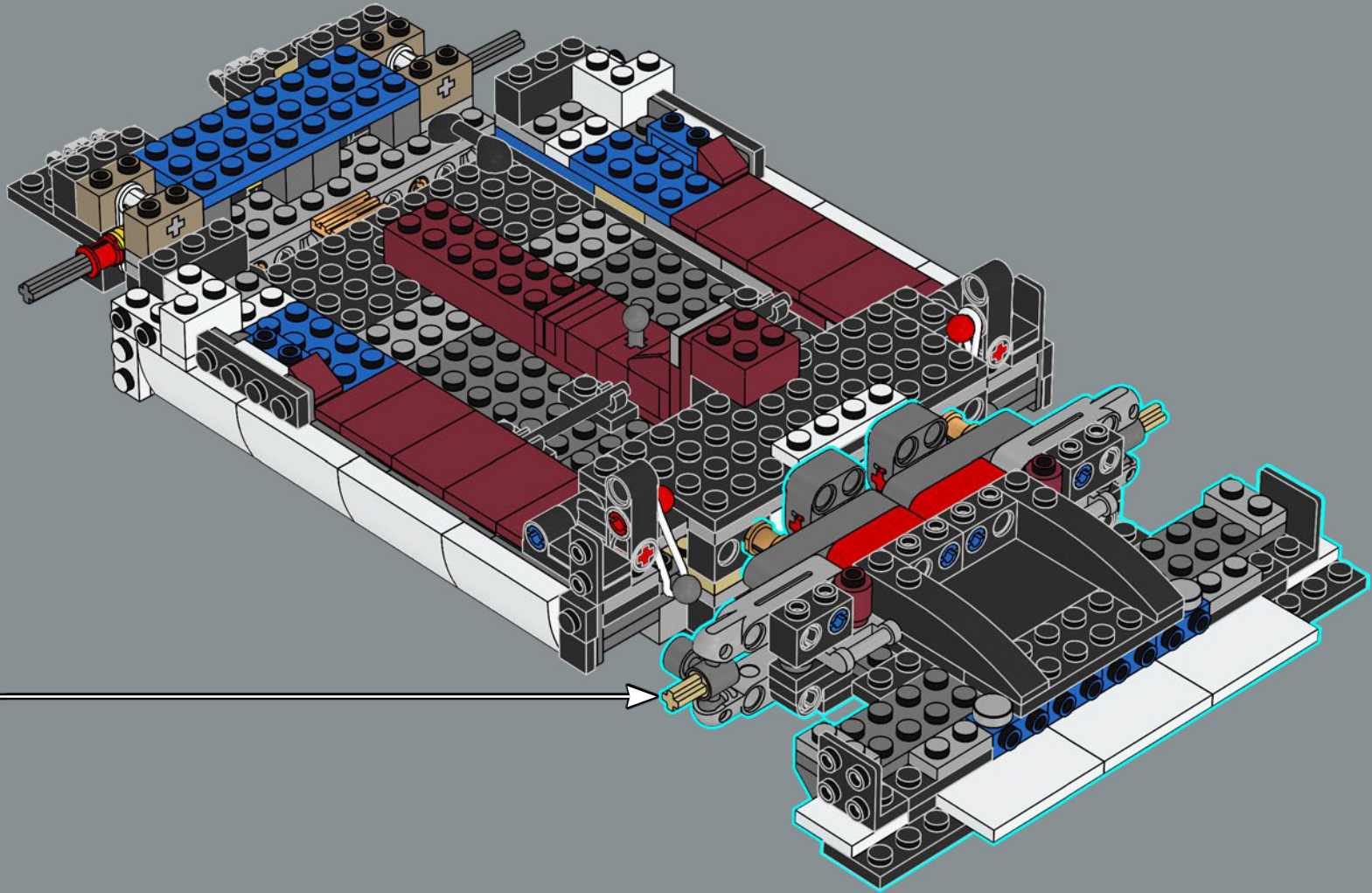

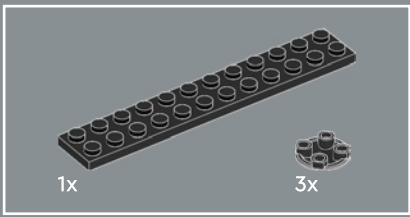

79

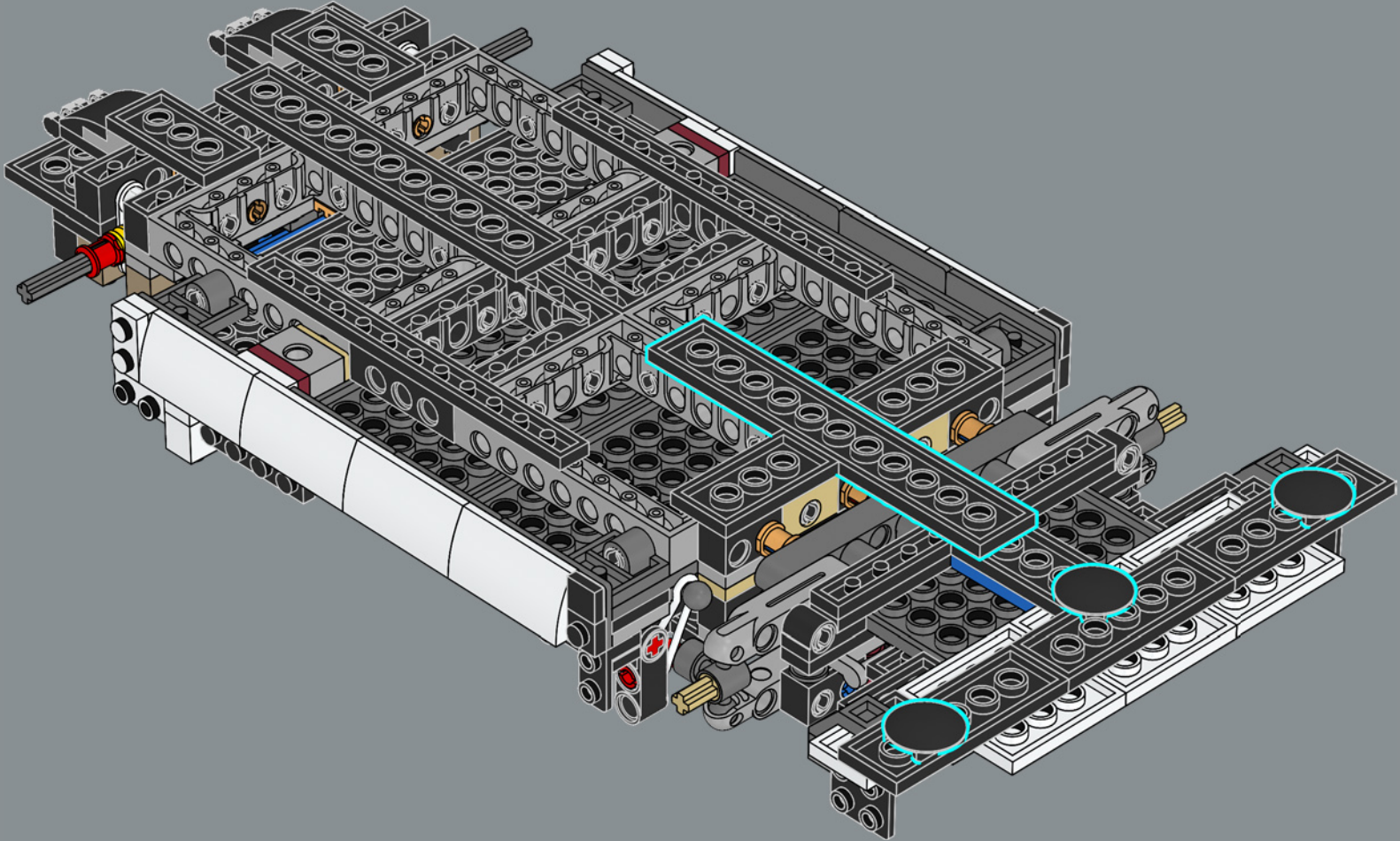

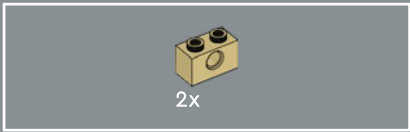

80

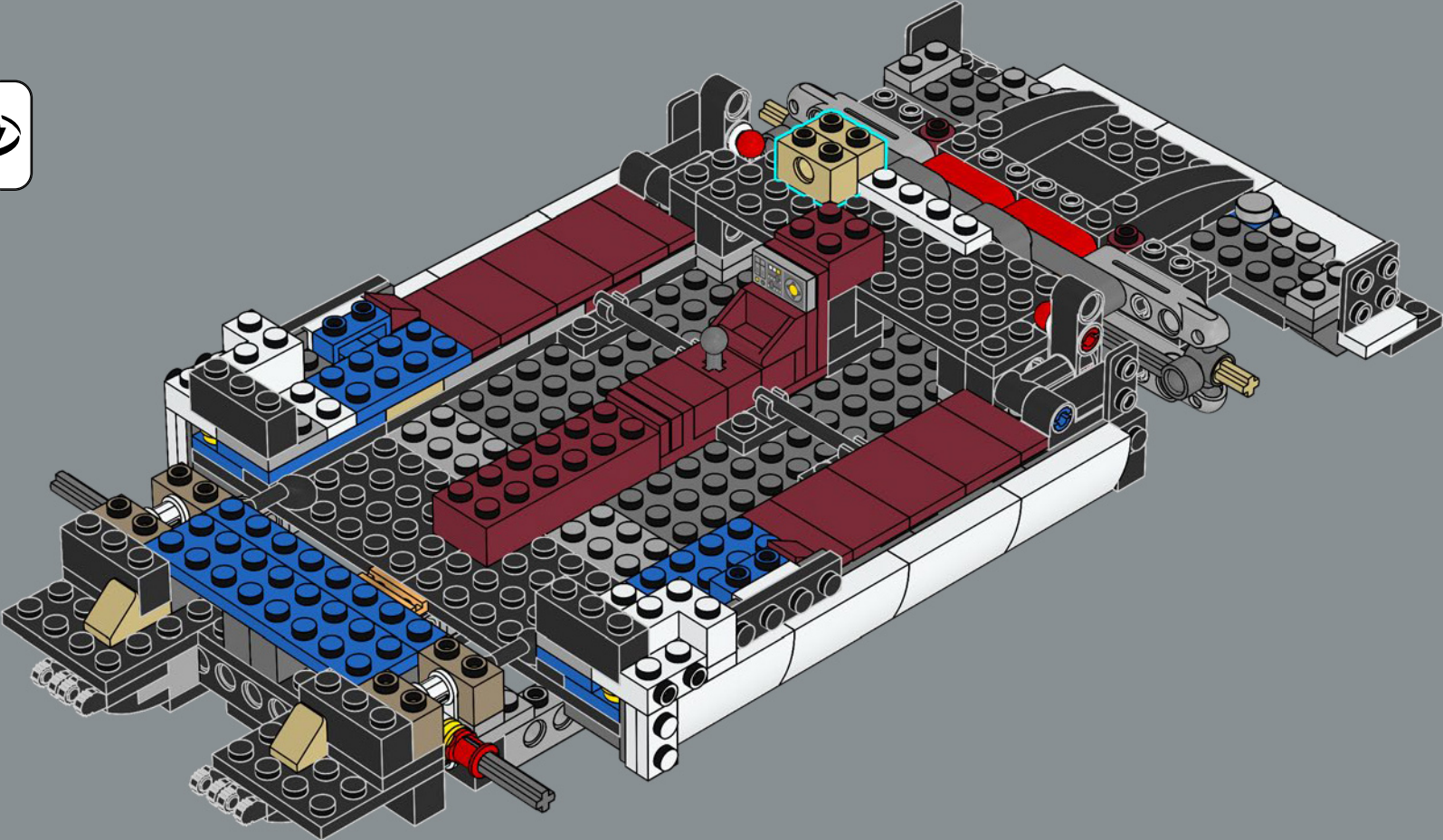

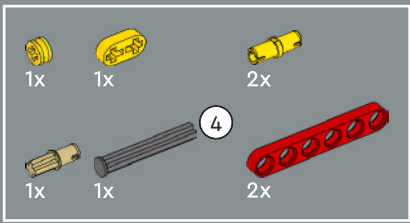

81

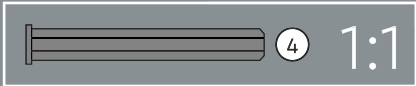
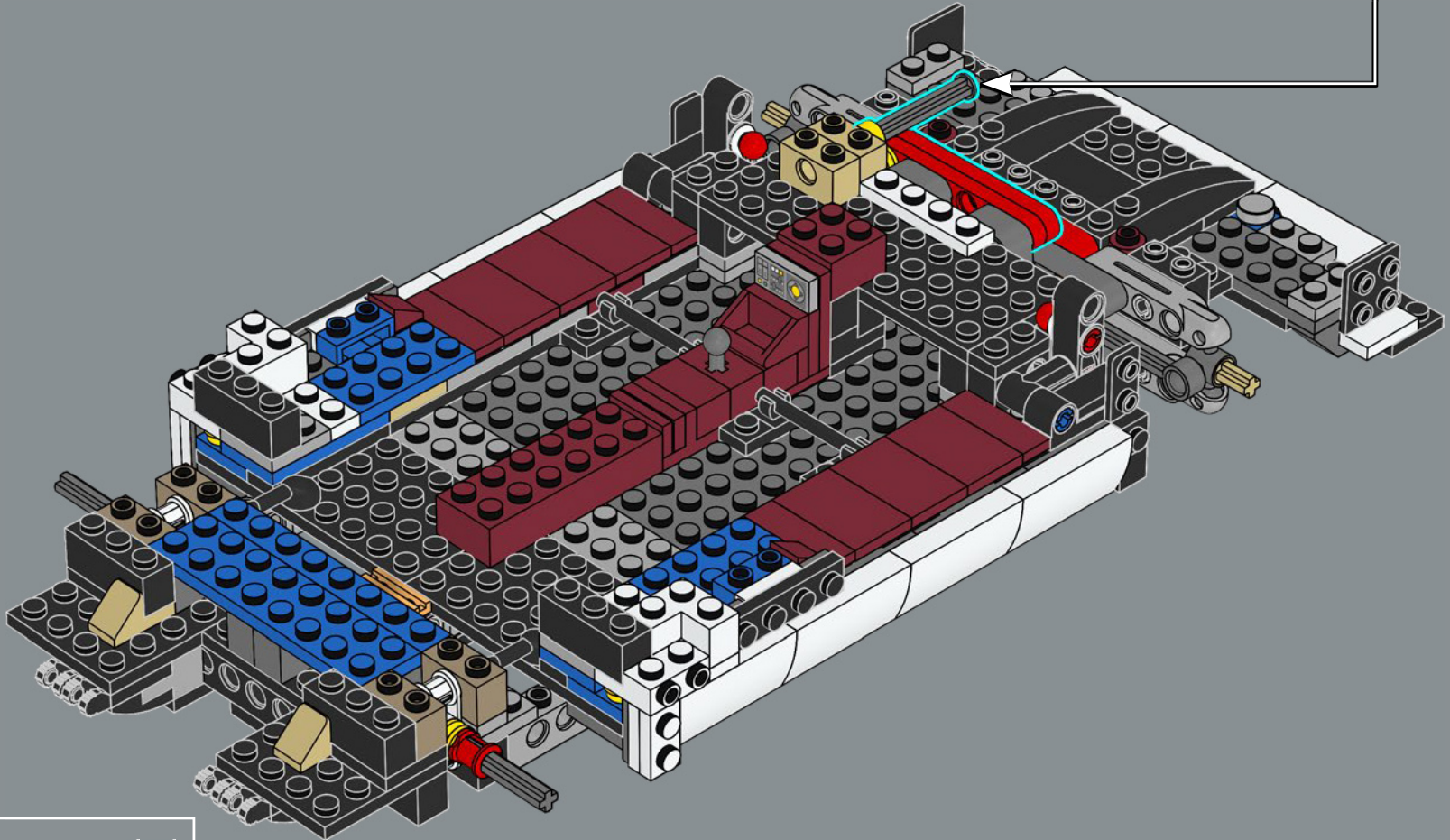
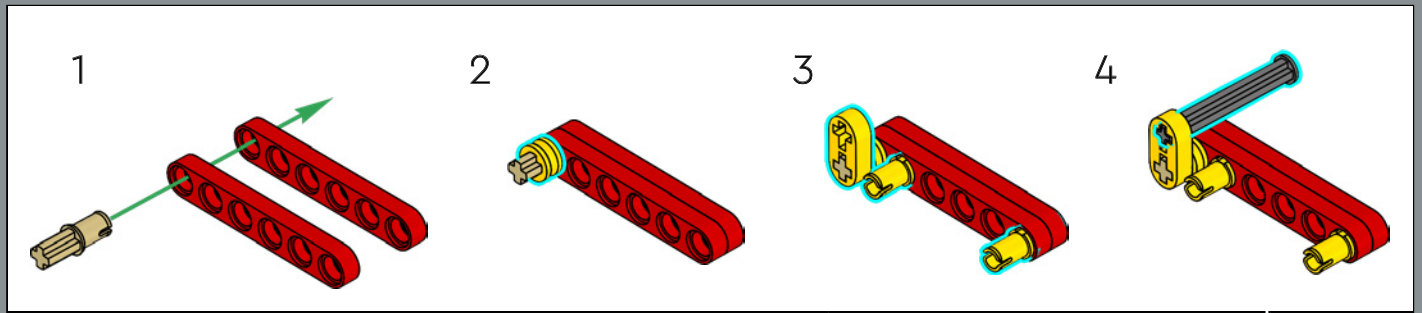



1x

82

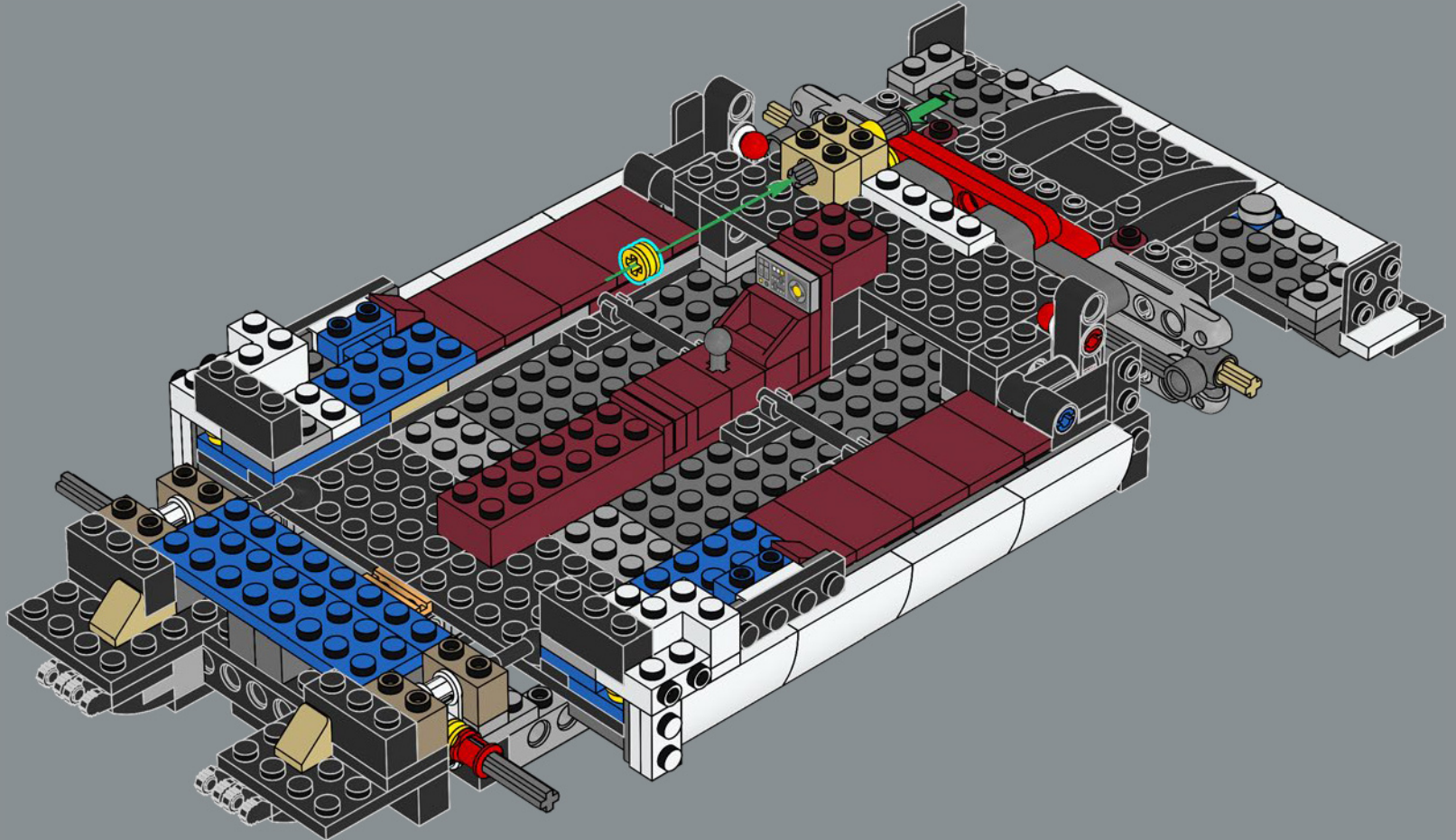

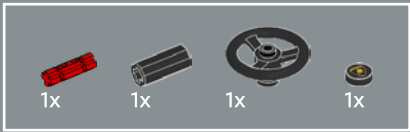

83

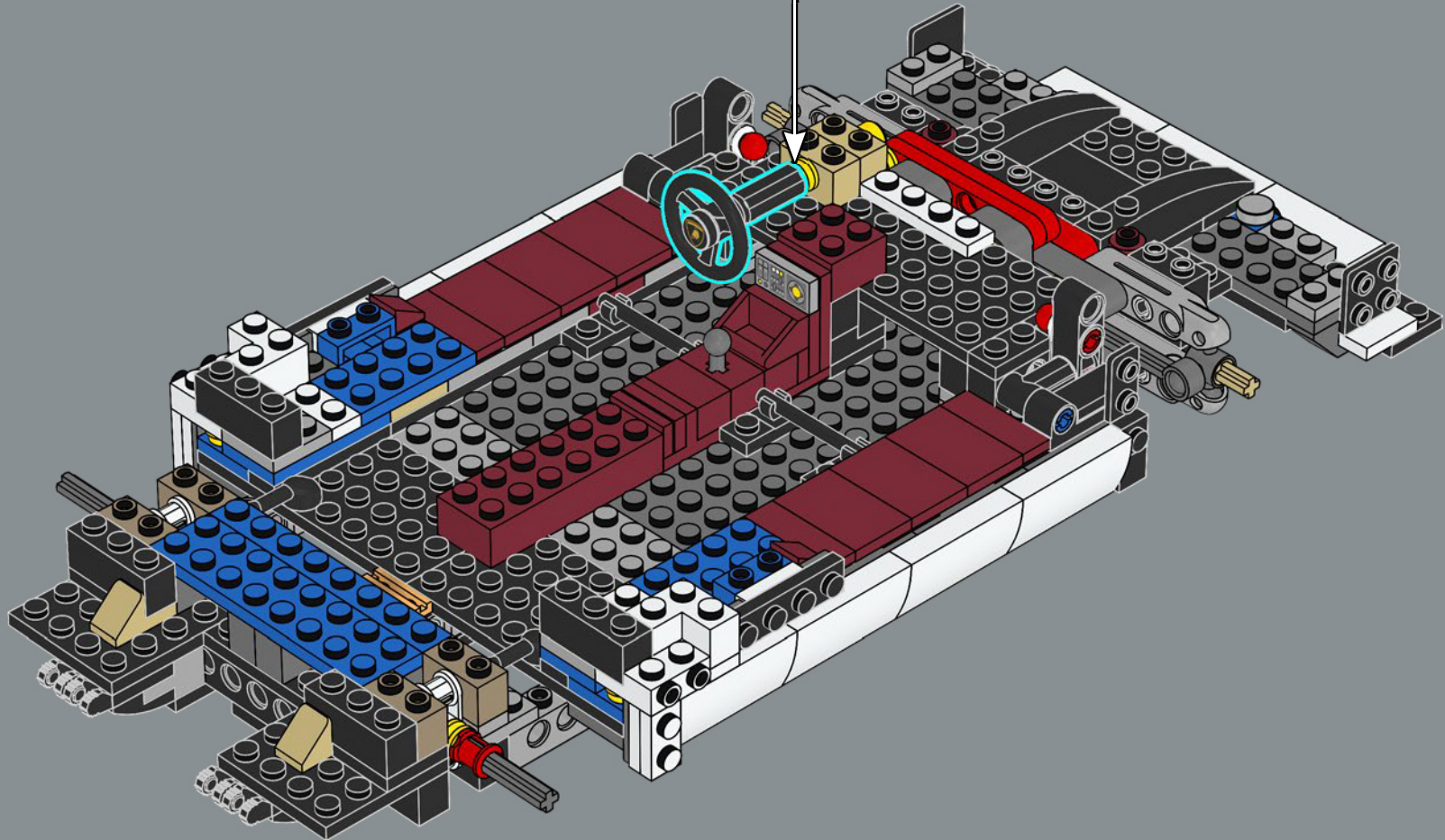
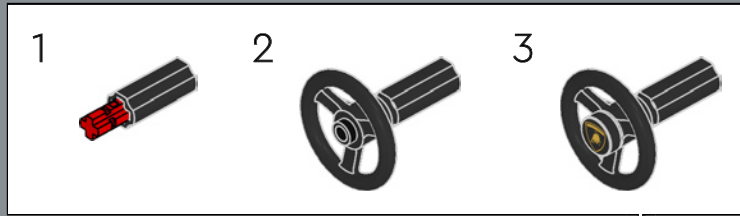

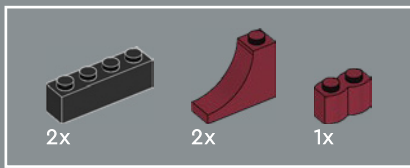

84

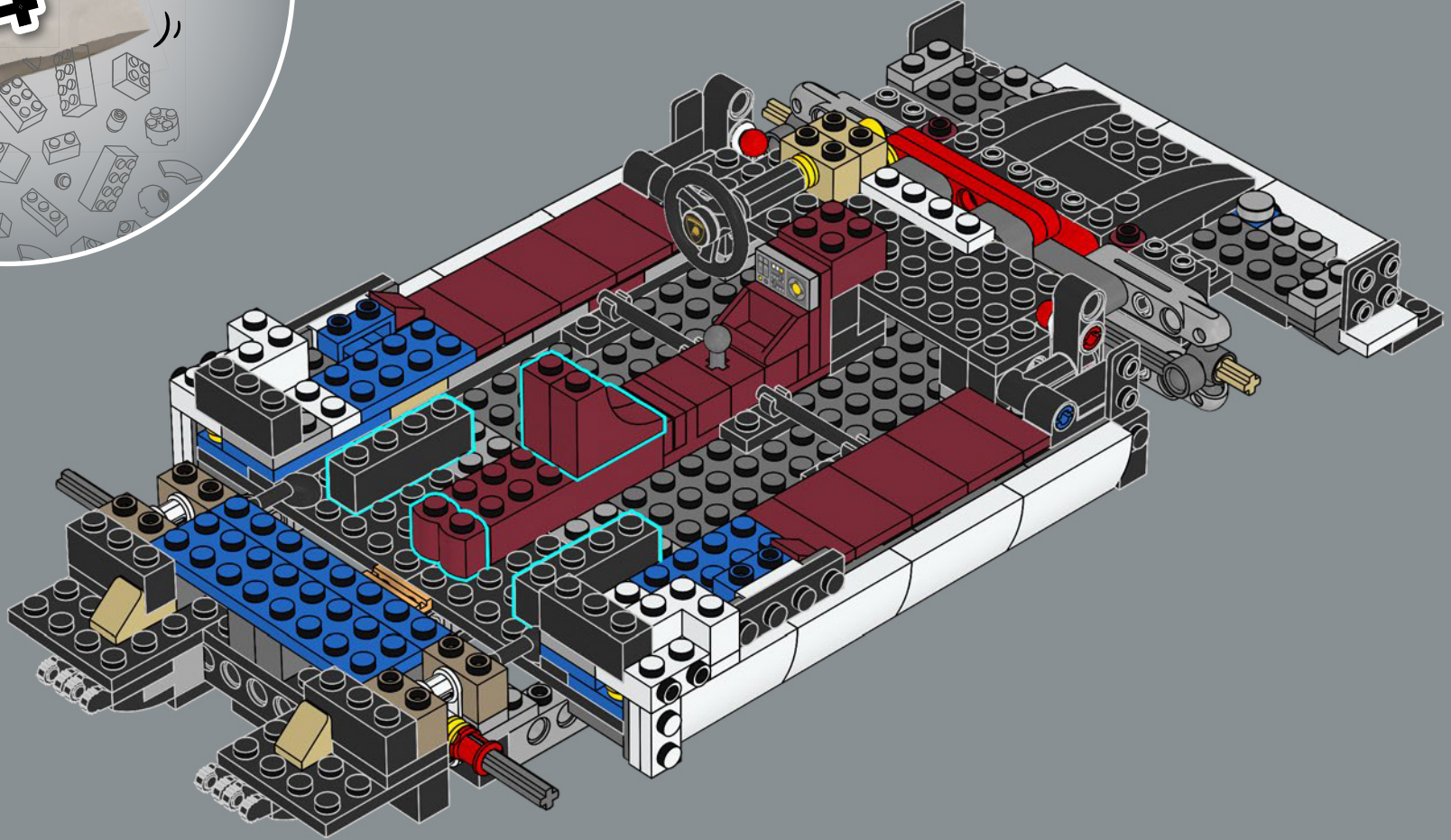

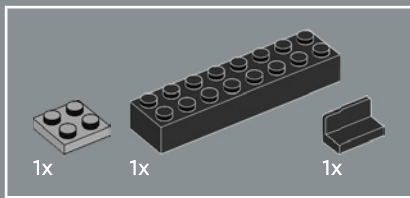

85

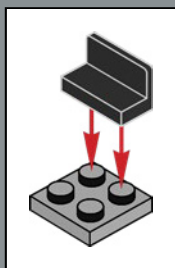
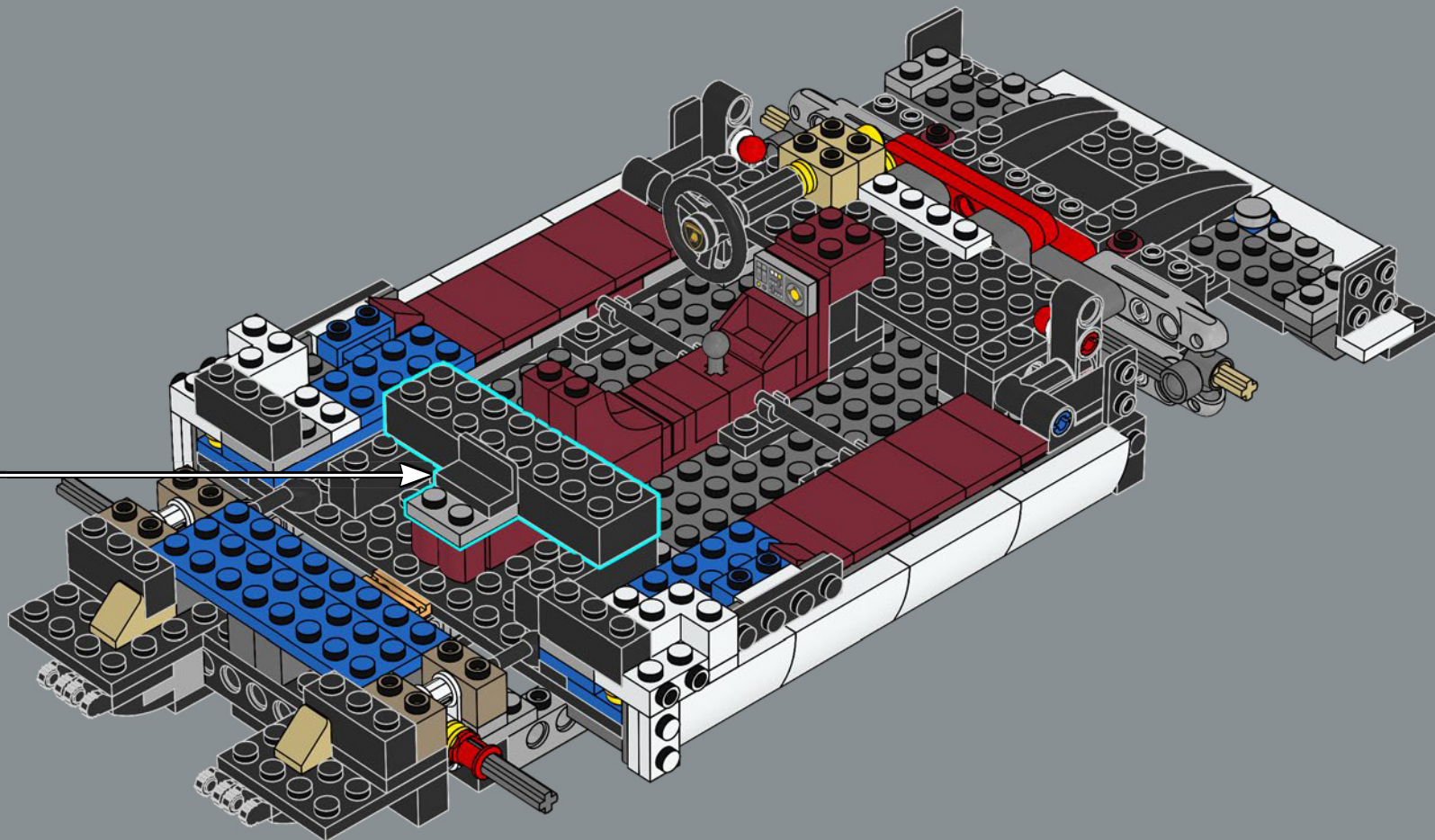

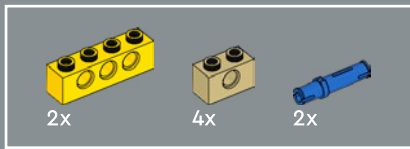

86

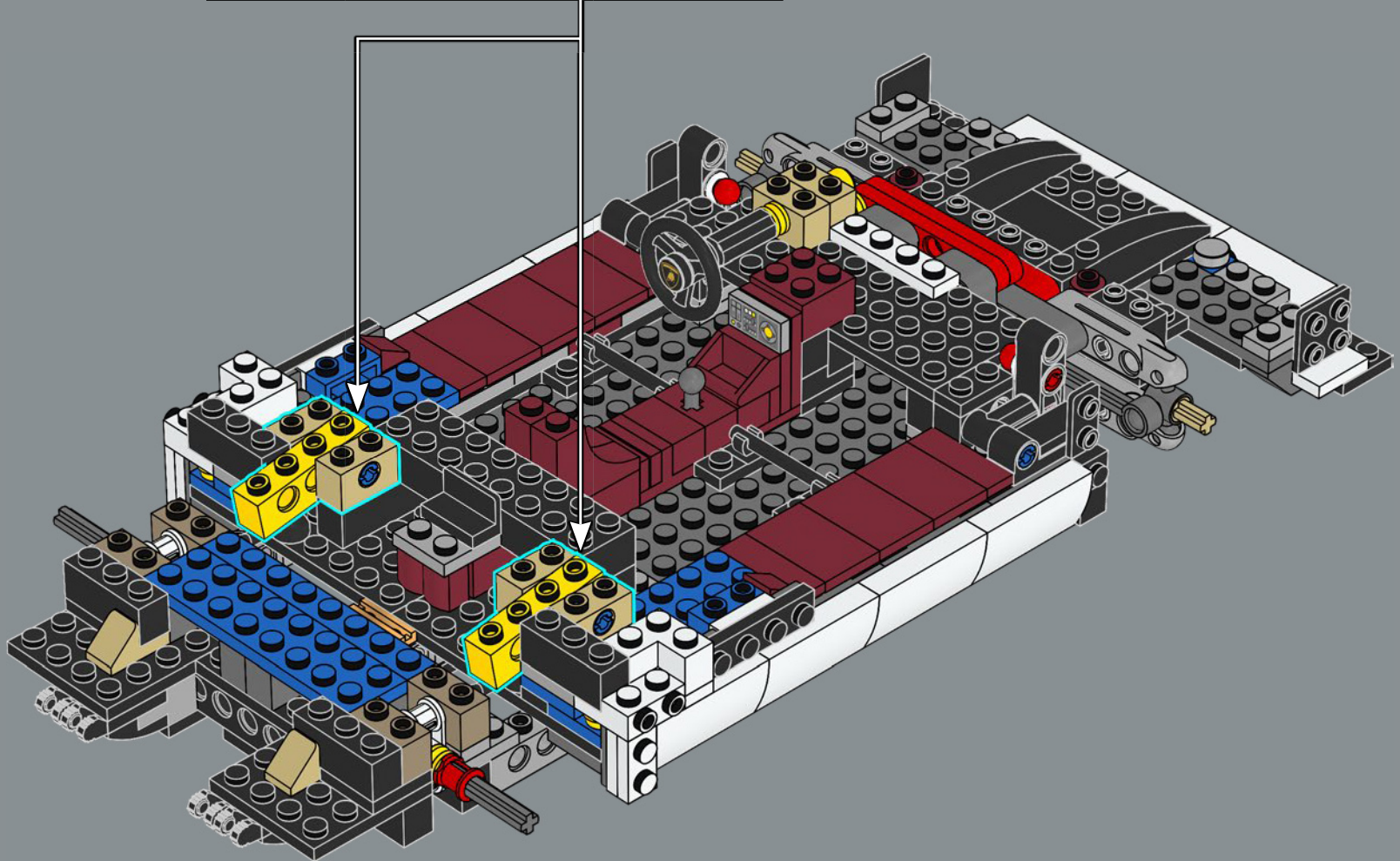
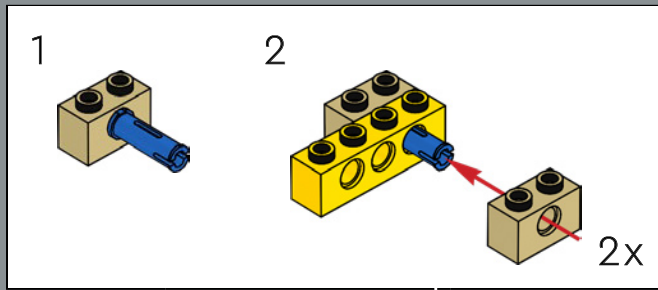

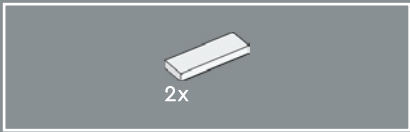

87

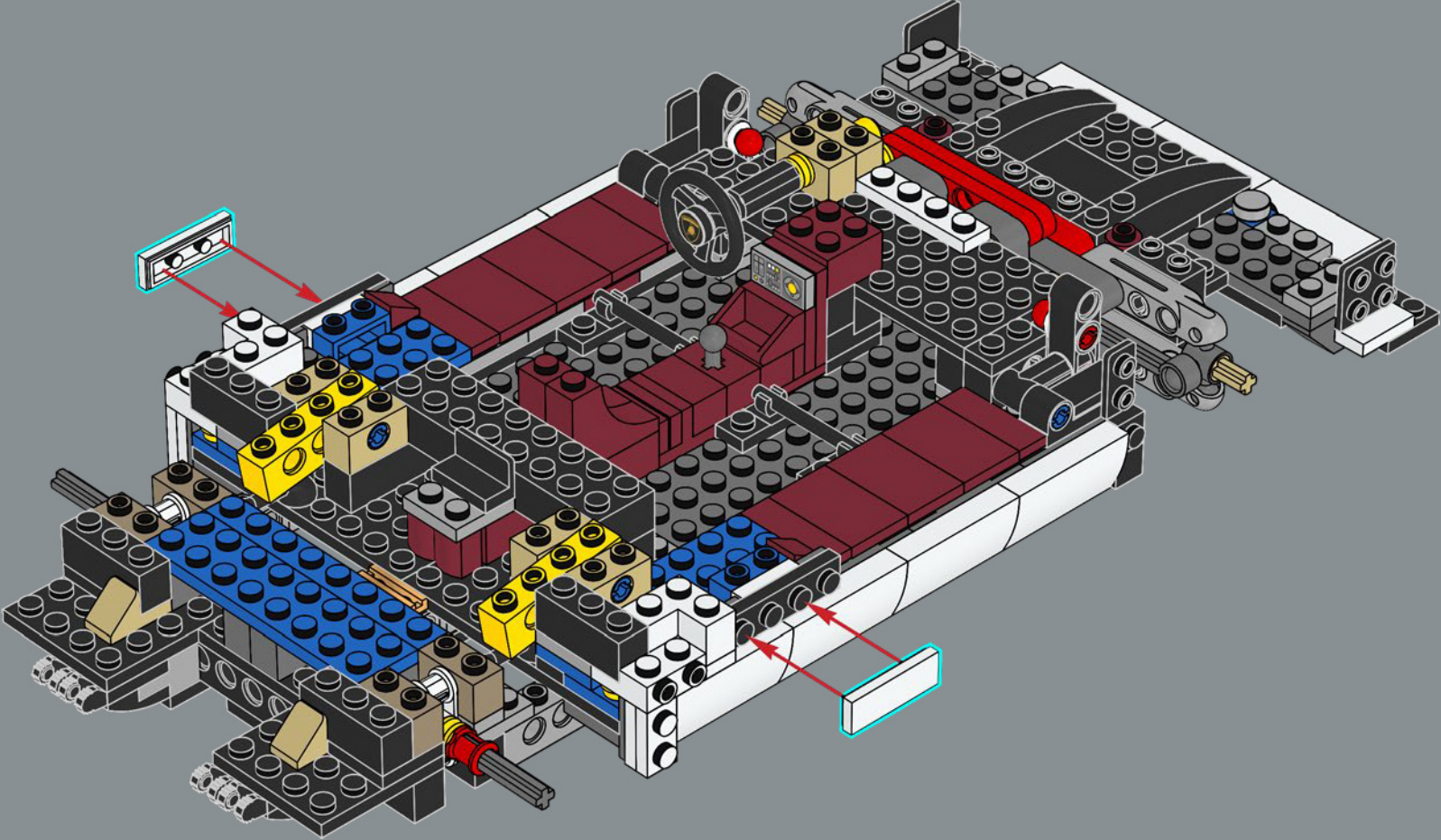

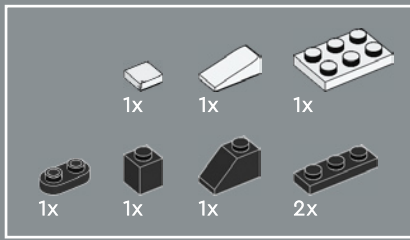

88

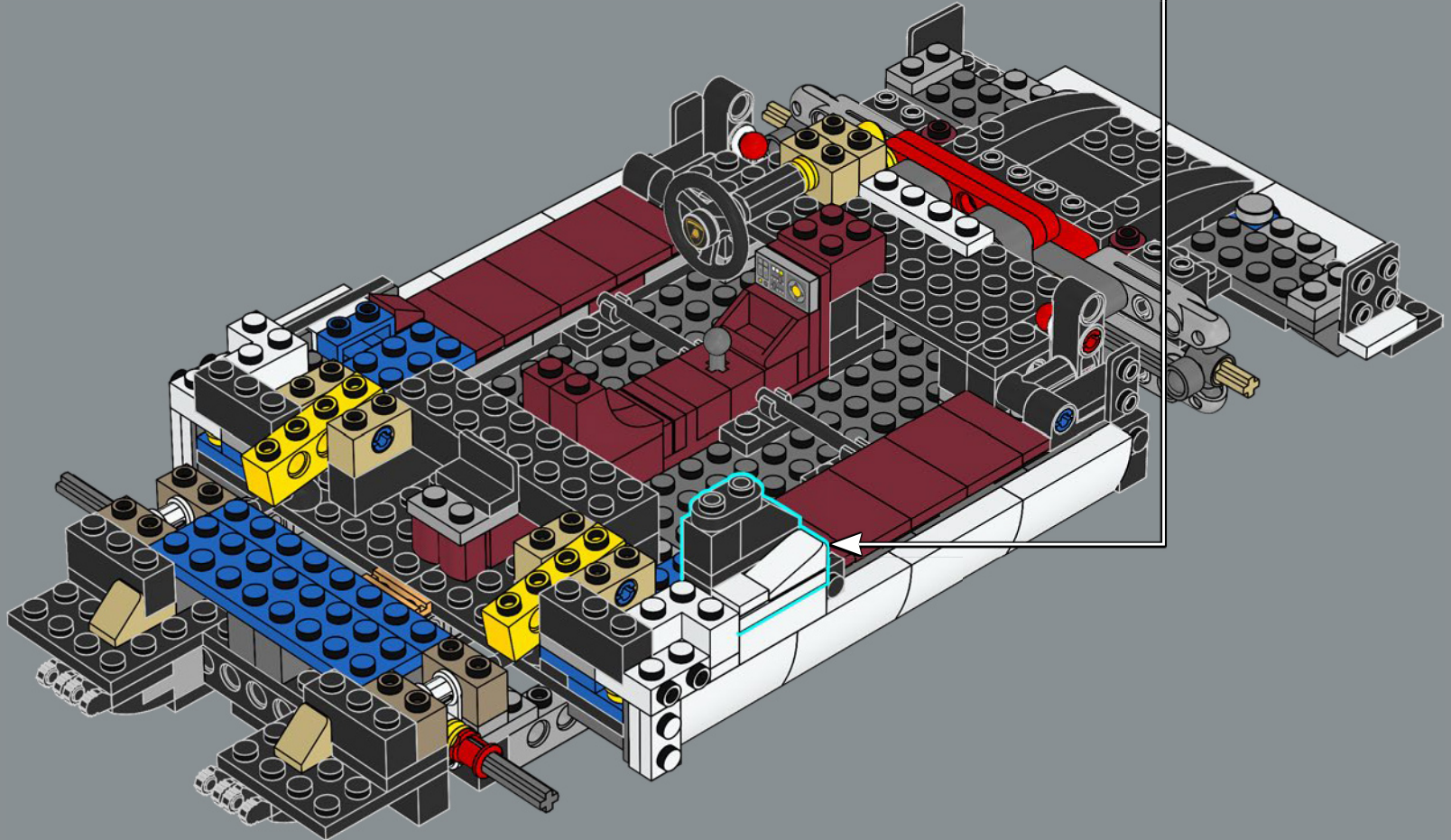
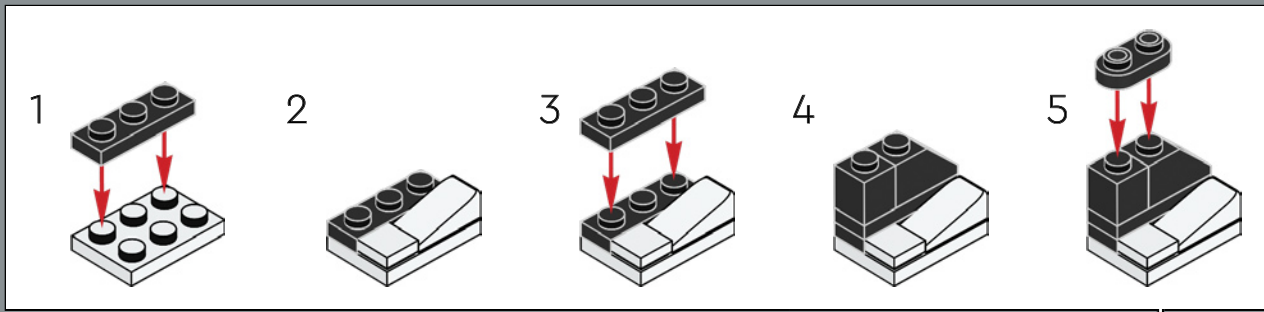

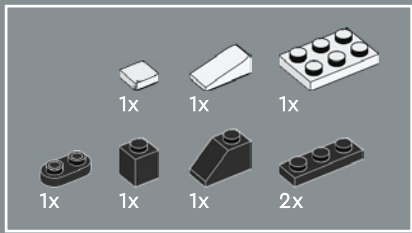

89

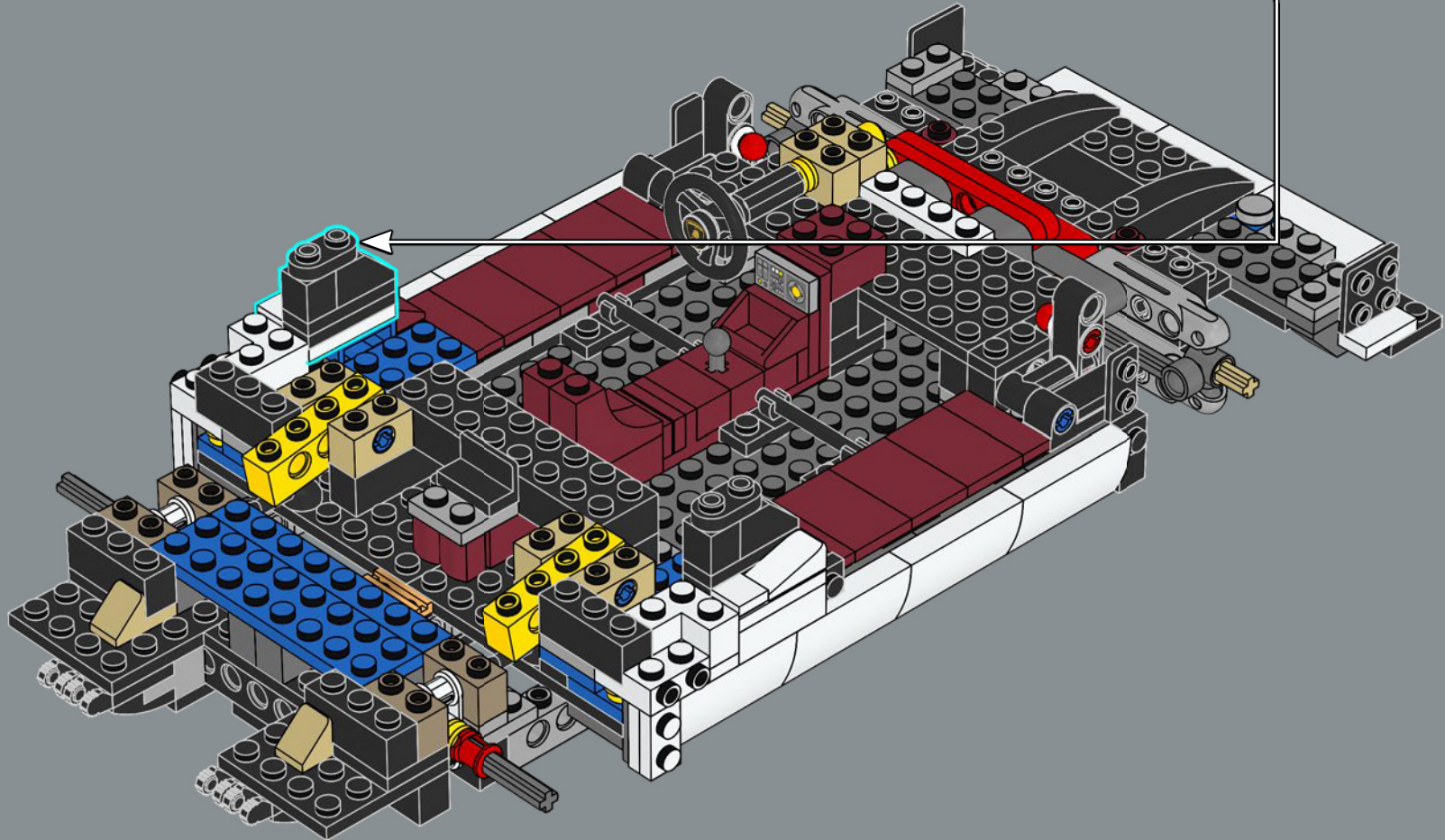
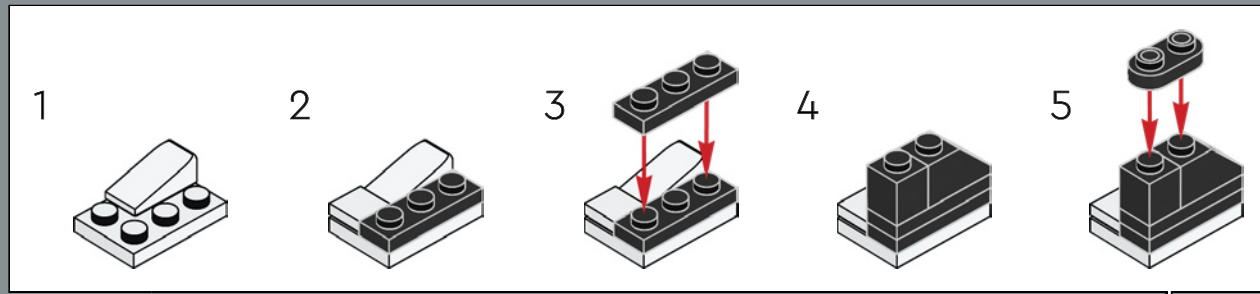

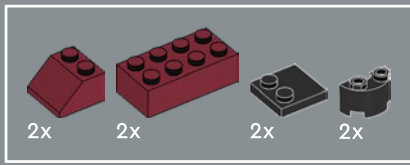

90

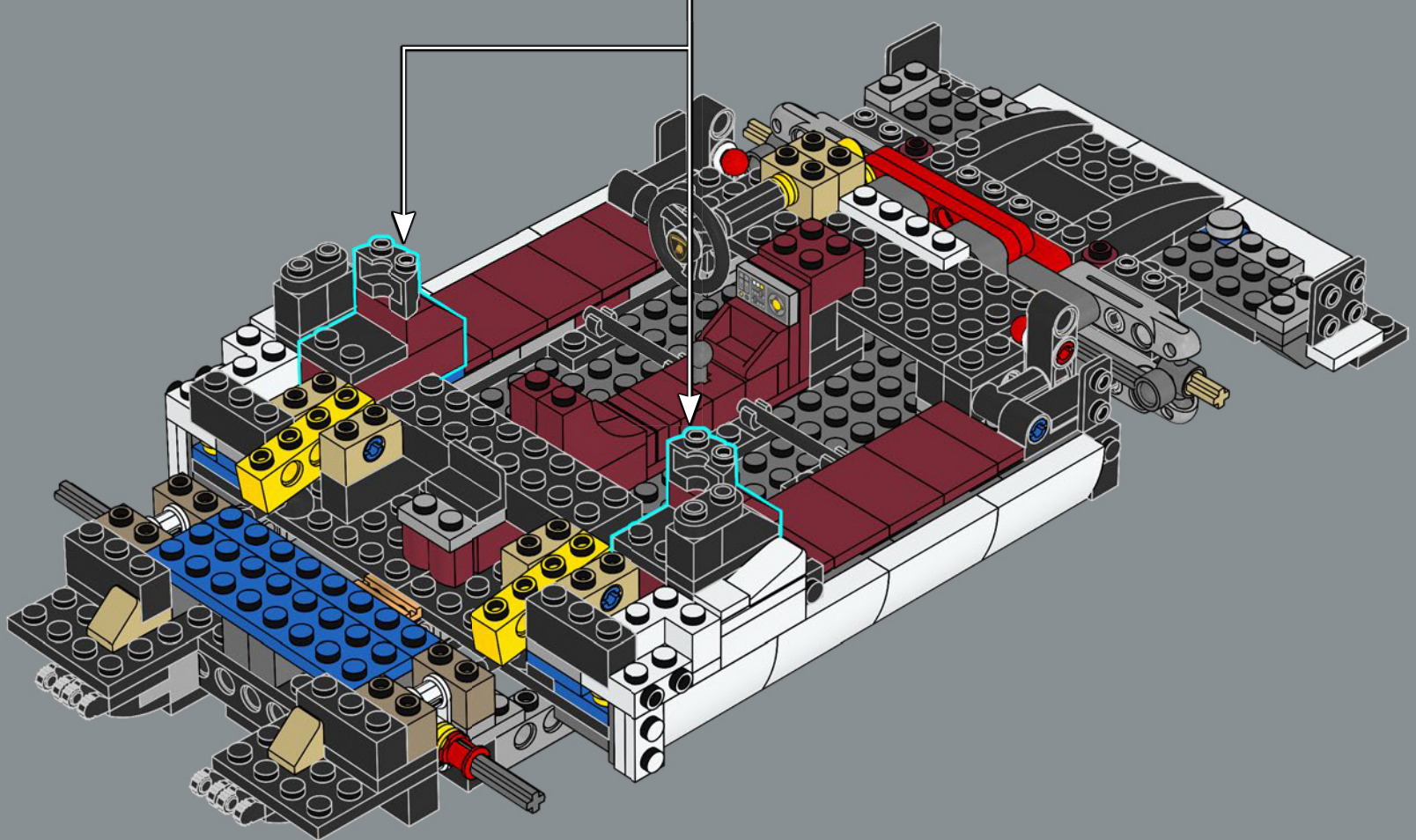
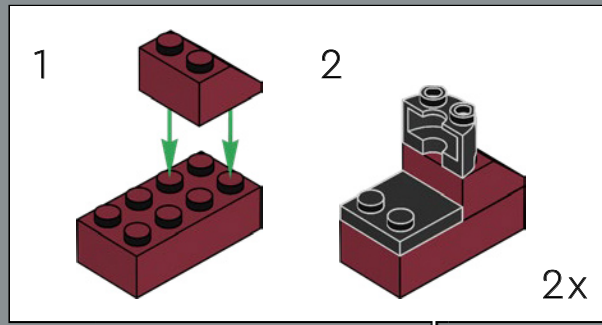

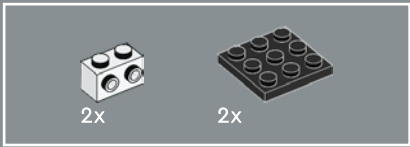

91

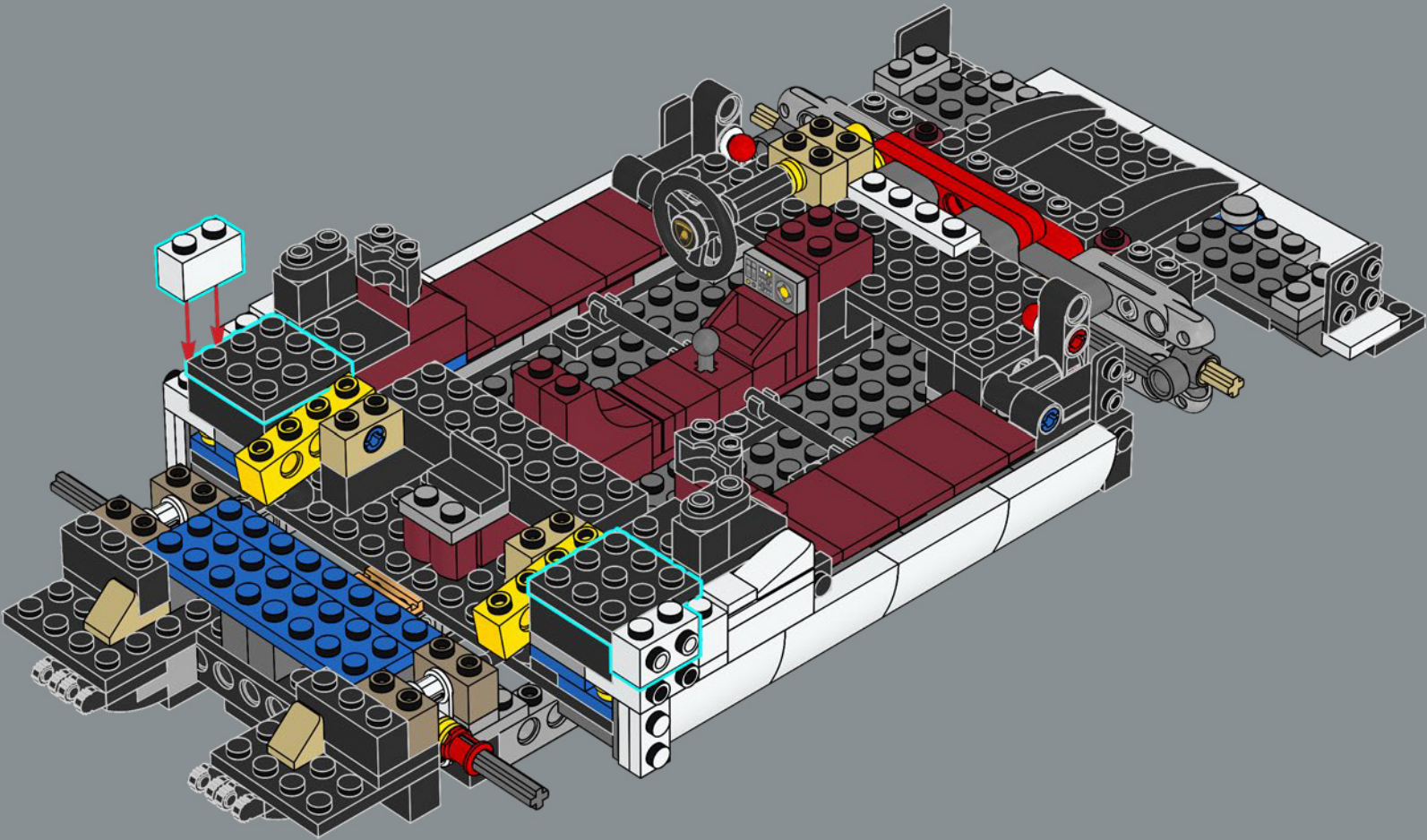

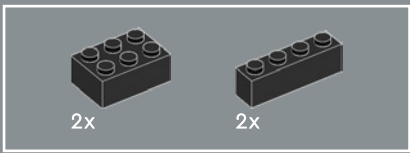

92

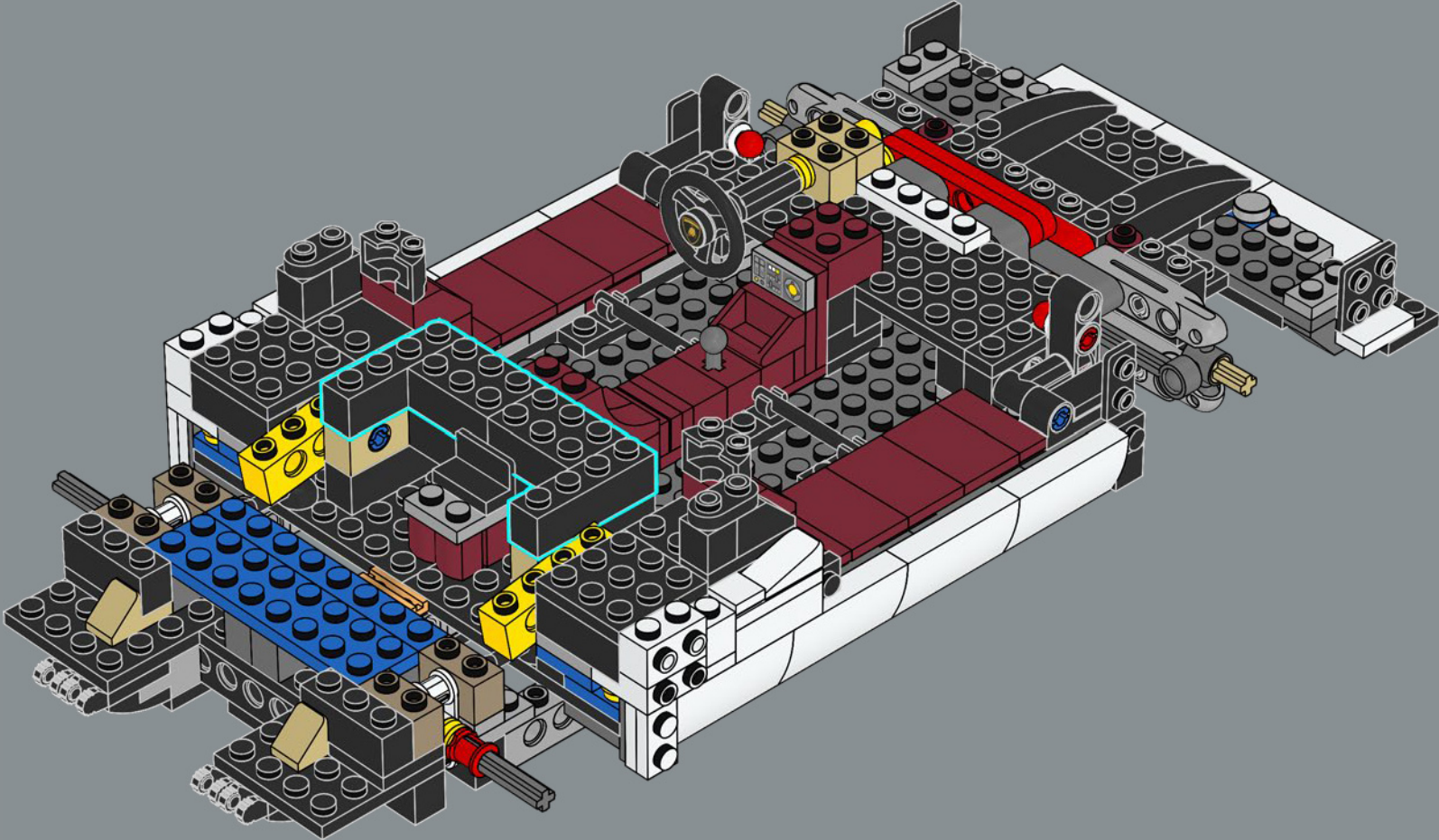

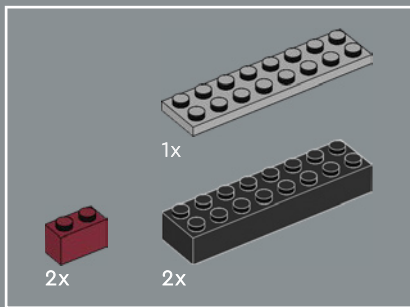

93

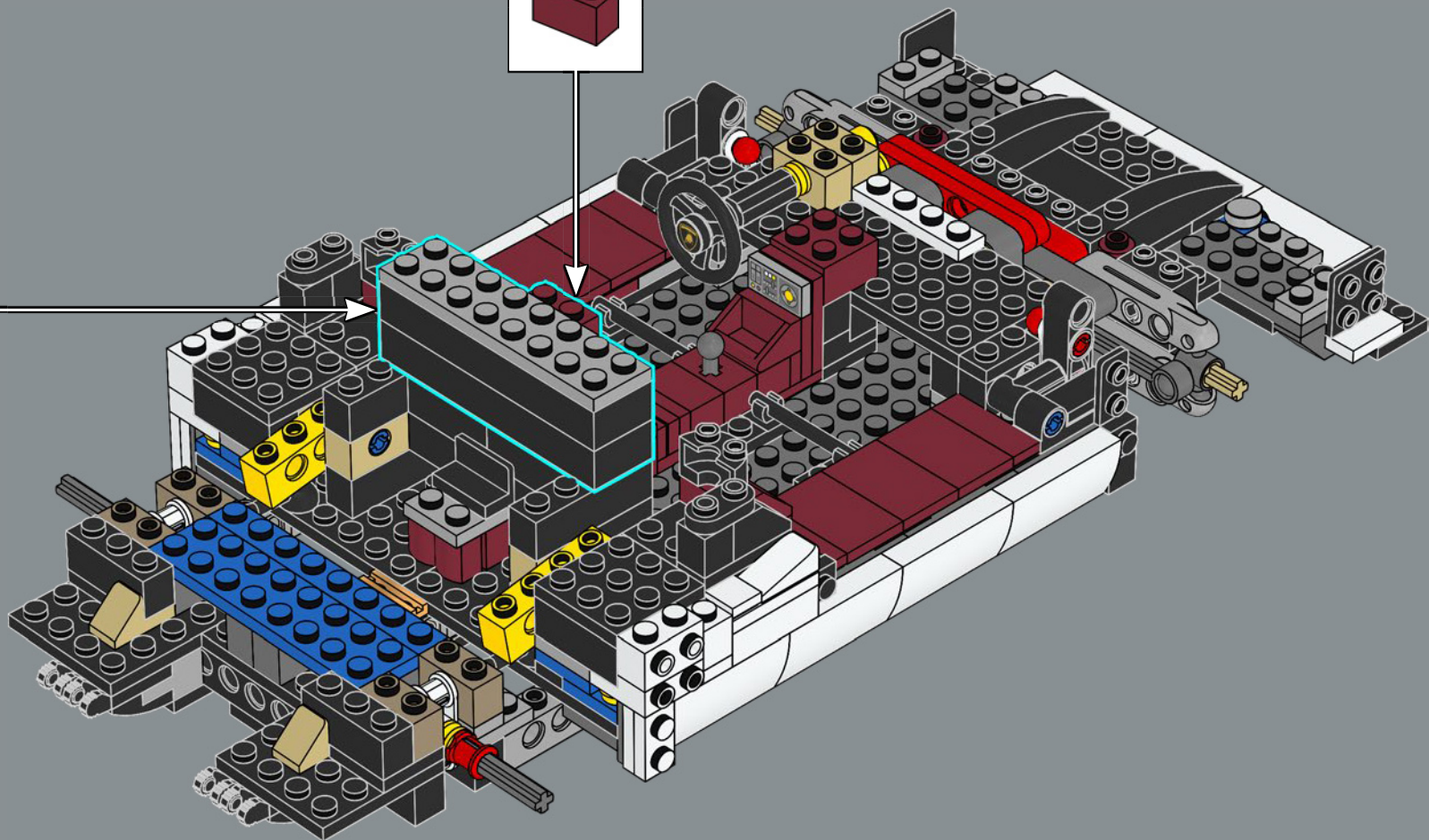
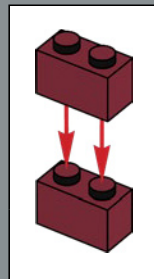
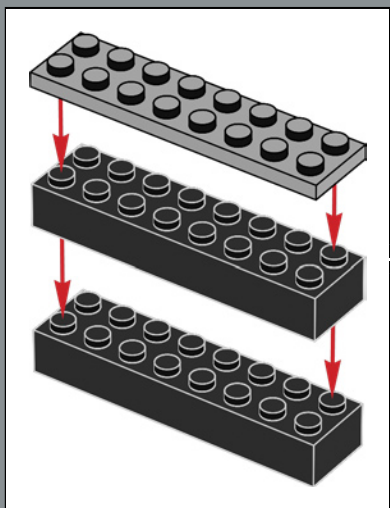

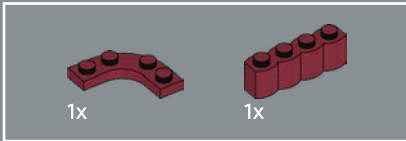
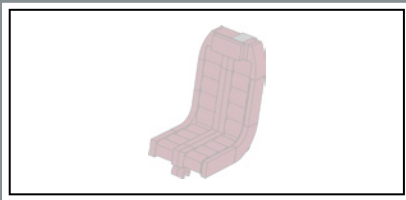

94

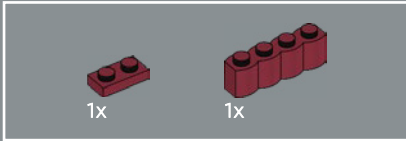
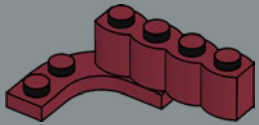

95

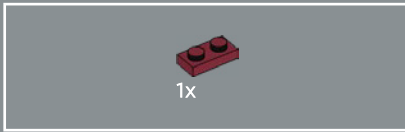
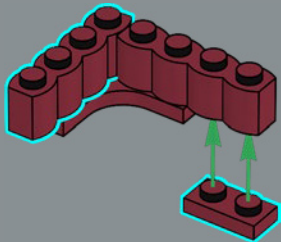

96

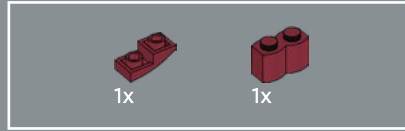
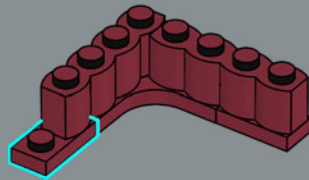

97

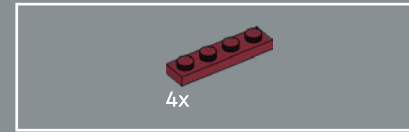
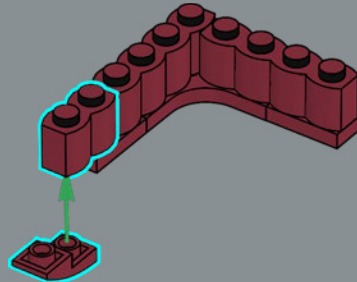

98

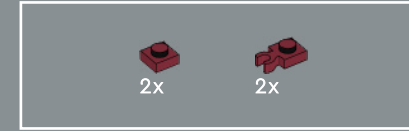
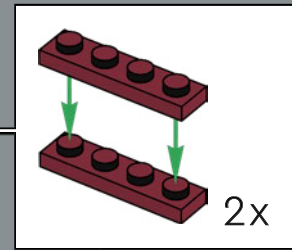
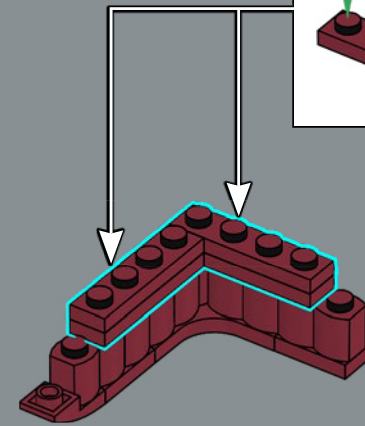

99

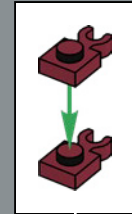
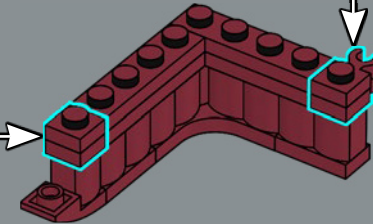
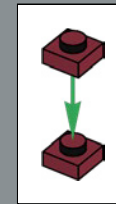

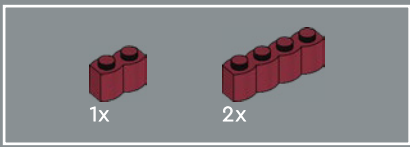

100

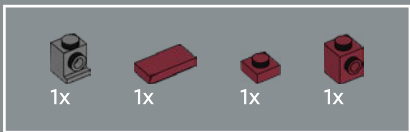
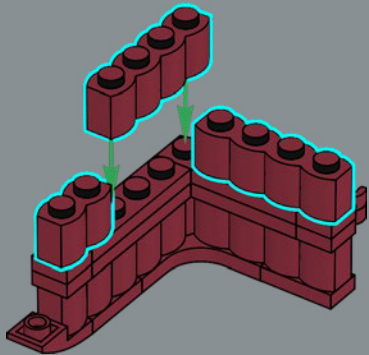

101

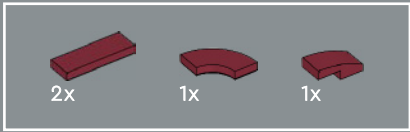
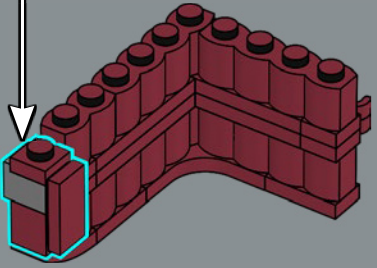
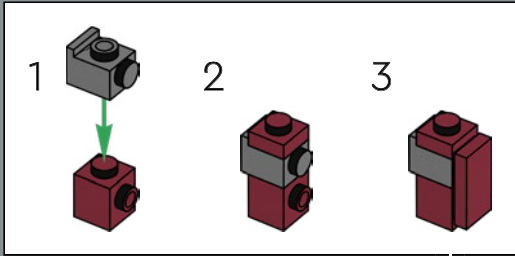

102

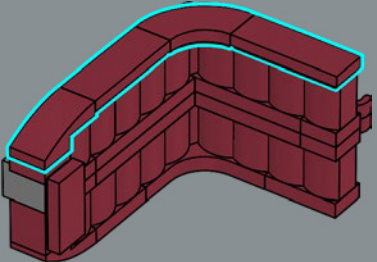

103

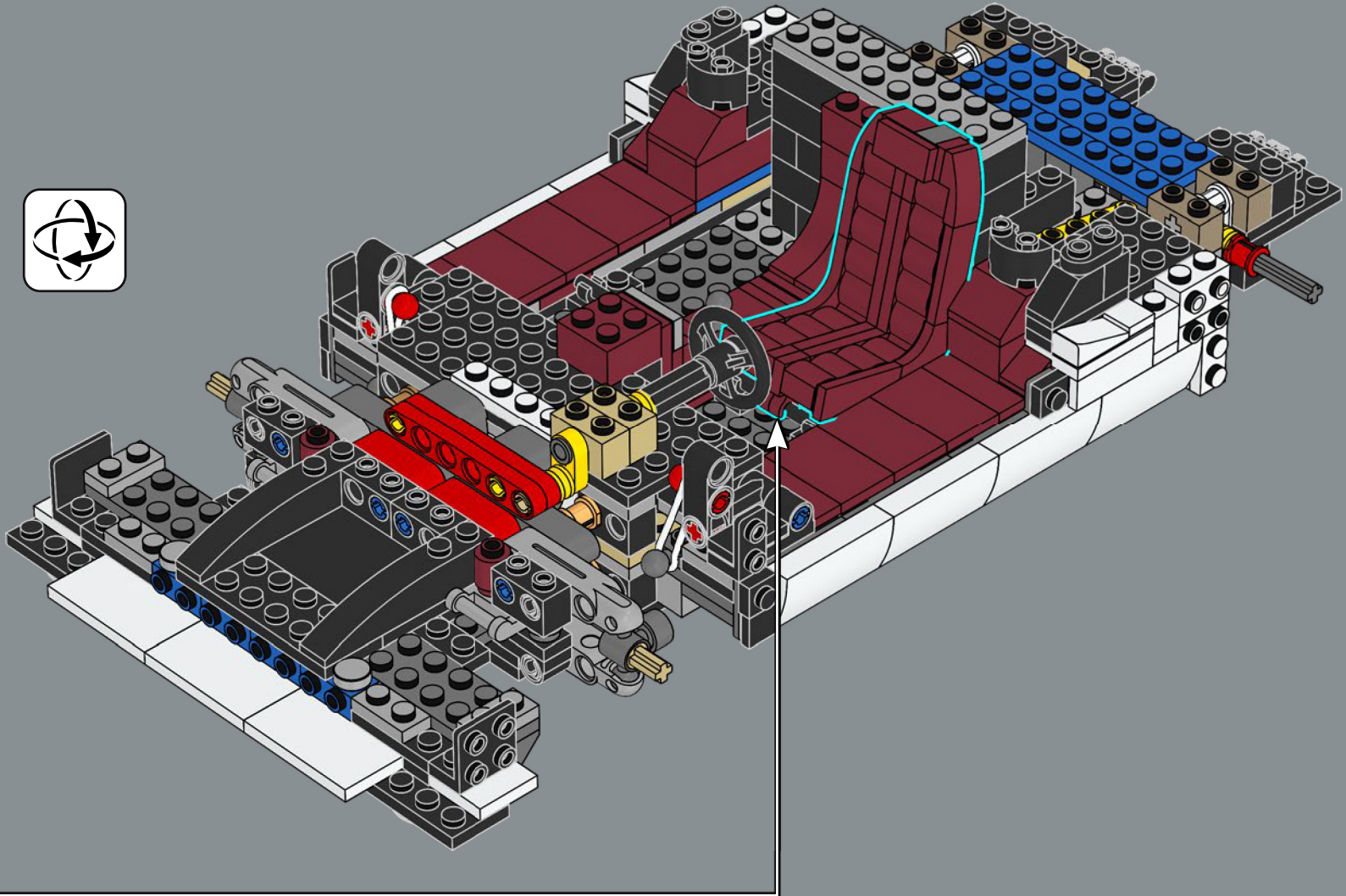

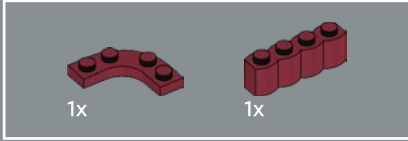

104

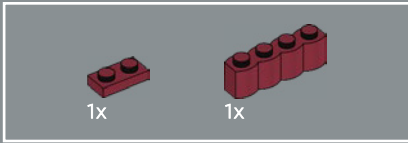
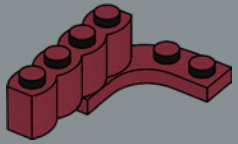

105

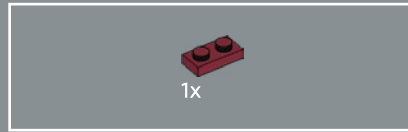
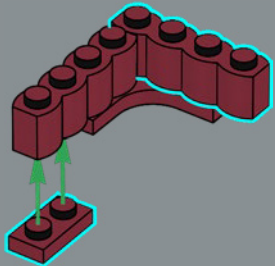

106

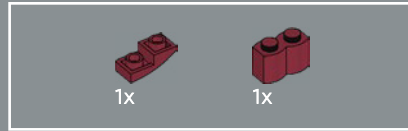
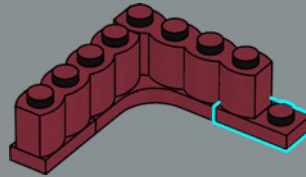

107

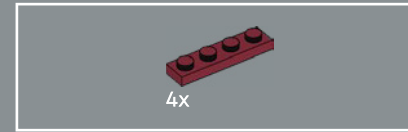
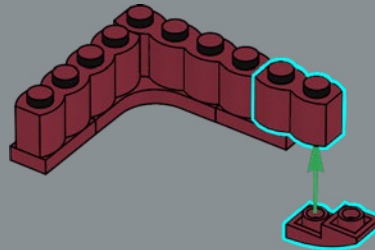

108

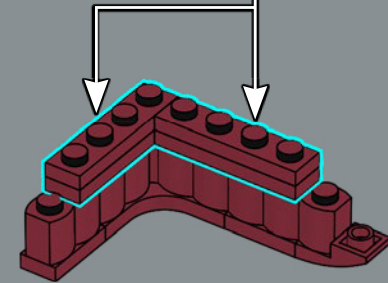
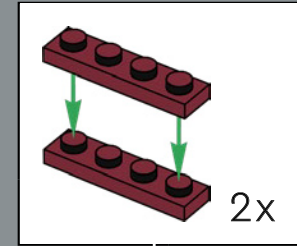



109

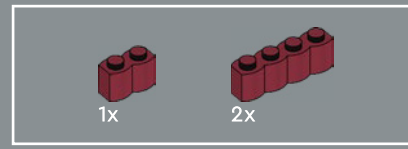
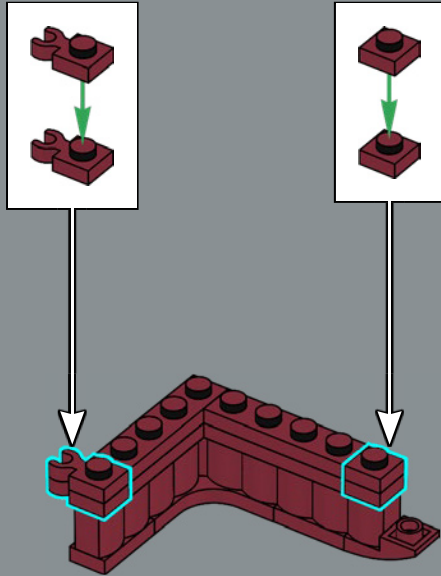

110

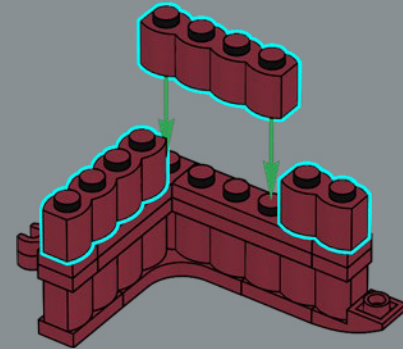

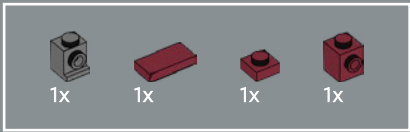

111

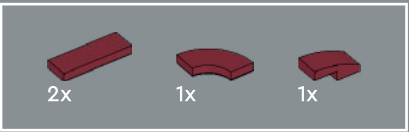
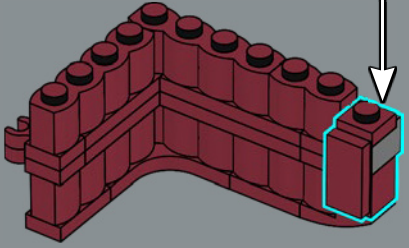
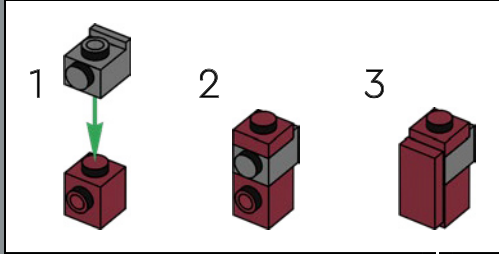

112

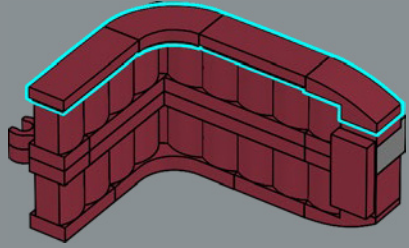

113

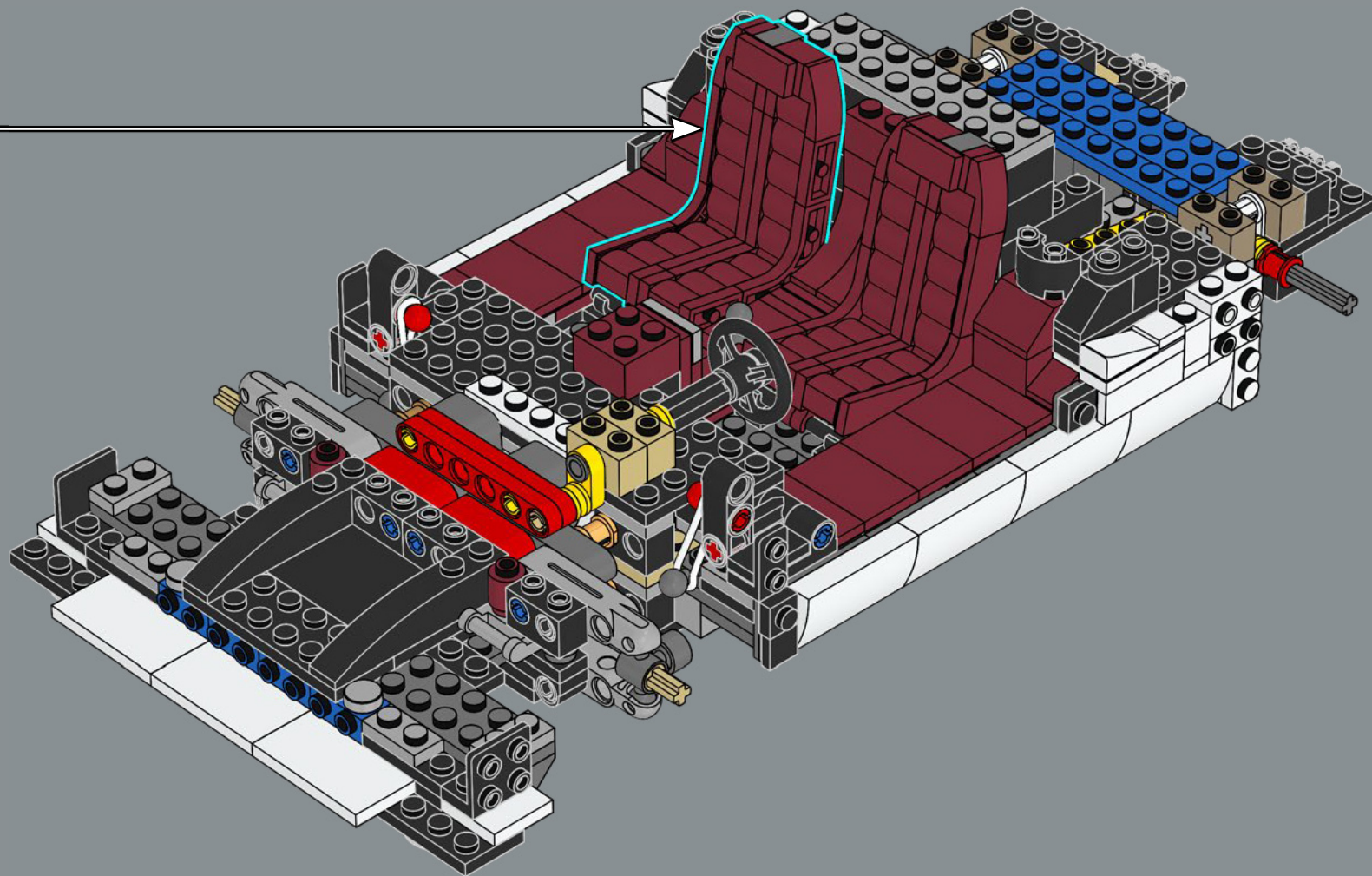

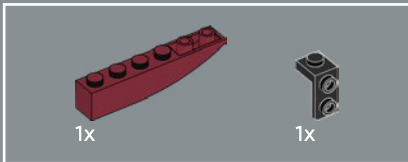
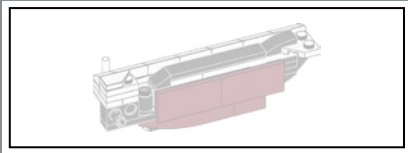

114

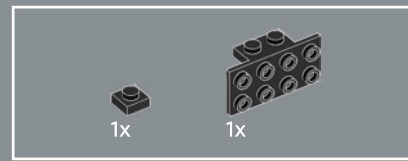
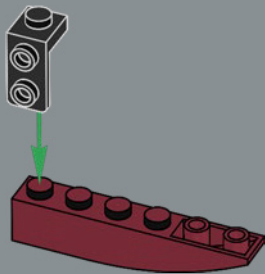

115

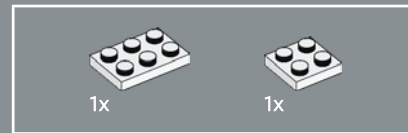
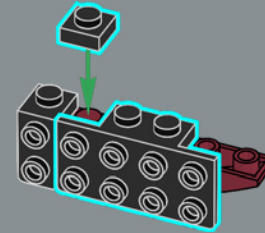

116

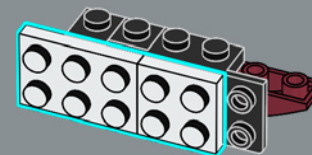

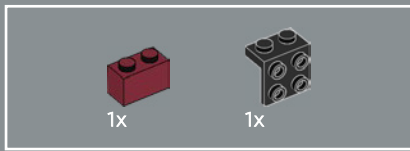

117

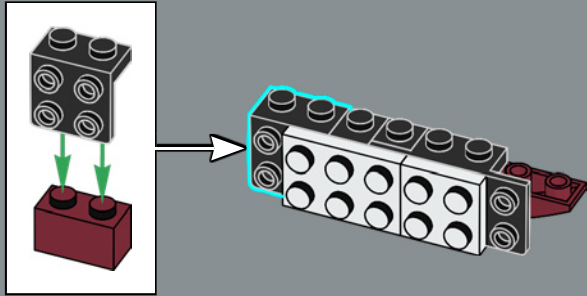

118

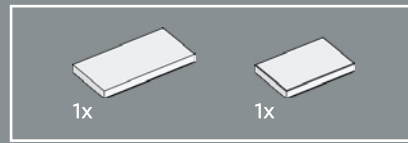
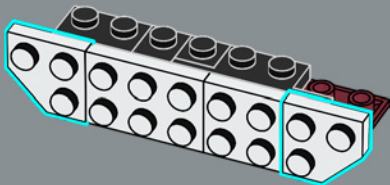

119

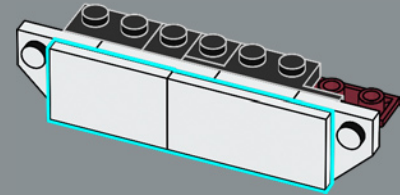

120

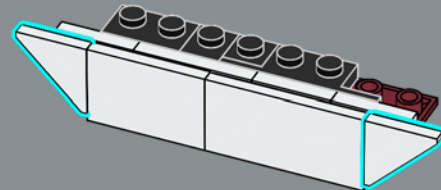

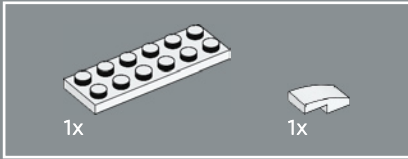
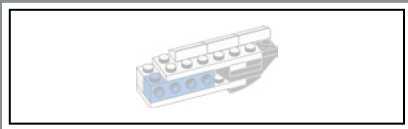

121

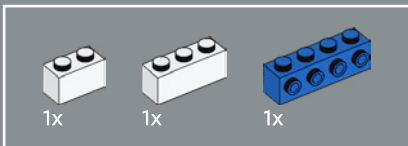
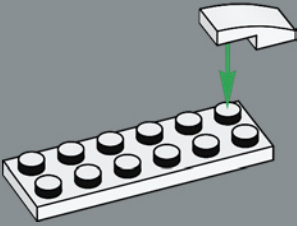

122

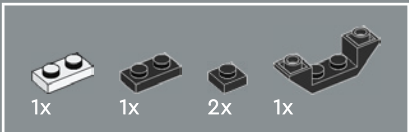
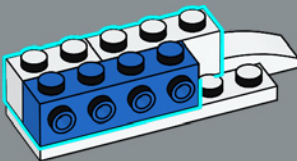

123

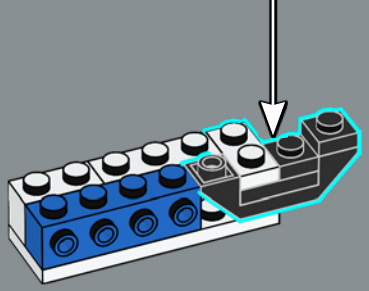
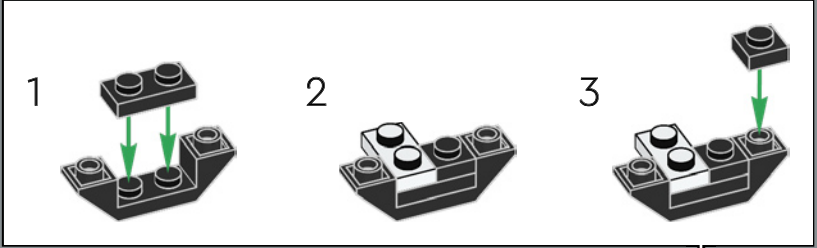

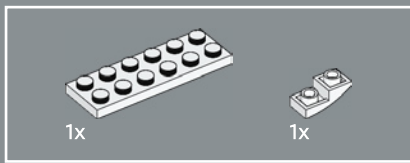

124

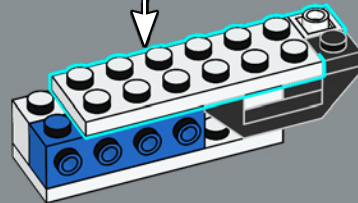
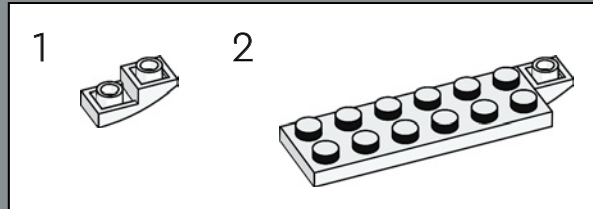

125

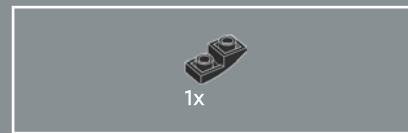
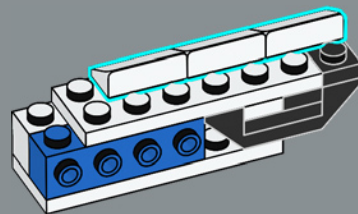

126

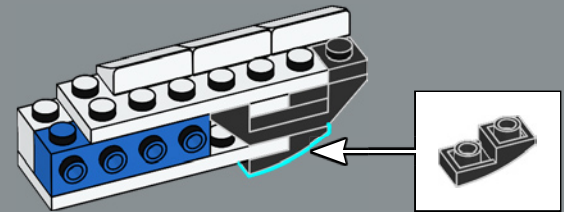

127

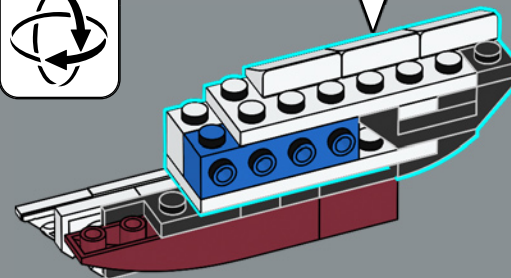



128

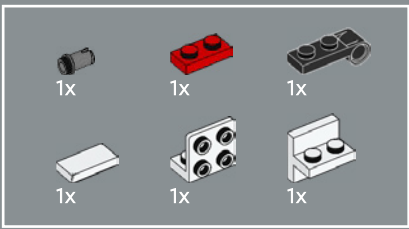
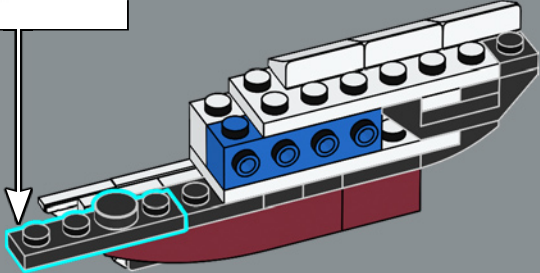
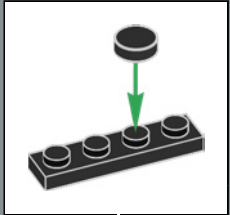

129

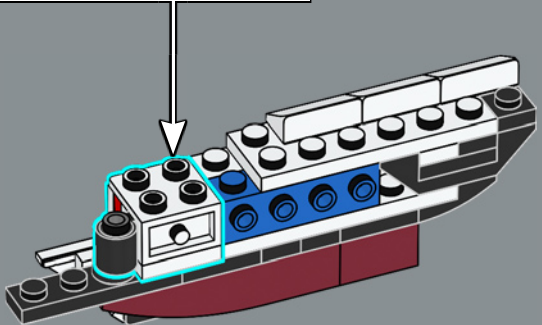
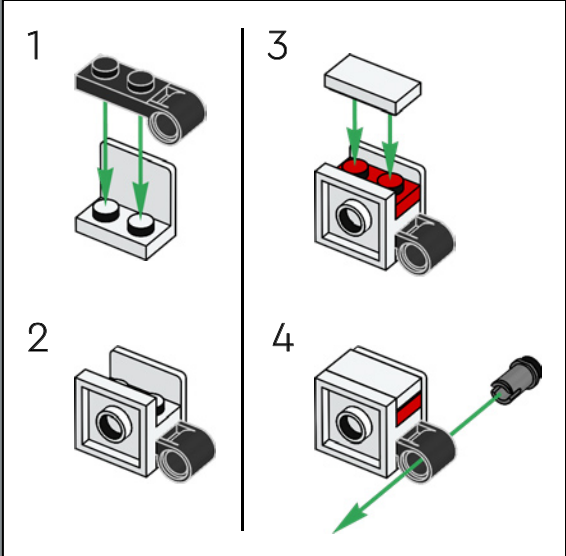

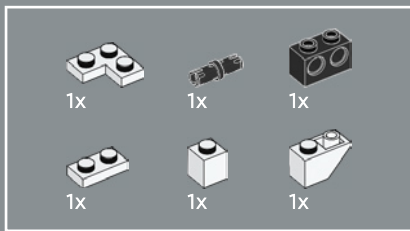

130

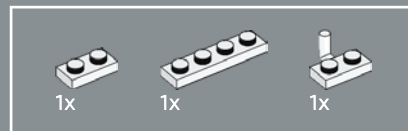
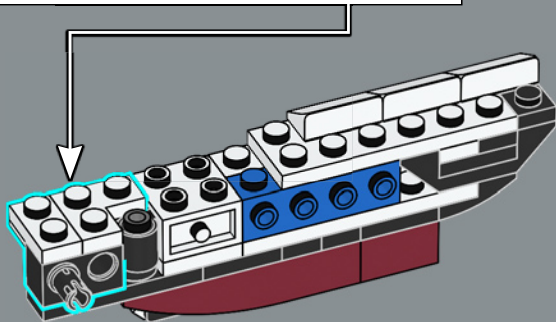
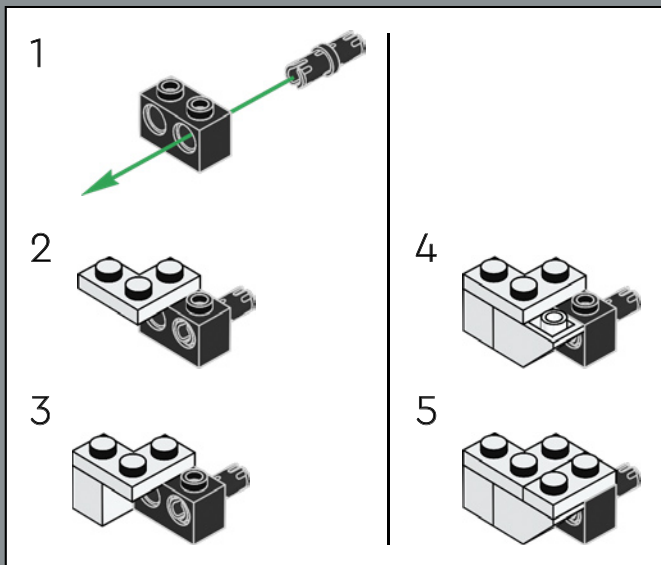

131

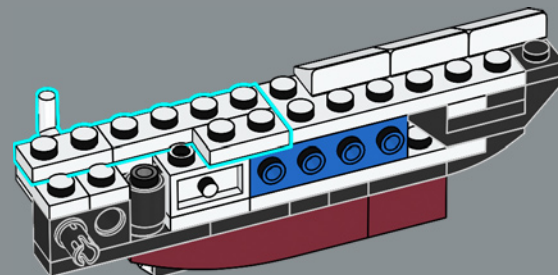

132

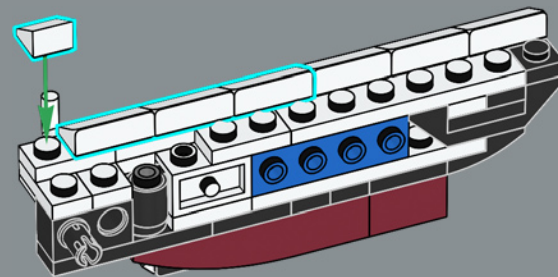



133

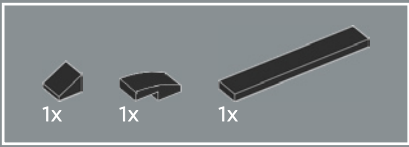
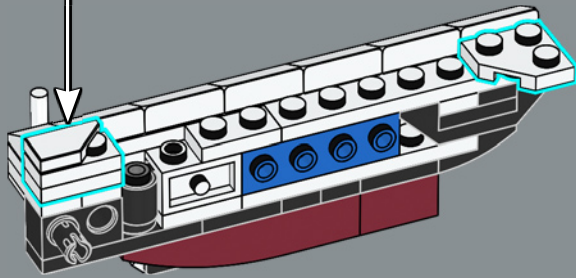
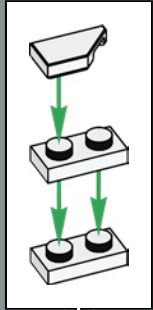

134

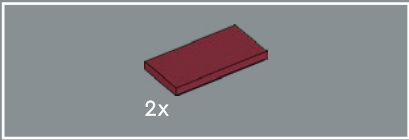
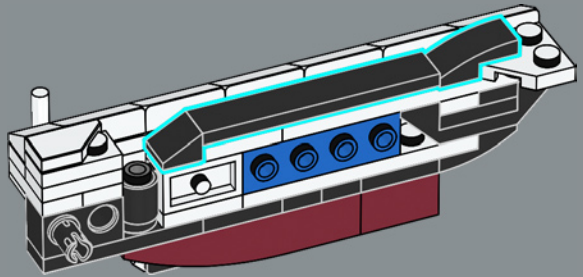

135

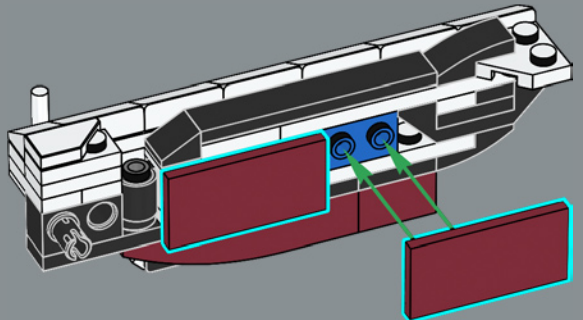

136

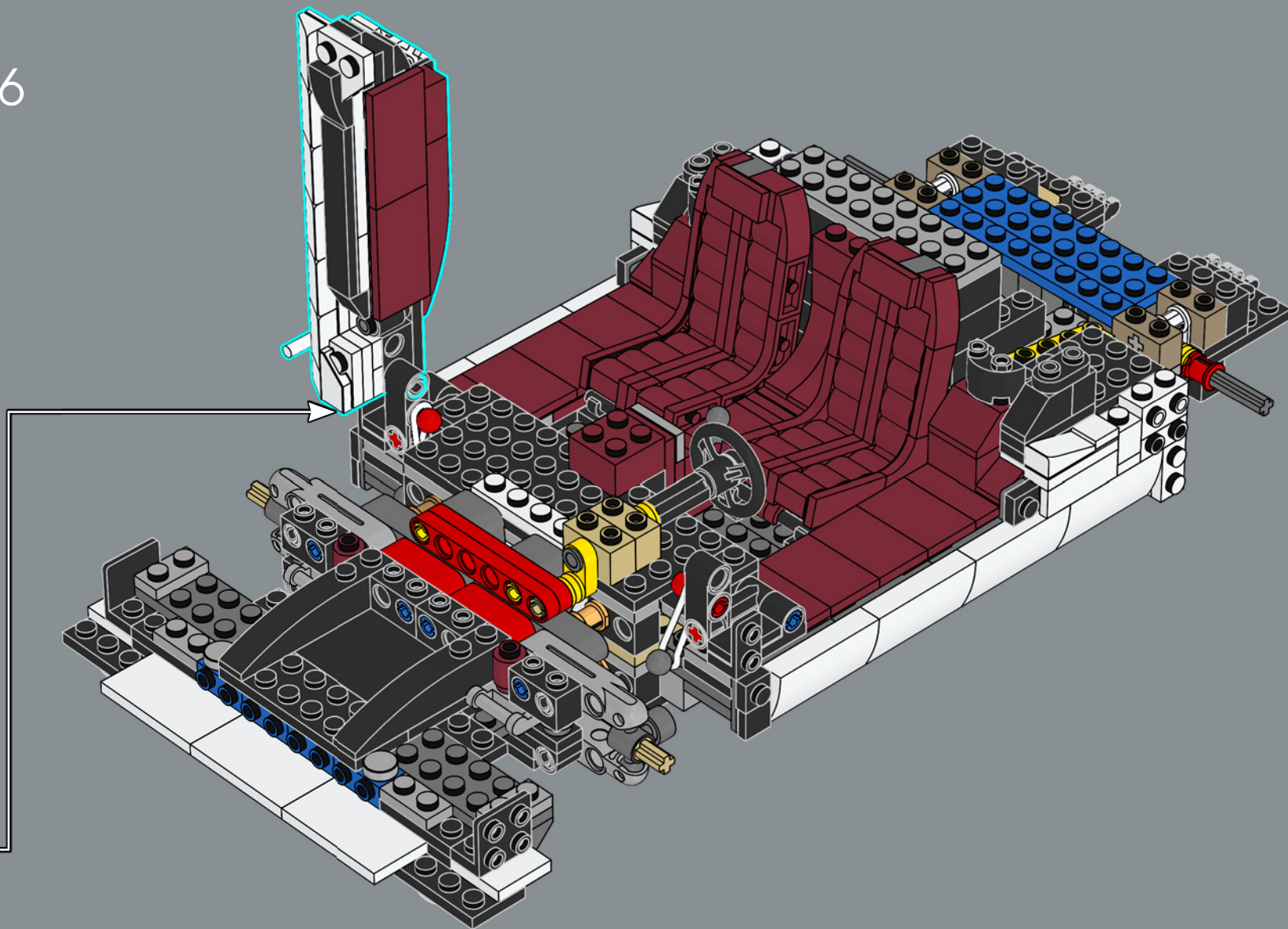

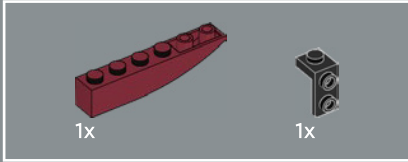
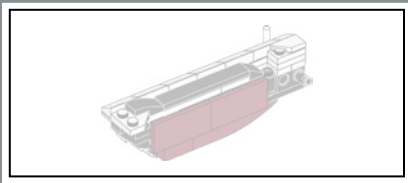

137

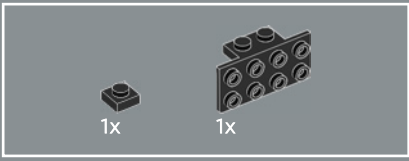
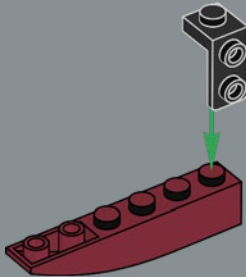

138

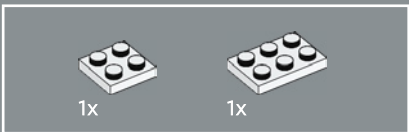
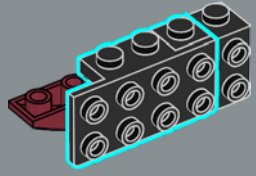

139

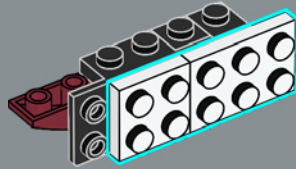

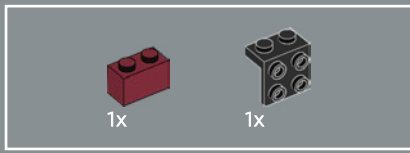

140

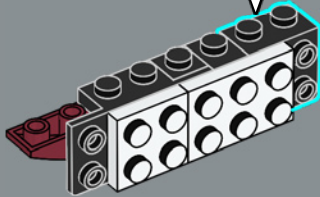
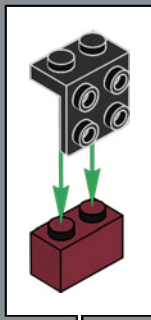

141

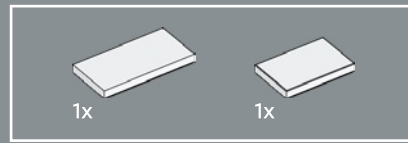
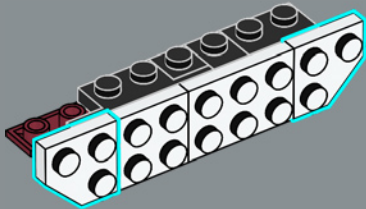

142

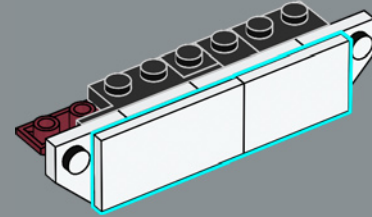

143

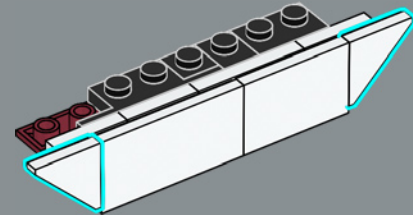

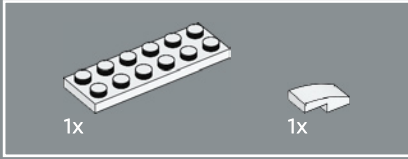
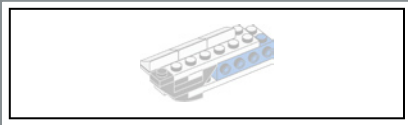

144

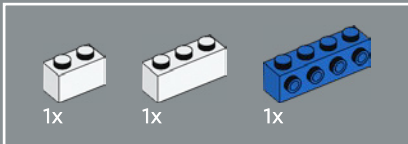
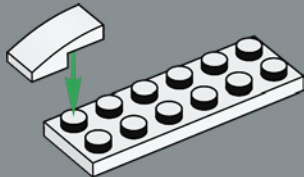

145

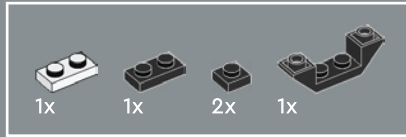
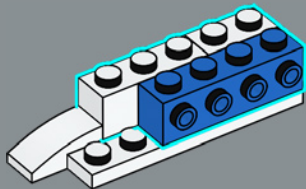

146

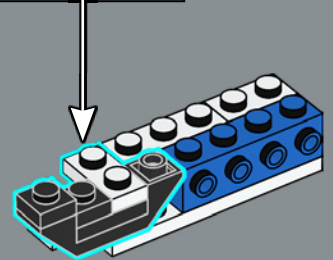
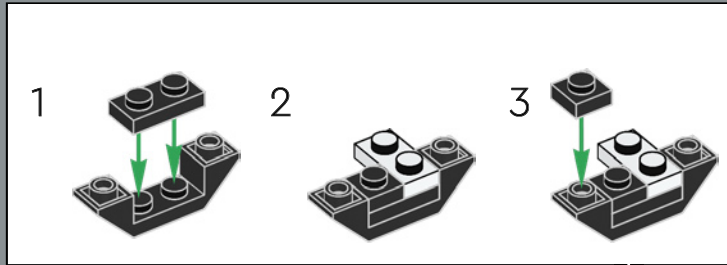

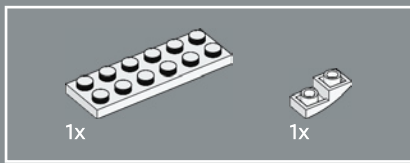

147

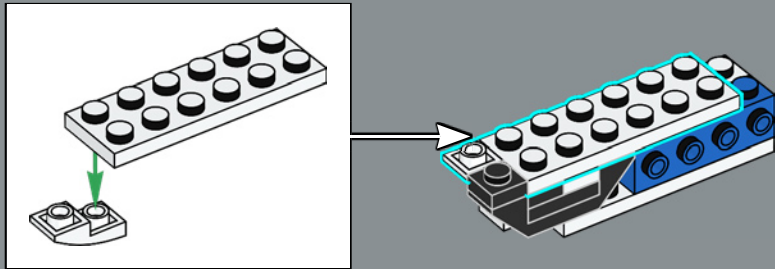

148

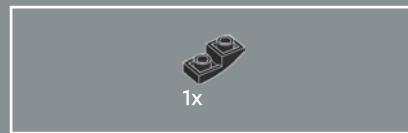
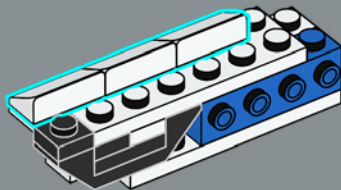

149

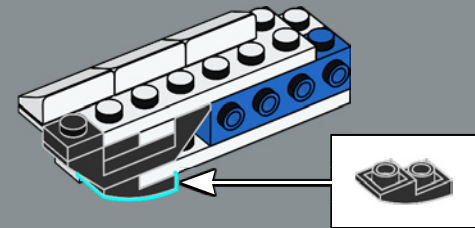

150

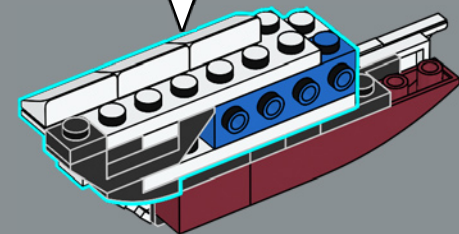

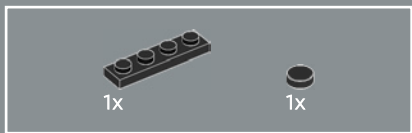

151

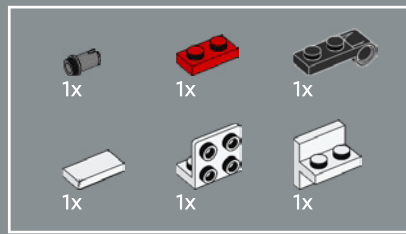
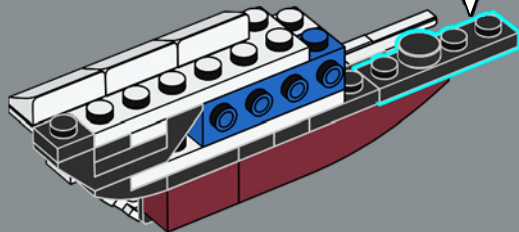
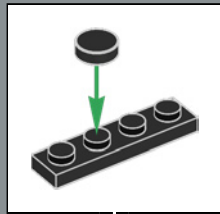

152

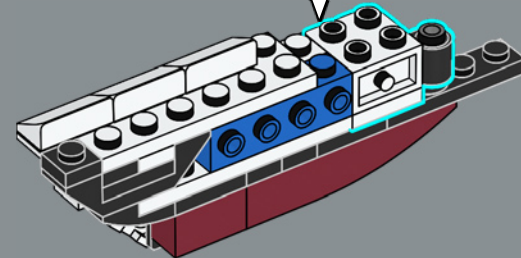
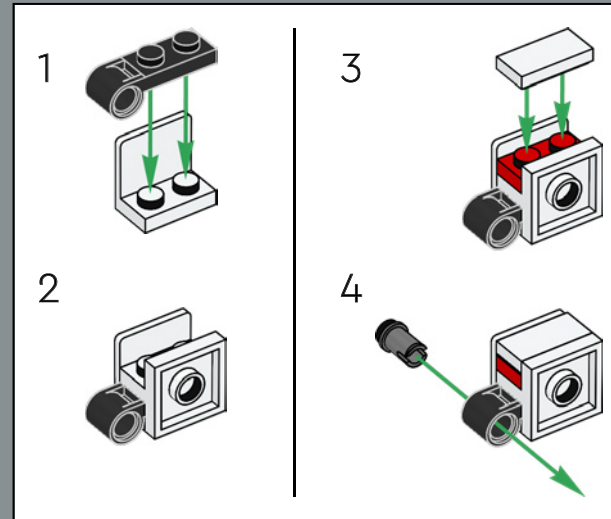

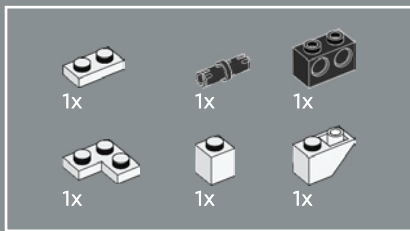

153

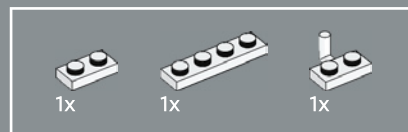
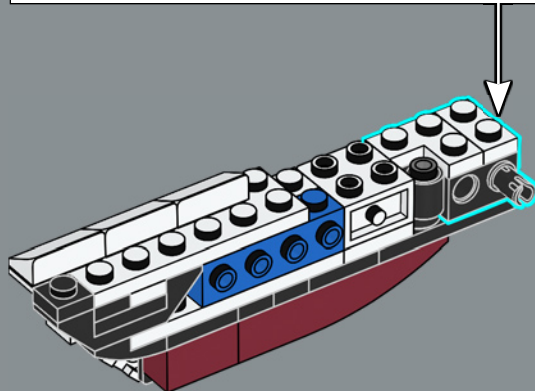
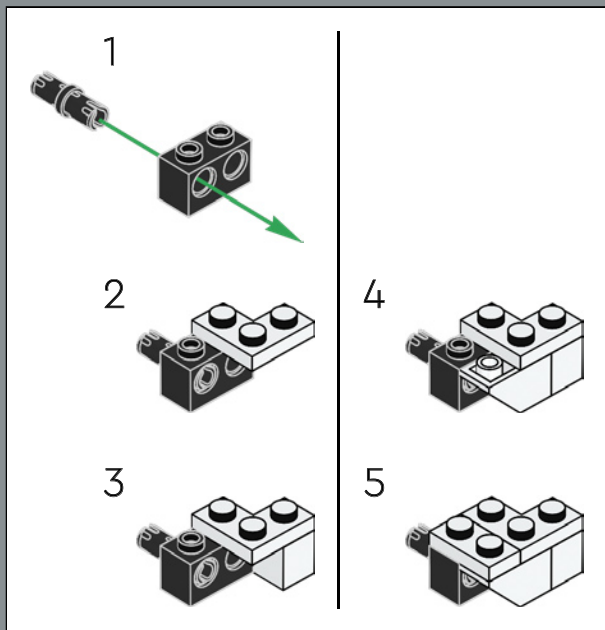

154

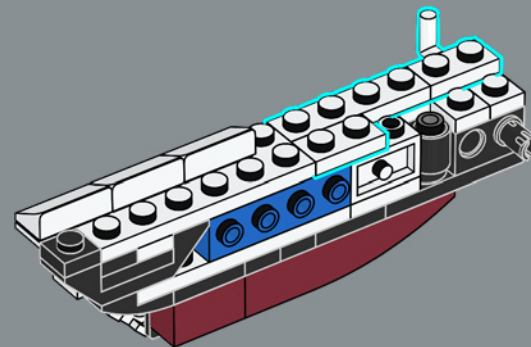



155

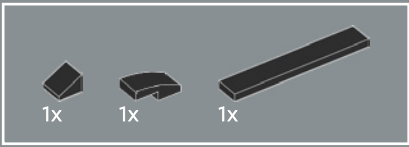
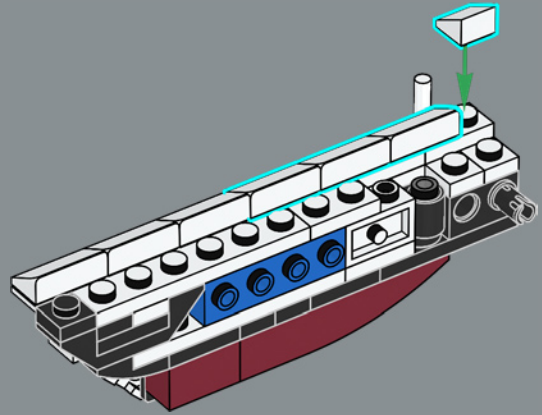

157

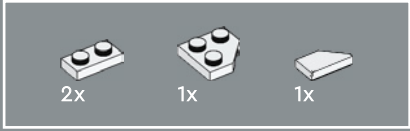
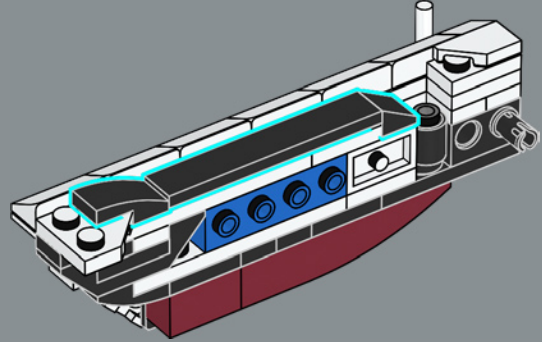

156

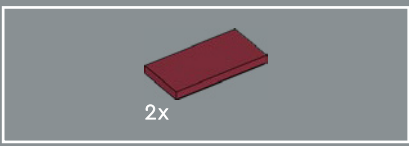
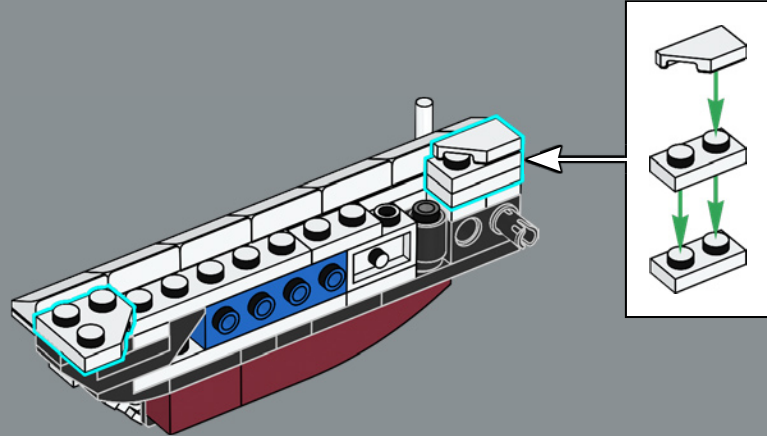

158

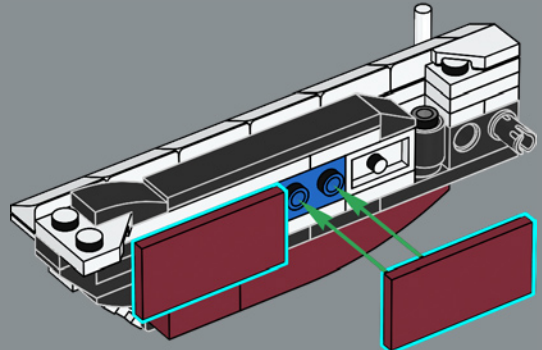



Die nach oben aufklappenden Türen werden
üblicherweise als „Scherentüren“ bezeichnet.

159

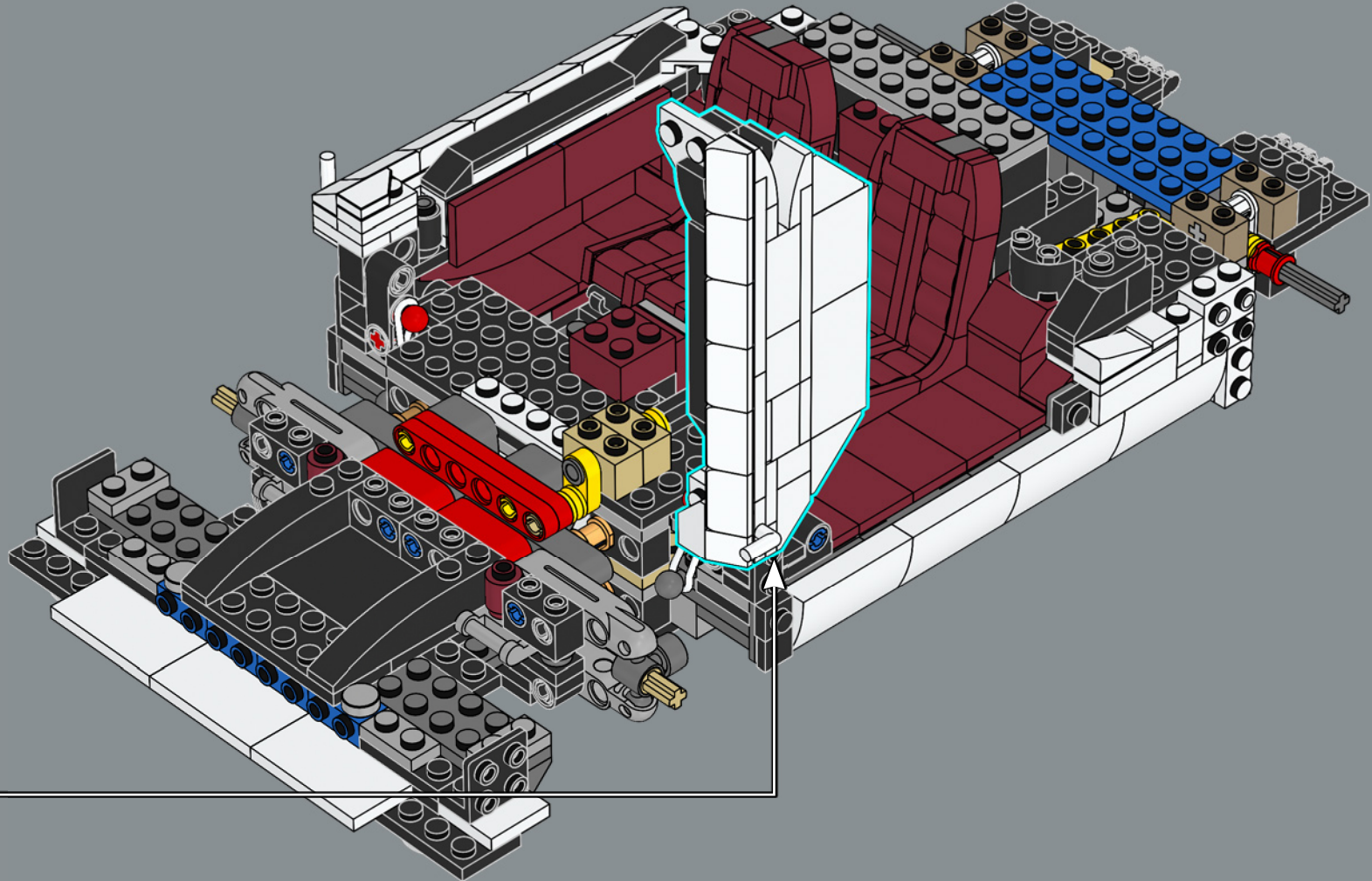

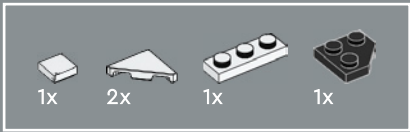

160

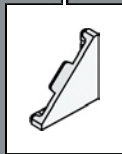
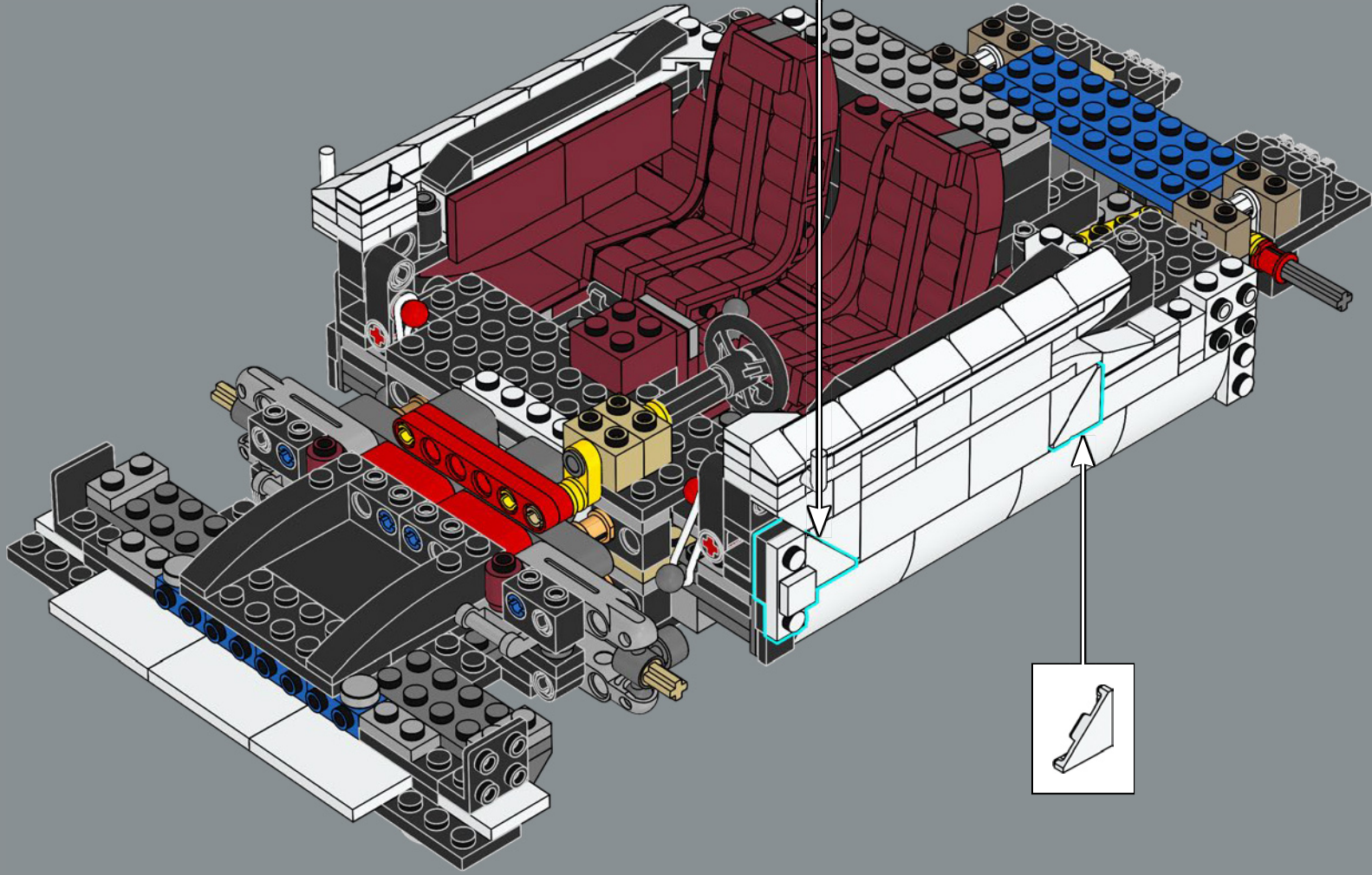
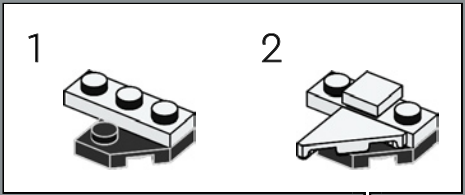

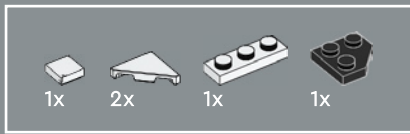

161

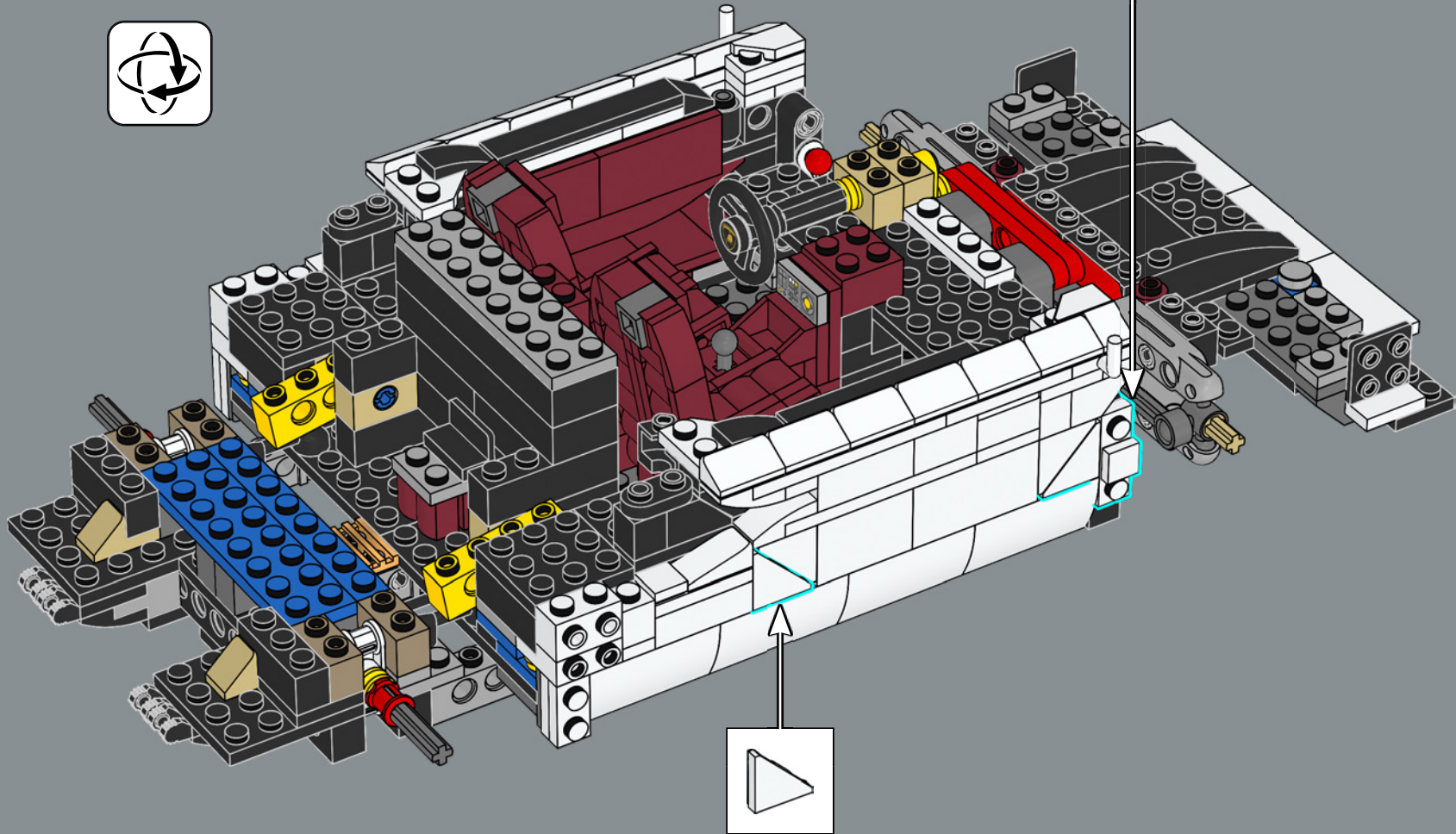
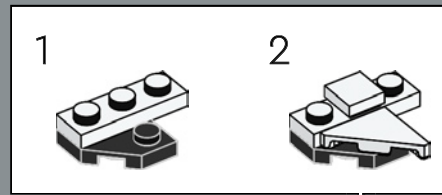

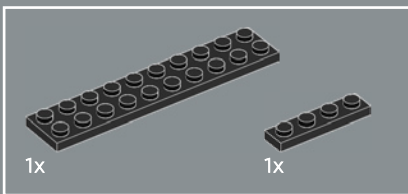
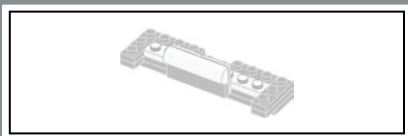

162

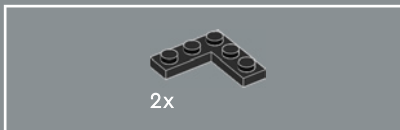
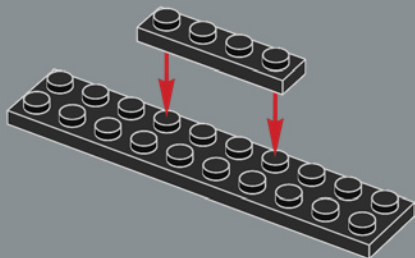

163

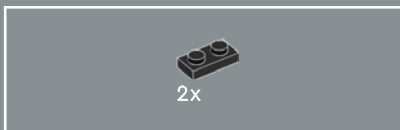
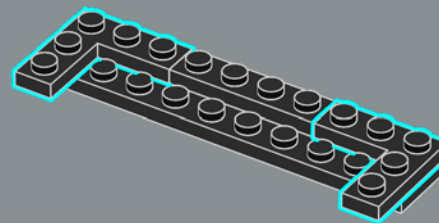

164

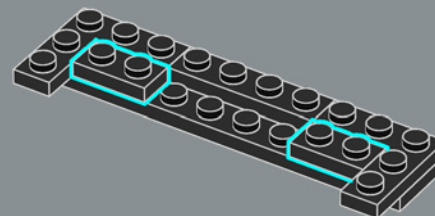



165

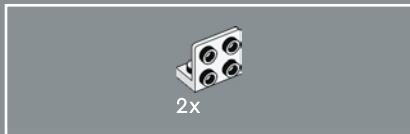
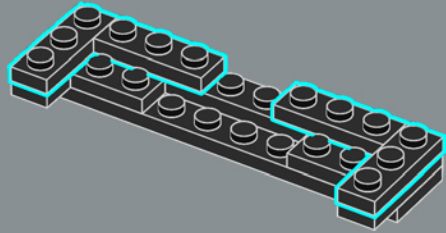

166

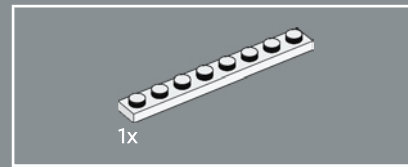
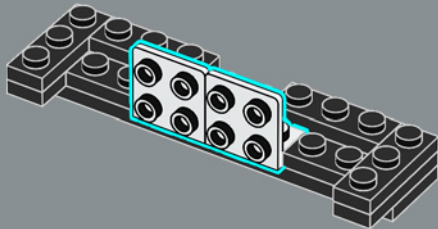

167

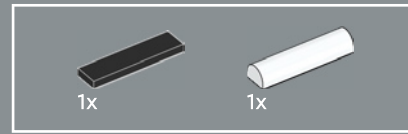
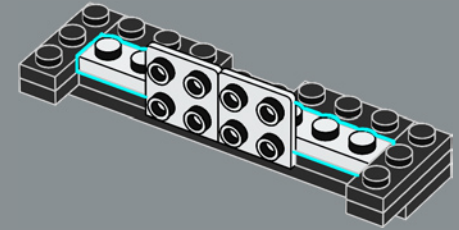

168

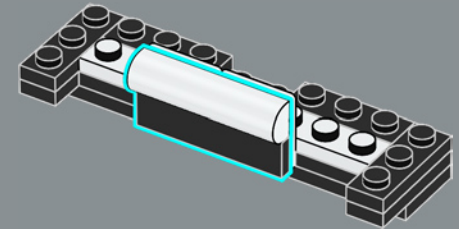

169

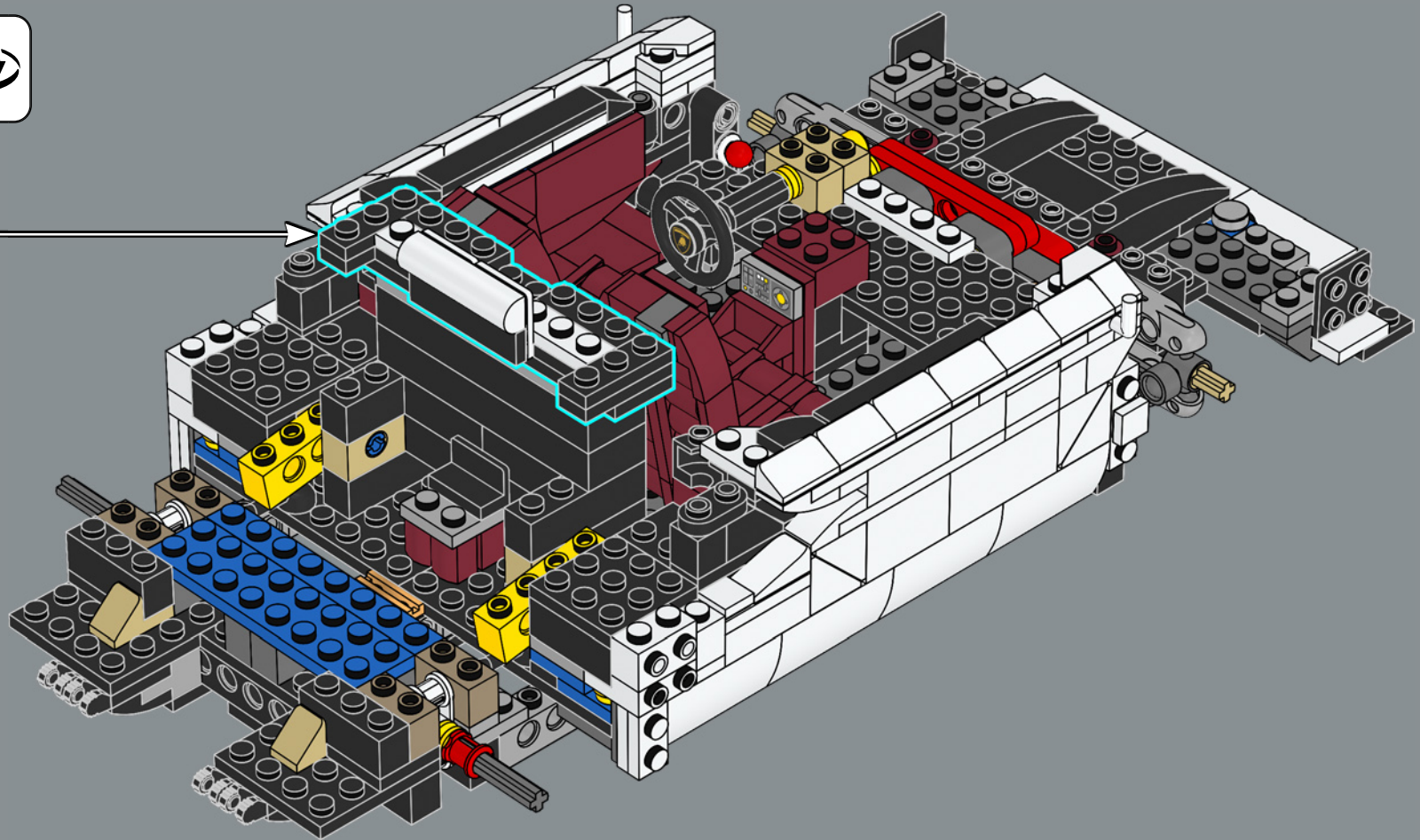

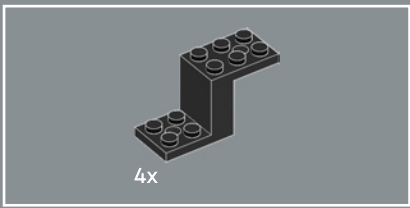

170

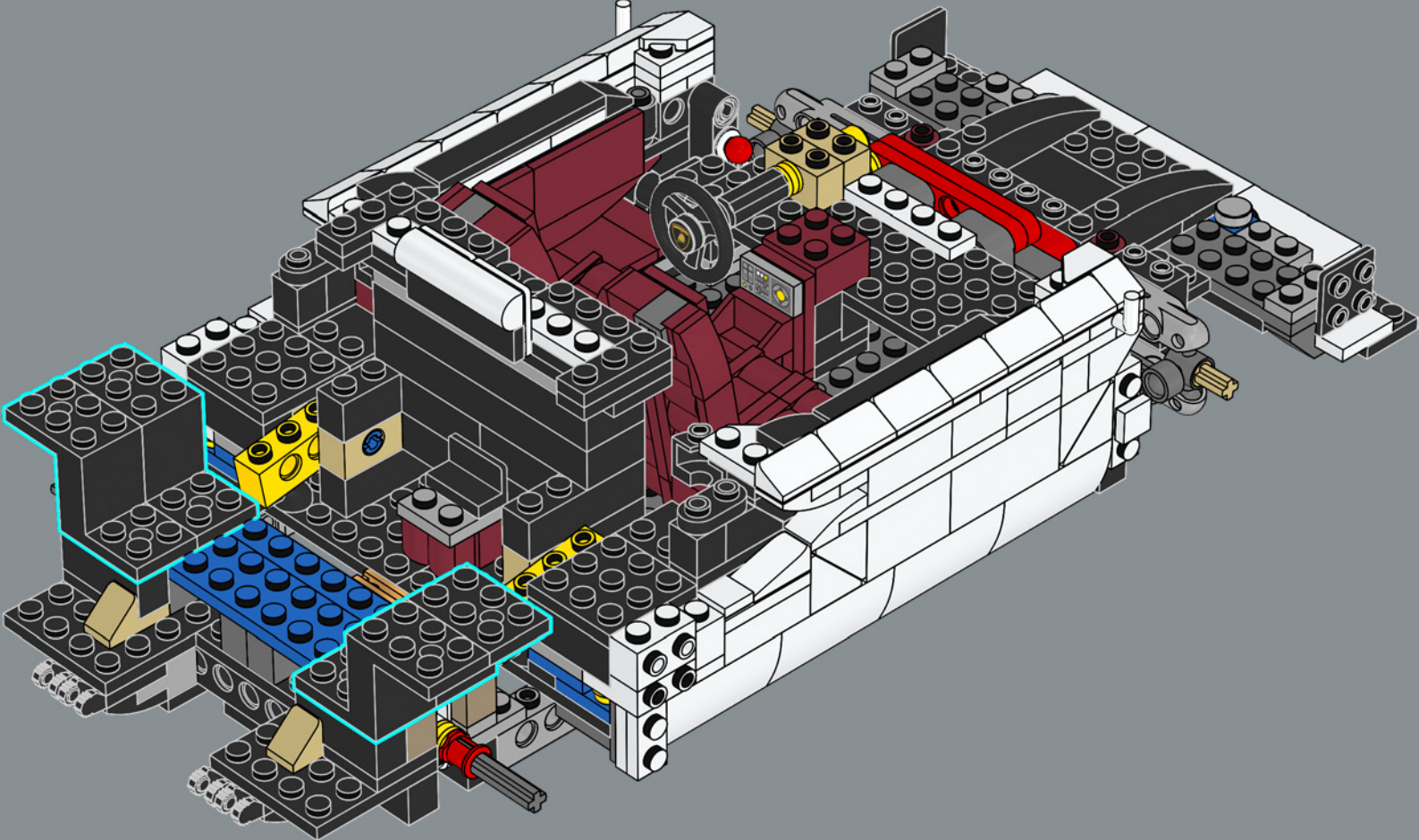

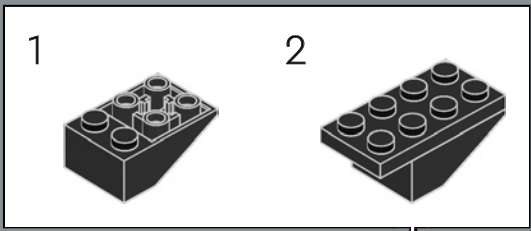
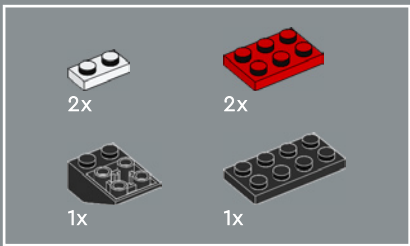

171

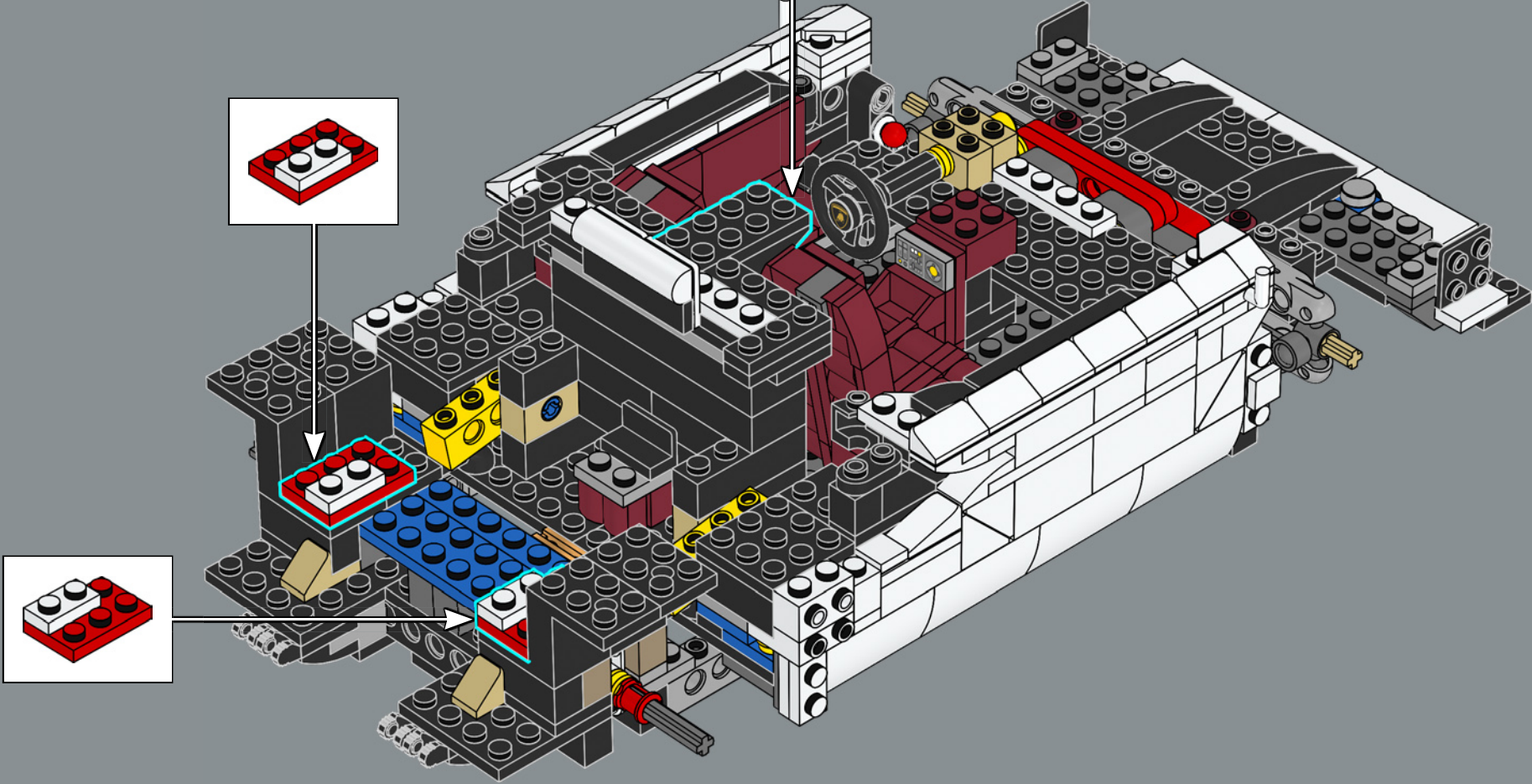

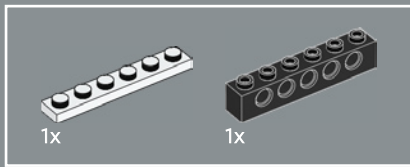

172

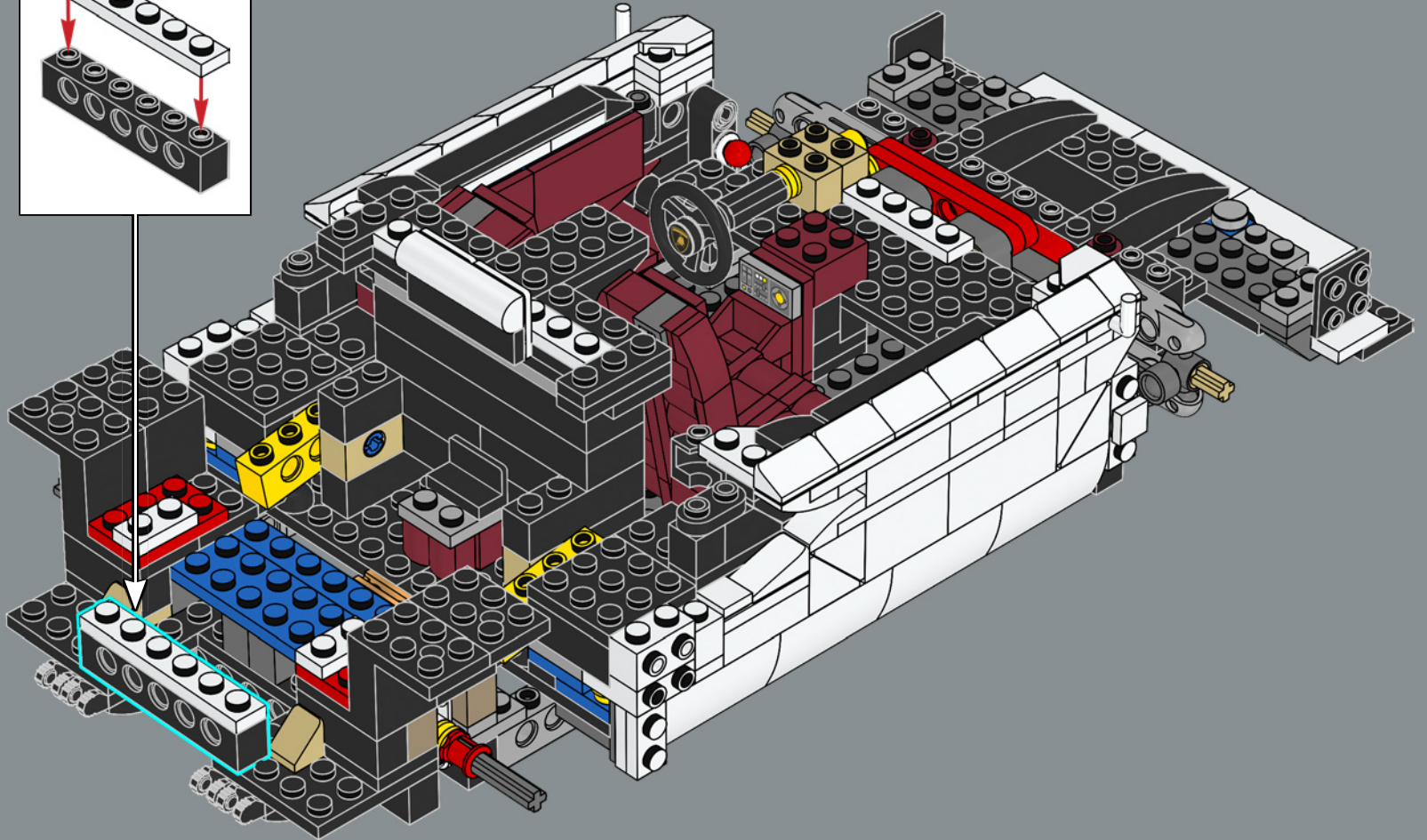
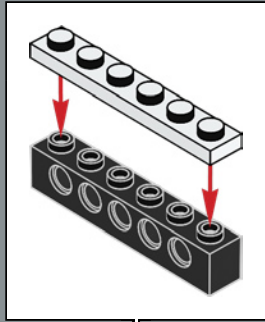

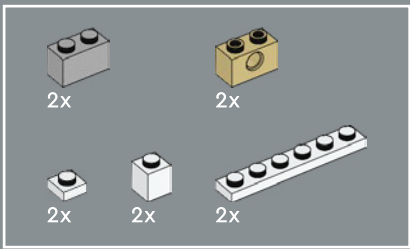

173

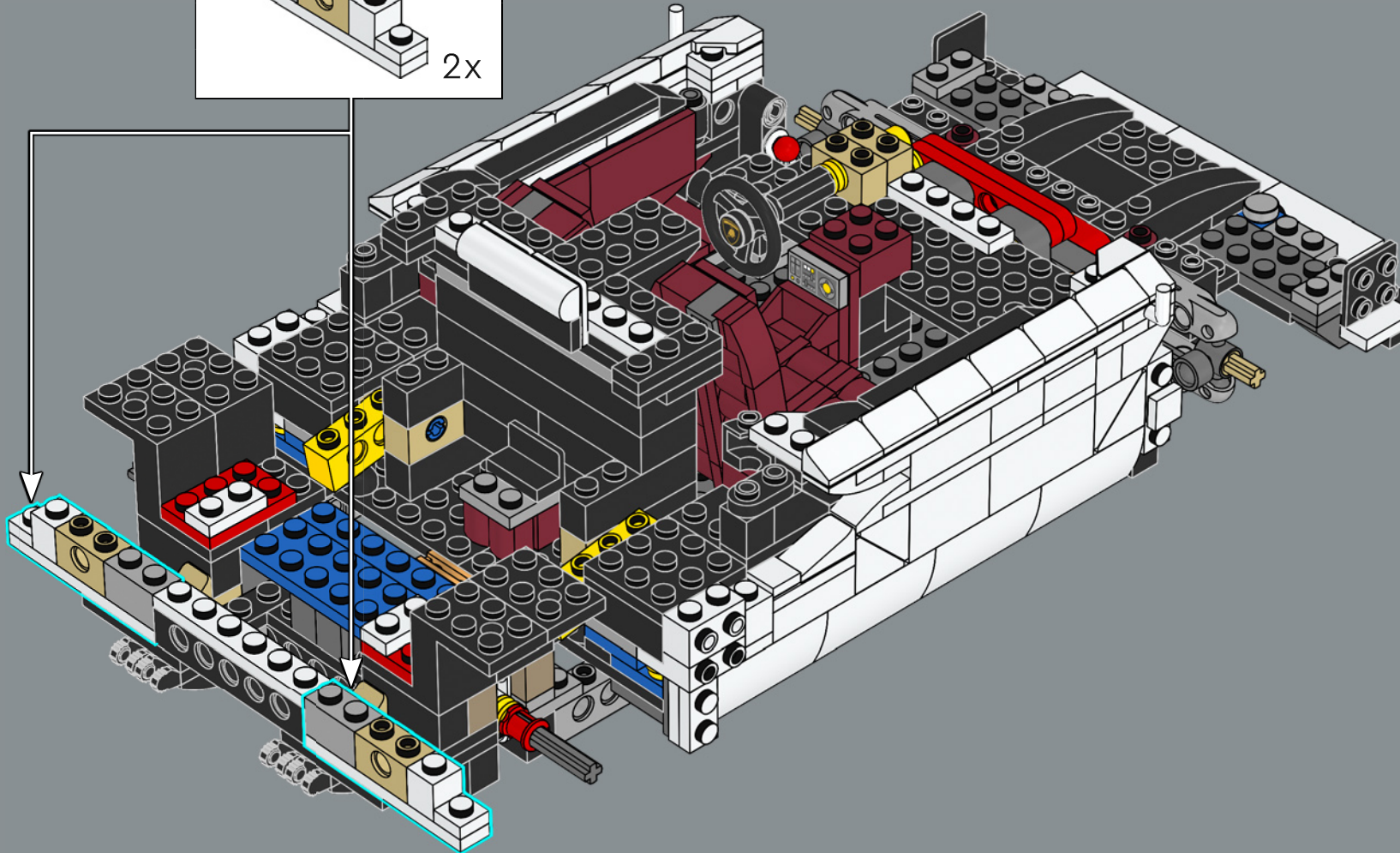
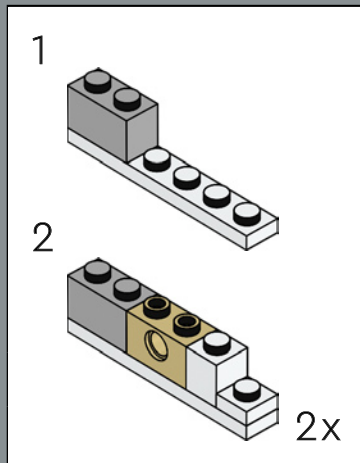

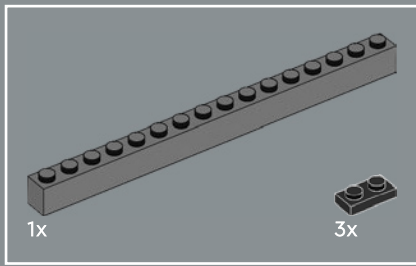

174

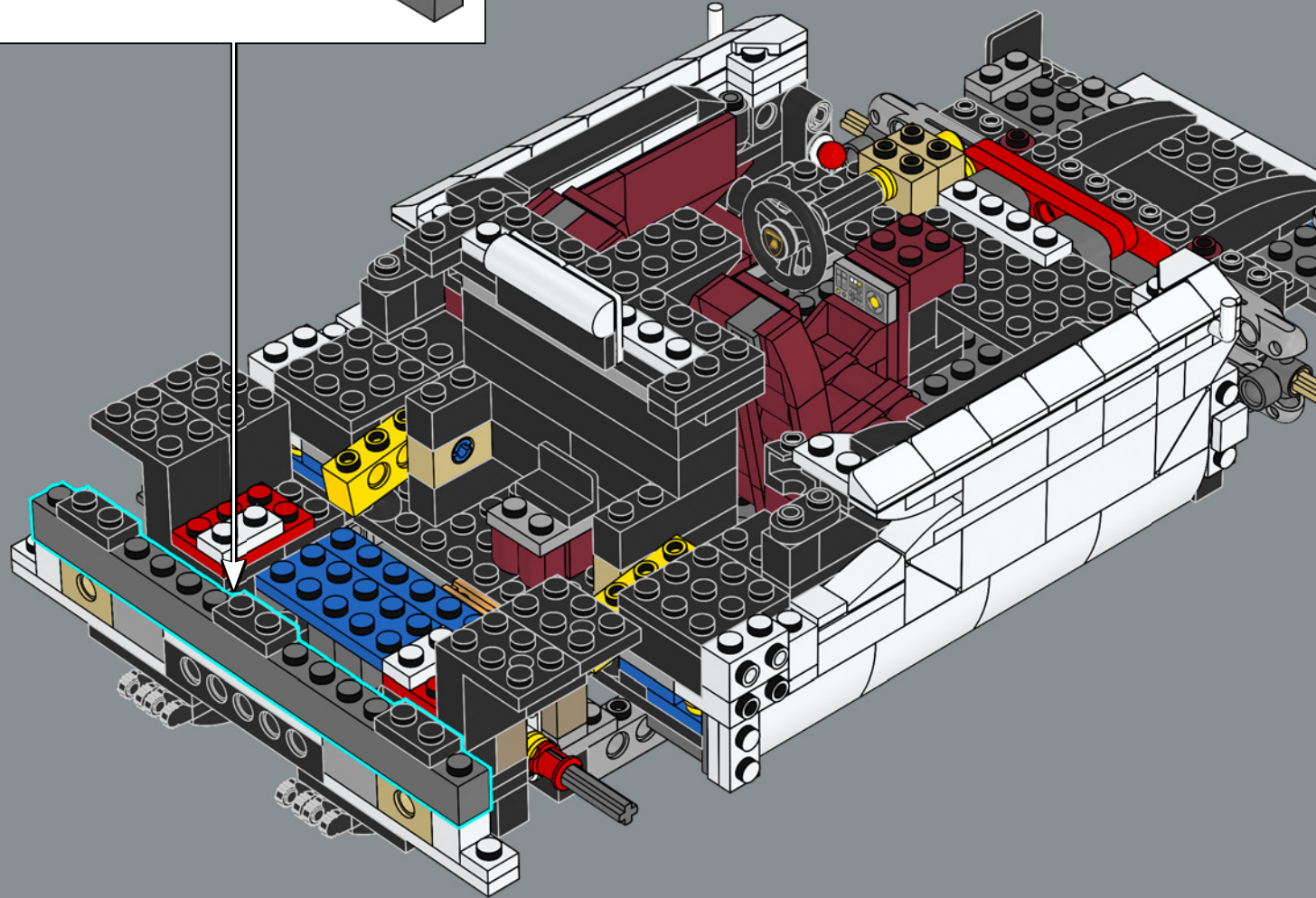
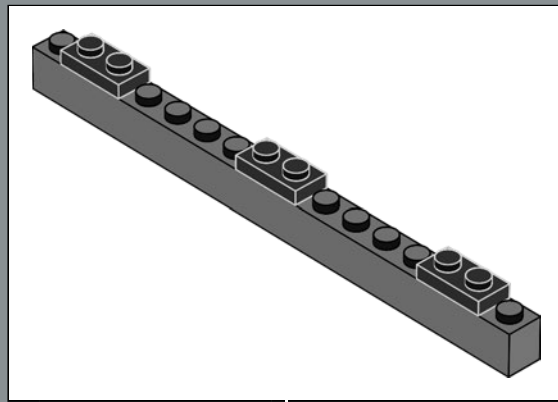

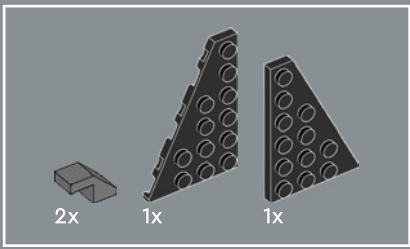

175

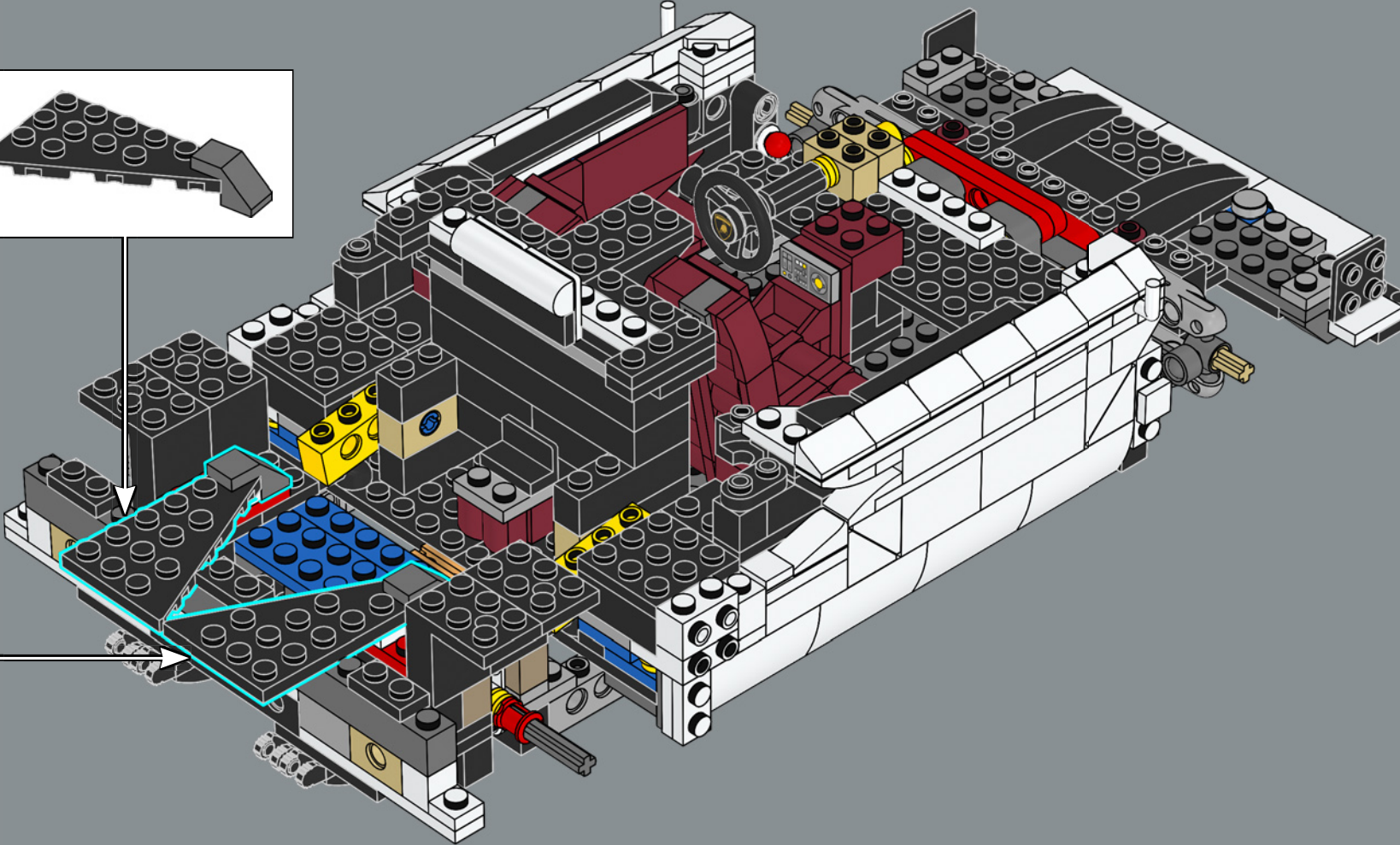
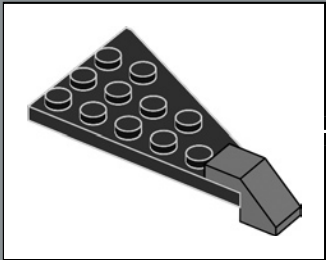
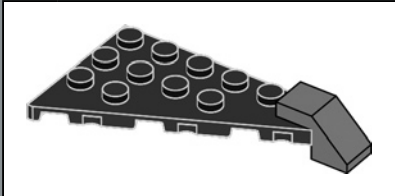

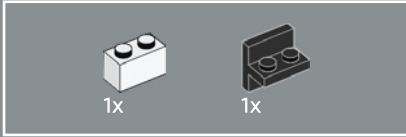
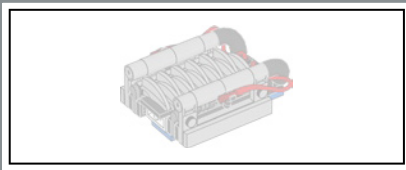

176

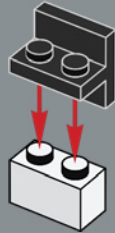

177

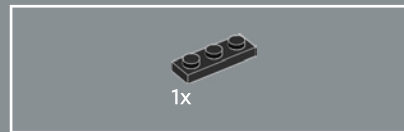
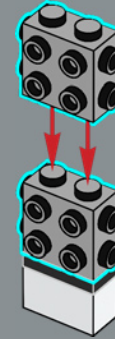

178



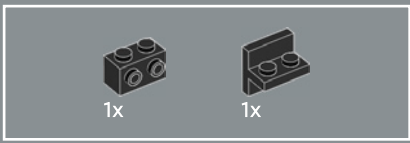

179

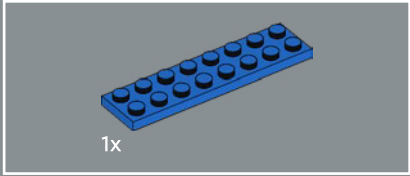
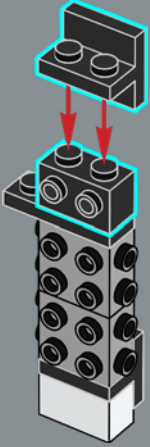

180

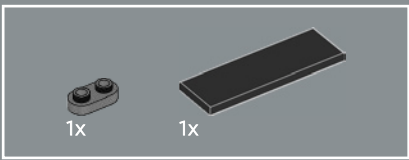
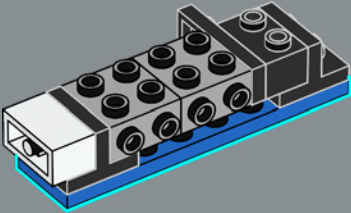

181

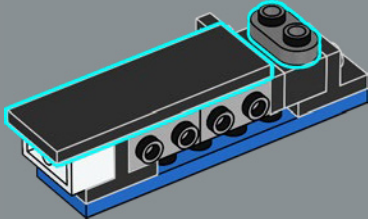

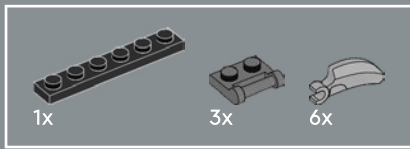

182

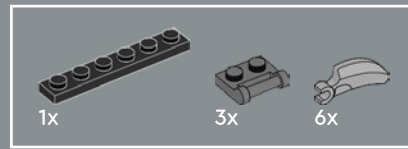
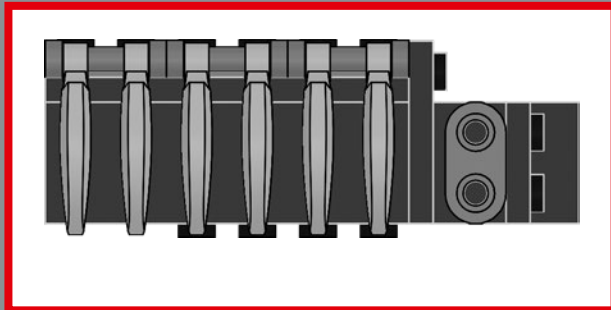
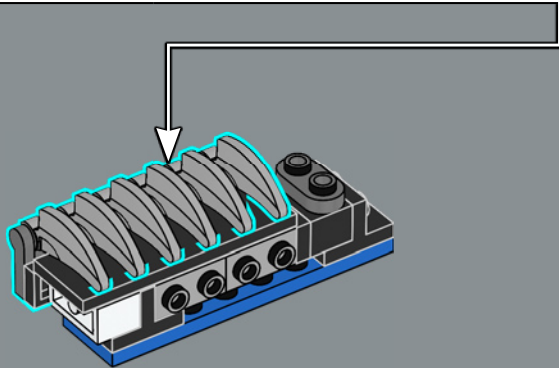
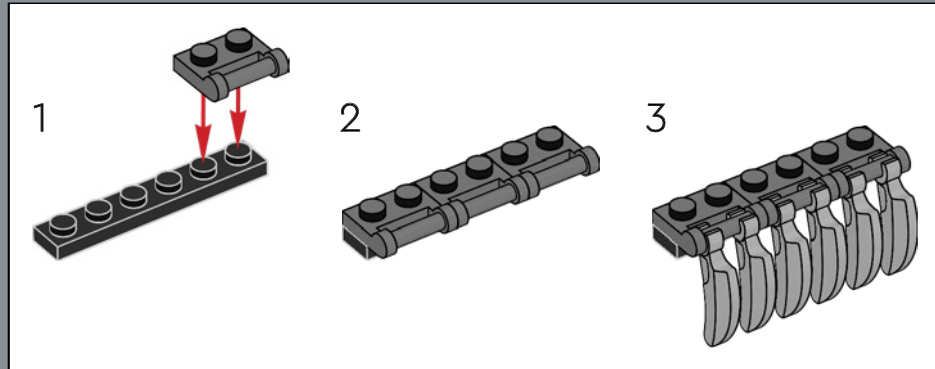

183

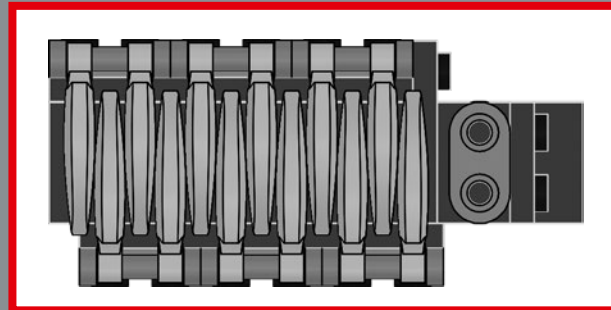
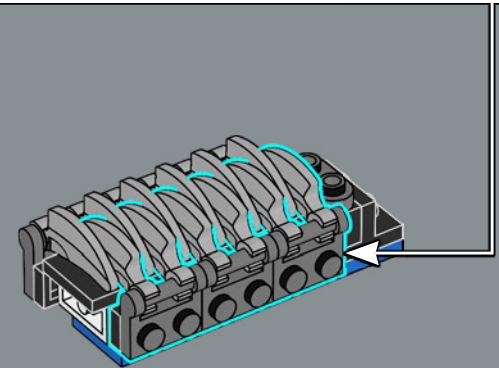
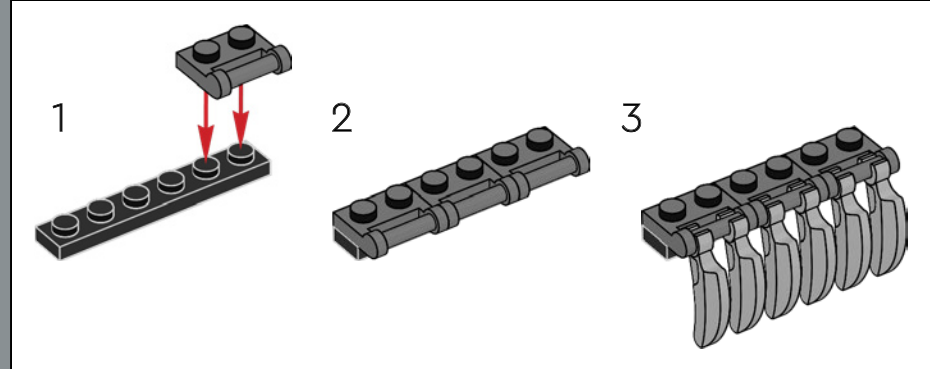

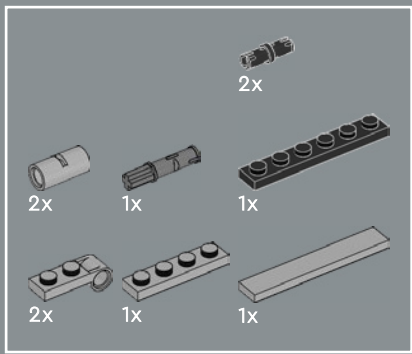

184

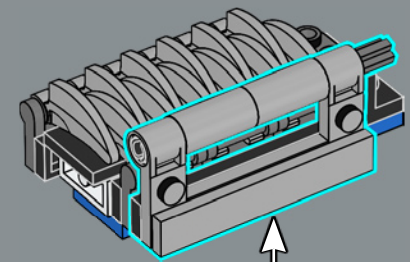
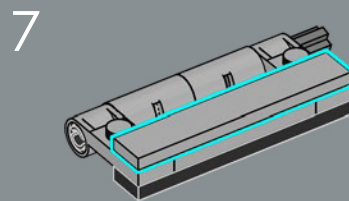
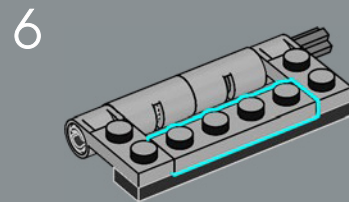
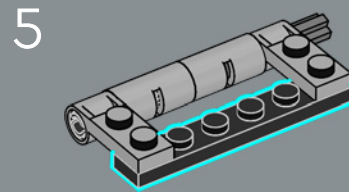
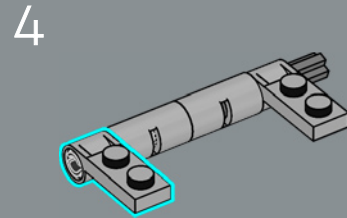
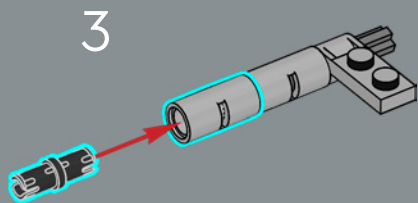
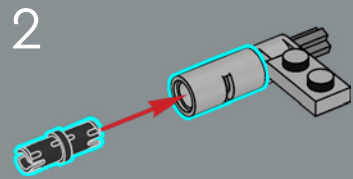
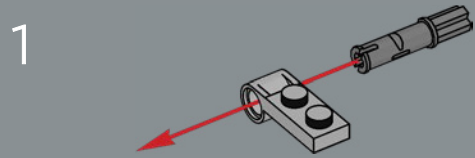

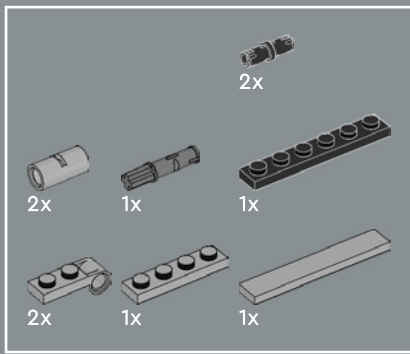

185

1

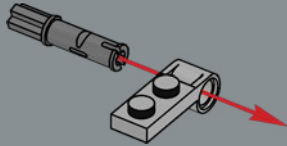

2

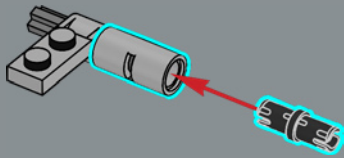

3

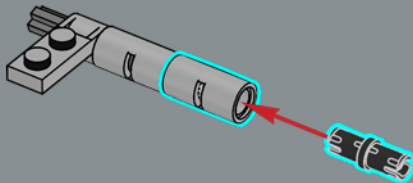

4

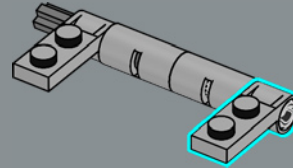

5

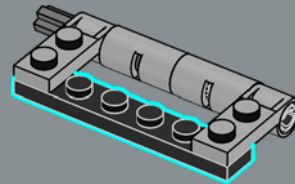

6

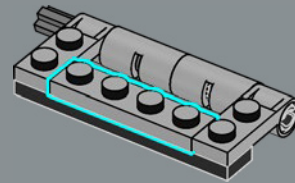

7

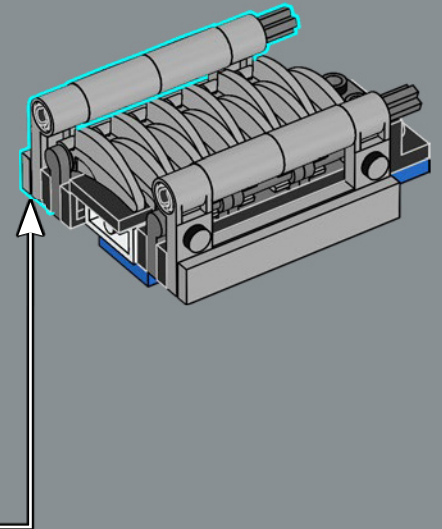
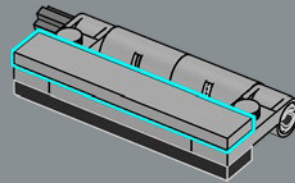

2x

186

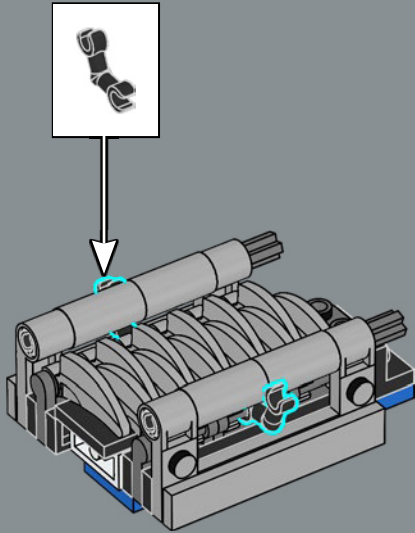

2x

187

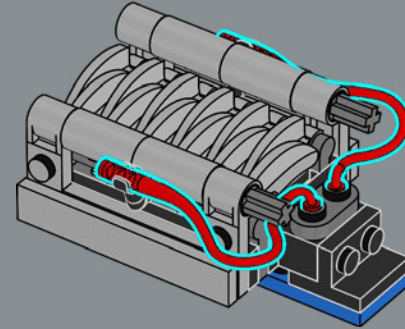

2x

188

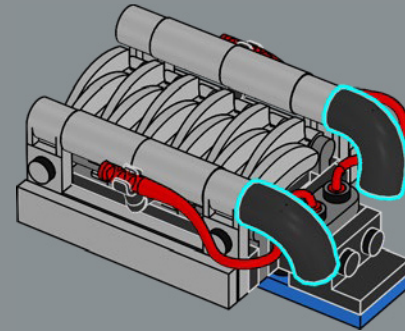



LP steht in den Countach Modellnamen für Longitudinale Posteriore (hintere Längsachse) und gibt die Position des Motors an.

189

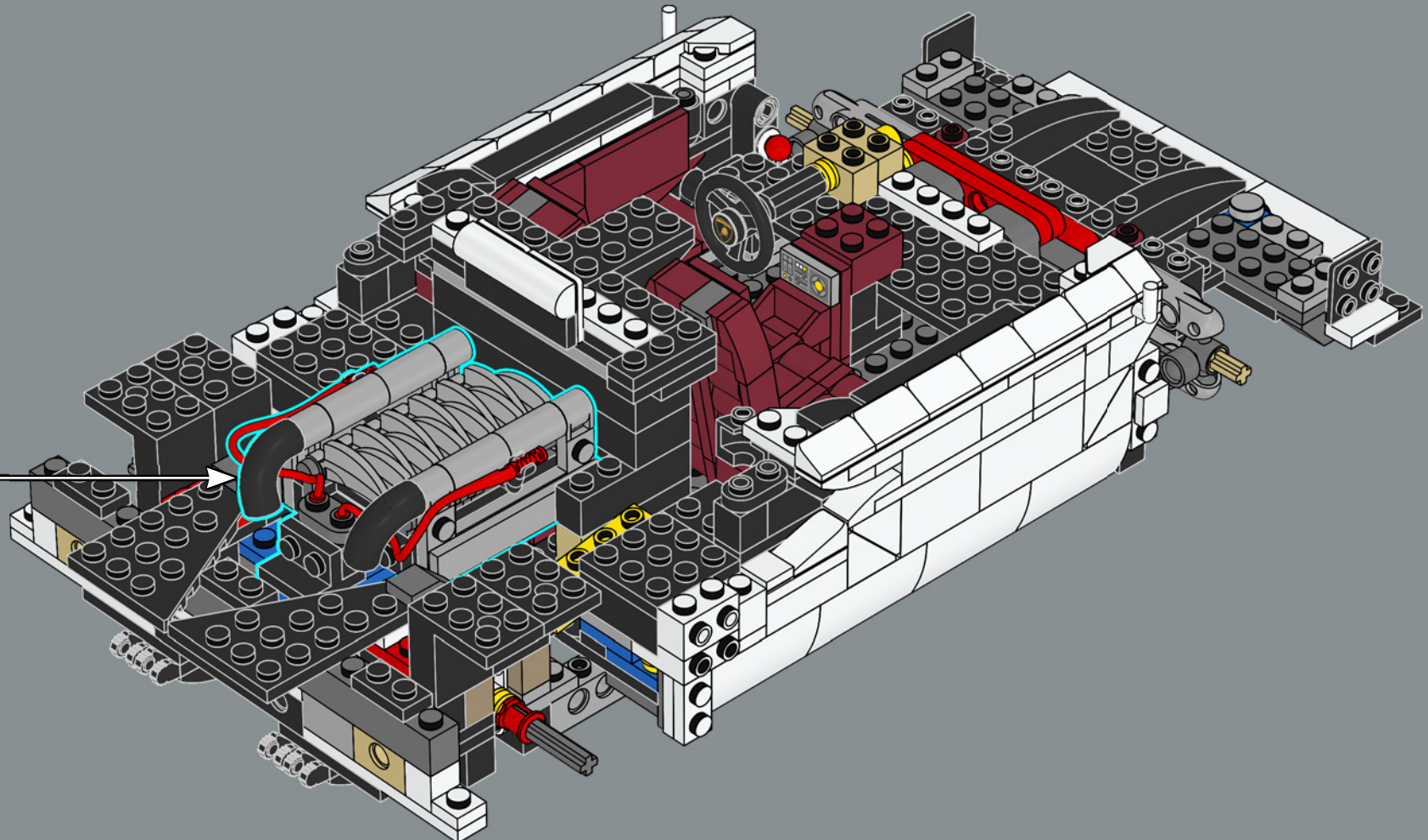

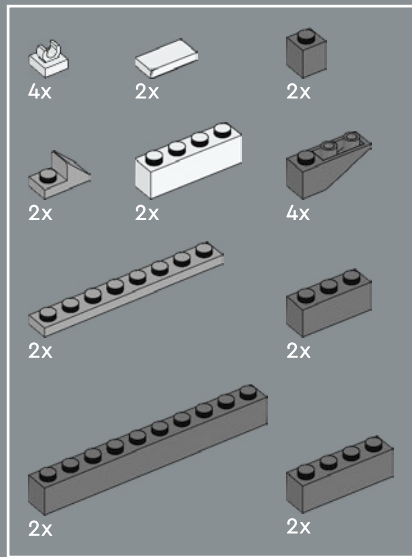
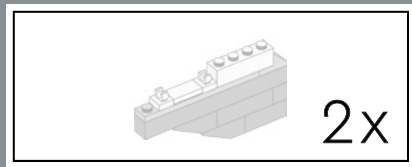

190

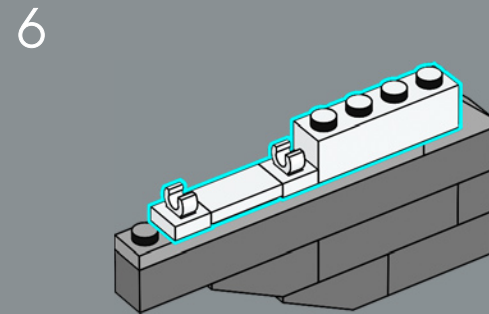
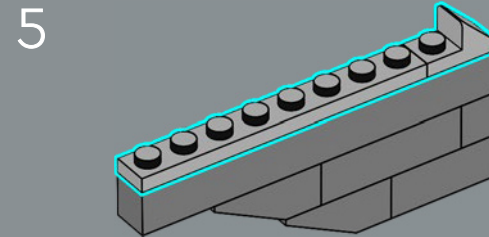
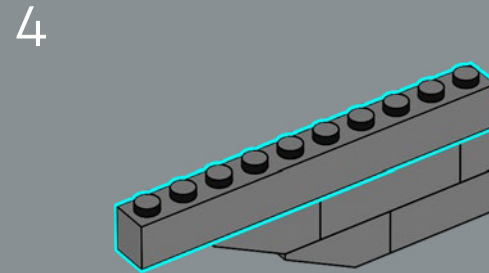
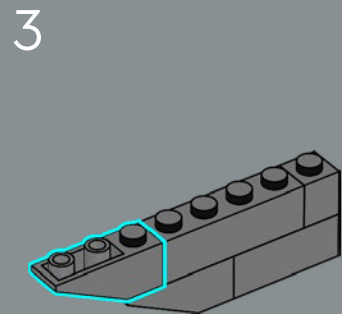
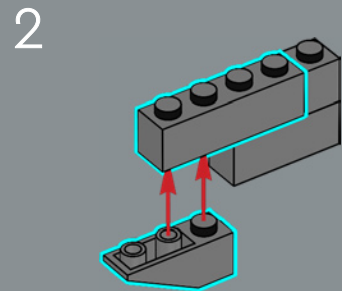
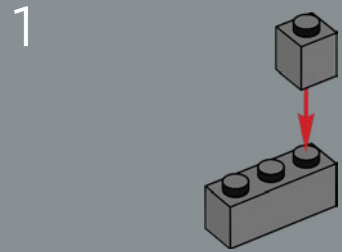

2x

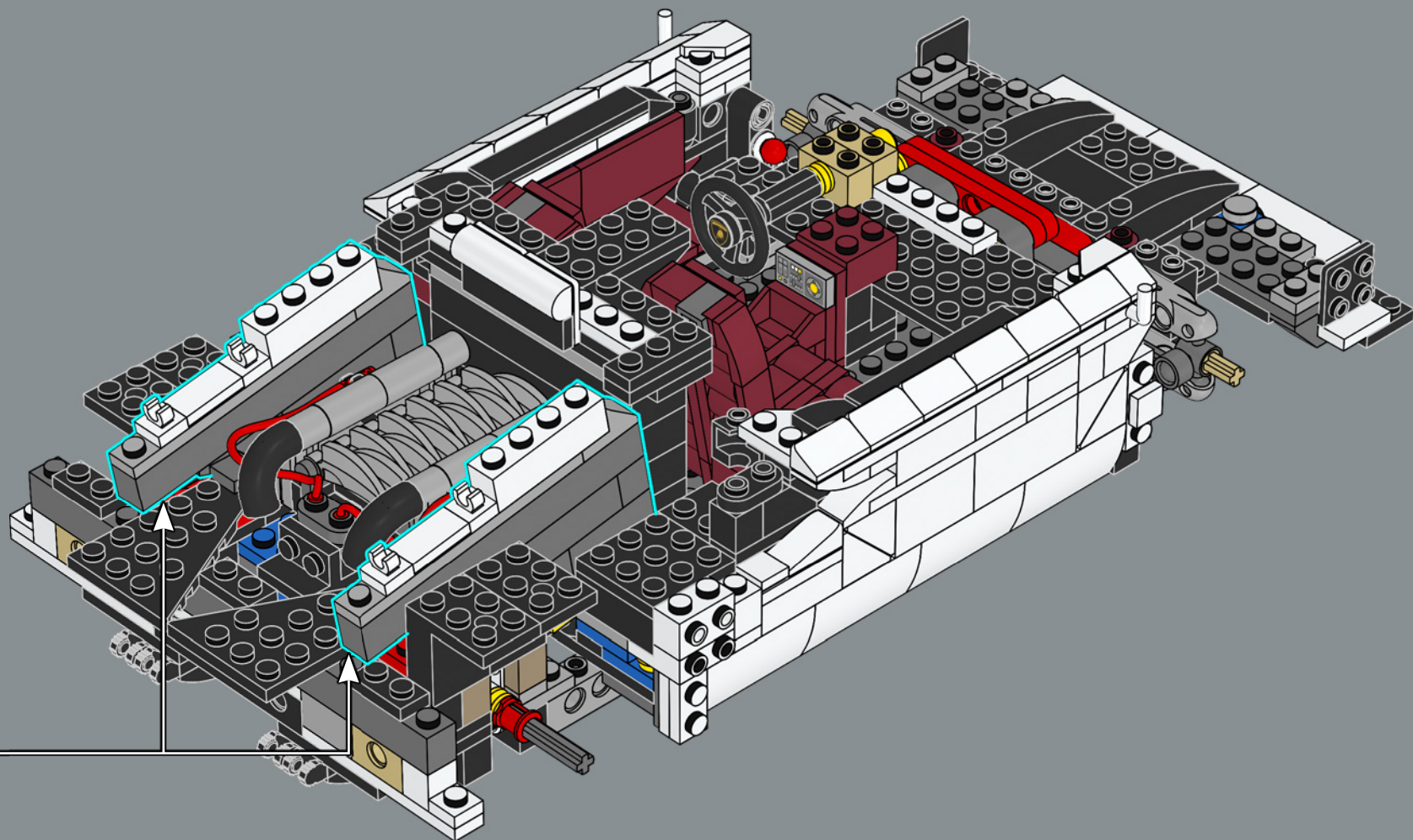

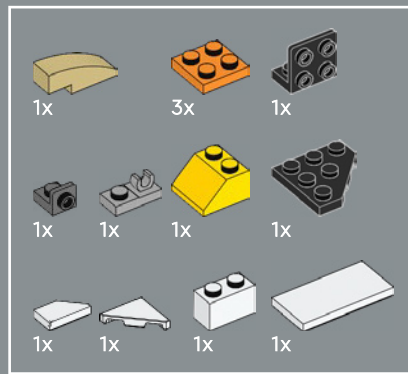

191

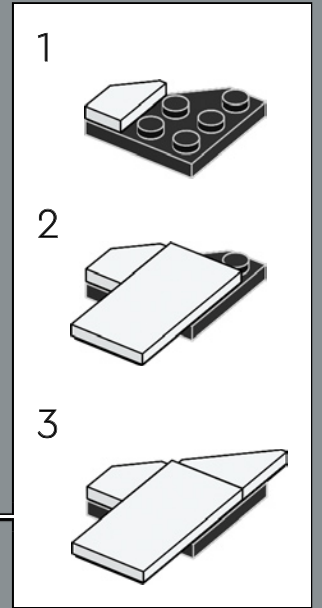
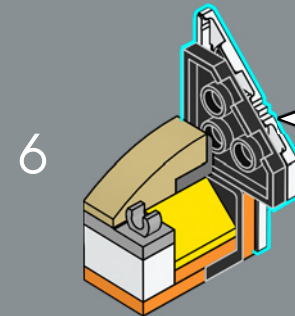
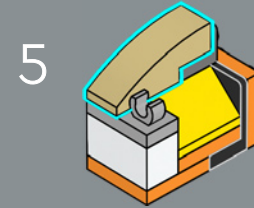
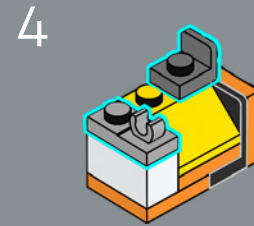
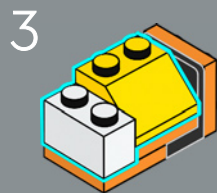
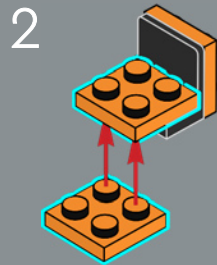
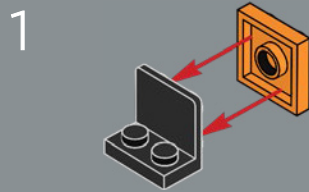

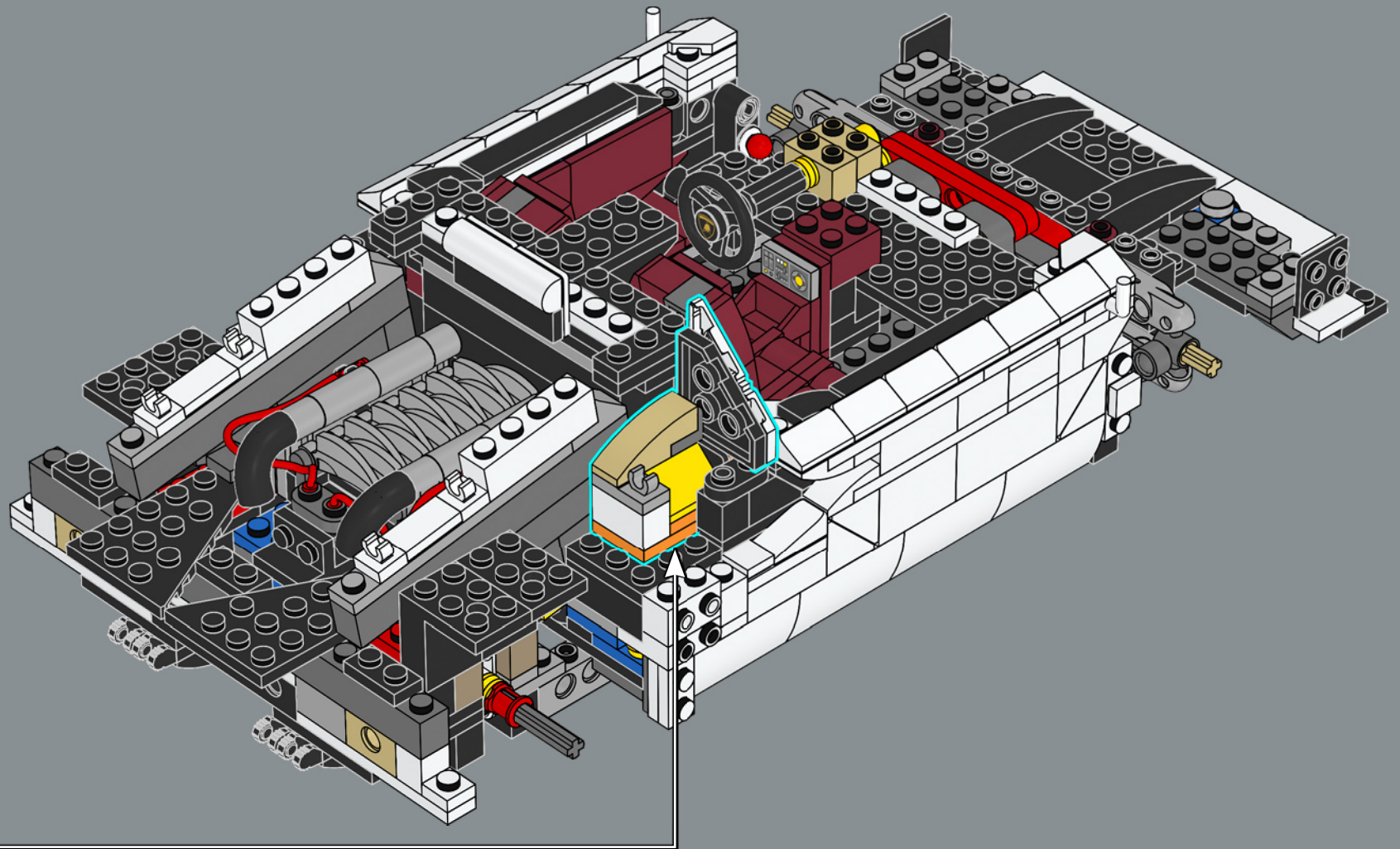

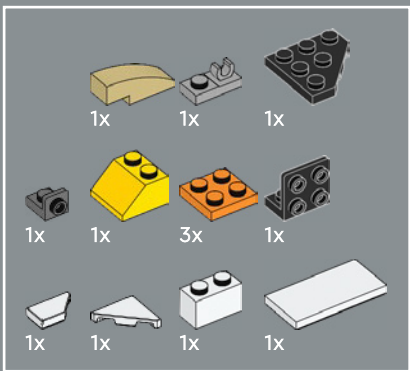

192

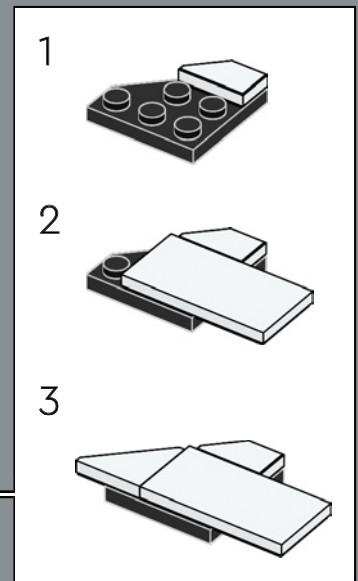
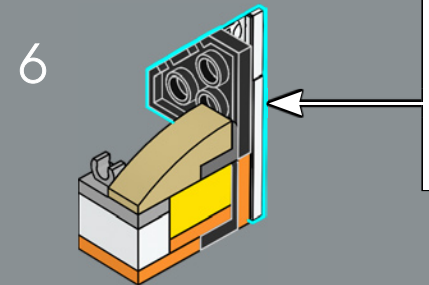
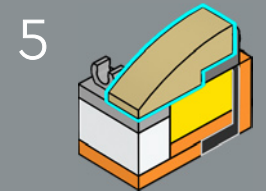
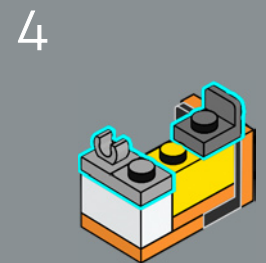
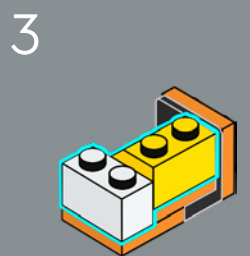
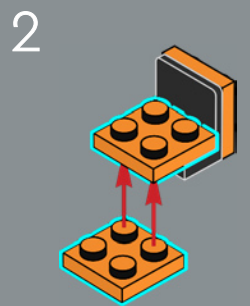
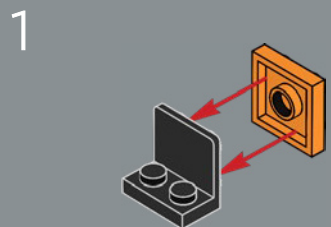

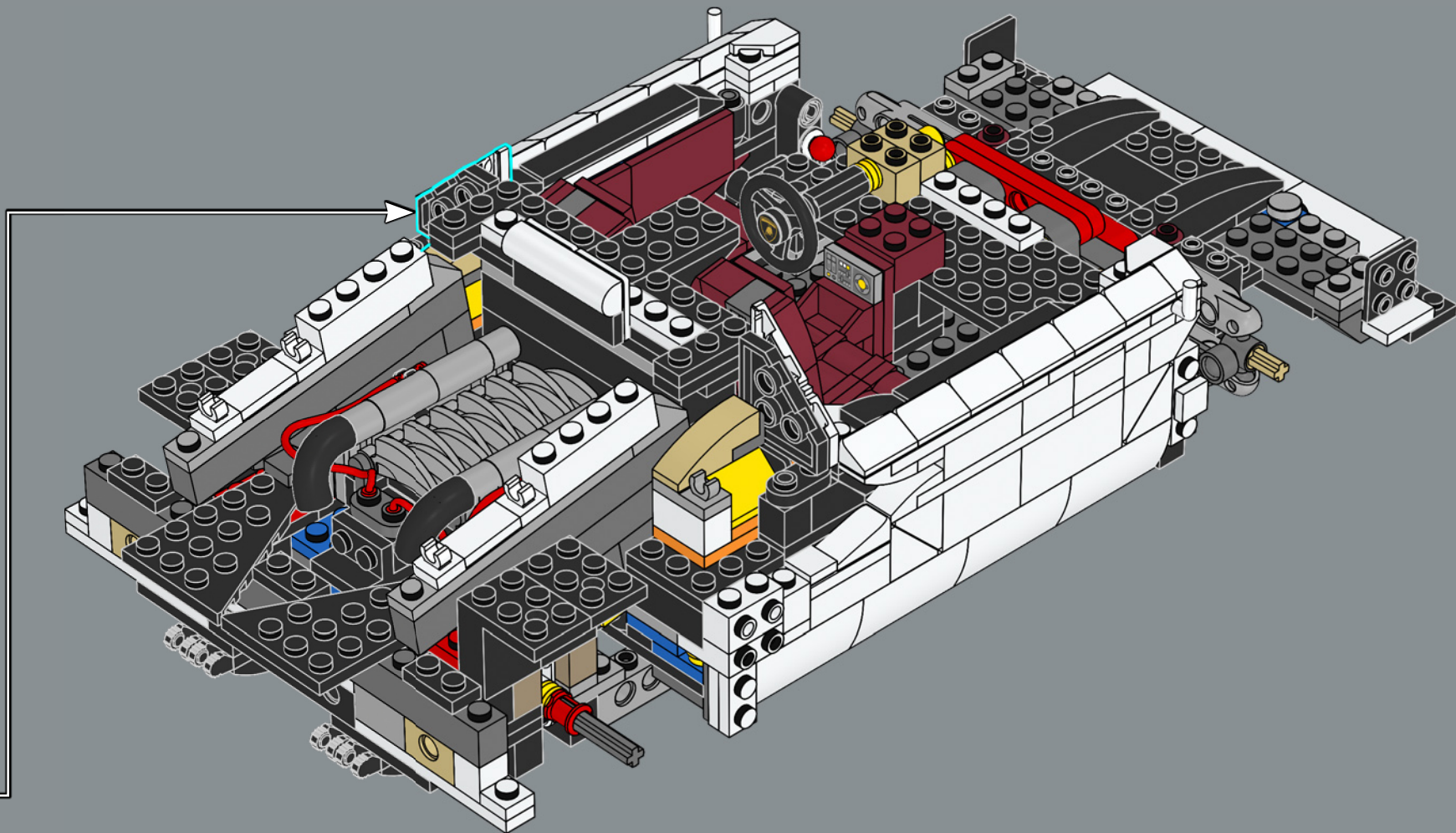

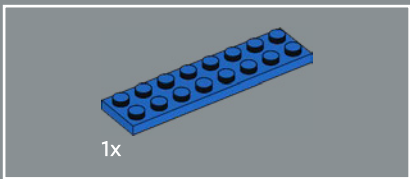

193

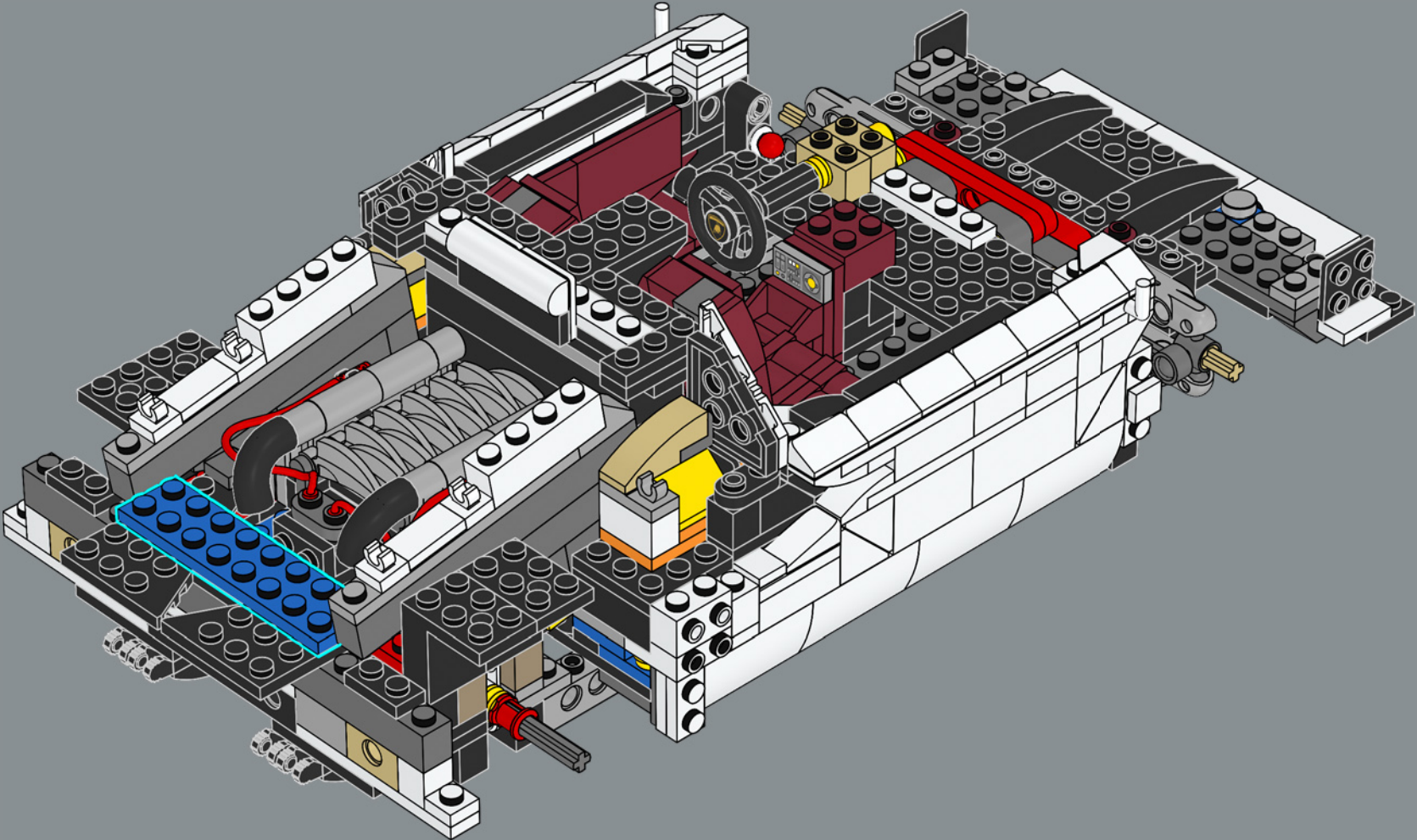

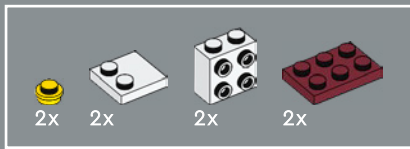

194

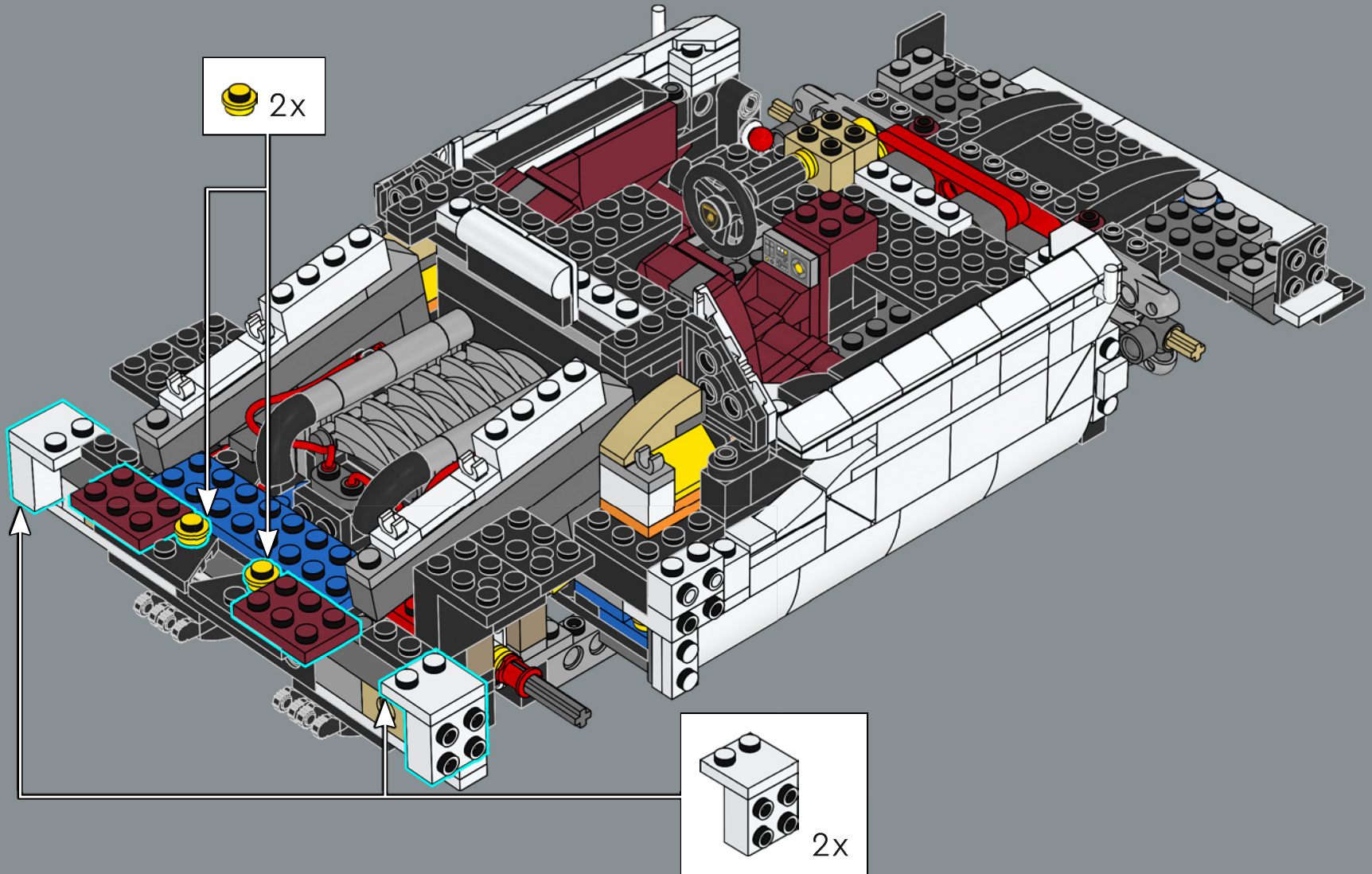



2x

195

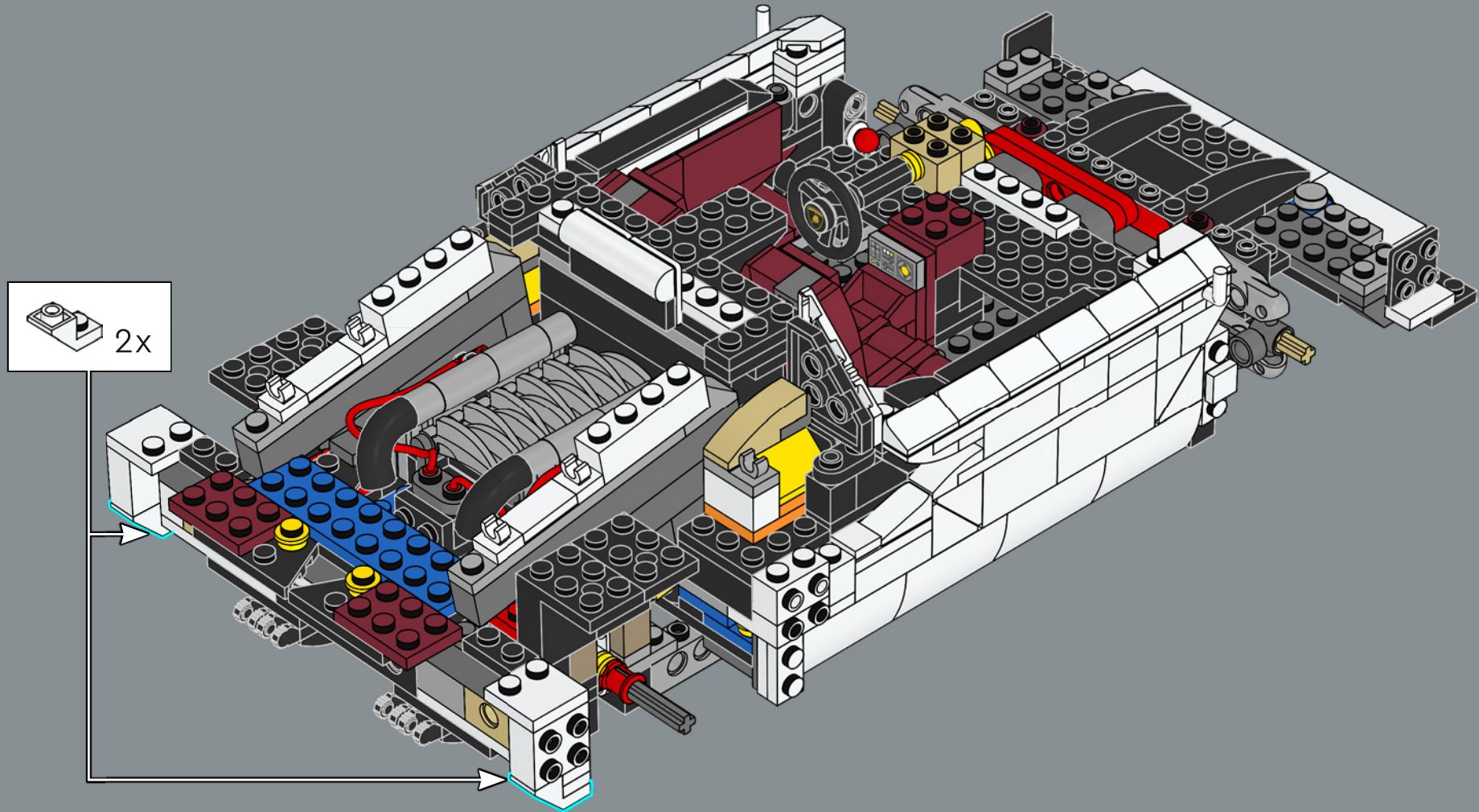

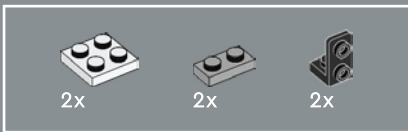

196

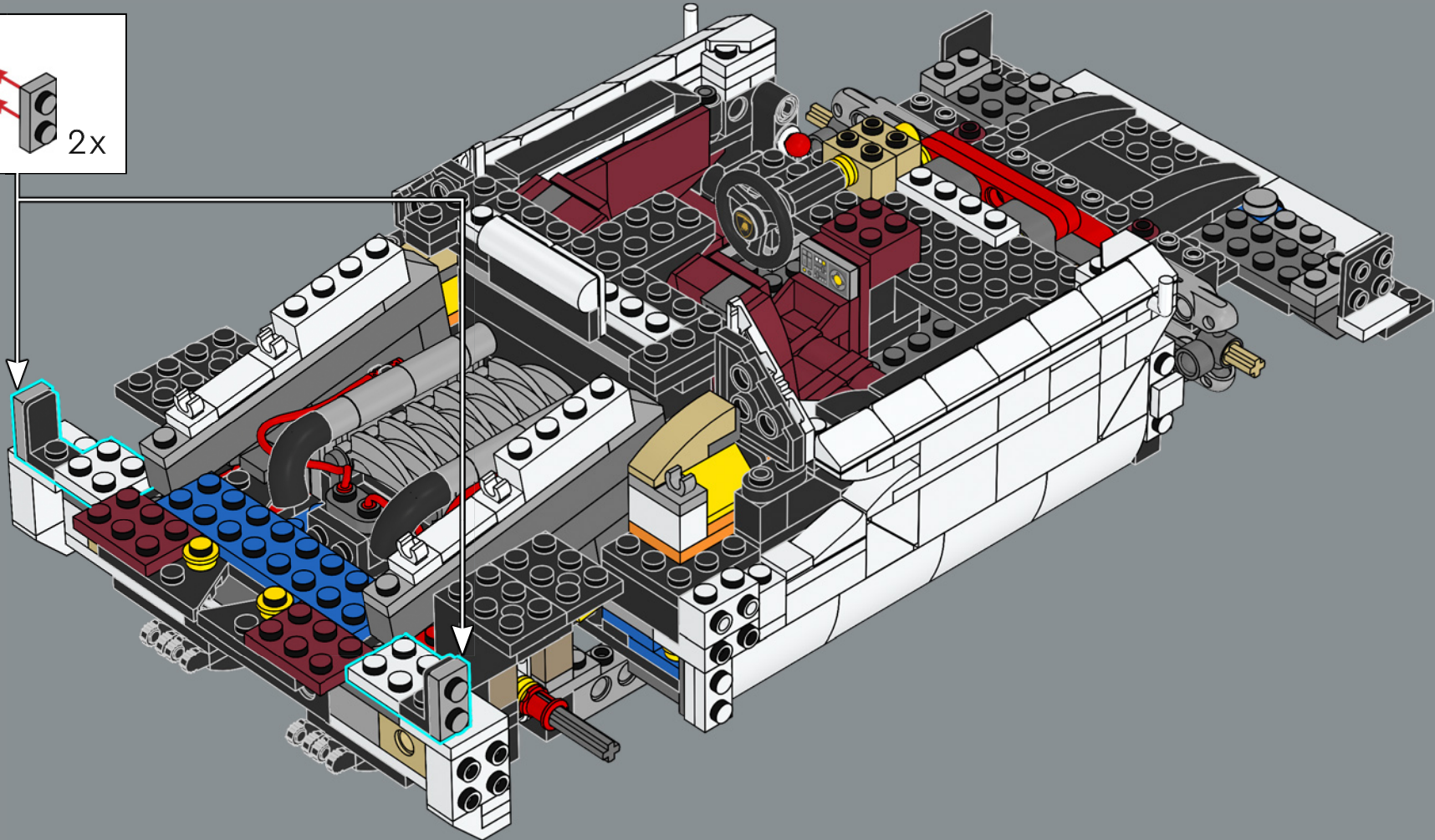
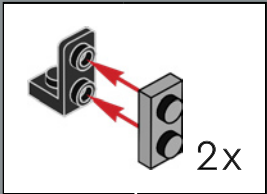

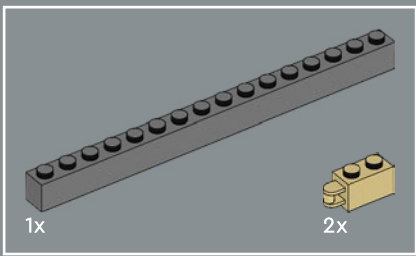

197

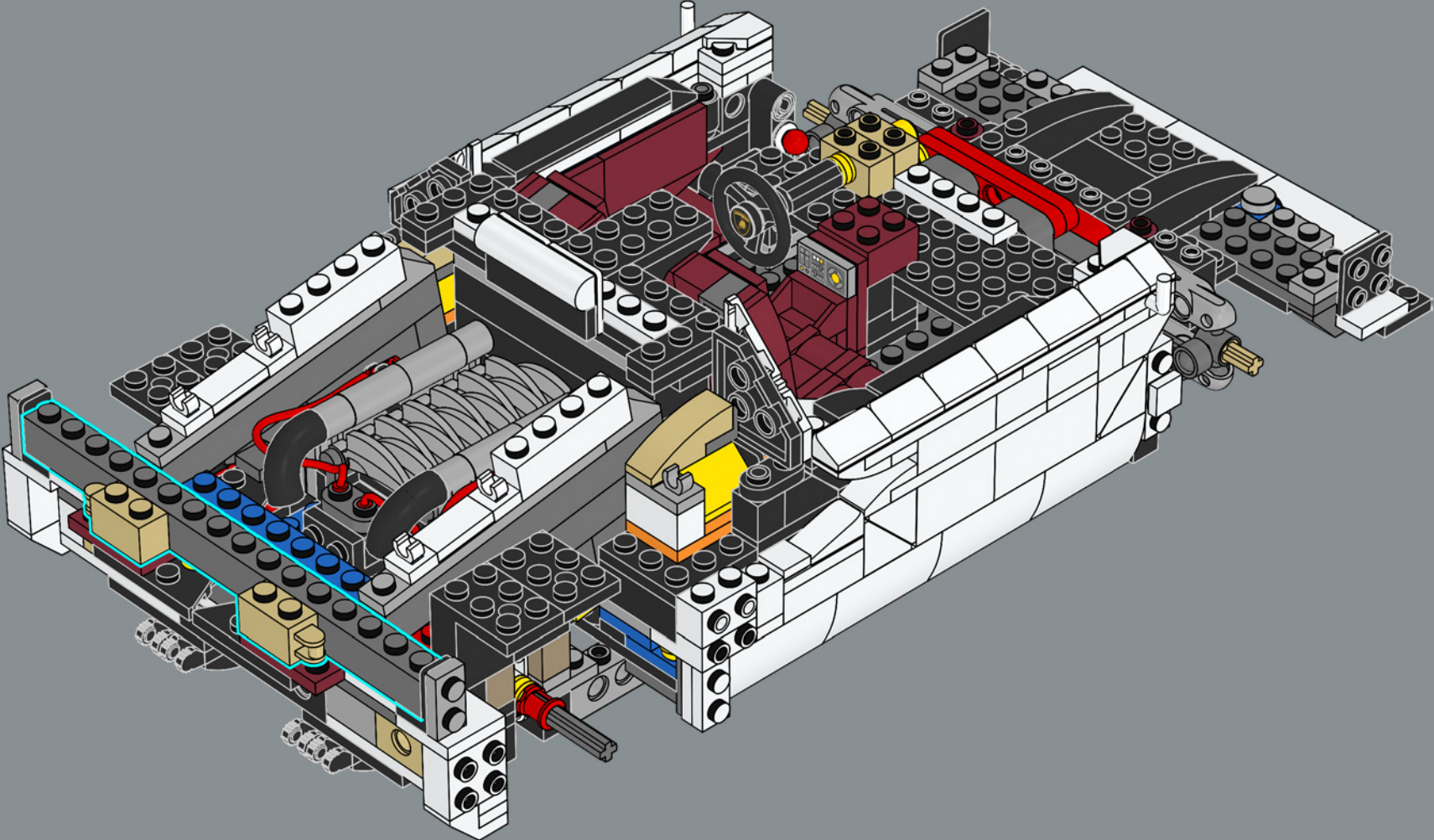

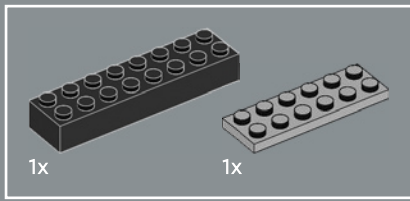

198

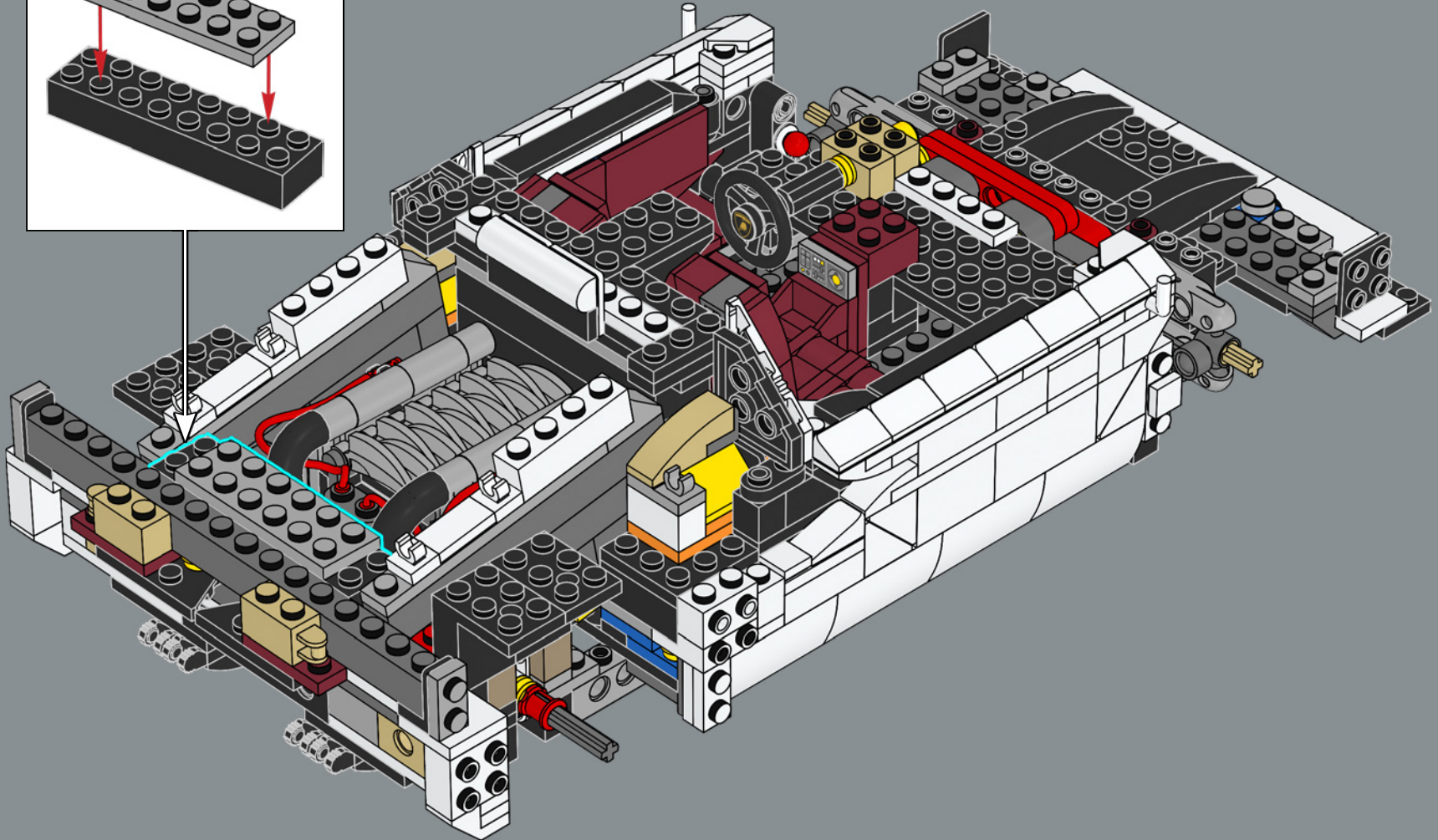
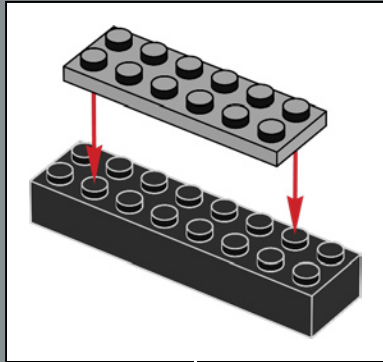

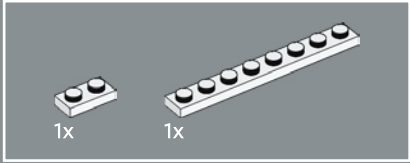
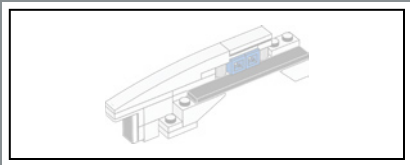

199

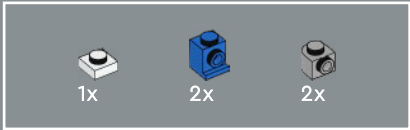
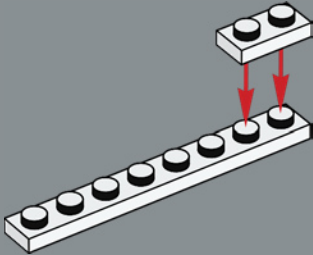

200

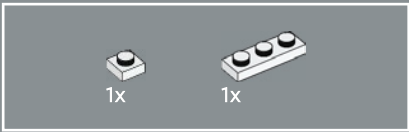
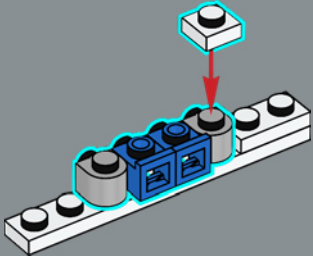

201

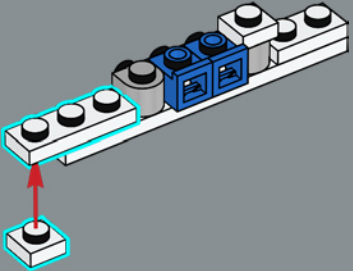

202

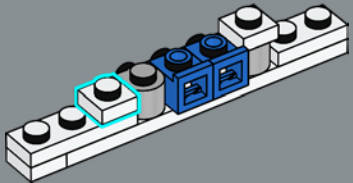

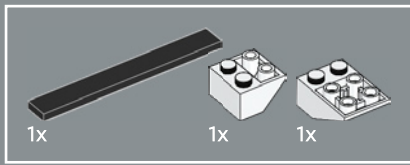

203

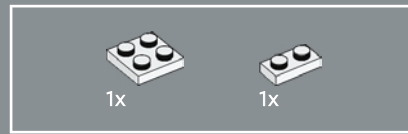
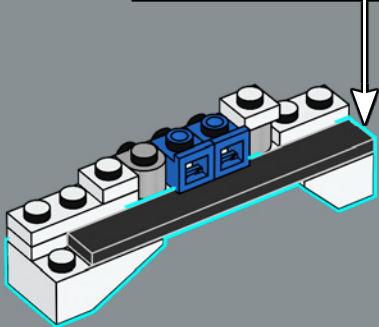
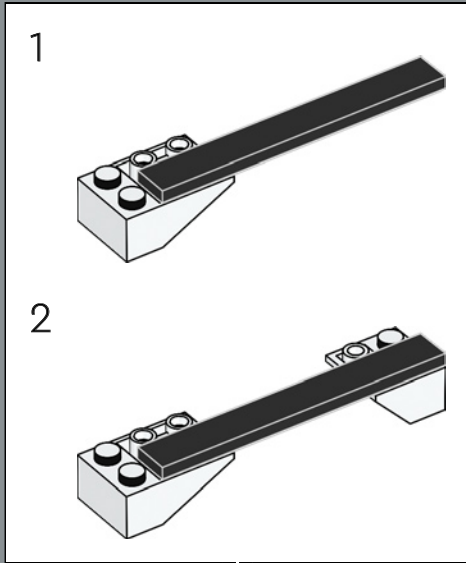

204

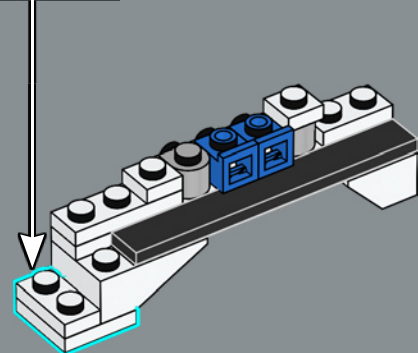
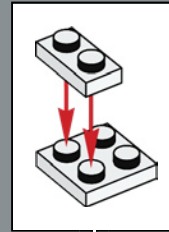

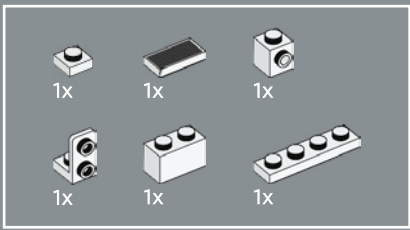

205

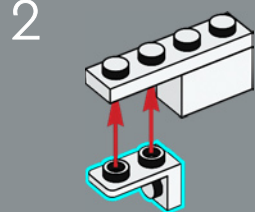
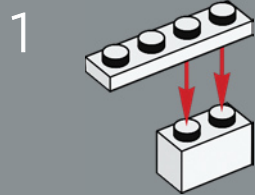

3

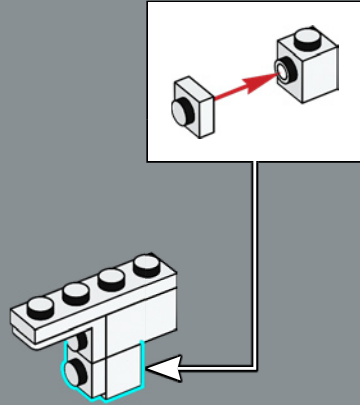

4

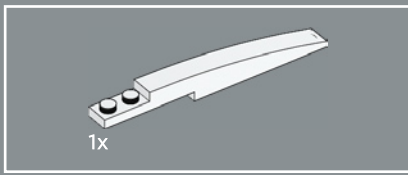
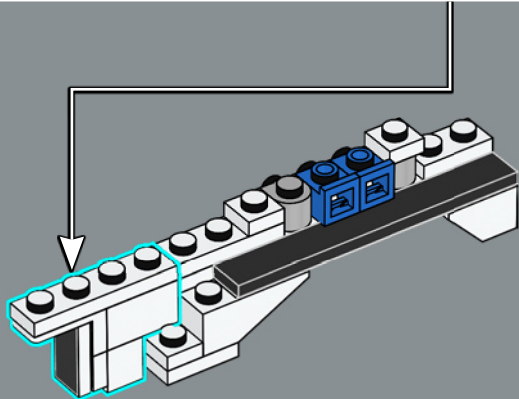
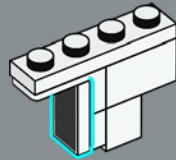

206

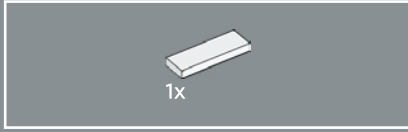
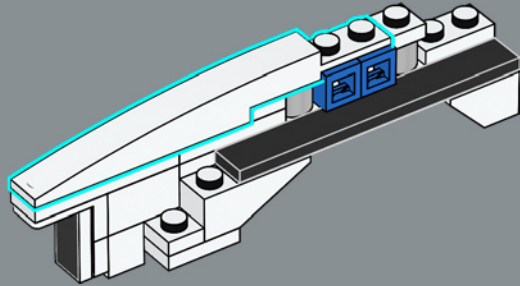

207

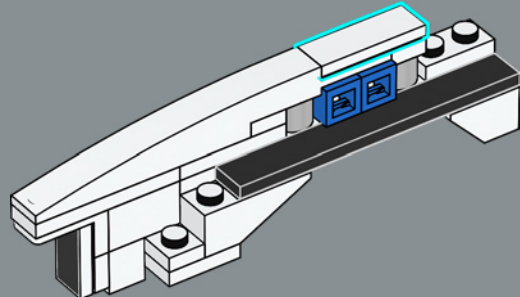

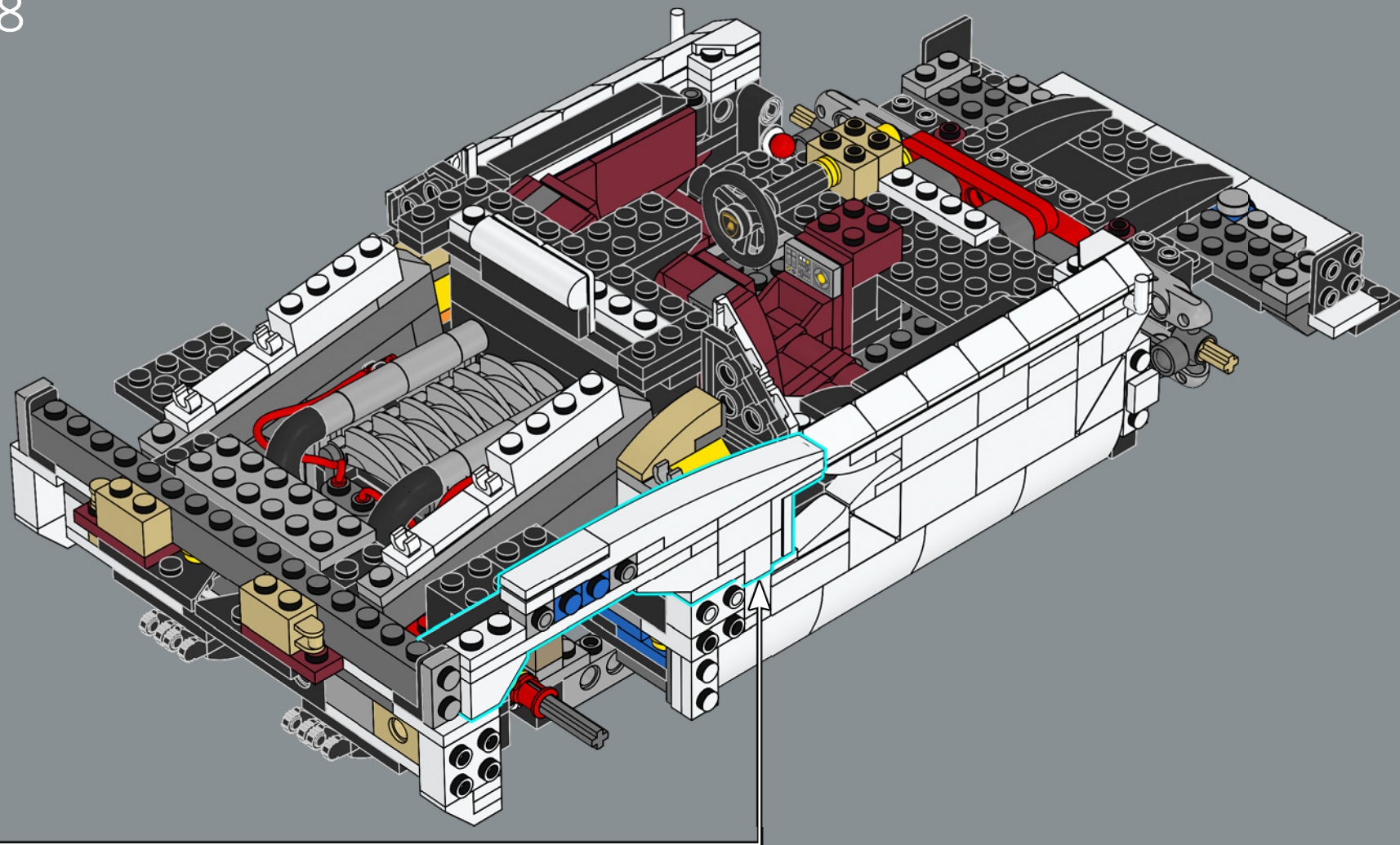

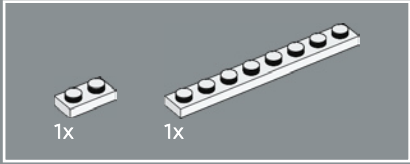
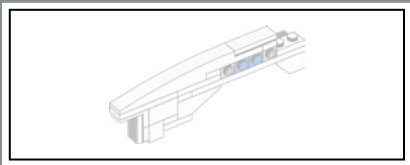

209

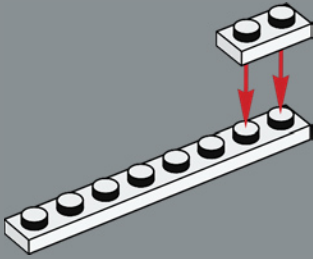

210

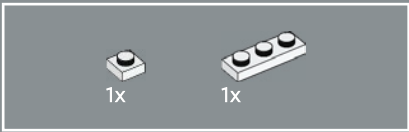
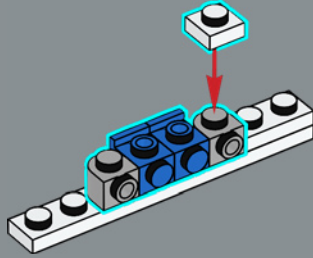

211

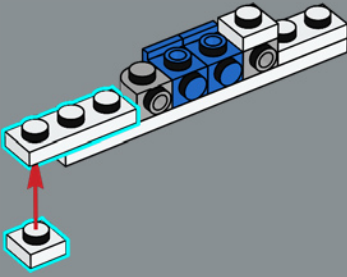

212

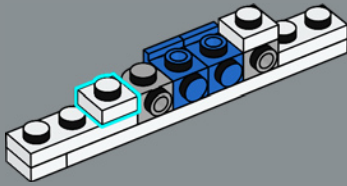

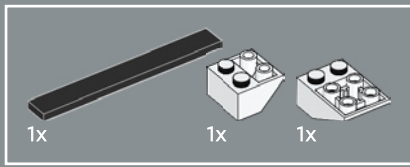

213

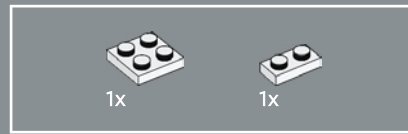
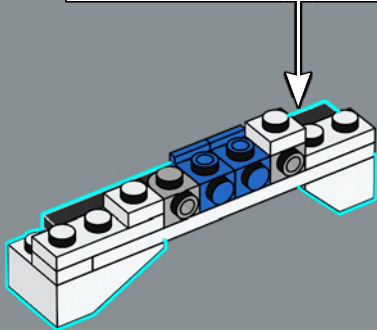
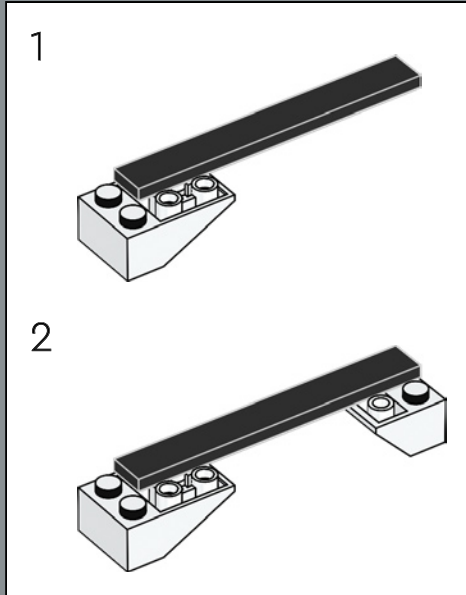

214

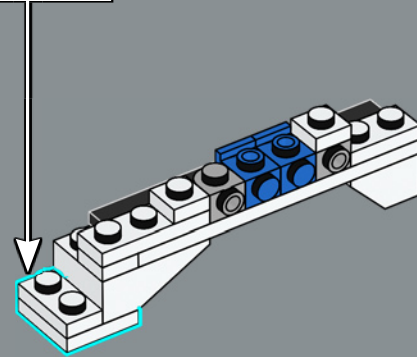
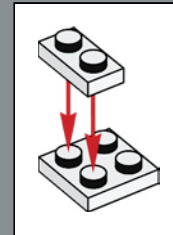

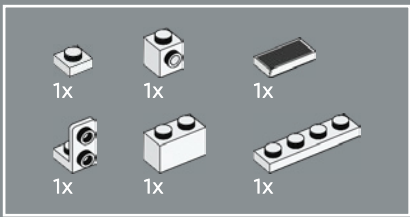

215

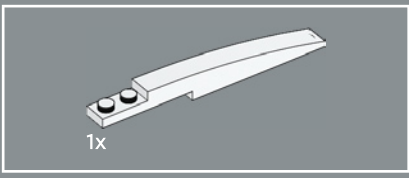
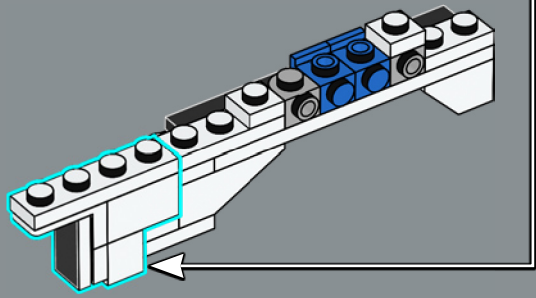
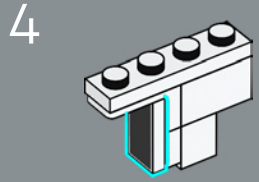
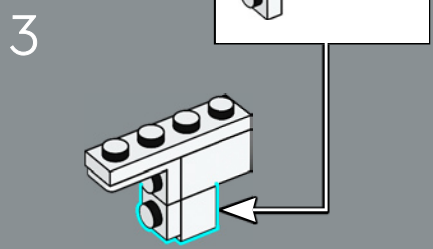
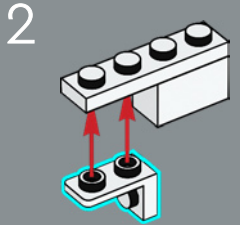
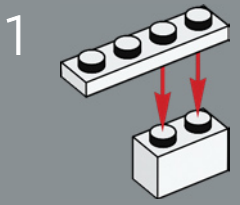

216

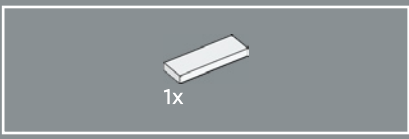
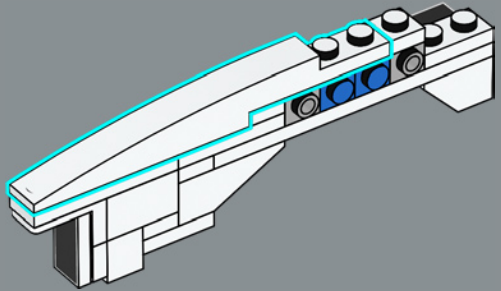

217

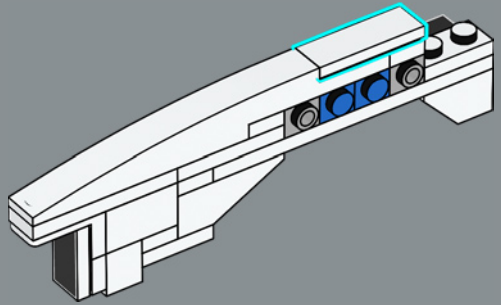

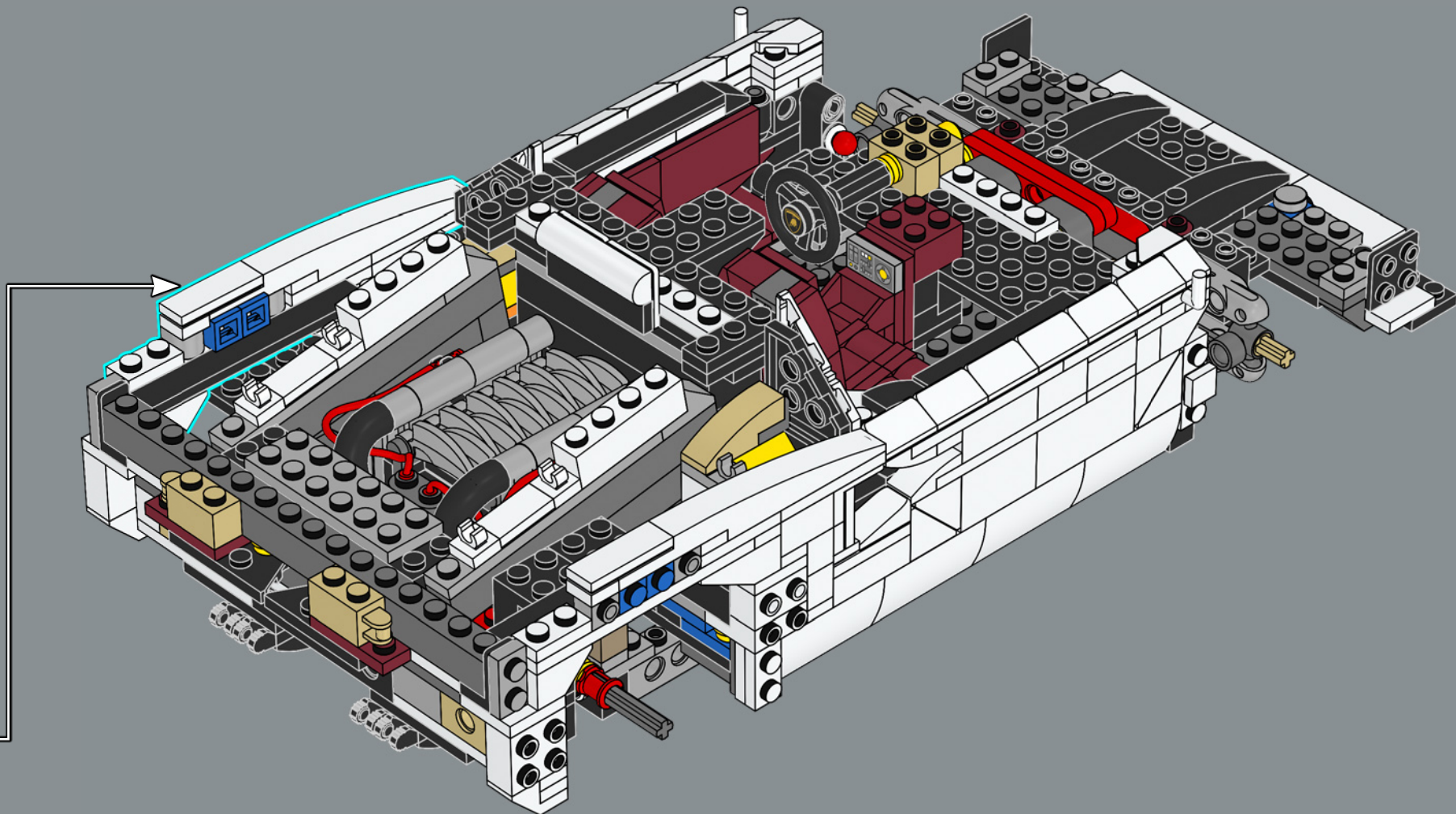

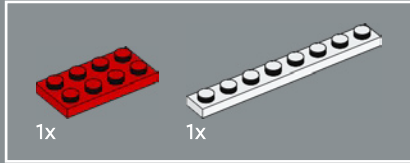
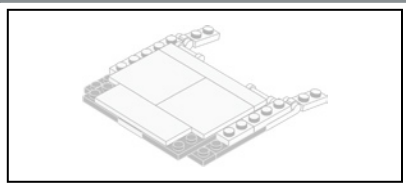

219

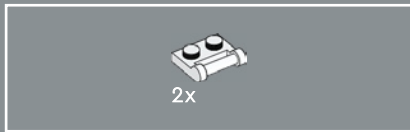
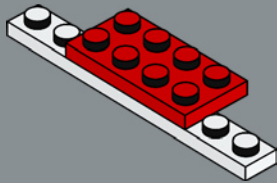

220

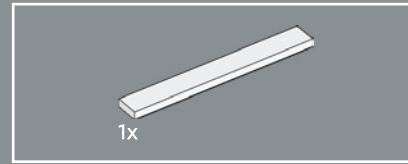
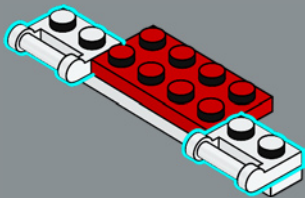

221

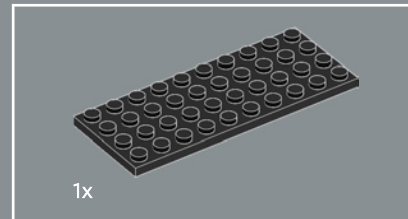
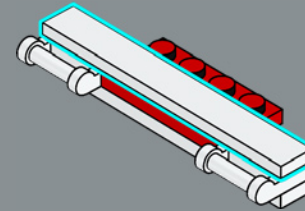

222

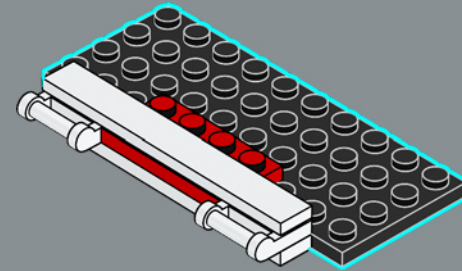

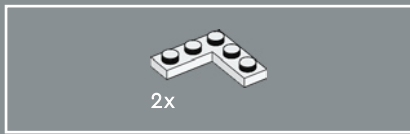

223

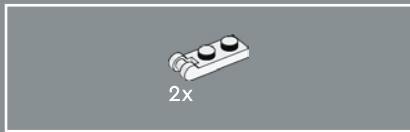
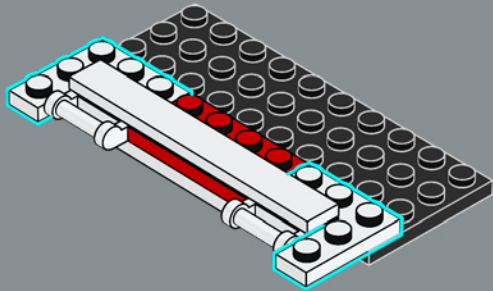

224

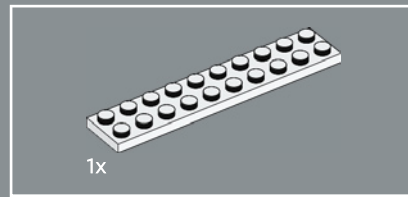
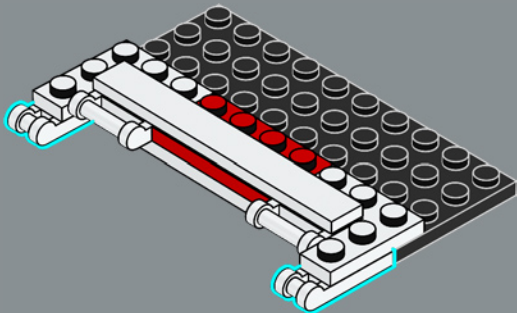

225

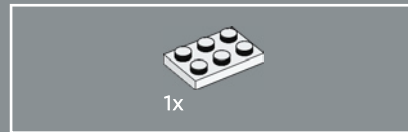
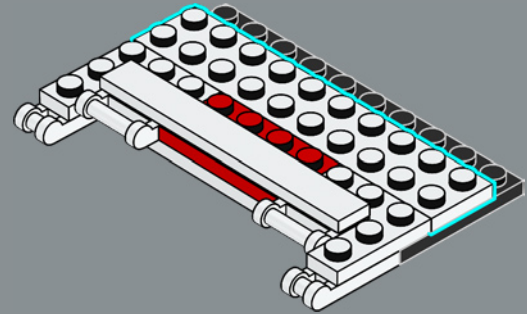

226

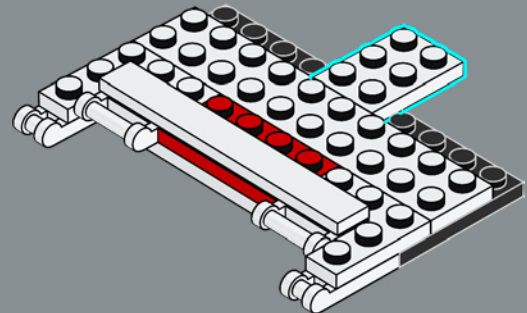

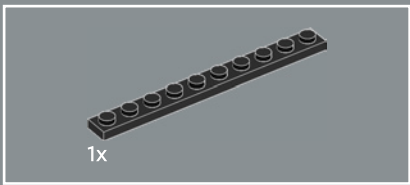

227

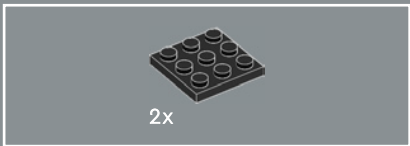
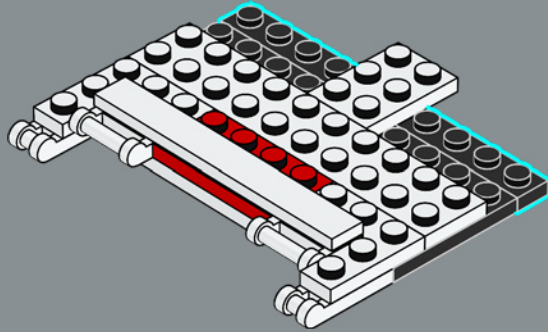

228

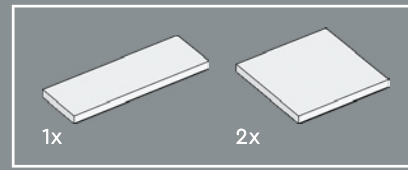
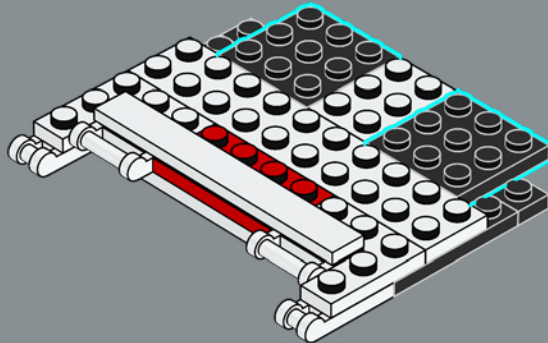

229

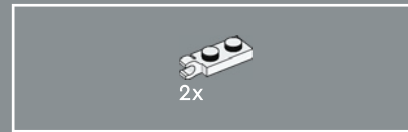
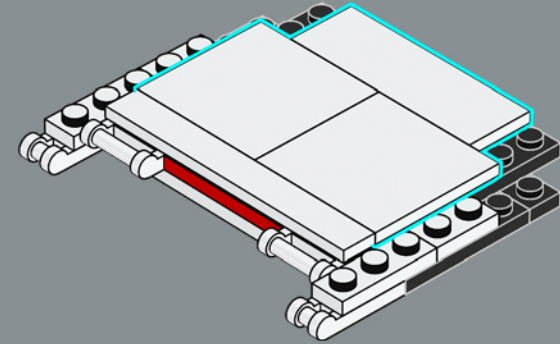

230

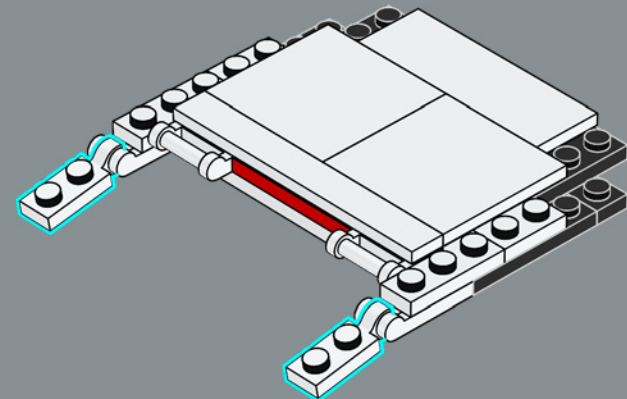

231

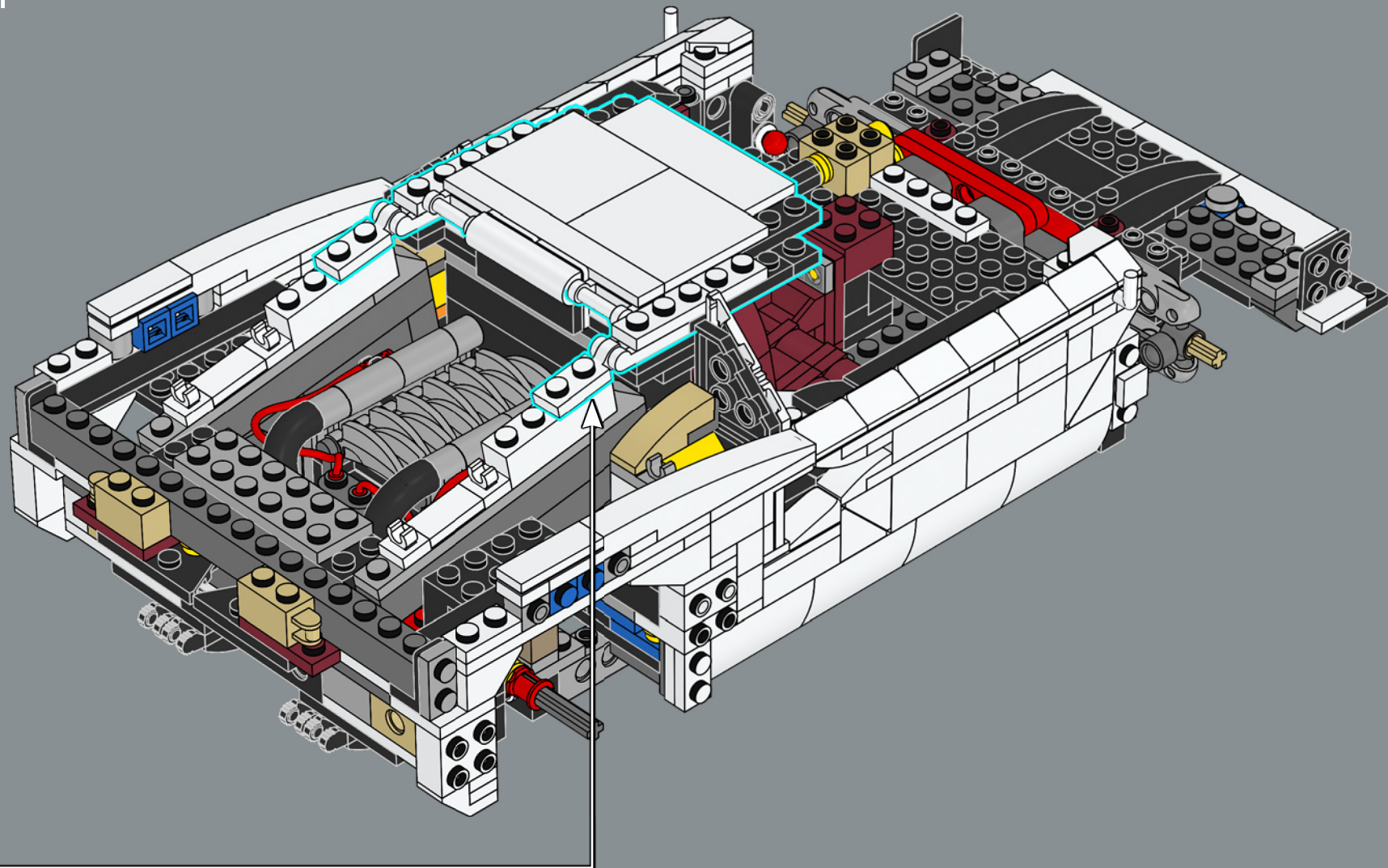

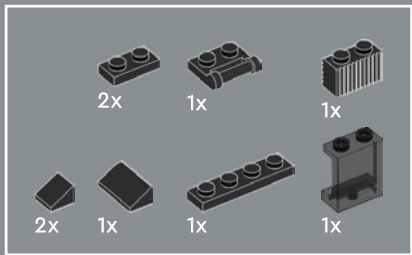

232

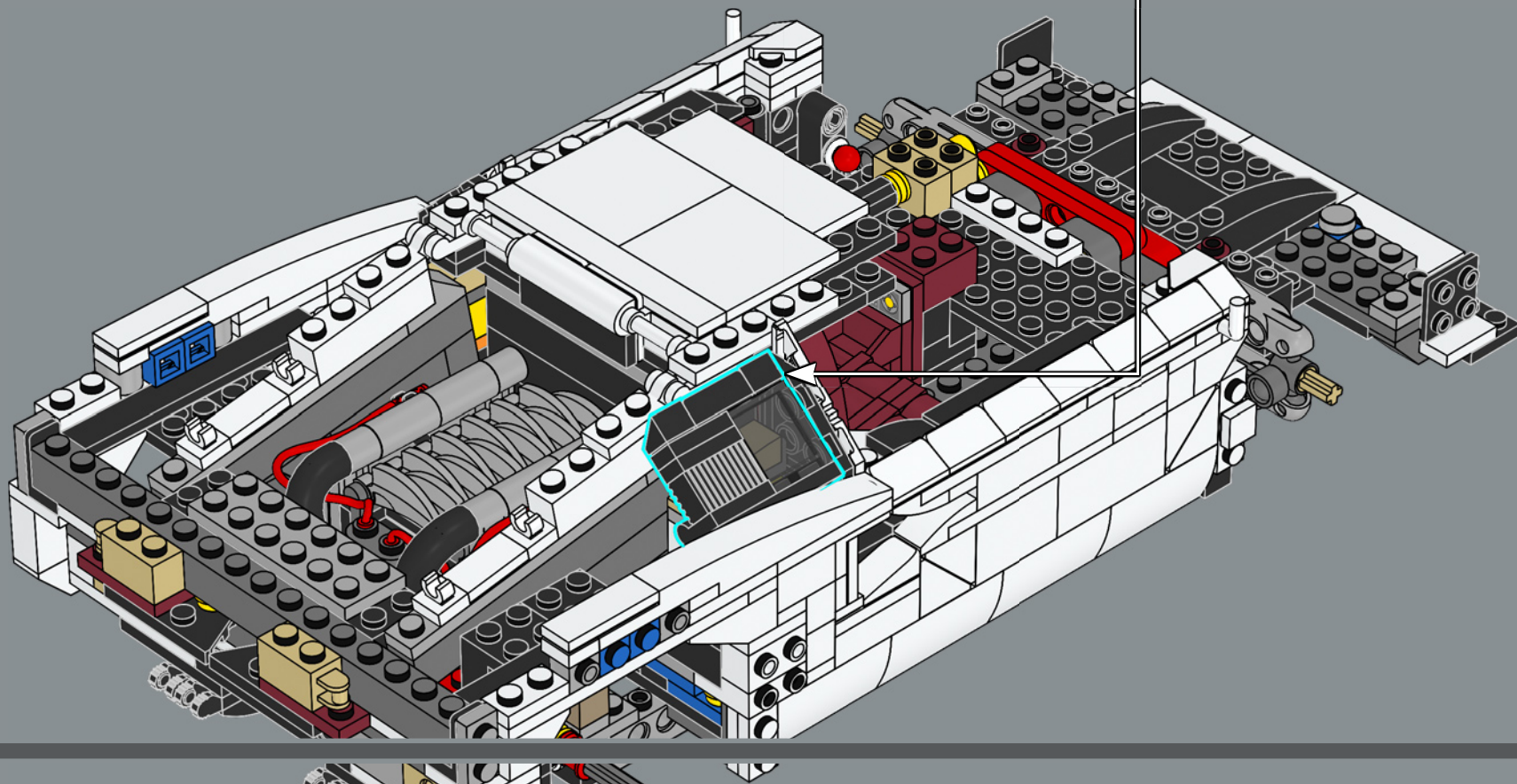
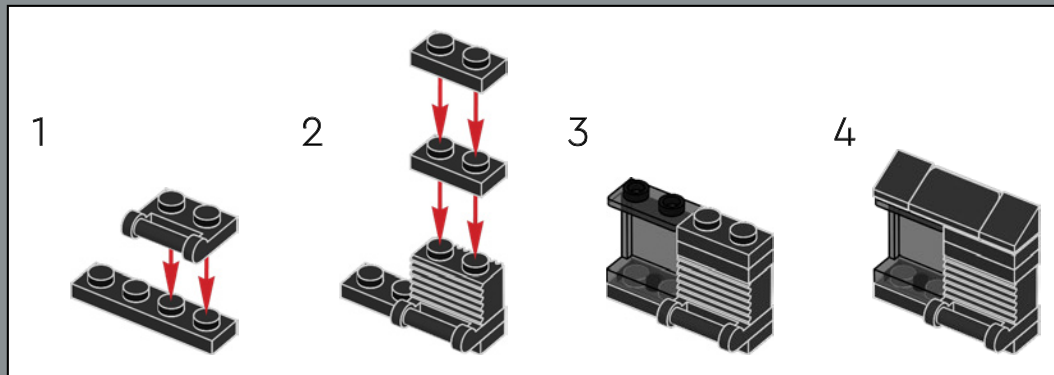

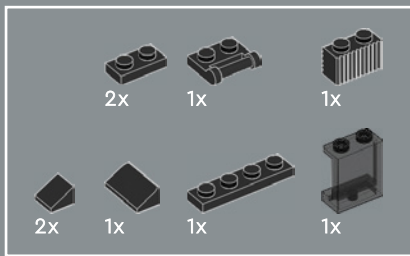

233

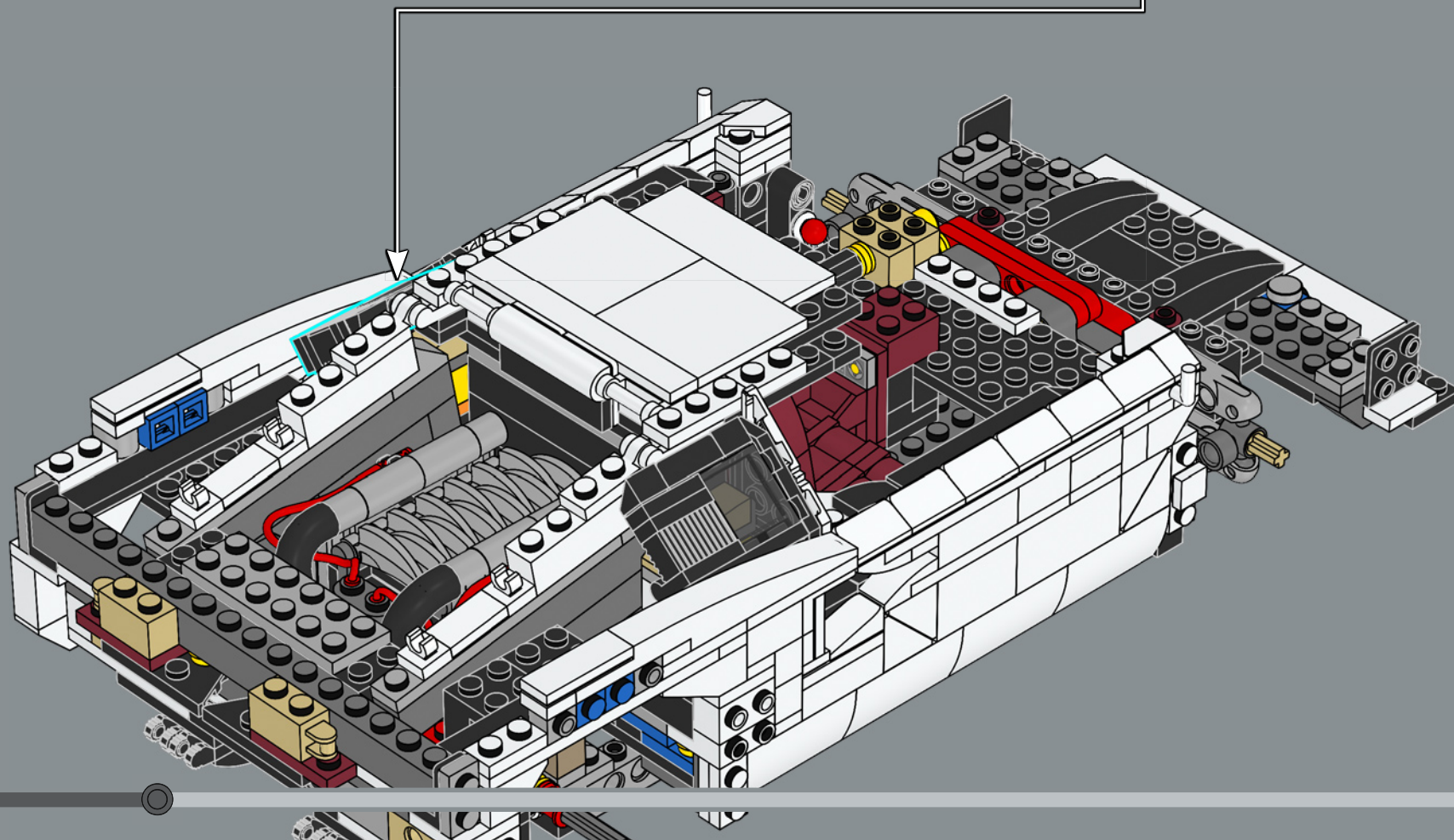
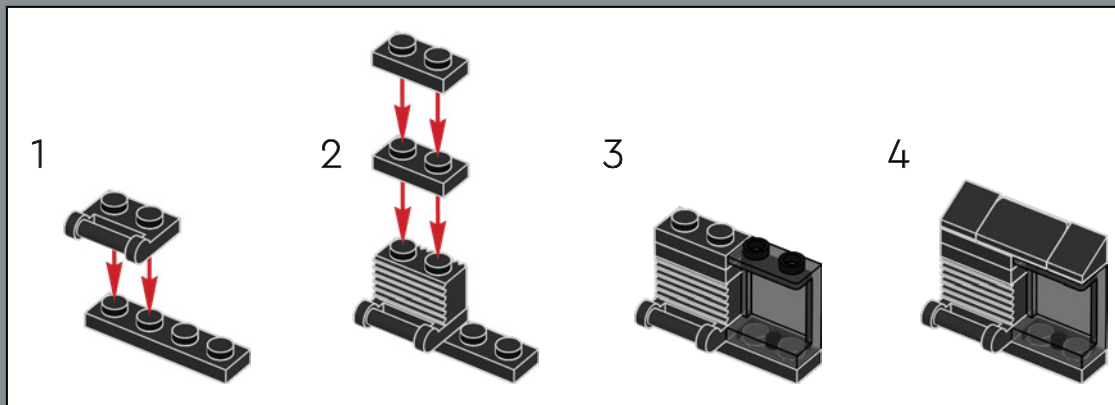

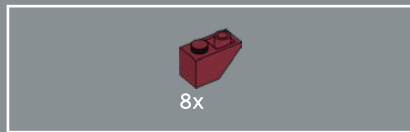

234

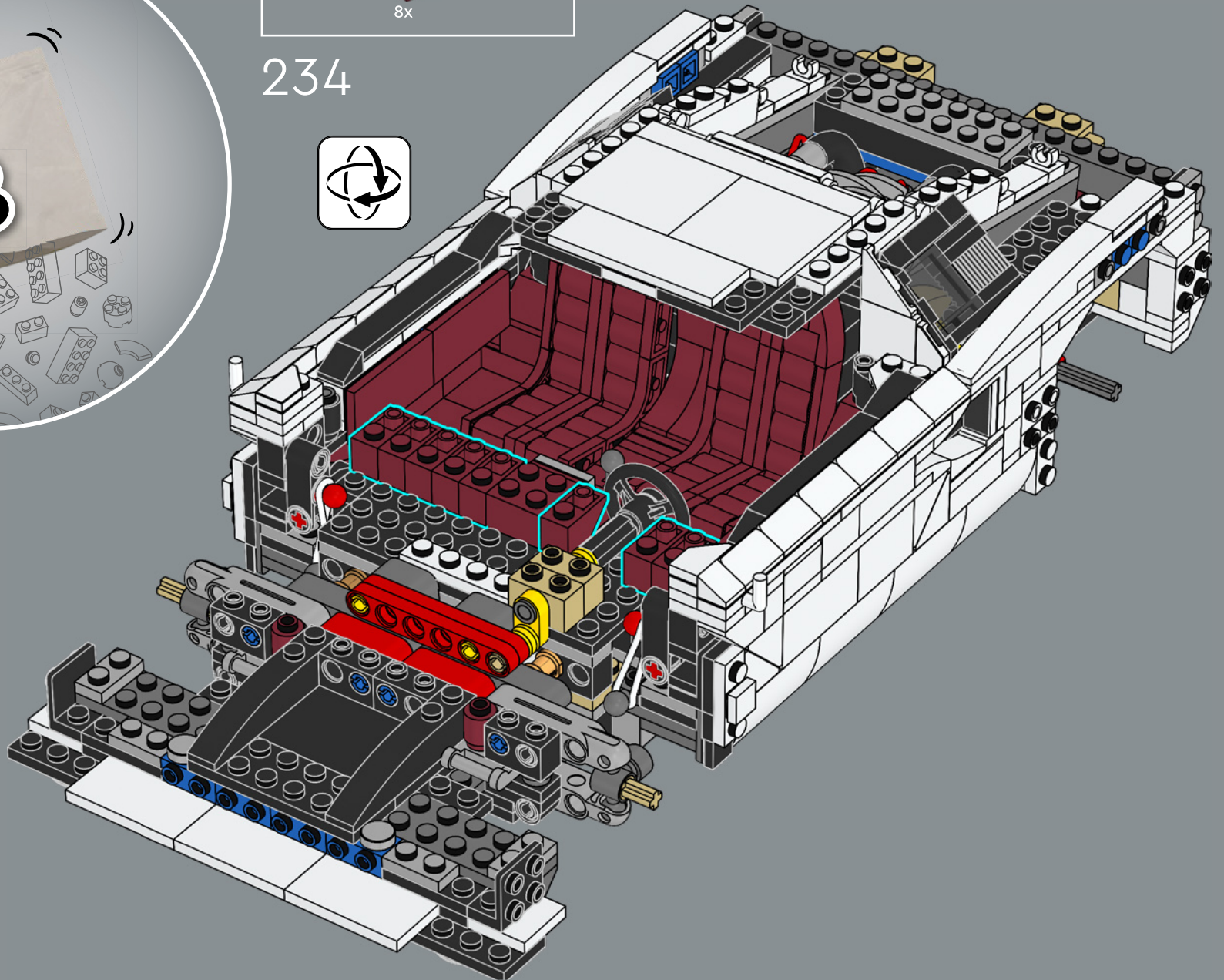

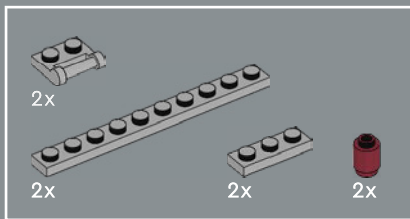

235

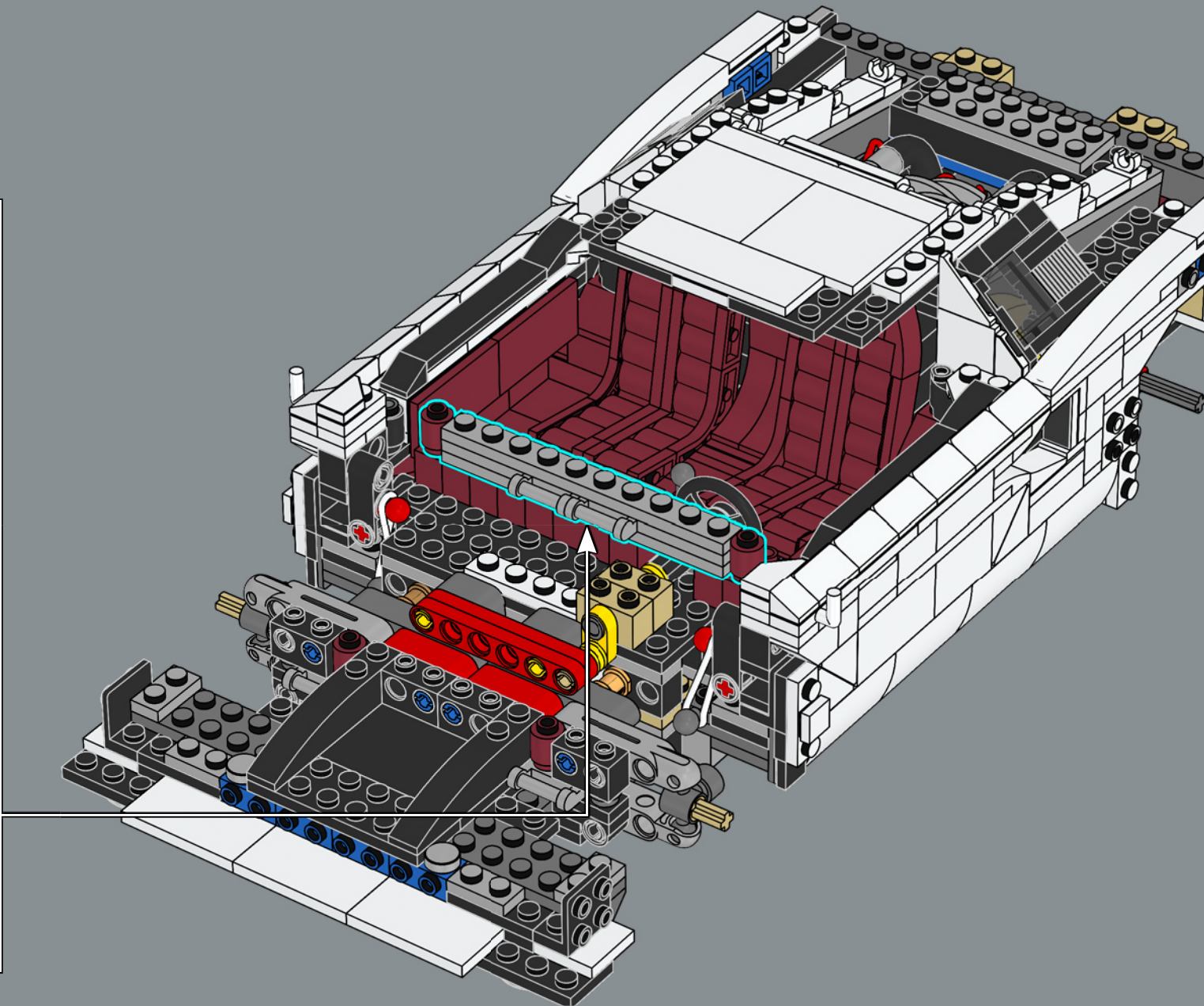
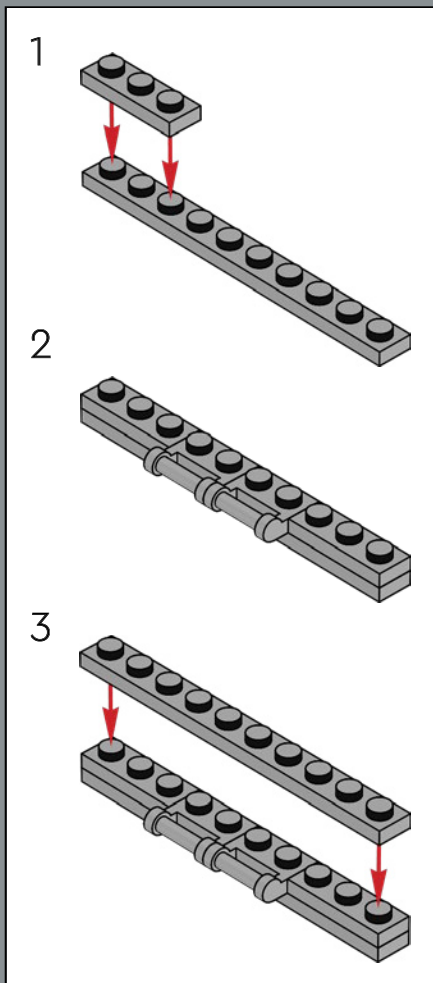

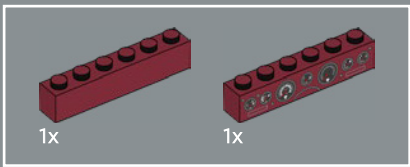

236

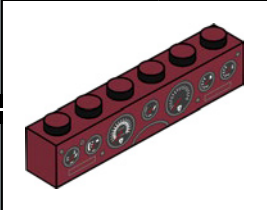
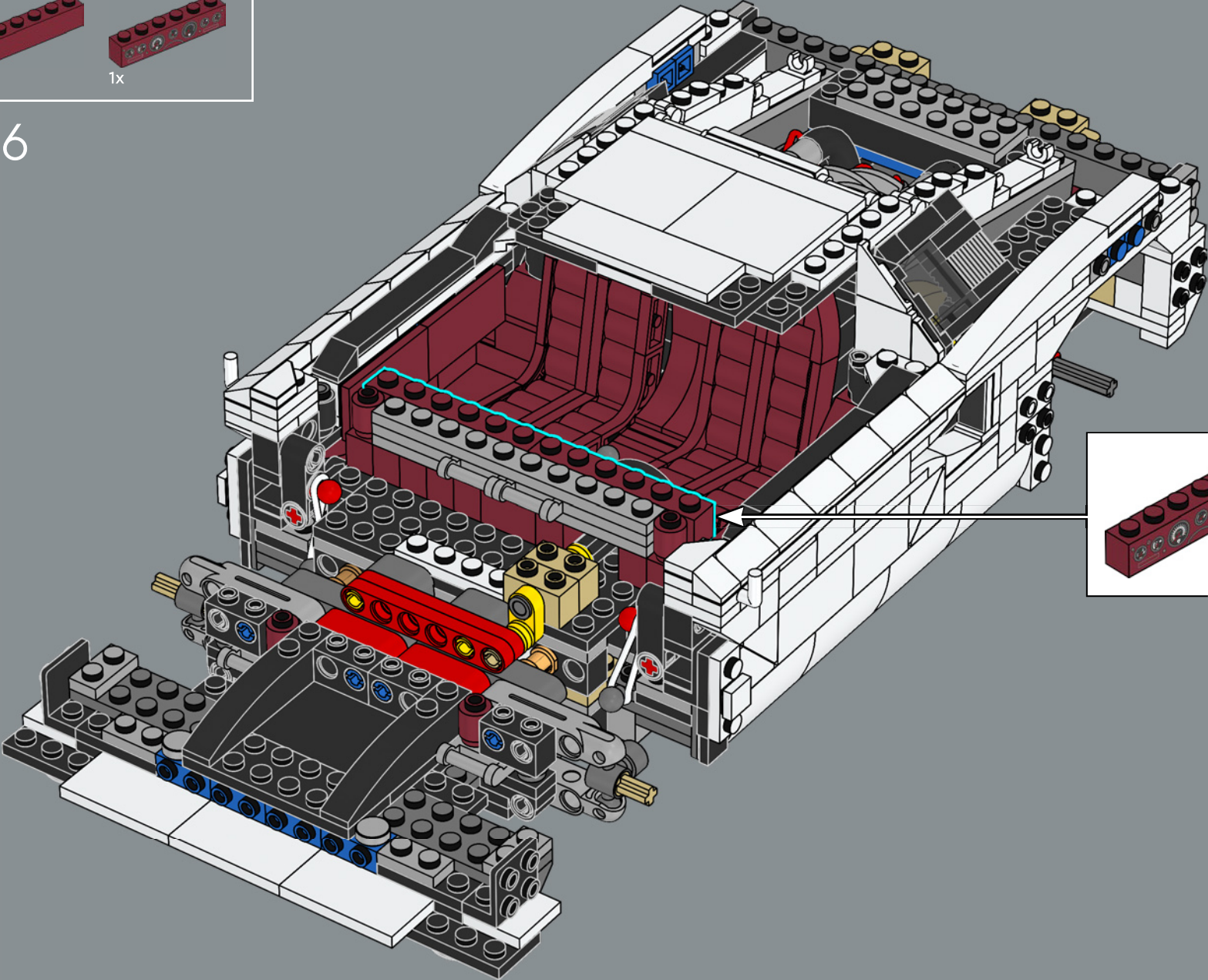

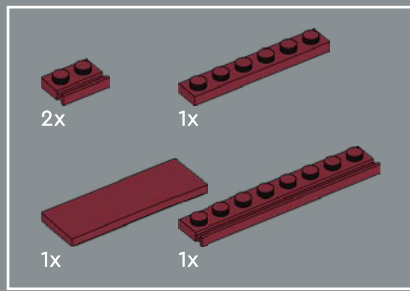

237

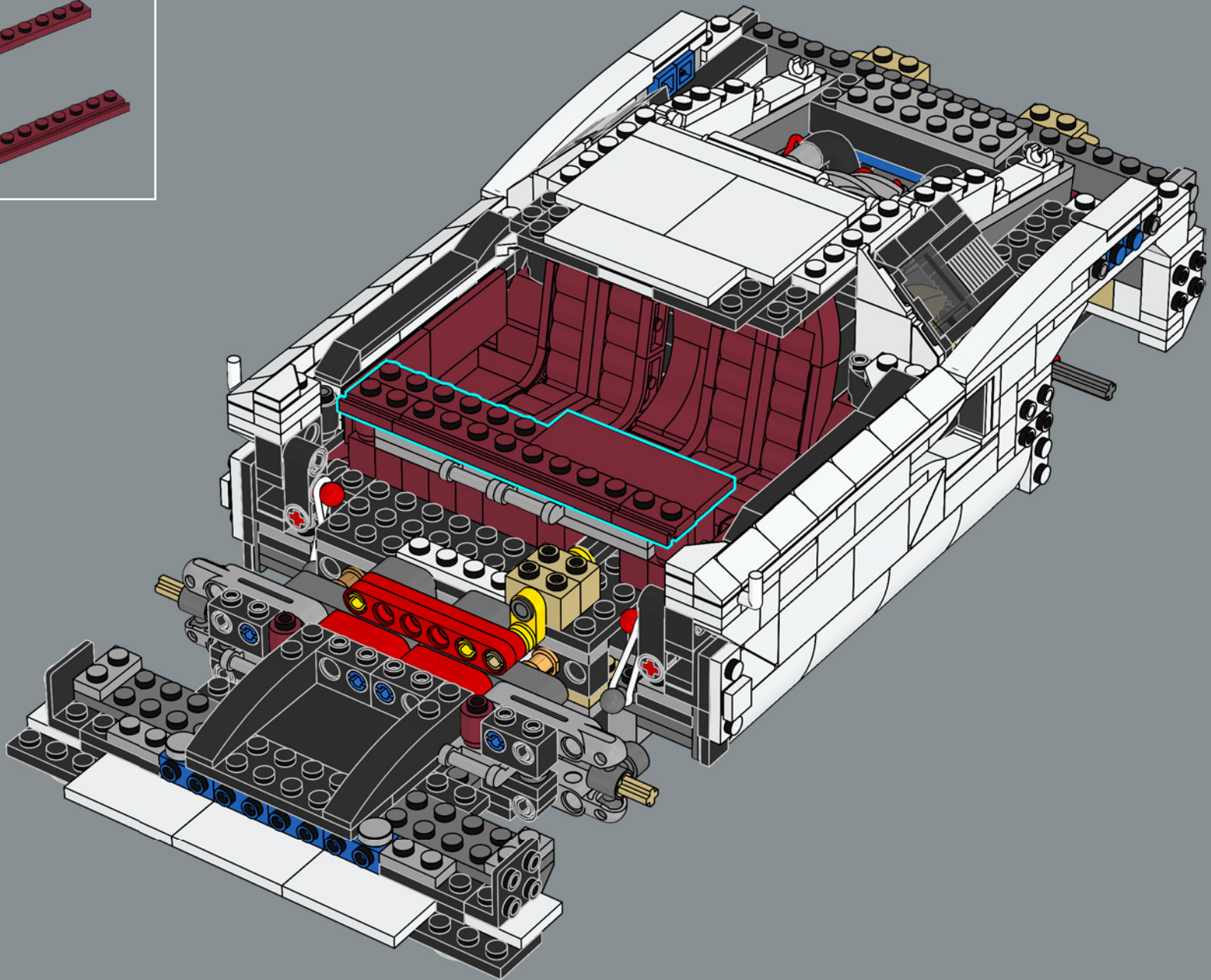



238

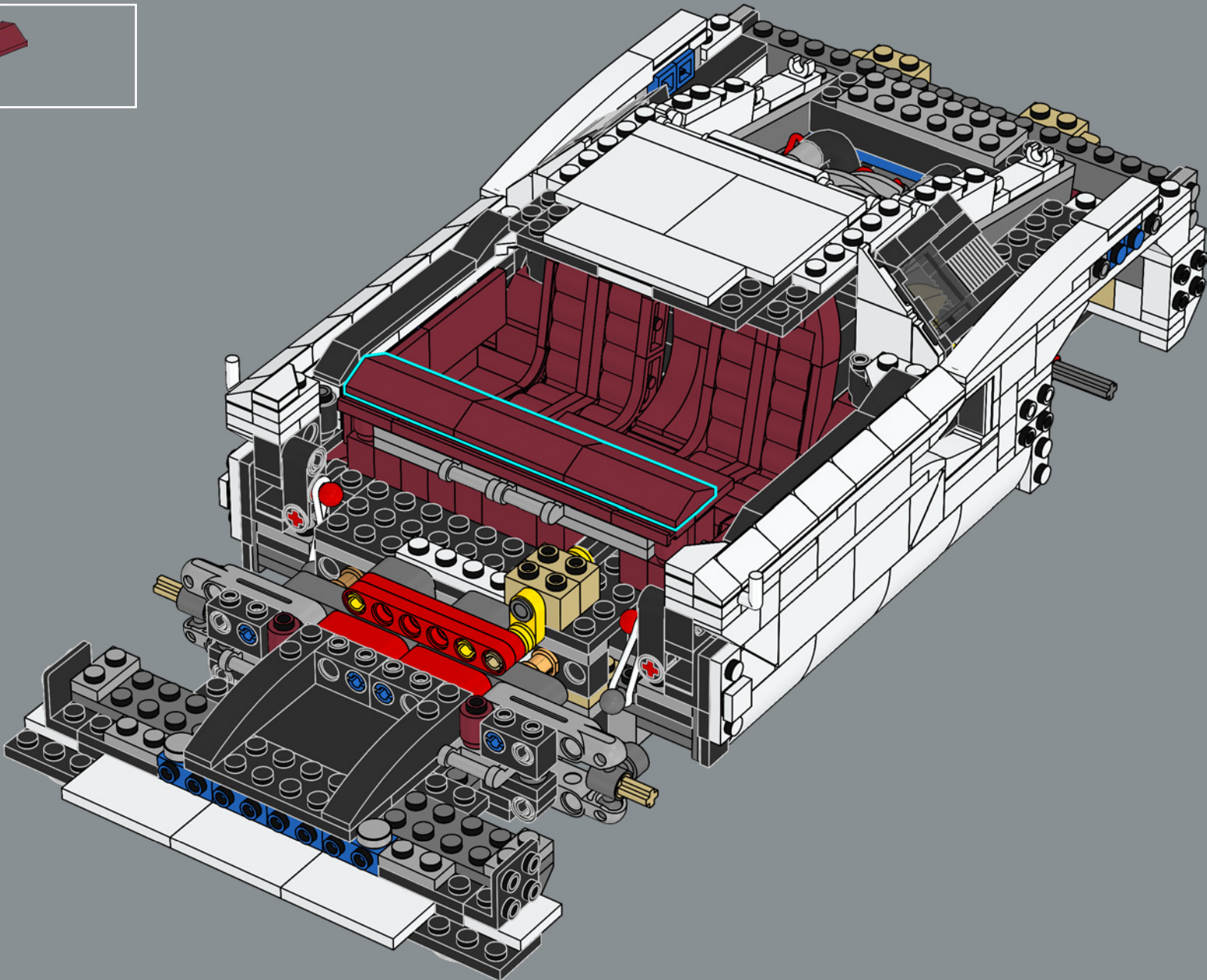

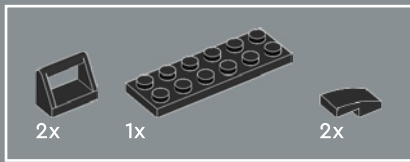

239

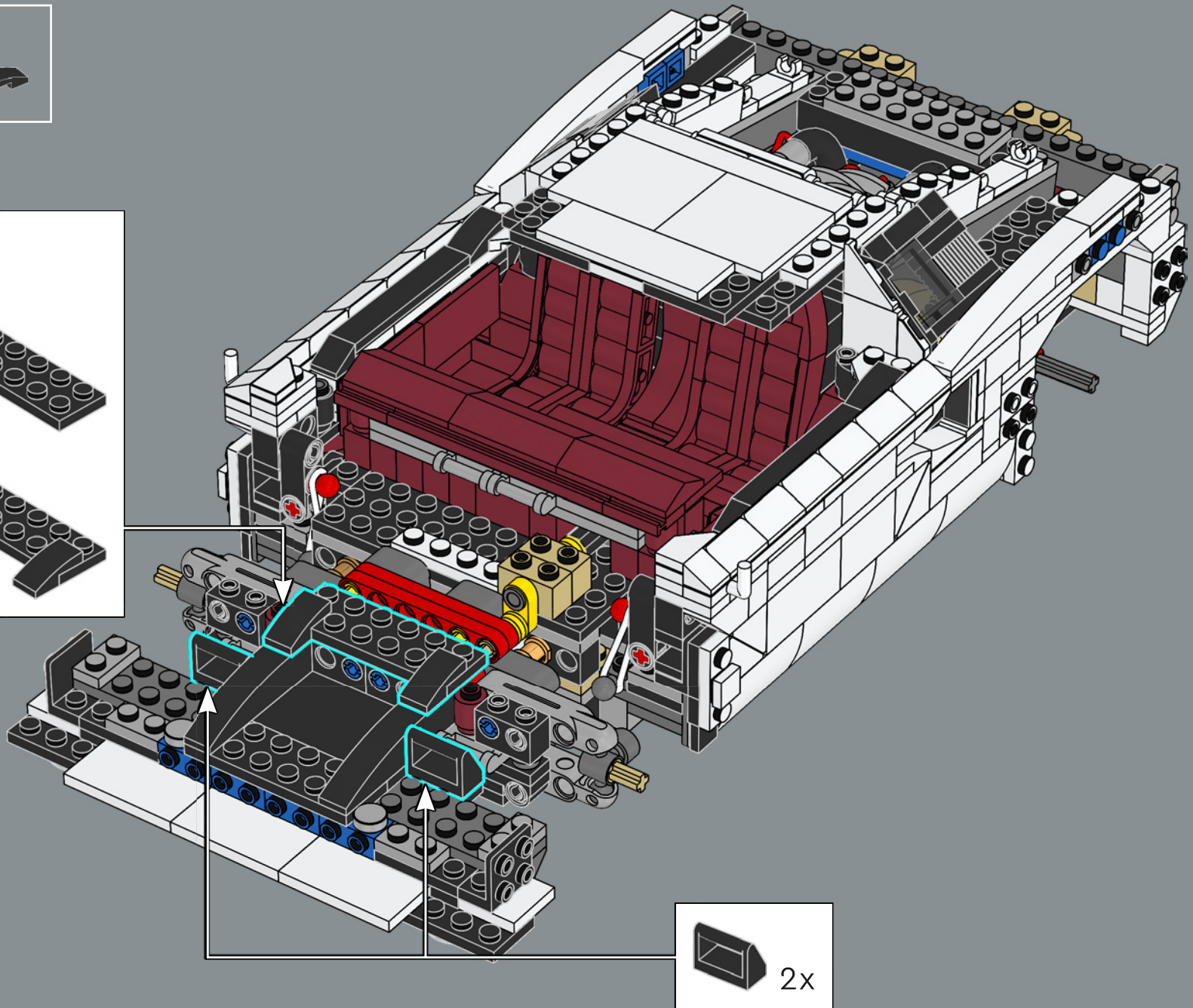
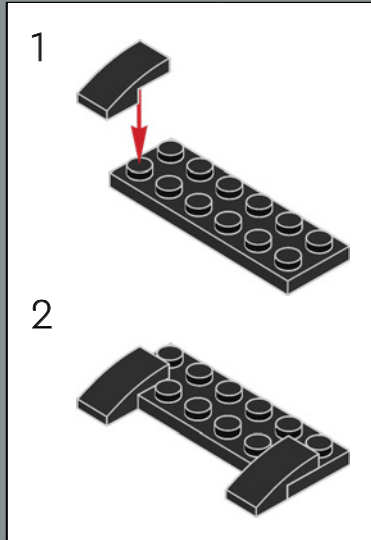

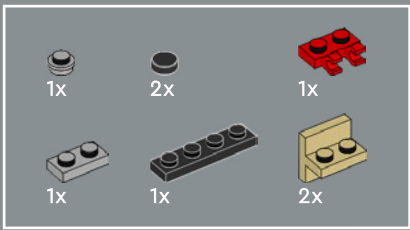

240

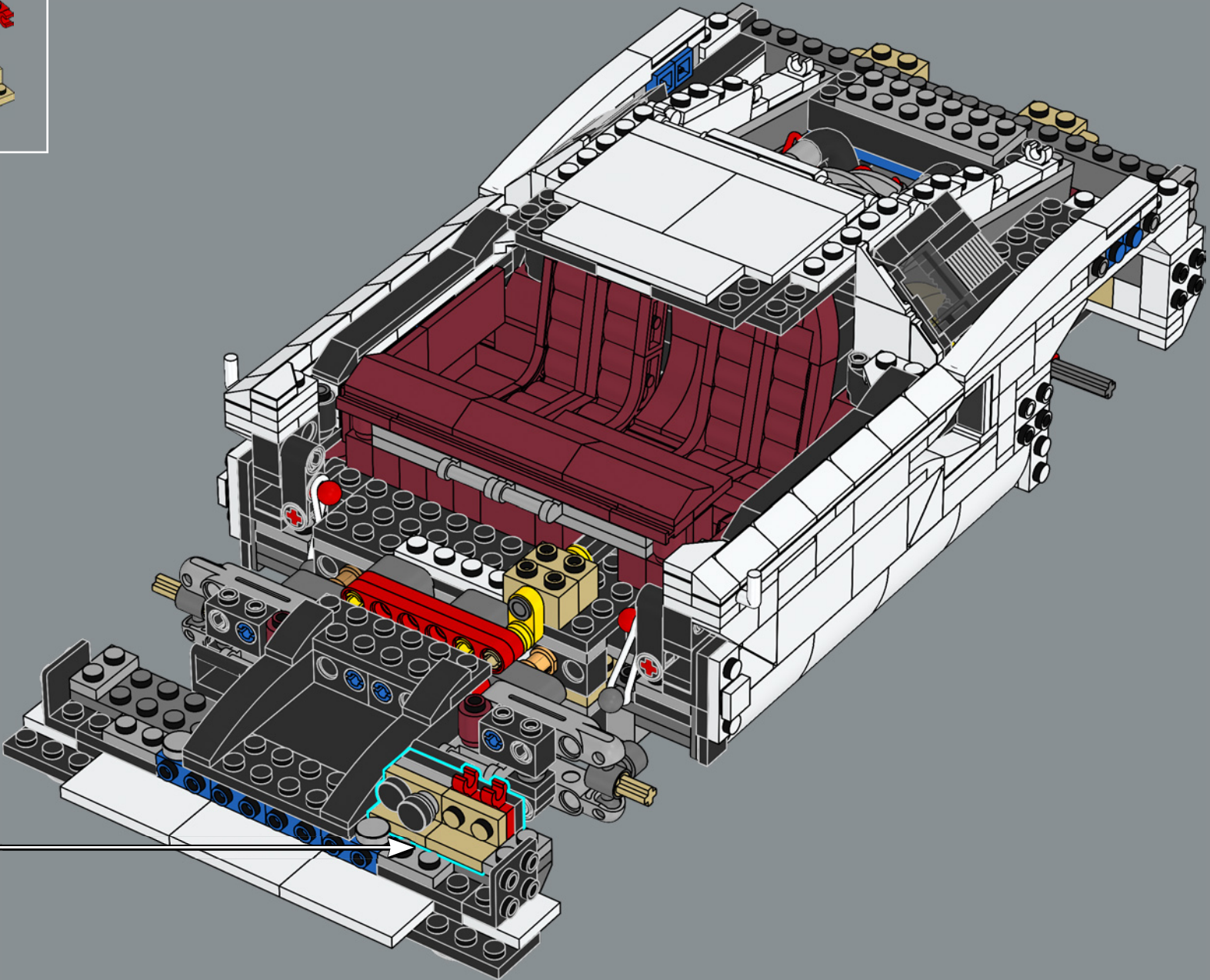
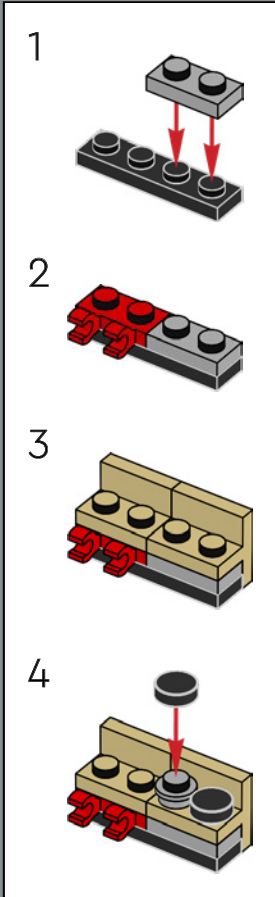

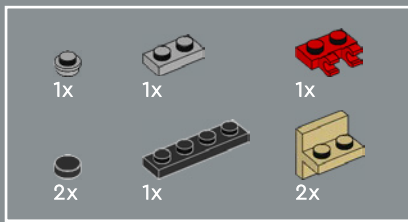

241

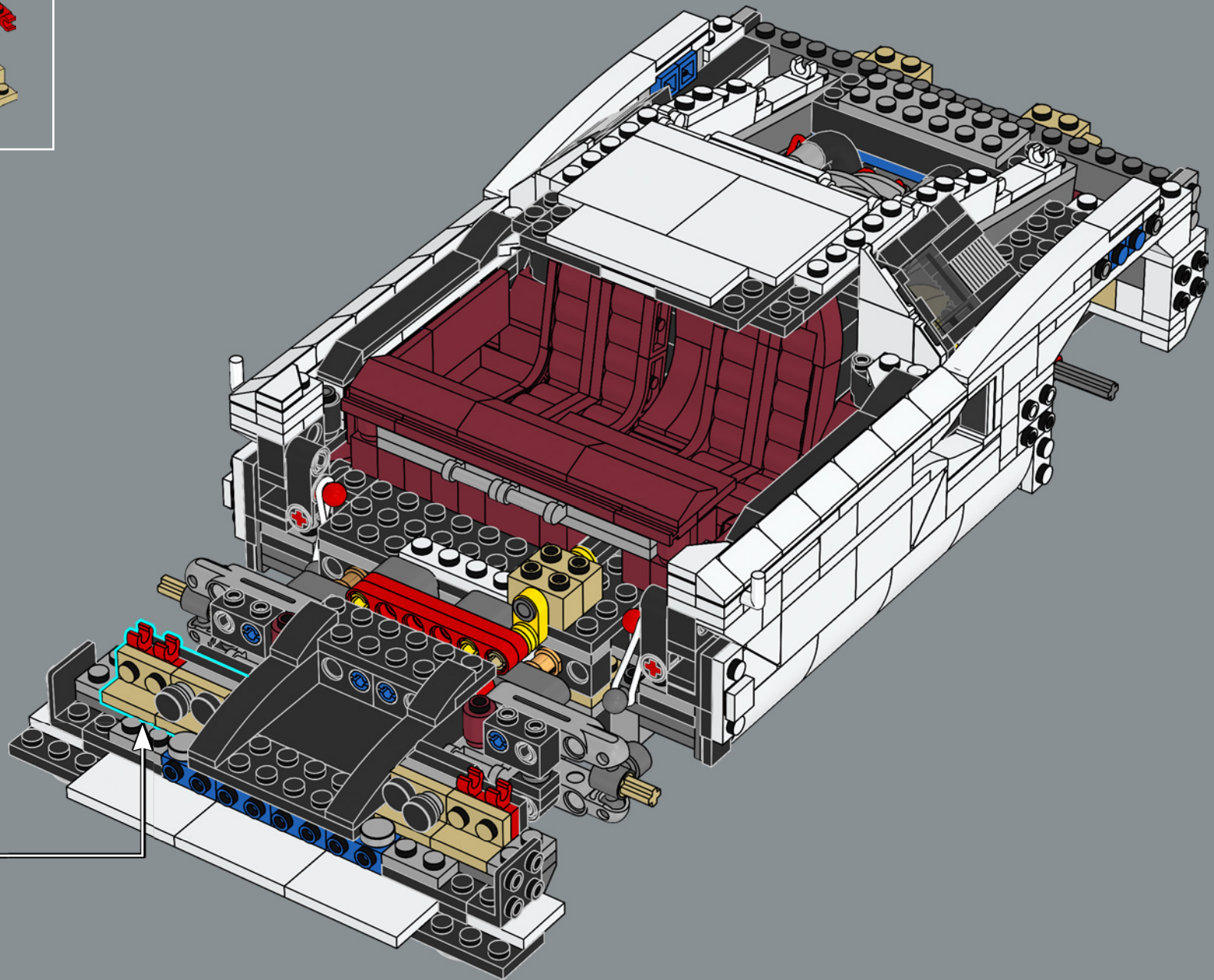
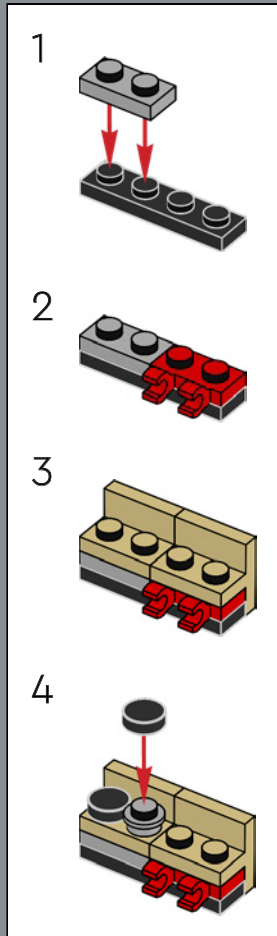



2x

242

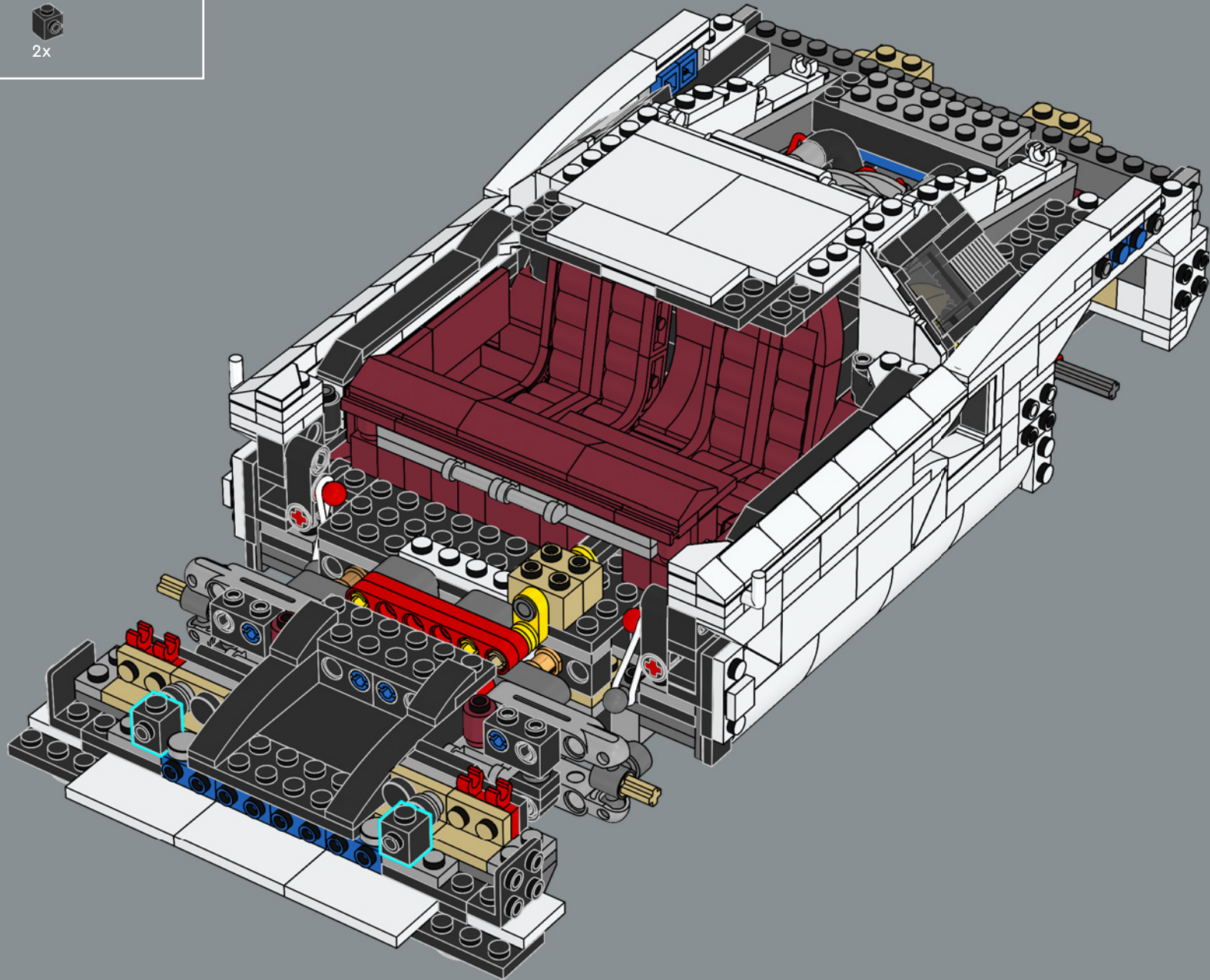

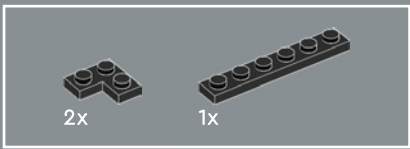

243

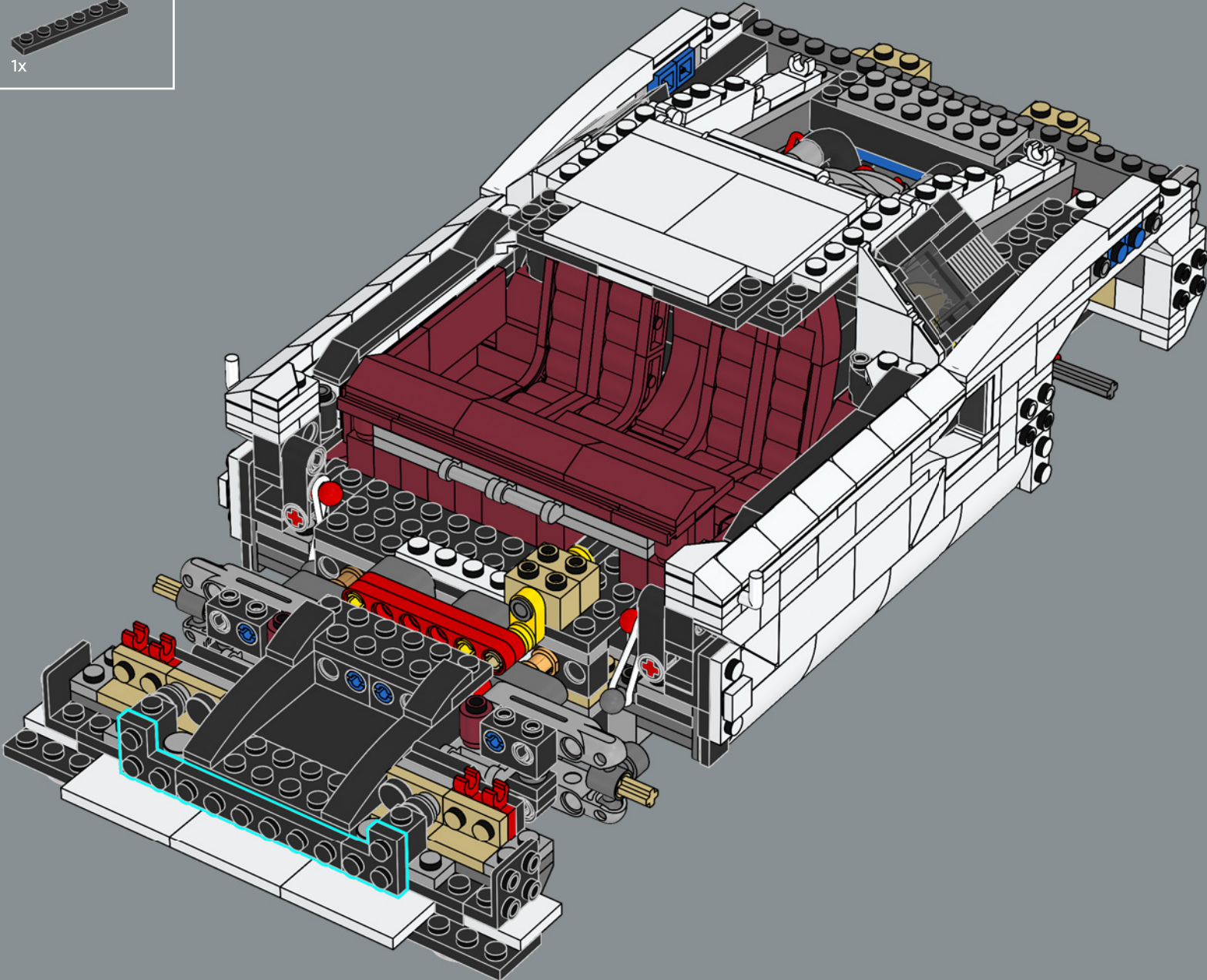



244

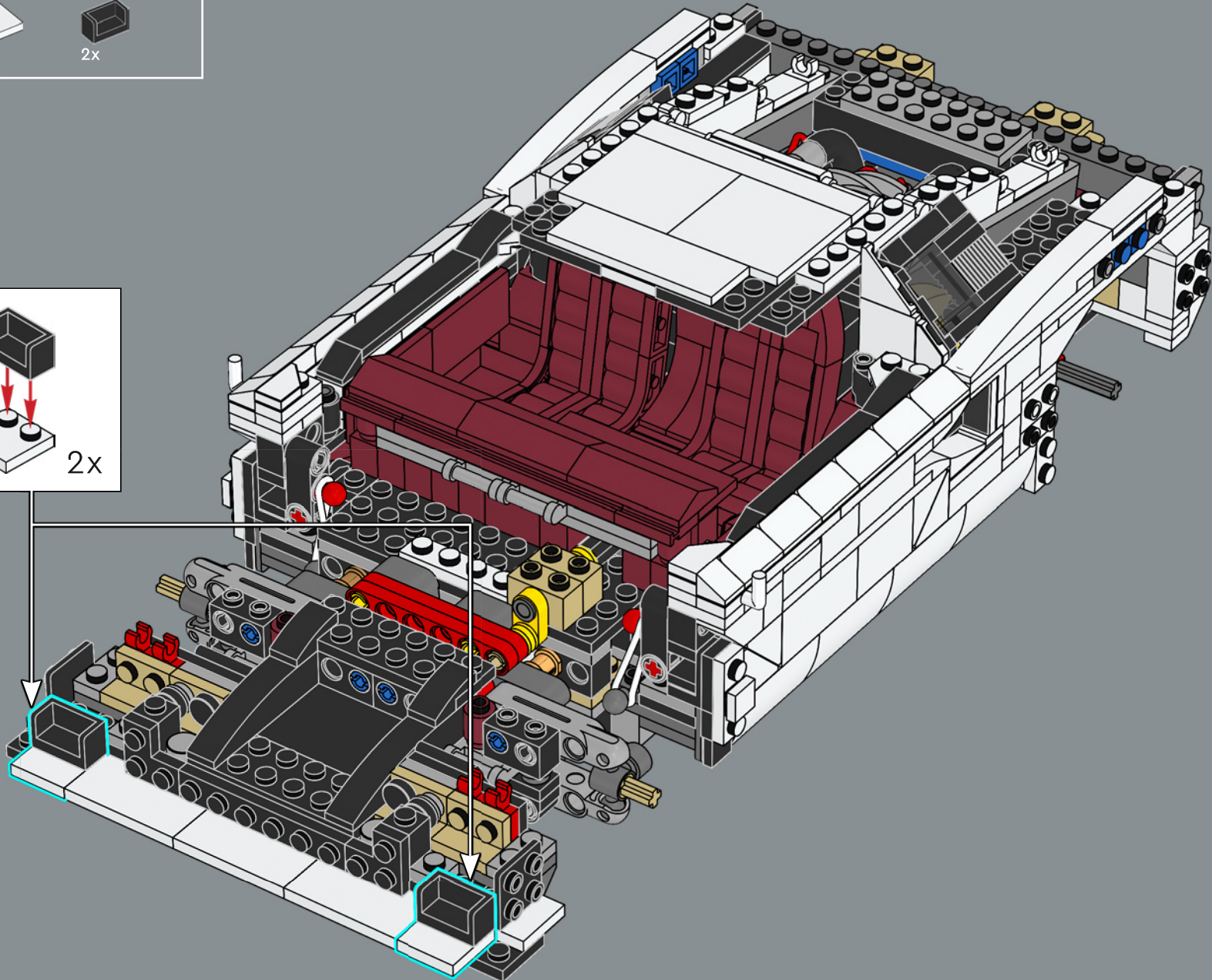
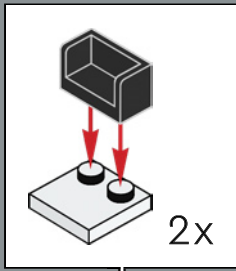

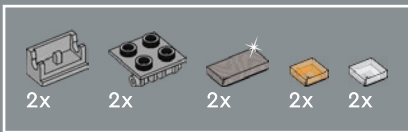

245

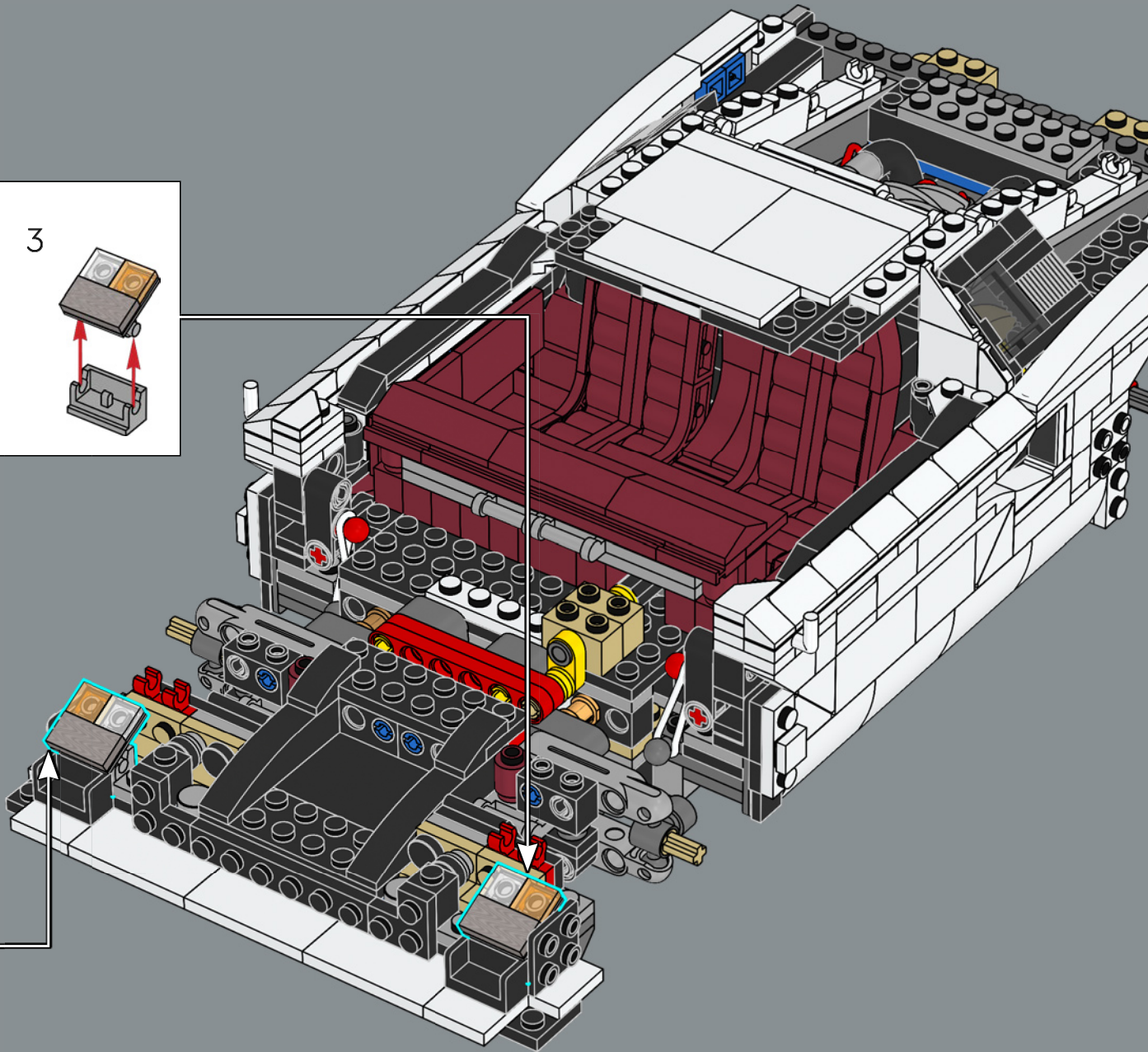
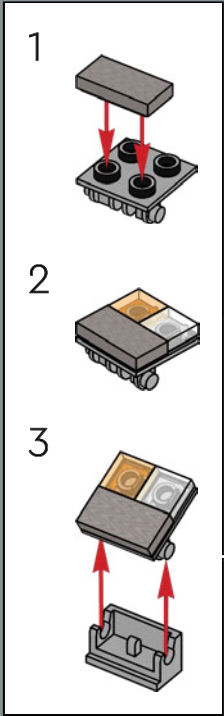
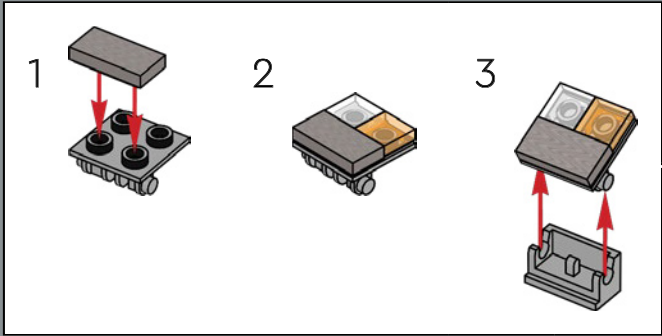

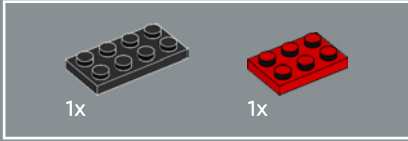
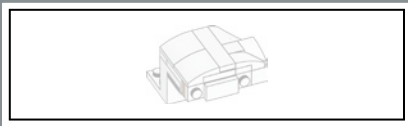

246

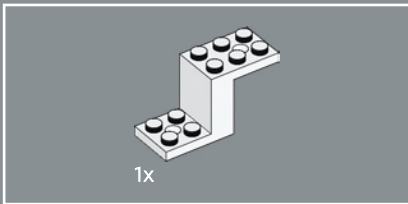
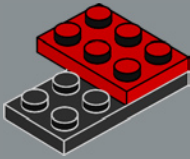

247

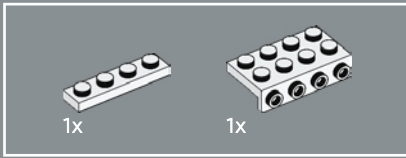
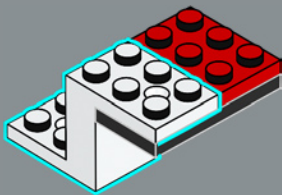

248

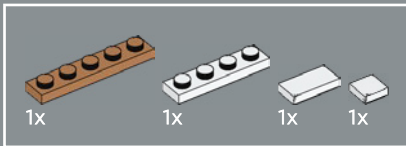
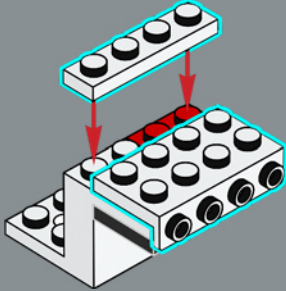

249

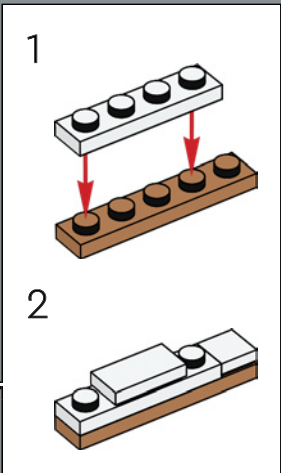
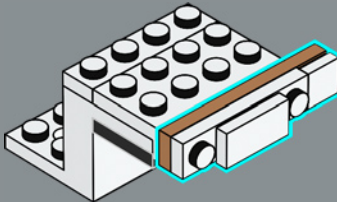

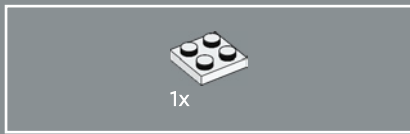

250

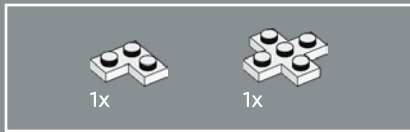
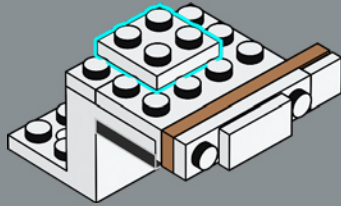

251

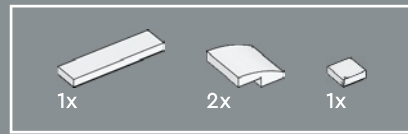
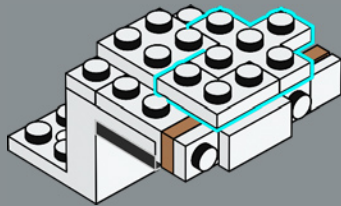

252

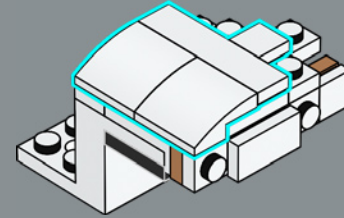

253

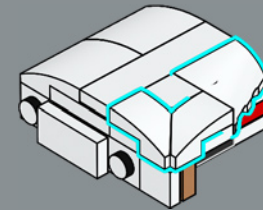

254

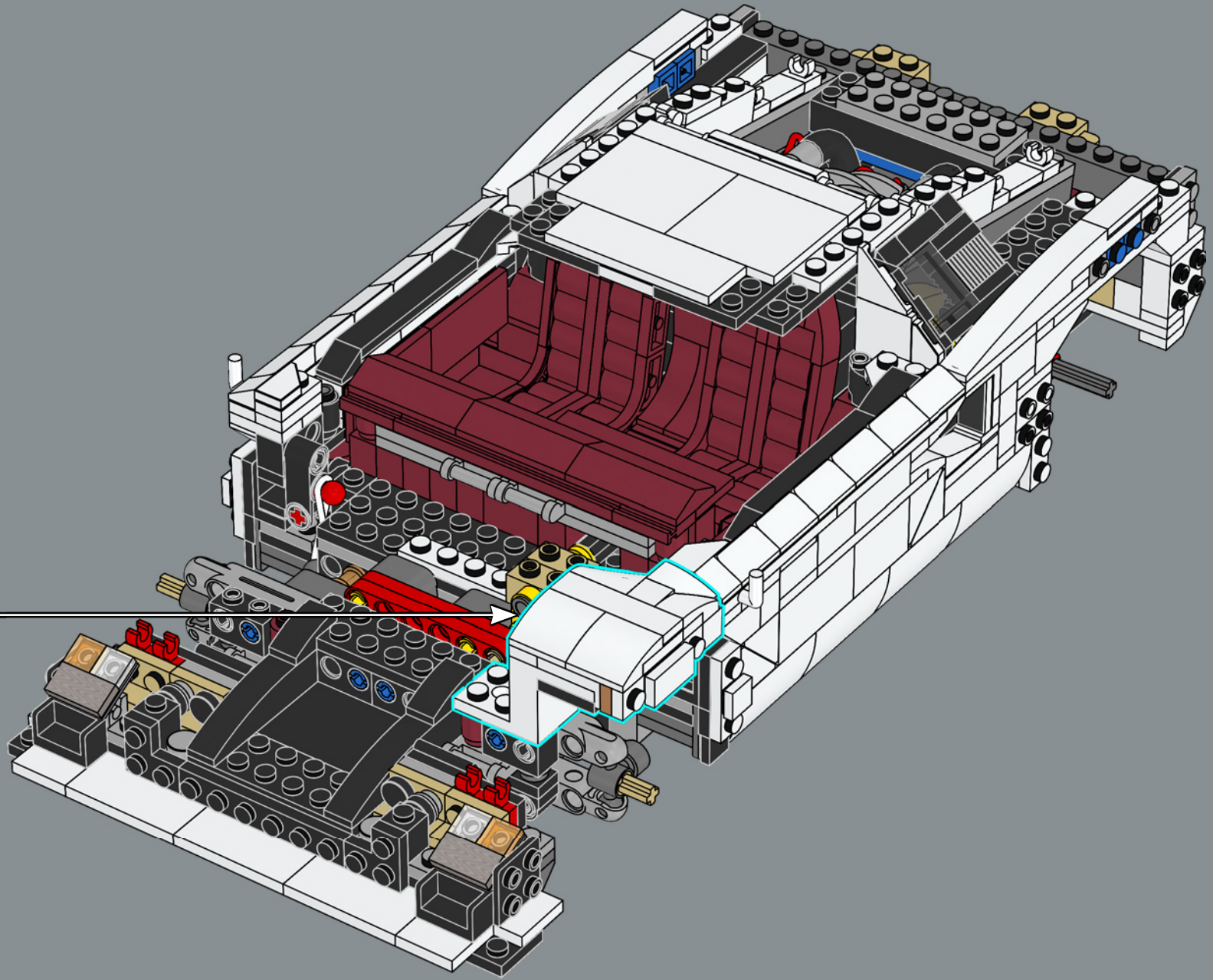

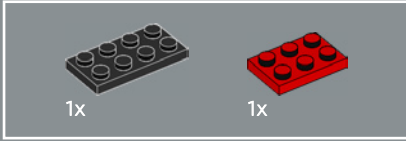
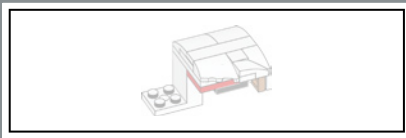

255

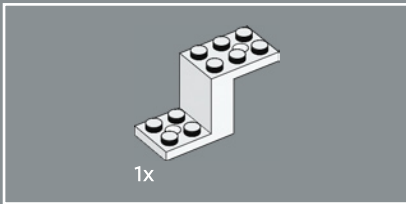
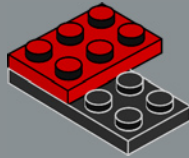

256

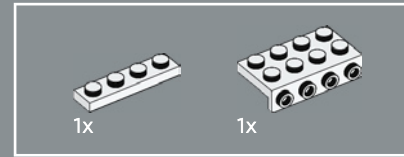
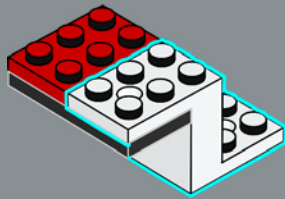

257

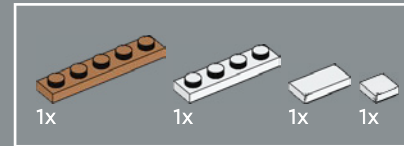
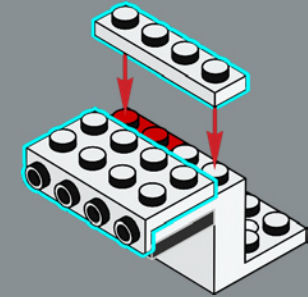

258

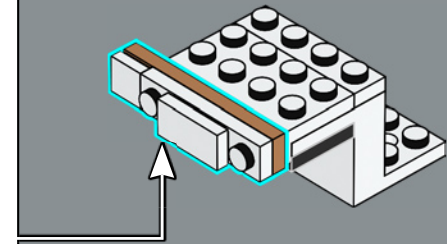
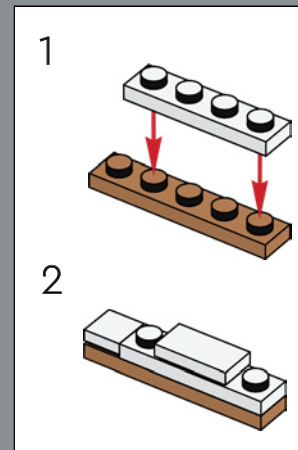

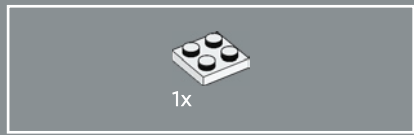

259

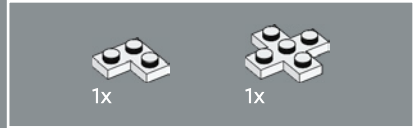
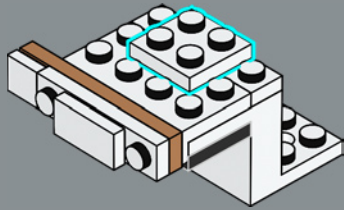

260

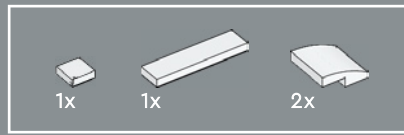
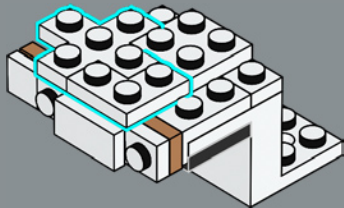

261

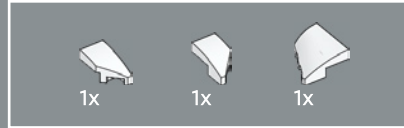
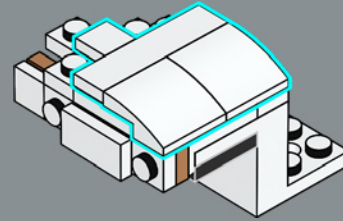

262

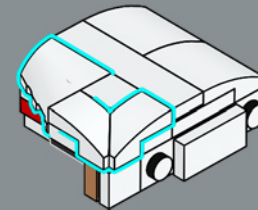

263

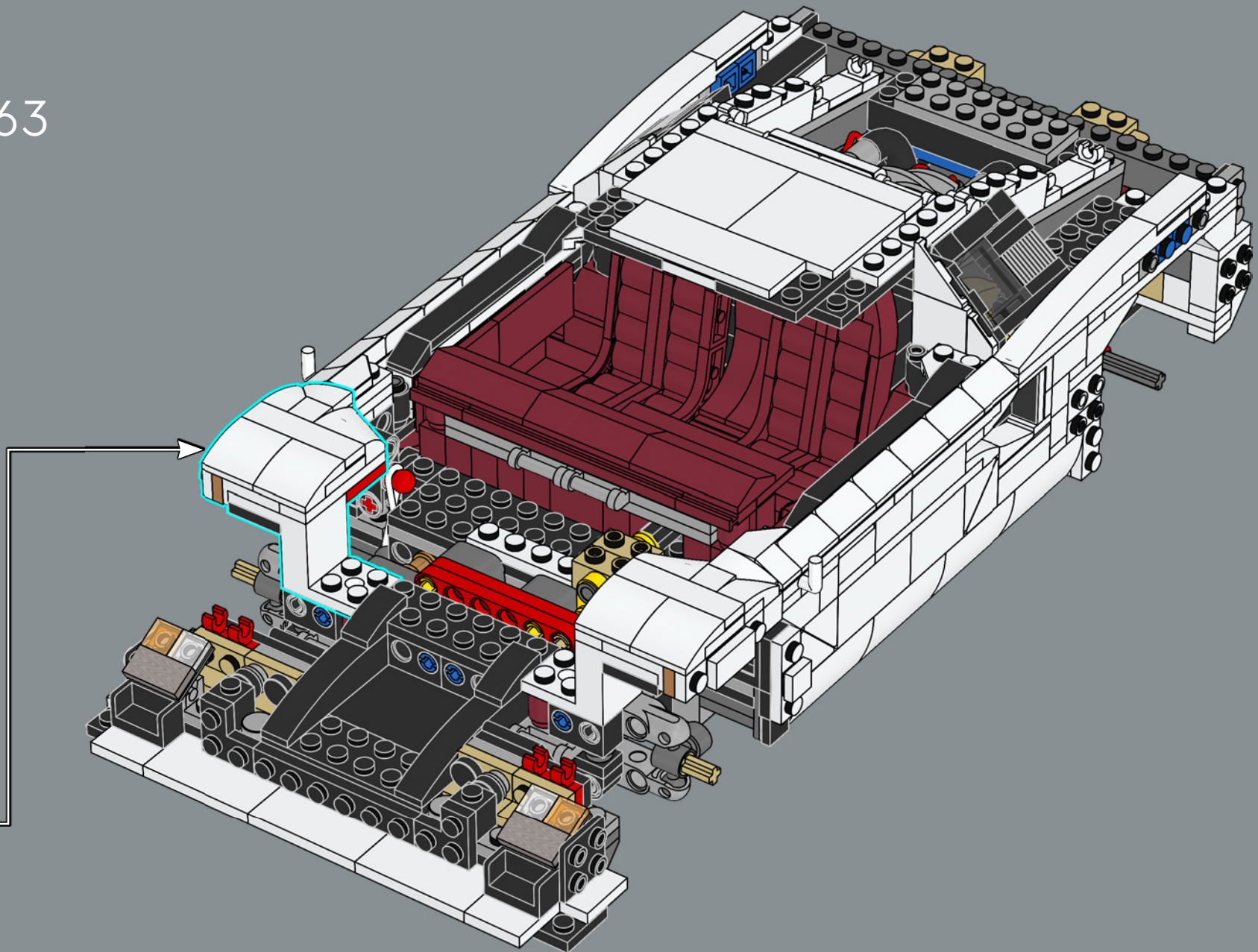

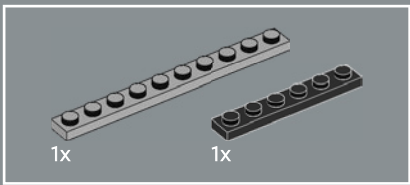

264

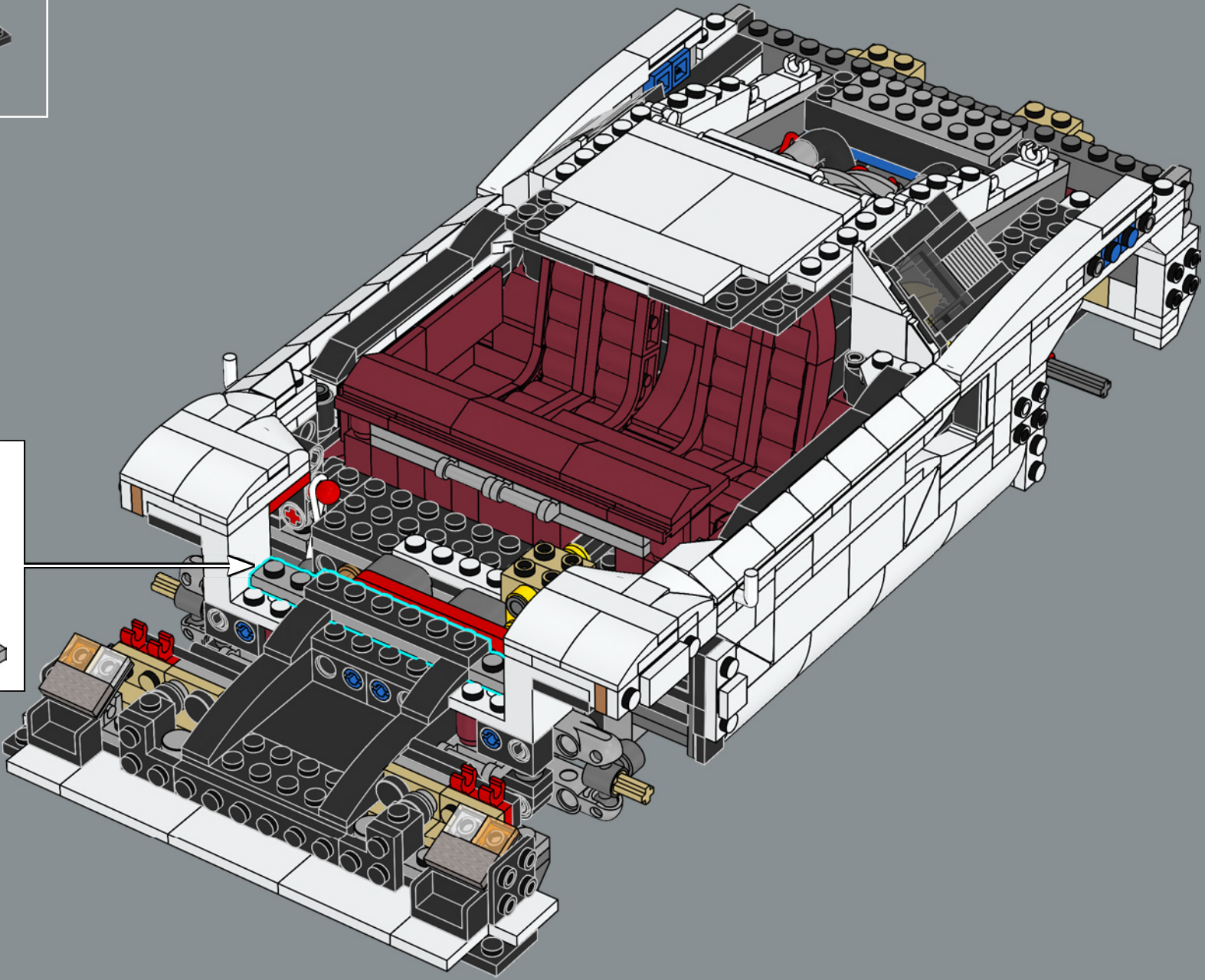
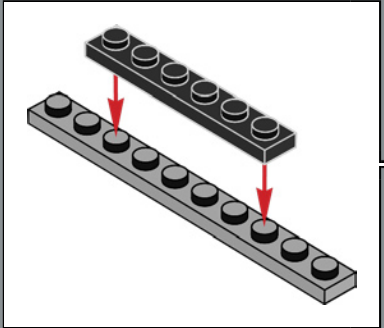

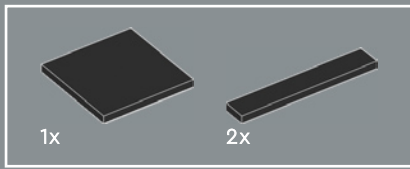

265

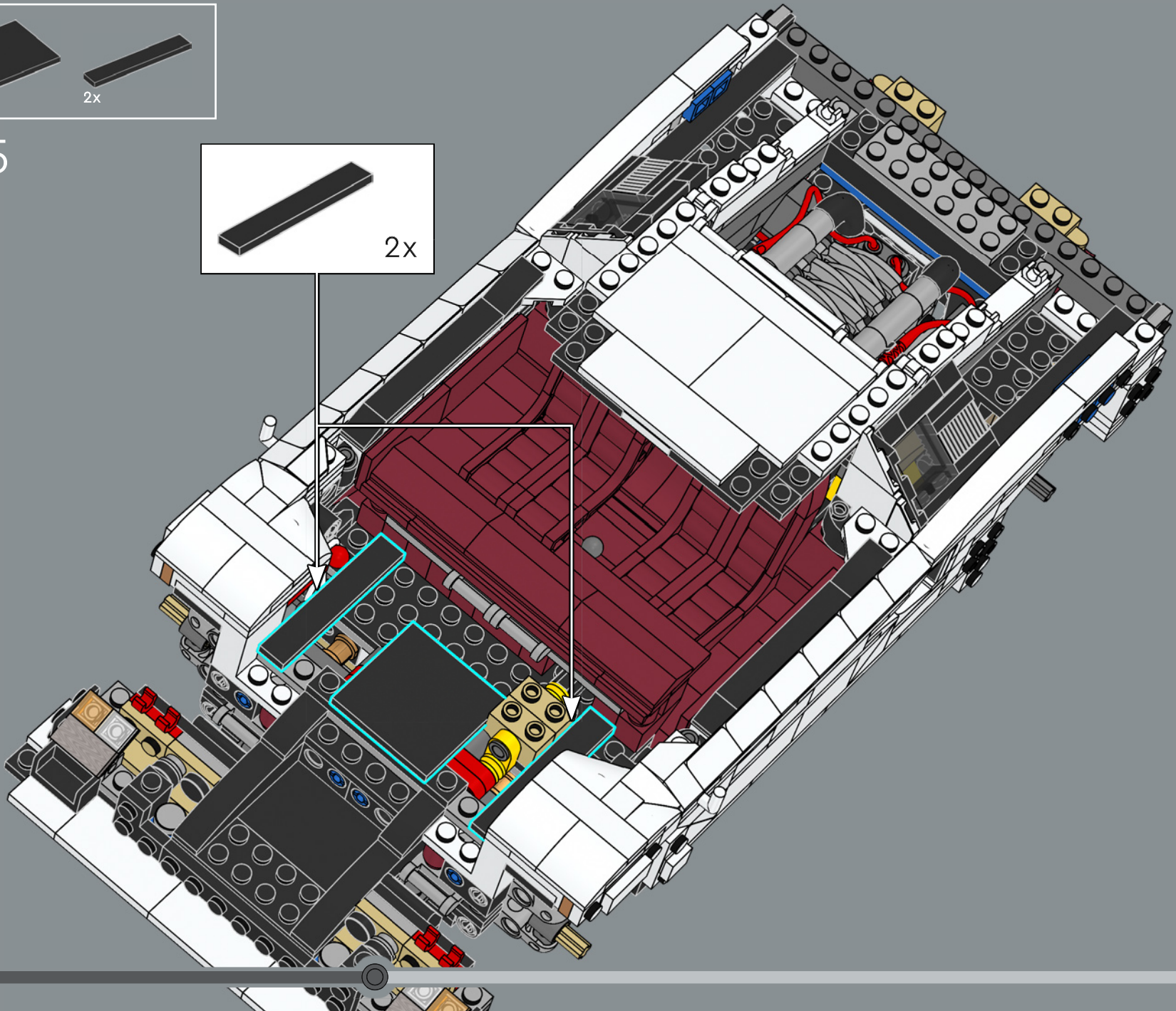
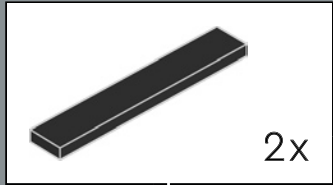

-  2x
-  2x
-  6x
-  2x

266

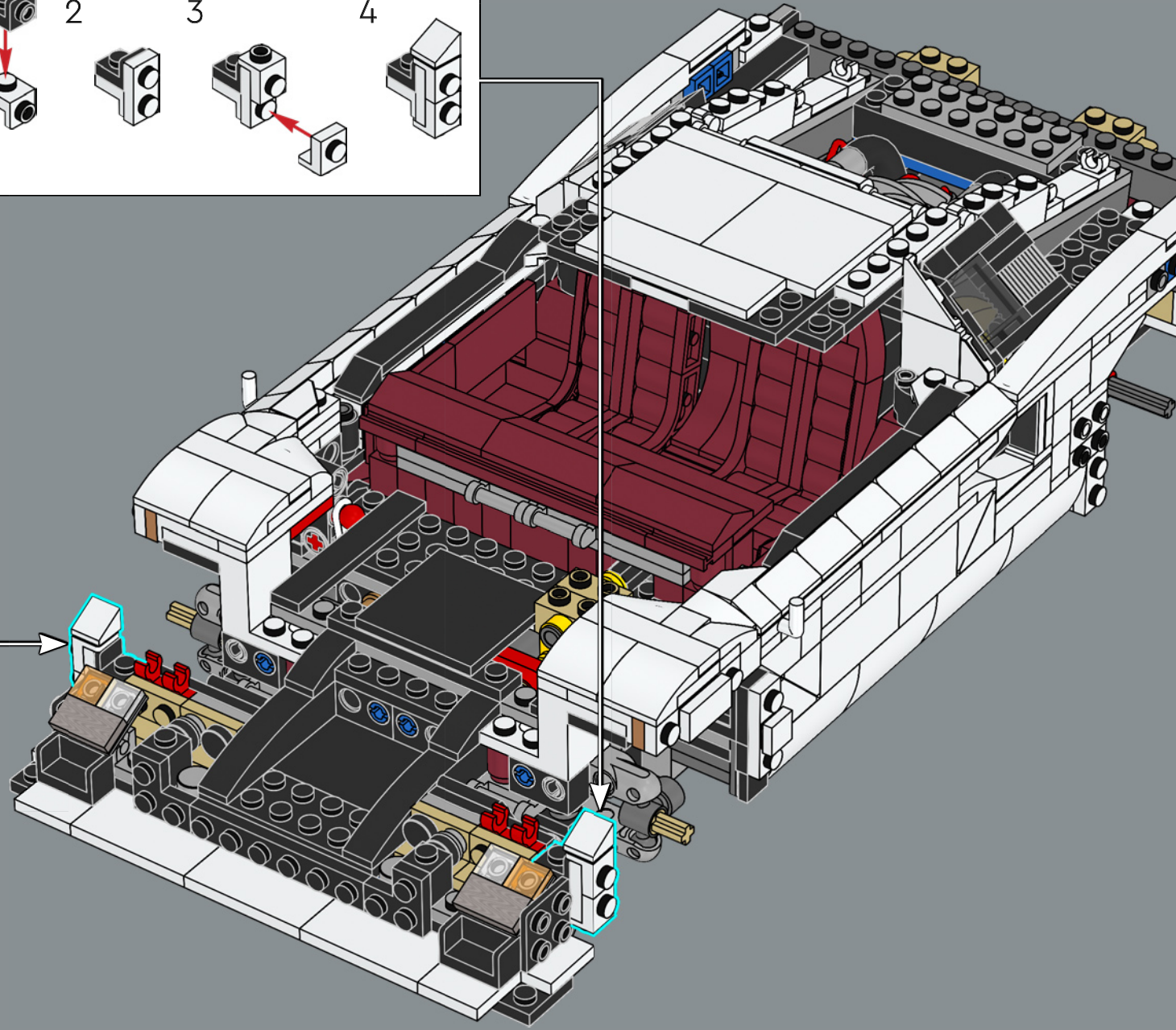
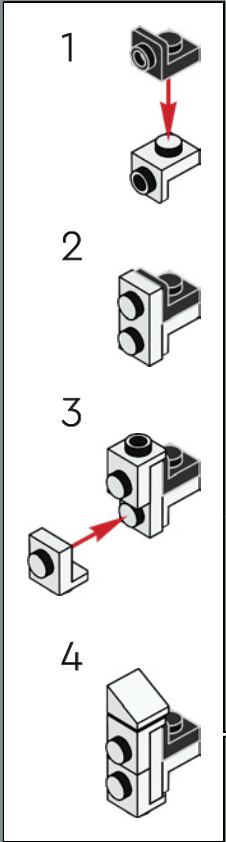
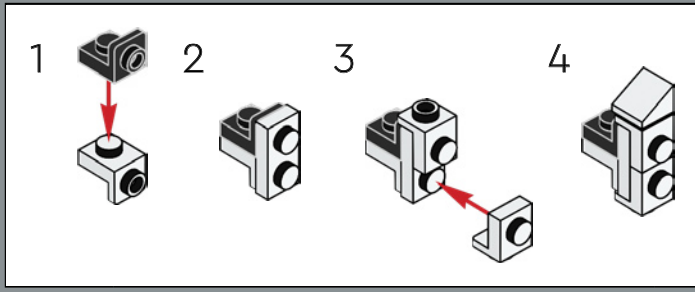



2x

267



2x

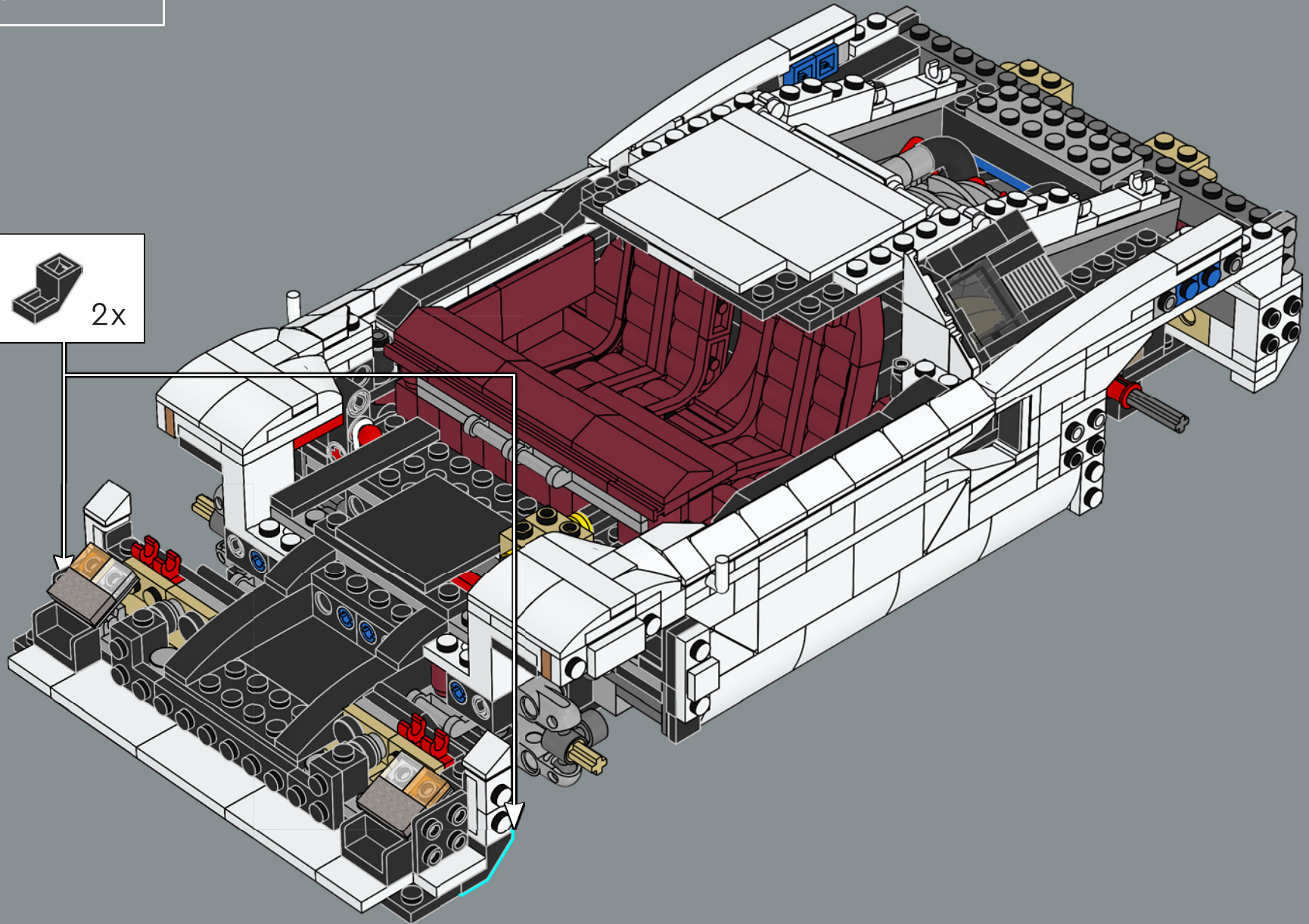

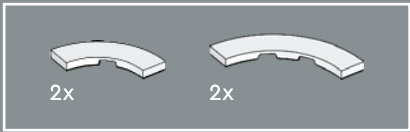

268

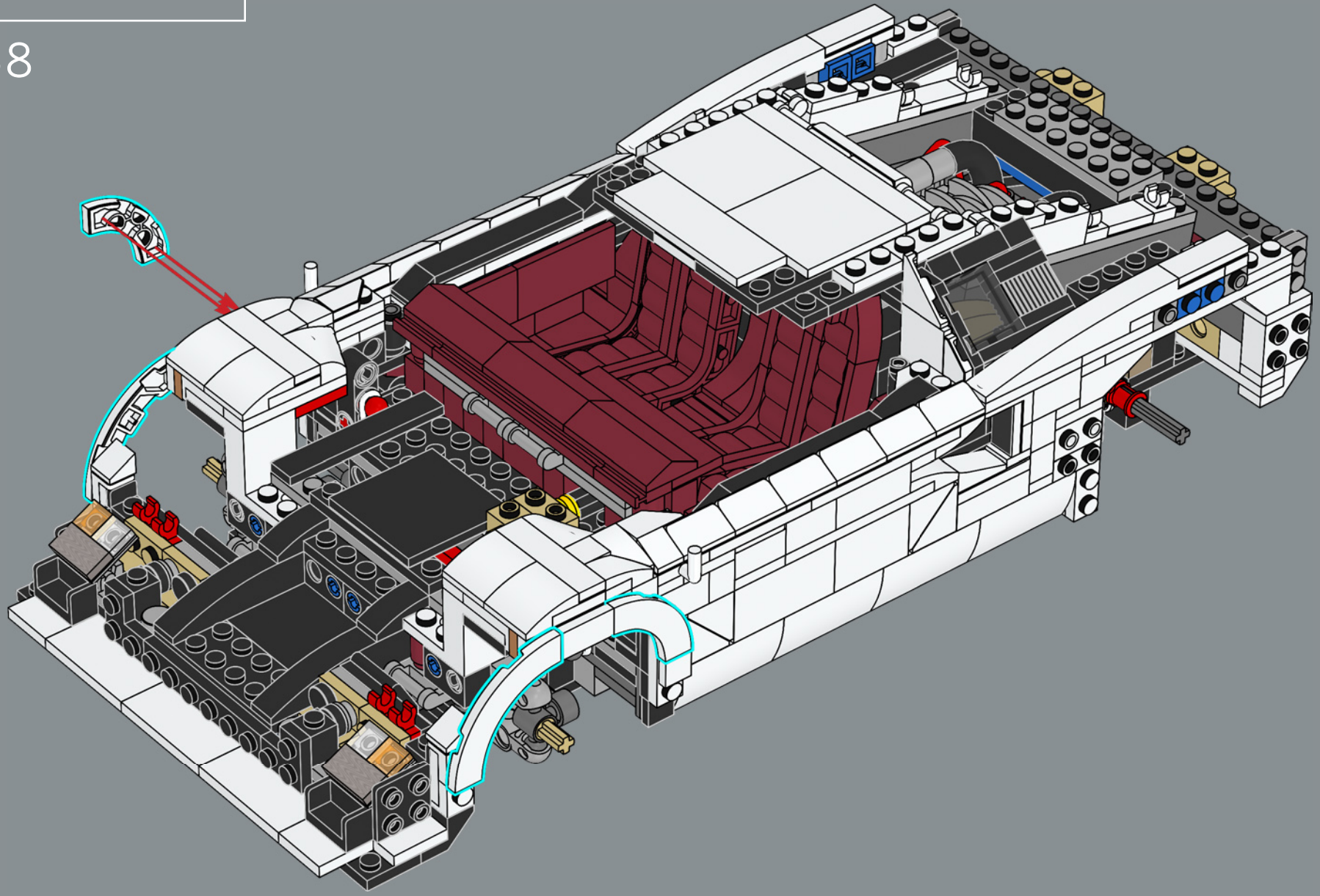

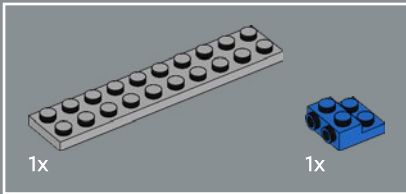
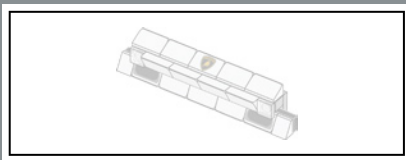

269

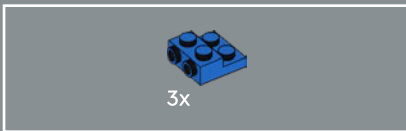
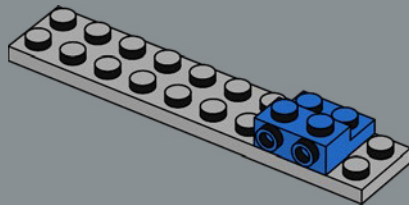

270

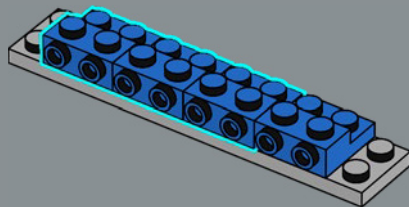

271

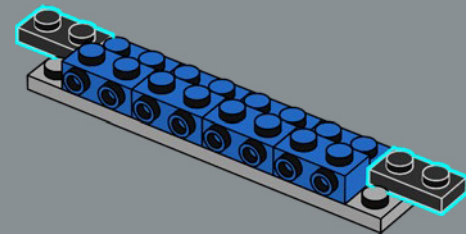

272

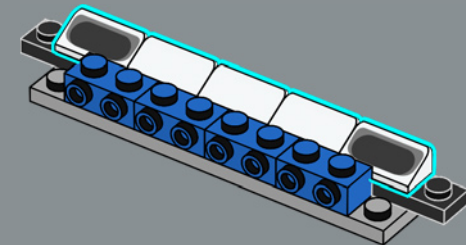



2x

273

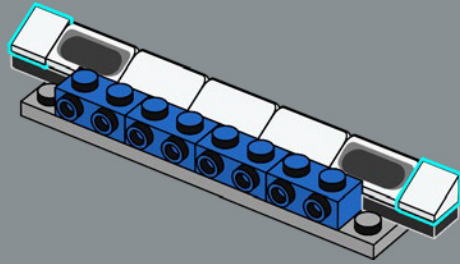

4x

274

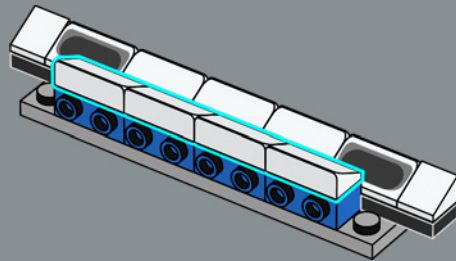

2x



2x

275

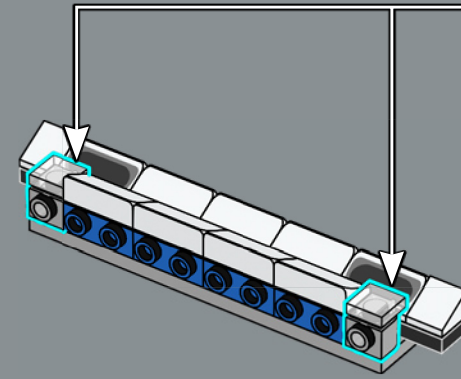

4x



1x

276

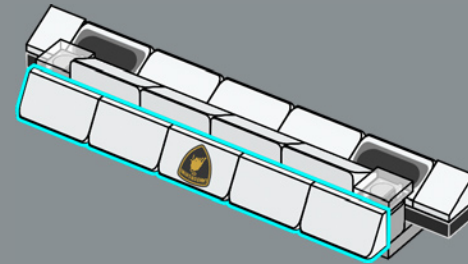

277

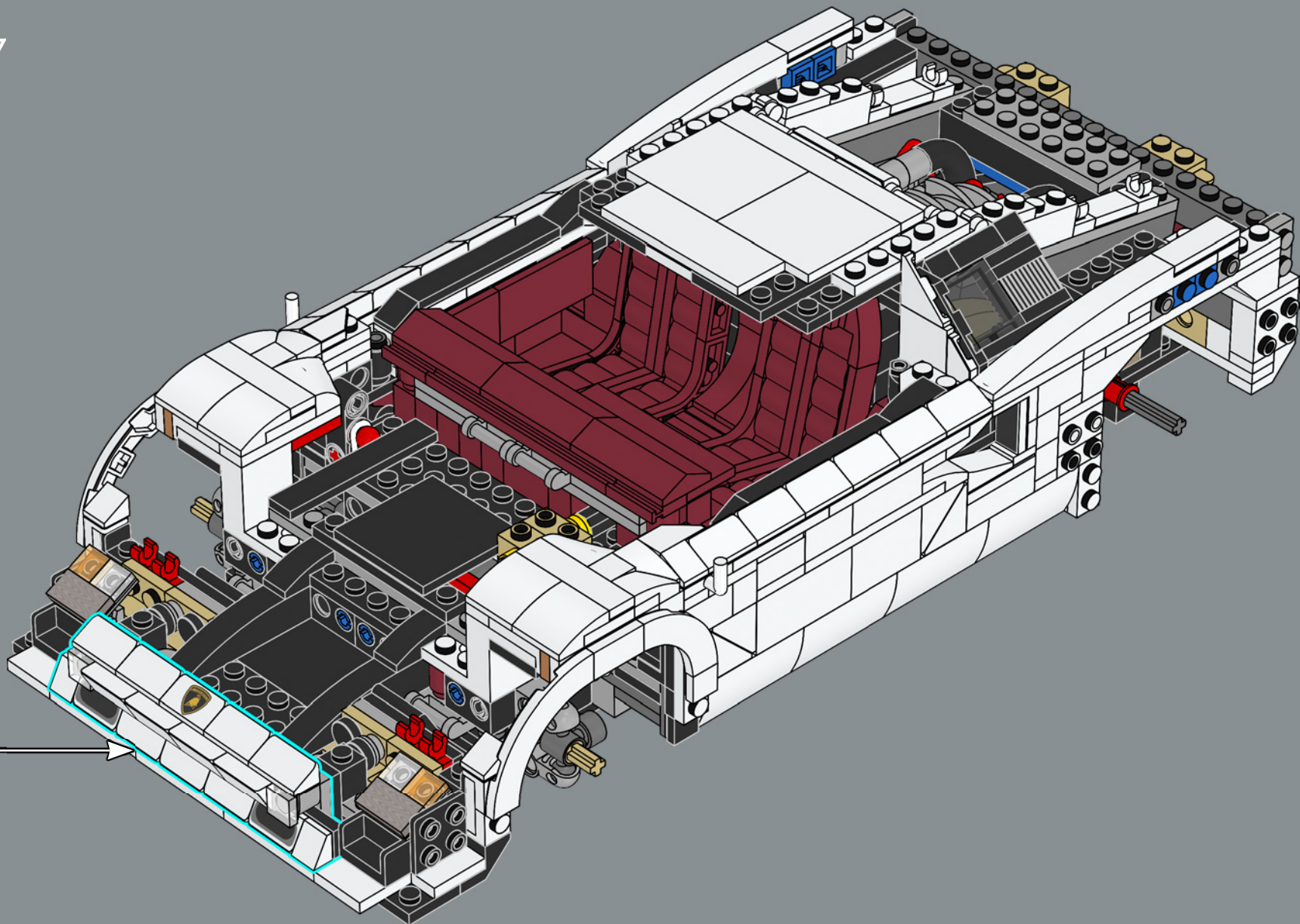

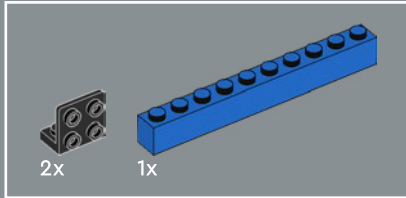
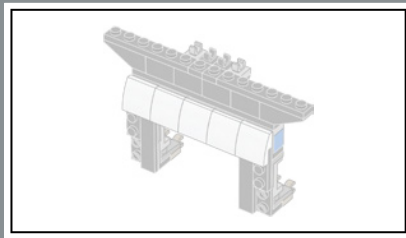

278

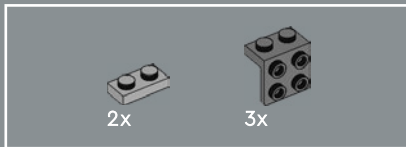
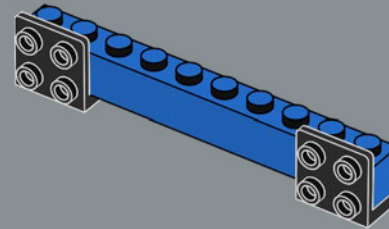

279

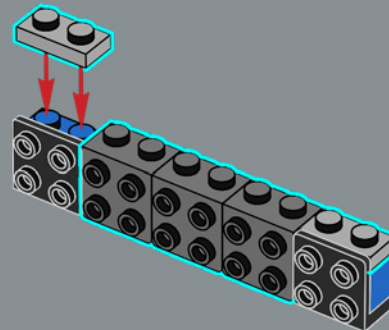

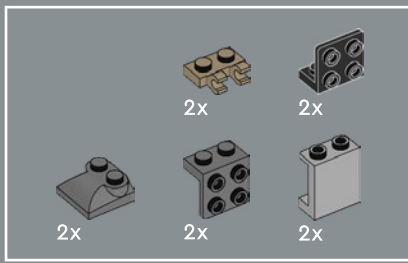

280

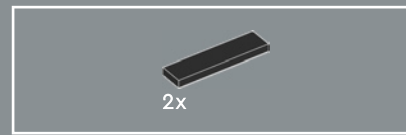
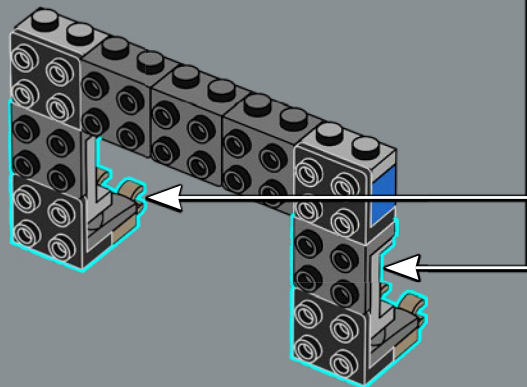
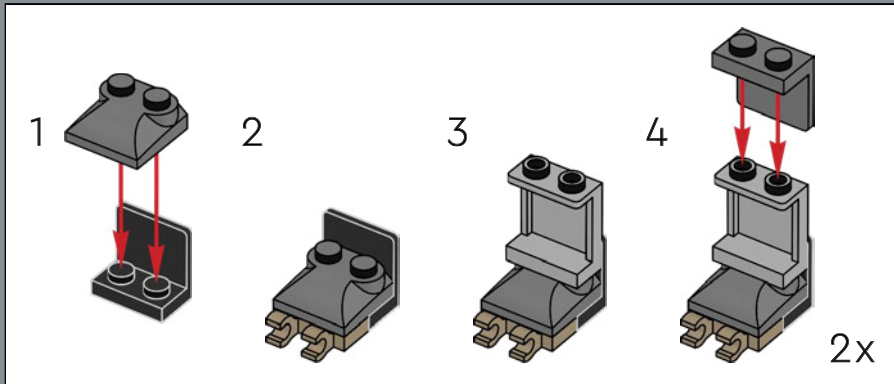

281

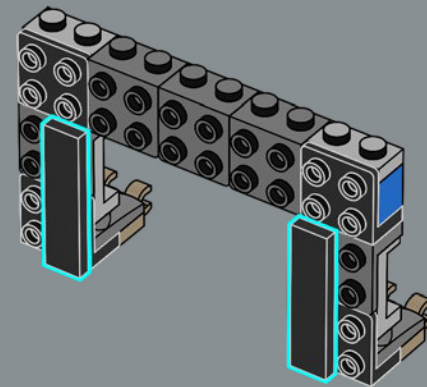

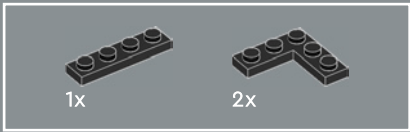

282

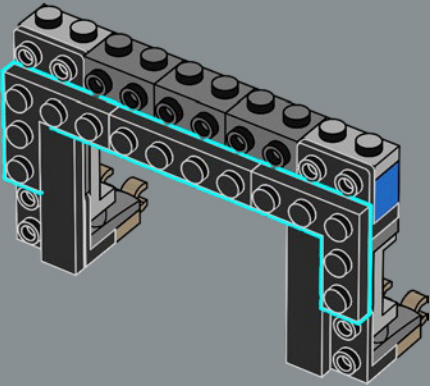

283

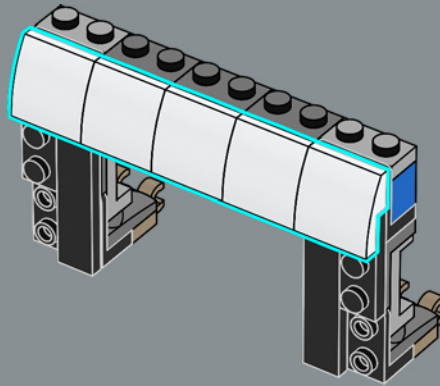

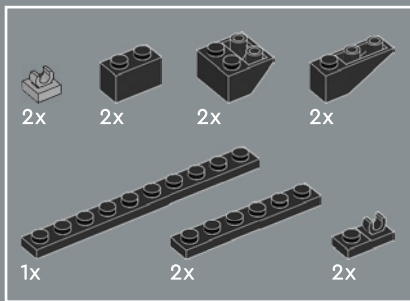

284

1

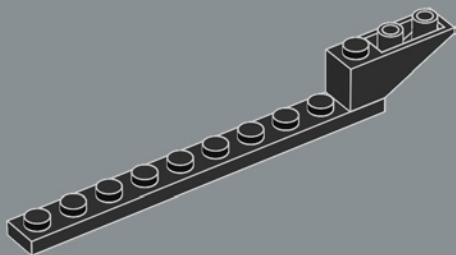

2

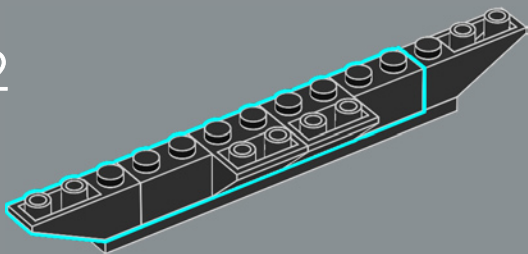

3

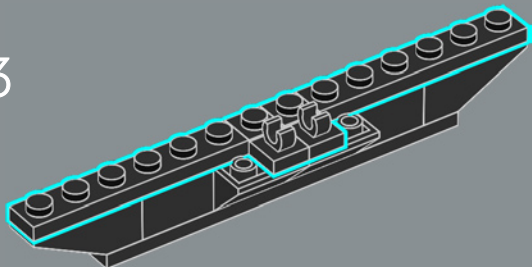

4

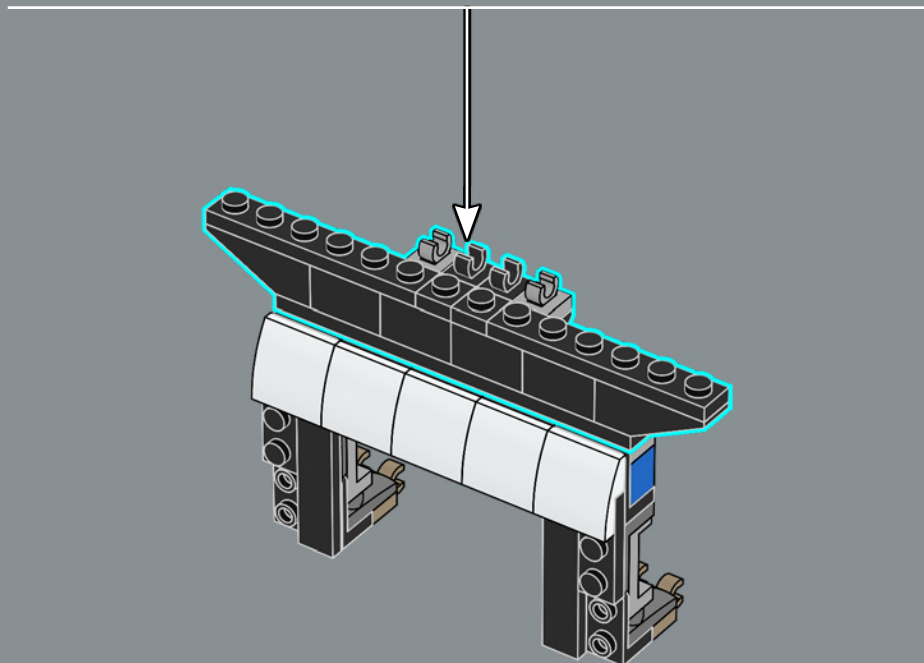
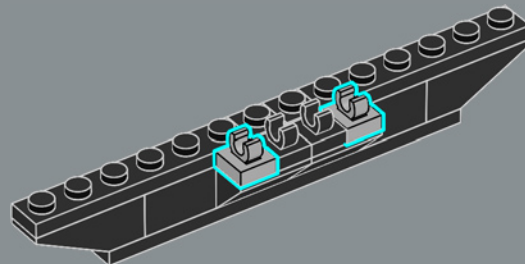

285

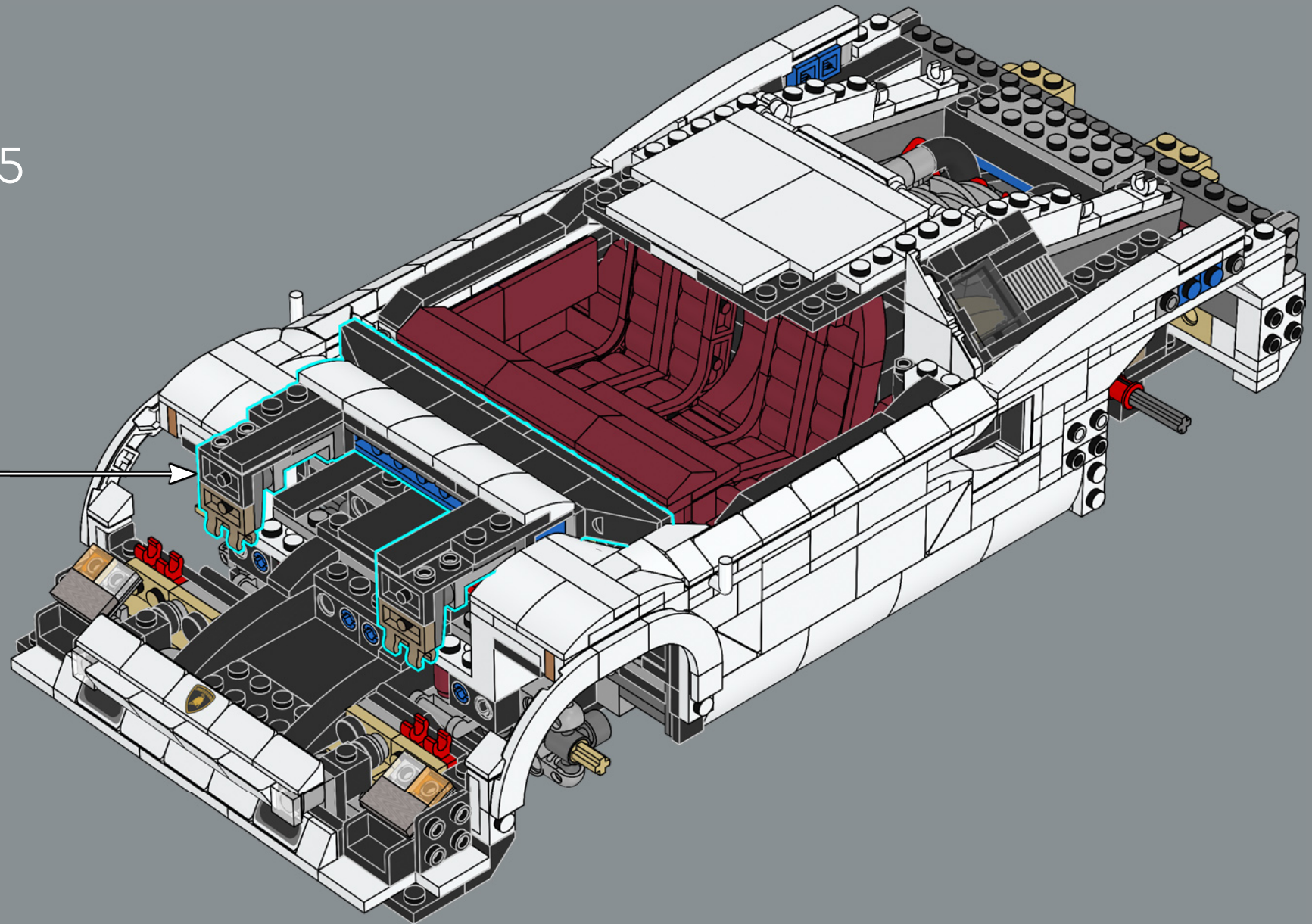

286

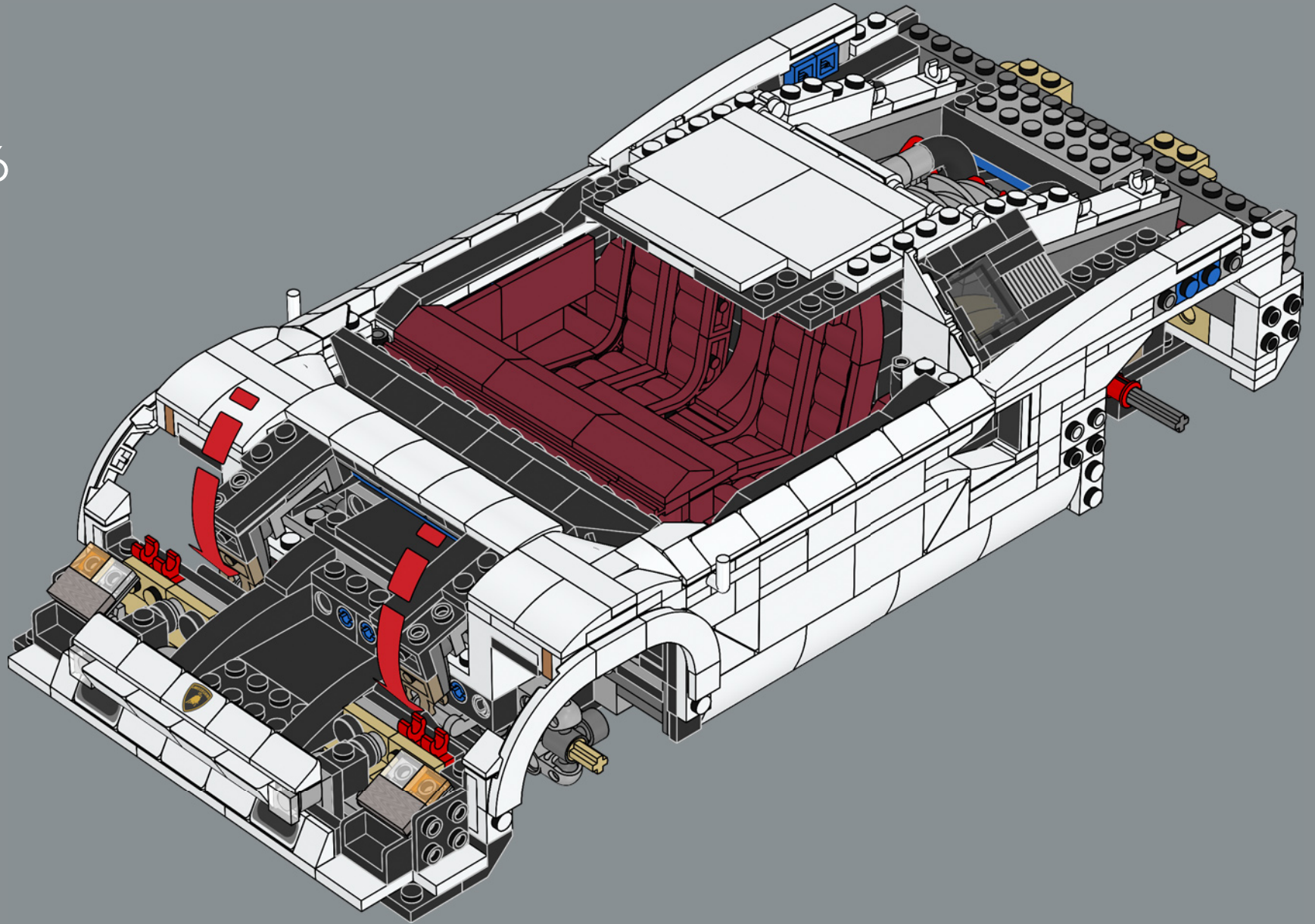



287

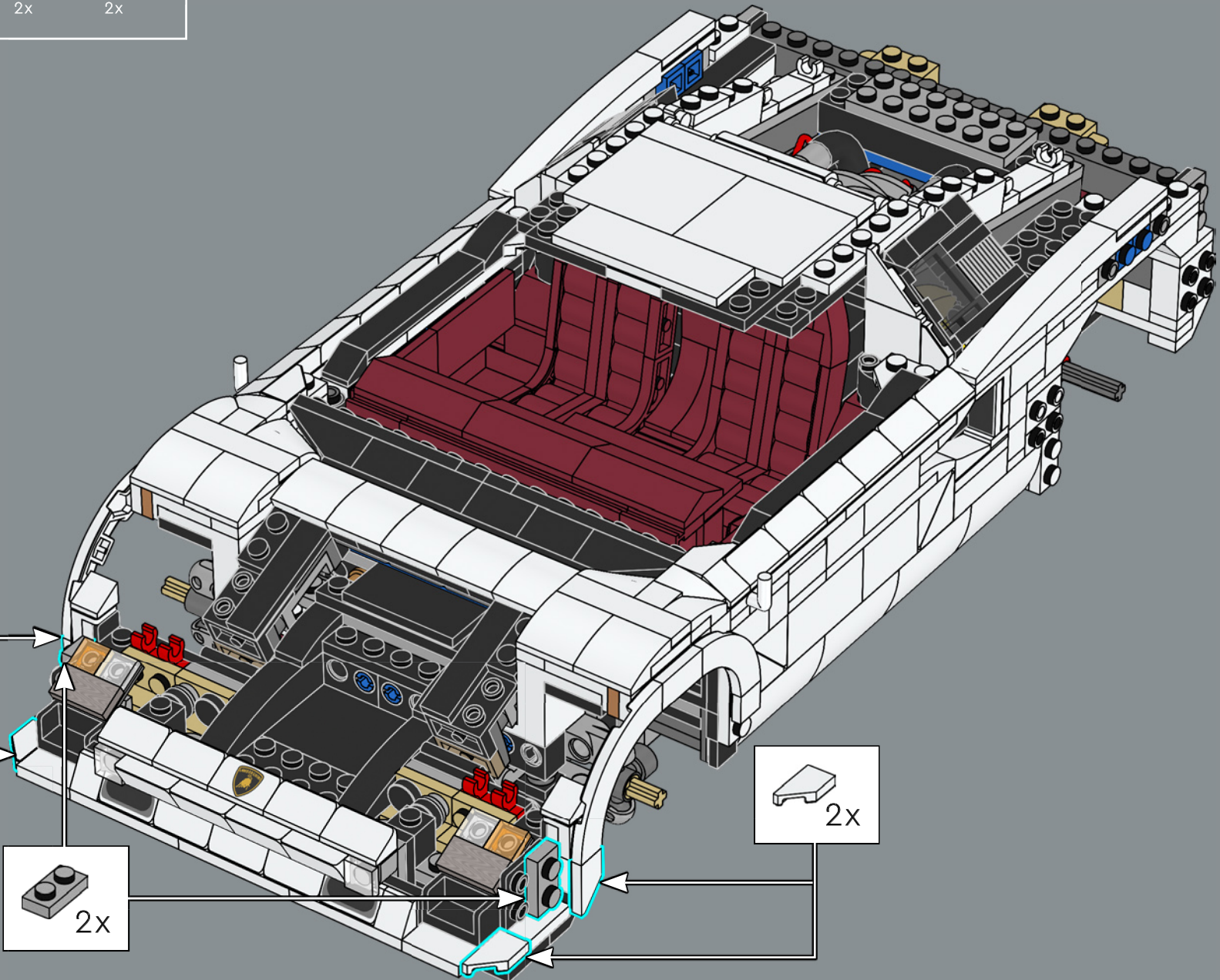
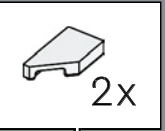
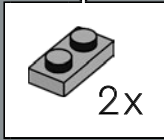
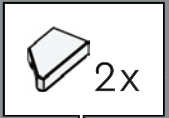



2x

288

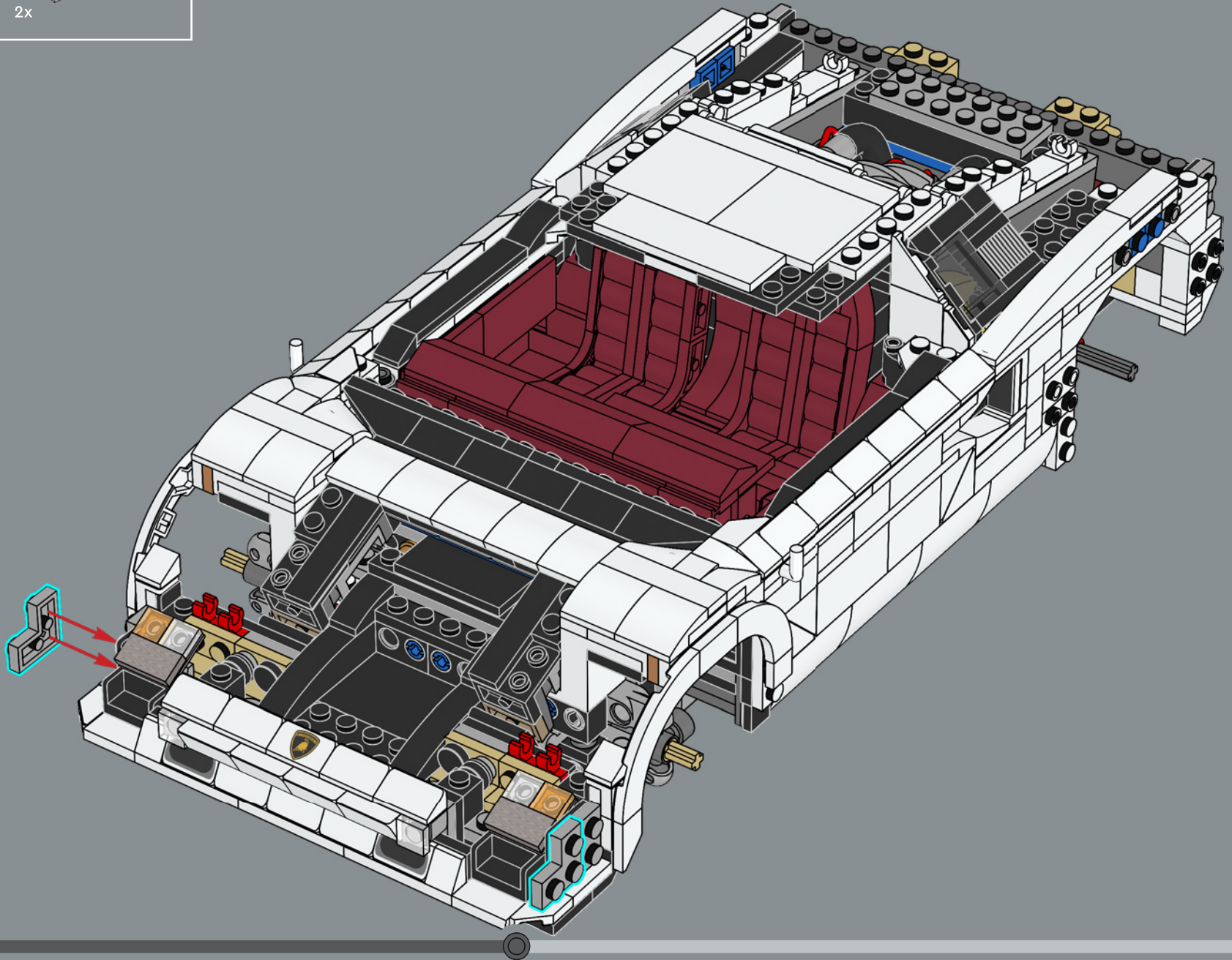

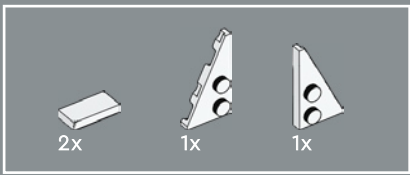

289

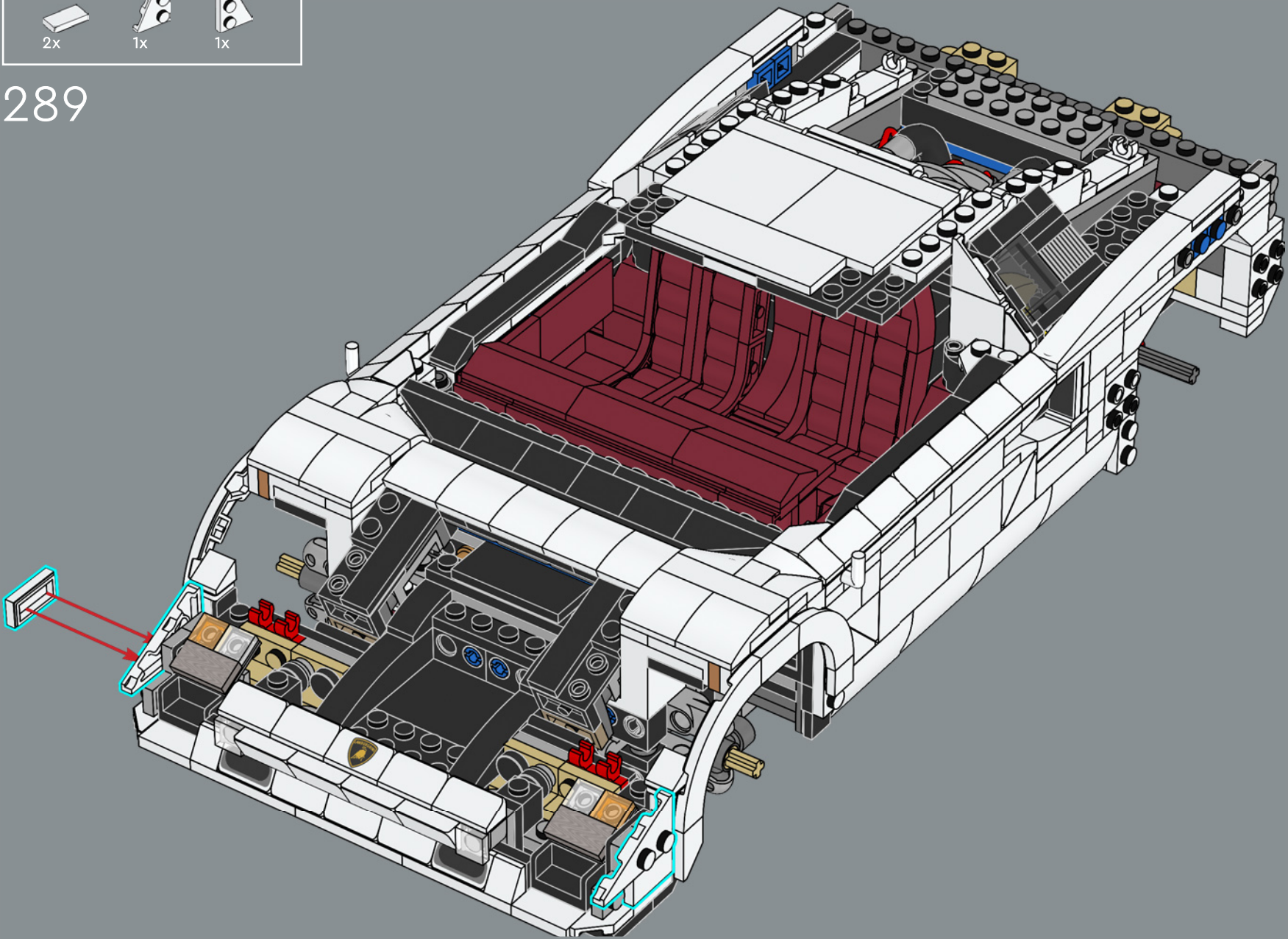

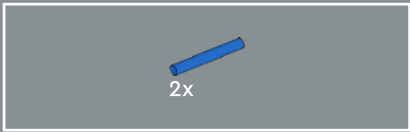

290

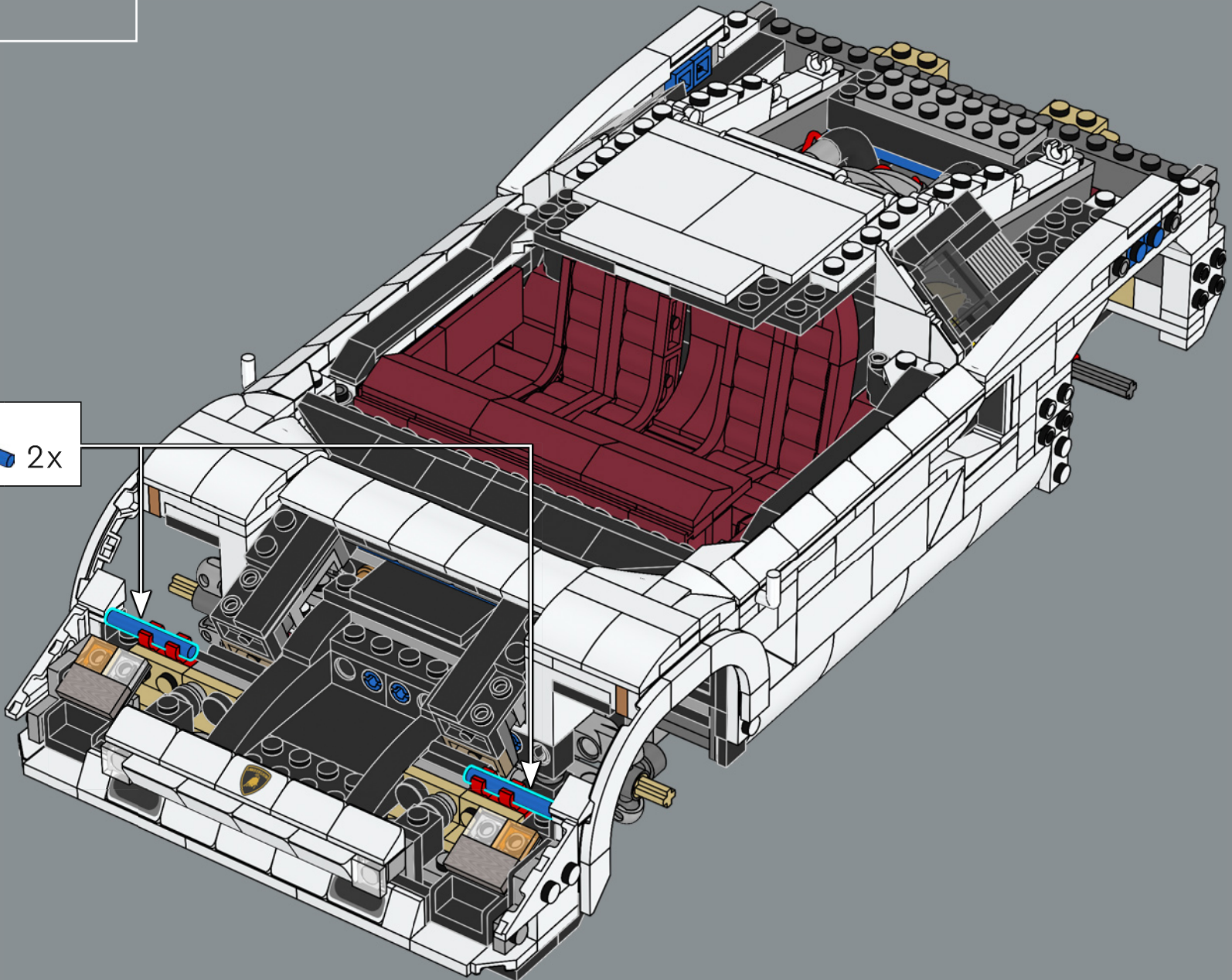
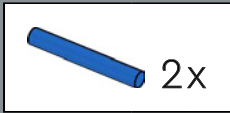

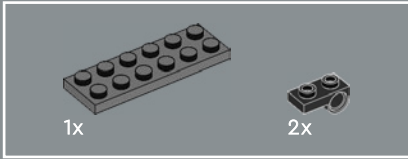
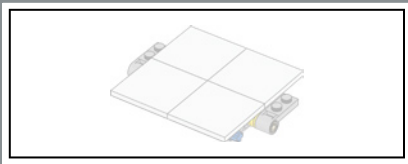

291

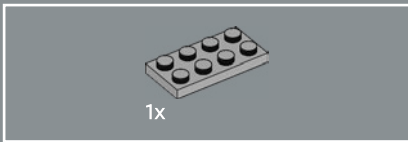
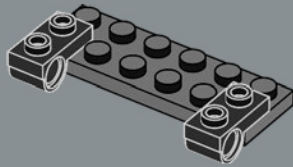

292

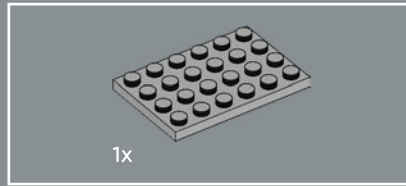
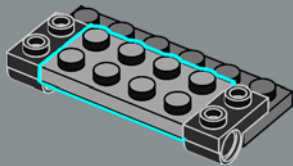

293

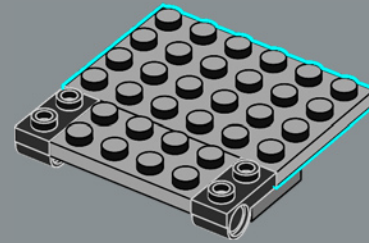

294

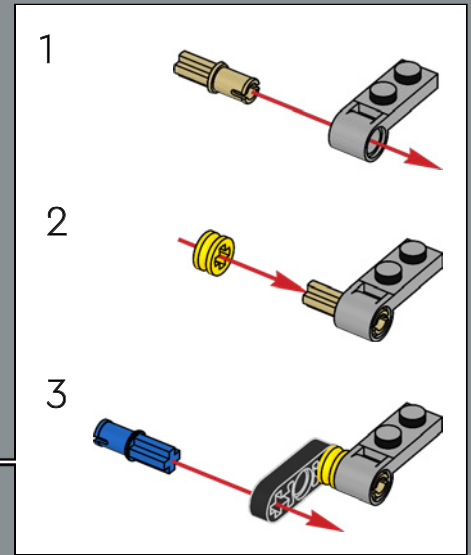
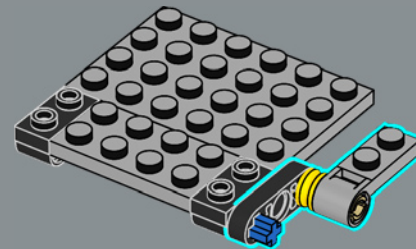



295

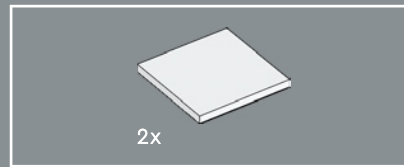
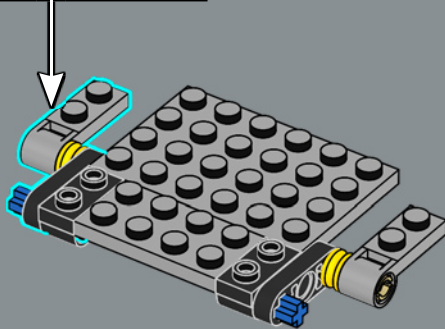
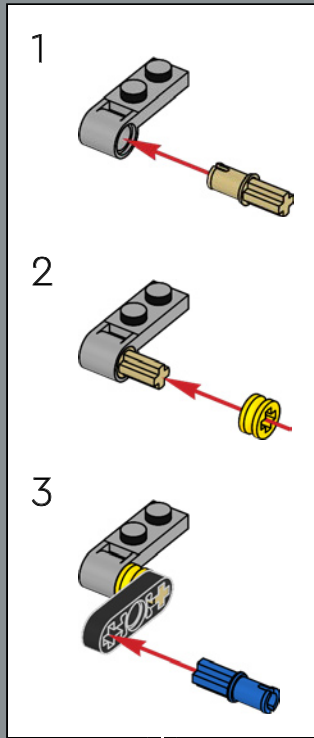

296

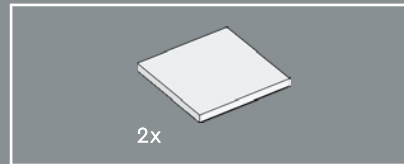
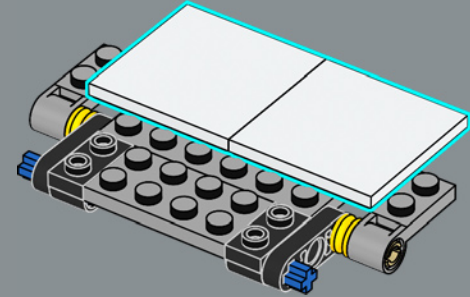

297

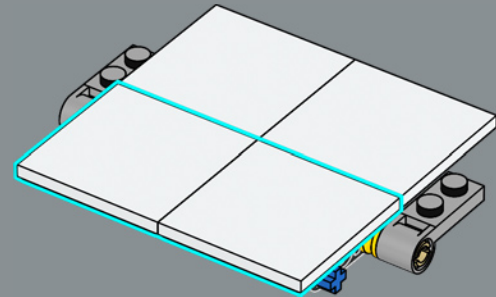

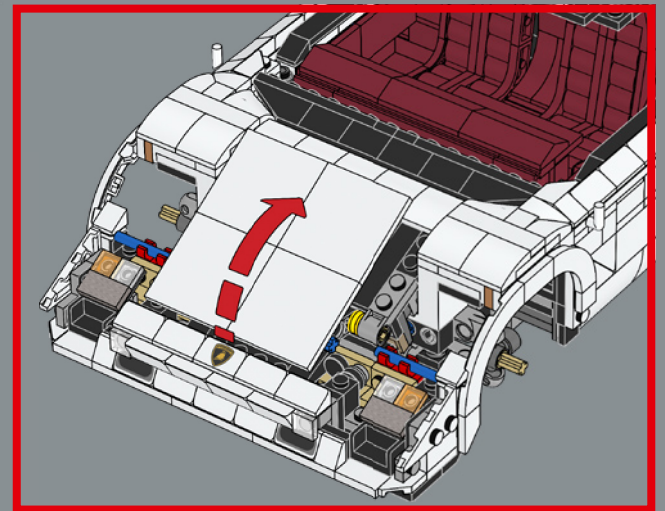
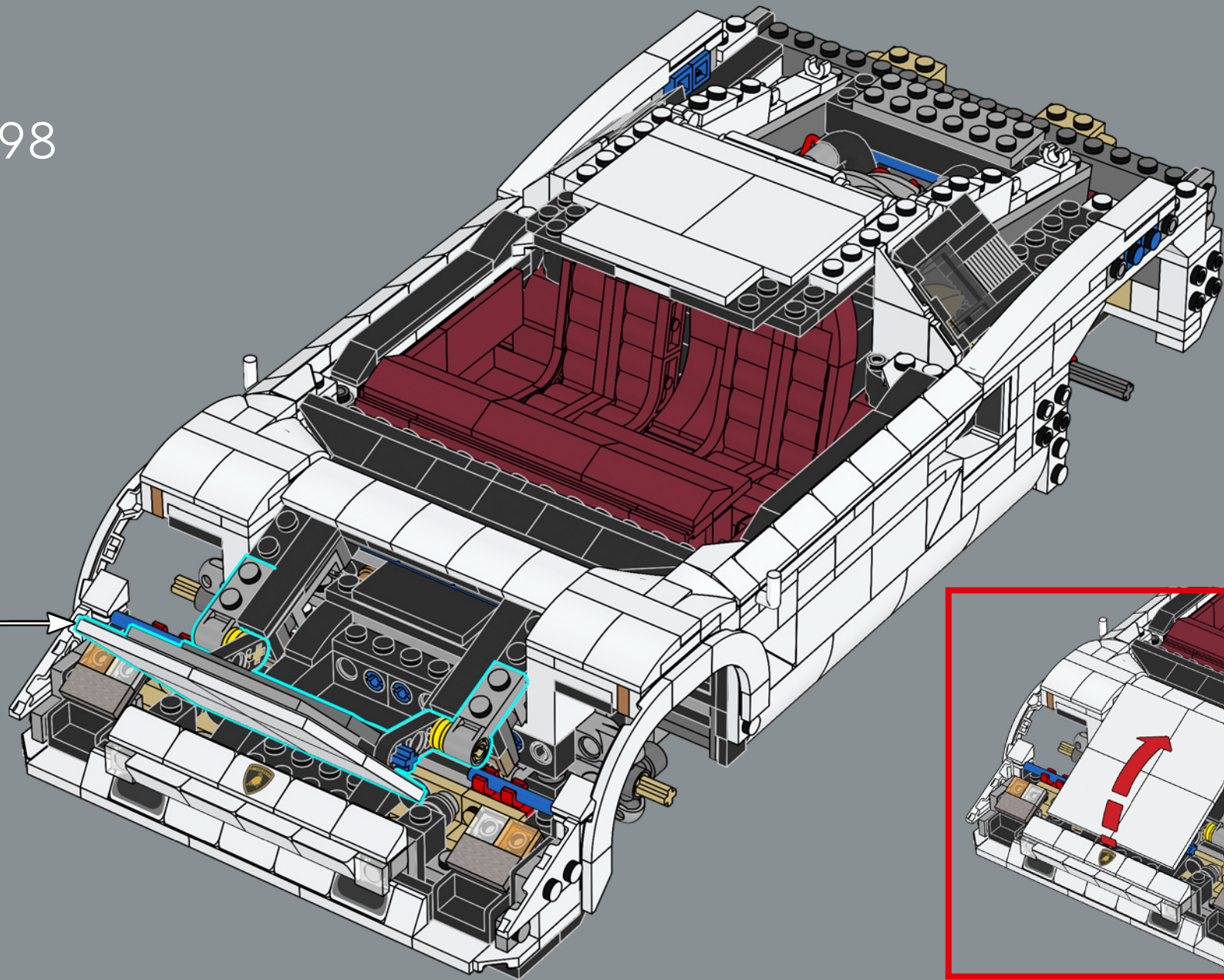

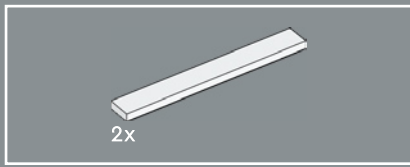

299

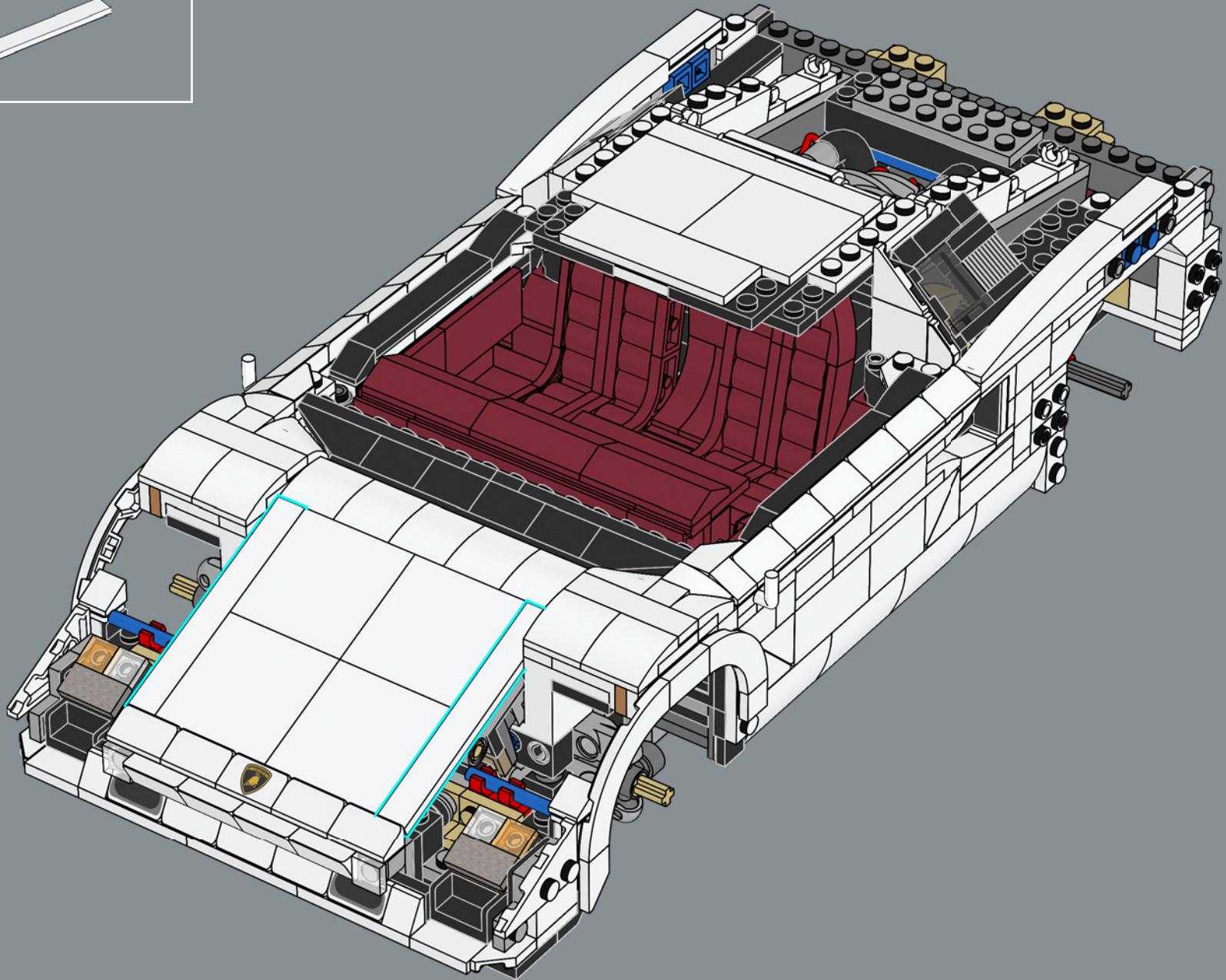

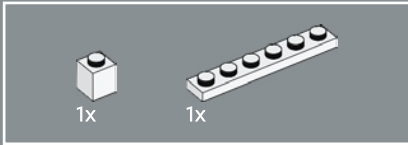
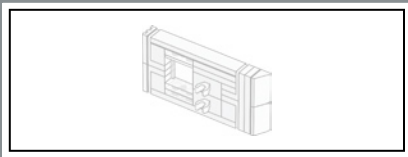

300

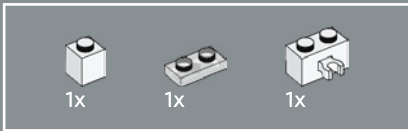
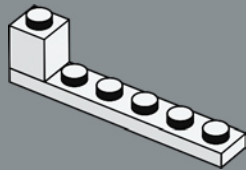

301

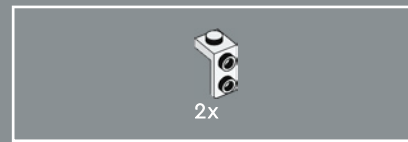
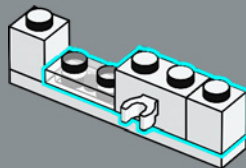

302

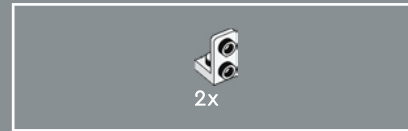
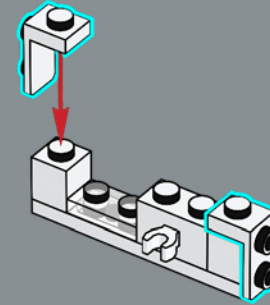

303

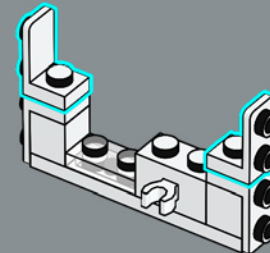

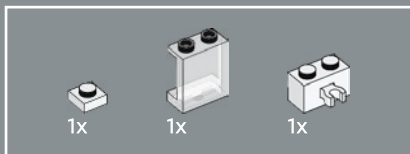

304

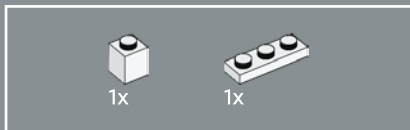
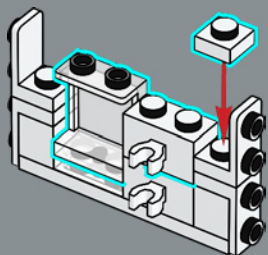

305

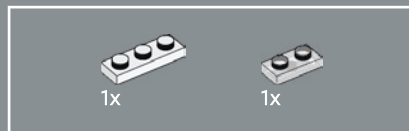
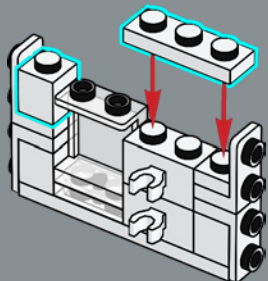

306

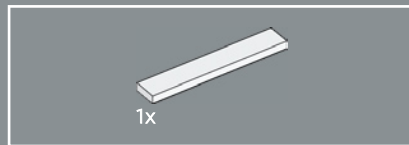
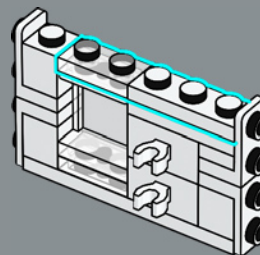

307

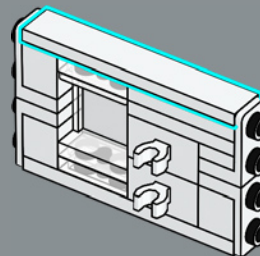



2x

308

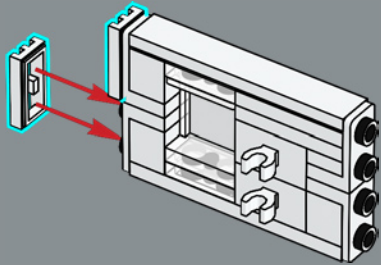

2x



2x

309

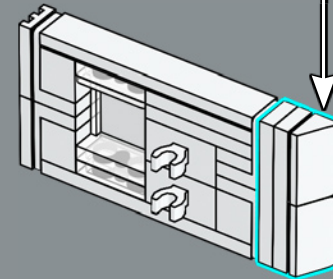
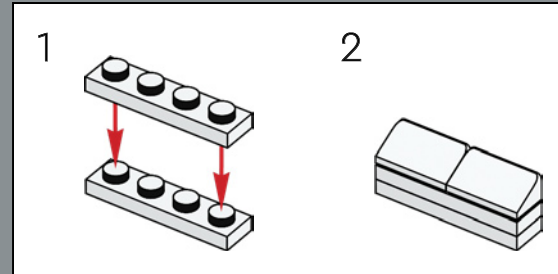

310

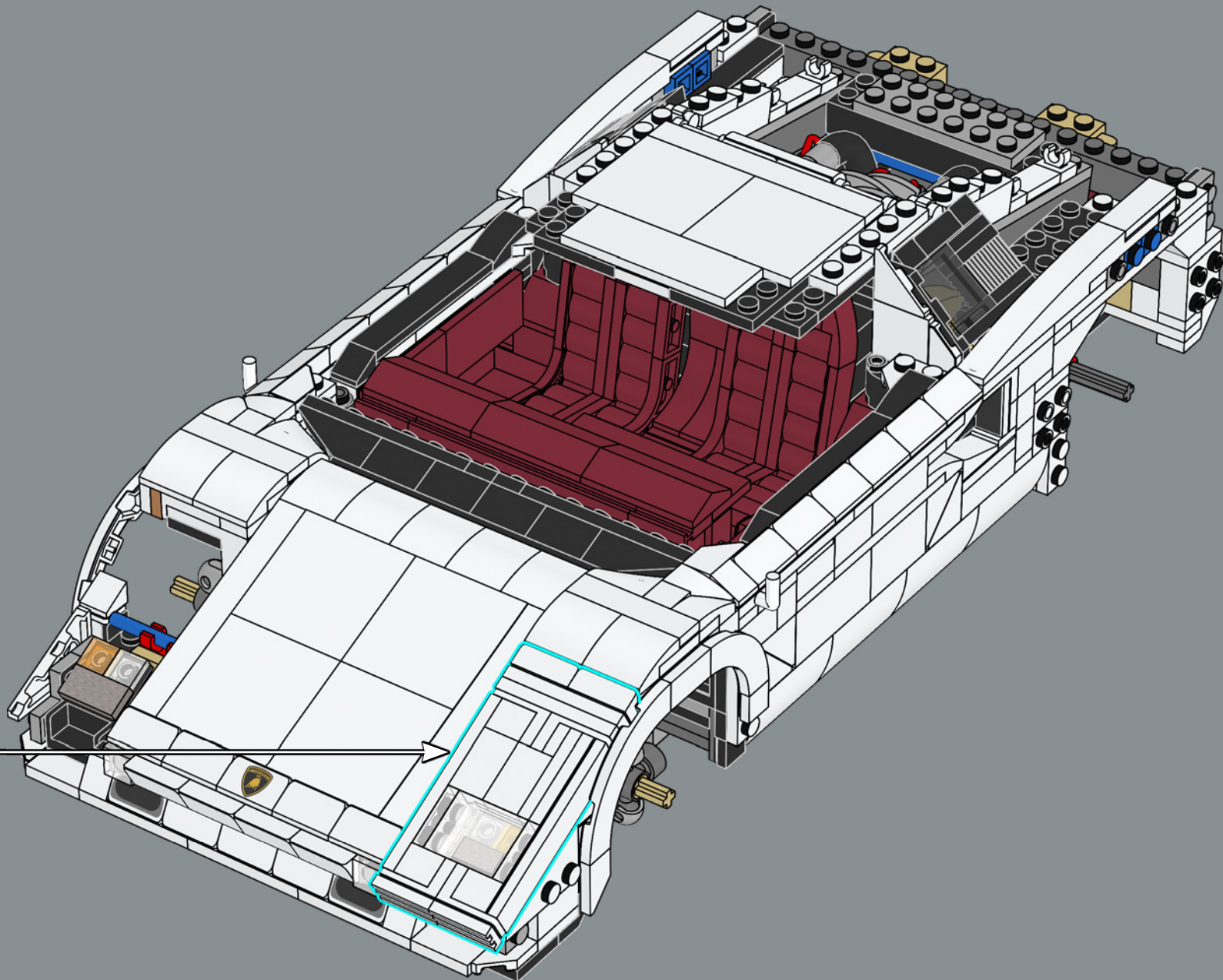

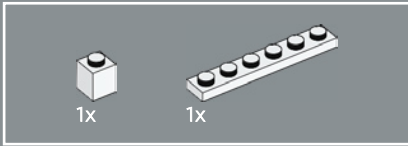
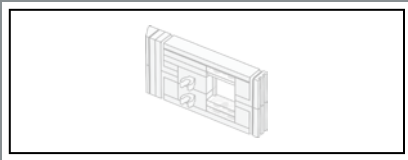

311

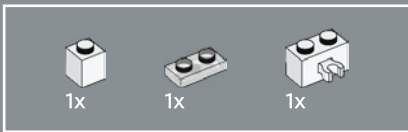
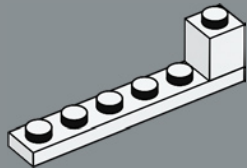

312

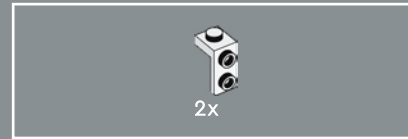
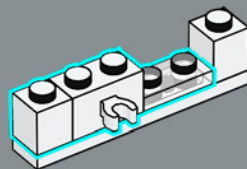

313

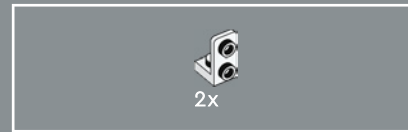
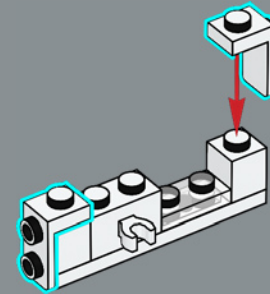

314

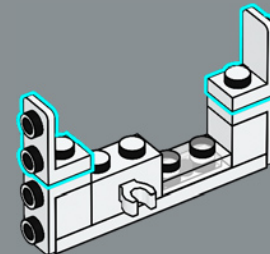

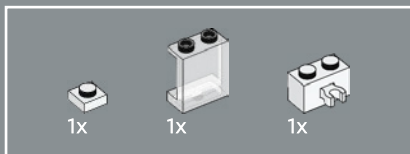

315

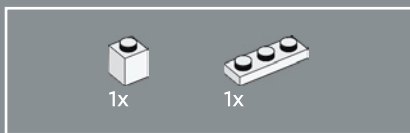
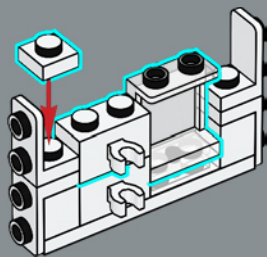

316

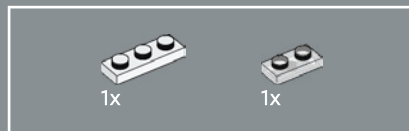
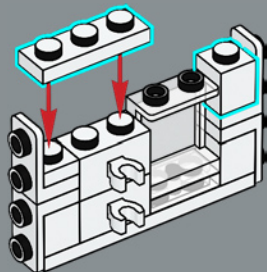

317

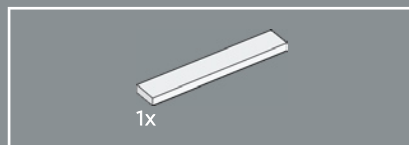
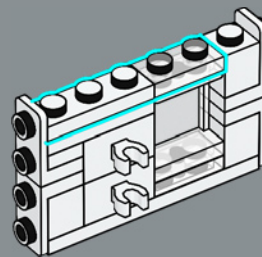

318

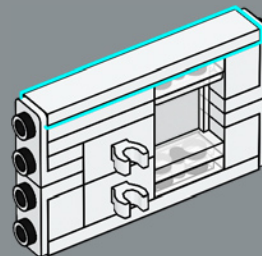



2x

319

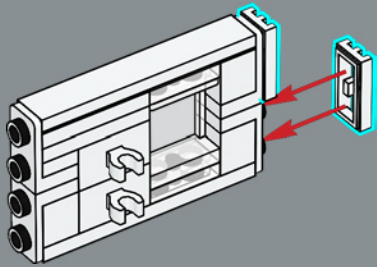

2x



2x

320

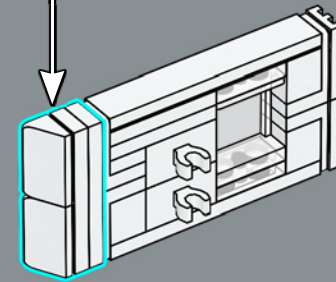
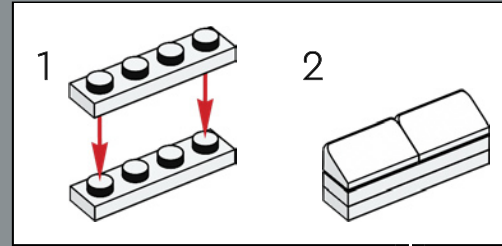

321

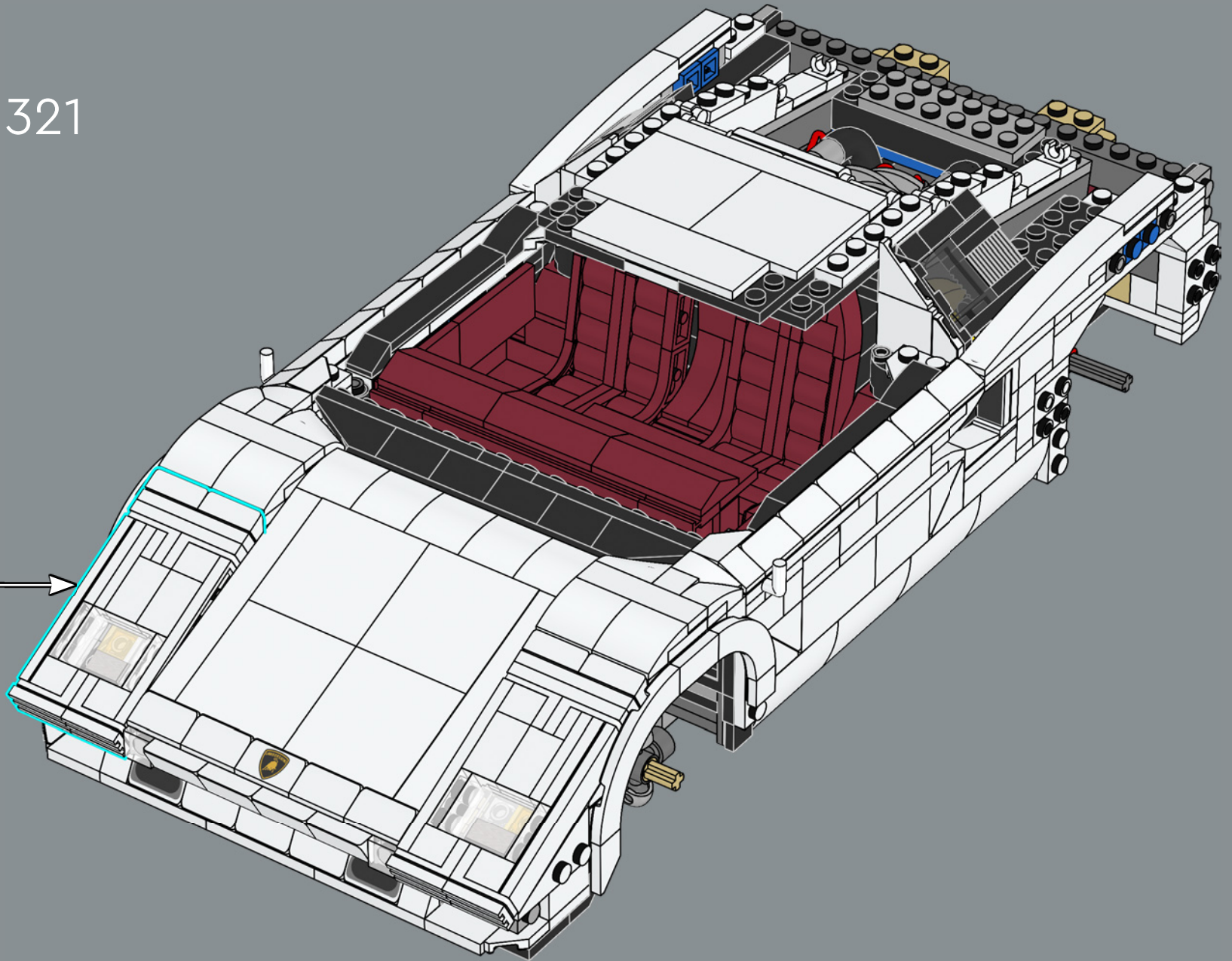

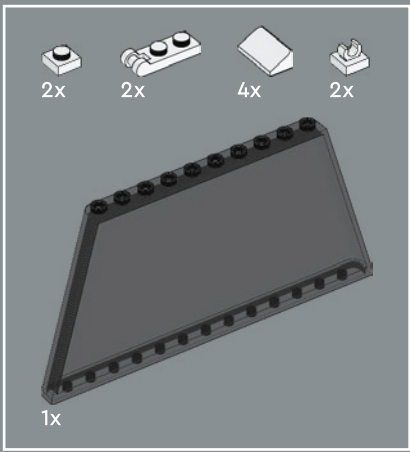

322

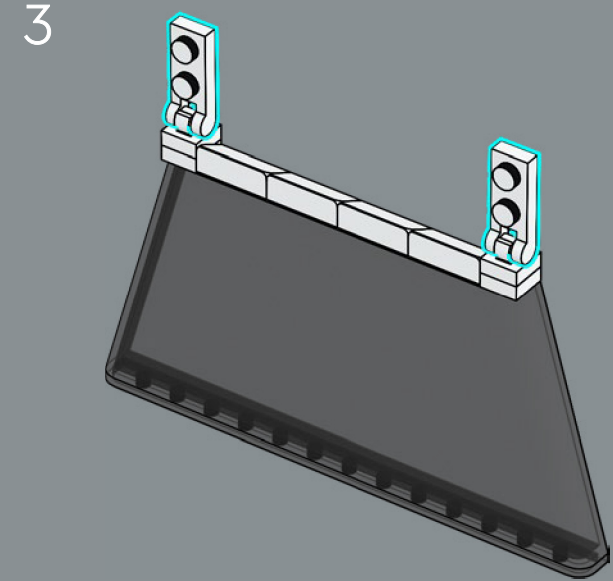
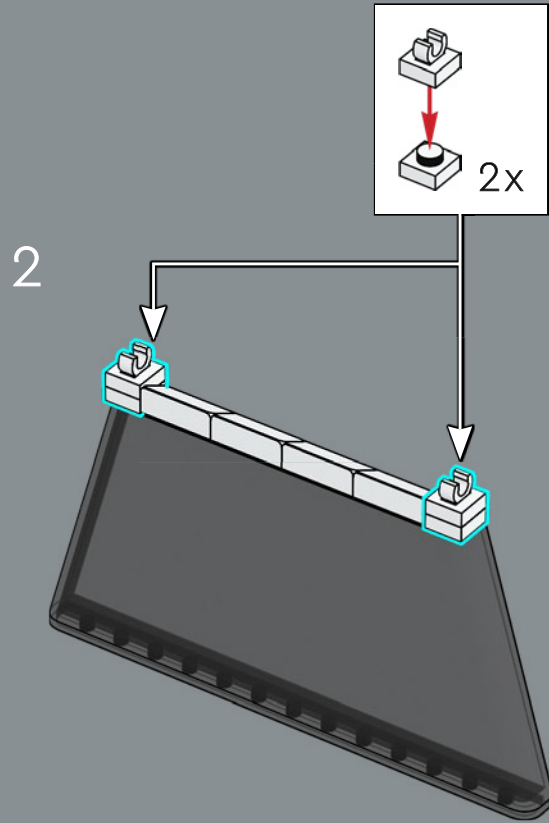
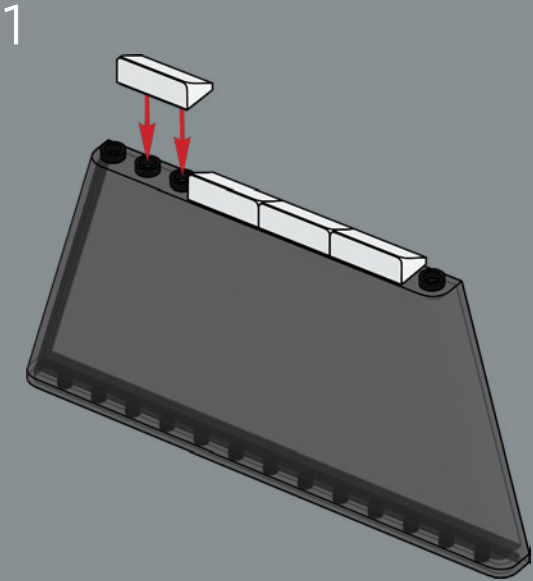

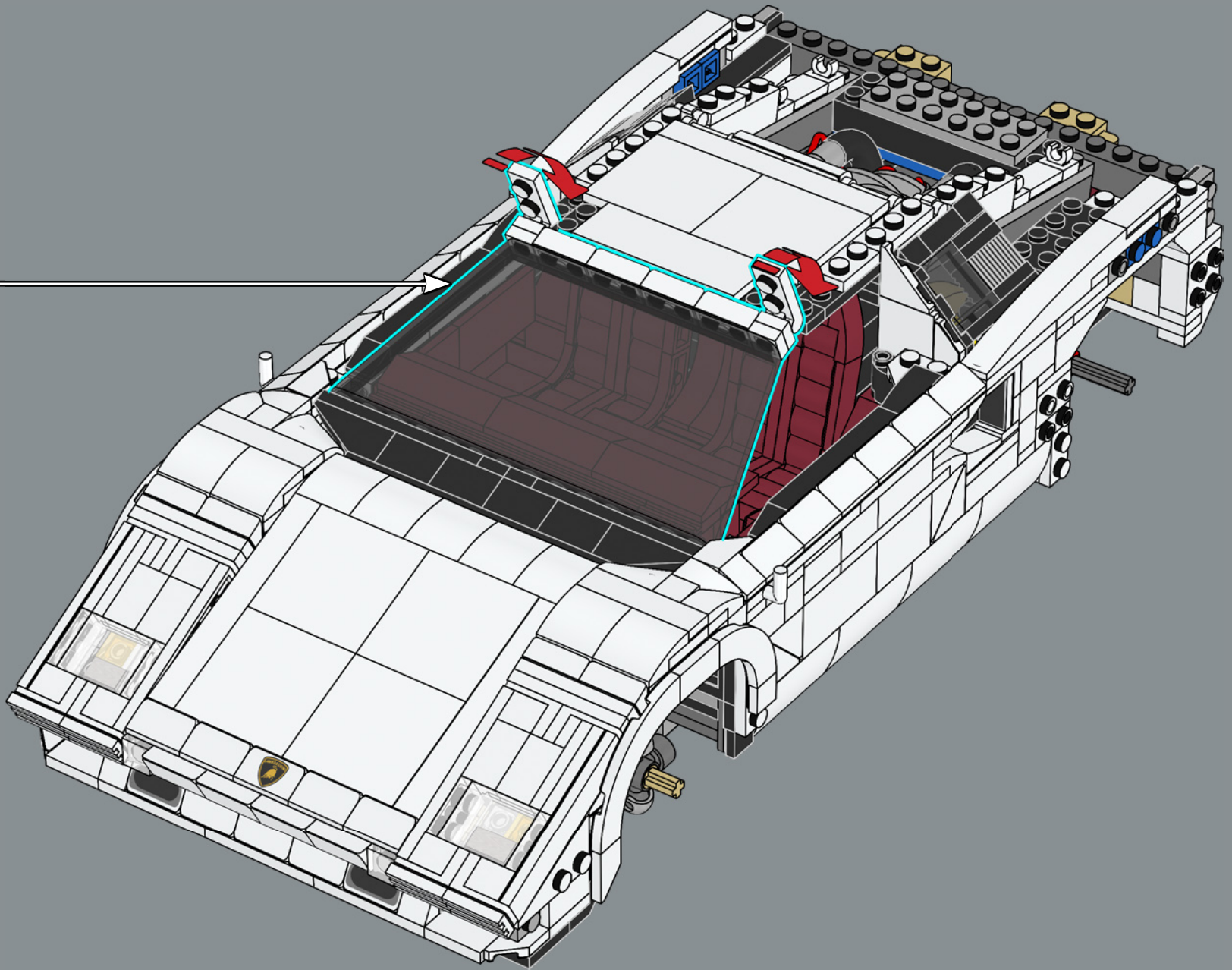

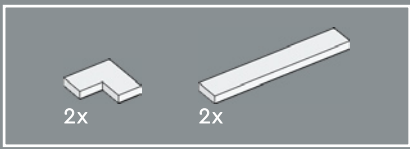

323

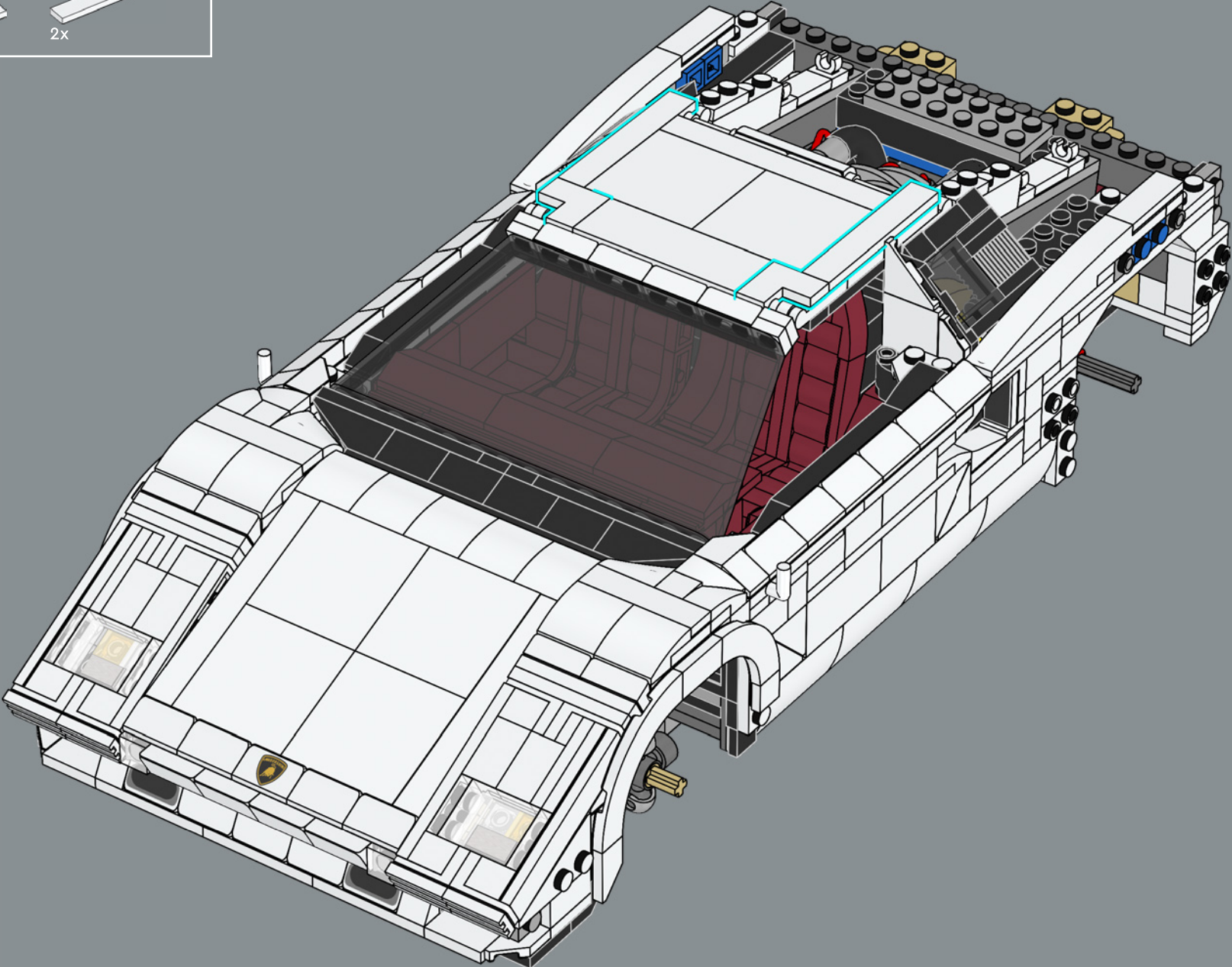

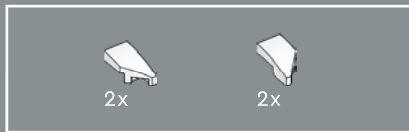

324

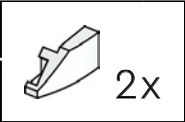
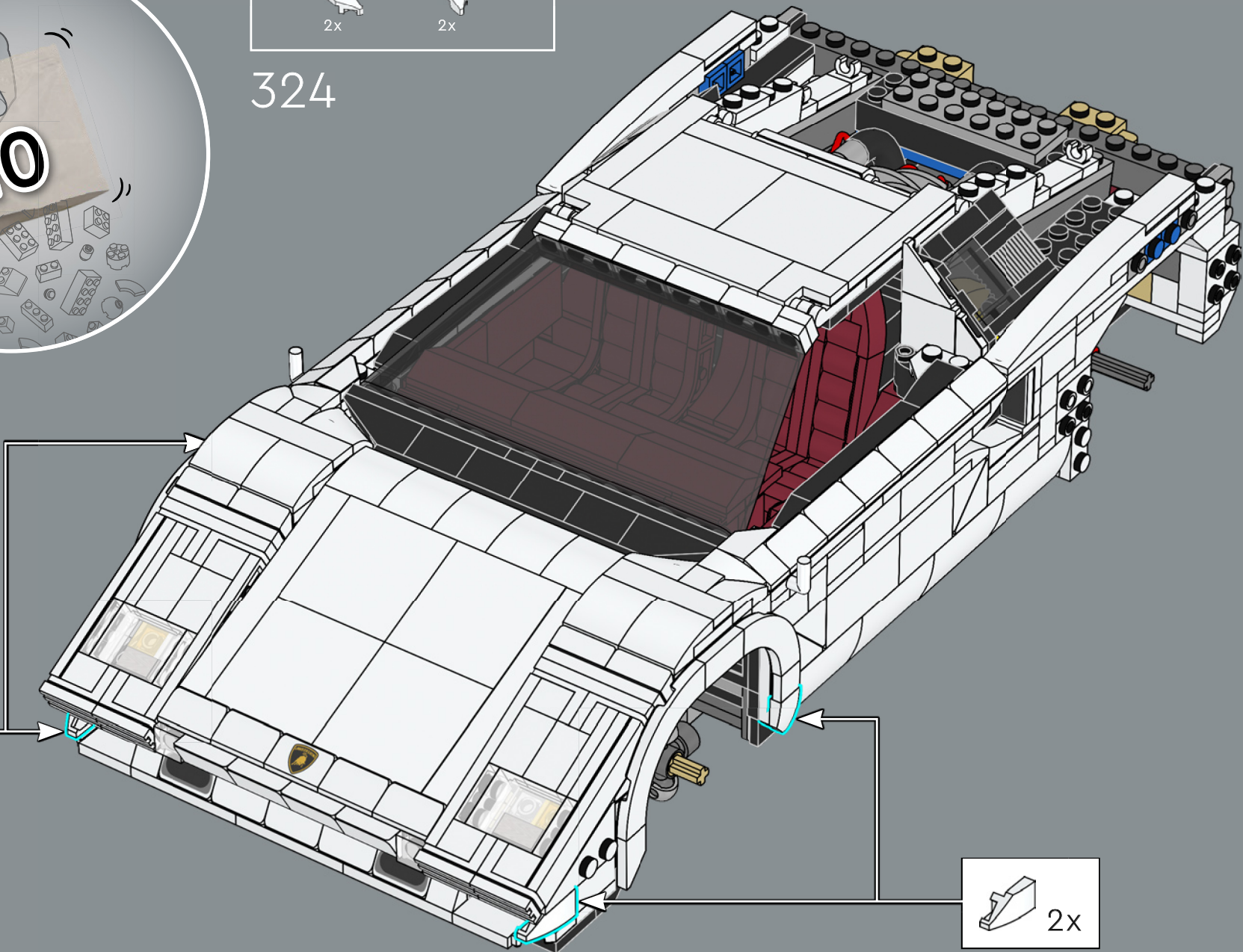

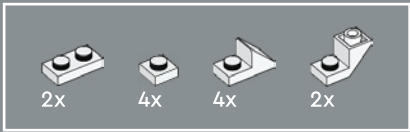

325

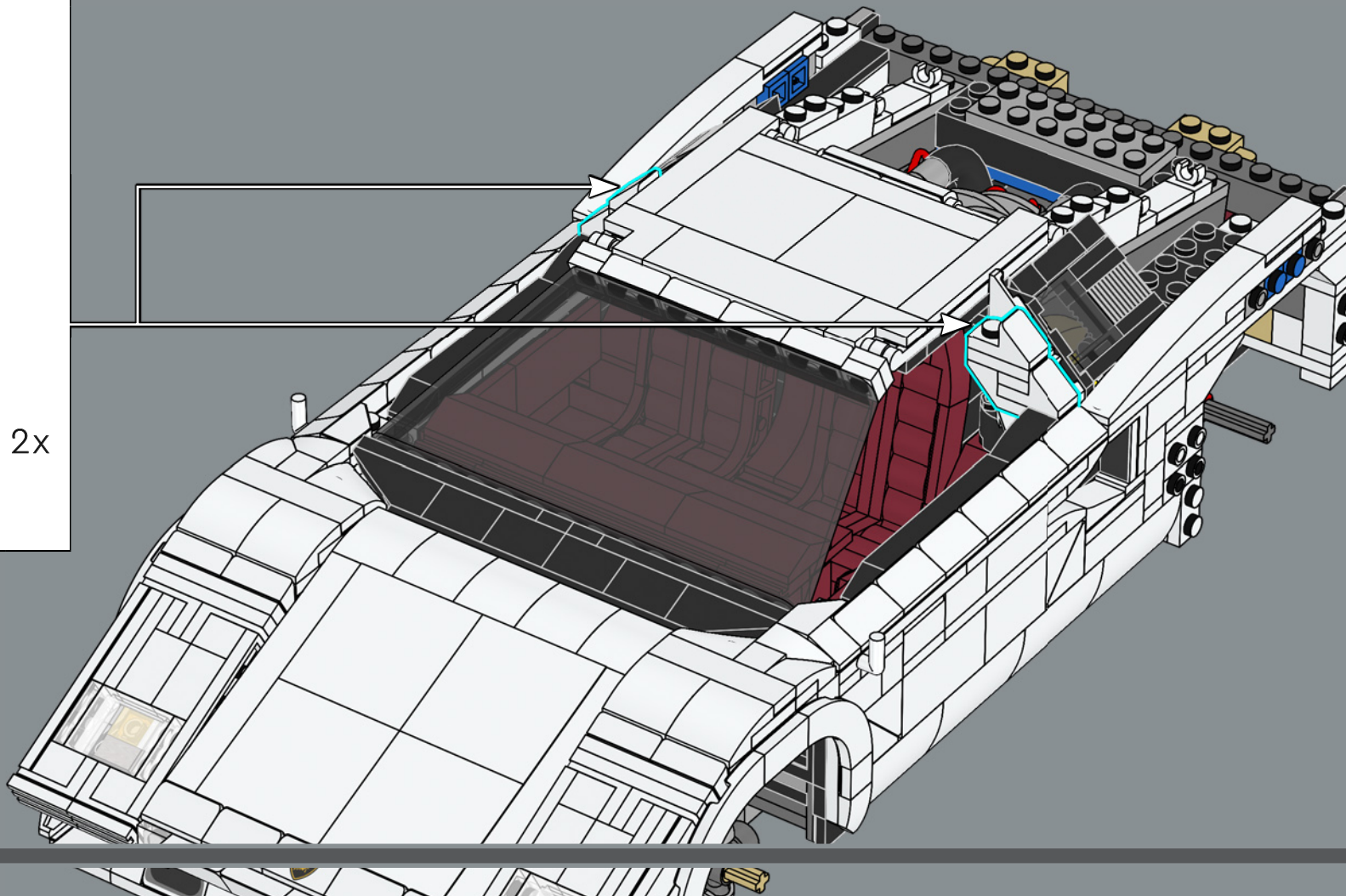
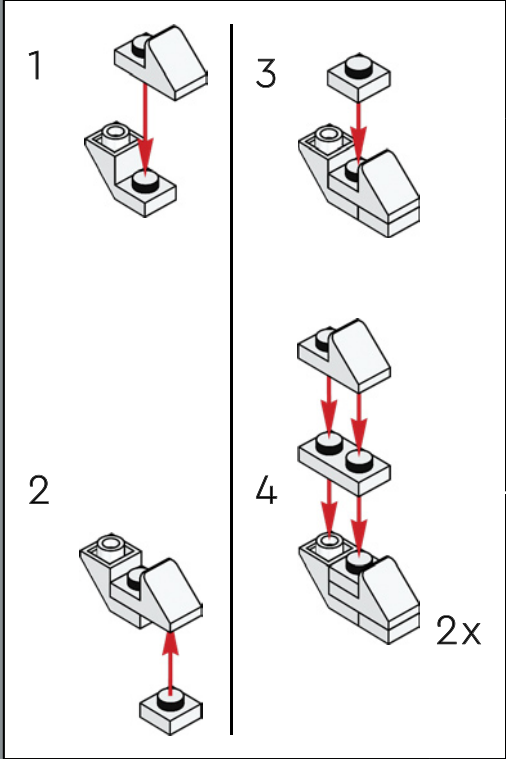

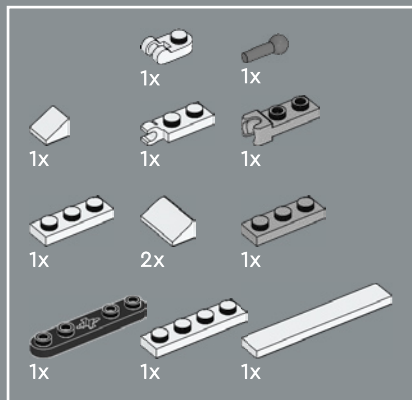

326

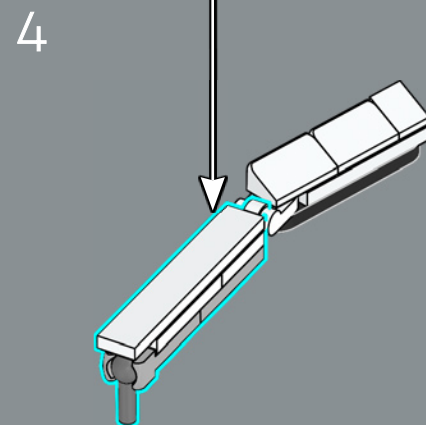
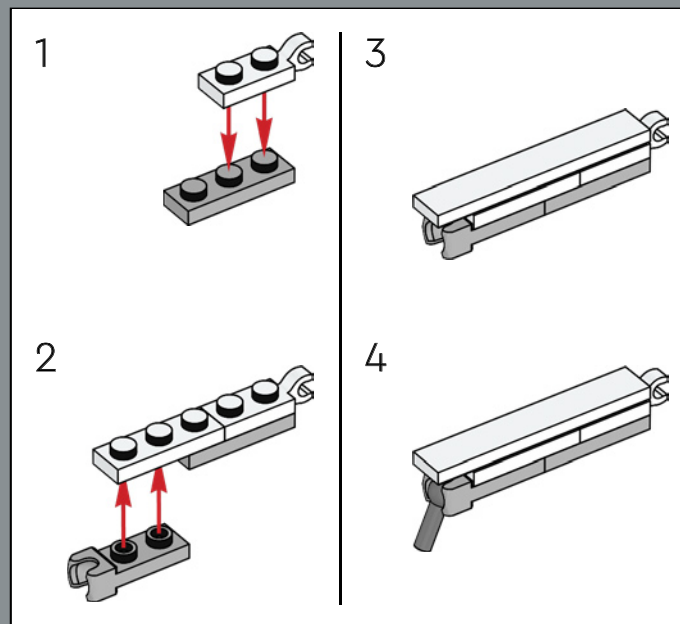
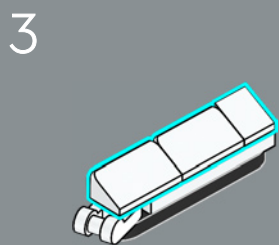
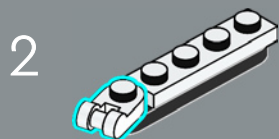
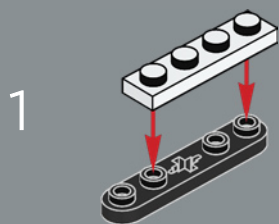

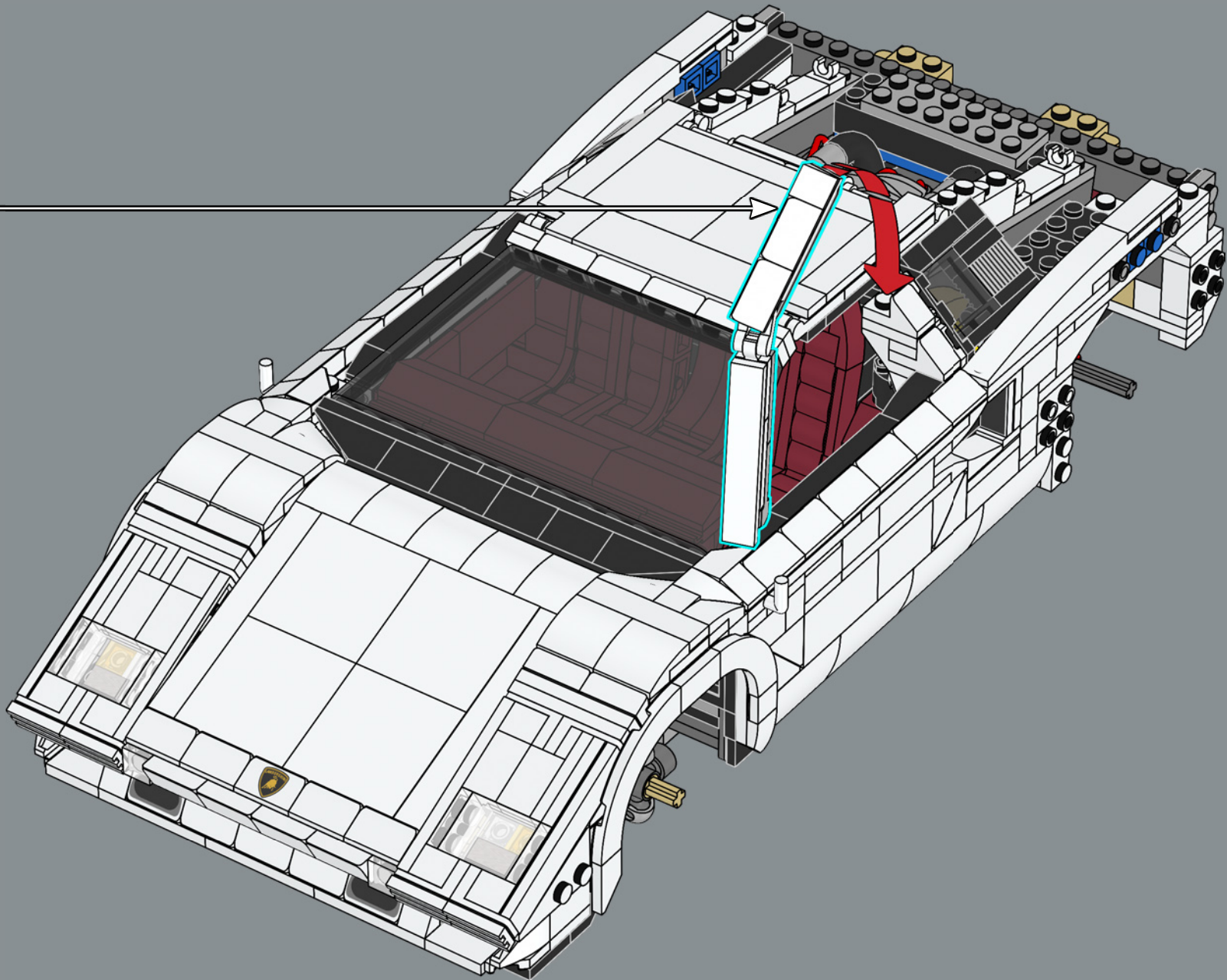

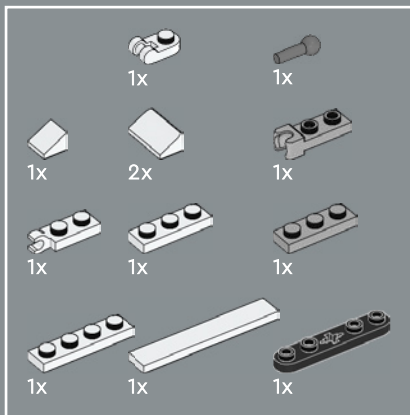

327

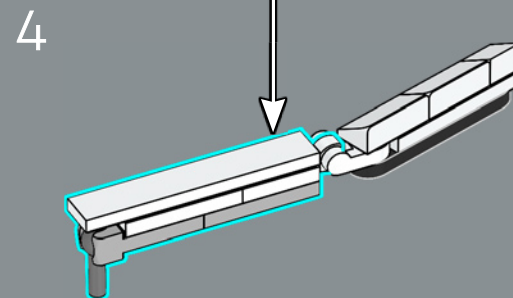
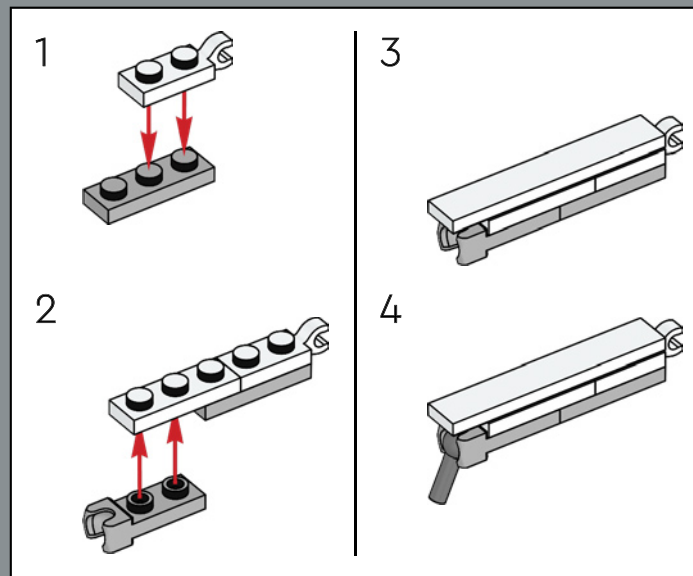
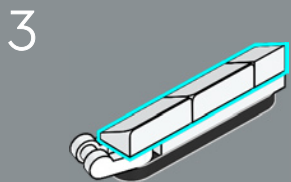
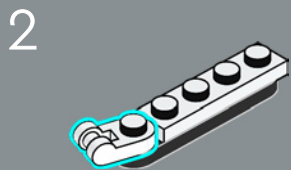
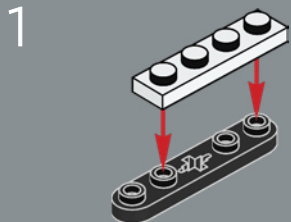

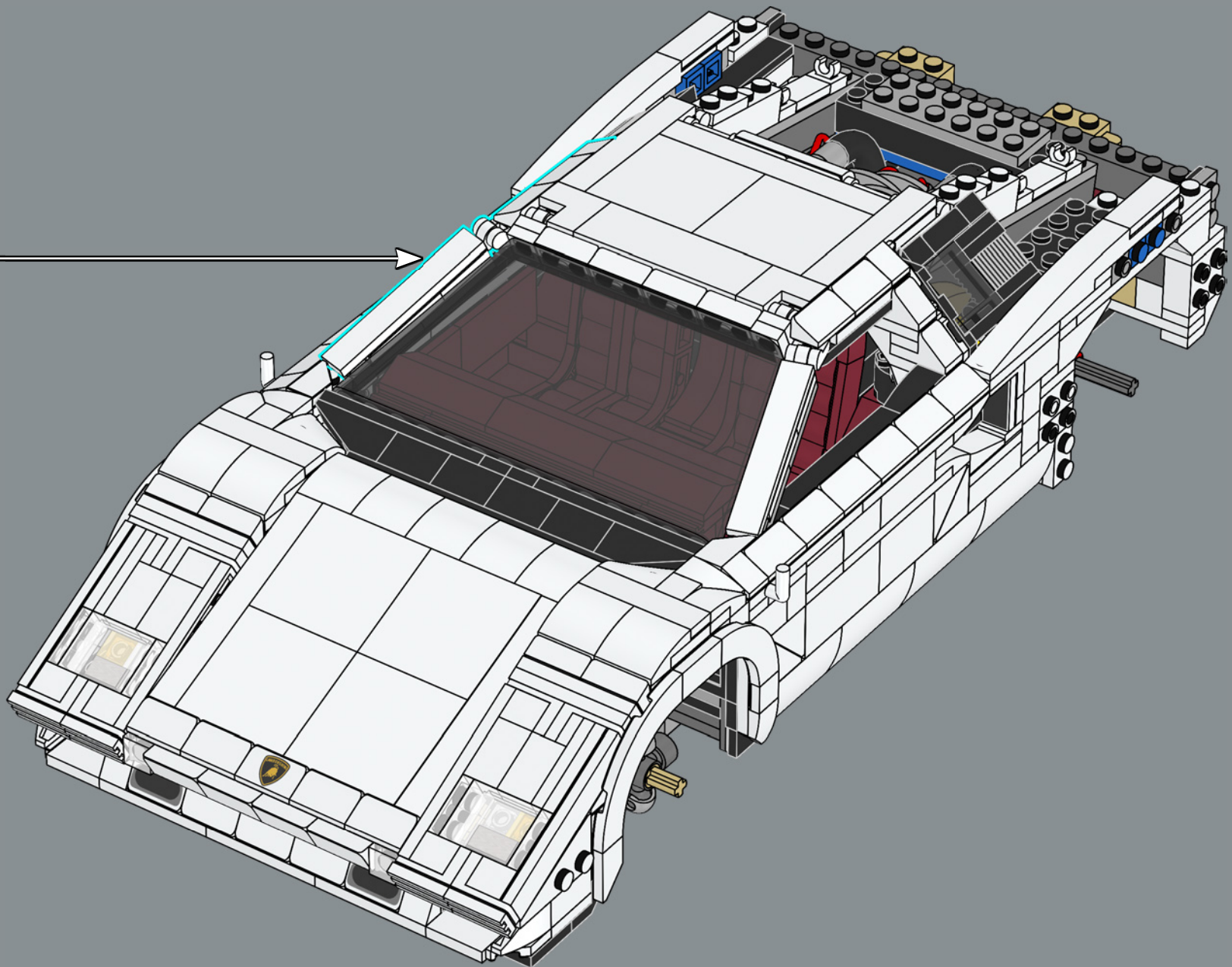

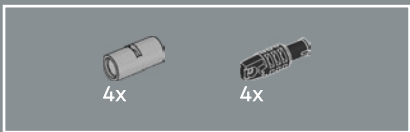

328

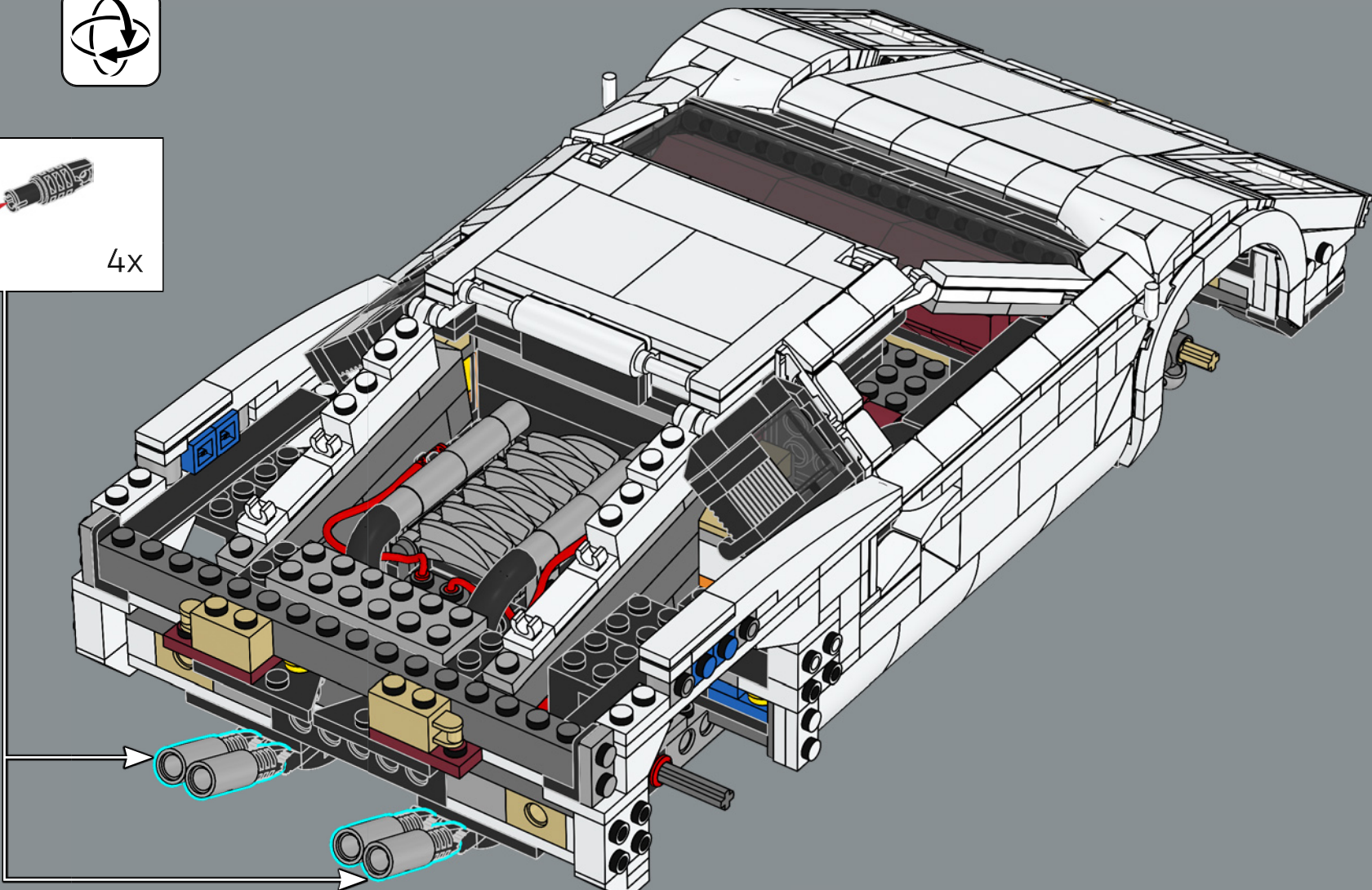
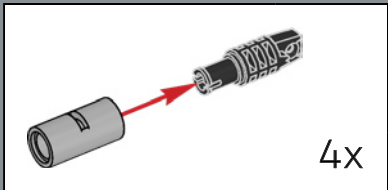

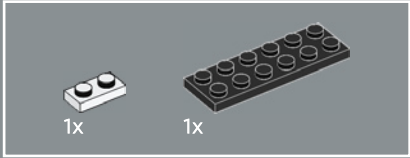
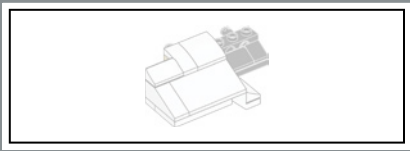

329

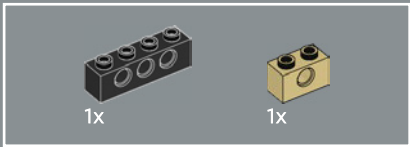
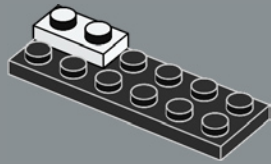

330

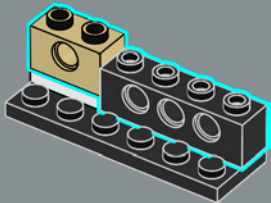

331

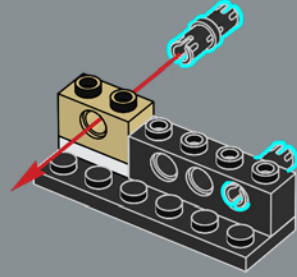

332

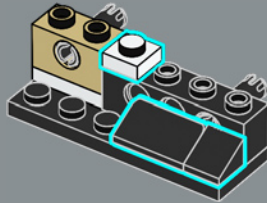

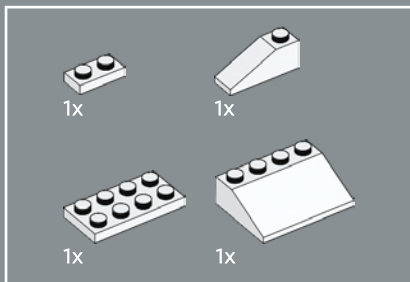

333

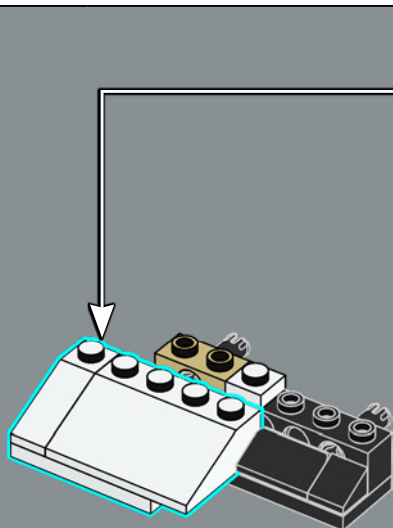
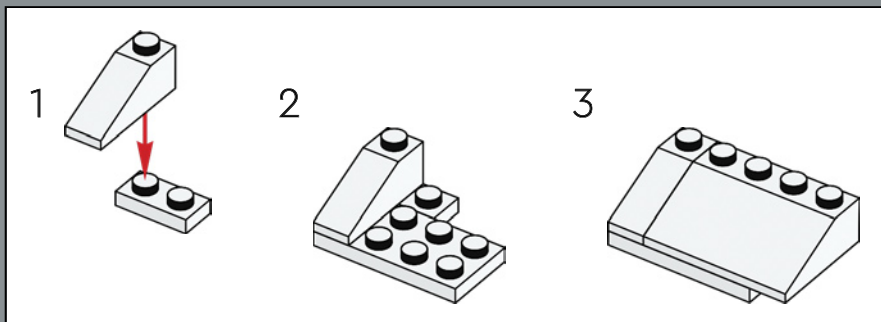

334

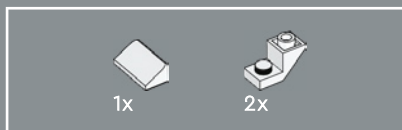
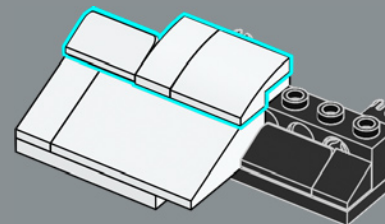

335

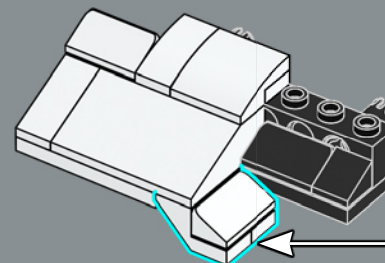
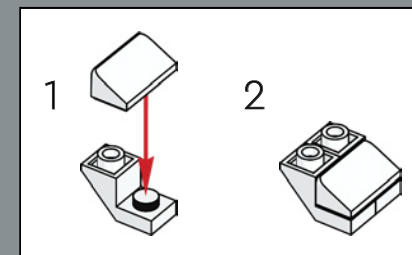

336

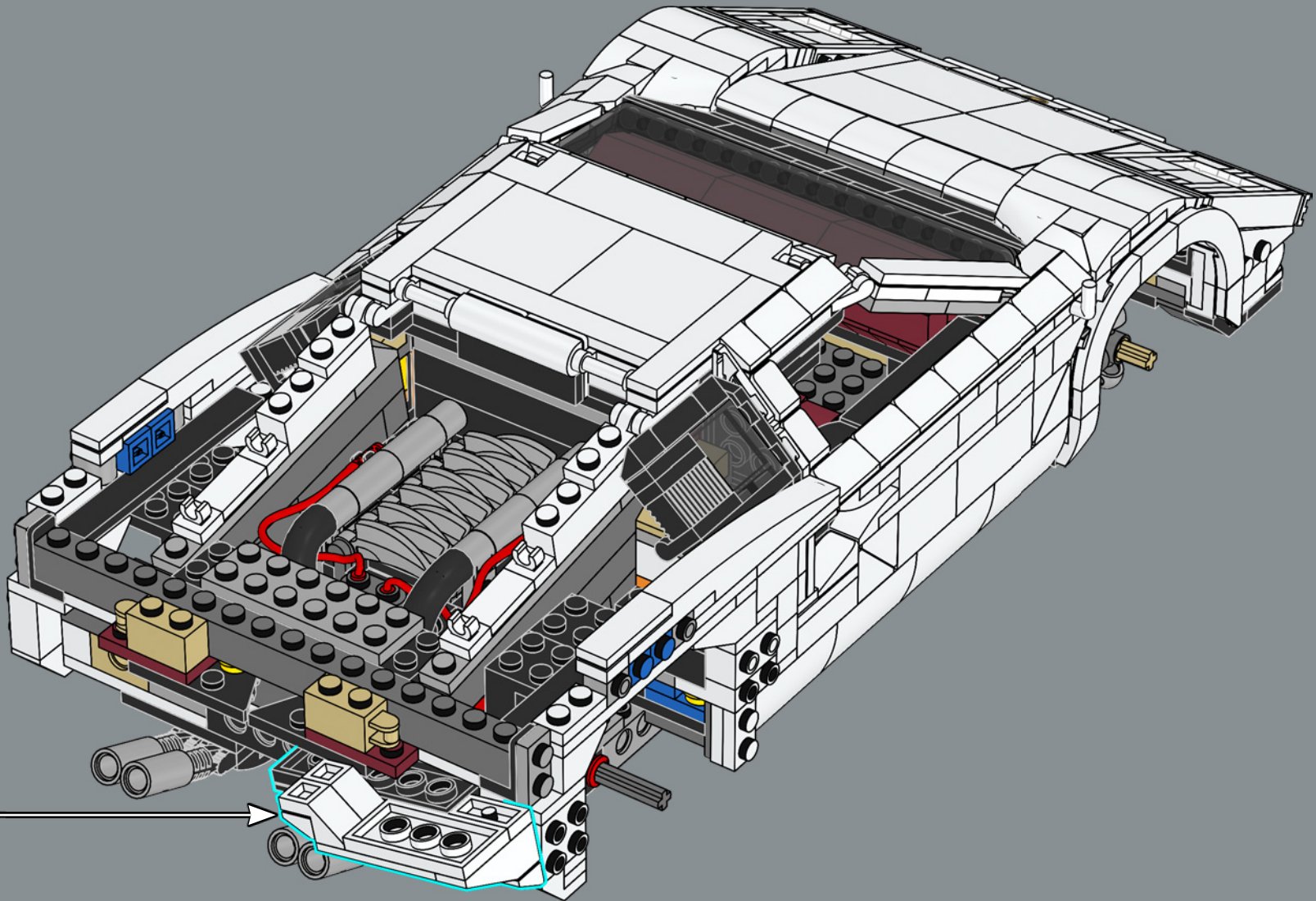

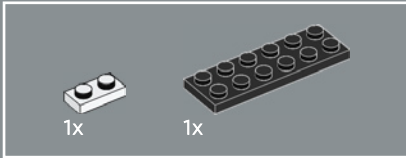
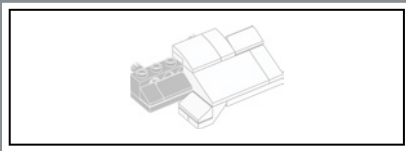

337

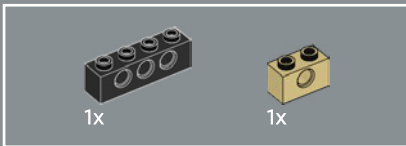
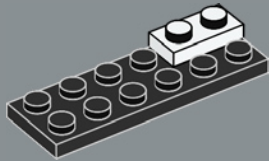

338

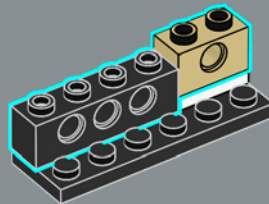

339

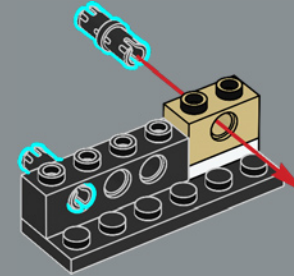

340

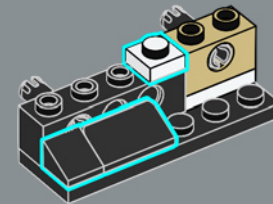

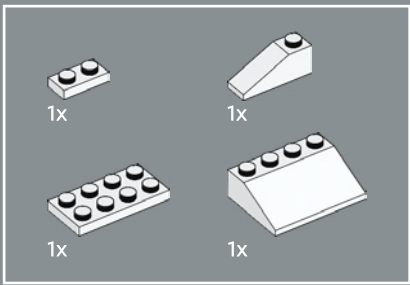

341

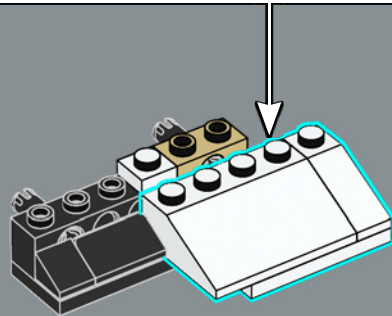
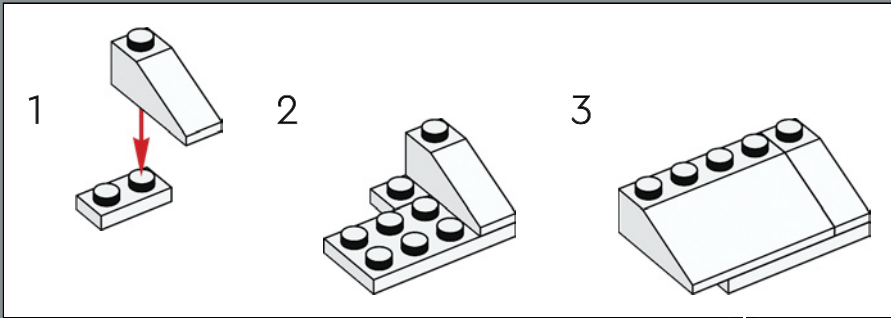

342

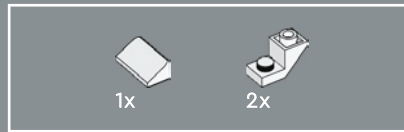
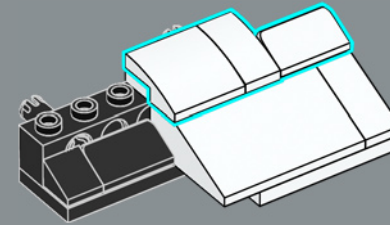

343

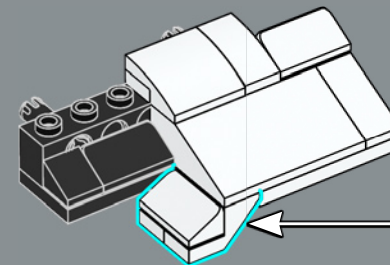
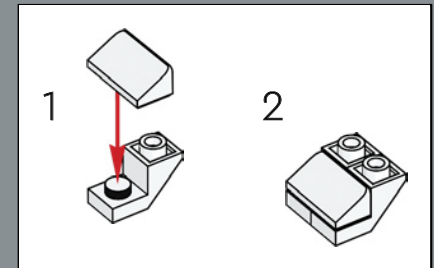

344

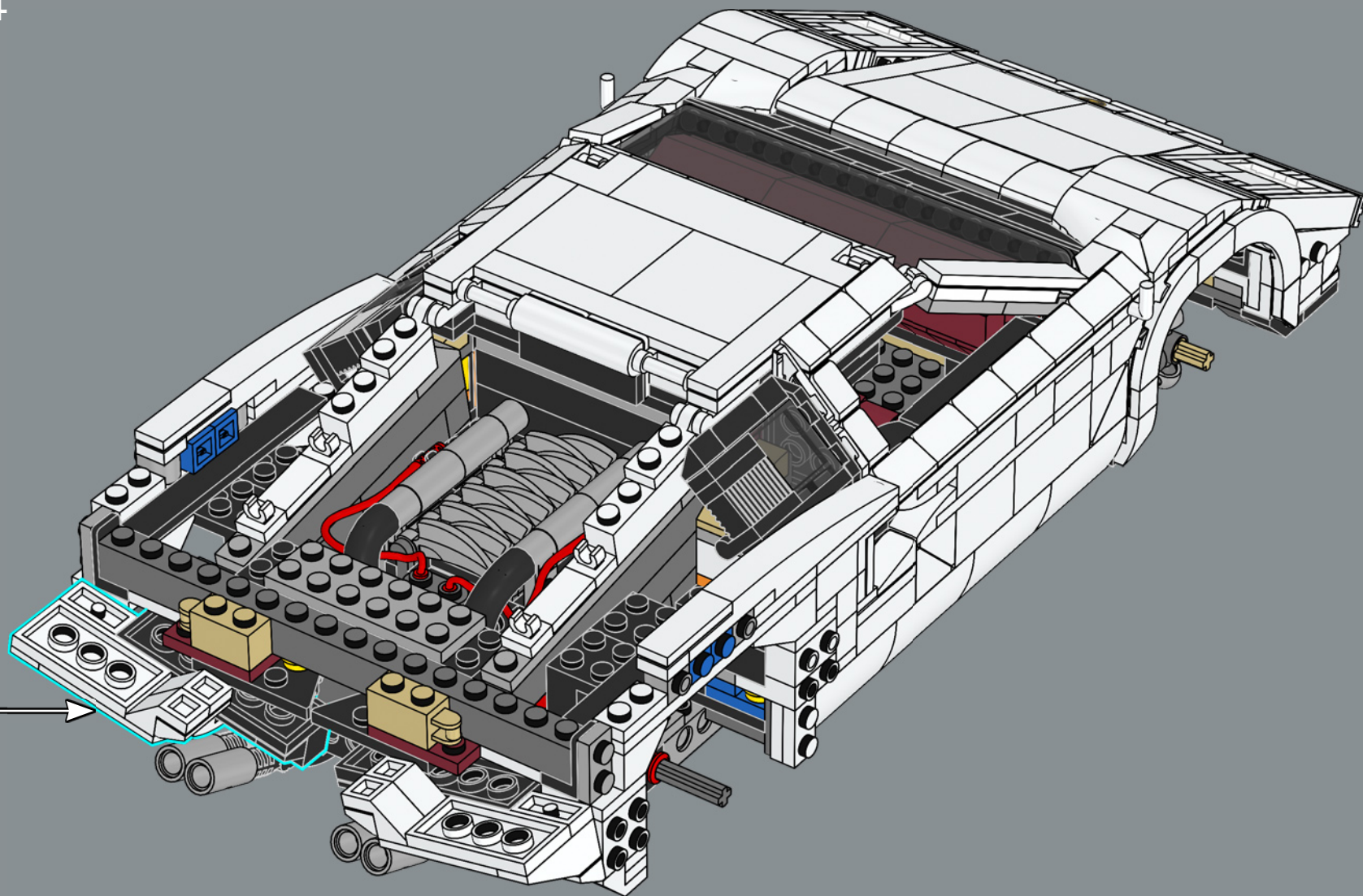

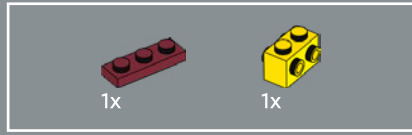
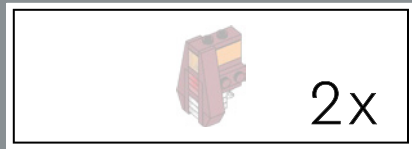

345

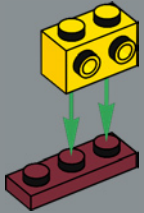

346

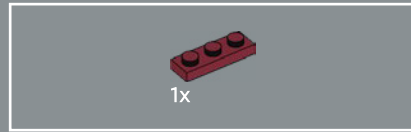
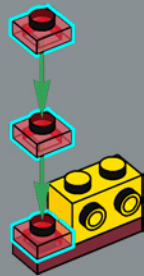

347

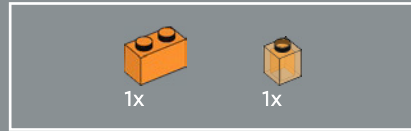
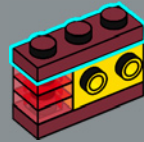

348

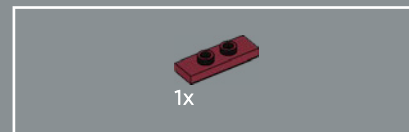

349

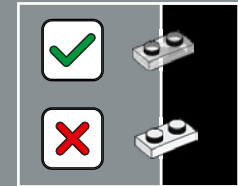
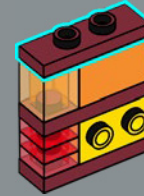

350

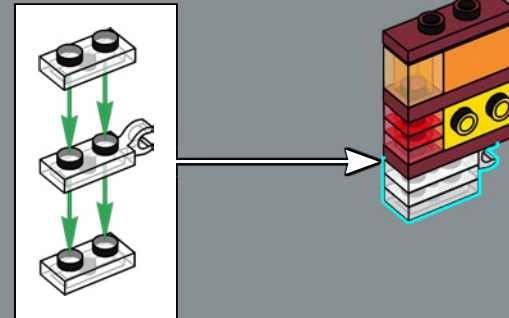

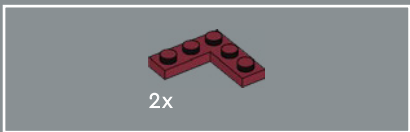

351

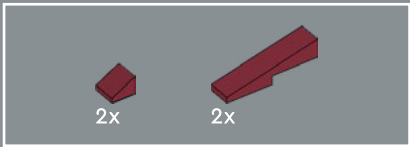
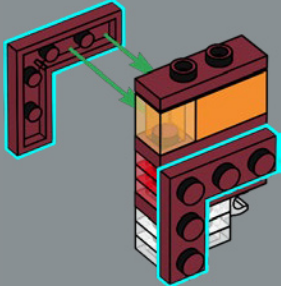

352

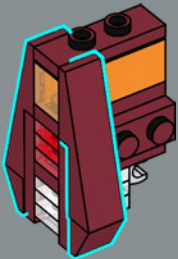

2x

353

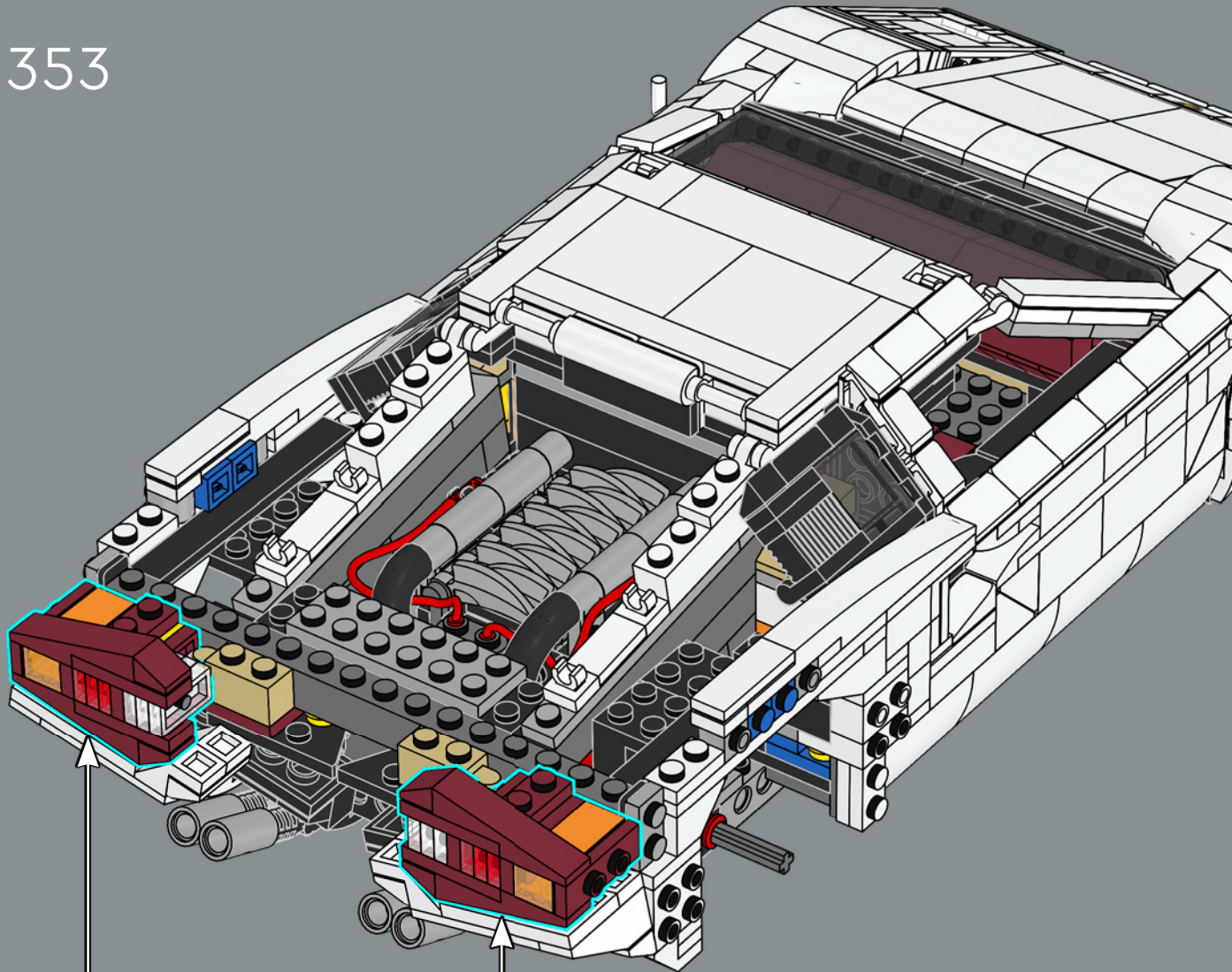

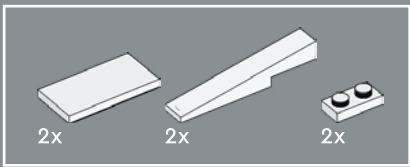

354

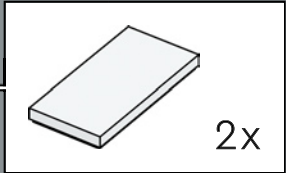
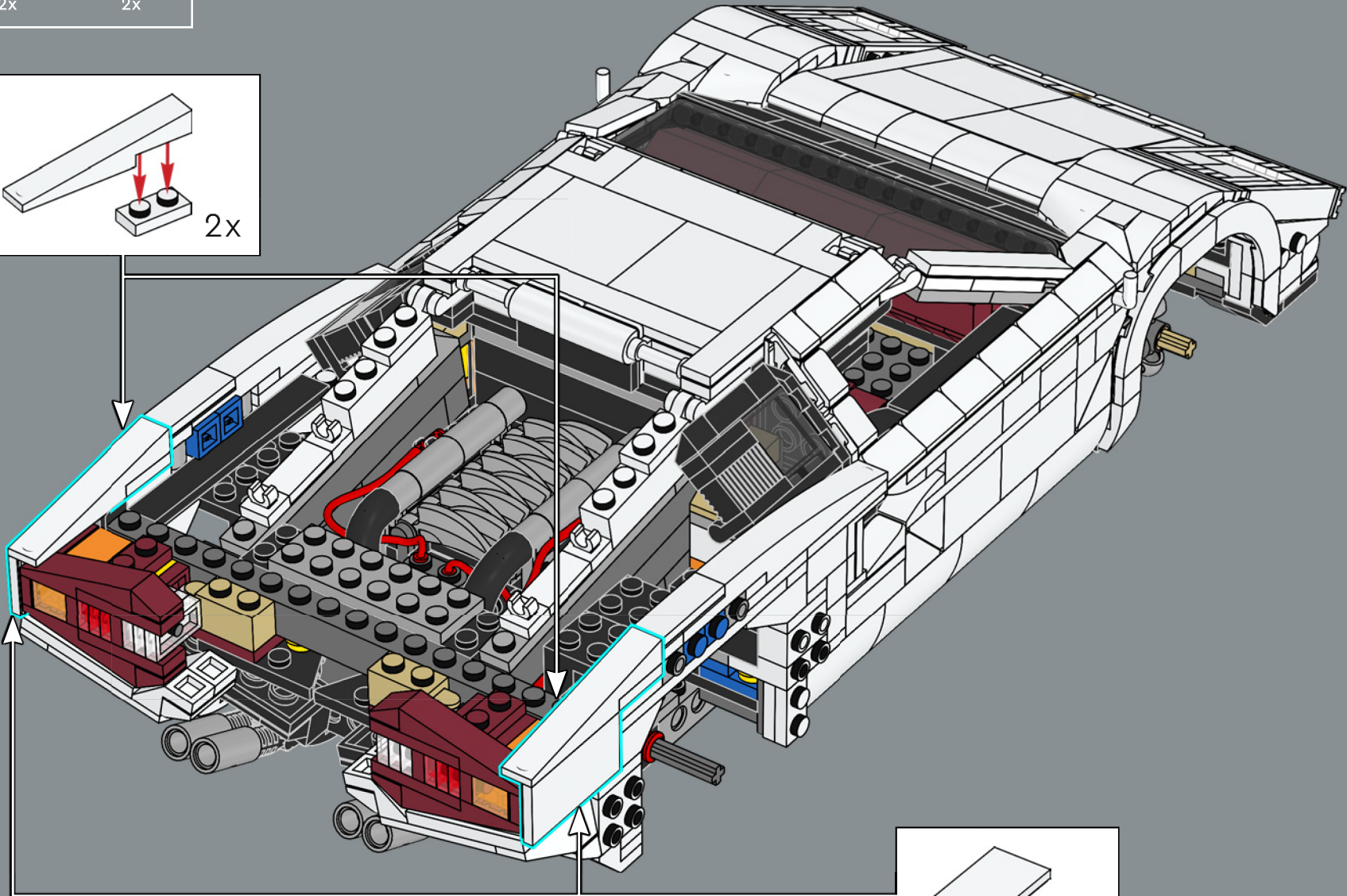
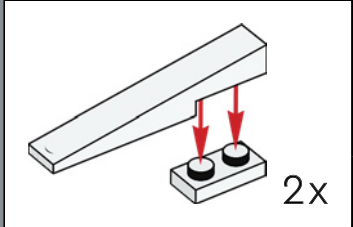

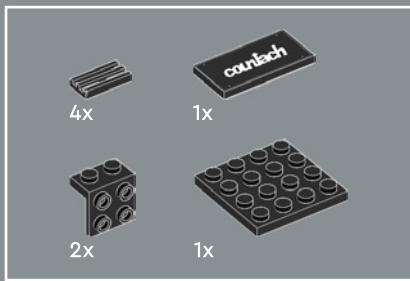

355

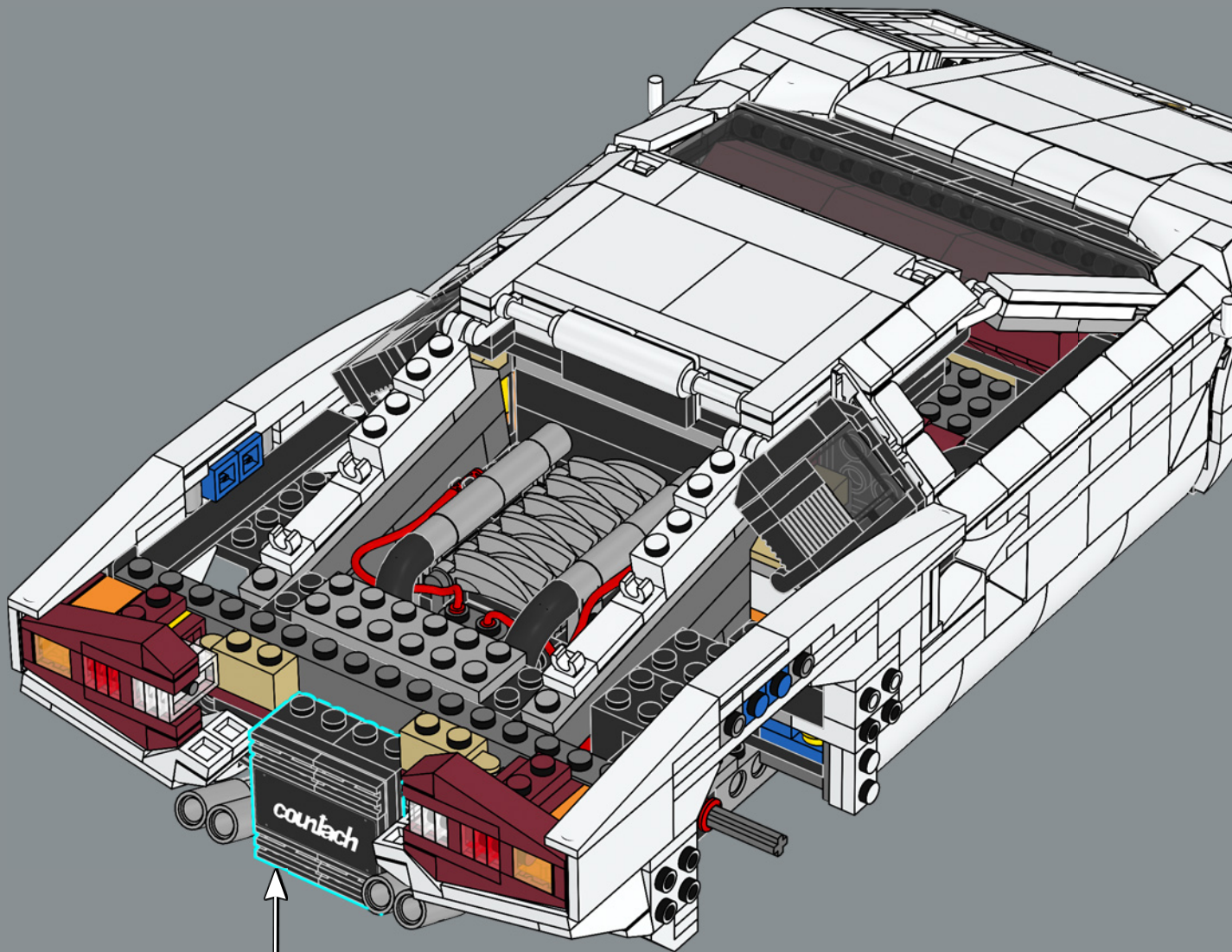
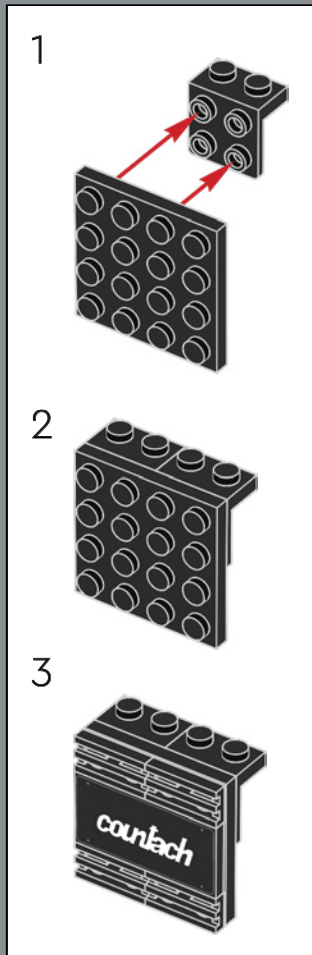

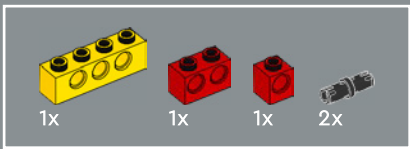

356

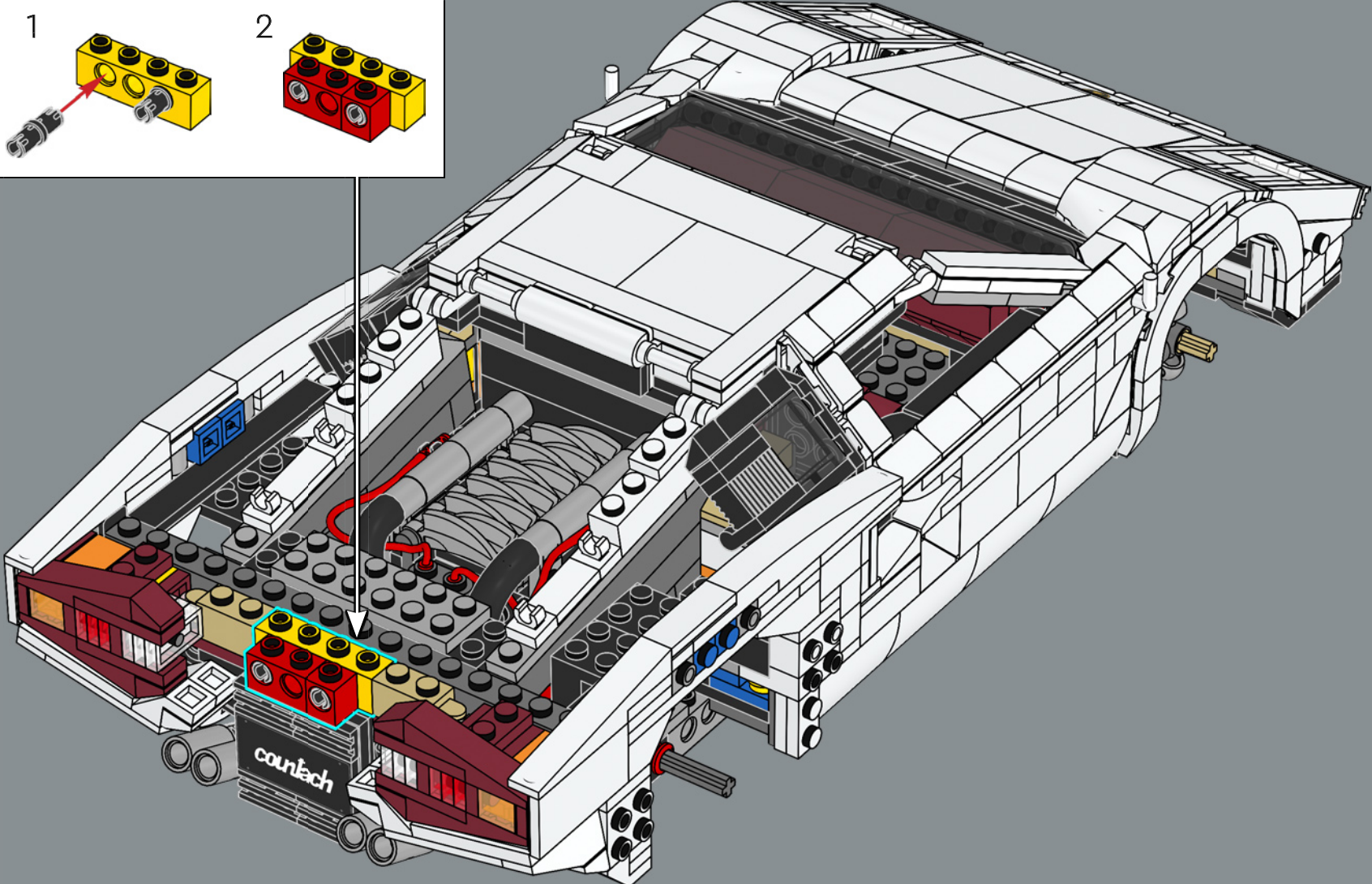
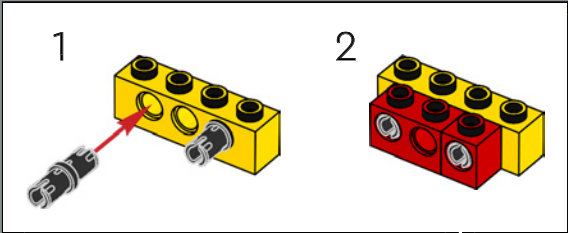

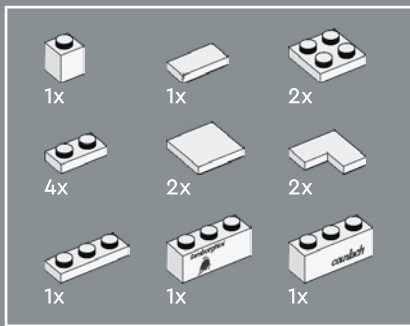

4

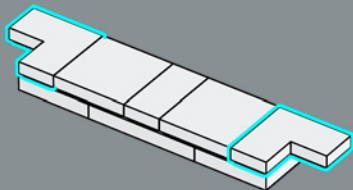

357

1

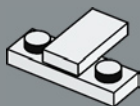

2

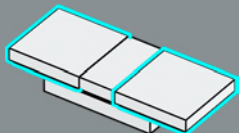

3

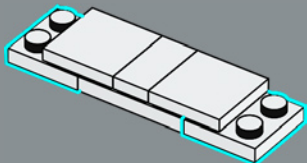

5

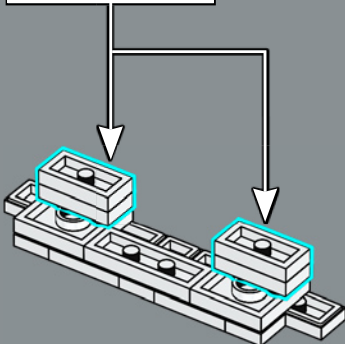
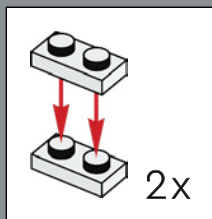

6

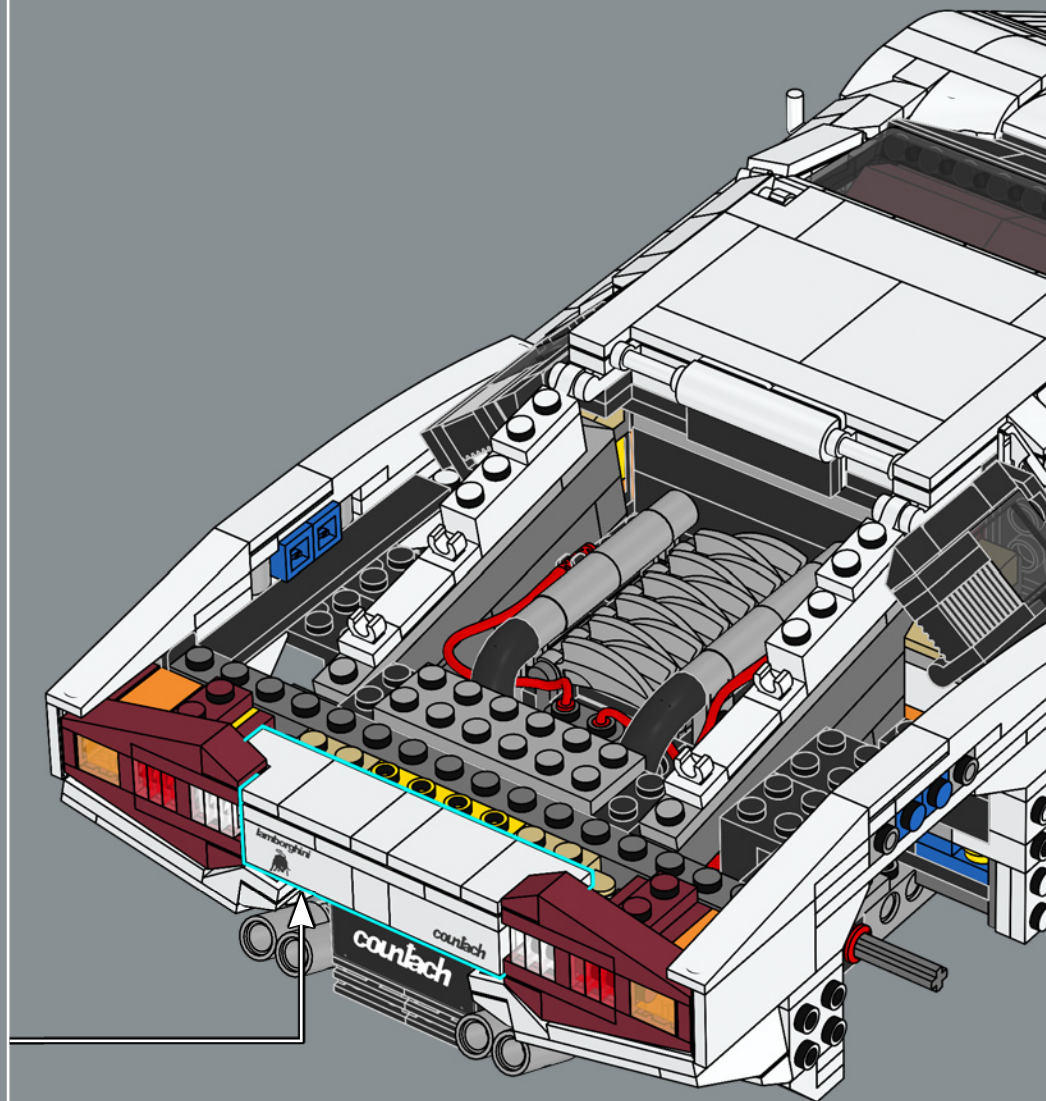
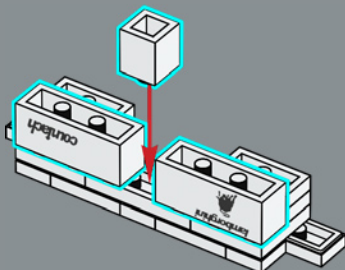

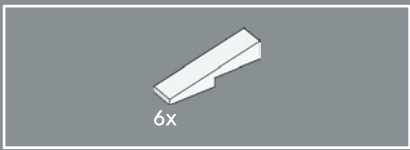

358



Ein neues schräges LEGO® Element ermöglicht es, die kurzen flachen Winkel des legendären Designs nachzubilden.

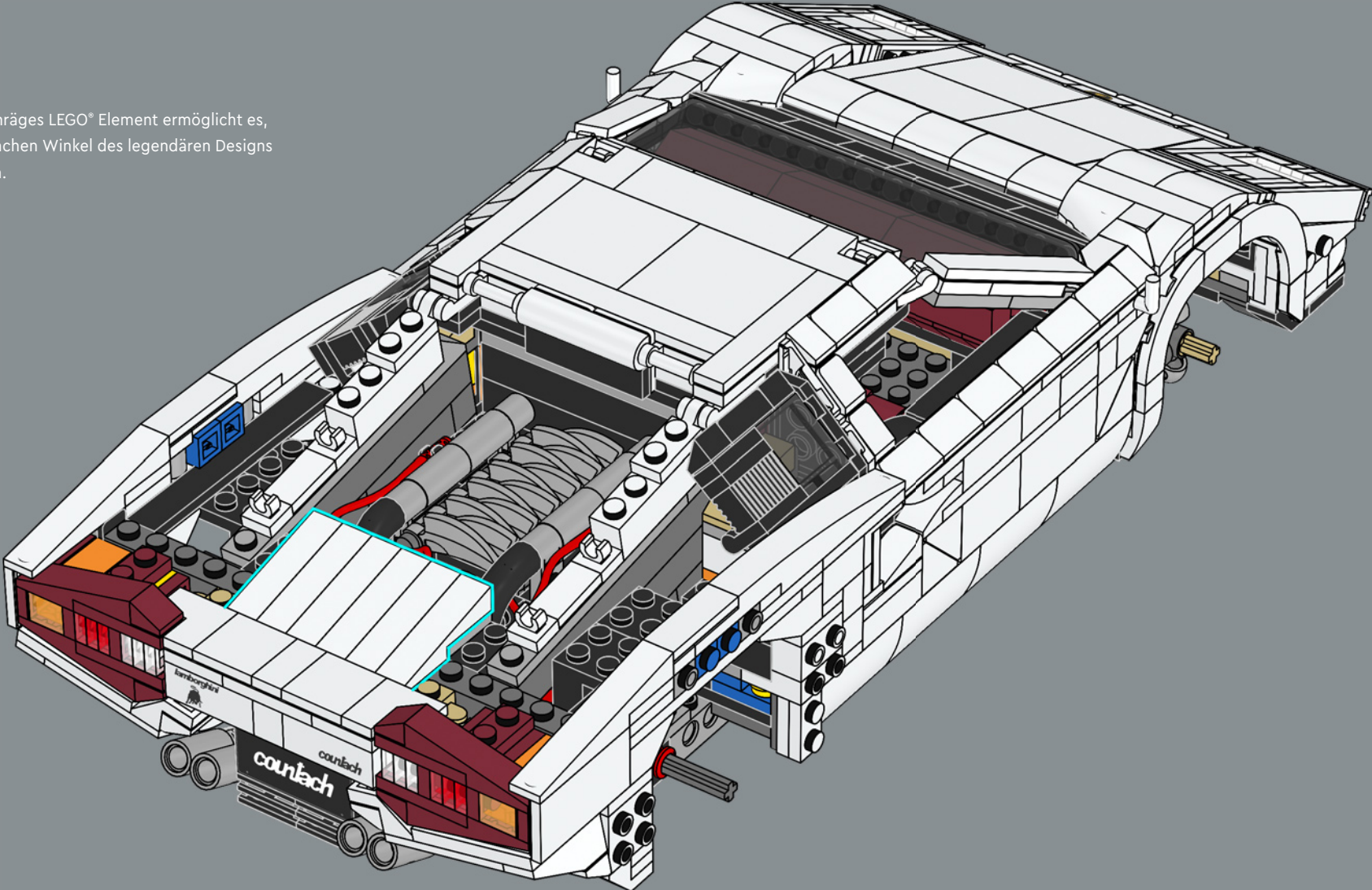

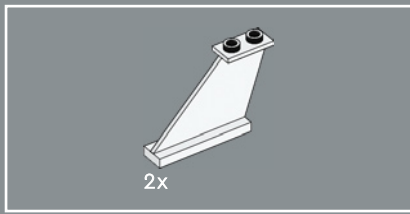

359

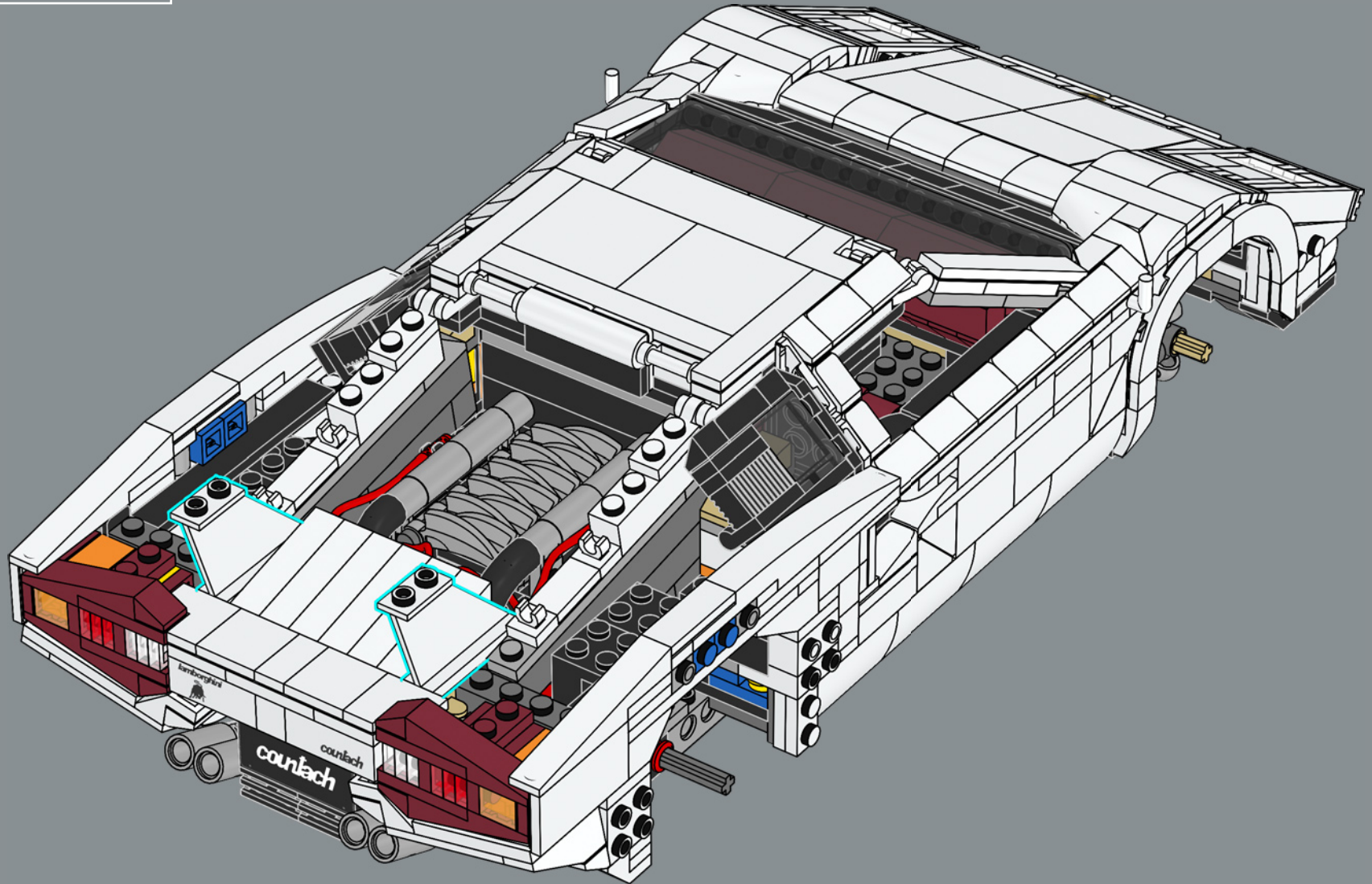

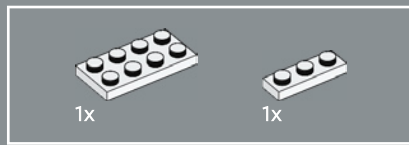
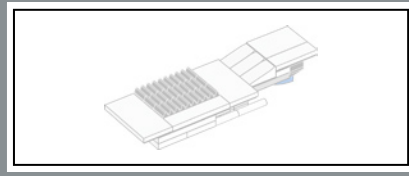

360

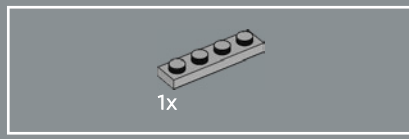
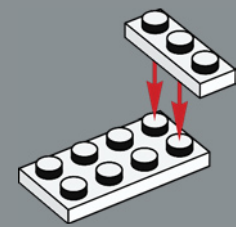

361

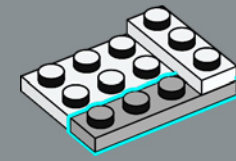



362

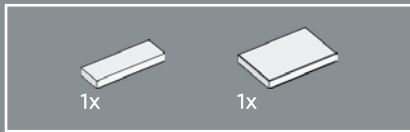
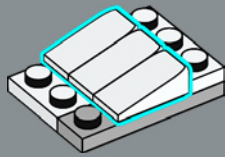

363

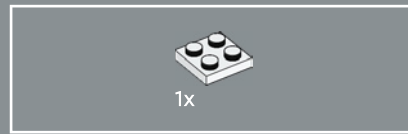
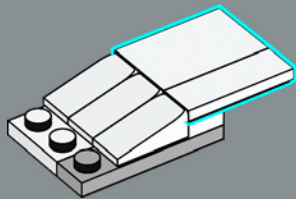
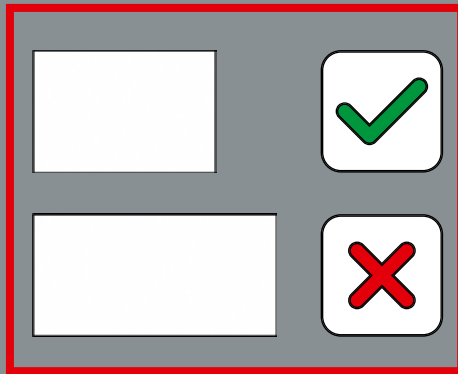

364

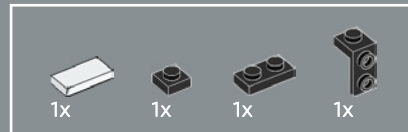
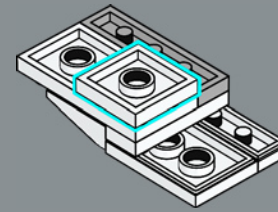

365

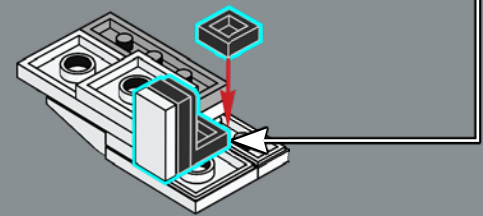
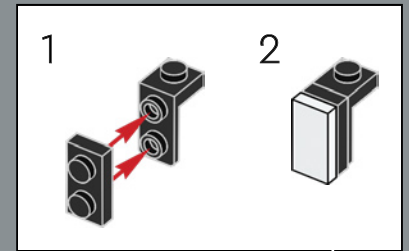



366

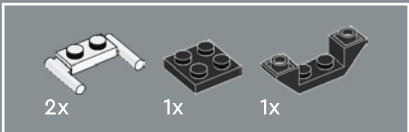
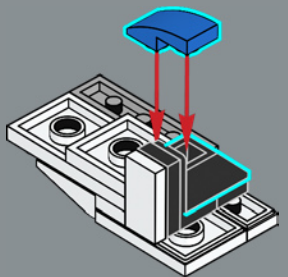

367

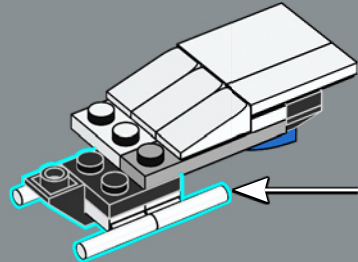
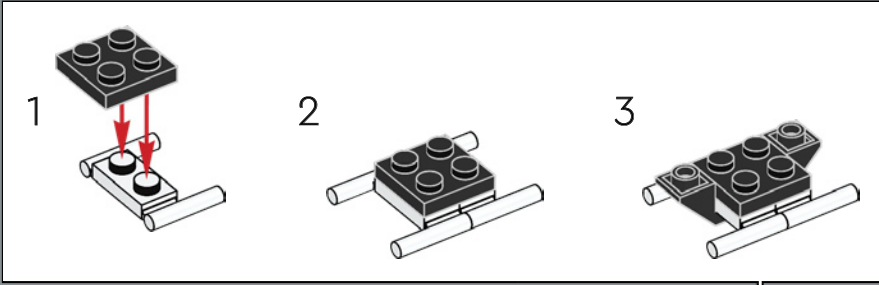

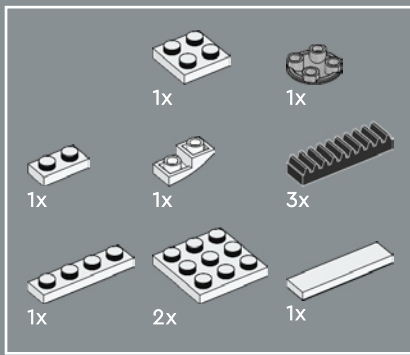

368

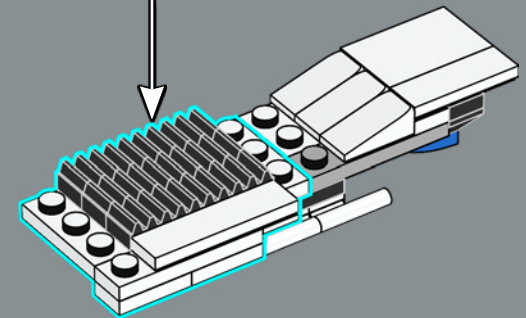
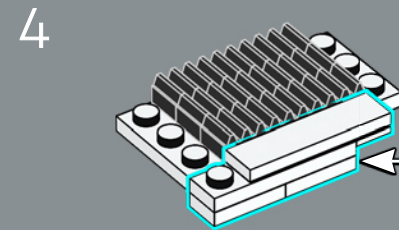
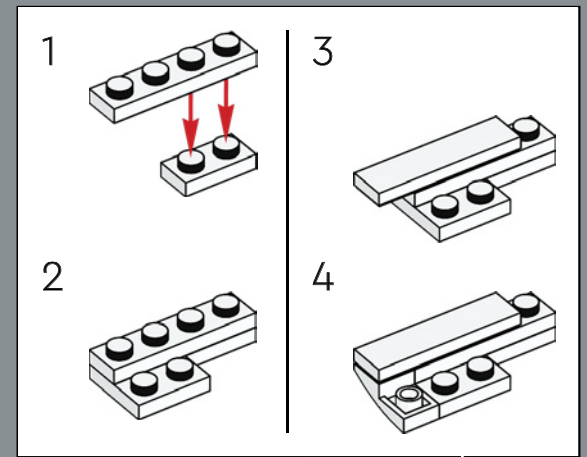
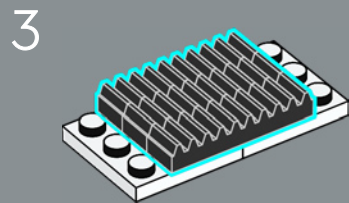
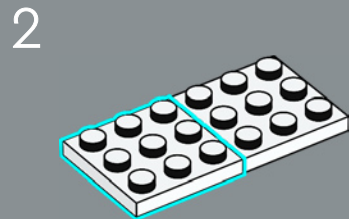
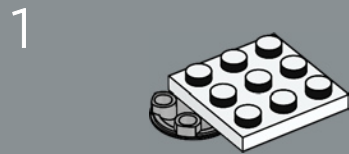

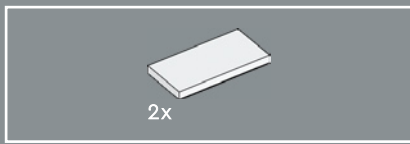

369

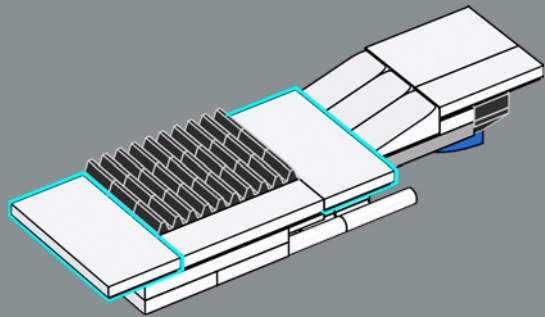
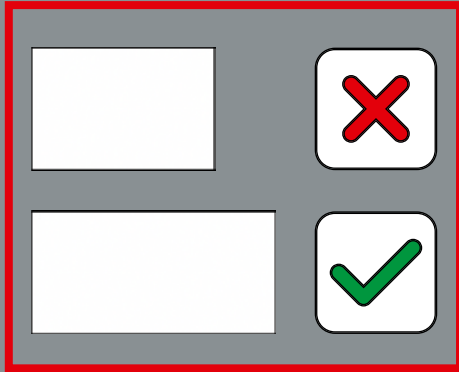

370

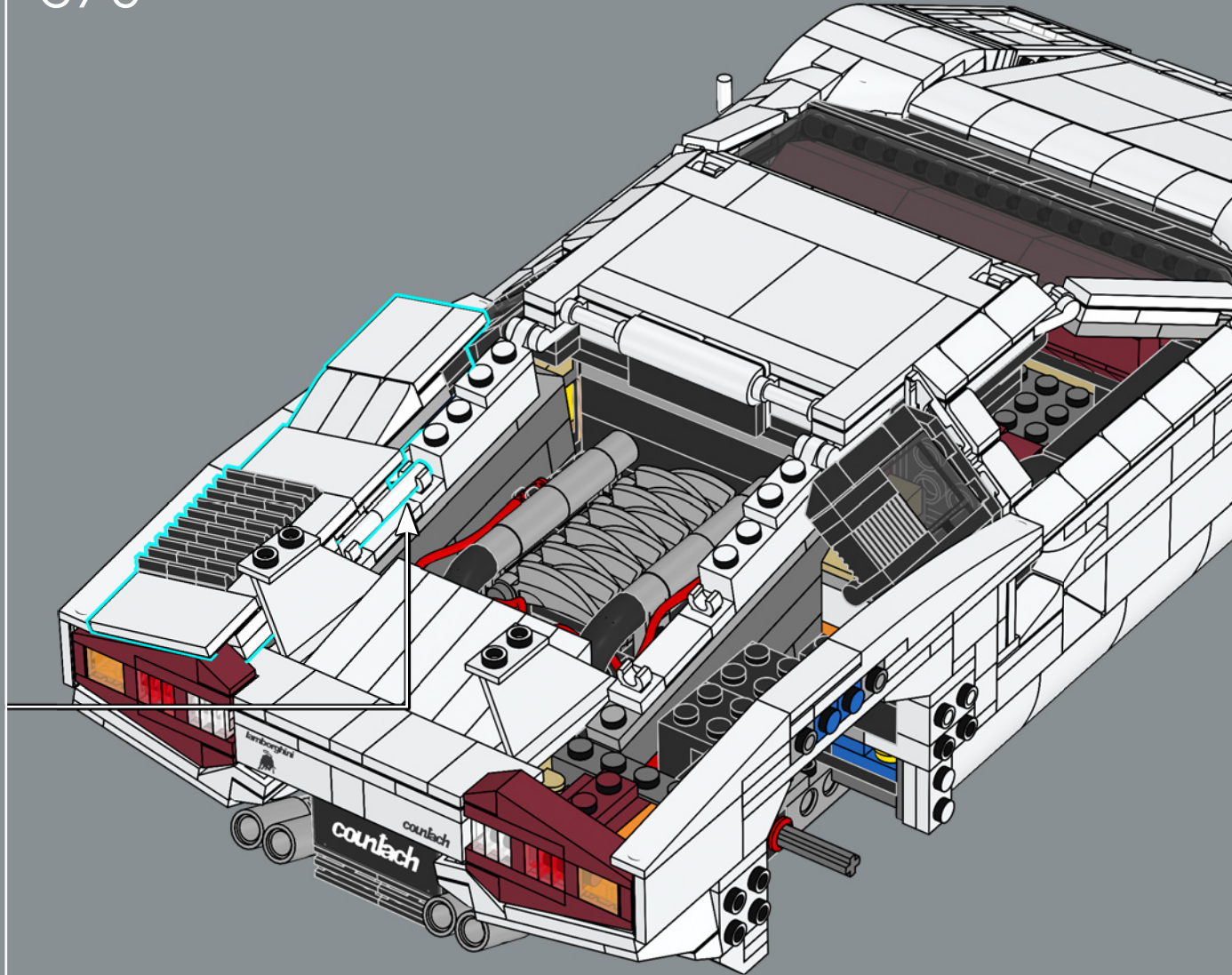

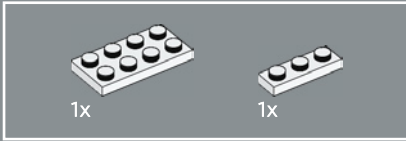
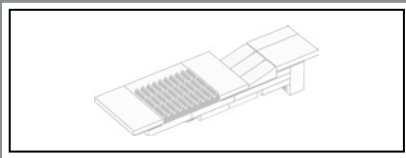

371

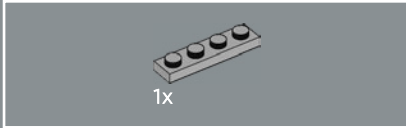
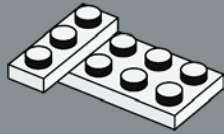

372

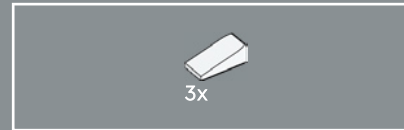
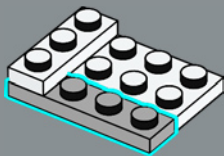

373

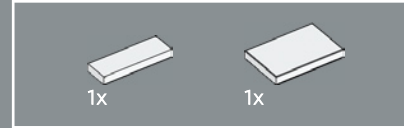
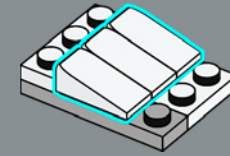

374

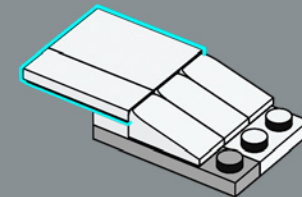
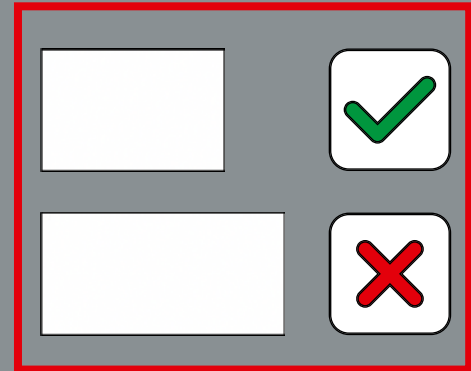

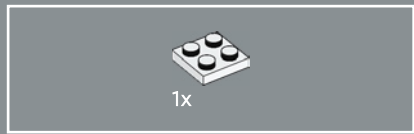

375

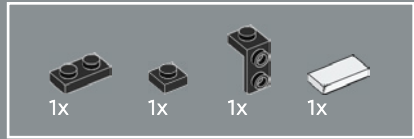
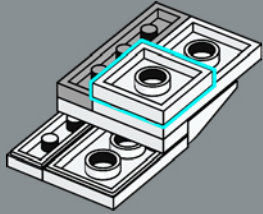

376

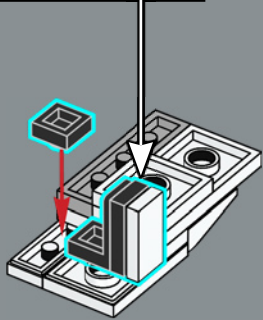
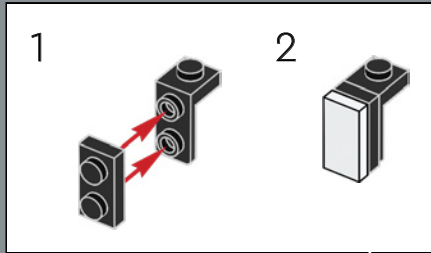

377

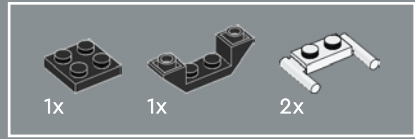
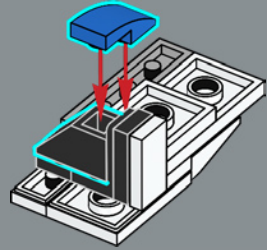

378

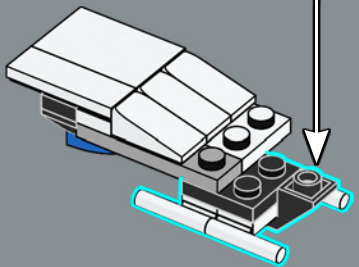
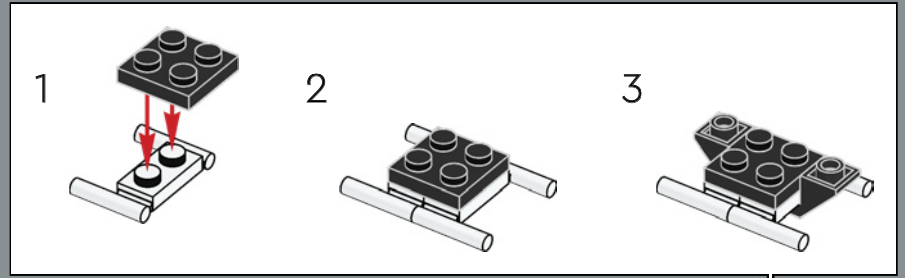

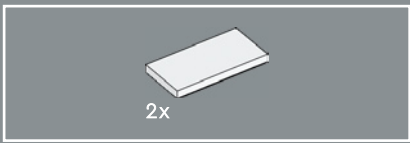

380

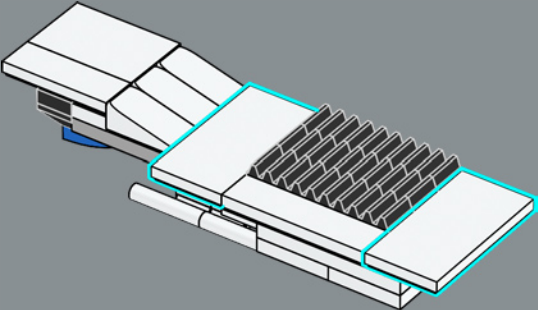
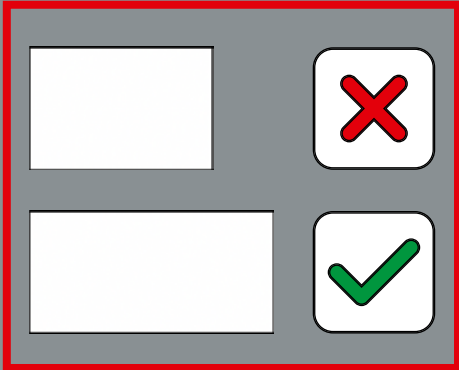

381

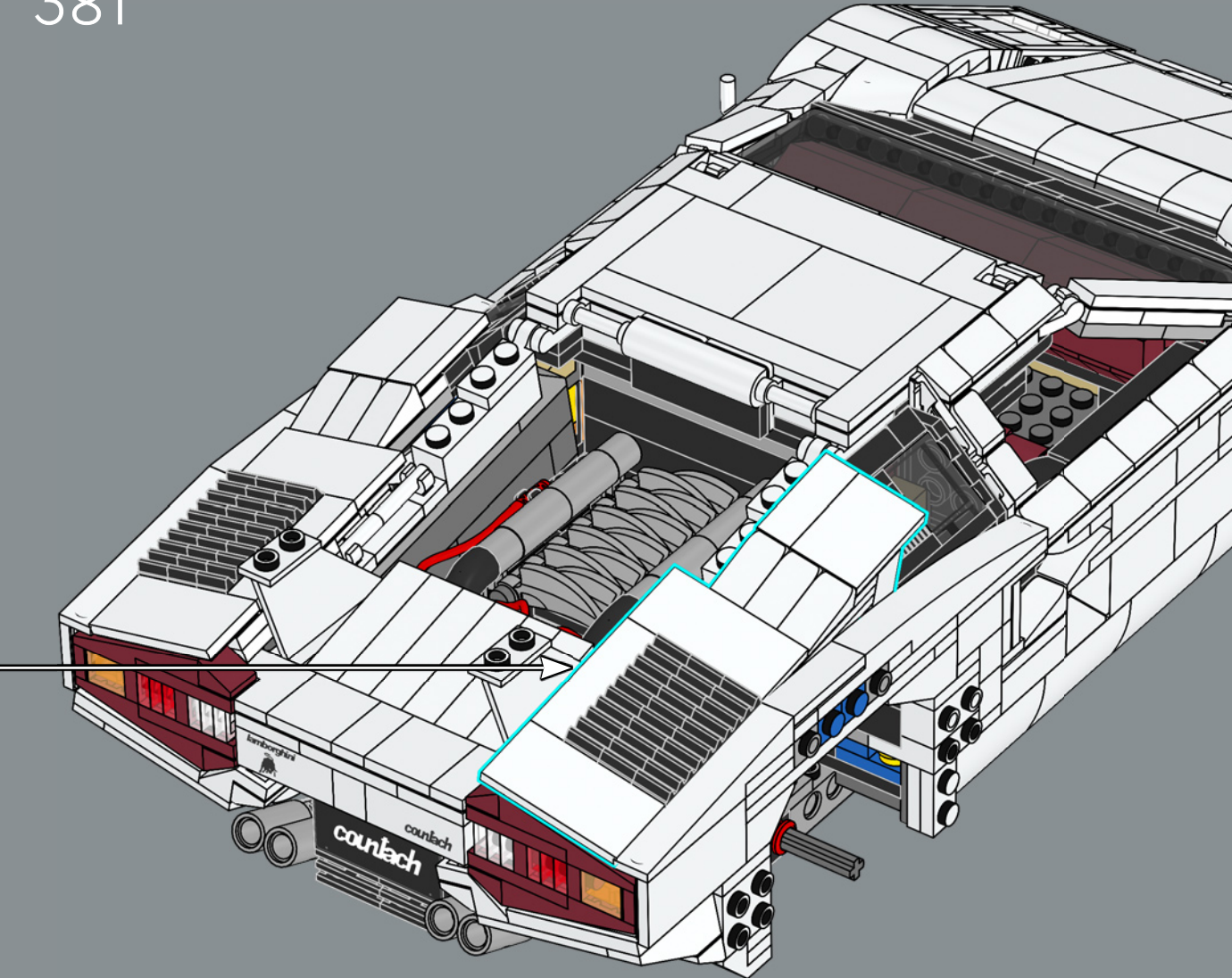

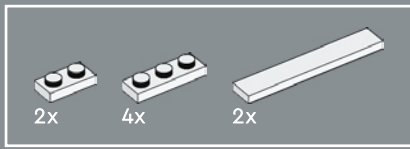

382

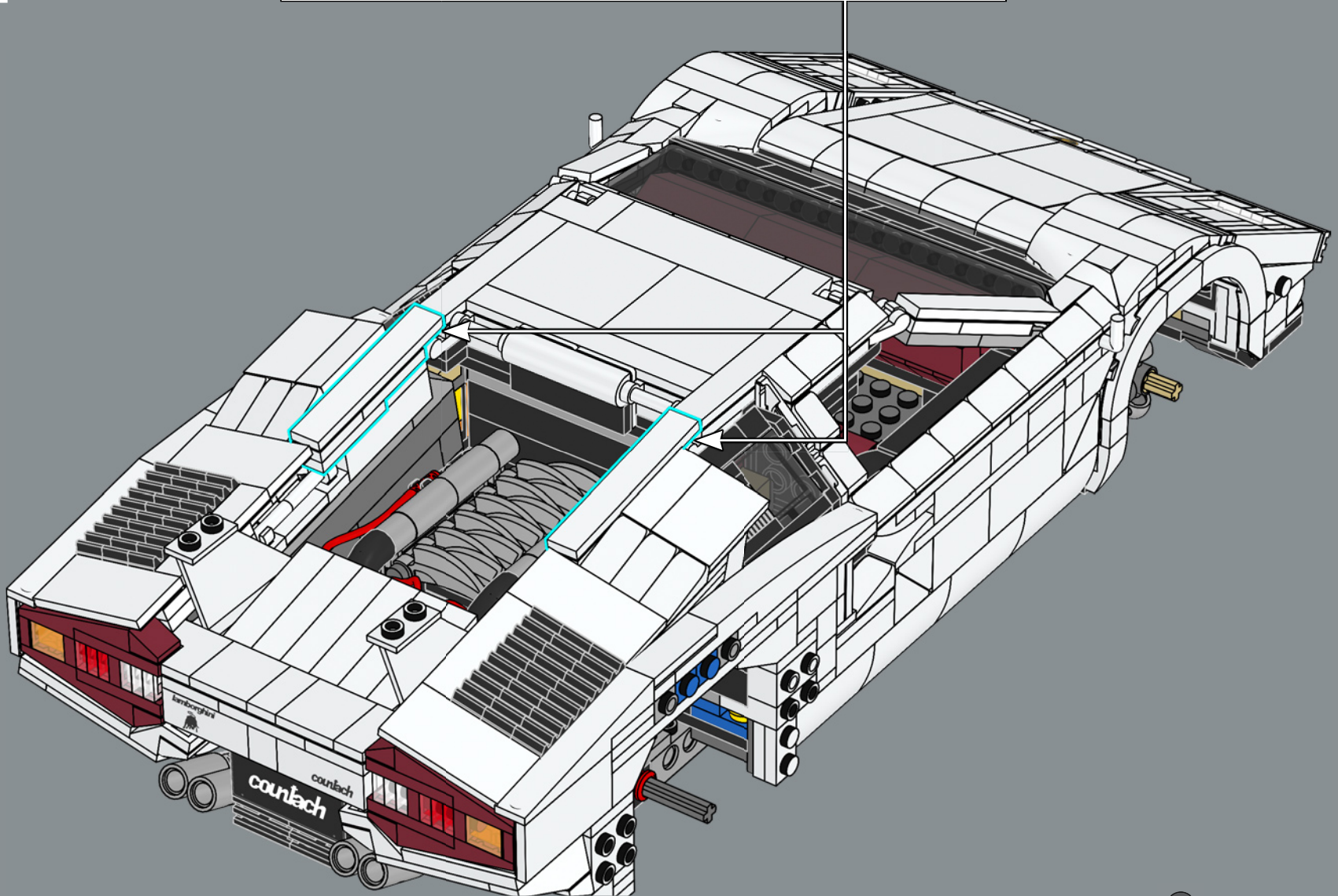
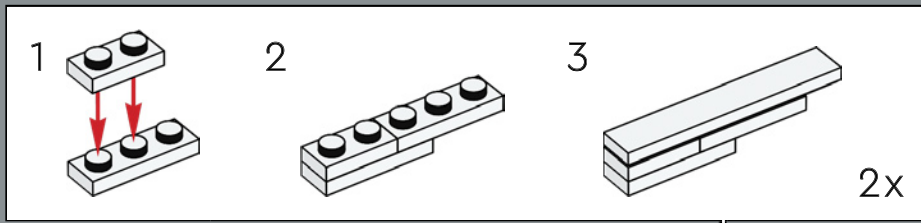

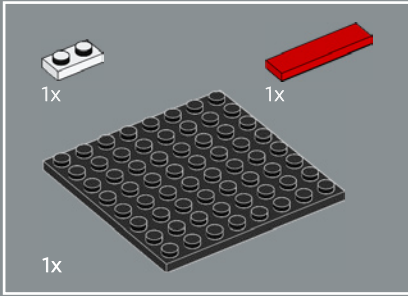
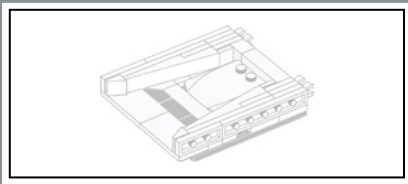

383

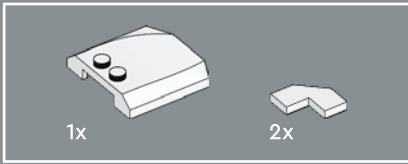
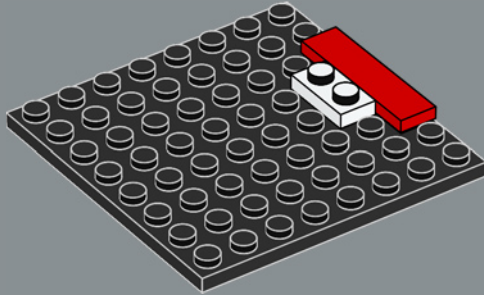

384

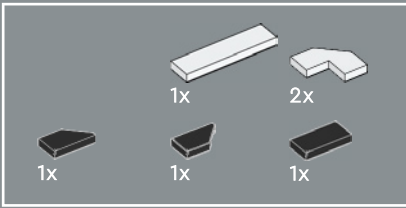
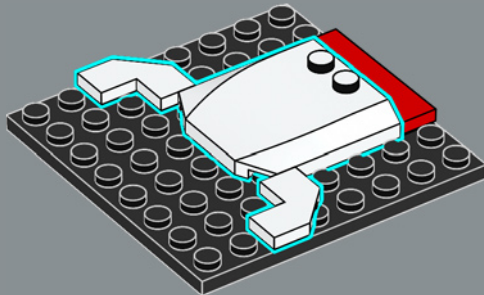

385

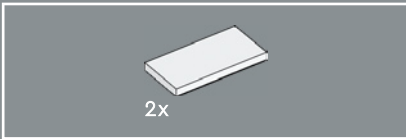
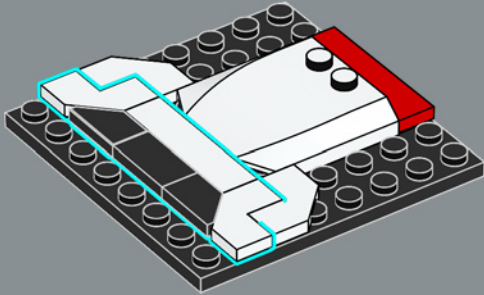

386

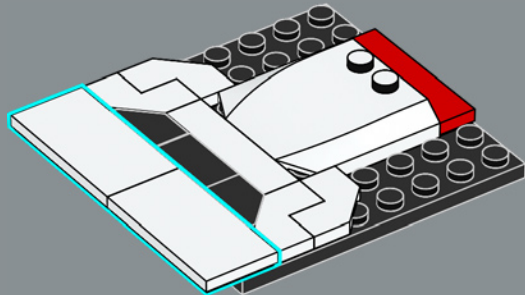

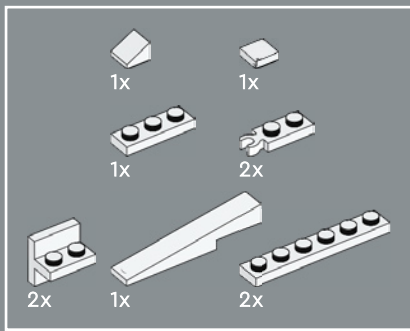

387

1

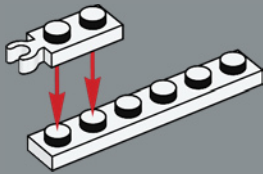

2

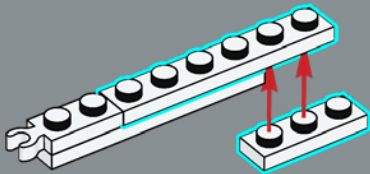

3

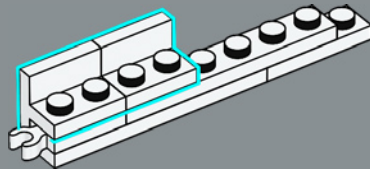

4

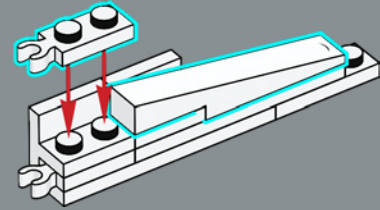

5

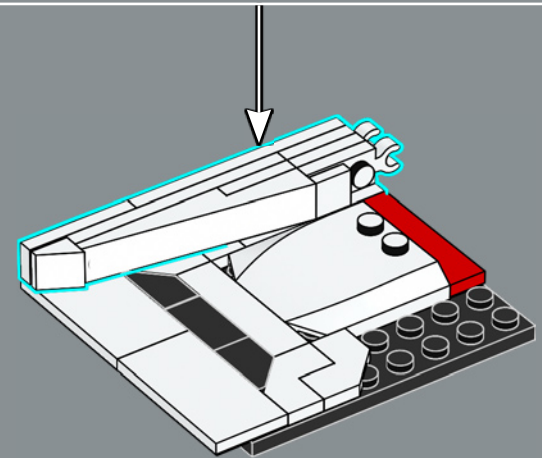
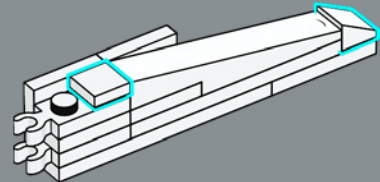

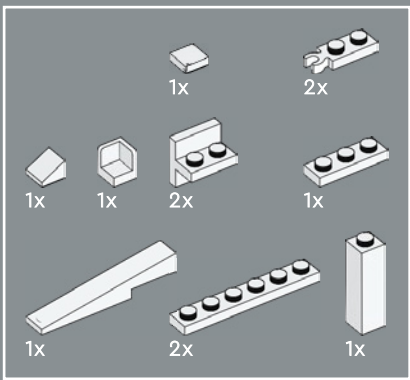

388

1

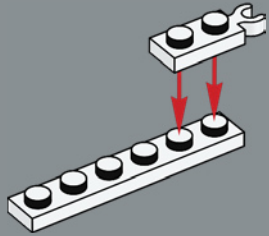

2

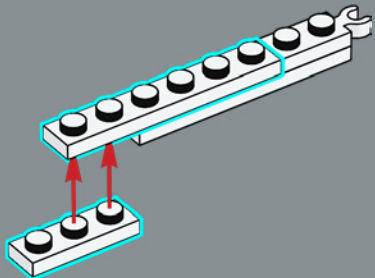

3

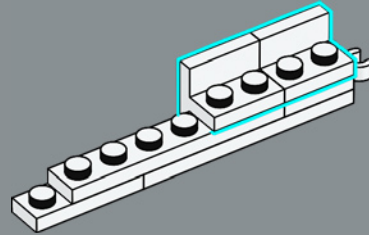

4

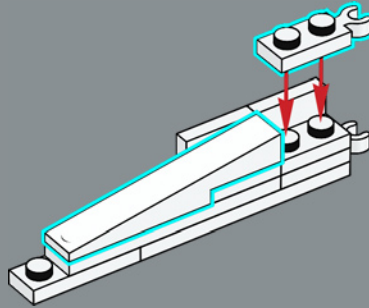

5

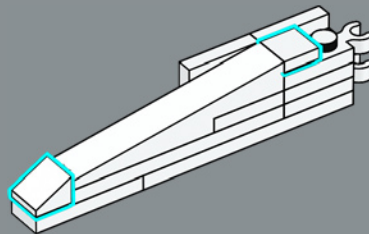

6

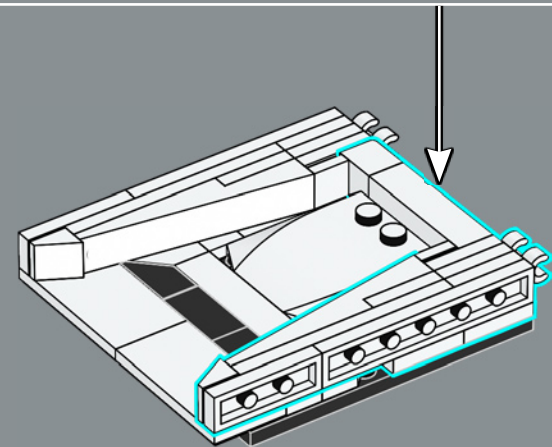
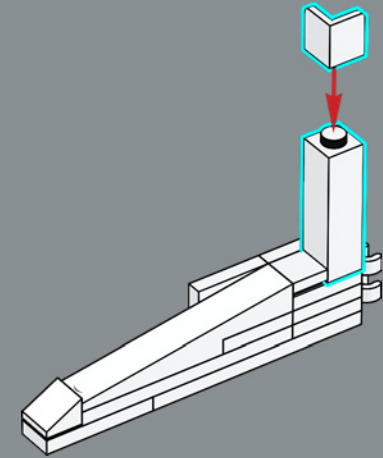

389

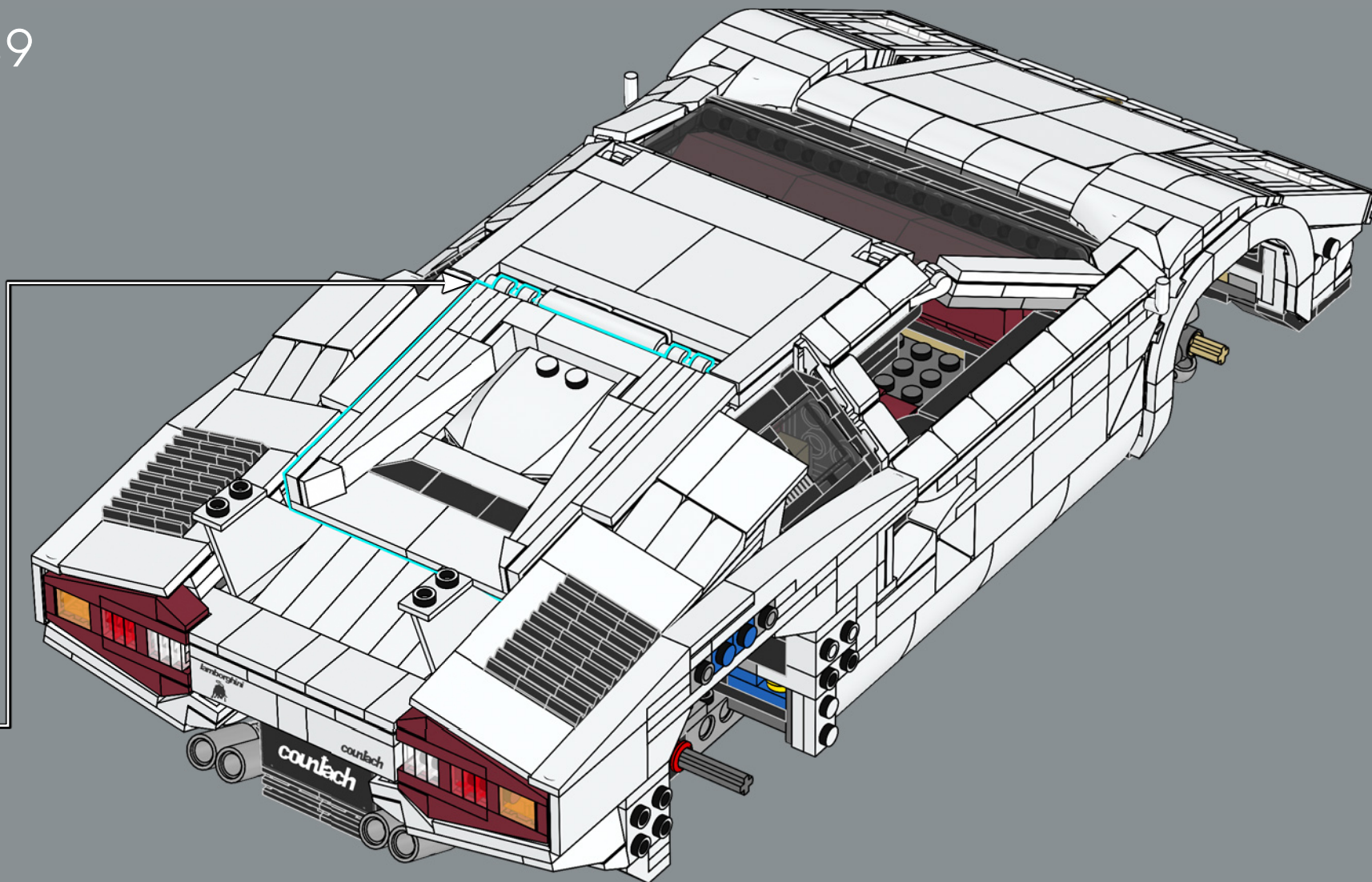

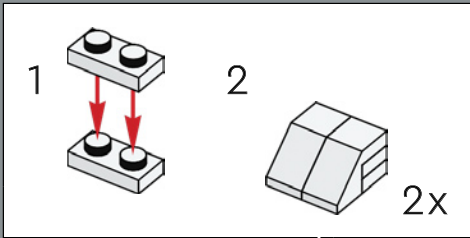
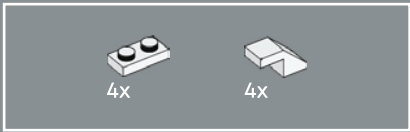

390

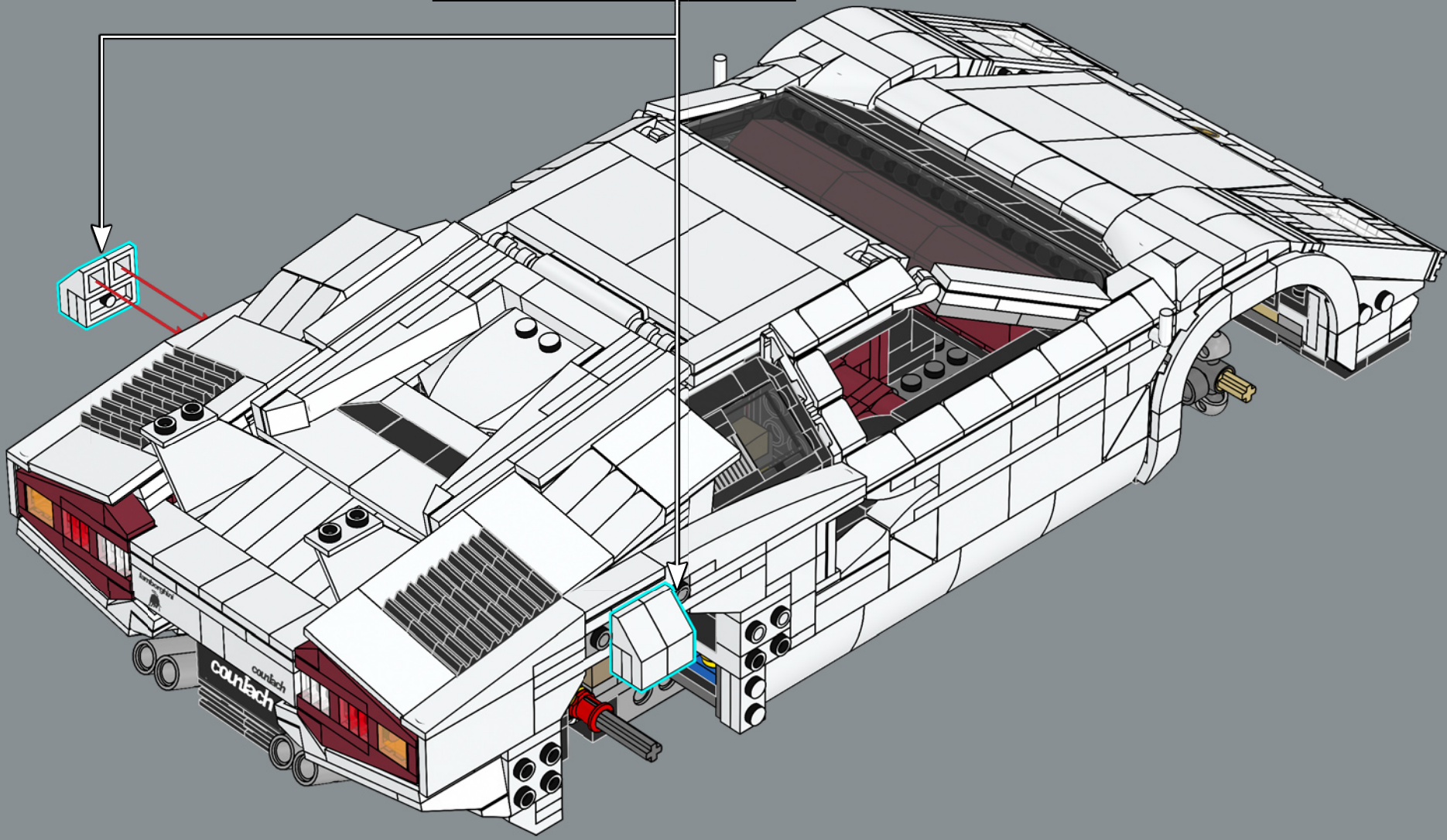



Mithilfe eines neuen kegelförmigen
LEGO® Elements lässt sich der
charakteristische Flügel nachbauen.

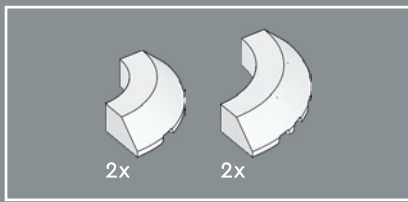

391

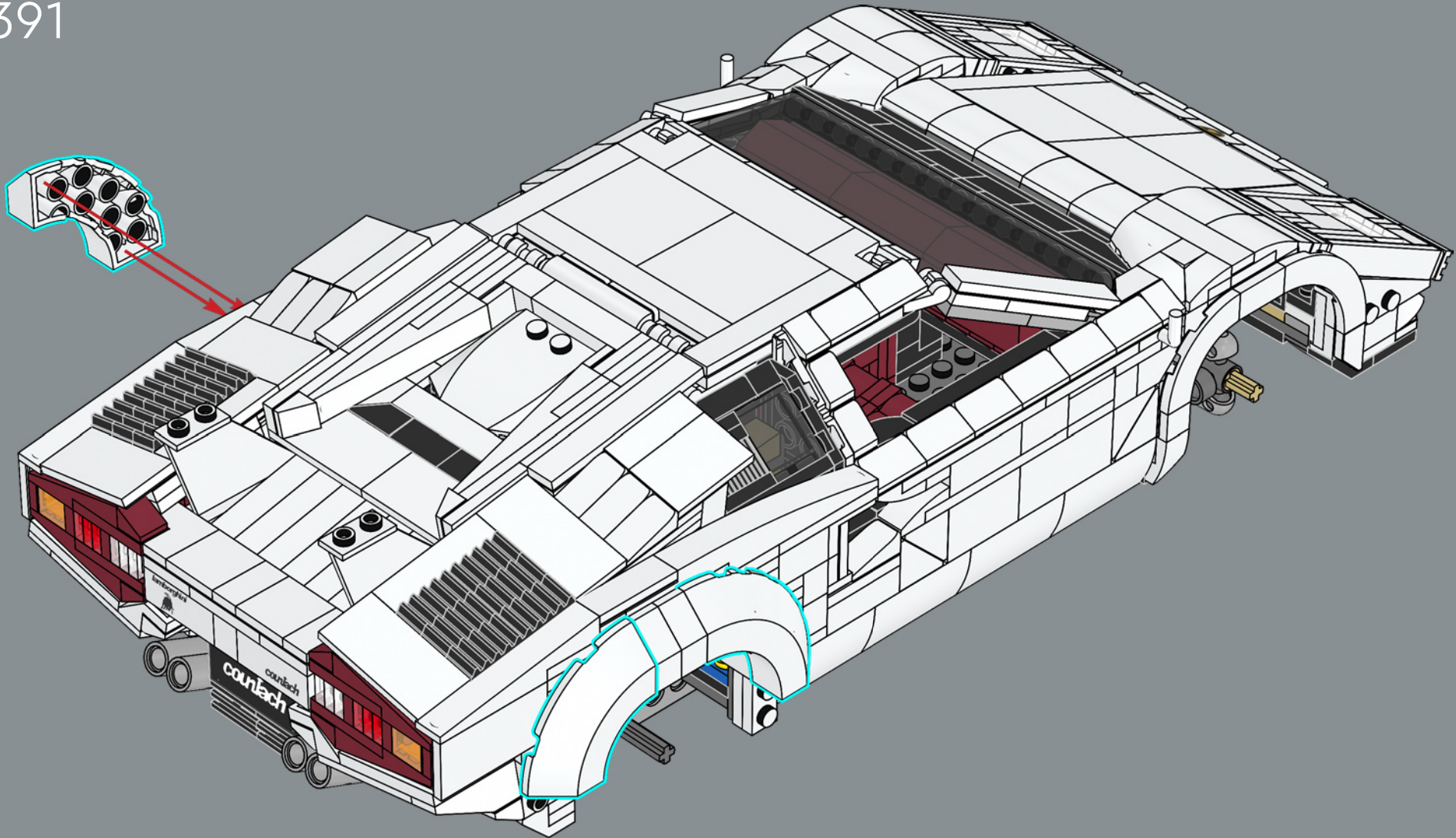



392

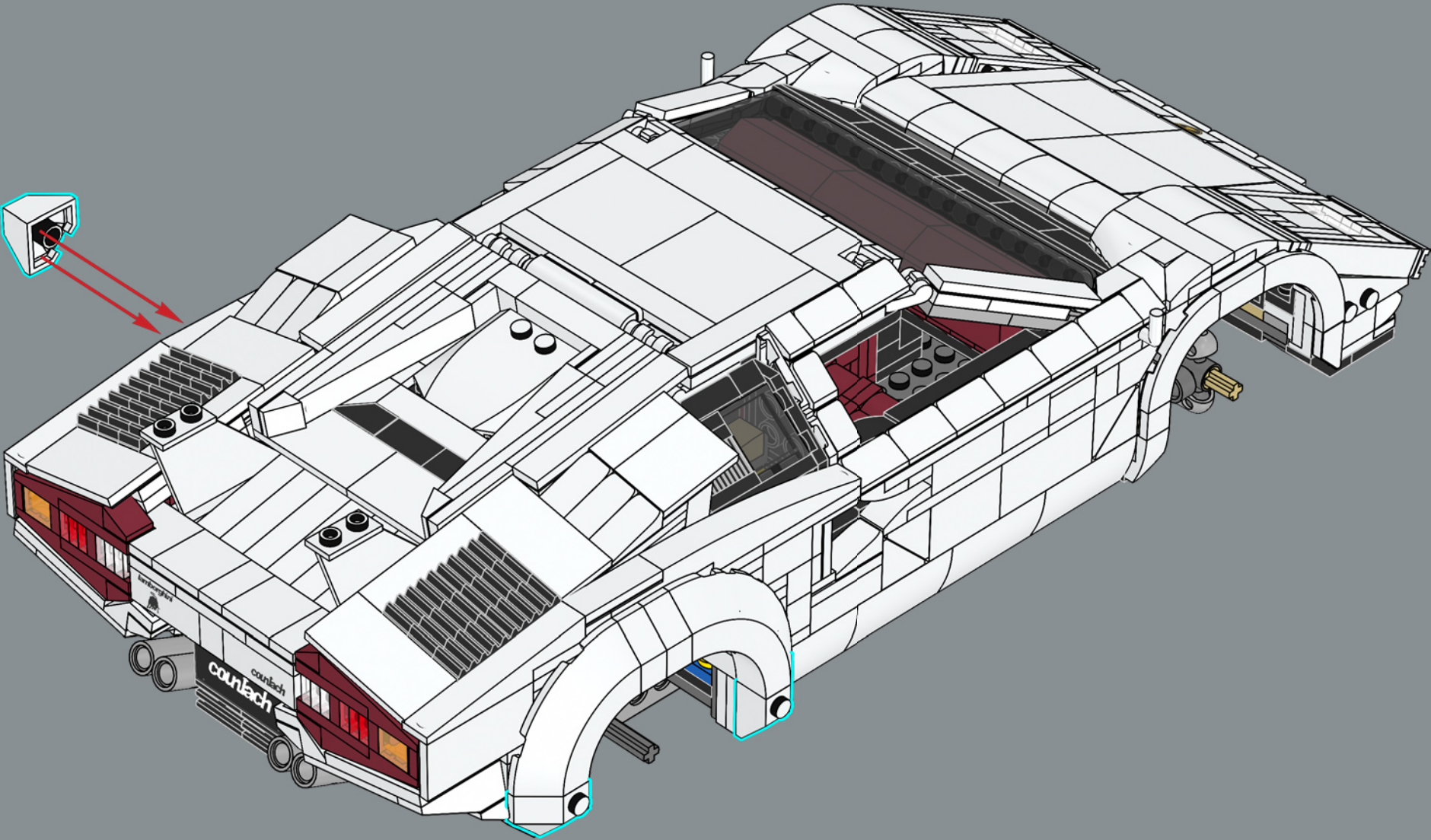

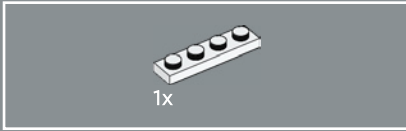
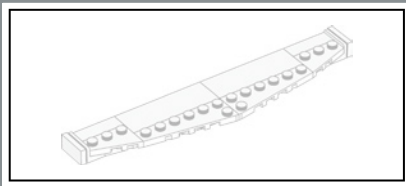

393

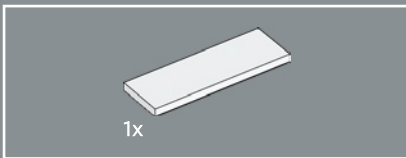

394

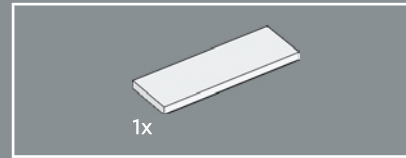
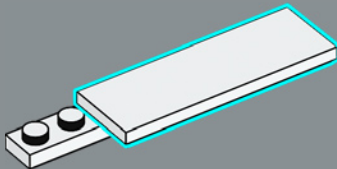

395

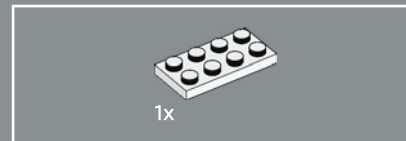
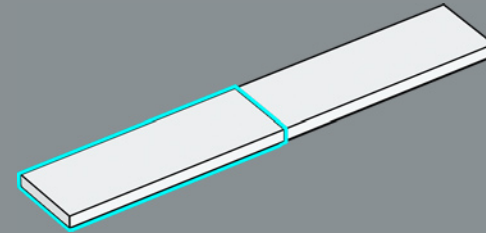

396

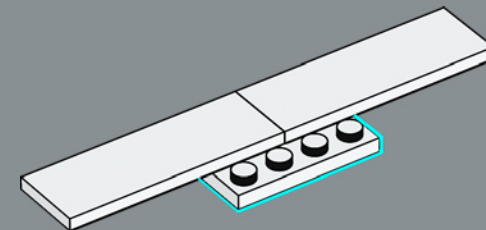

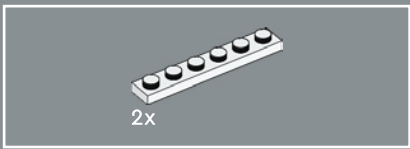

397

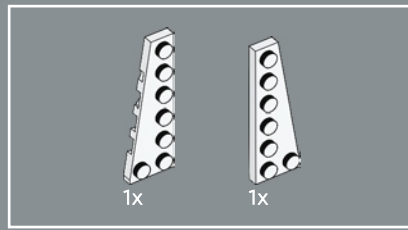
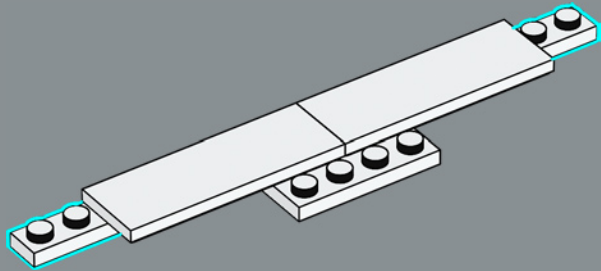

398

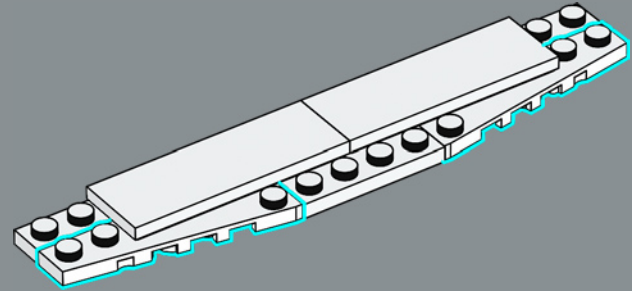

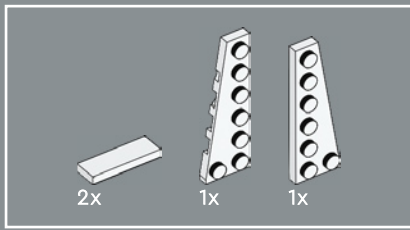

399

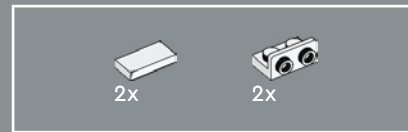
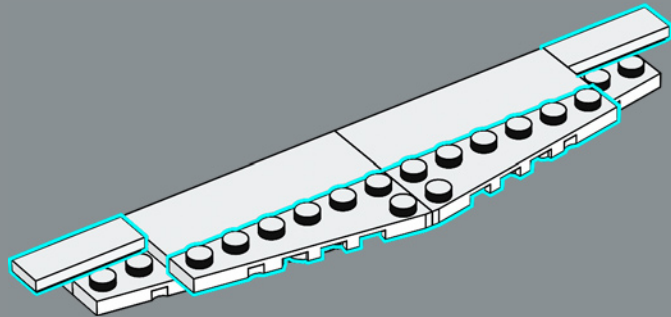

400

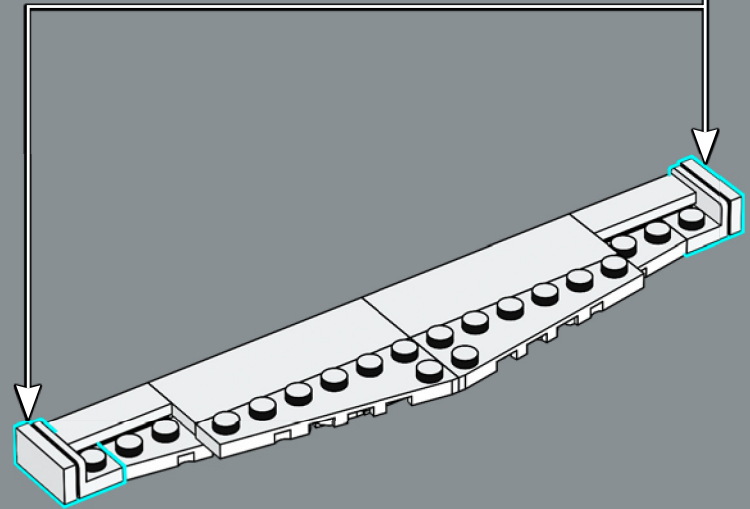
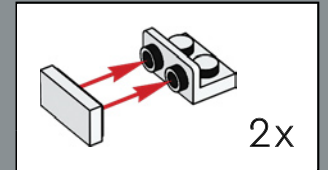

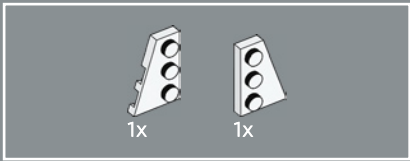

401

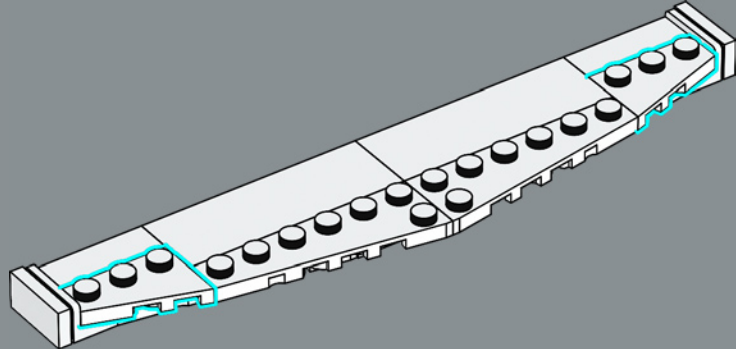

402

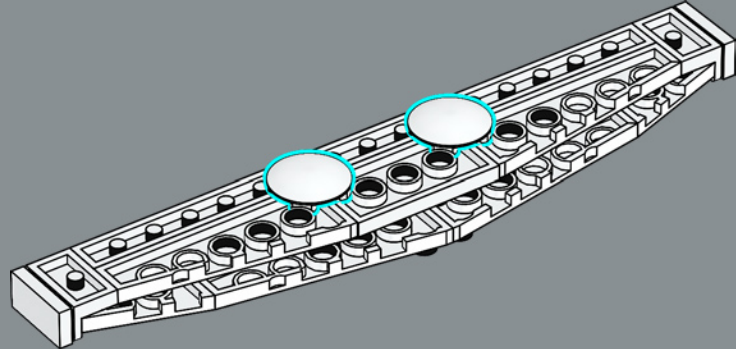

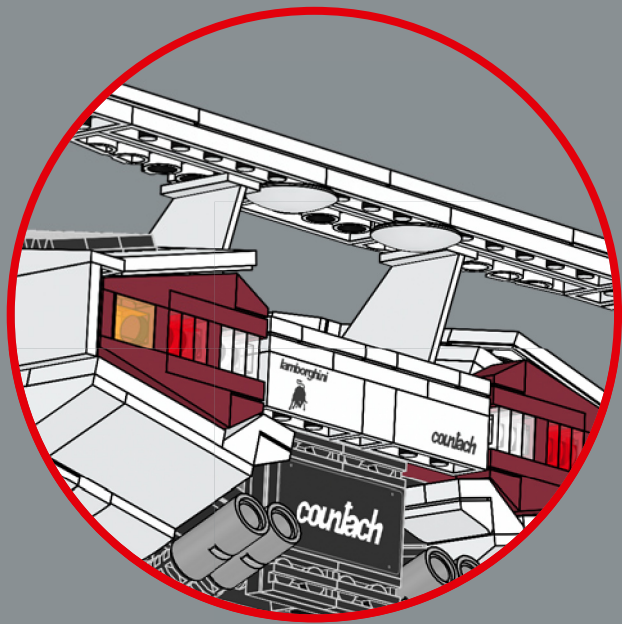

403

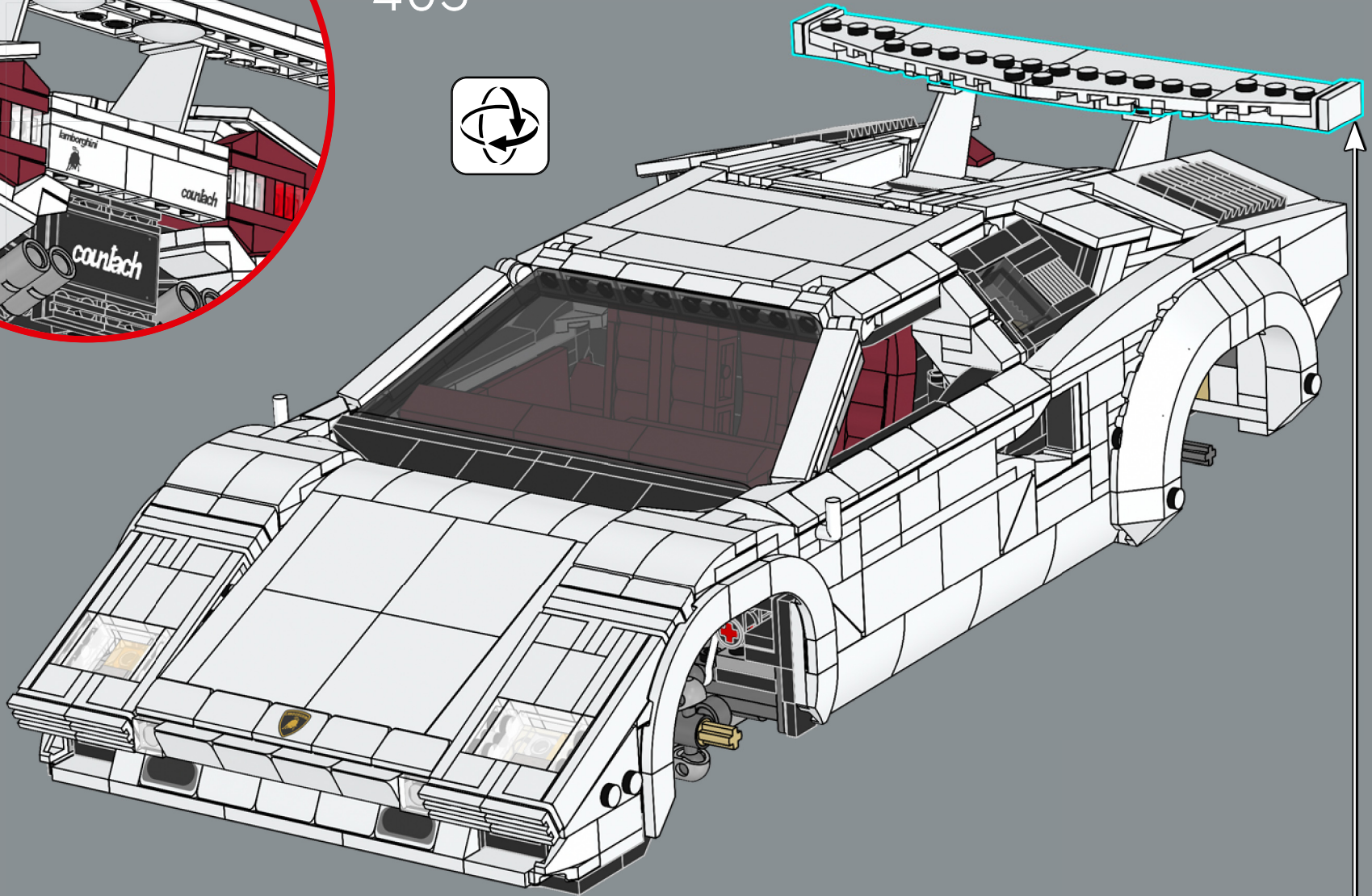

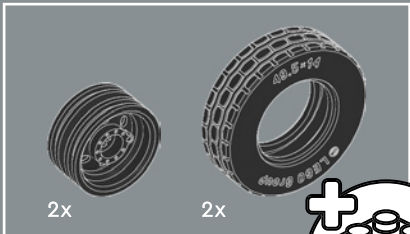

404

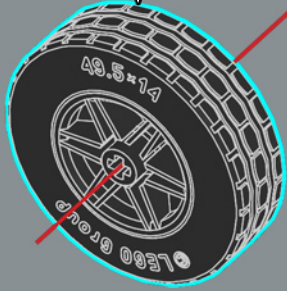
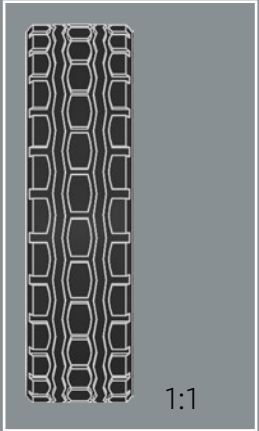
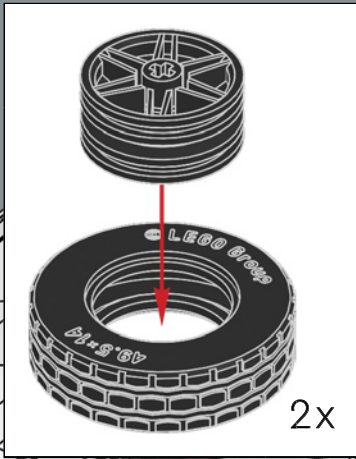
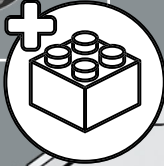

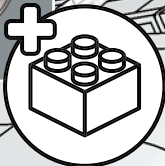
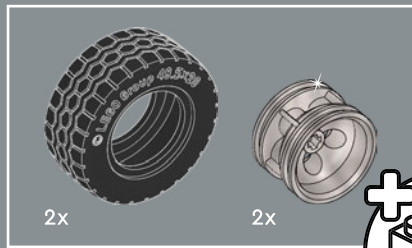

405

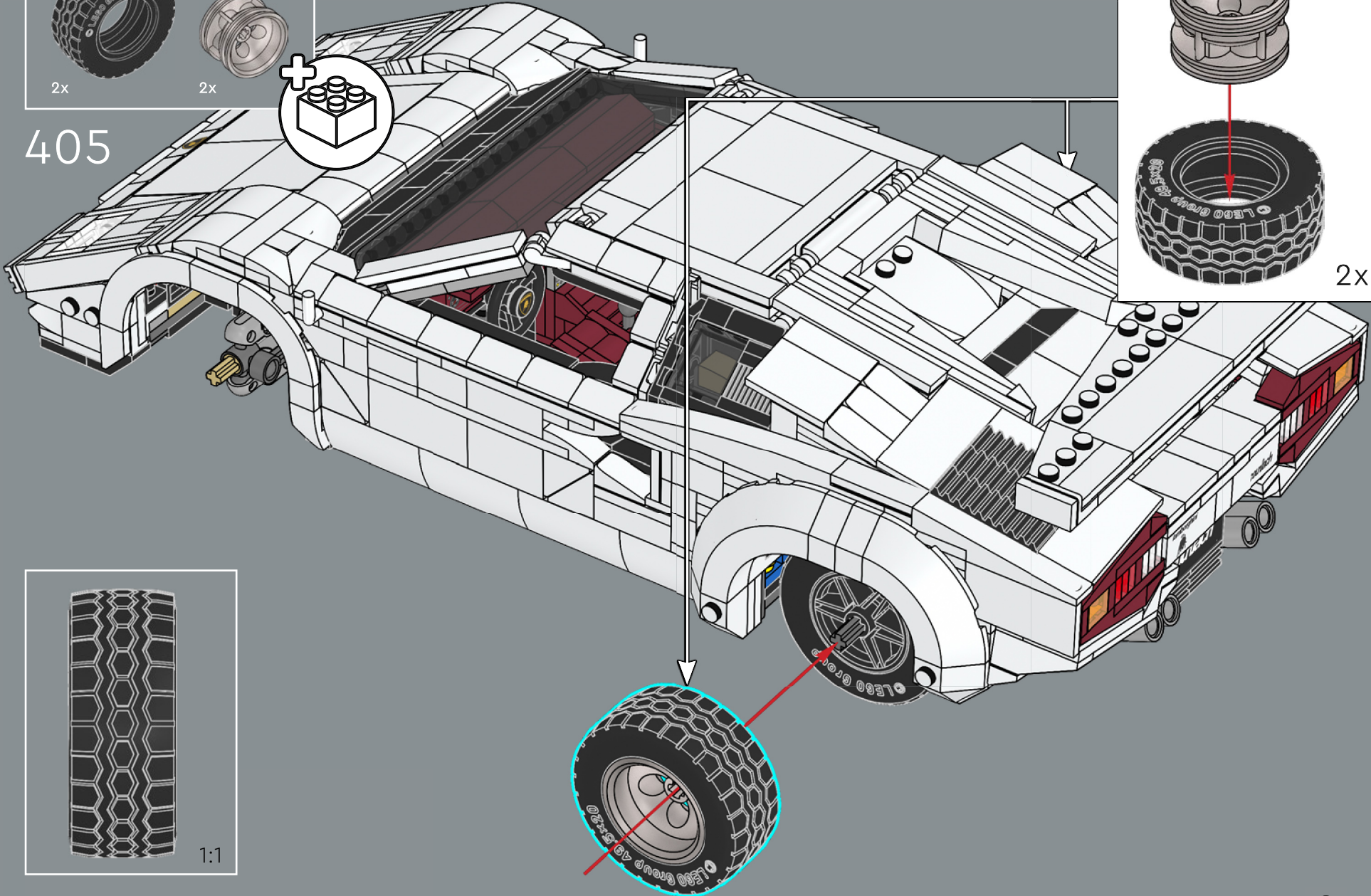
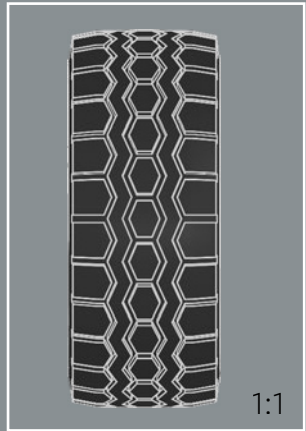
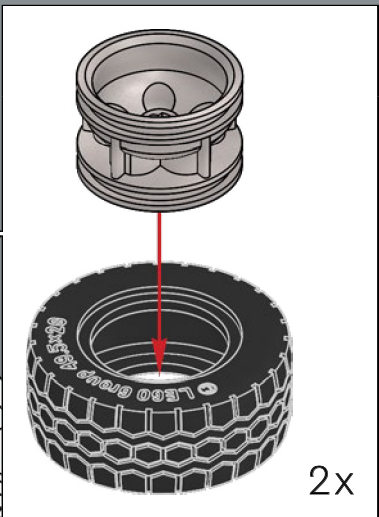



Eine neue Felge nimmt die Lenkung auf und verleiht den Hinterrädern die typische Deep-Dish-Optik.



2x



2x

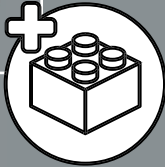

406

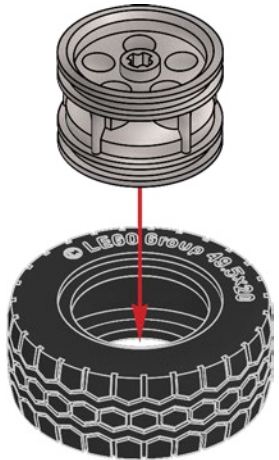

2x

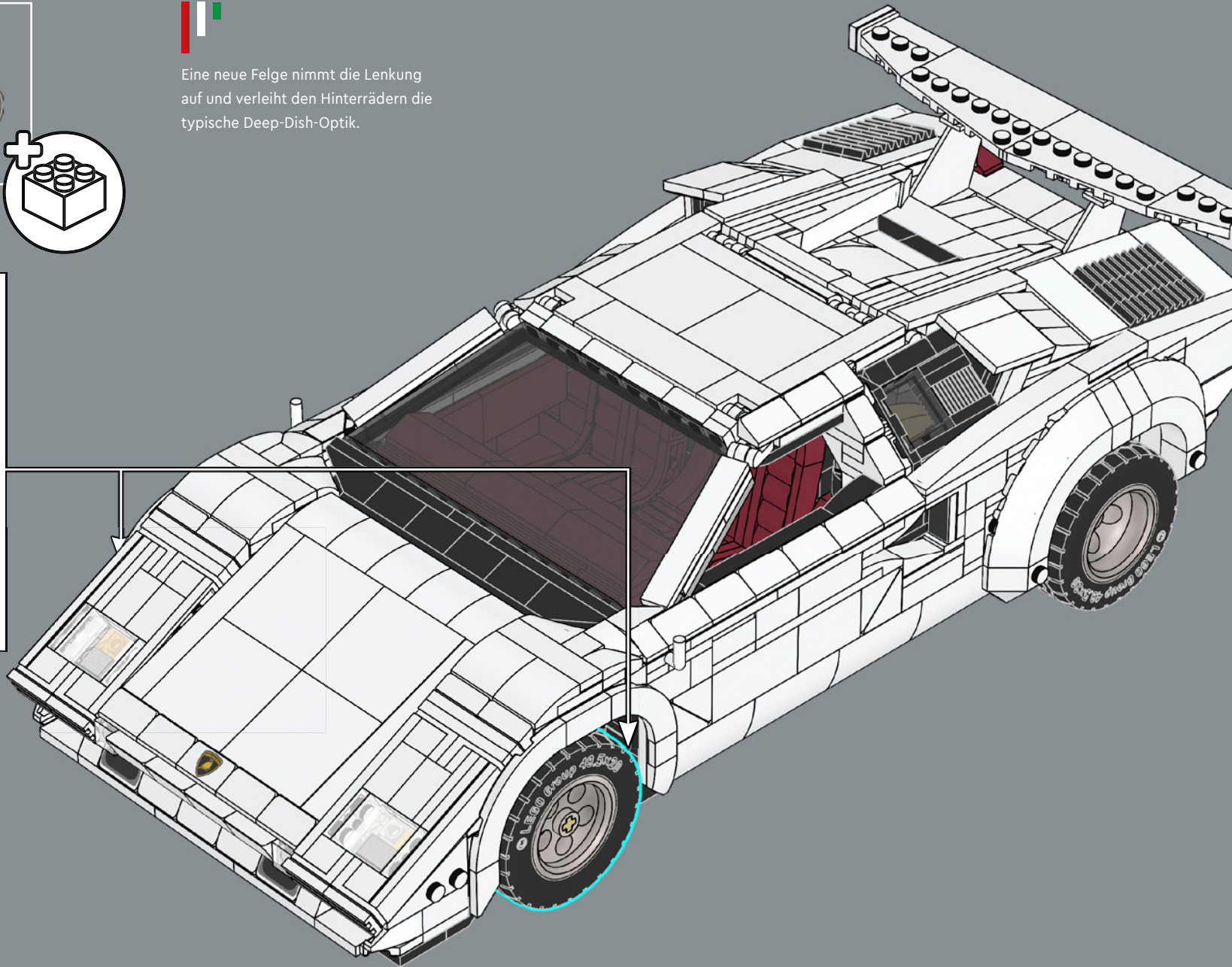

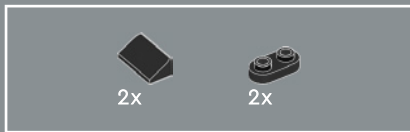

407

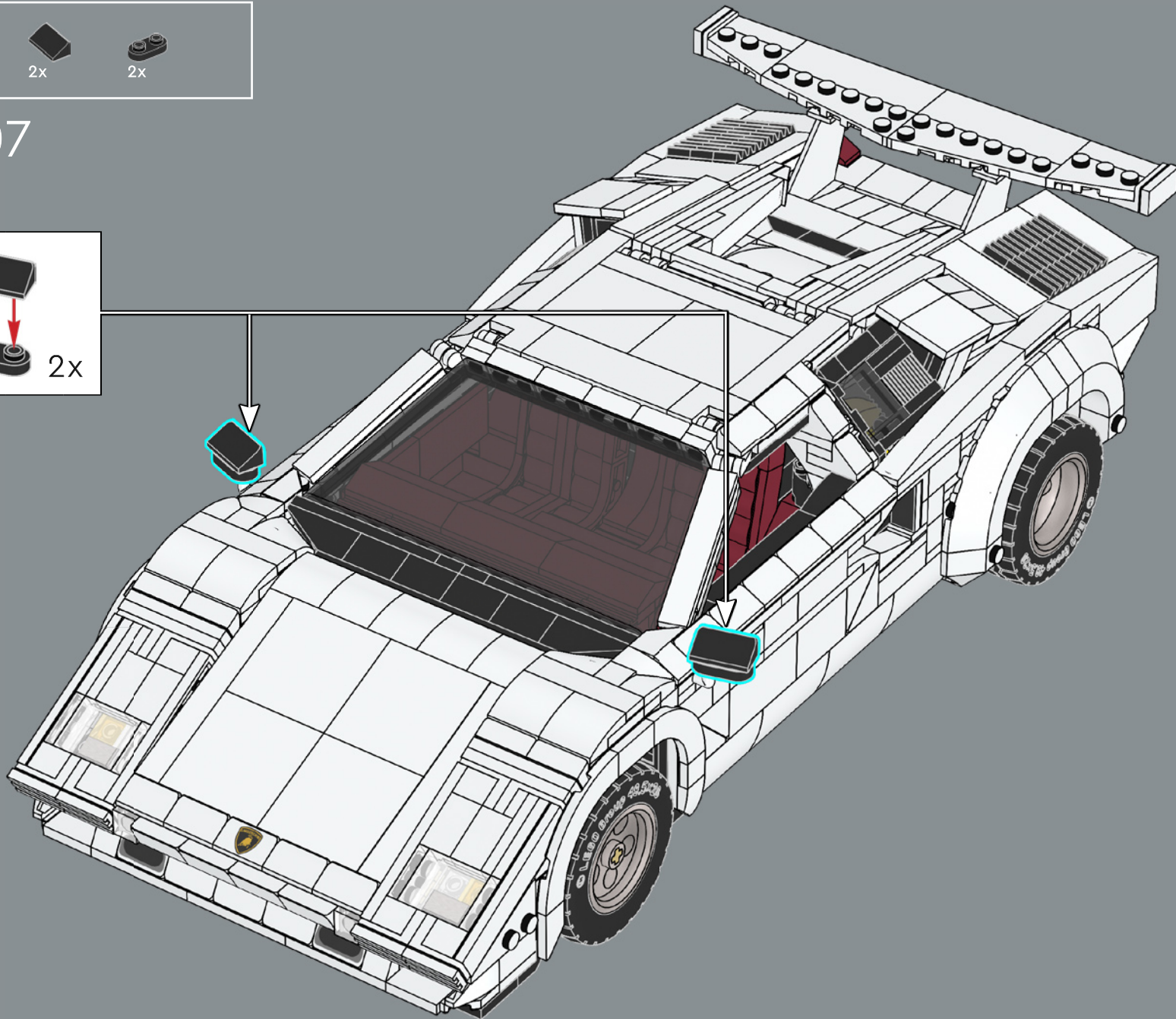
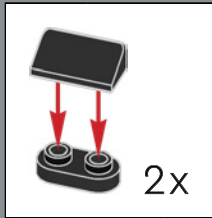

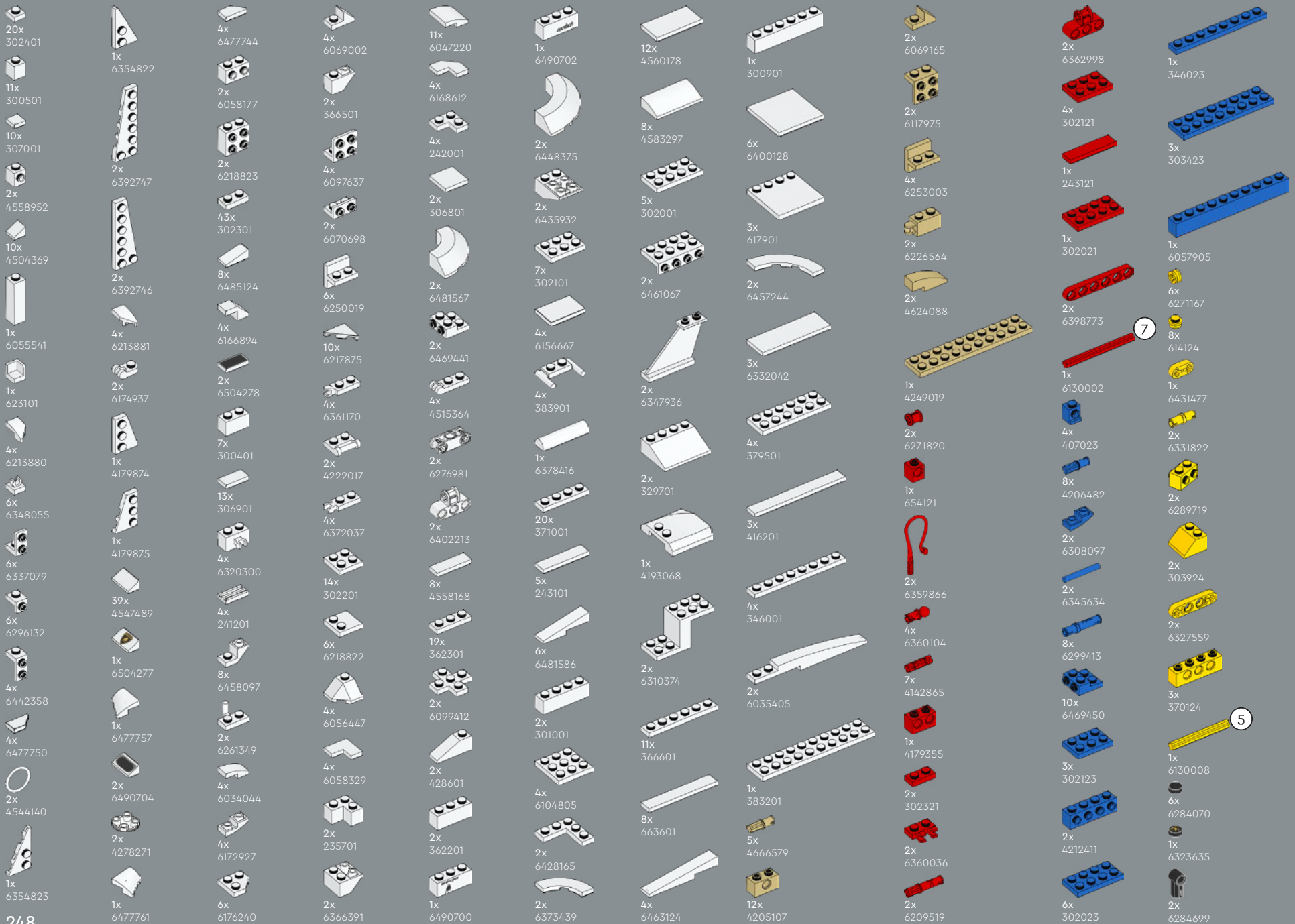



6x
64448793

2x
6284071

2x
6308012

2x
4211525

2x
4278273

8x
6173127

18x
4211398

2x
4211388

2x
6326078

1x
6329662

2x
4593679

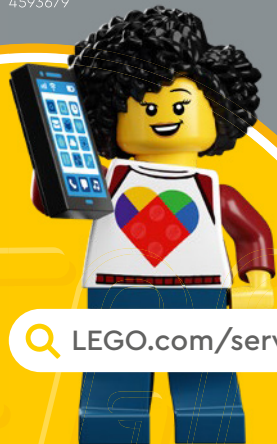

LEGO.com/service

2x
4211469

2x
6093859

2x
6301870

4x
4244627

12x
6359723

4x
6326478

3x
4211397

2x
4211353

2x
4211815

2x
4211881

3

2x
6043639

6x
6438836

4x
4211429

8x
4211396

4x
4211445

4x
6247352

1x
4211395

2x
4211549

1x
4211452

2x
4211425

1x
4211404

1x
4211406

5x
4251149

1x
4211462

4x
6421513

2x
4211360

1x
6335319

2x
6240550

2x
6254252

1x
4490599

8x
6287672

2x
6343854

4x
6481570

2x
6217492

2x
6469858

2x
4210633

2x
6395635

2x
4211044

2x
4211098

6x
6225494

1x
6221607

4x
6261374

2x
6349479

2x
6168776

2x
6435267

5x
6117972

2x
6359227

6x
6146321

2x
6123814

2x
4218696

4x
6047417

3x
6364352

2x
6015356

4x
4652259

4x
4211068

2x
4211104

8x
6118832

1x
6083620

2x
4211103

4x
4210686

2x
4629920

4

2x
4508553

1x
4211002

2x
4211107

1x
4211061

4x
4210794

2x
4210783

1x
4210796

1x
6490496



YOU COULD WIN



YOU COULD WIN

Your feedback will help shape the future development of this product series.

Visit:

DU KÖNNTEST GEWINNEN

Dein Feedback trägt zur Weiterentwicklung dieser Produktreihe bei.

Geh auf:

VOUS POURRIEZ GAGNER

Vos commentaires nous aideront à concevoir les futurs produits de cette gamme.

Visitez :

POTRESTI VINCERE TU

La tua opinione ci aiuterà a migliorare la creazione futura di questa linea di prodotti.

Visita:

PUEDES GANAR

Tu opinión contribuirá al futuro de esta serie de productos.

Visita:

轻松获奖

您的反馈将有助于我们在今后改进本产品系列。

请访问:

[LEGO.com/productfeedback](https://www.lego.com/productfeedback)

You also have the chance to win a LEGO® set.

Terms and conditions apply.*

Außerdem hast du die Chance, ein LEGO® Set zu gewinnen.

Es gelten die Teilnahmebedingungen.*

Vous pourriez également gagner un ensemble LEGO®.

Des conditions s'appliquent.*

Hai anche la possibilità di vincere un set LEGO®.

Termini e condizioni sono applicabili.*

También tienes la oportunidad de ganar un set LEGO®.

Aplican términos y condiciones.*

您还有机会赢取乐高®套装。

条款和条件适用。*

*[LEGO.com/productfeedback-terms](https://www.lego.com/productfeedback-terms)



LEGO and the LEGO logo are trademarks of the LEGO Group. ©2024 The LEGO Group.
The "Lamborghini" and "Lamborghini Bull and Shield" trademarks, copyrights, designs and models are used under license from Automobili Lamborghini S.p.A, Italy.