



10335





LEGO.com/sustainable-packaging



FR
DONNEZ
OU
RECYCLEZ



OU



OU



ASSOCIATION MAGASIN DÉCHÈTERIE

Adresses sur quefairedemesdechets.fr



BUILDER



Apple and the Apple logo are trademarks of Apple Inc., registered in the U.S. and other countries and regions. App Store is a service mark of Apple Inc. Google Play and the Google Play logo are trademarks of Google LLC. Tencent and the Tencent logo are trademarks of Tencent Inc.

LEGO.com/devicecheck



LEGO® Builder



坚忍号探险船被重新发现

2022年，在欧内斯特·沙克尔顿逝世一百年之后，他最具传奇色彩的探险船坚忍号的残骸在南极洲海岸附近的威德尔海底被重新发现。这艘豪华帆船于1912年首次下水，为了使它能够承受最恶劣的环境，对其进行了整修。在沙克尔顿1914年的帝国跨南极探险中，它保护船员免受恶劣天气的影响。由于坚忍号在到达岸边之前被极地冰层围困，穿越南极洲的大胆任务最后以失败而告终。然而，它的船员奇迹般生还的事件已成为上个世纪体现人类韧性、智谋和友情的最激励人心的故事之一。虽然坚忍号将留在它最后的安息之地，但这艘保存完好的沉船被重新发现让这个令人难以置信的故事再次浮出水面。玩乐这款细致入微的乐高® Icons 模型，体验拼搭的乐趣，颂扬这个史诗般的生存故事。



《南极条约》

1959年12月1日, 12个国家签署了《南极条约》, 将南极洲作为独立的科学研究中心加以保护。根据该条约, 由于没有土著居民拥有主权, 任何国家都没有法定权力声明所有权, 或者试图回收坚忍号。

经久耐用

/// 这艘三桅帆船配备三胀式蒸汽机, 以在狂风和寒冷冰层中航行。

/// 橡木、松木和绿心木组合使船体足够坚固, 能够承受最极端的条件。

/// 在2022年发现这艘沉船时, 金色船名 *Endurance* (坚忍号) 和金色星星仍然完好无损。



不落下任何一个人

1914年12月5日，沙克尔顿和他的船员从南乔治亚岛的古利德维肯起航，执行为期一年的任务：到达南极。到1915年2月下旬，坚忍号被威德尔海周围漂浮和移动的海冰无情地围困了起来。船员们没有被吓倒，一直留在船上，直到1915年10月27日，探险船的裂缝已可能导致船沉没。它一直漂浮在水面上，直到11月21日最终沉没。

这28名男子使用保存完好的救生艇在冰面上建造“耐心营地”，直到1916年4月，他们乘坐救生艇前往象岛。每个船员可以携带两磅重的个人物品，还有一把班卓琴，沙克尔顿宣称这是重要的精神良药！沙克尔顿和他的几名队员从象岛出发，完成最后为期两周的返回南乔治亚岛的航程，然而他们在一场可怕的风暴中到达了该岛“错误”一端的斯特罗姆内斯捕鲸站。经过一天半的跨岛行进之后，疲惫不堪的探险队返回了古利德维肯。在那里，沙克尔顿花了将近四个半月的时间，进行了多次尝试，最终从象岛救出了他的最后一批队员。

历史将坚忍号船员的奇迹生还归功于欧内斯特·沙克尔顿爵士的非凡领导，高度评价了他自我牺牲的英雄行为和鼓舞人心的乐观主义精神。从让出手套和命令队员睡觉以保持体力，到不顾一切地让每个人都活着回家，他的船员们对他的信任似乎是值得的。



“坚忍制胜”

— 沙克尔顿家族箴言



象岛

1916年4月15日，沙克尔顿和他的船员
耗时497天首次抵达象岛，最后一批船员于
1916年8月30日获救。



旅程

- 1 1914年12月5日 - 坚忍号探险船从南乔治亚岛的古利德维肯起航。
- 2 1915年1月18日 - 在冰冷的威德尔海航行数周后，坚忍号被困在冰层中。
- 3 1915年11月21日 - 在船体开始破裂的几周后，探险船在南极海岸沉没。
- 4 1916年4月15日 - 部分船员在乘坐其中一艘救生艇离开“耐心营地”，两周后抵达象岛。
- 5 1916年5月21日 - 沙克尔顿和第一批船员抵达南乔治亚岛
- 6 1916年8月30日 - 最后一批船员最终从象岛获救



乐高®设计团队感言

“为了确定模型的规模，我们首先选择了一个重要的细节，即救生艇（采用两种不同的尺寸），并尽可能将它们拼搭得小巧精致。通过这一步，我们计算了船的尺寸。真实的坚忍号可以容纳 28 个人，我们把它缩小了一点，引入了欧内斯特·沙克尔顿爵士和一位探险科学家的舱室。内部还展现了这艘船的蒸汽机，可将其取出。在现实生活中，蒸汽机大约有两层楼的房屋那么大！乐高® Icons 展示模型通常拥有很酷的功能，我们想要一个与舵轮相连且可以工作的船舵。为实现这一功能，我们创造了一个基于角板的微型变速箱，角板此次采用深棕色。这是为使这艘船拥有逼真外观而进行的众多组件颜色更改之一。毕竟，坚忍号是有史以来最坚固的木船之一，值得我们的尊敬！”

Hans Burkhard Schlömer
乐高®模型设计师



“毕竟，坚忍号是有史以来最坚固的木船之一，值得我们的尊敬！”



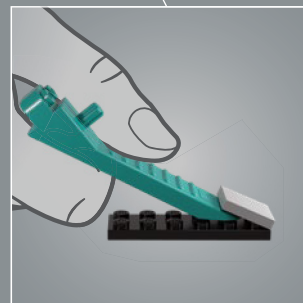
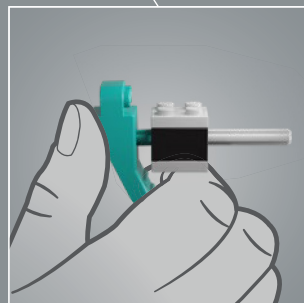
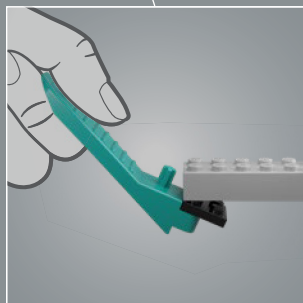
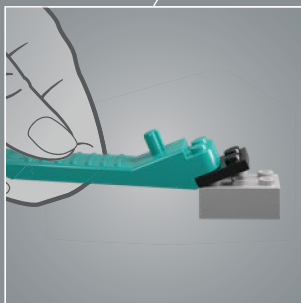
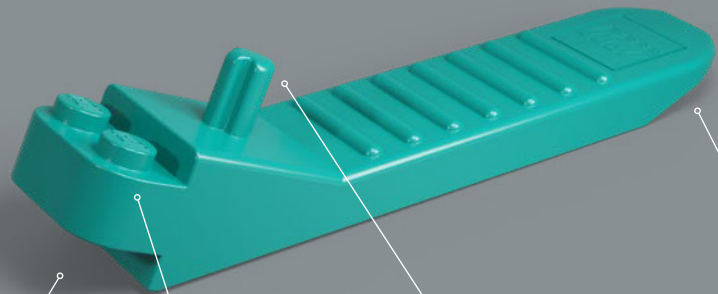

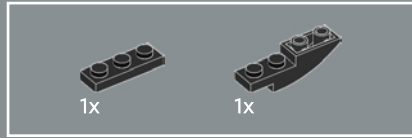

1

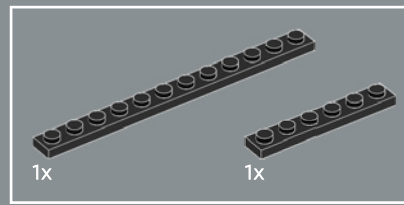
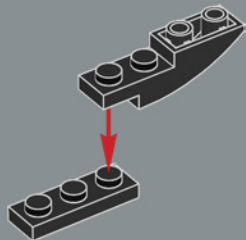

2

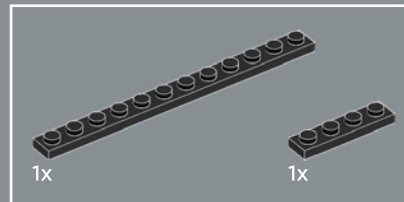
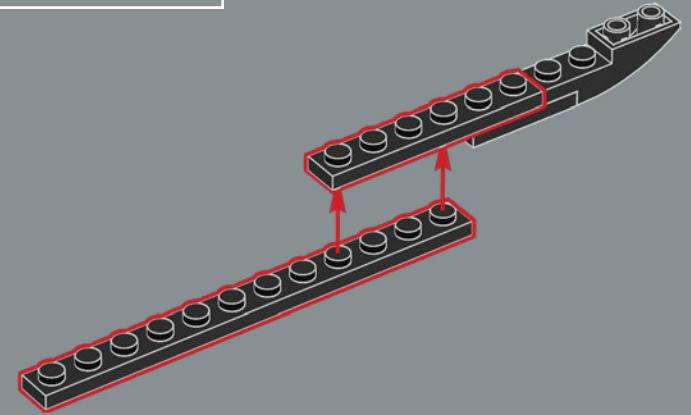

3

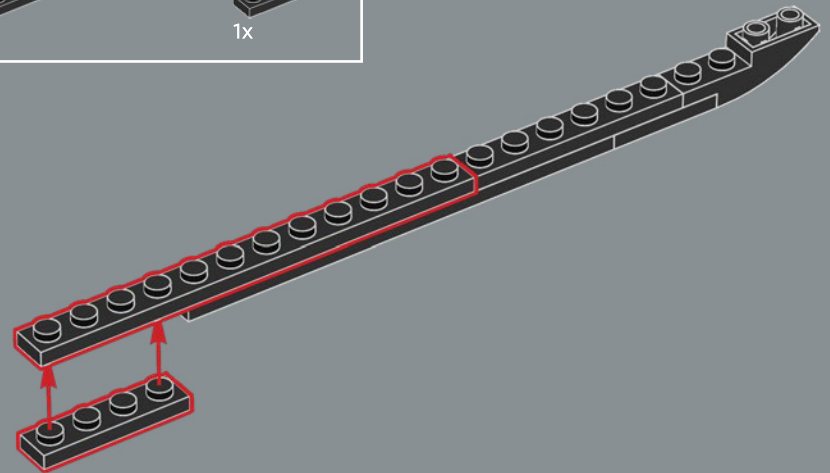

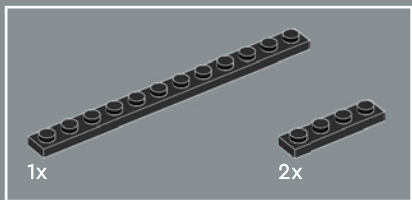

4

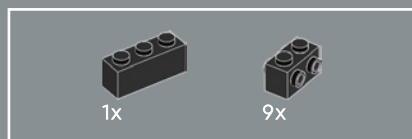
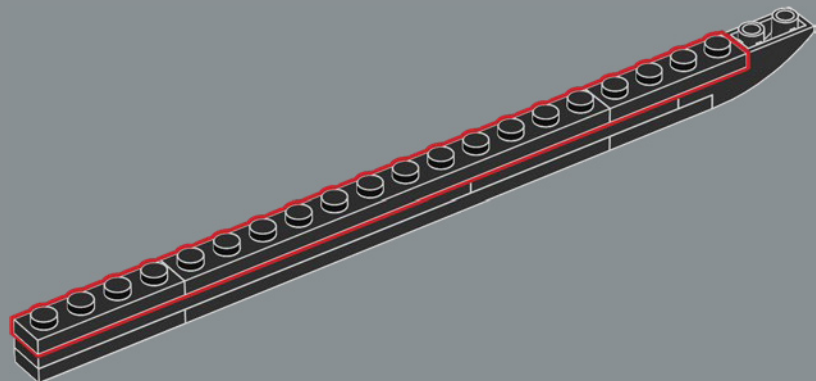

5

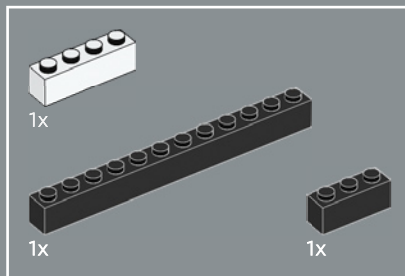
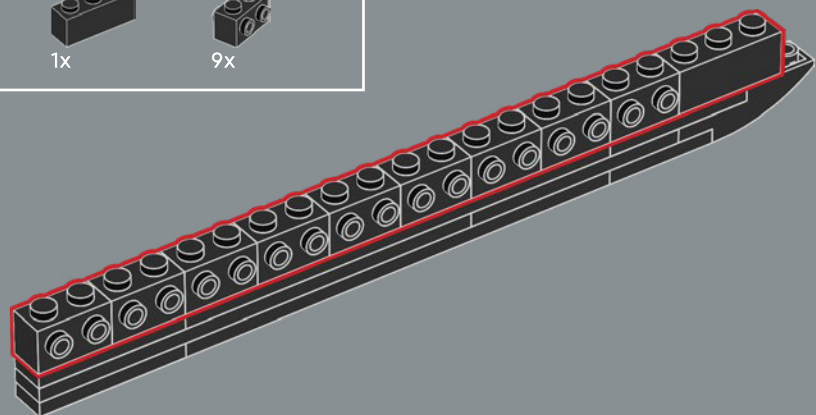

6

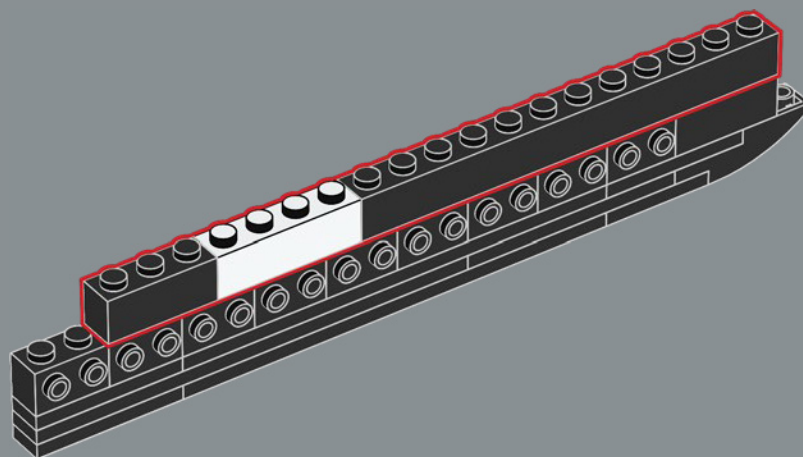

龙骨只有一块积木宽，以保持这艘船流畅的外观，它在前部构成一面墙，凸粒朝向侧面。
这种技术可为船体带来漂亮的外形。



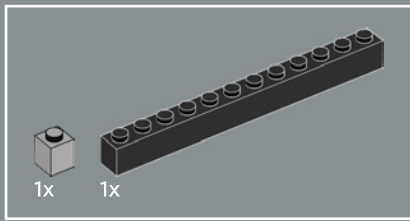

7

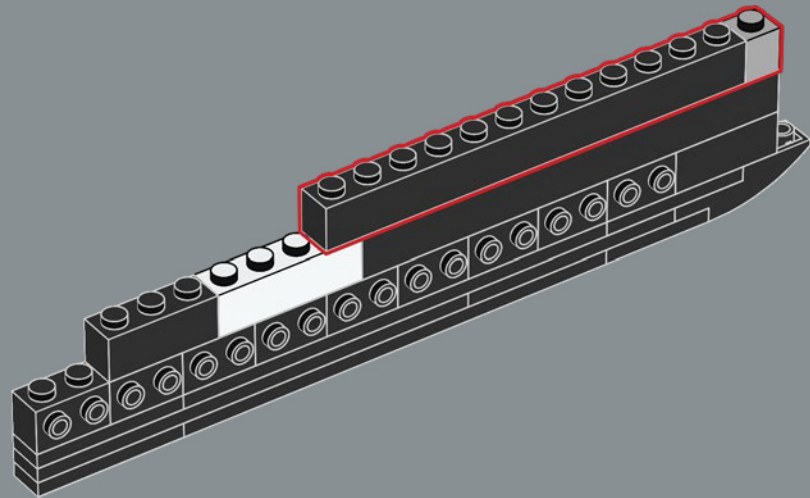

8

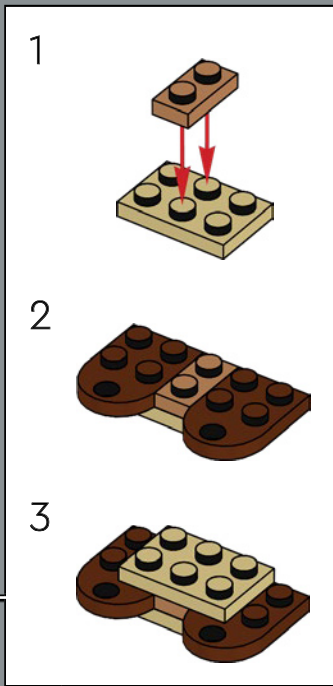
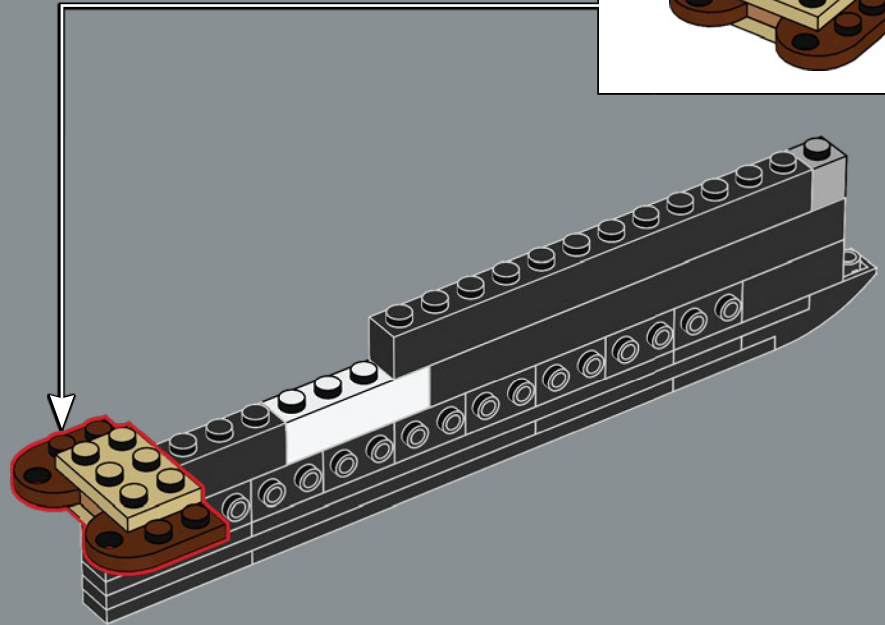

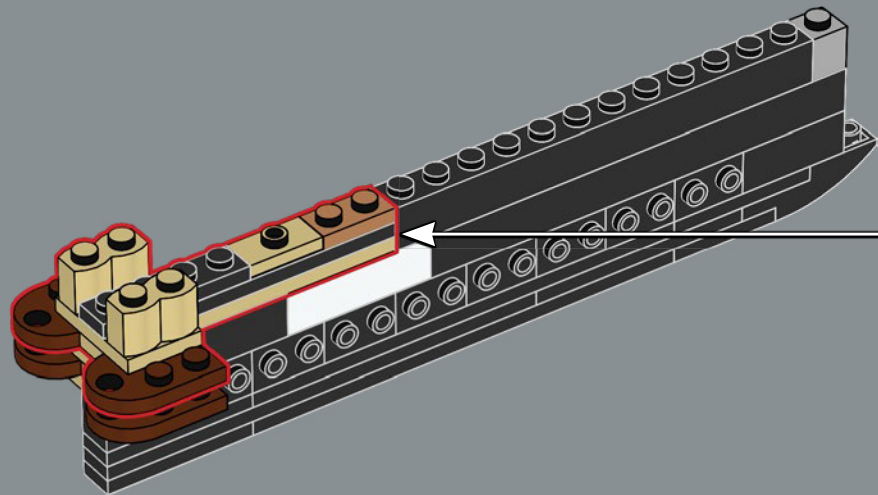
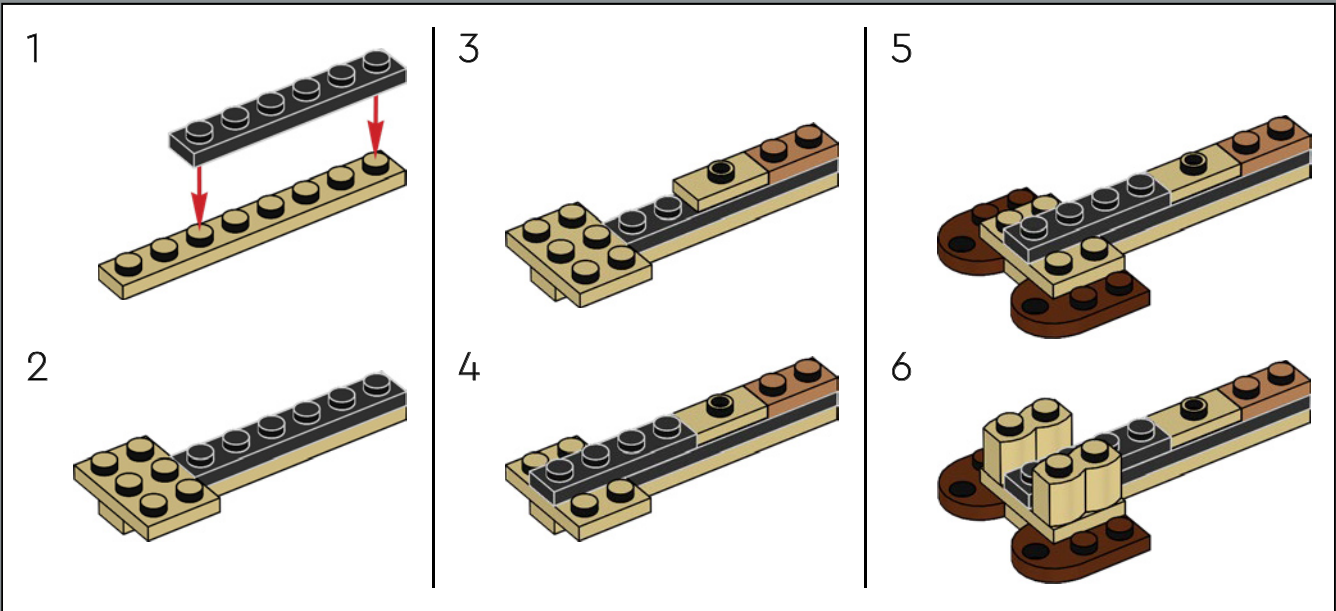
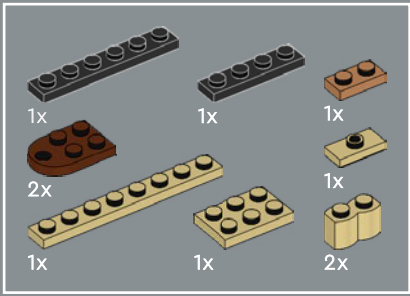

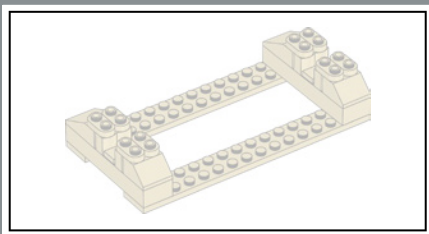

由于龙骨很窄，所以可以使用棕褐色“辅助支架”，
使模型在建造过程中保持稳定。

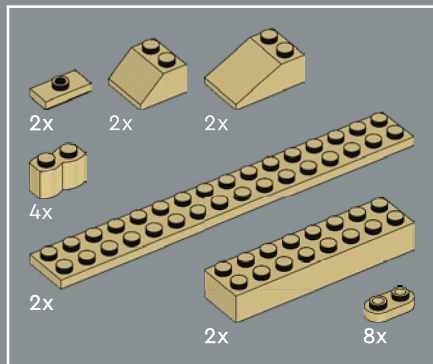

10

1

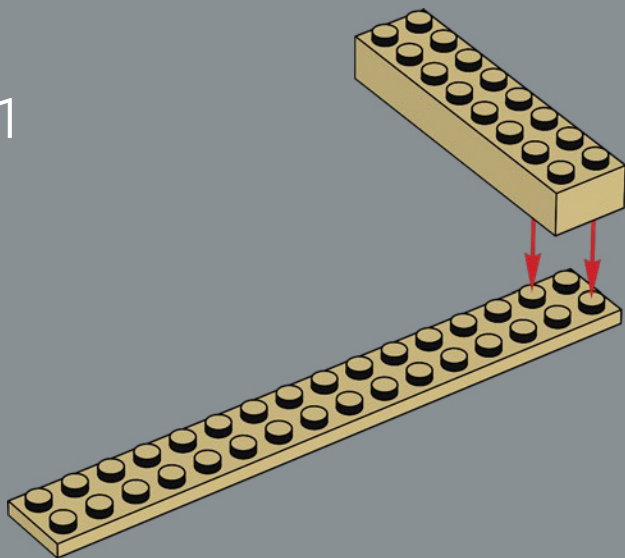

2

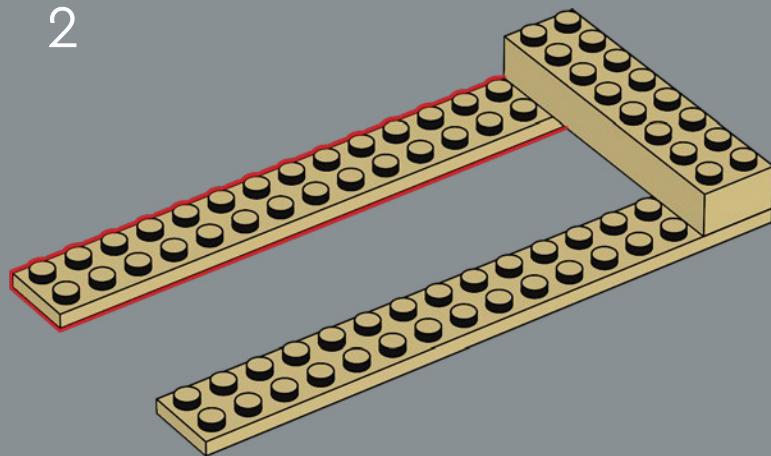

3

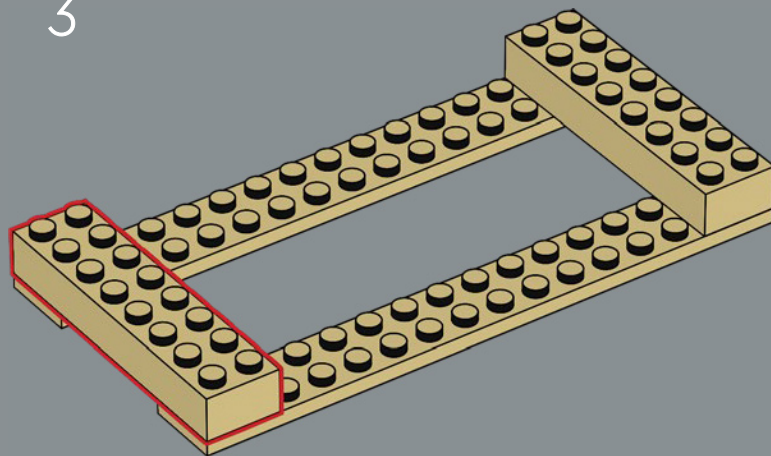

4

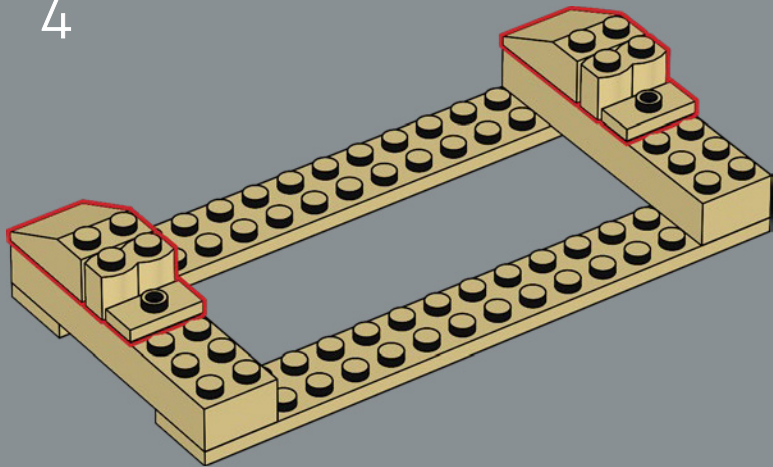

6

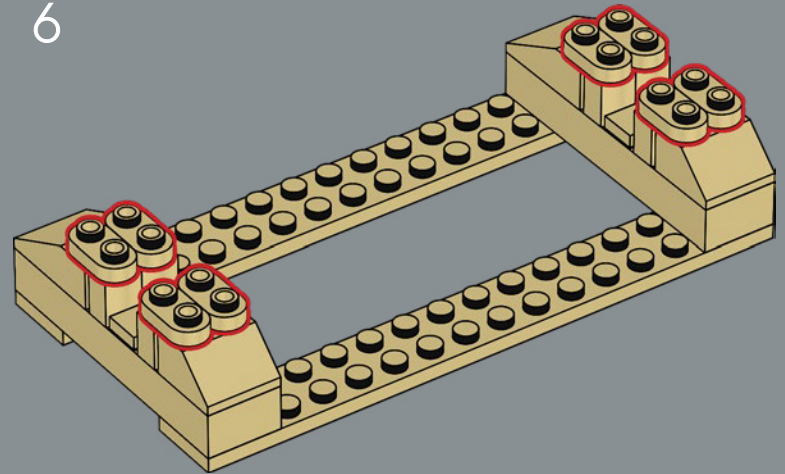

5

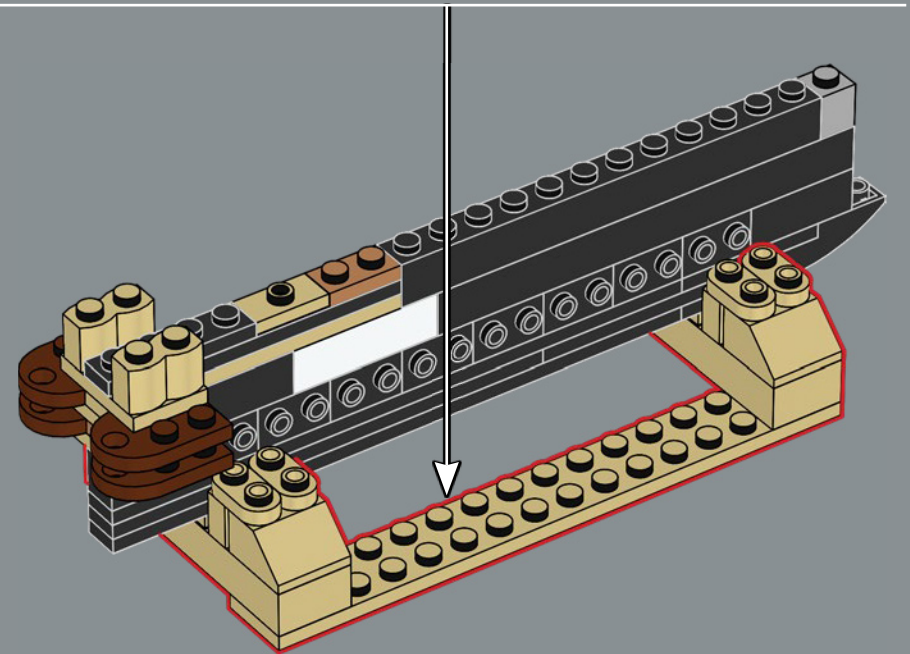
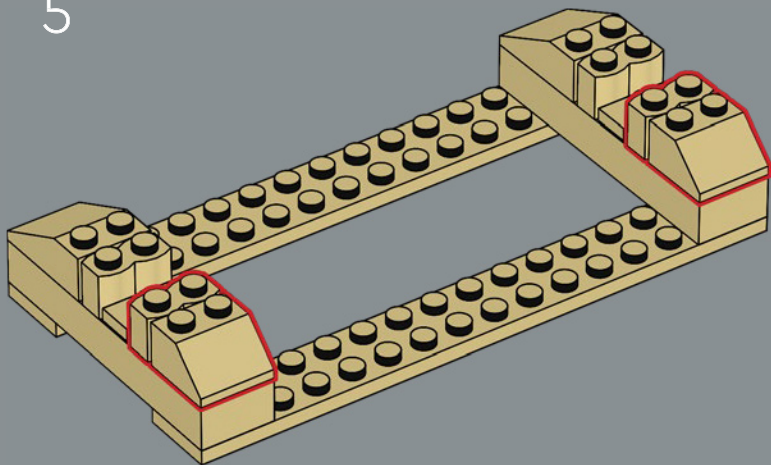

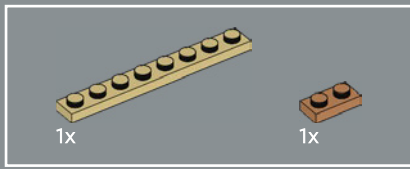

11

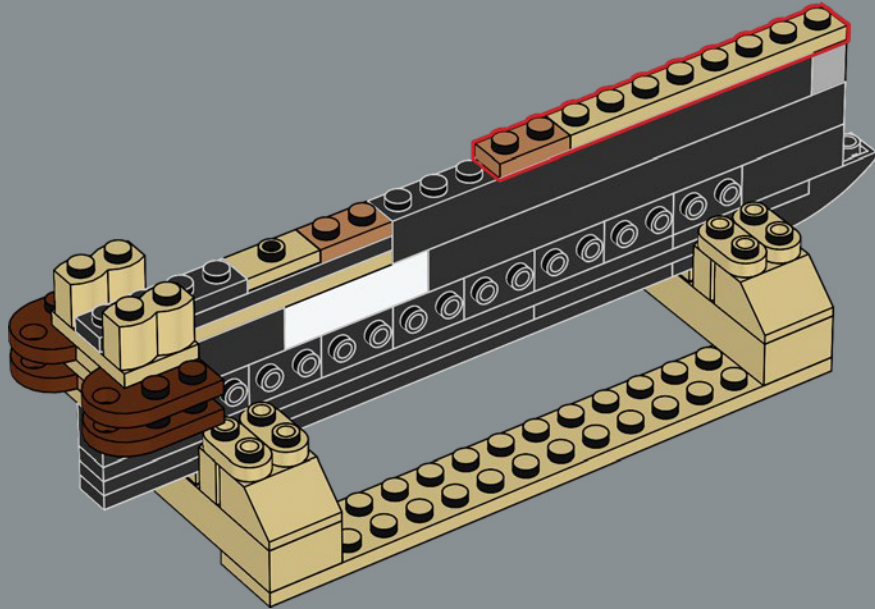

12

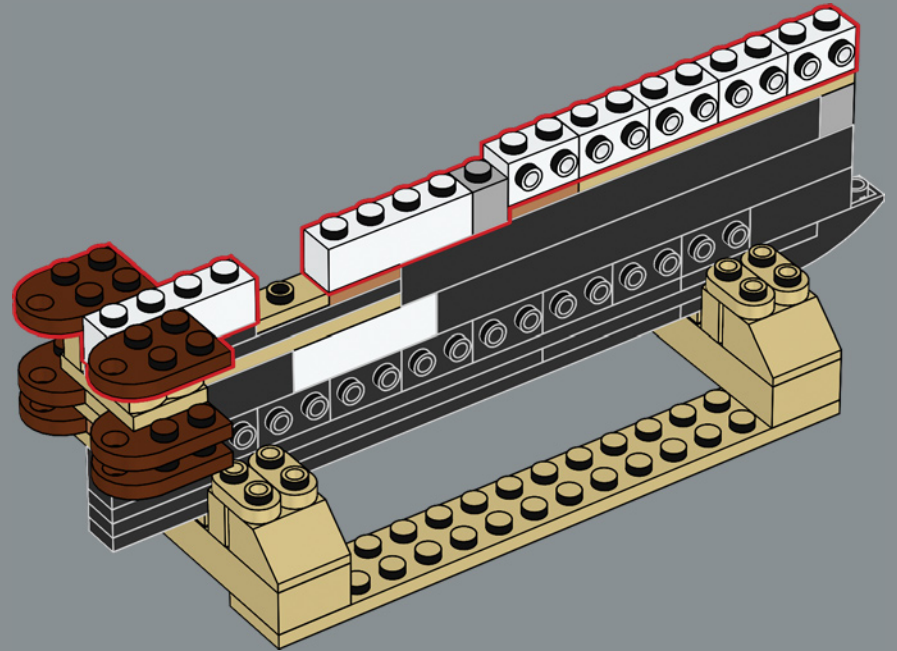

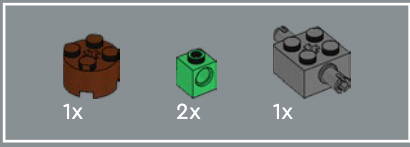

13

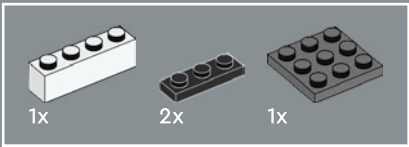
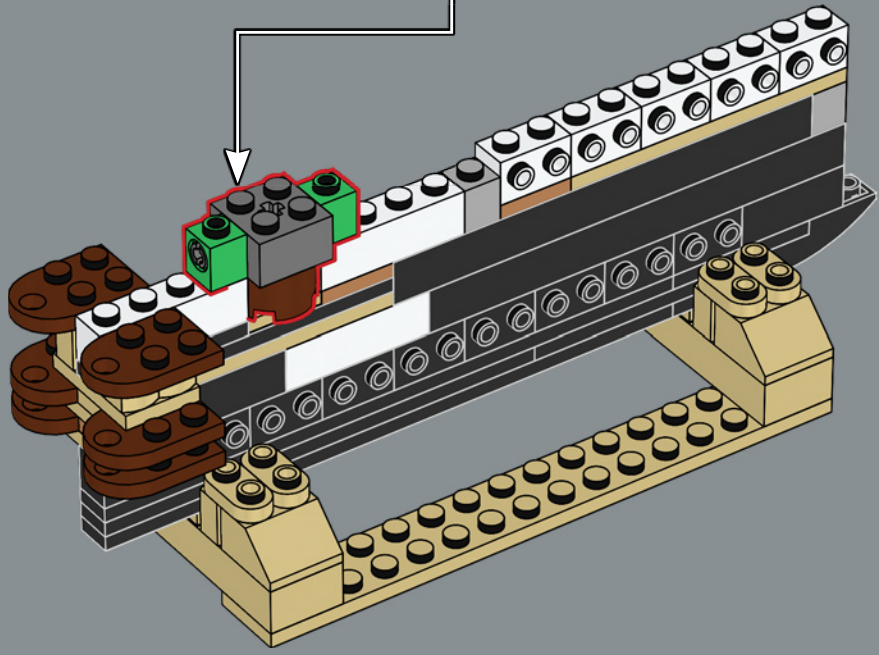
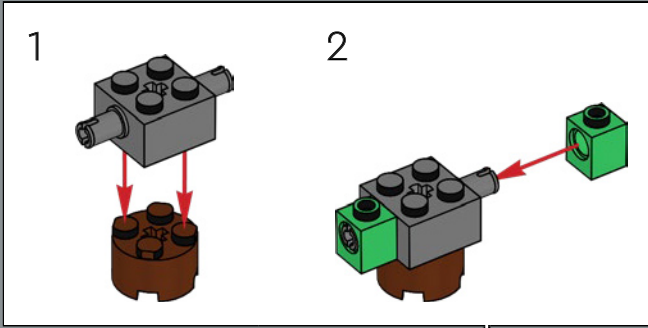

14

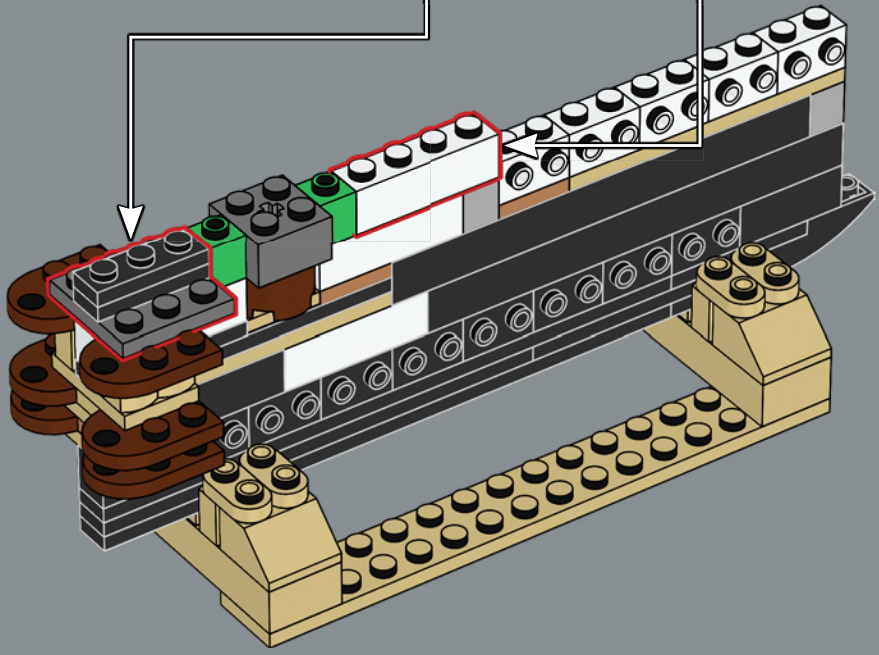
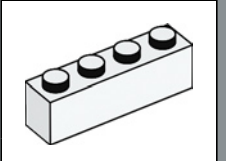
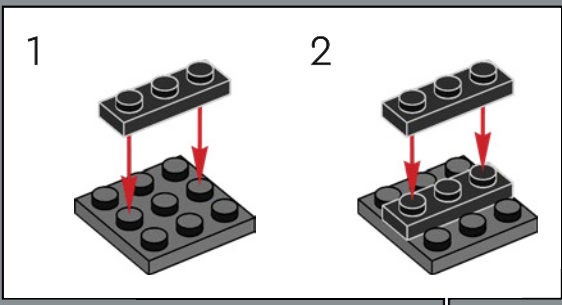

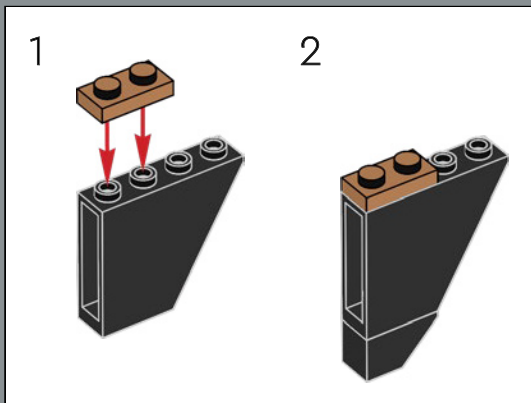
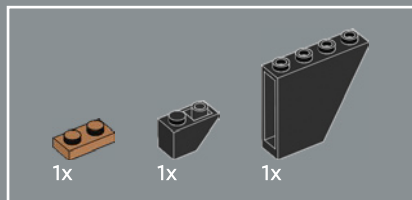

15

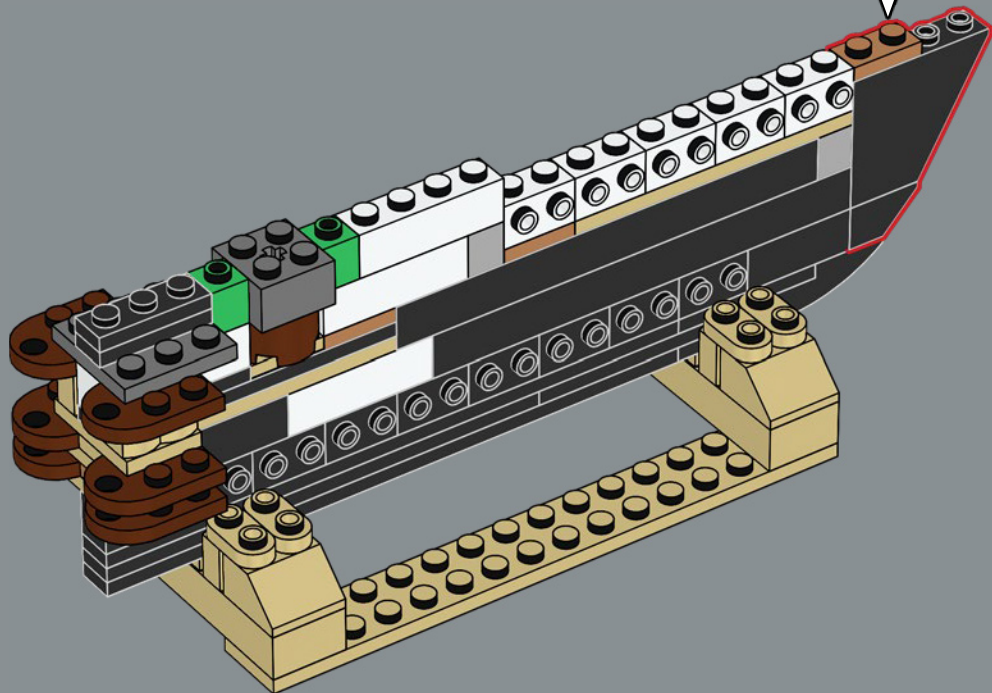

船体前部覆盖着金属板，以保护木质龙骨免受极地冰层的损伤。在模型中，该部分是利用极少使用的 1x4x3 倒斜坡积木重现的。

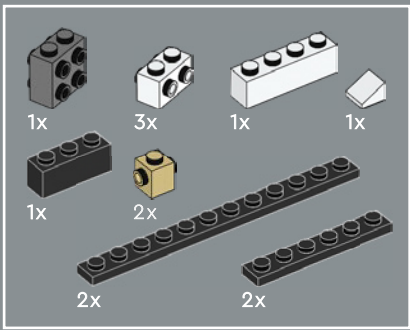

16

1

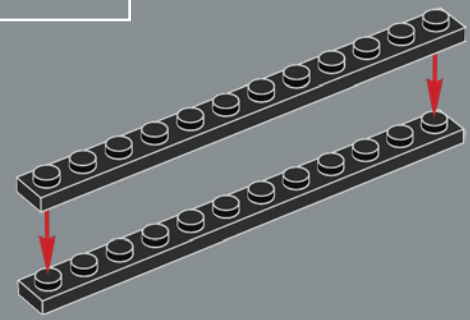

2

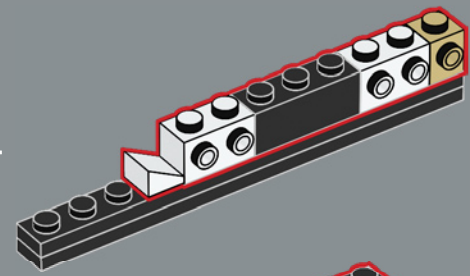

3

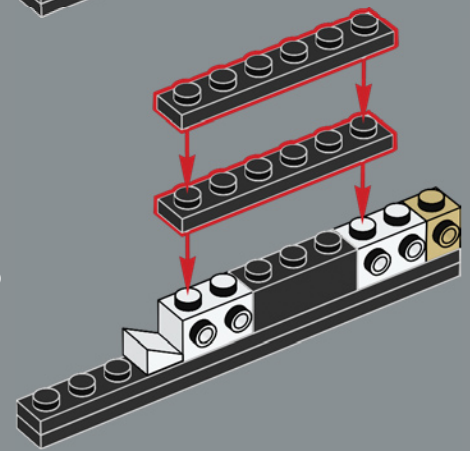

4

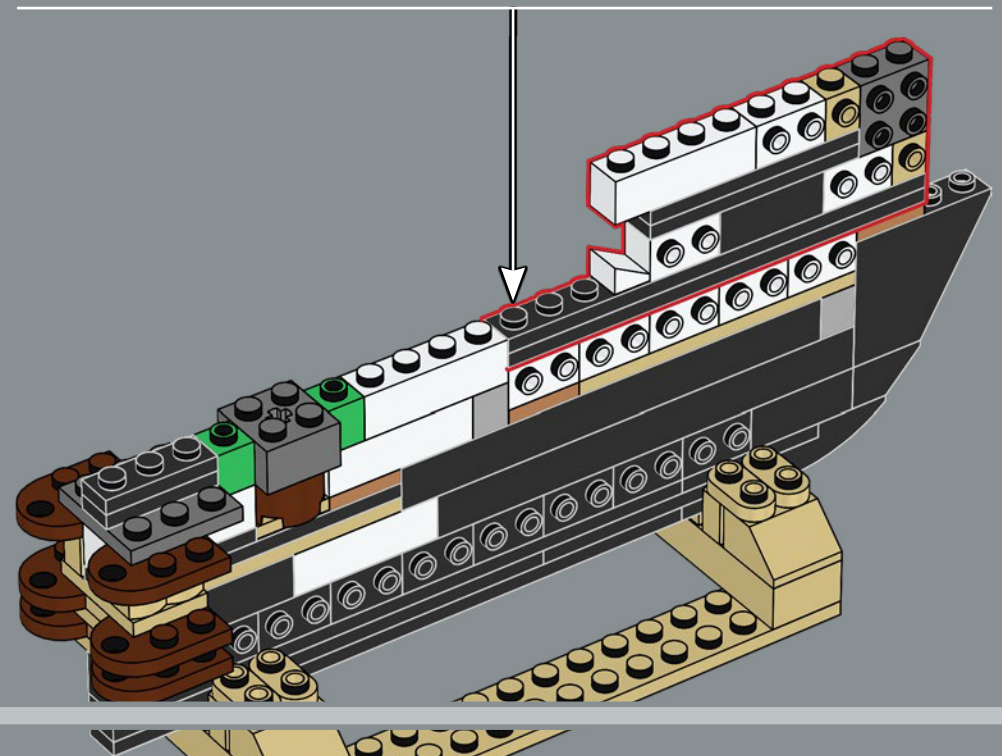
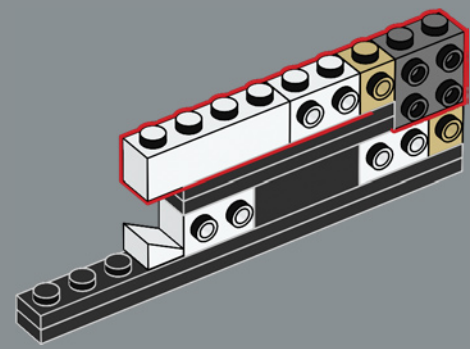

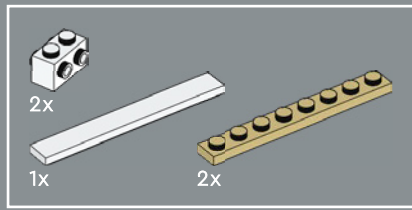

17

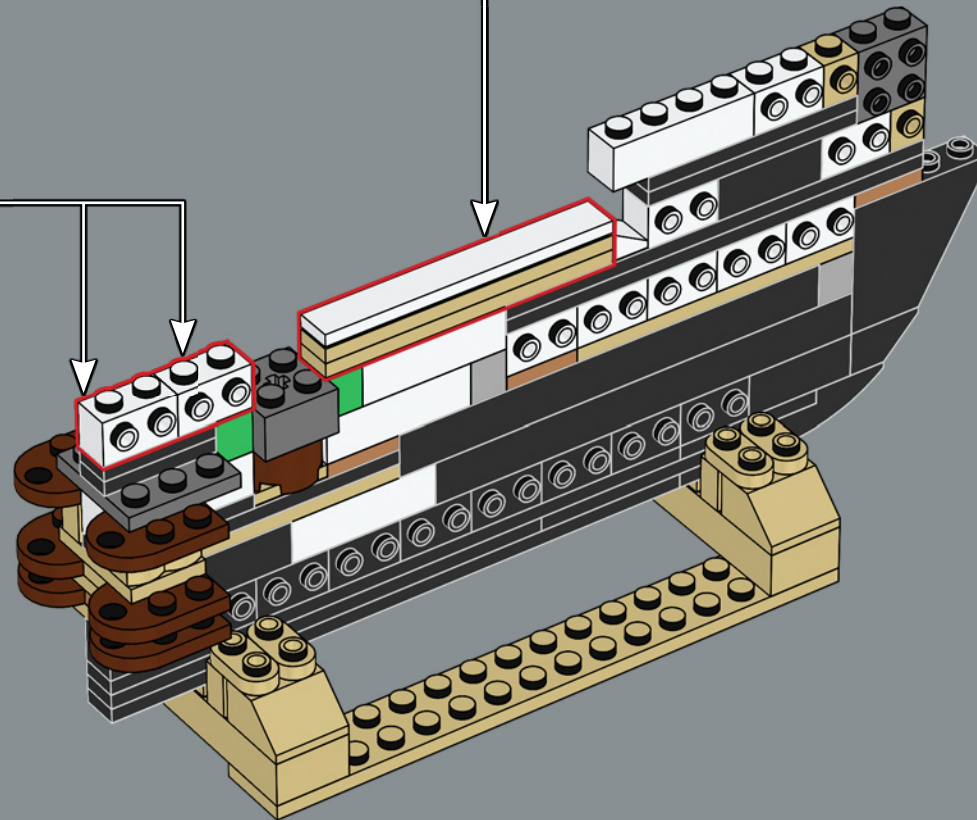
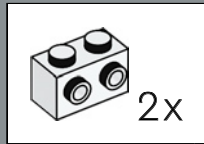
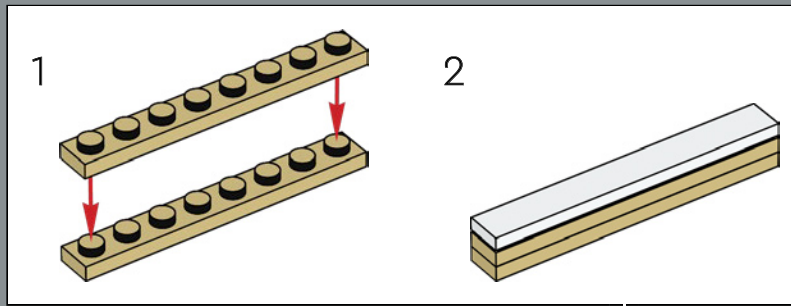

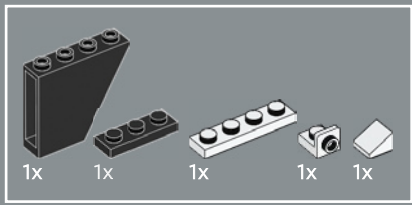

18

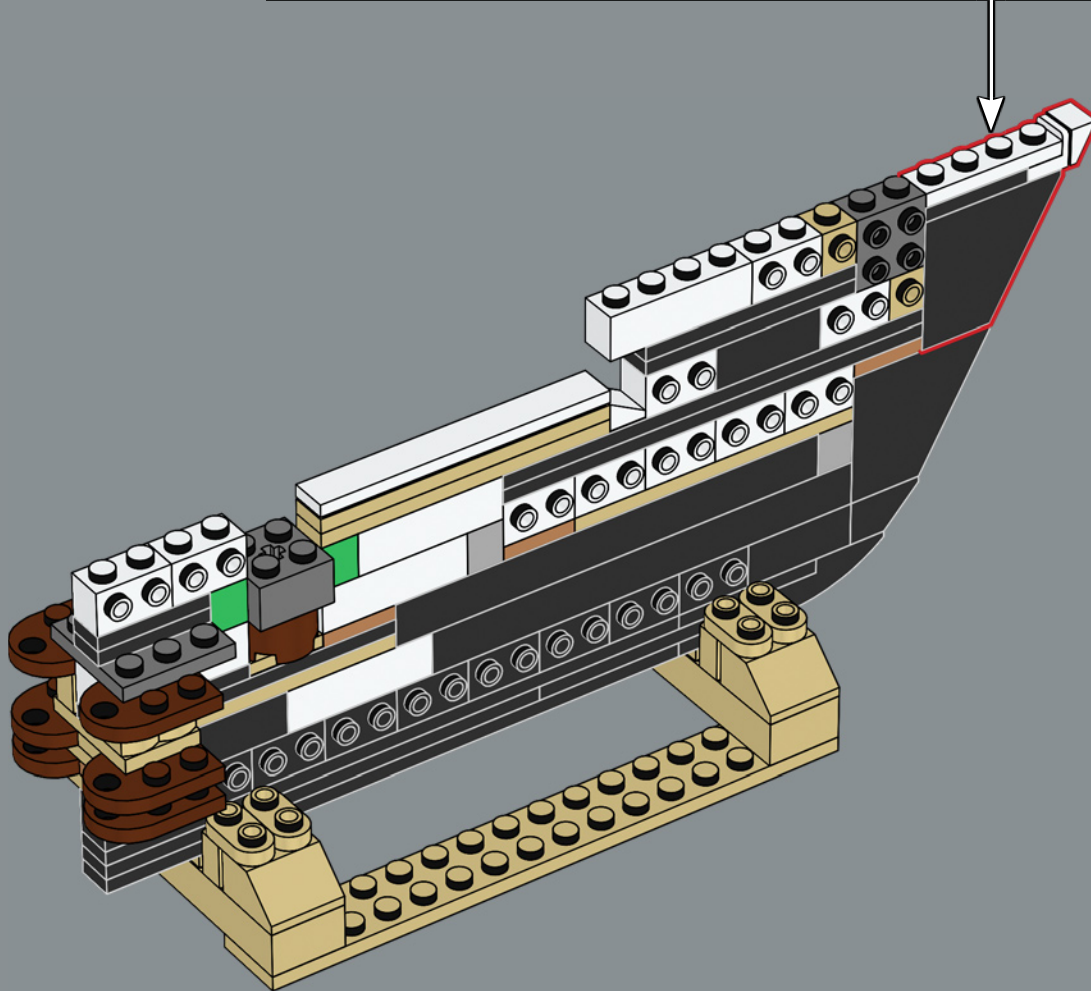
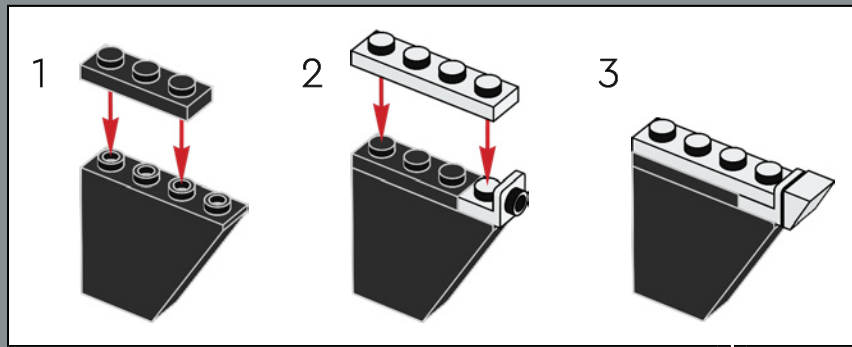

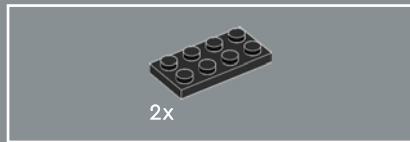
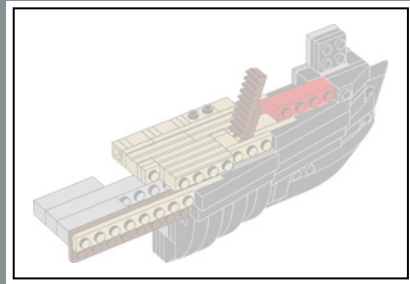

19

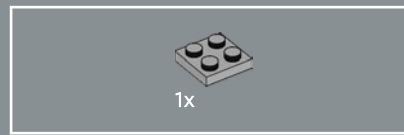
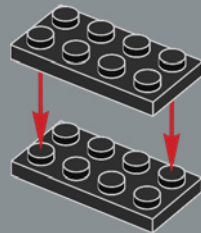

20

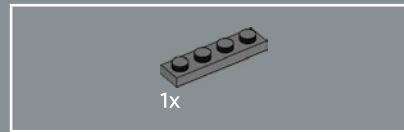
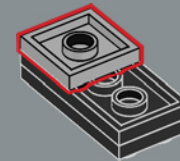

21

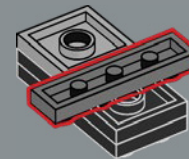

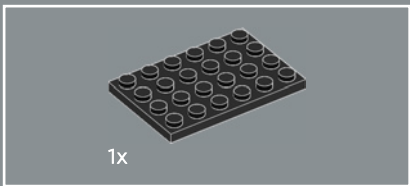

22

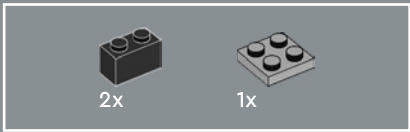
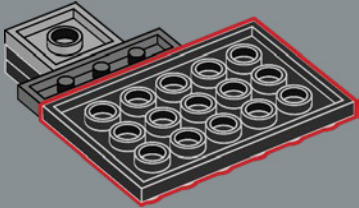

23

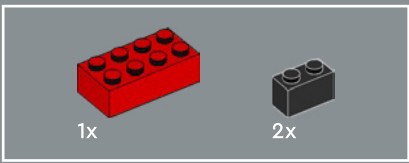
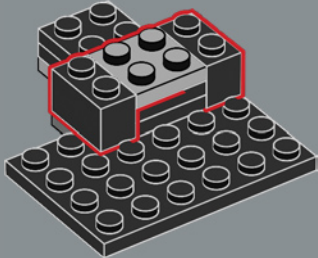

24

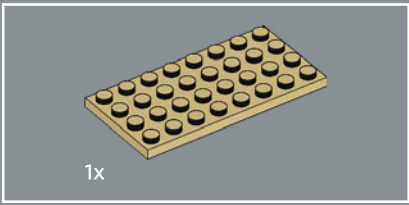
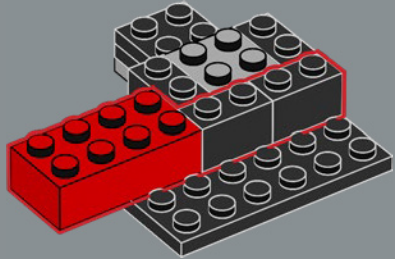

25

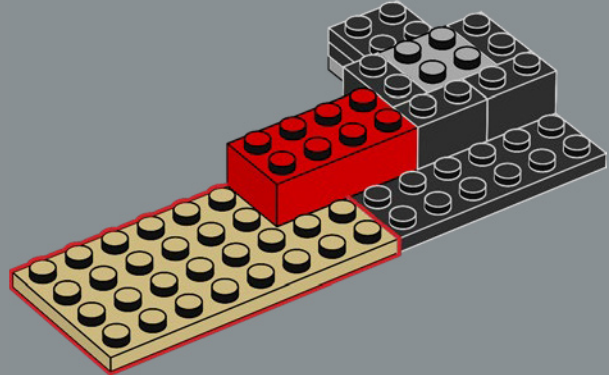

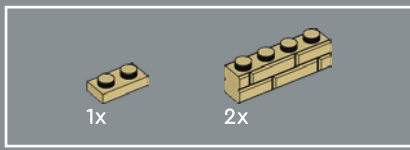

26

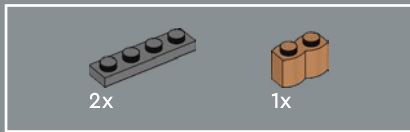
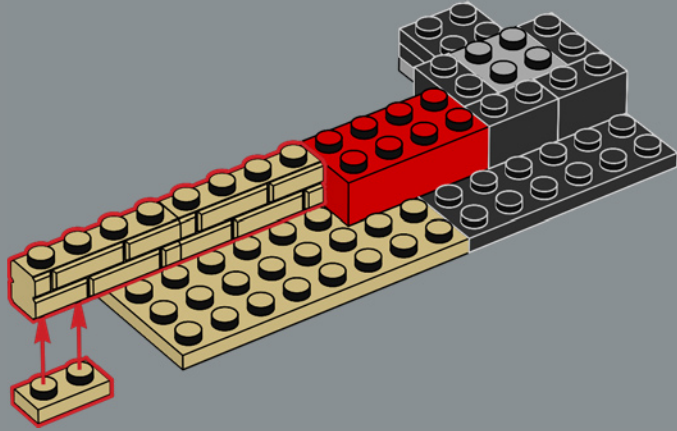

27

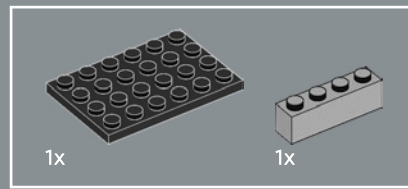
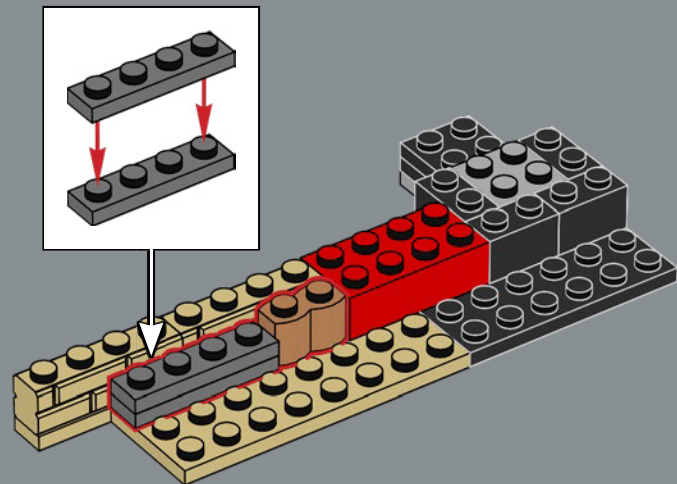

28

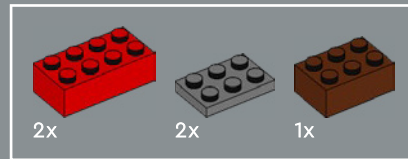
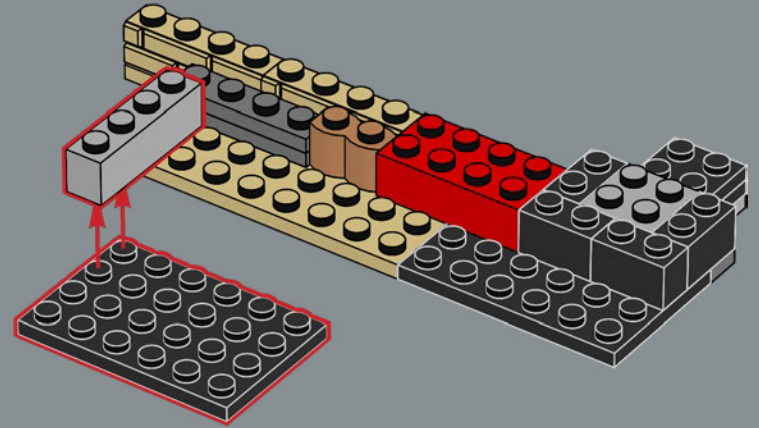

29

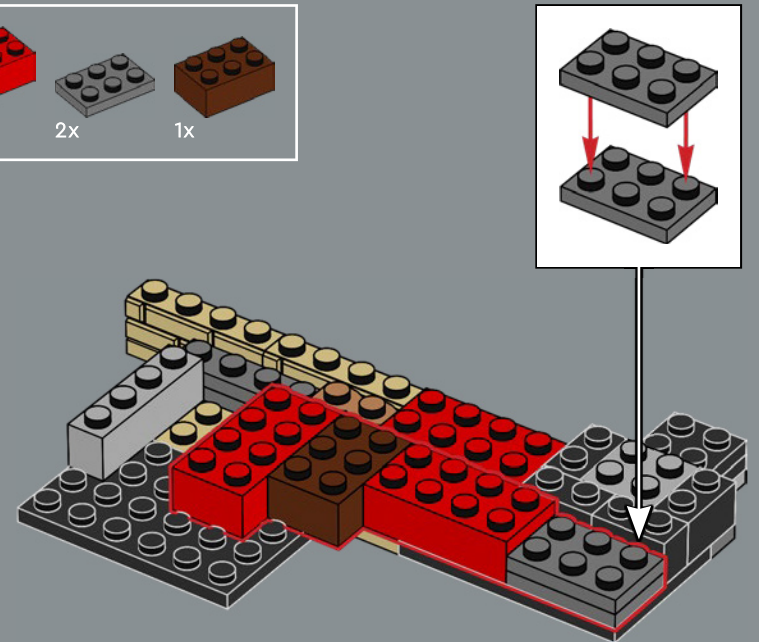

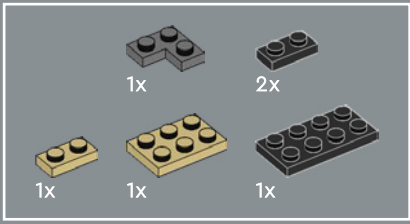

30

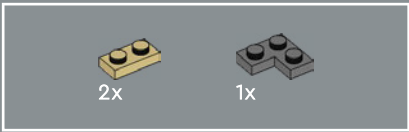
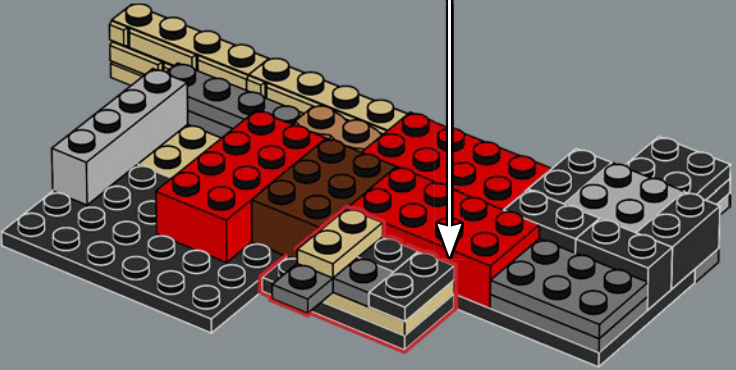
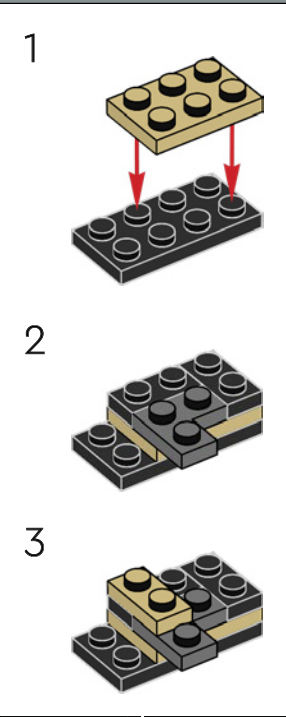

31

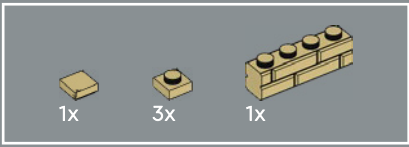
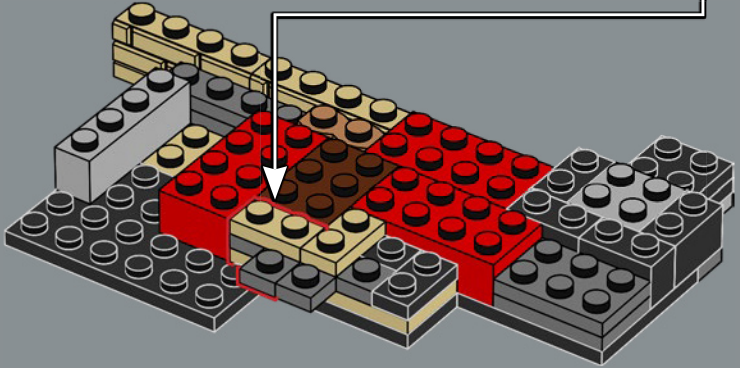
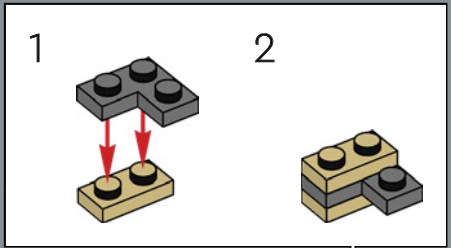

32

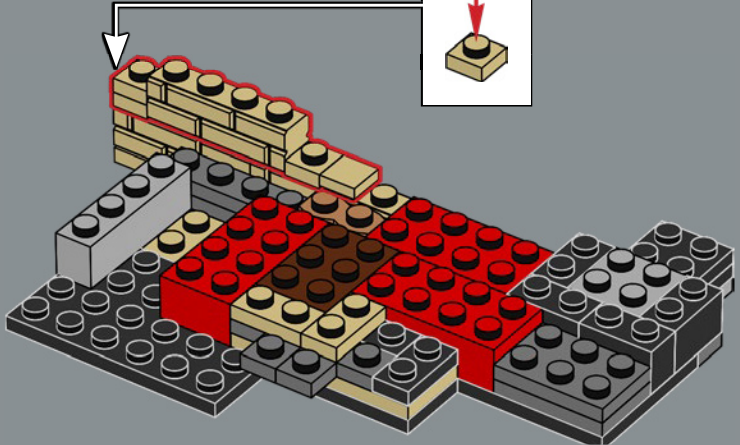
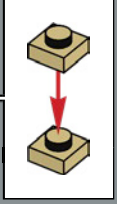



33

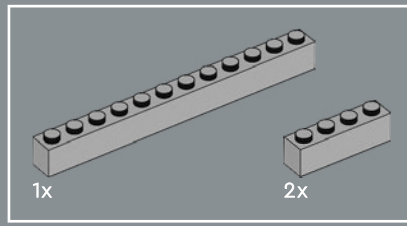
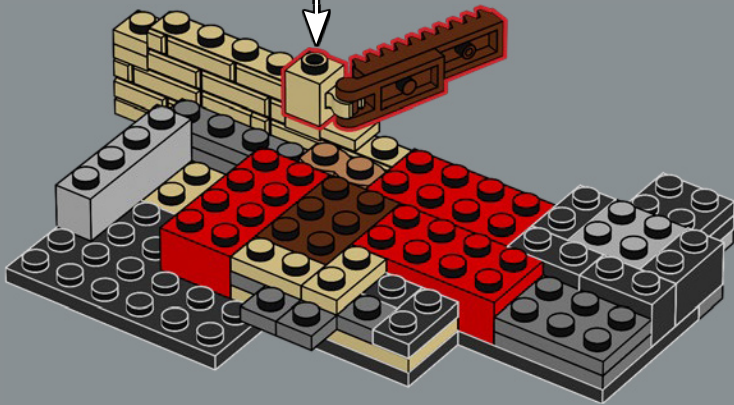
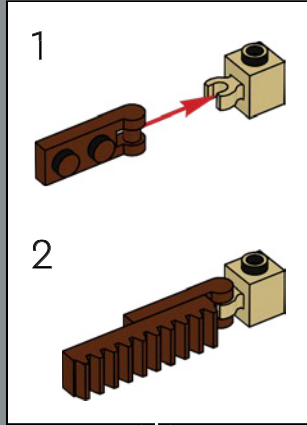

34

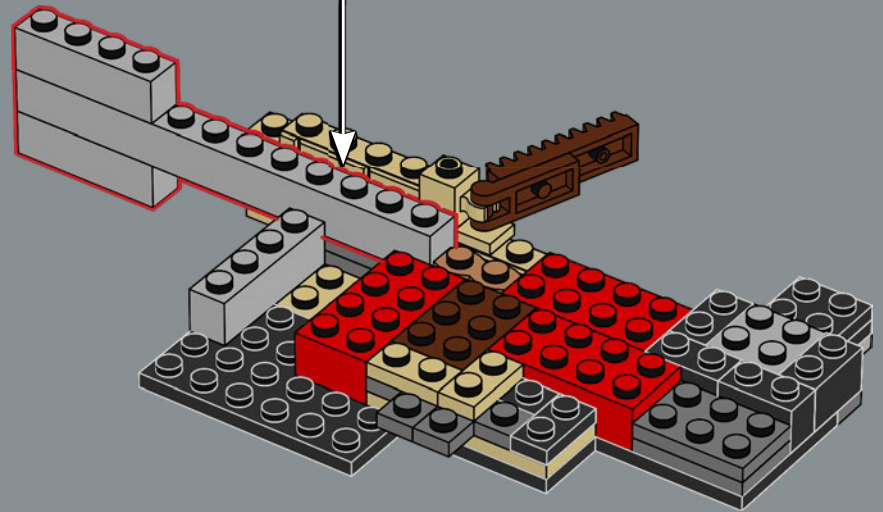
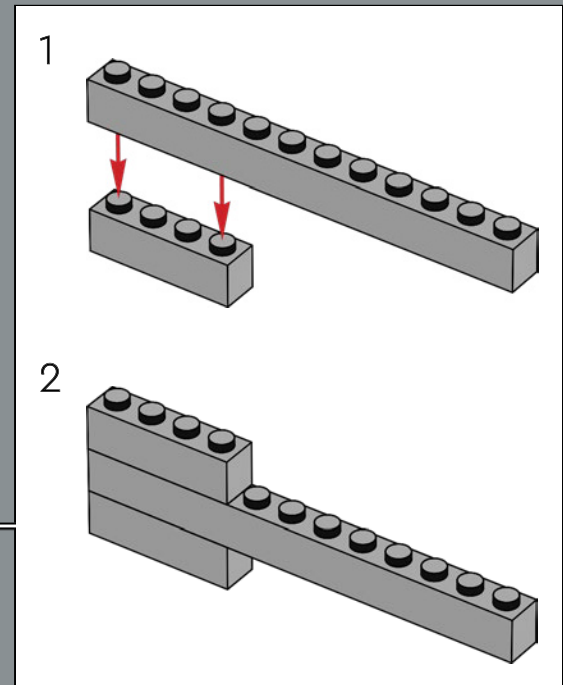

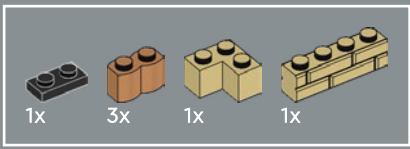

35

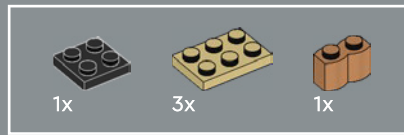
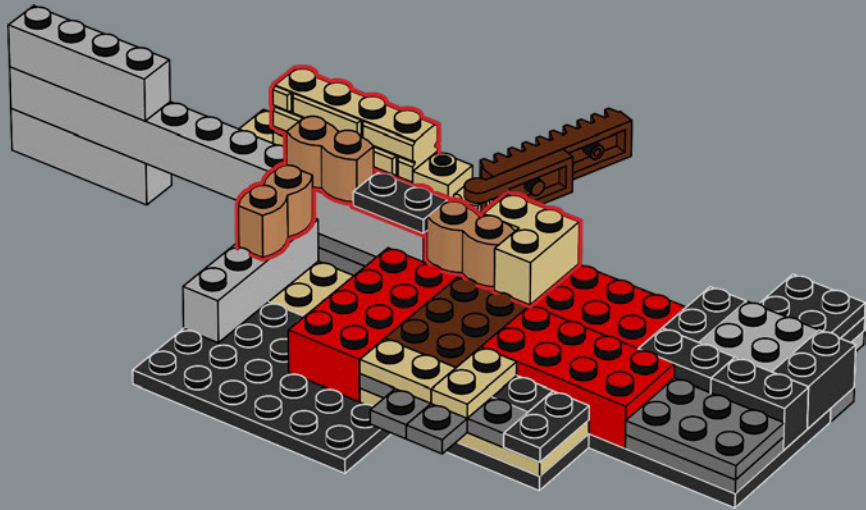

36

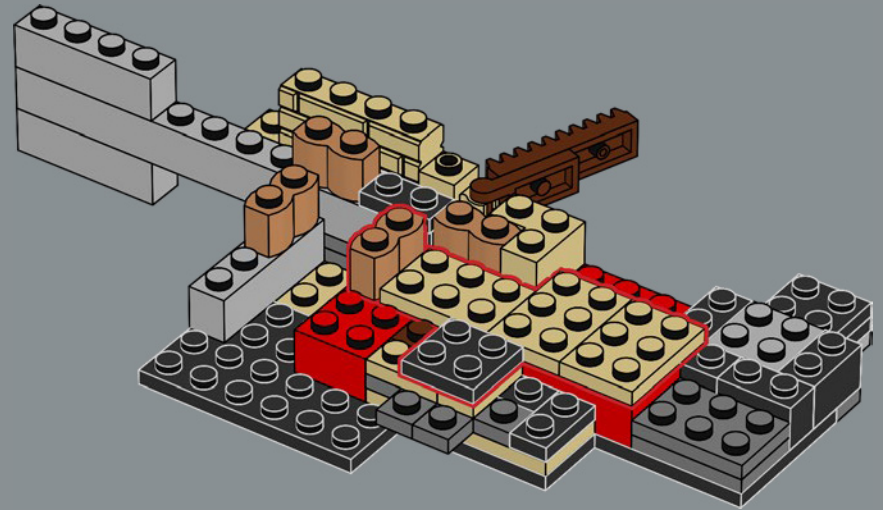

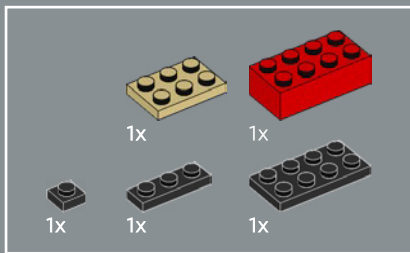

37

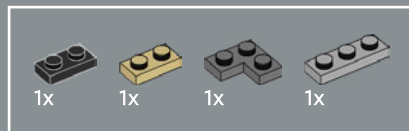
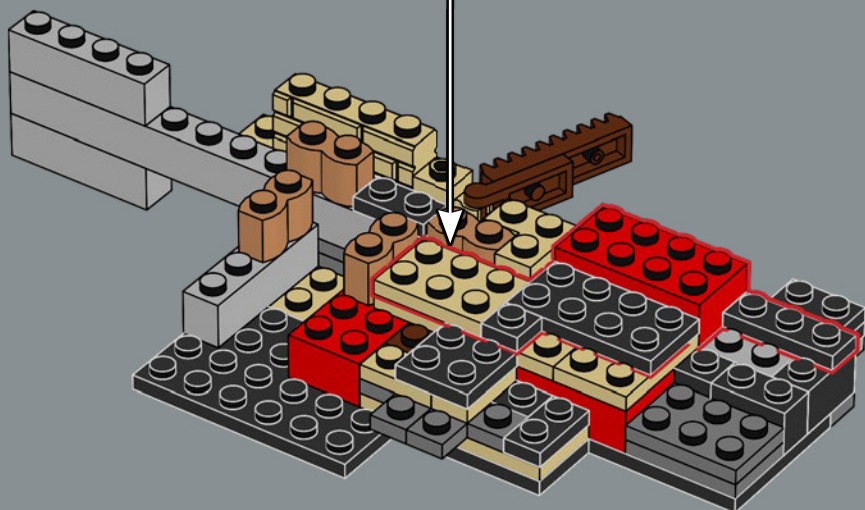
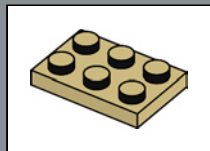

38

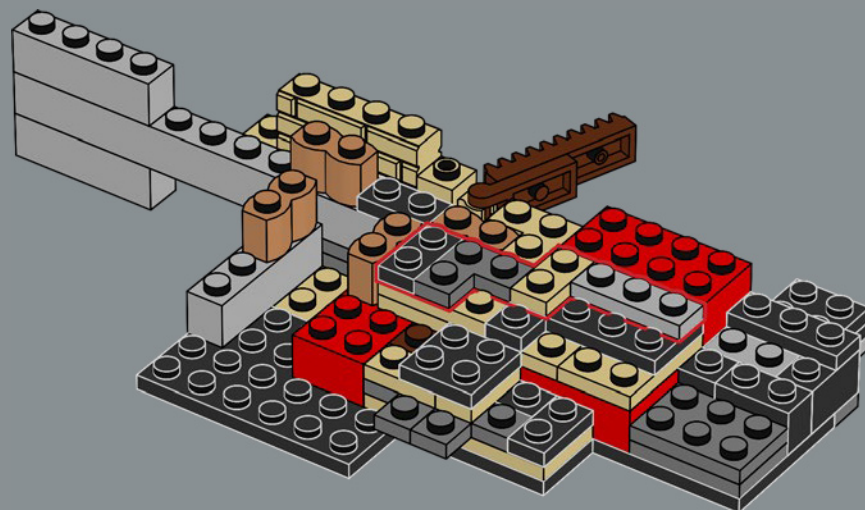

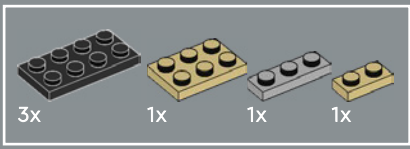

39

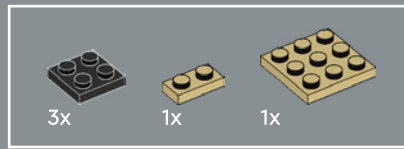
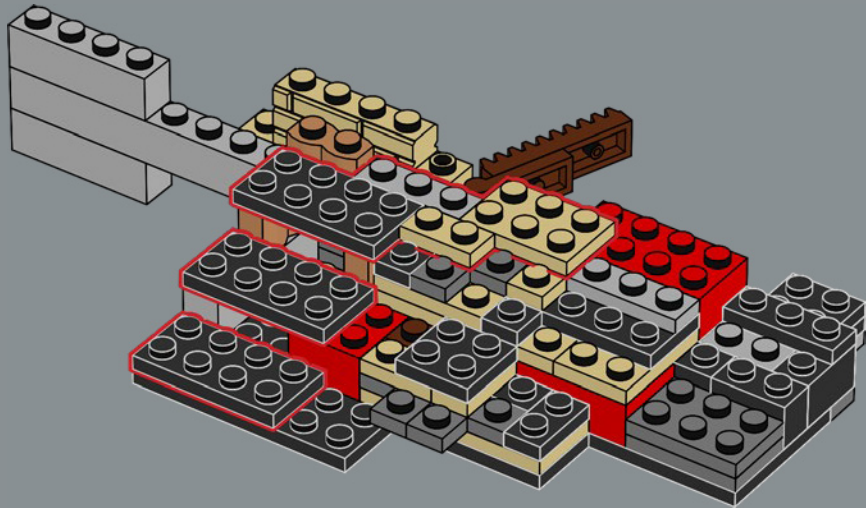

40

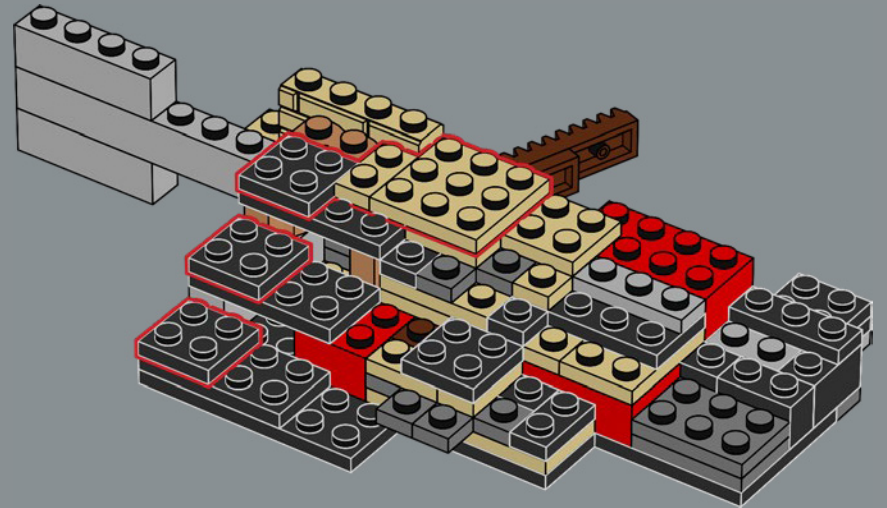

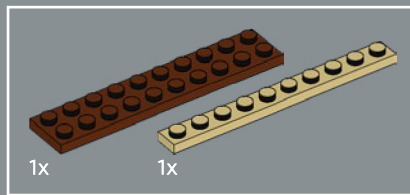

41

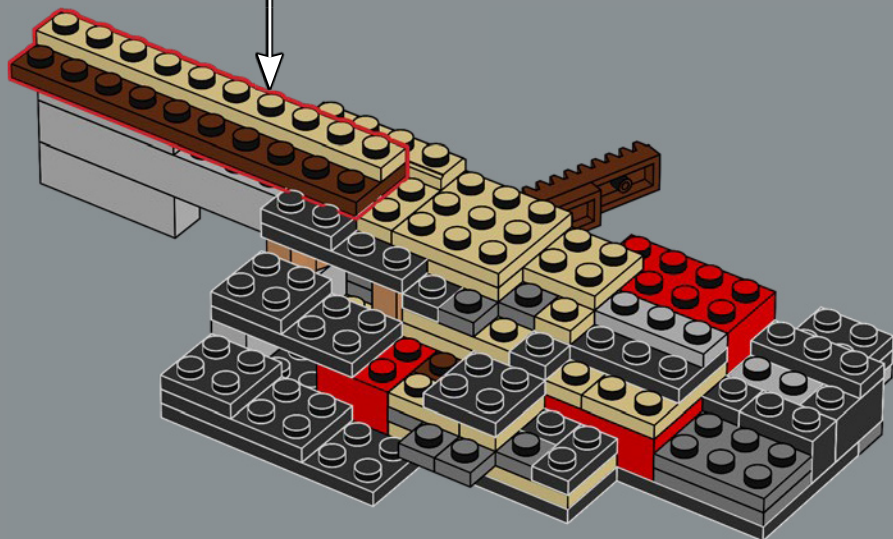
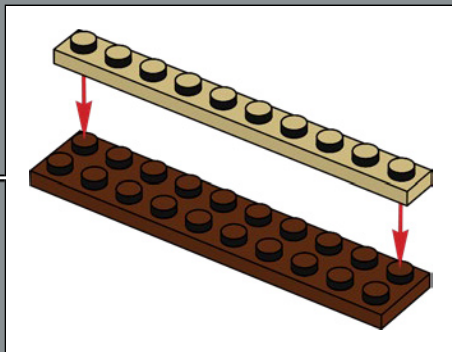

42

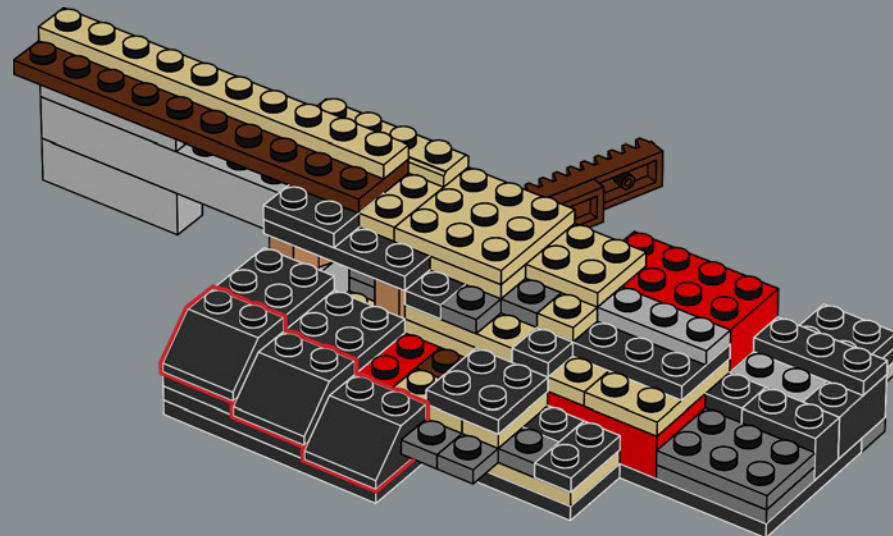



43

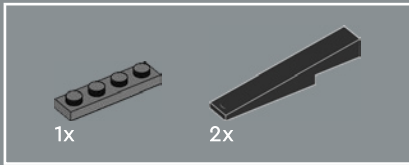
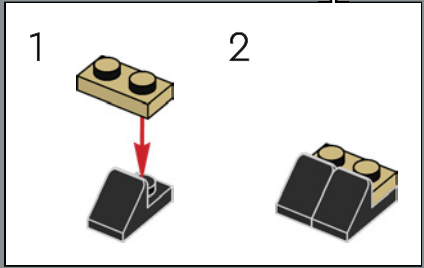
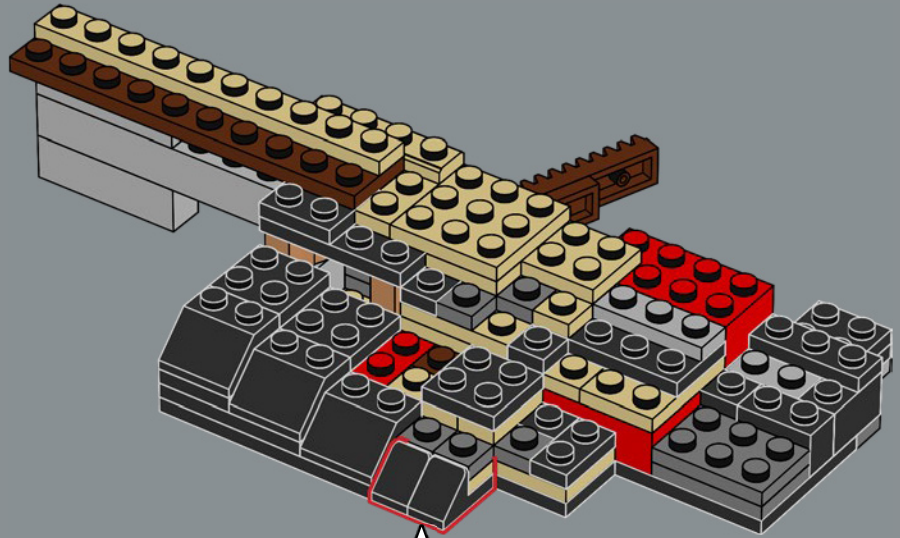

44

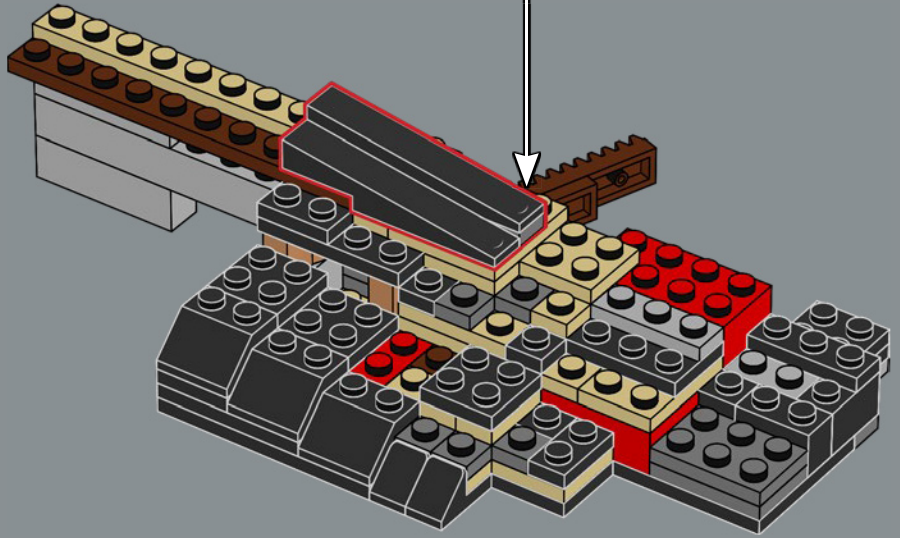
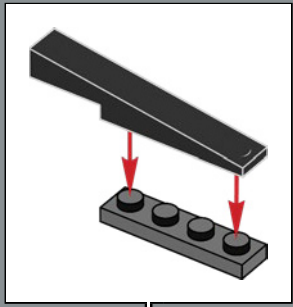



45

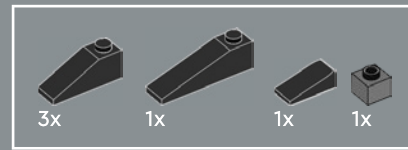
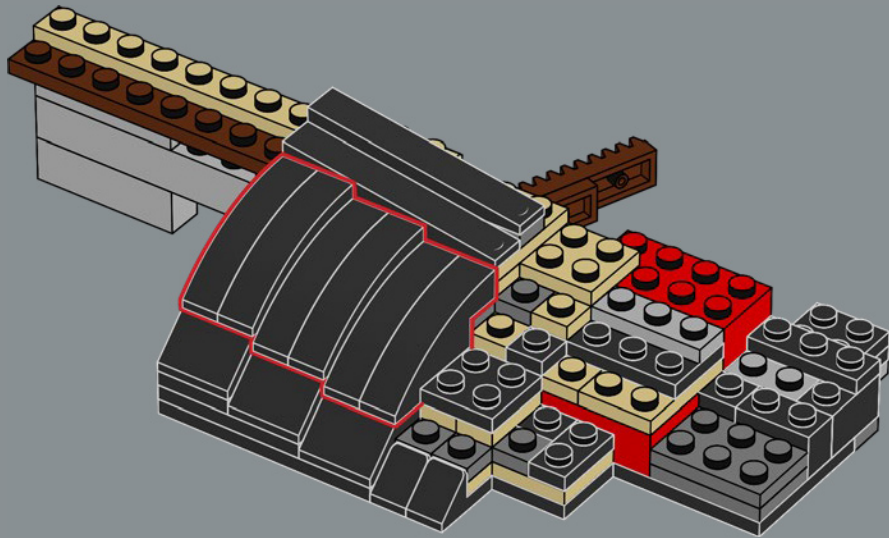

46

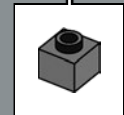
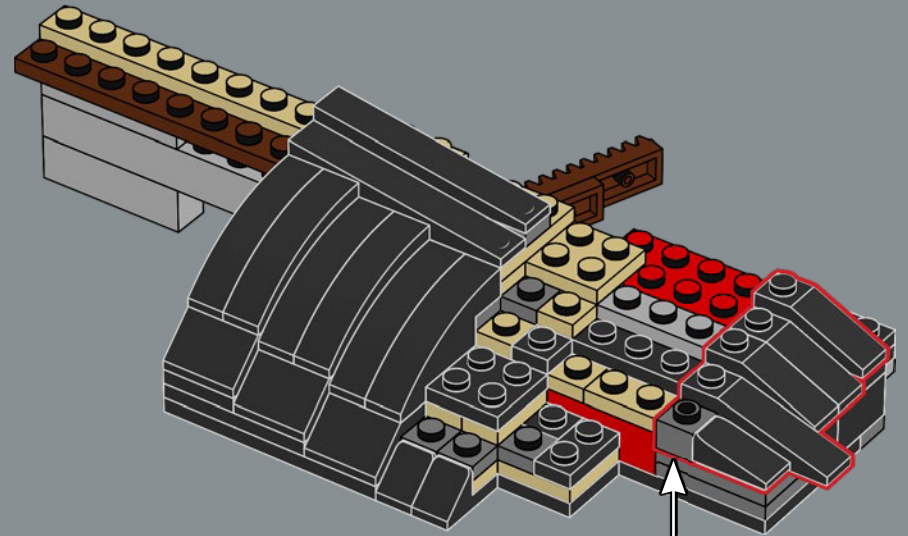

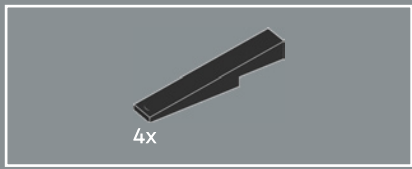

47

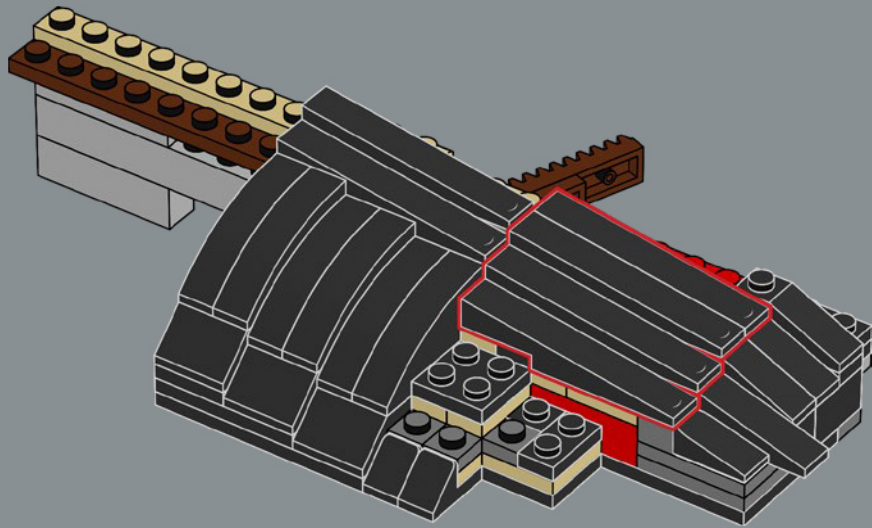

48

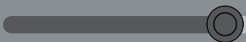
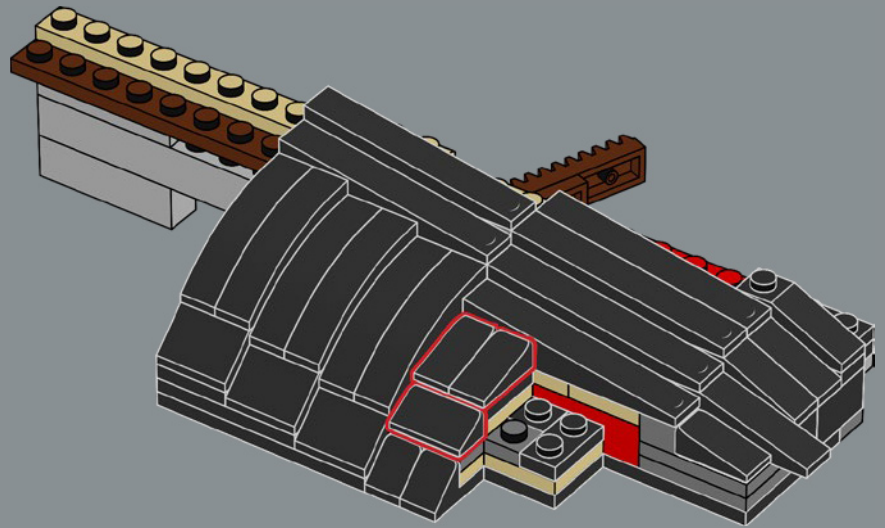

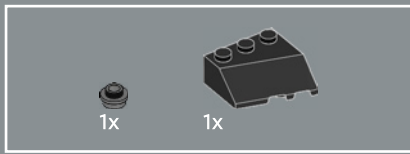

49

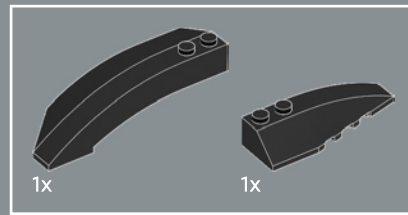
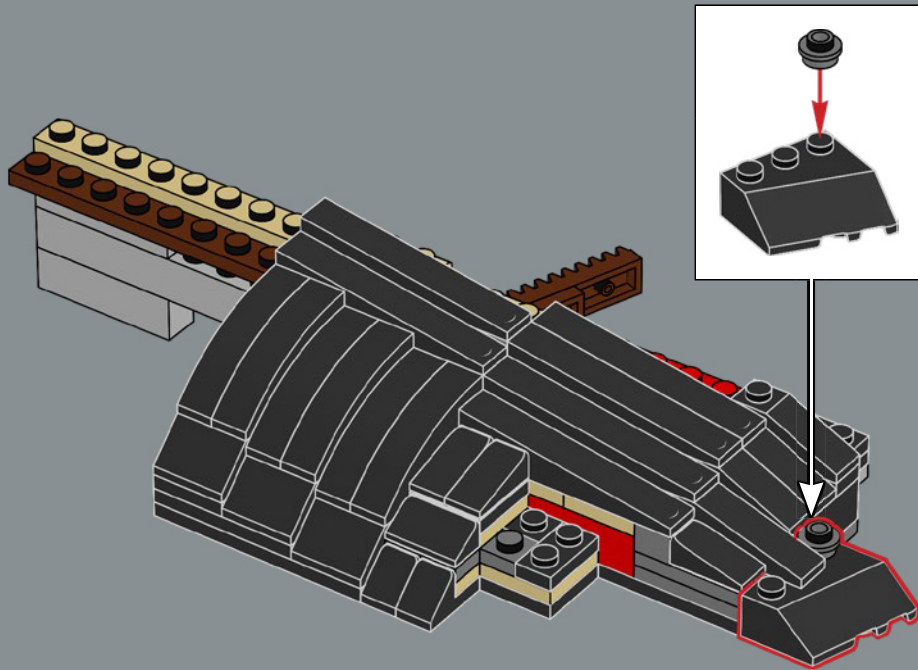

50

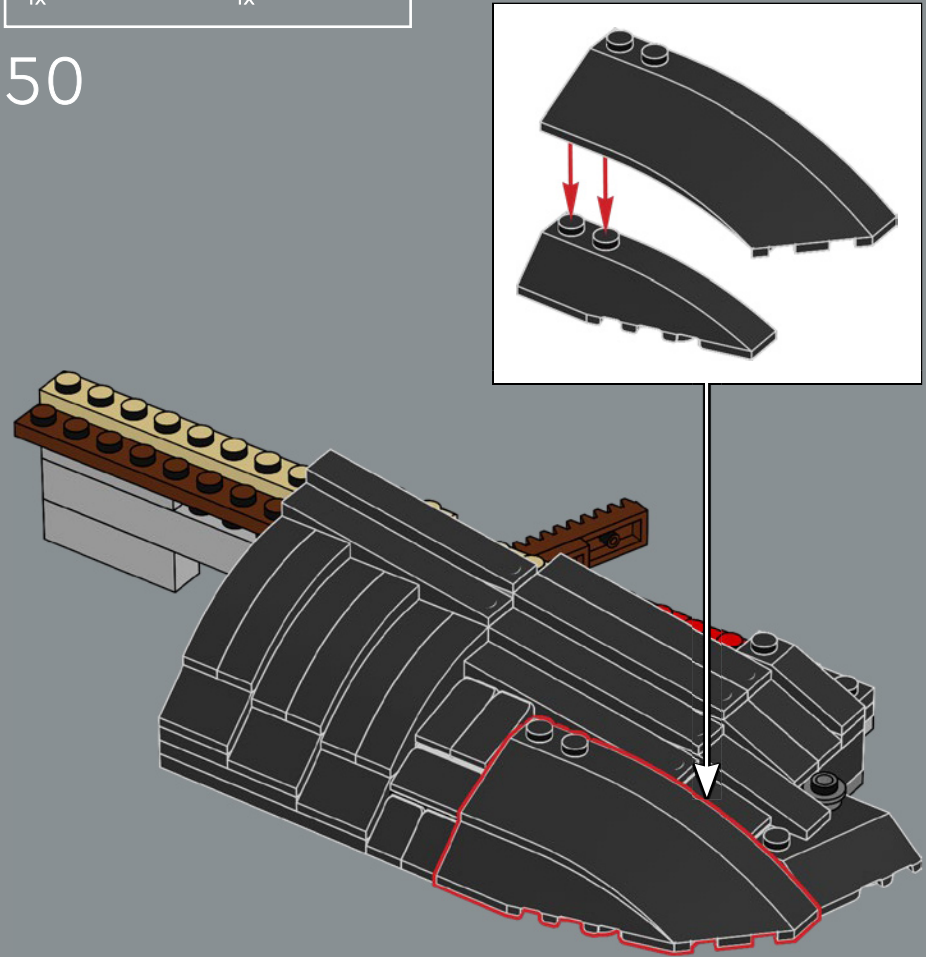



51

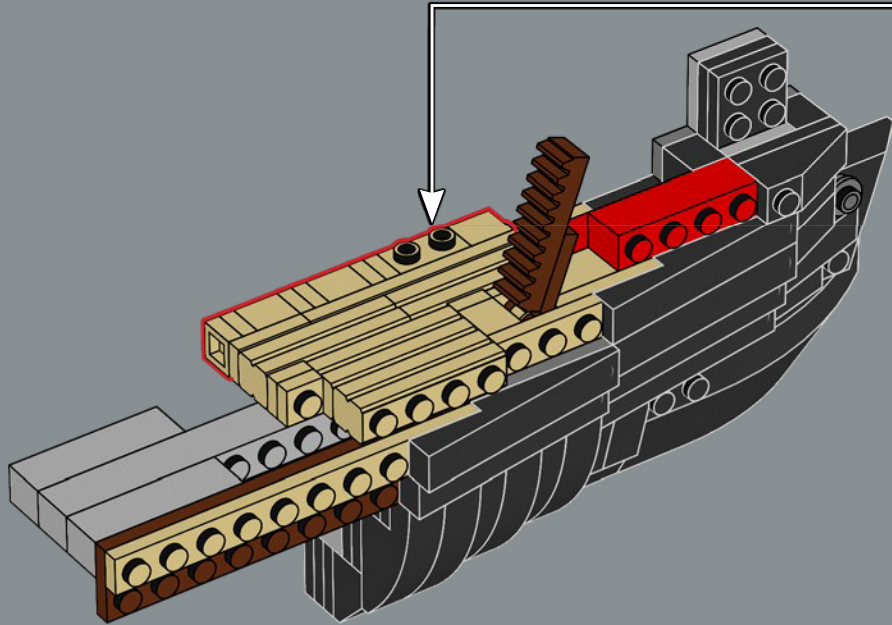
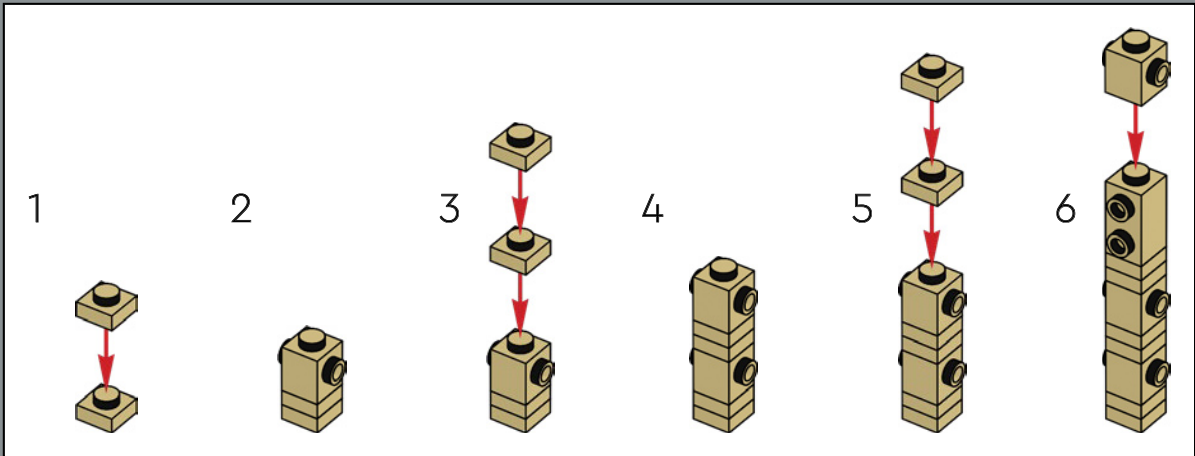

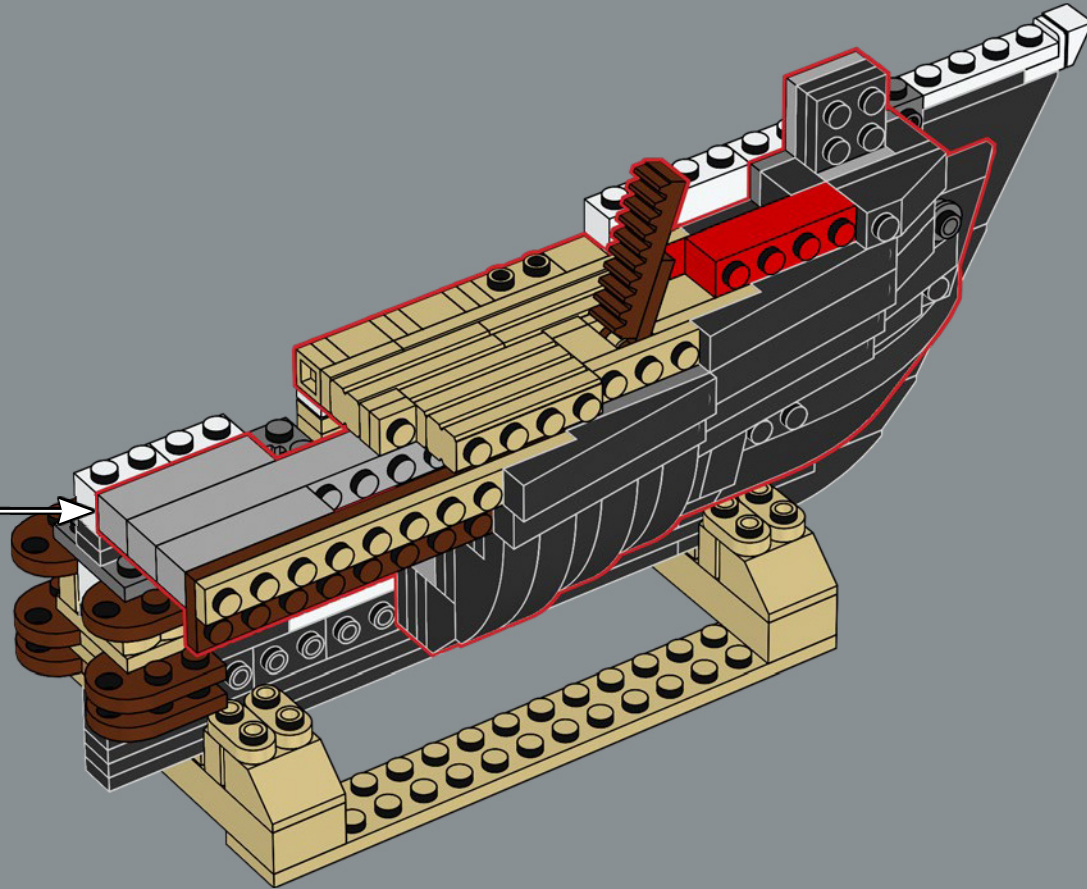

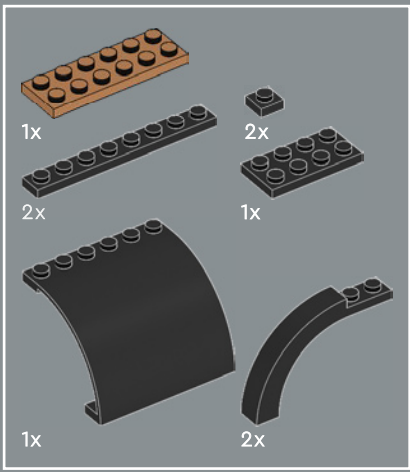

53

1

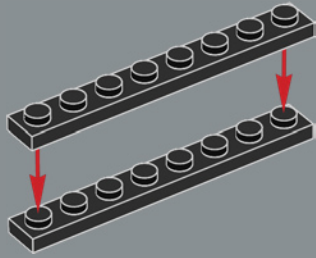

2

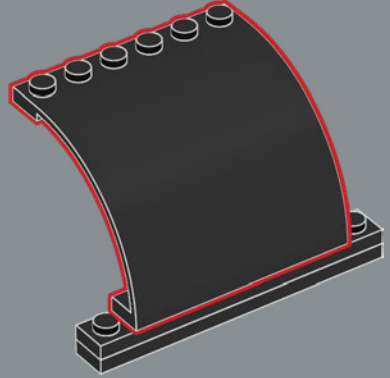

3

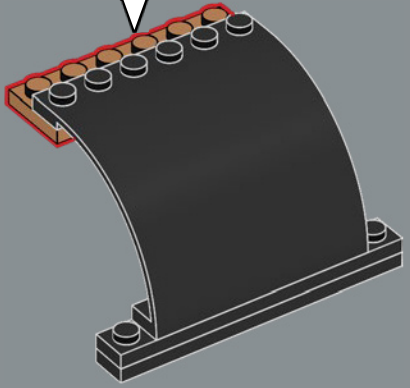
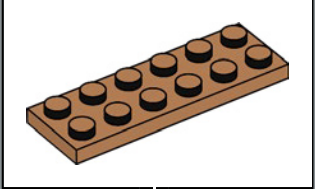

4

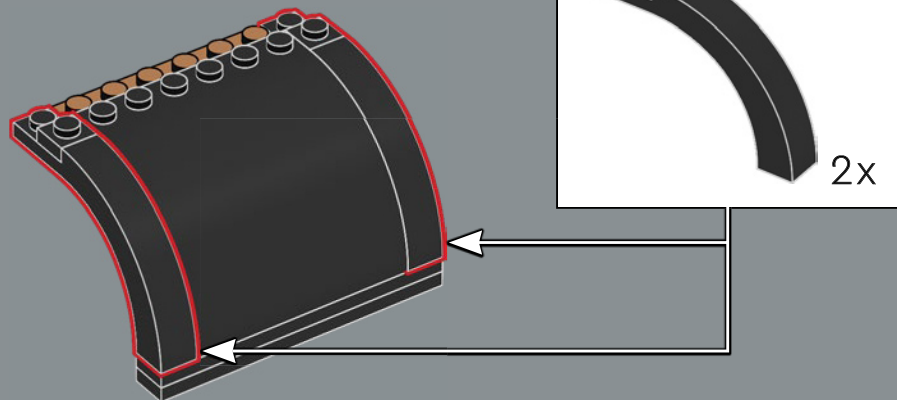

5

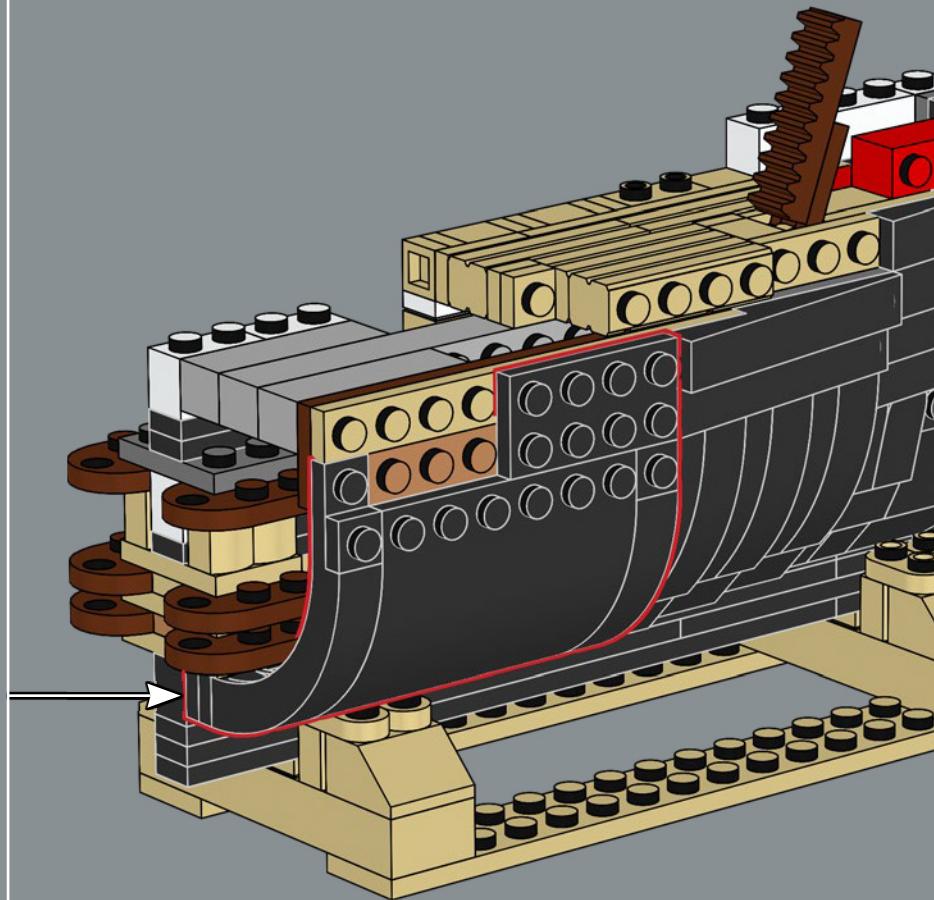
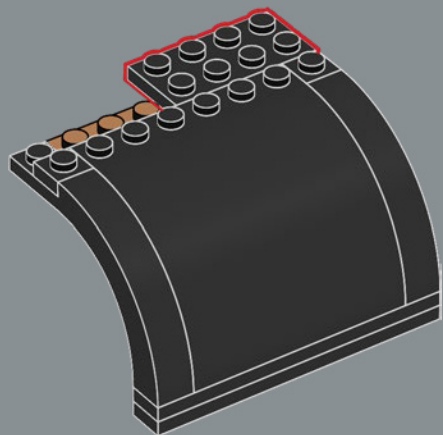

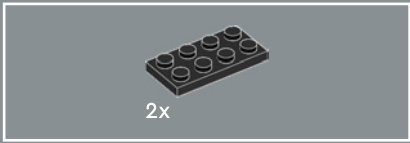
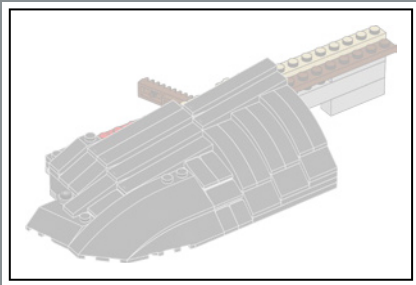

54

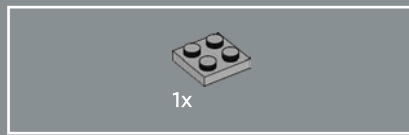
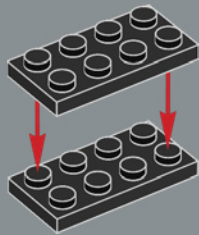

55

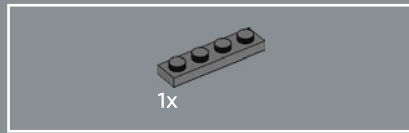
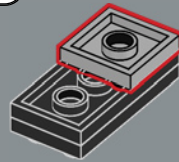

56

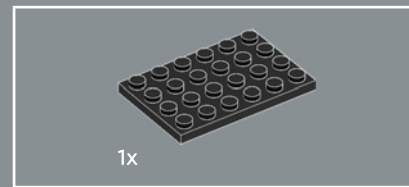
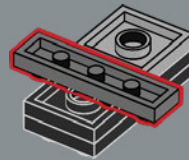

57

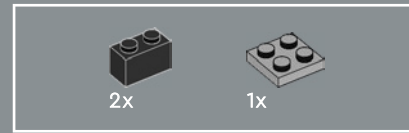
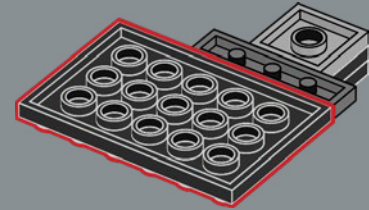

58

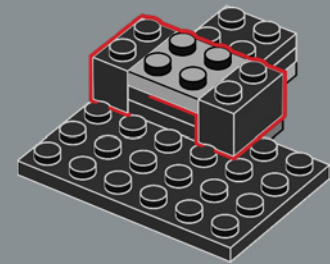

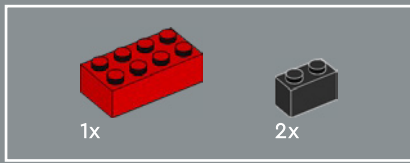

59

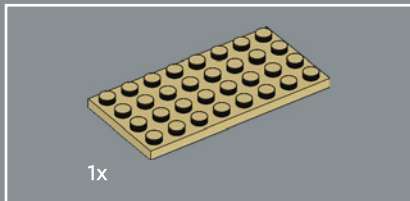
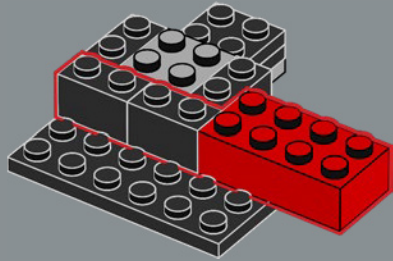

60

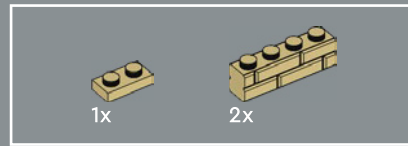
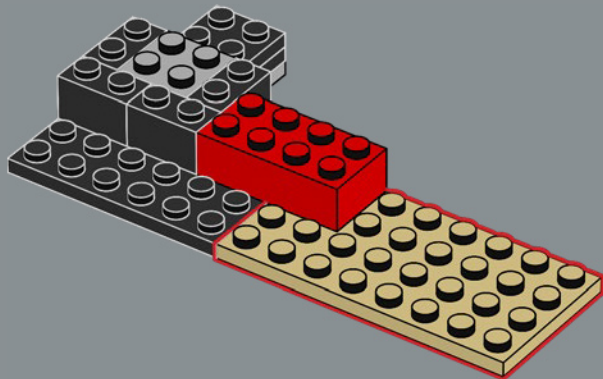

61

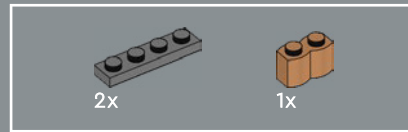
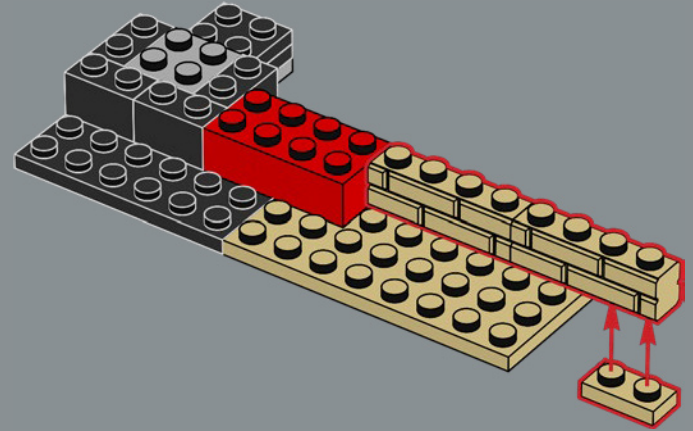

62

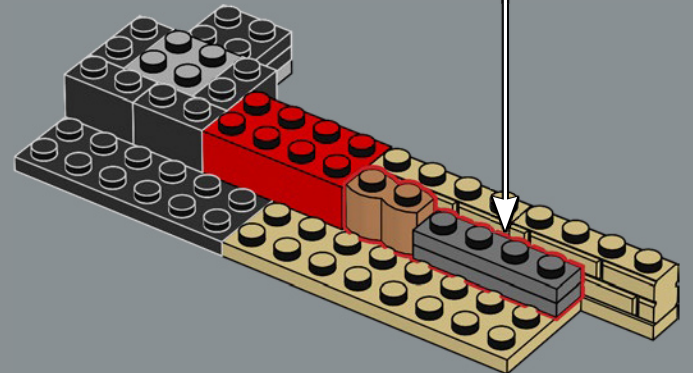
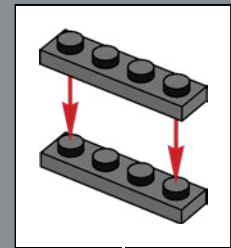

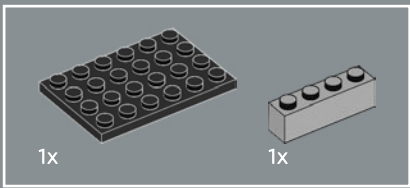

63

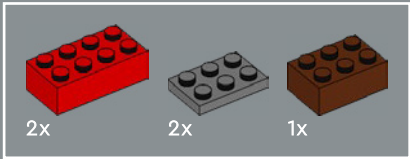
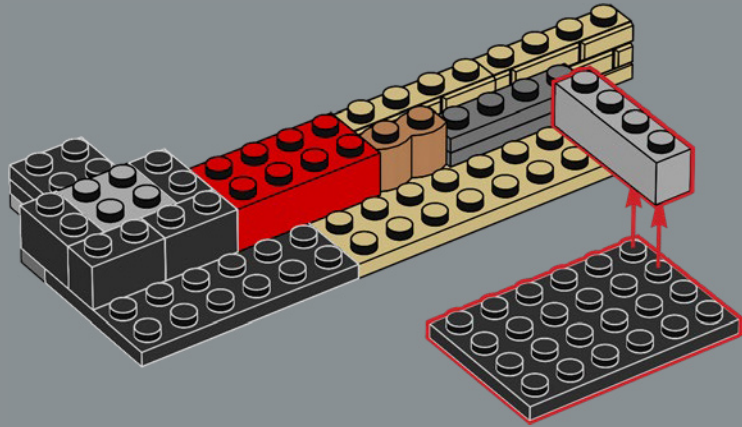

64

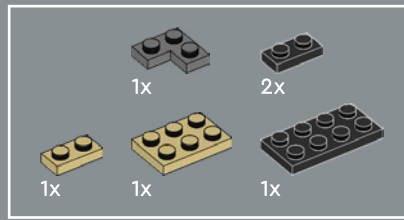
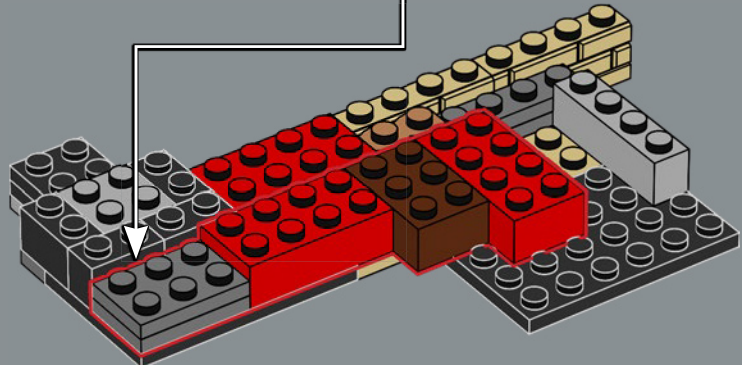
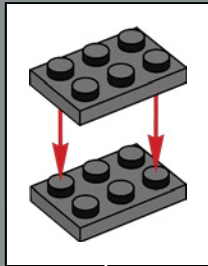

65

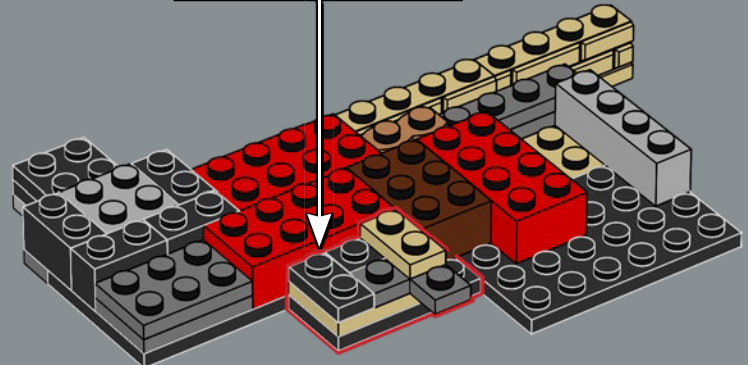
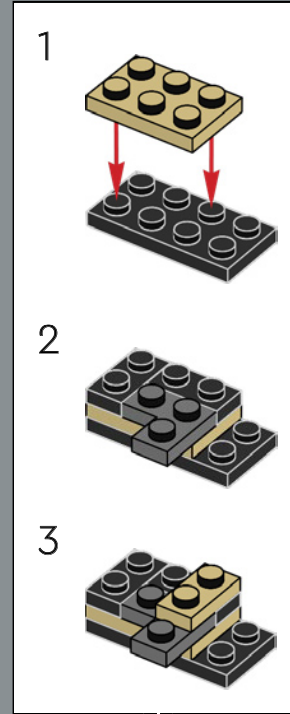



66

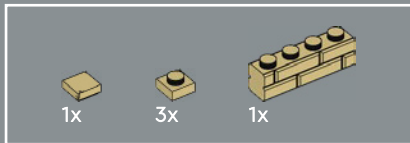
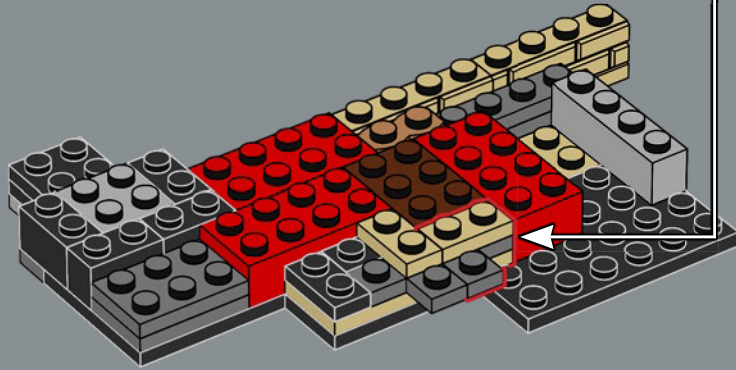
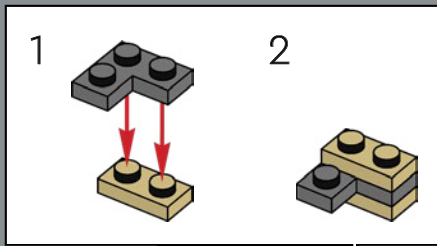

67

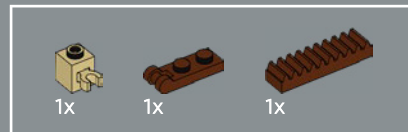
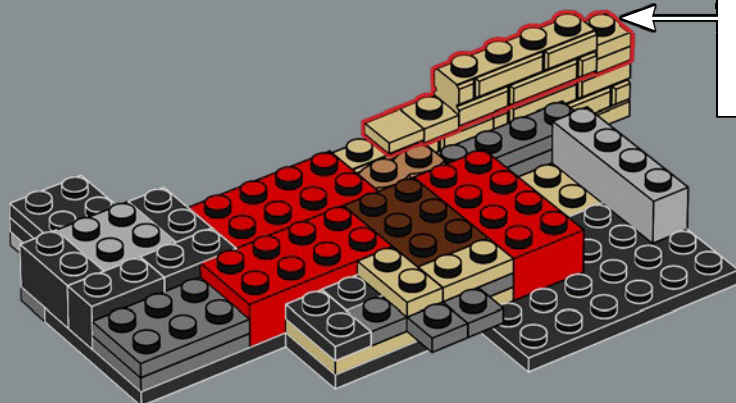
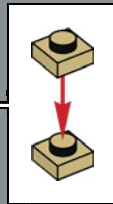

68

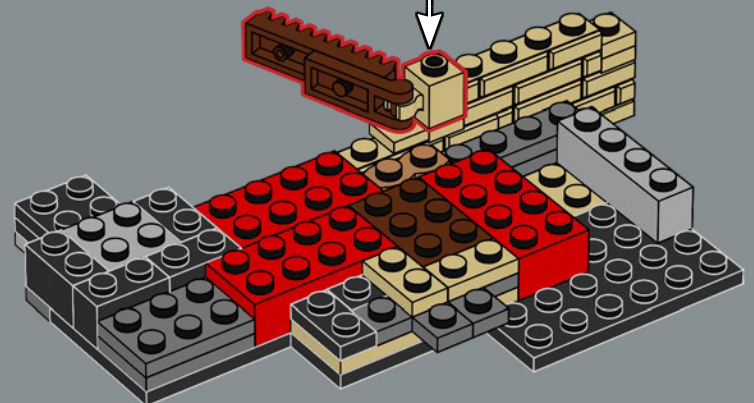
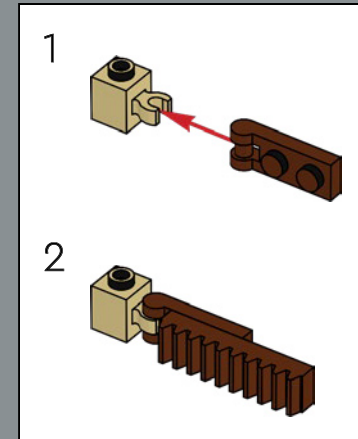

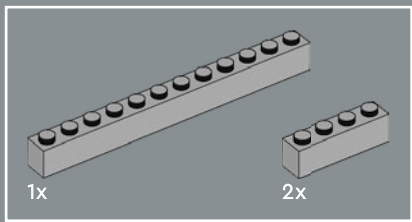

69

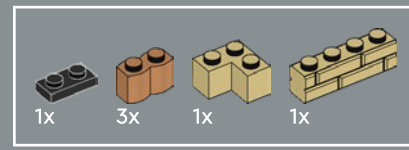
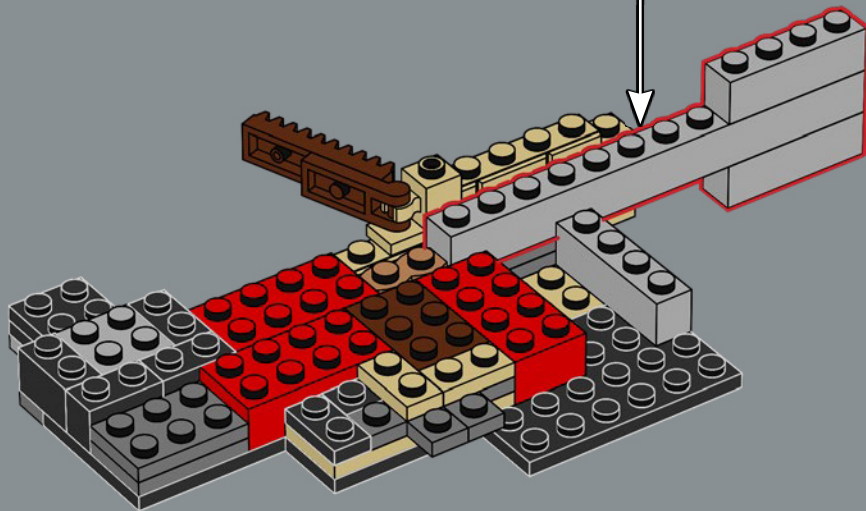
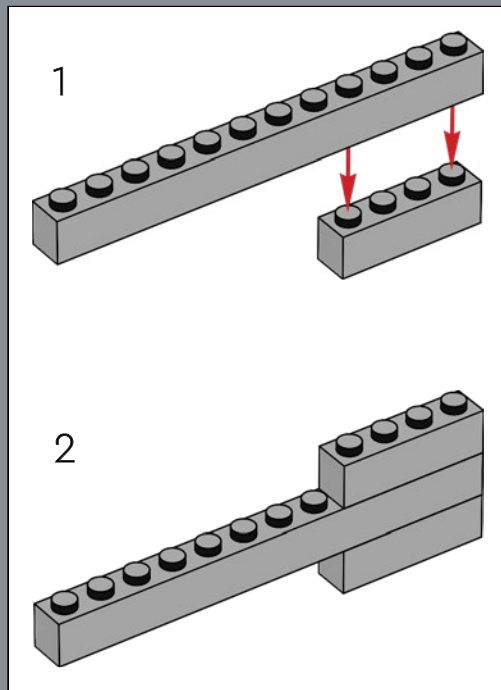

70

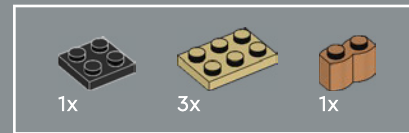
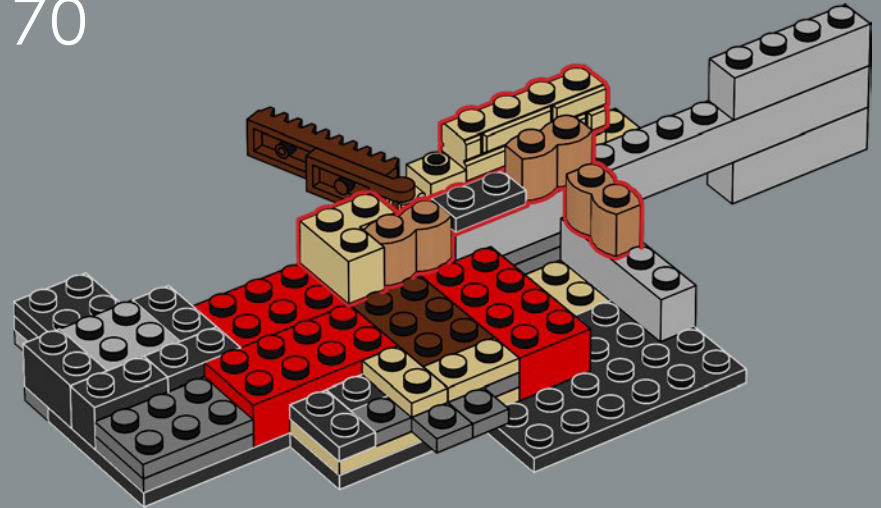

71

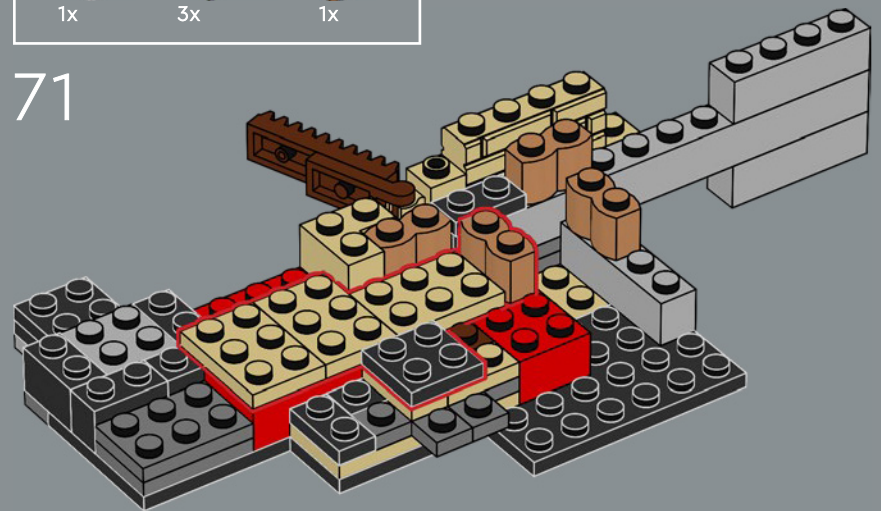

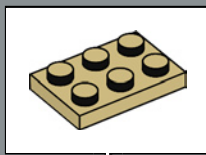
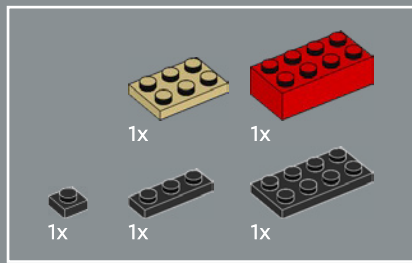

72

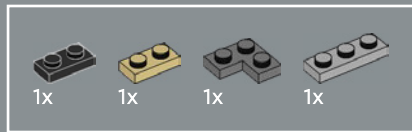
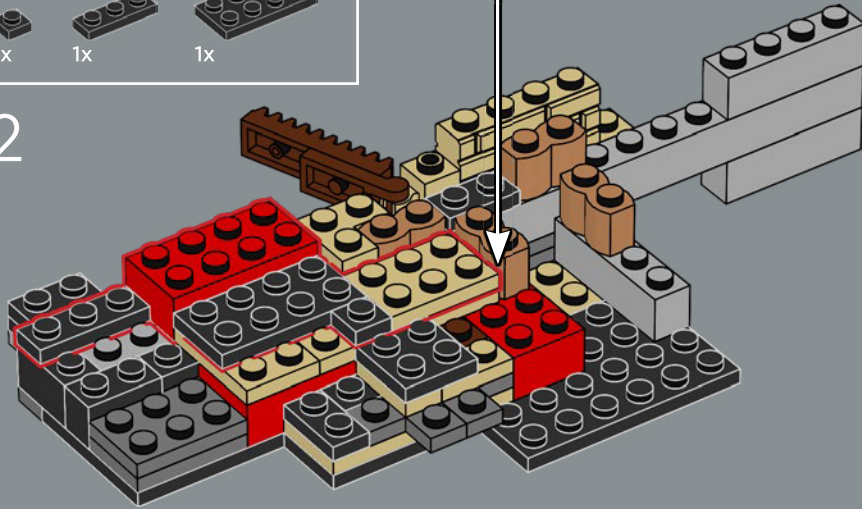

73

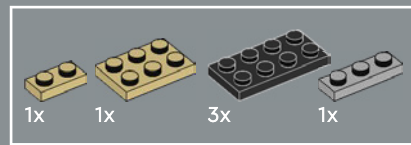
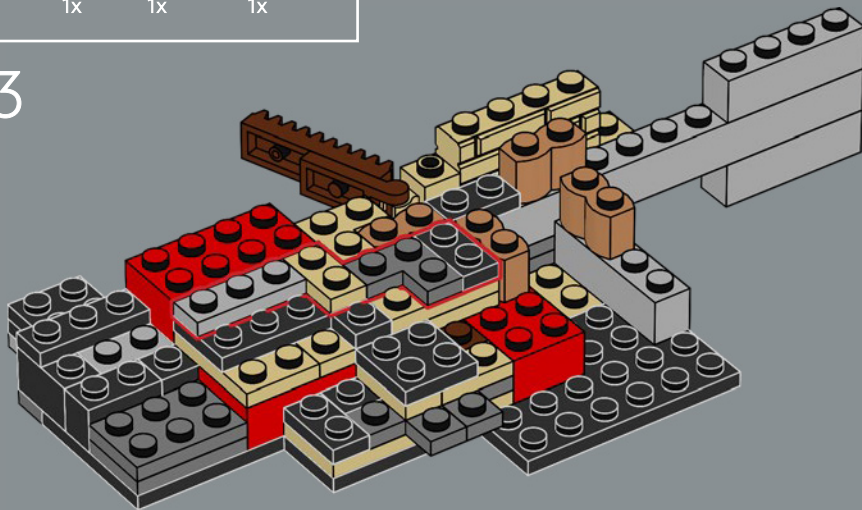

74

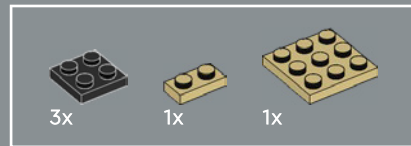
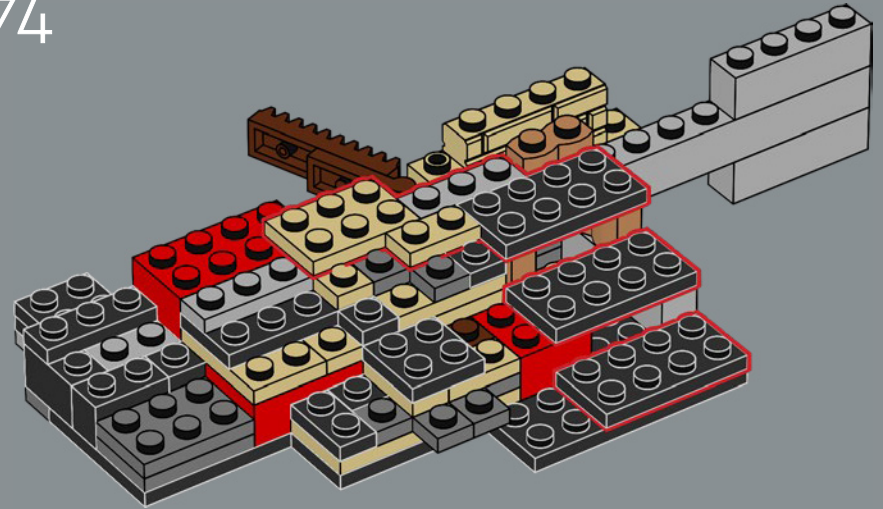

75

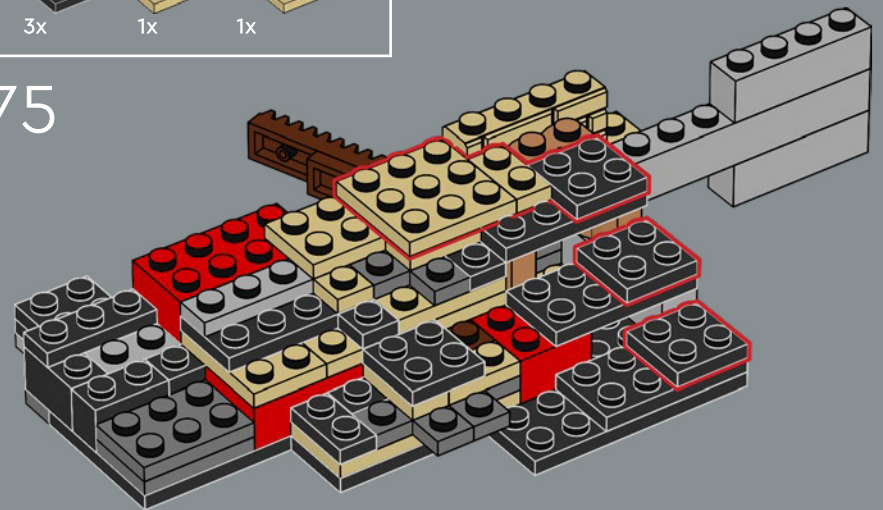

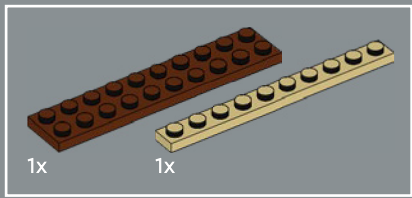

76

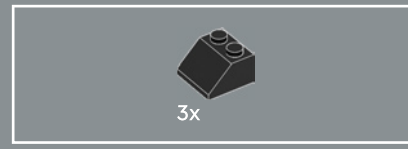
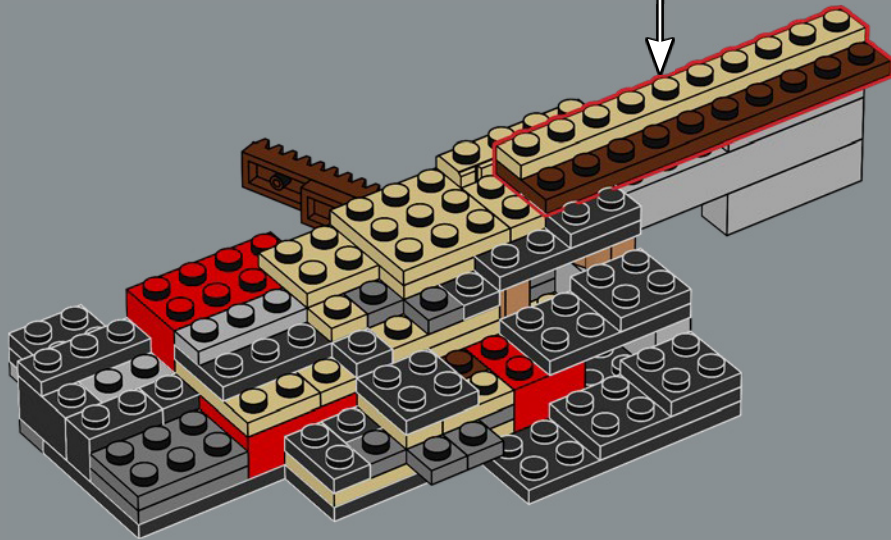
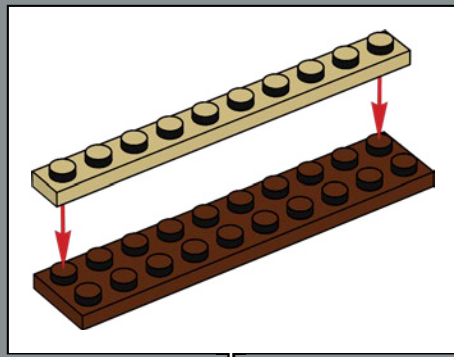

77

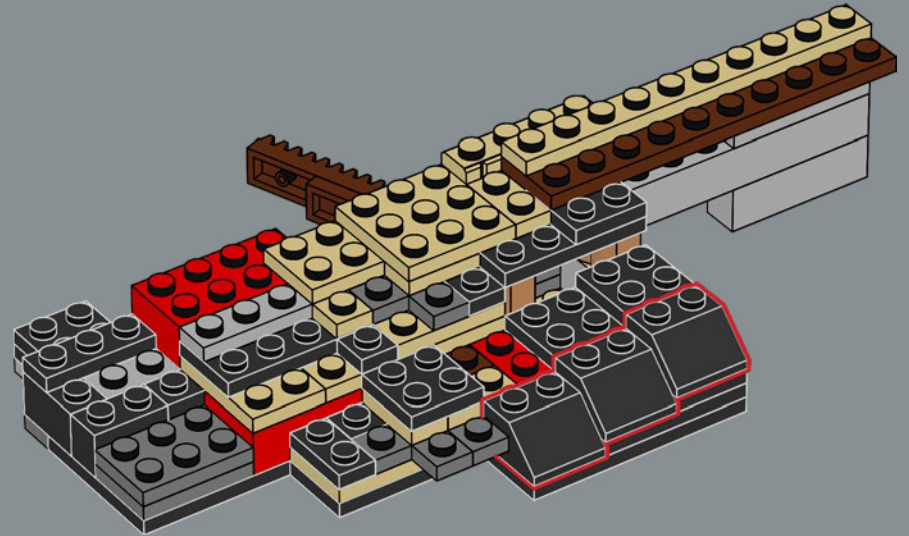



78

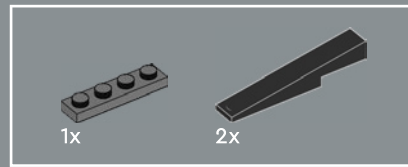
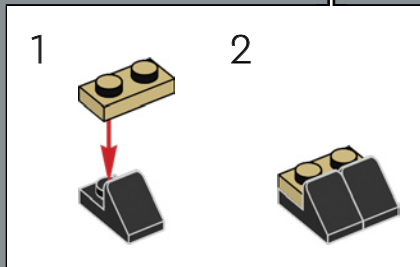
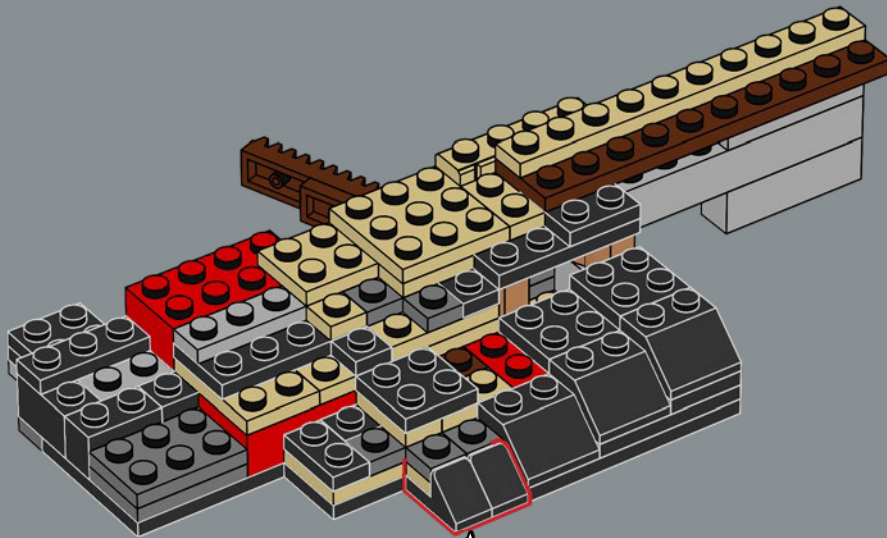

79

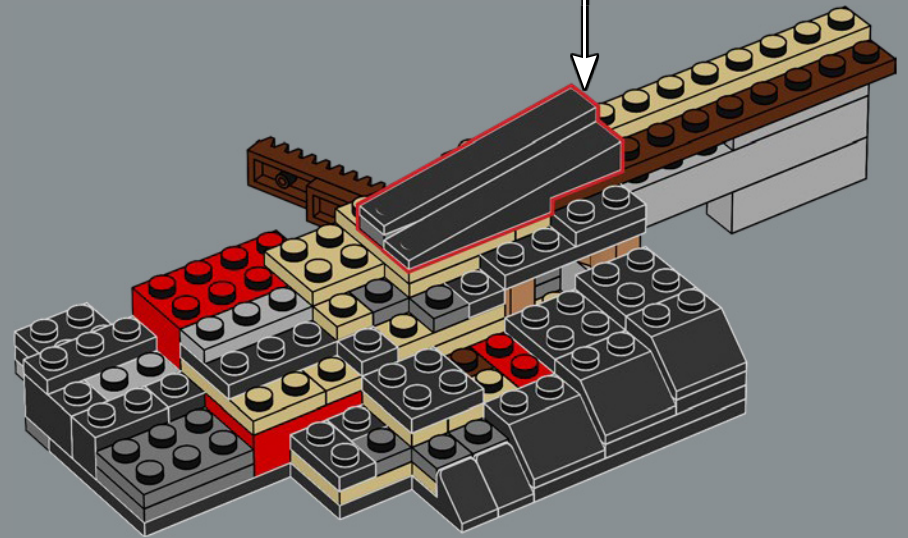
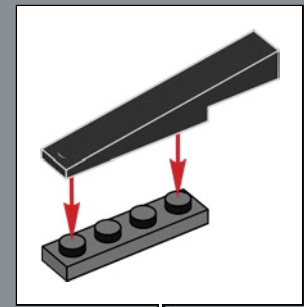



80

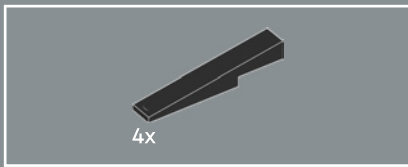
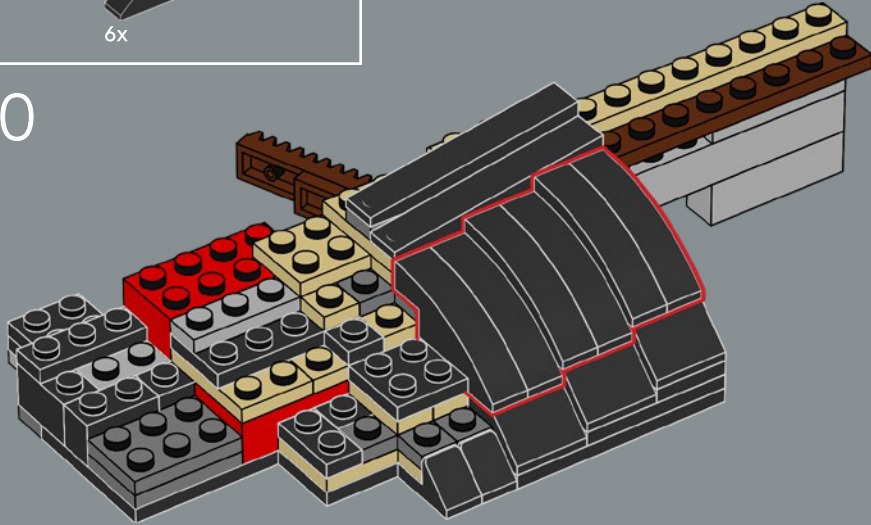

82

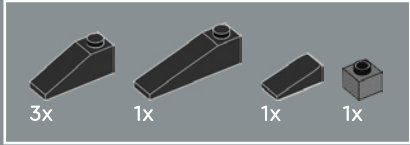
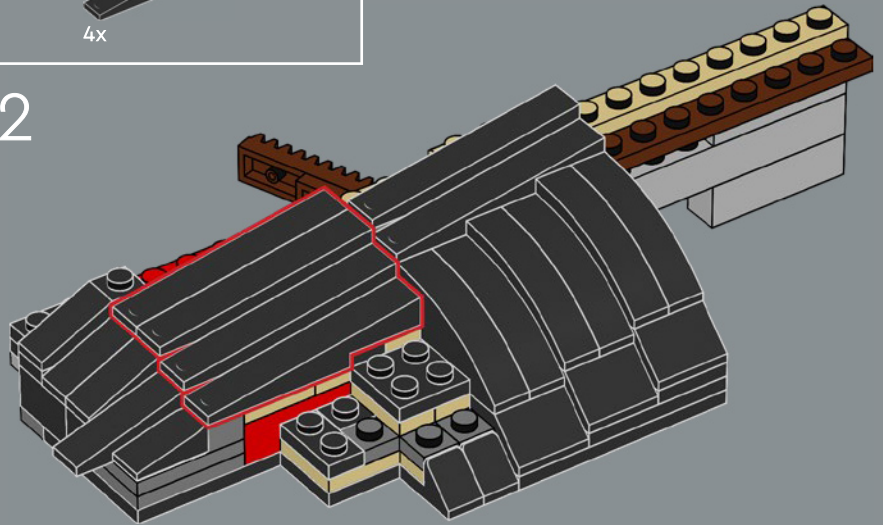

81

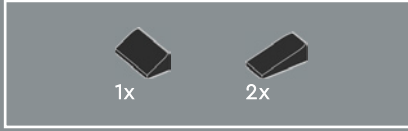
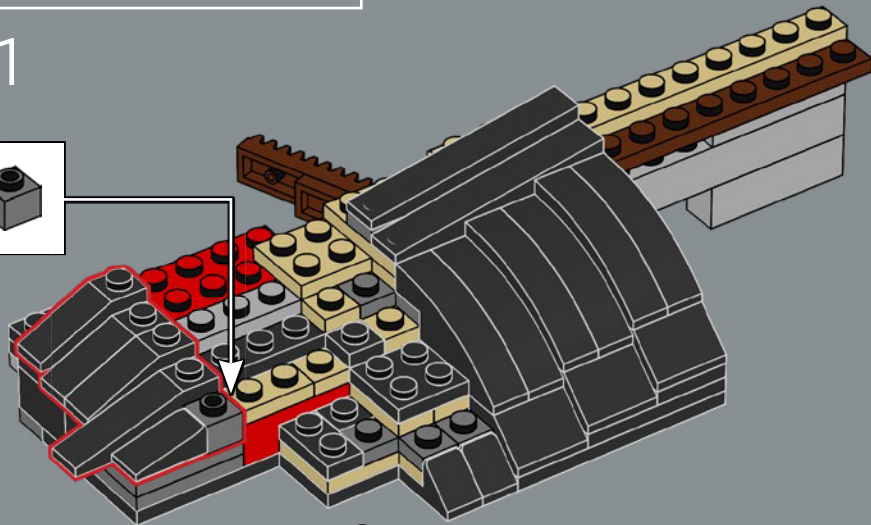

83

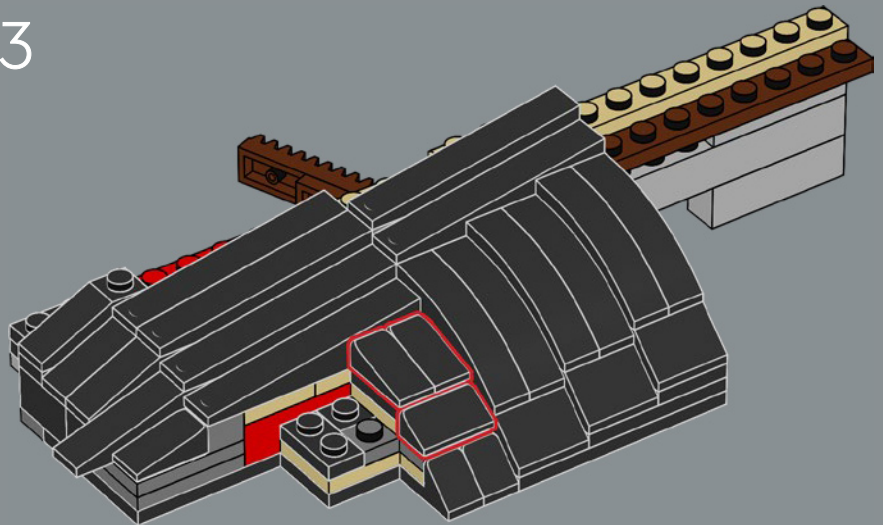

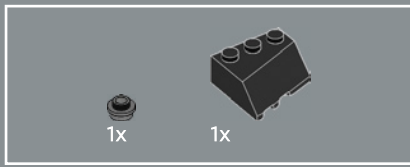

84

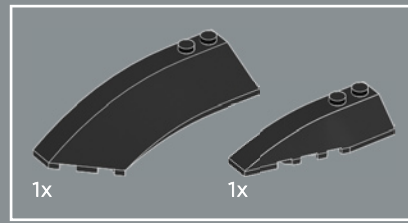
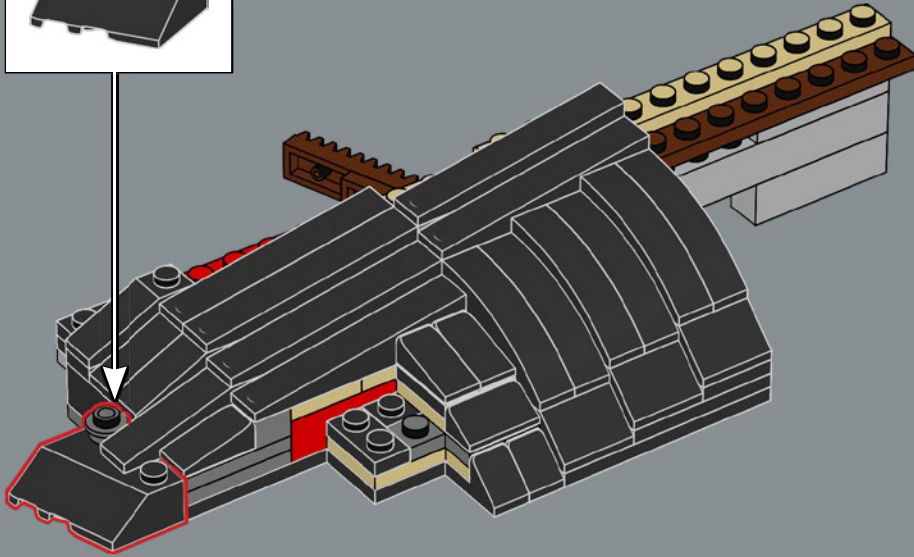
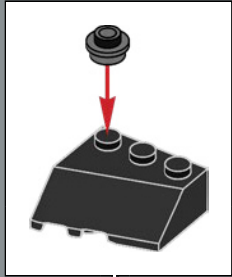

85

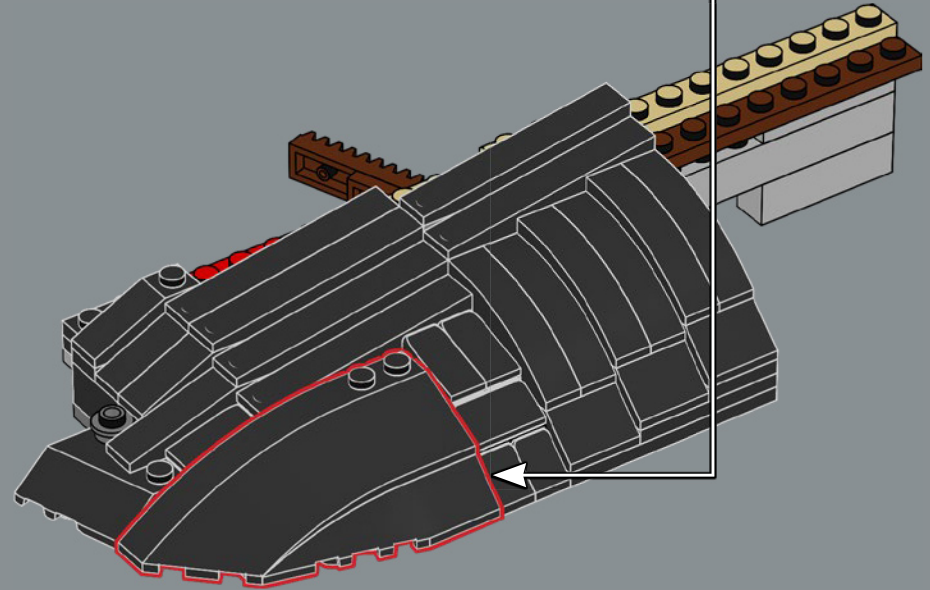
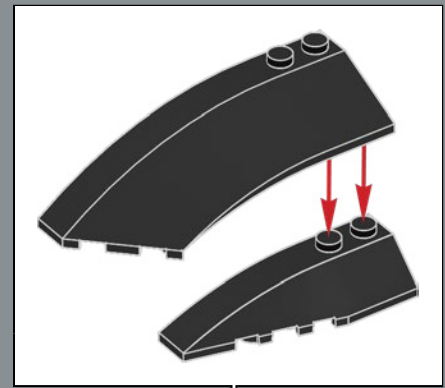



棕色乐高®机械组 1x4 齿杆齿条组件
可用来制作精美的小木梯。

86

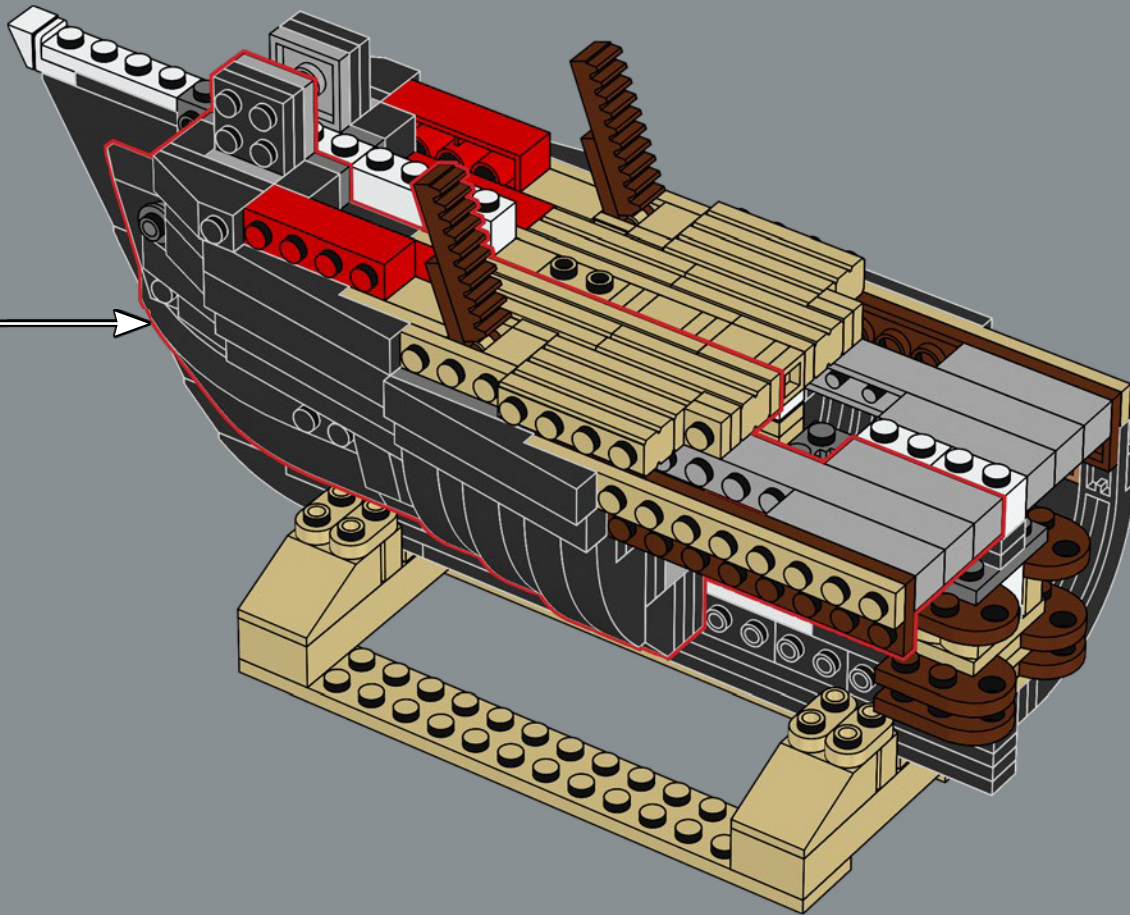

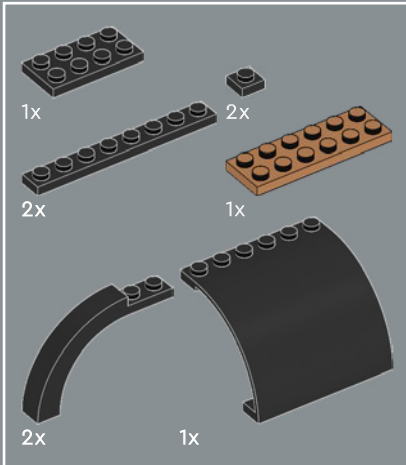
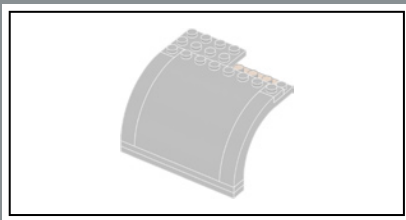

87

1

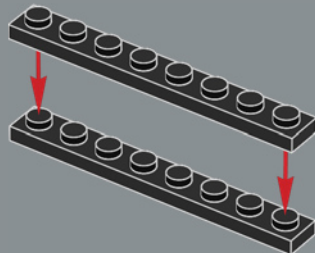

2

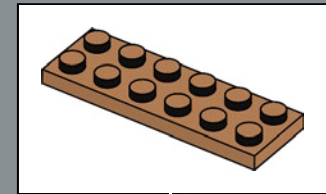
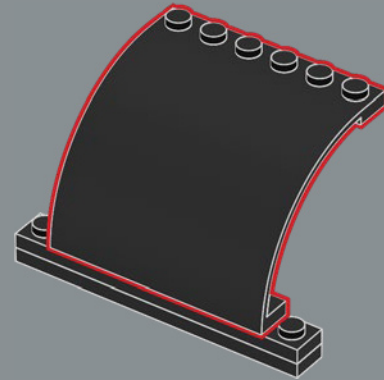

3

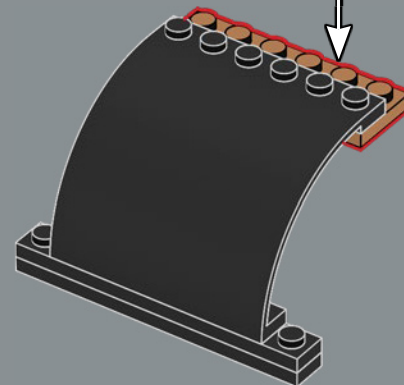

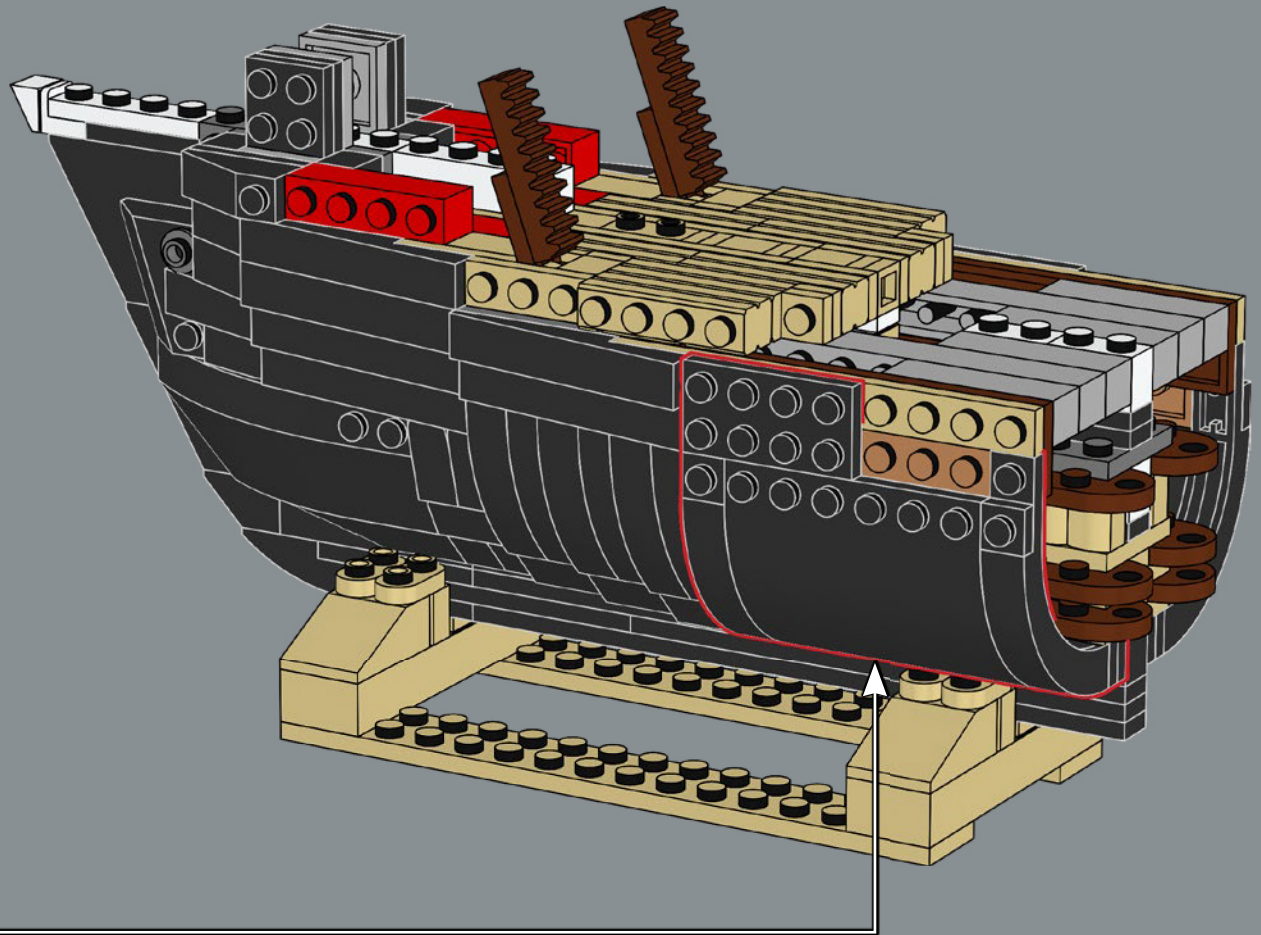
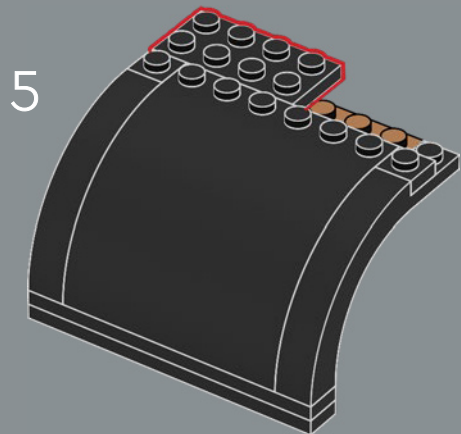
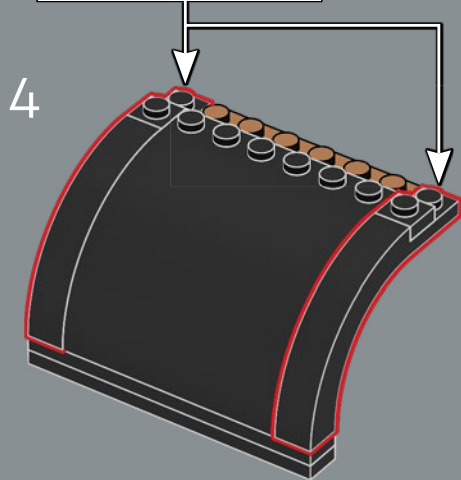
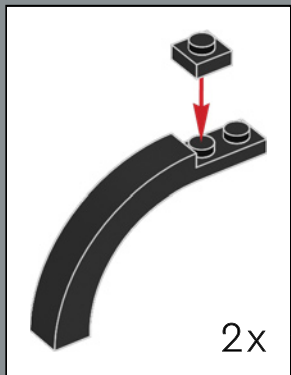

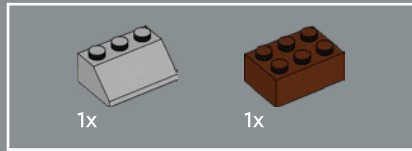

88

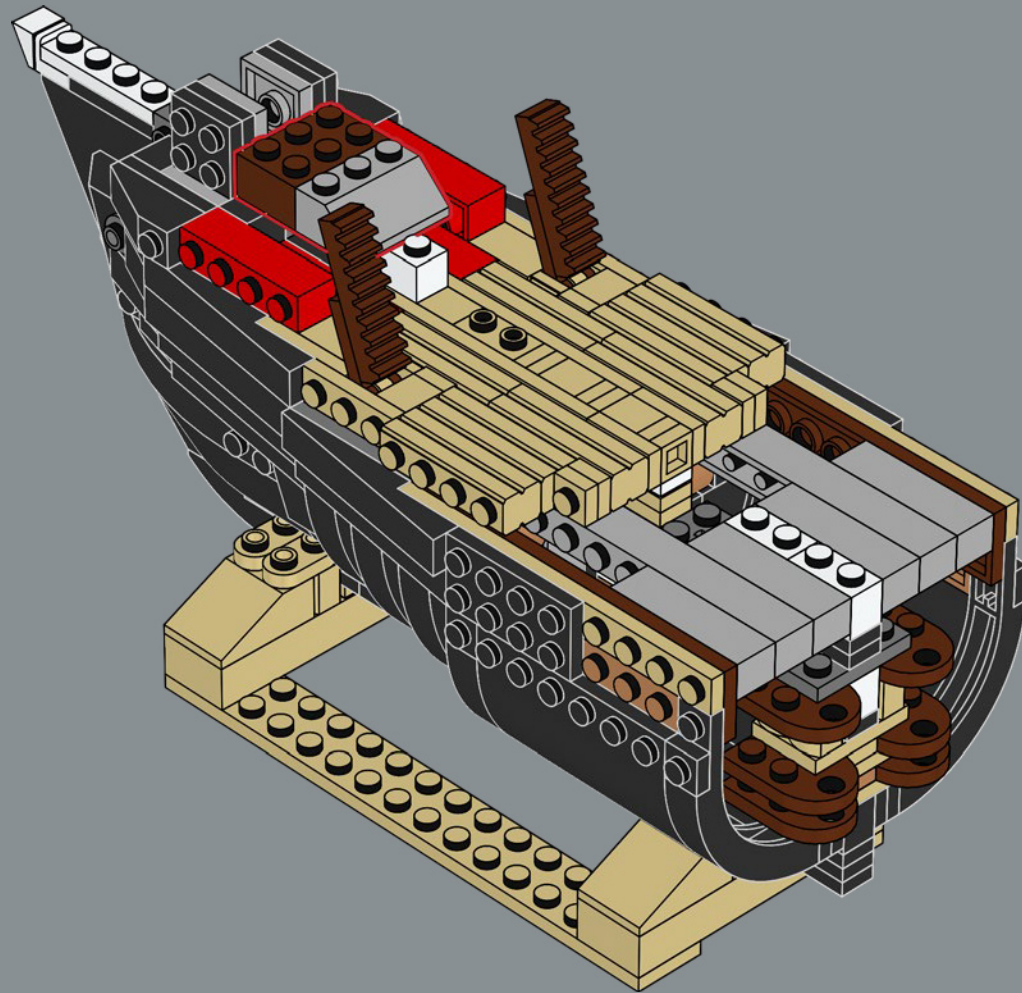



2x

89

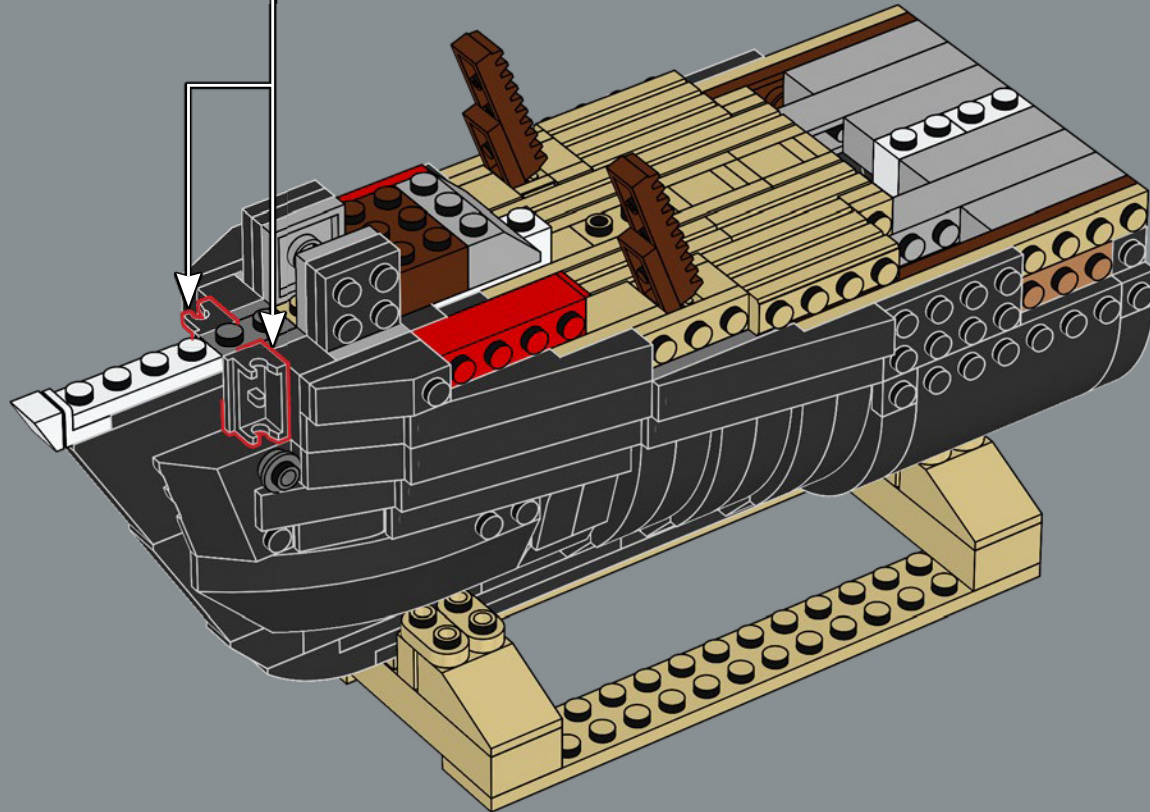
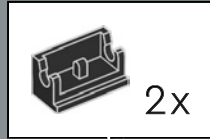

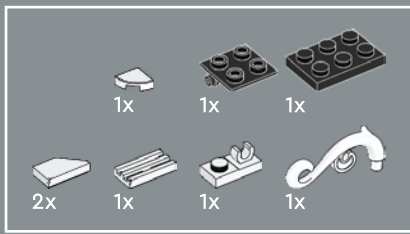

90

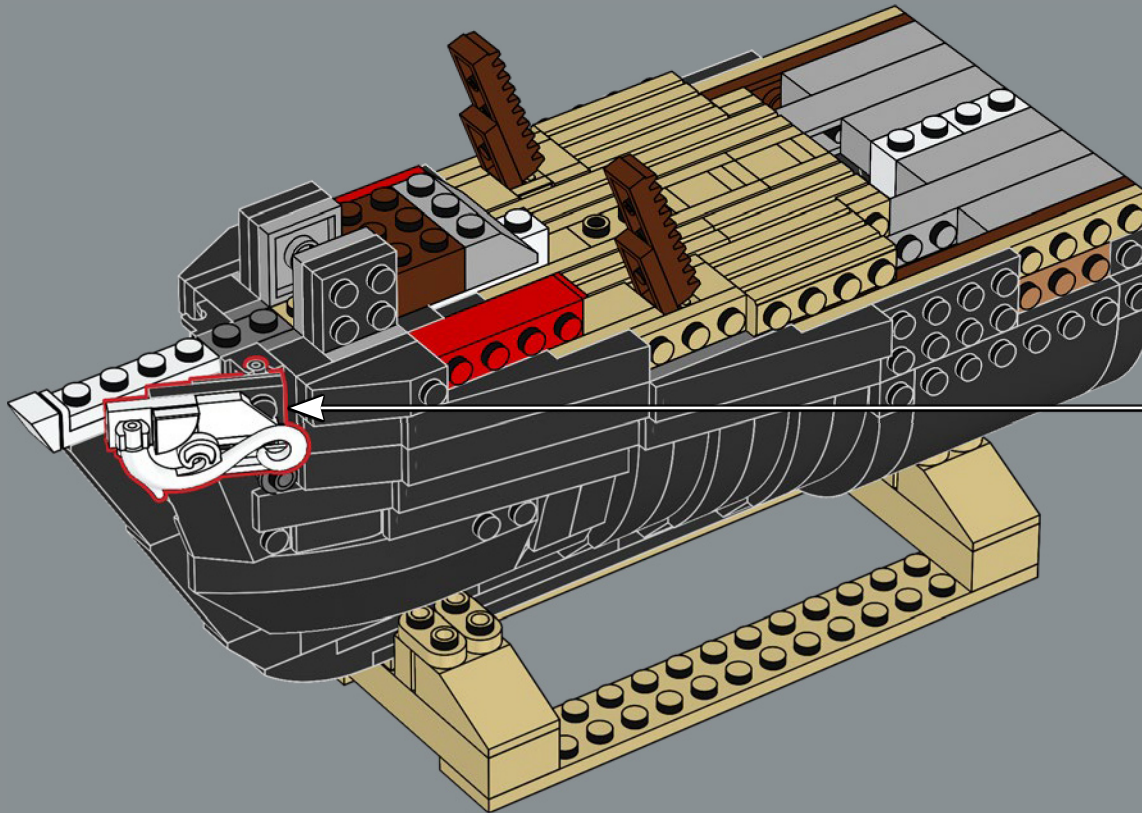
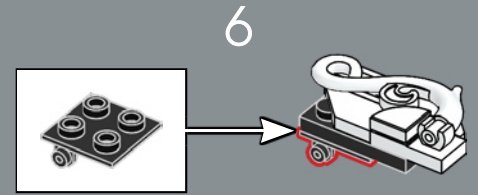
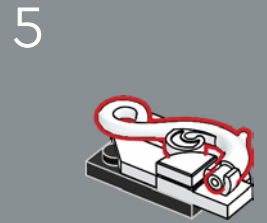
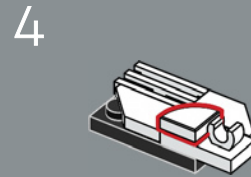
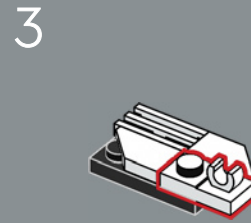
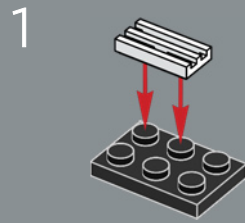

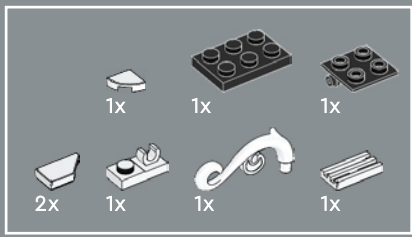

91

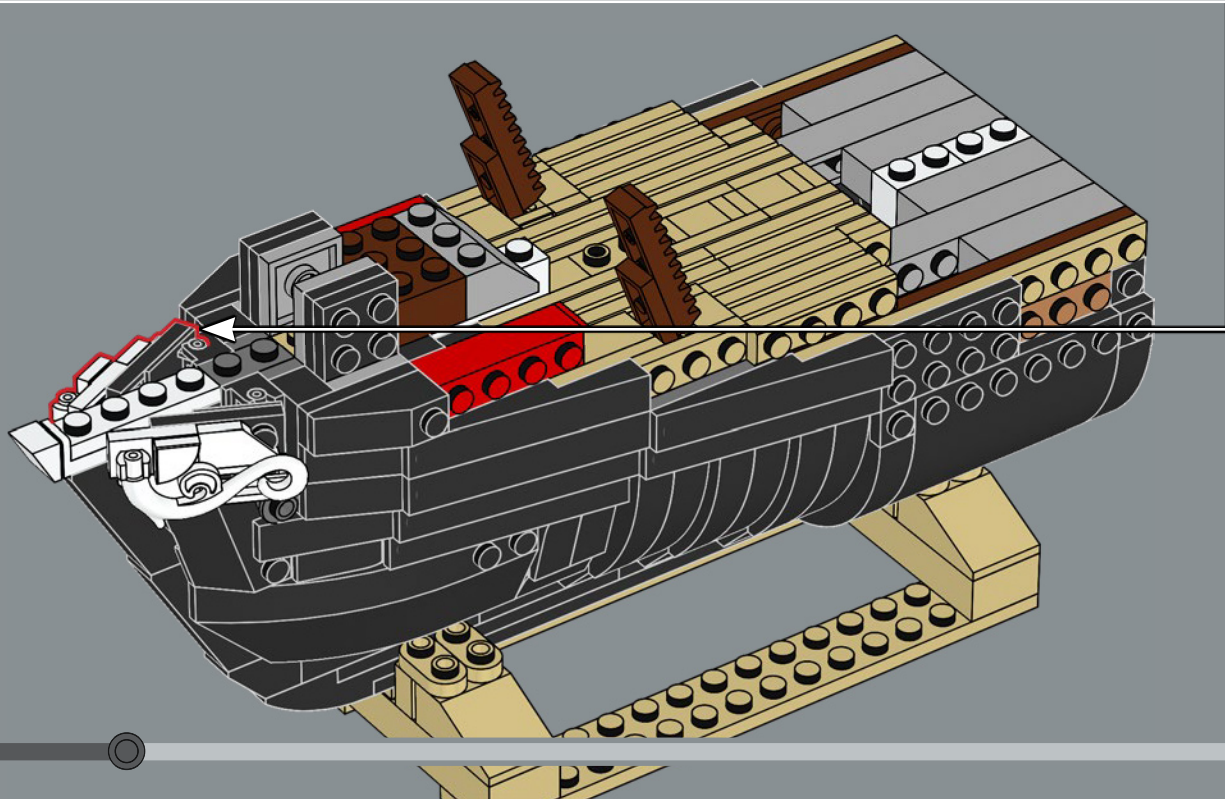
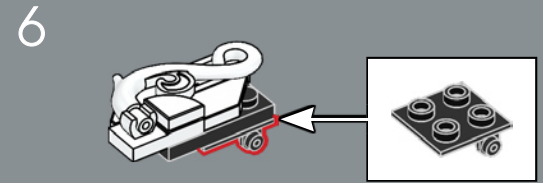
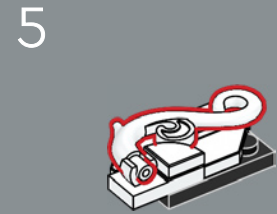
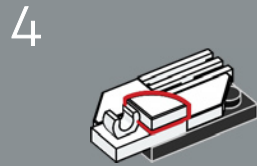
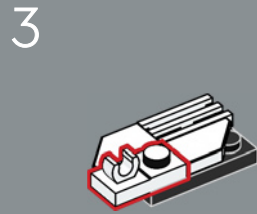
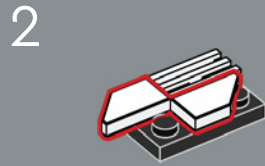
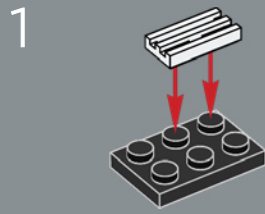

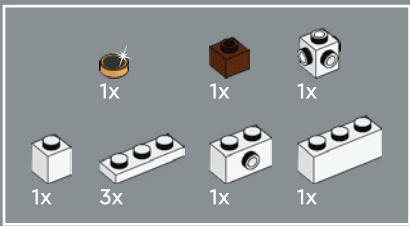

92

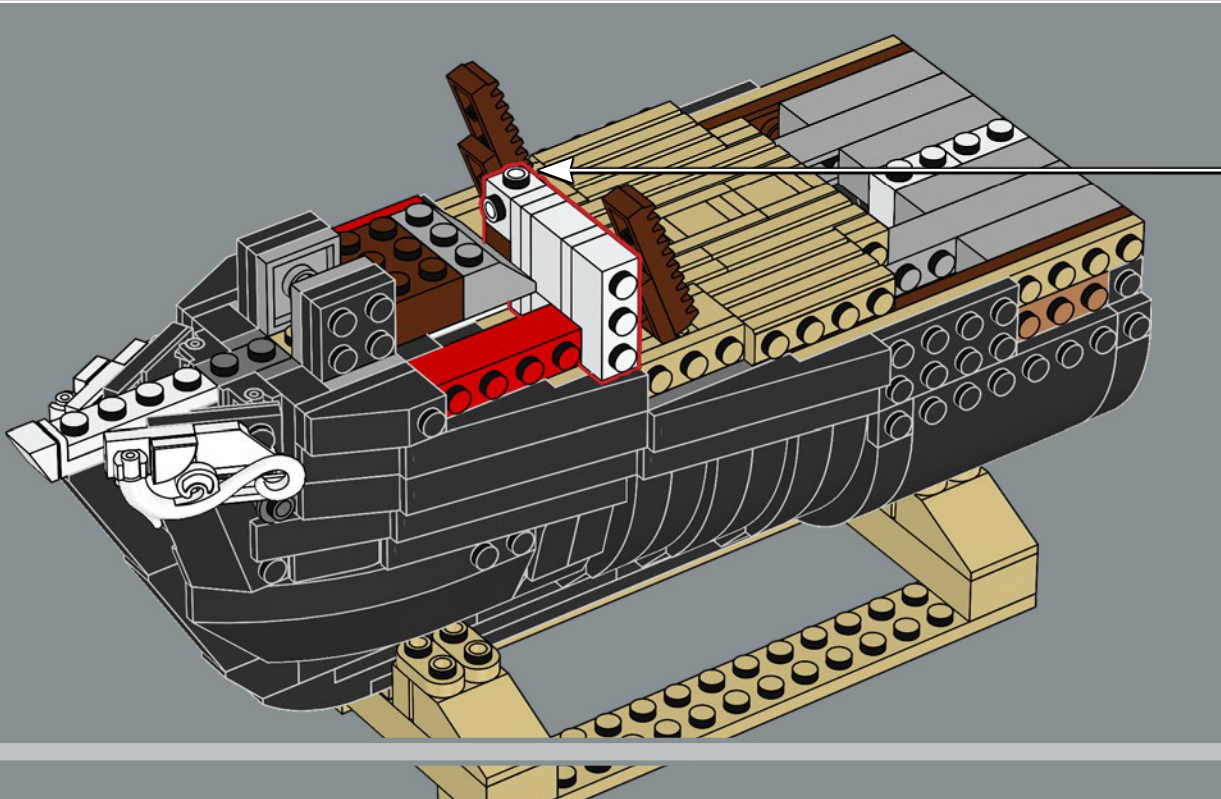
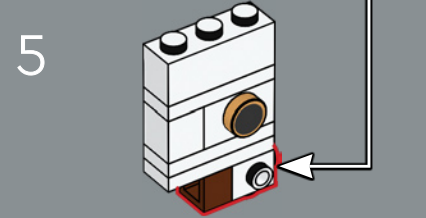
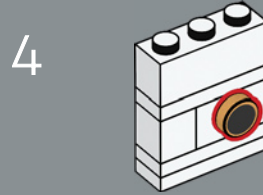
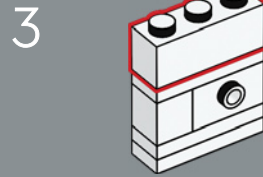
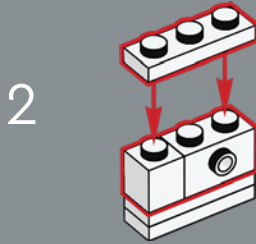
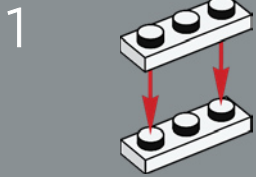

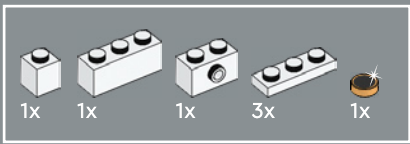

93

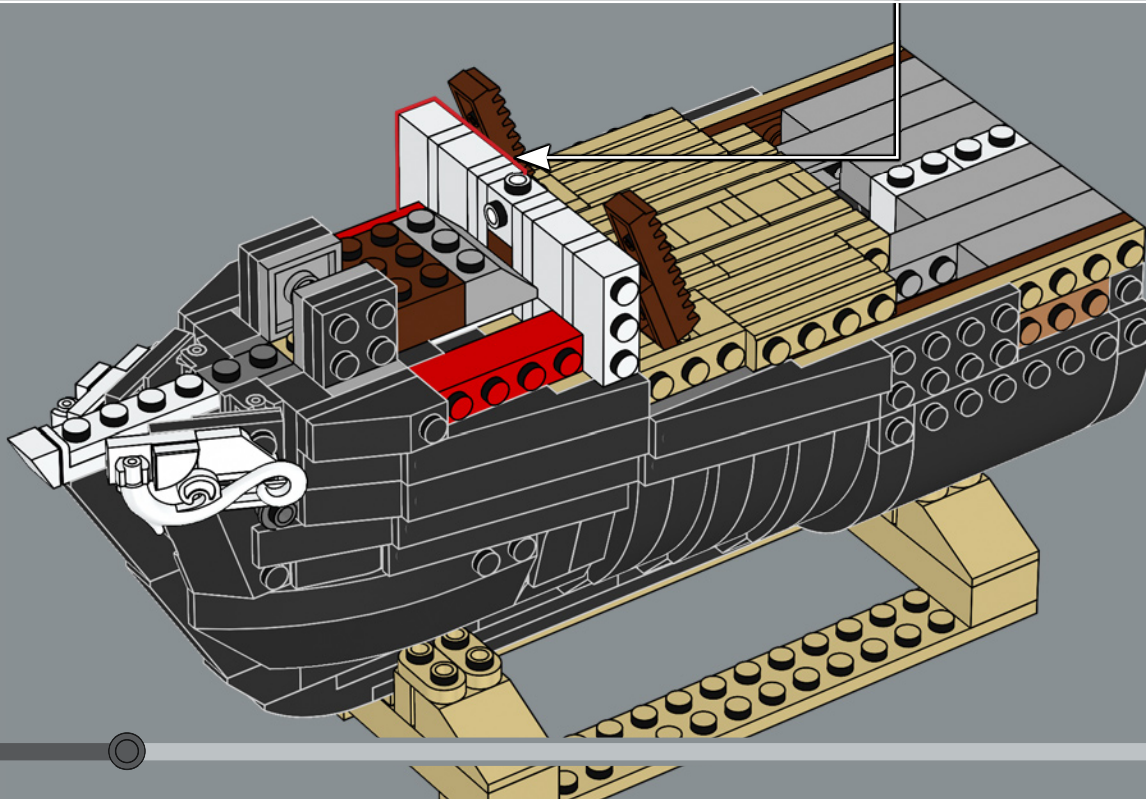
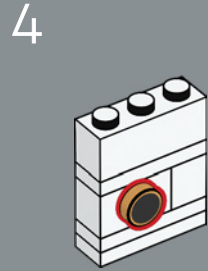
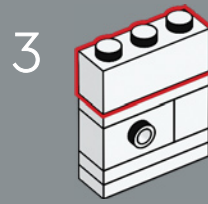
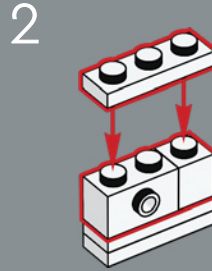
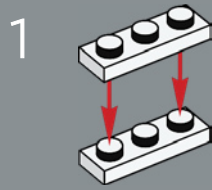

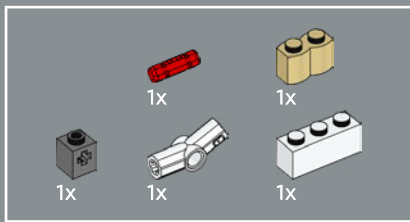

94

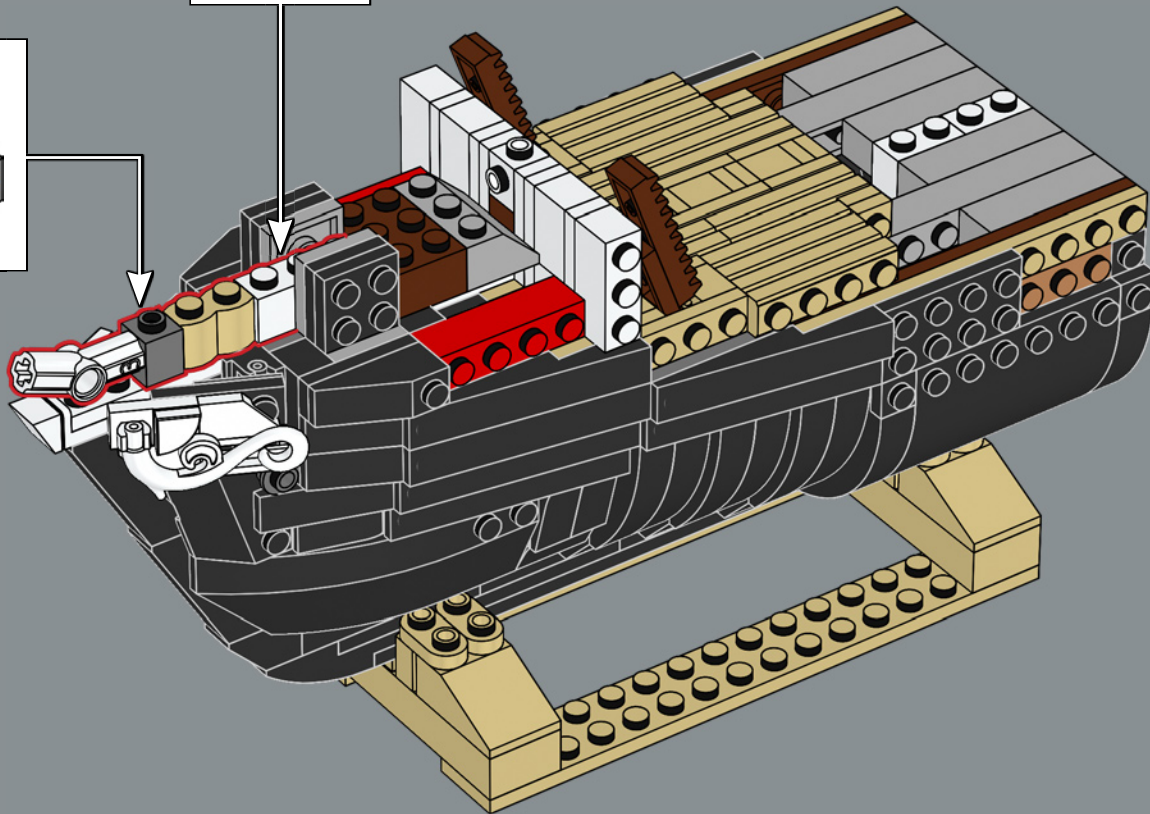
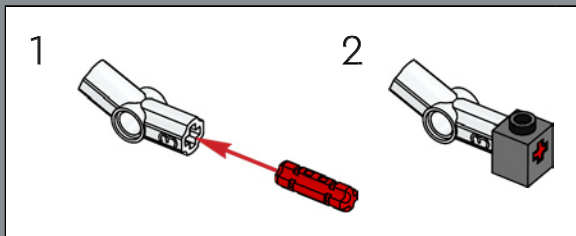
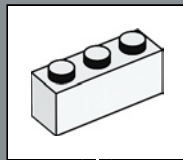

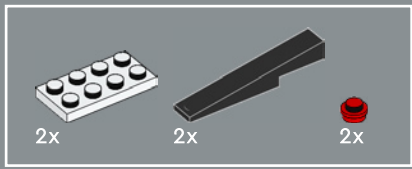

95

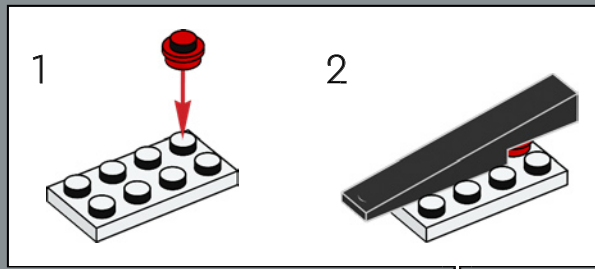

2

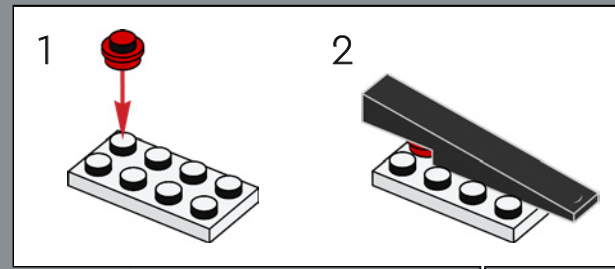
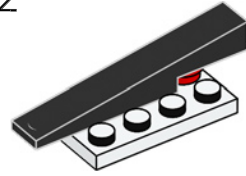

2

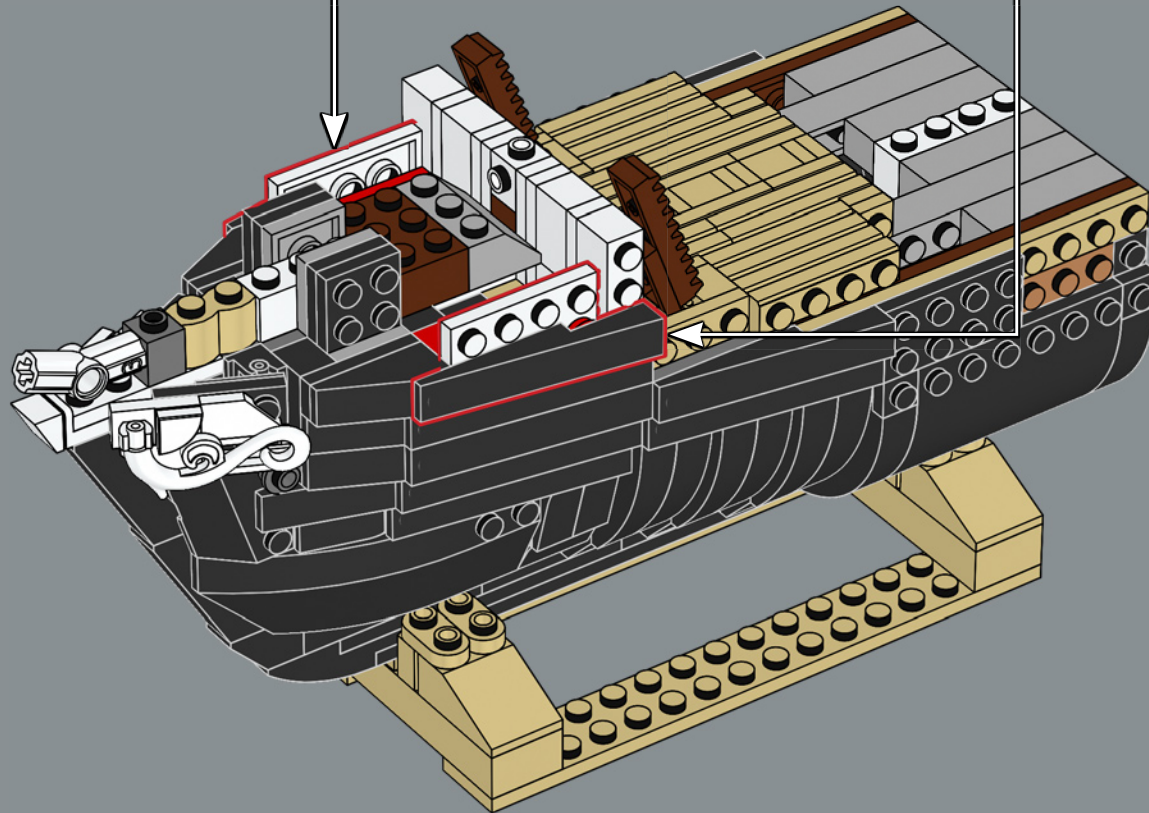
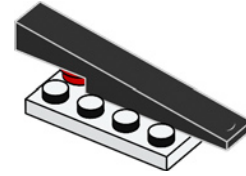

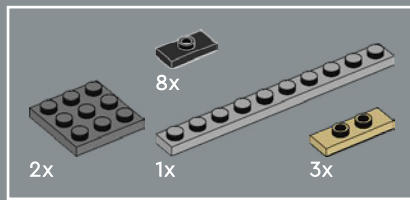

96

1

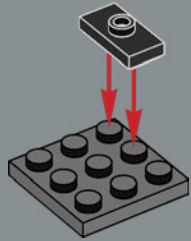

2

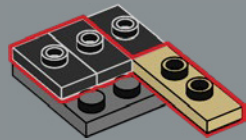

3

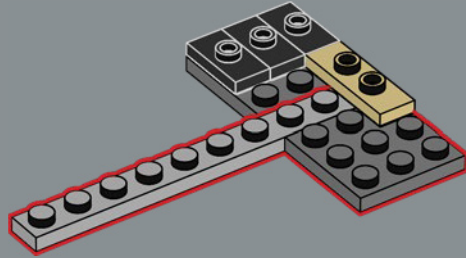

4

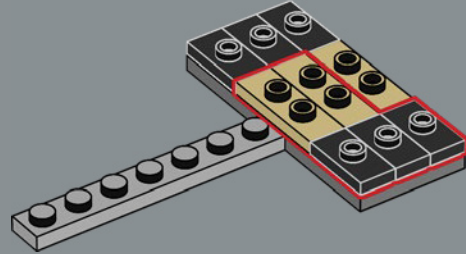

5

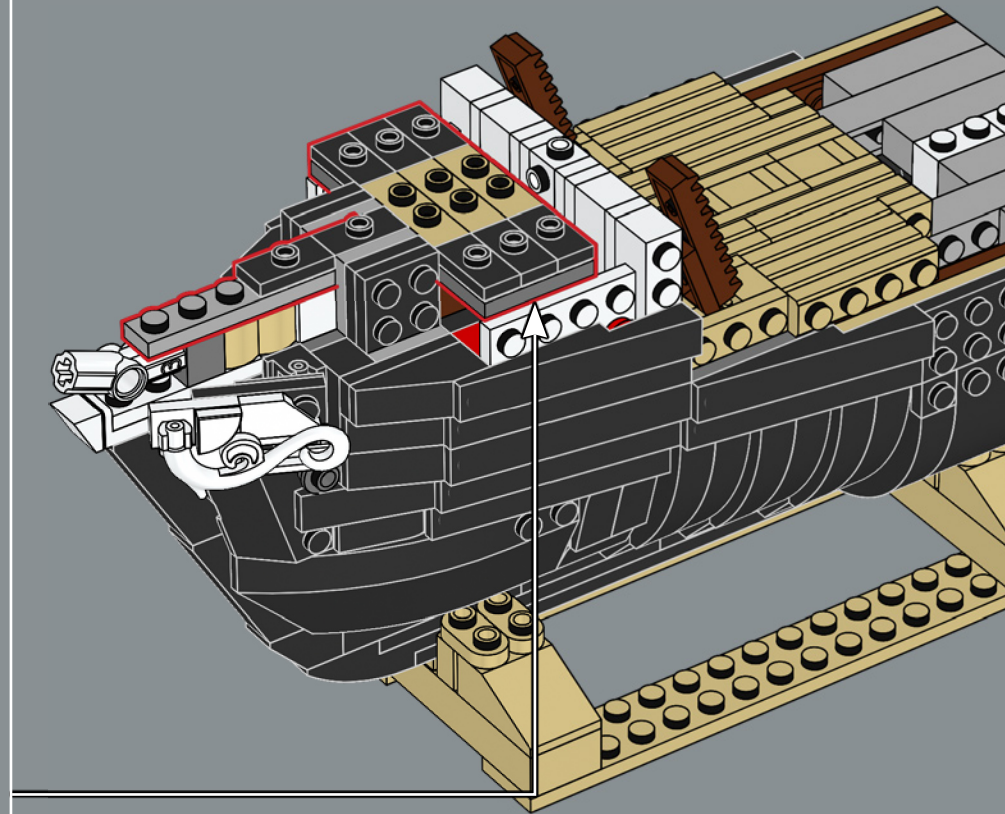
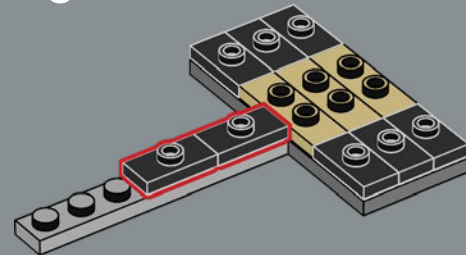

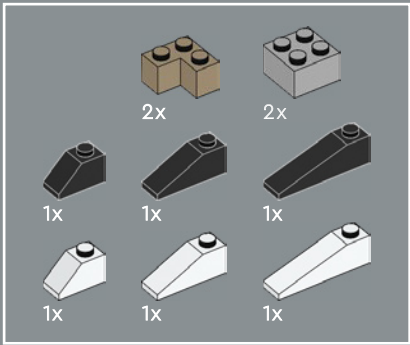

97

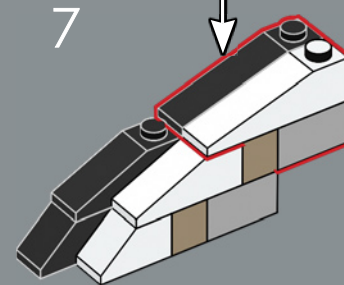
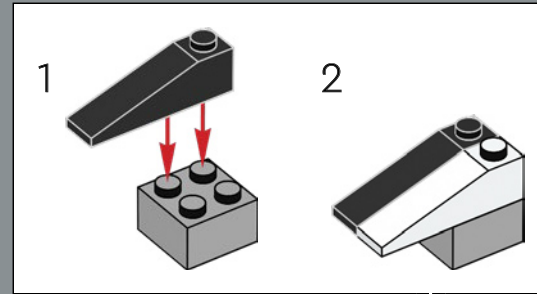
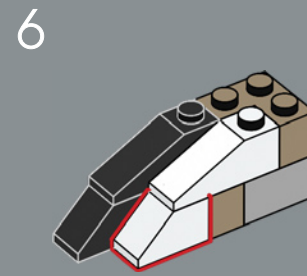
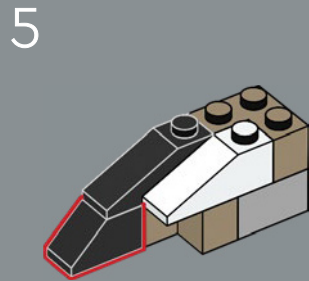
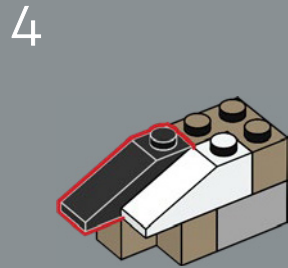
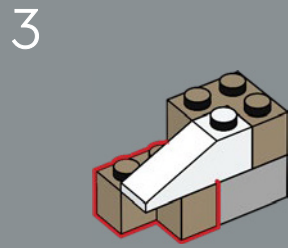
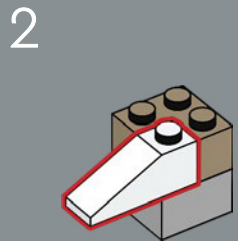
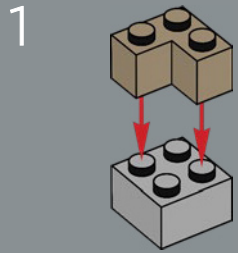

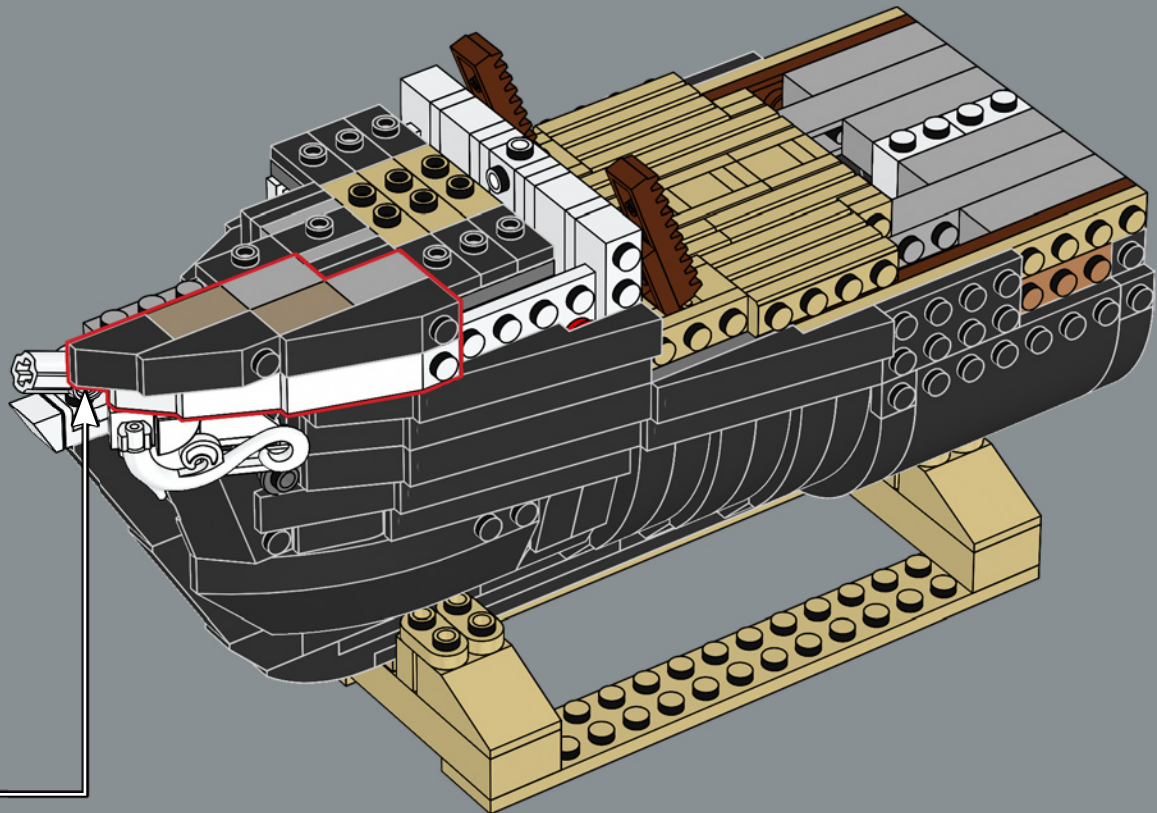

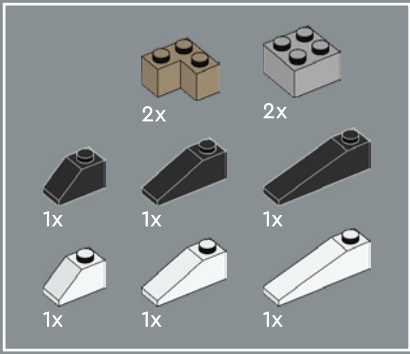

98

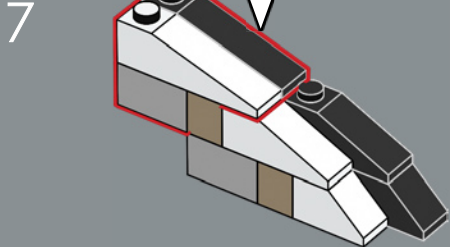
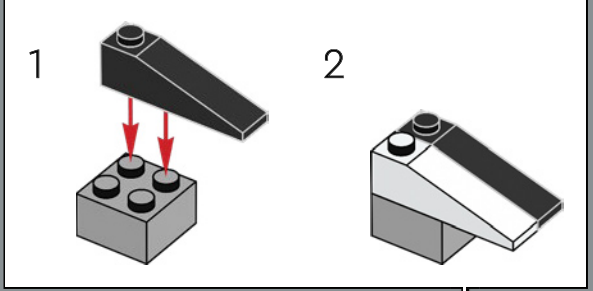
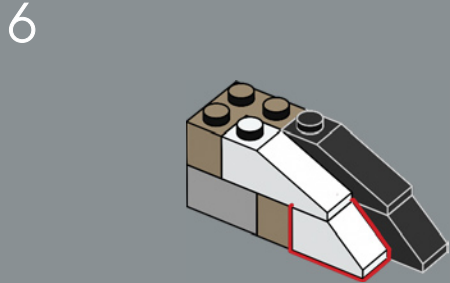
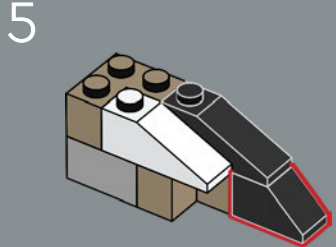
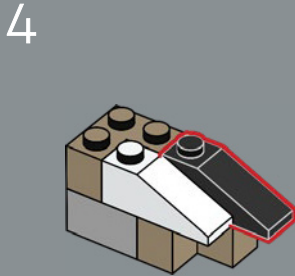
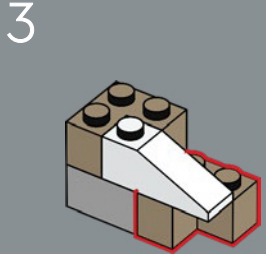
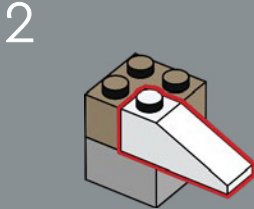
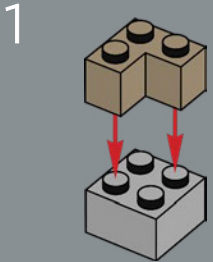

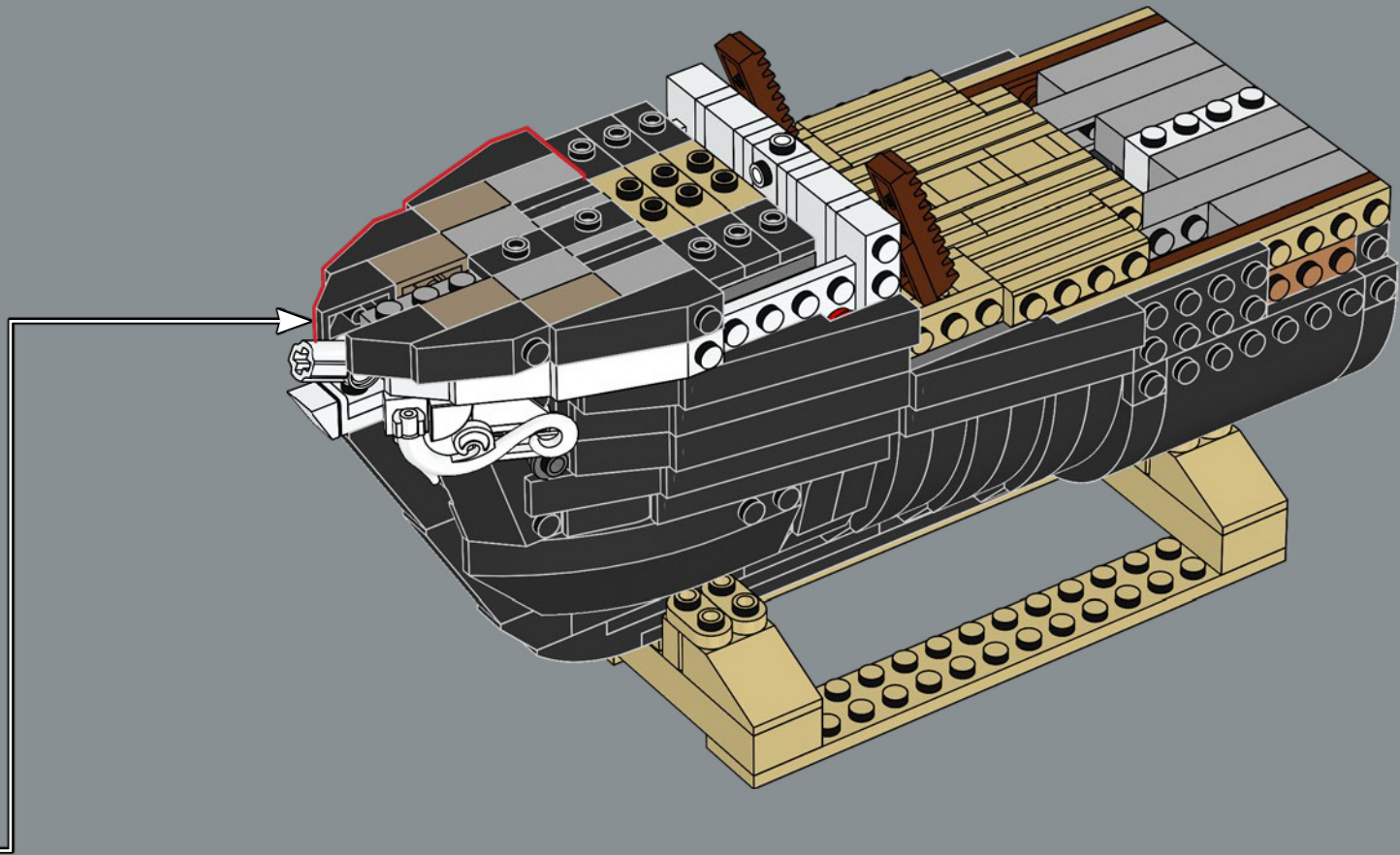



1x

99

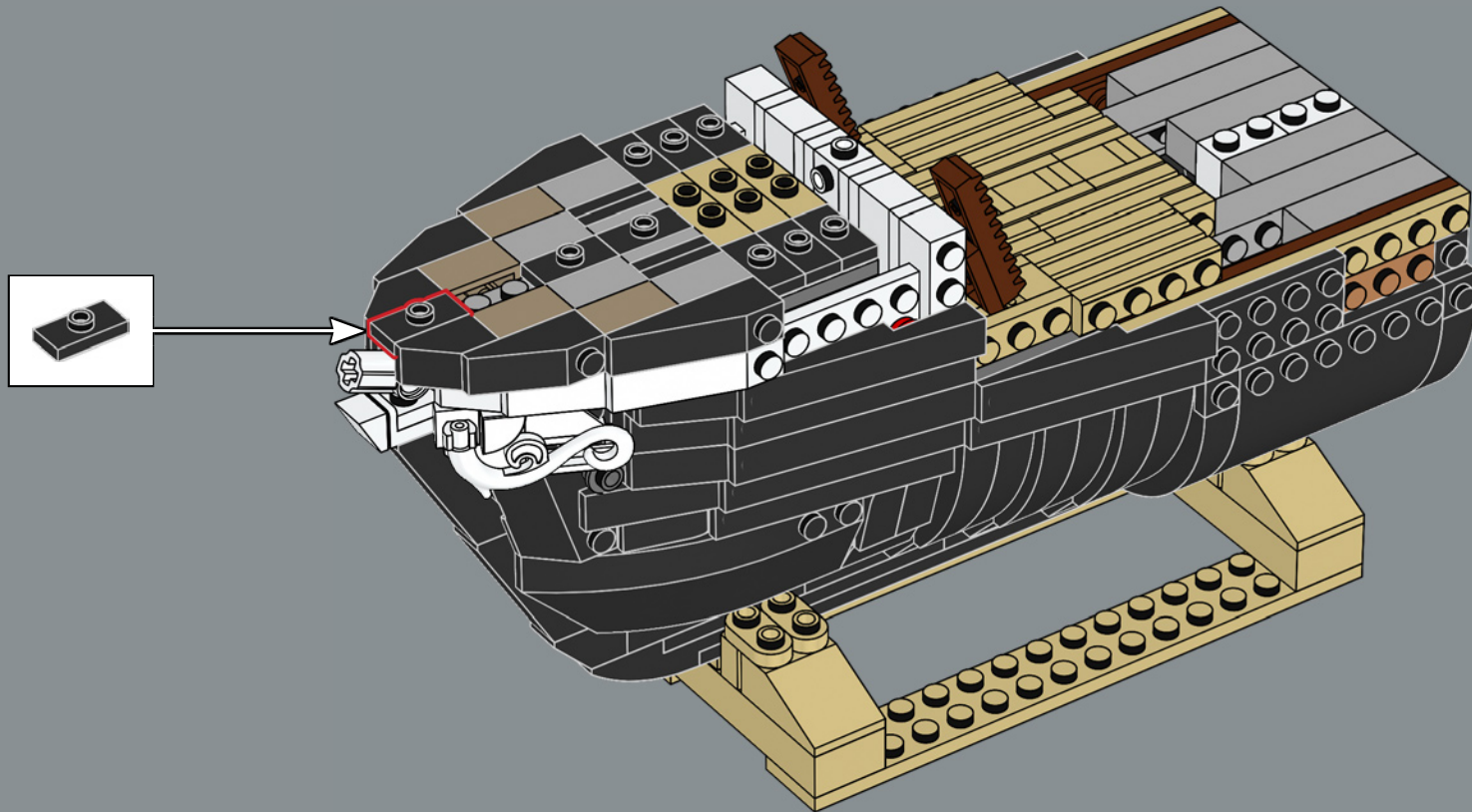

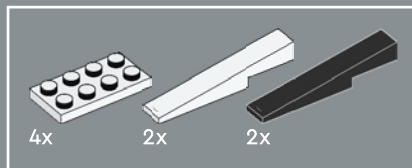

100

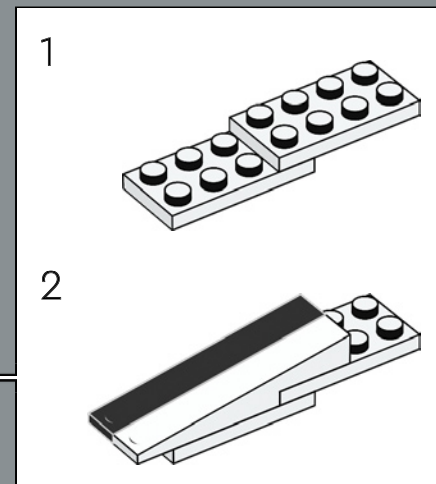
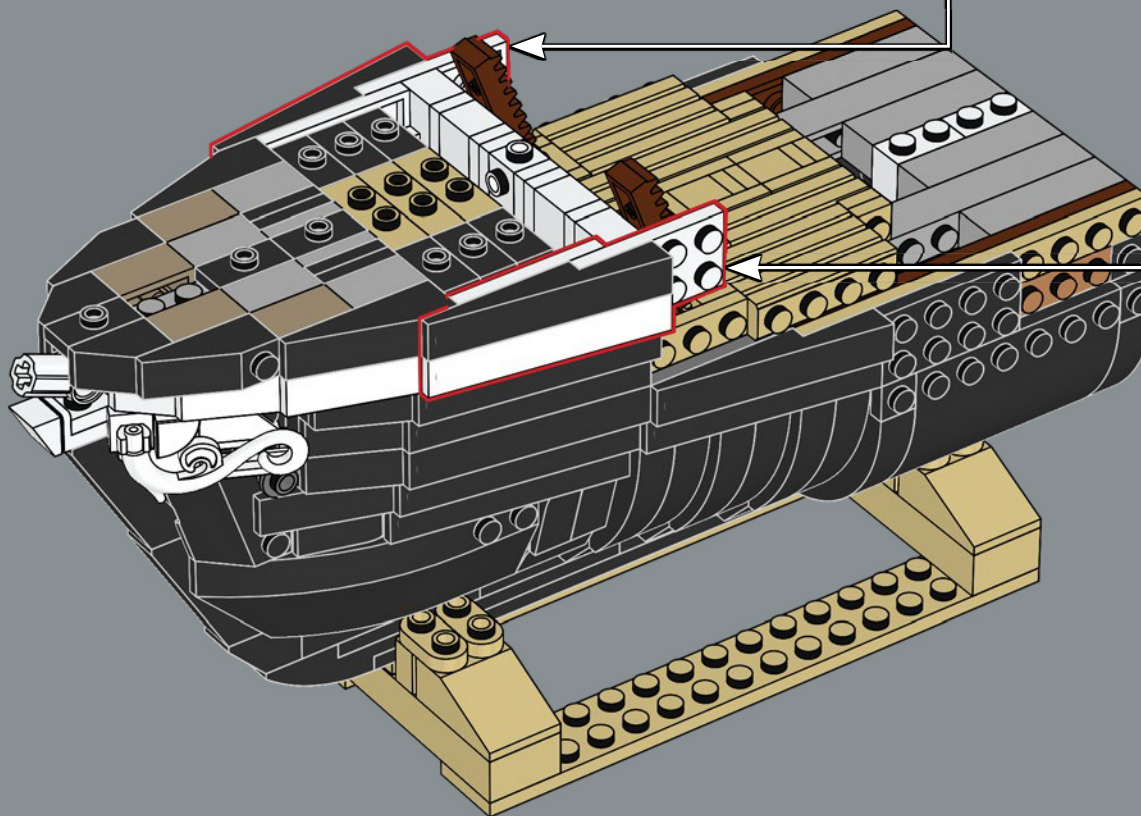
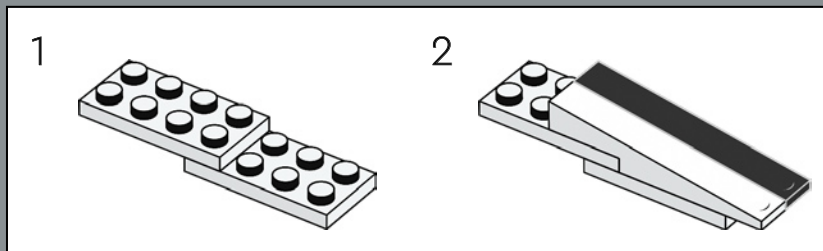

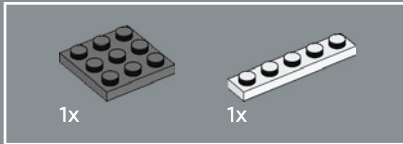
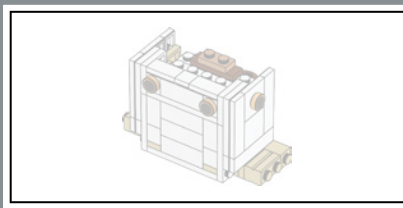

101

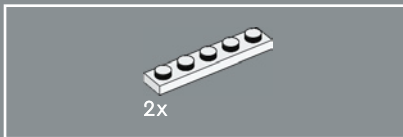
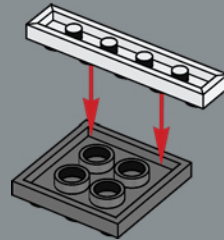

102

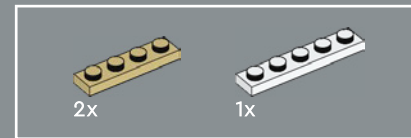
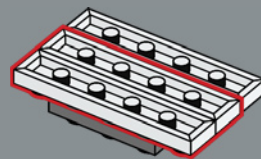

103

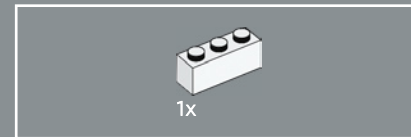
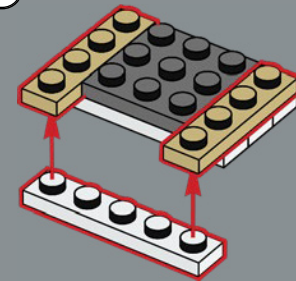

104

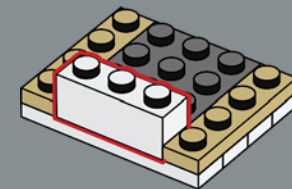

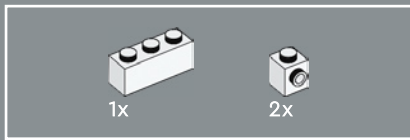

105

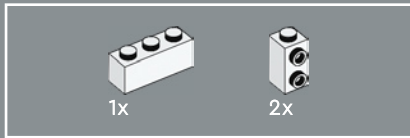
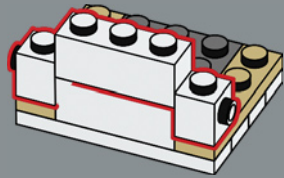

106

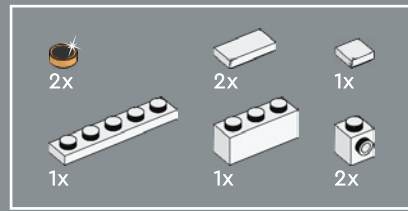
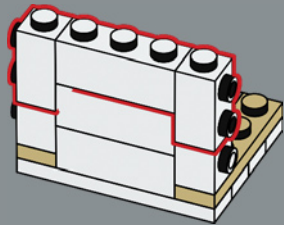

107

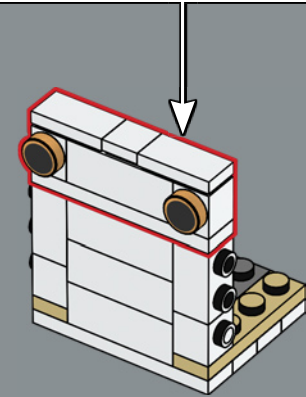
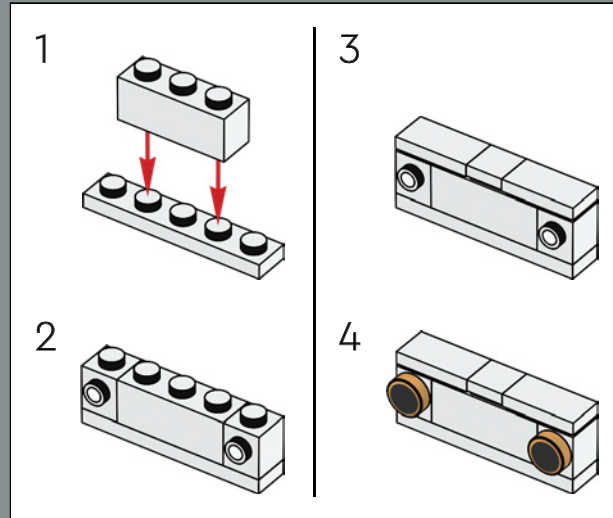



2x

108

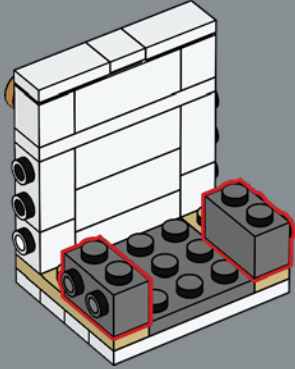

2x

109

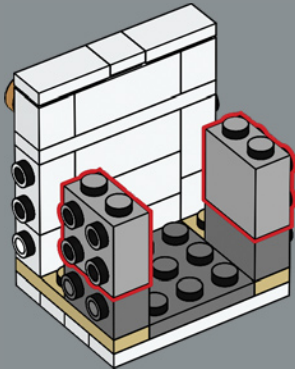

1x

2x

2x

1x

110

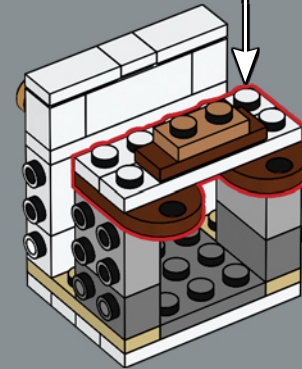
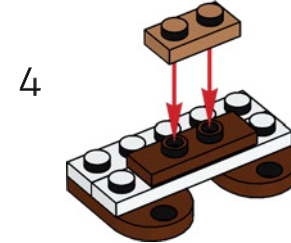
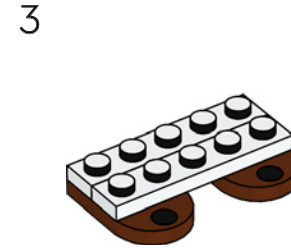
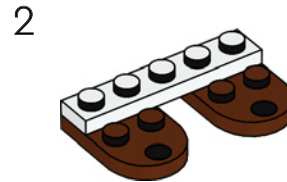
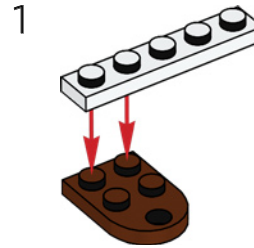

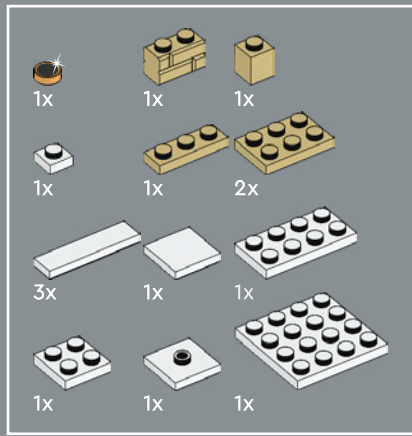

111

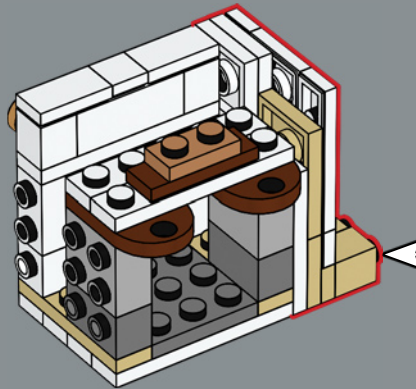
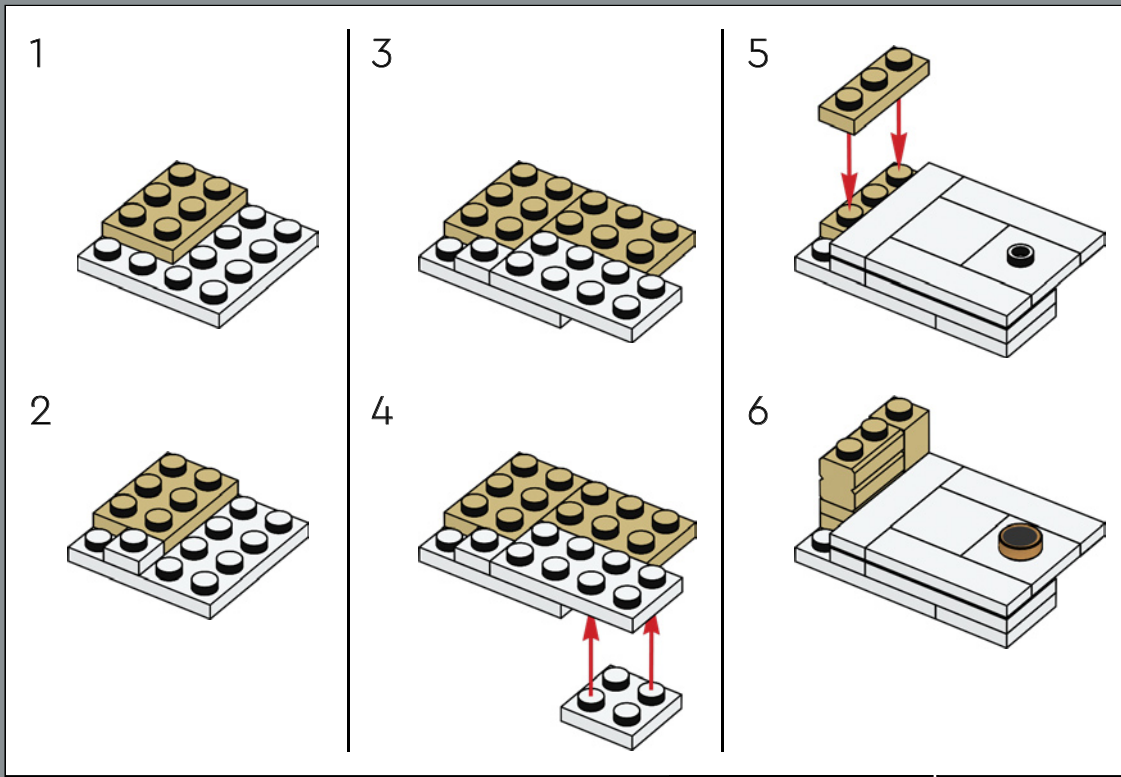

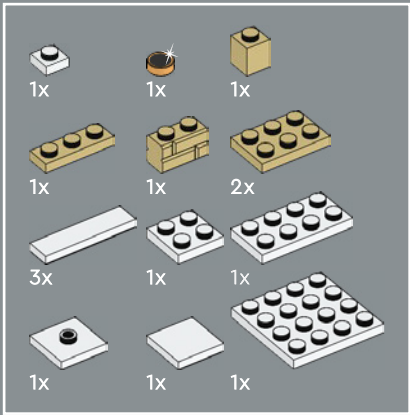

112

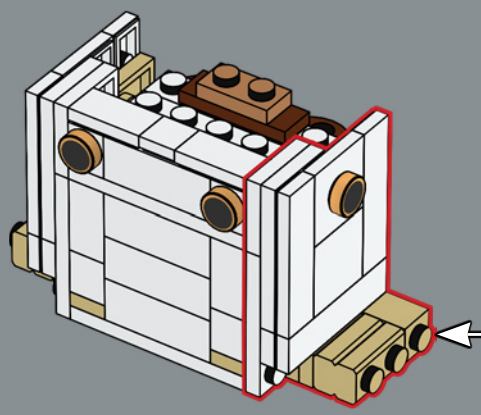
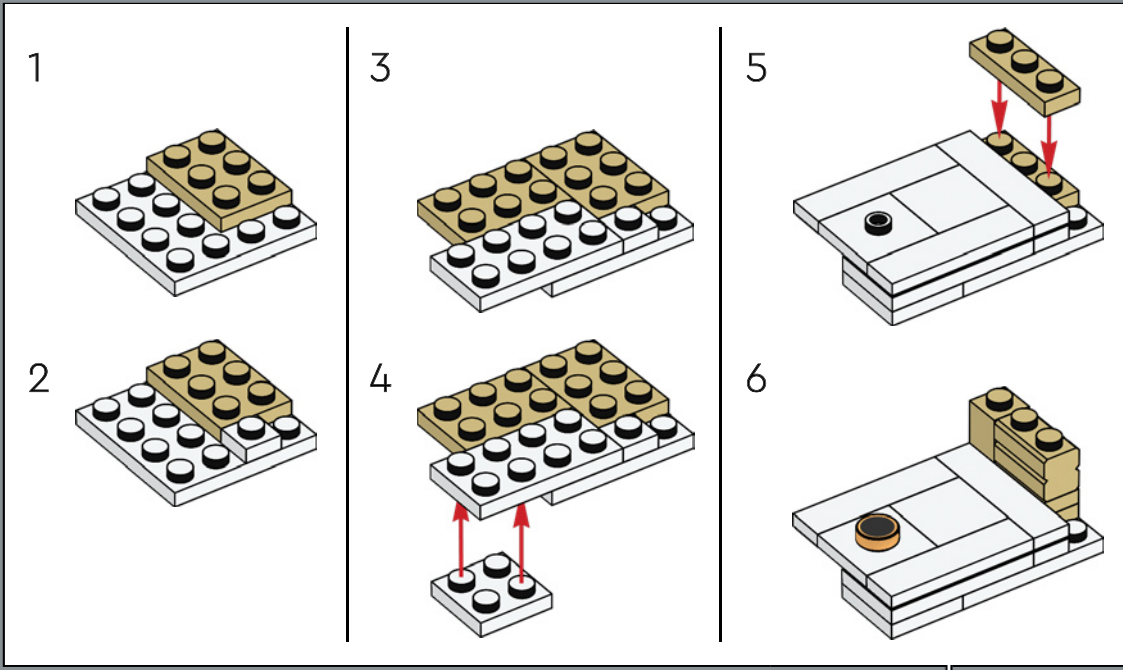

113

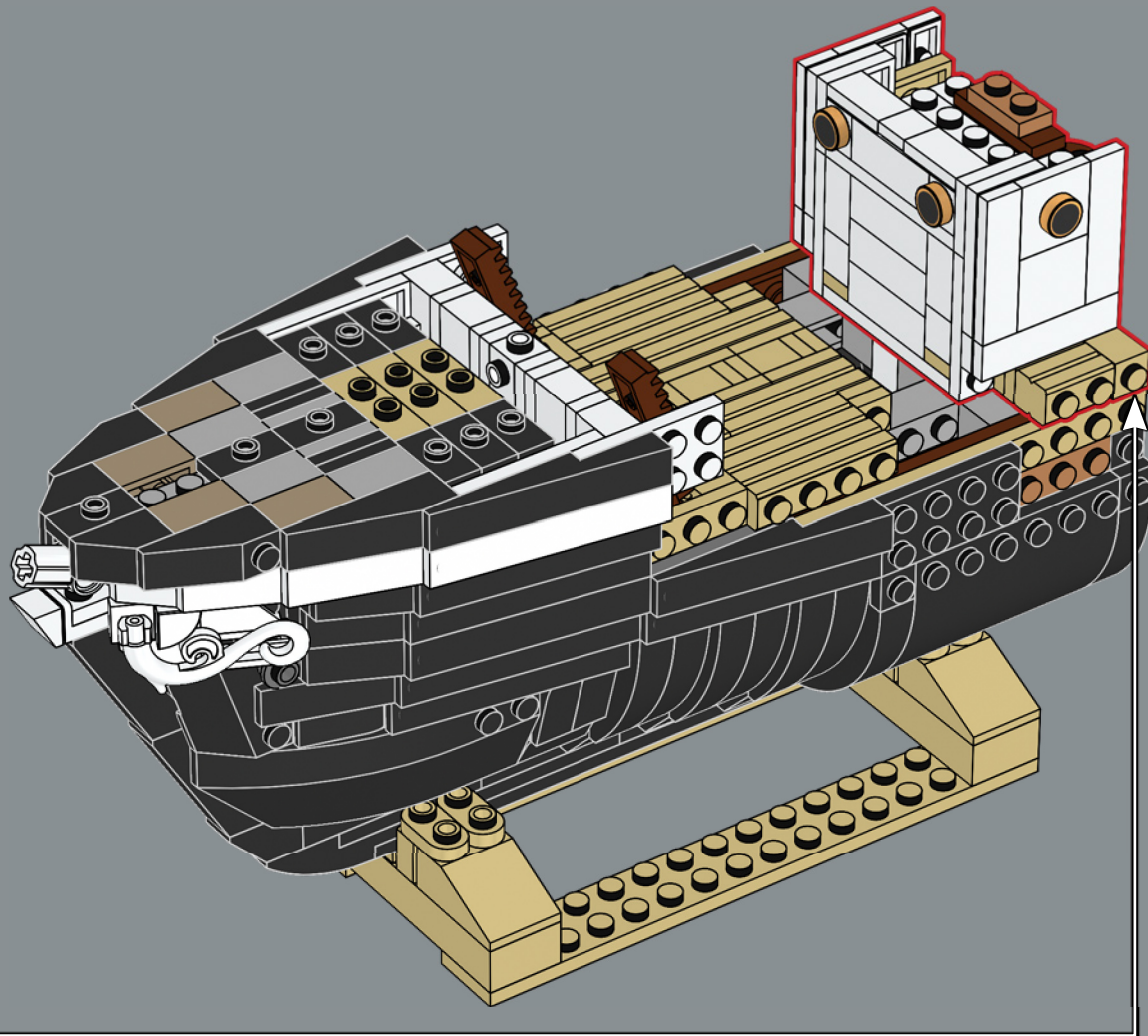

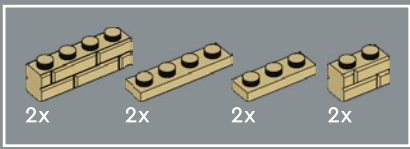

114

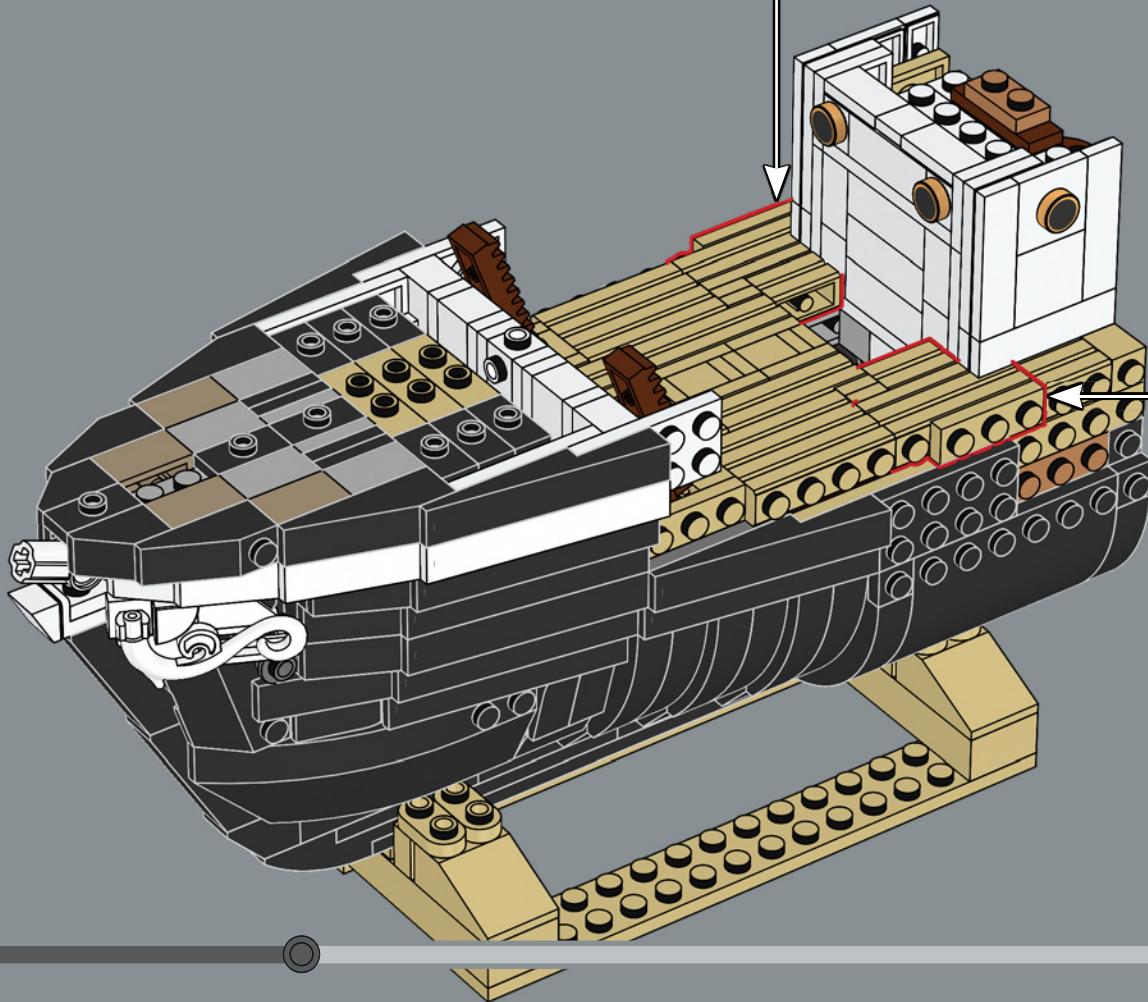
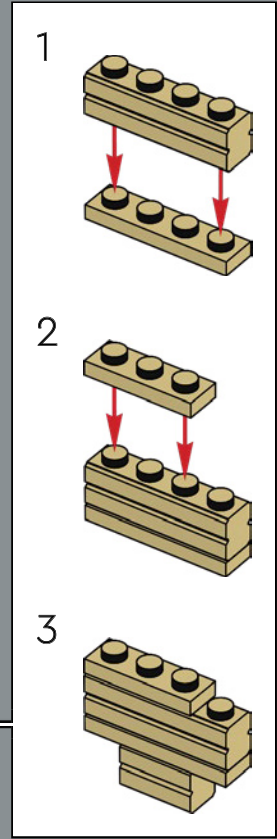
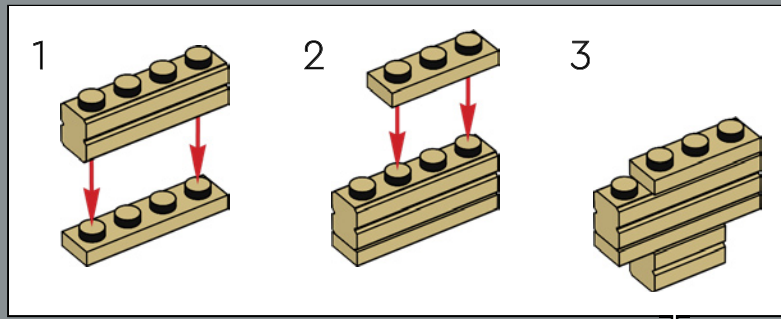

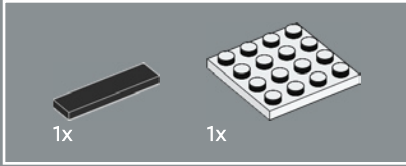
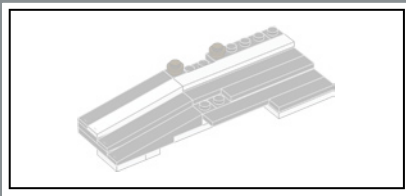

115

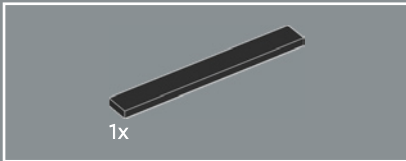
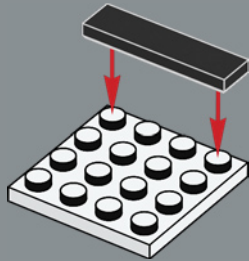

116

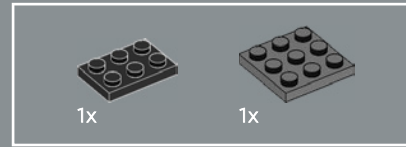
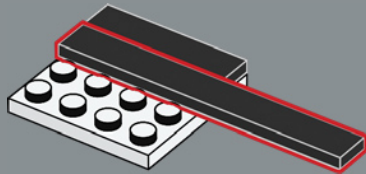

117

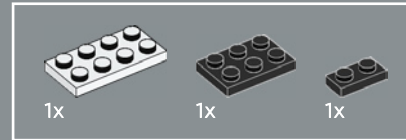
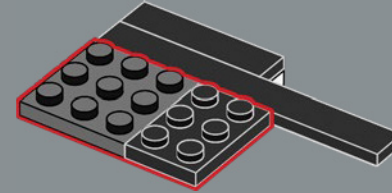

118

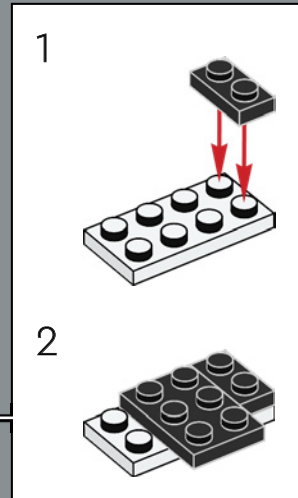
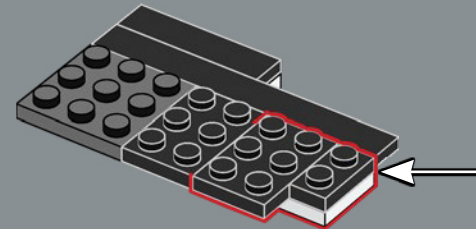

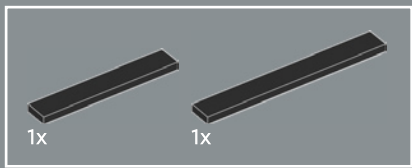

119

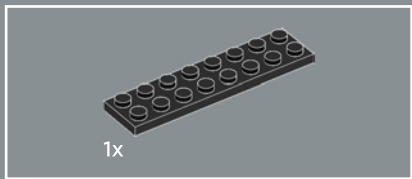
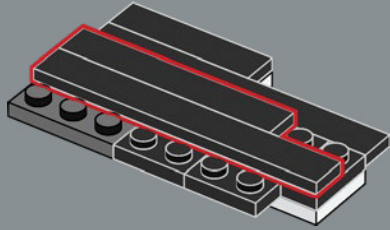

120

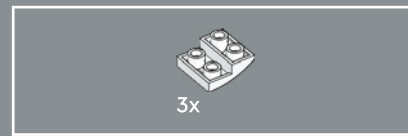
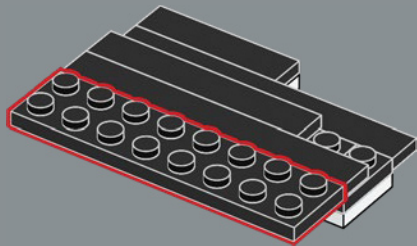

121

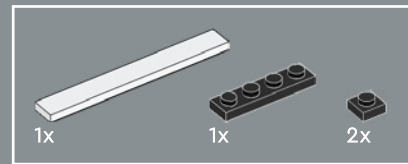
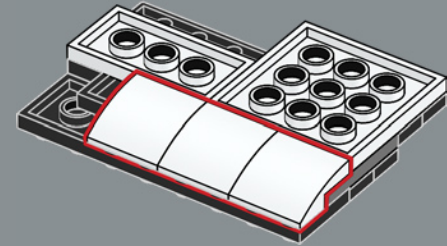

122

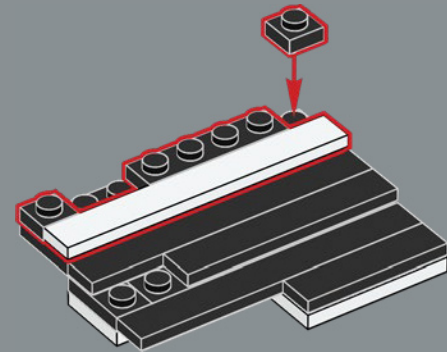



123

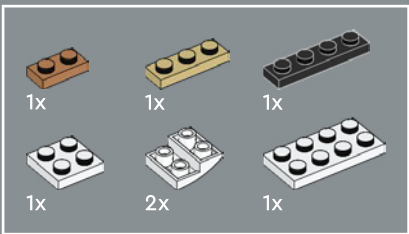
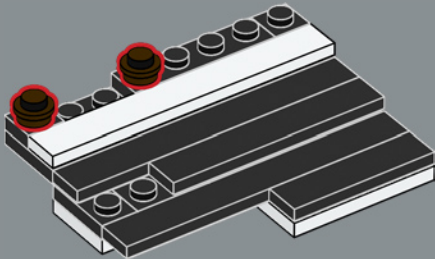

124

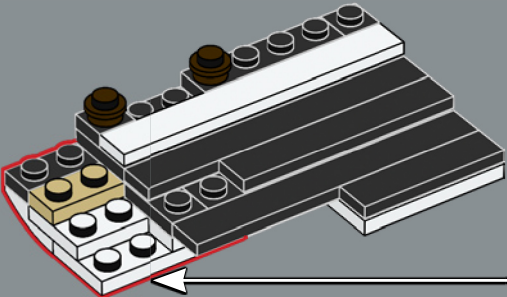
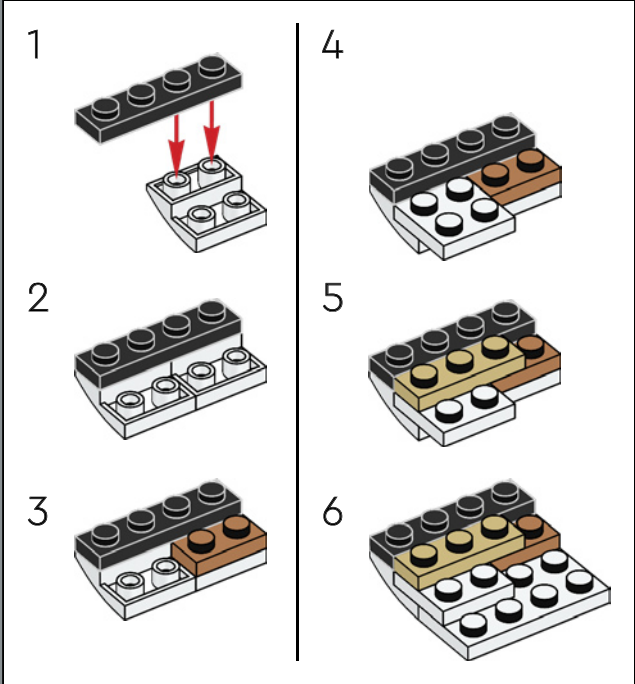

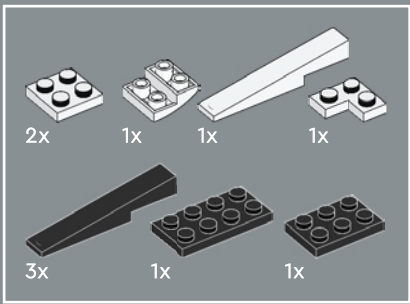

125

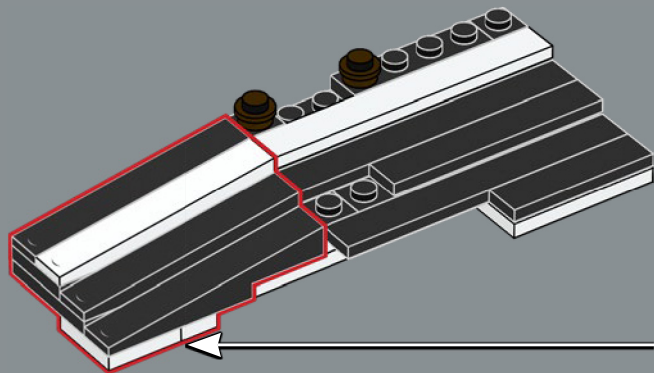
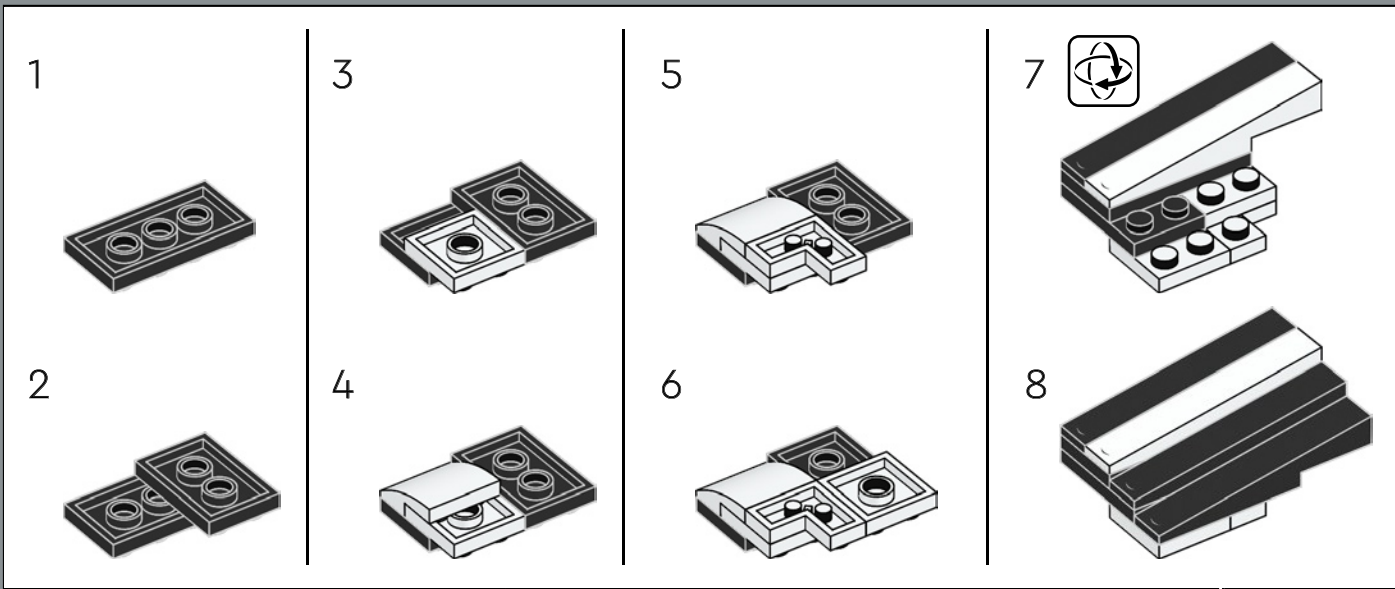

126

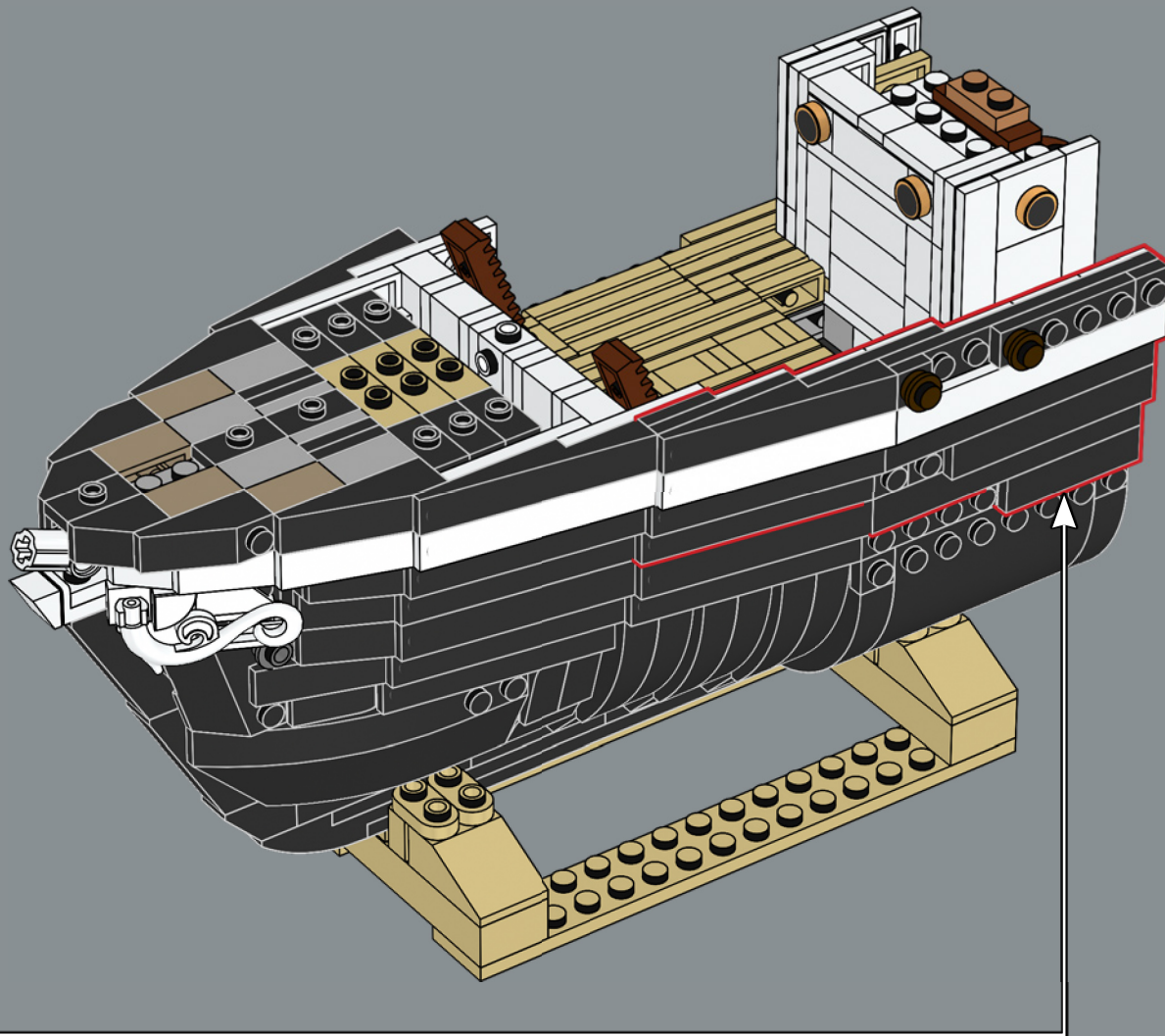

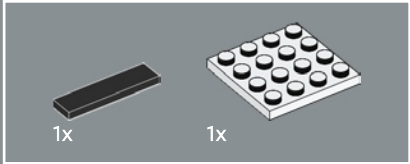
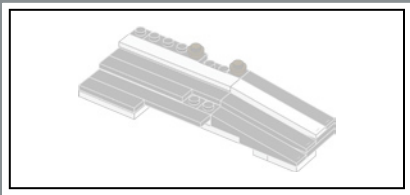

127

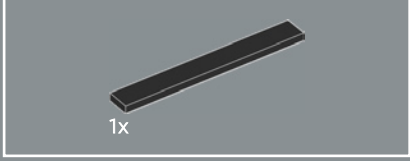
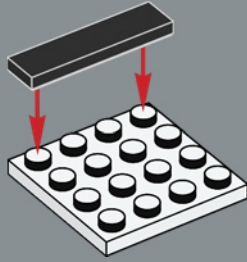

128

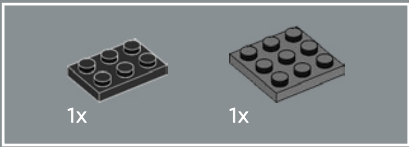
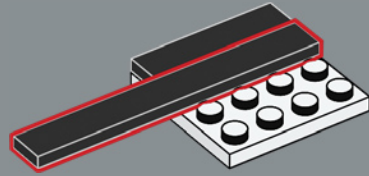

129

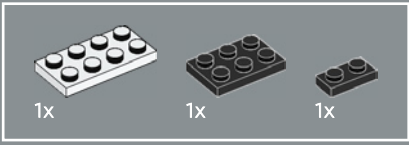
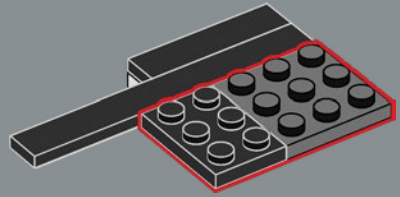

130

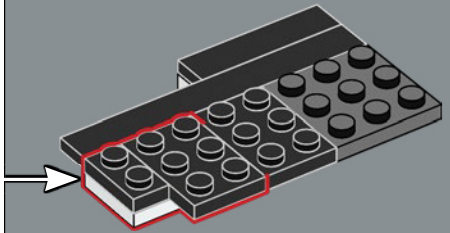
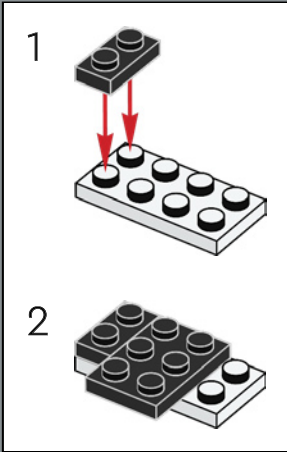

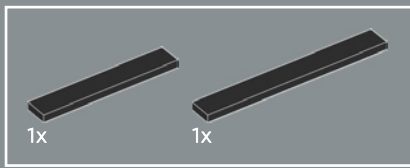

131

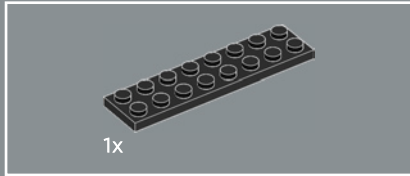
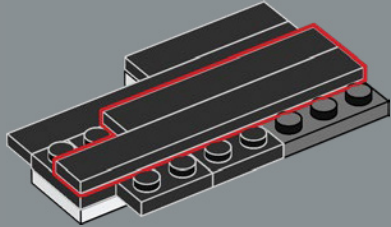

132

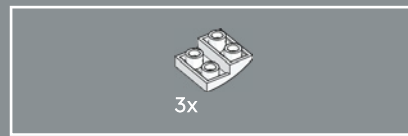
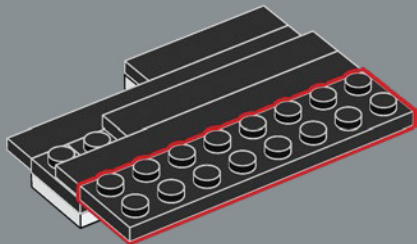

133

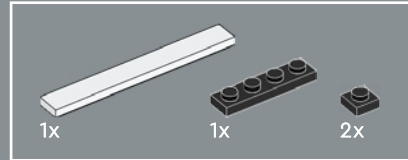
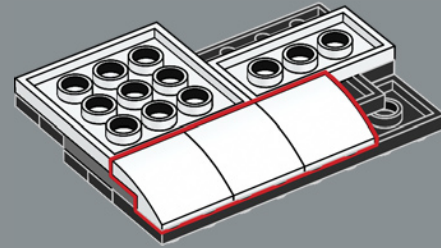

134

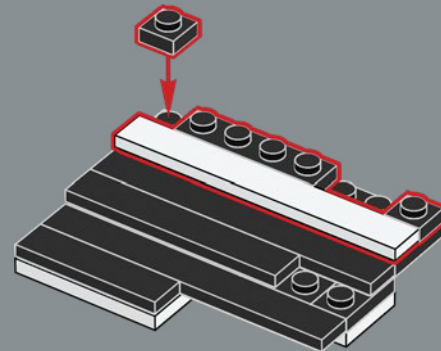

2x

135

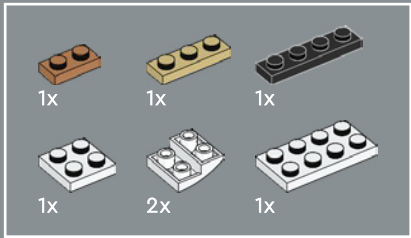
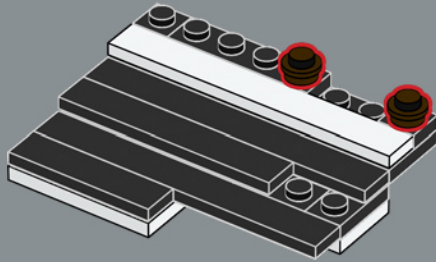

136

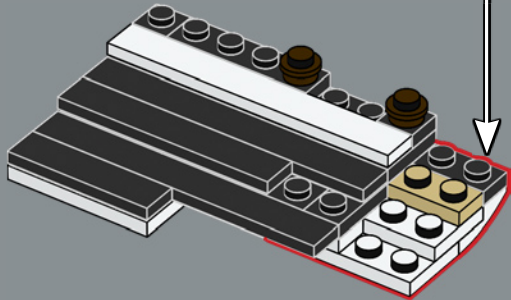
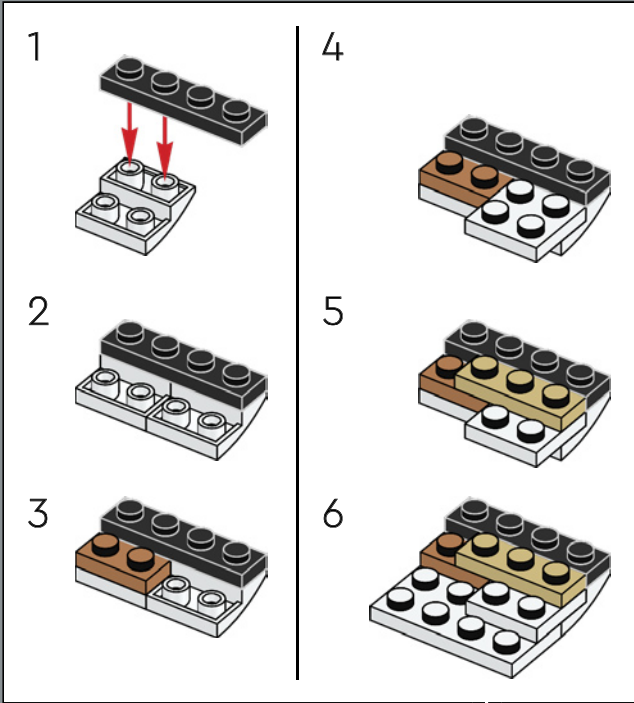

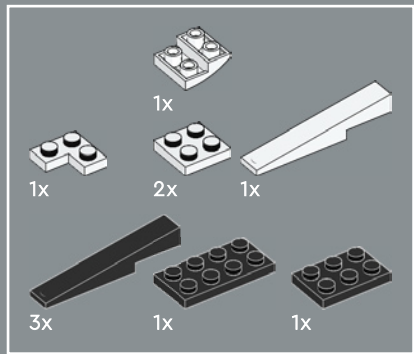

137

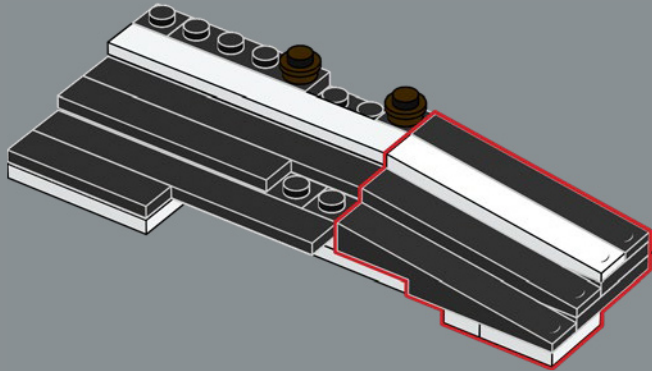
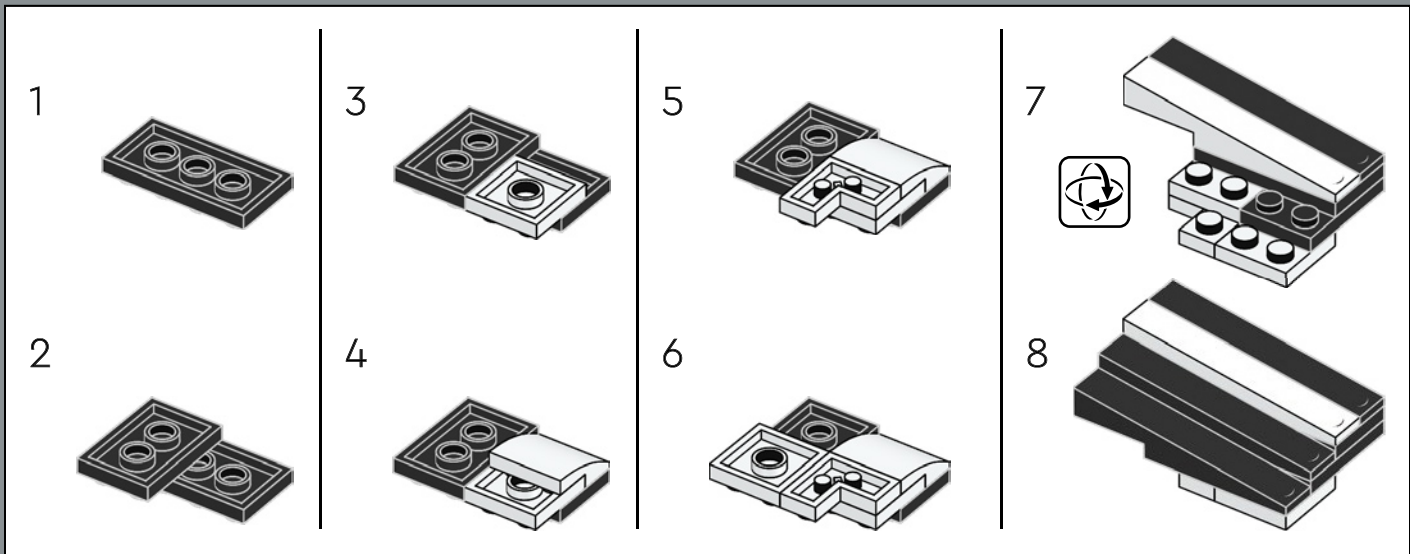

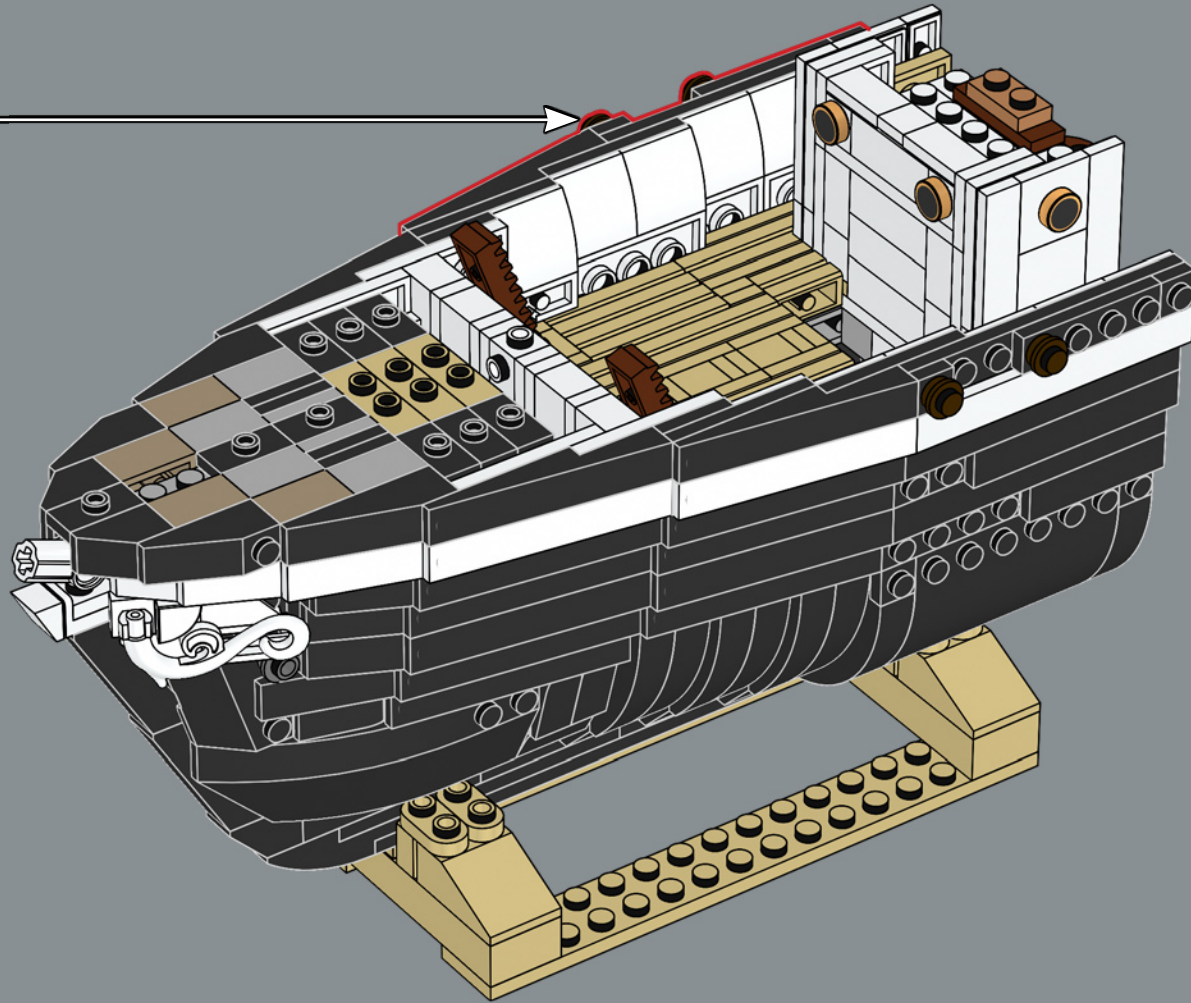

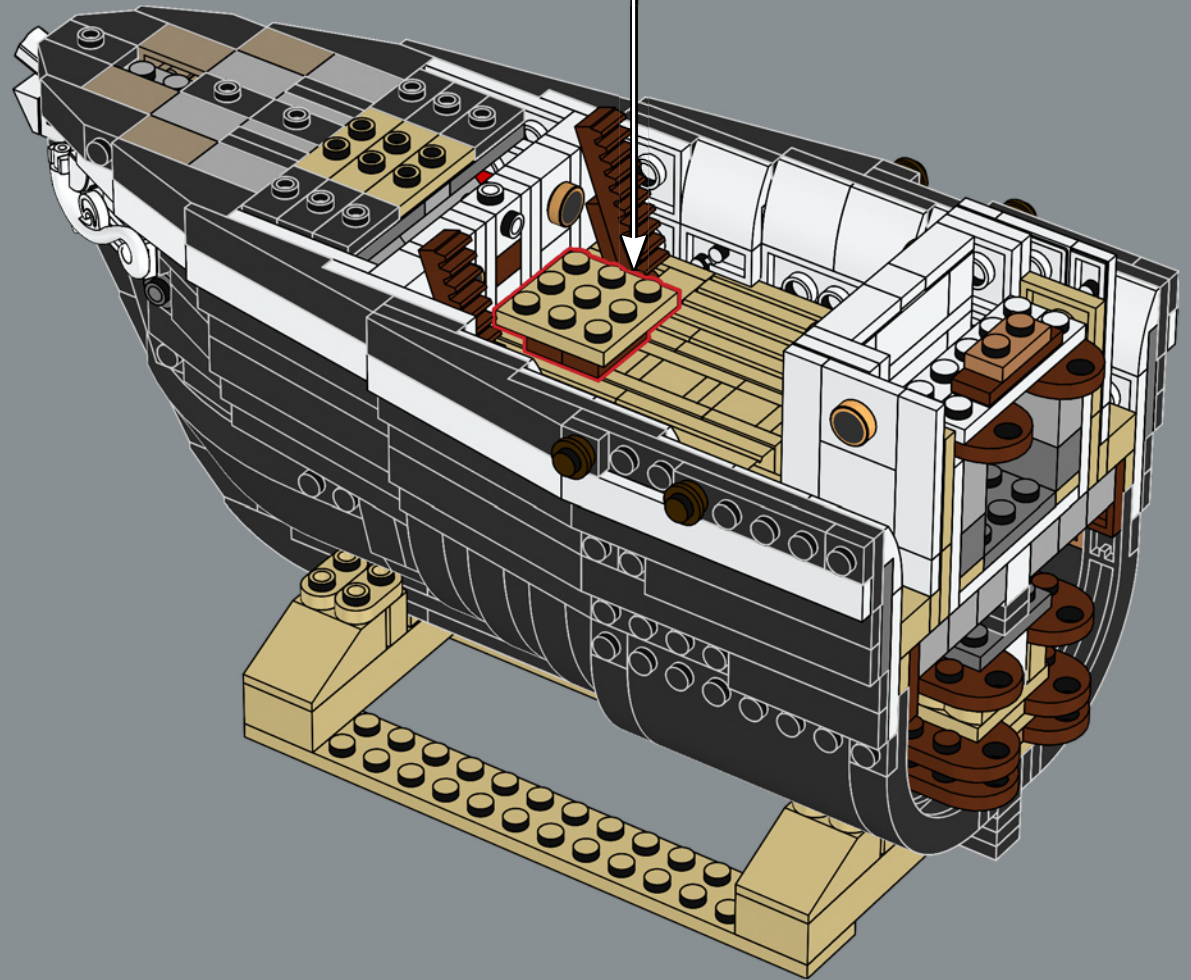
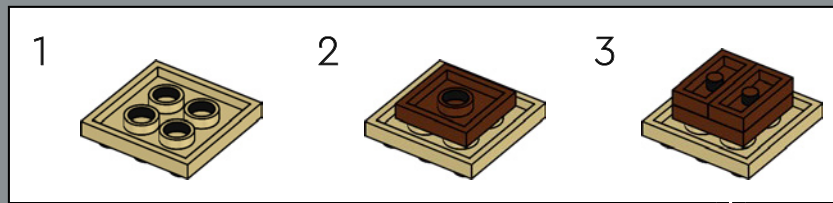
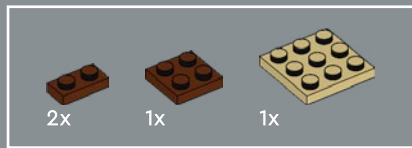

139

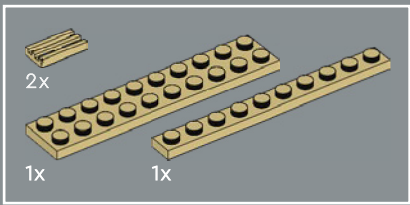

140

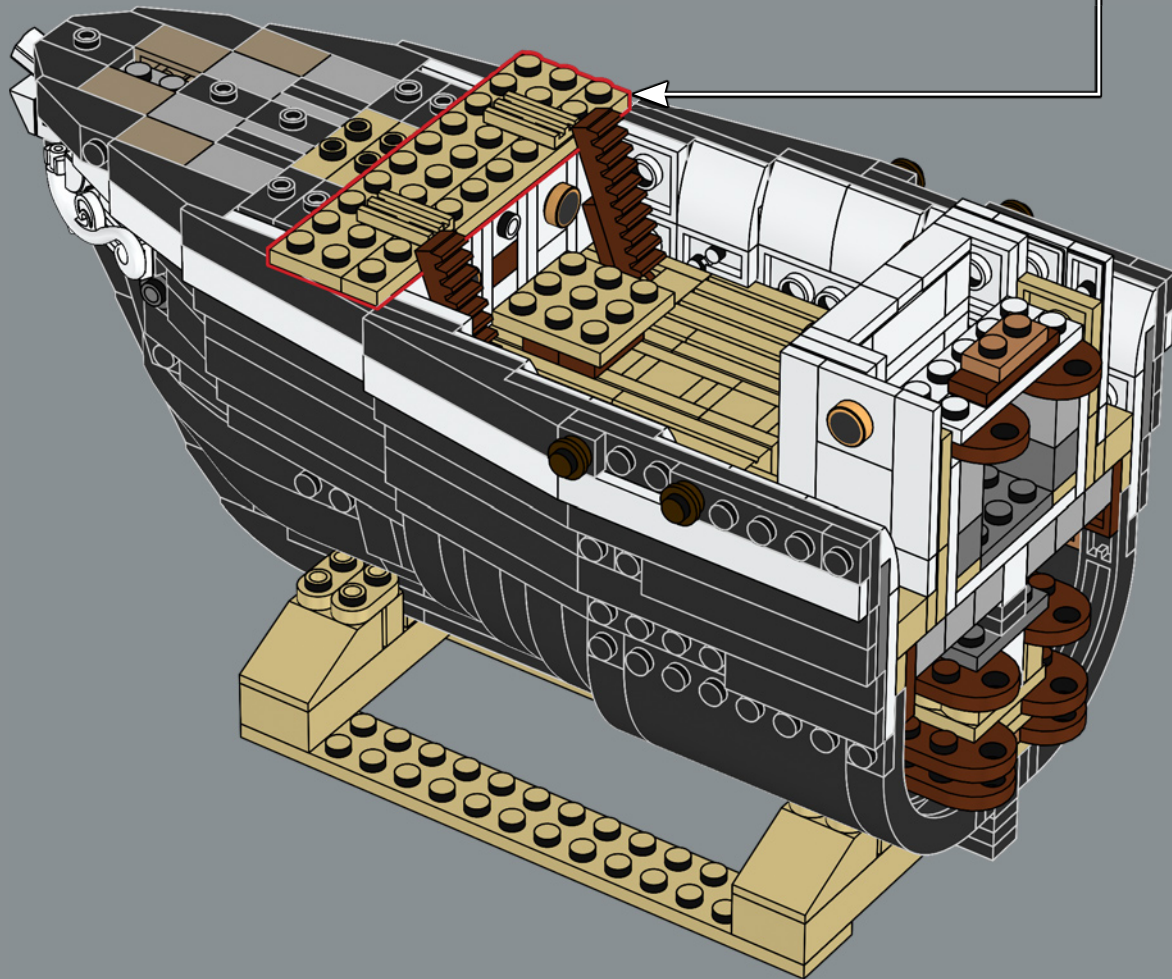
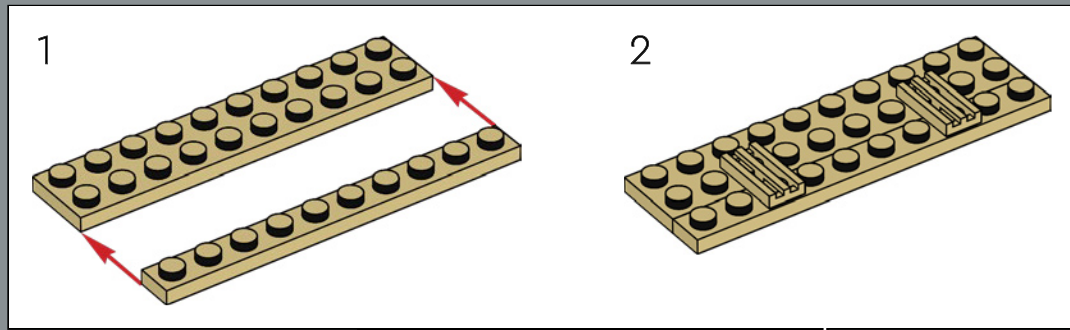

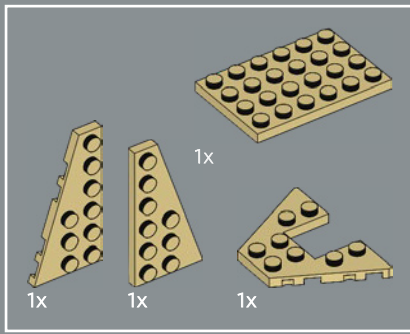

141

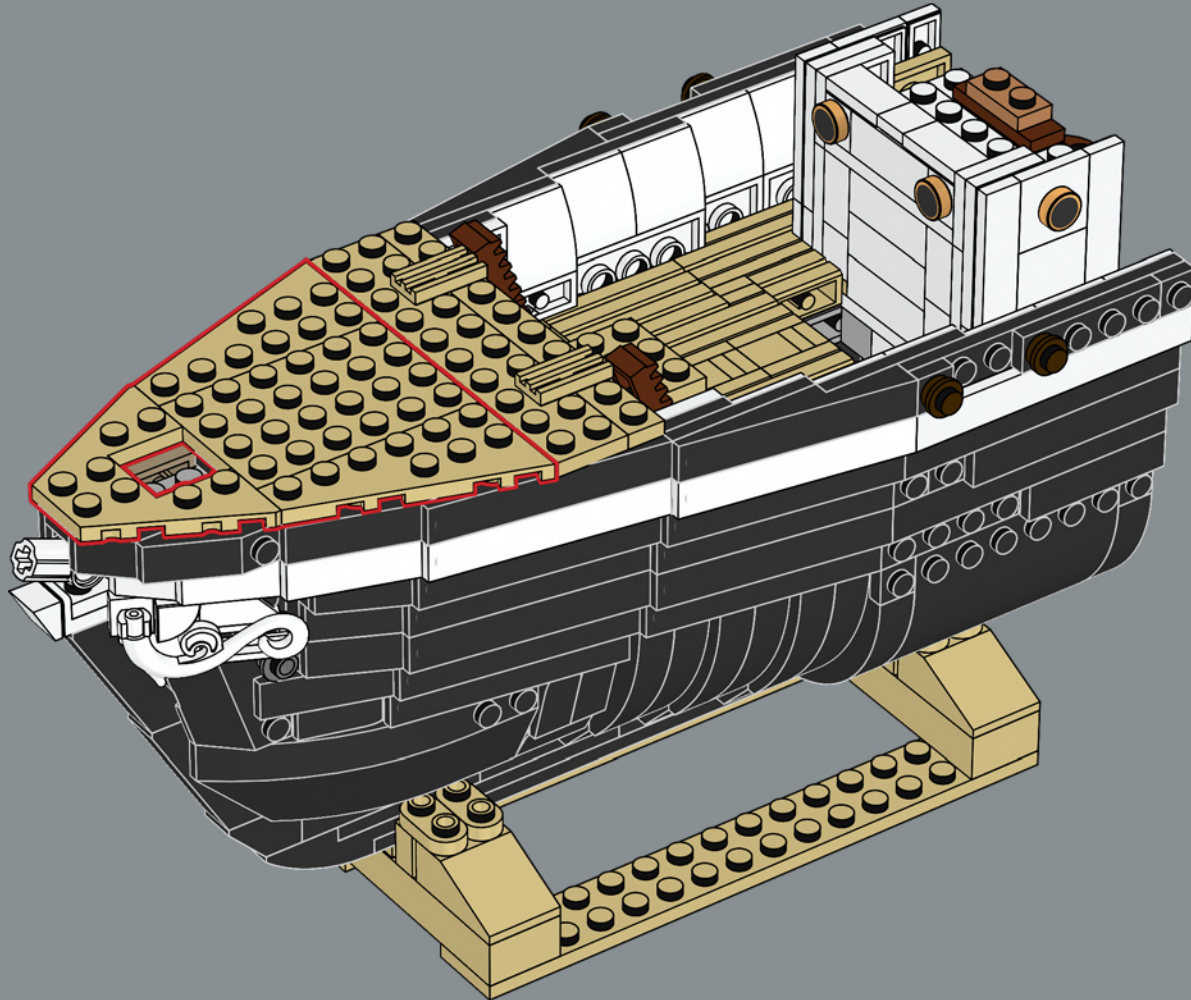

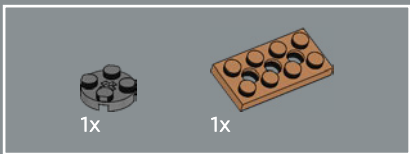

142

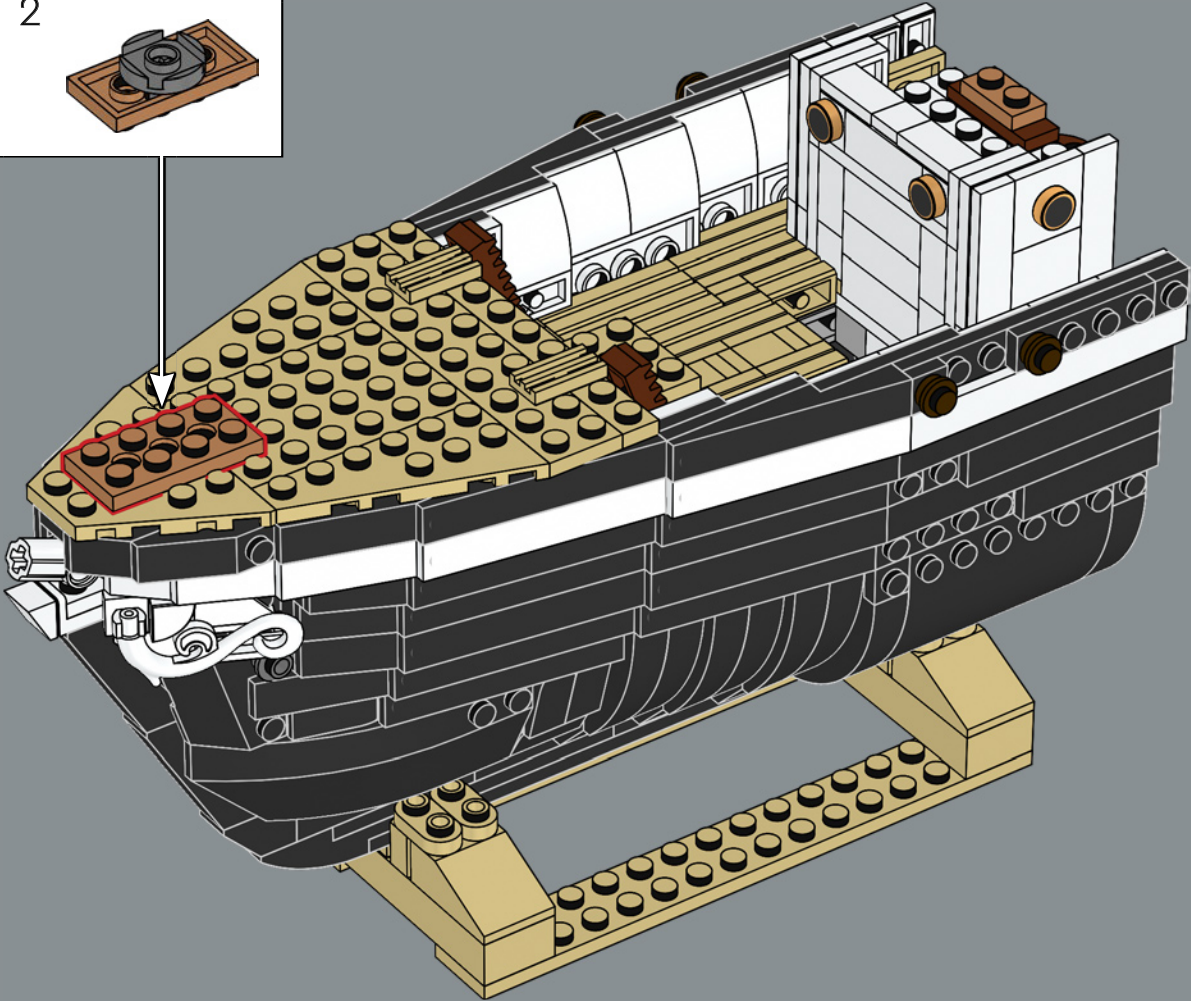
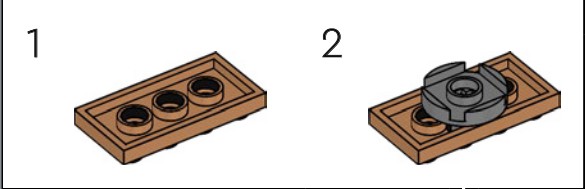

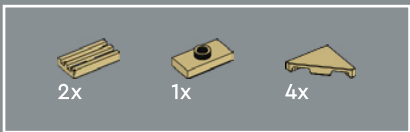

143

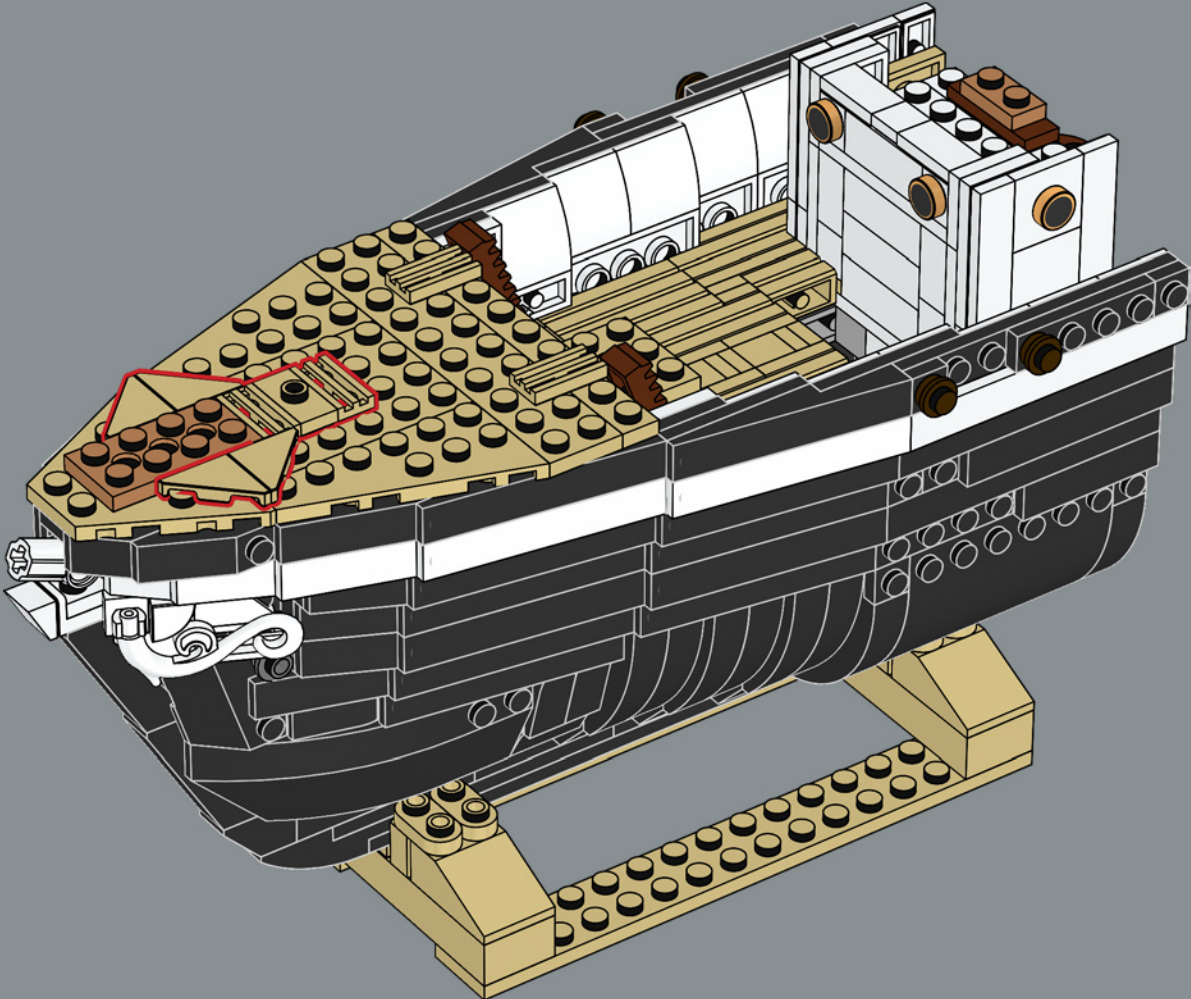



144

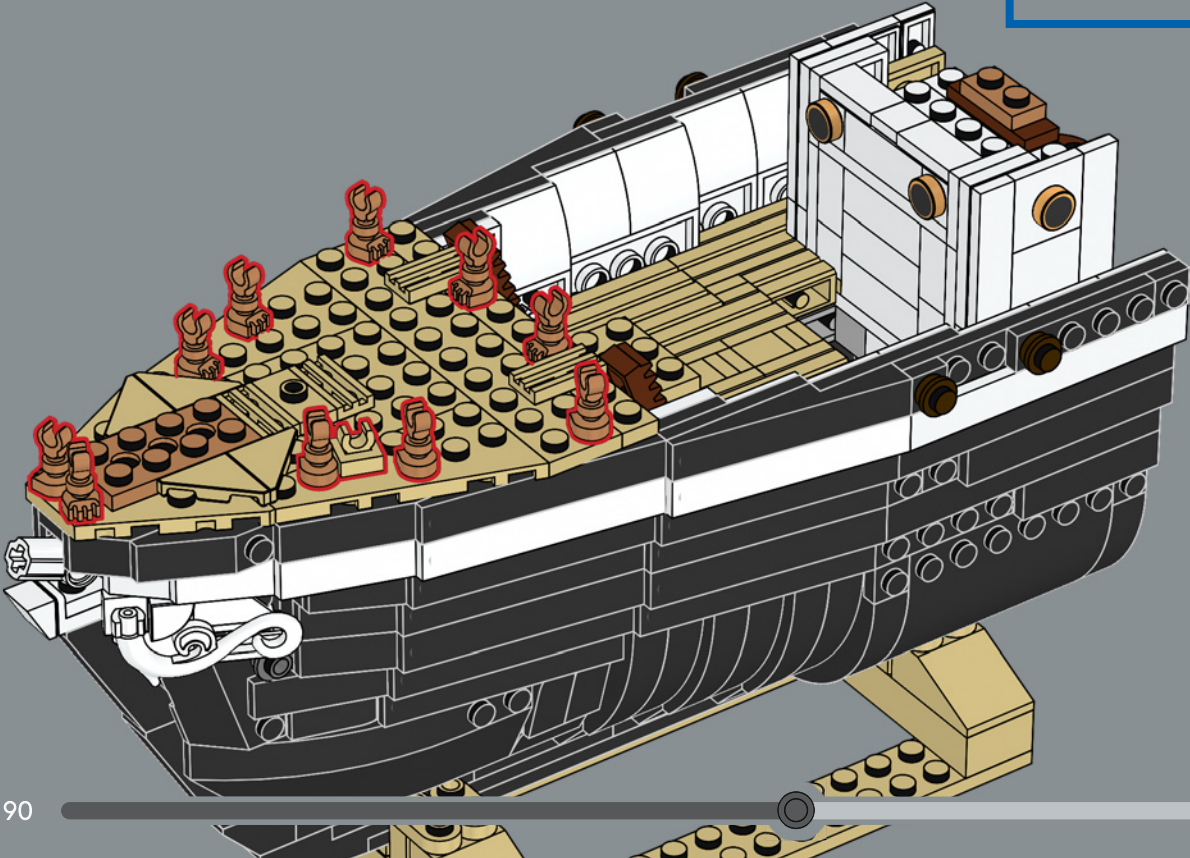
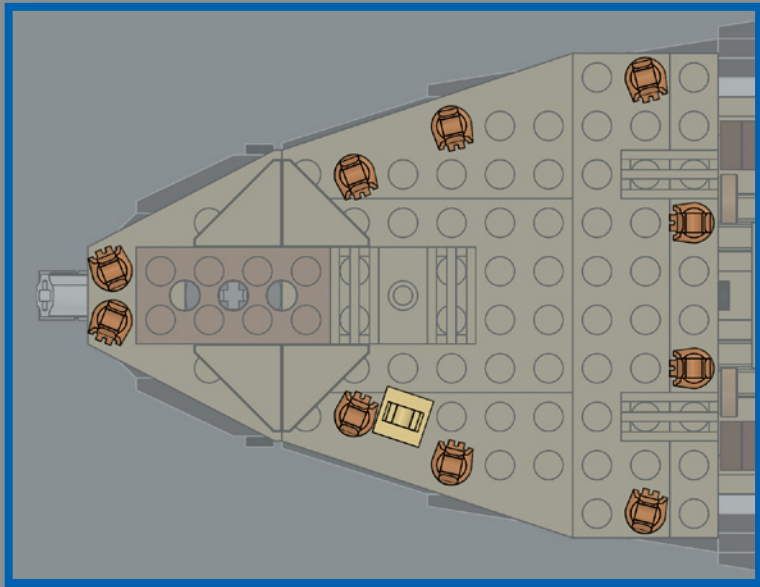



145

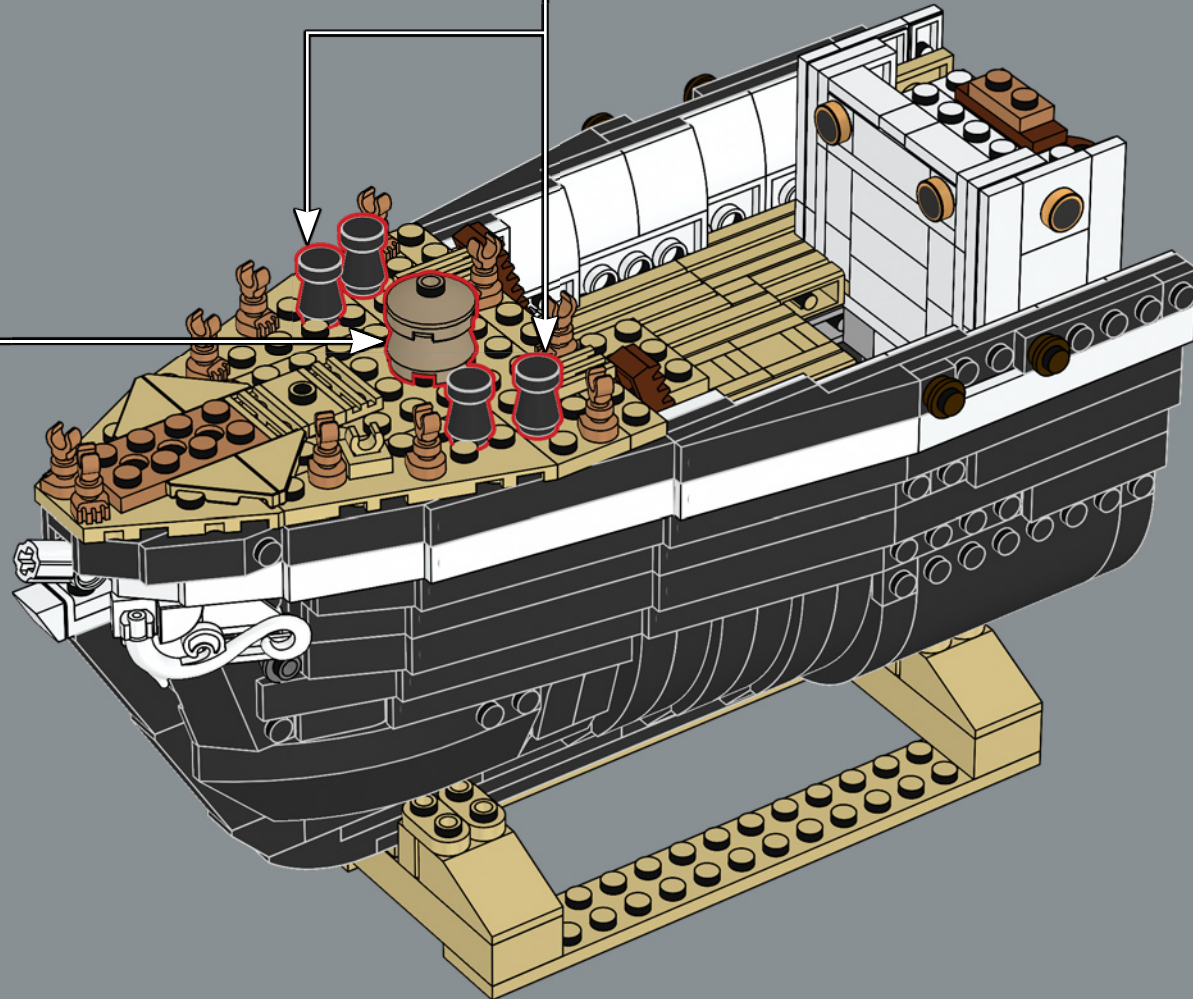
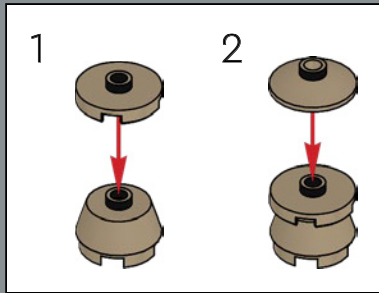
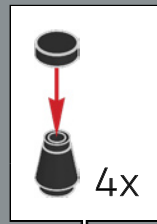

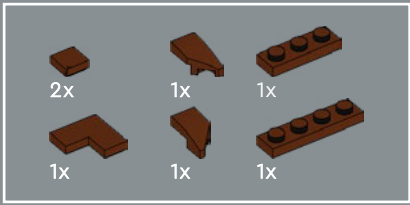

146

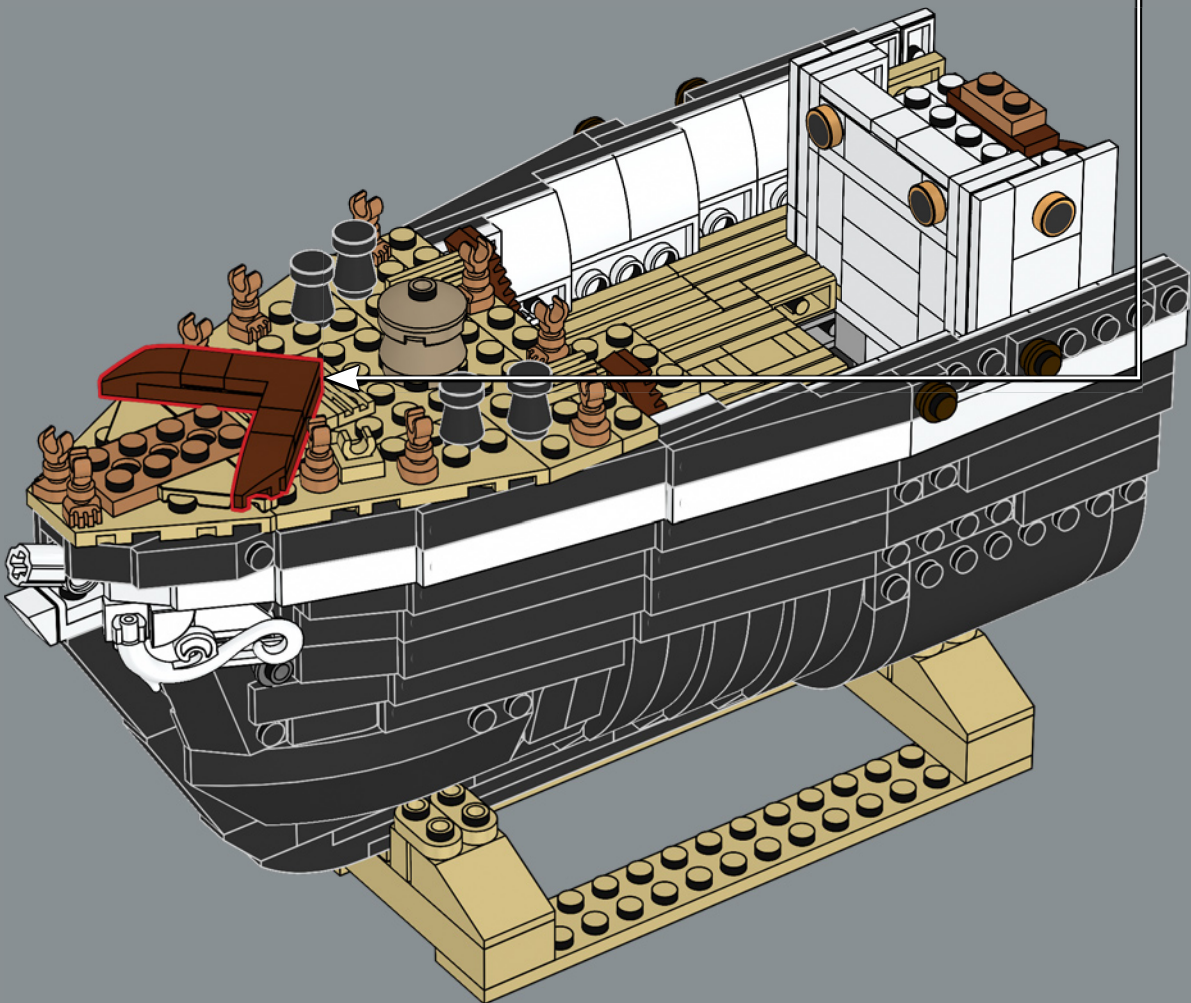
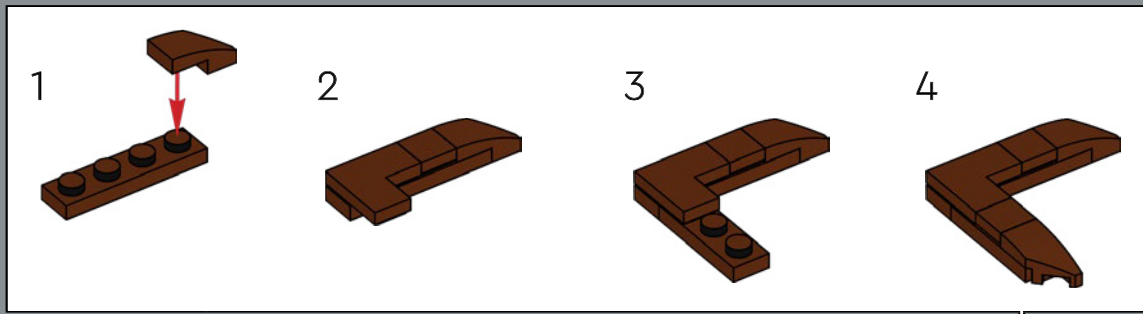

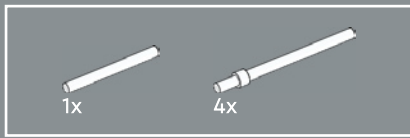

147

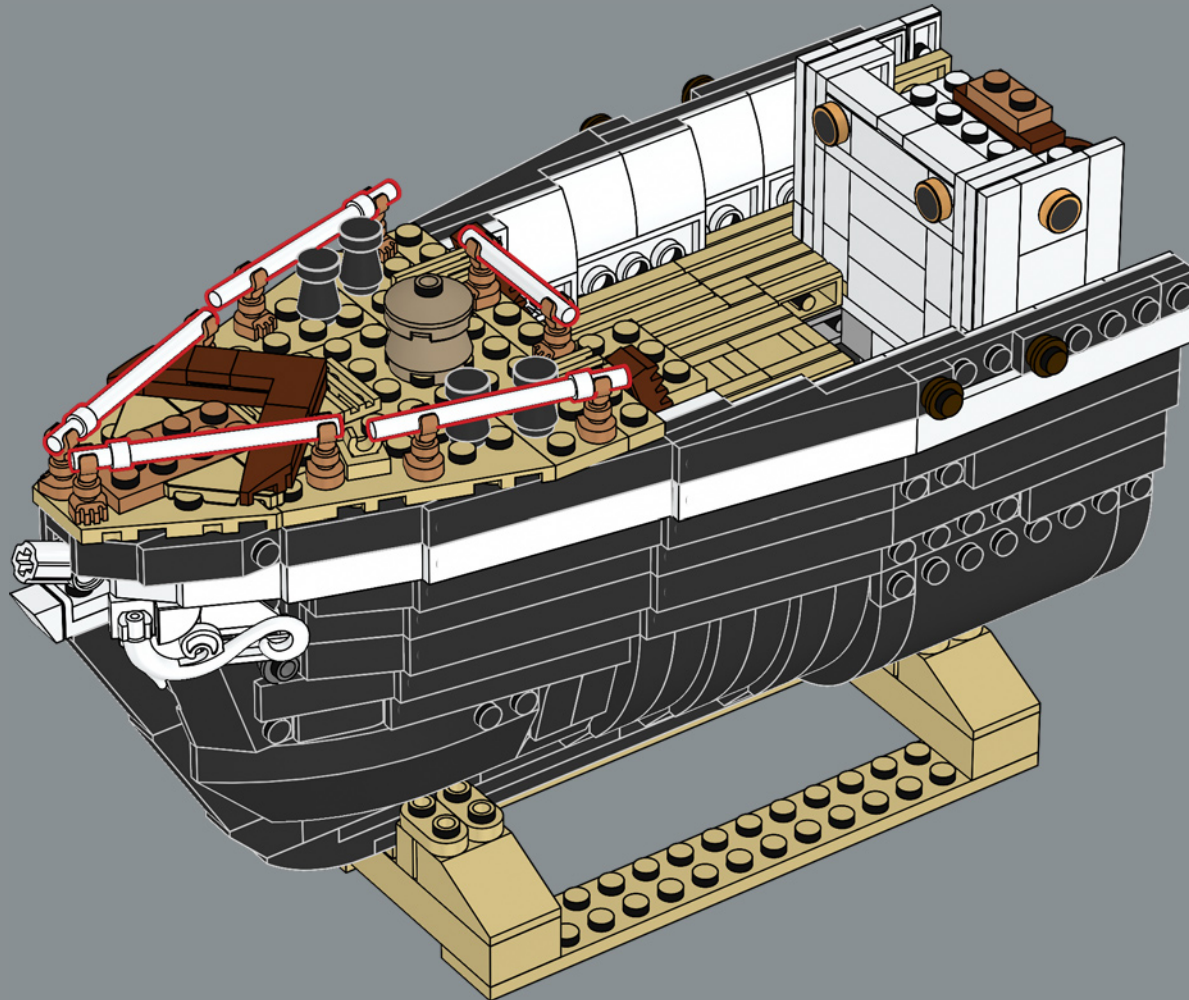



148

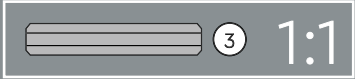
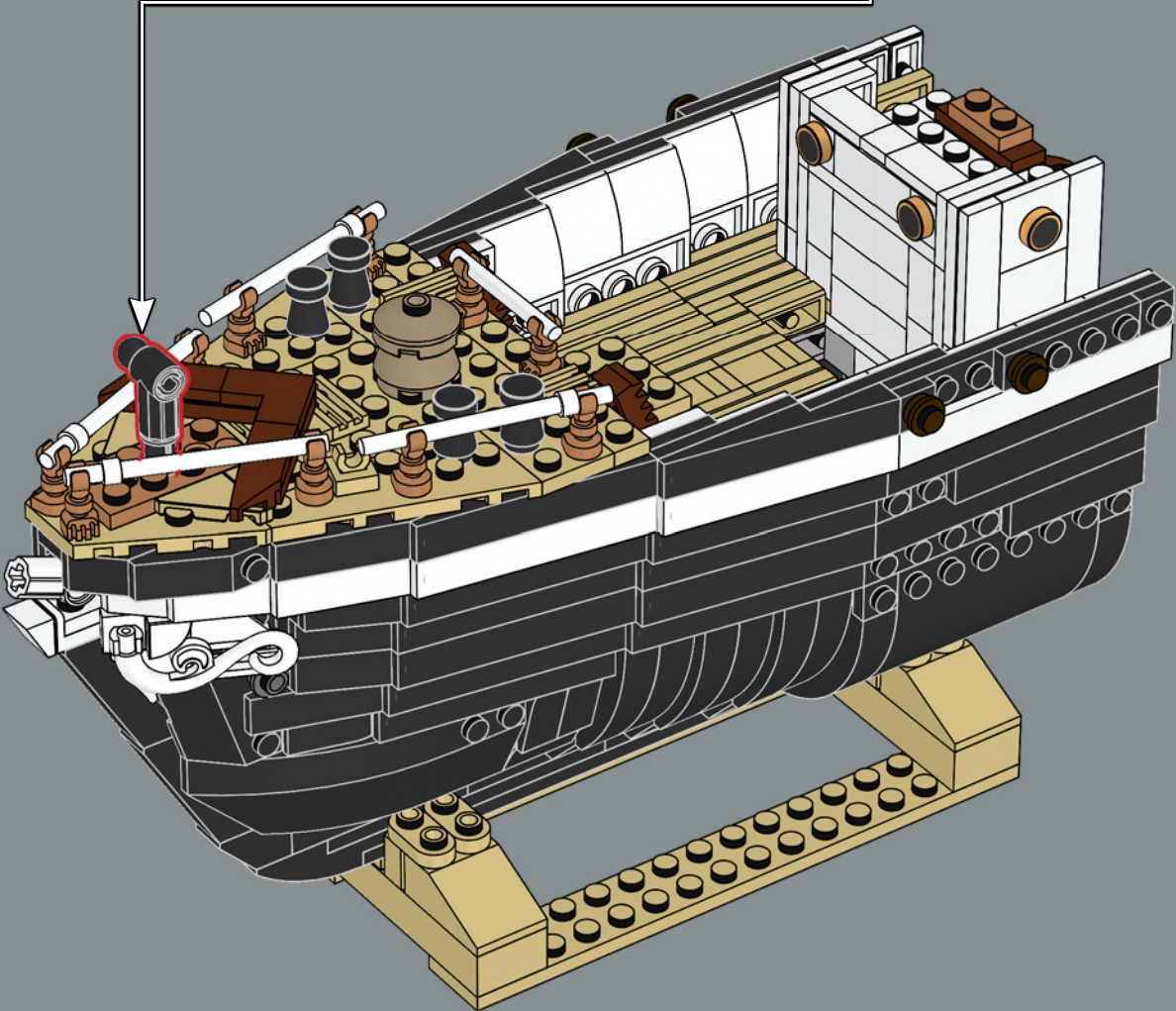
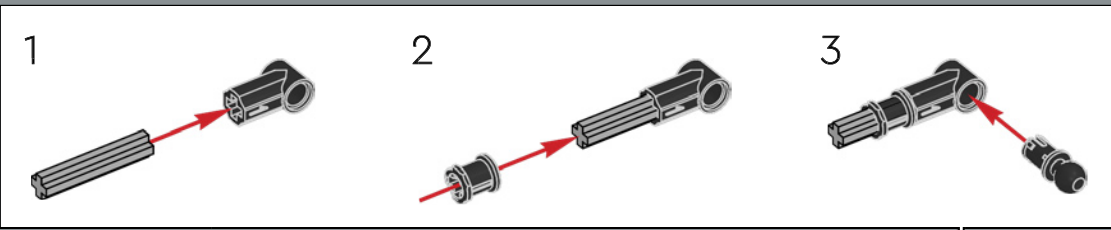

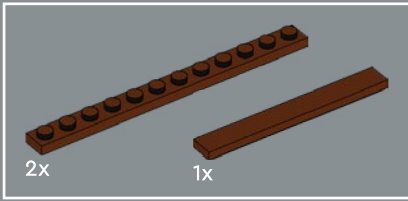
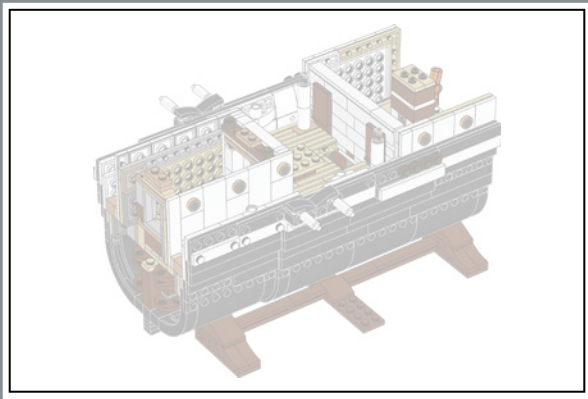

149

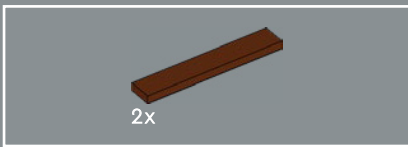
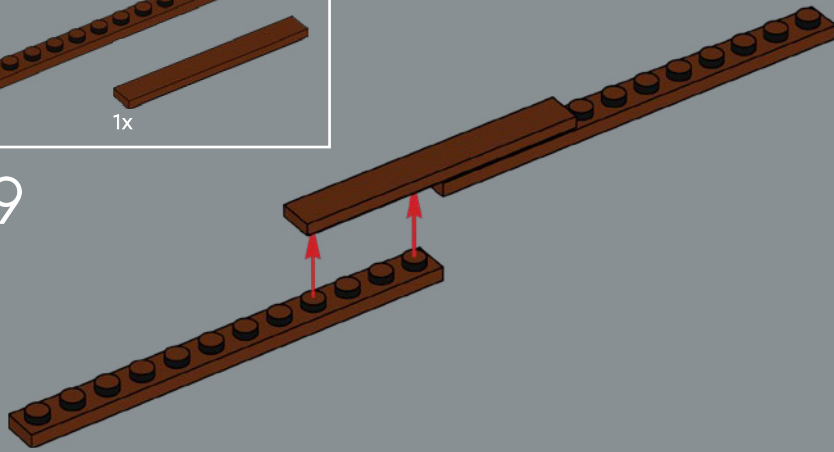

150

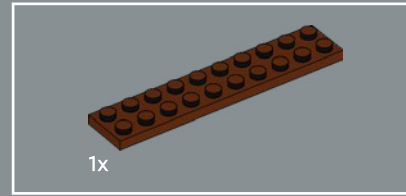
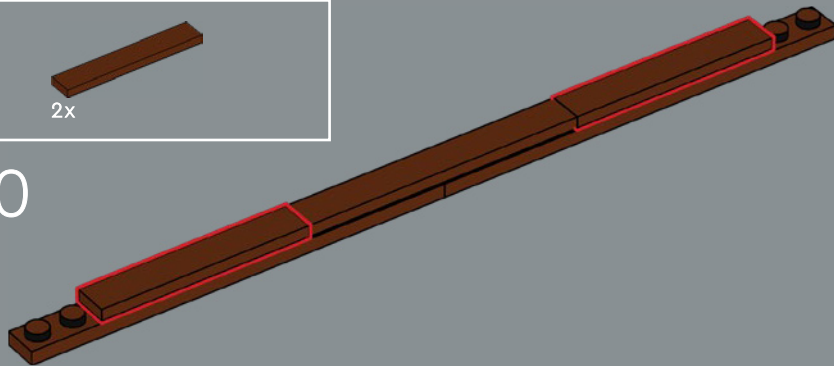

151

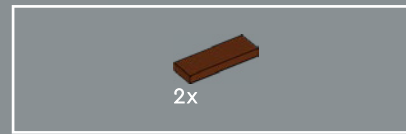
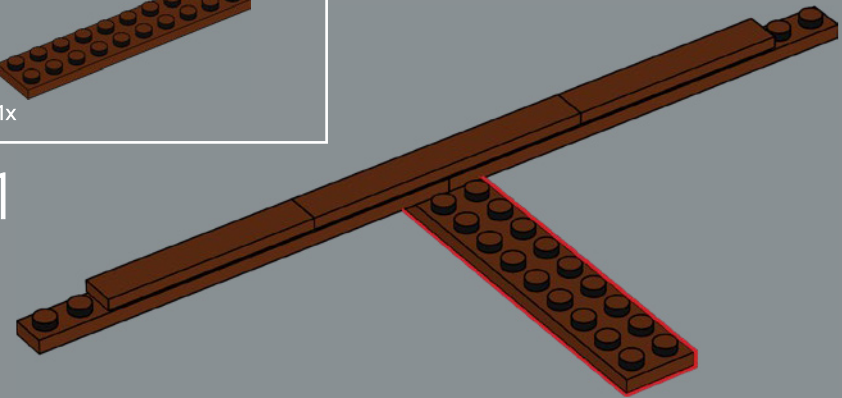

152

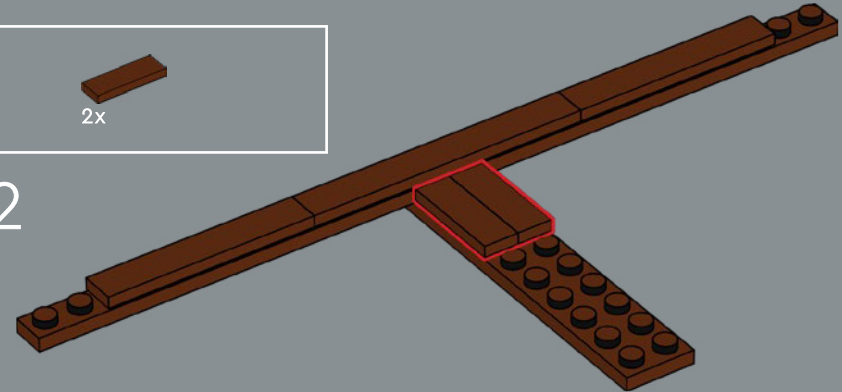

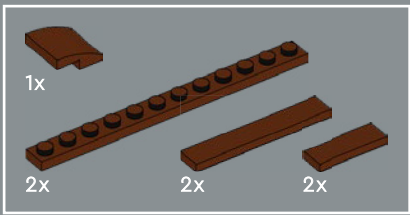

153

1

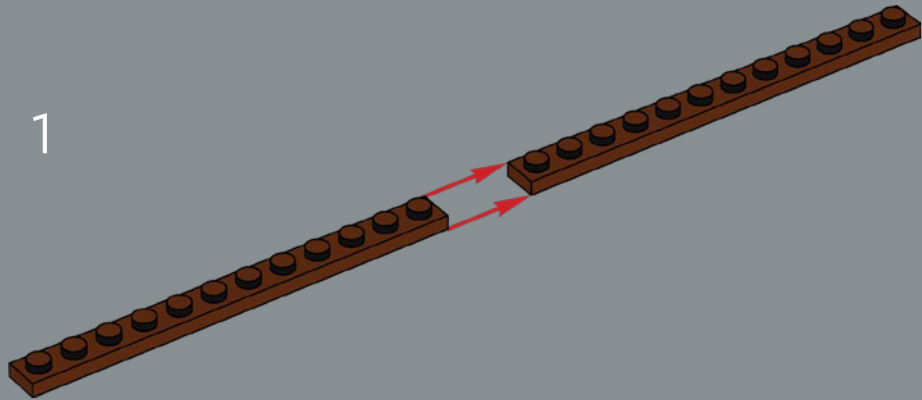

2

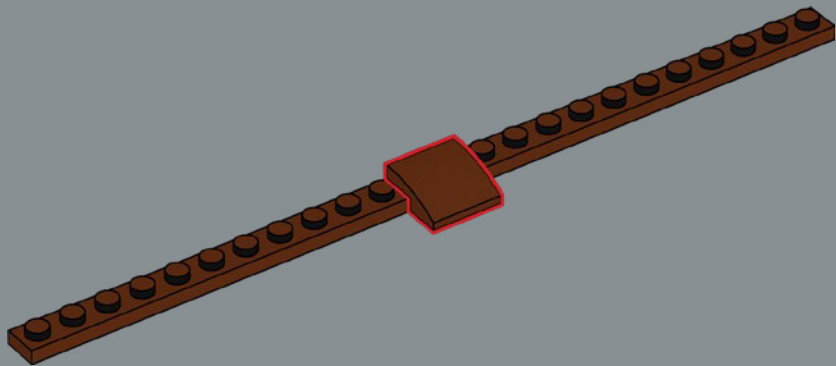

3

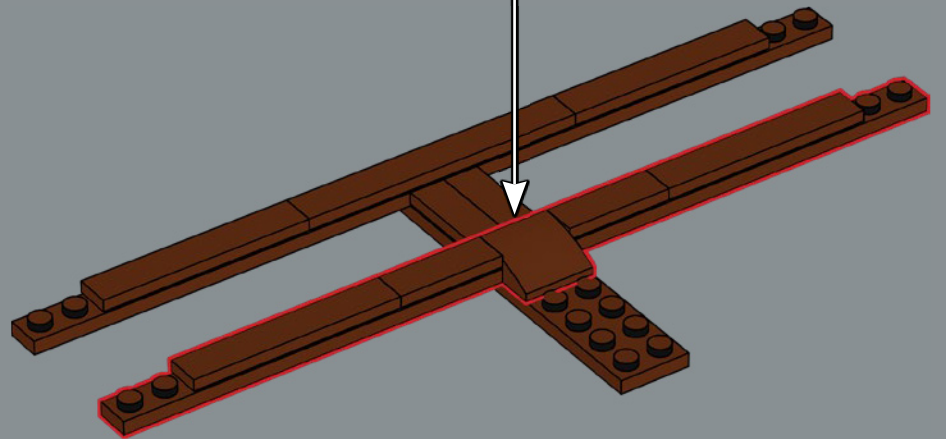
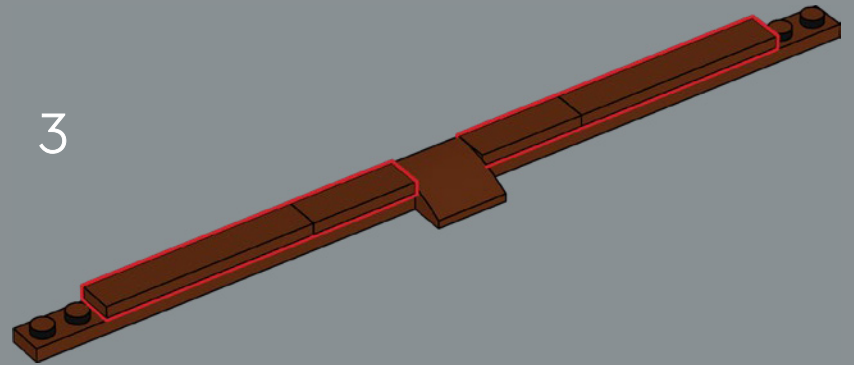

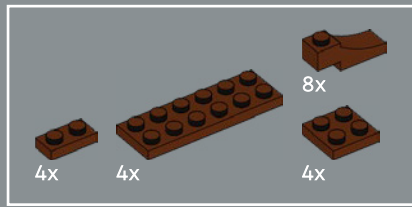

154

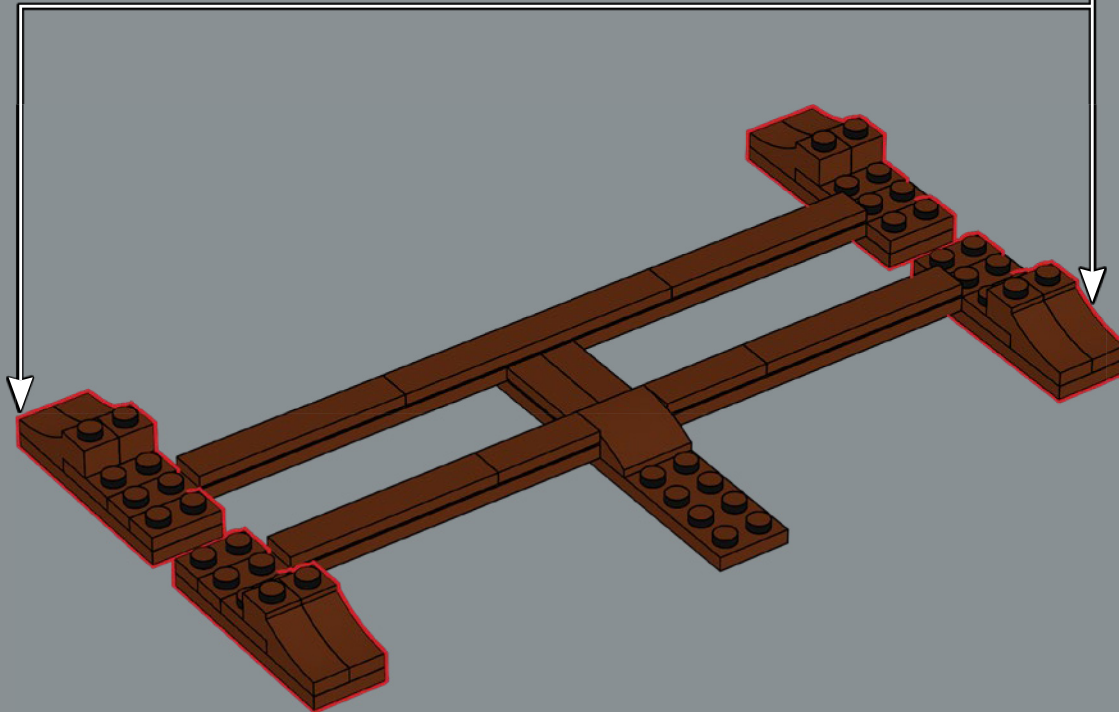
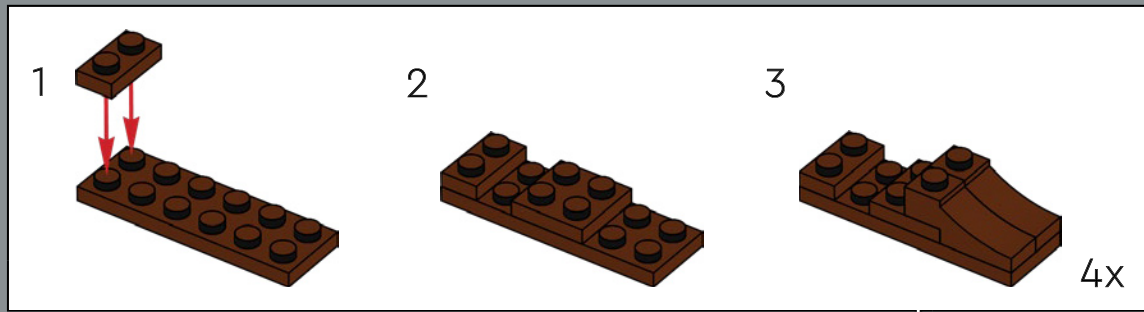

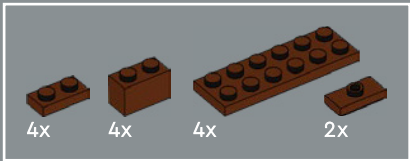

155

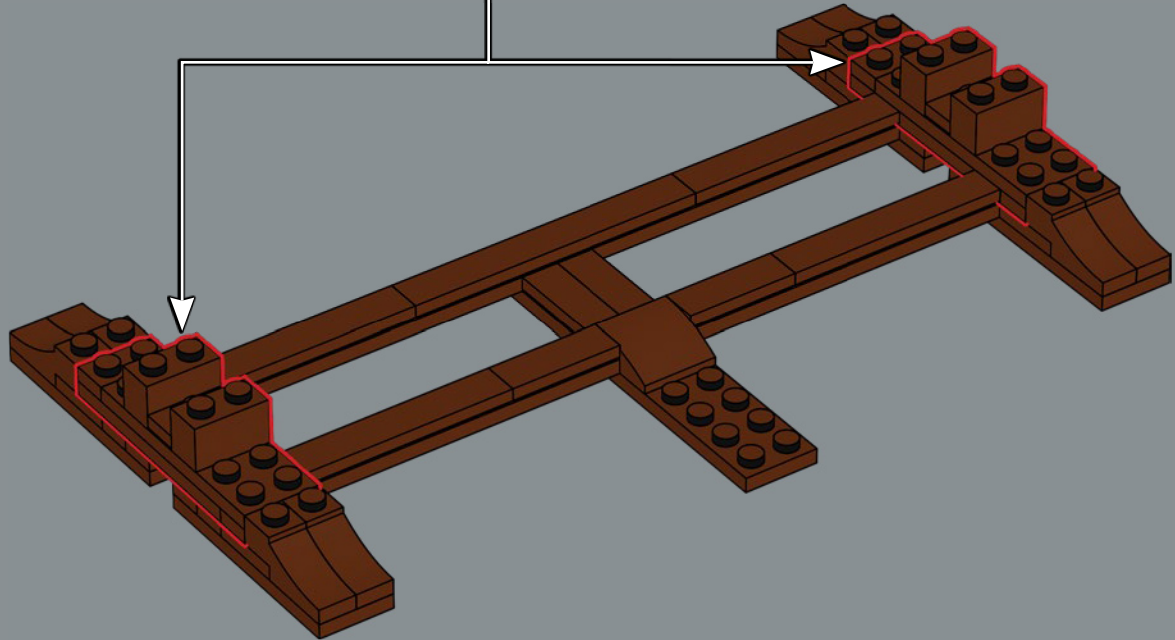
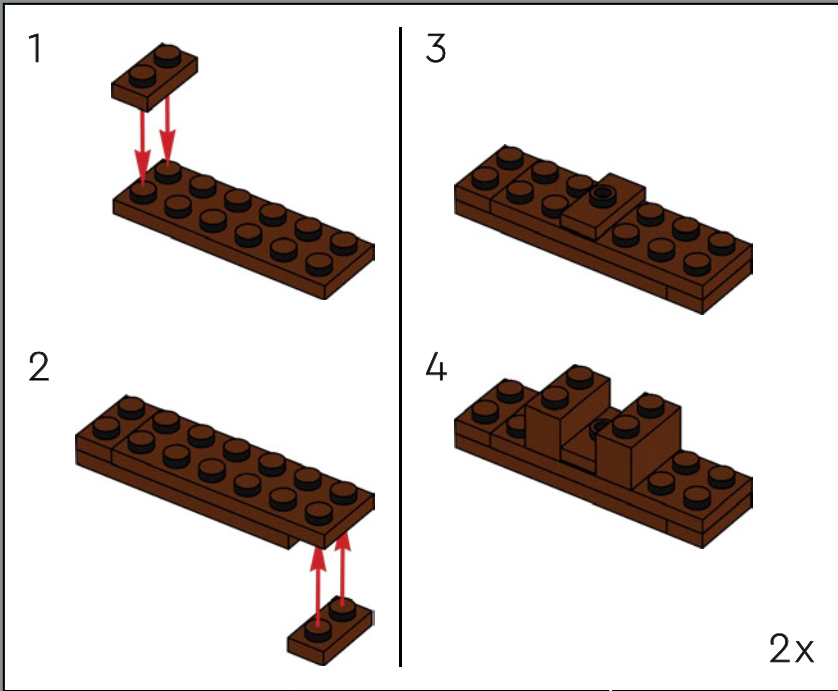



156

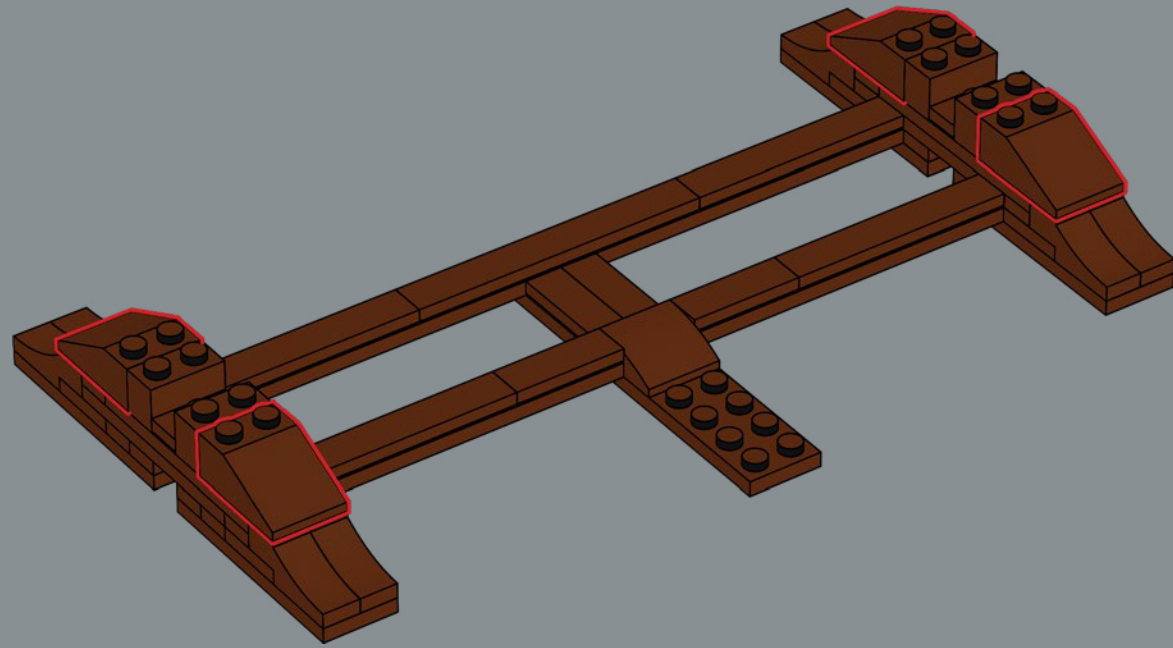

157

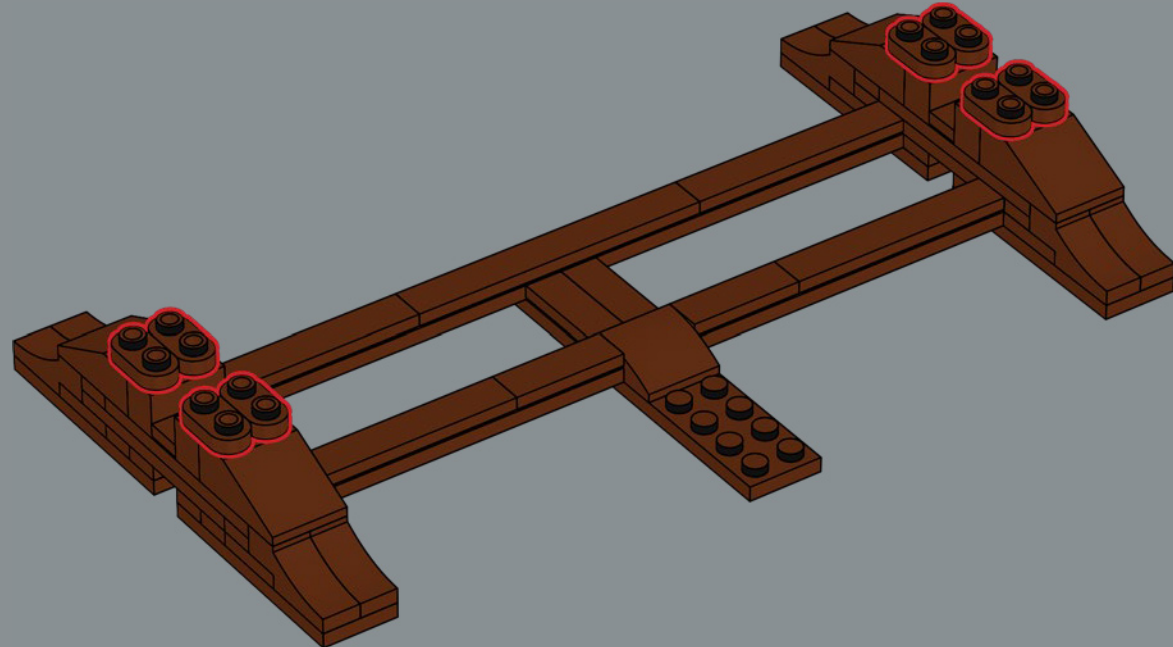

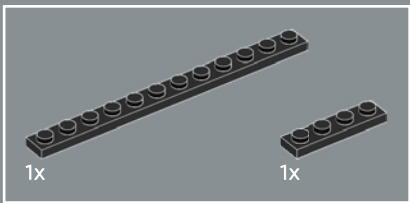
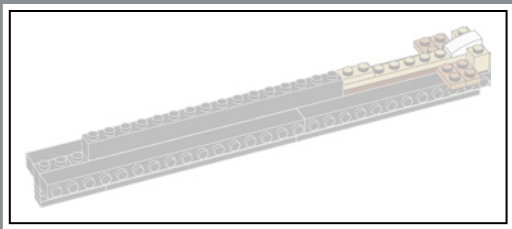

158

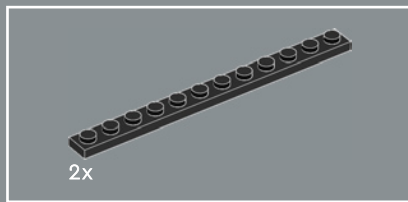
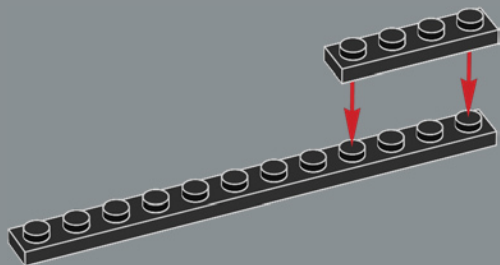

159

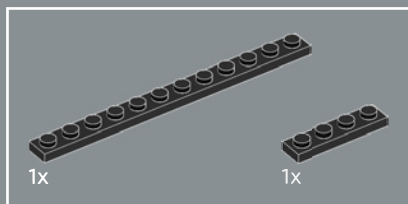
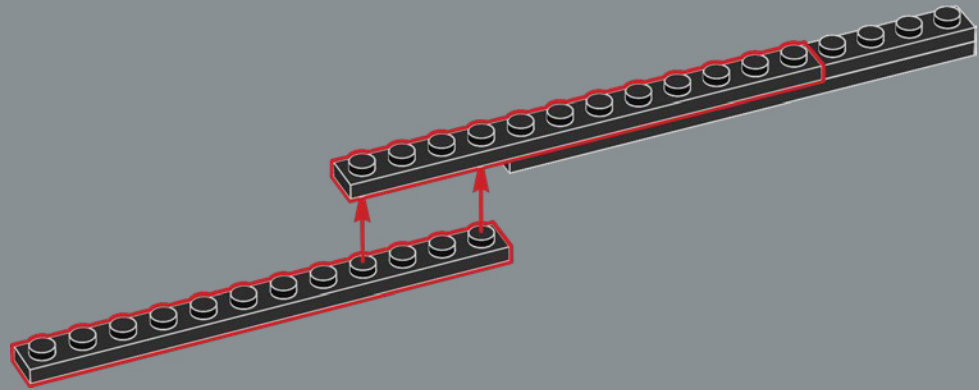

160

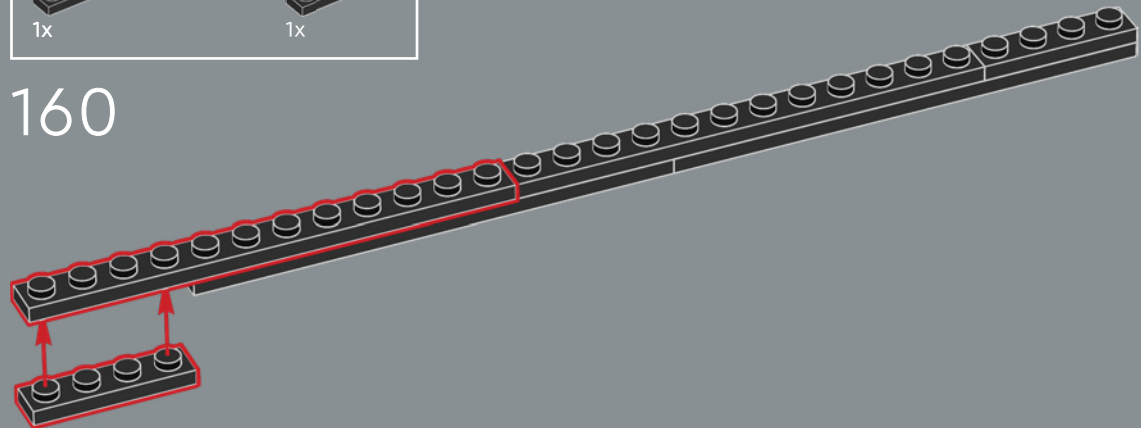

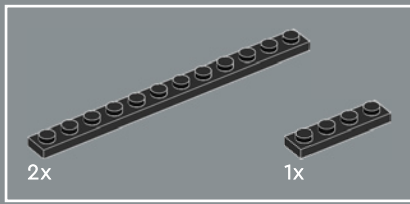

161

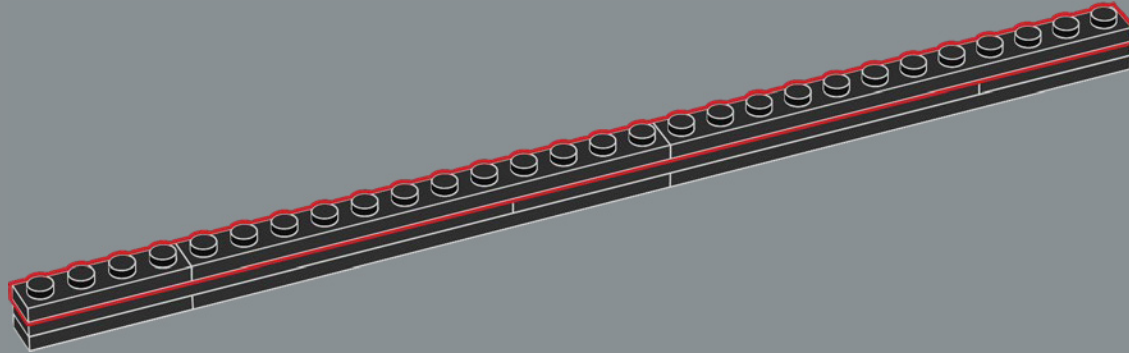

162

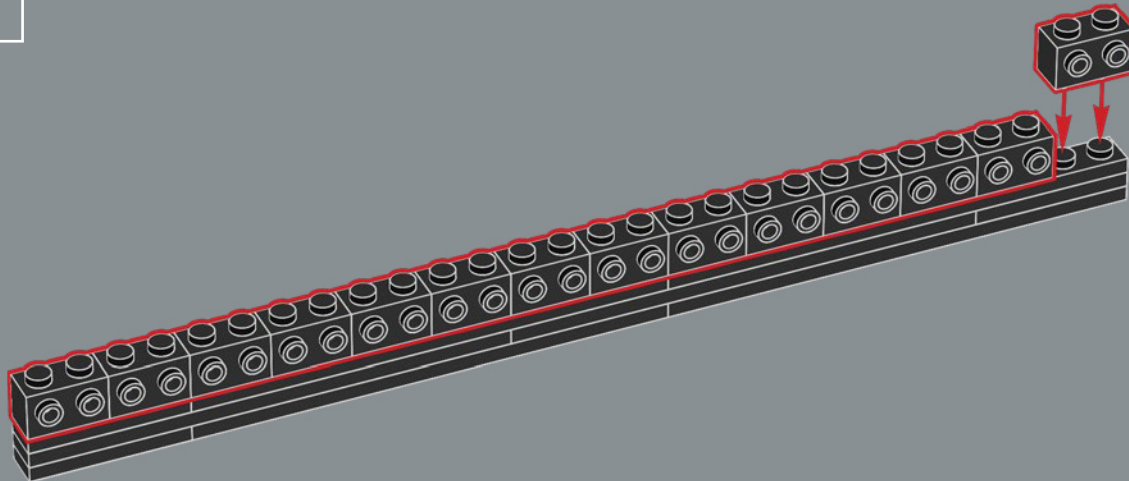

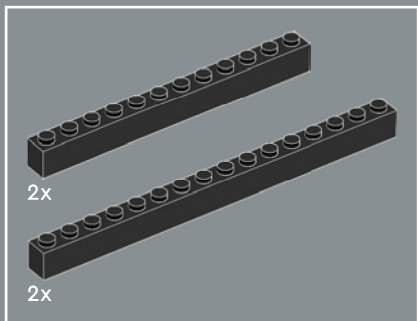

163

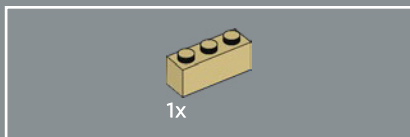
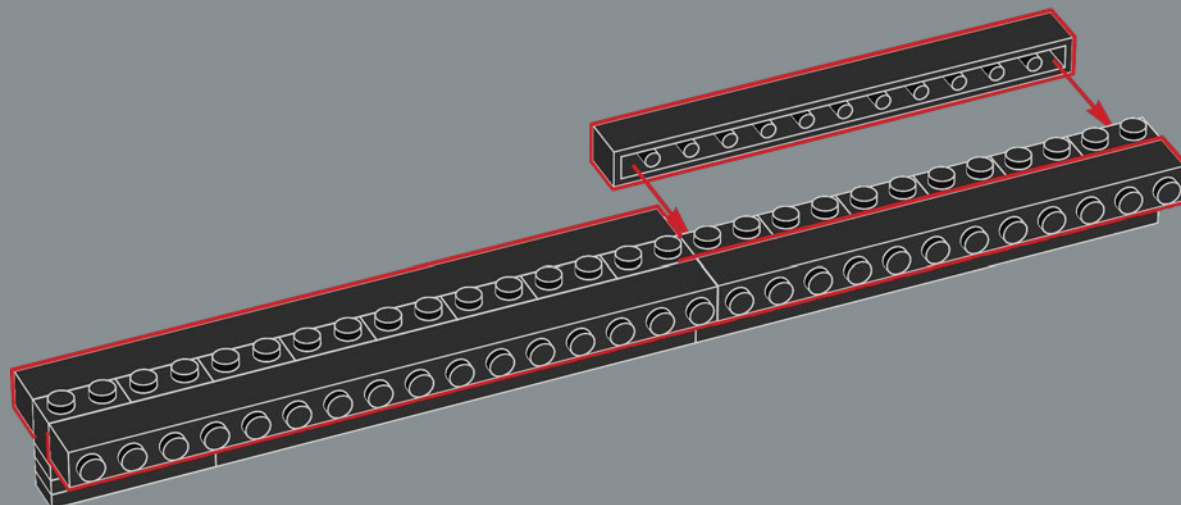

164

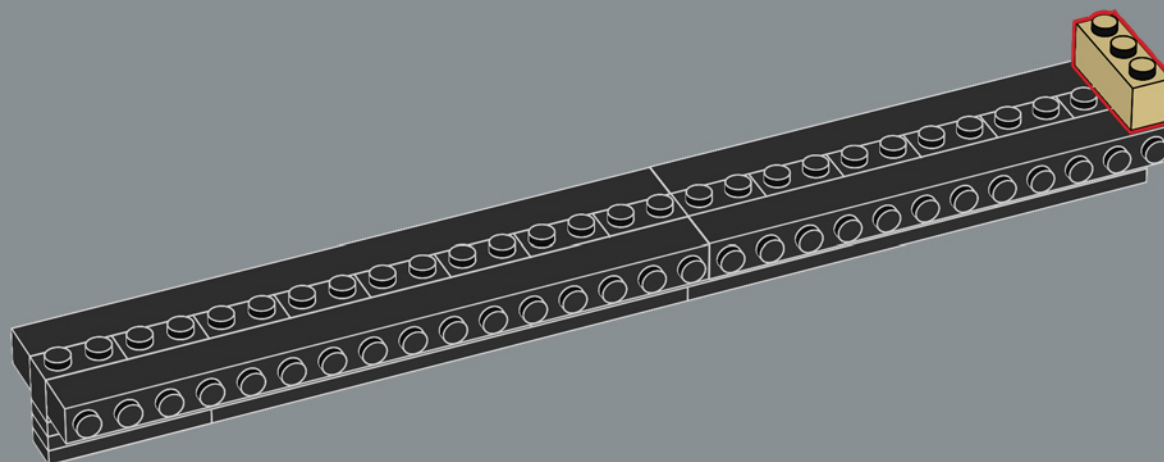

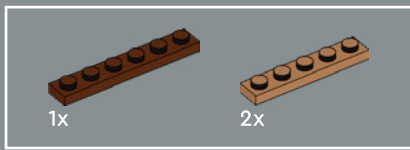

165

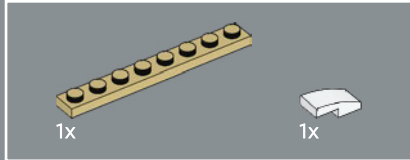
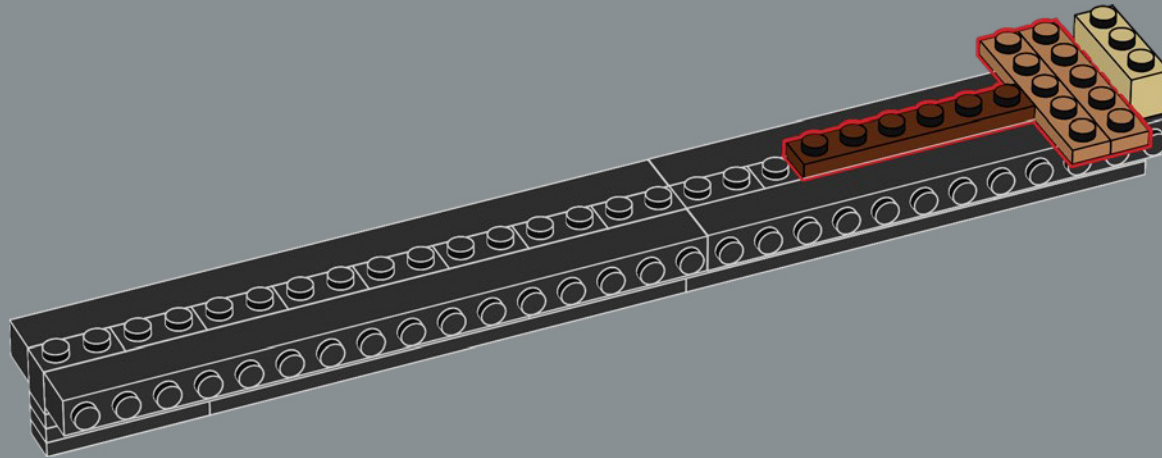

166

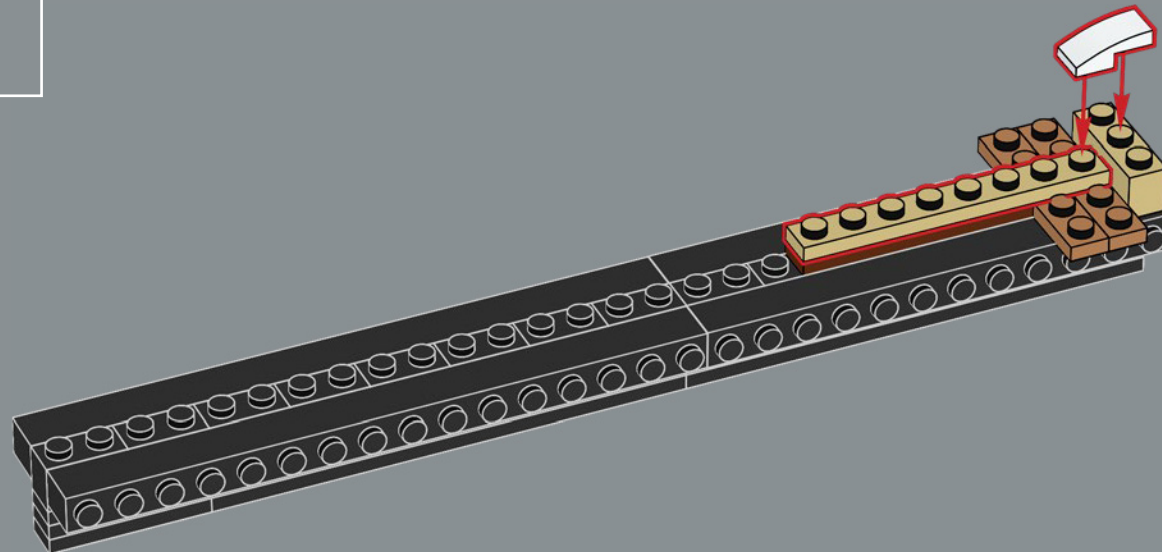

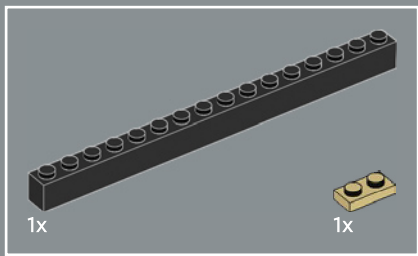

167

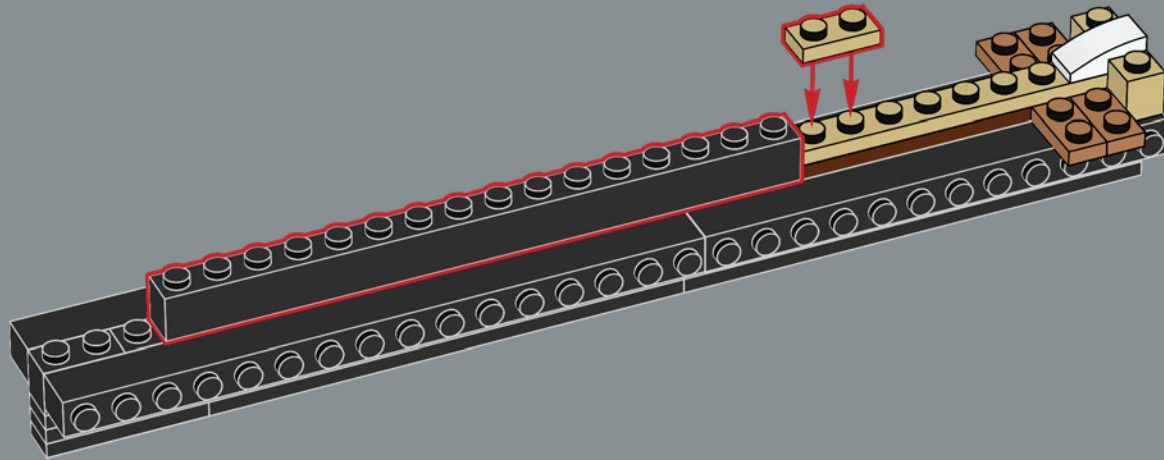

168

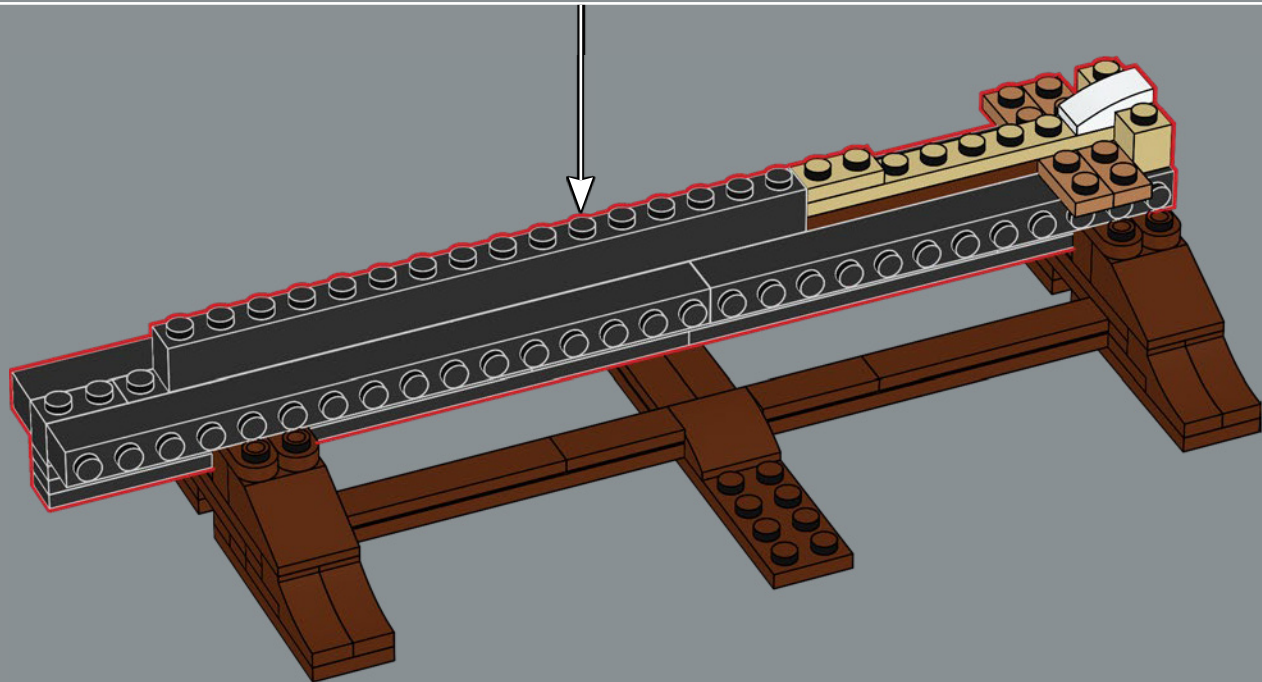



169

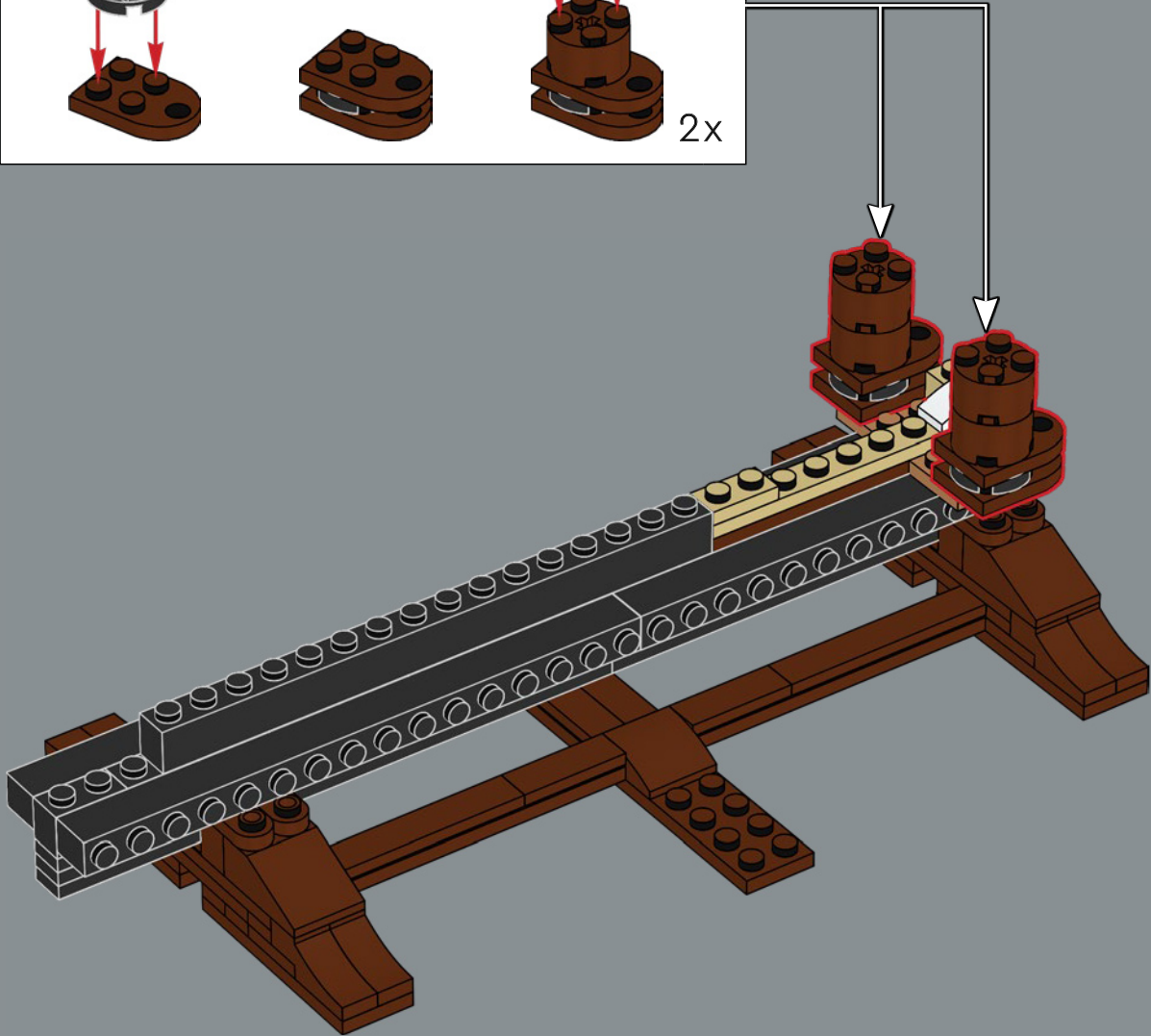
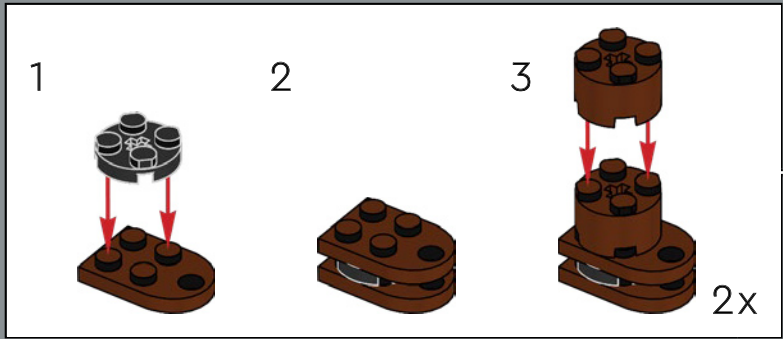

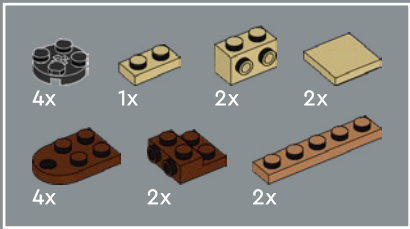

170

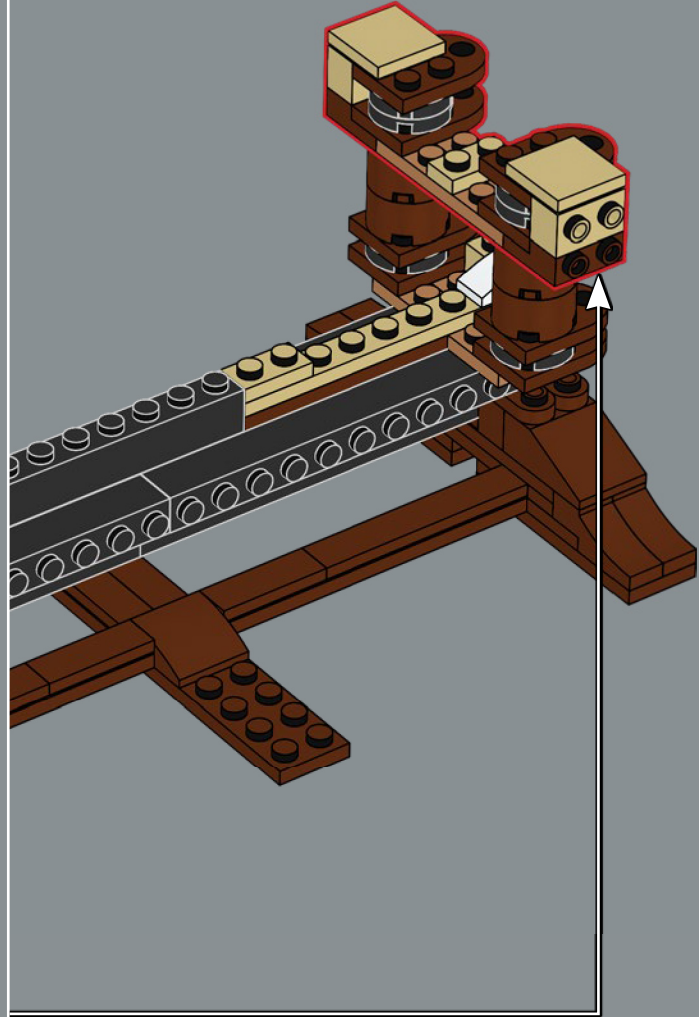
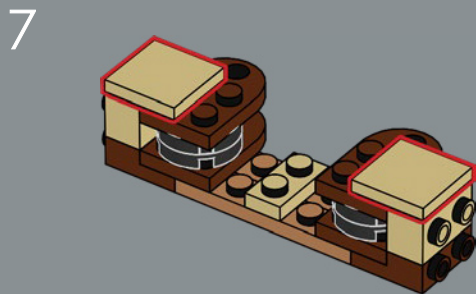
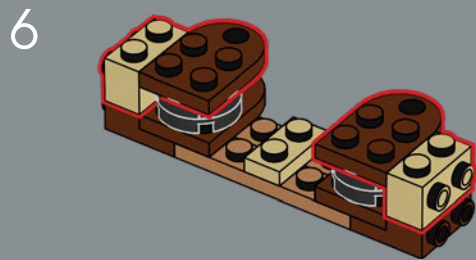
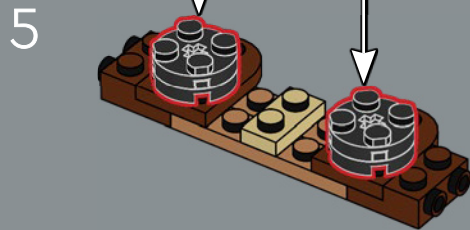
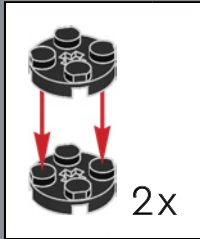
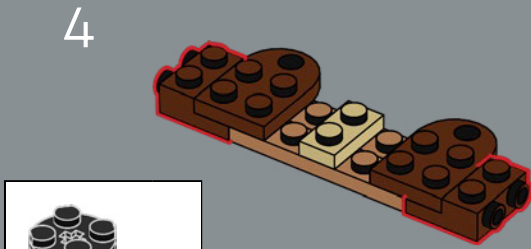
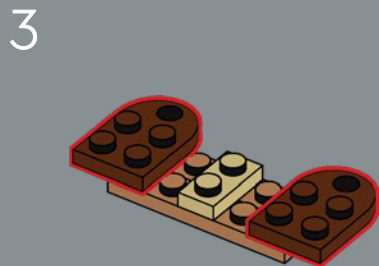
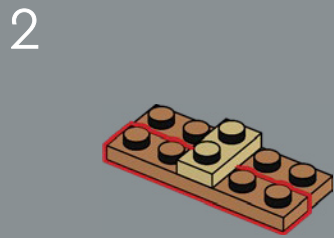
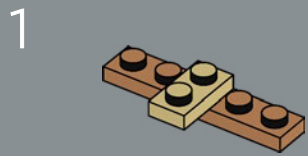

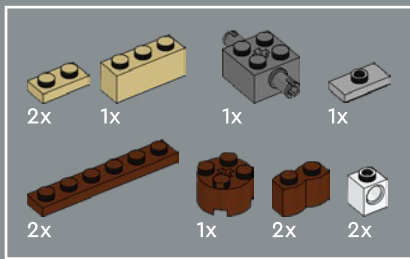

171

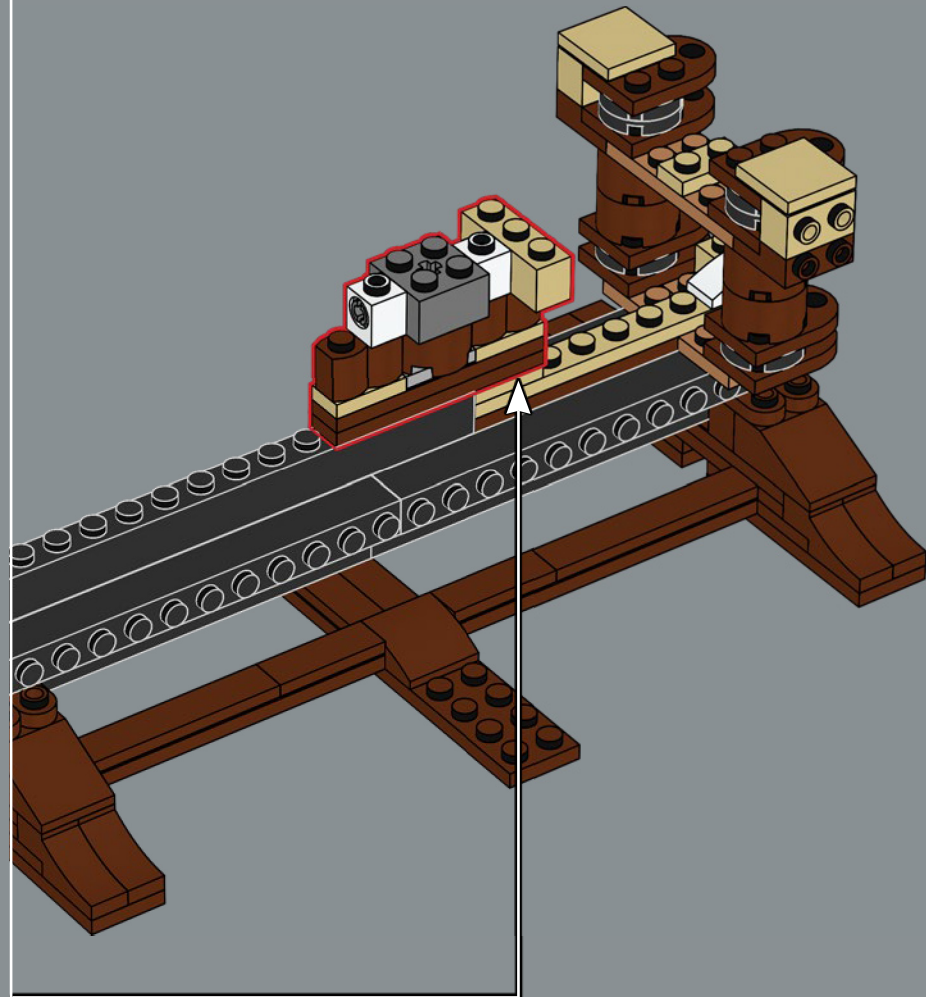
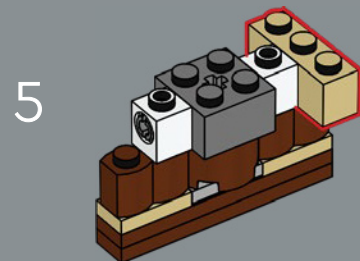
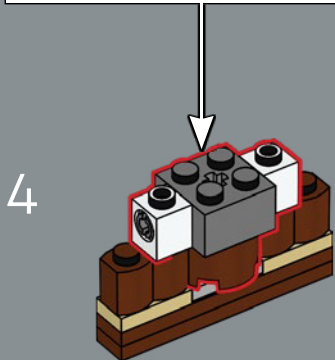
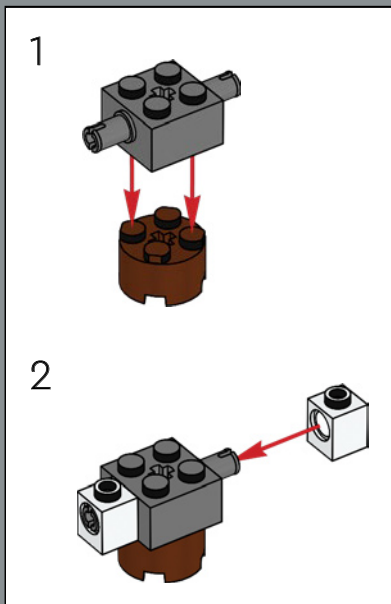
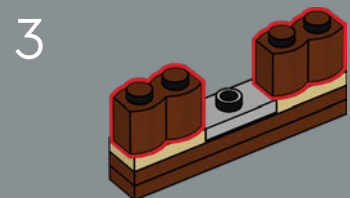
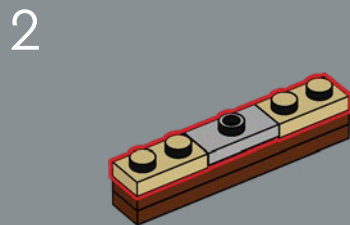
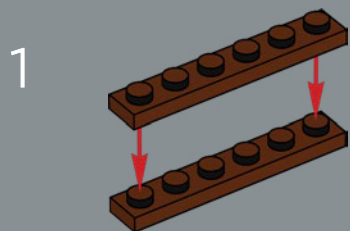

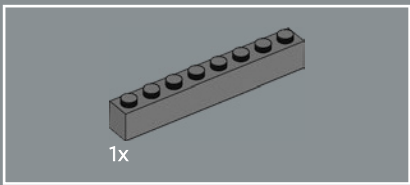

172

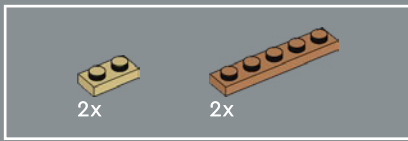
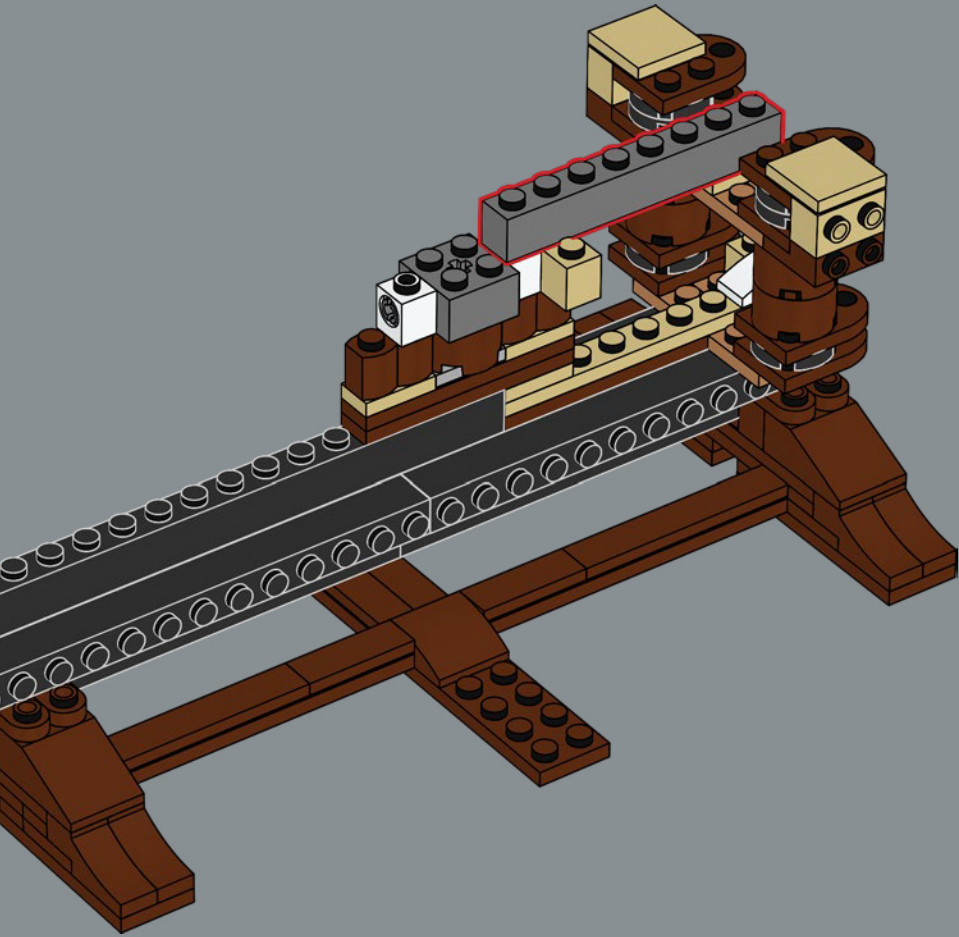

173

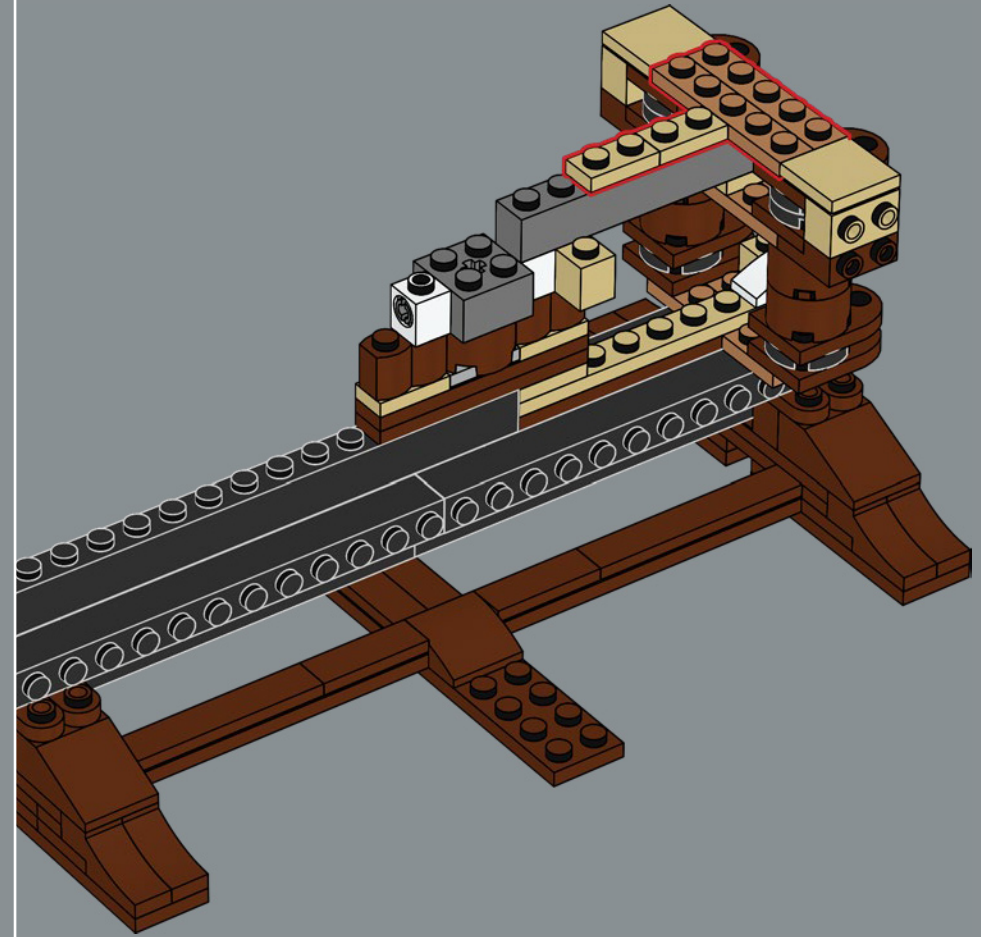

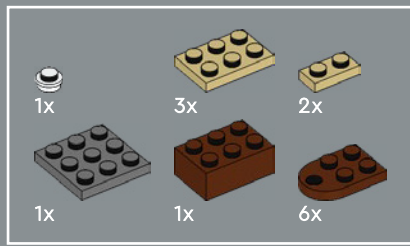

174

1

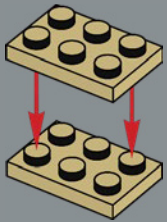

2

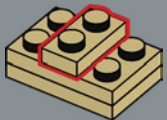

3



4



5

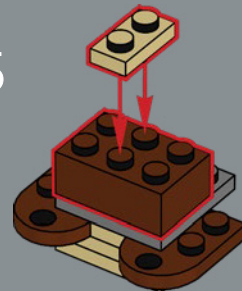

6

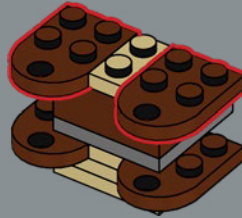

7

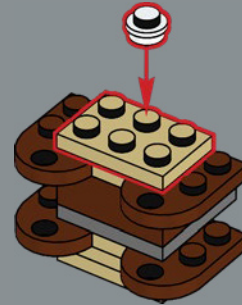

8

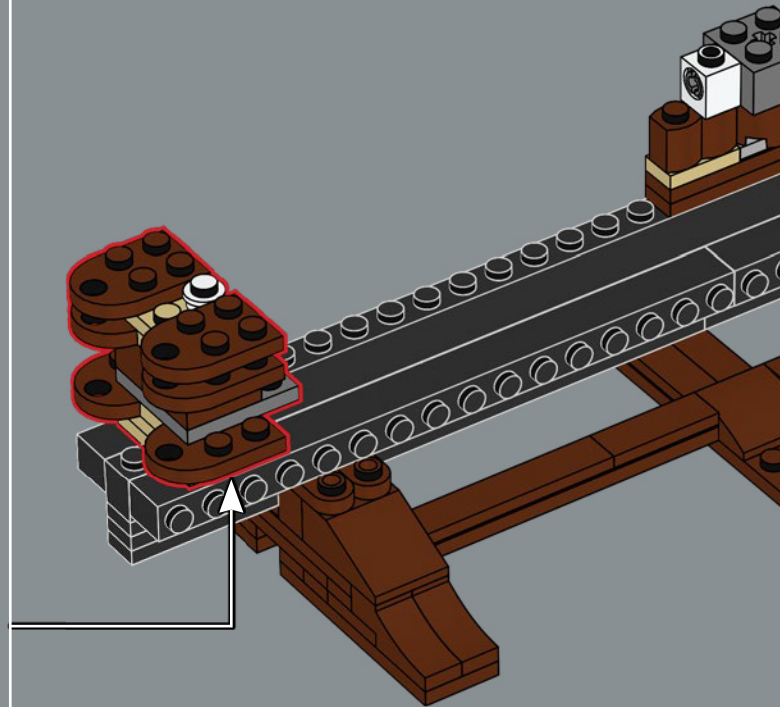
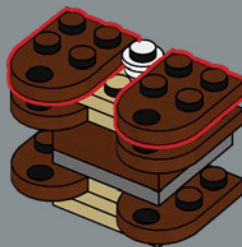

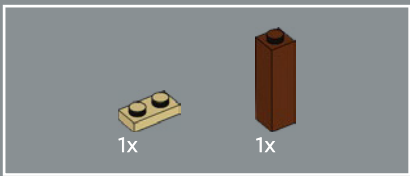

175

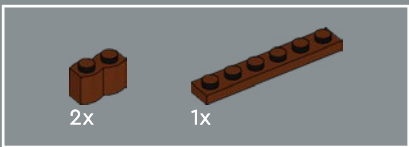
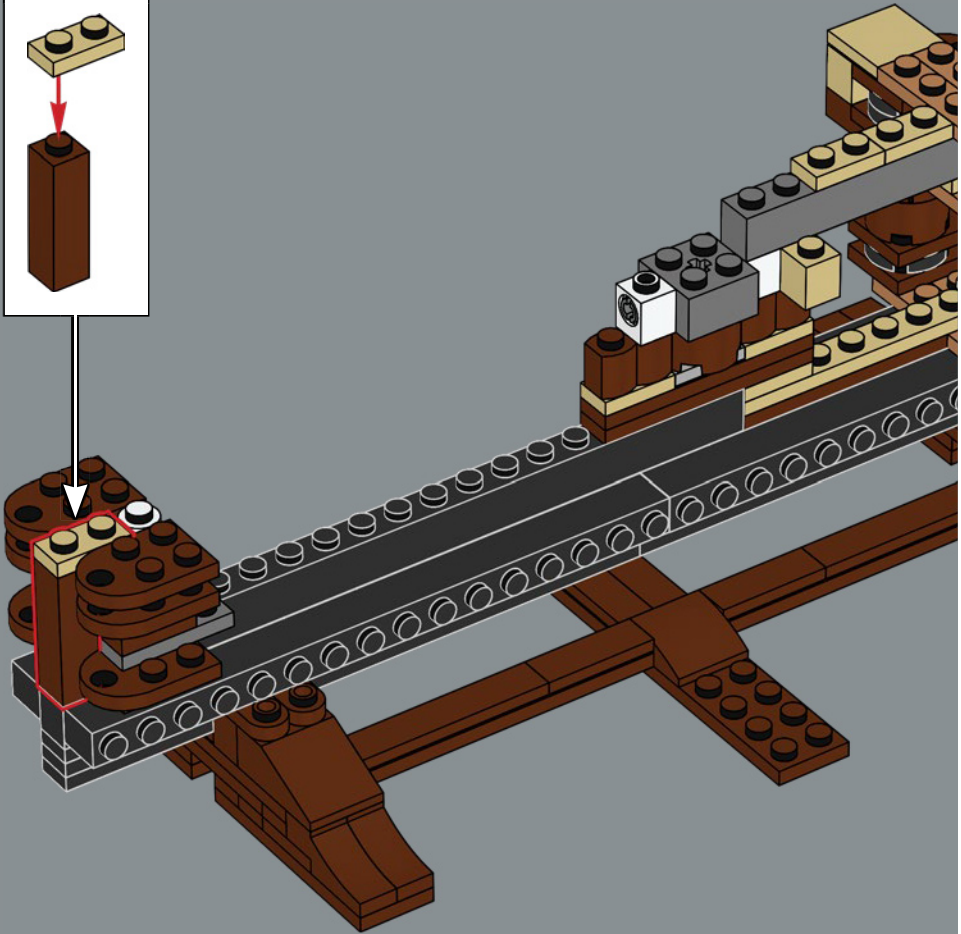
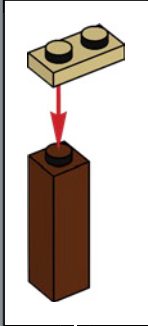

176

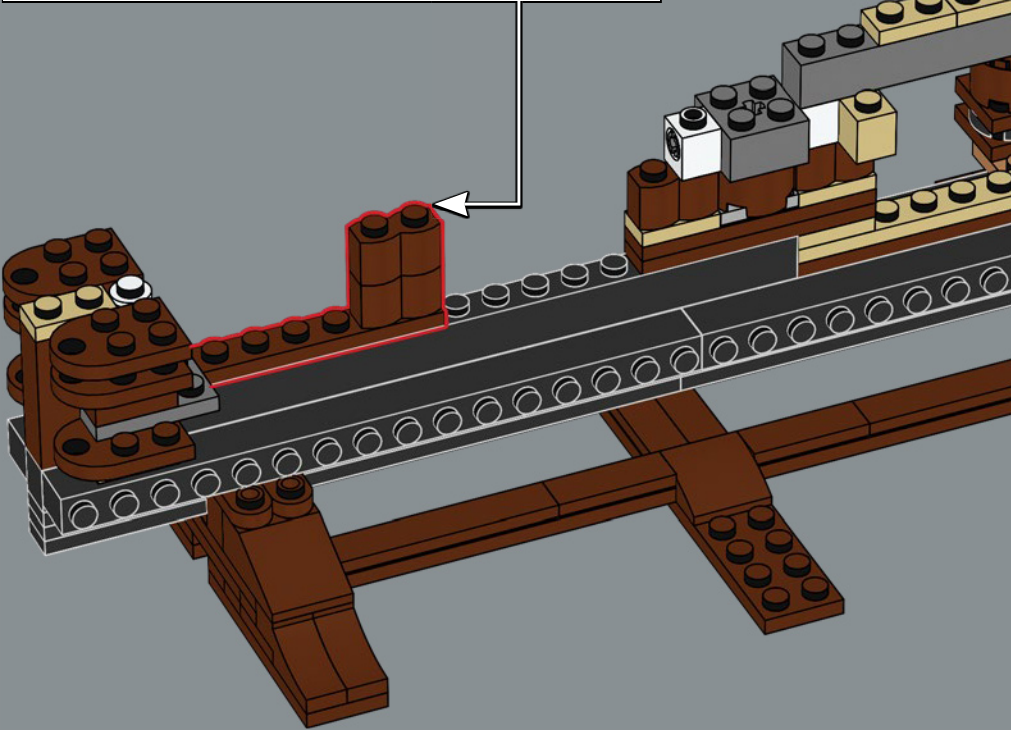
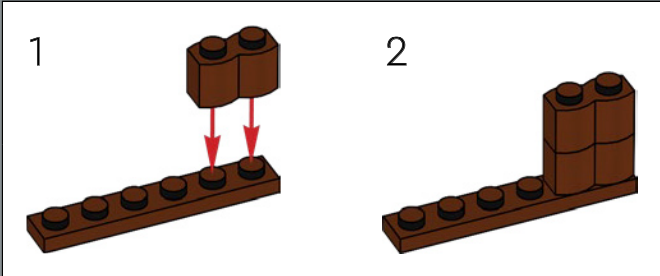

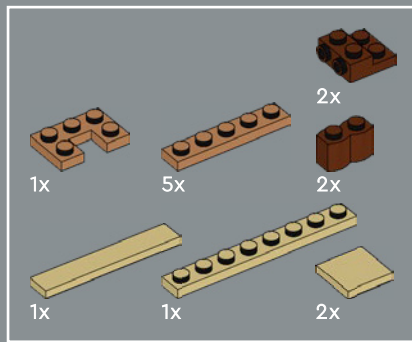

177

1

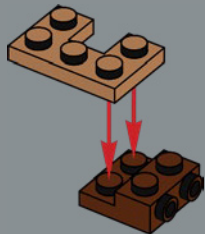

2

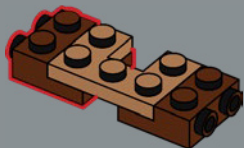

3

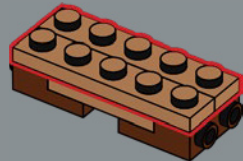

4

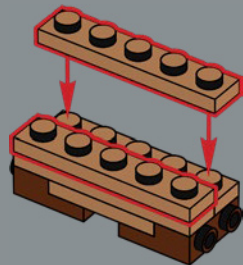

5

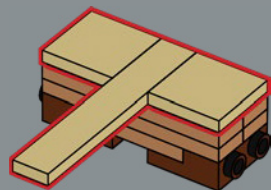

6

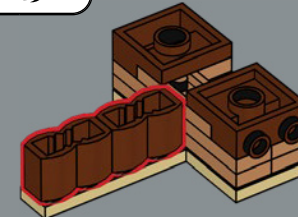

7

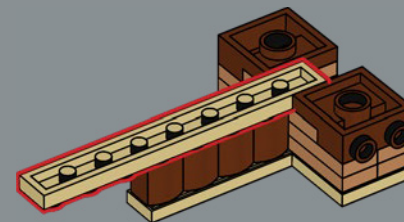

8

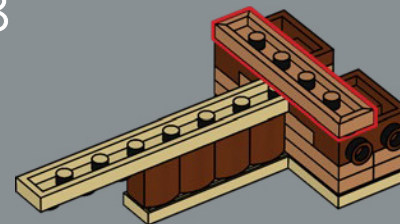

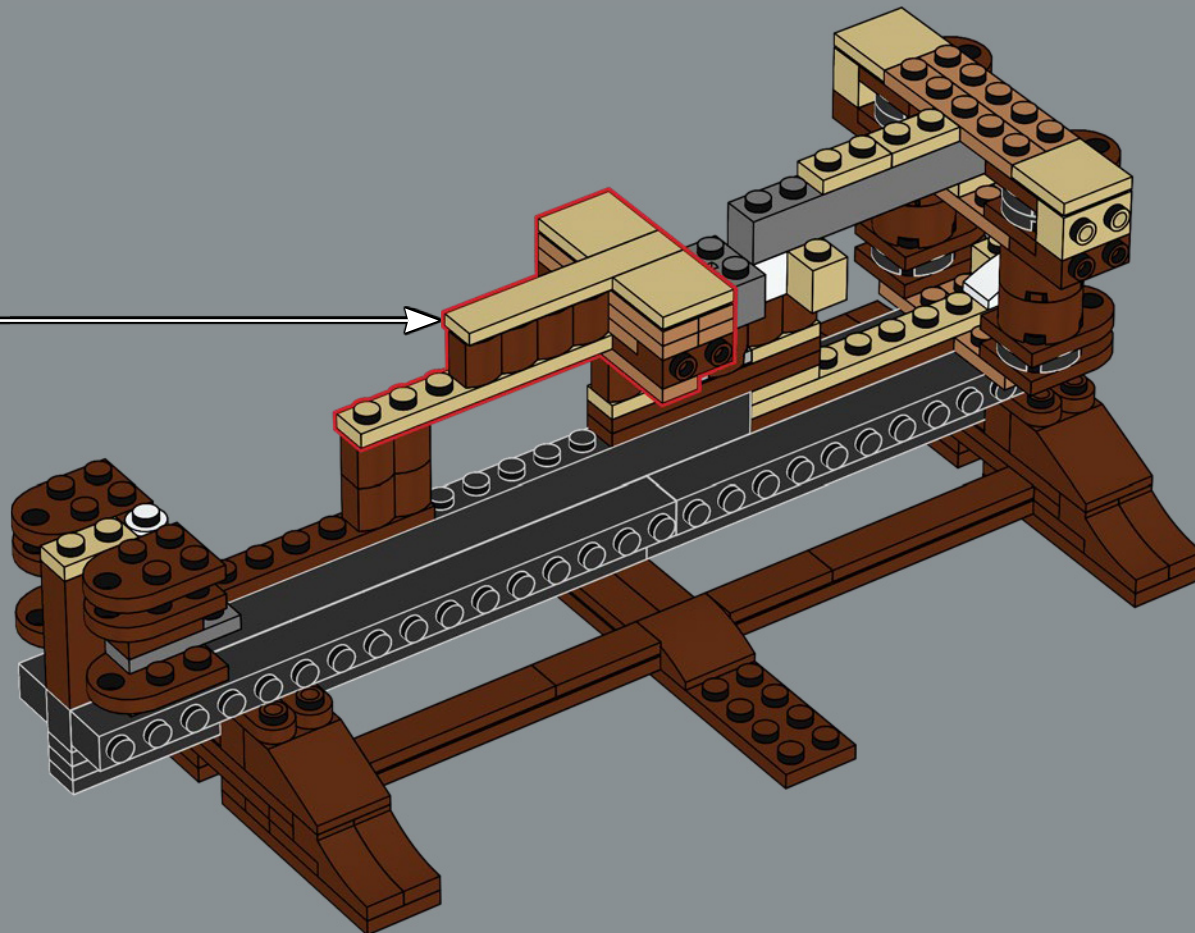

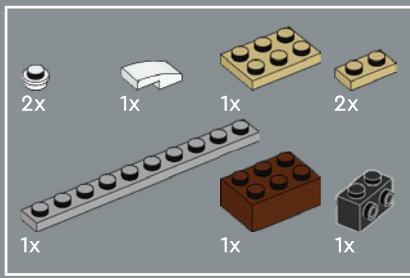

178

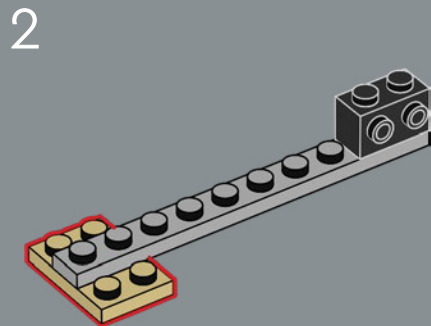
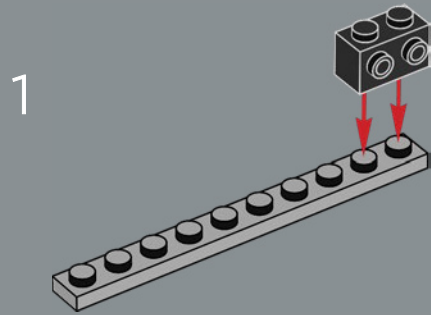

3

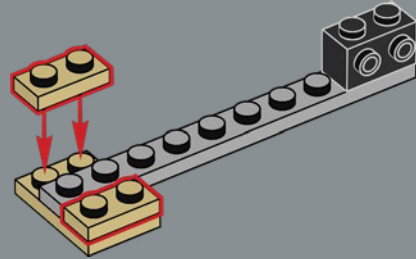

4

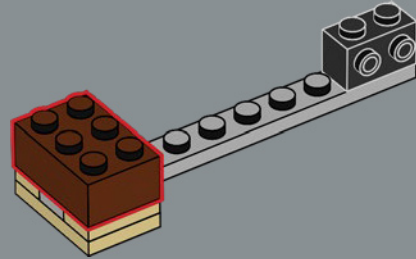

5

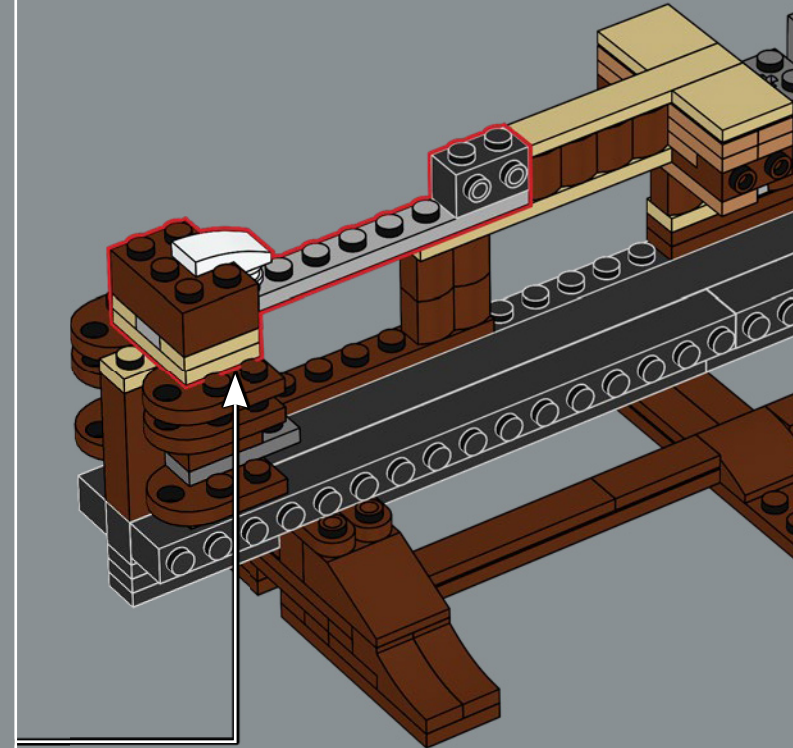
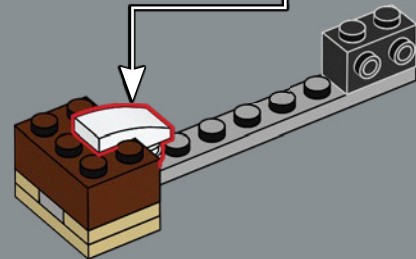
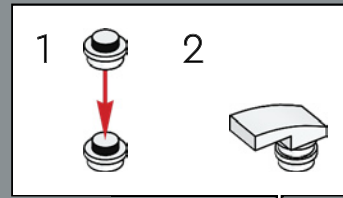

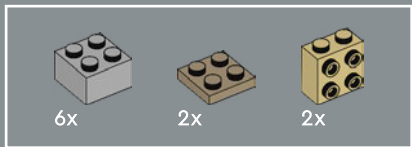

179

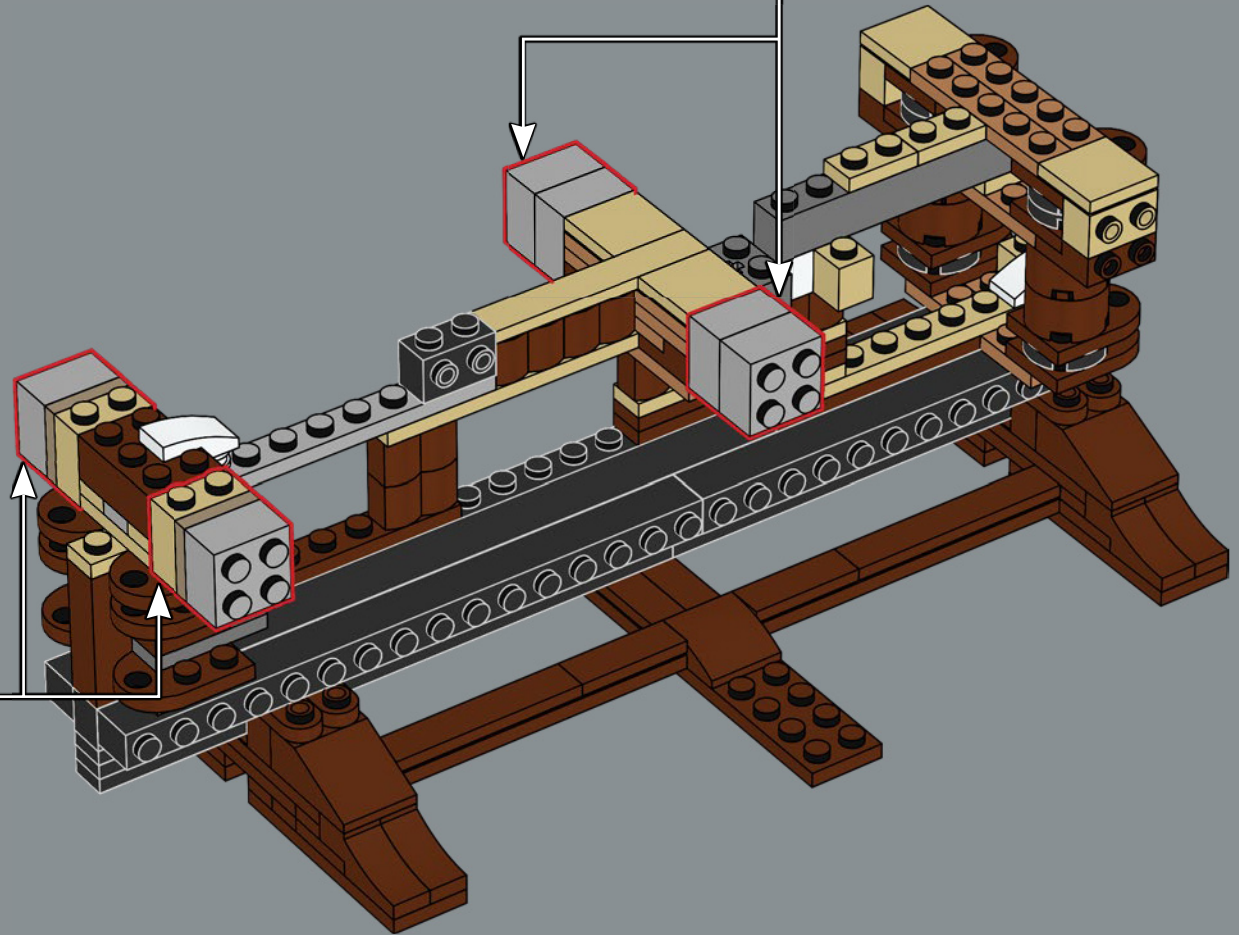
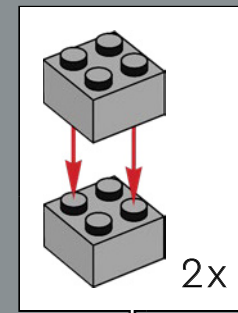
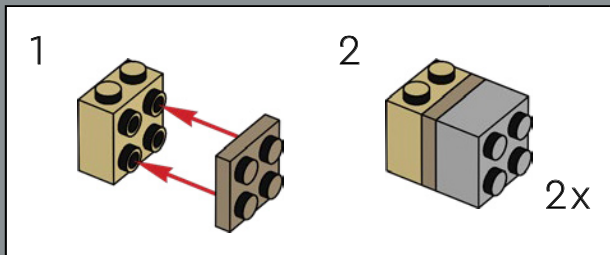

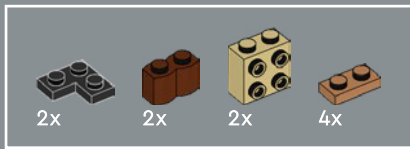

180

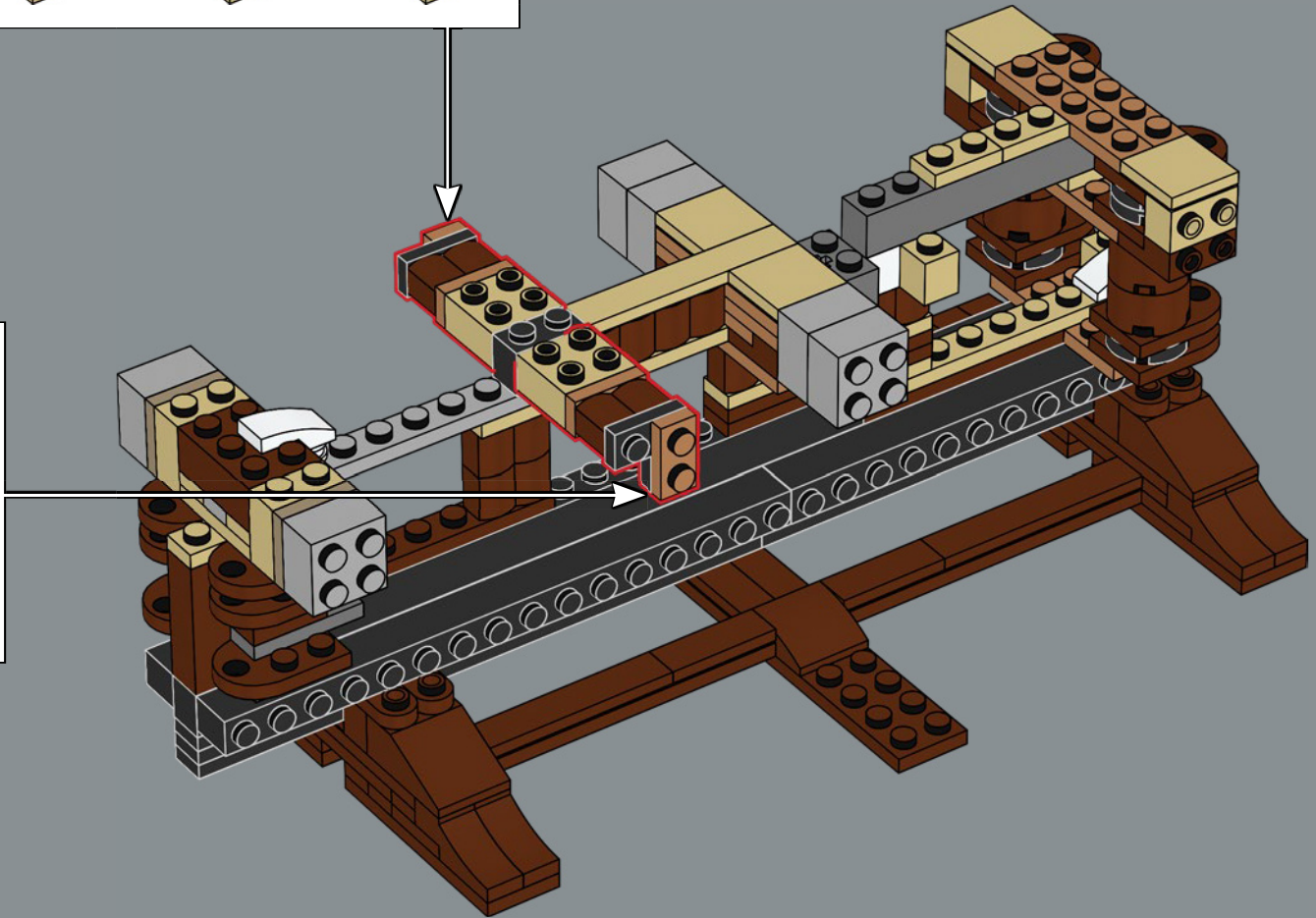
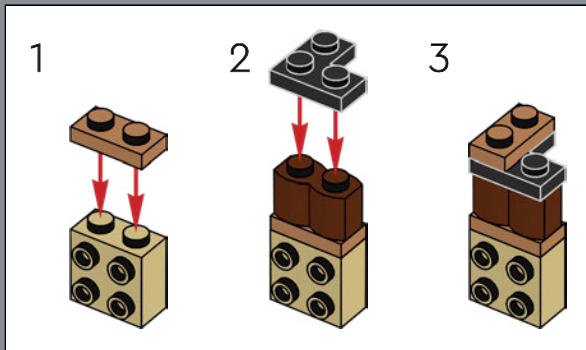
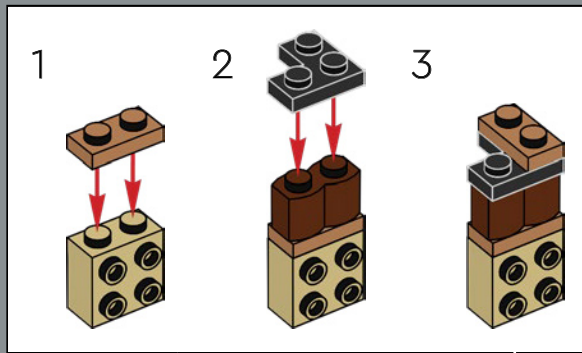

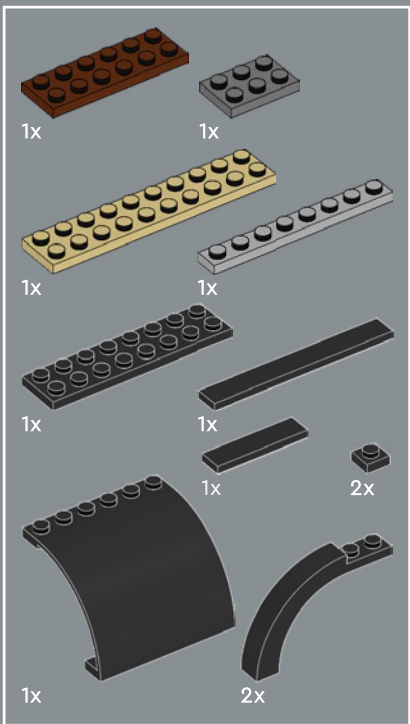

181

1

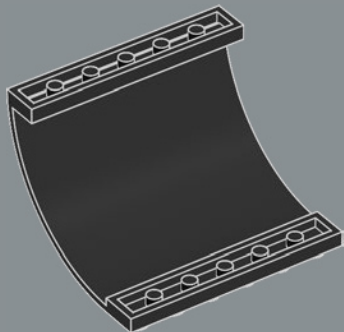

2

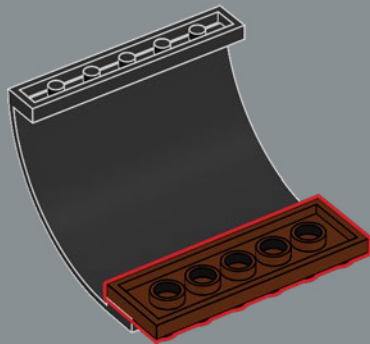

3

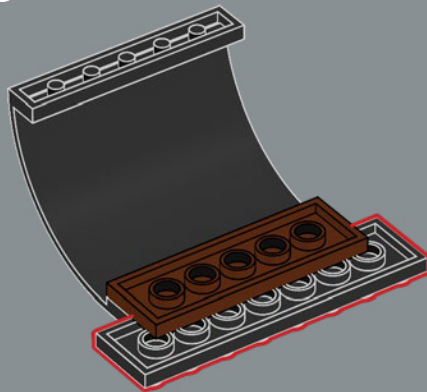

4

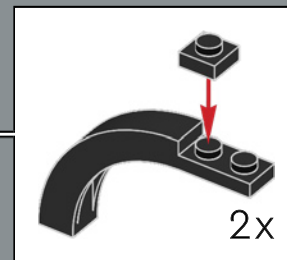
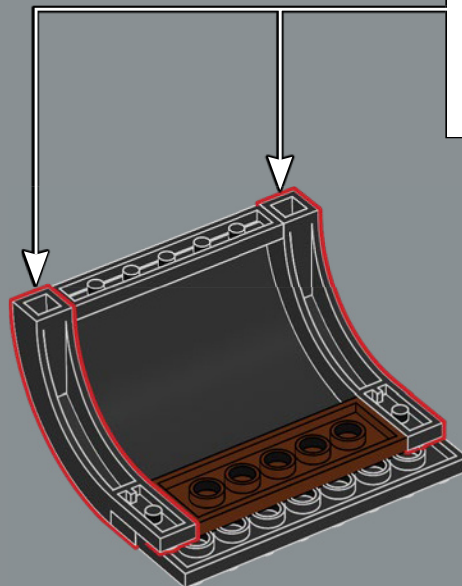

5

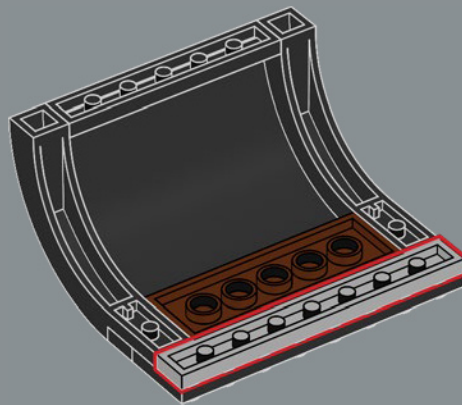

6

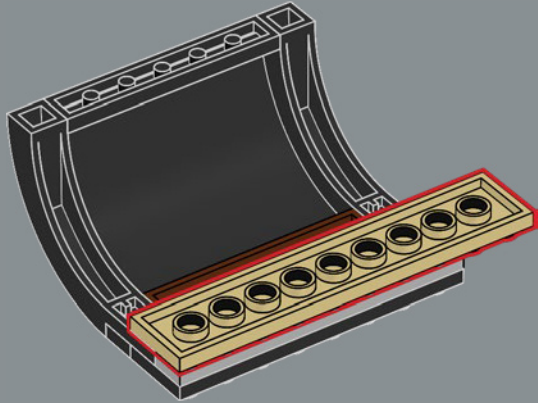

7

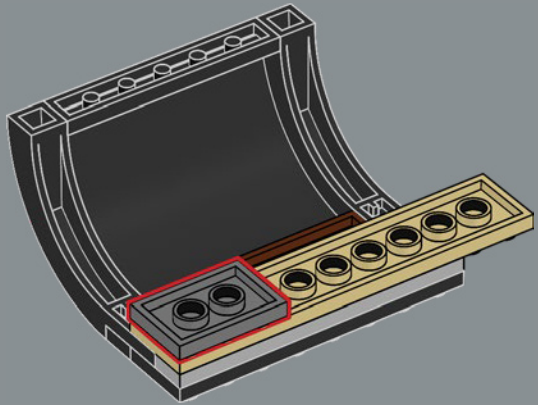

8

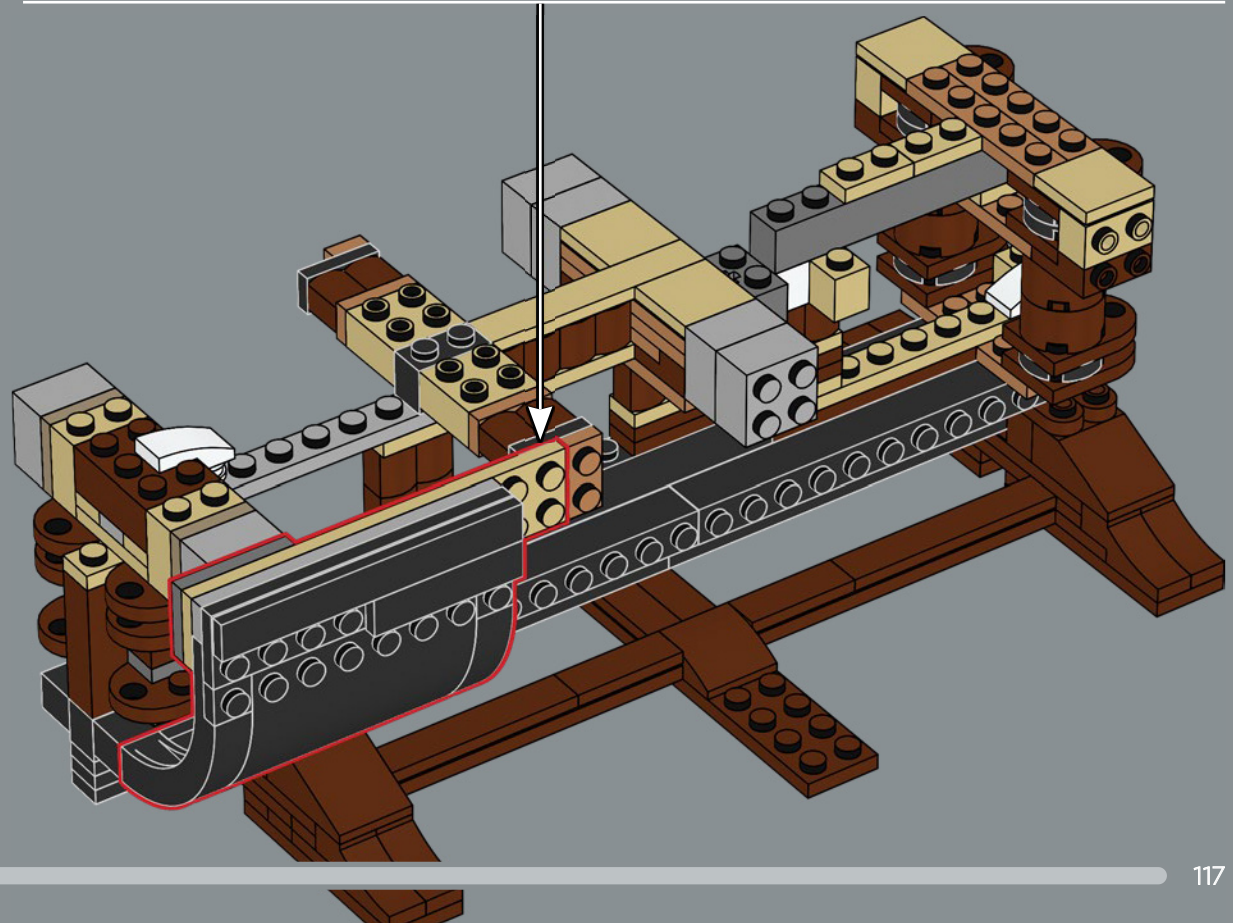
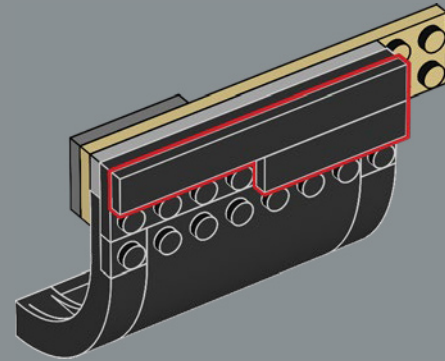

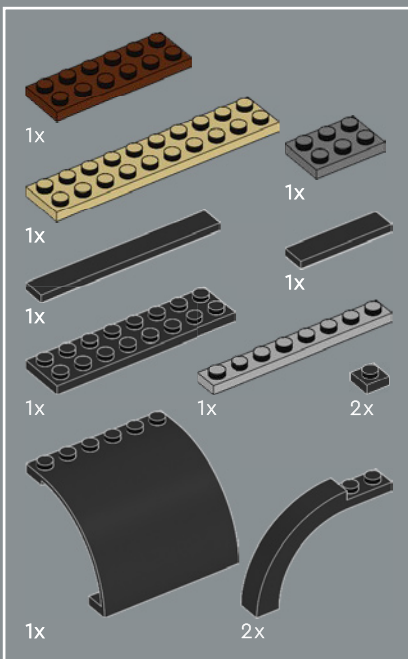

182

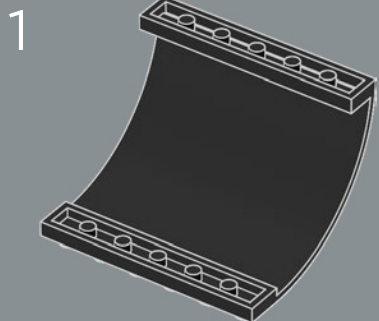

2

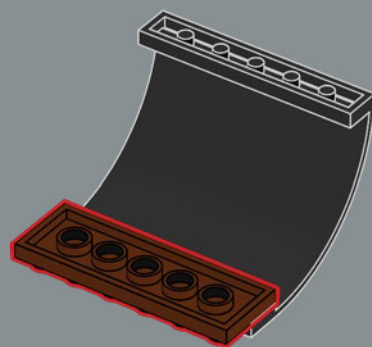

3

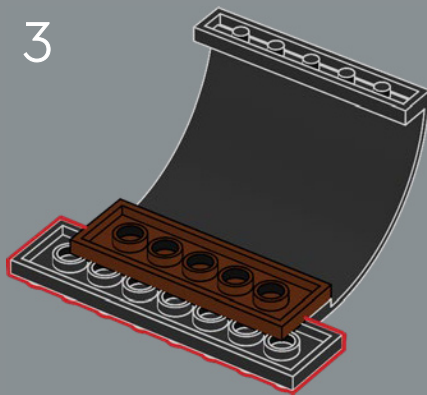

4

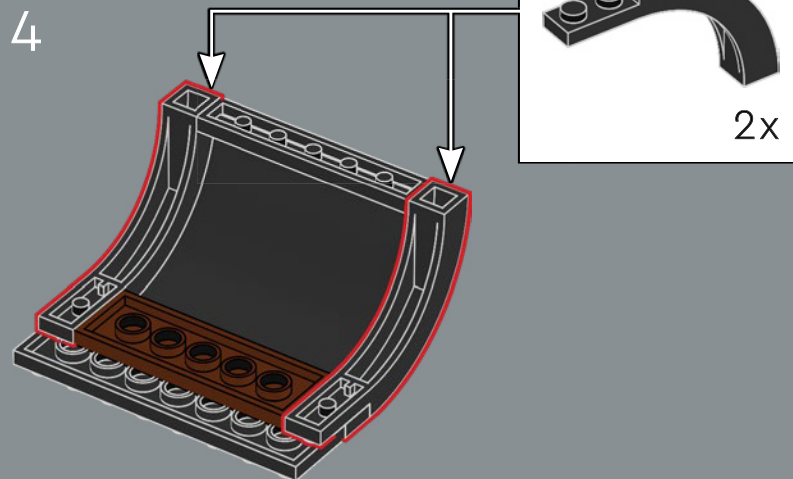

5

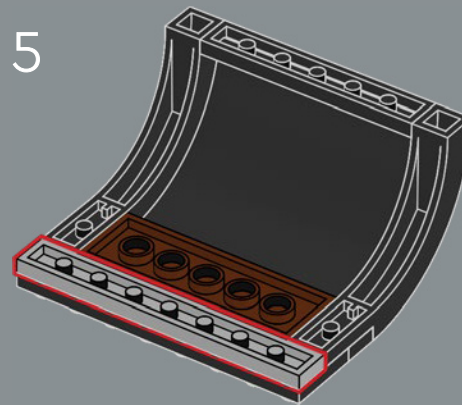

6

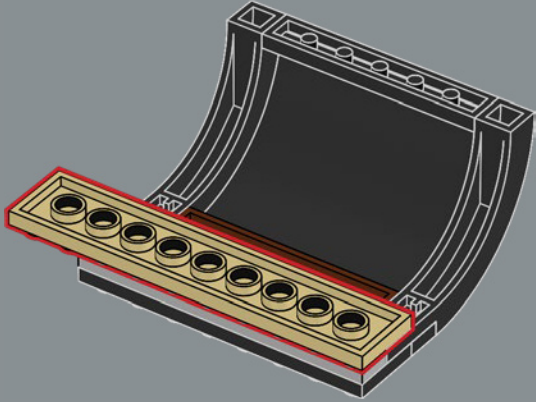

7

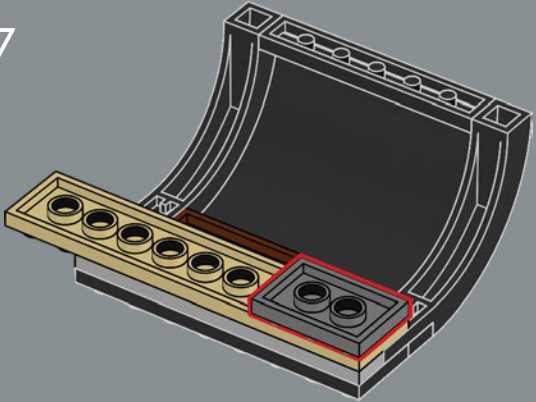

8

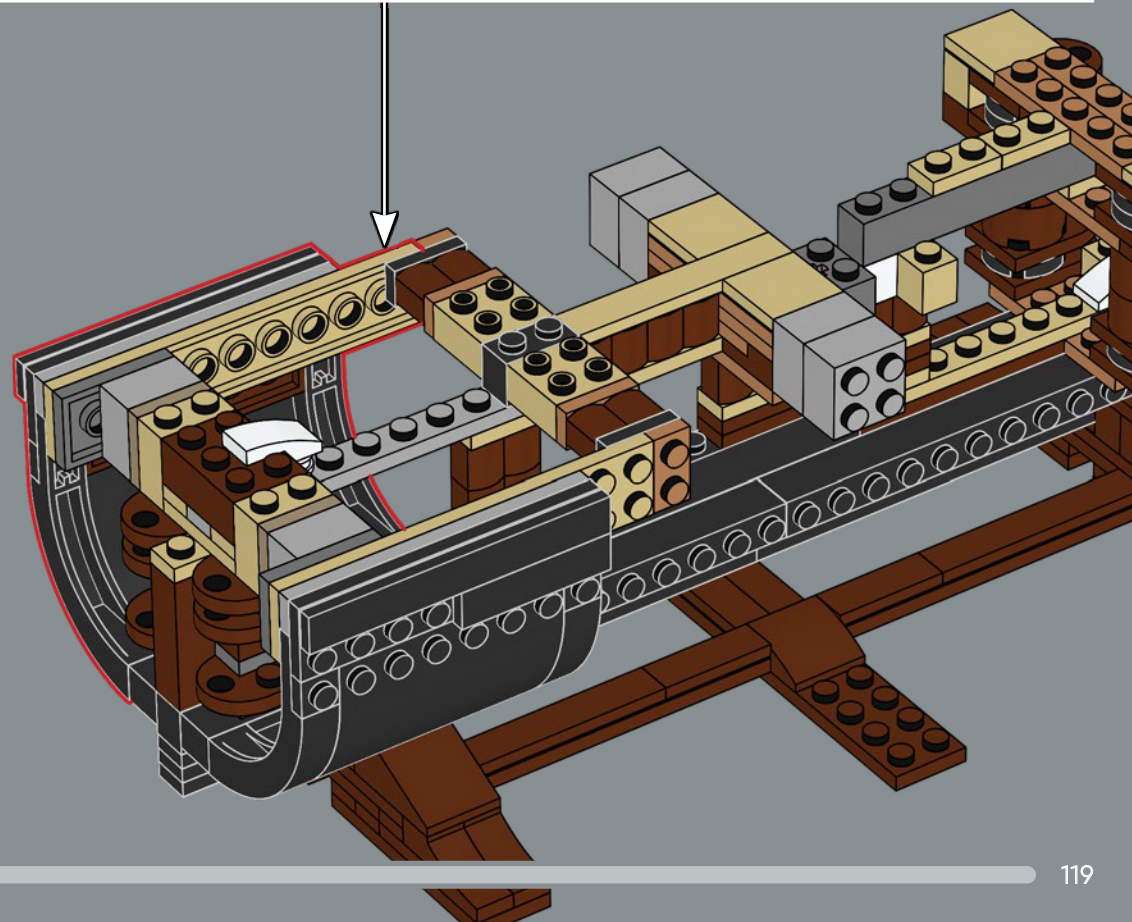
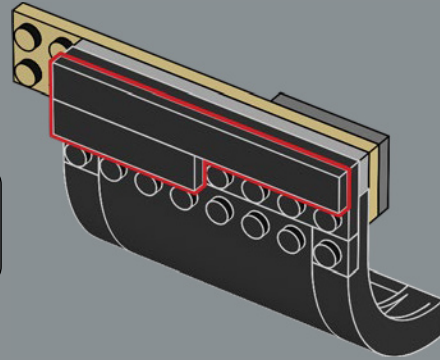

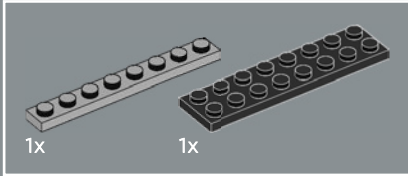
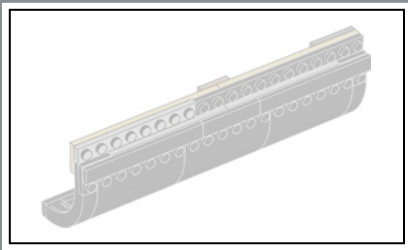

183

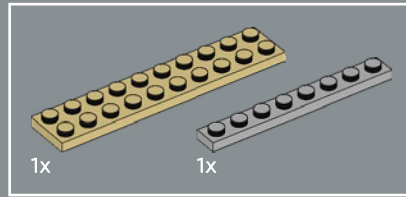
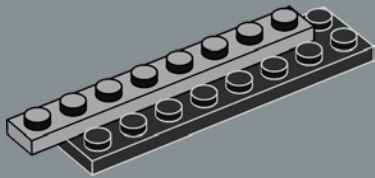

184

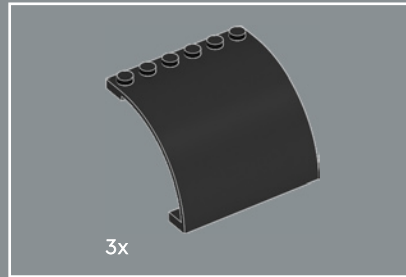
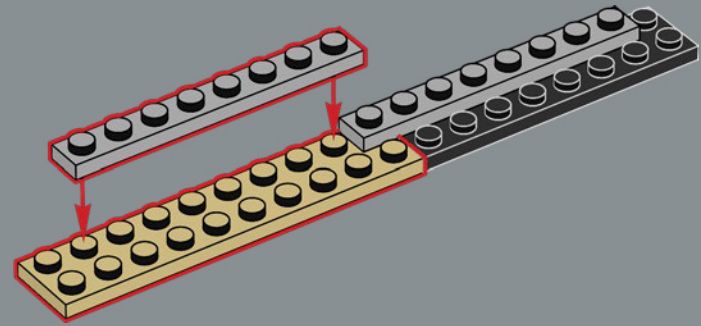

185

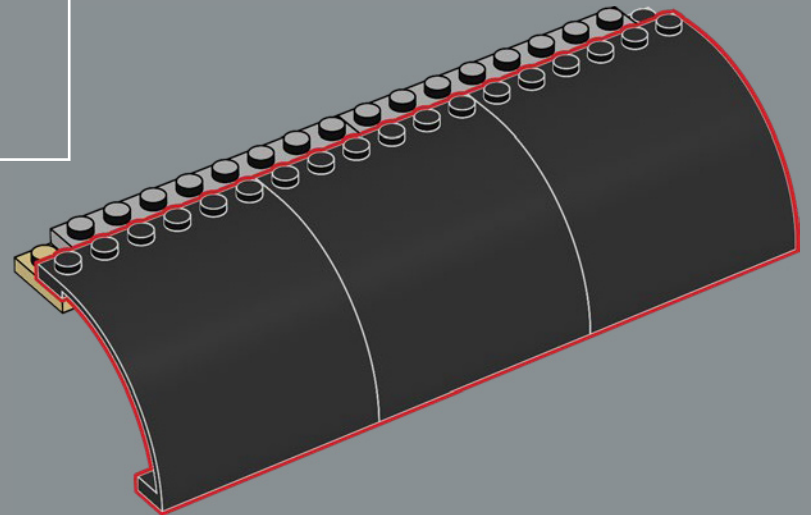



186

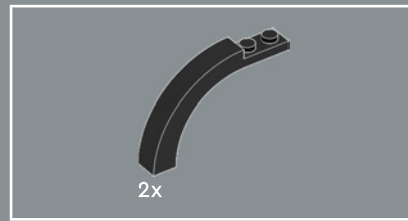
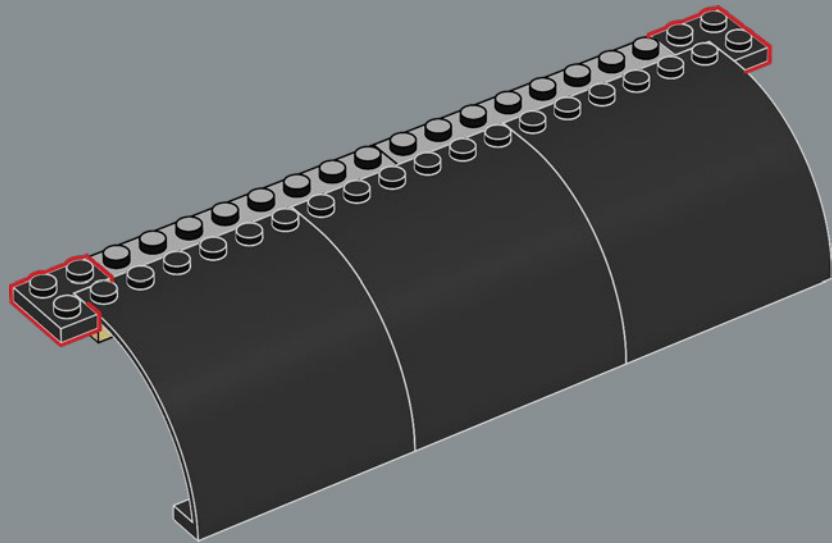

187

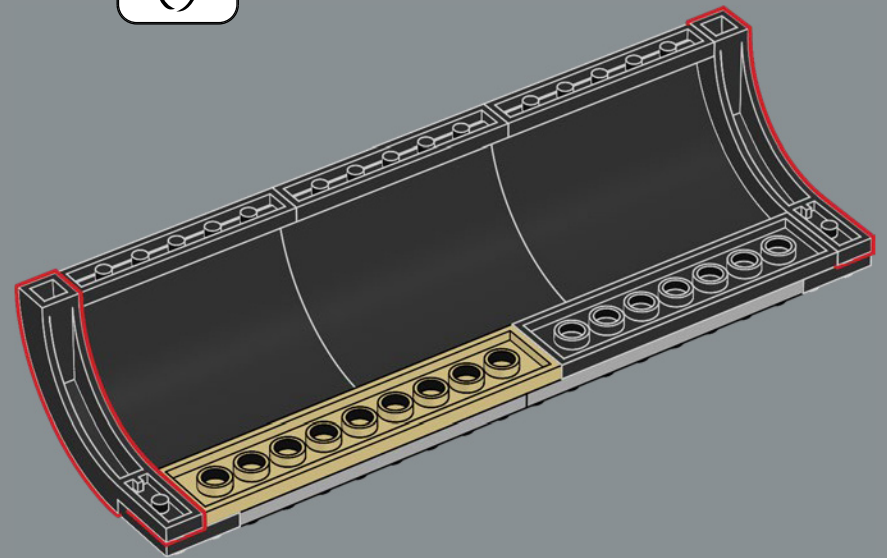

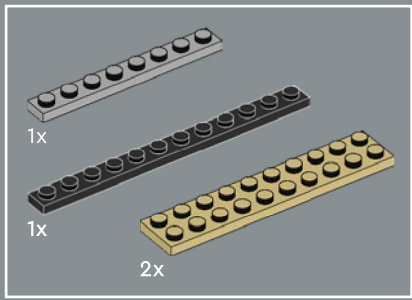

188

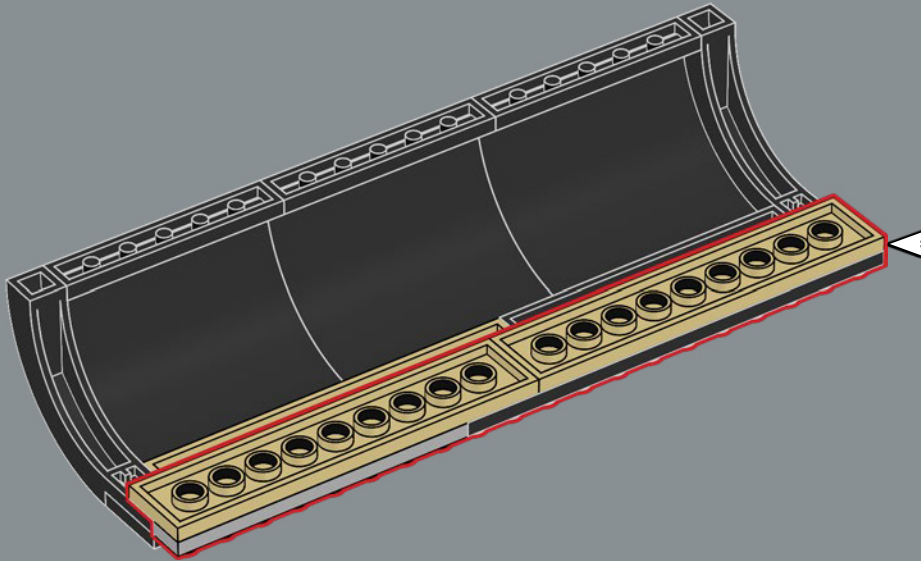
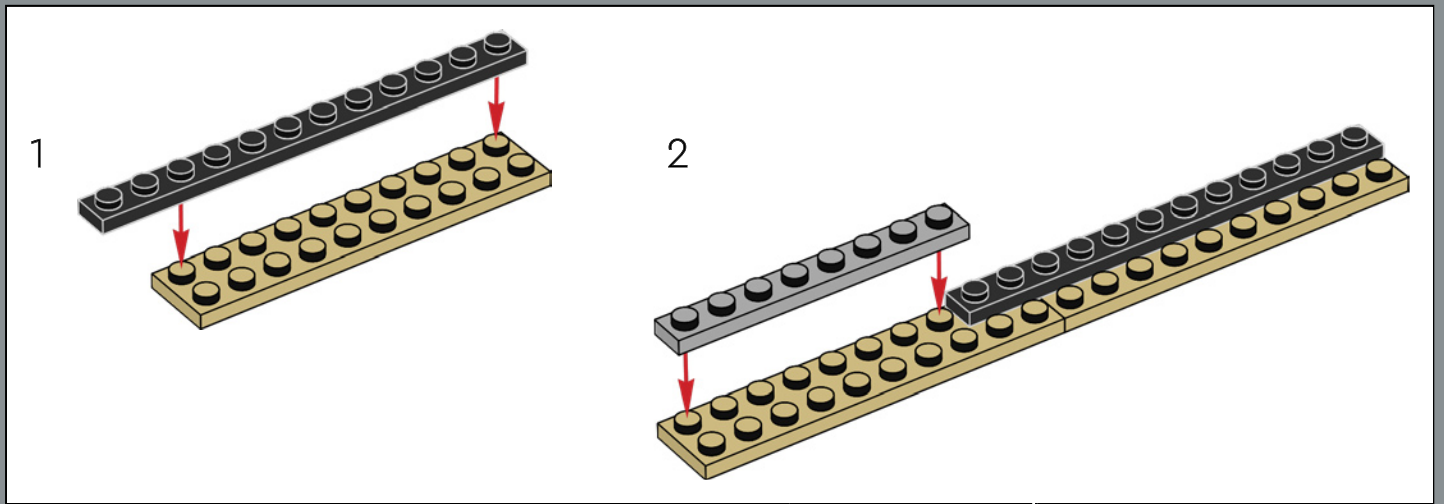



189

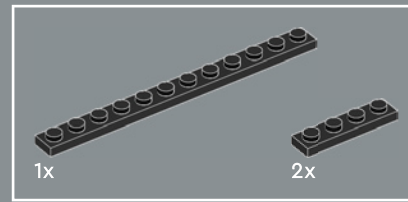
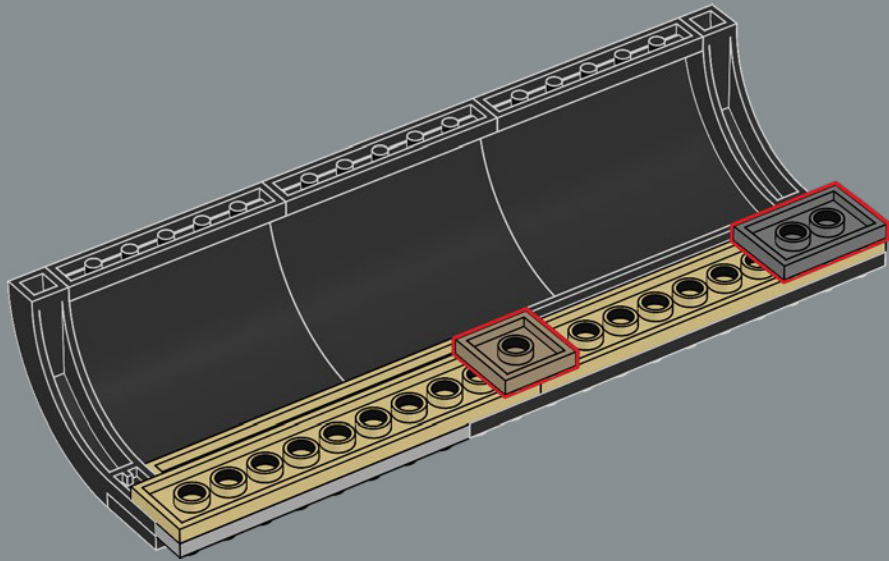

190

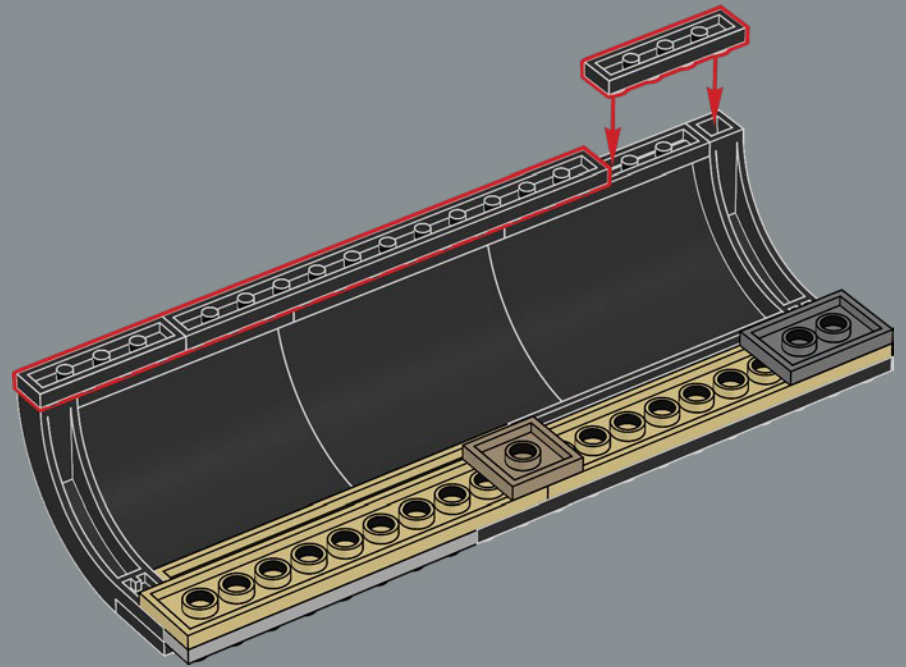

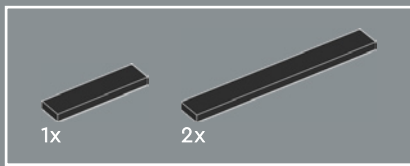

191

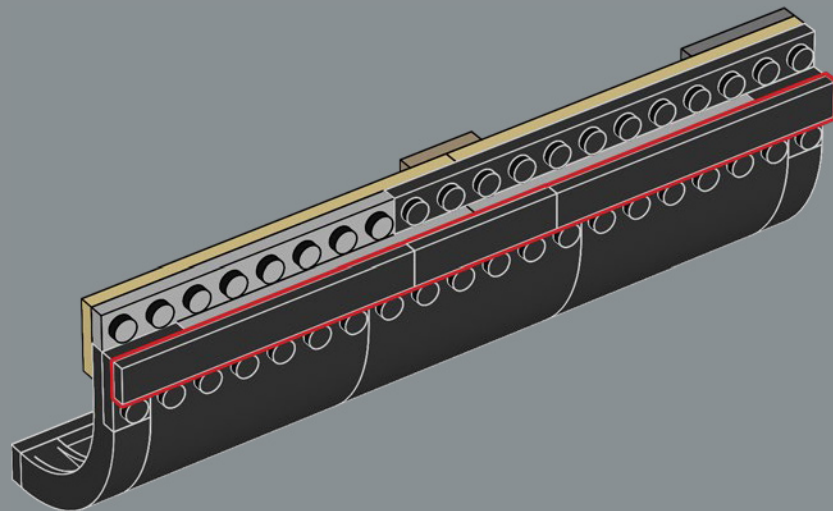

192

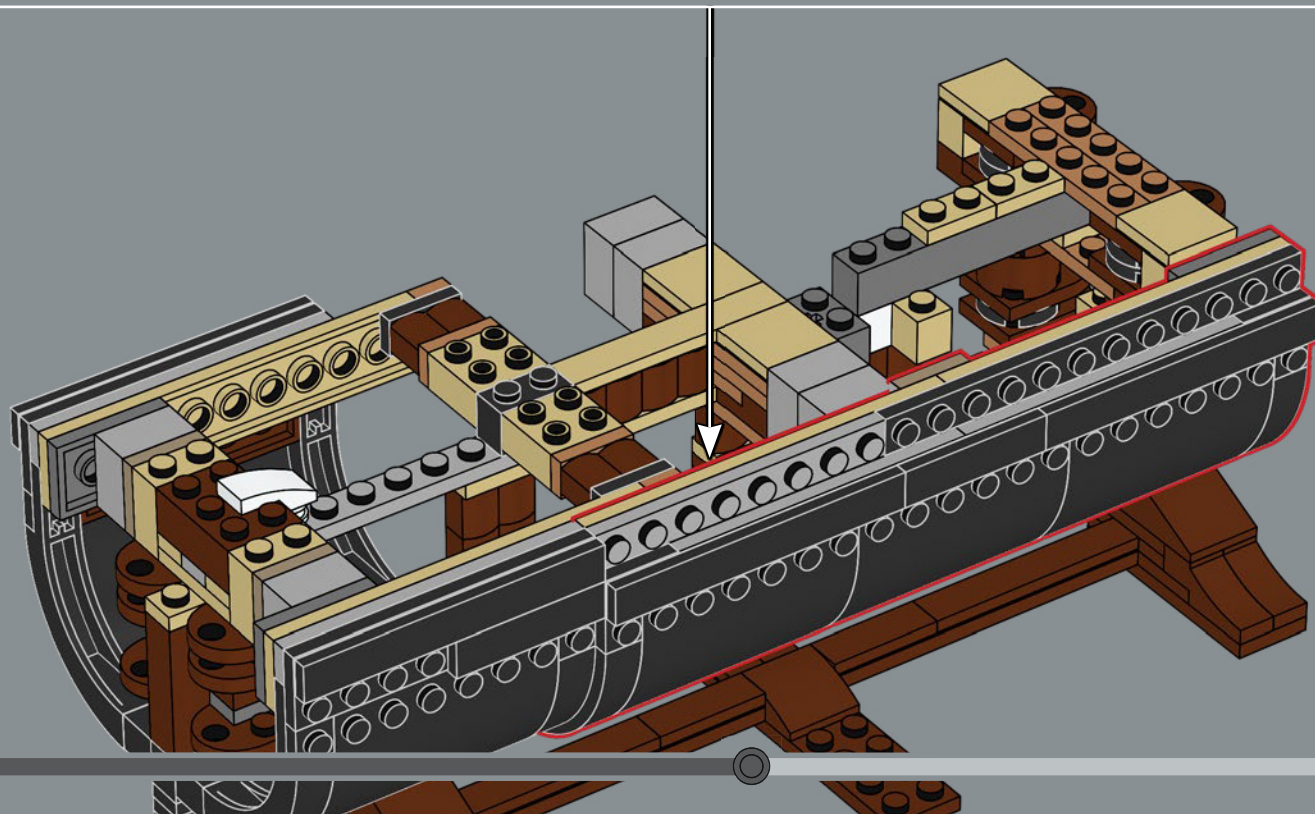

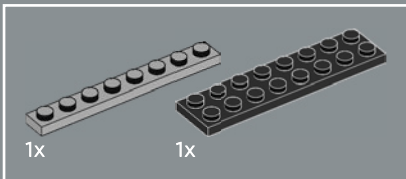
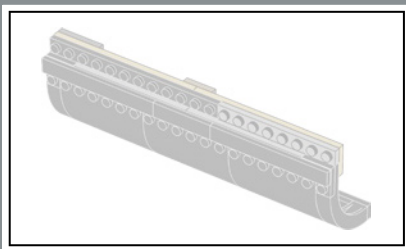

193

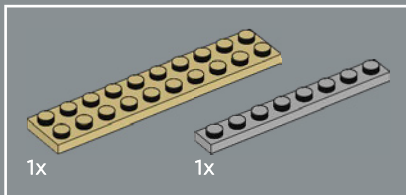
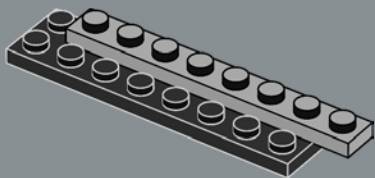

194

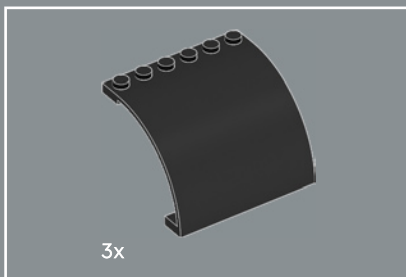

195



在乐高®设计术语中，构成船体下部大部分区域的黑色面板被认为是“墙”组件。它们采用黑色，尺寸和形状与船体完美搭配。

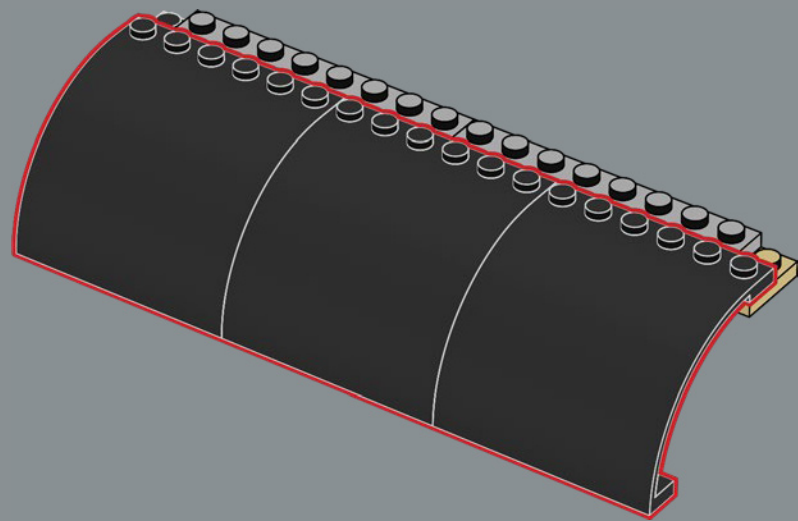
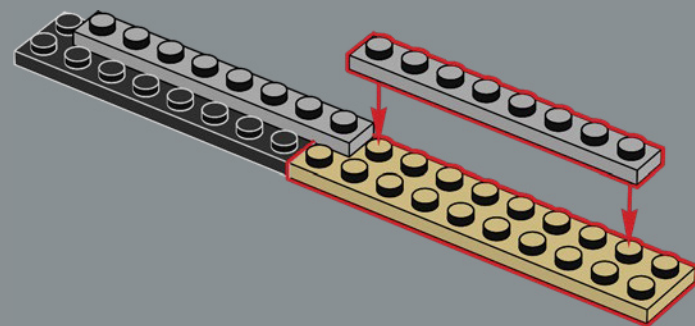

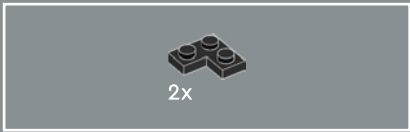

196

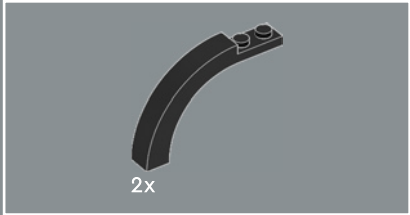
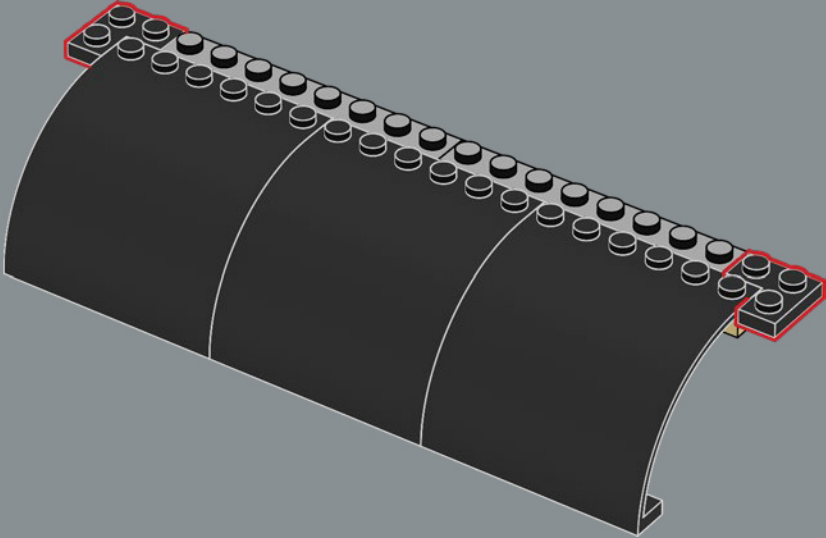

197

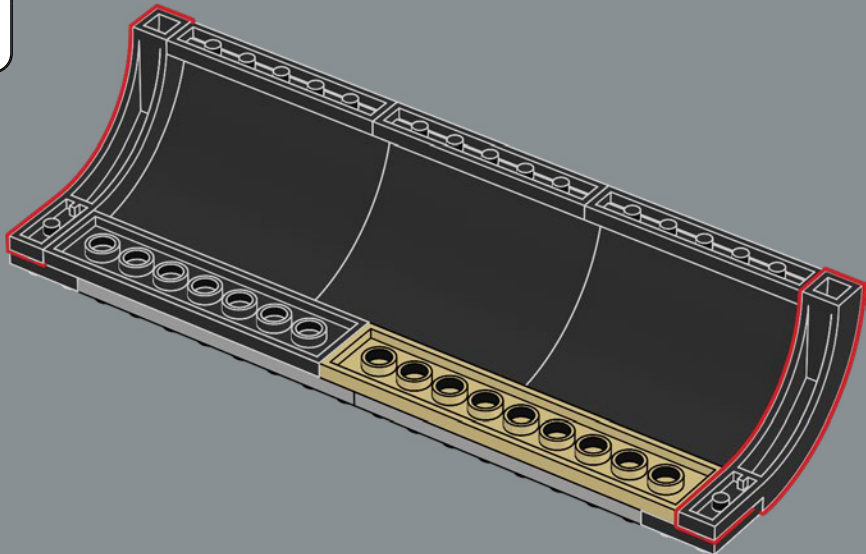

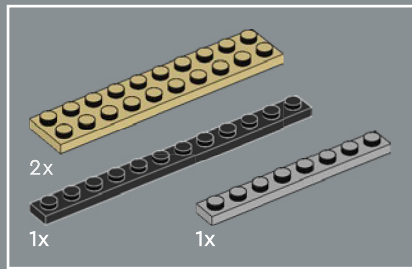

198

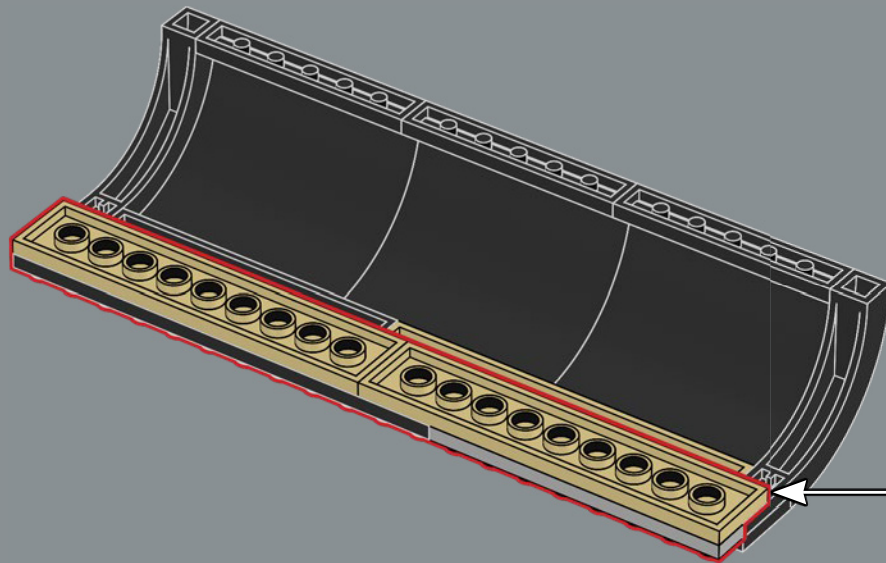
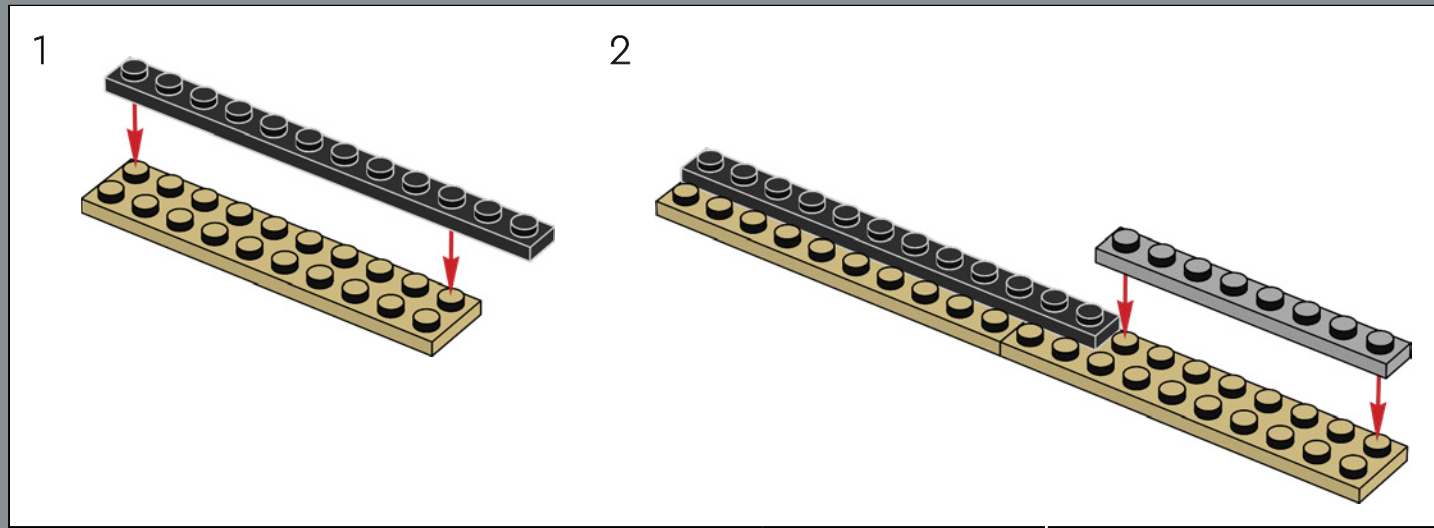



199

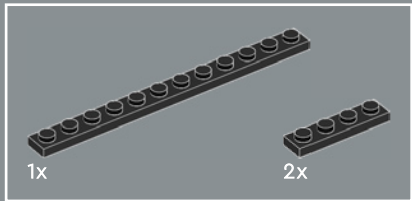
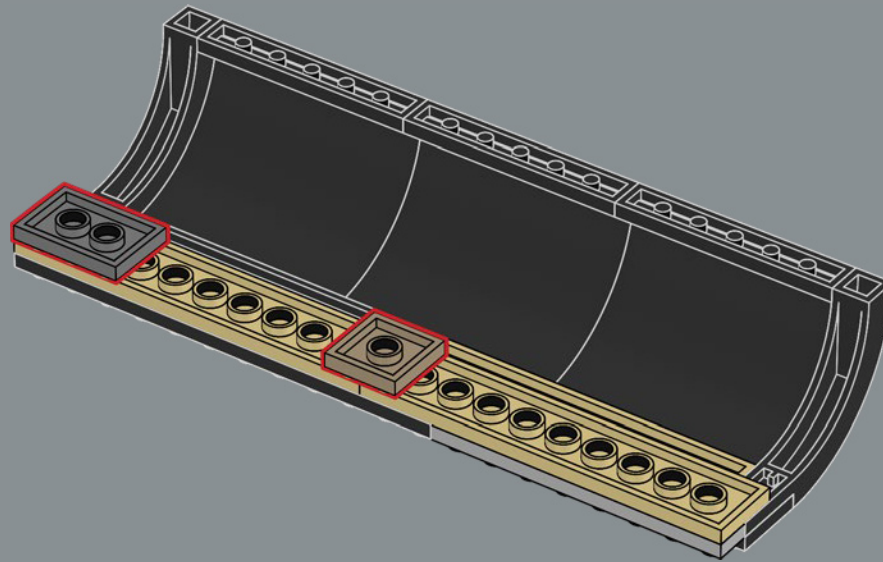

200

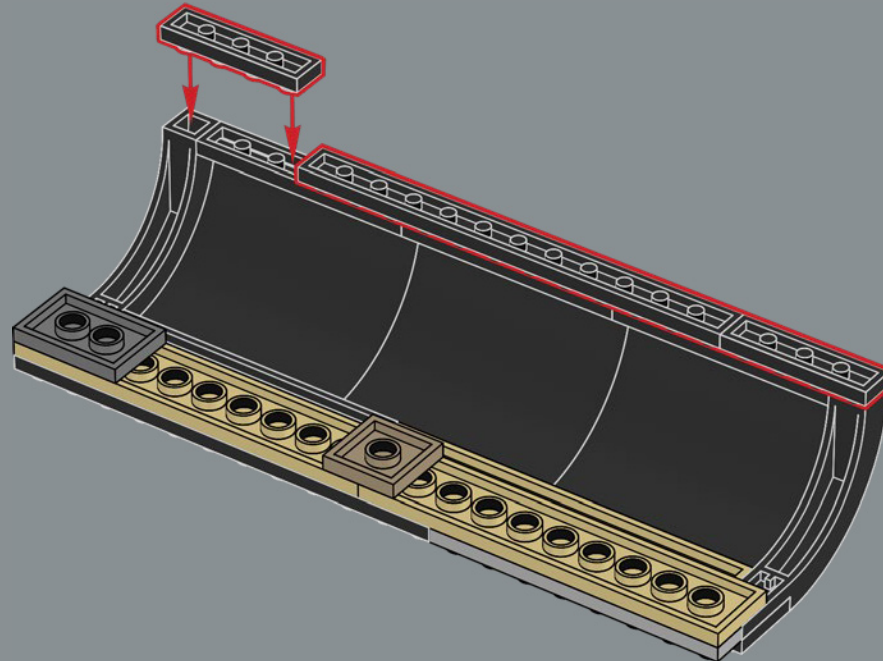

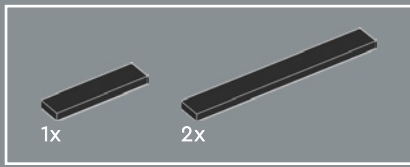

201

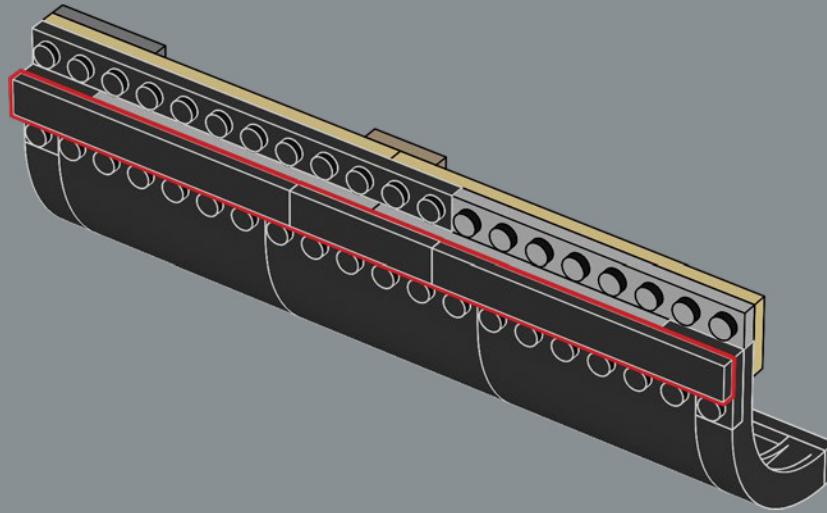

202

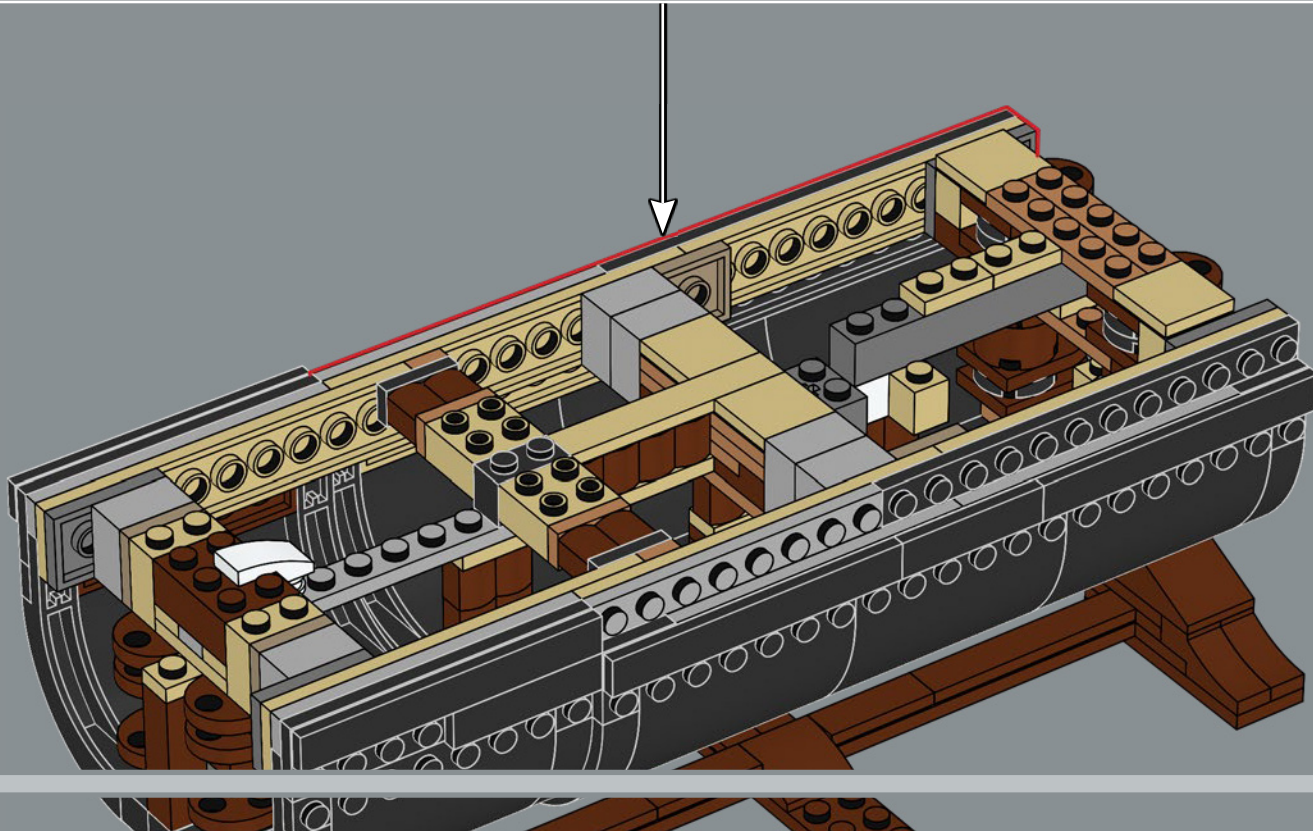

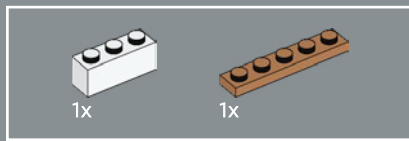
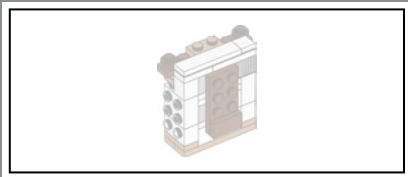

203

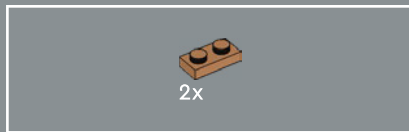
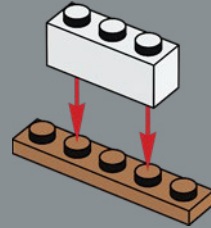

204

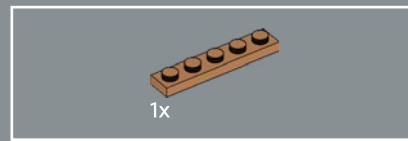
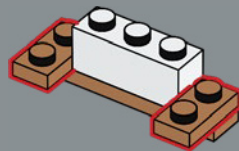

205

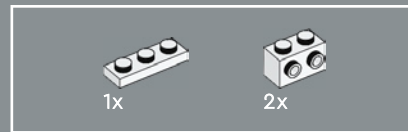
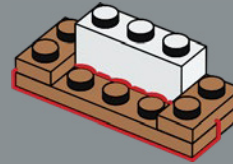

206

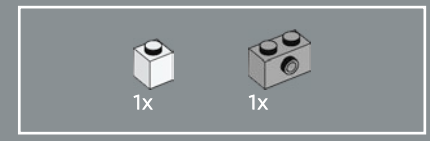
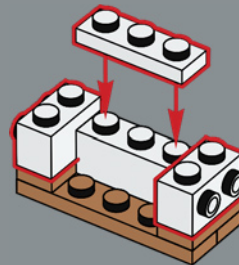

207

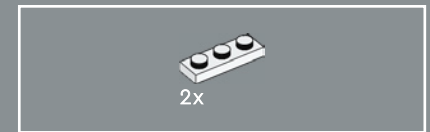
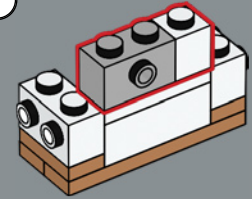

208

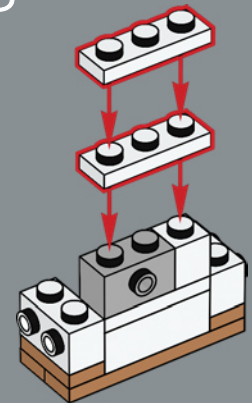

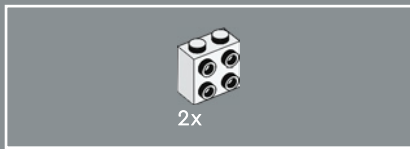

209

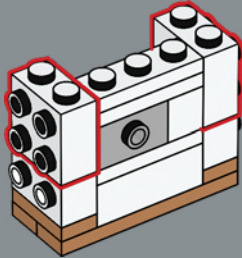

210

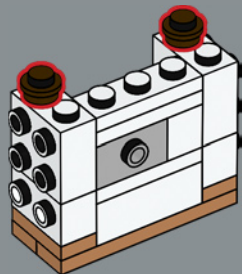

211

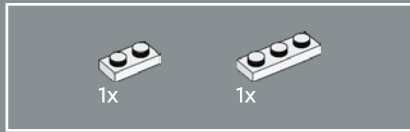
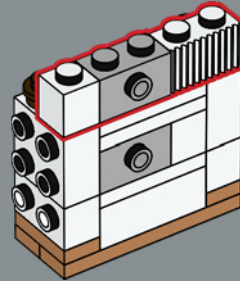

212

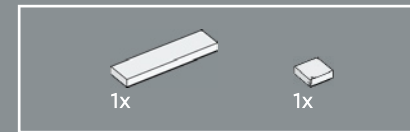
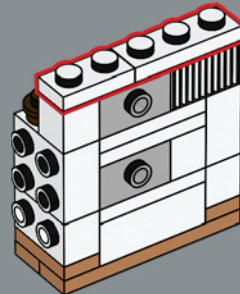

213

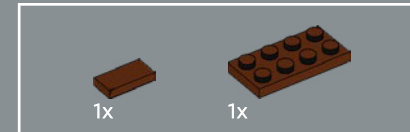
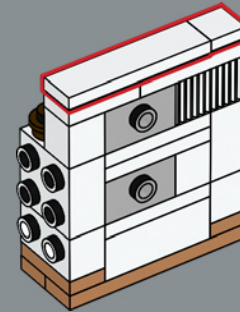

214

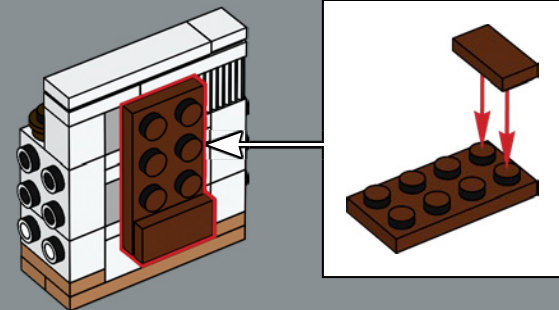

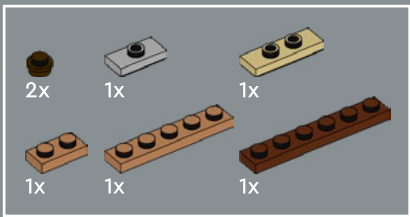

215

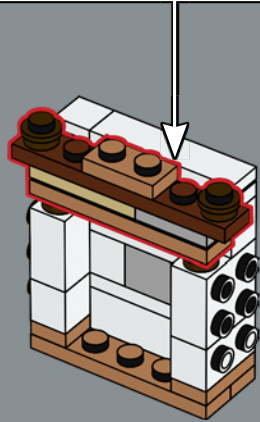
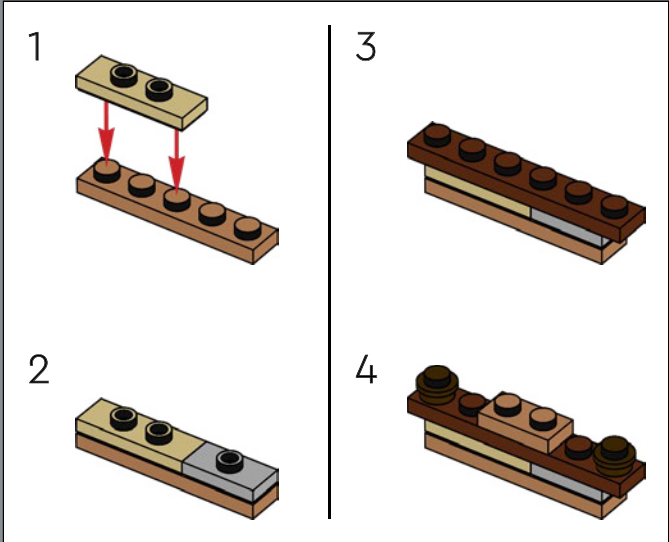

216

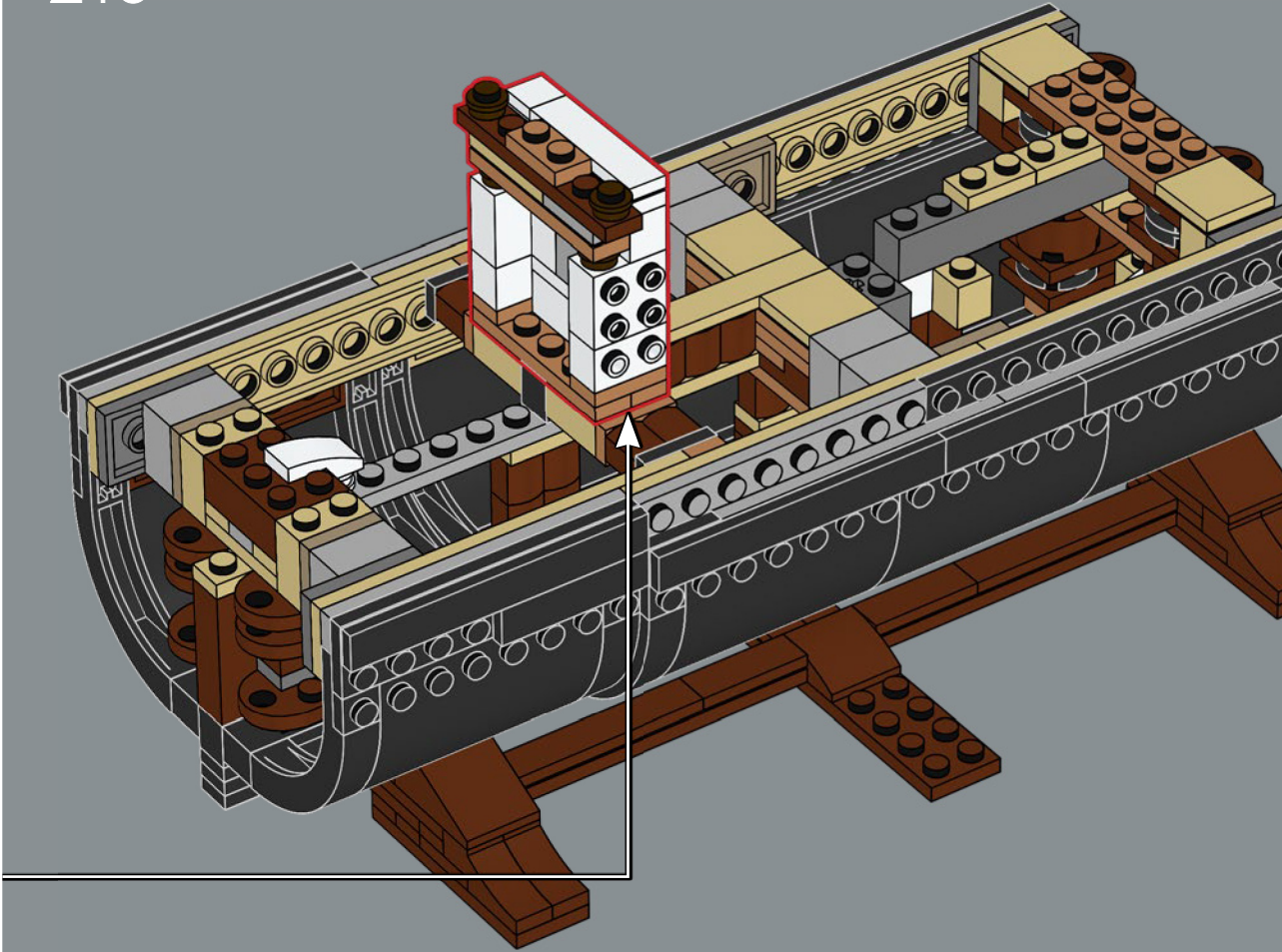

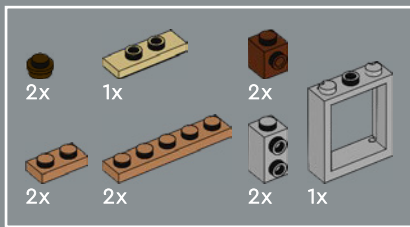

217

1

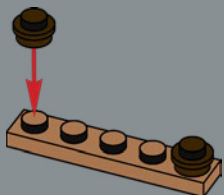

2

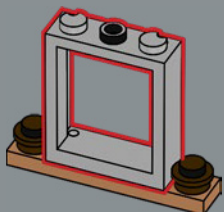

3

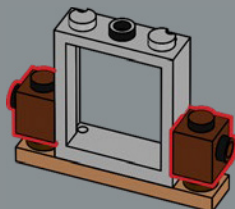

4

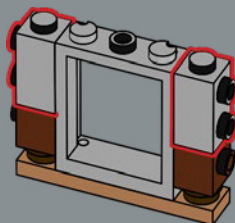

5

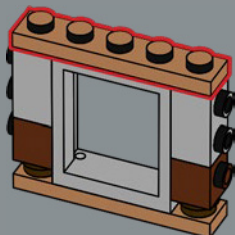

6

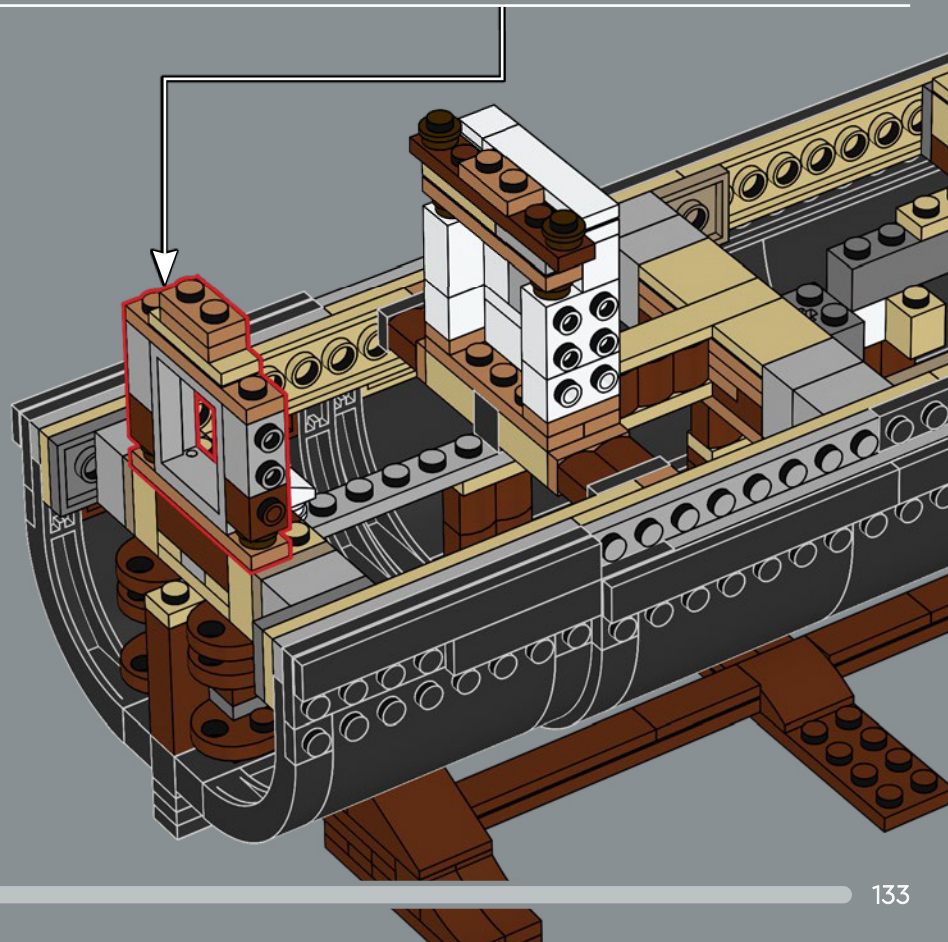
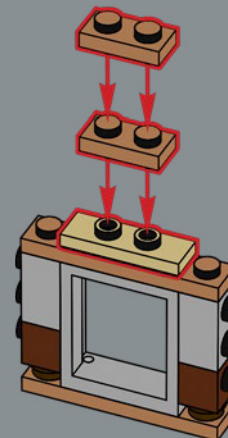

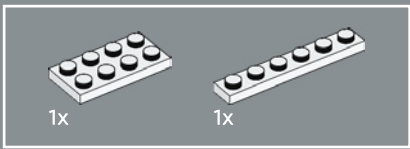

218

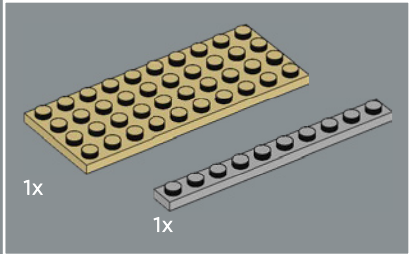
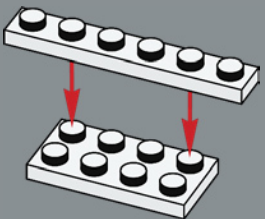

219

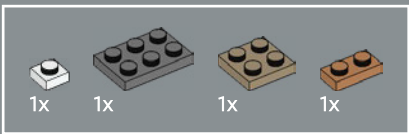
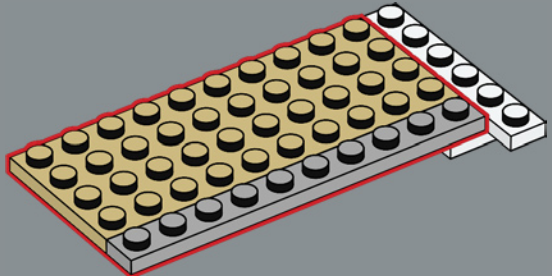

220

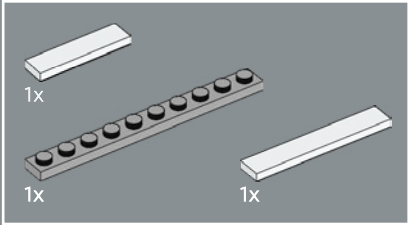
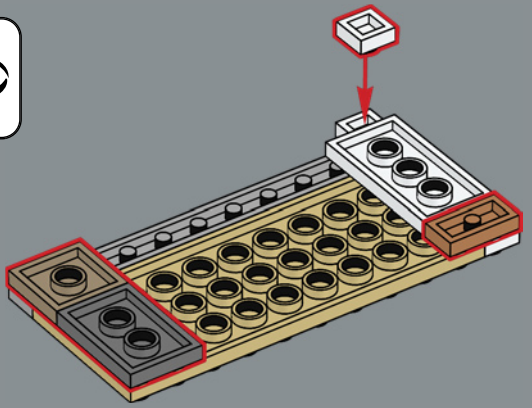

221

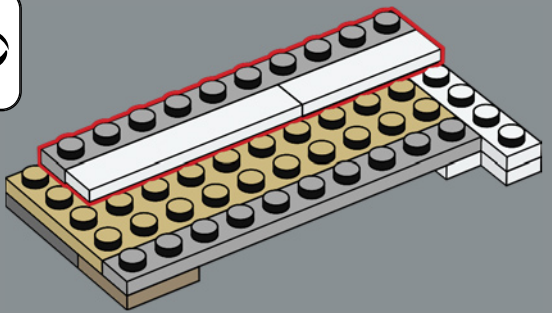

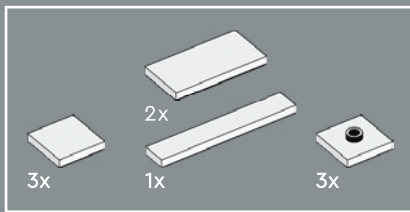

222

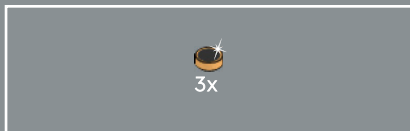
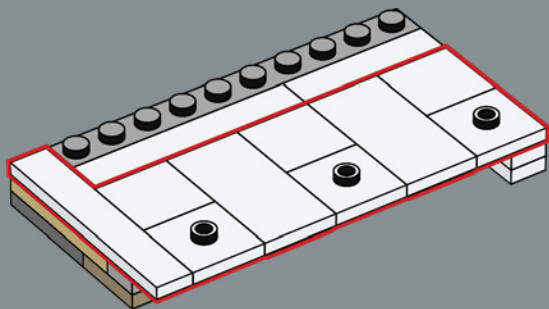

223

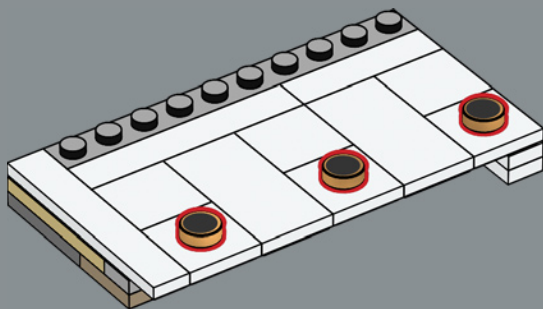

224

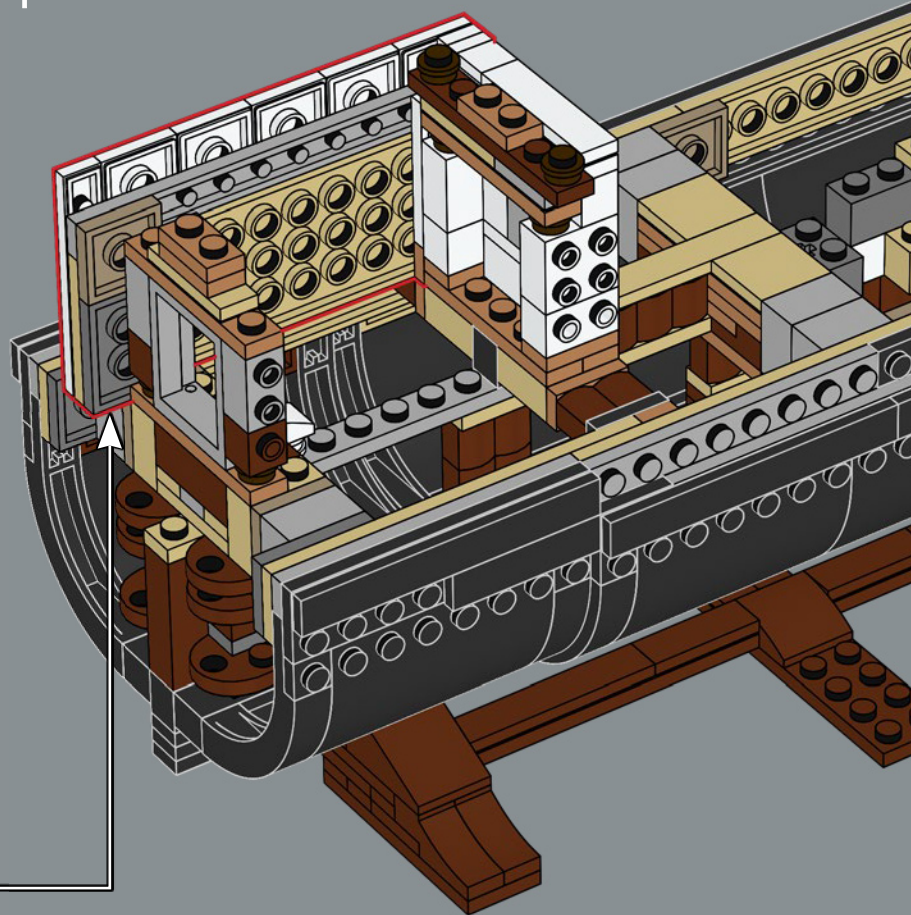

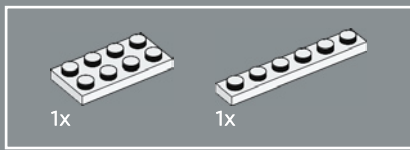

225

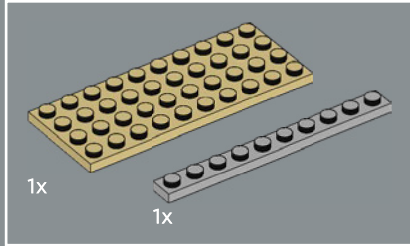
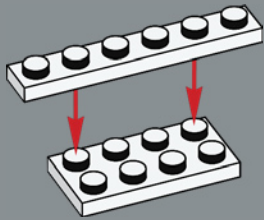

226

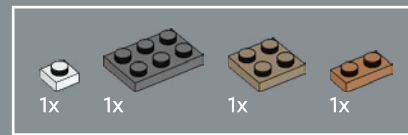
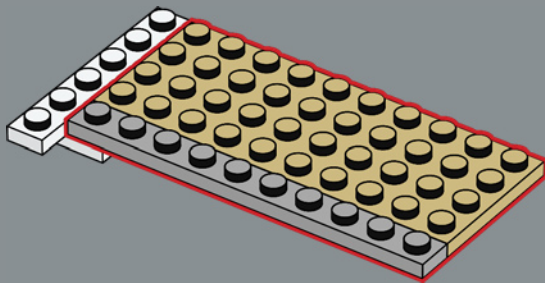

227

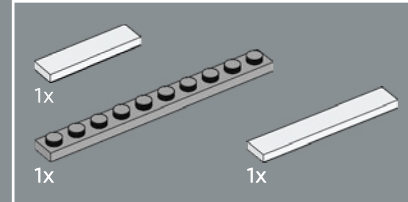
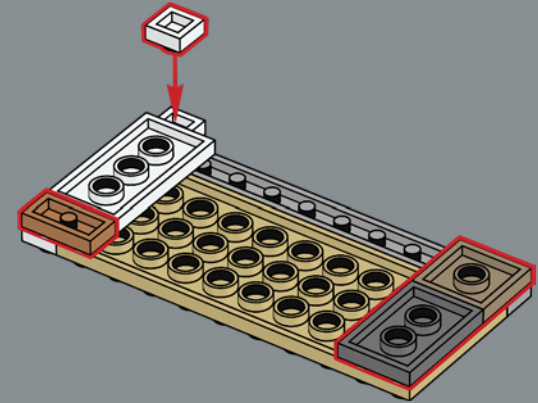

228

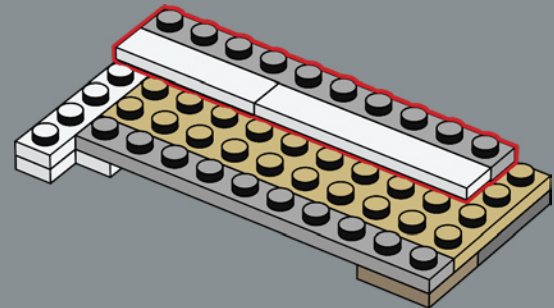

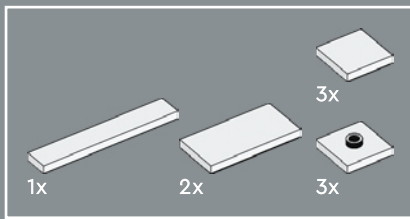

229

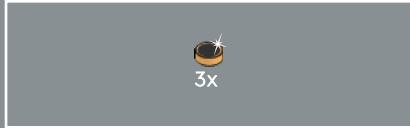
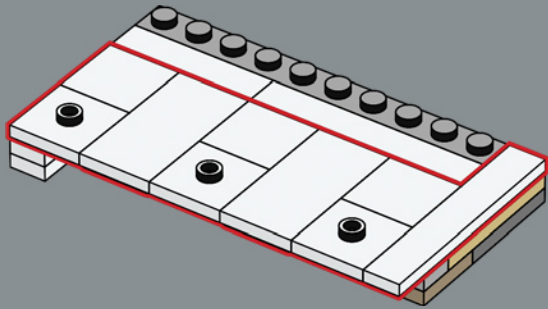

230

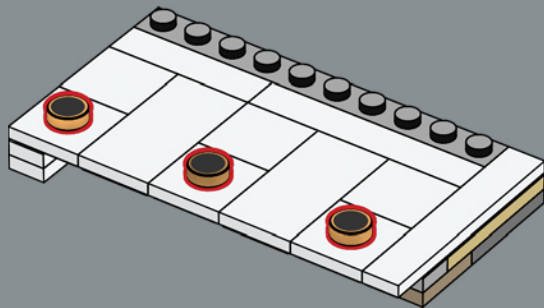

231

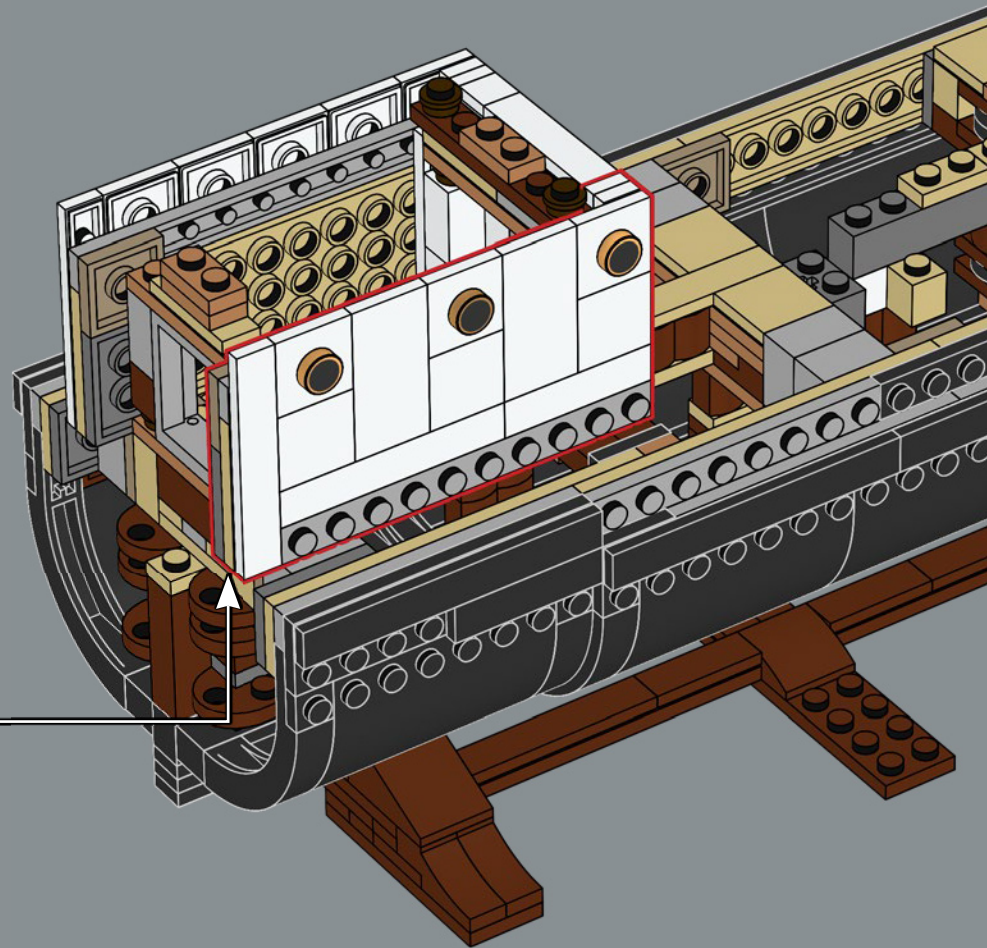



1

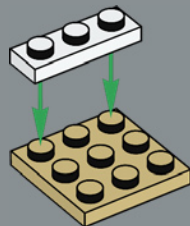

2



3

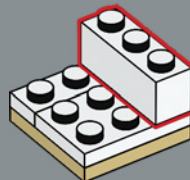

4

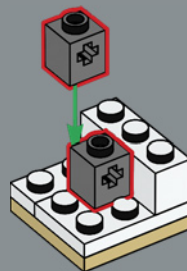

5

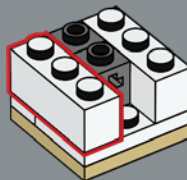

6

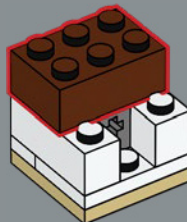

7

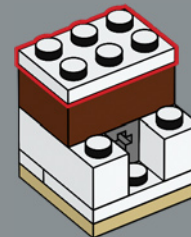

8

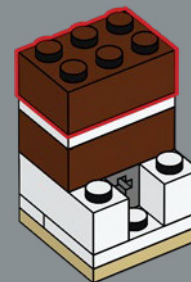

9

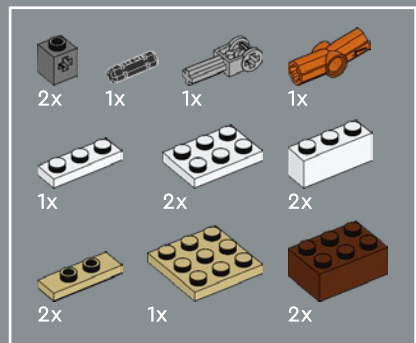
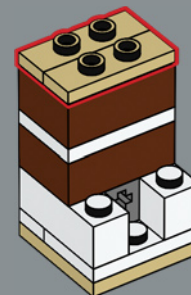

232

10

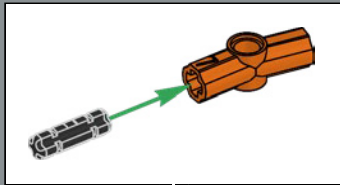
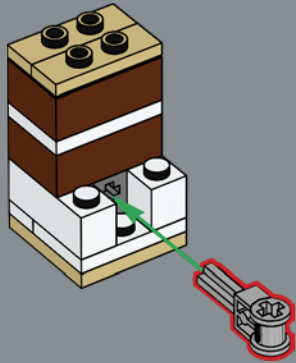

11

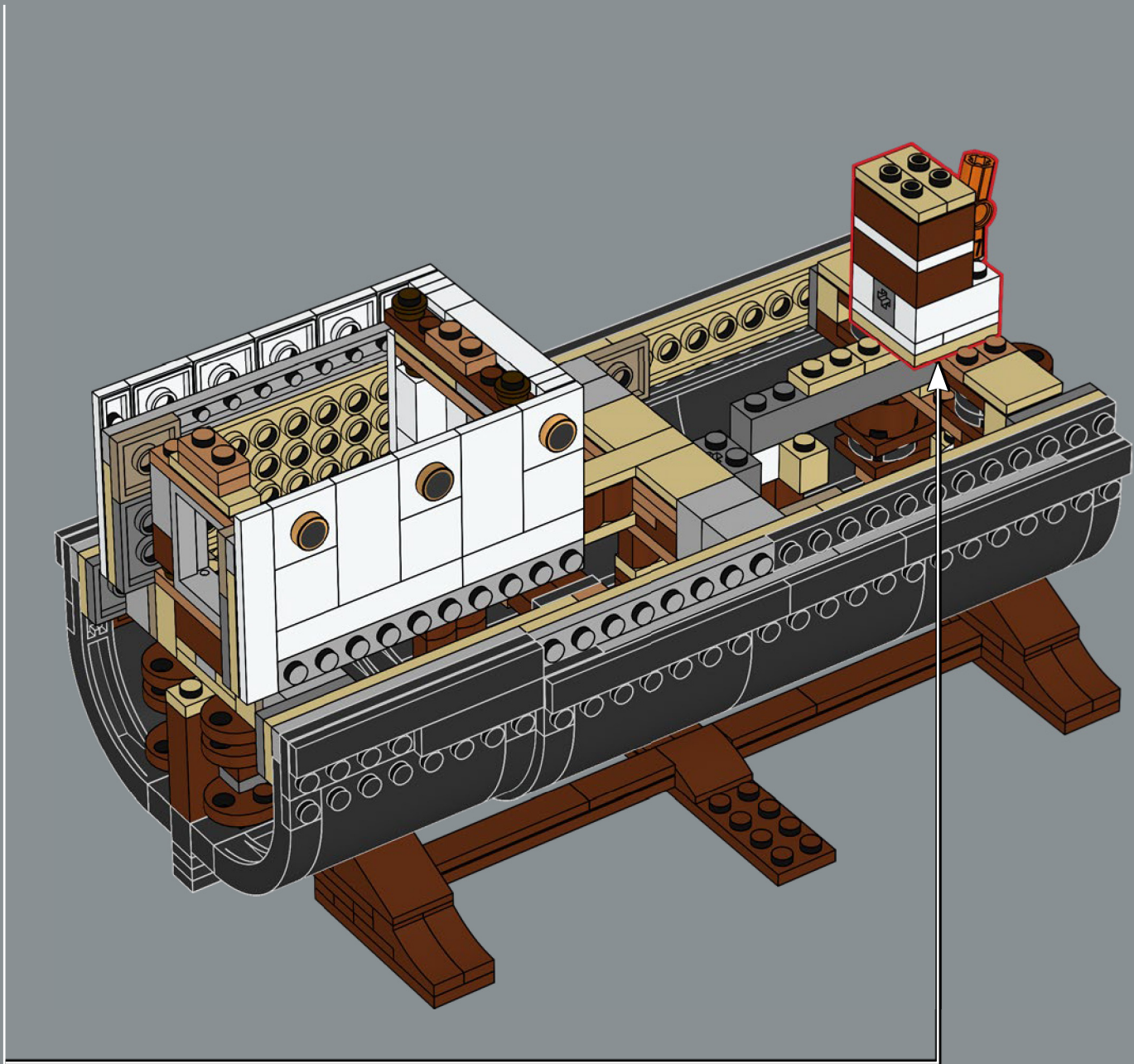
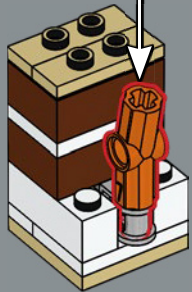

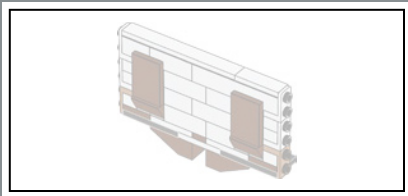

233

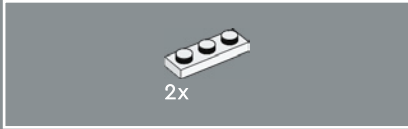
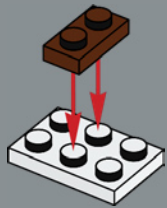

234

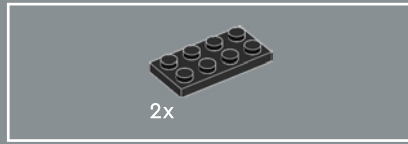
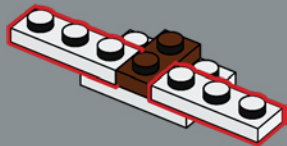

235

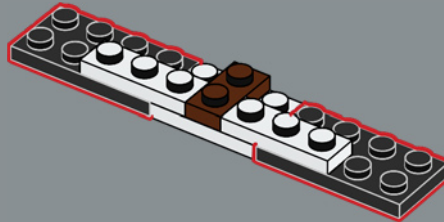

236

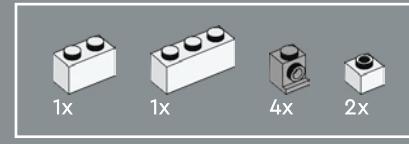
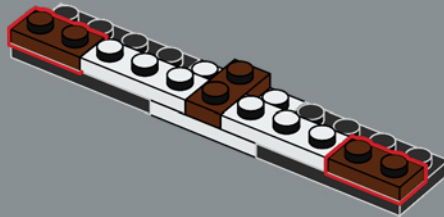

237

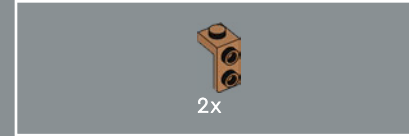
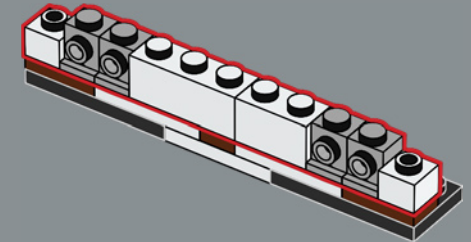

238

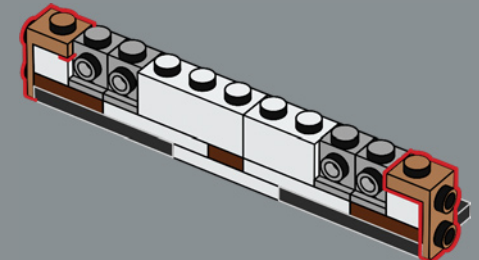

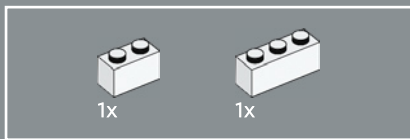

239

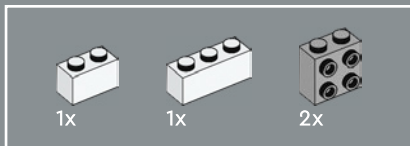
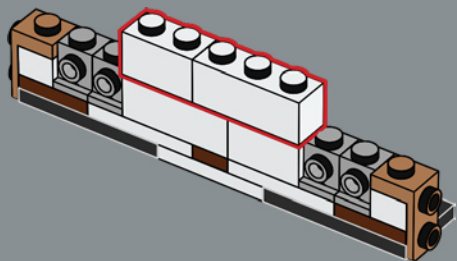

240

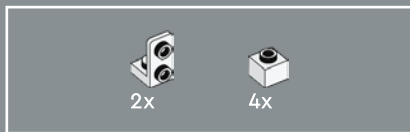
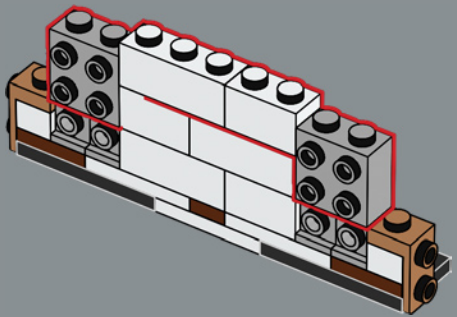

241

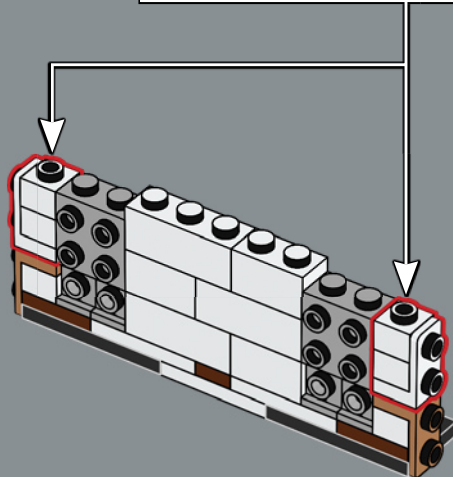
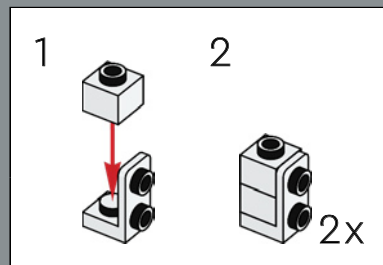

242

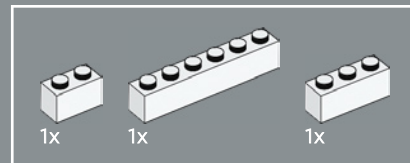
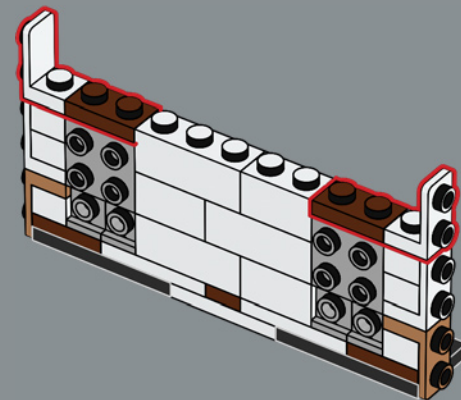

243

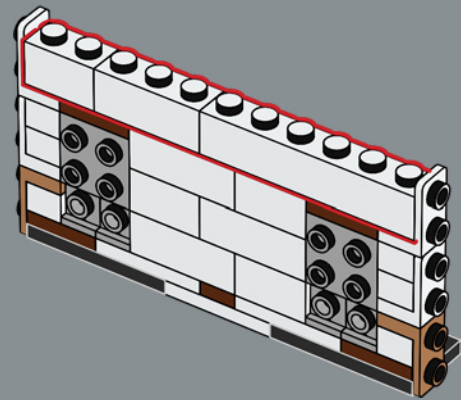

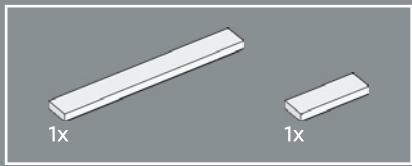

244

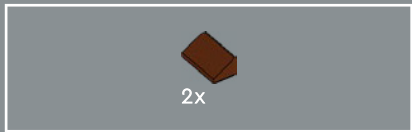
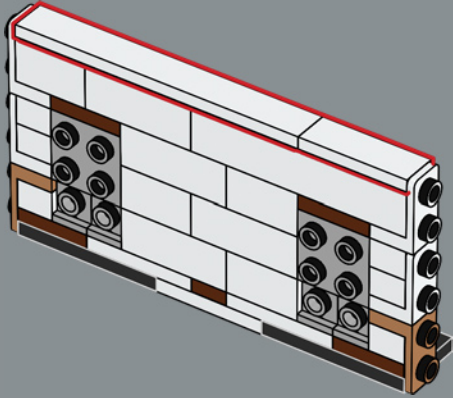

245

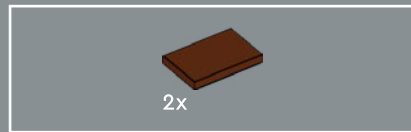
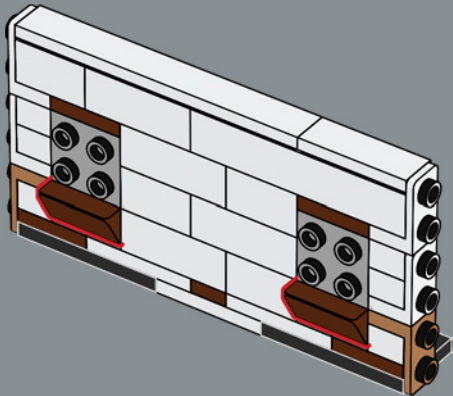

246

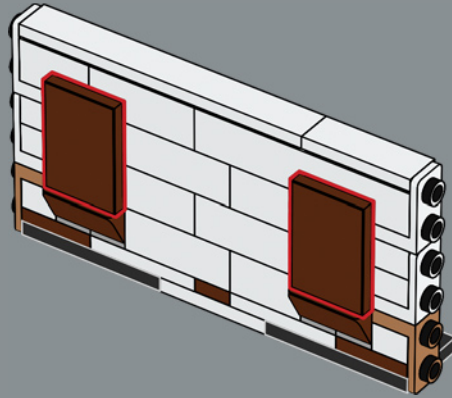

247

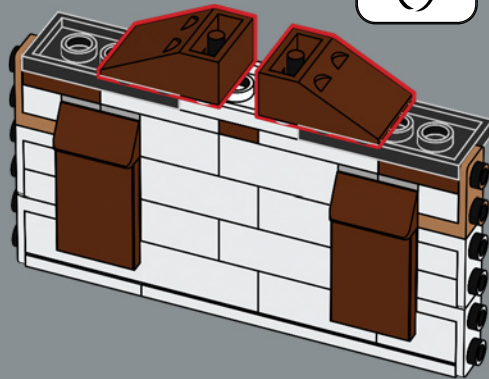

248

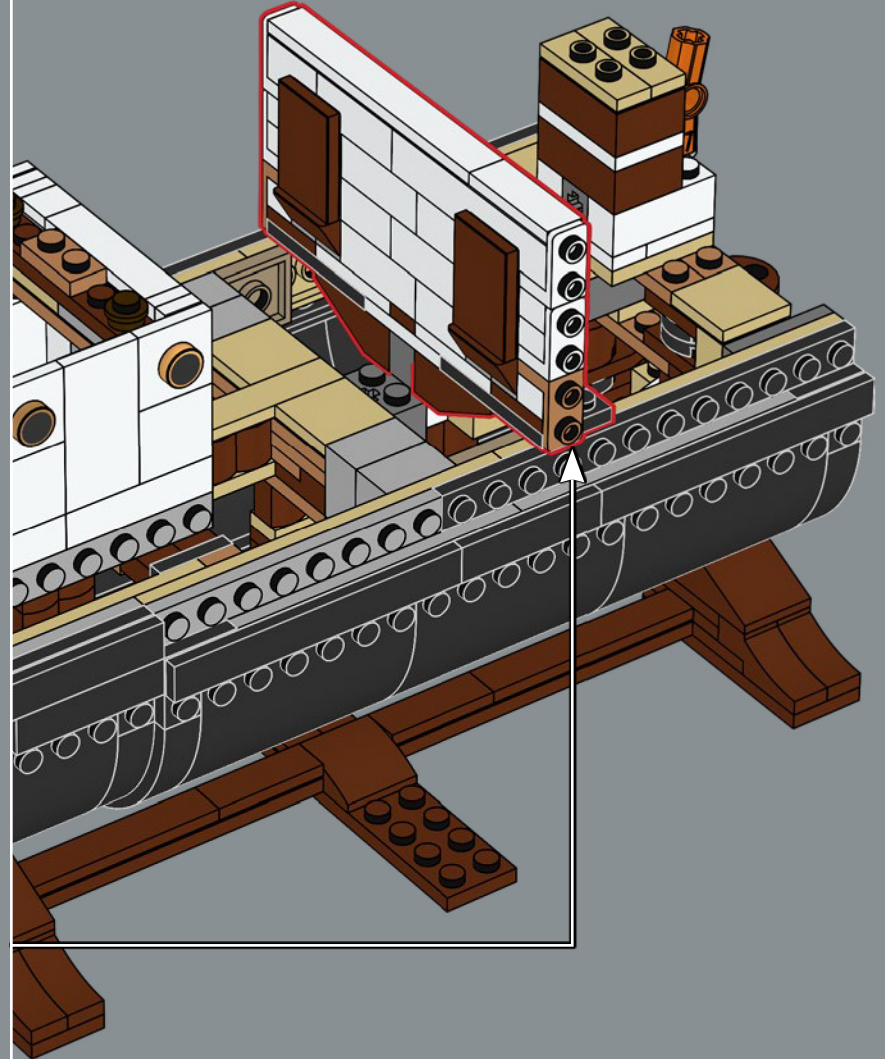

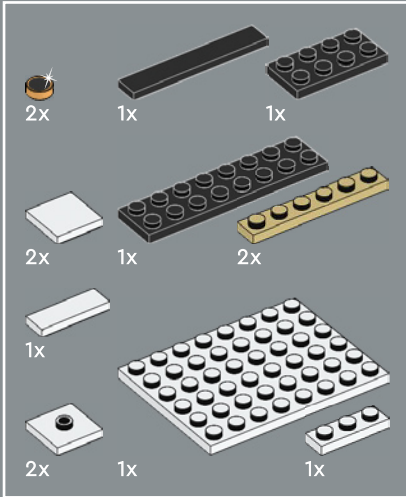
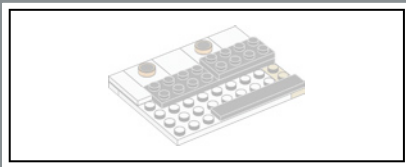

249

1

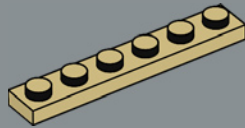

2

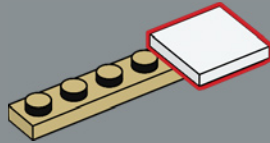

3

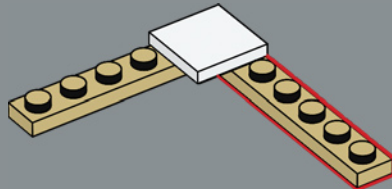

4

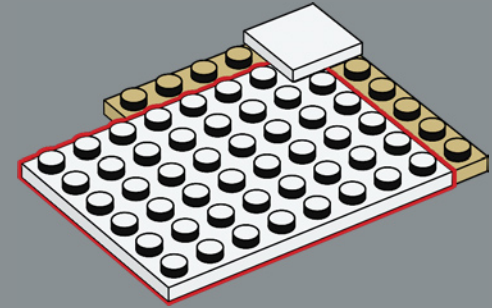

5

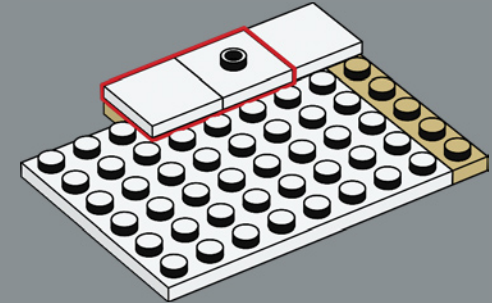

6

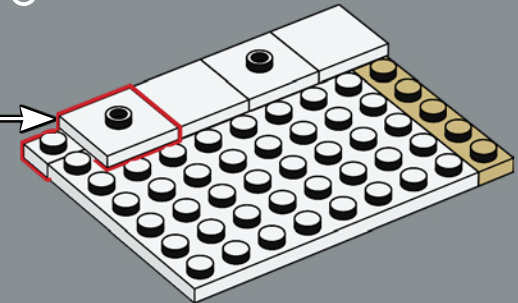
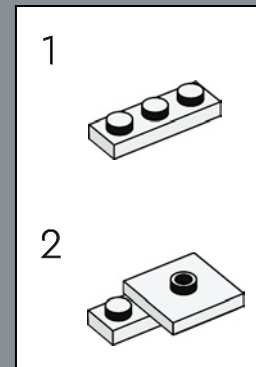

7

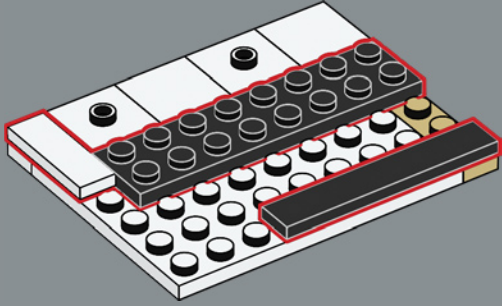

8

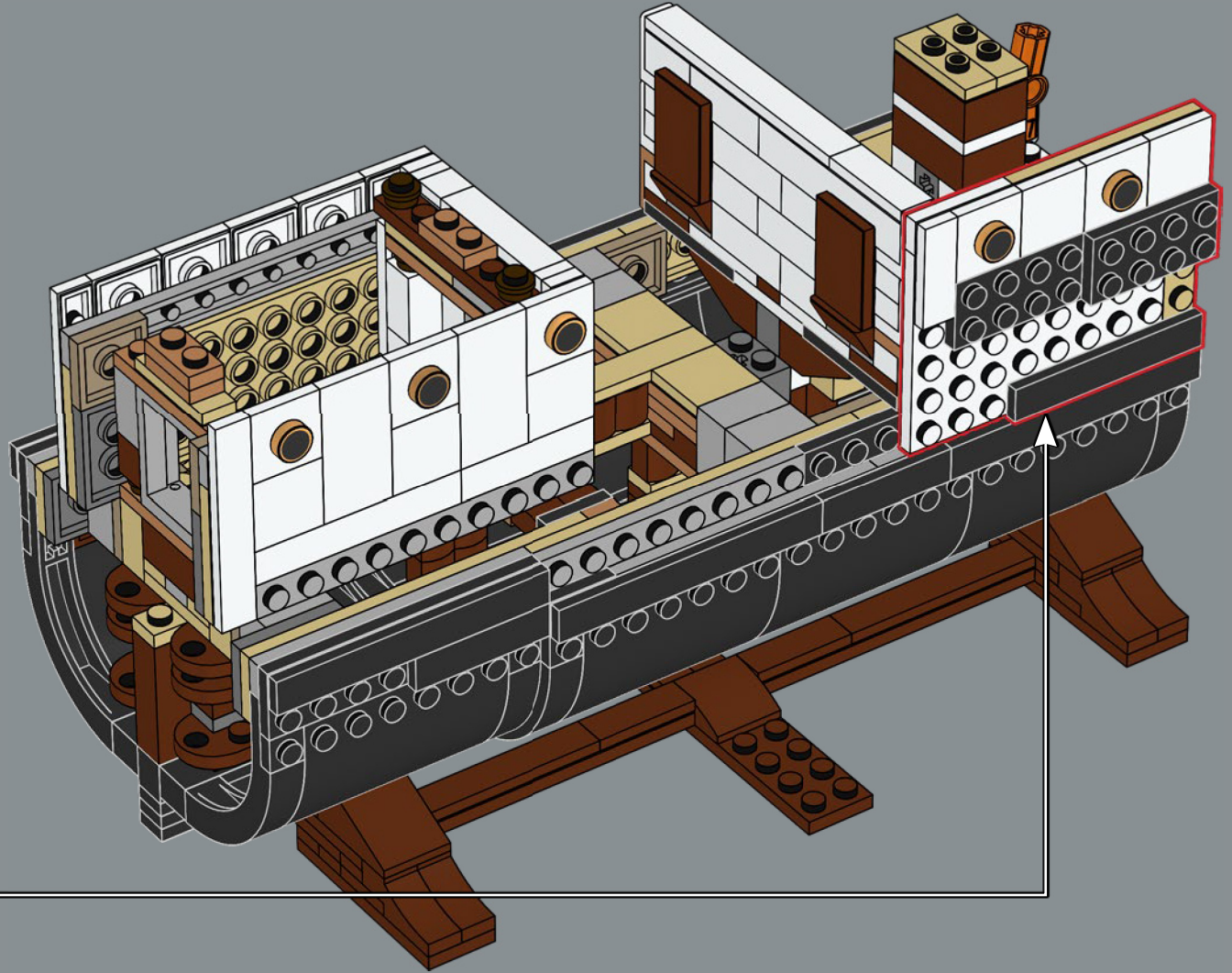
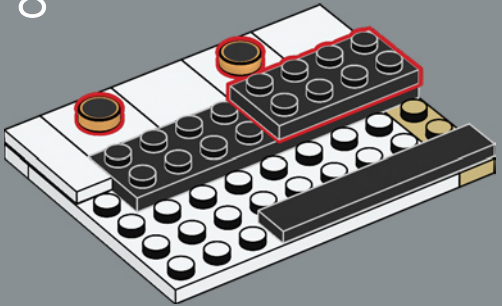

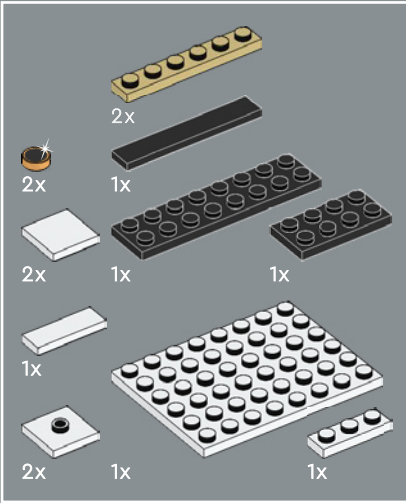
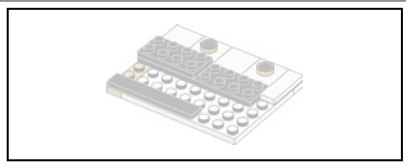

250

1

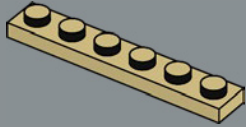

2

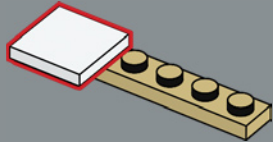

3

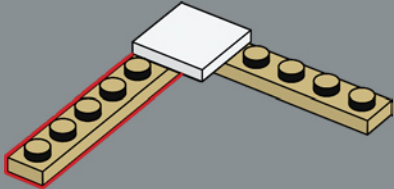

4

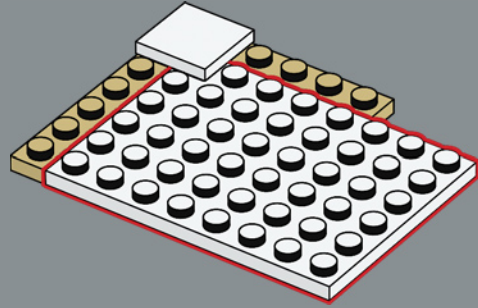

5

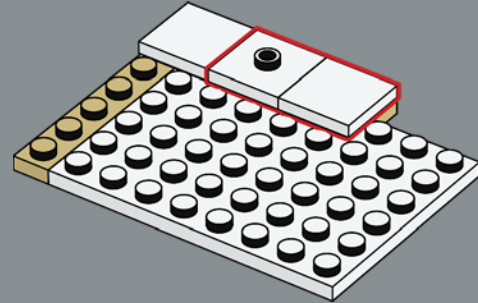

6

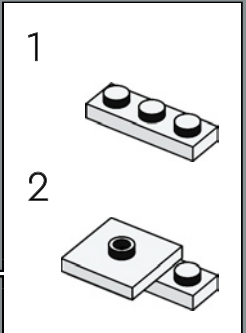
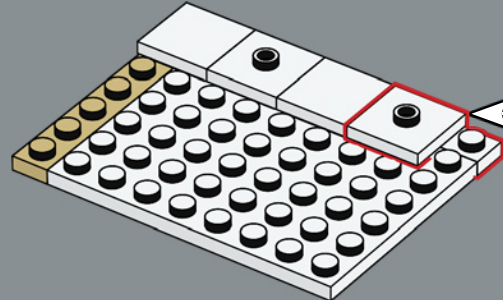

7

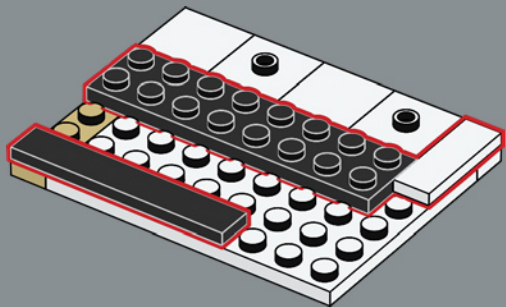

8

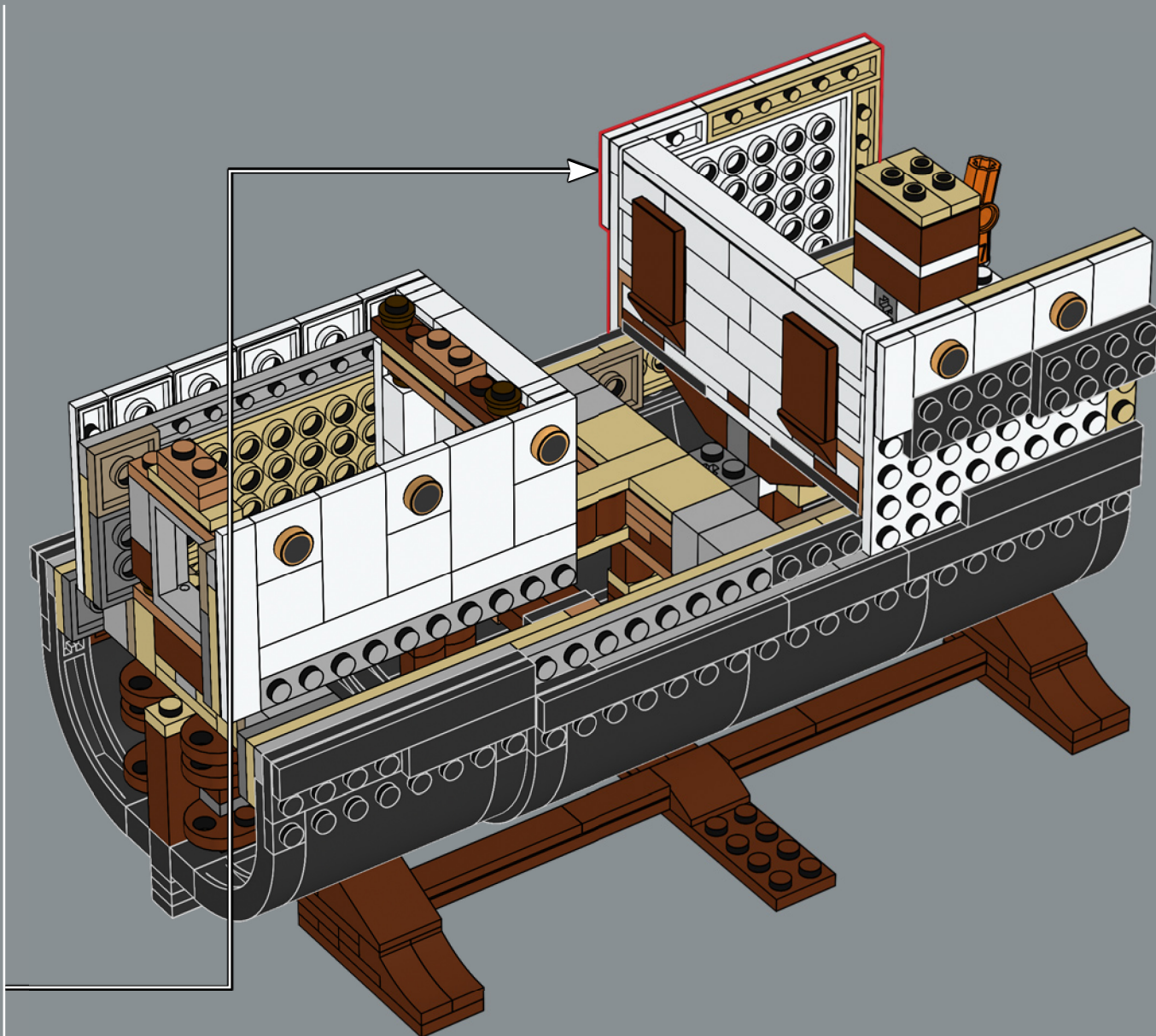
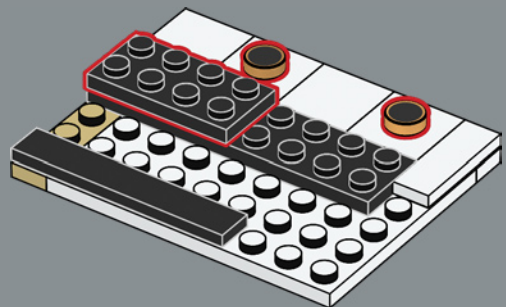

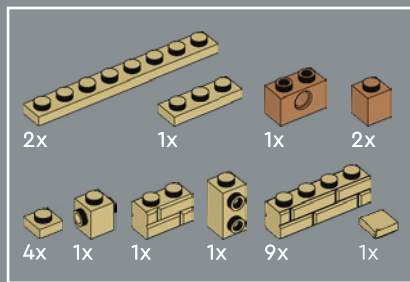
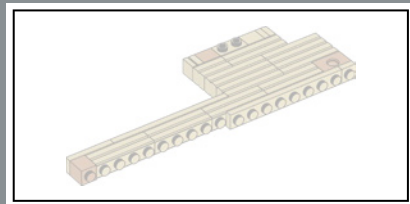

251

1

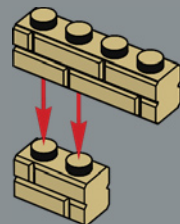

2

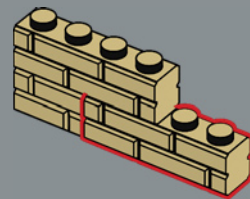

3

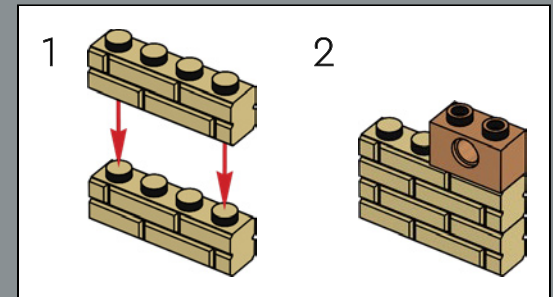
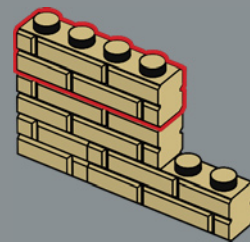

4

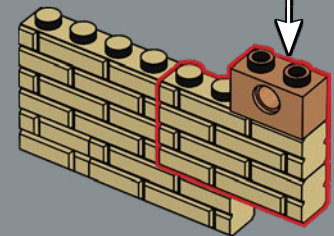

5

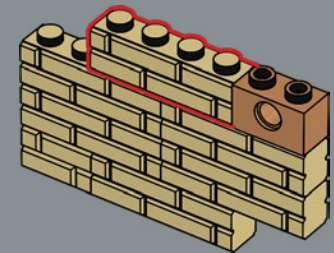

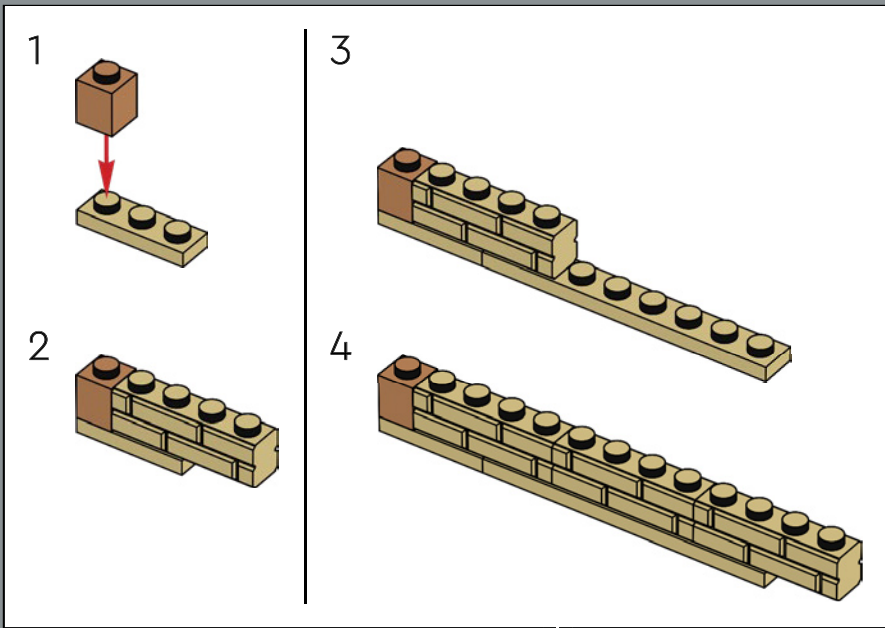

6

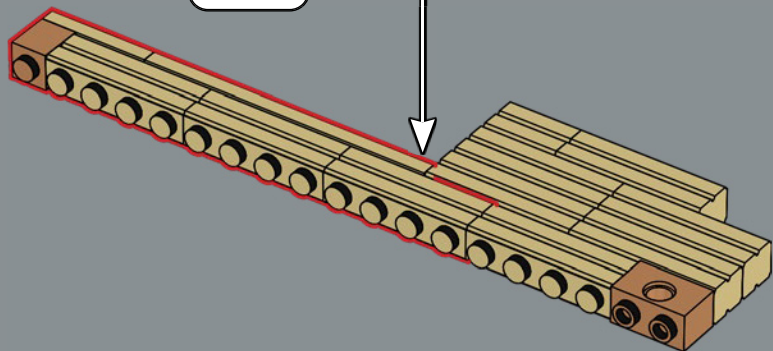

7

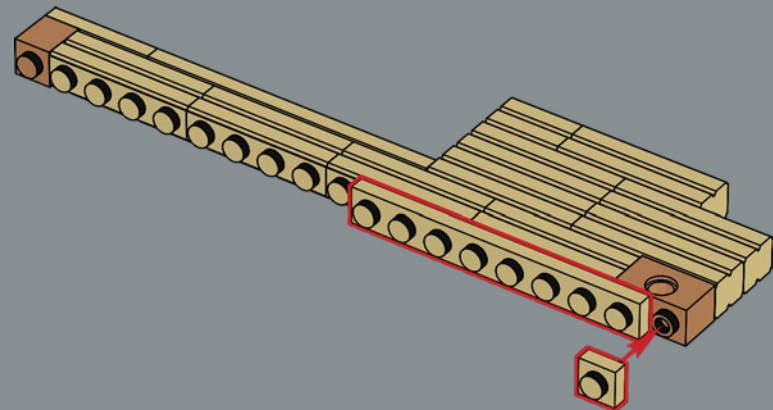

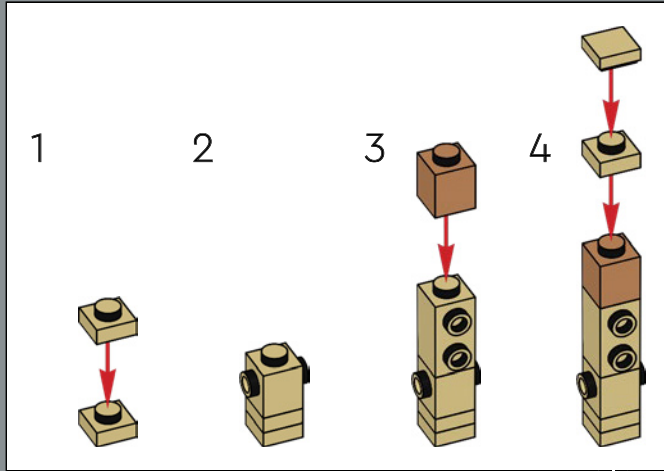

8

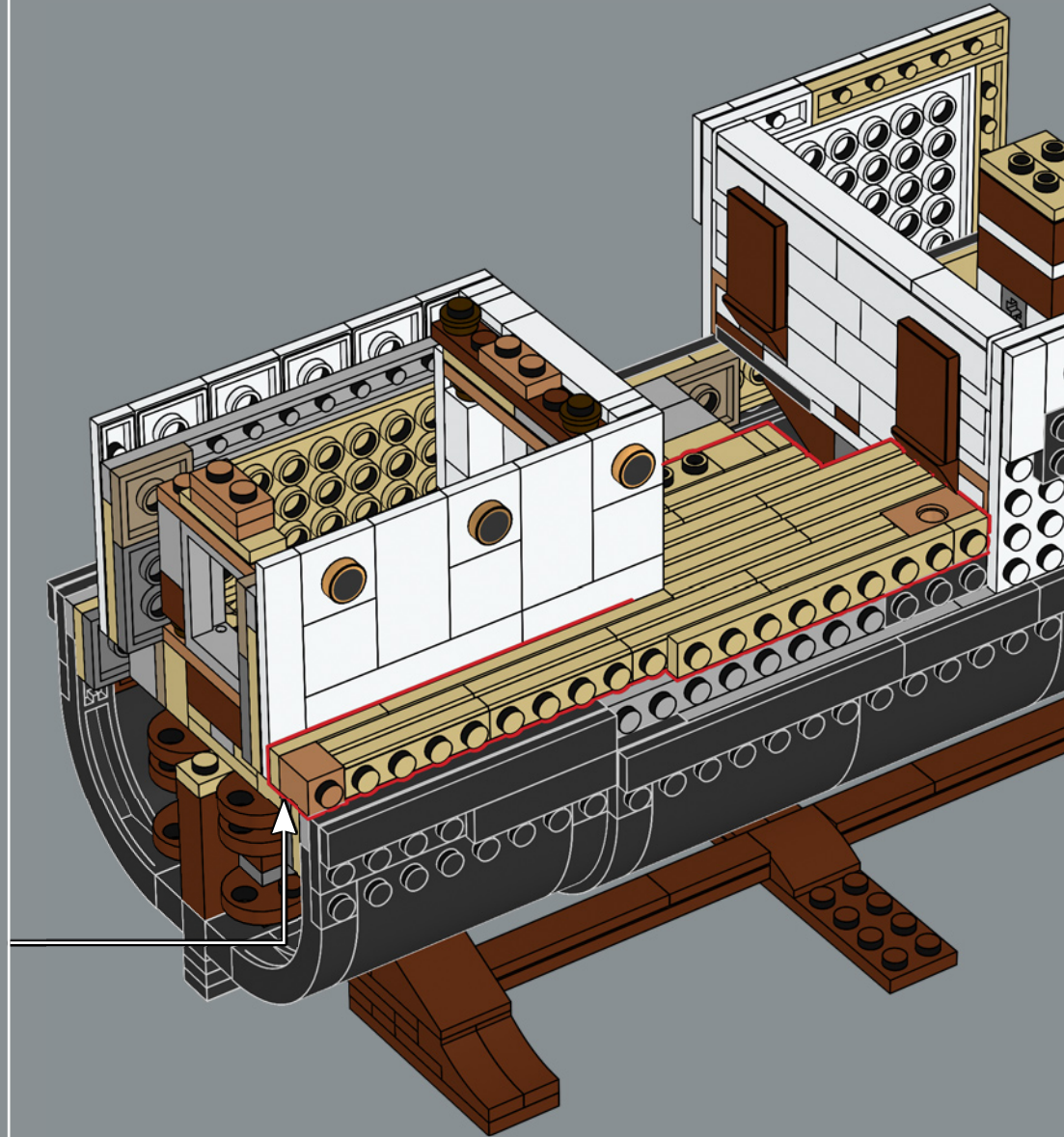
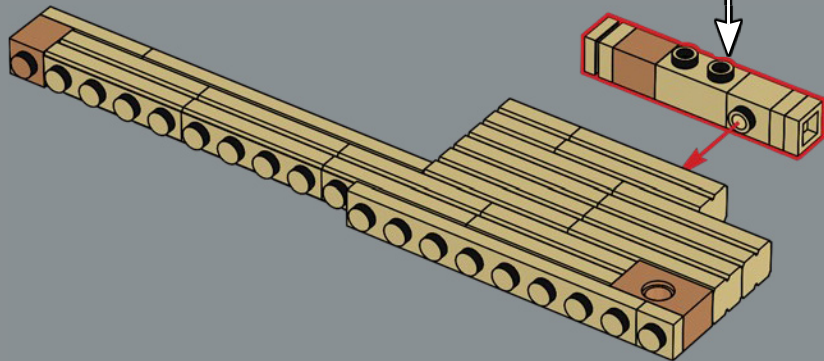

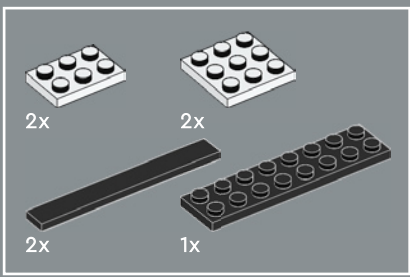

252

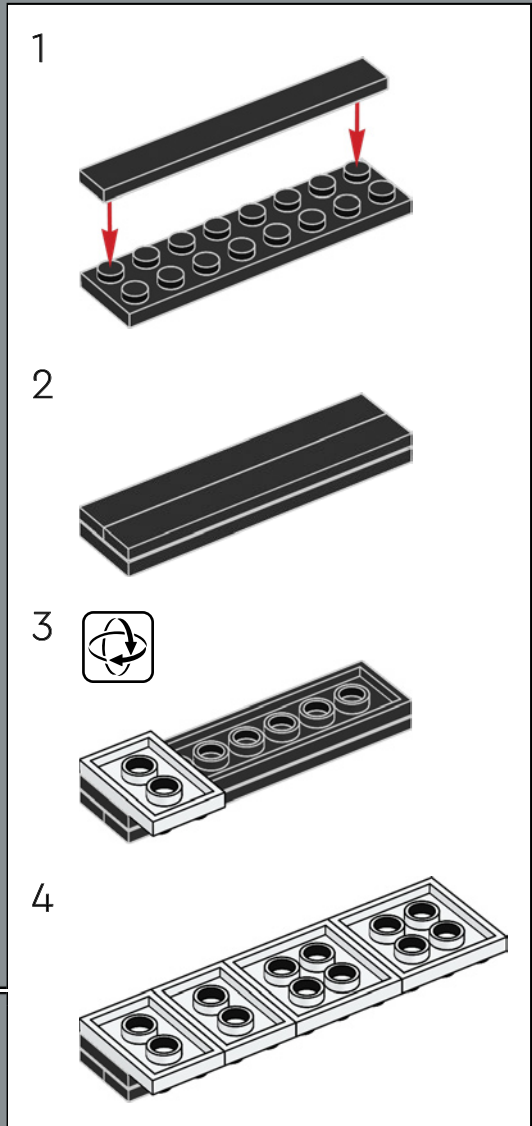
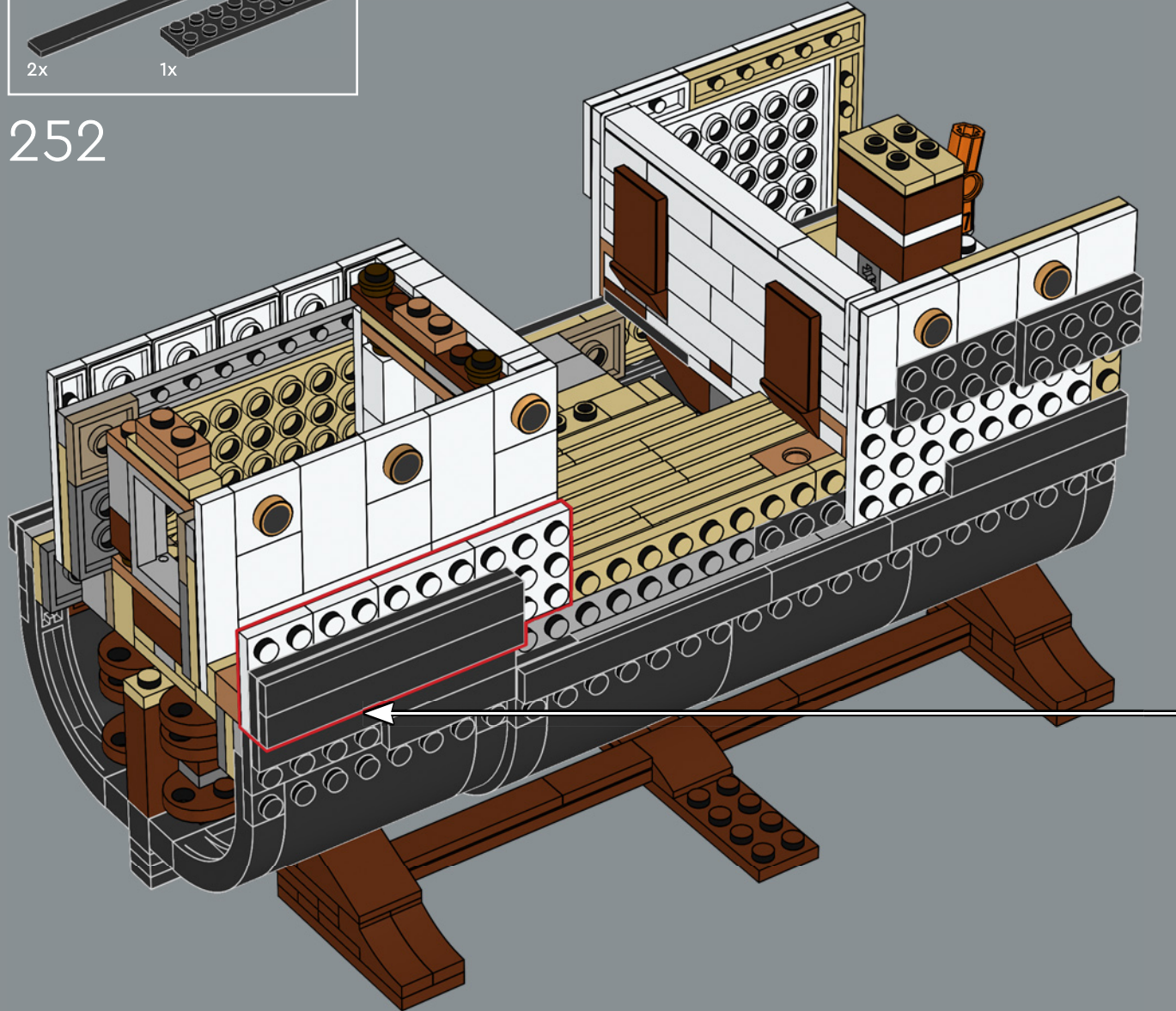

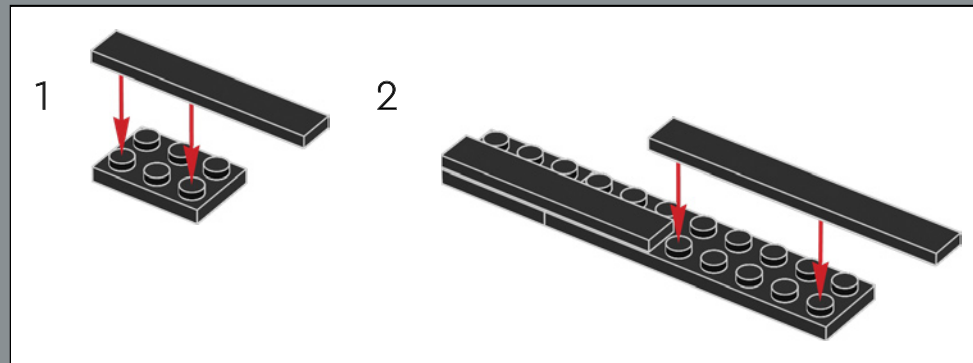
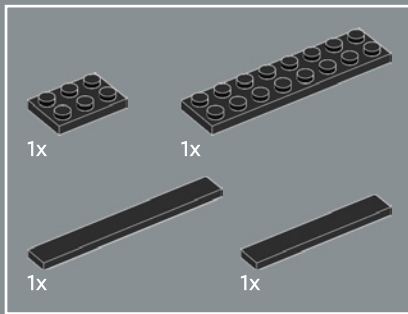

253

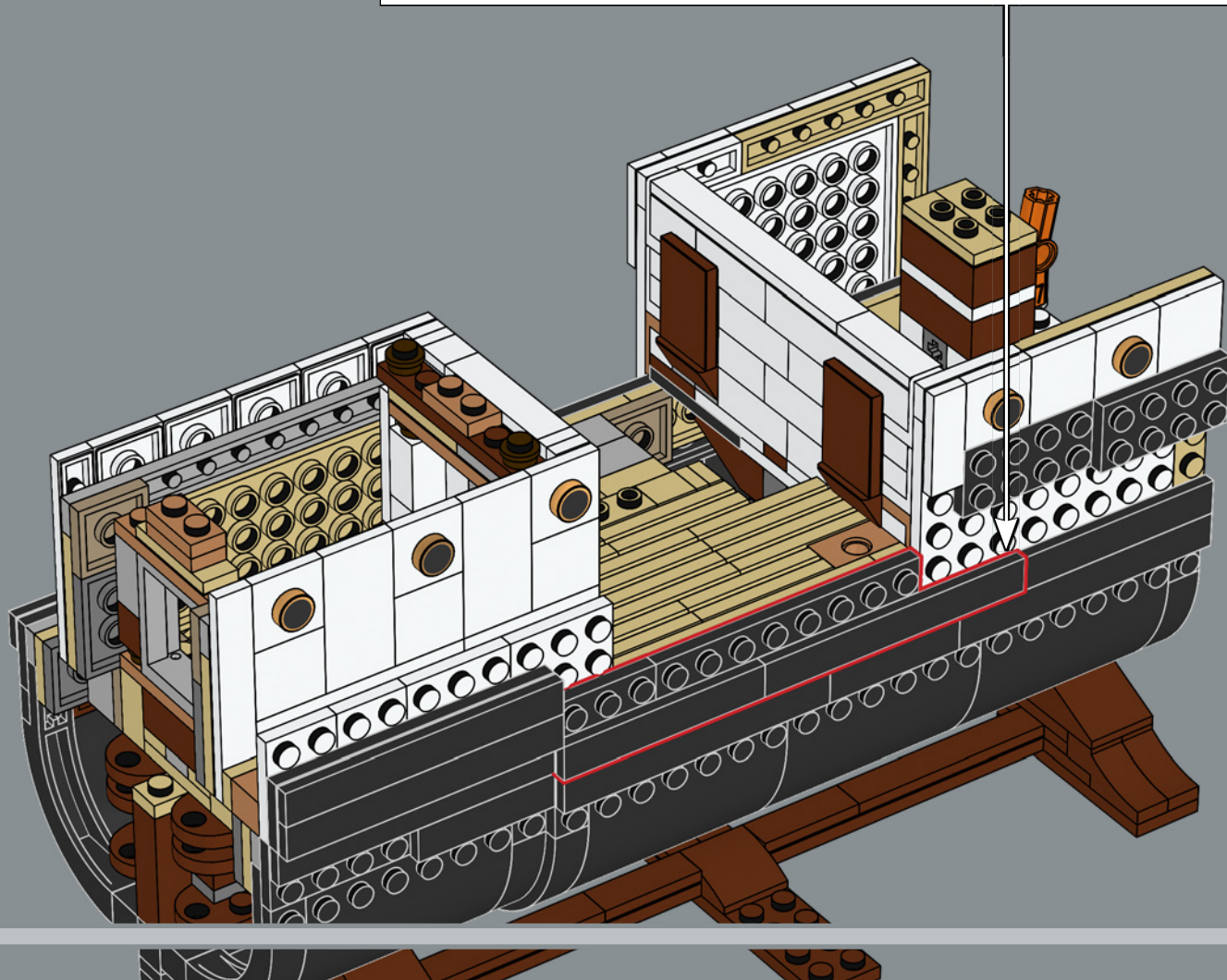

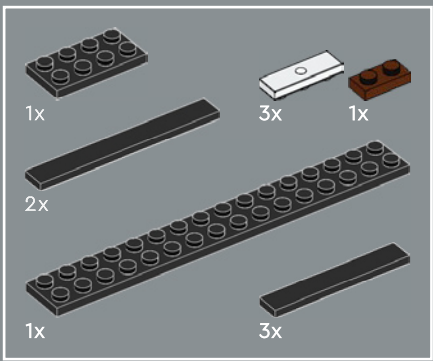

254

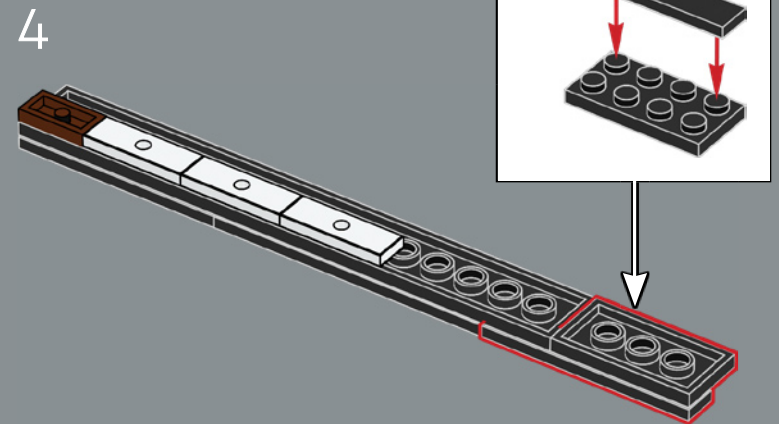
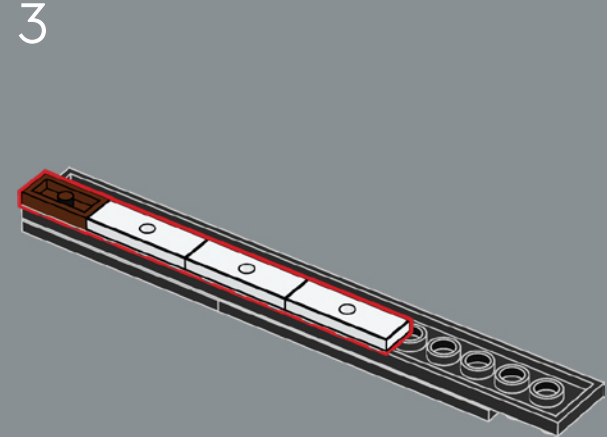
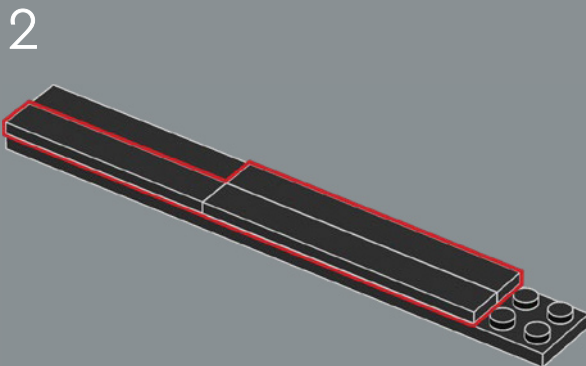
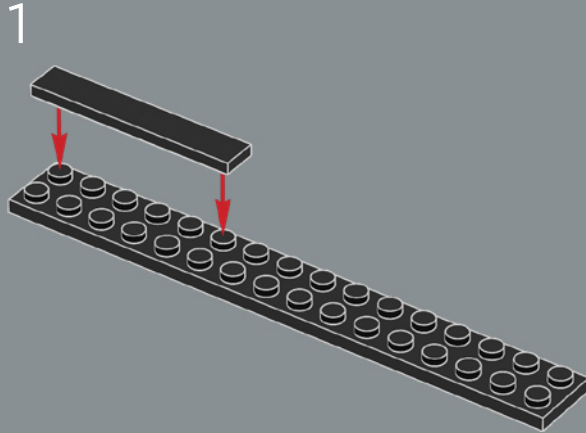

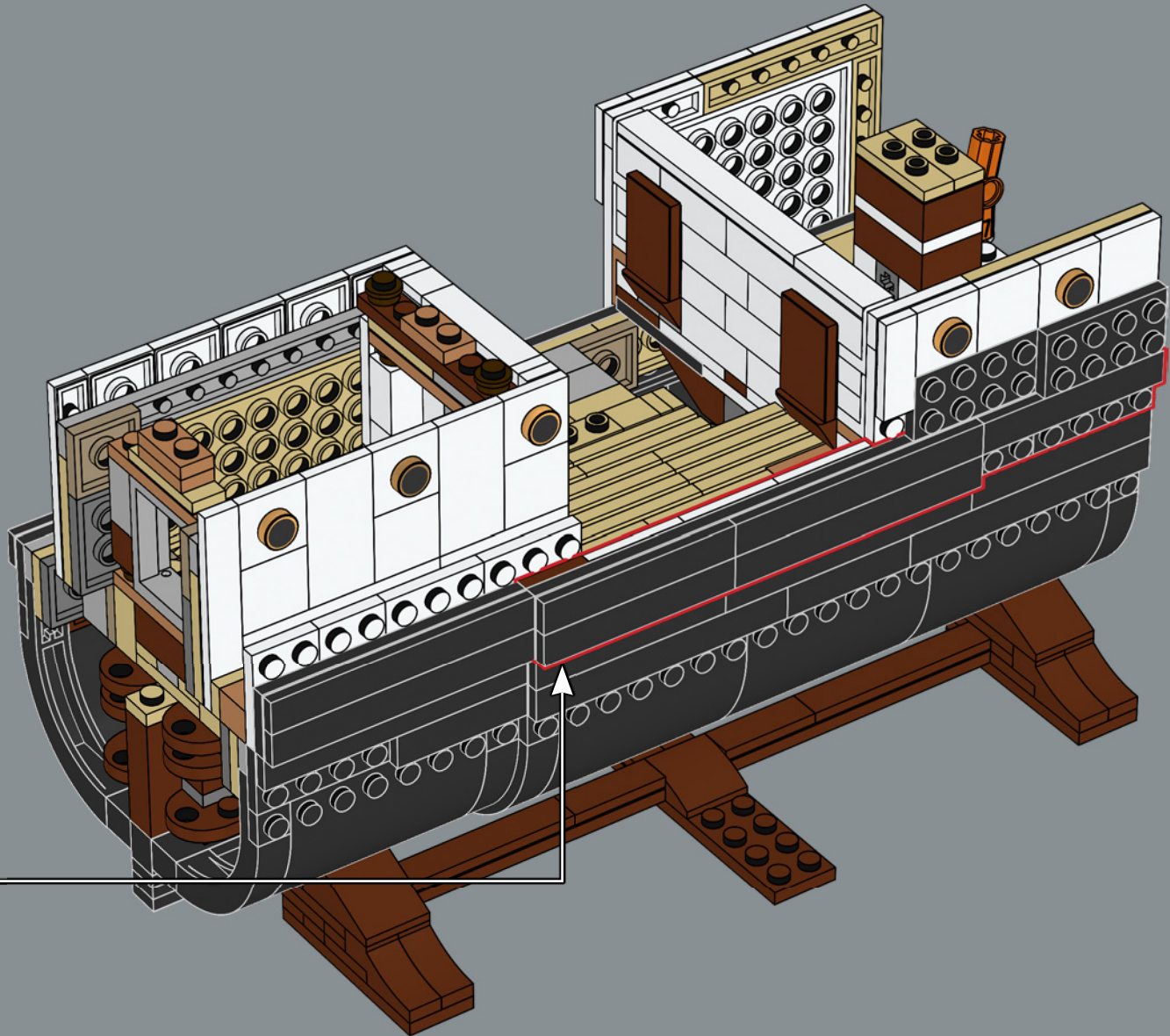

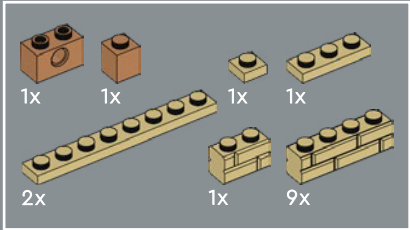
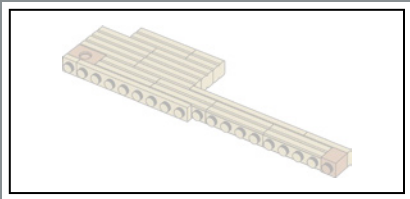

255

1

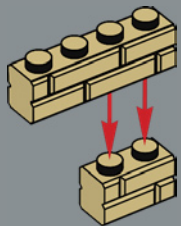

2

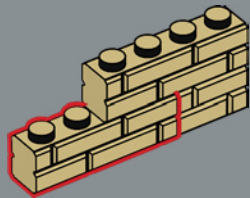

3

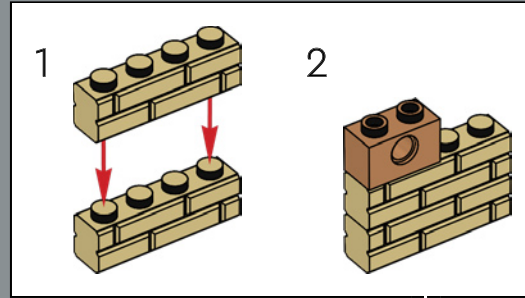
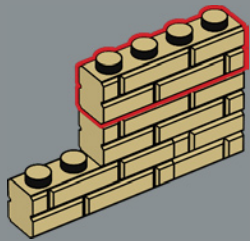

4

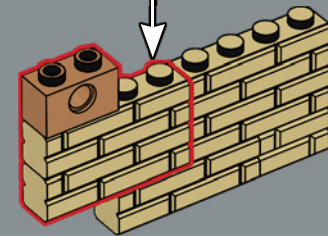

5

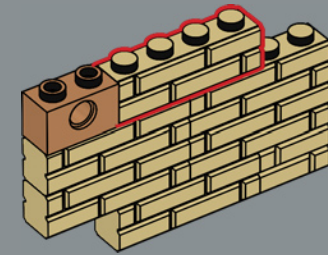

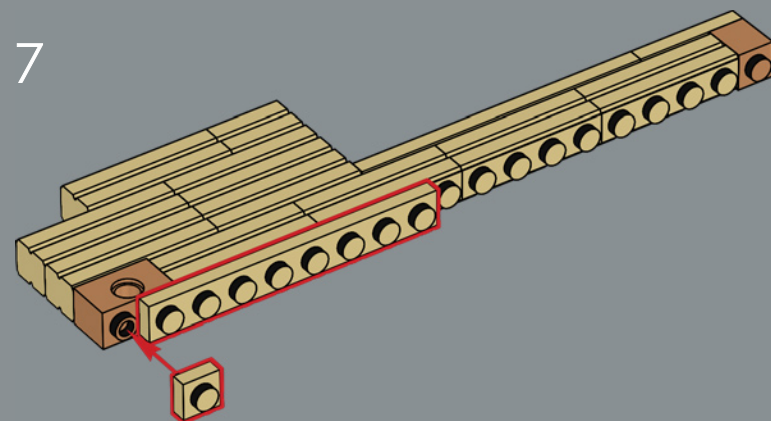
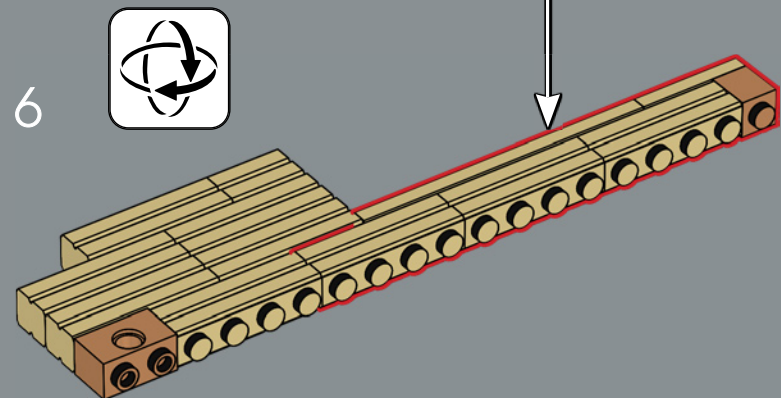
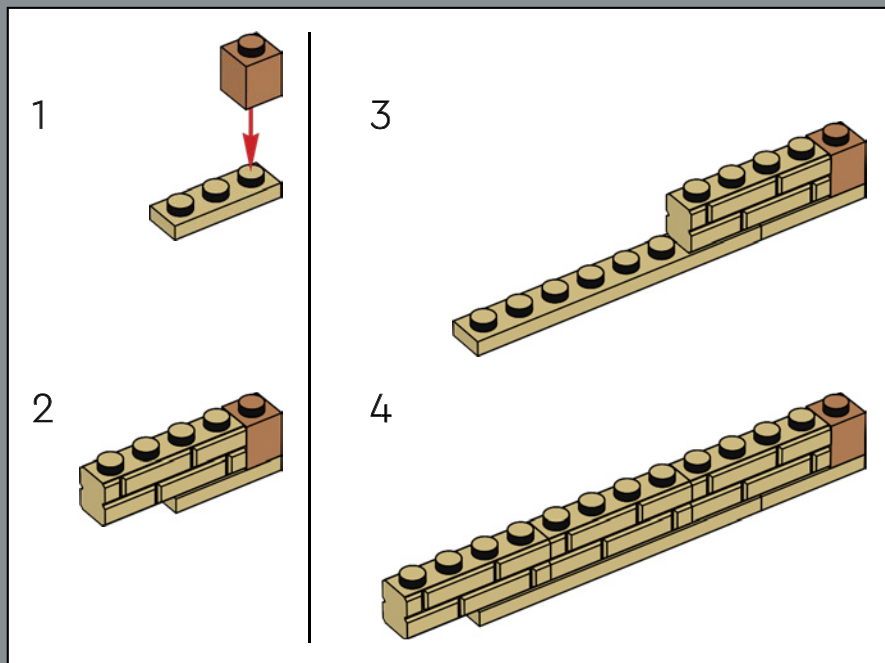

为使下层甲板看起来像是由木板制成的，此处采用了乐高®“砖墙”形积木的背面。

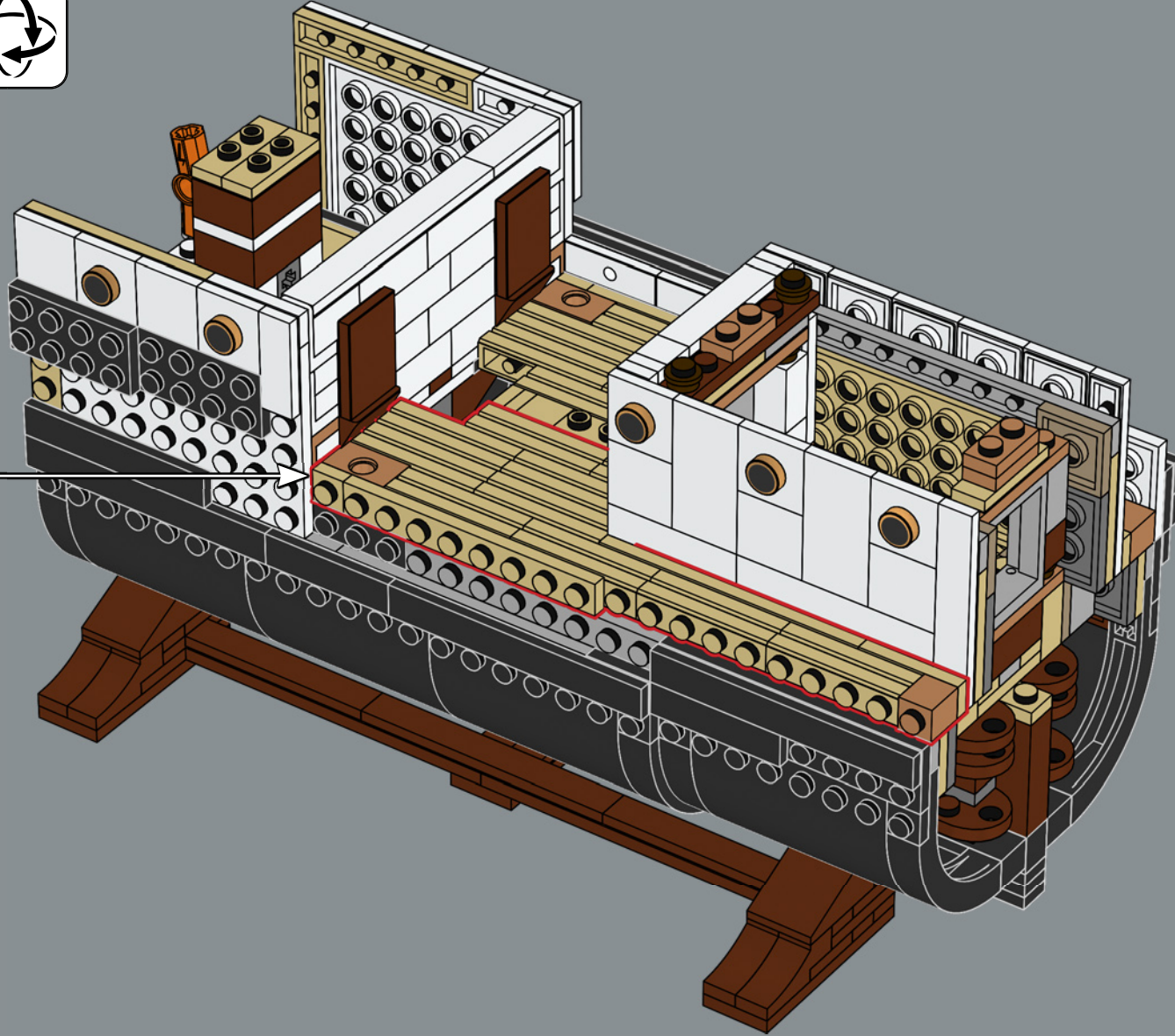

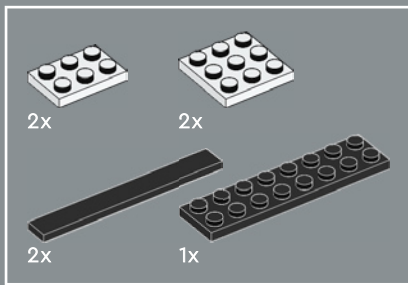

256

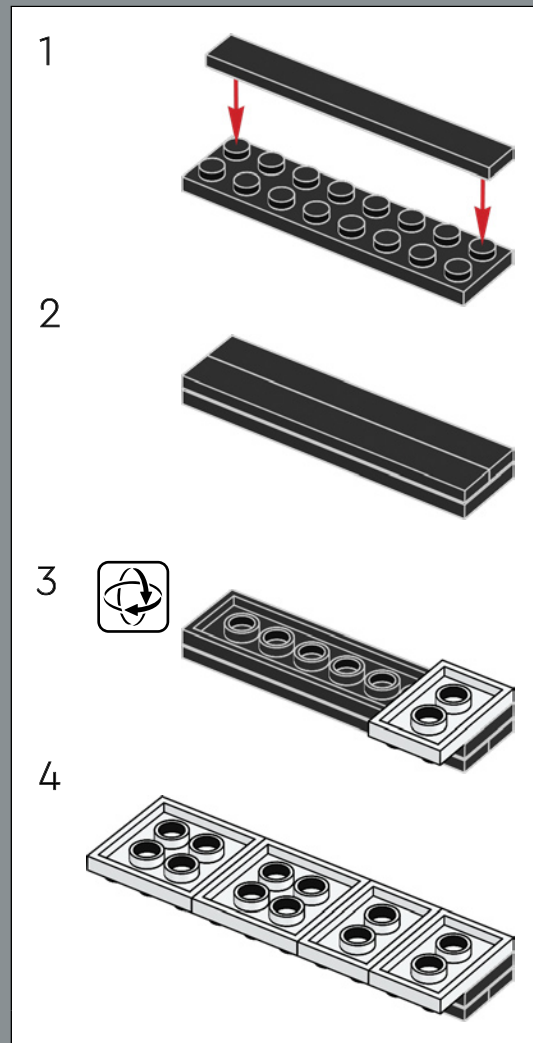
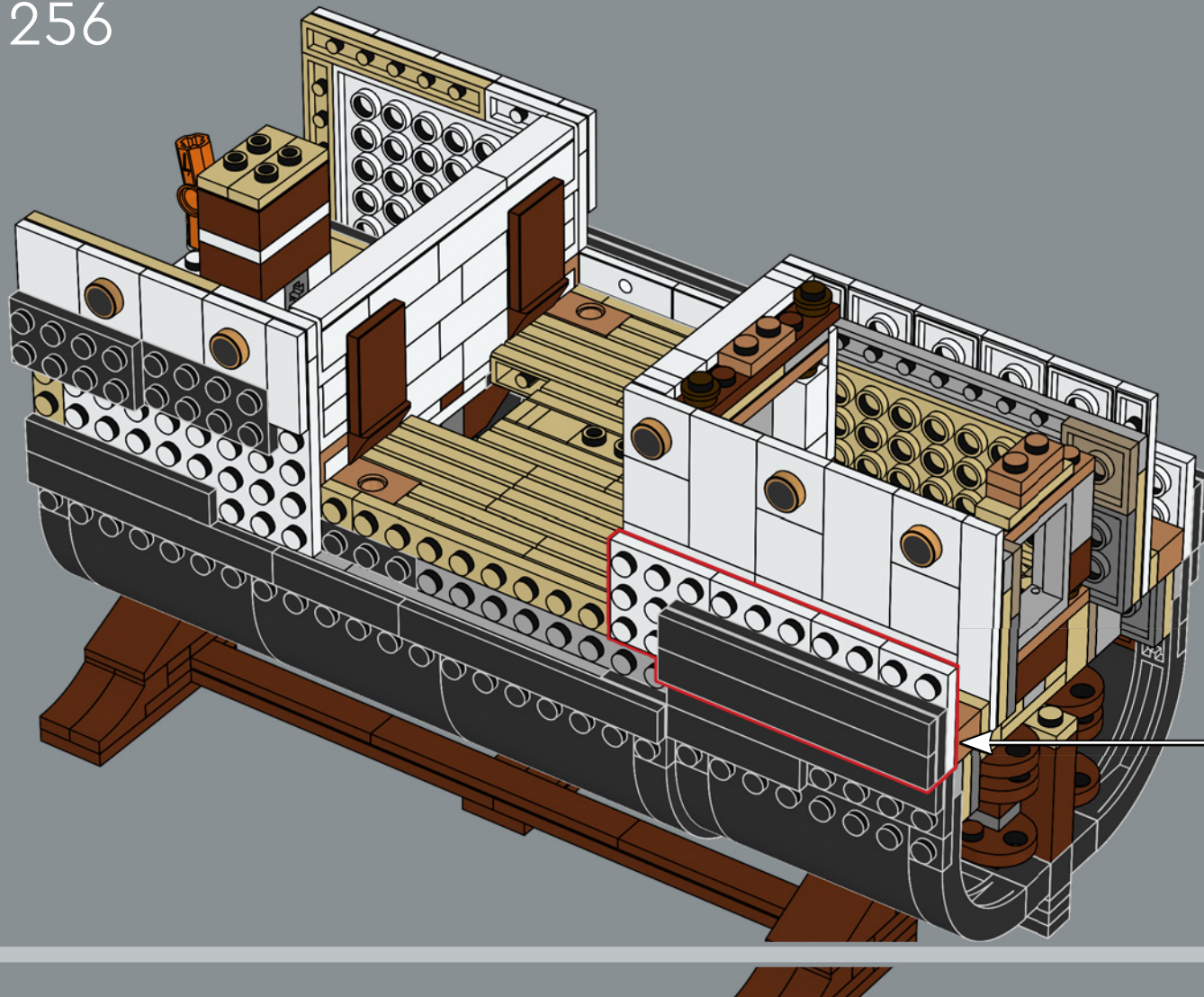

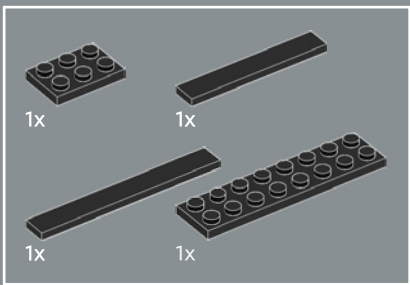

257

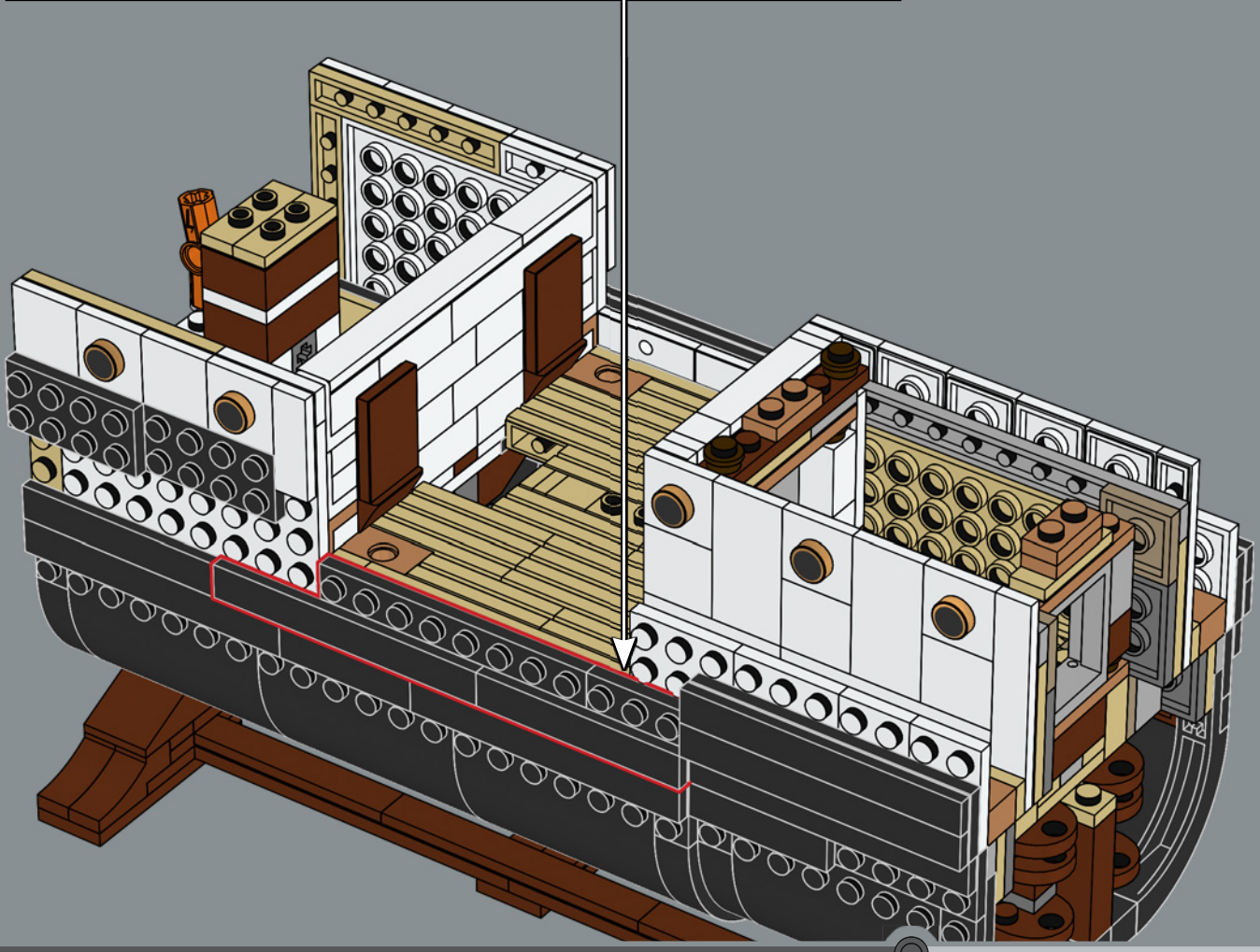
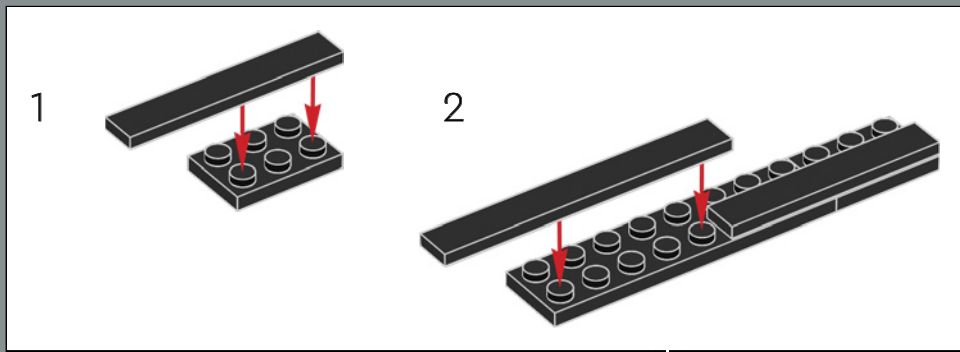

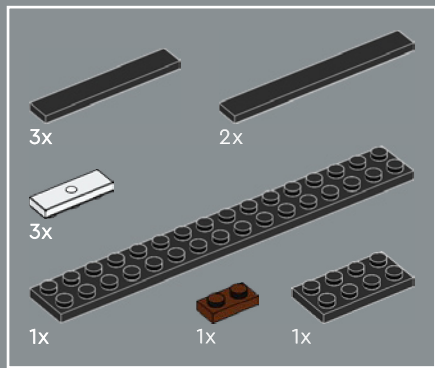

258

1

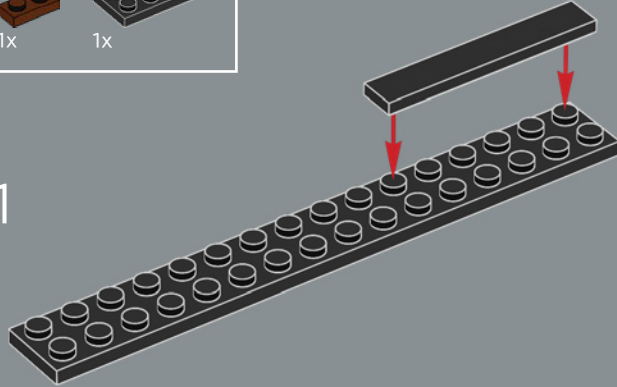

2

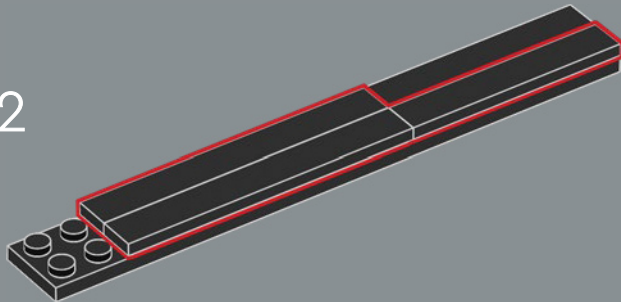

3

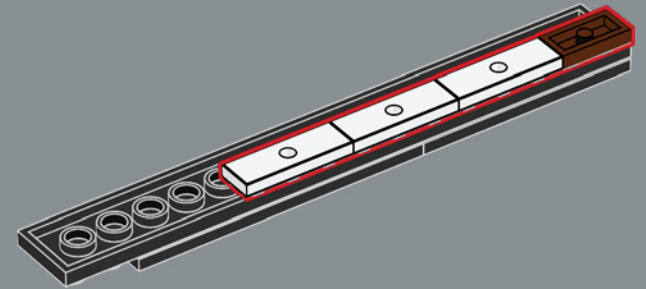

4

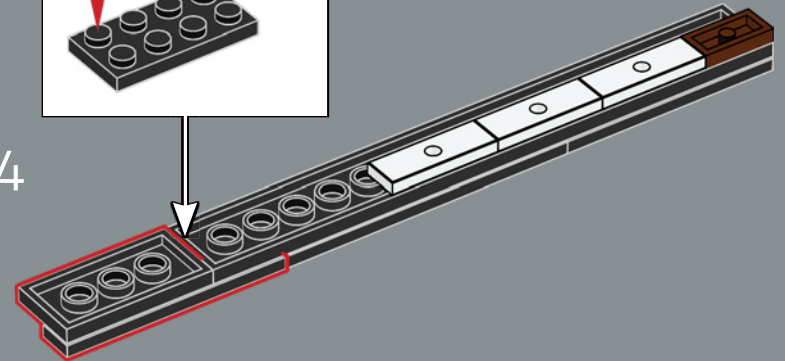
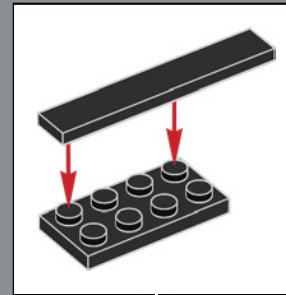

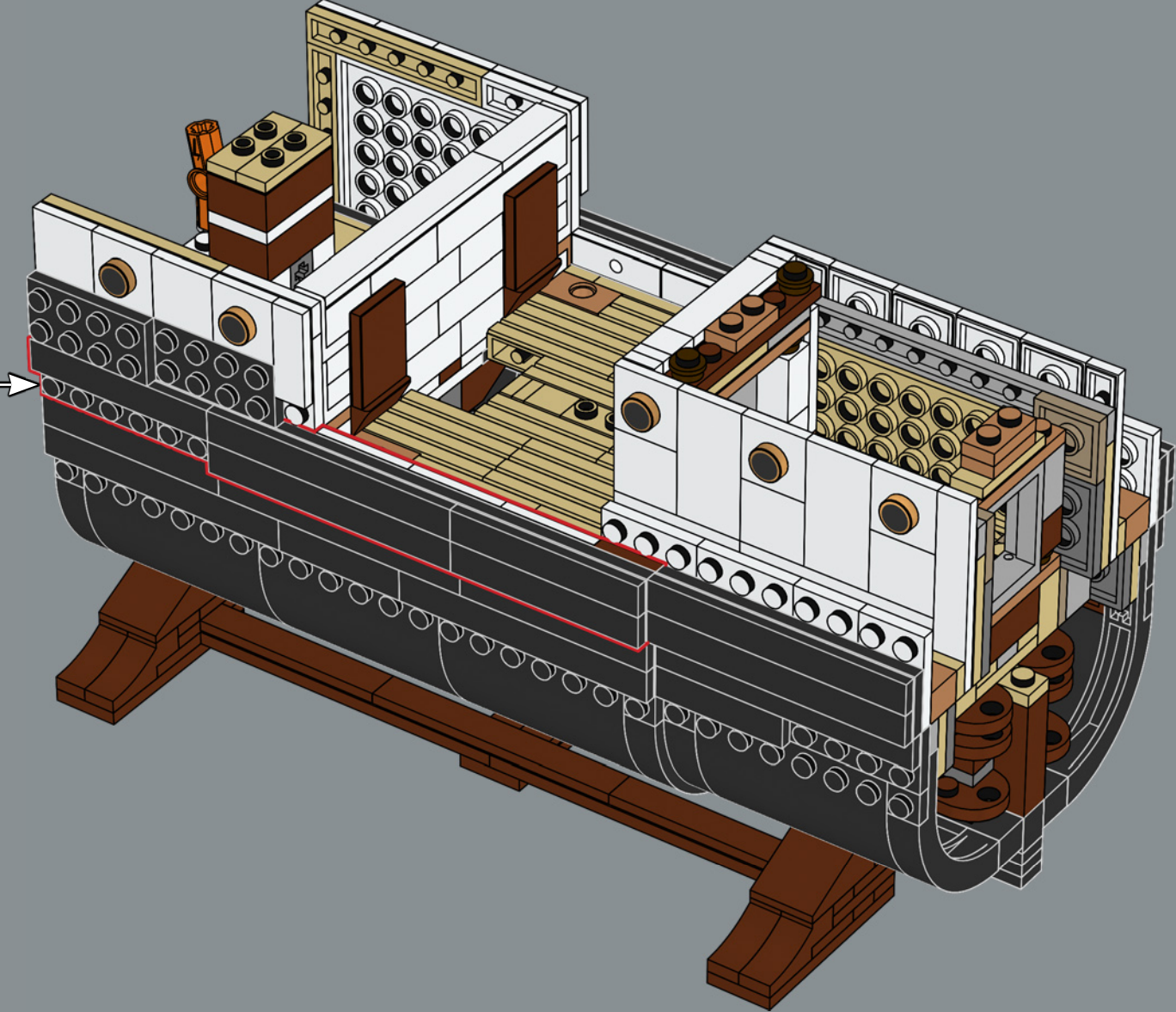

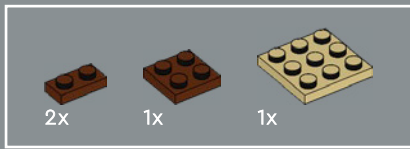

259

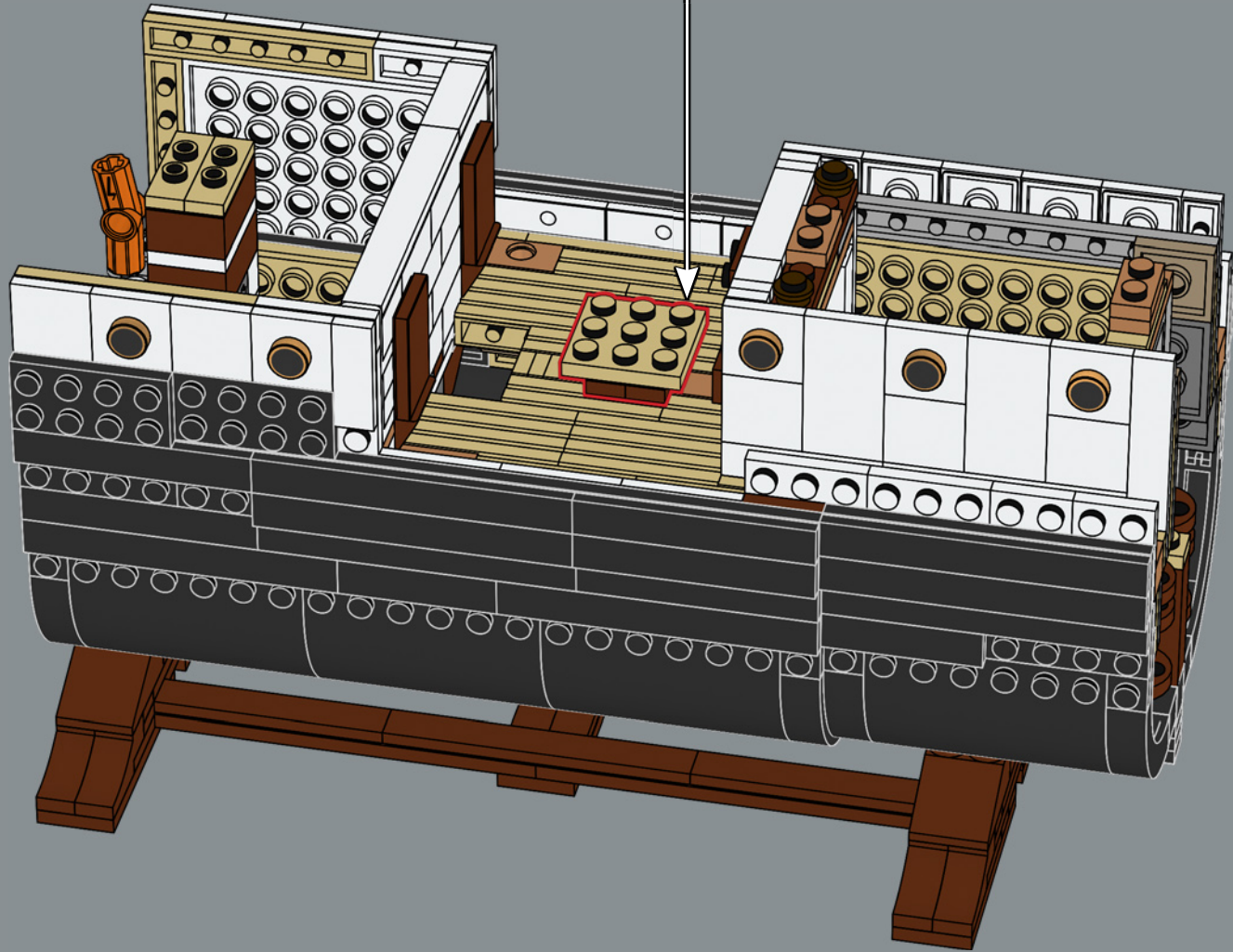
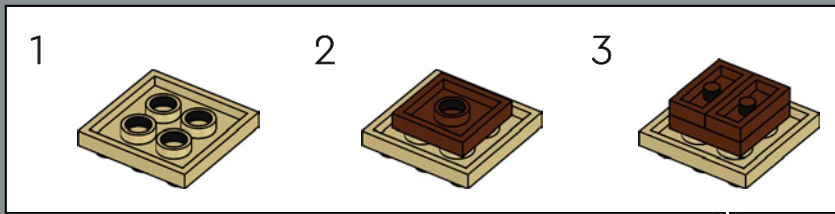

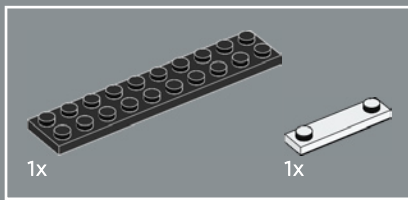
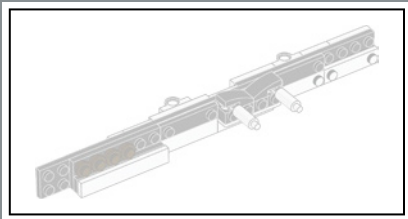

260

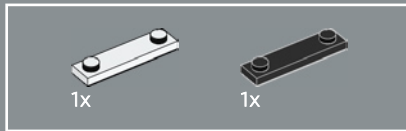
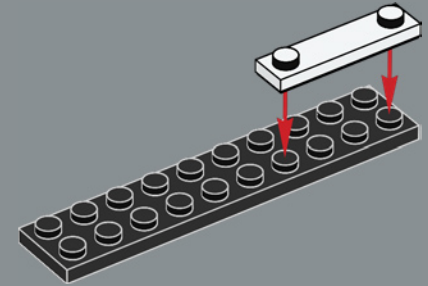

261

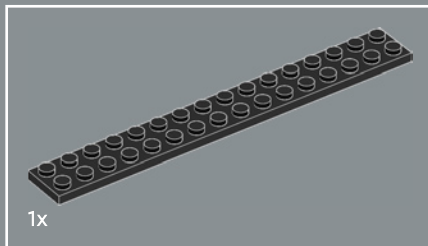
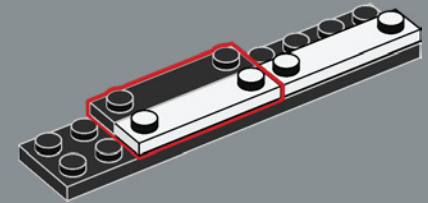

262

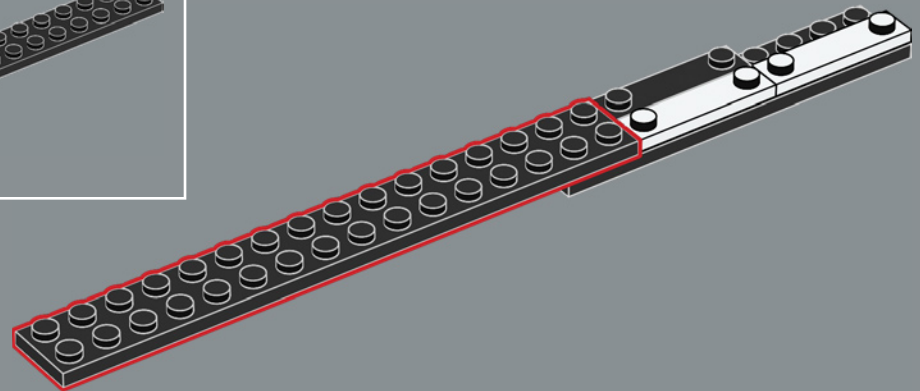

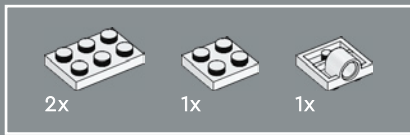

263

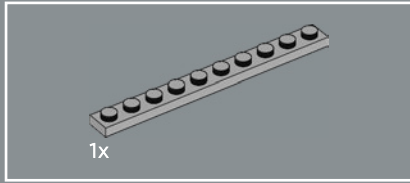
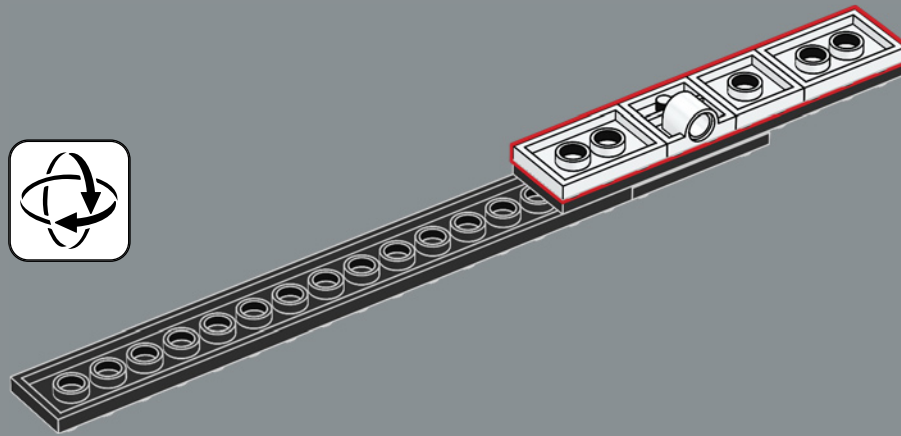

264

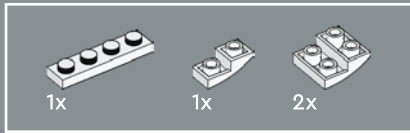
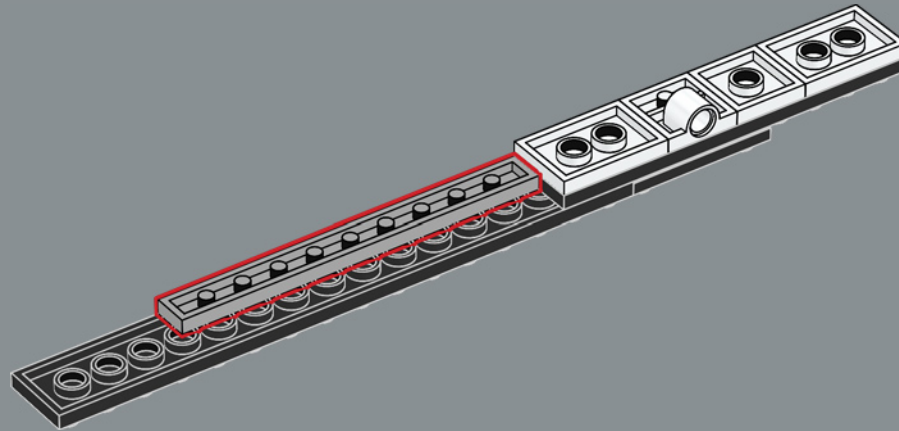

265

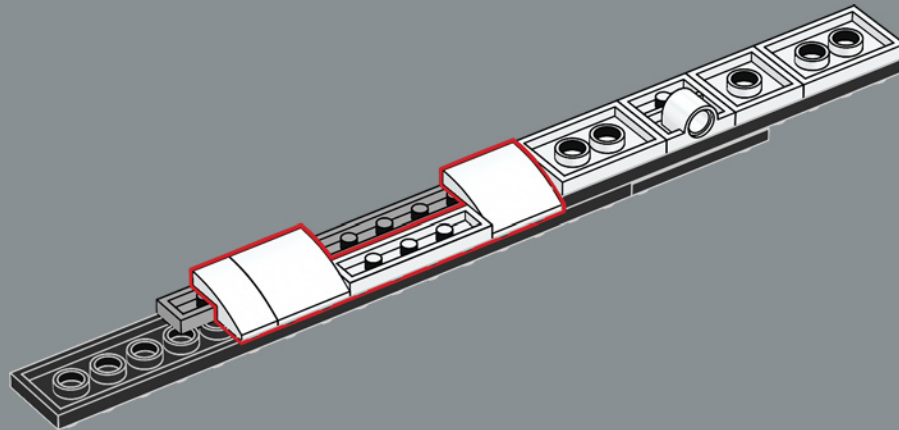



266

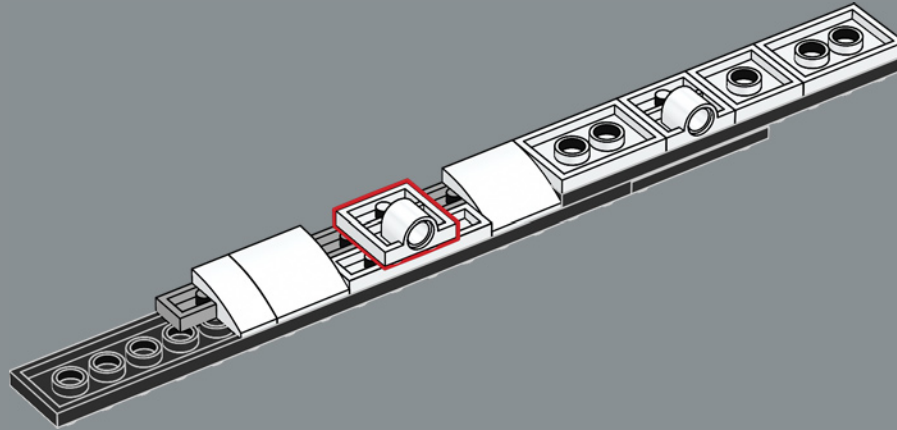

267

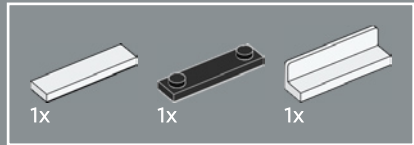
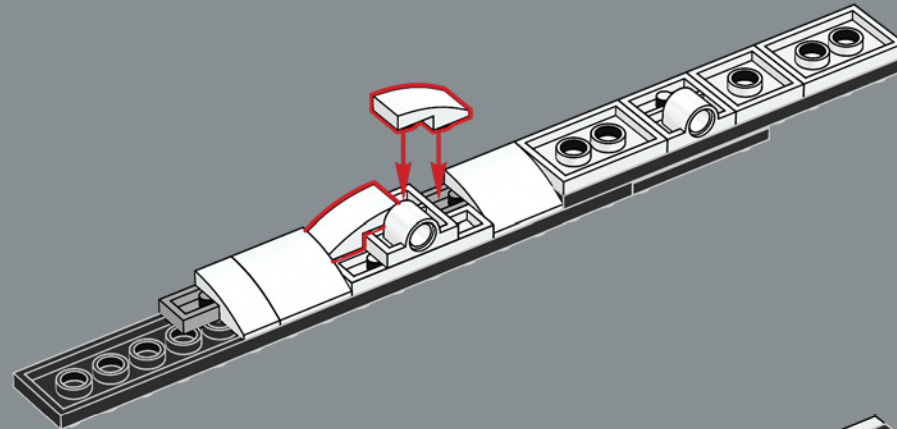

268

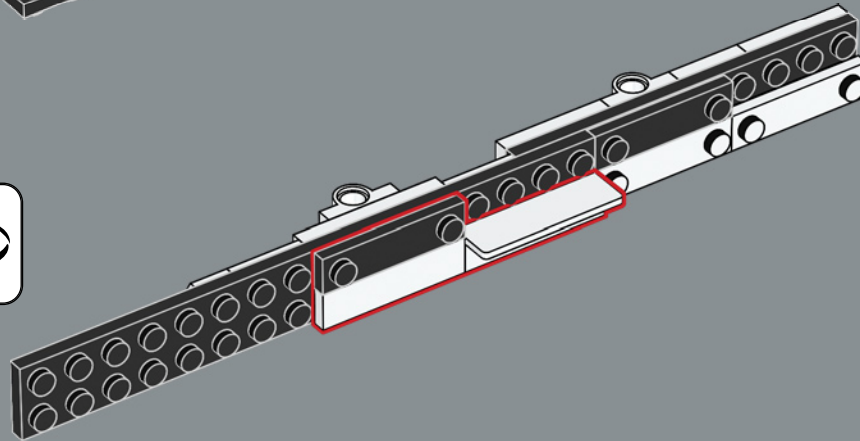

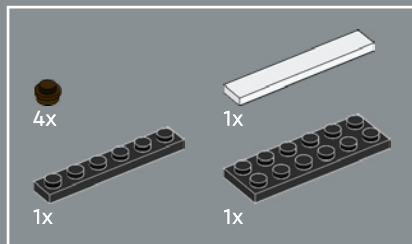

269

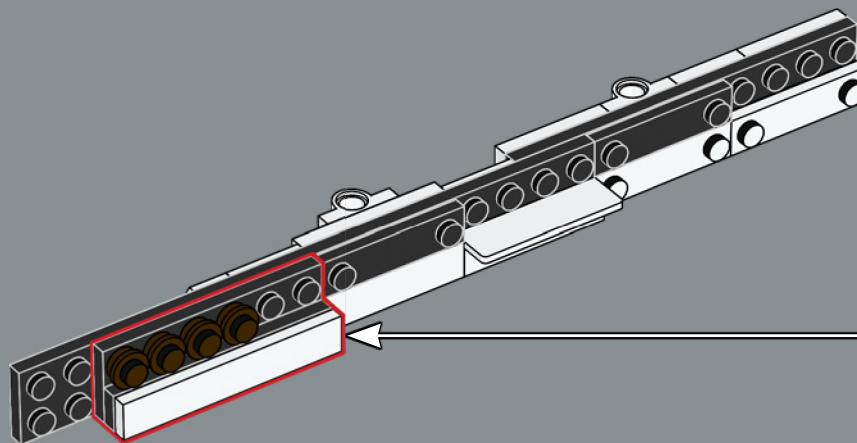
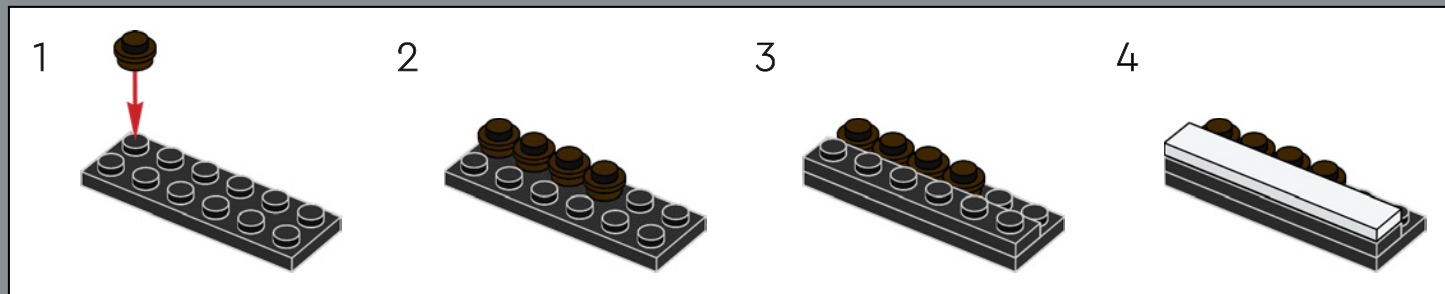



4x

270

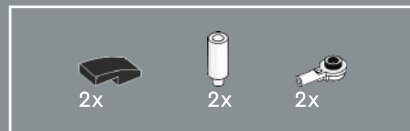
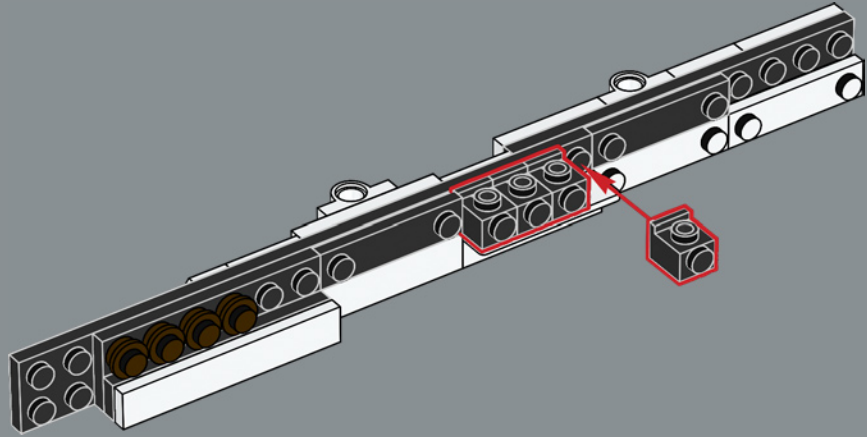

271

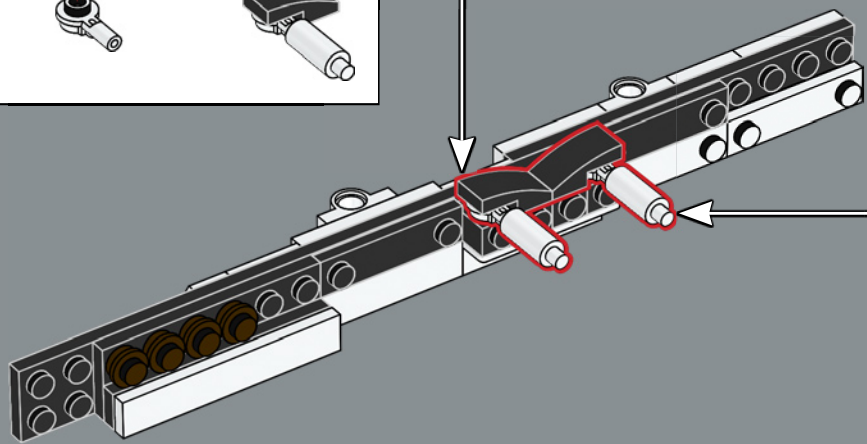
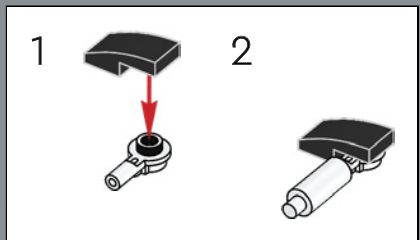
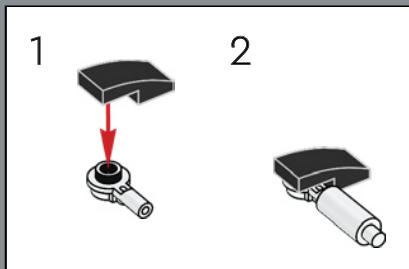

272

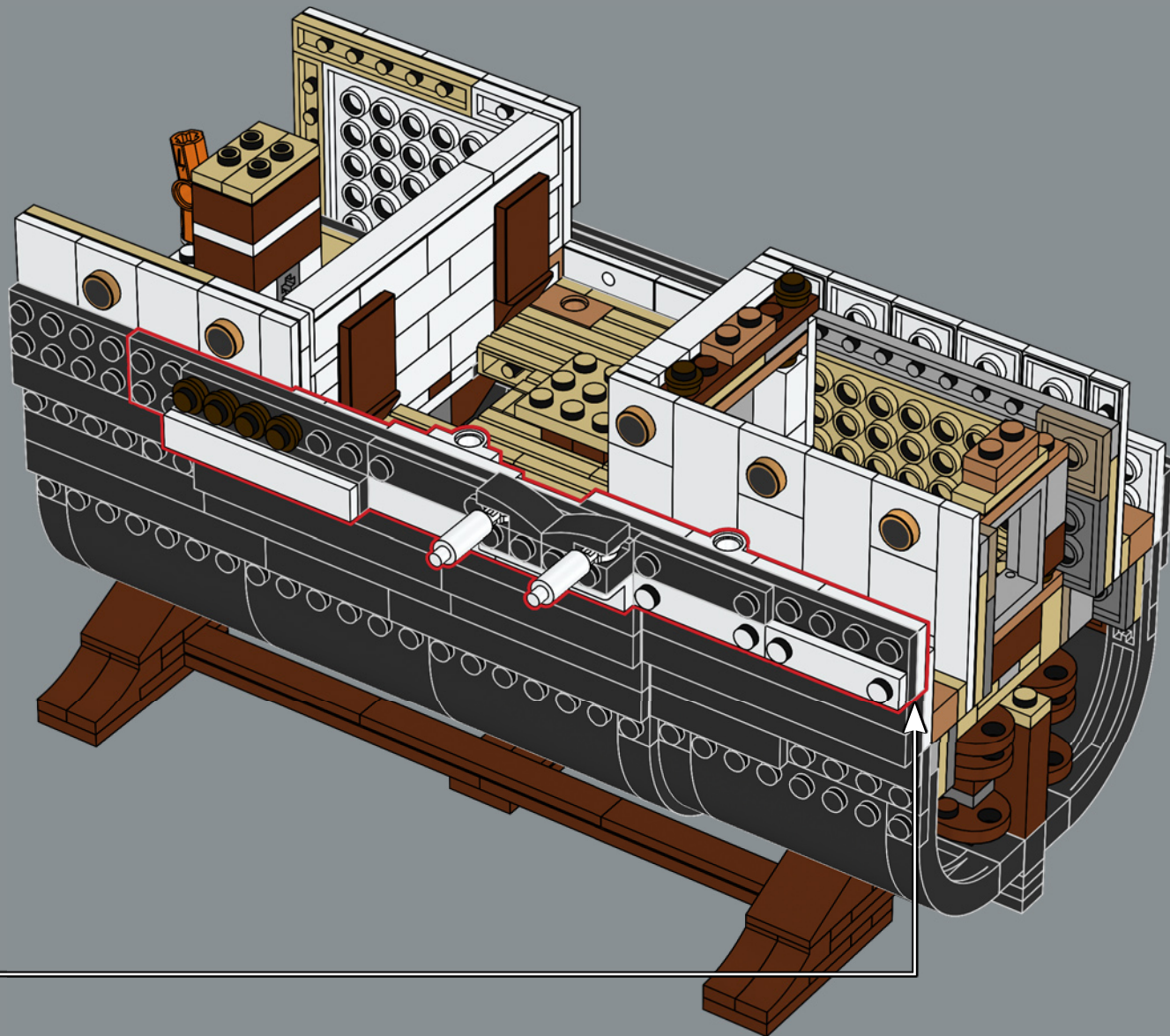

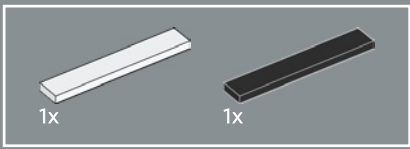

273

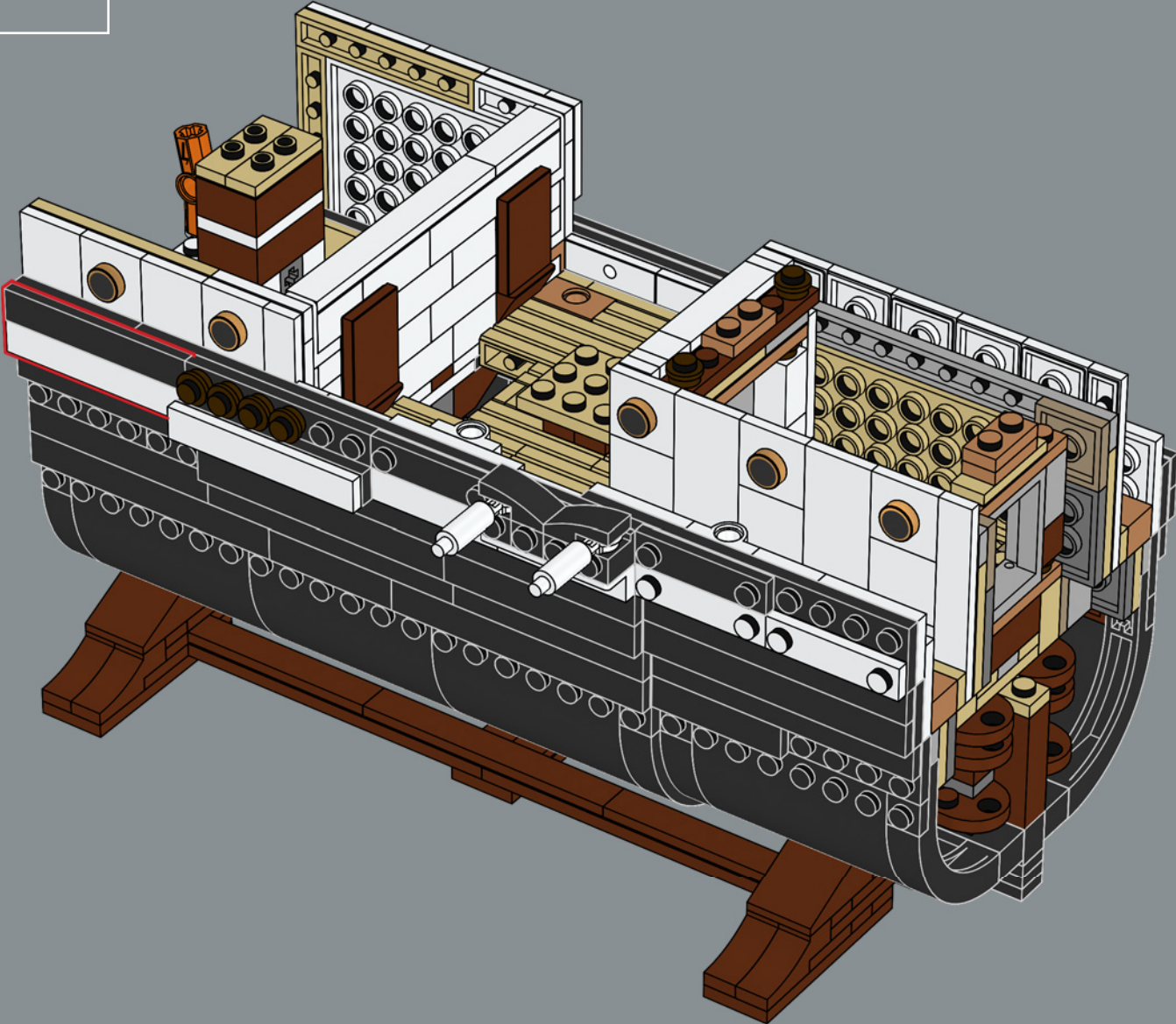

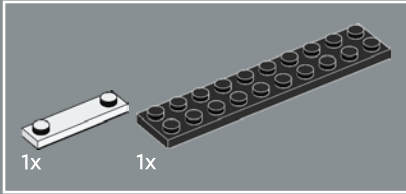
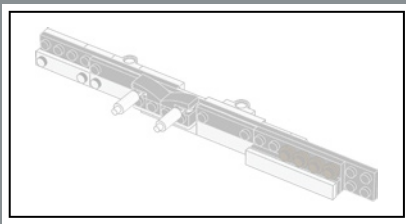

274

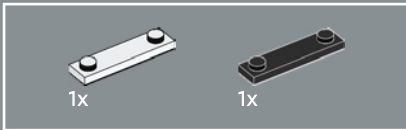
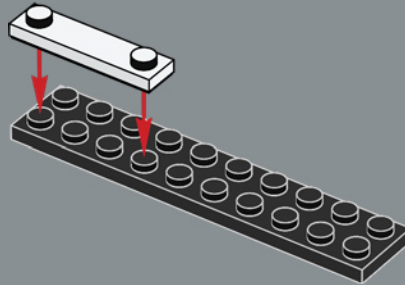

275

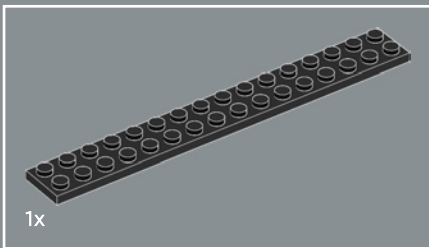
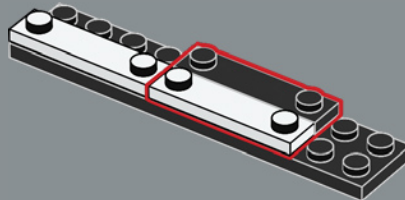

276

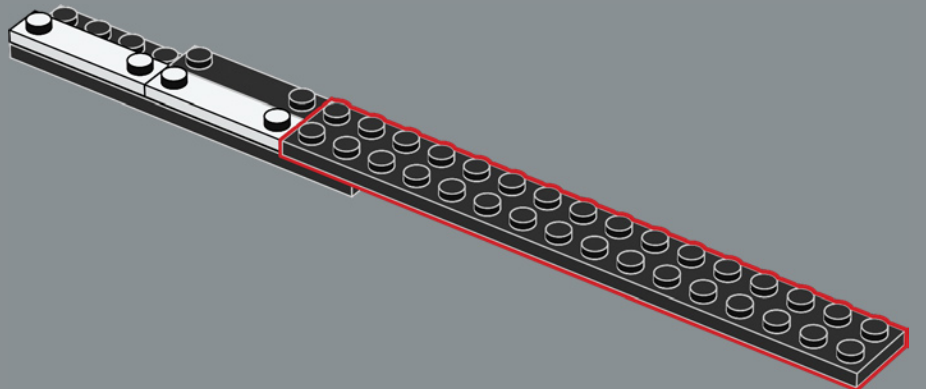

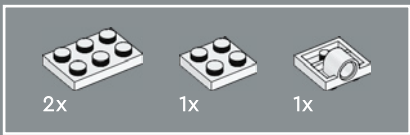

277

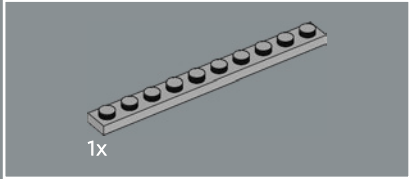
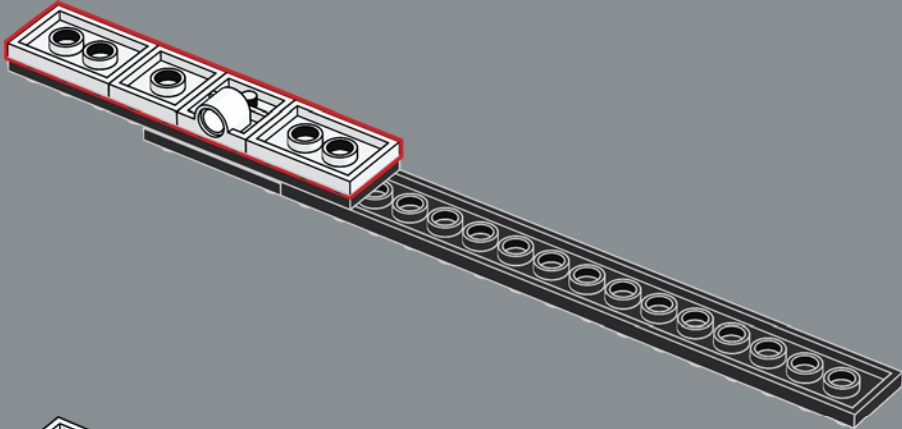

278

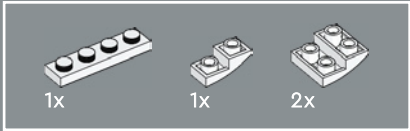
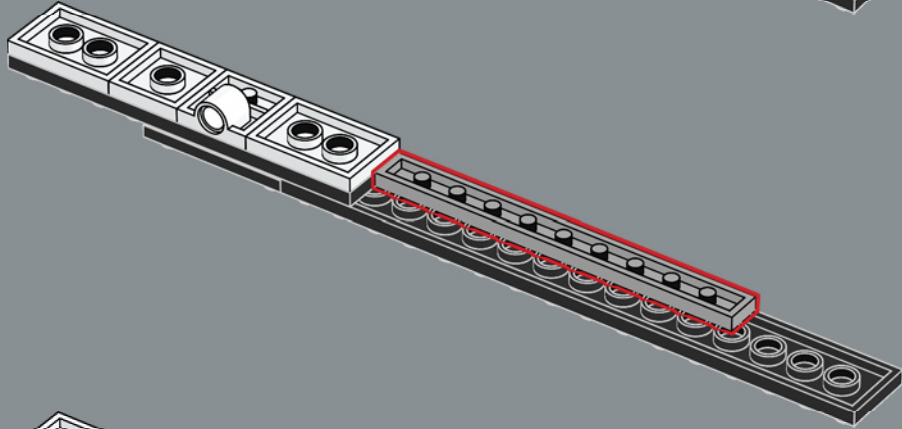

279

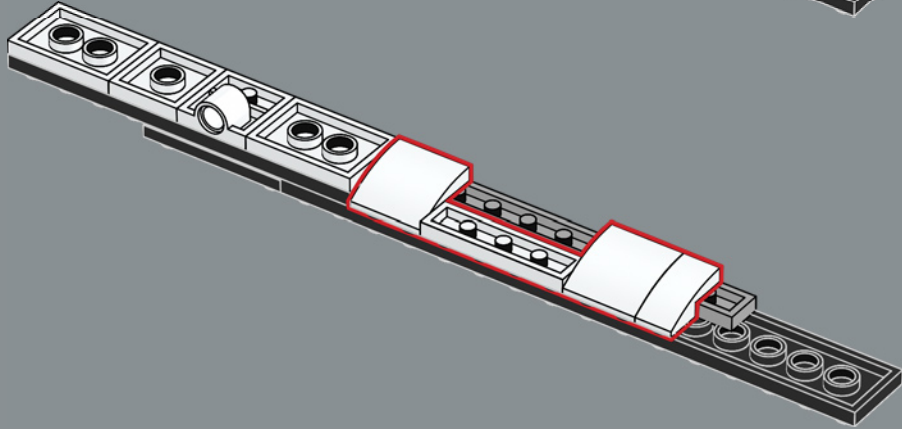



280



281

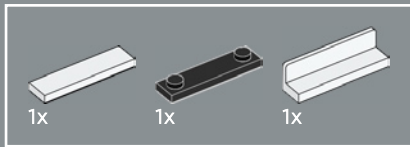

282

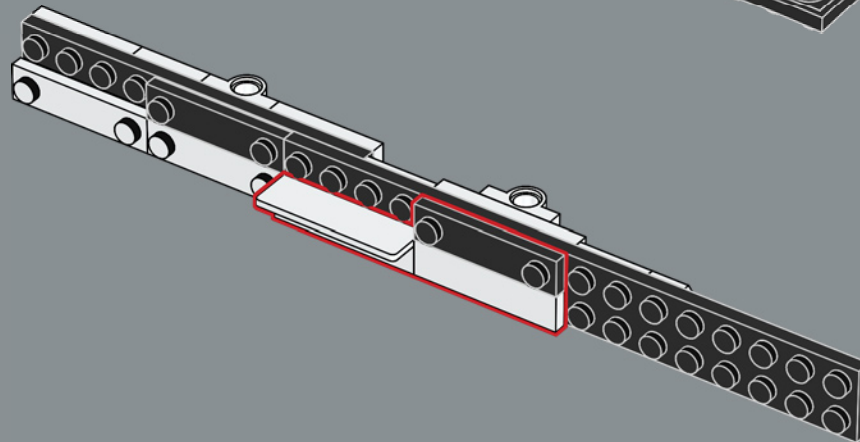
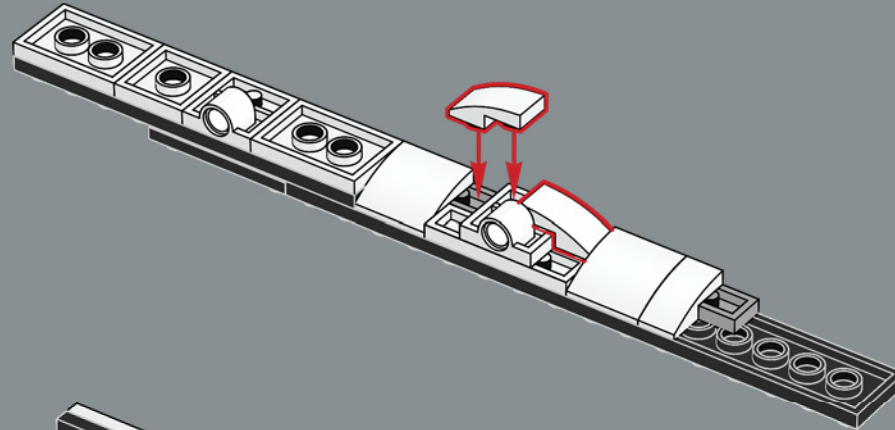
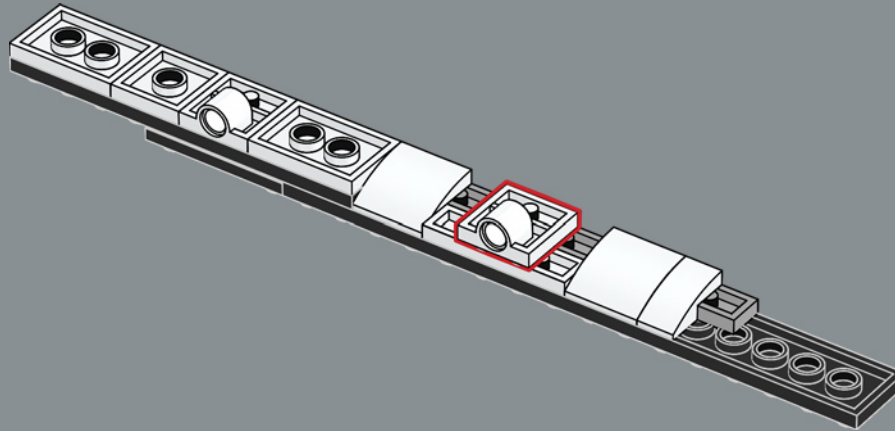

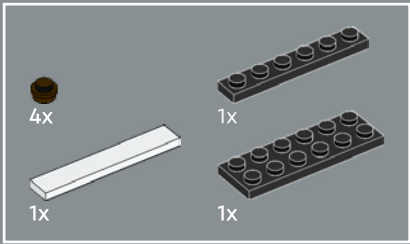

283

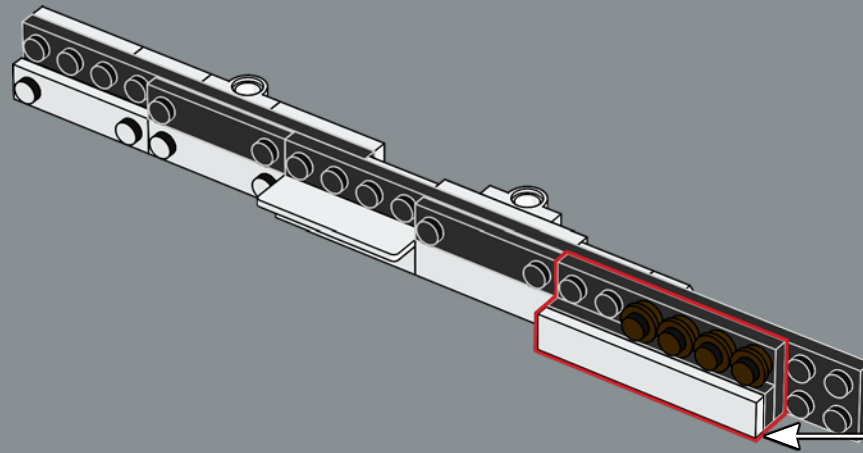
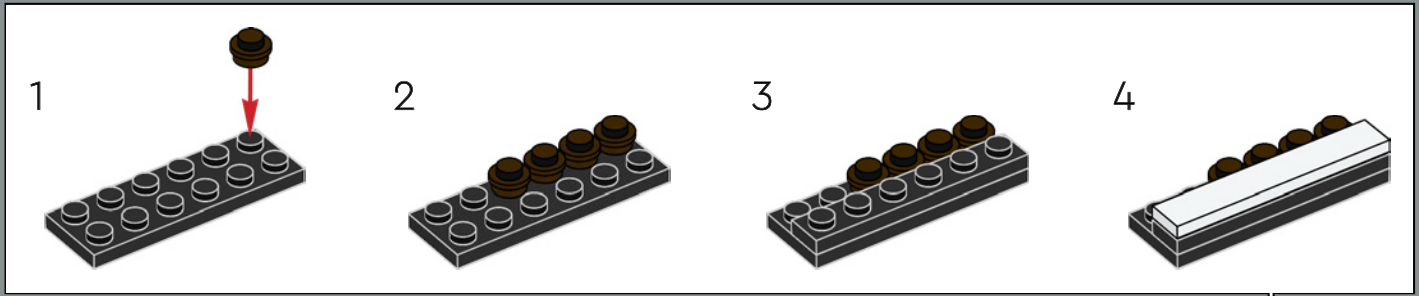



284

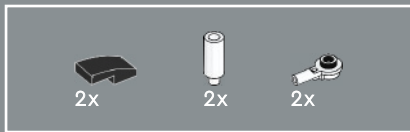
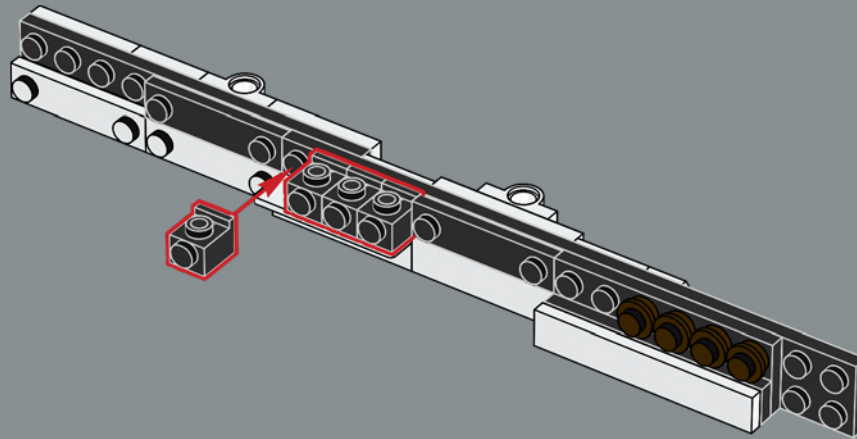

285

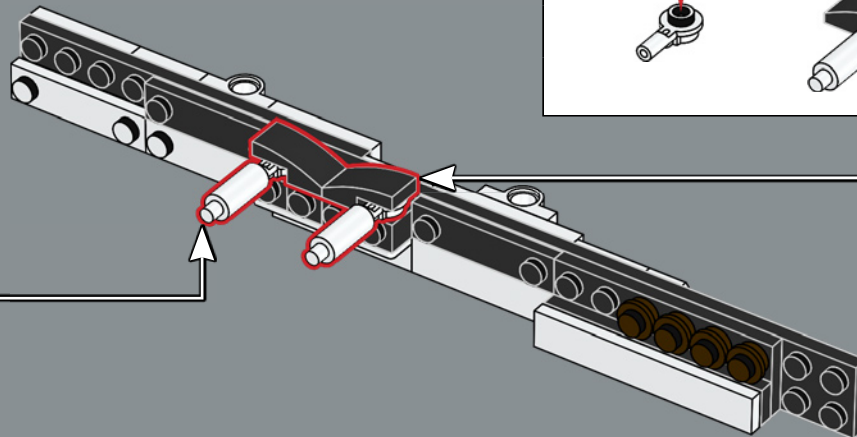
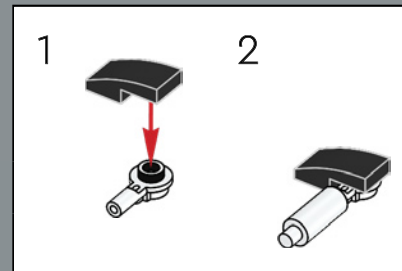
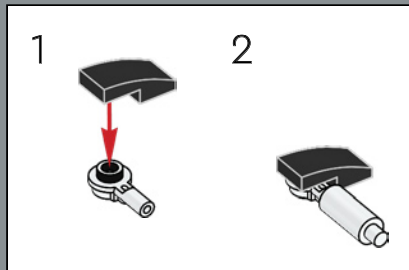

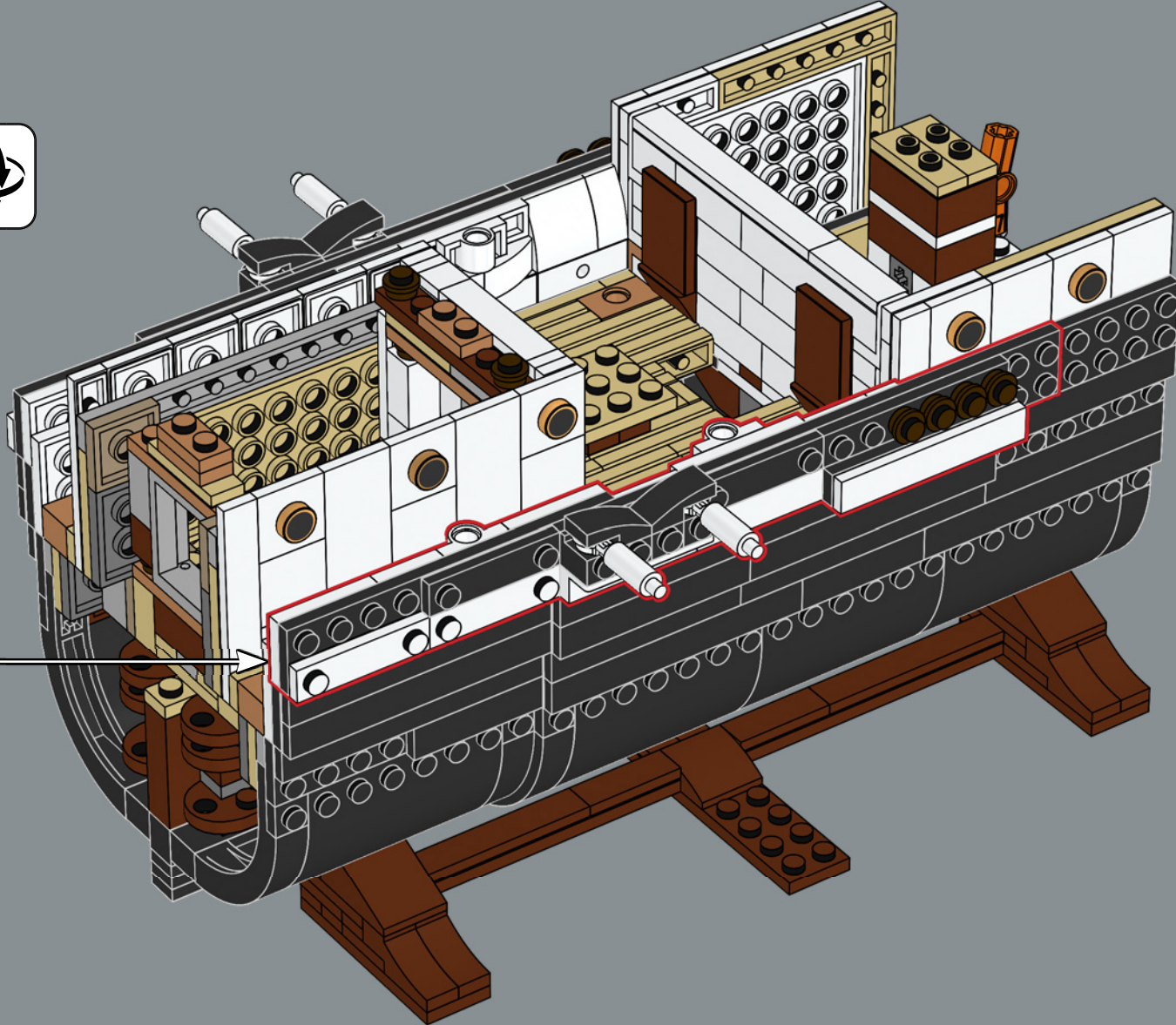

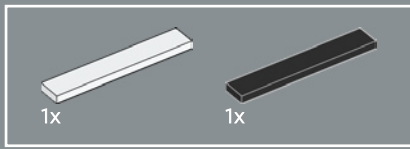

287

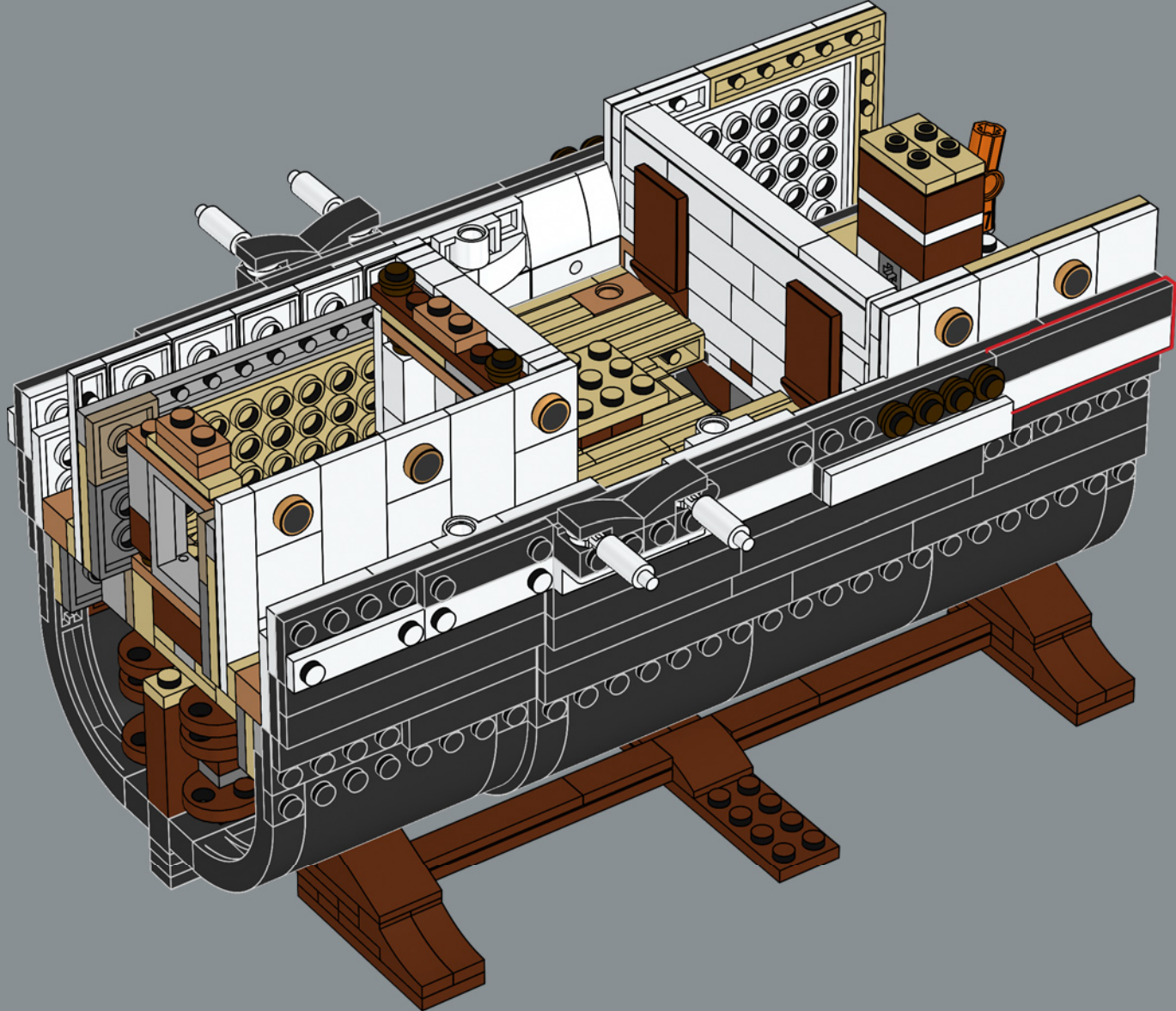

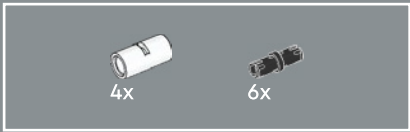

288

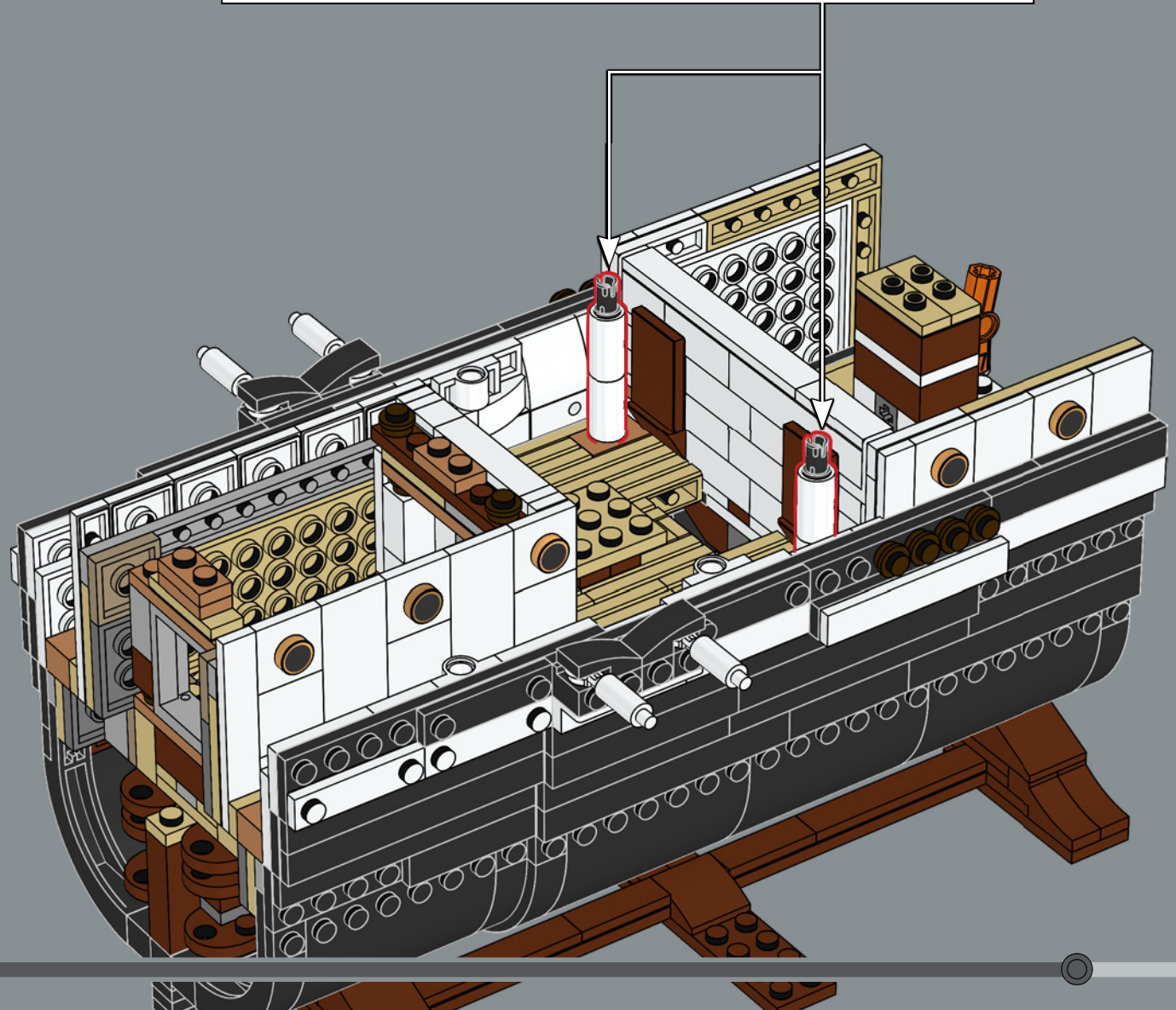
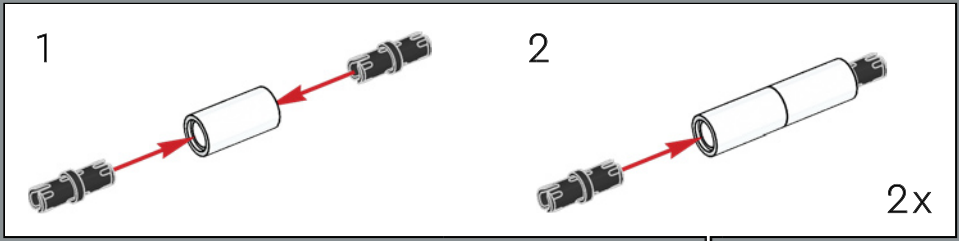

289

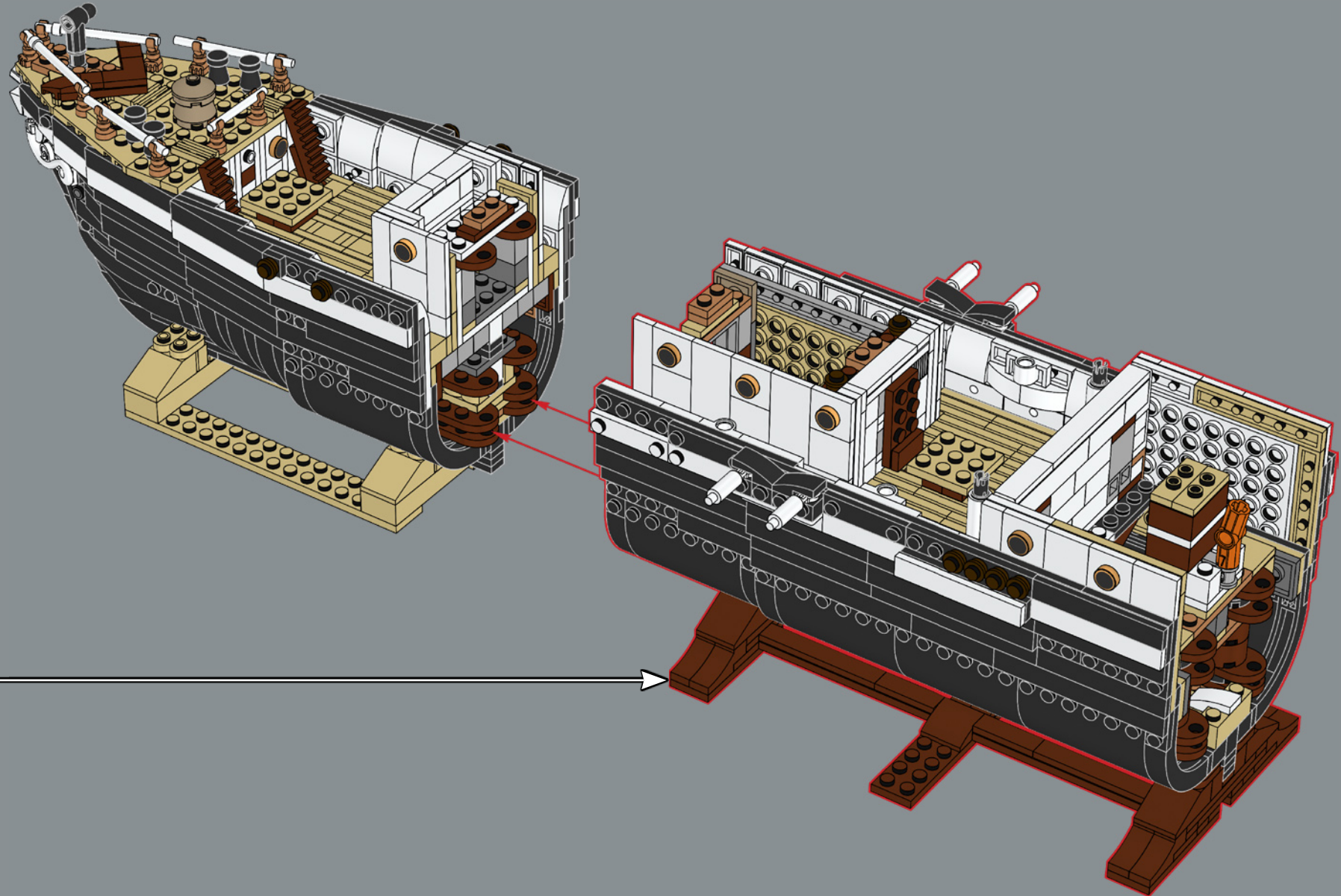



造船大师使坚忍号成为有史以来最坚固的木船之一，并尽可能增强船体的强度。在乐高®模型中，三个船体部分由乐高机械组轴组件连接，将它们牢牢地固定到位。

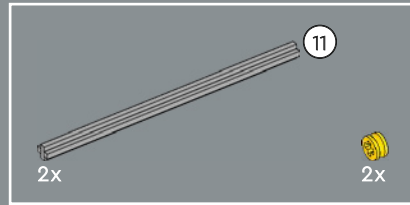

290

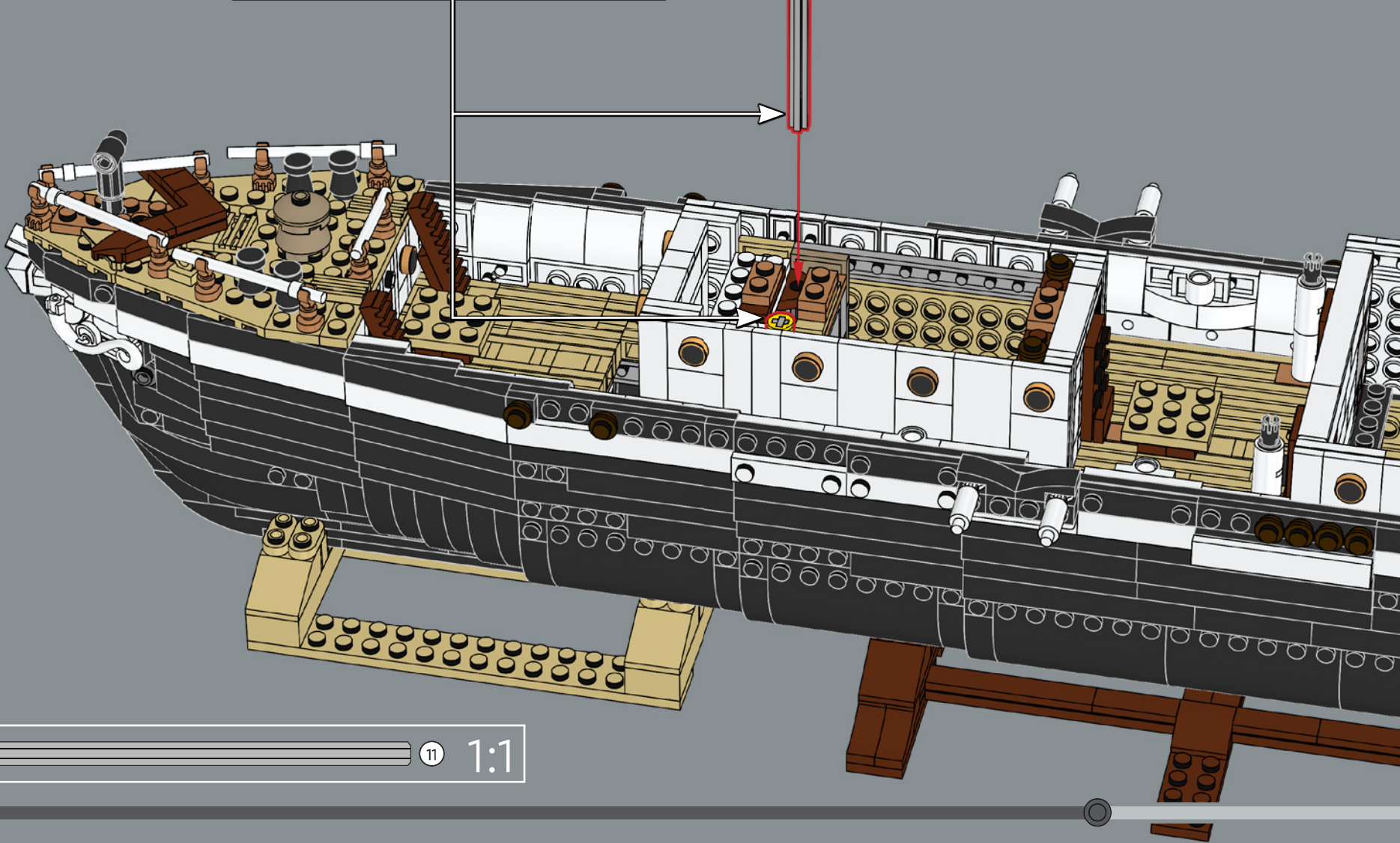
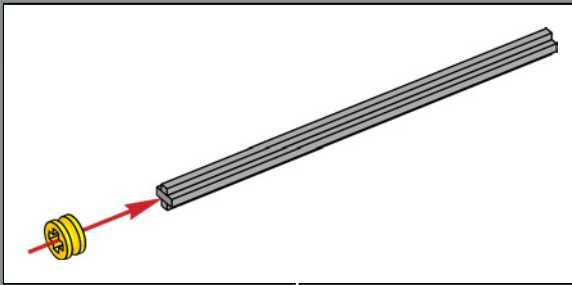

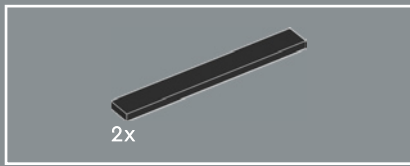

291

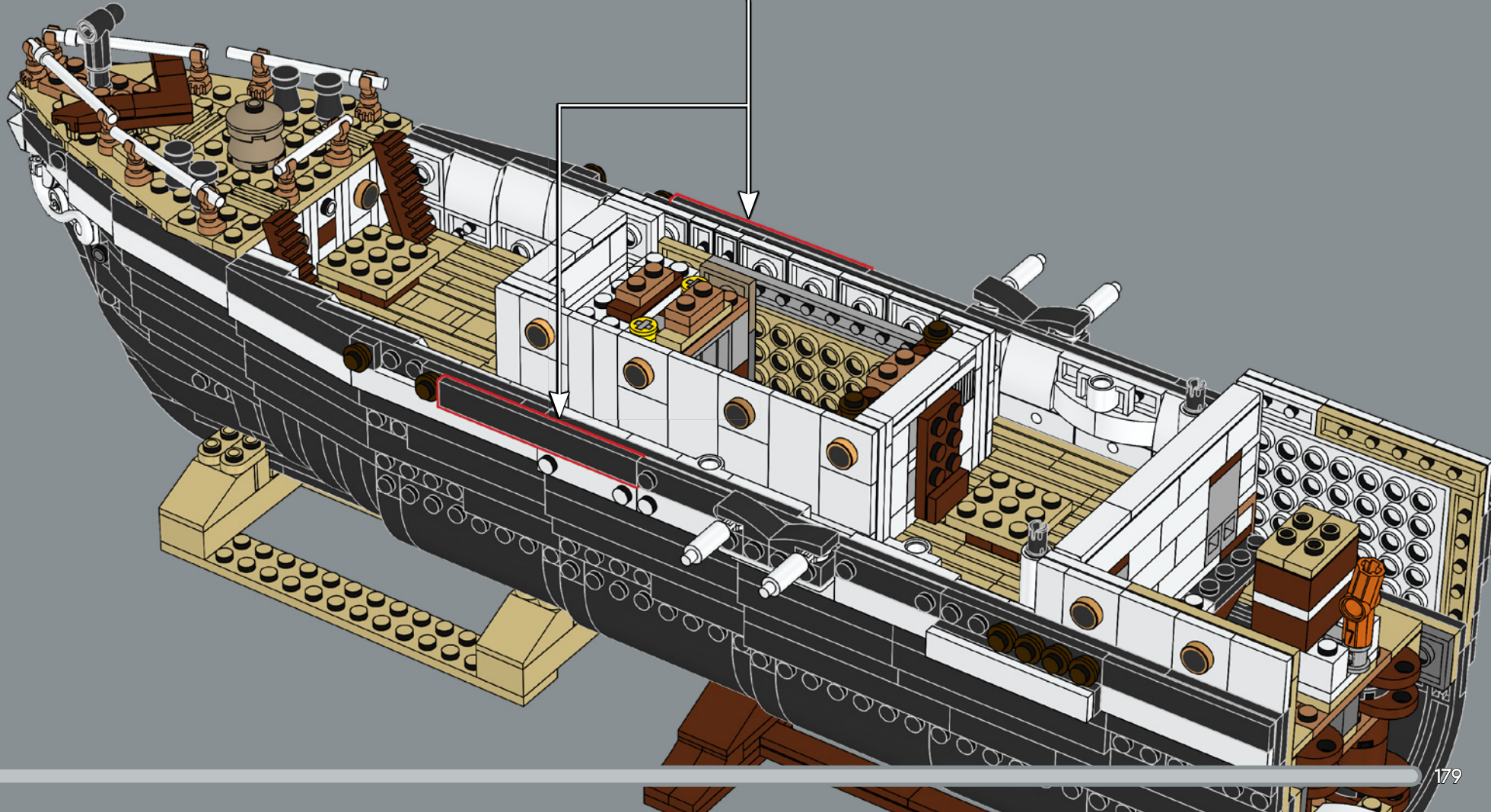
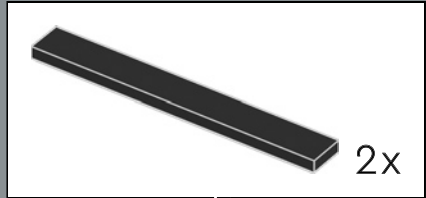

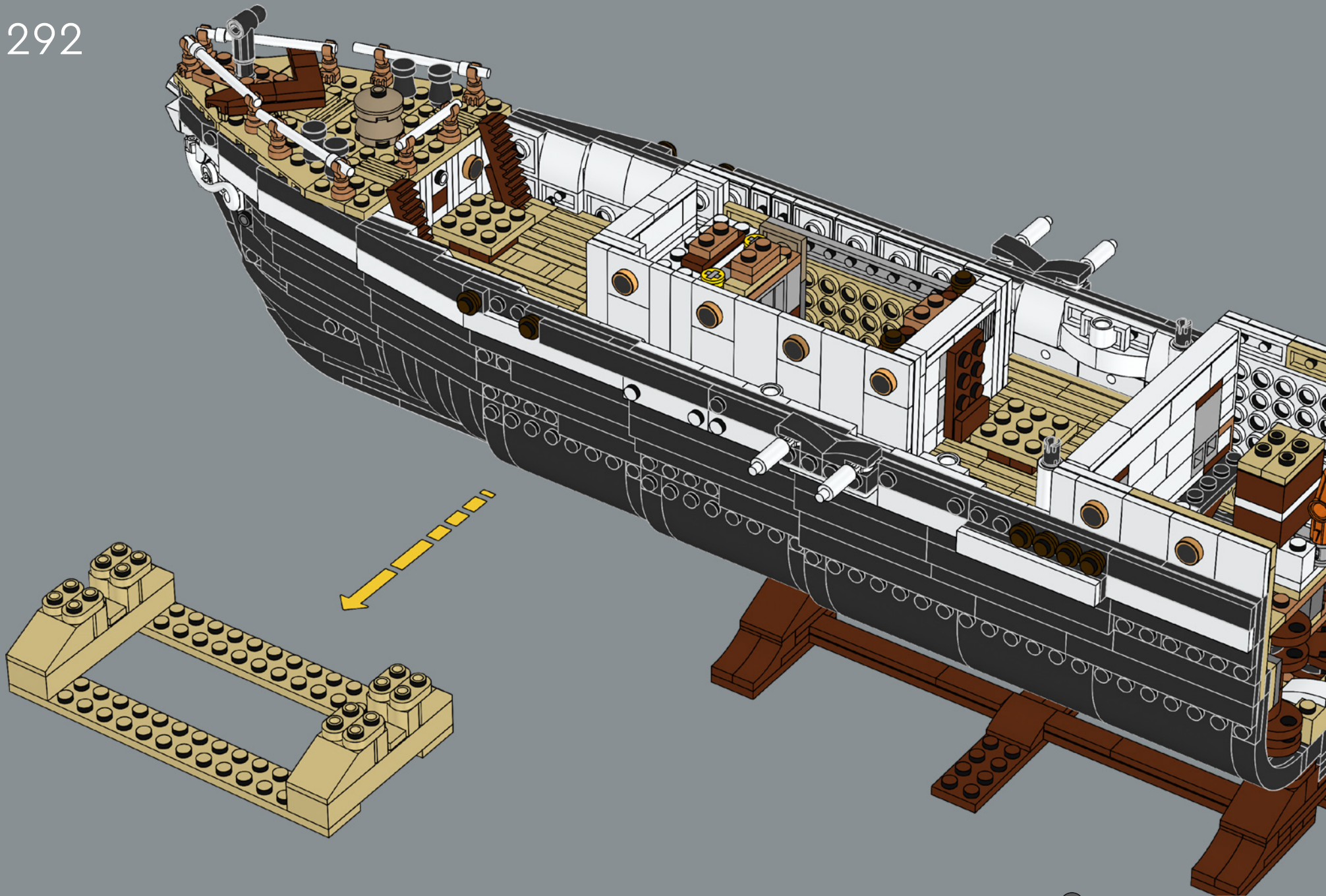

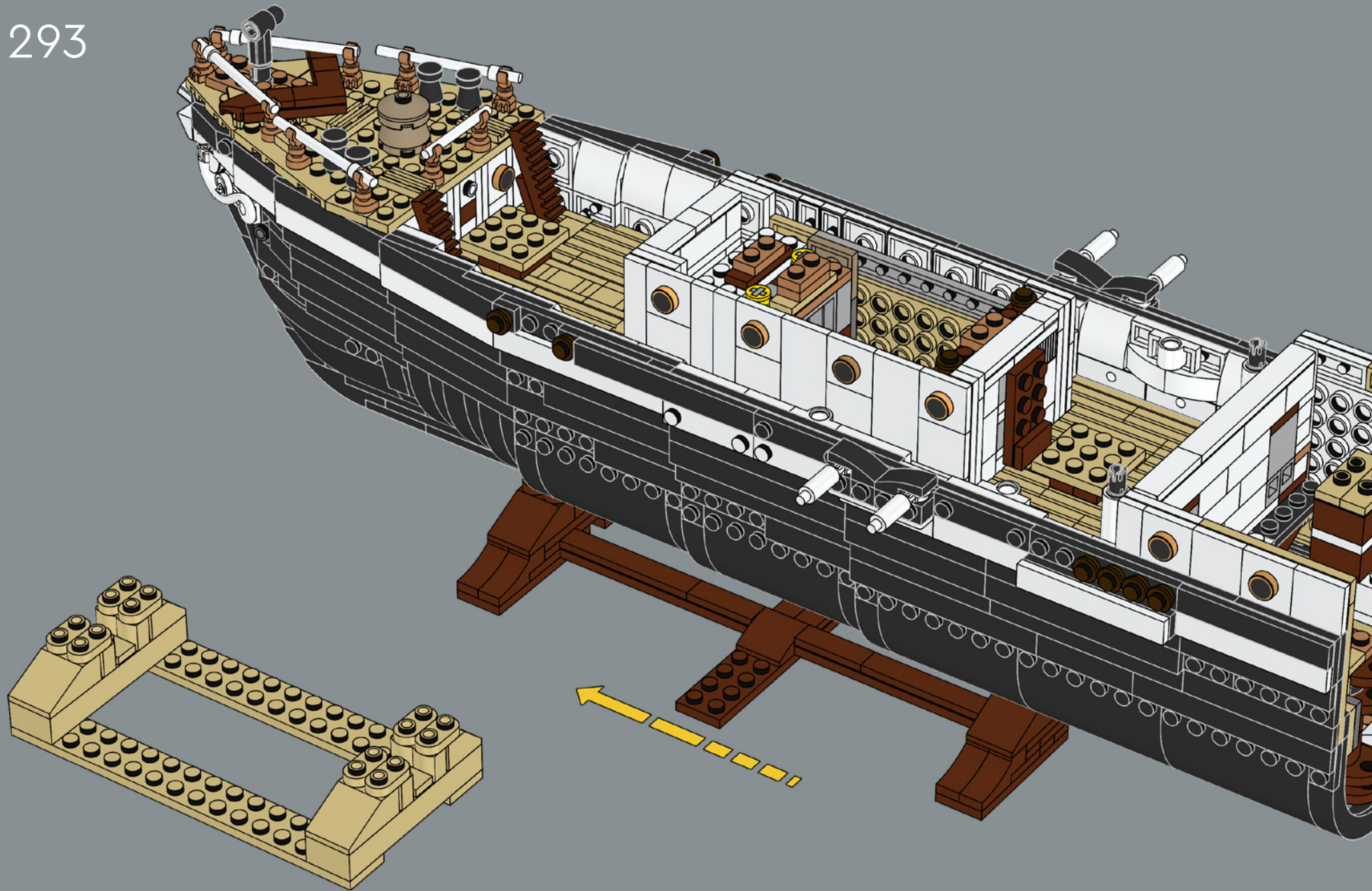

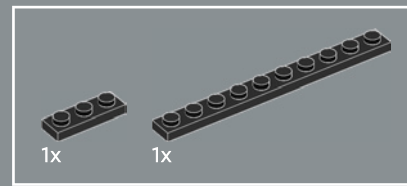
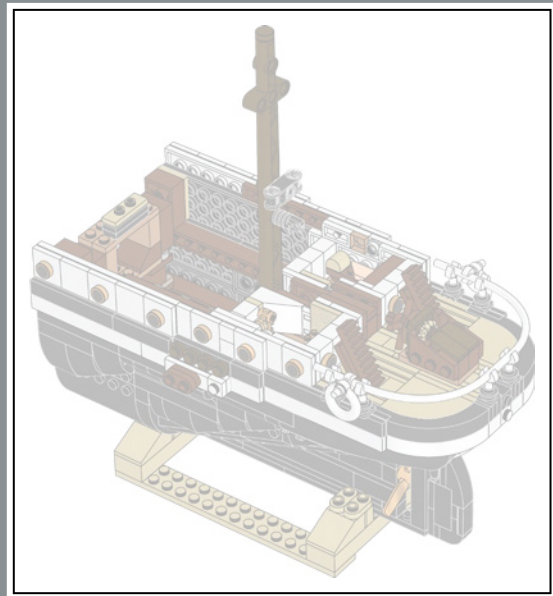
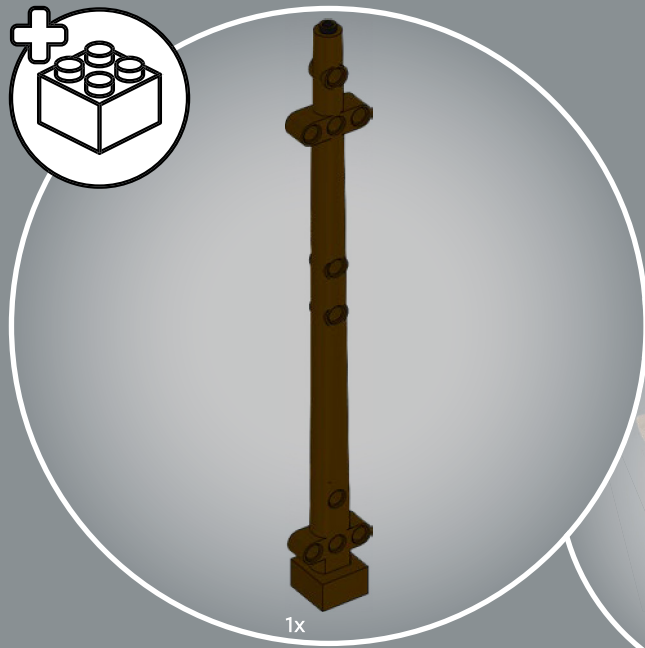
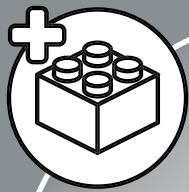

294

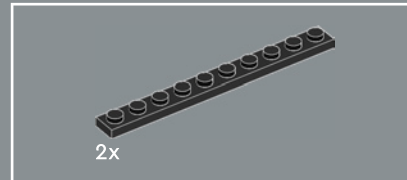
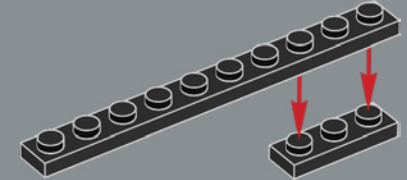

295

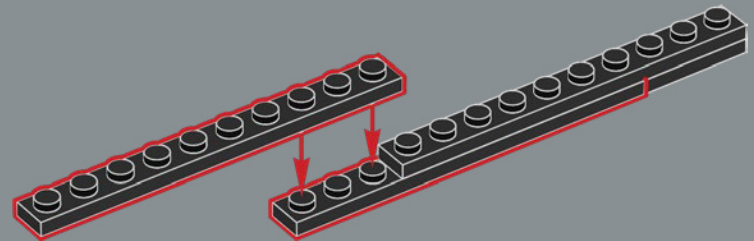

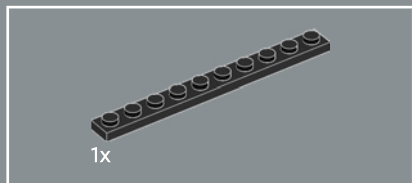

296

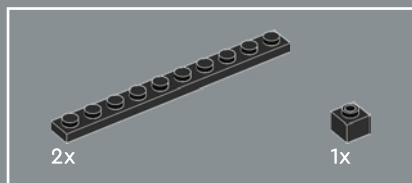
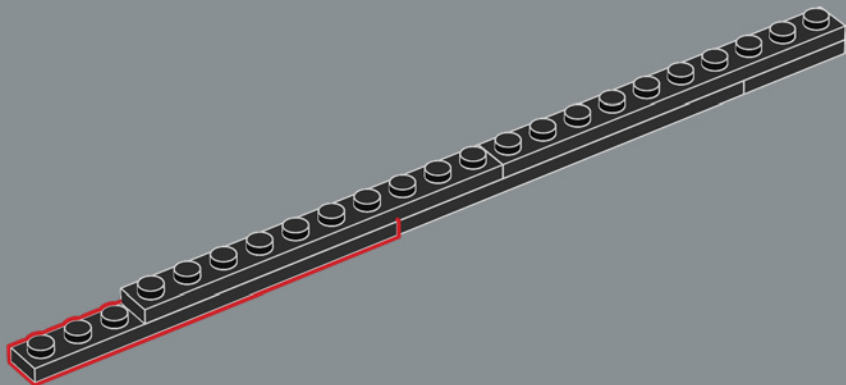

297

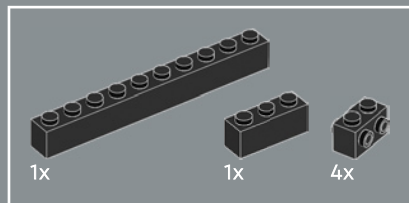
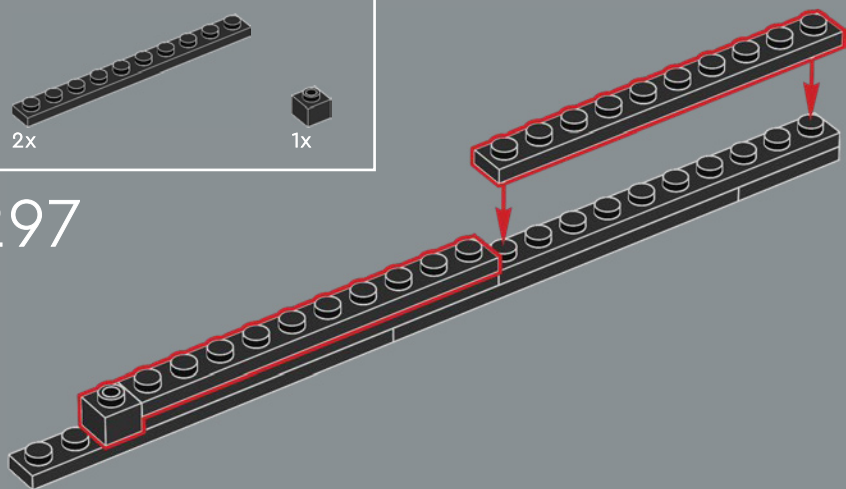

298

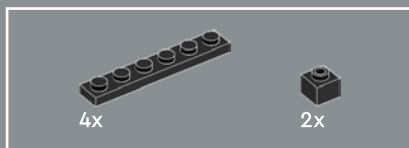
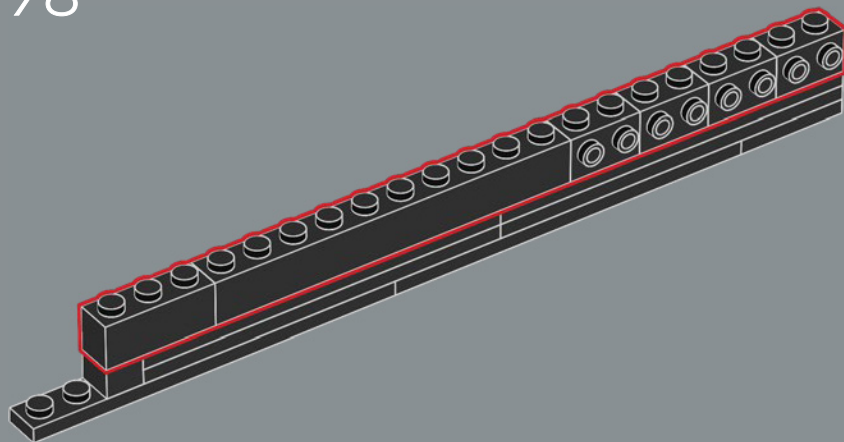

299

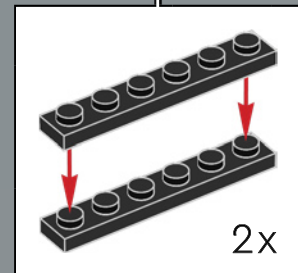
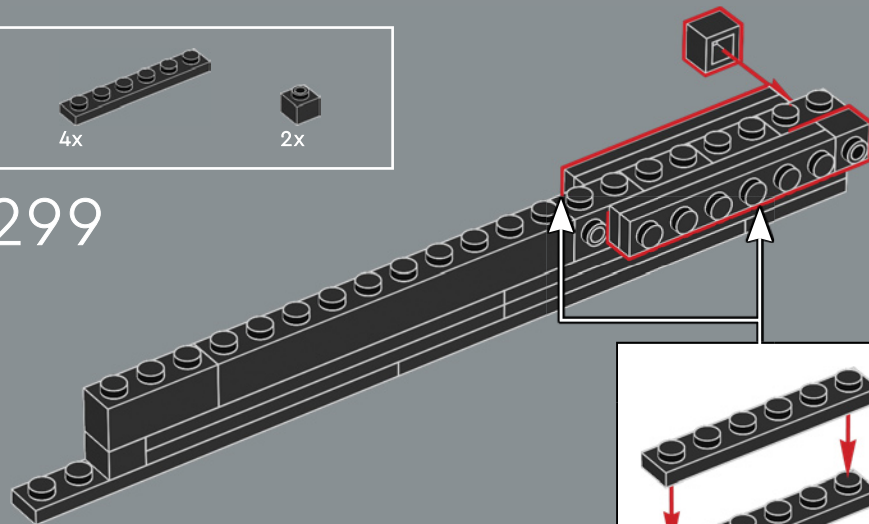

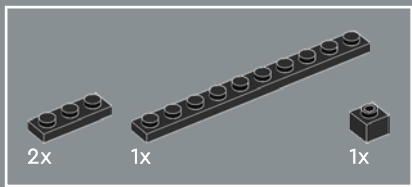

300

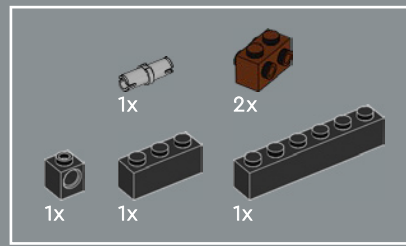
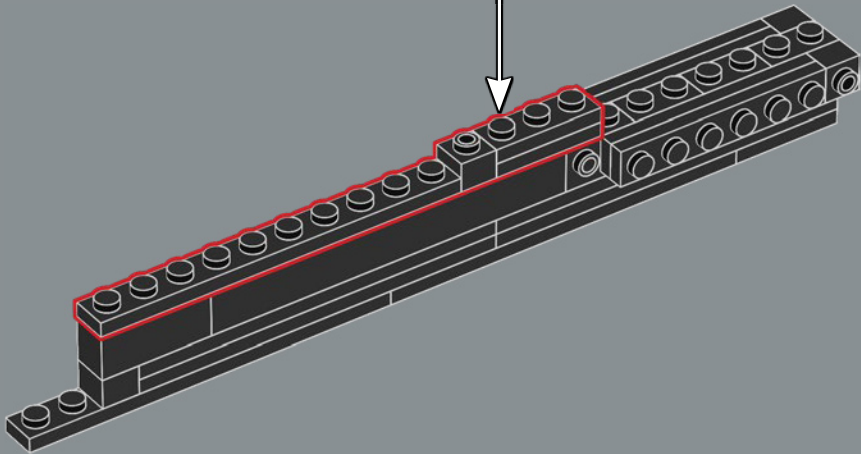
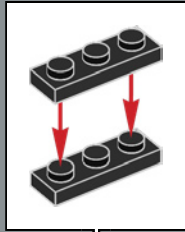

301

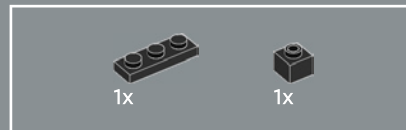
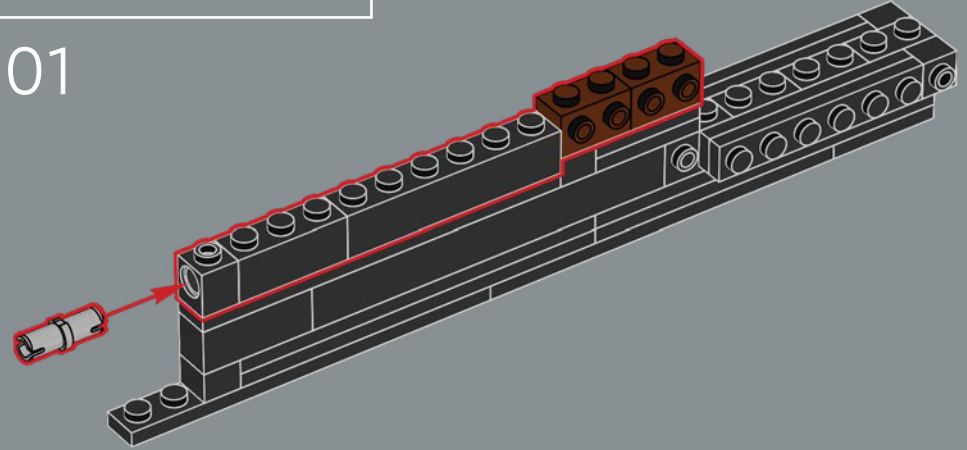

302

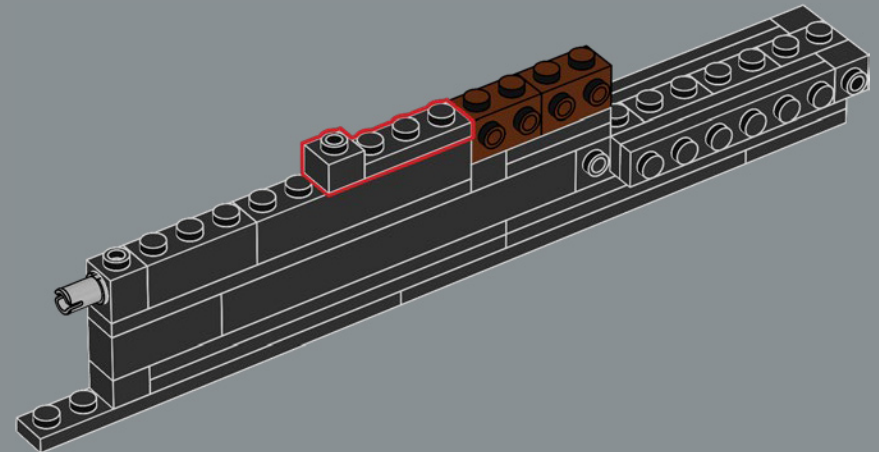

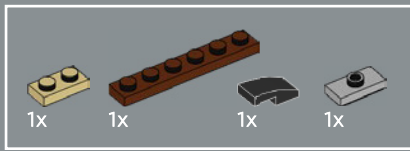

303

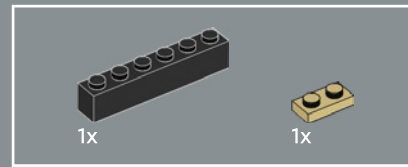
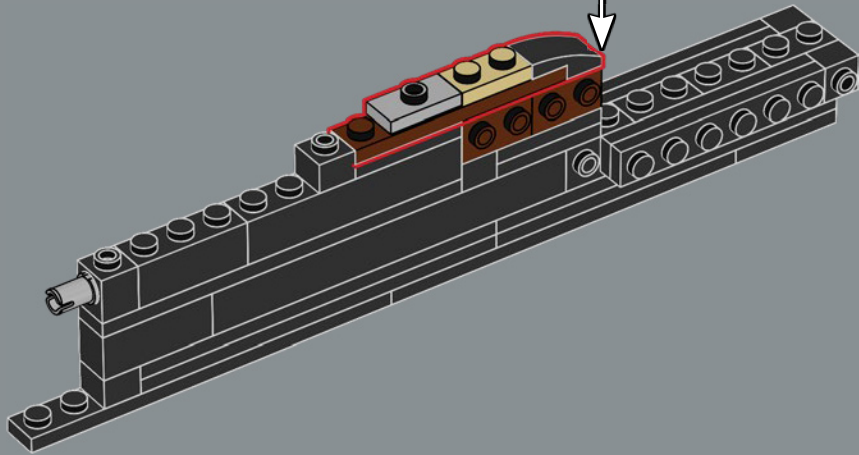
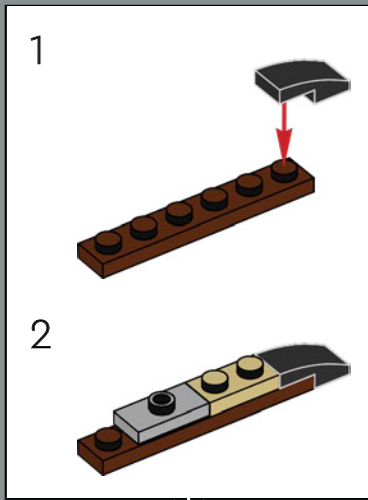

304

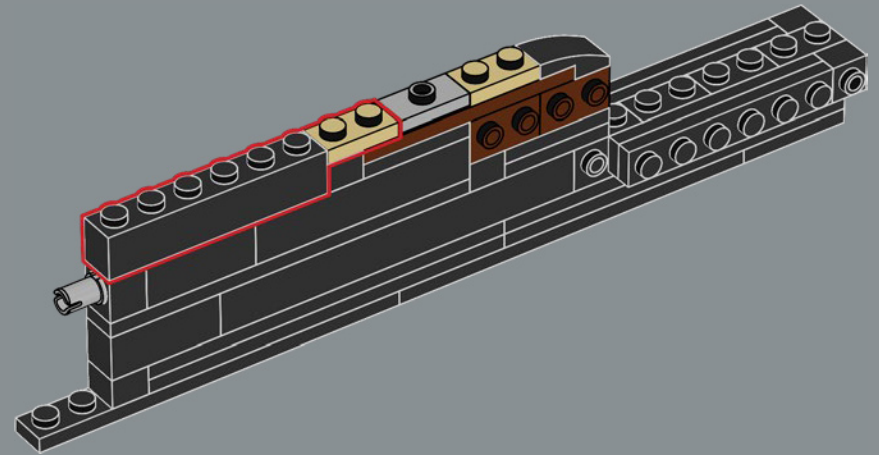



305

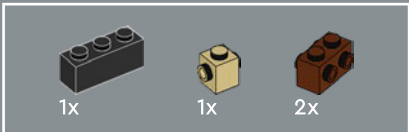
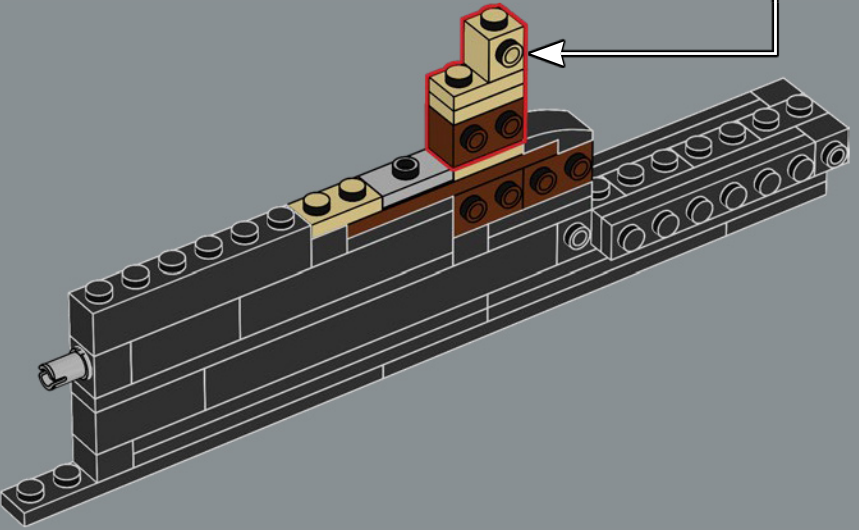
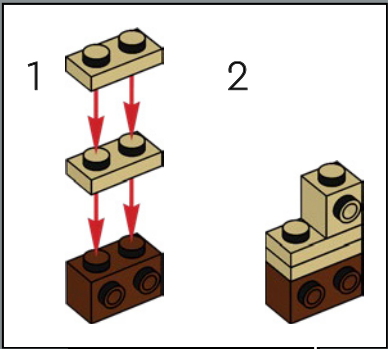

306

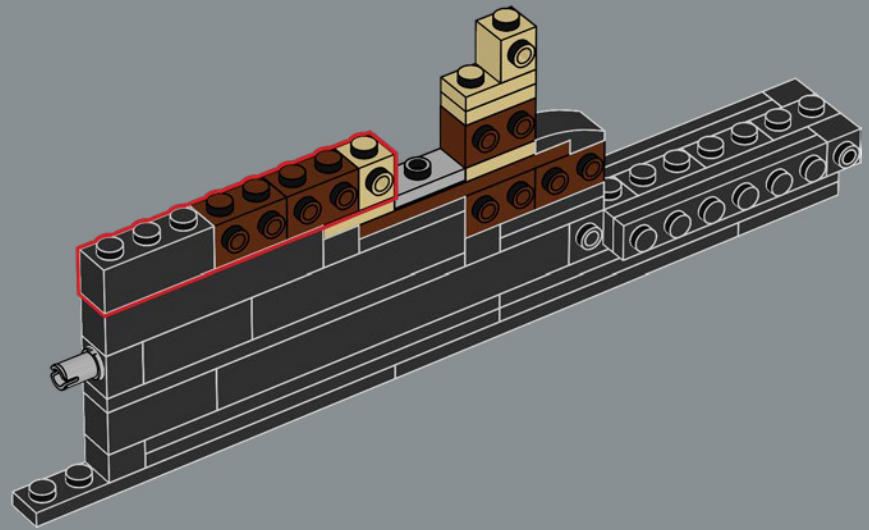

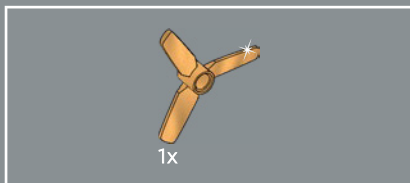

★
在真实的坚忍号上，螺旋桨是黑色的，
而相应的乐高®组件采用模塑金色，
使其从黑色船体中凸显出来。

307

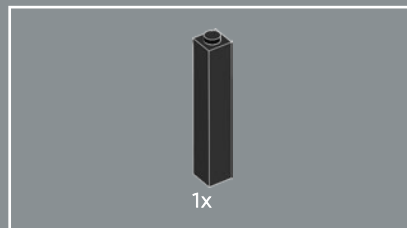
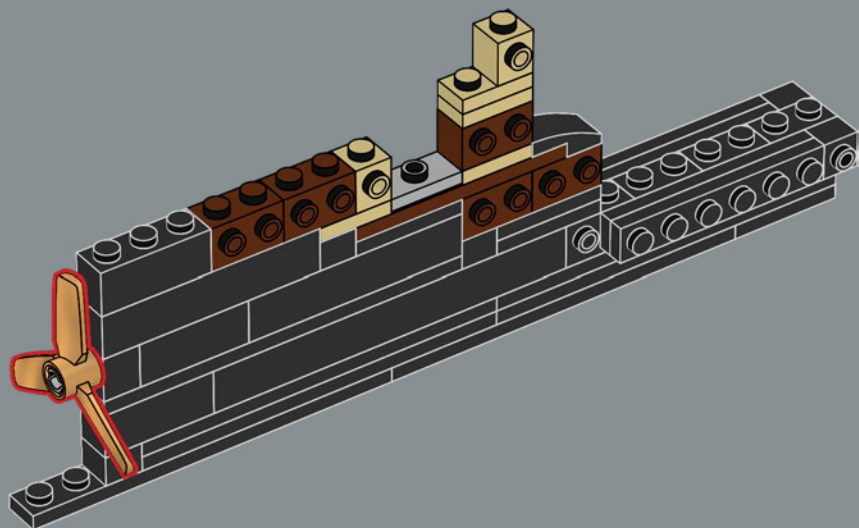

308

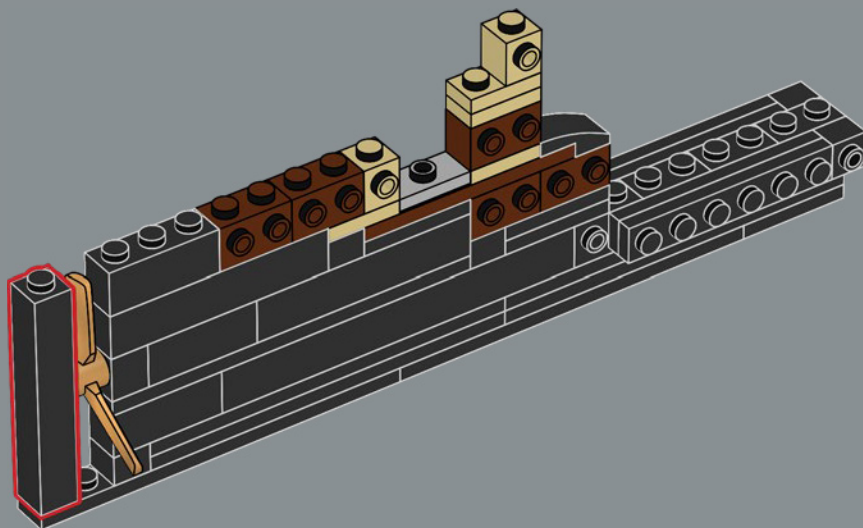

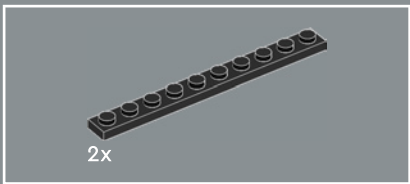

309

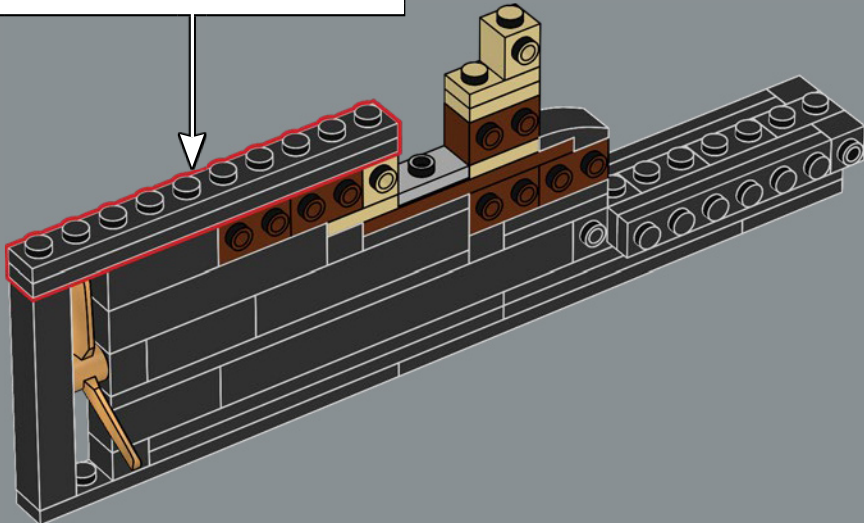
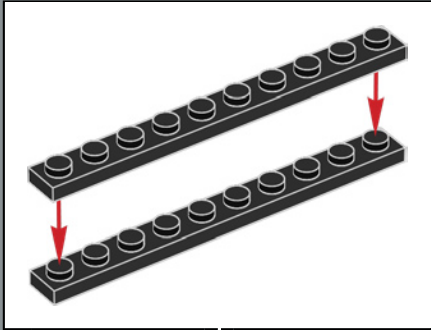

310

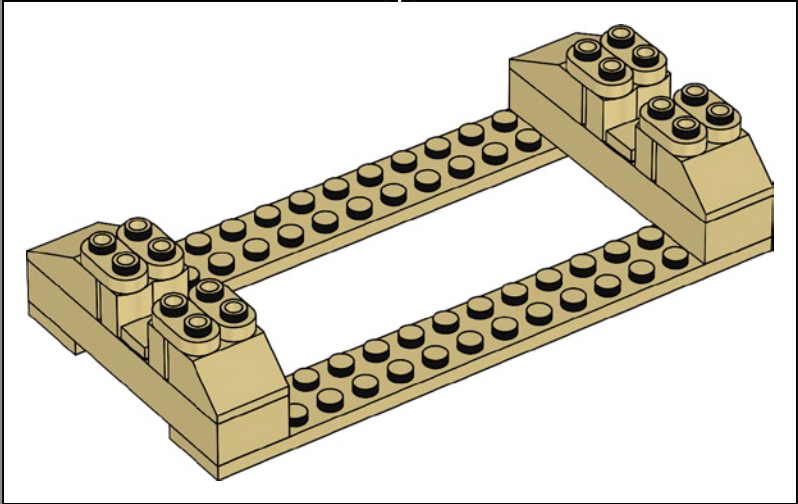
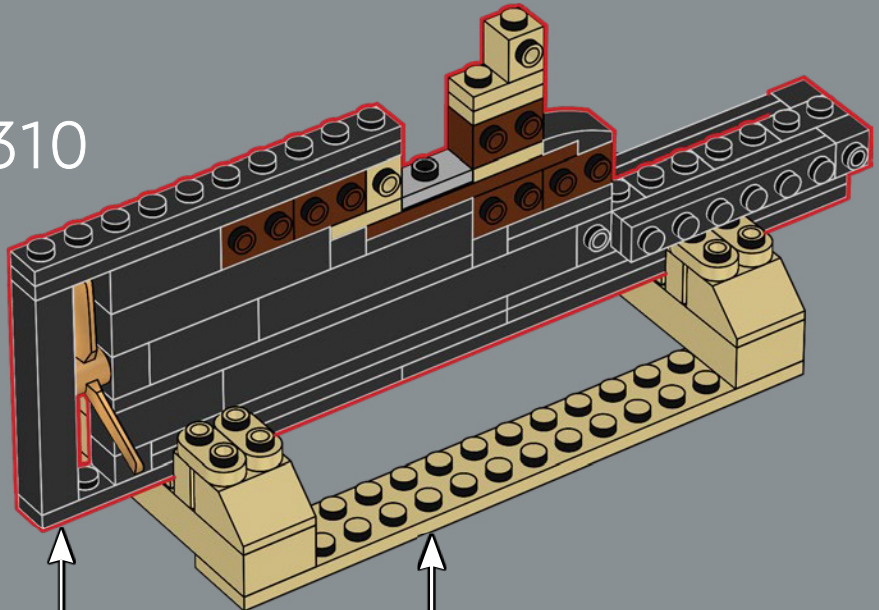

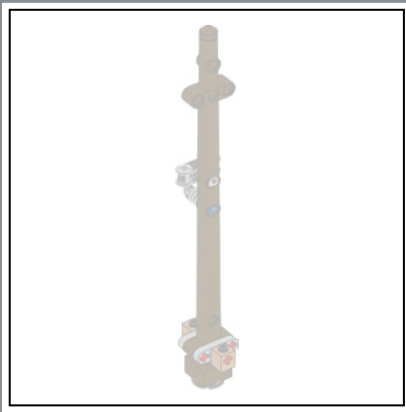

1



2

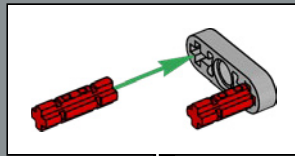

3

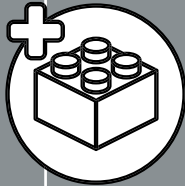
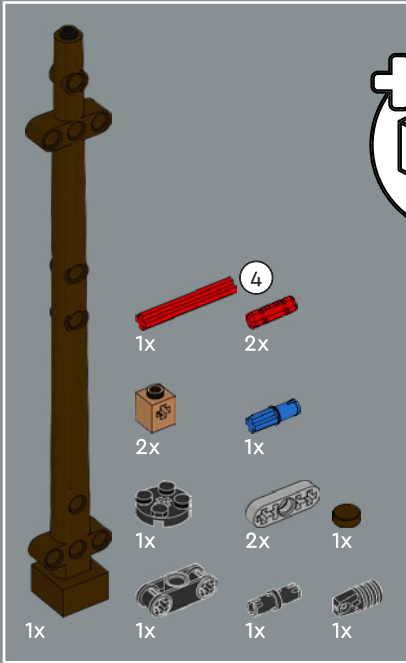
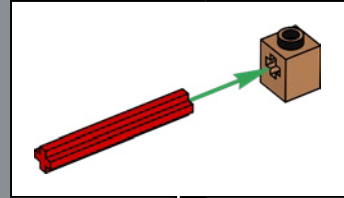

311

4

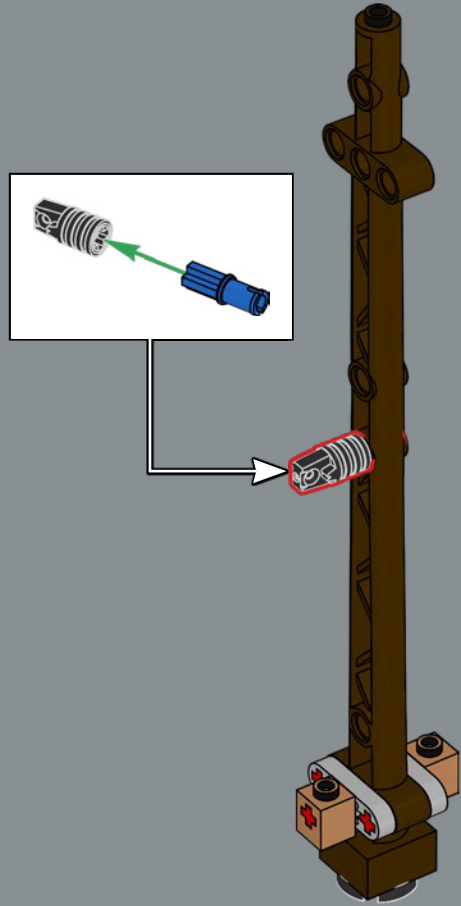

5

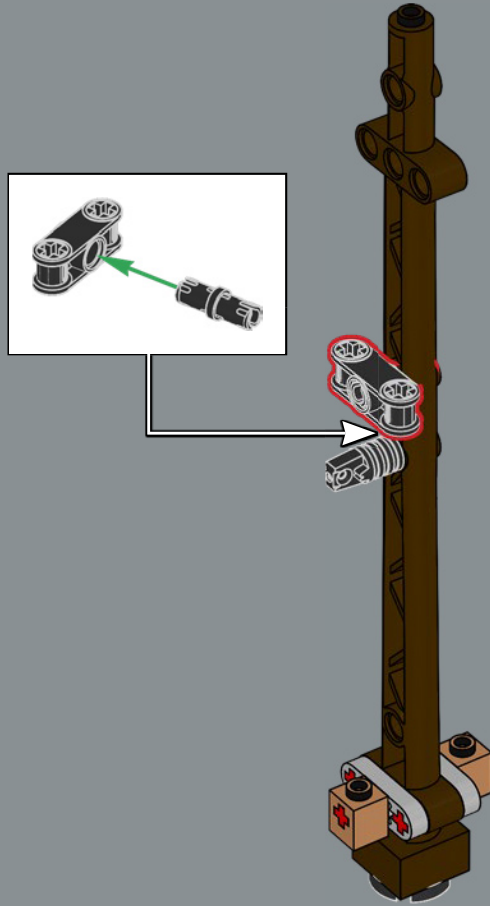

6

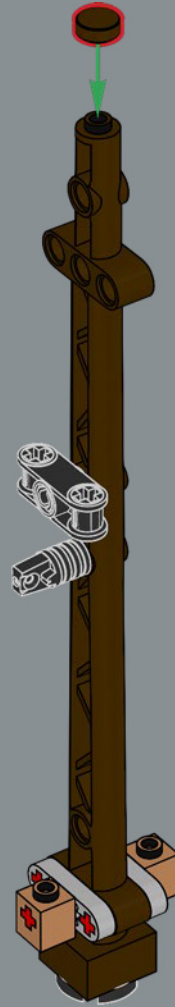

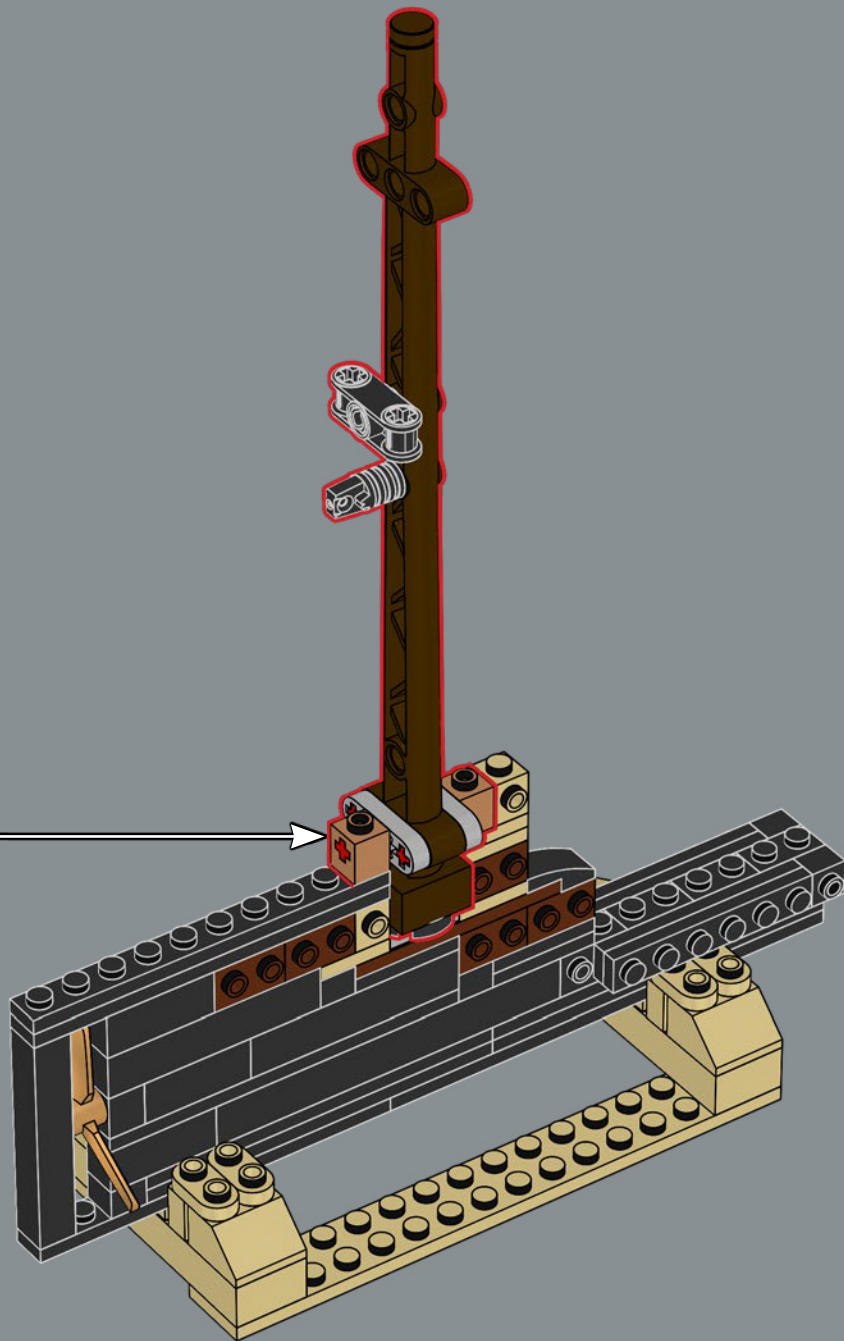

- 4x
- 1x
- 1x

312

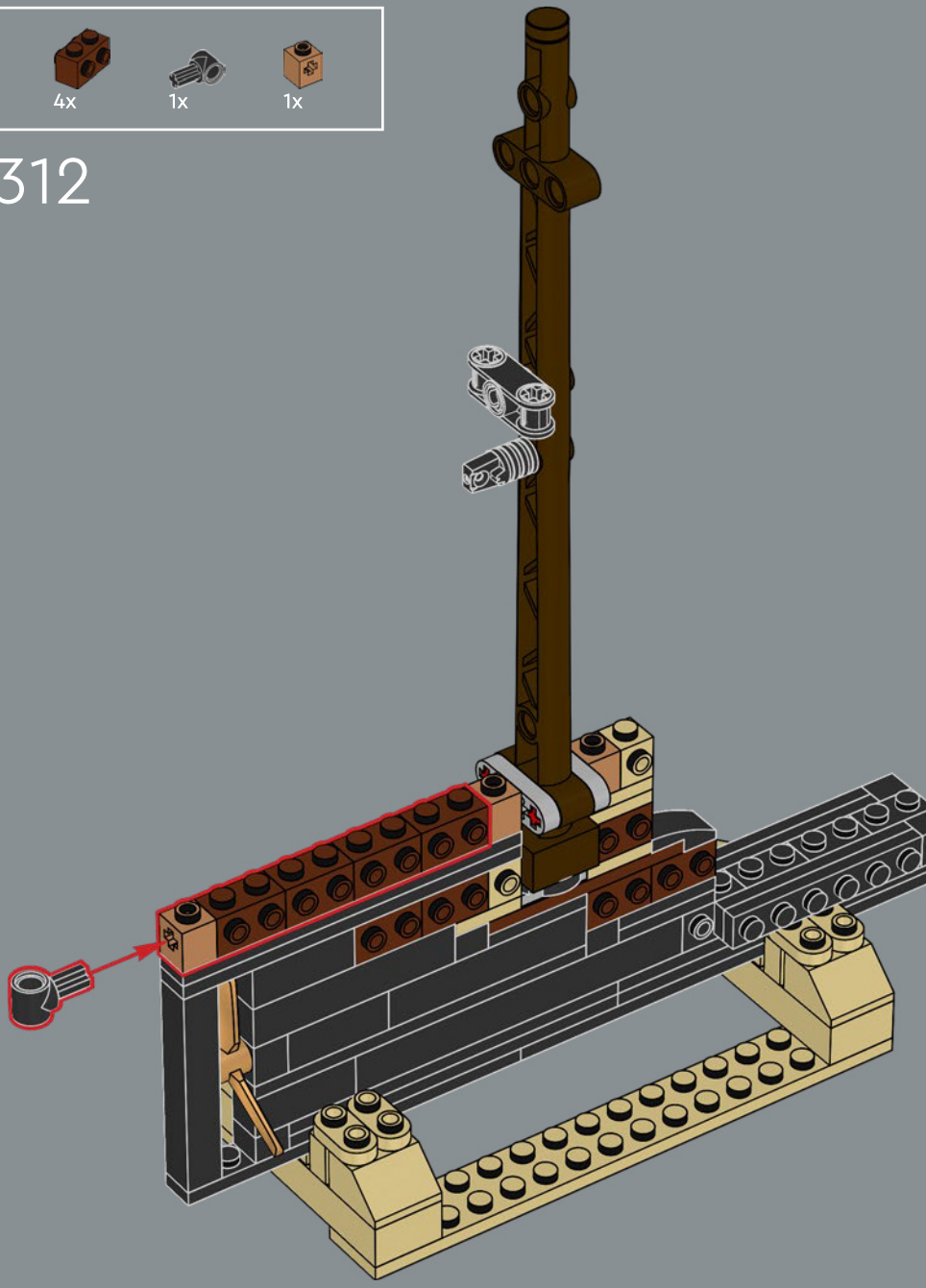

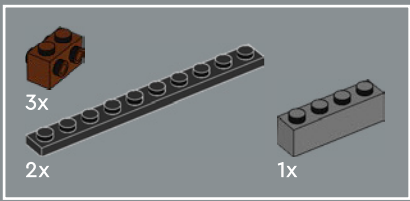

313

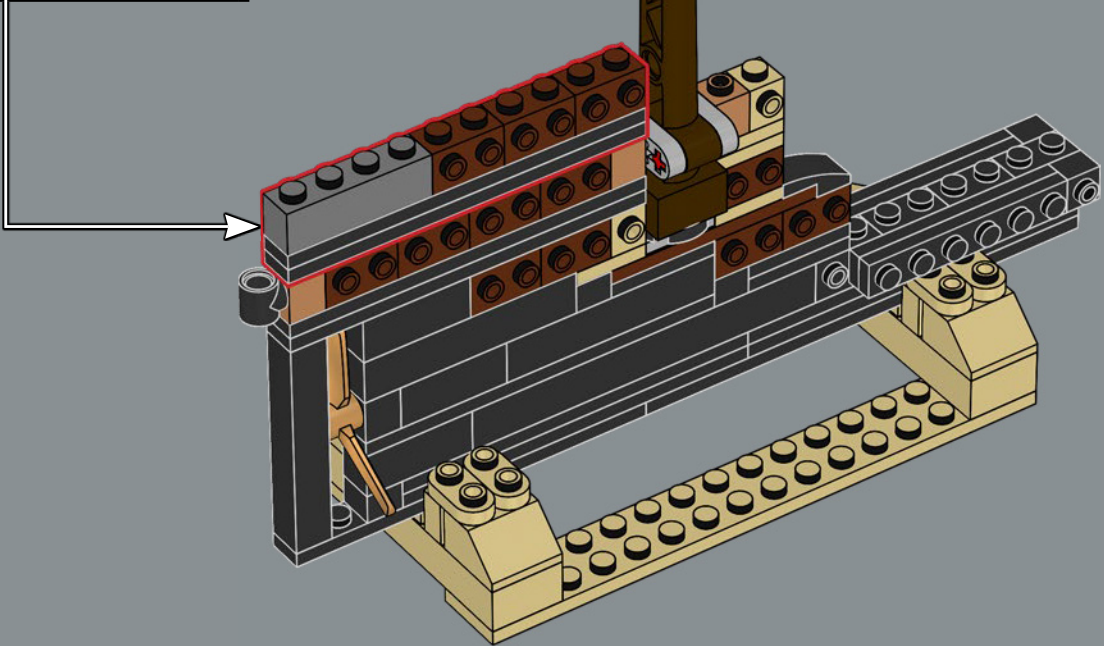
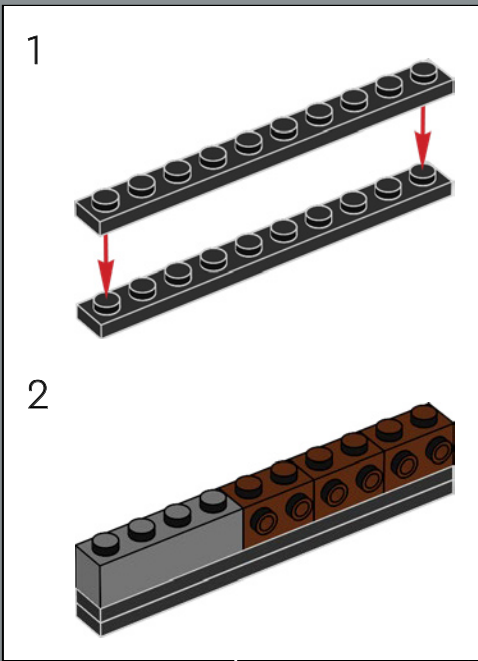

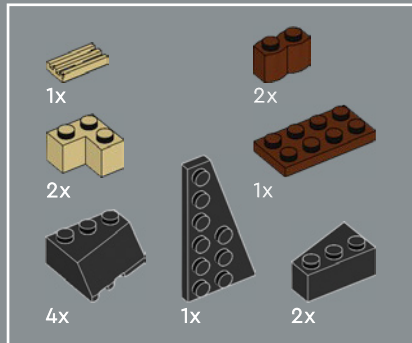
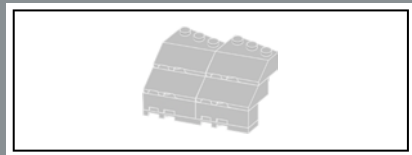

314

1

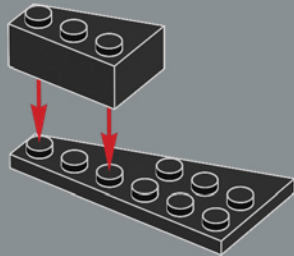

2

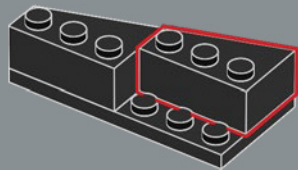

3

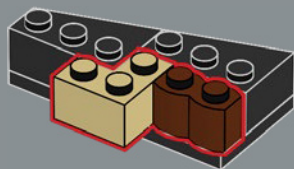

4

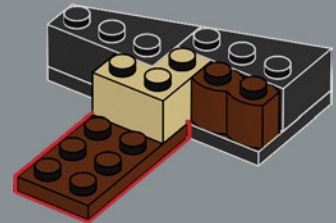

5

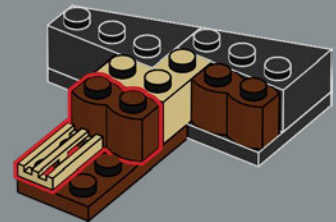

6

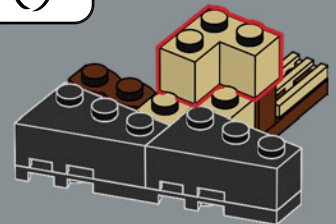

7

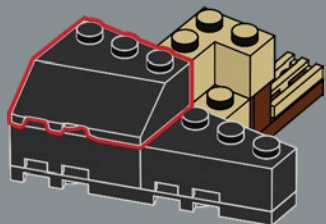

8

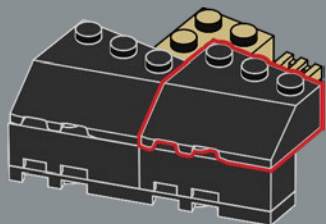

9

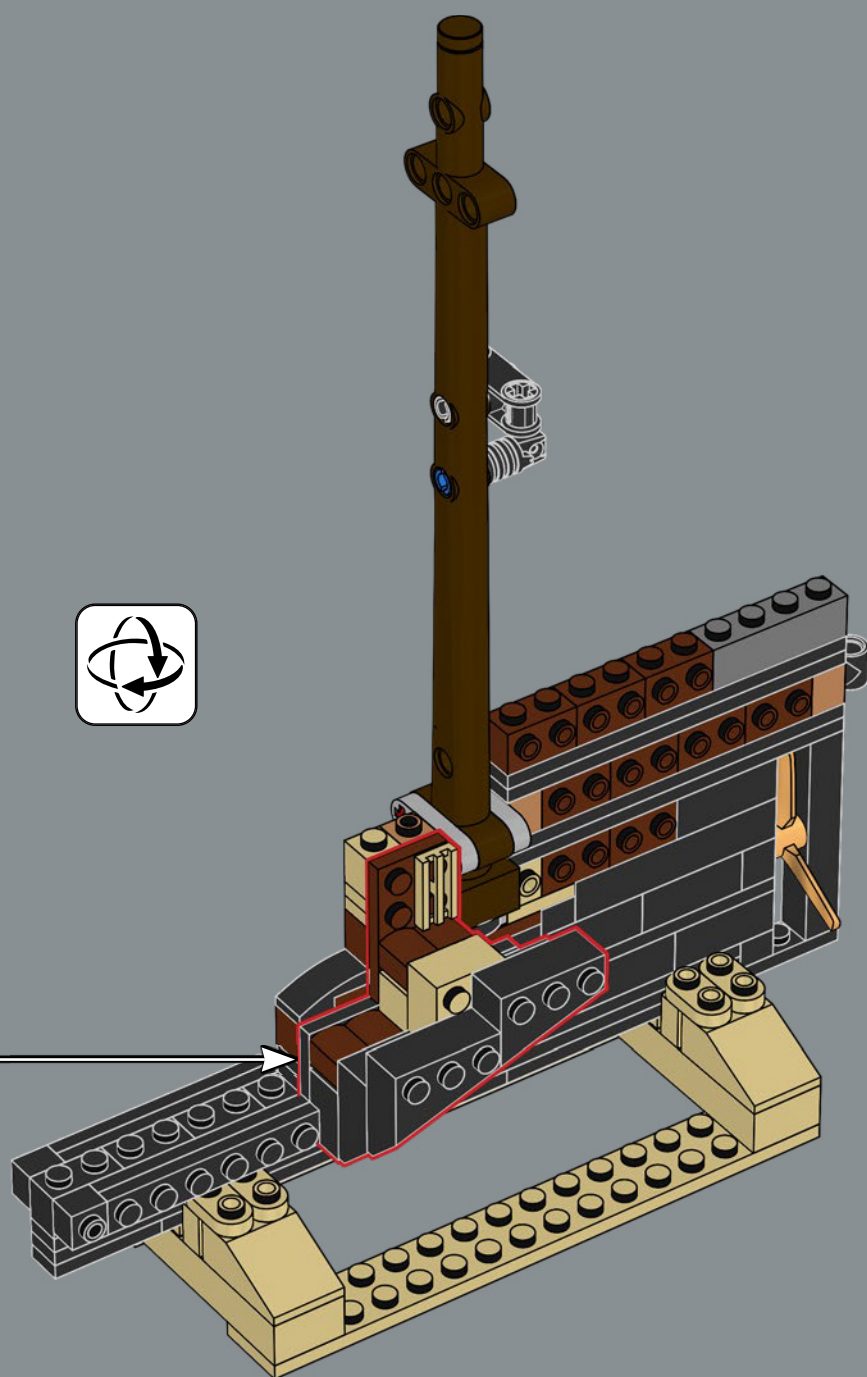
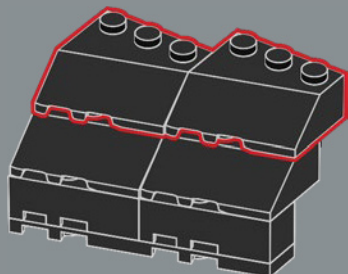

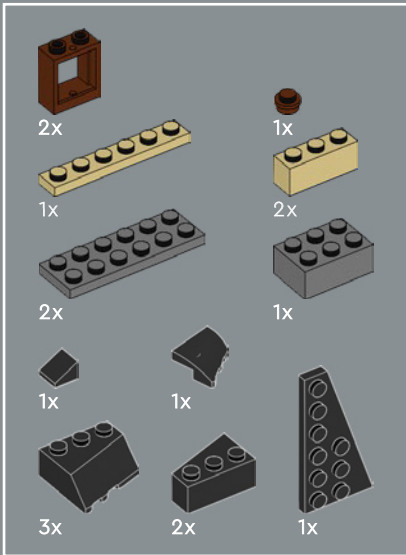
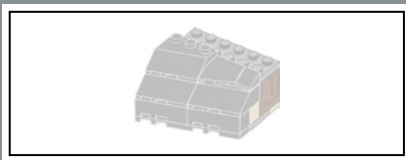

315

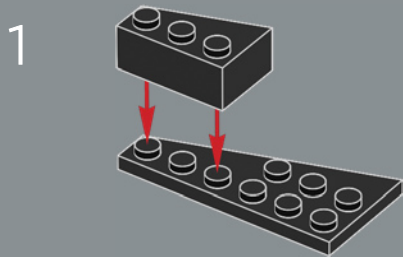

2

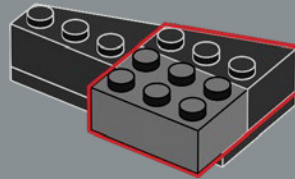

3

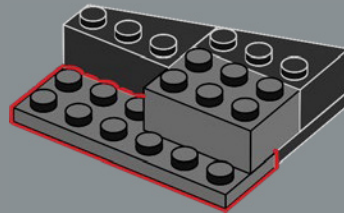

4

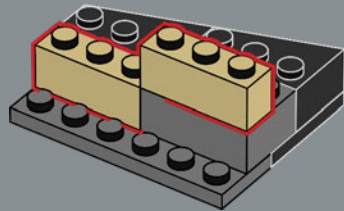

5

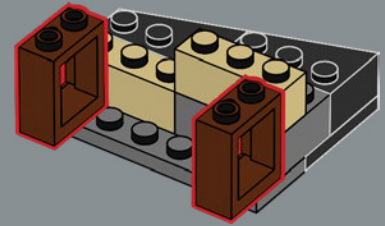

6

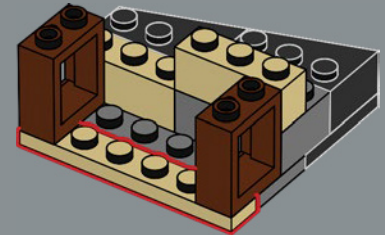

7

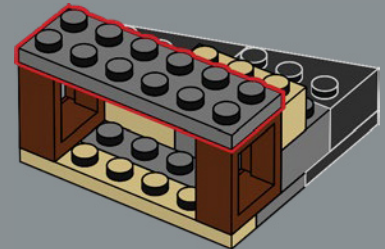

8

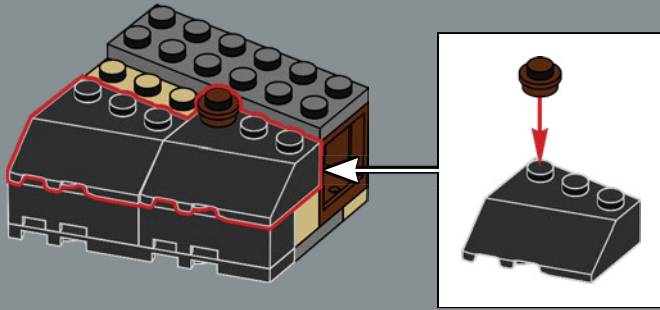

9

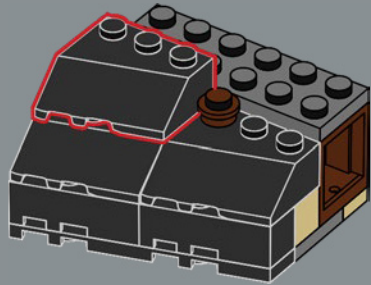

10

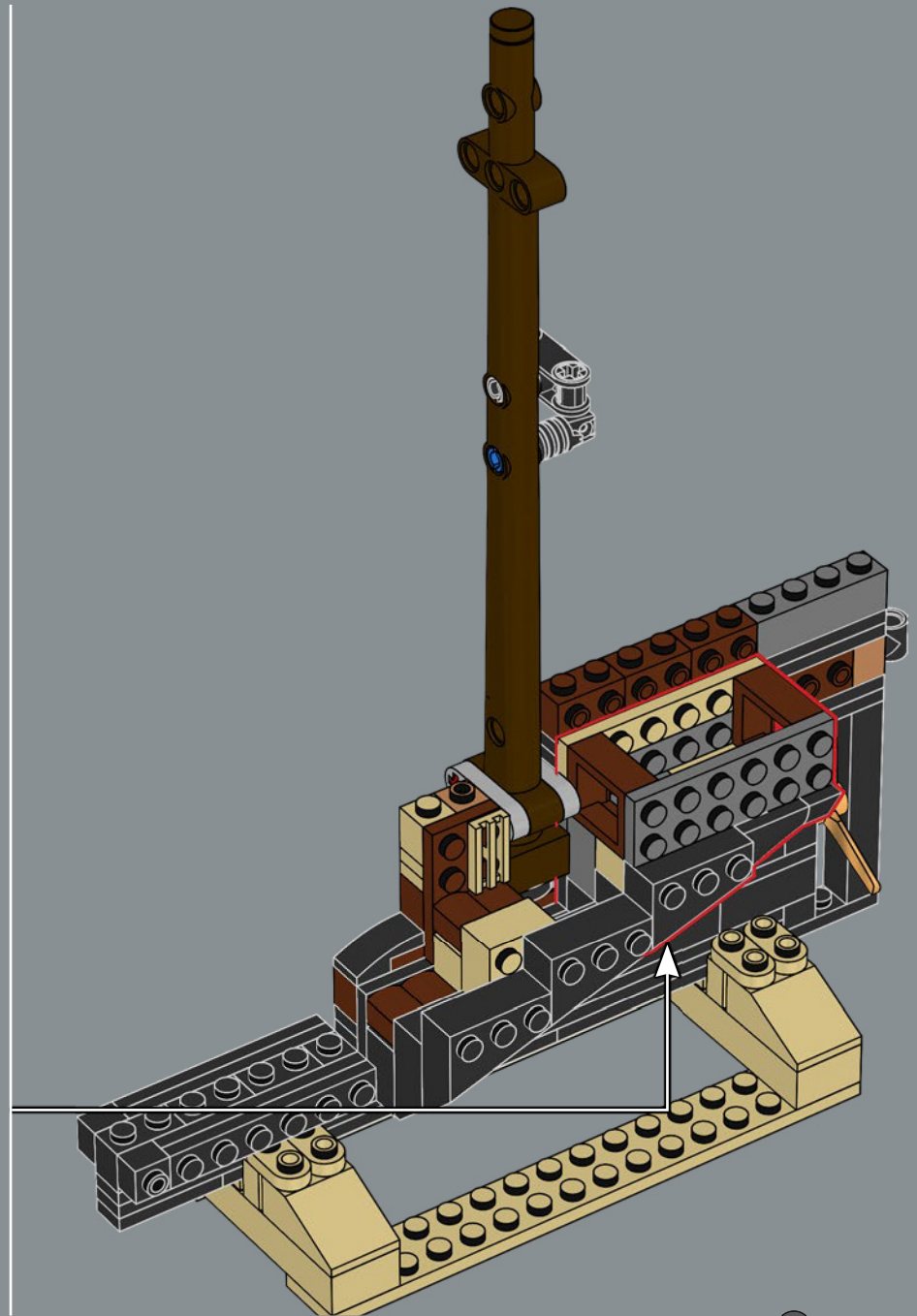
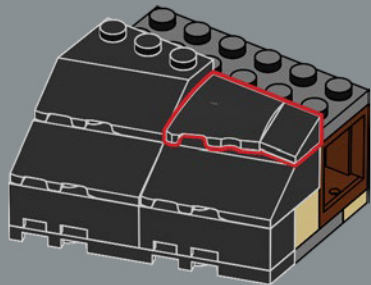

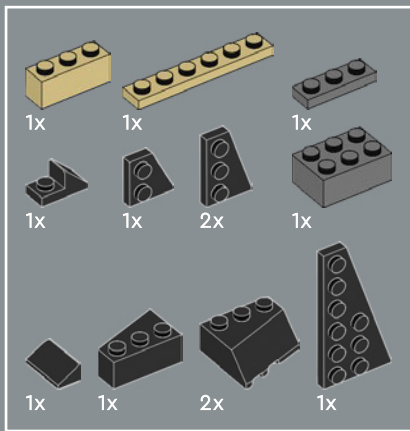

316

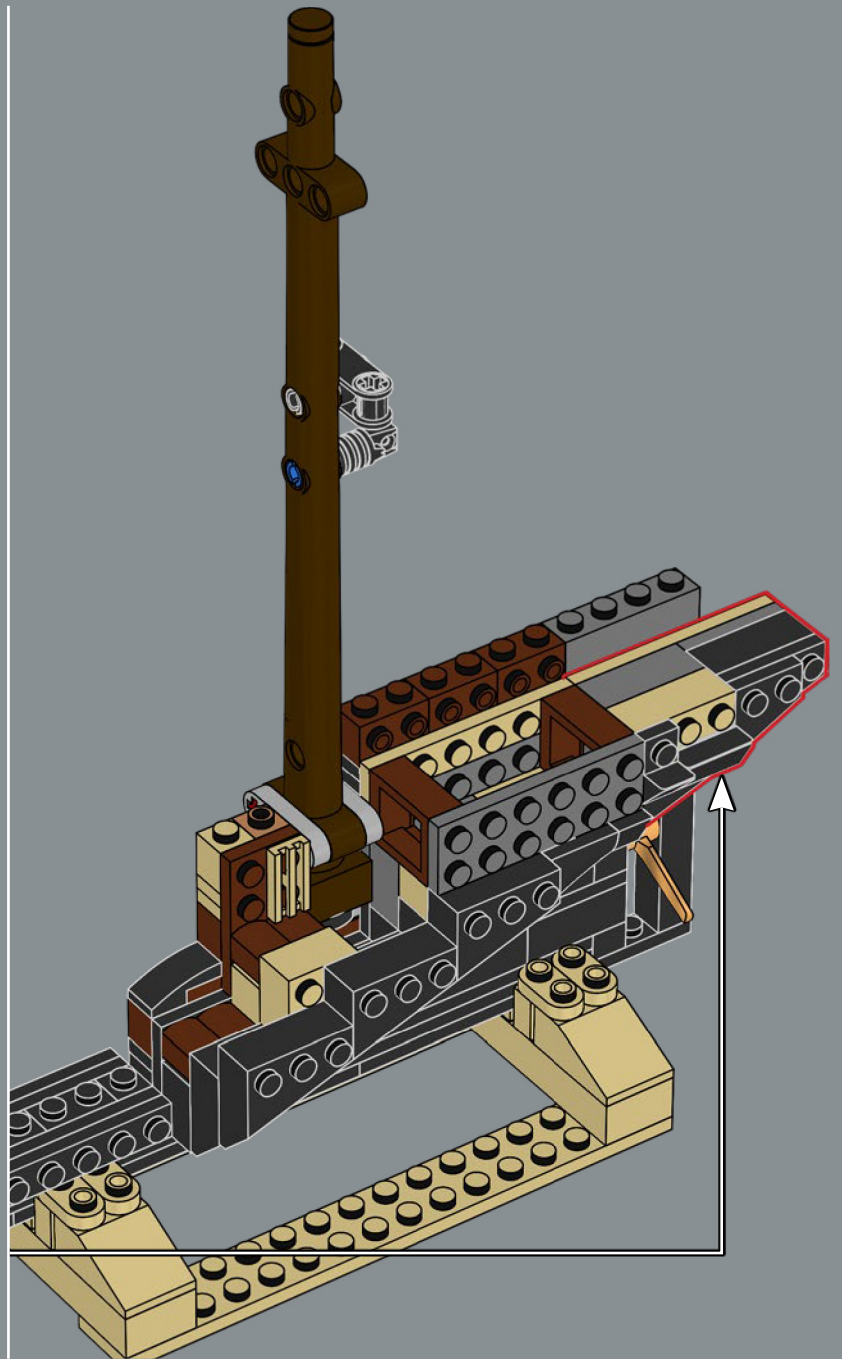
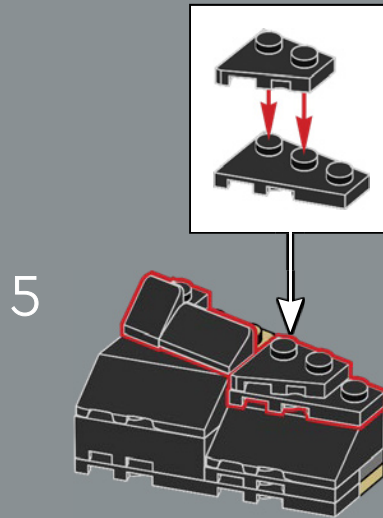
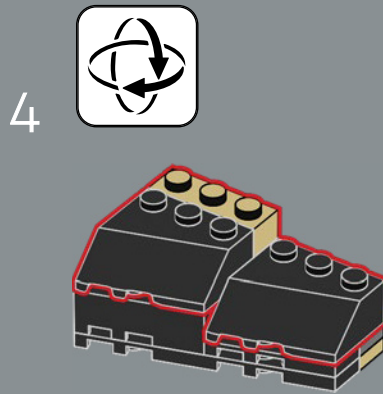
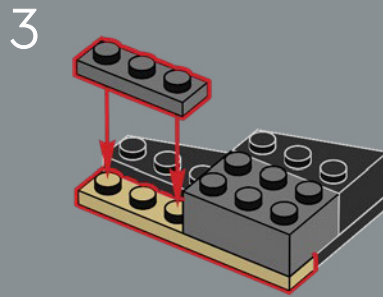
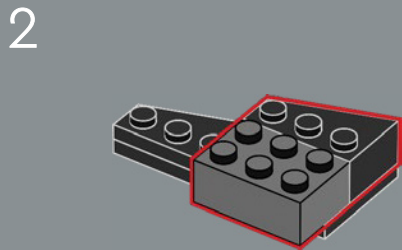
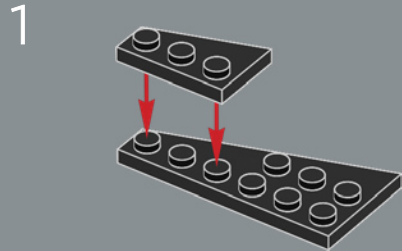

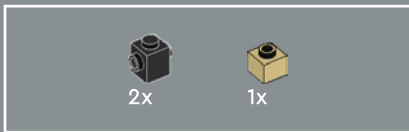

317

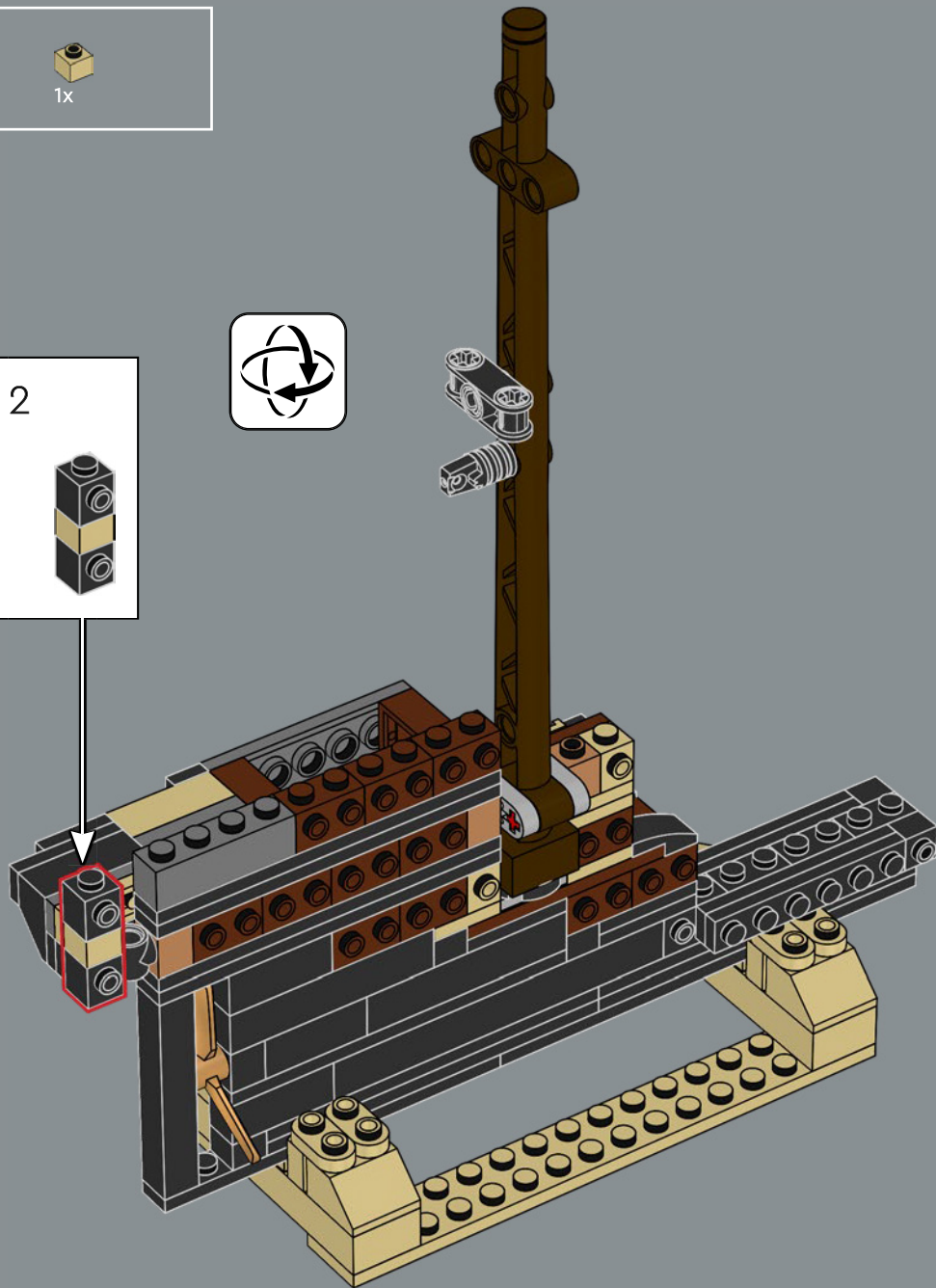
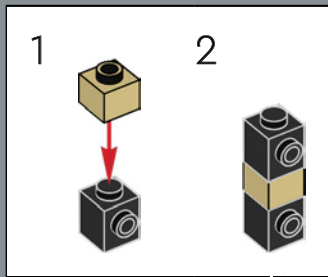

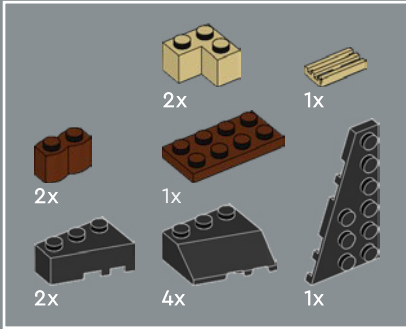
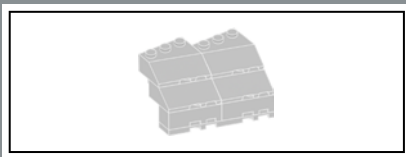

318

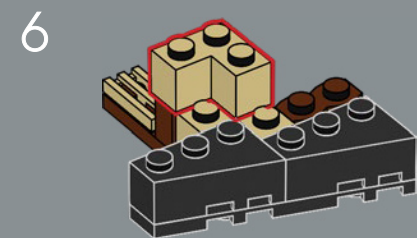
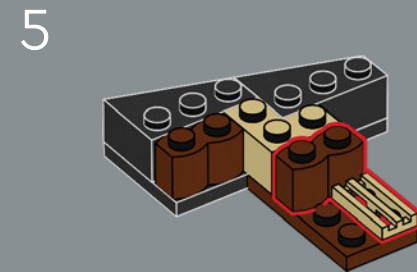
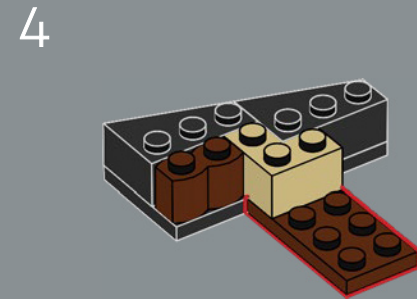
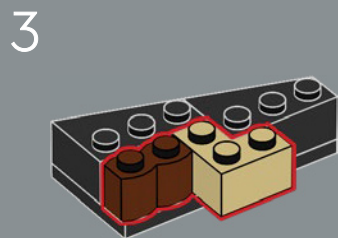
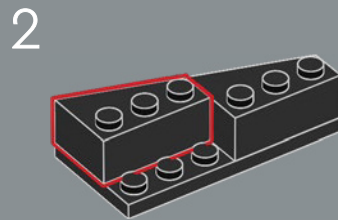
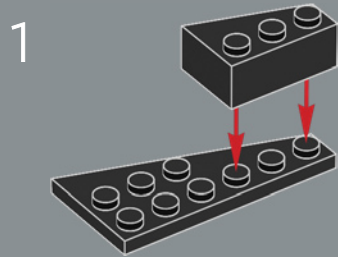

7

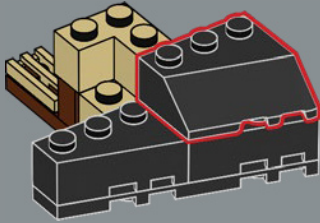

8

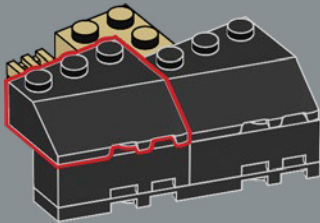

9

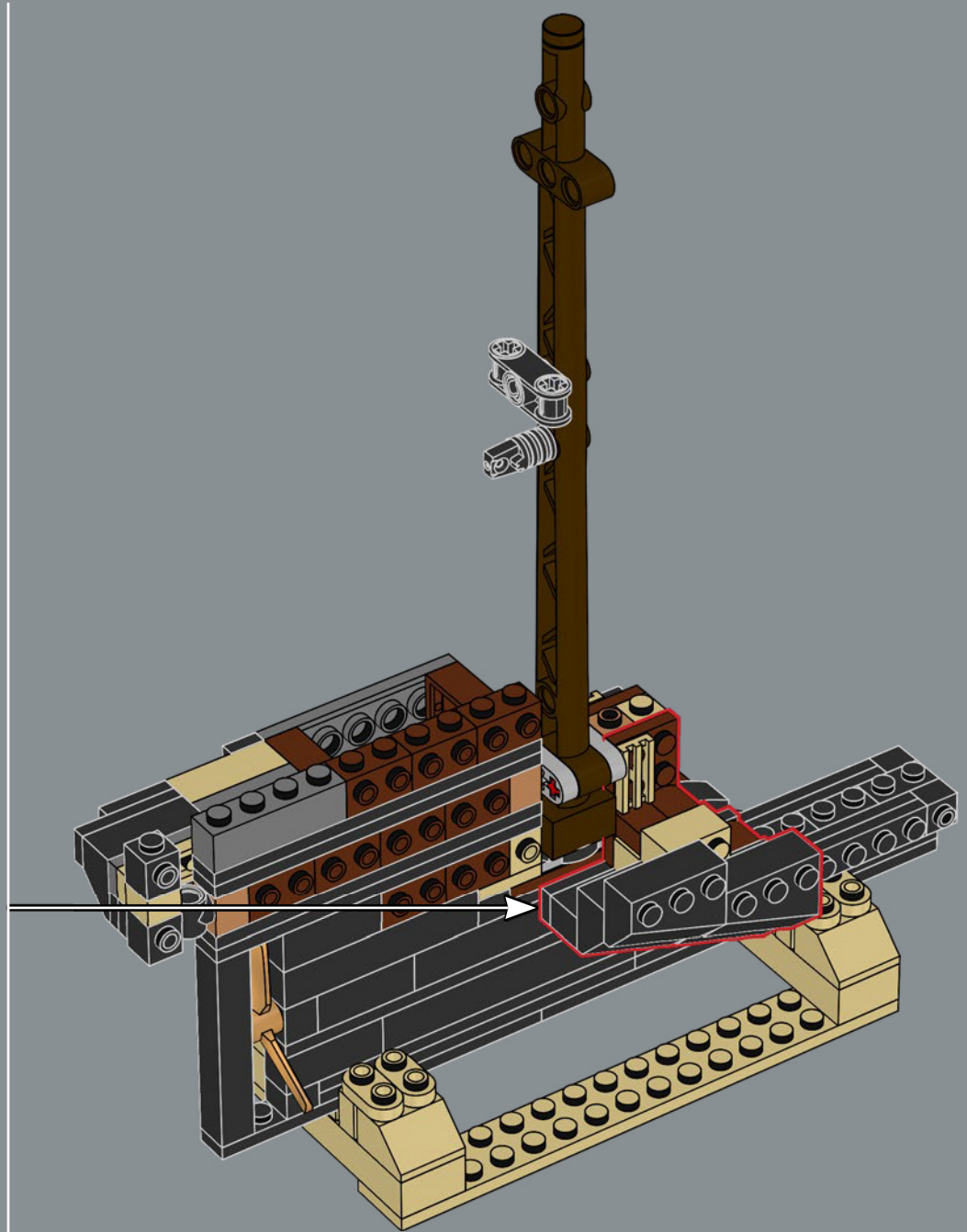
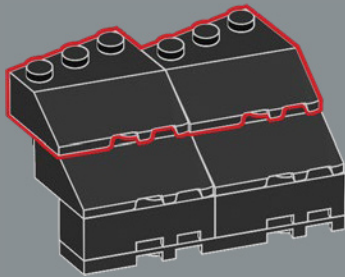

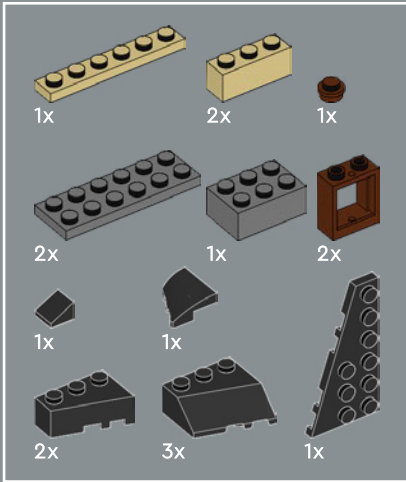
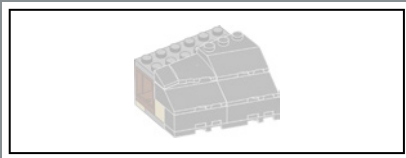

319

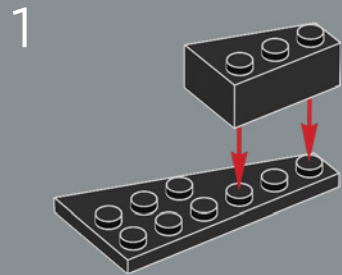

2

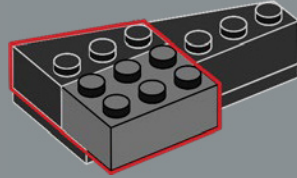

3

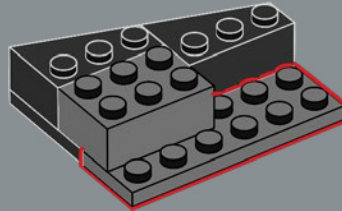

4

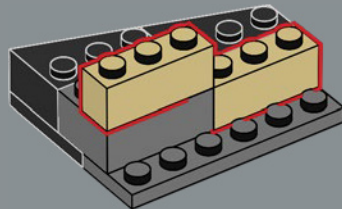

5

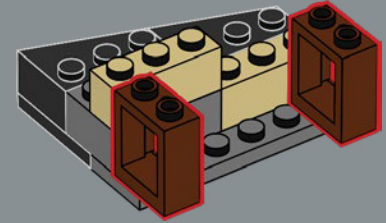

6

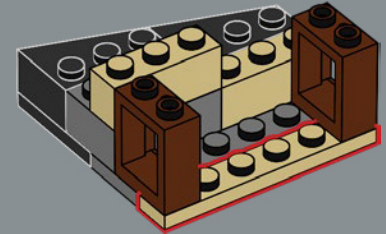

7

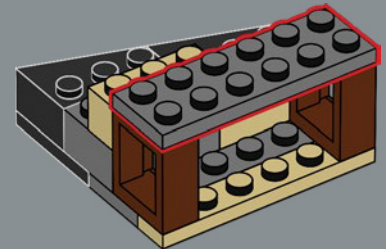

8

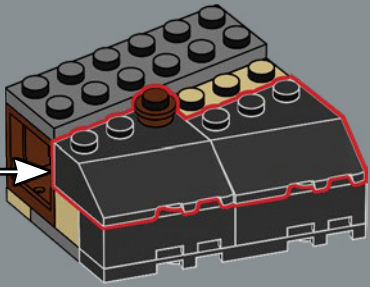
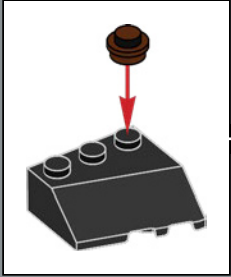

9

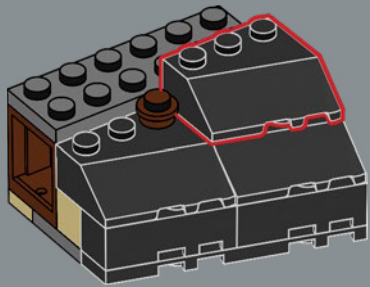

10

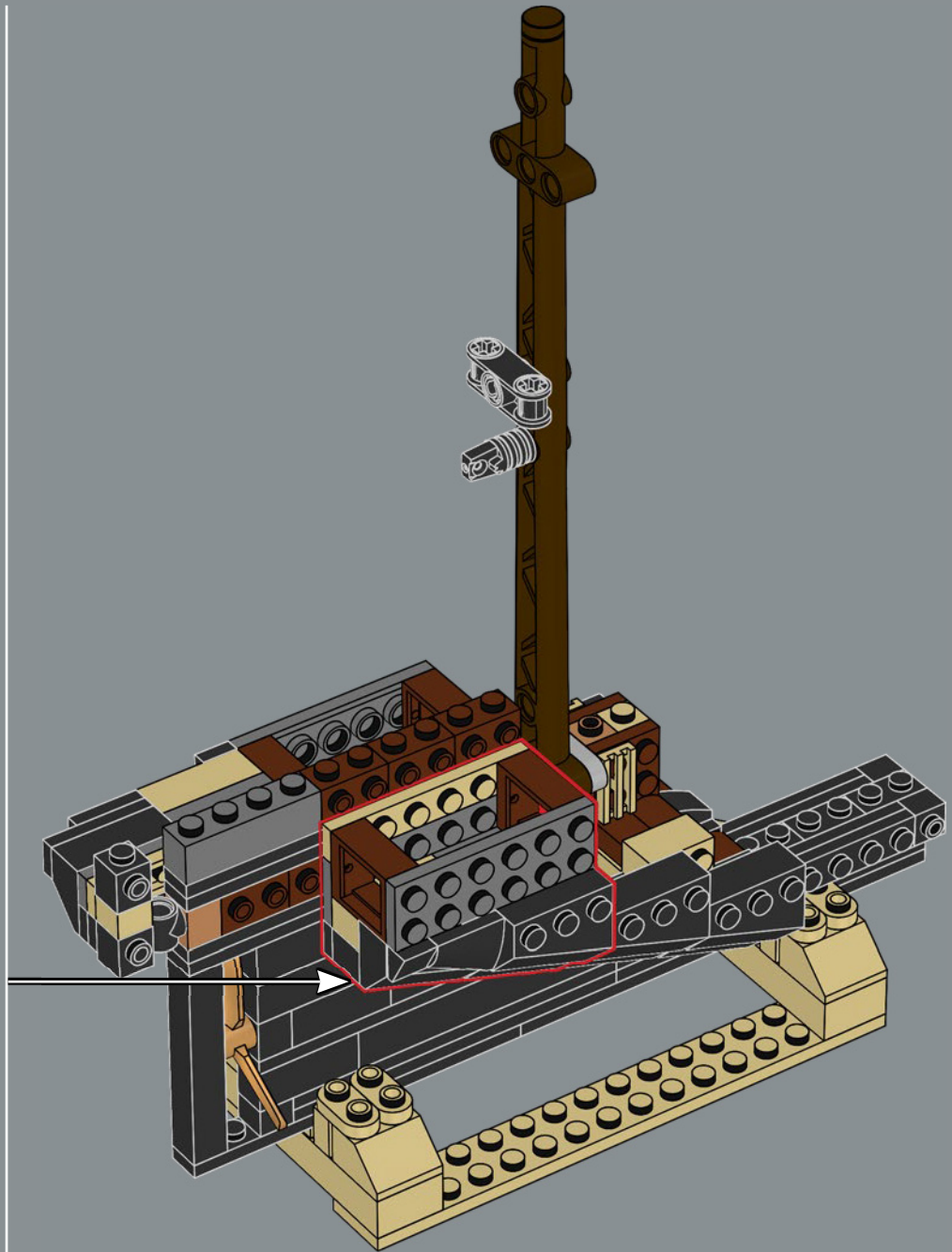
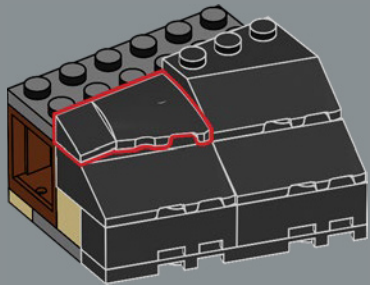

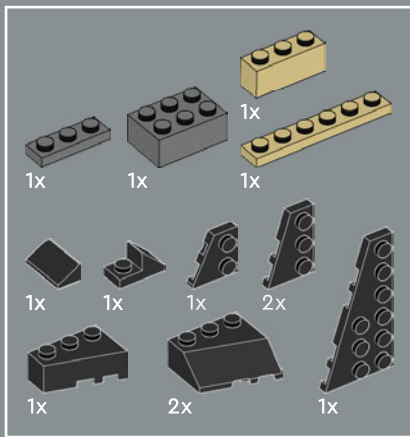

320

1

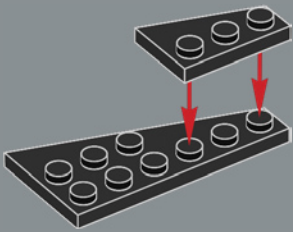

2

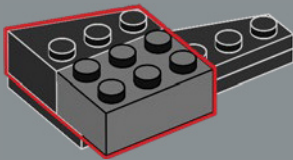

3

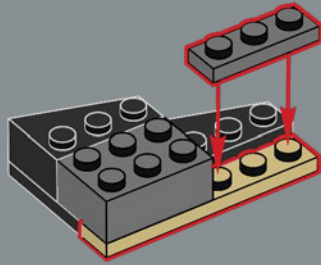

4

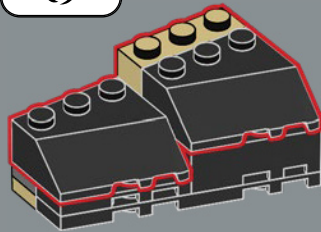

5

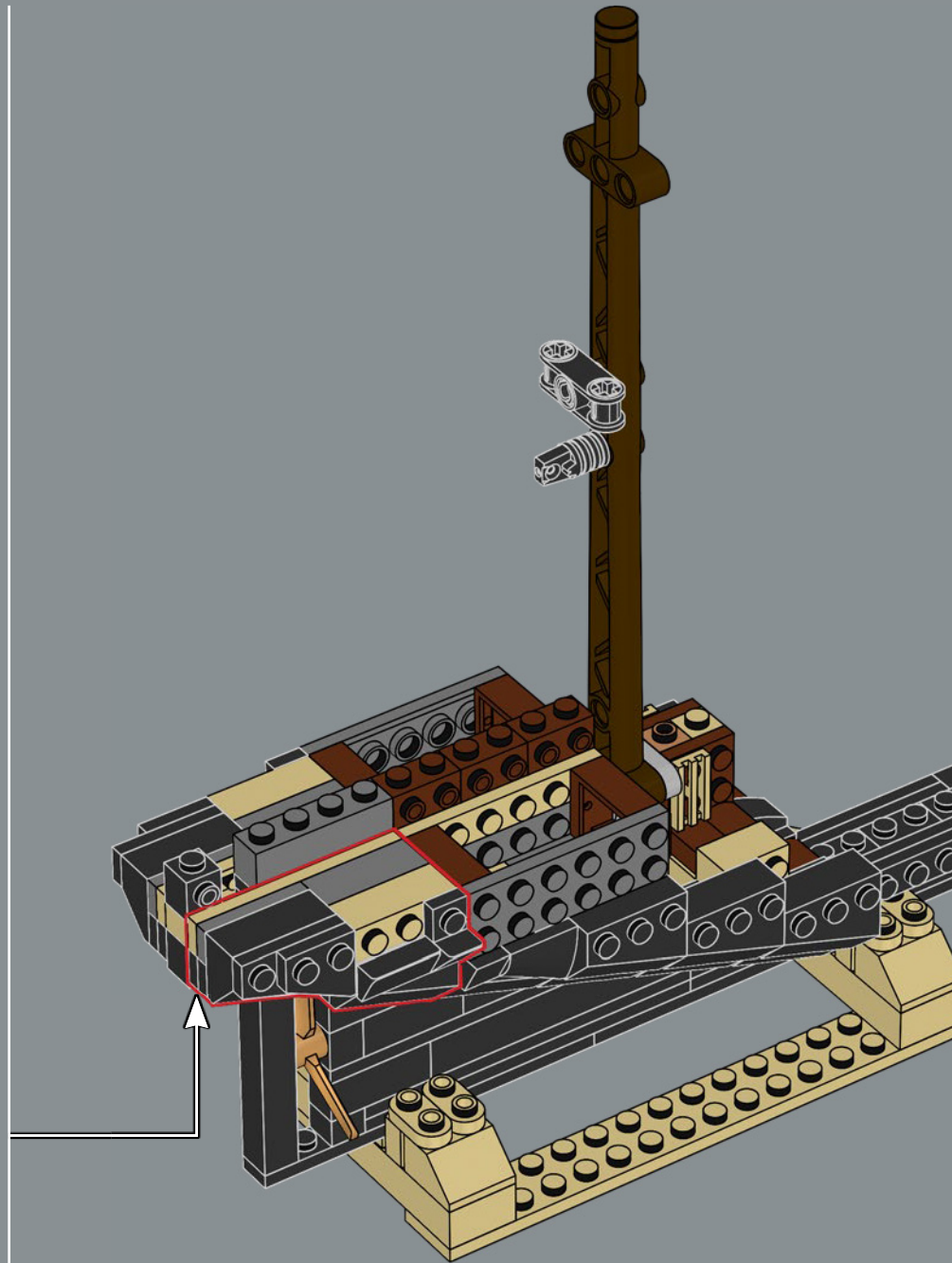
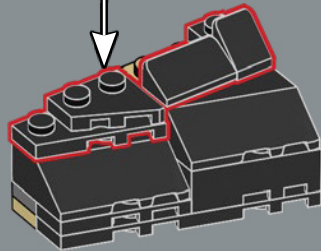
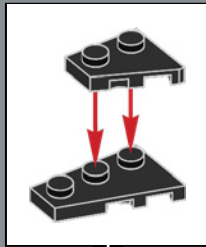

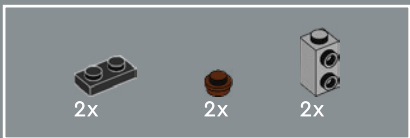

321

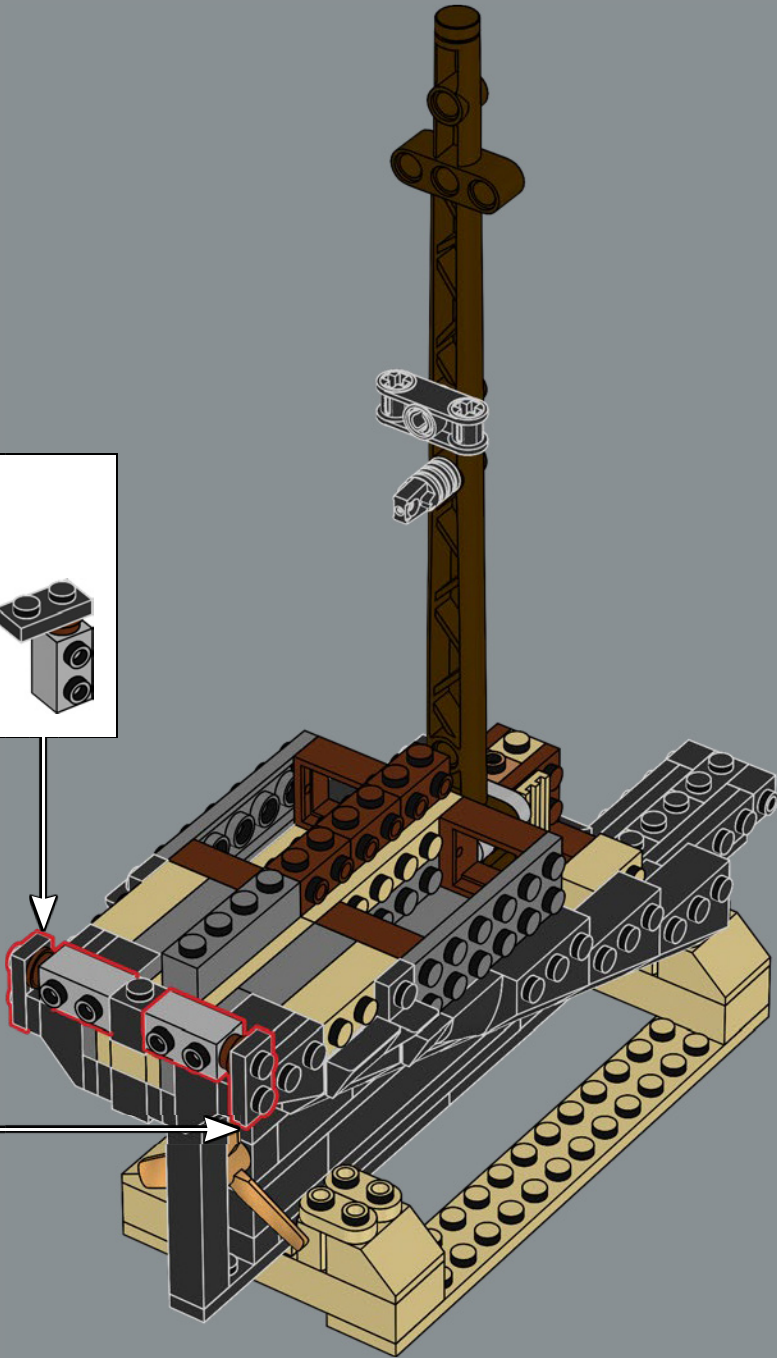
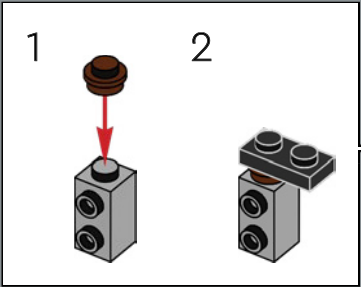
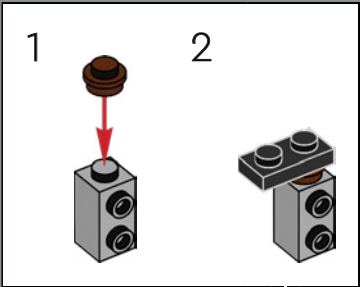

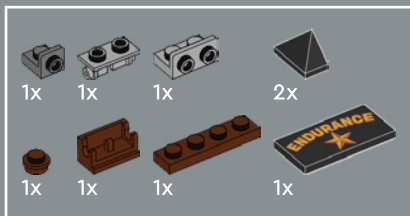

322

1

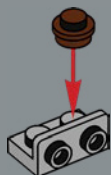

2

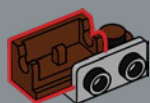

3

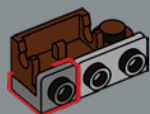

4

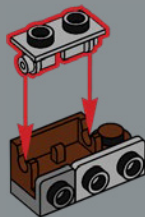

5

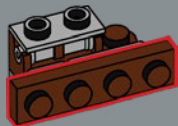

6

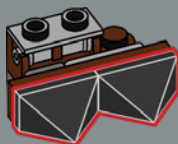

7



坚忍号最初被命名为北极星 (*Polaris*)。到底是沙克尔顿认为名称“北极星”不适合远征南极，还是他受到家族箴言“坚忍制胜”的启发，目前尚不可知。无论哪种方式，星星都保留了下来！

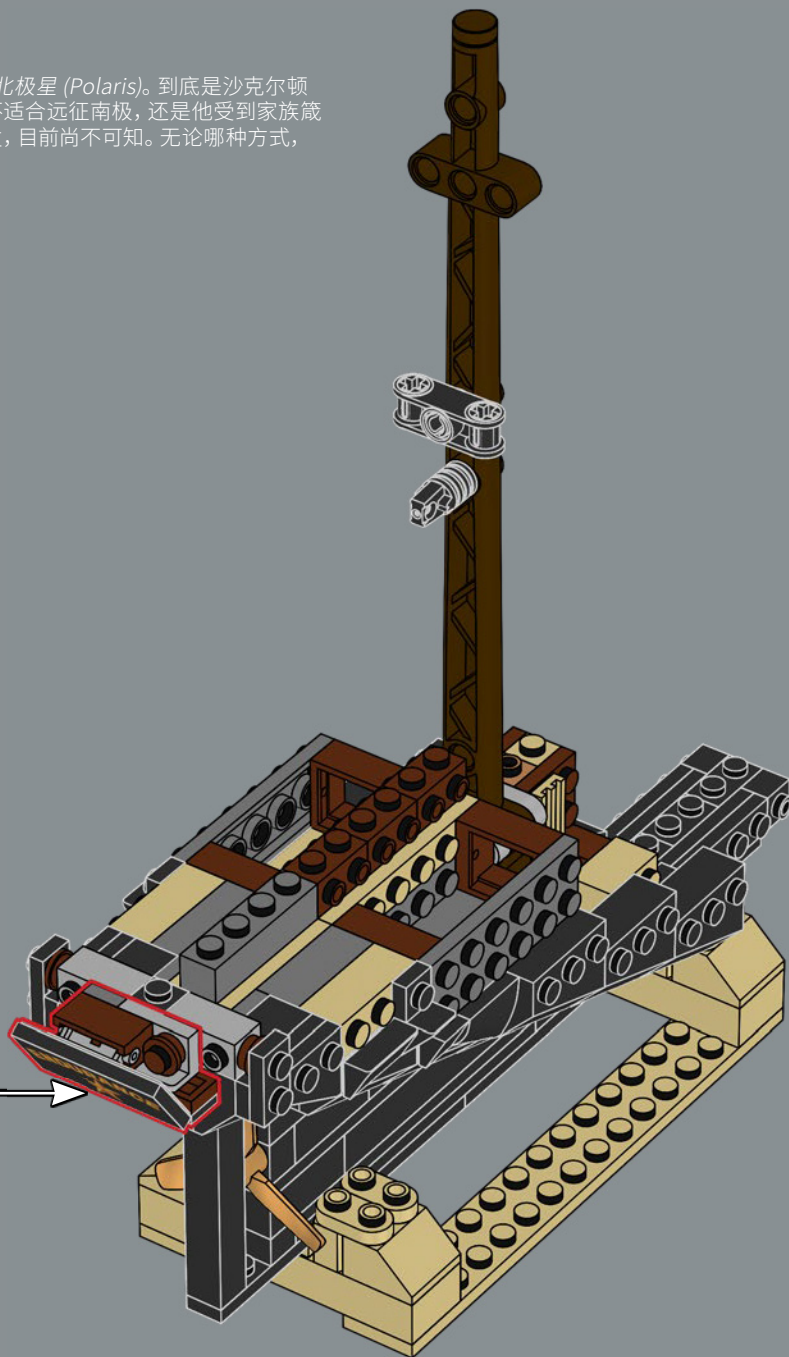

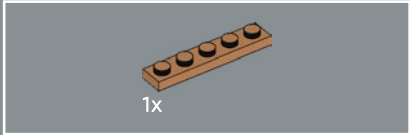
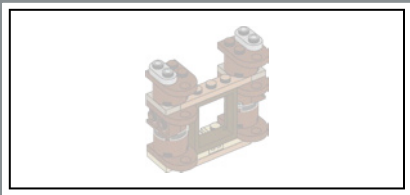

323

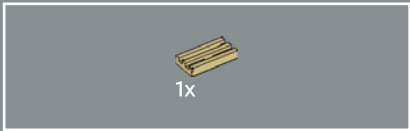
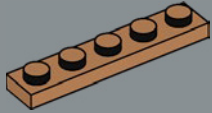

324

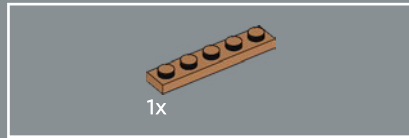
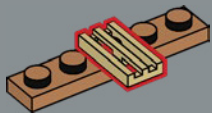

325

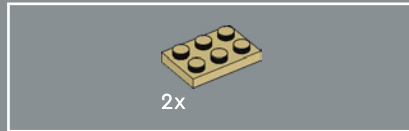
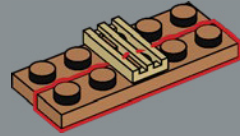

326

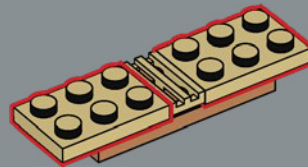

327

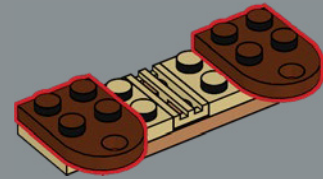

328

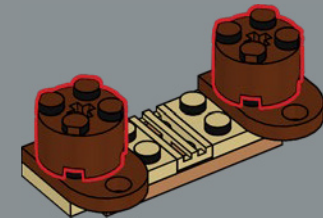



329

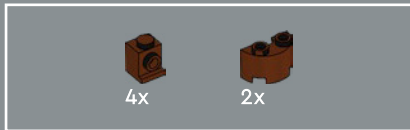
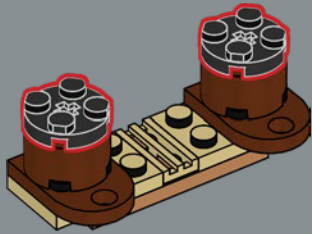

330

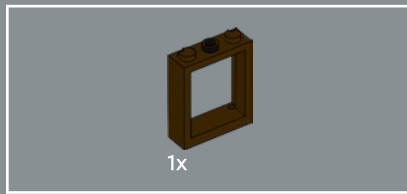
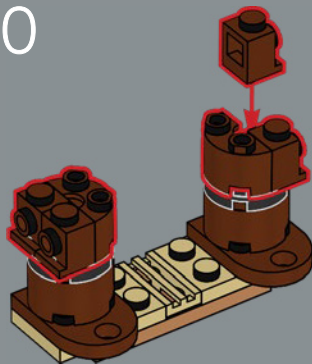

331

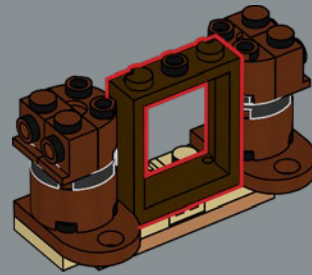

332

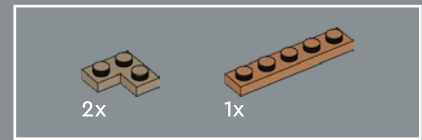
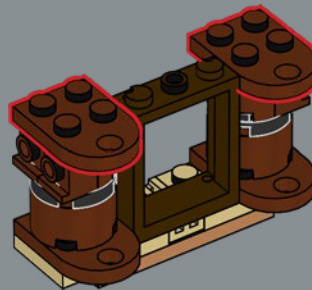

333

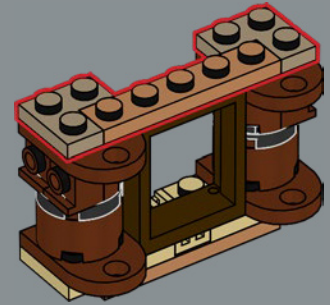

334

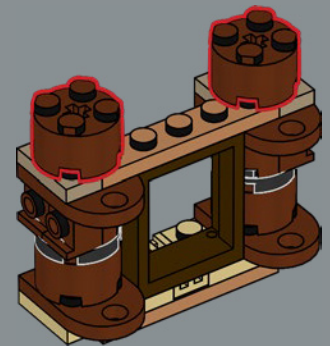



335

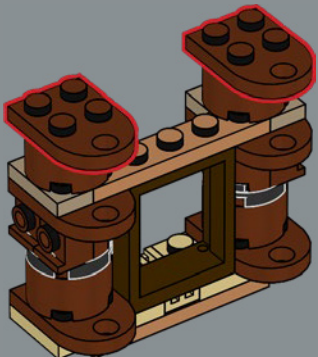

336

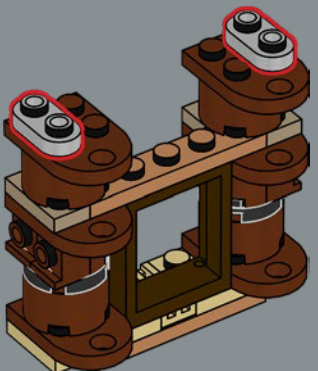

337

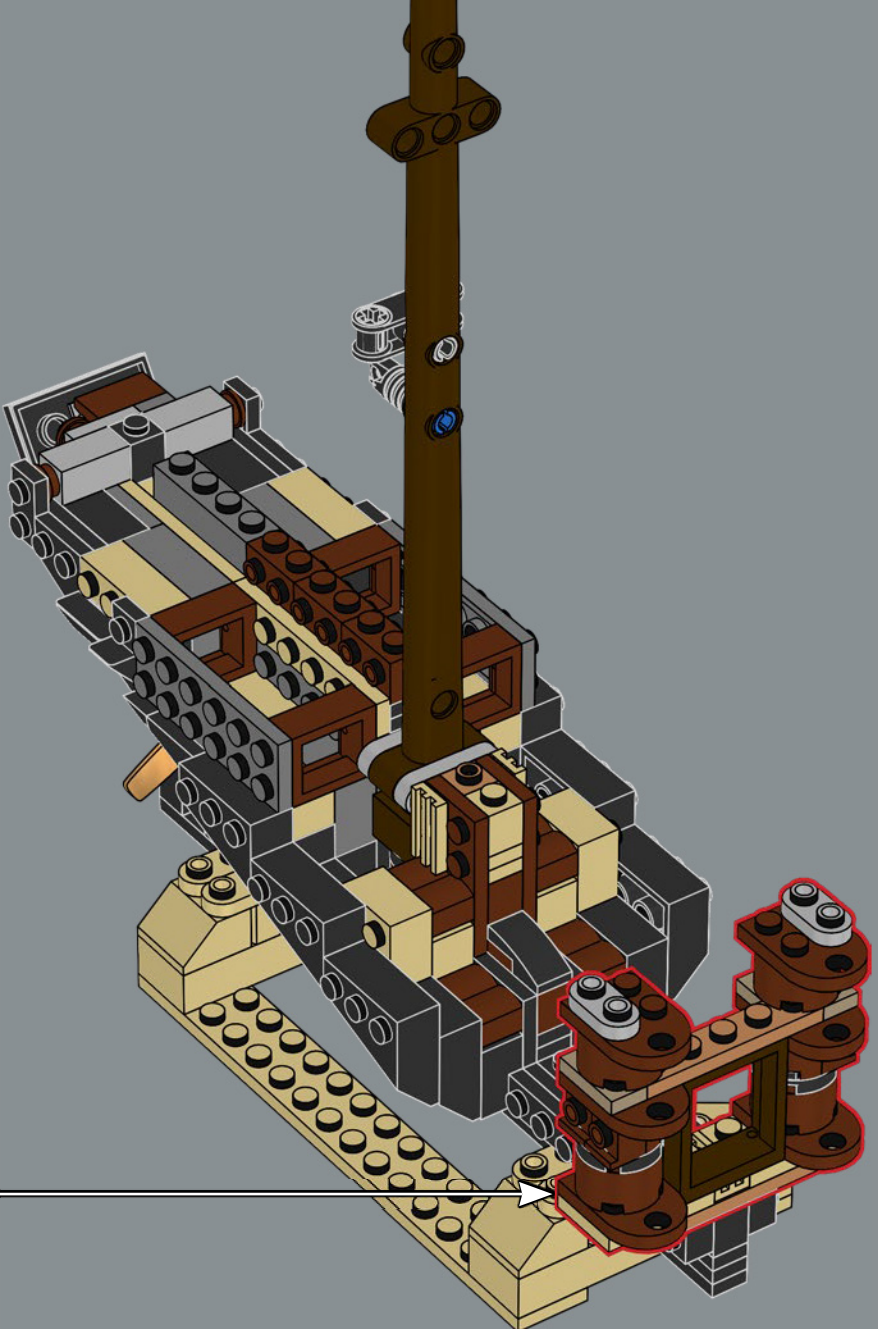

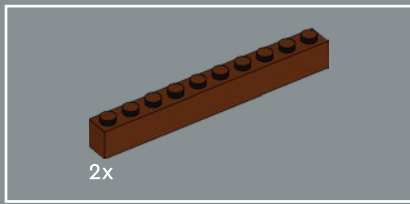

338

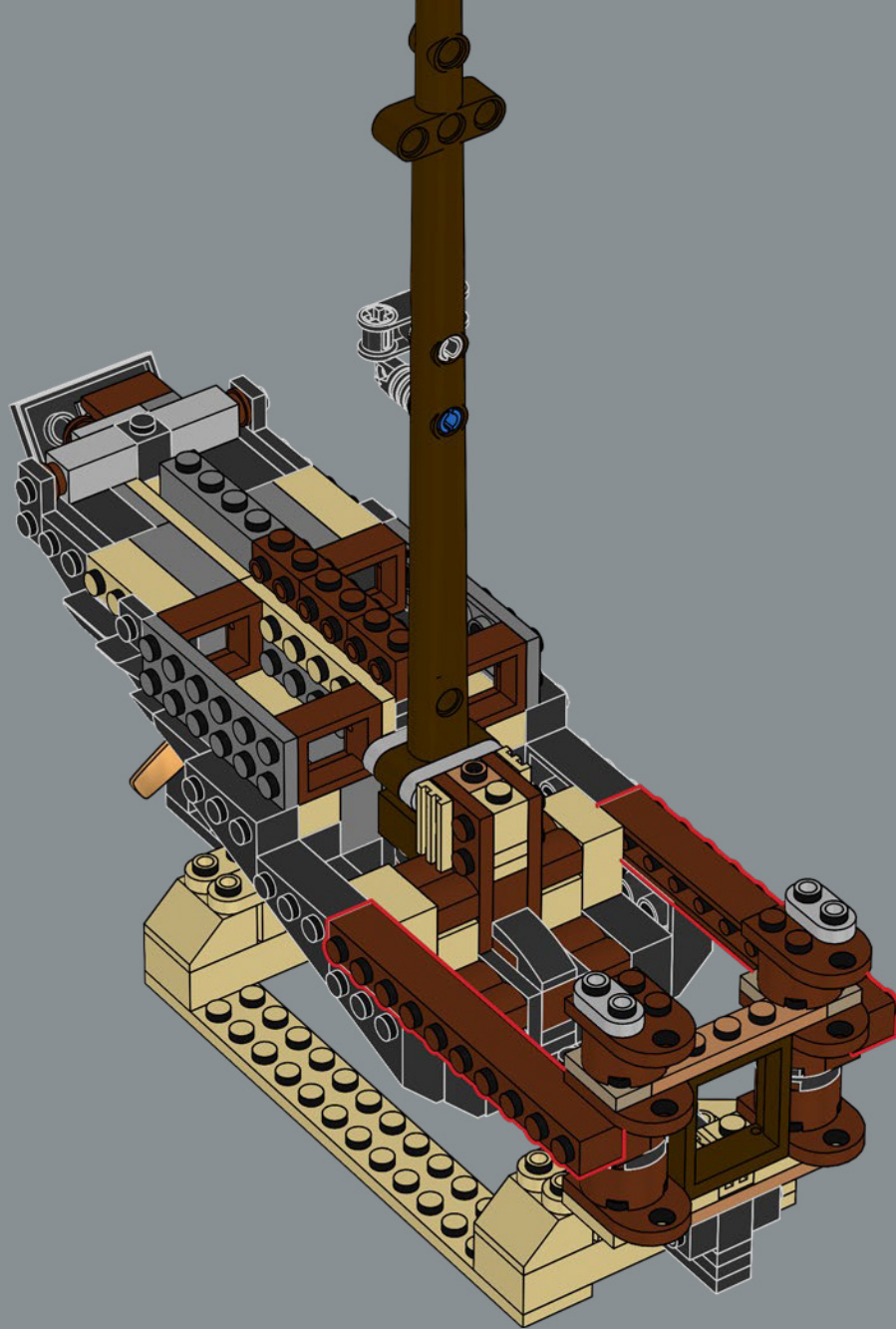

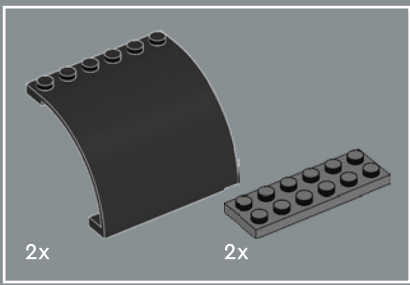

339

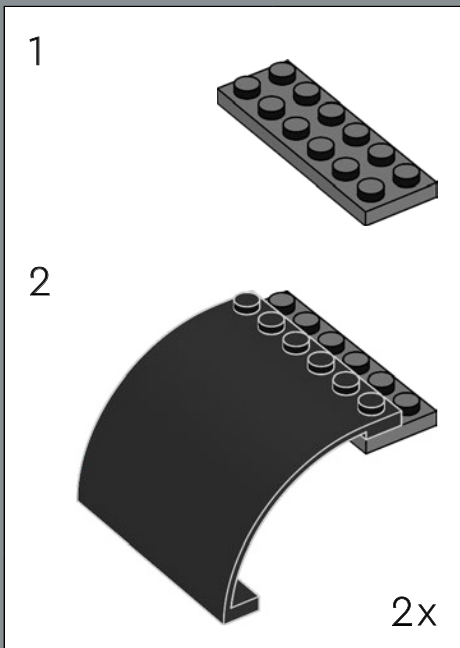
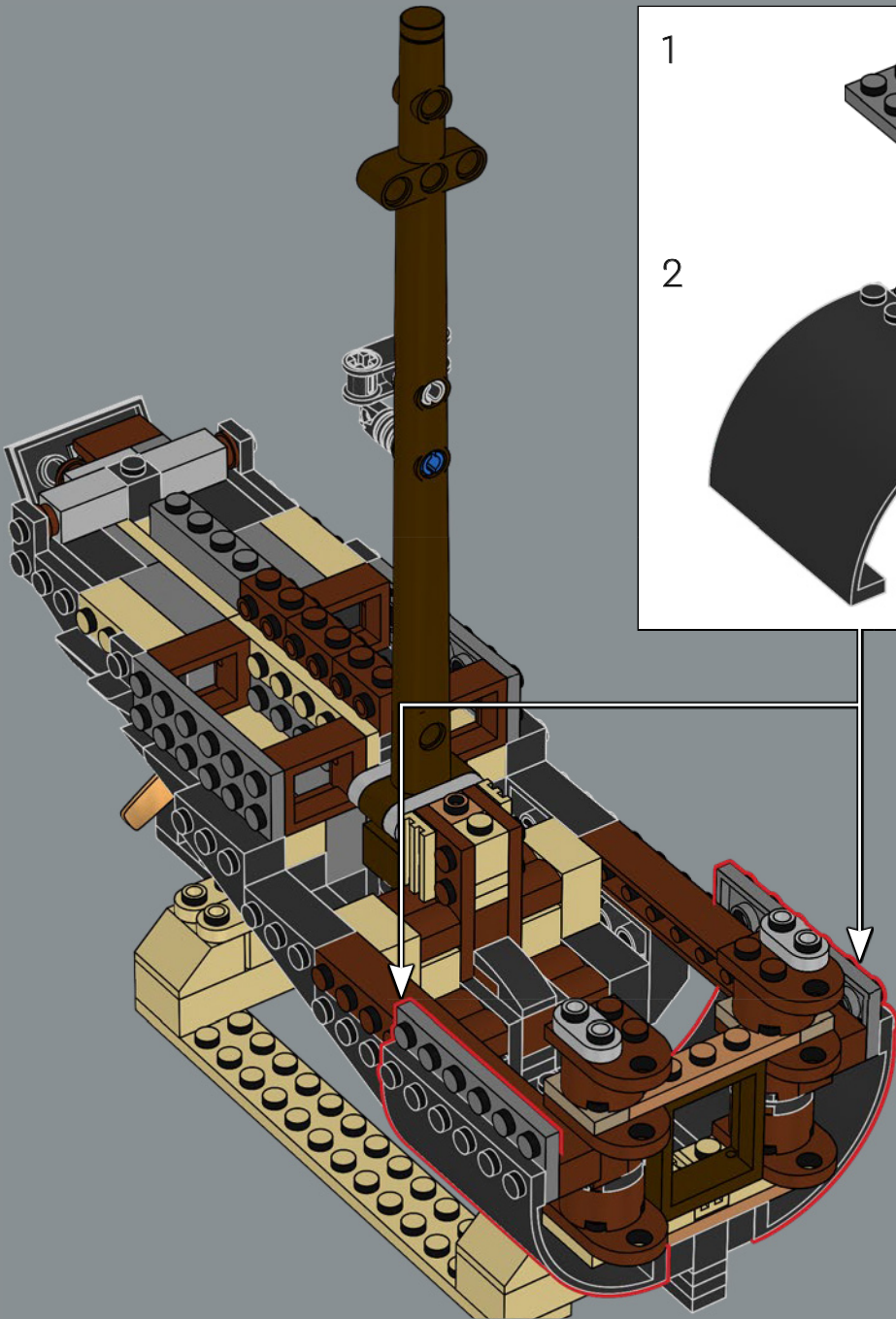

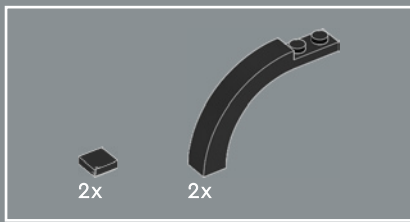

340

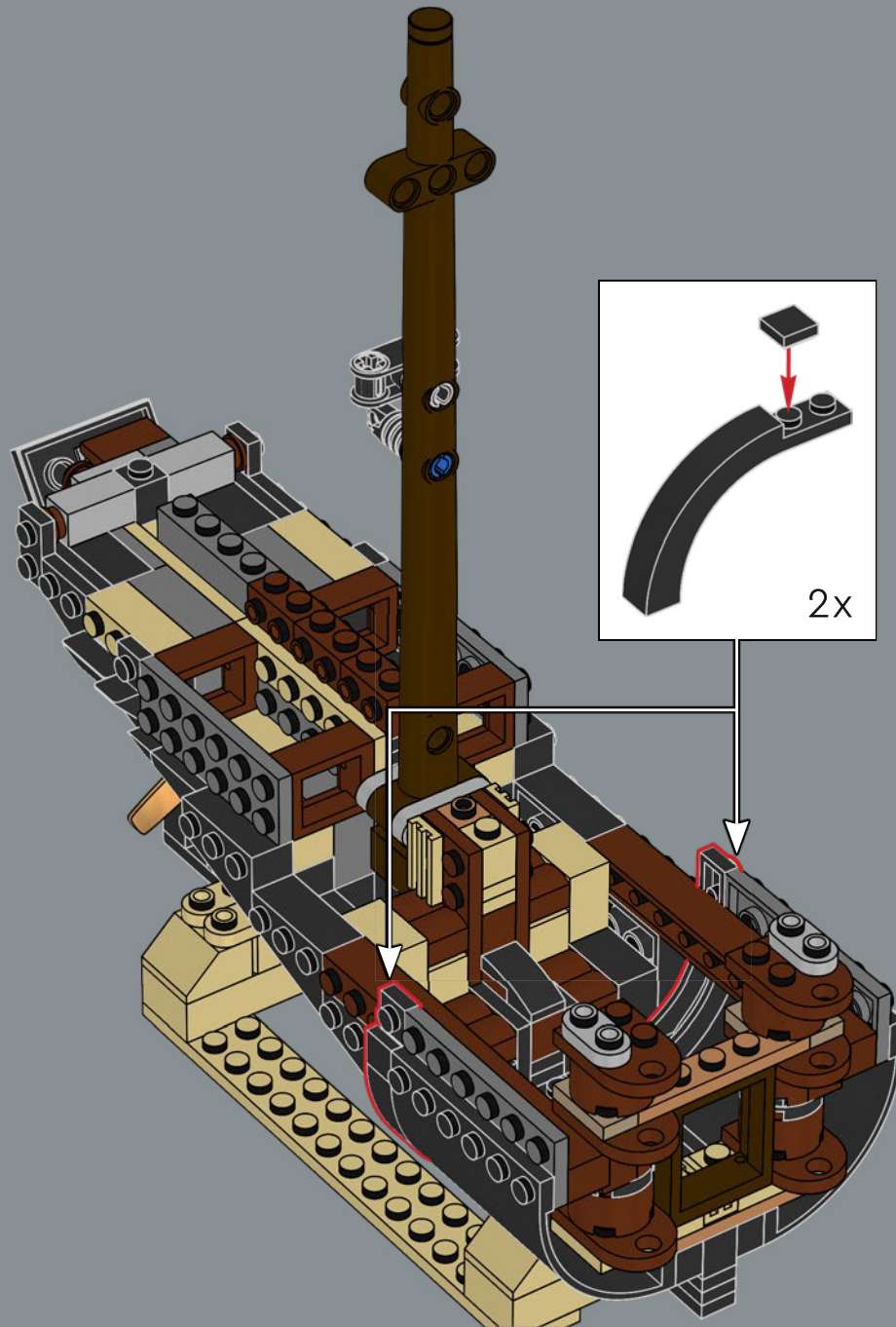

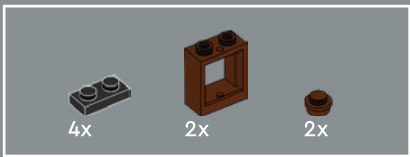

341

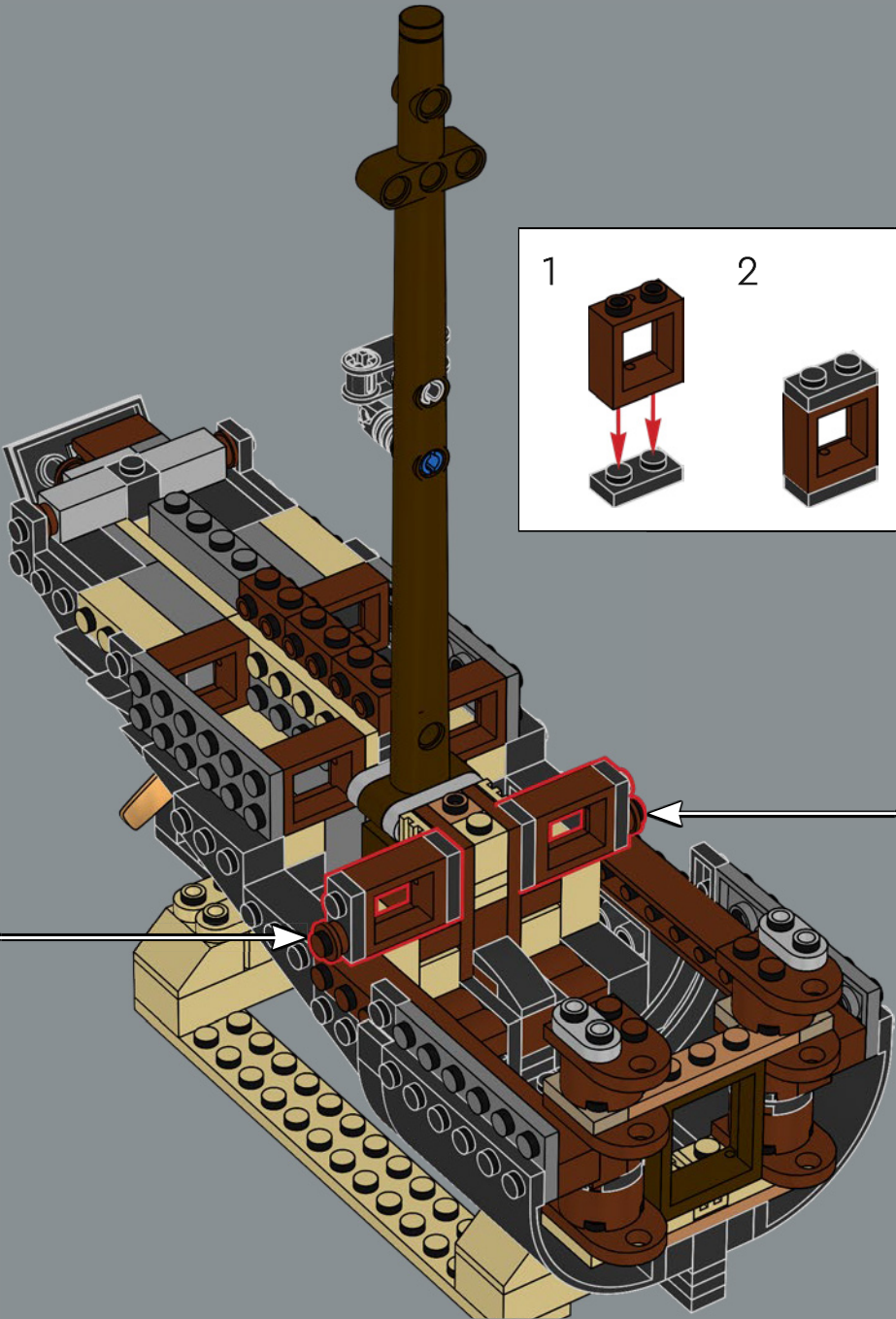
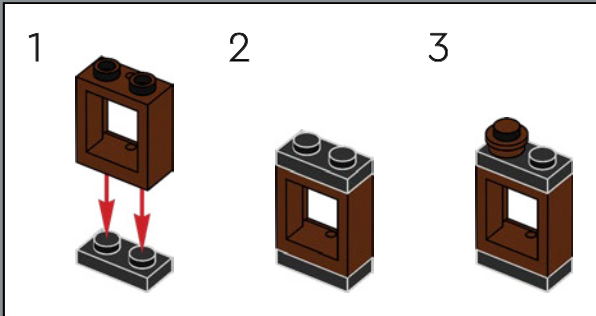
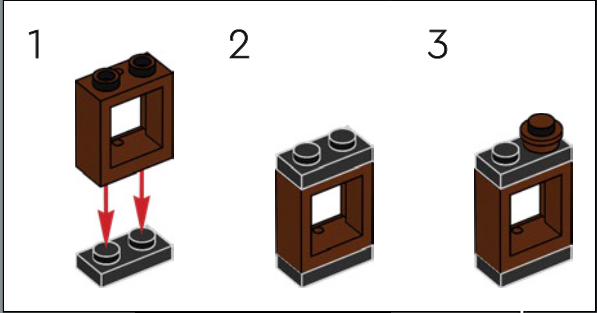

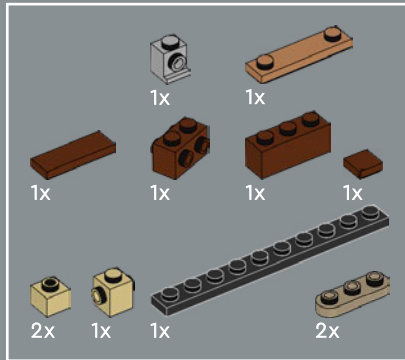
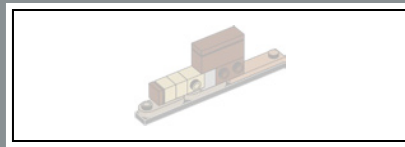

342

1

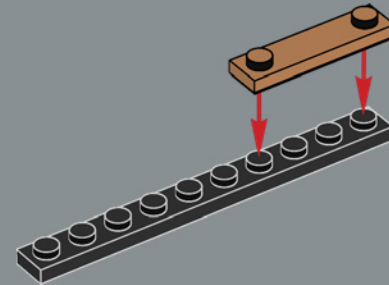

2

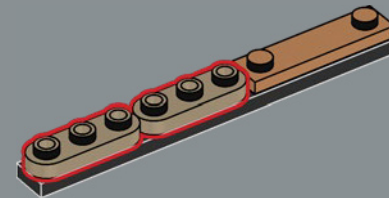

3

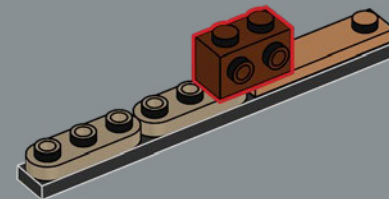

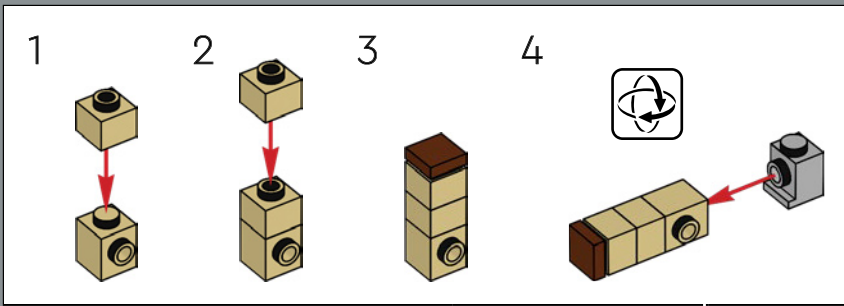

4

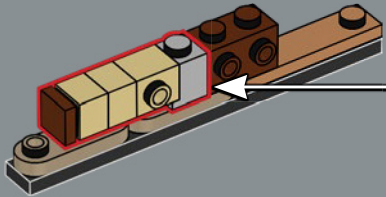

5

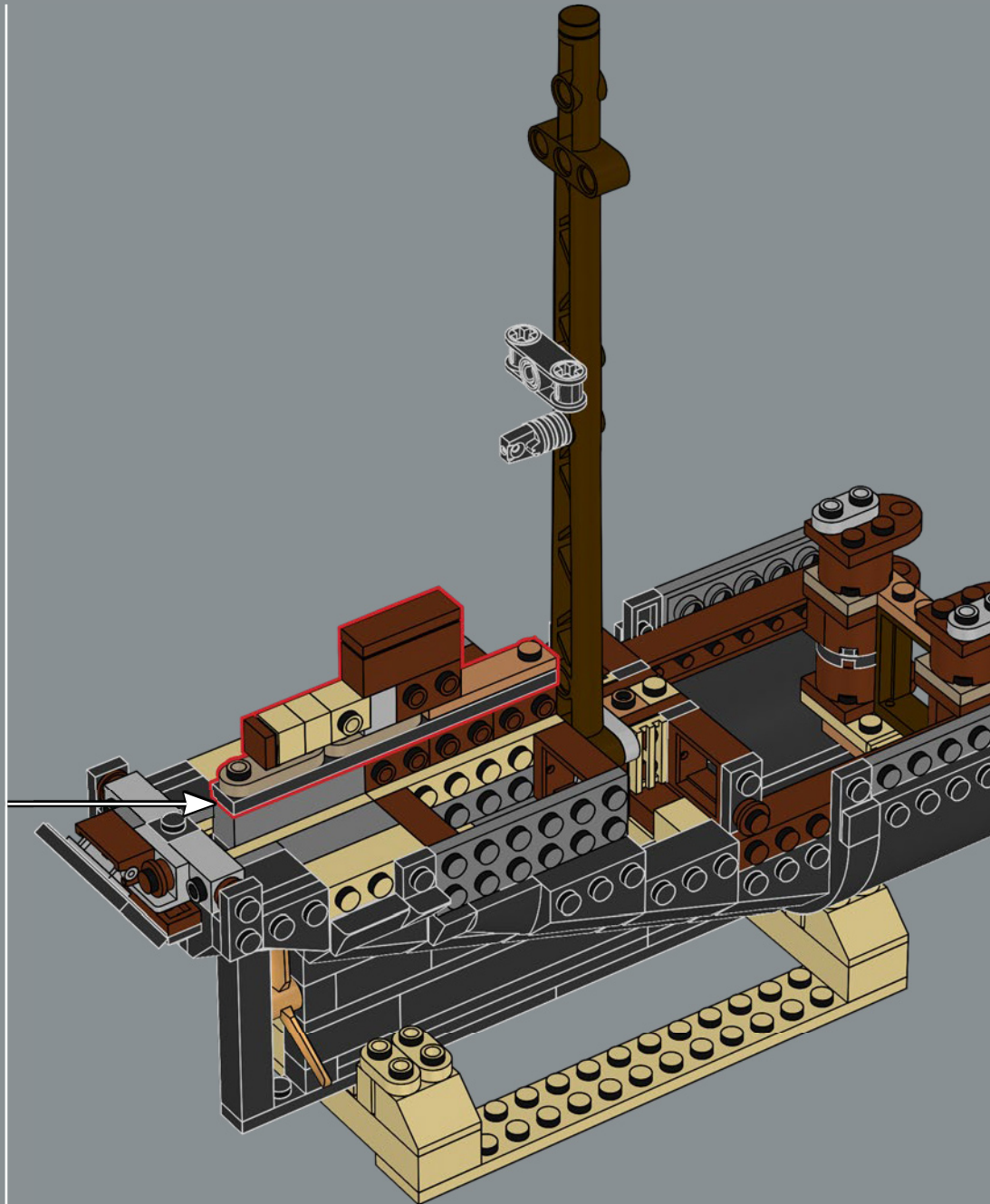
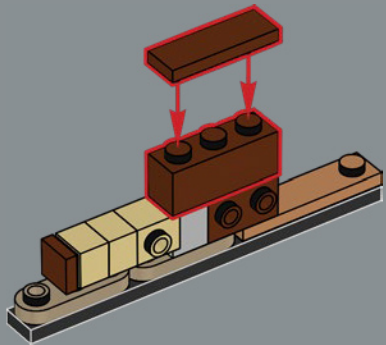

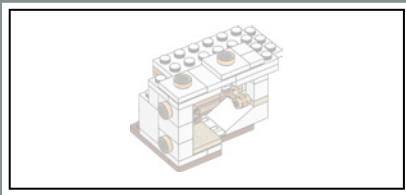

343

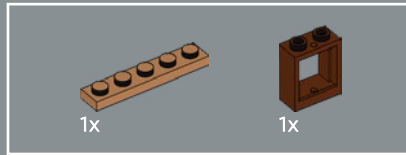
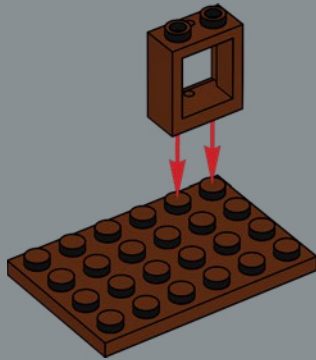

344

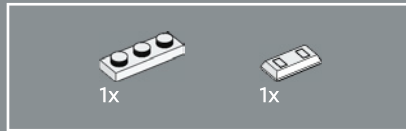
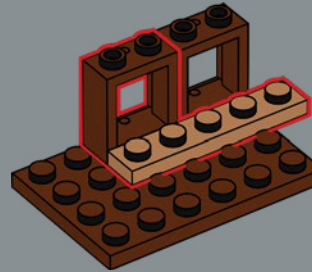

345

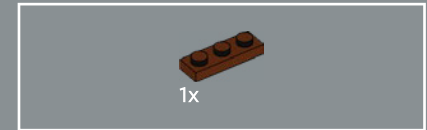
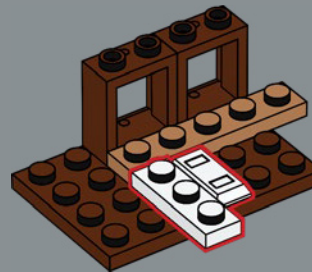

346

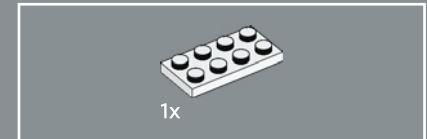
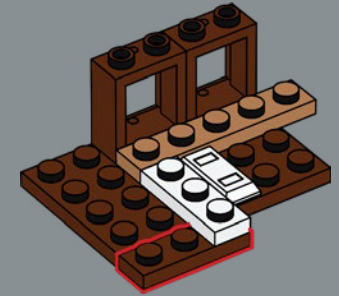

347

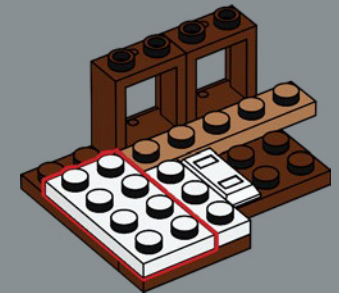

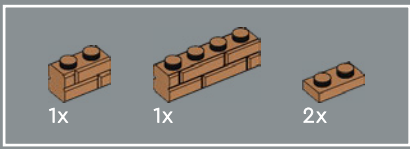

348

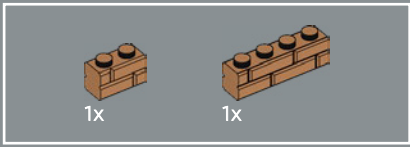
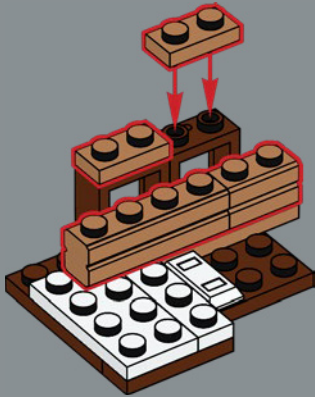

349

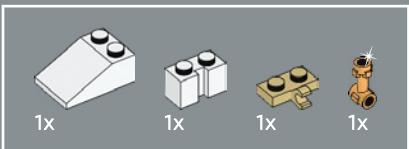
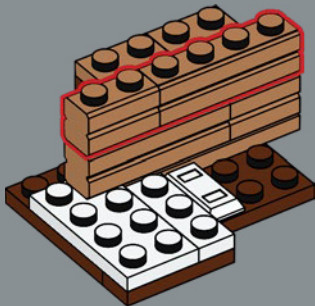

350

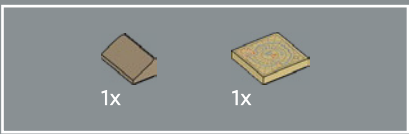
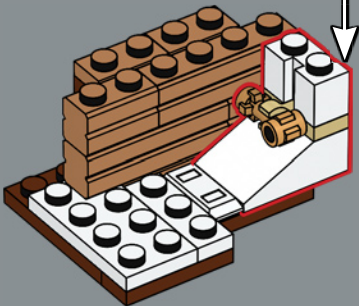
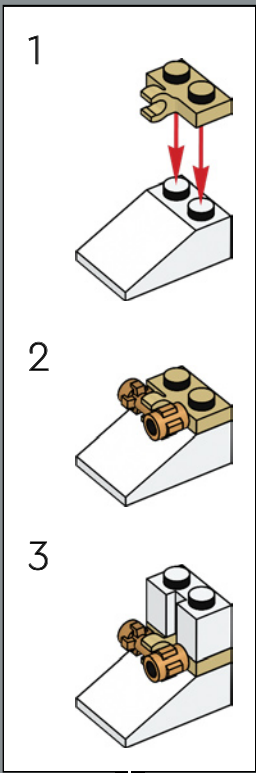

351

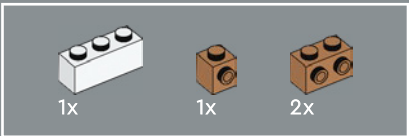
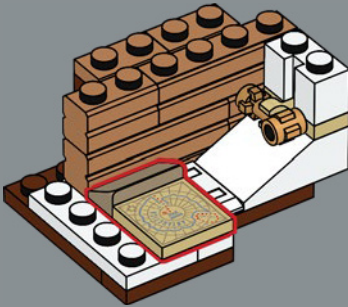

352

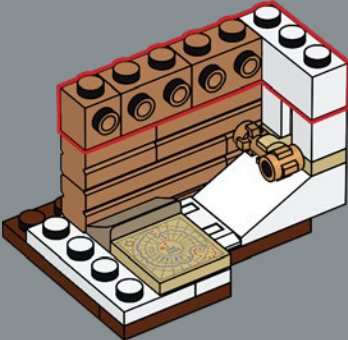

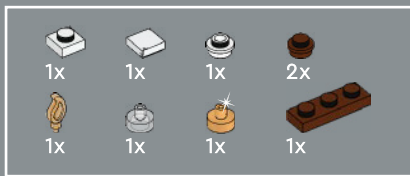

353

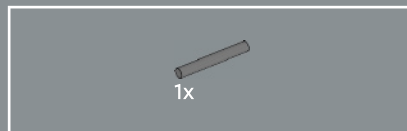
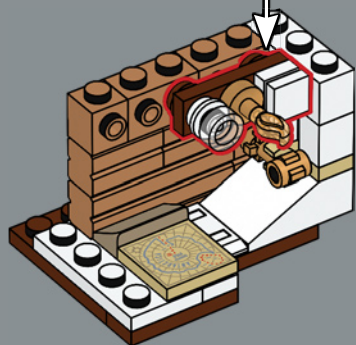
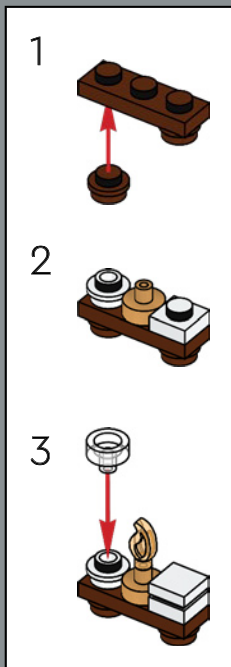

354

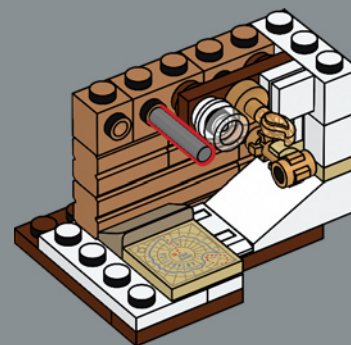

机舱内的深灰色竖杆是蒸汽加热管。科学家舱室配有独家的乐高®南极洲地图。

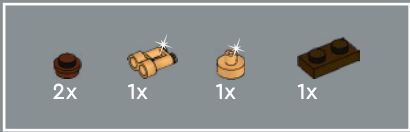

355

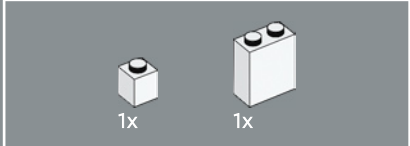
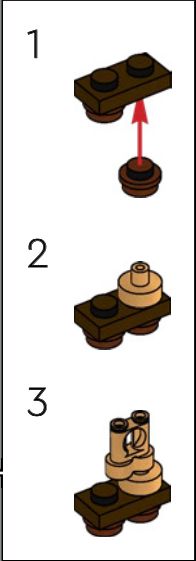
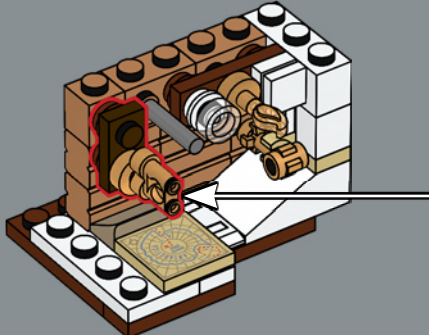

356

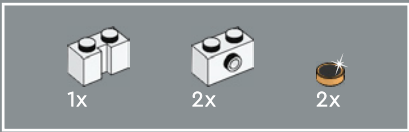
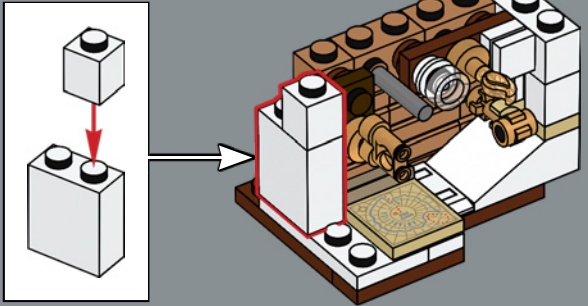

357

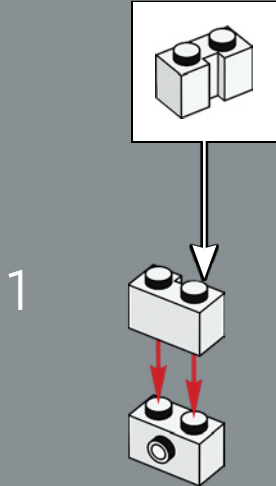

2

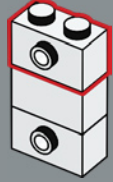

3

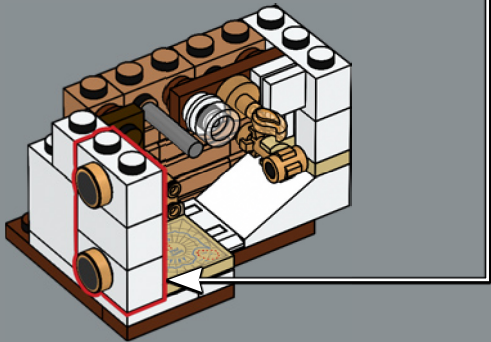
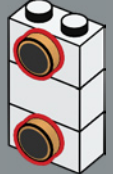

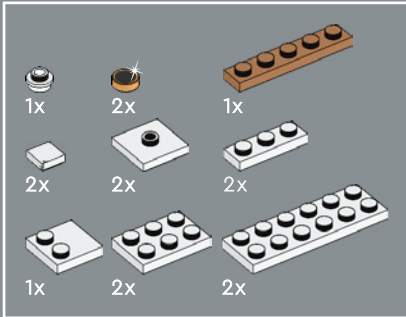
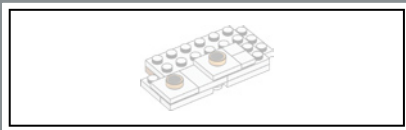

358

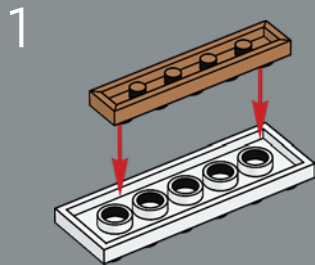

2

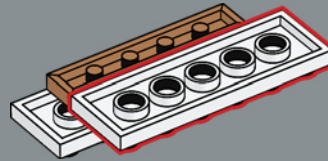

3

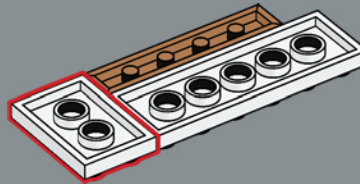

4

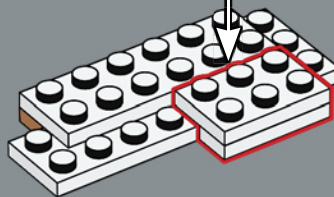
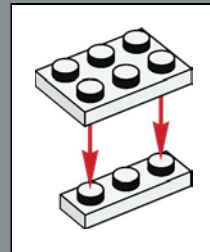

5

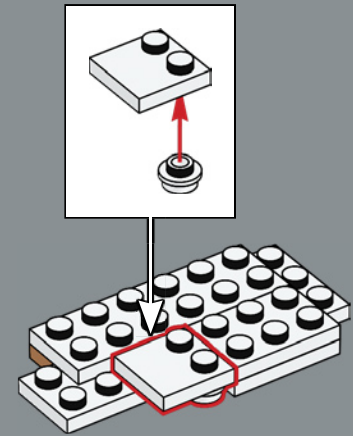

6

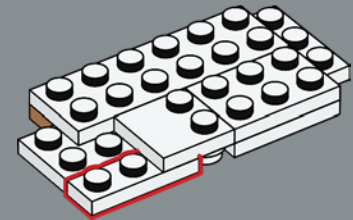

7

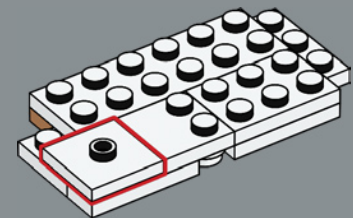

8

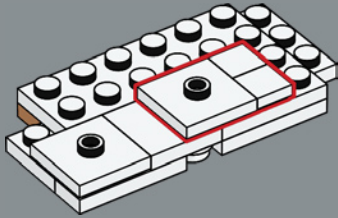

9

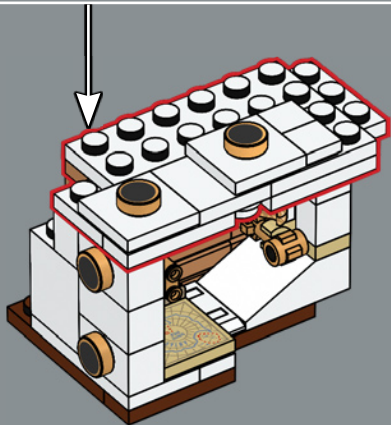
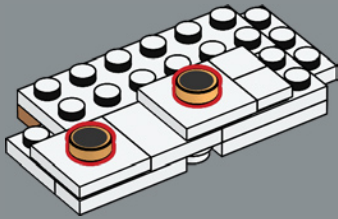

359

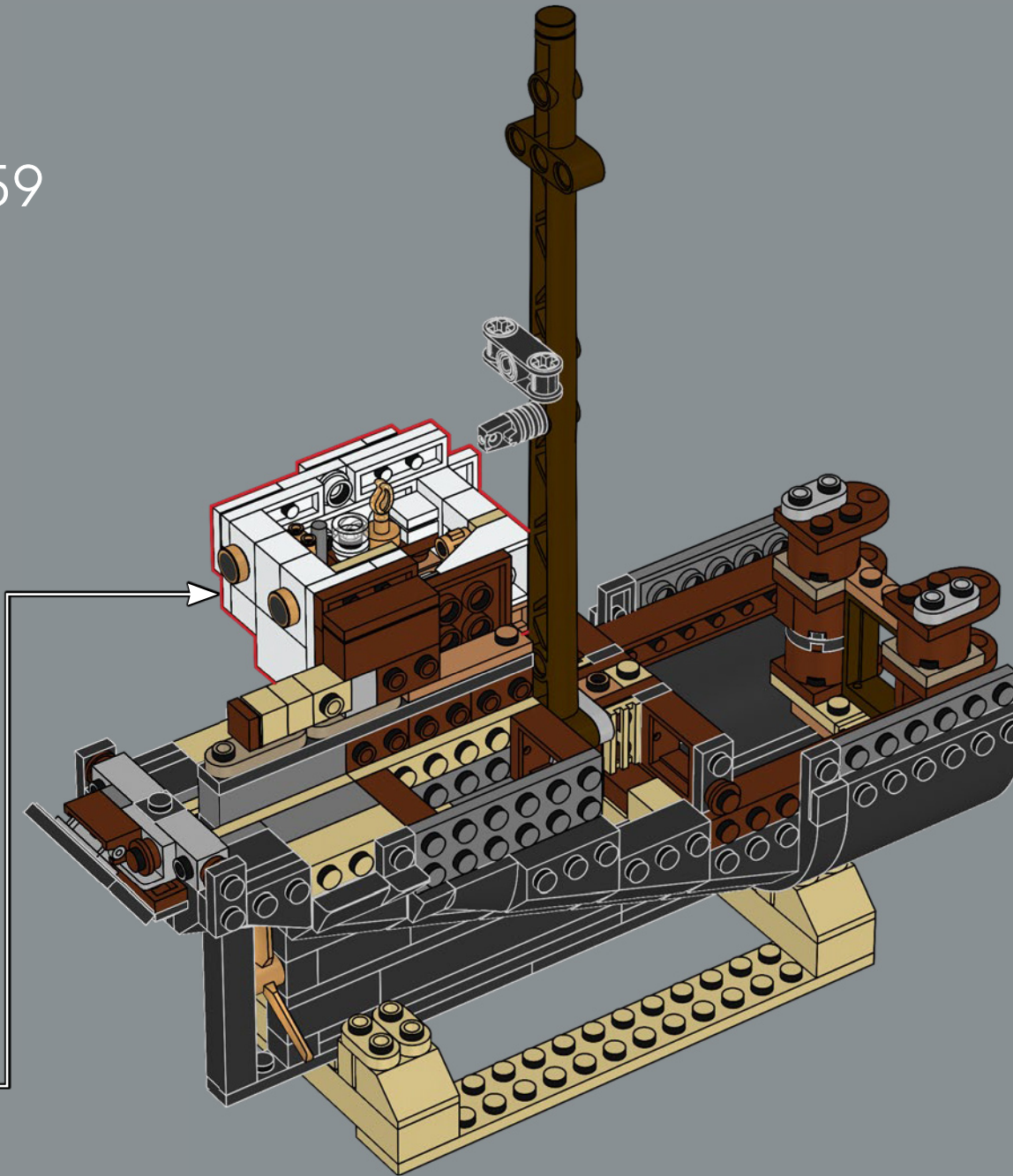

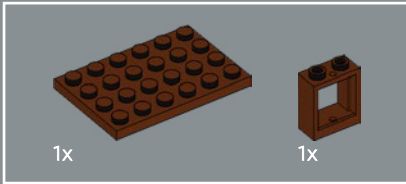
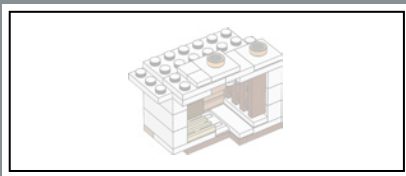

360

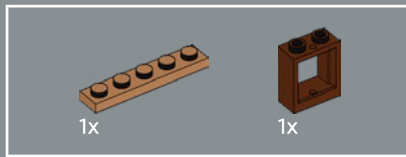
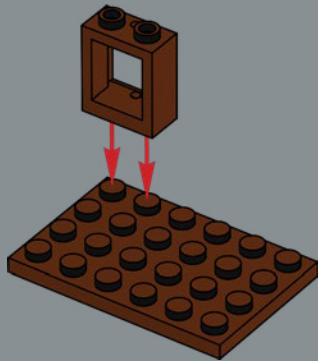

361

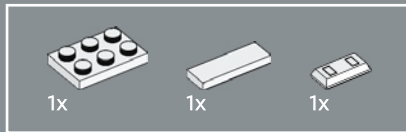
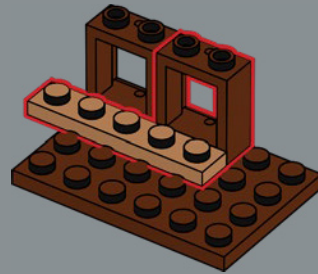

362

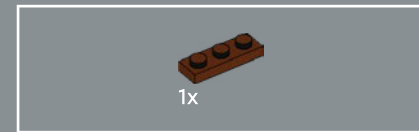
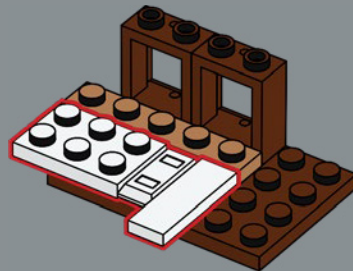

363

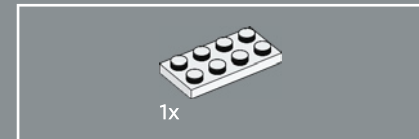
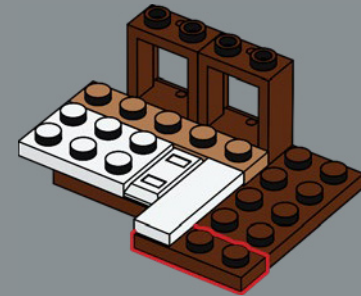

364

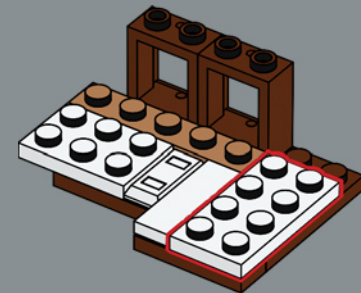

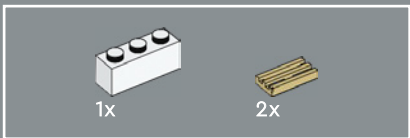

365

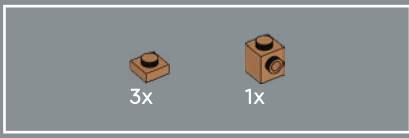
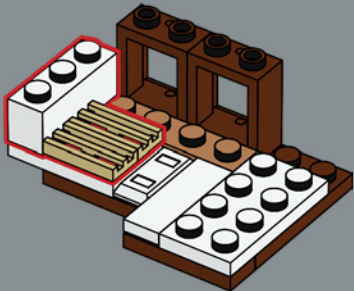

367

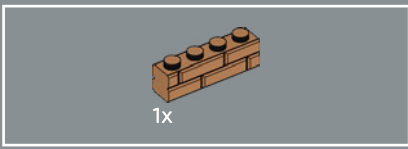
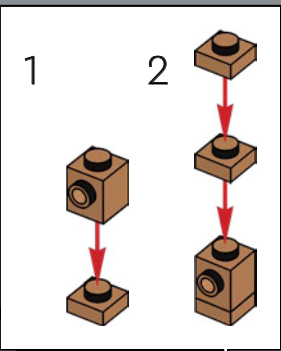
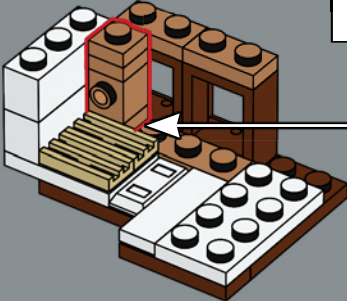

369

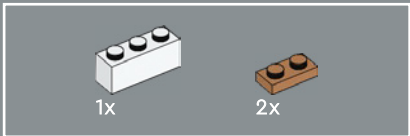
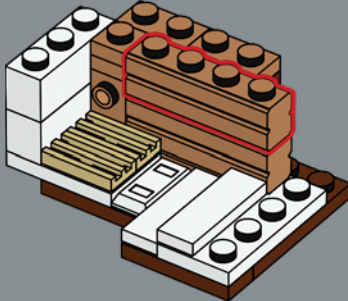

366

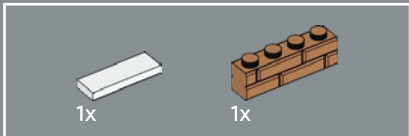
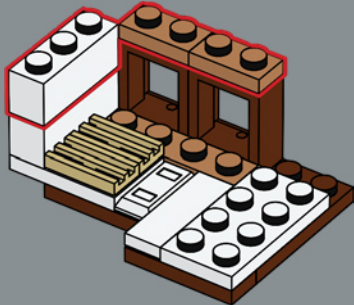

368

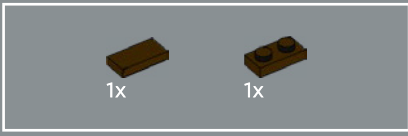
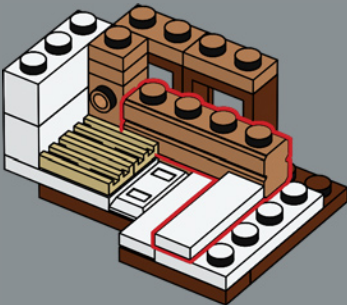

370

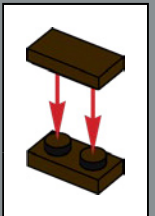
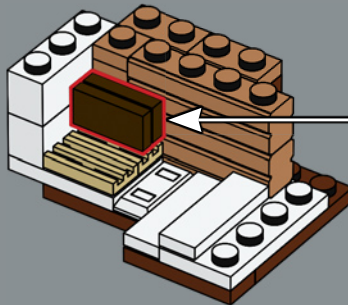

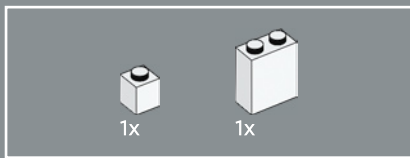

371

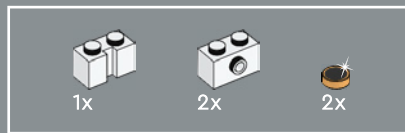
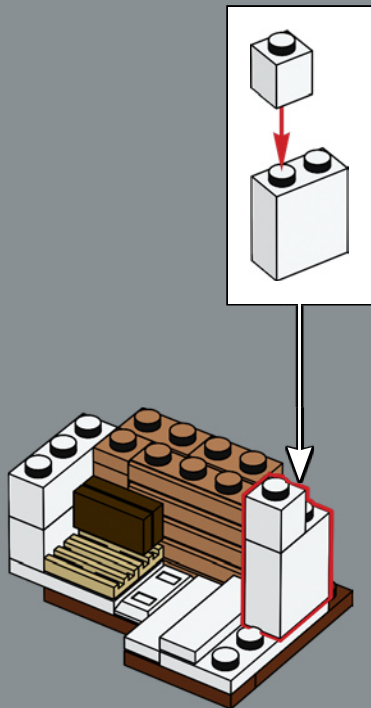

372

1

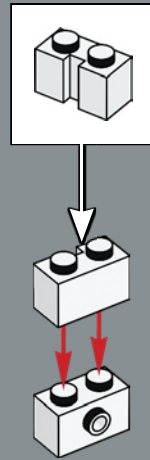

2

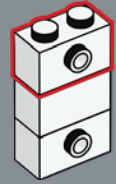

3

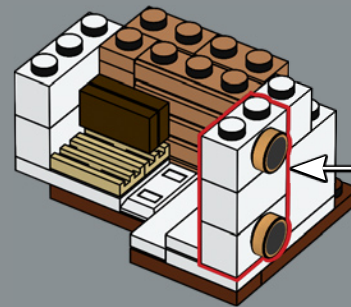
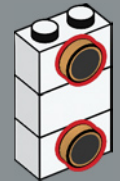

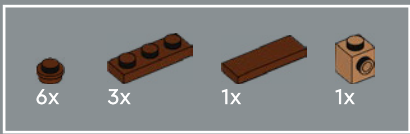

373

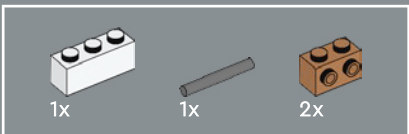
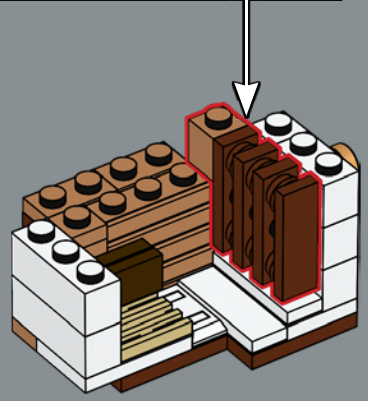
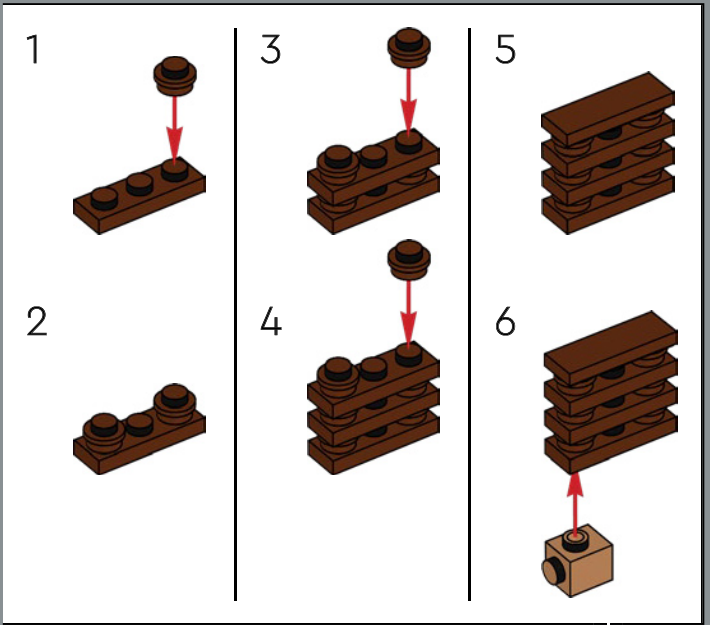

374

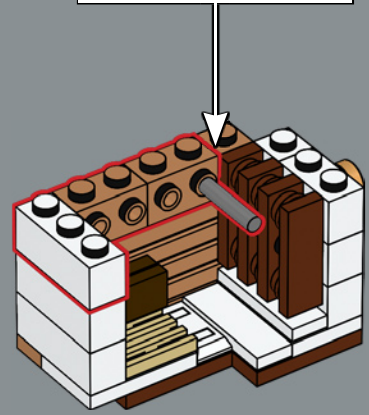
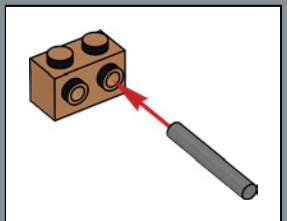

375

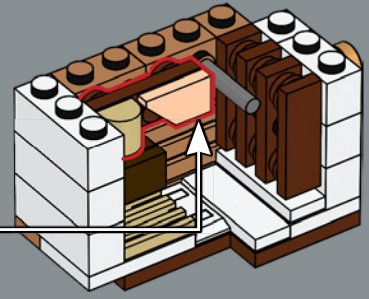
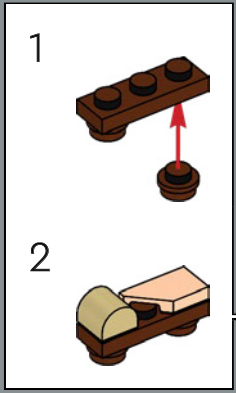

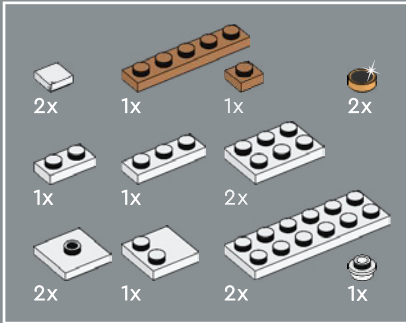
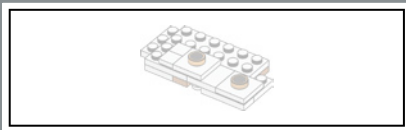

376

1

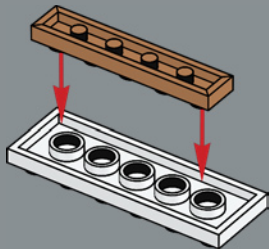

2

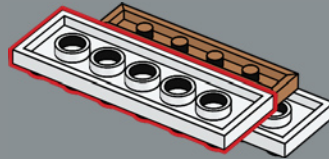

3

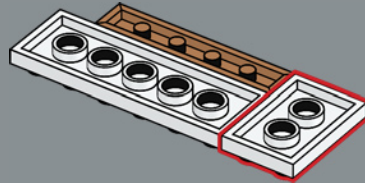

4

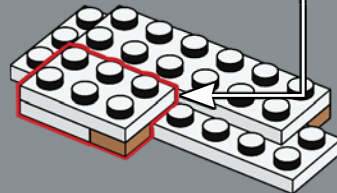
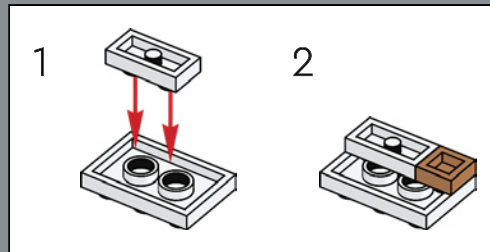

5

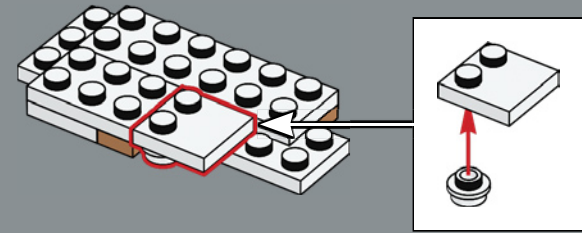

6

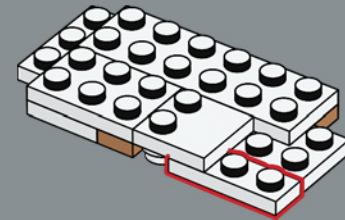

7

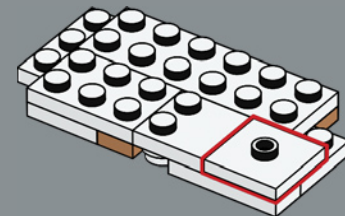

8

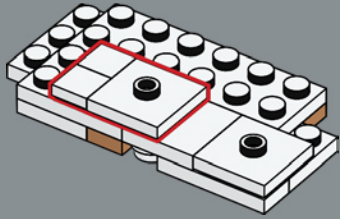

9

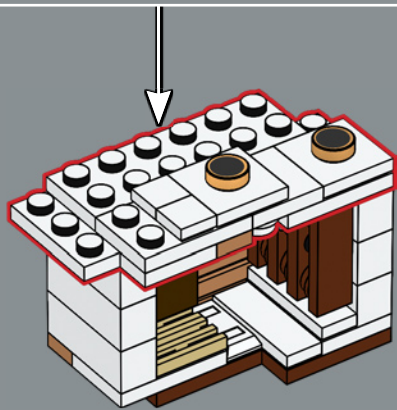
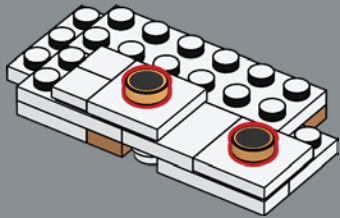

377

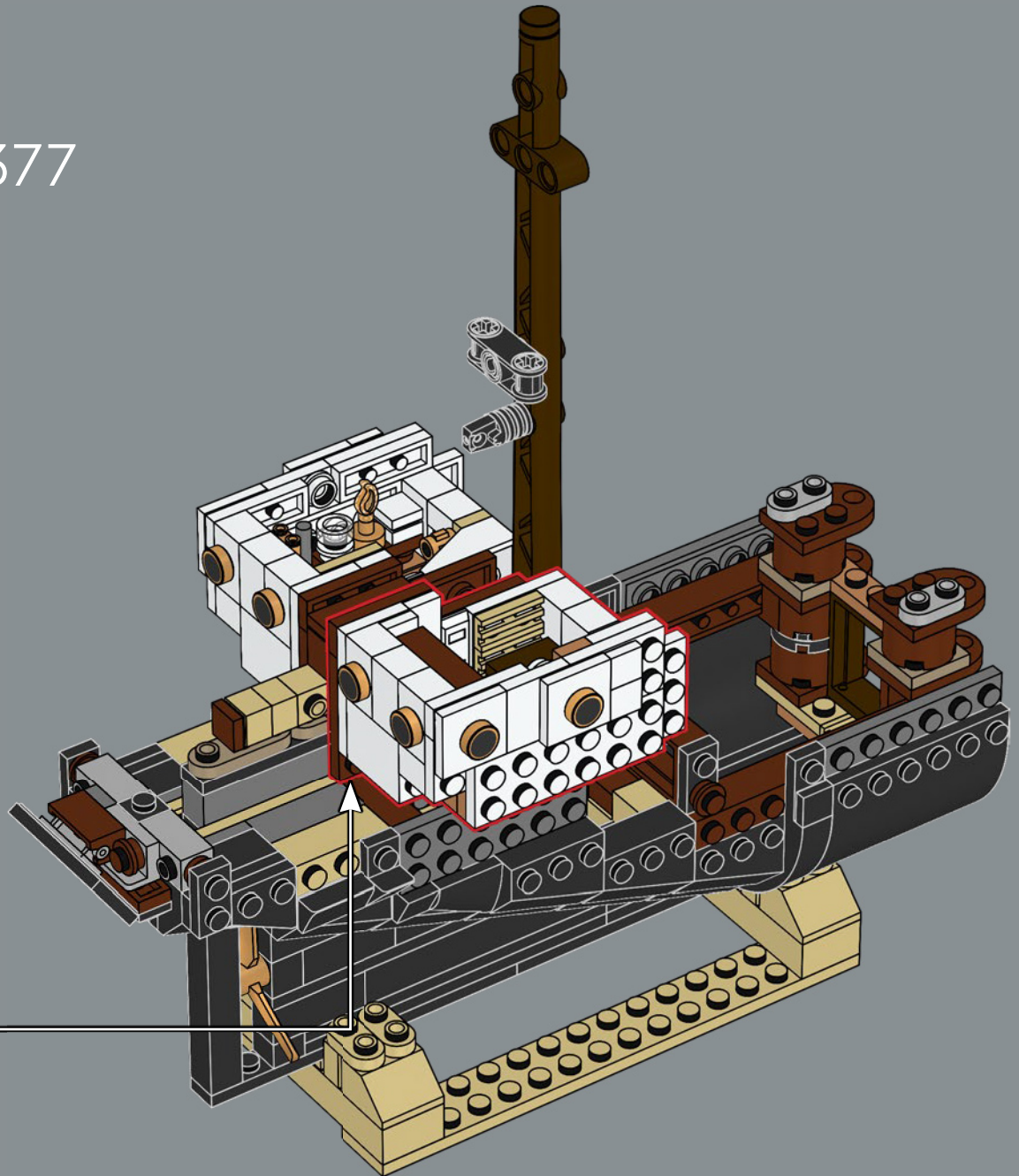

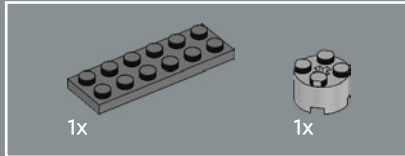
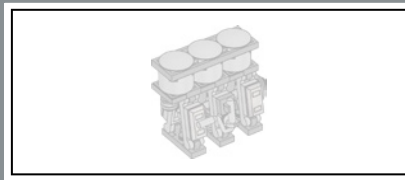

378

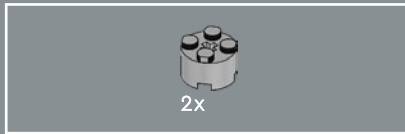
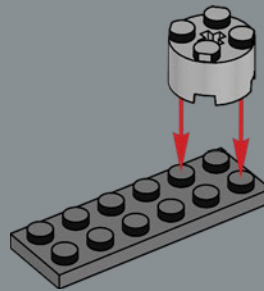

379

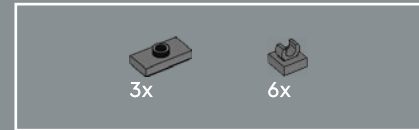
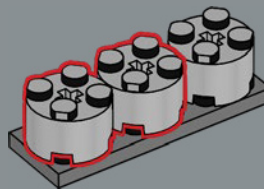

380

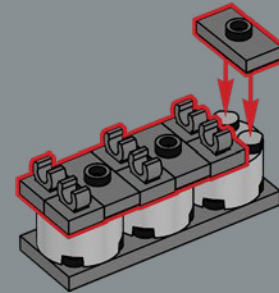

381

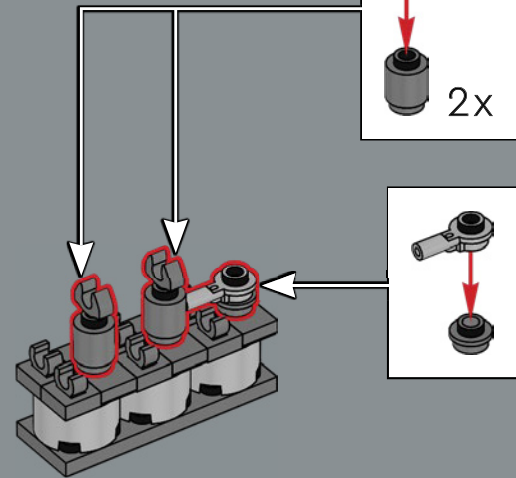

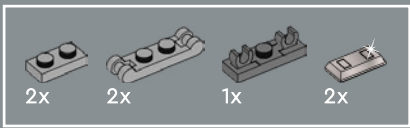

382

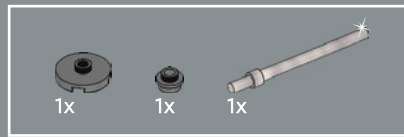
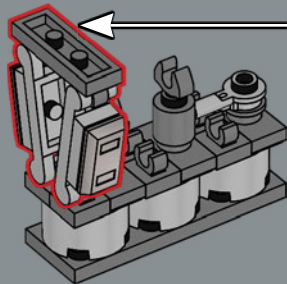
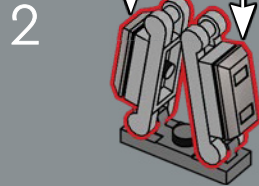
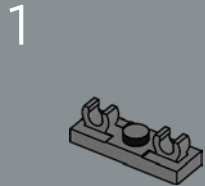
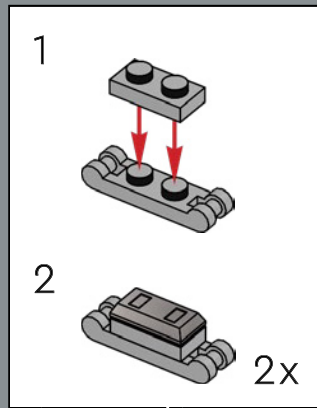

383

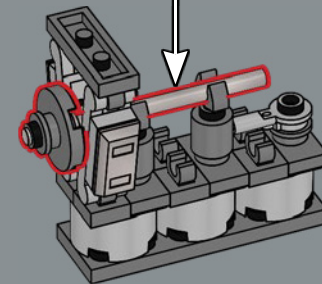
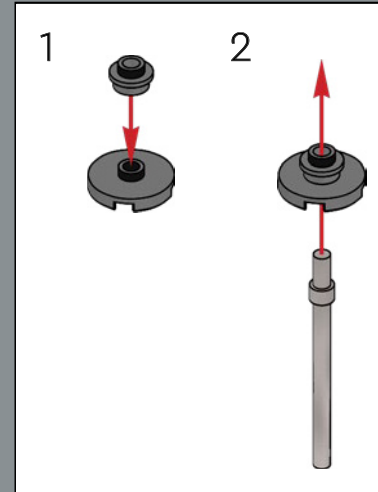

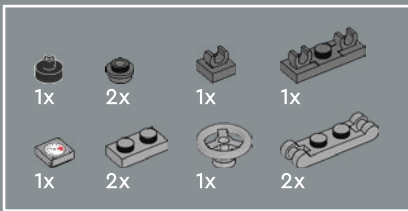

384

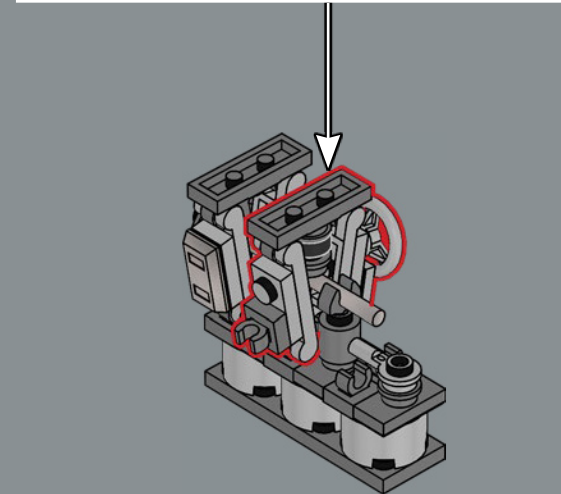
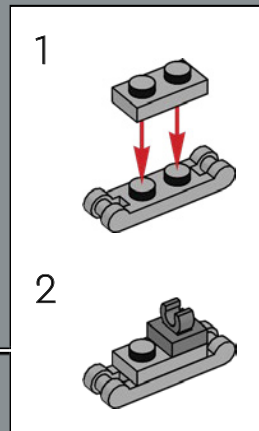
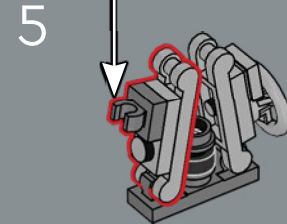
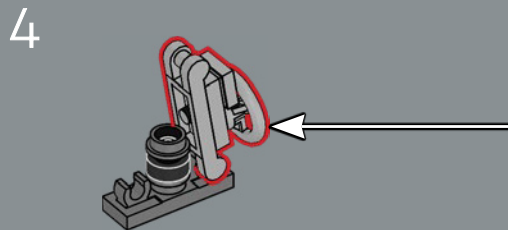
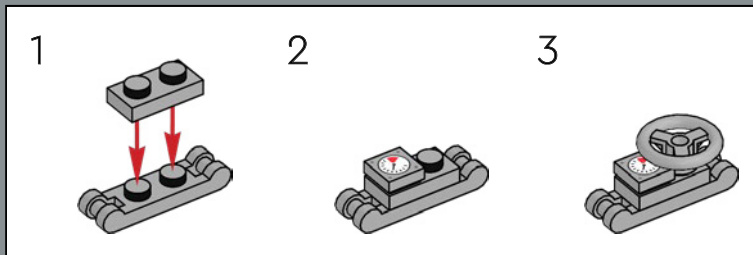
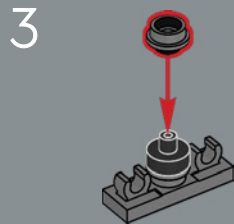
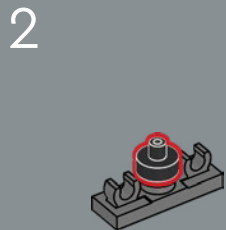
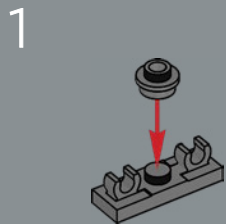

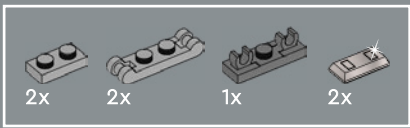

385

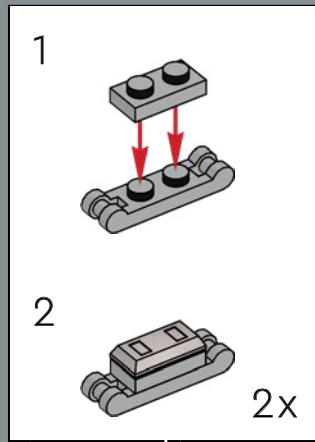

1

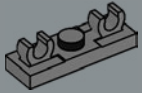

2

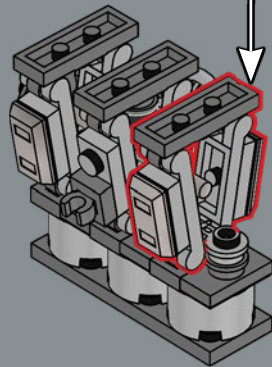
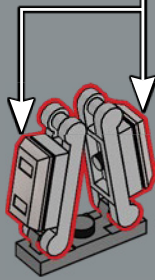

386

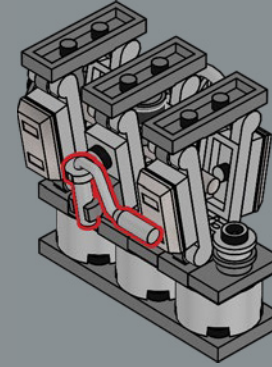

387

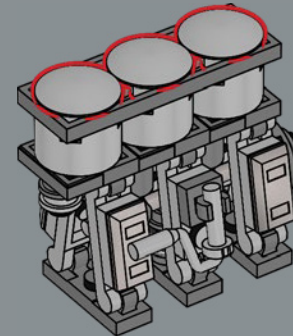



“三胀式蒸汽机”可从机舱中取出并展示。

388

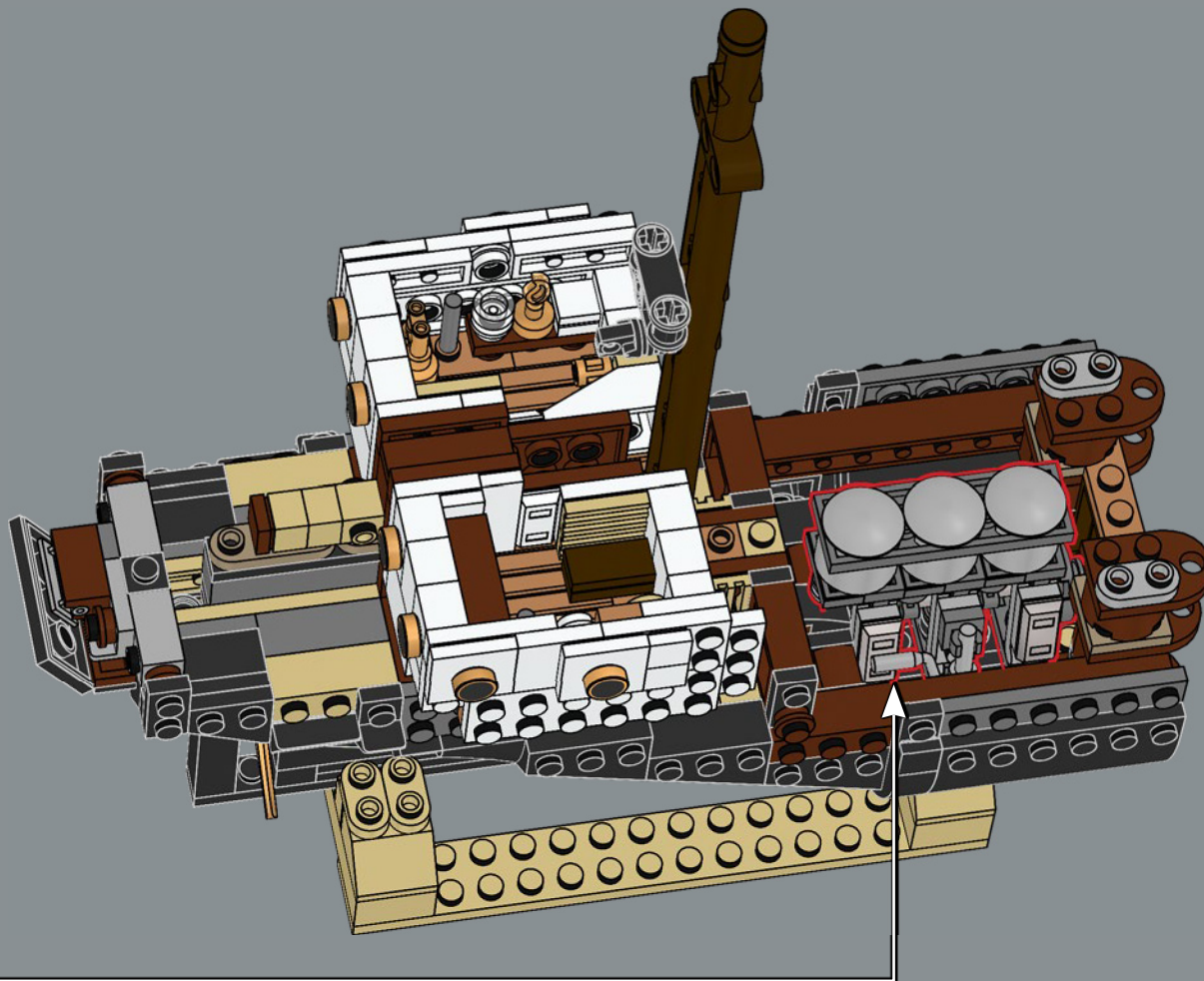

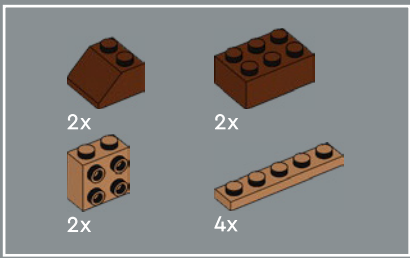

389

1



2

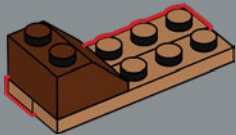

3

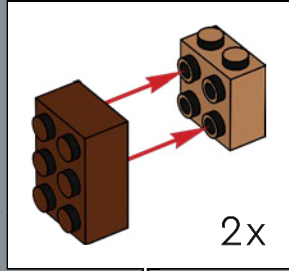
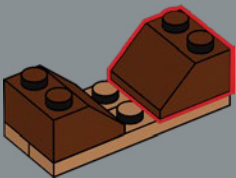

4

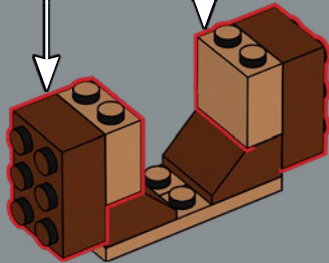

5

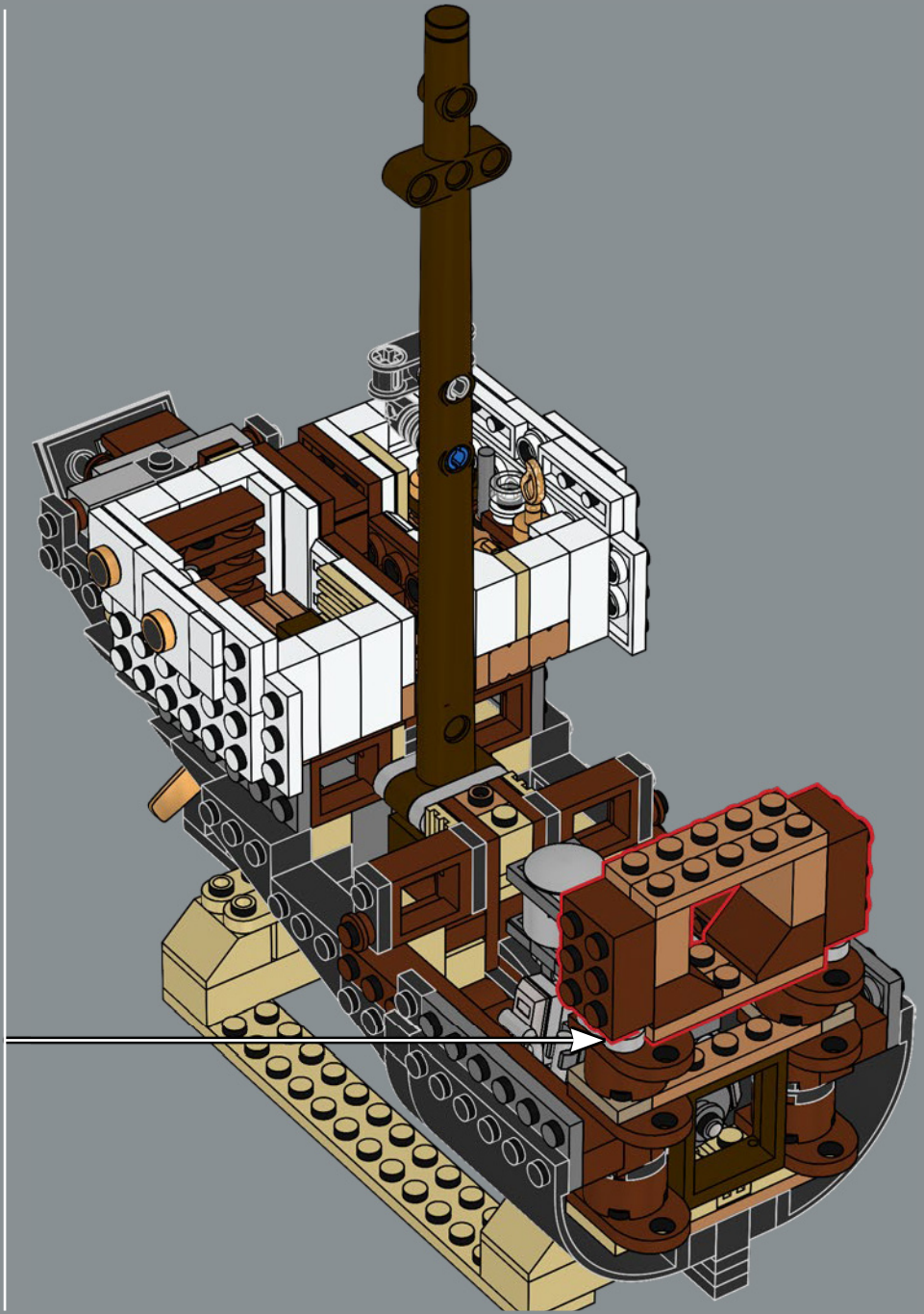
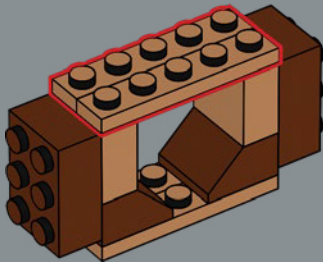

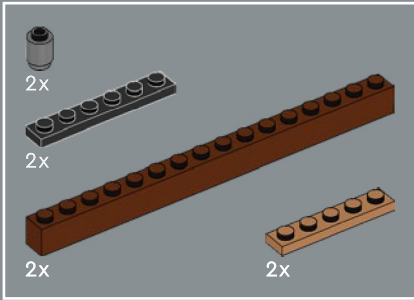
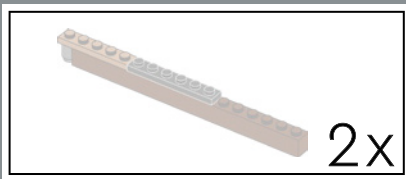

390

1

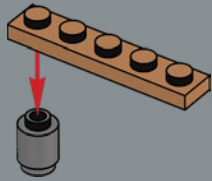

2

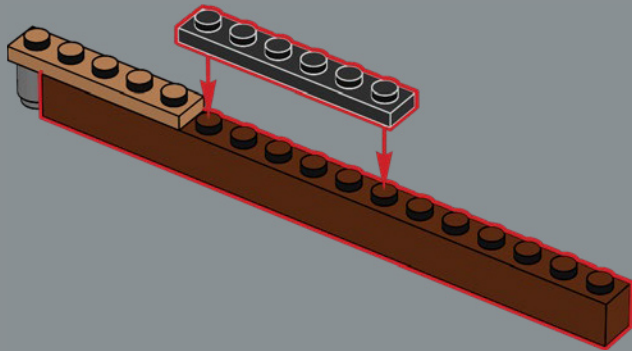

2x

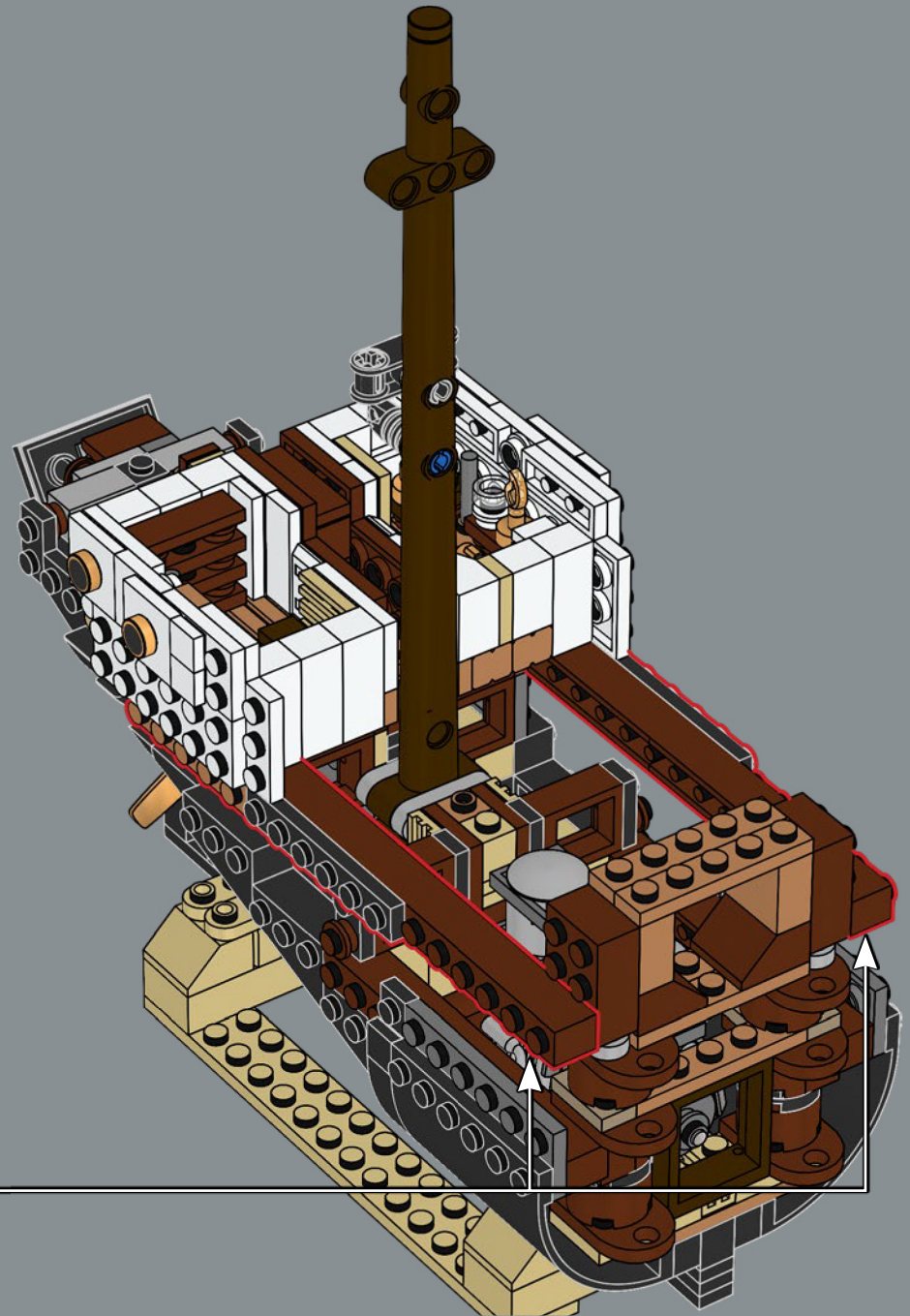

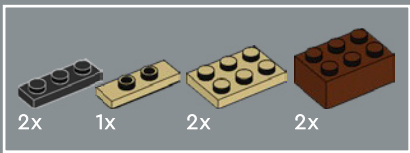

391

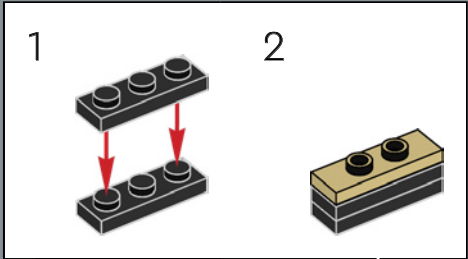
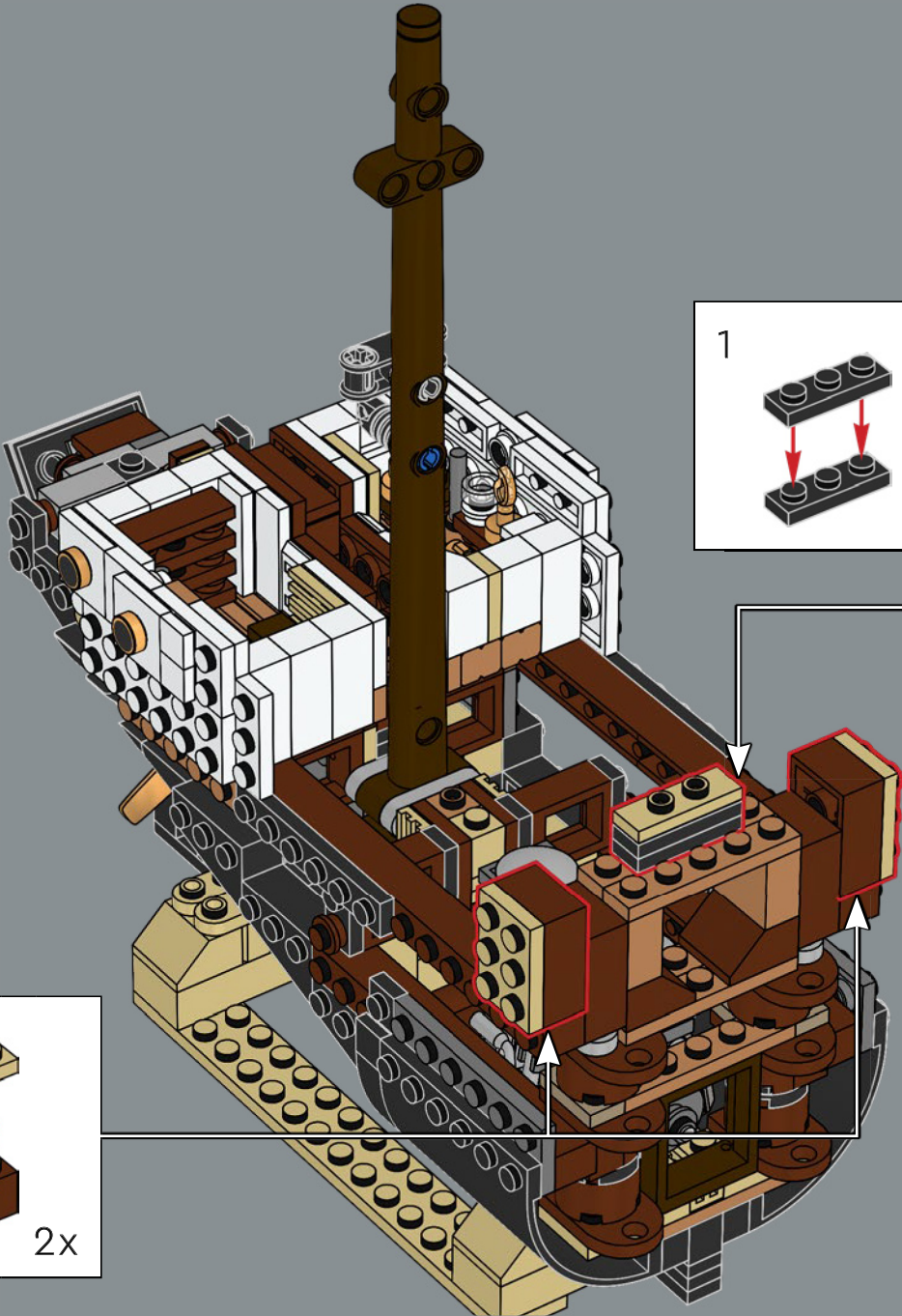

2

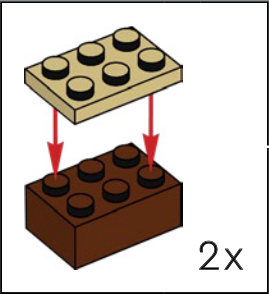
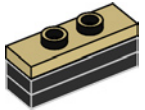

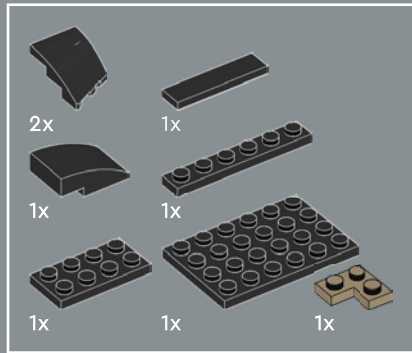

392

1

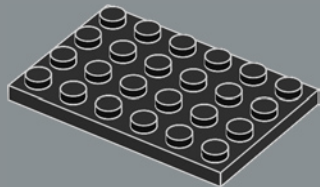

2

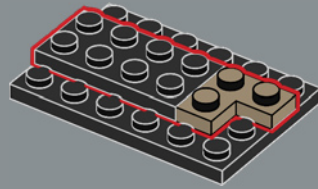

3

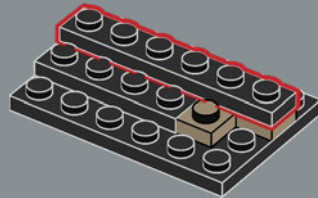

4

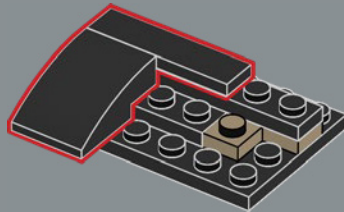

5

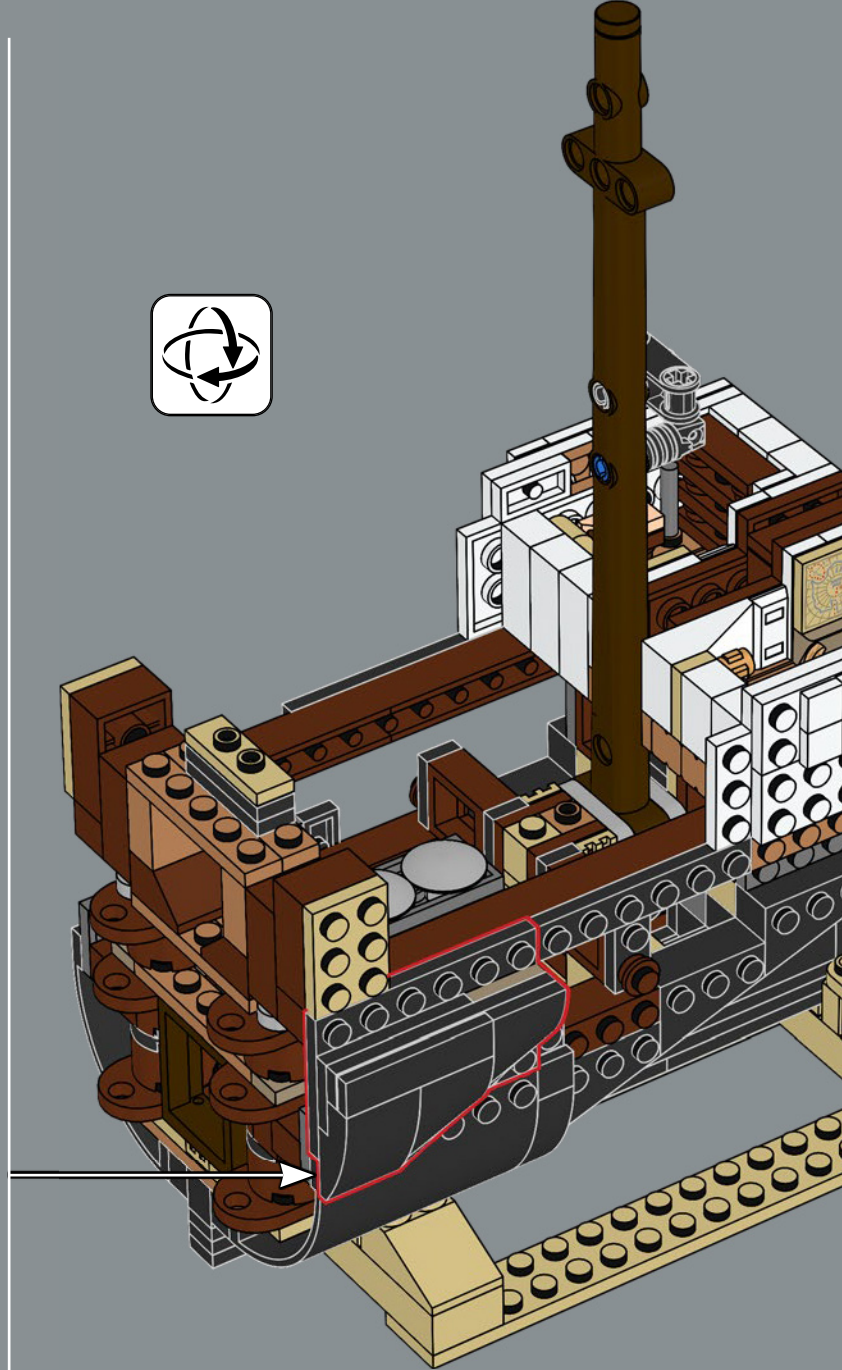
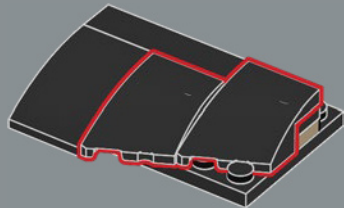

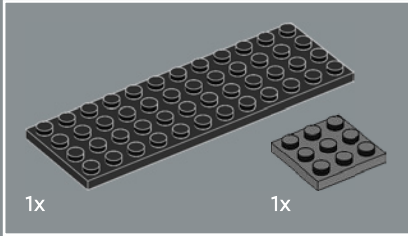
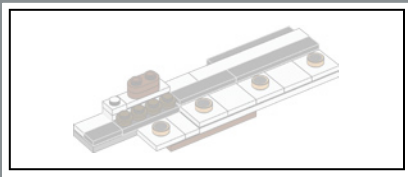

393

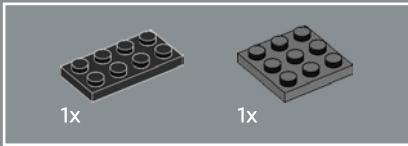
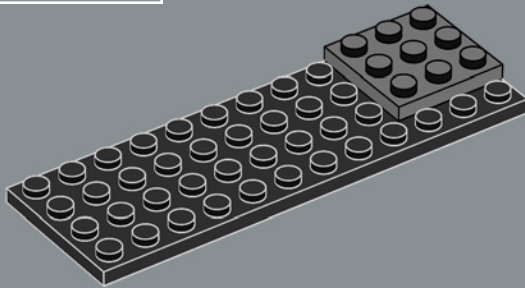

394

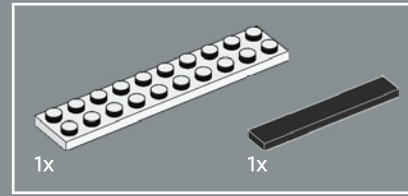
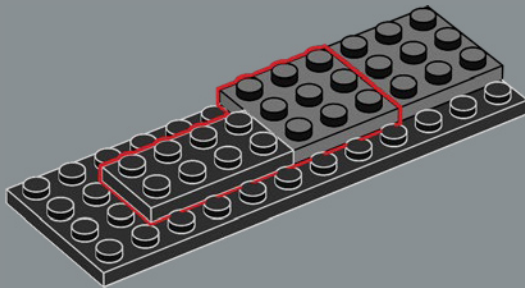

395

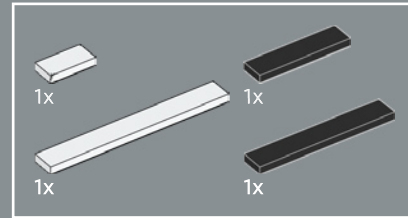
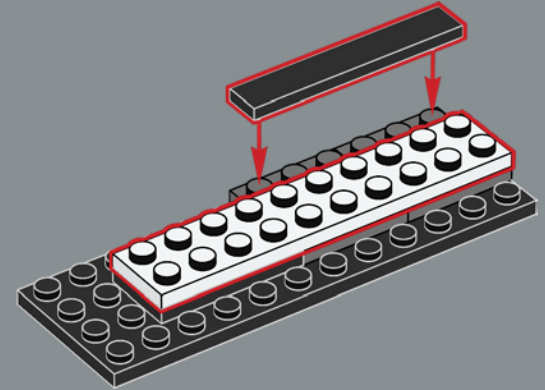

396

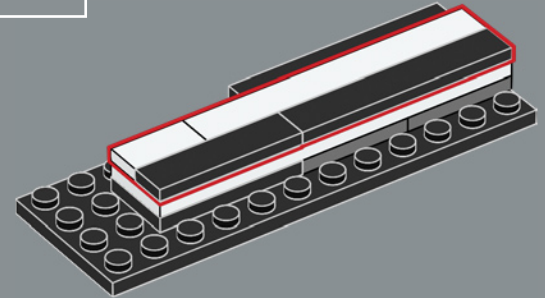

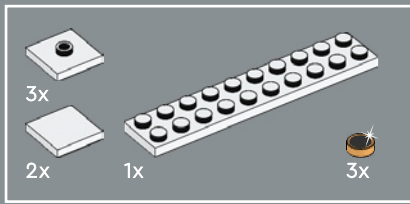

397

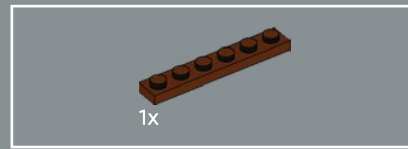
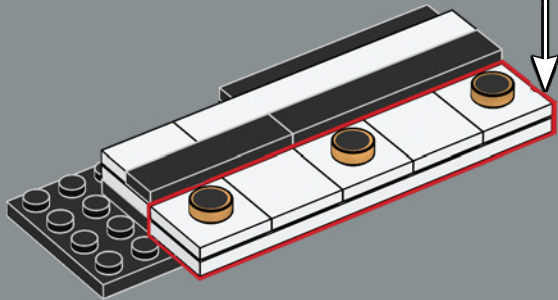
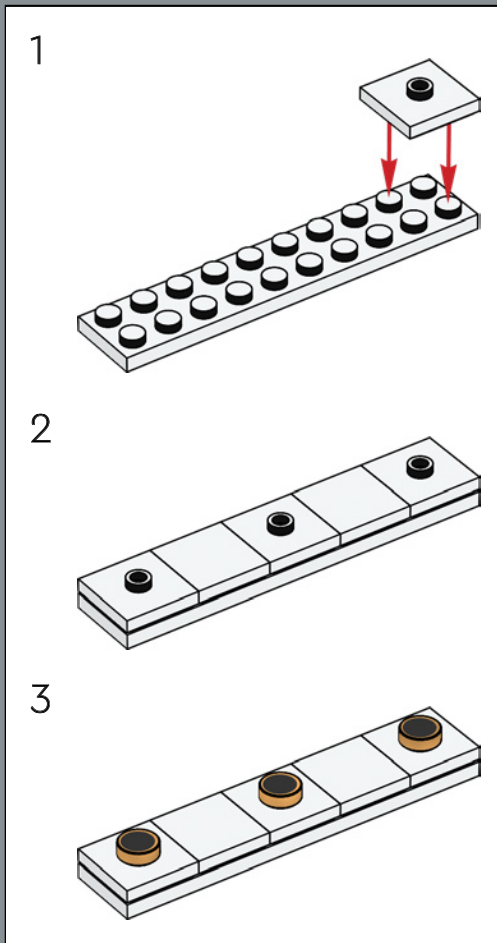

398

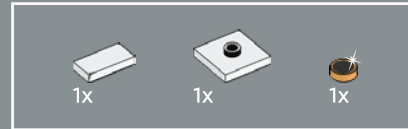
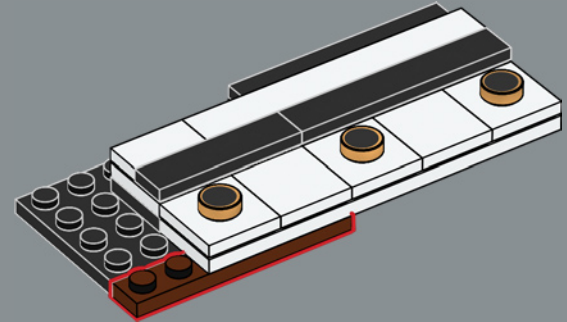

399

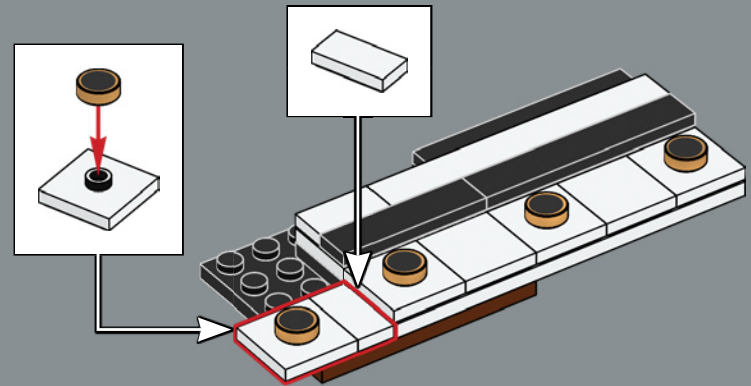

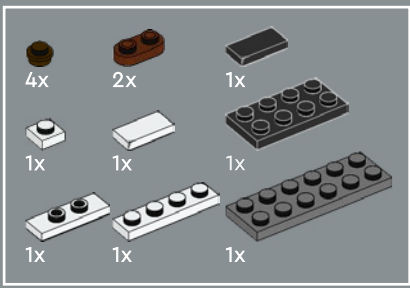

400

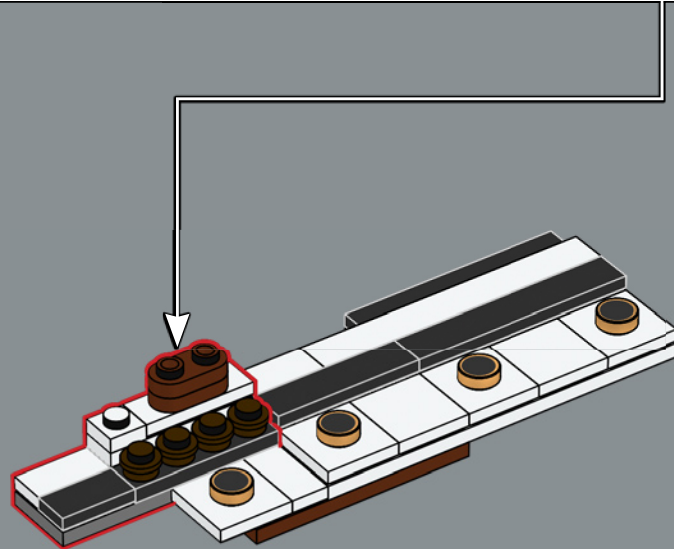
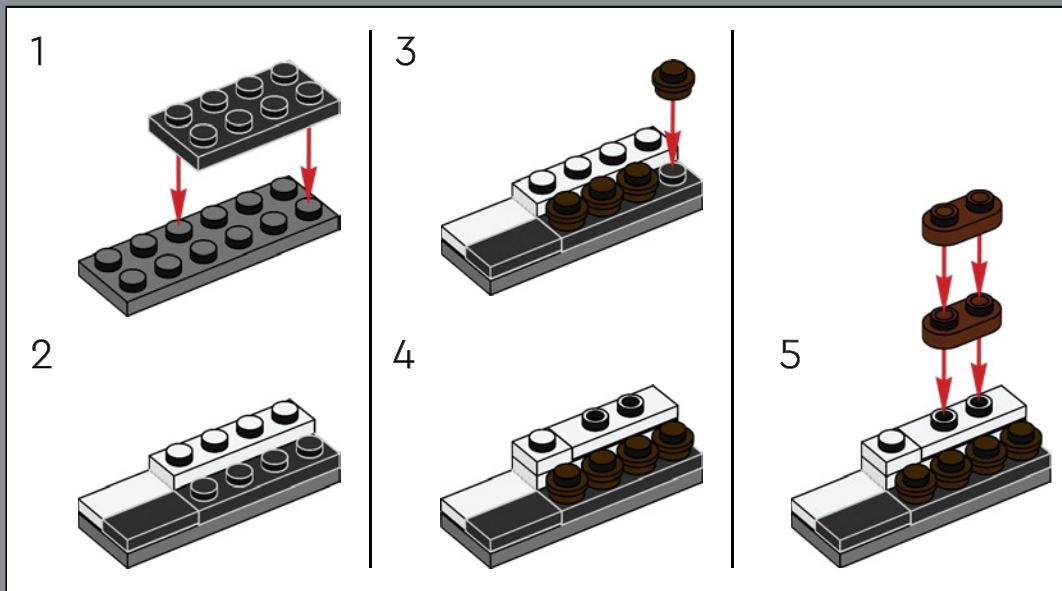

401

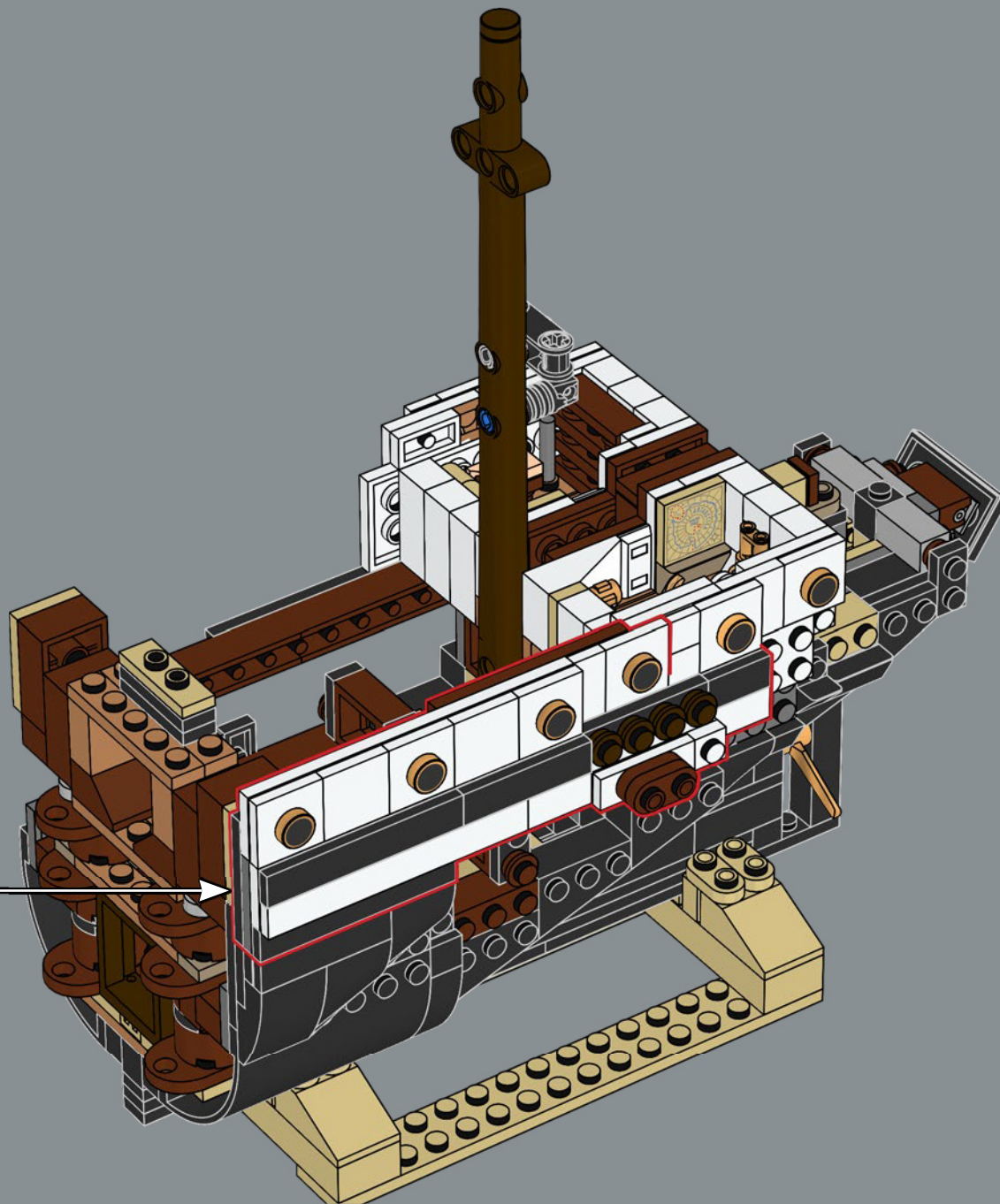

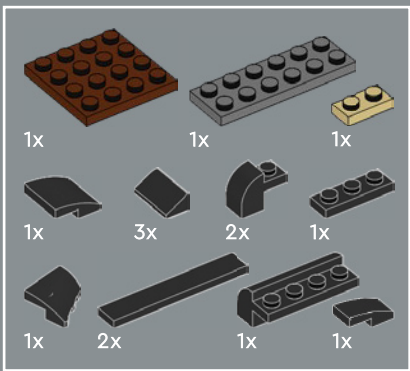

402

1

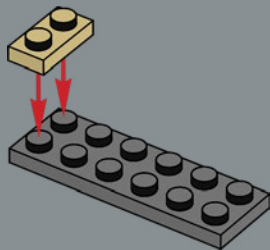

2

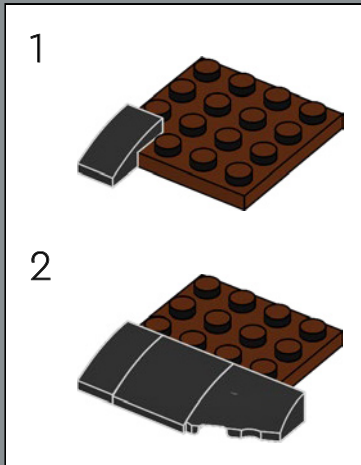
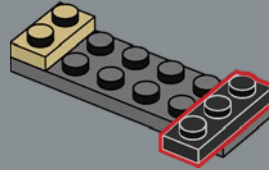

3

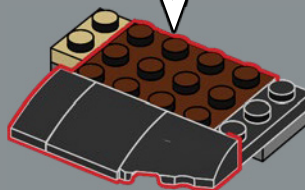

4

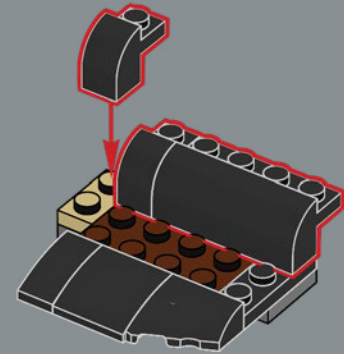

5

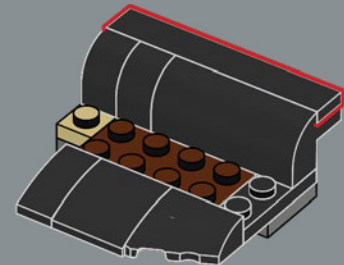

6

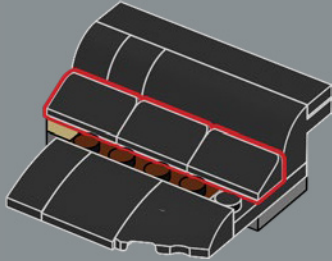

7

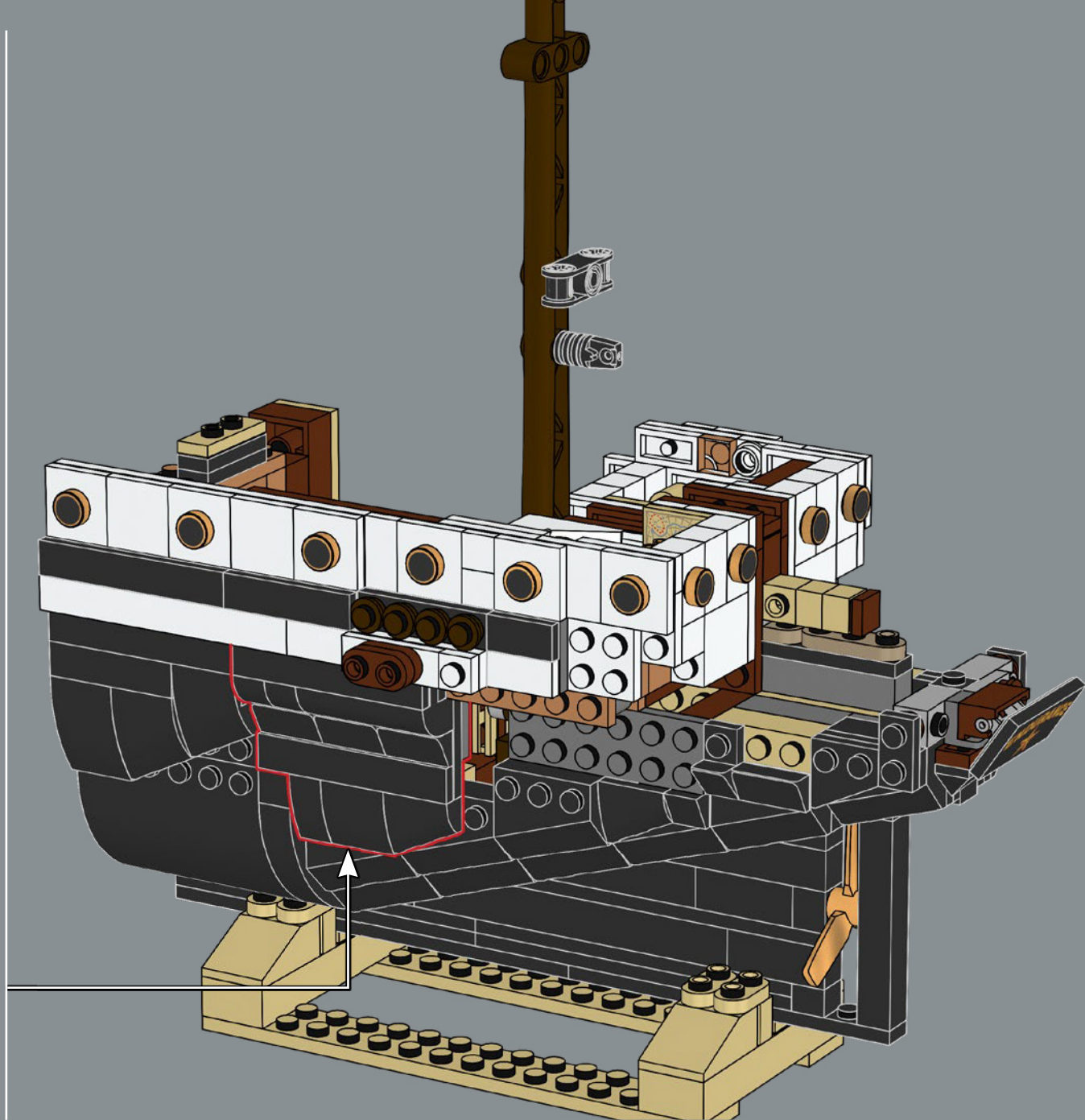
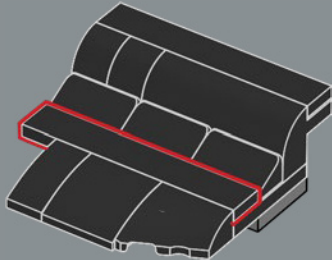

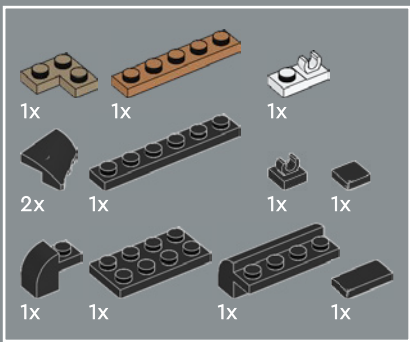

403

1

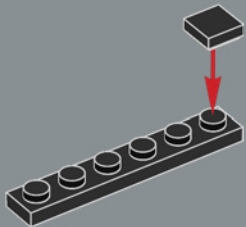

2

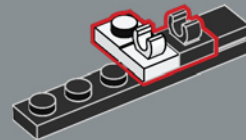

3

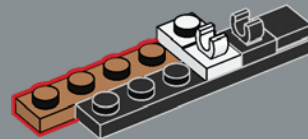

4



5

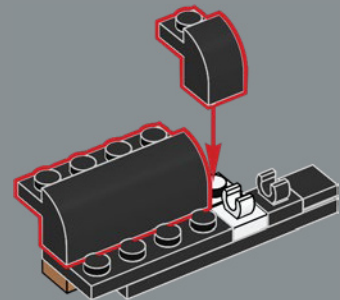

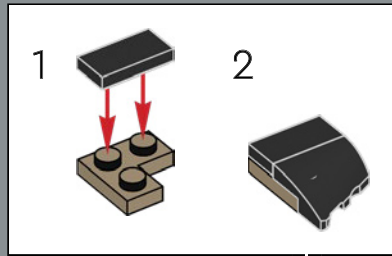

6

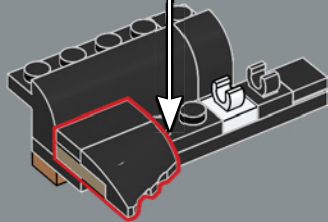

7

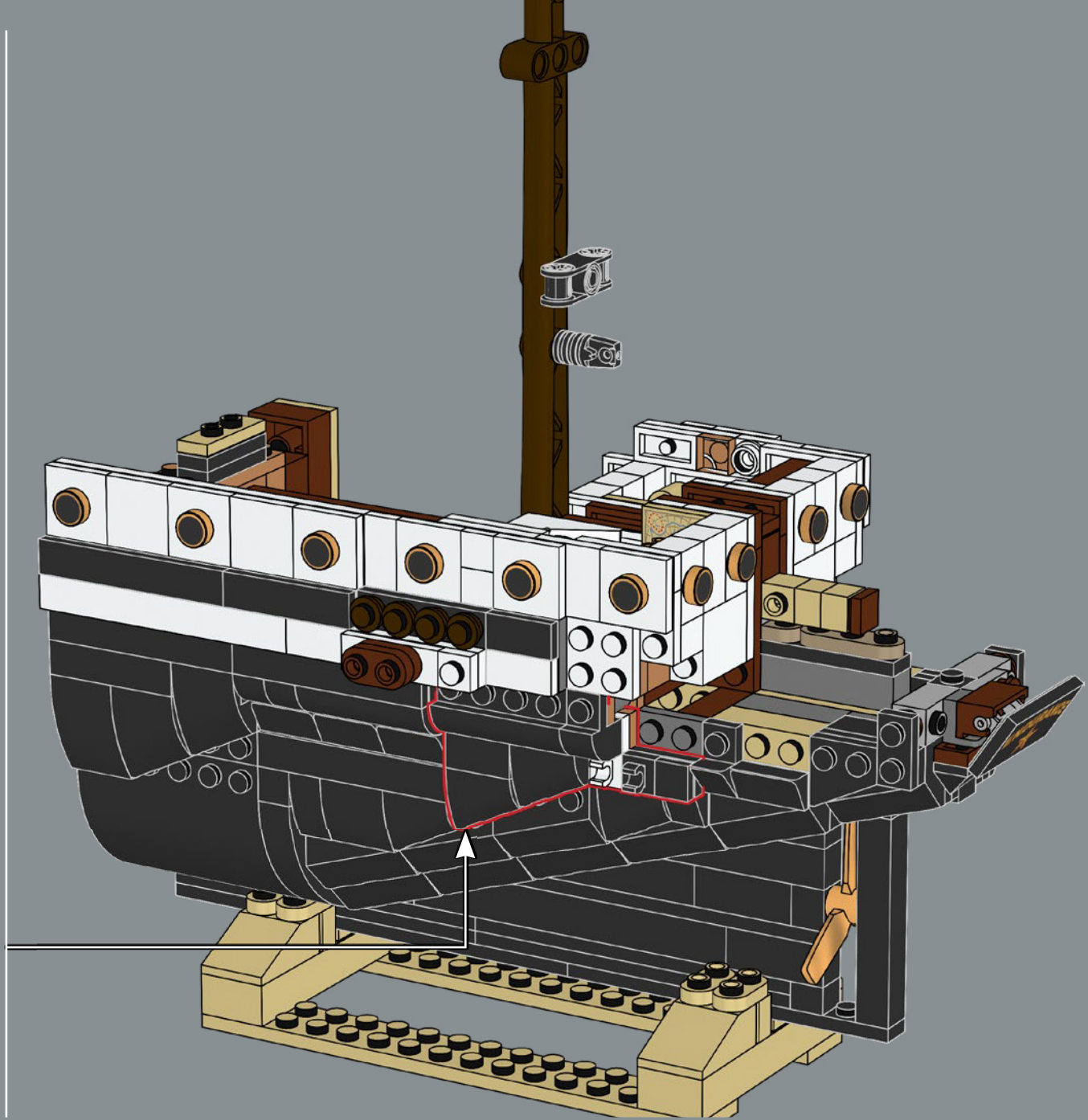
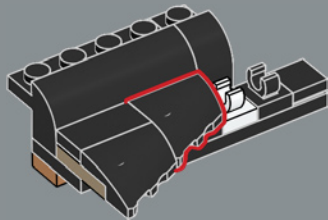

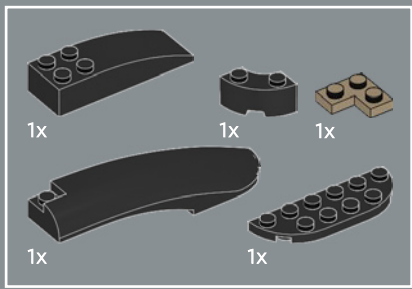

404

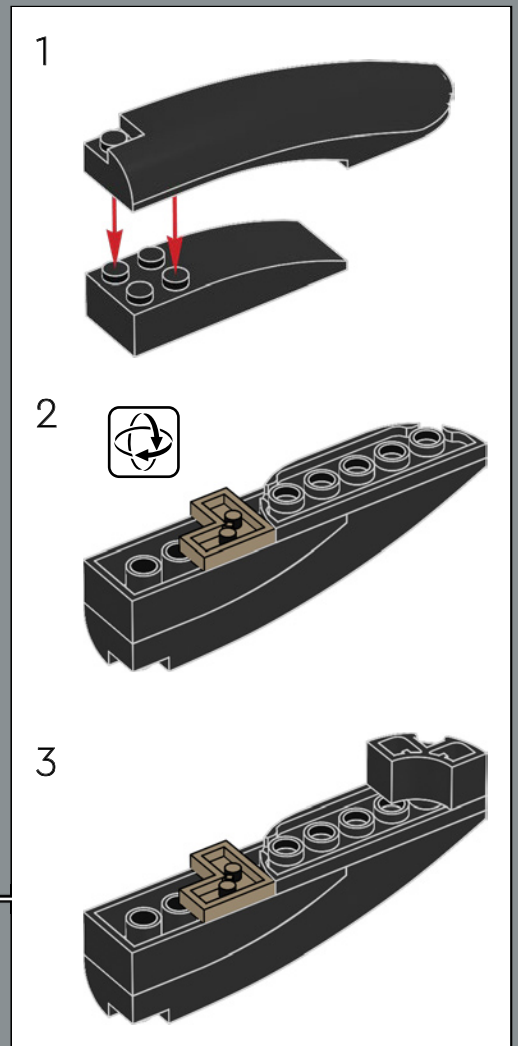
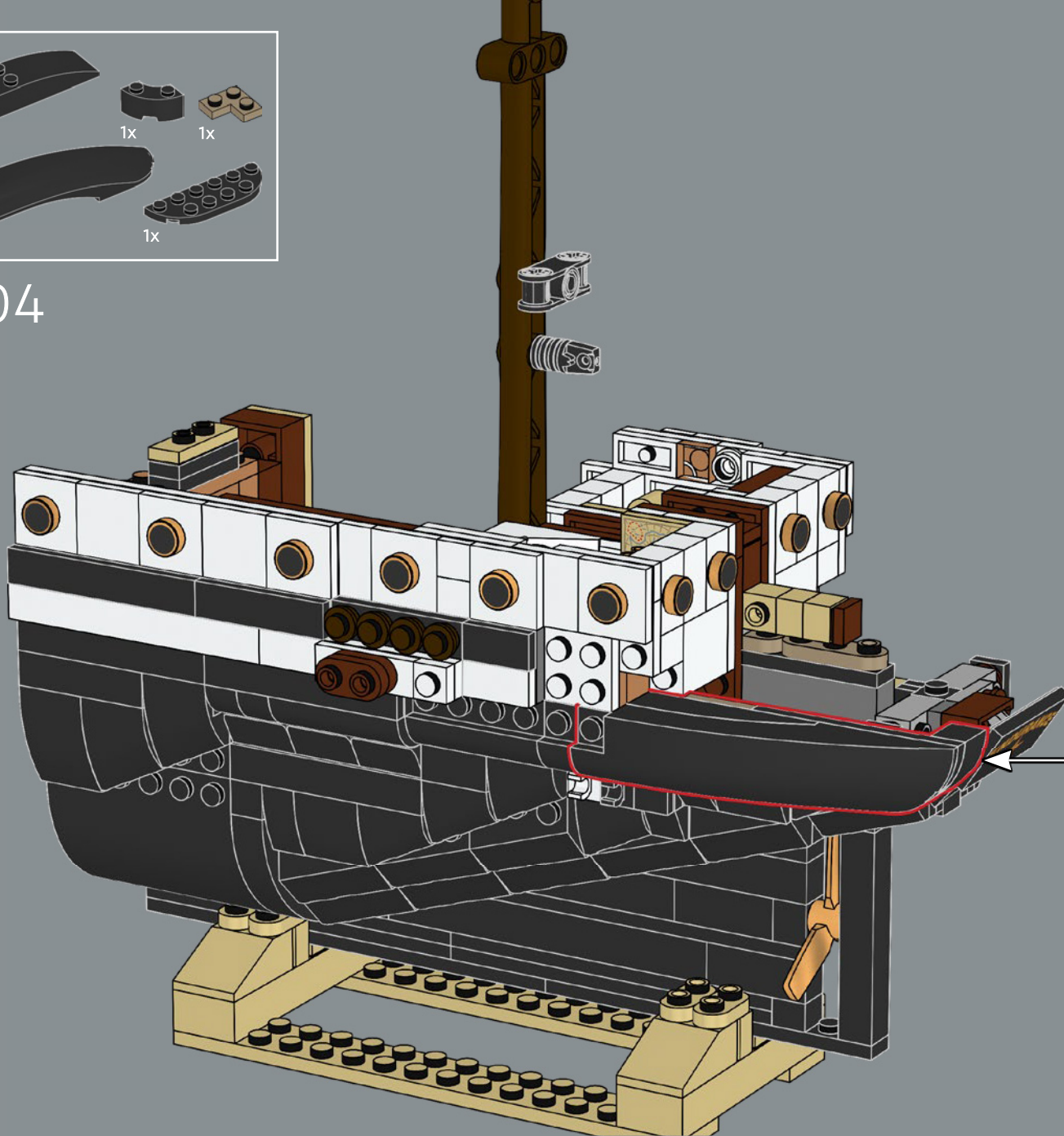

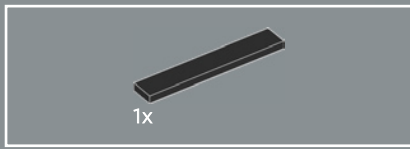

405

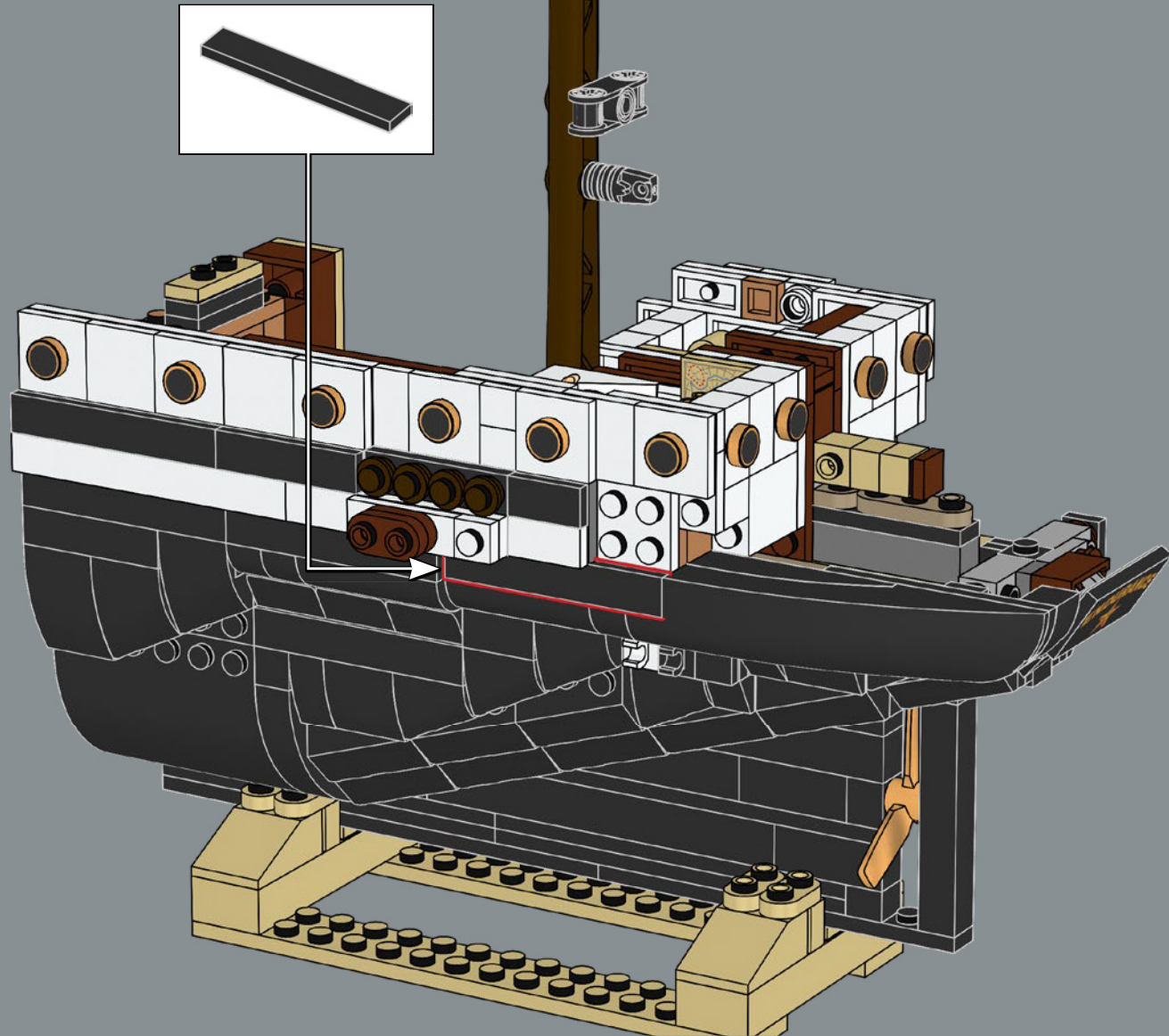

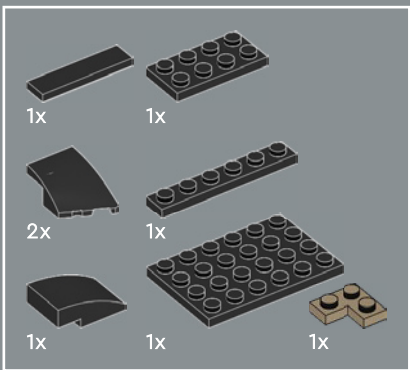
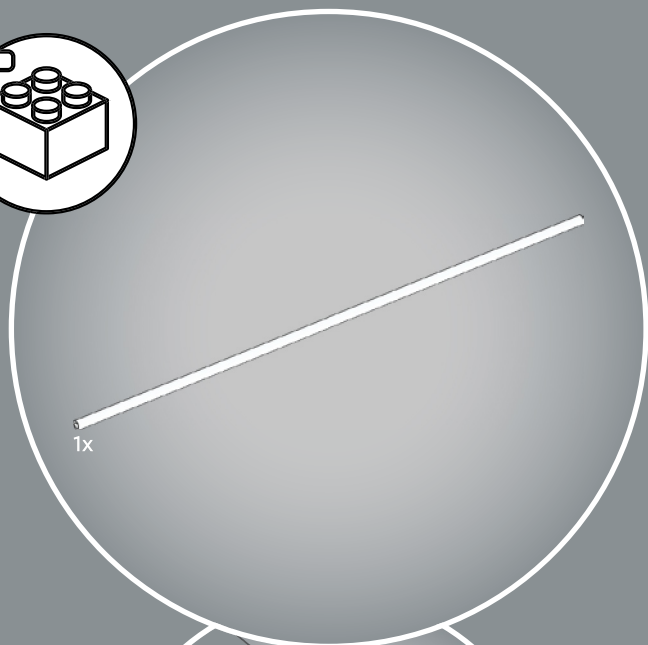
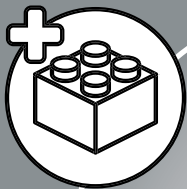

406



1

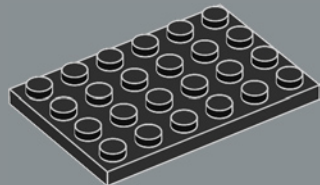

2

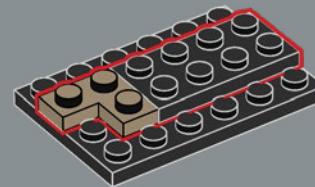

3

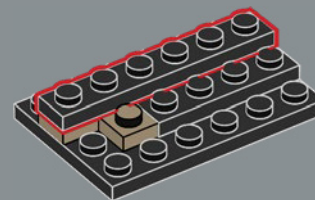

4

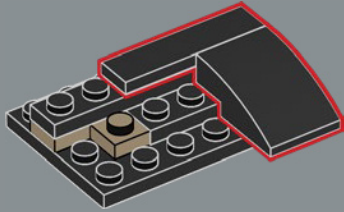

5

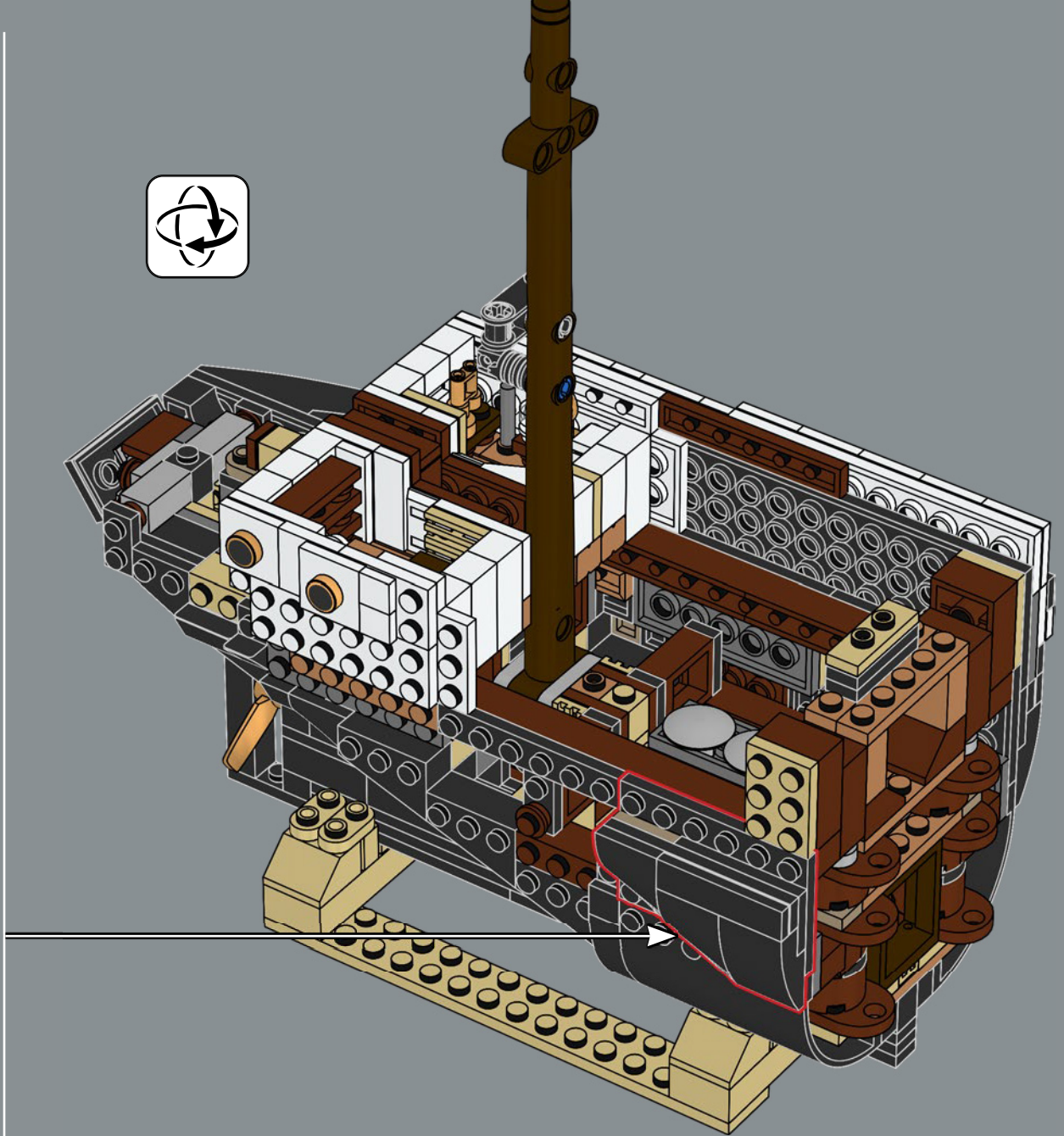
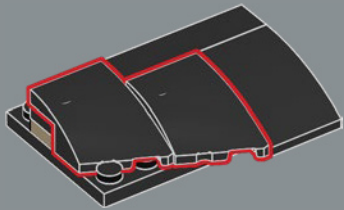

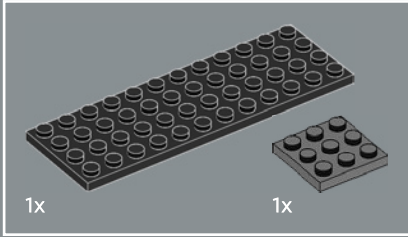
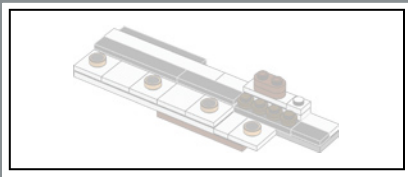

407

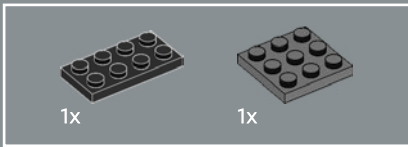
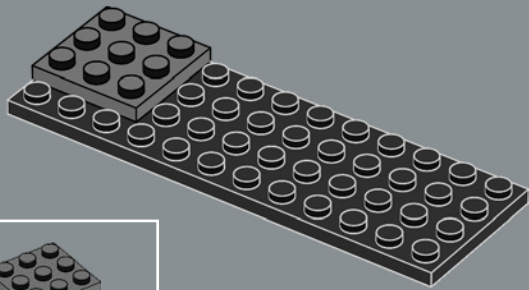

408

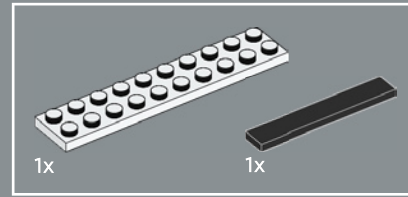
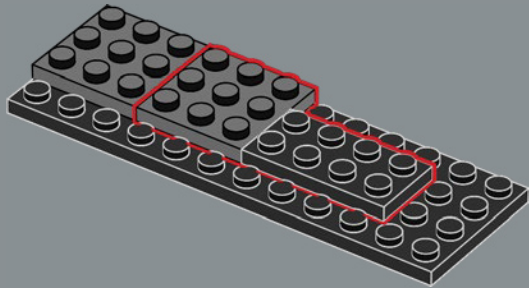

409

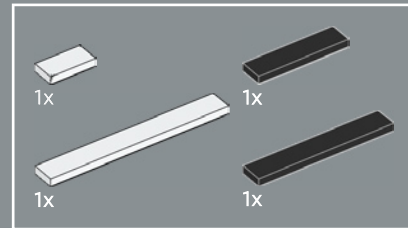
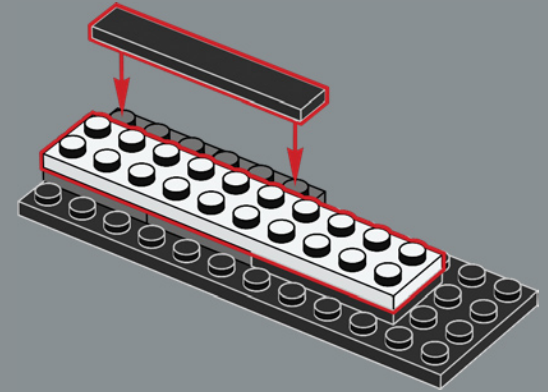

410

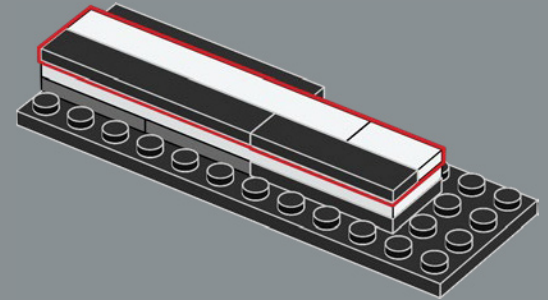

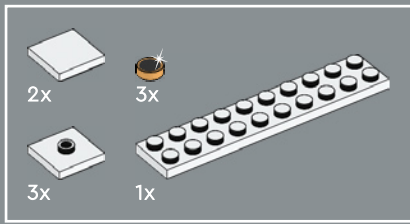

411

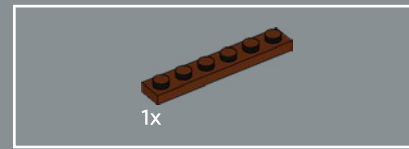
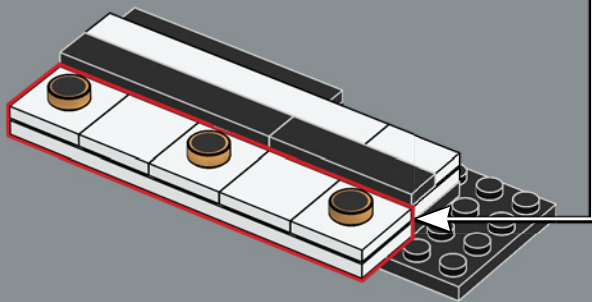
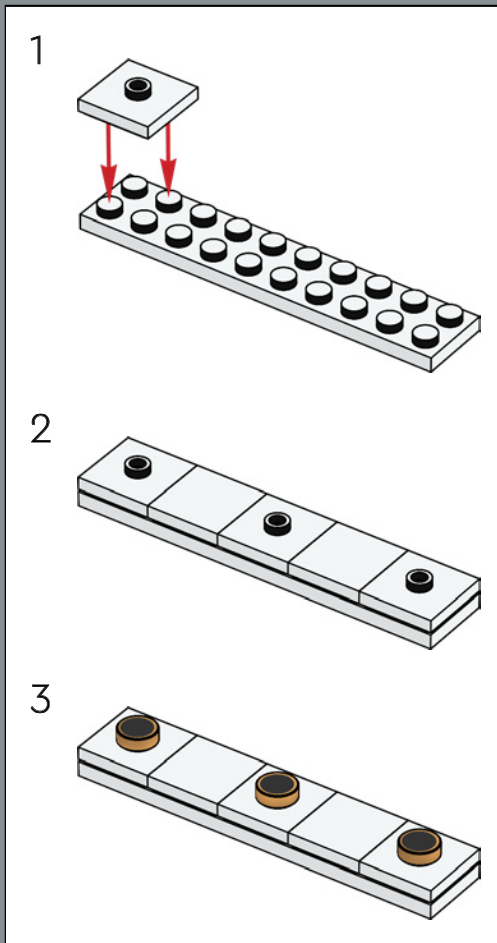

412

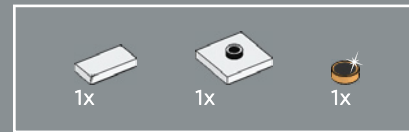
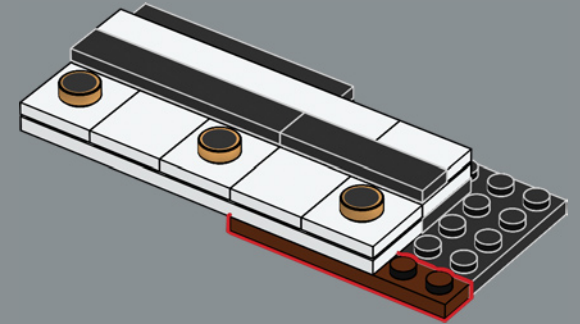

413

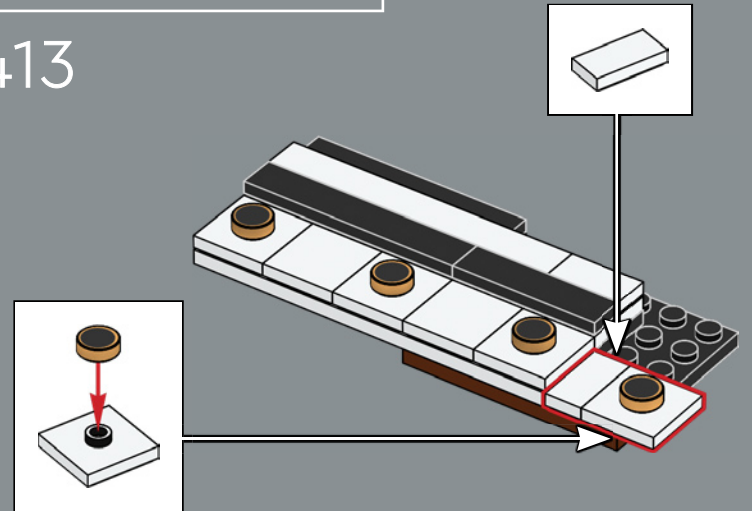

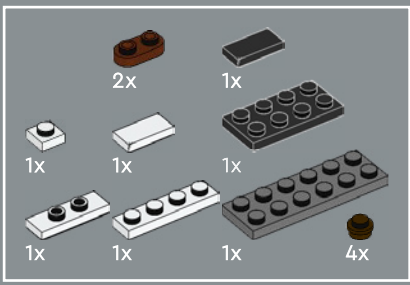

414

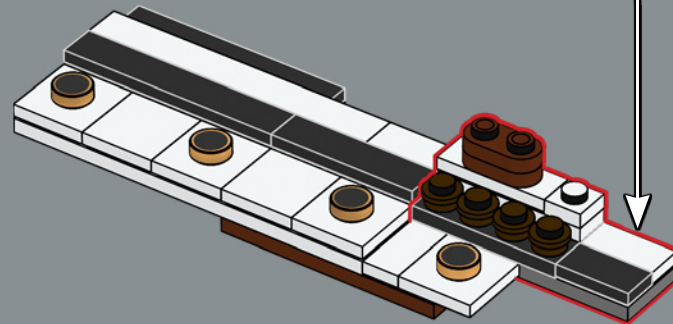
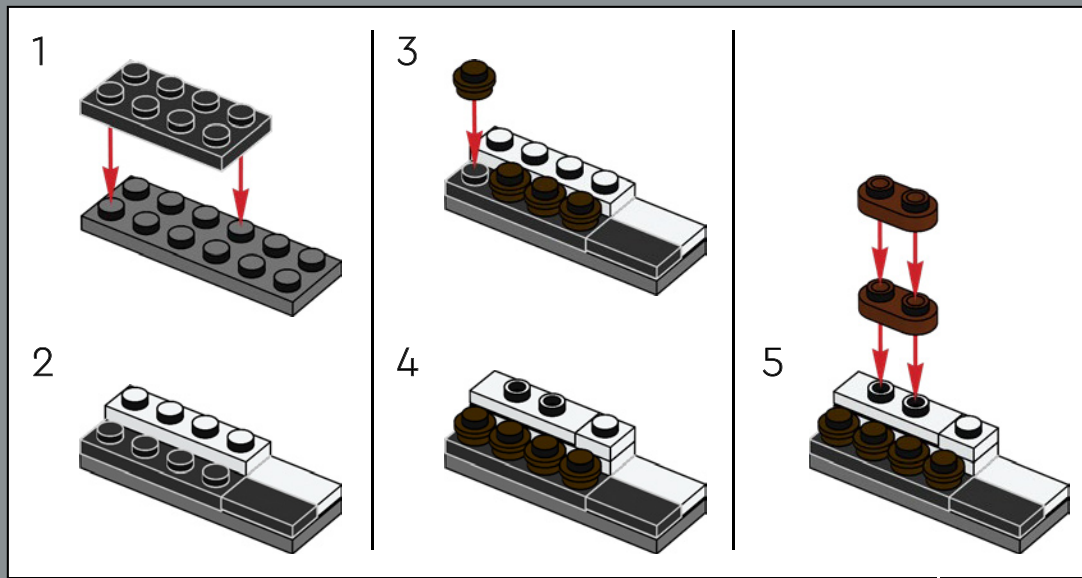

415

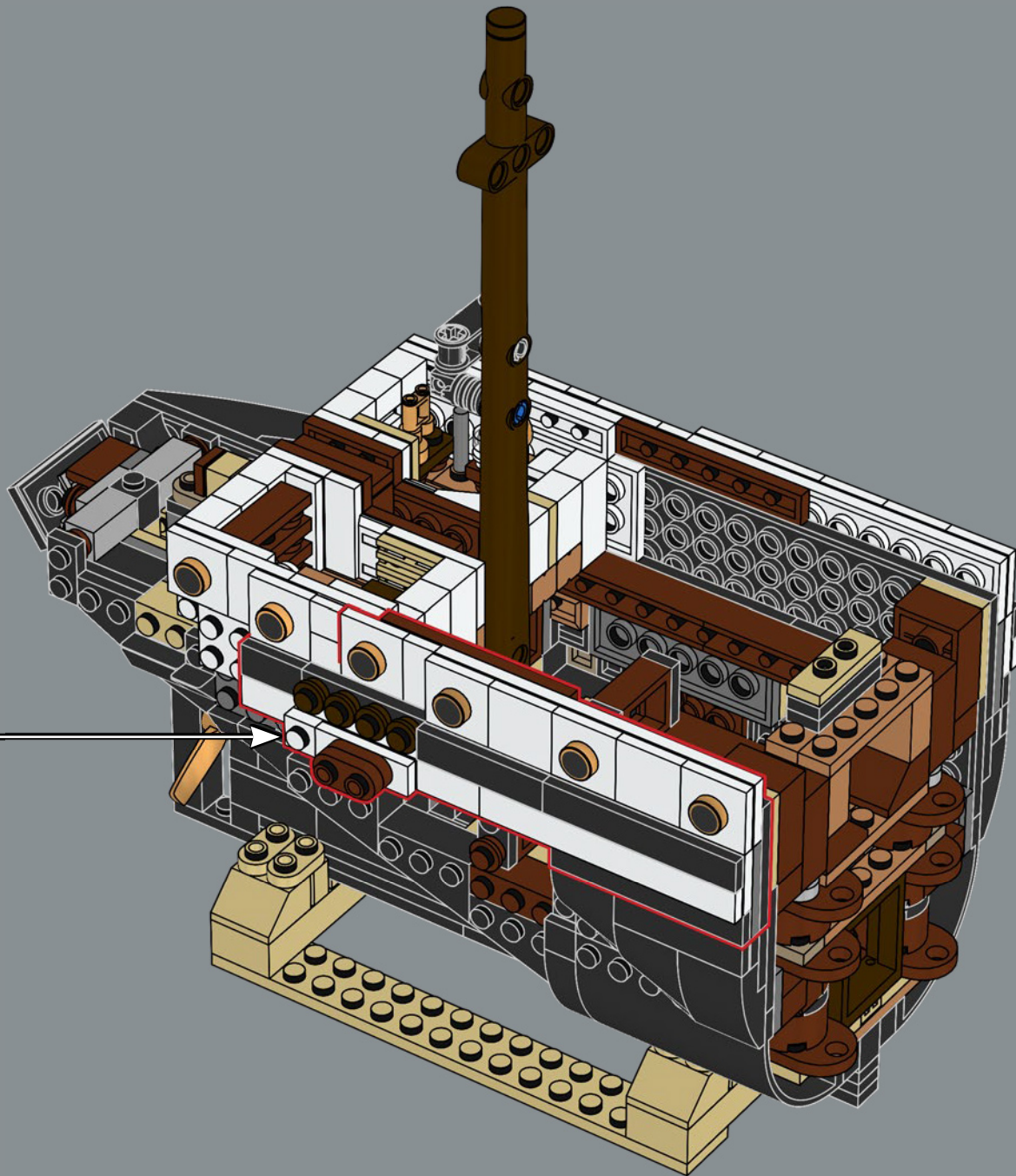

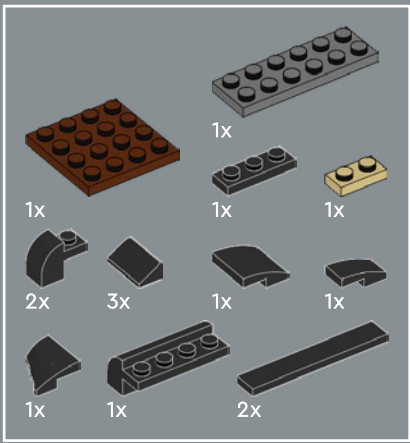

416

1

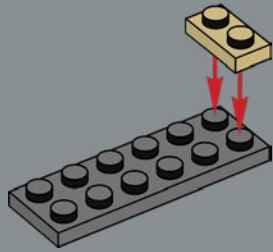

2

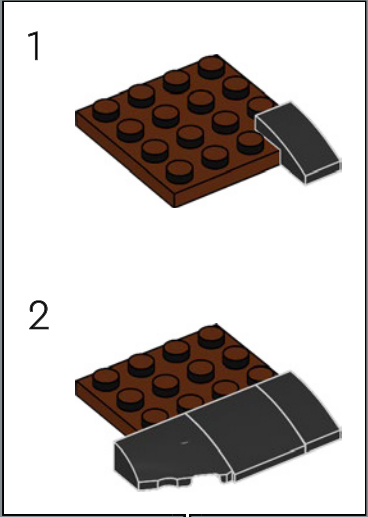
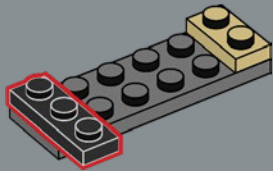

3



4

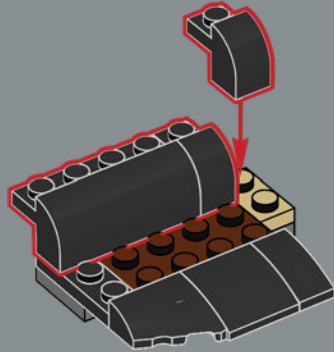

5

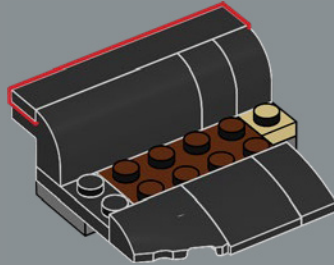

6

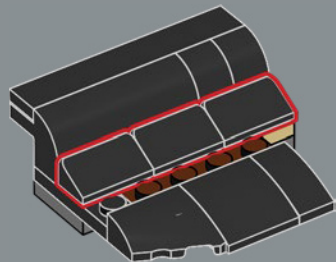

7

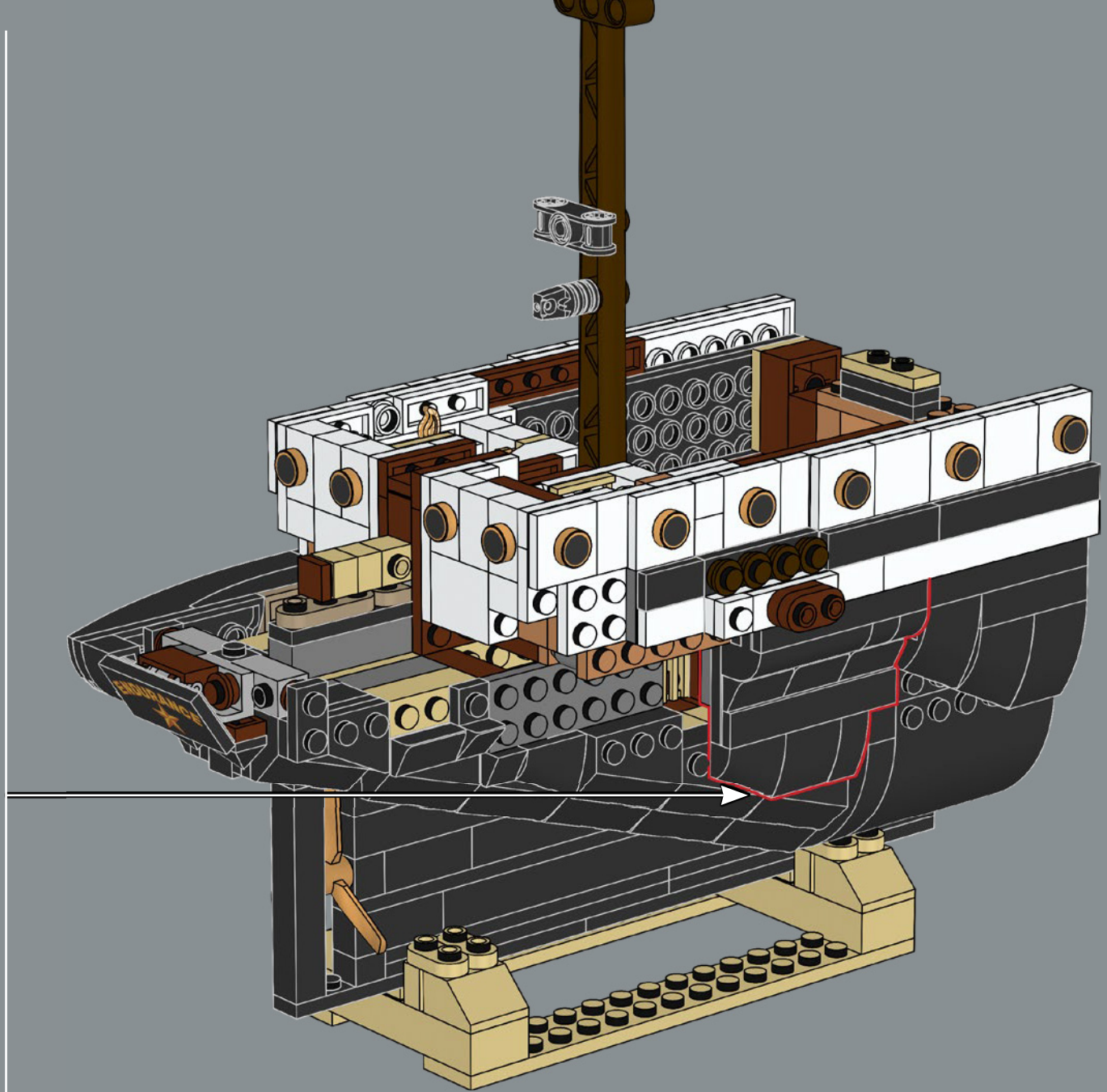
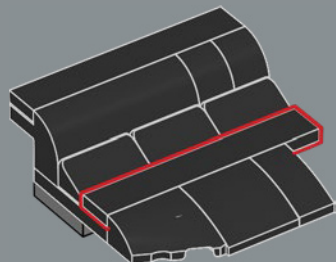

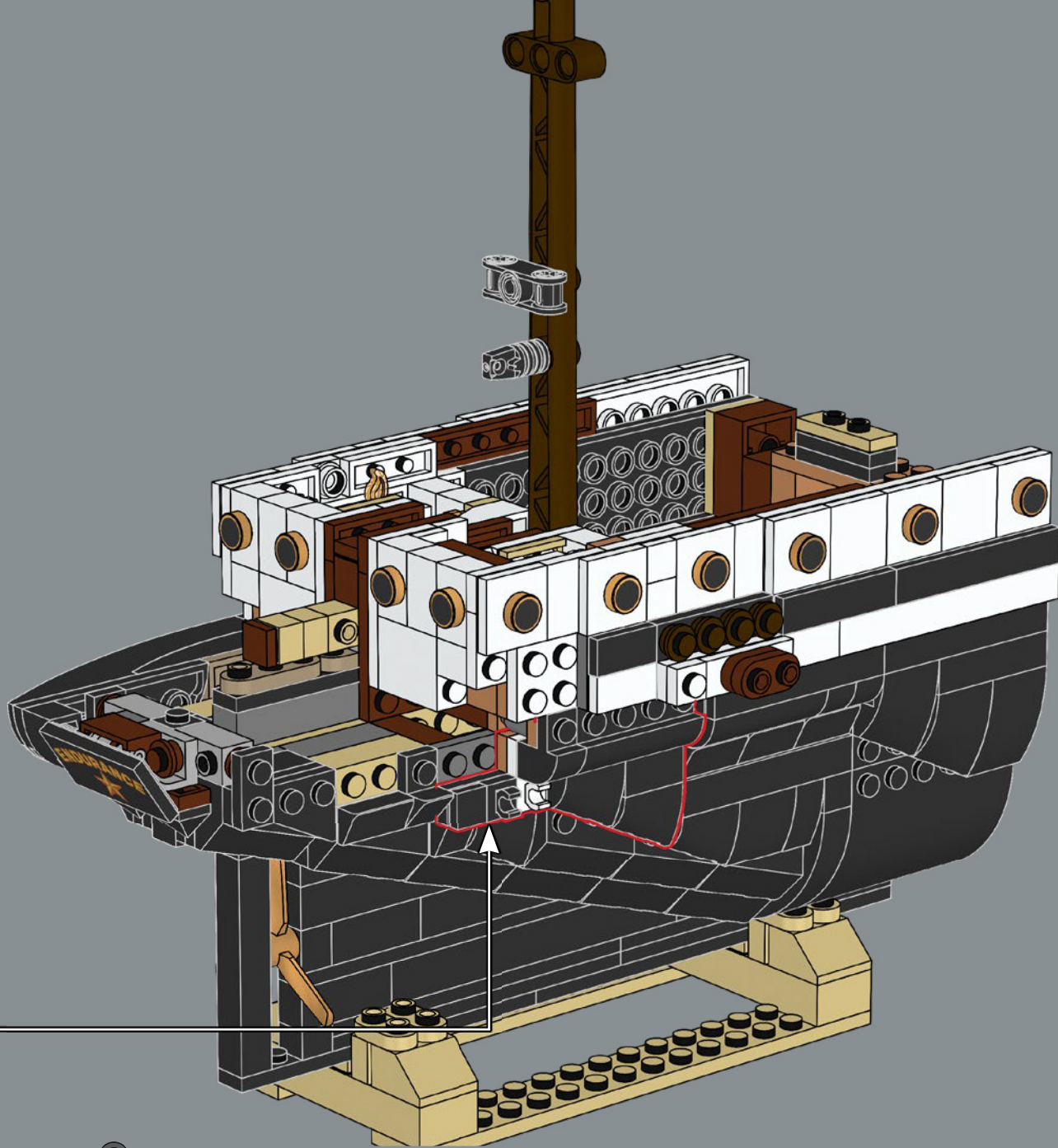

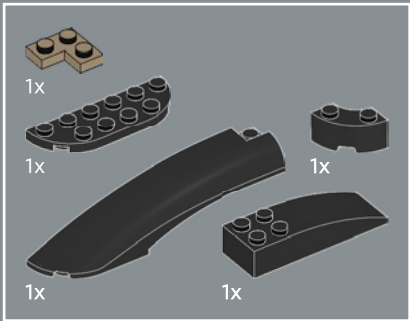

418

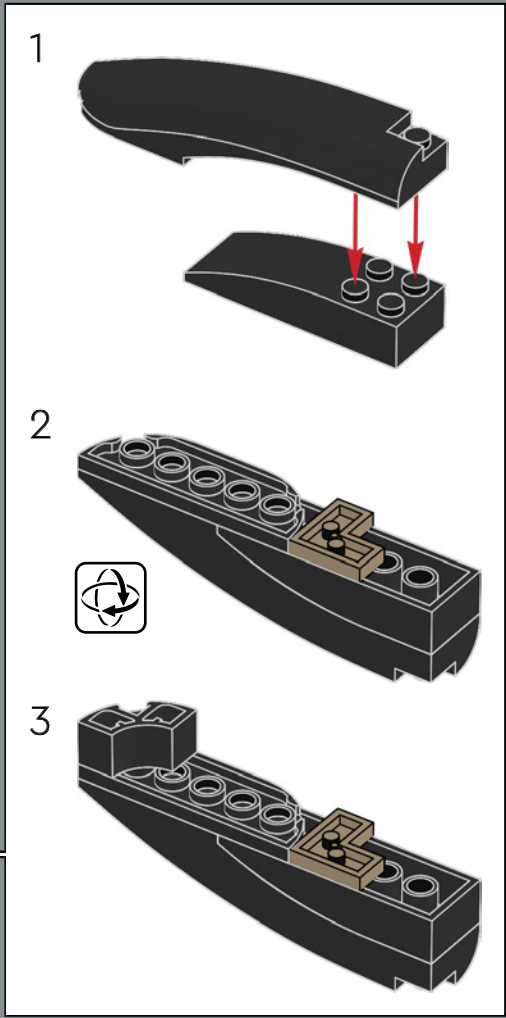
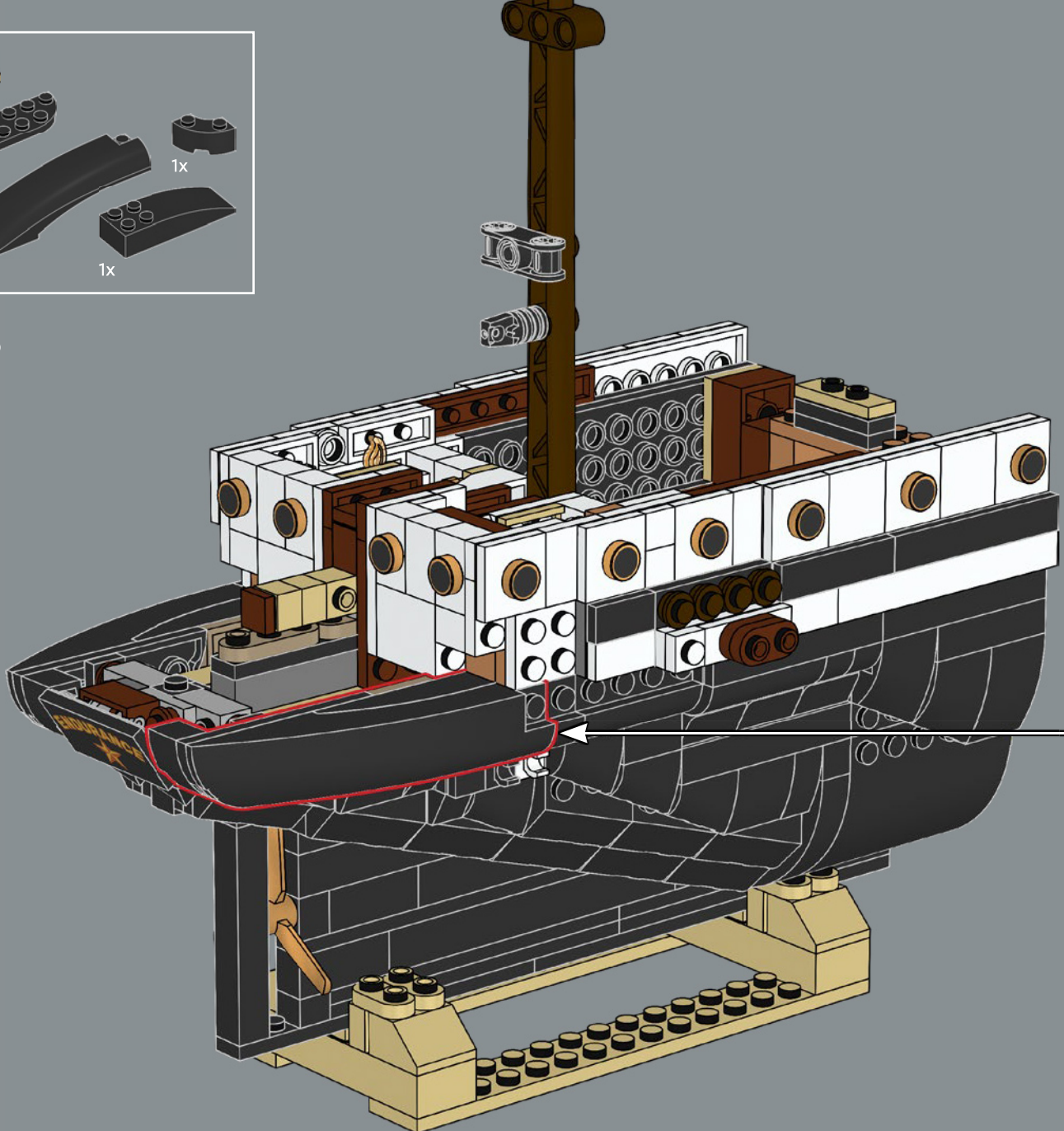

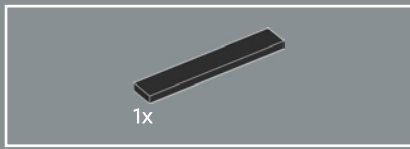

419

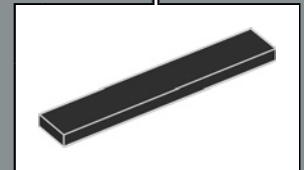
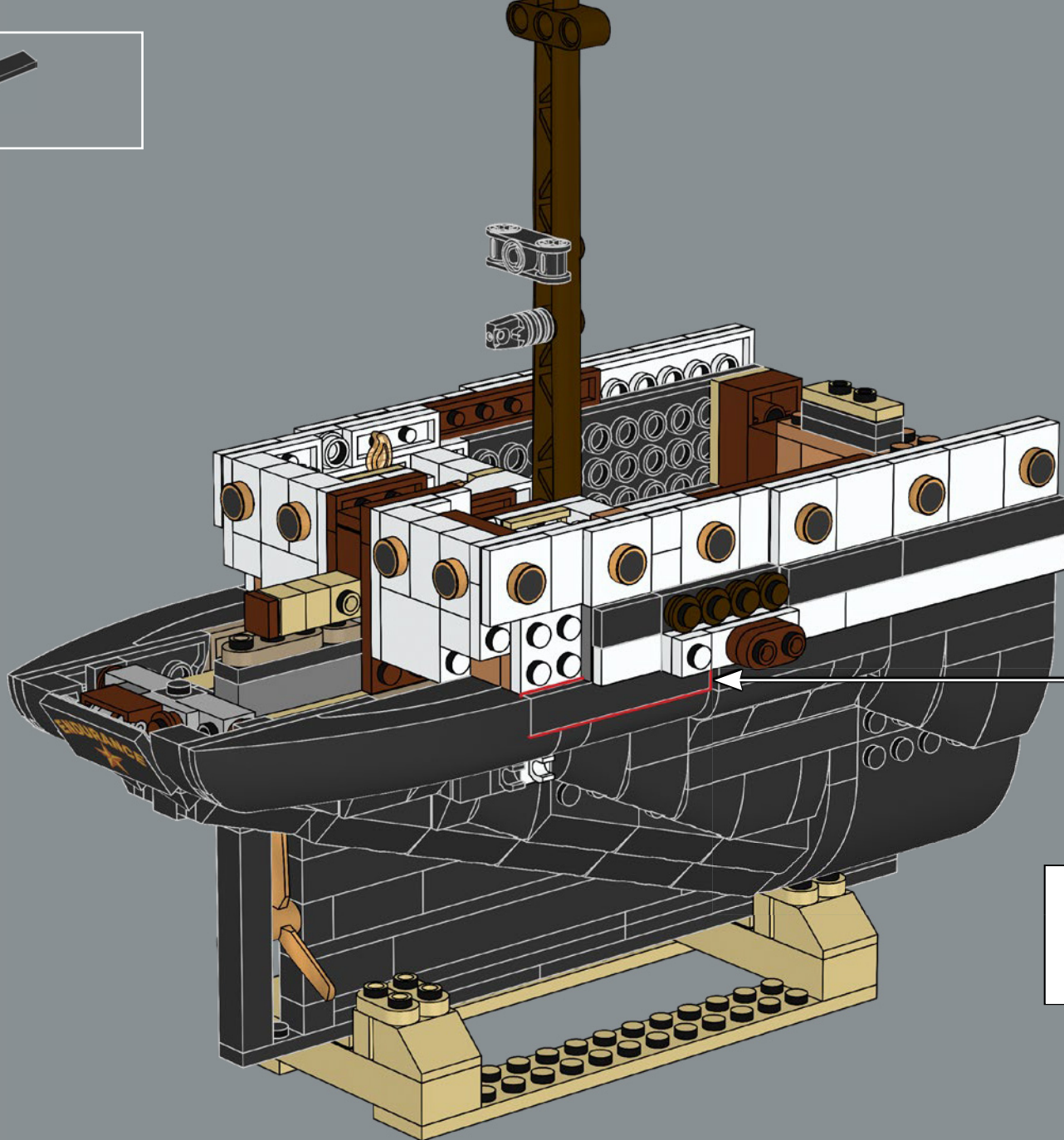

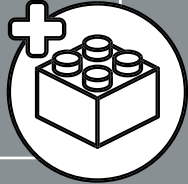
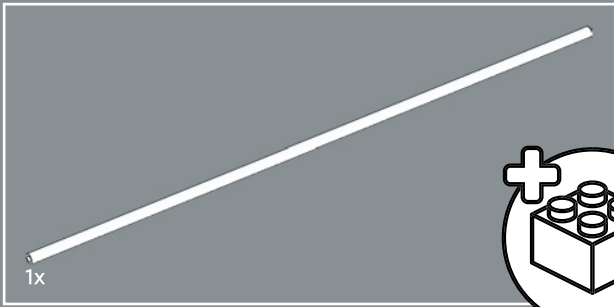

420

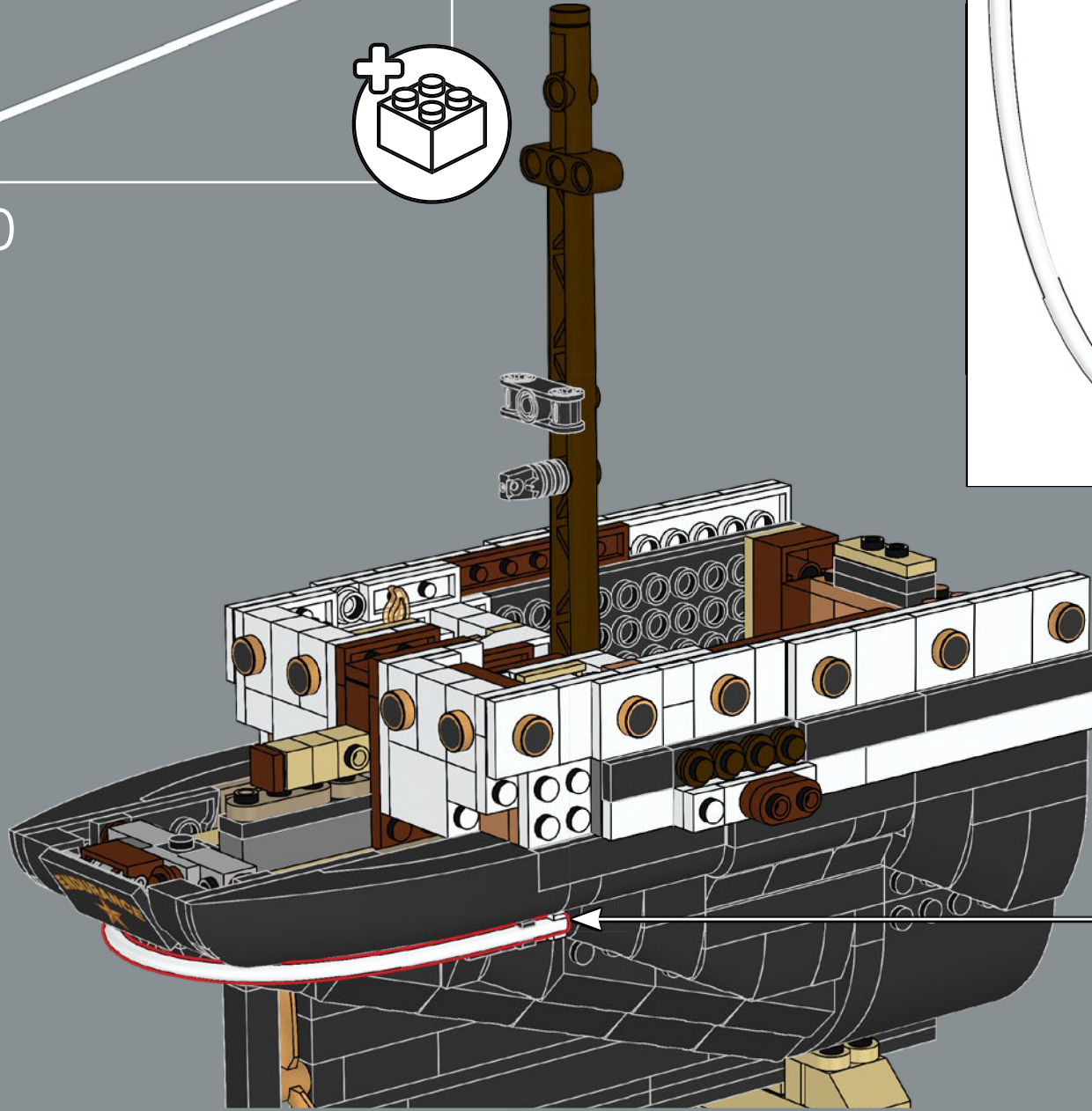
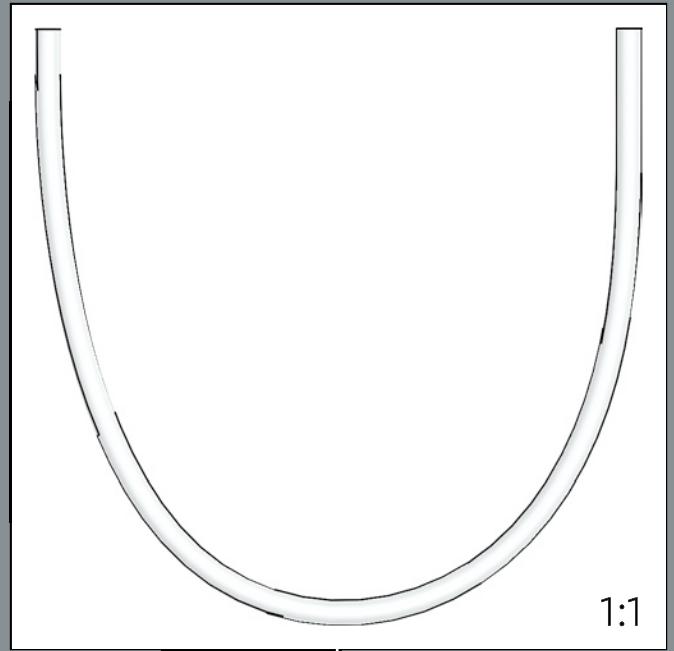

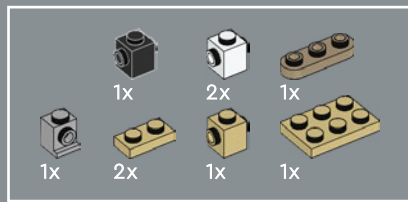
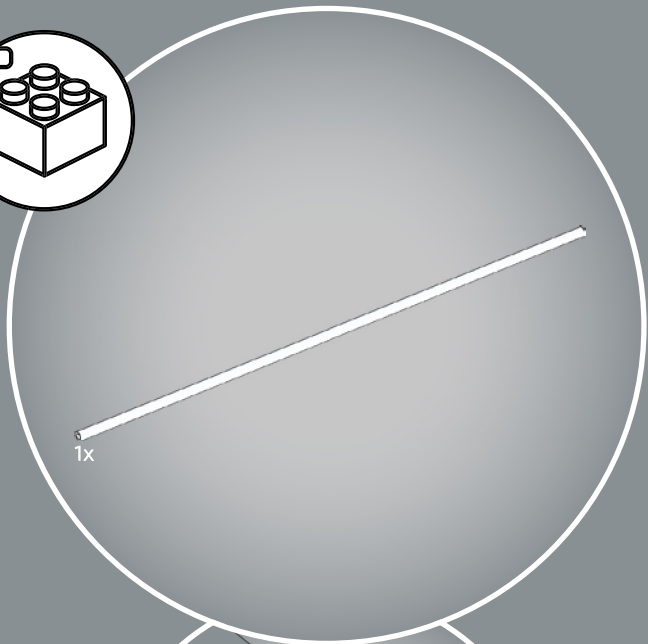
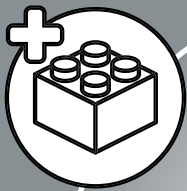

421

1

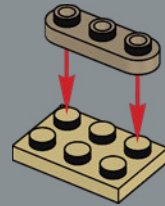

2

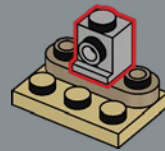

3

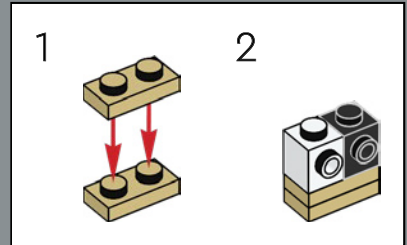
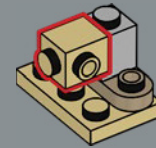

4

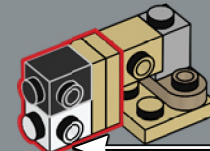

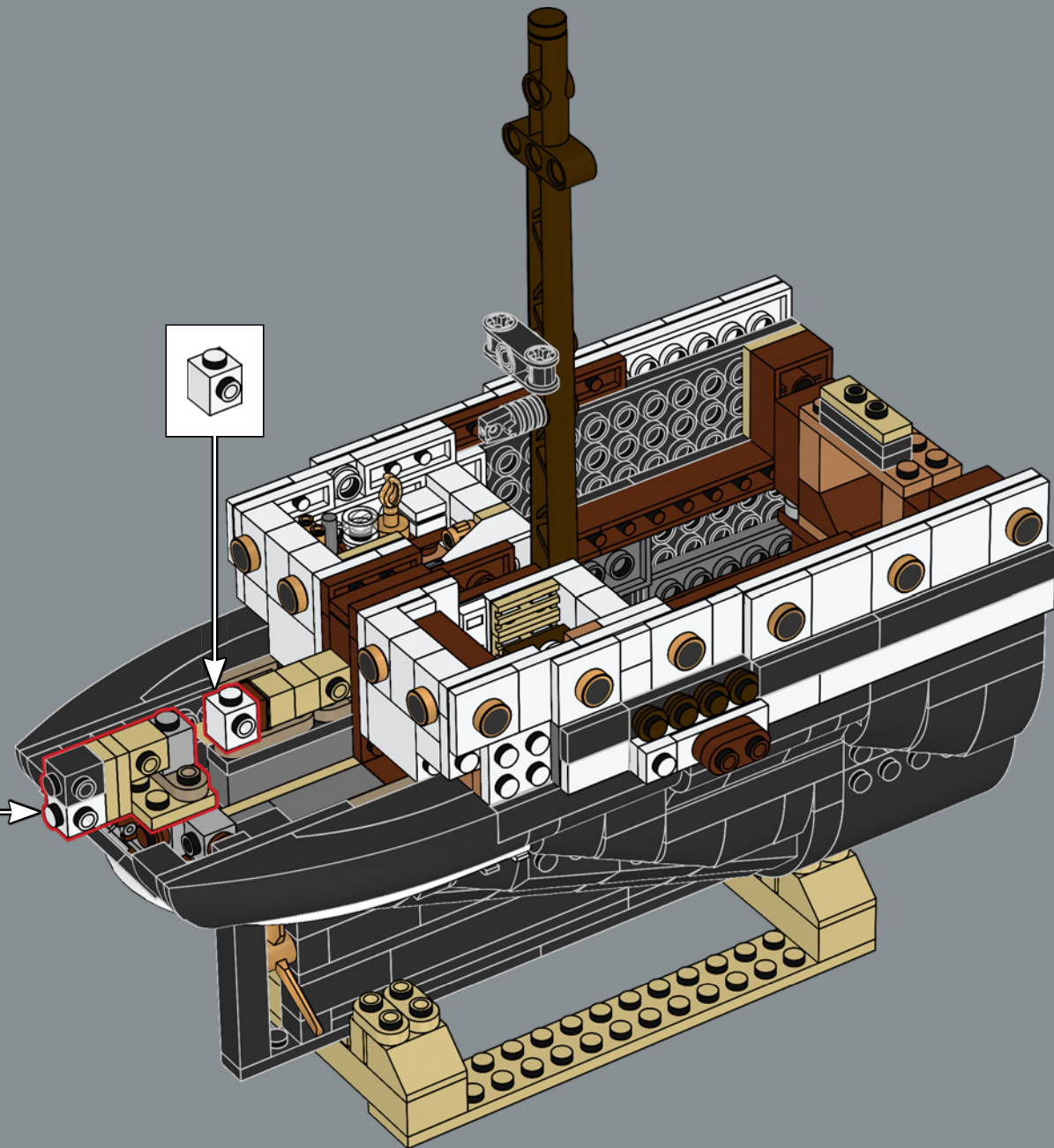

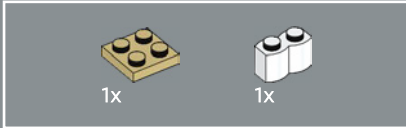
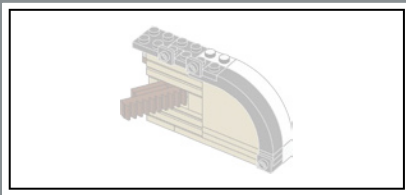

422

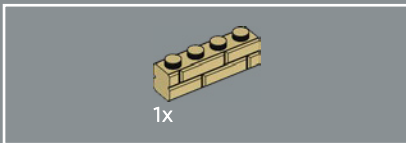
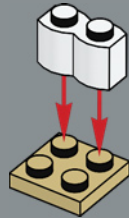

423

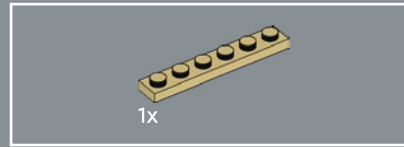
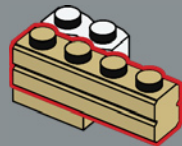

424

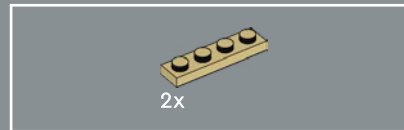
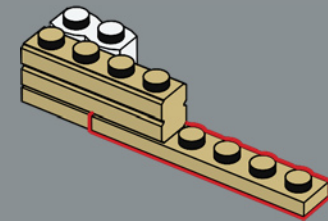

425

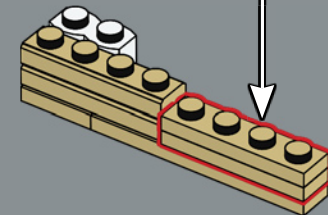
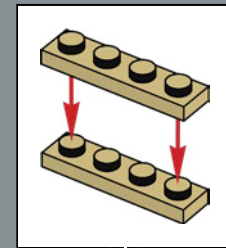

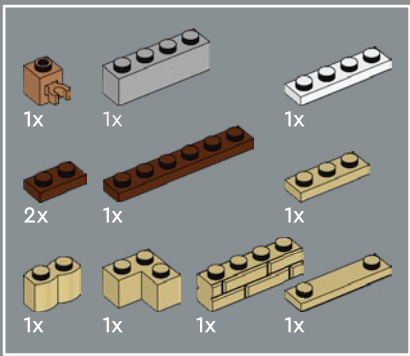

426 1

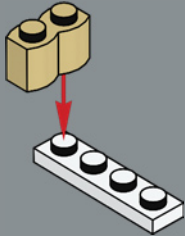

2

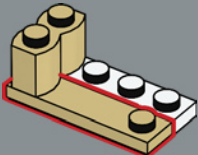

3

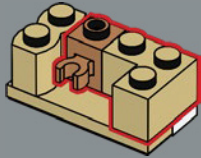

4

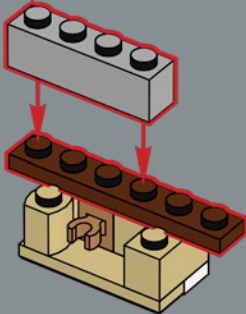

5

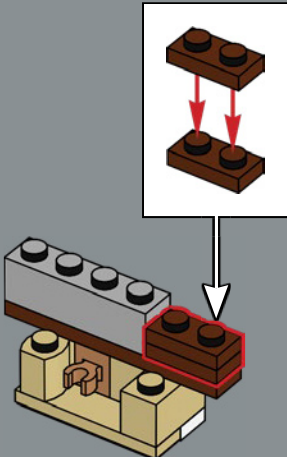

6

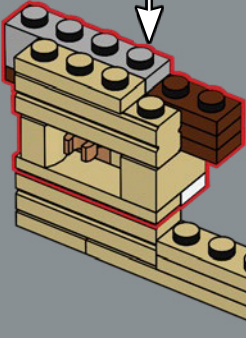
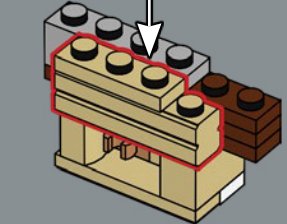
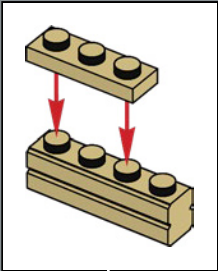

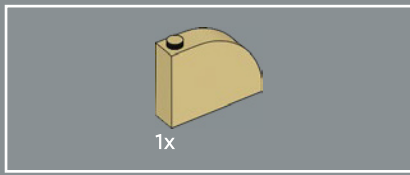

427

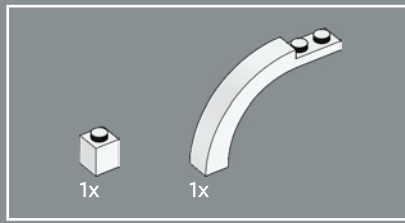
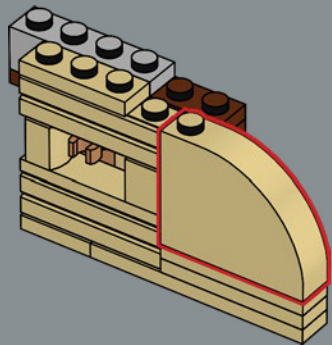

428

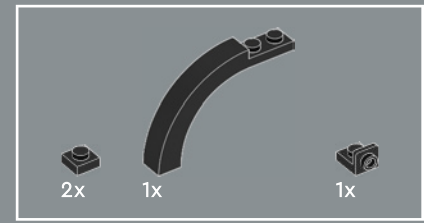
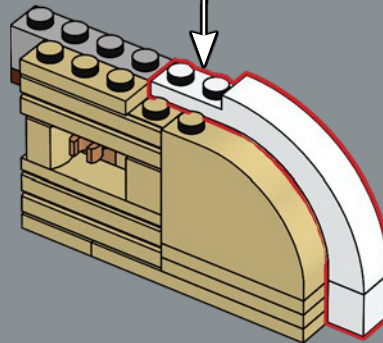
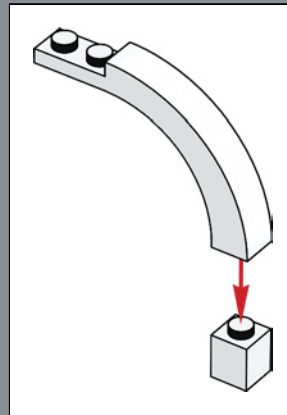

429

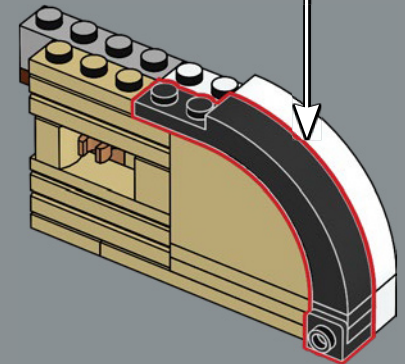
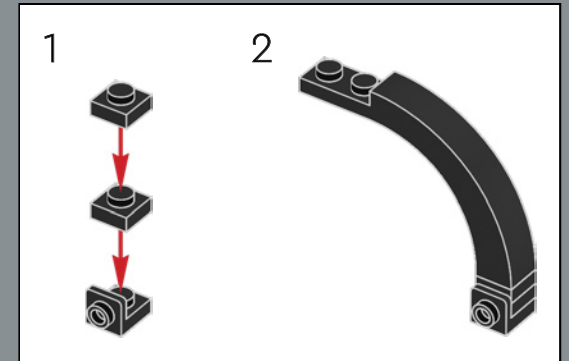

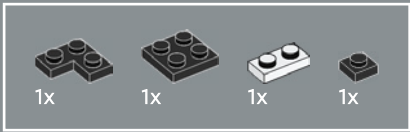

430

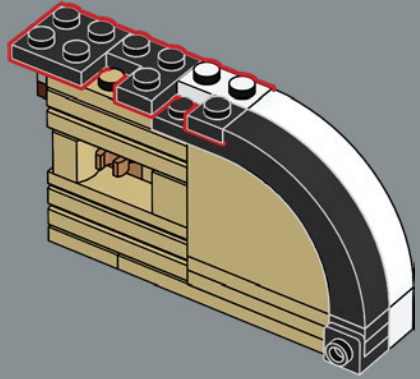

431

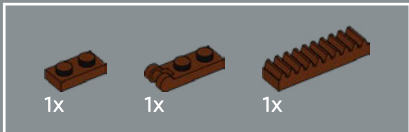
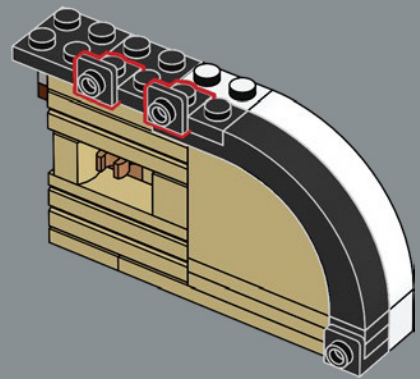

432

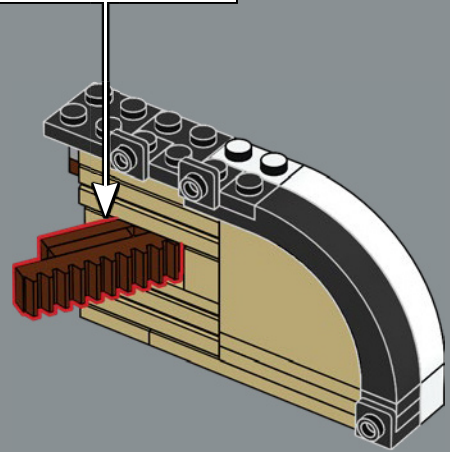
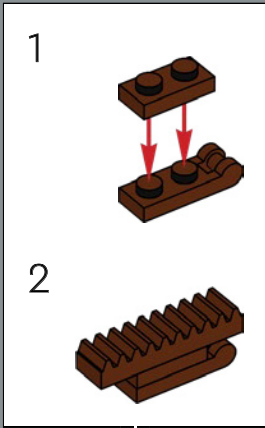

433

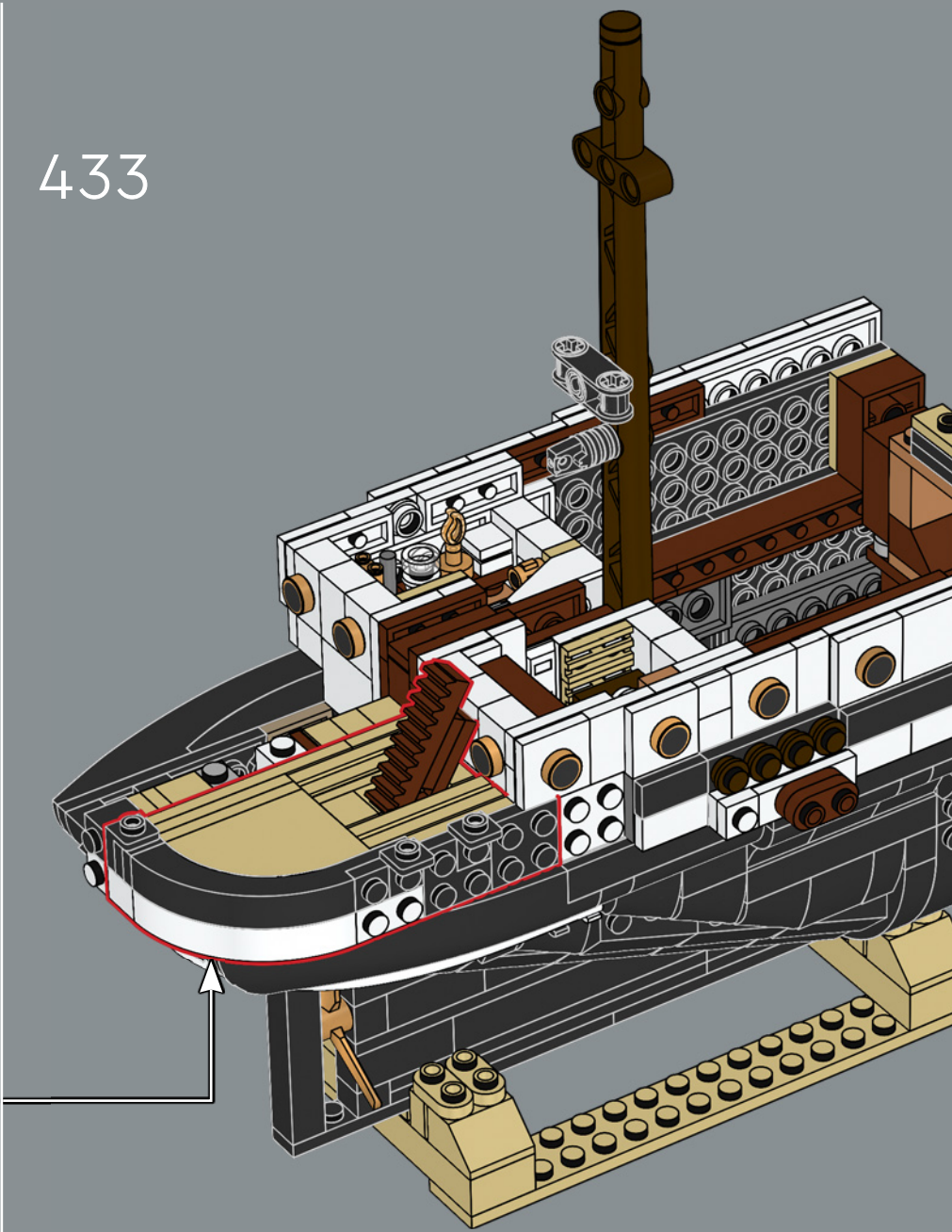

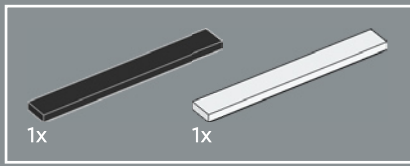

434

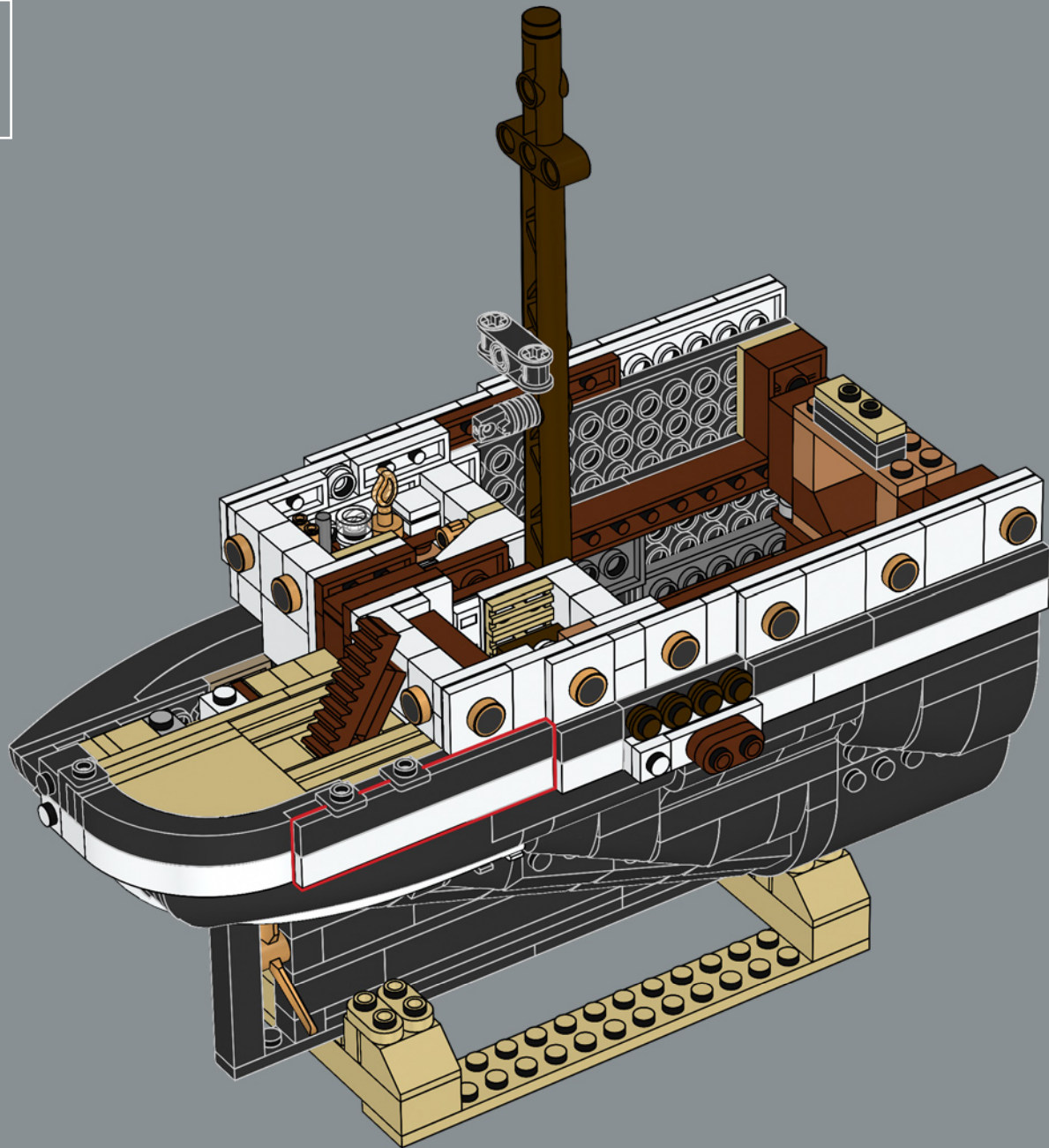

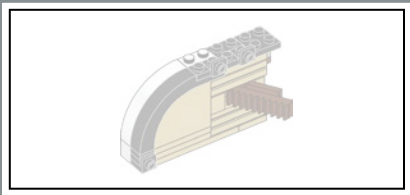

435

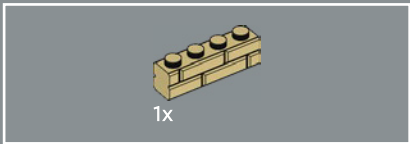
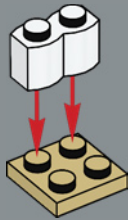

436

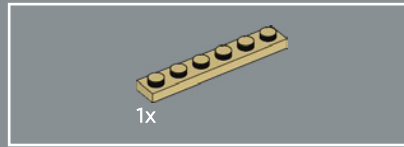
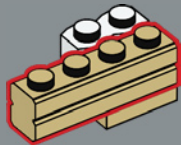

437

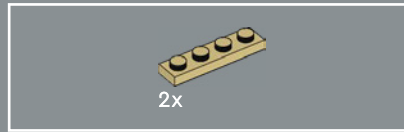
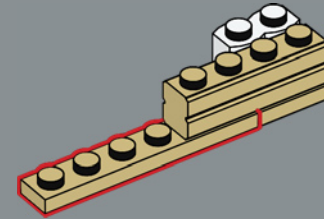

438

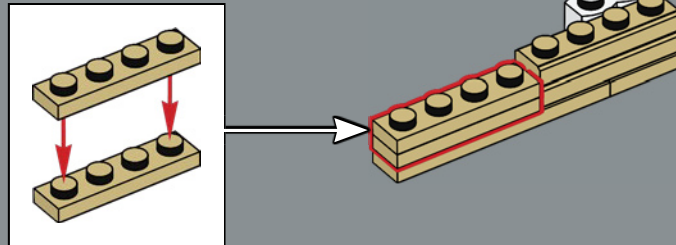

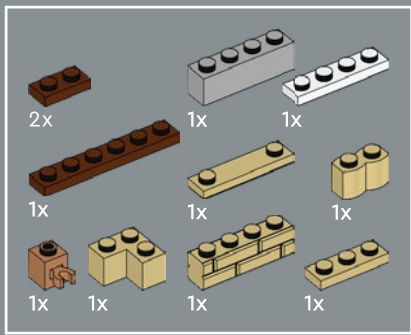

439

1

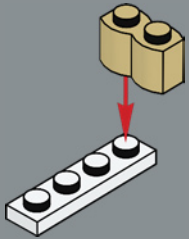

2

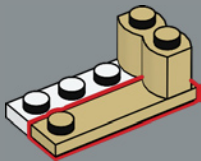

3

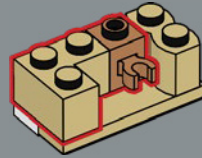

4

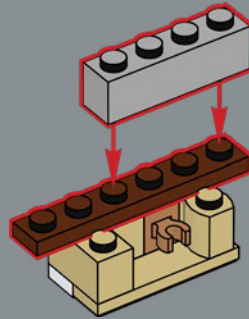

5

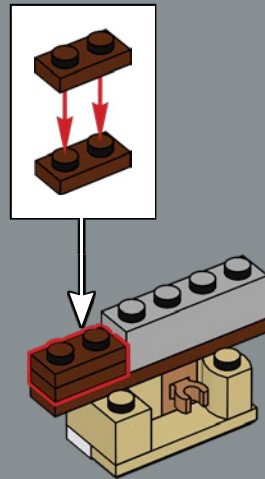

6

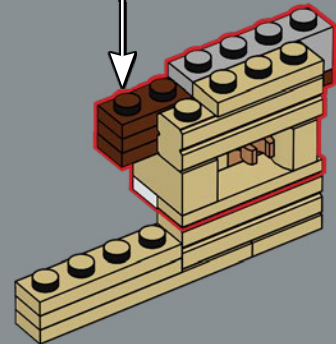
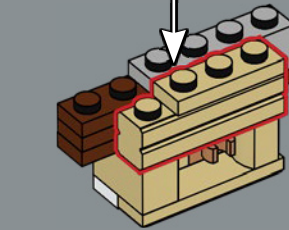
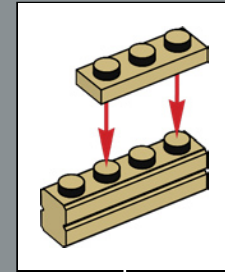

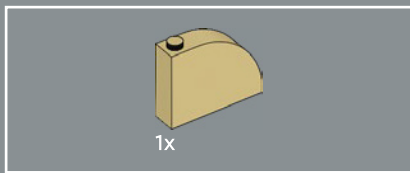

440

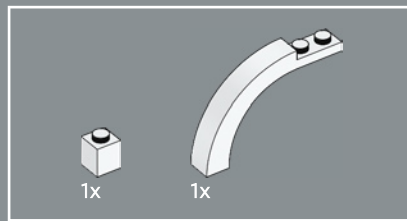
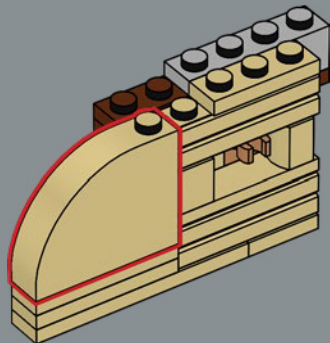

441

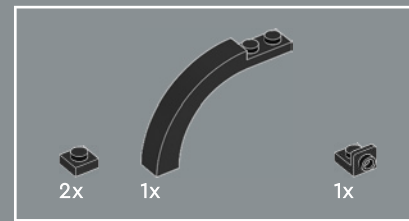
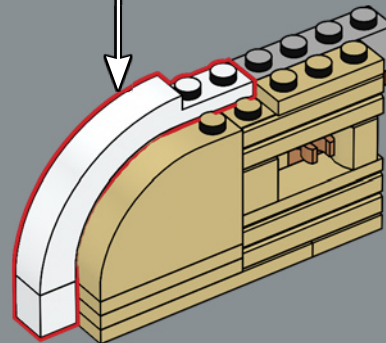
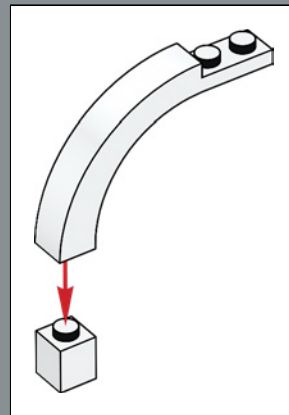

442

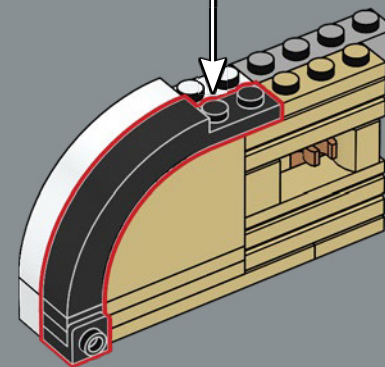
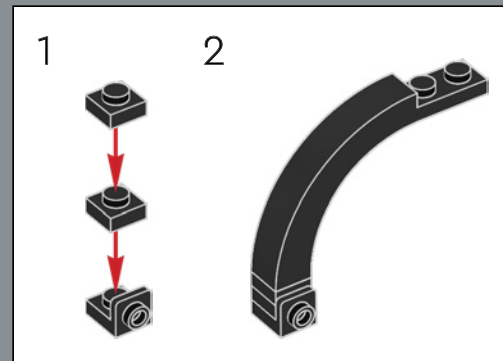

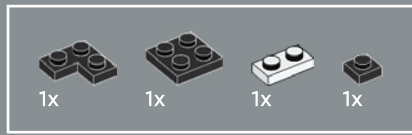

443

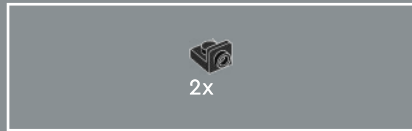
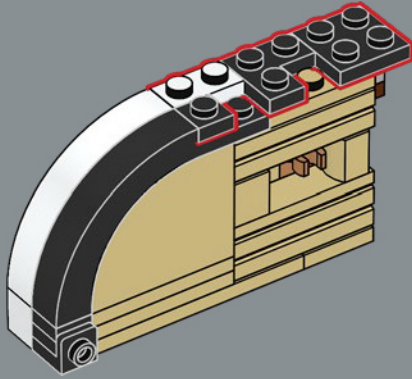

444

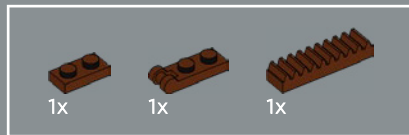
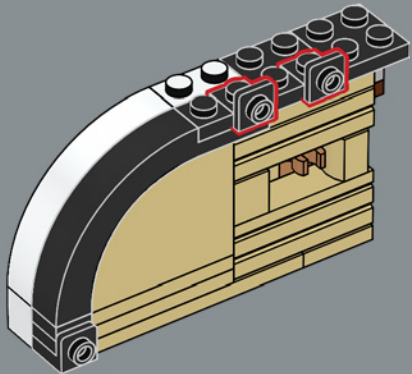

445

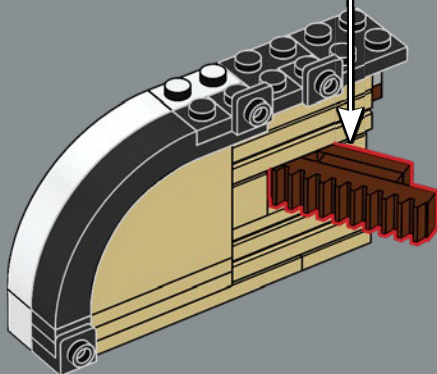
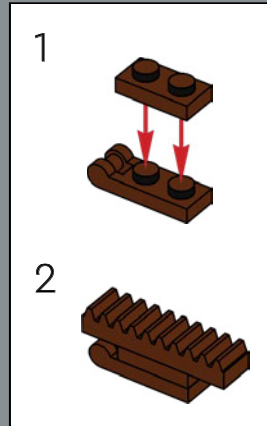

446

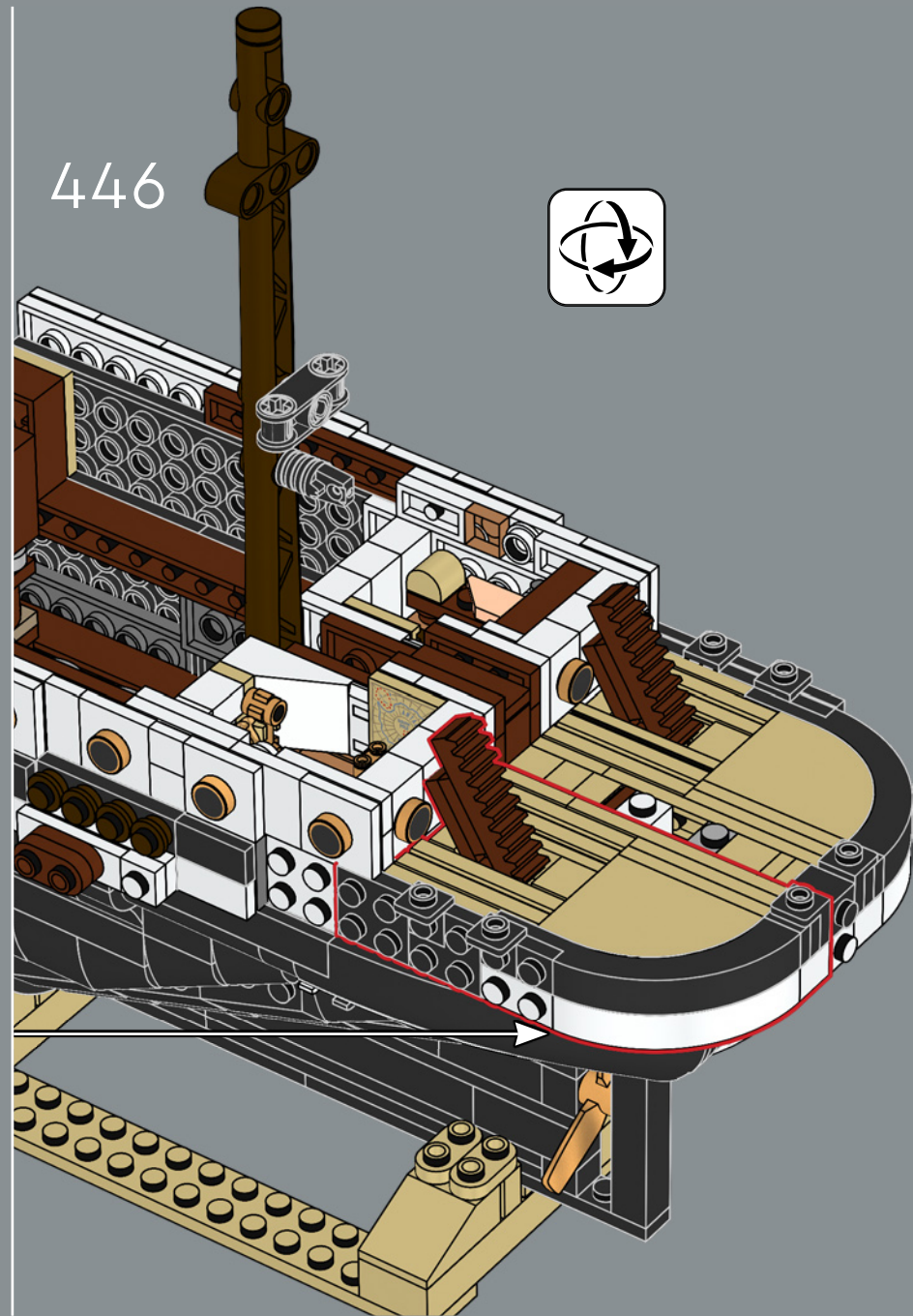

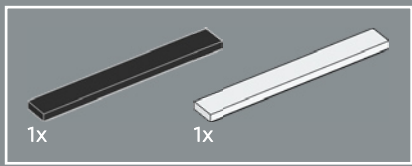

447

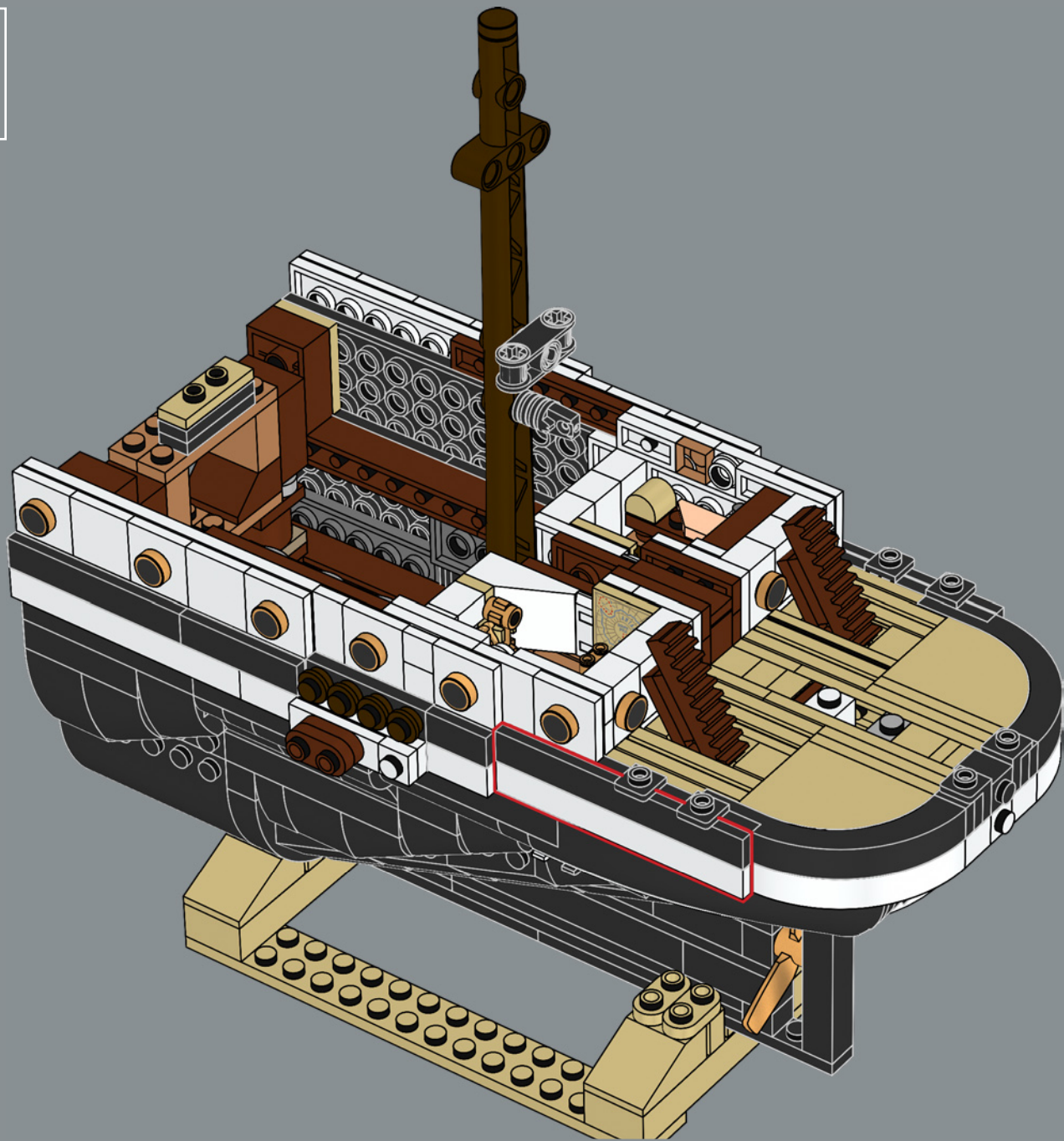

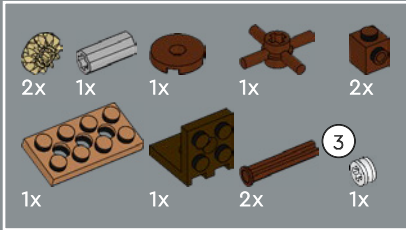
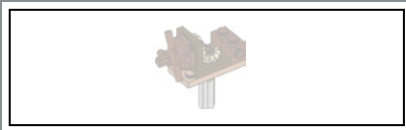

448

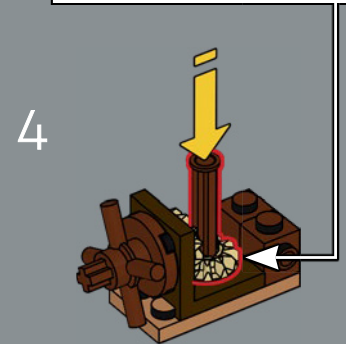
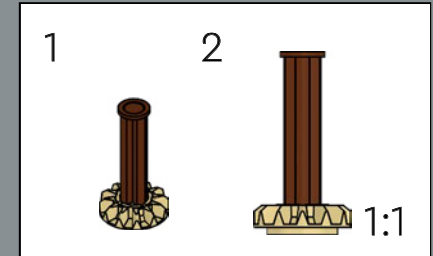
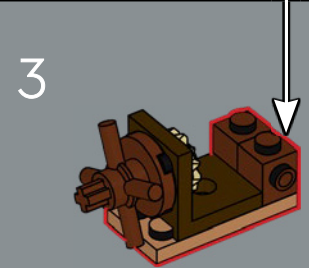
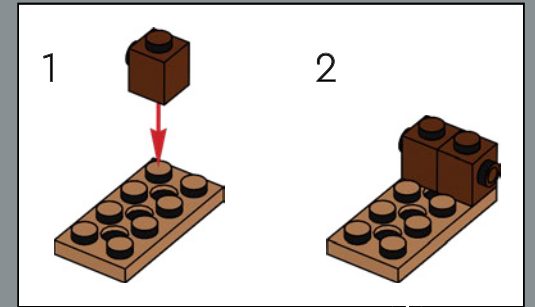
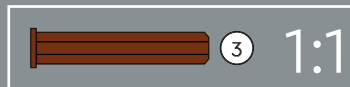
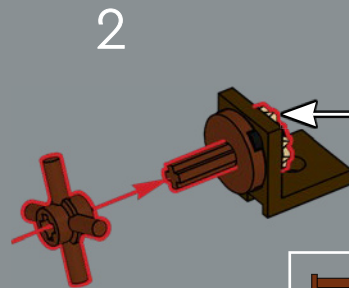
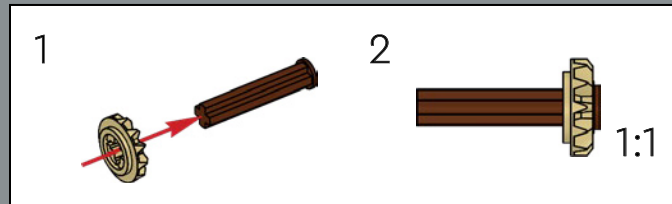
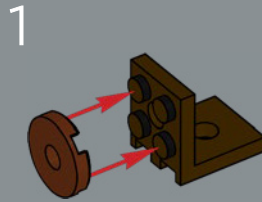

5

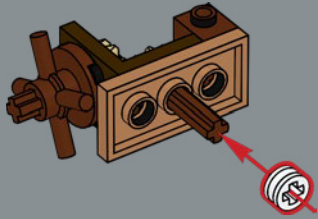

6

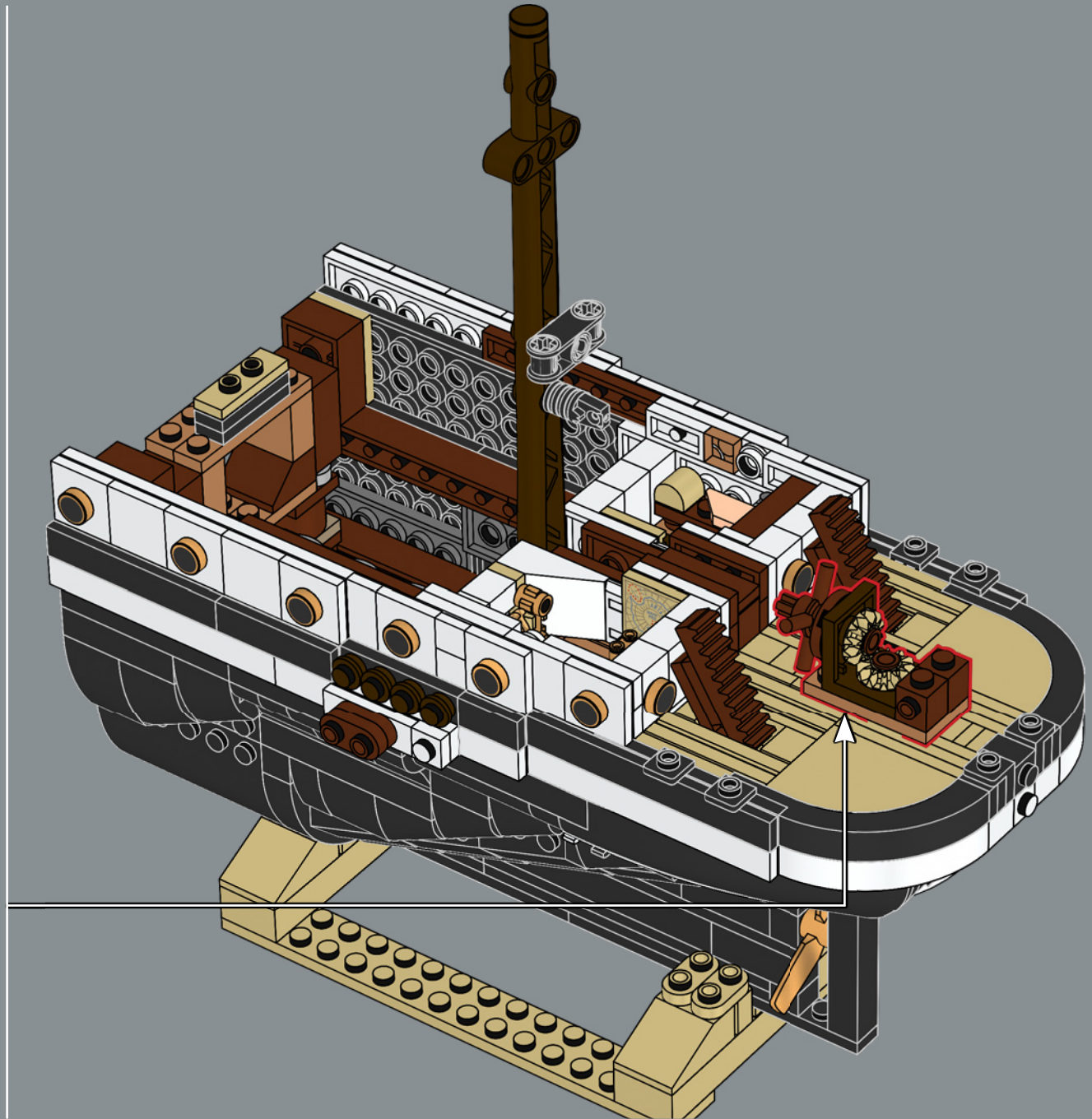
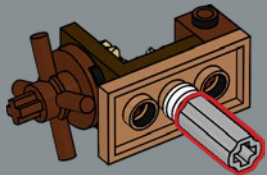

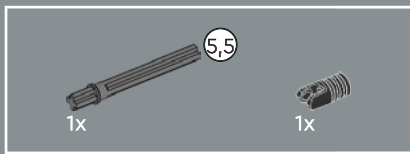

449

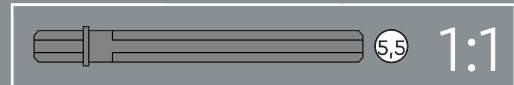
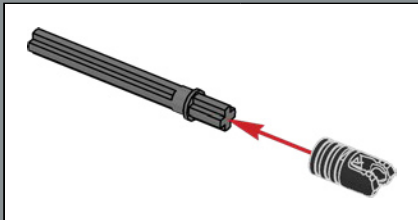
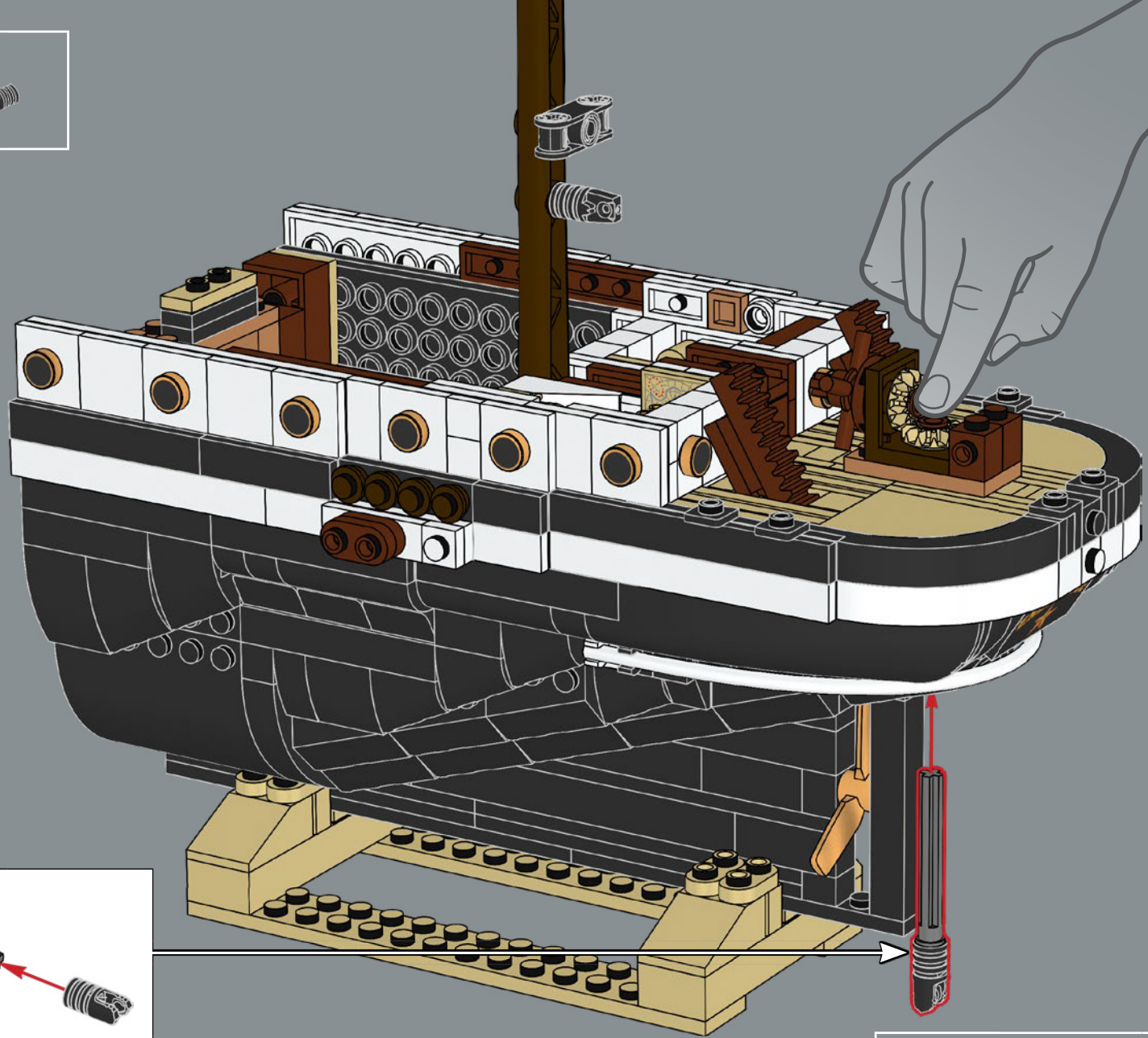

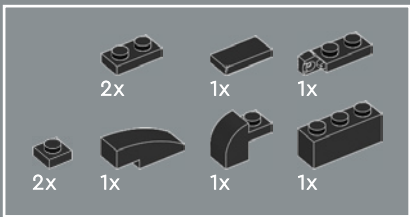

450

1

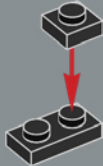

2

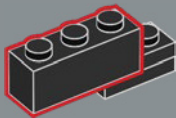

3

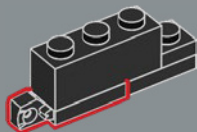

4

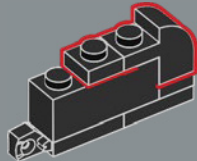

5

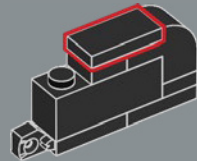

6

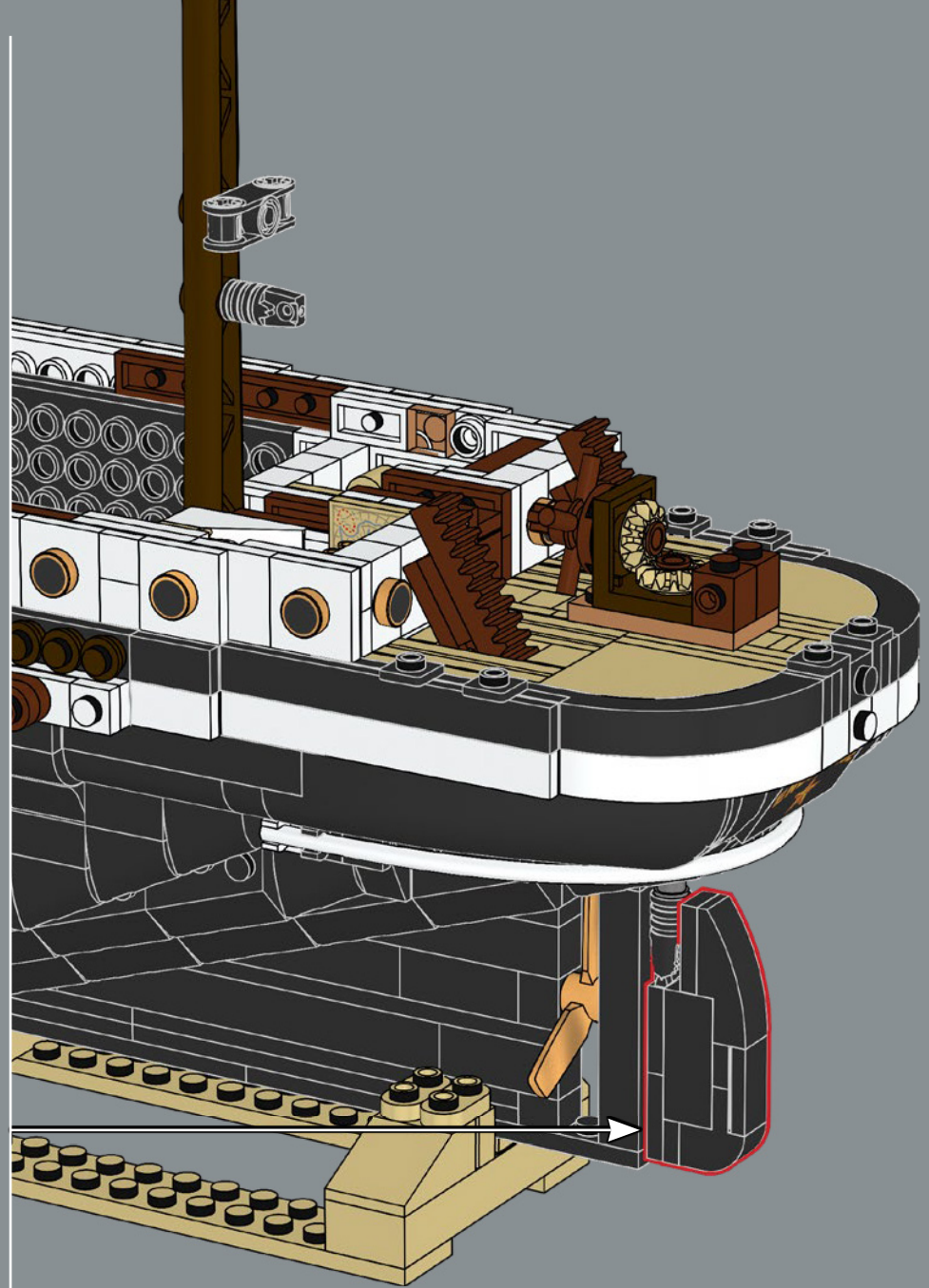
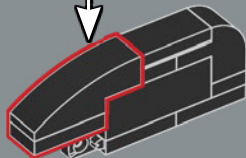
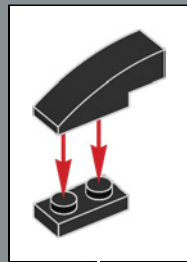

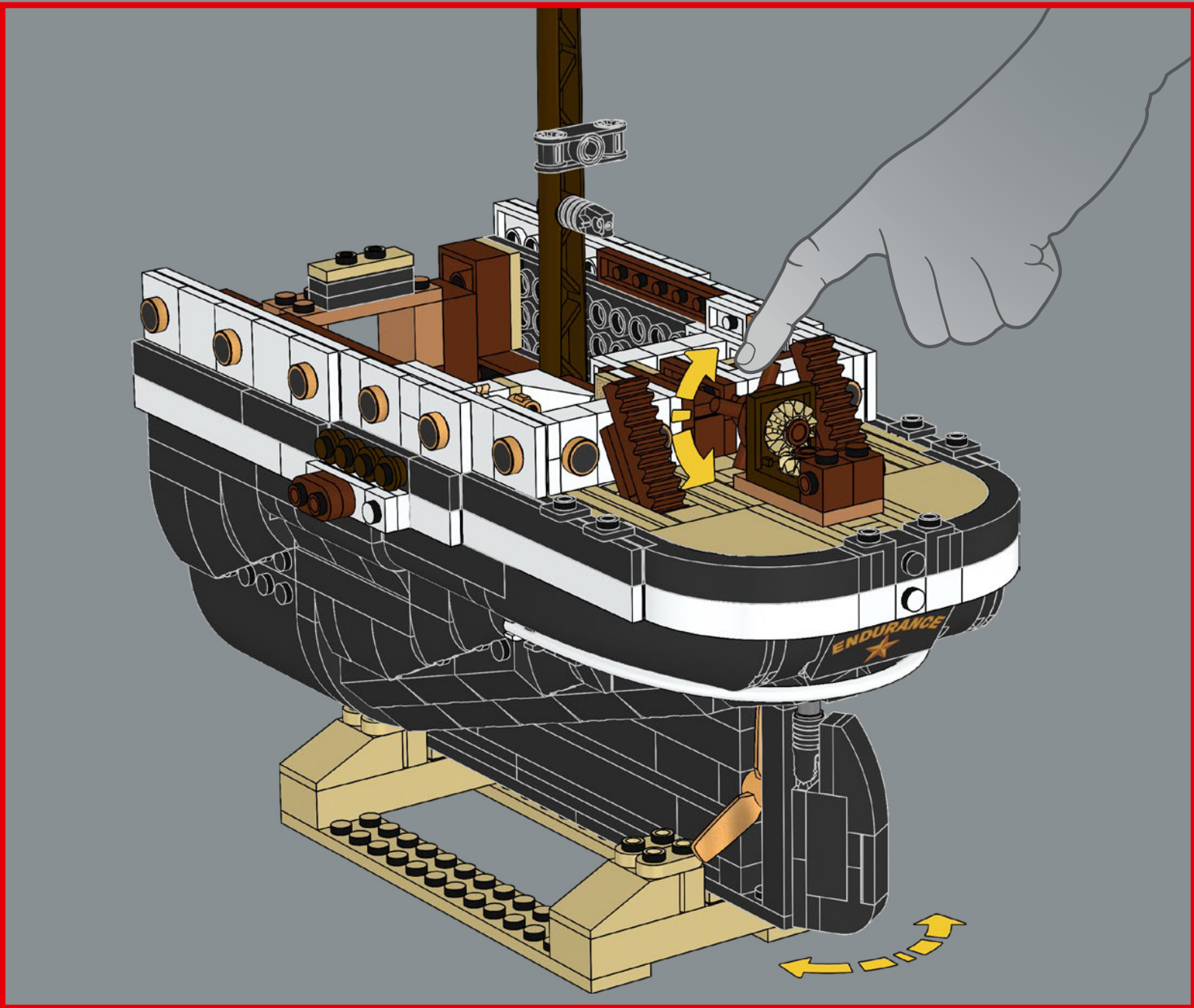

2x

451

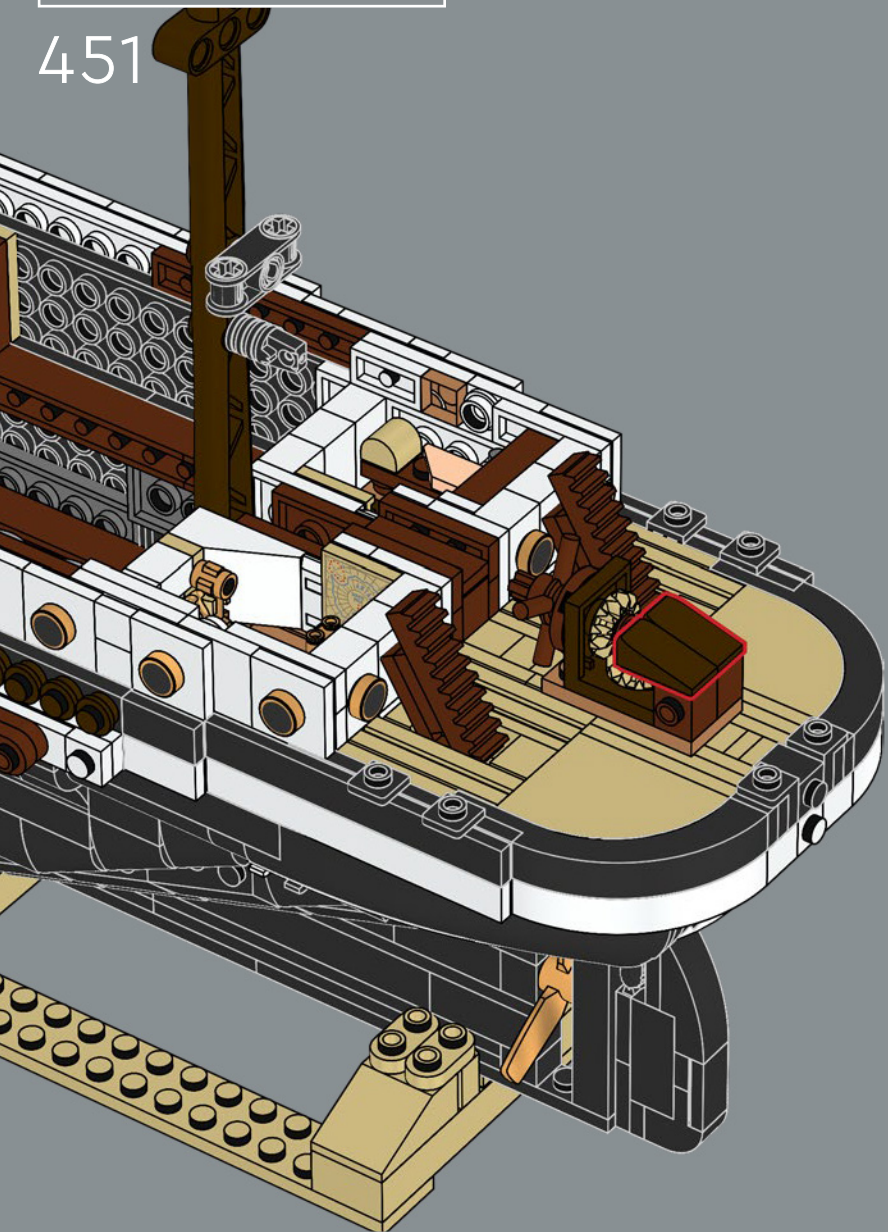

1x

1x

452

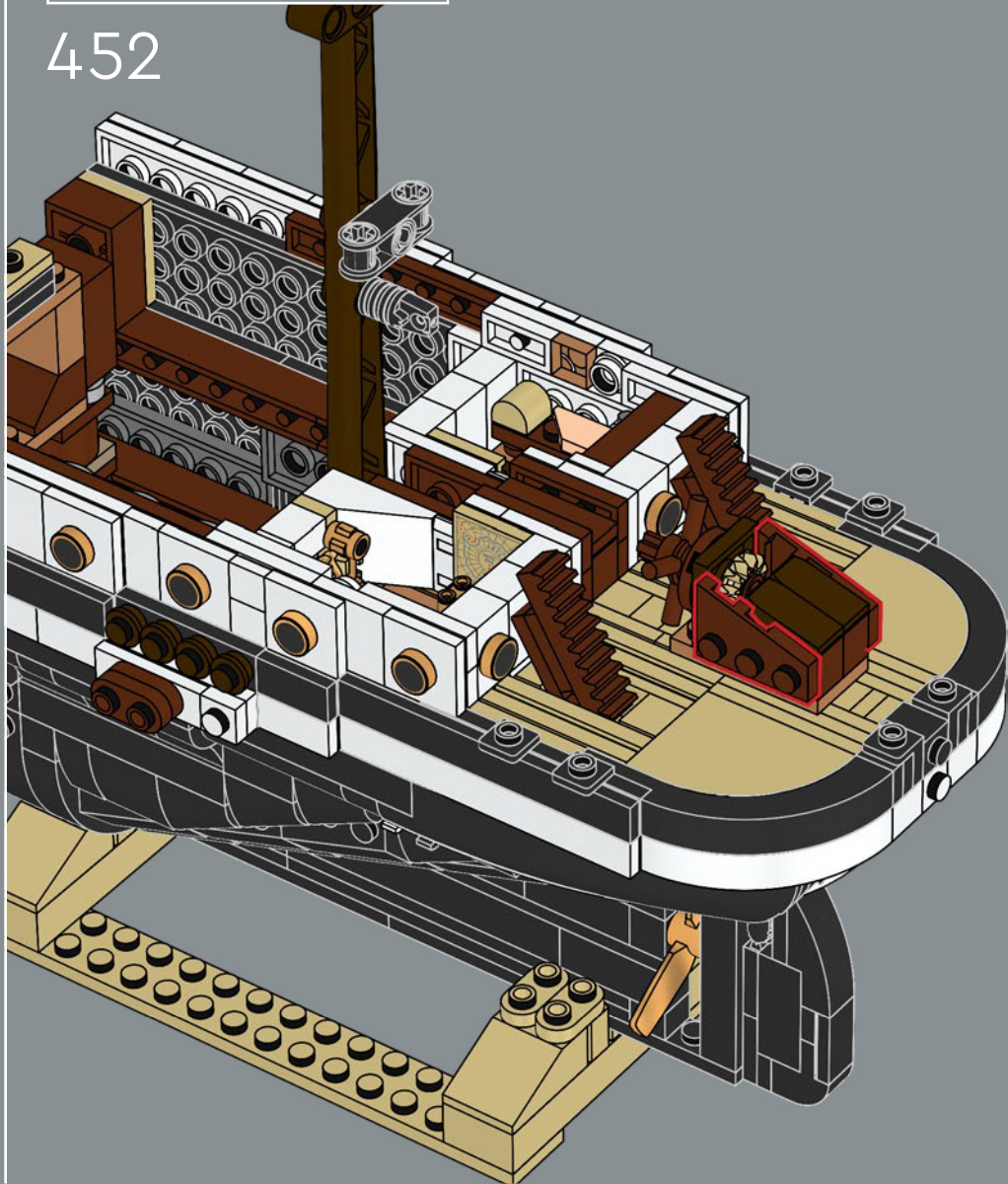

★
对于控制船舵的转向柜，我们用原始的 2x2 角板设计了有史以来最小的乐高“变速箱”之一。在这里，我们进行了独特的颜色变化，采用了深棕色。



6x

453

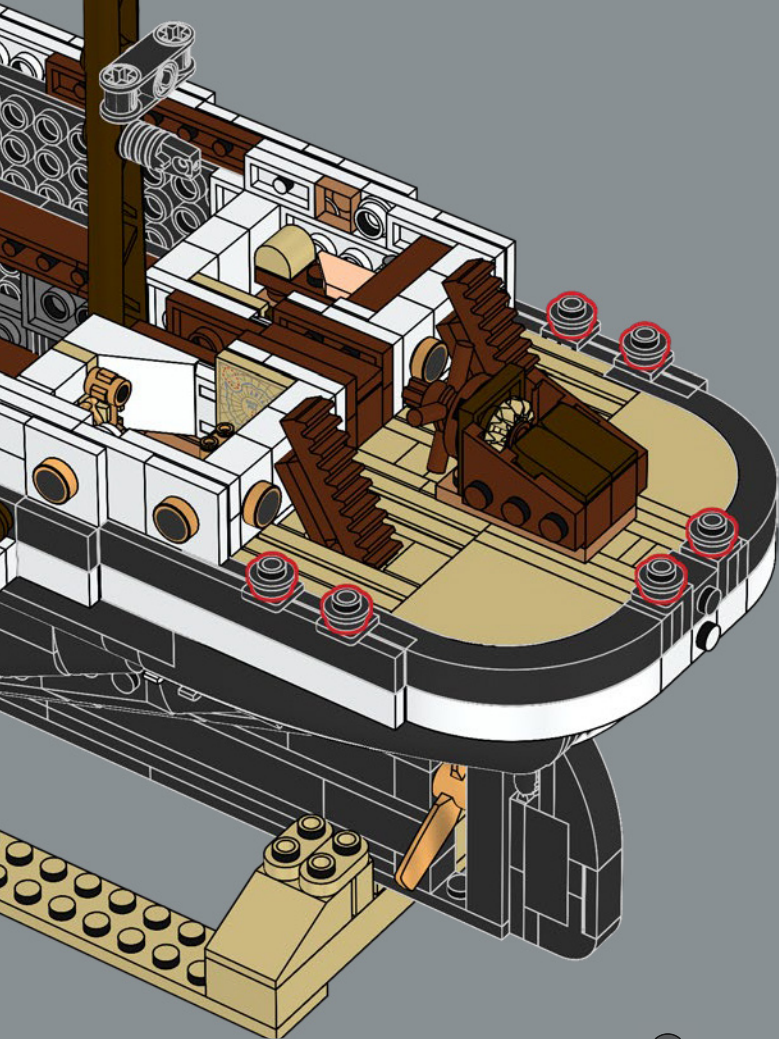

6x

454

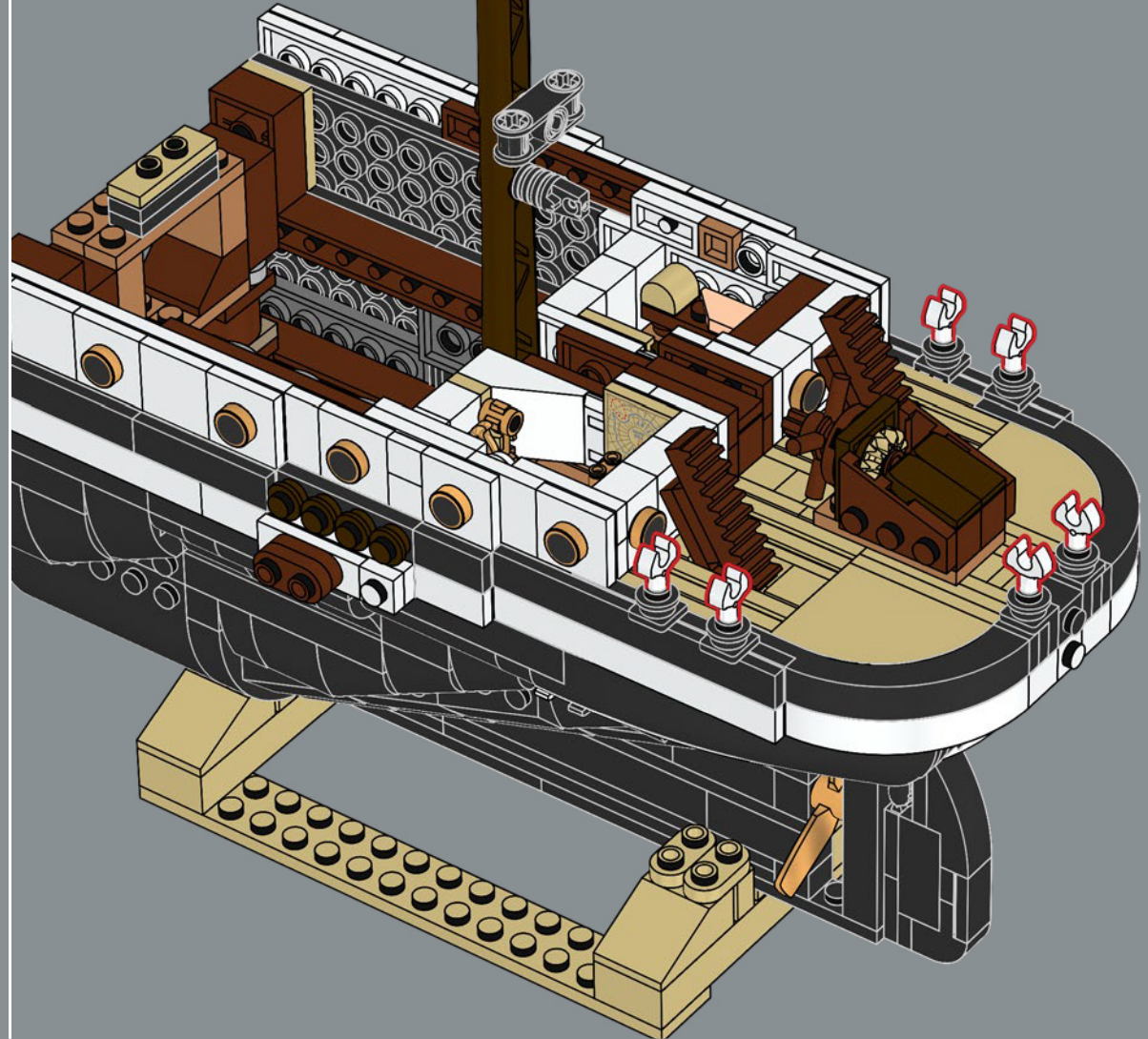

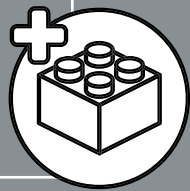
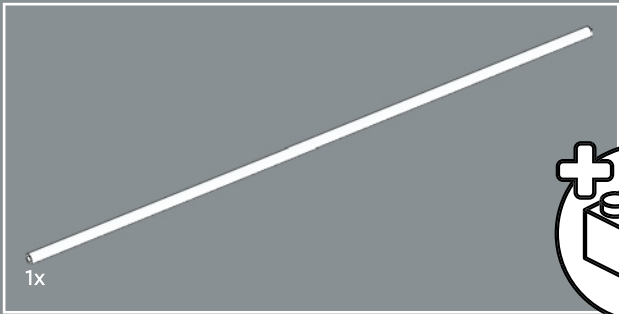

455

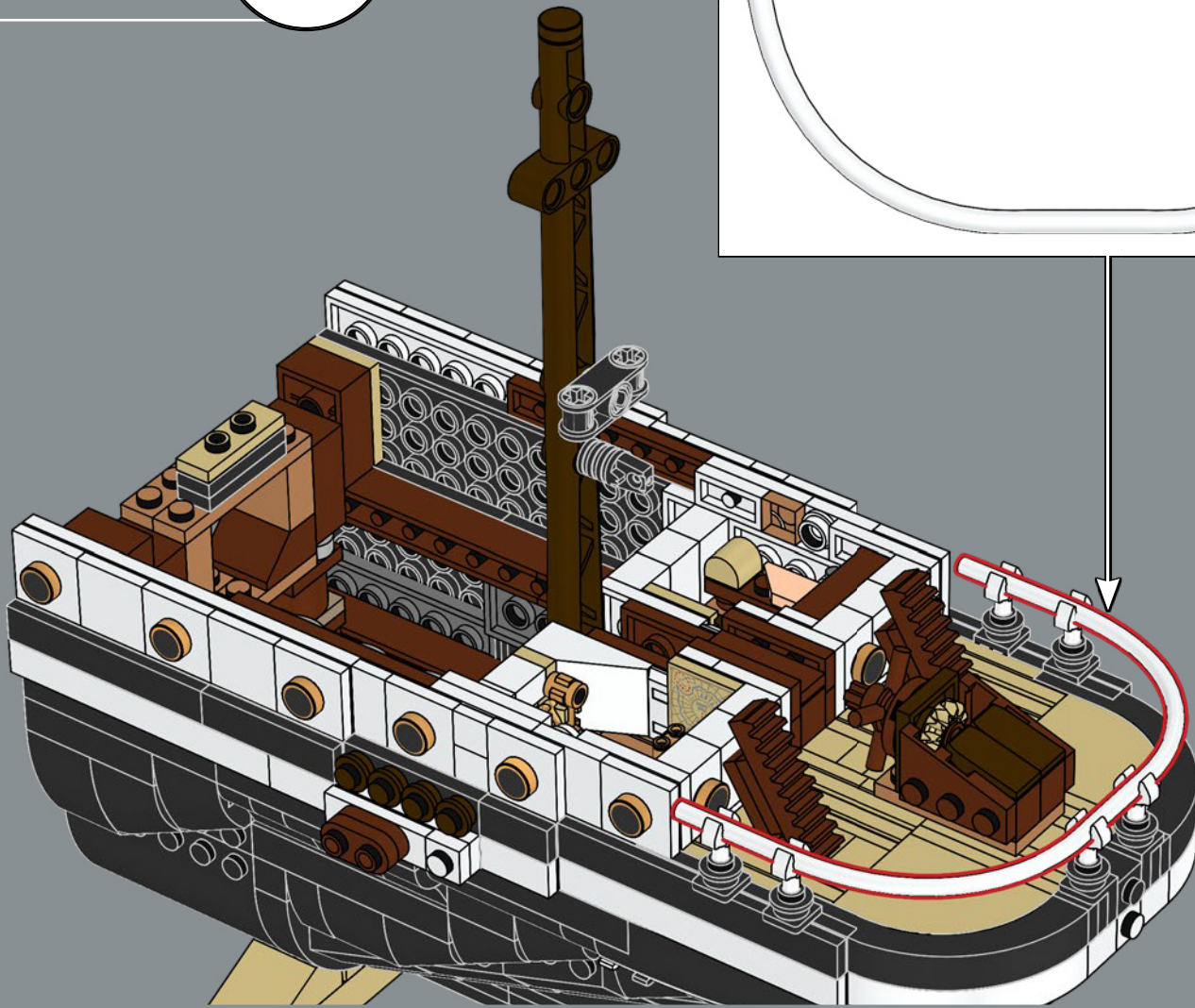
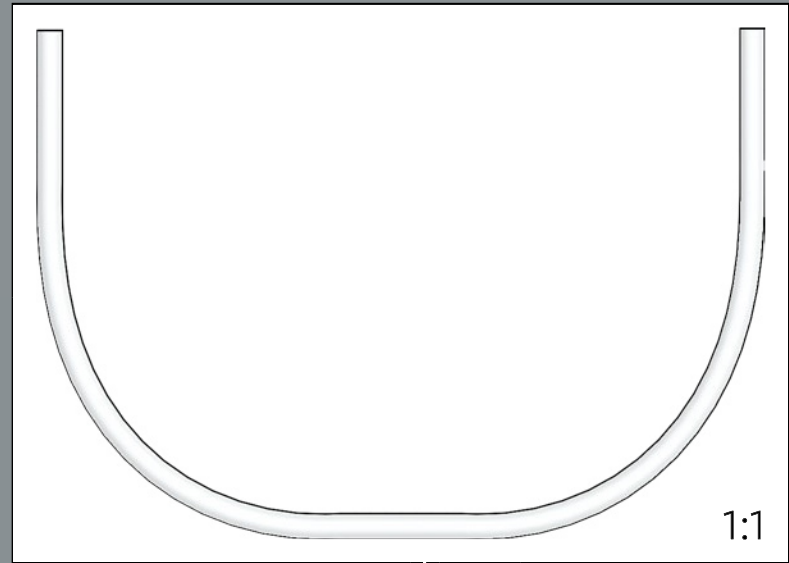



2x

456

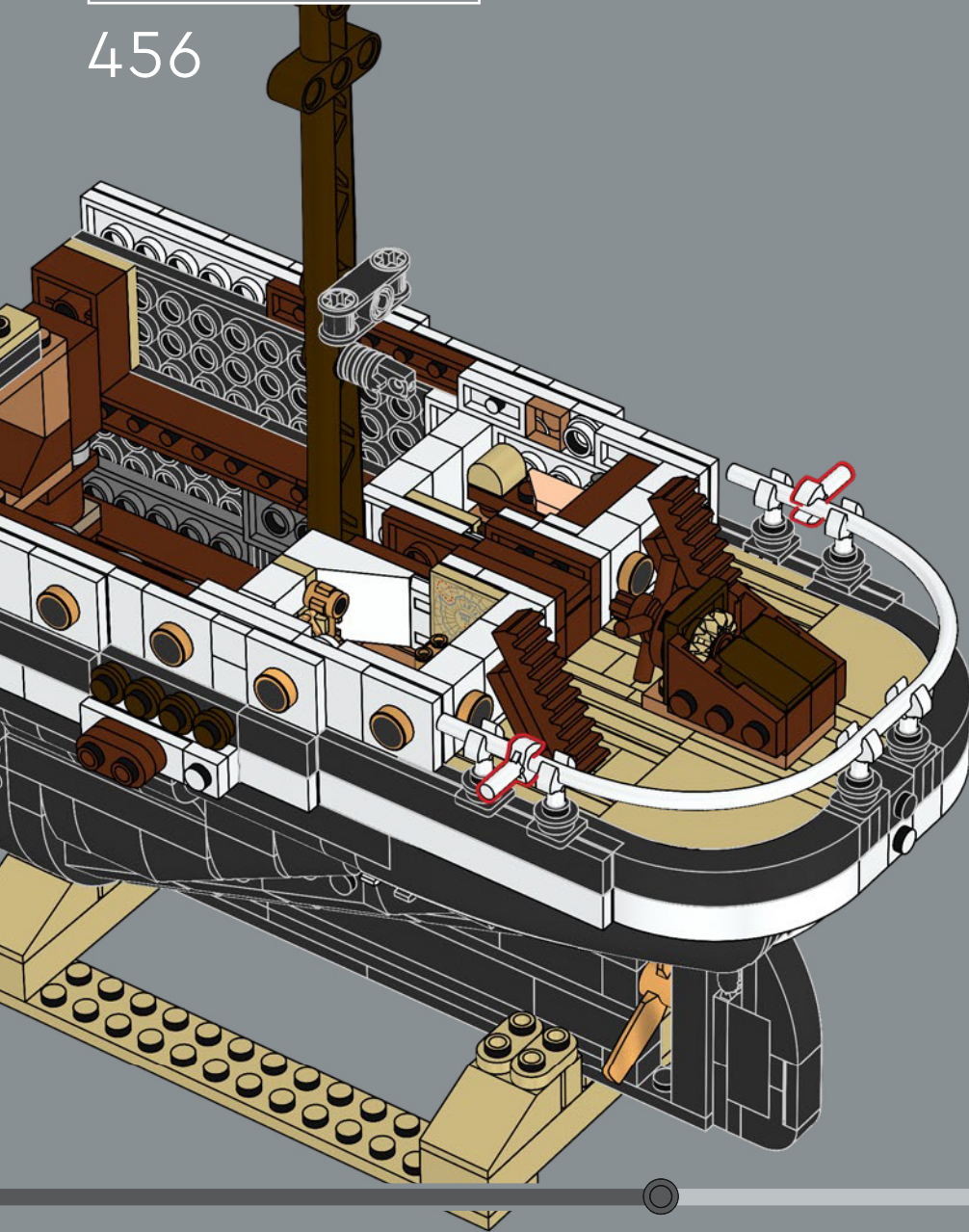

2x

457

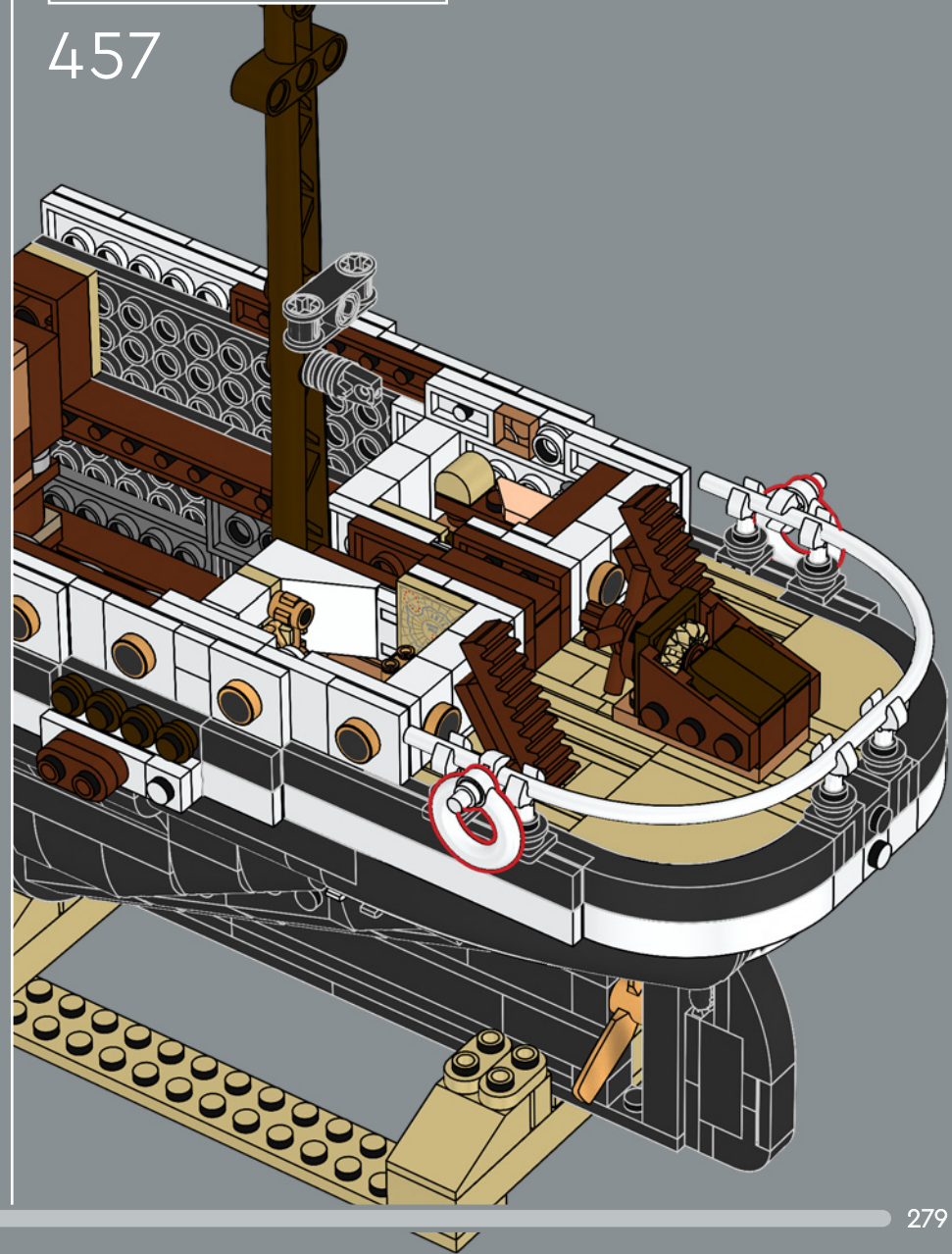

458

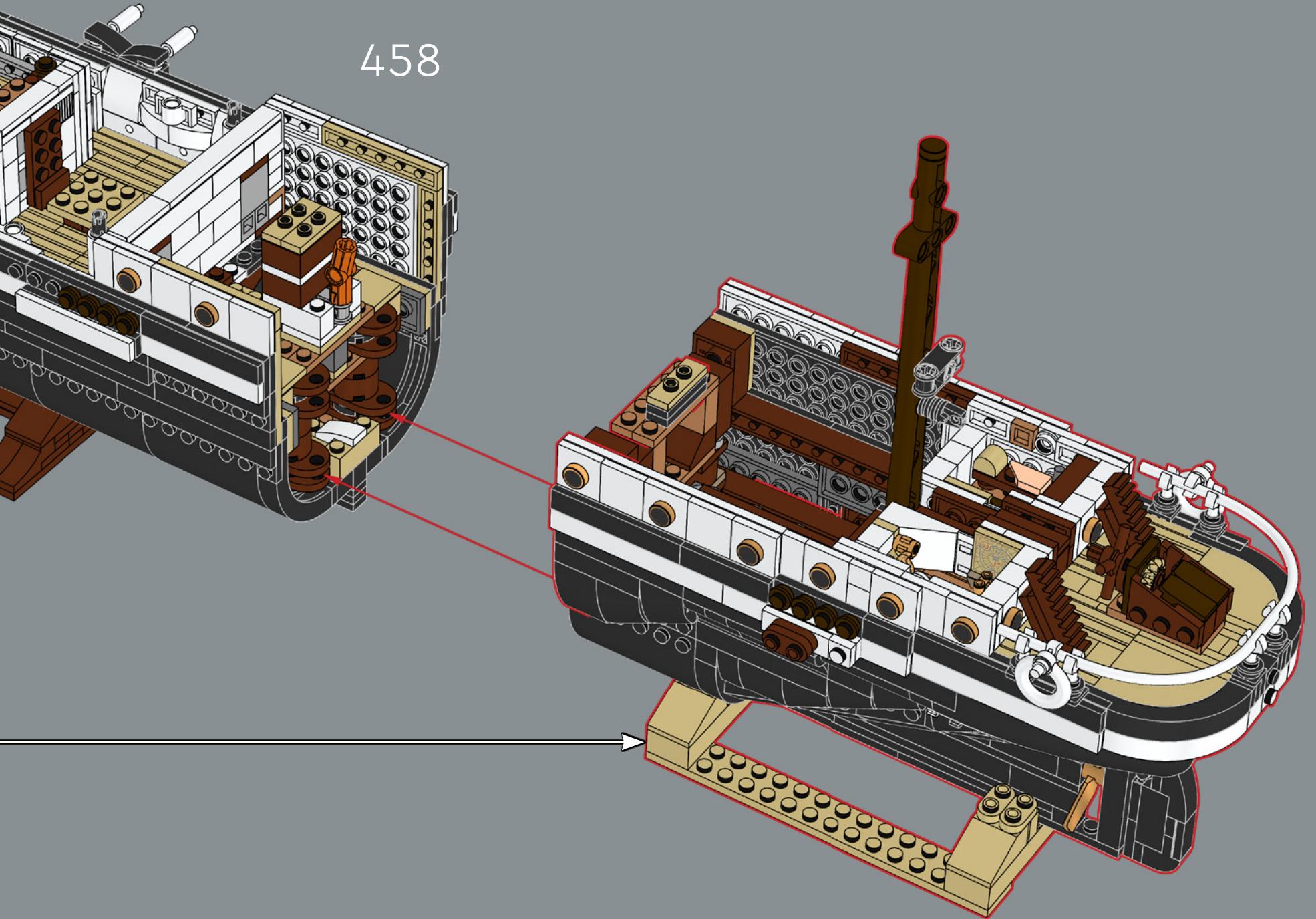

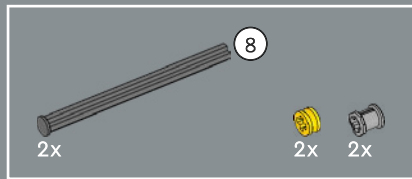

459

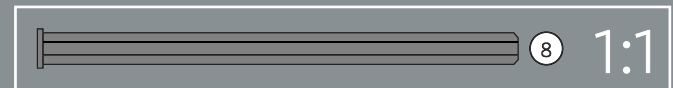
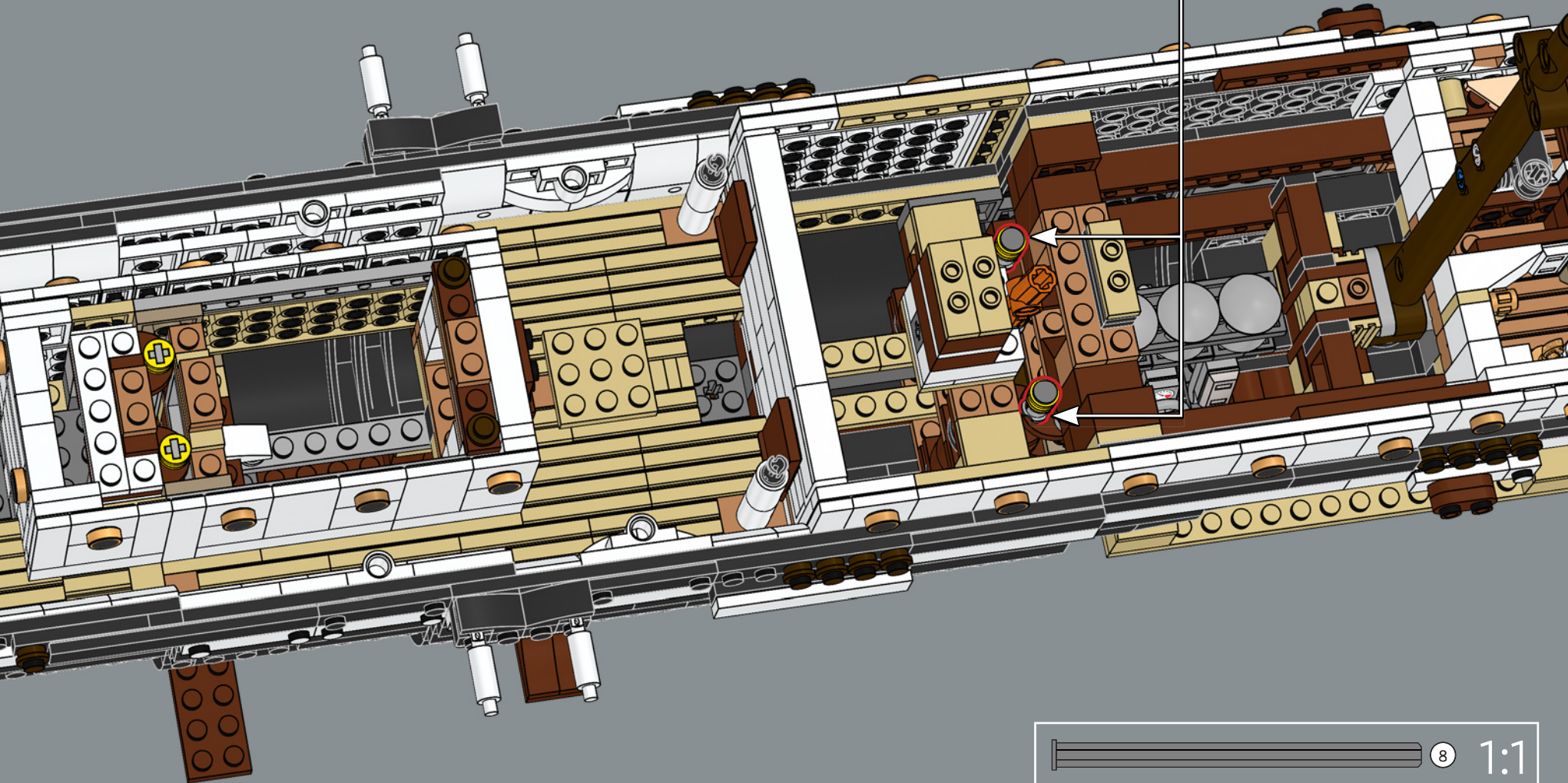
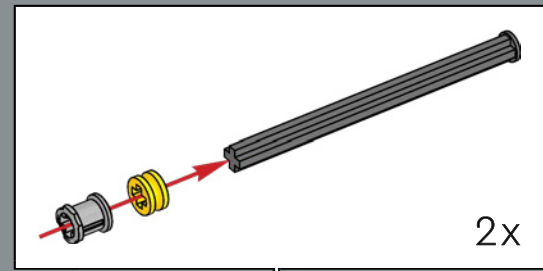

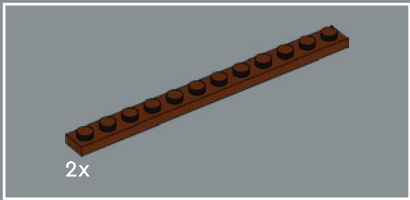

2x

460

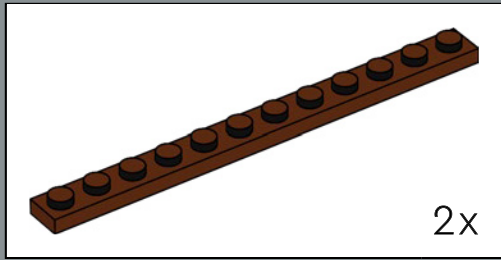

2x

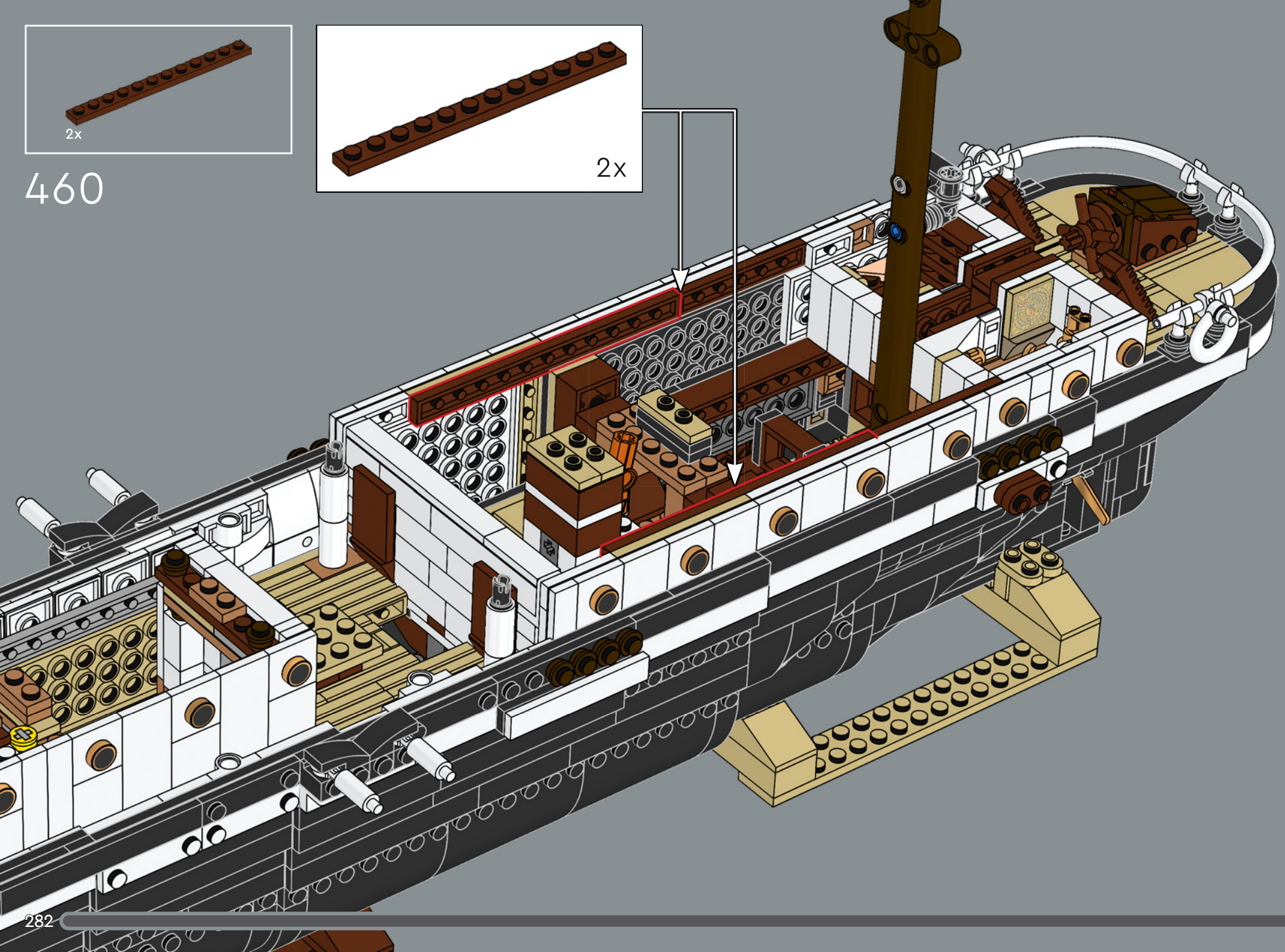

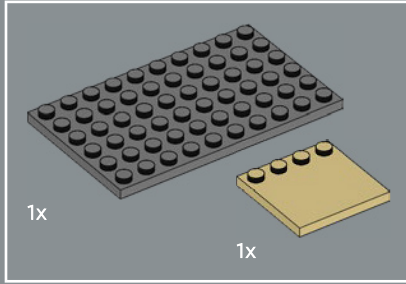
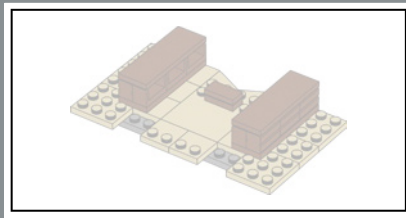

461

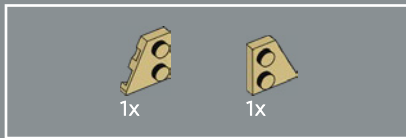
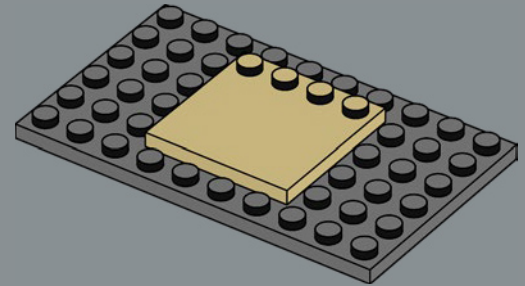

462

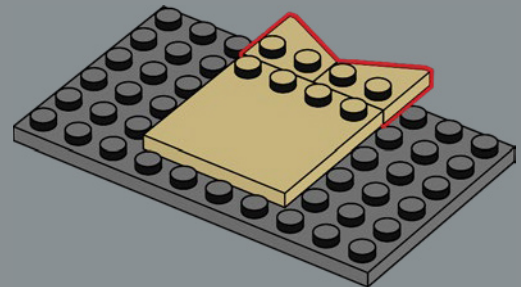

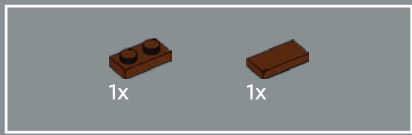

463

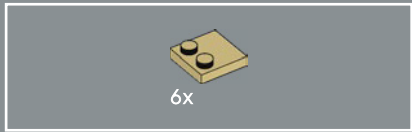
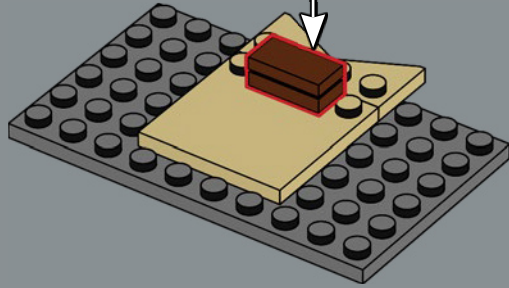
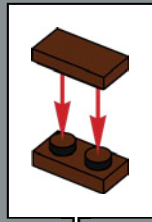

464

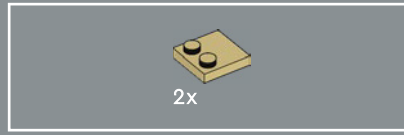
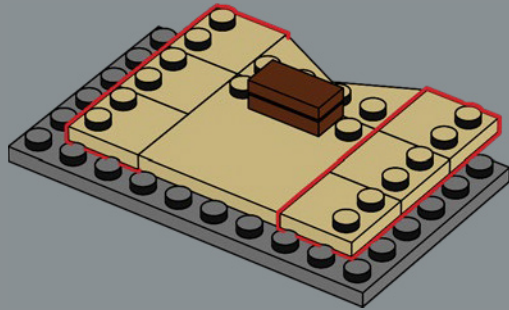

465

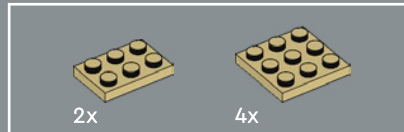
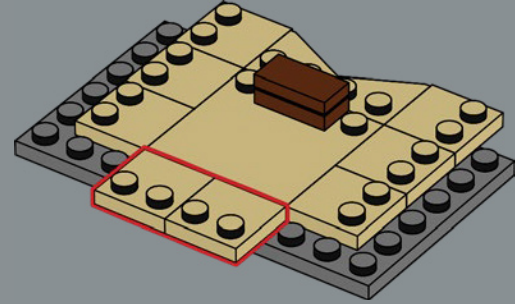

466

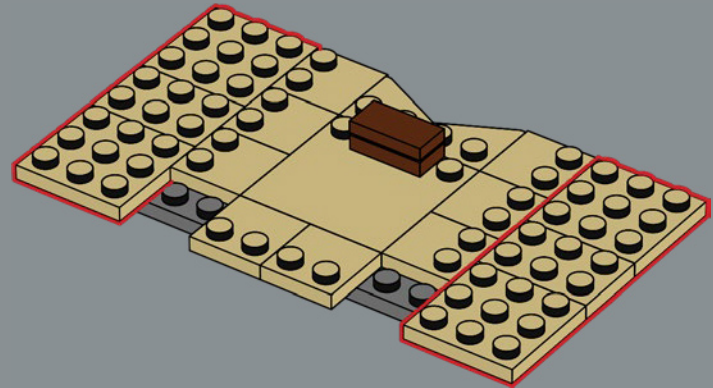

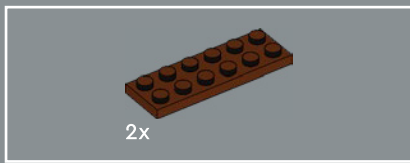

467

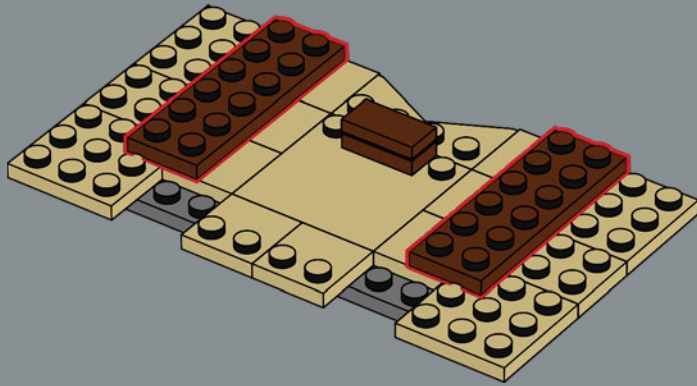

468

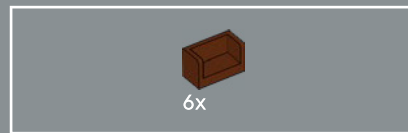
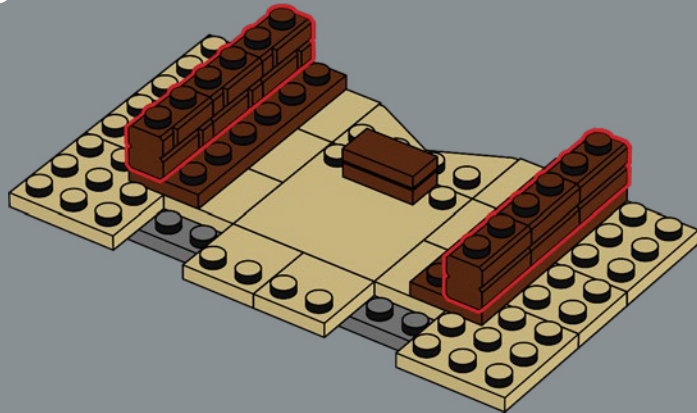

469

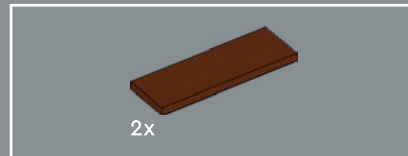
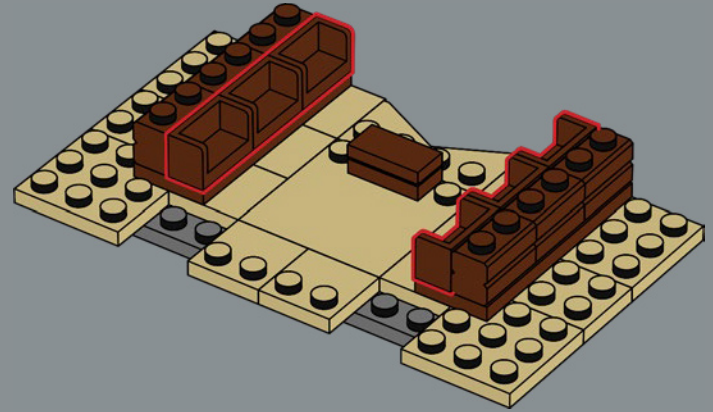

470

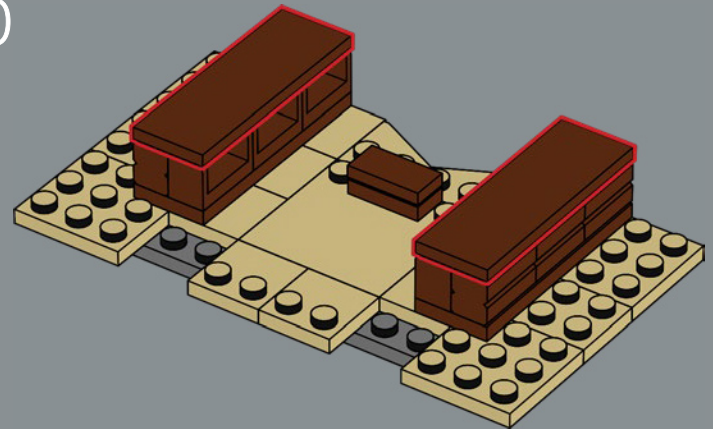

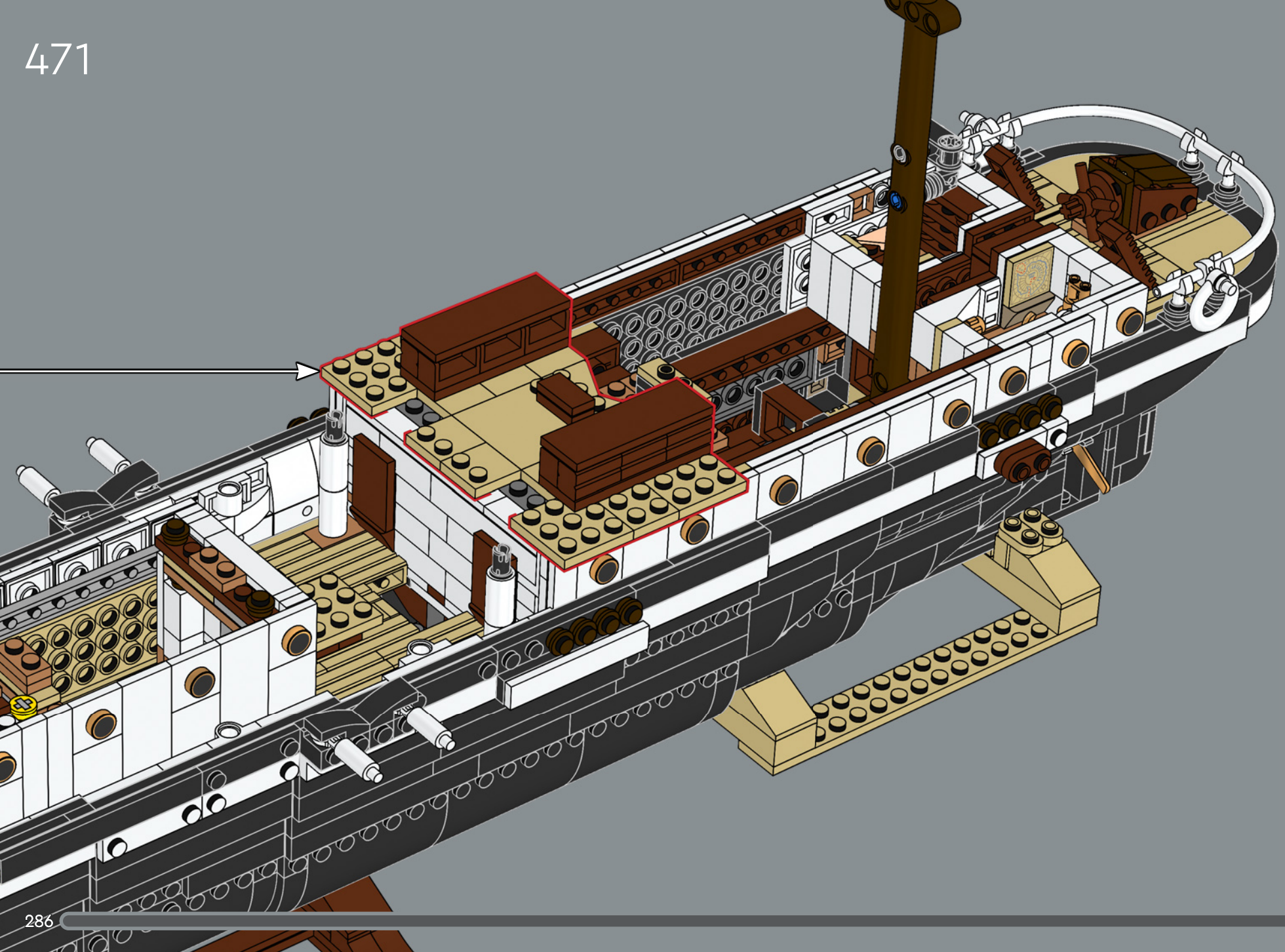

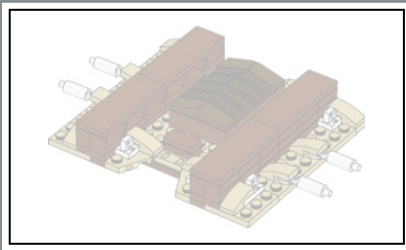

472

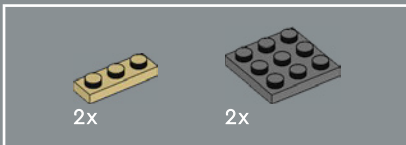
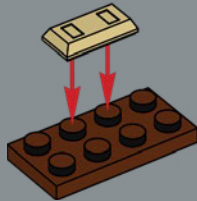

473

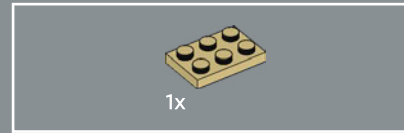
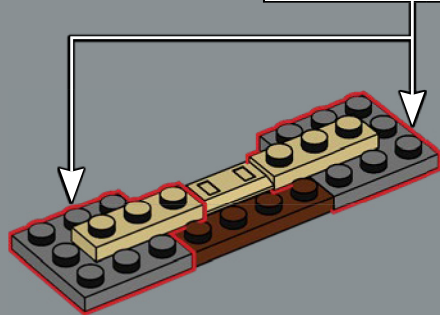
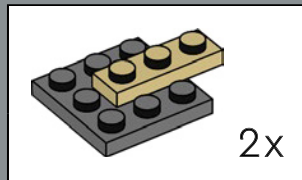

474

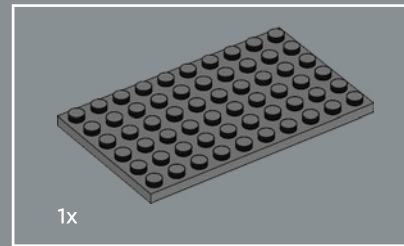
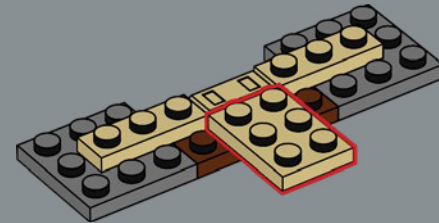

475

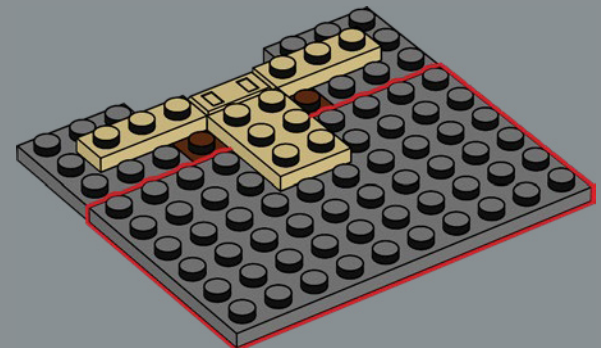

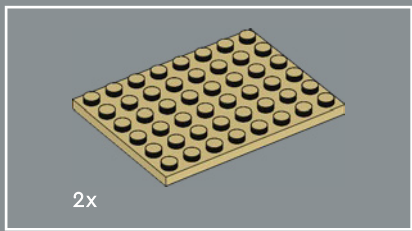

476

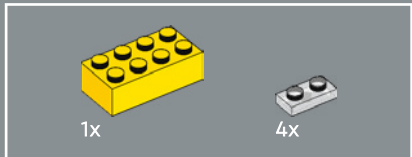
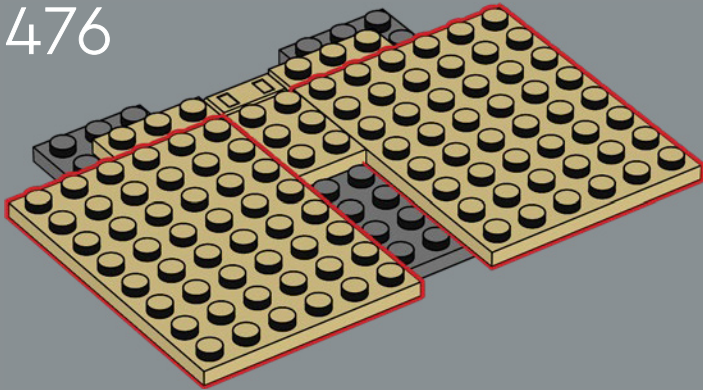

477

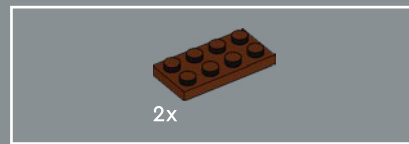
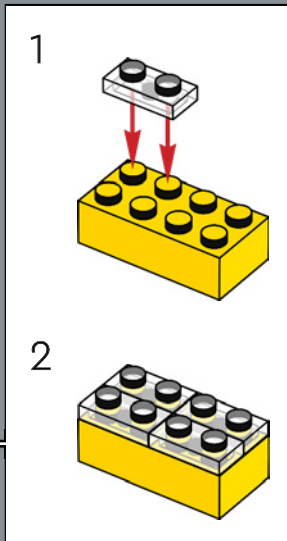
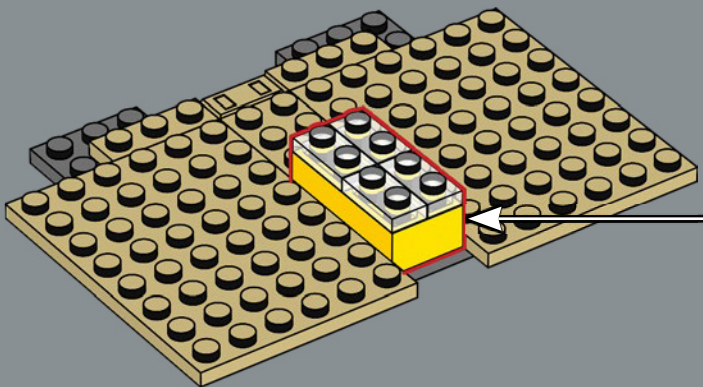

478

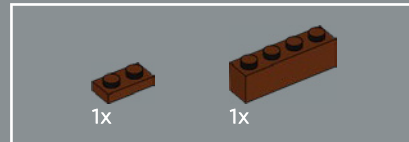
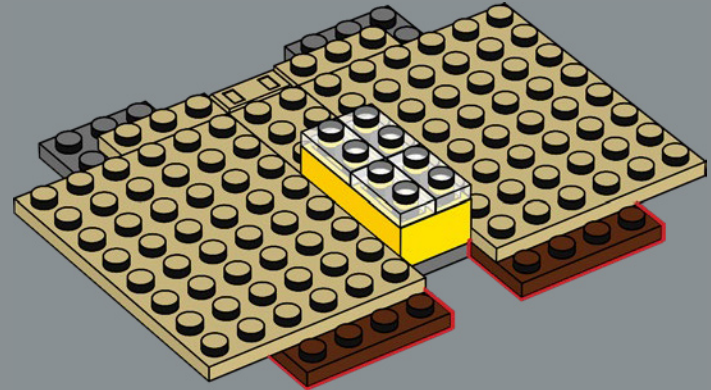

479

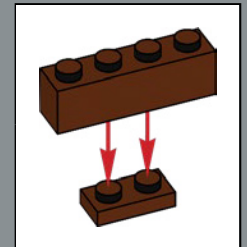
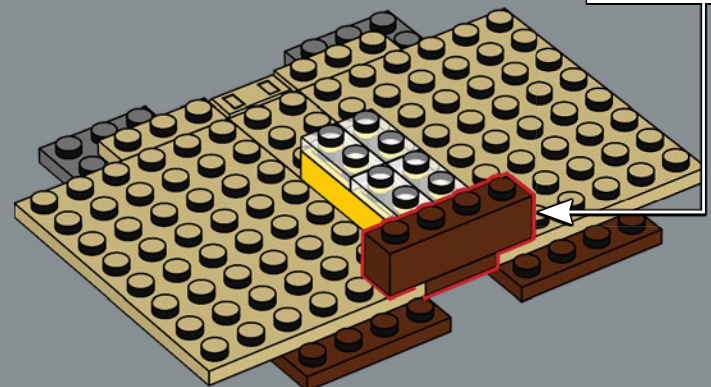

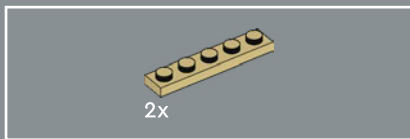

480

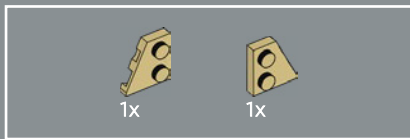
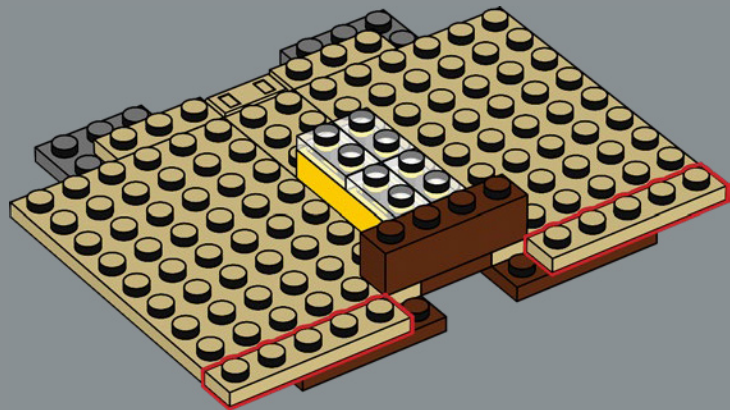

481

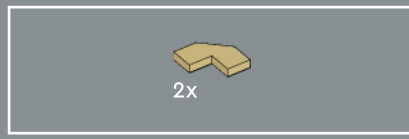
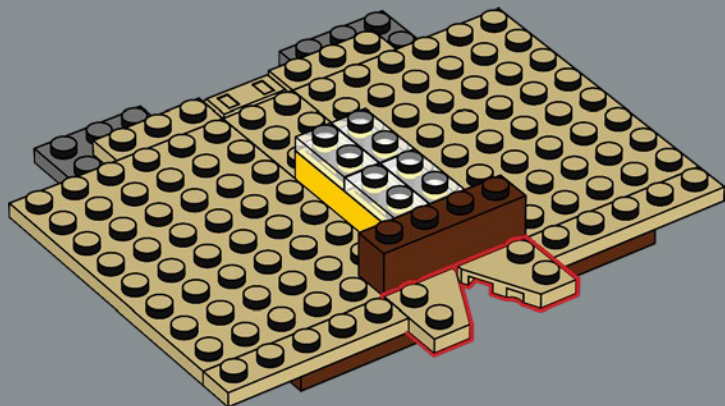

482

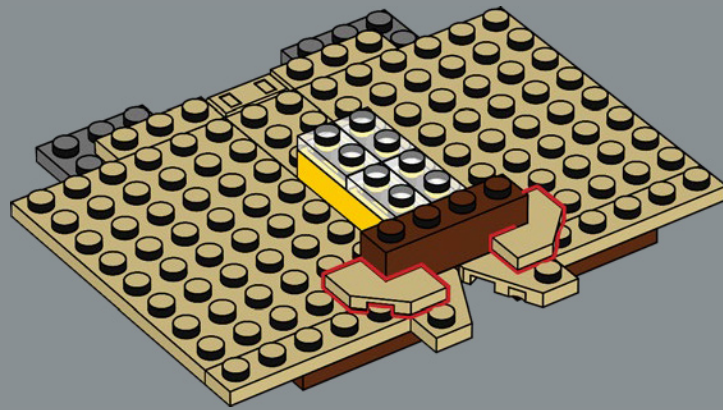

483

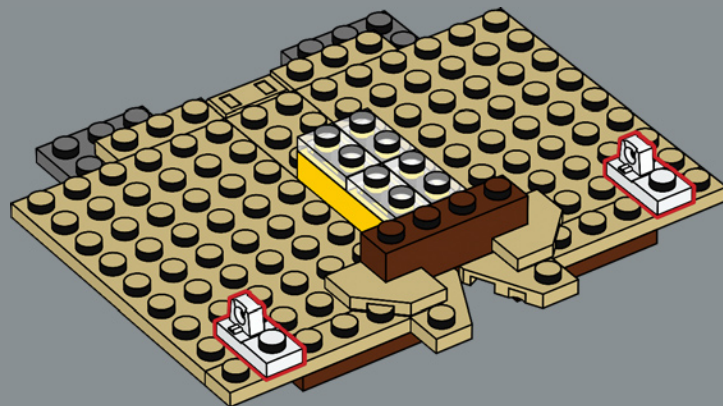



2x

484

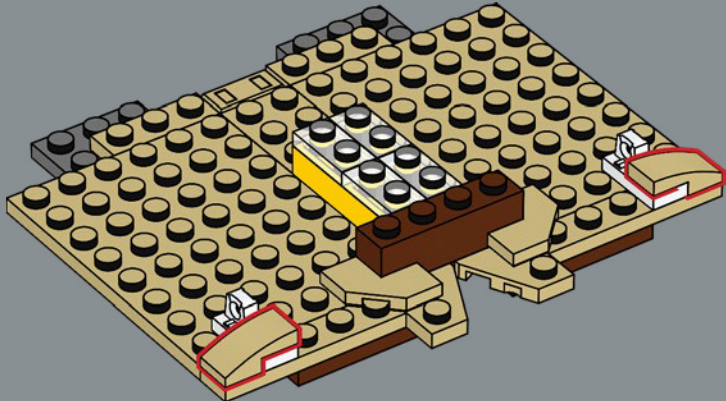

3x

485

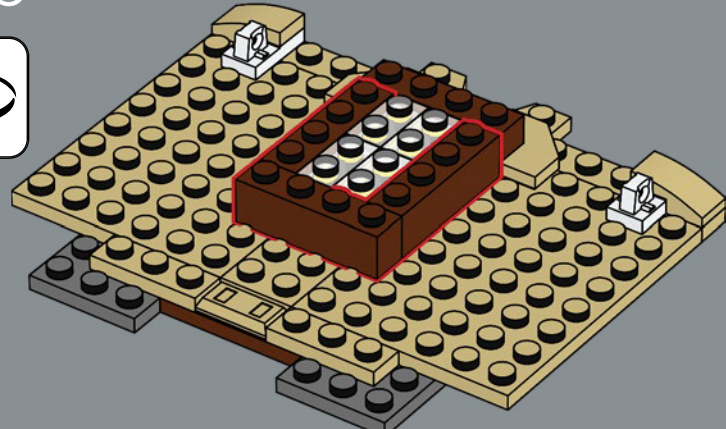

4x



8x

486



为使模型的舱室顶部看起来更坚固，此处的小型1x2斜坡组件首次采用了深棕色。

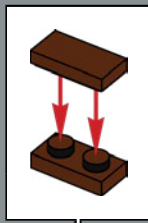
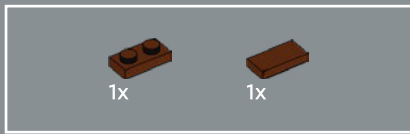

487

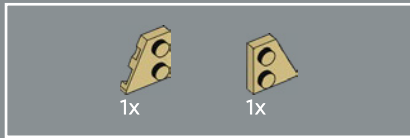
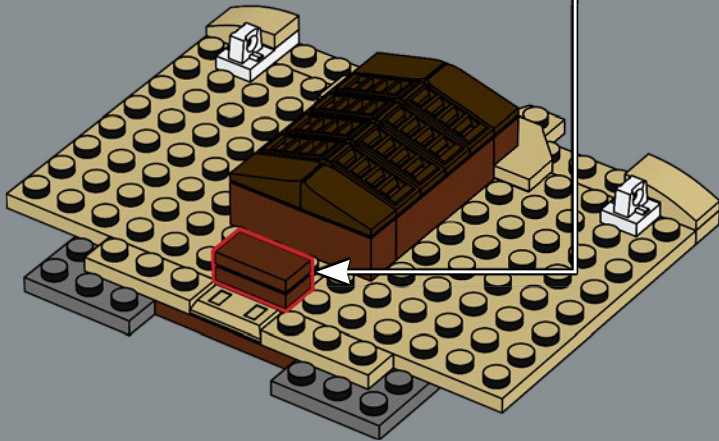

488

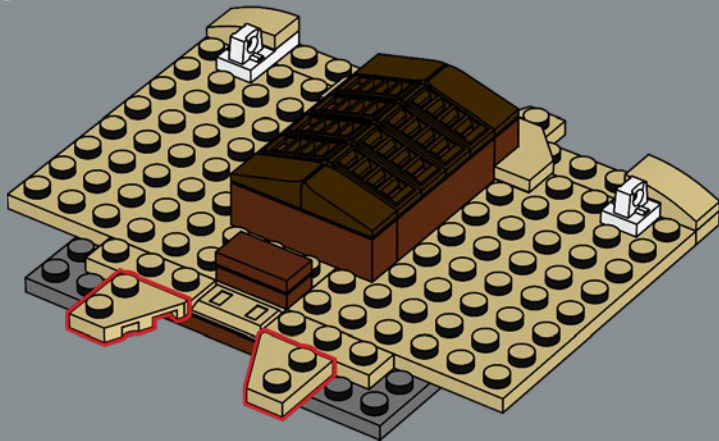

489

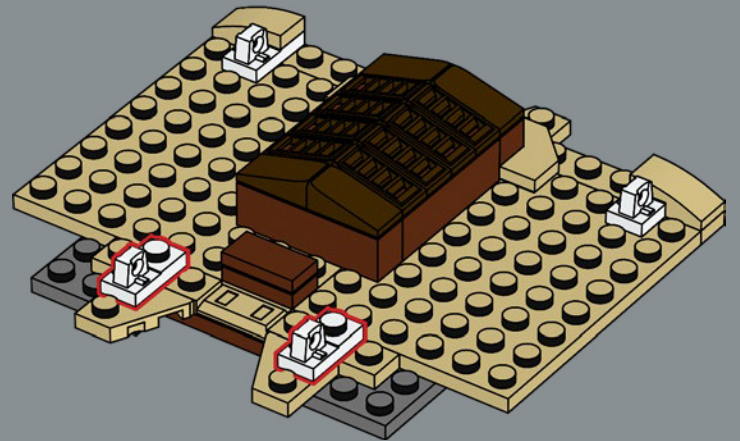

490

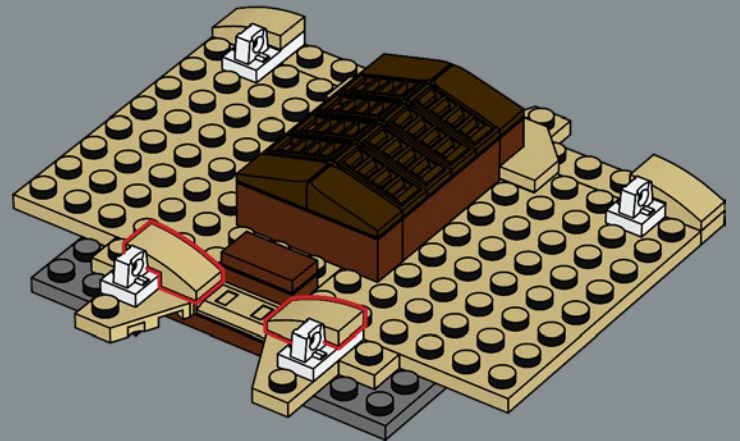

2x

491

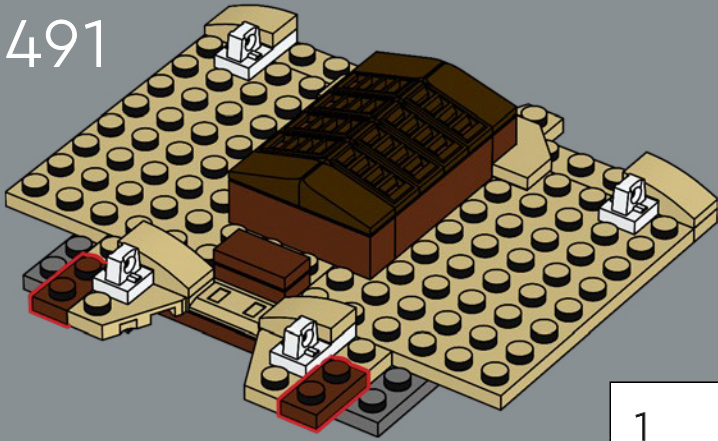

2x

2x

2x

492

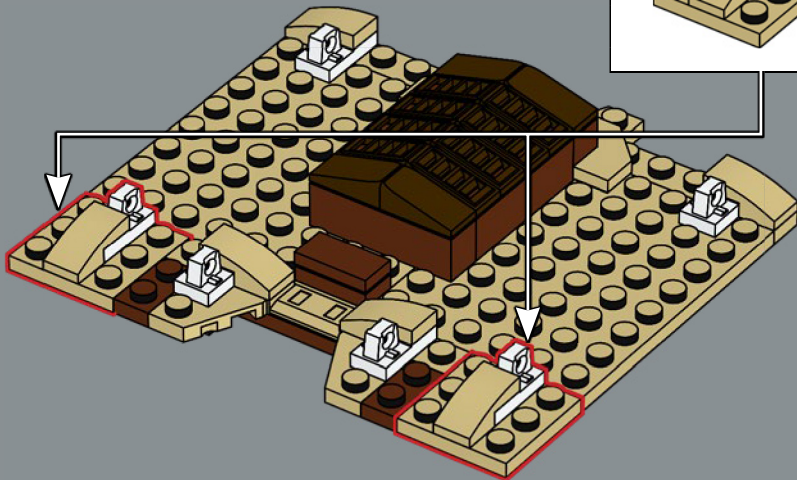

1

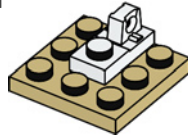

2

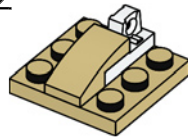

2x

4x

493

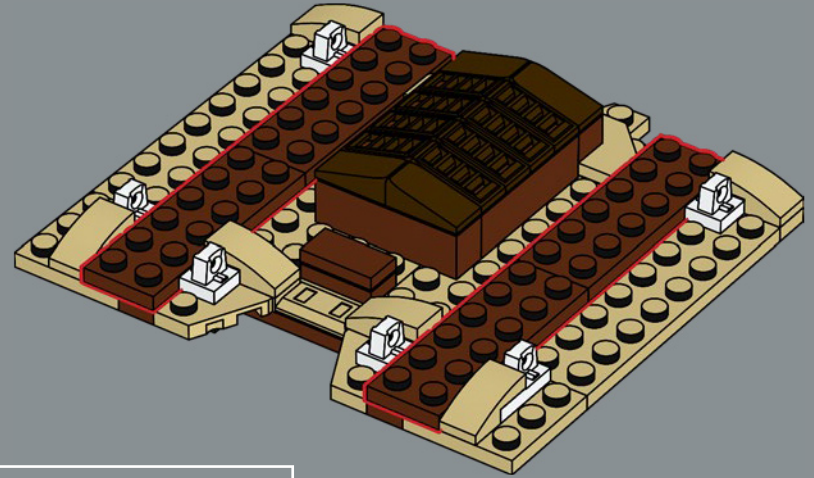

4x



4x

494

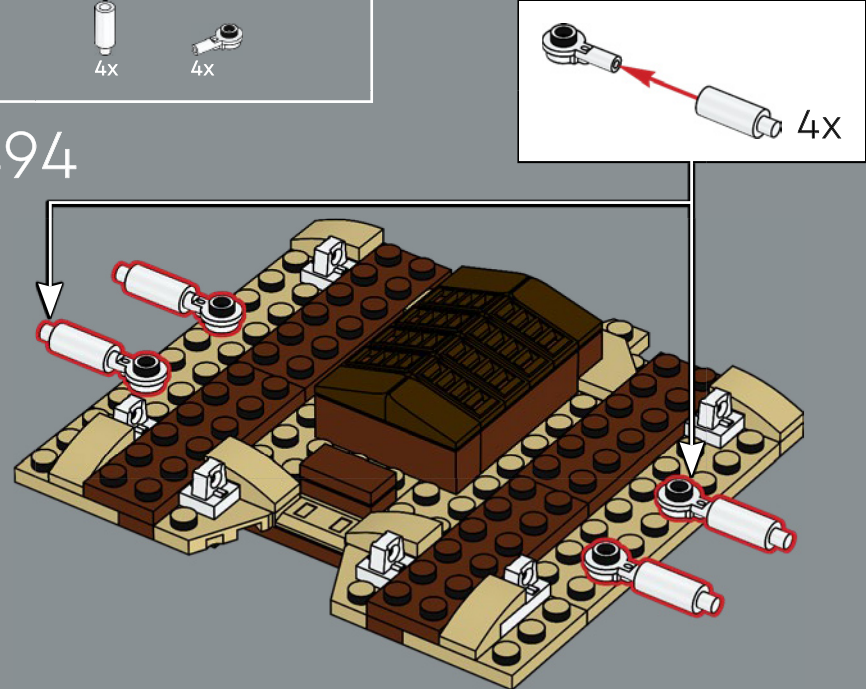

4x



495

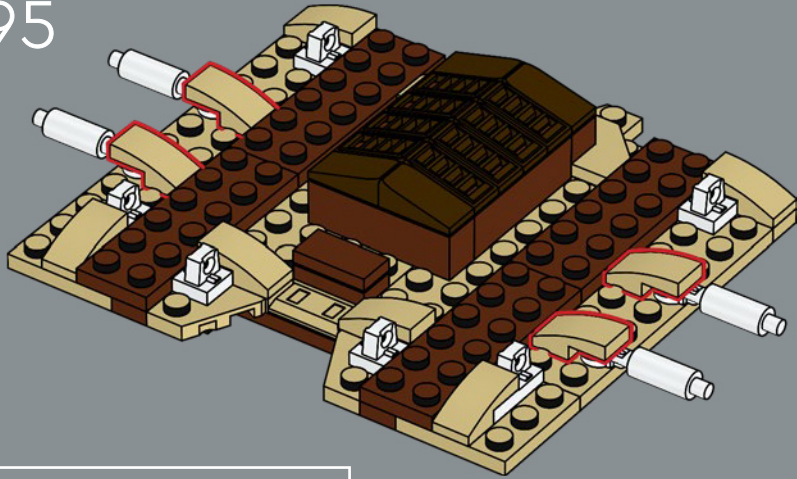

496

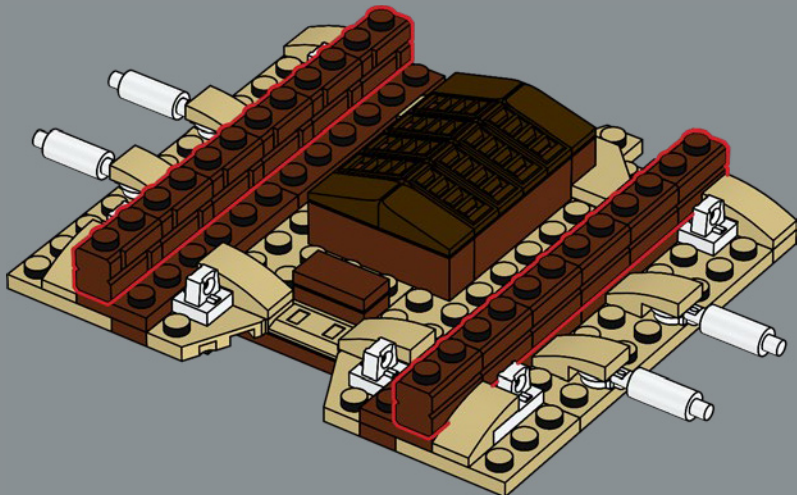

497

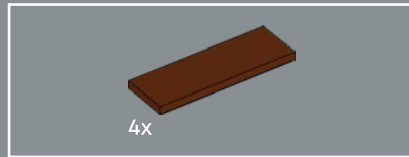
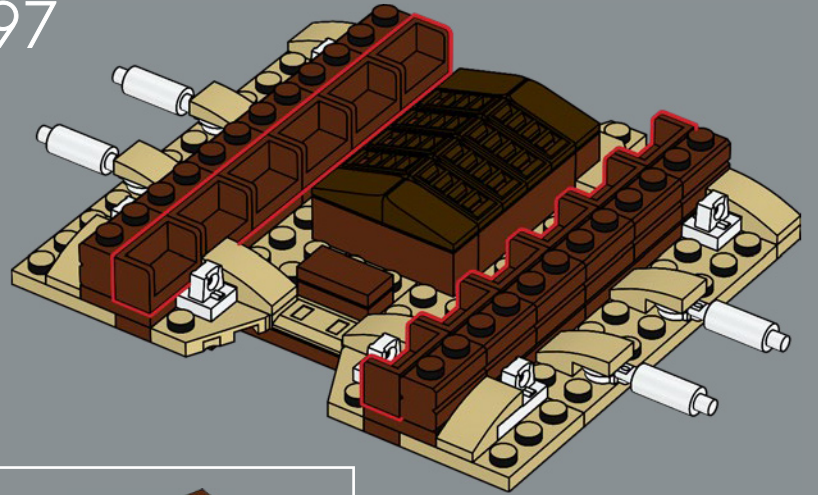

498

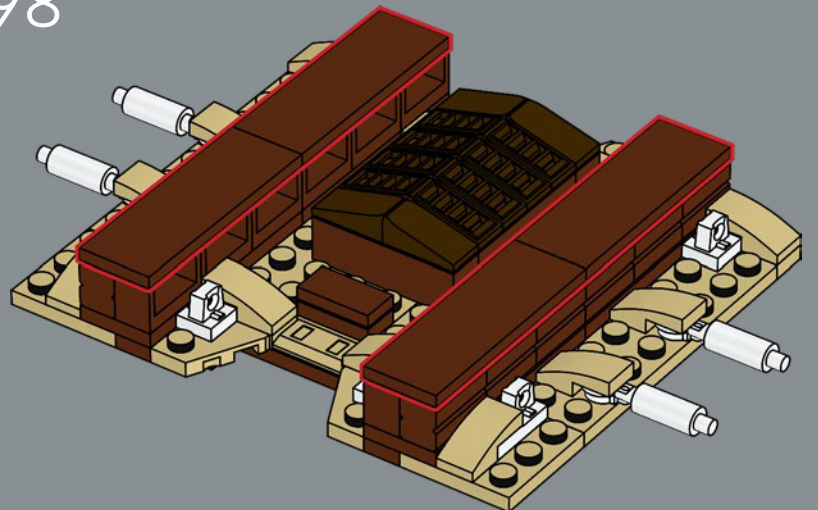

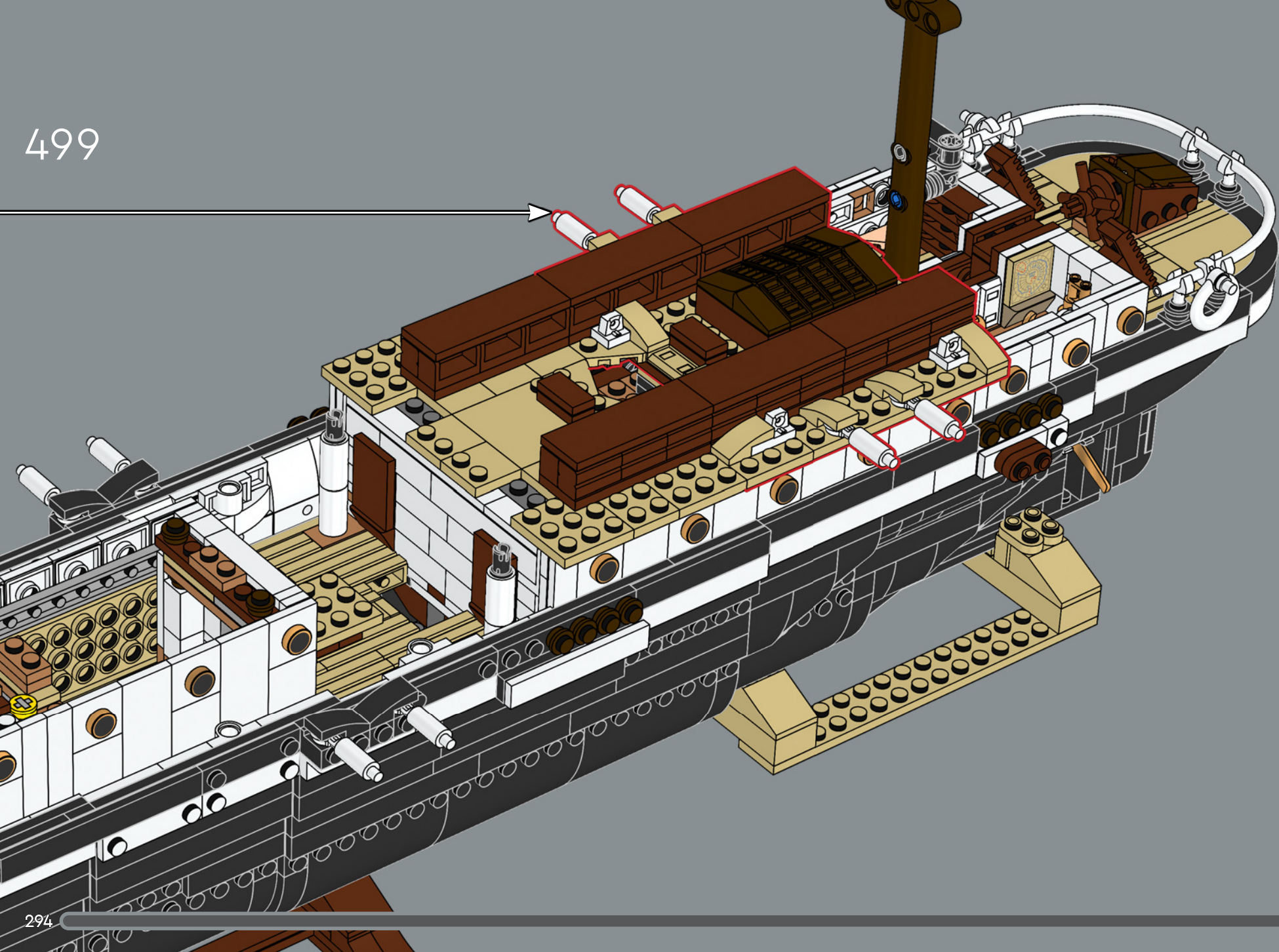

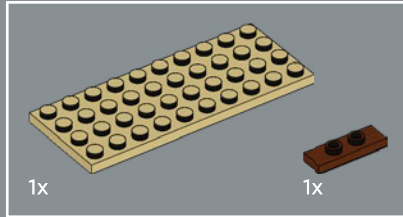
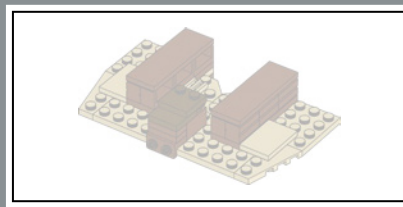

500

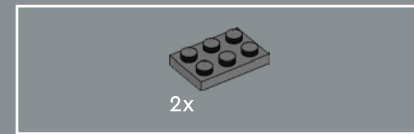
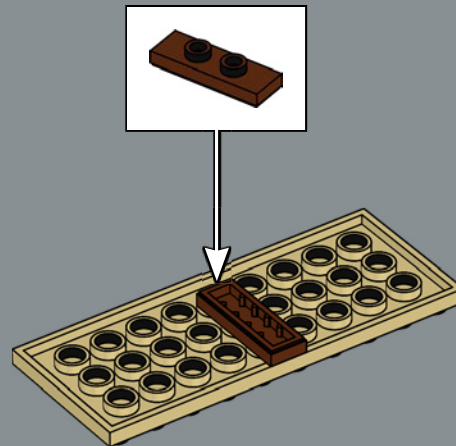

501

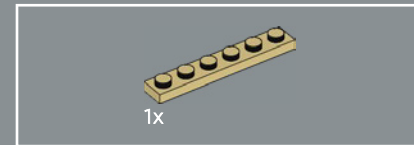
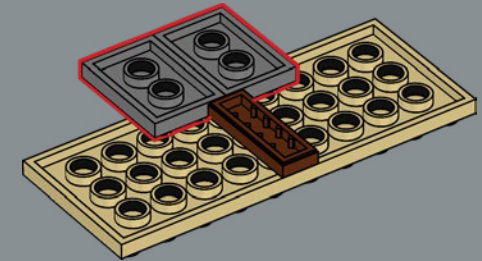

502

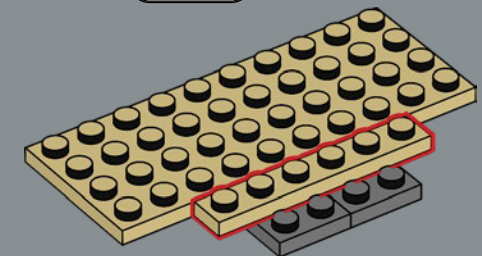



503

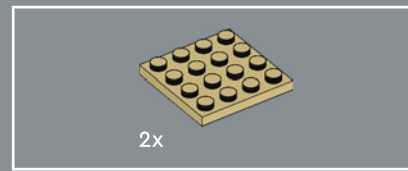
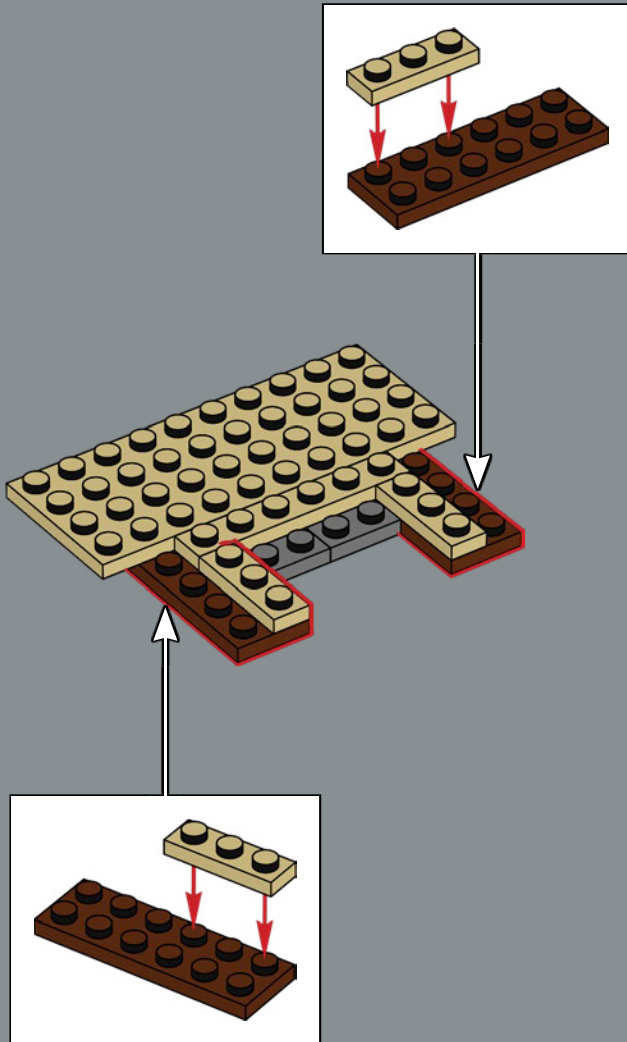

504

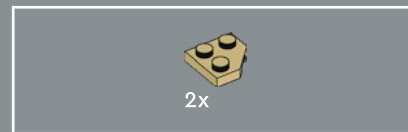
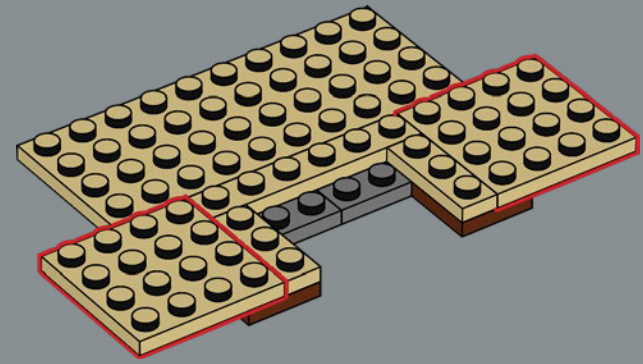

505

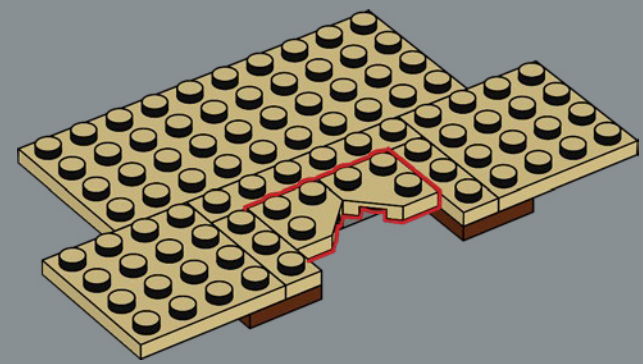

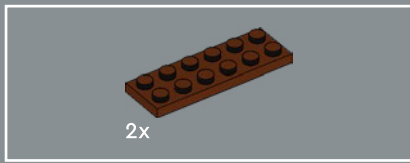

506

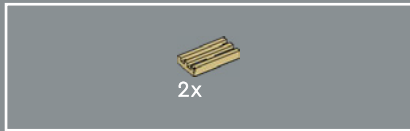
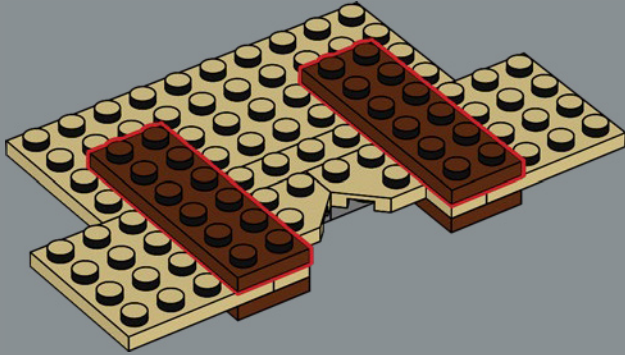

507

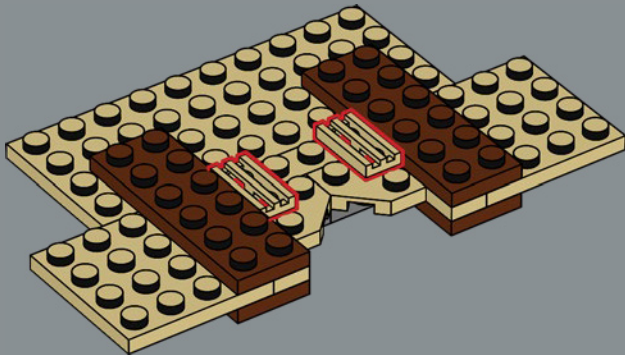

508

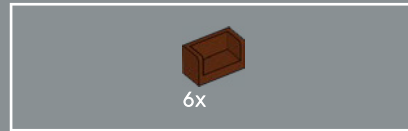
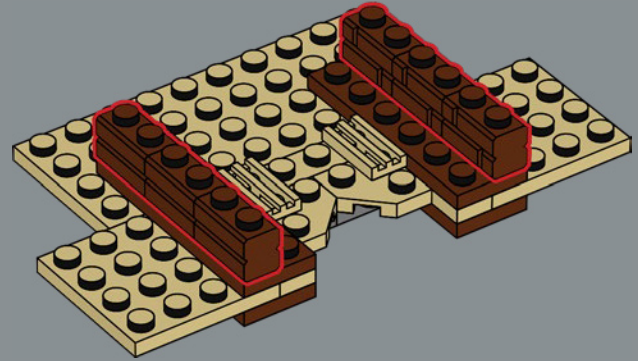

509

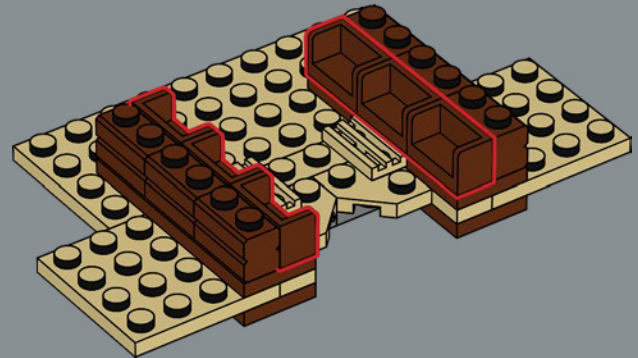

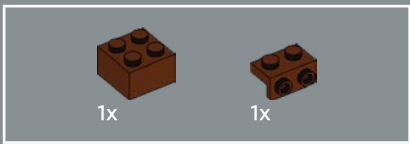

510

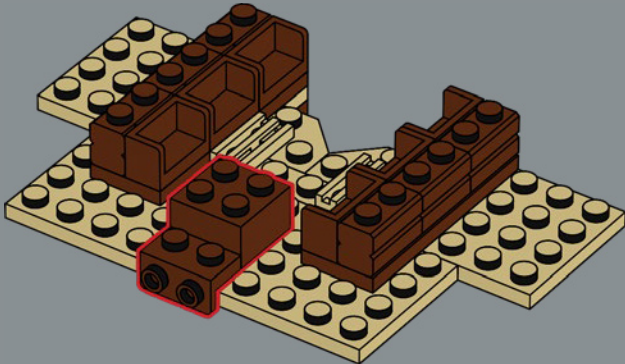

511

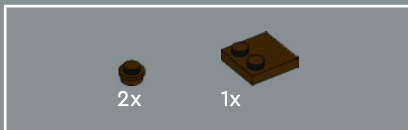
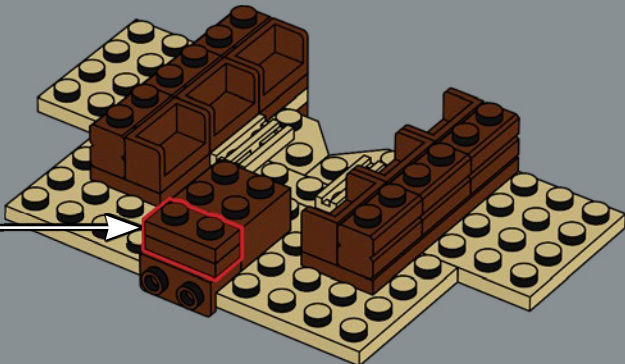
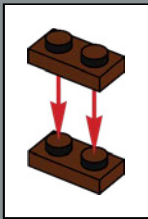

512

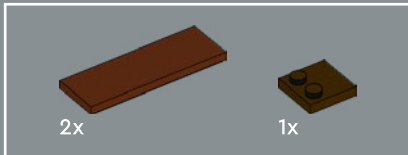
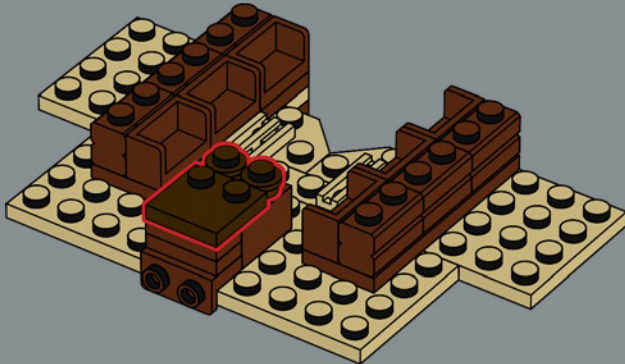

513

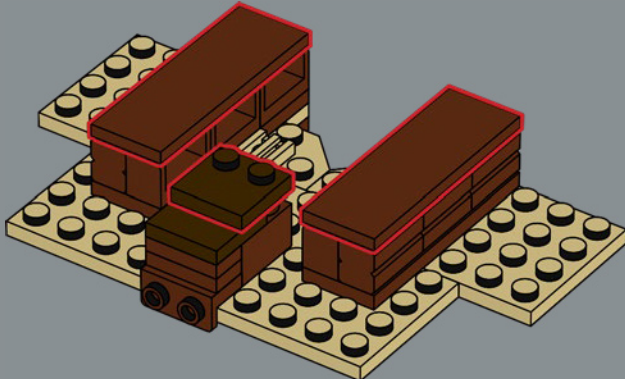

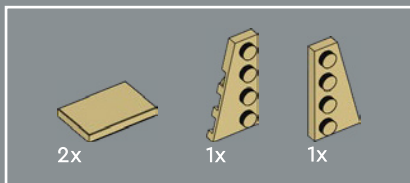

514

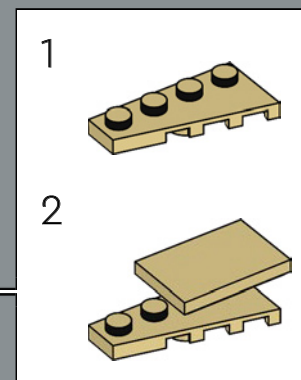
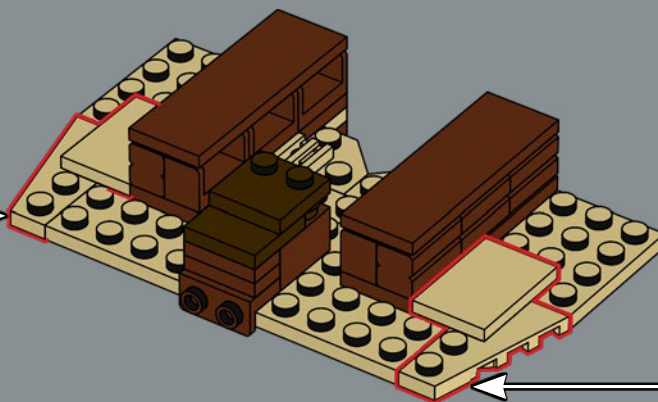
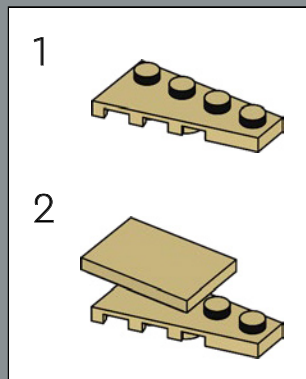

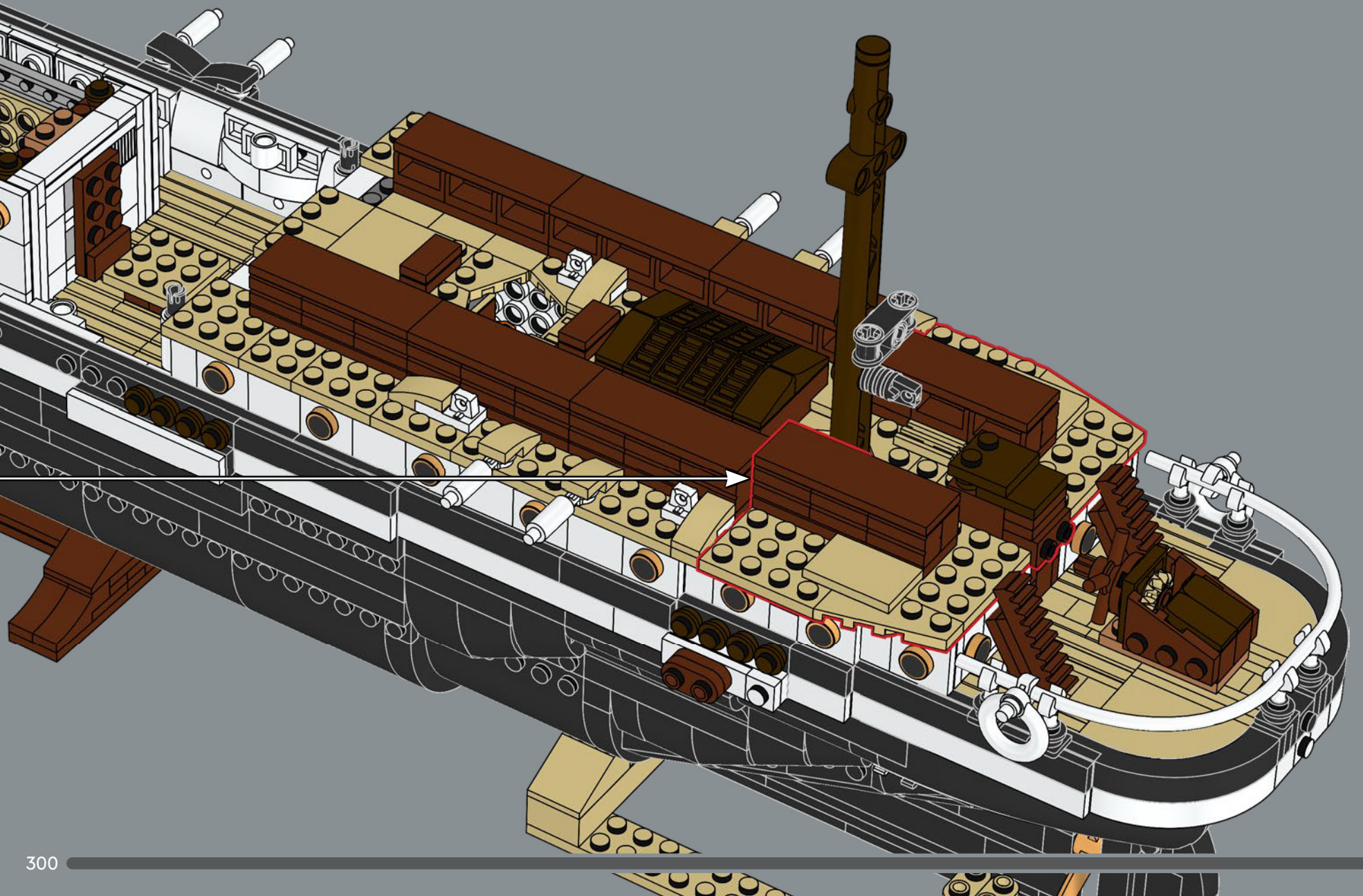

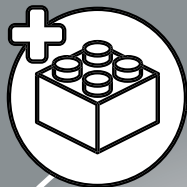

2x

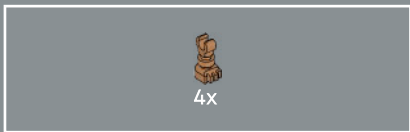

4x

516

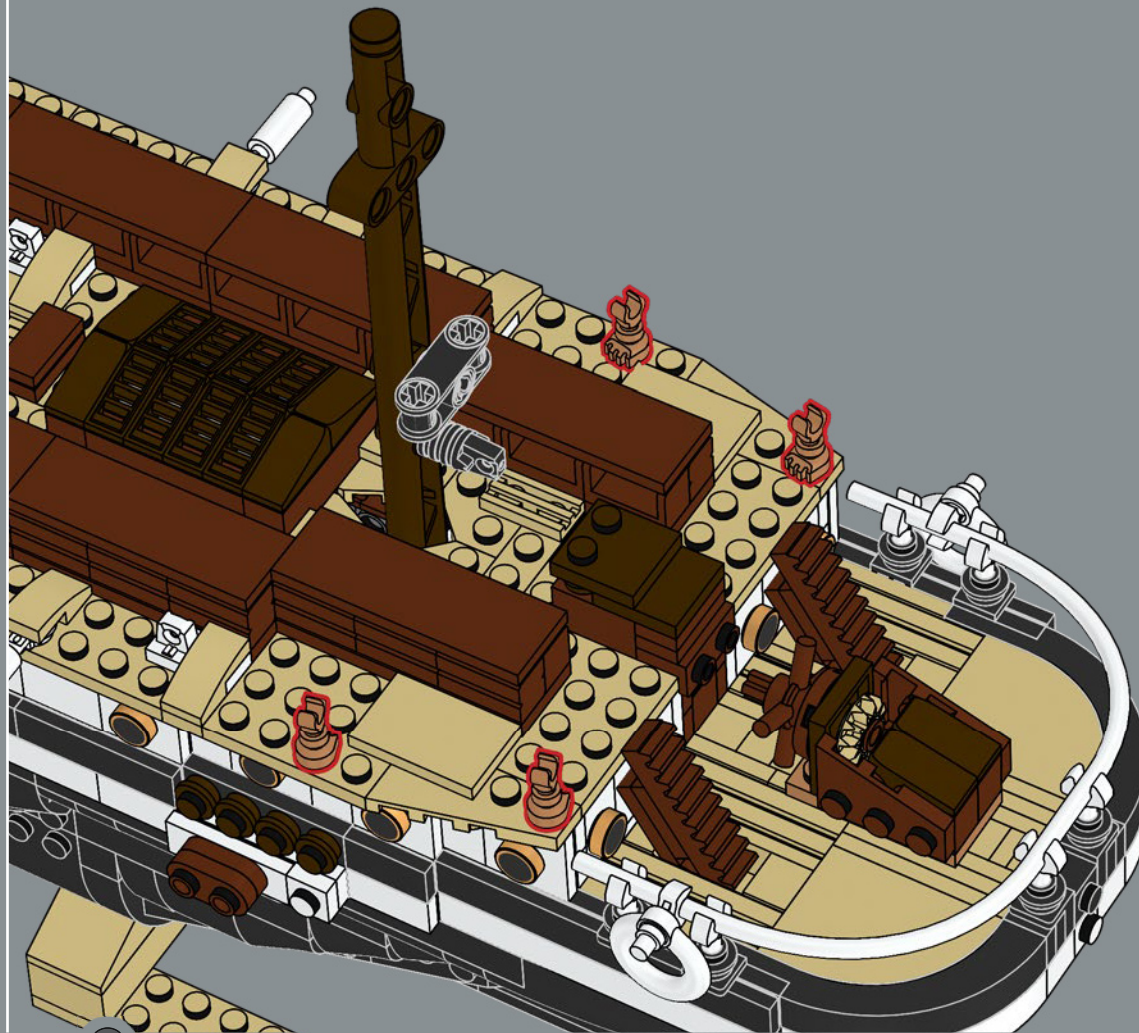



517

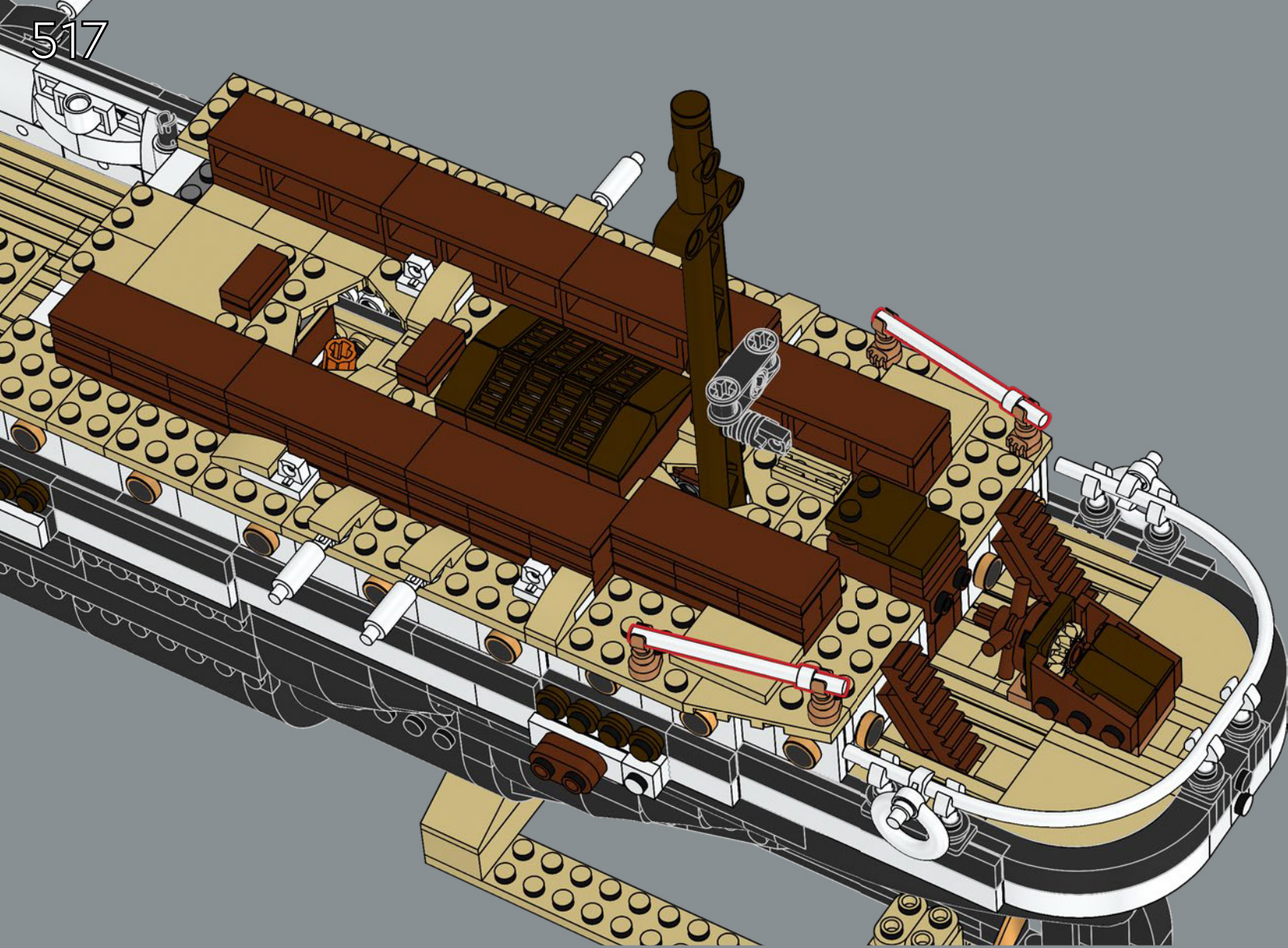

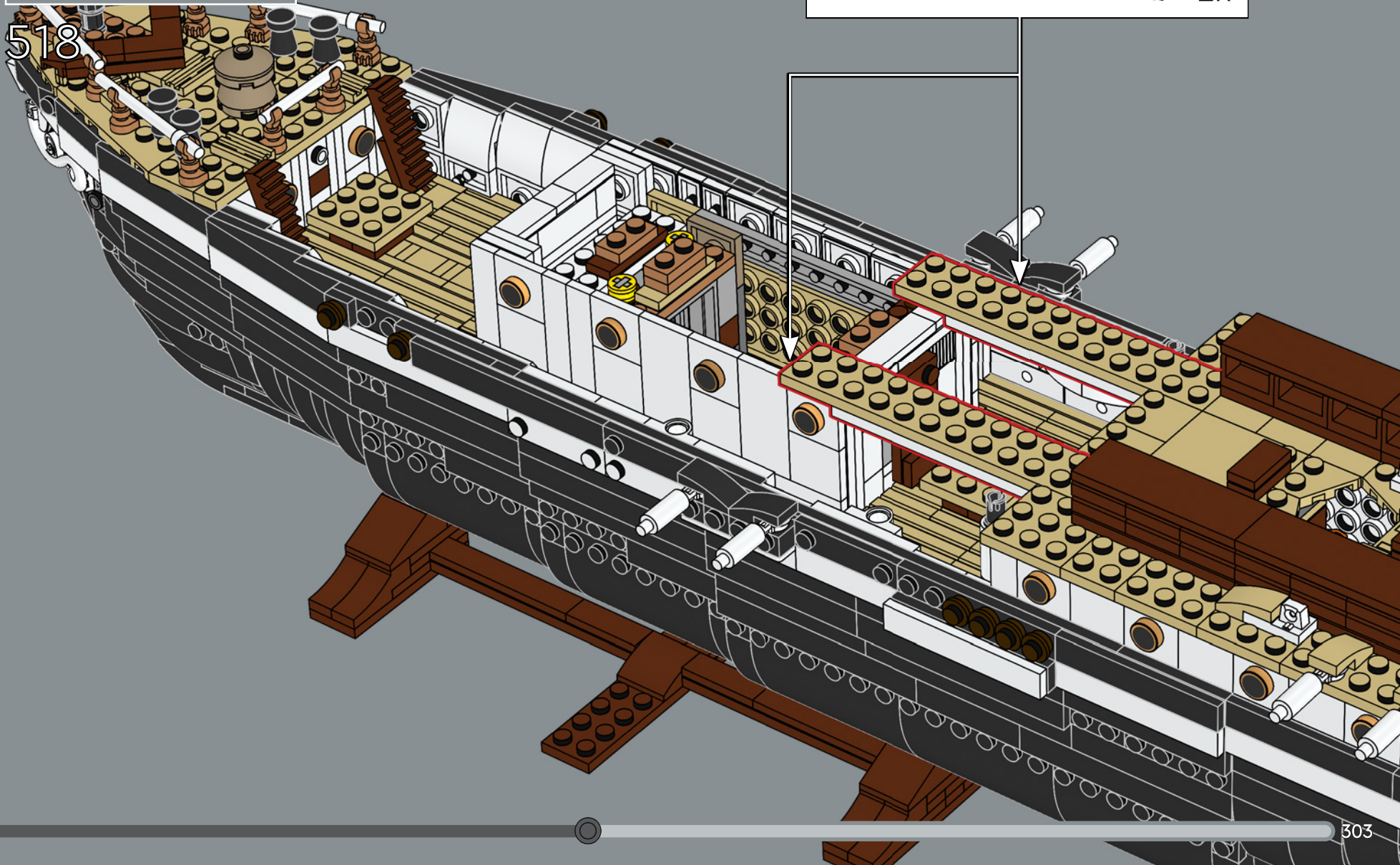
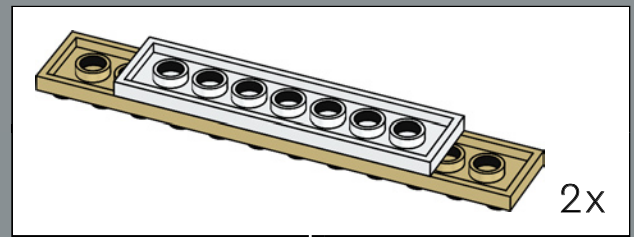
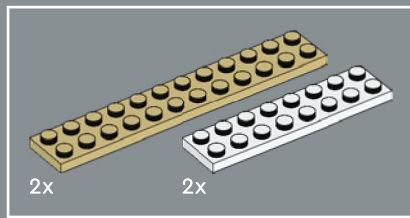

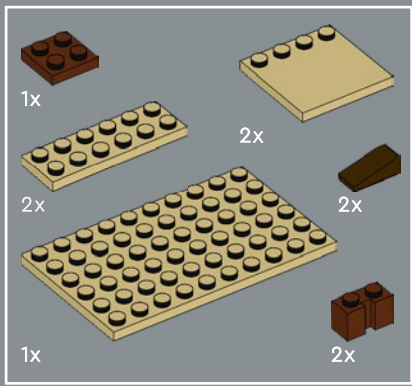

519

1

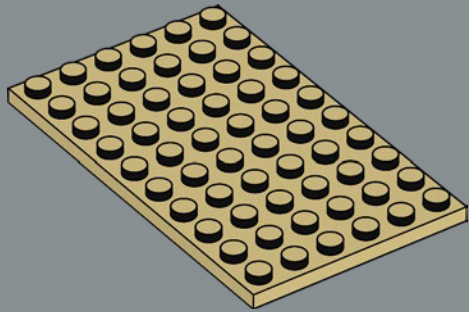

2

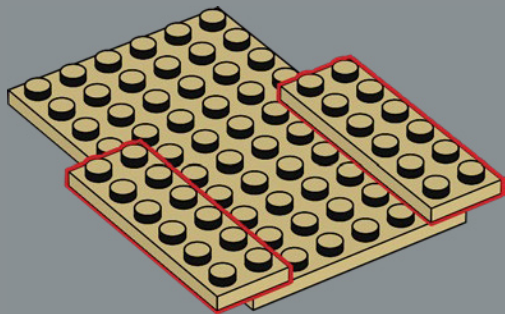

3

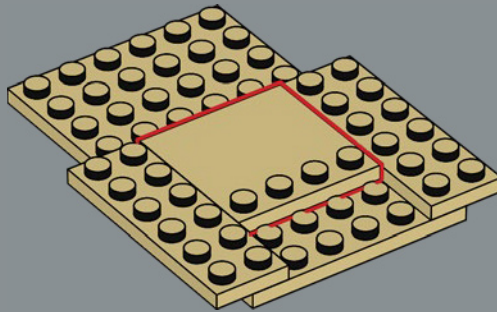

4

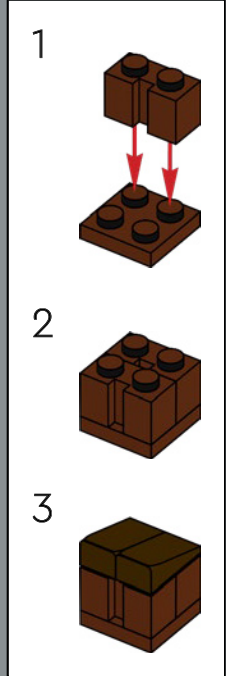
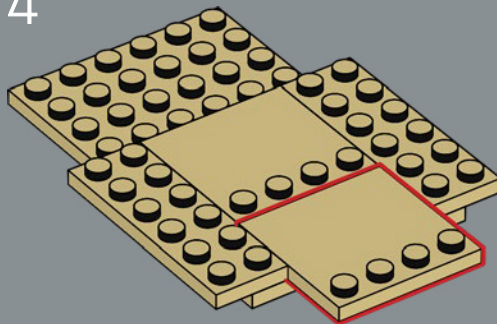

5

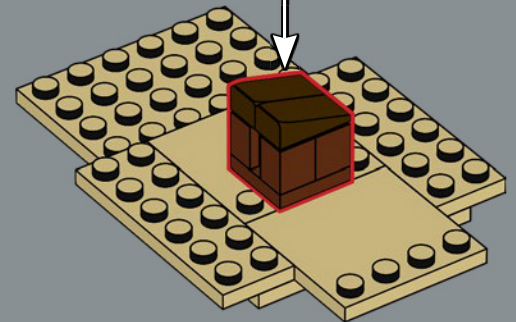

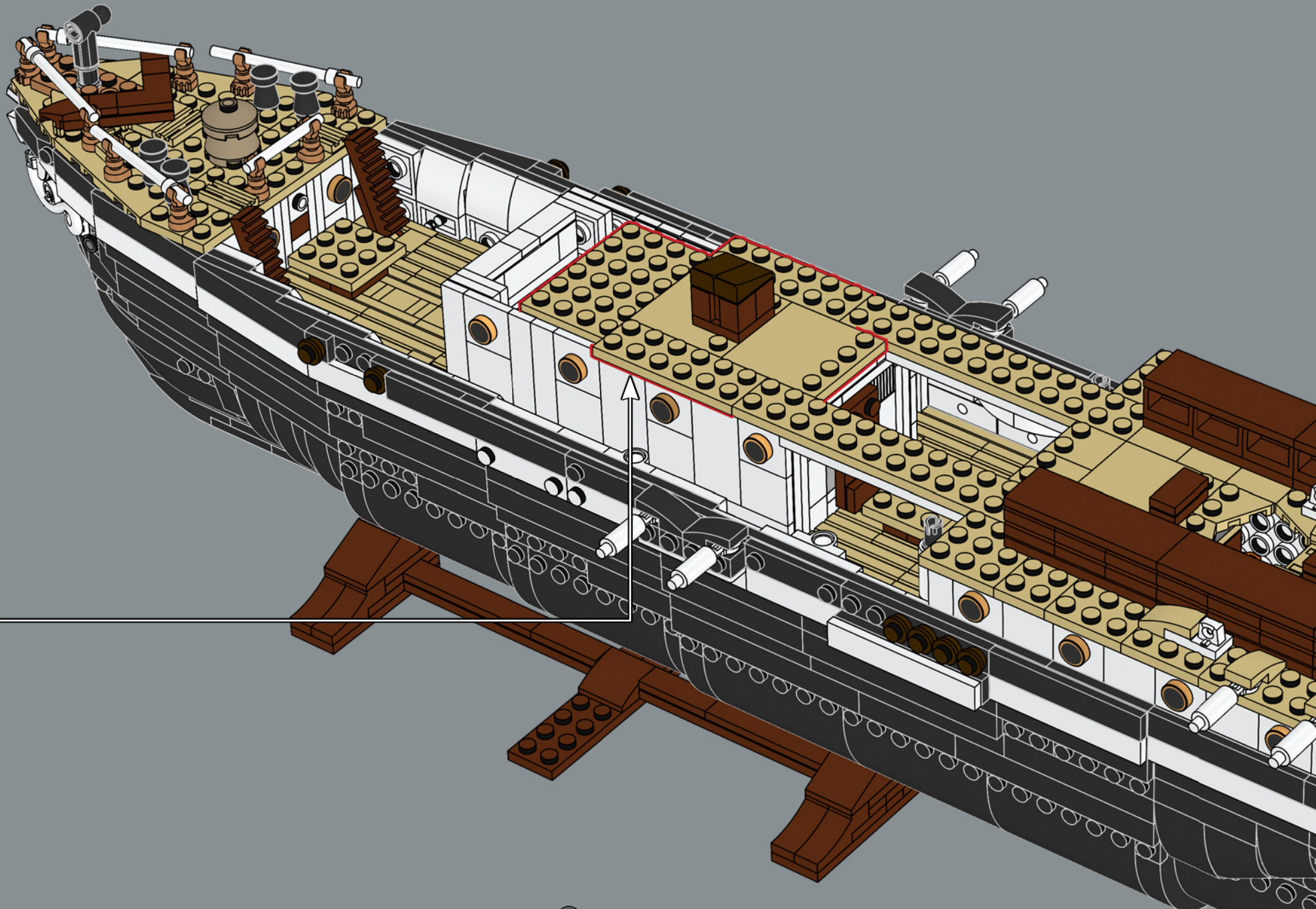

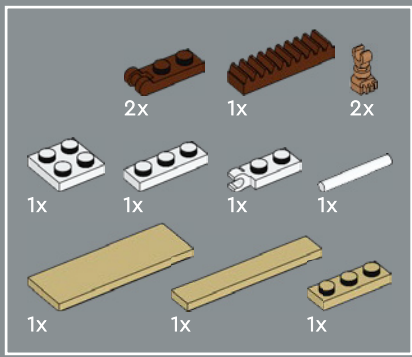

520

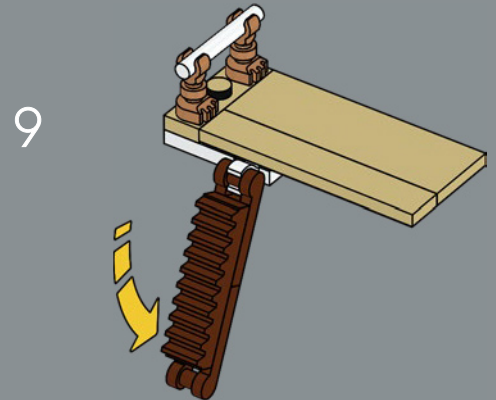
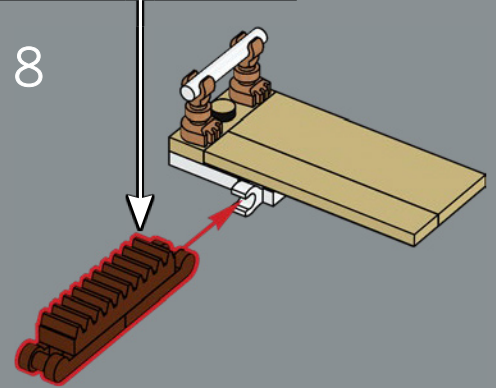
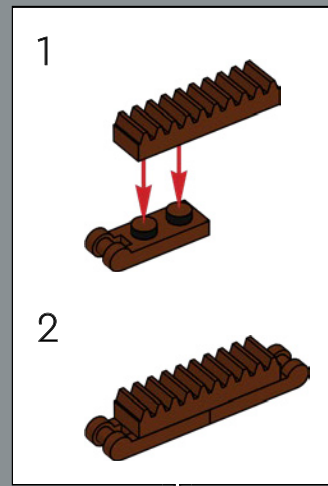
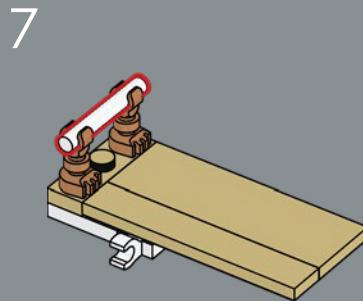
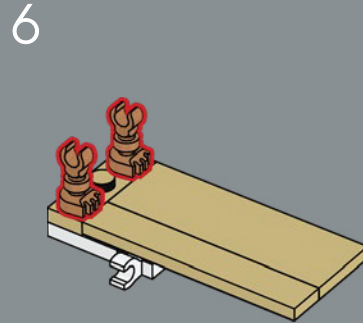
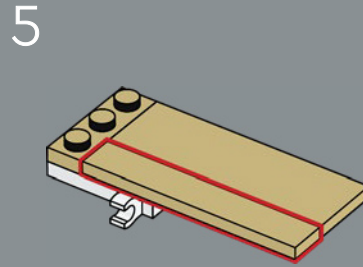
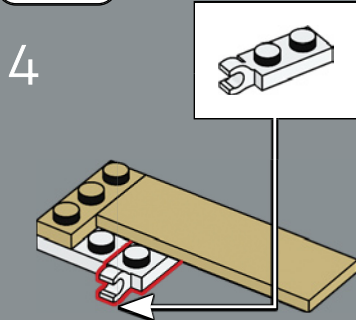
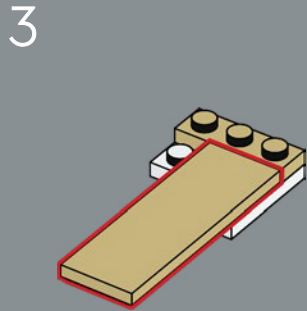
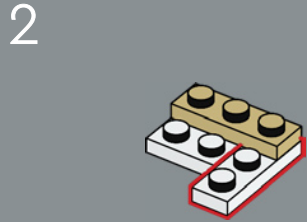
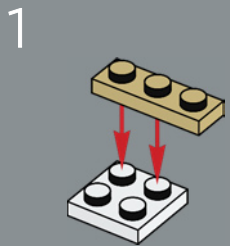

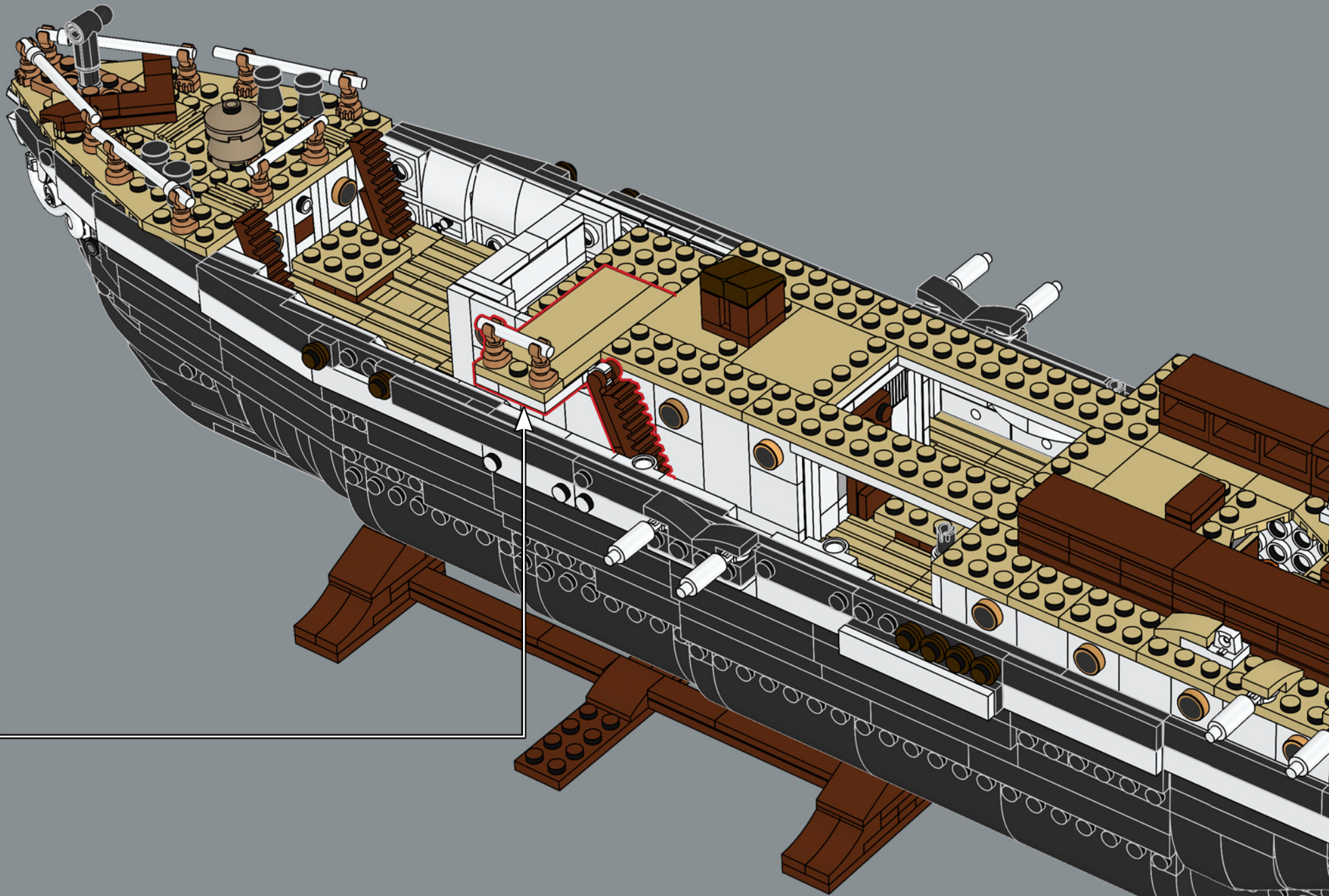

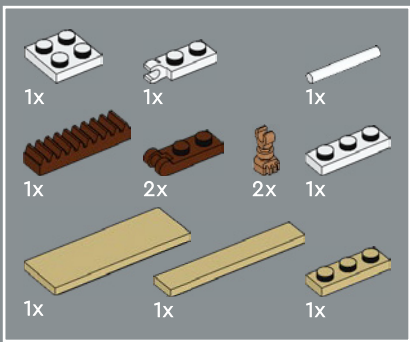

521

1

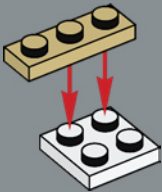

2

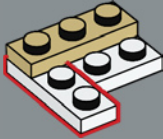

3

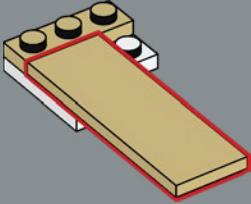

4

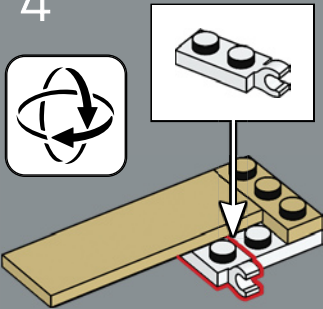

5

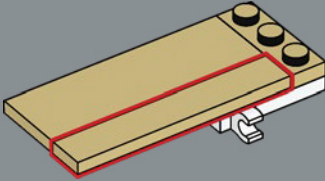

6

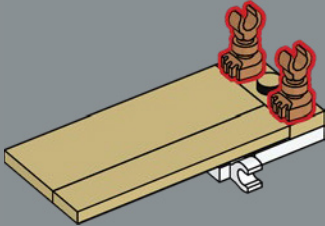

7

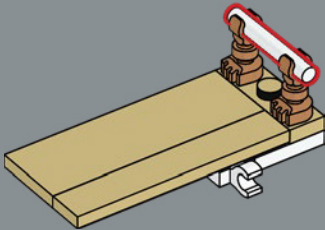

8

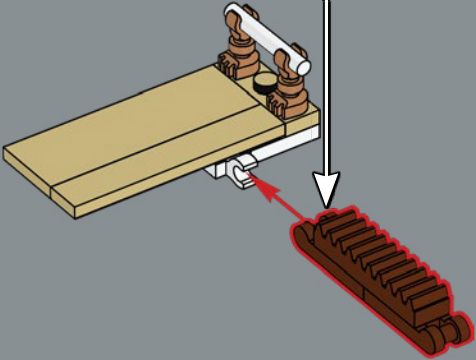

9

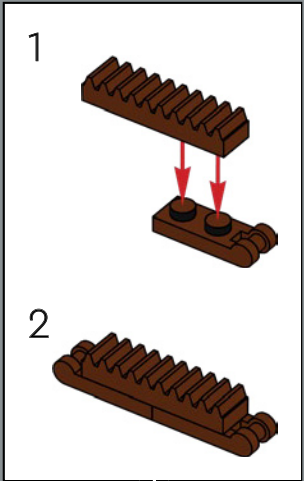
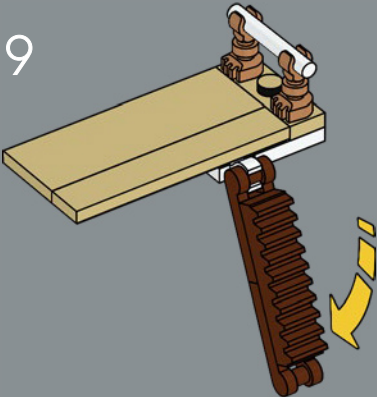

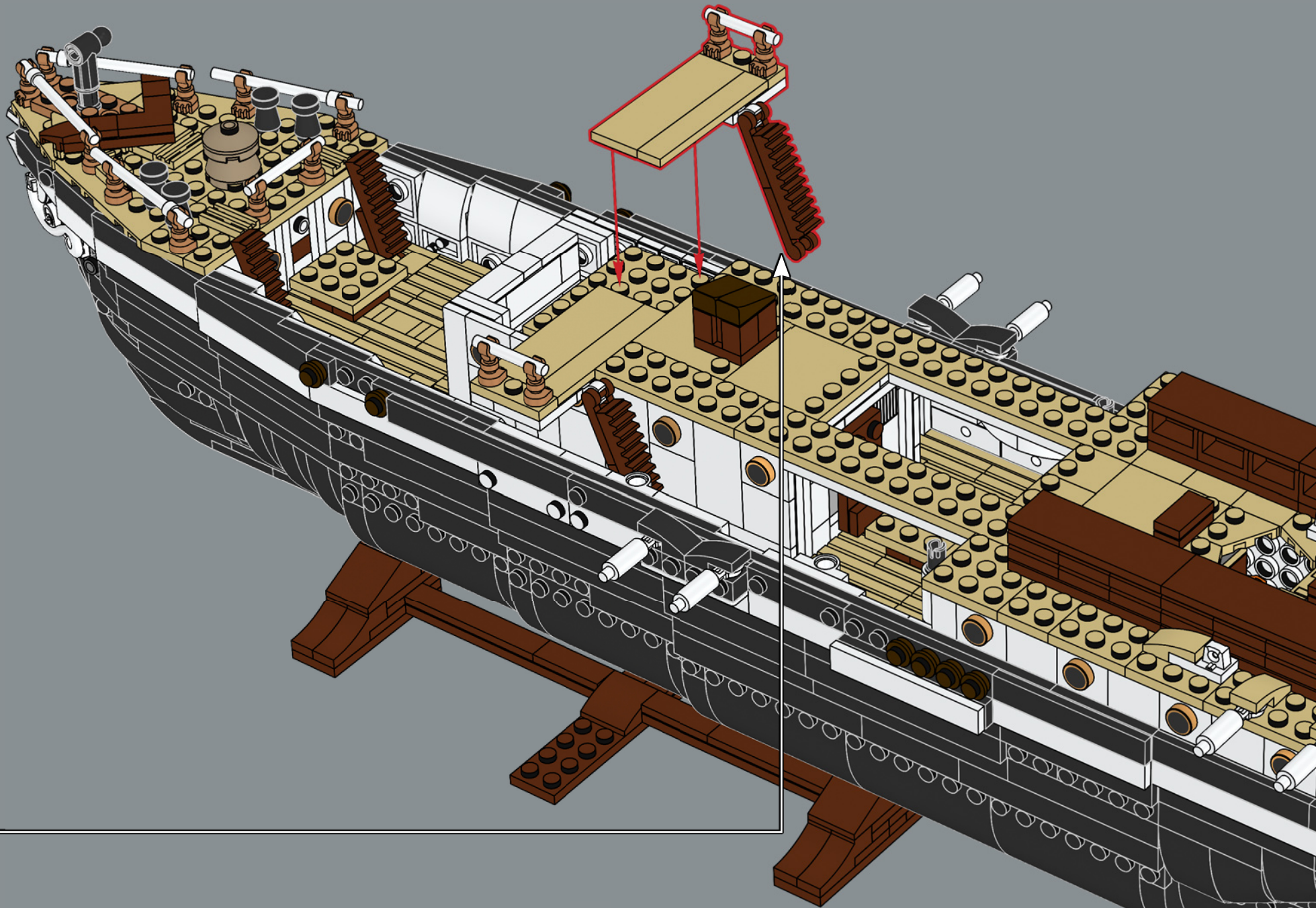

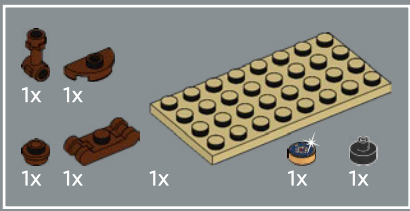

522

1

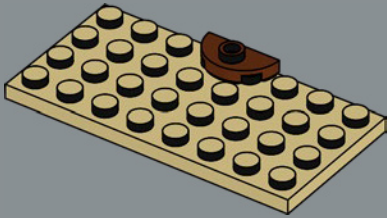

2

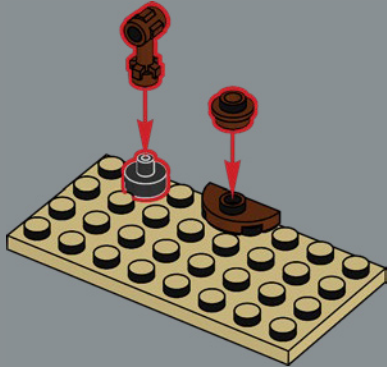

3

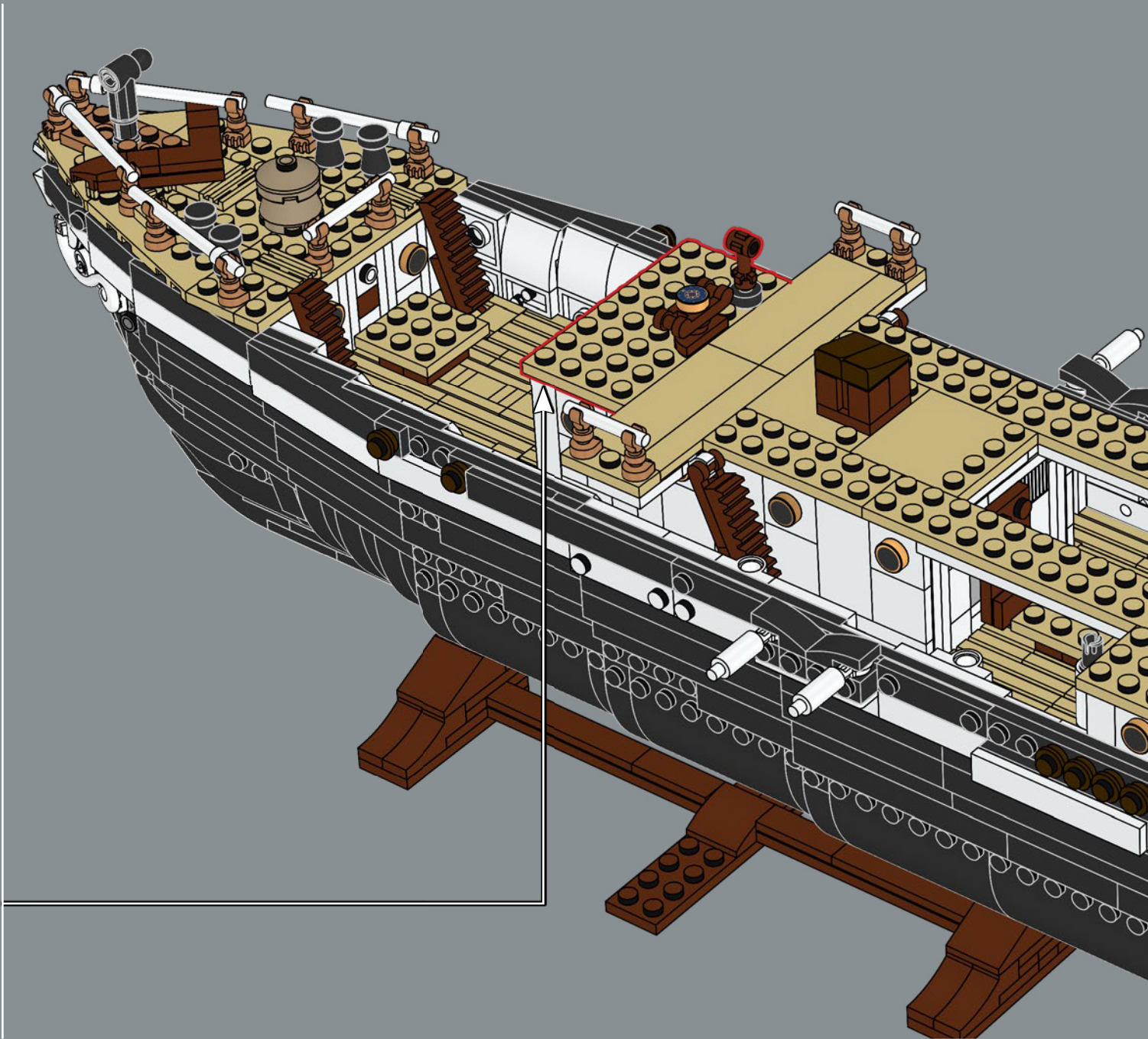

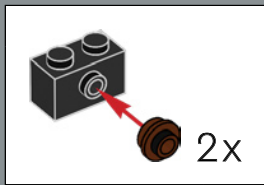

523

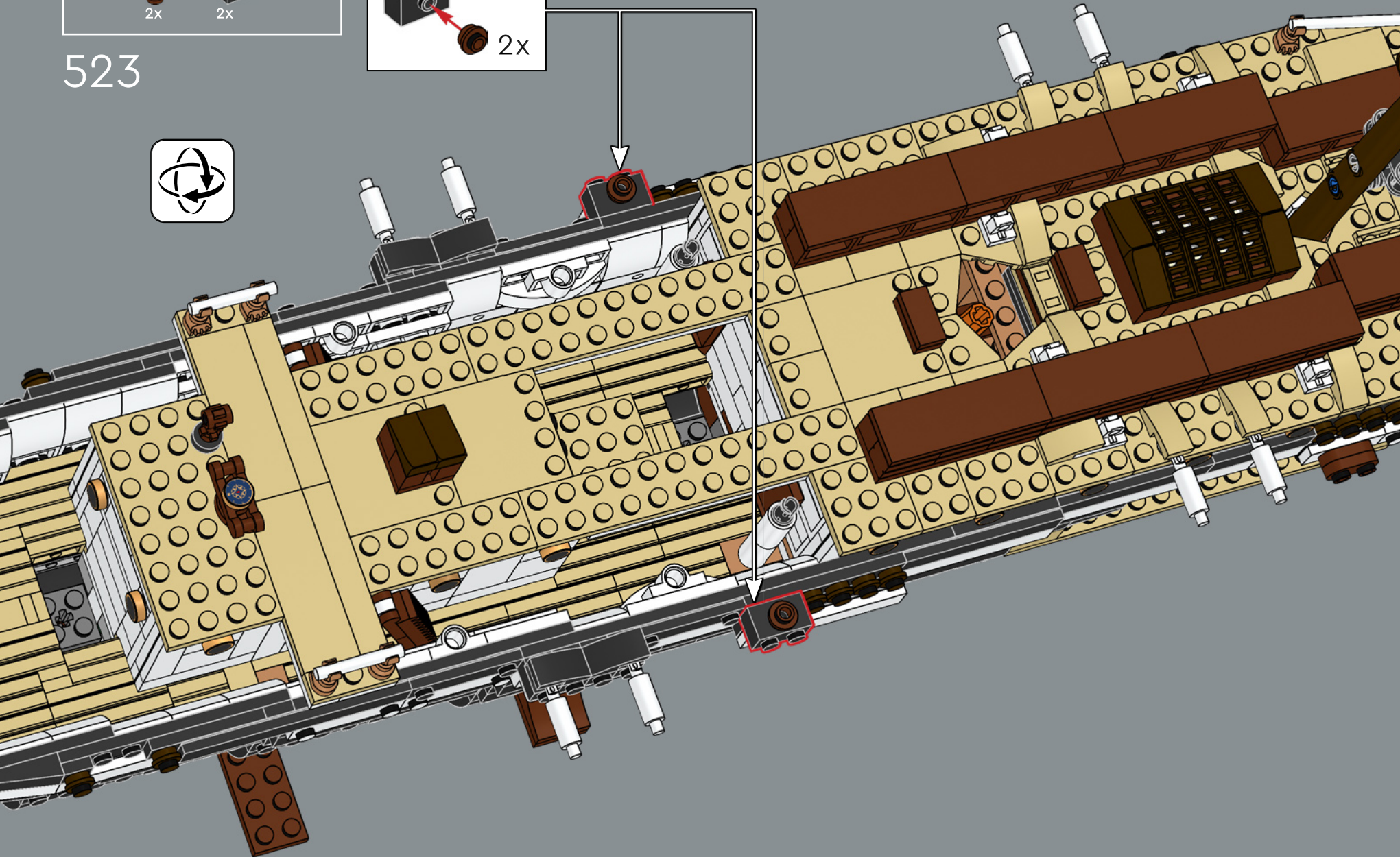



38x

524

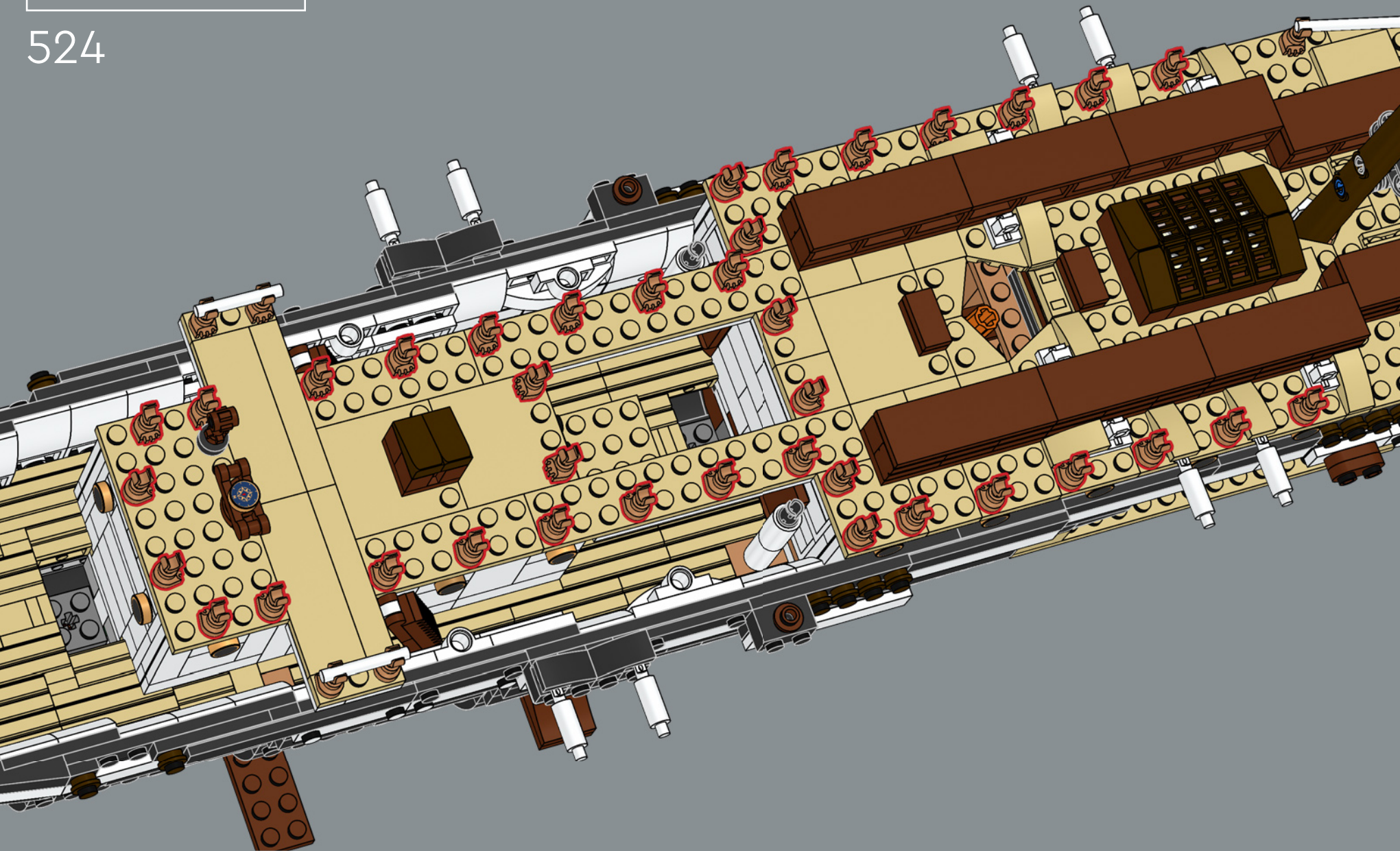

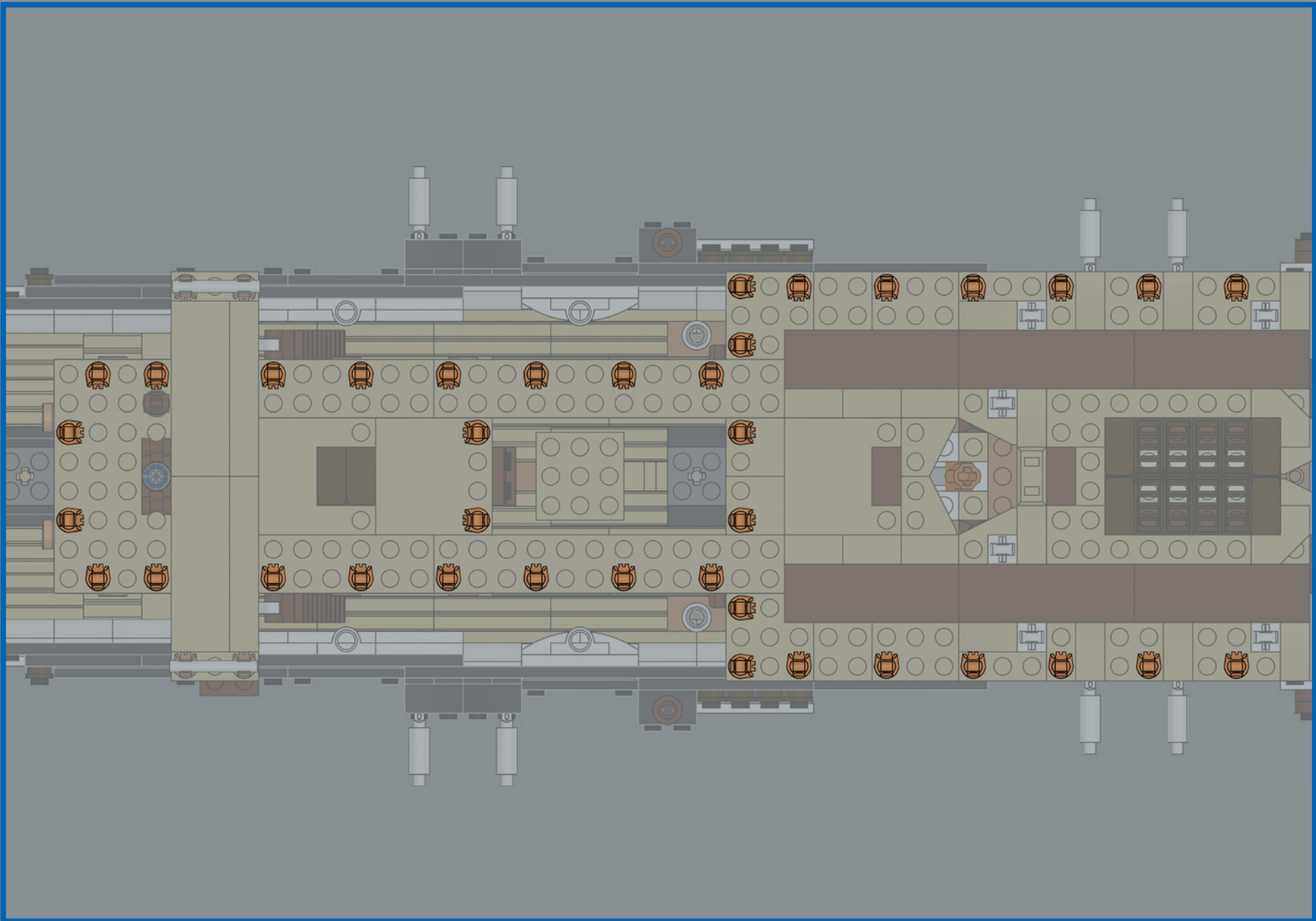

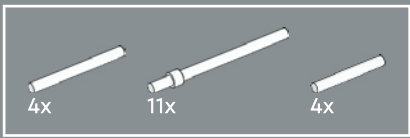

525

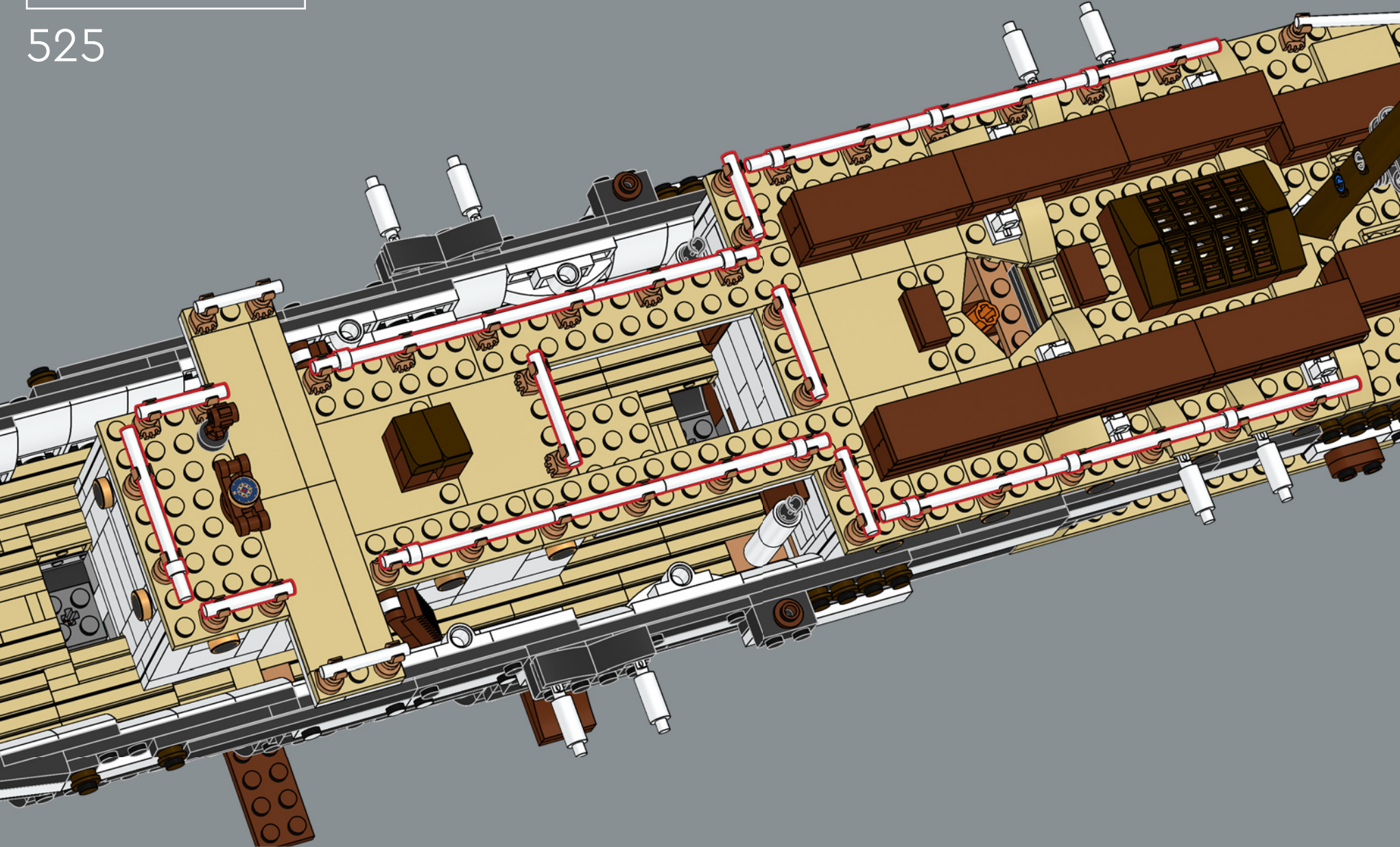

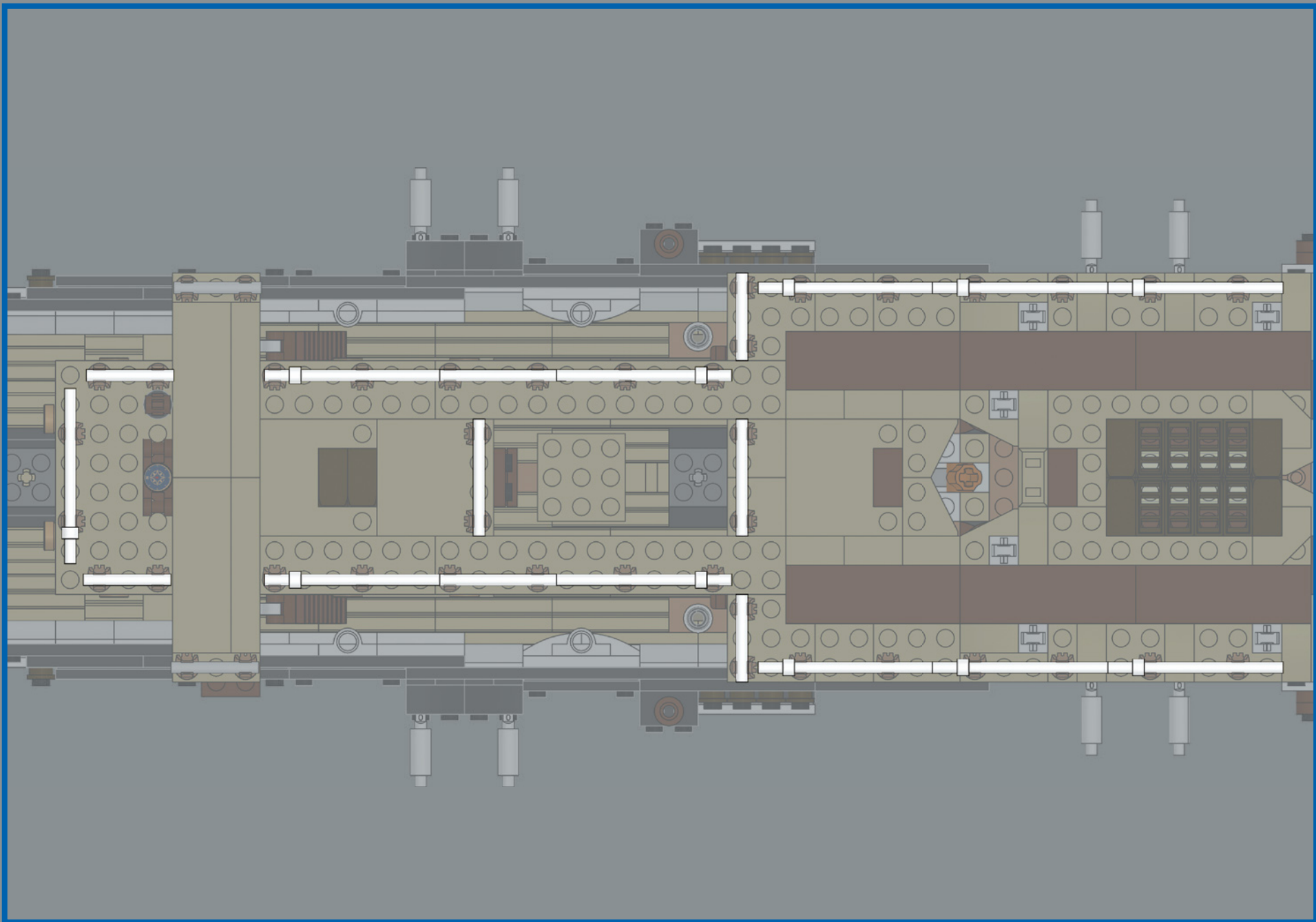

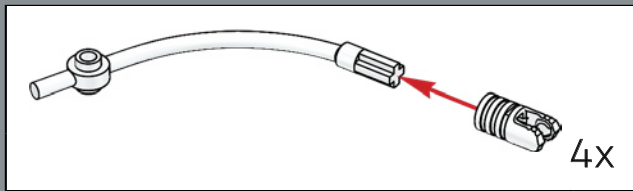
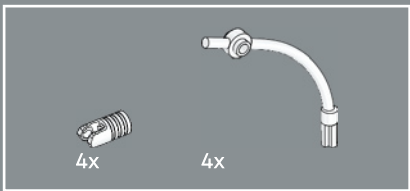

526

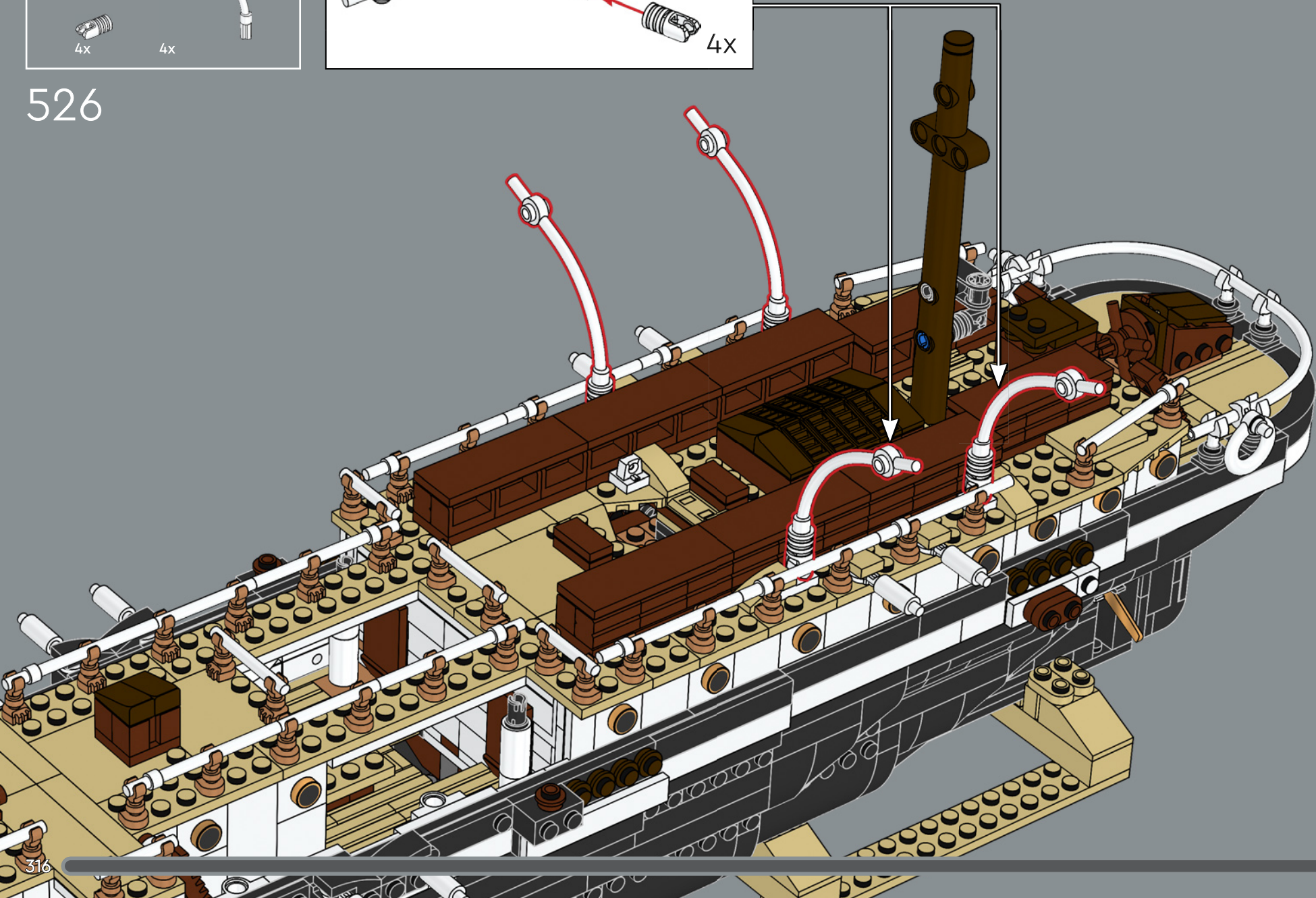

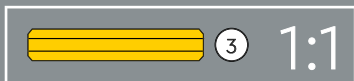
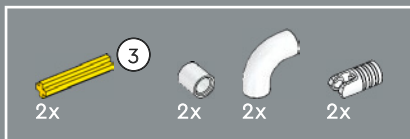

527

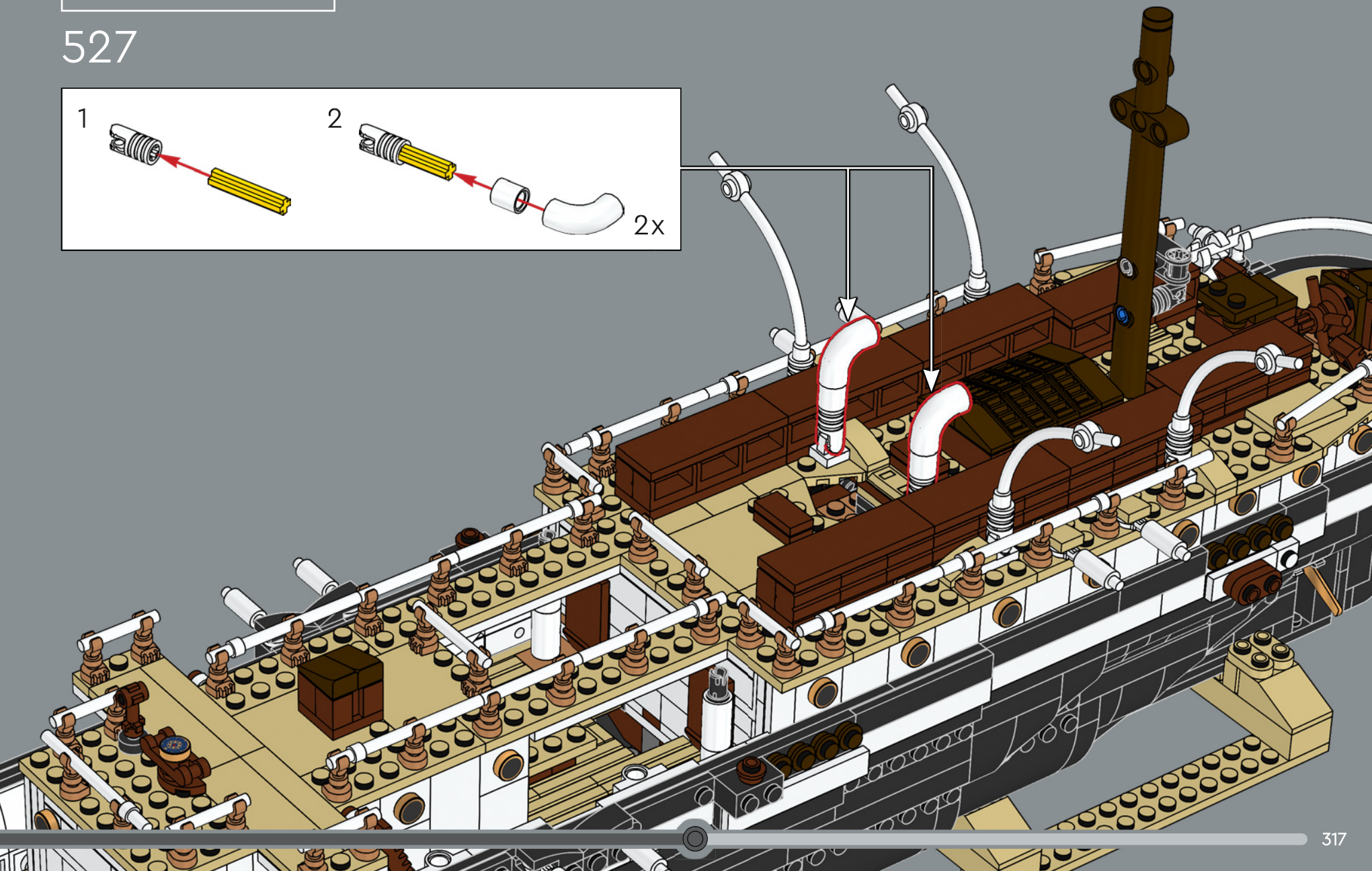
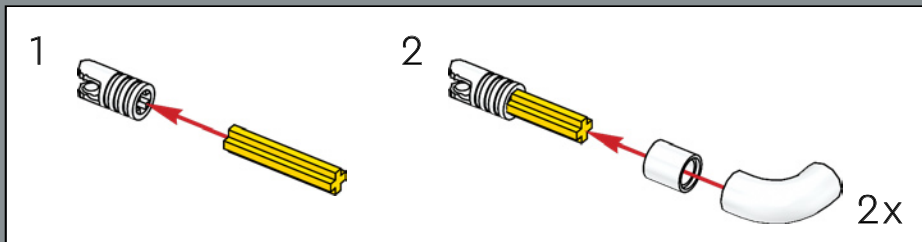

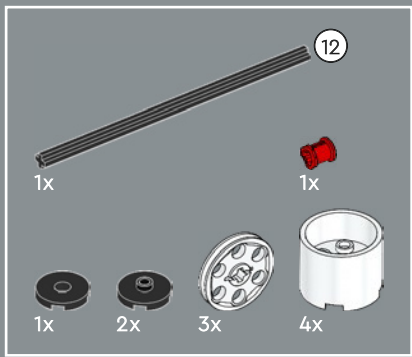

528

1

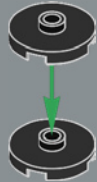

2

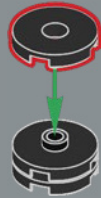

3



4

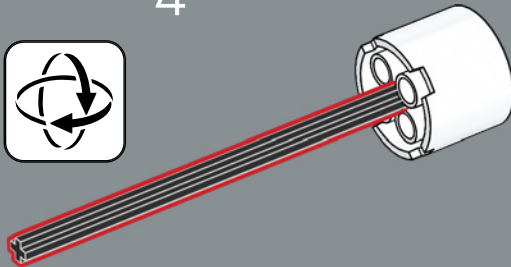

5



6

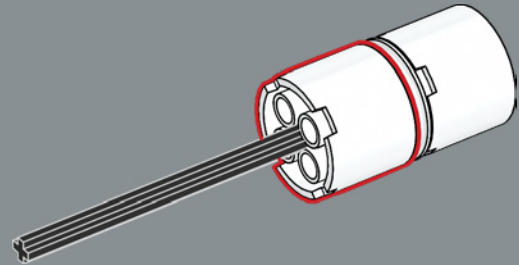

7

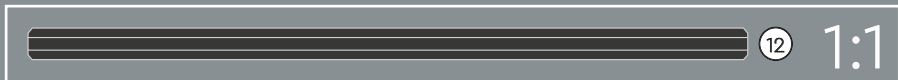
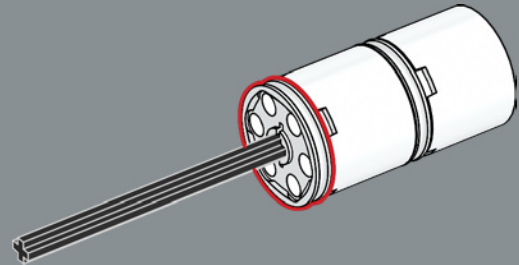

8

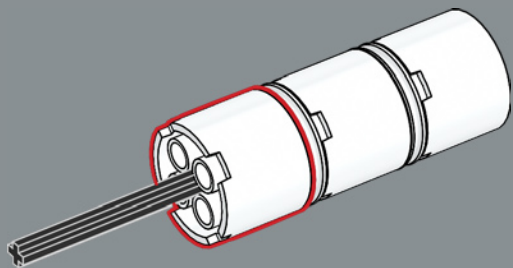

9

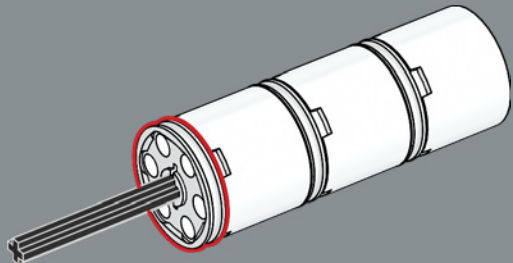

10

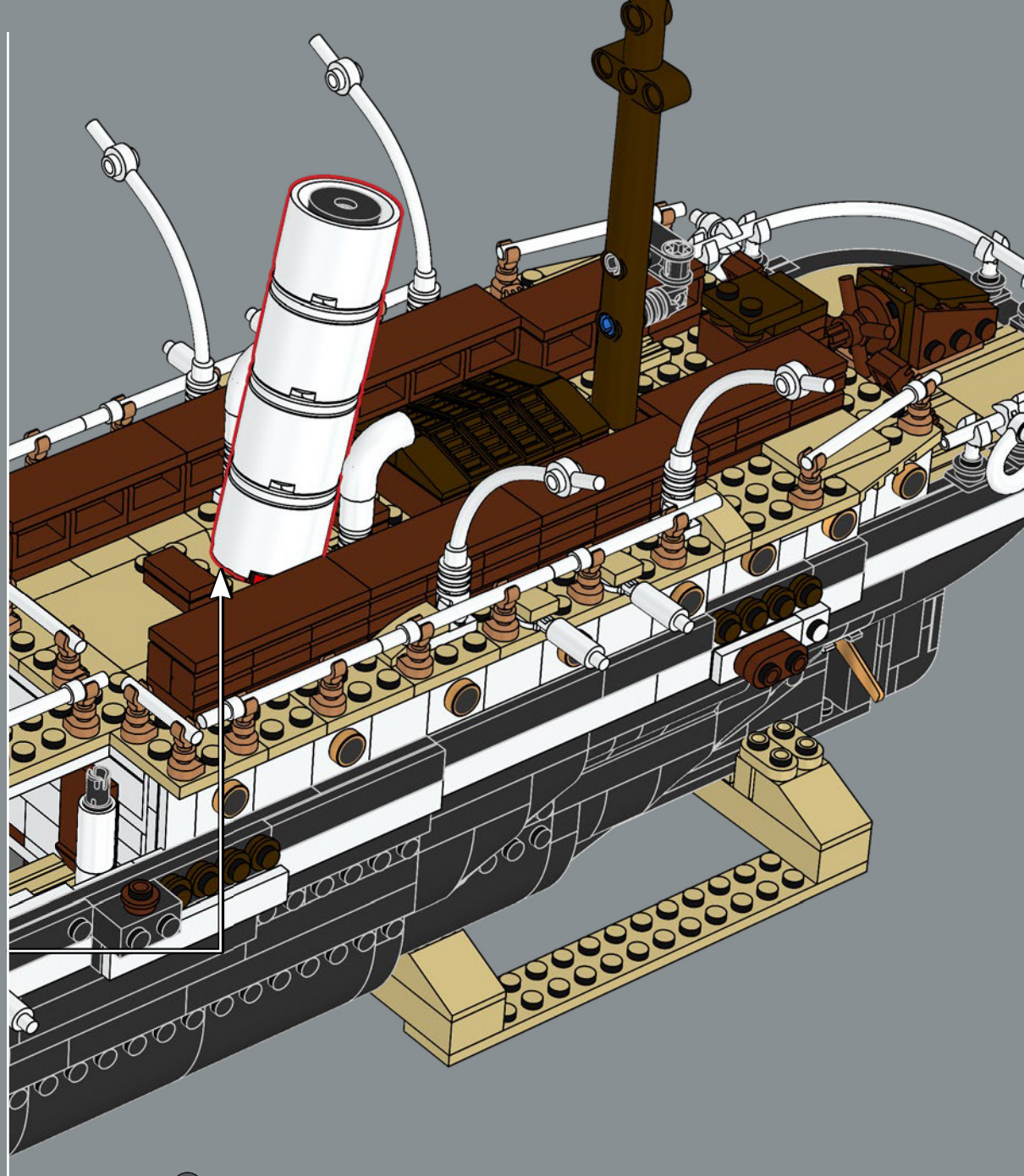
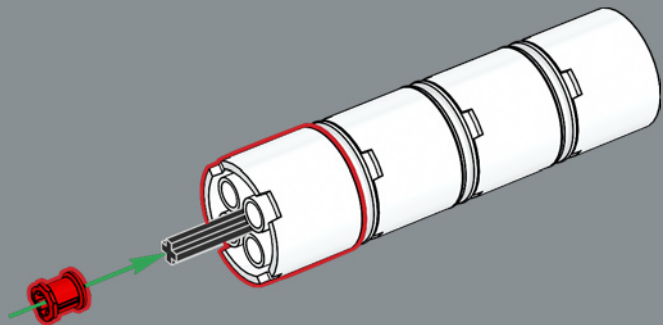

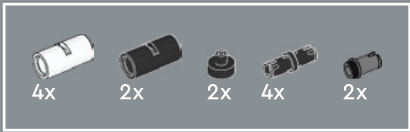

529

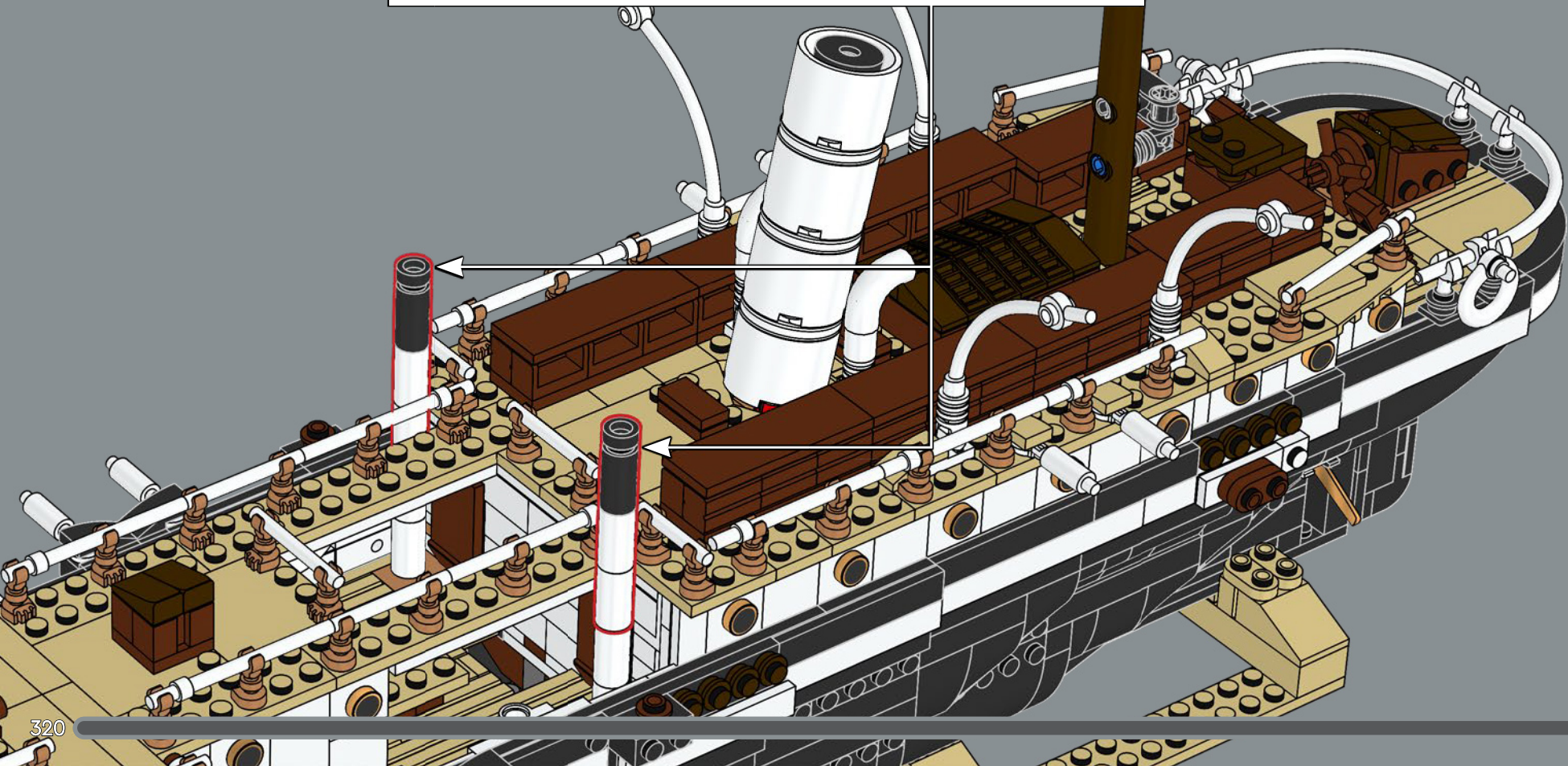
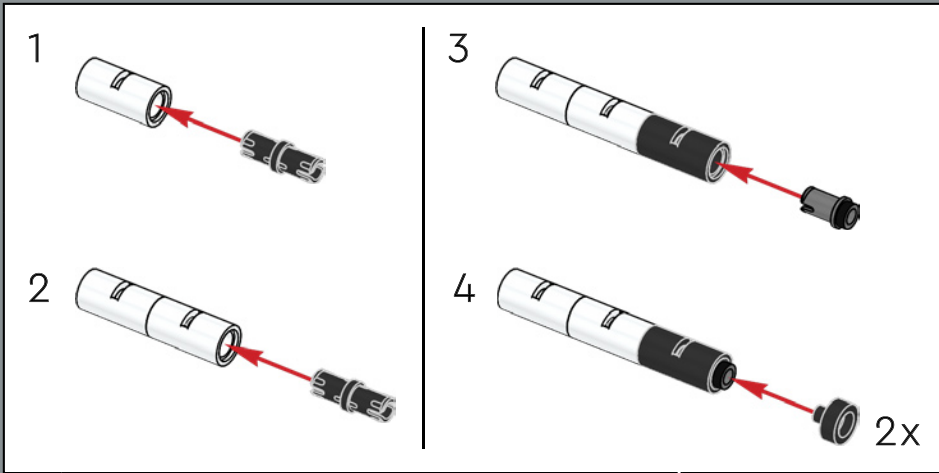

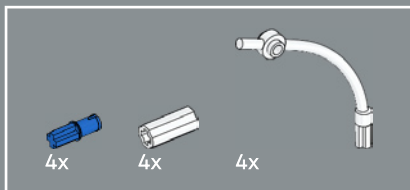

530

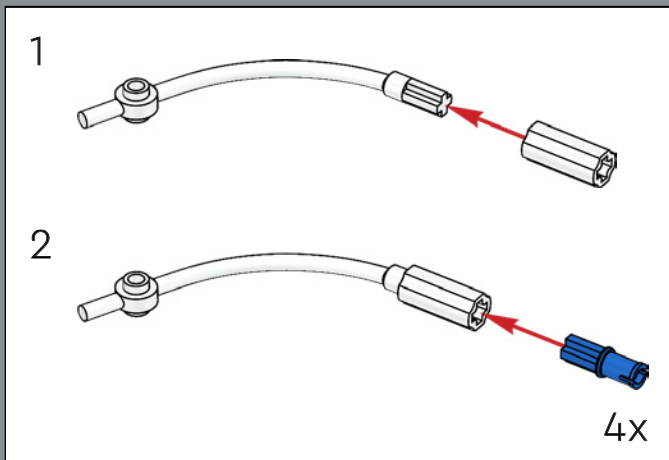

固定四艘救生艇的曲臂最初被设计为乐高® 小人仔支架组件。

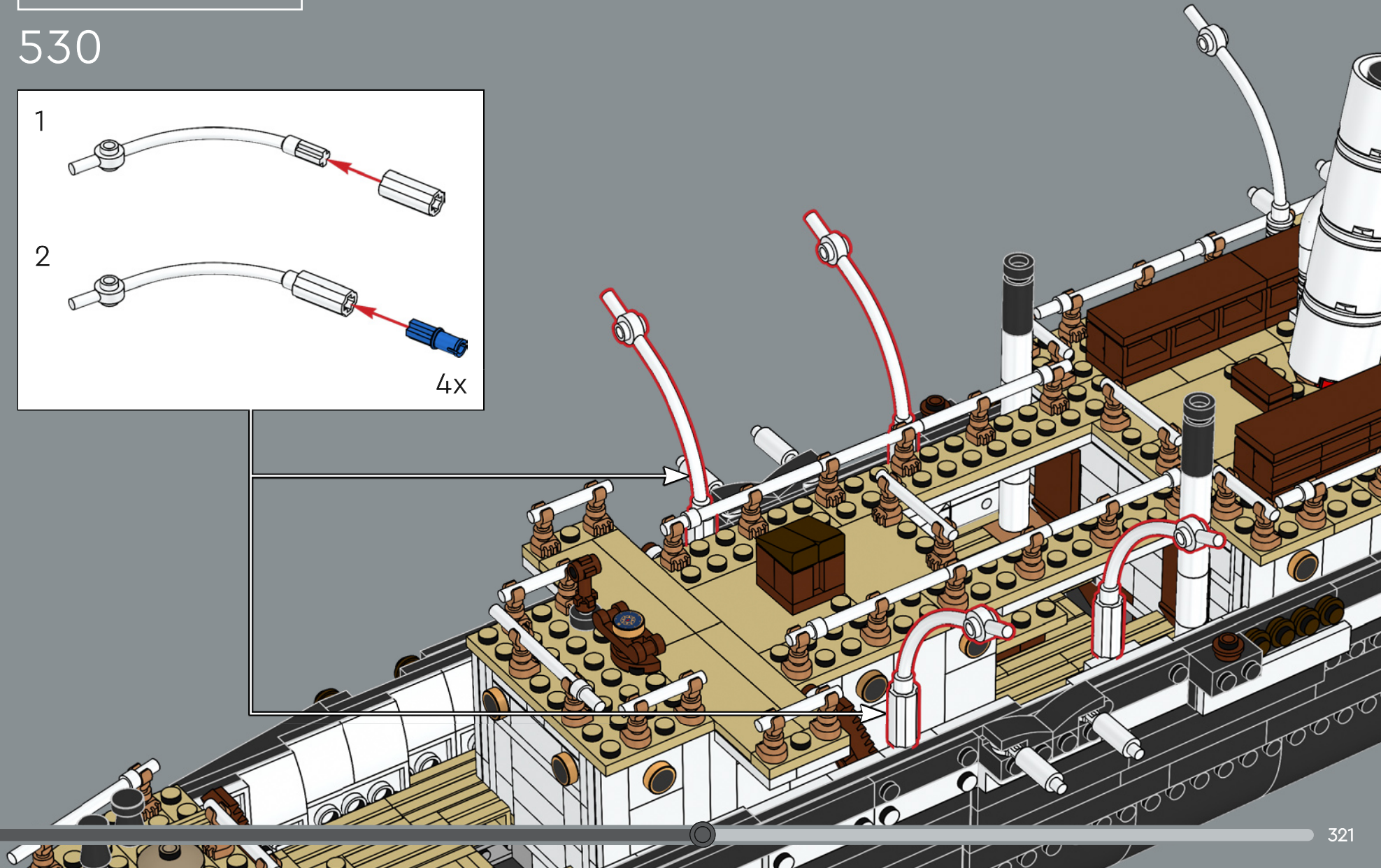

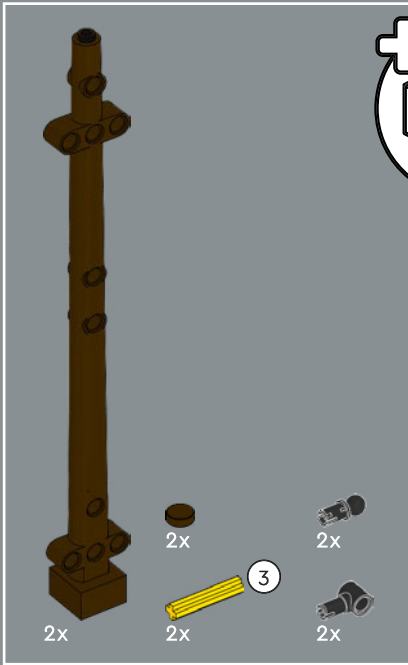
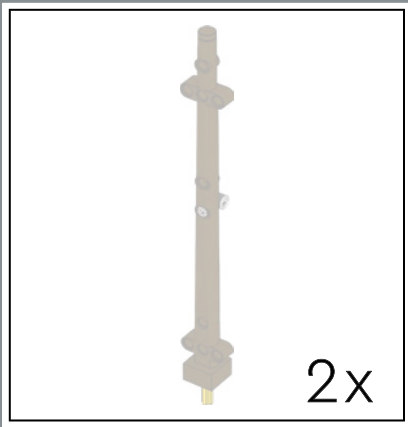

531

1



2

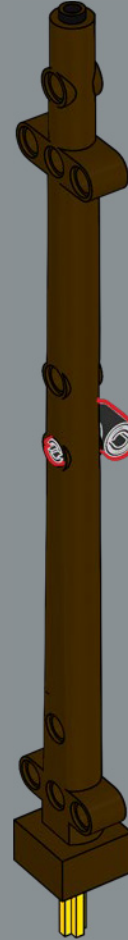

3



2x

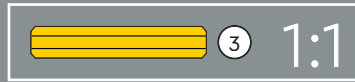

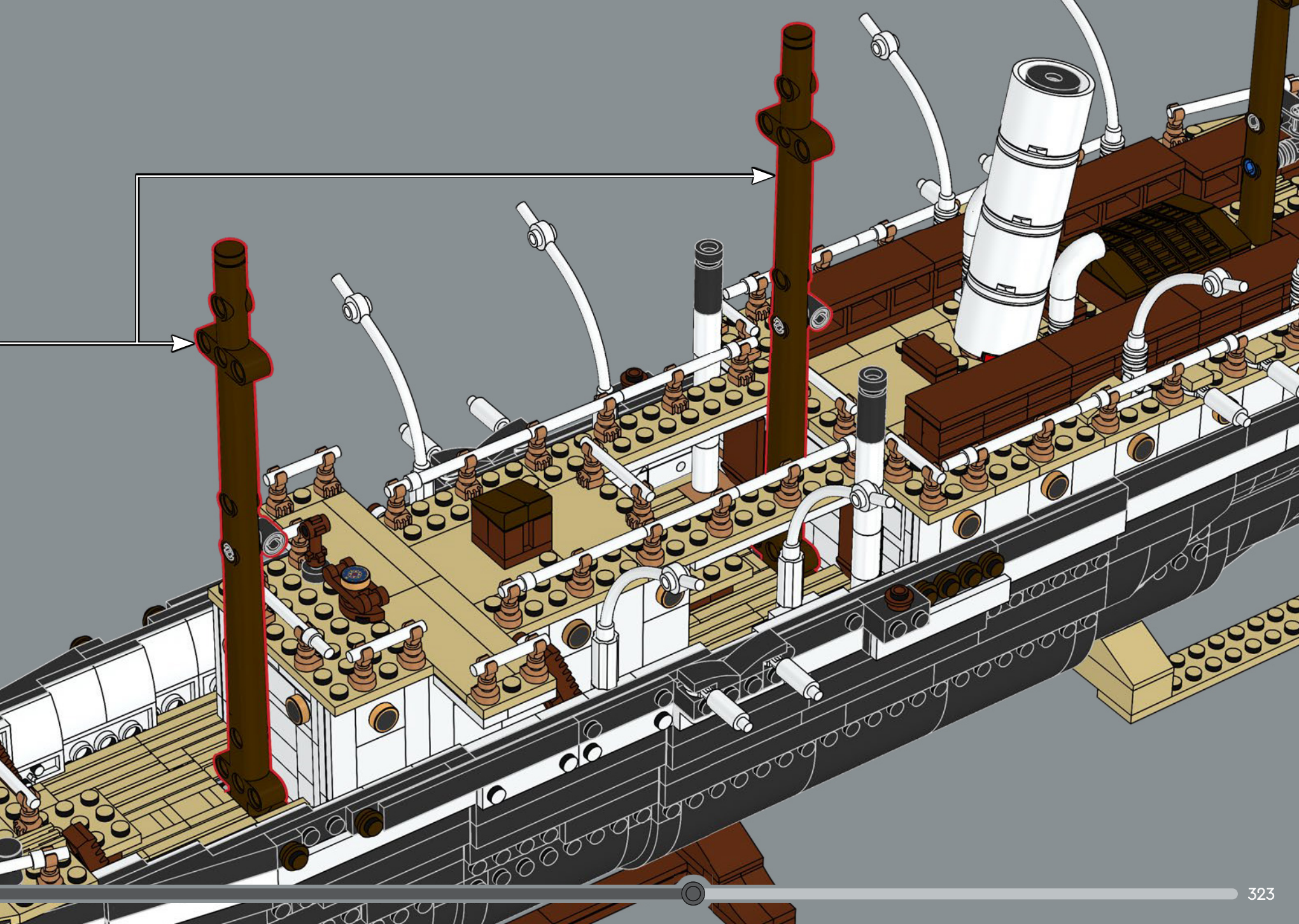

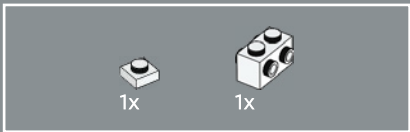
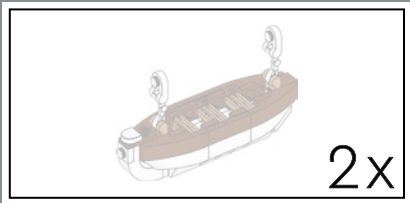

532

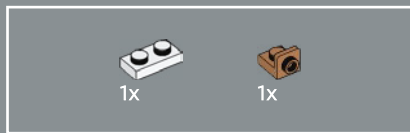
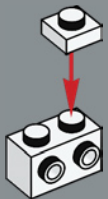

533

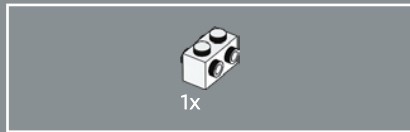
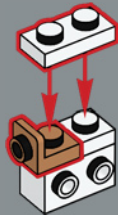

534

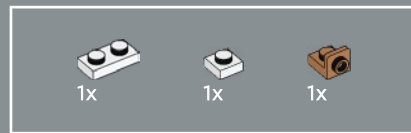
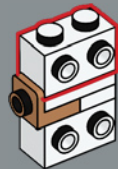

535

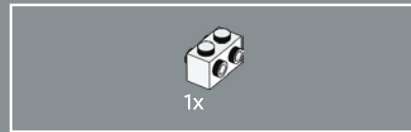

536

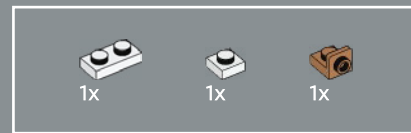
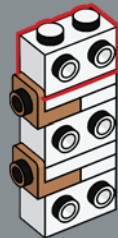

537

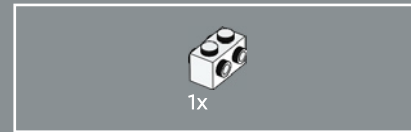

538





539

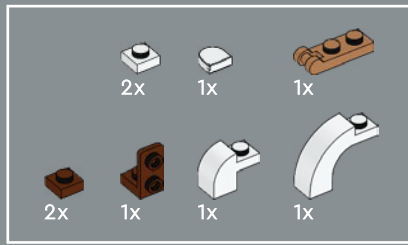
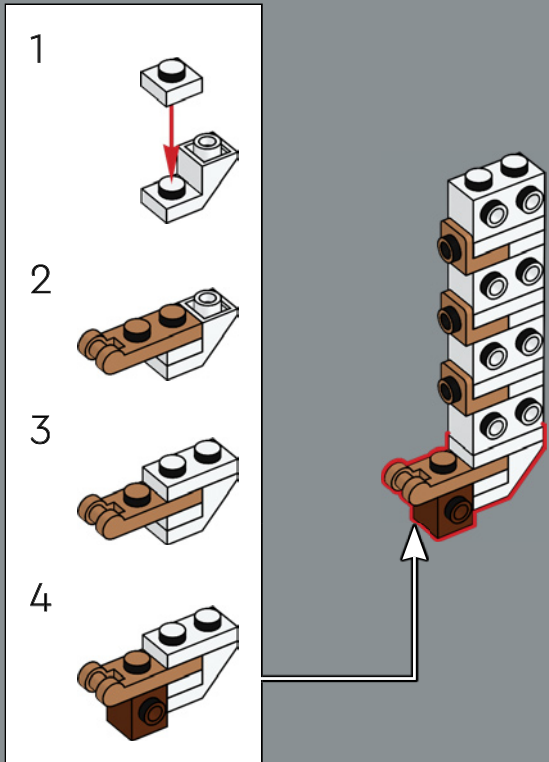

540

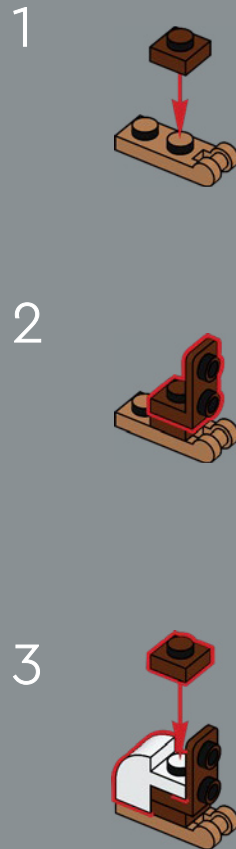

4

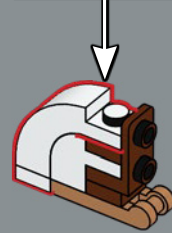
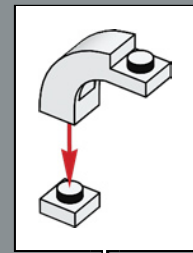

5

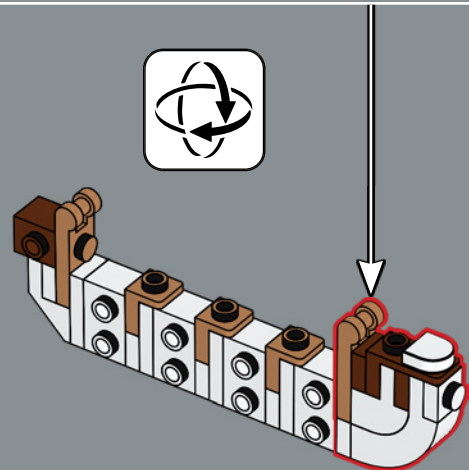
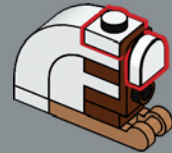

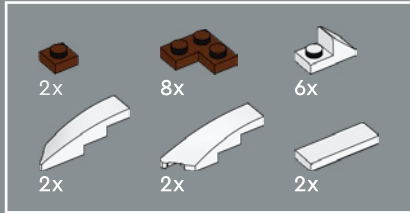
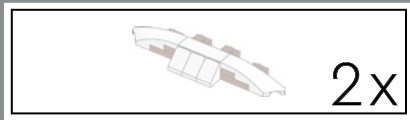

541

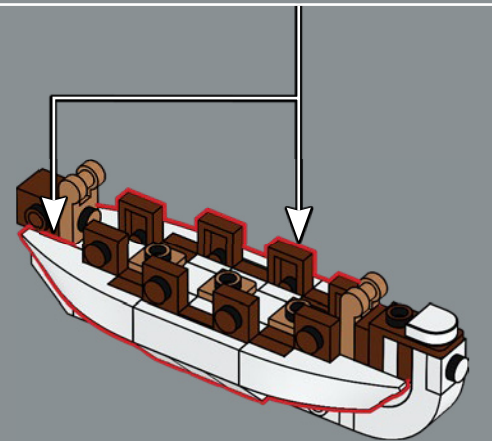
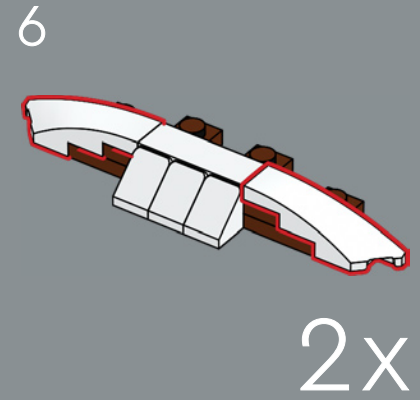
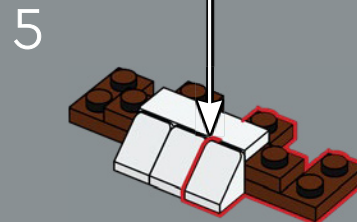
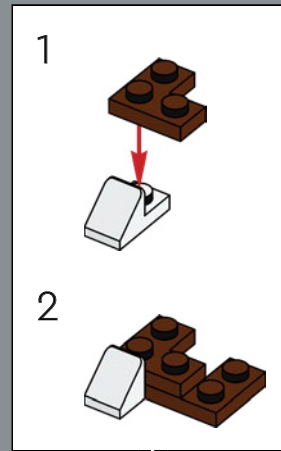
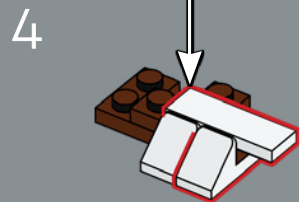
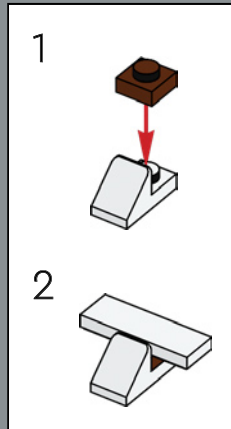
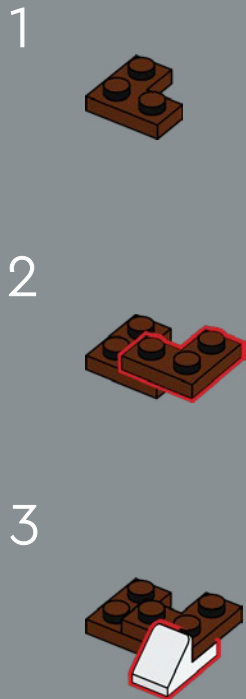



542

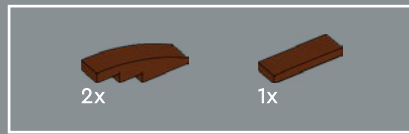
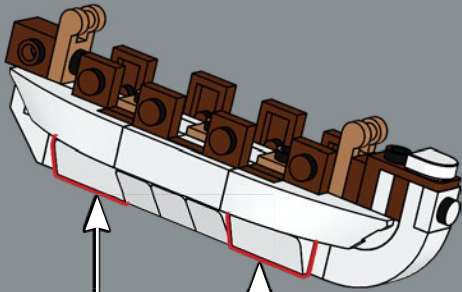

543

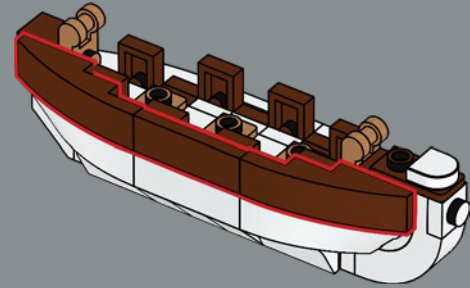

544

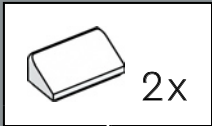
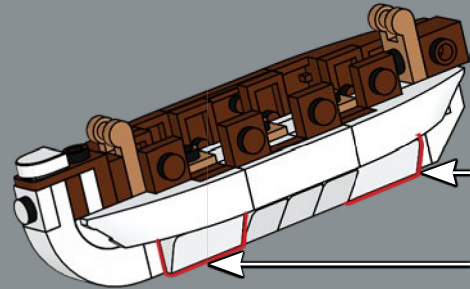



545

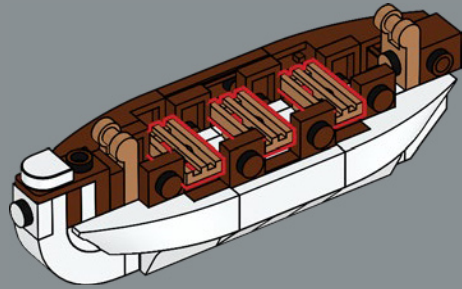

546

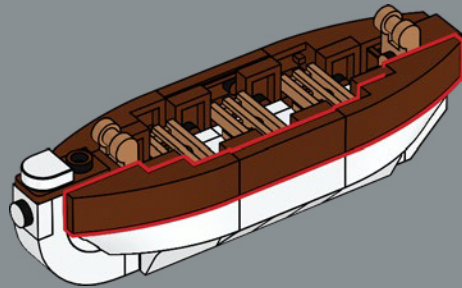

547

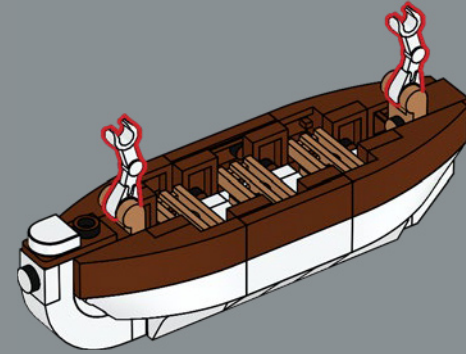

548

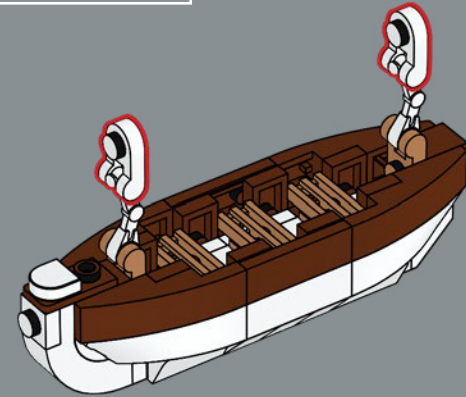

2x

549

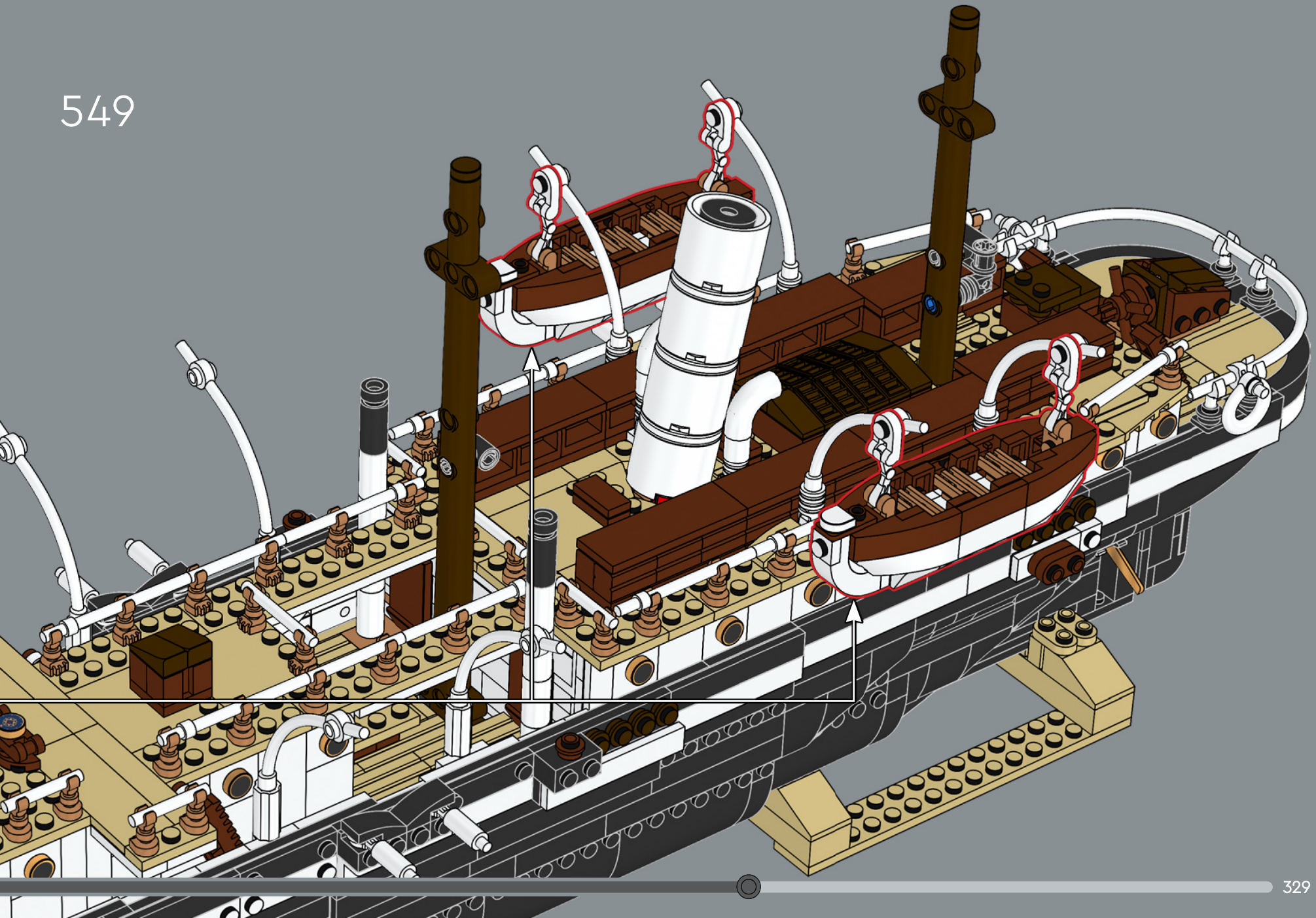

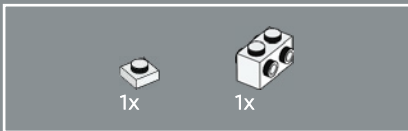
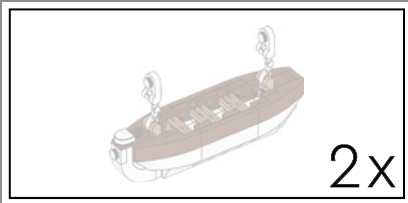

550

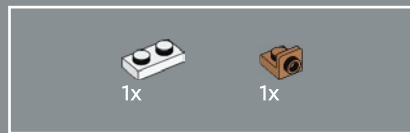
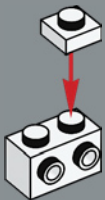

551

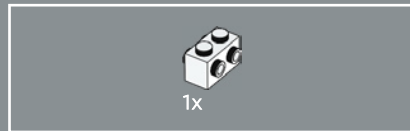
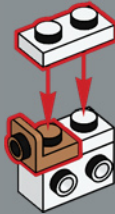

552

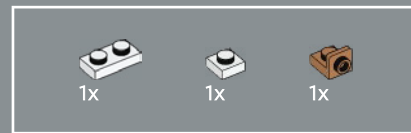

553

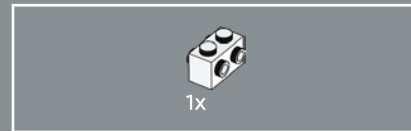
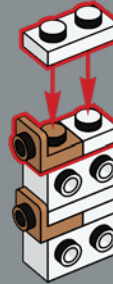

554

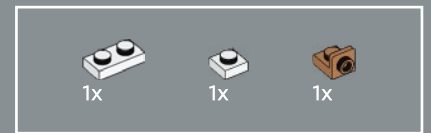
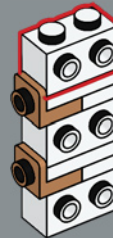

555

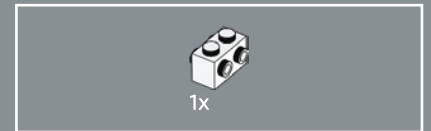

556

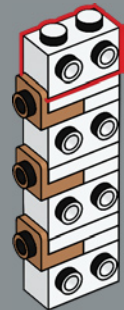

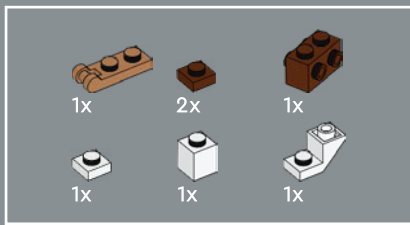

557

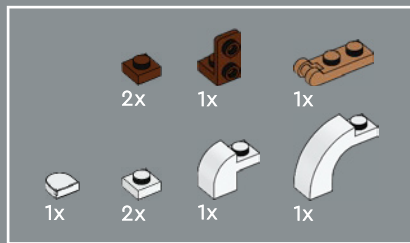
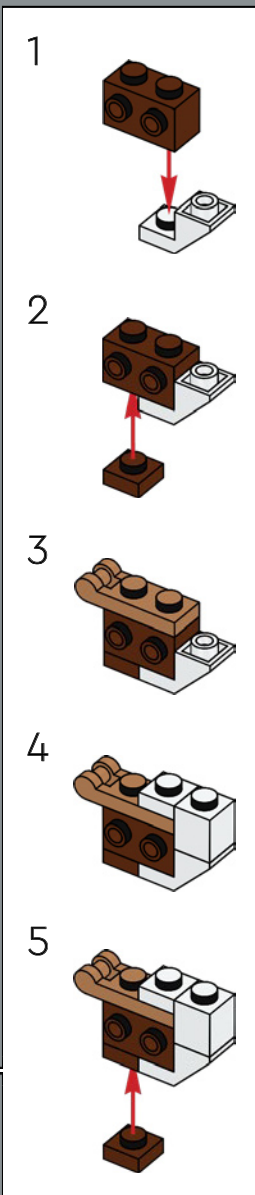
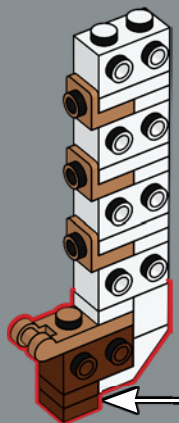

558

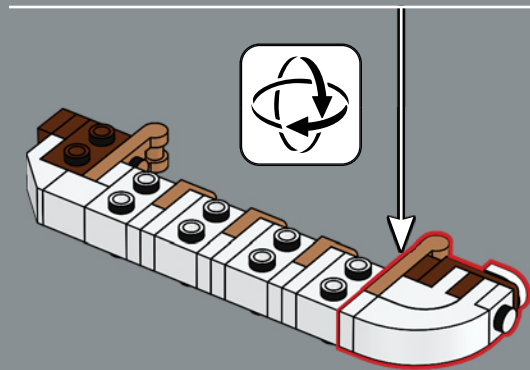
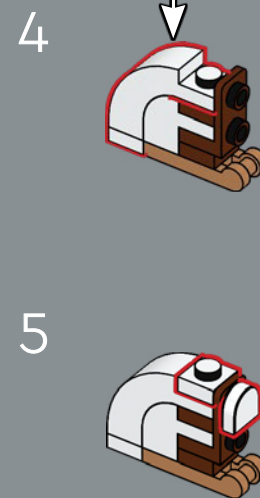
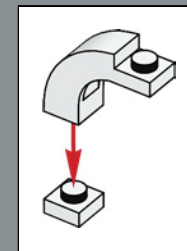
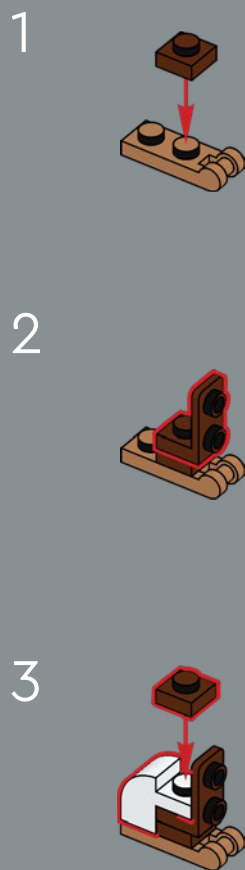

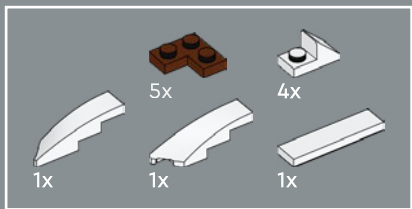

559

1



2



3

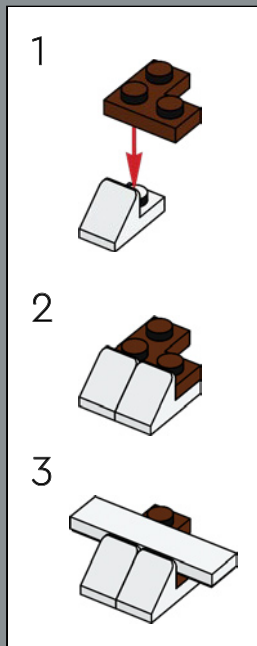

4

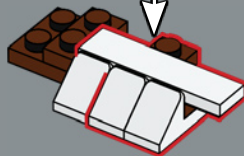

5

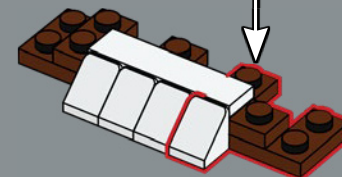
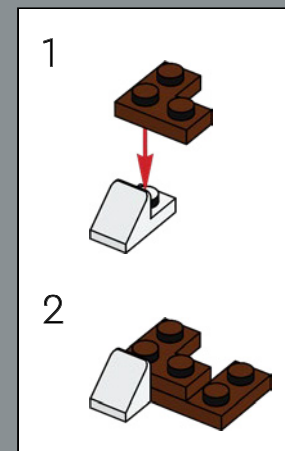

6

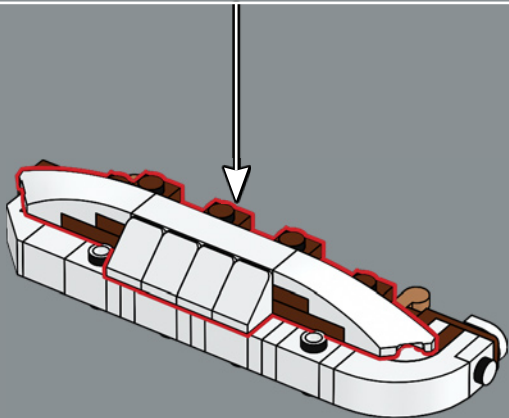
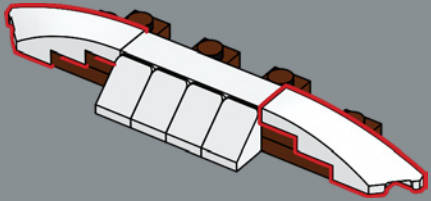

2x

560

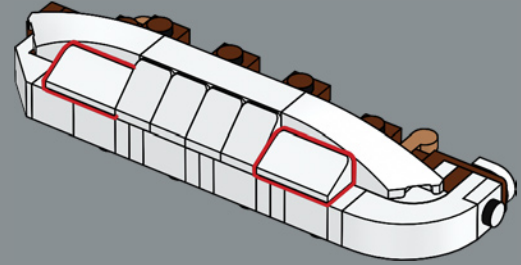

1x

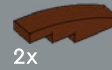

2x

561

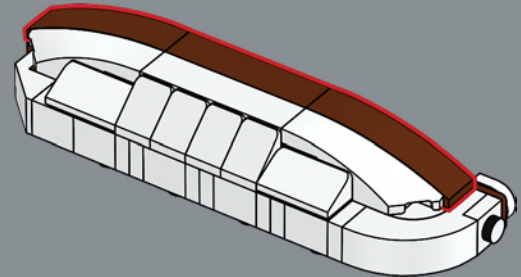

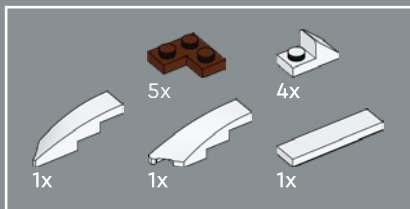

562

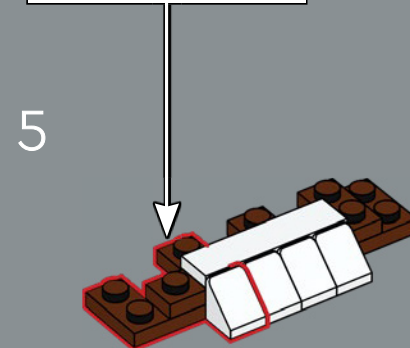
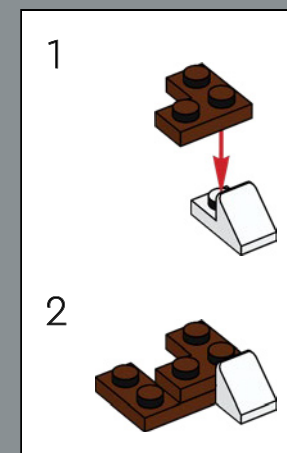
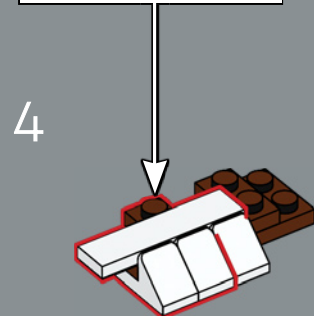
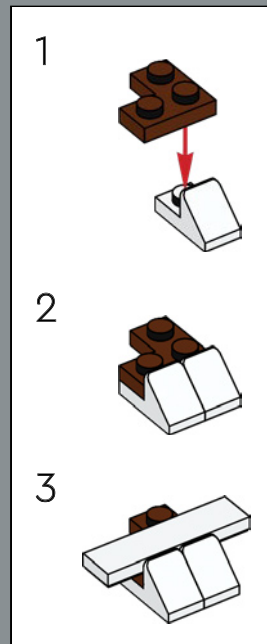
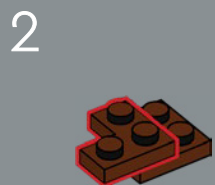

6

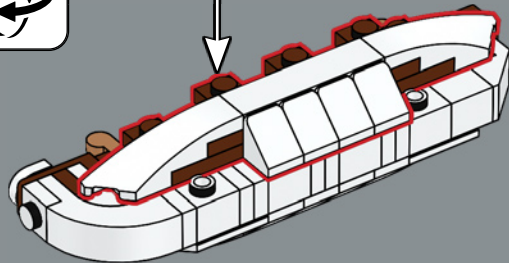
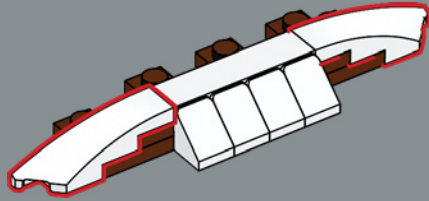

2x

563

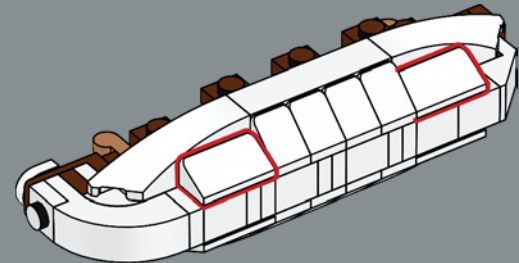



3x

564

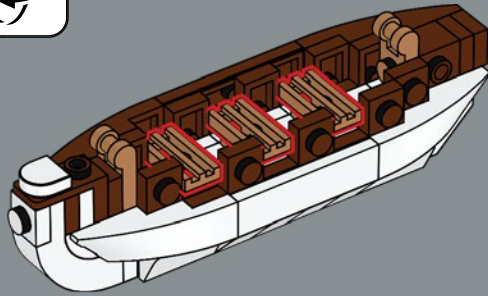

1x



2x

565

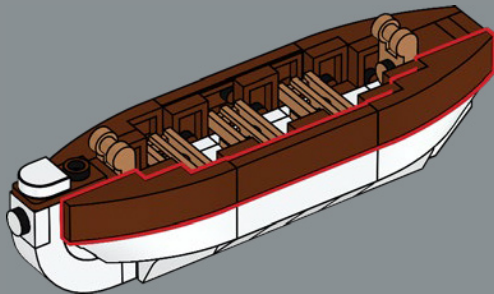

2x

566

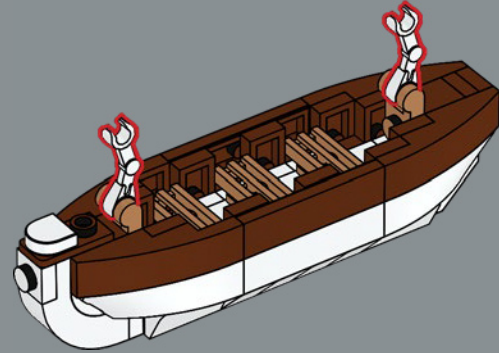

2x

567

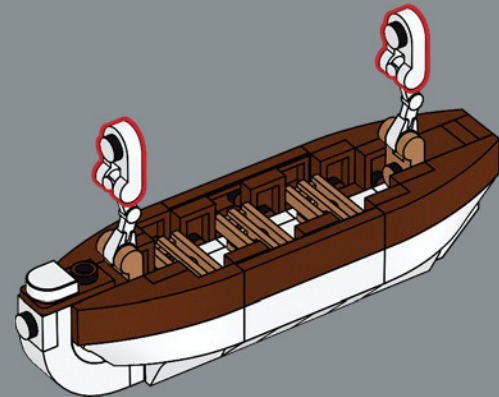

2x

568

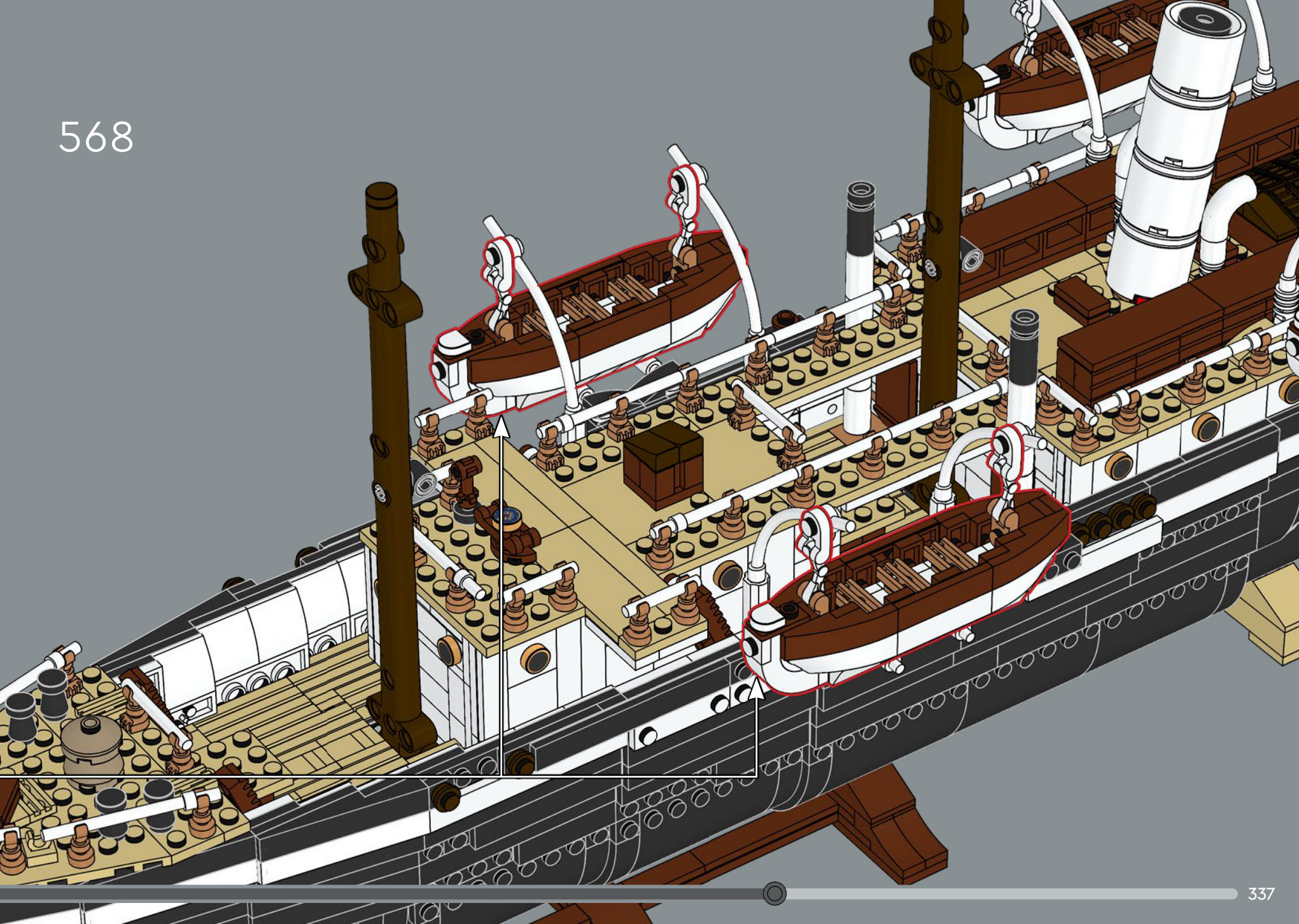

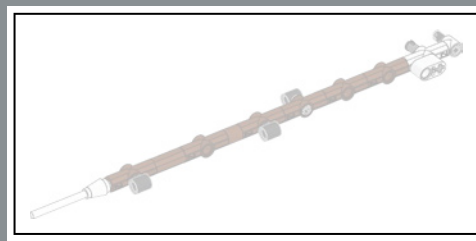

569

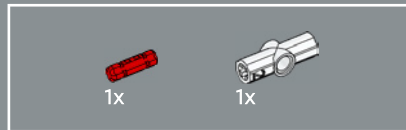
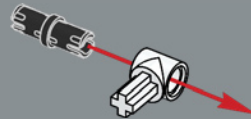

570

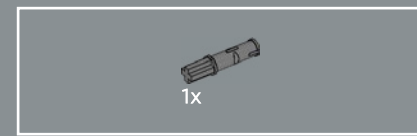
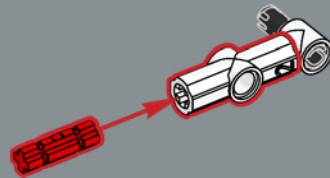

571

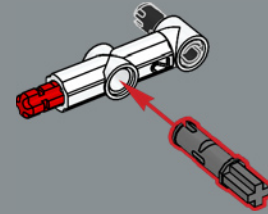

572

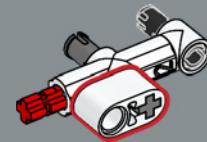

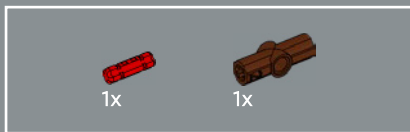

573

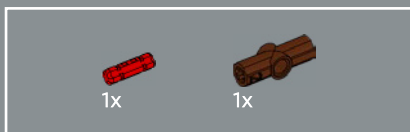
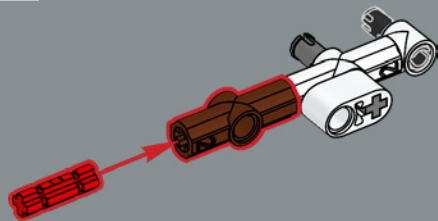

574

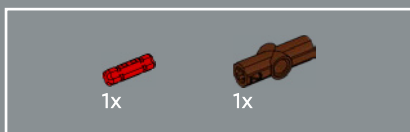
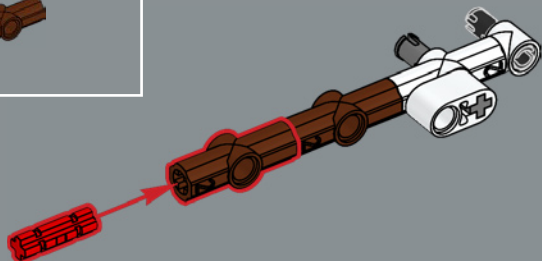

575

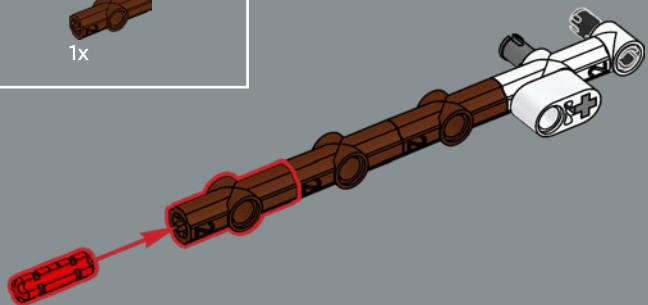

576

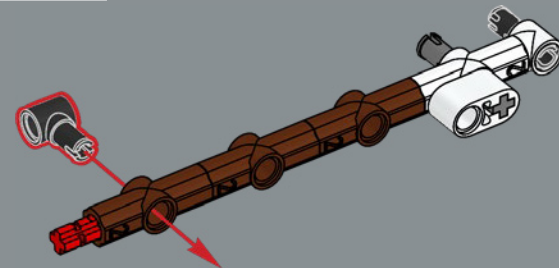

577

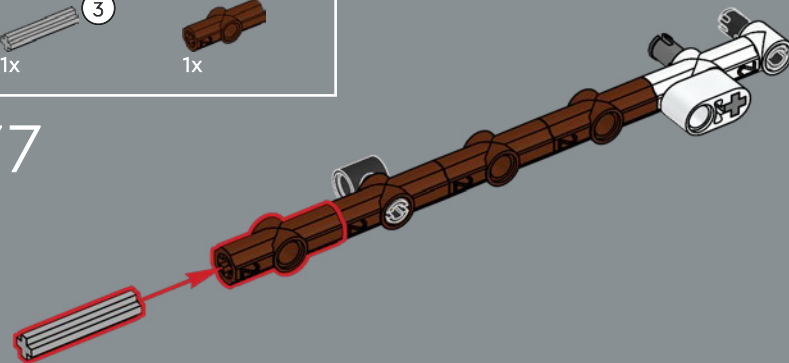

578

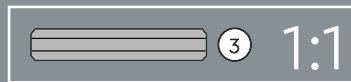
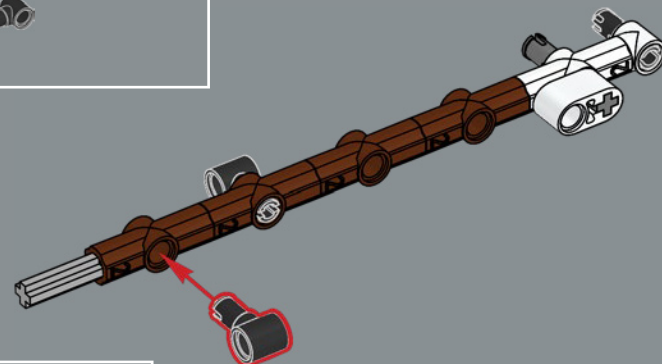

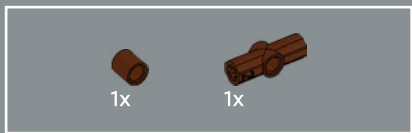

579

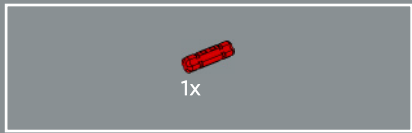
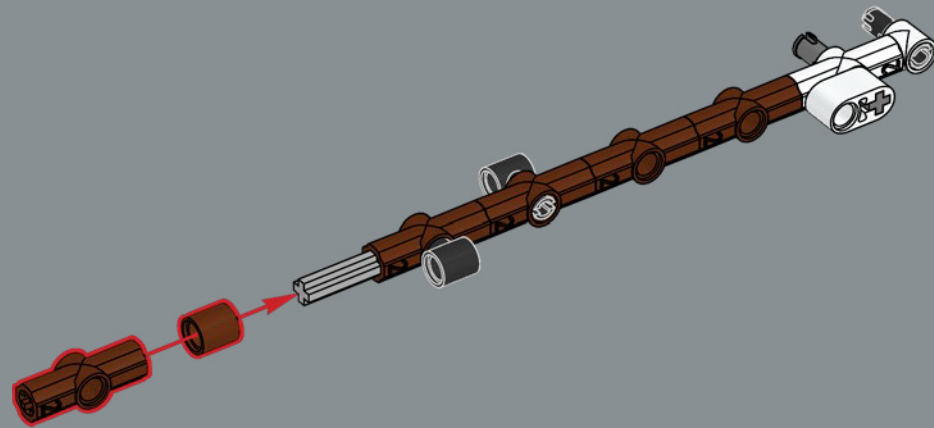

580

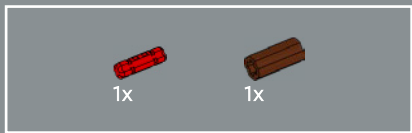
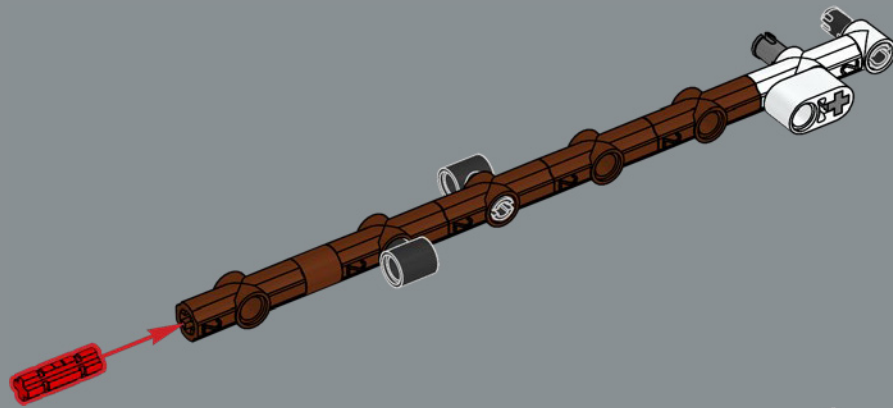

581

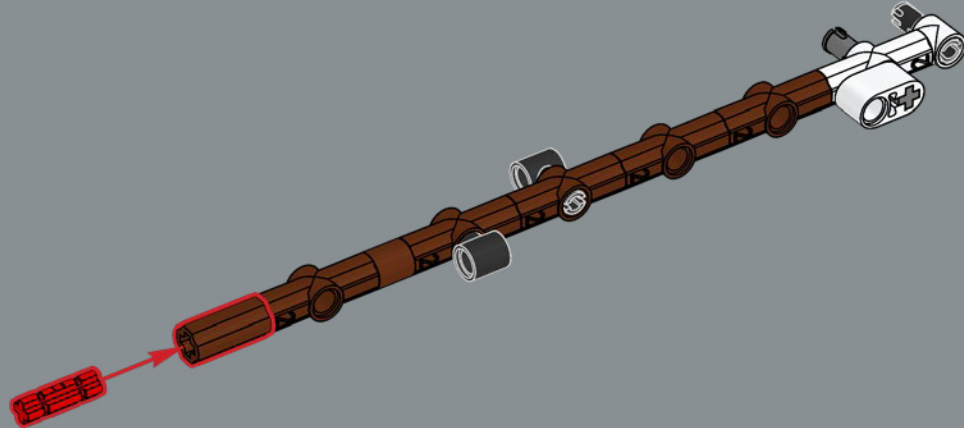



582

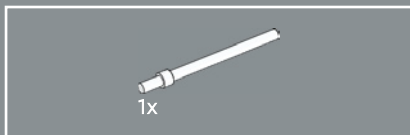
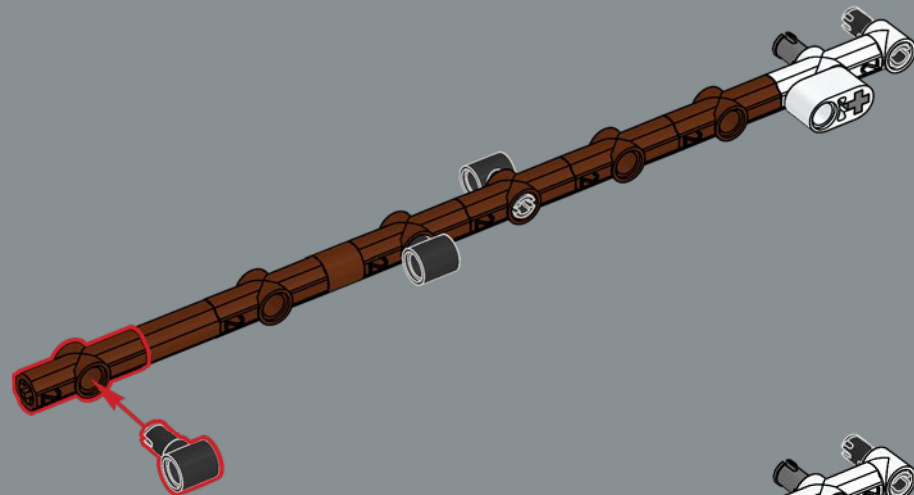

583

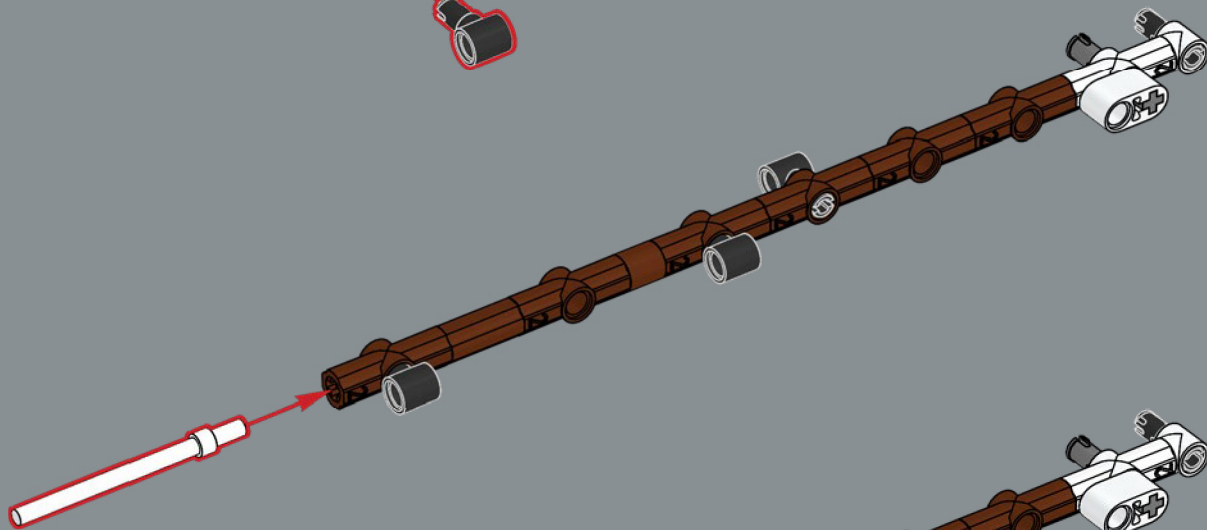

584

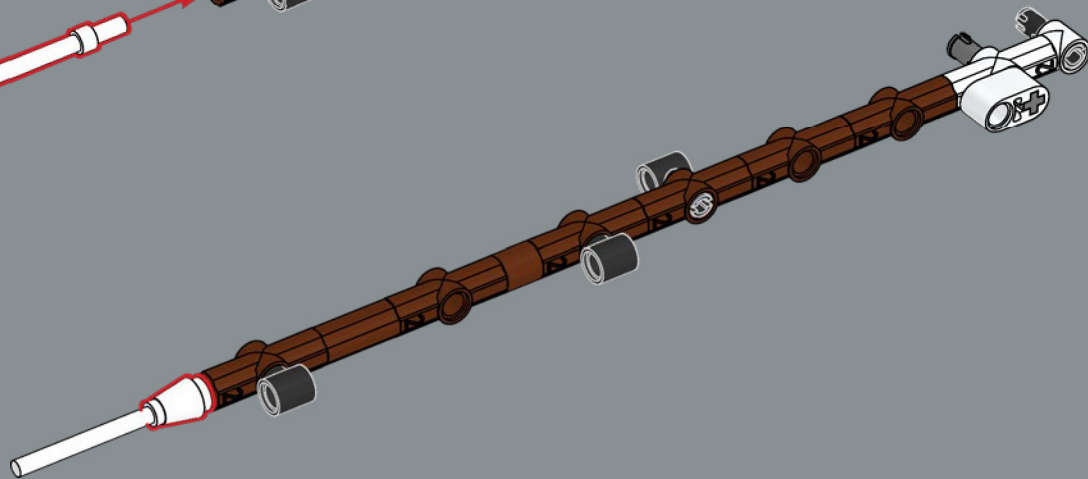

585

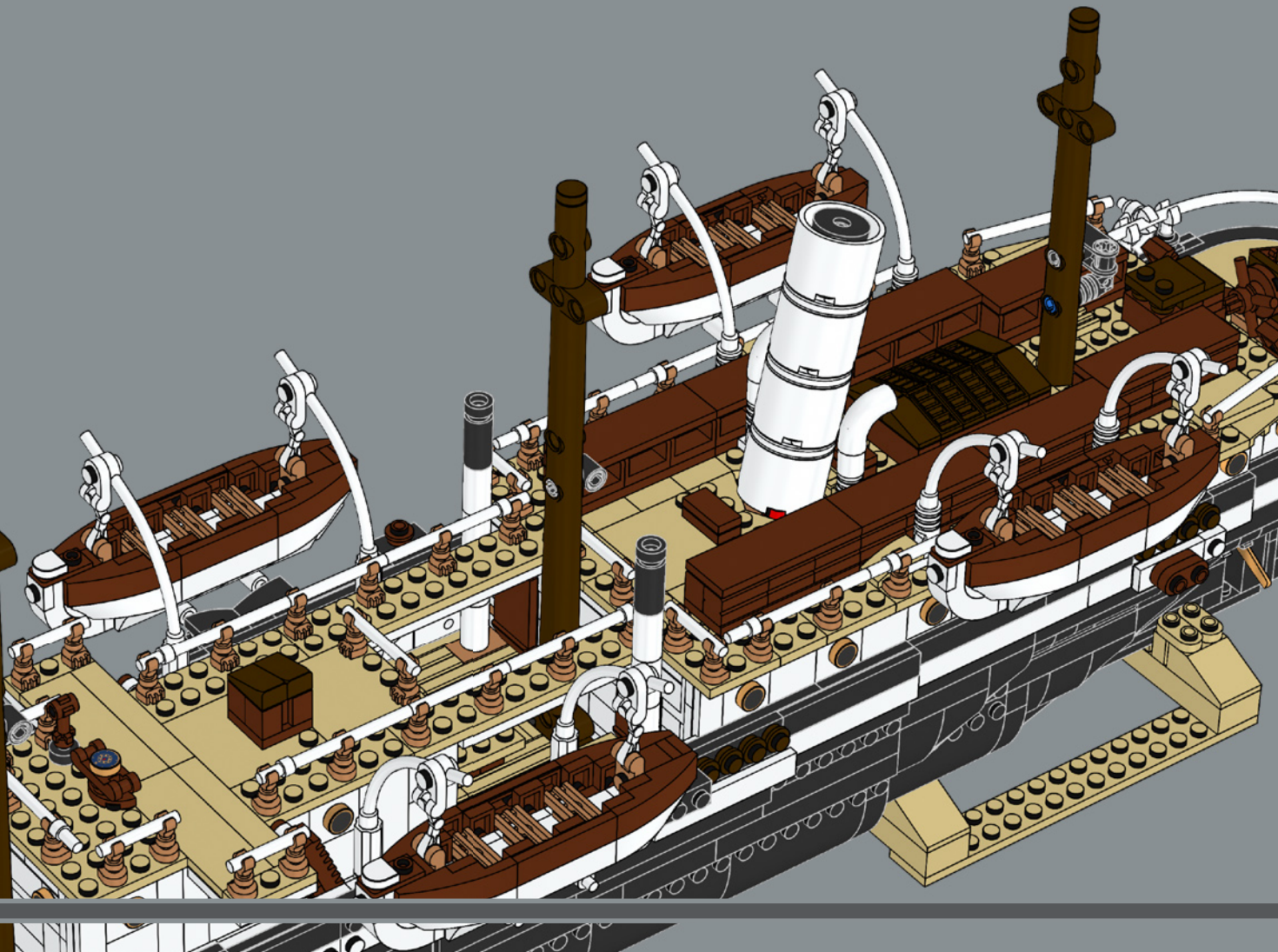
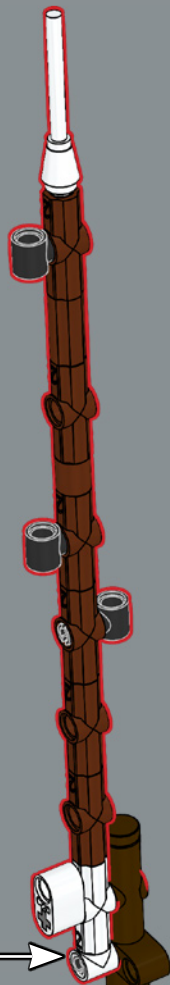

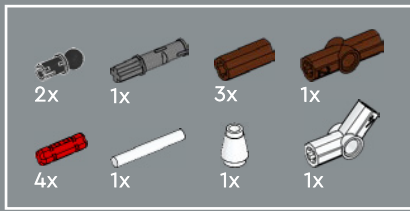

586

1

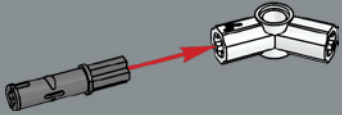

2

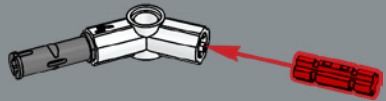

3

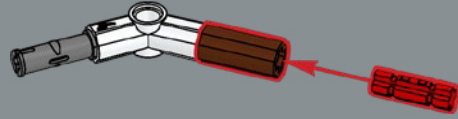

4



5

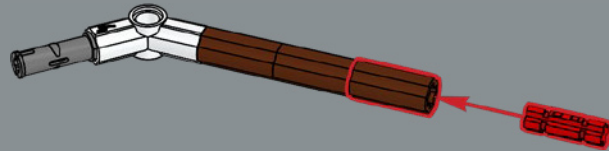

6

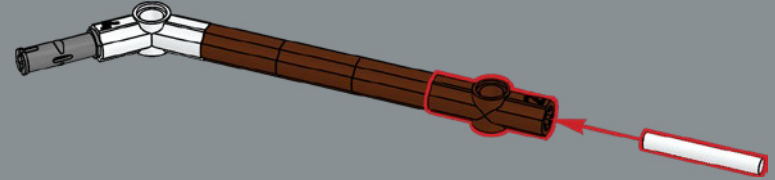

7

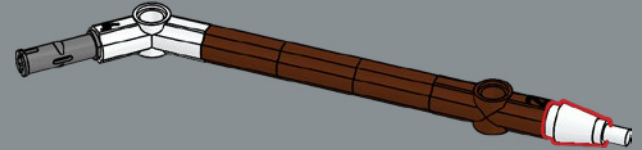

8

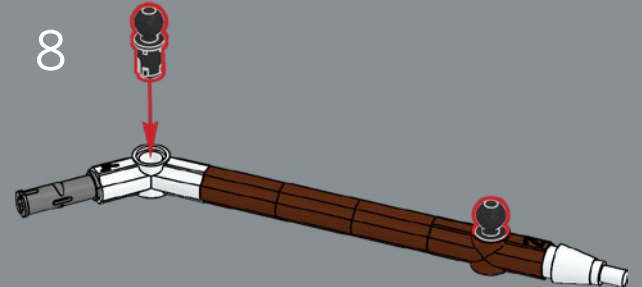

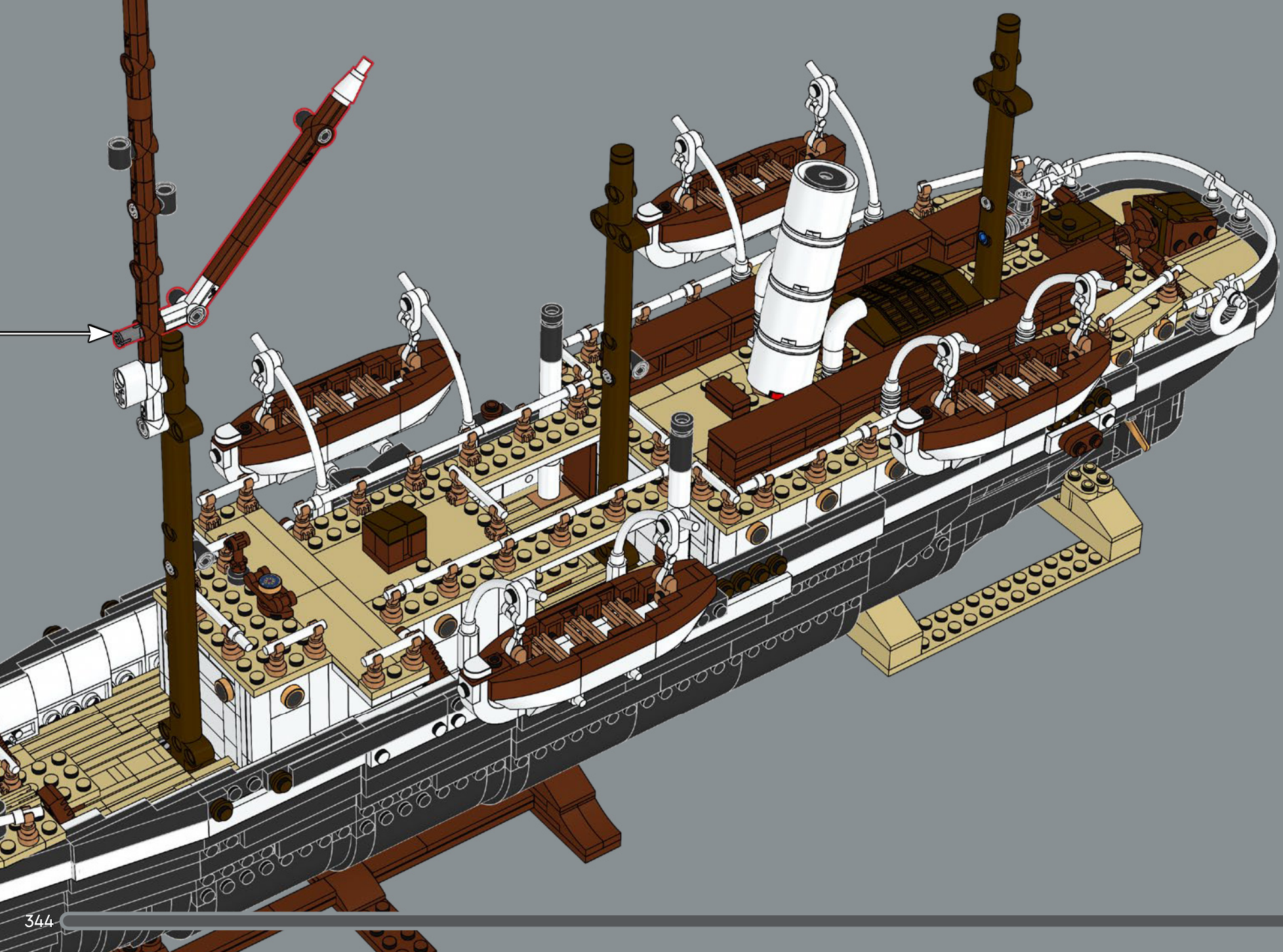

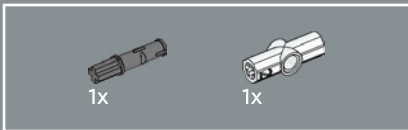
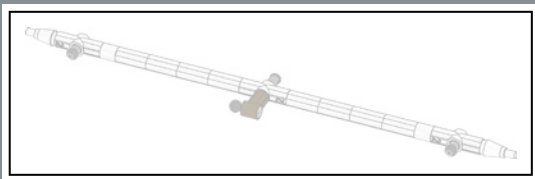

587

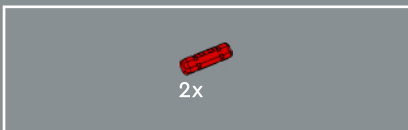
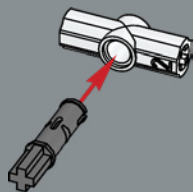

588

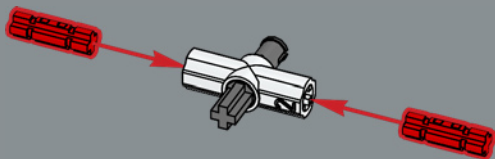

589

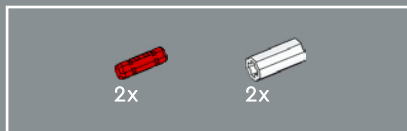
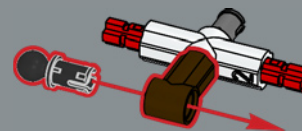

590

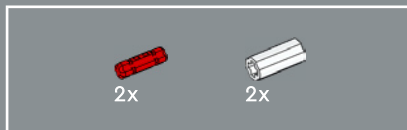
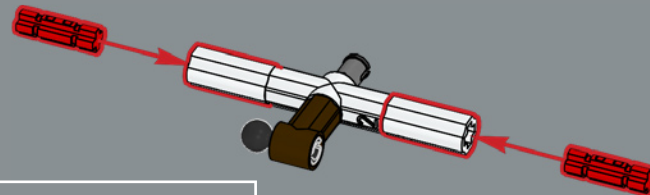

591

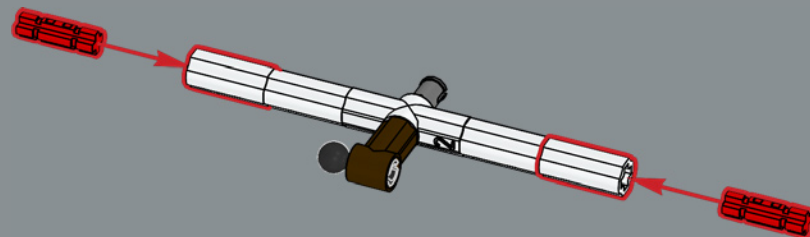

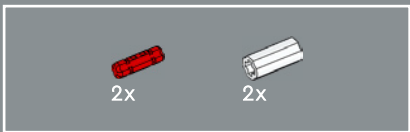

592

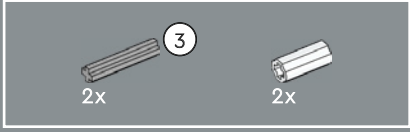
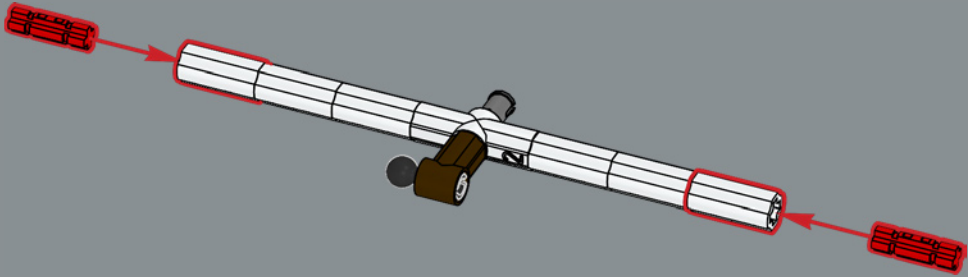

593

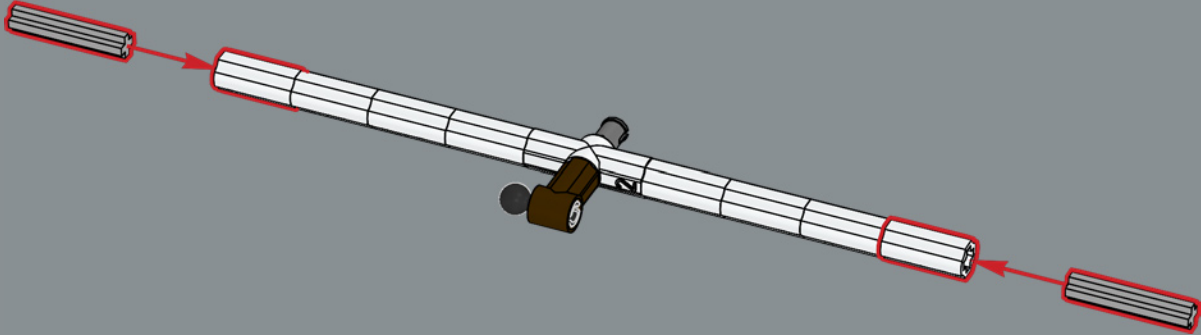

594

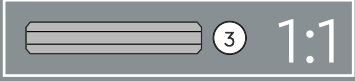
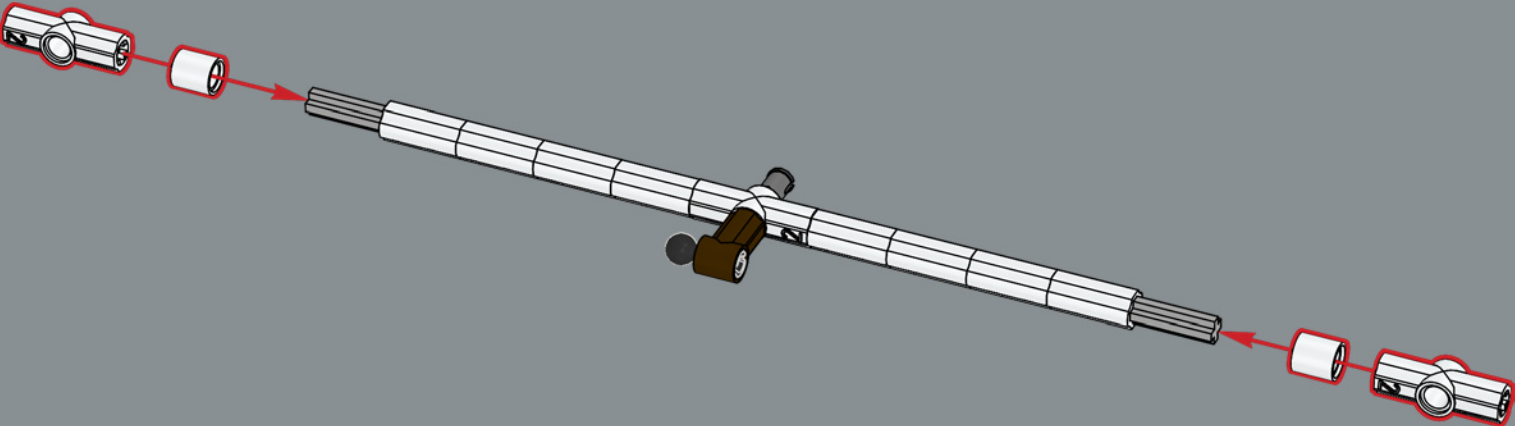



595

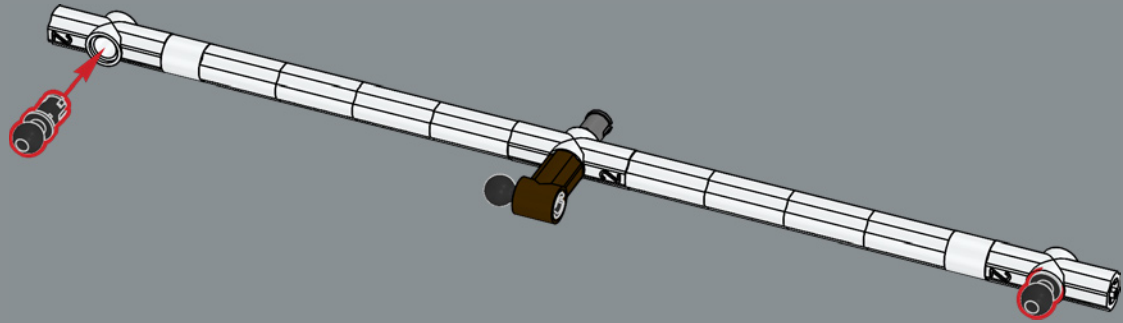

596

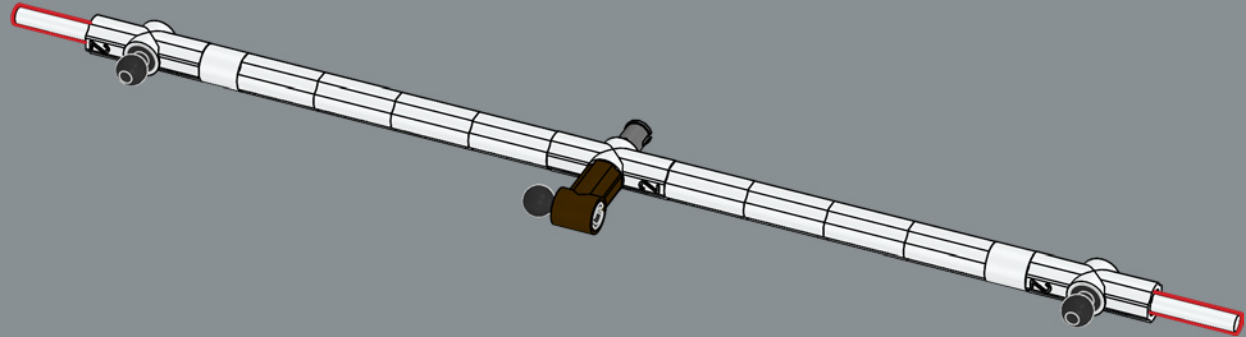

597

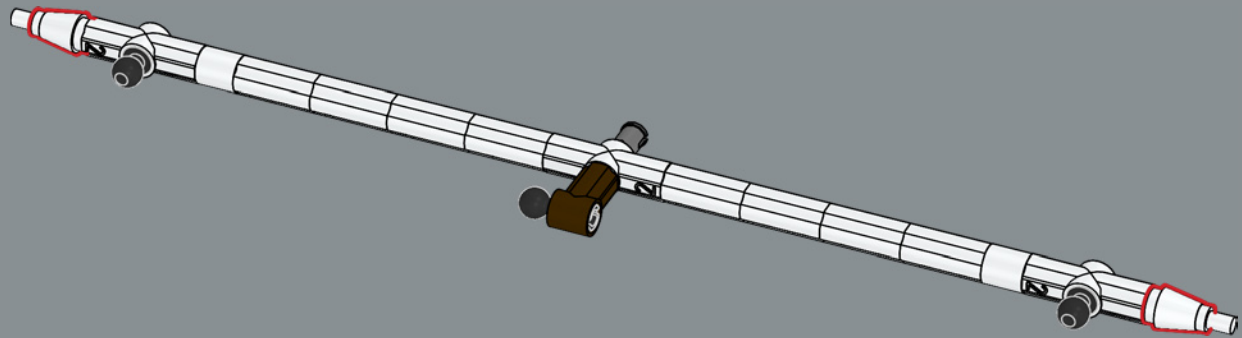

598

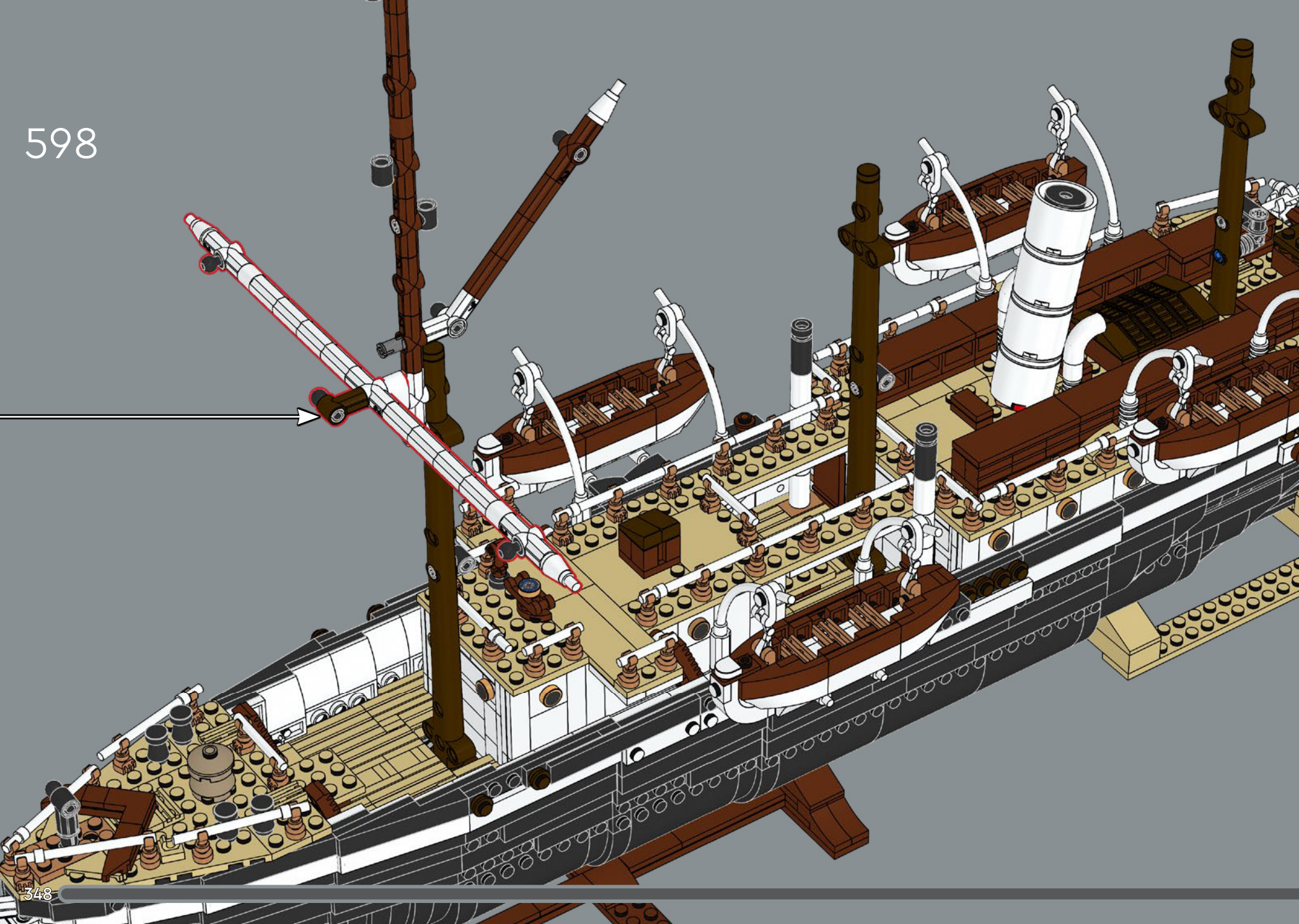



599

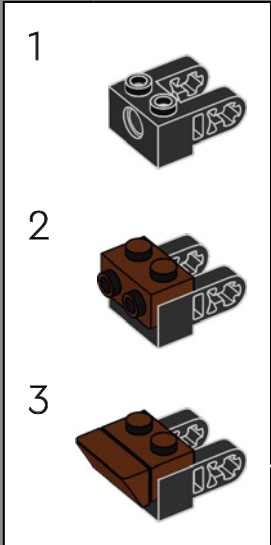

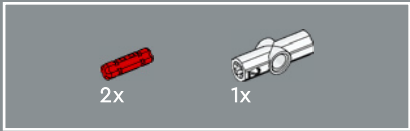
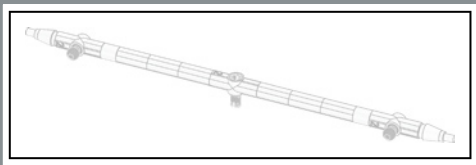

600

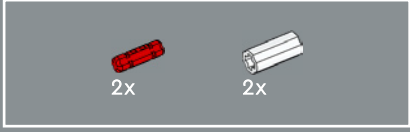
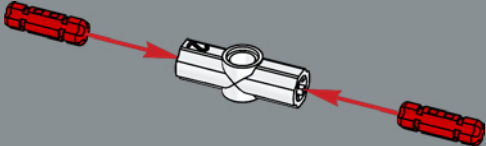

601

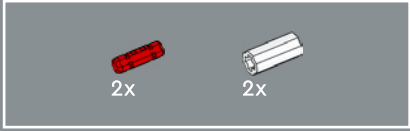
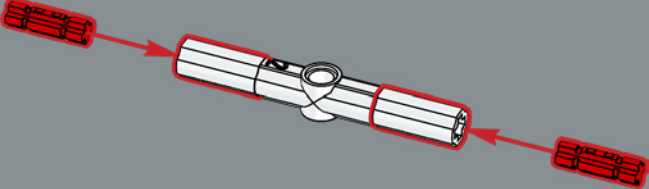

602

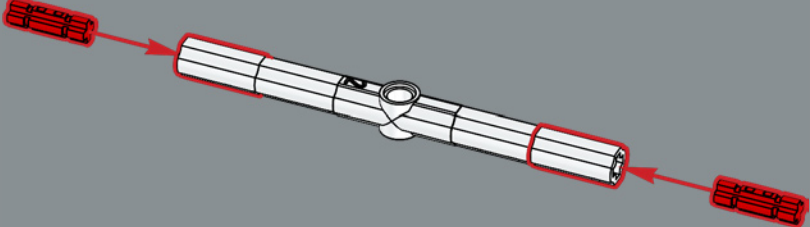

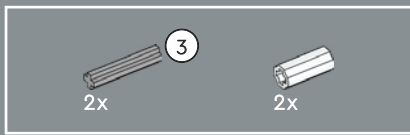

603

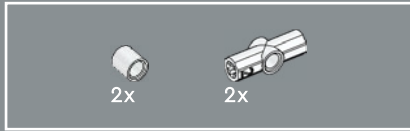
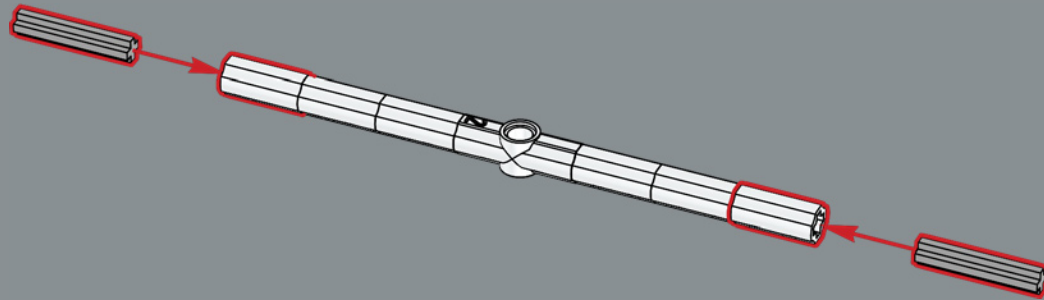

604

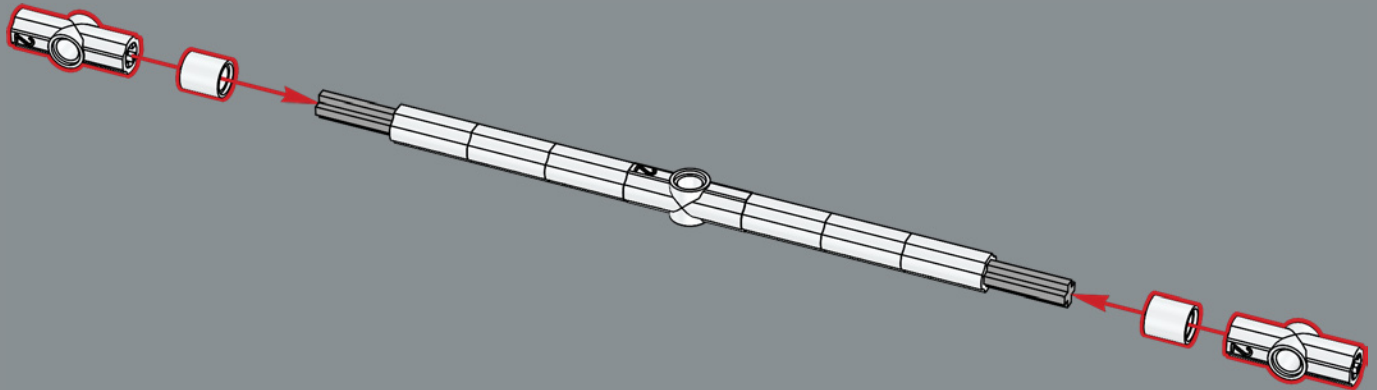

605

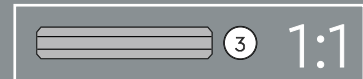
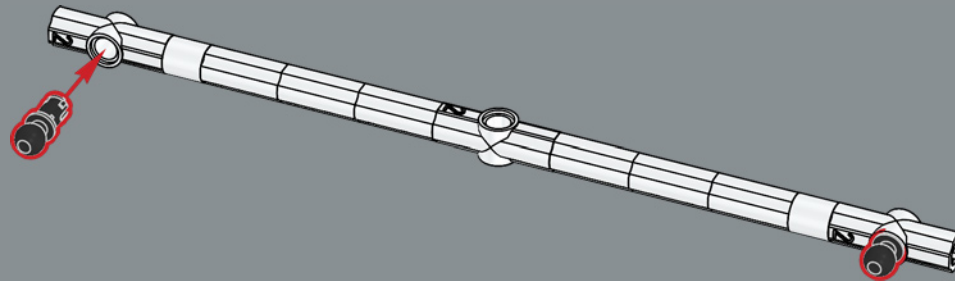



606

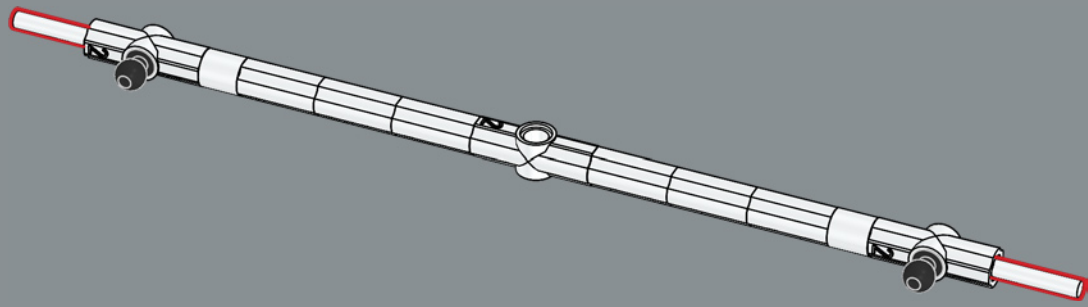

607

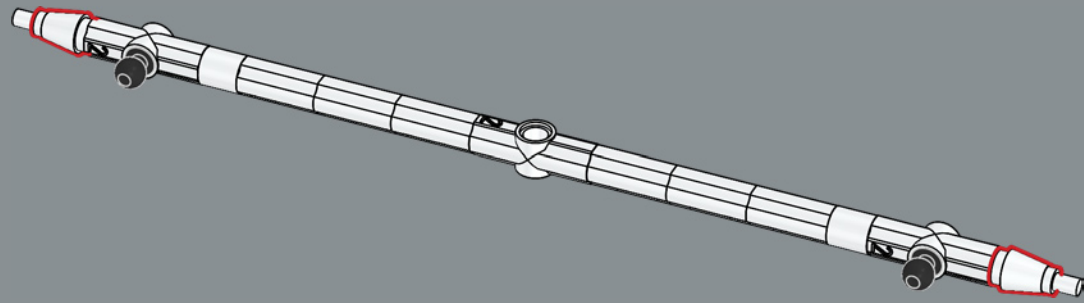

608

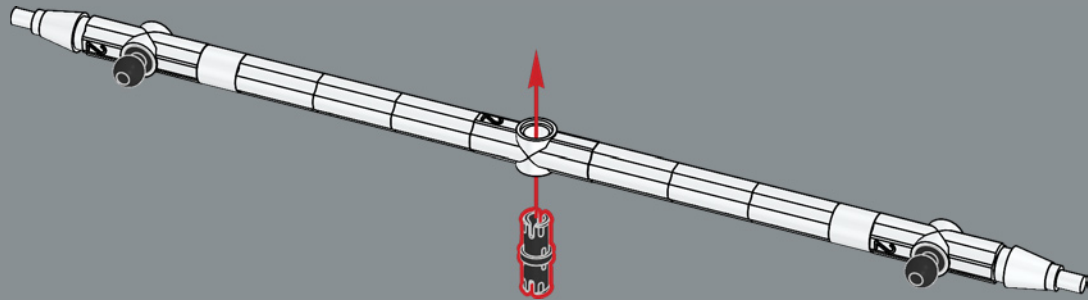

609



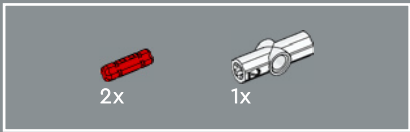
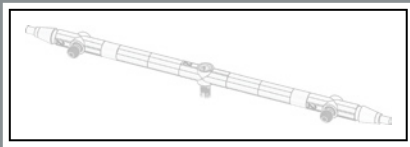

610

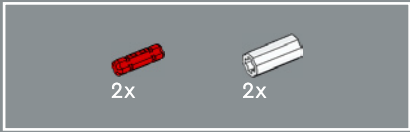
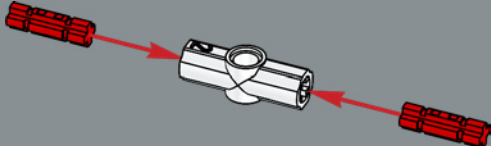

611

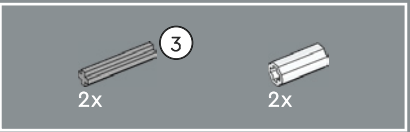
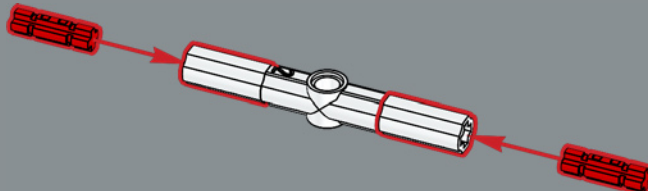

612

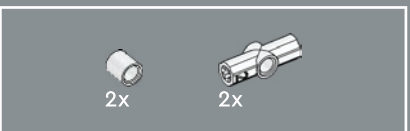
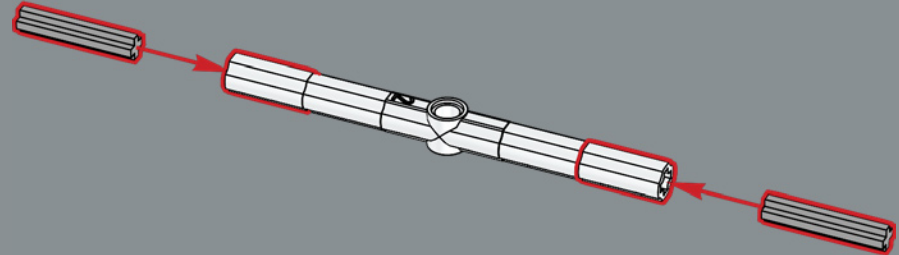

613

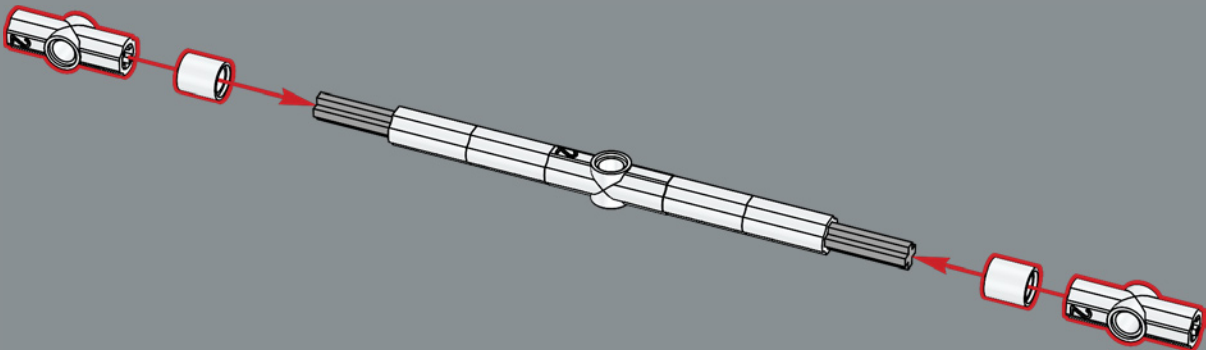



614

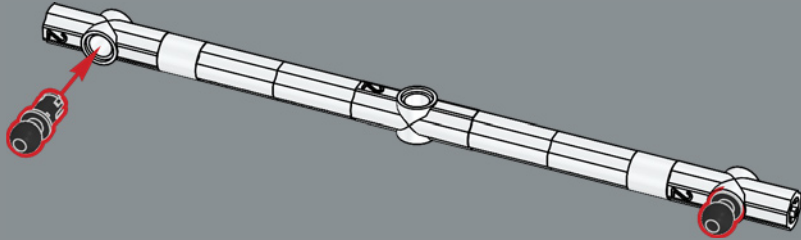

615

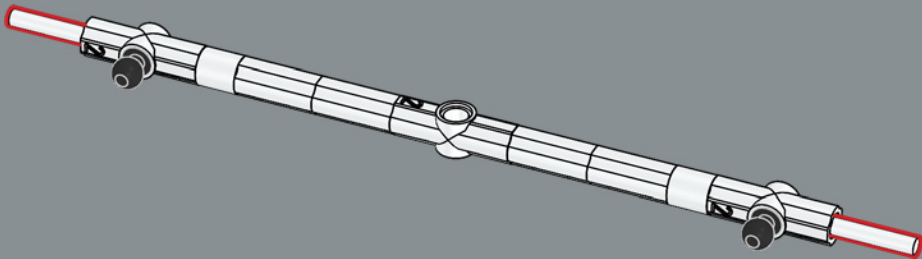

616

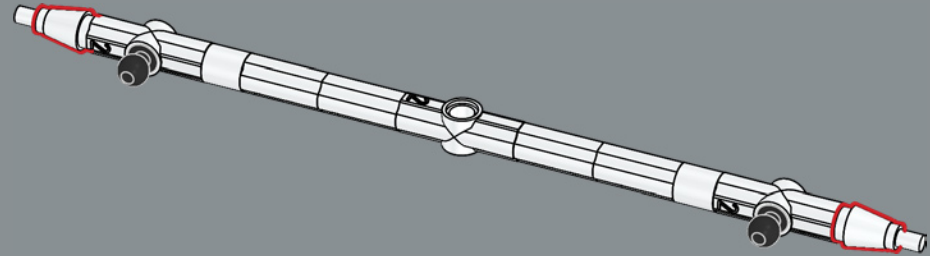

617

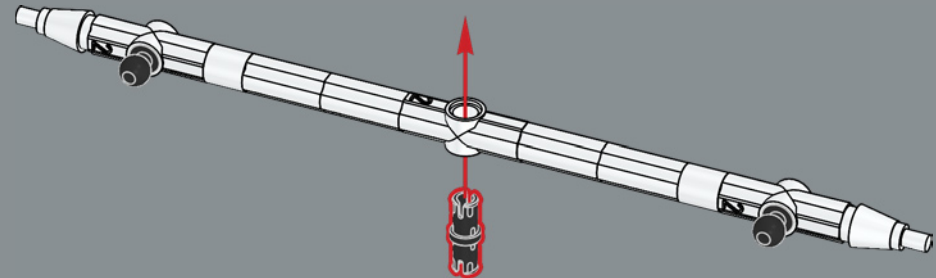

618



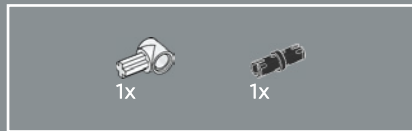
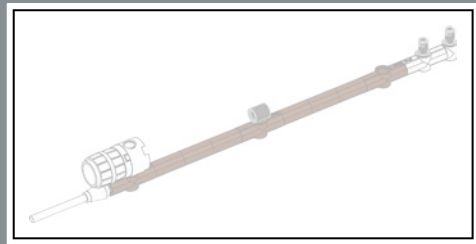

619

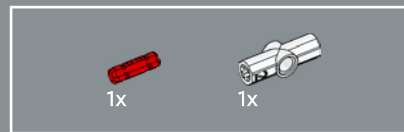
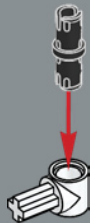

620

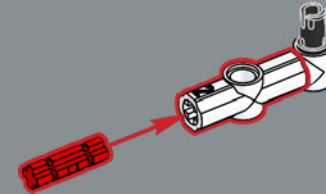

621

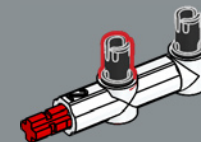

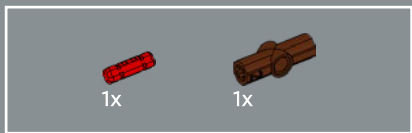

622

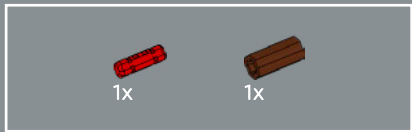
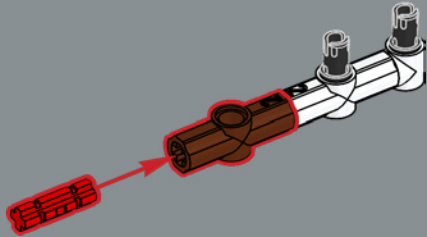

623

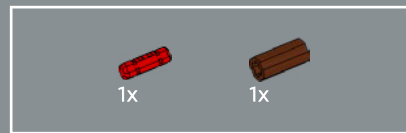
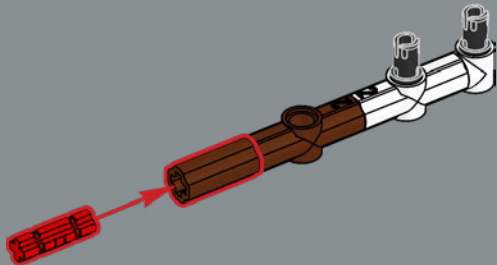

624

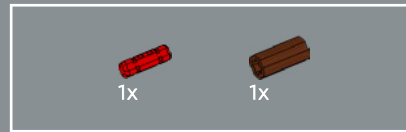
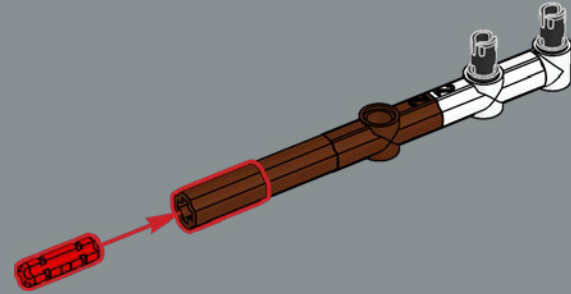

625

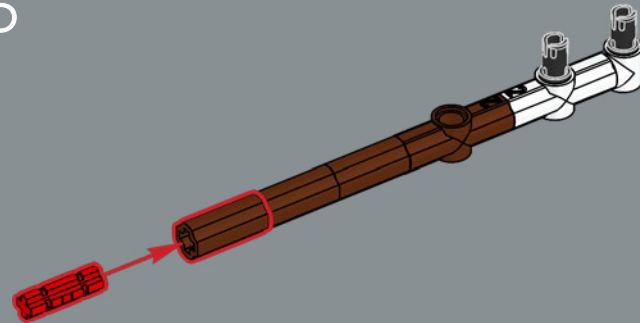

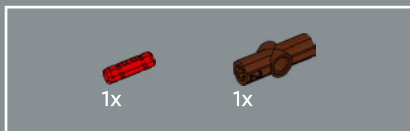

626

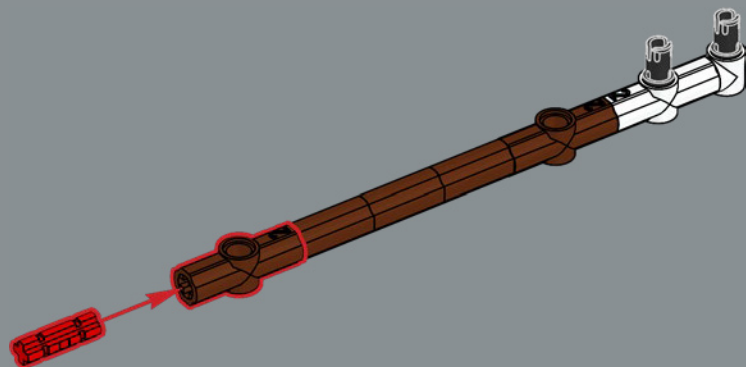

627

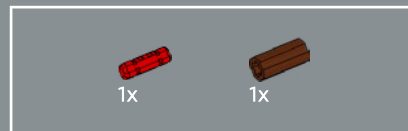
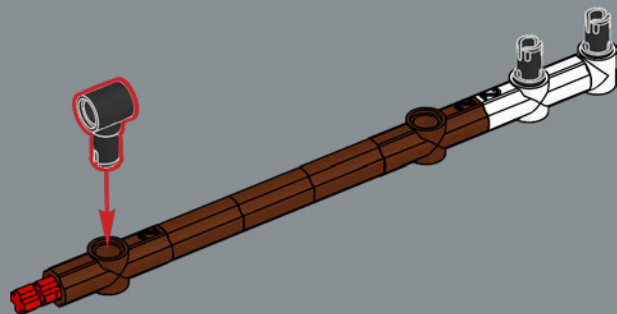

628

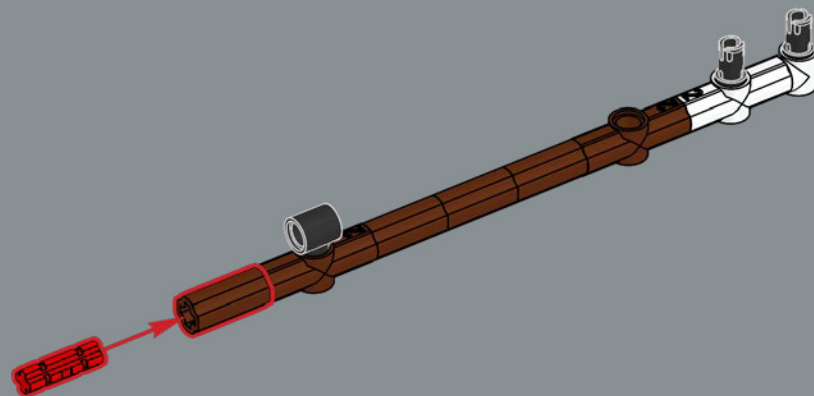

629

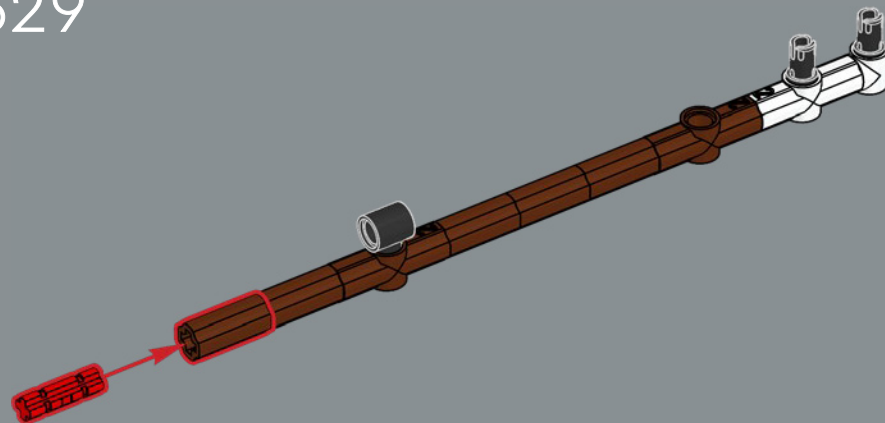

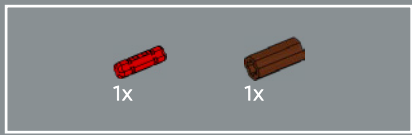

630

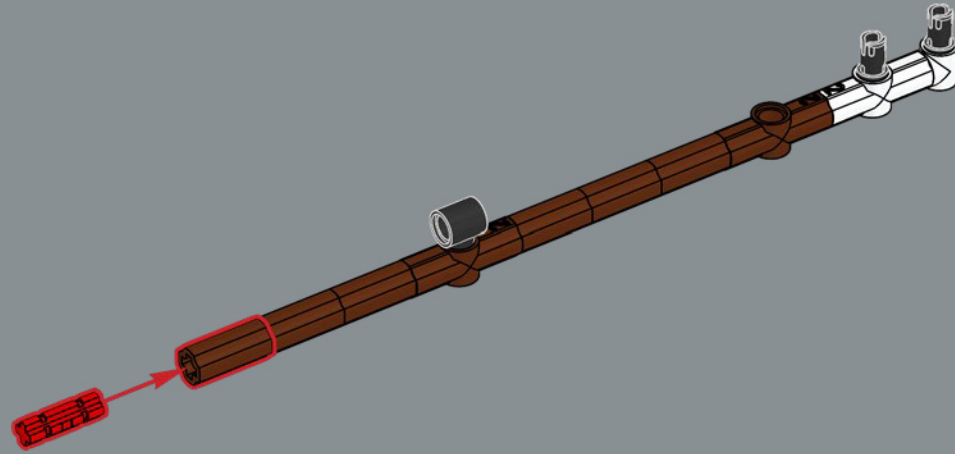

631

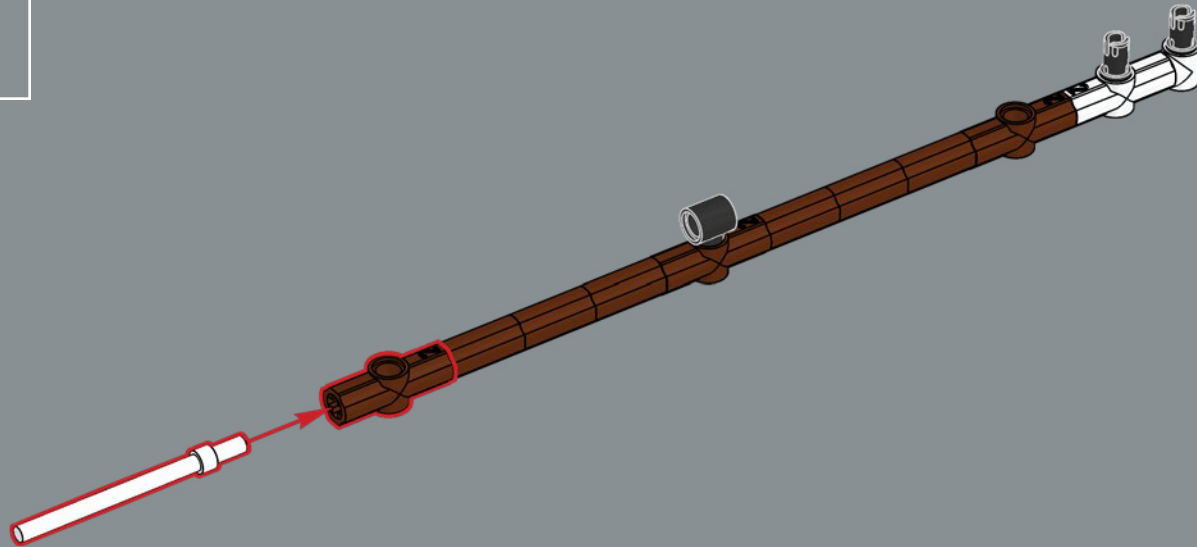



632

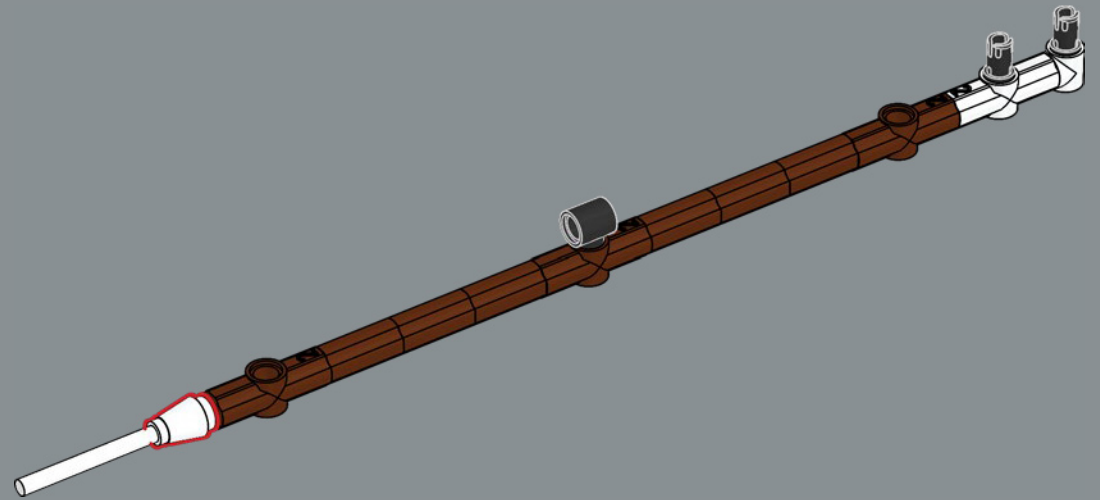

633

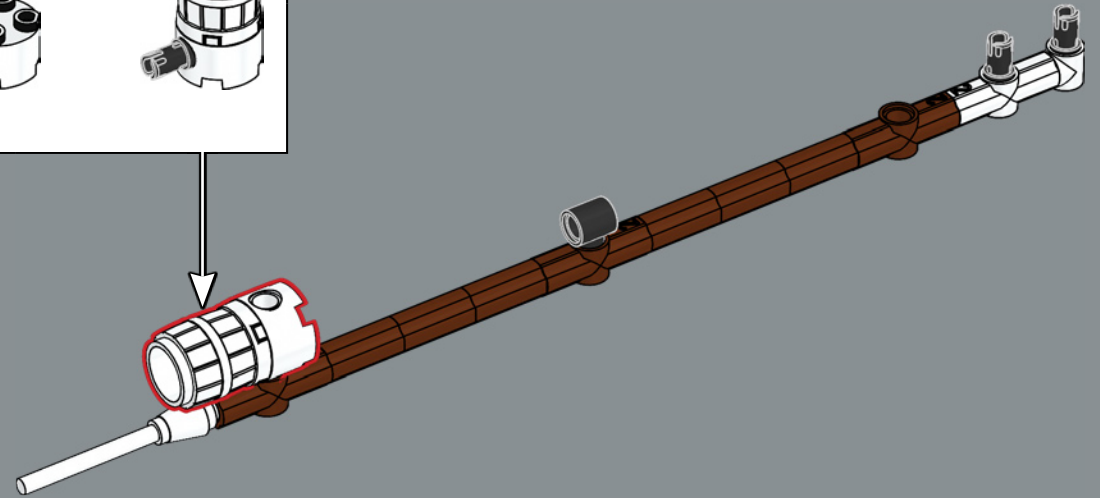
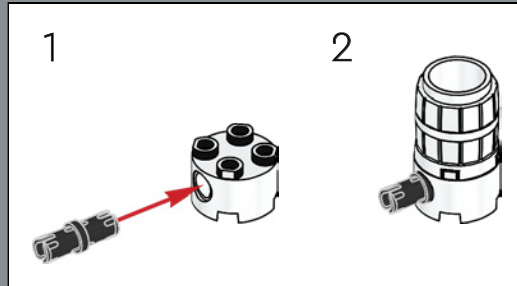

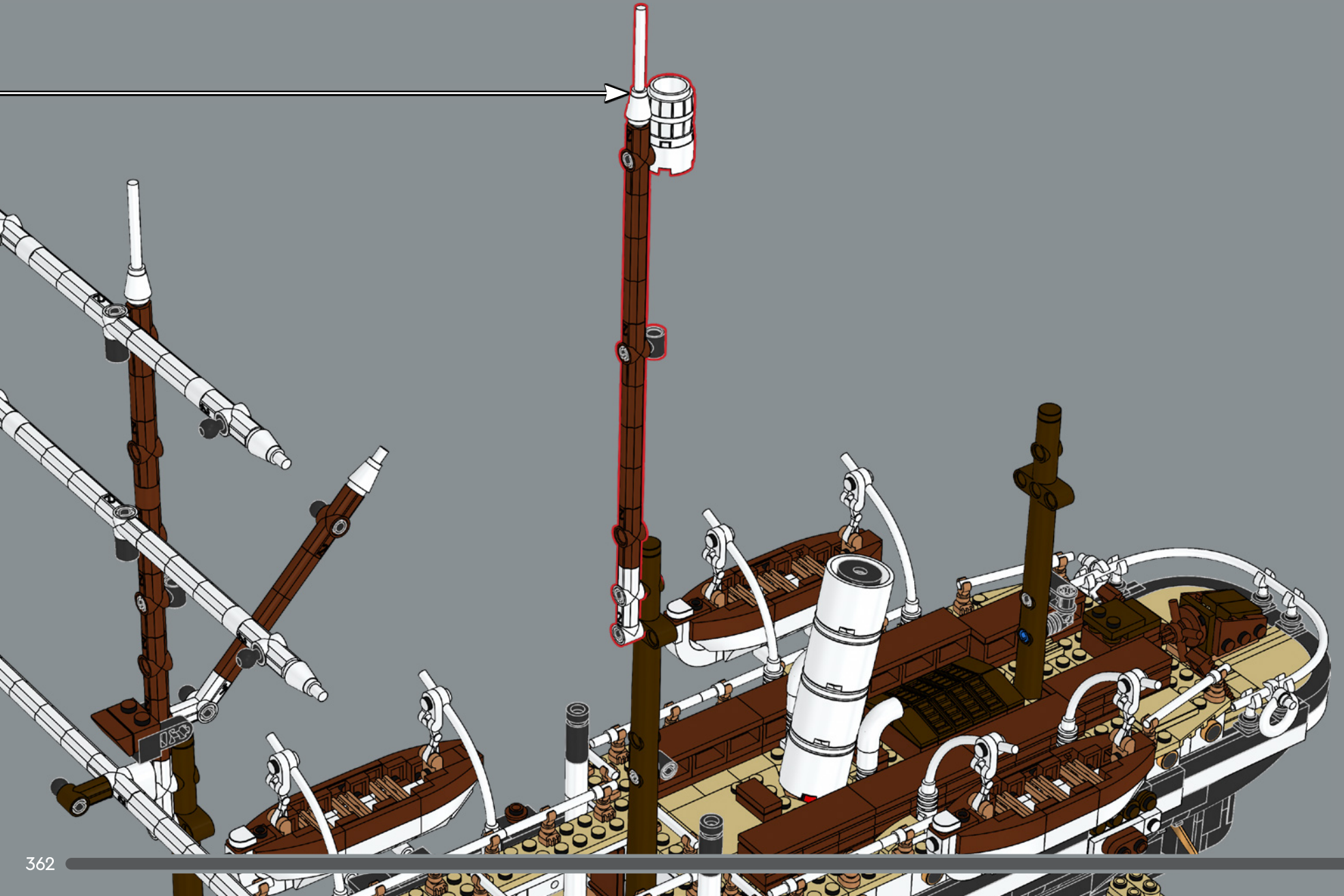

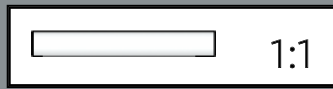
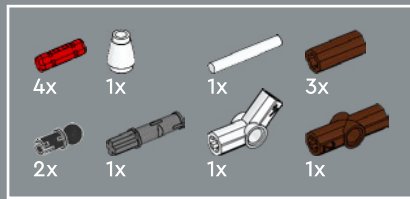

635

1

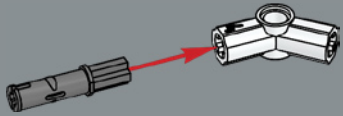

2

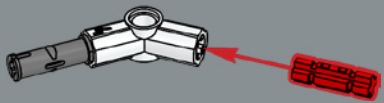

3

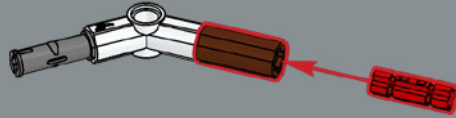

4



5

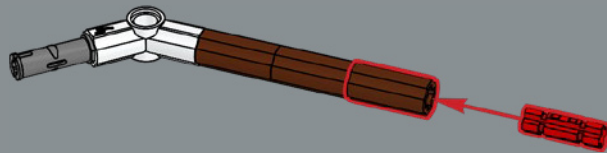

6

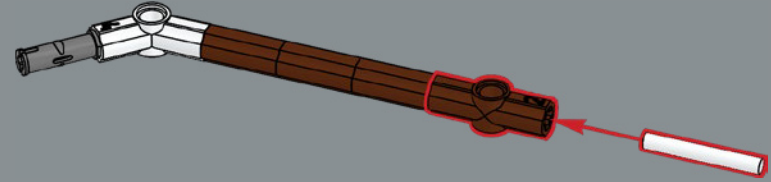

7

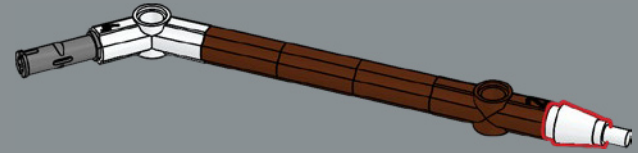

8

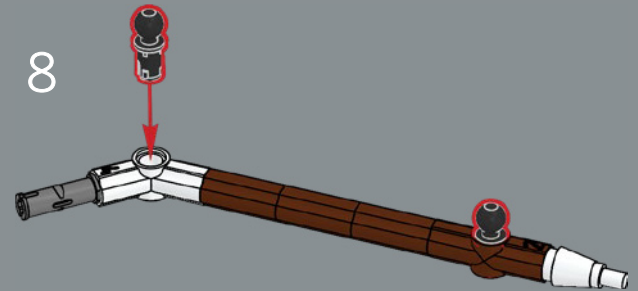





636

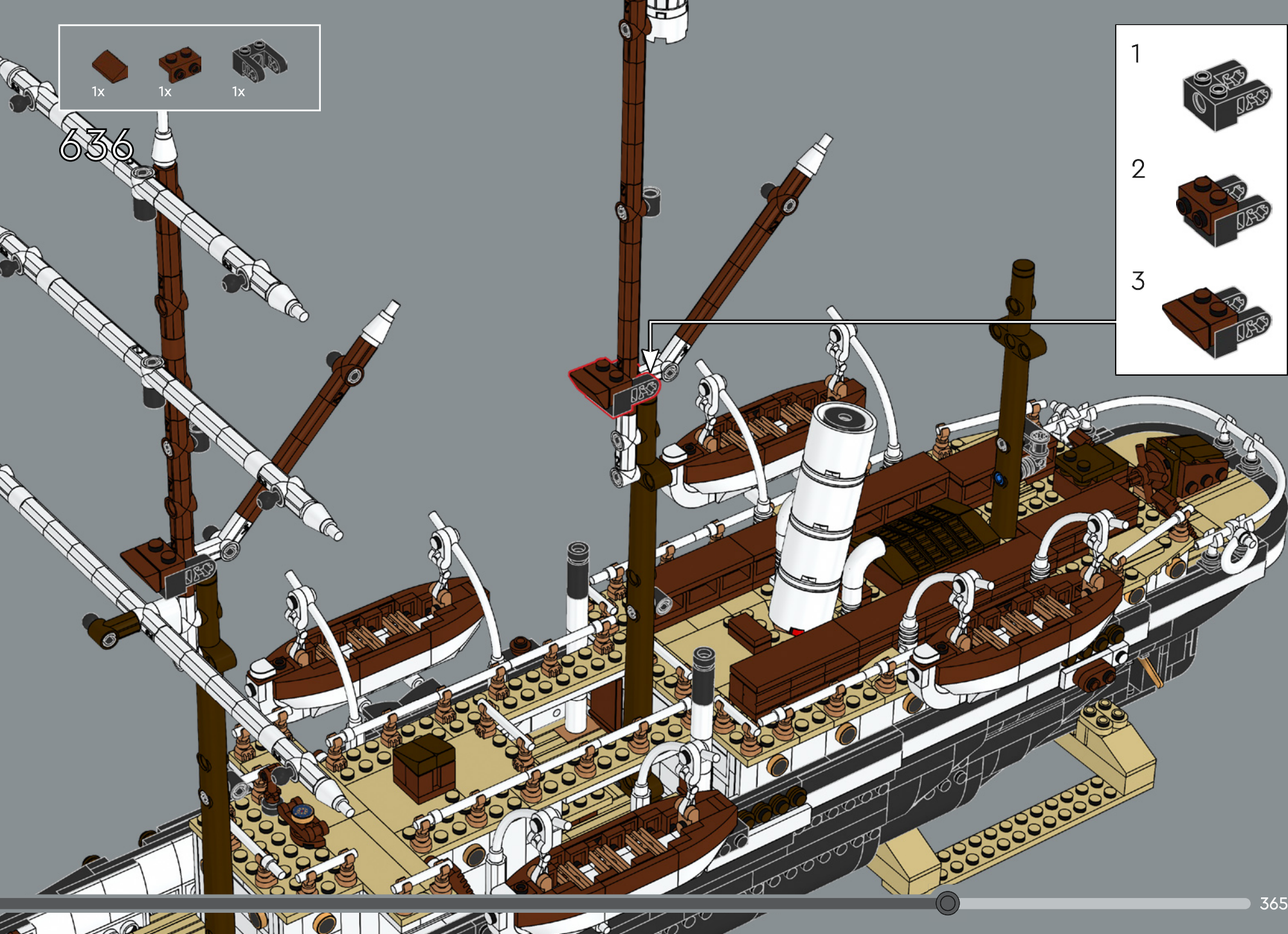
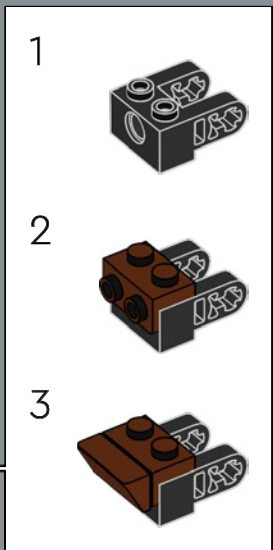

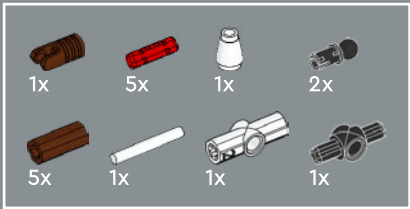

637

1

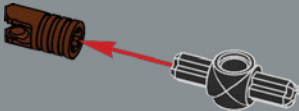

2

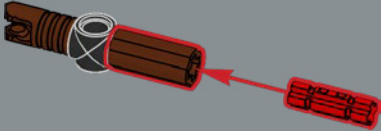

3

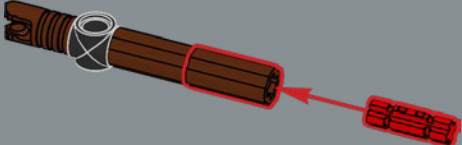

4

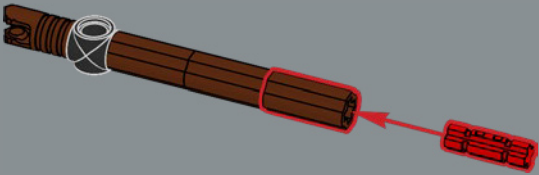

5

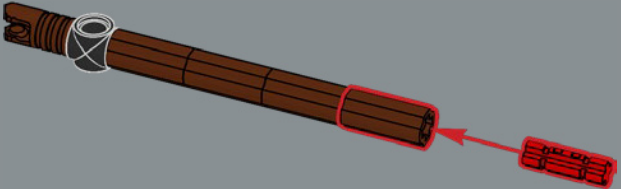

6

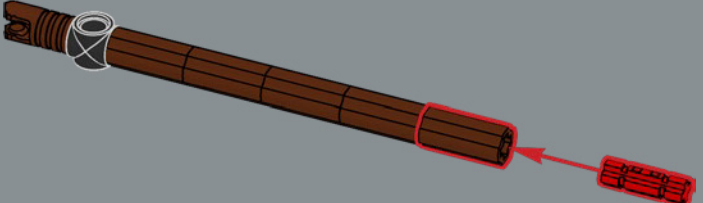

7

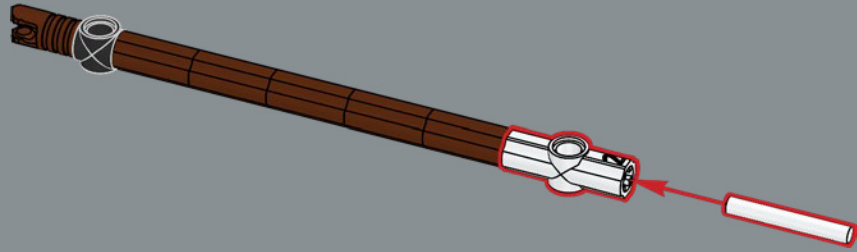

8

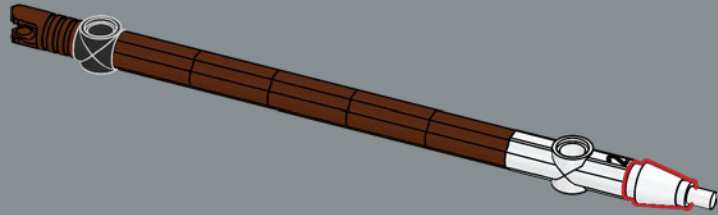

9

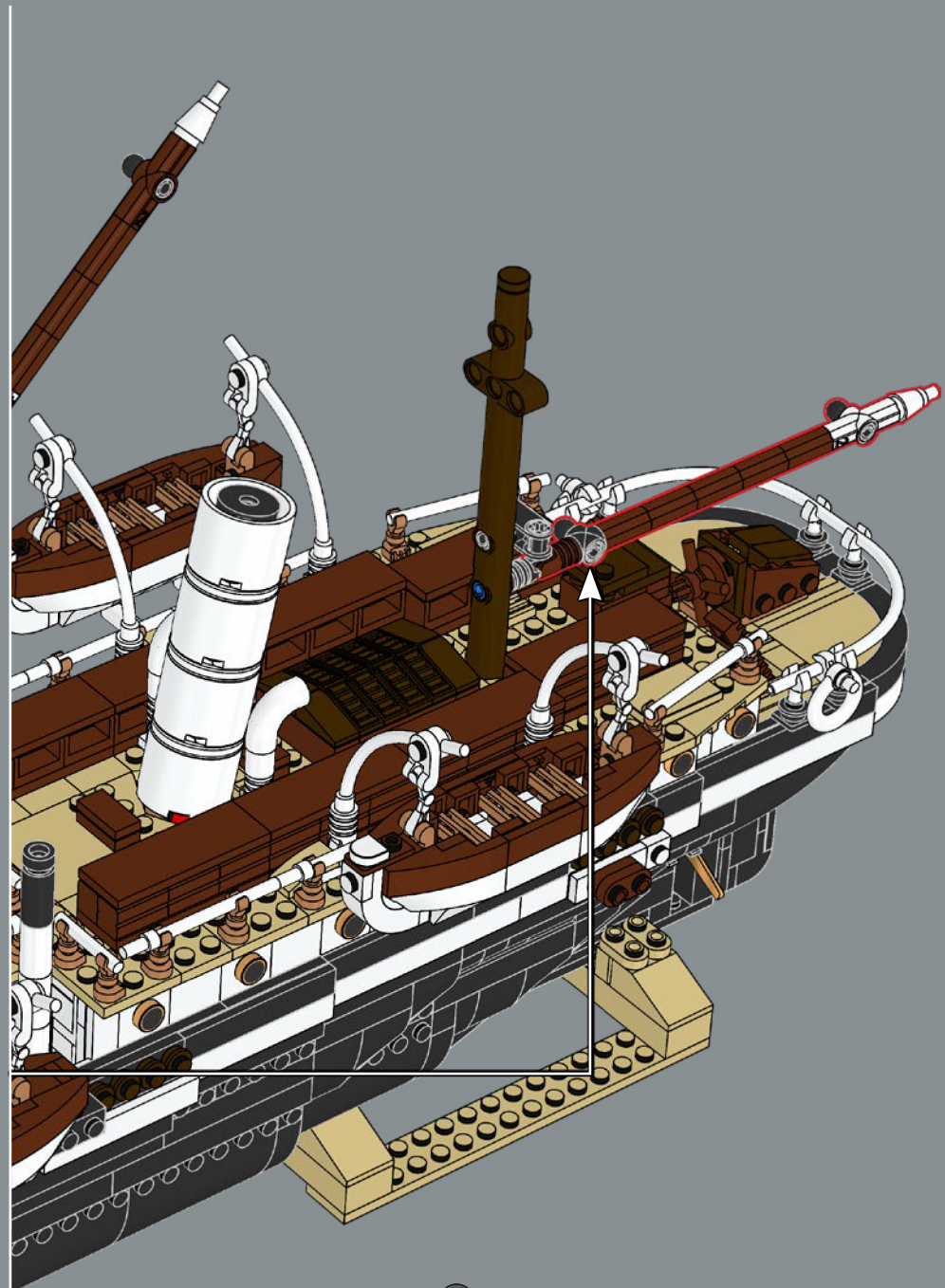
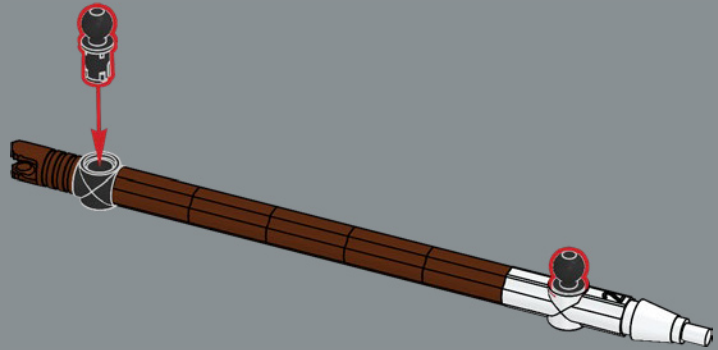

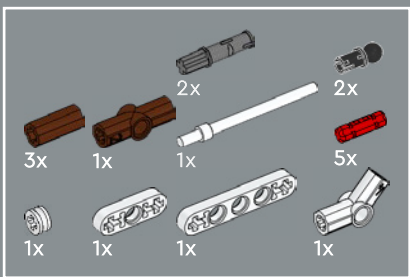

638

1

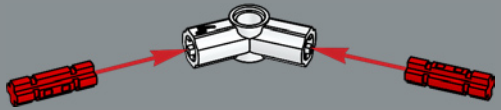

2

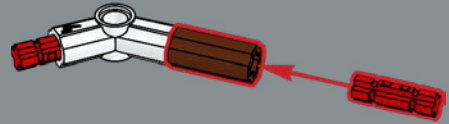

3

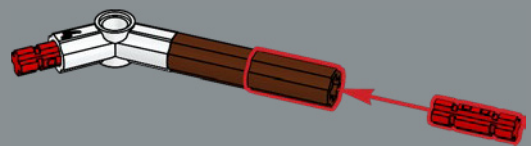

4

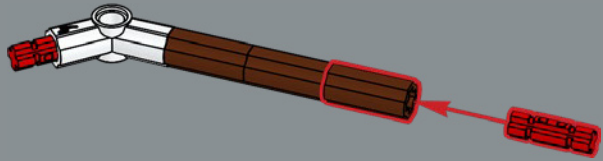

5

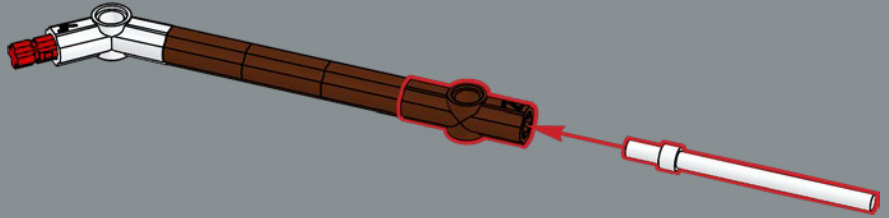

6

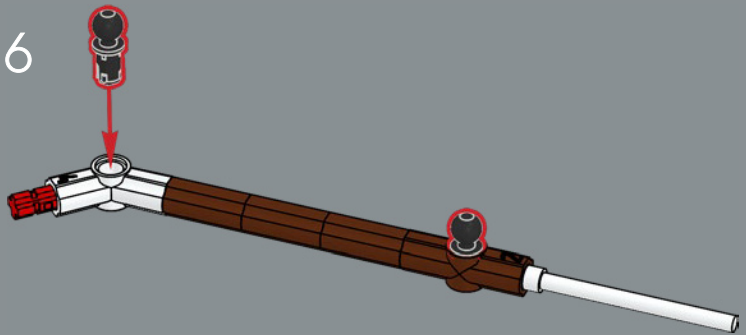

7

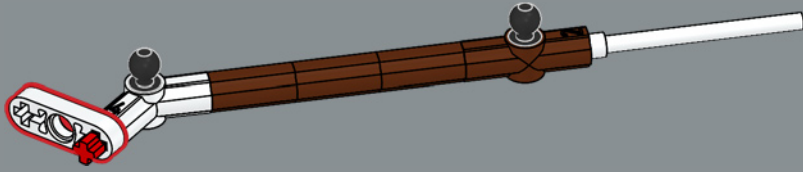

9

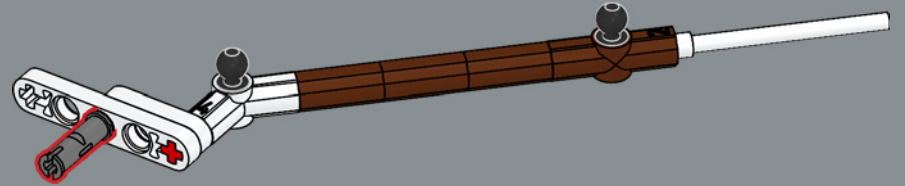

8

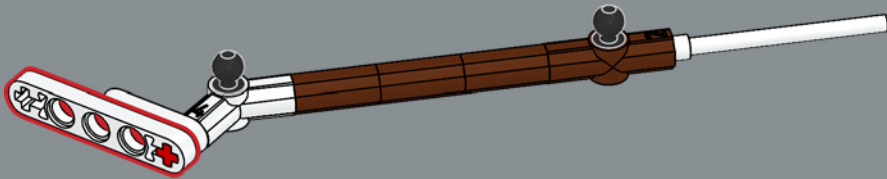

10

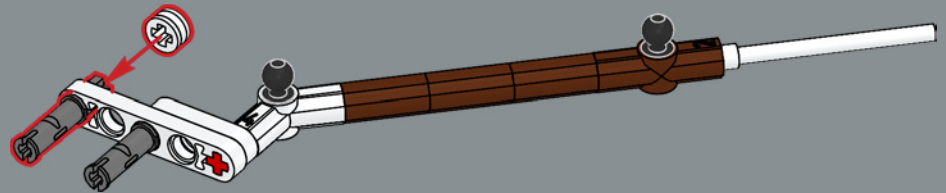

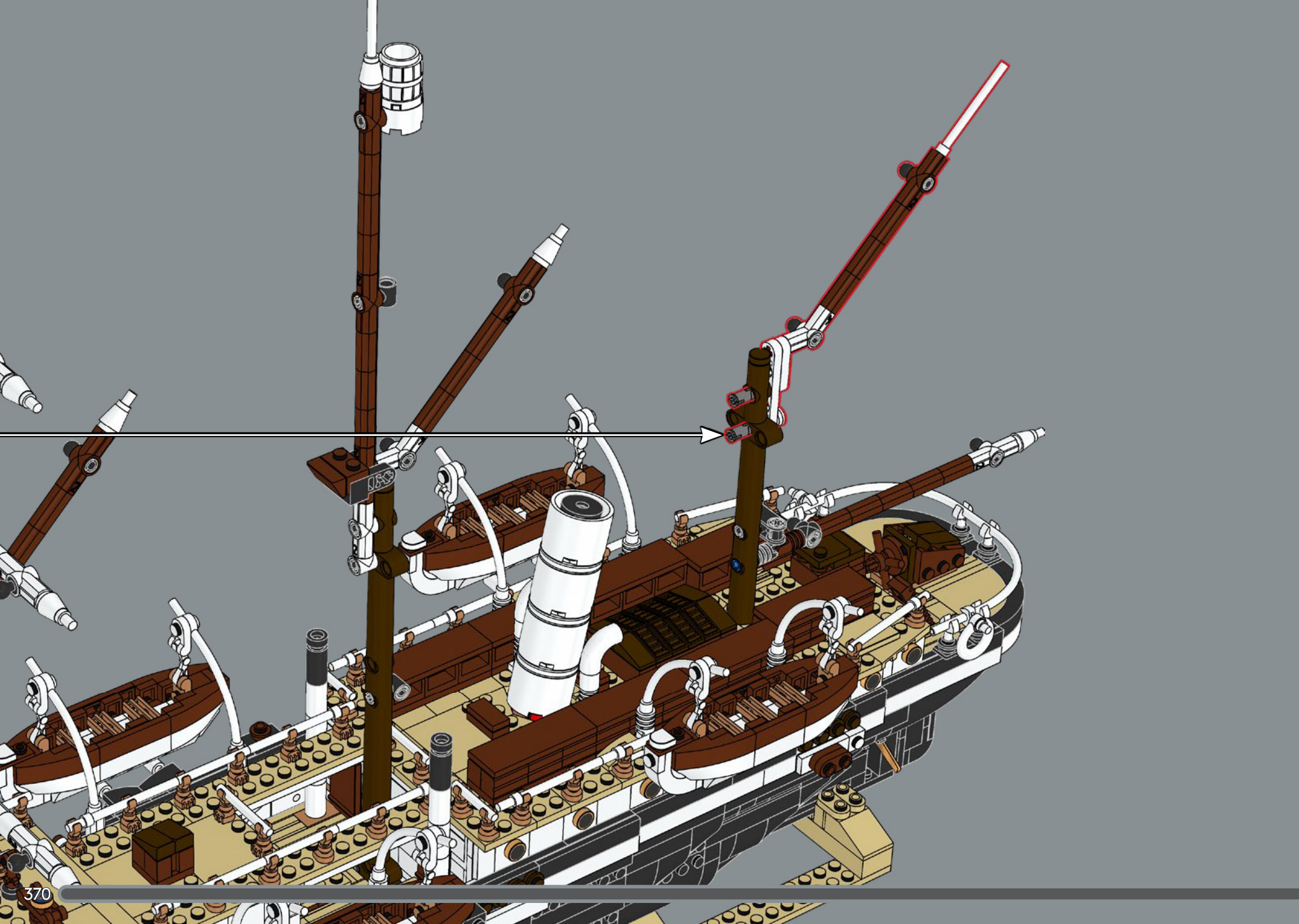

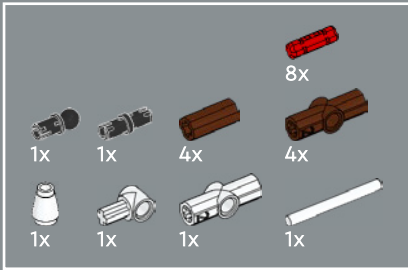
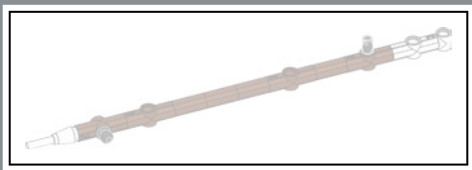

639

1

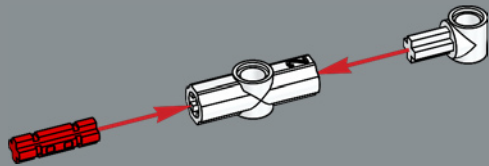

2

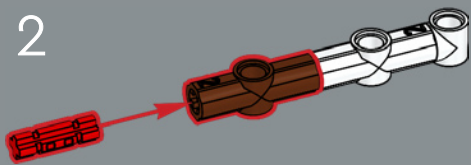

3

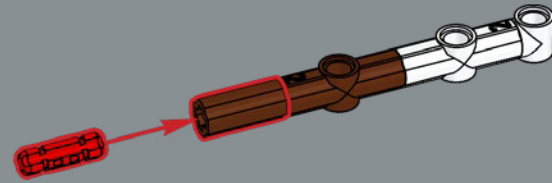

4

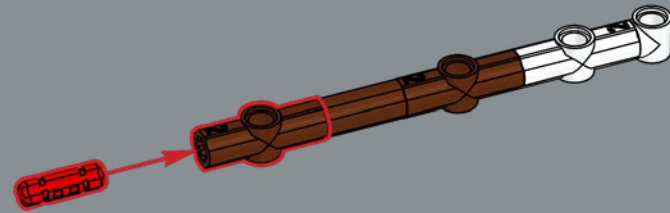

5

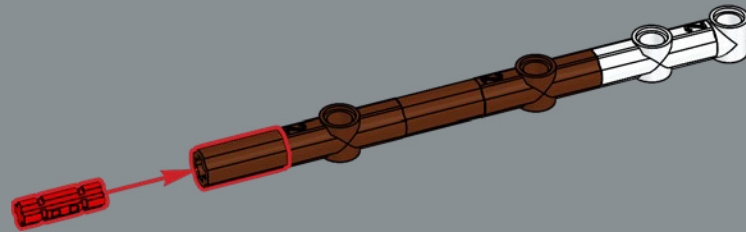

6

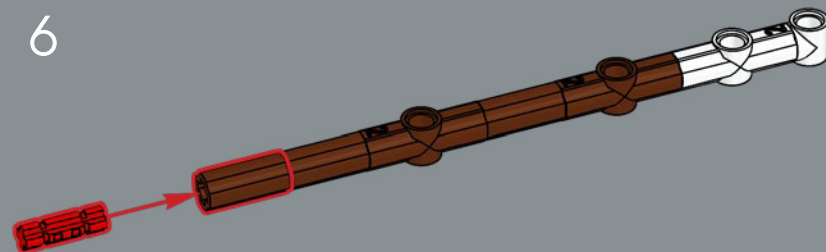

7

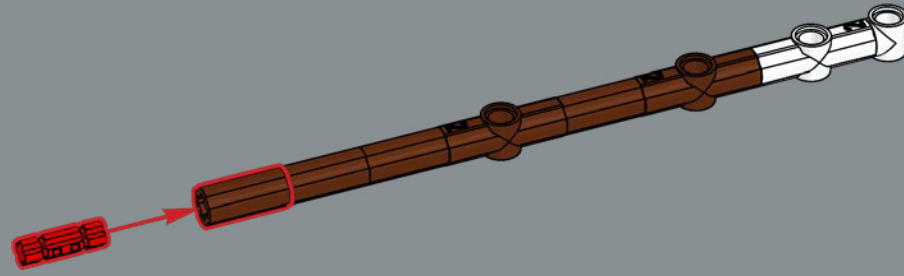

8

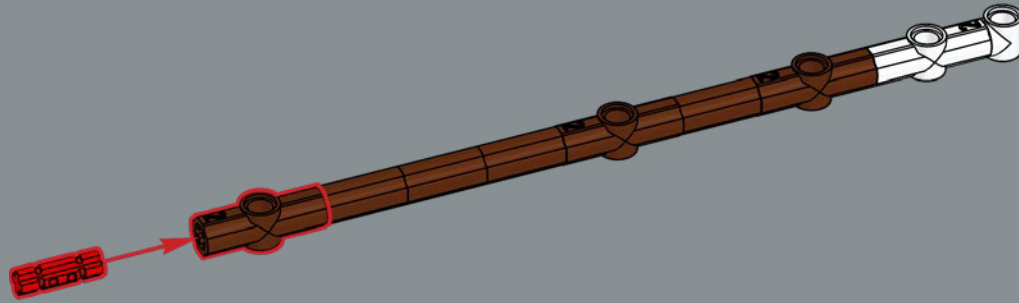

9

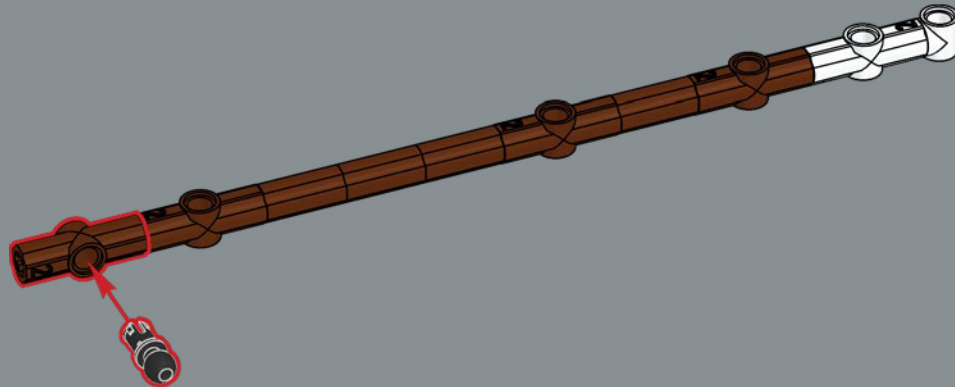

10



11

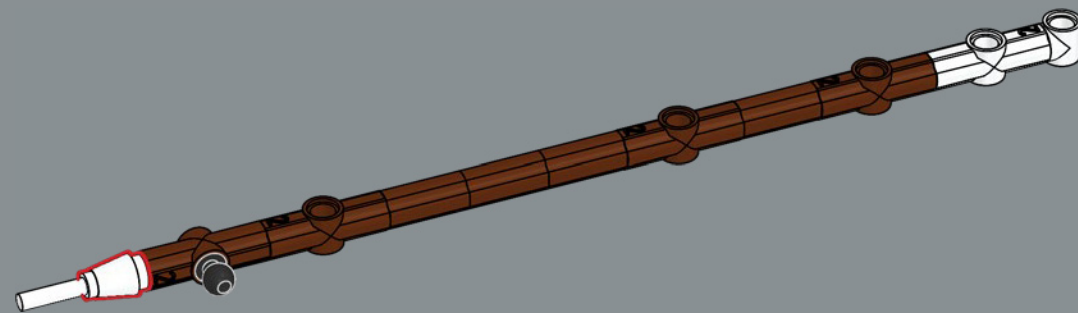

12

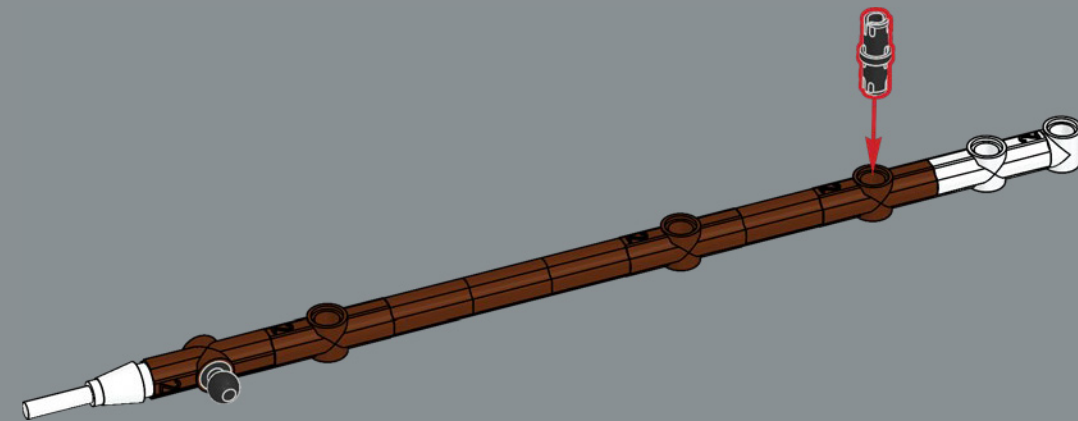

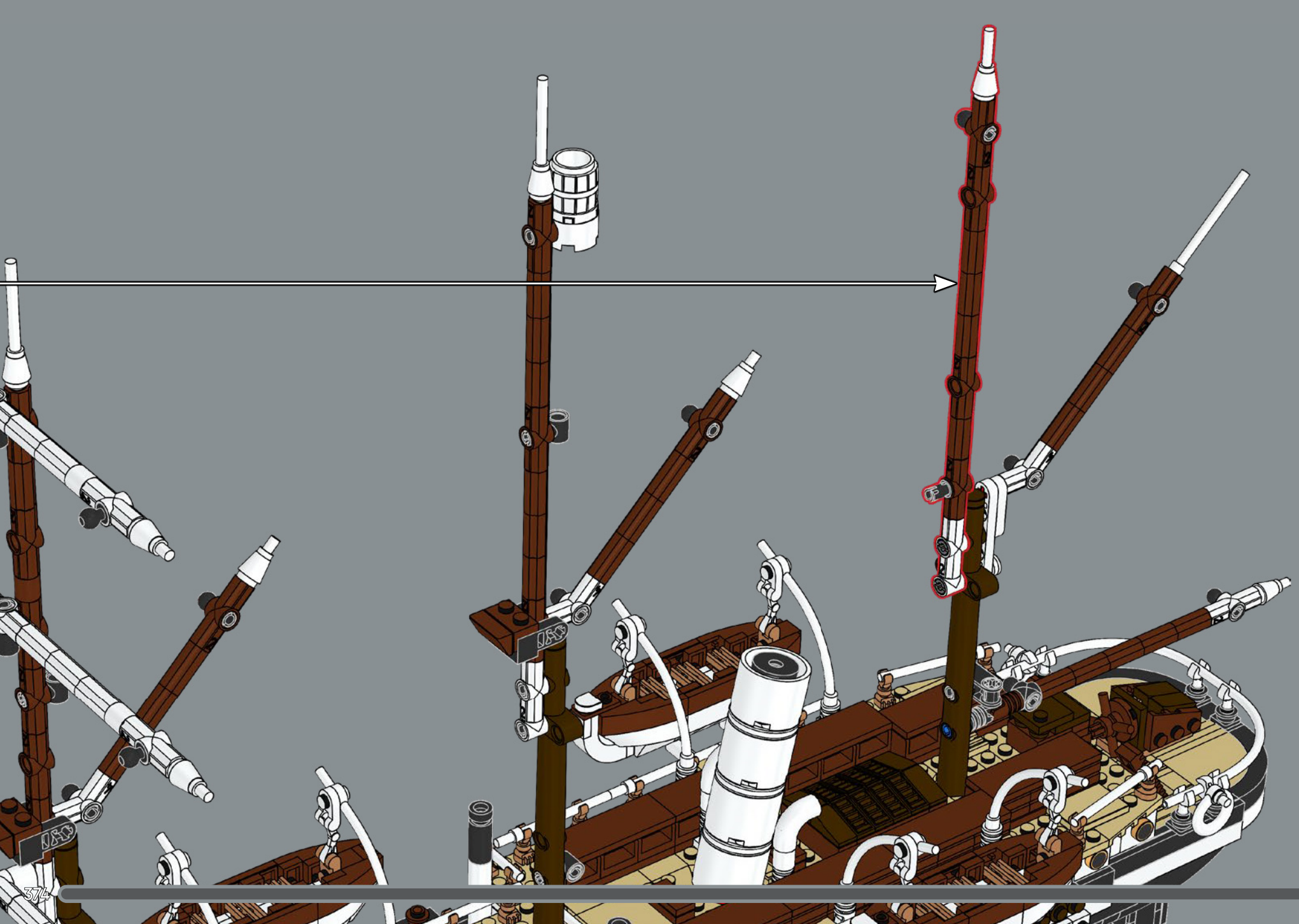



640

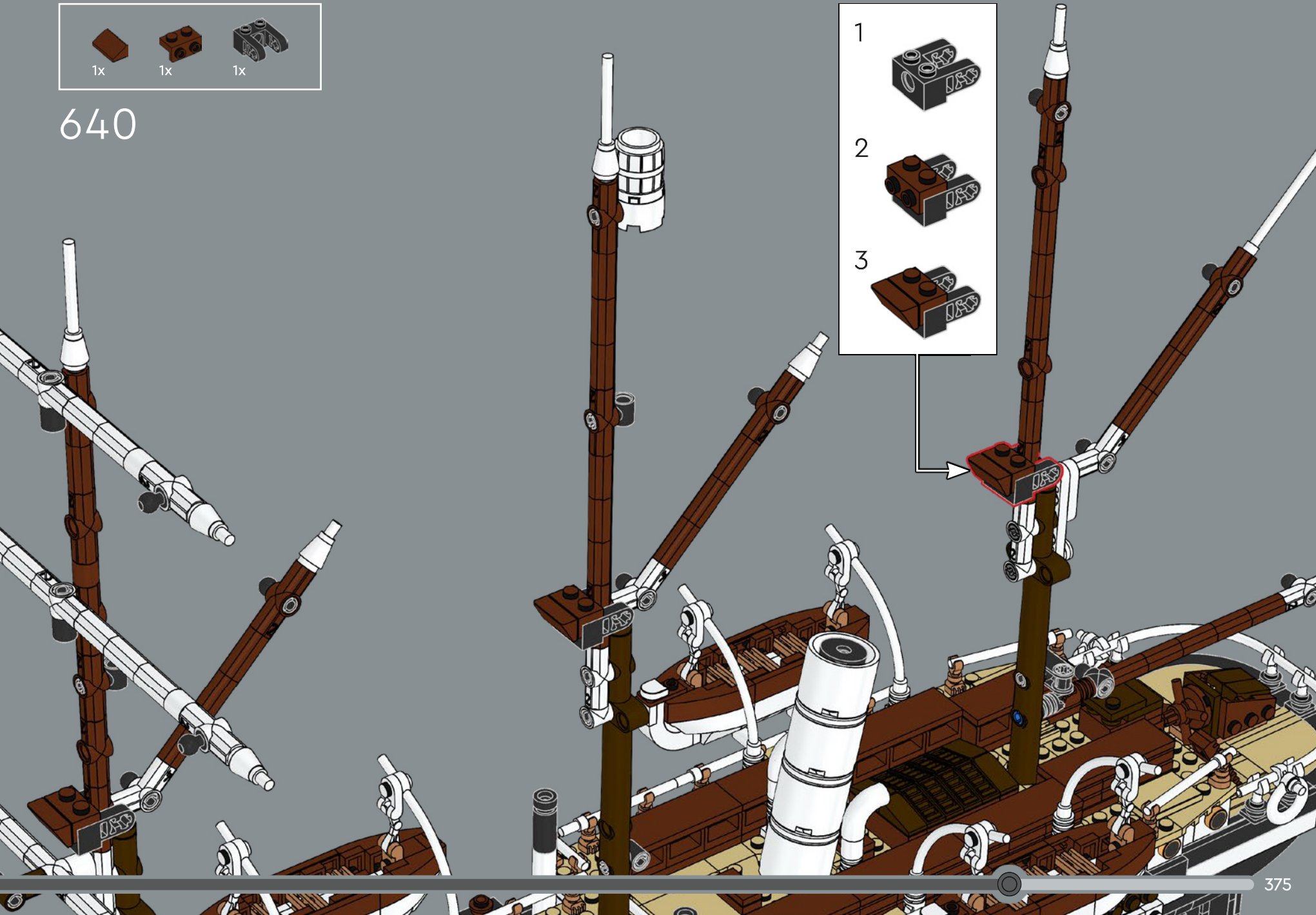
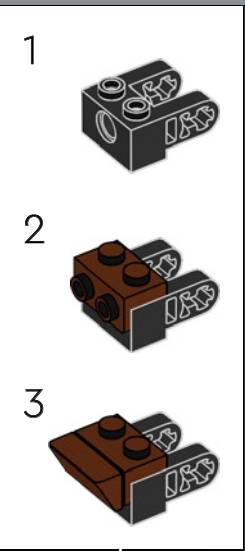

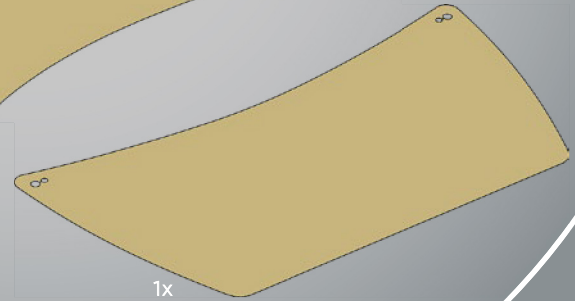
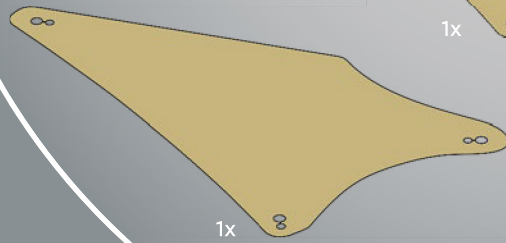
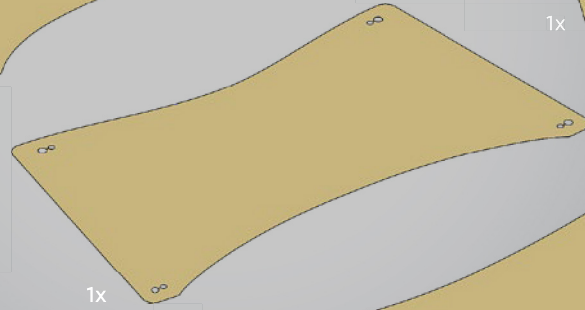
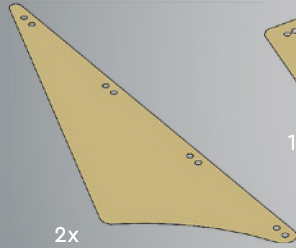
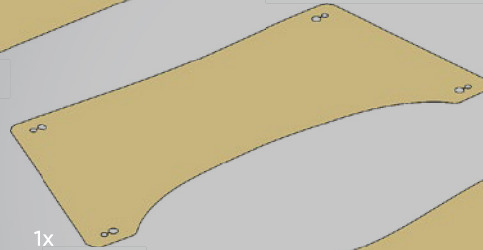
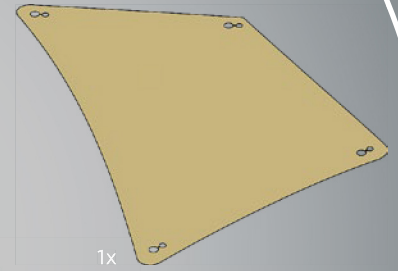
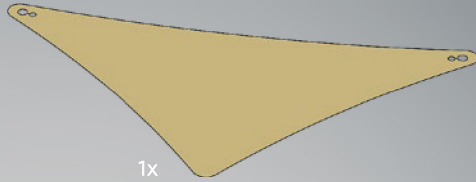
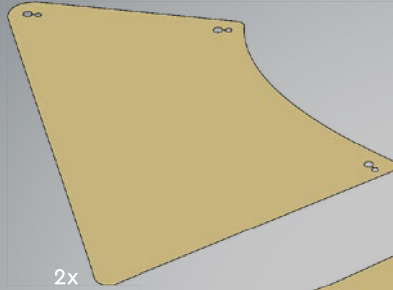
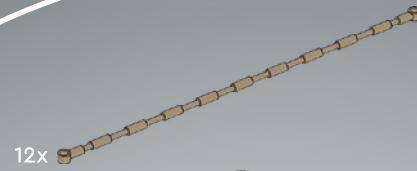
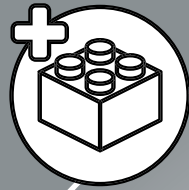



641

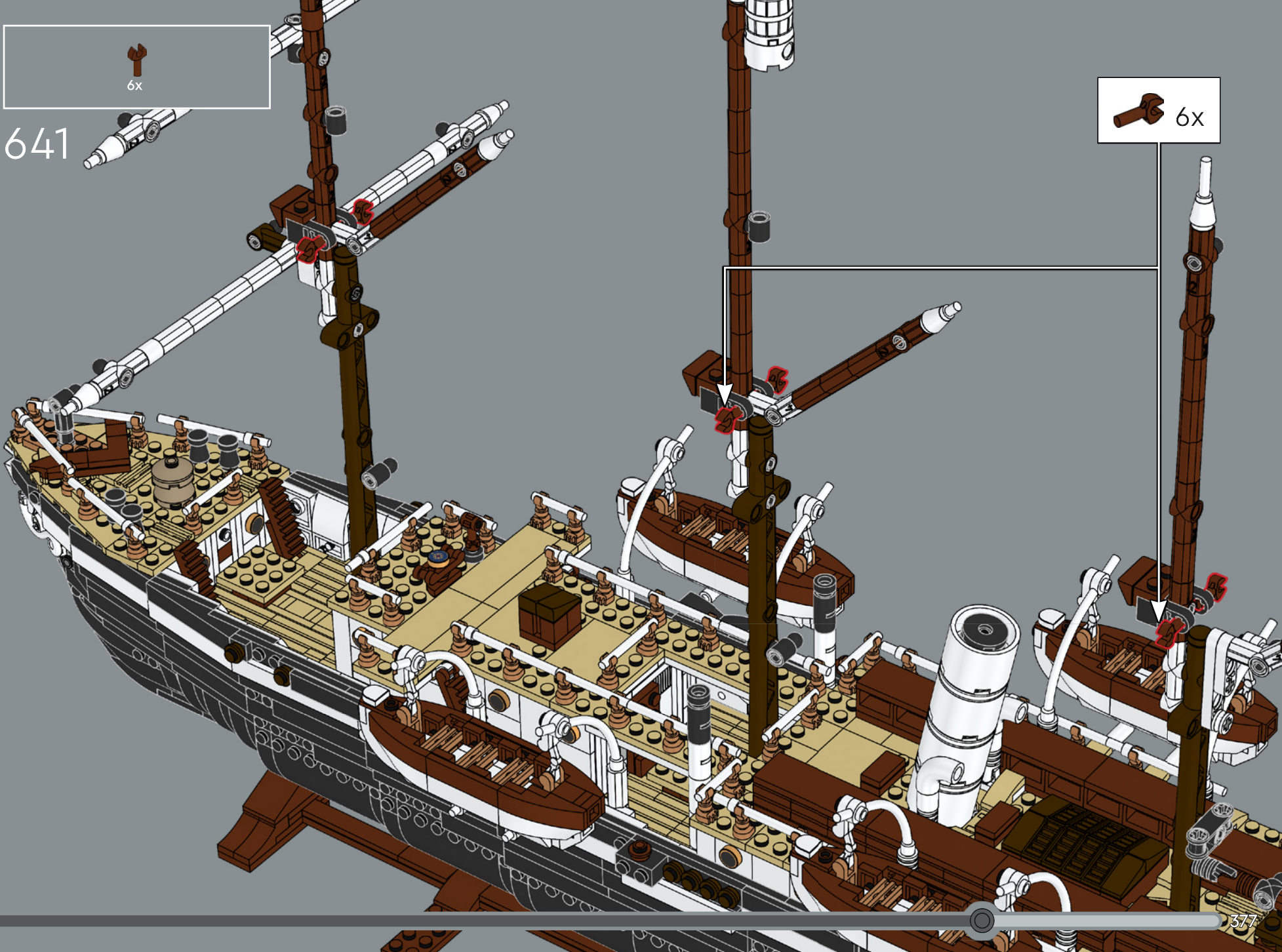

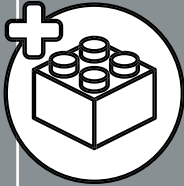
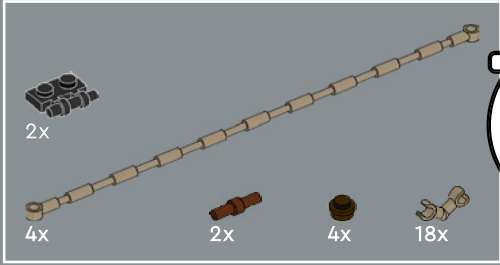
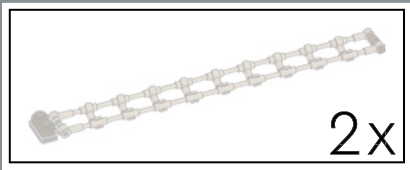

642

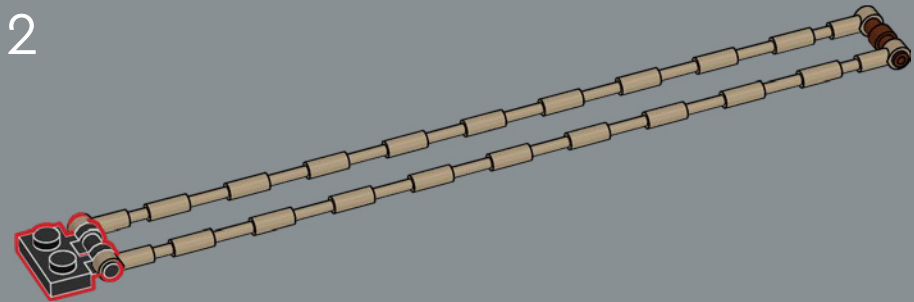
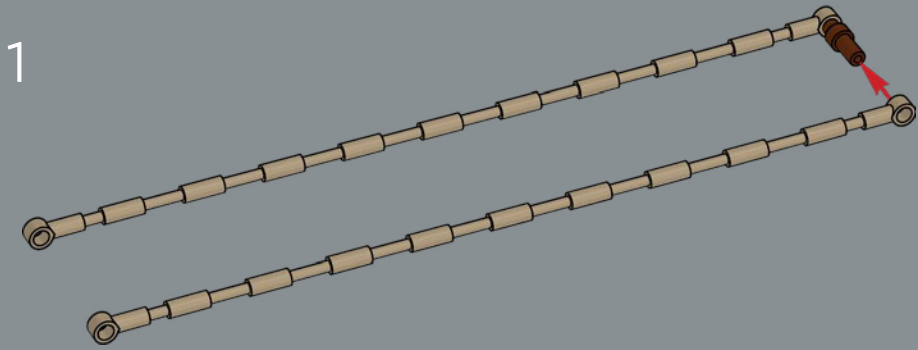

3

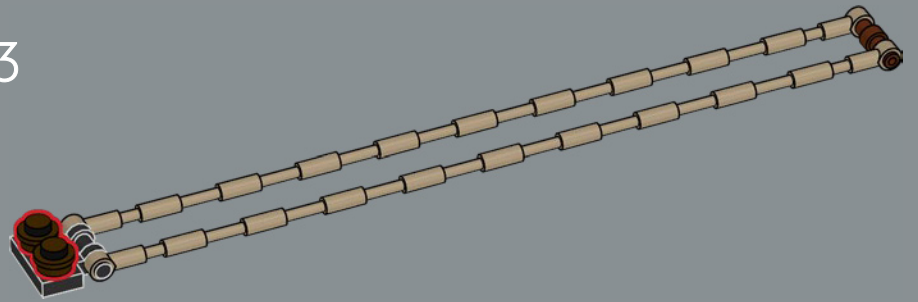

4

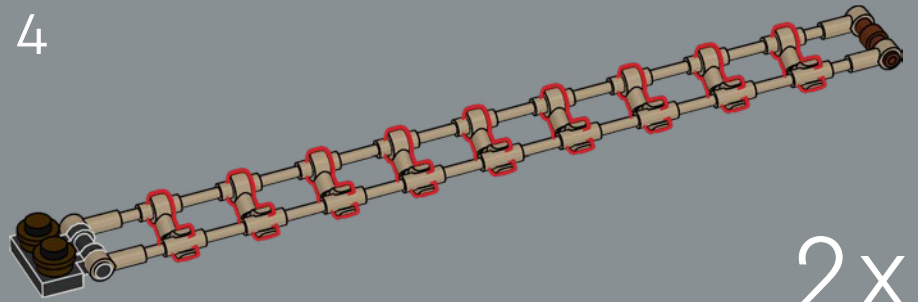

2x



绳梯采用深棕褐色，以区别于船上的大部分木质结构。



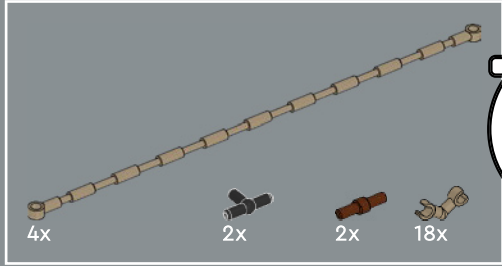
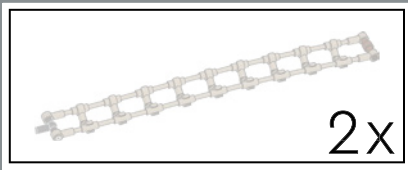

643

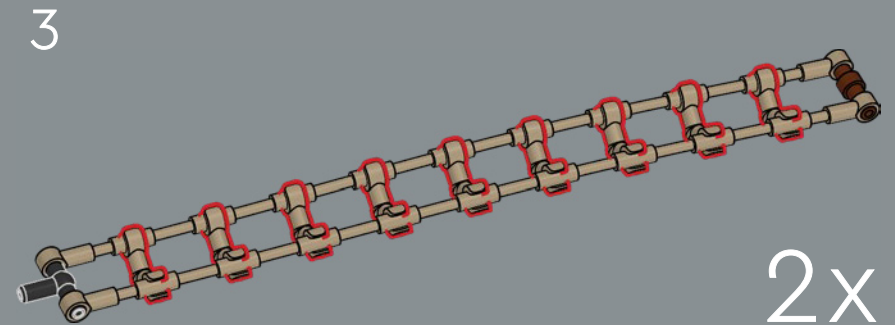
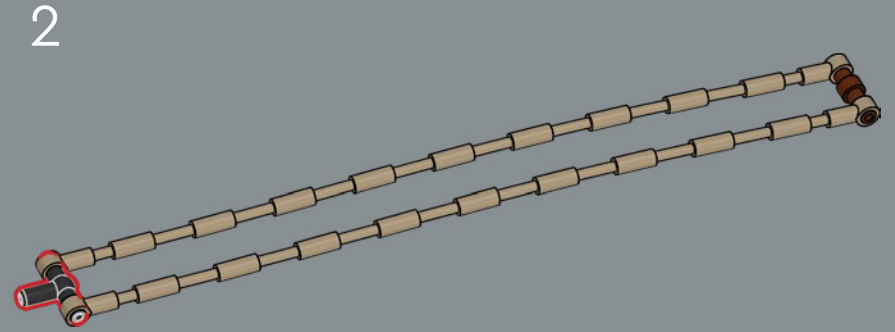
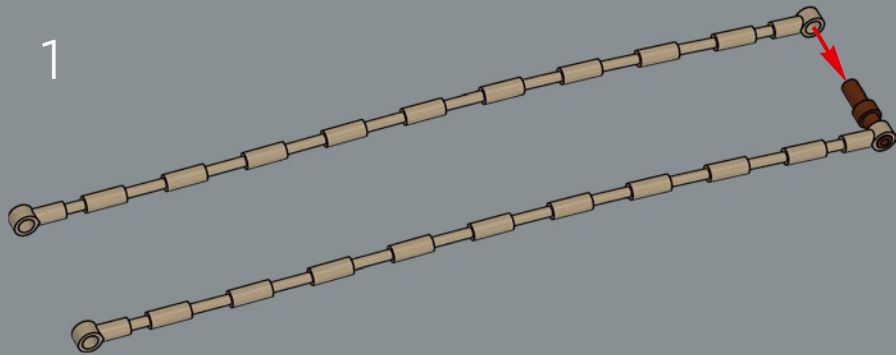

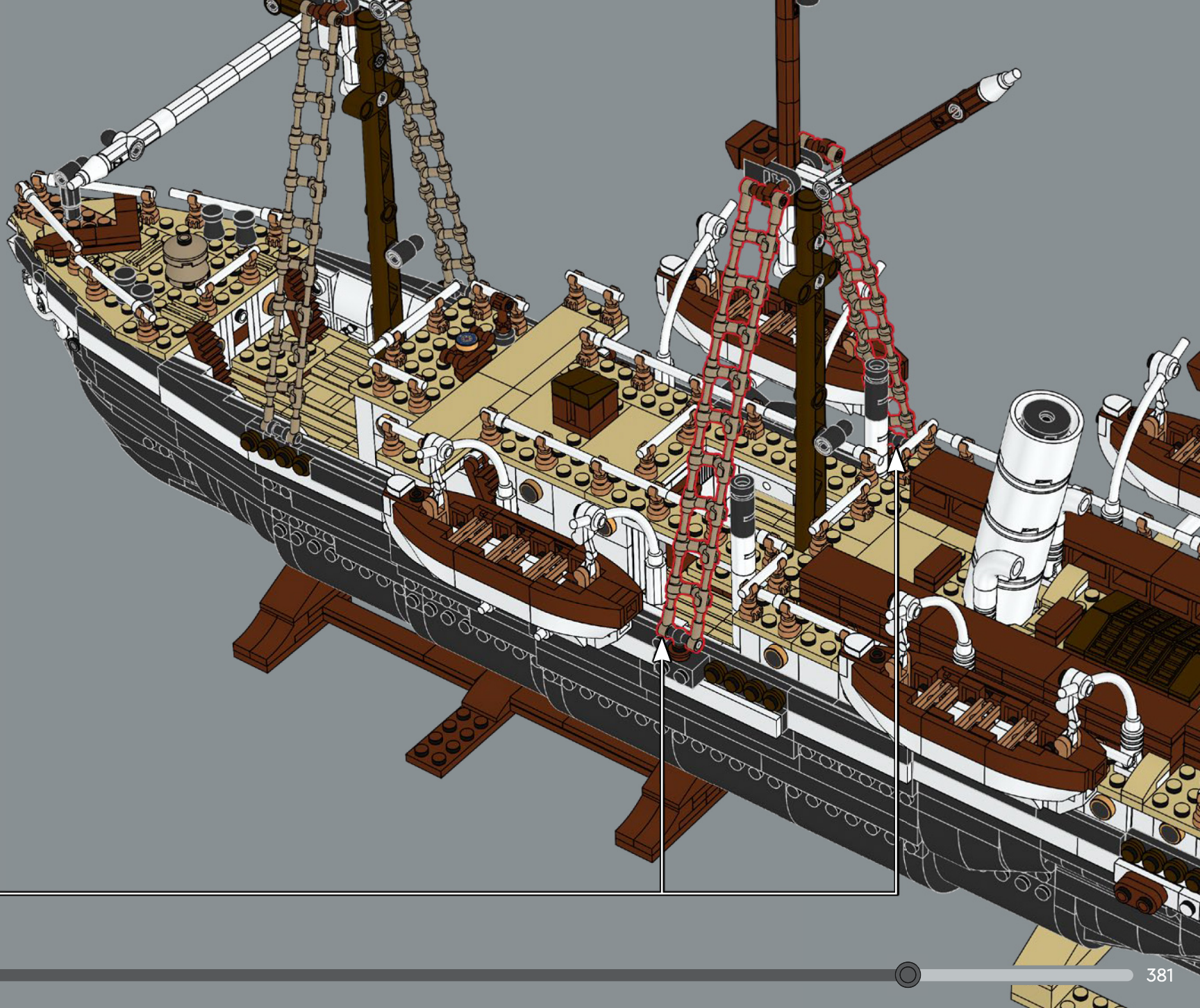

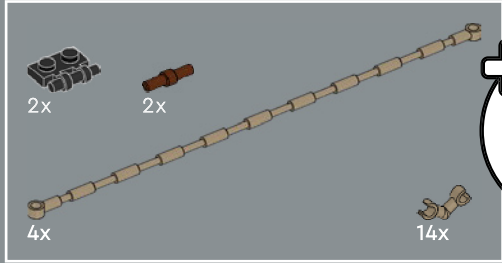
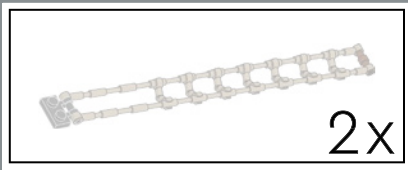

644

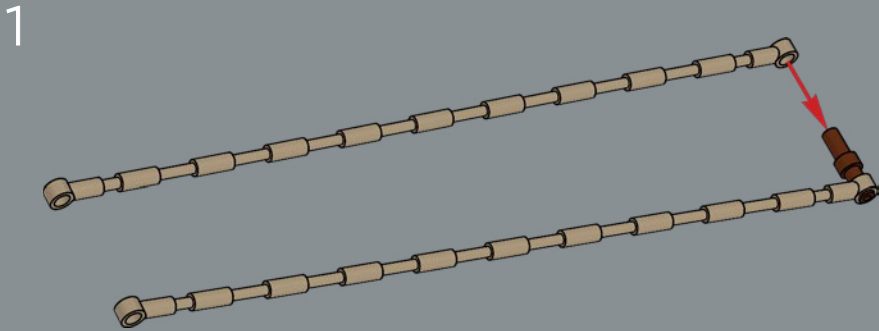

2

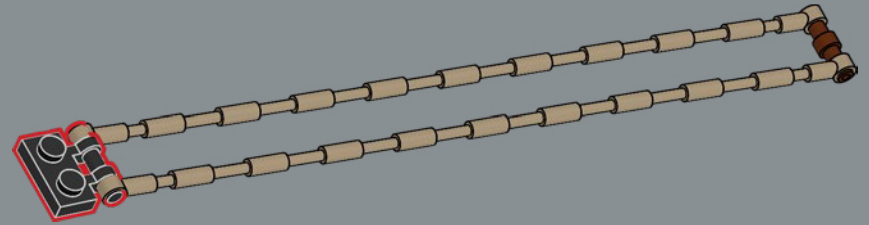

3

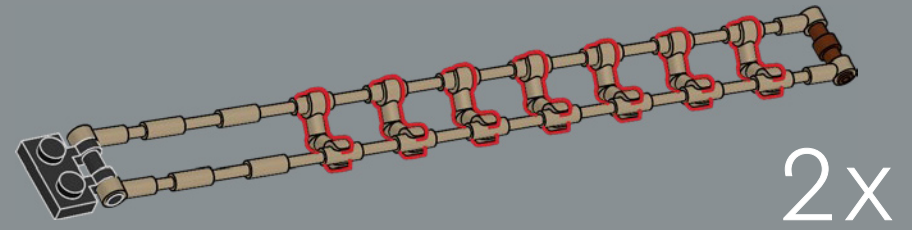

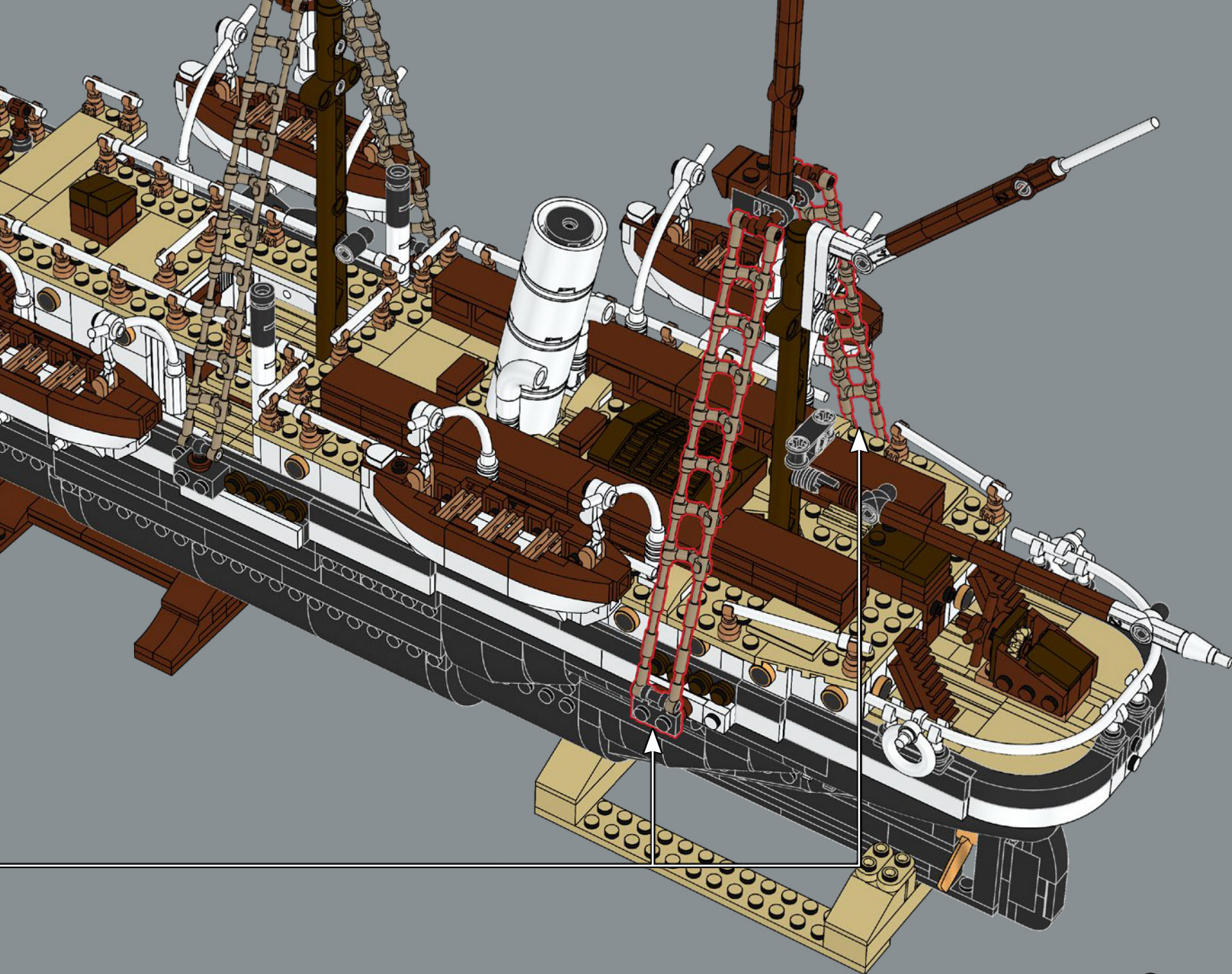

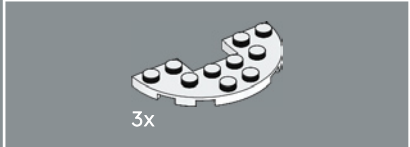

3x

645



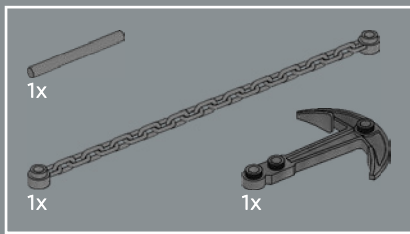

646

1

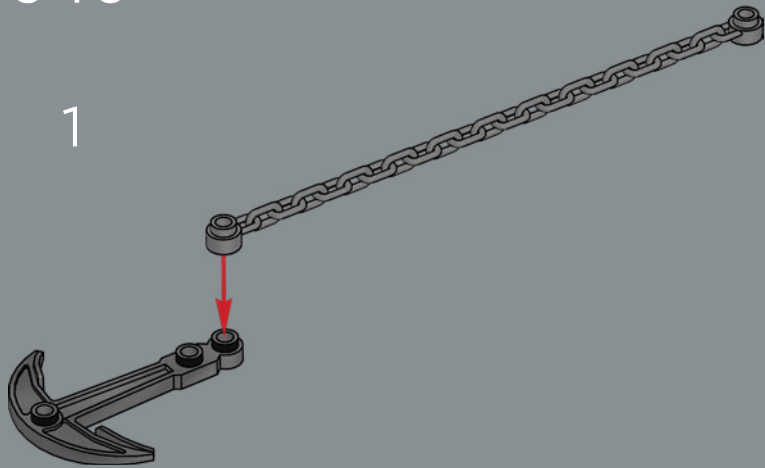

2

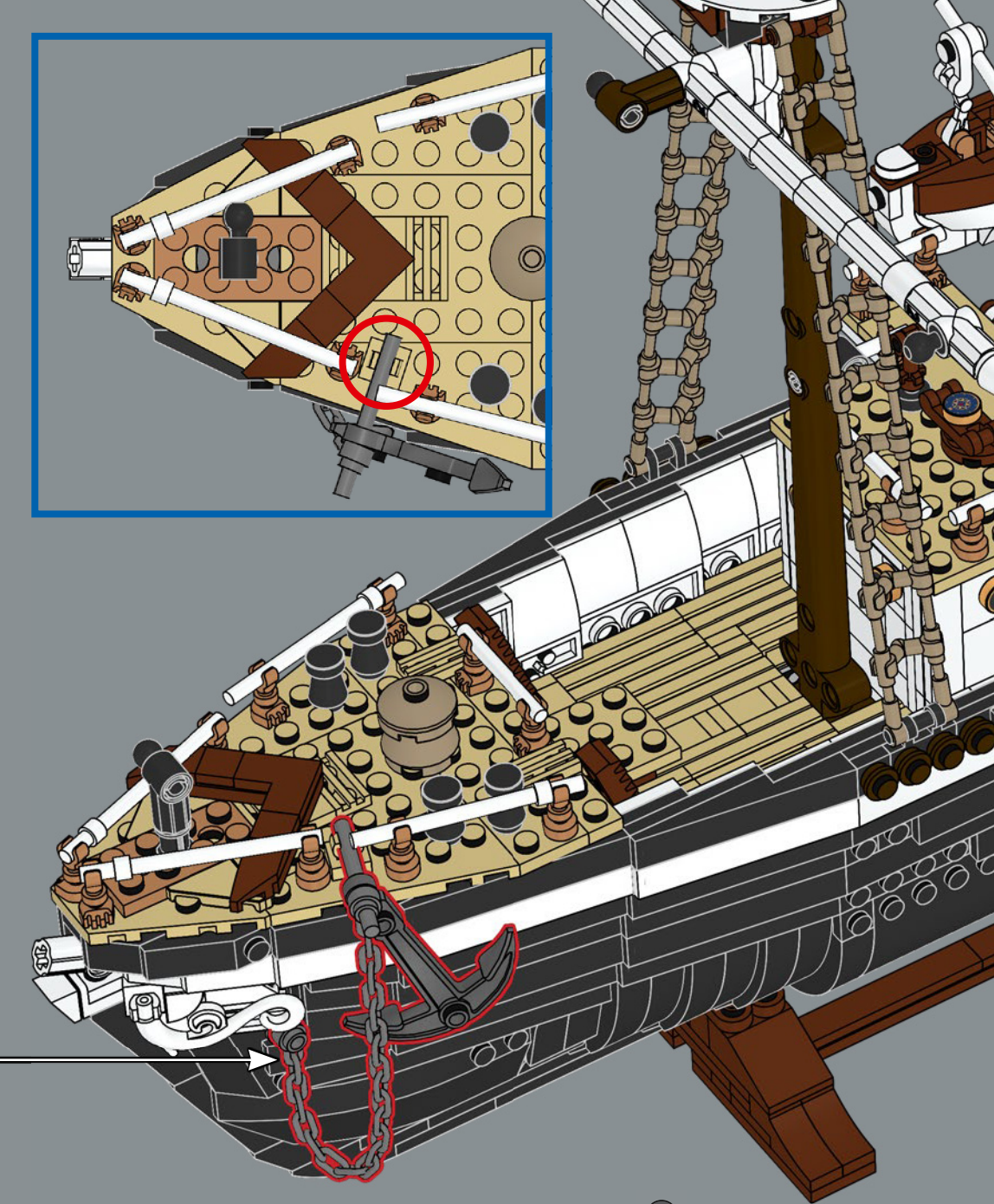
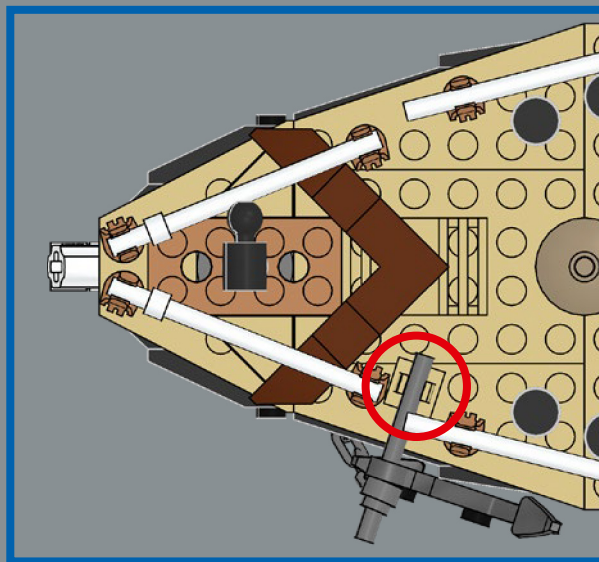
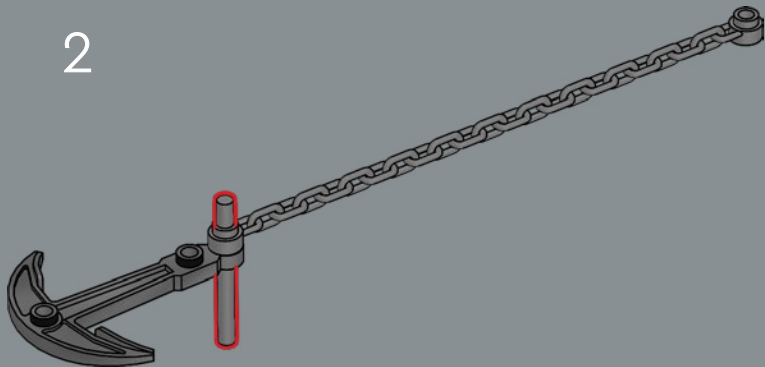

647

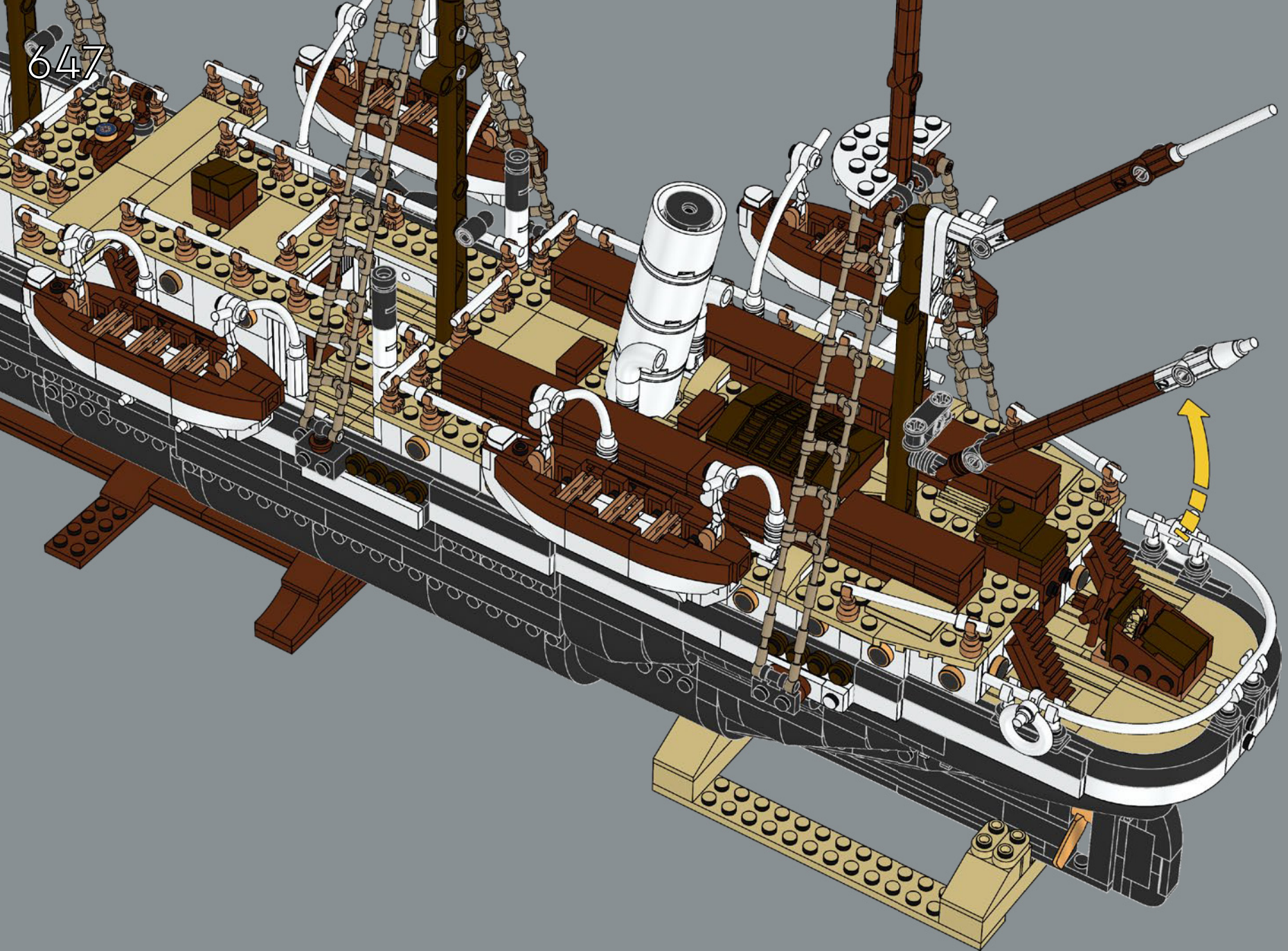

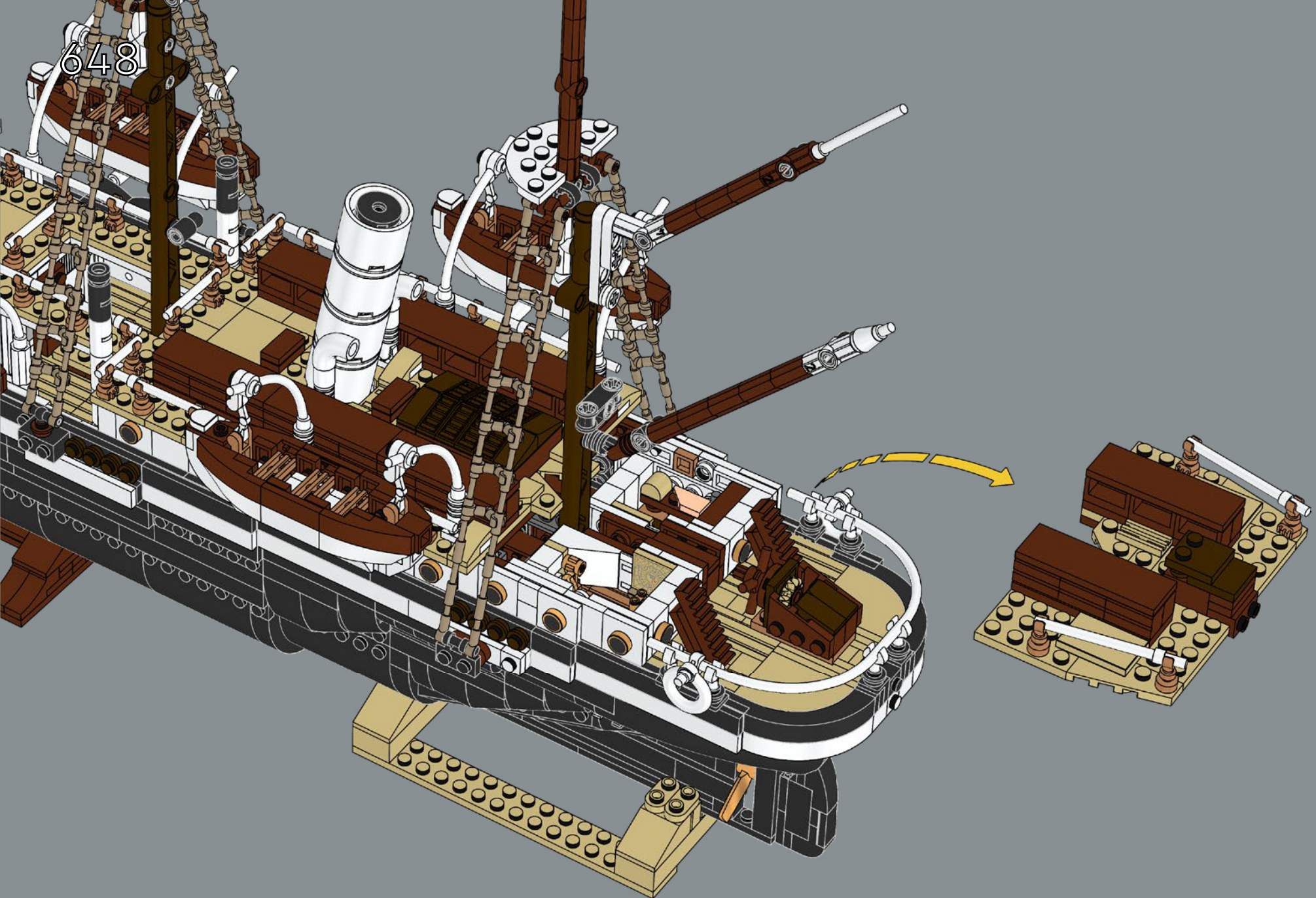

648



649

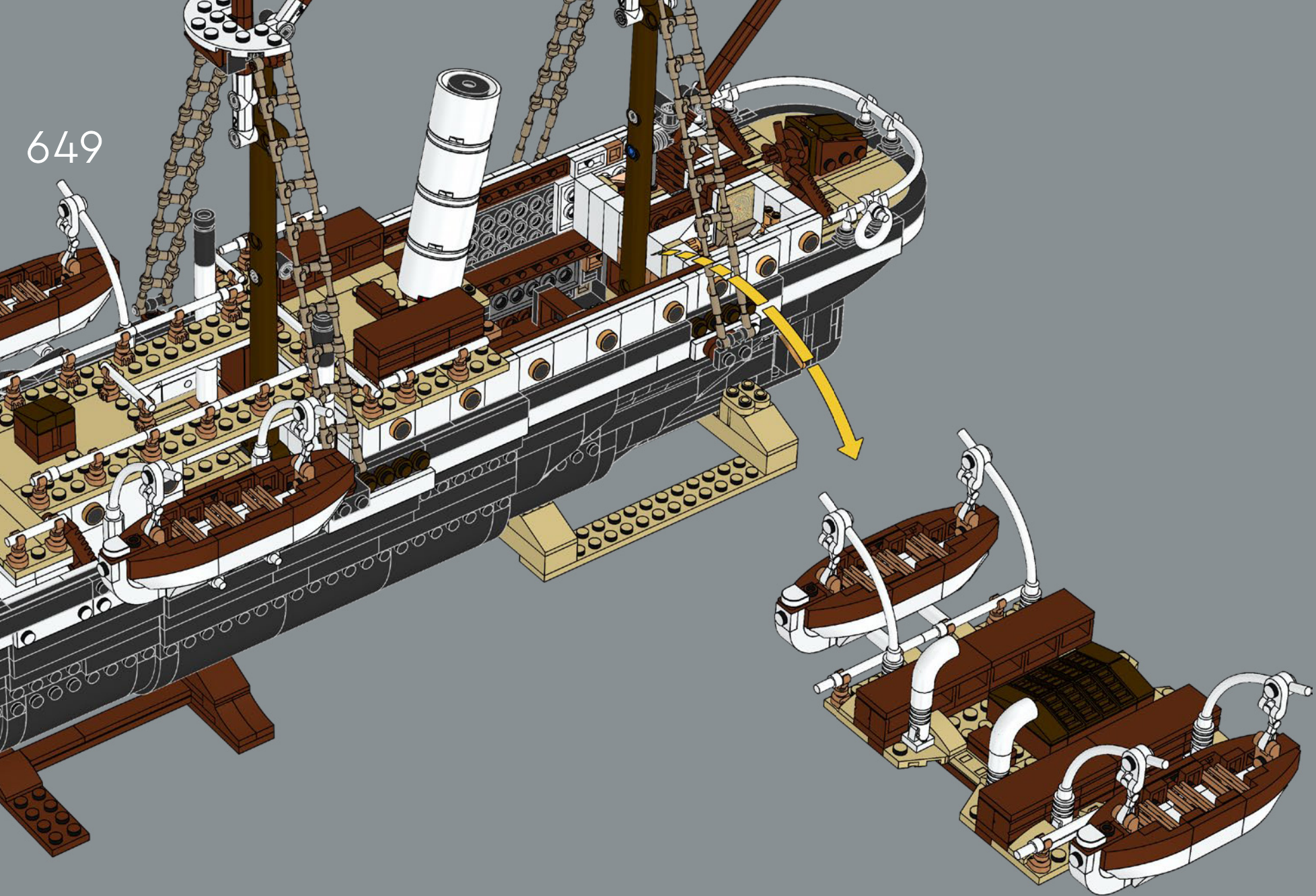

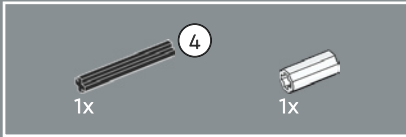
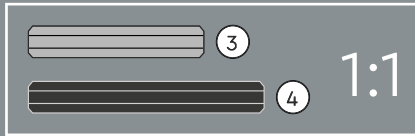
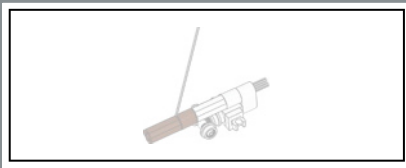

650

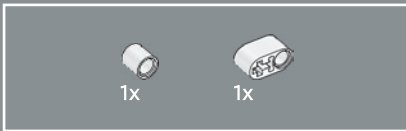
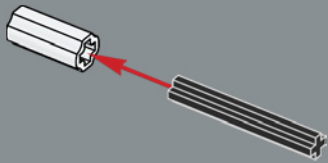

651

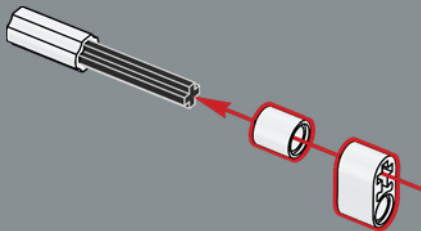

652

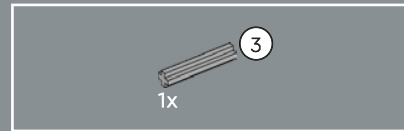
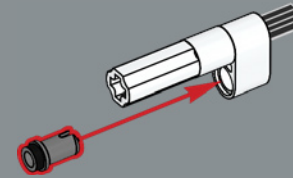

653

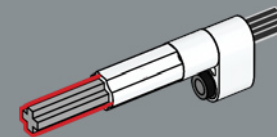

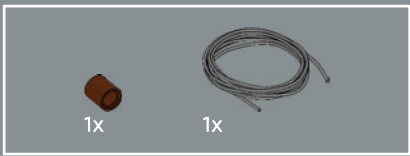

654

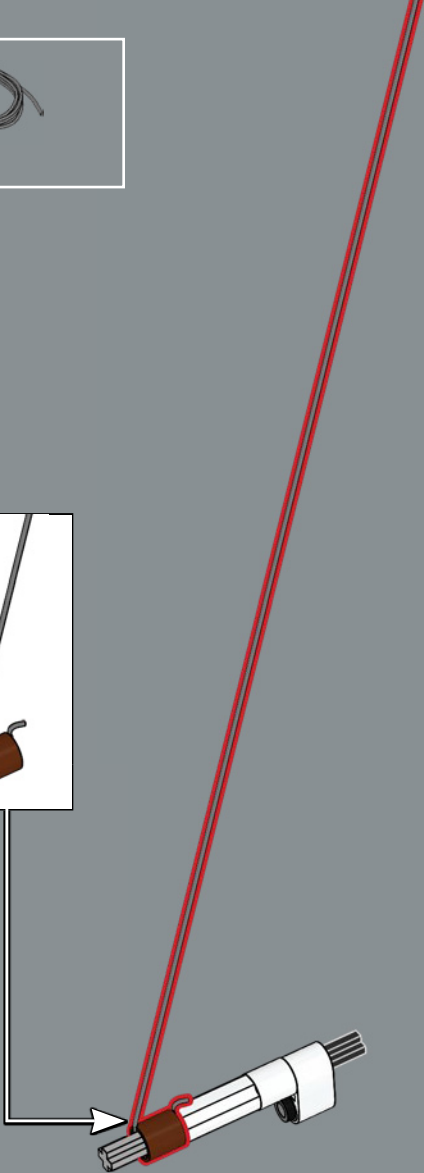
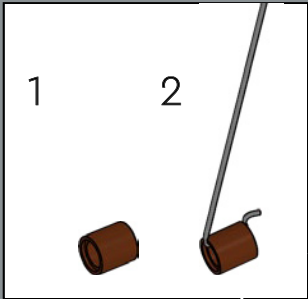

655

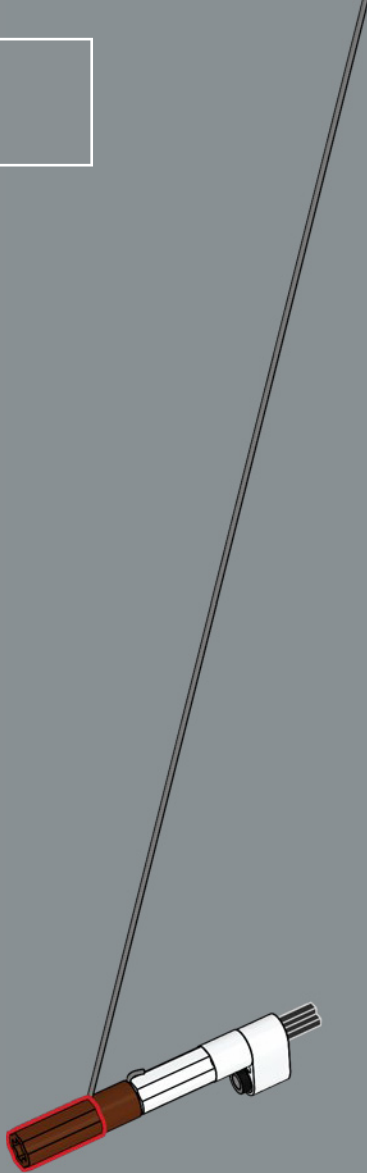

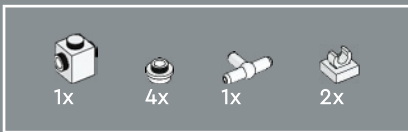

656

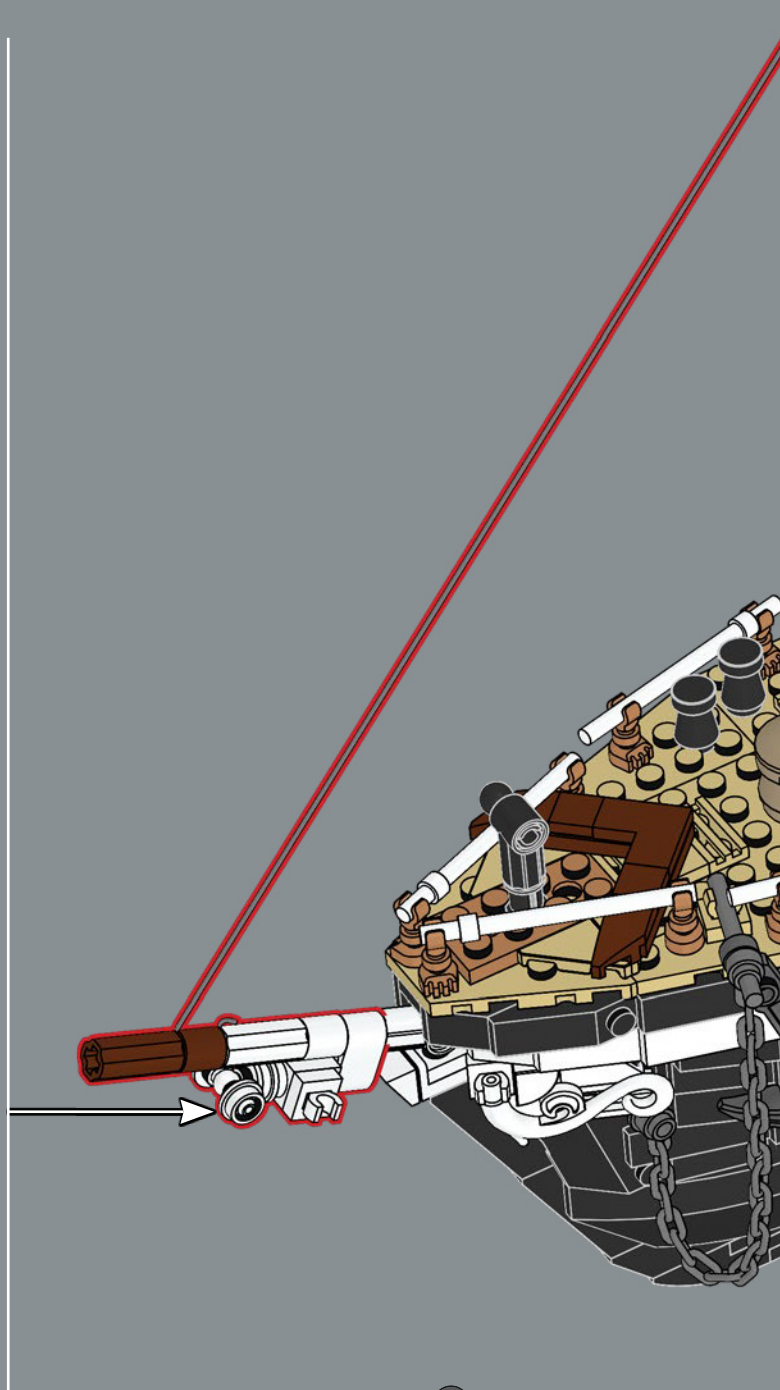
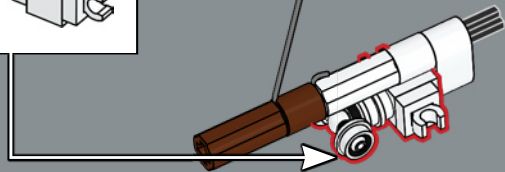
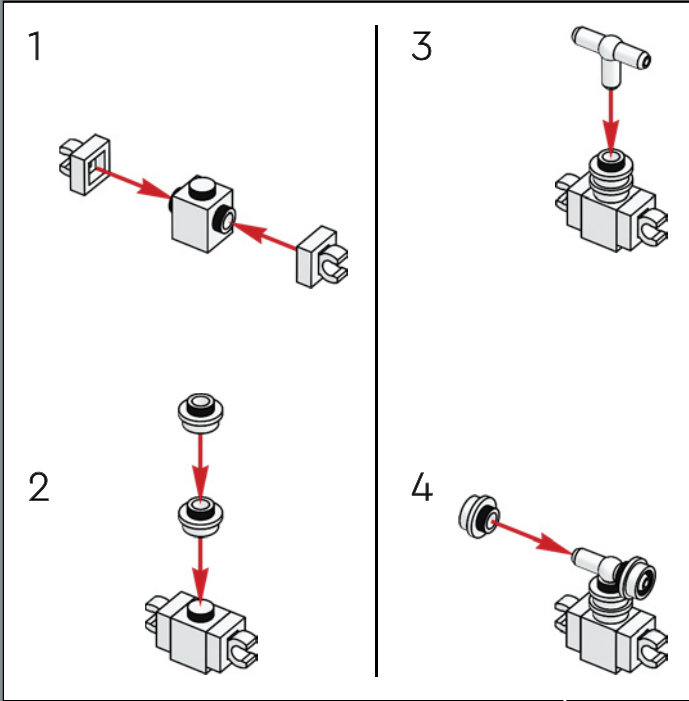



657

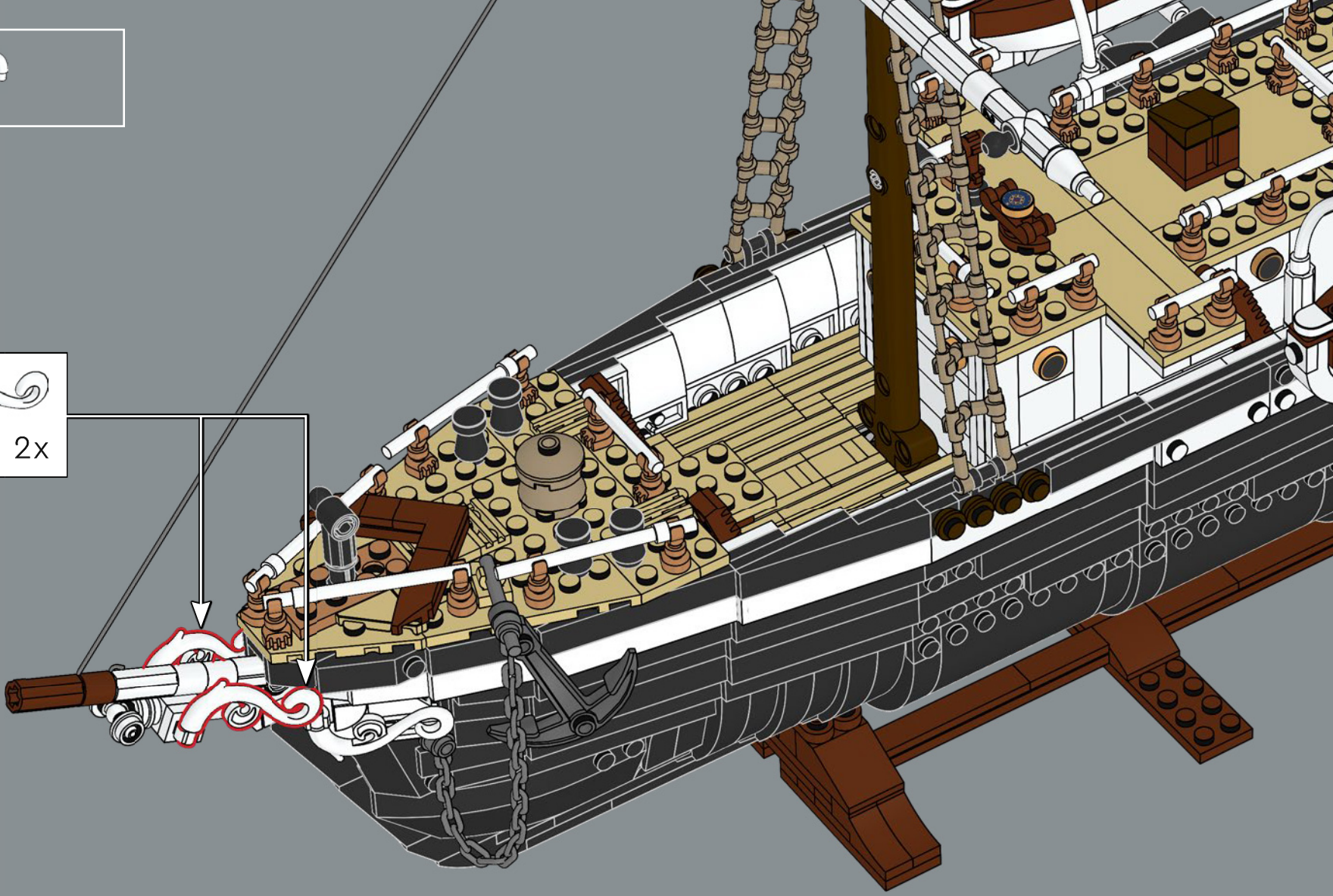
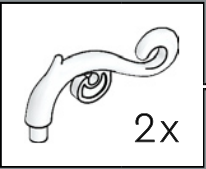

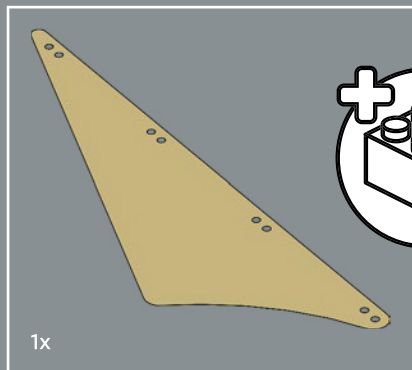

乐高®织物采用了与乐高积木相同的颜色。
对于船帆来说，棕褐色被认为是最吸引人和
最合适的颜色。

658

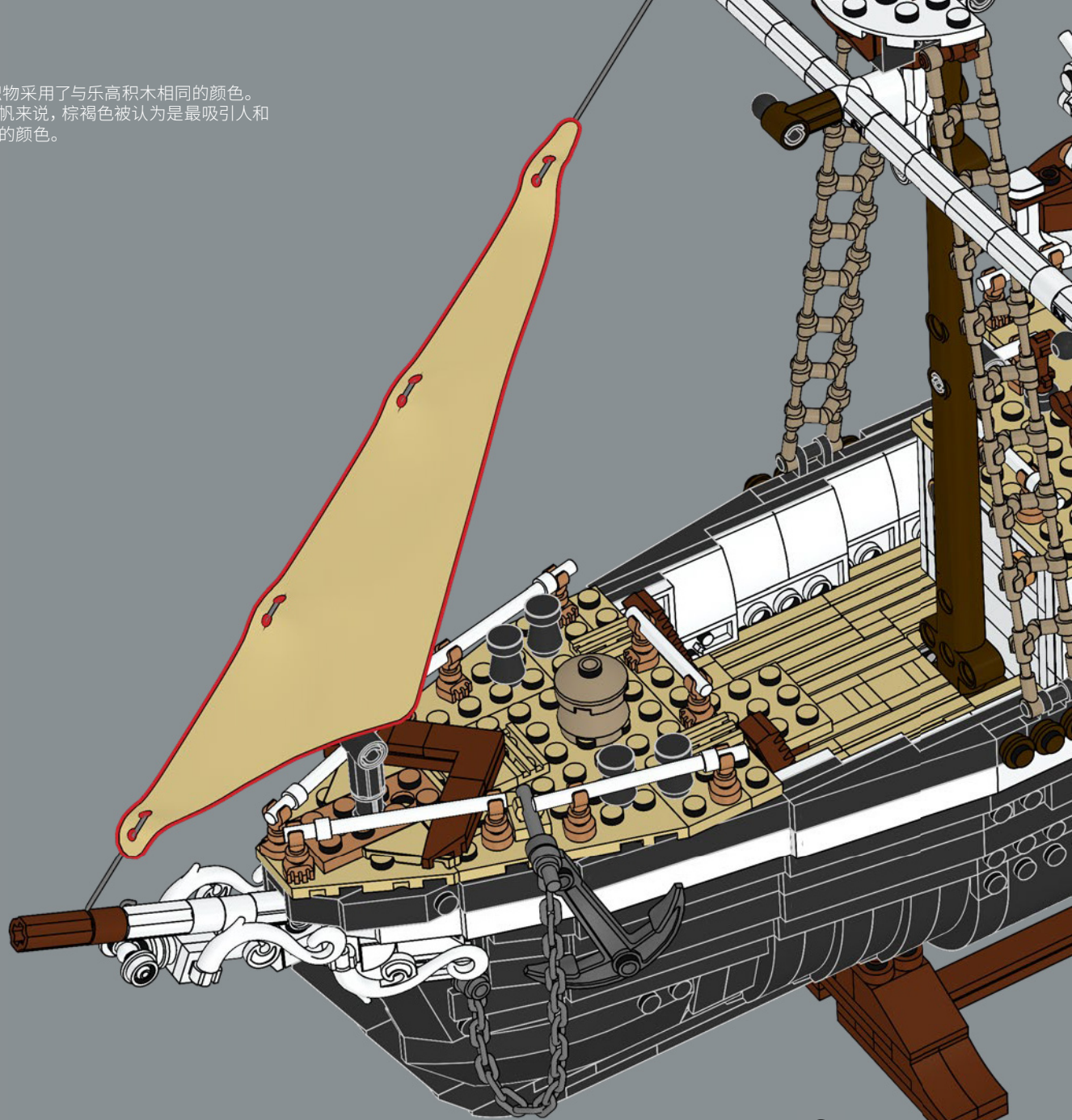

659

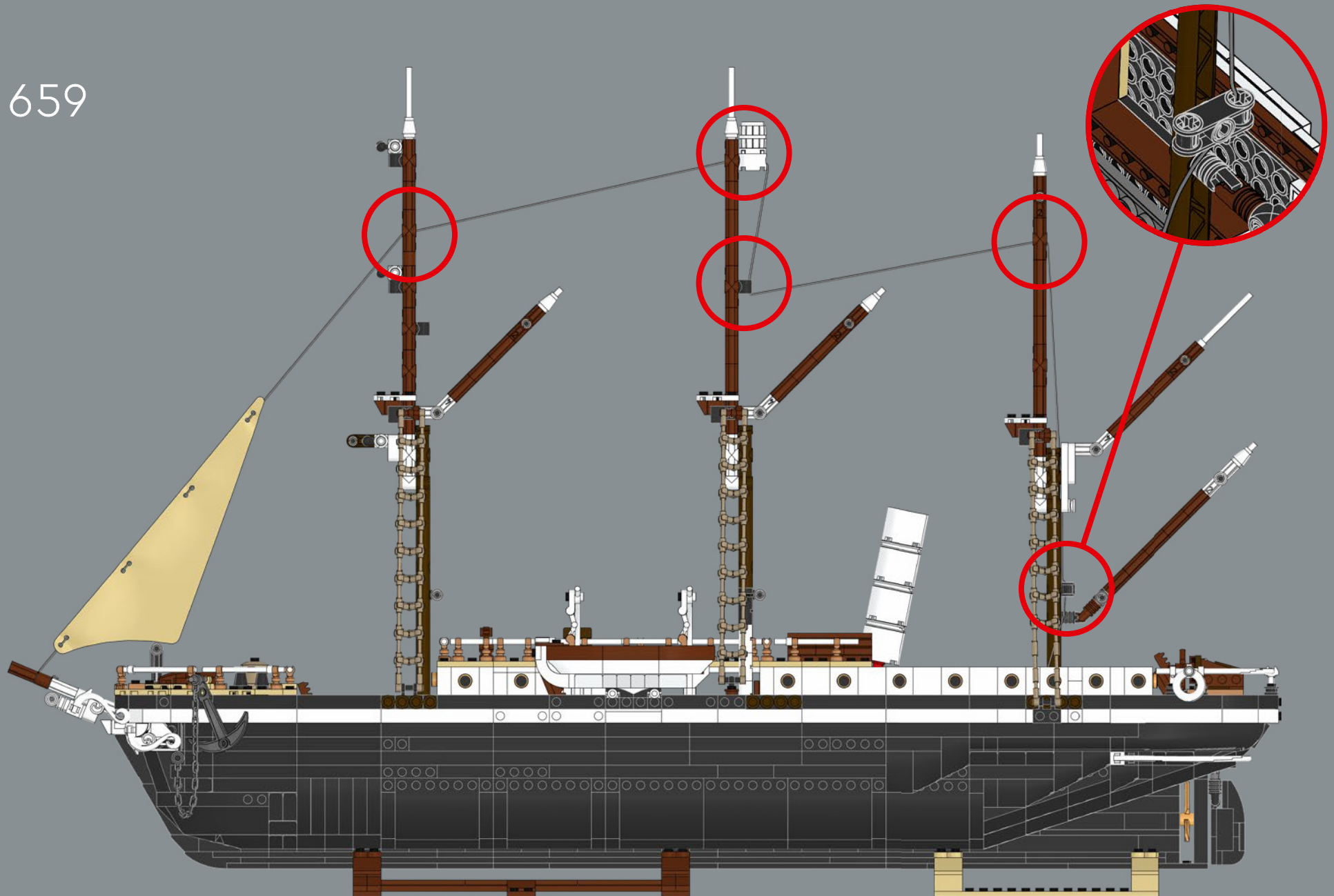

1x



660

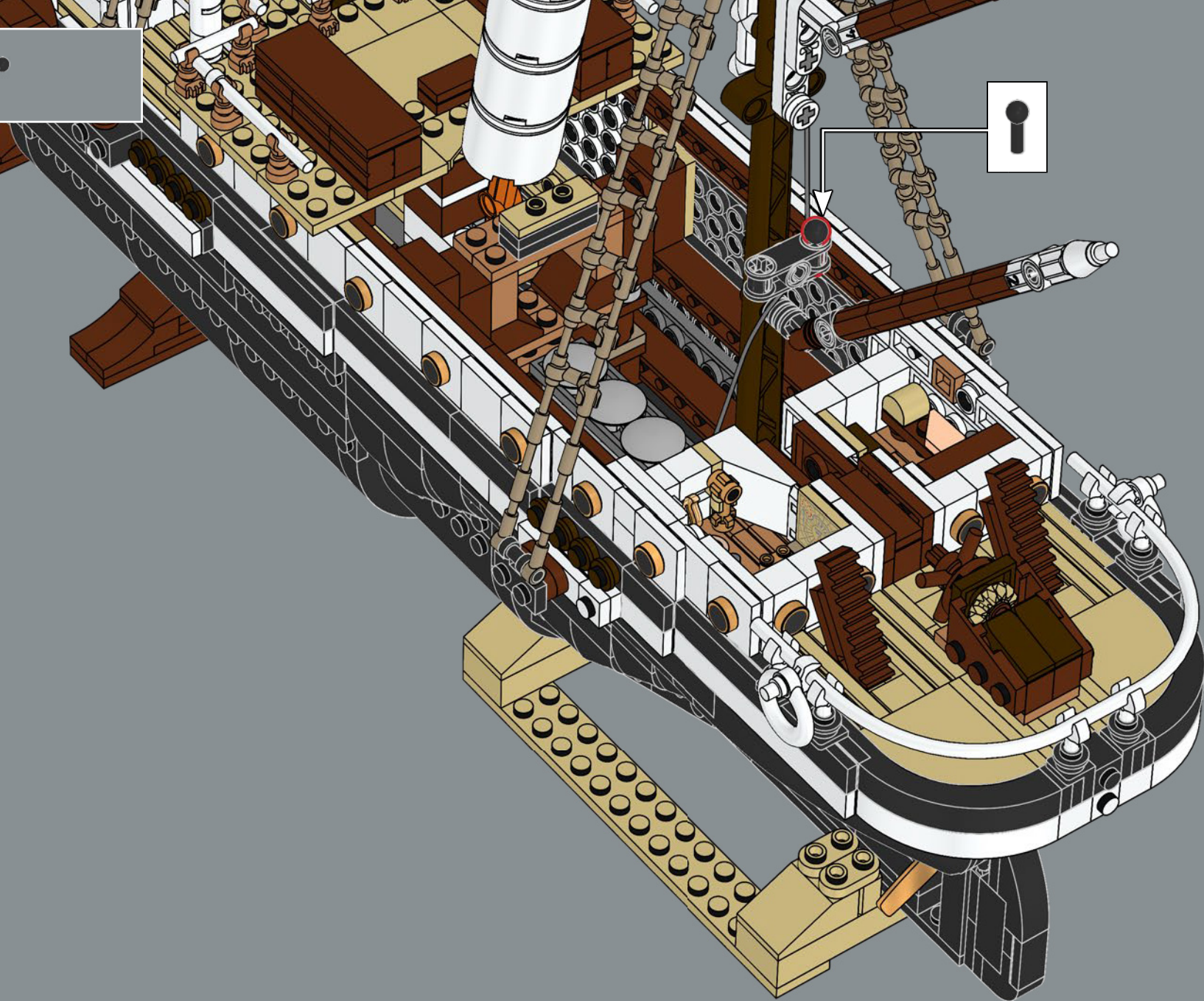

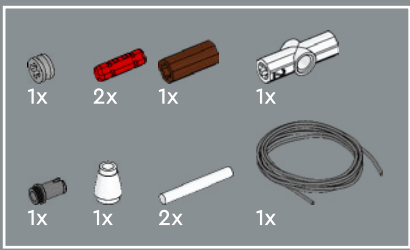

661

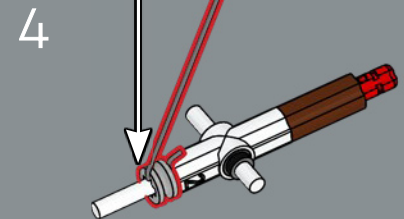
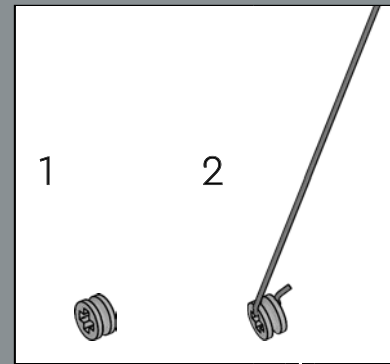
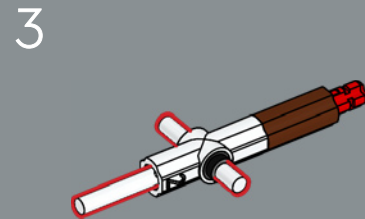
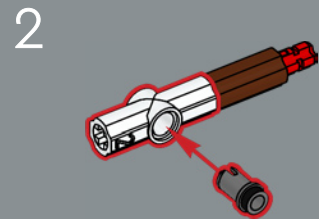
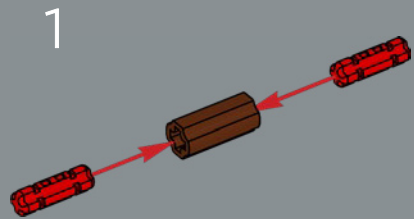

5

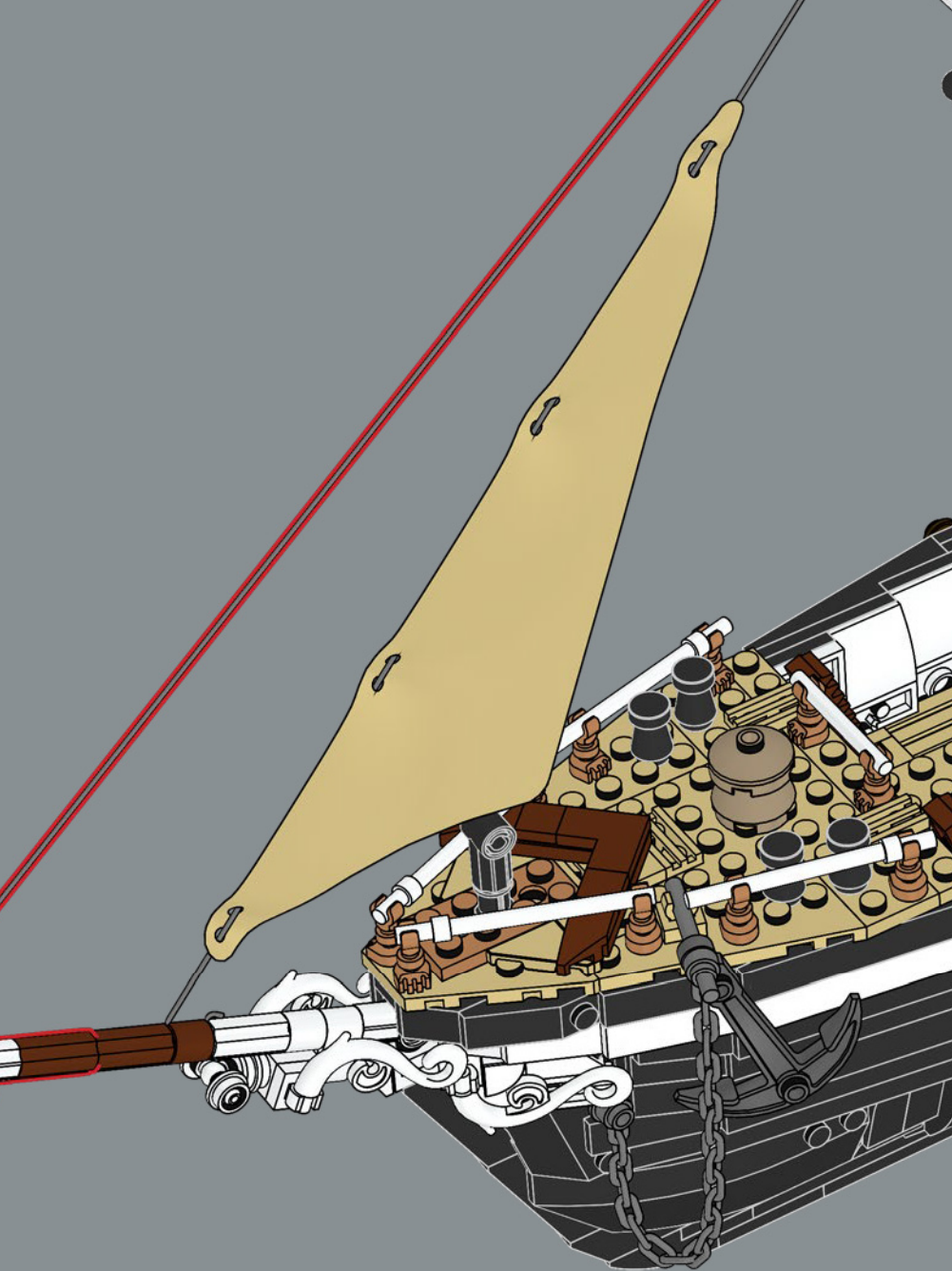
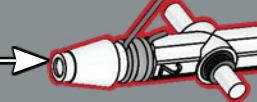
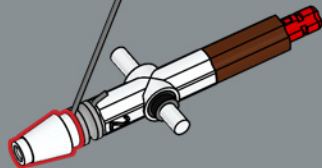

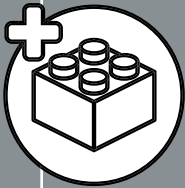
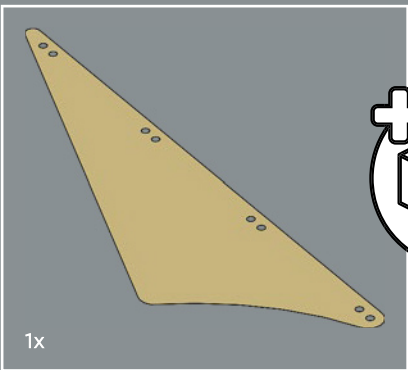

662

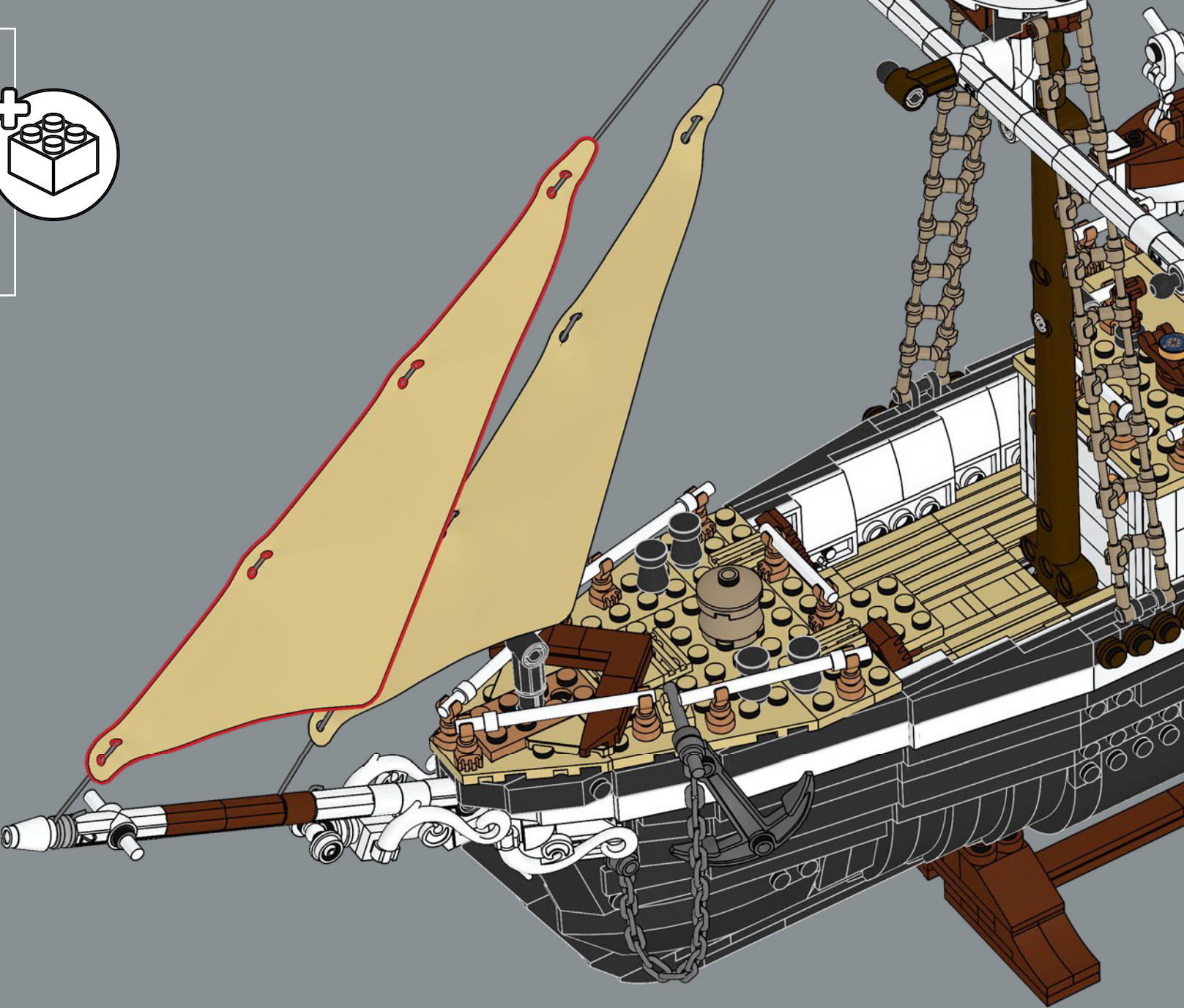

663

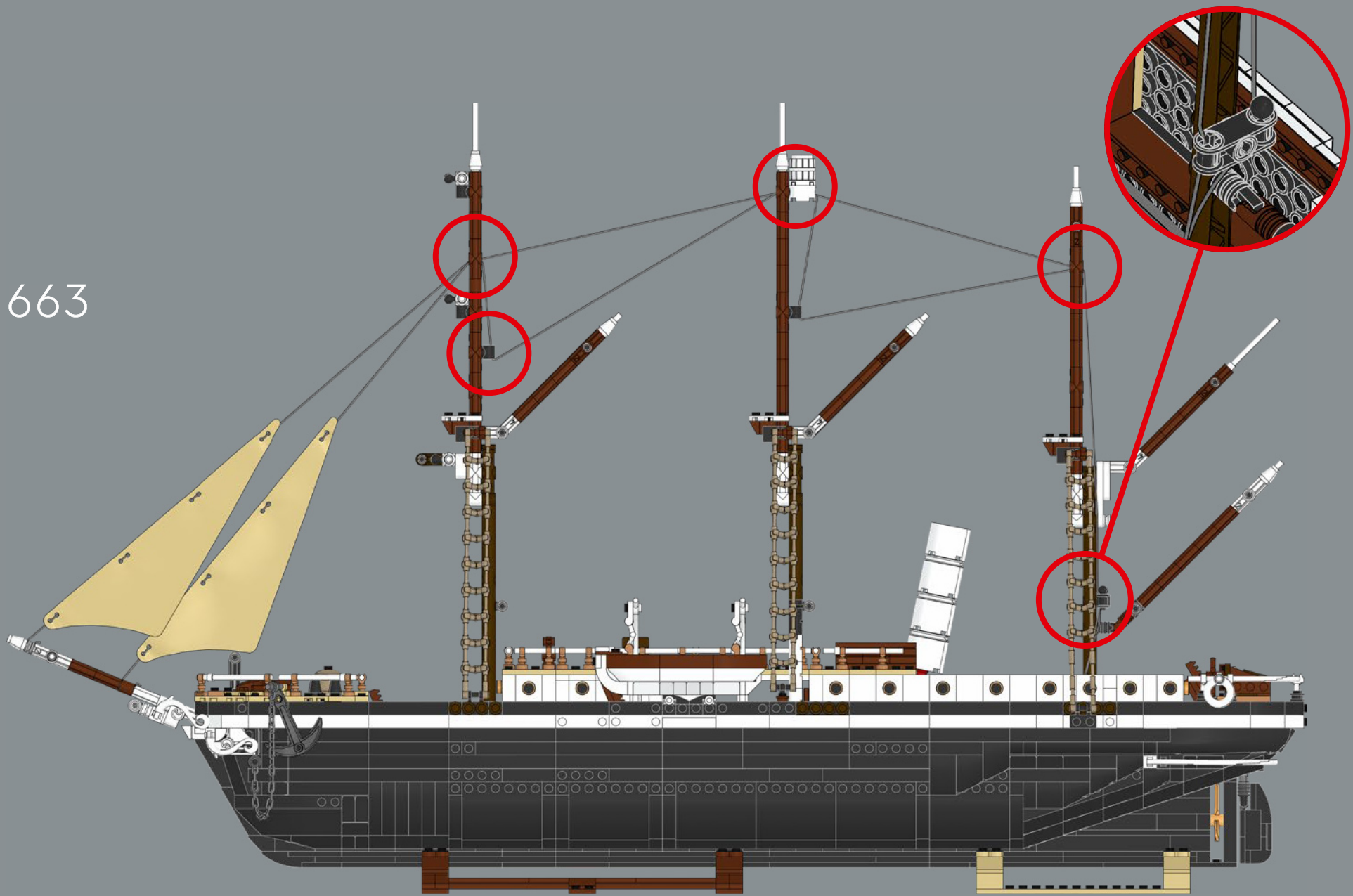



1x

664



乐高® 绳索组件经过热切割，以防止末端磨损。对于这个模型，我们找到了一种不打结和不切割的解决方案，将多余的绳子缠绕在浮标上，并藏在甲板下方。

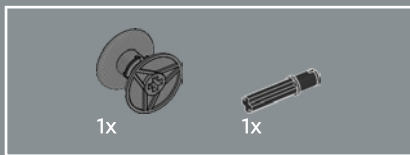

665

1

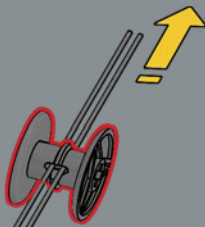

2

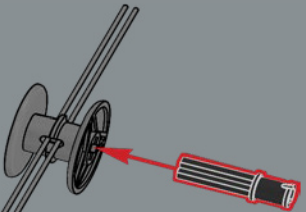

3

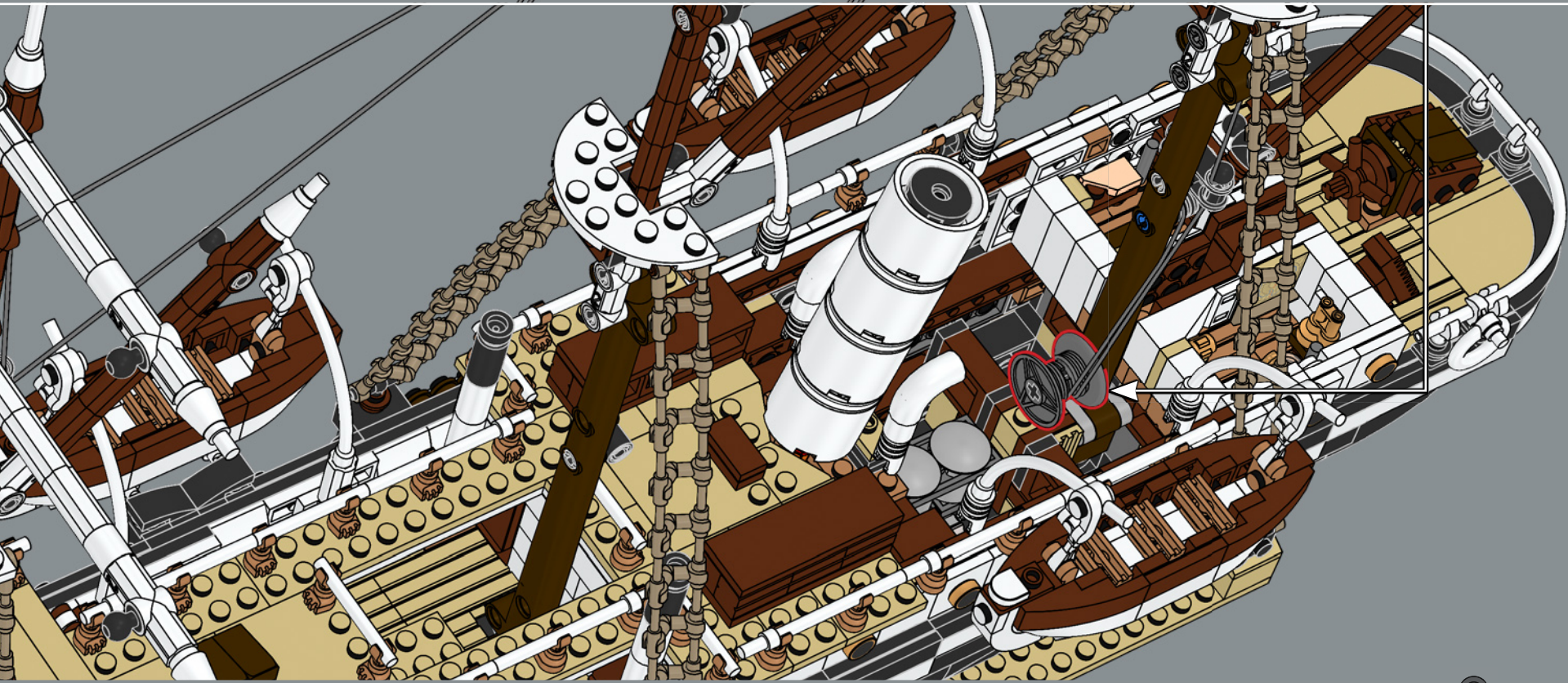

666

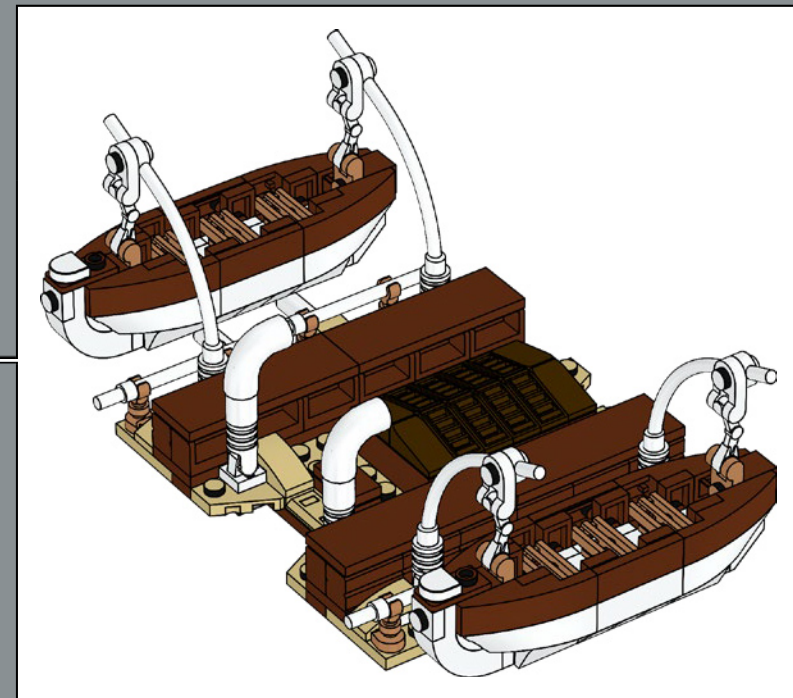
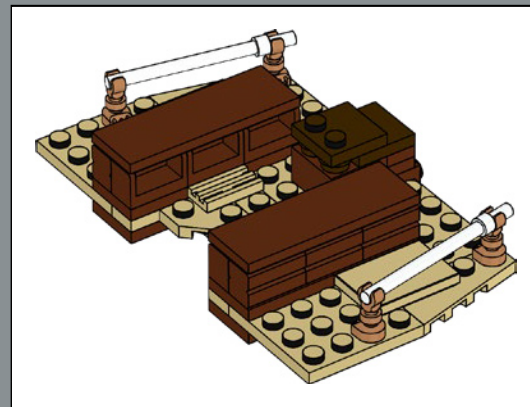
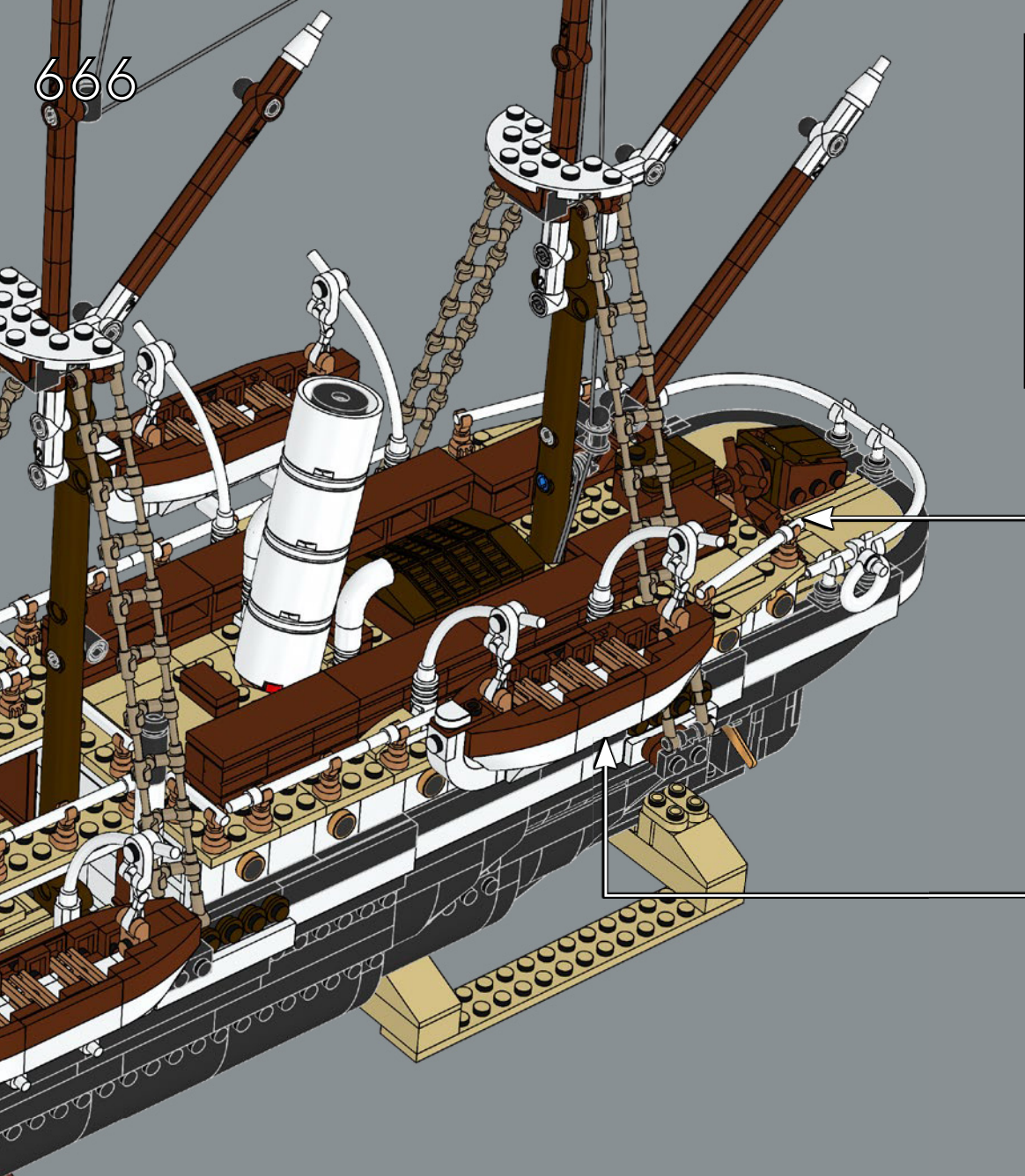

667

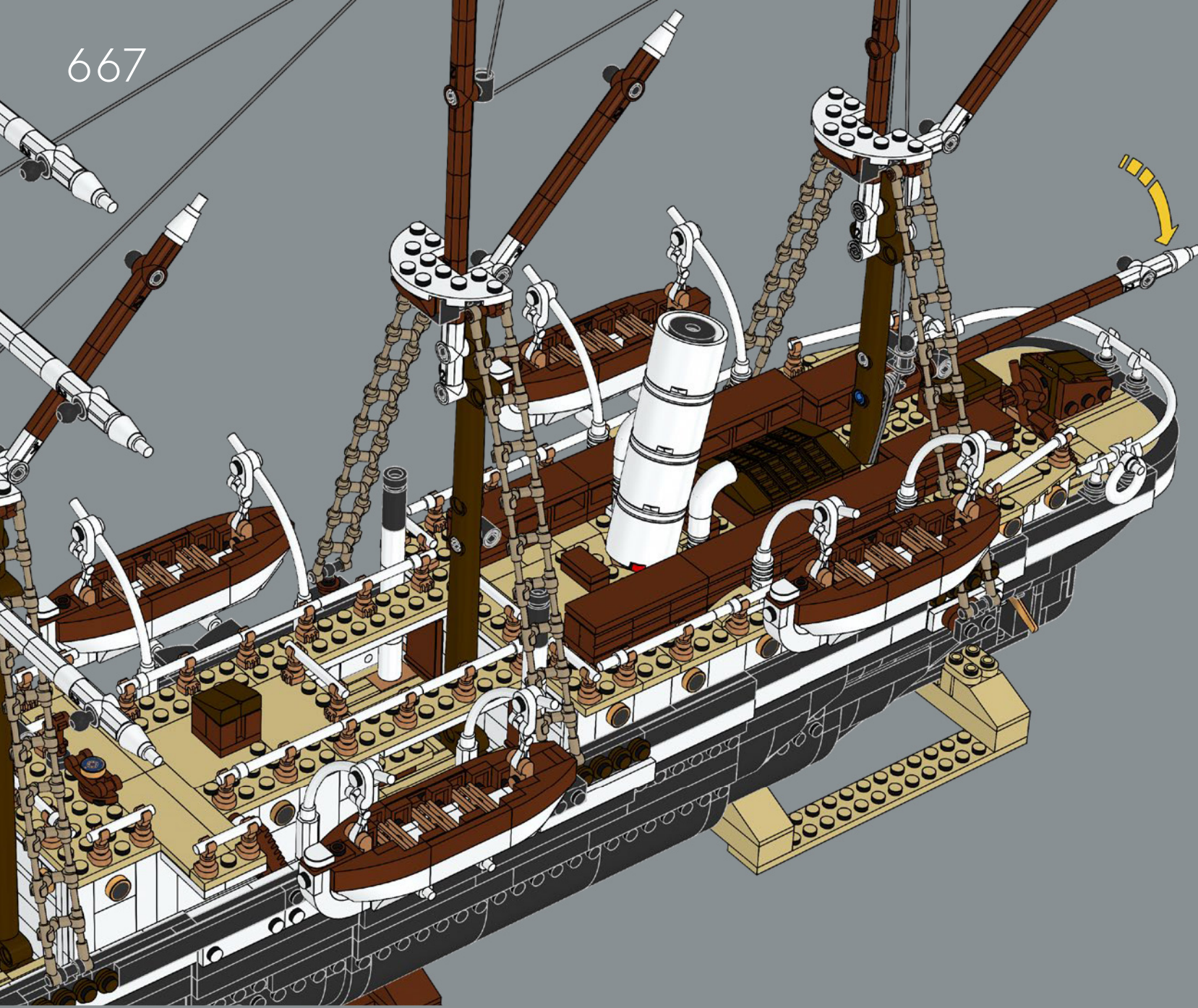

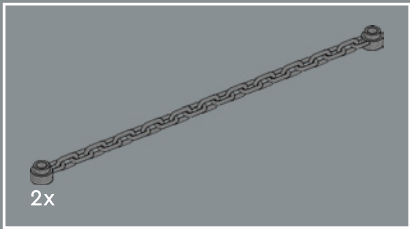

668

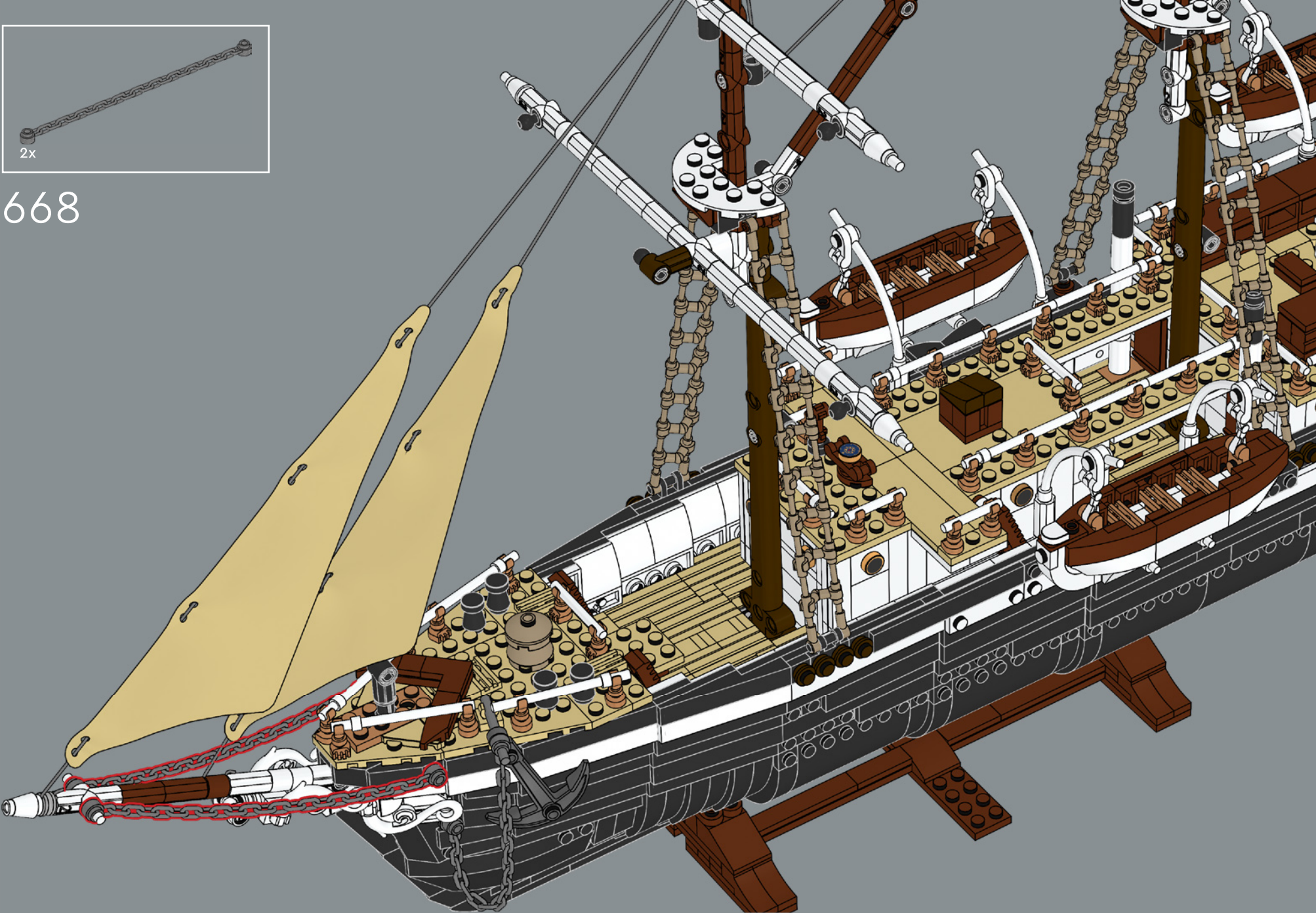

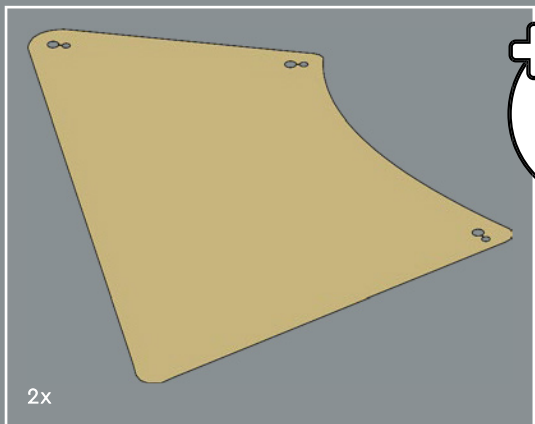

669



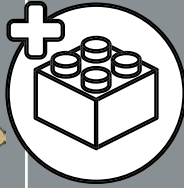
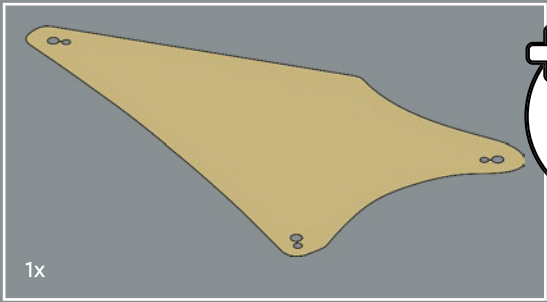

1x

670

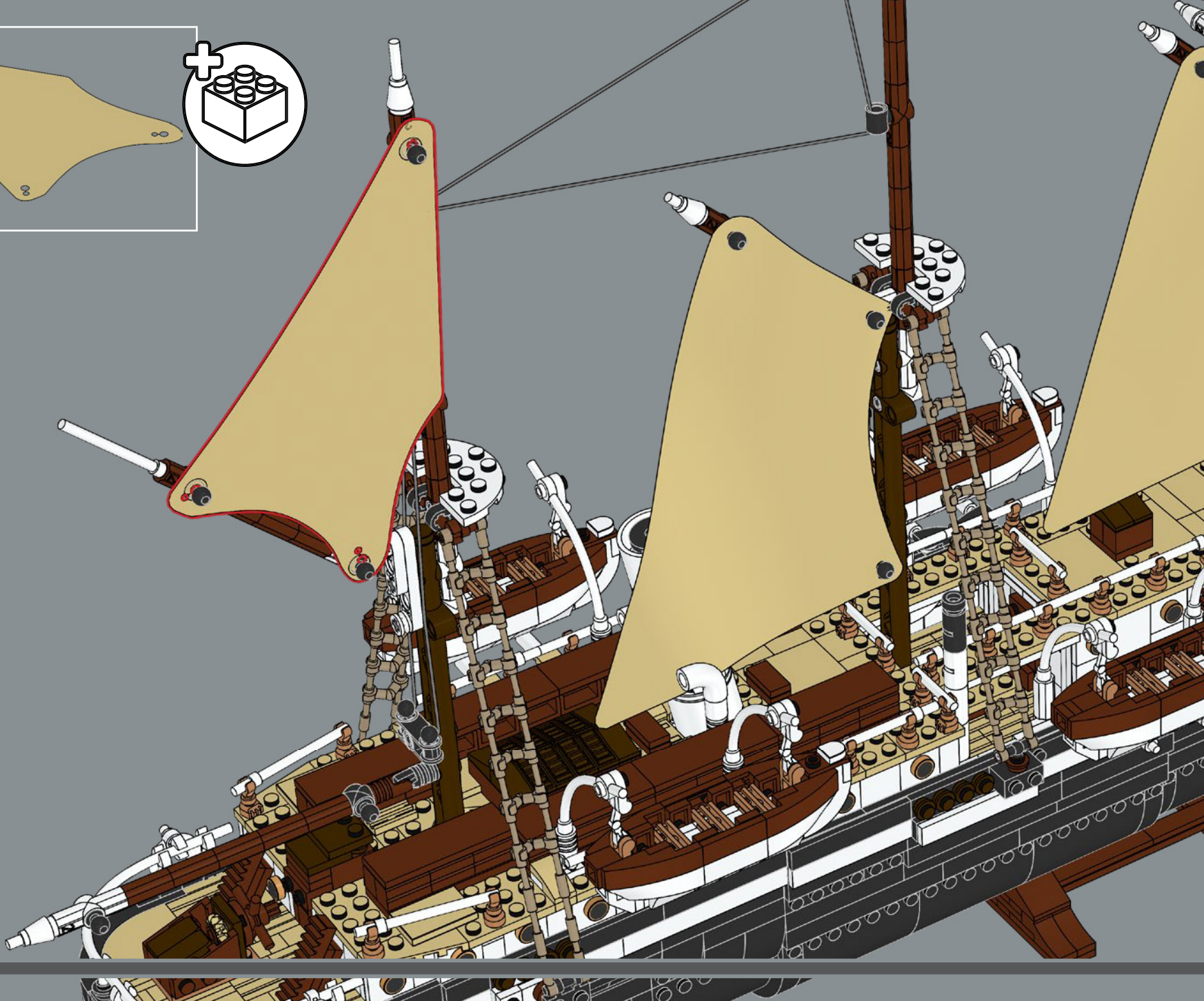

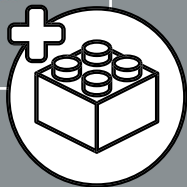

671



这面英国国旗被称为“红船旗”，是那个时期商人和私人船只悬挂的旗帜。



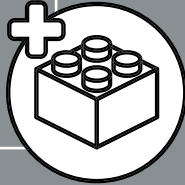
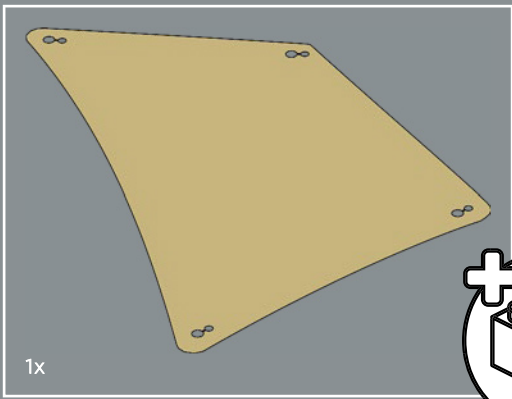

1x

672

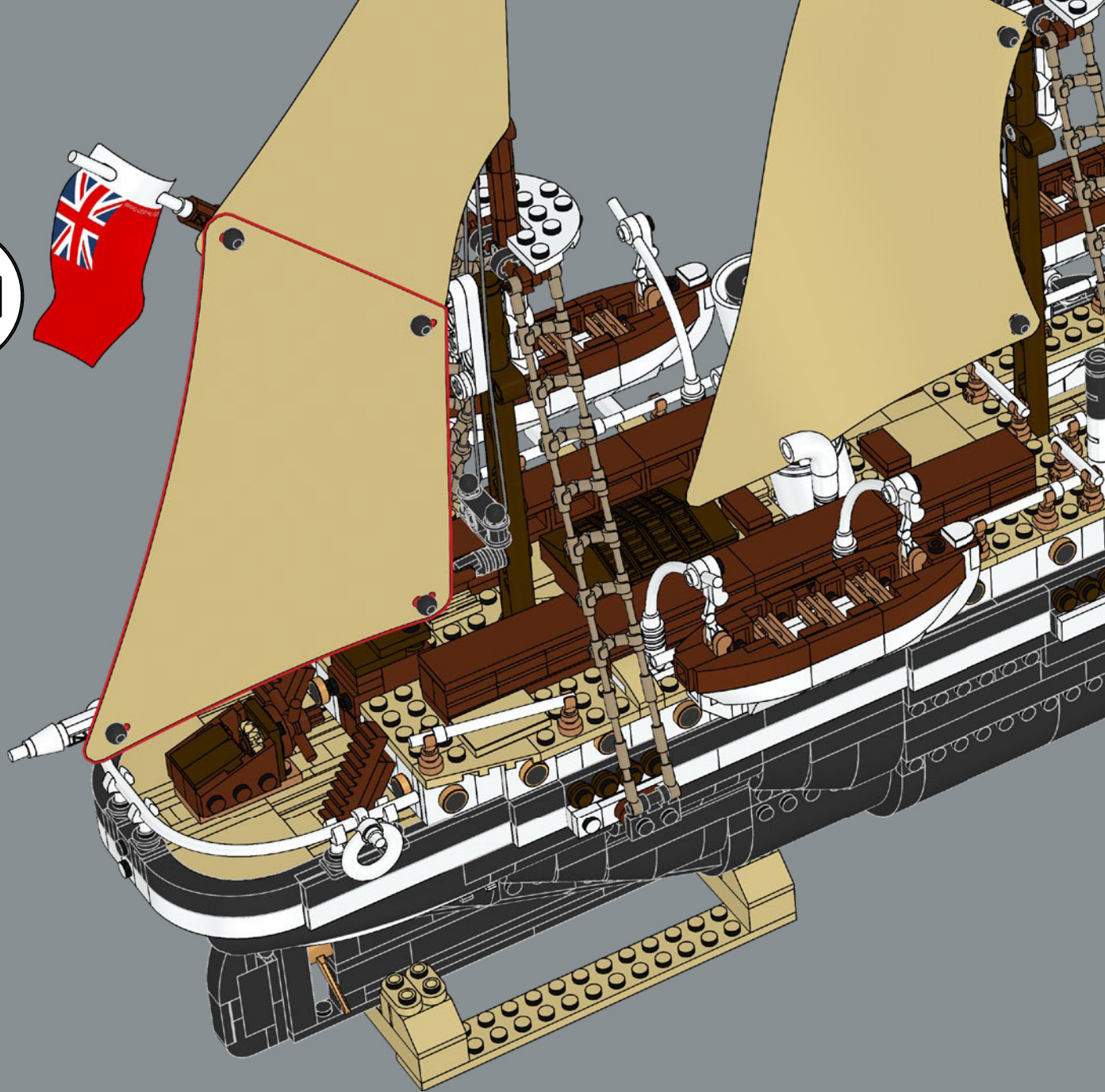

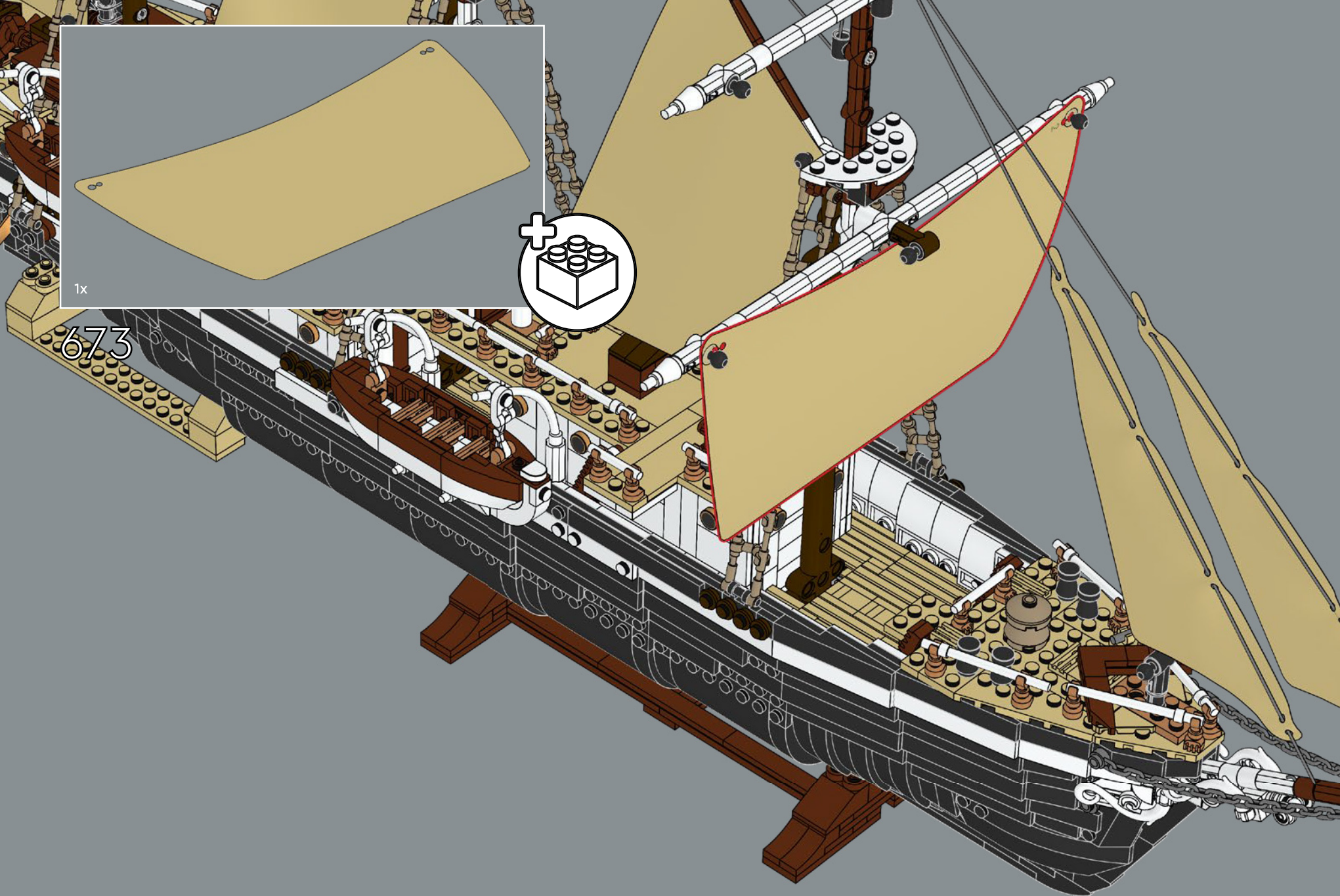

1x

673



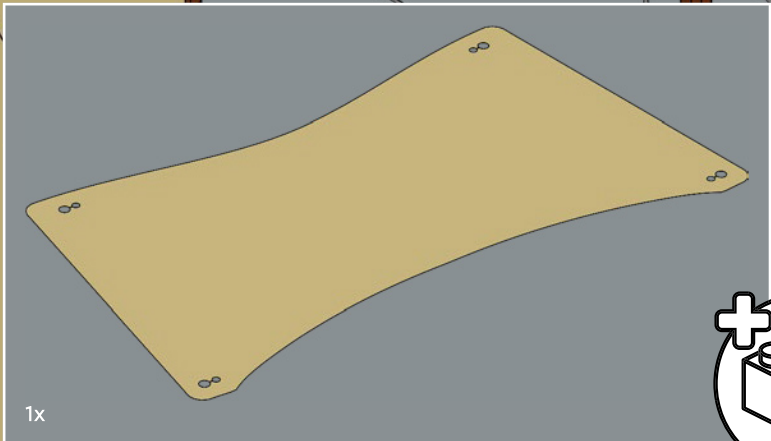

1x

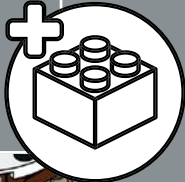

674

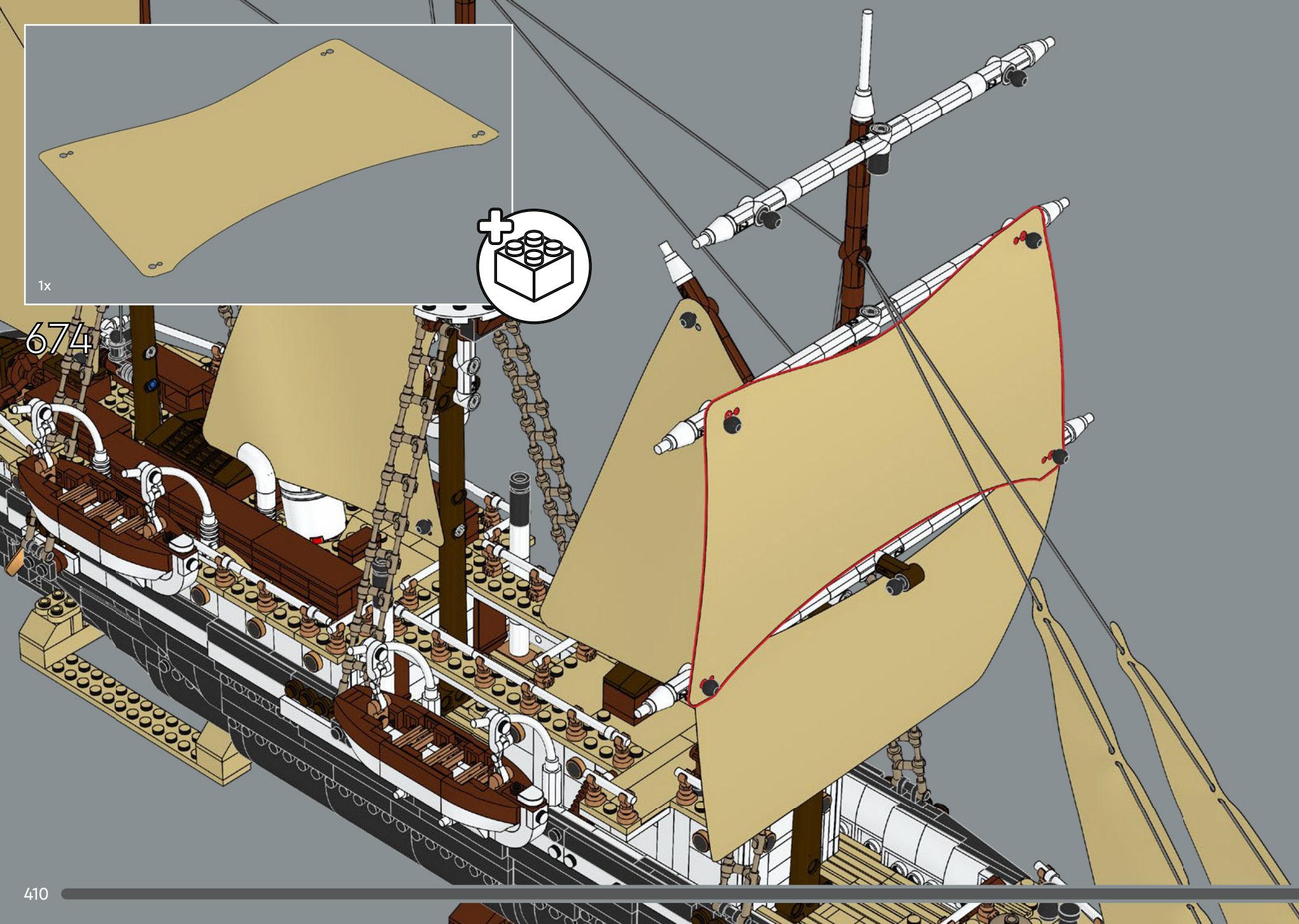

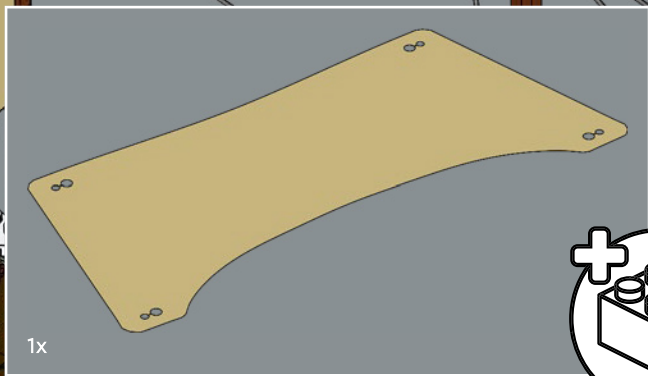

1x

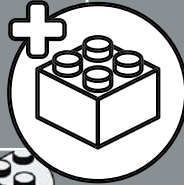

675

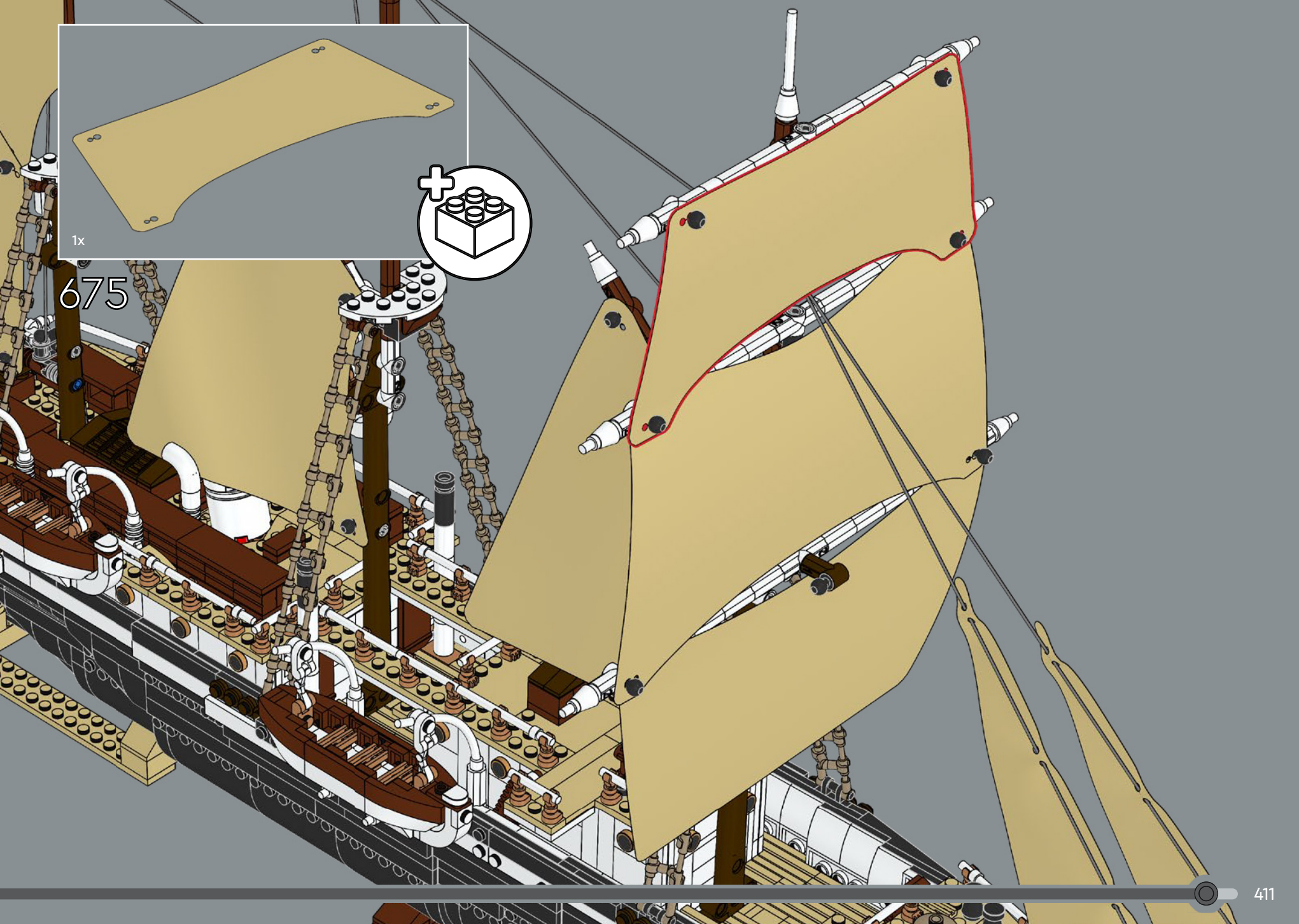

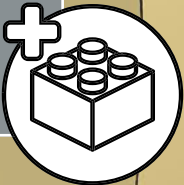
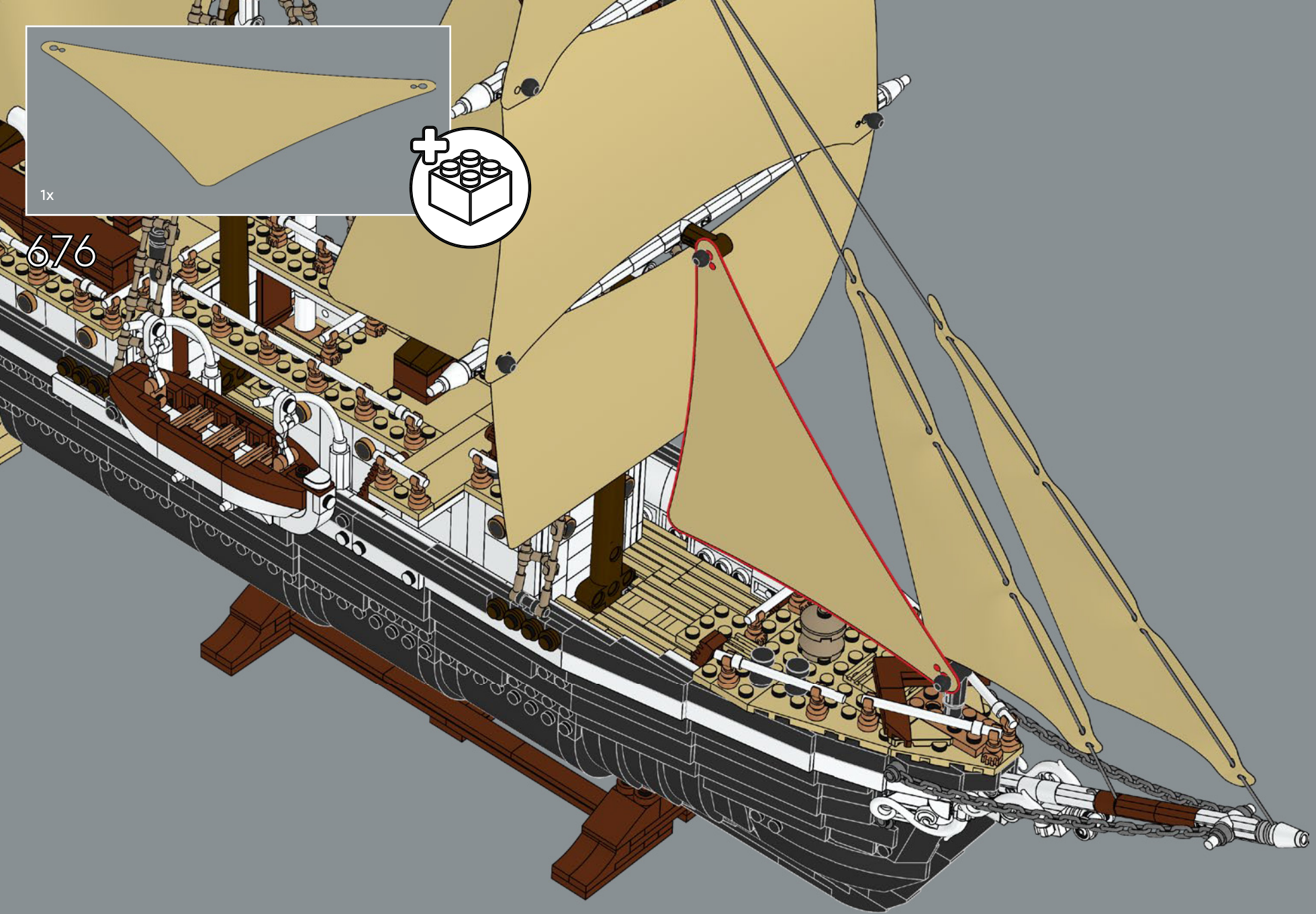

1x

676

677

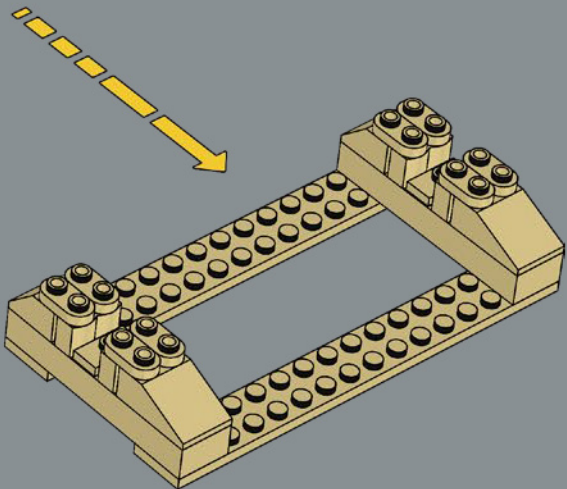
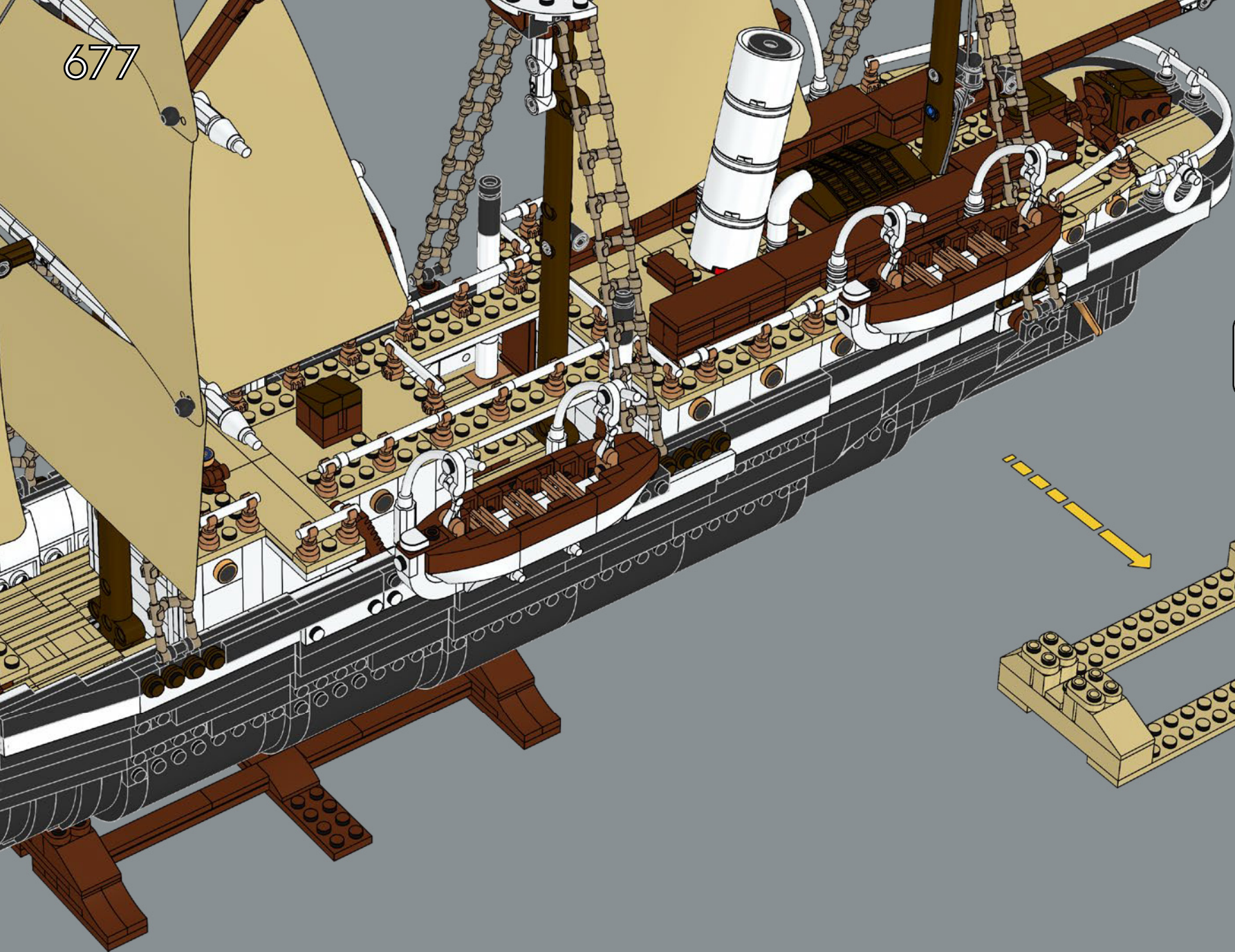

678

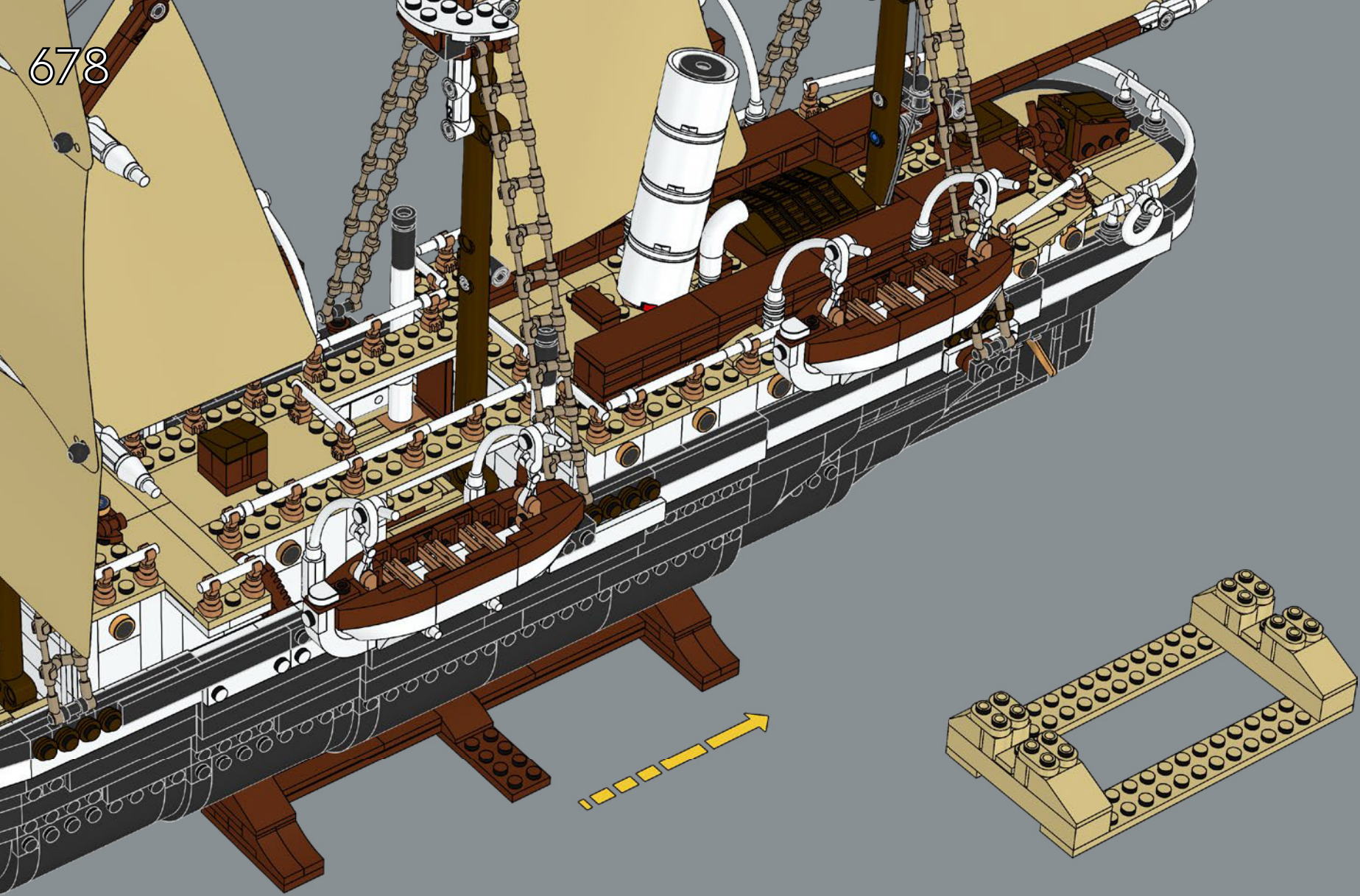

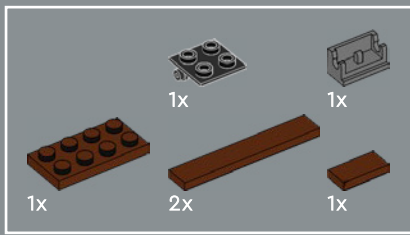

679

1

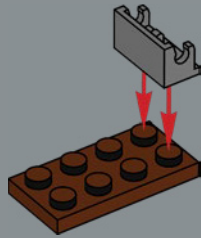

2

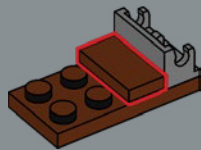

3

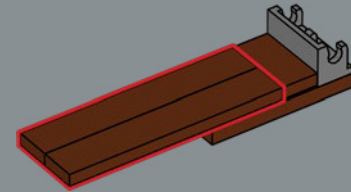

4

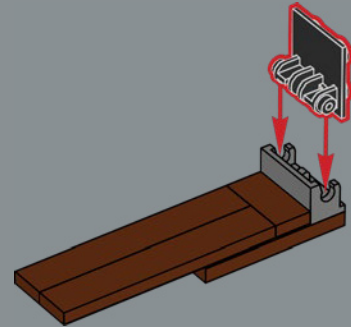

5

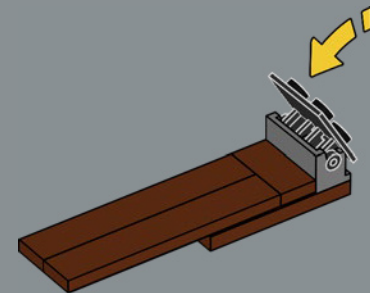

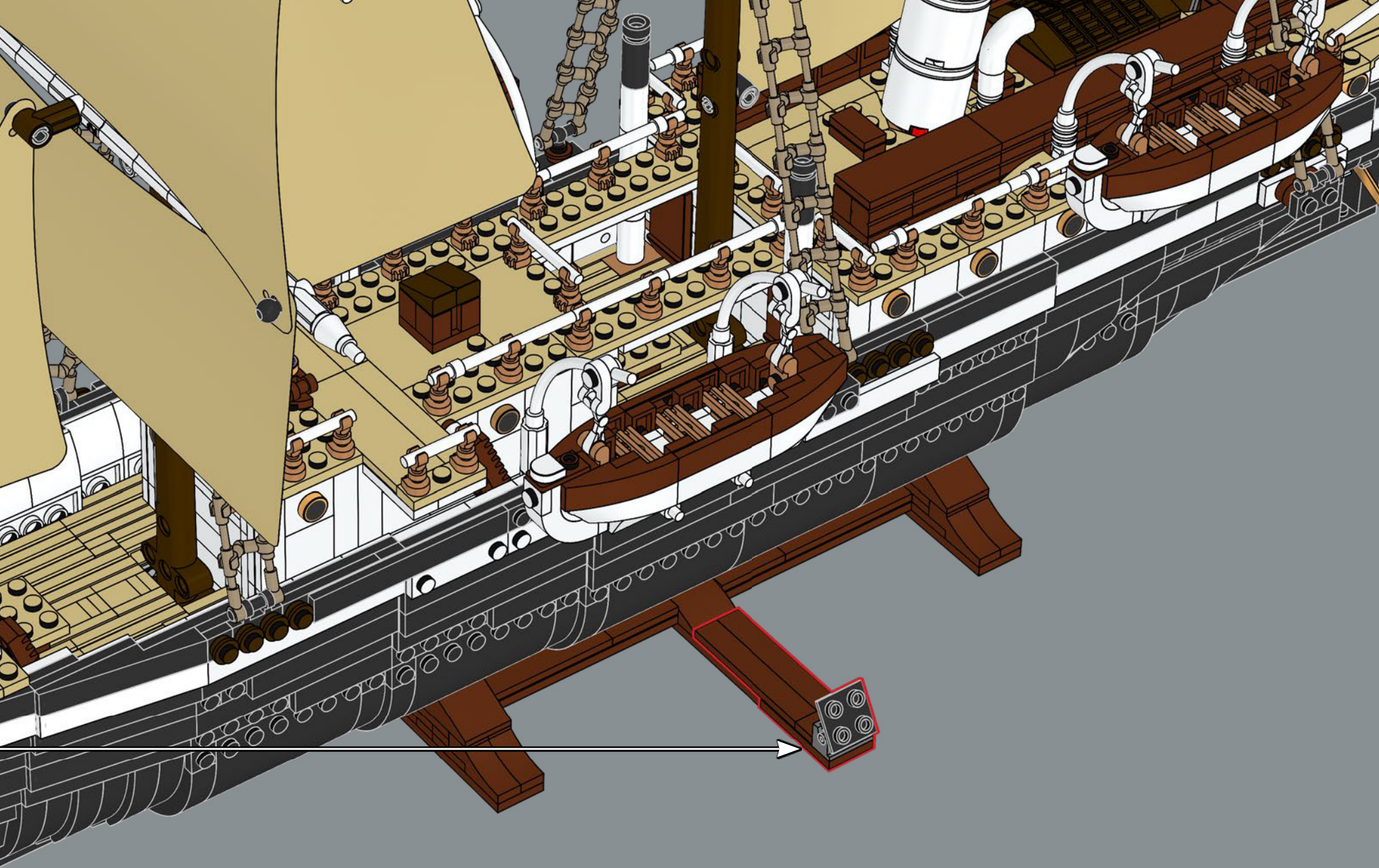

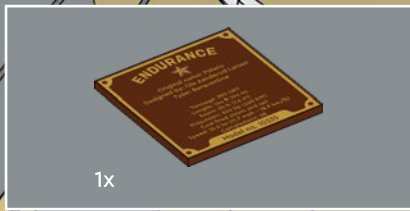

680

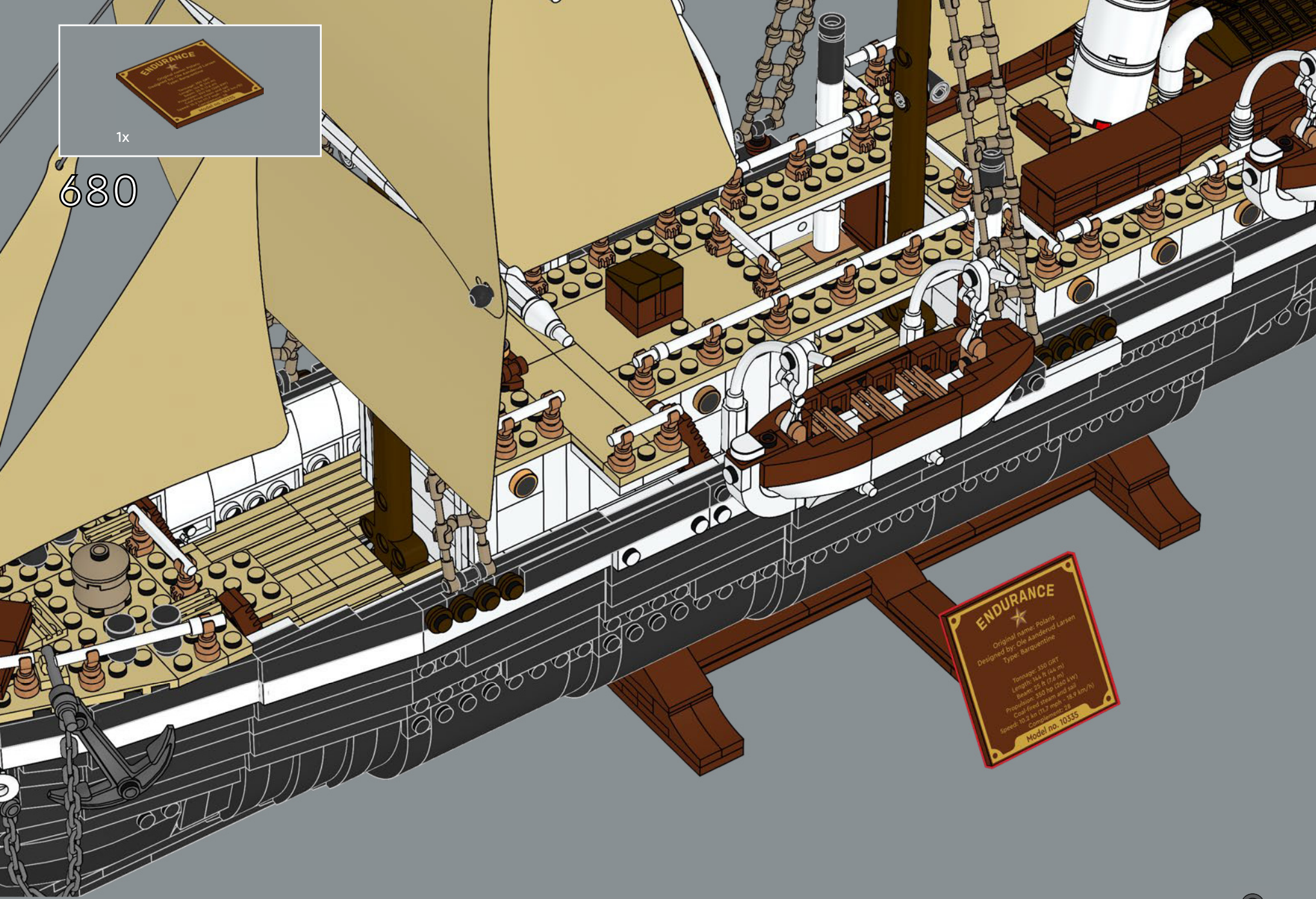

ENDURANCE
★
Original name: Polaris
Designed by: Ole Aanderød Larsen
Type: Barquentine

Tonnage: 150 GRT
Length: 116 ft (35 m)
Beam: 25 ft (7.6 m)
Crew: 300 (up to 400) (W)
Coal-fired steam and sail
Speed: 10.2 kn (11.7 mph, 18.9 km/h)
Compliment: 28
Model no. 10335

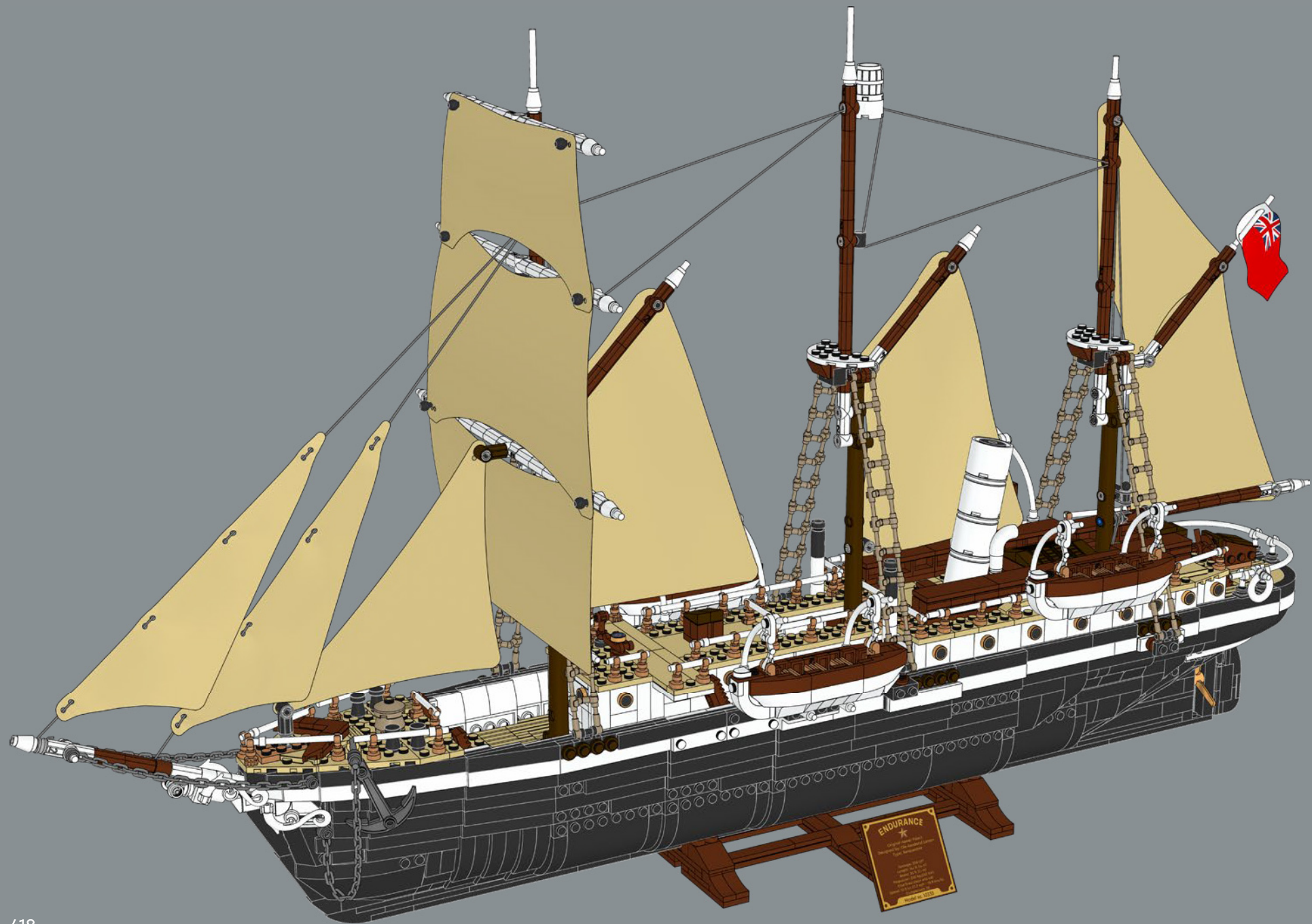

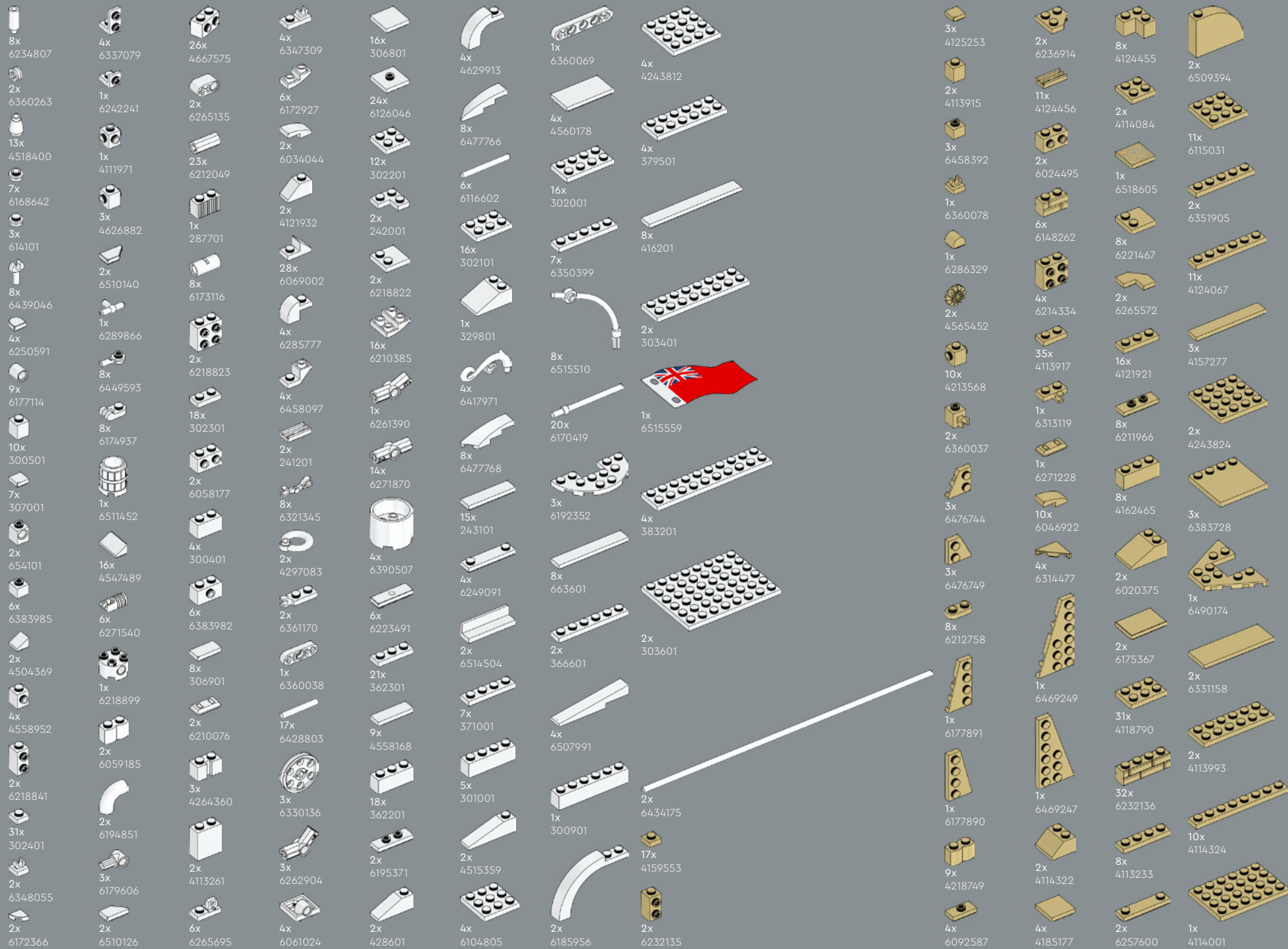

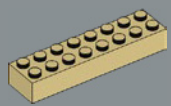

2x
6037398



3x
4143409

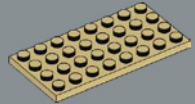

3x
4509897

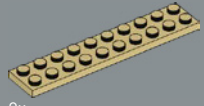

9x
4249019

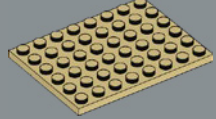

2x
6070501

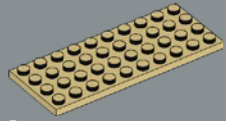

3x
6037834

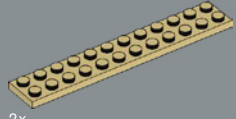

2x
6093864

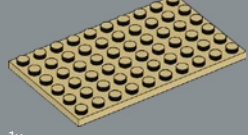

1x
4624185

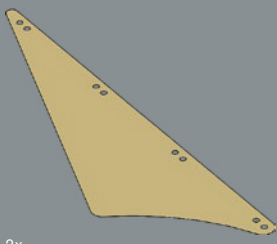

2x
6509959

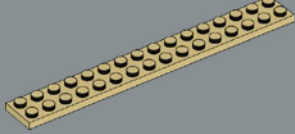

2x
6030980

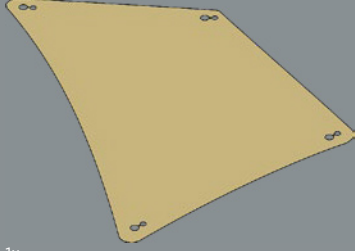

1x
6509952

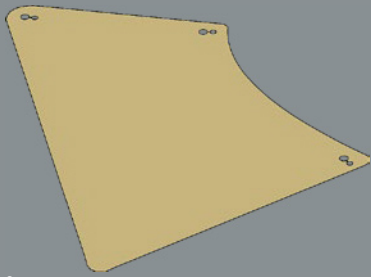

2x
6509954

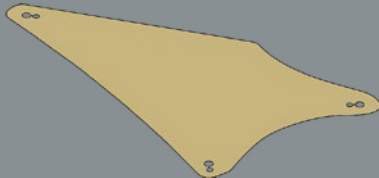

1x
6509953

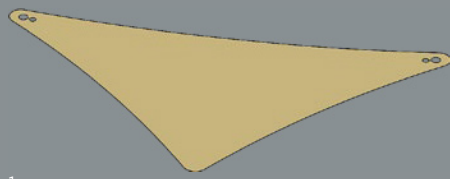

1x
6509958

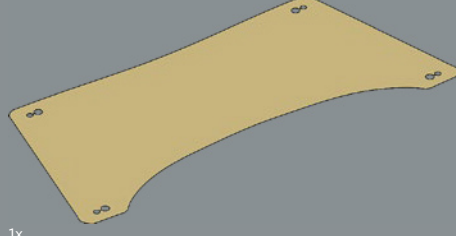

1x
6509955

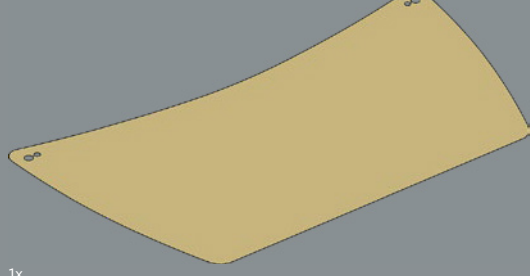

1x
6509957

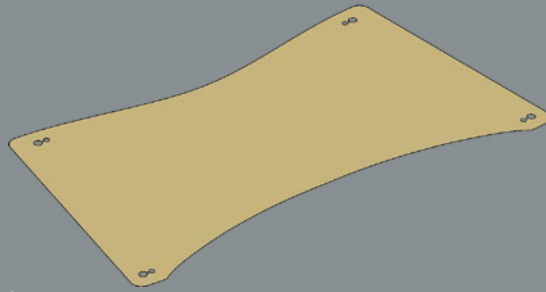

1x
6509956

2x
614121

1x
6271820

64x
4142865

1x
4142865



1x
6129995

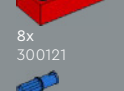

8x
300121

5x
4206482

4x
6271167

4x
6130007



1x
300124

4x
6186675

6x
6168646

4x
6284070

4x
4529236

1x
6332148

1x
6284699

8x
407026

4x
307026

22x
302426

2x
4504382

1x
654126

6x
6513918

10x
4548180

2x
6475339

18x
302326

2x
6475339

8x
242026

2x
6390749

4

5x
6388352

2x
6335388

1x
4566308

6x
6234695

3x
4214559

2x
6509664

19x
6344752

1x
6141554

2x
6104209

1x
6265699

1x
6141556

2x
4180536

2x
4180508

6x
6513918

10x
4548180

2x
6475339

8x
242026

2x
6390749

2x
6051508

4x
6477759

9x
403226

18x
6279875

1x
4109810

1x
6271535

2x
6195325

1x
6143850

4x
6507846

6x
6282140

1x
4283260

28x
4253815

2x
6173119

7x
6047276

2x
6475339

18x
302326

8x
242026

2x
6390749

2x
393726

1x
366526

8x
300426

9x
6092585

5x
306926

7x
6184784

6x
6069000

2x
4121966

4x
4140588

3x
4283047

3x
4283046

1x
6266224

1x
6396457

8x
242026

2x
6390749

2x
6390749

2x
6390749

2x
6390749

6x
303926

10x
302226

2x
6053077

2x
6390748

2x
4567436

3x
4124096

1x
6089119

1x
6276951

14x
362326

8x
428626

7x
362226

5x
4526931

1x
4251161

3x
6517676

2x
6390749





2x
4271874



1x
6511449



2x
6469351



3x
4211214



6x
6055145

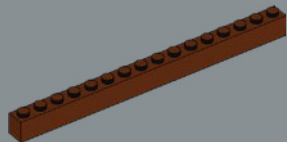

2x
6258989



[LEGO.com/service](https://www.LEGO.com/service)

1x
6271165

2x
6275844

4x
6225242

6x
4211476

2x
4211389

1x
6329584

1x
6253856

2x
6248890

1x
6227897

1x
4211807

3x
4278273

3x
4211526

1x
6092956

1x
4512360

3x
6066097

4x
6123809

2x
6383177

6x
4211398

1x
4211470

1x
6004990

2x
6360043

10x
4211387

4x
4211397

9x
4211815

1x
4211536

4x
4211429

1x
6381253

6x
6093058

1x
4211773

8x
4211394

8x
4211425

8x
4251149

2x
6178172

2x
4211522

3x
6092572

2x
6310596

6x
4210635

4x
4211090

6x
6231765

2x
6439040

4x
6395635

3x
6362259

7x
6344022

2x
6388133

1x
6225494

1x
4211042

1x
6115080

1x
6514456

2x
6230233

1x
4211066

3x
6092572

2x
6310596

6x
4210635

3

11

55

8

2x
6405646

6x
6015356

2x
4211133

3x
6365692

1x
4239891

1x
6378143

12x
4211043

4x
4211105

8x
4211001

1x
4211103

13x
6039176

2x
6431485

1x
4508553

11x
4211002

2x
4499858

1x
4211099

2x
4211114

3x
6258887

1x
6510133

32x
6511448

1x
6287847

2x
6186672

1x
6328909

1x
6034543

1x
6490722

32x
6315780

3x
6322813

1x
6332586

8x
6509391

8x
6509392

1x
4566688

2x
6058221

2x
6347604

1x
6515036

1x
6331950

3x
6258887

1x
6510133

32x
6511448

1x
6287847

2x
6186672

1x
6328909

1x
6034543

1x
6490722

32x
6315780

3x
6322813

1x
6332586

3x
6314190

3x
6457557

4x
6215606

2x
6474266

12x
6324205

2x
6360035

10x
4651231

2x
6192920

22x
6218360

2x
6431328

4x
6411587

2x
4656783

12x
6452541

8x
6167699

1x
6336665

3x
6057986

1x
6336665

1x
6452863

4x
6055309

1x
6257605

2x
6489195

31x
6343854

2x
6313600

4x
6208446

1x
6474270

1x
6474270

1x
6474270

1x
6474270

1x
6474270

1x
6474270

1x
6474270

1x
6474270

1x
6474270

1x
6474270

1x
6474270

1x
6474270



YOU COULD WIN



YOU COULD WIN

Your feedback will help shape the future development of this product series.

Visit:

DU KÖNNTEST GEWINNEN

Dein Feedback trägt zur Weiterentwicklung dieser Produktreihe bei.

Geh auf:

VOUS POURRIEZ GAGNER

Vos commentaires nous aideront à concevoir les futurs produits de cette gamme.

Visitez :

POTRESTI VINCERE TU

La tua opinione ci aiuterà a migliorare la creazione futura di questa linea di prodotti.

Visita:

PUEDES GANAR

Tu opinión contribuirá al futuro de esta serie de productos.

Visita:

轻松获奖

您的反馈将有助于我们在今后改进本产品系列。

请访问:

[LEGO.com/productfeedback](https://www.lego.com/productfeedback)

You also have the chance to win a LEGO® set.

Terms and conditions apply.*

Außerdem hast du die Chance, ein LEGO® Set zu gewinnen.

Es gelten die Teilnahmebedingungen.*

Vous pourriez également gagner un ensemble LEGO®.

Des conditions s'appliquent.*

Hai anche la possibilità di vincere un set LEGO®.

Termini e condizioni sono applicabili.*

También tienes la oportunidad de ganar un set LEGO®.

Aplican términos y condiciones.*

您还有机会赢取乐高®套装。

条款和条件适用。*

*[LEGO.com/productfeedback-terms](https://www.lego.com/productfeedback-terms)



LEGO and the LEGO logo are trademarks of the LEGO Group.
©2024 The LEGO Group.