



10335







LEGO.com/sustainable-packaging



FR  
**DONNEZ**  
OU  
**RECYCLEZ**



ASSOCIATION

OU



MAGASIN

OU



DÉCHÈTERIE

Adresses sur [quefairedemesdechets.fr](http://quefairedemesdechets.fr)



# BUILDER



Apple and the Apple logo are trademarks of Apple Inc., registered in the U.S. and other countries and regions. App Store is a service mark of Apple Inc. Google Play and the Google Play logo are trademarks of Google LLC. Tencent and the Tencent logo are trademarks of Tencent Inc.

LEGO.com/devicecheck



LEGO® Builder





# Wiederentdeckung der *Endurance*

Ausgerechnet im Jahr des 100. Todestags von Sir Ernest Shackleton wurde 2022 das Wrack seines legendären Schiffs *Endurance* vor der Antarktisküste am Grund des Weddell-Meereres entdeckt. Die einstmalige Luxusjacht lief im Jahr 1912 vom Stapel und wurde generalüberholt, um den menschenfeindlichsten Bedingungen zu trotzen und ihre Mannschaft auf Shackletons Imperial Trans-Antarctic Expedition im Jahr 1914 vor den Elementen zu schützen. Das waghalsige Unterfangen, die Antarktis zu durchqueren, scheiterte, weil die *Endurance* im Polareis versank, bevor sie das Ufer erreichte. Das Überleben ihrer Mannschaft wurde jedoch zu einer der inspirierendsten Geschichten des letzten Jahrhunderts. Sie erzählt von dem Durchhaltevermögen, dem Einfallsreichtum und der Kameradschaft der Crew. Die *Endurance* wird ihren letzten Ruheort zwar nie verlassen, doch der Fund des erstaunlich gut erhaltenen Wracks bringt auch ihre unfassbare Geschichte wieder ans Licht. Viel Spaß beim Bauen dieses ebenso prächtigen wie detailreichen LEGO® Icons Modells, mit dem wir eine legendäre Überlebensgeschichte feiern wollen.



## Der Antarktisvertrag

*Am 1. Dezember 1959 unterzeichneten zwölf Länder den Antarktisvertrag, um den 6. Kontinent als unabhängiges Forschungszentrum zu erhalten. Gemäß diesem Vertrag und ohne einheimische Bevölkerung, die hoheitliche Ansprüche geltend machen könnte, hat kein Land das Recht, die Endurance für sich zu beanspruchen oder zu bergen.*

## Robuste Konstruktion

/// Die Dreimastschonerbark war auch mit einer Dreifachexpansionsdampfmaschine ausgestattet, um heftigen Winden zu trotzen und durch Packeis fahren zu können.

/// Die Kombination aus Eichen-, Kiefern- und Grünherzholz machte den Rumpf robust genug, um besonders extremen Wetterverhältnissen zu trotzen.

/// Bei der Entdeckung des Wracks im Jahr 2022 waren die goldenen Buchstaben des Namens *Endurance* und der goldene Stern noch immer erhalten.





# Keiner wird zurückgelassen

Am 5. Dezember 1914 stach Shackleton mit seiner Mannschaft von Grytviken in Südgeorgien aus in See, um innerhalb eines Jahres den Südpol zu erreichen. Ab Ende Februar 1915 saß die Crew der *Endurance* im Packeis fest und driftete durch das Weddell-Meer. Davon völlig unbeirrt blieb die Mannschaft bis zum 27. Oktober 1915 an Bord. Doch dann wurden Risse bemerkt, und das Schiff drohte zu sinken. Das Schiff hielt sich noch mehr als drei Wochen über Wasser und sank schließlich am 21. November.

Die noch unversehrten Rettungsboote wurden von der 28-köpfigen Besatzung benutzt, um das *Patience Camp* aufzuschlagen. Im April 1916 brach die Crew schließlich in einem der Rettungsboote nach Elephant Island auf. Jedes Besatzungsmitglied durfte zwei Pfund an persönlichen Habseligkeiten einpacken – sowie ein Banjo, das von Shackleton zu lebenswichtiger Medizin für die geistige Gesundheit erklärt wurde. Von Elephant Island aus brach Shackleton dann mit einigen seiner Männer zur letzten zweiwöchigen Etappe zurück nach Südgeorgien auf. Allerdings landeten sie in der Walfangstation Stromness auf der falschen Seite der Insel. Nach einem eineinhalbtägigen Fußmarsch über die Insel kehrten die völlig erschöpften Expeditionsteilnehmer nach Grytviken zurück. Ab diesem Zeitpunkt sollten noch fast viereinhalb Monate vergehen und mehrere Rettungsversuche scheitern, bis er schließlich auch seine letzten Männer von Elephant Island holen konnte.

Der Geschichtsschreibung zufolge hat die Mannschaft der *Endurance* ihr Überleben den Führungsqualitäten von Sir Ernest Shackleton zu verdanken. So werden ihm heldenhafte Taten, Selbstaufopferung und die Moral stärkender Optimismus bescheinigt. Das Vertrauen, das ihm seine Mannschaft entgegengebracht hatte, hatte er sich dadurch verdient, dass er anderen seine Handschuhe lieh, seine Männer schlafen ließ, damit sie Kraft tanken konnten, und dass er allen Widrigkeiten trotzte, um alle lebendig nach Hause zu bringen.



„By Endurance  
We Conquer.“

– Der Leitspruch der  
Familie Shackleton



## Elephant Island

*Am 15. April 1916 gingen Shackleton und seine Mannschaft zum ersten Mal seit 497 Tagen auf Elephant Island wieder an Land. Die letzten Mitglieder der Crew wurden erst am 30. August 1916 gerettet.*

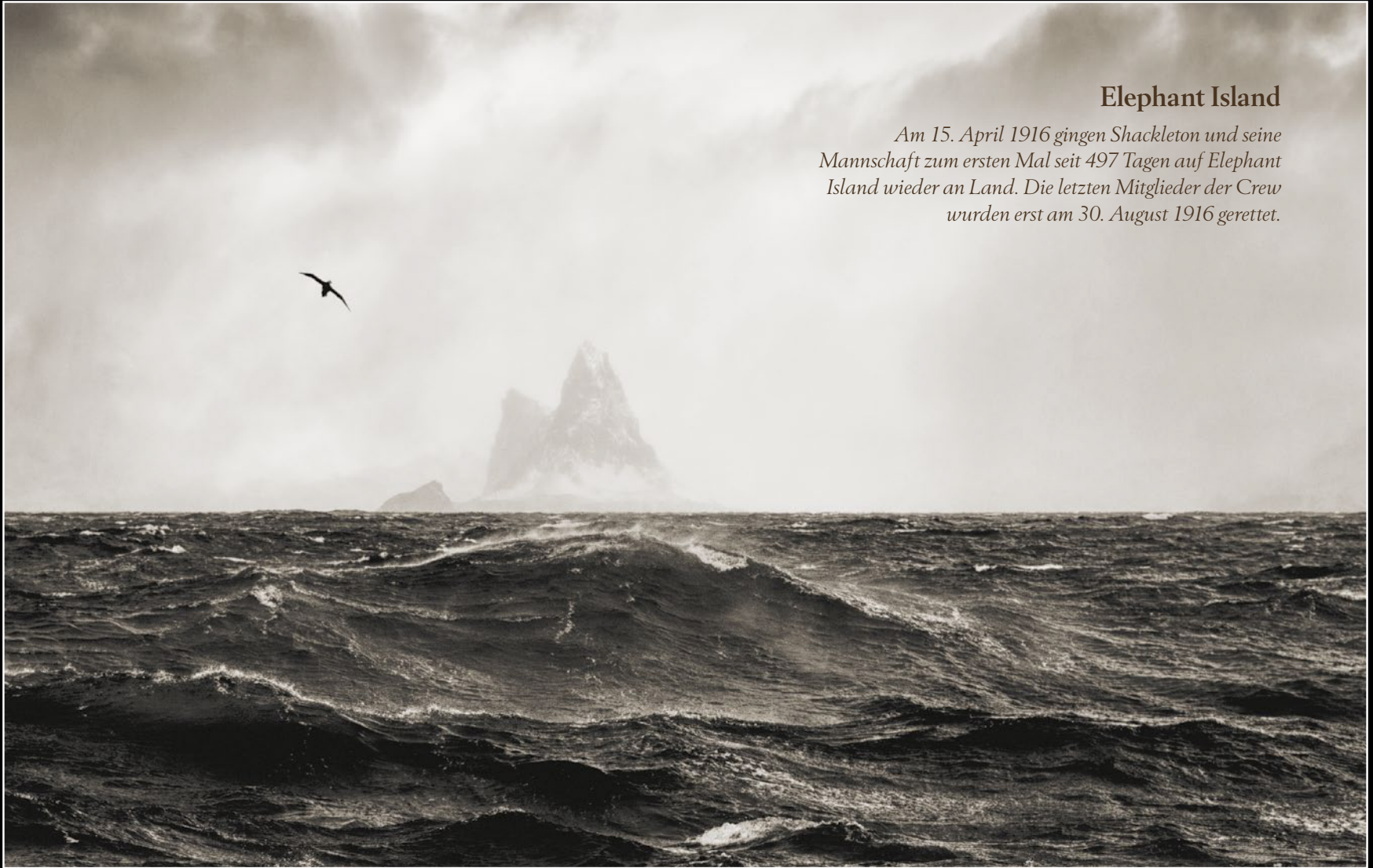



# Die Reise

- 1 5. Dez. 1914: Die *Endurance* sticht von Grytviken in Südgeorgien in See.
- 2 18. Jan. 1915: Nach wochenlanger Fahrt durch das eisige Weddell-Meer sitzt die *Endurance* jetzt im Eis fest.
- 3 21. Nov. 1915: Einige Wochen nach den ersten Rissen im Rumpf sinkt das Schiff schließlich vor der Antarktisküste.
- 4 15. Apr. 1916: Zwei Wochen, nachdem die Mannschaft *Patience Camp* in einem der Rettungsboote verlassen hatte, geht sie auf Elephant Island an Land.
- 5 21. Mai 1916: Shackleton erreicht mit einigen wenigen Mitgliedern seiner Mannschaft Südgeorgien.
- 6 30. Aug. 1916: Die letzten Mitglieder der Crew werden schließlich von Elephant Island gerettet.



# Anmerkungen des LEGO® Designteams

„Wir haben zunächst ein wichtiges Detail, genauer gesagt die Rettungsboote, ausgewählt (die in zwei Größen an Bord waren), um den Maßstab des Modells festzulegen. Diese Rettungsboote haben wir dann so klein und detailreich wie möglich nachgebildet. Das war unser wichtigster Anhalt dafür, wie groß das Schiff selbst werden würde. An Bord der echten *Endurance* hatten 28 Mann Platz. Wir haben den Maßstab jedoch ein wenig verringert und nur Kabinen für Sir Ernest Shackleton und den Expeditionswissenschaftler in dem Modell untergebracht. Im Inneren befindet sich auch die Dampfmaschine, die man herausnehmen kann. Die echte Dampfmaschine war so hoch wie ein zweigeschossiges Haus! LEGO® Icons Modelle zum Ausstellen haben normalerweise coole Funktionen, deshalb wollten wir ein funktionierendes Ruder mit dem Steuerrad verbinden. Für diese Funktion haben wir ein winziges Getriebe konstruiert, das auf einer Winkelplatte sitzt, die jetzt zum ersten Mal in Dunkelbraun in einem Set enthalten ist. Das ist nur eine der zahlreichen Farbänderungen an Elementen, die wir vornehmen mussten, um dem Schiff seinen authentischen Look zu verpassen. Schließlich war die *Endurance* eines der robustesten Holzschiffe, das jemals gebaut wurde. Deshalb hat sie auch eine gebührende Würdigung verdient!“

Hans Burkhard Schlömer,  
LEGO® Modelldesigner



*„Schließlich war die  
Endurance eines der  
robustesten Holzschiffe,  
das jemals gebaut wurde.  
Deshalb hat sie auch eine  
gebührende Würdigung  
verdient!“*





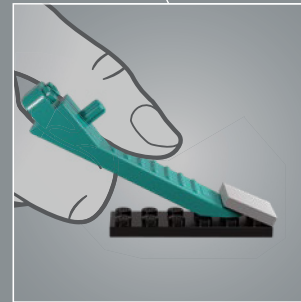
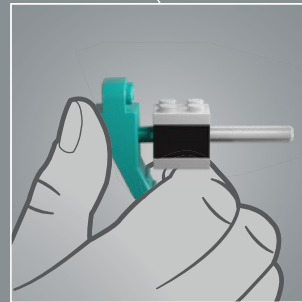
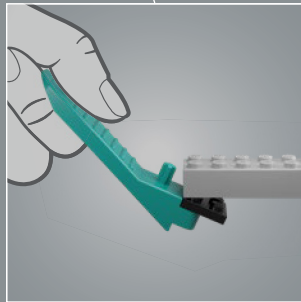
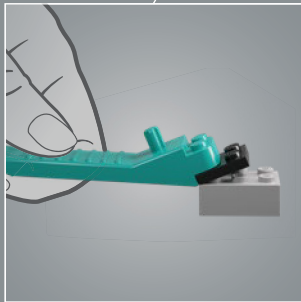
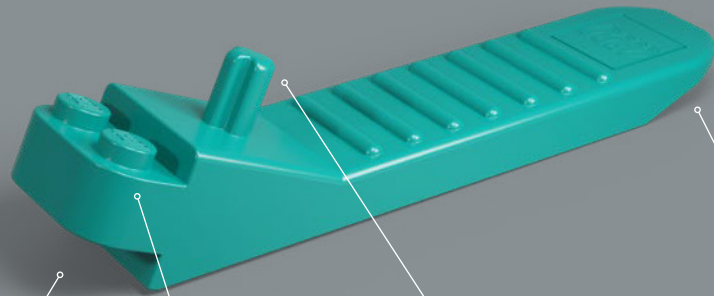

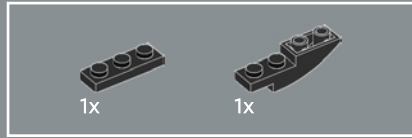

1

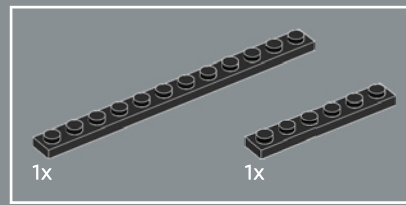
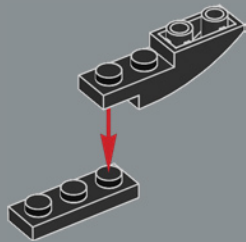

2

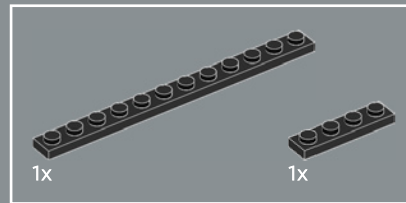
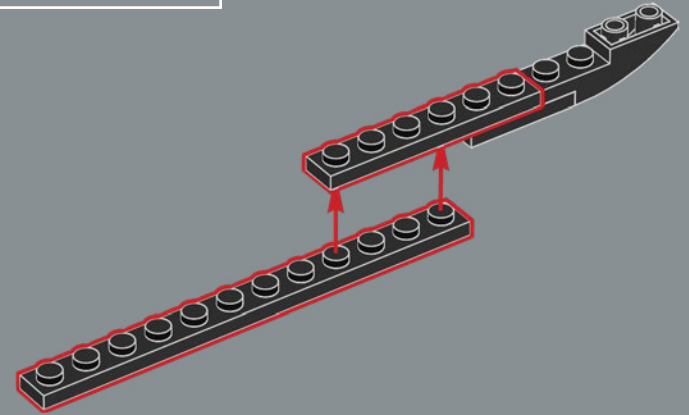

3

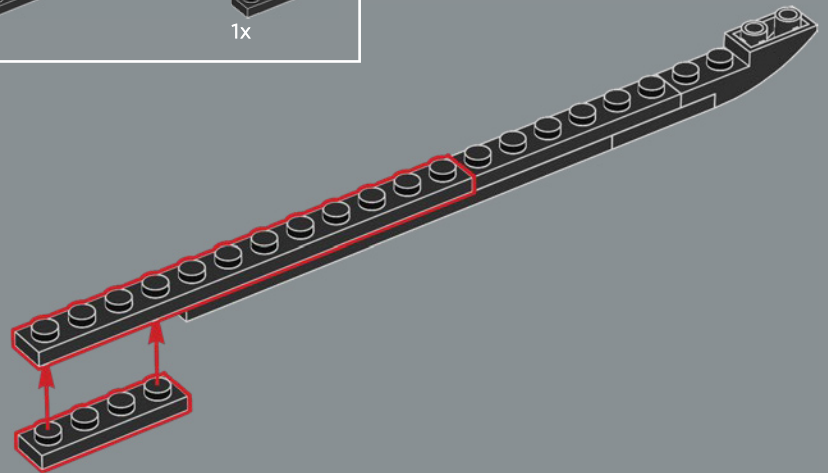

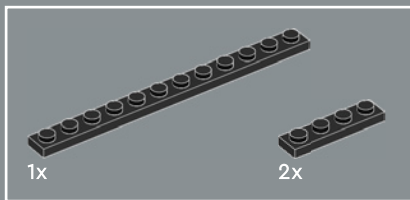

4

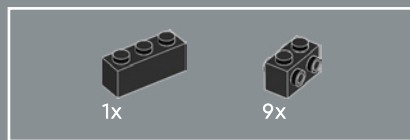
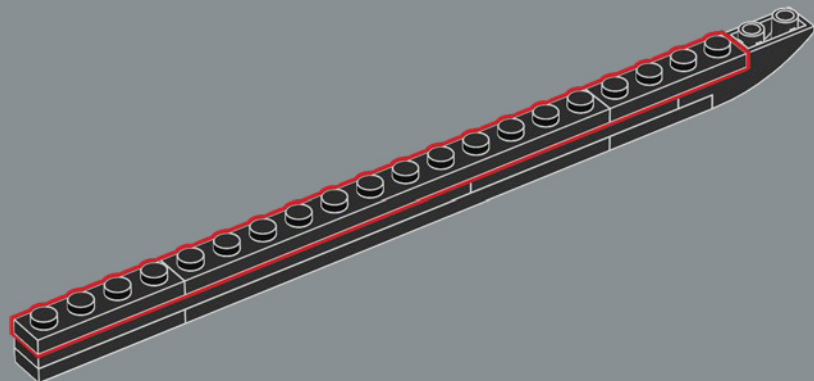

5

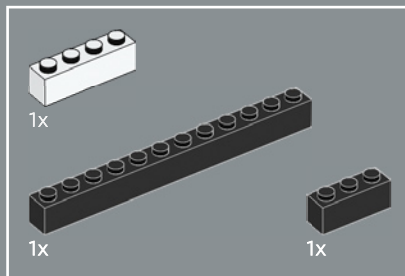
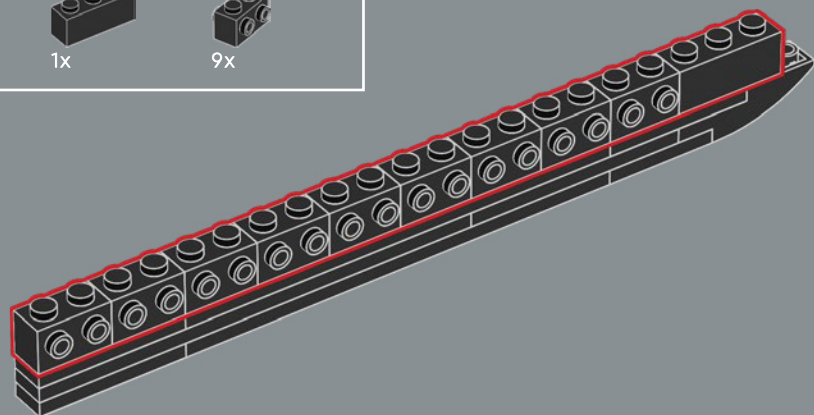

6

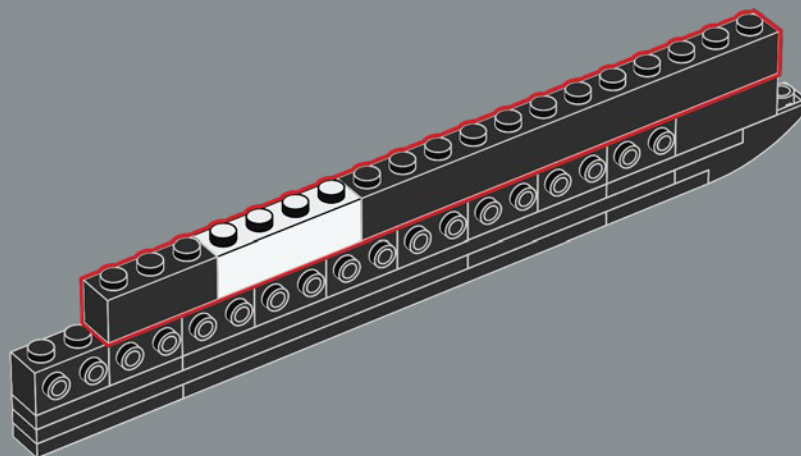

Der Kiel ist nur eine Noppe breit, um dem Schiff seinen schnittigen Look zu verleihen. Im vorderen Segment bildet der Kiel eine Wand, an der die Noppen zur Seite zeigen. Dieser Bautechnik verdankt der Rumpf seine tolle Form.



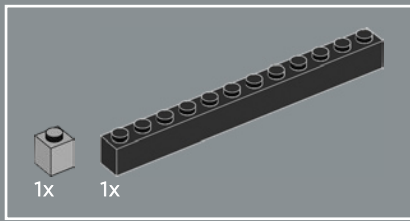

7

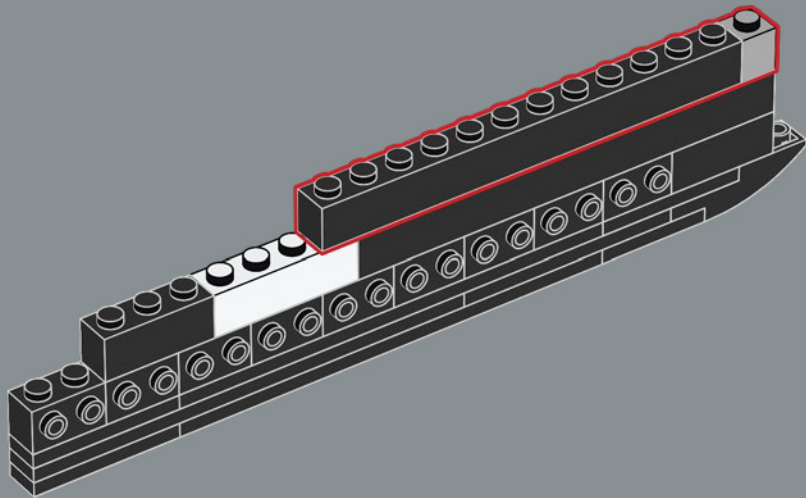

8

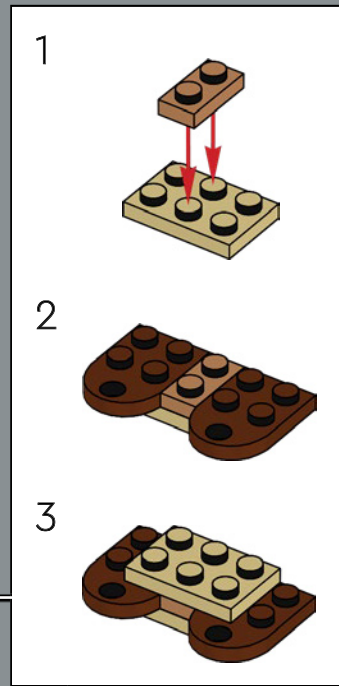
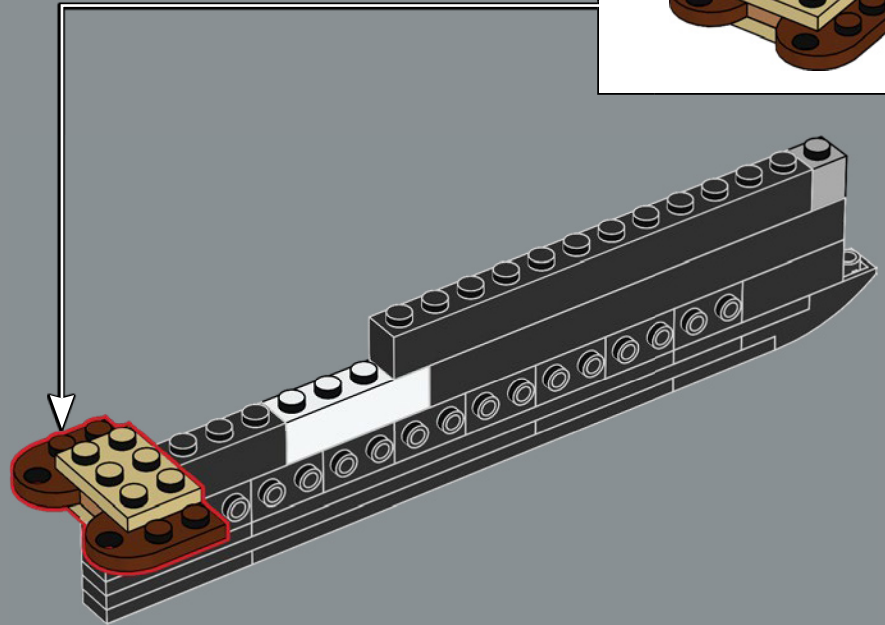



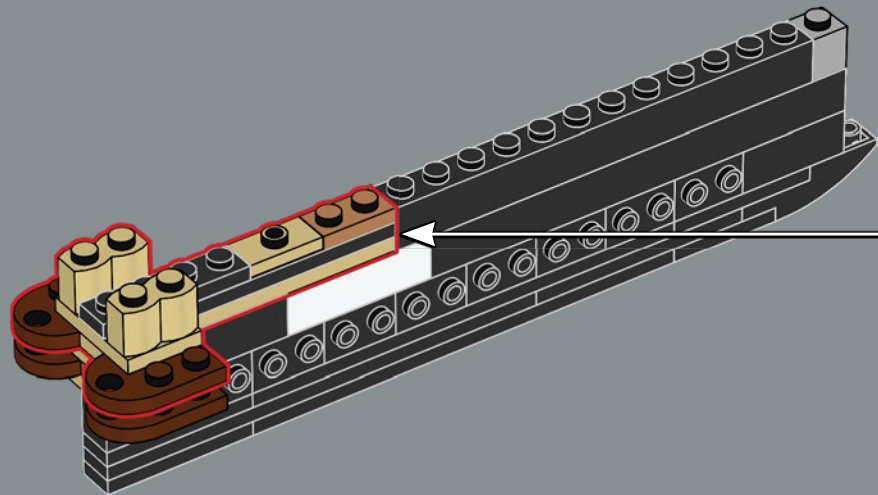
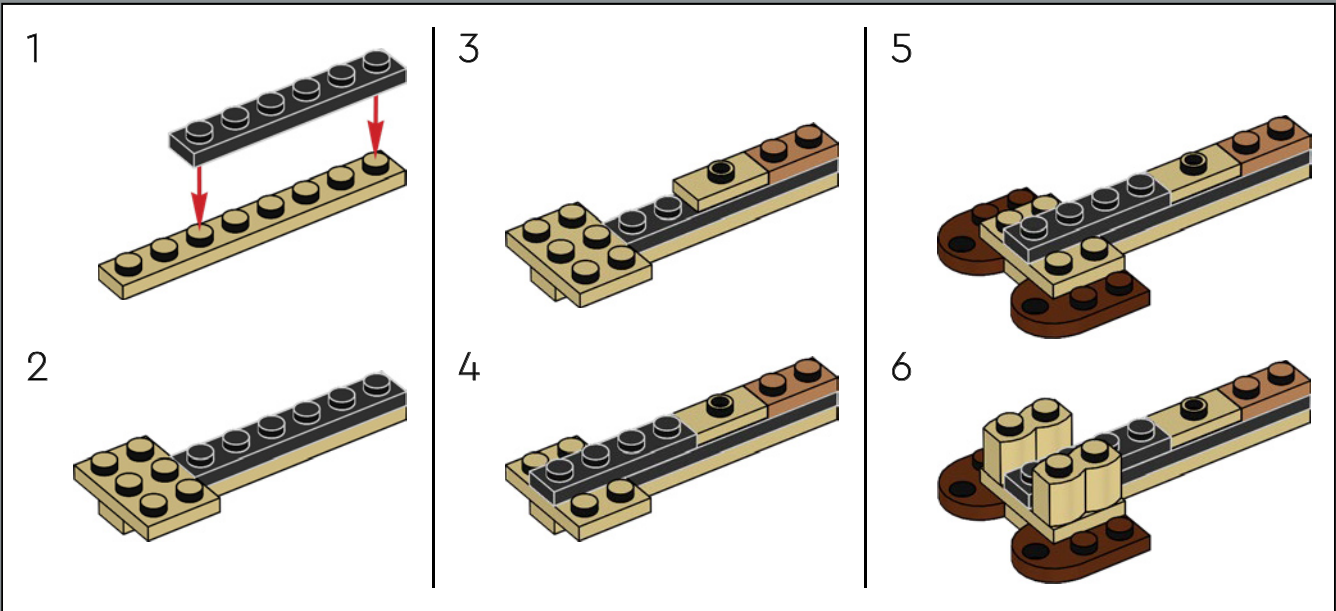
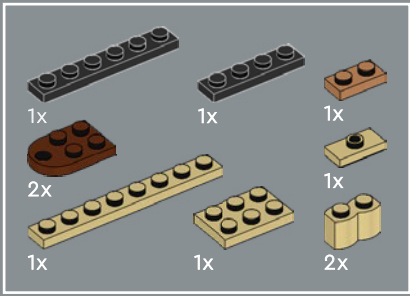

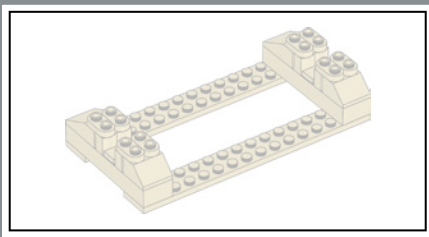

Da der Kiel sehr schmal ist, kann man den hellbraunen „Hilfsständer“ benutzen, um dem Modell während des Bauens einen stabilen Stand zu geben.

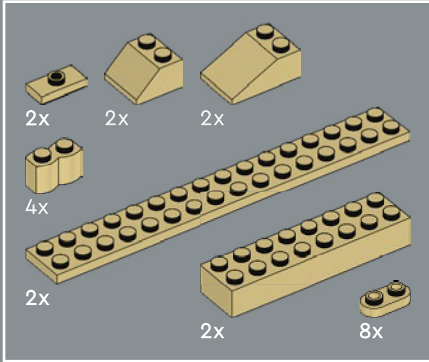

10

1

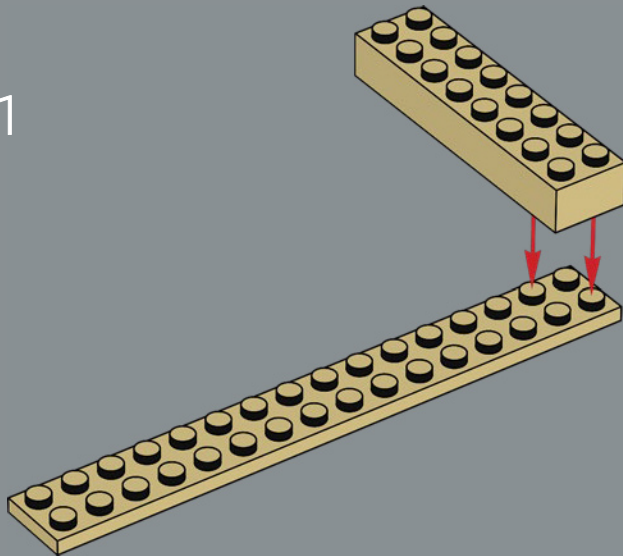

2

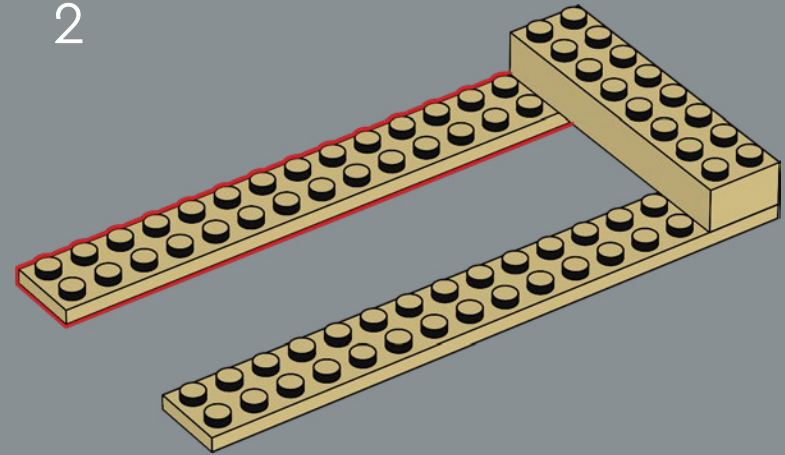

3

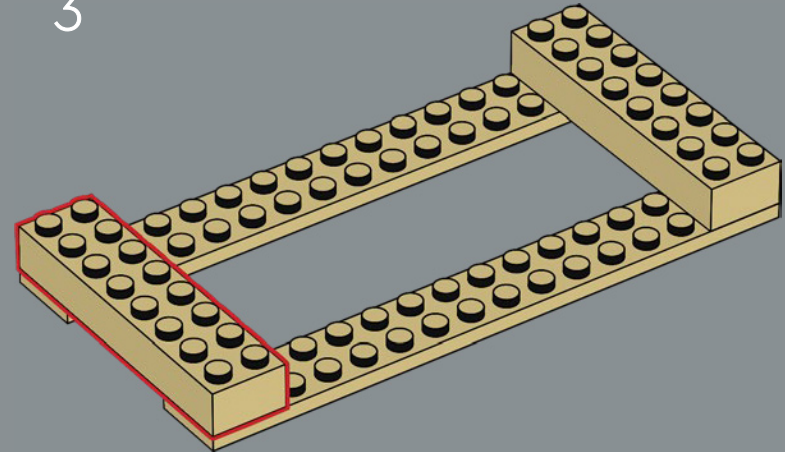

4

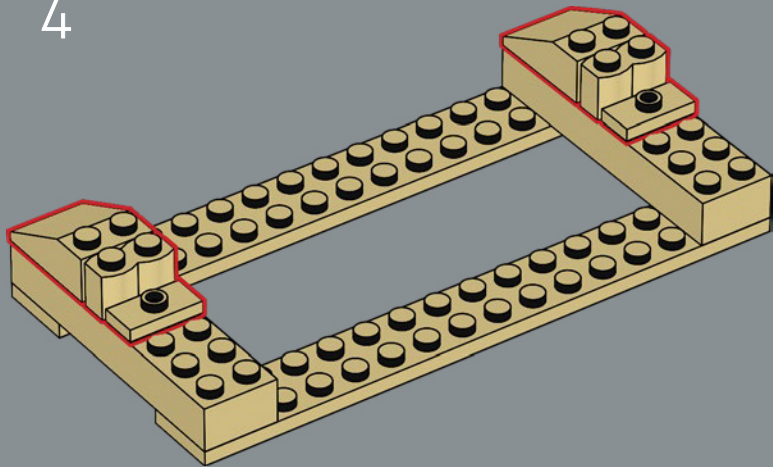

6

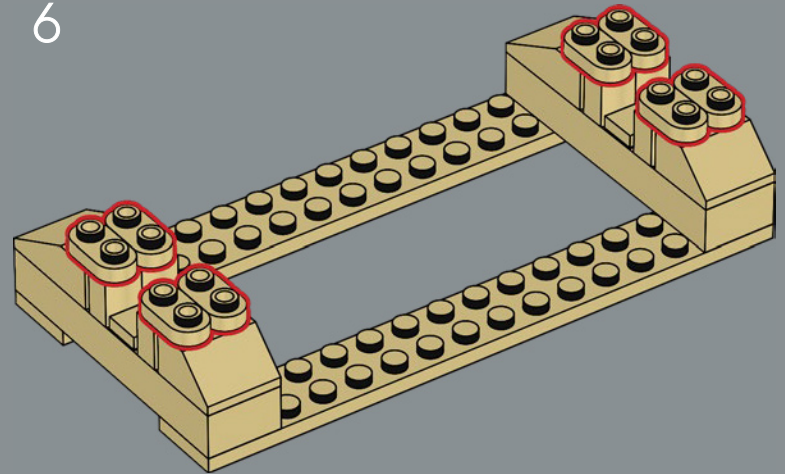

5

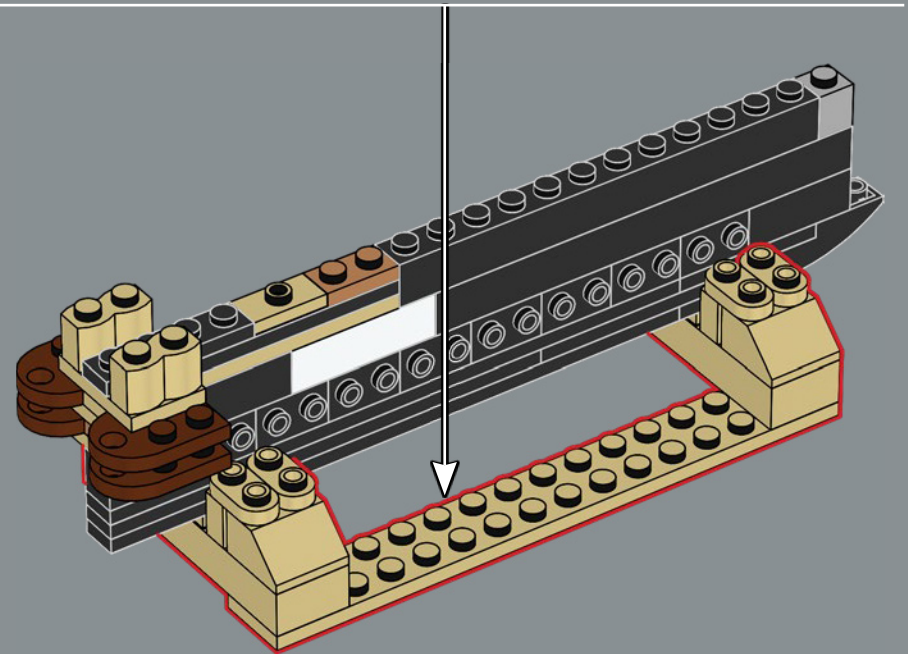
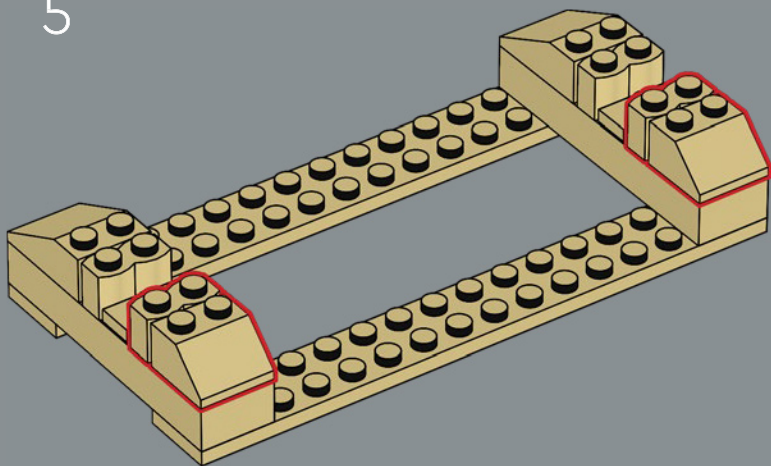



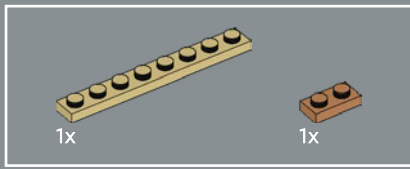

11

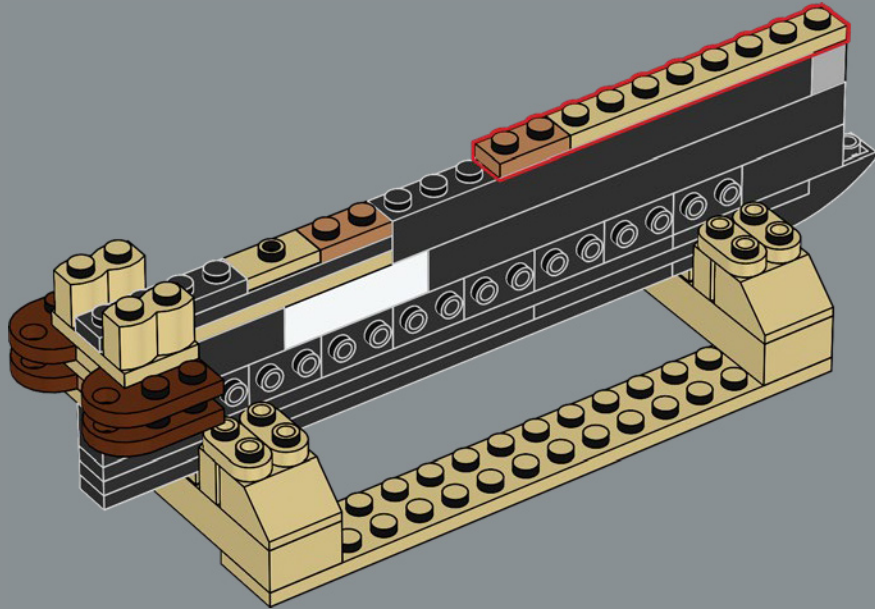

12

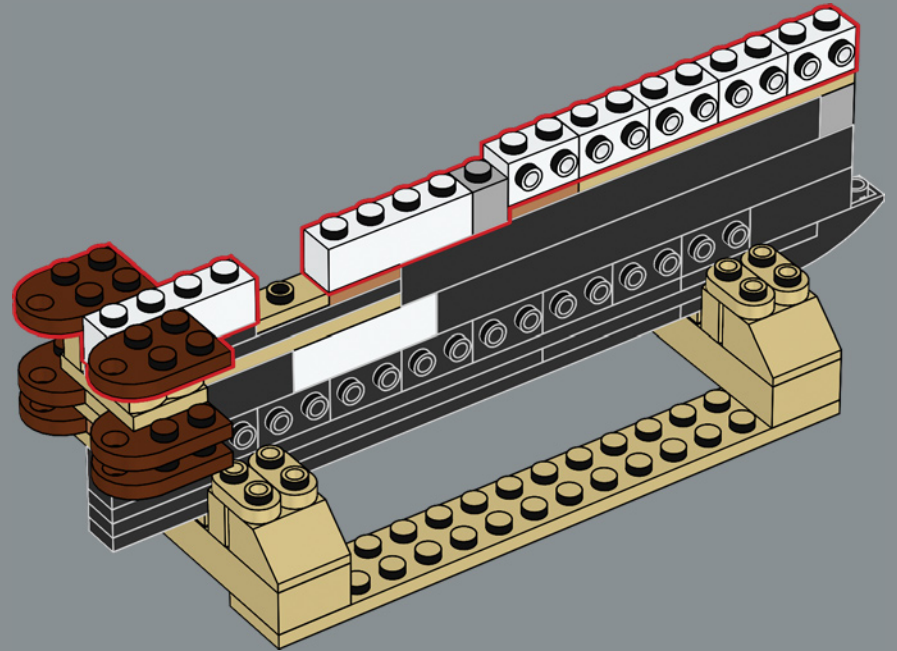



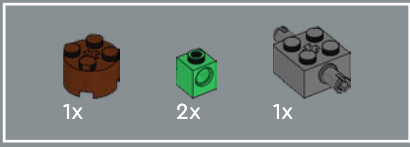

# 13

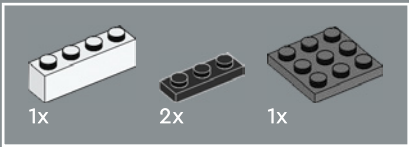
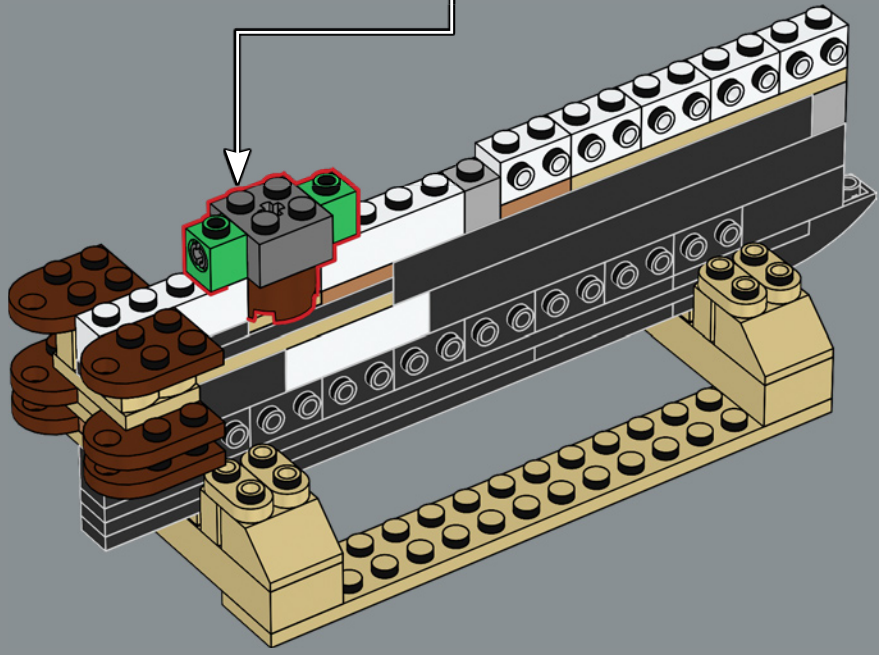
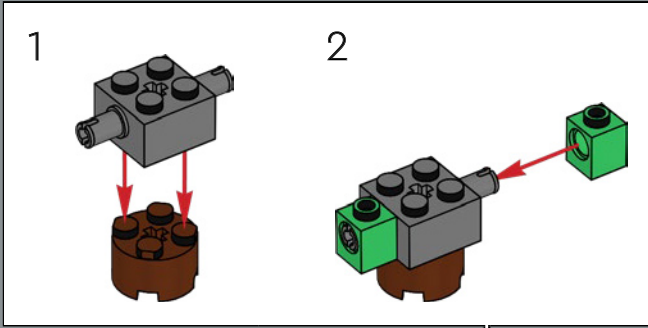

# 14

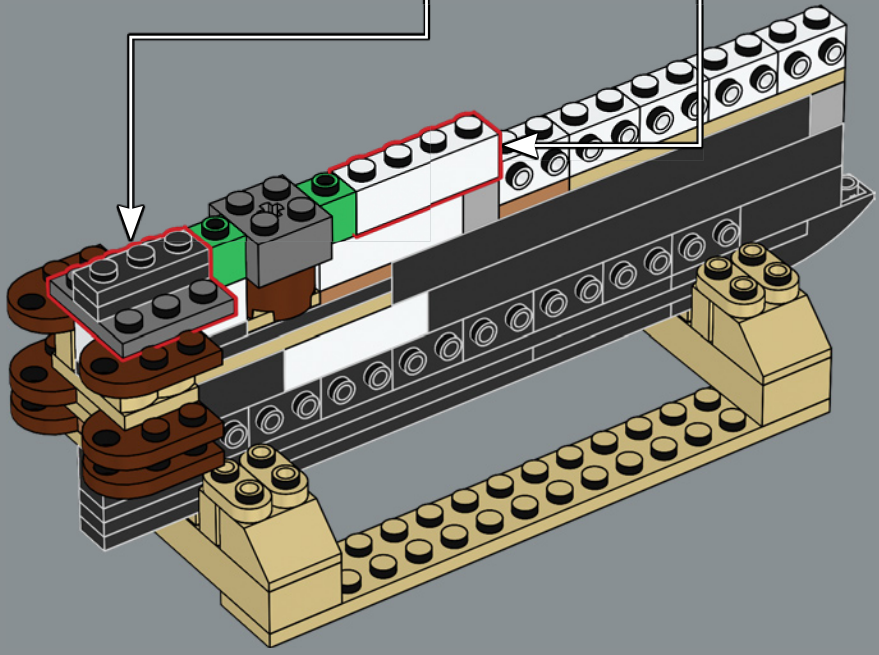
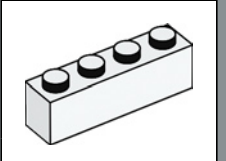
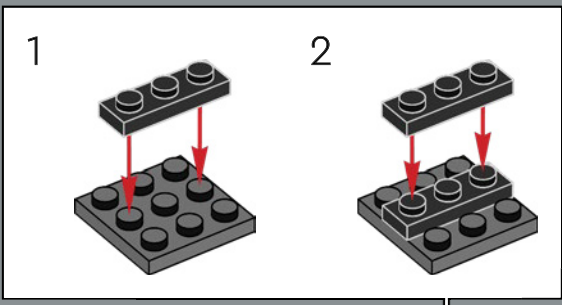

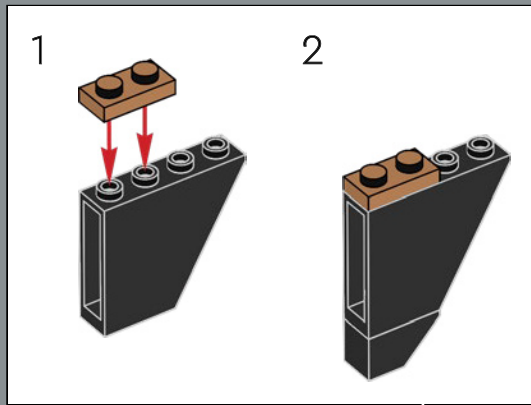
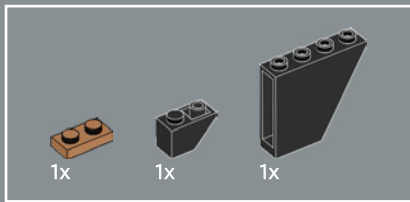

15

Vorne war der Schiffsrumpf mit Metallblechen verkleidet, um den Holzkiel vor dem Polareis zu schützen. An dem Modell wurde dieses Segment mit einem nur selten benutzten 1x4x3 Schrägelement nachgebildet.

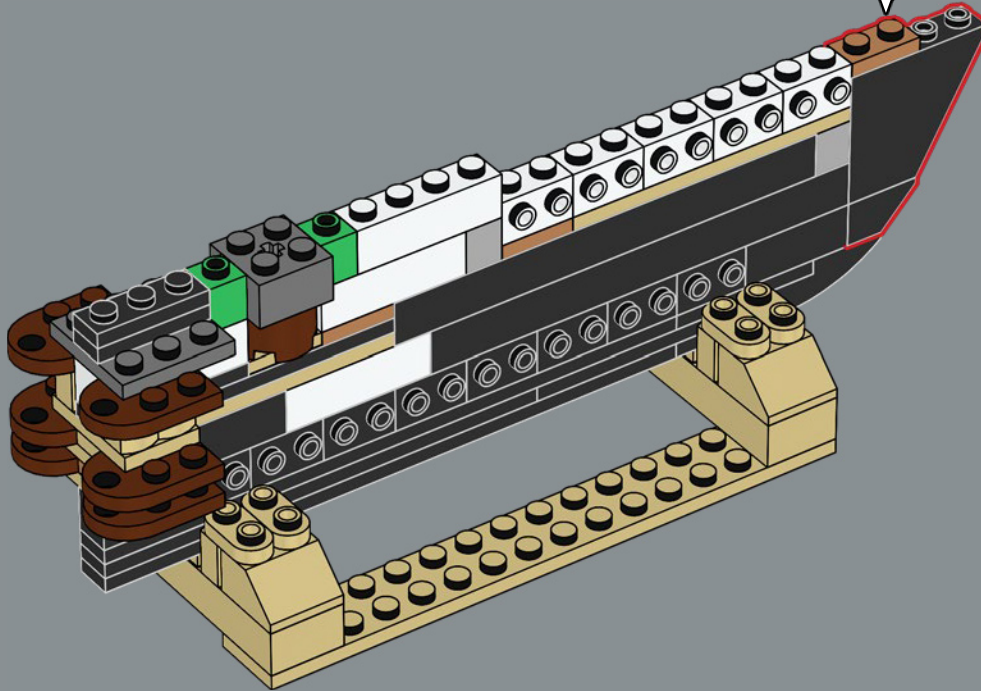

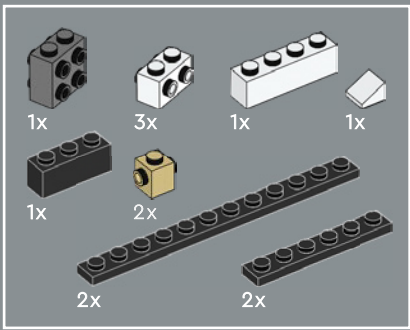

16

1

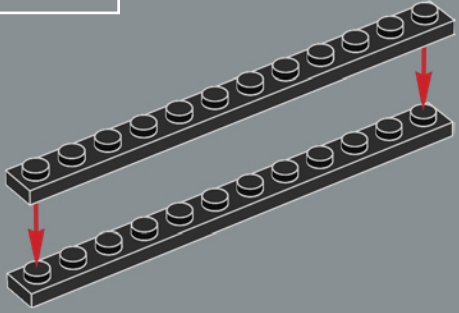

2

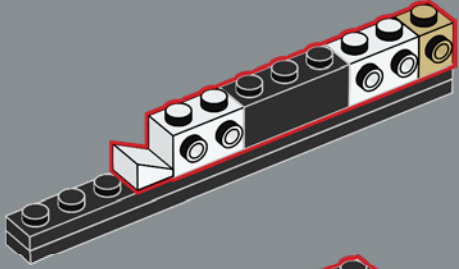

3

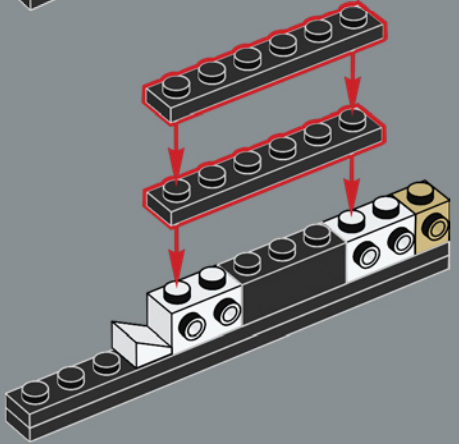

4

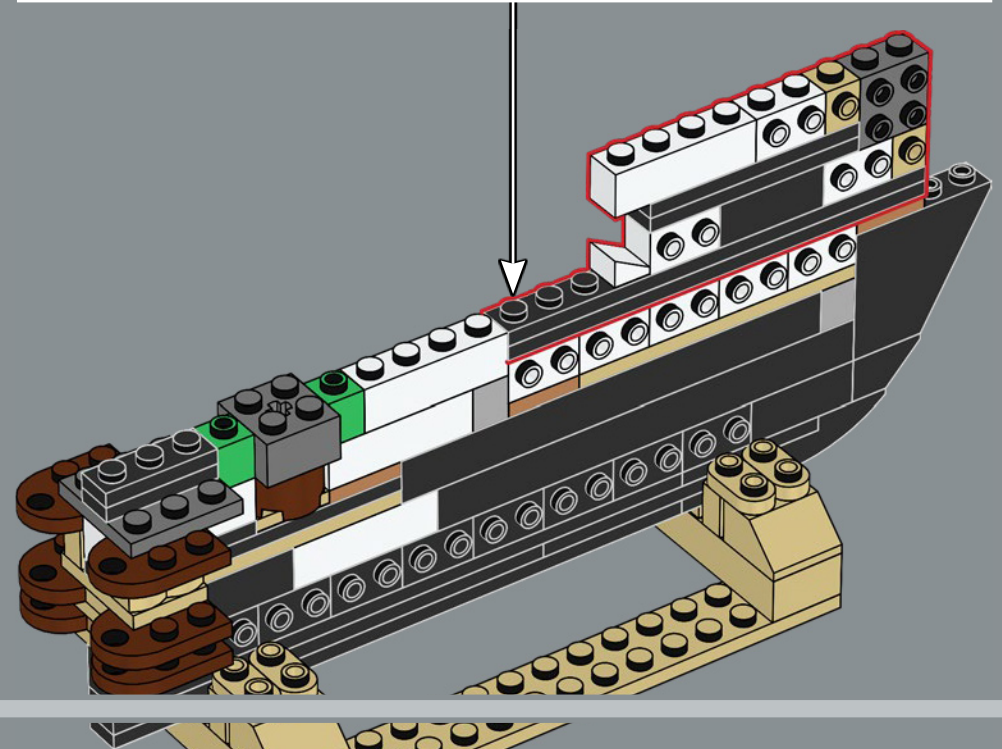
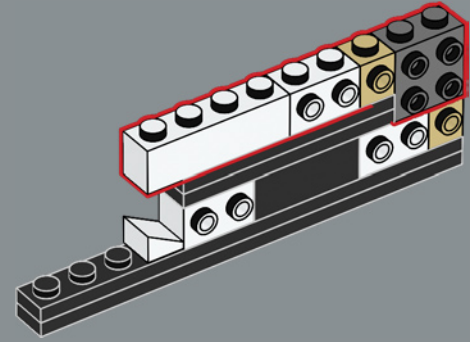



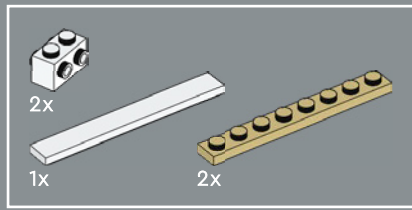

17

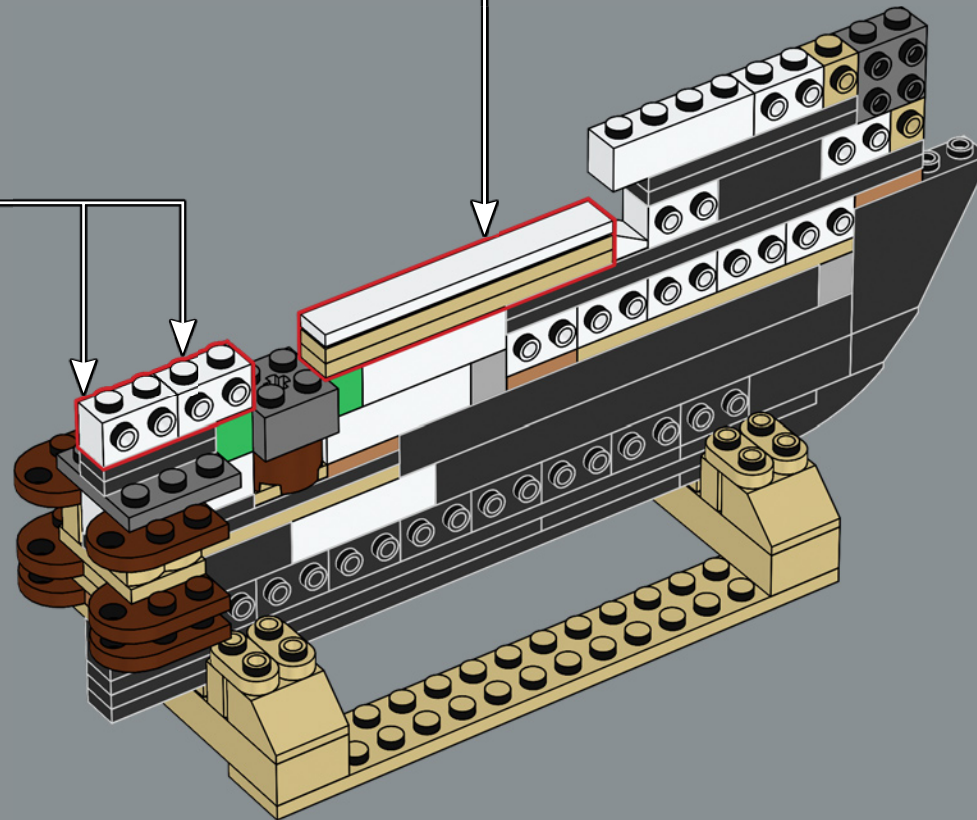
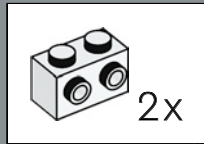
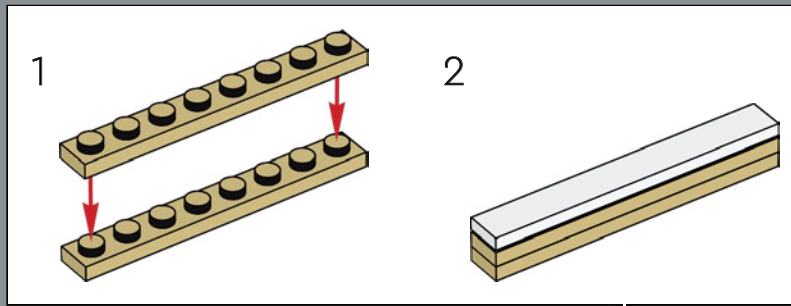

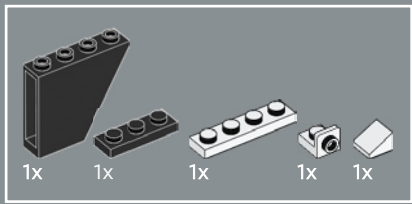

18

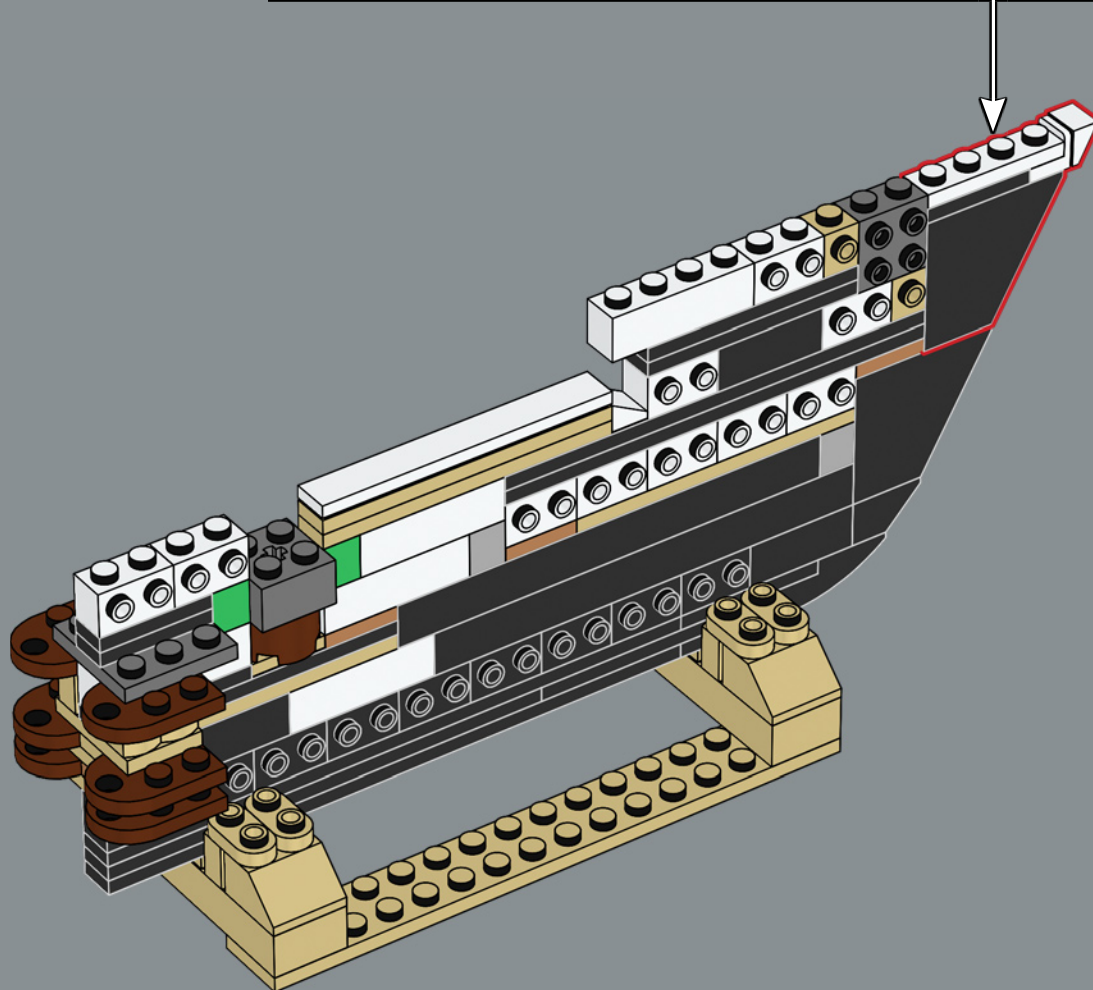
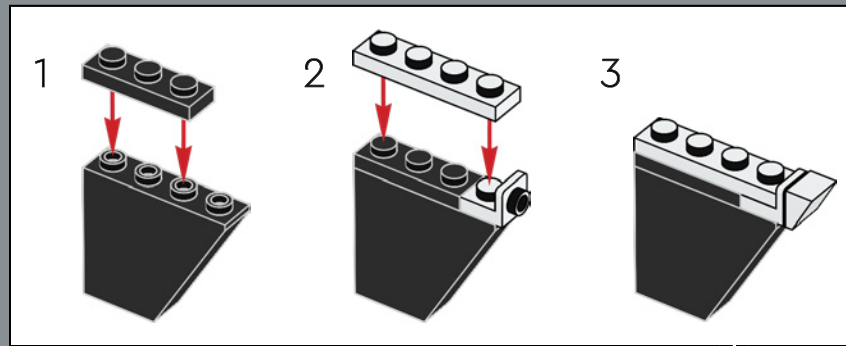

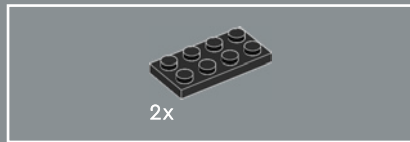
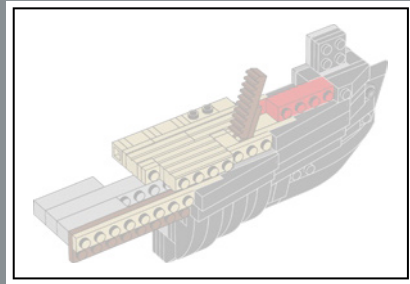

19

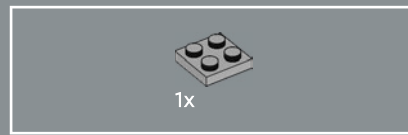
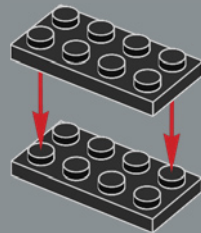

20

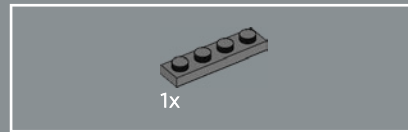
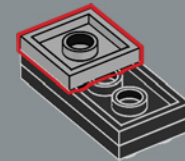

21

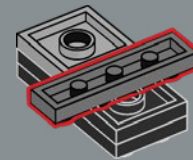



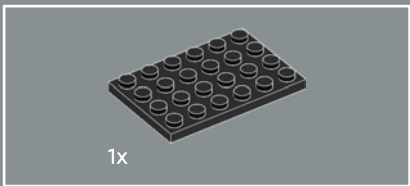

22

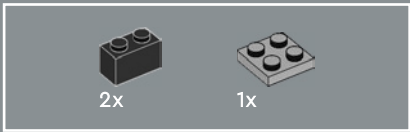
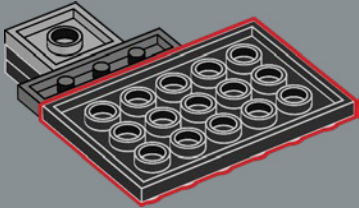

23

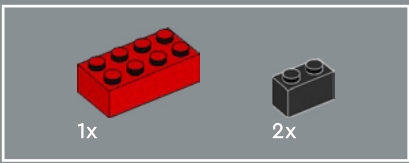
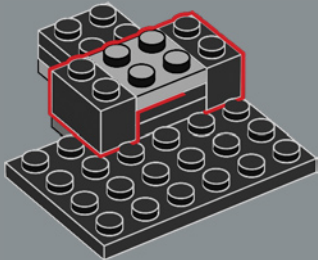

24

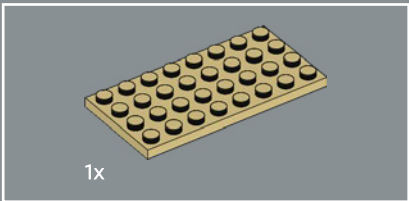
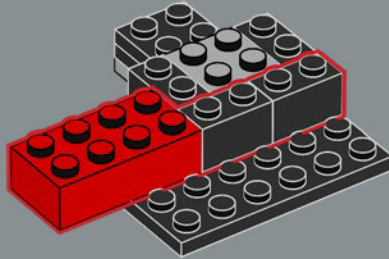

25

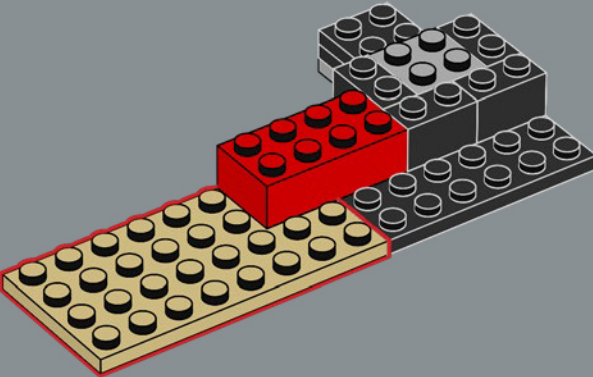

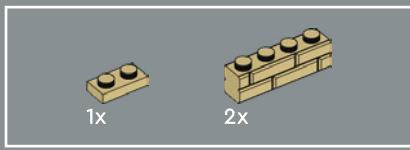

26

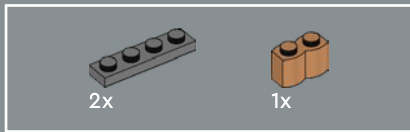
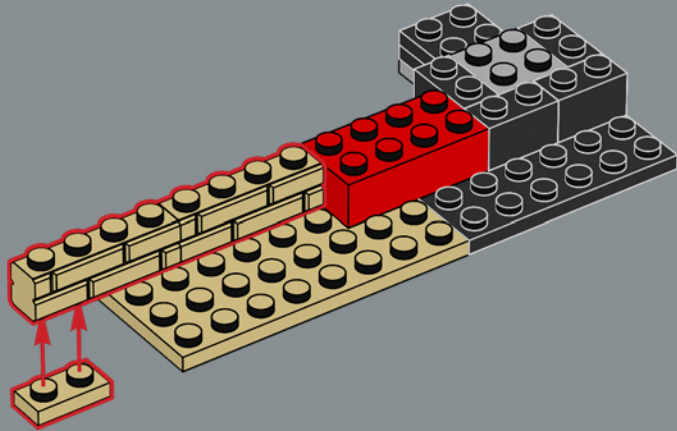

27

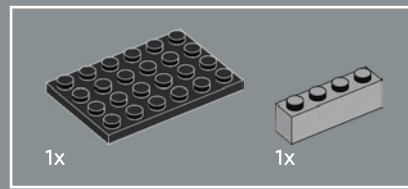
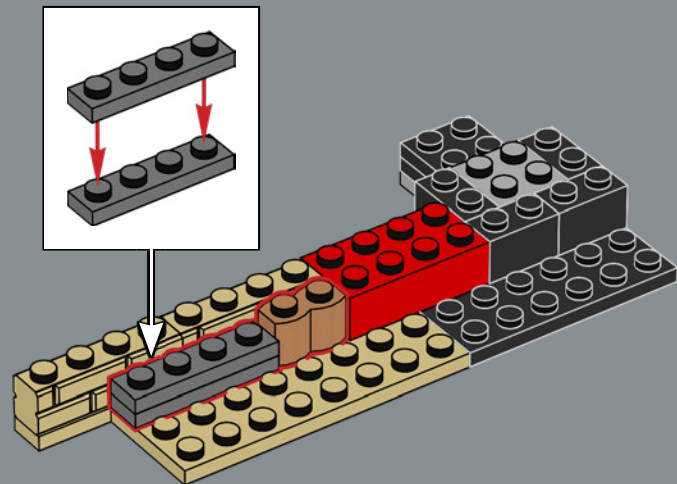

28

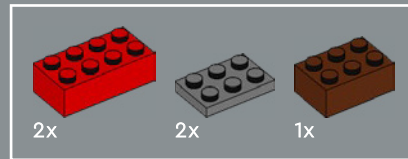
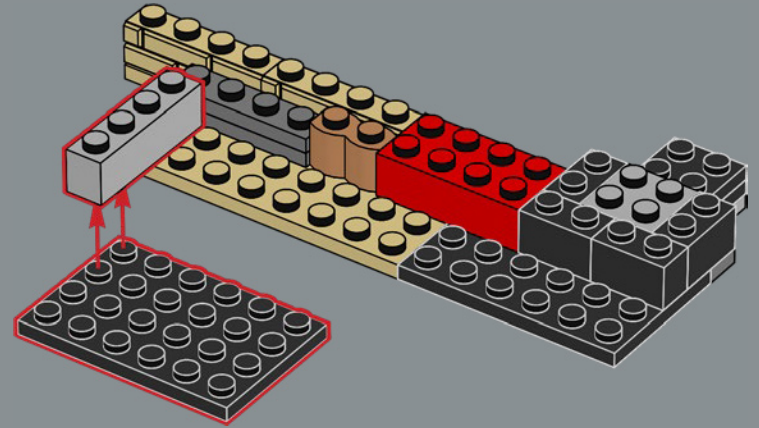

29

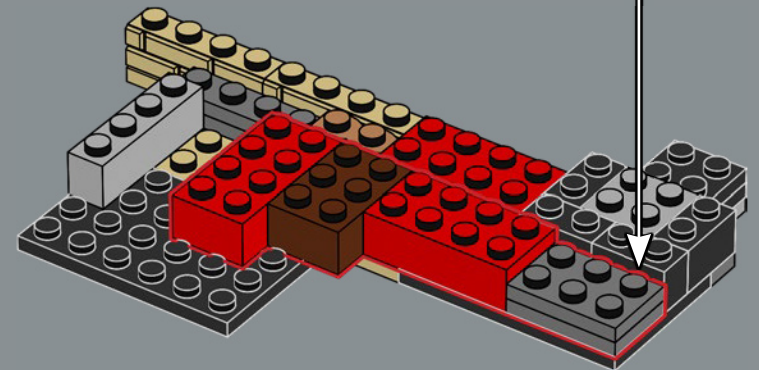

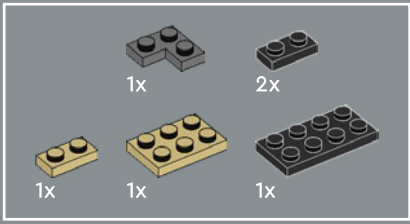

30

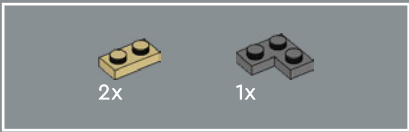
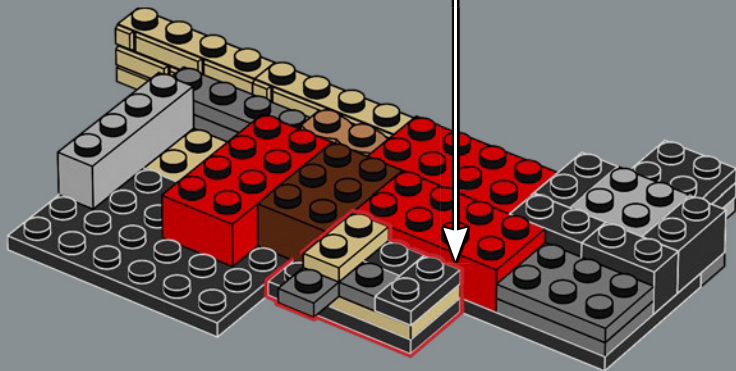
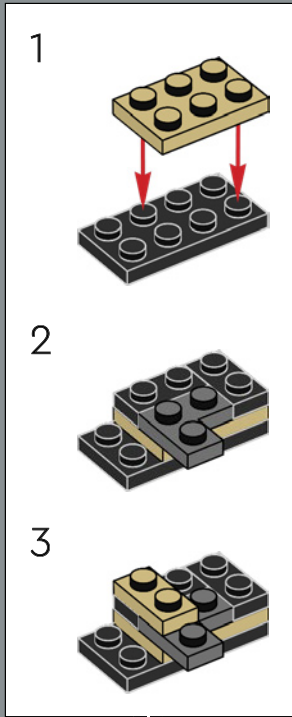

31

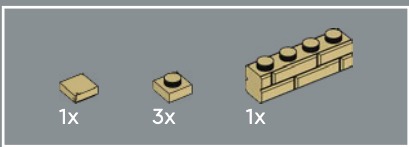
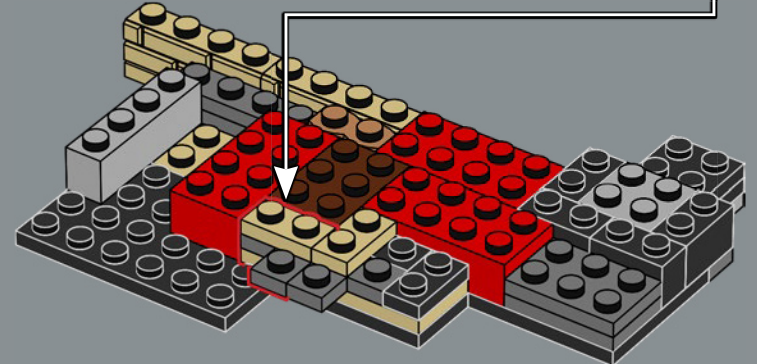
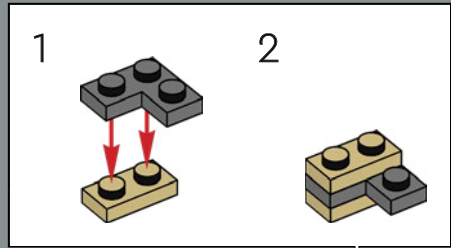

32

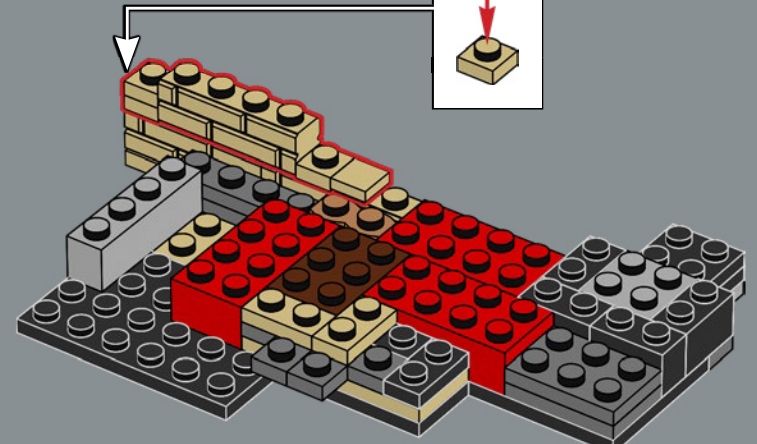
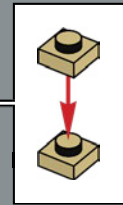



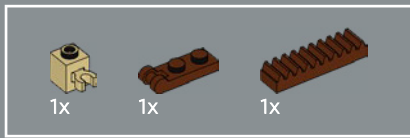

33

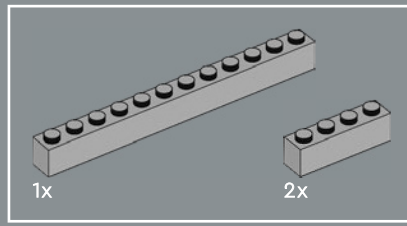
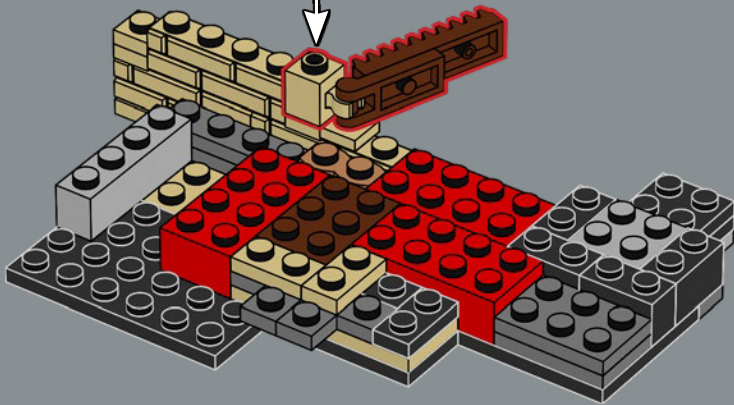
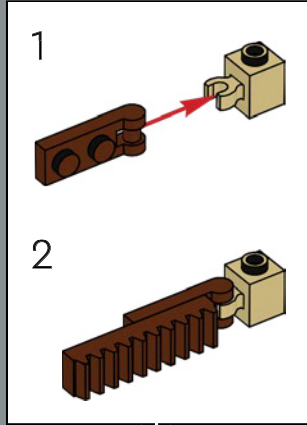

34

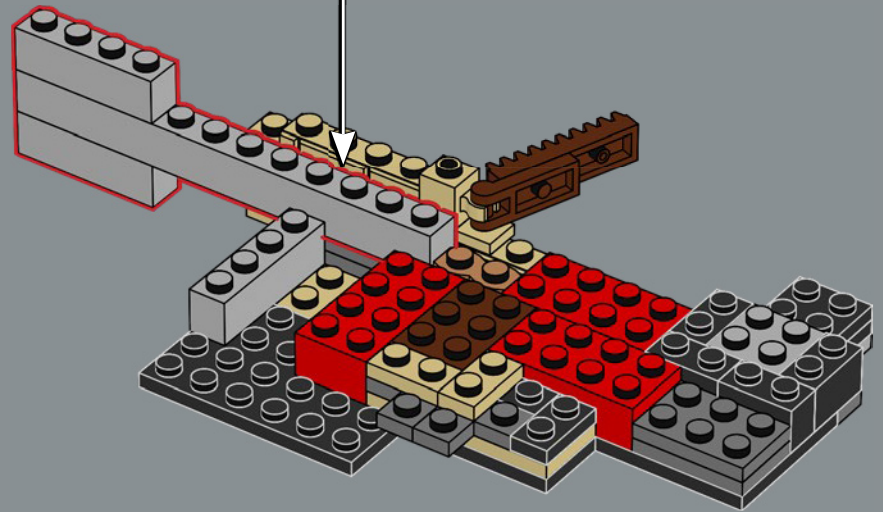
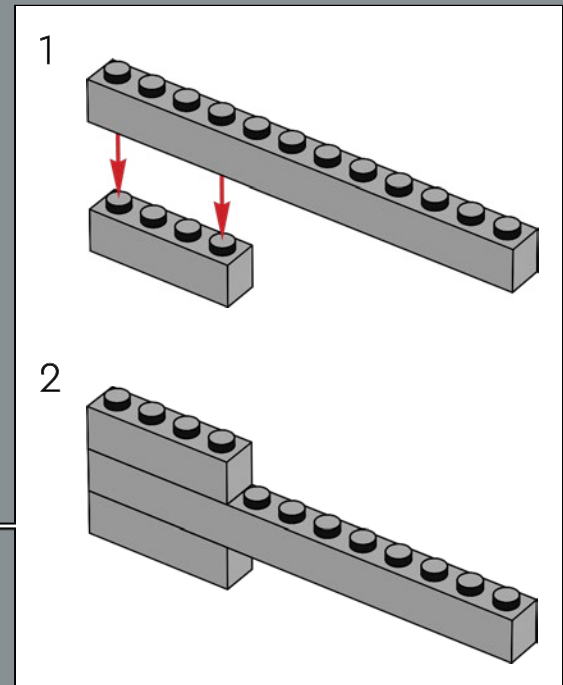



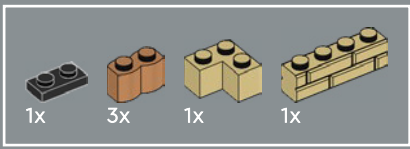

35

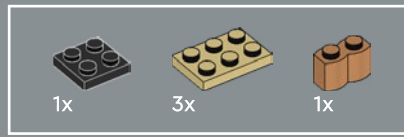
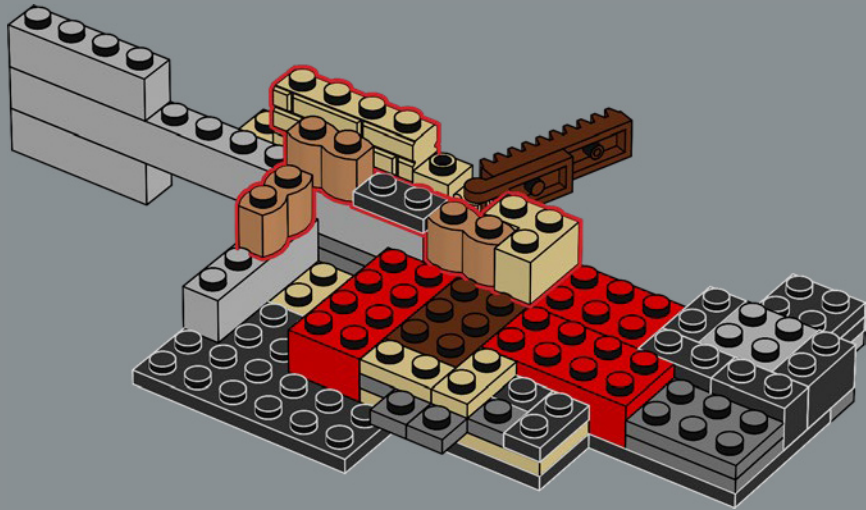

36

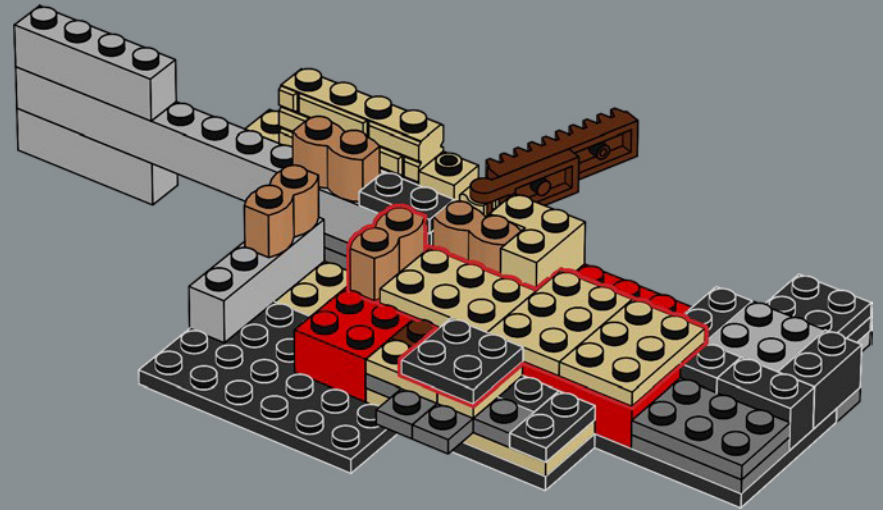

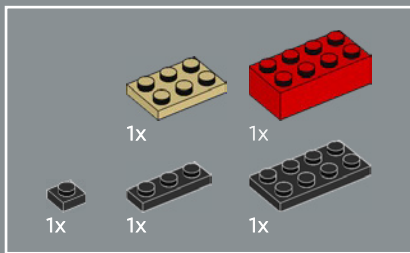

37

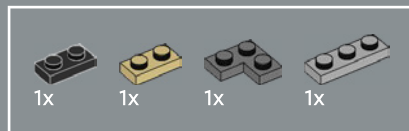
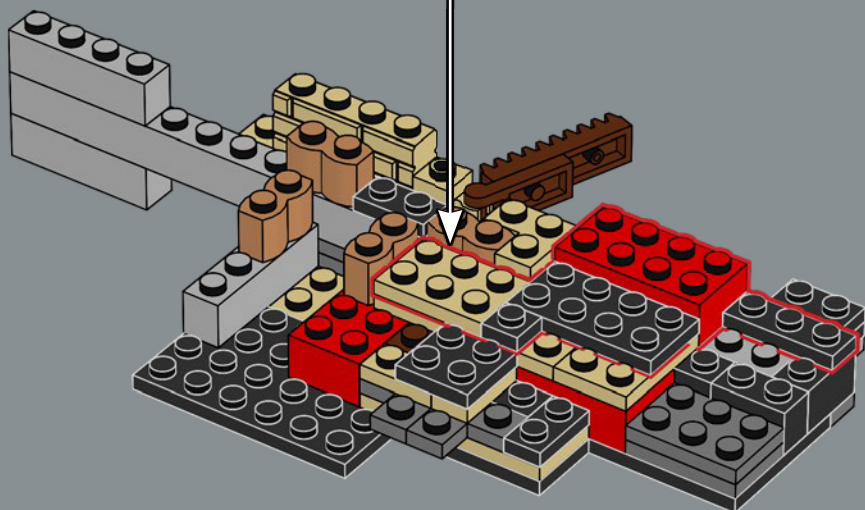
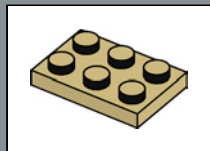

38

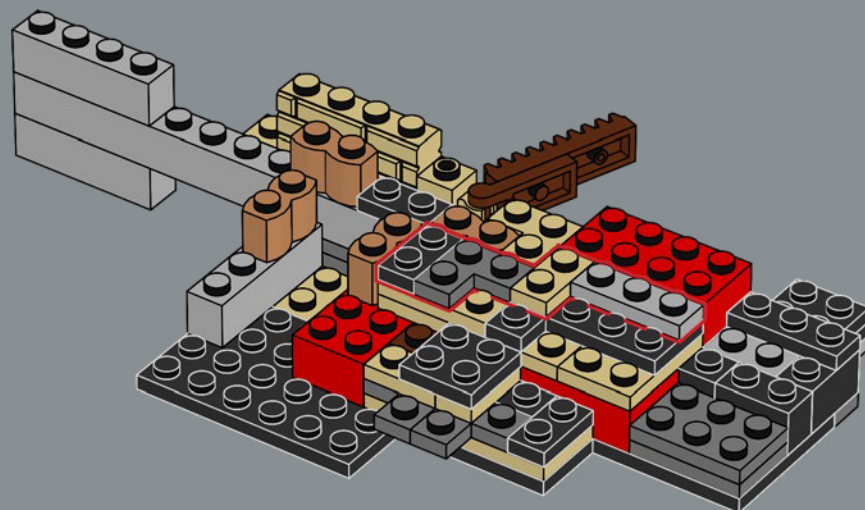

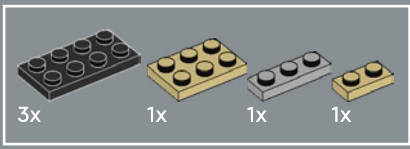

39

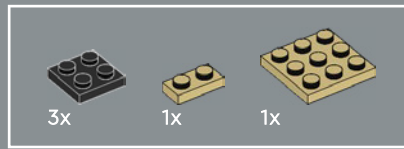
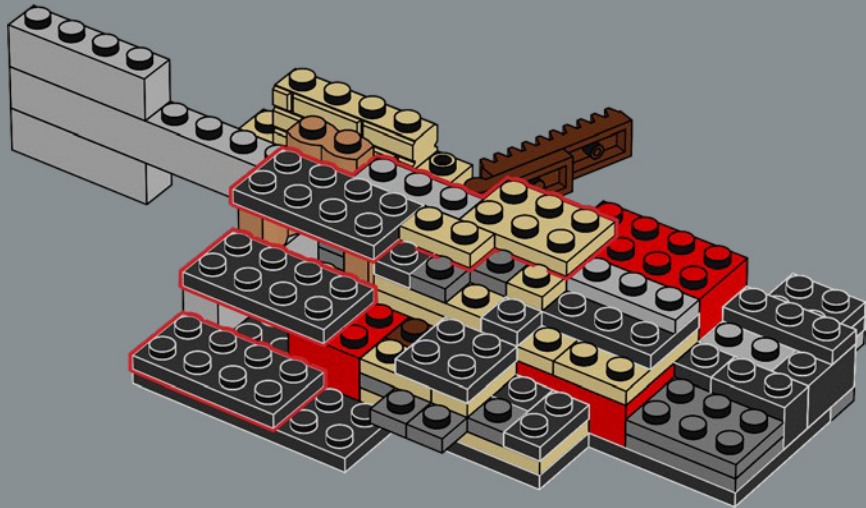

40

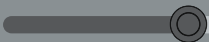
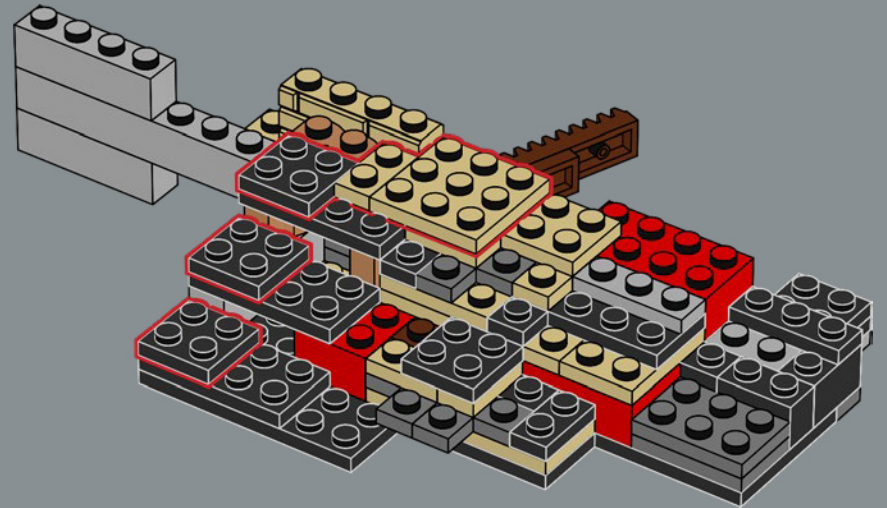

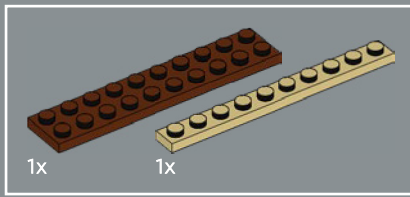

41

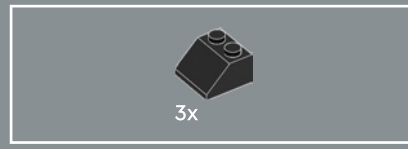
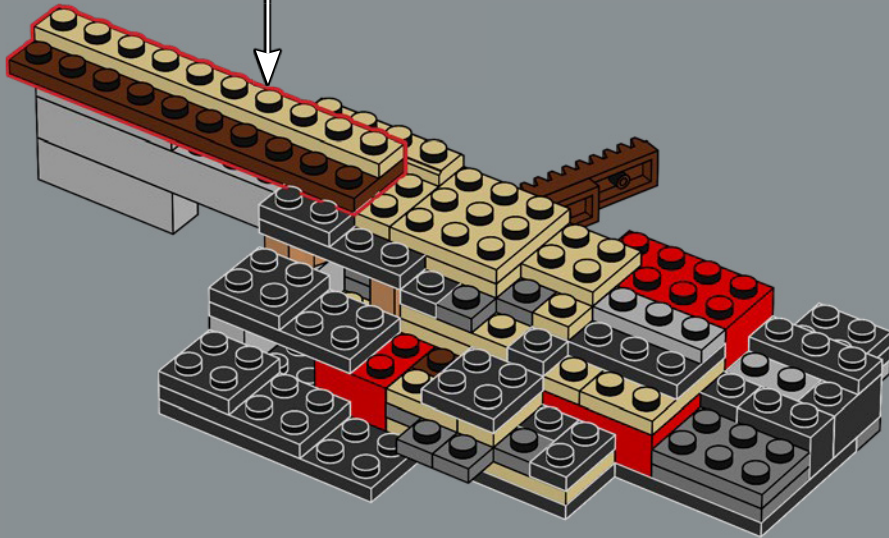
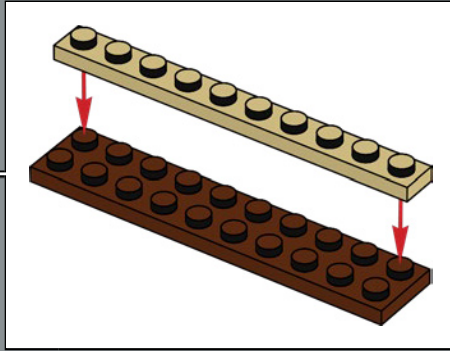

42

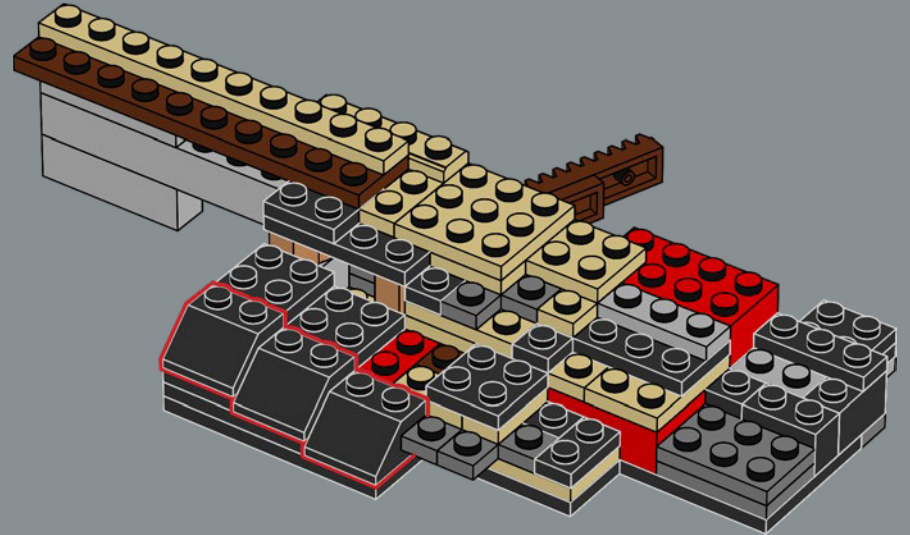





43

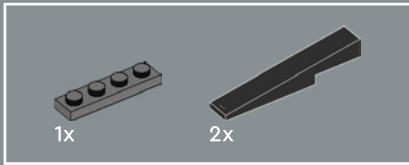
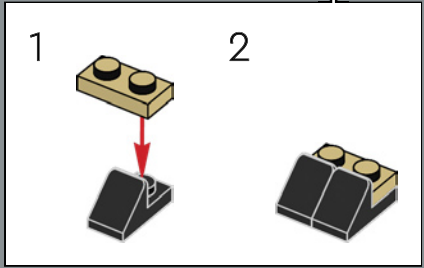
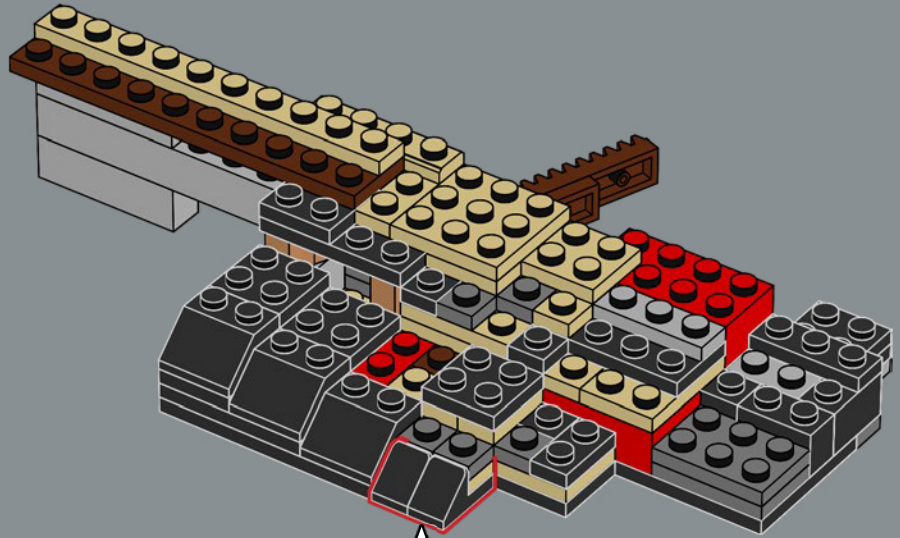

44

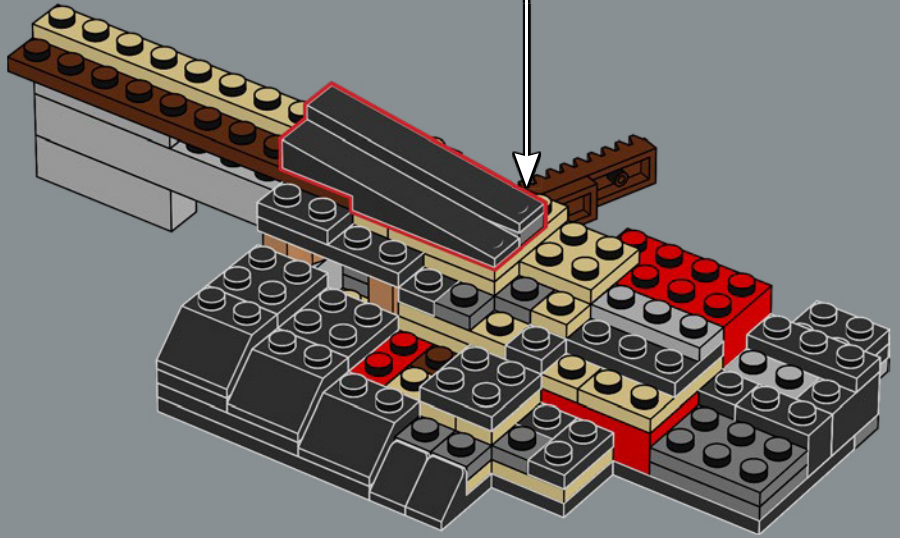
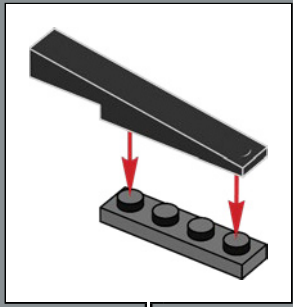



45

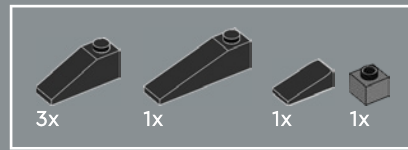
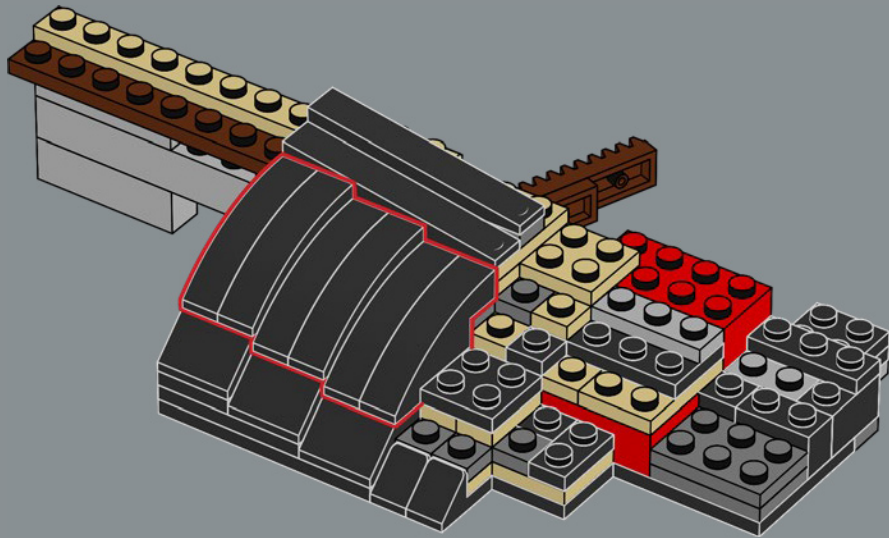

46

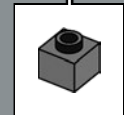
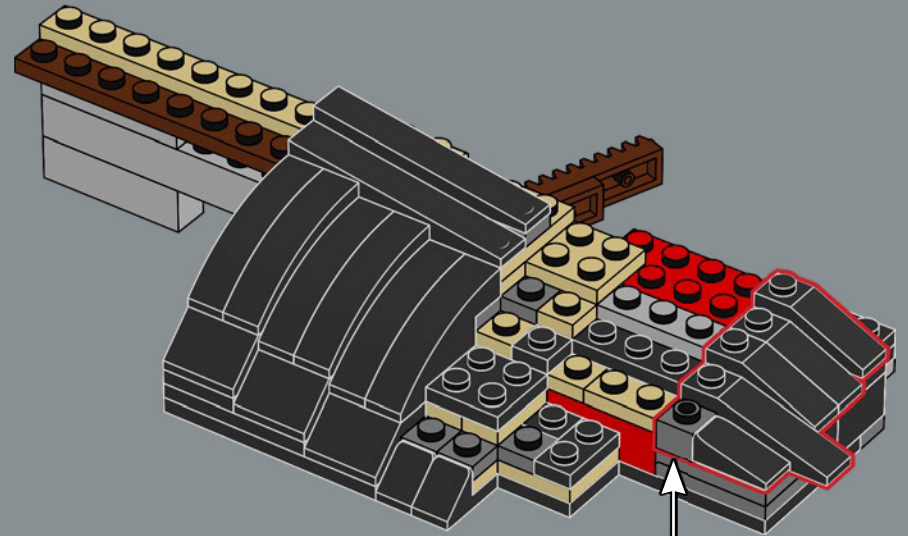

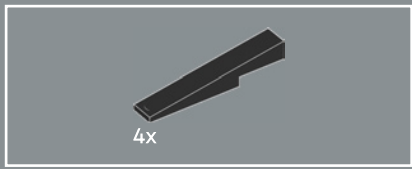

47

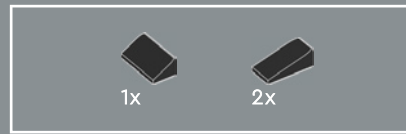
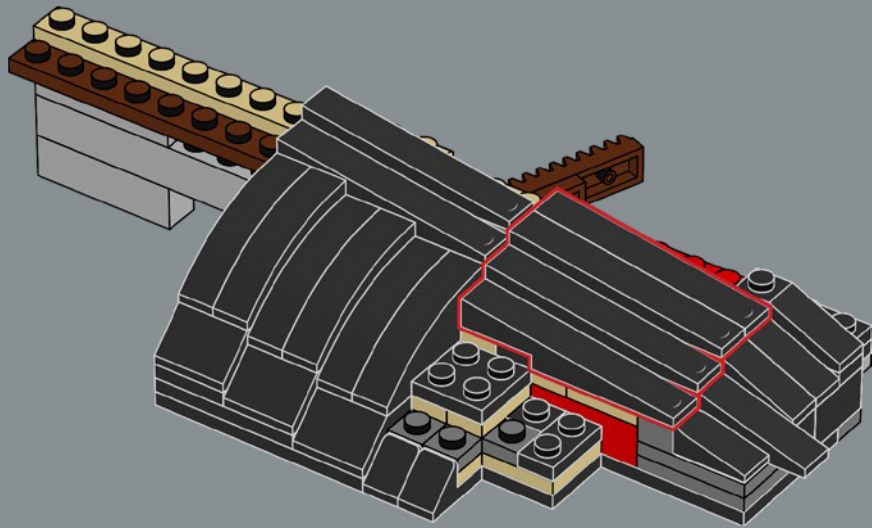

48

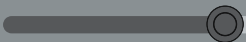
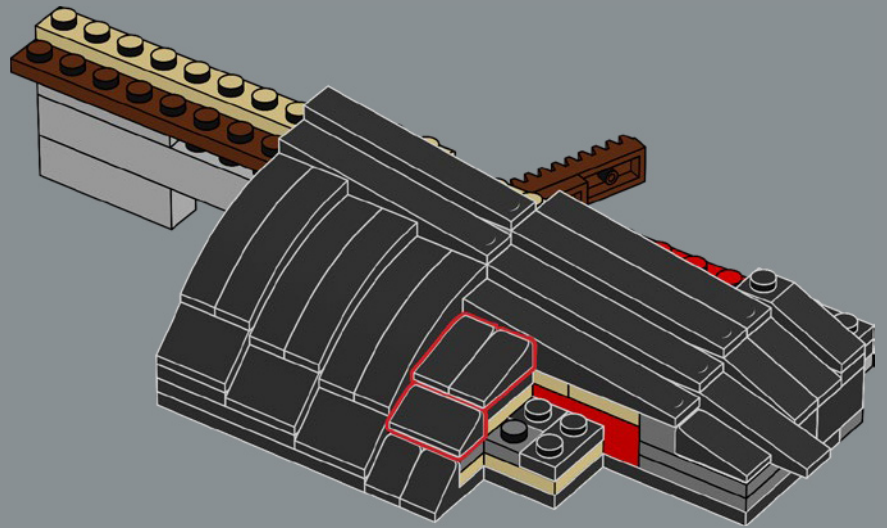

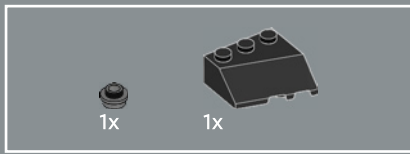

49

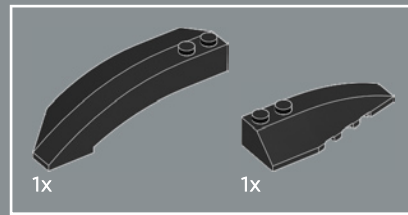
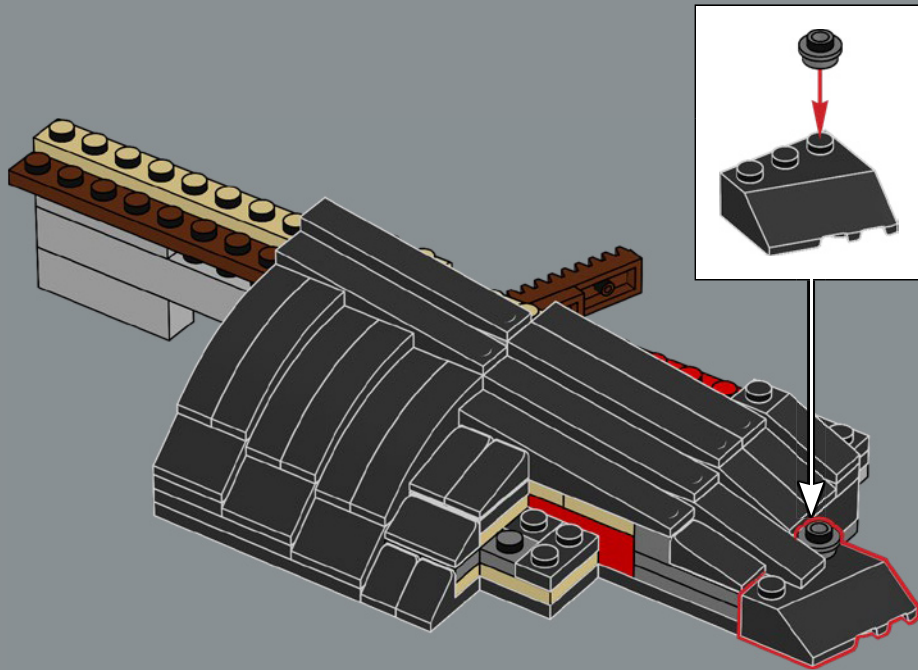

50

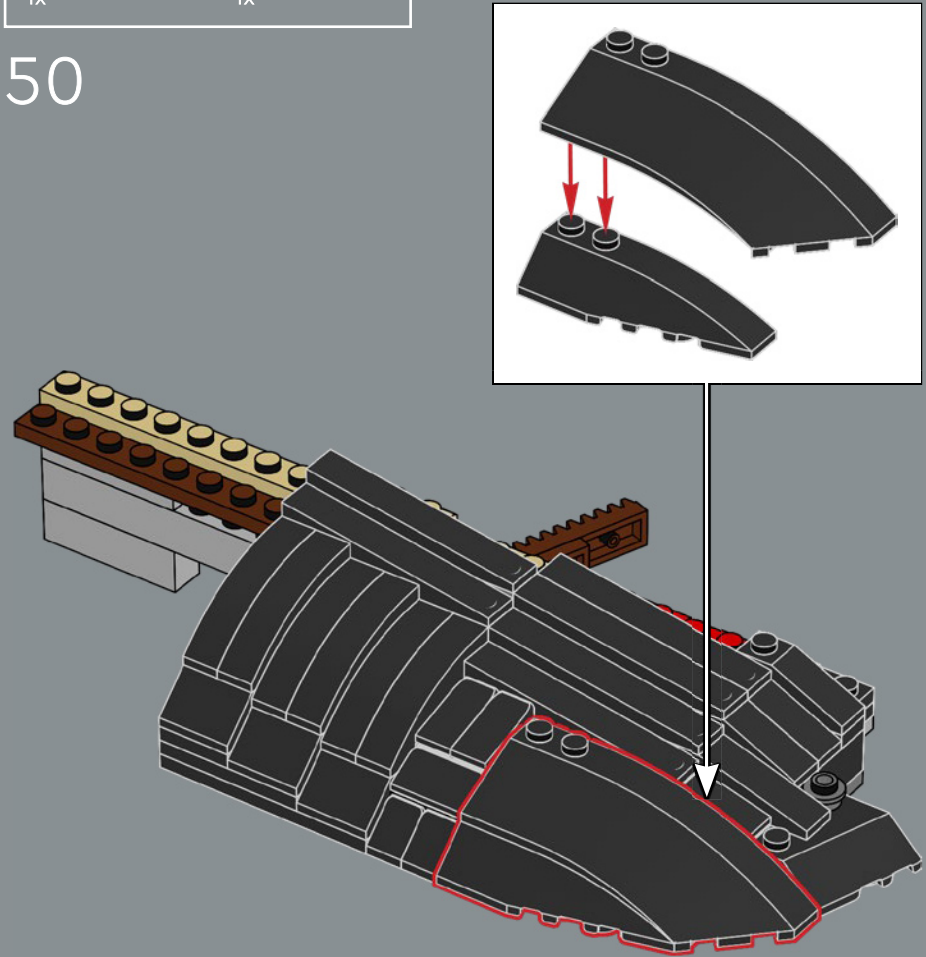





51

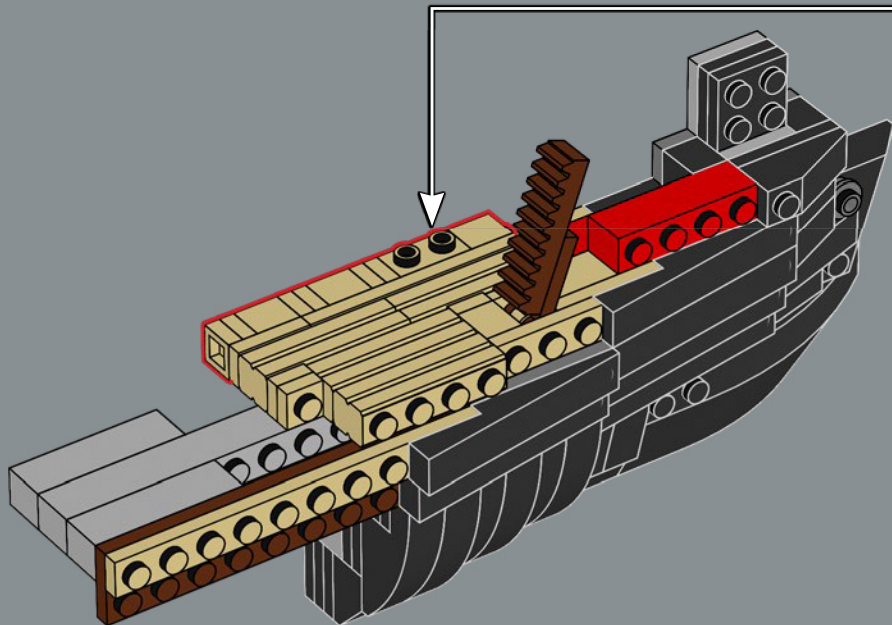
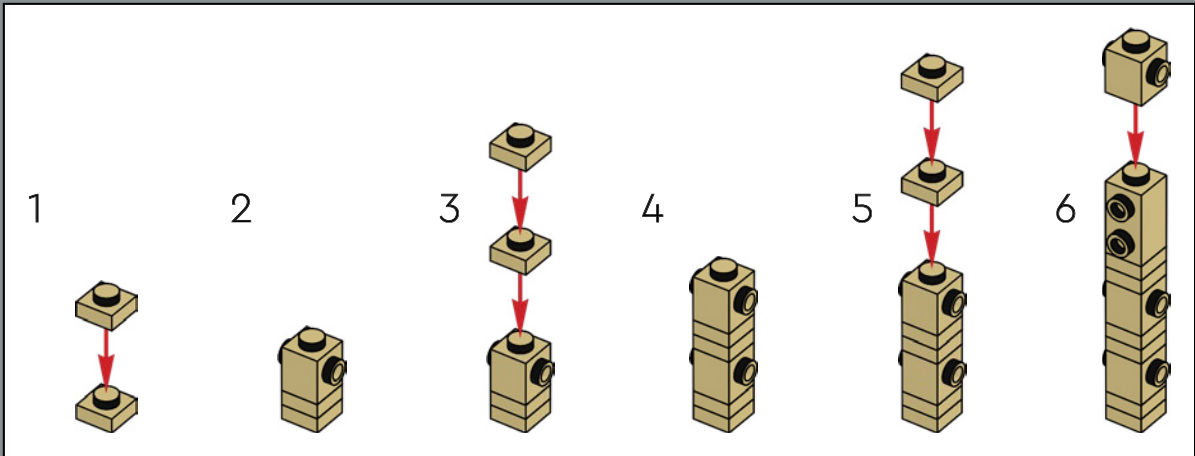

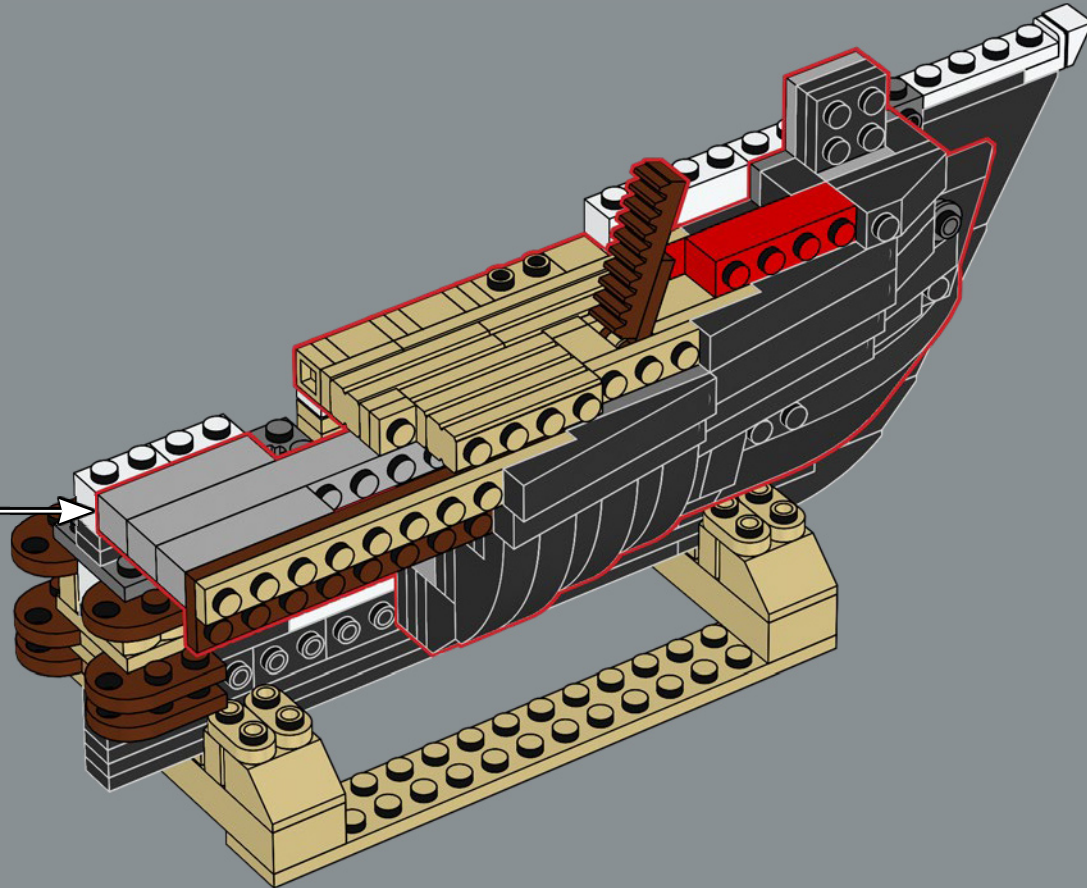

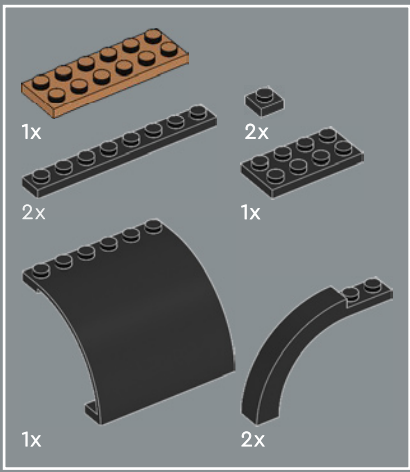

53

1

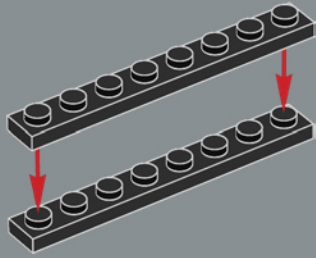

2

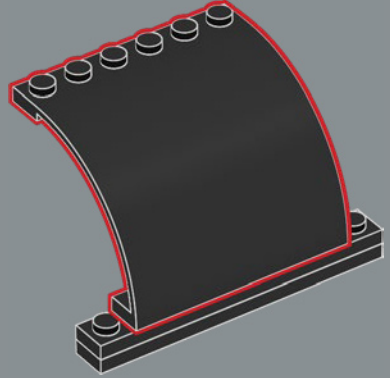

3

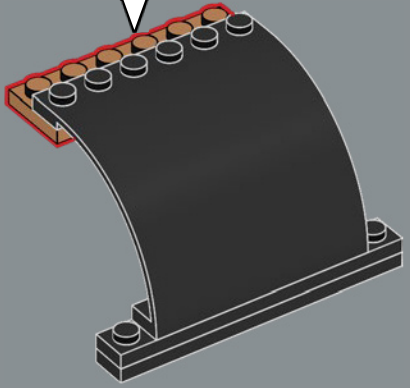
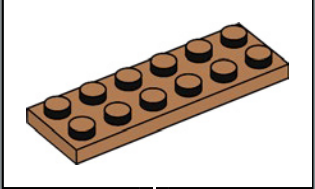

4

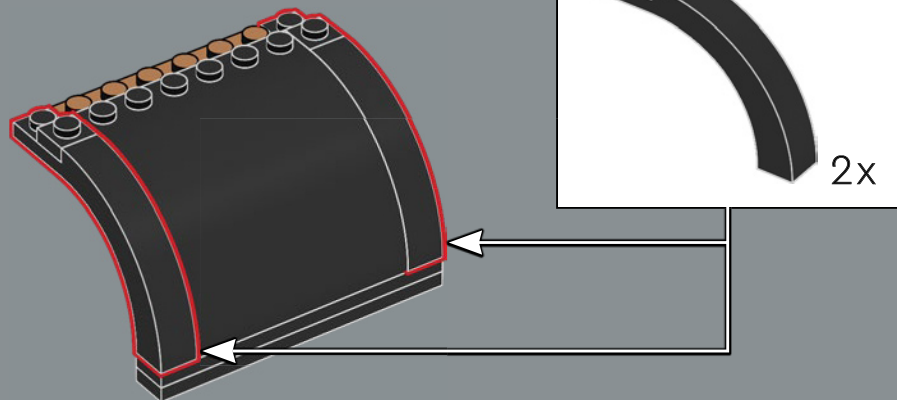

5

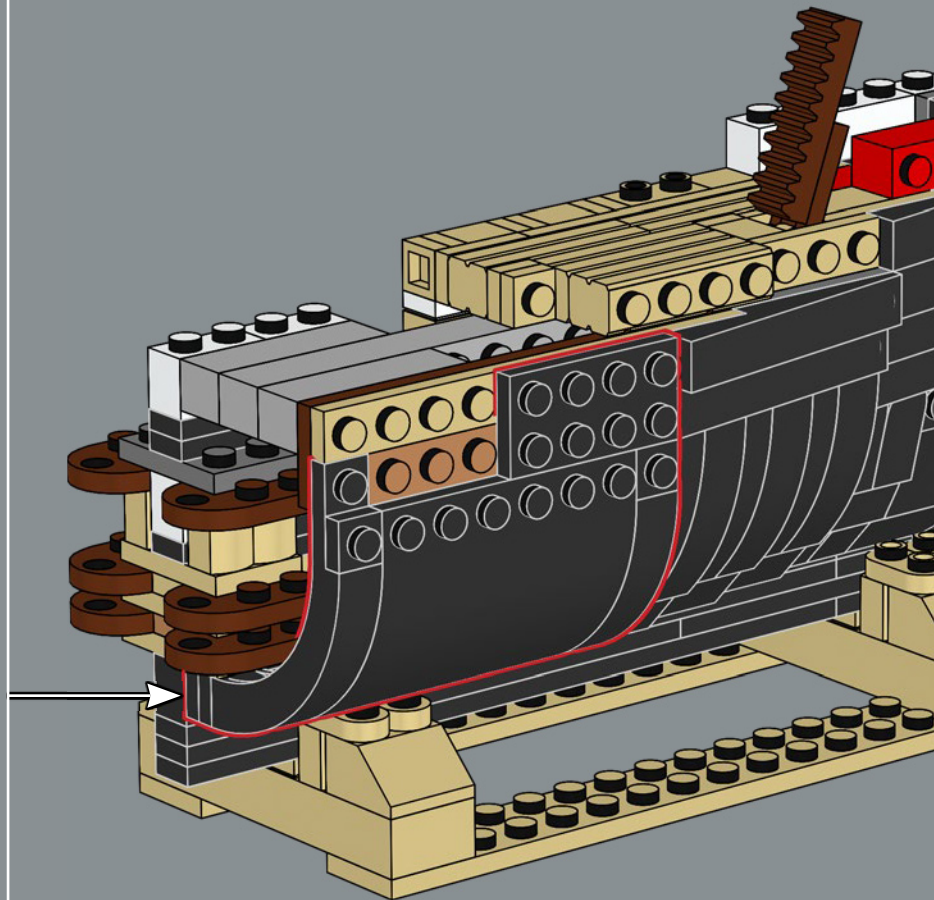
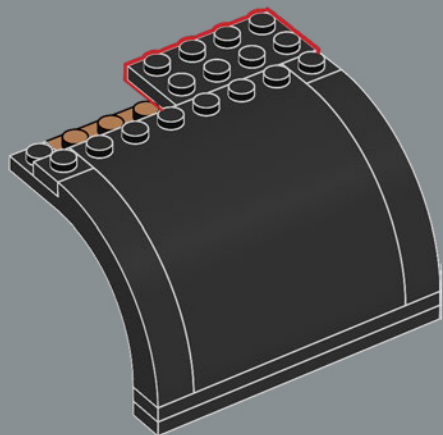



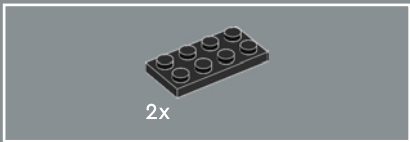
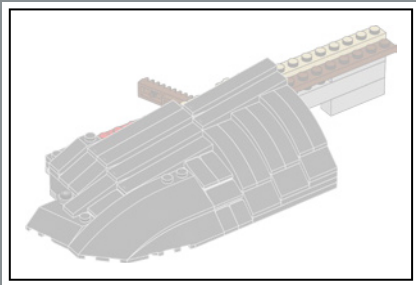

54

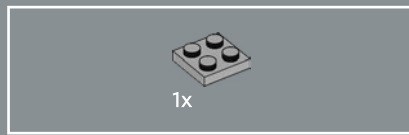
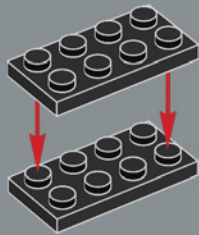

55

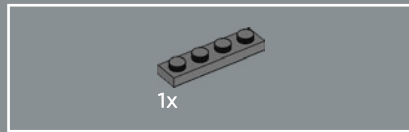
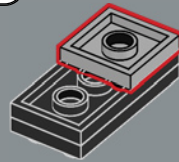

56

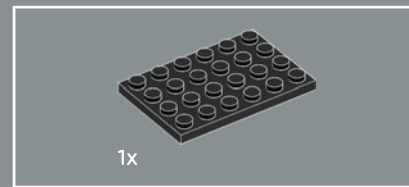
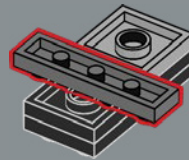

57

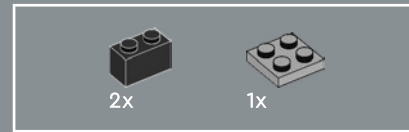
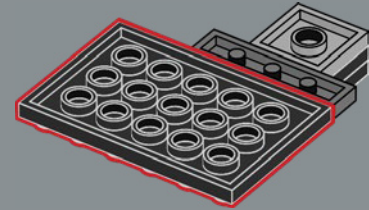

58

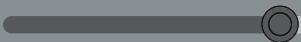
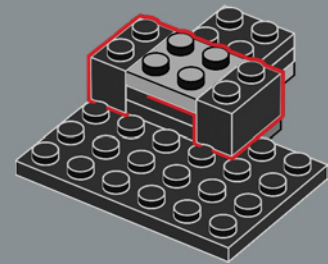

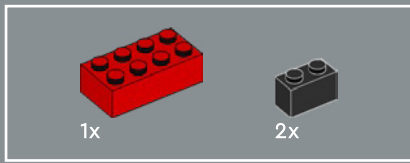

59

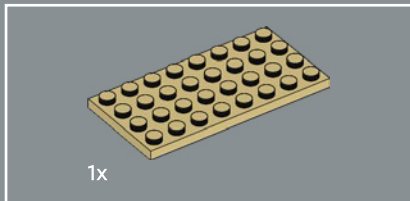
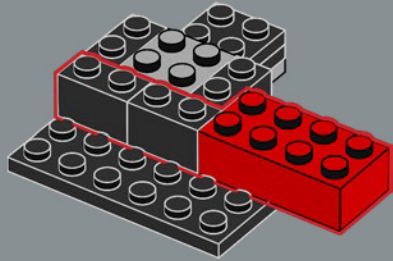

60

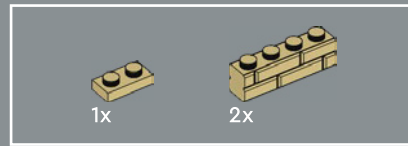
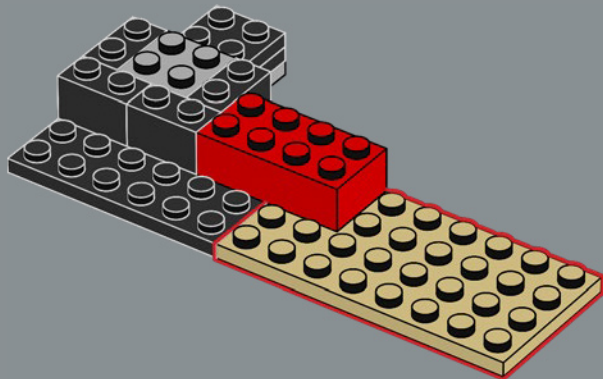

61

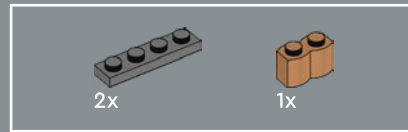
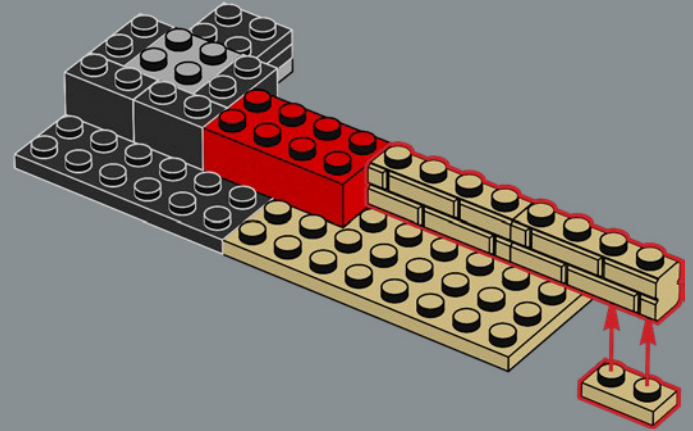

62

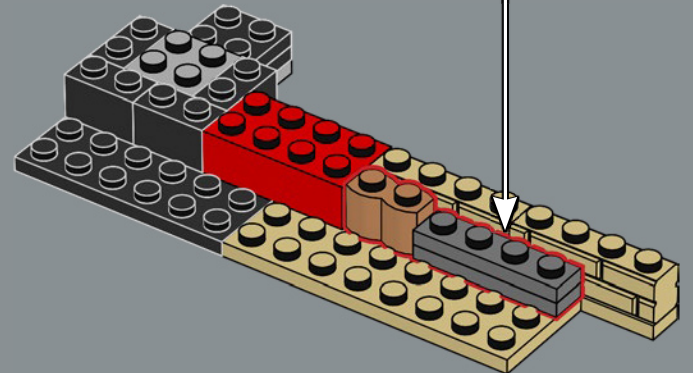
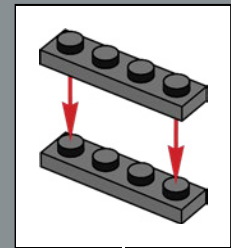

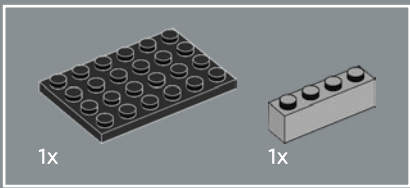

63

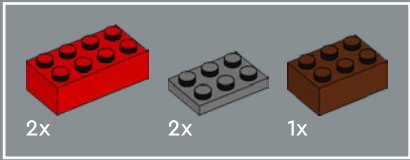
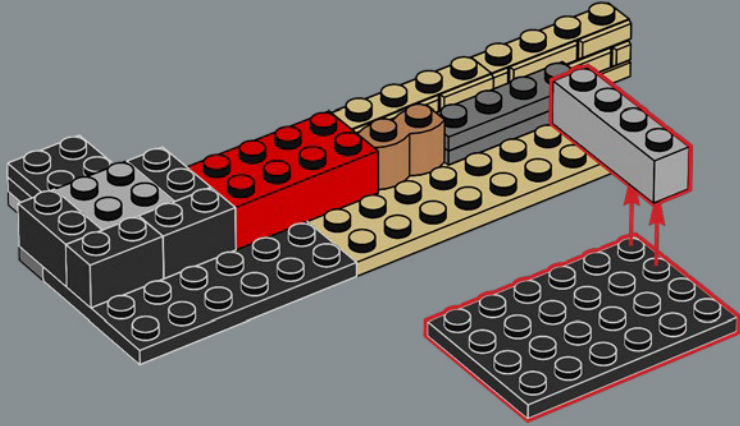

64

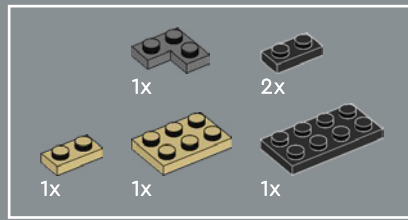
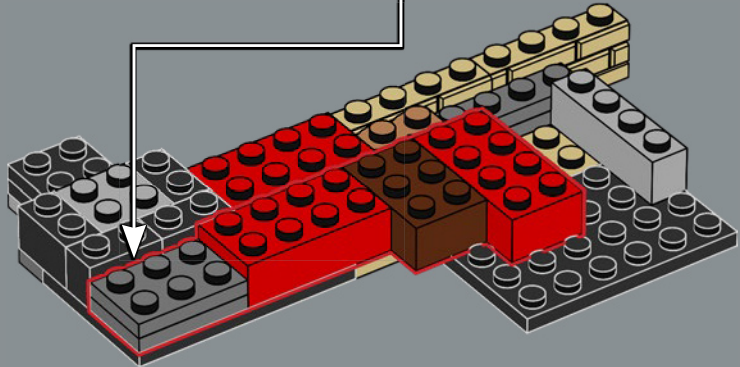
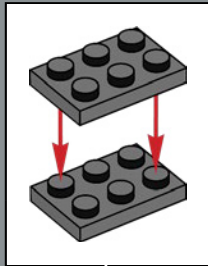

65

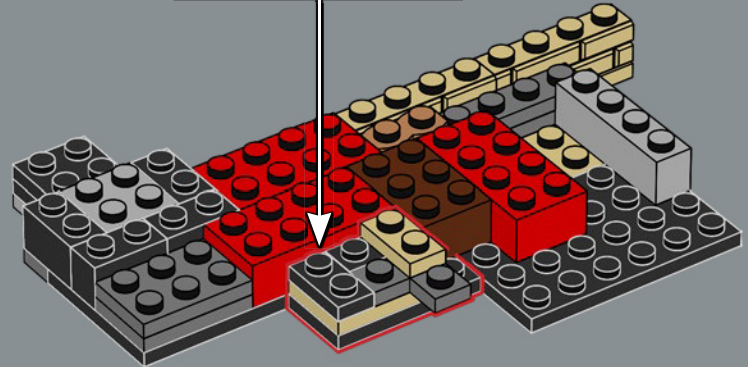
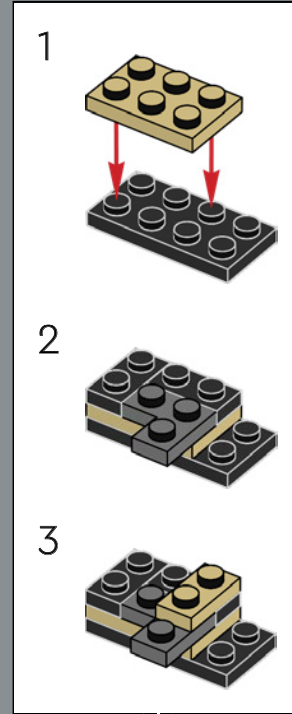



66

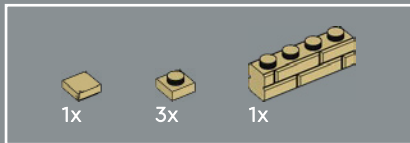
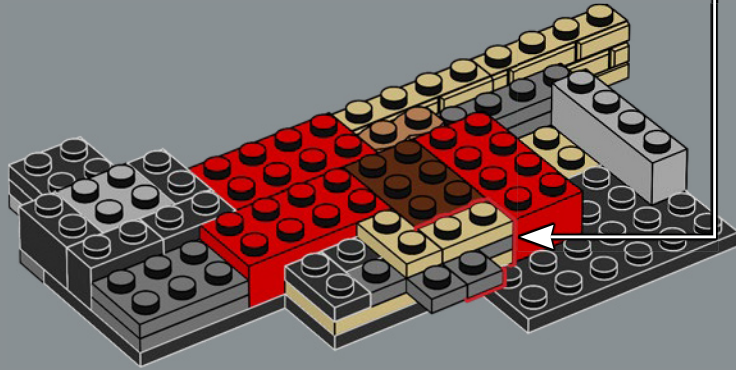
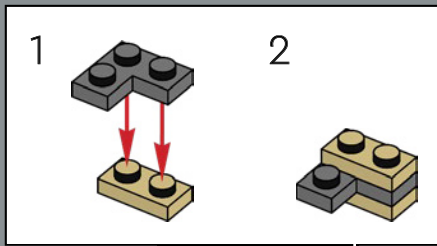

67

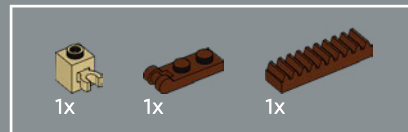
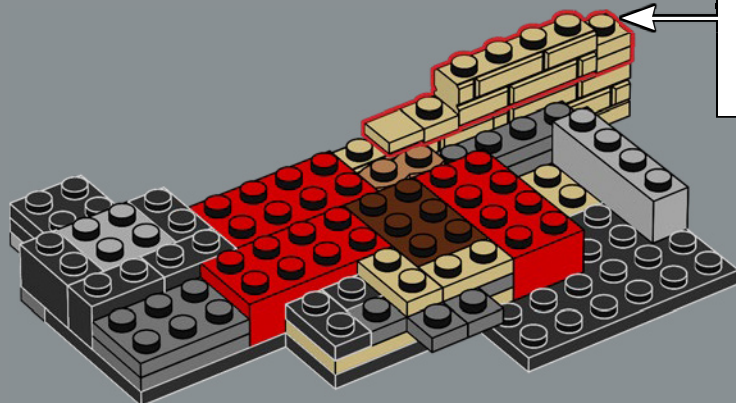
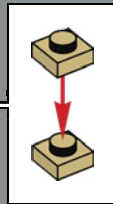

68

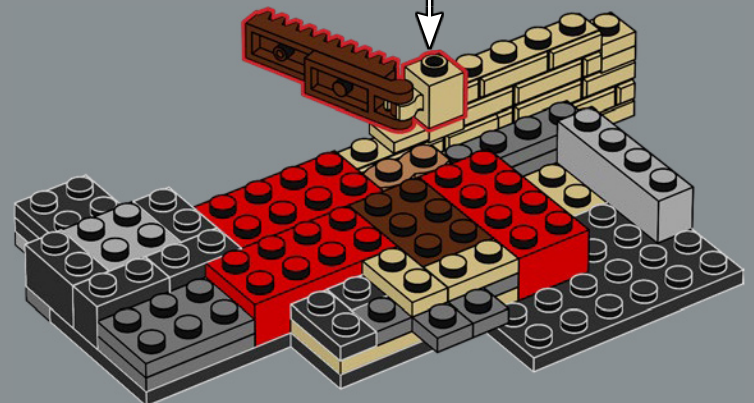
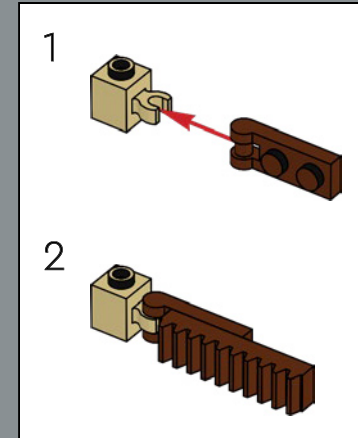



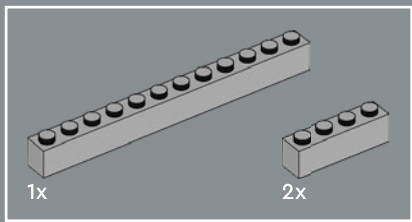

69

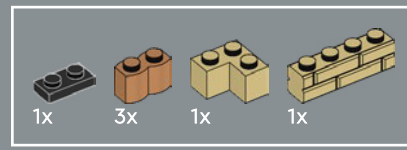
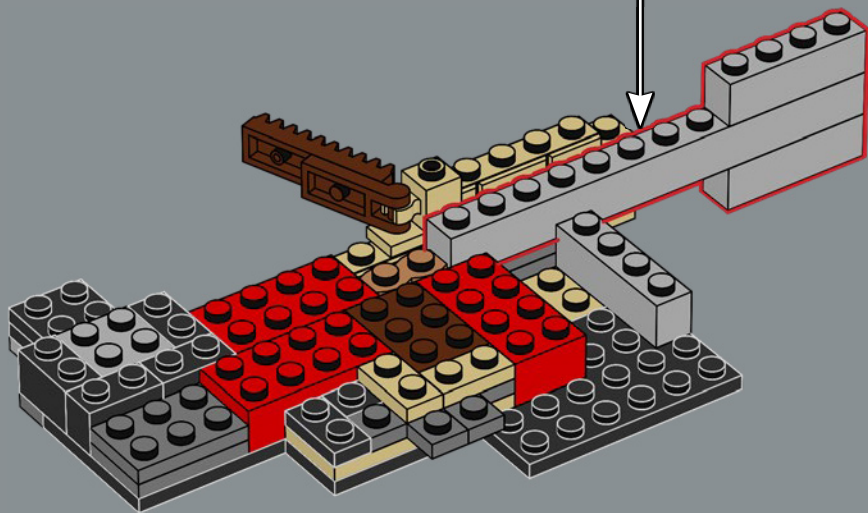
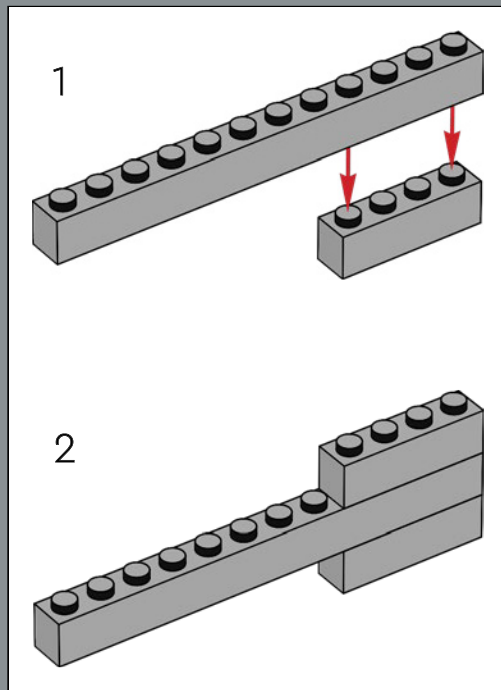

70

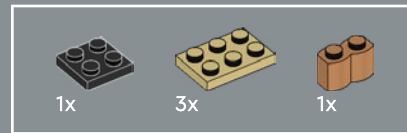
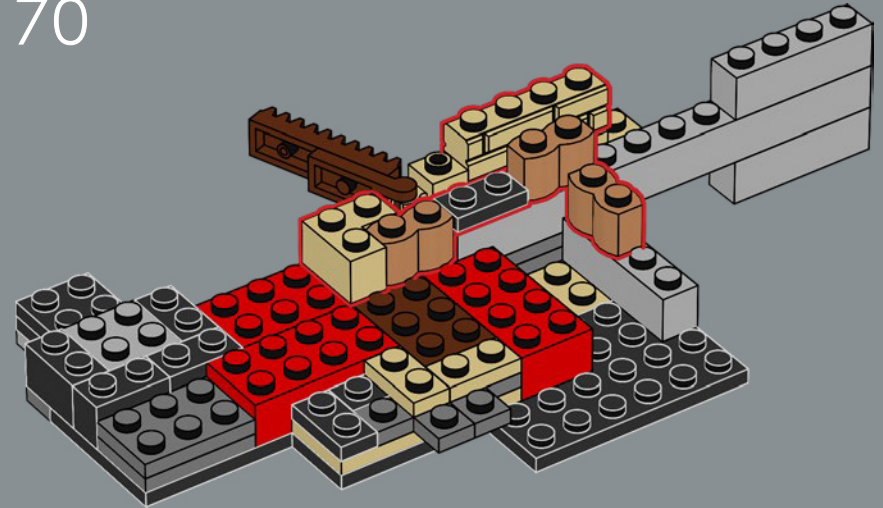

71

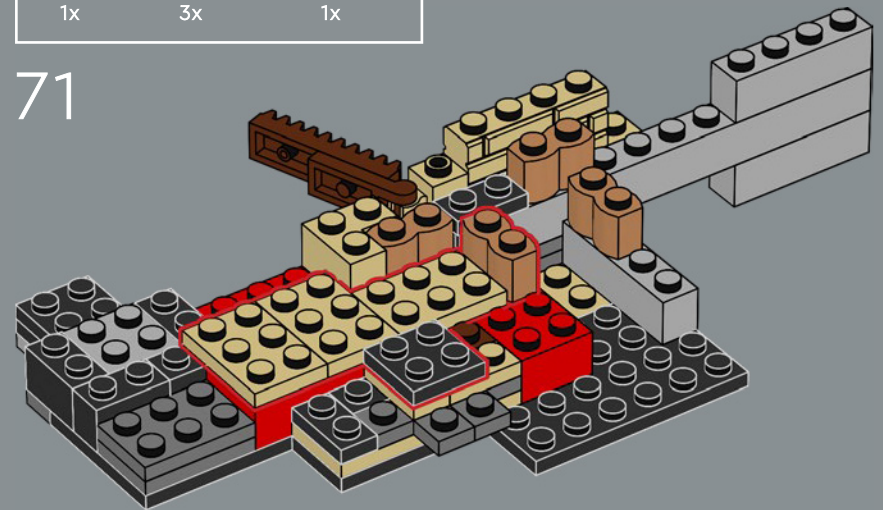

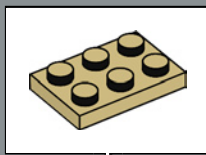
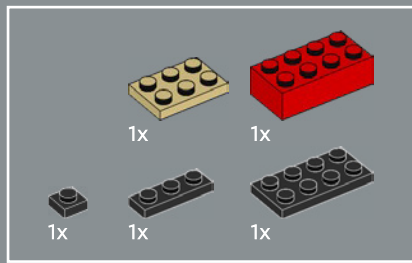

72

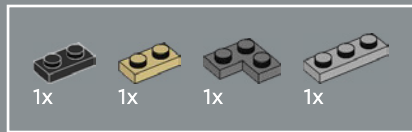
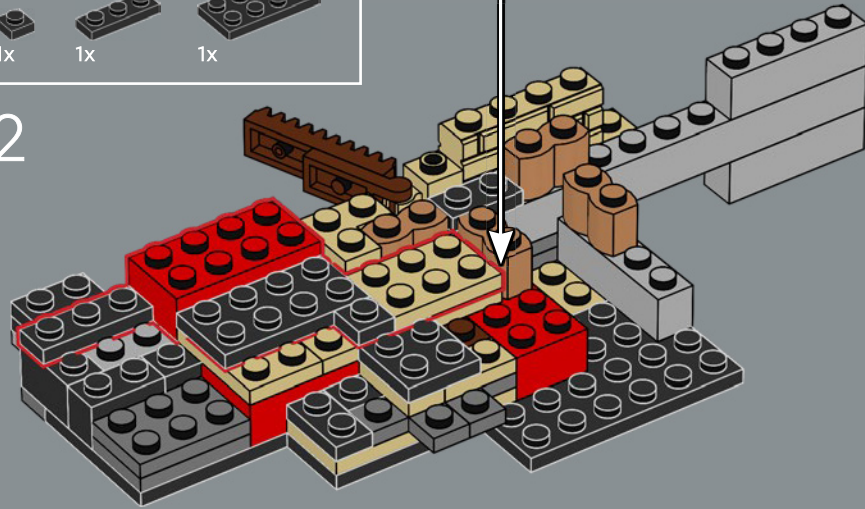

73

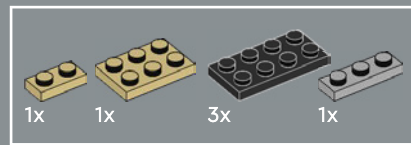
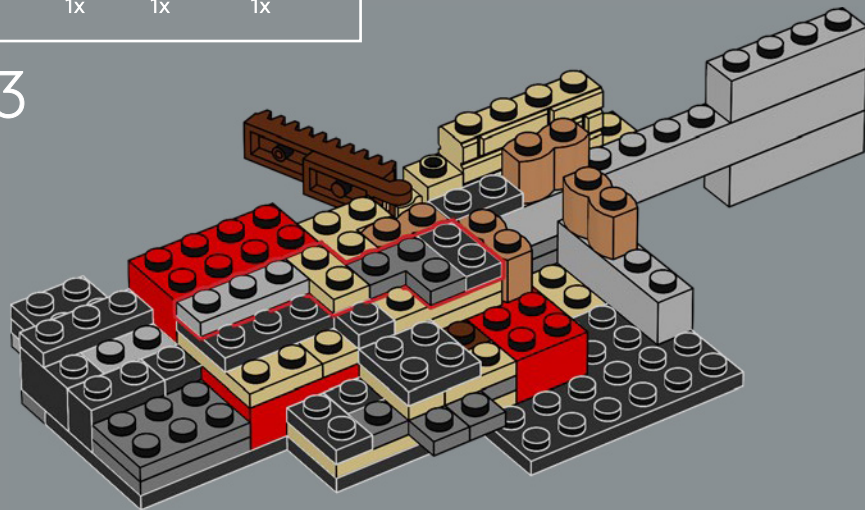

74

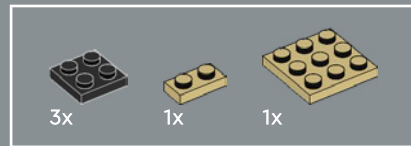
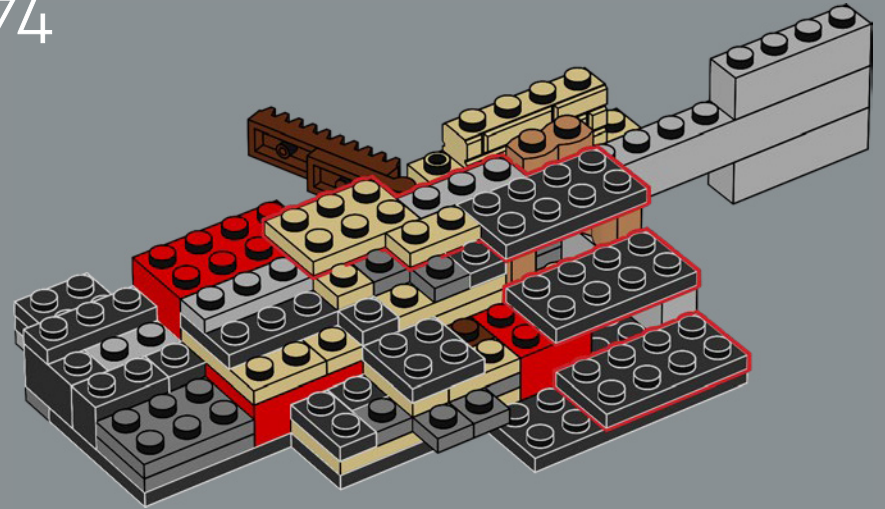

75

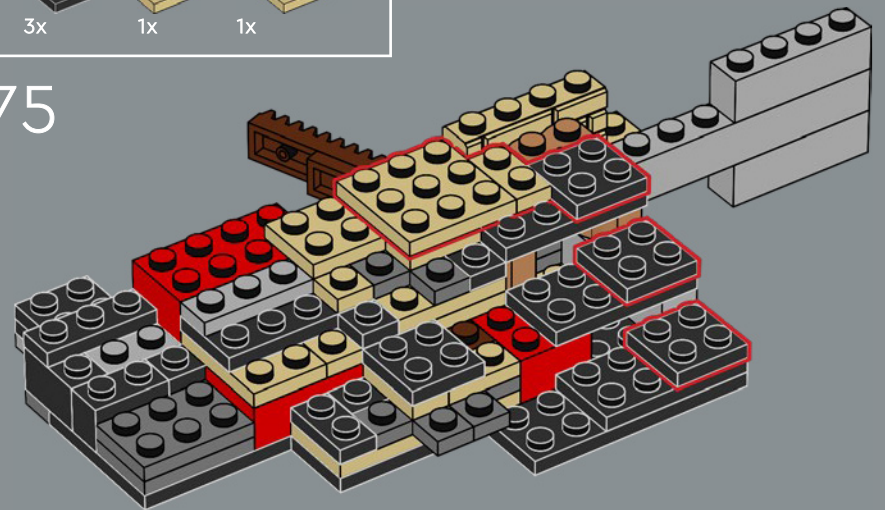



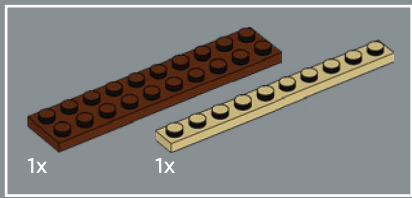

76

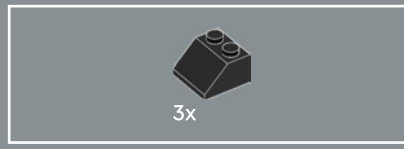
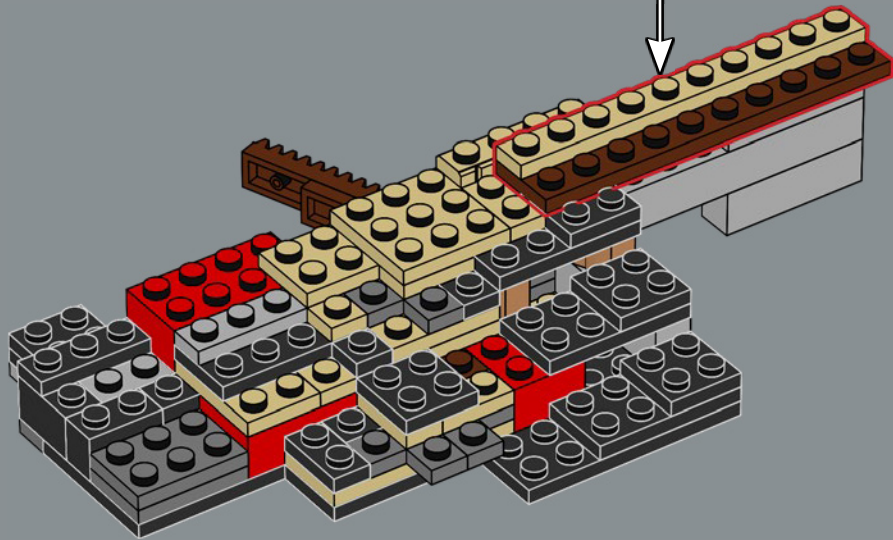
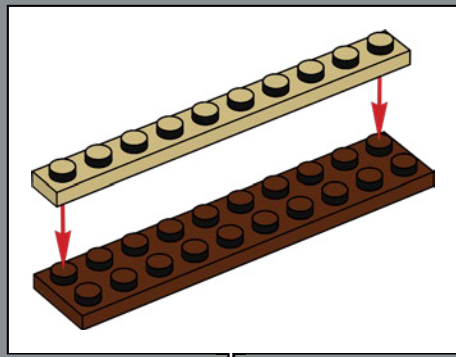

77

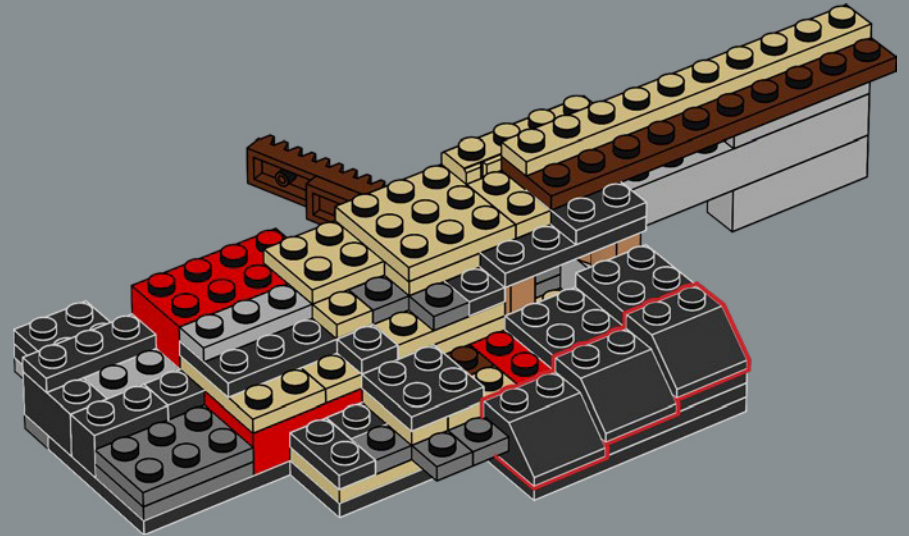



78

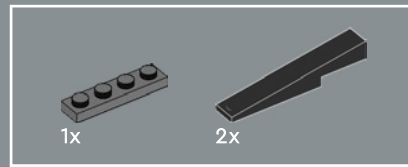
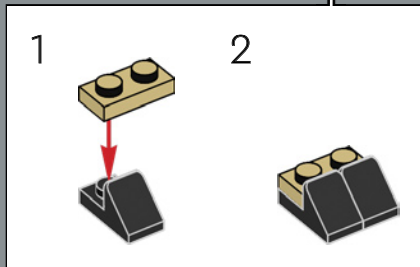
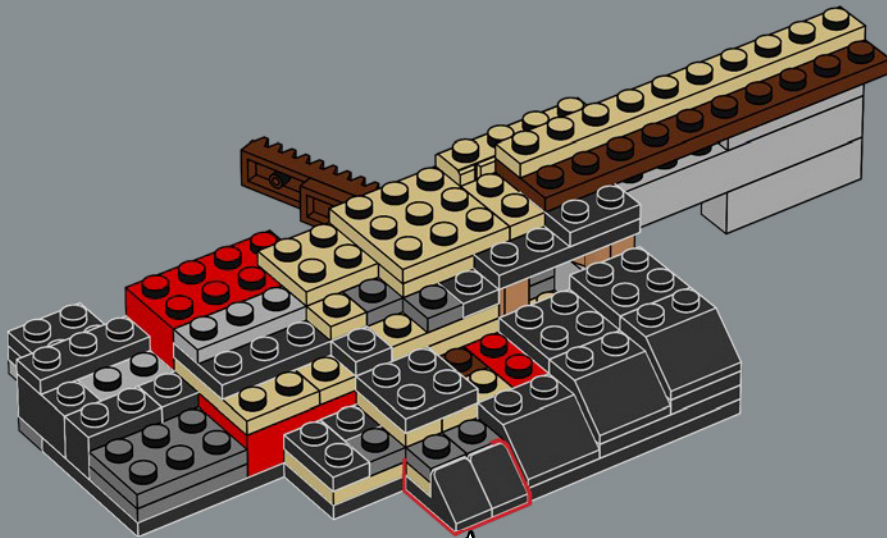

79

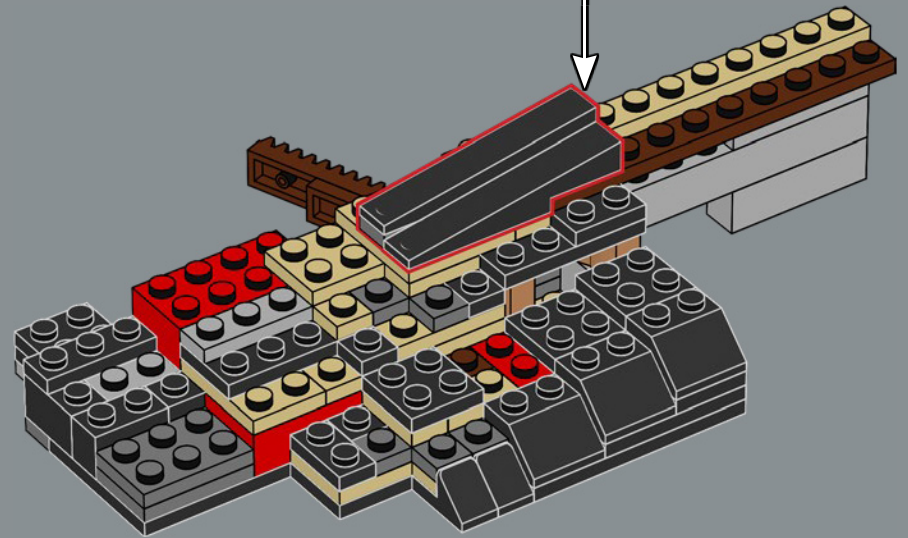
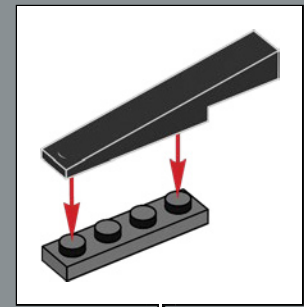





80

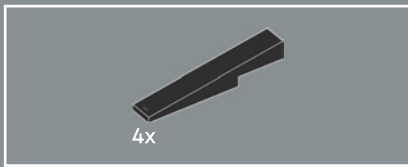
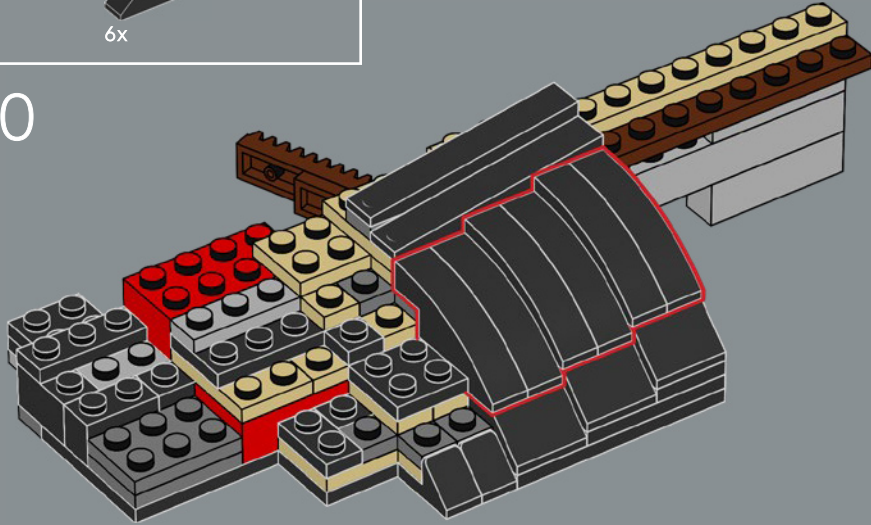

82

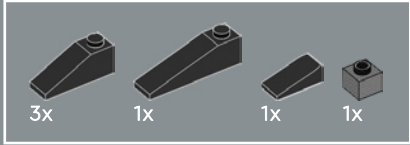
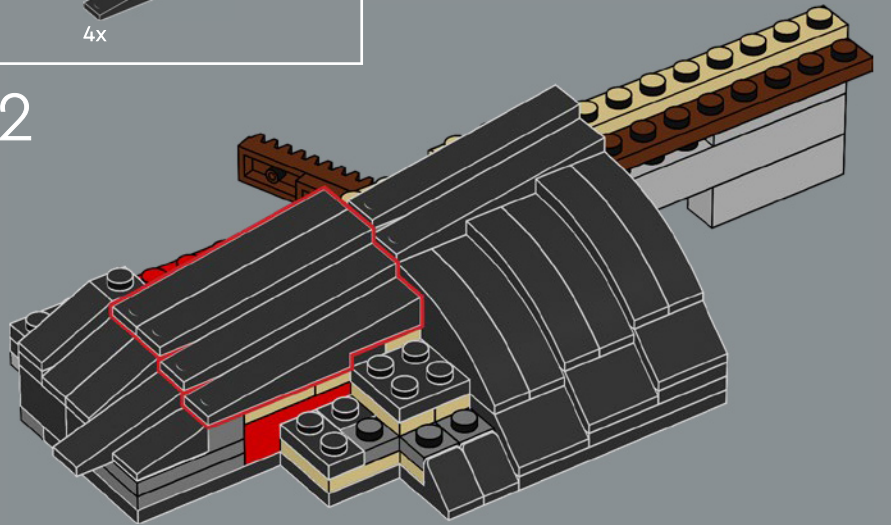

81

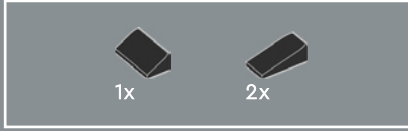
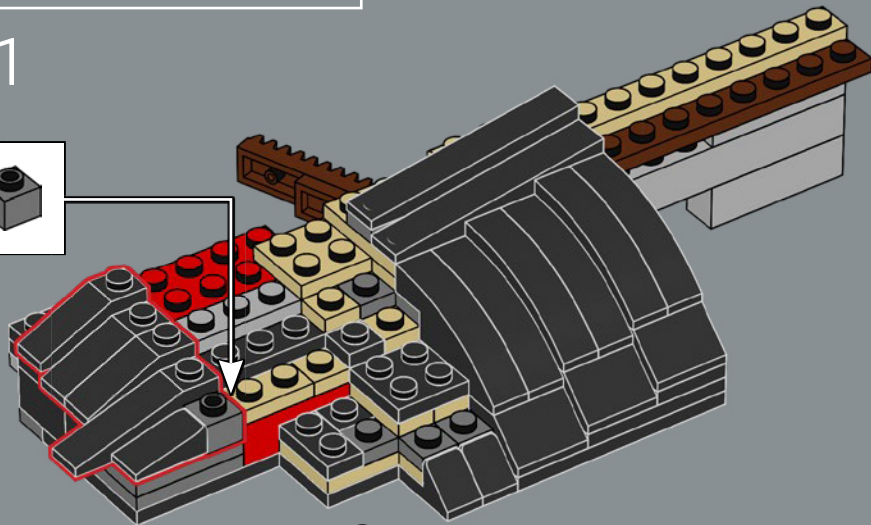
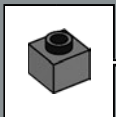

83

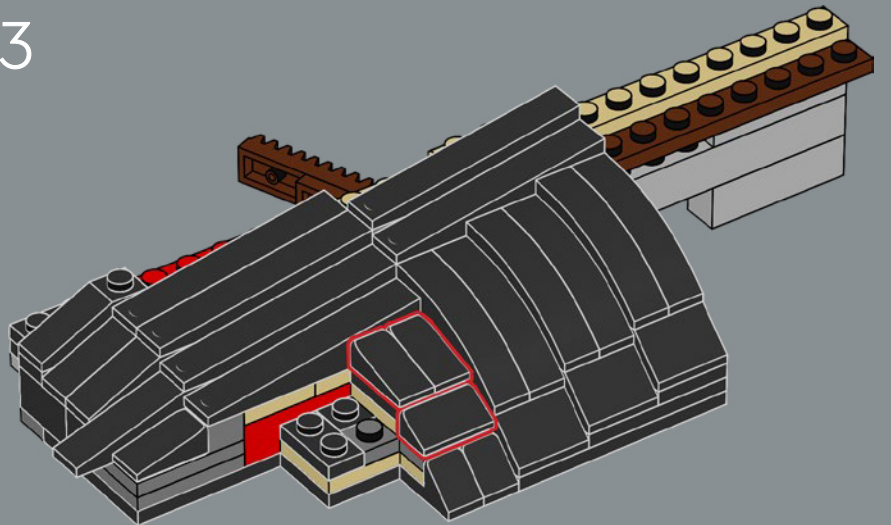

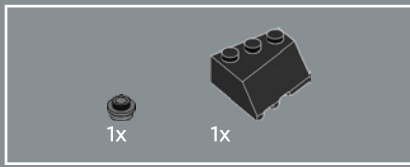

84

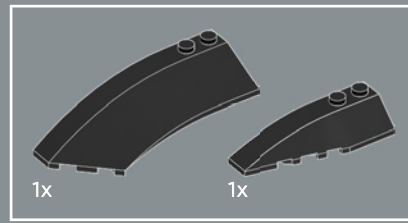
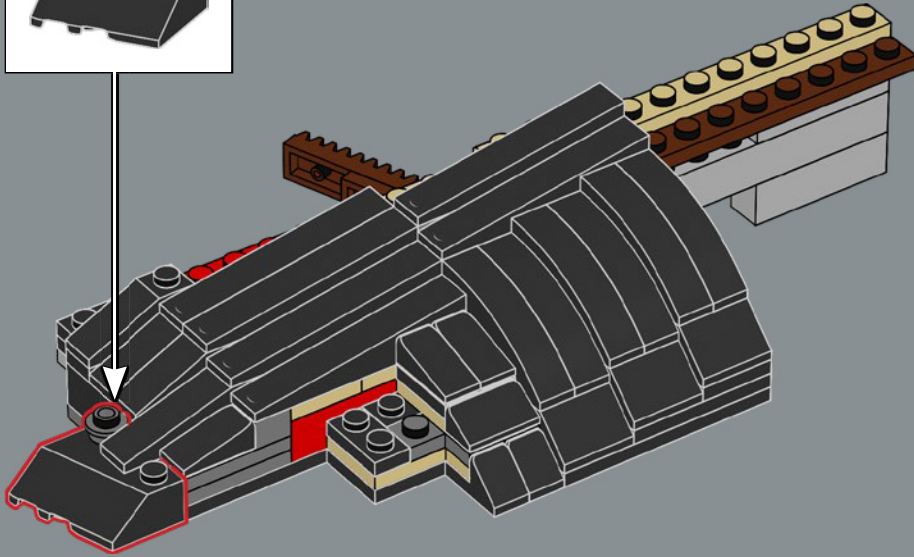
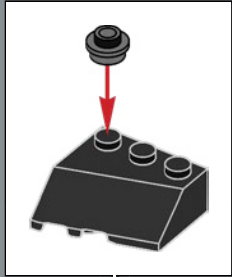

85

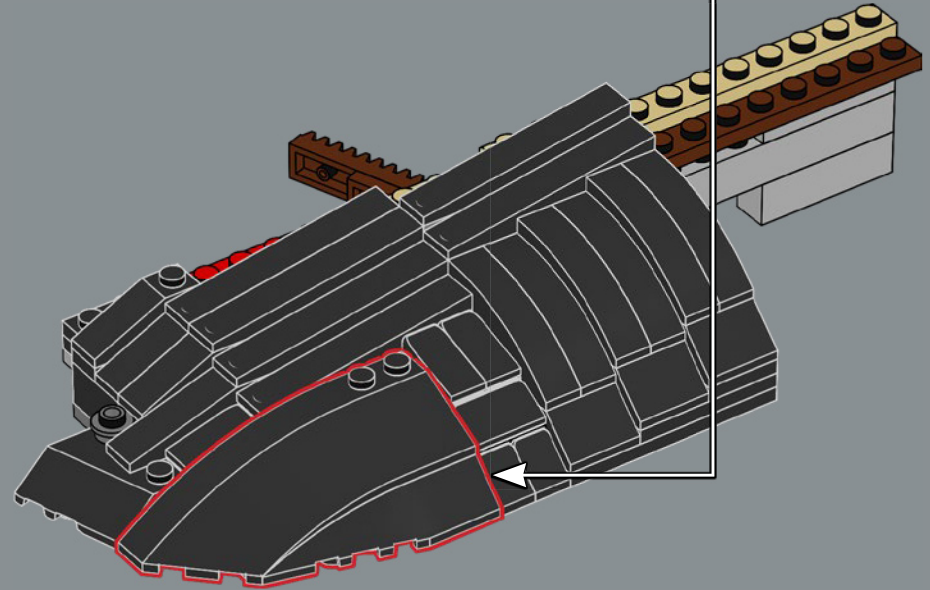
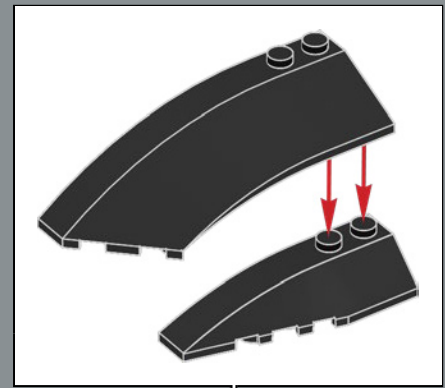



Aus braunen LEGO® Technic 1x4 Zahnstangenelementen werden schöne kleine Holzleitern.

86

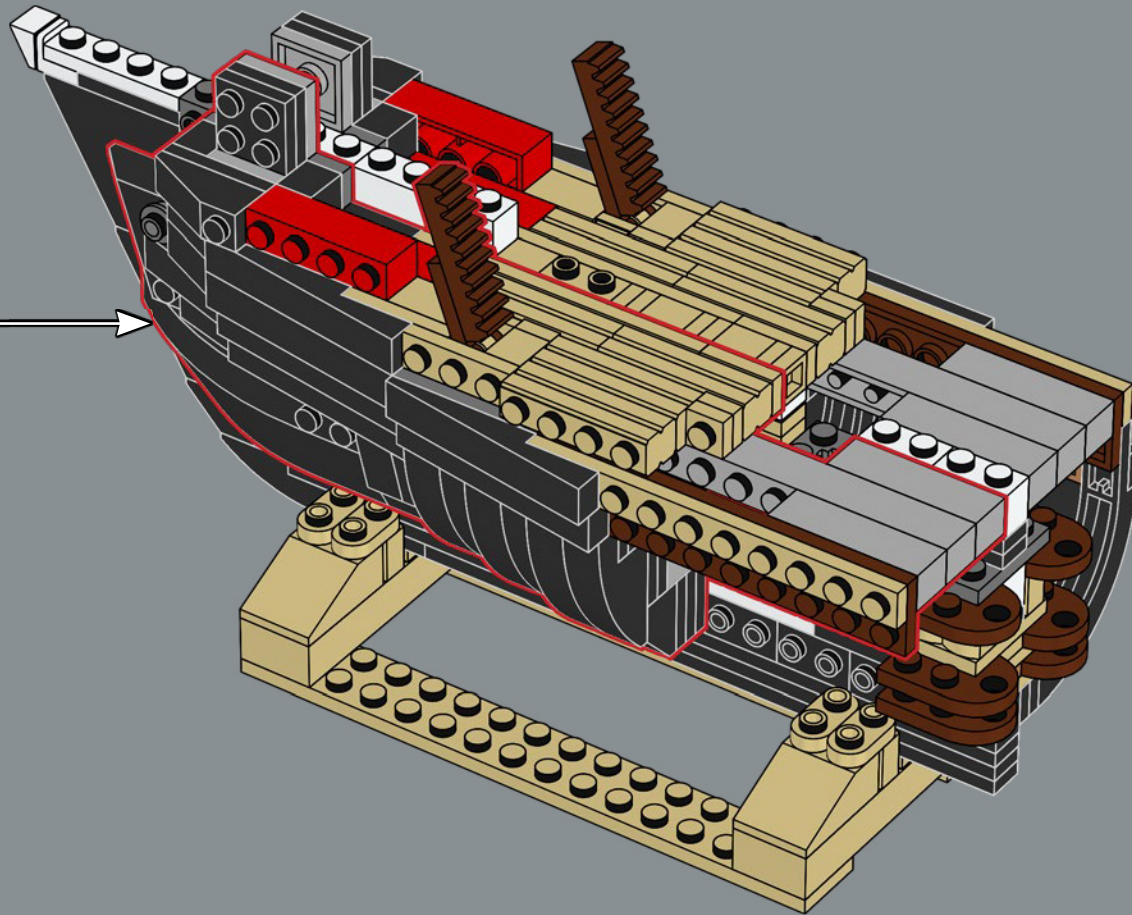



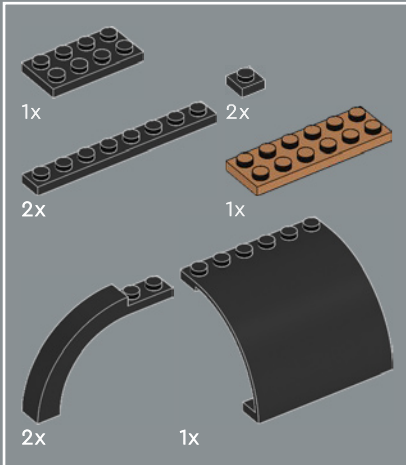
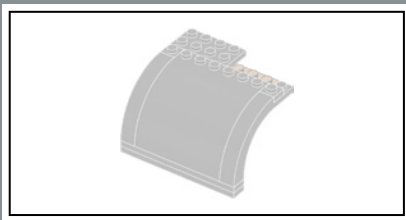

87

1

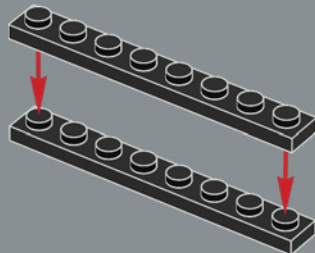

2

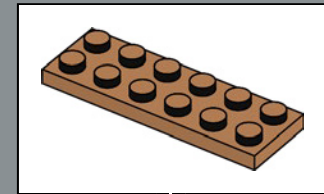
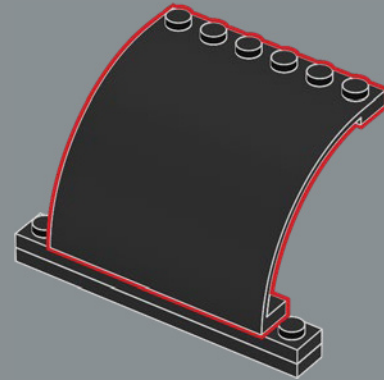

3

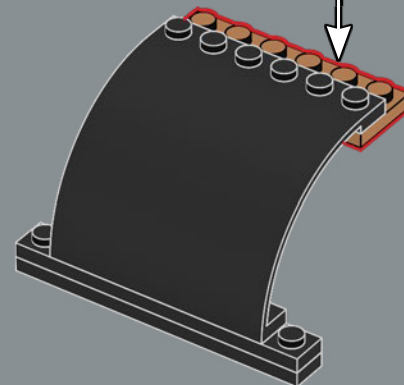



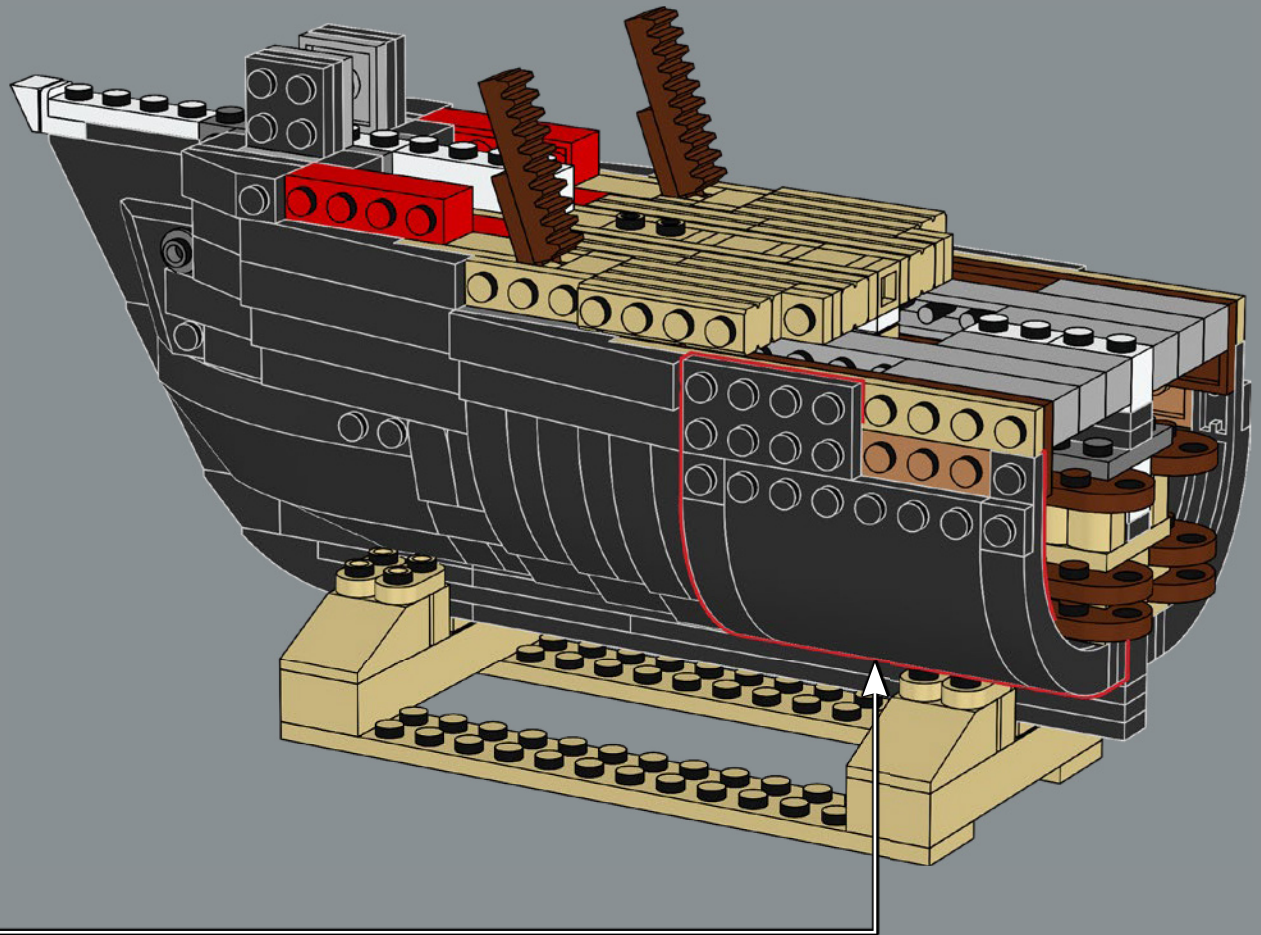
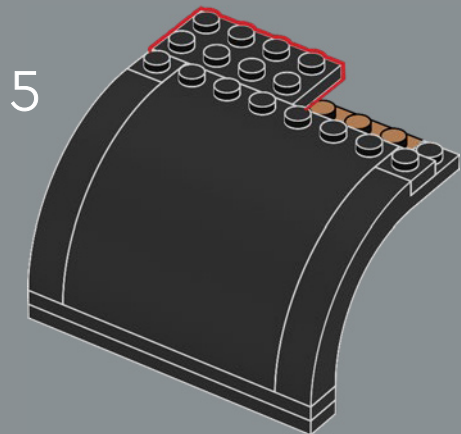
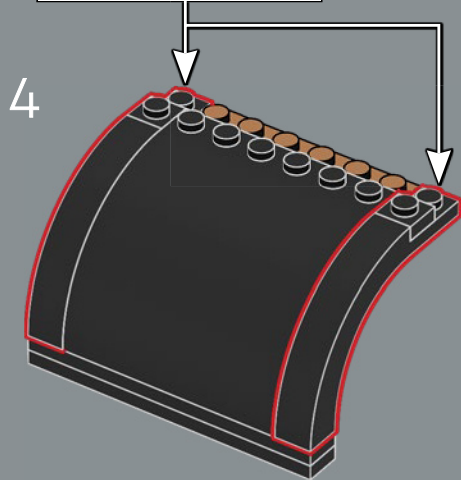
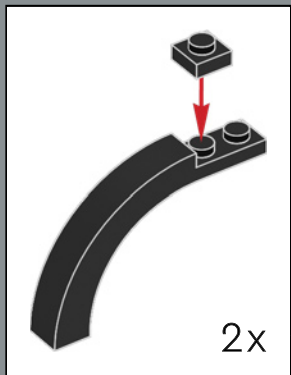

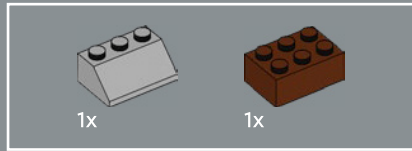

88

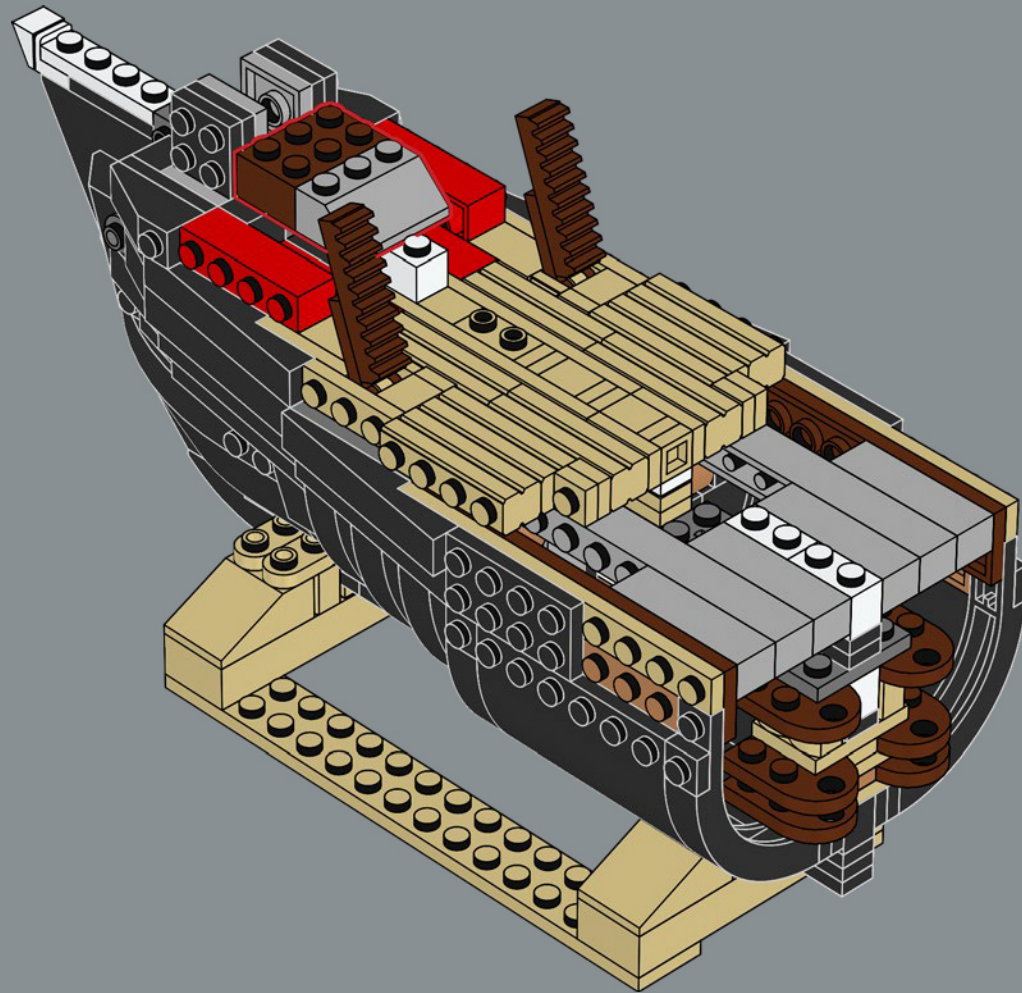



2x

89

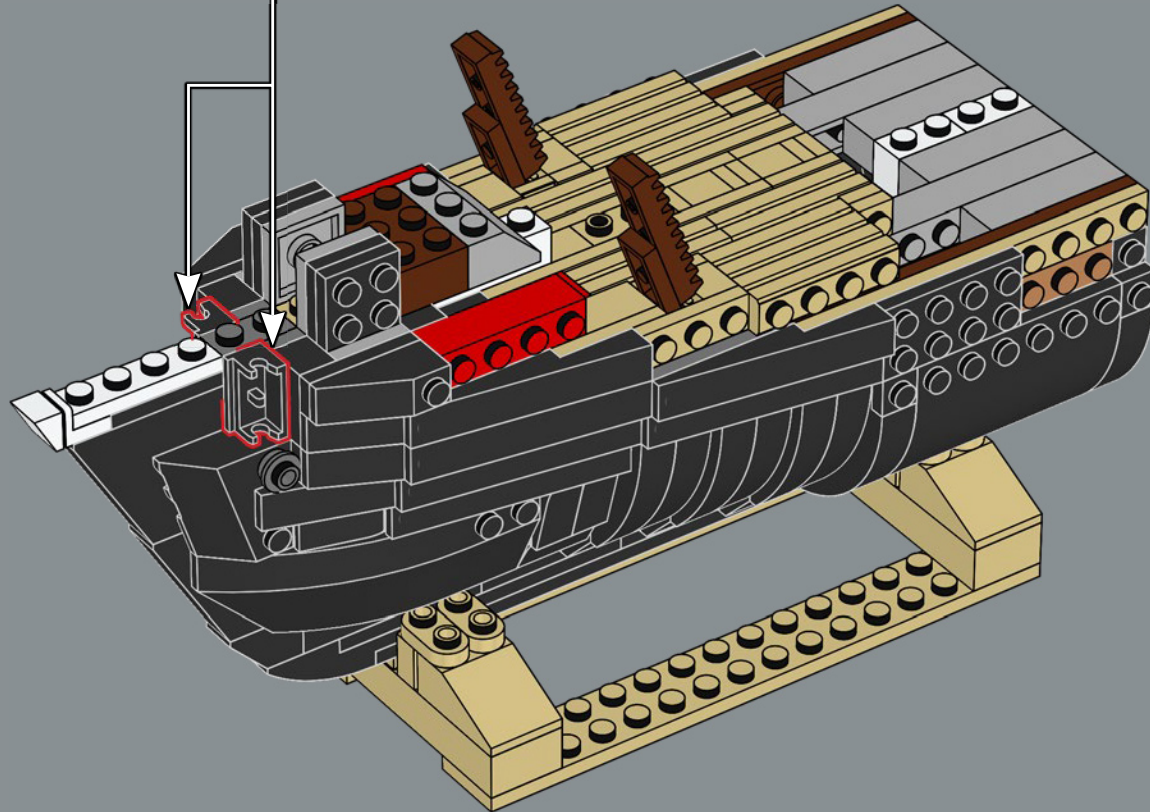
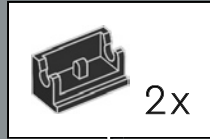



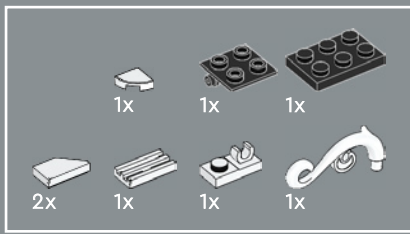

90

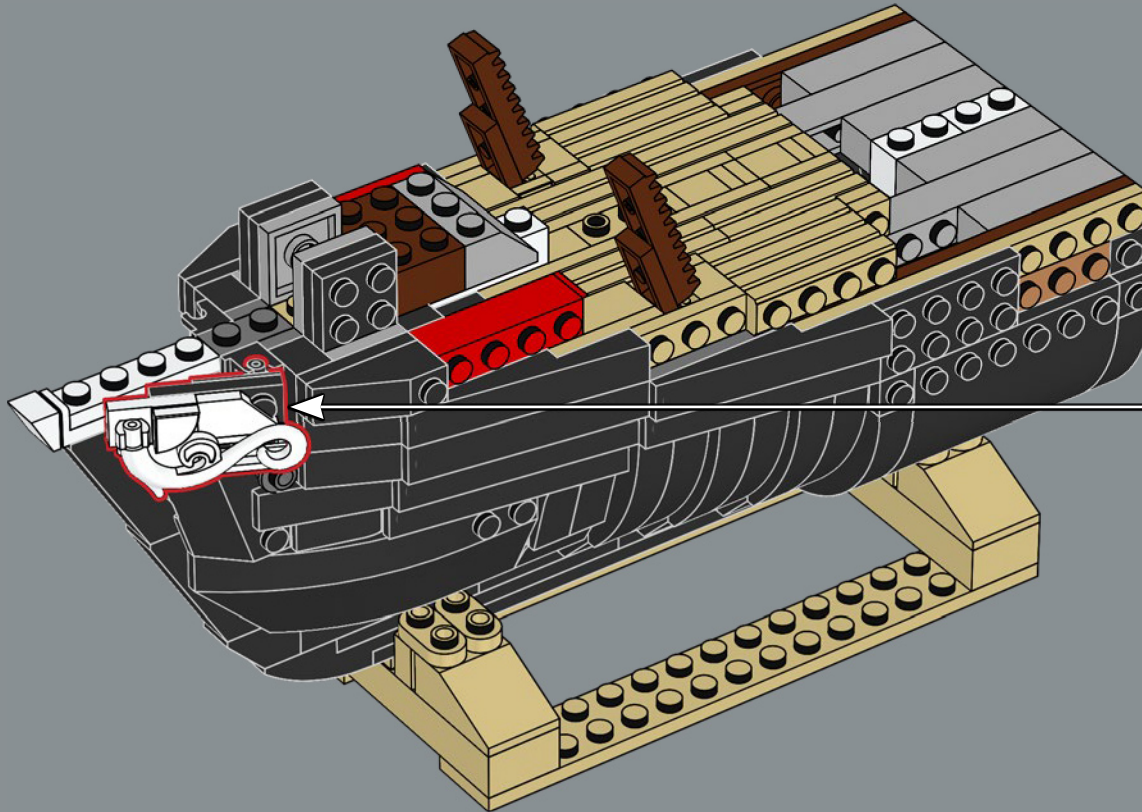
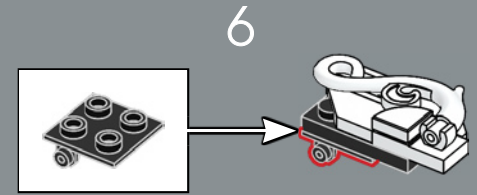
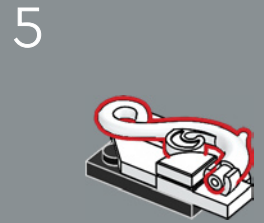
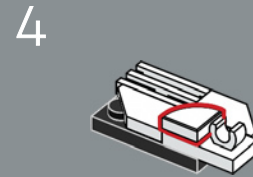
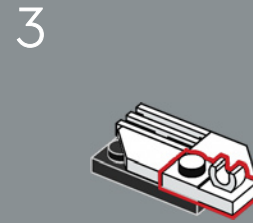
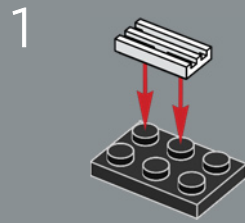



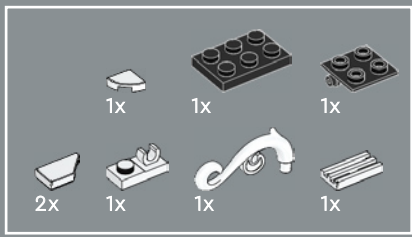

91

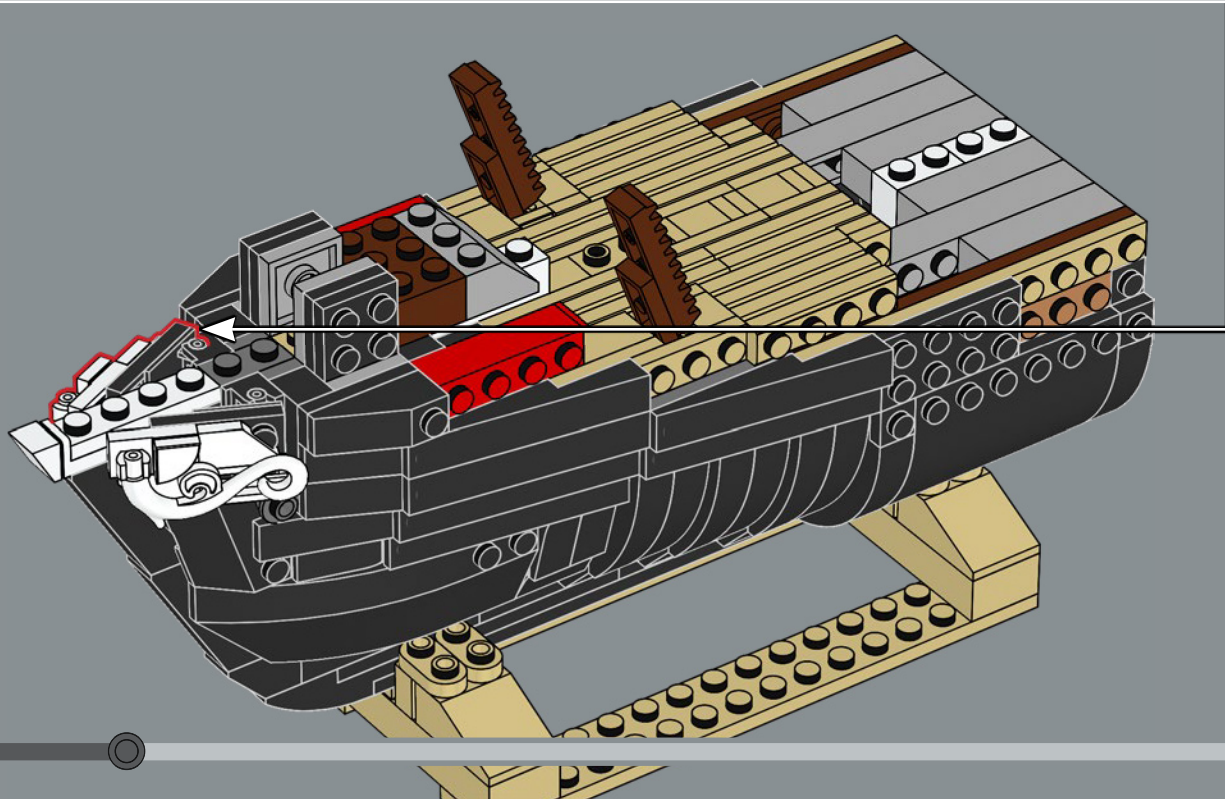
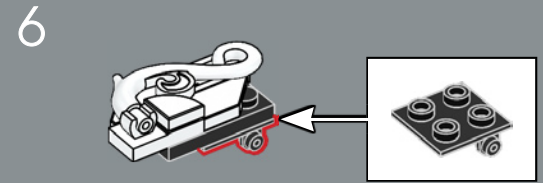
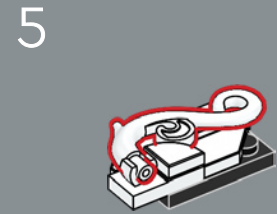
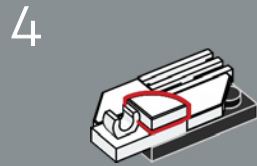
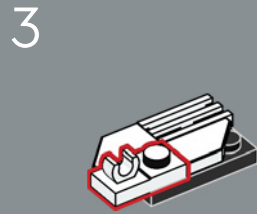
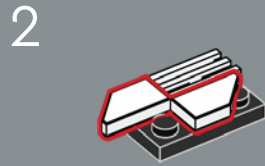
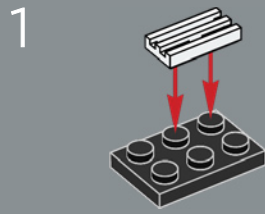

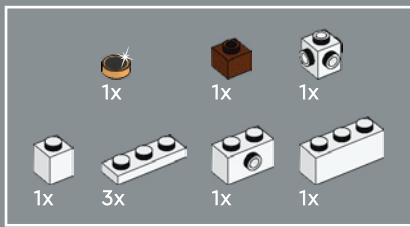

92

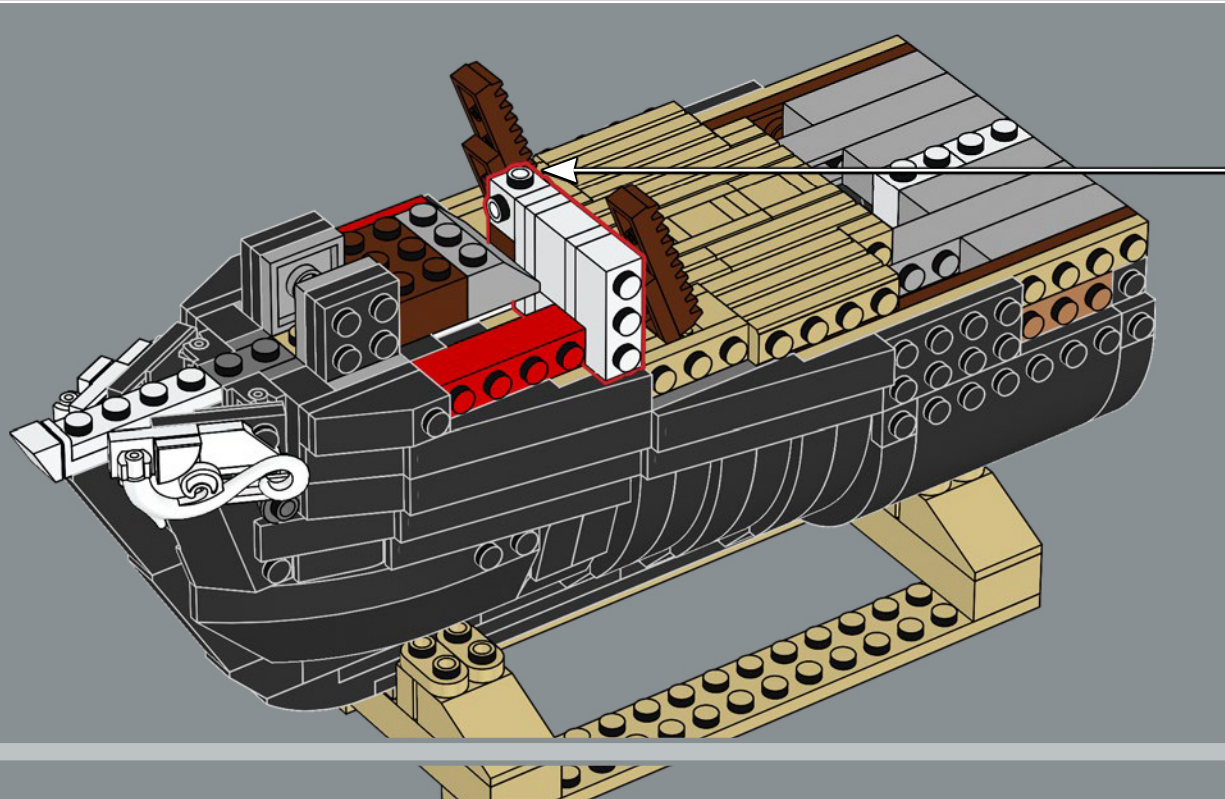
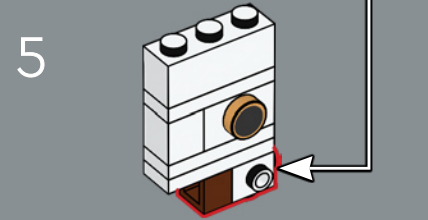
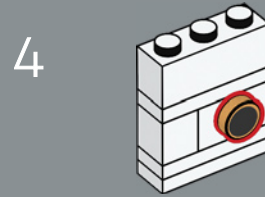
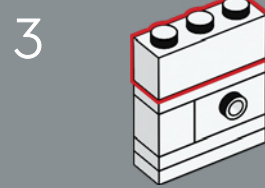
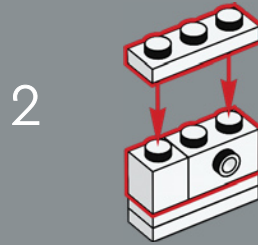
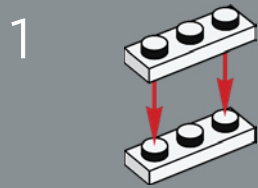

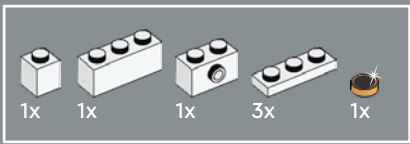

93

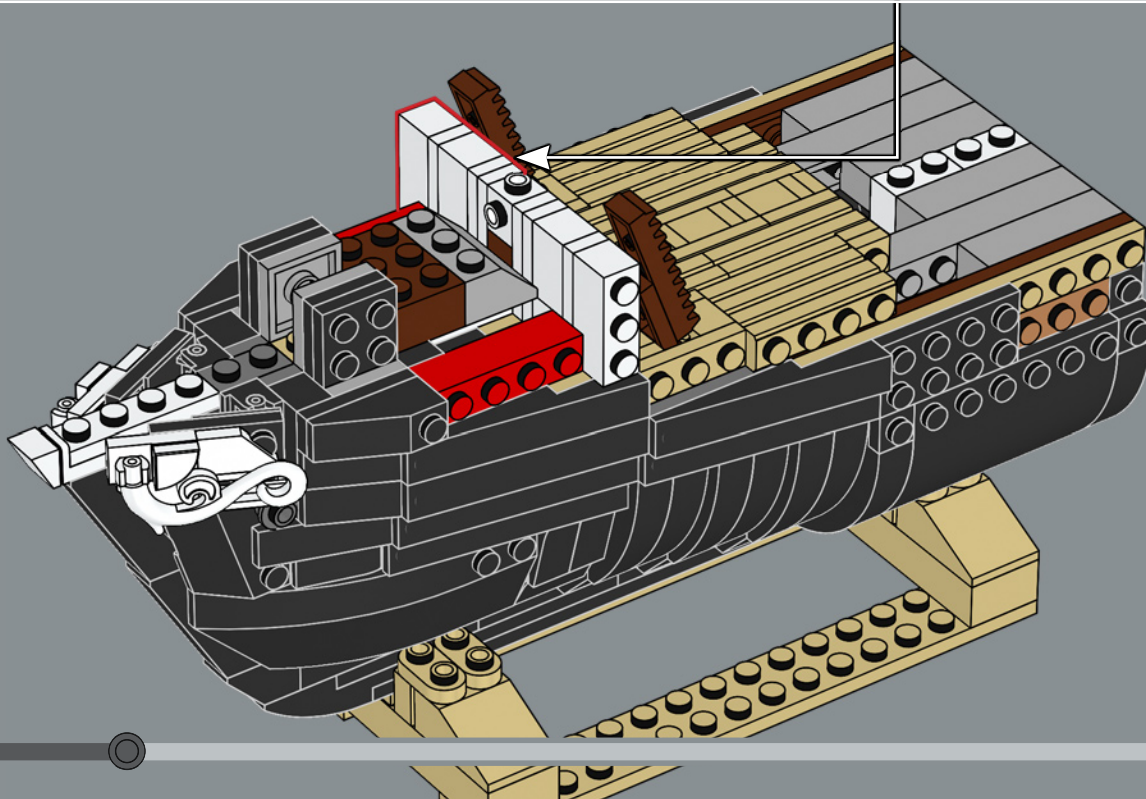
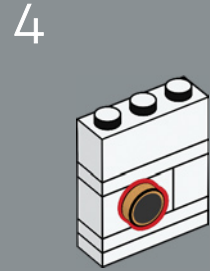
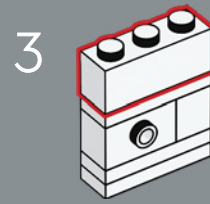
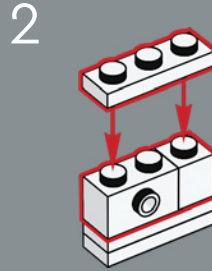
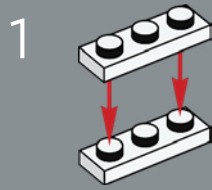



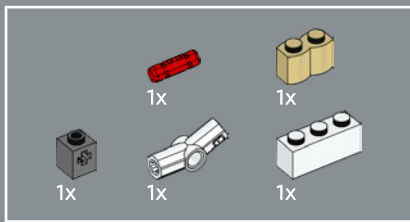

94

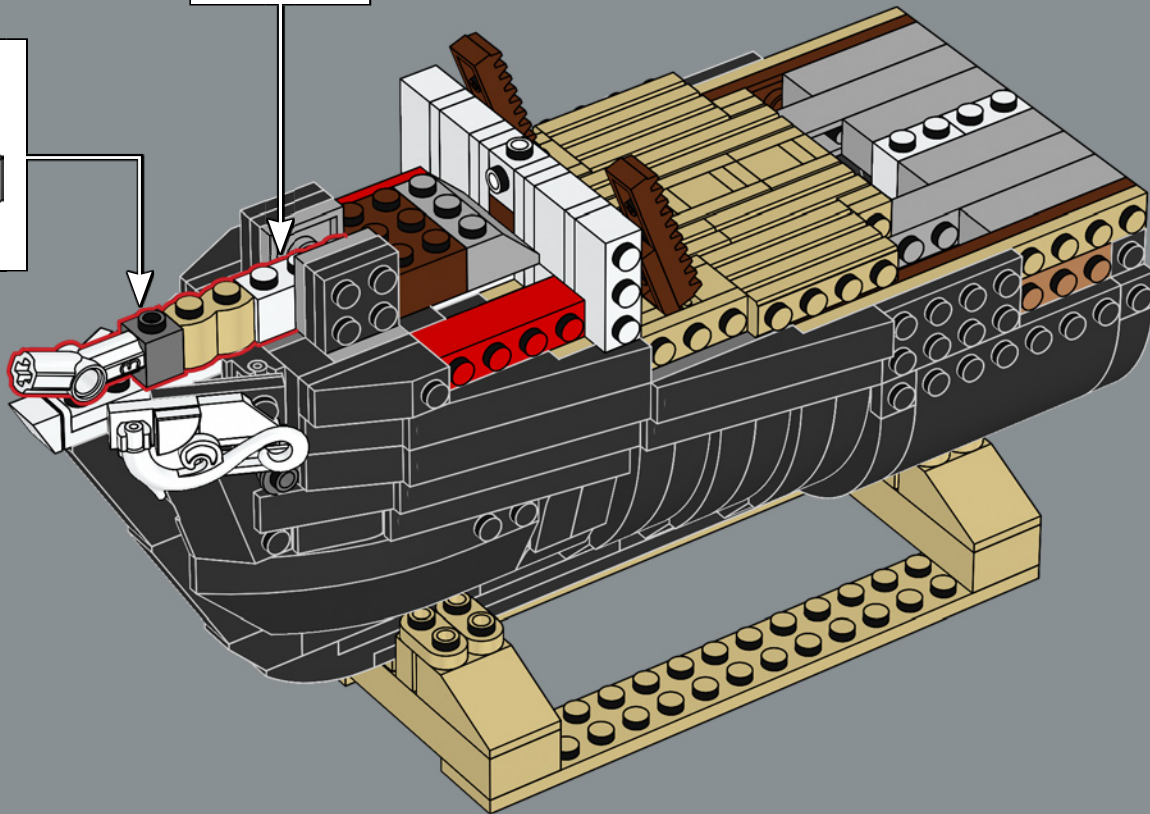
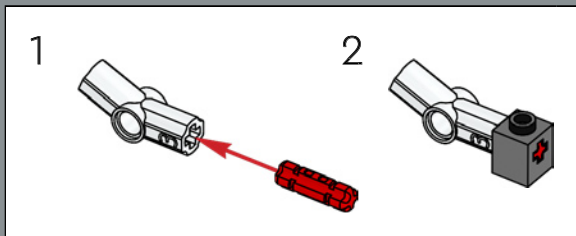
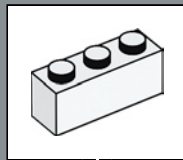



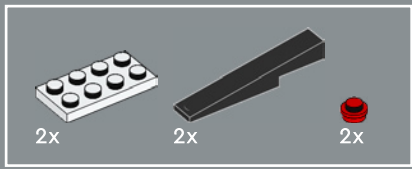

95

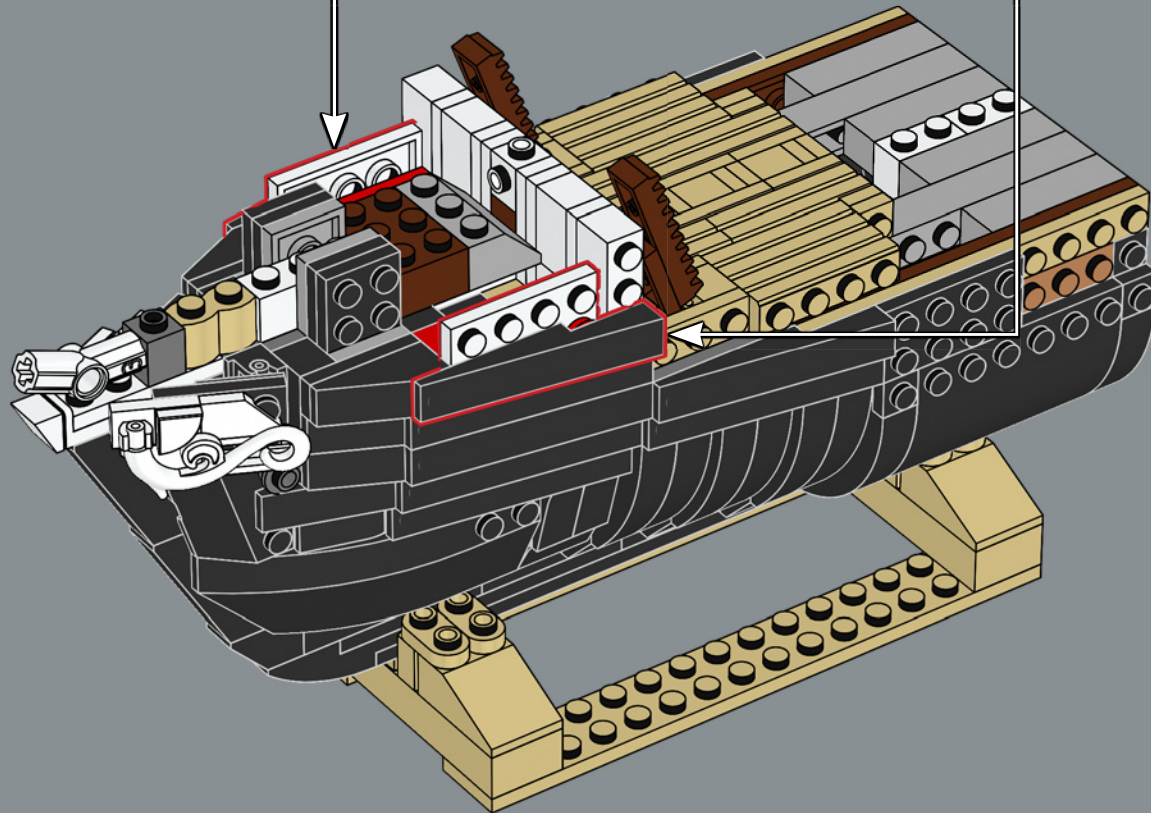
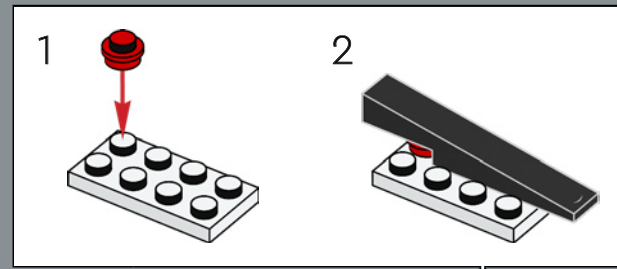
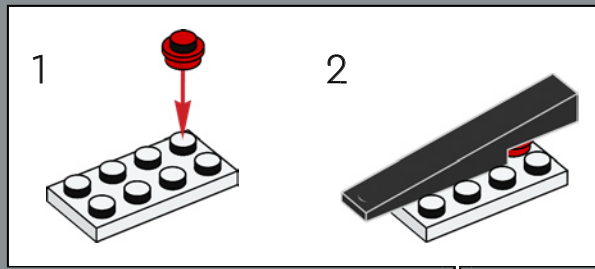

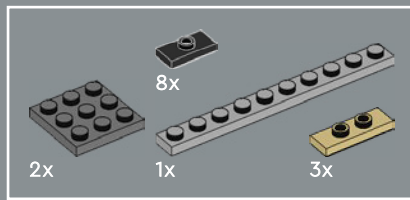

96

1

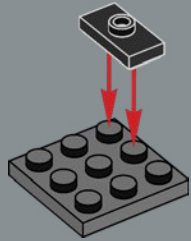

2

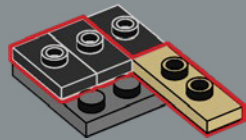

3

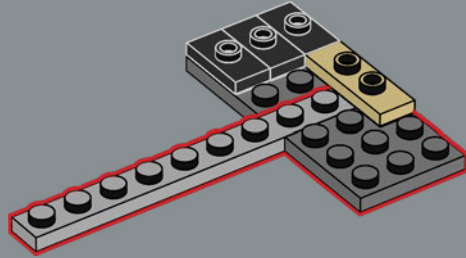

4

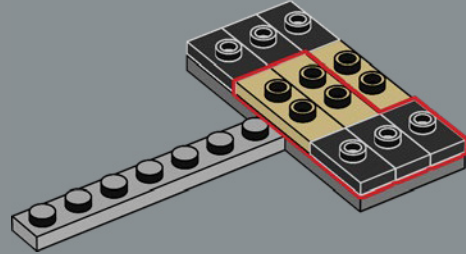

5

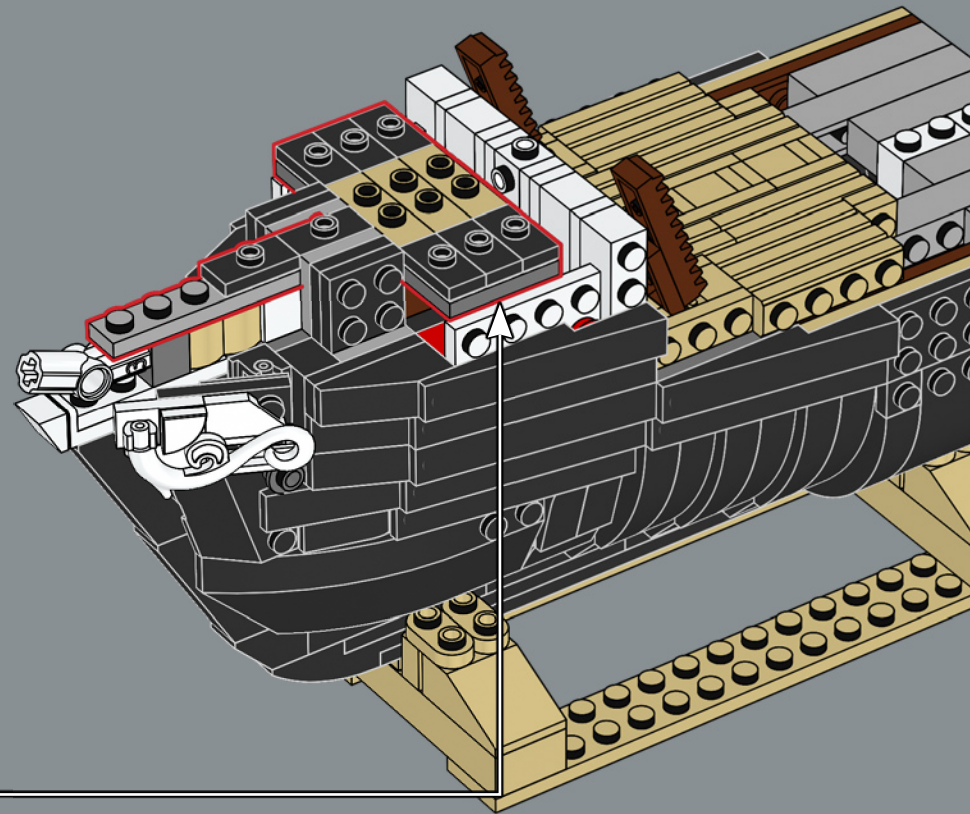
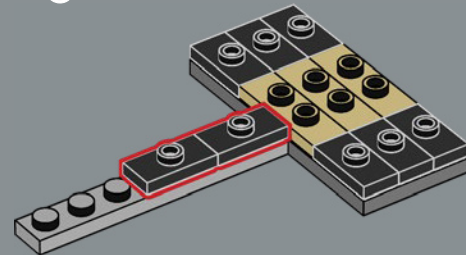

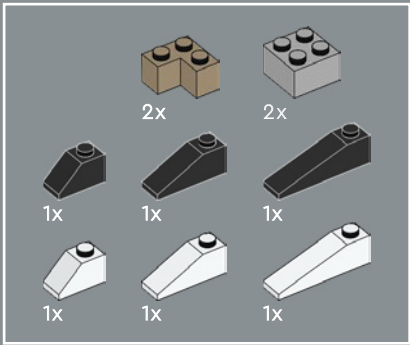

97

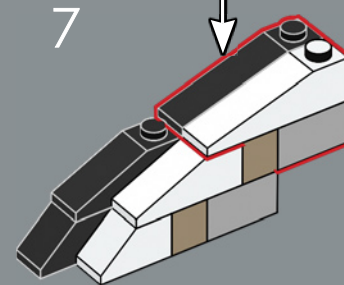
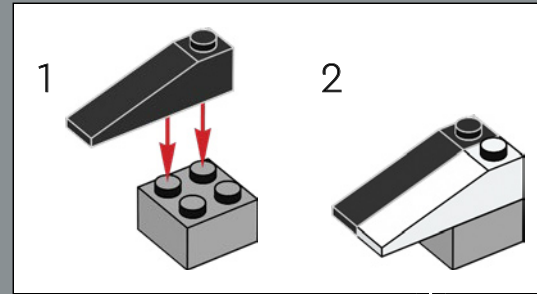
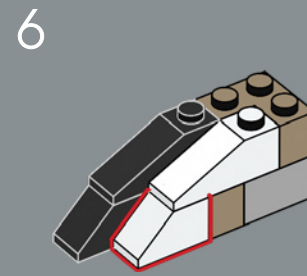
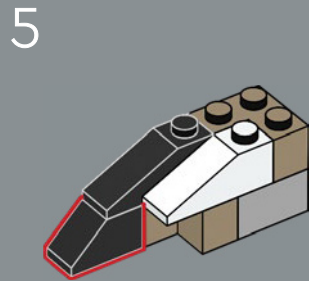
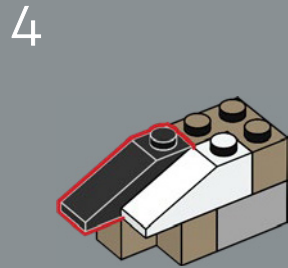
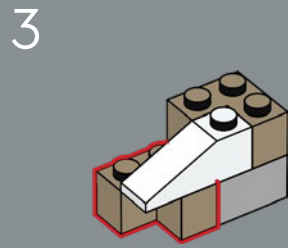
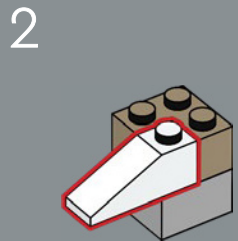
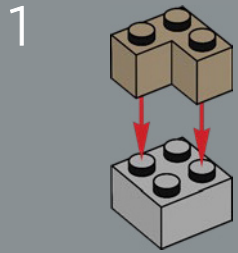

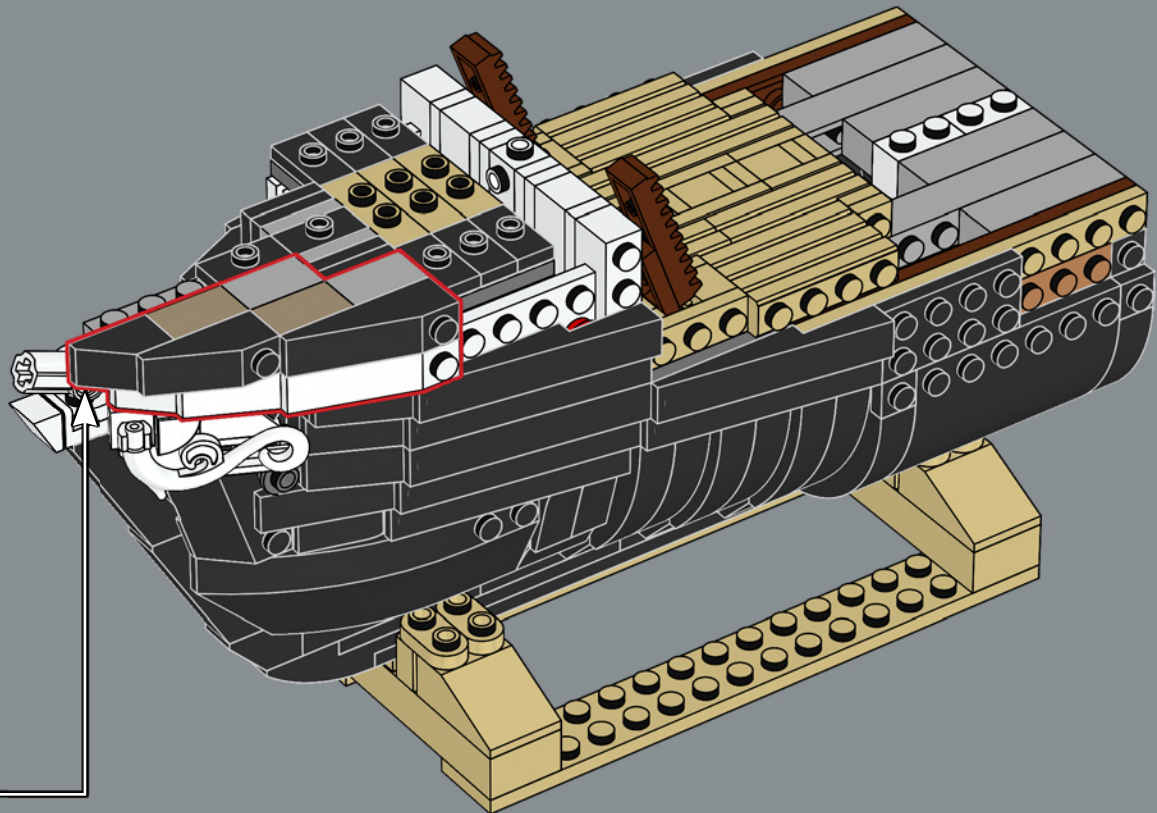



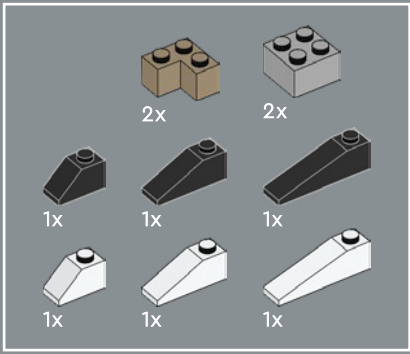

98

1

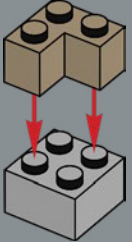

2

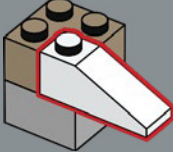

3

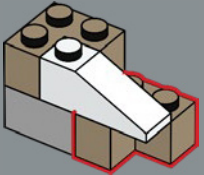

4

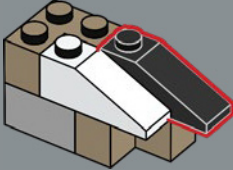

5

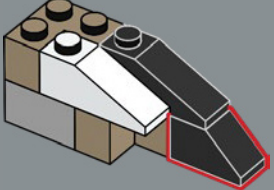

6

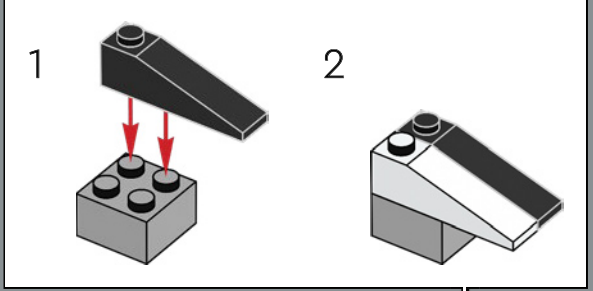
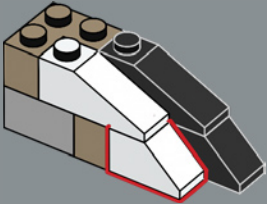

7

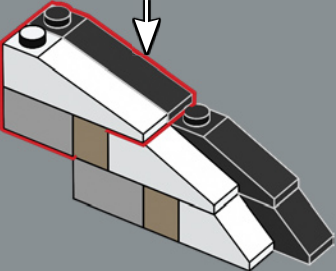

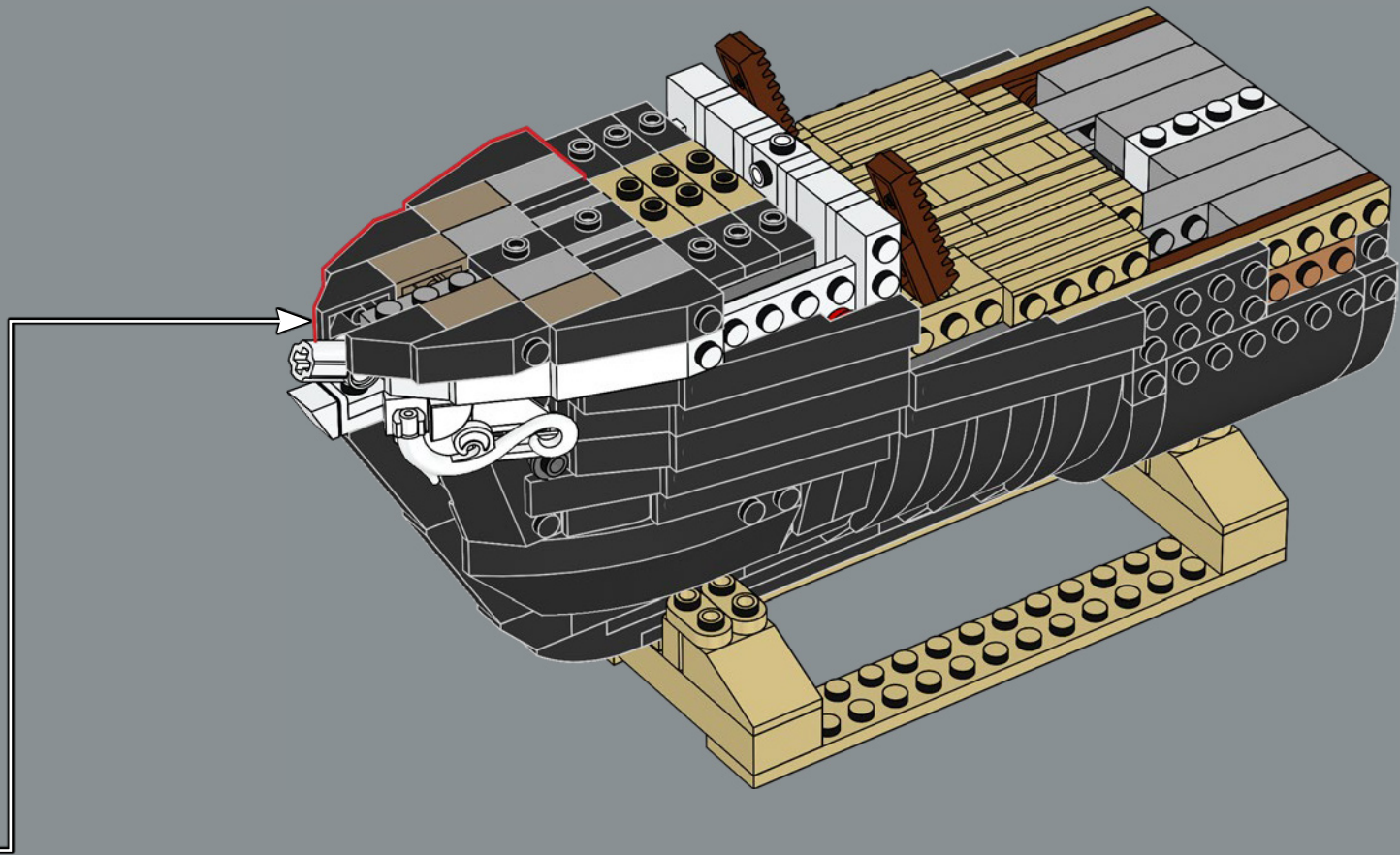



1x

99

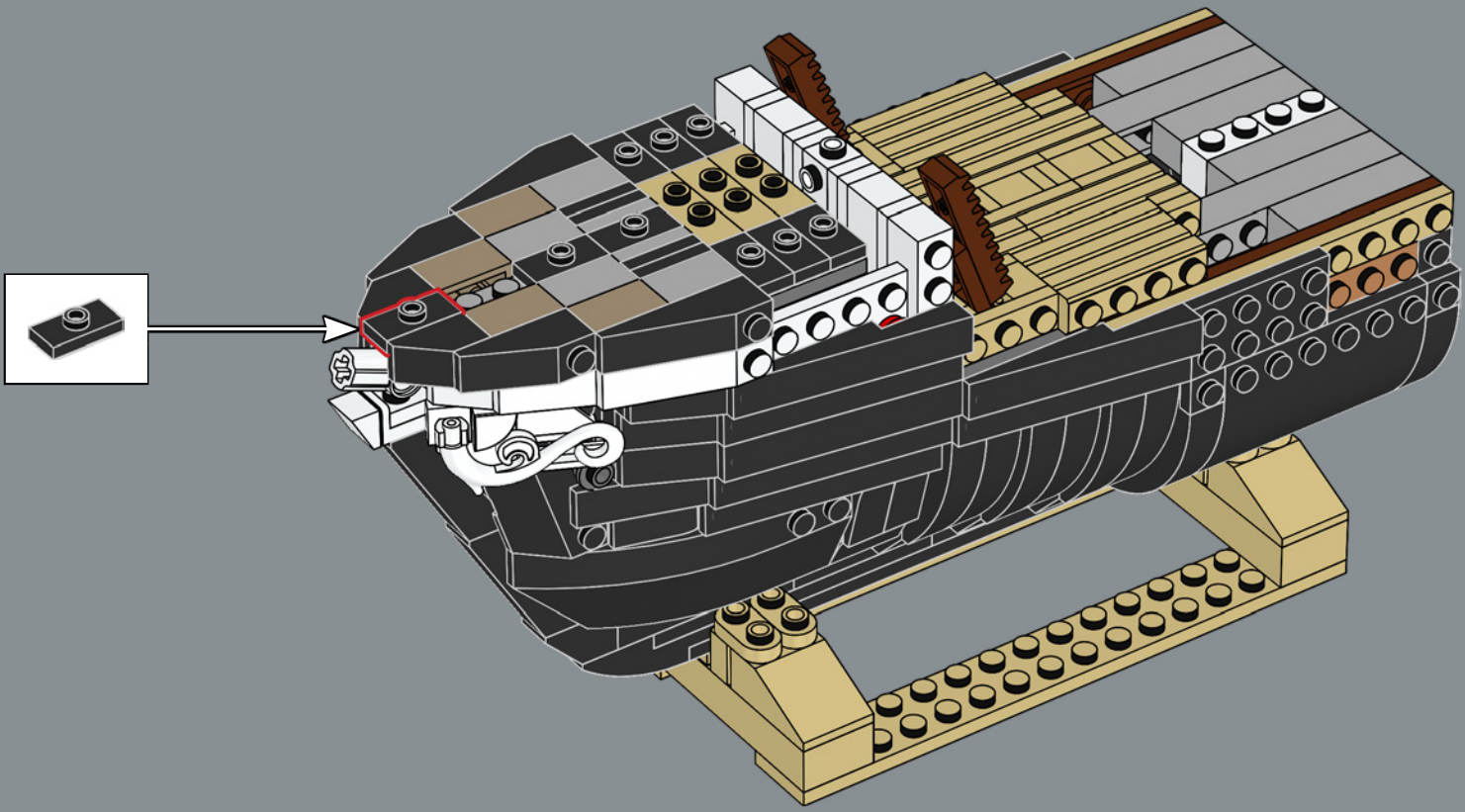

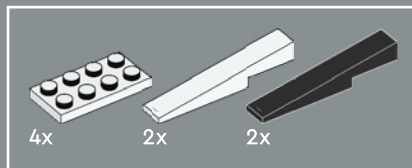

100

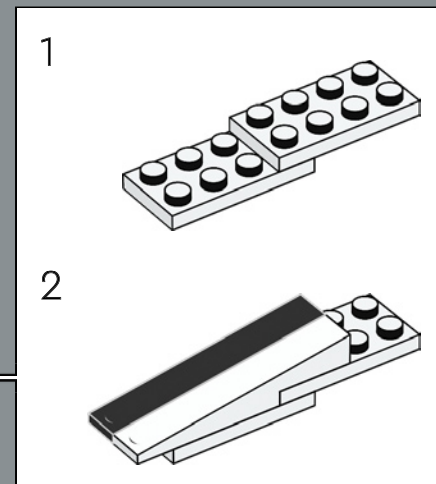
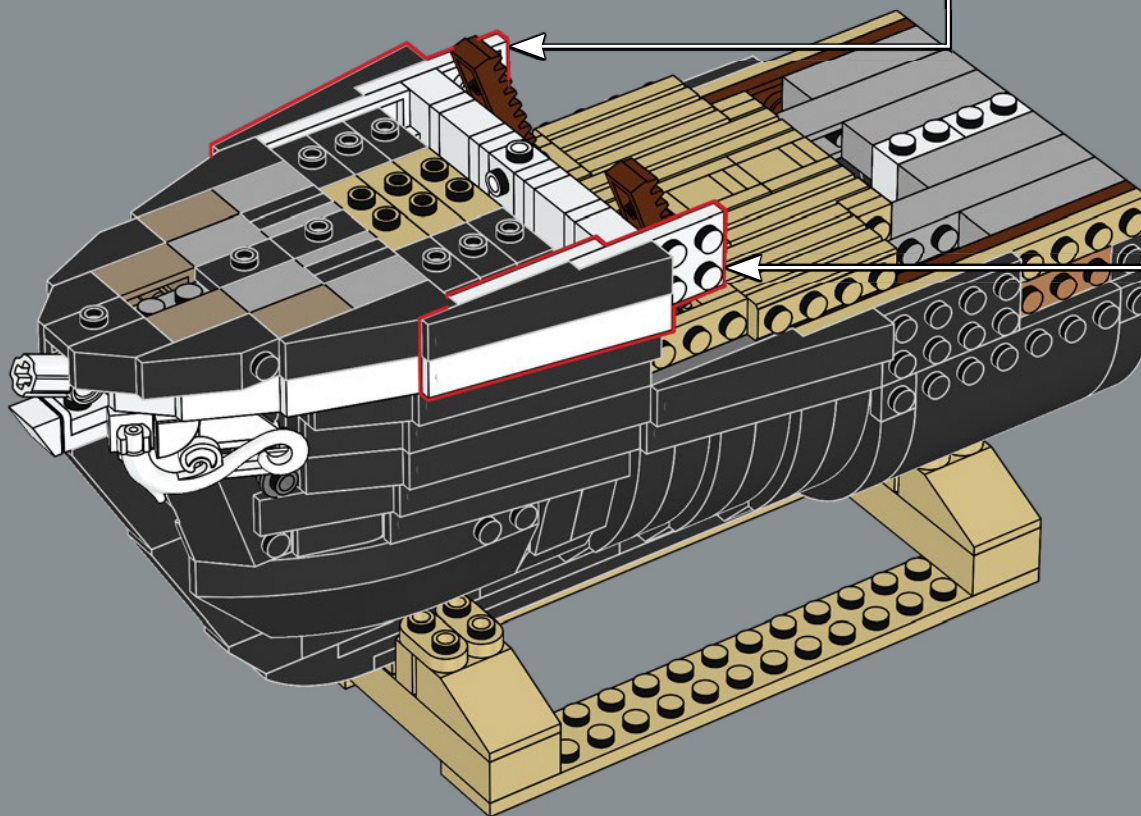
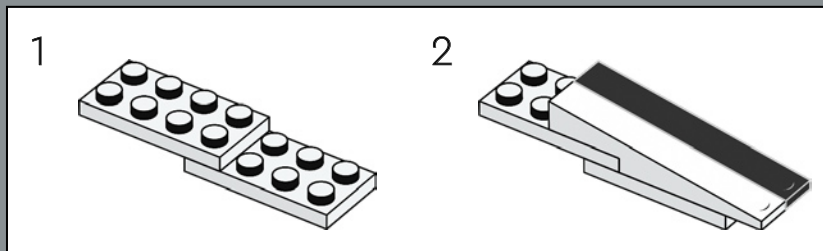



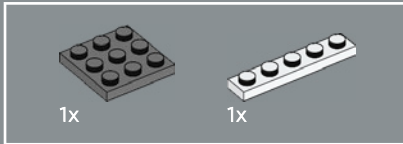
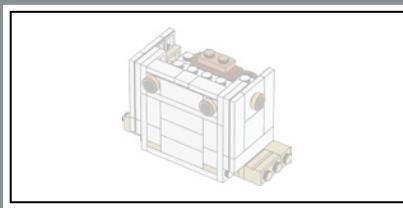

101

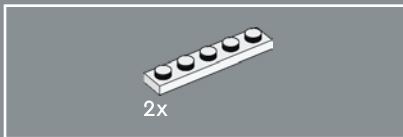
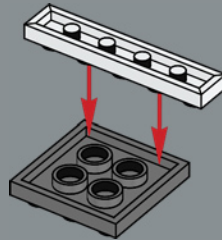

102

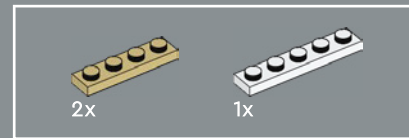
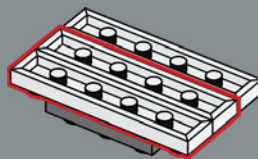

103

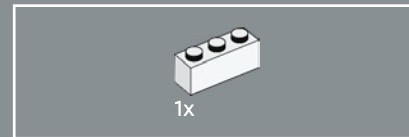
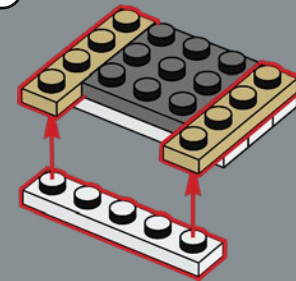

104

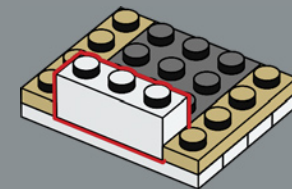

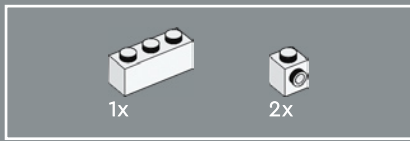

105

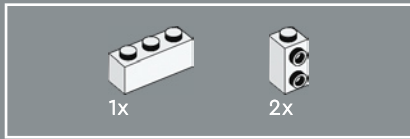
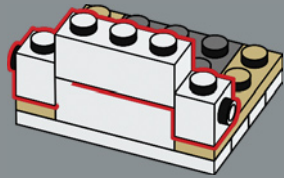

106

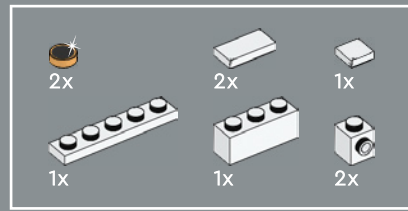
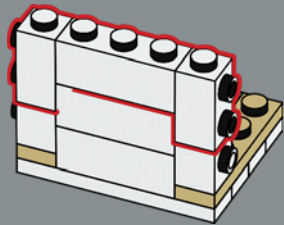

107

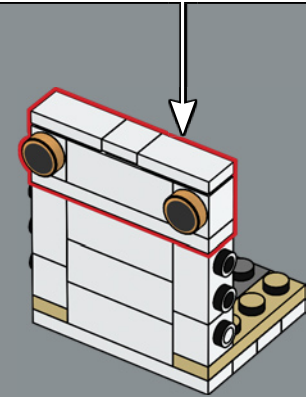
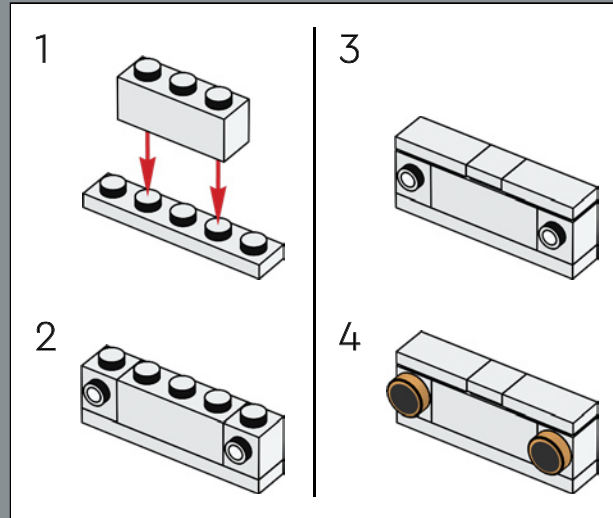



2x

108

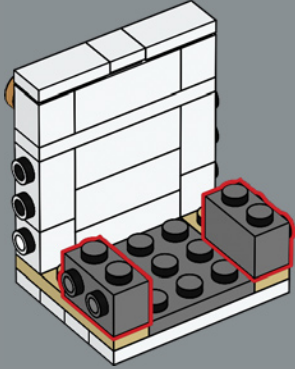

2x

109

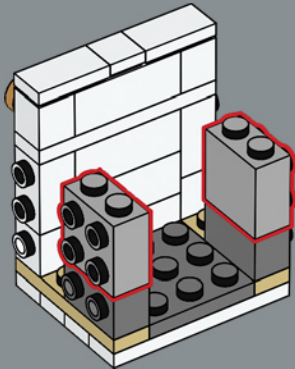

1x

2x

2x

1x

110

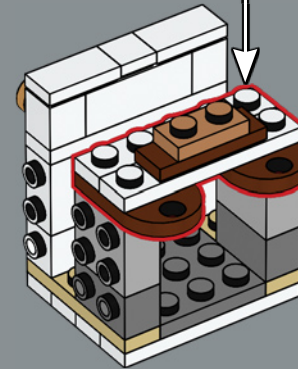
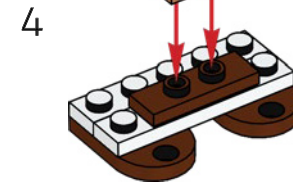
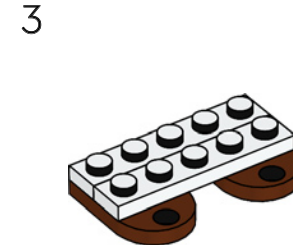
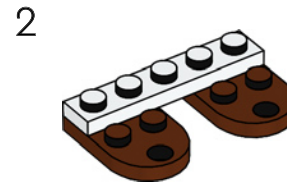
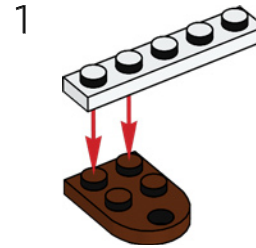

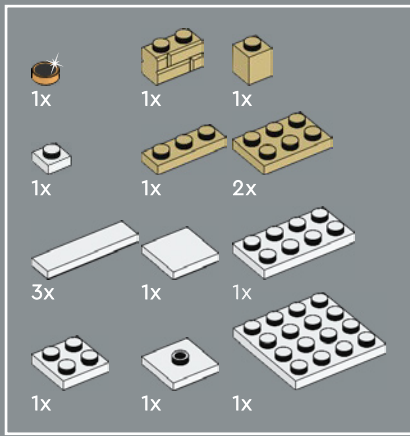

111

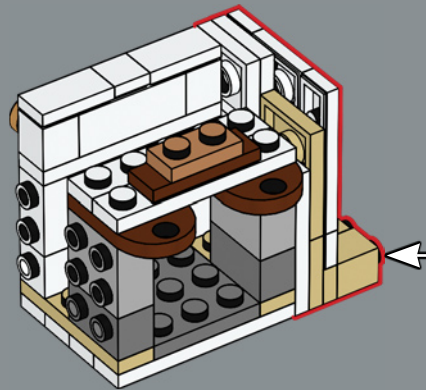
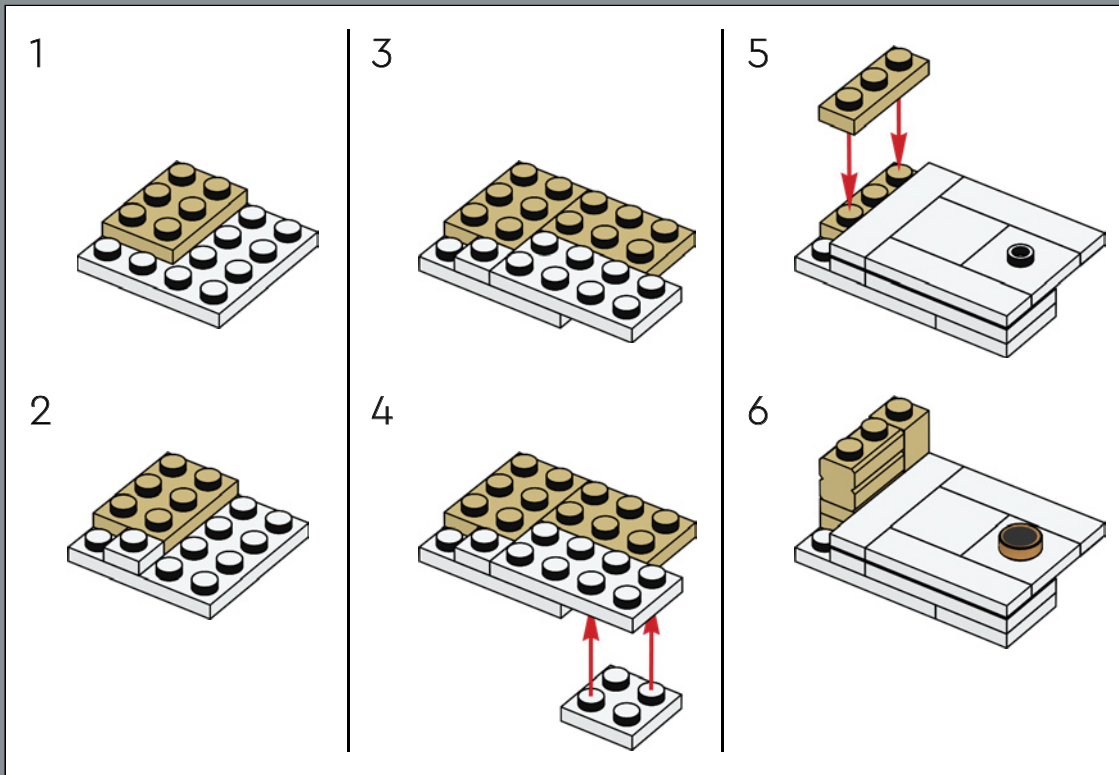



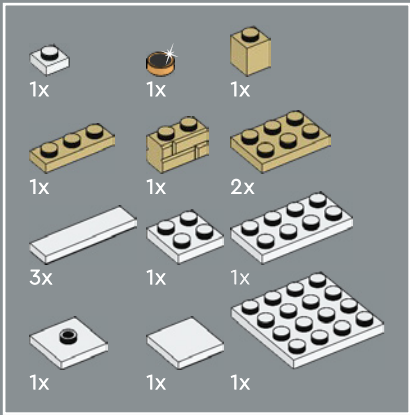

112

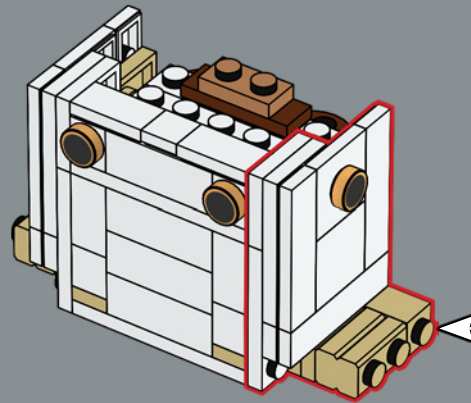
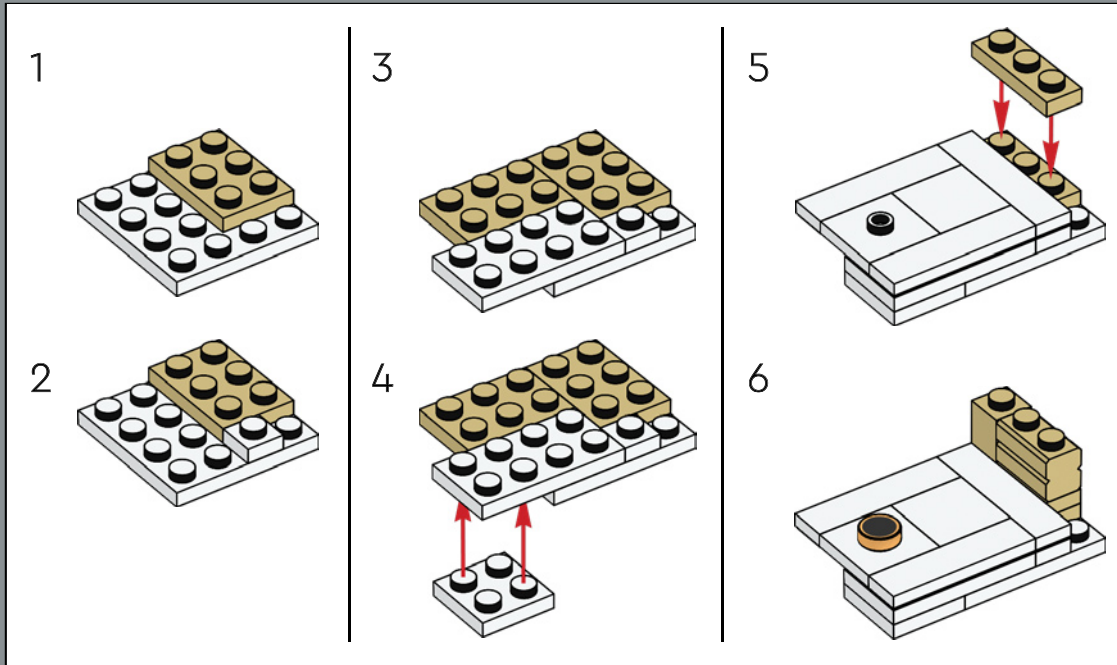

113

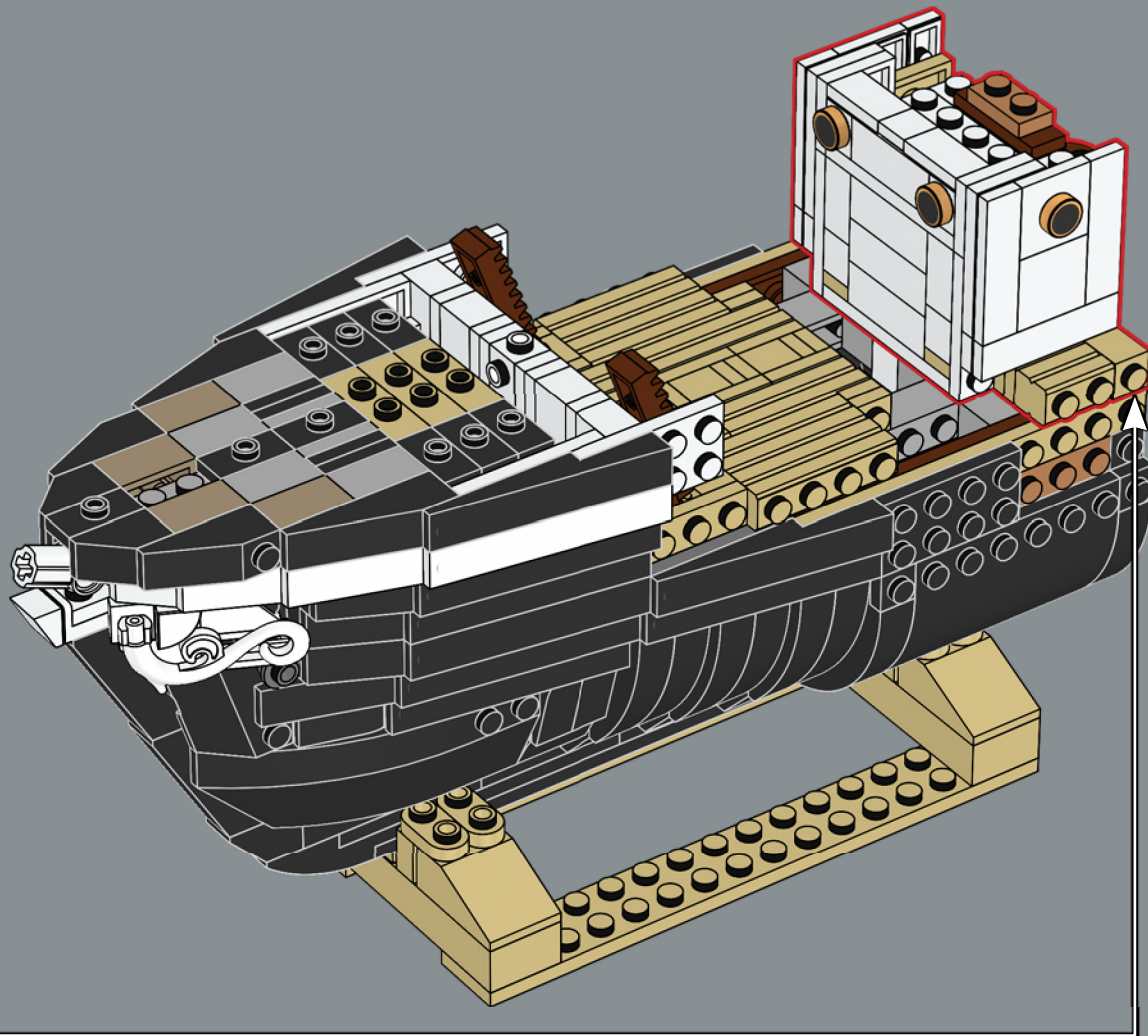

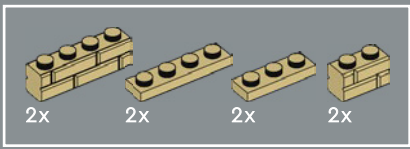

114

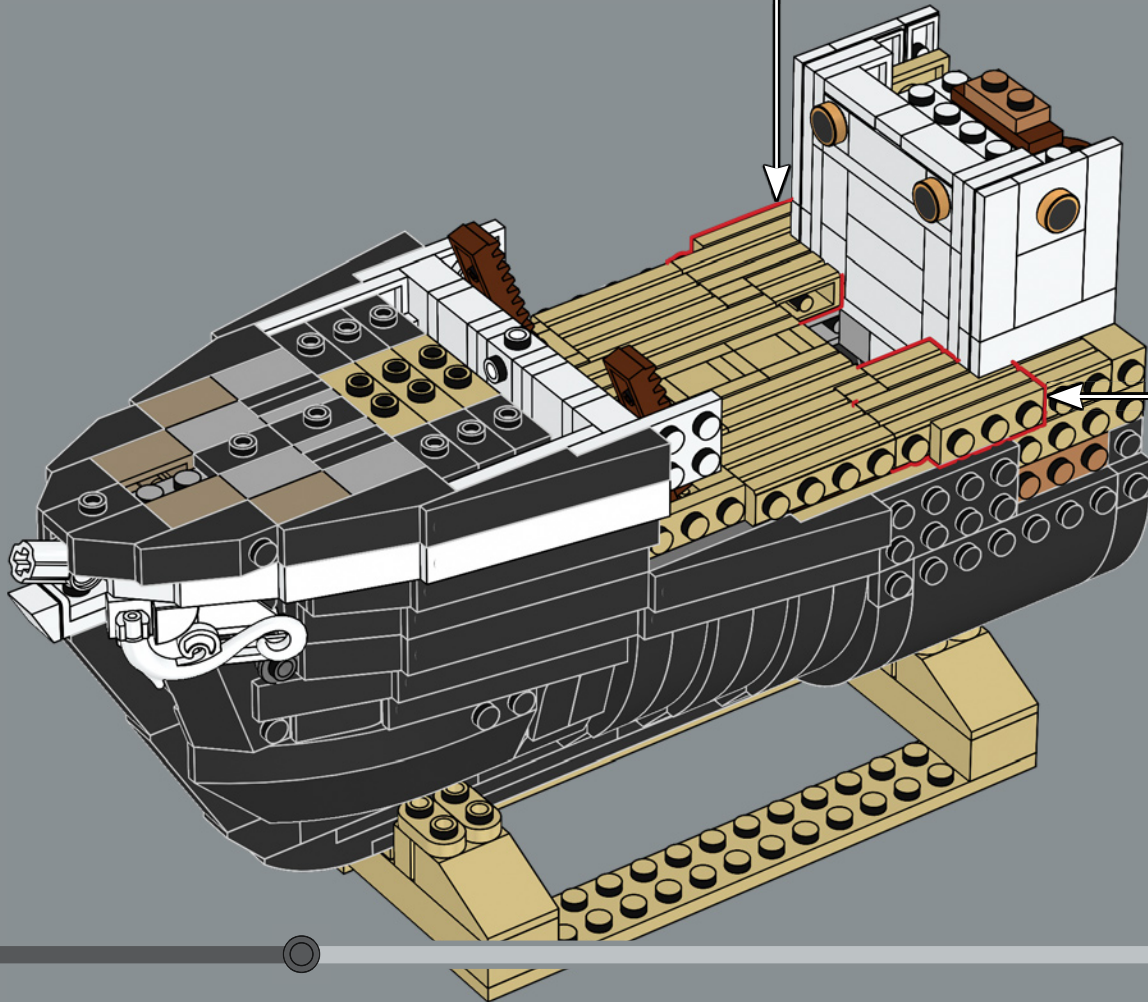
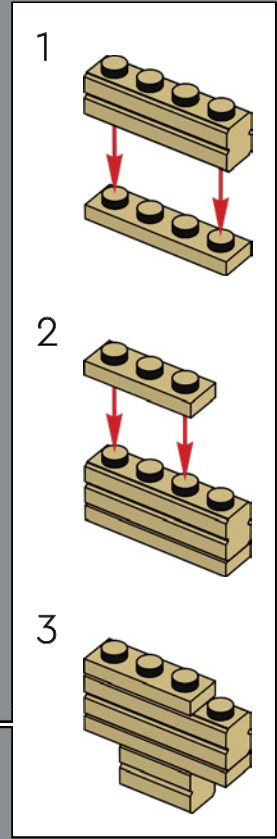
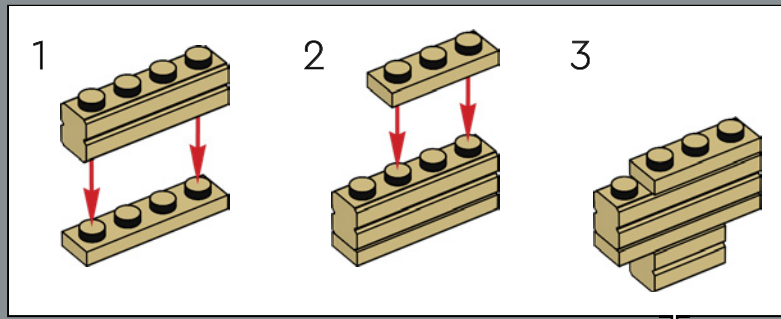

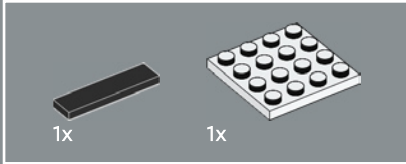
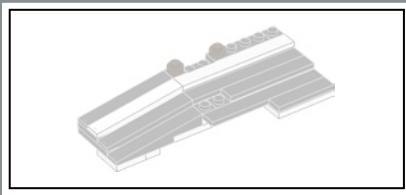

115

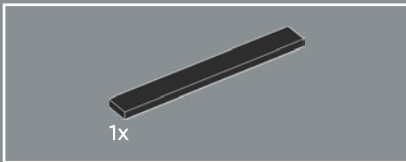
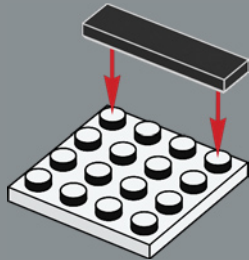

116

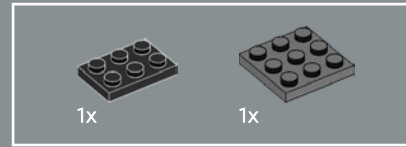
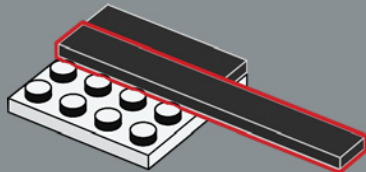

117

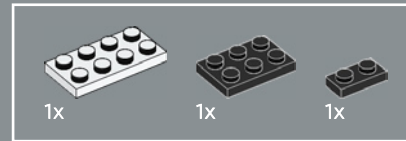
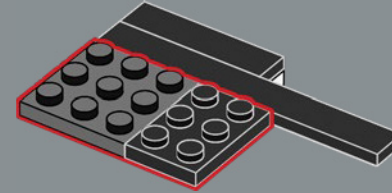

118

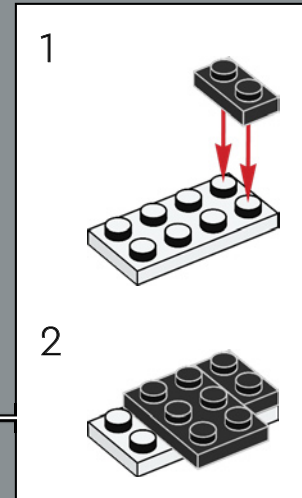
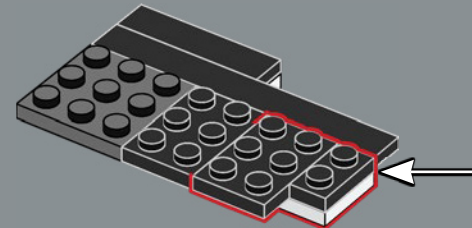



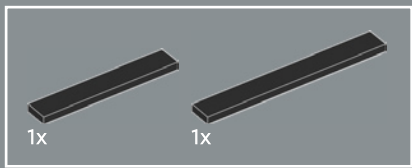

119

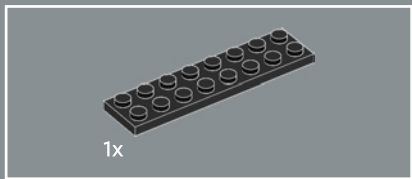
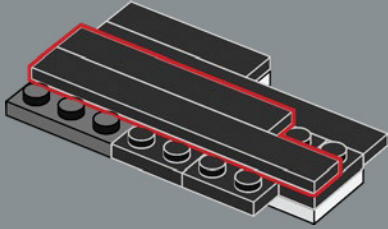

120

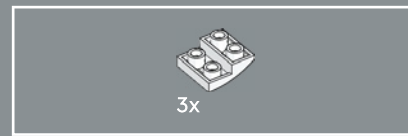
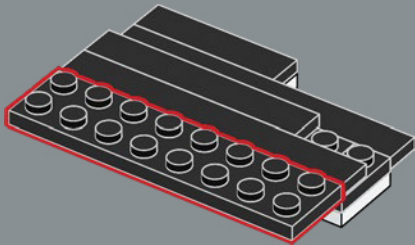

121

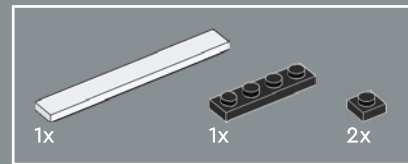
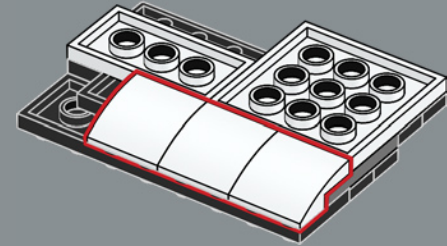

122

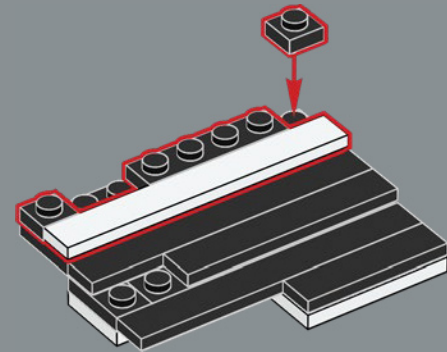



123

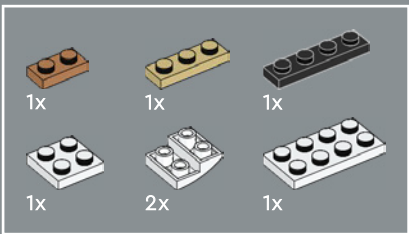
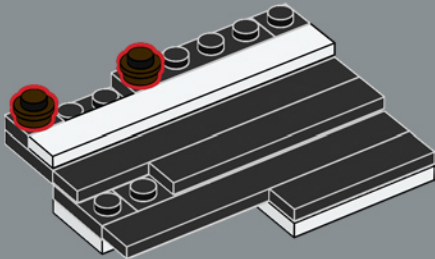

124

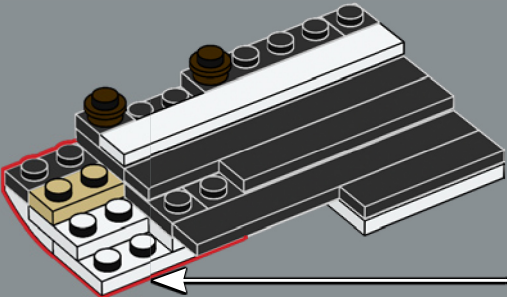
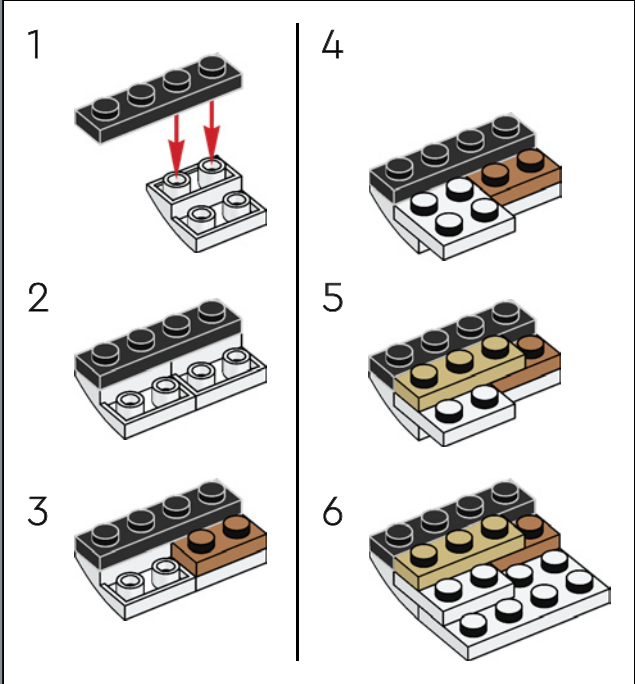

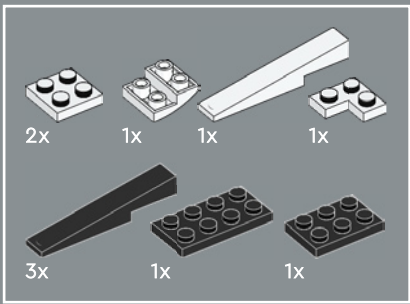

125

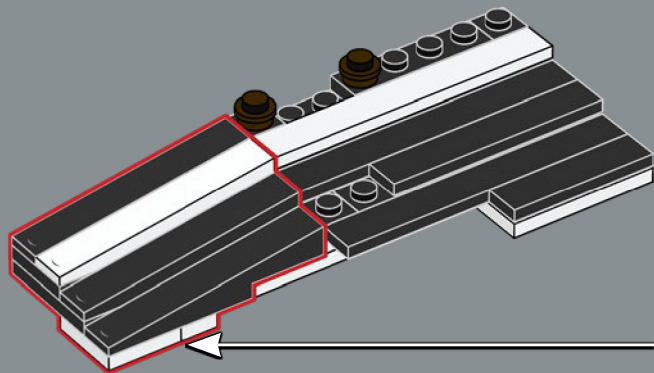
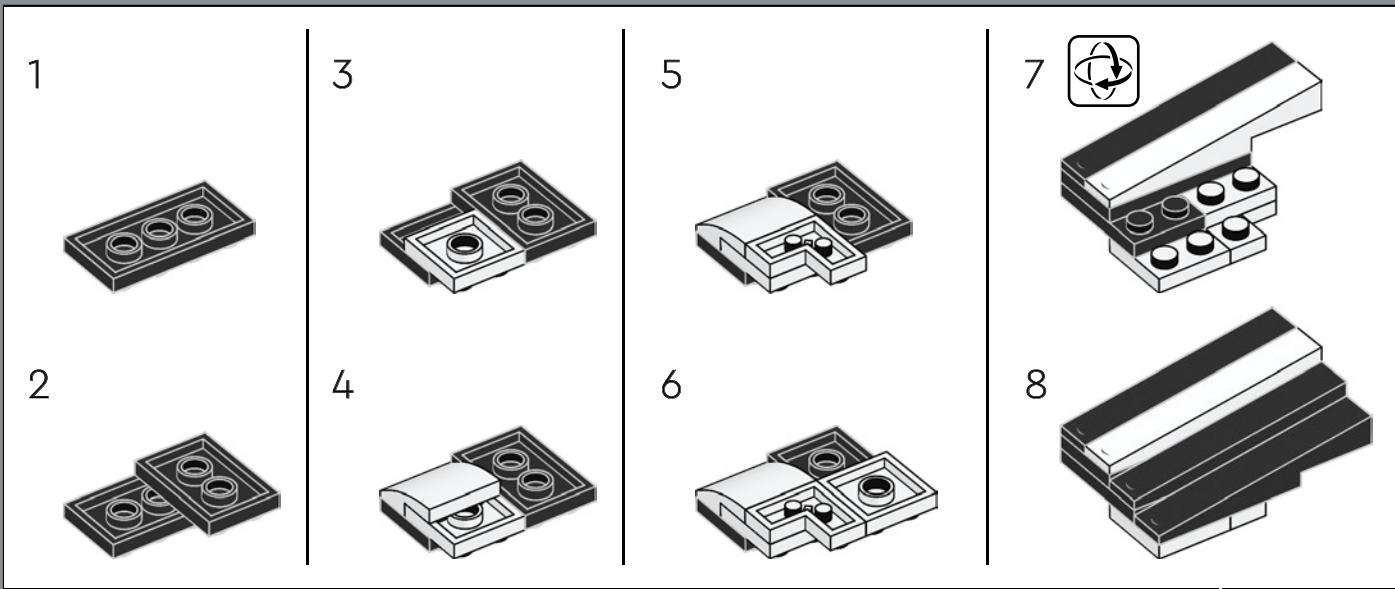

126

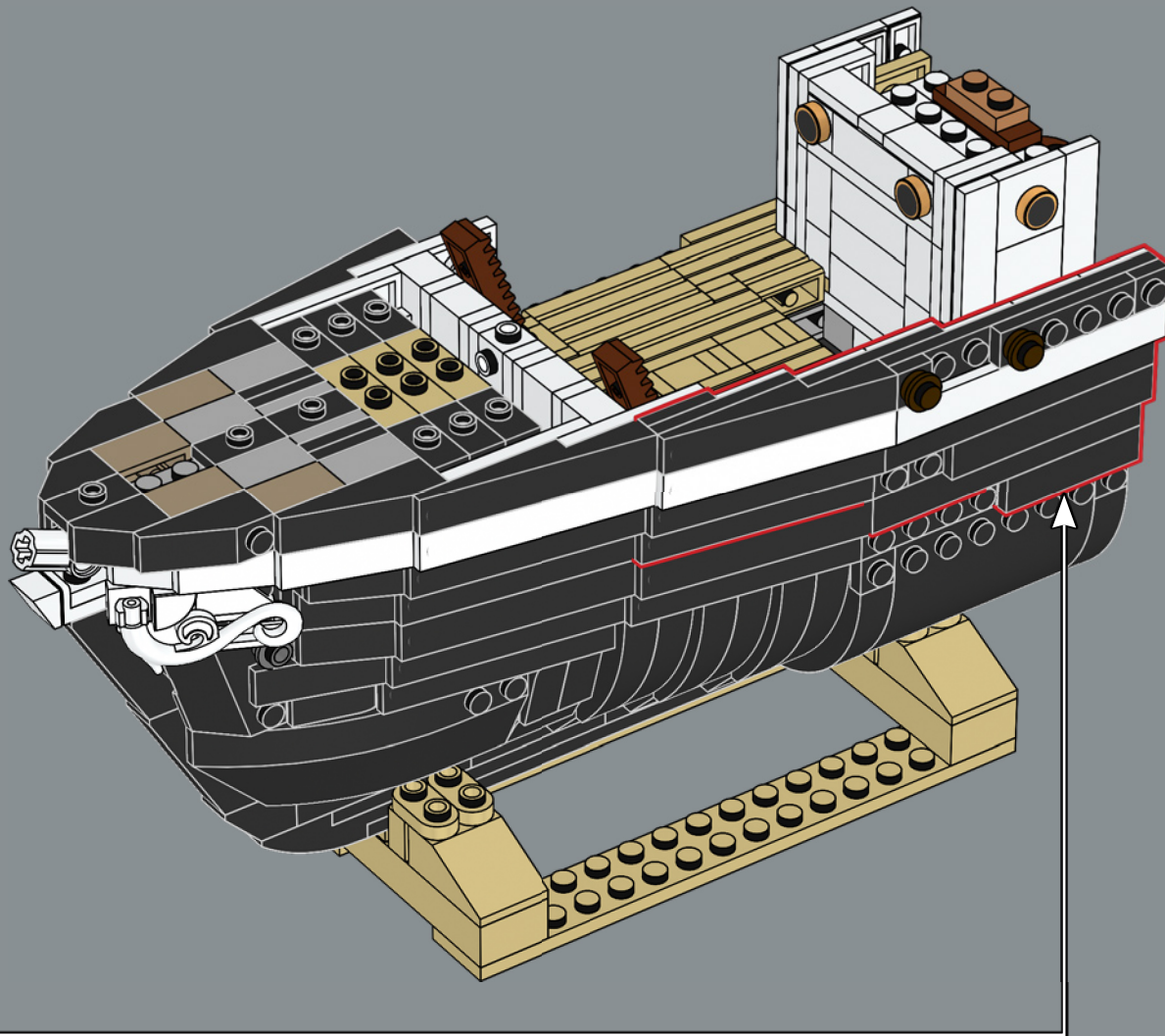



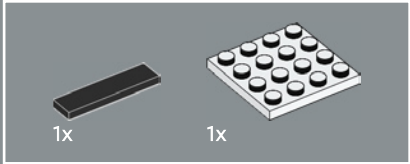
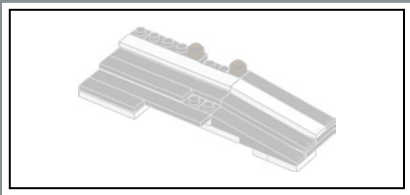

127

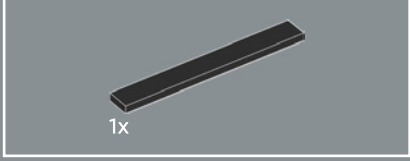
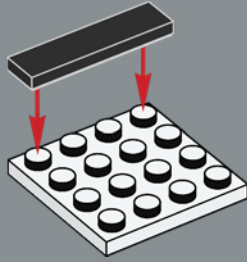

128

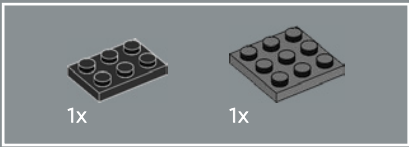
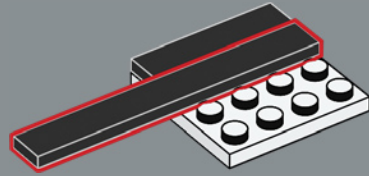

129

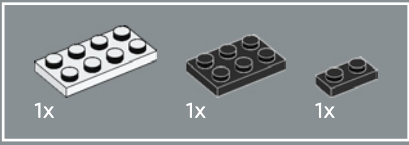
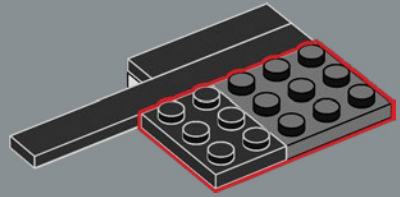

130

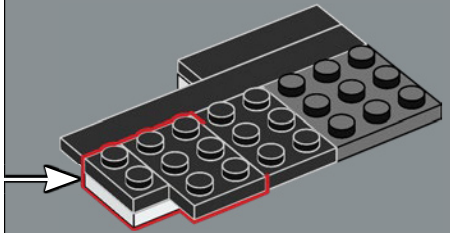
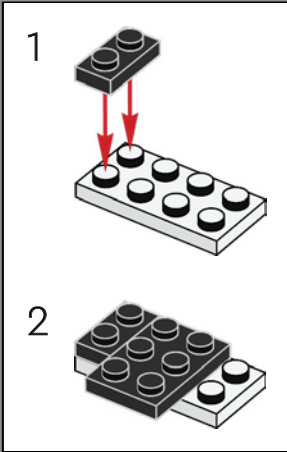

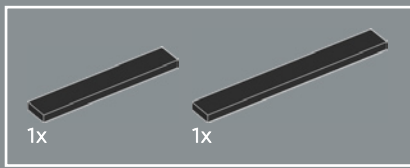

131

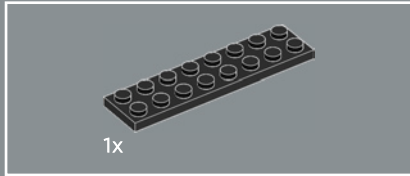
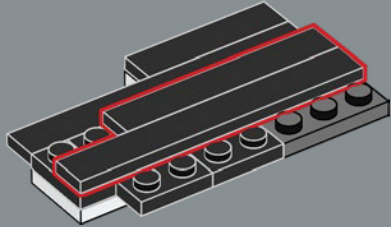

132

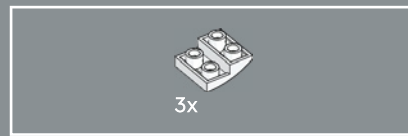
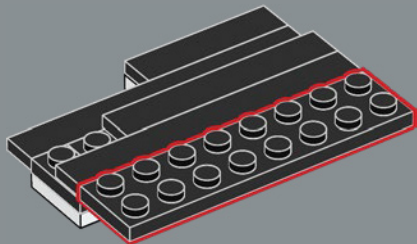

133

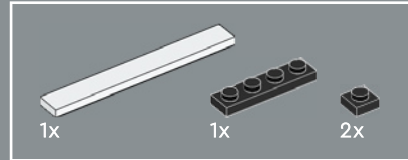
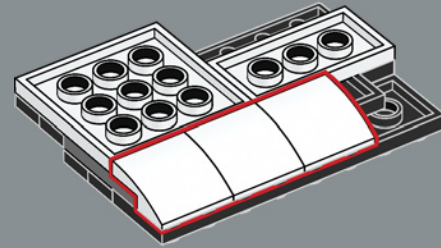

134

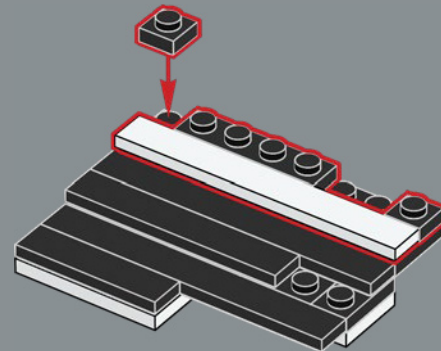

2x

135

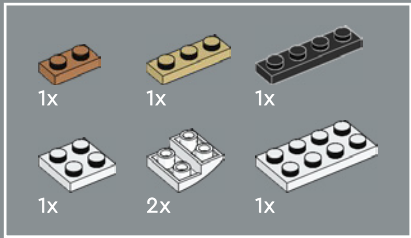
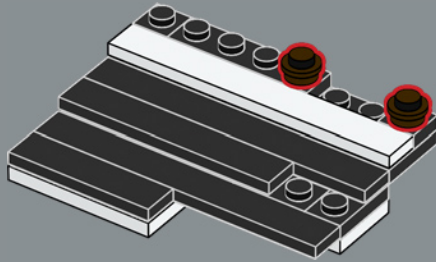

136

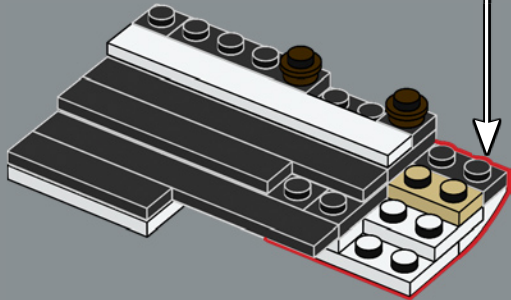
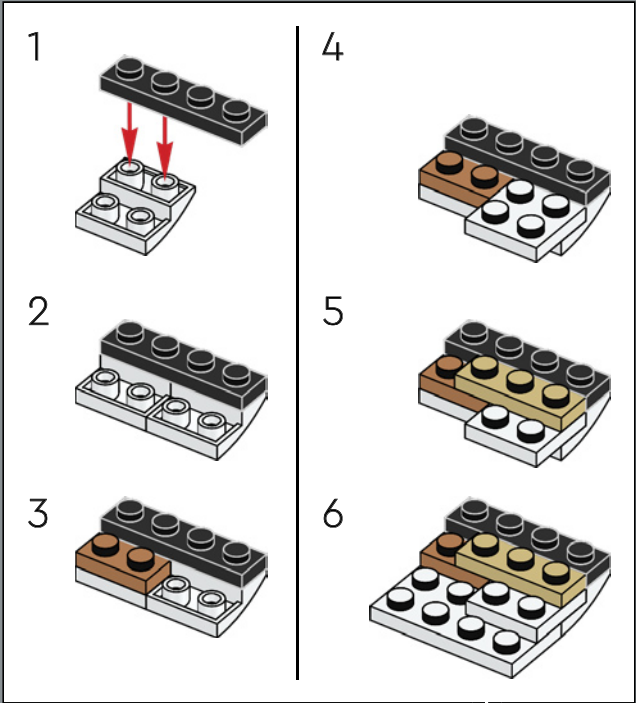

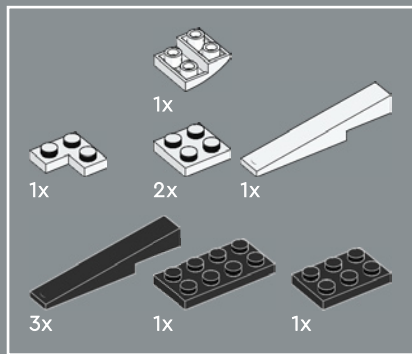

137

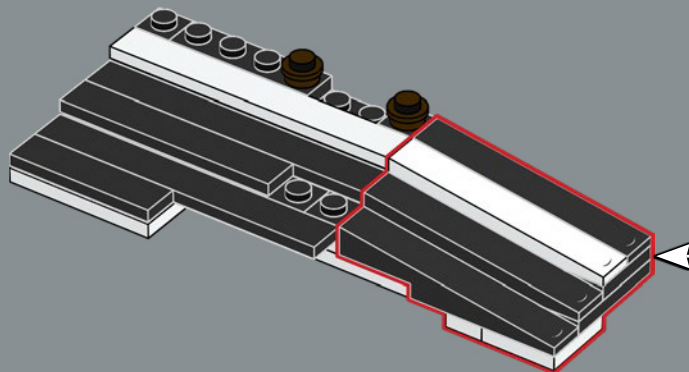
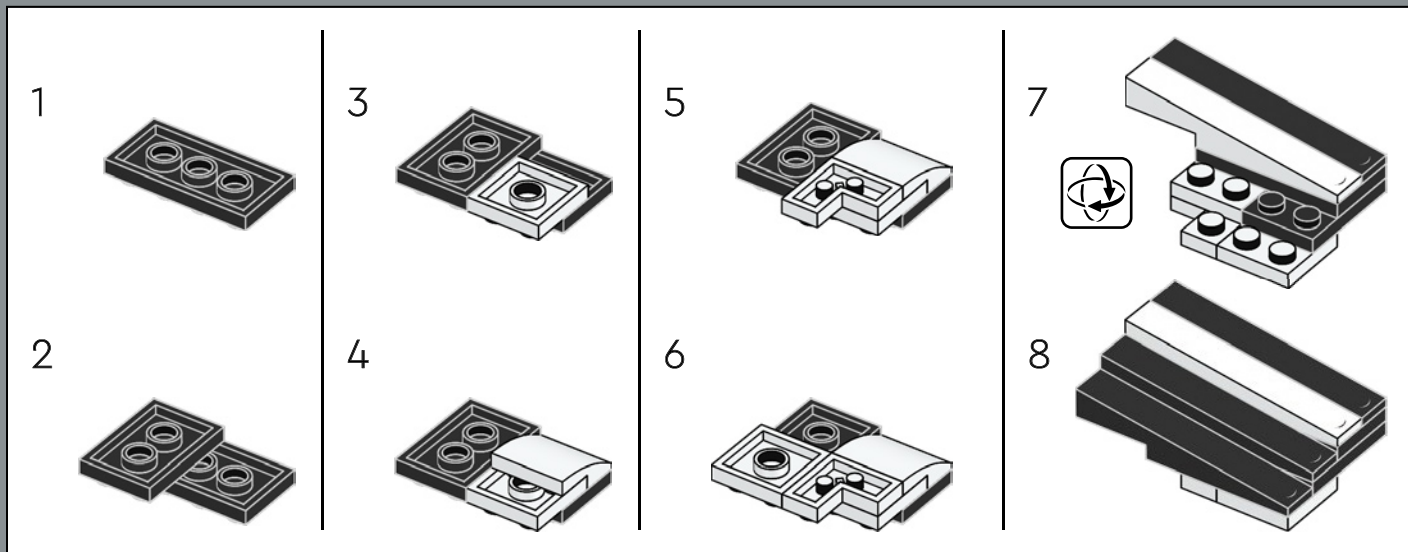



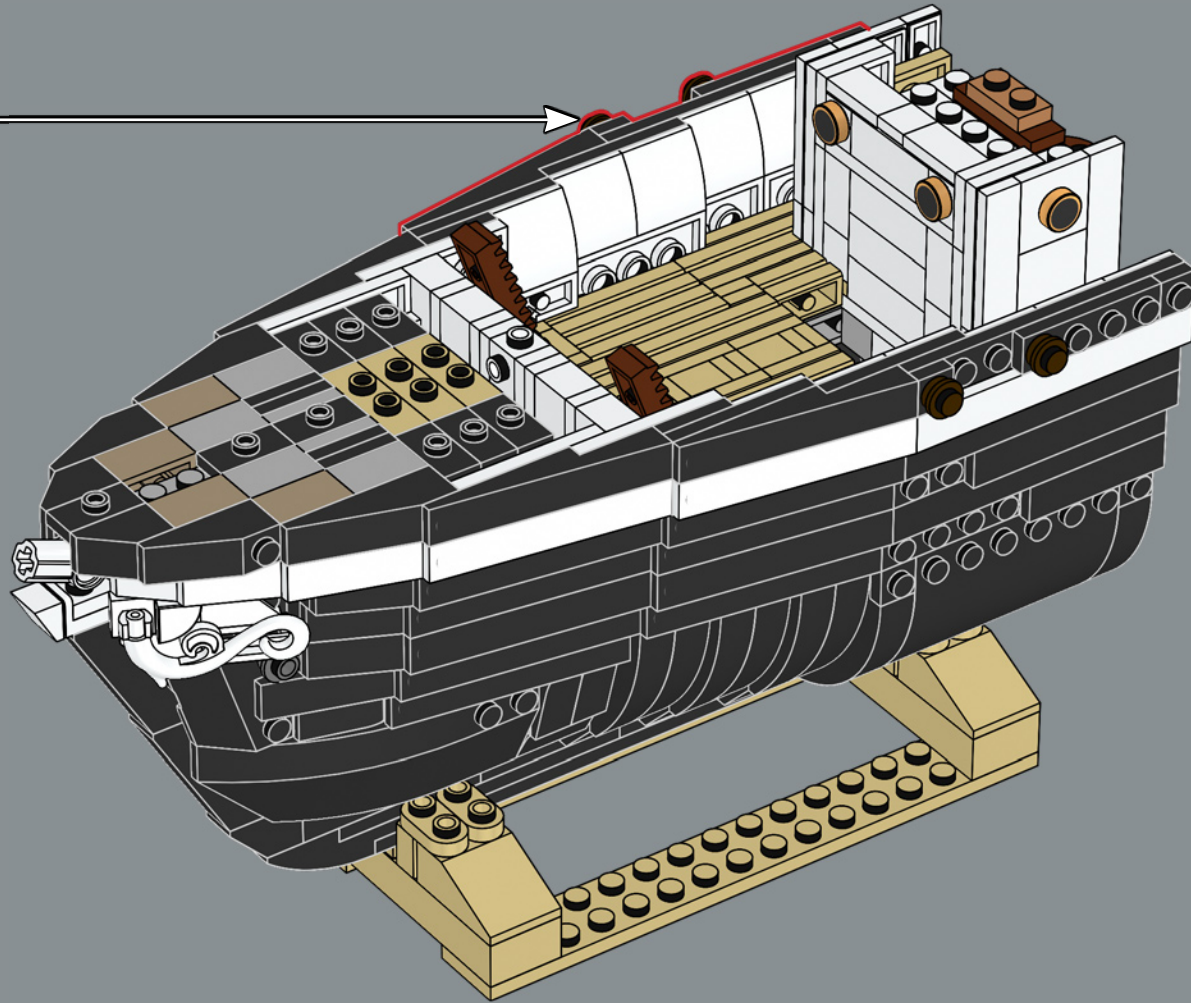

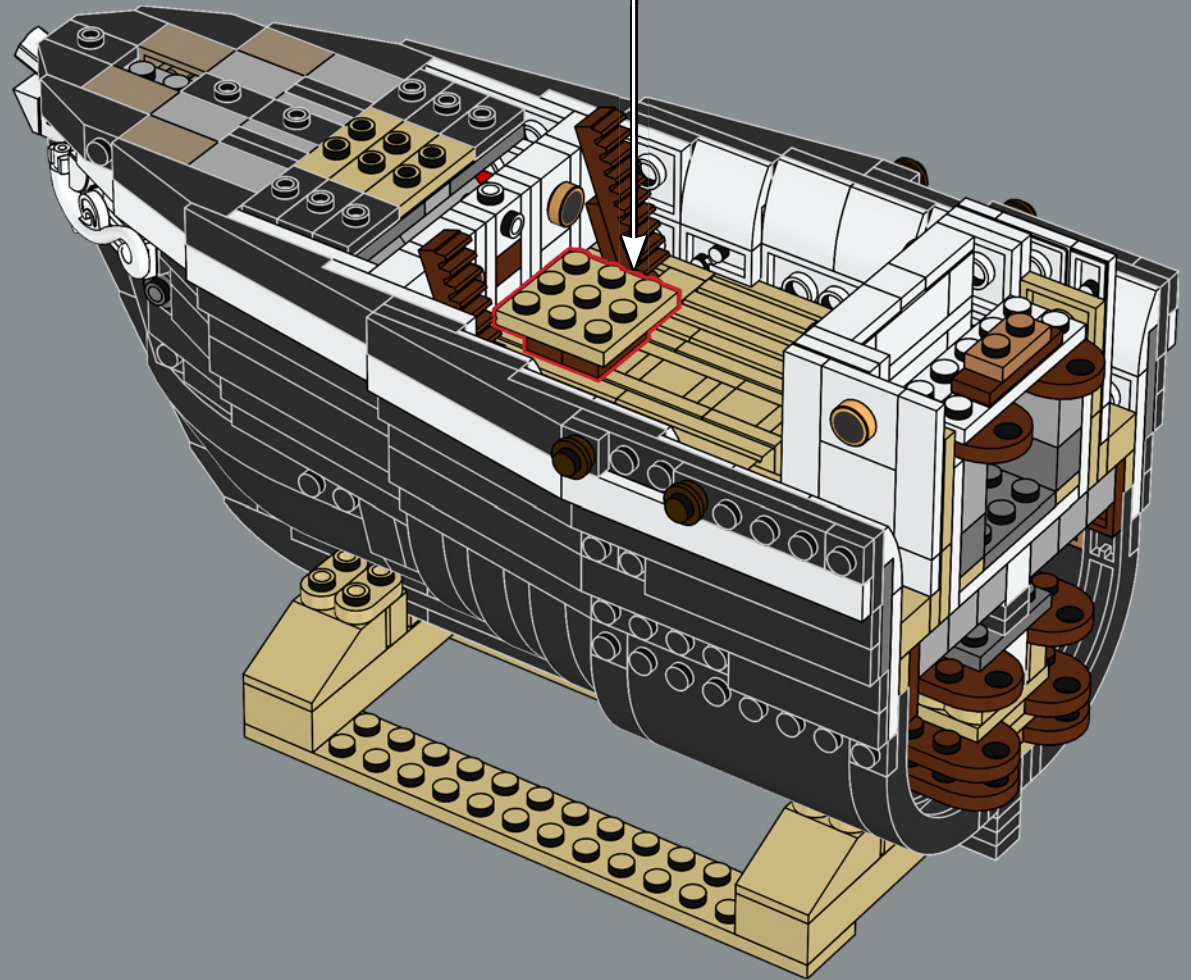
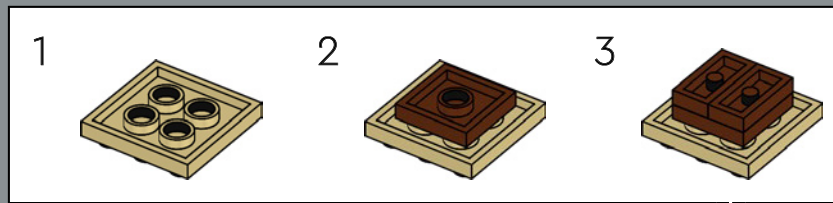
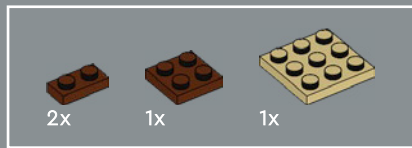

139

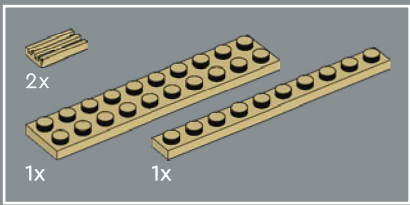

140

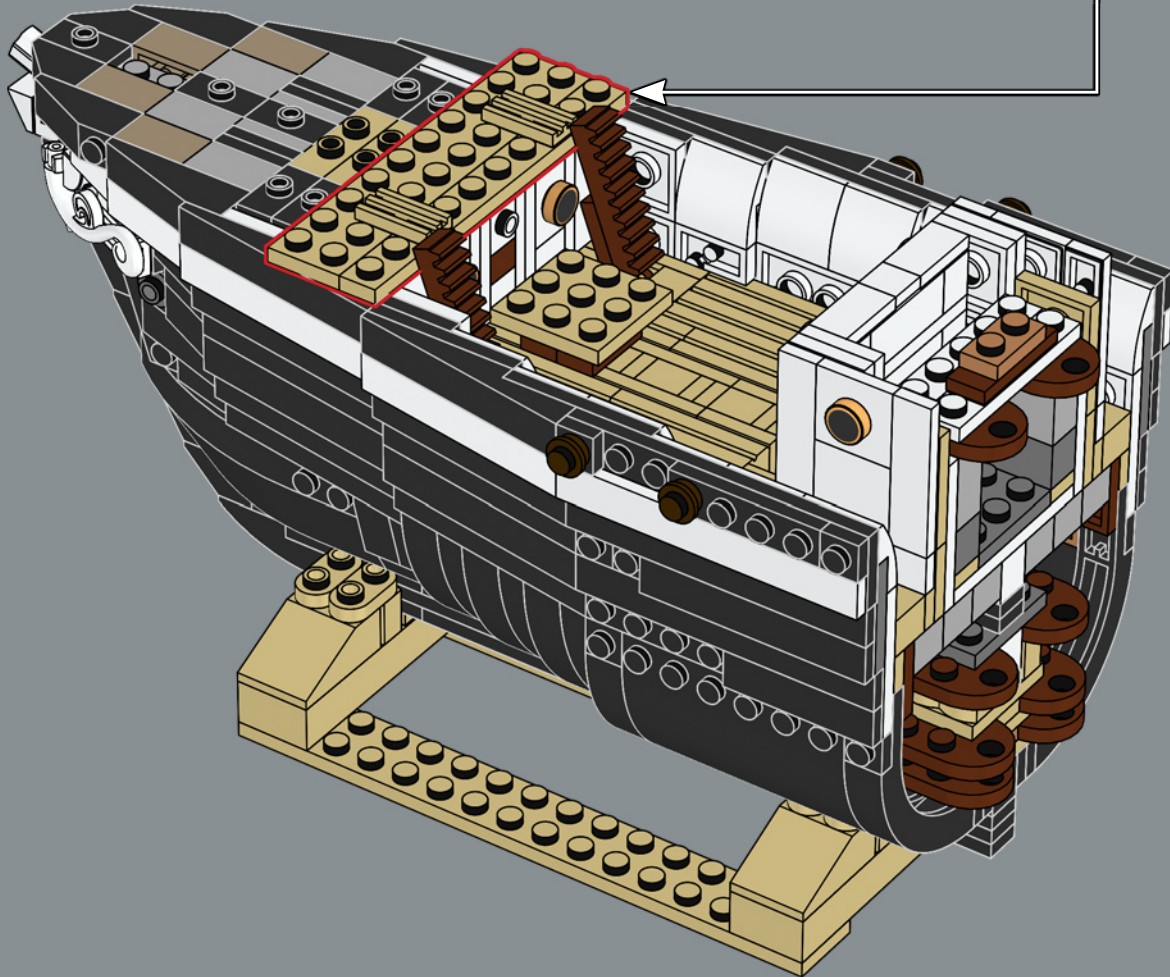
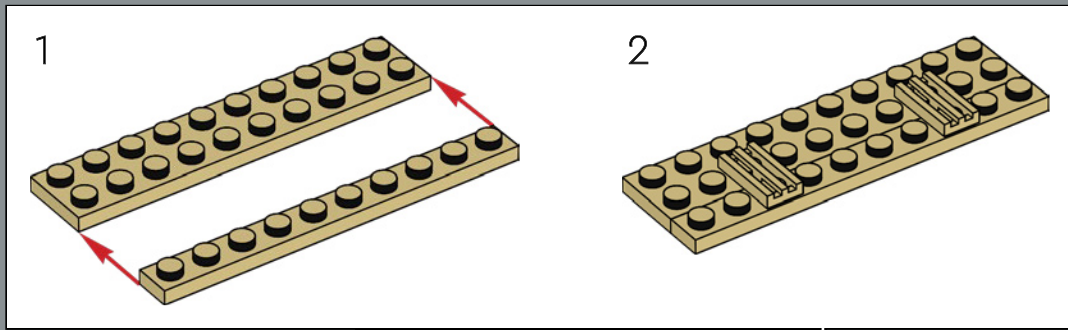



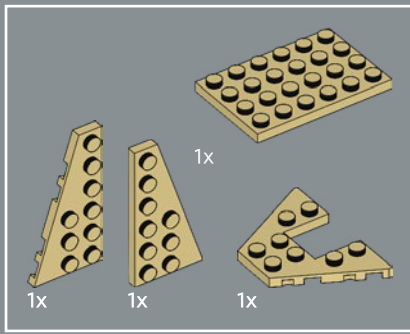

141

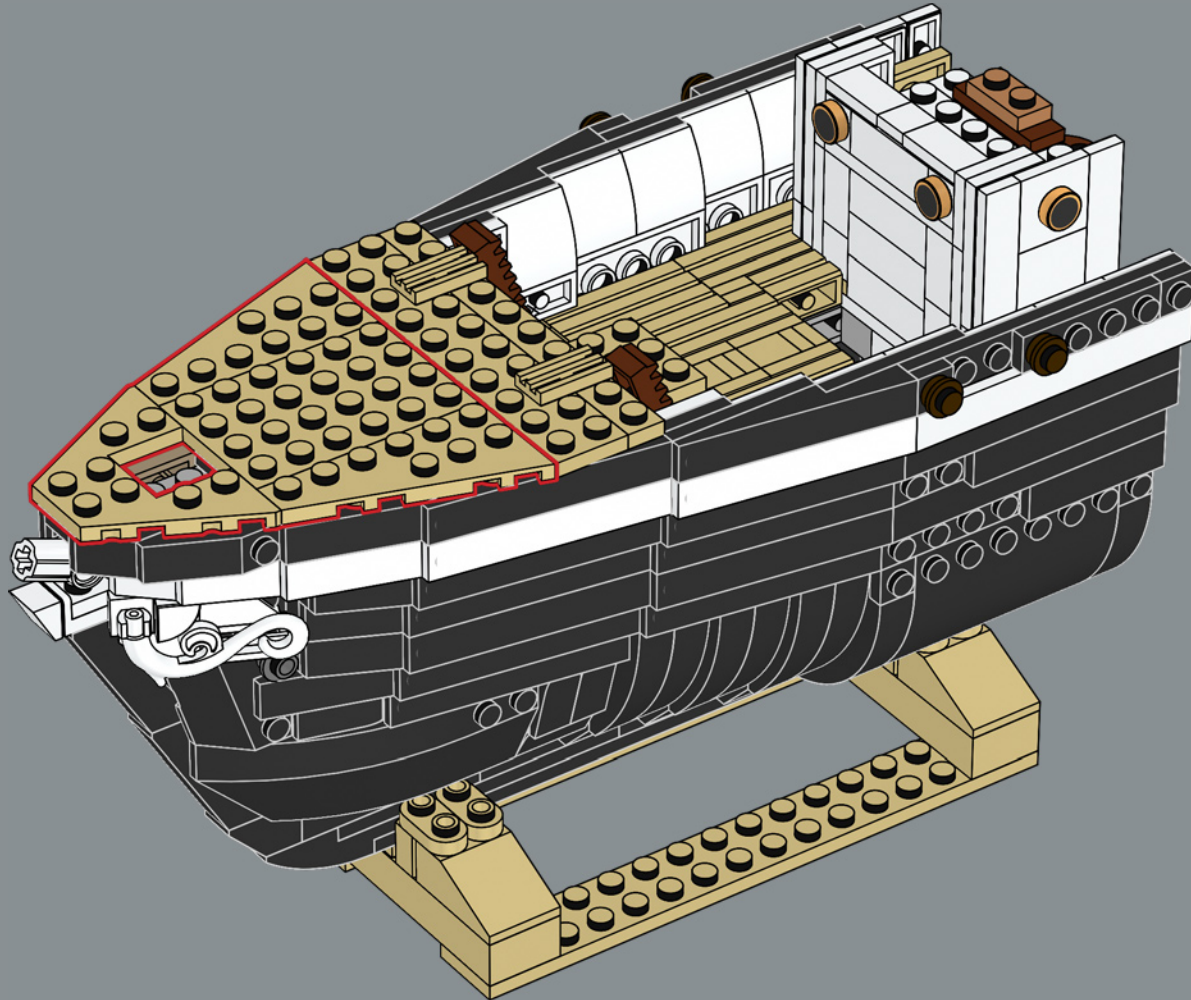



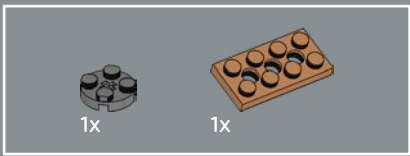

142

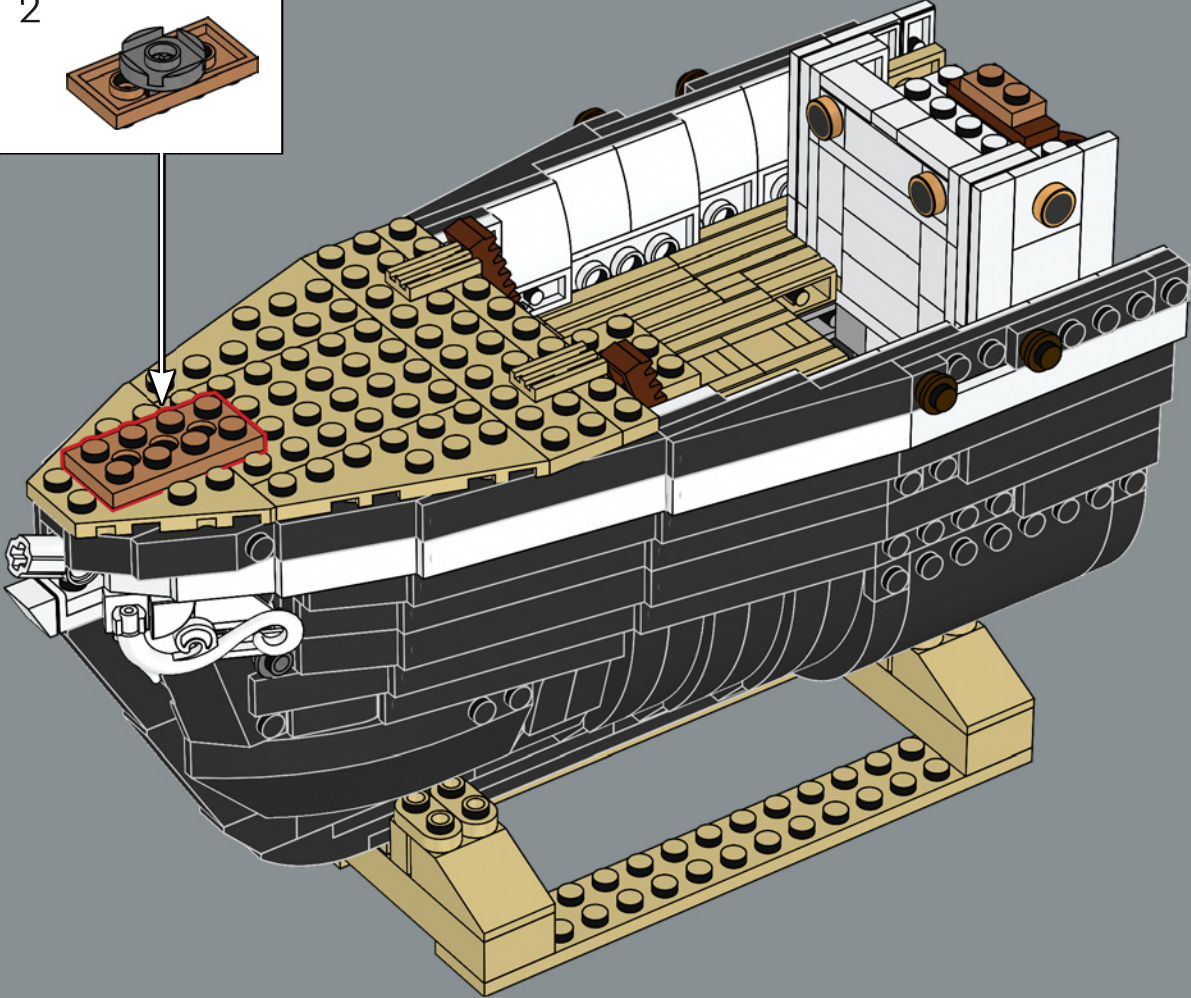
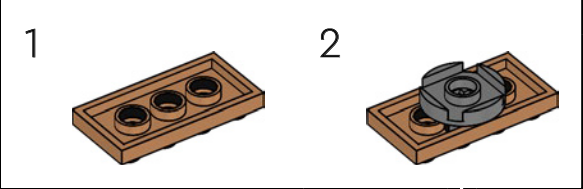

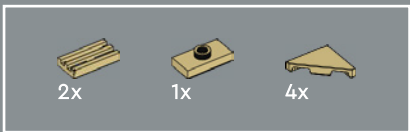

143

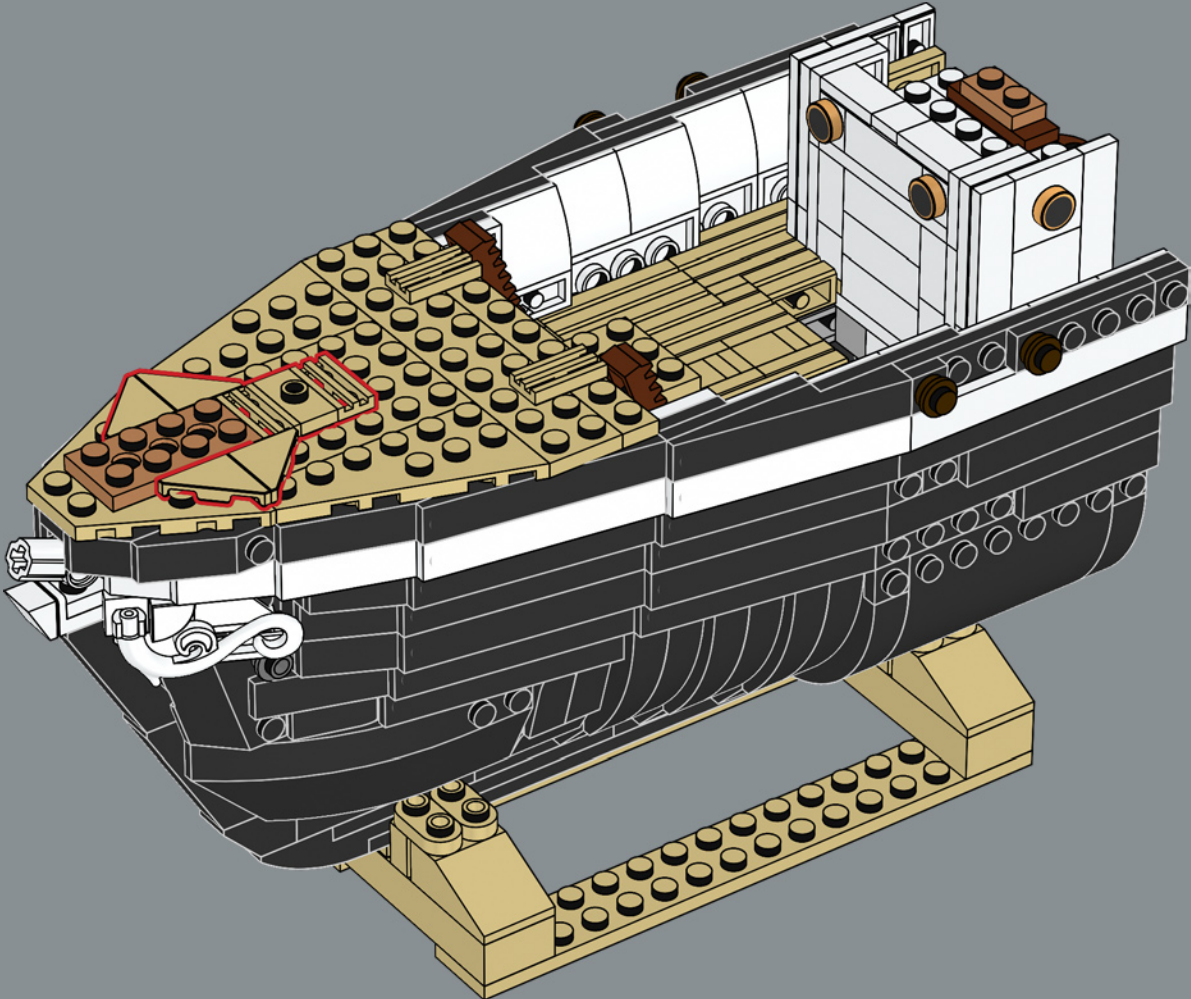



144

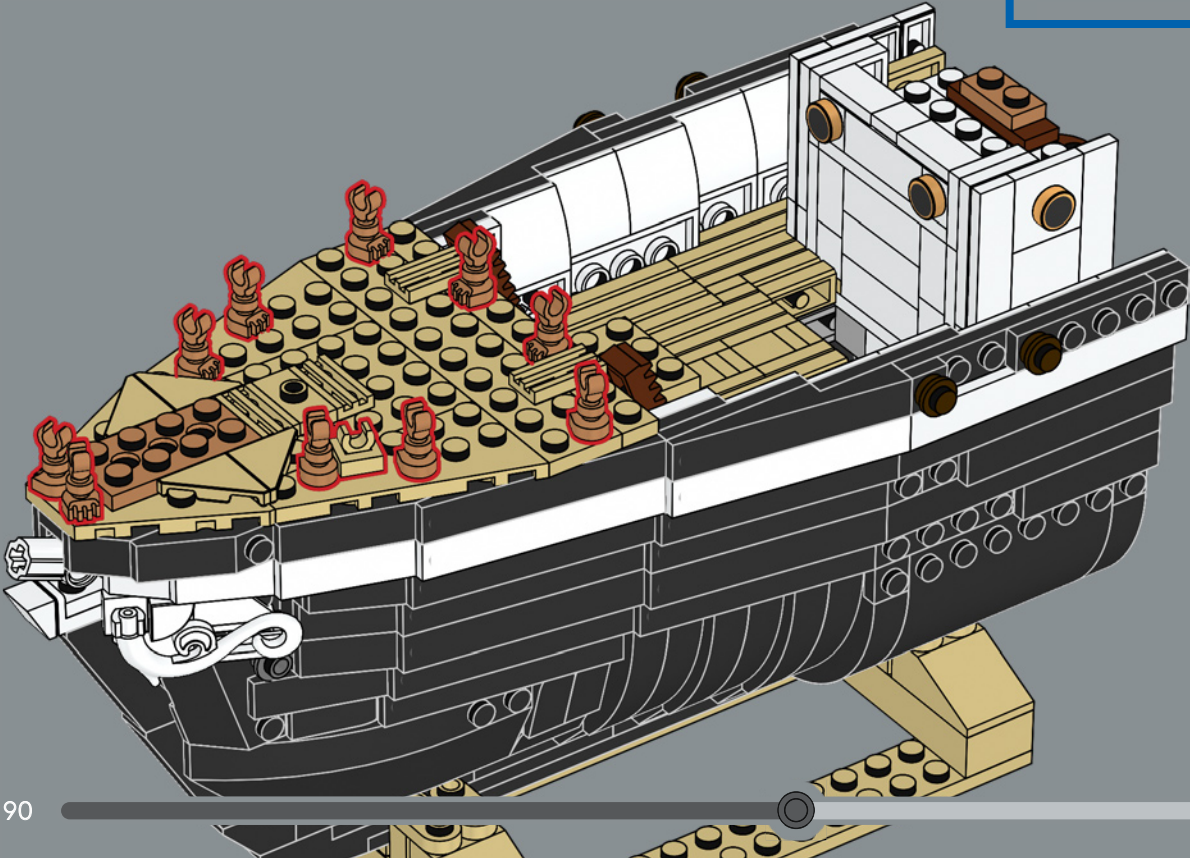
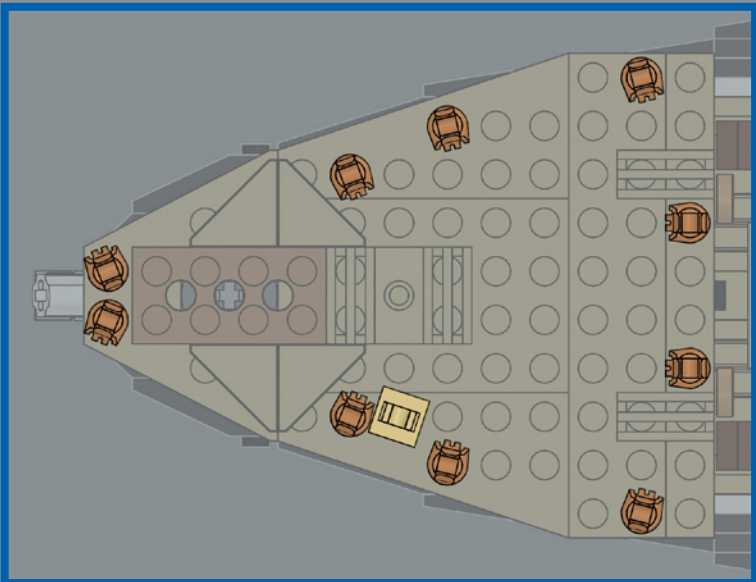





145

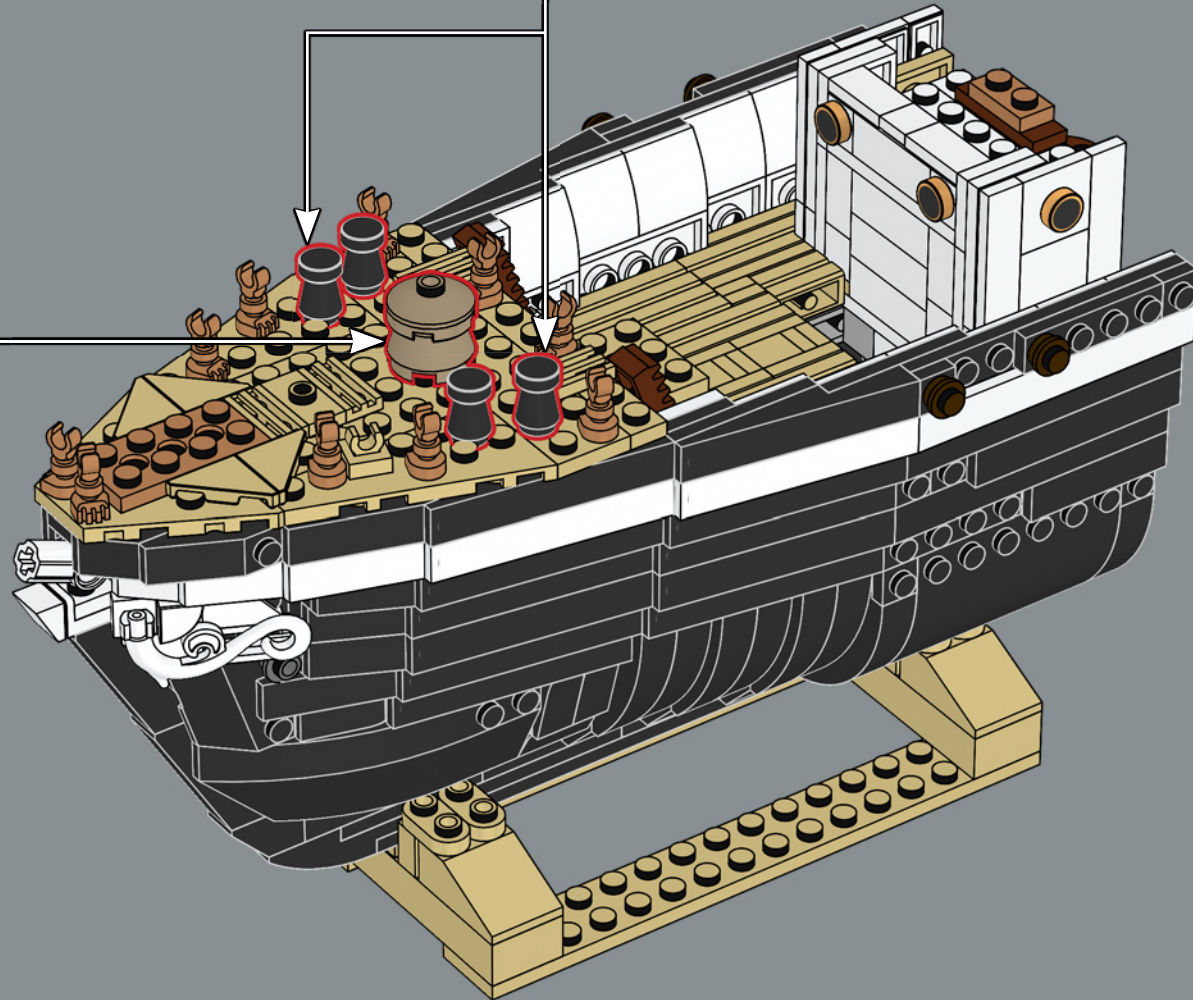
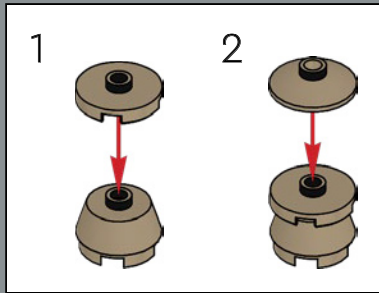
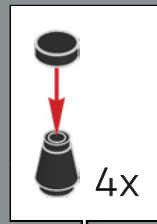



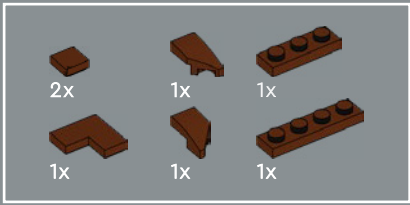

146

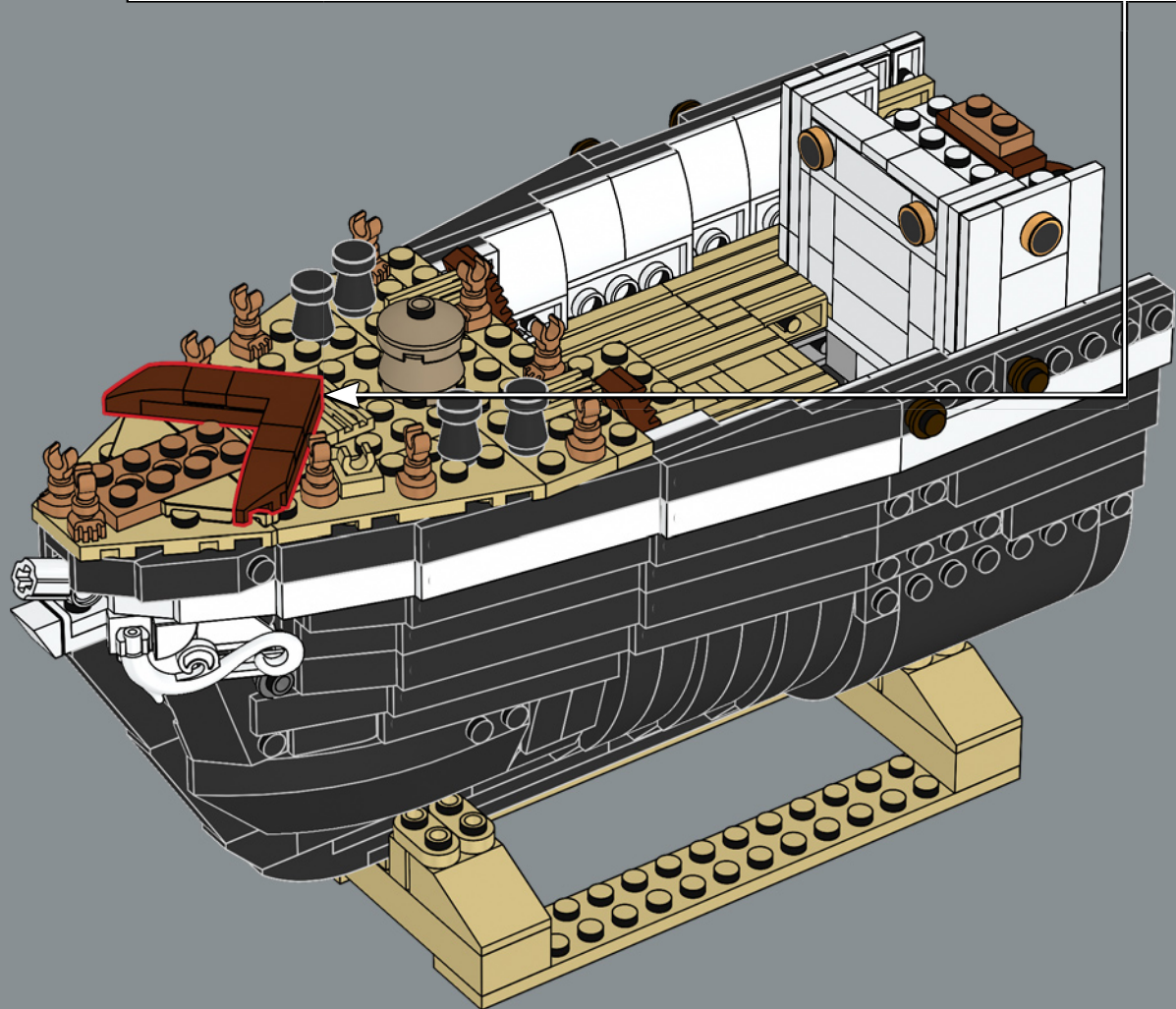
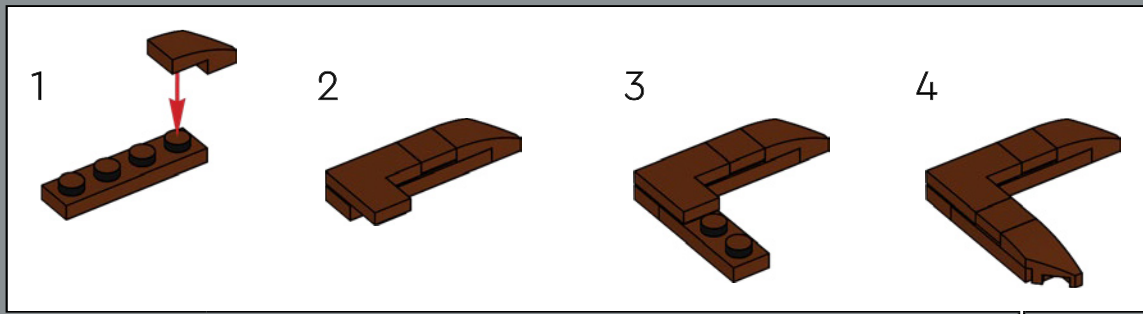

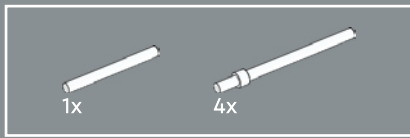

147

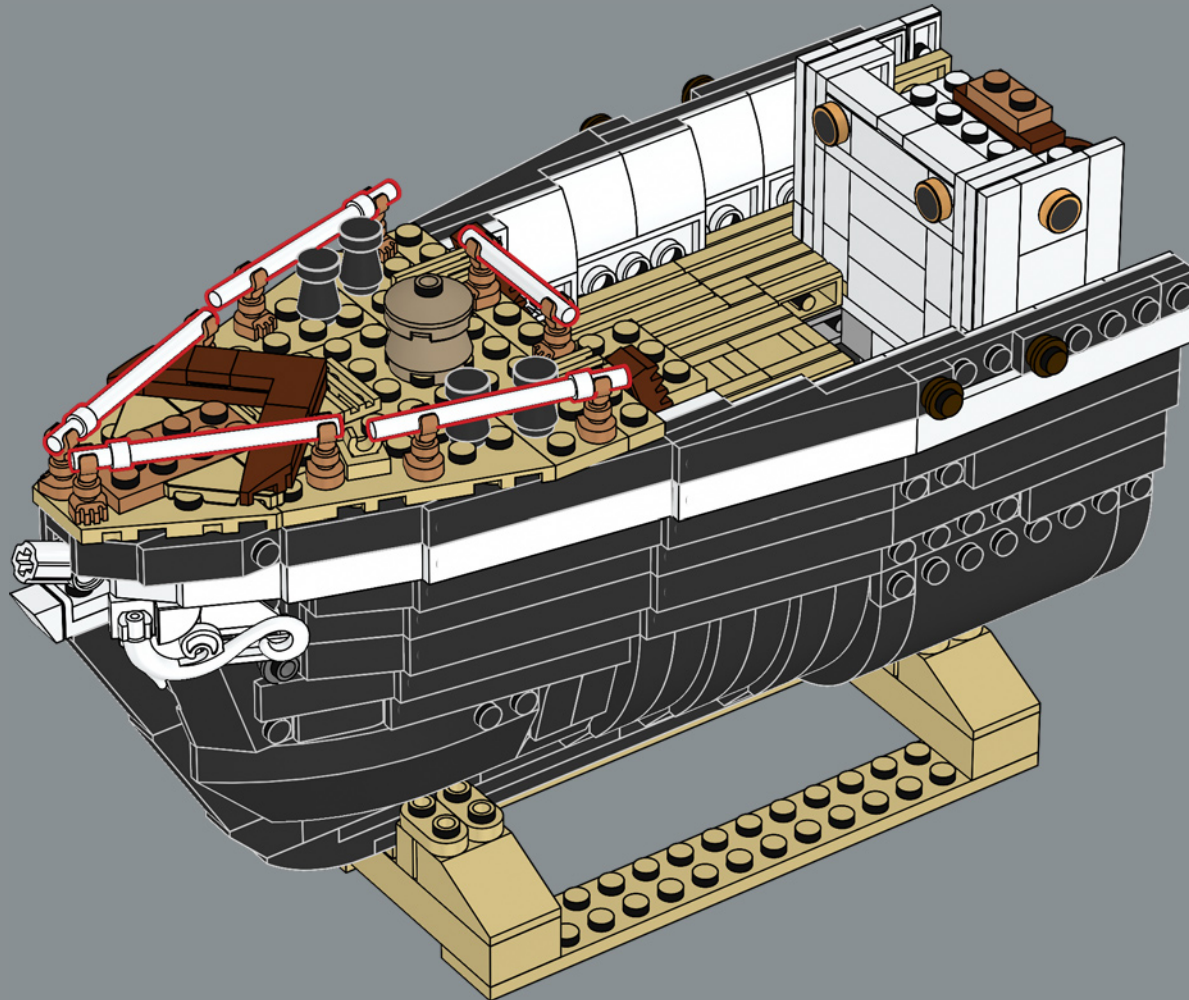



148

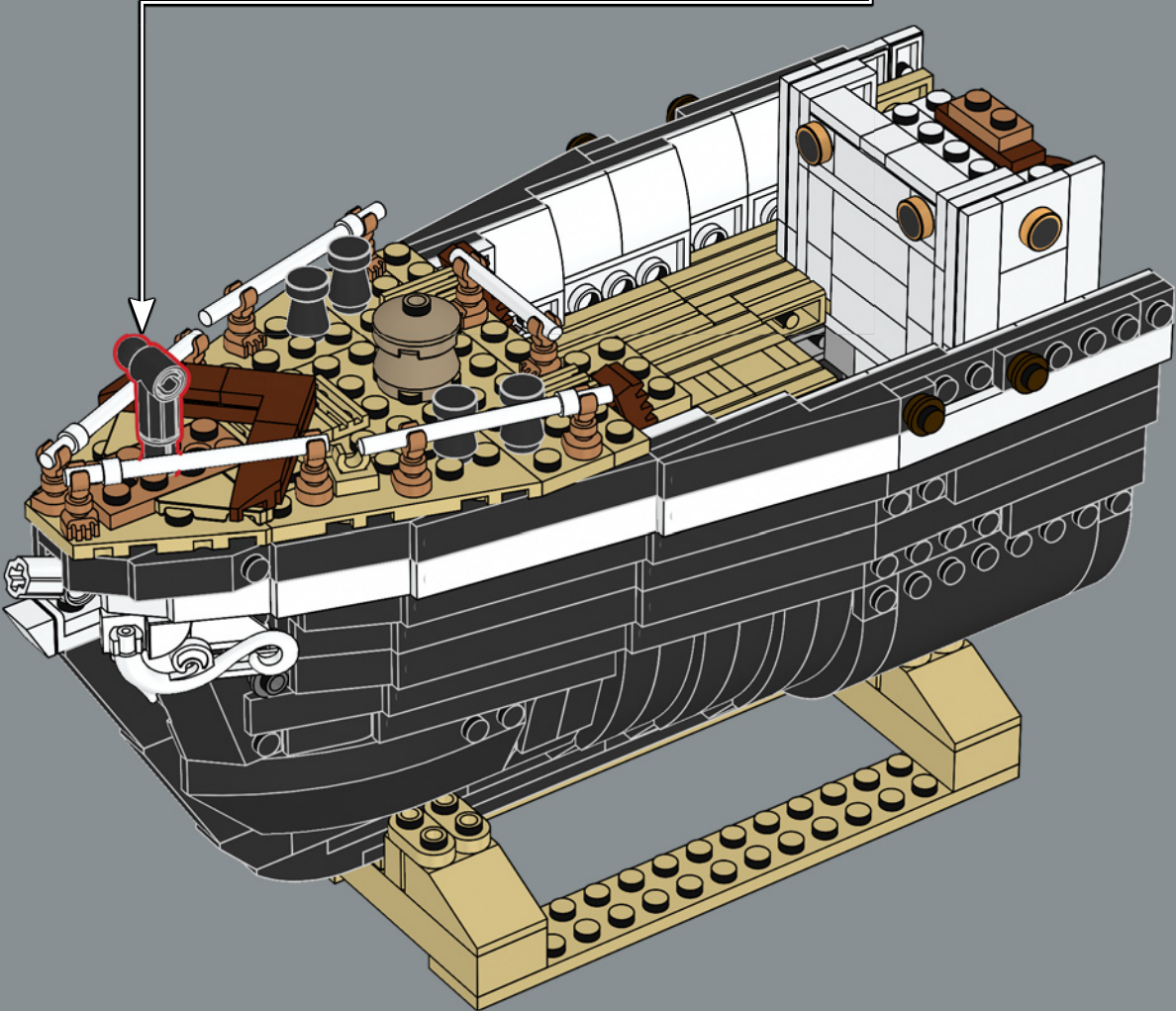
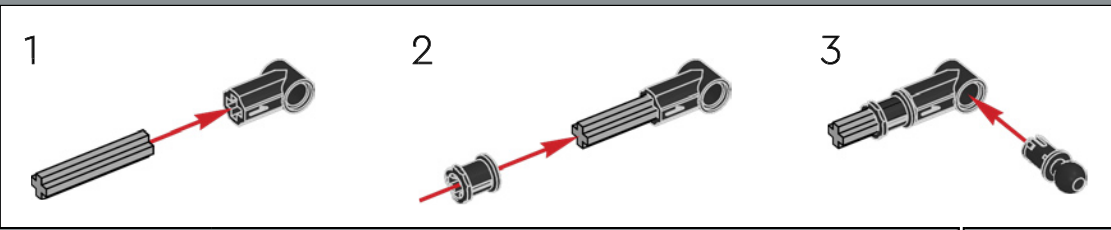



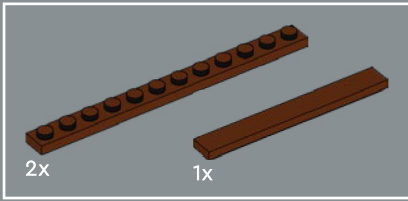
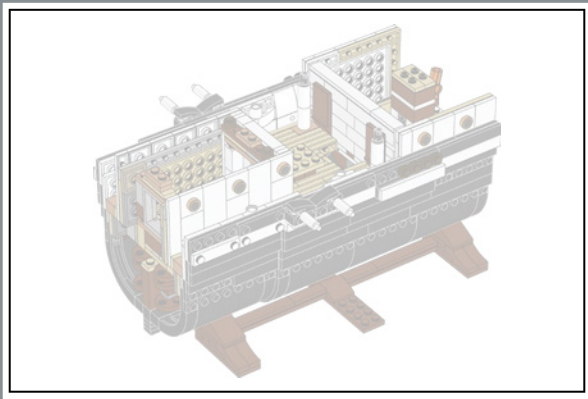

149

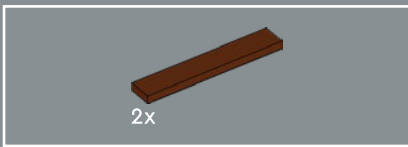
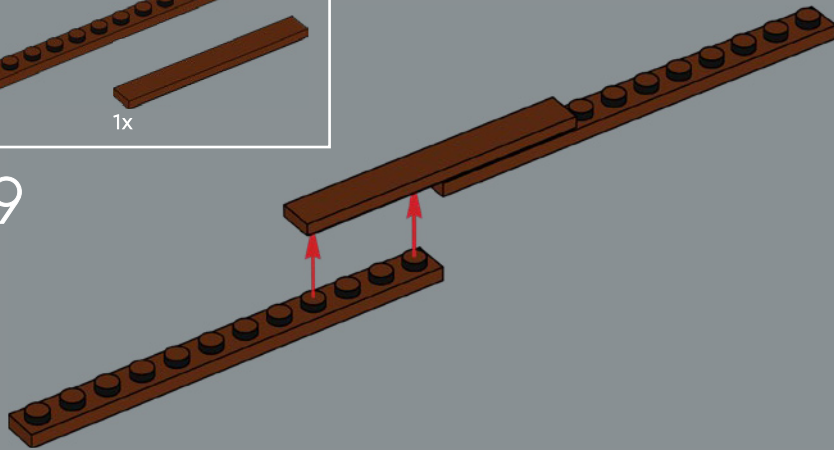

150

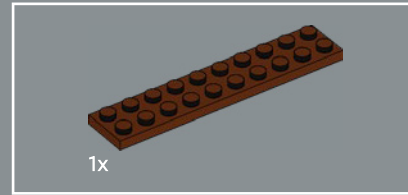
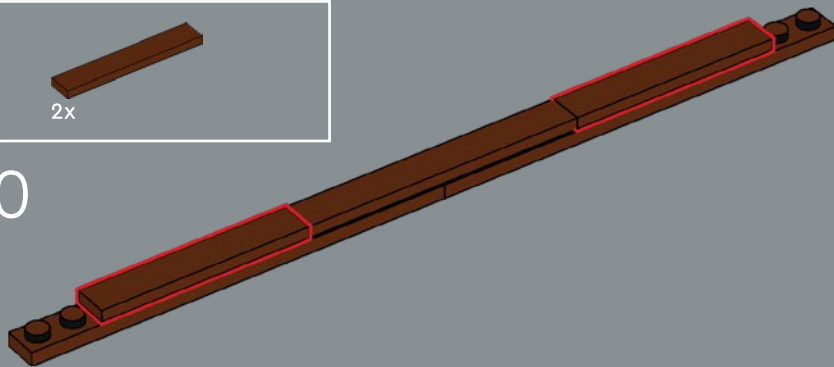

151

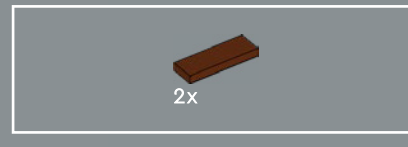
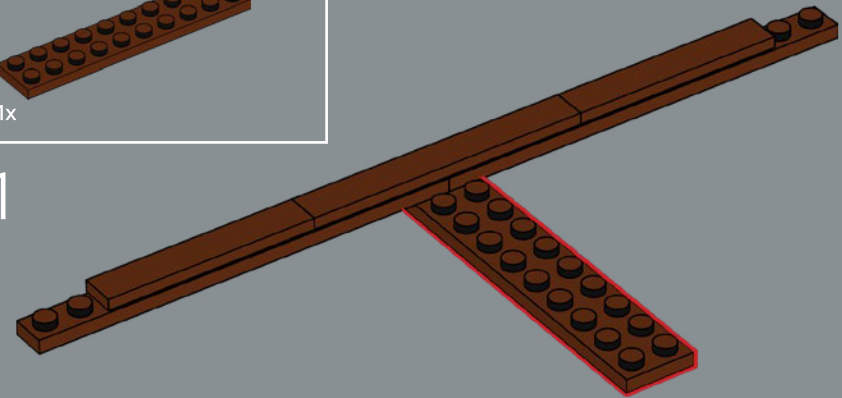

152

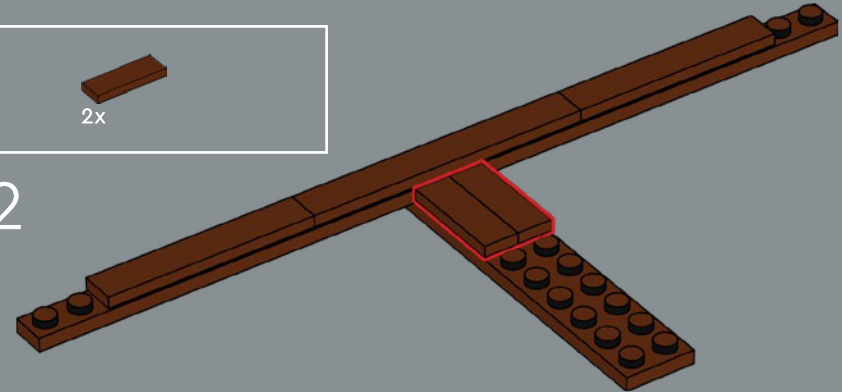



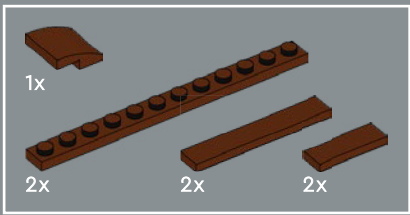

153

1

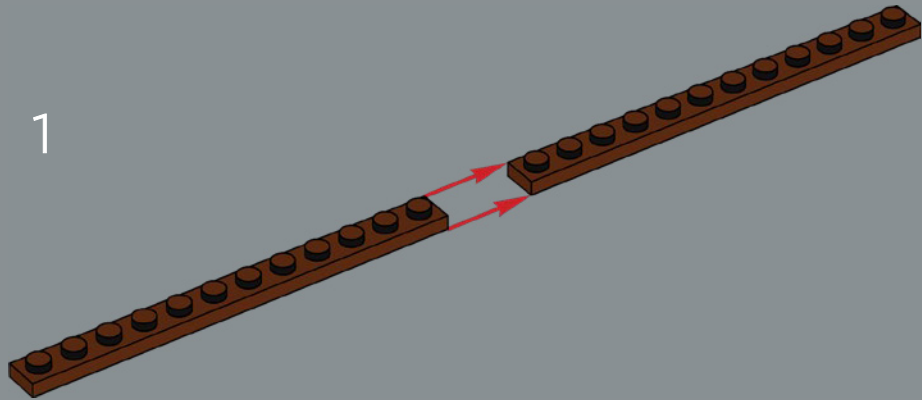

2

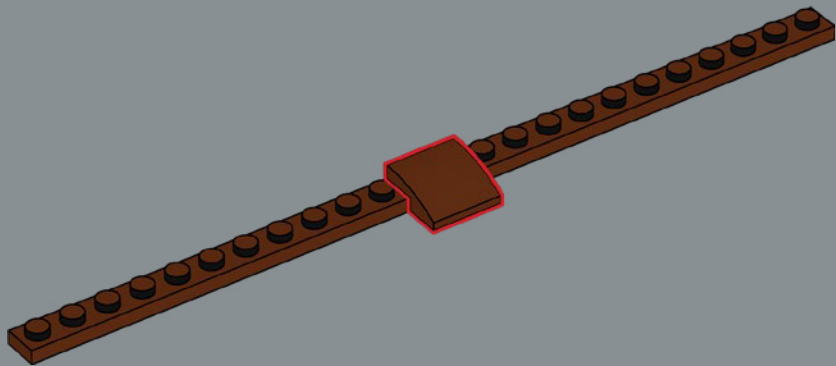

3

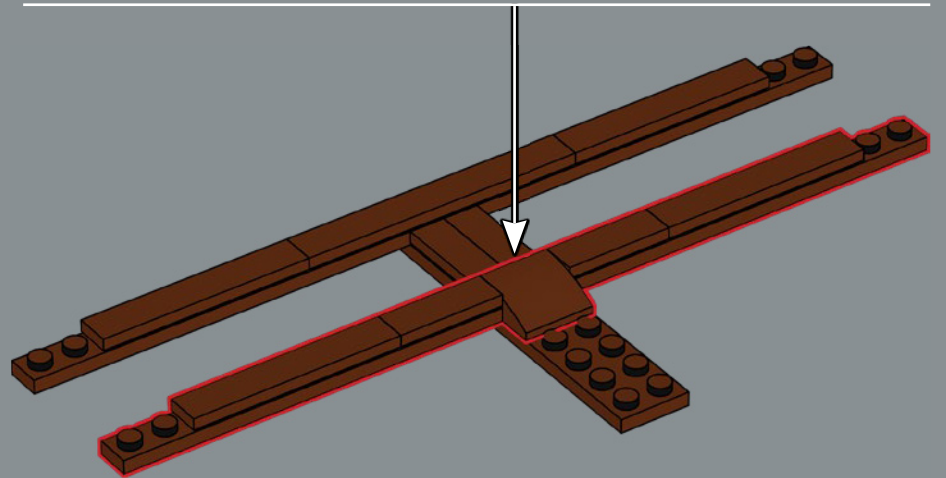
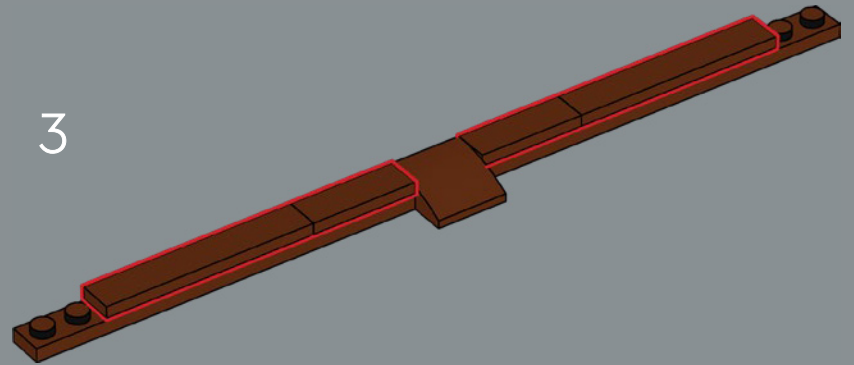

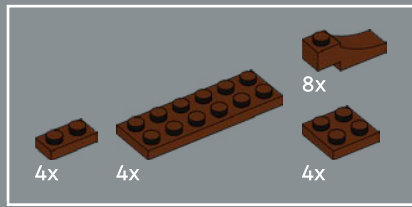

154

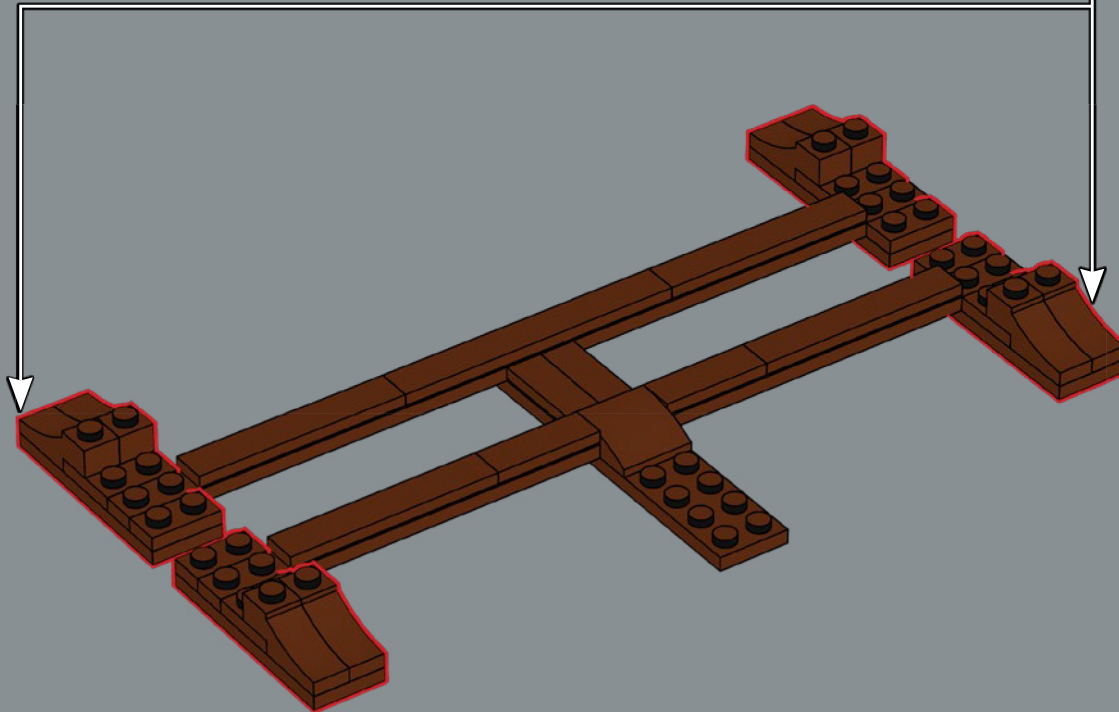
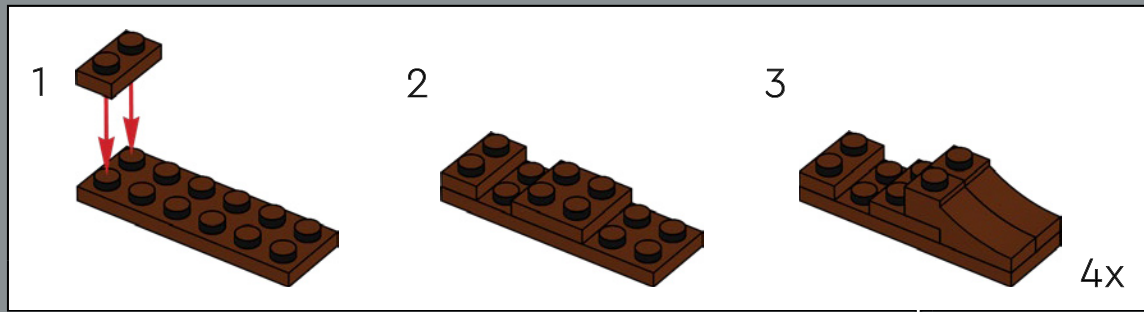

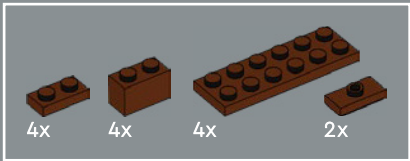

155

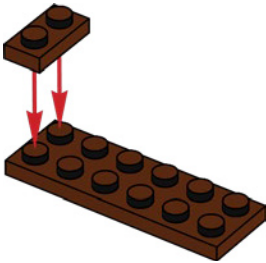
1 

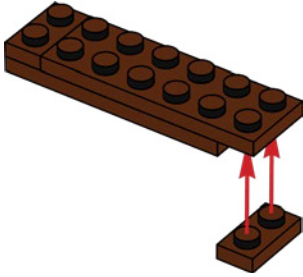
2 

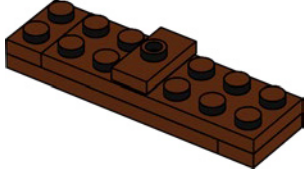
3 

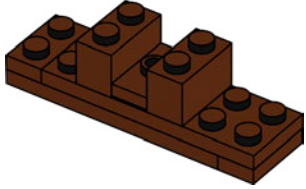
4 

2x

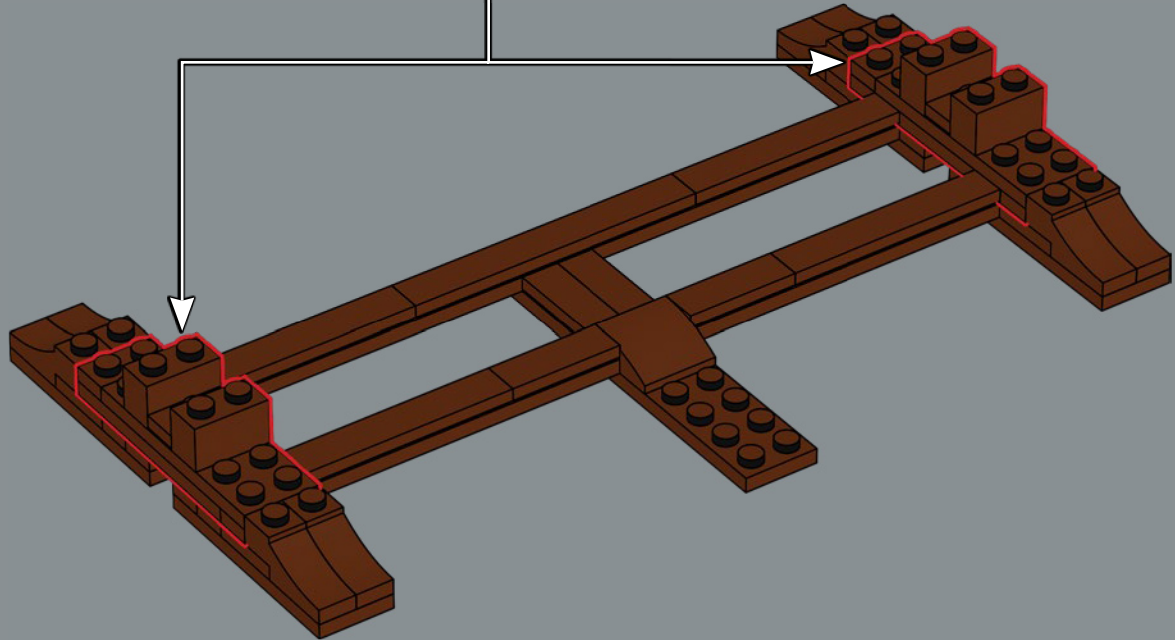



156

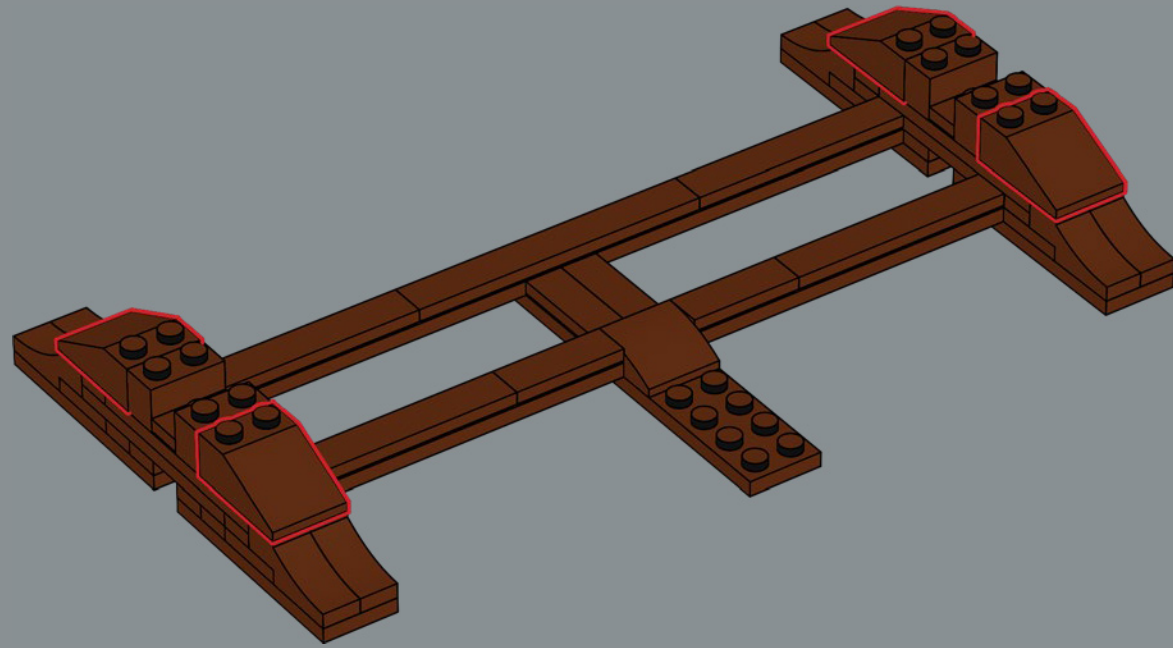

157

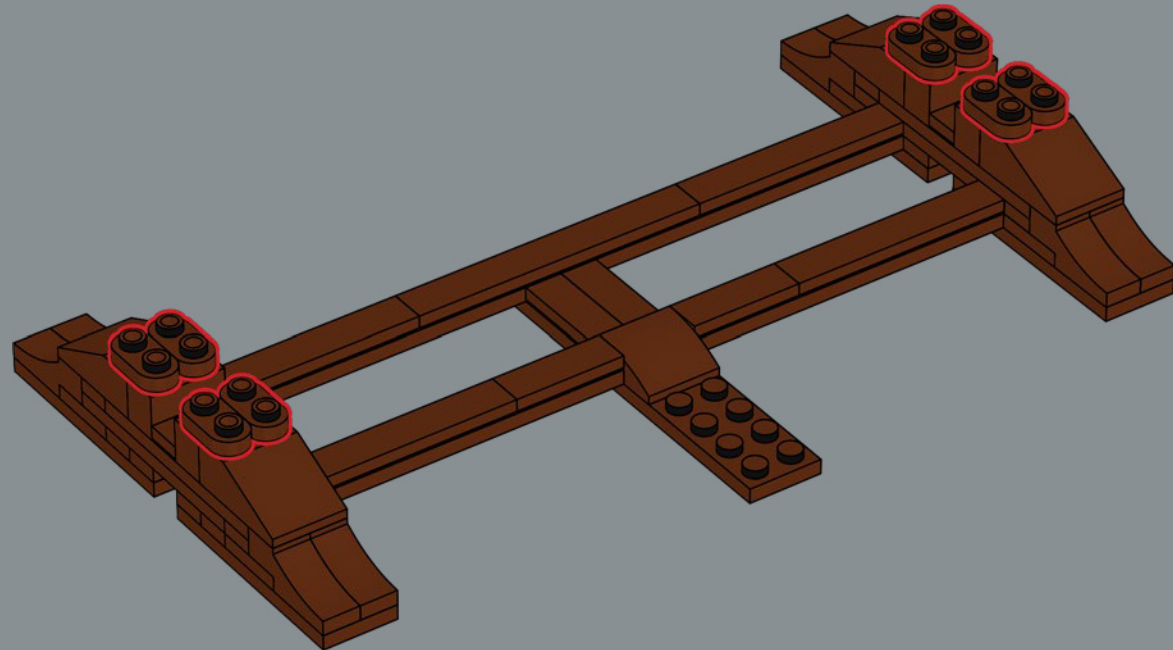



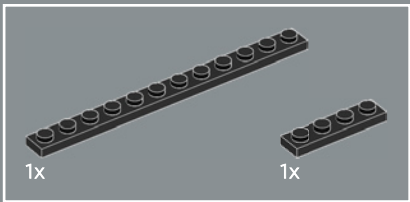
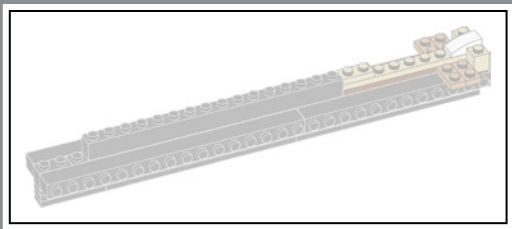

158

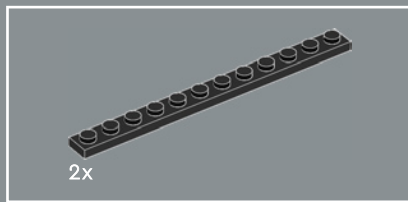
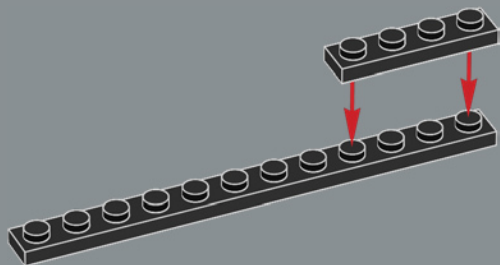

159

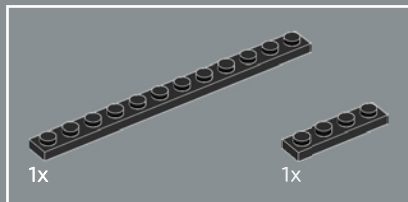
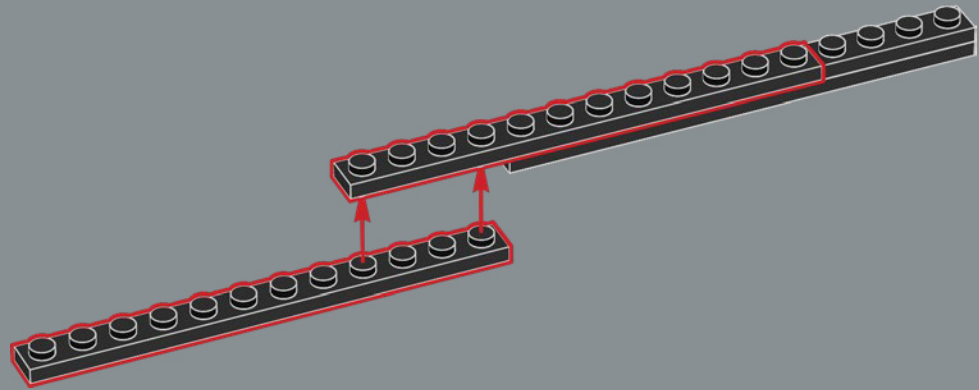

160

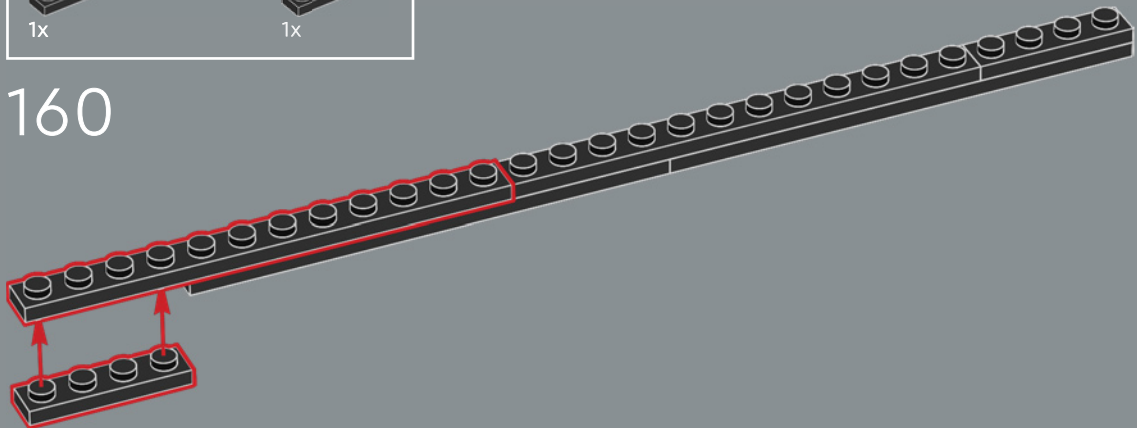

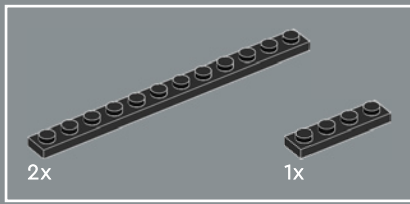

161

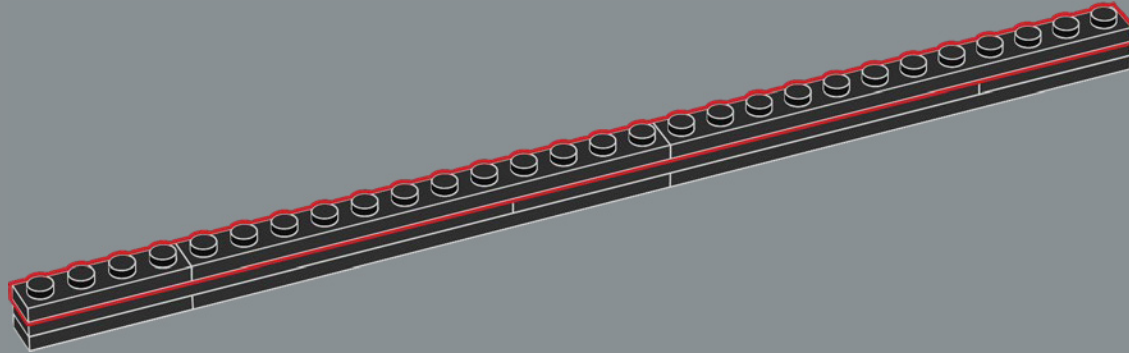

162

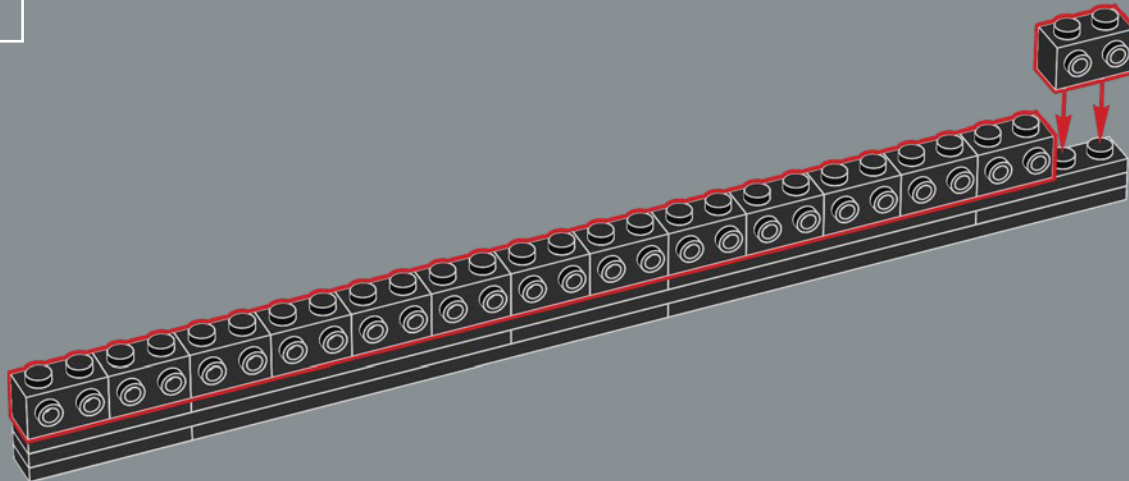

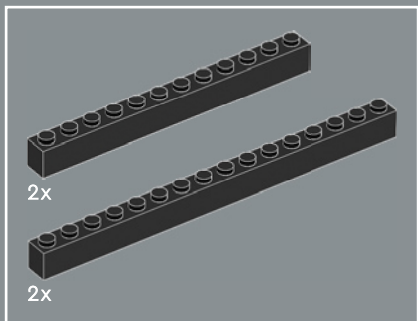

163

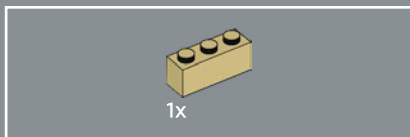
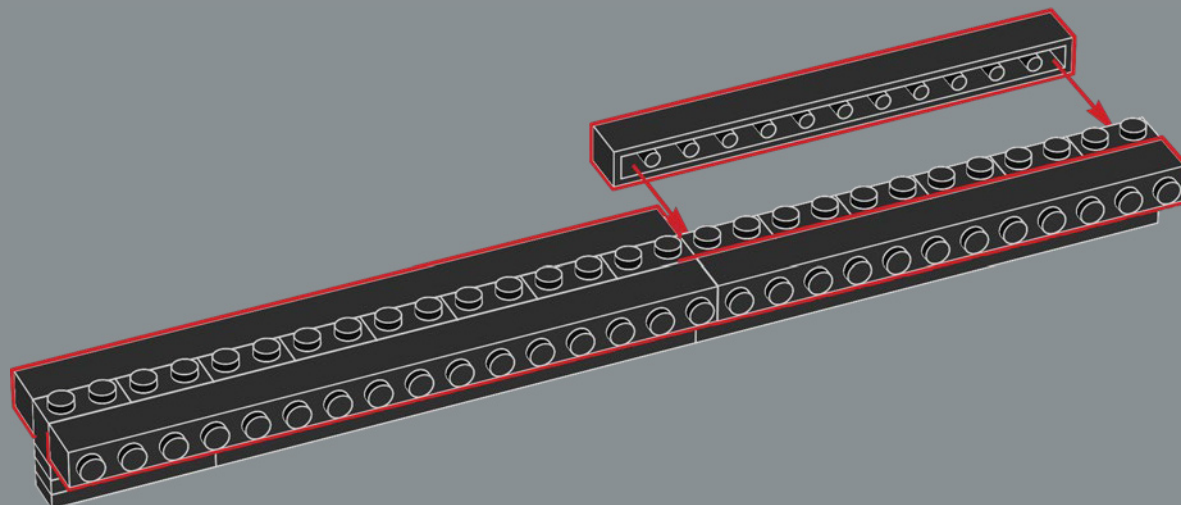

164

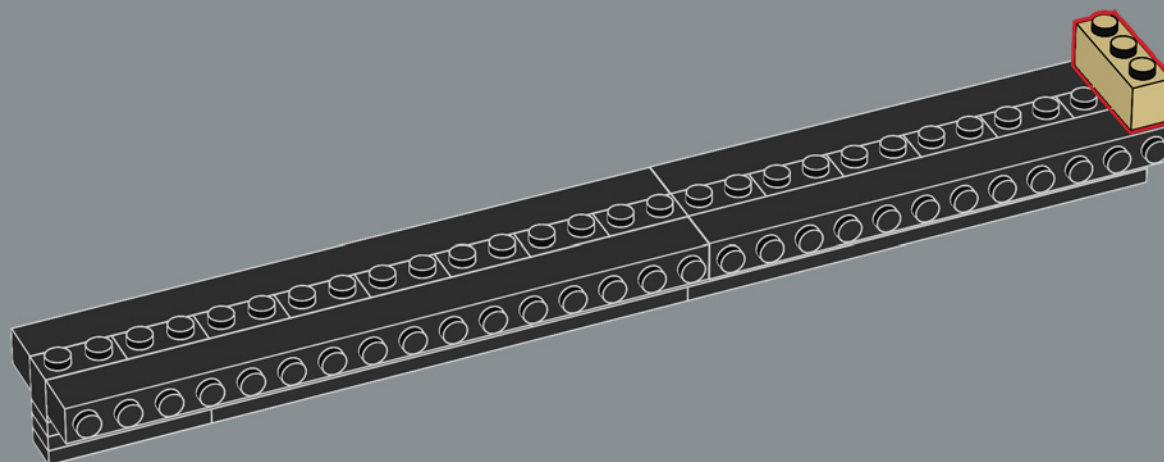

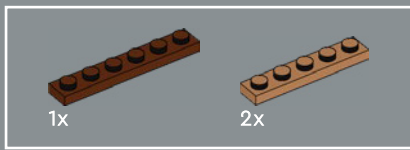

165

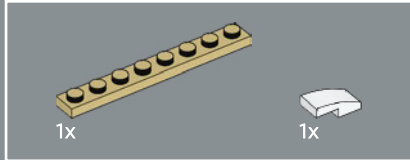
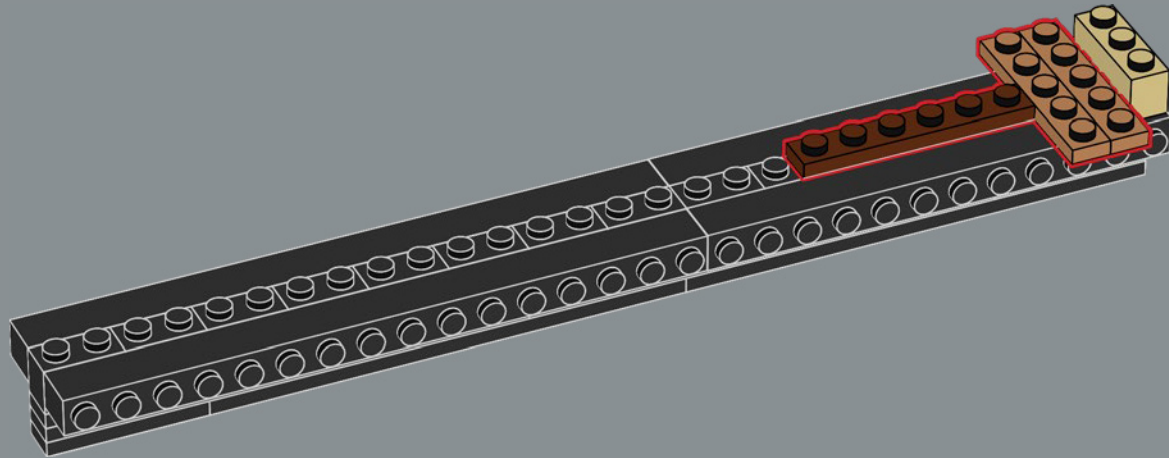

166

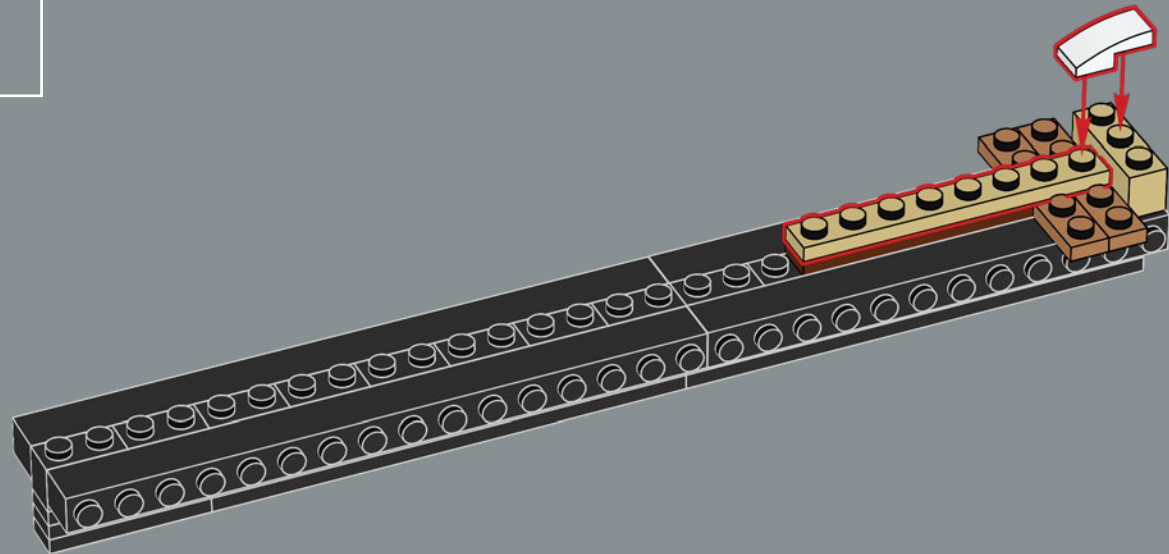



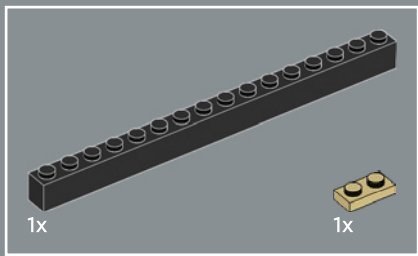

167

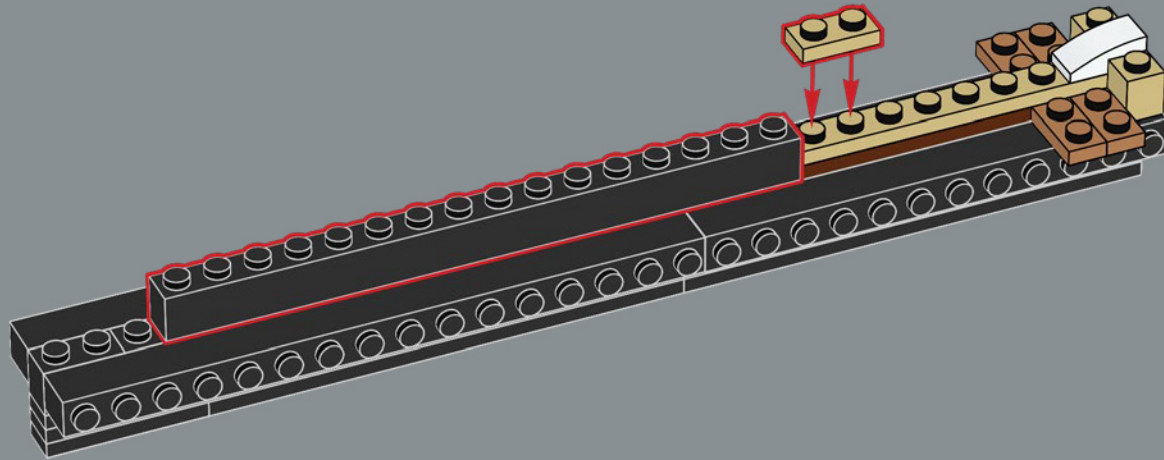

168

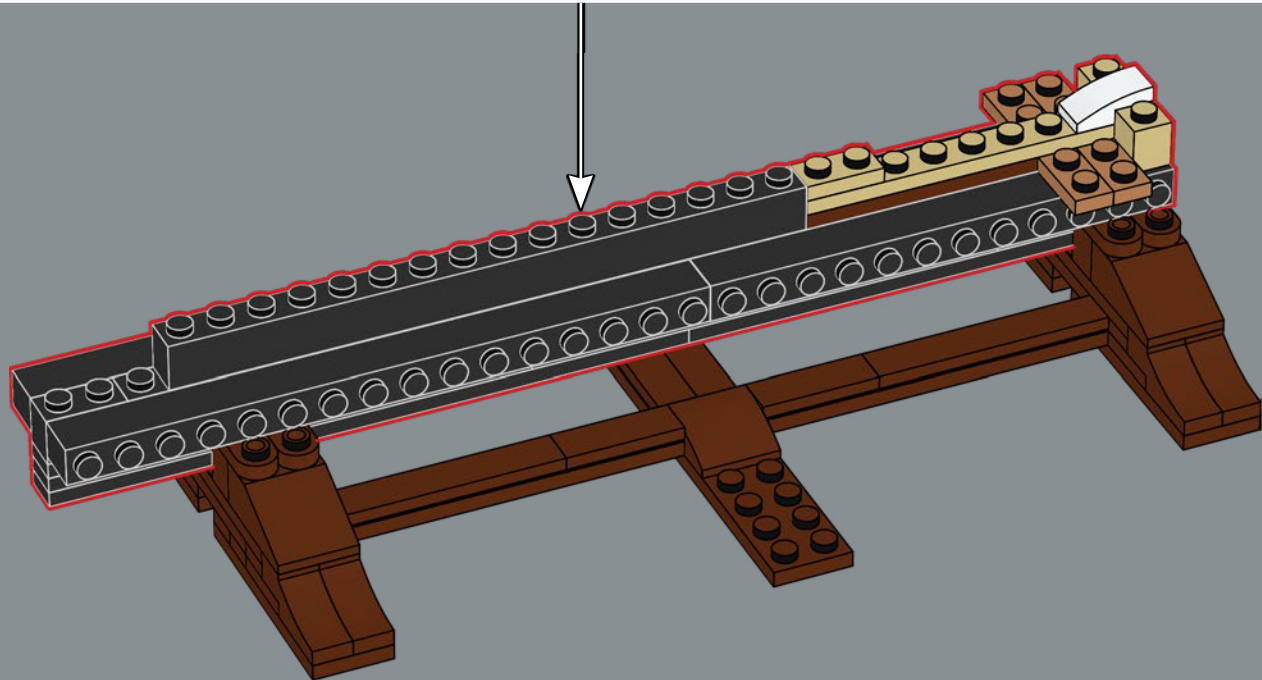



169

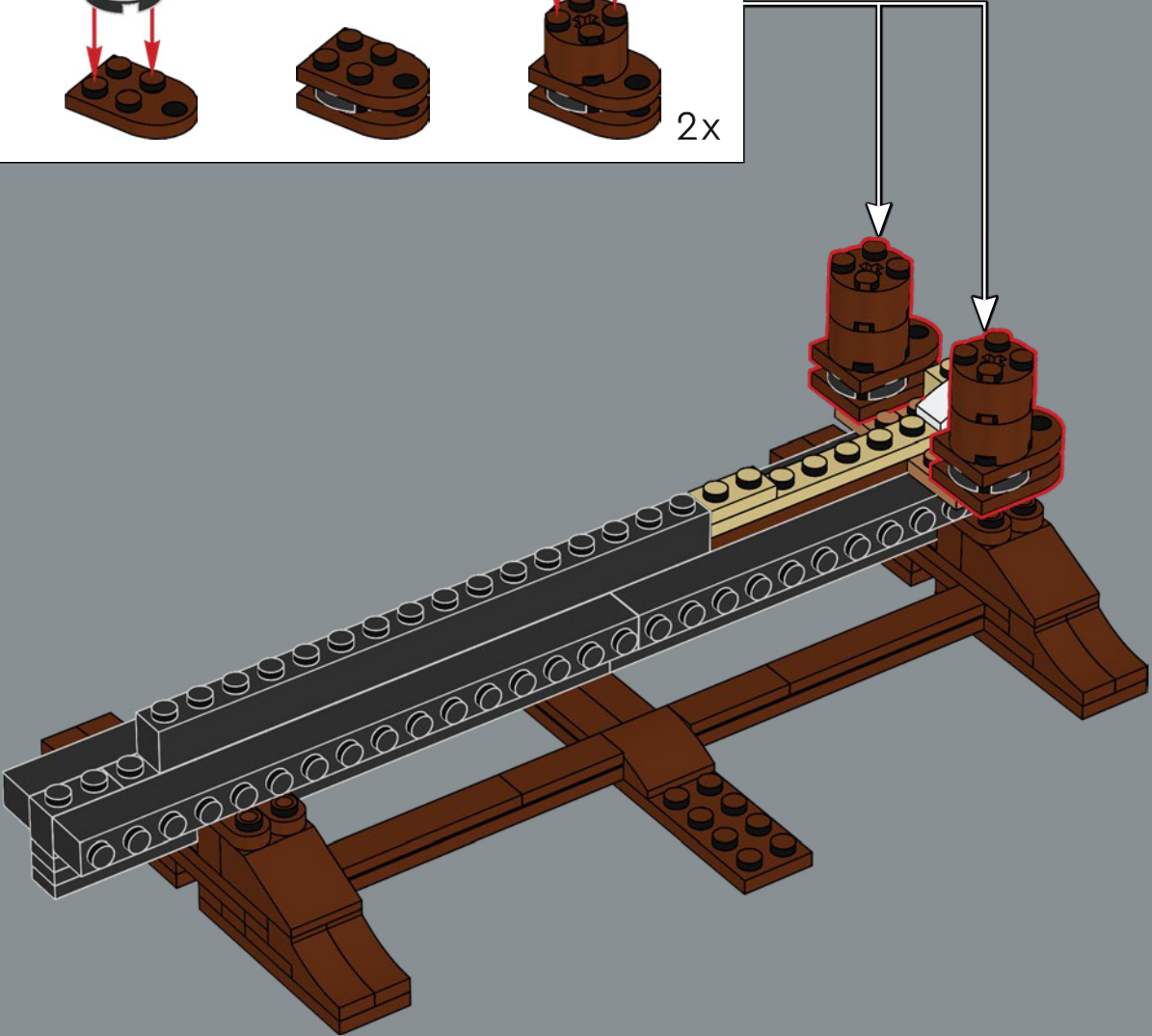
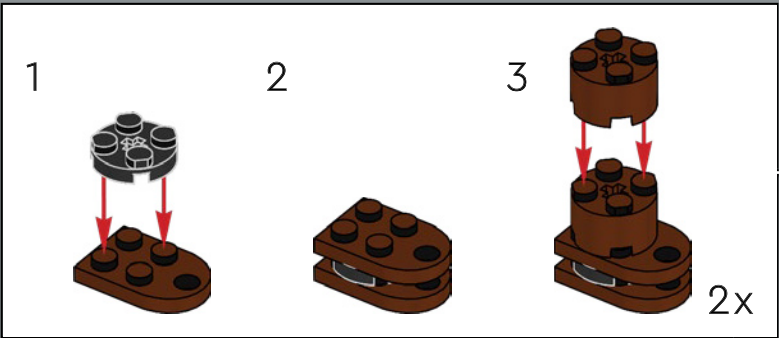

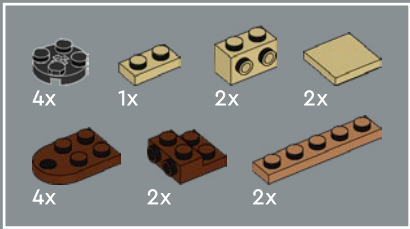

170

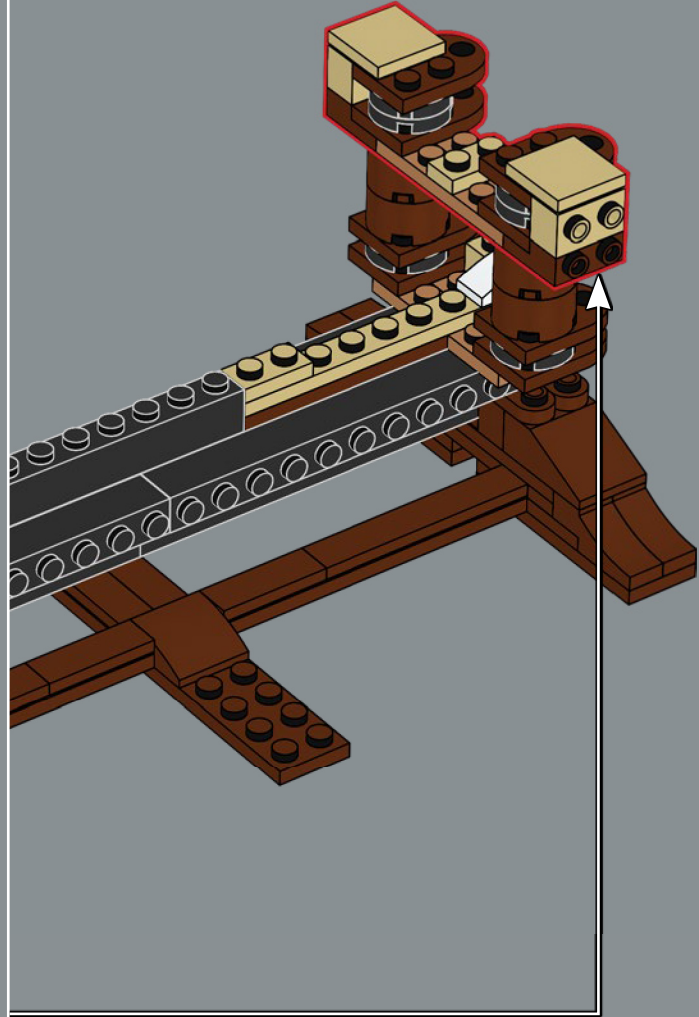
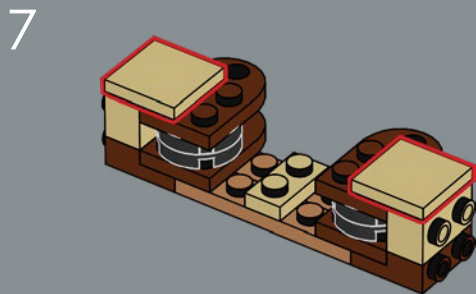
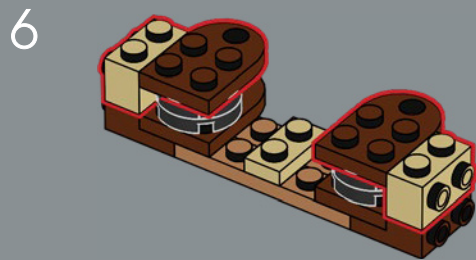
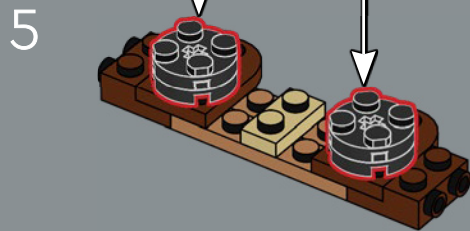
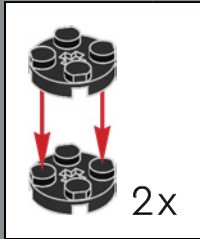
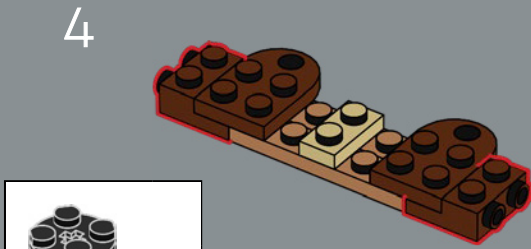
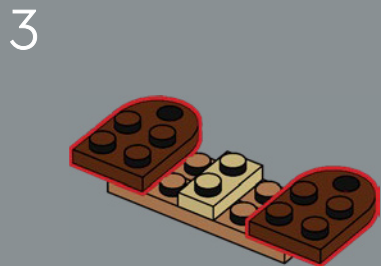
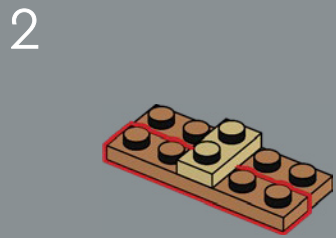
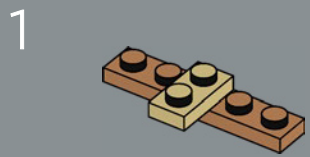

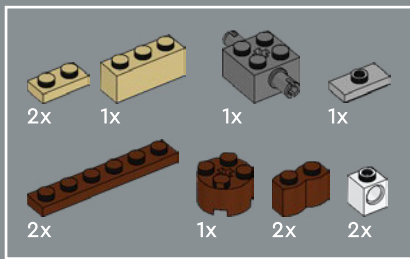

171

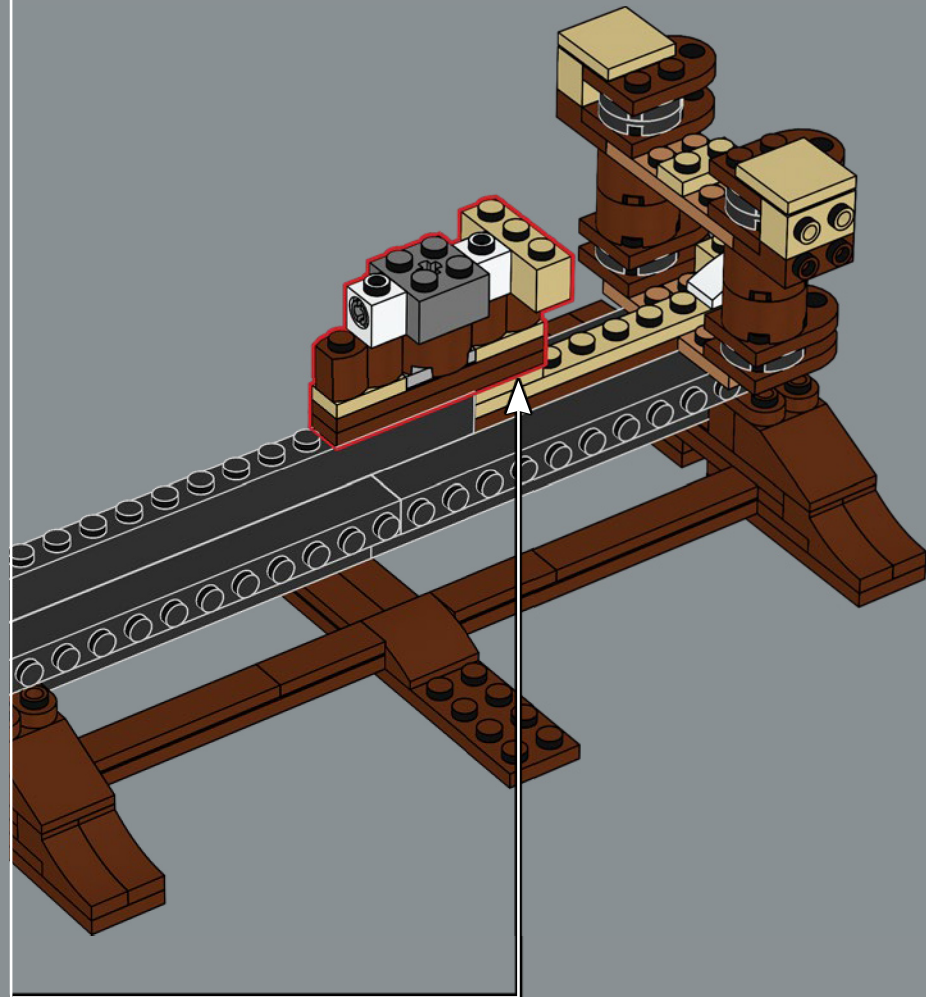
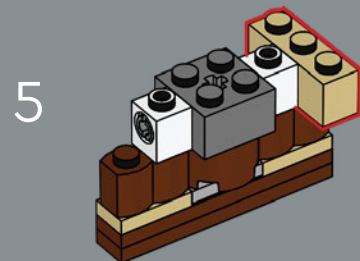
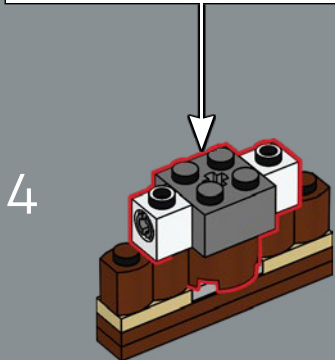
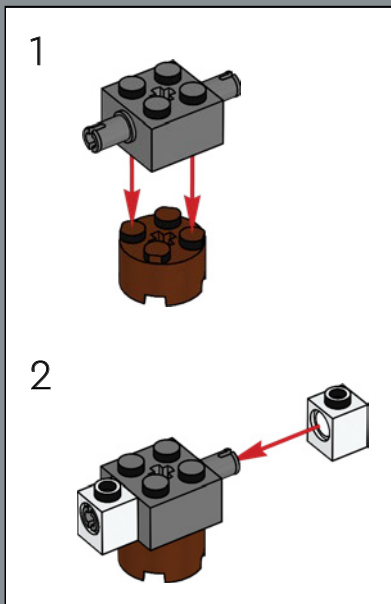
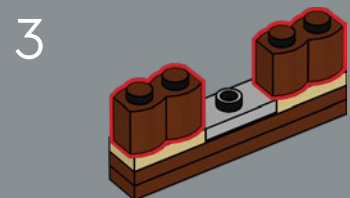
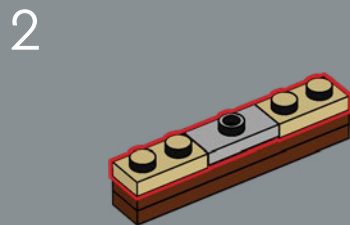
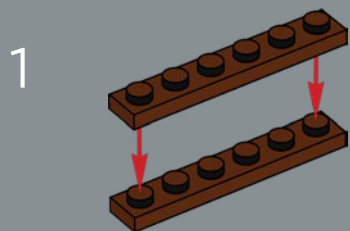



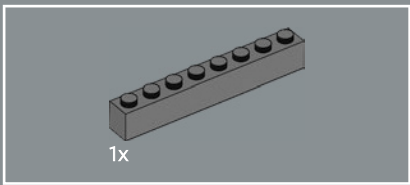

172

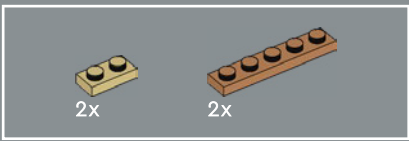
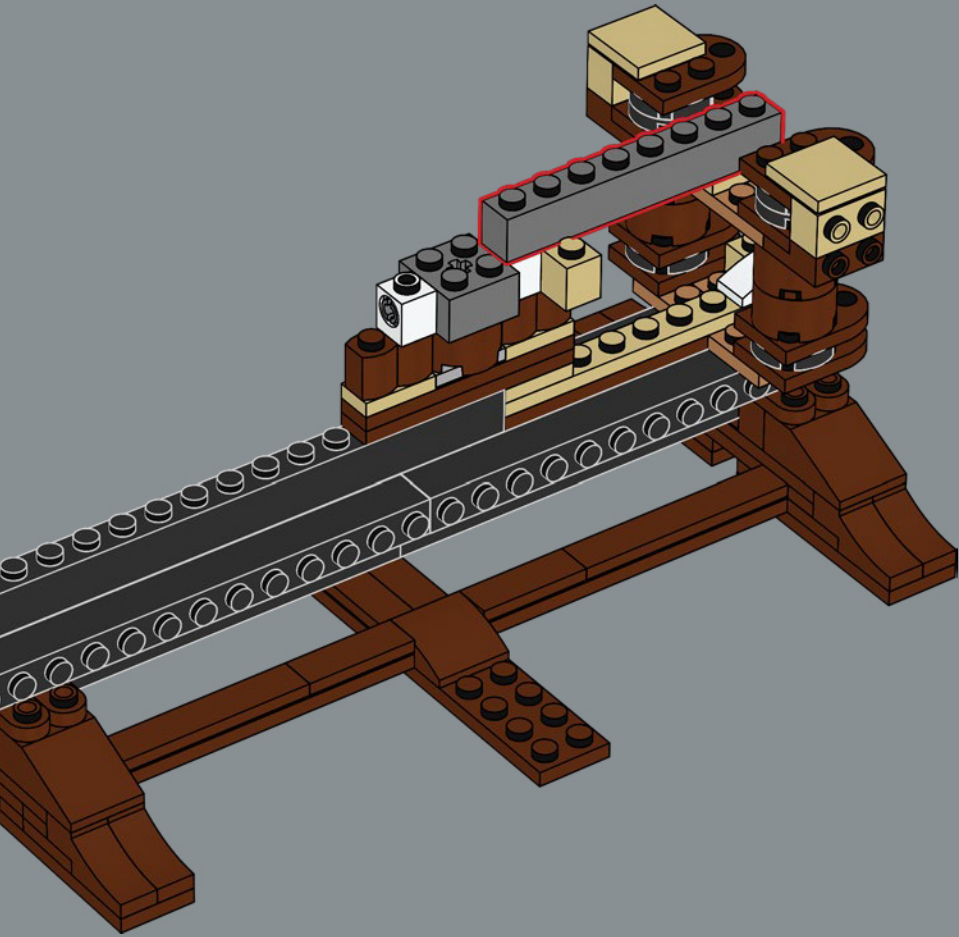

173

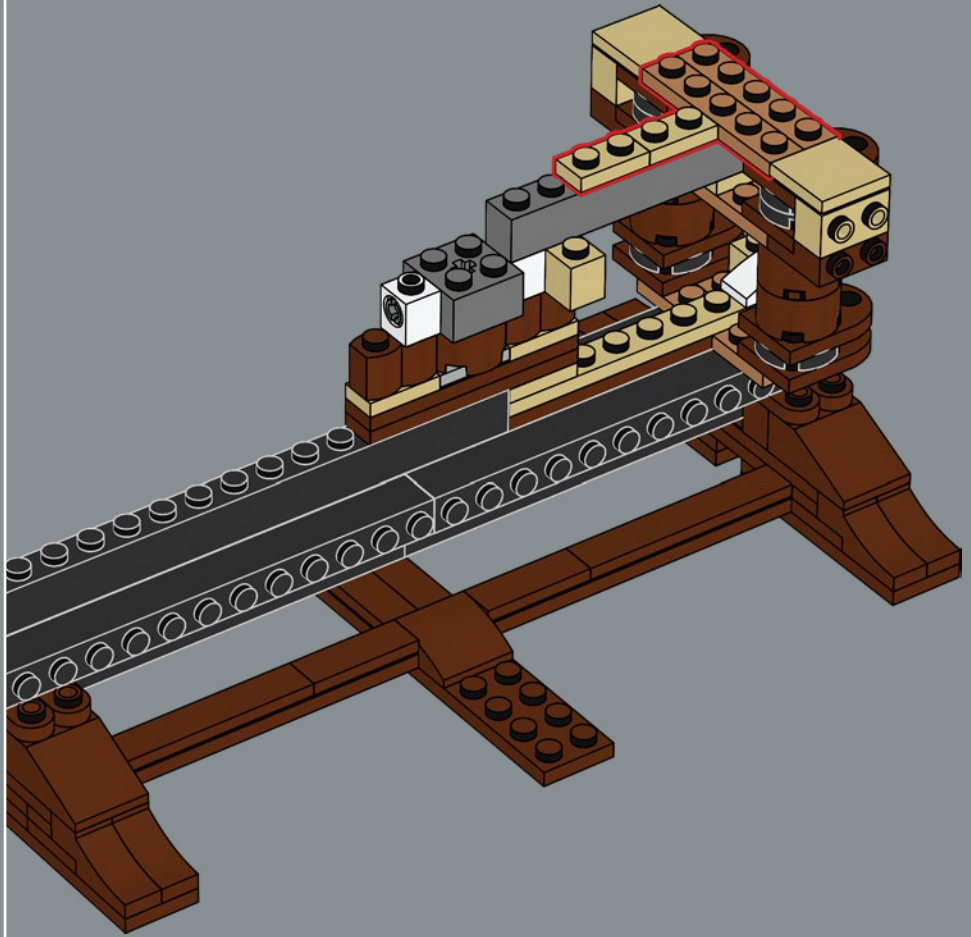

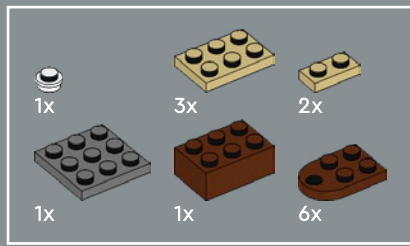

174

1

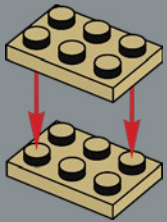

2

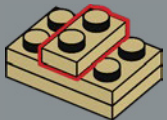

3

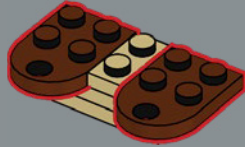

4



5

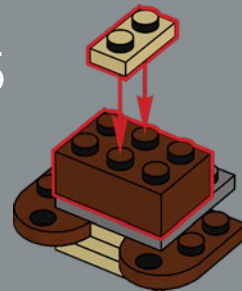

6

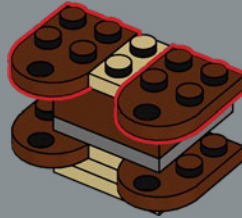

7

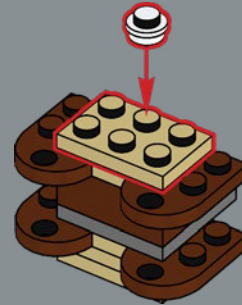

8

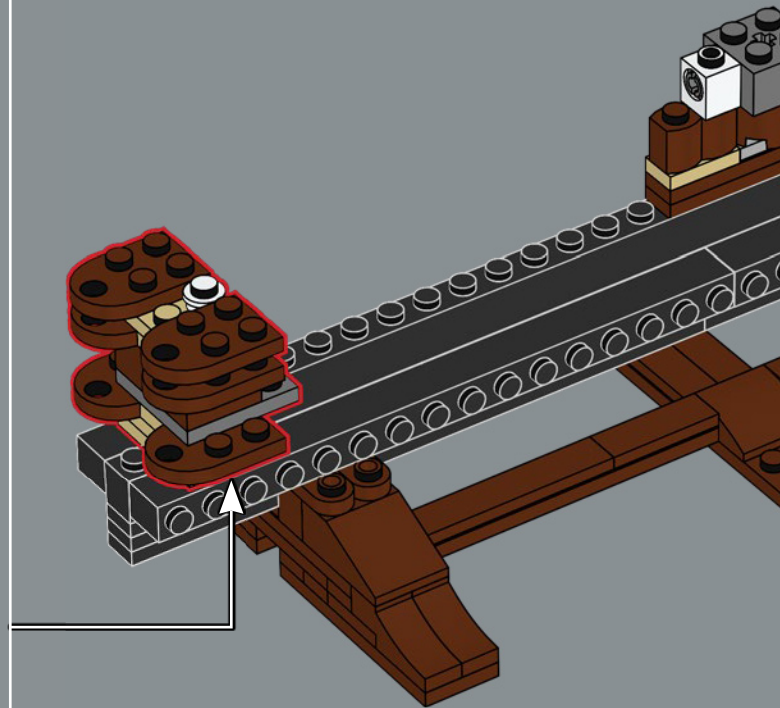
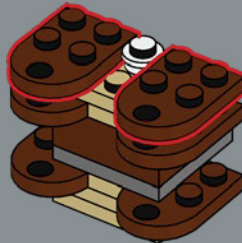

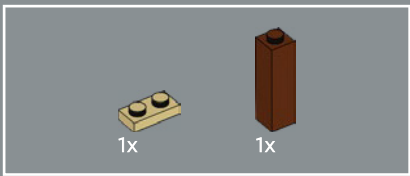

175

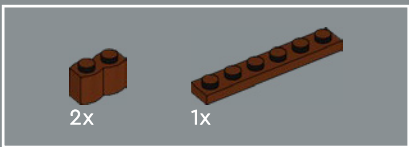
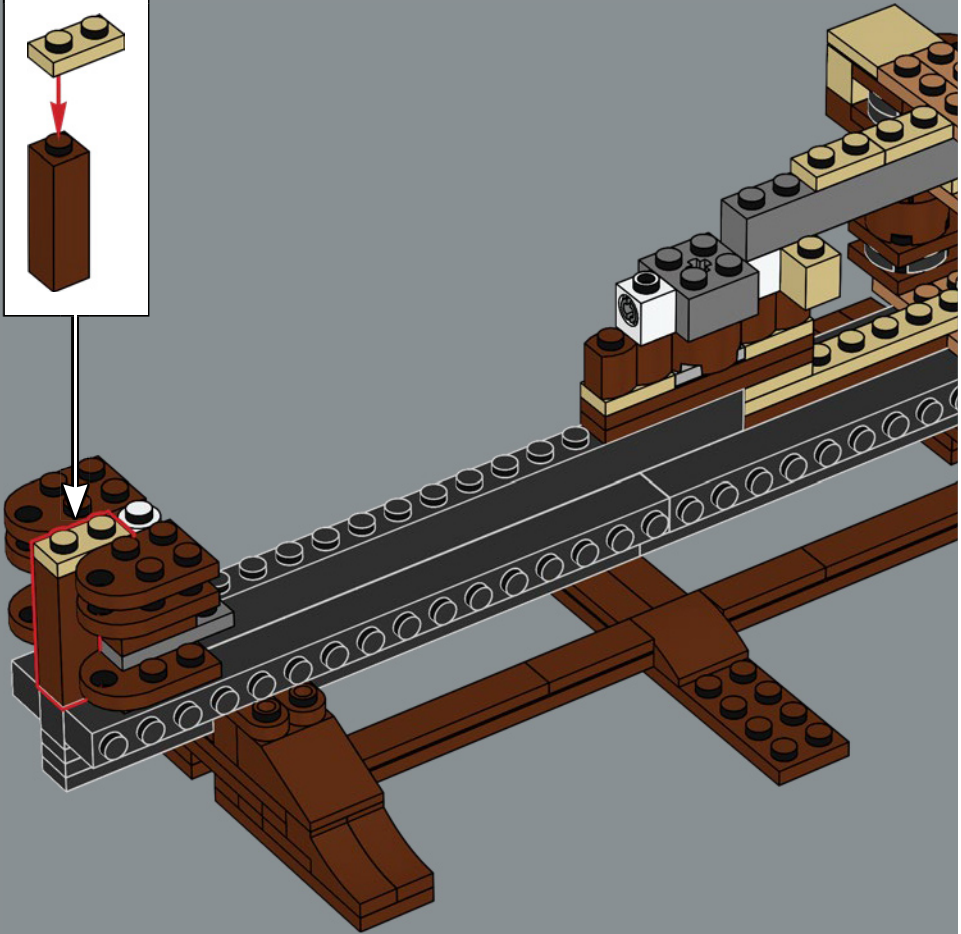
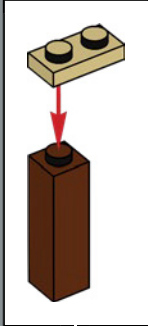

176

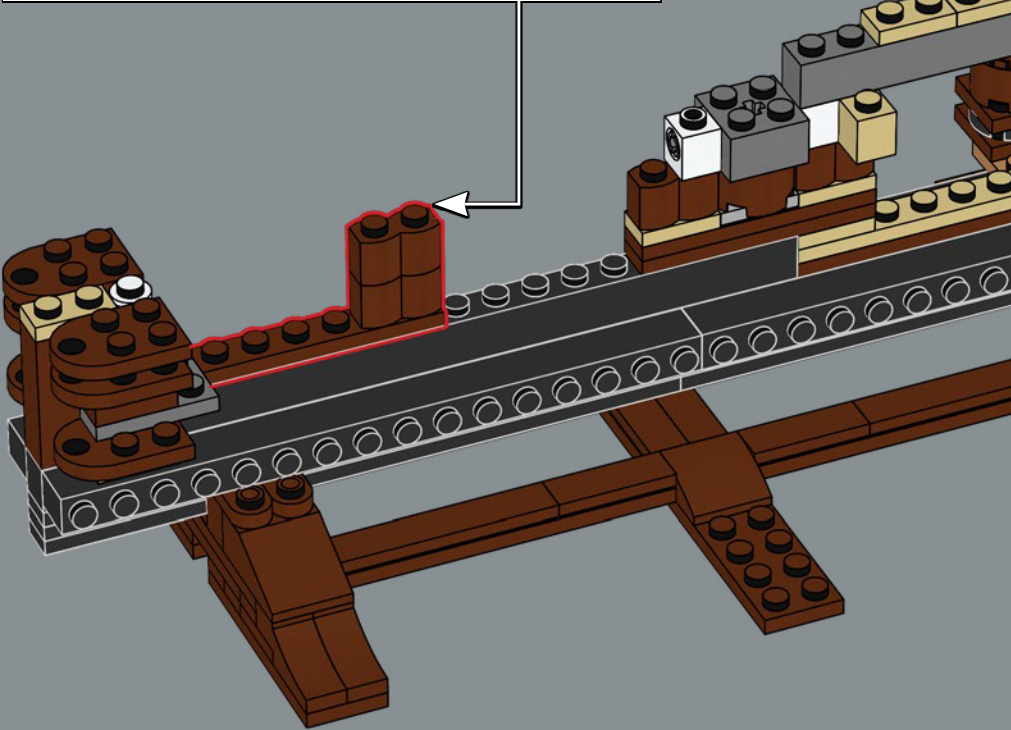
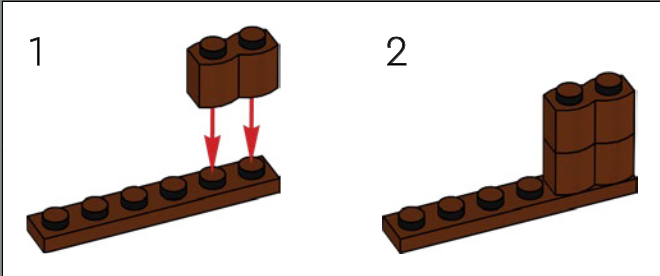



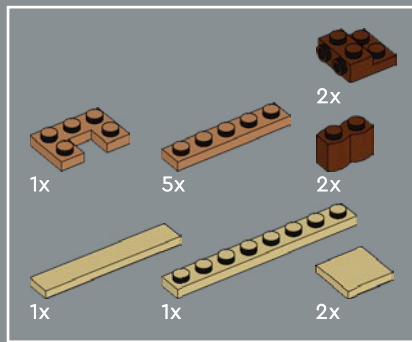

177

1

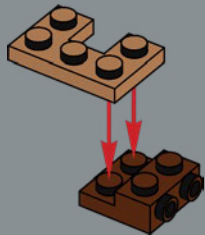

2

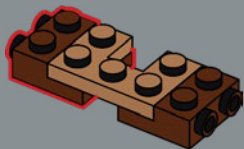

3

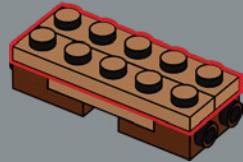

4

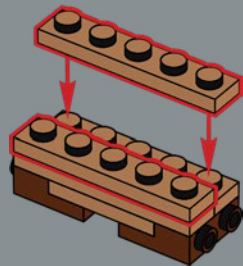

5

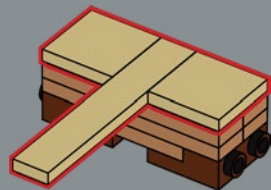

6

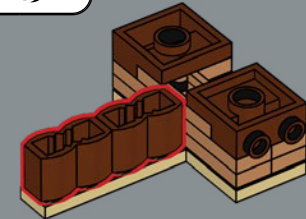

7

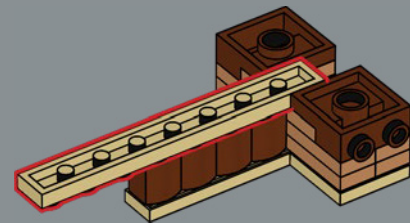

8

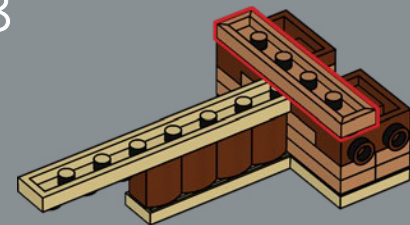



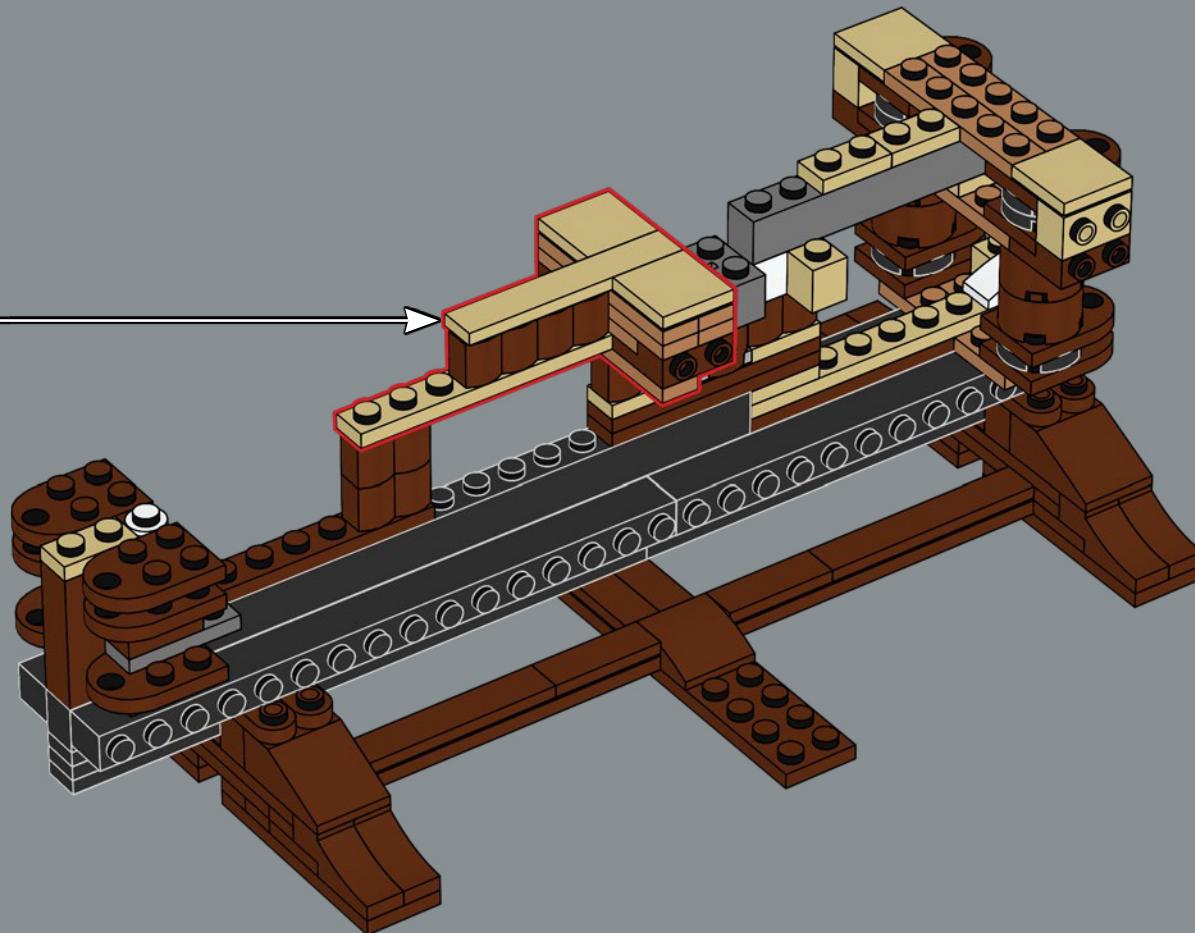

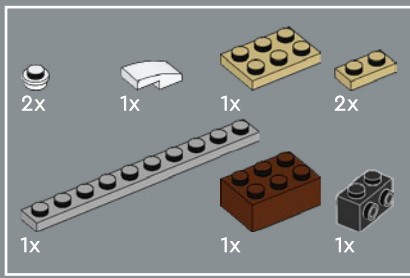

178

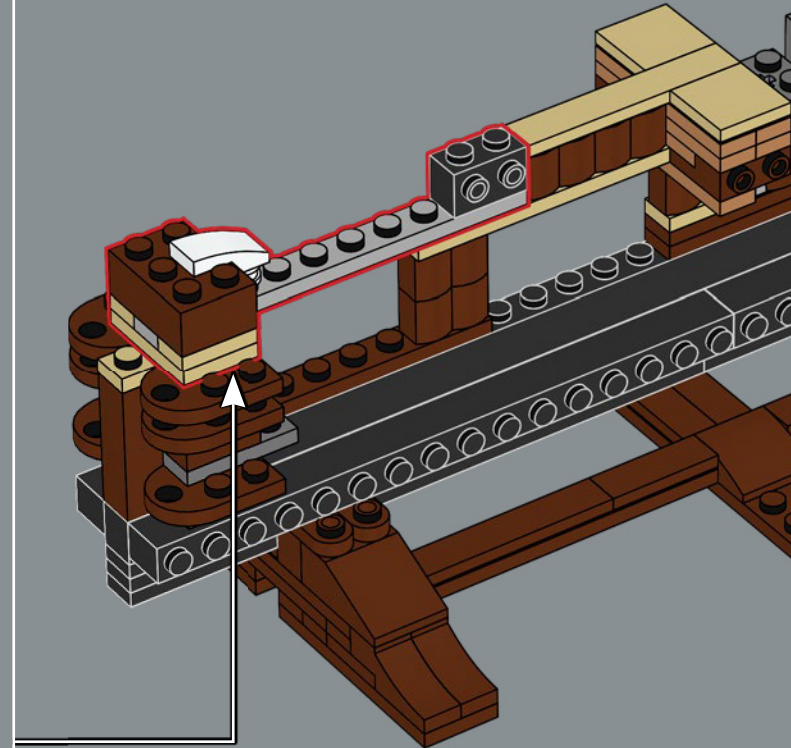
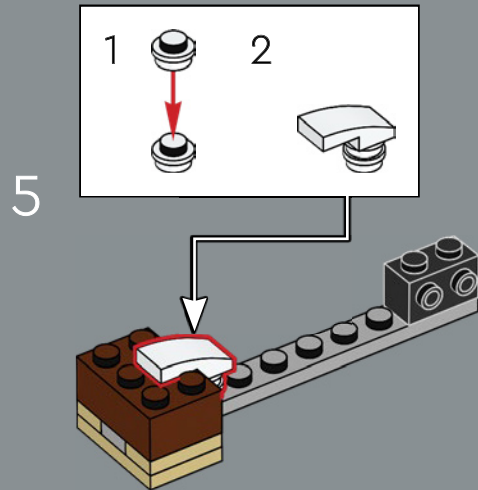
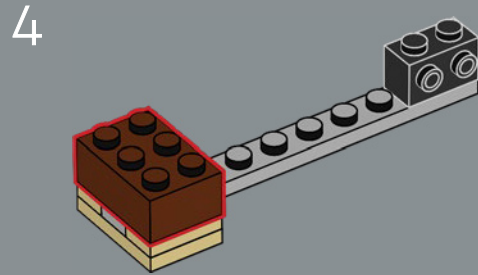
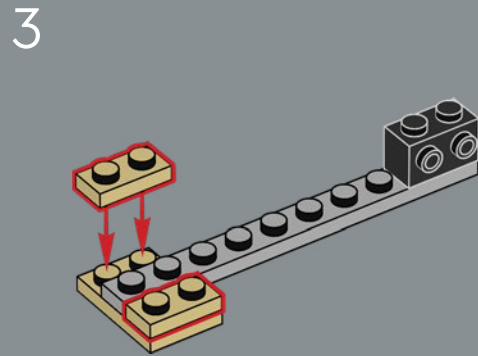
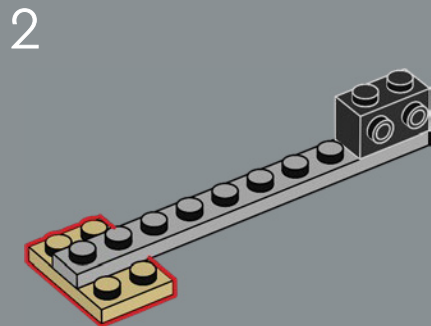
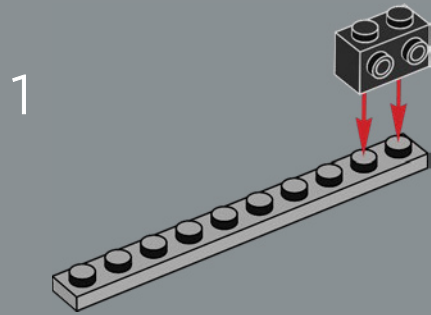

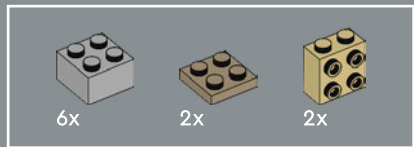

179

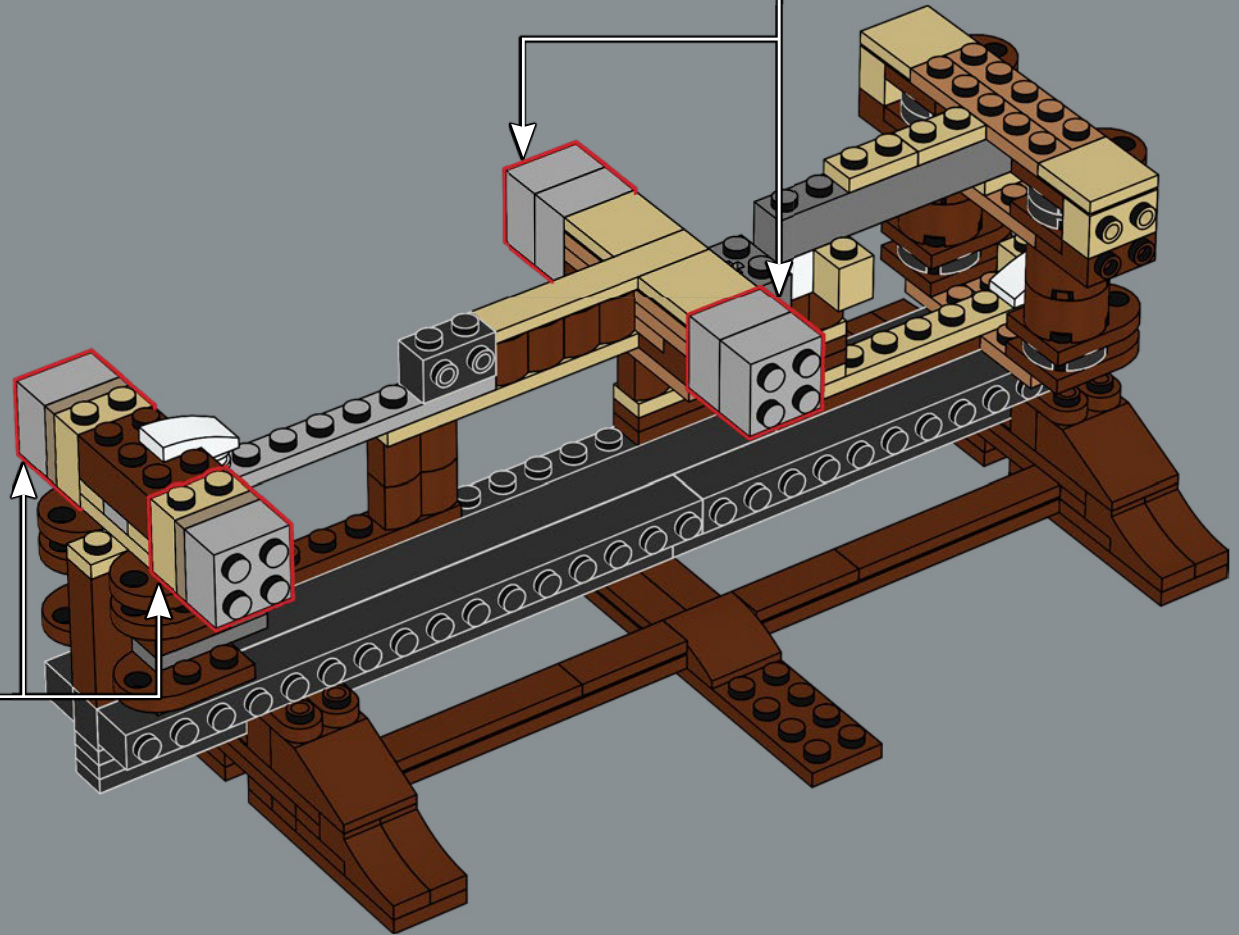
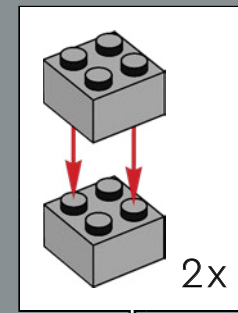
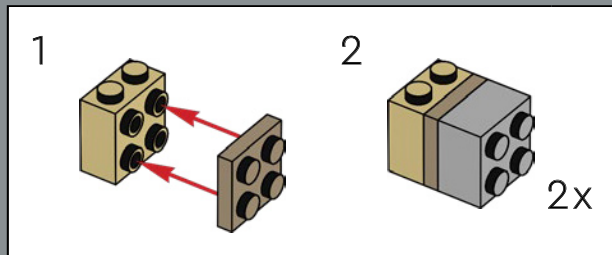



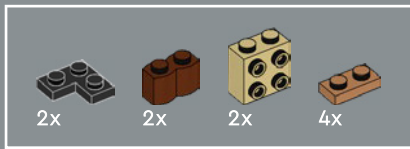

180

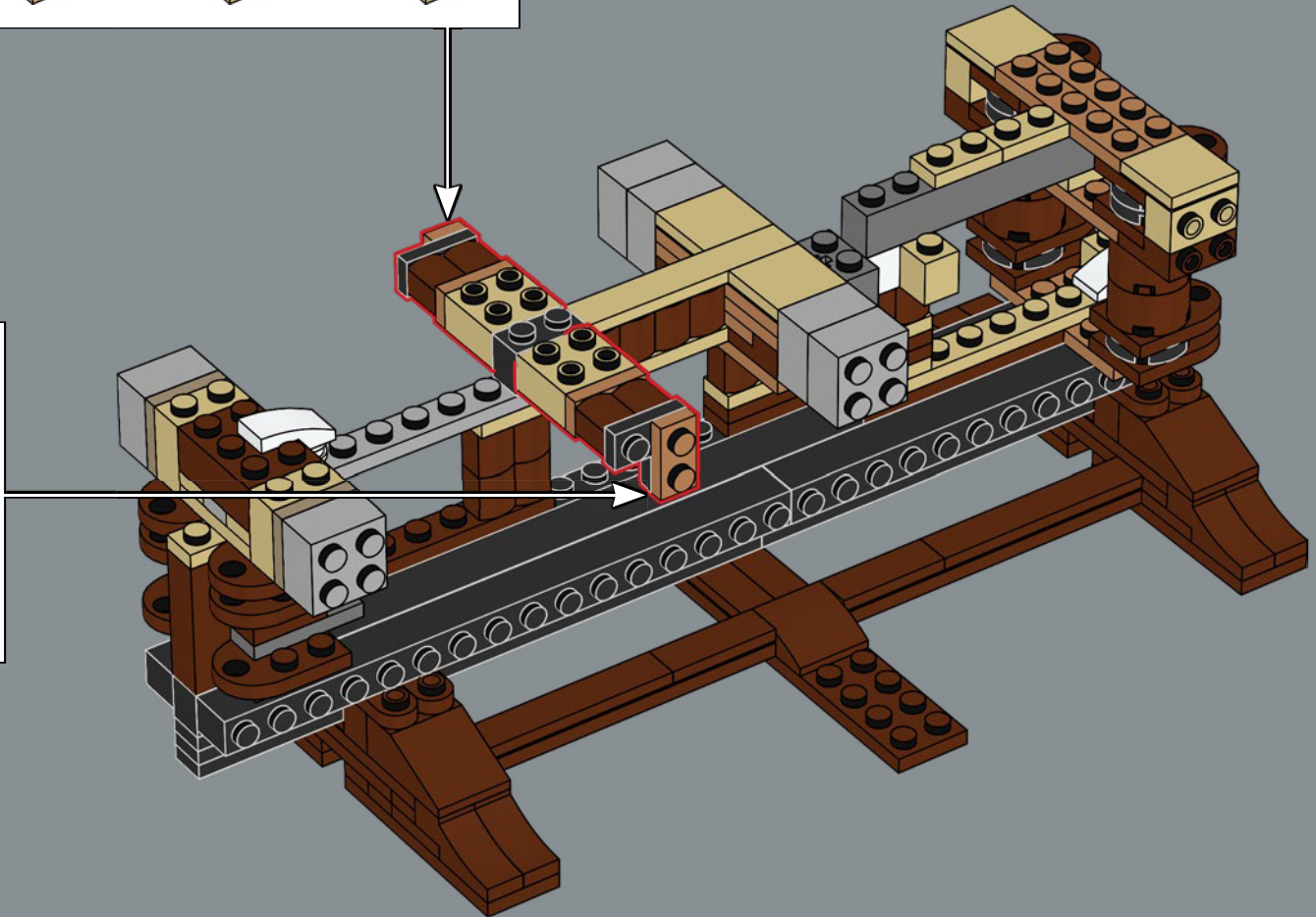
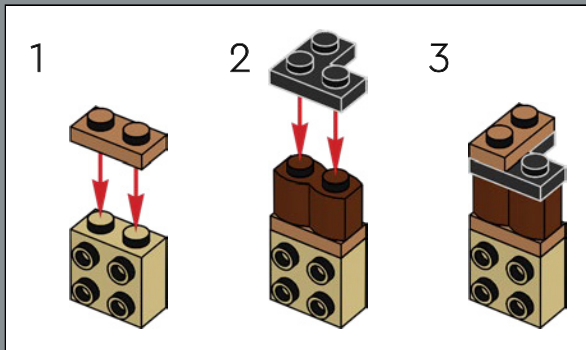
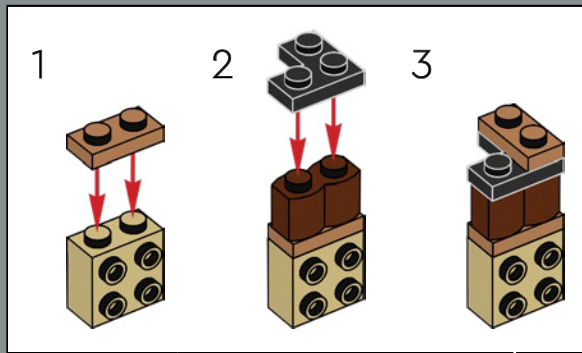



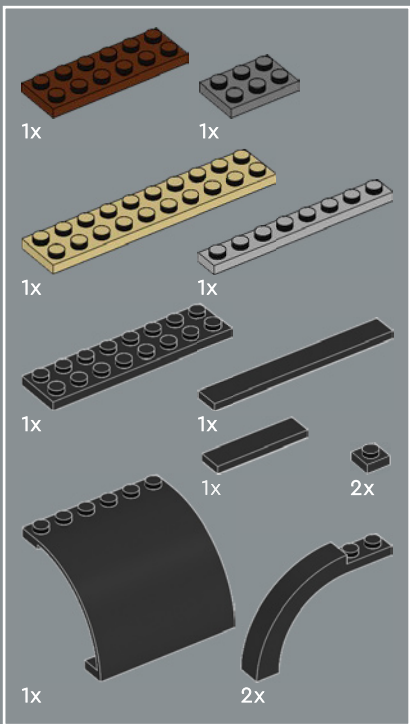

181

1

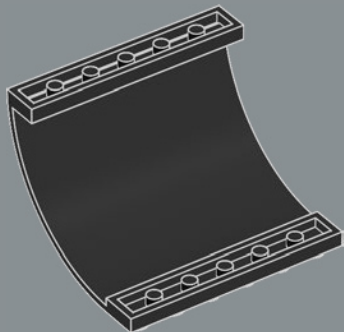

2

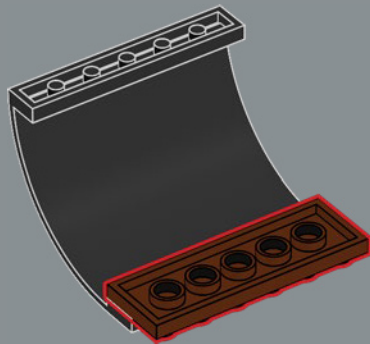

3

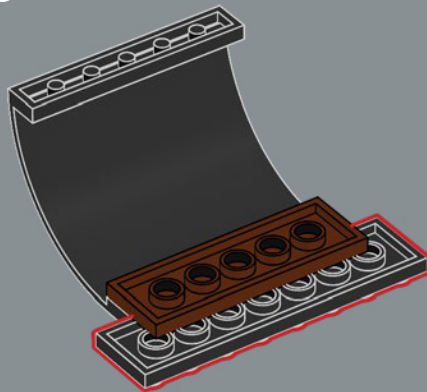

4

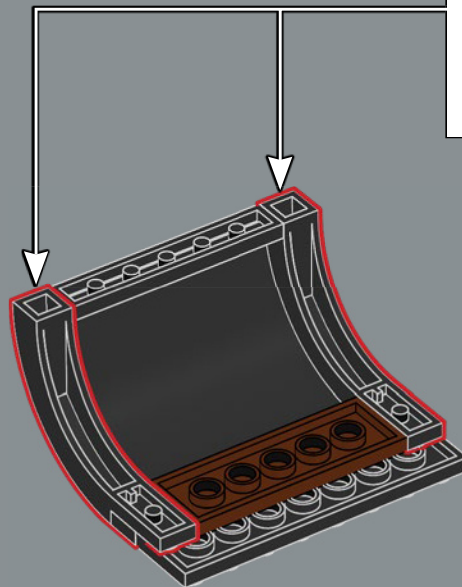

5

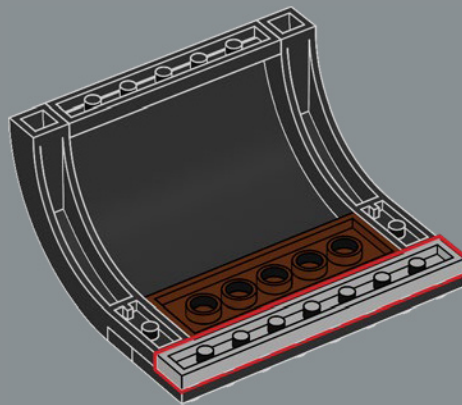

6

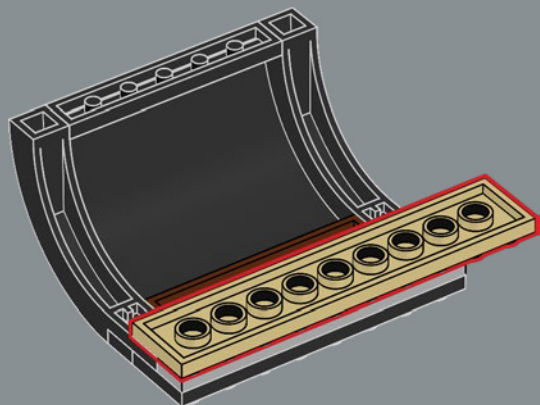

7

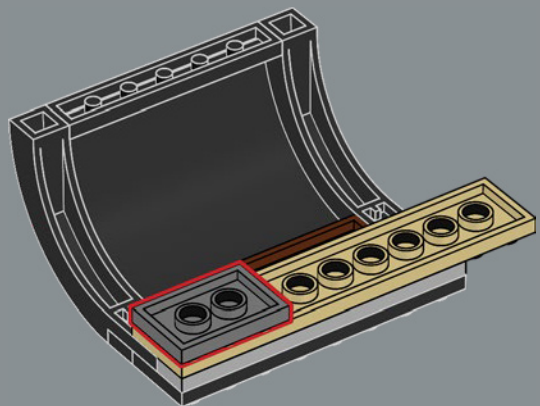

8

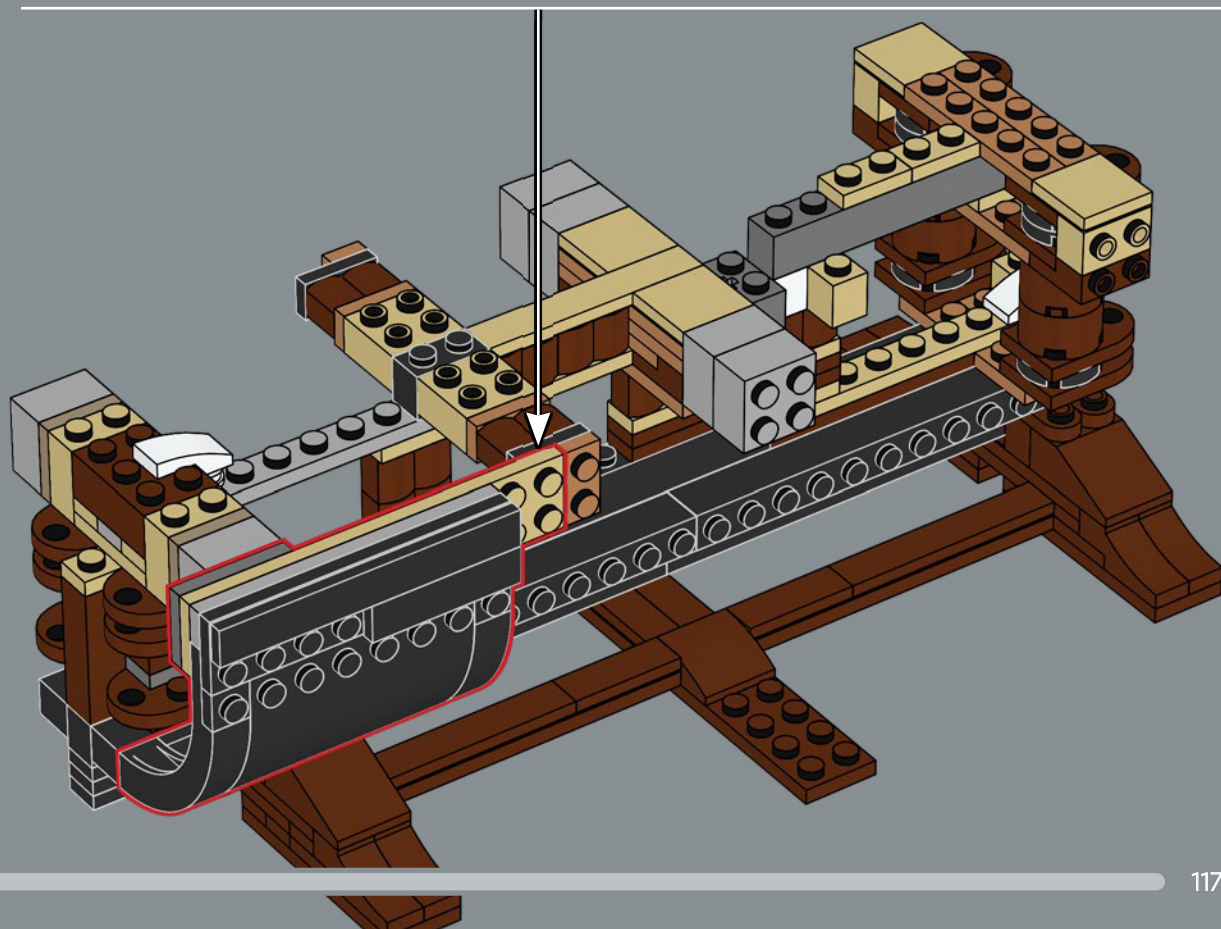
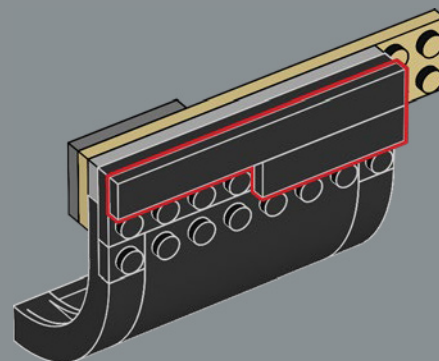

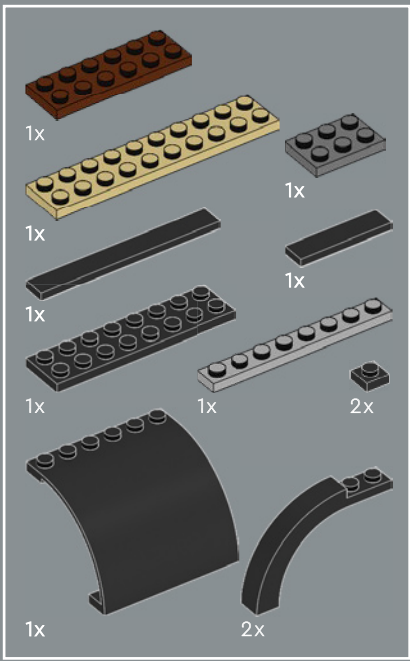

182

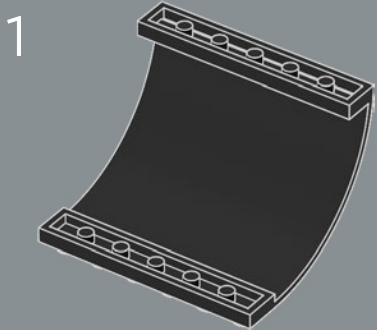

2

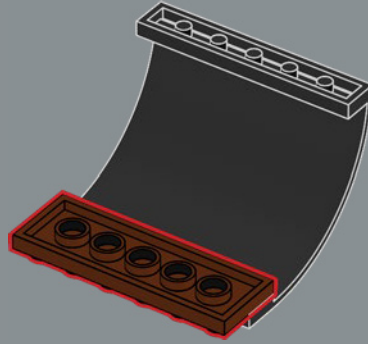

3

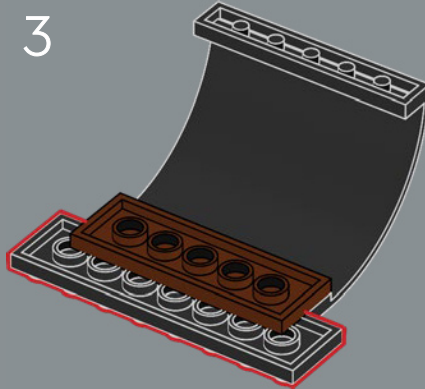

4

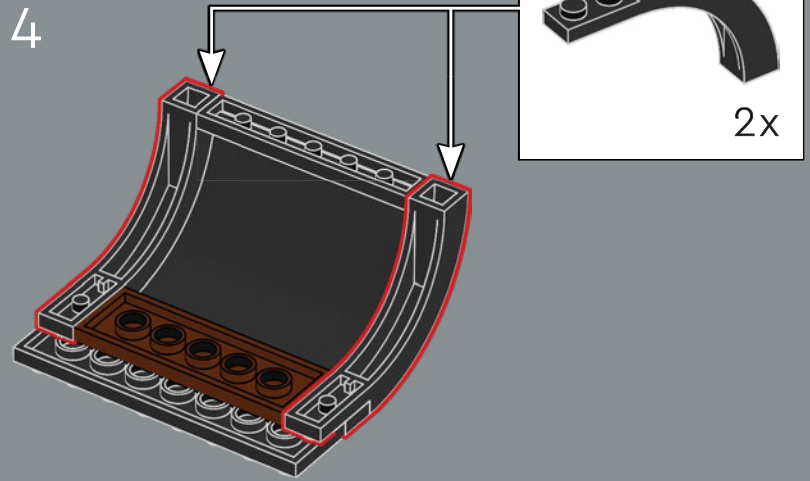

5

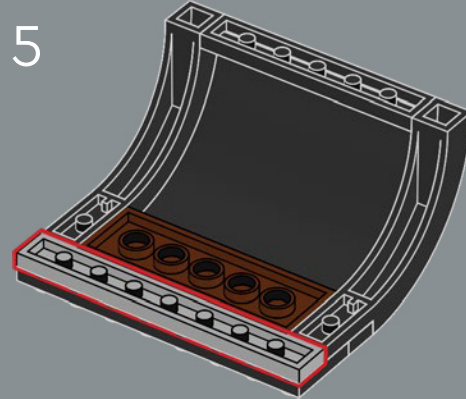



6

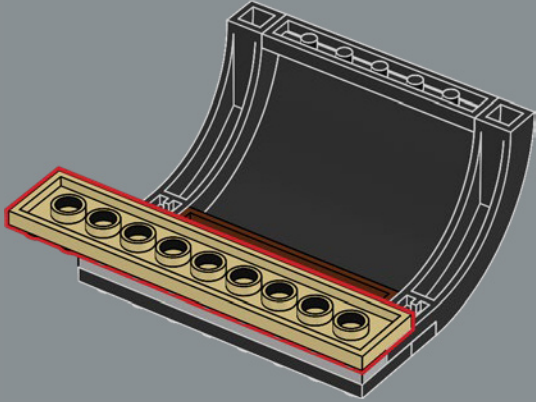

7

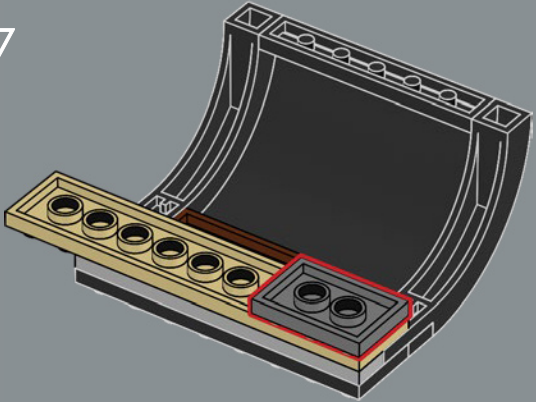

8

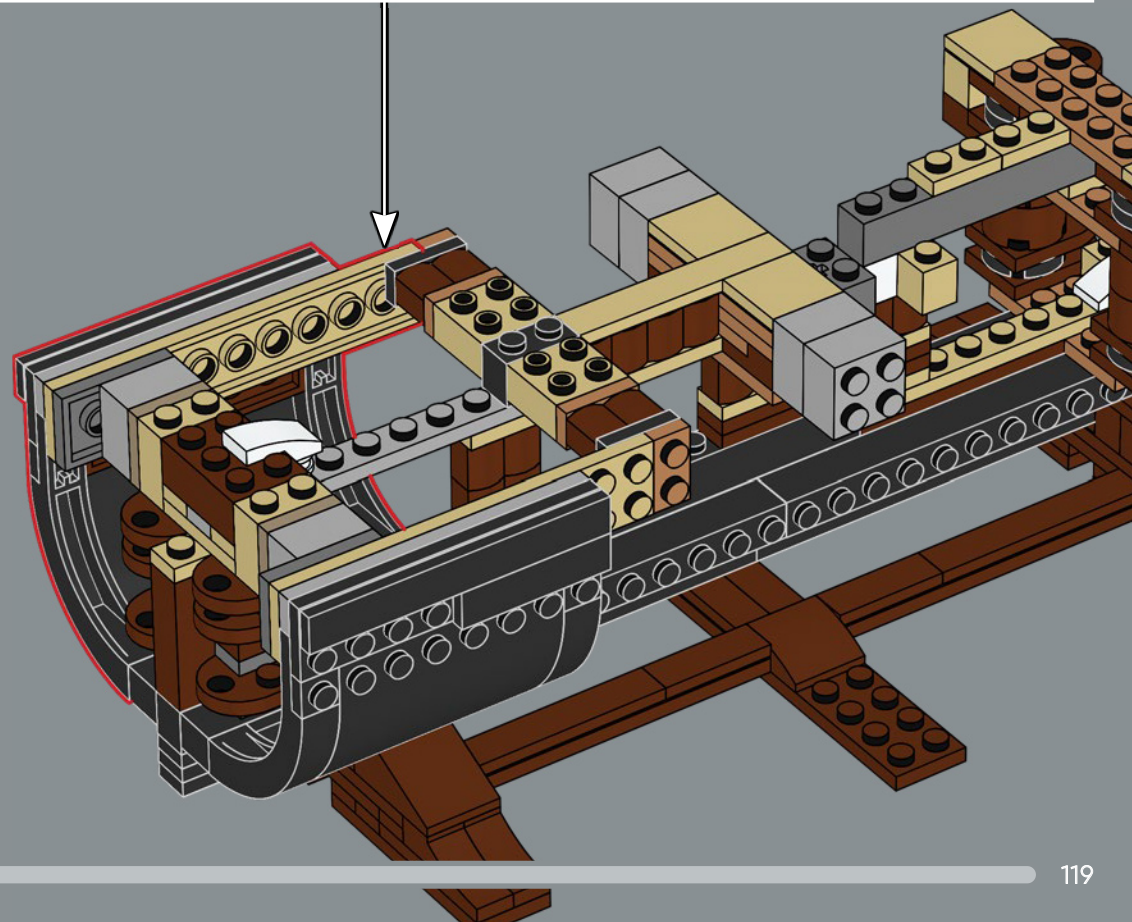
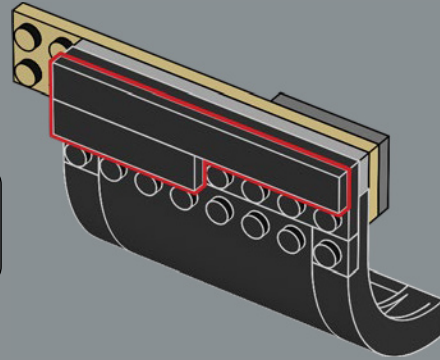



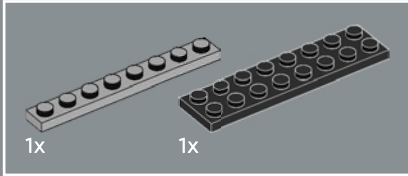
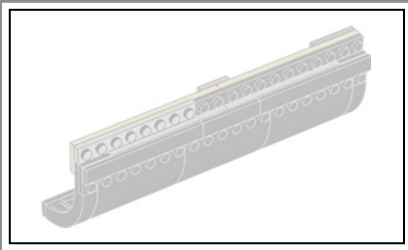

183

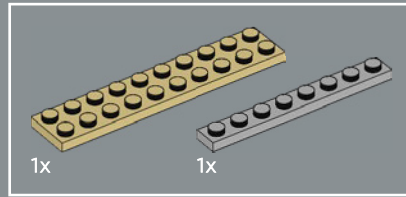
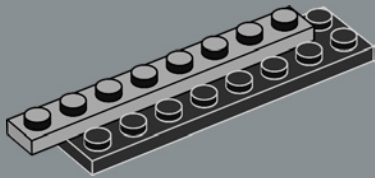

184

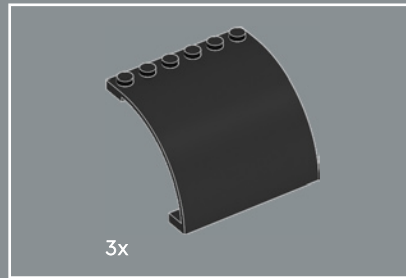
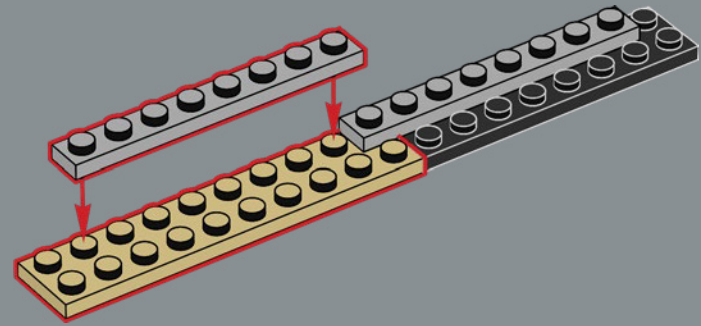

185

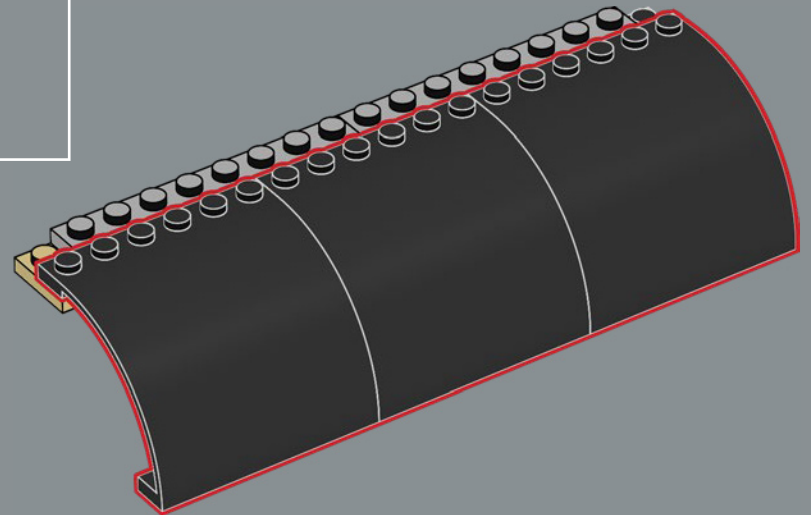



186

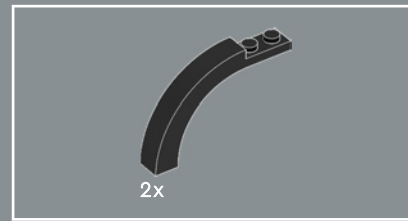
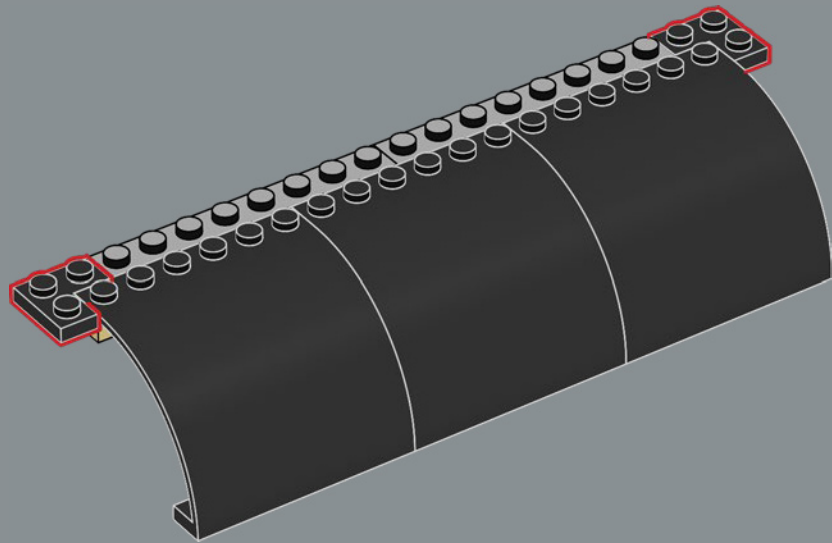

187

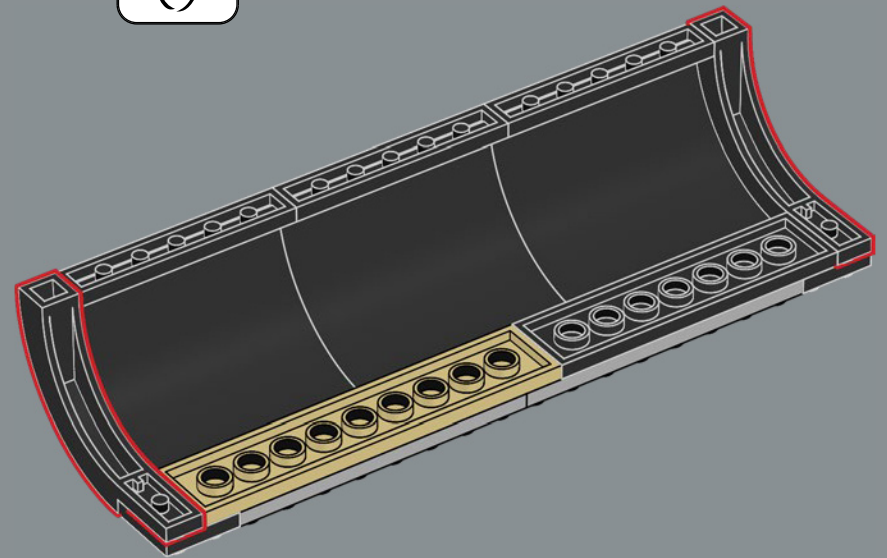

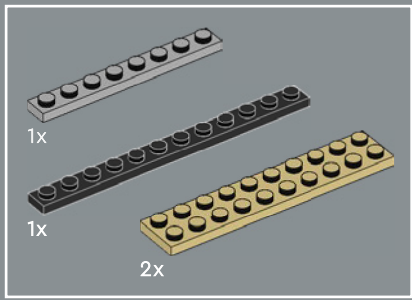

188

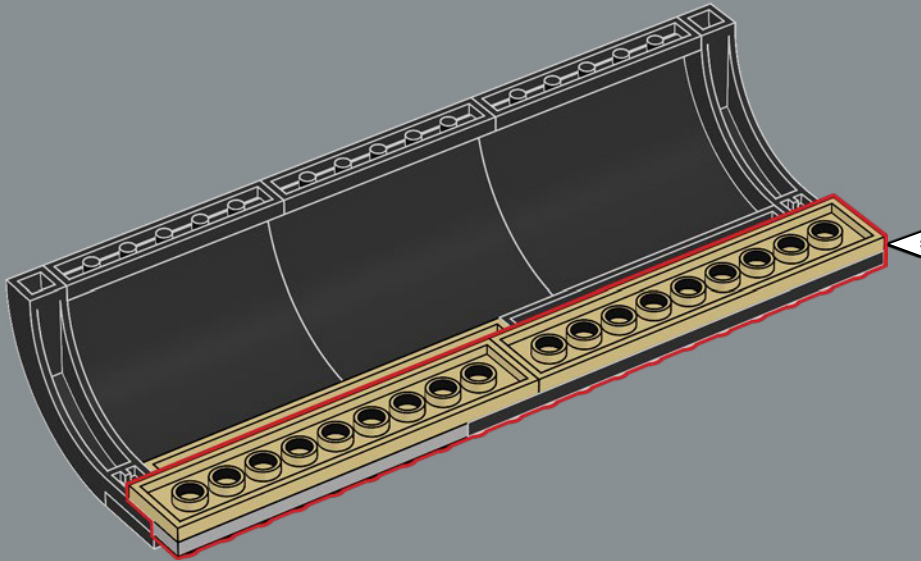
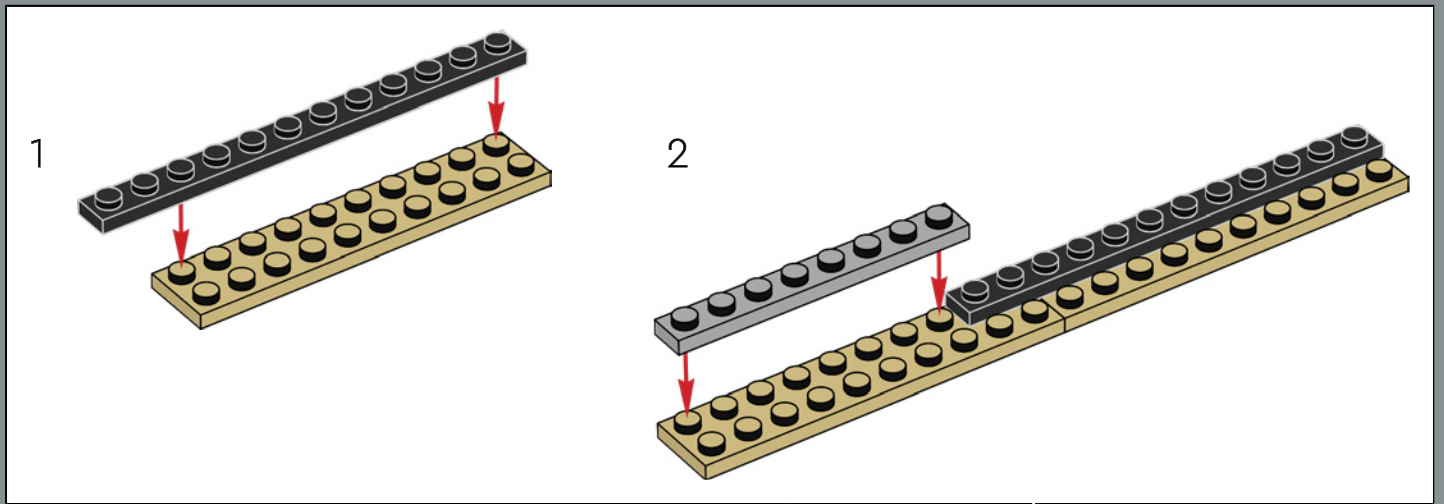



189

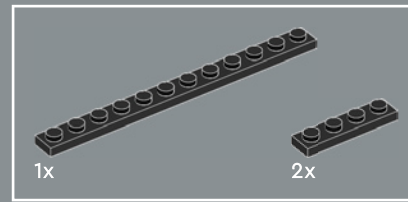
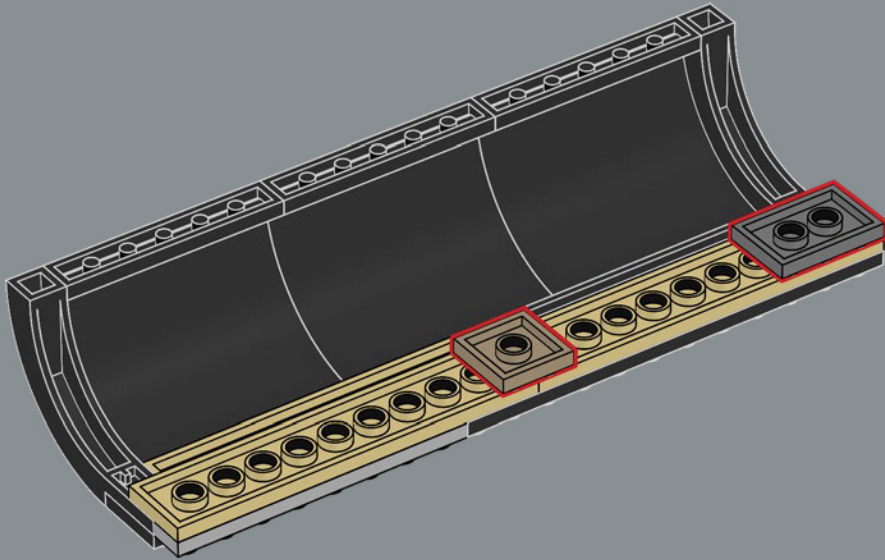

190

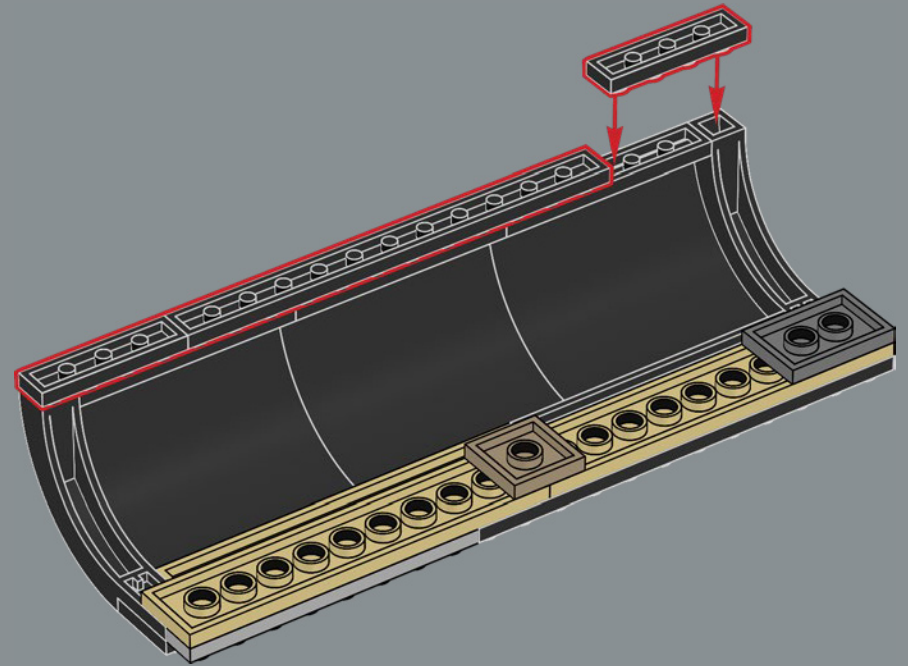



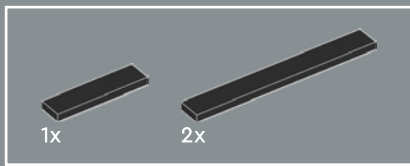

191

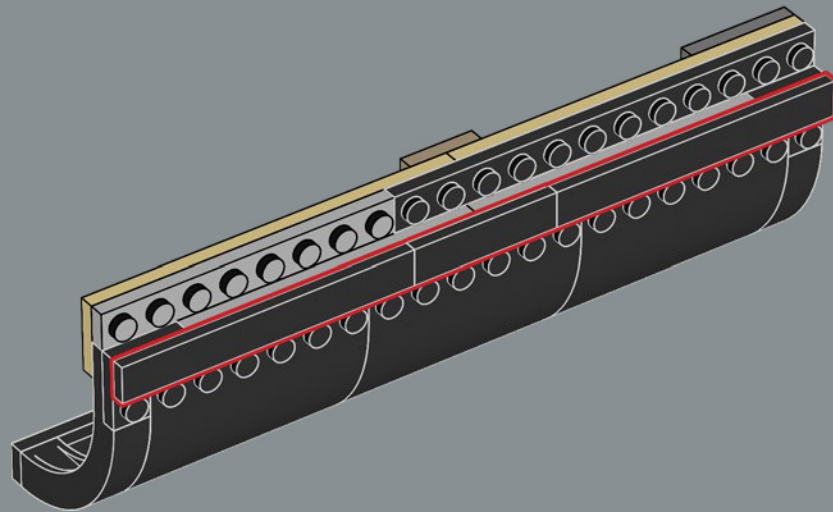

192

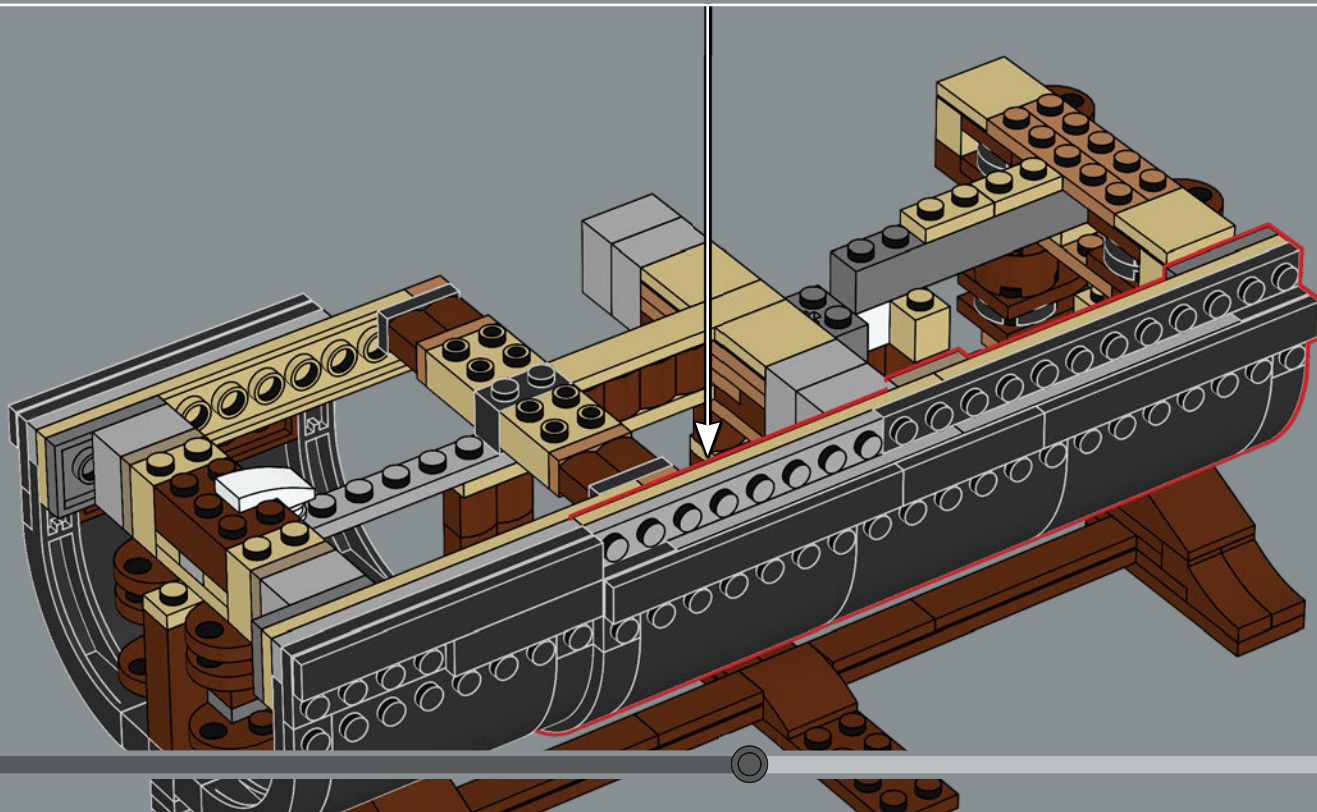

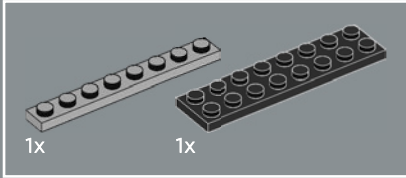
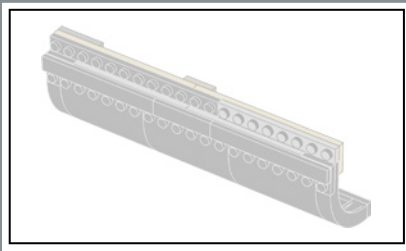

193

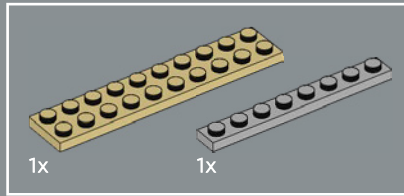
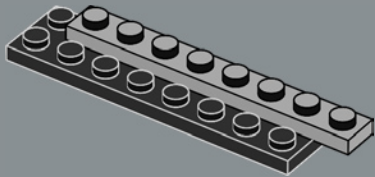

194

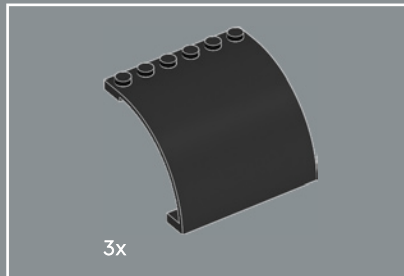

195



Die schwarzen Platten bilden den Großteil des unteren Schiffsrumpfs und werden von den LEGO® Designern als „Wandelemente“ bezeichnet. Diese Elemente in schwarzer Ausführung hatten genau die richtige Form und Größe für den Schiffsrumpf.

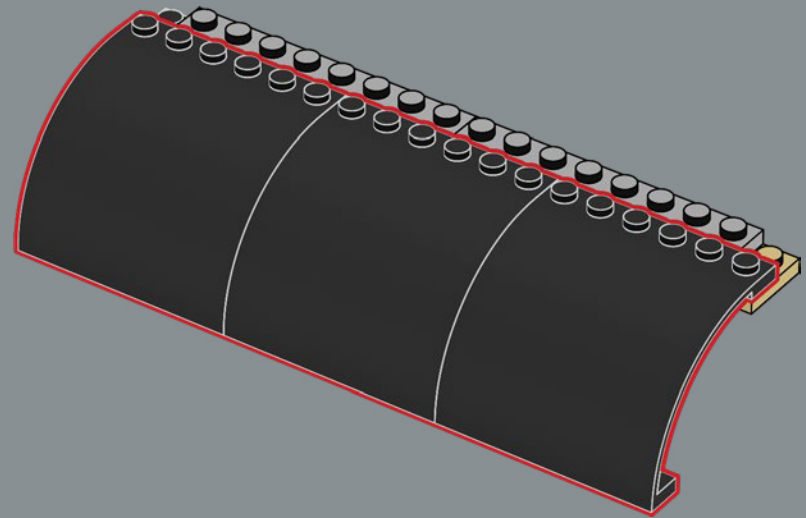
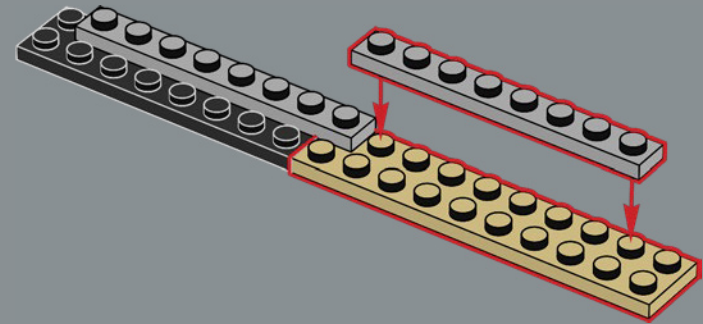

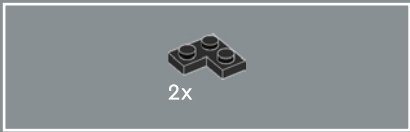

196

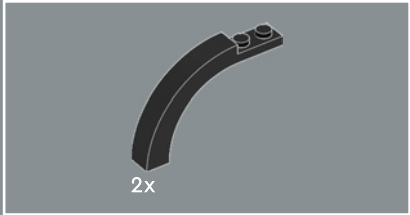
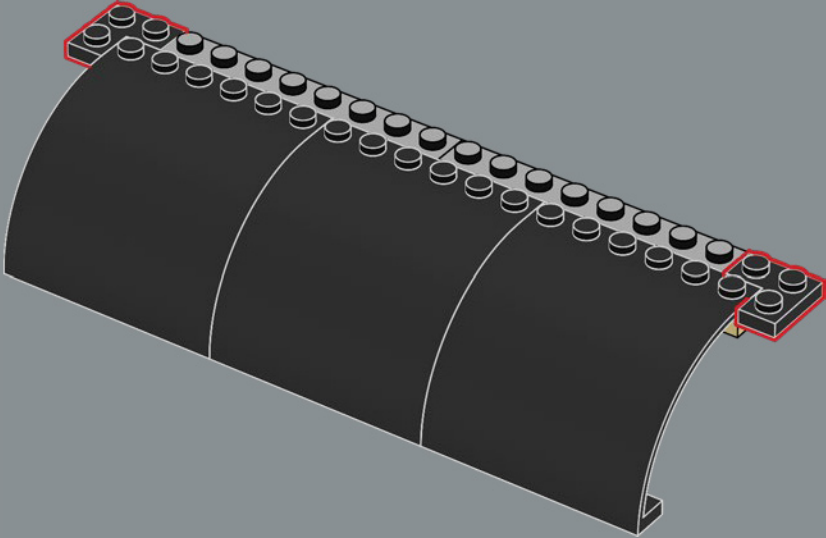

197

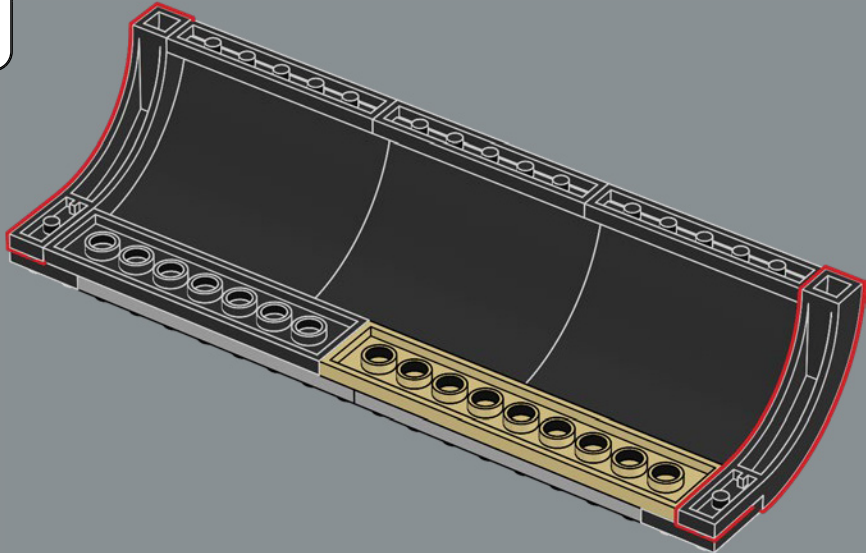

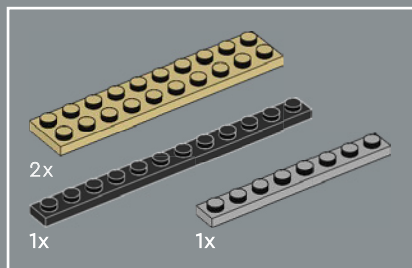

198

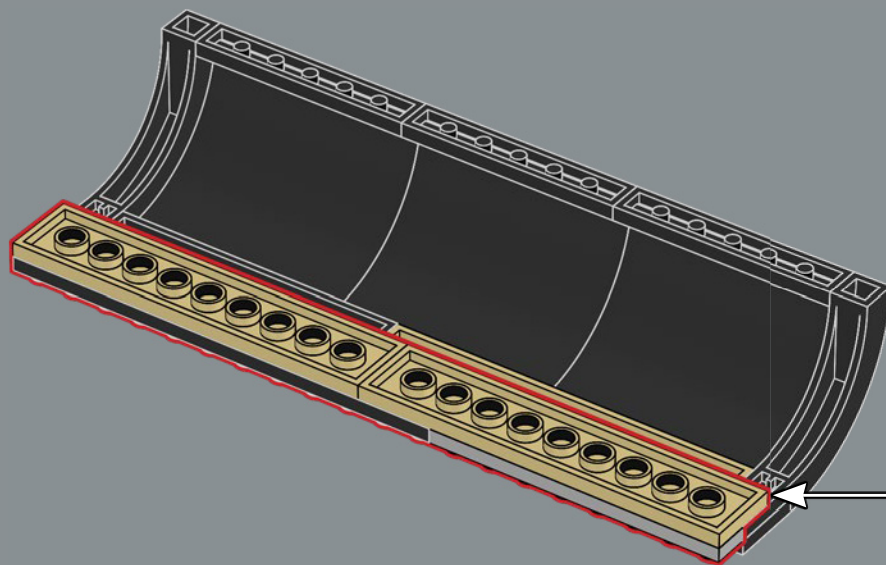
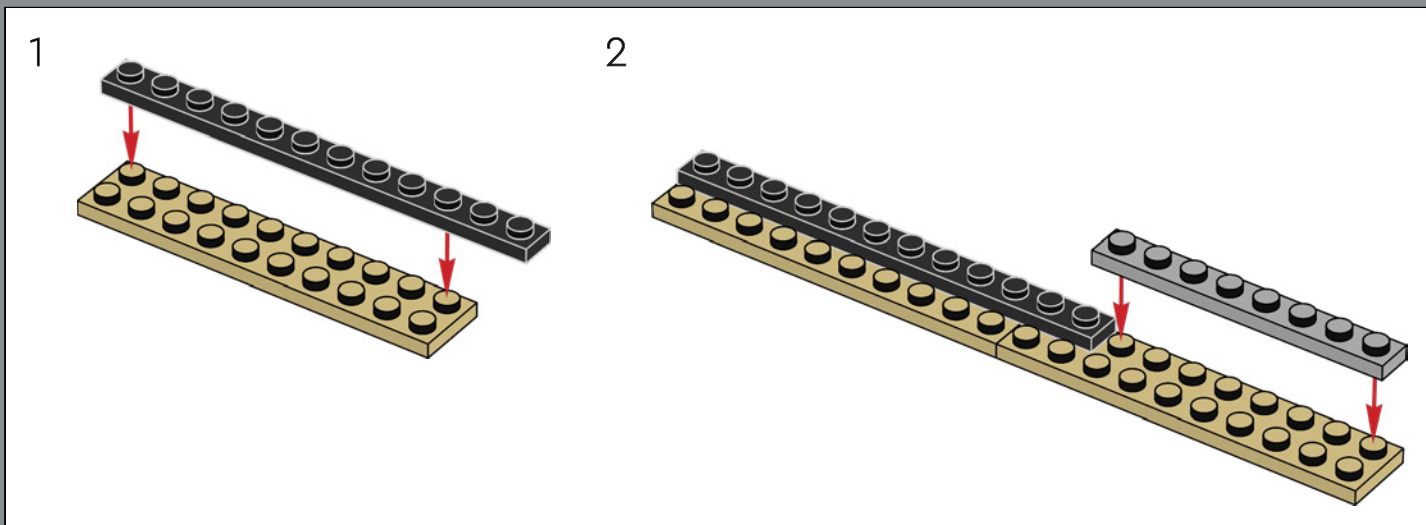



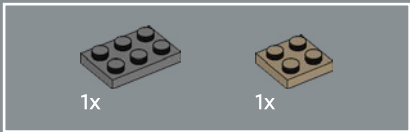

199

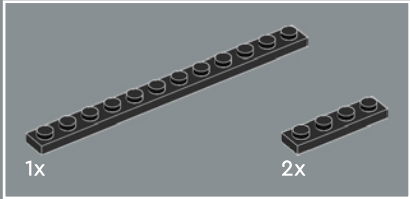
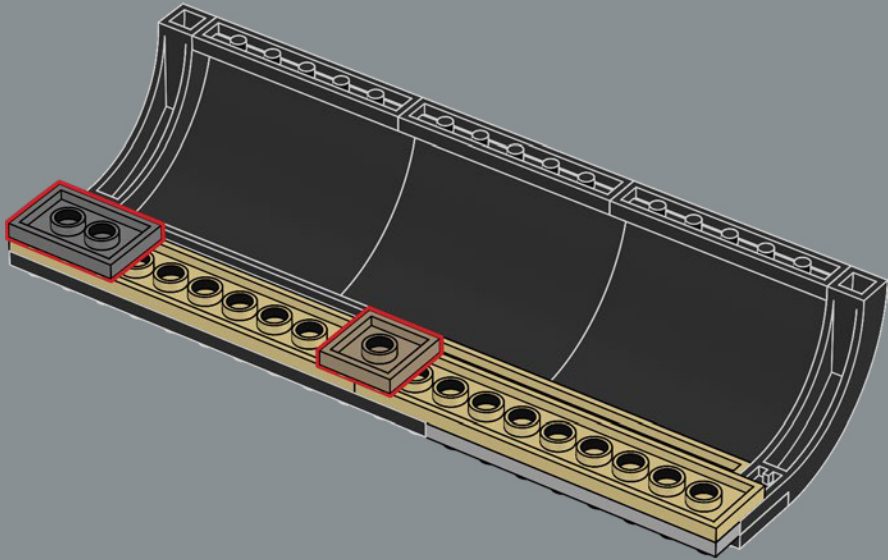

200

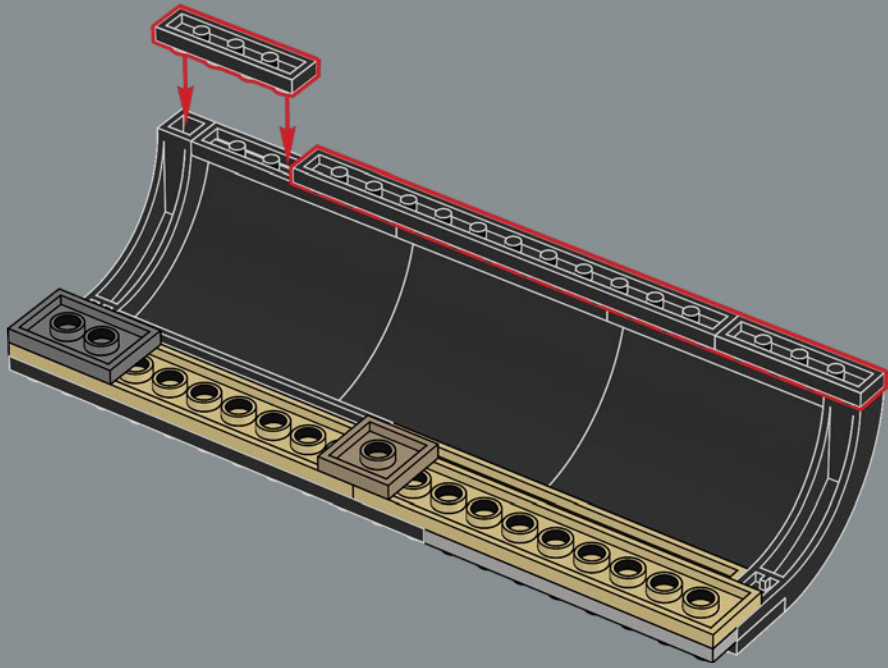

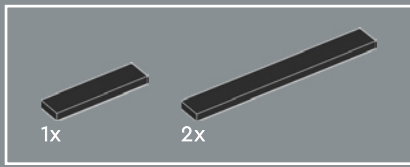

201

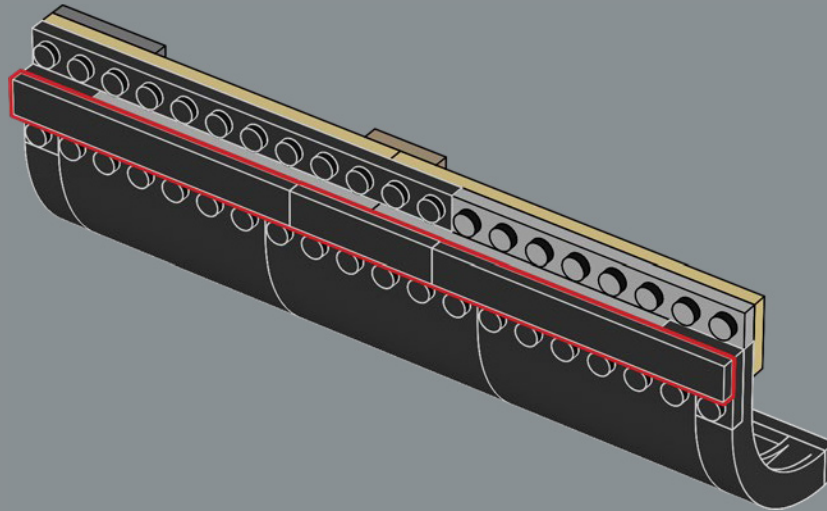

202

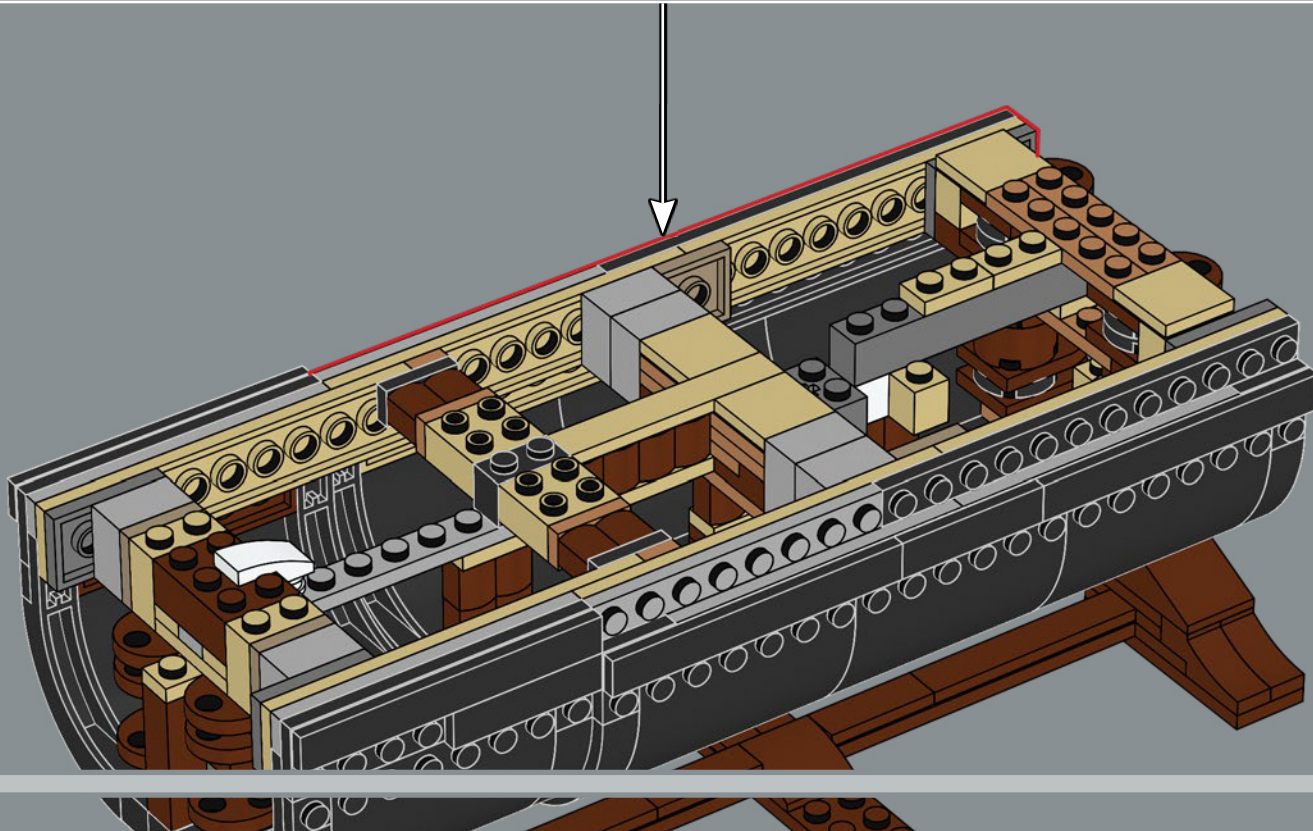

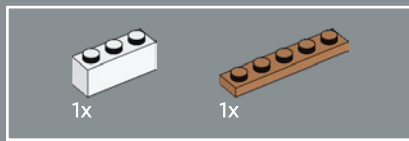
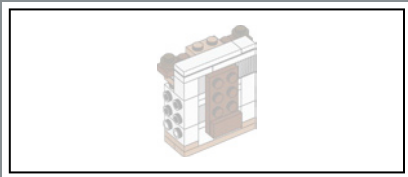

203

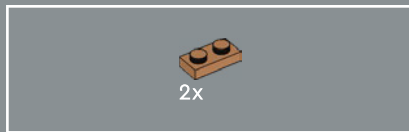
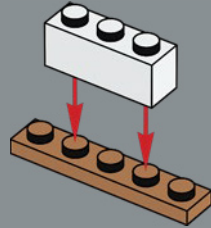

204

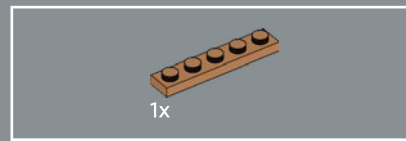
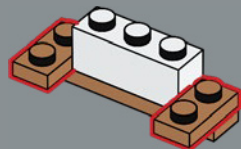

205

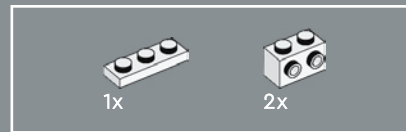
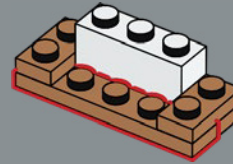

206

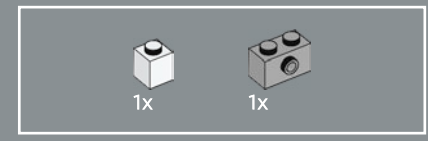
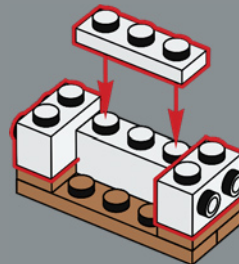

207

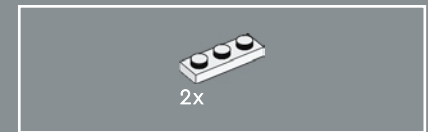
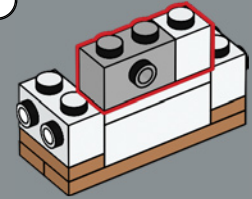

208

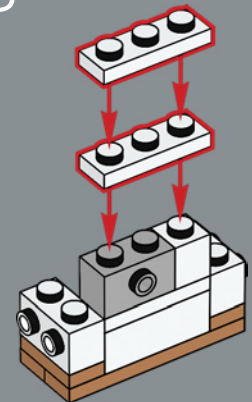

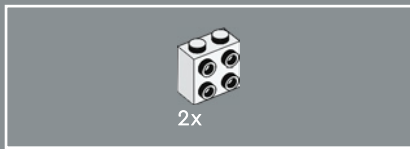

209

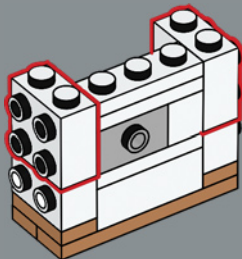

211

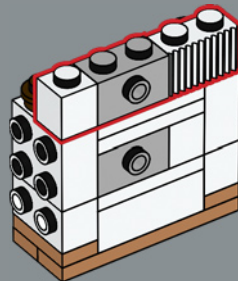

213

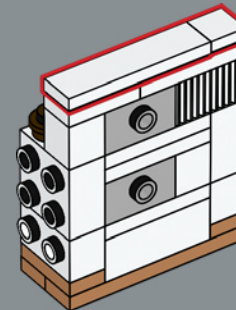

210

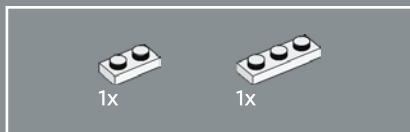
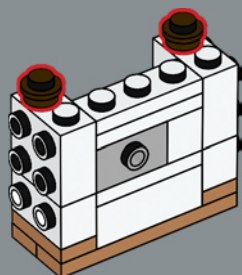

212

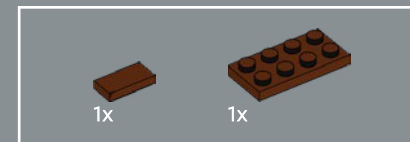
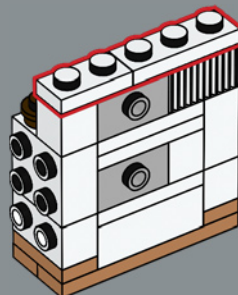

214

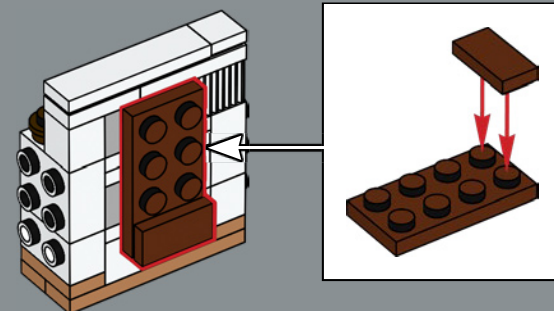



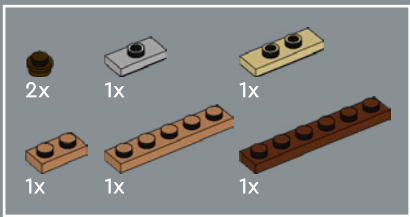

215

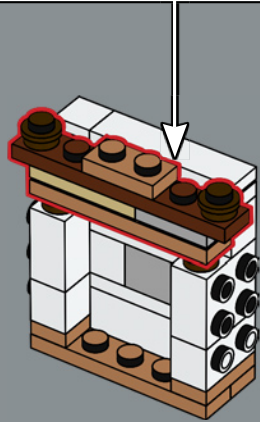
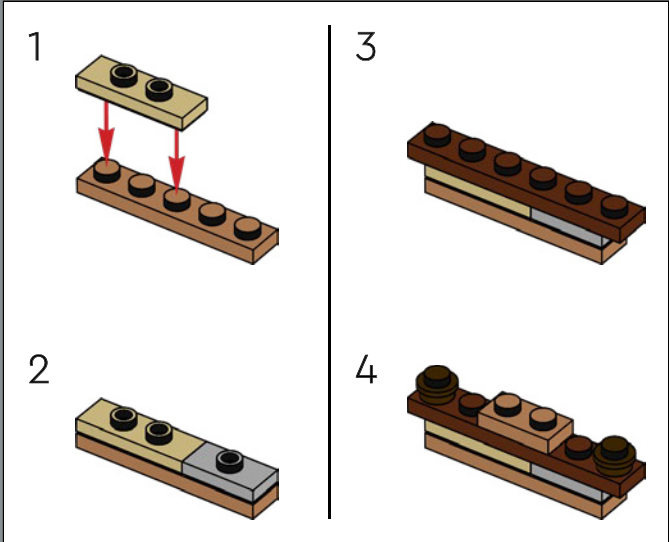

216

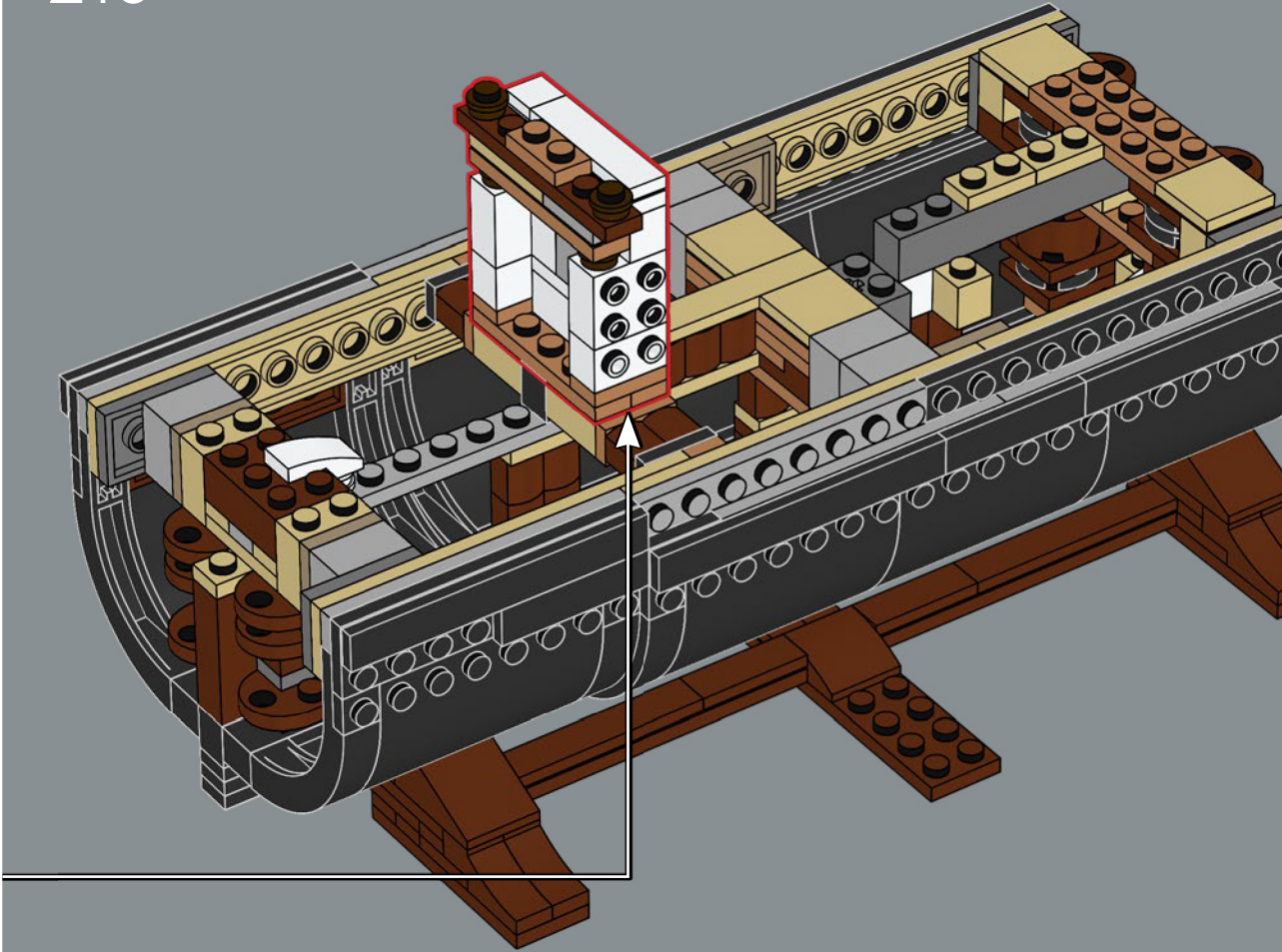

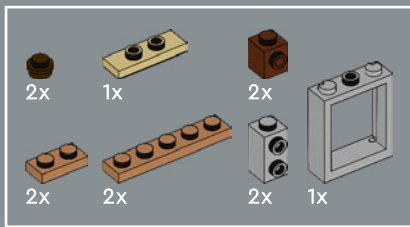

217

1

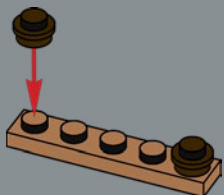

2

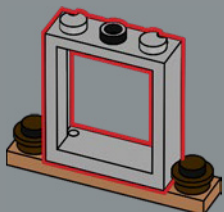

3

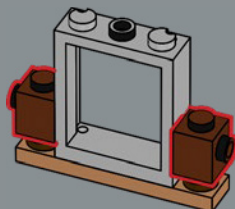

4

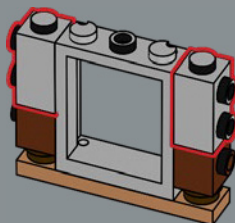

5

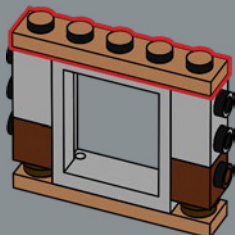

6

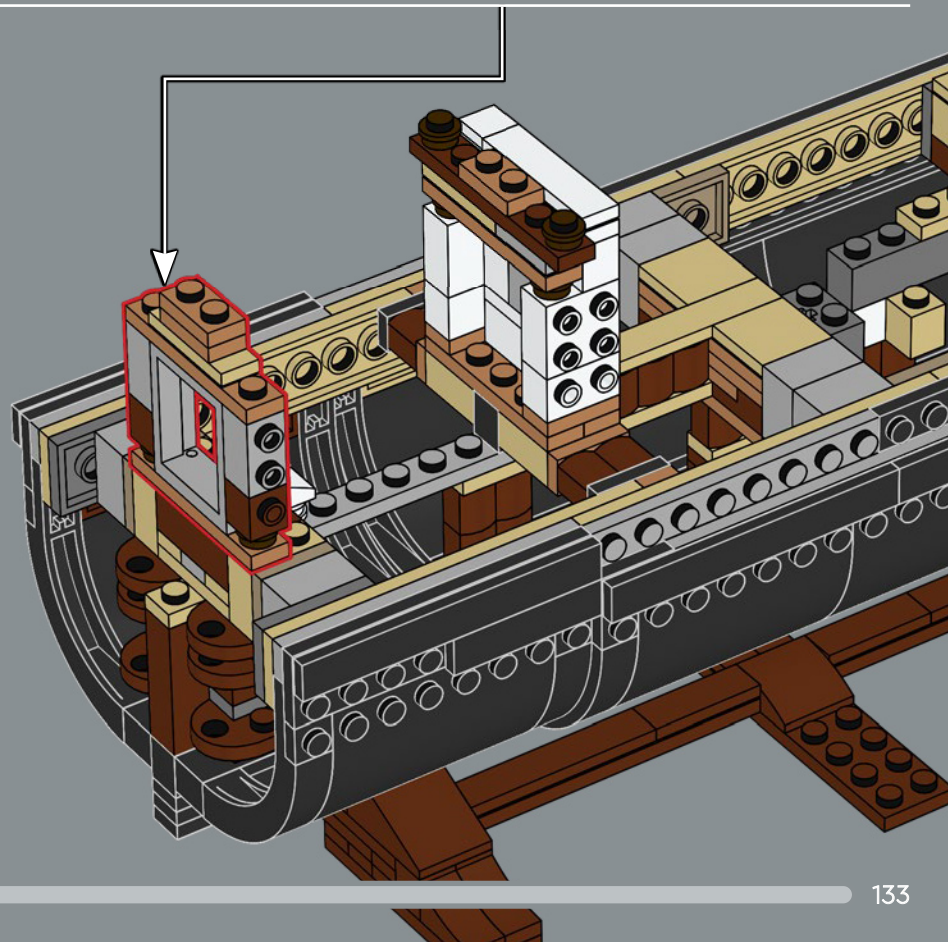
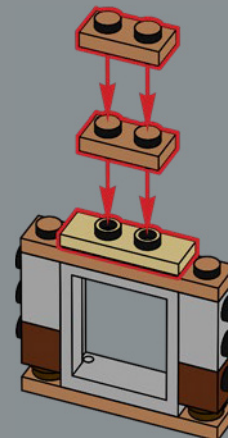

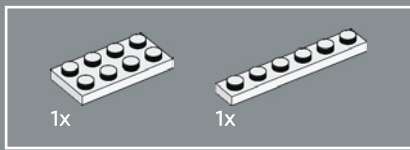

218

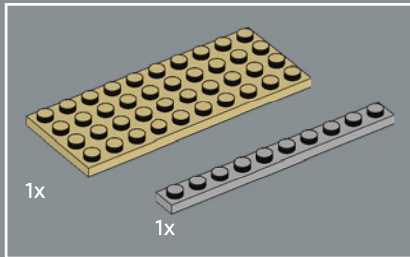
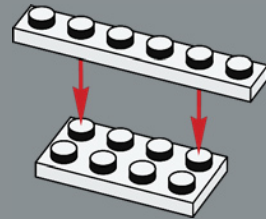

219

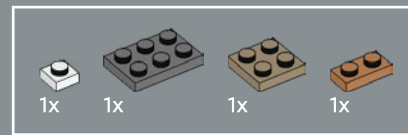
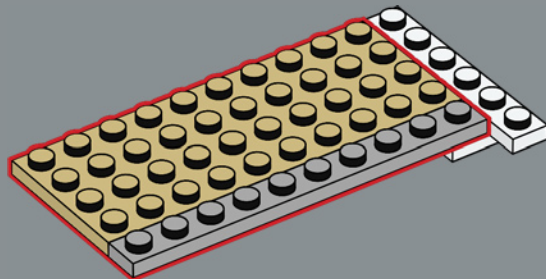

220

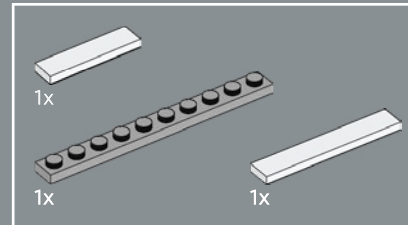
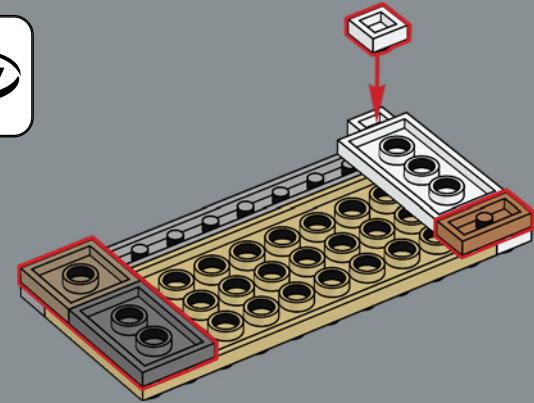

221

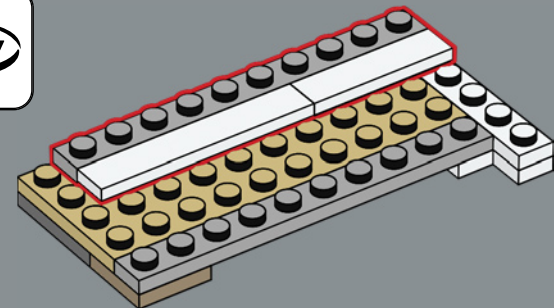



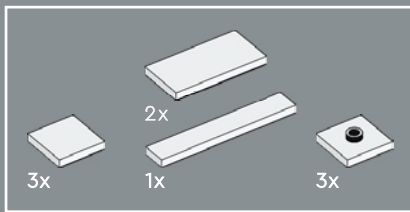

222

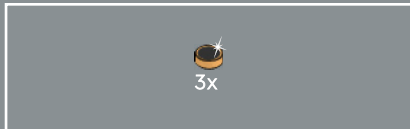
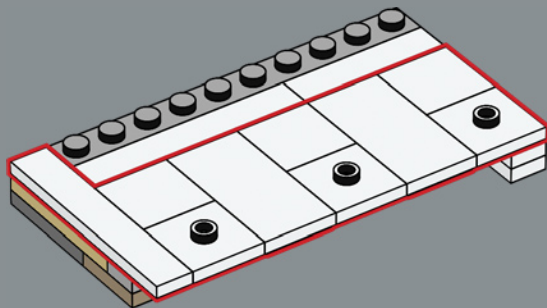

223

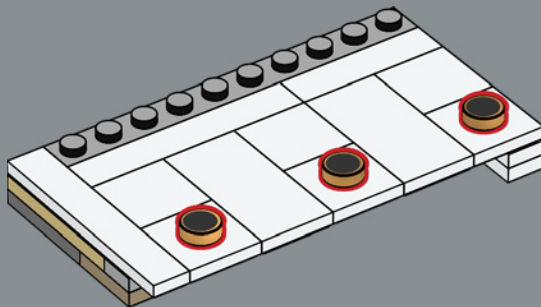

224

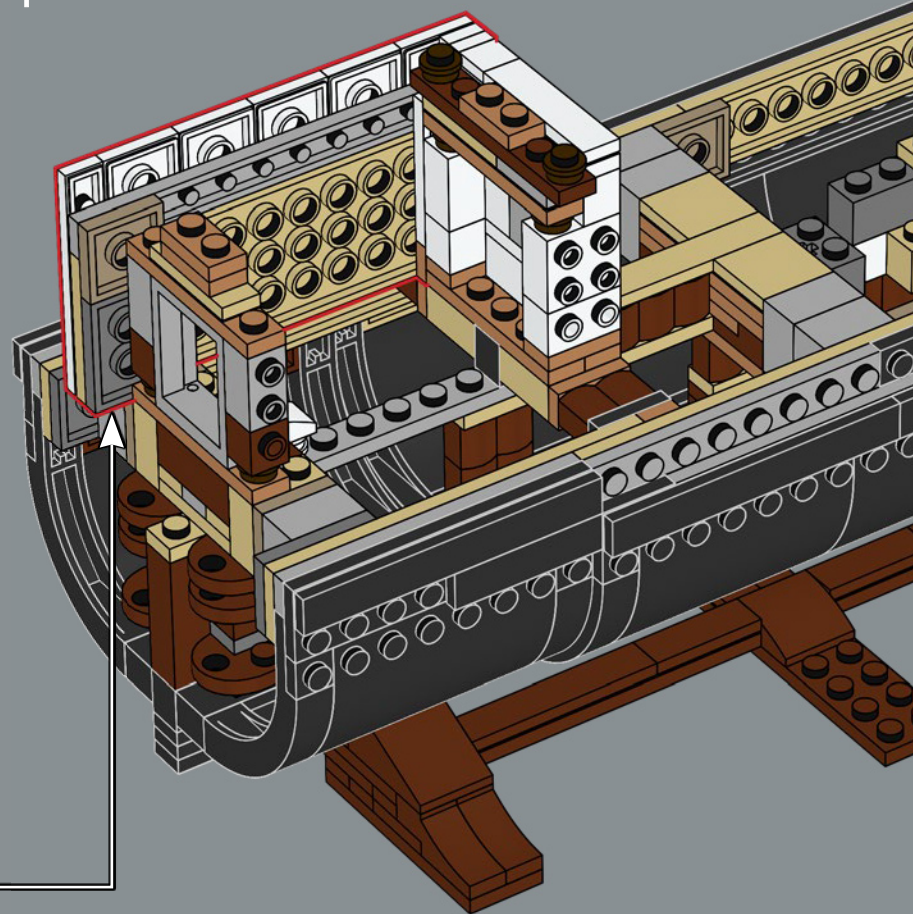



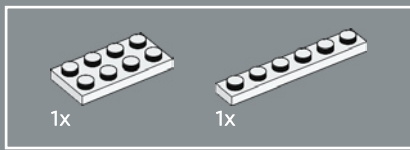

225

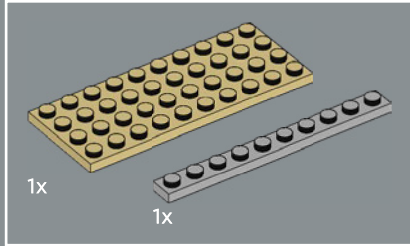
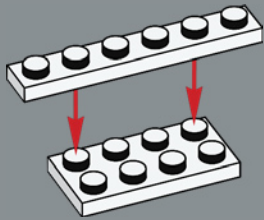

226

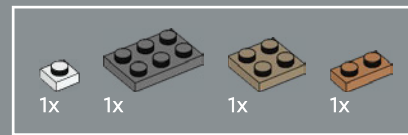
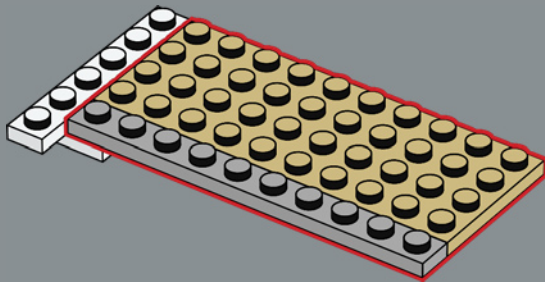

227

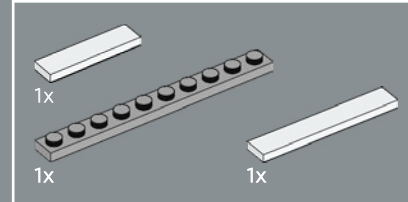
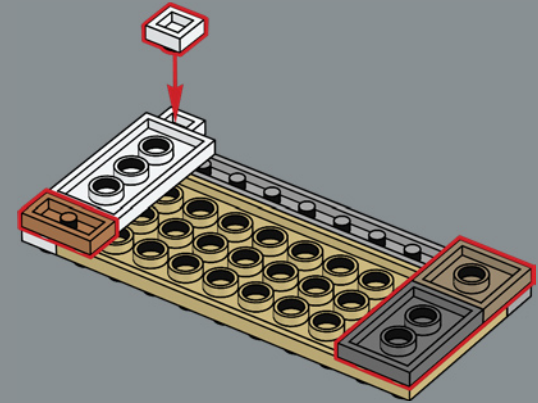

228

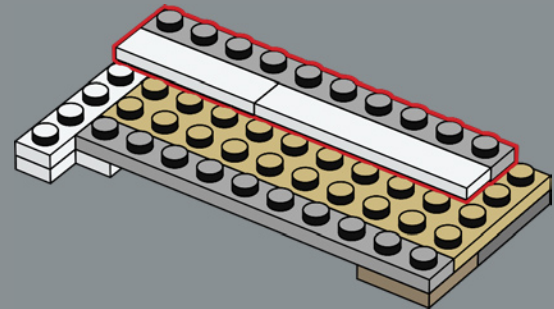

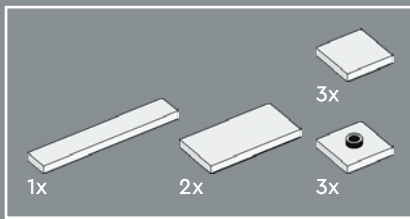

229

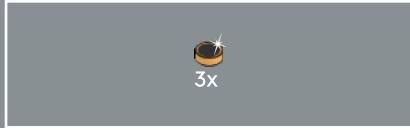
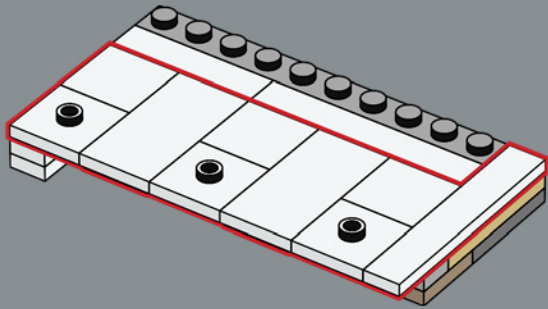

230

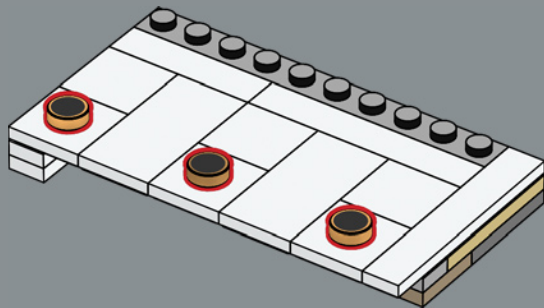

231

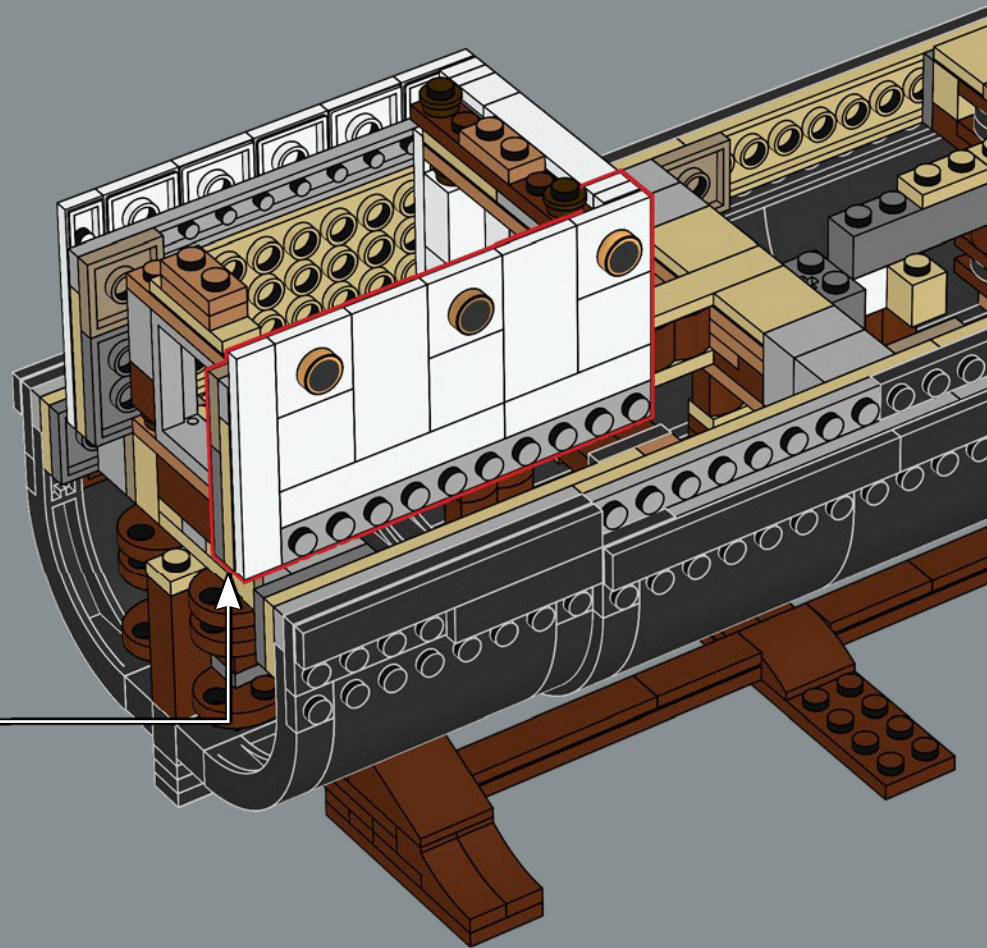



1

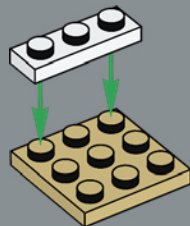

2



3

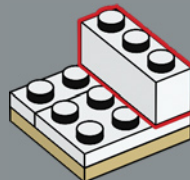

4

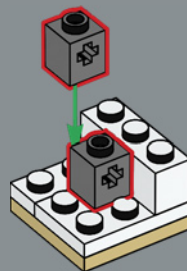

5

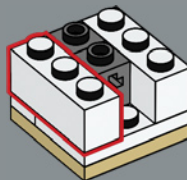

6

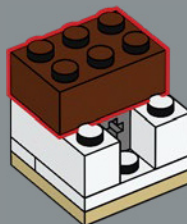

7

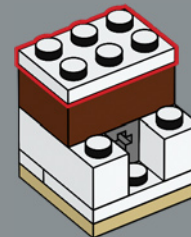

8

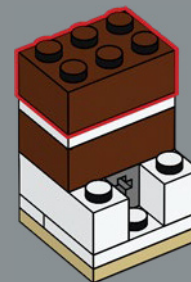

9

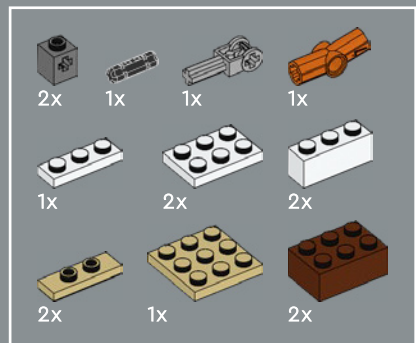
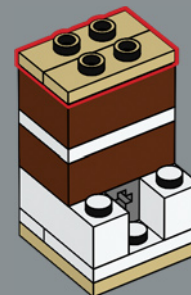

232



10

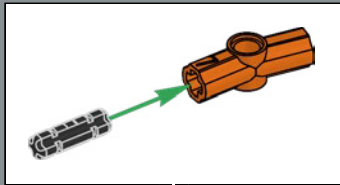
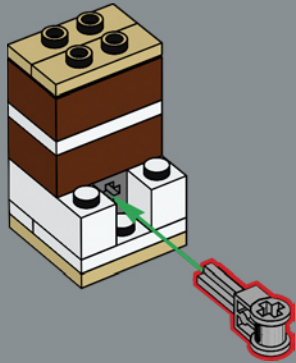

11

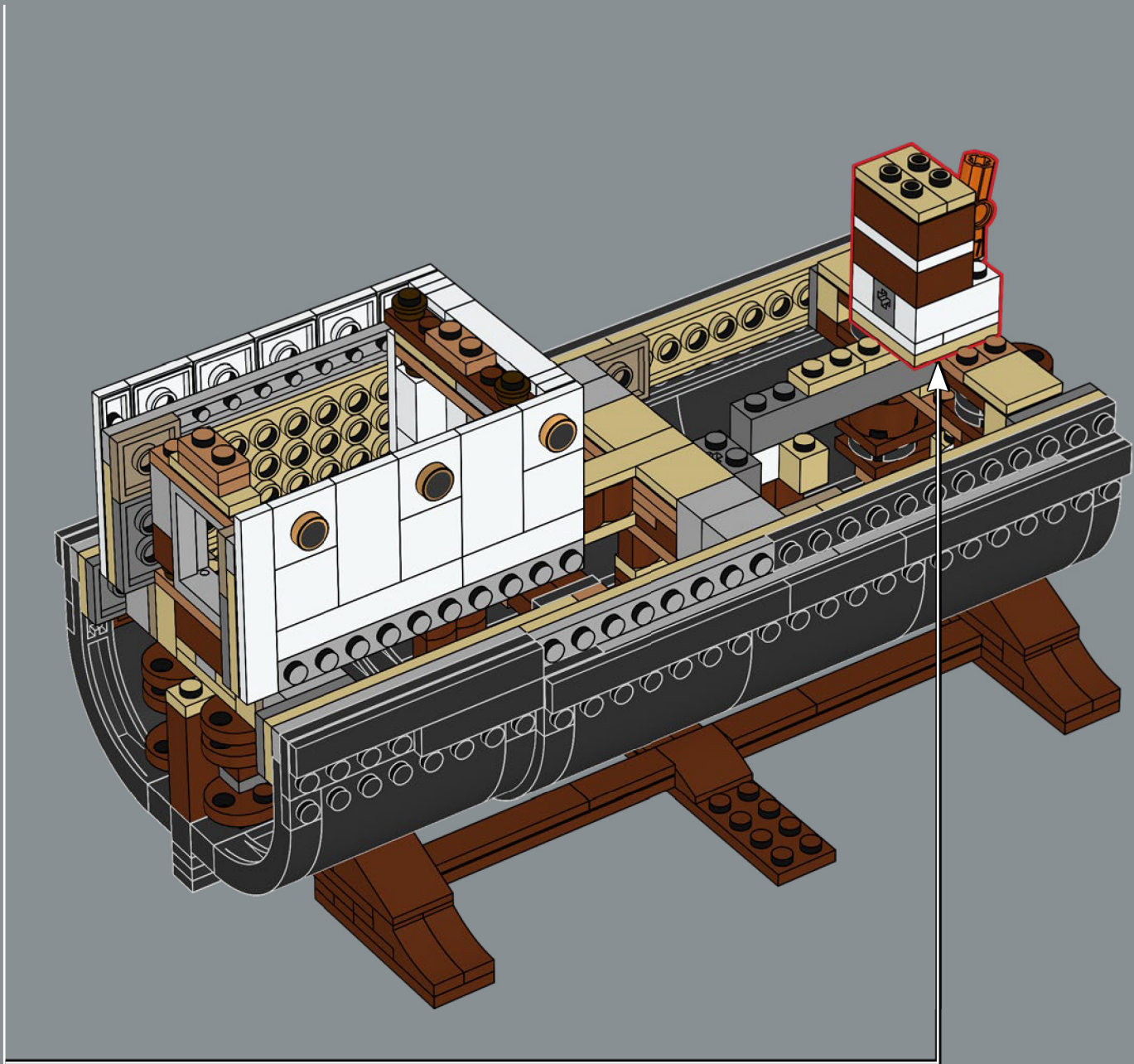
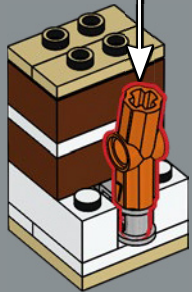



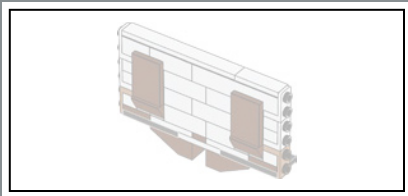

233

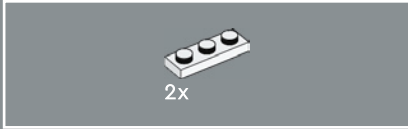
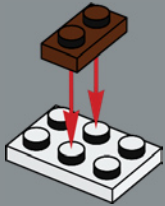

234

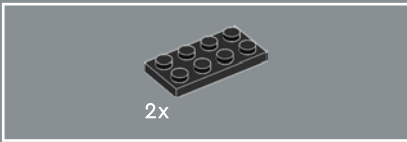
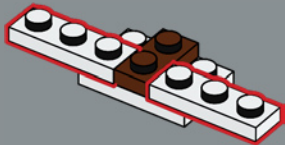

235

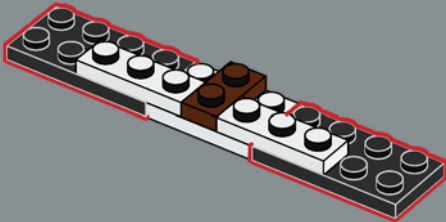

236

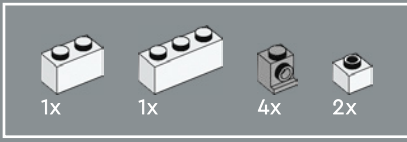
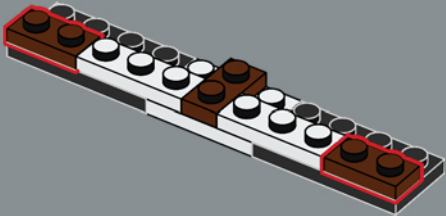

237

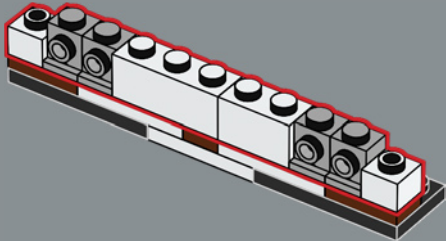

238

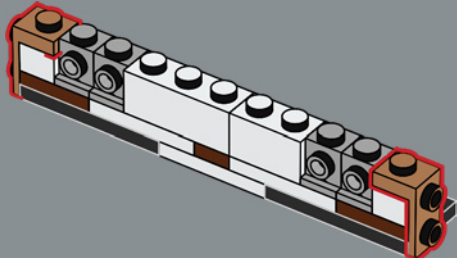

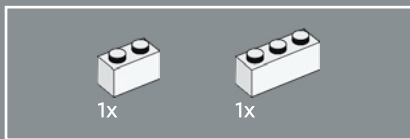

239

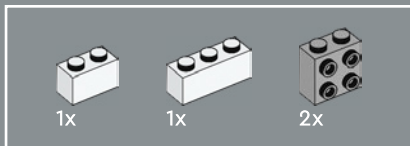
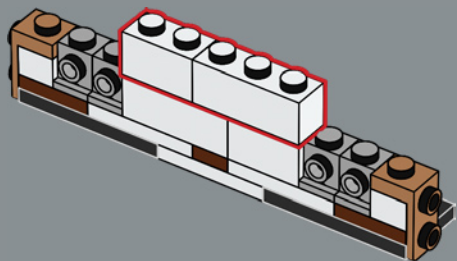

240

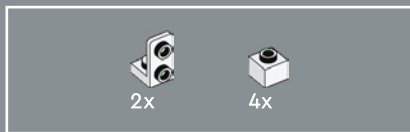
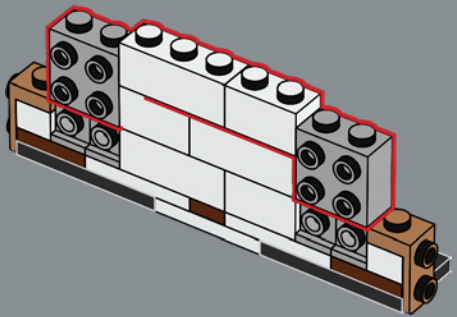

241

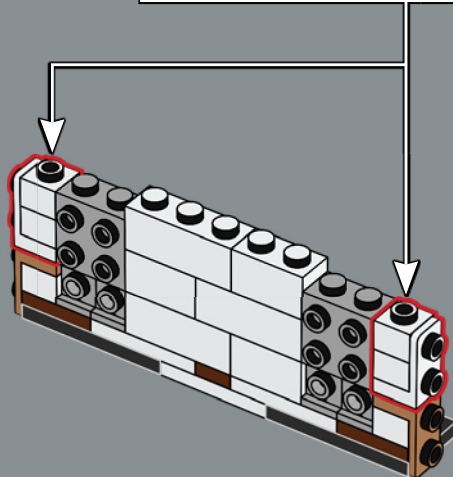
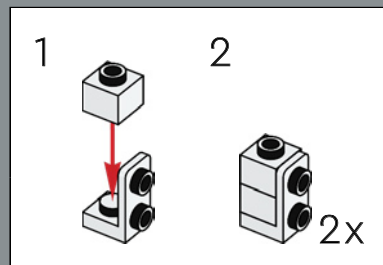

242

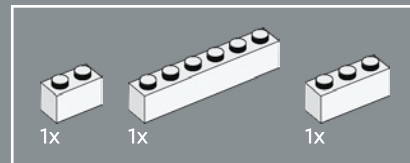
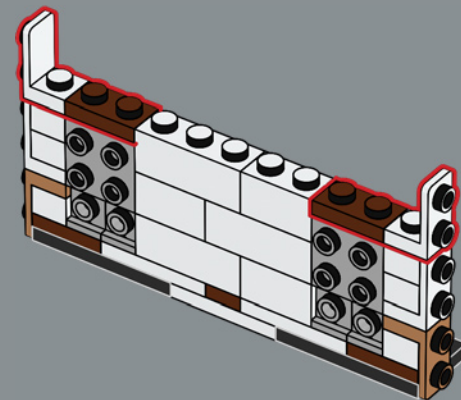

243

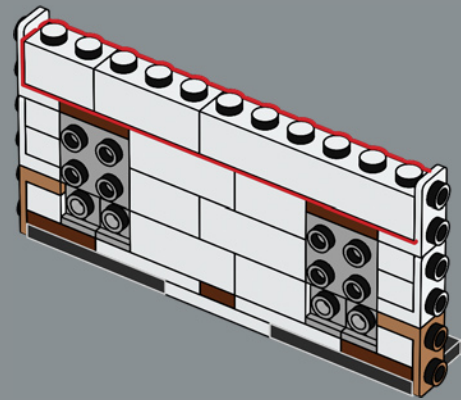

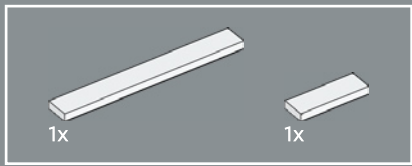

244

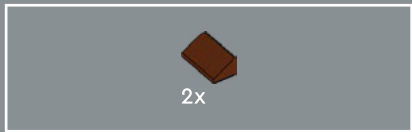
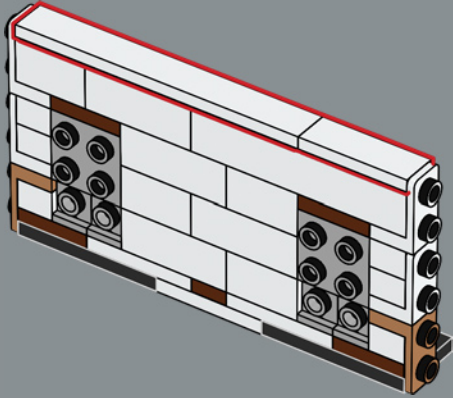

245

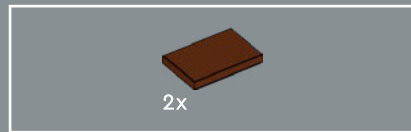
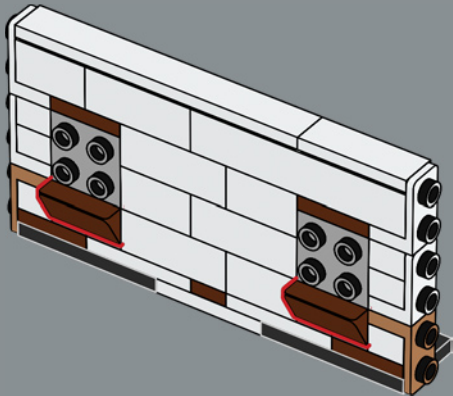

246

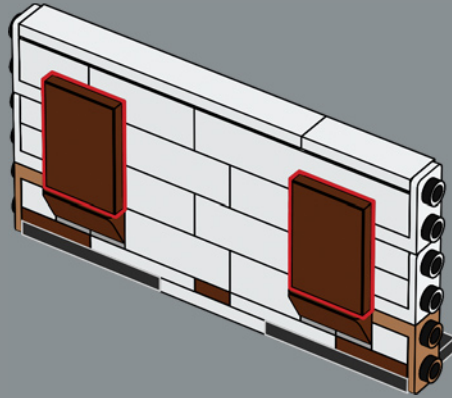

247

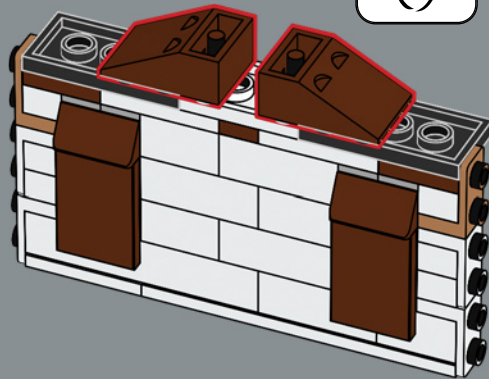

248

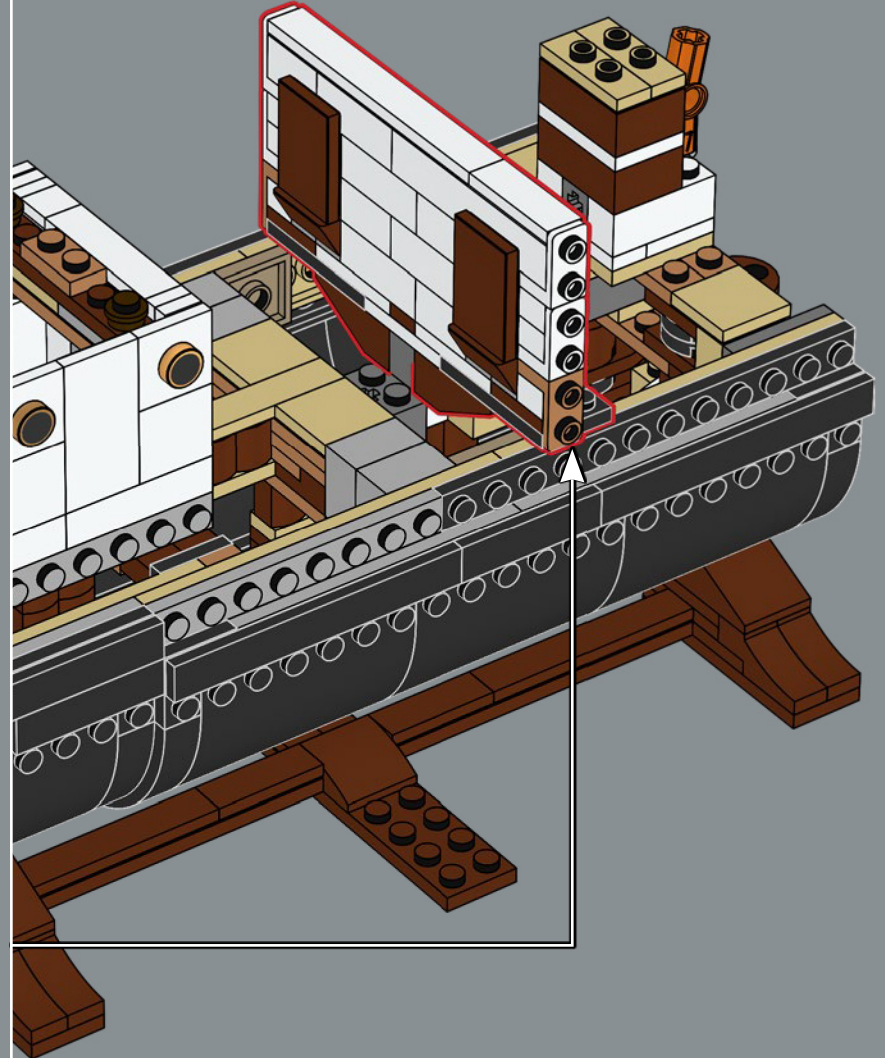

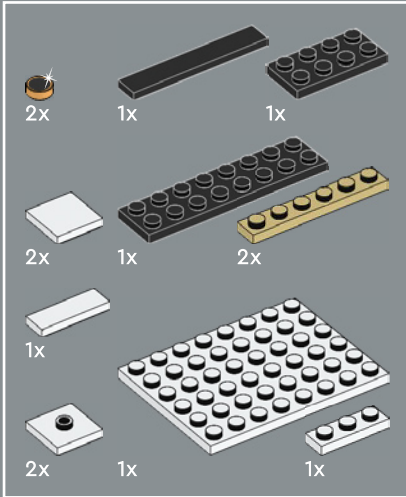
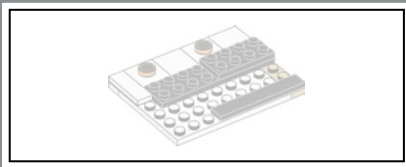

249

1

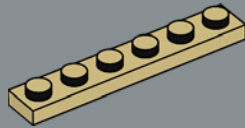

2

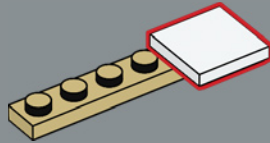

3

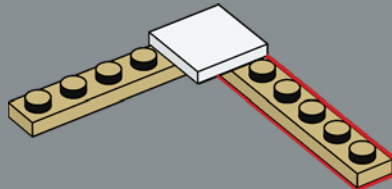

4

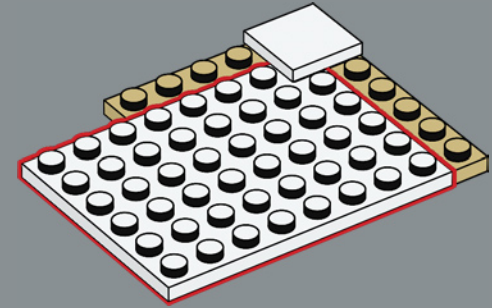

5

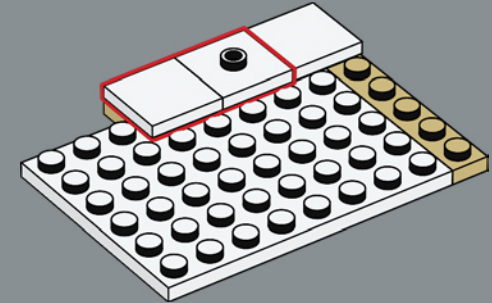

6

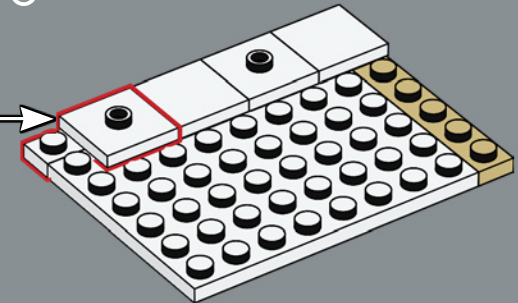
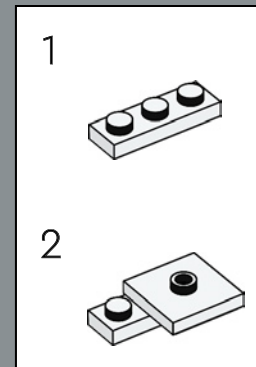



7

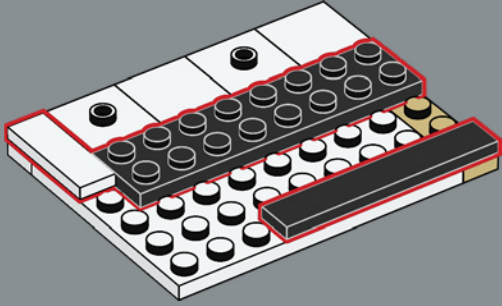

8

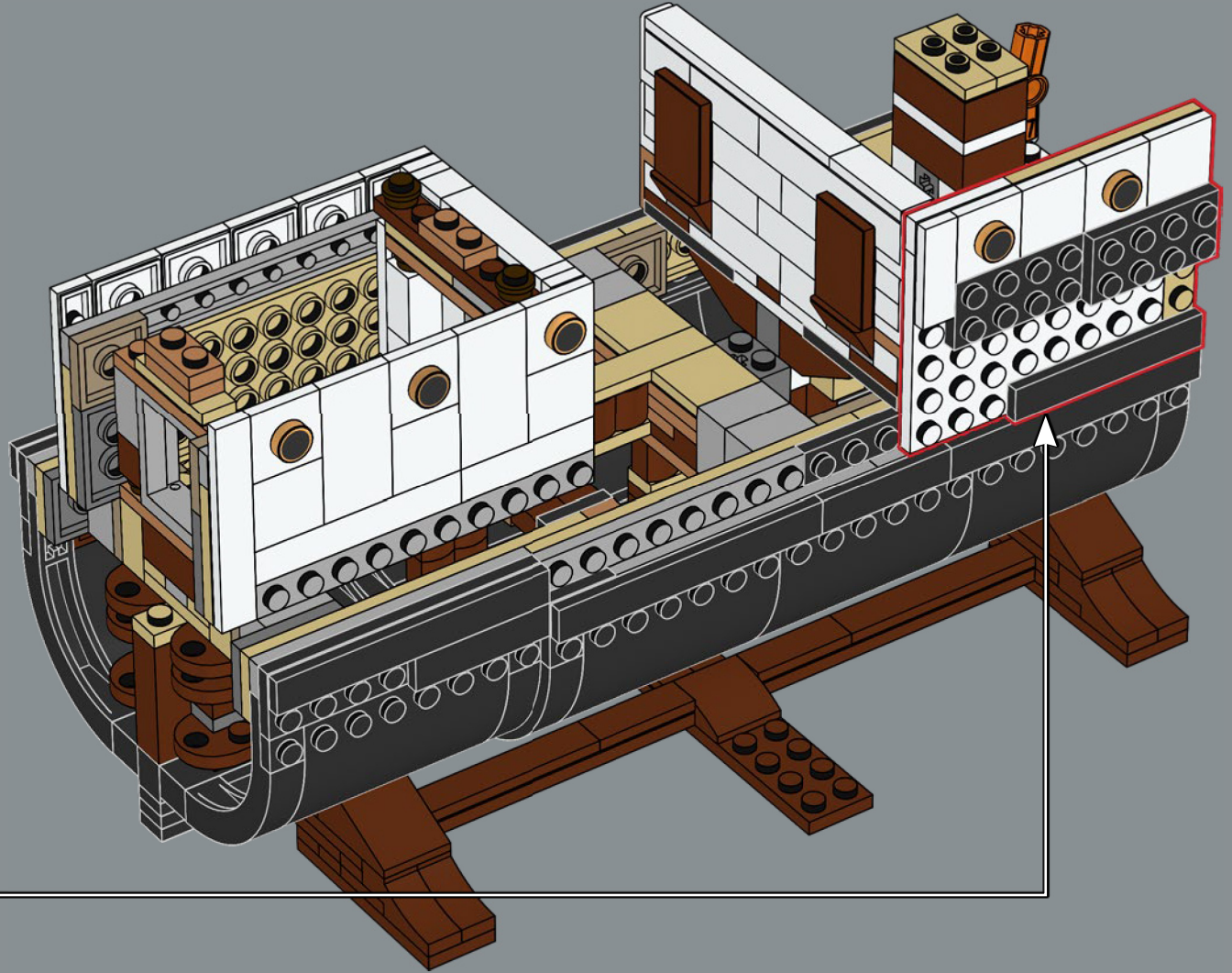
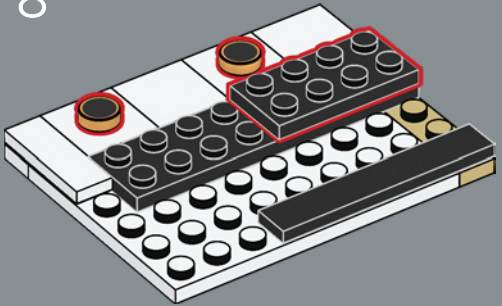

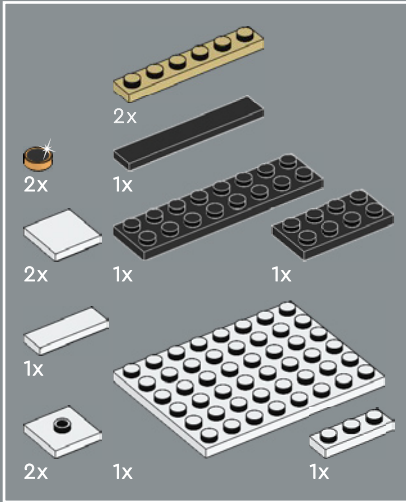
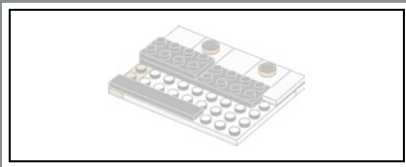

250

1

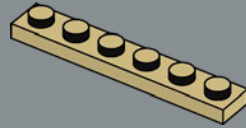

2

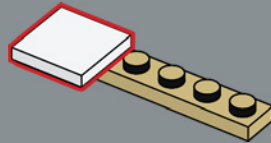

3

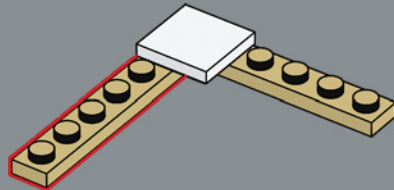

4

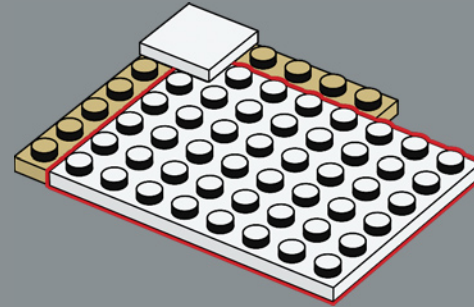

5

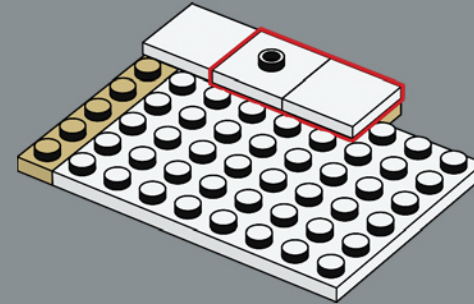

6

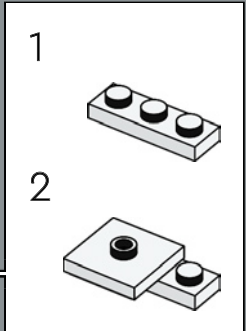
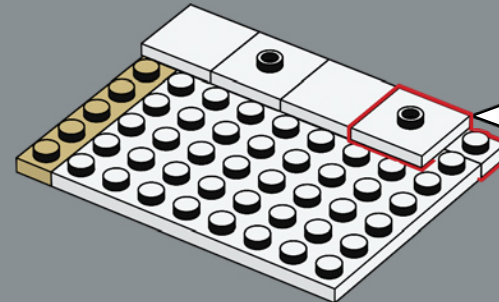



7

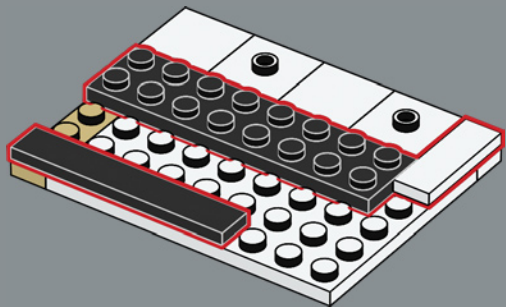

8

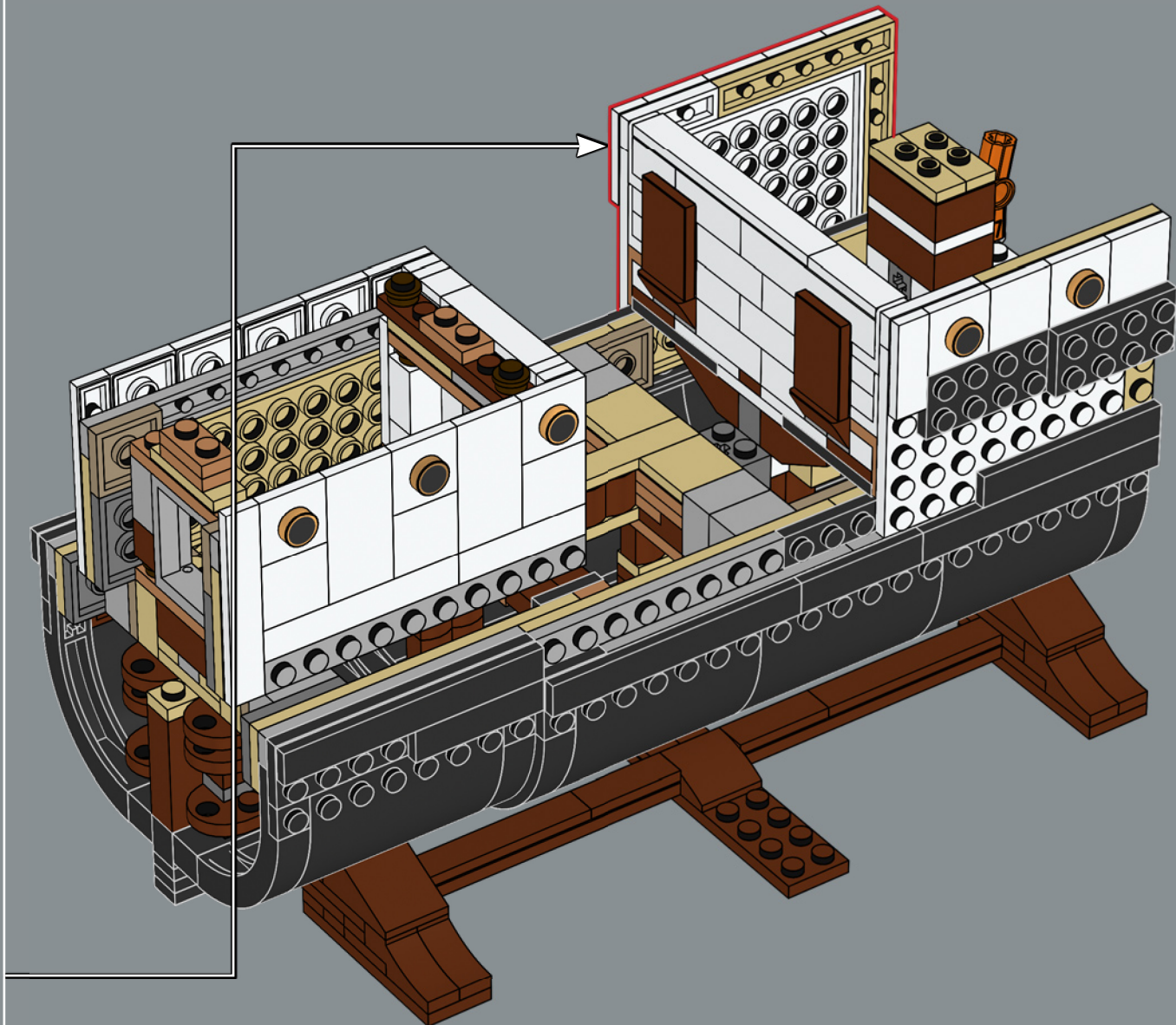
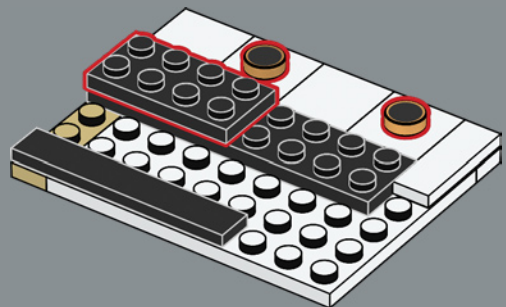

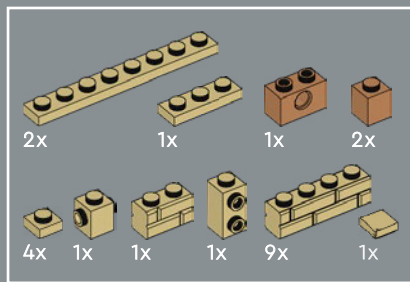
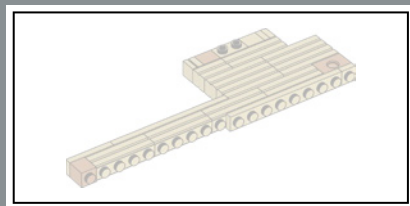

251

1

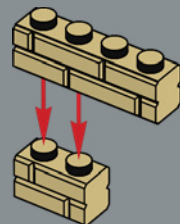

2

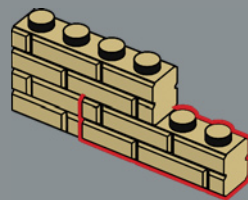

3

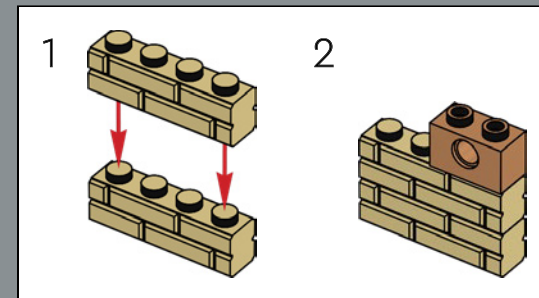
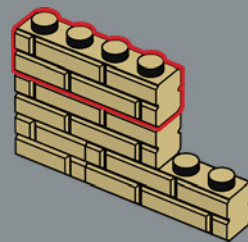

4

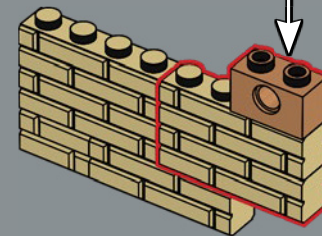

5

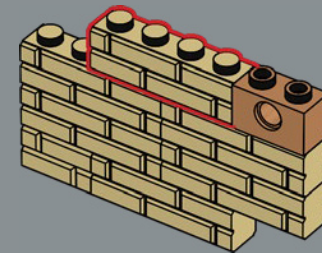



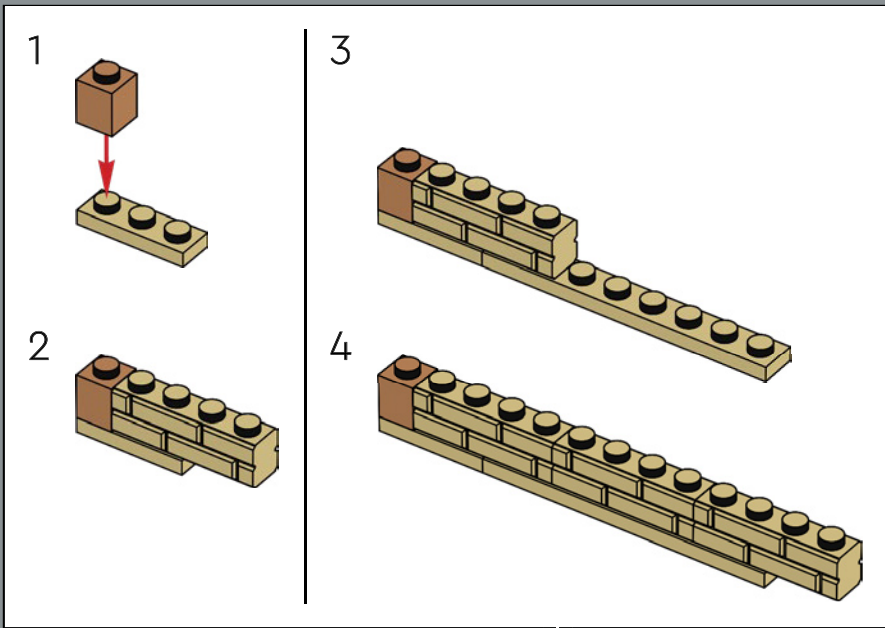

6

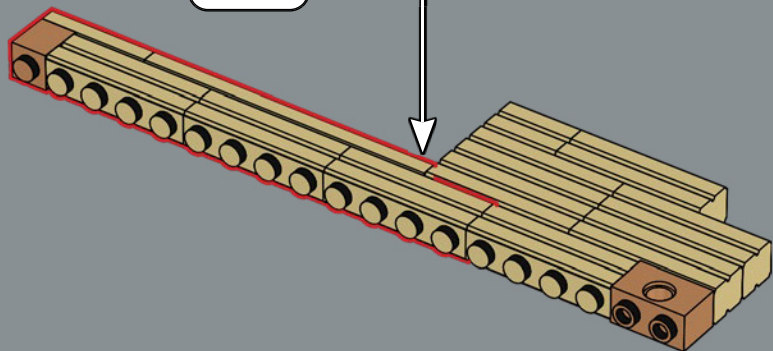

7

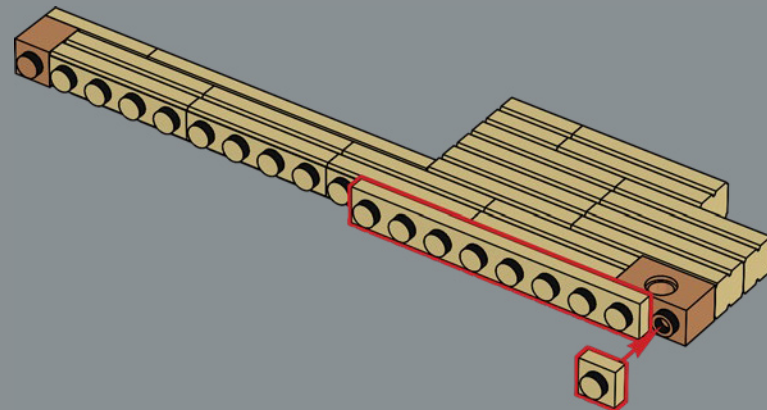

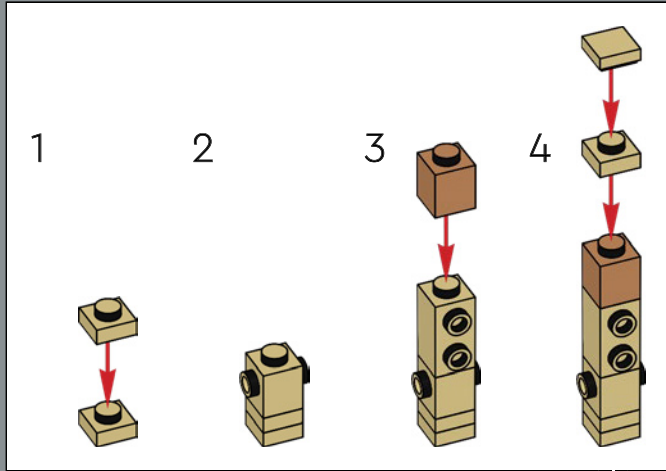

8

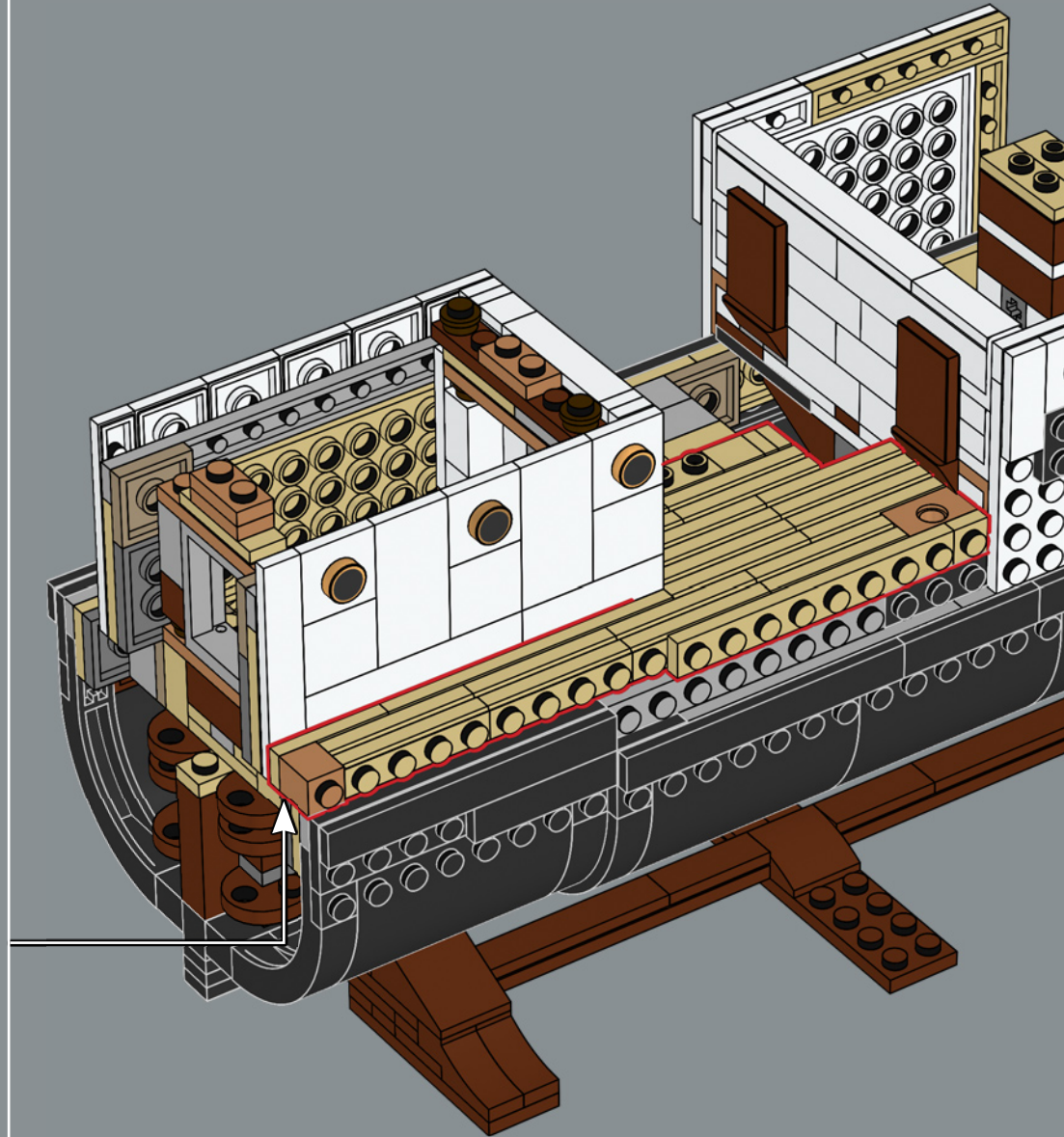
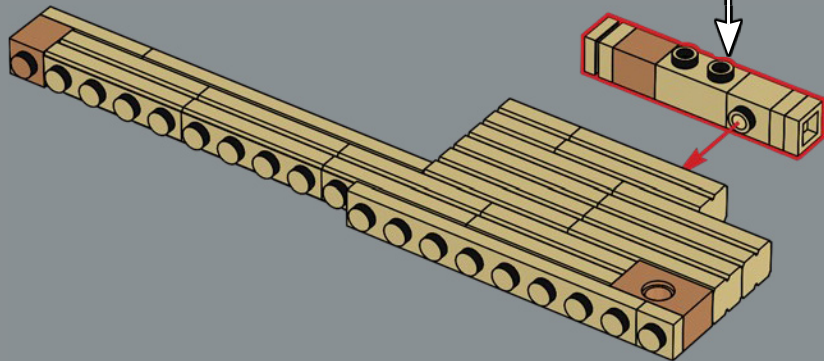

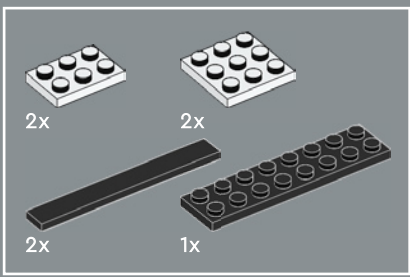

252

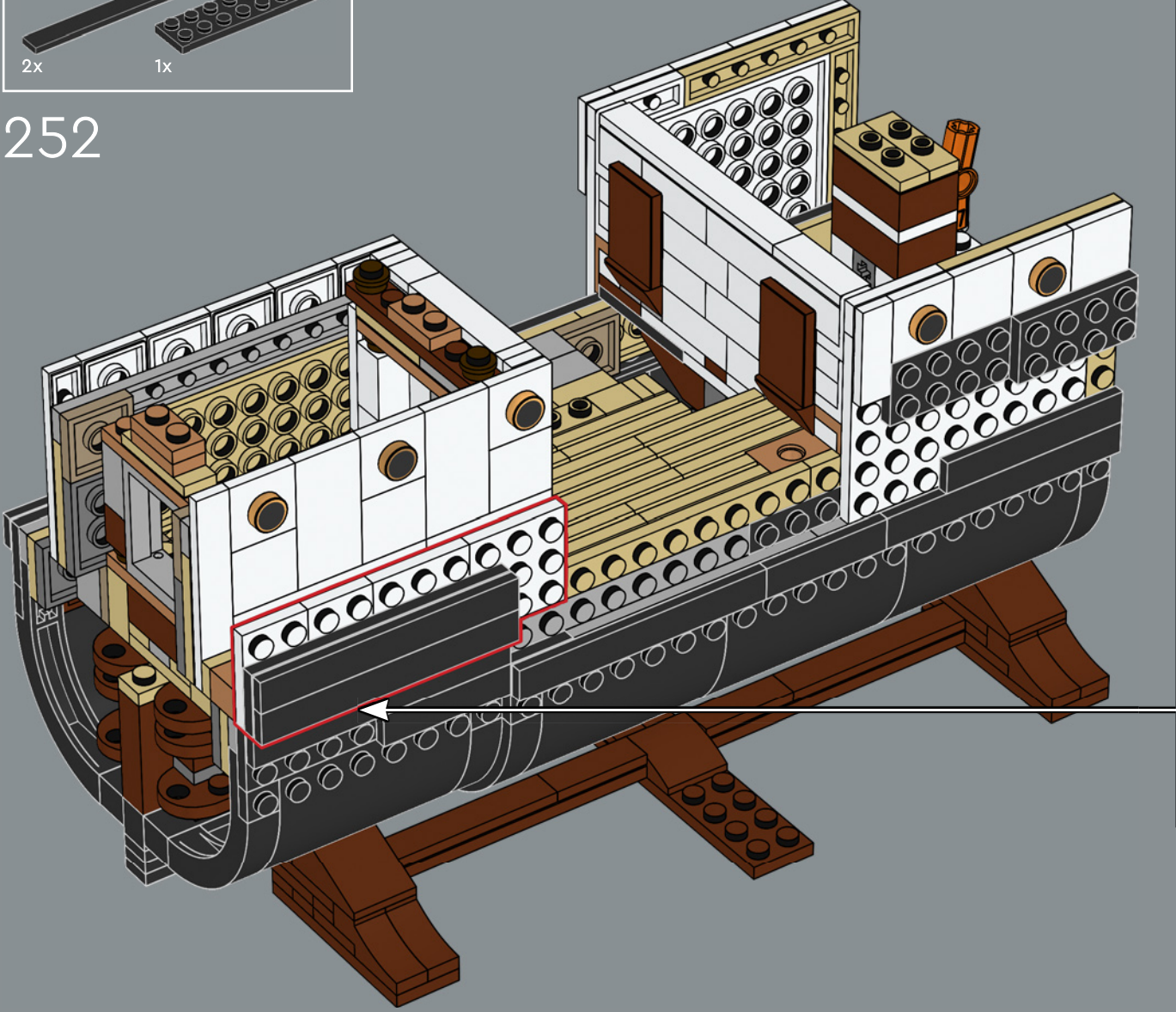

1

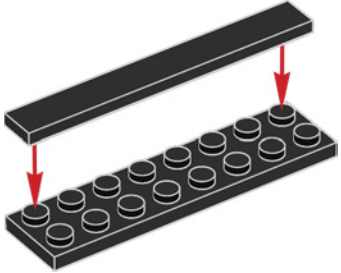

2

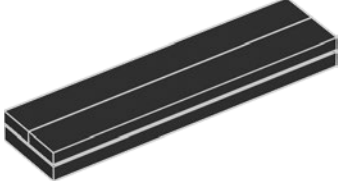

3

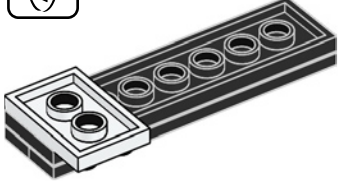

4

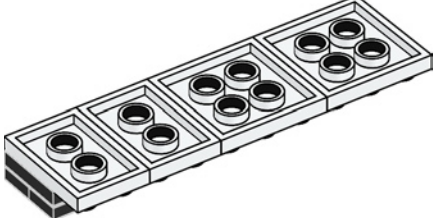



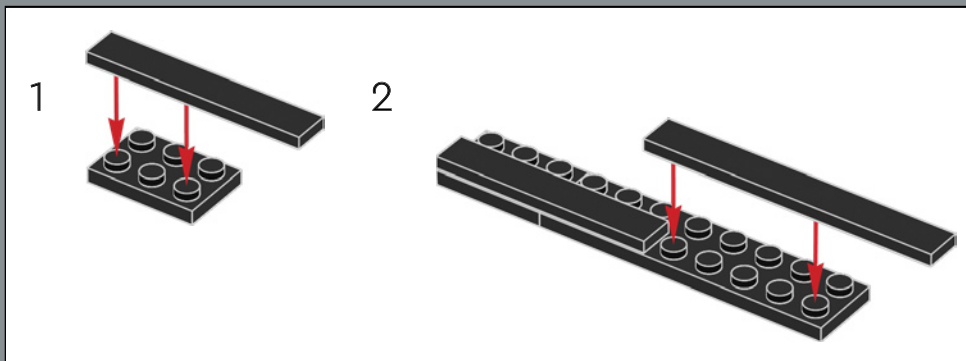
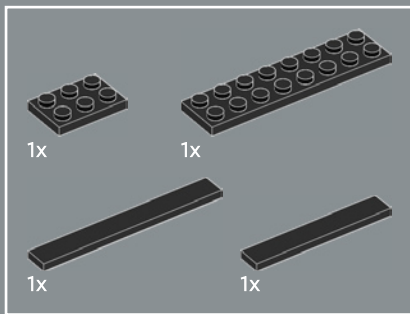

253

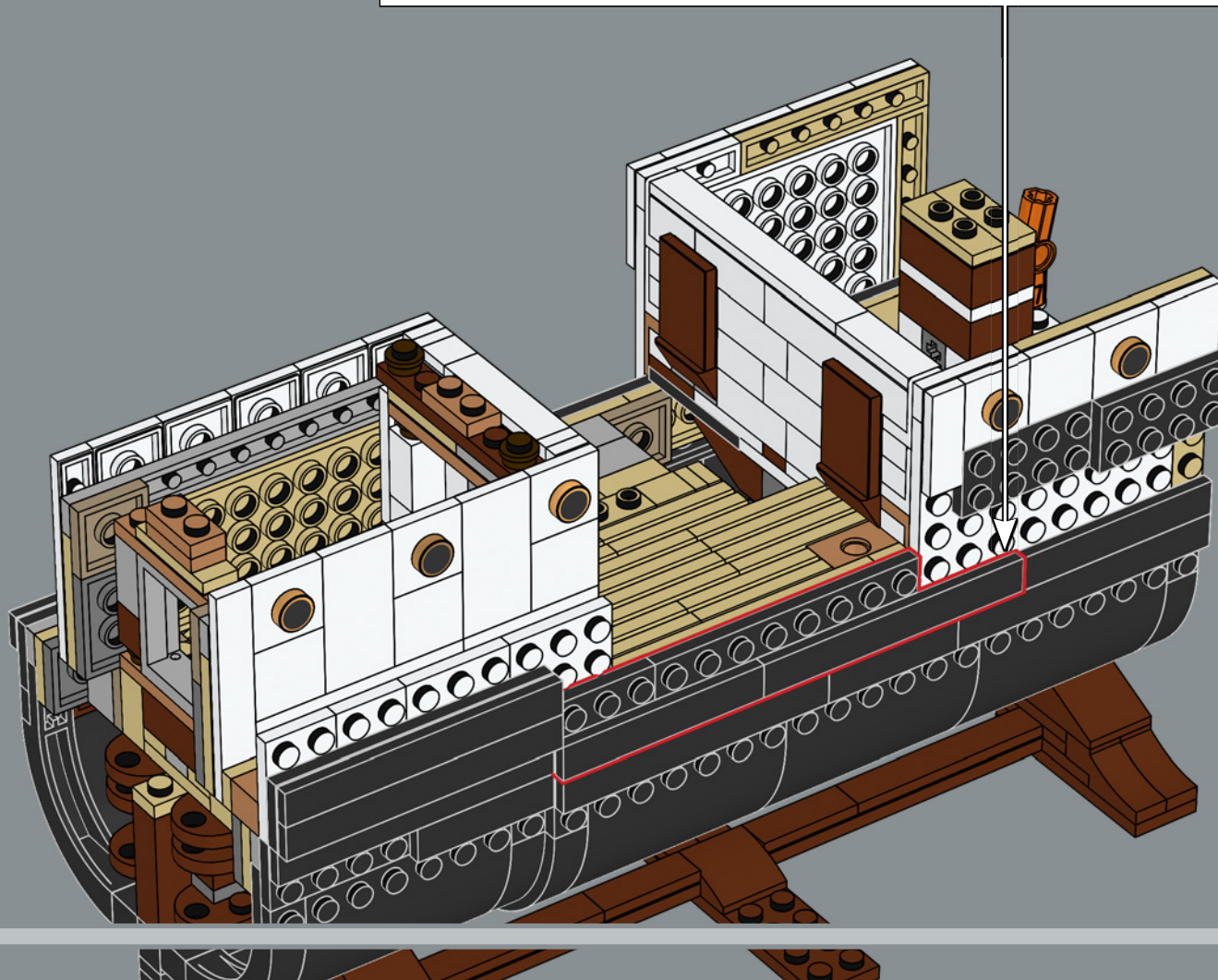



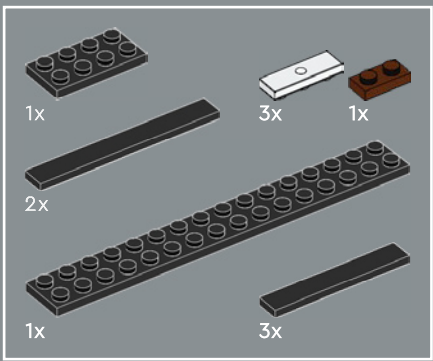

254

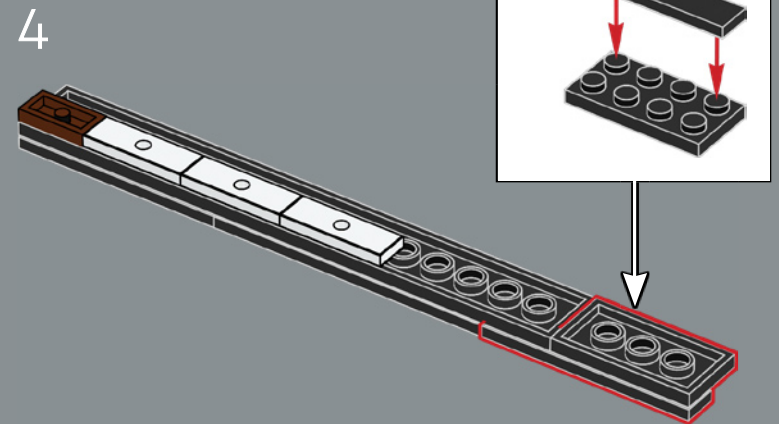
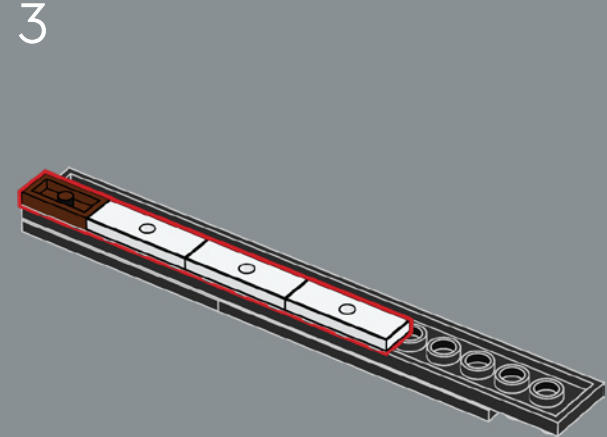
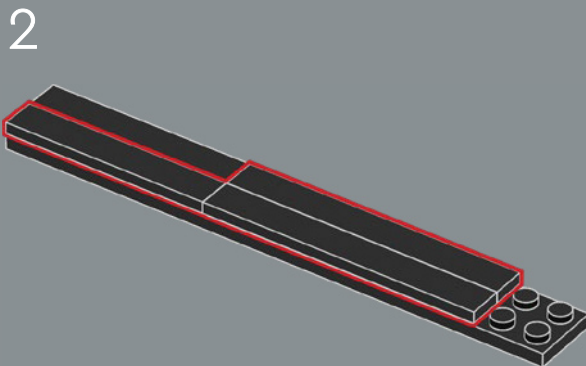
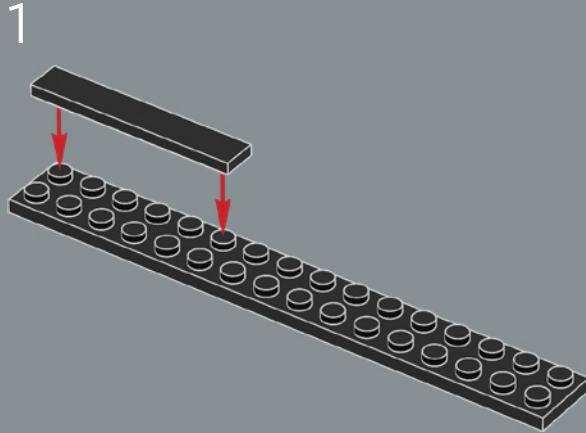

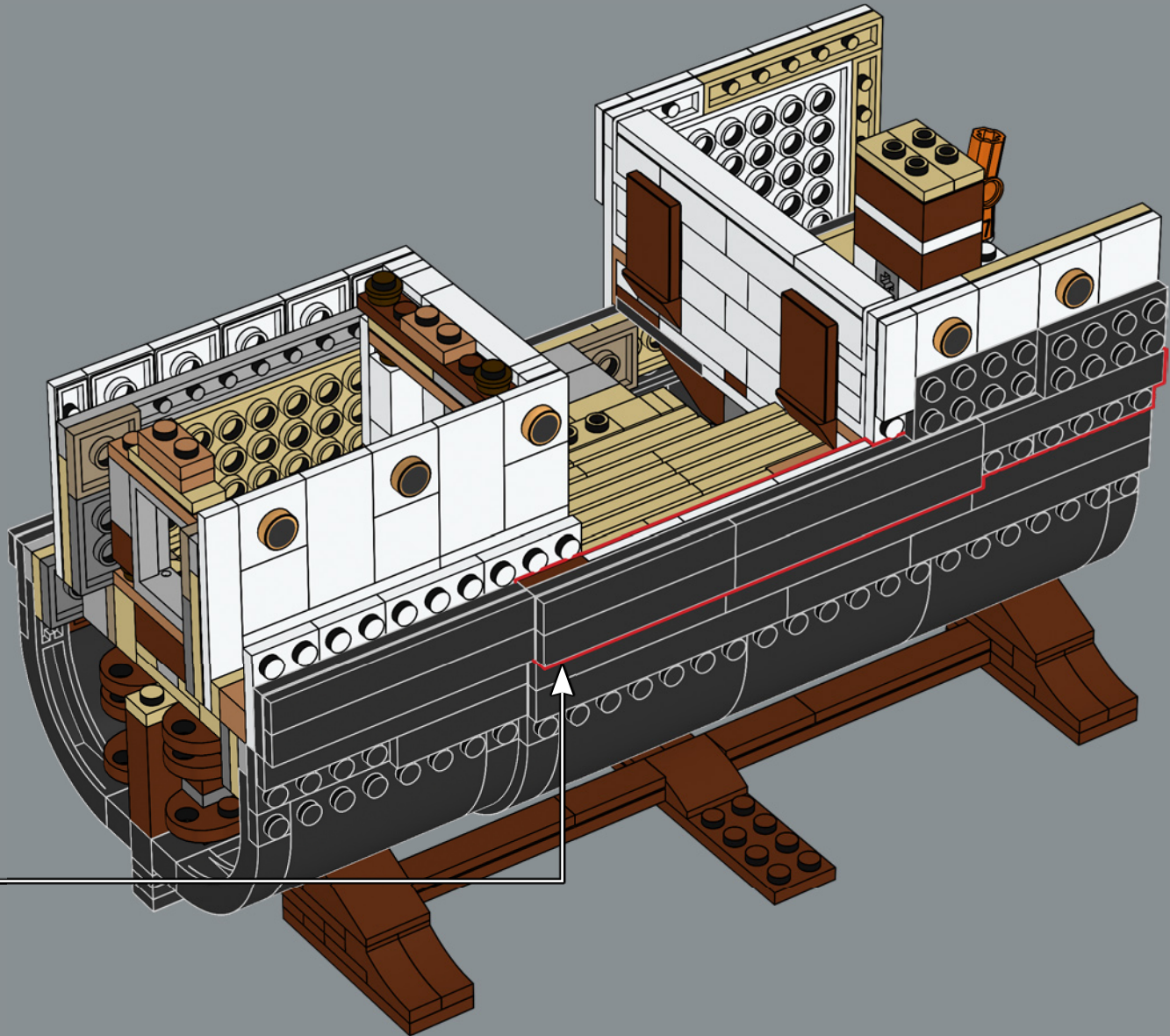

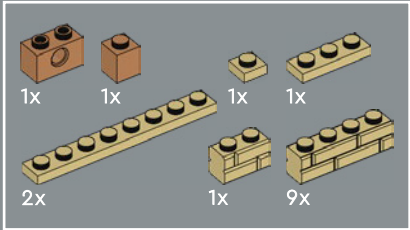
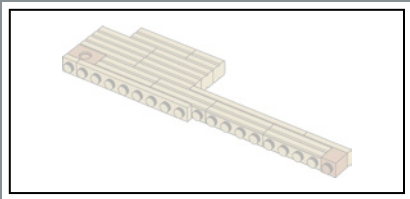

255

1

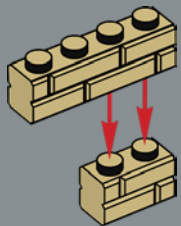

2

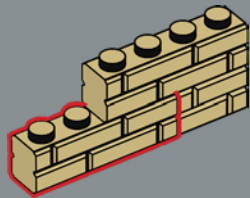

3

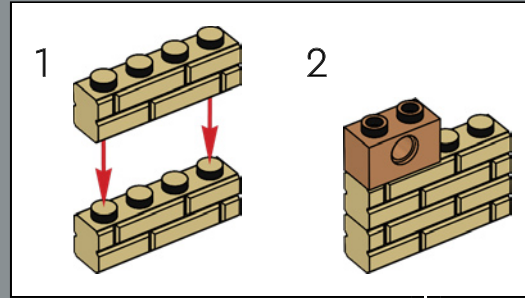
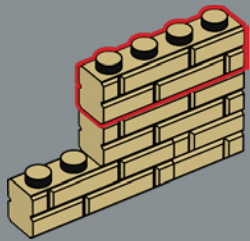

4

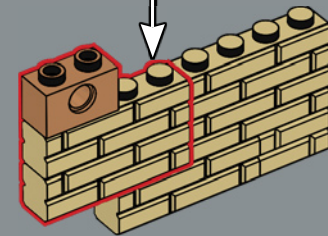

5

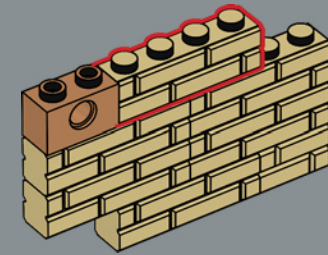

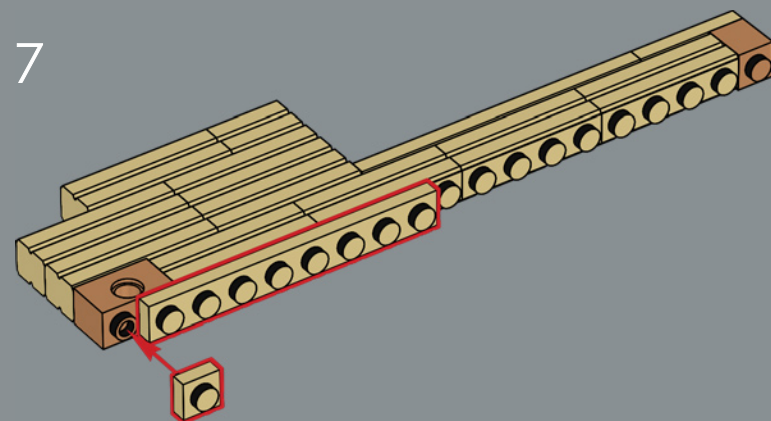
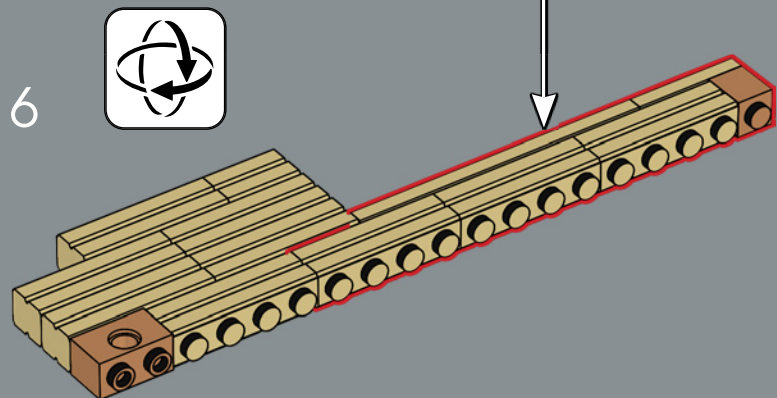
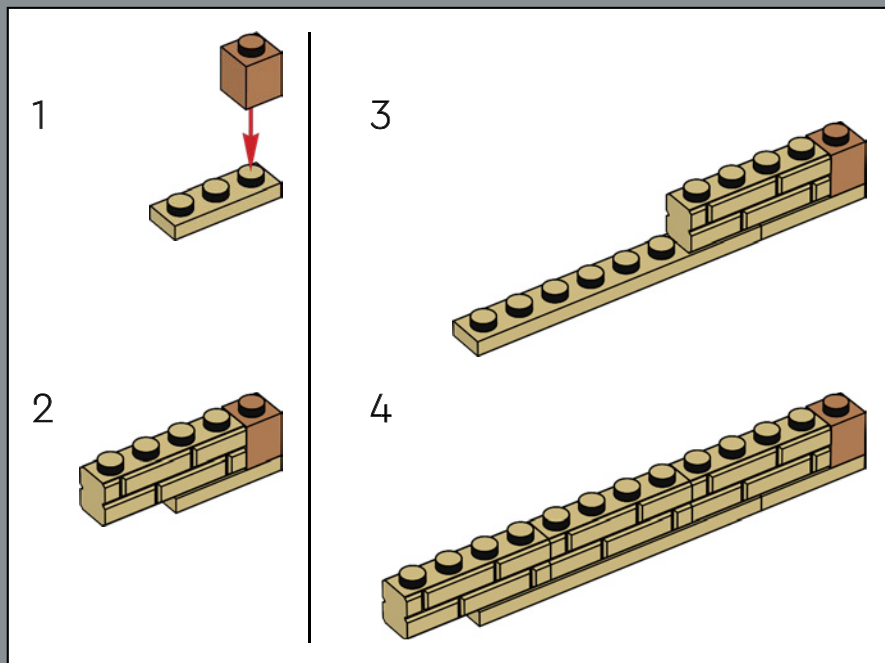

Um das Unterdeck so aussehen zu lassen, als wäre es aus Holzplanken gebaut, haben wir hier die Rückseite der Profilsteine einer LEGO® „Steinmauer“ benutzt.



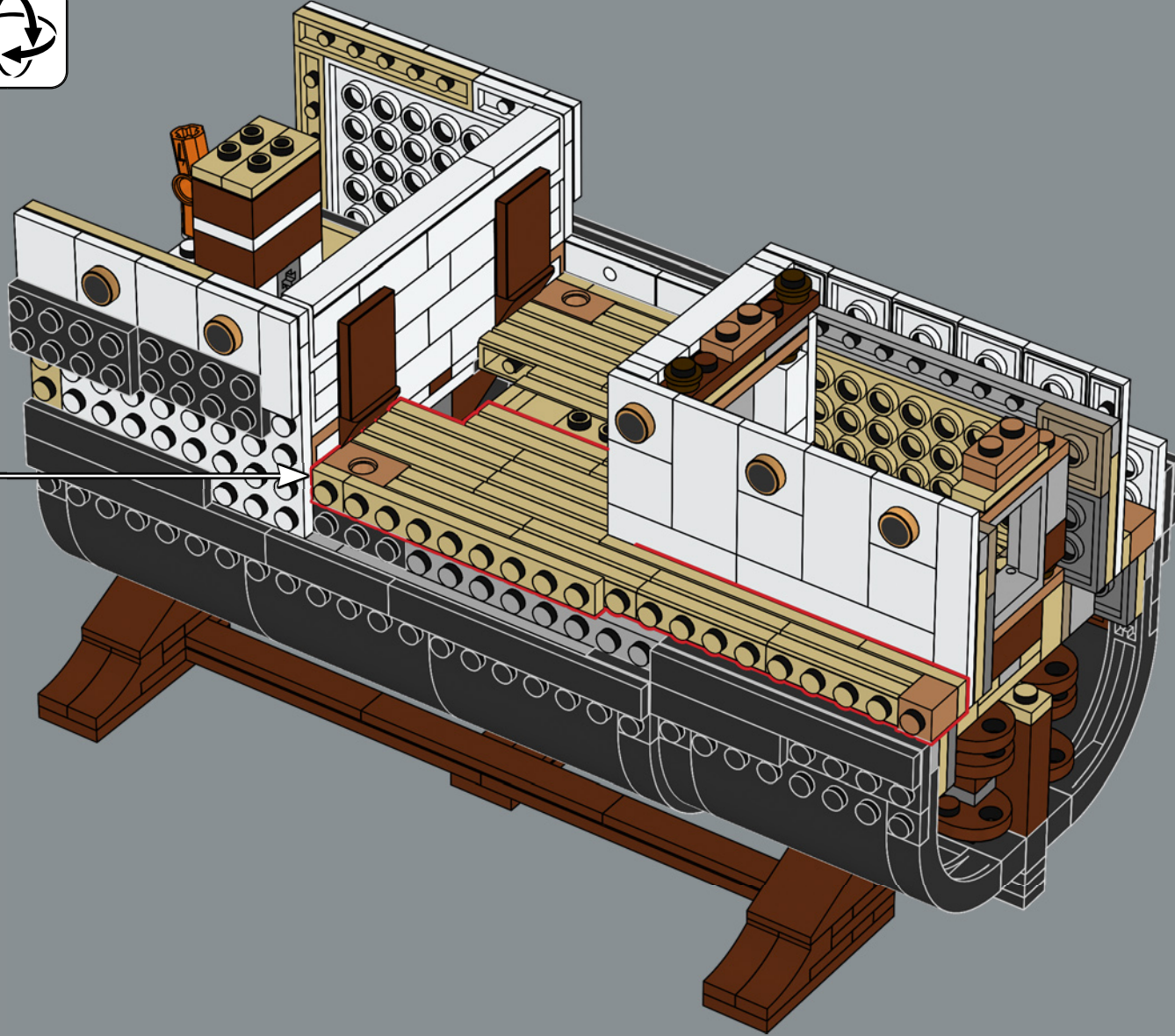

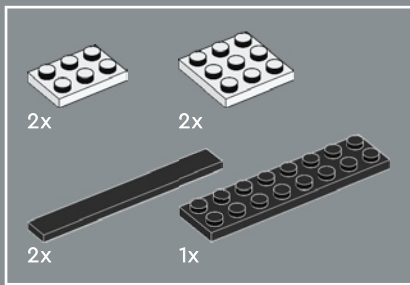

256

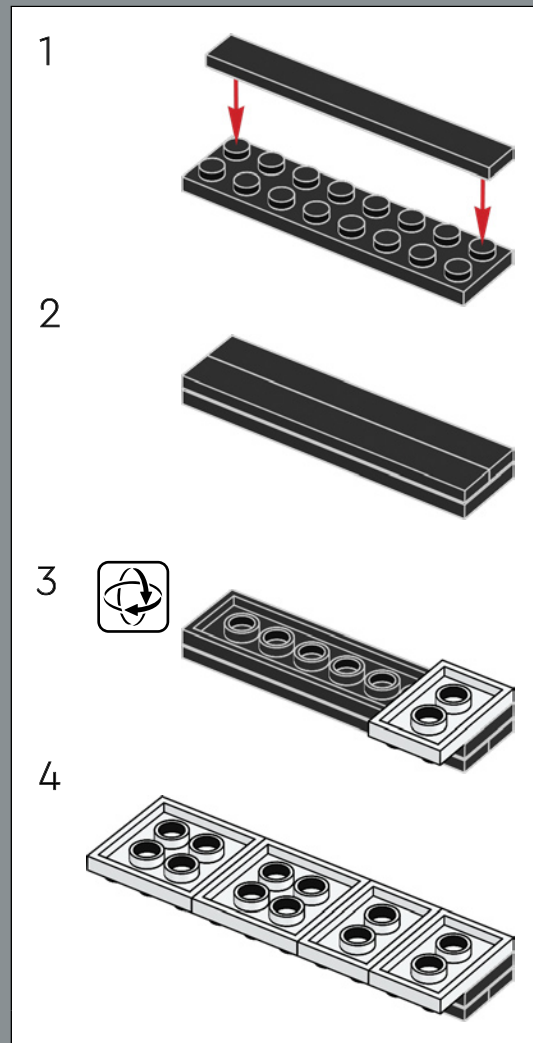
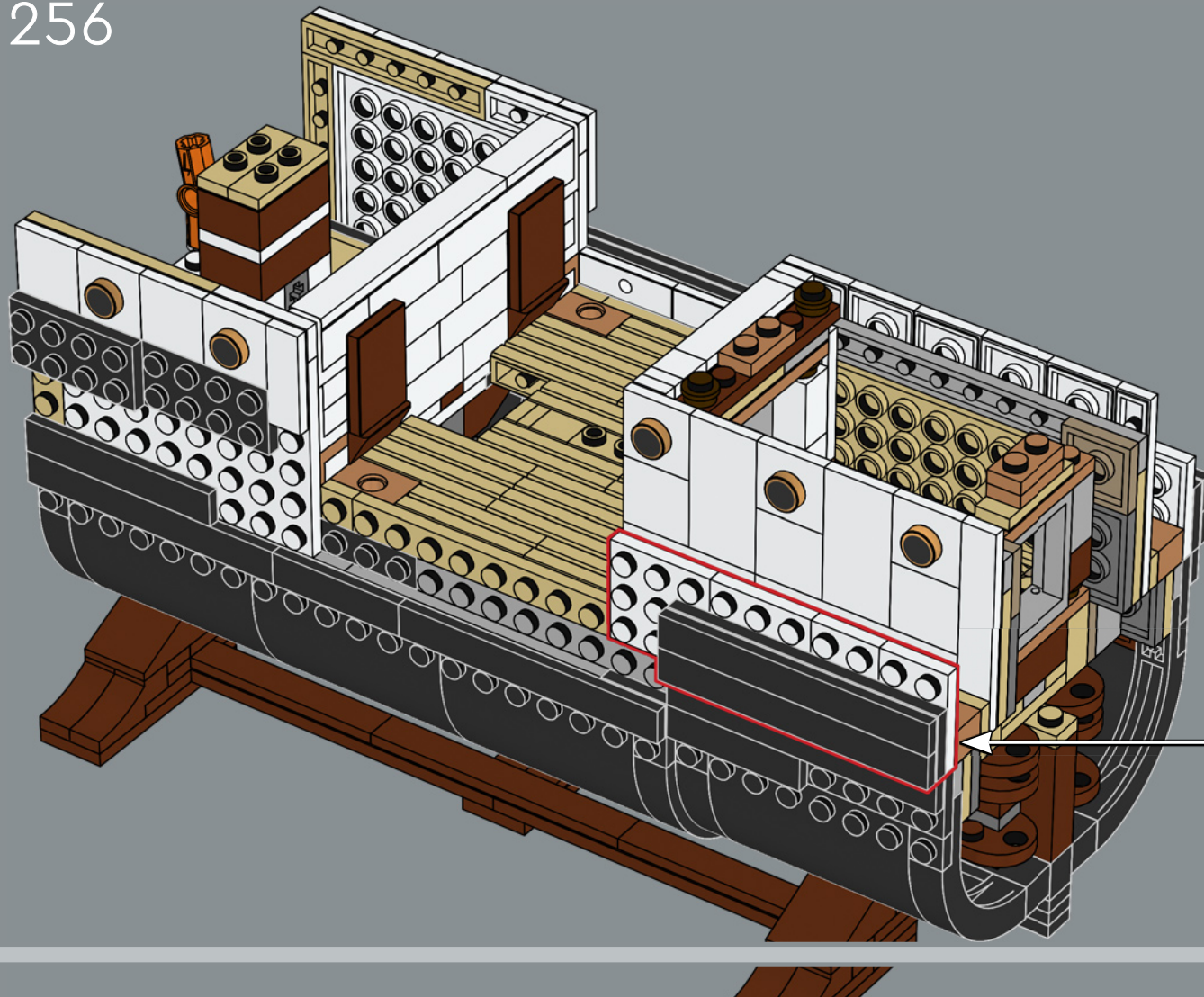



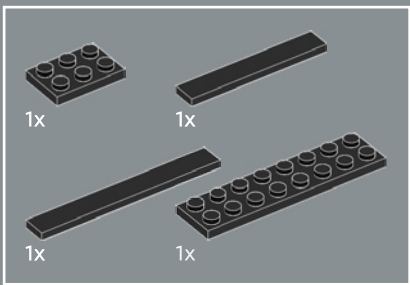

257

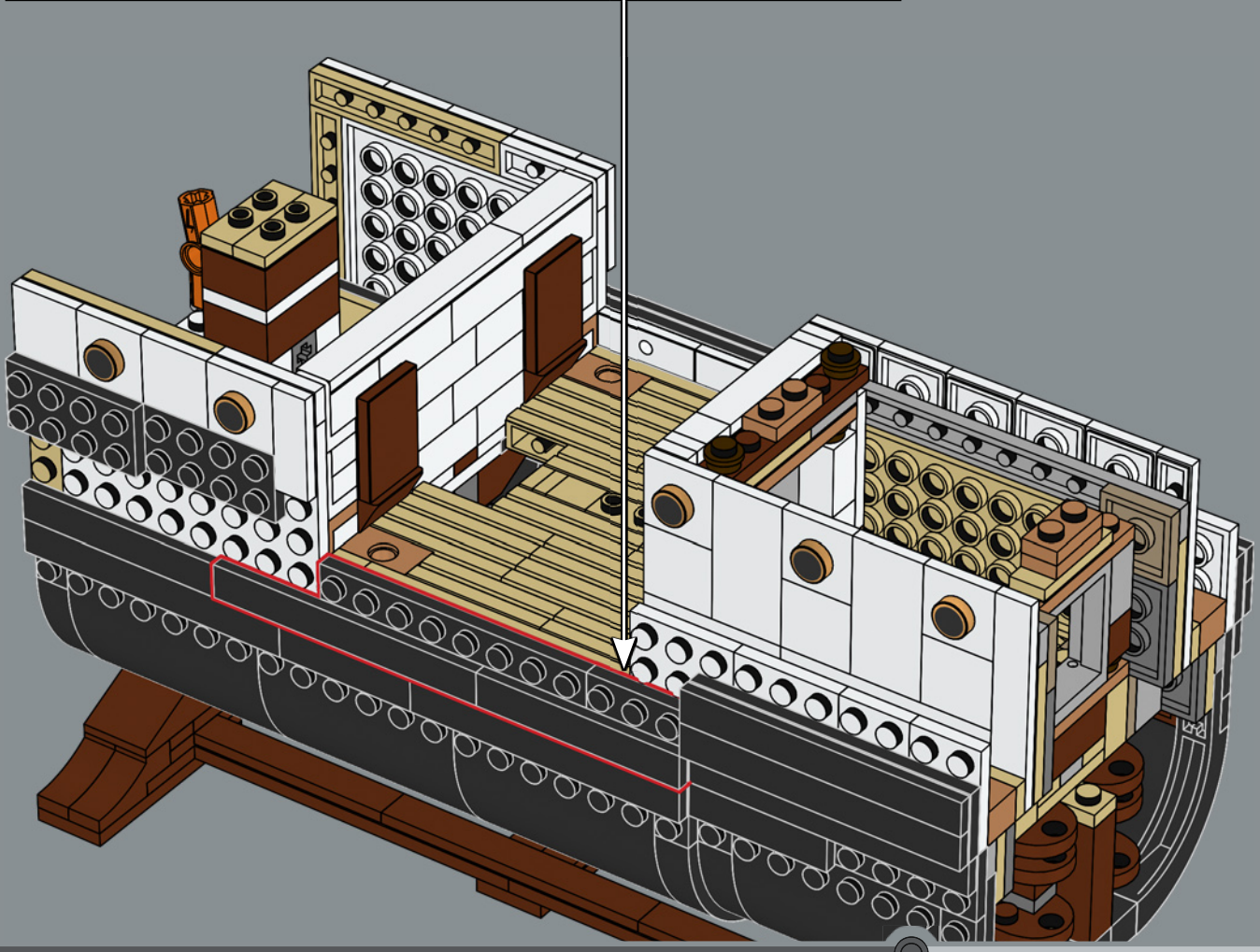
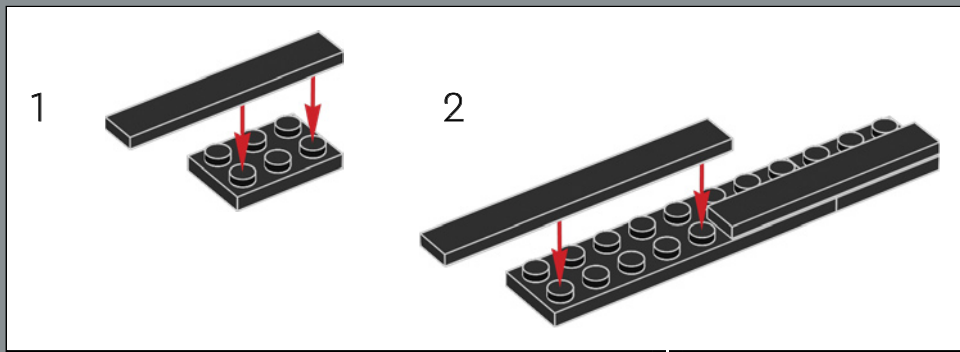

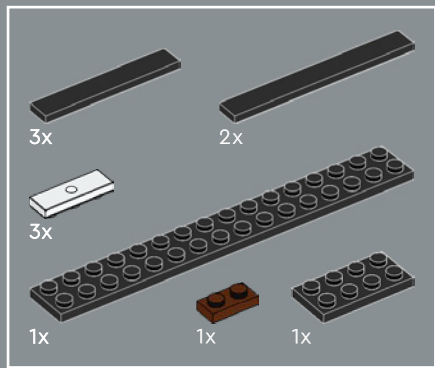

258

1

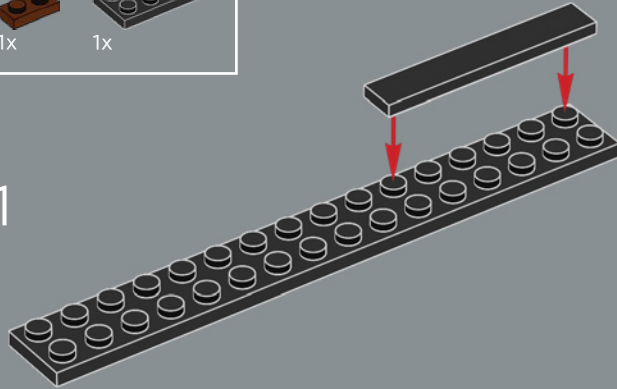

2

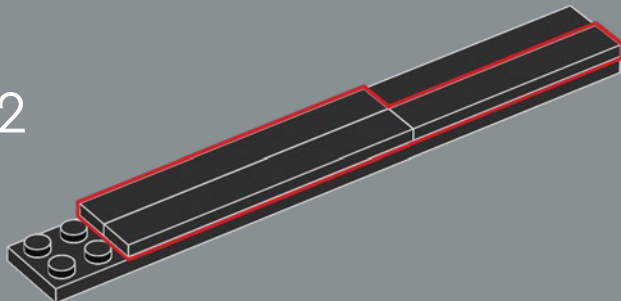

3

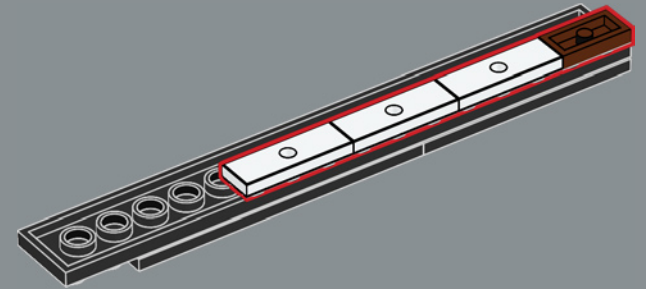

4

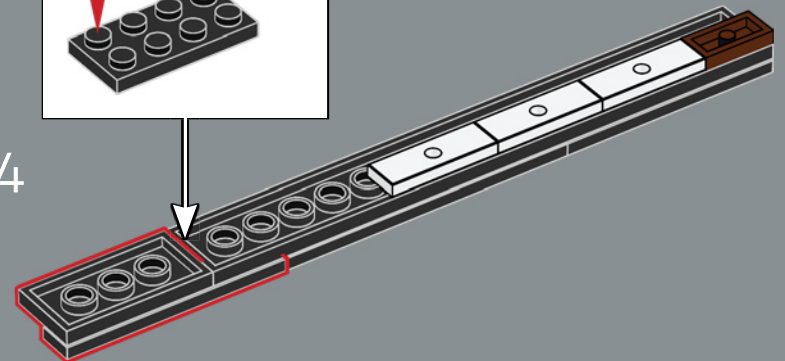
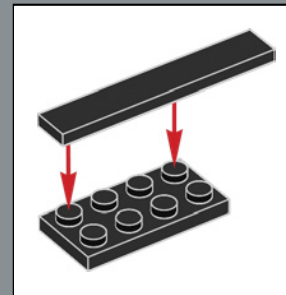



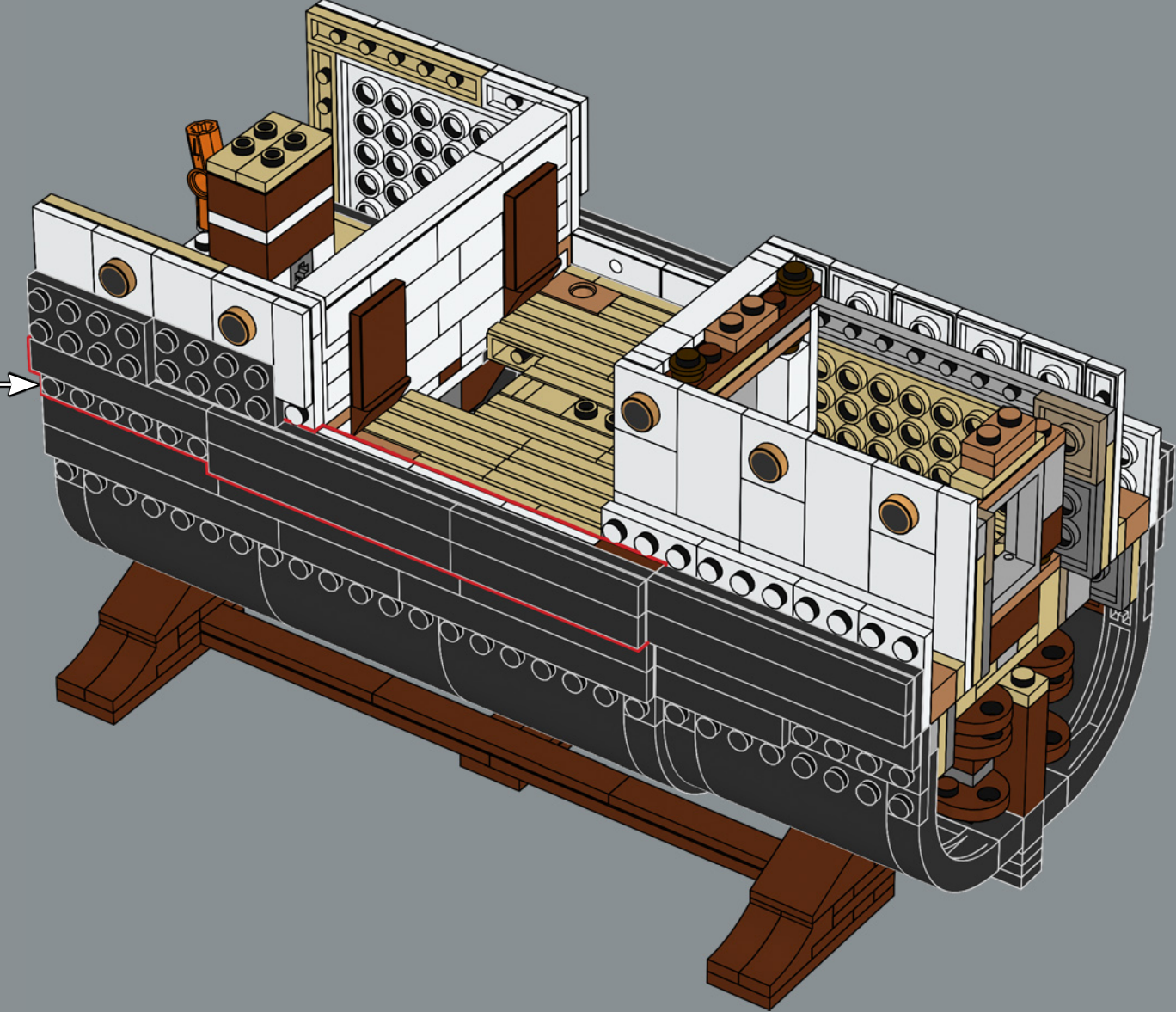

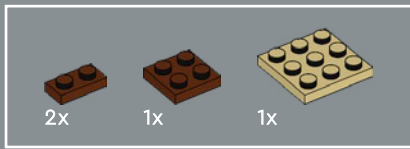

259

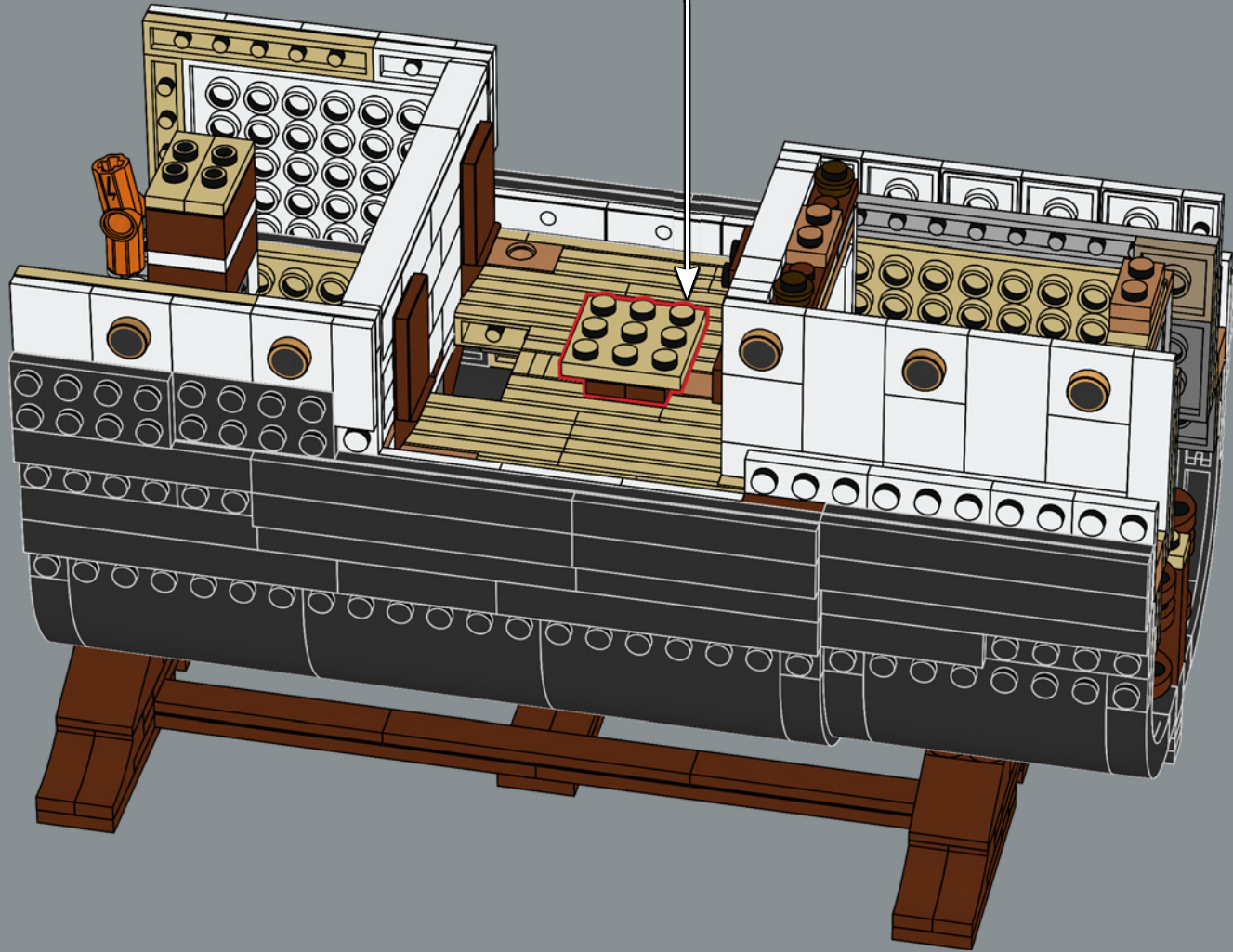
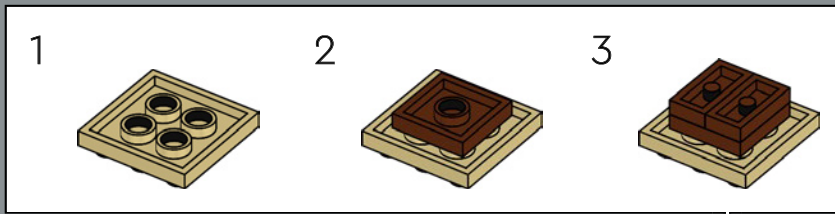

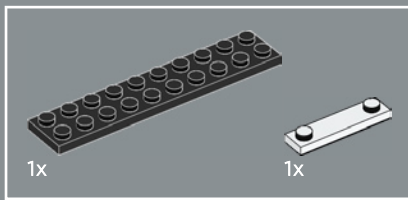
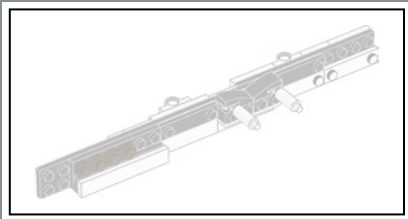

260

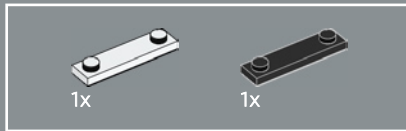
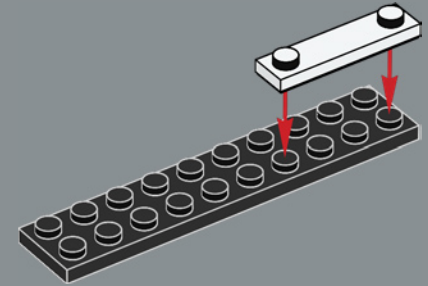

261

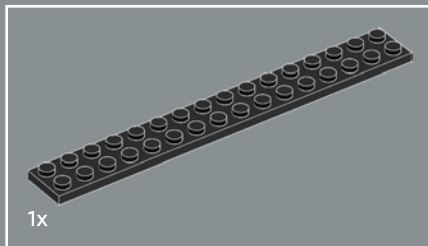
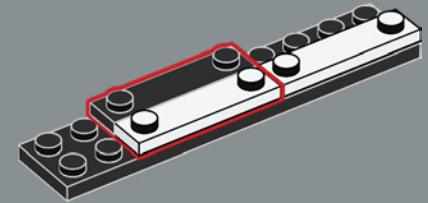

262

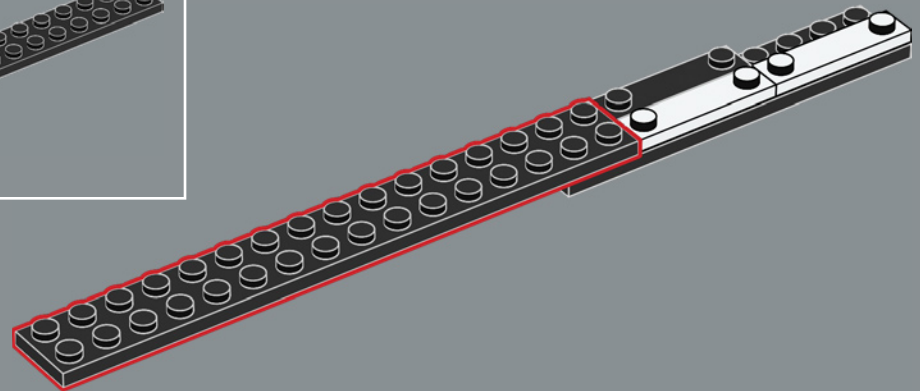

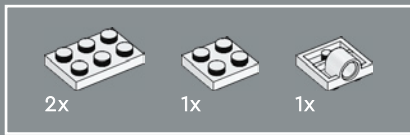

263

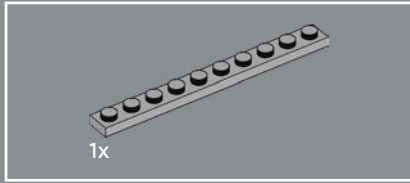
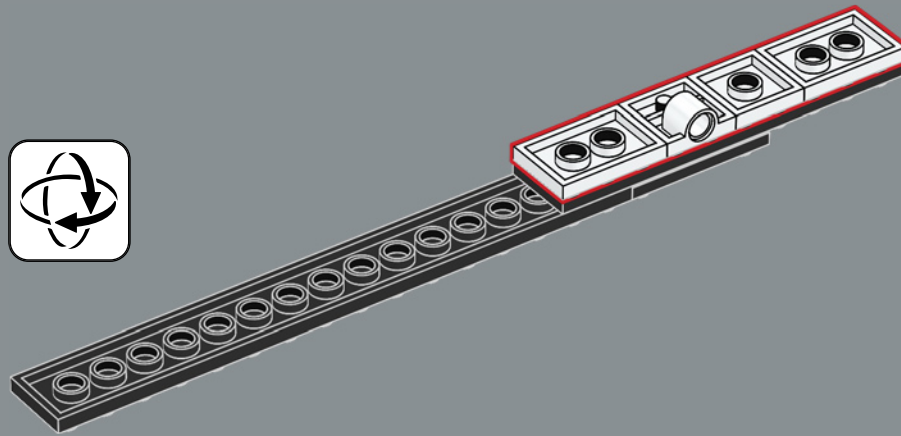

264

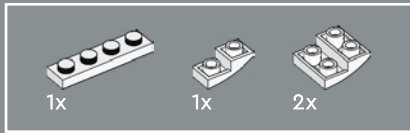
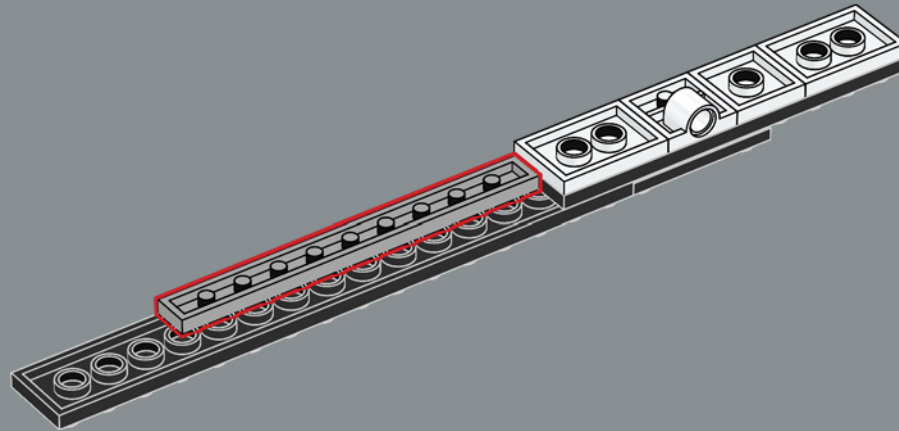

265

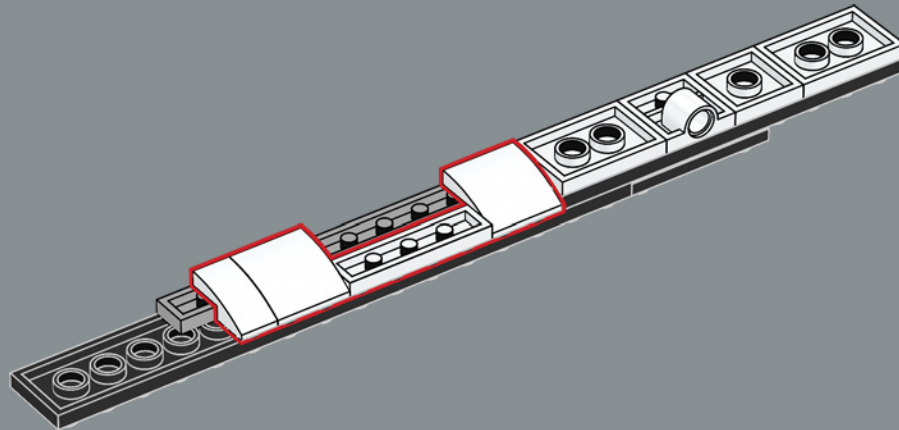





266

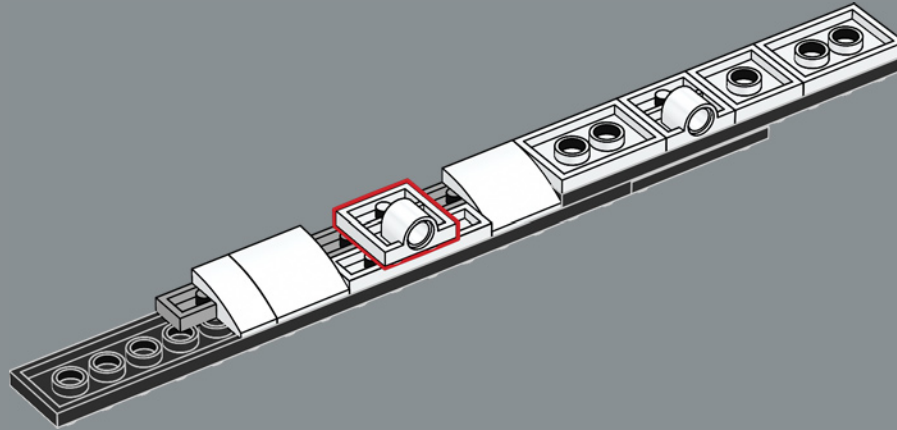

267

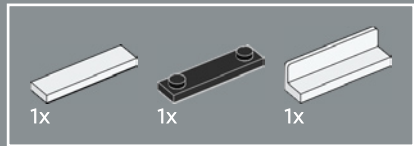
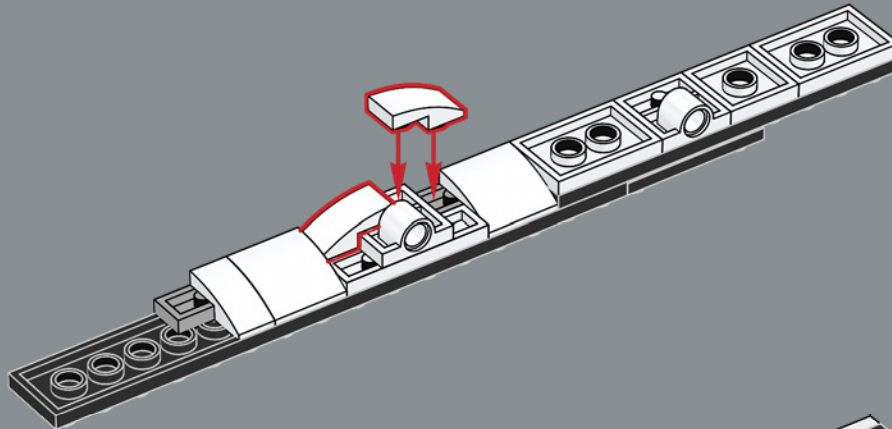

268

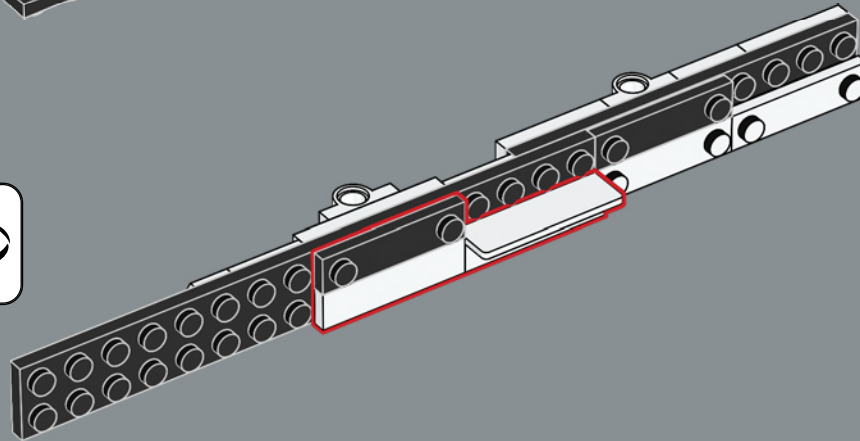

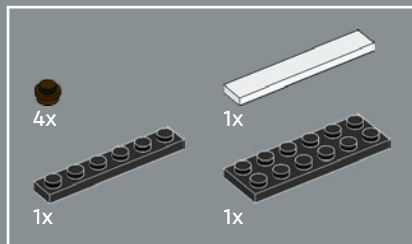

269

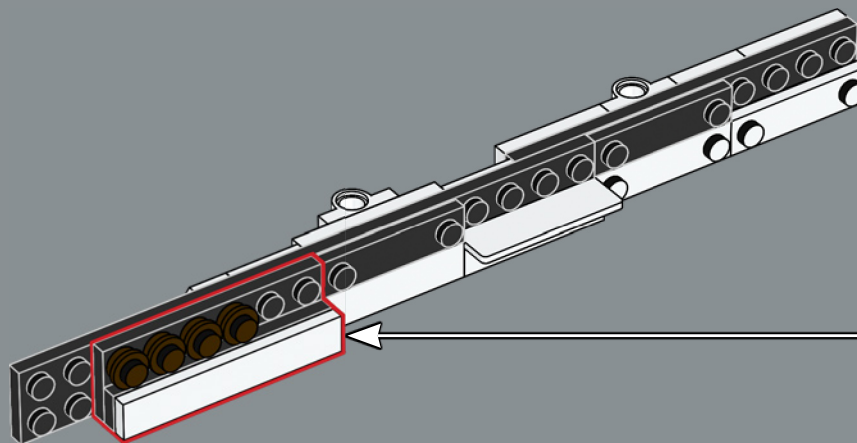
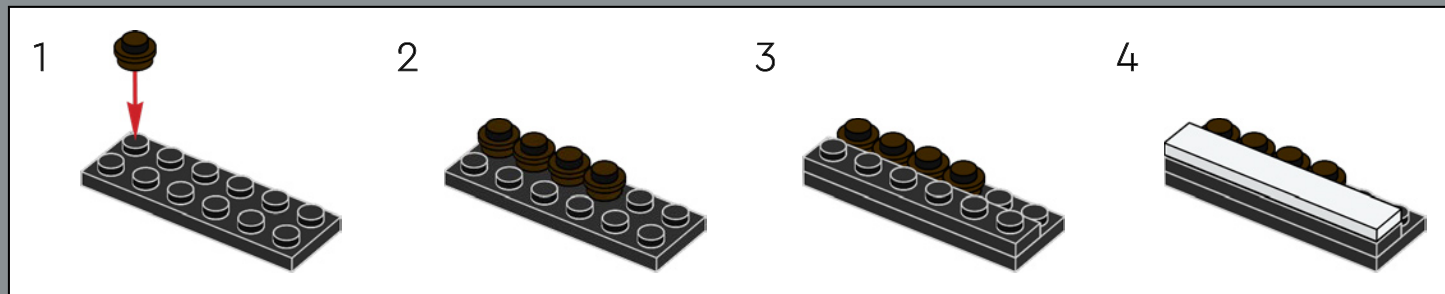



4x

270

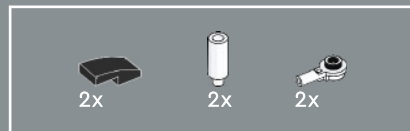
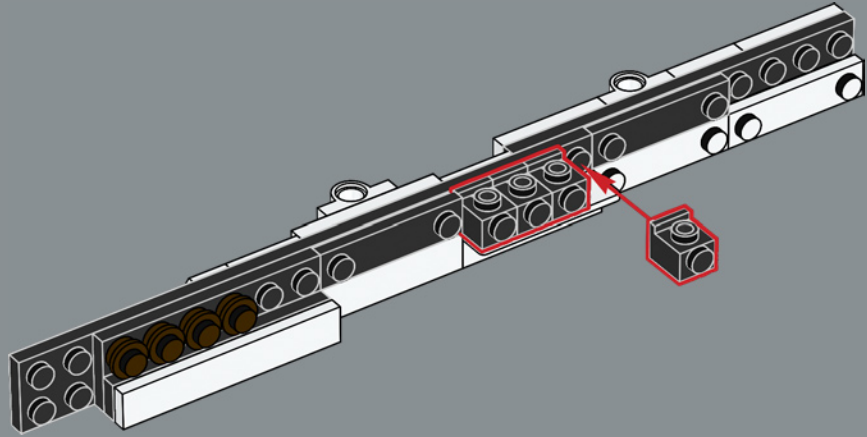

271

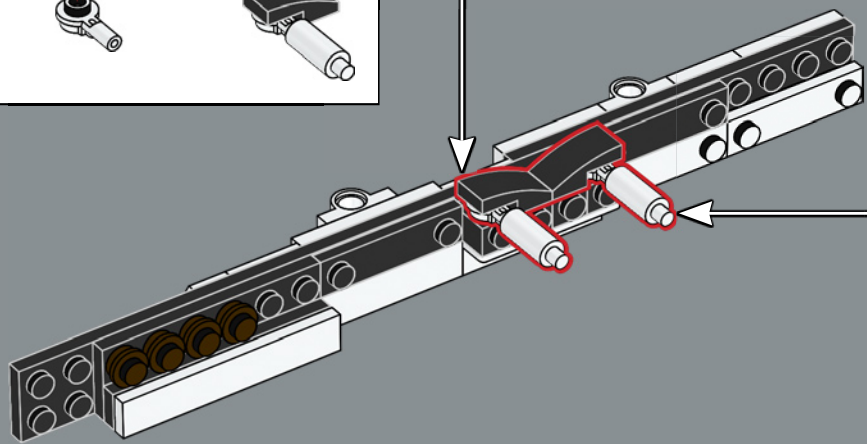
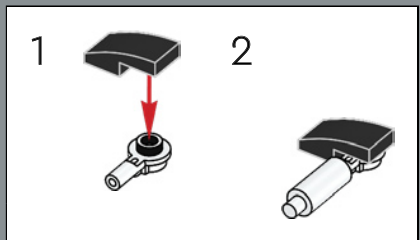
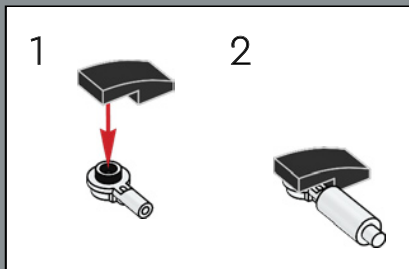

272

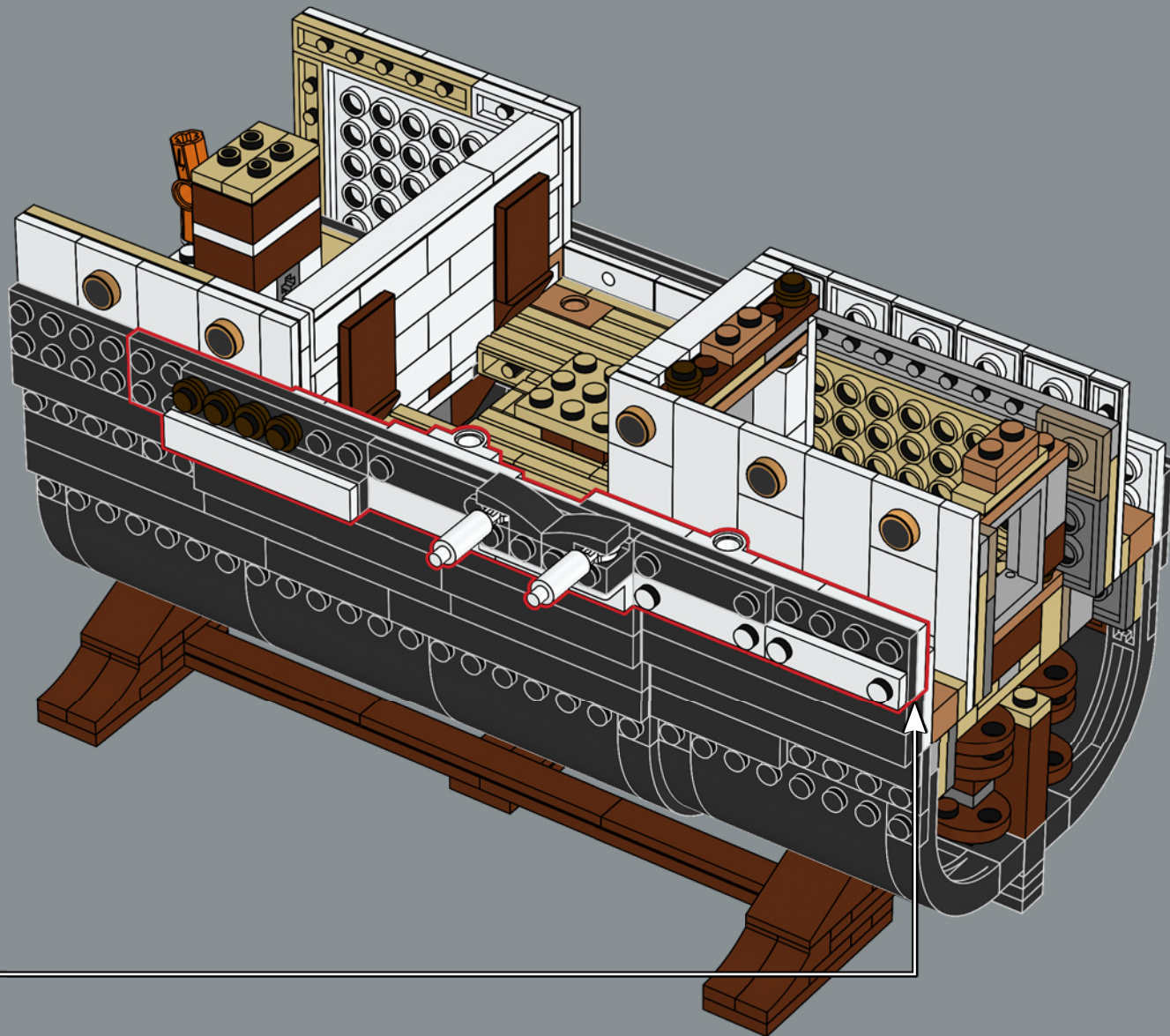



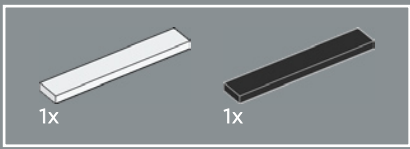

273

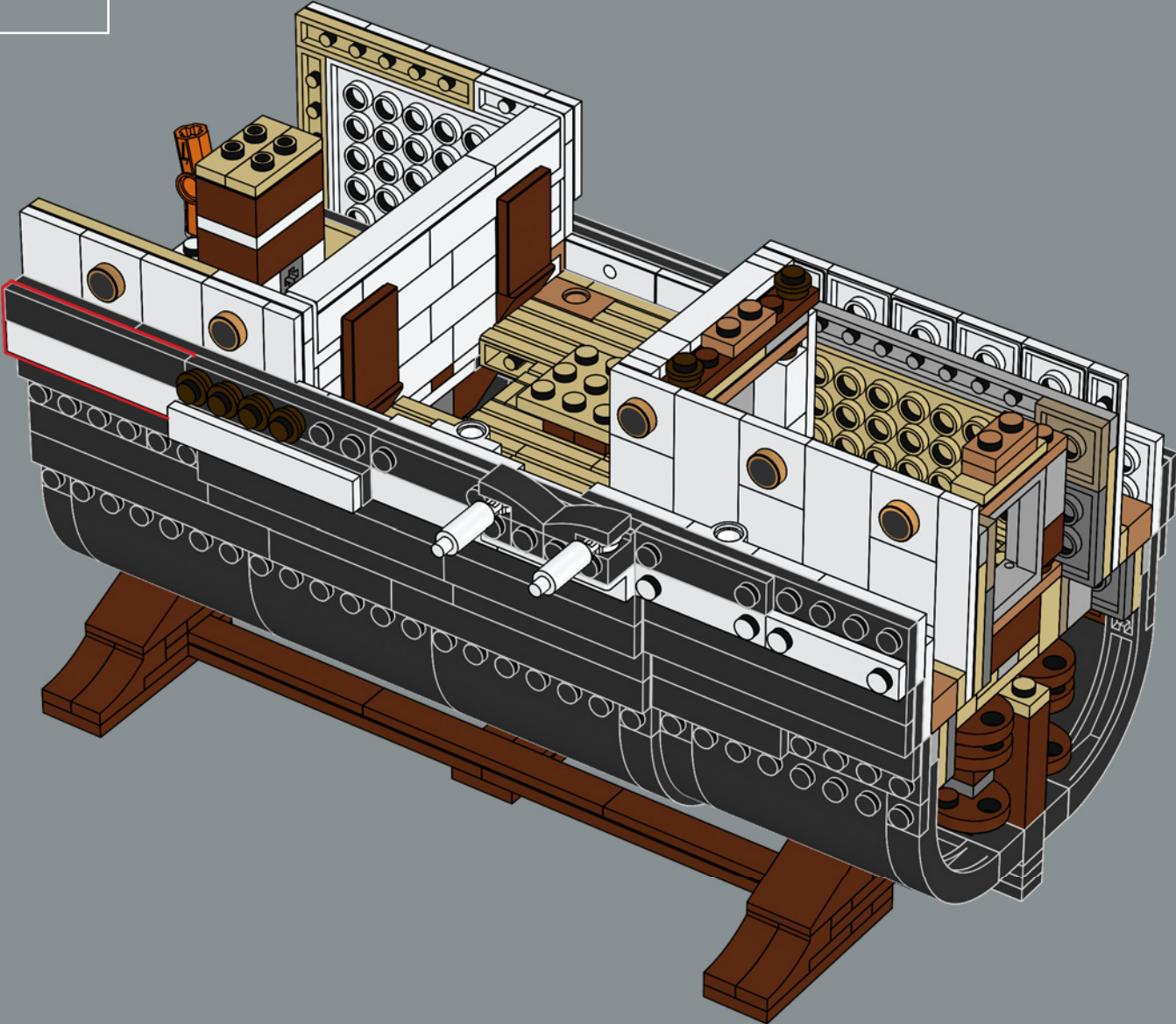

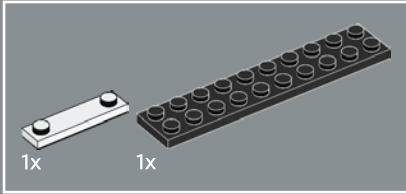
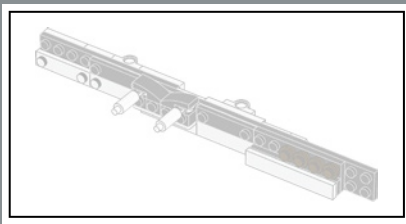

274

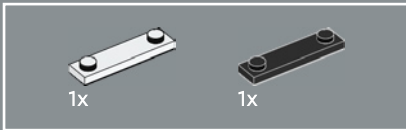
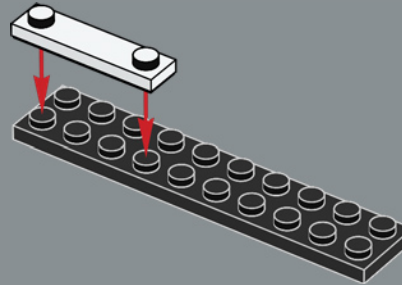

275

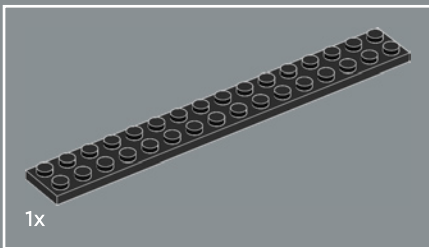
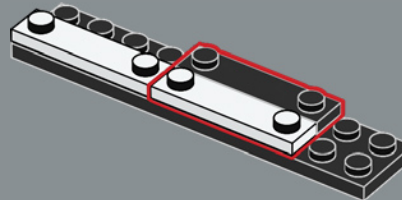

276

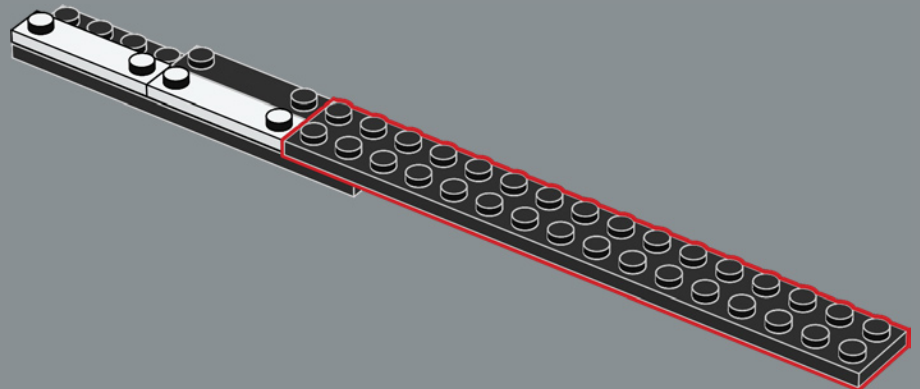

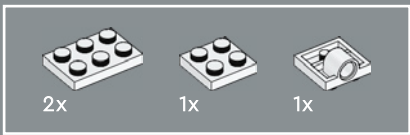

277

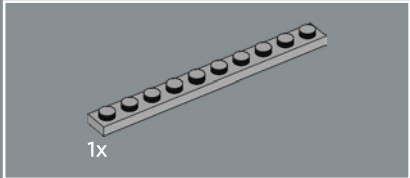
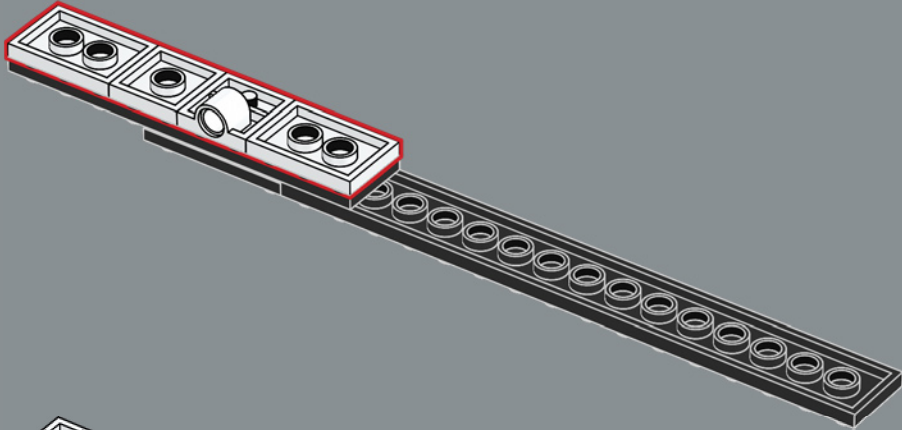

278

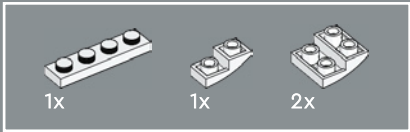
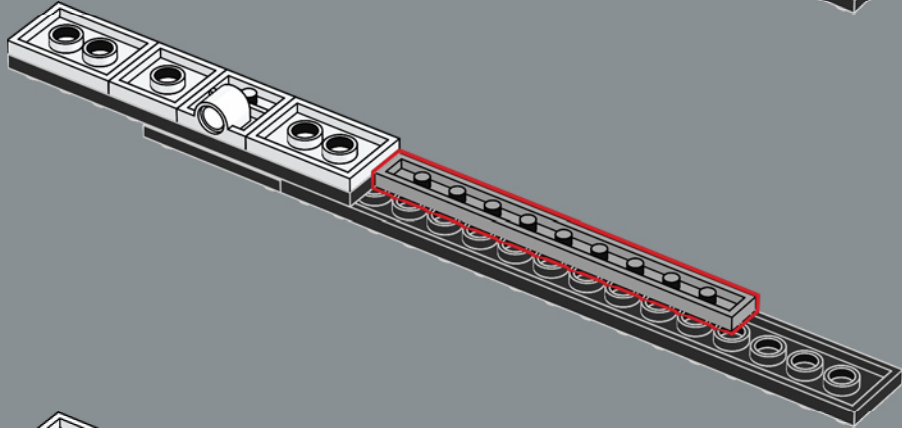

279

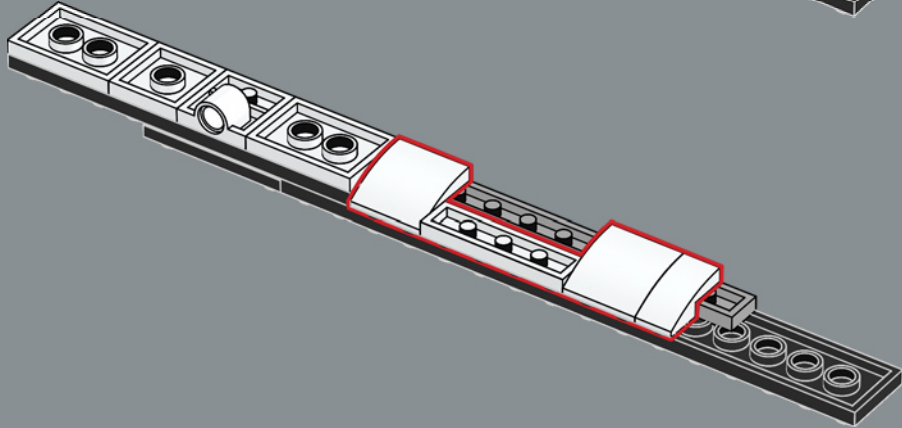

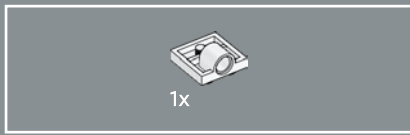

280



281

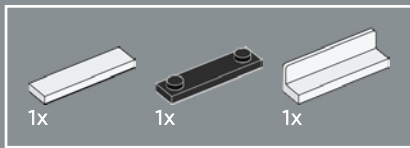

282

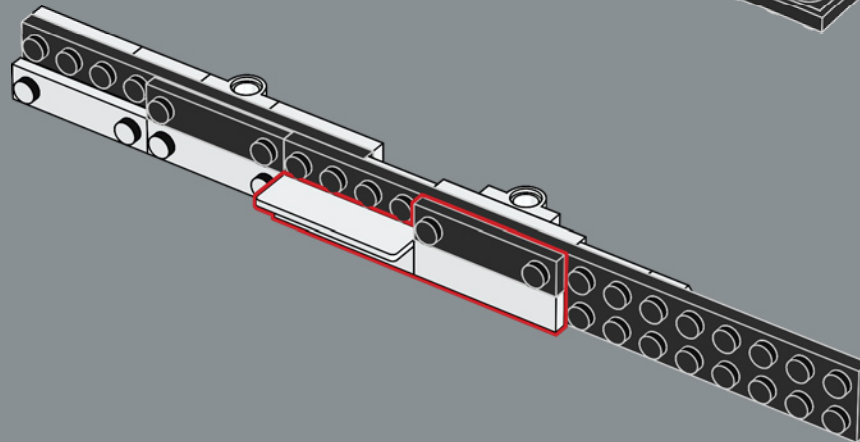
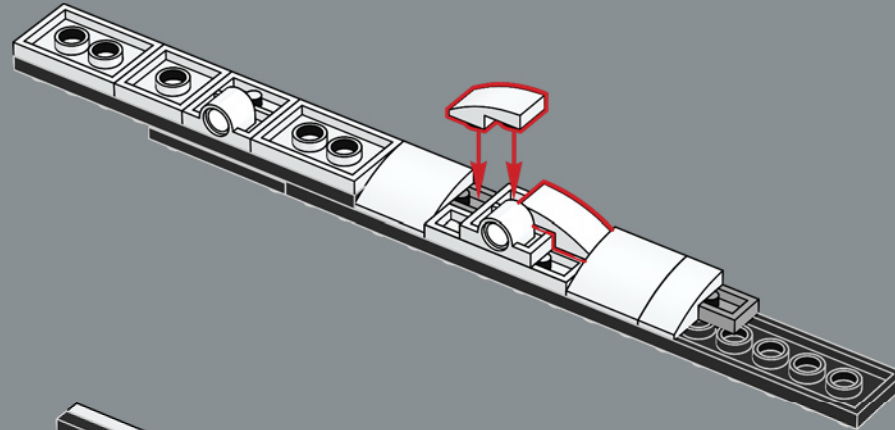
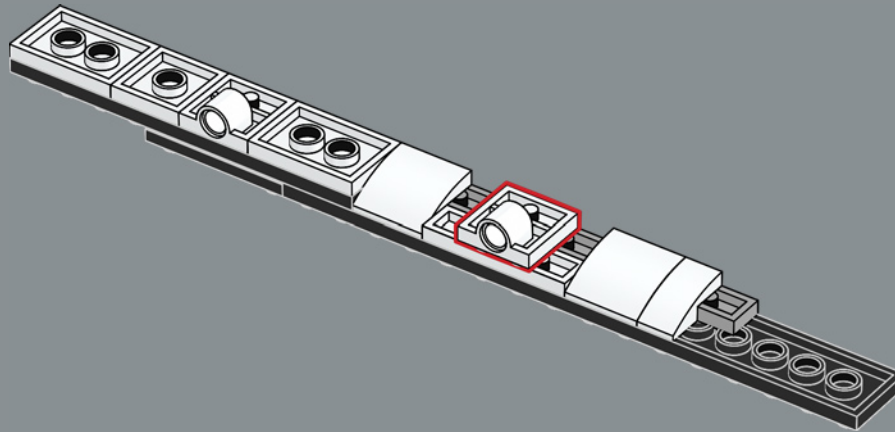



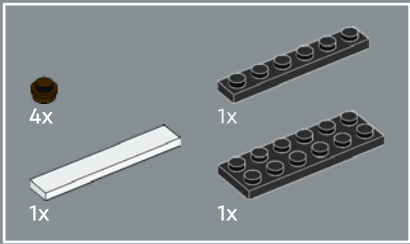

283

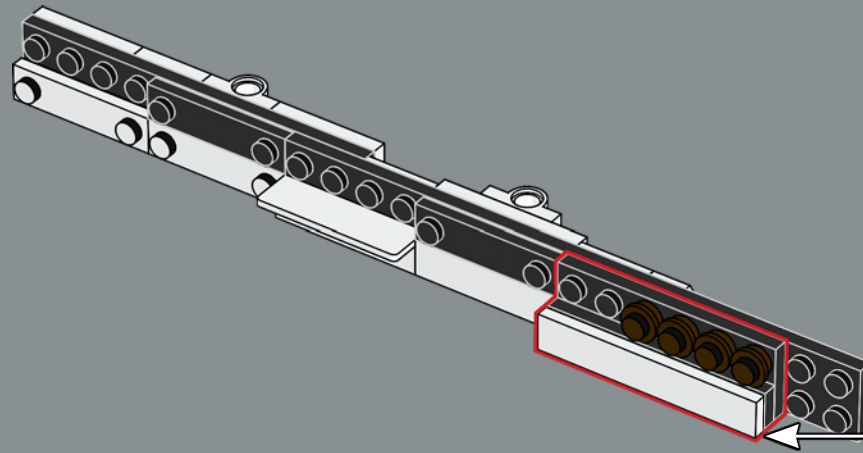
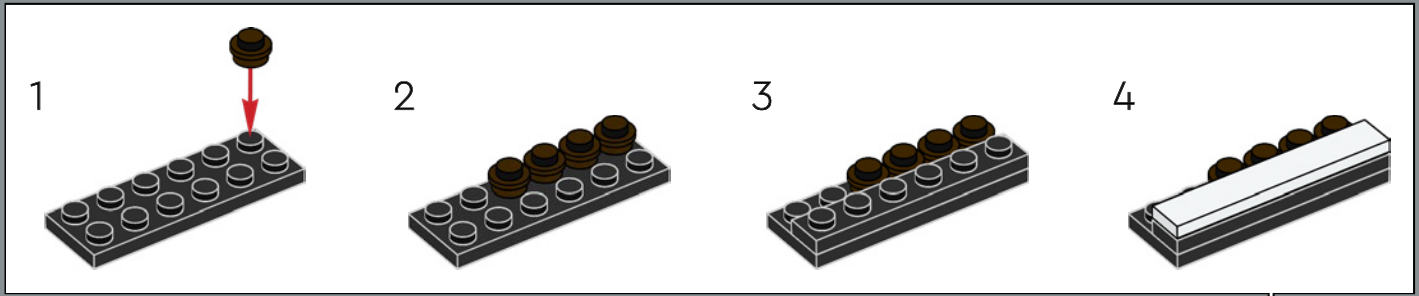



284

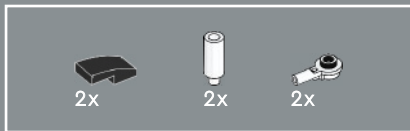
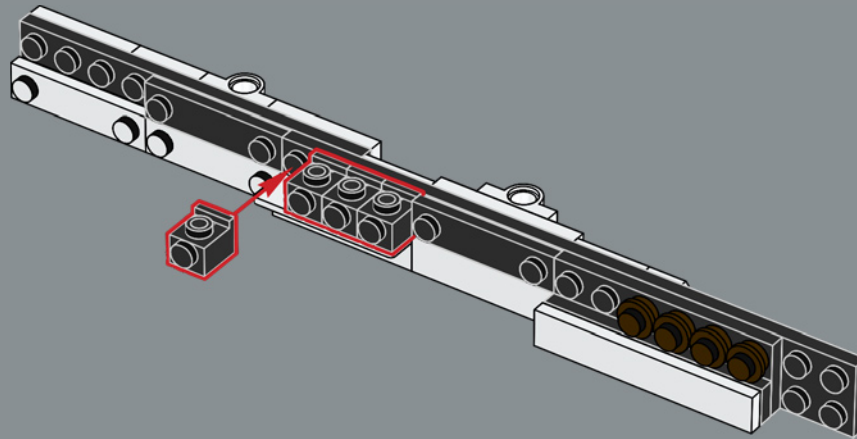

285

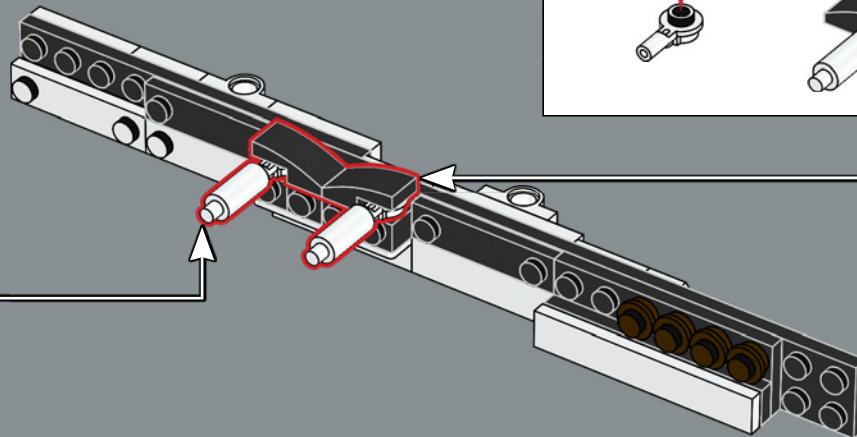
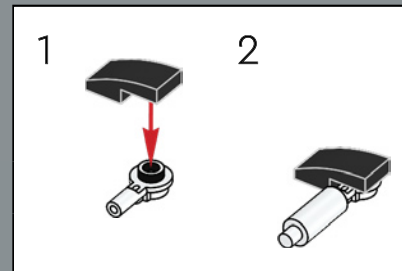
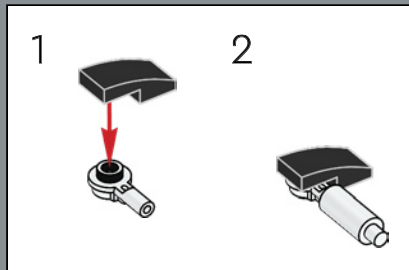

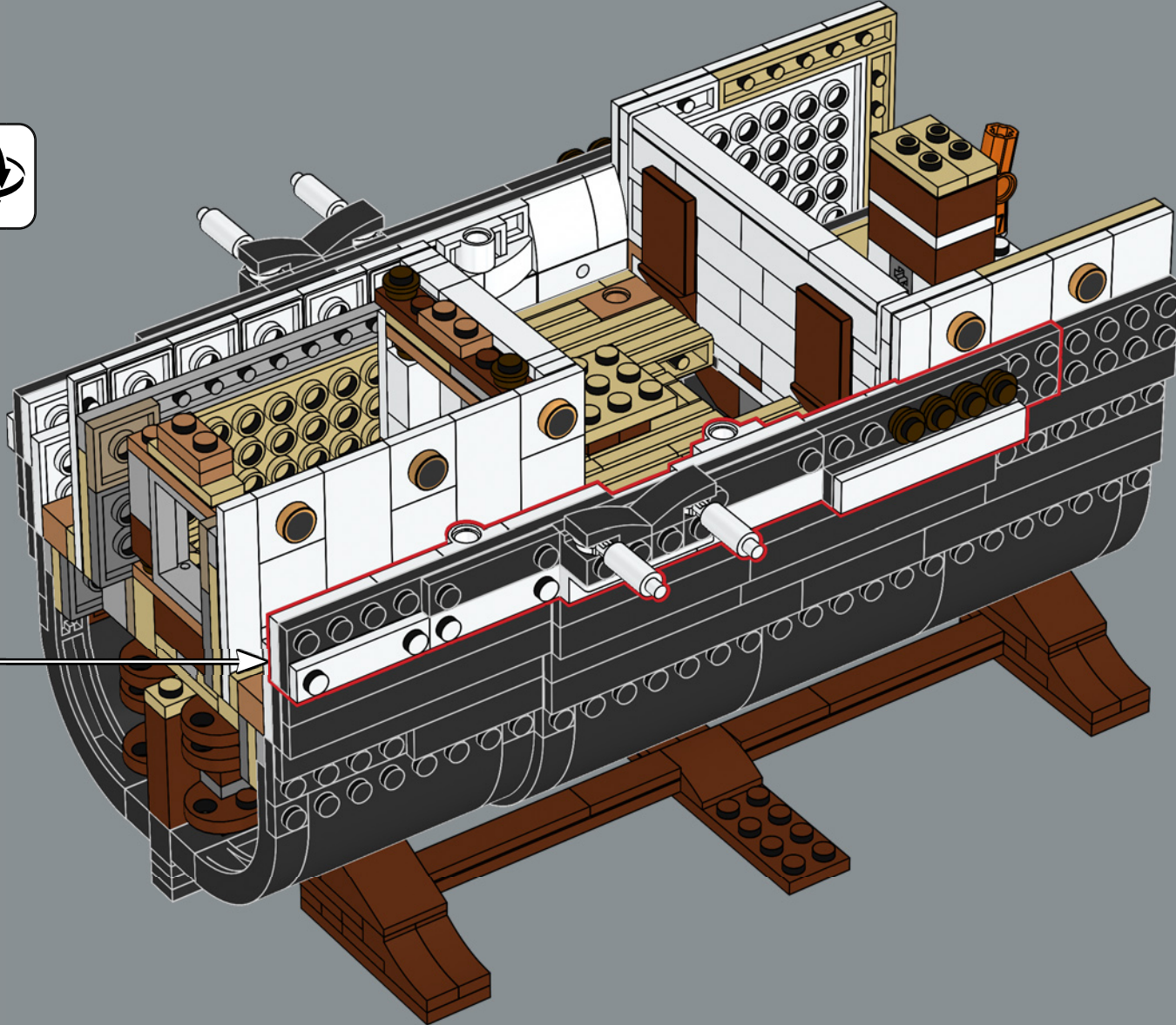

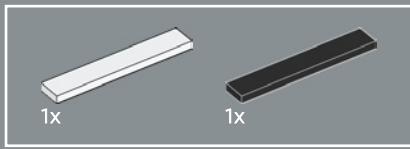

287

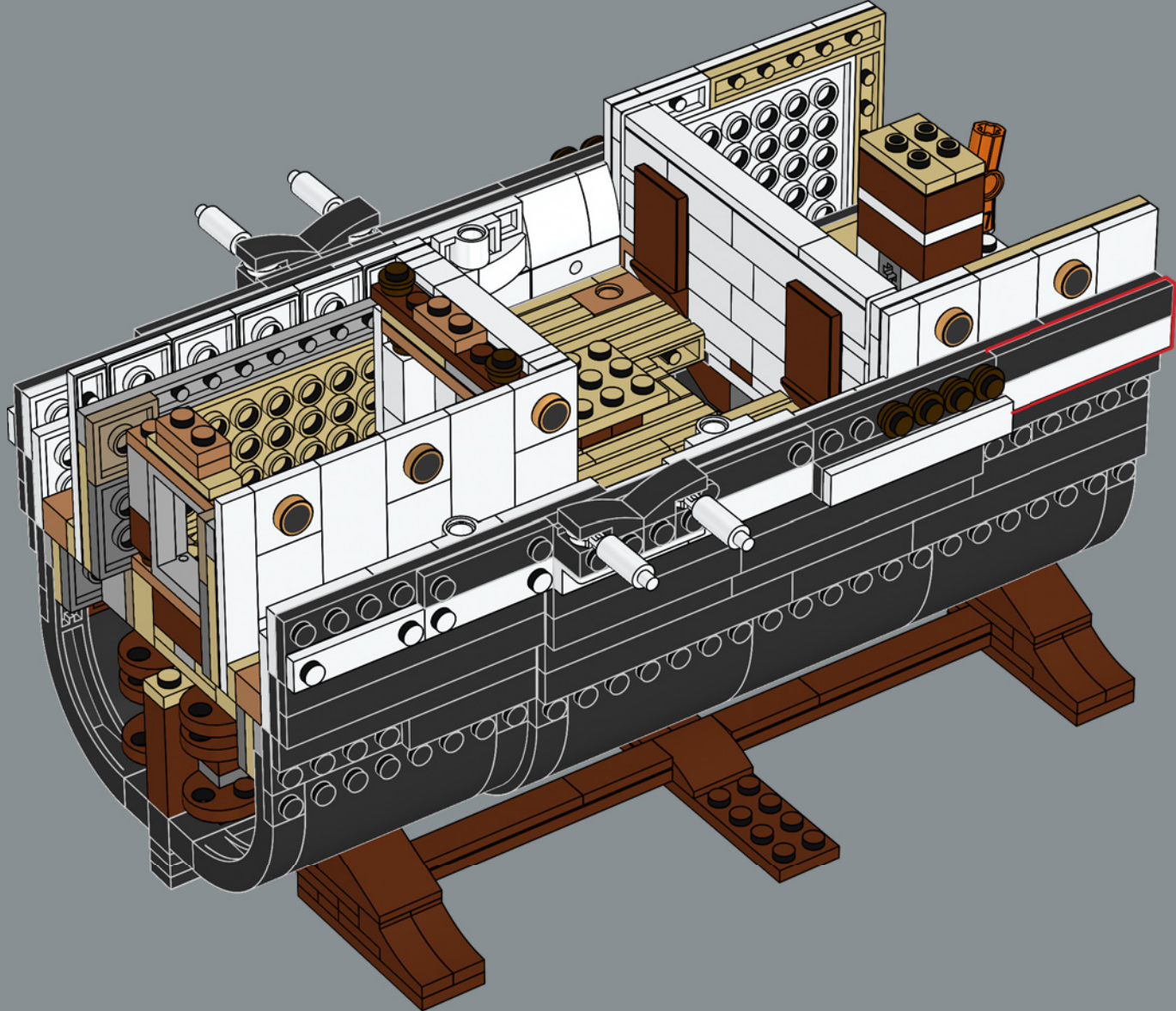



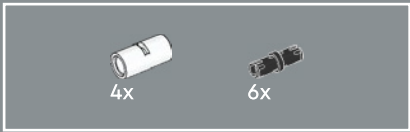

288

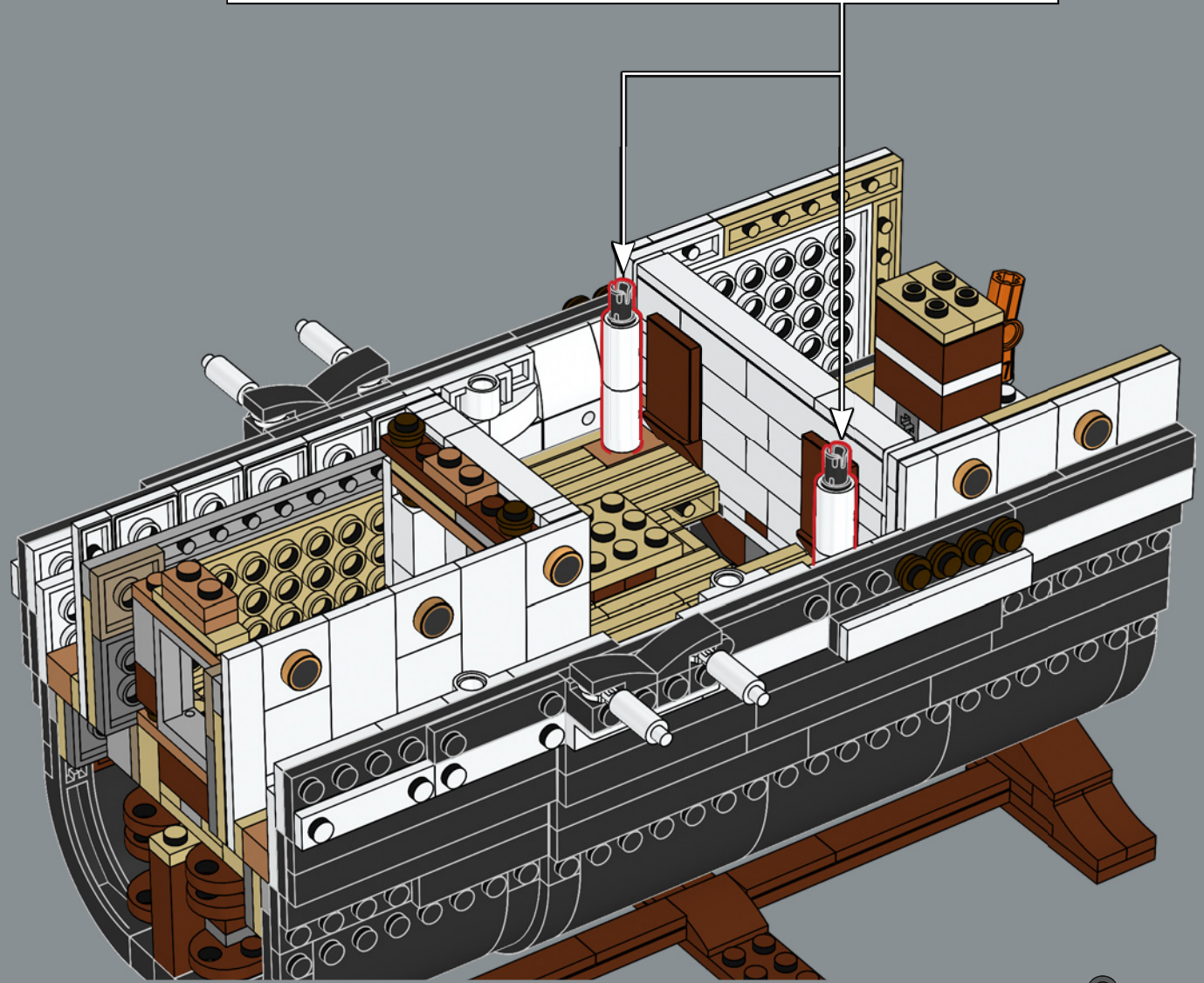
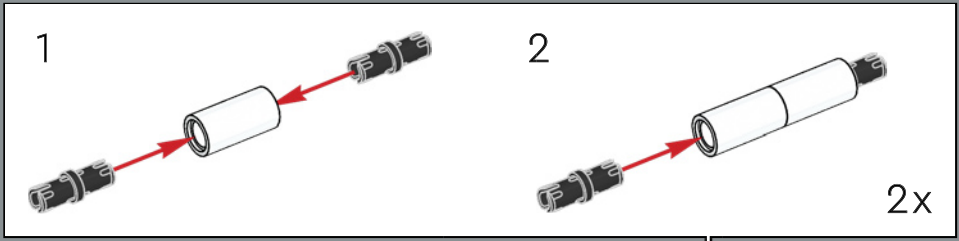

289

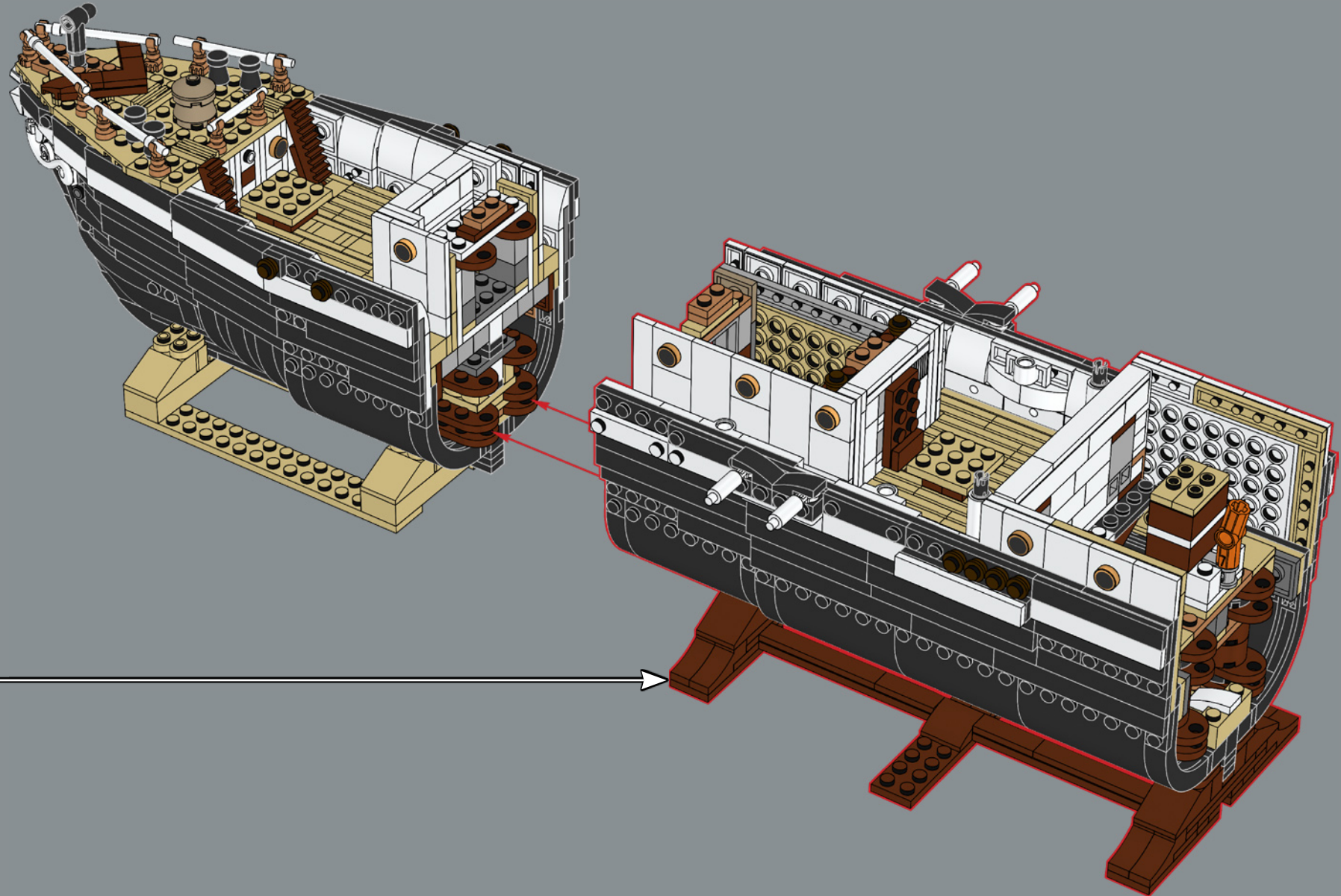





Handwerksmeister machten die *Endurance* zu einem der robustesten Holzschiffe, das jemals gebaut wurde, und verstärkten den Rumpf auf jede nur erdenkliche Weise. Am LEGO® Modell werden die drei Rumpfssegmente mithilfe von LEGO Technic Achsen sicher miteinander verbunden.

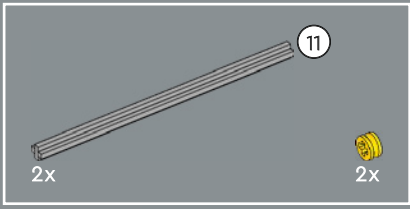

290

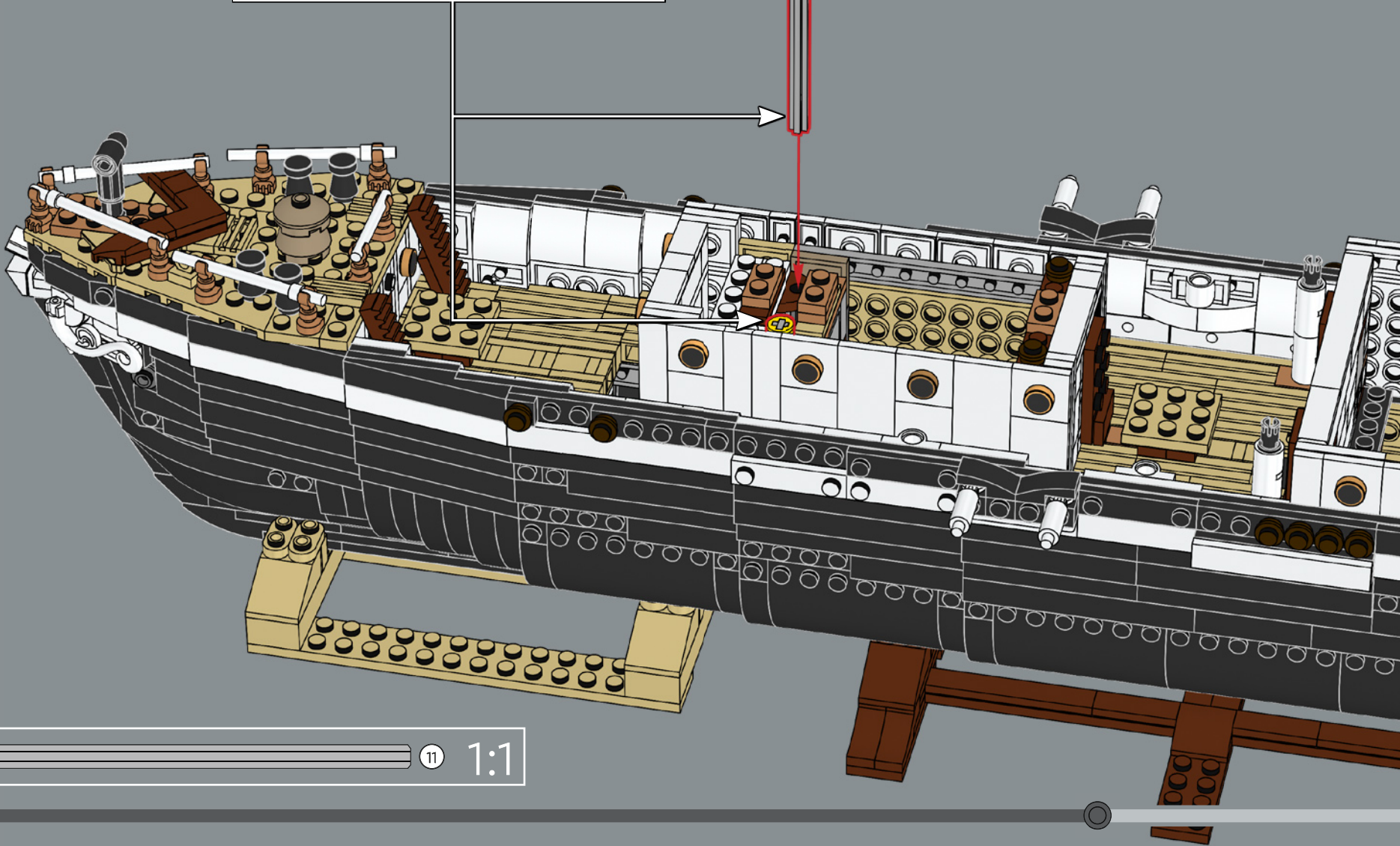
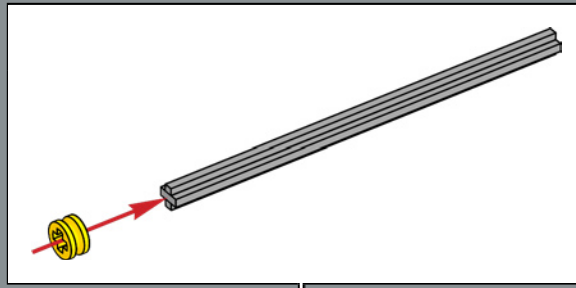

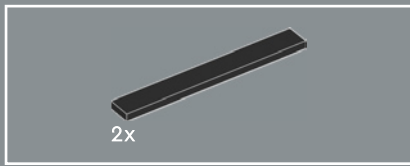

291

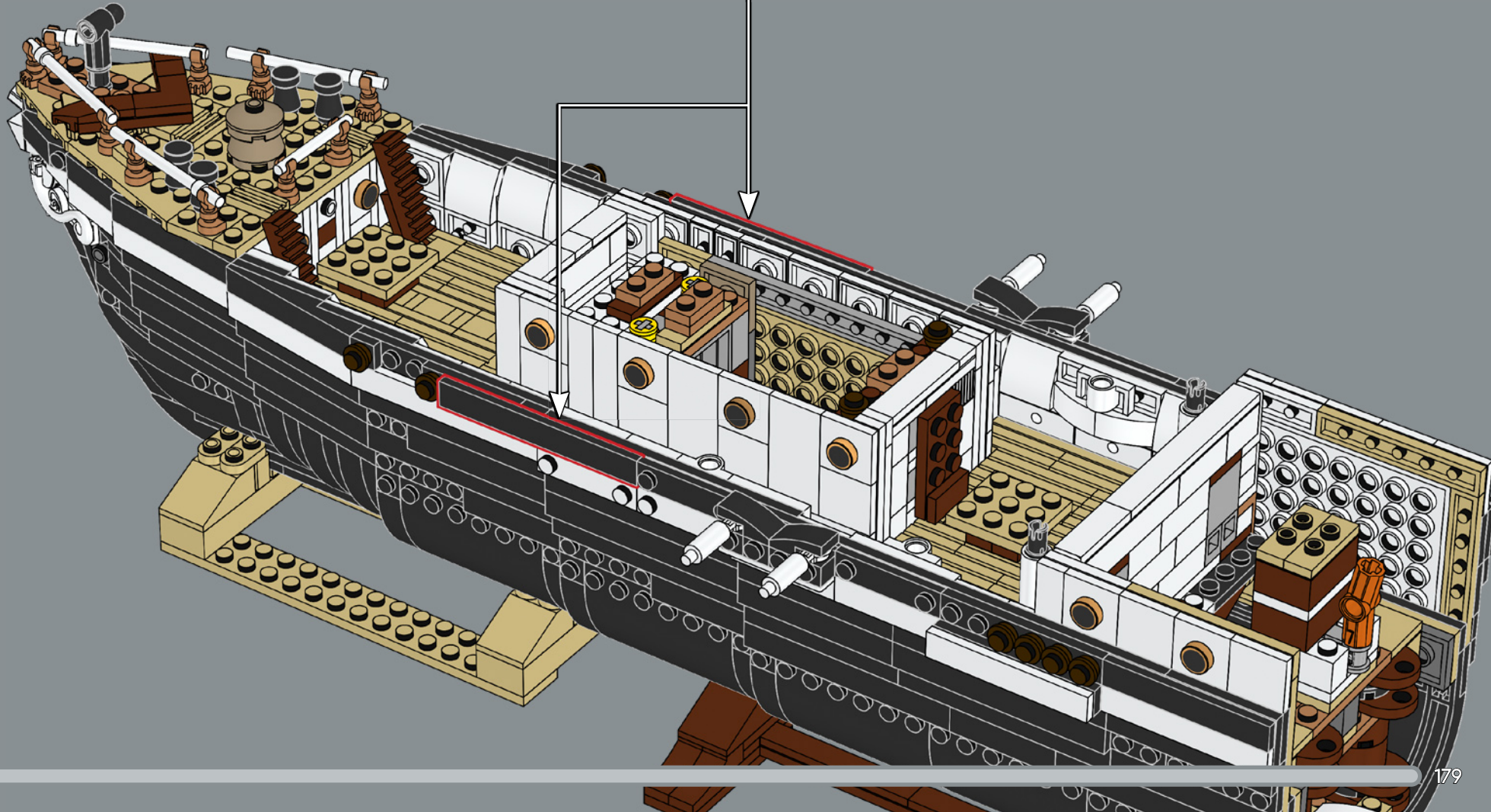
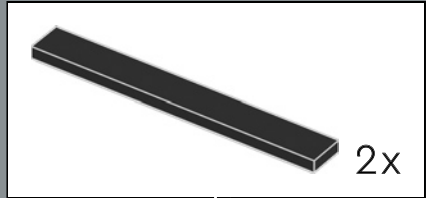



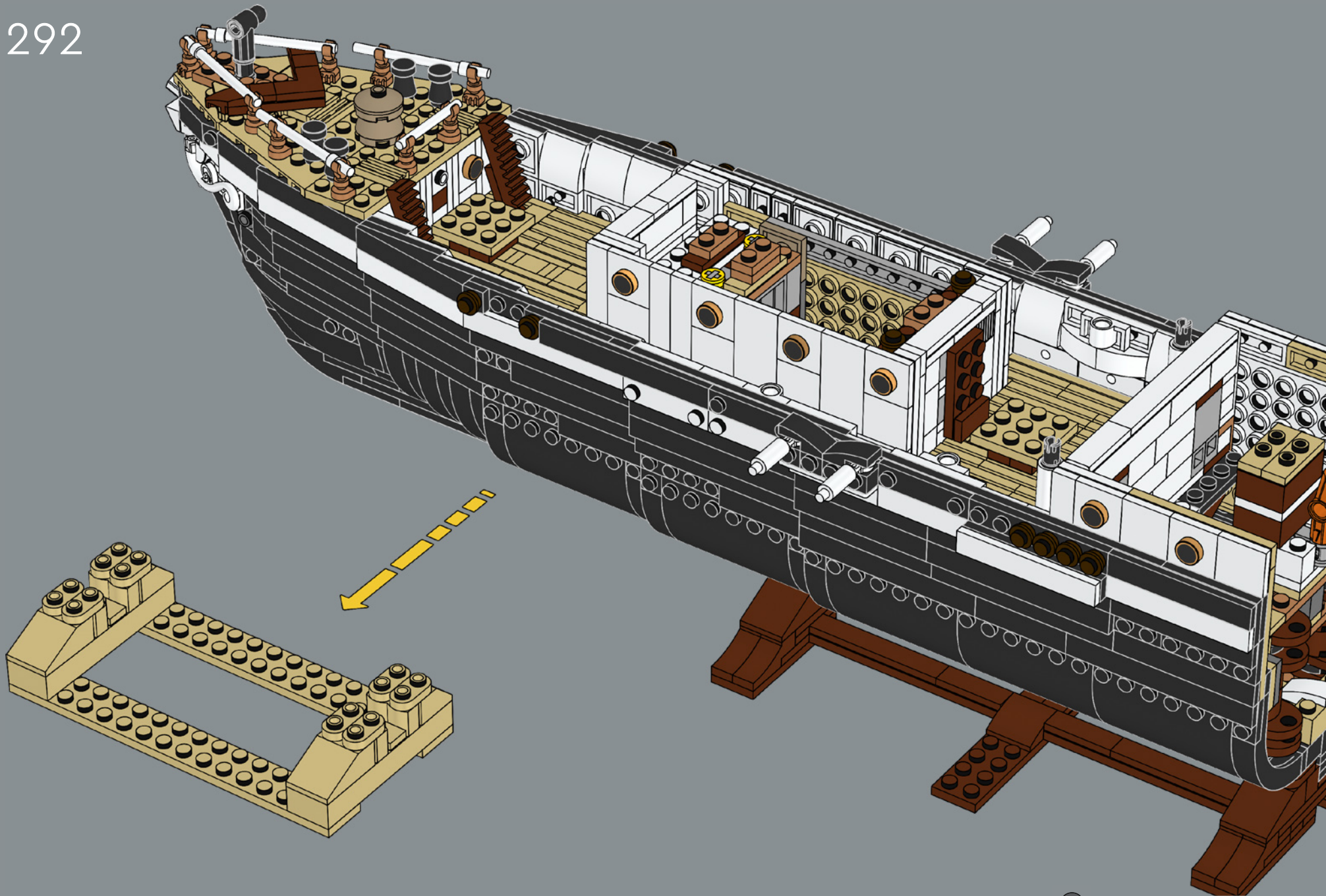



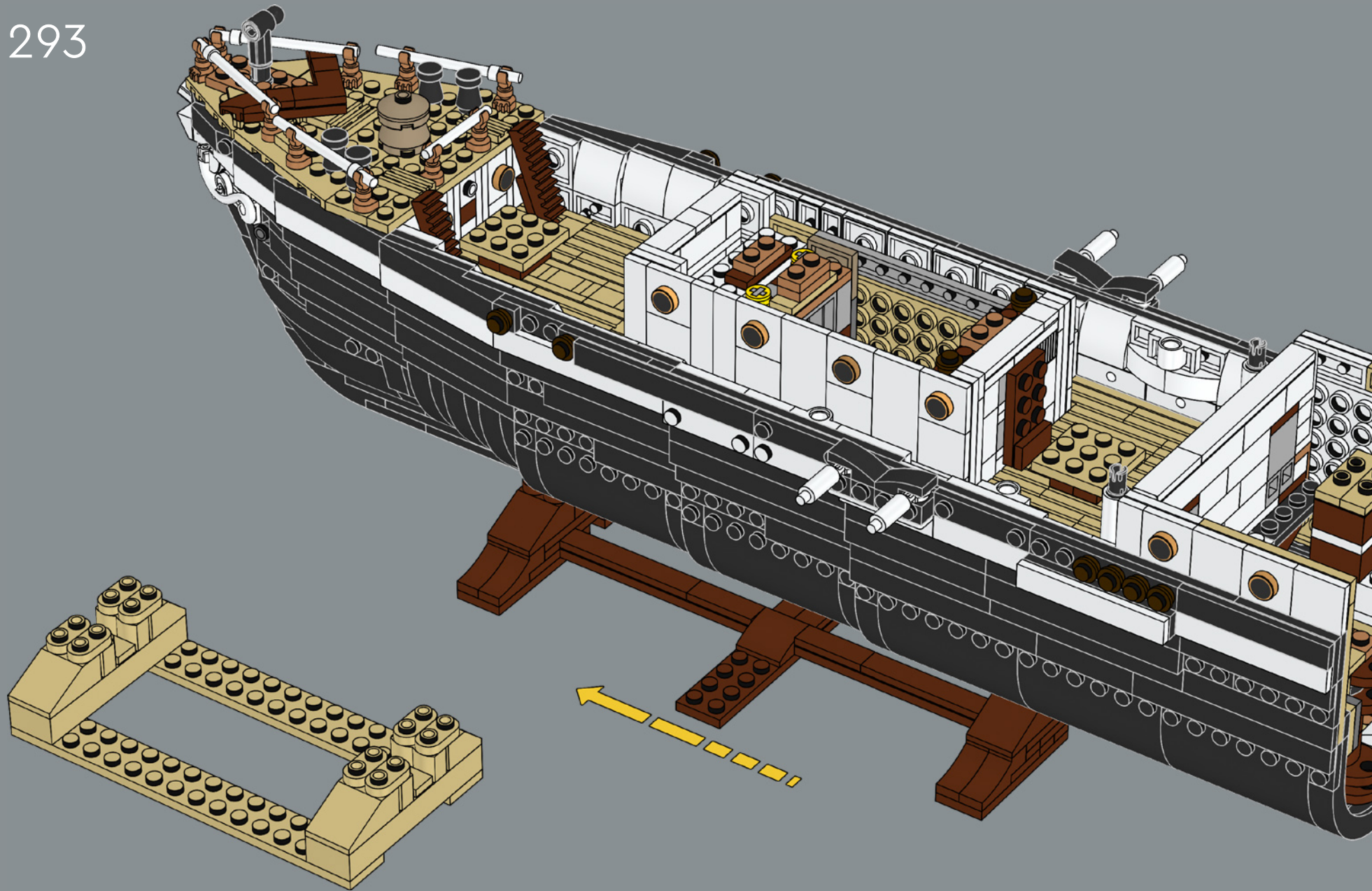

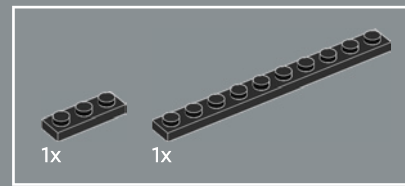
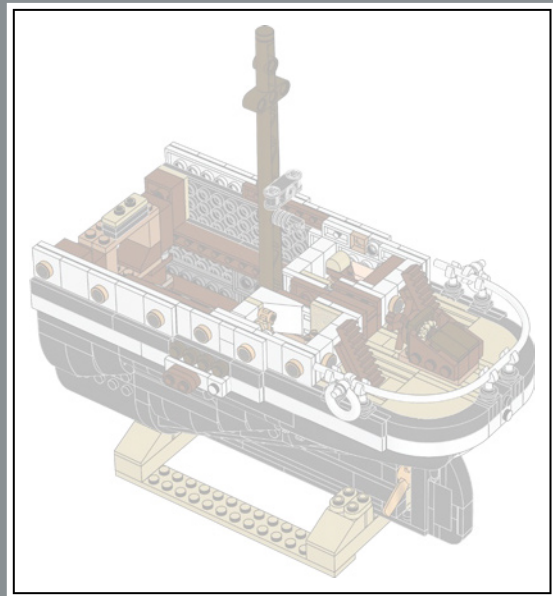
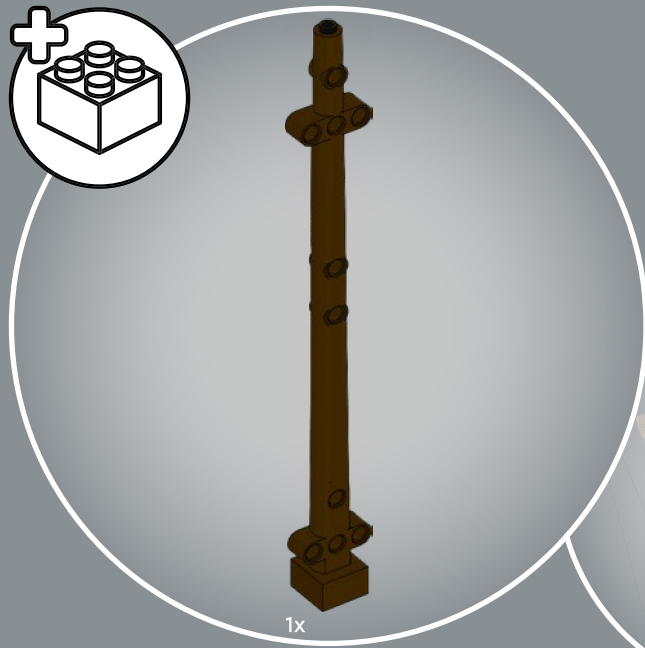
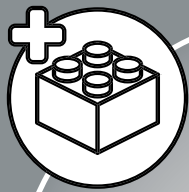

294

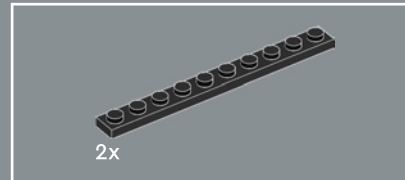
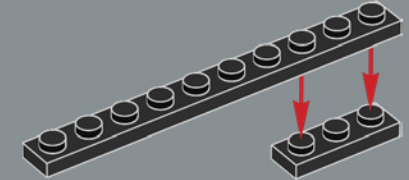

295

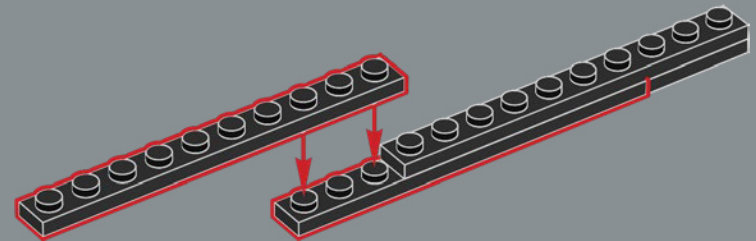

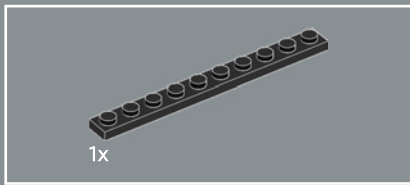

296

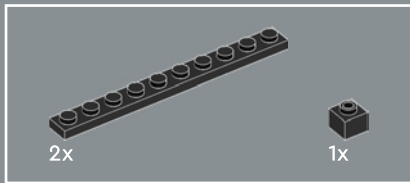
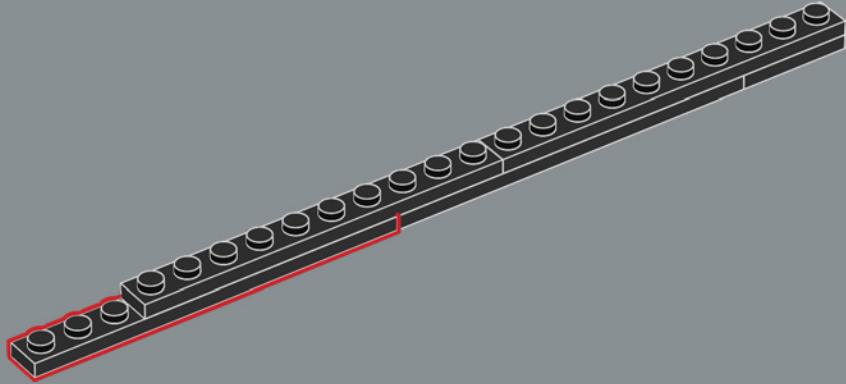

297

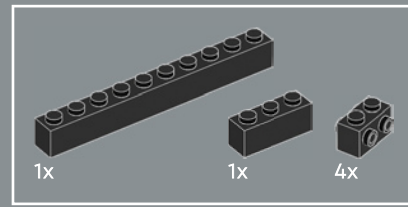
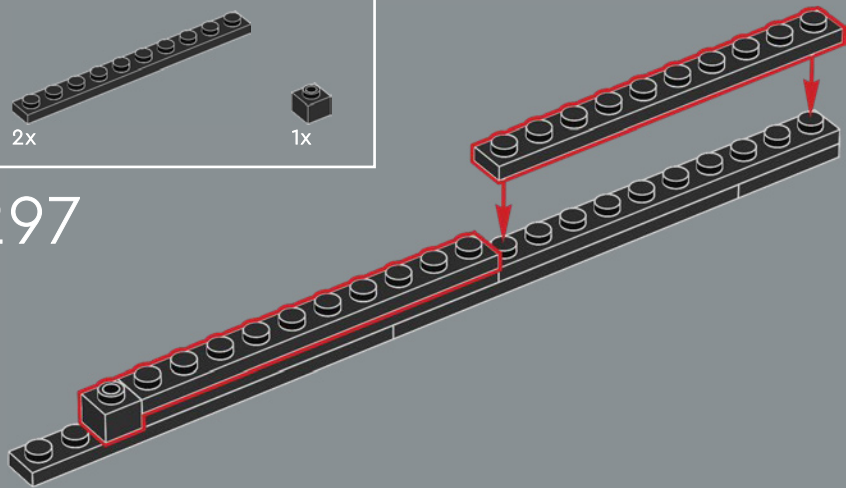

298

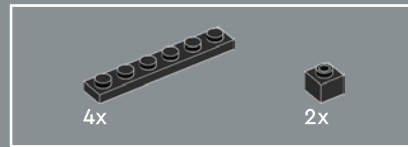
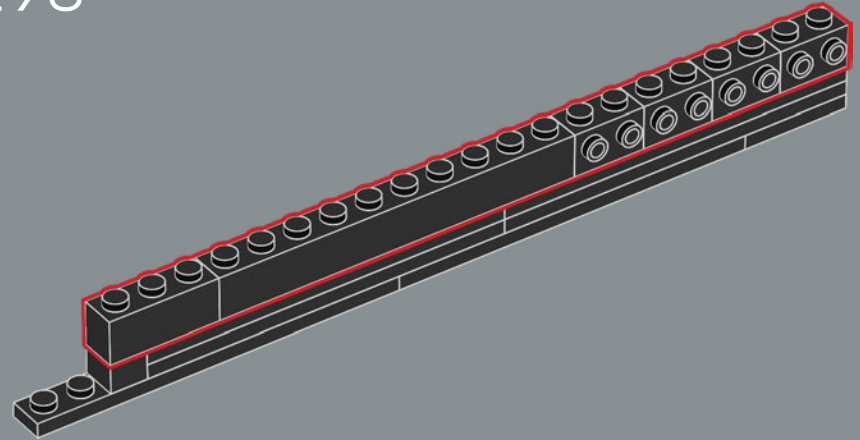

299

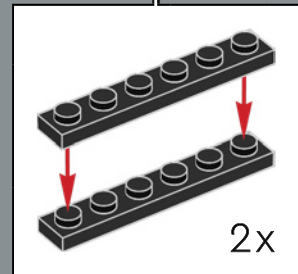
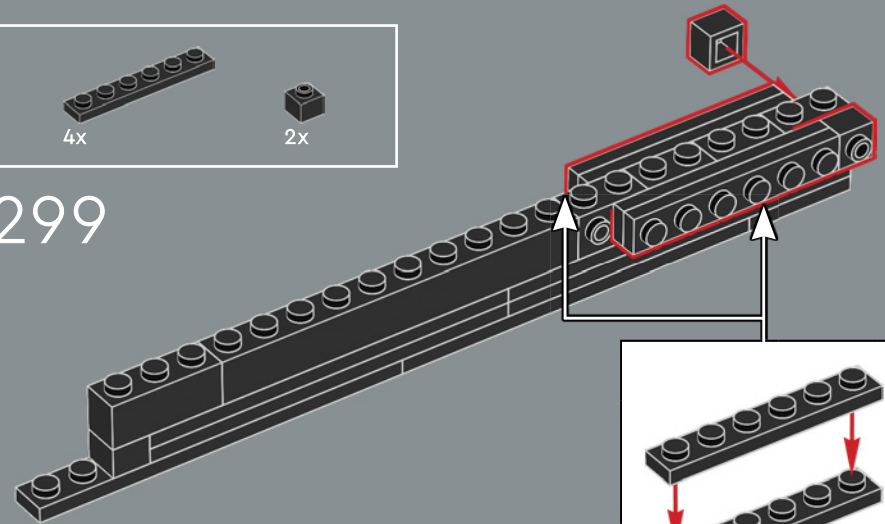



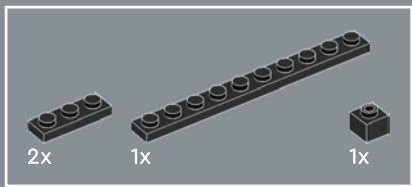

300

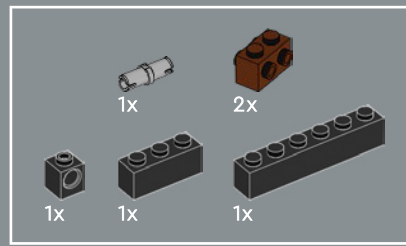
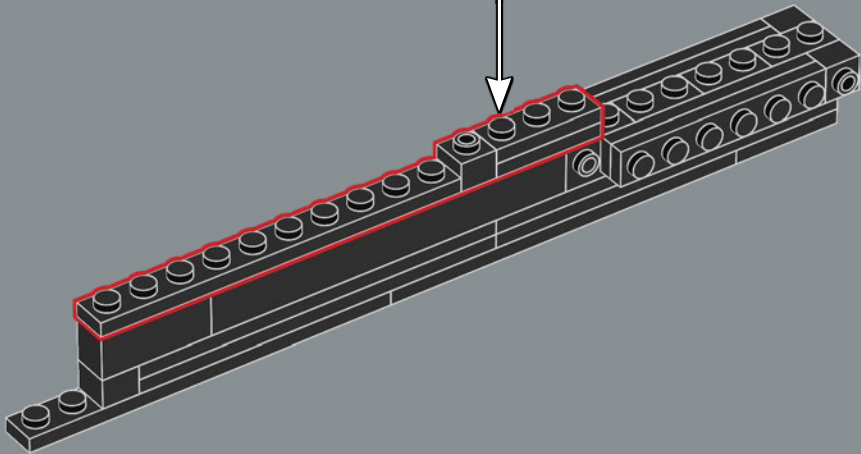
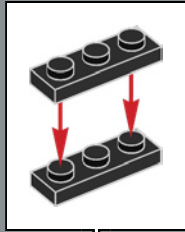

301

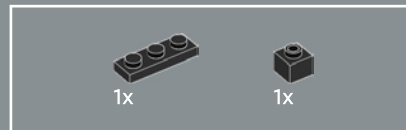
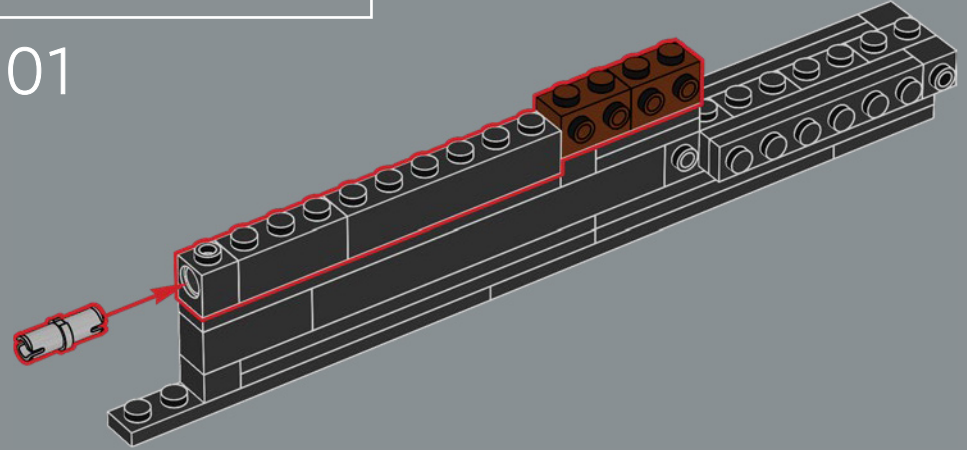

302

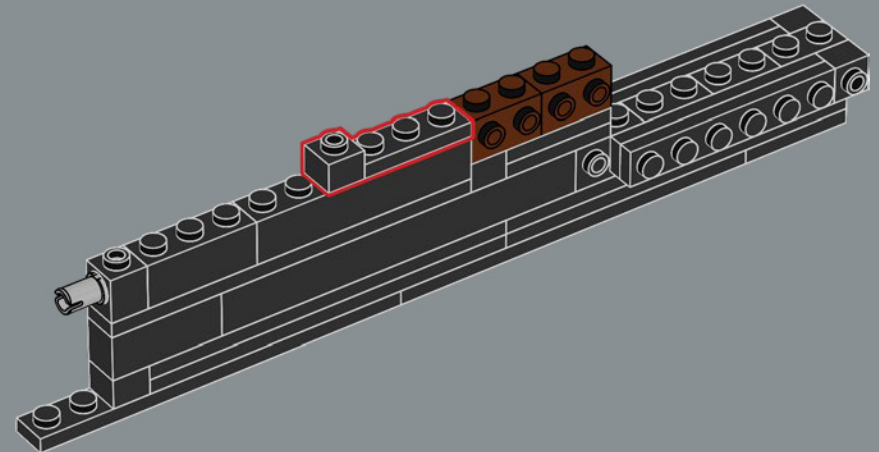

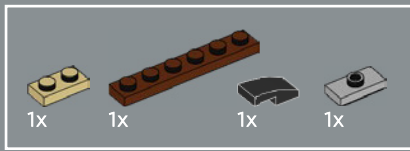

303

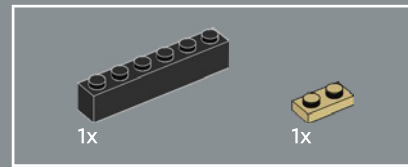
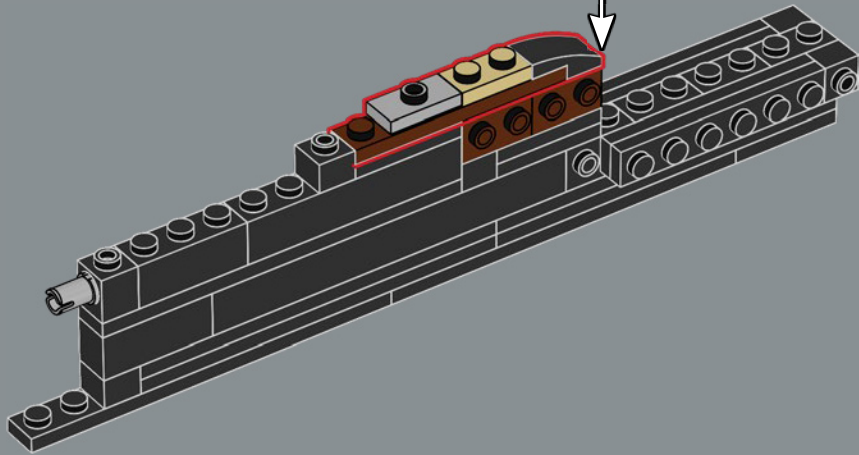
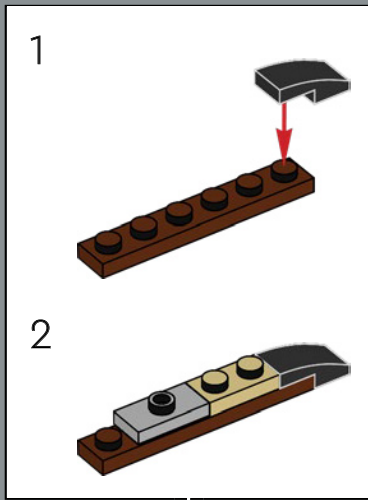

304

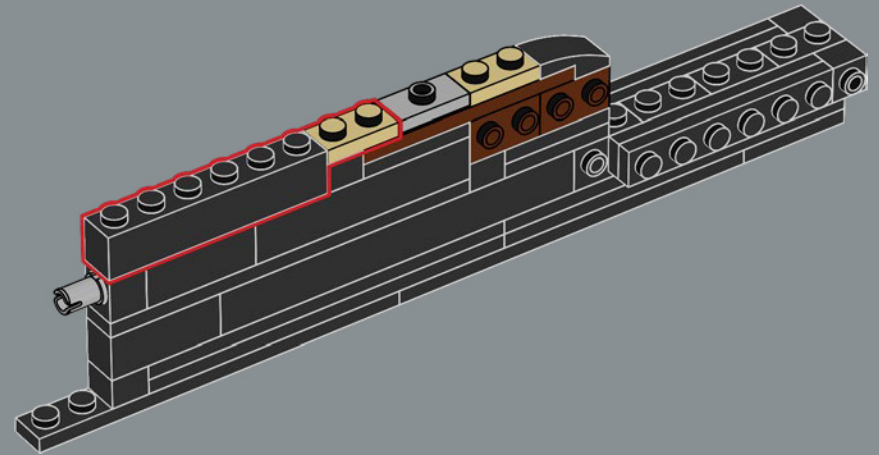



305

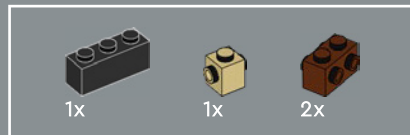
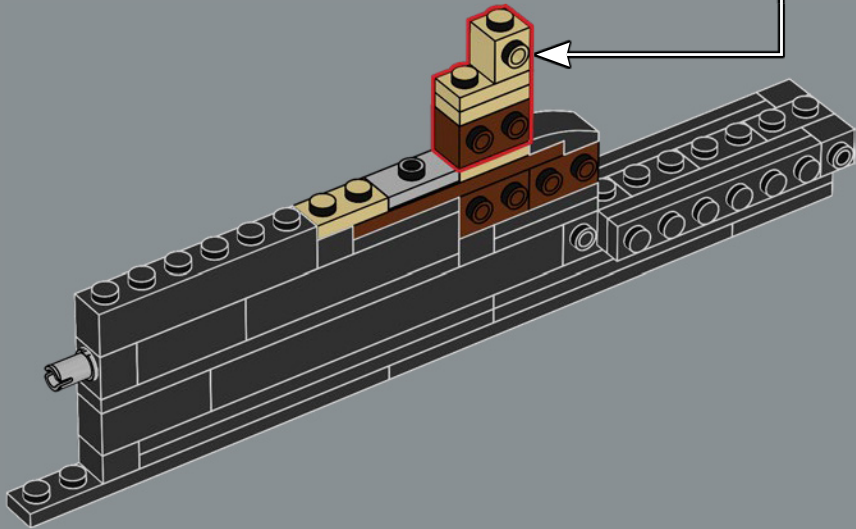
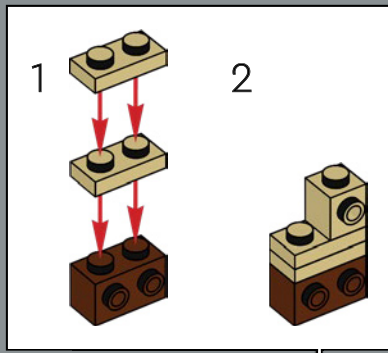

306

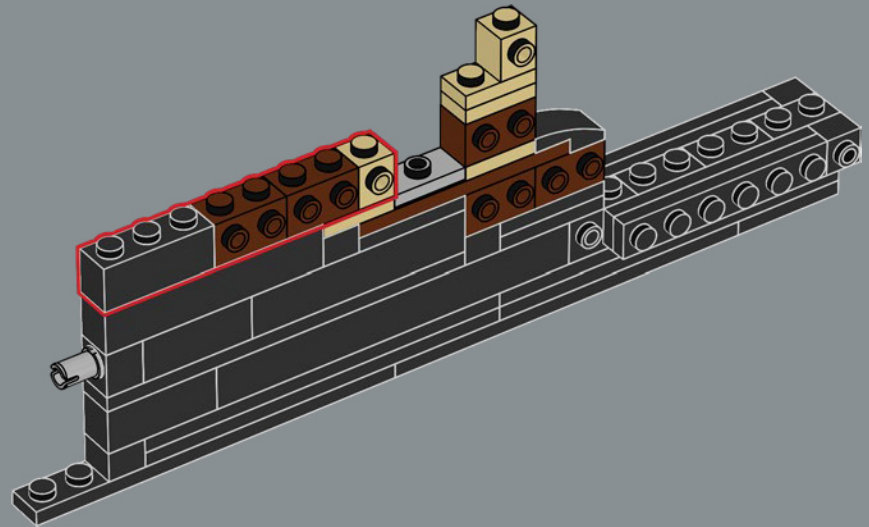

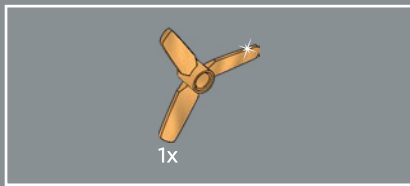

★  
Die echte *Endurance* hatte eine schwarze Schiffsschraube, doch das LEGO® Element wurde golden gestaltet, um den Propeller besser vom schwarzen Rumpf abzuheben.

307

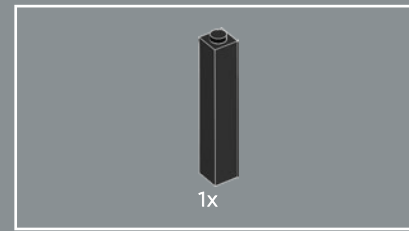
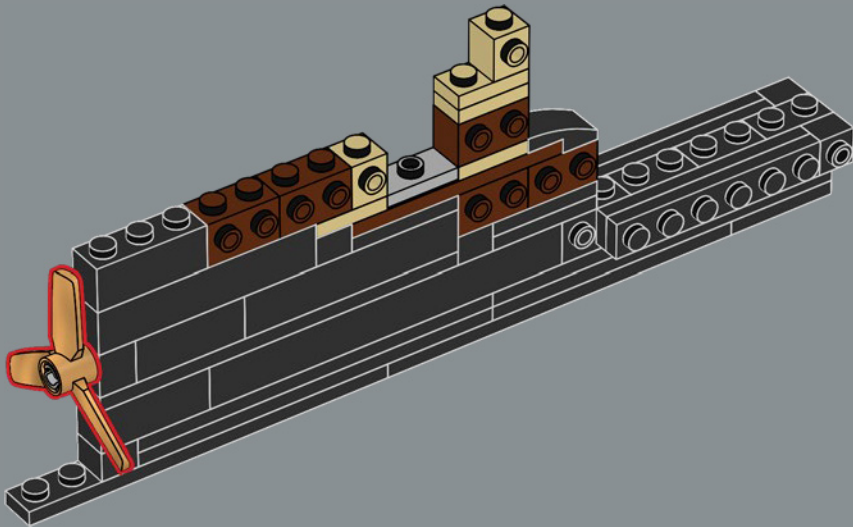

308

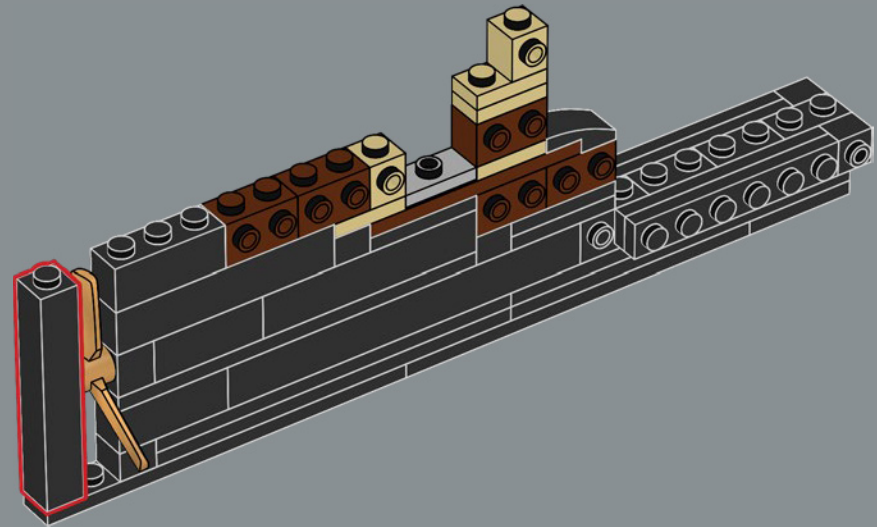



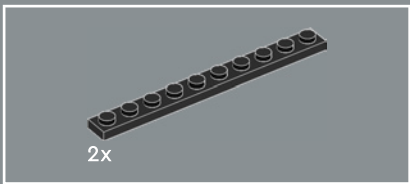

309

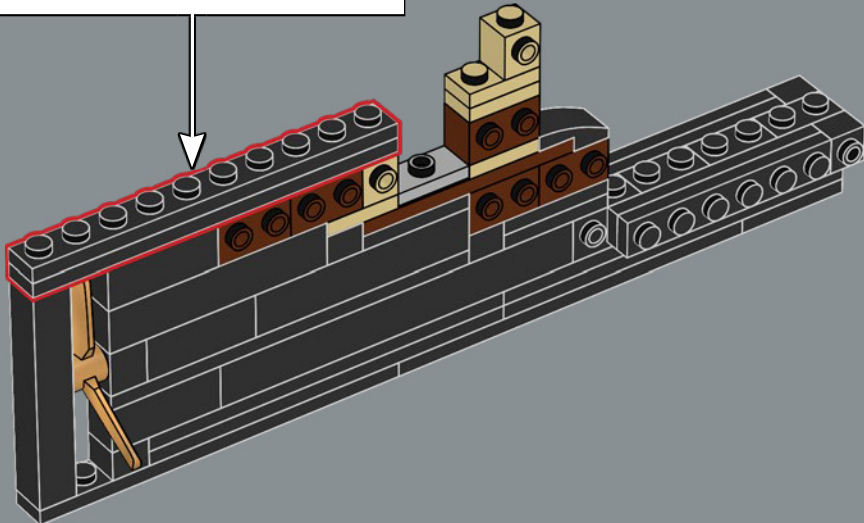
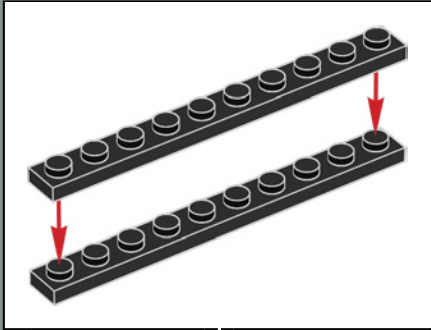

310

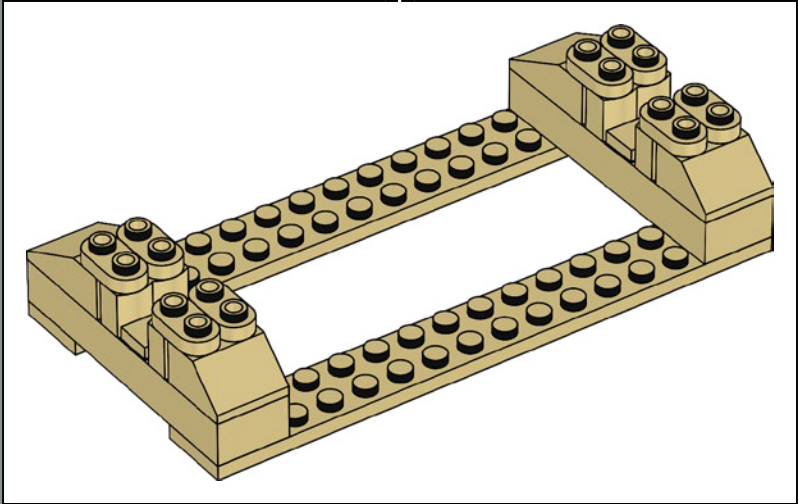
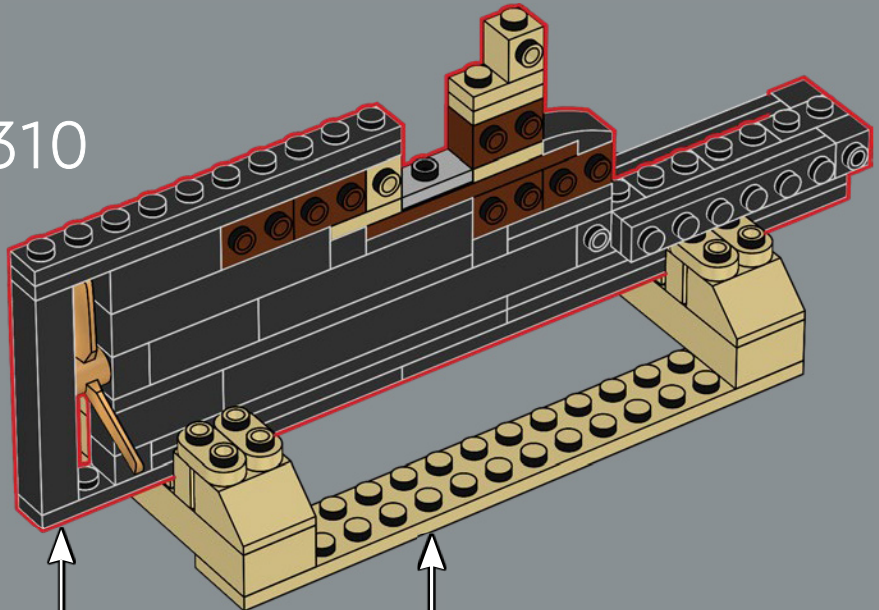

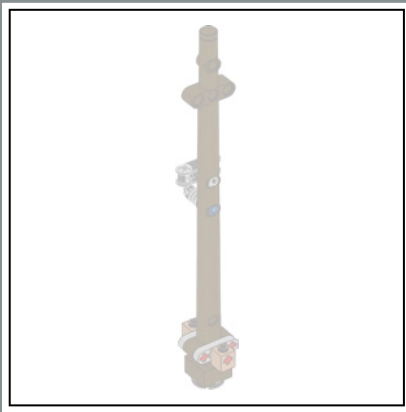

1



2

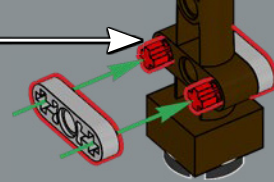
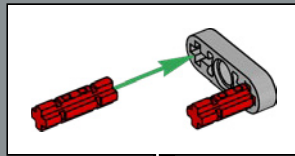

3

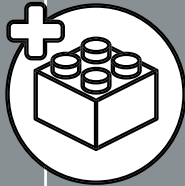
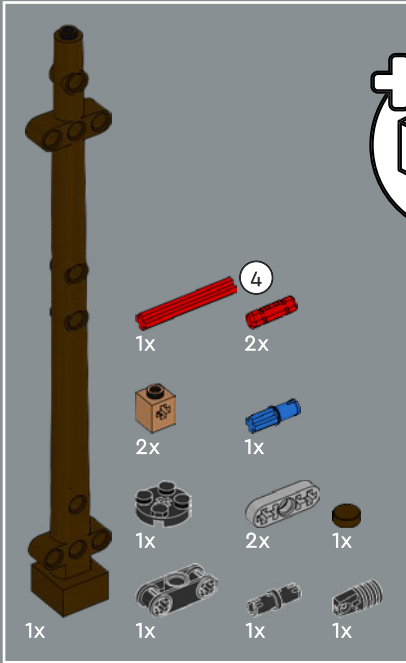
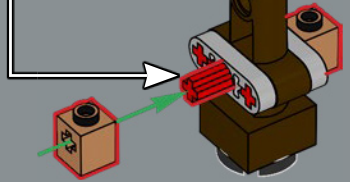
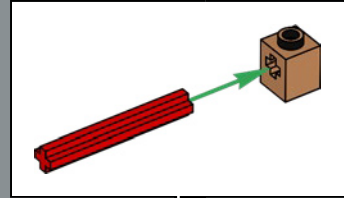

311

4

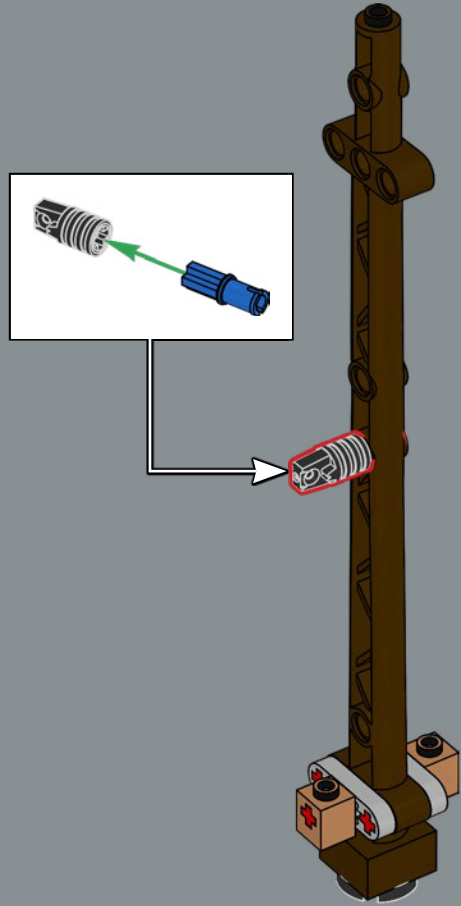

5

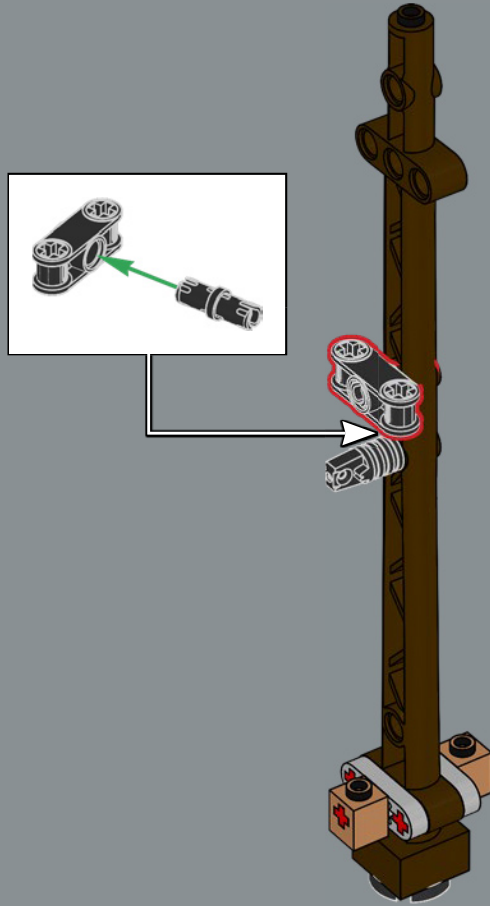

6

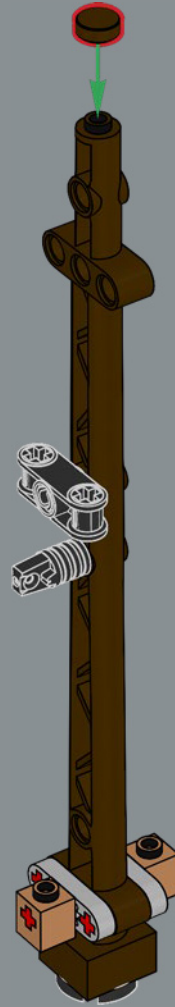

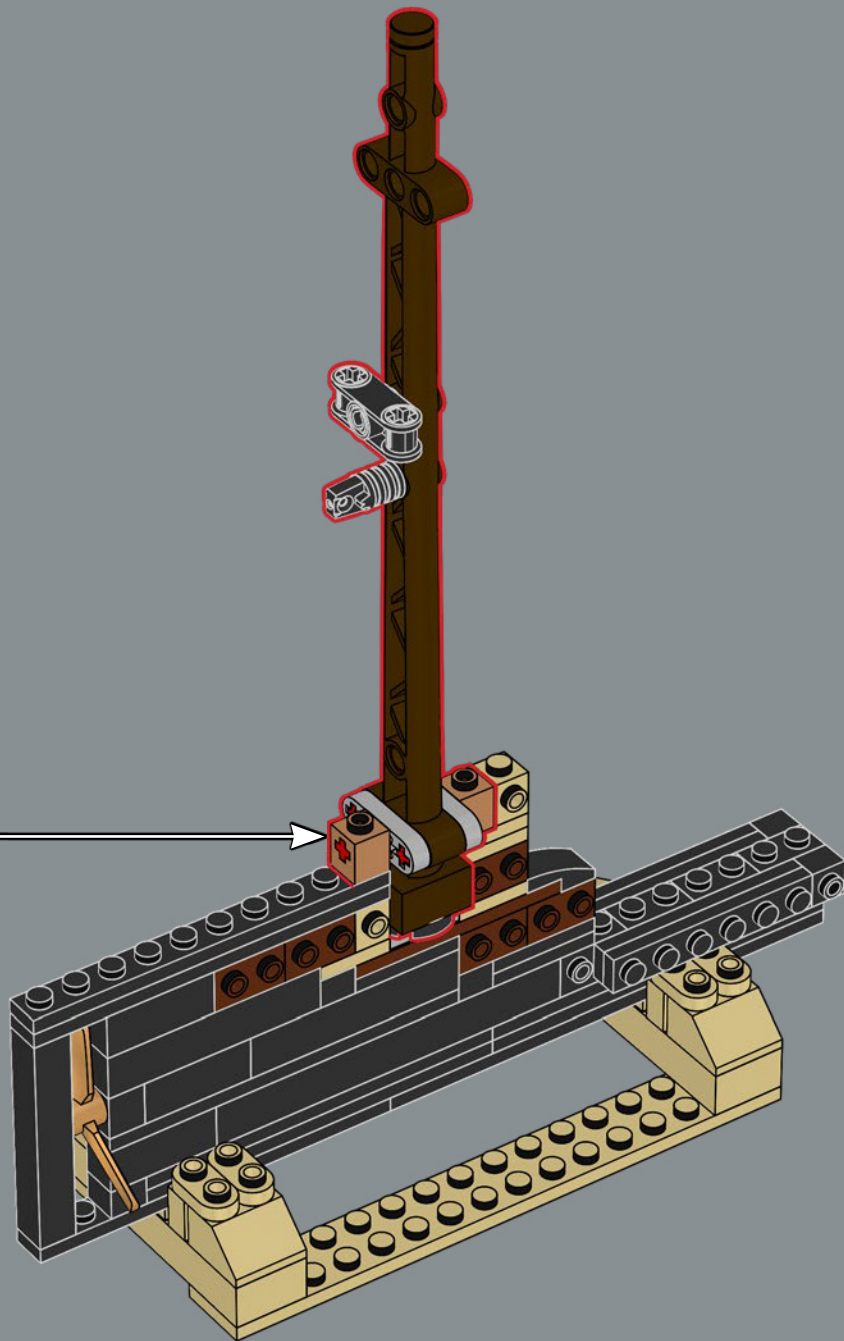

- 4x
- 1x
- 1x

312

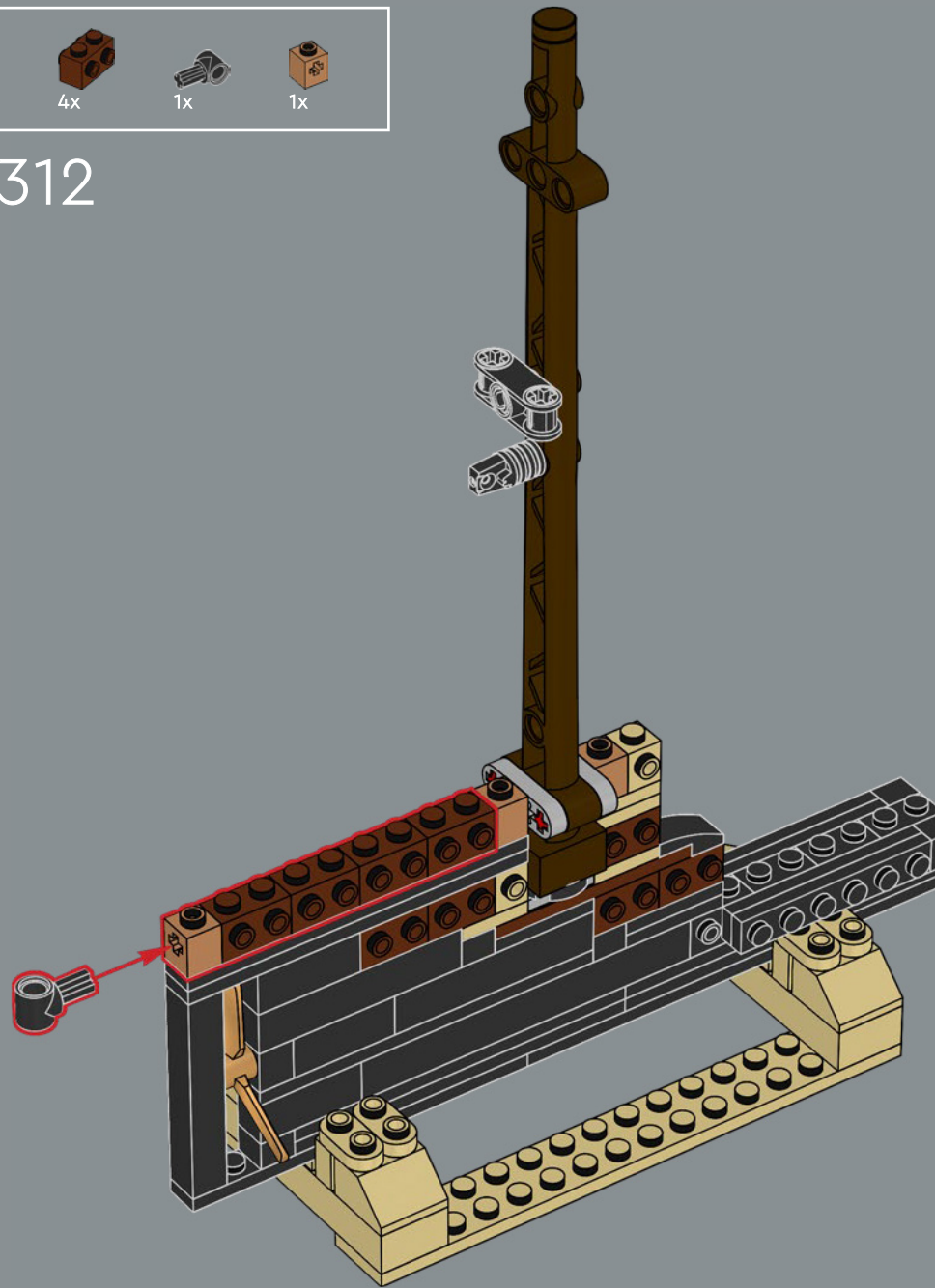



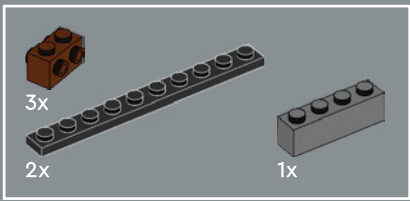

313

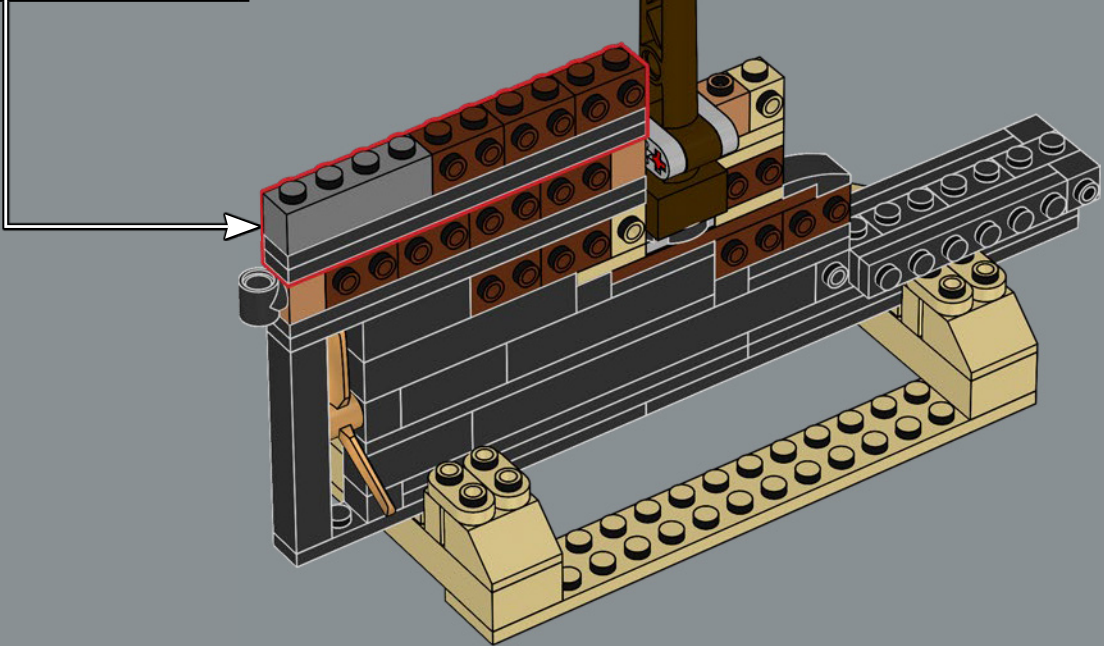
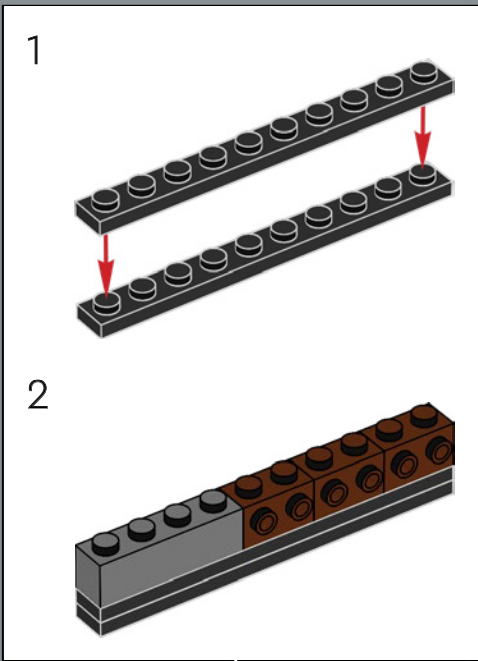

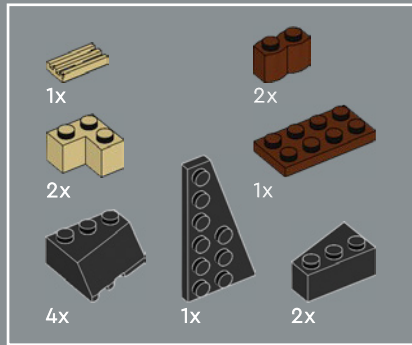
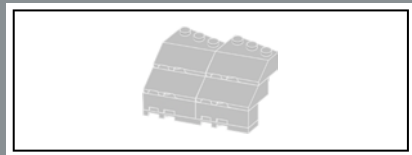

314

1

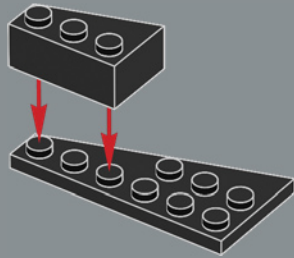

2

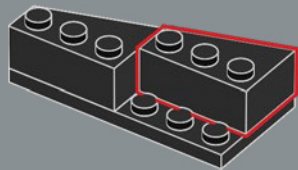

3

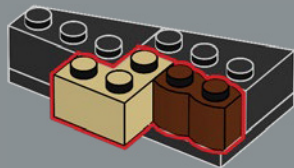

4

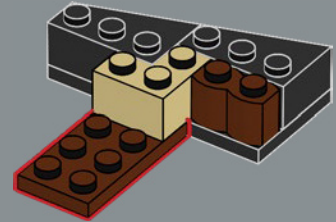

5

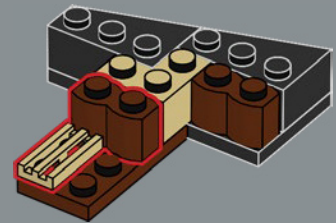

6

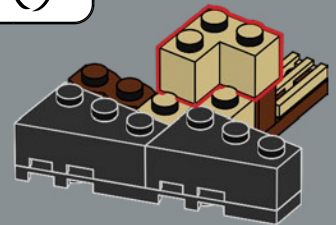

7

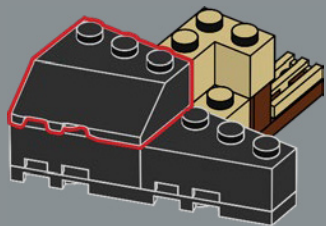

8

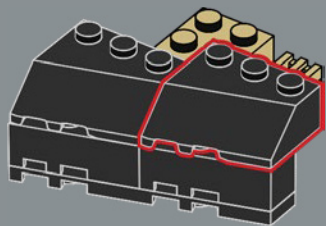

9

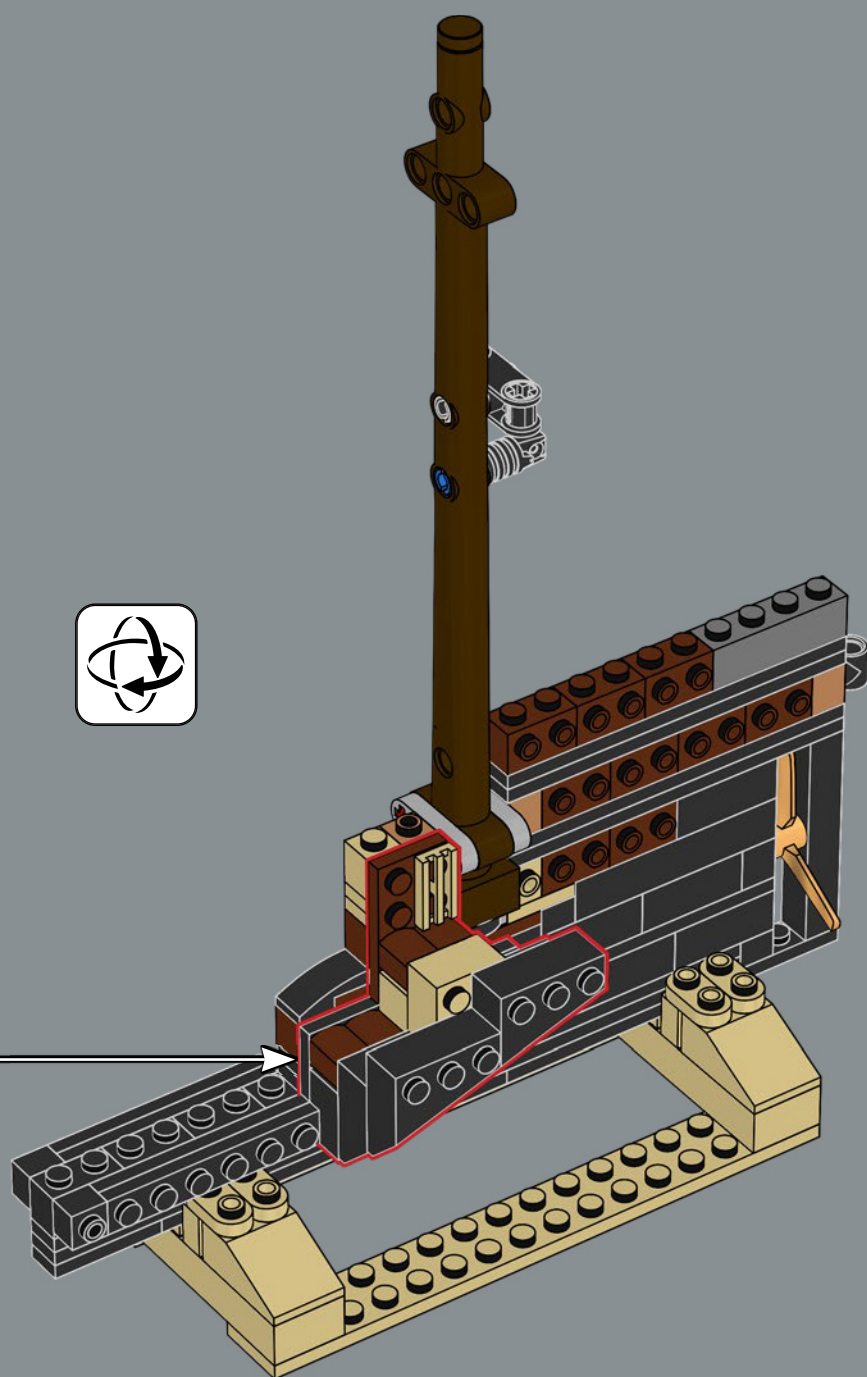
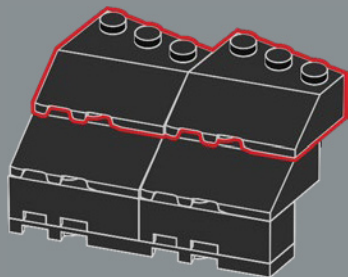

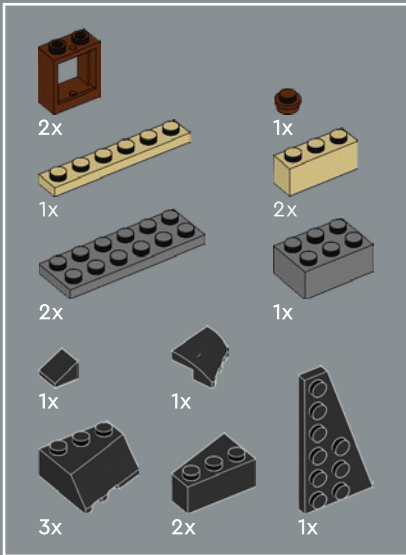
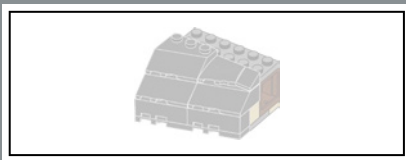

315

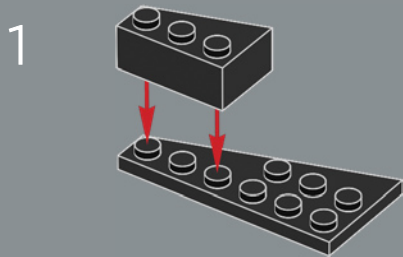

2

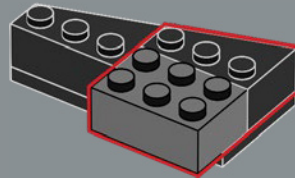

3

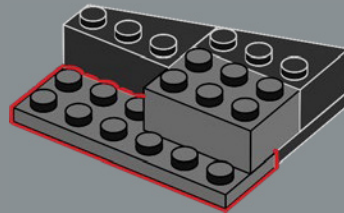

4

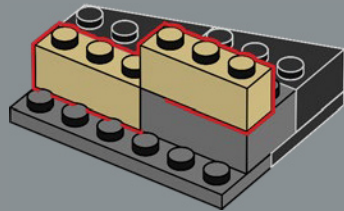

5

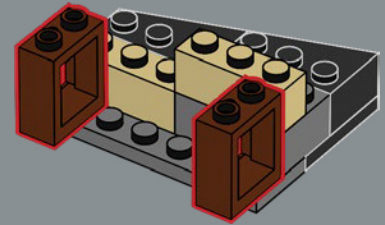

6

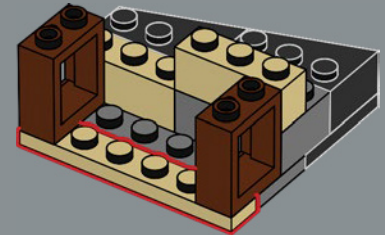

7

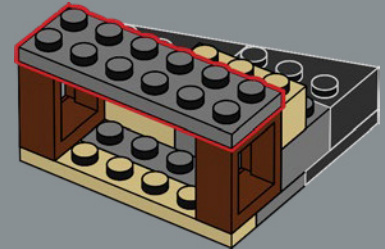



8

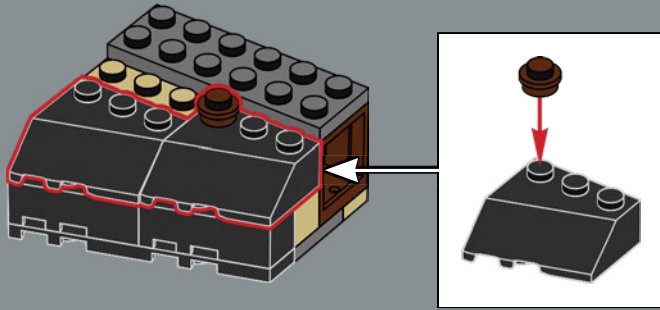

9

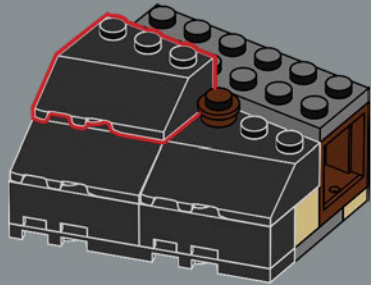

10

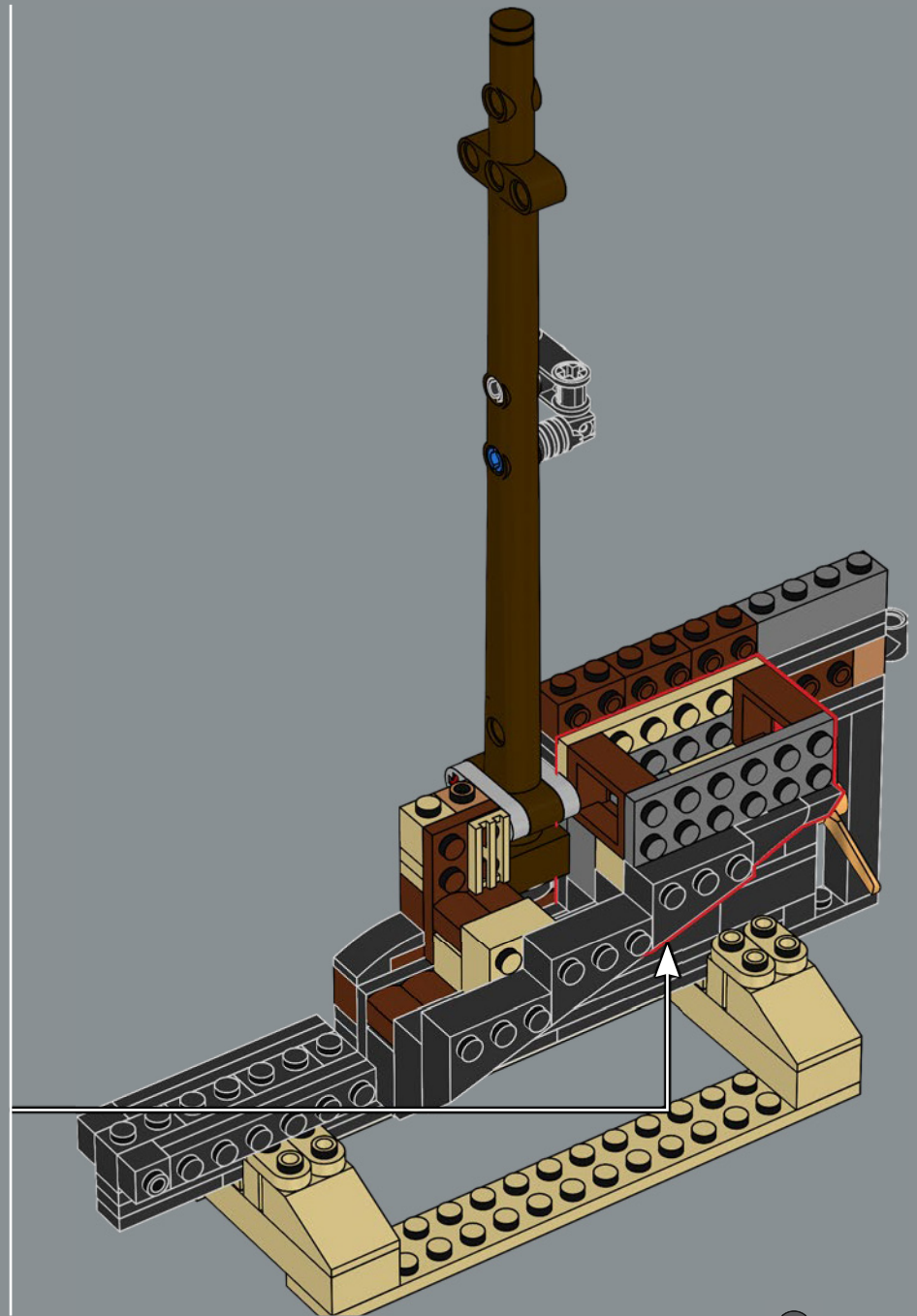
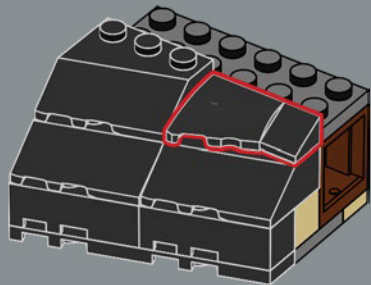

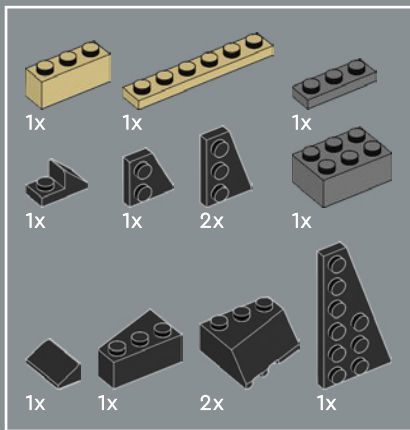

316

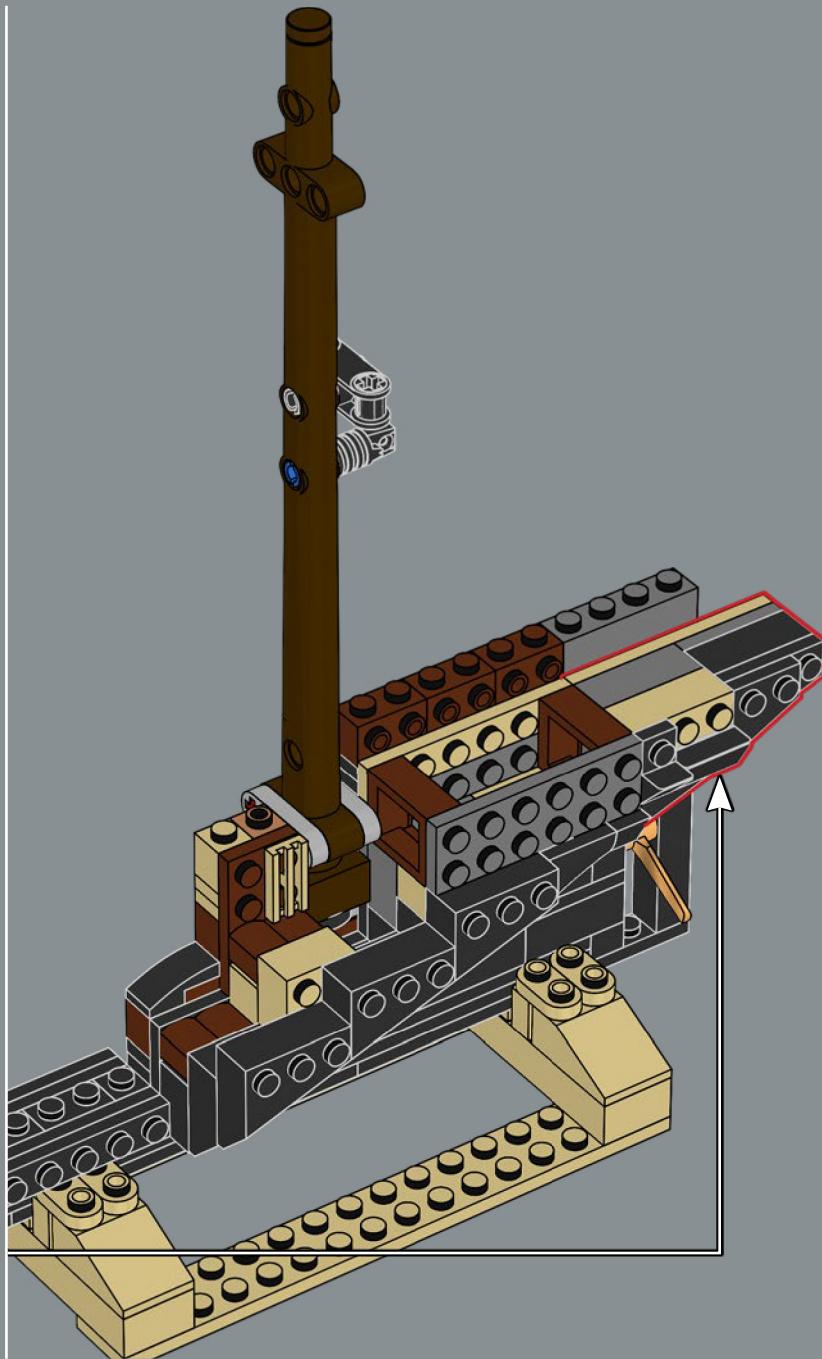
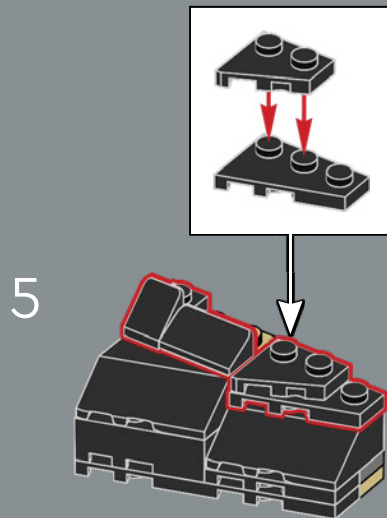
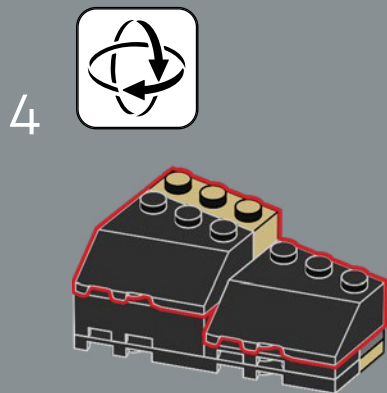
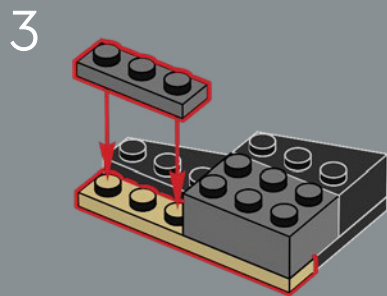
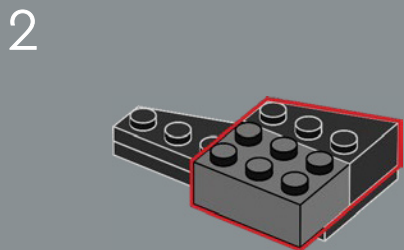
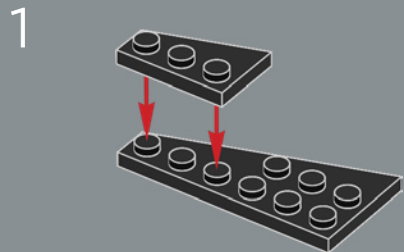

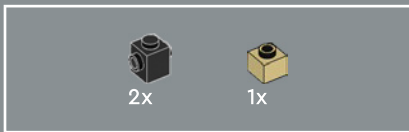

317

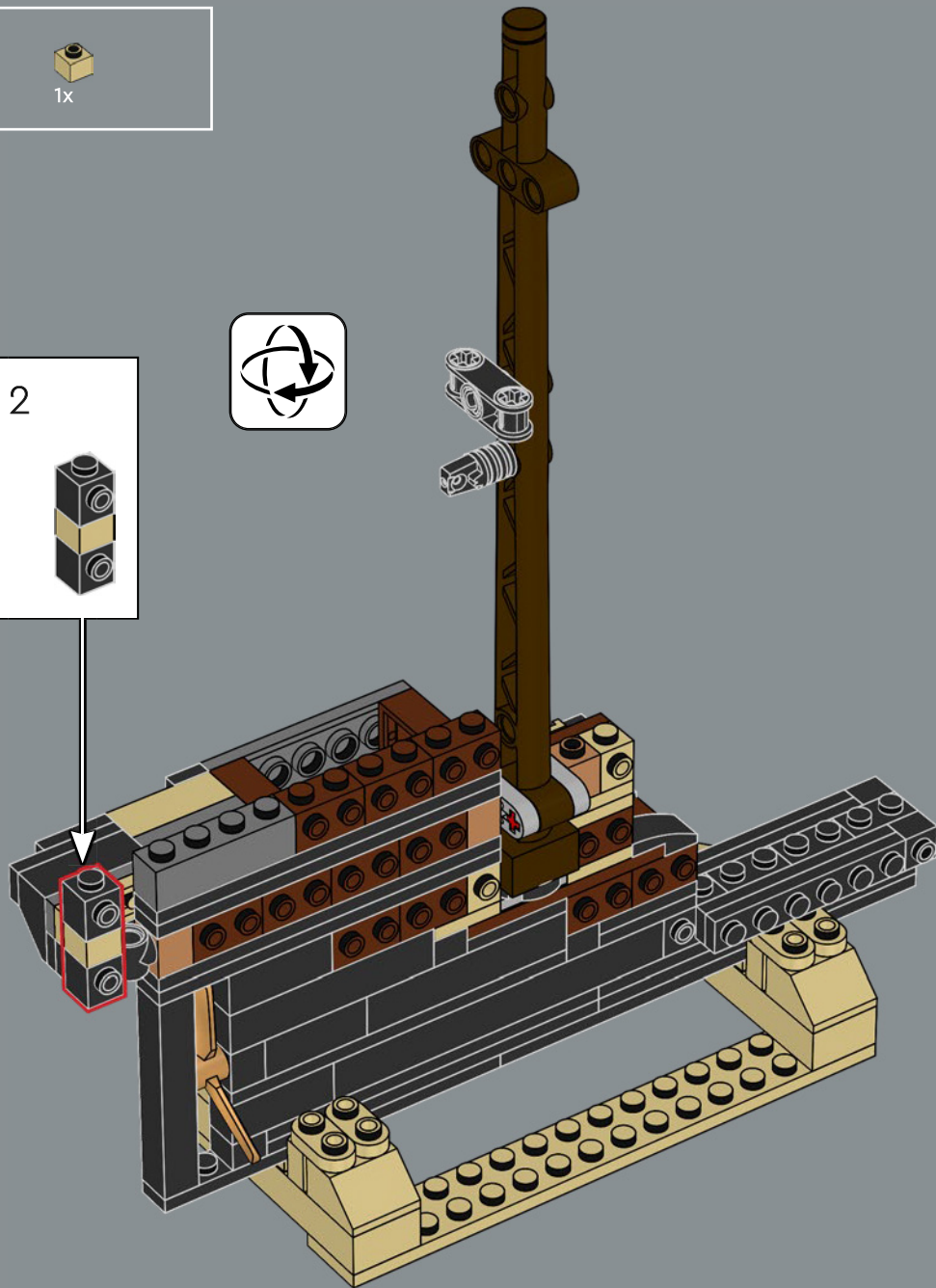
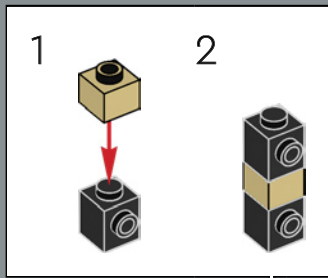

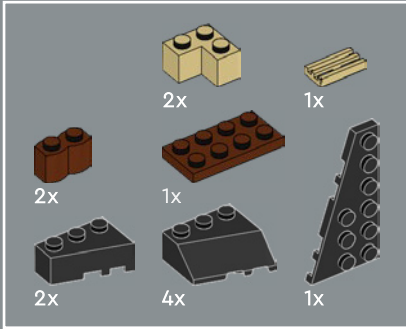
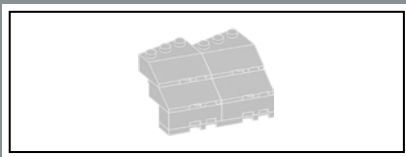

318

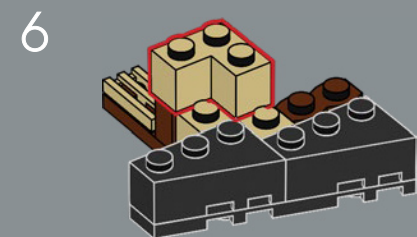
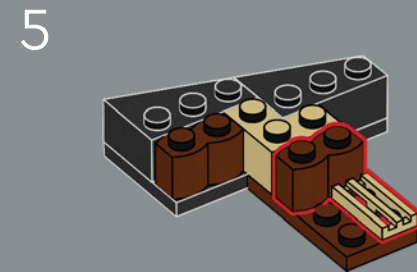
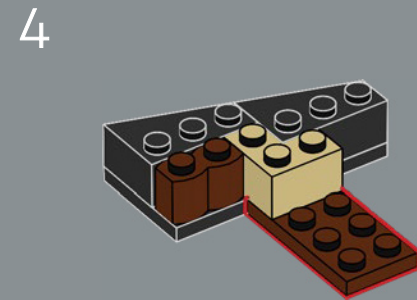
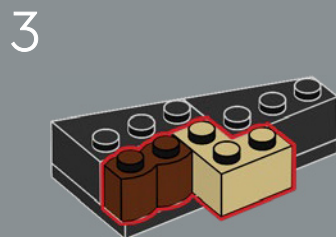
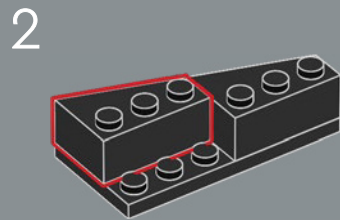
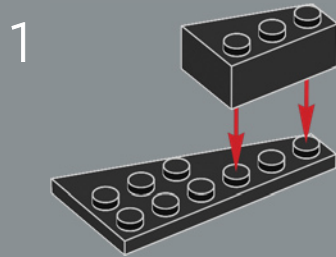



7

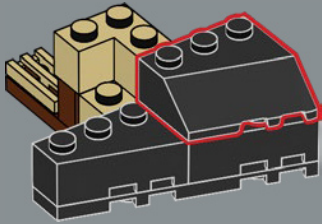

8

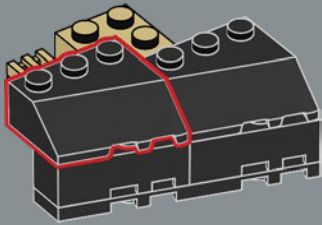

9

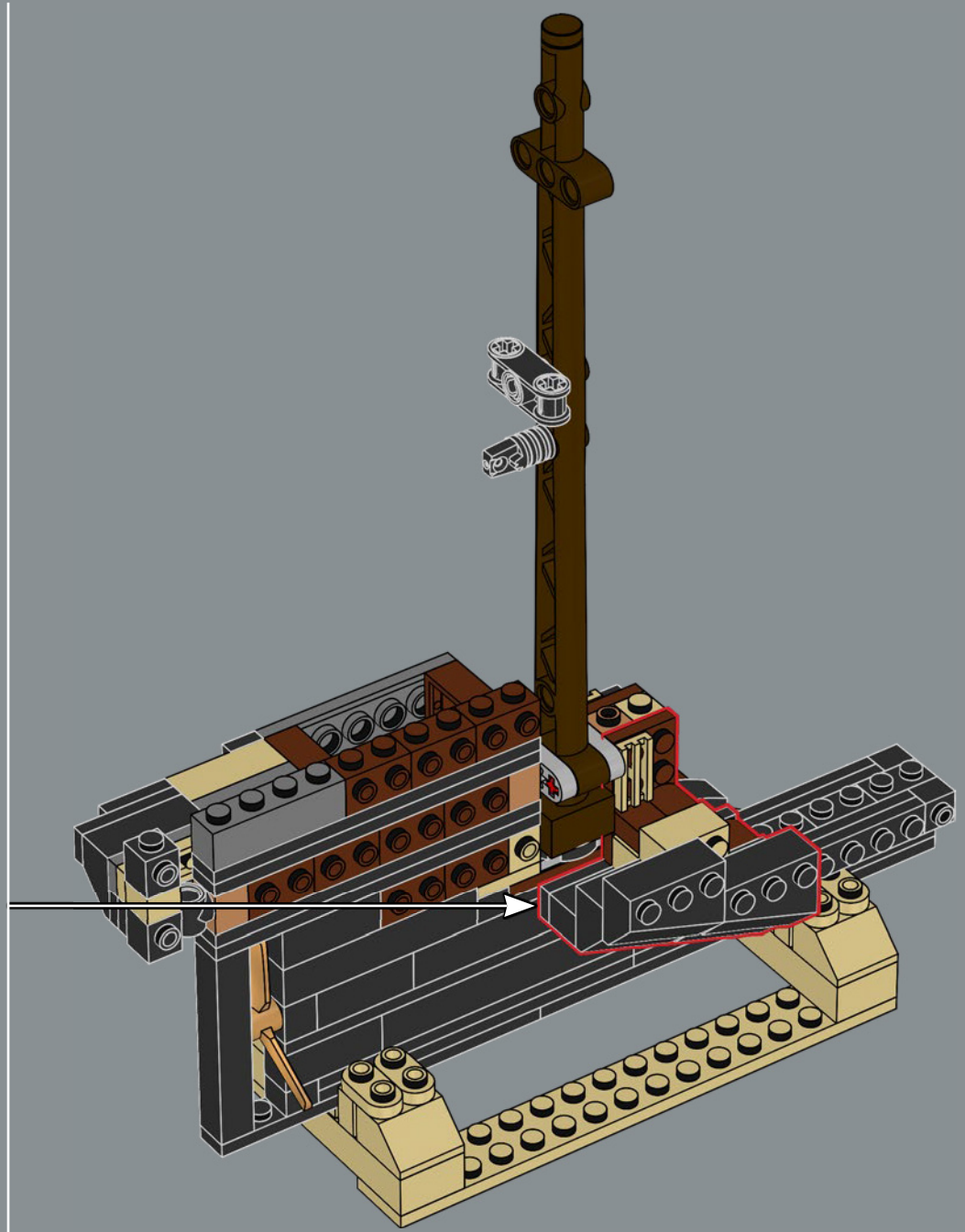
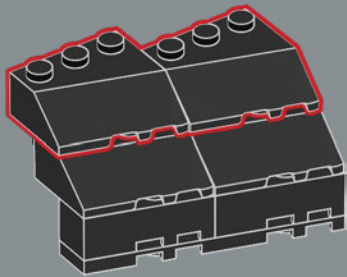

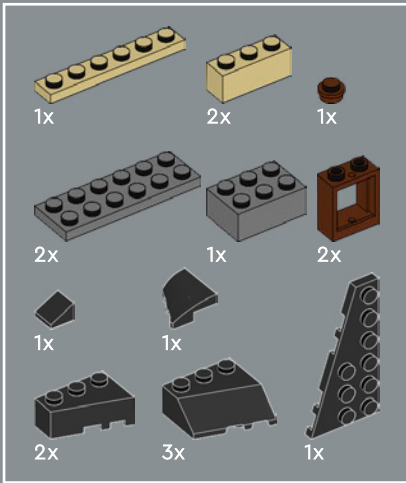
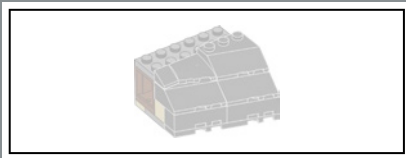

319

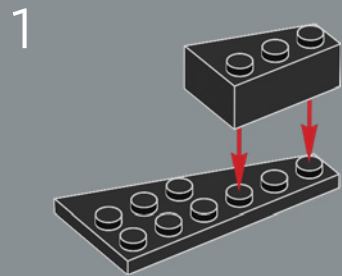

2

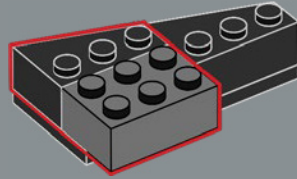

3

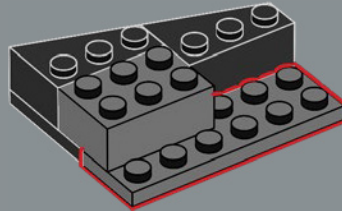

4

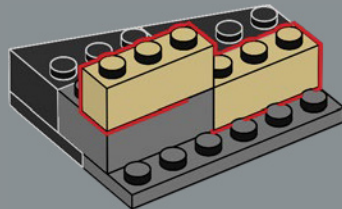

5

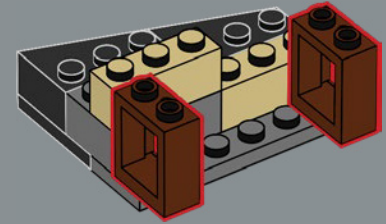

6

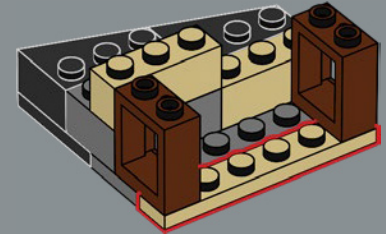

7

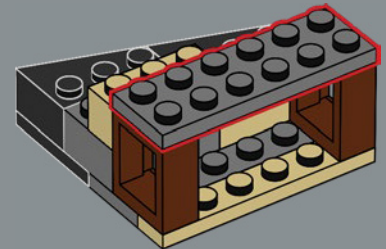

8

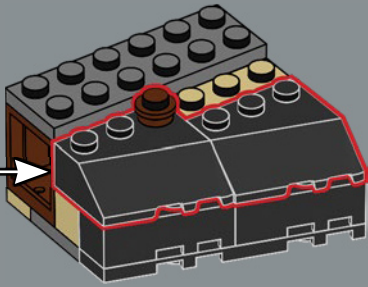
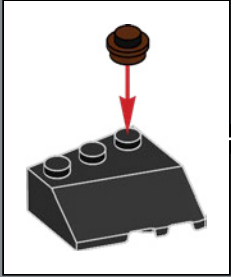

9

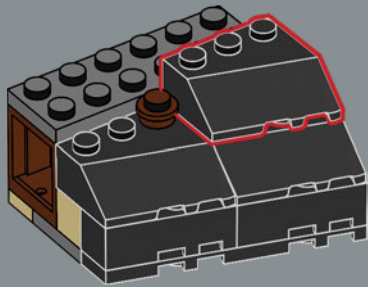

10

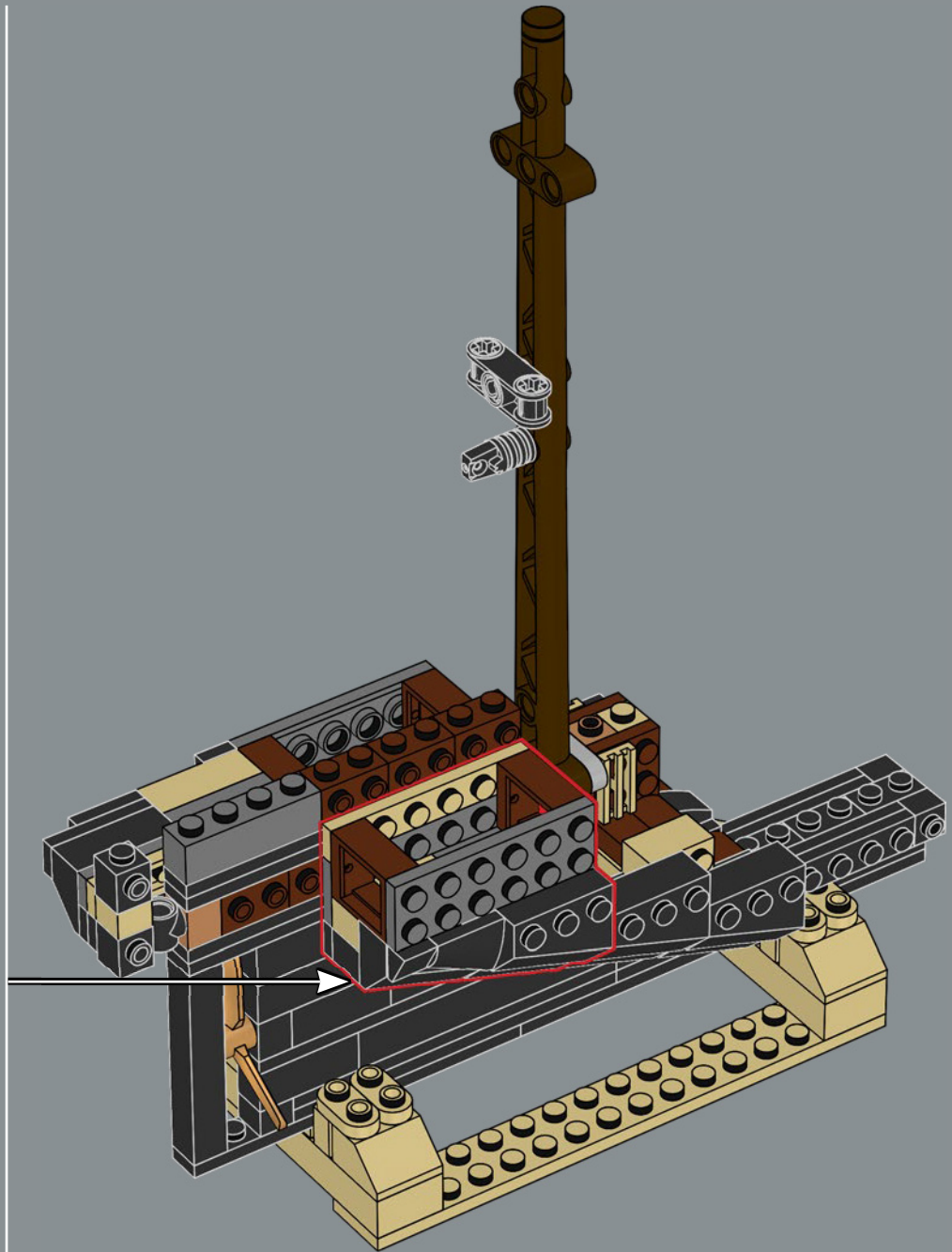
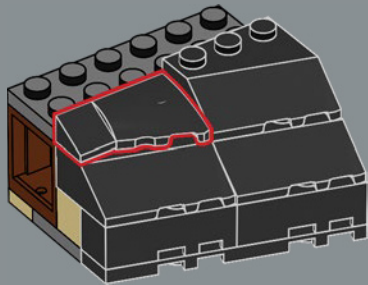

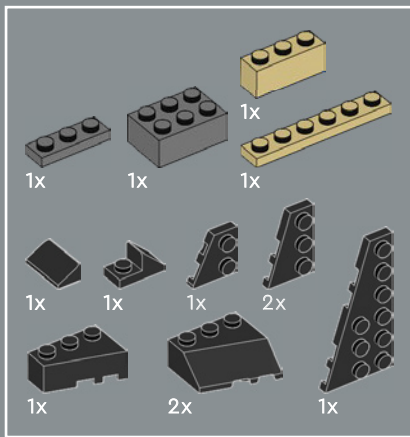

320

1

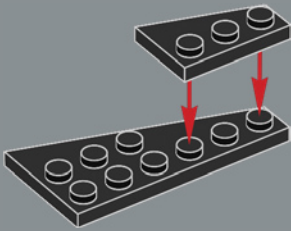

2

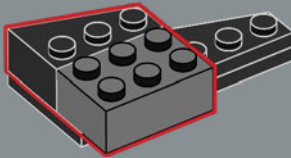

3

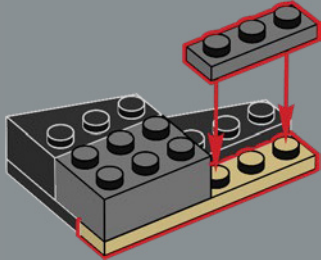

4

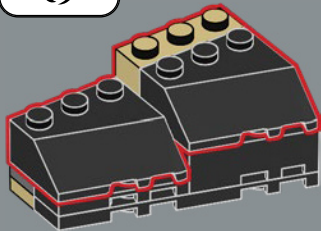

5

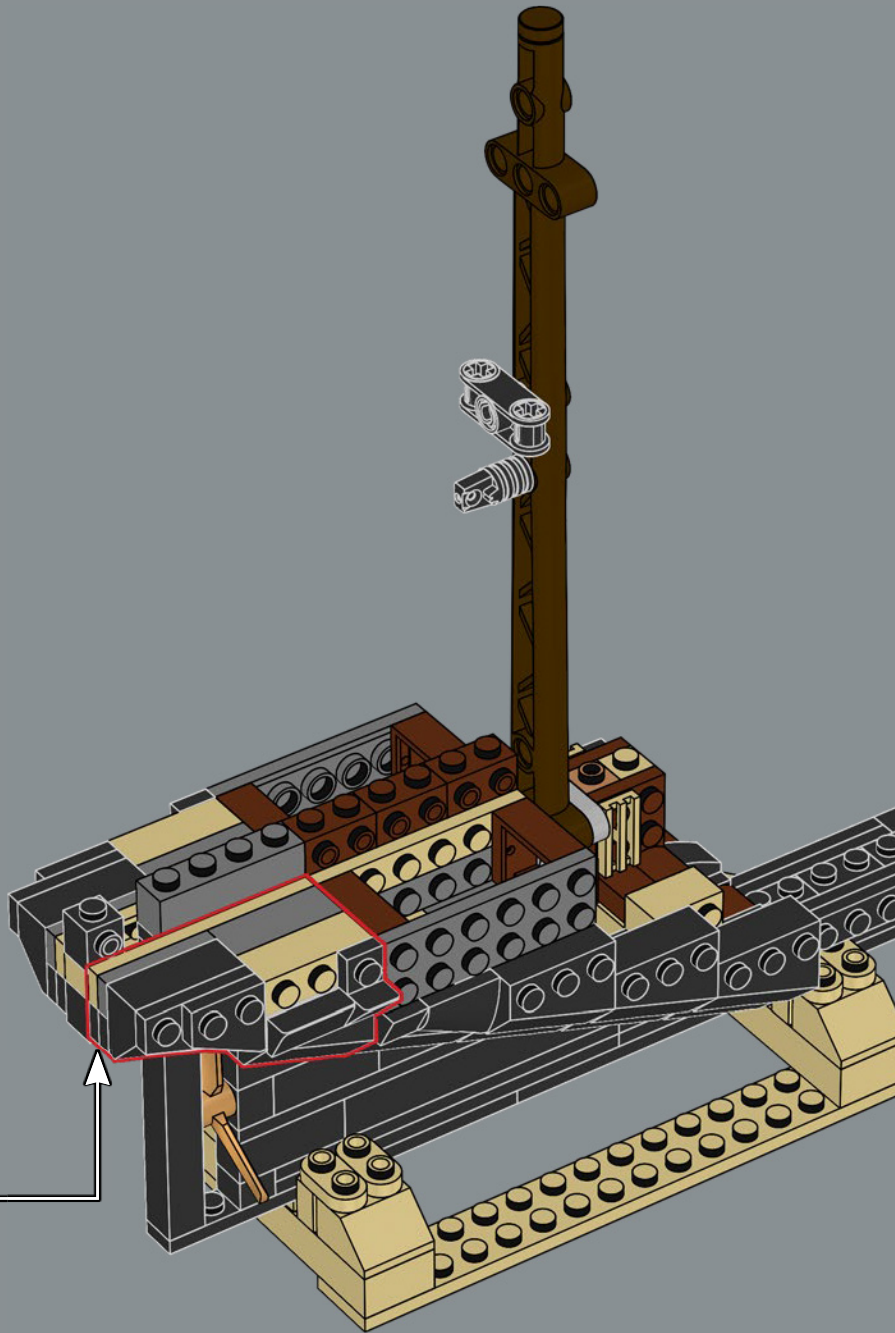
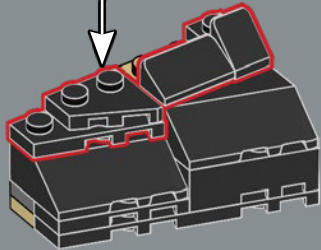
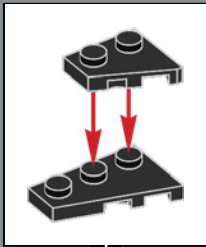



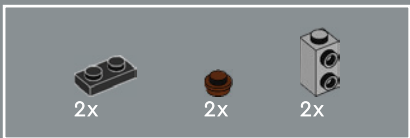

321

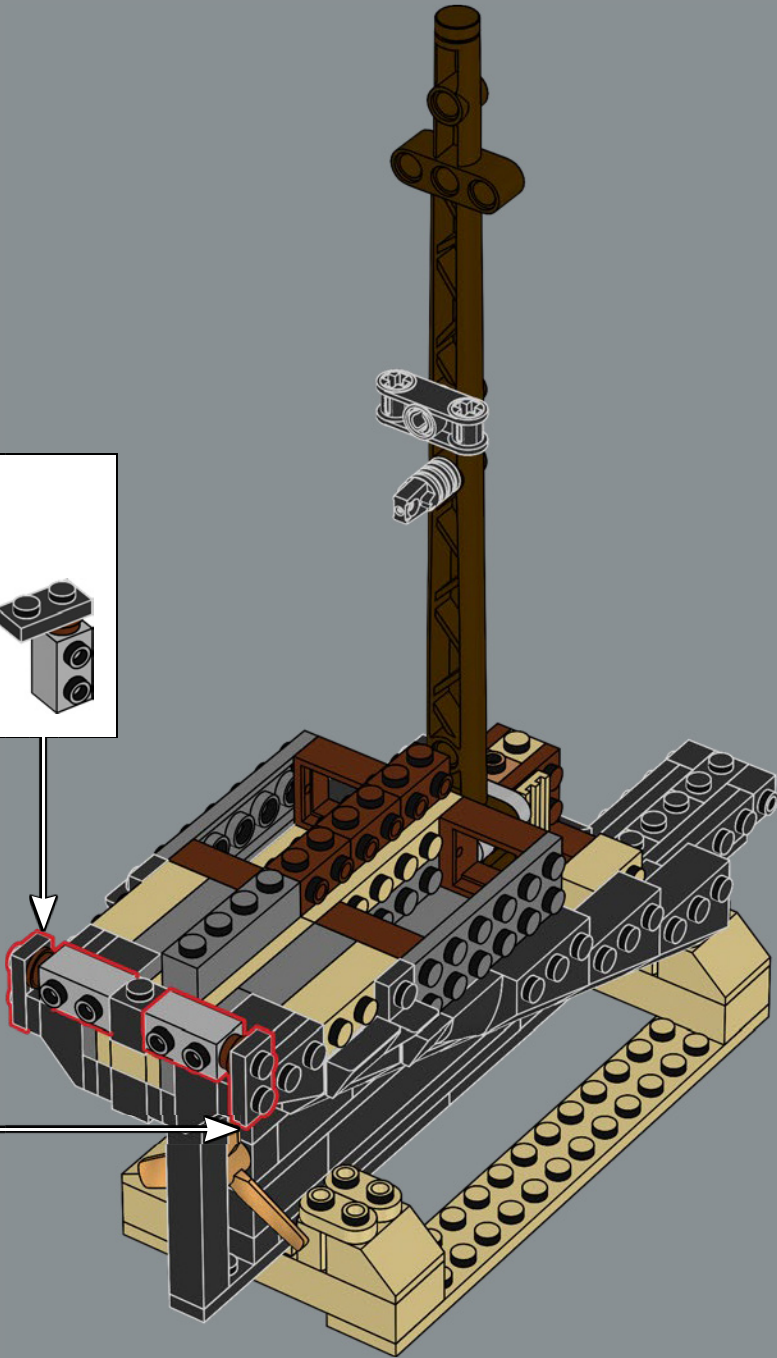
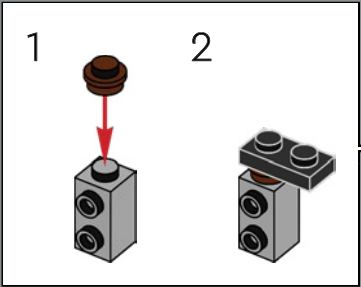
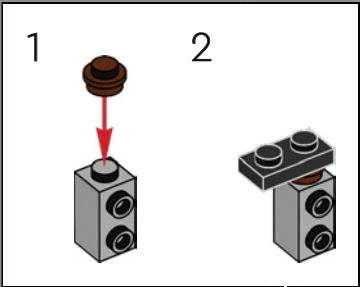

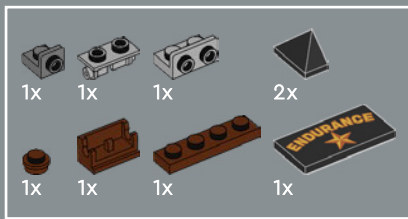

322

1

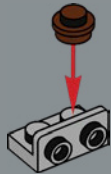

2

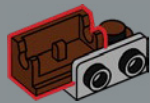

3

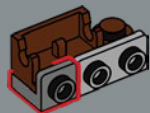

4

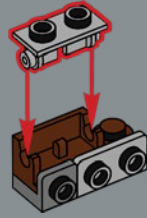

5

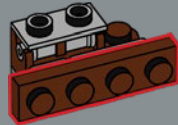

6

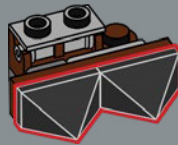

7



Die *Endurance* wurde ursprünglich auf den Namen *Polaris* getauft. Es ist leider nicht überliefert, ob Shackleton den Namen des Polarsterns für eine Expedition zum Südpol einfach nur unpassend fand, oder ob er sich bei der Namensgebung am Leitspruch seiner Familie „By *Endurance* We Conquer“ (sinngemäß: Unser Durchhaltevermögen macht uns zu Siegern) orientierte. Der Stern selbst blieb jedoch auf dem Schiff!

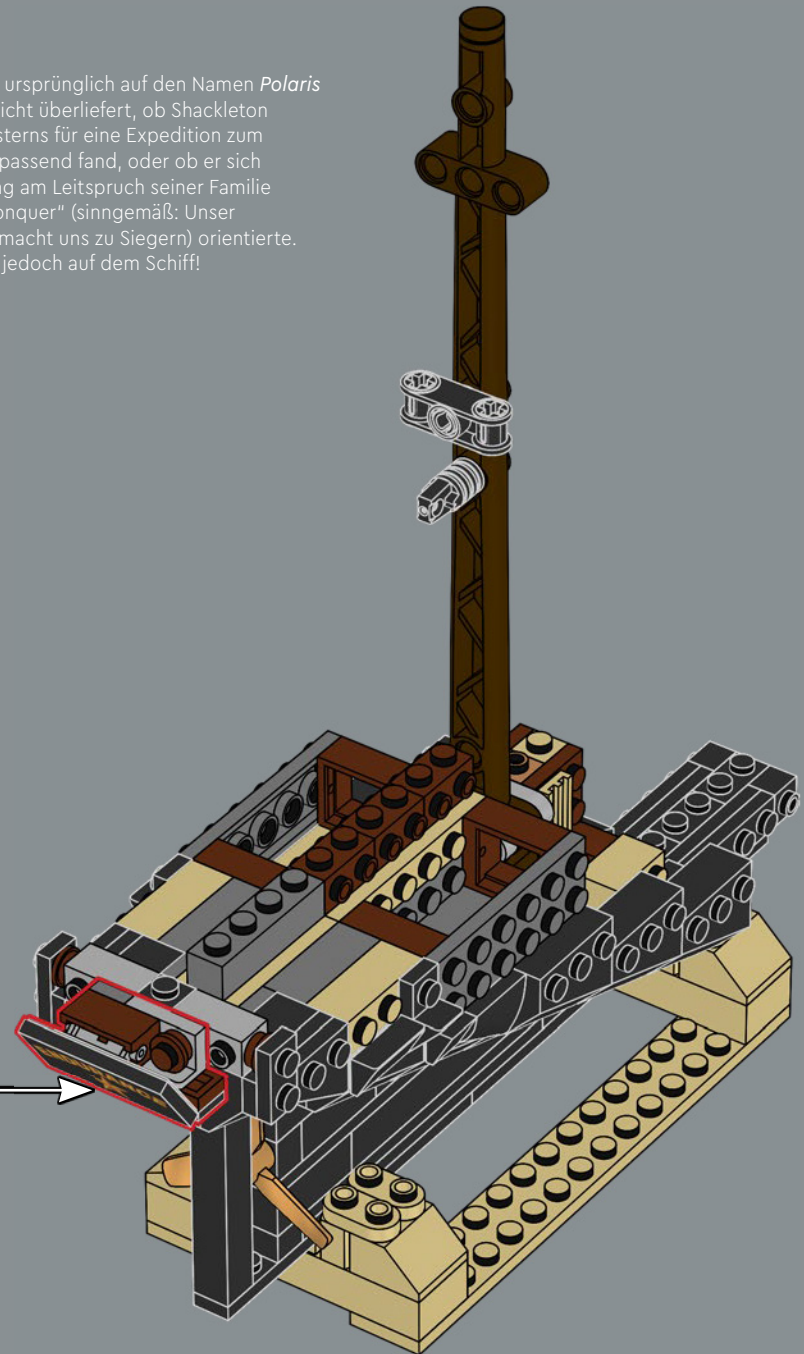

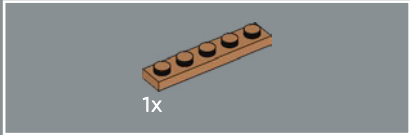
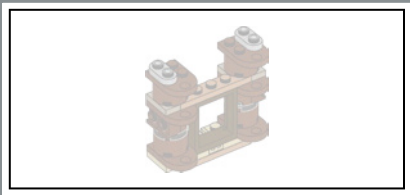

323

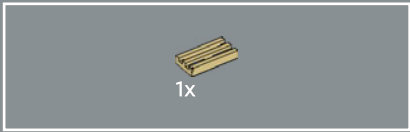
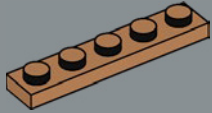

324

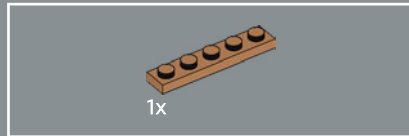
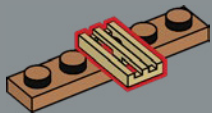

325

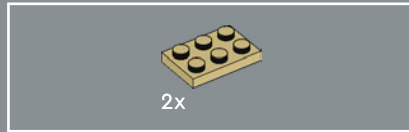
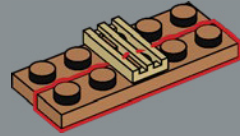

326

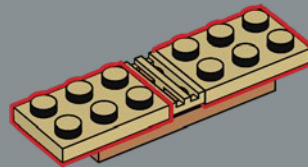

327

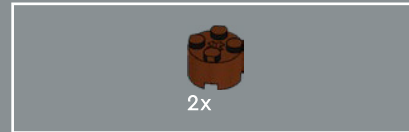
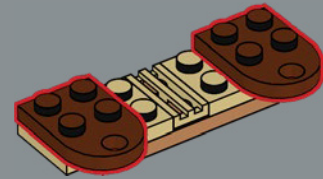

328

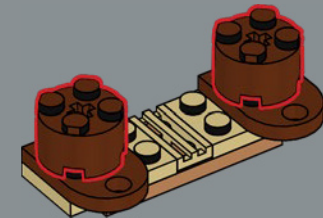



329

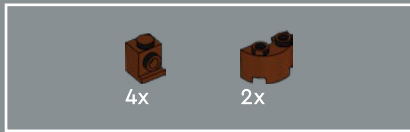
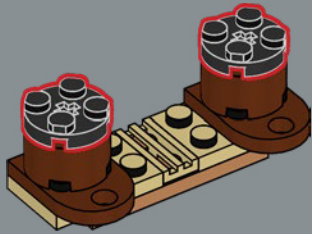

330

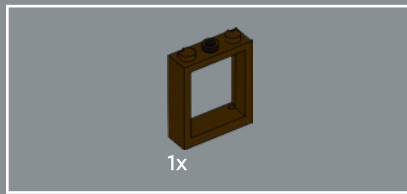
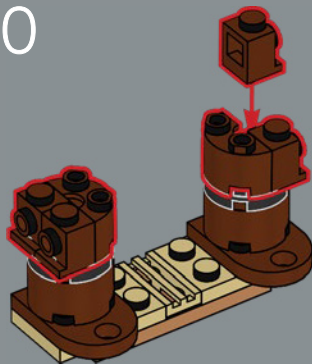

331

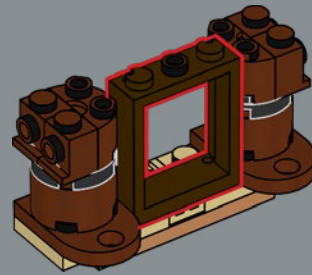

332

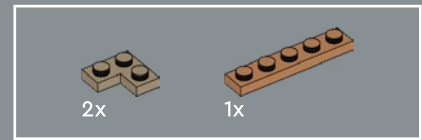
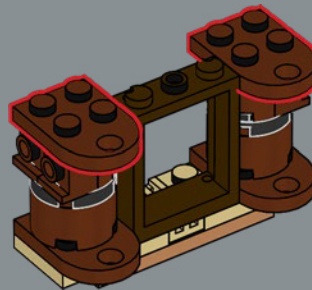

333

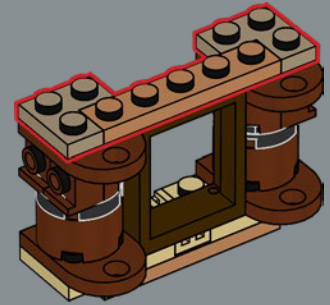

334

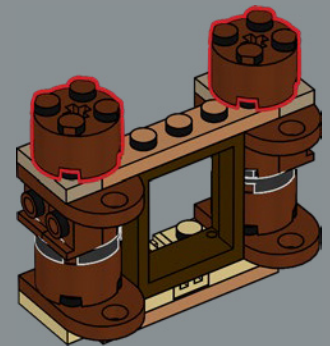





335

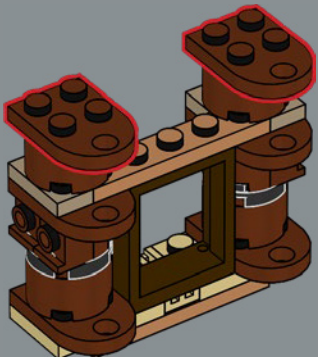

336

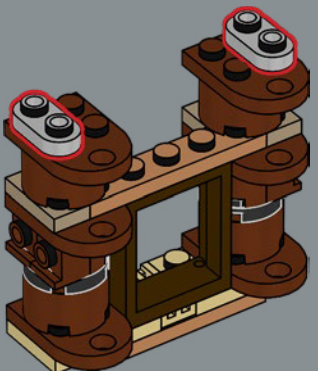

337

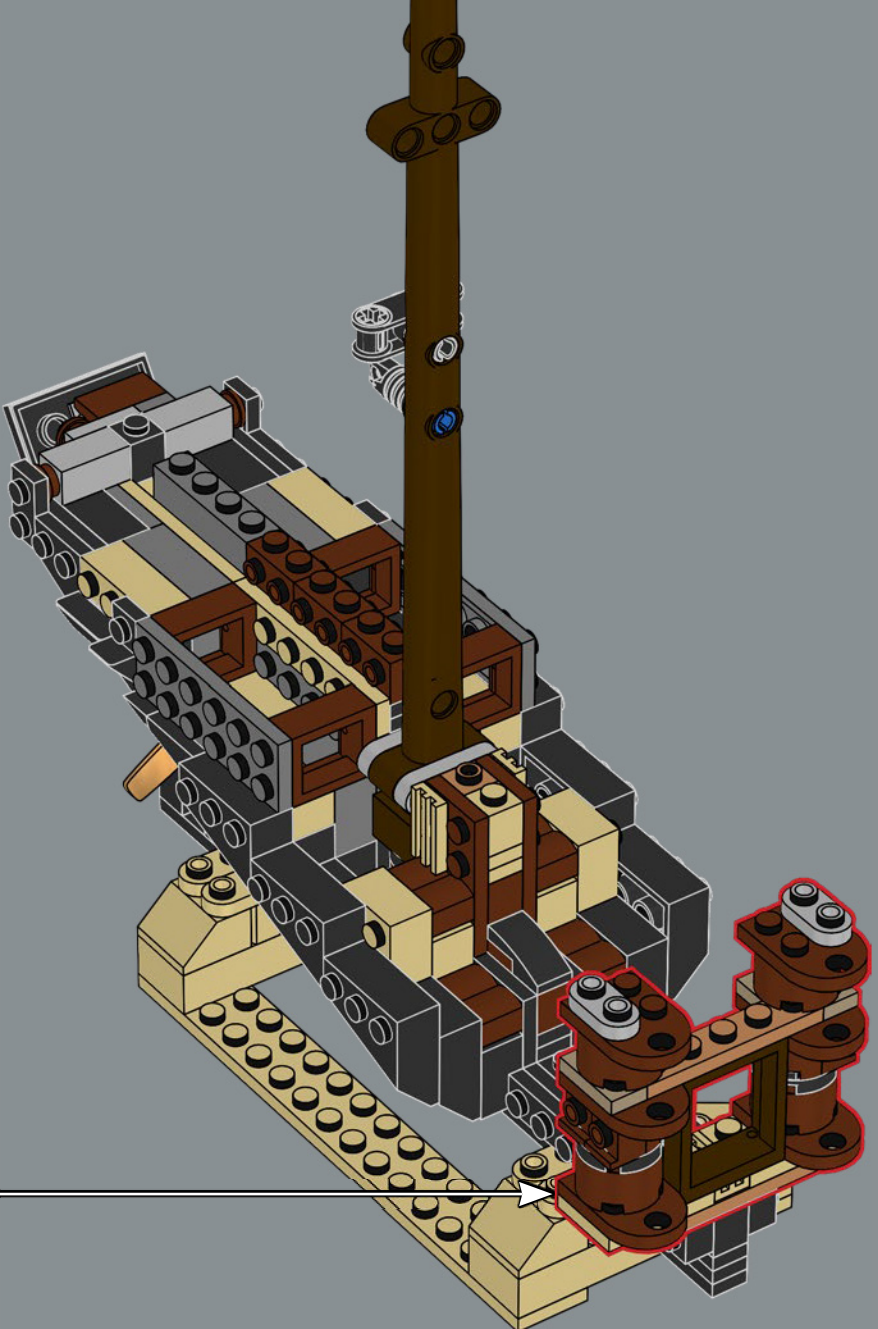

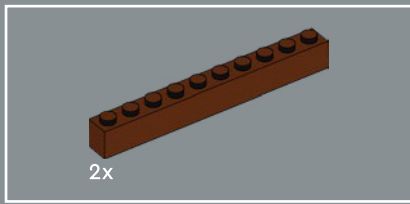

338

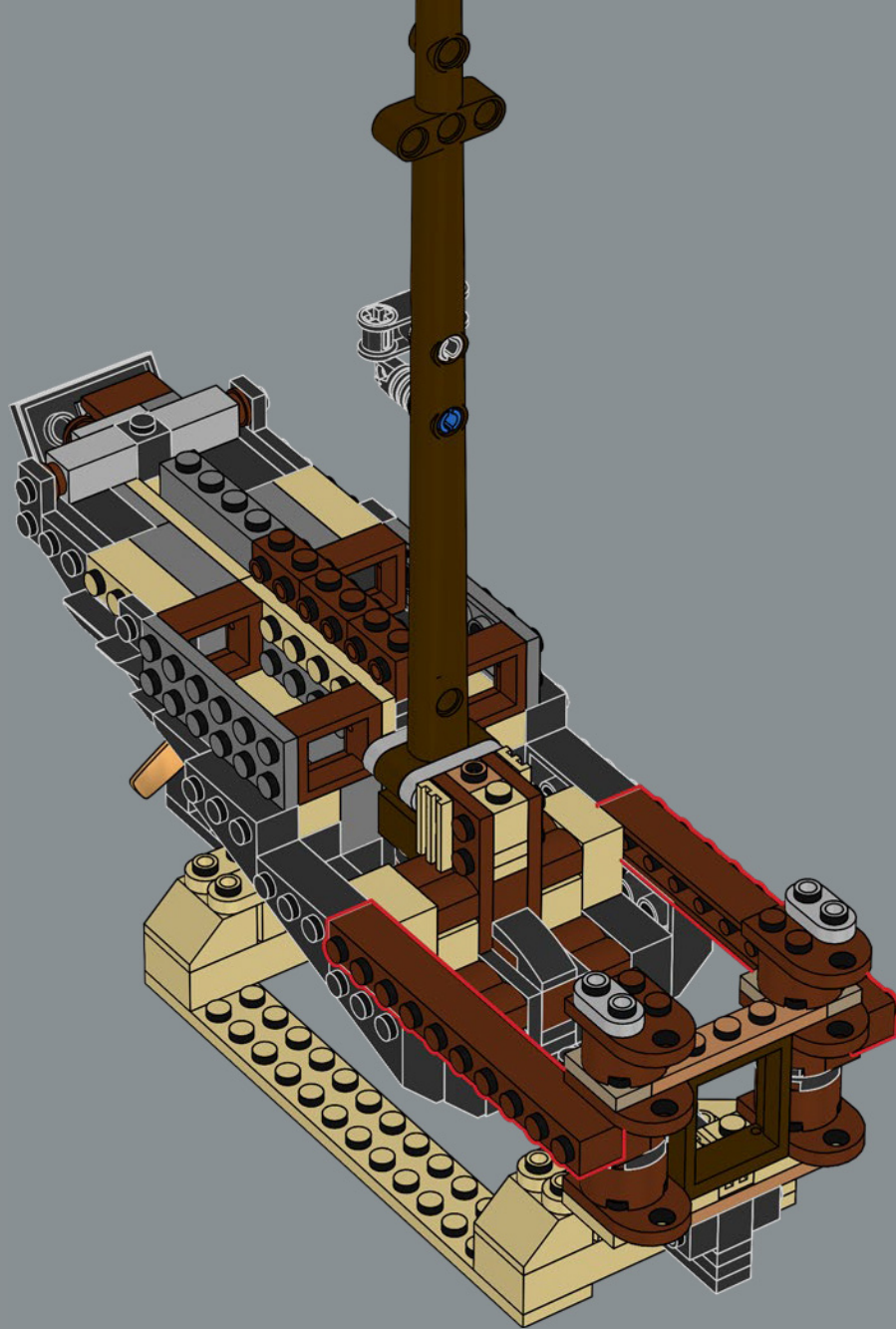

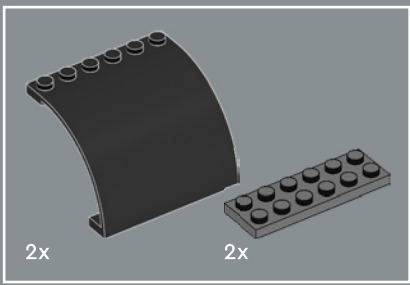

339

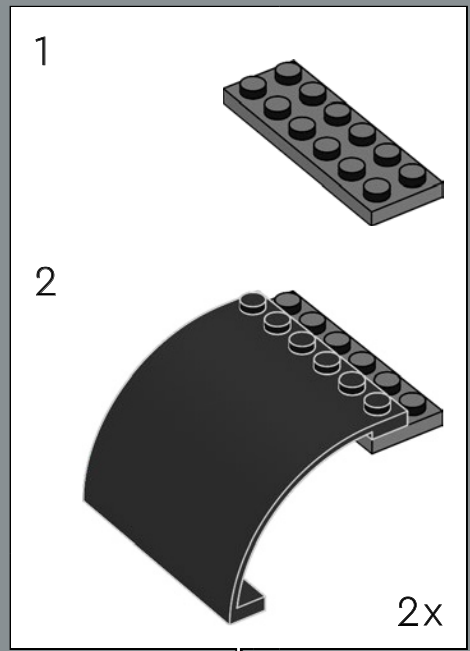
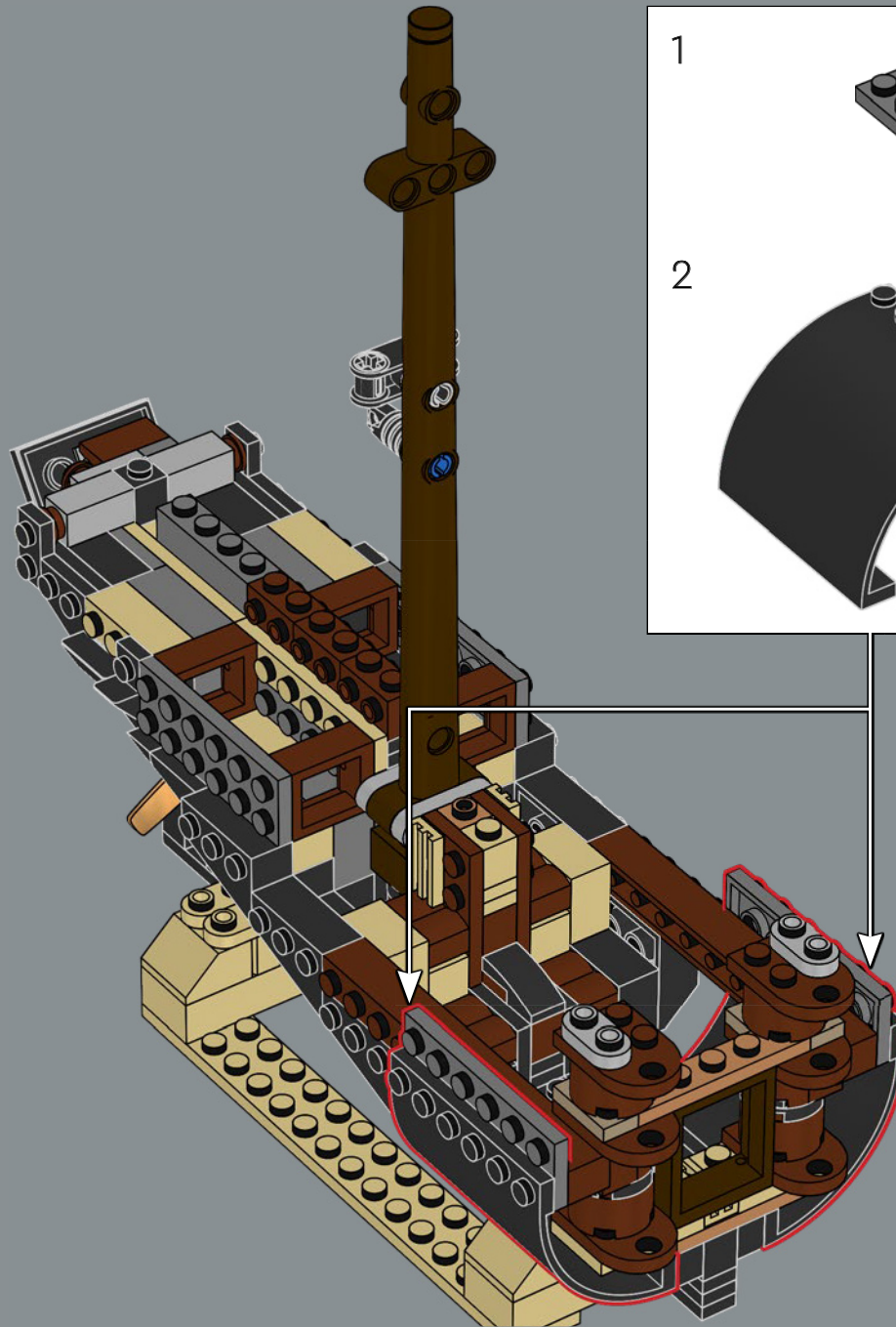



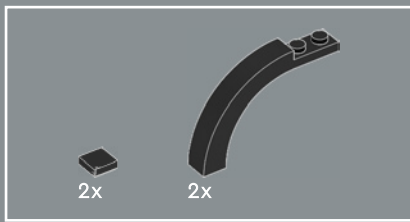

340

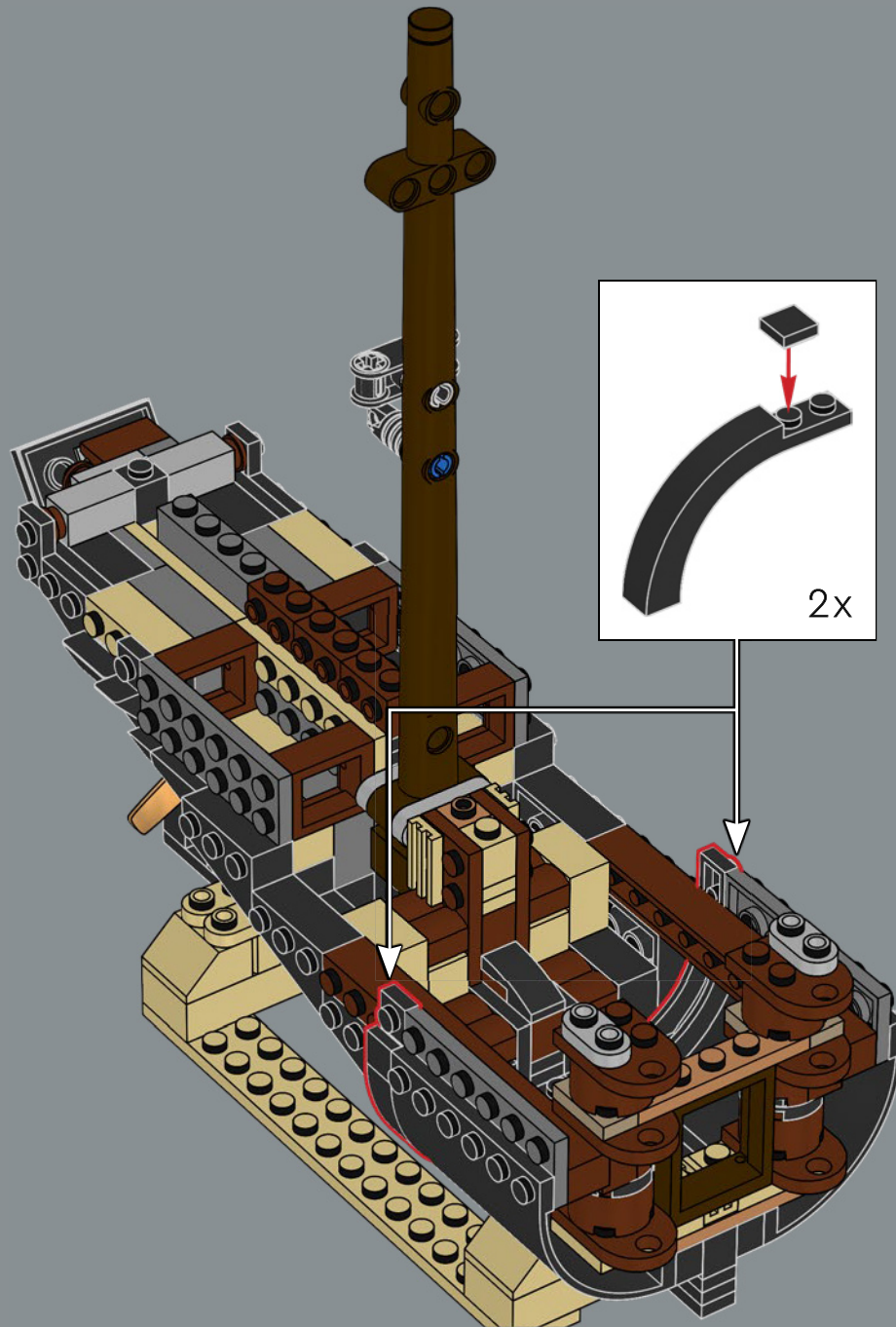



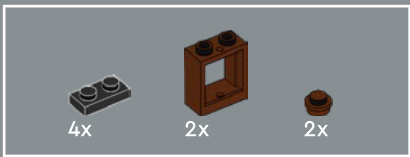

341

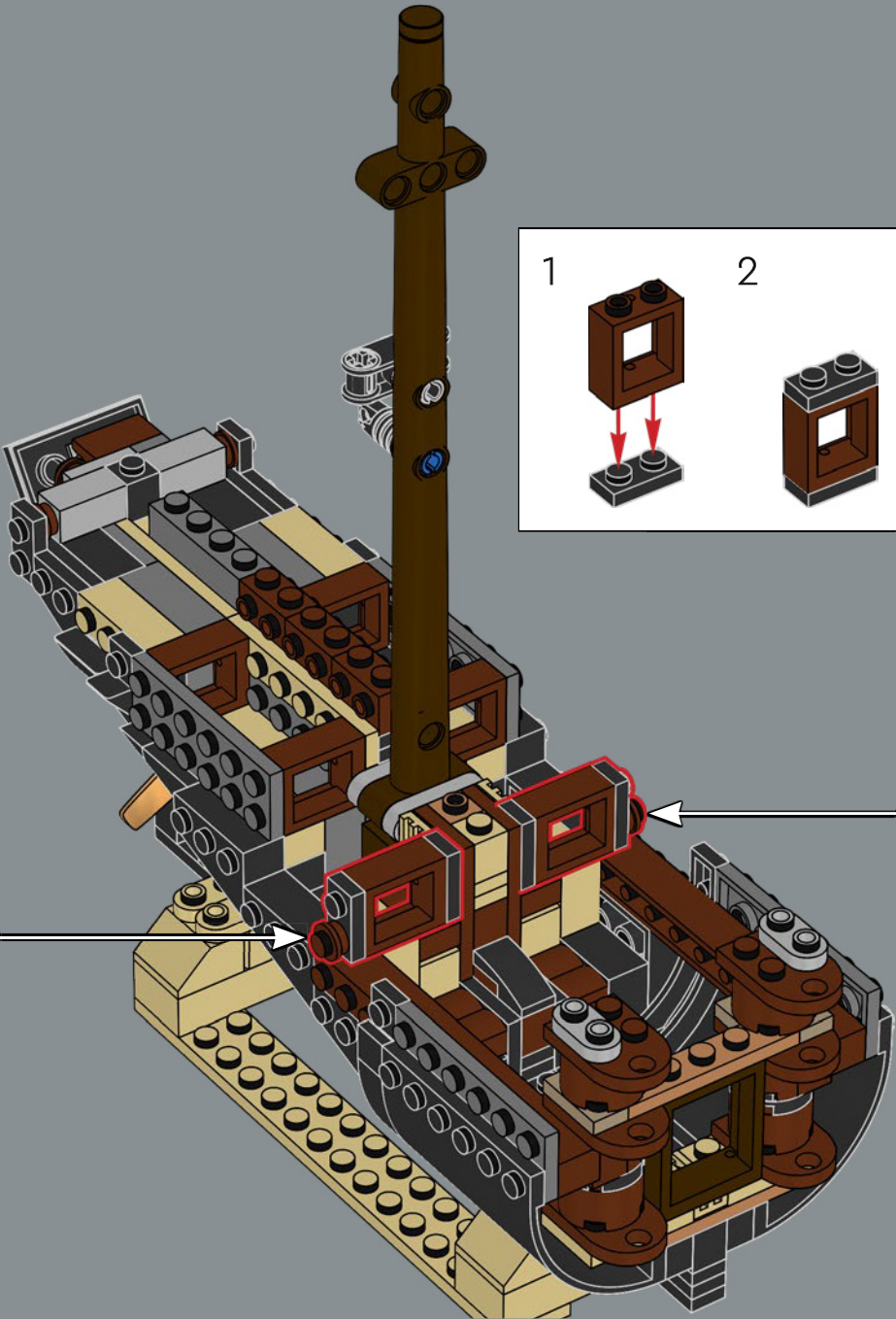
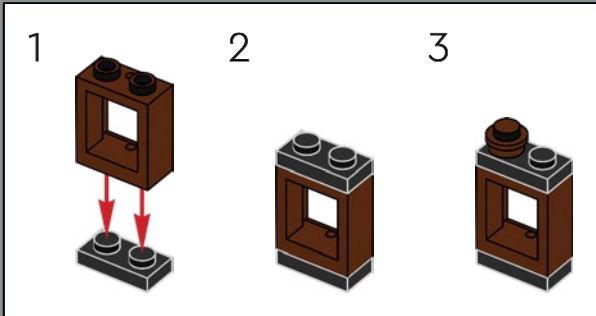
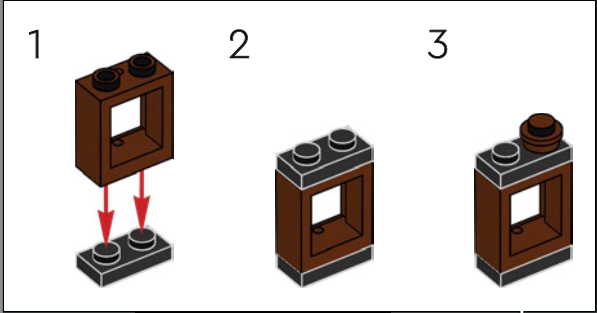

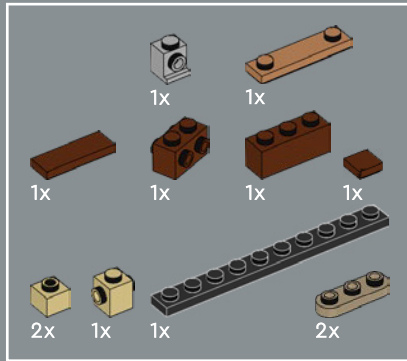
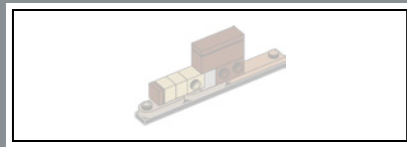

342

1

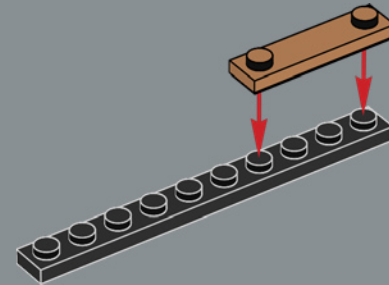

2

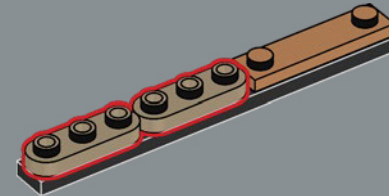

3

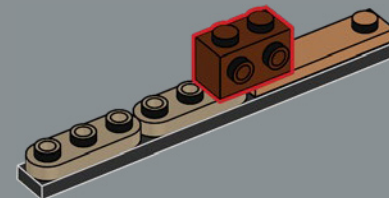

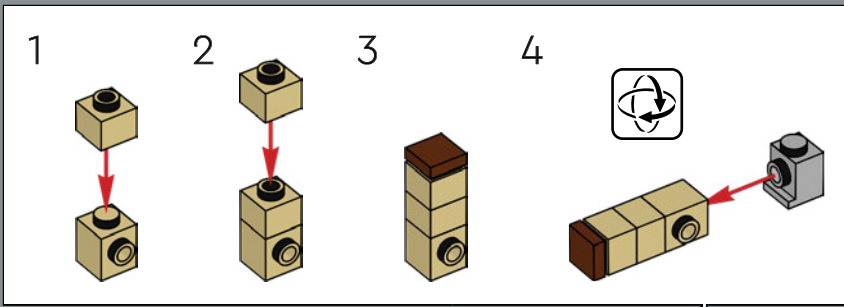

4

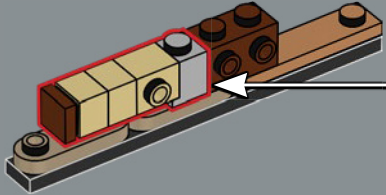

5

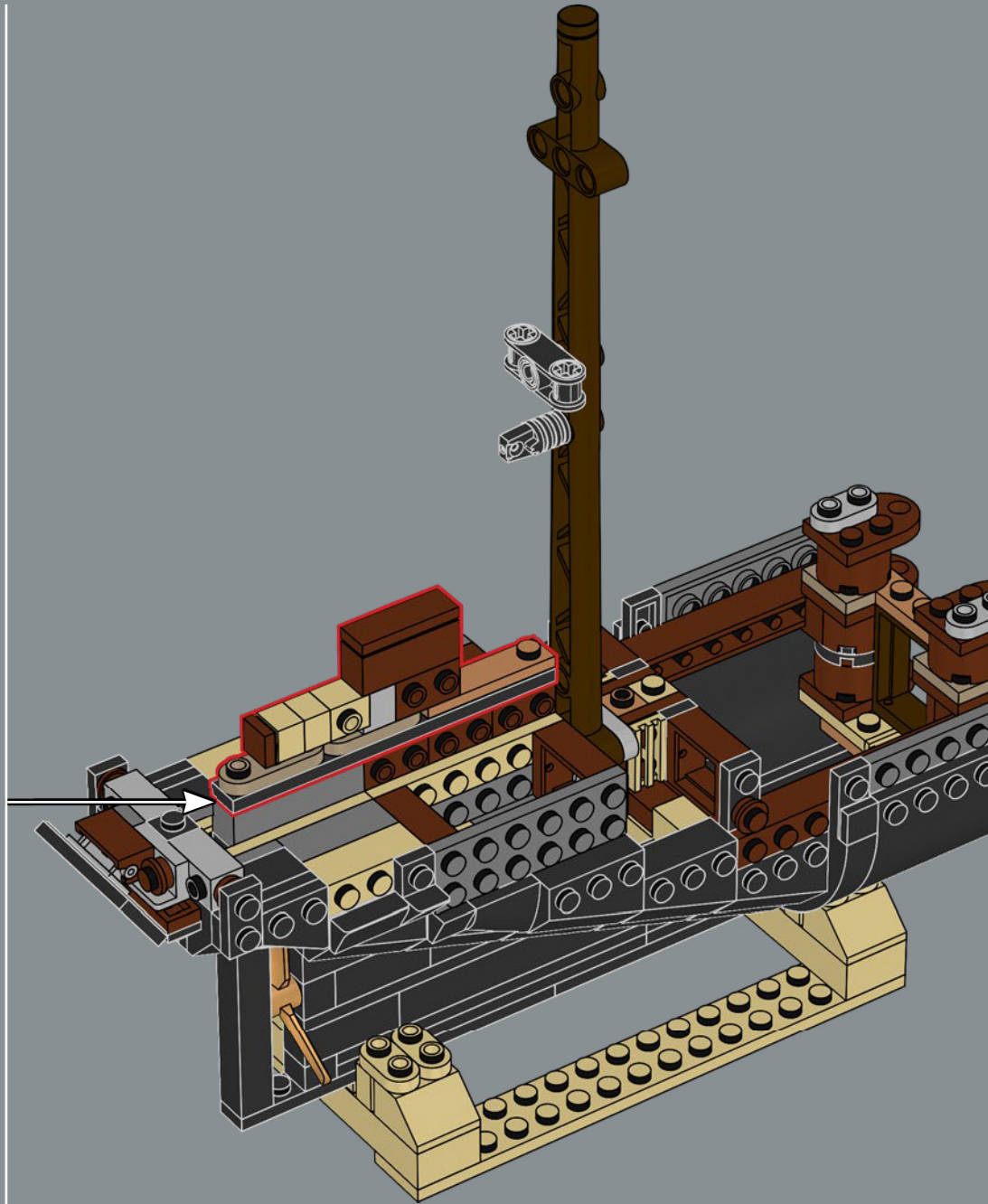
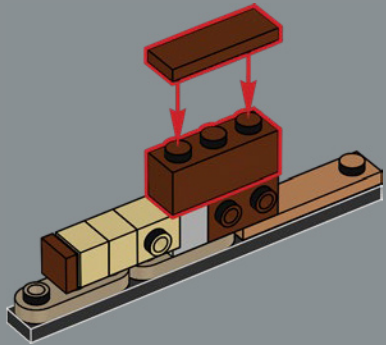

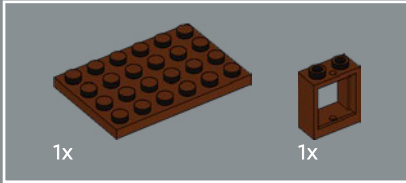
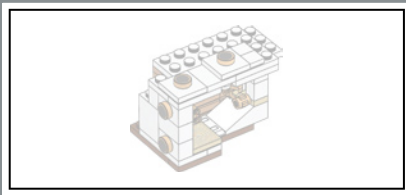

343

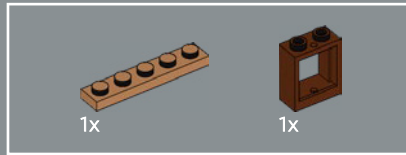
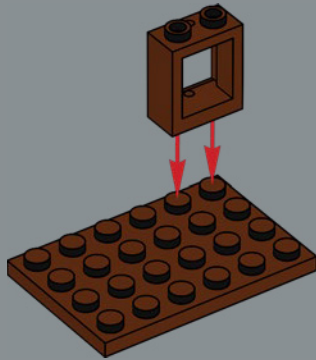

344

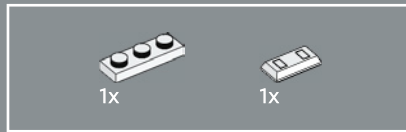
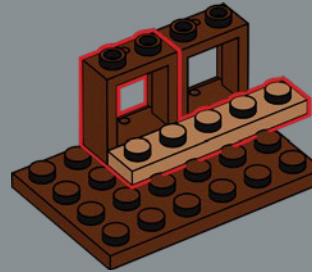

345

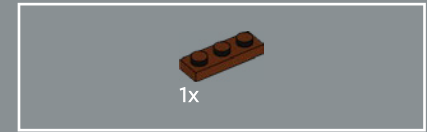
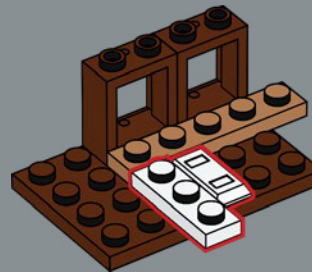

346

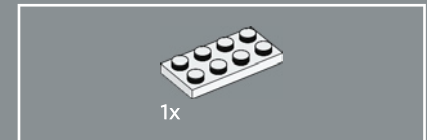
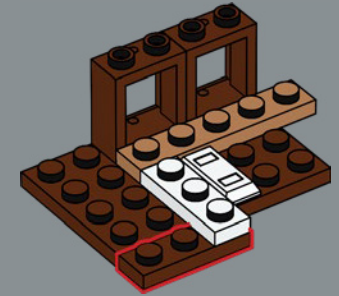

347

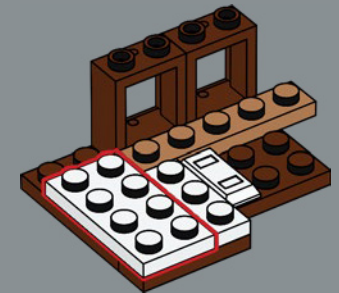



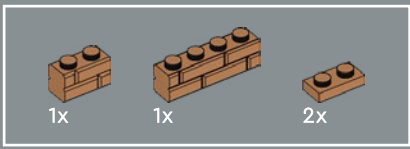

348

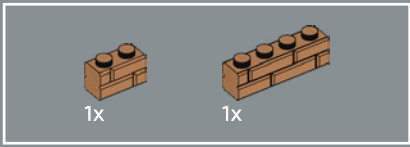
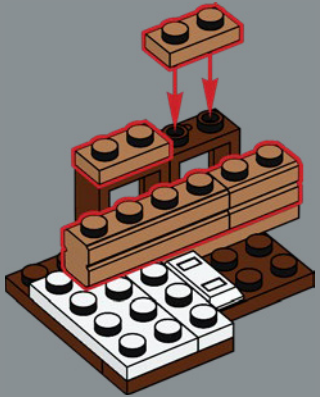

349

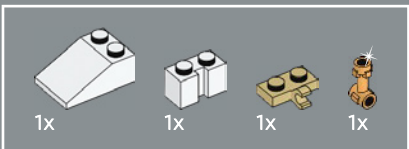
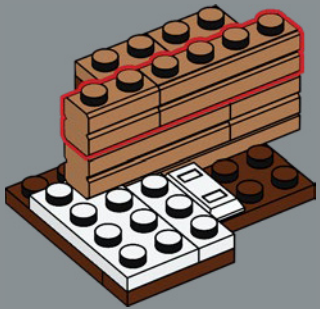

350

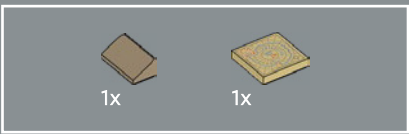
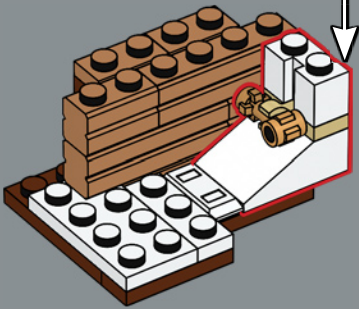
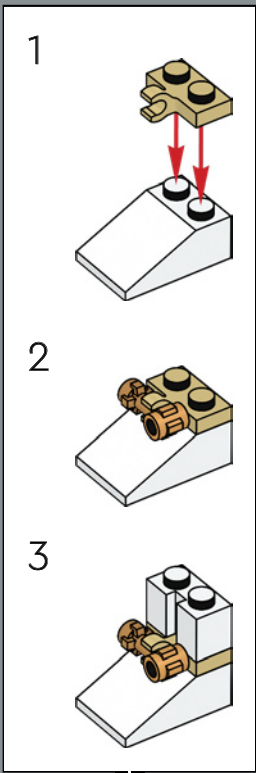

351

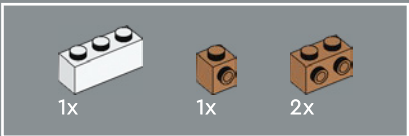
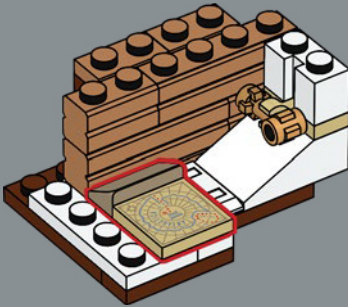

352

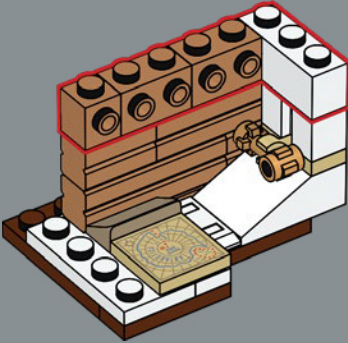

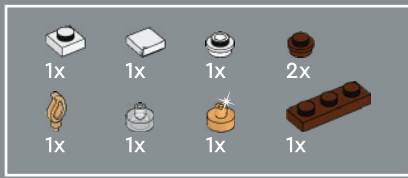

353

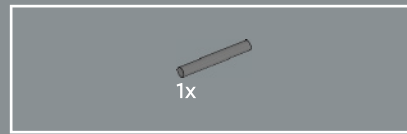
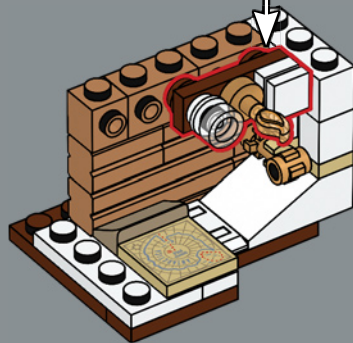
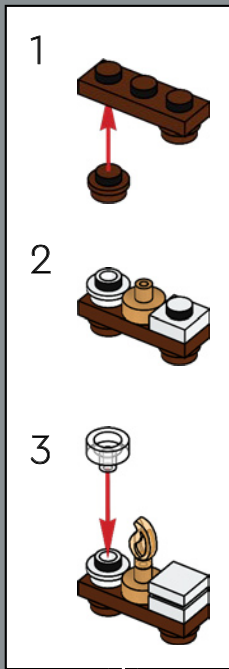

354

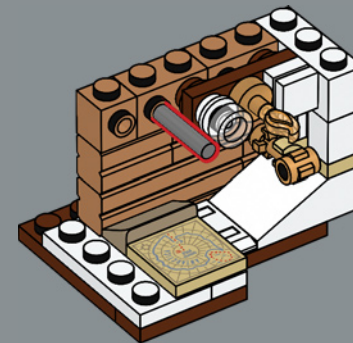

Die dunkelgrauen vertikalen Stäbe in den Kabinen stellen Dampfheizungsrohre dar. In der Kabine des Wissenschaftlers befindet sich eine exklusive LEGO® Karte der Antarktis.

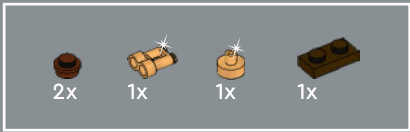

355

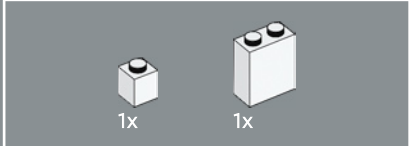
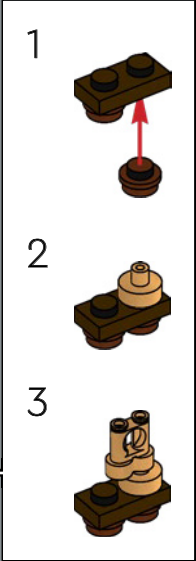
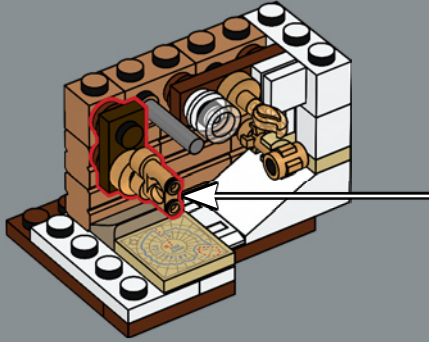

356

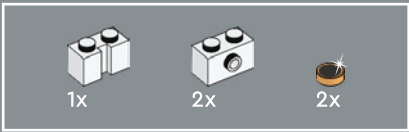
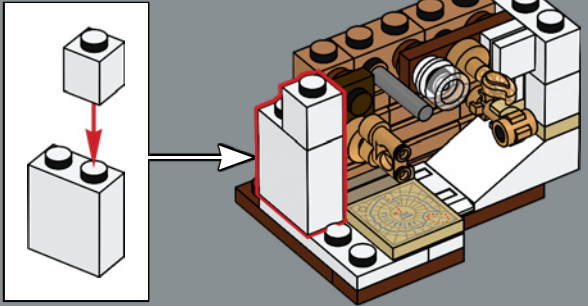

357

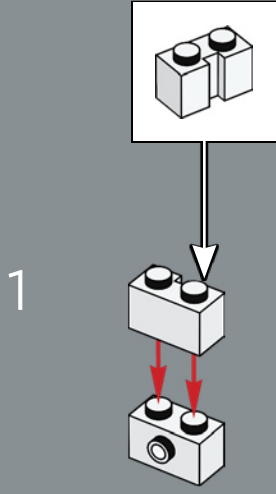

2

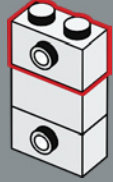

3

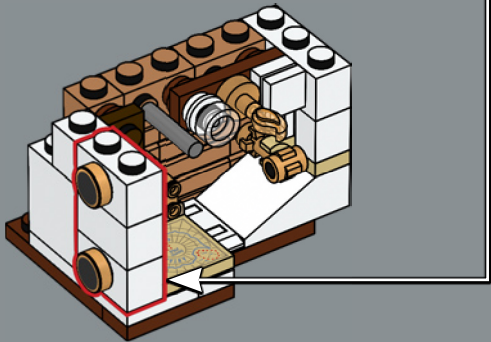
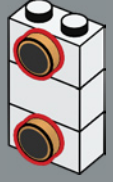

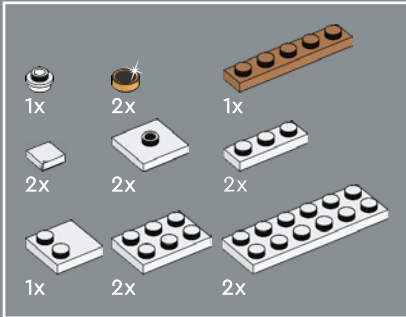
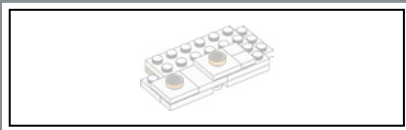

358

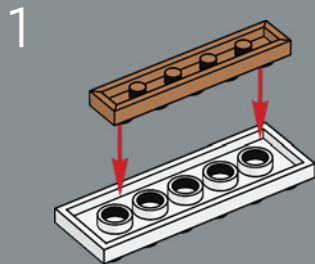

2

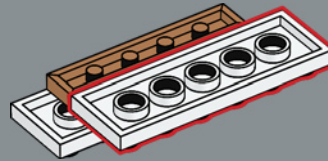

3

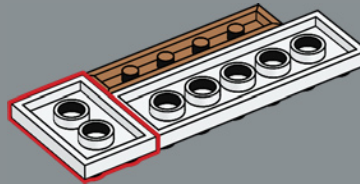

4

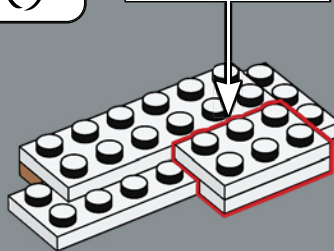
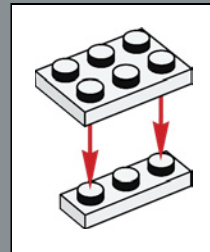

5

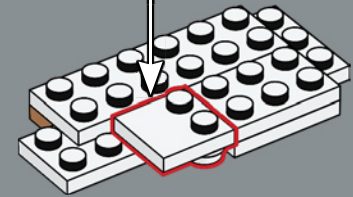
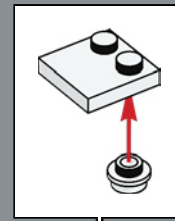

6

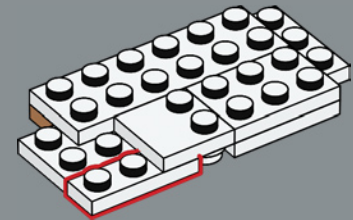

7

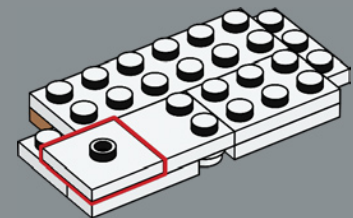



8

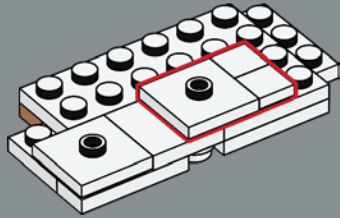

9

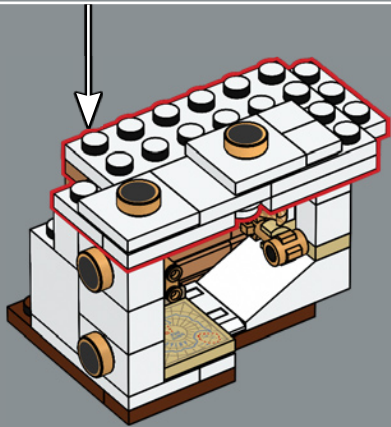
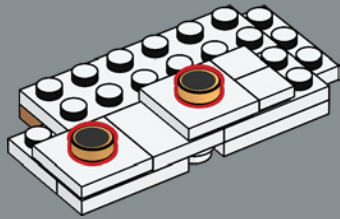

359

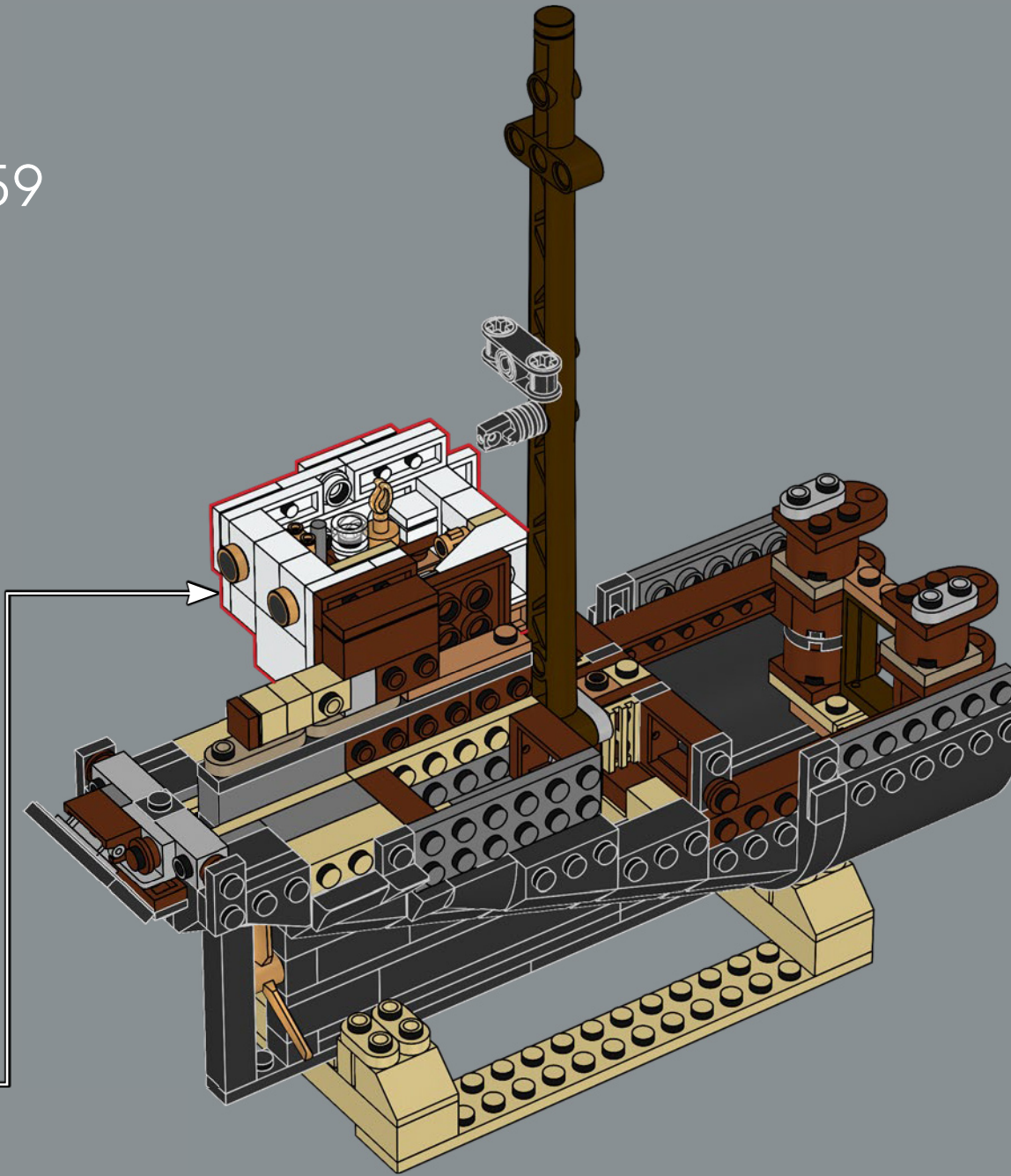

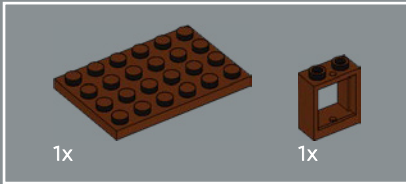
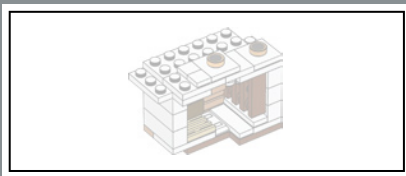

360

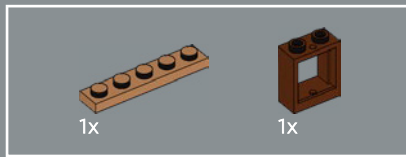
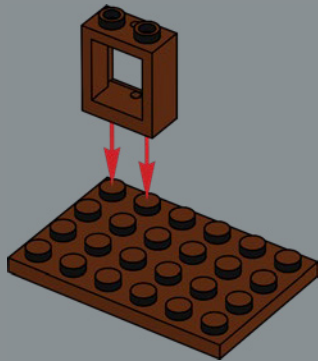

361

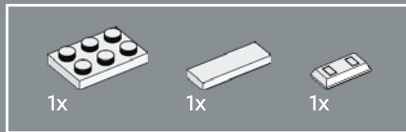
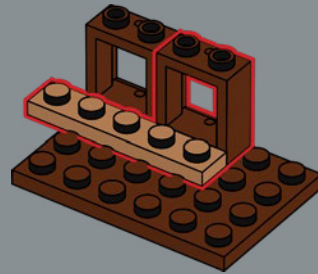

362

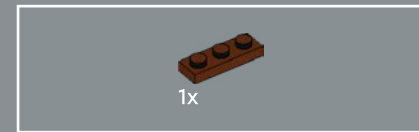

363

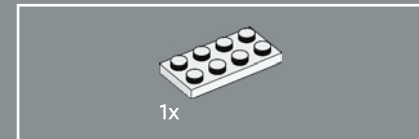
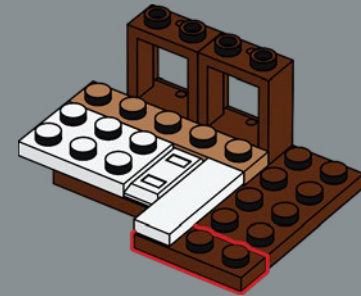

364



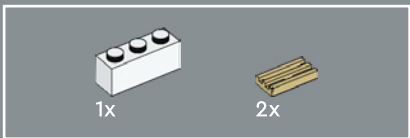

365

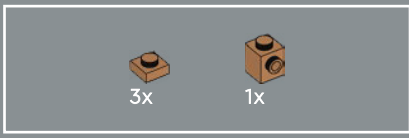

367

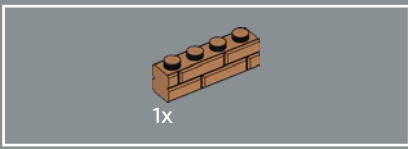
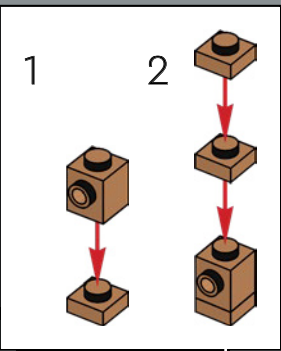
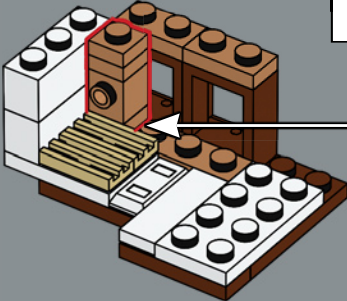

369

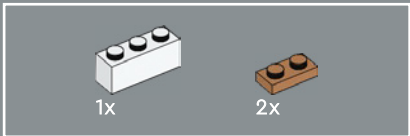
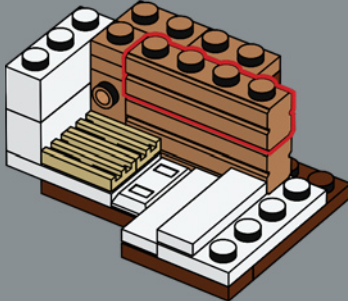

366

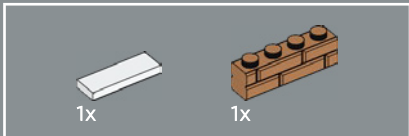
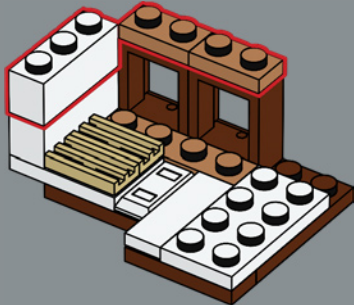

368

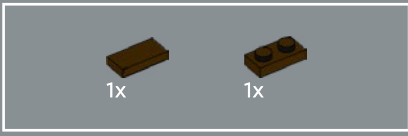
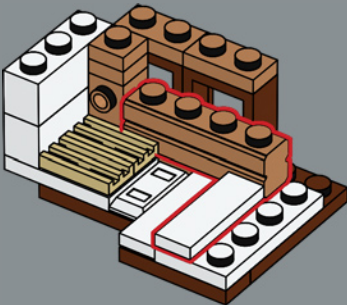

370

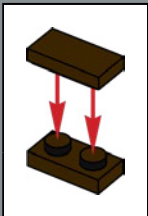
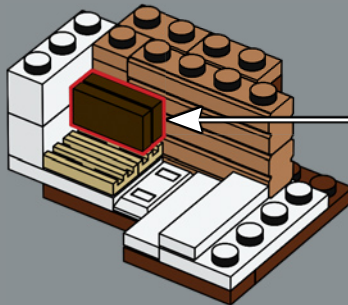

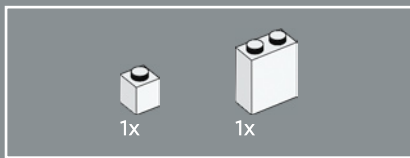

371

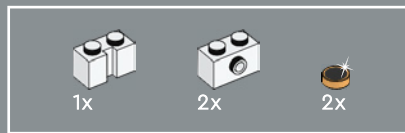
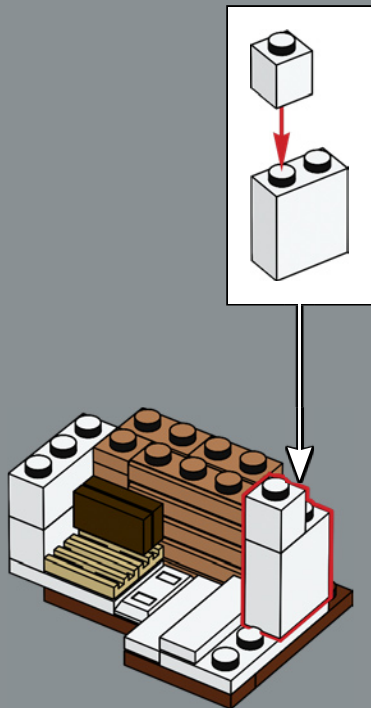

372

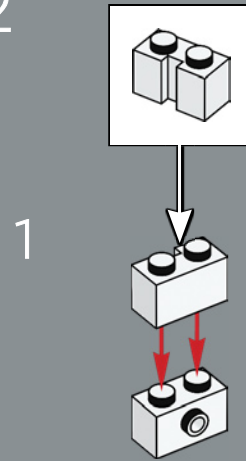

1

2

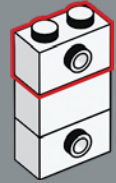

3

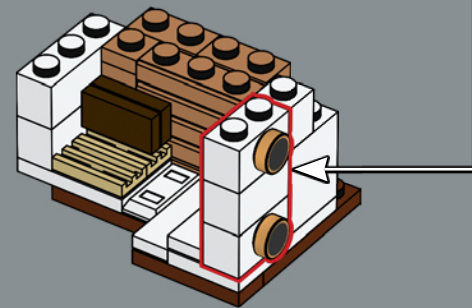
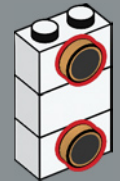



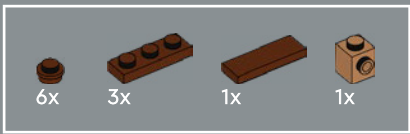

373

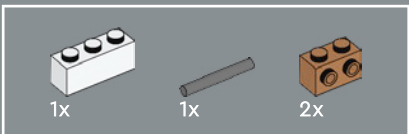
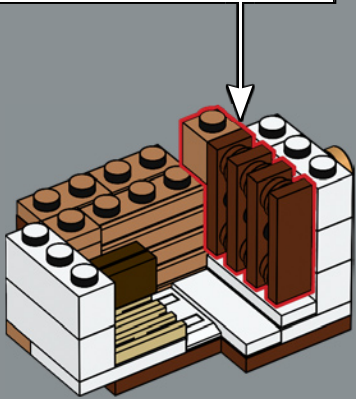
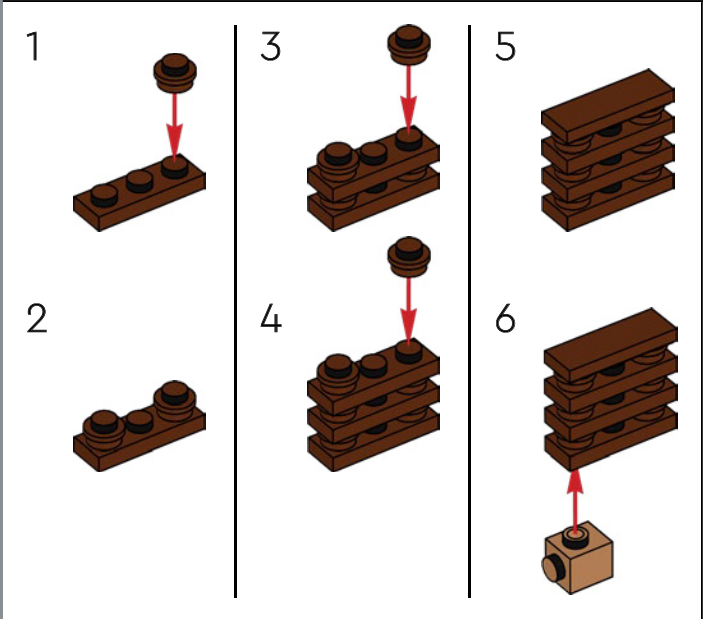

374

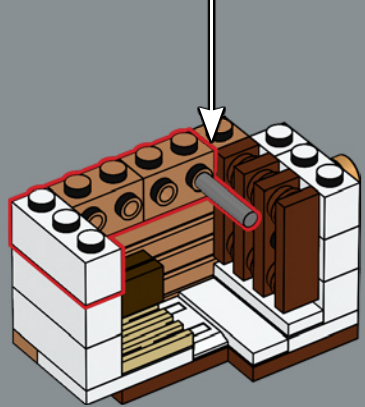
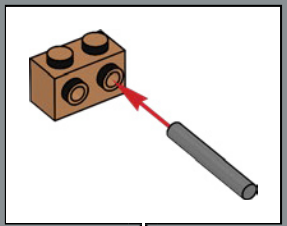

375

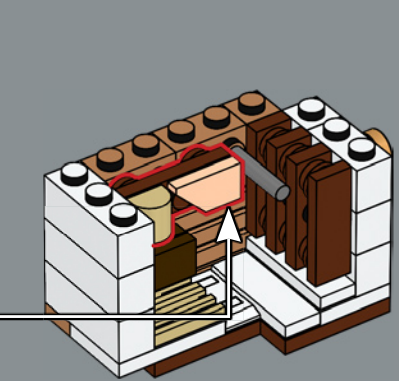
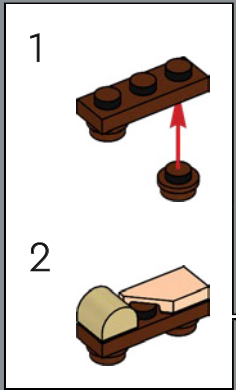

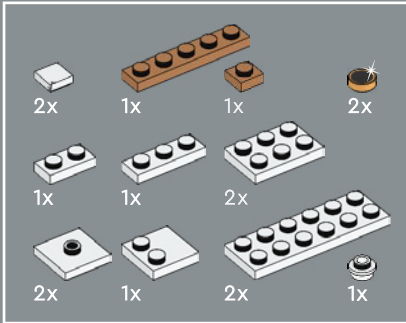
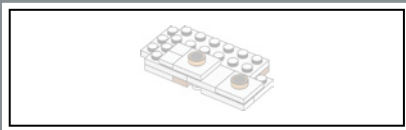

376

1

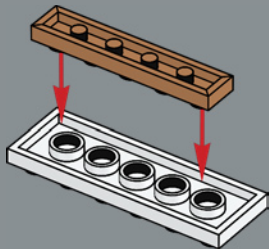

2

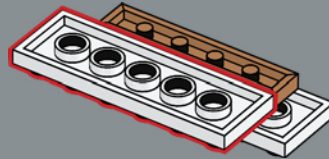

3

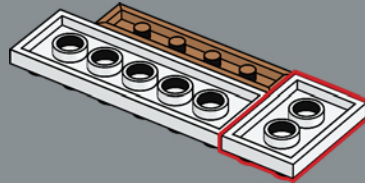

4

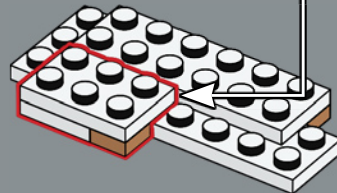
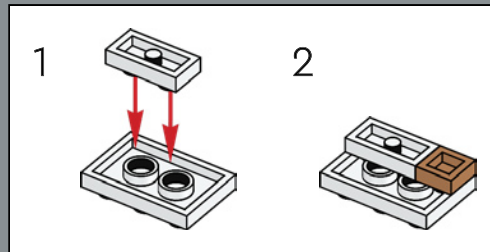

5

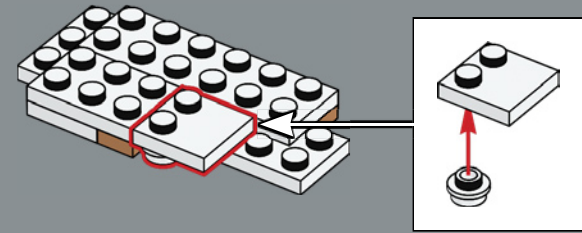

6

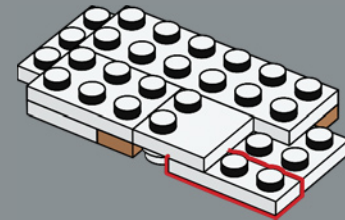

7

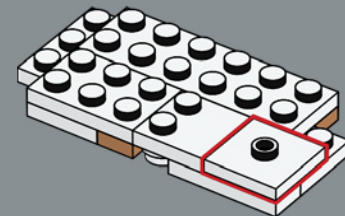

8

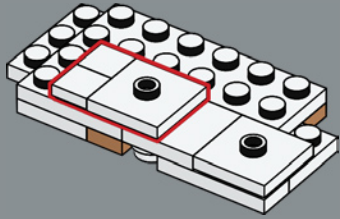

9

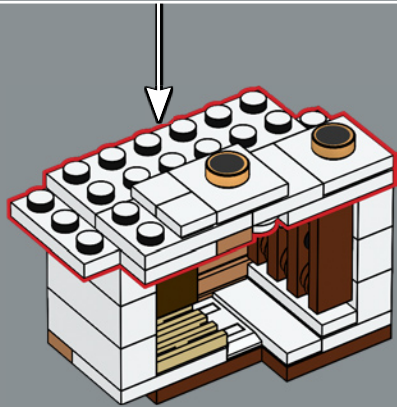
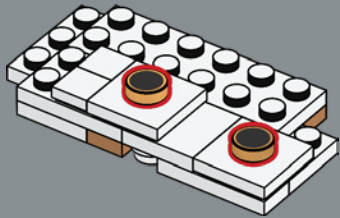

377

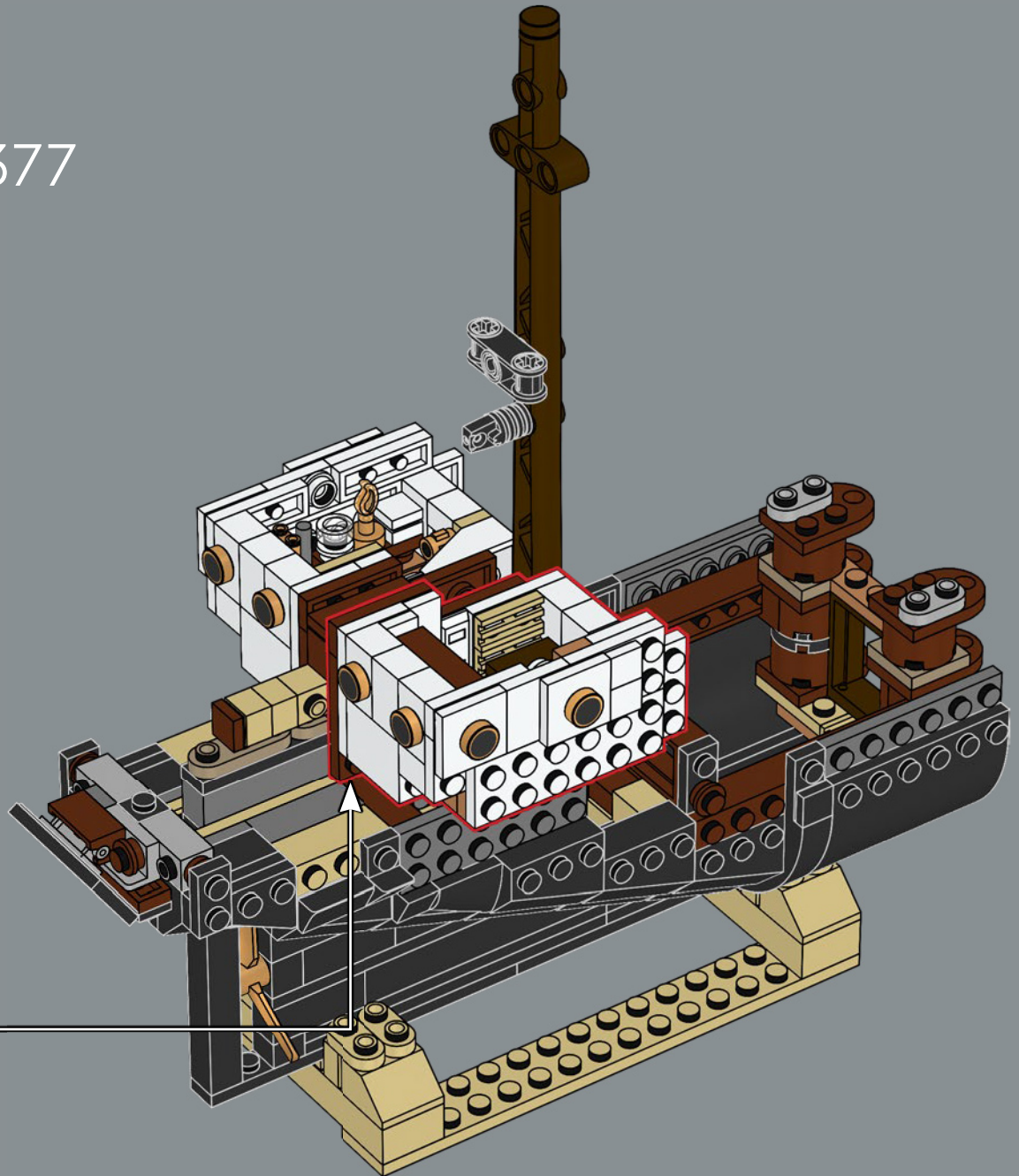

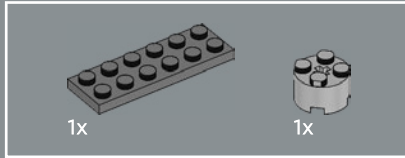
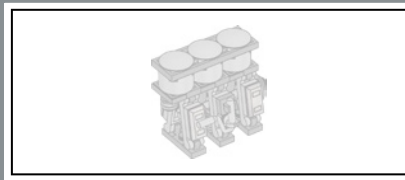

378

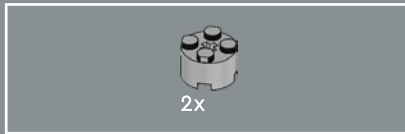
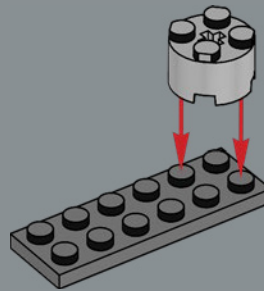

379

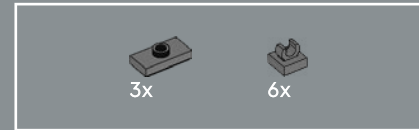
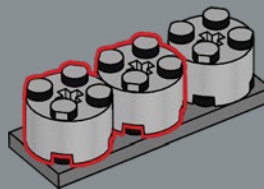

380

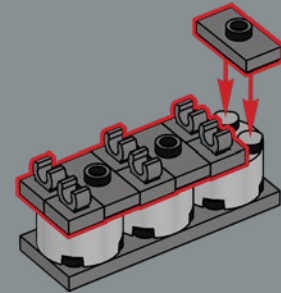

381

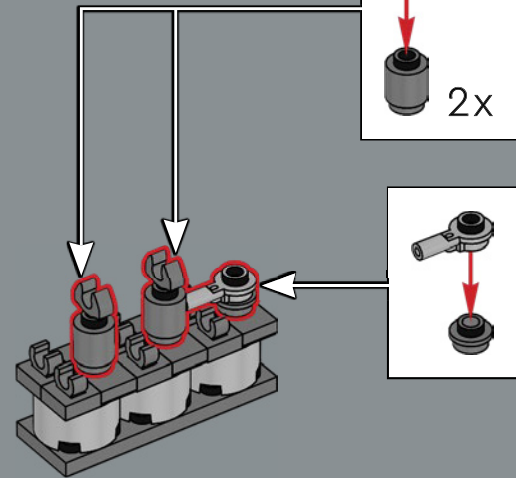



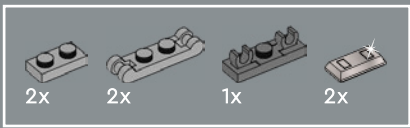

382

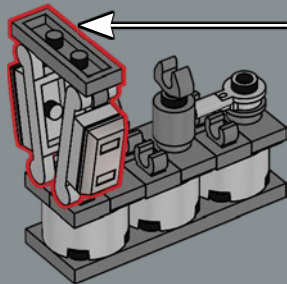
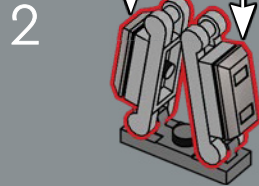
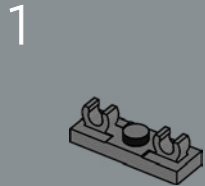
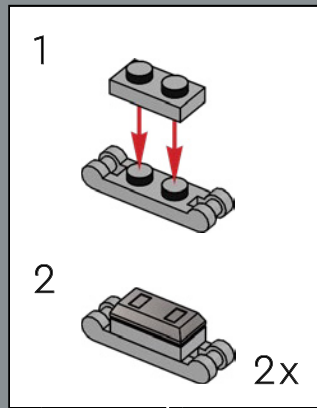

383

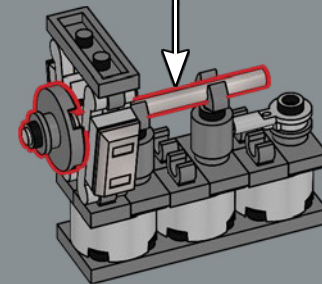
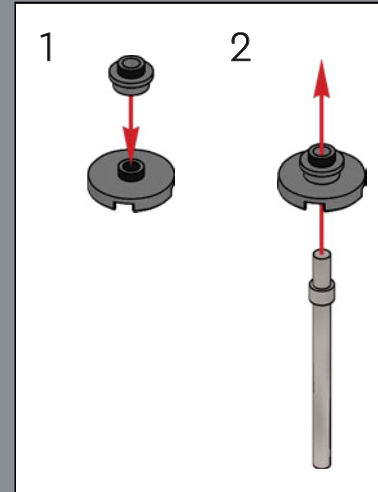

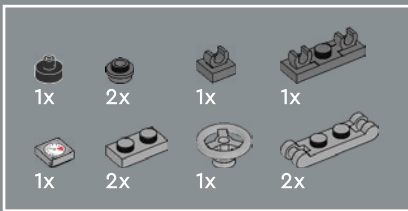

384

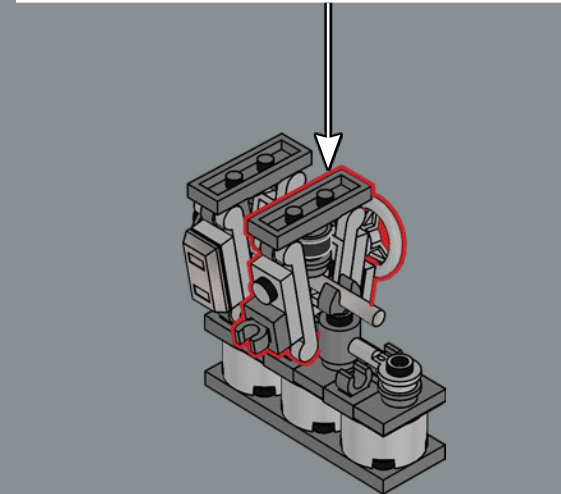
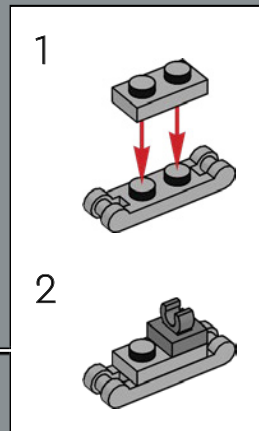
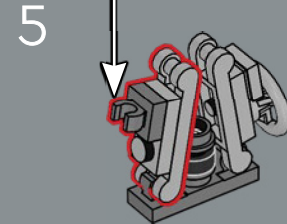
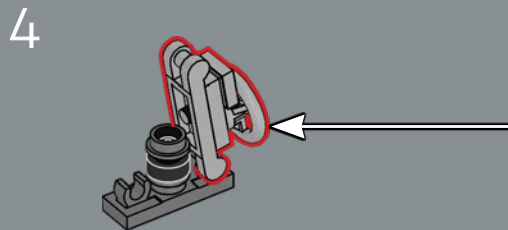
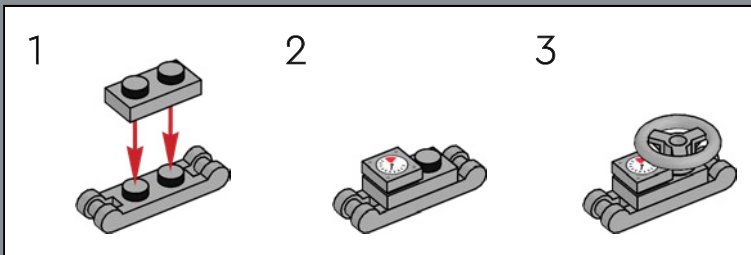
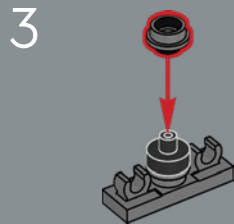
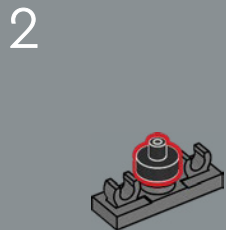
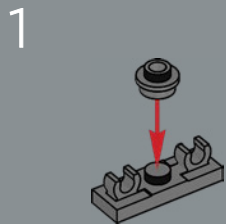

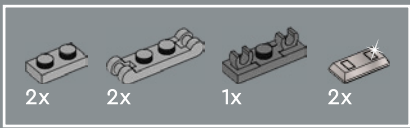

385

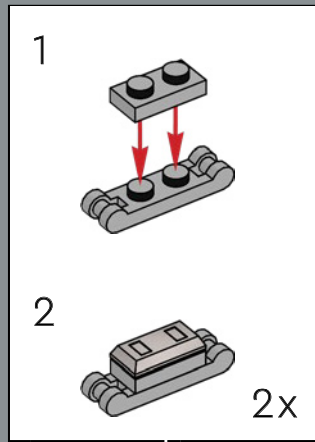

1

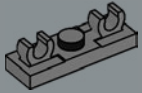

2

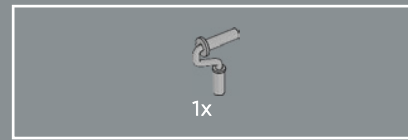
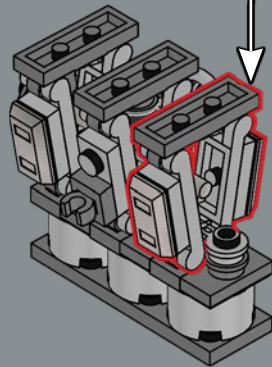
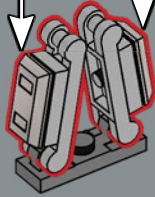

386

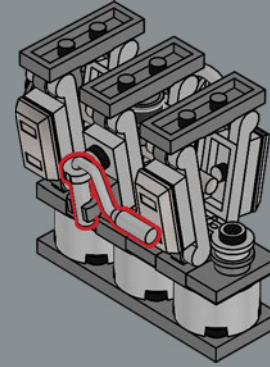

387

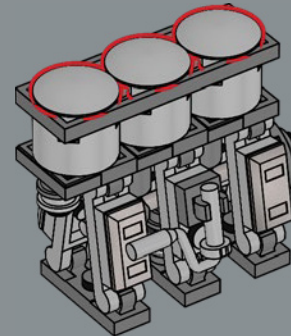



Die „Dreifachexpansionsdampfmaschine“ kann aus dem Maschinenraum herausgenommen und separat ausgestellt werden.

388

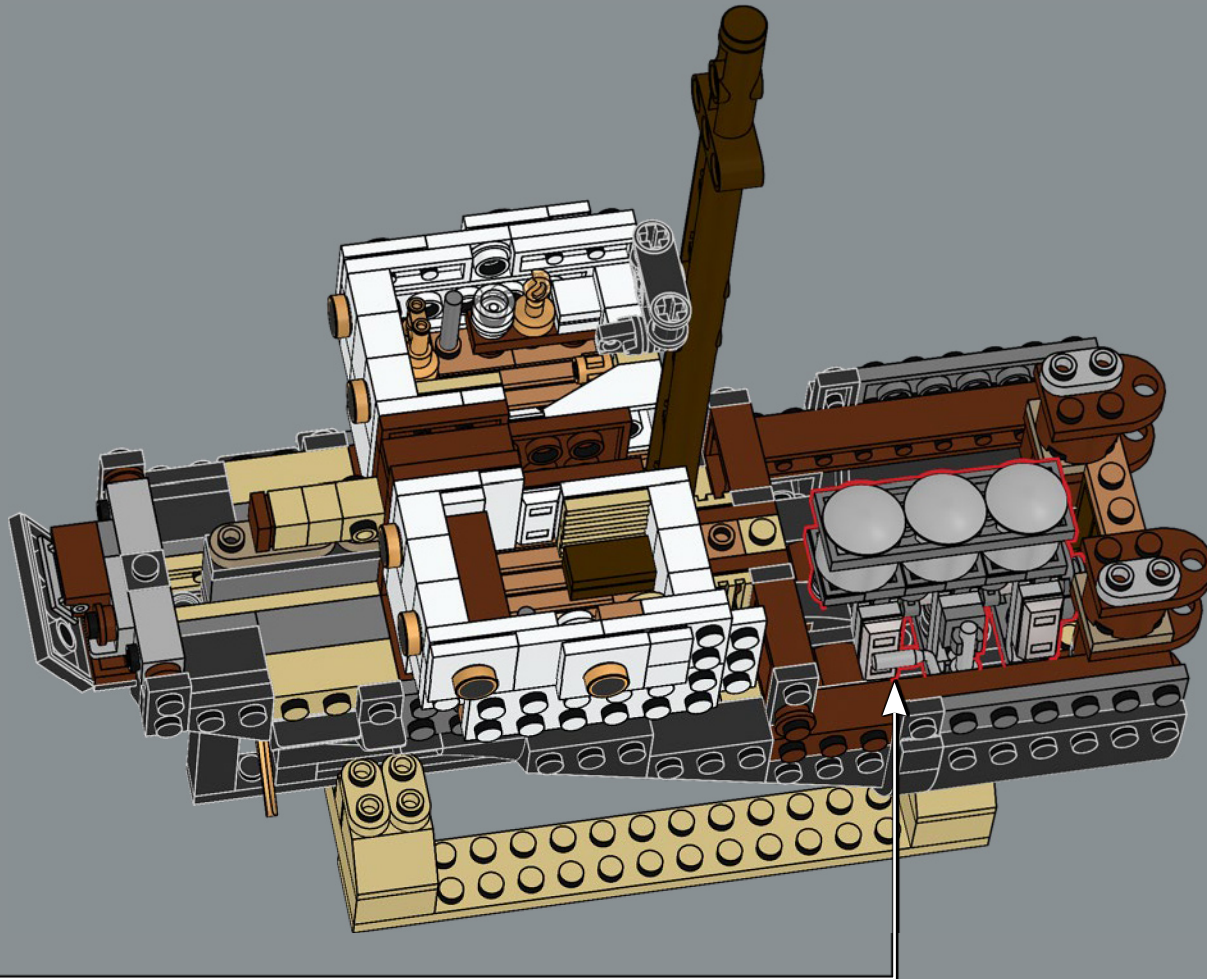



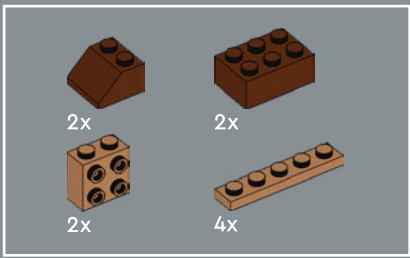

389

1



2

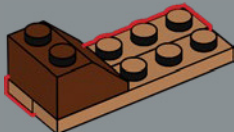

3

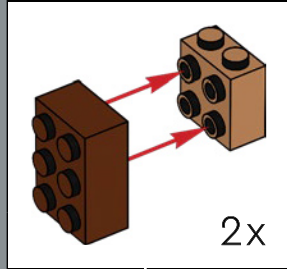
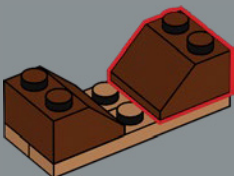

4

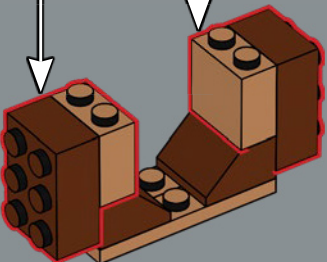

5

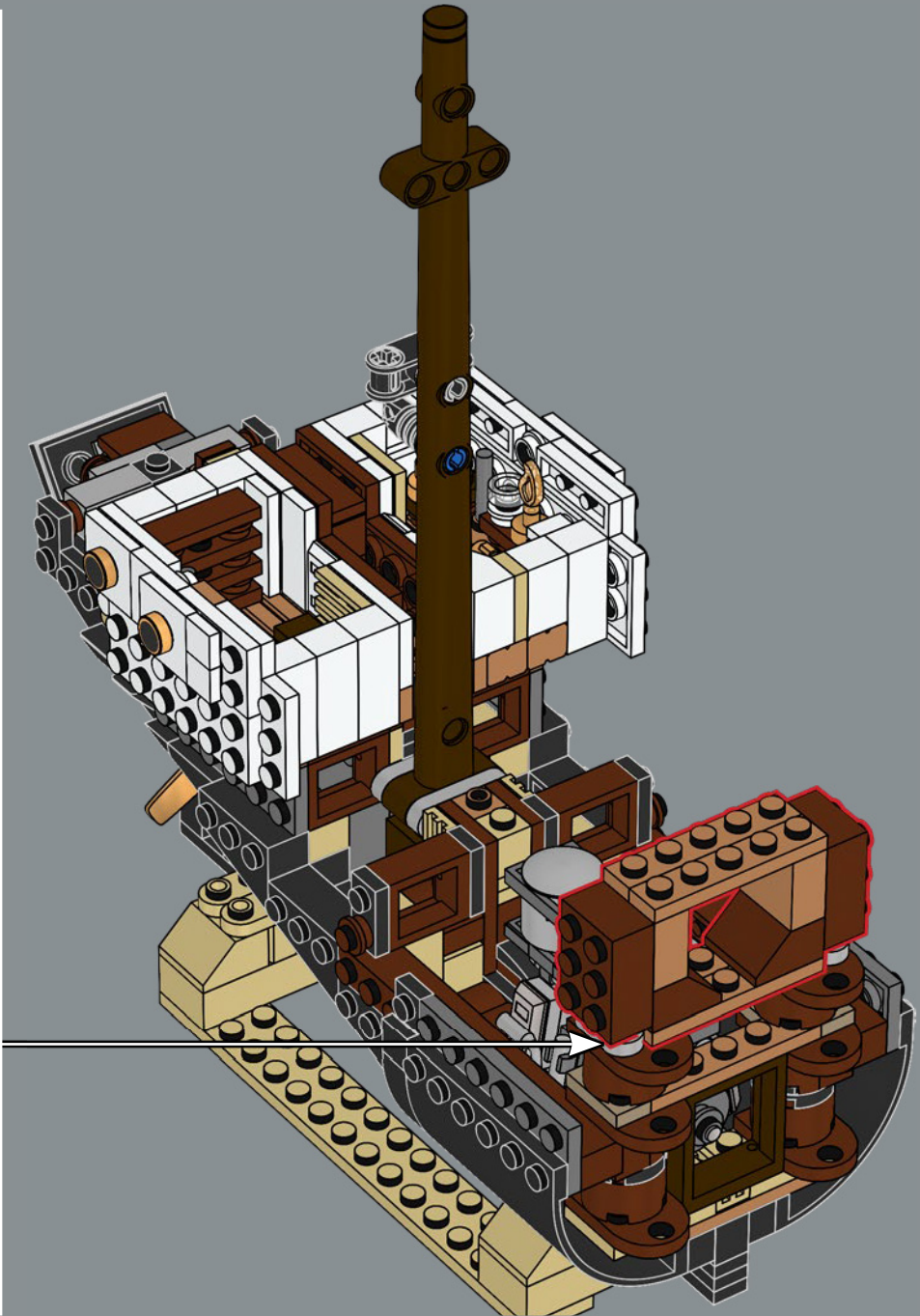
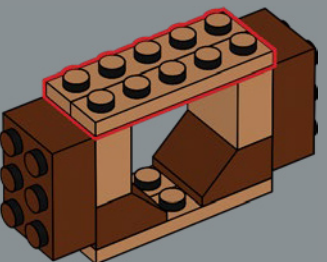

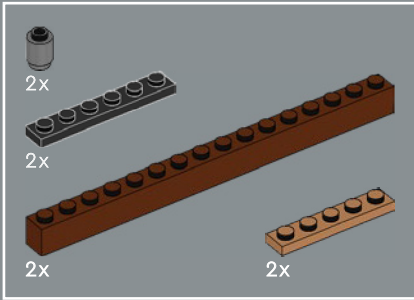
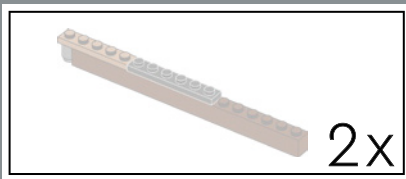

390

1

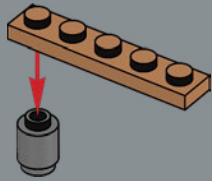

2

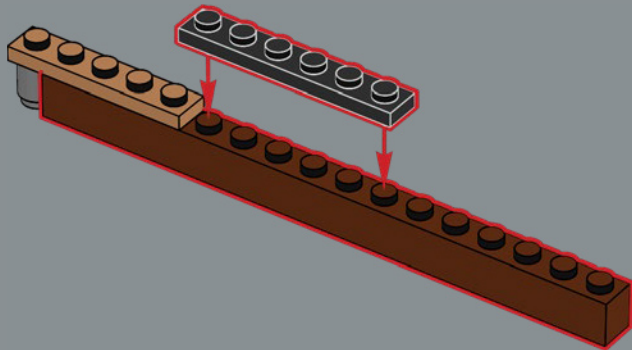

2x

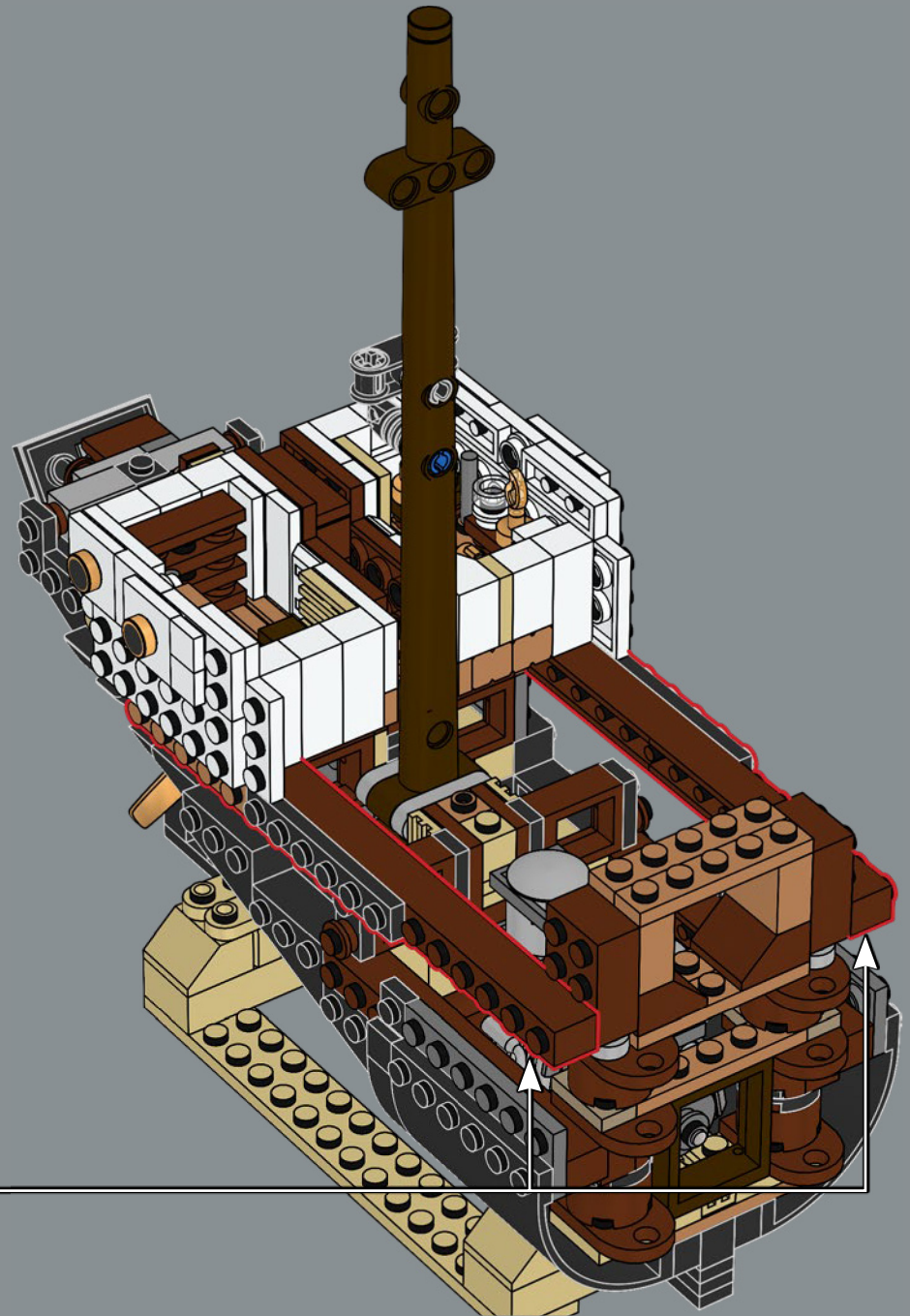



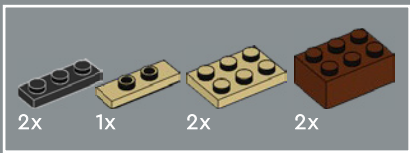

391

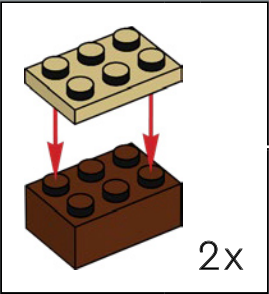
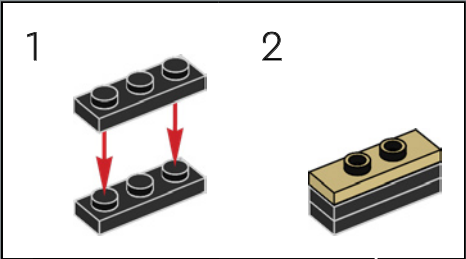
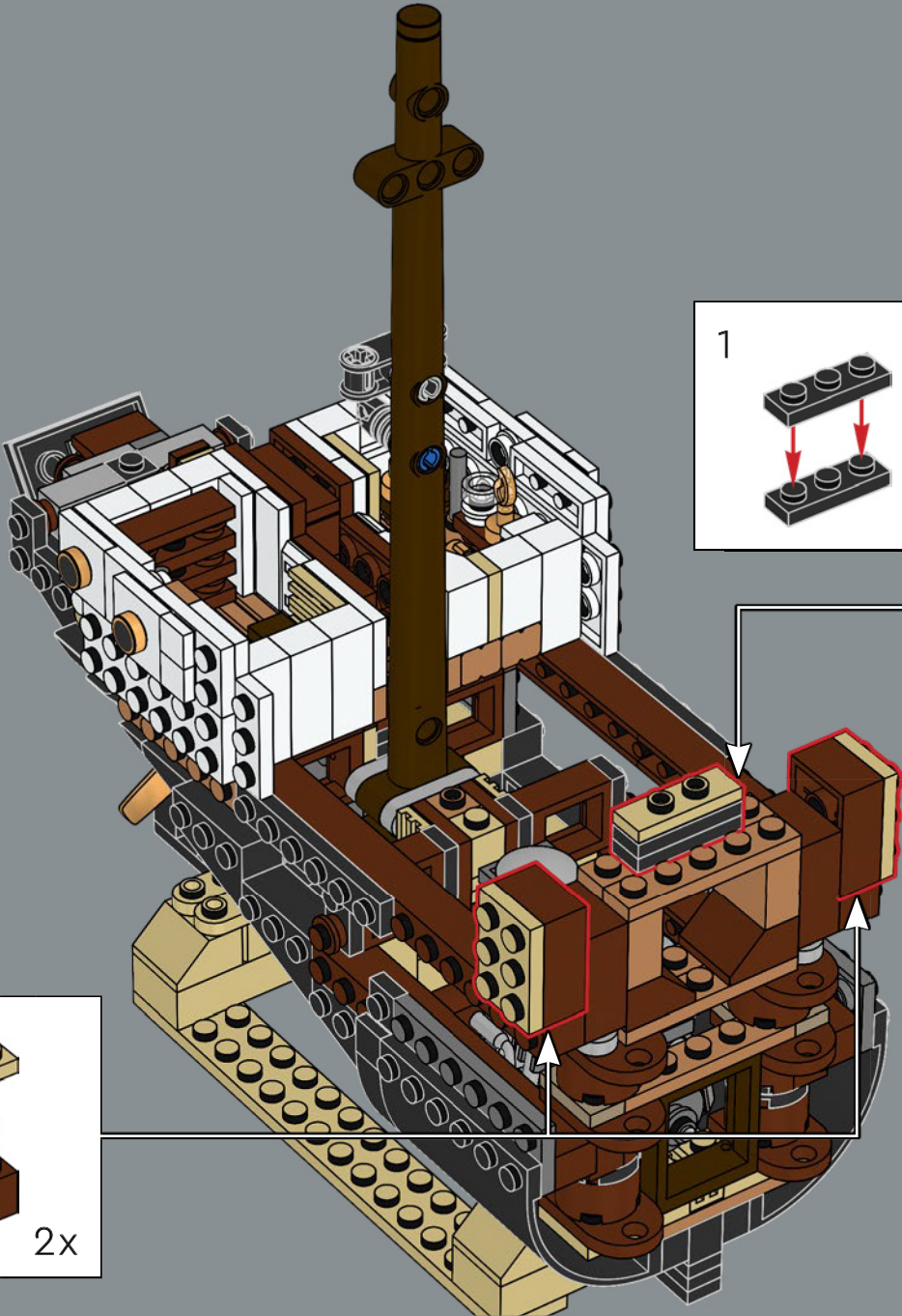

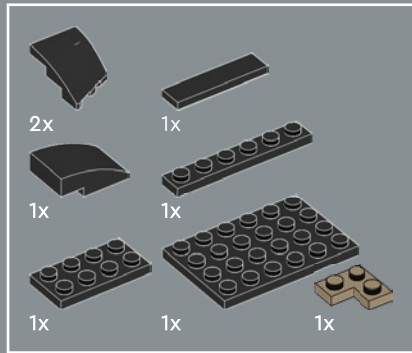

392

1

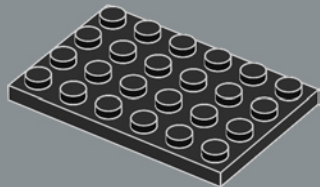

2

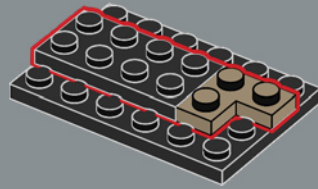

3

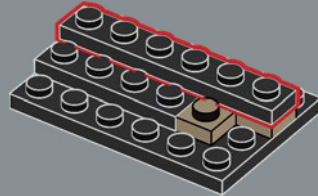

4

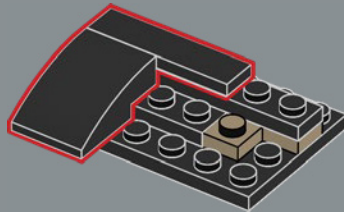

5

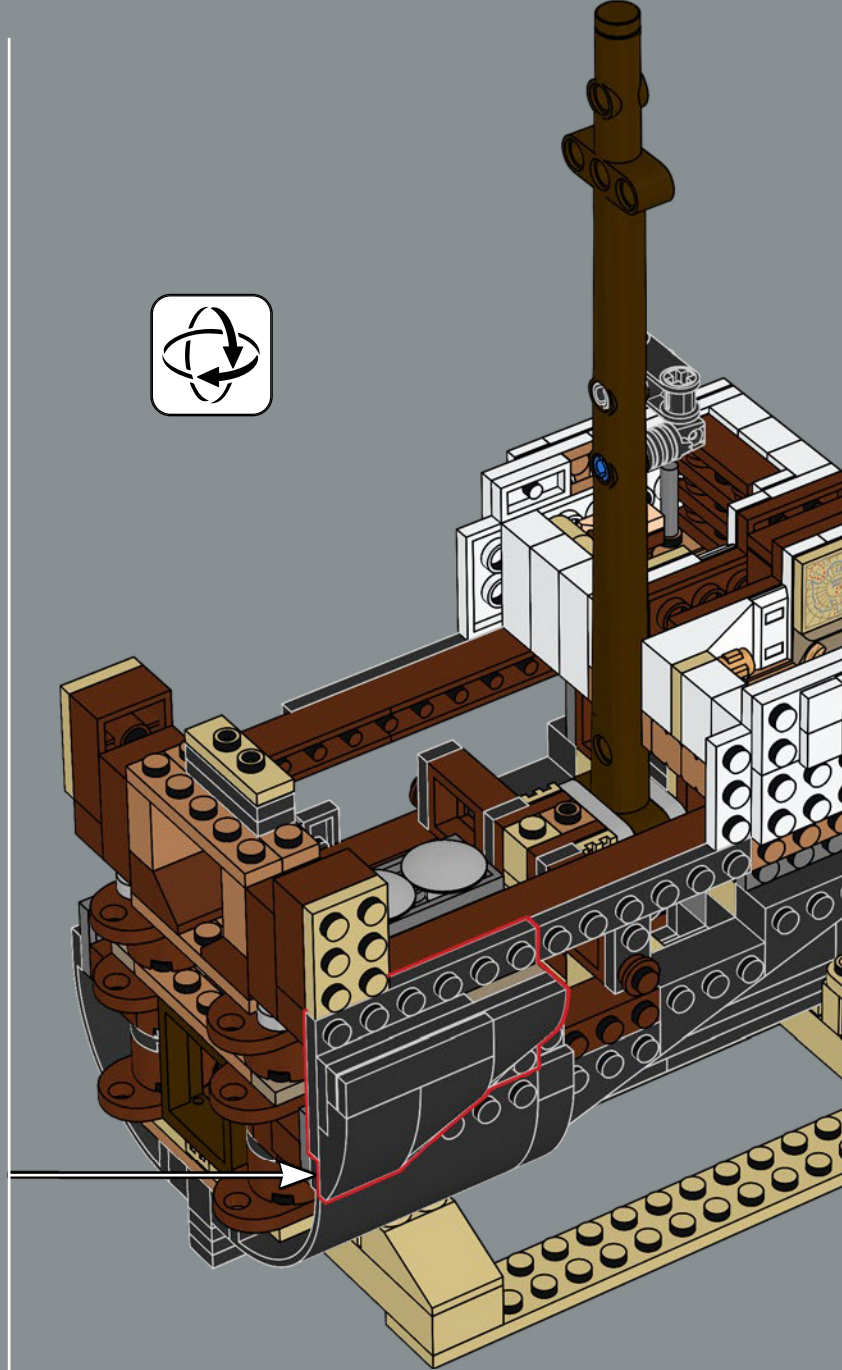
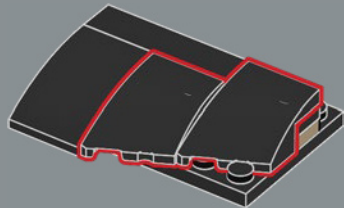



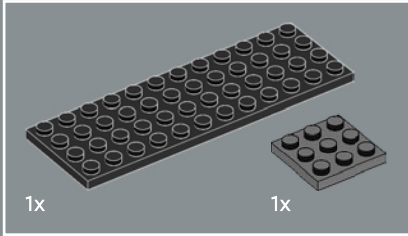
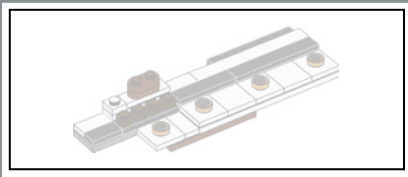

393

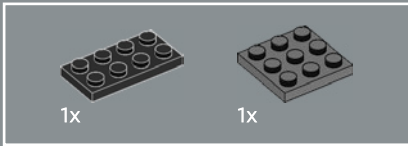
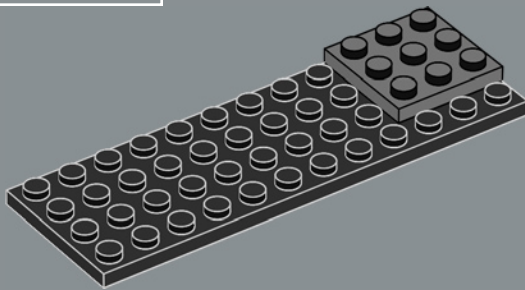

394

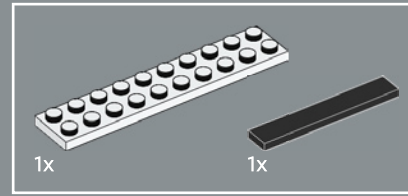
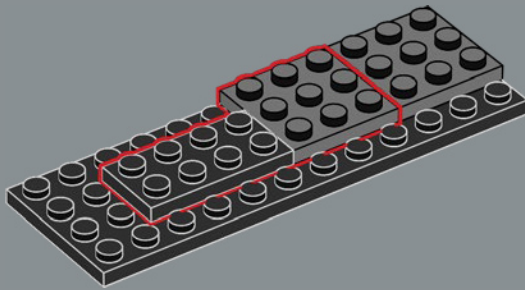

395

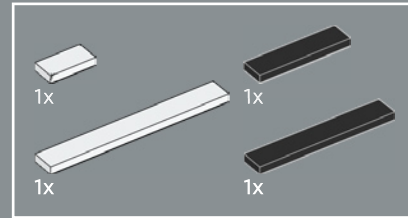
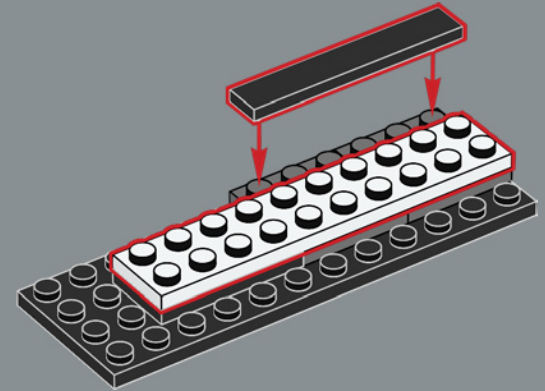

396

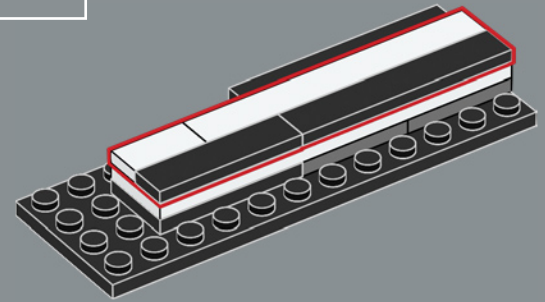

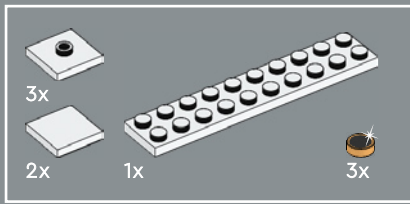

397

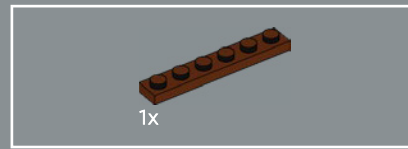
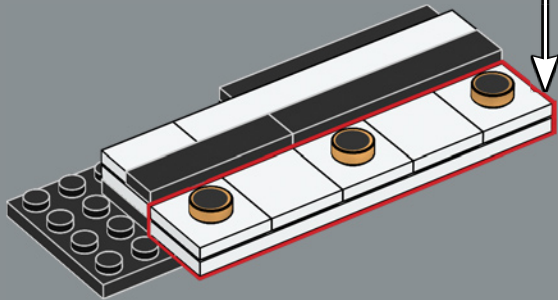
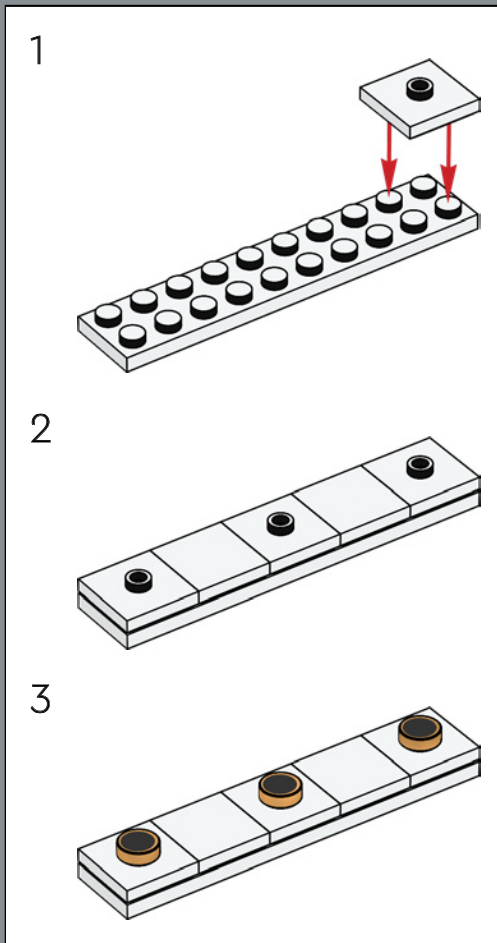

398

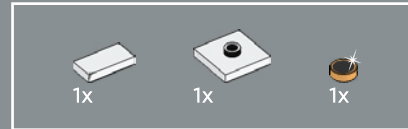
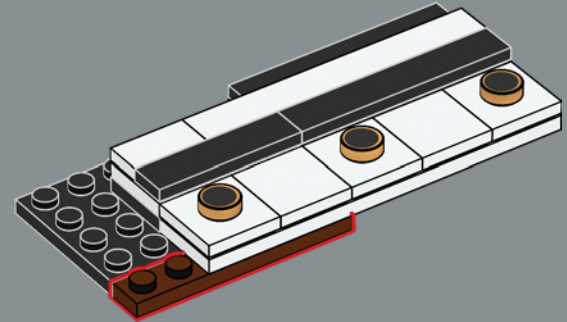

399

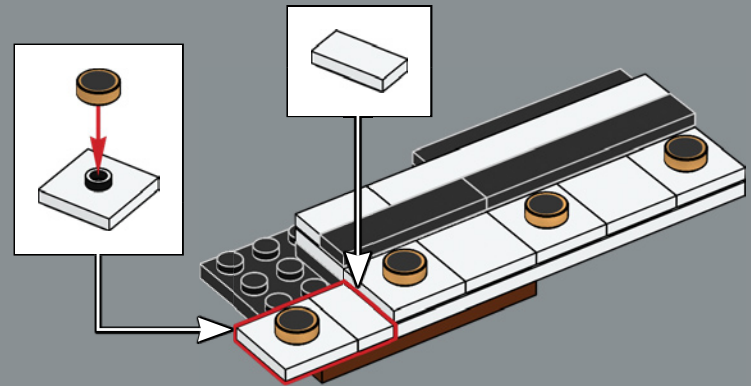

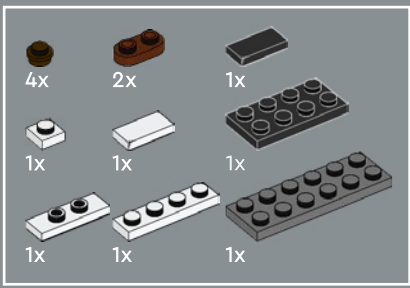

400

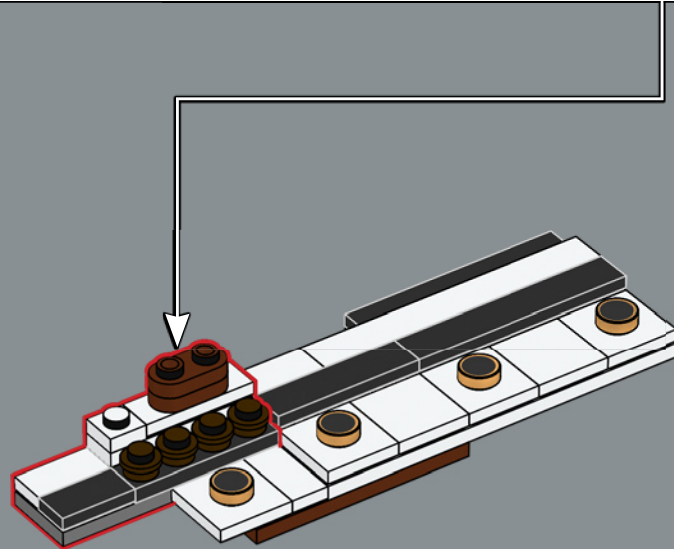
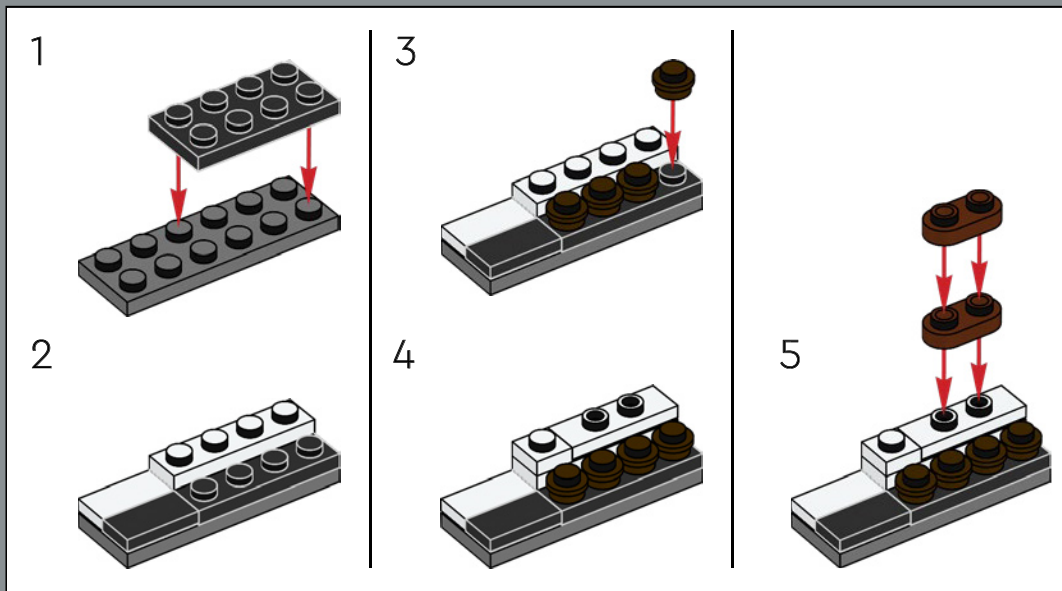

401

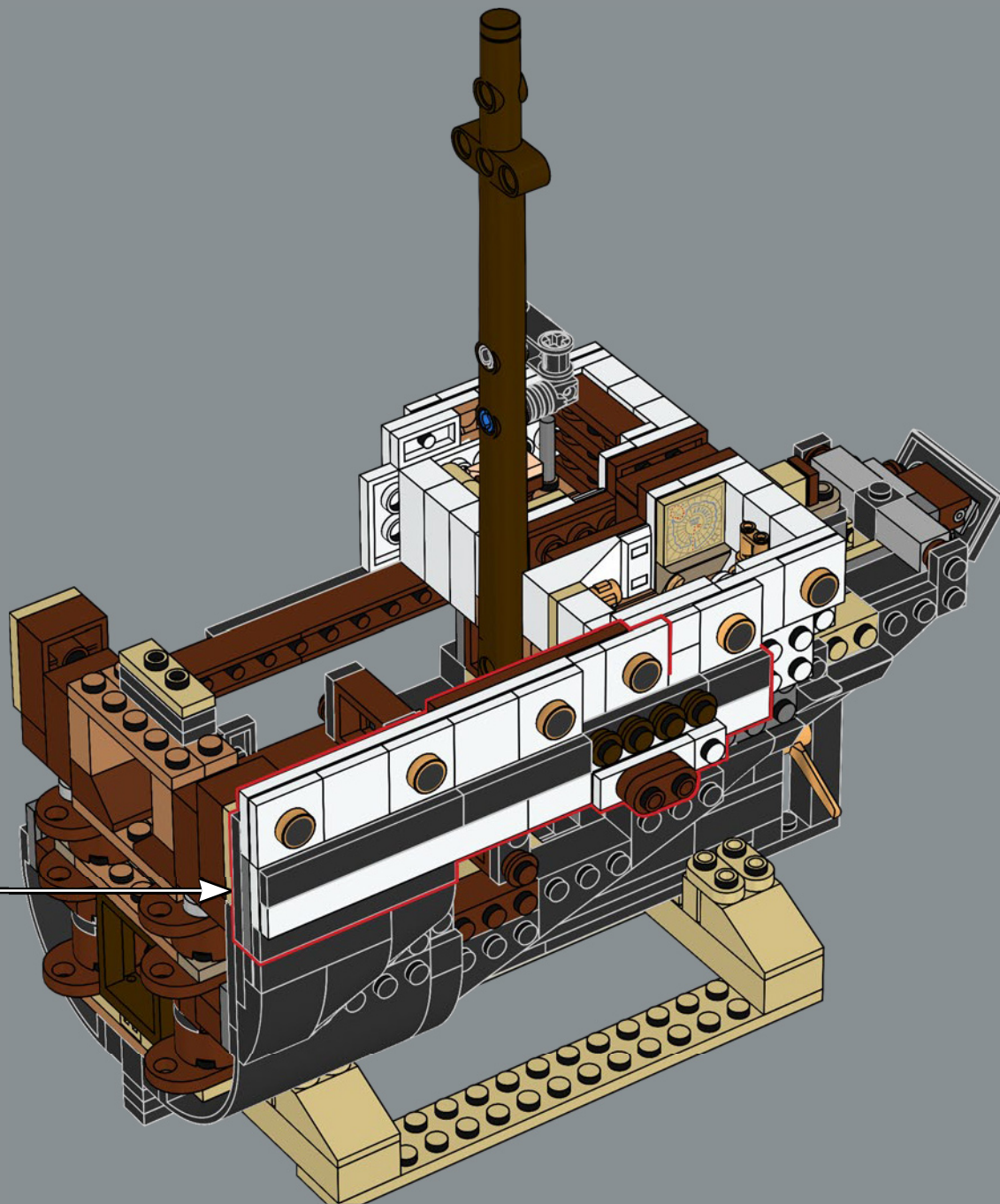



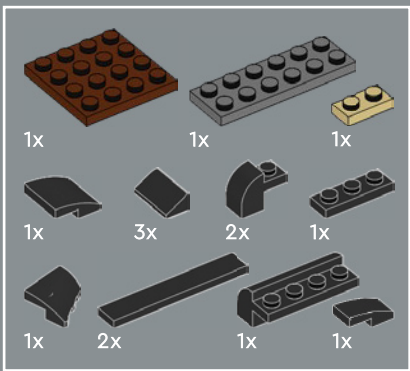

402

1

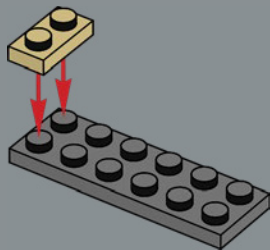

2

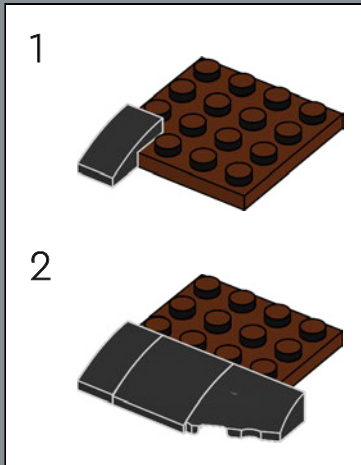
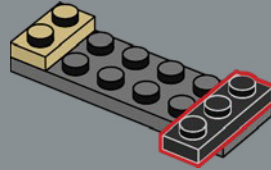

3

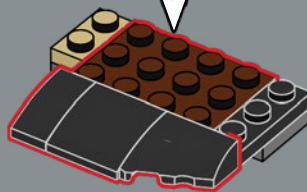

4

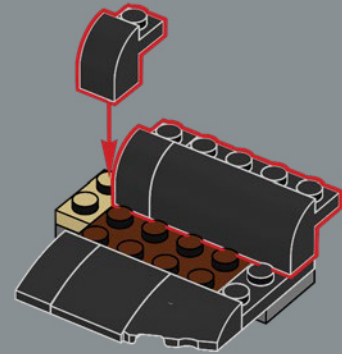

5

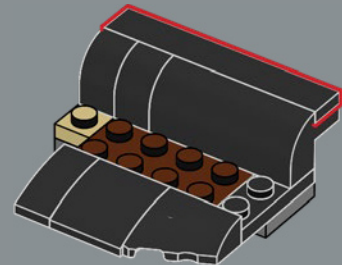

6

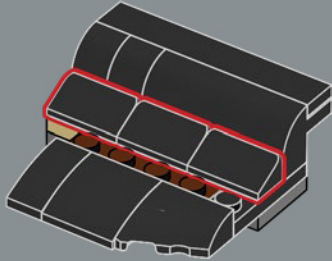

7

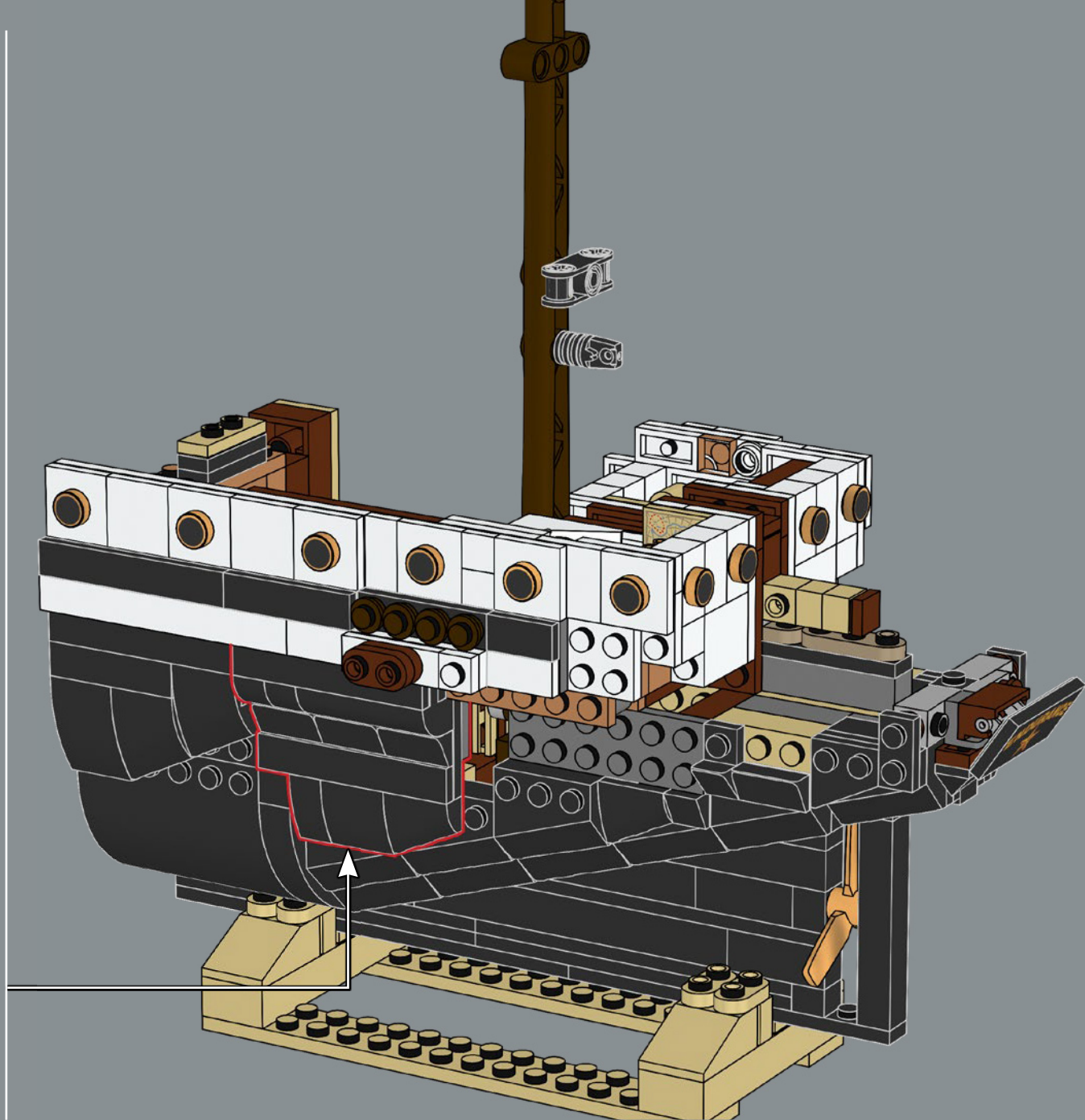
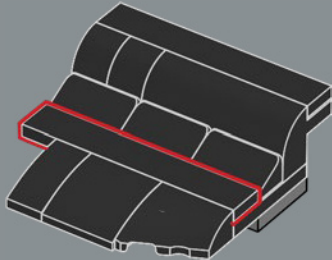

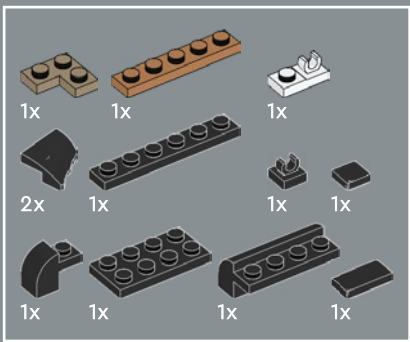

403

1

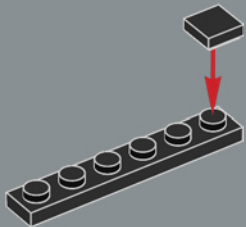

2

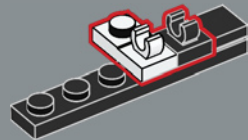

3

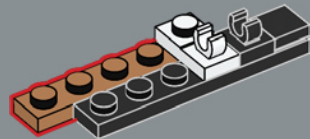

4

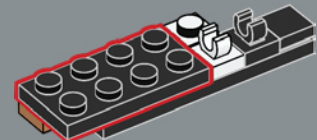

5

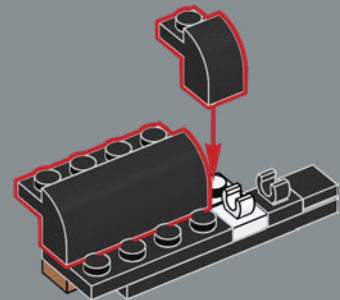

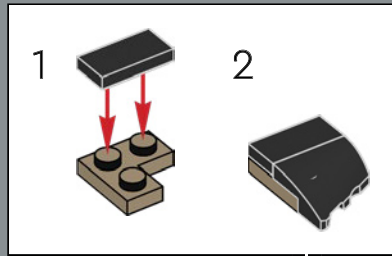

6

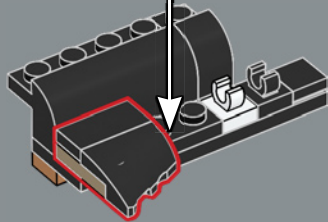

7

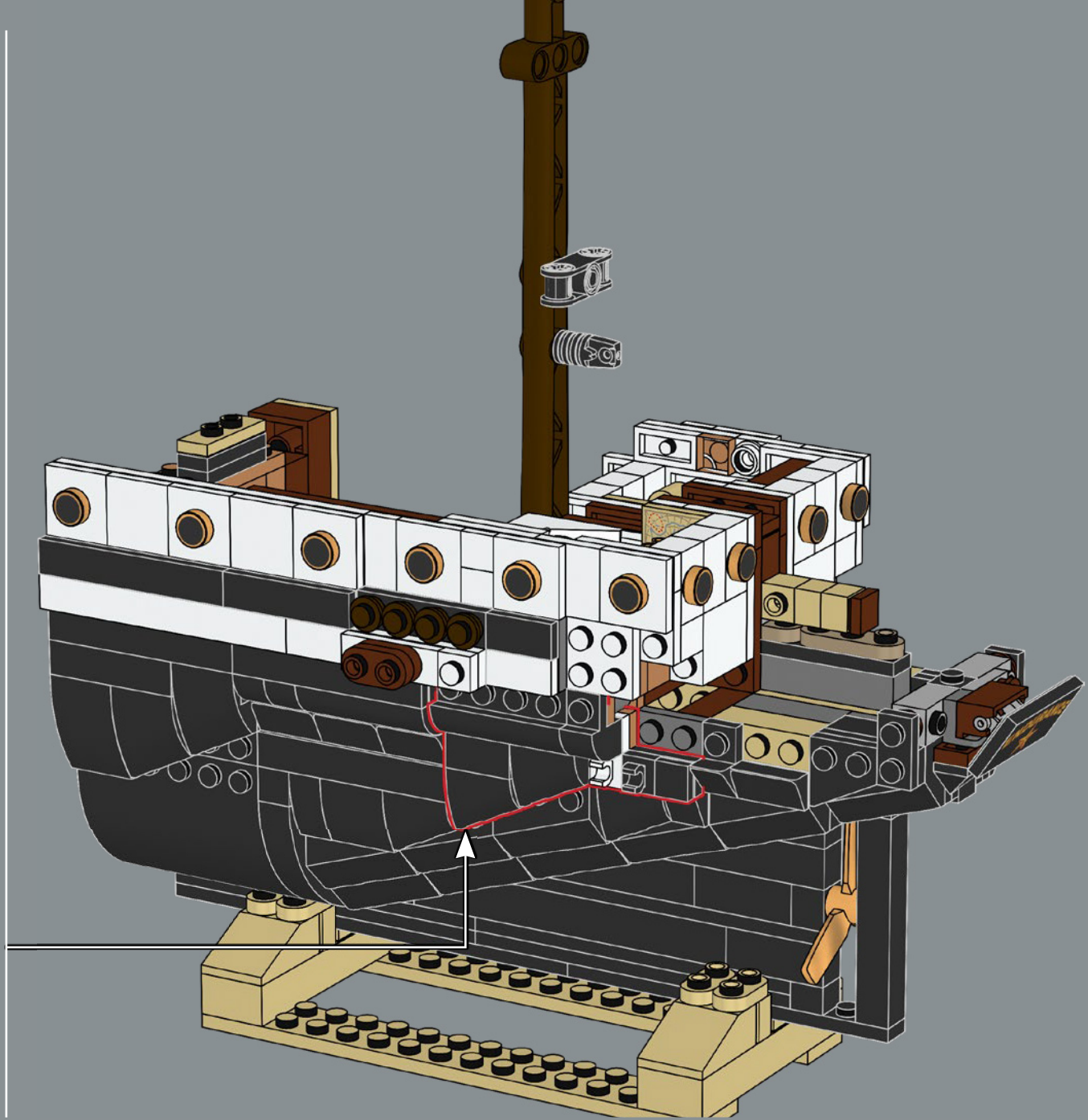
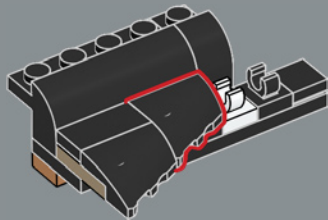



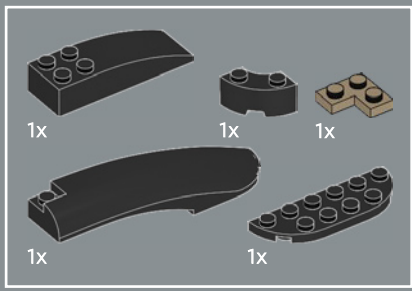

404

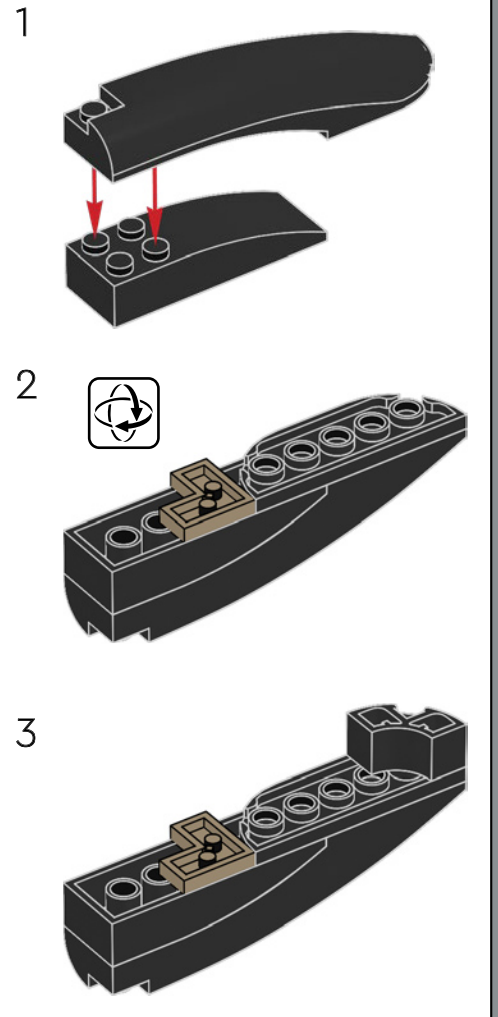
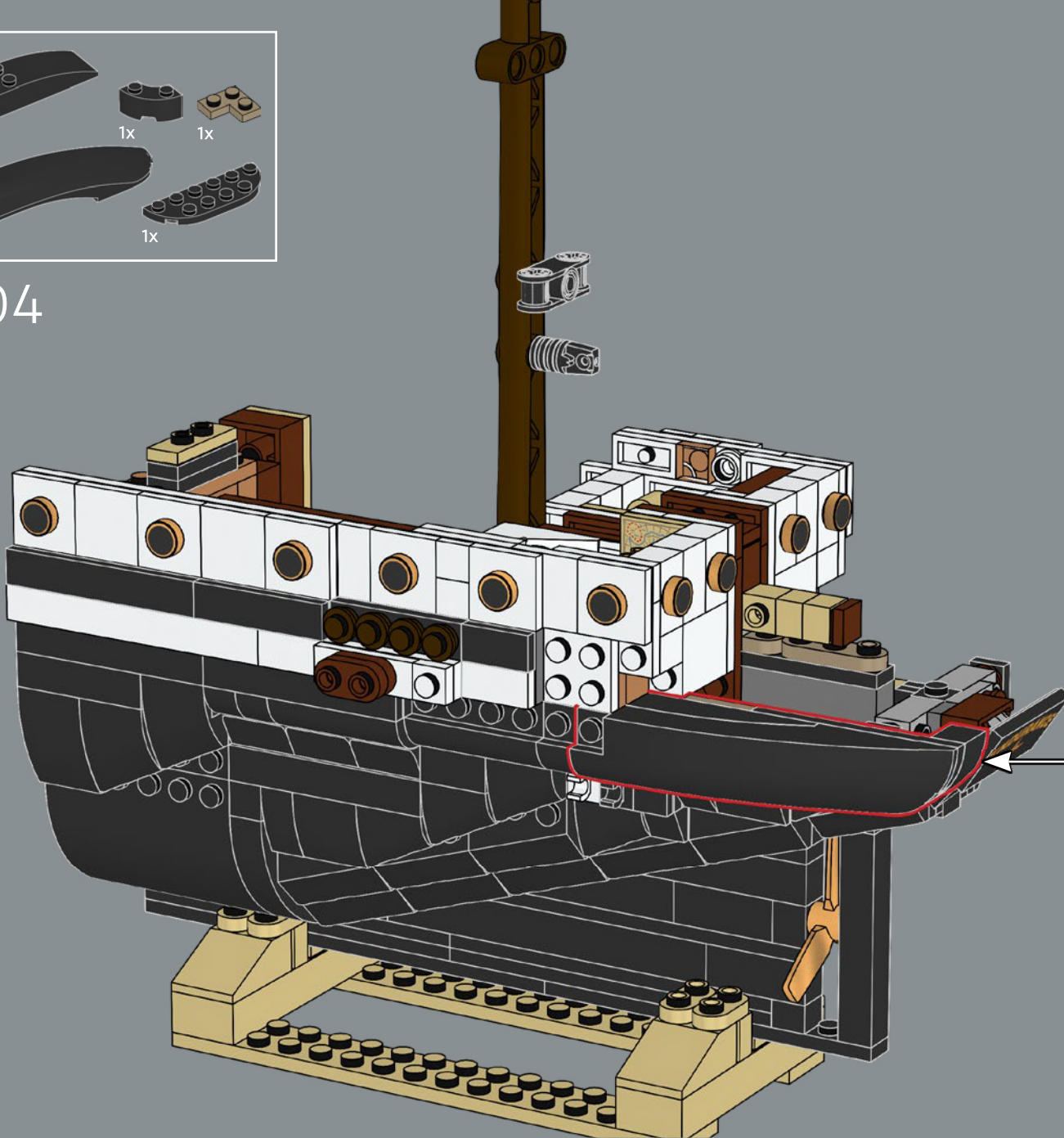

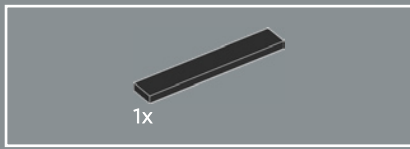

405

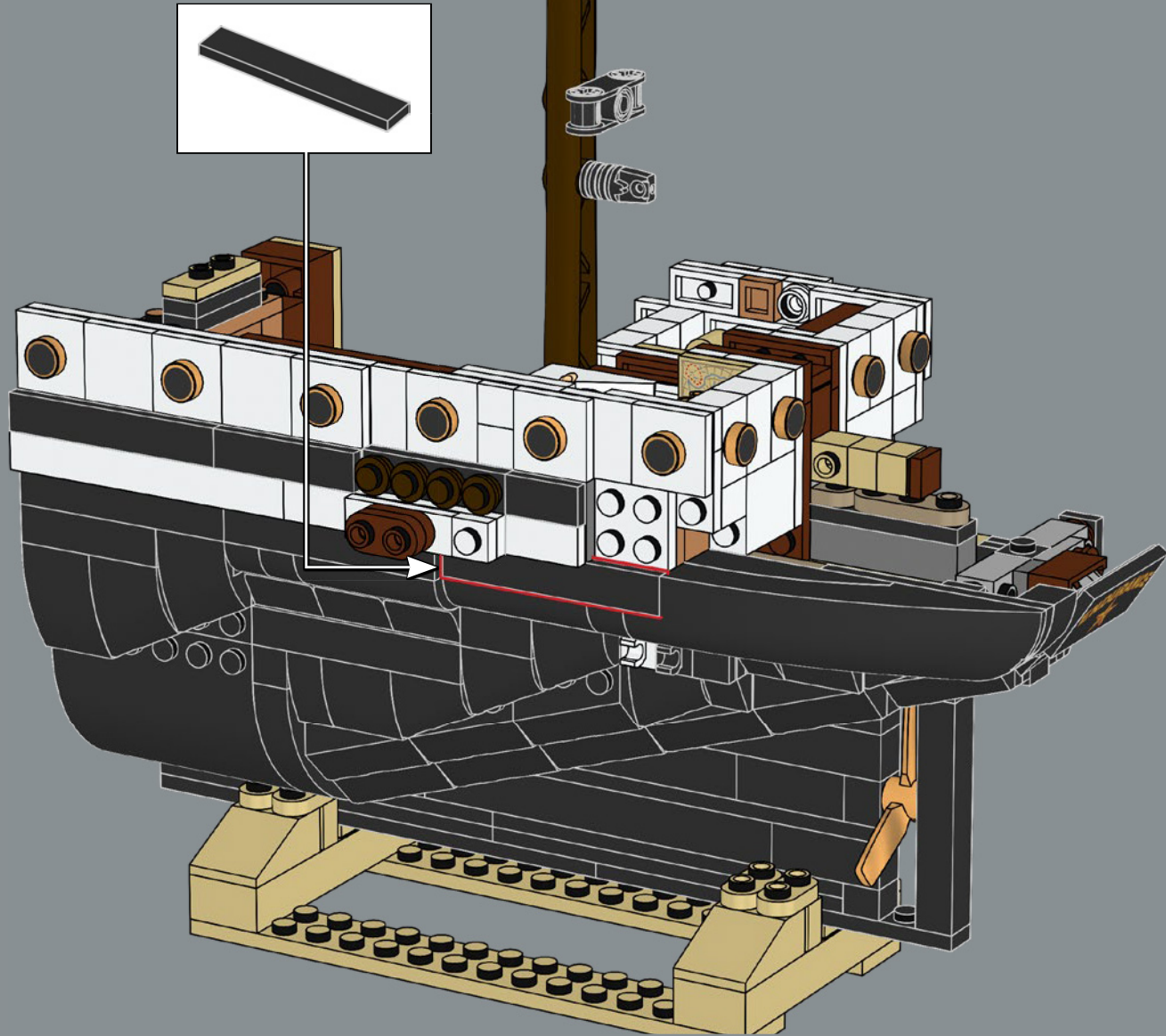

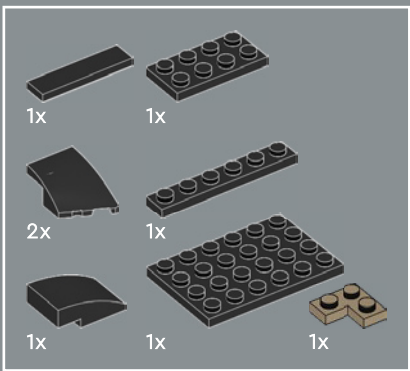
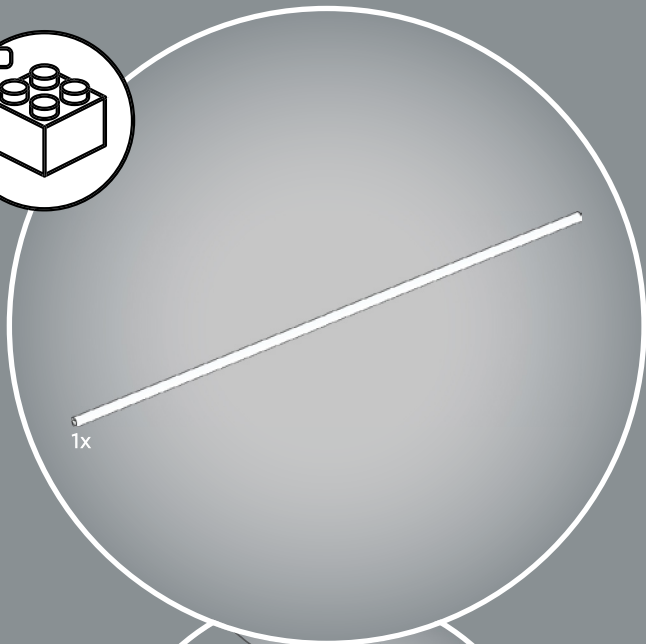
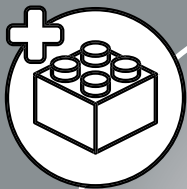

406



1

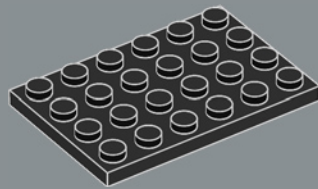

2

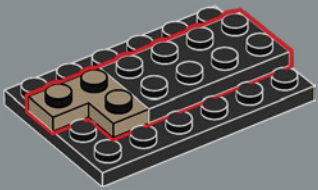

3

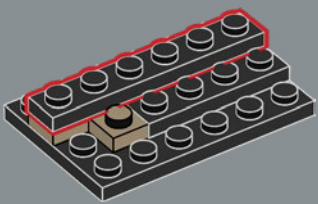



4

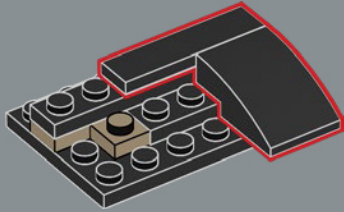

5

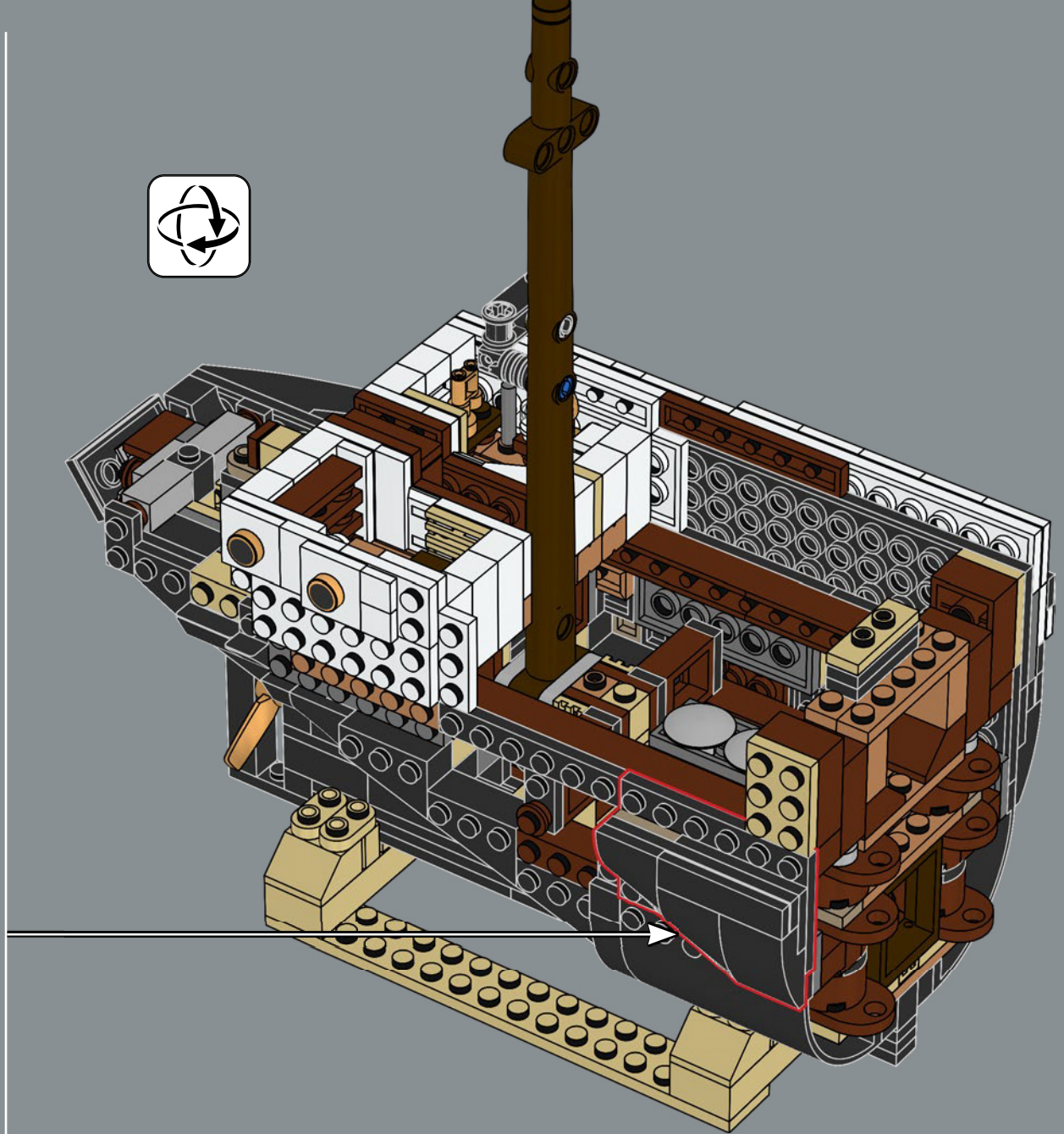
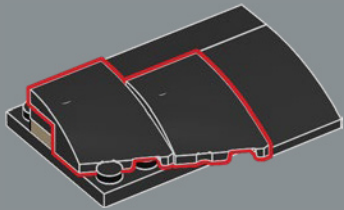



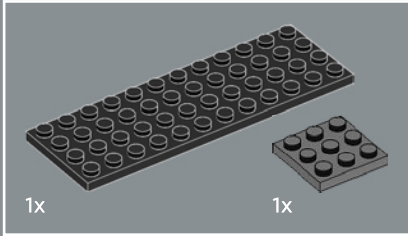
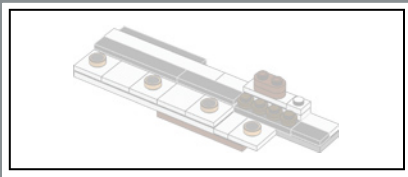

407

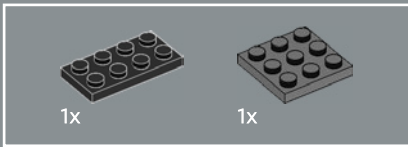
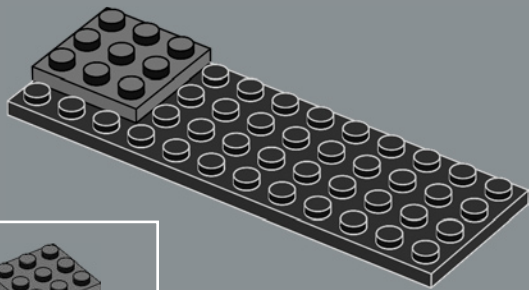

408

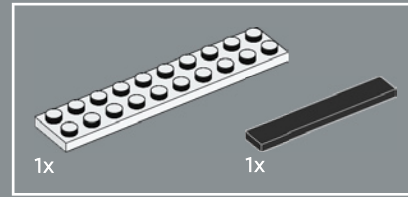
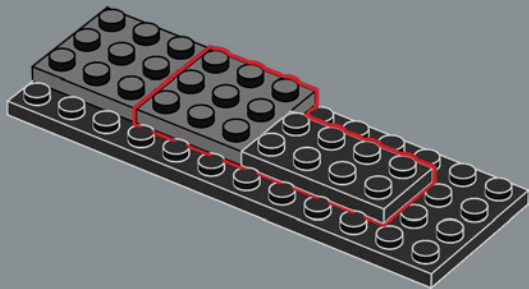

409

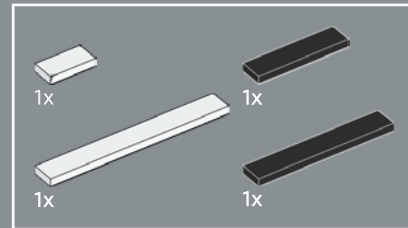
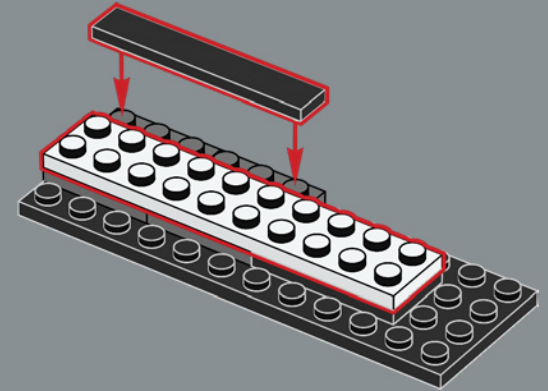

410

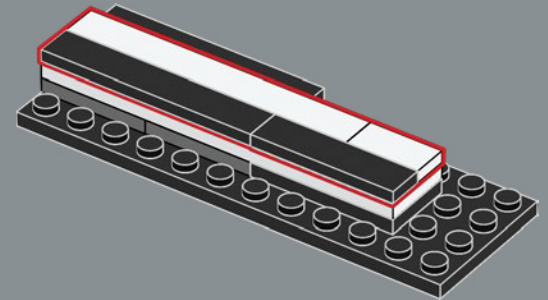

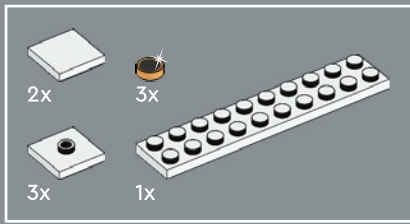

411

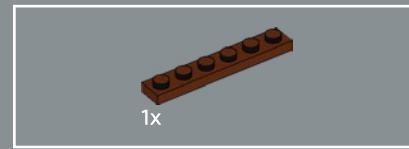
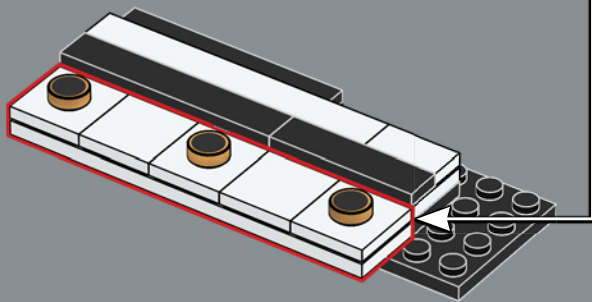
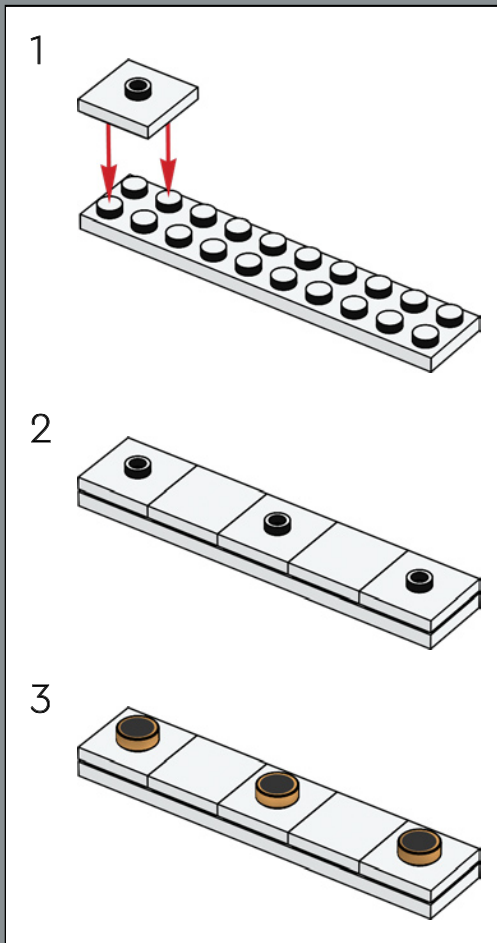

412

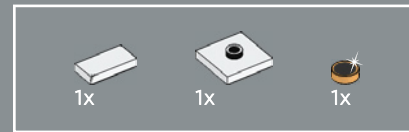
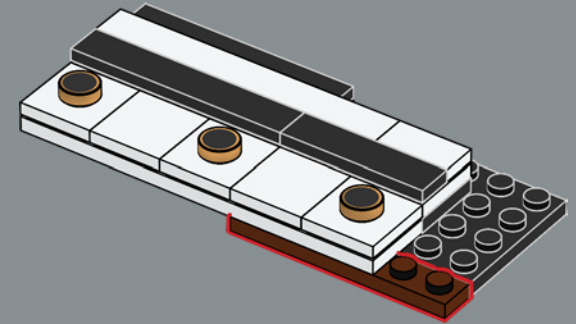

413

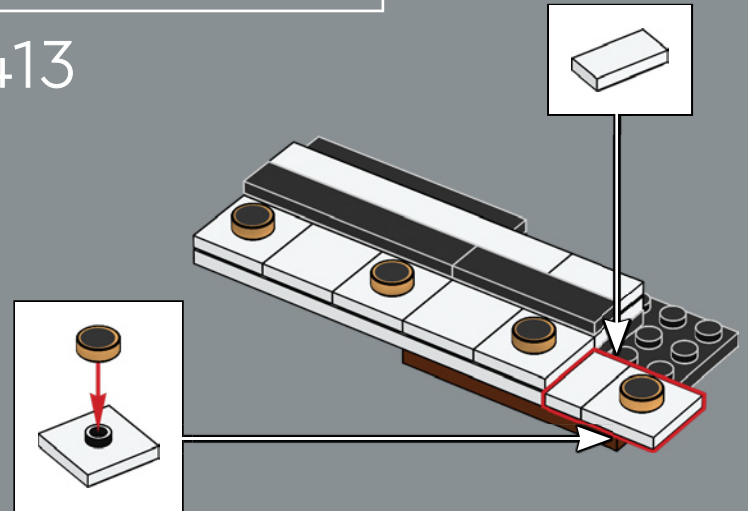

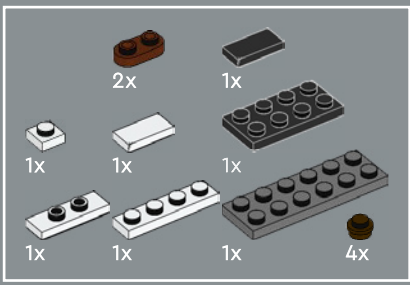

414

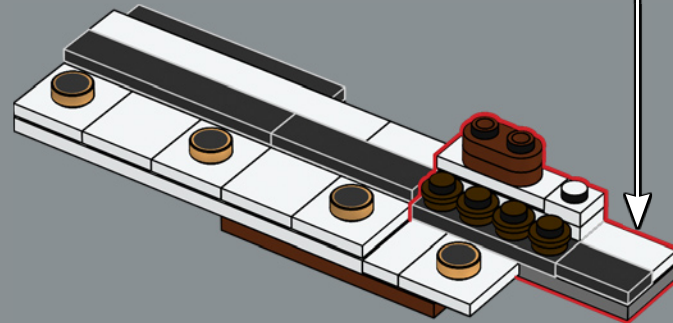
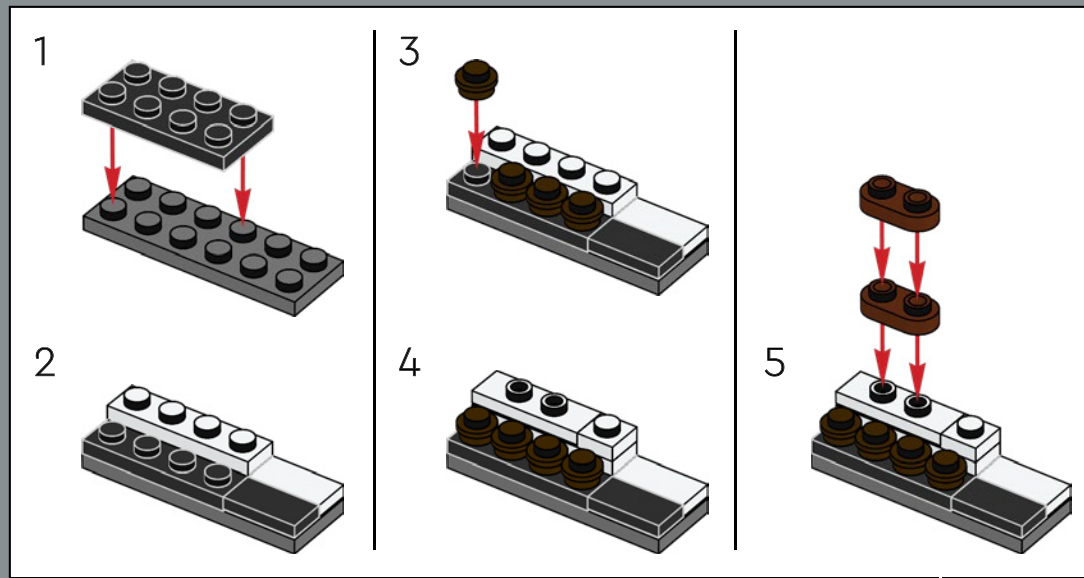

415

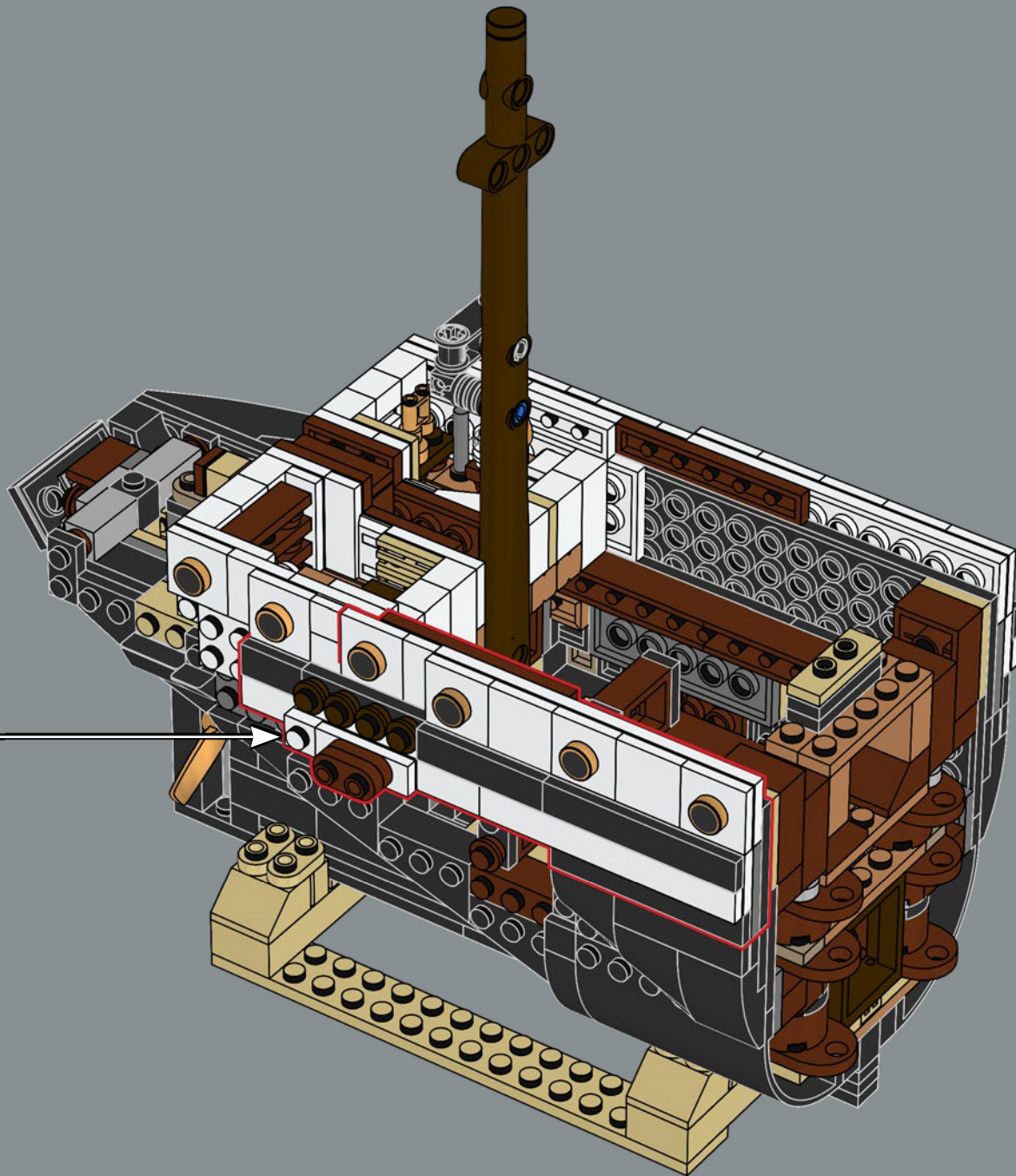



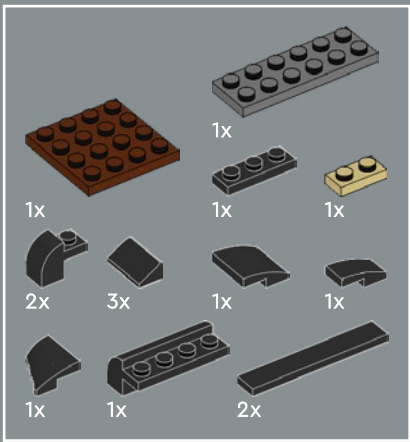

416

1

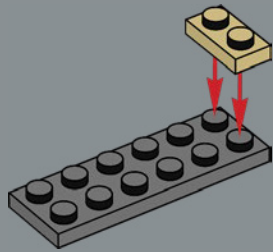

2

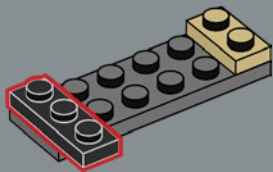

1

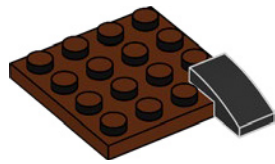

2

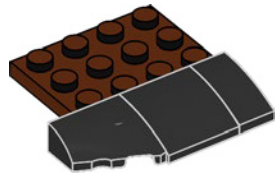

3

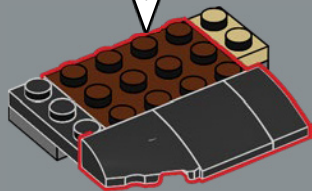

4

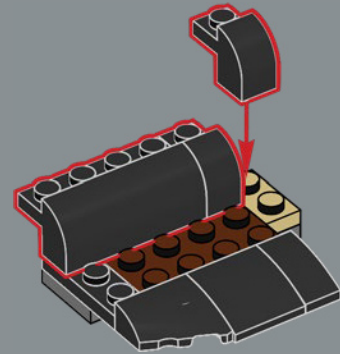

5

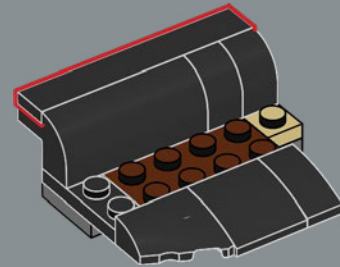

6

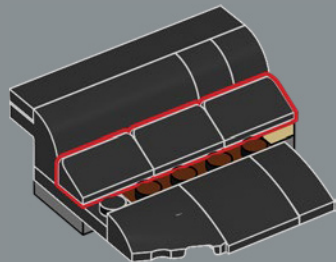

7

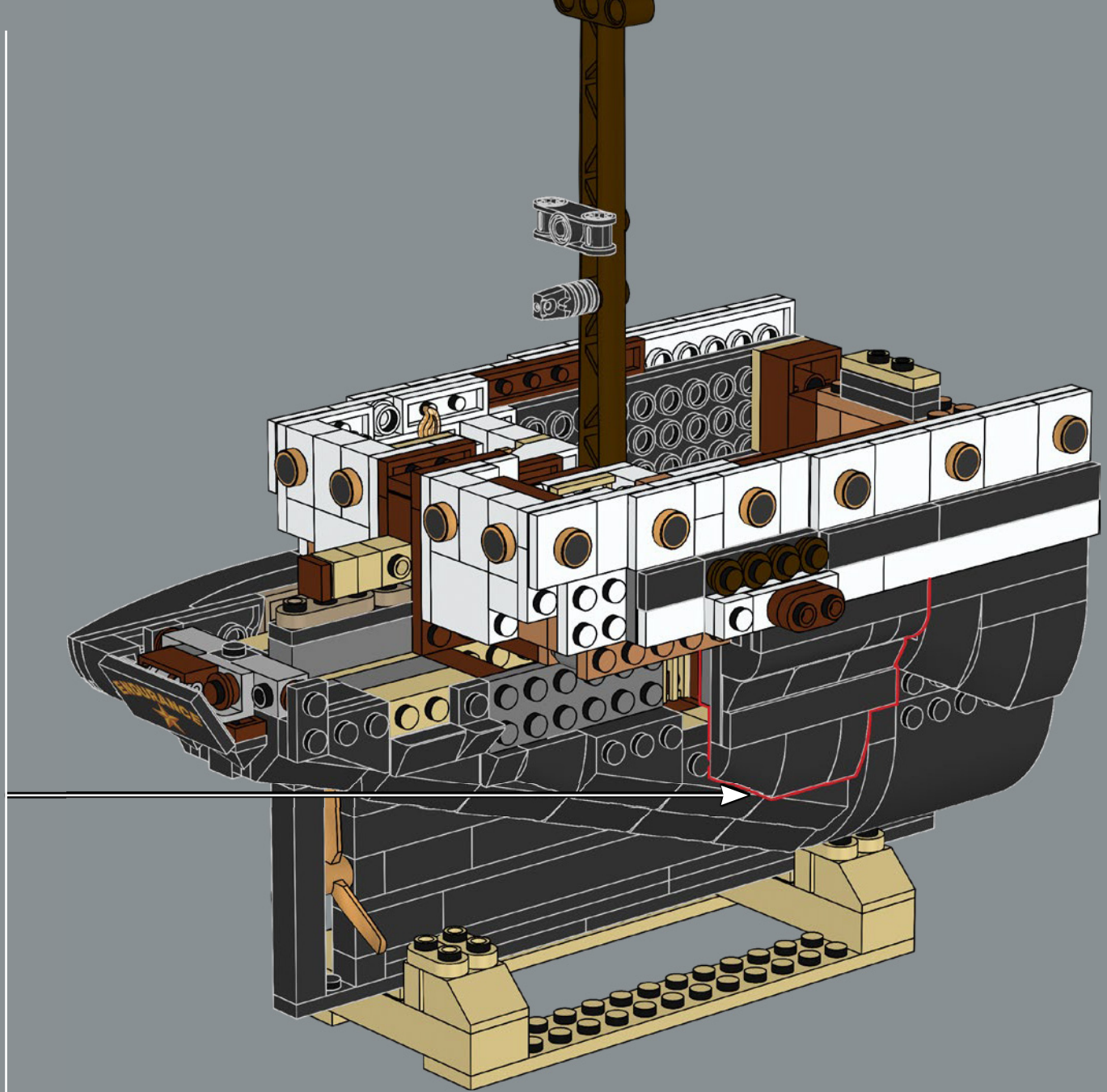
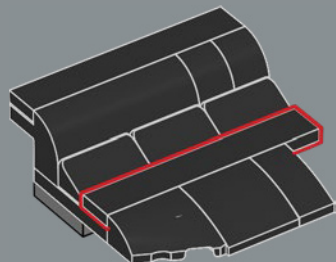

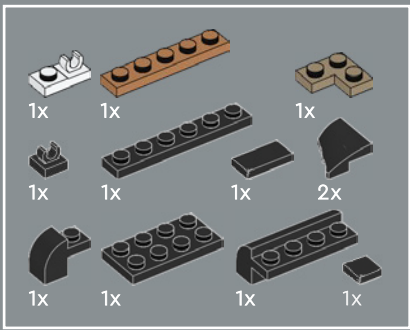

417

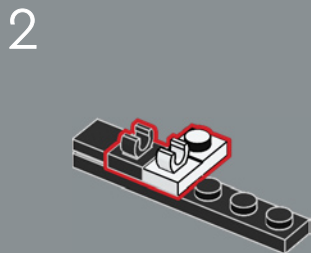
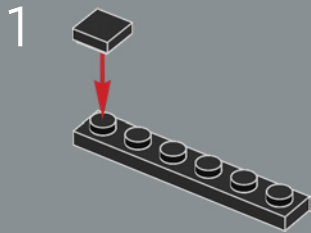

3

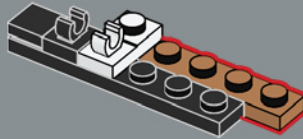

4

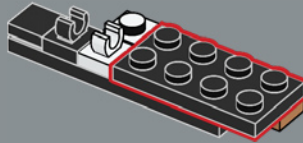

5

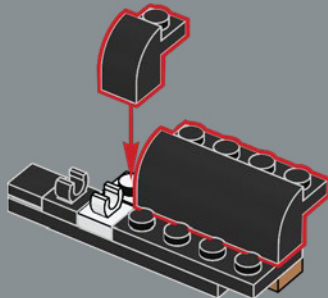

6

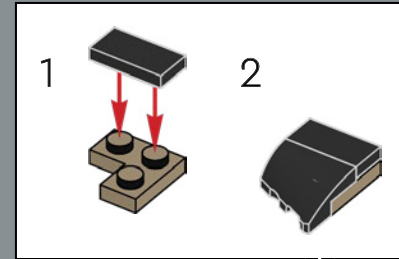

7



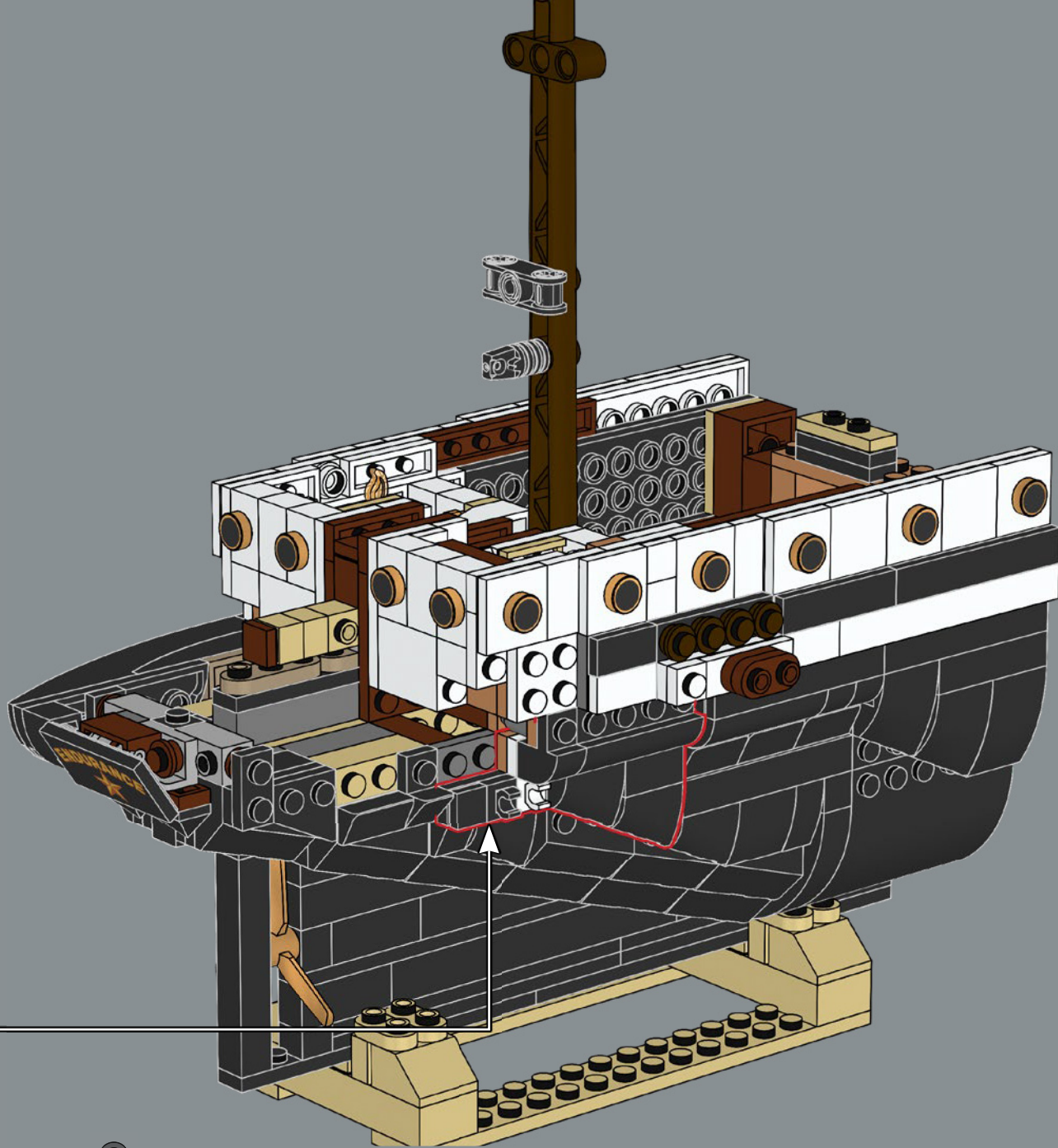



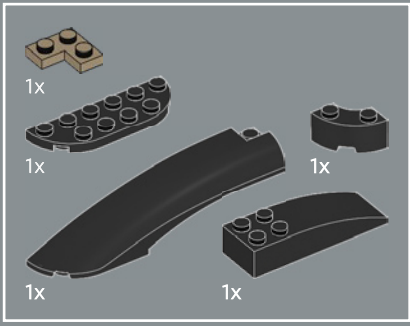

418

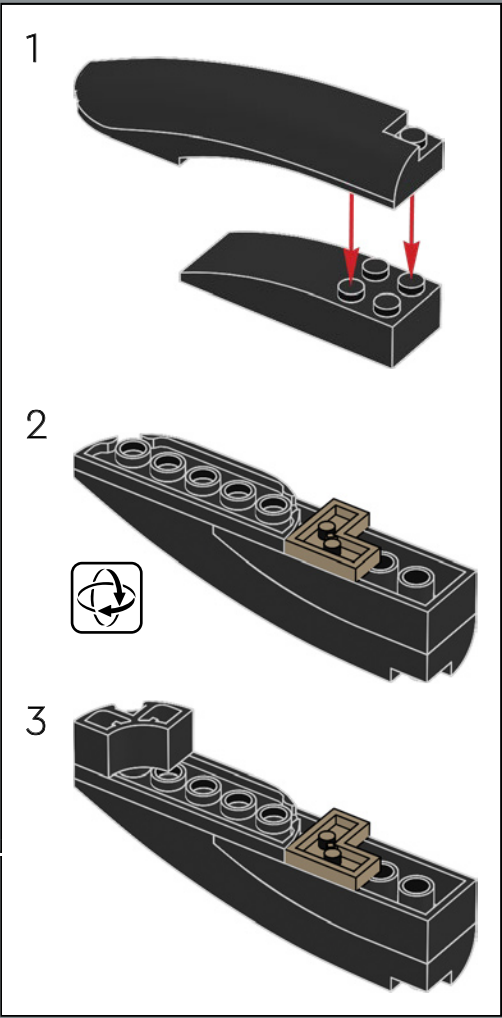
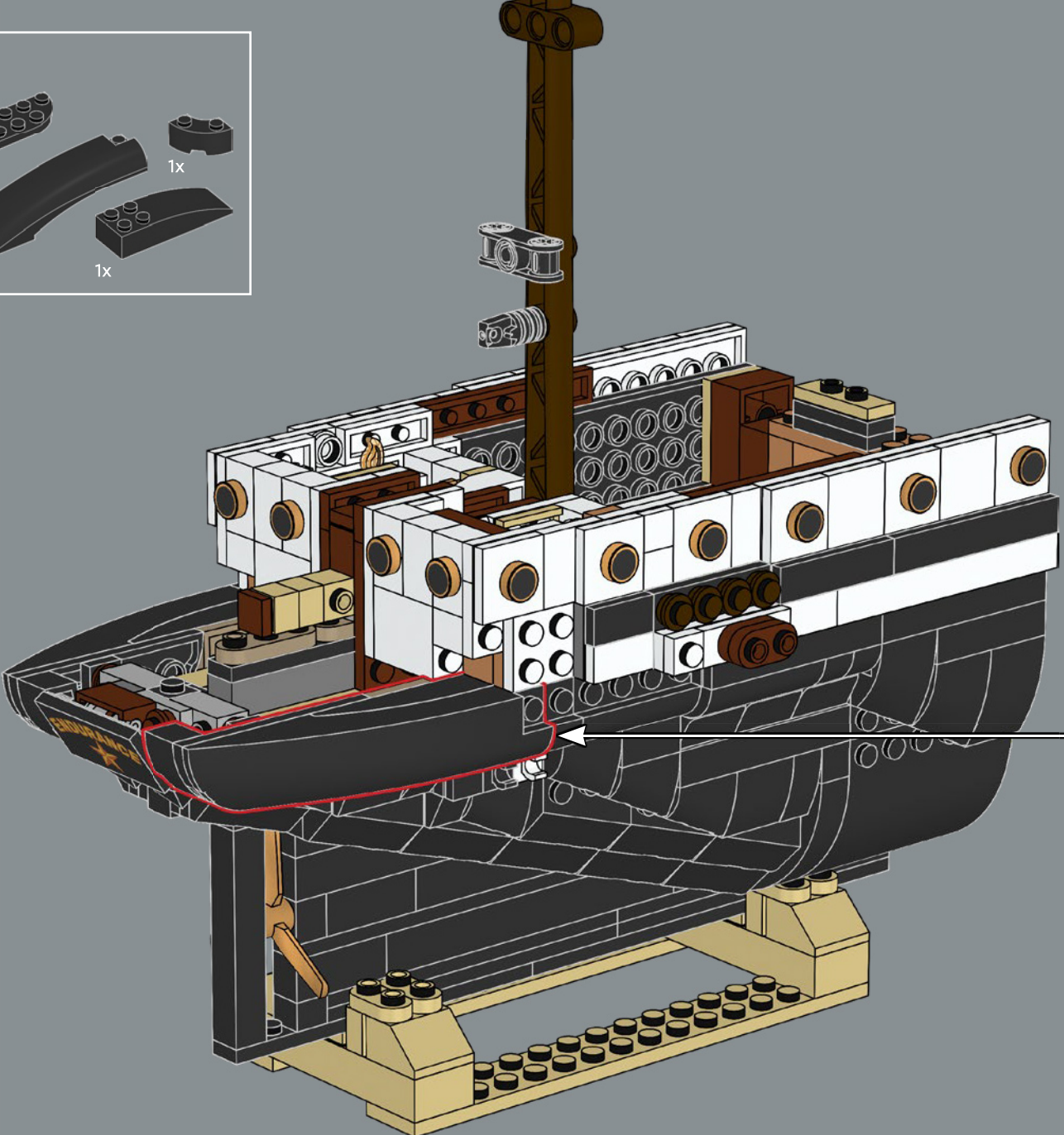

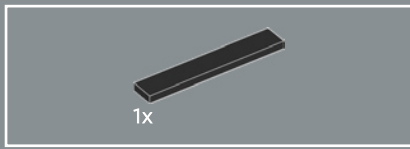

419

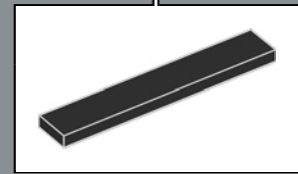
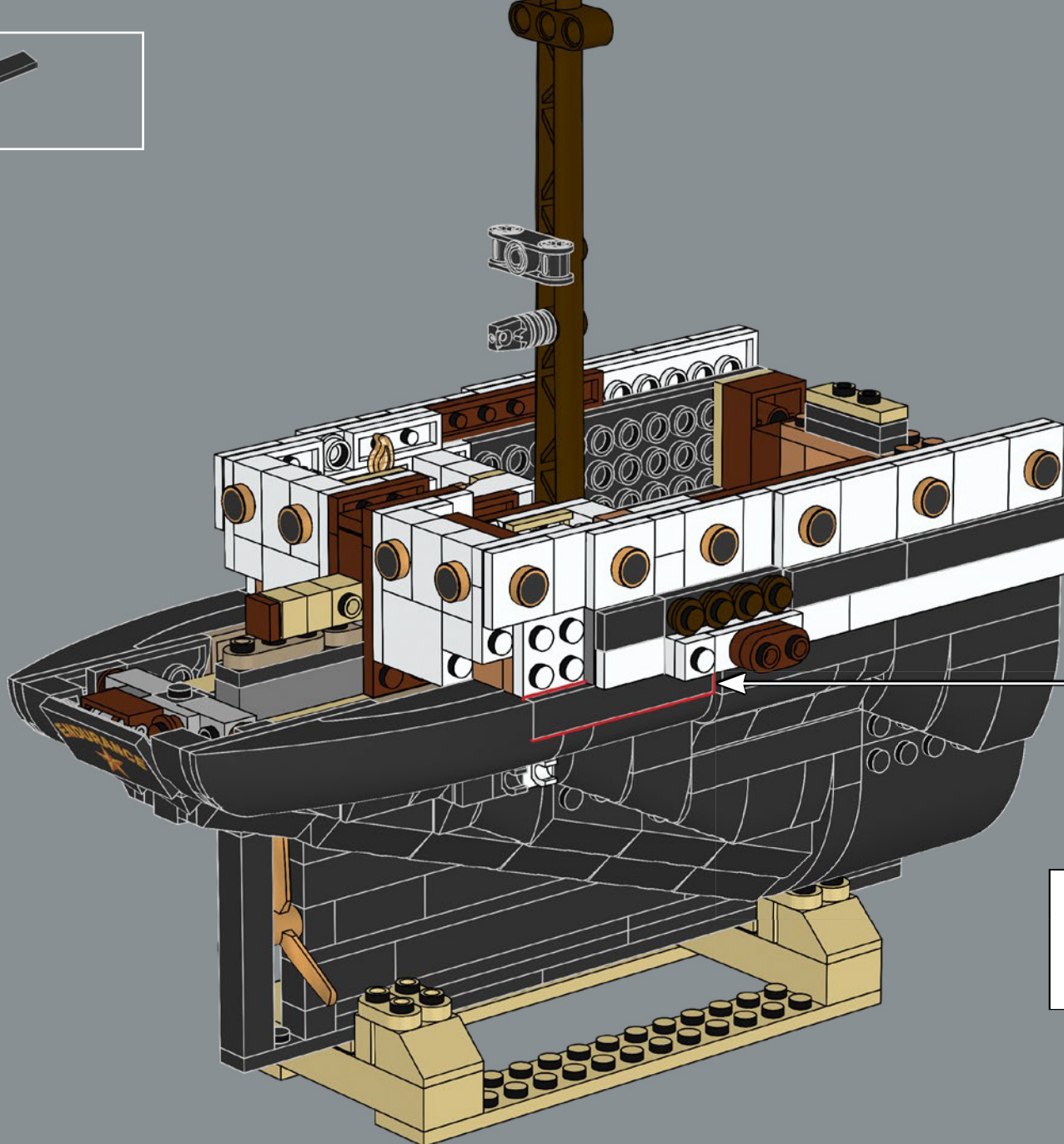

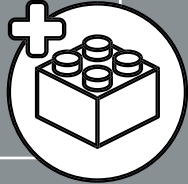
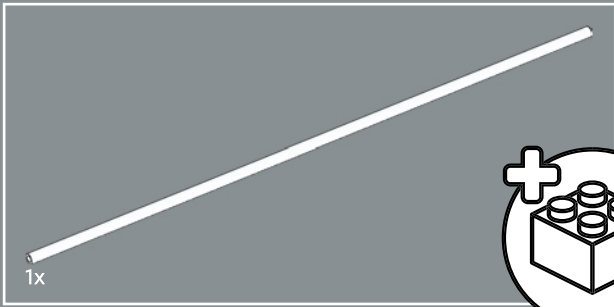

420

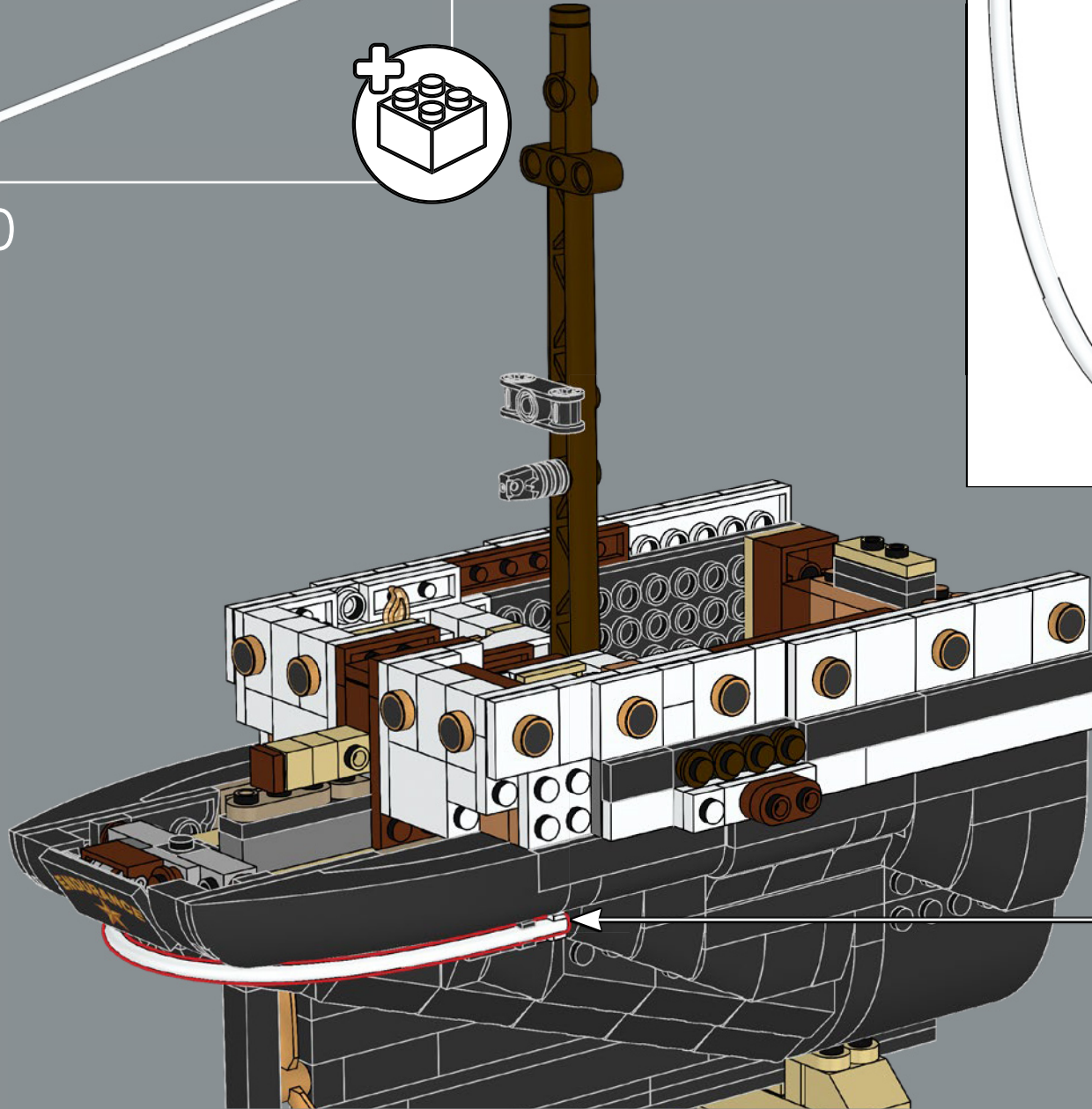
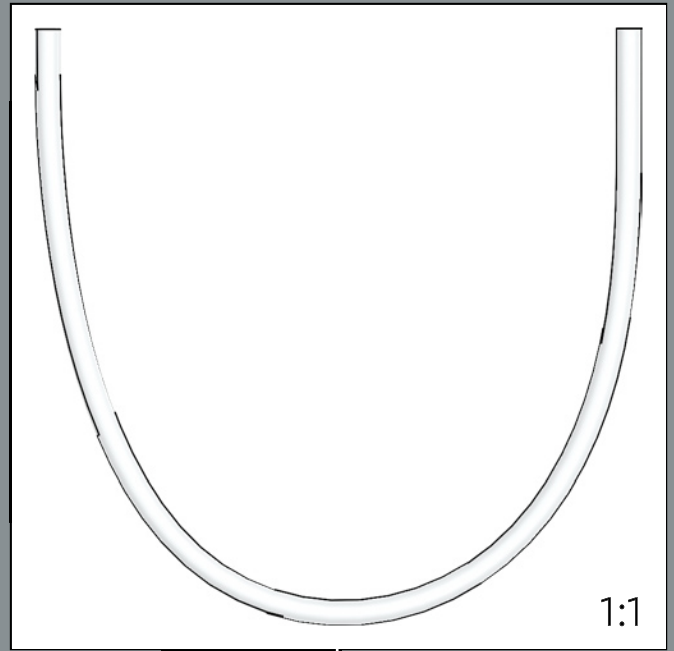



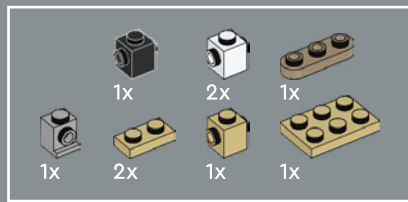
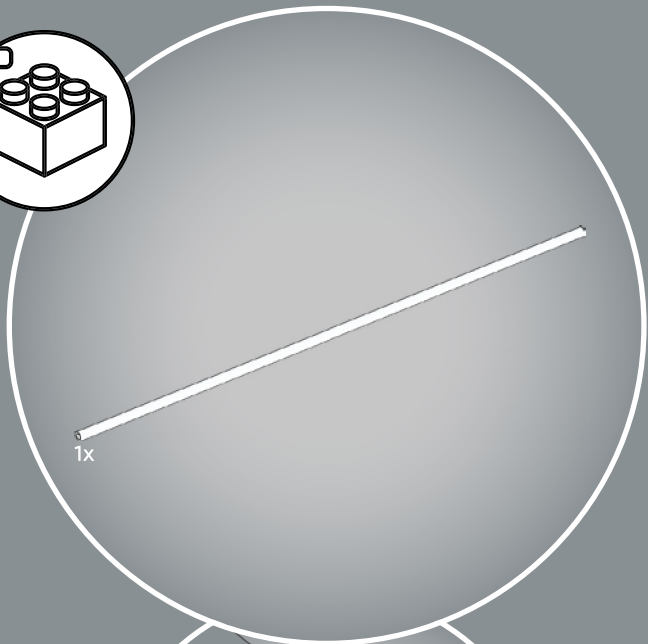
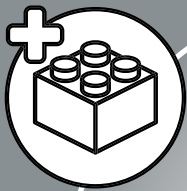

421

1

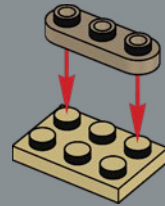

2

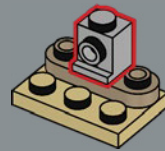

3

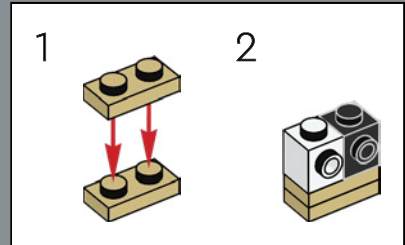
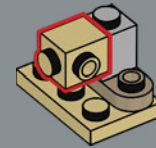

4

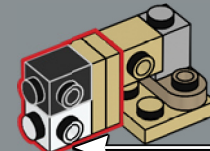



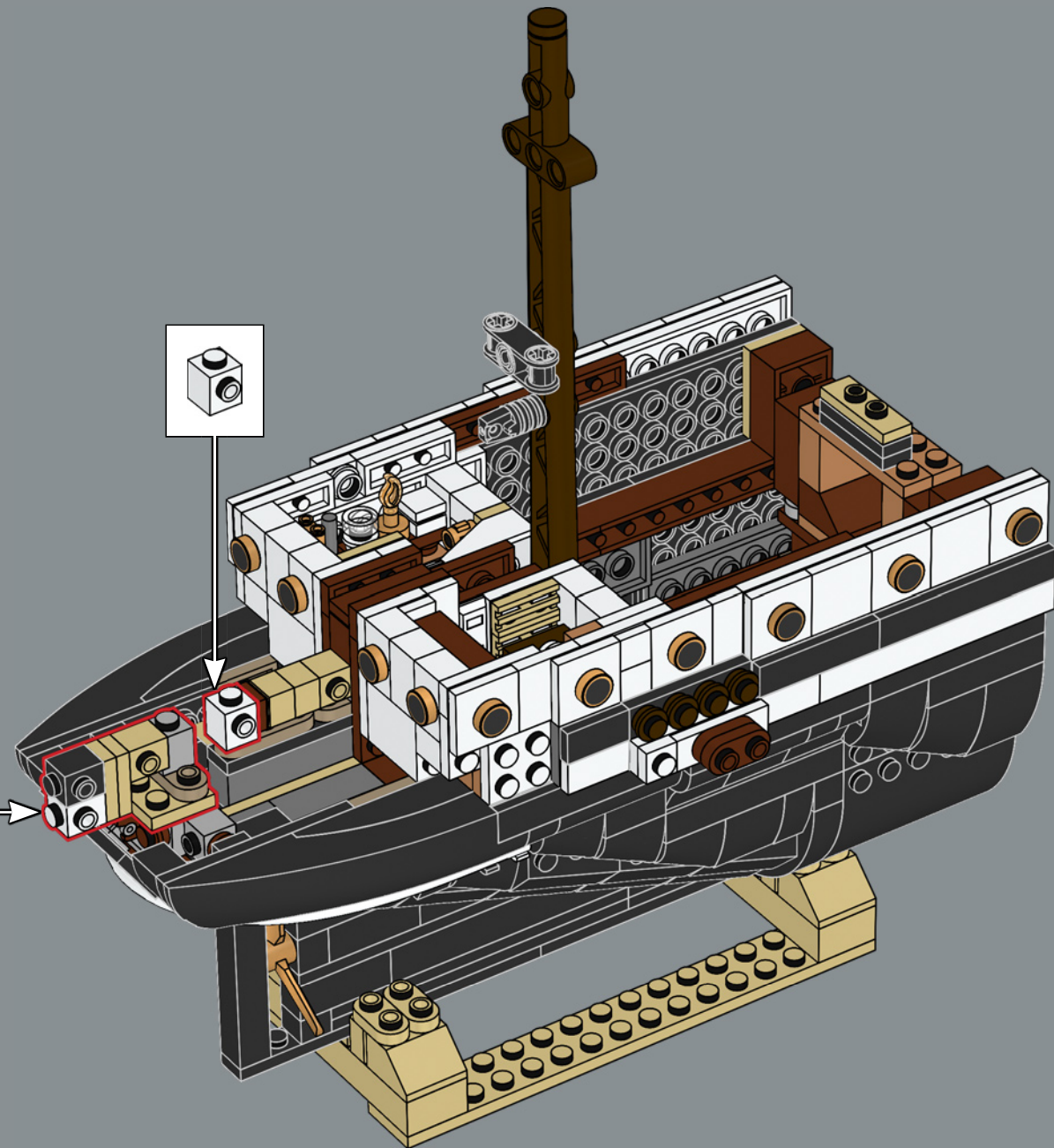

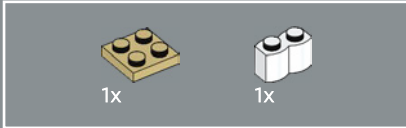
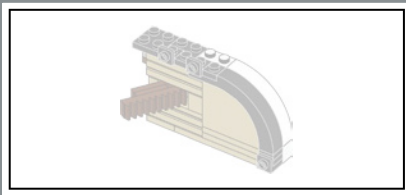

422

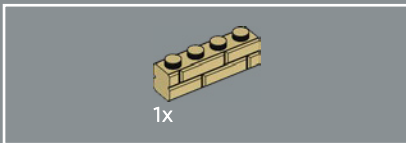
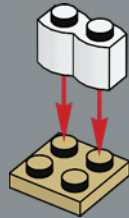

423

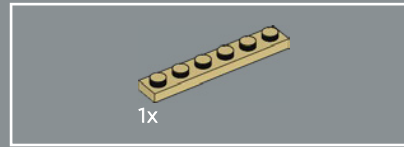
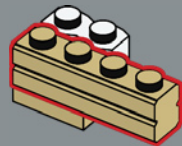

424

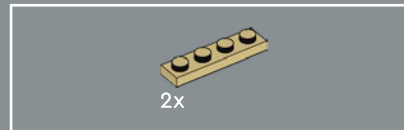
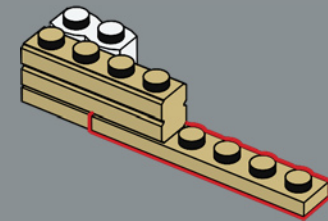

425

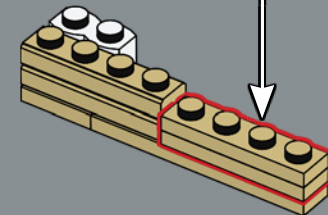
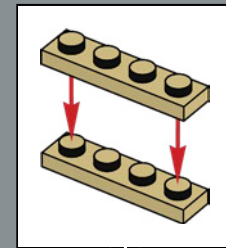

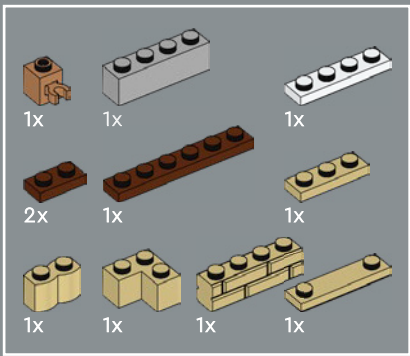

426 1

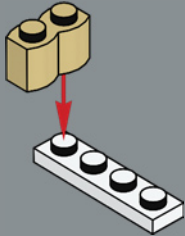

2

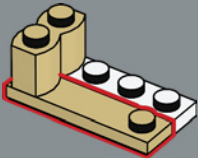

3

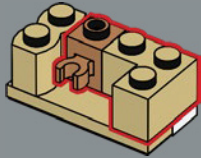

4

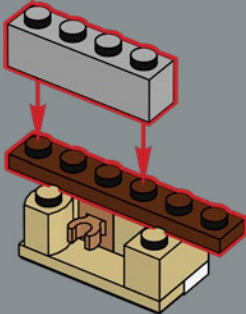

5

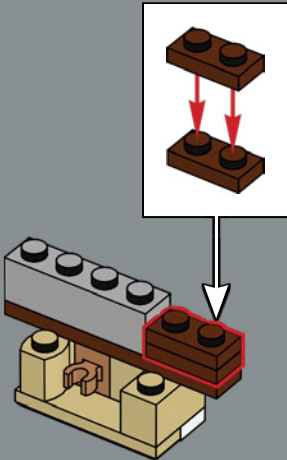

6

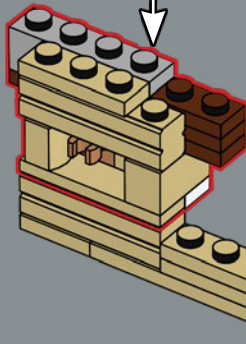
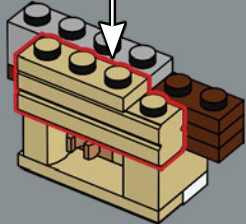
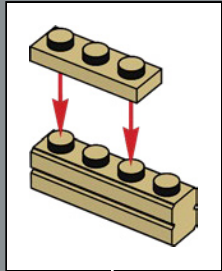

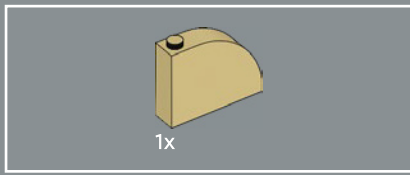

427

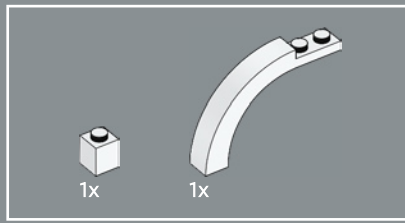
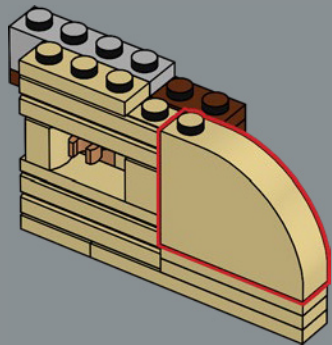

428

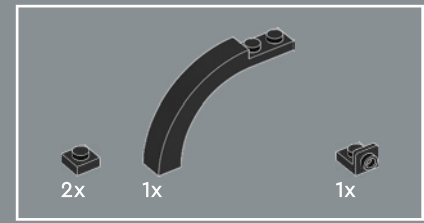
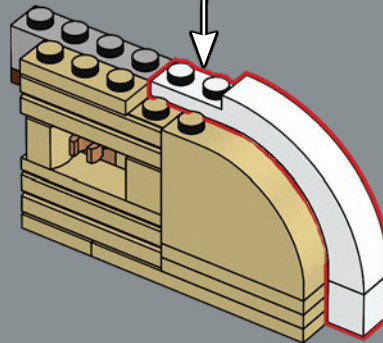
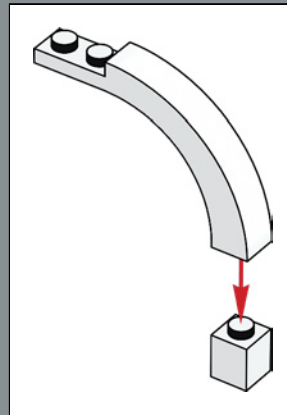

429

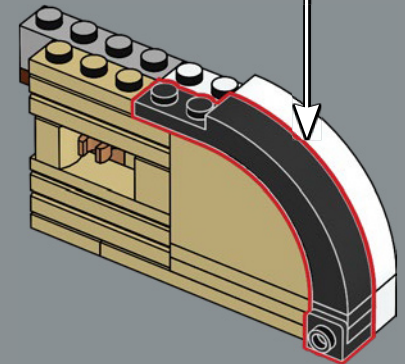
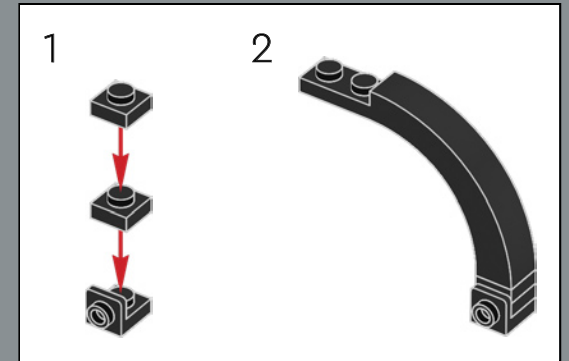



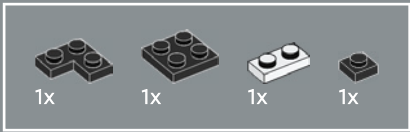

430

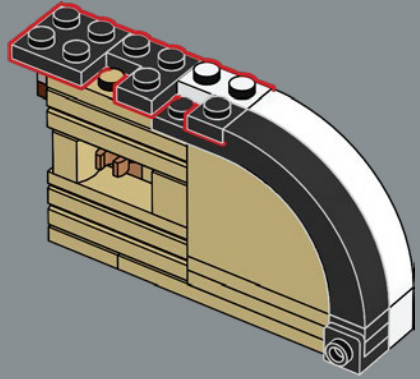

431

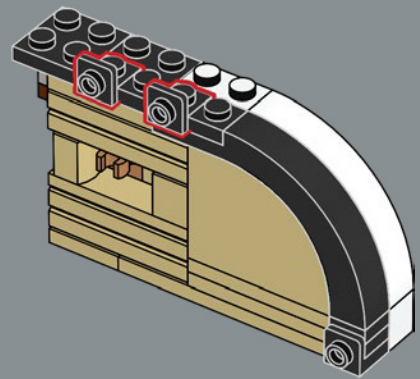

432

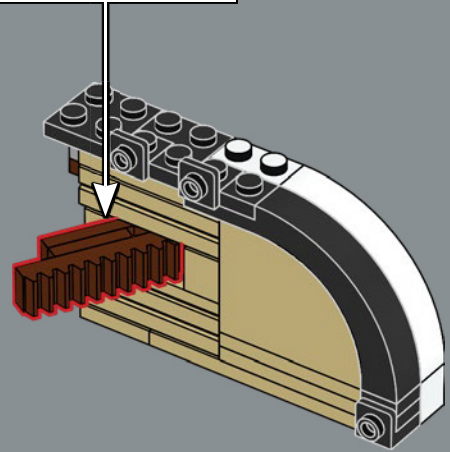
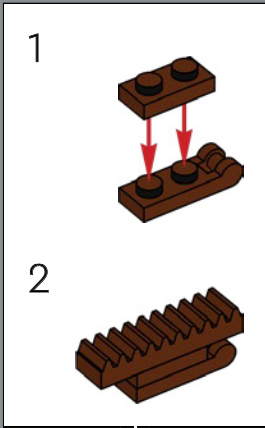

433

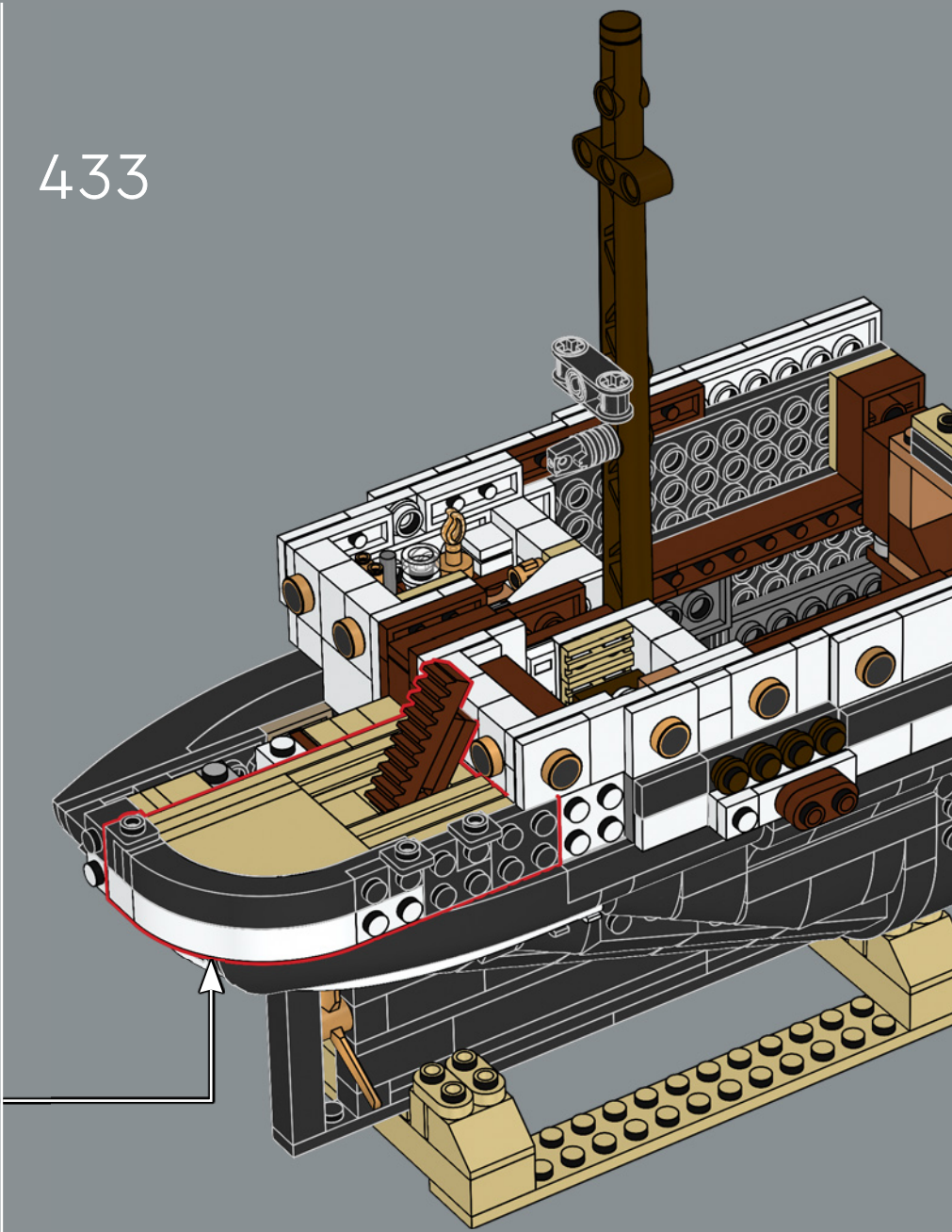

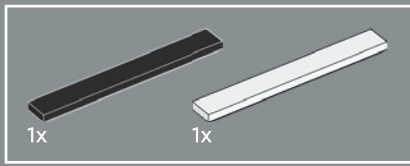

434

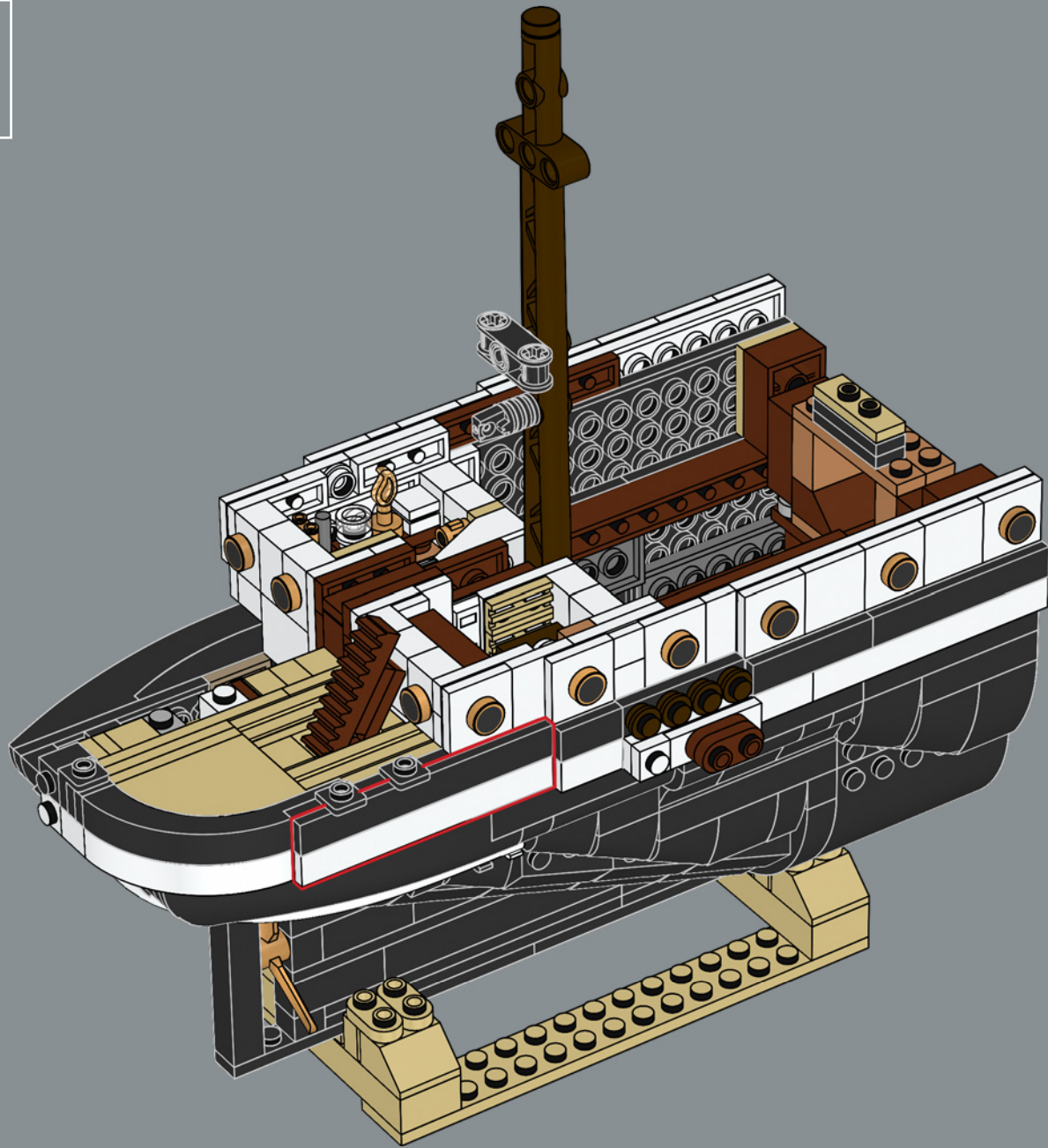

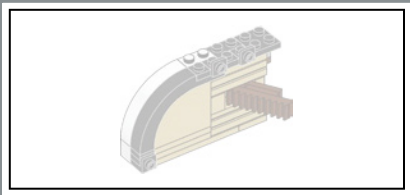

435

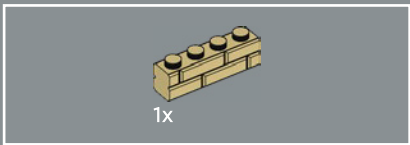
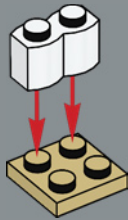

436

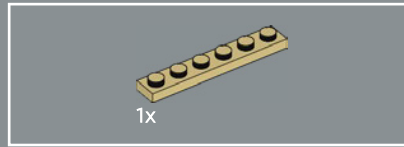
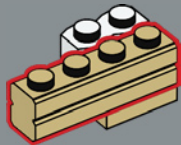

437

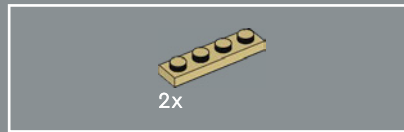
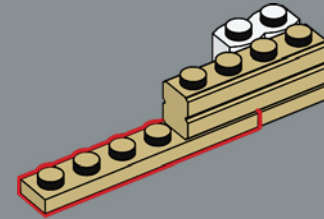

438

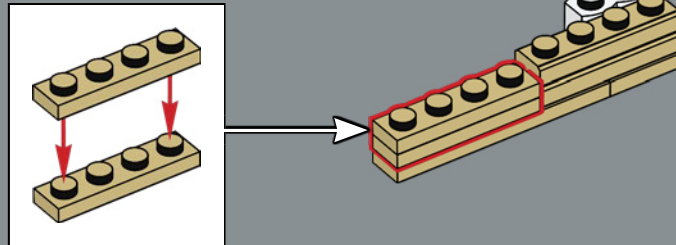

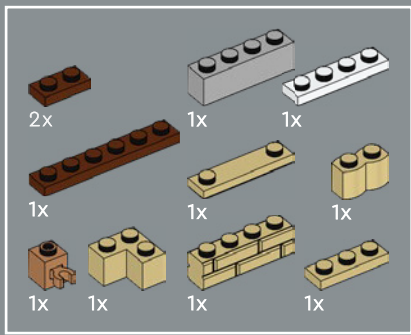

439

1

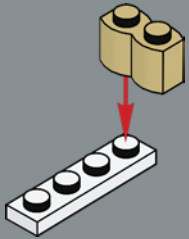

2

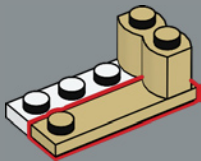

3

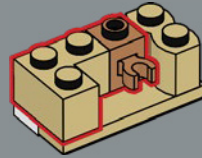

4

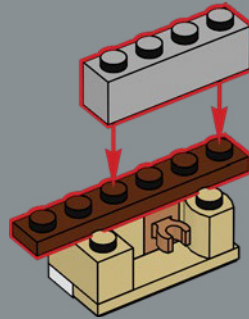

5

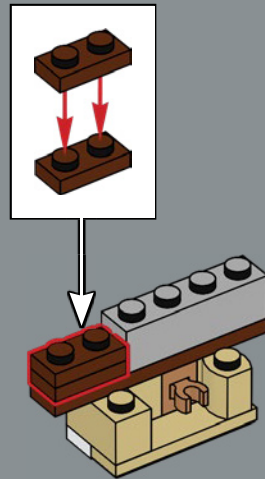

6

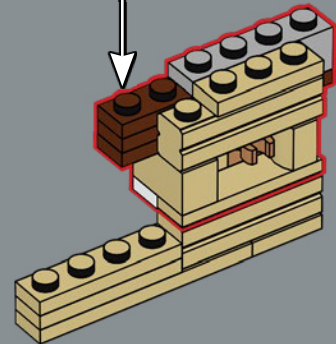
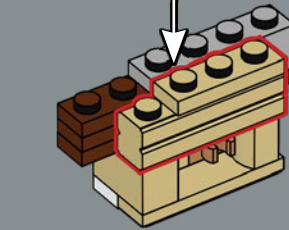
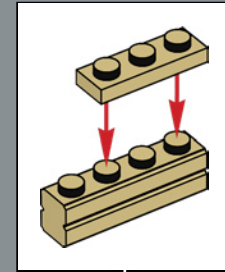



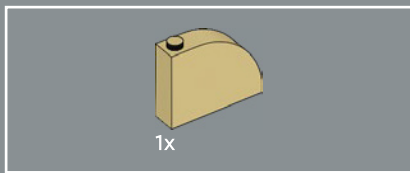

440

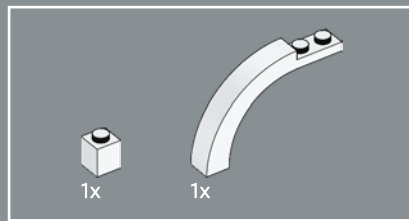
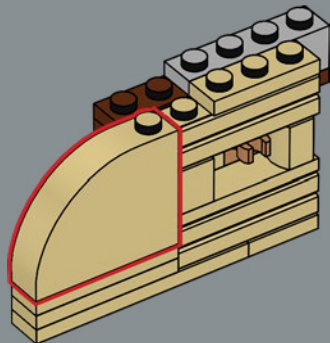

441

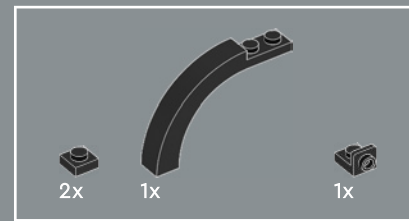
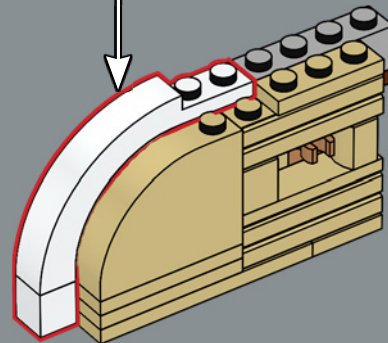
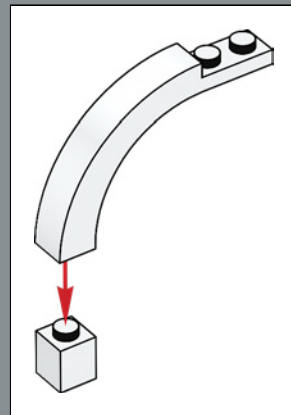

442

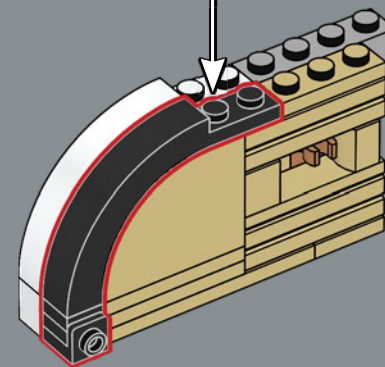
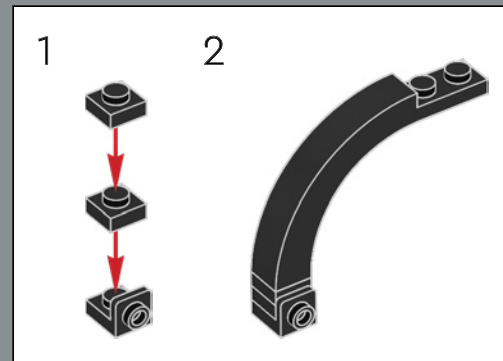

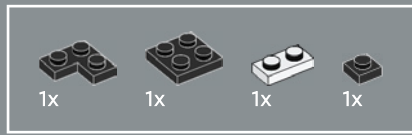

443

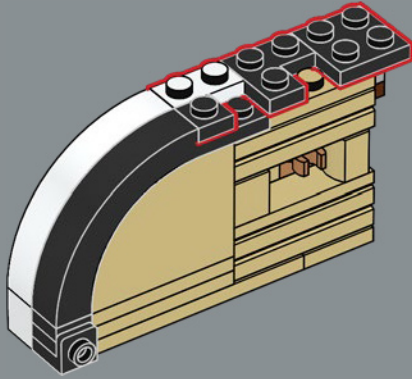

444

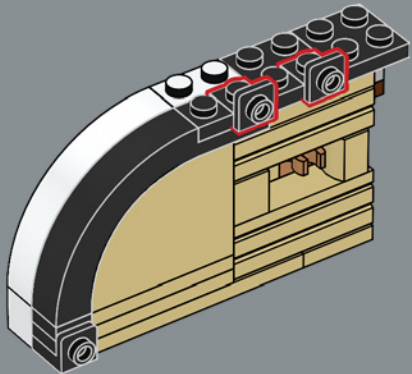

445

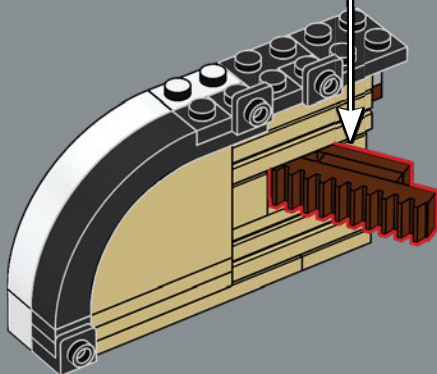
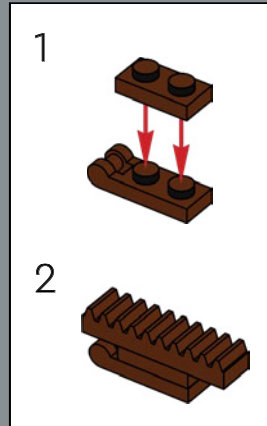

446

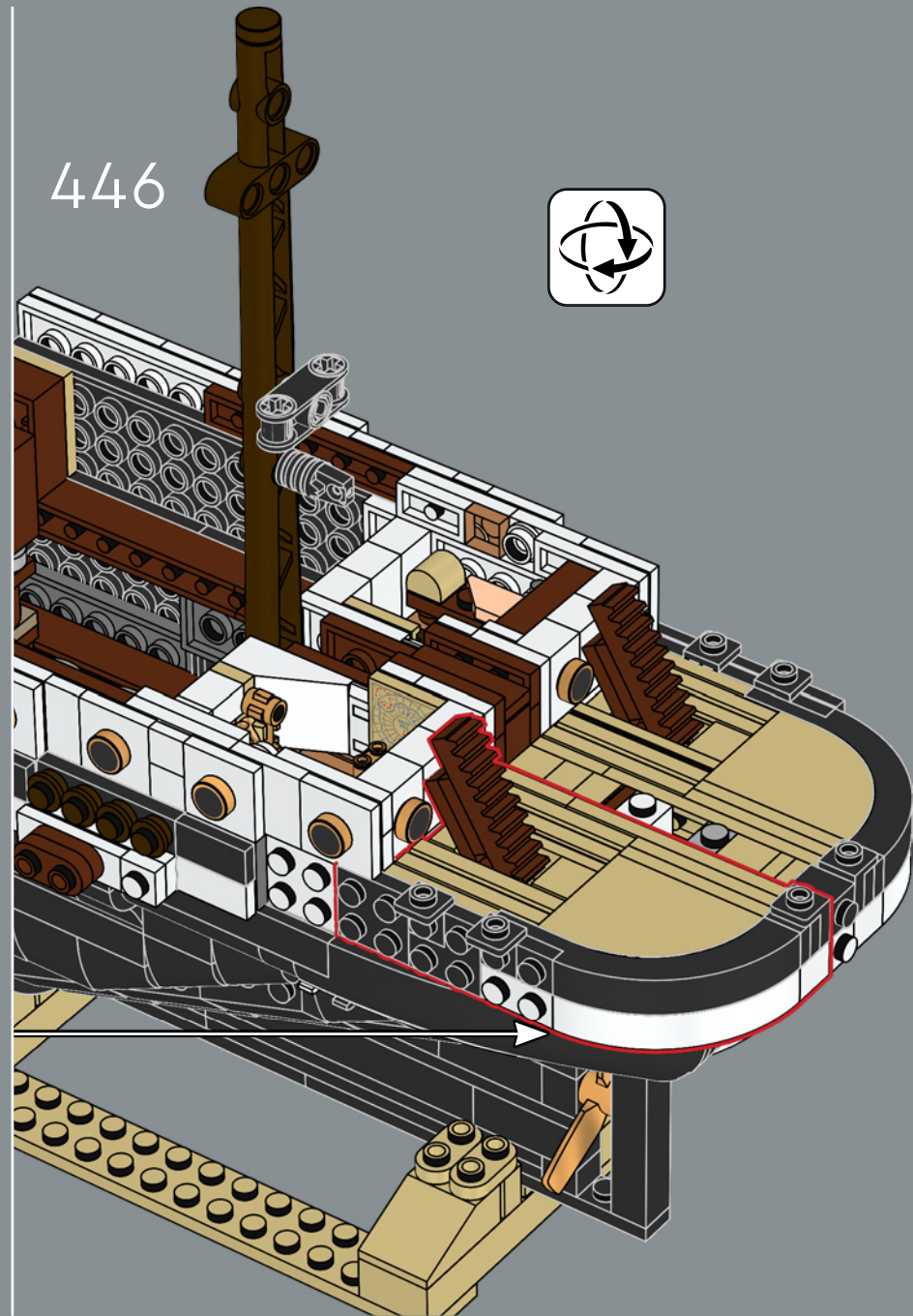

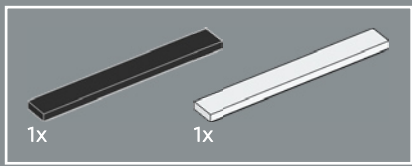

447

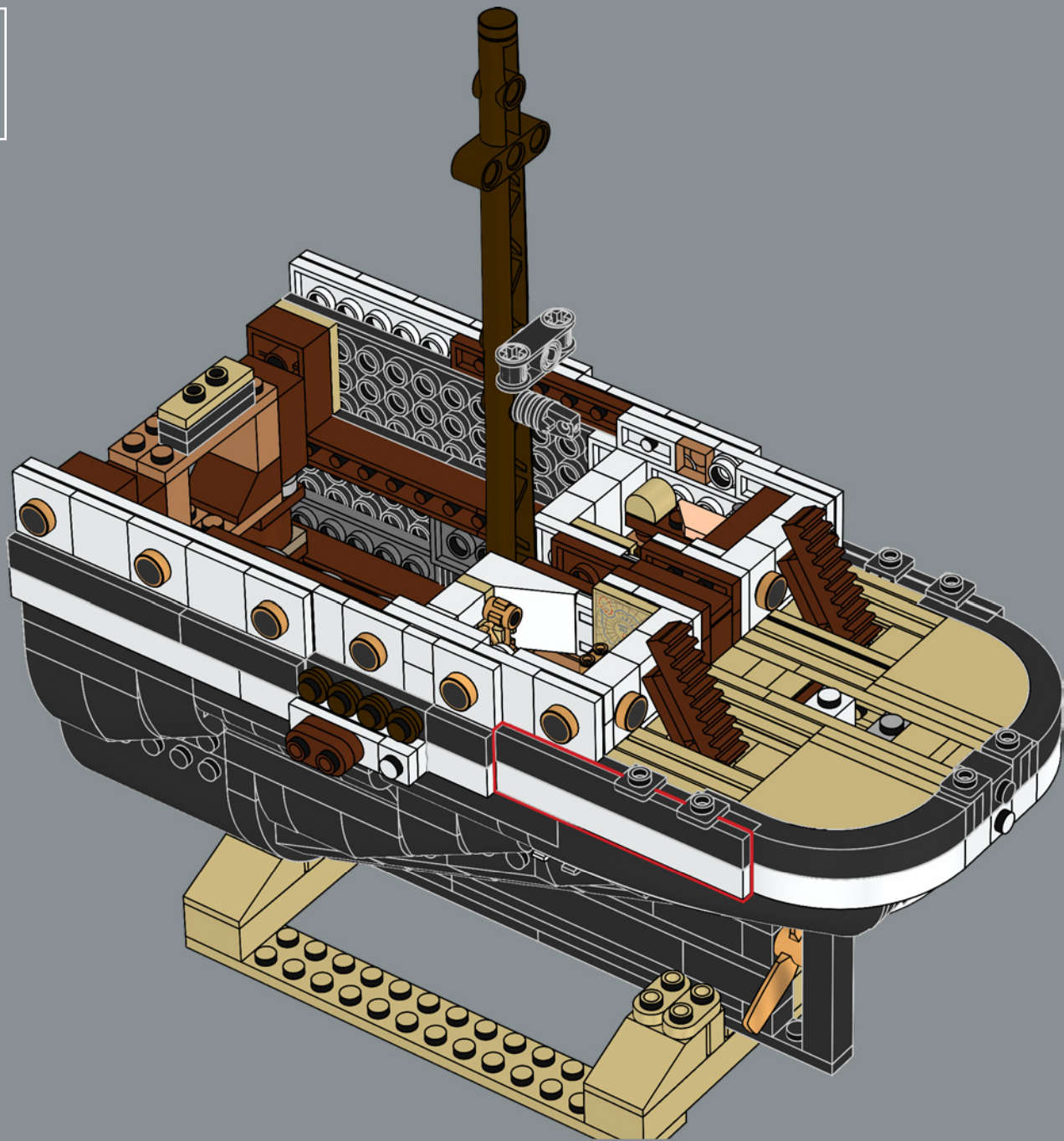



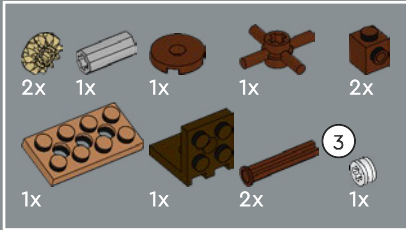
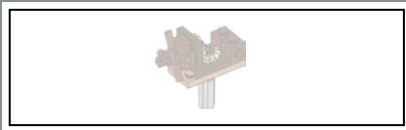

448

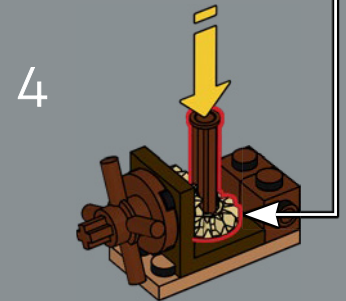
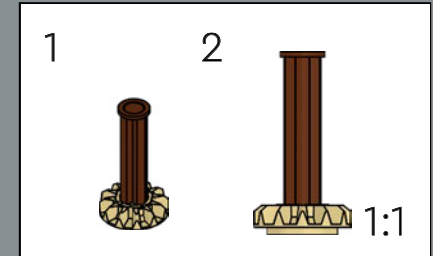
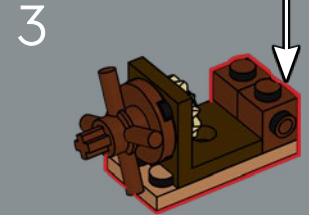
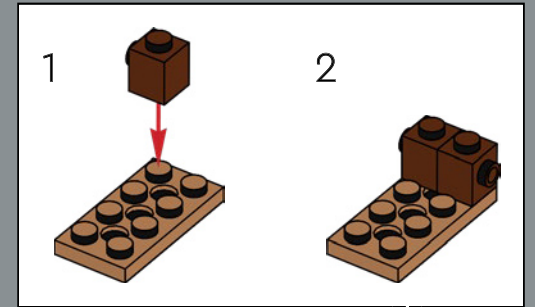
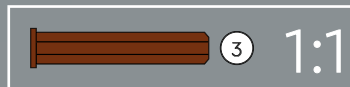
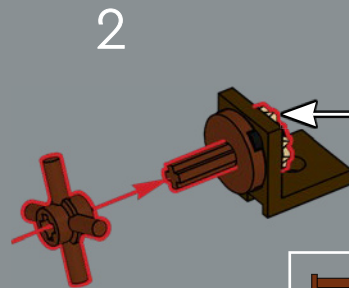
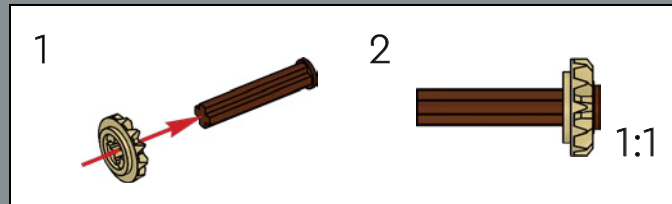
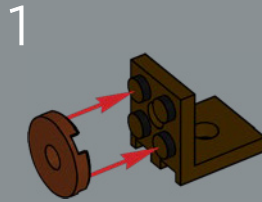



5

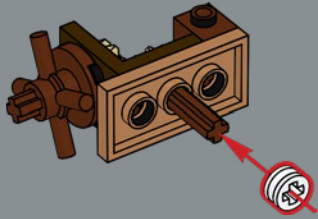

6

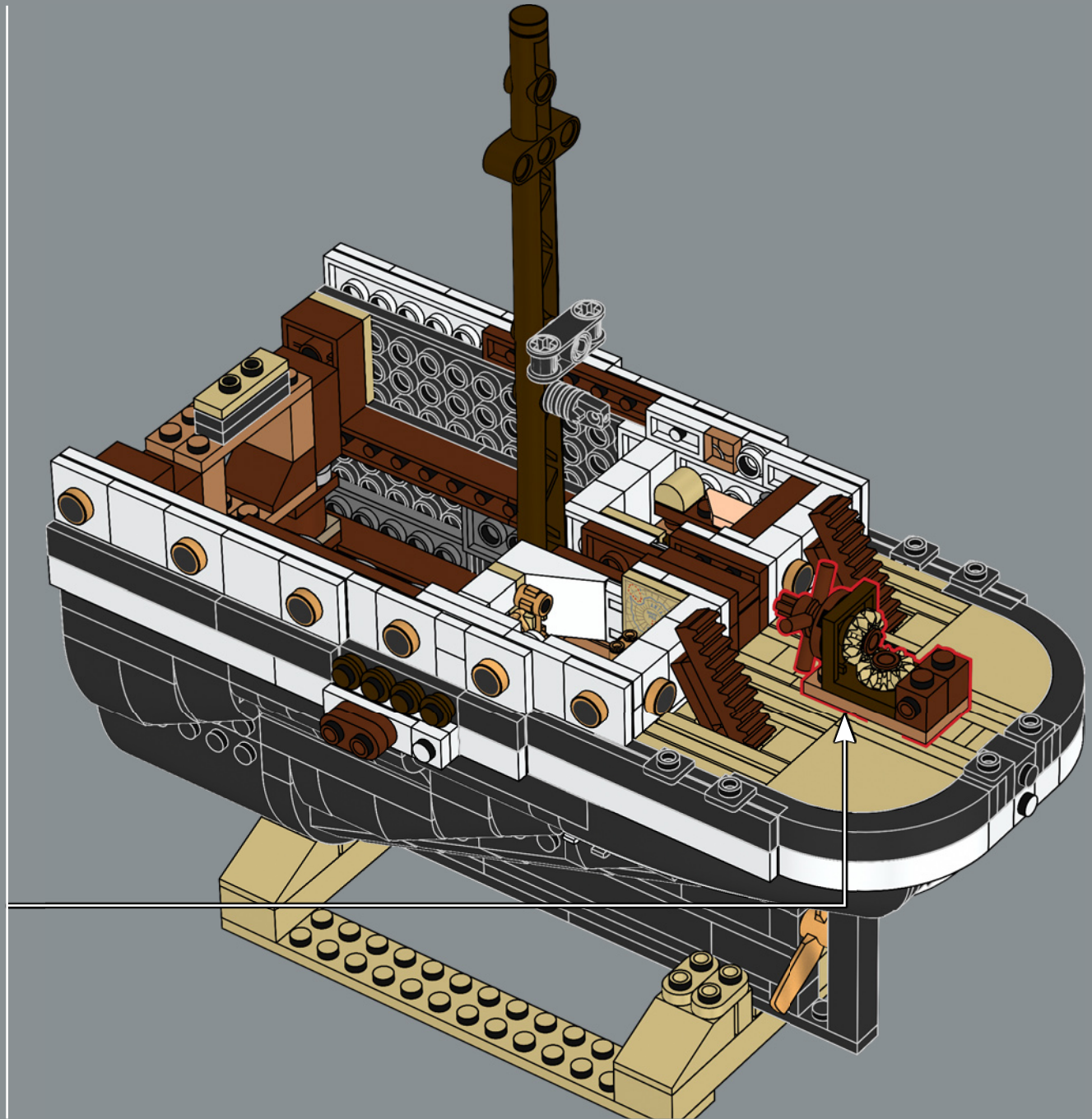
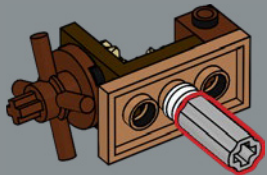

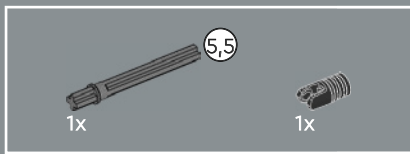

449

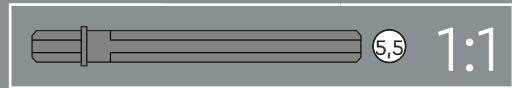
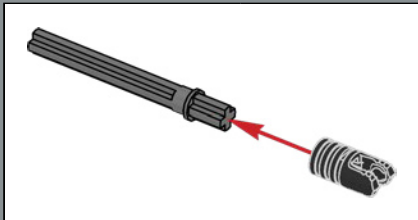
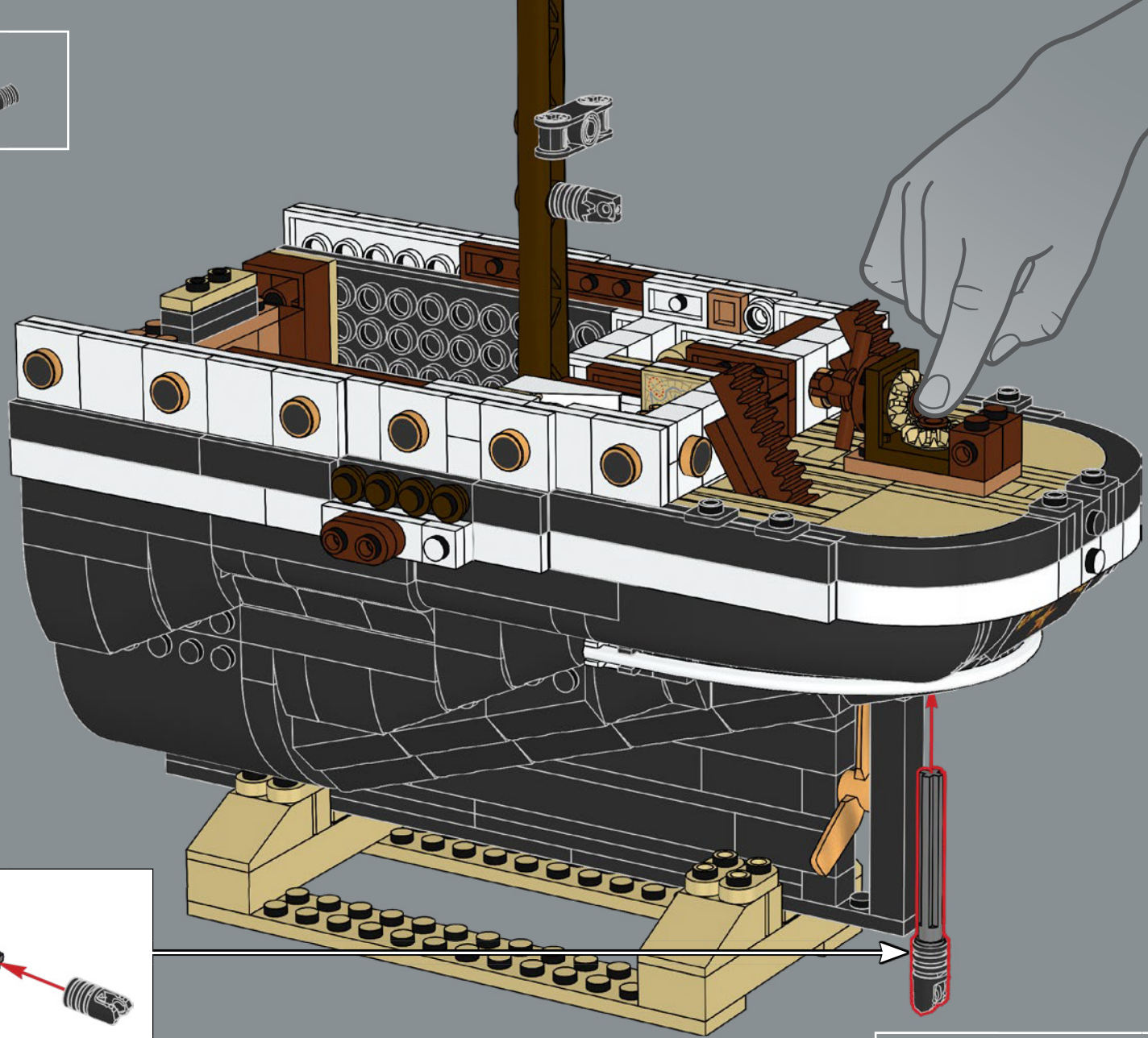



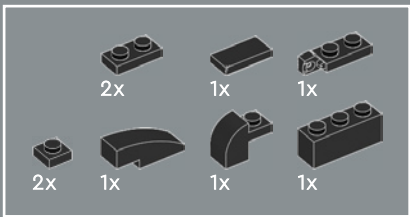

450

1

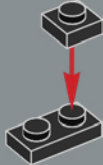

2

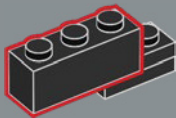

3

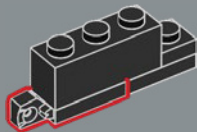

4

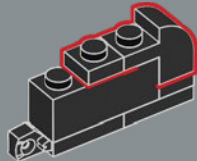

5

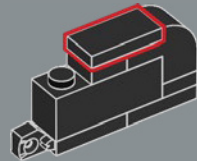

6

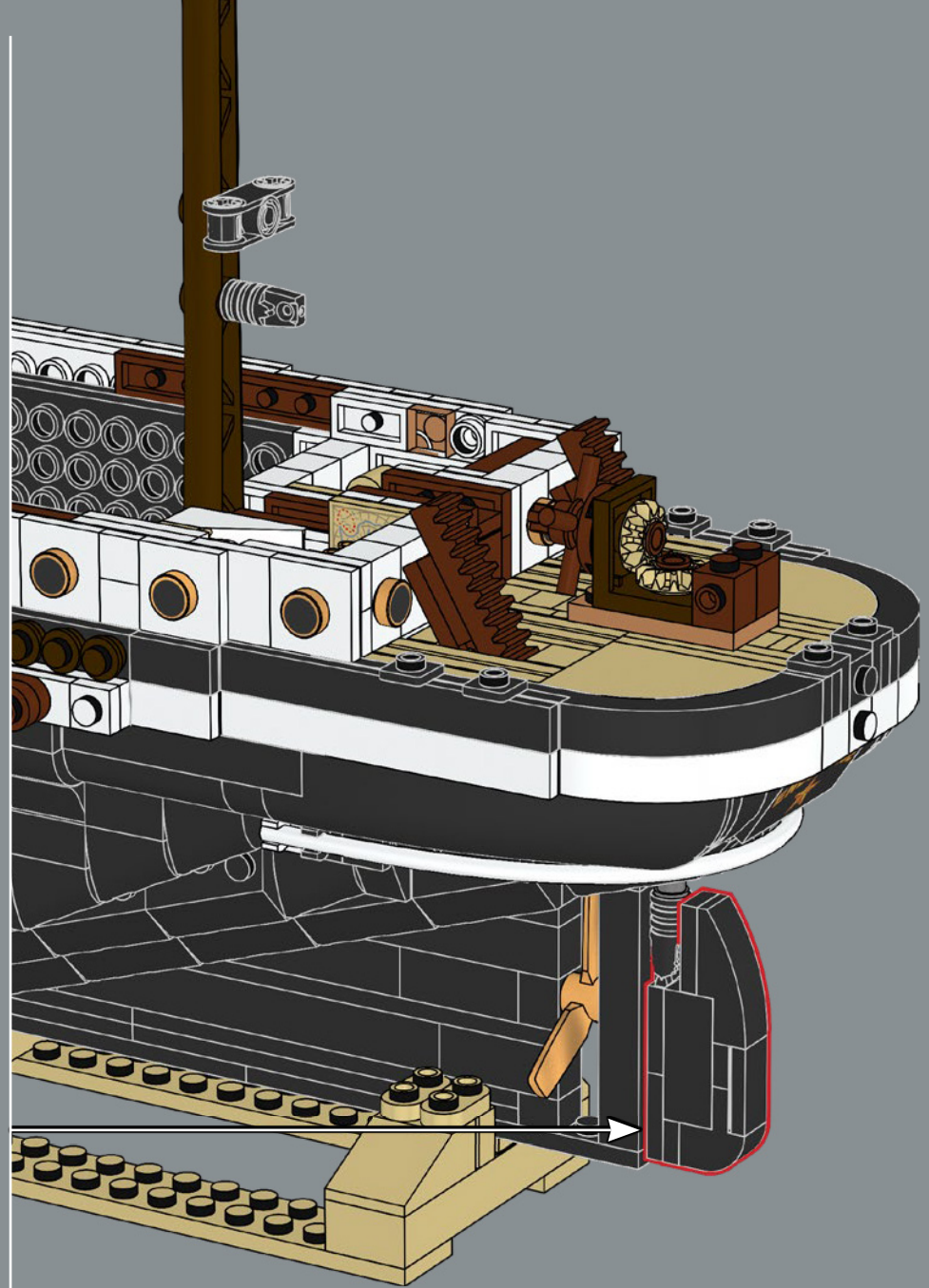
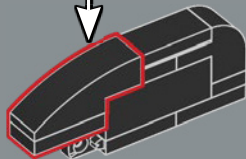
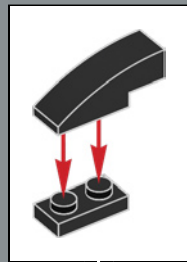

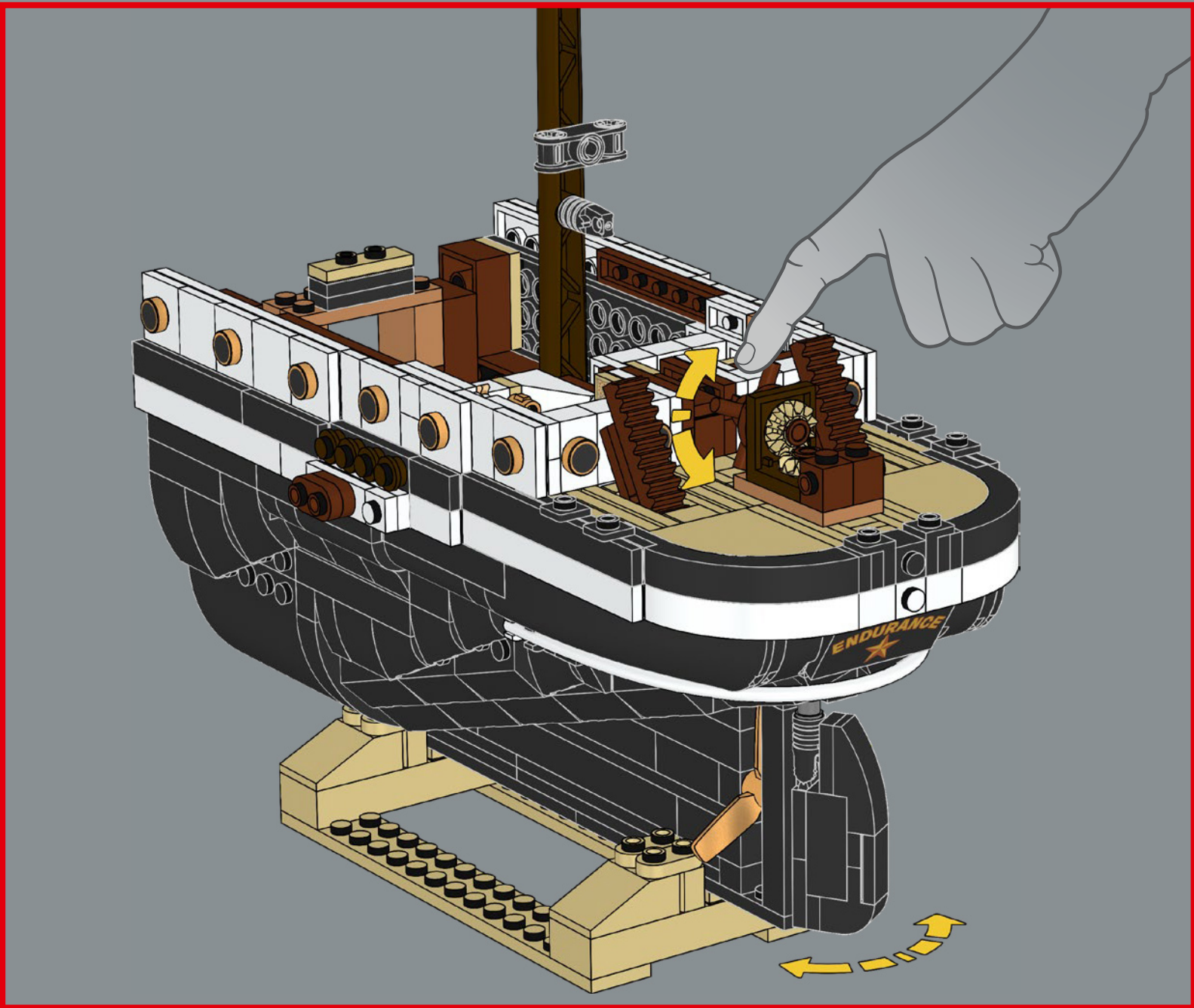



2x

451

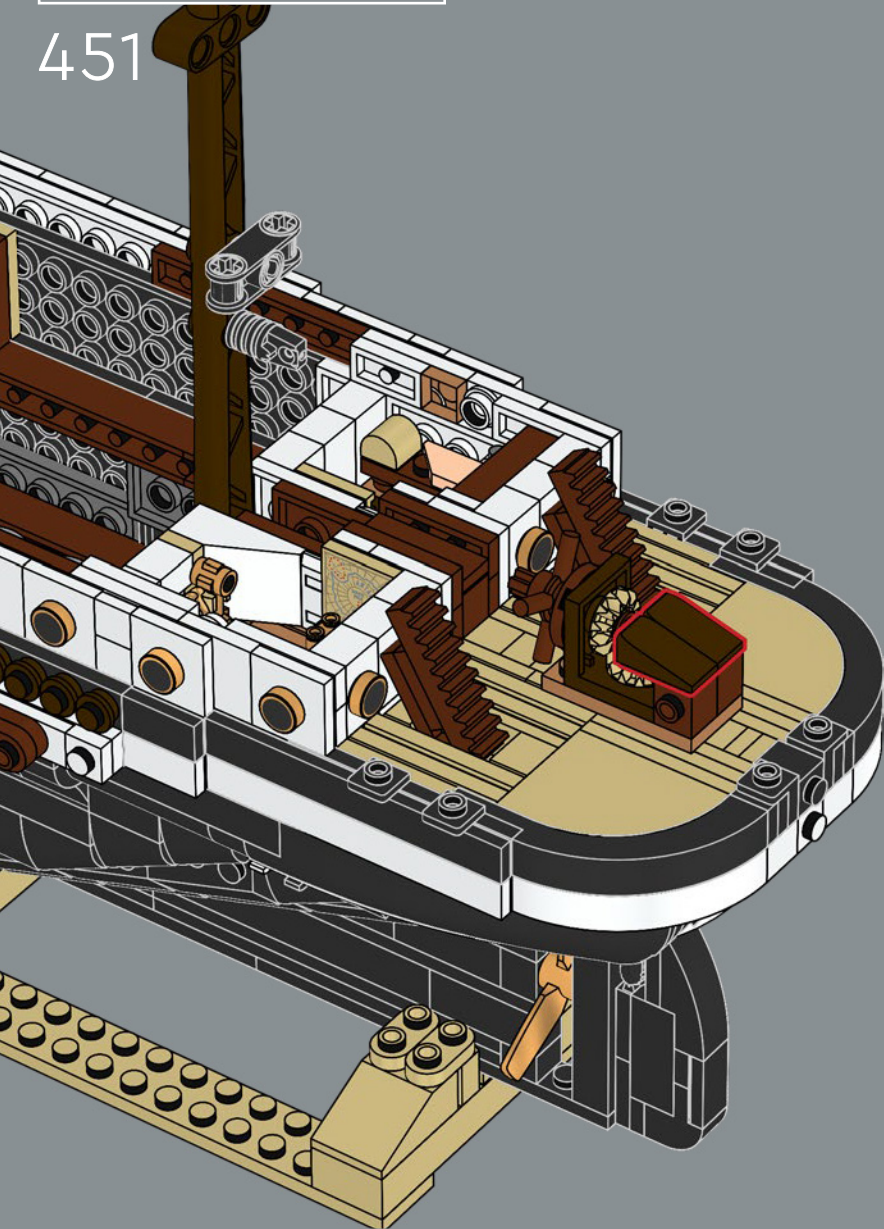

1x

1x

452

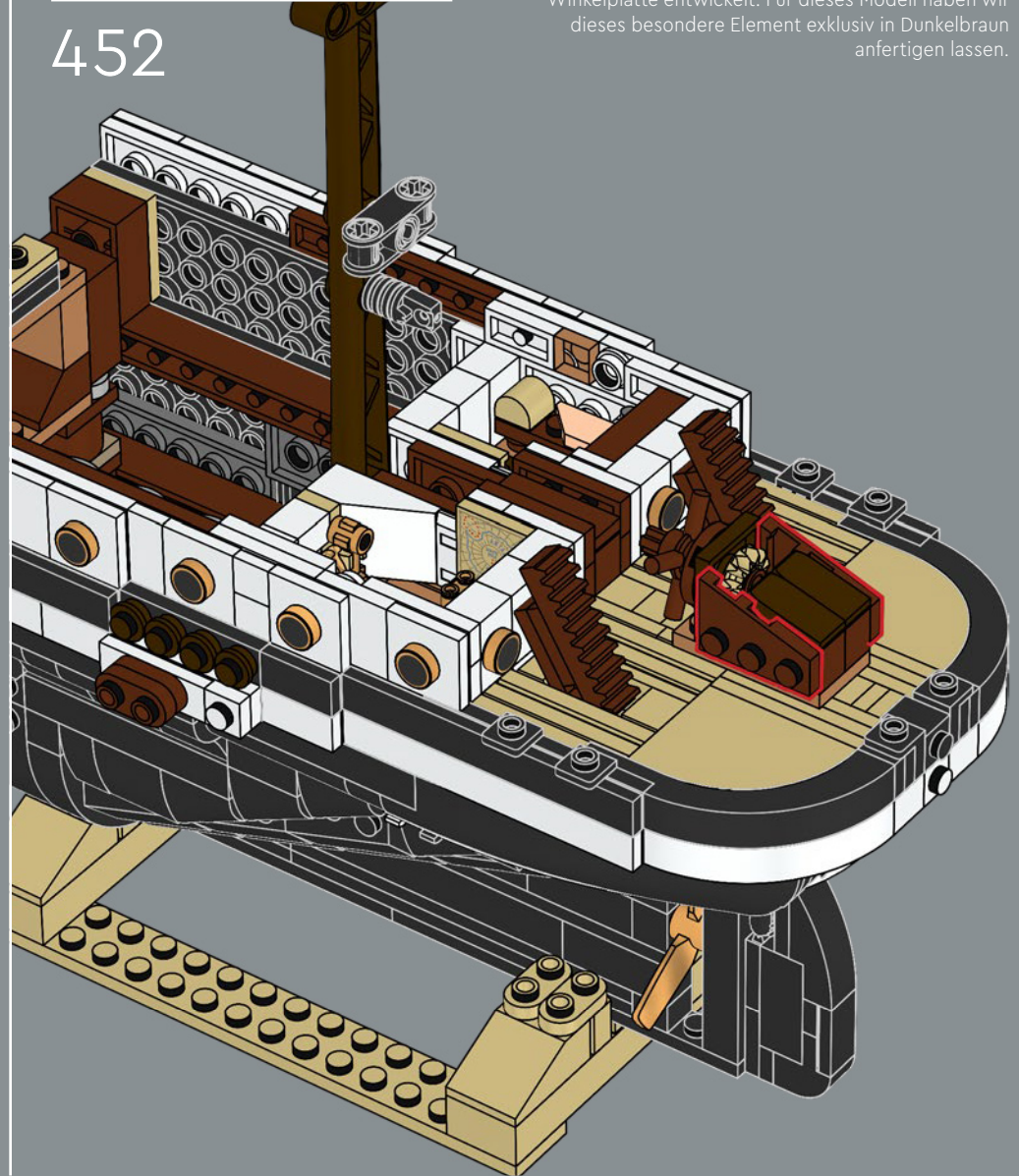

Für die Steuerkabine, in der das Ruder gelenkt wird, haben wir eines der kleinsten LEGO® Getriebe aller Zeiten mithilfe einer bereits vorhandenen 2x2 Winkelplatte entwickelt. Für dieses Modell haben wir dieses besondere Element exklusiv in Dunkelbraun anfertigen lassen.





6x

453

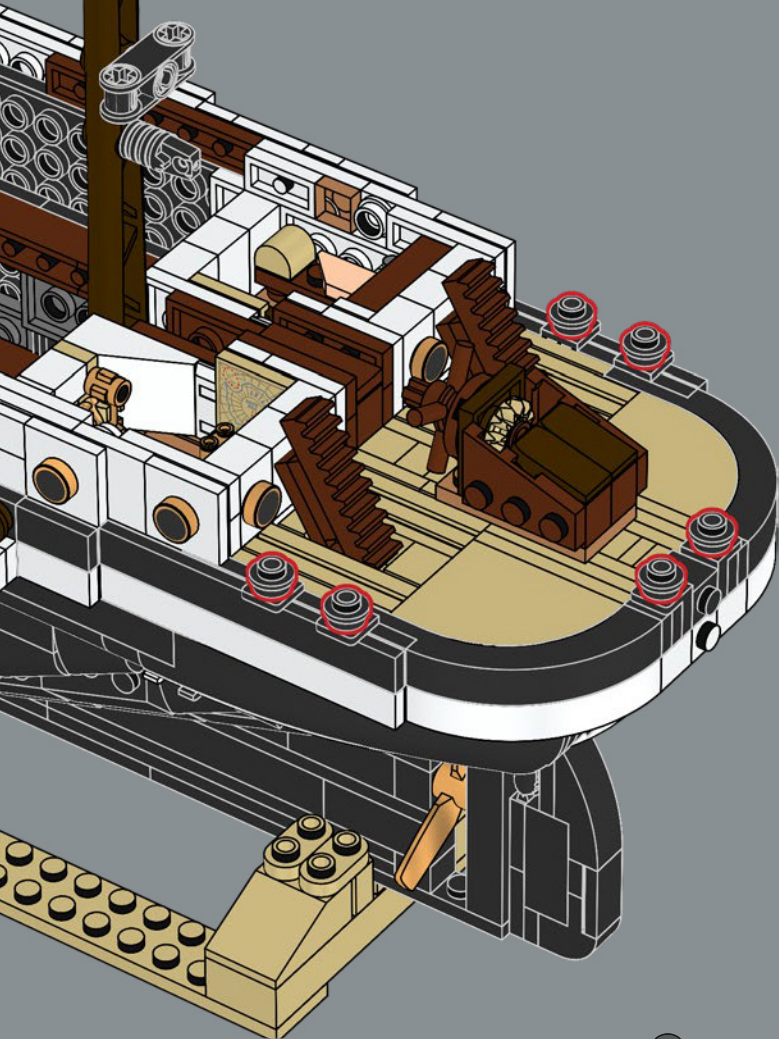

6x

454

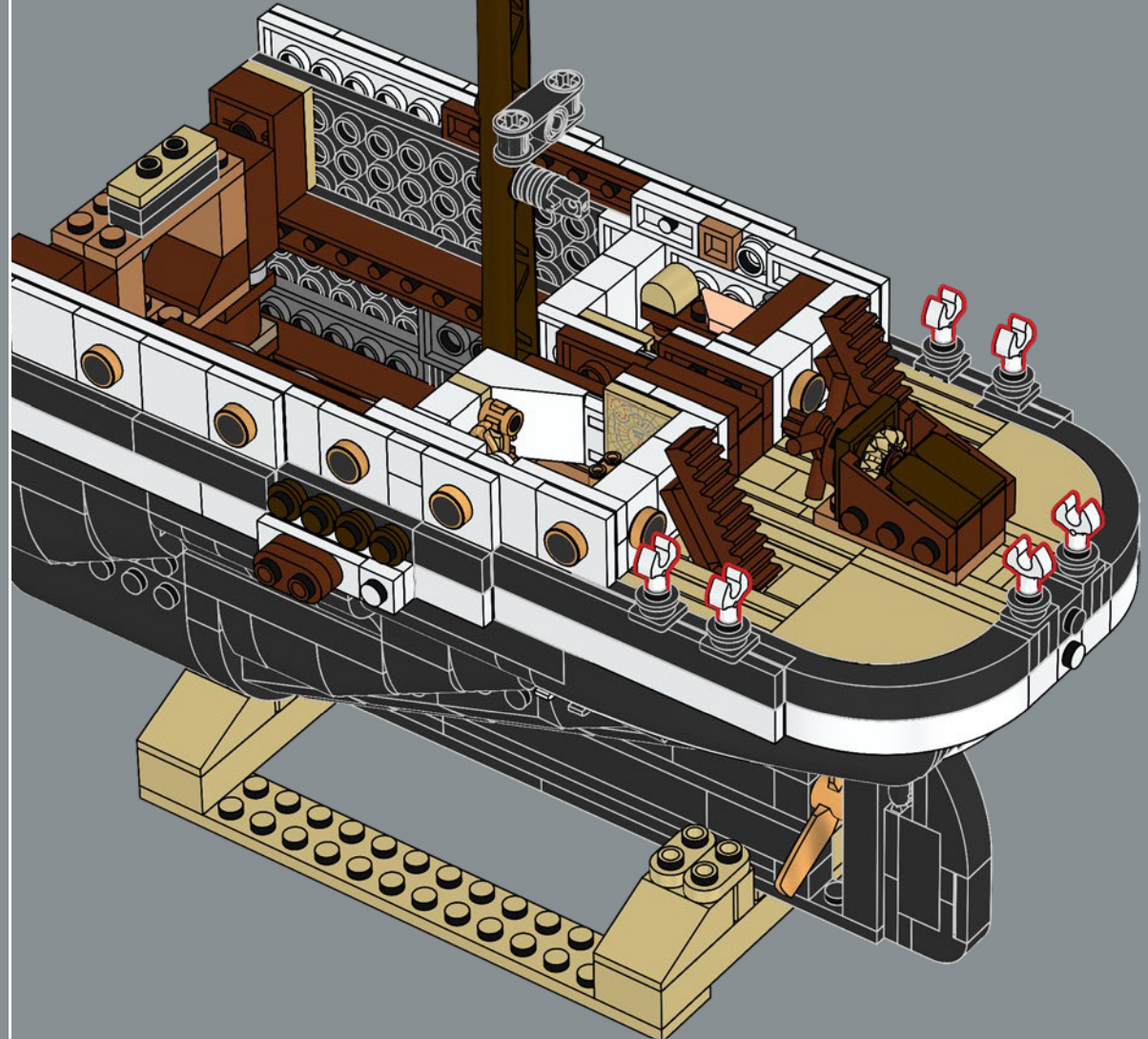

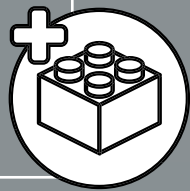
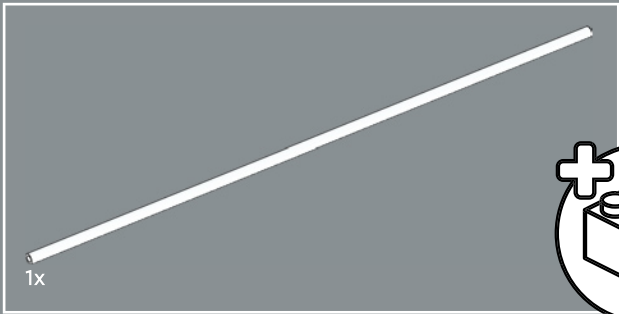

455

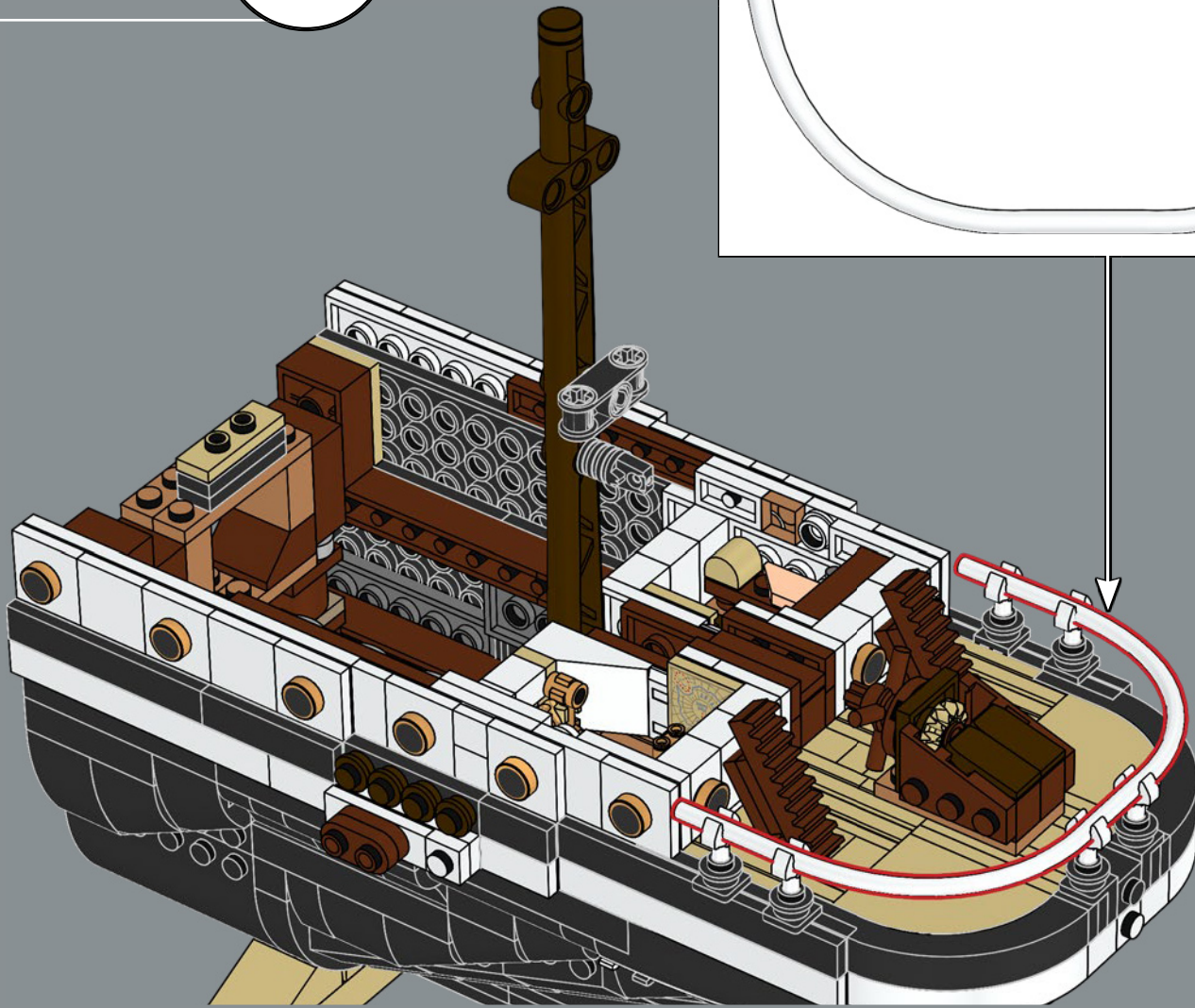
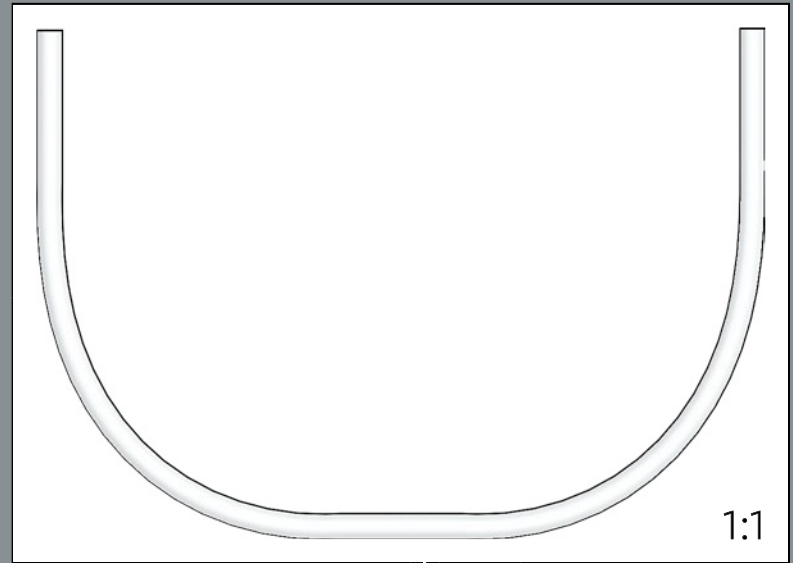





2x

456

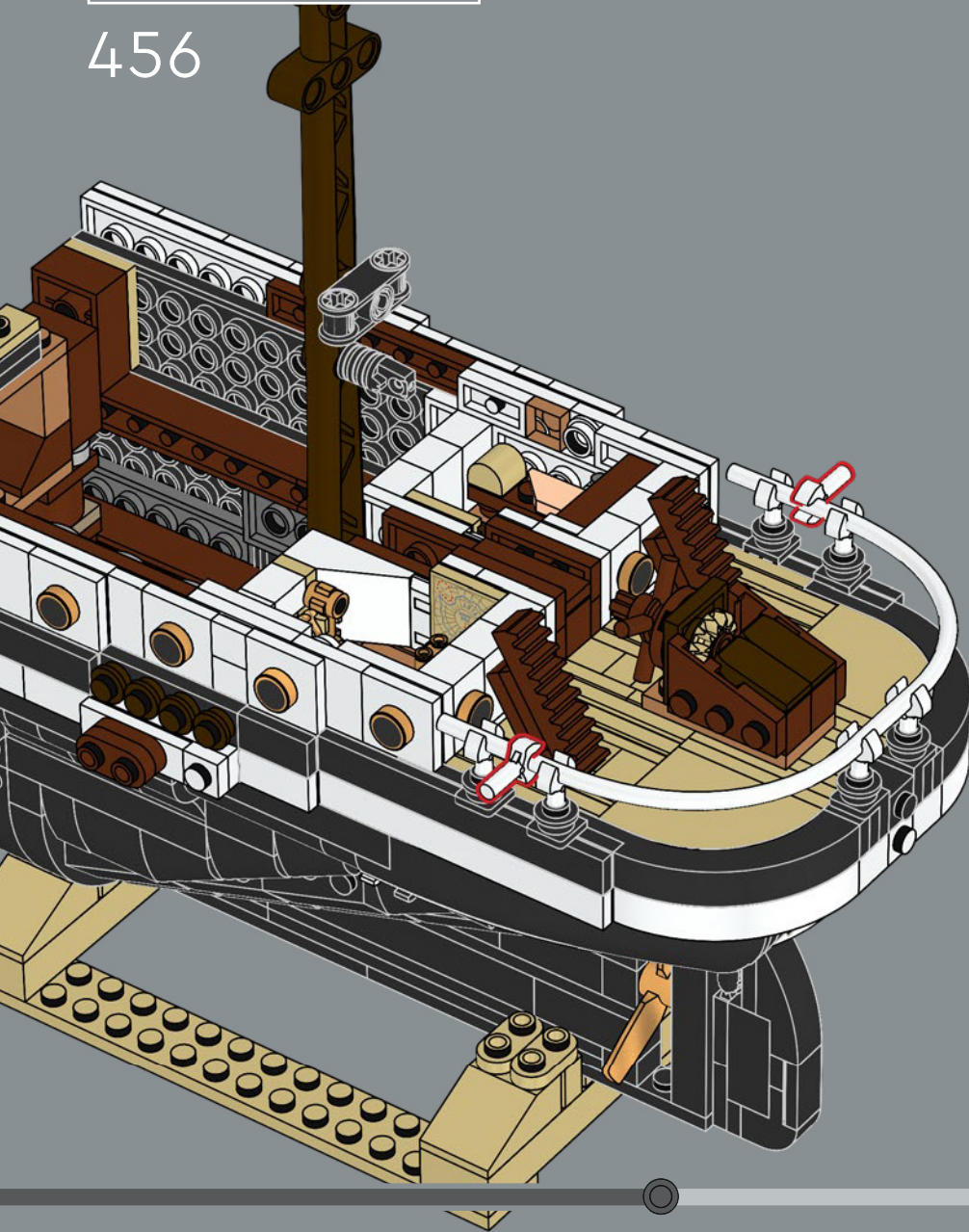

2x

457

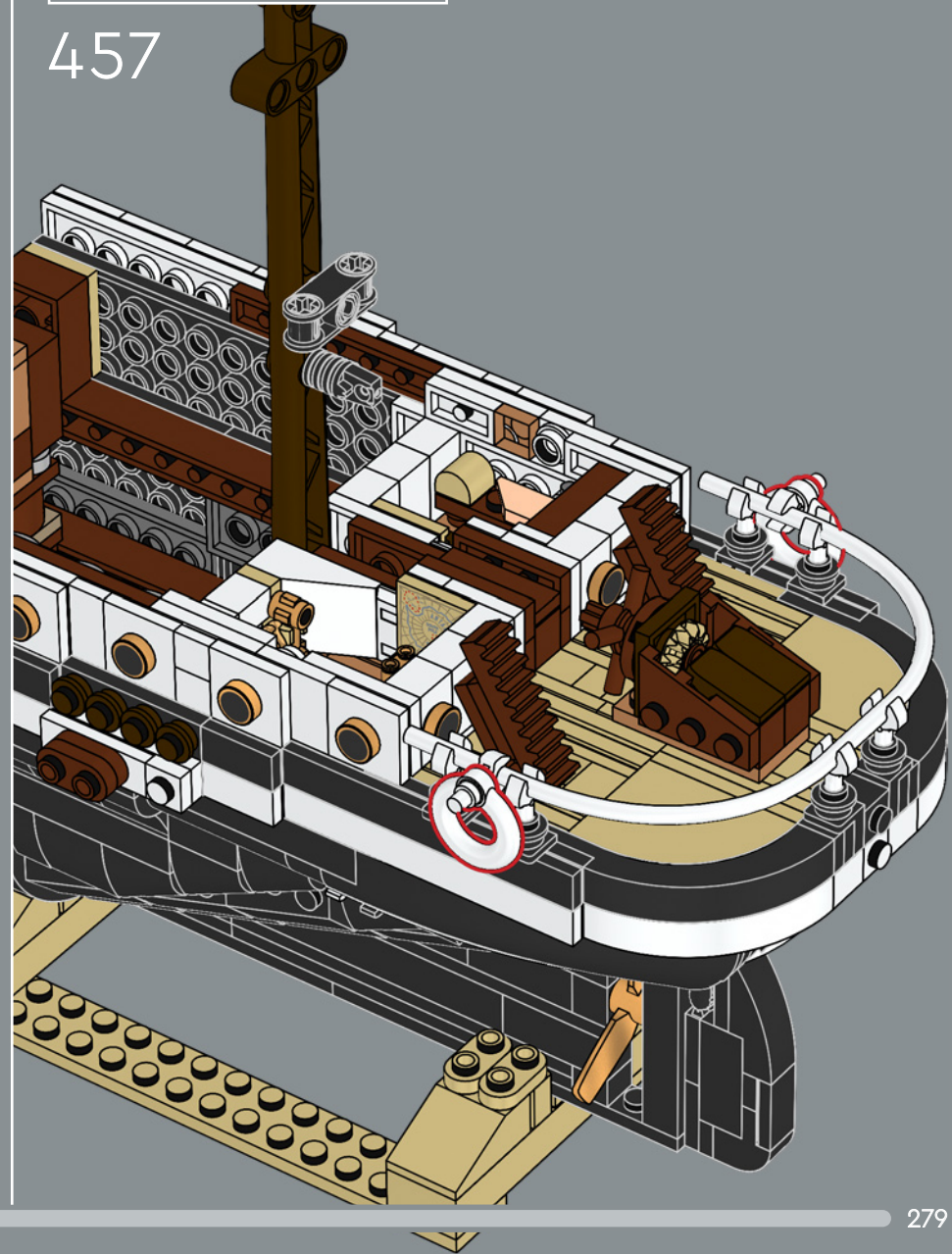



458

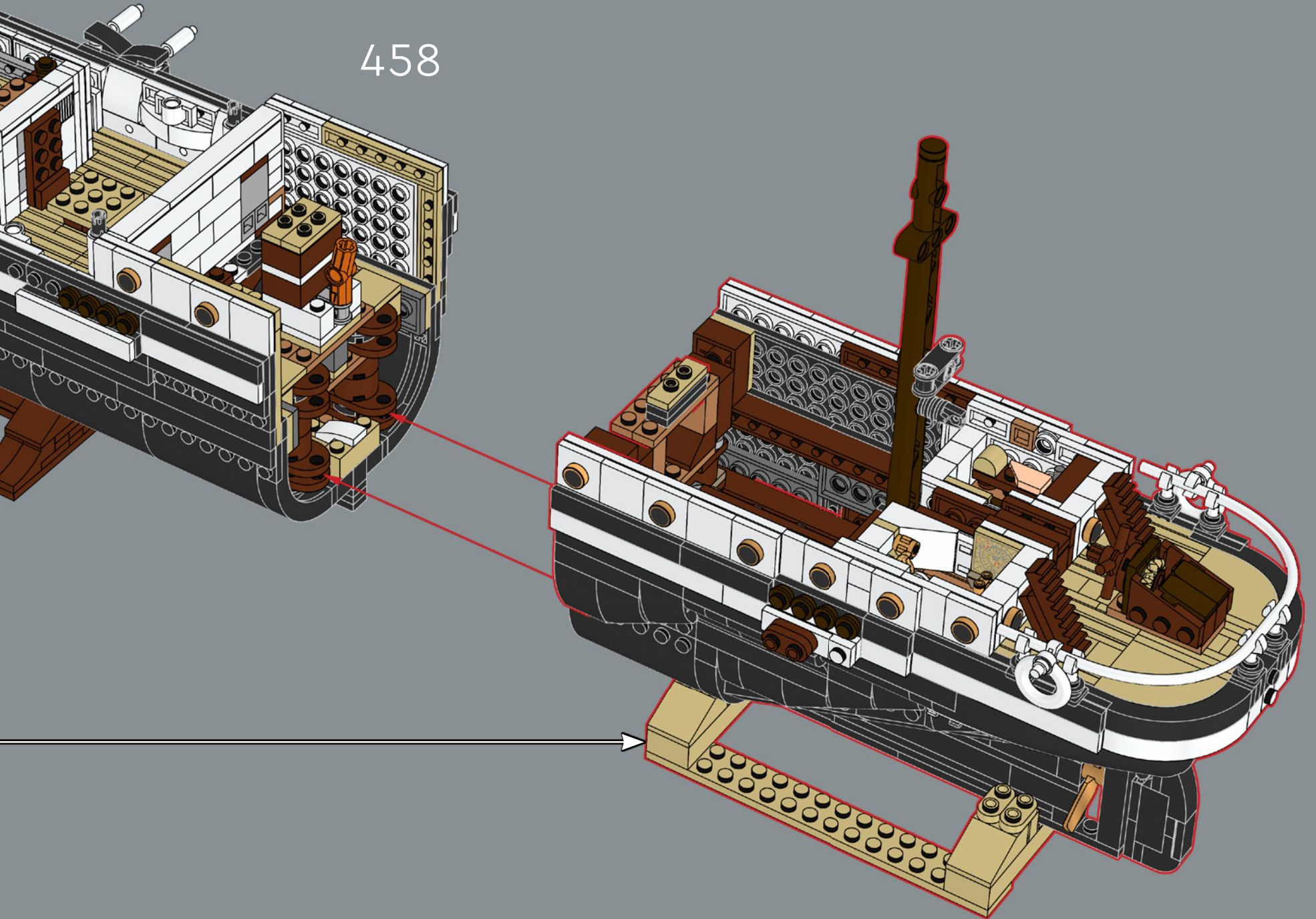

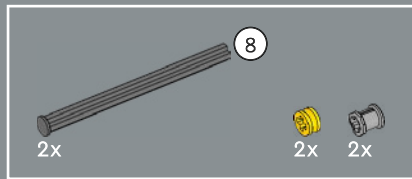

459

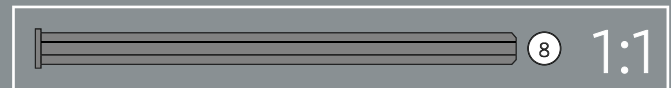
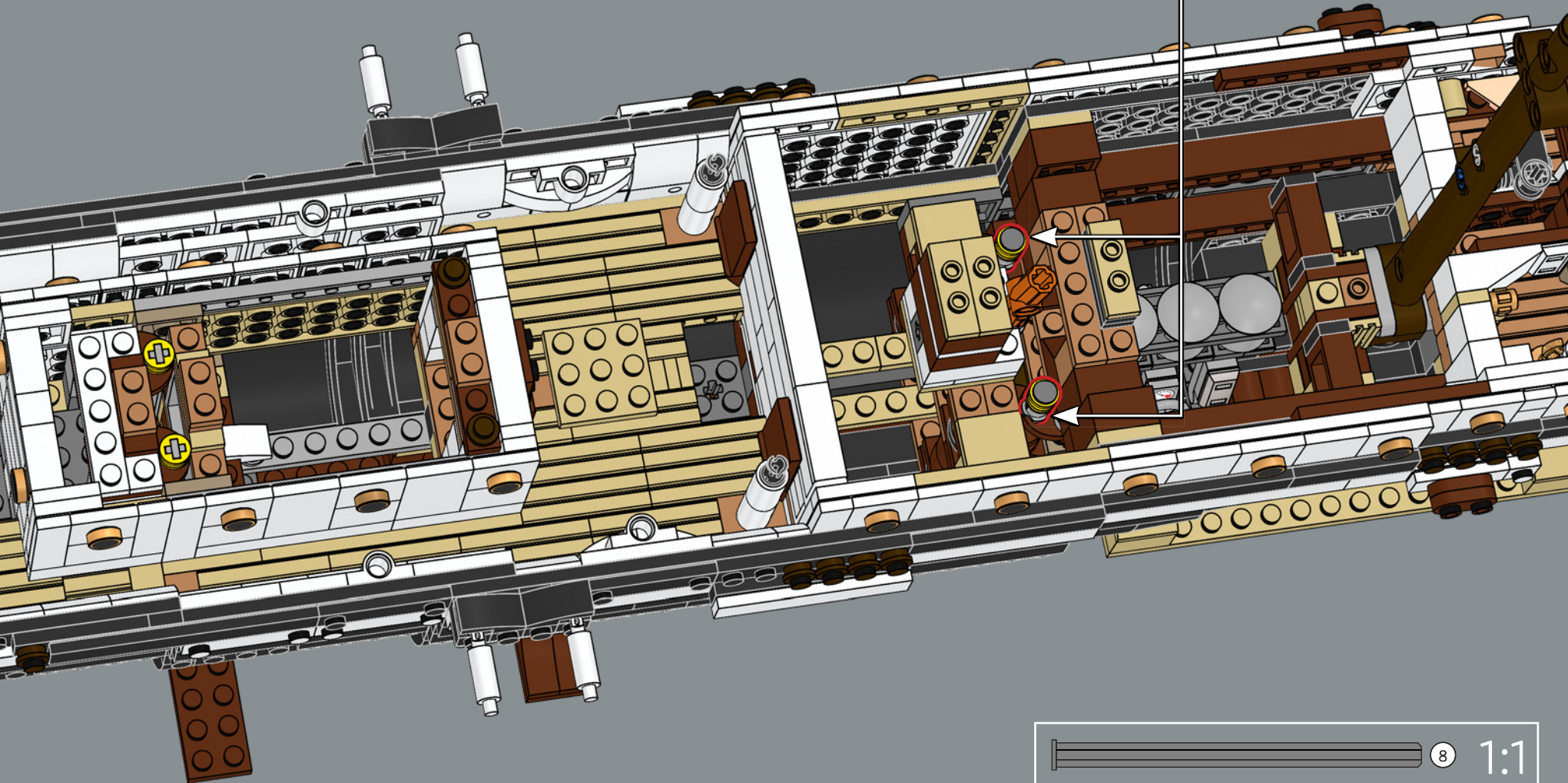
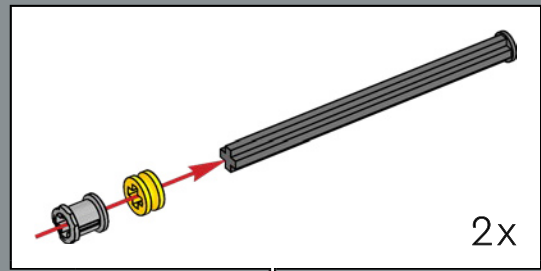



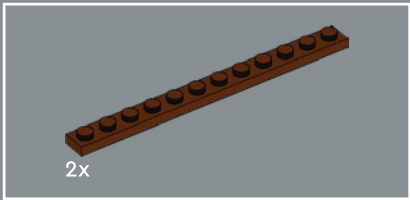

2x

460

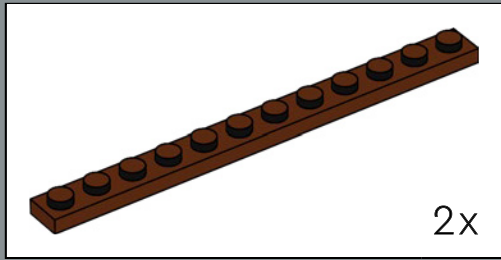

2x

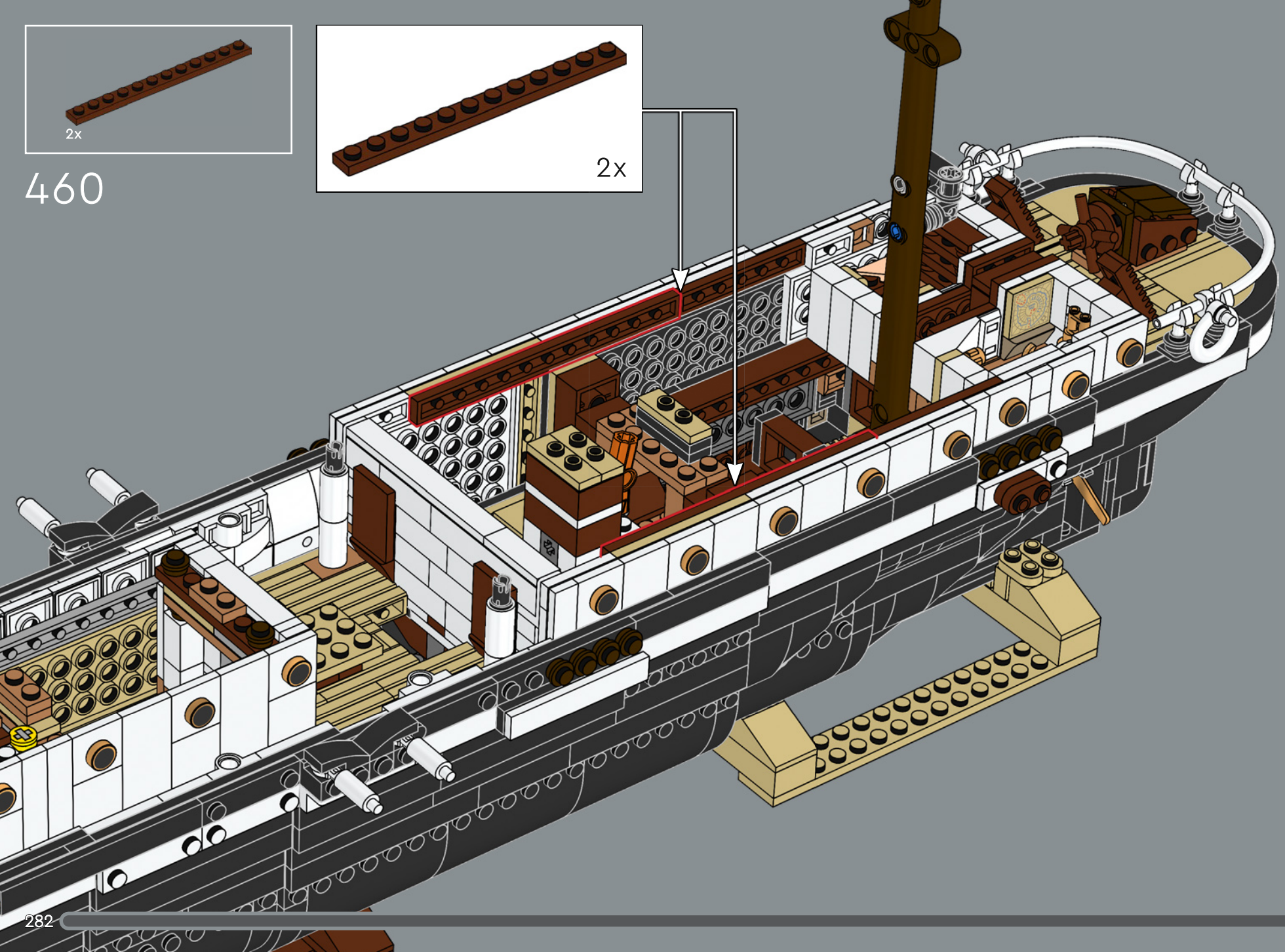

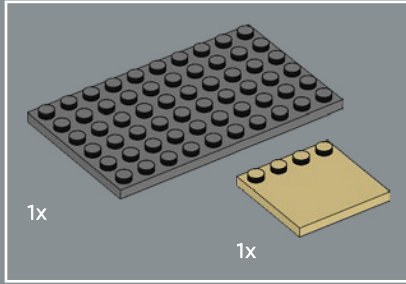
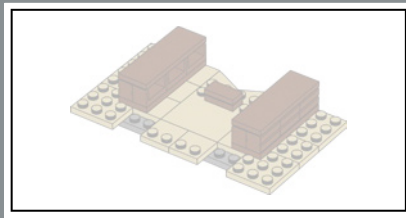

461

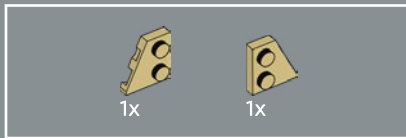
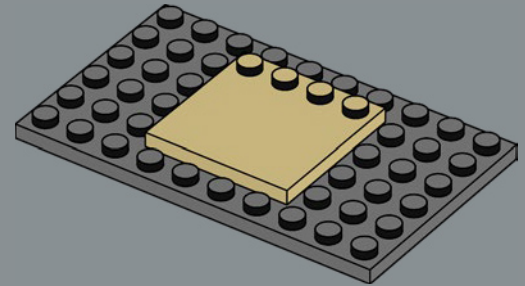

462

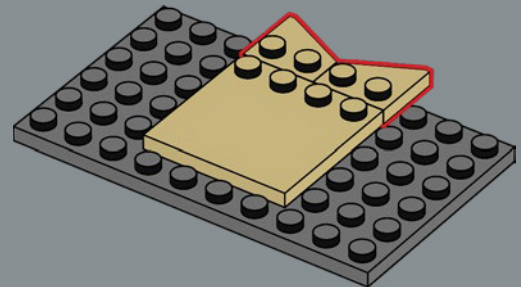



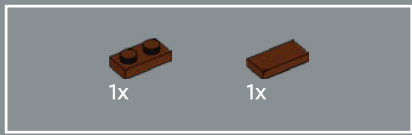

463

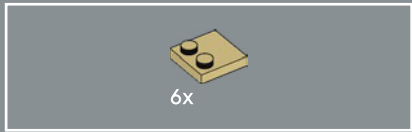
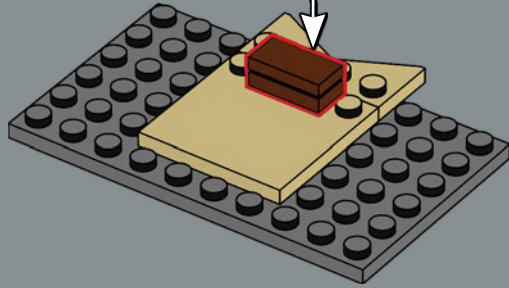
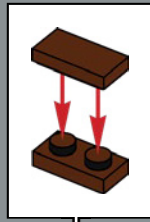

464

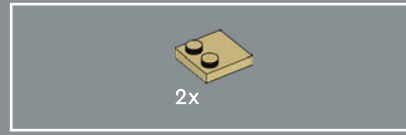
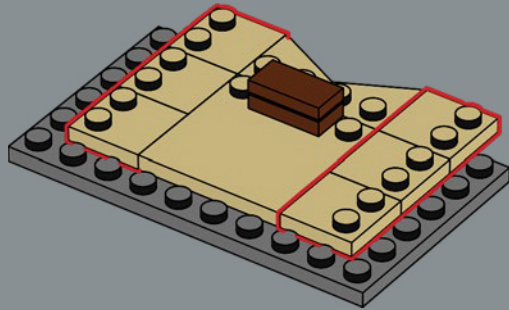

465

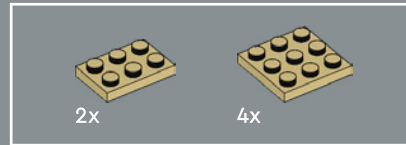
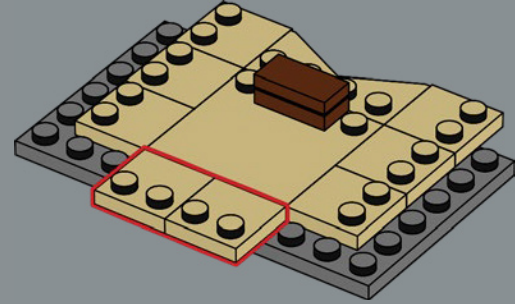

466

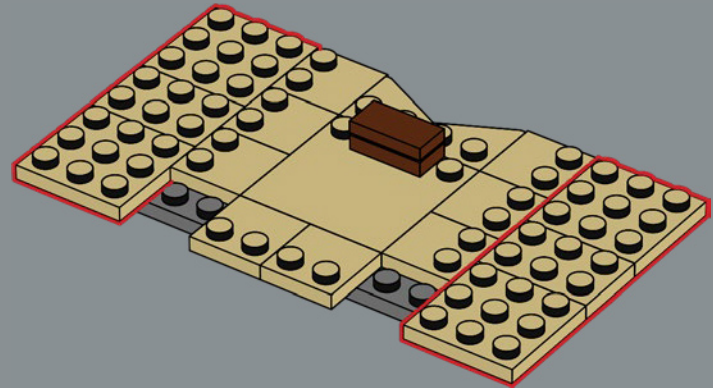

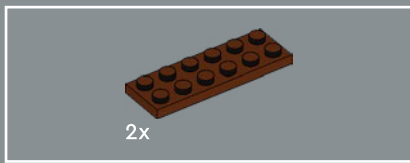

467

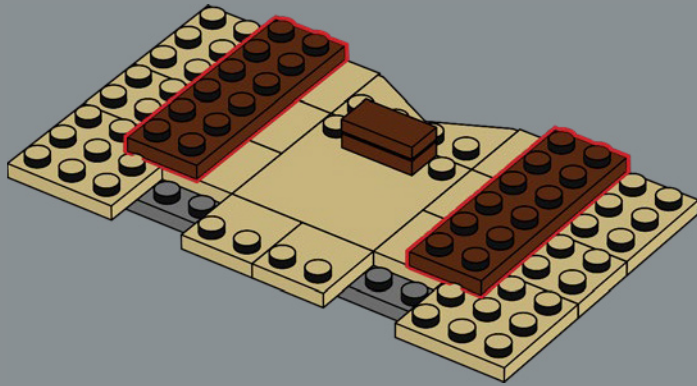

468

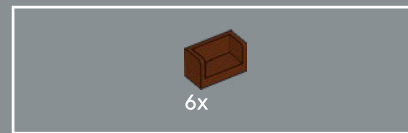
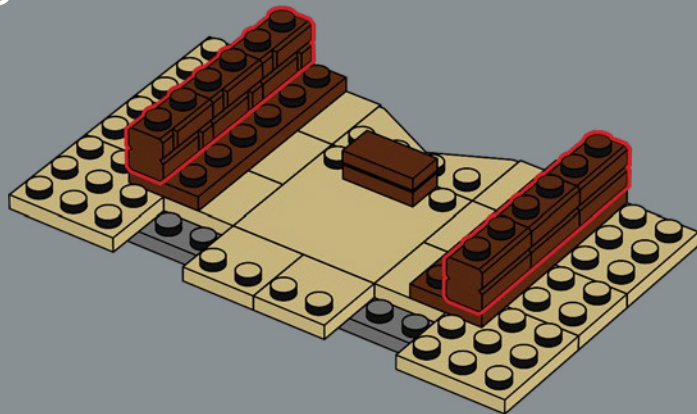

469

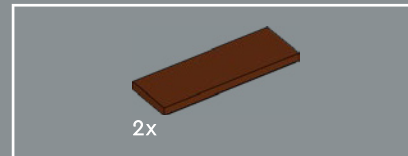
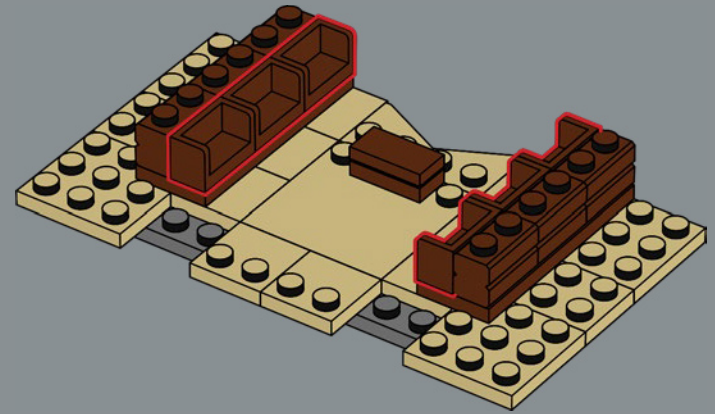

470

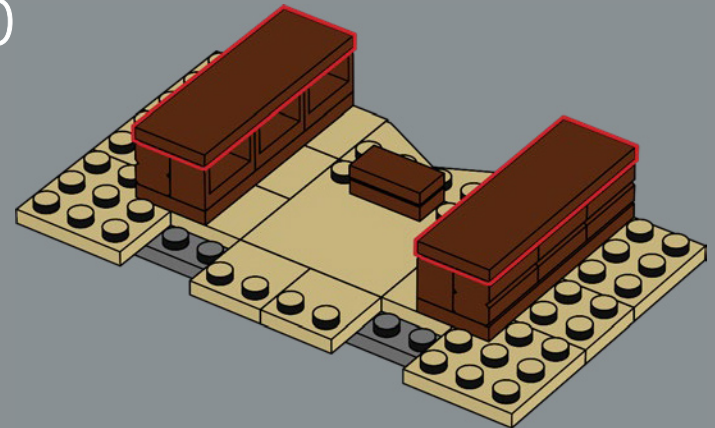



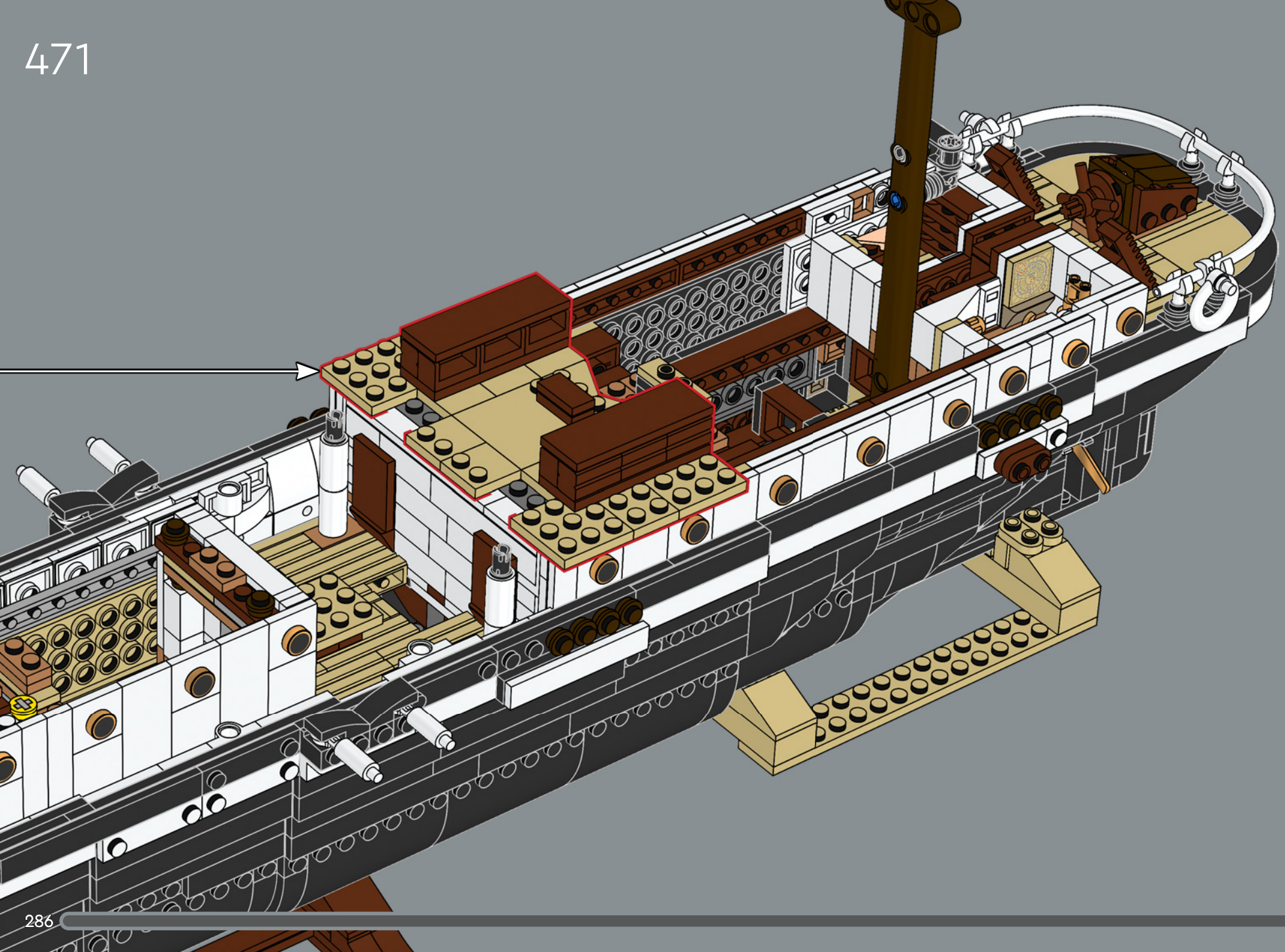

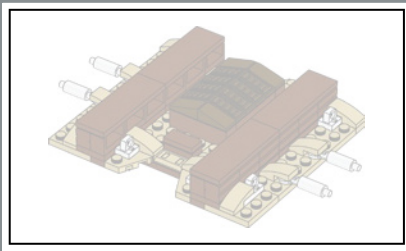

472

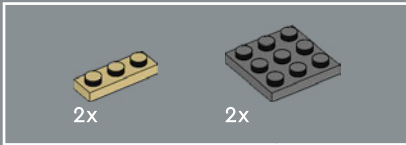
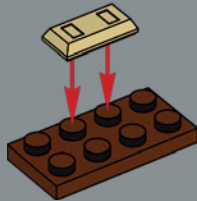

473

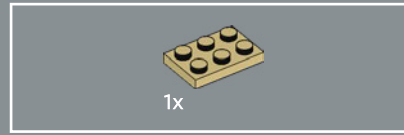
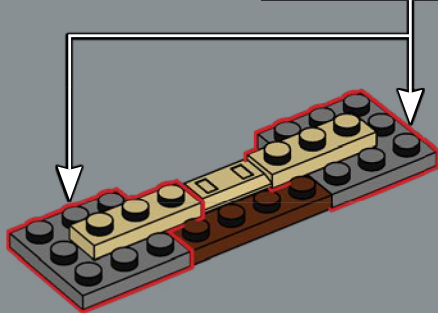
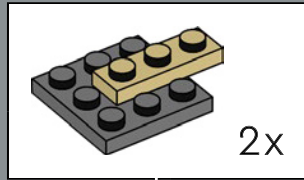

474

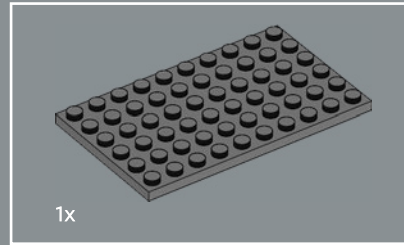
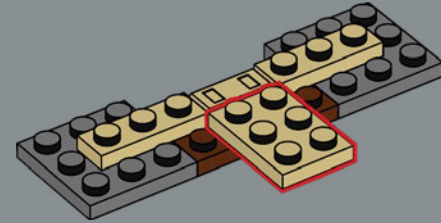

475

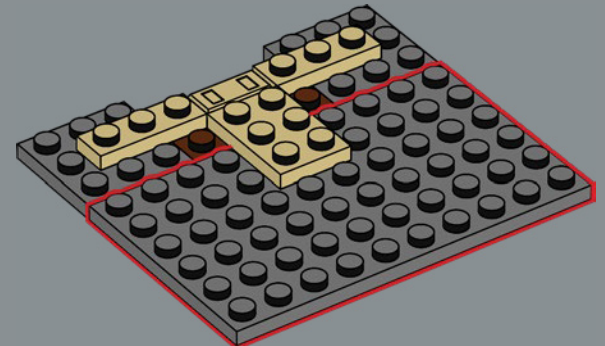



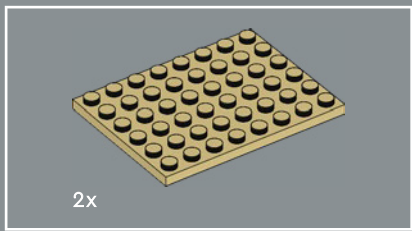

476

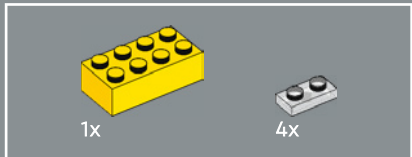
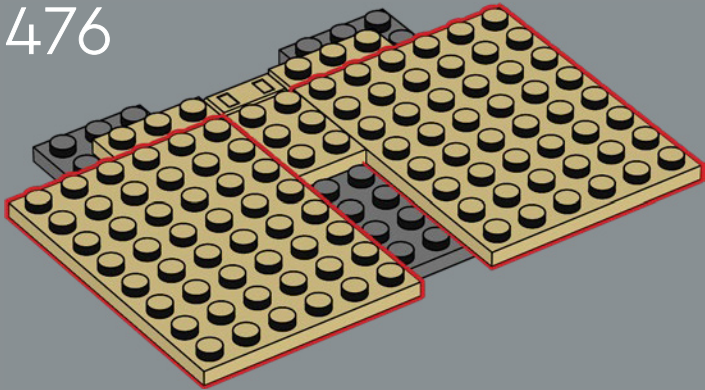

477

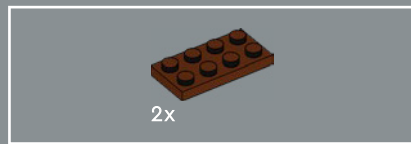
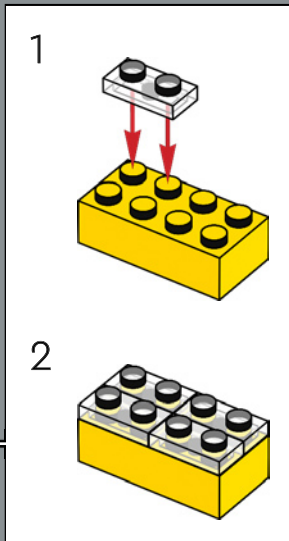
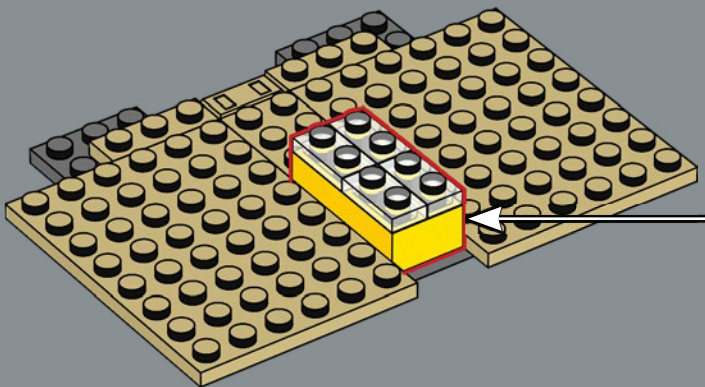

478

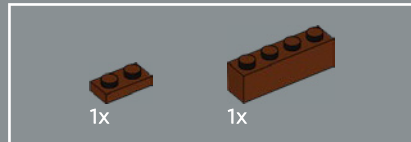
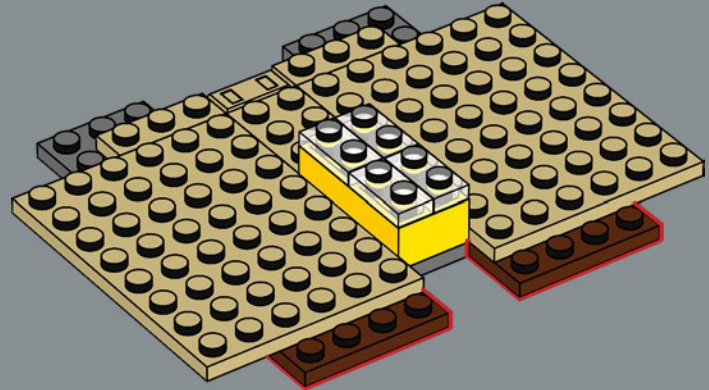

479

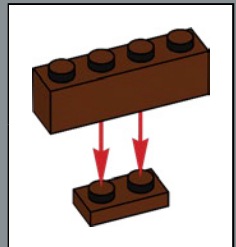
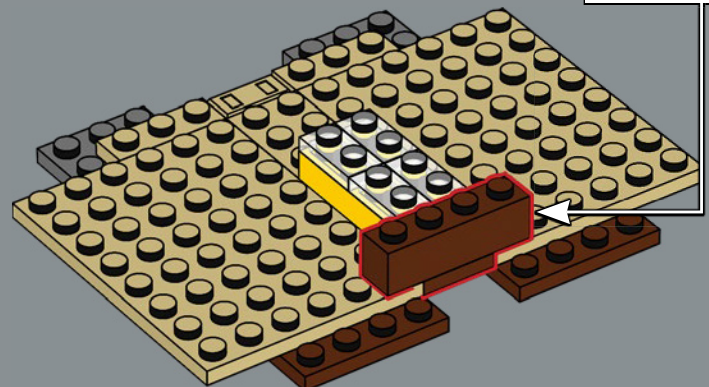

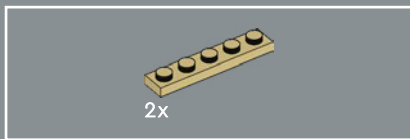

480

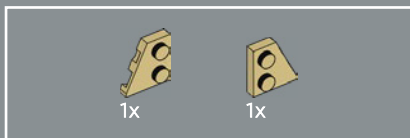
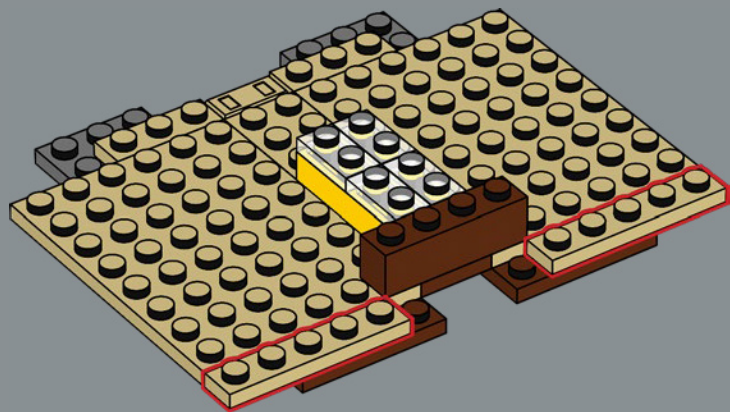

481

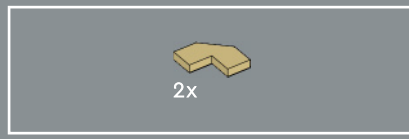
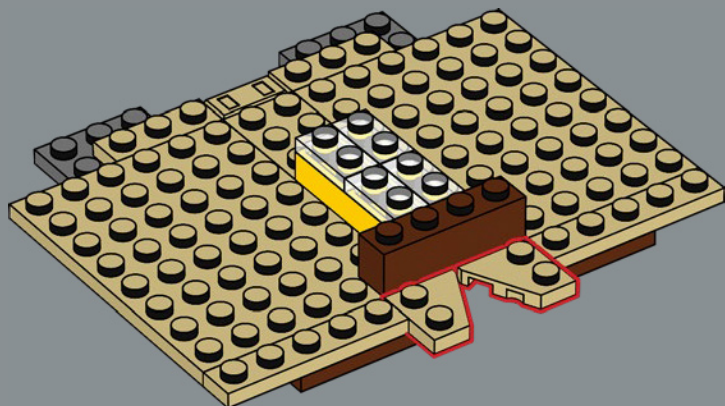

482

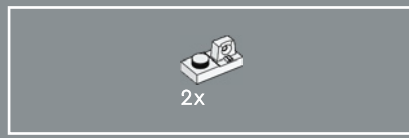
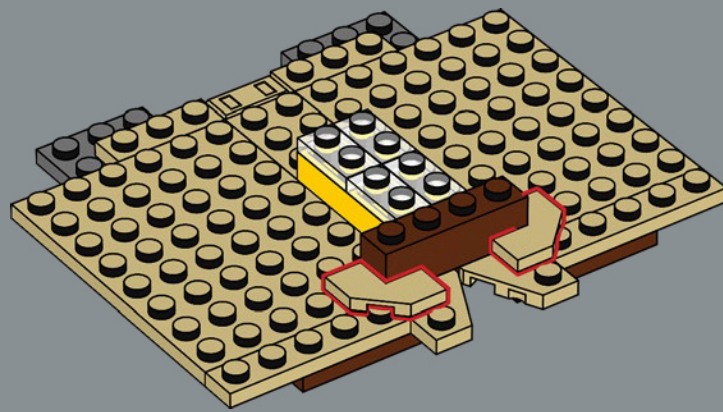

483

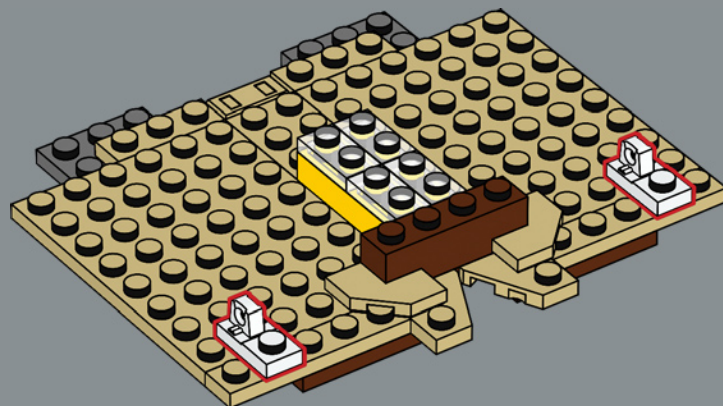





2x

484

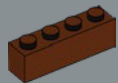
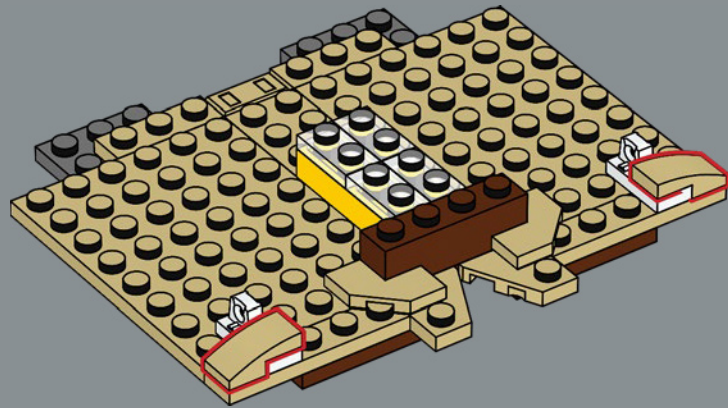

3x

485

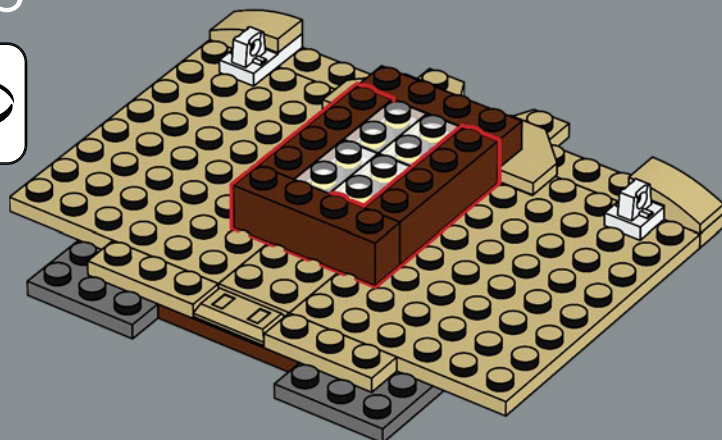

4x



8x

486

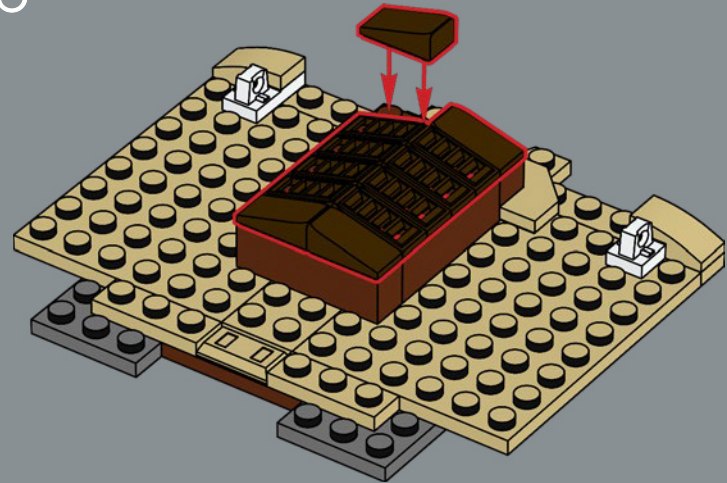

Um die Kabinen etwas rustikaler aussehen zu lassen, wurden die kleinen 1x2 Schrägelemente für die Kabinendächer zum ersten Mal in Dunkelbraun hergestellt.

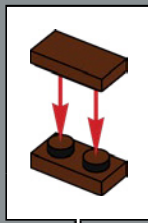
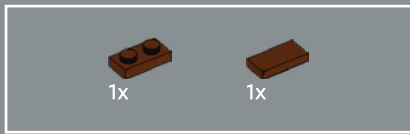

487

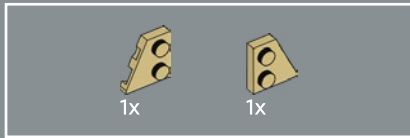
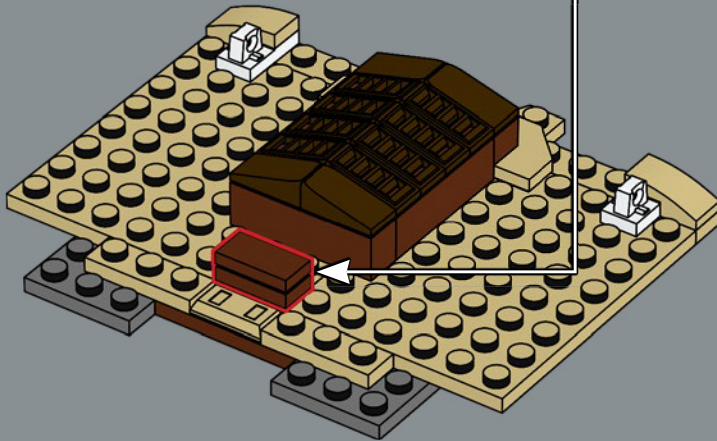

488

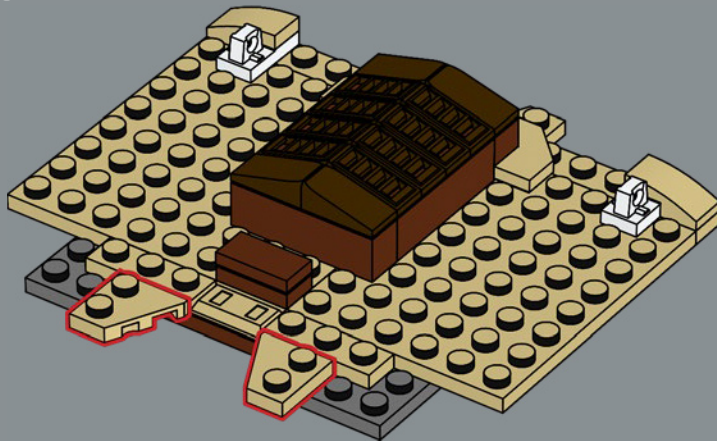

489

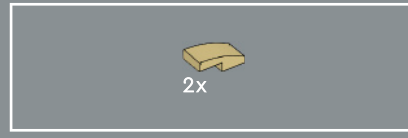
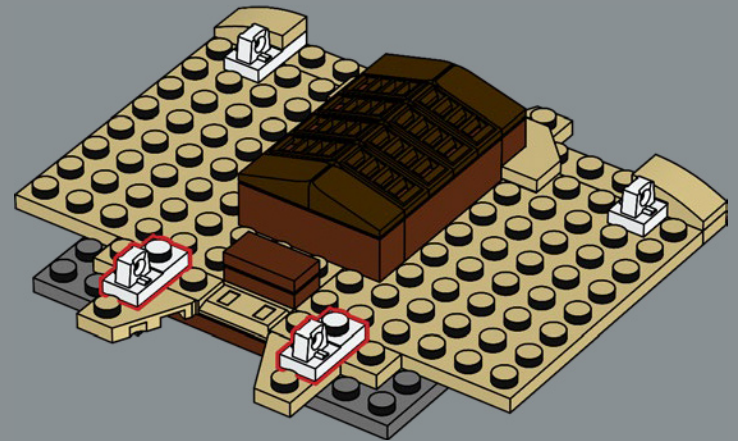

490

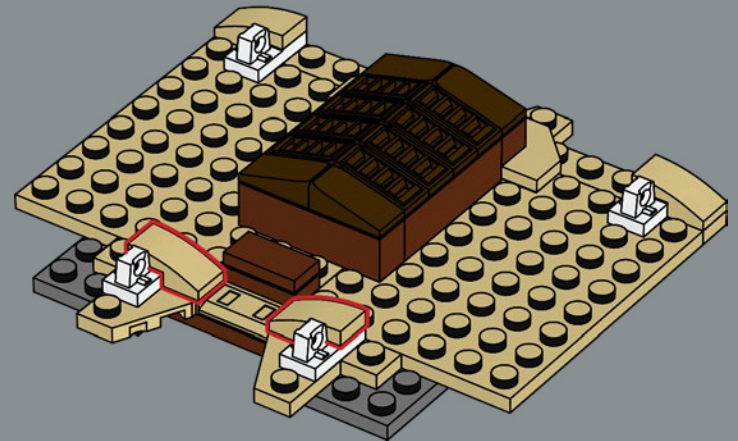



2x

491

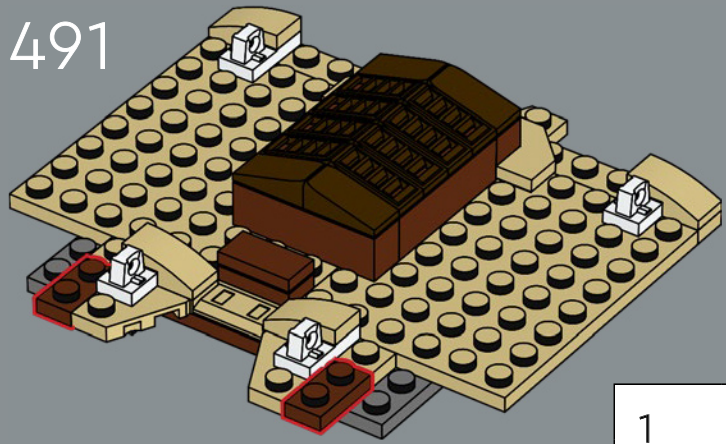

2x 2x 2x

492

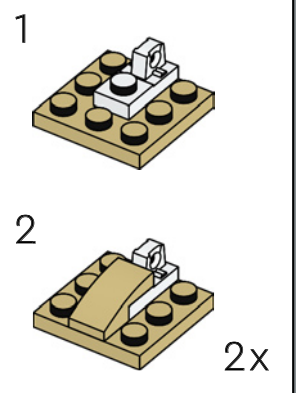
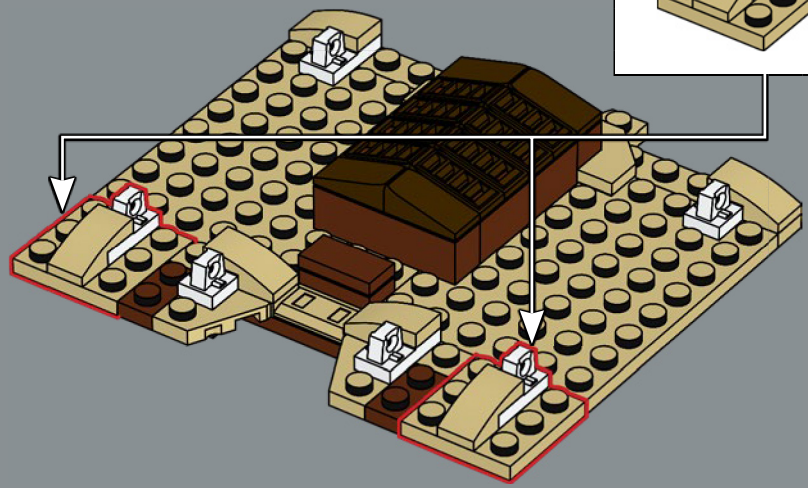

4x

493

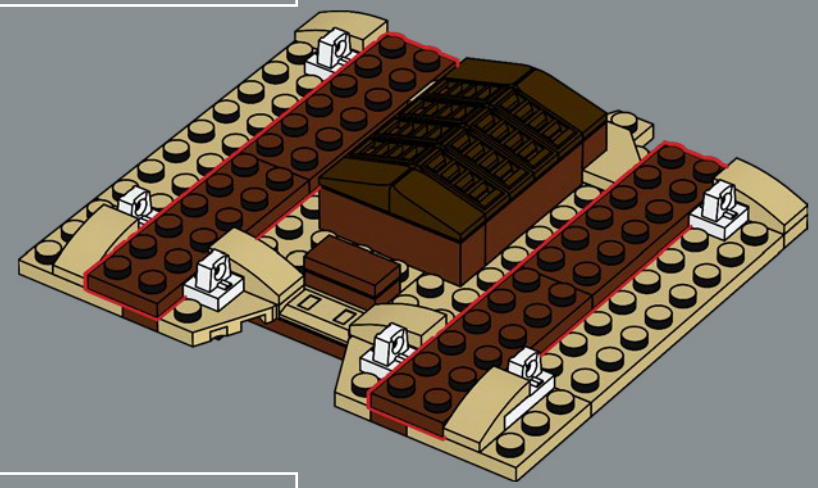

4x 4x

494

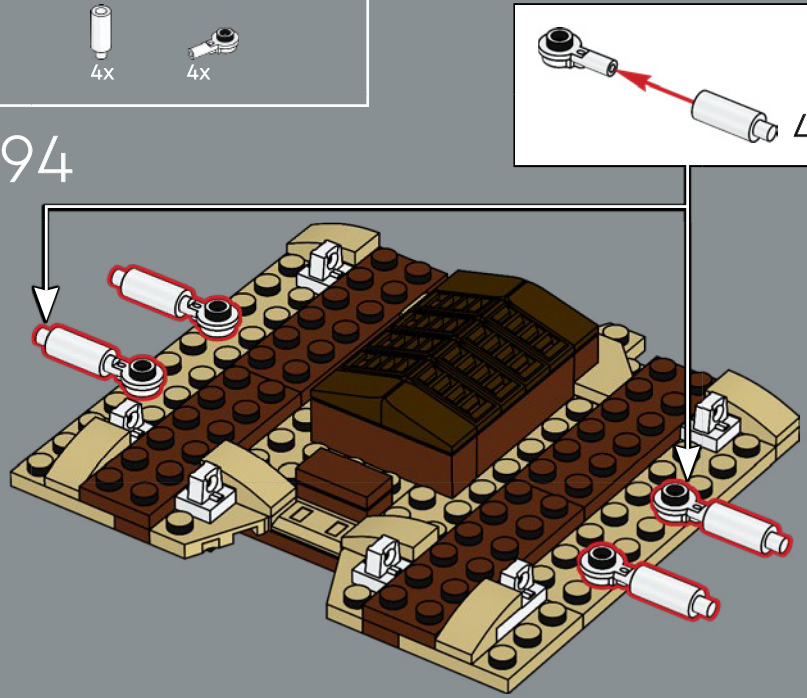

4x



495

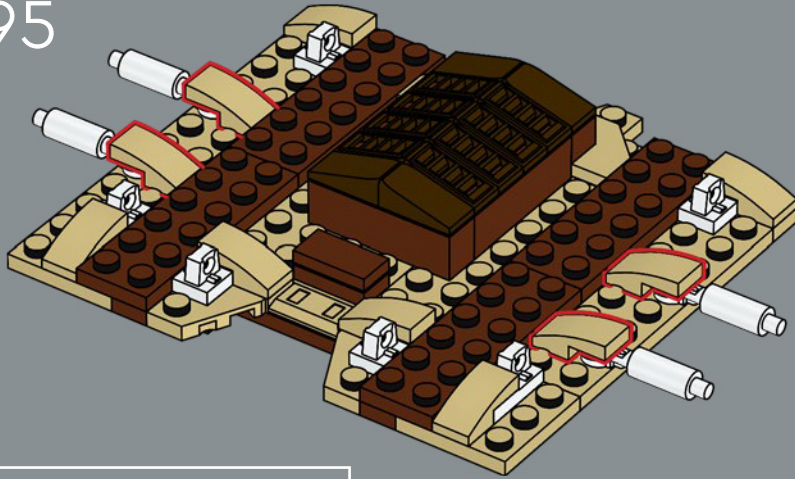

496

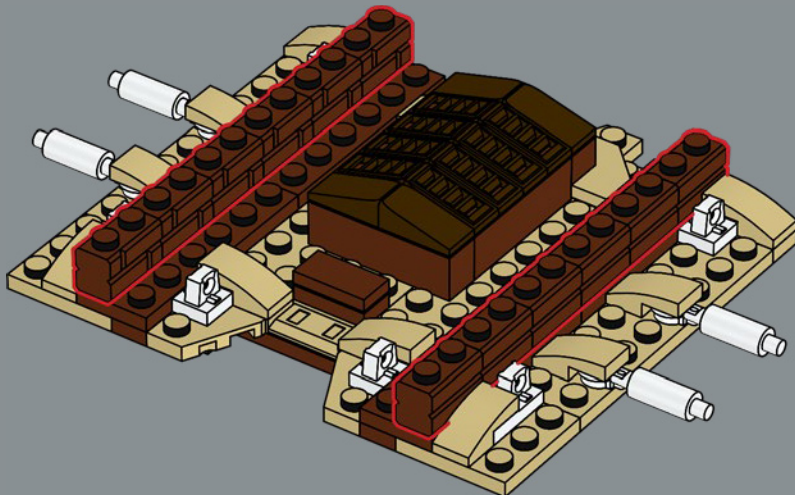

497

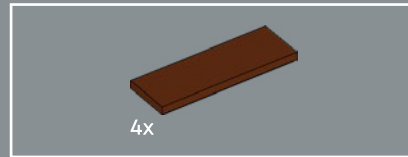
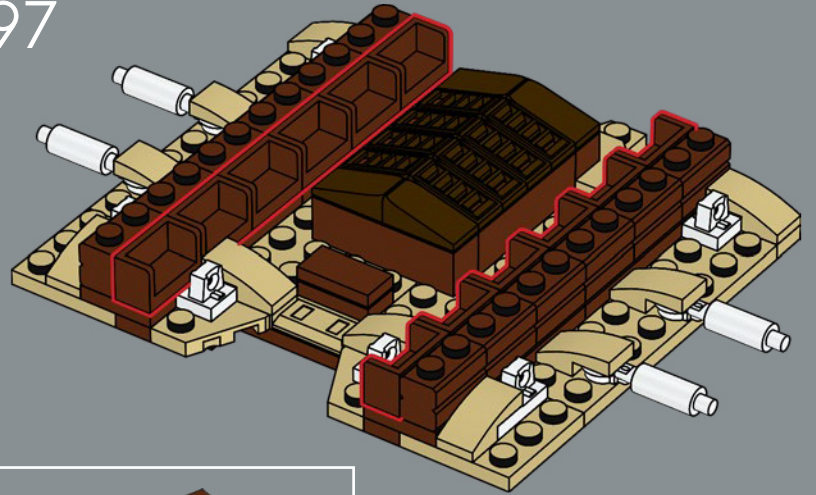

498

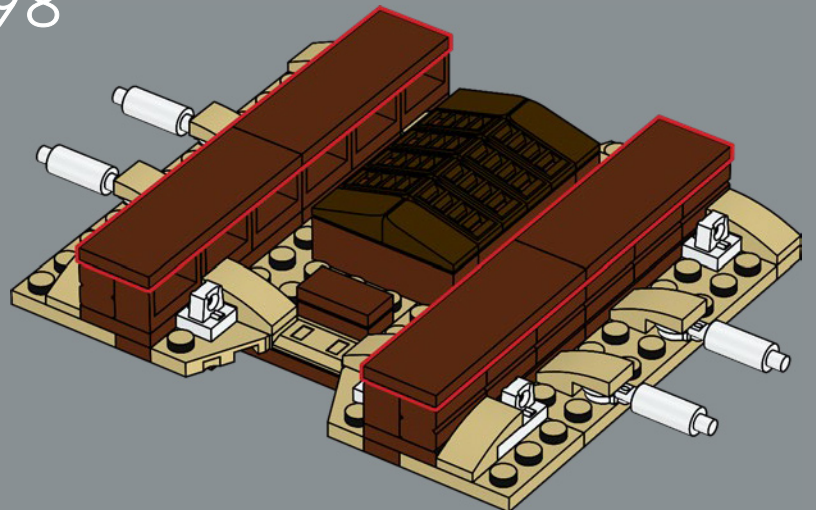



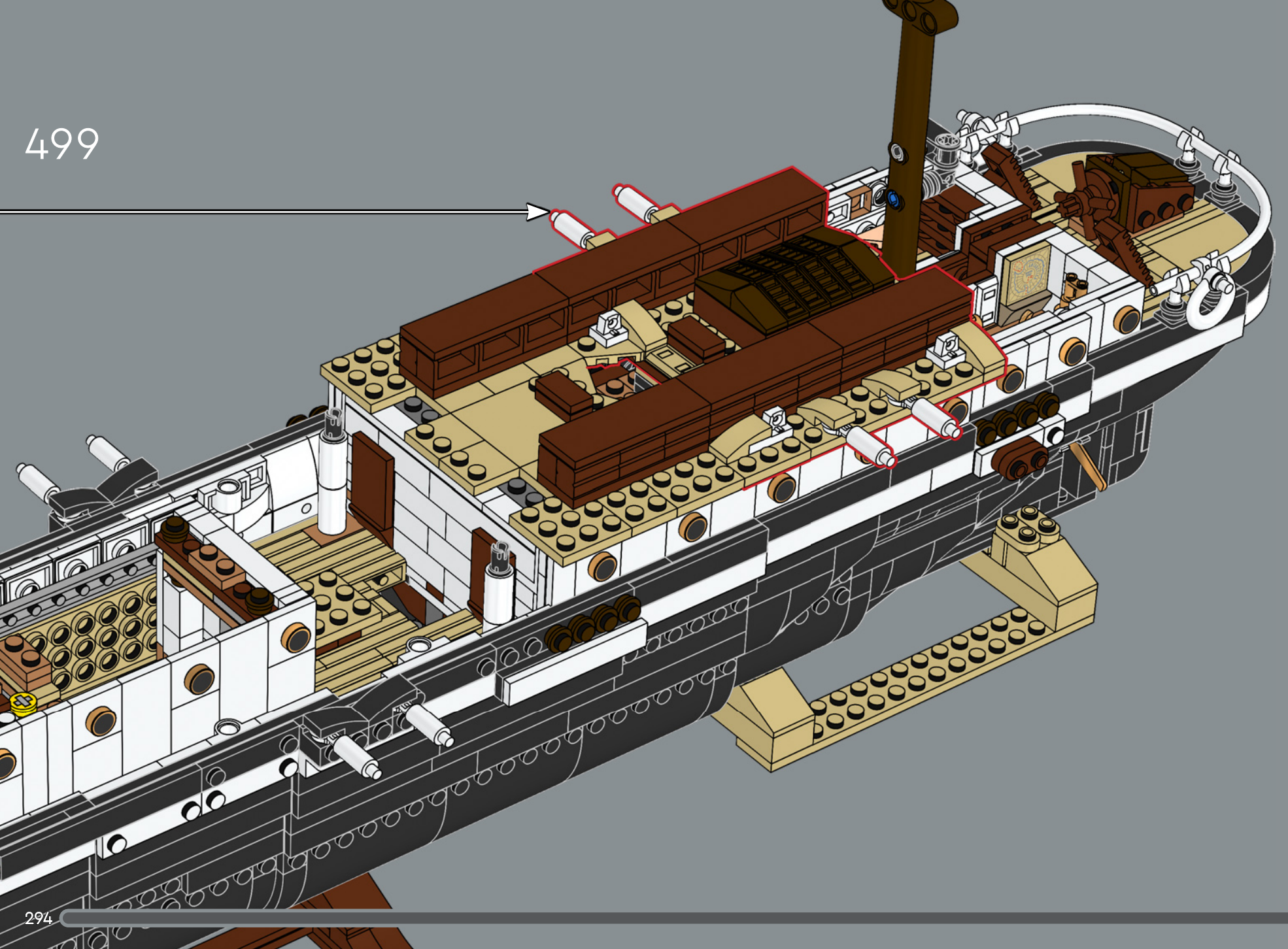

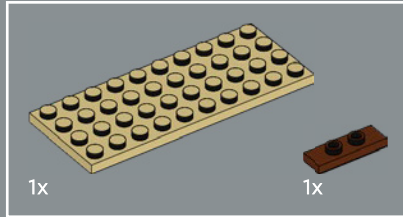
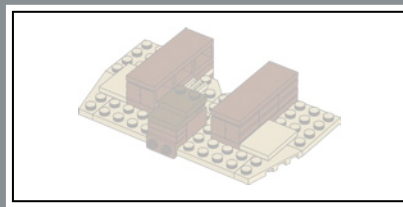

500

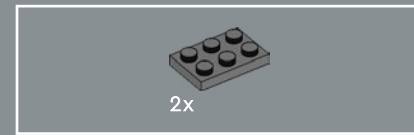
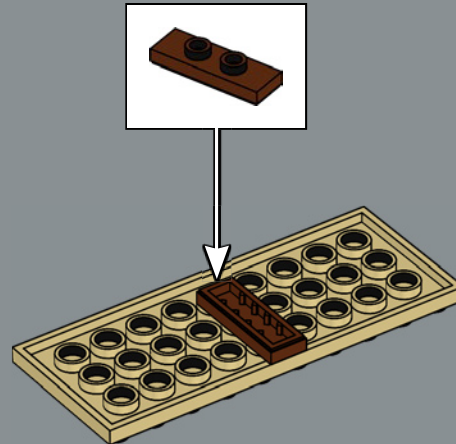

501

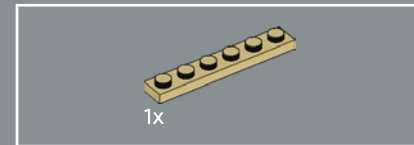
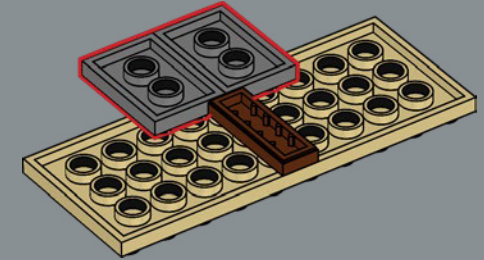

502

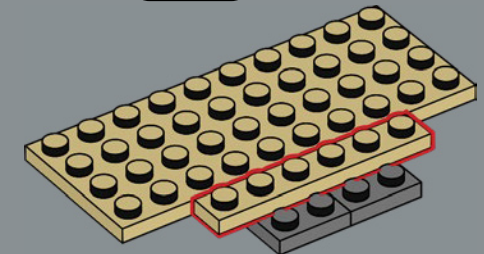





503

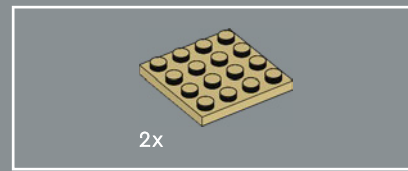
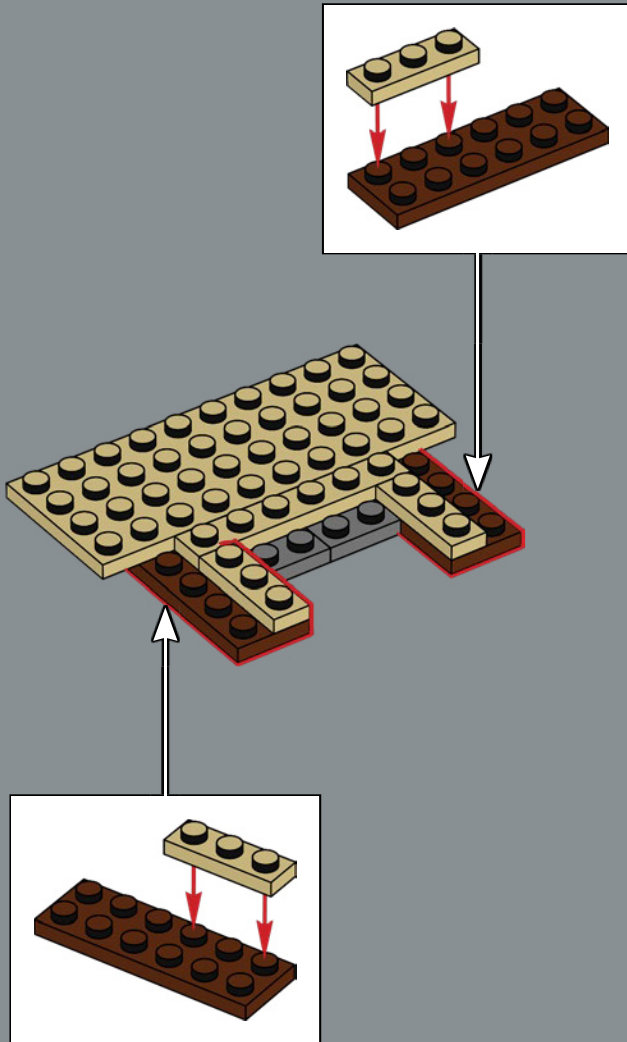

504

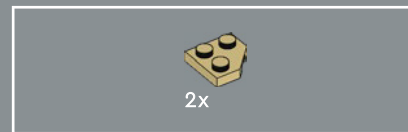
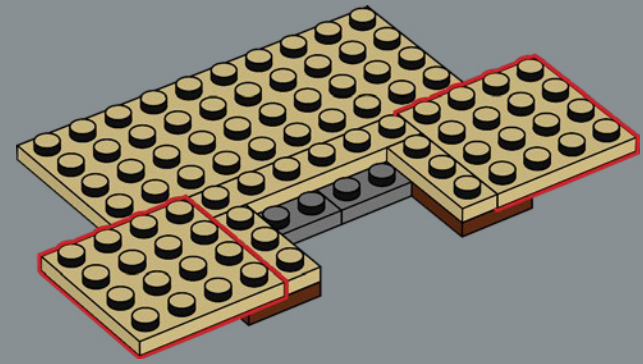

505

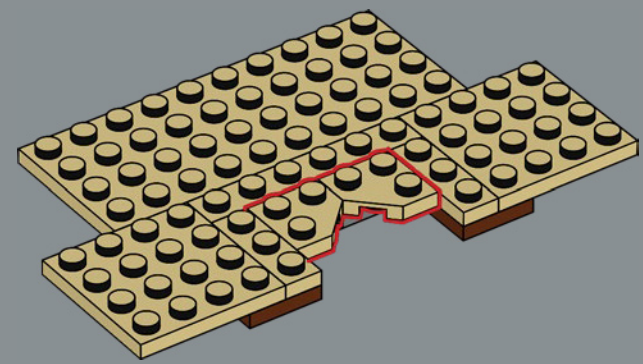

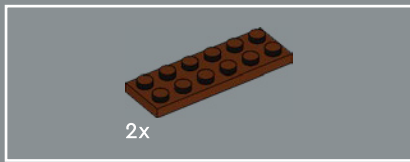

506

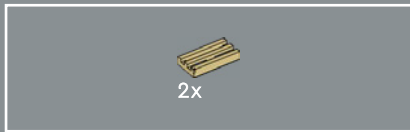
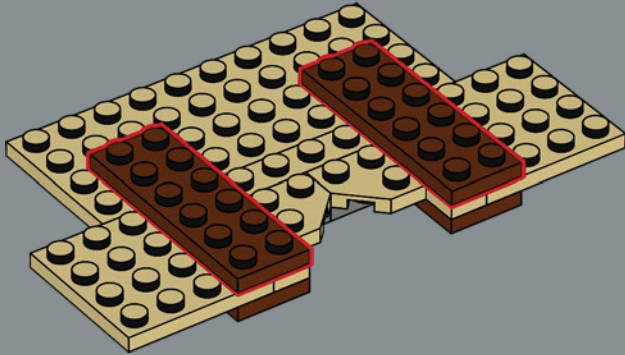

507

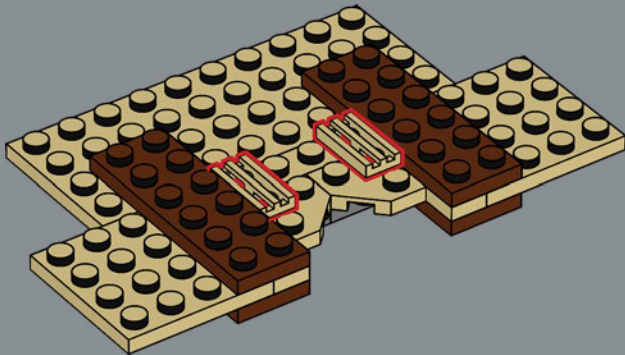

508

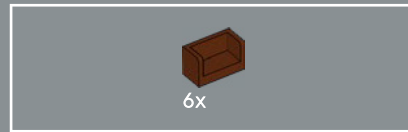
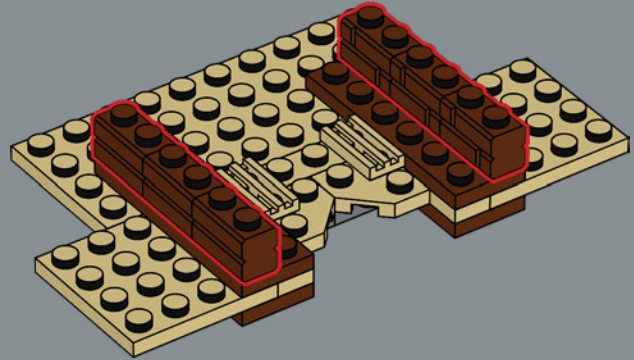

509

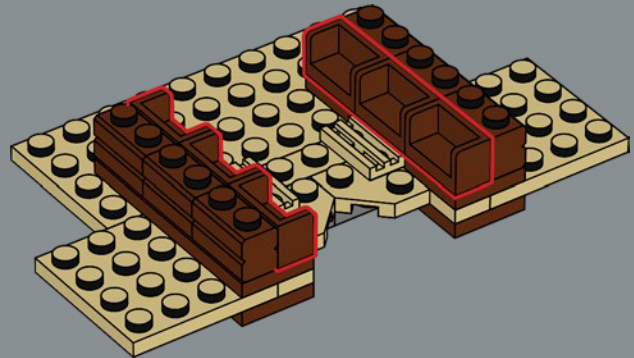

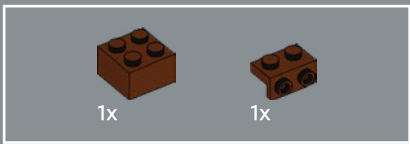

510

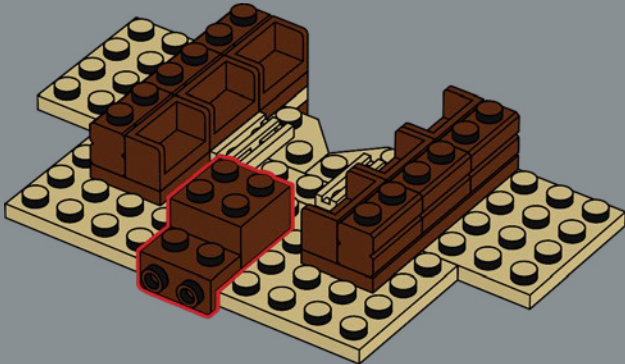

511

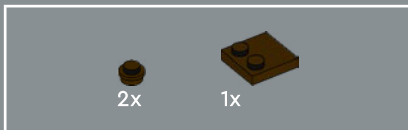
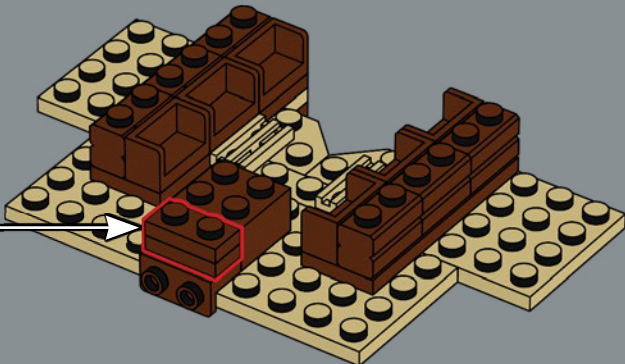
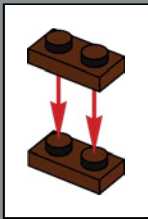

512

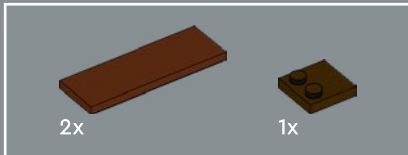
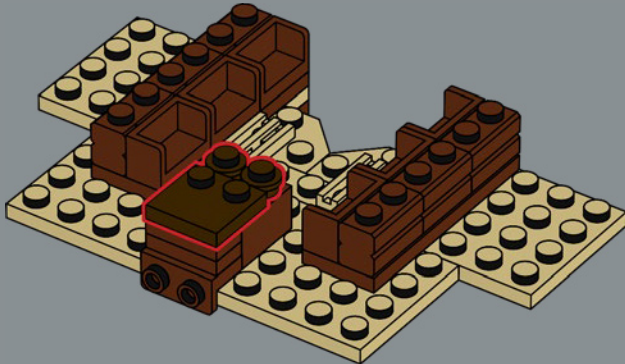

513

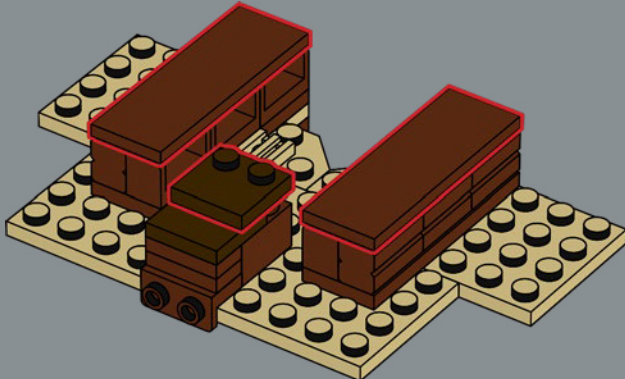



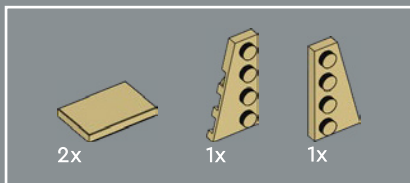

514

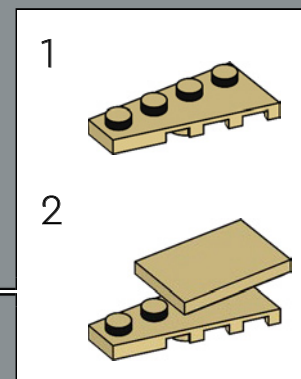
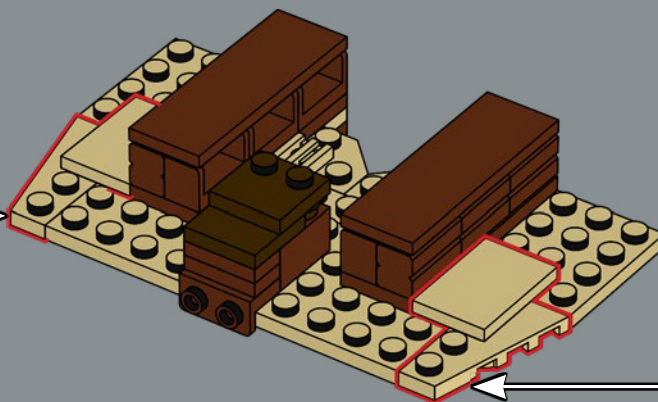
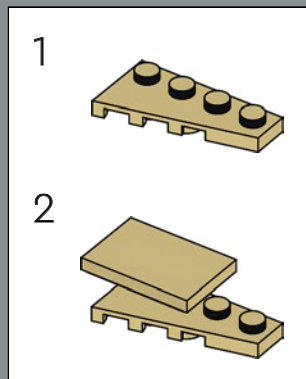

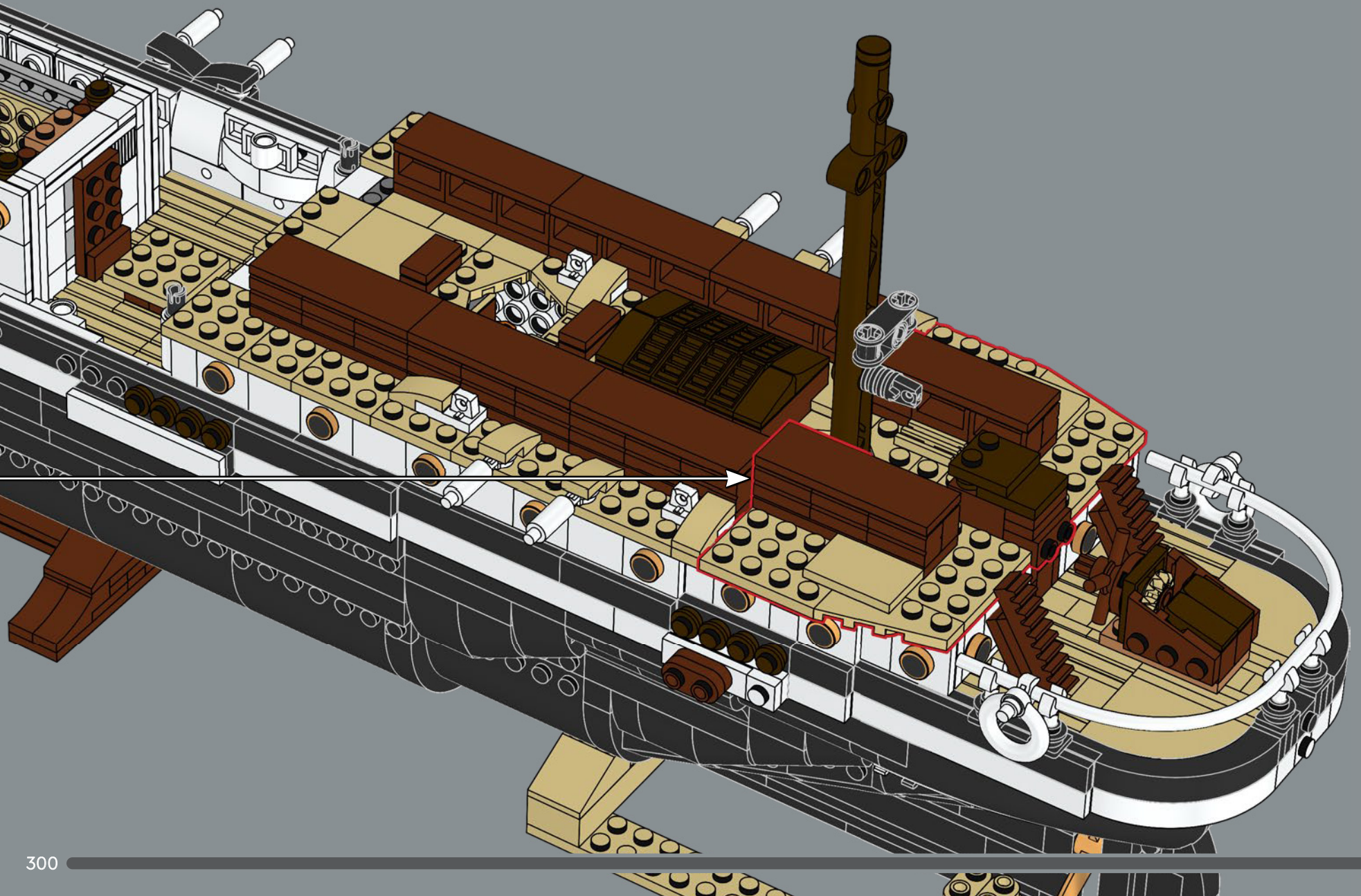



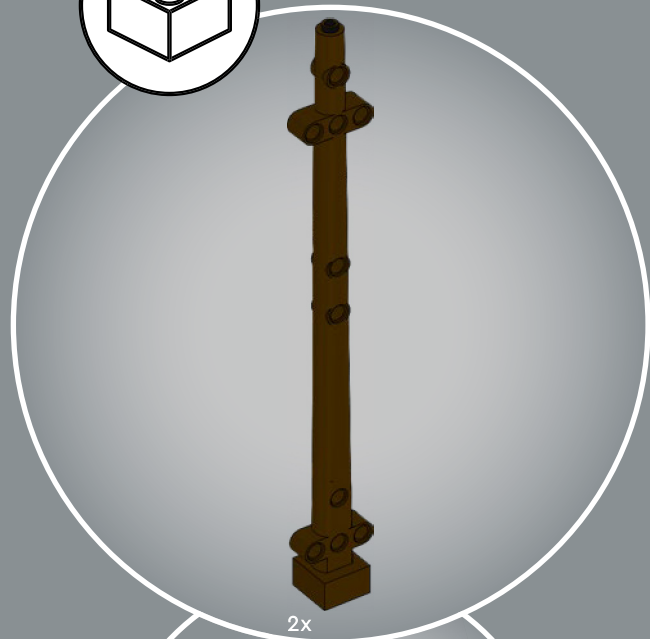
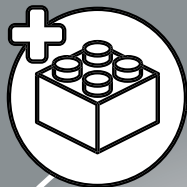

2x



516

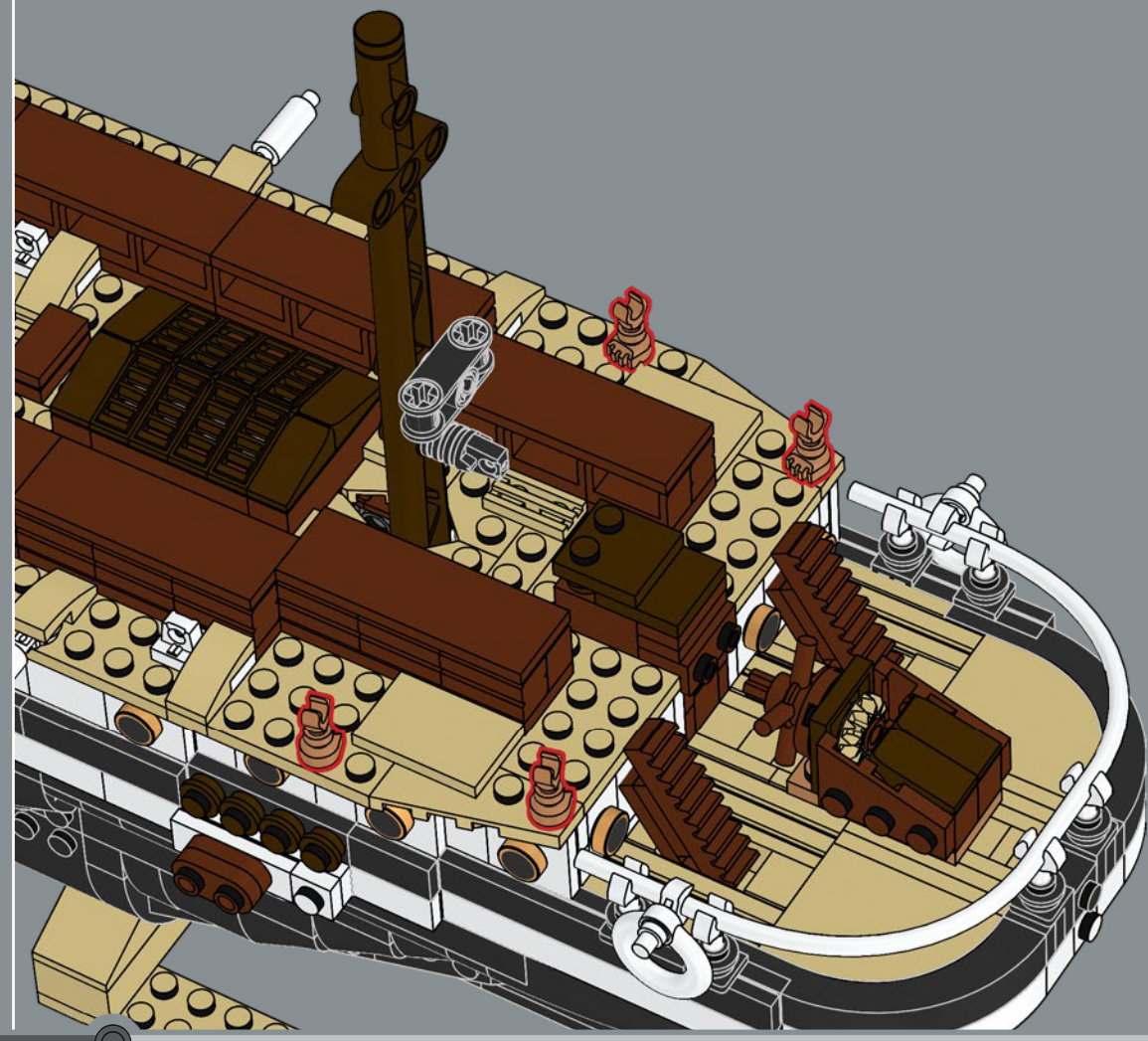



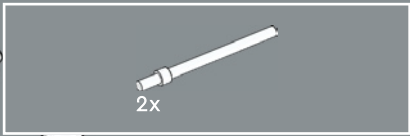

517

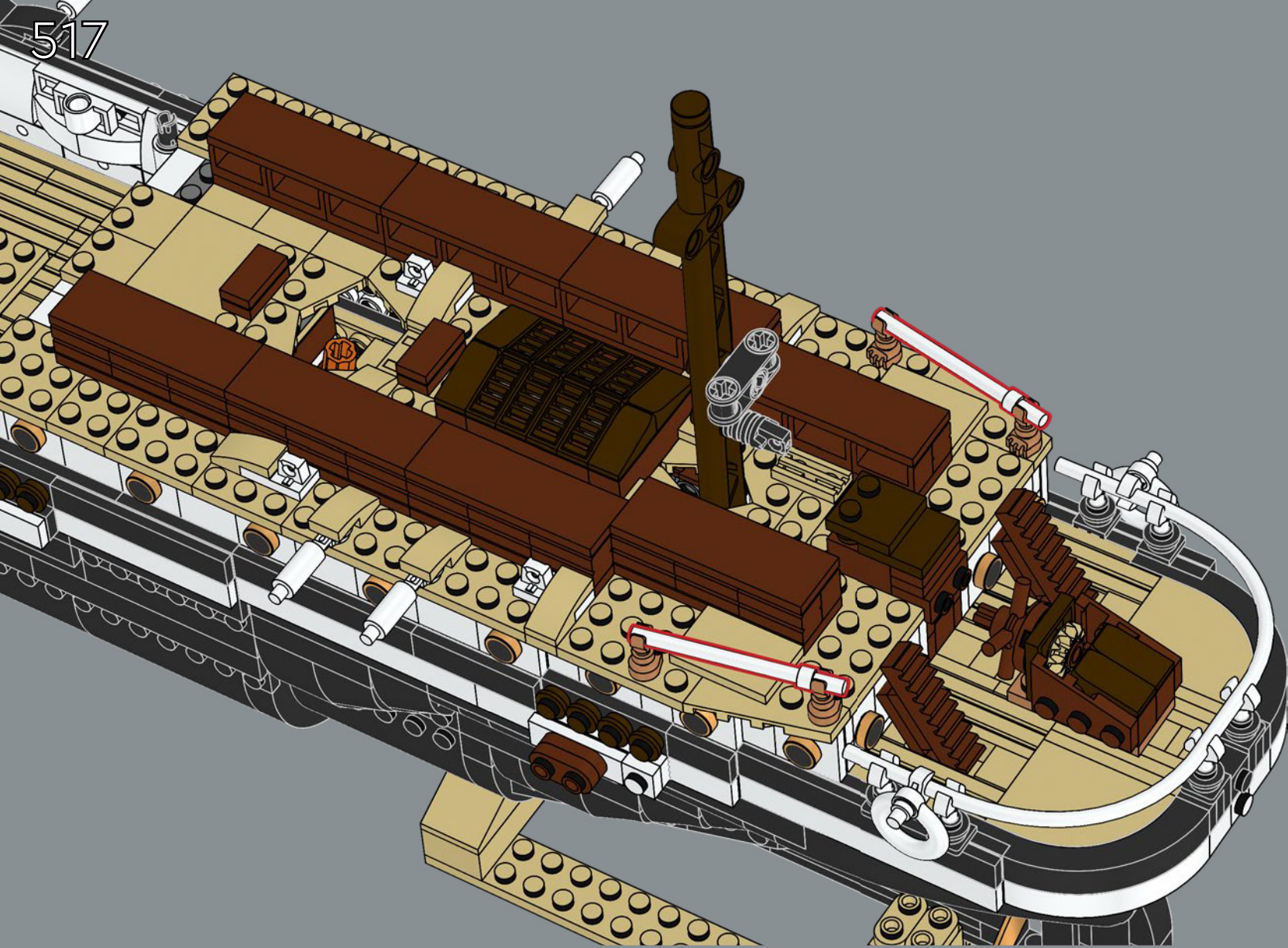



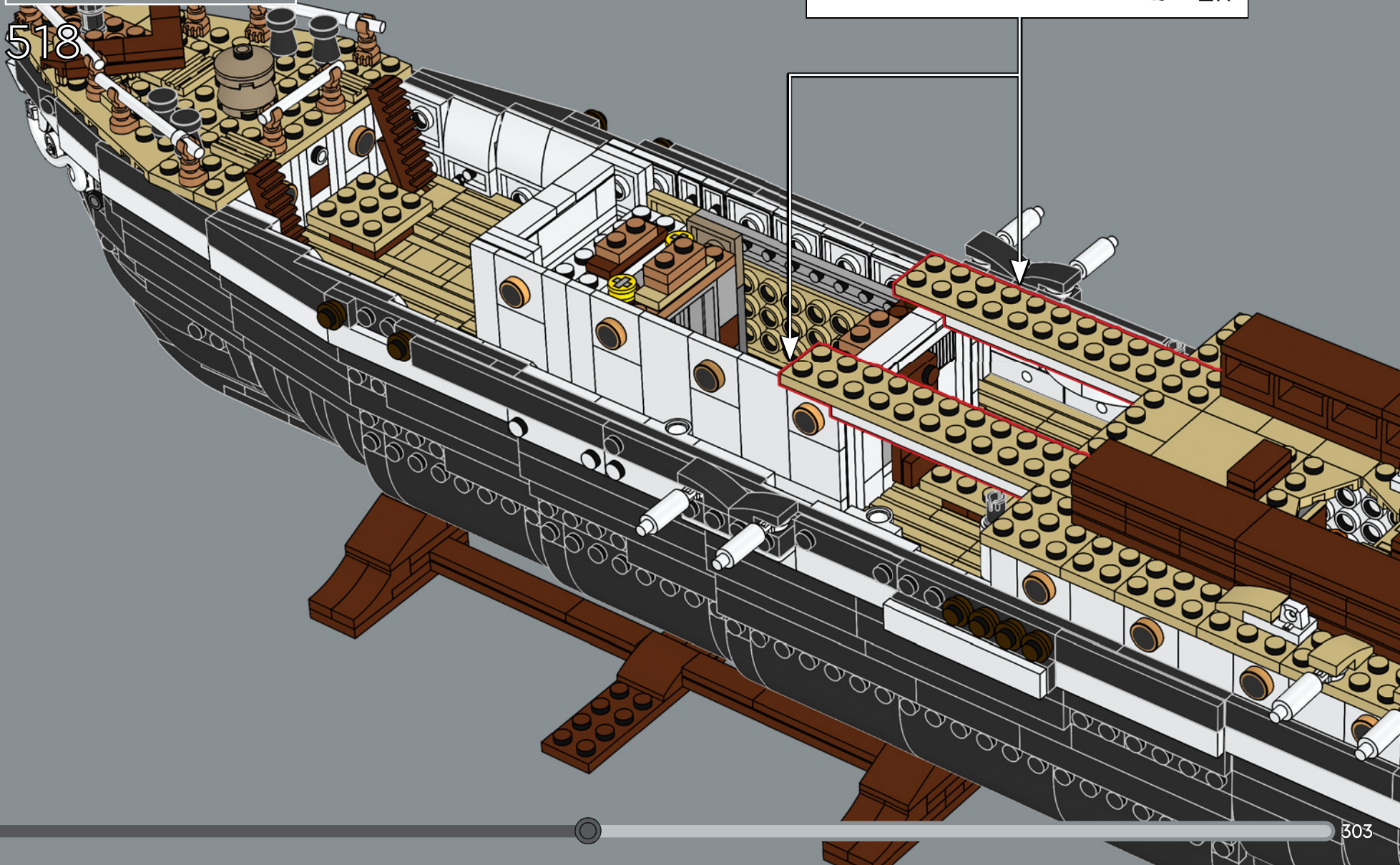
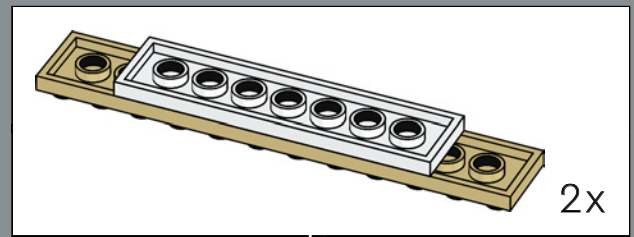
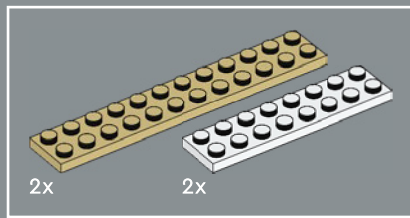

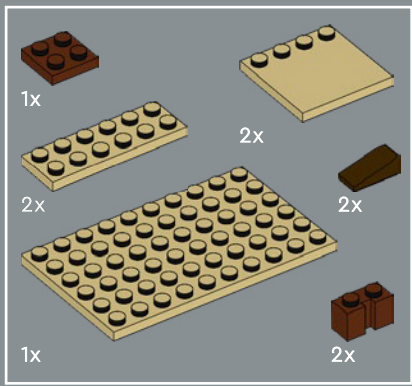

519

1

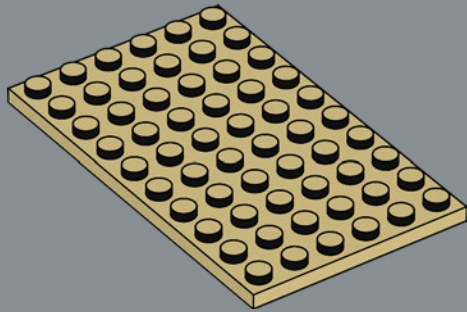

2

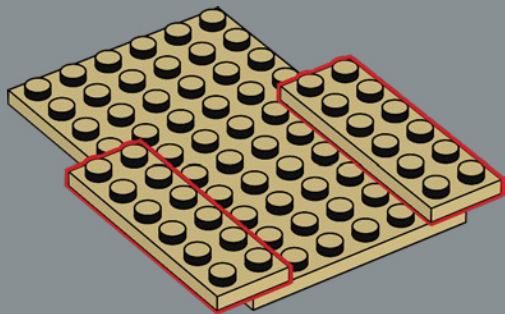

3

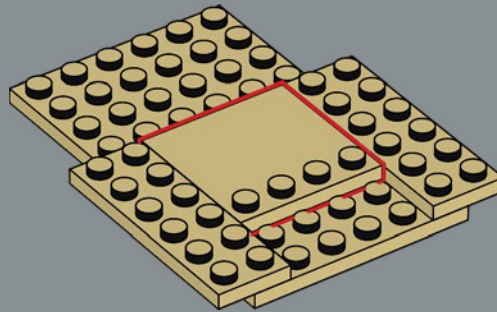

4

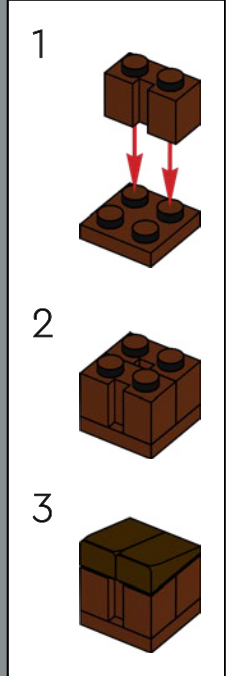
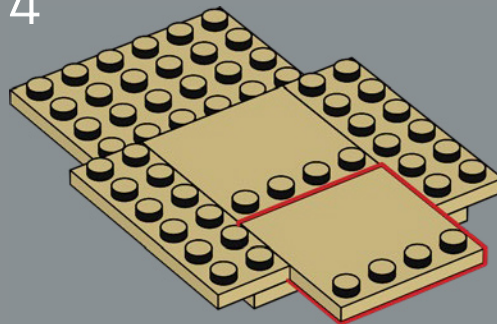

5

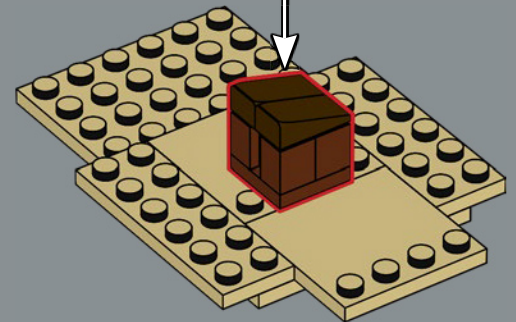



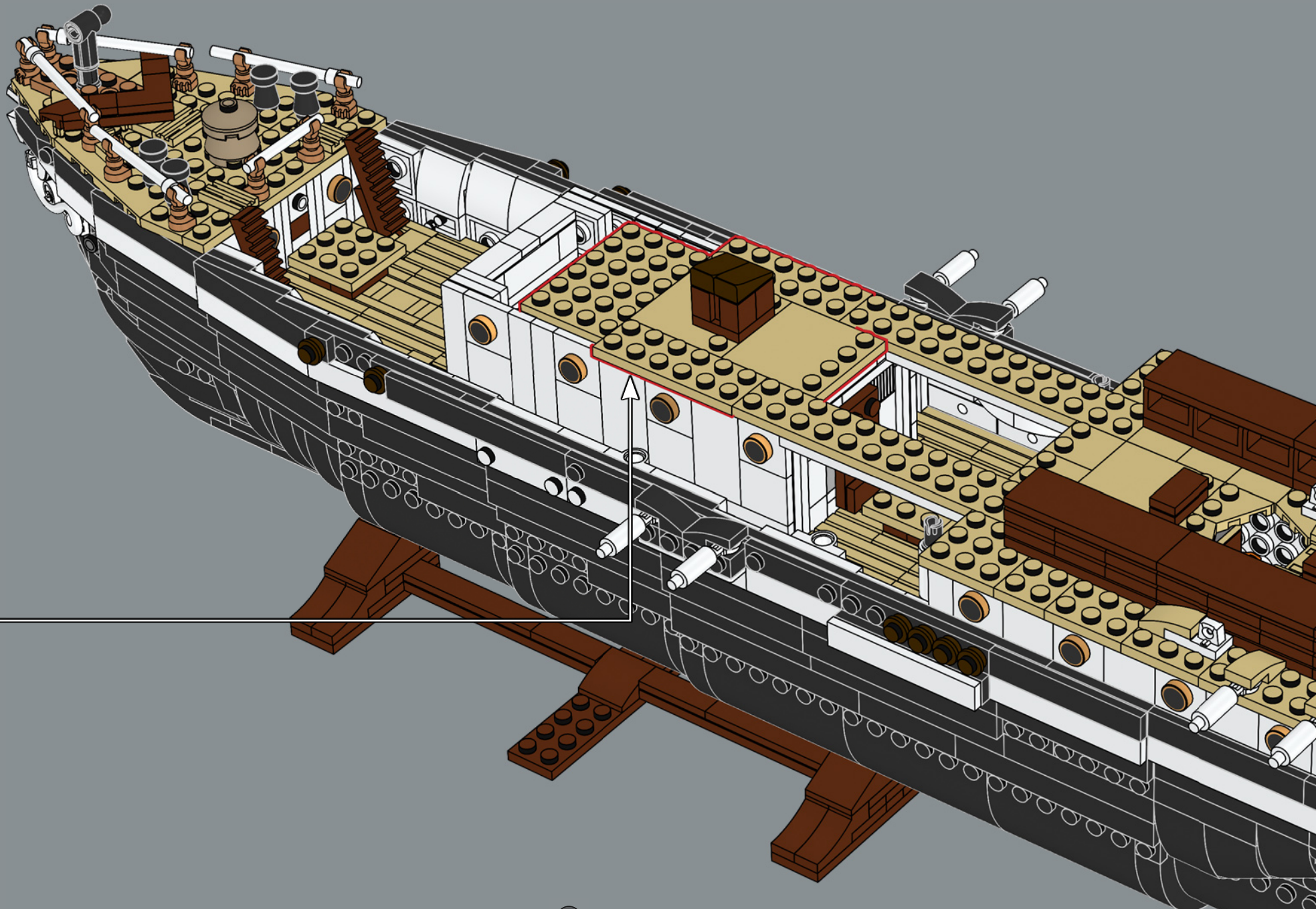

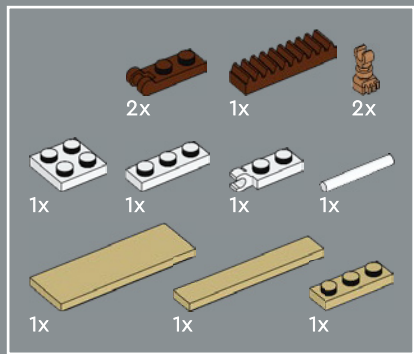

520

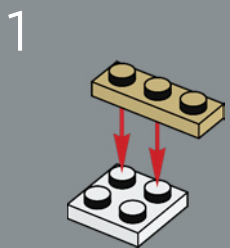

2

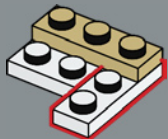

3

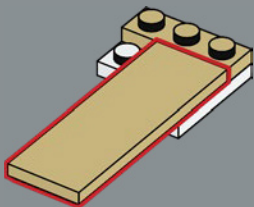

4

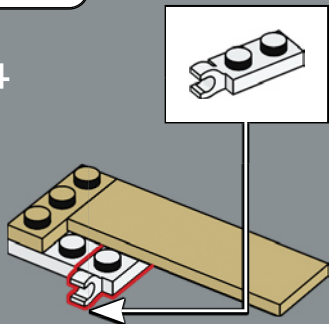

5

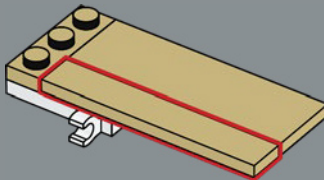

6

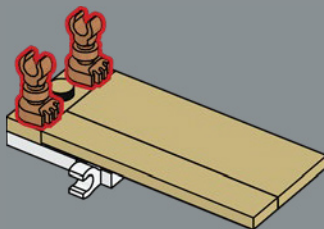

7

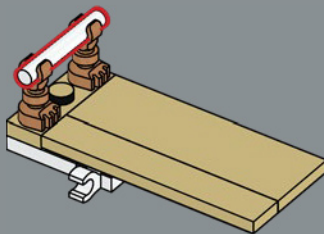

1

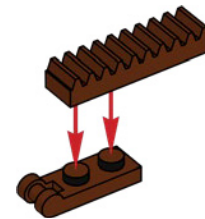

2

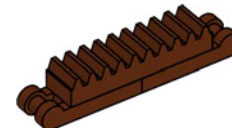

8

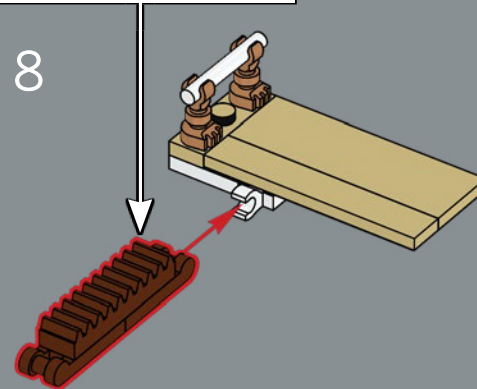

9

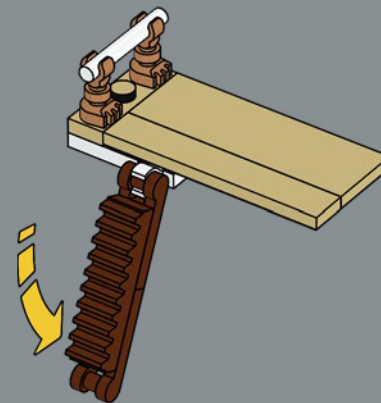



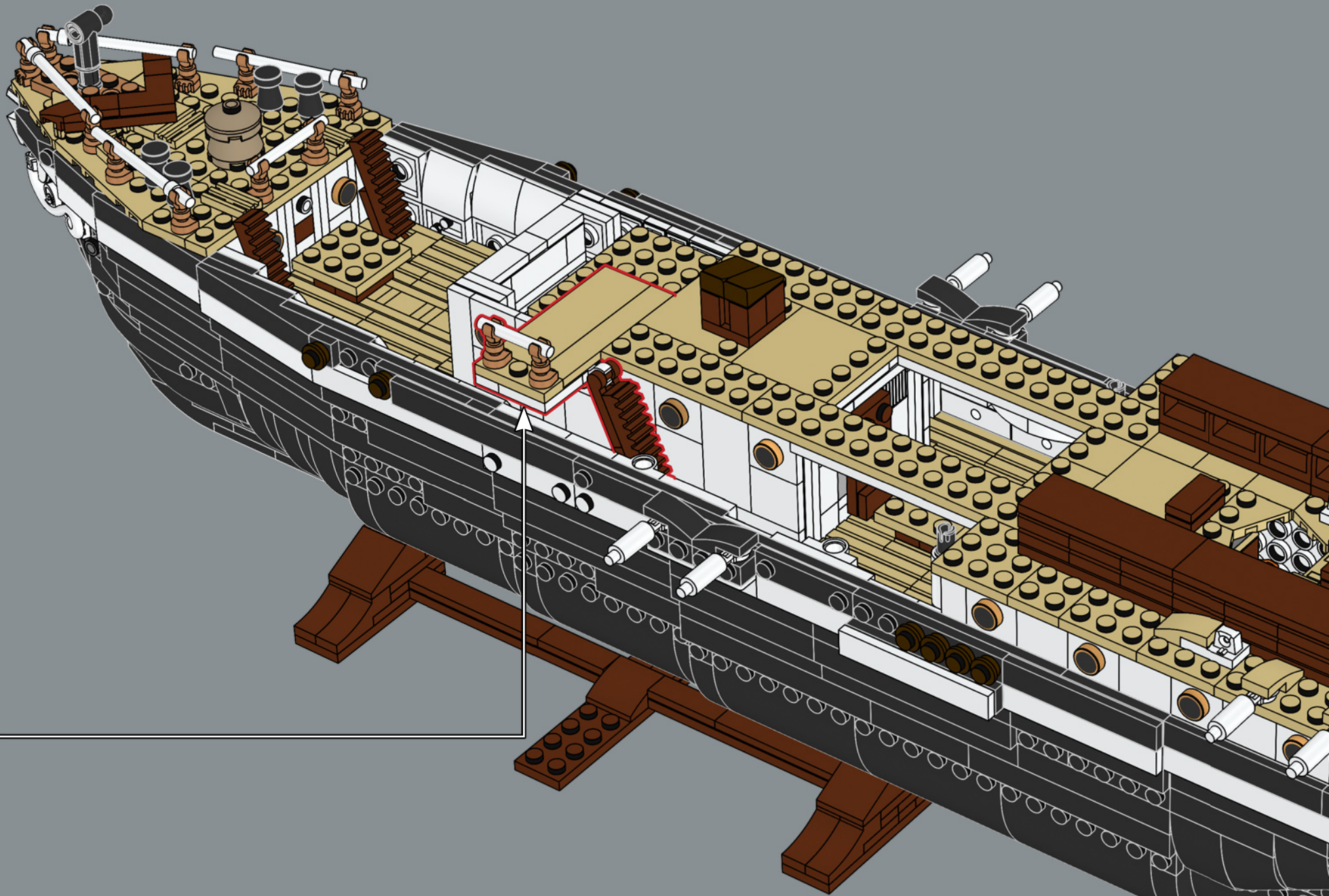



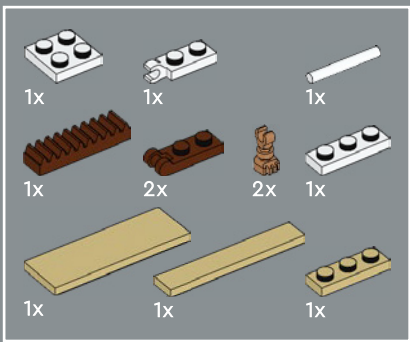

521

1

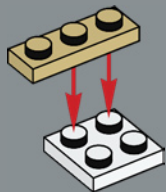

2

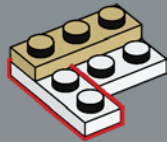

3

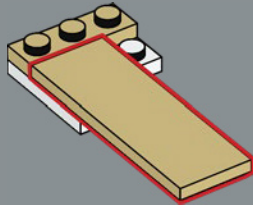

4

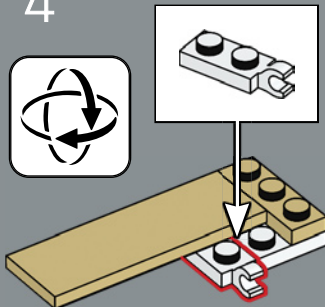

5

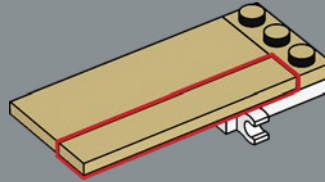

6

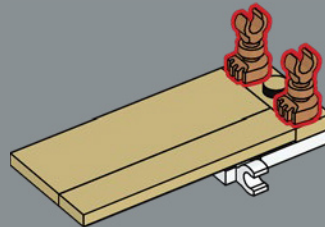

7

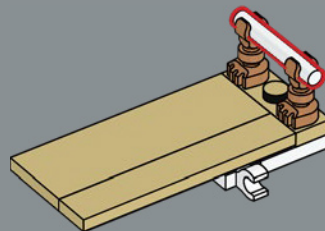

8

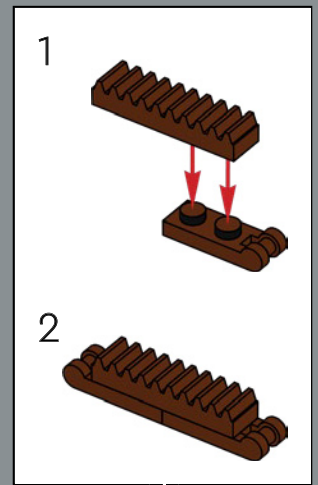

9

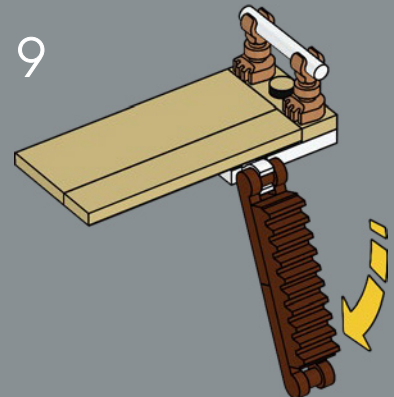

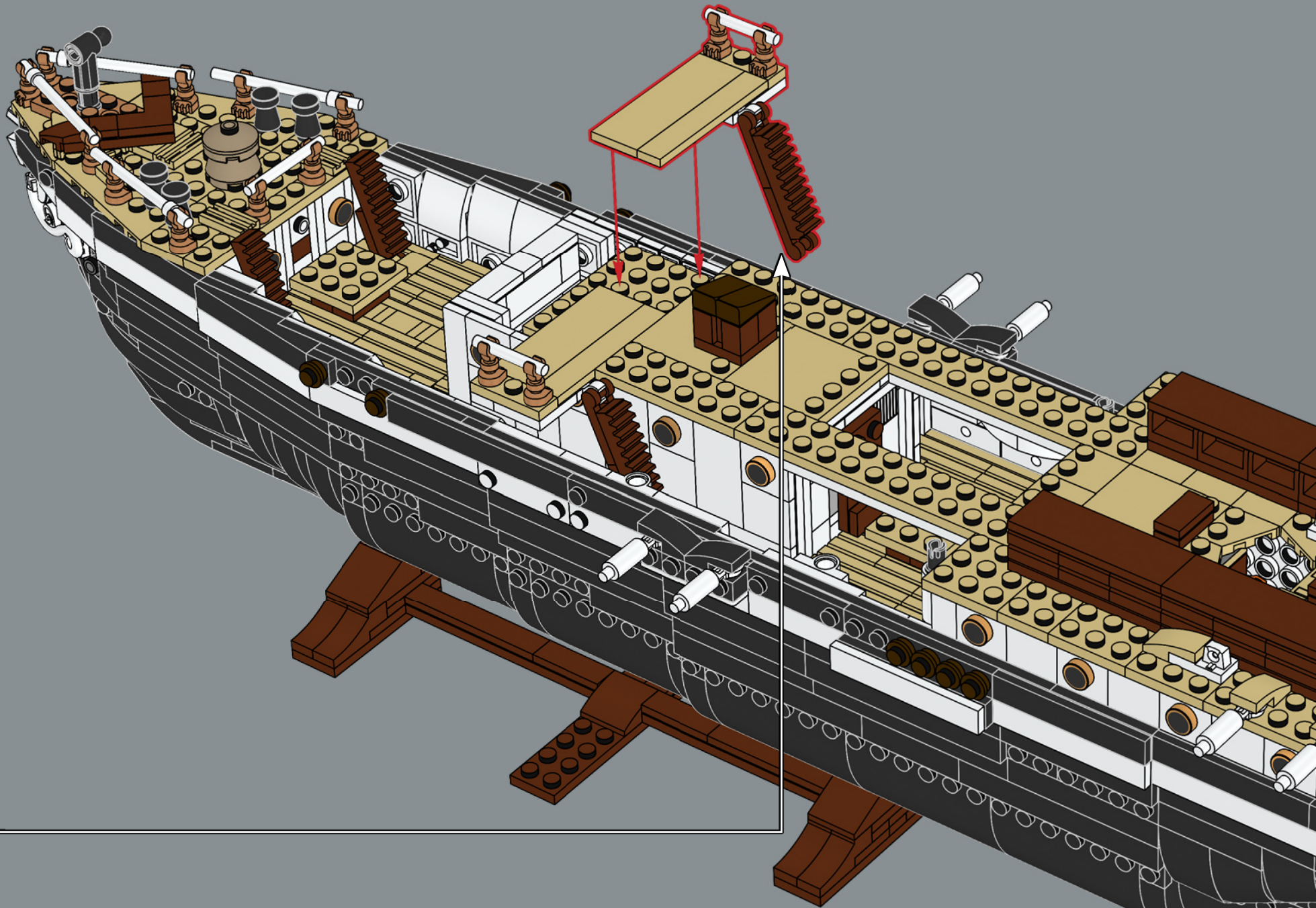



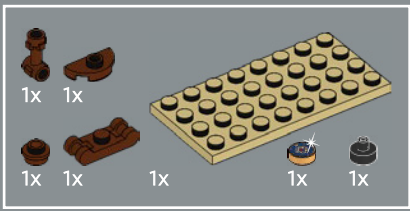

522

1

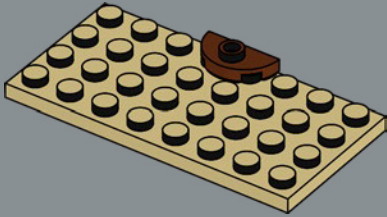

2

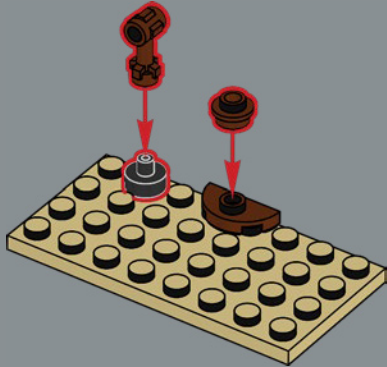

3

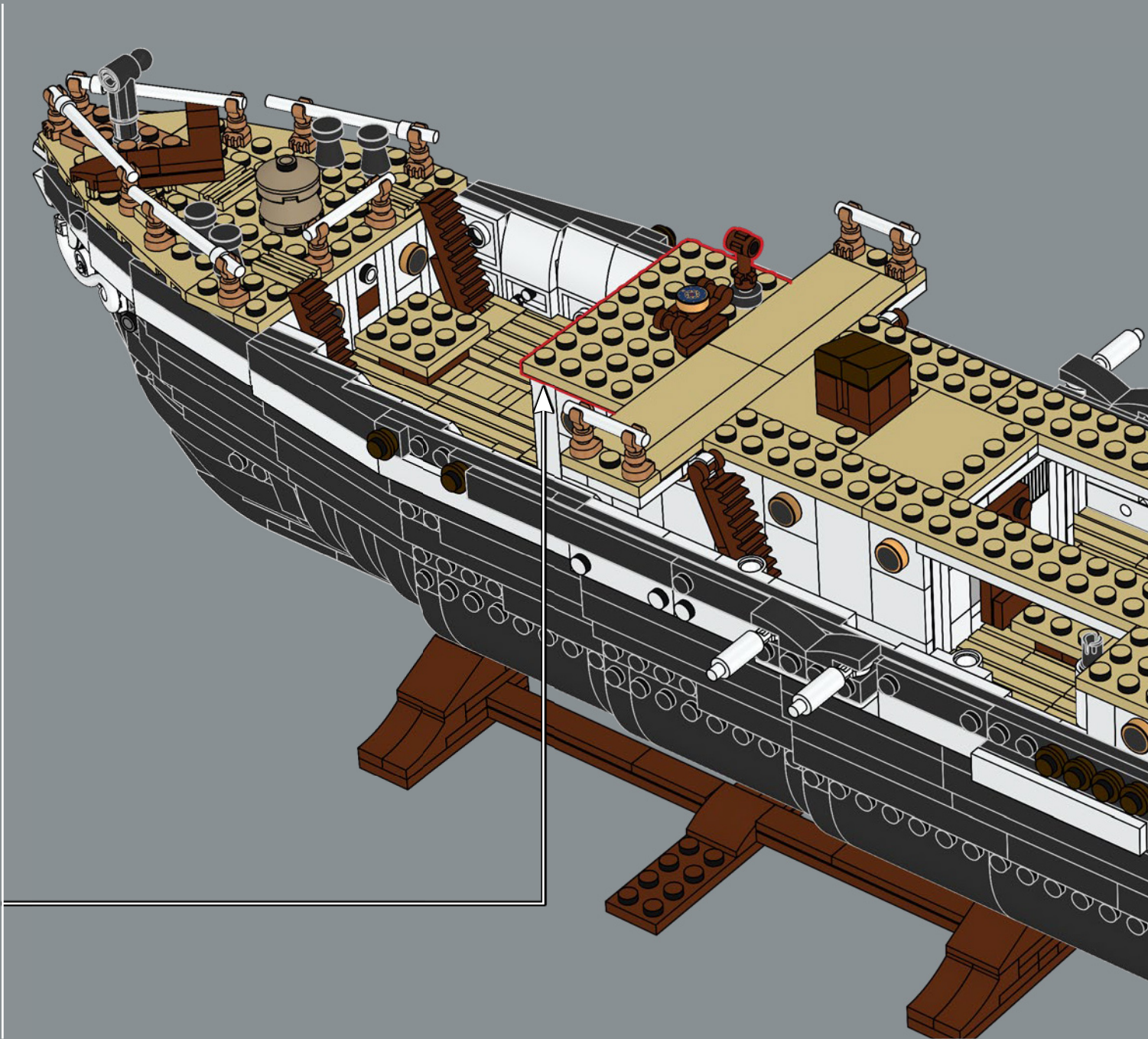



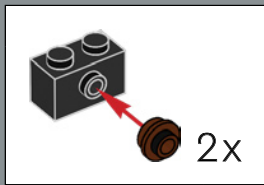

523

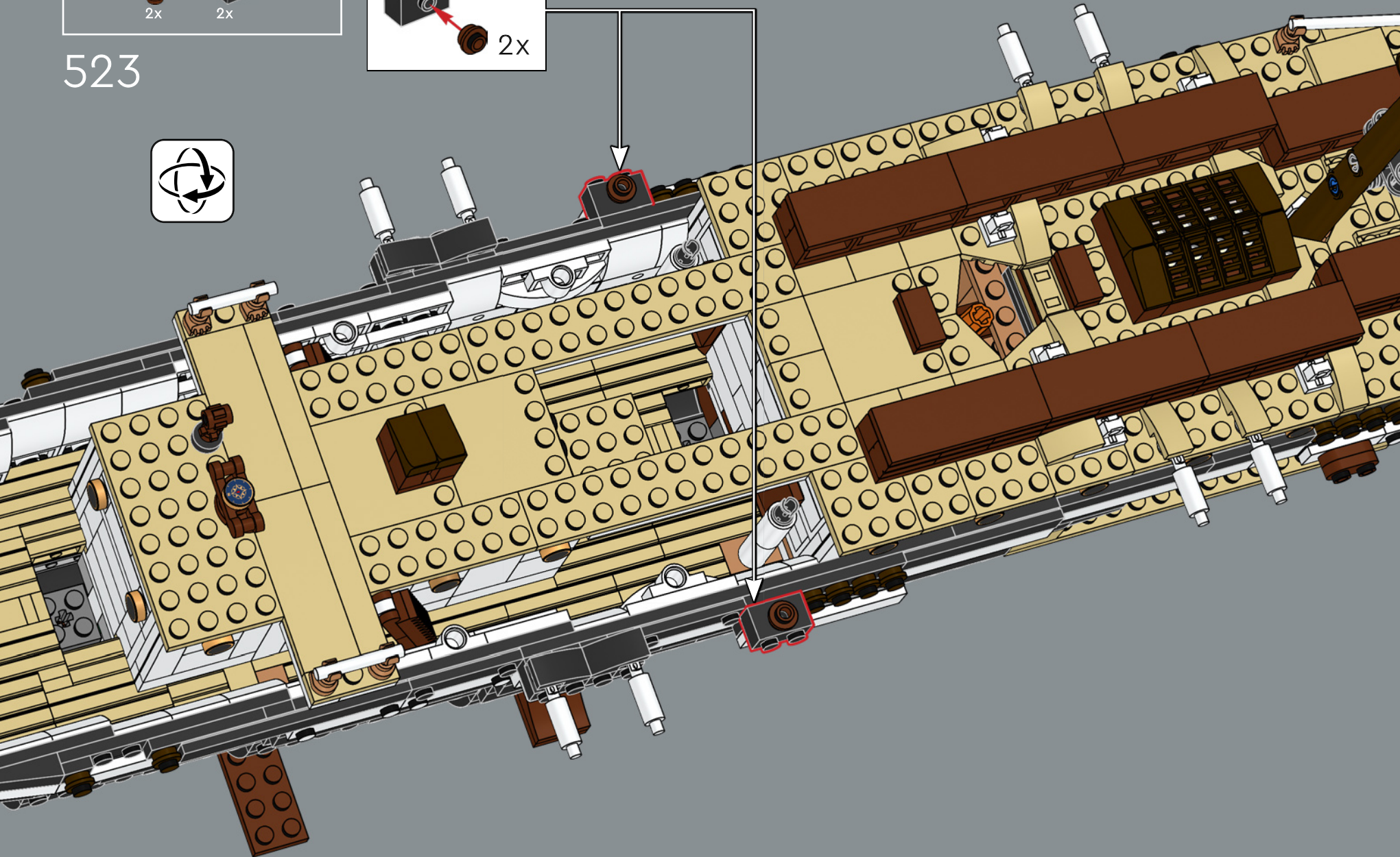





38x

524

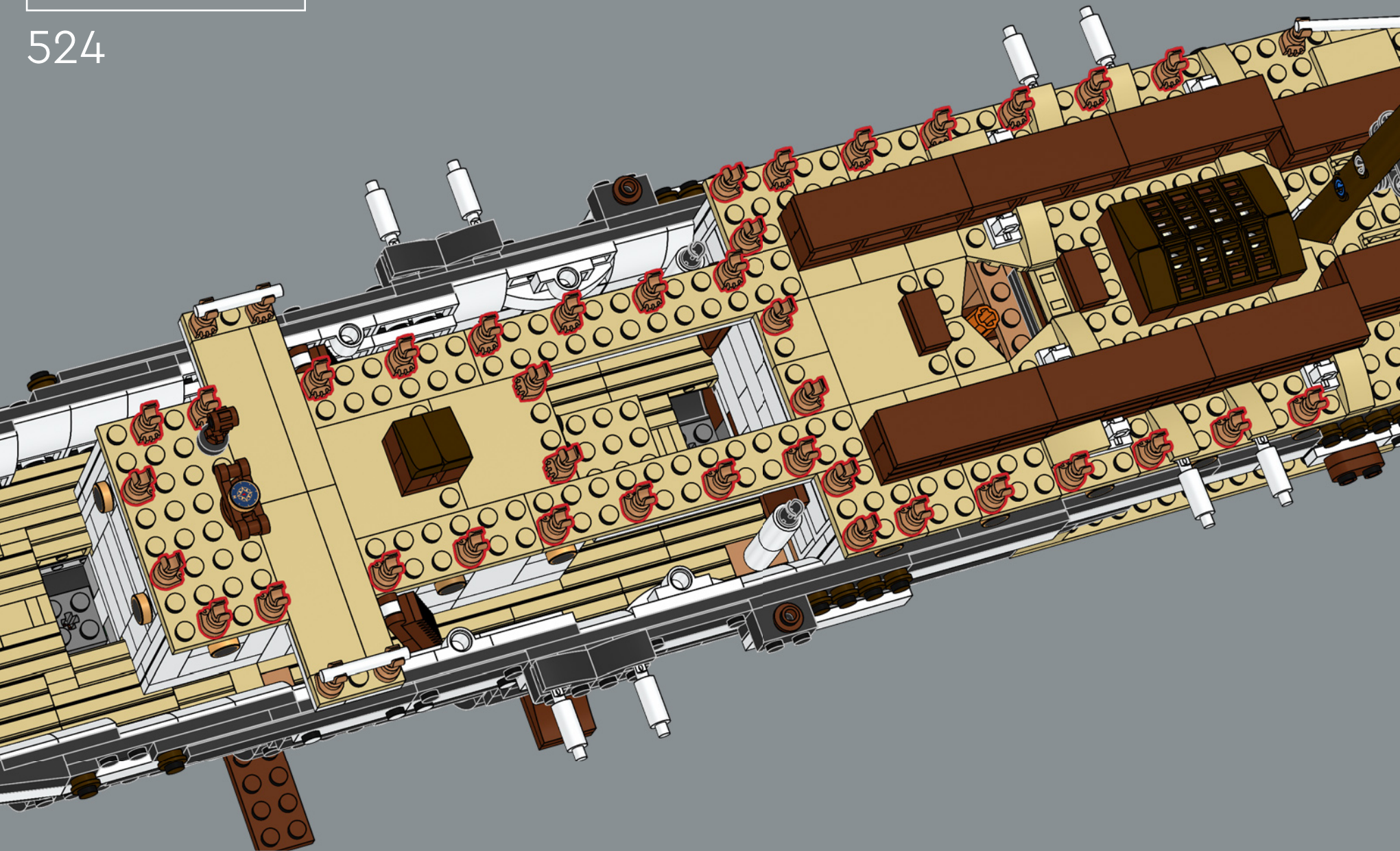

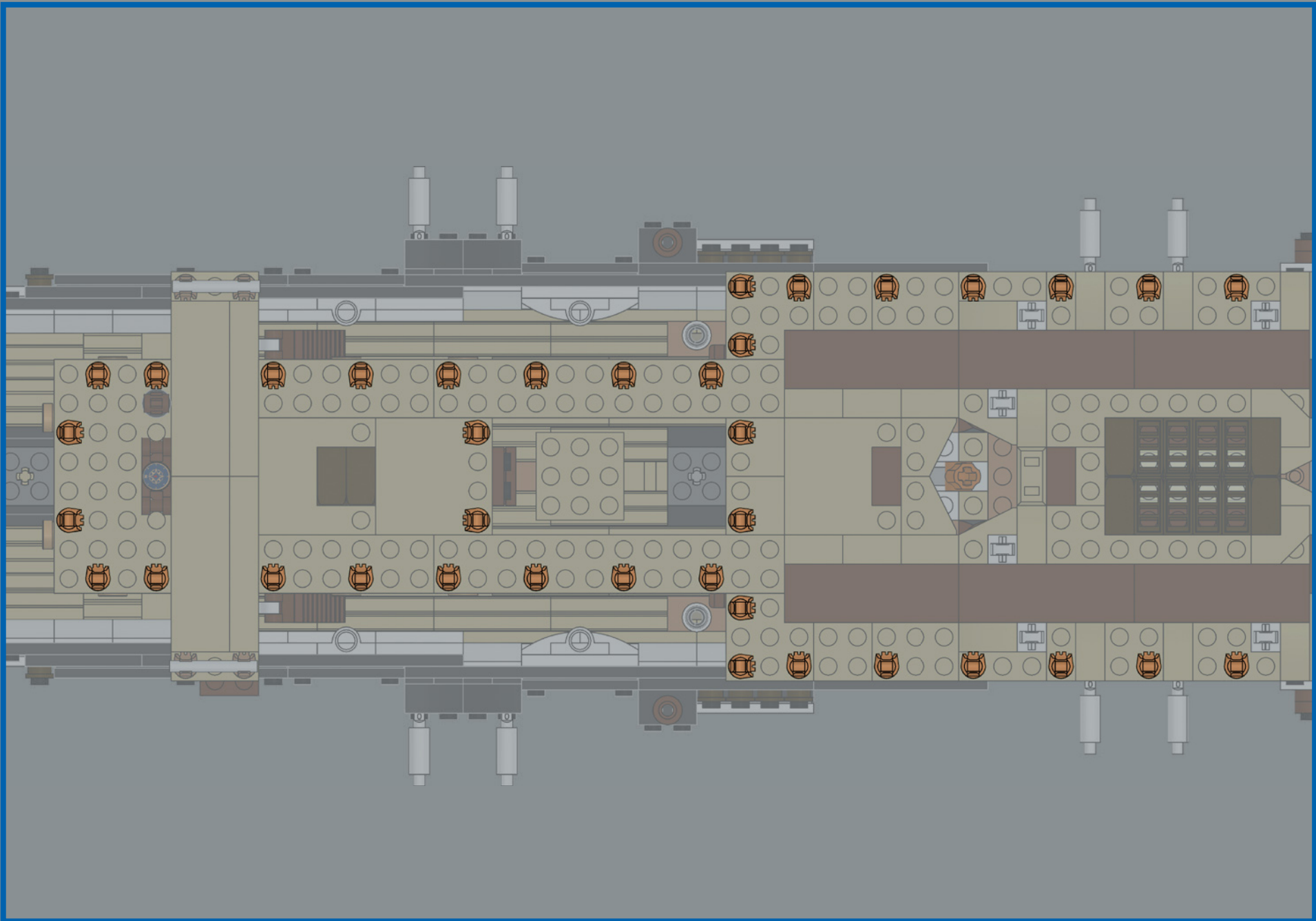



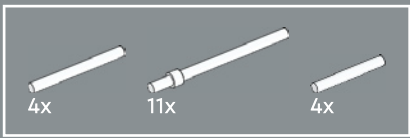

525

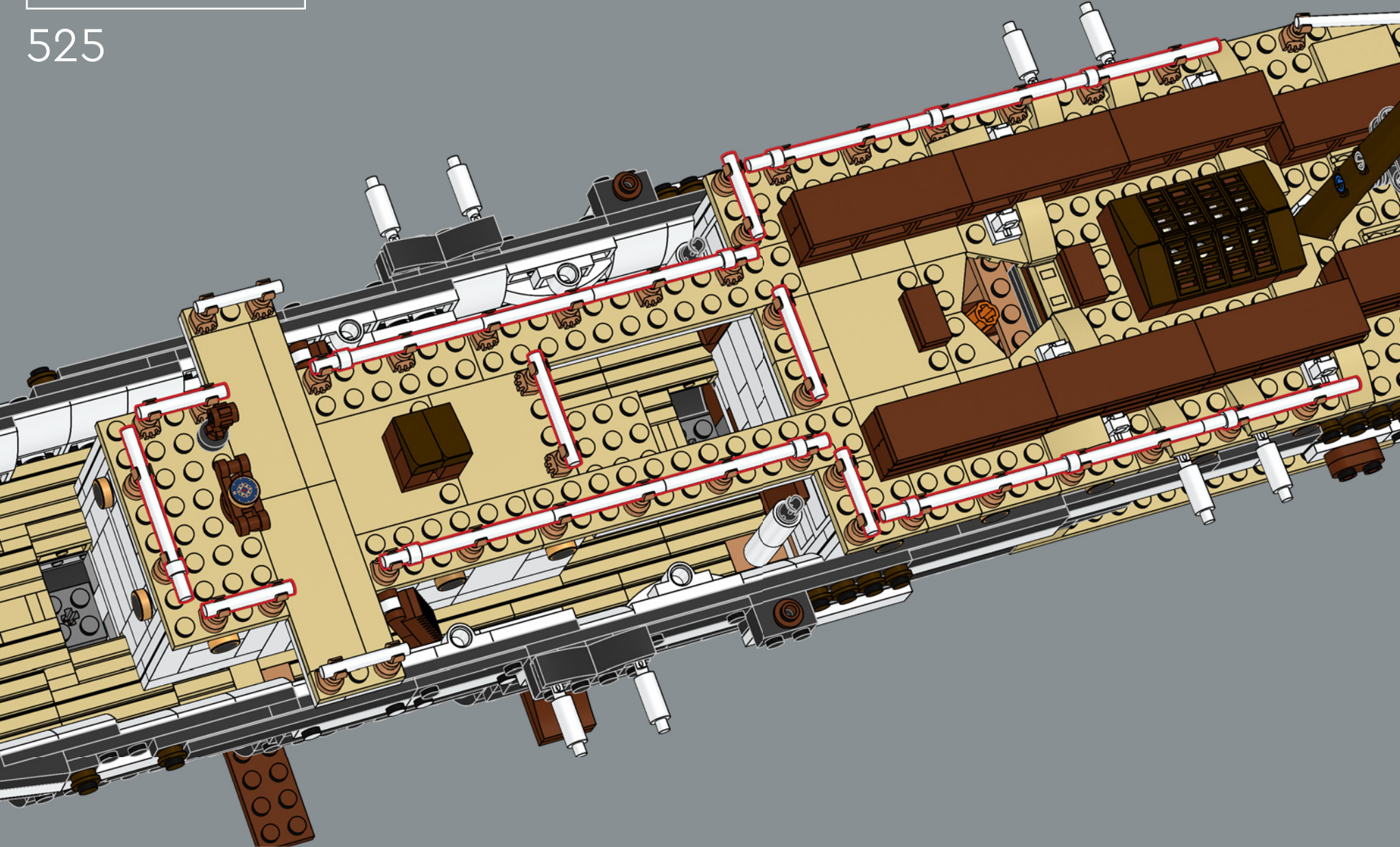

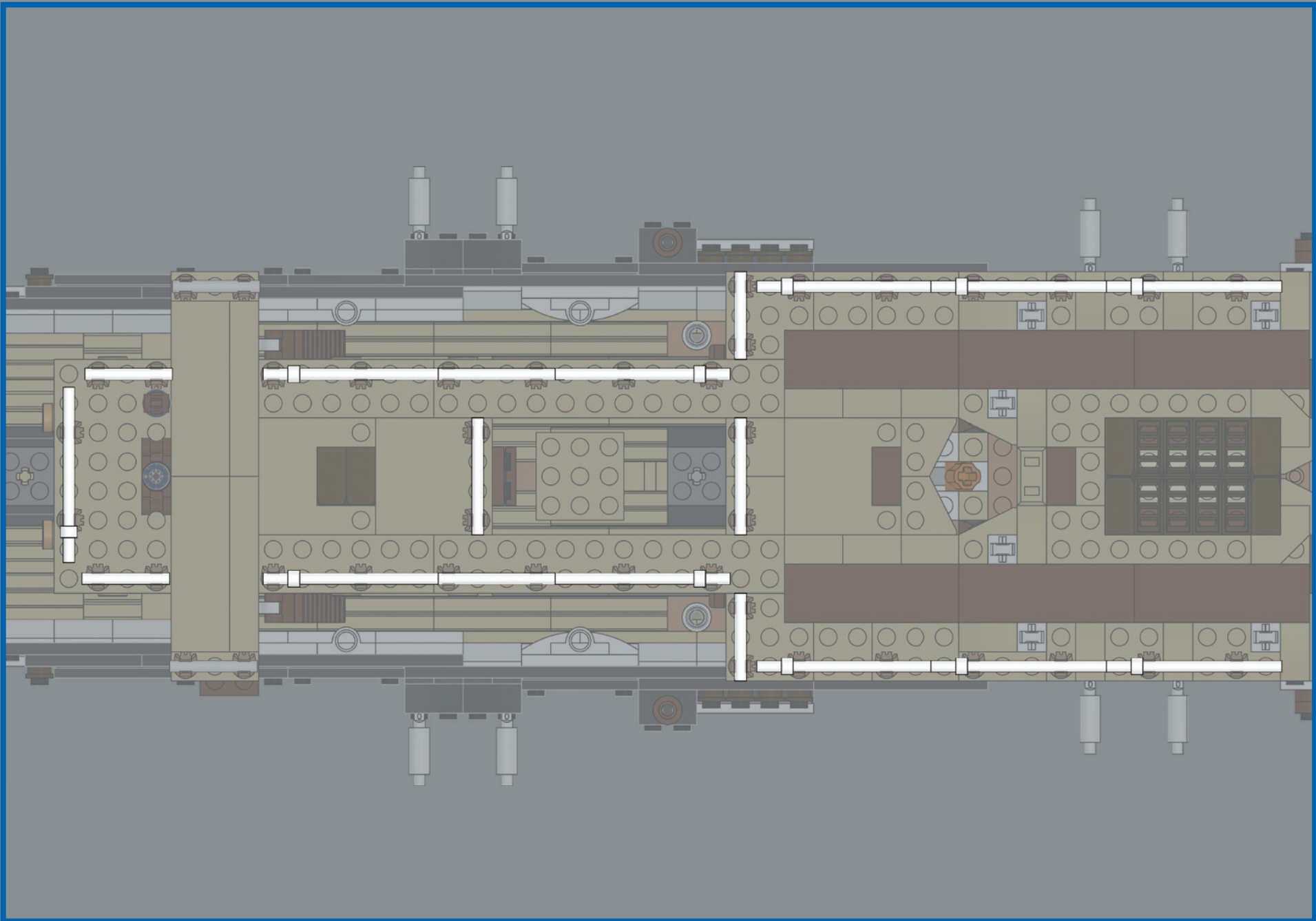



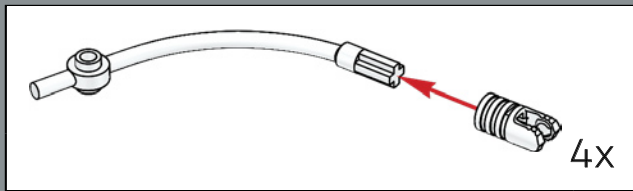
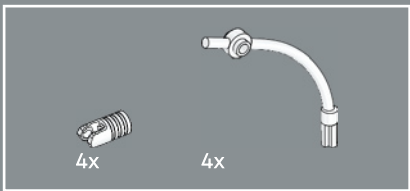

526

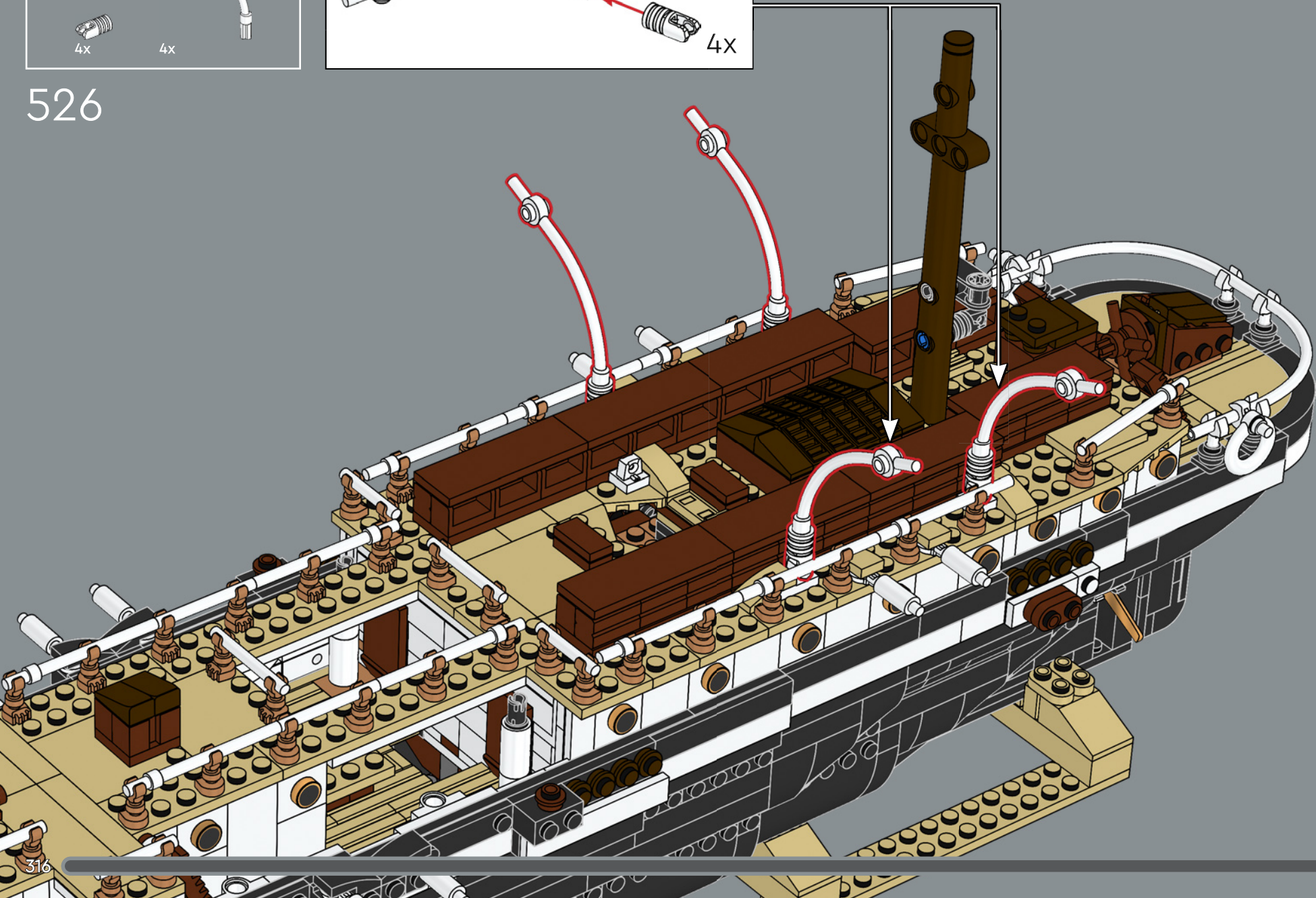



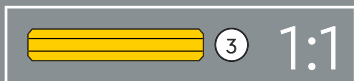
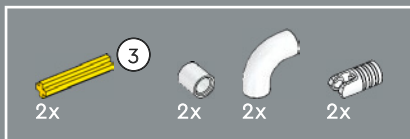

527

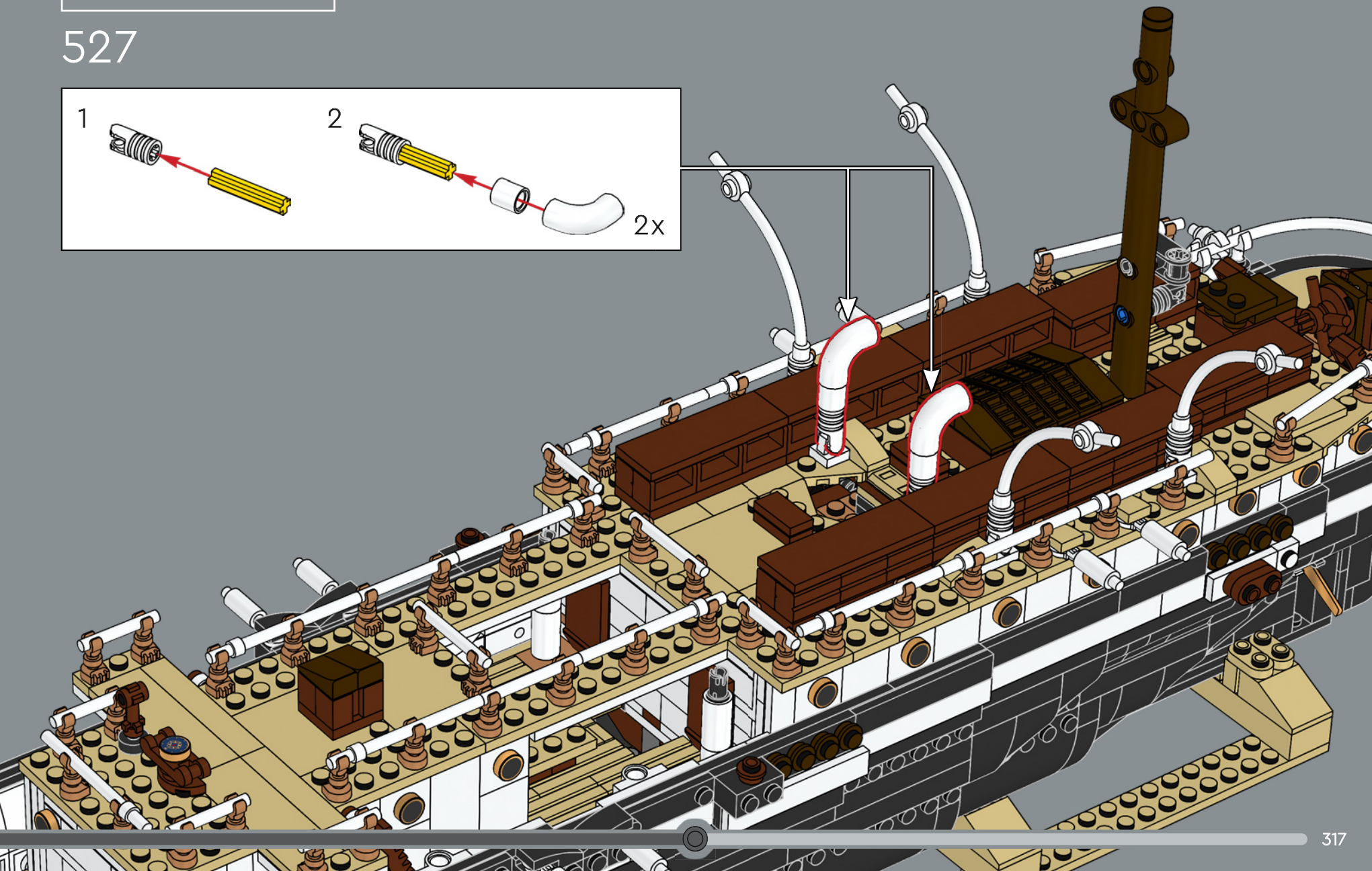
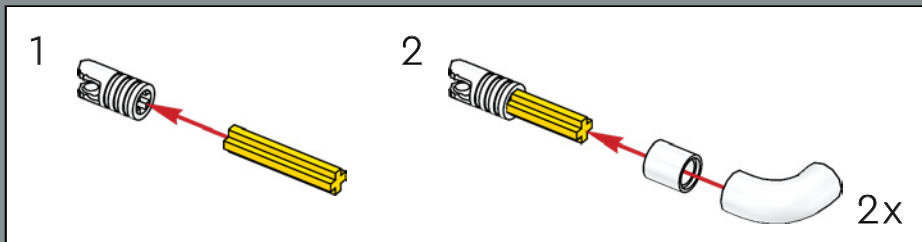

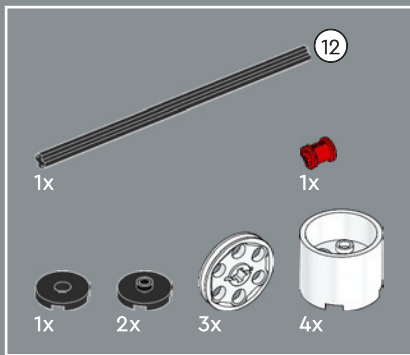

528

1

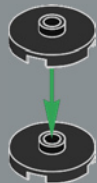

2

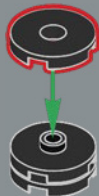

3



4

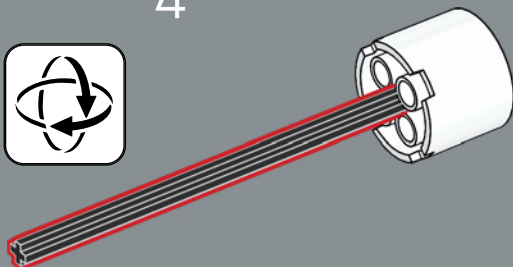

5



6

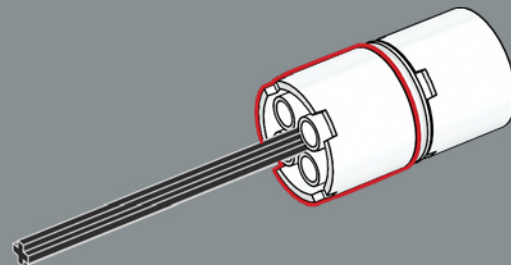

7

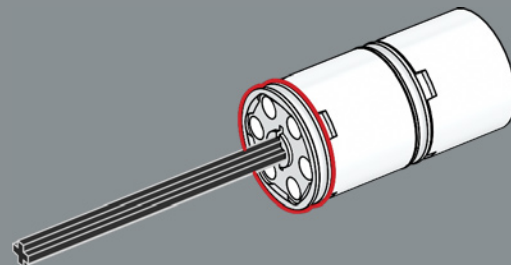



8

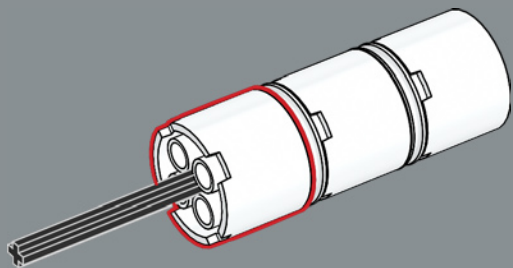

9

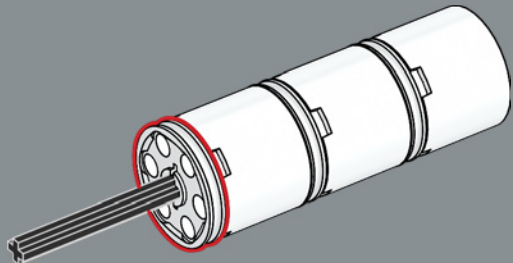

10

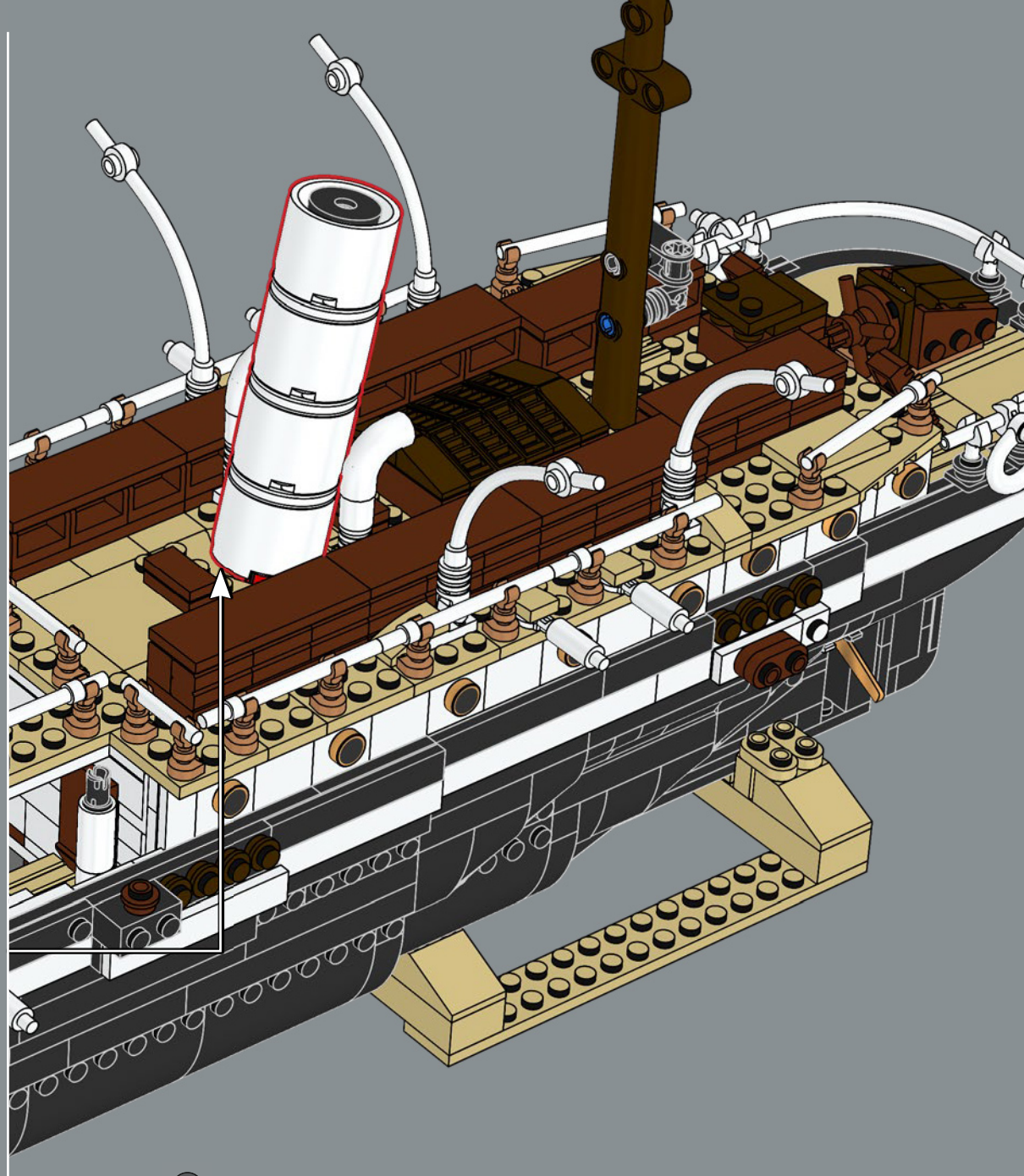
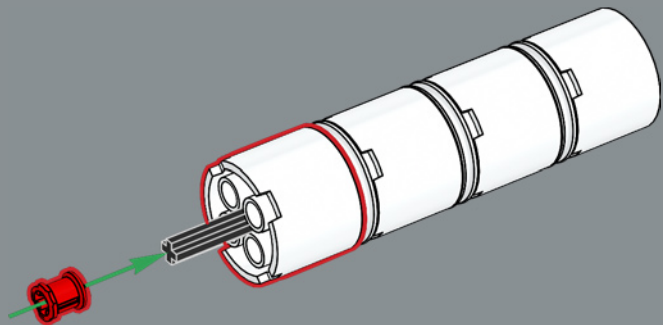



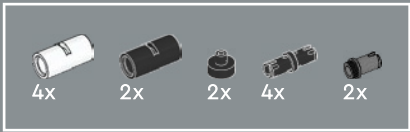

529

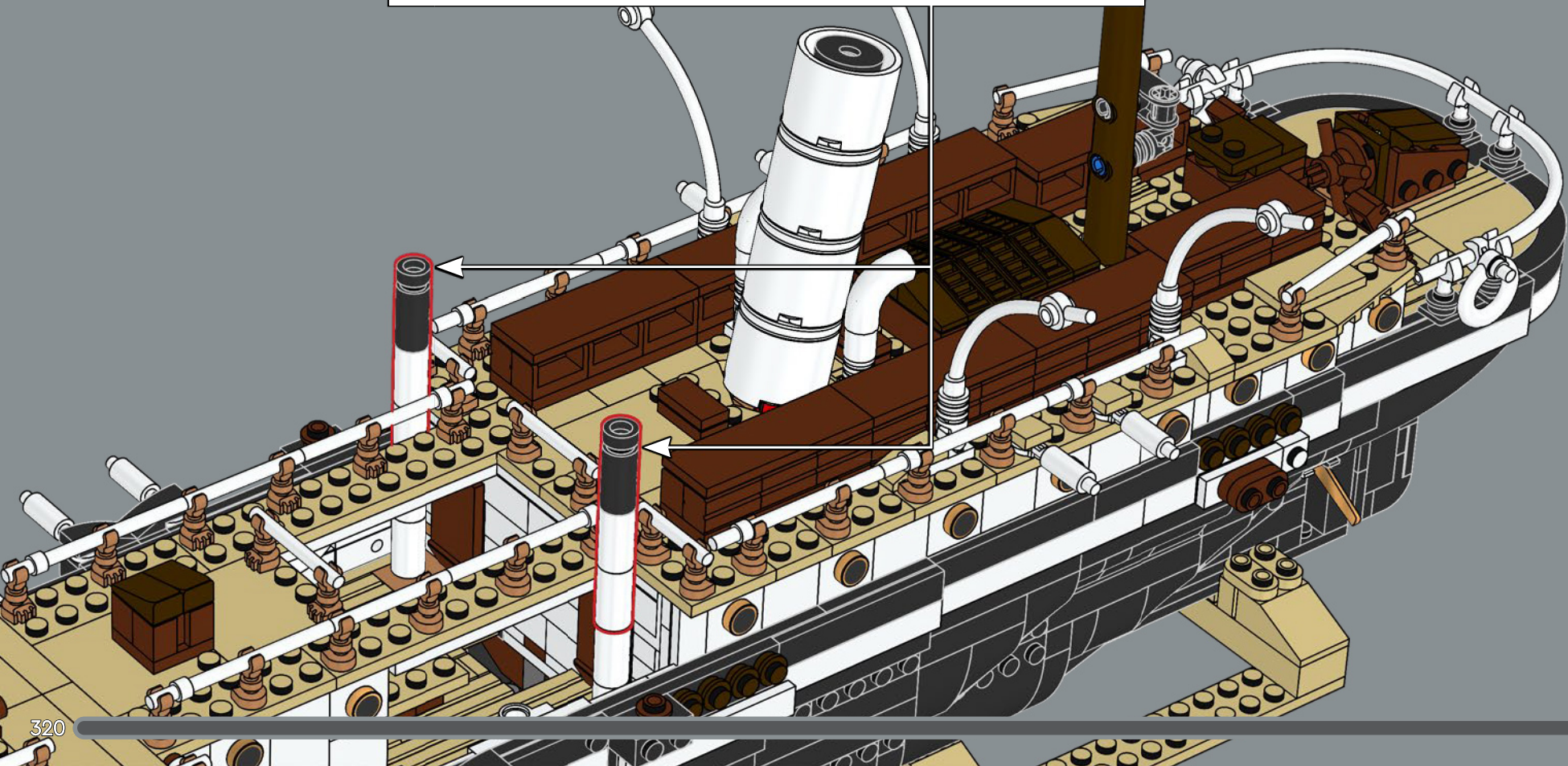
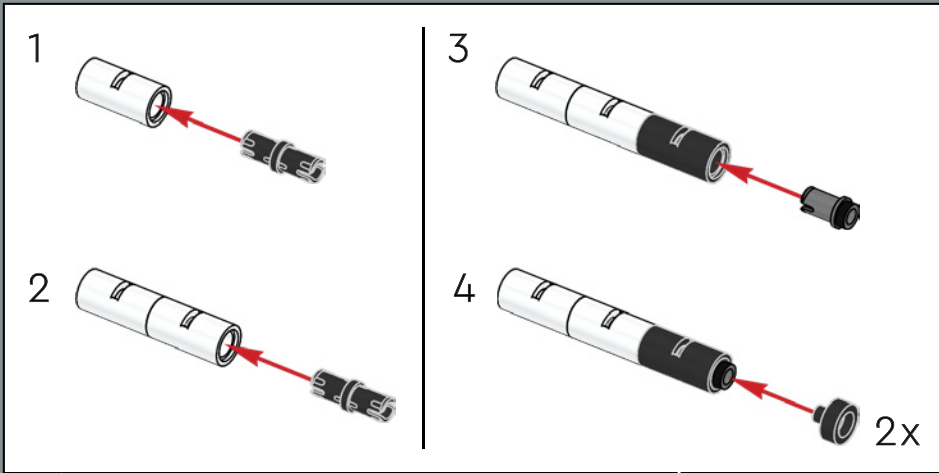

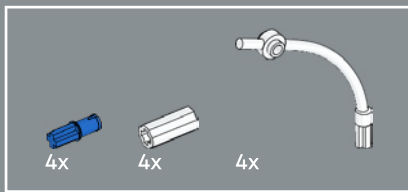

530

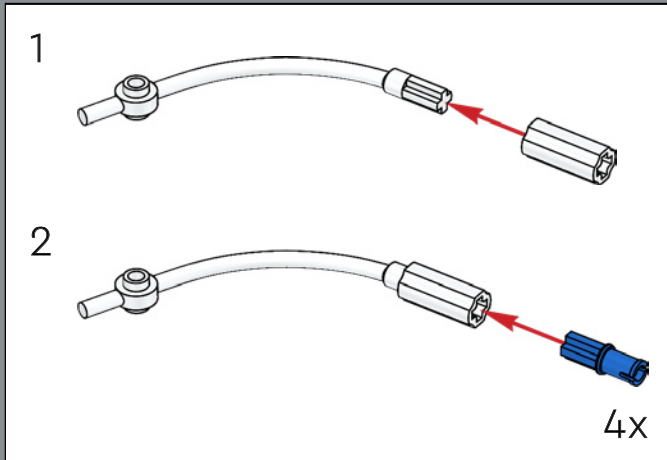

Die gebogenen Arme für die vier Rettungsboote dienen ursprünglich als LEGO® Minifiguren-Halter.

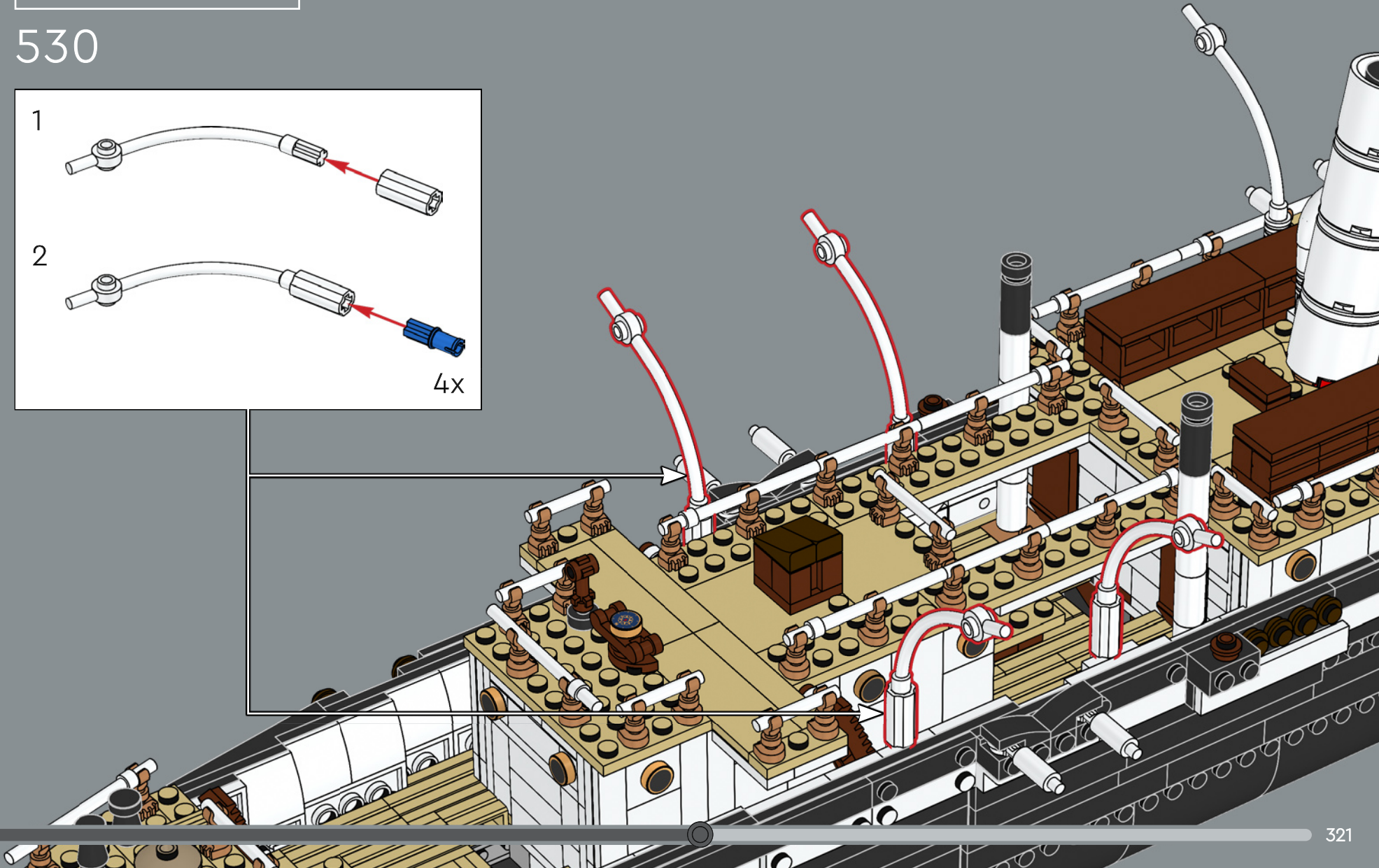



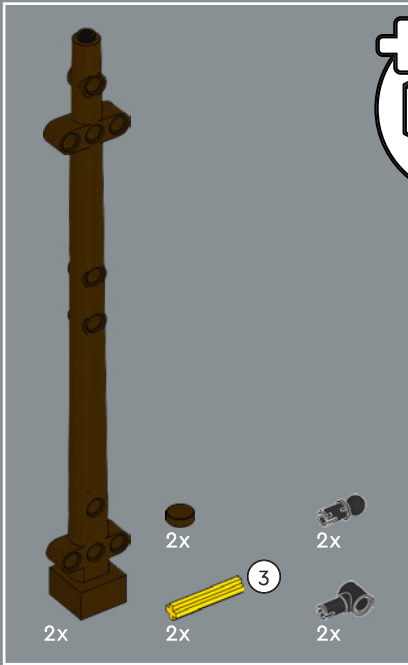
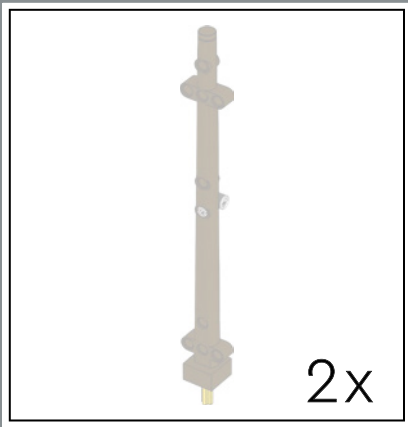

531

1



2

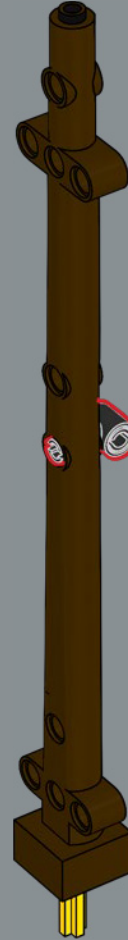

3



2x





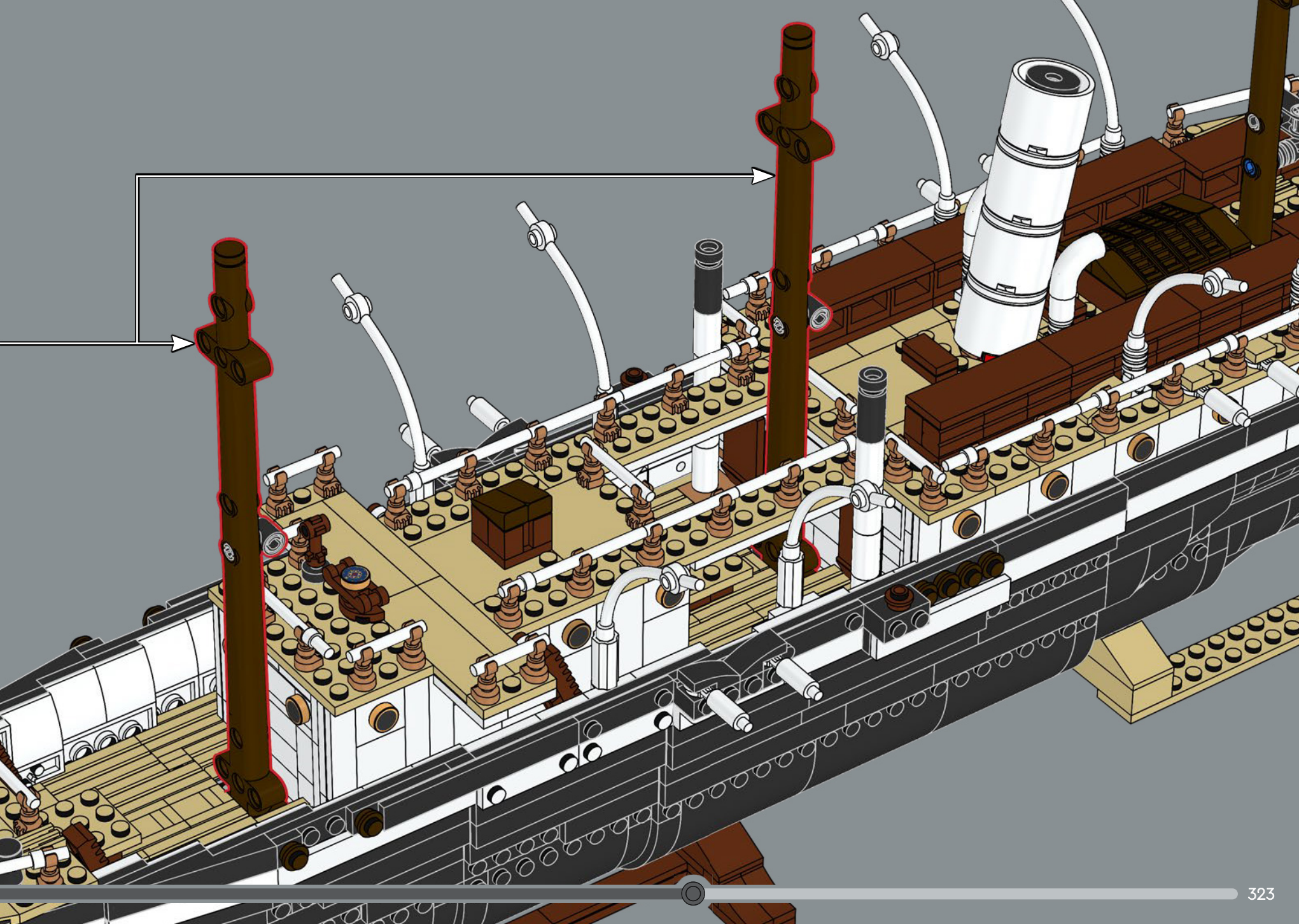

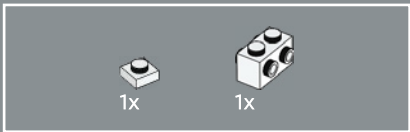
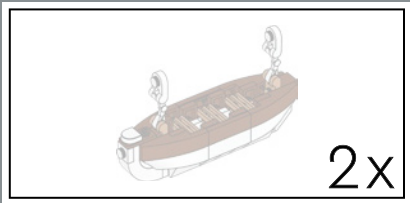

532

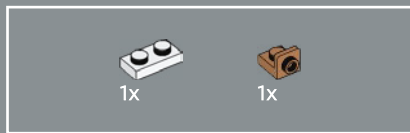
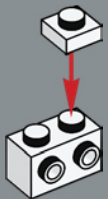

533

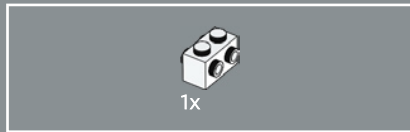
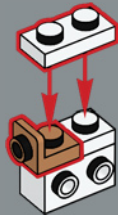

534

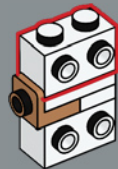

535

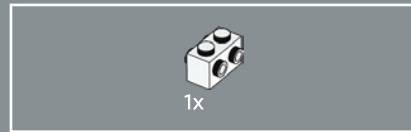

536

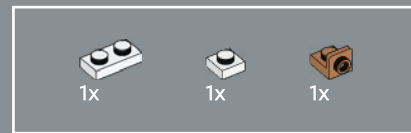
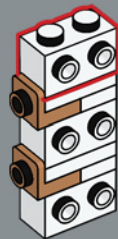

537

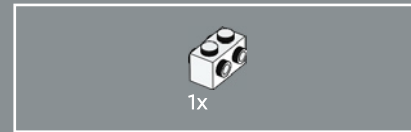

538



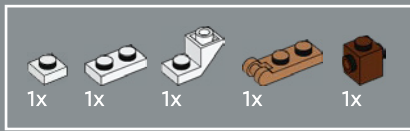

539

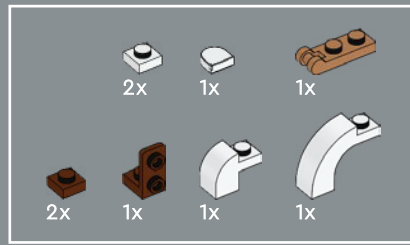
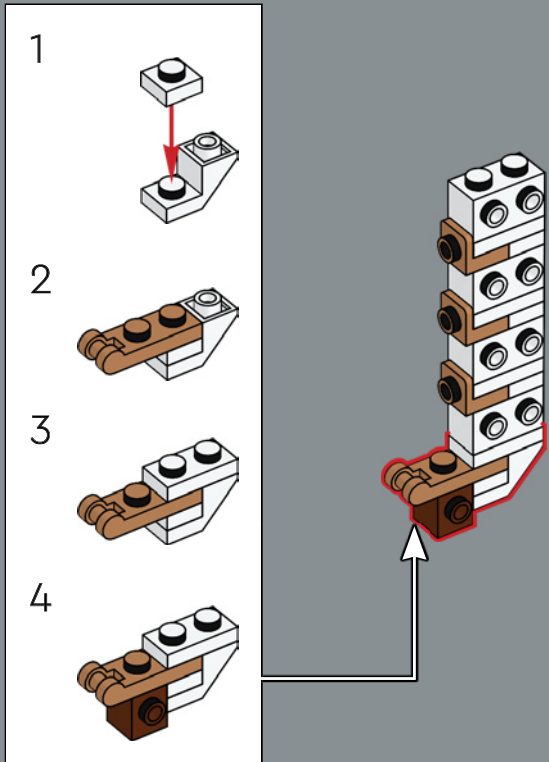

540

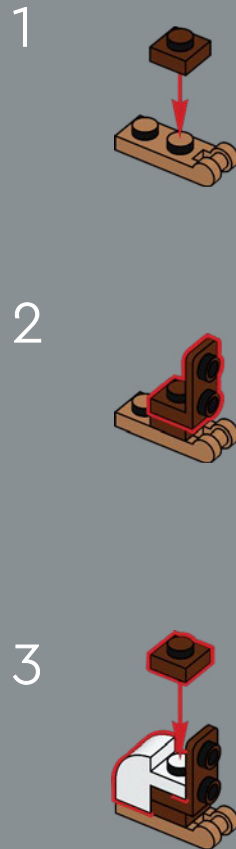

4

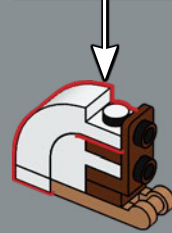
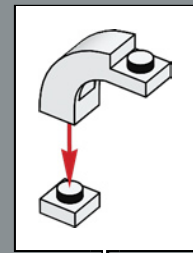

5

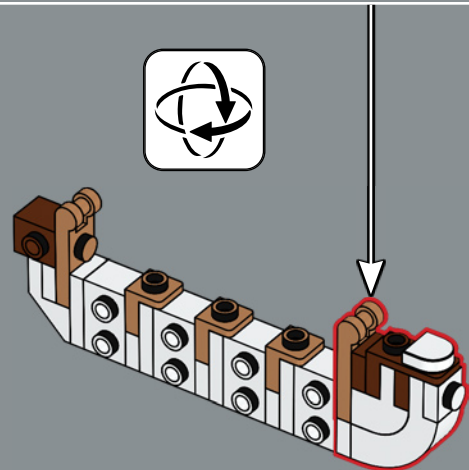
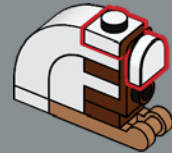



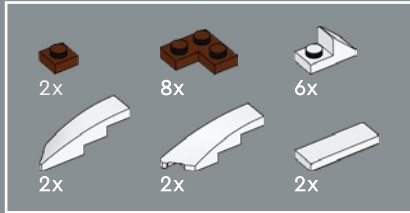
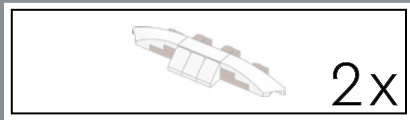

541

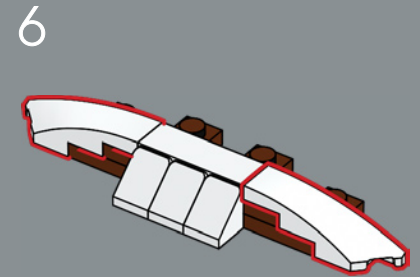
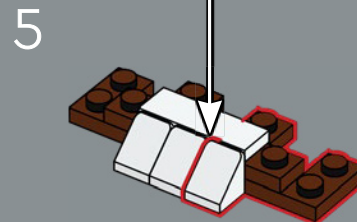
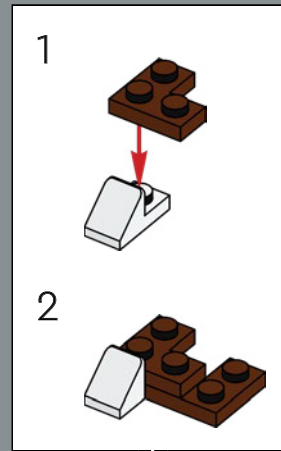
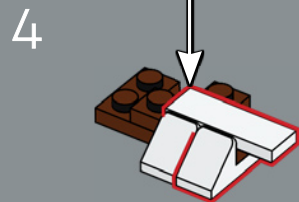
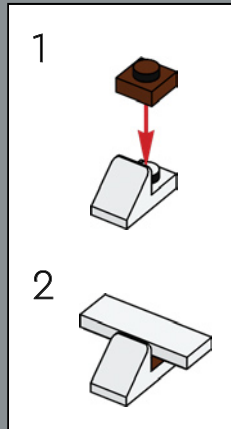
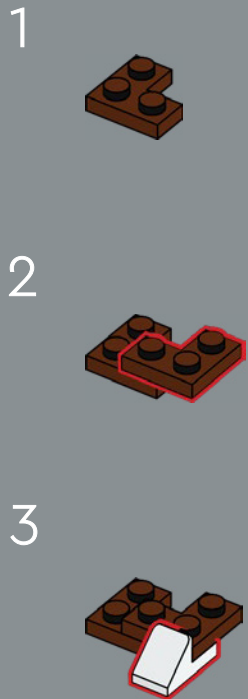

2x

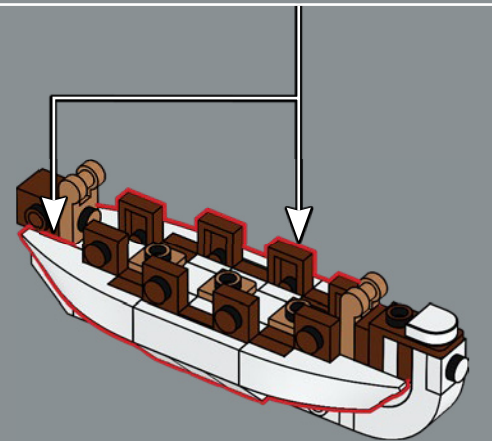



542

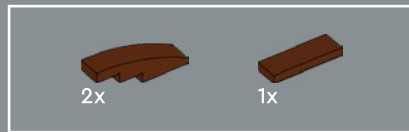
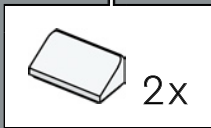
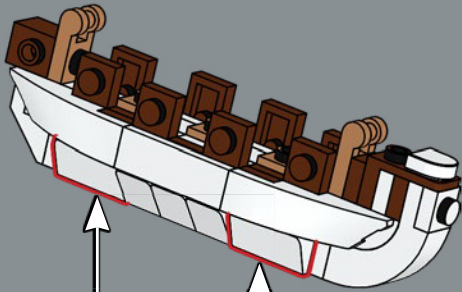

543

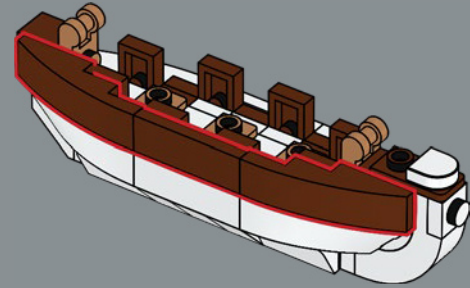

544

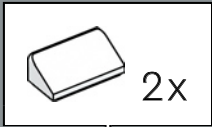
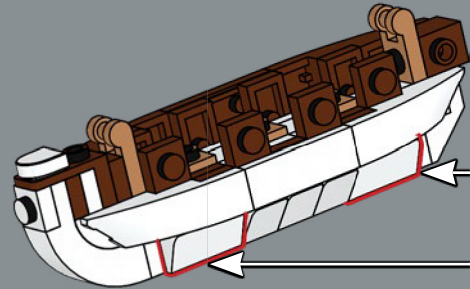



545

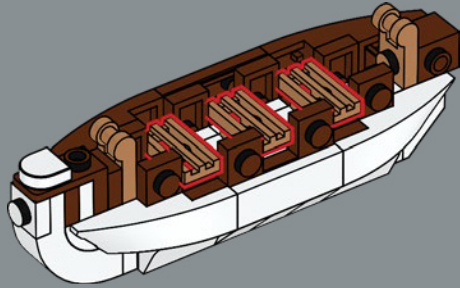

546

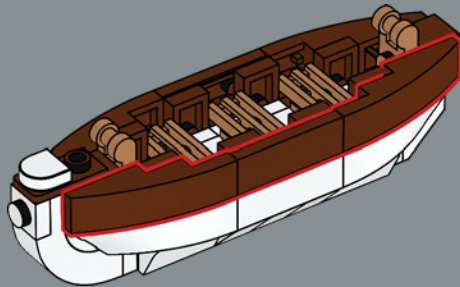

547

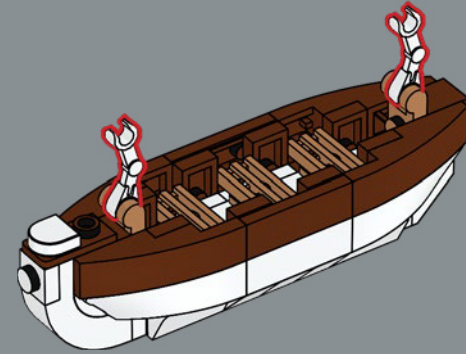

548

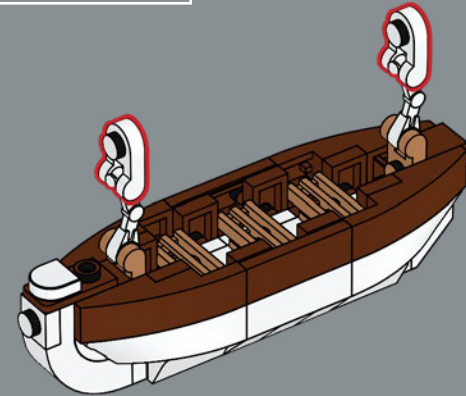

2x



549

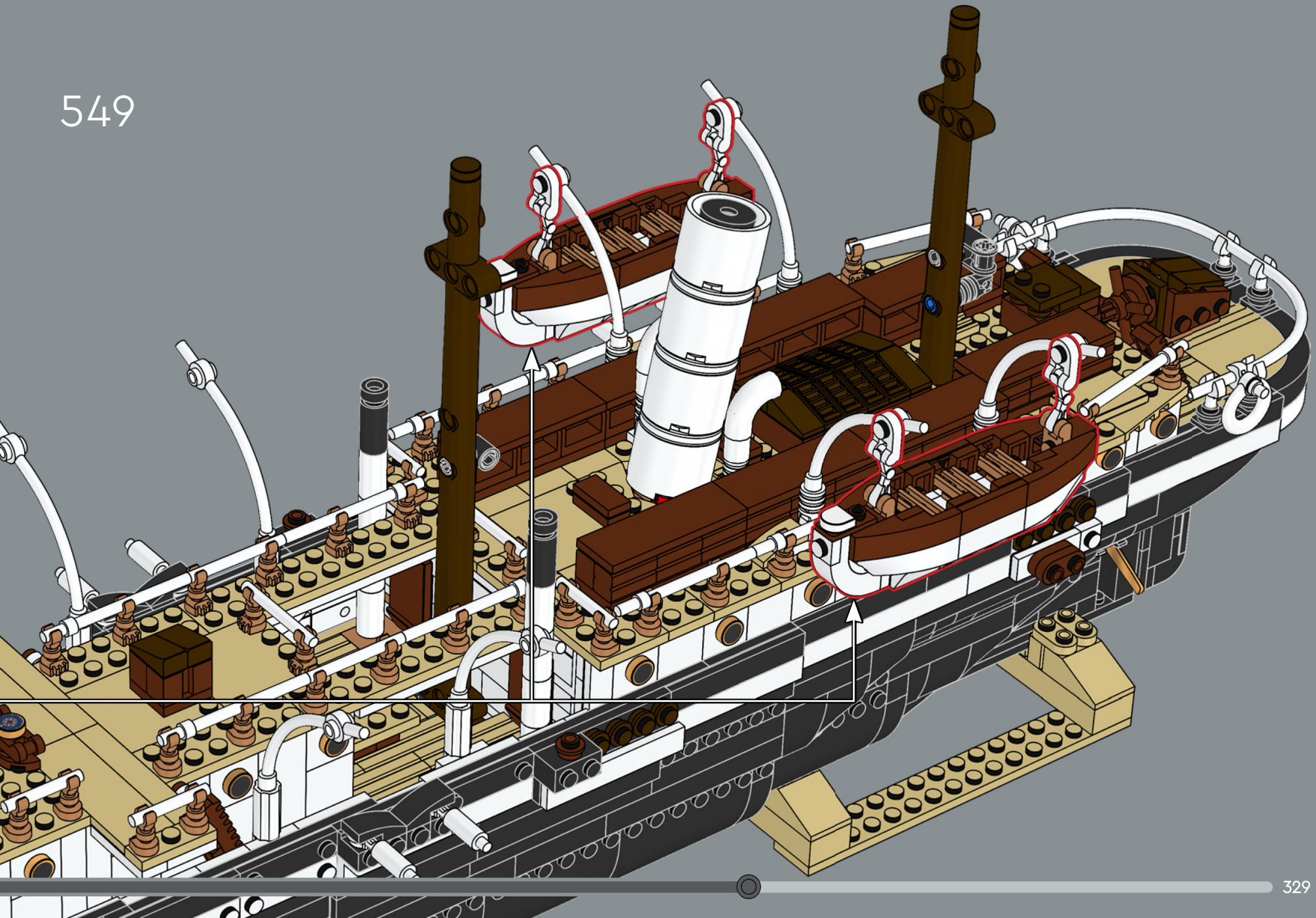

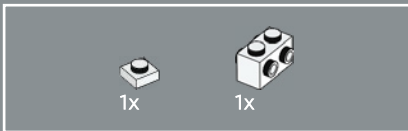
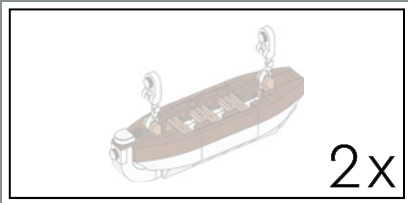

550

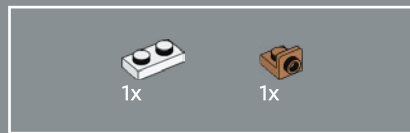
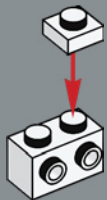

551

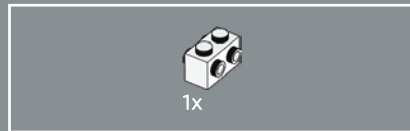
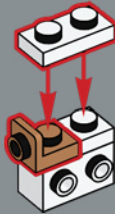

552

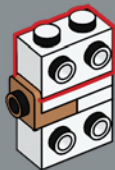

553

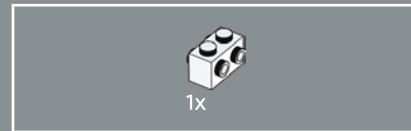
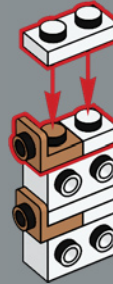

554

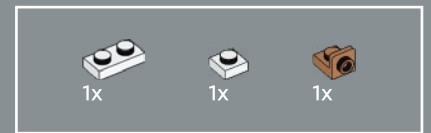
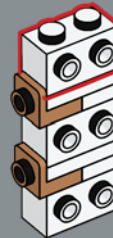

555

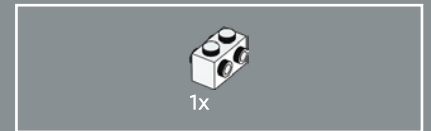

556

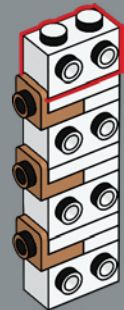

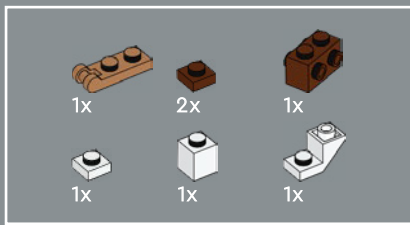

557

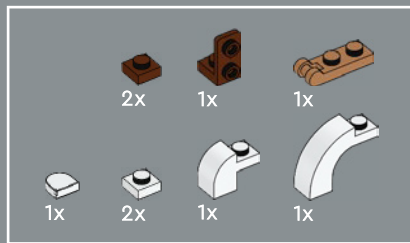
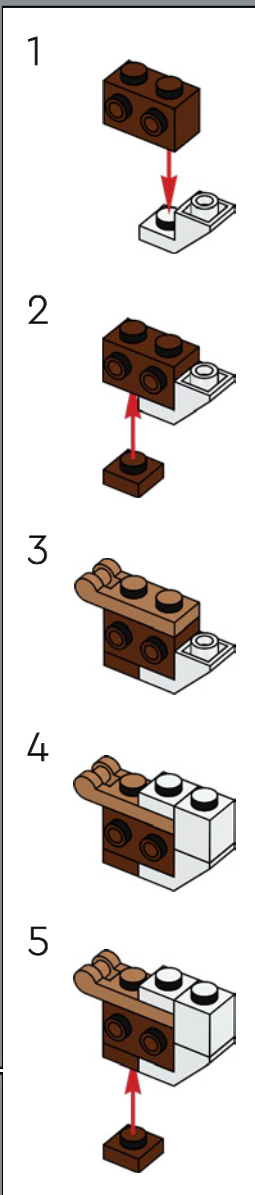
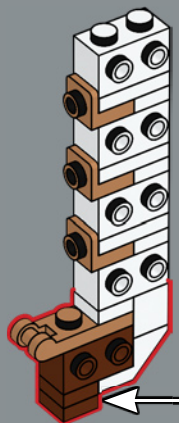

558

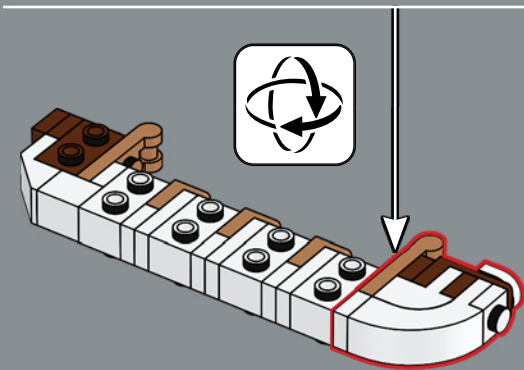
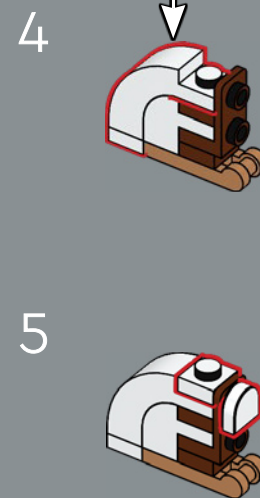
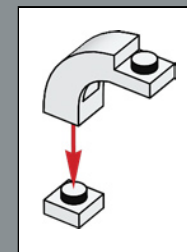
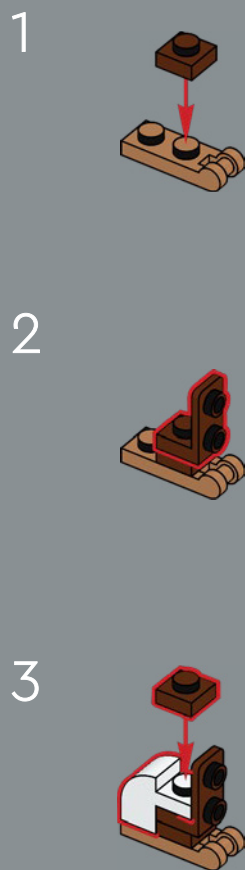



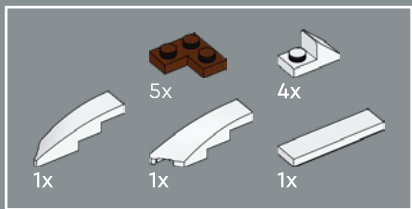

559

1



2



3

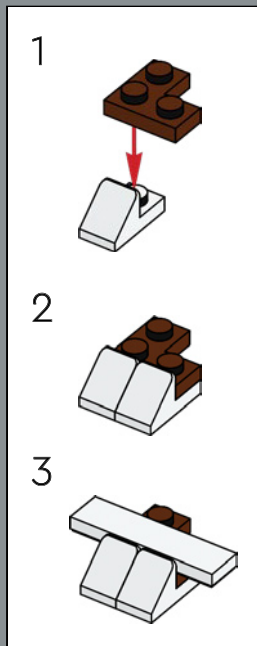

4

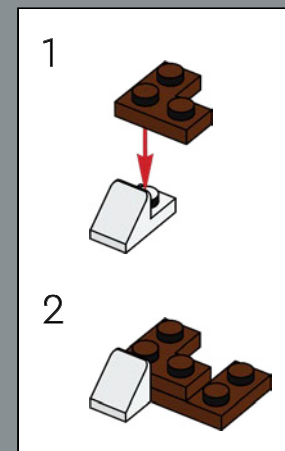
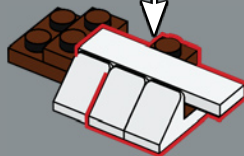

5

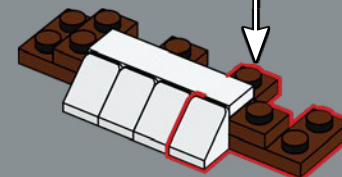

6

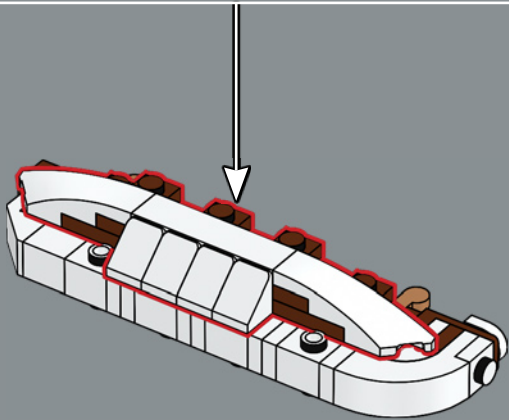
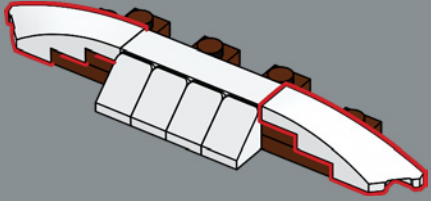

2x

560

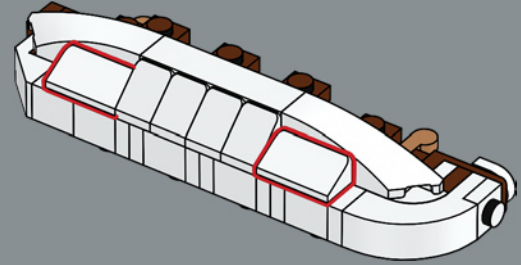

1x

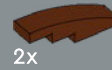

2x

561

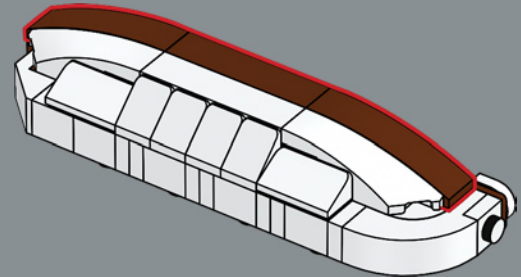

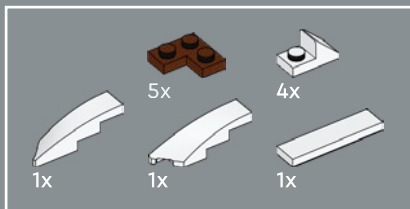

562

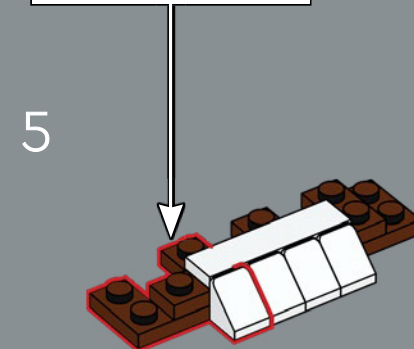
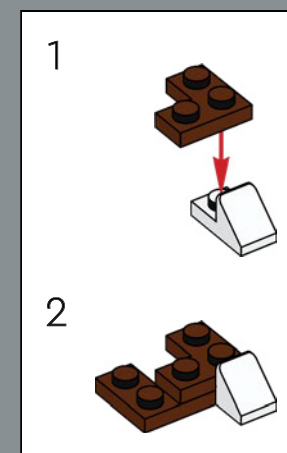
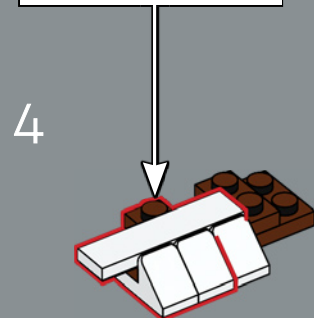
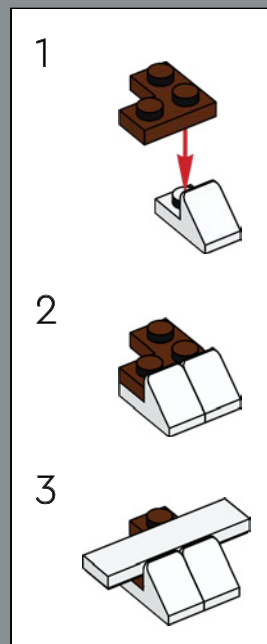
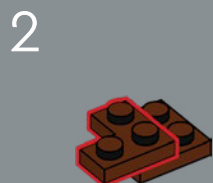



6

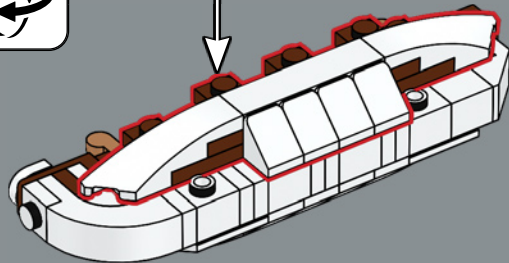
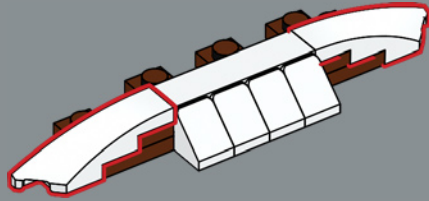

2x

563

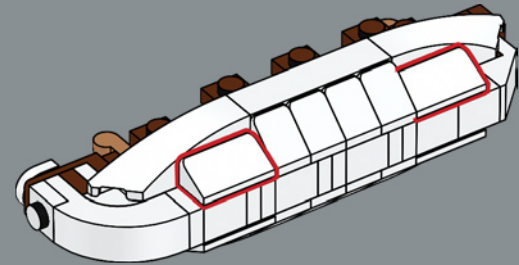



3x

564

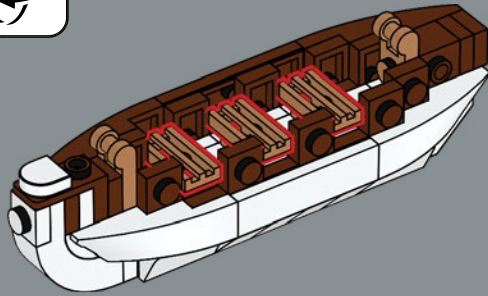

1x



2x

565

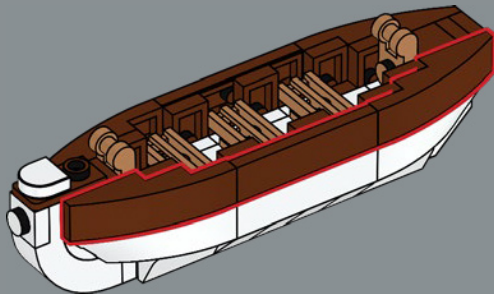

2x

566

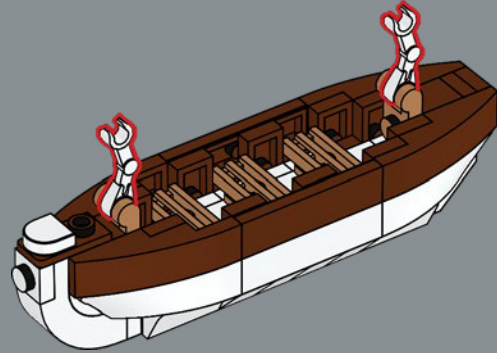

2x

567

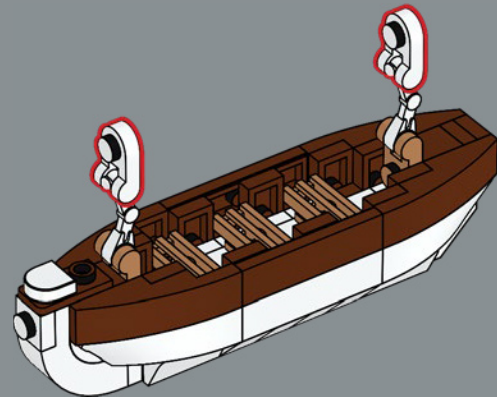

2x

568

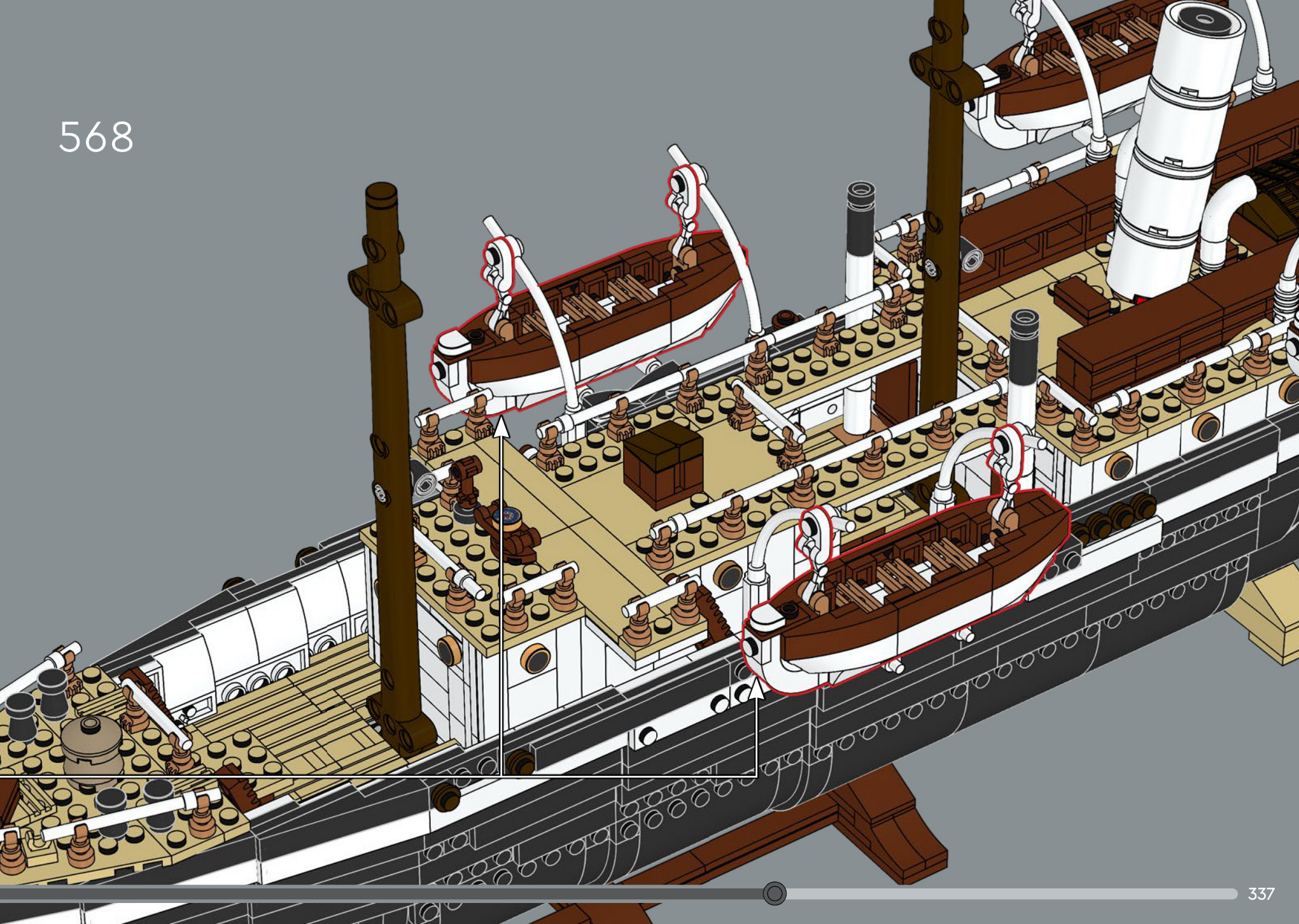



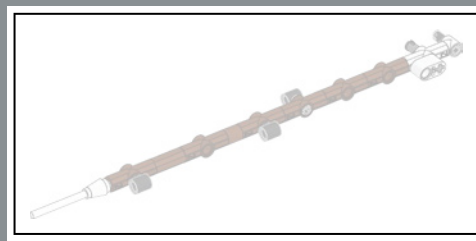

569

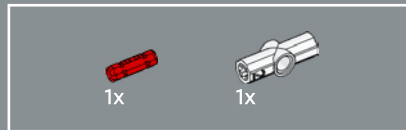
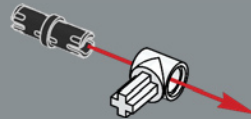

570

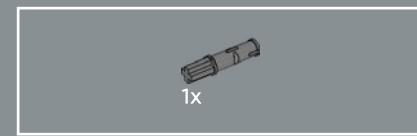
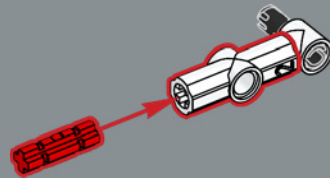

571

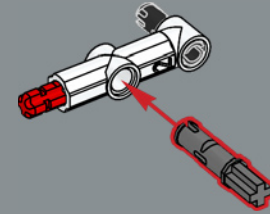

572

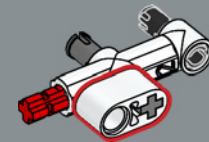

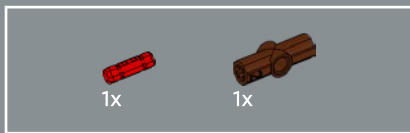

573

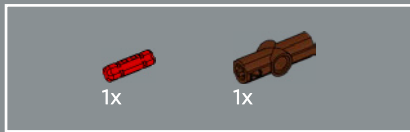
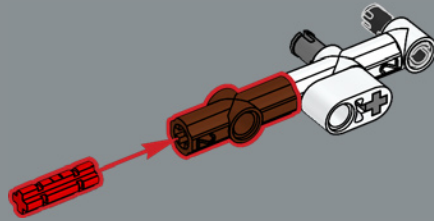

574

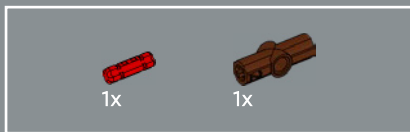
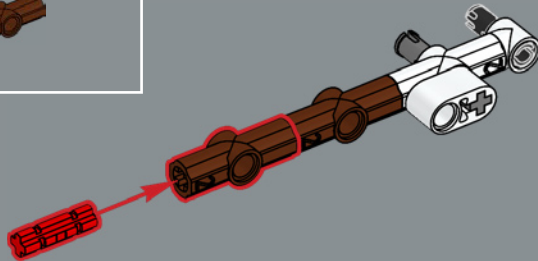

575

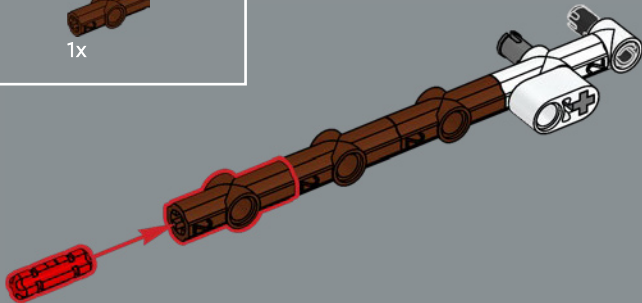

576

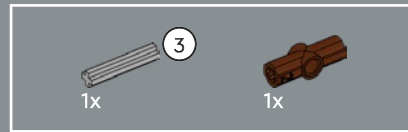
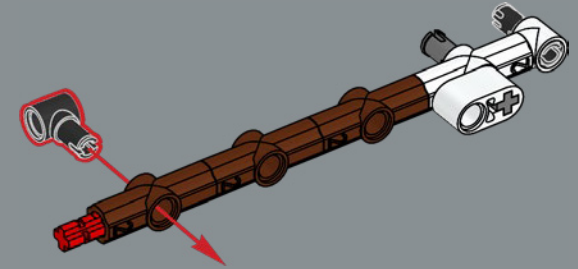

577

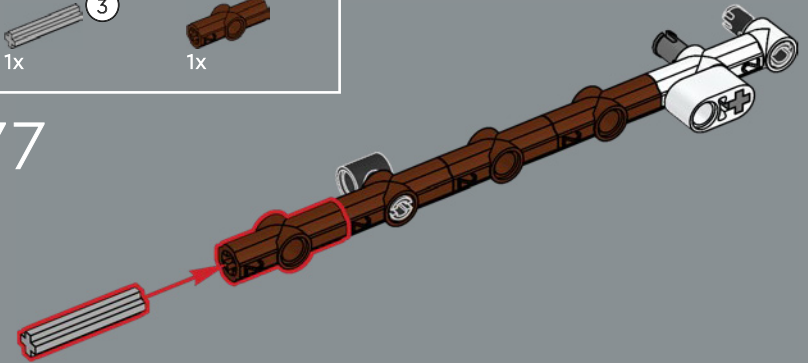

578

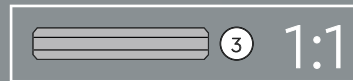
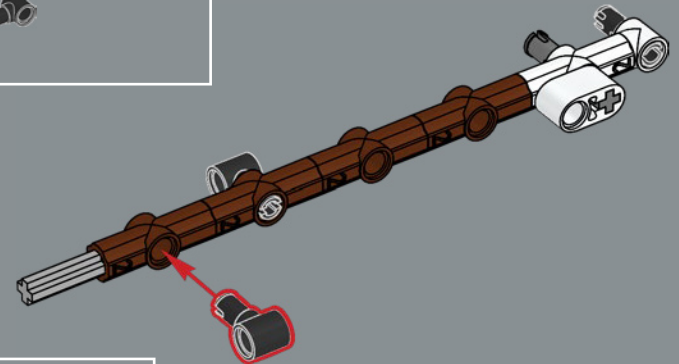



579

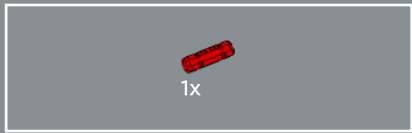
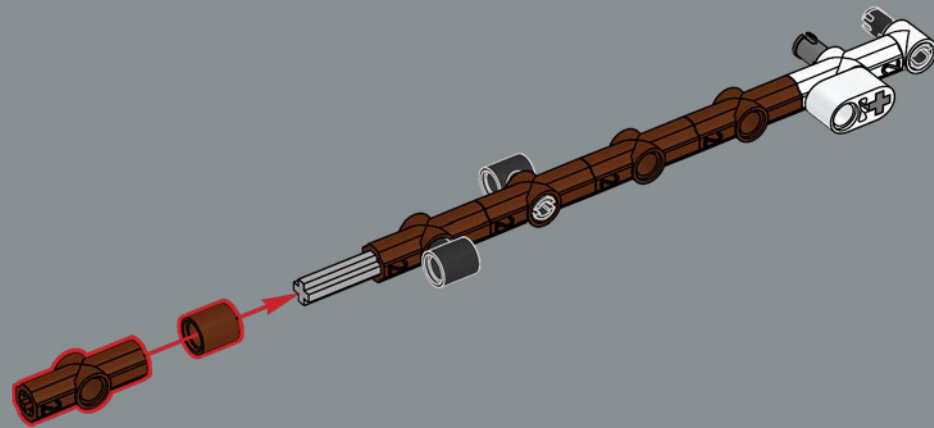

580

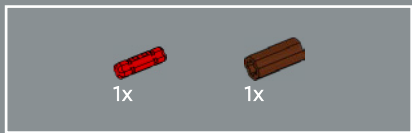
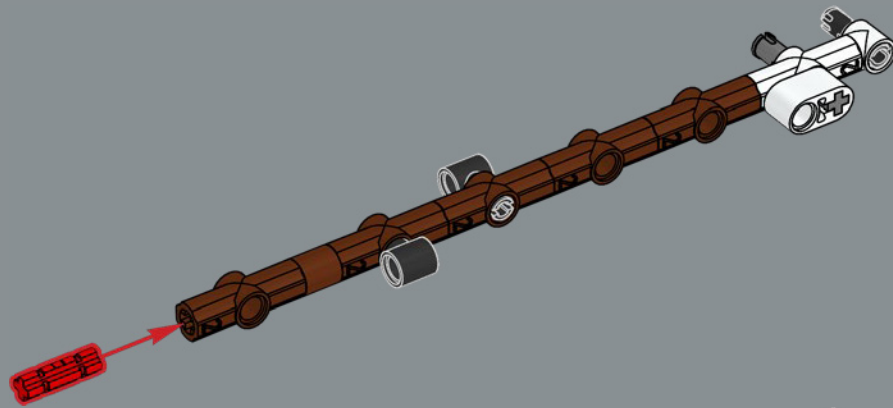

581

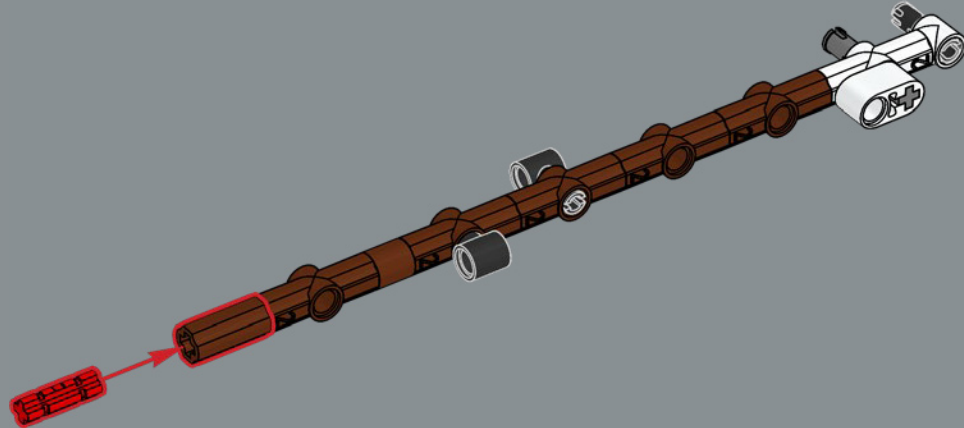





582

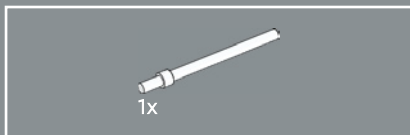
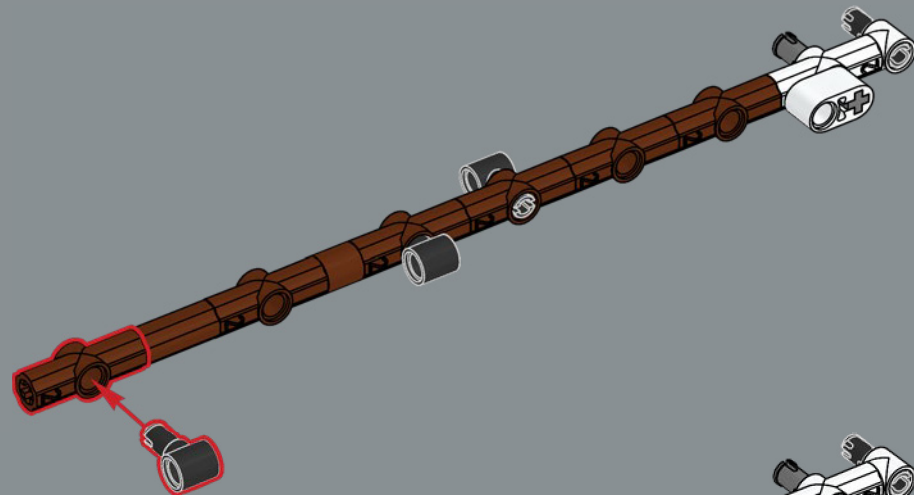

583

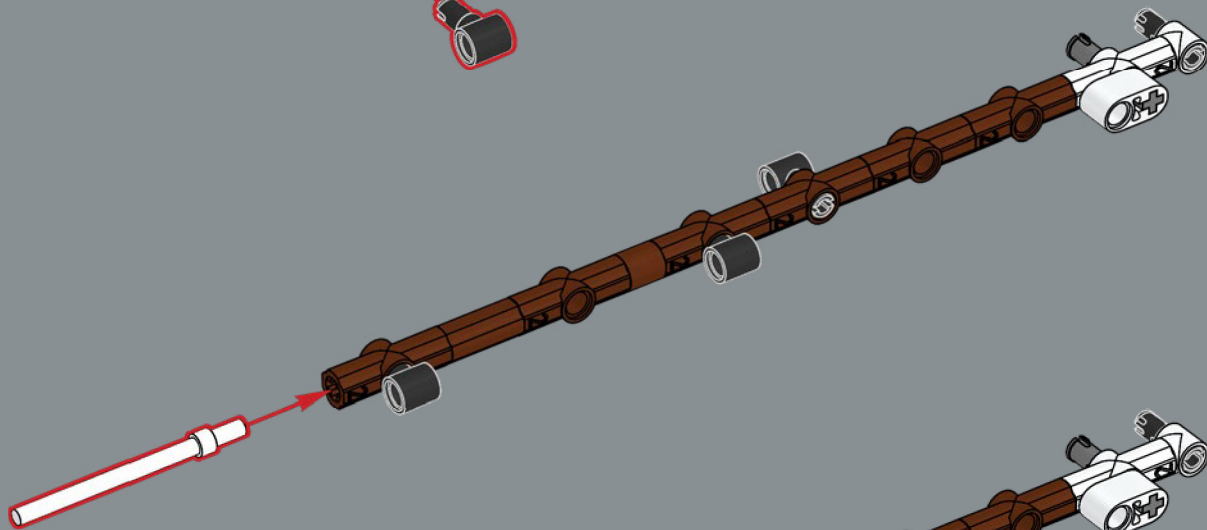

584

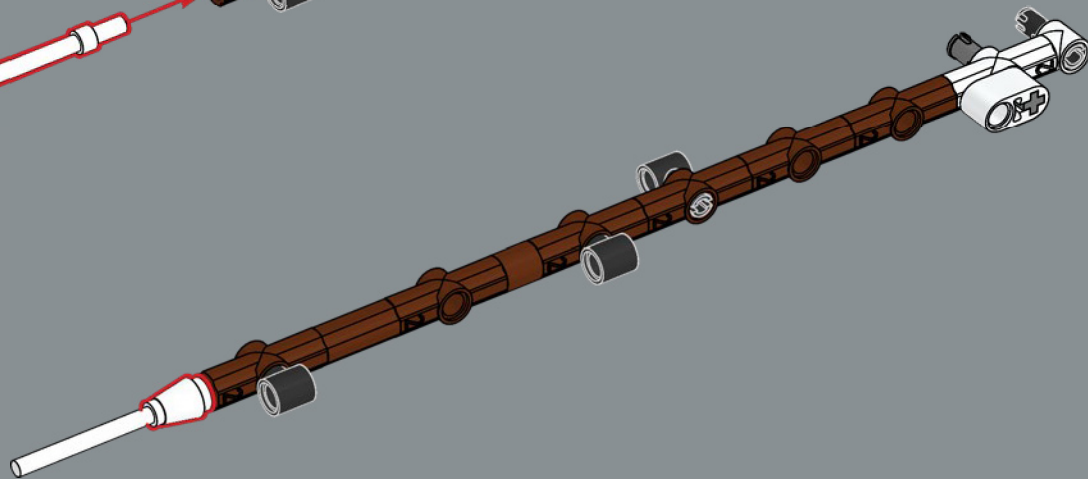

585

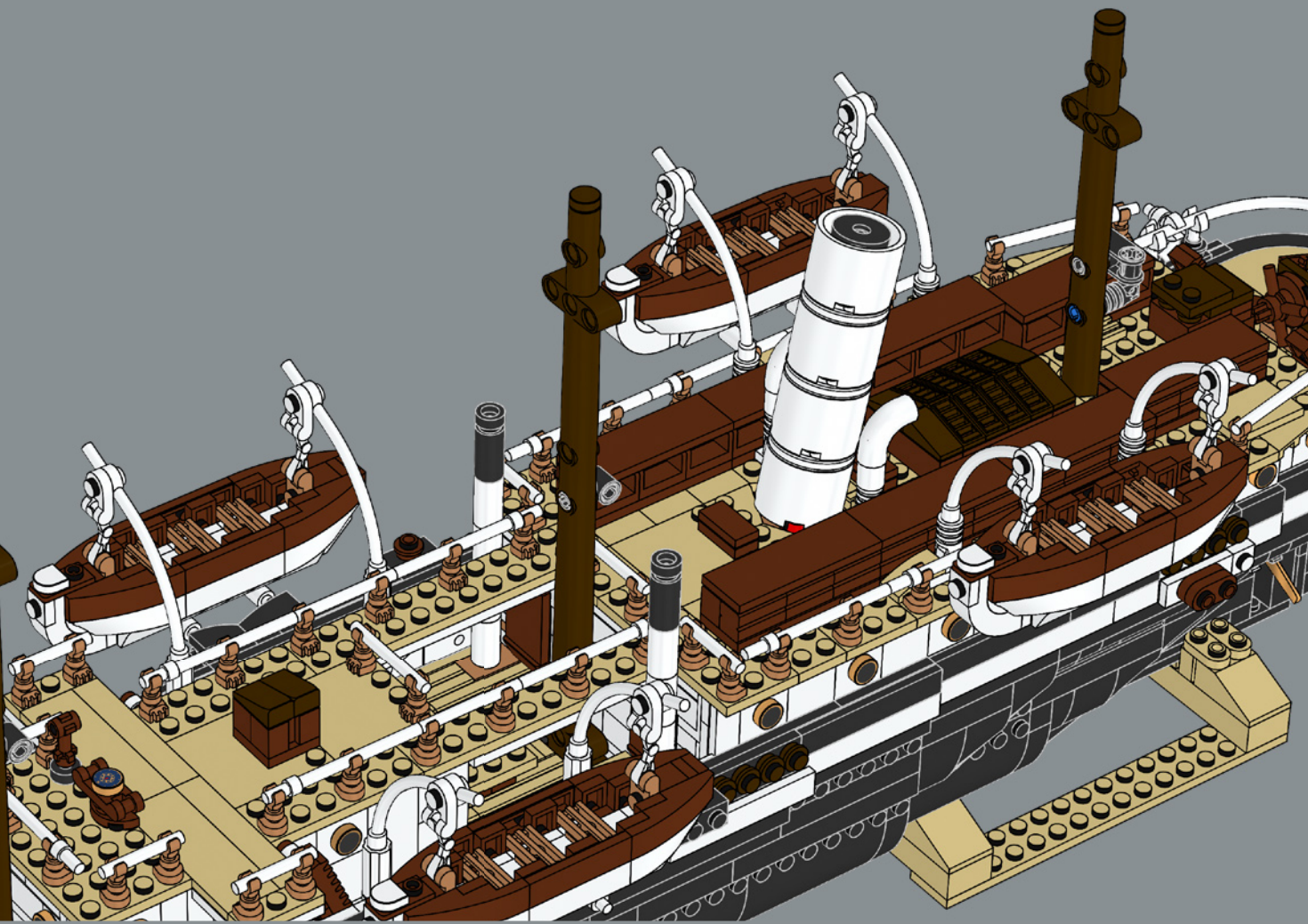
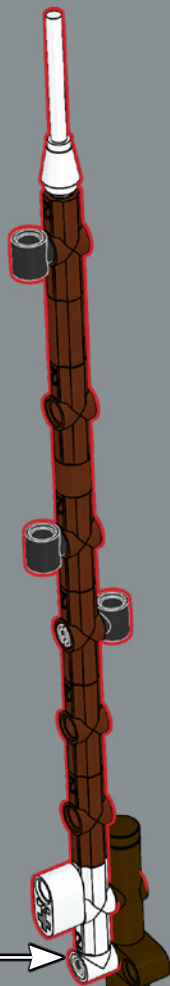

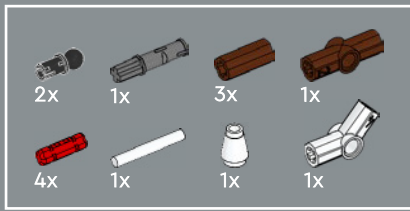

586

1

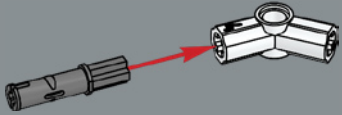

2

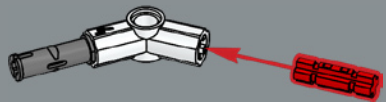

3



4



5

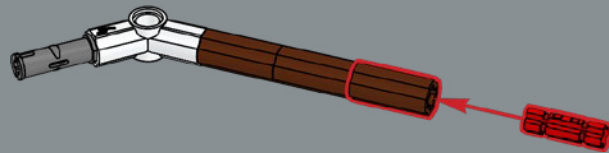

6

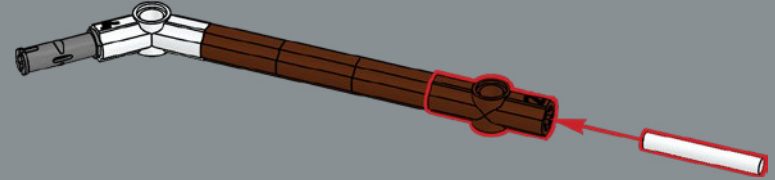

7

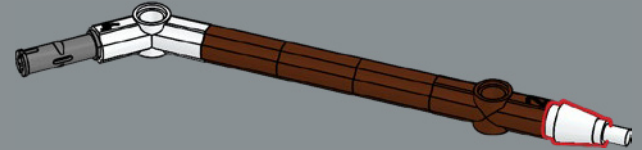

8

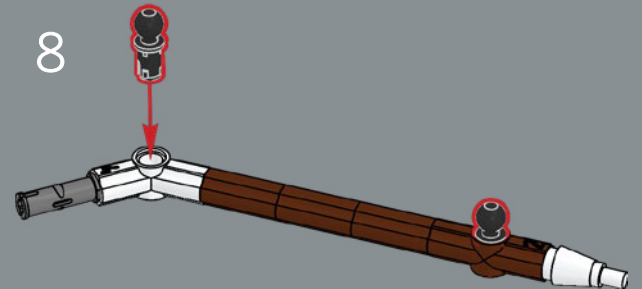



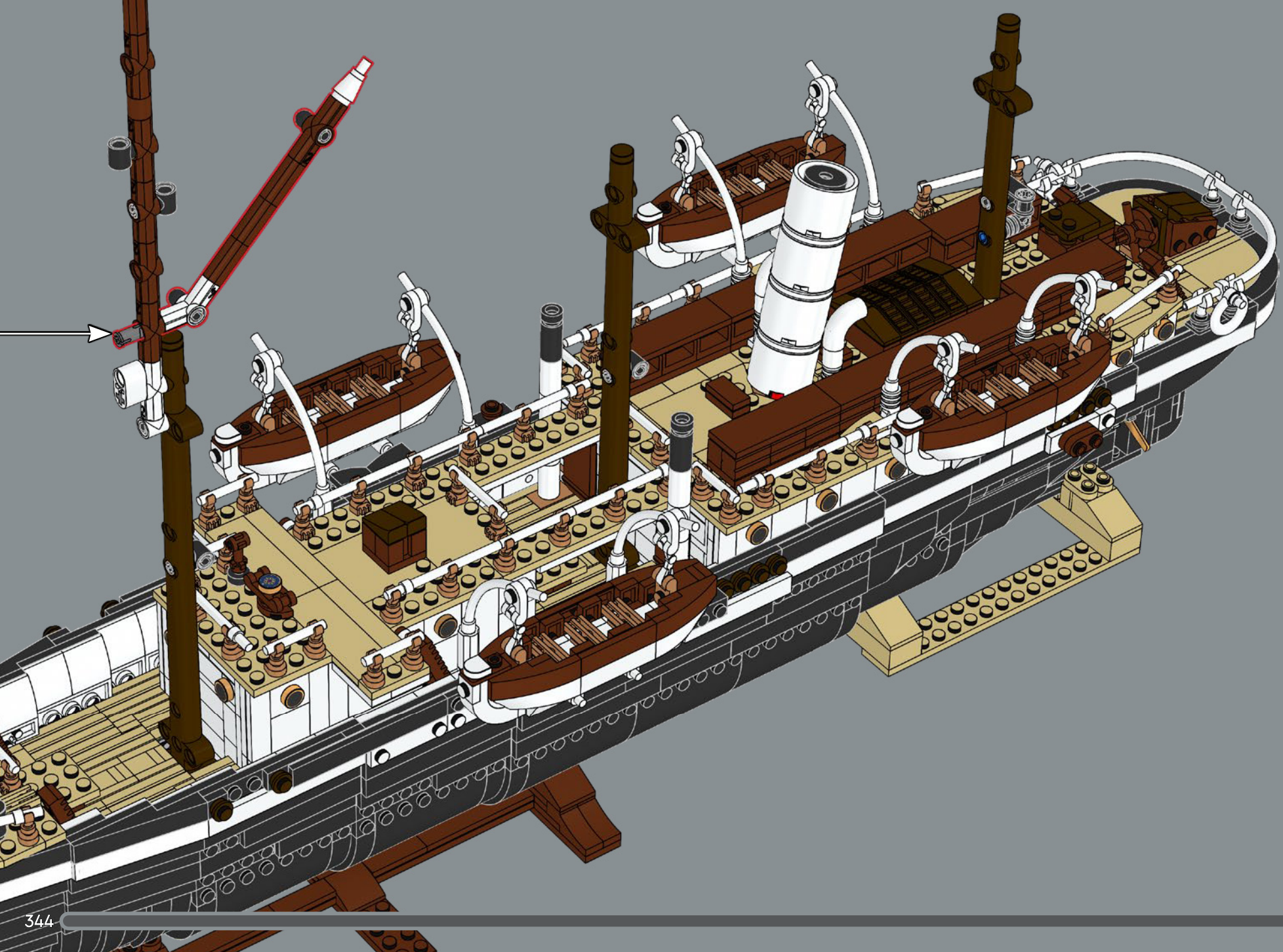

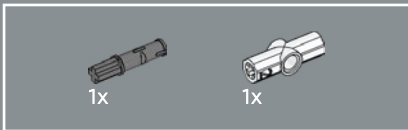
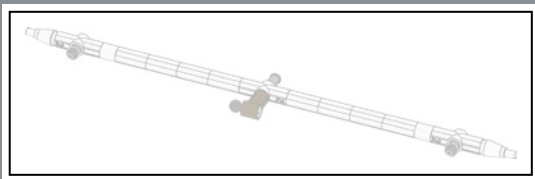

587

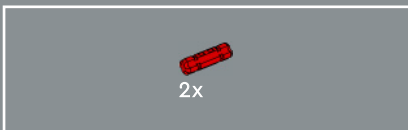
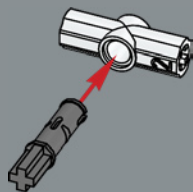

588

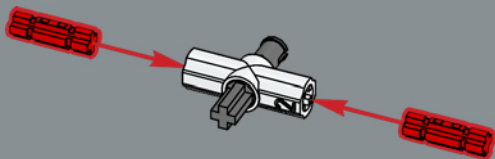

589

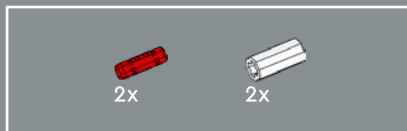
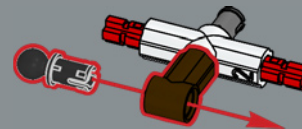

590

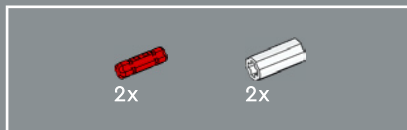
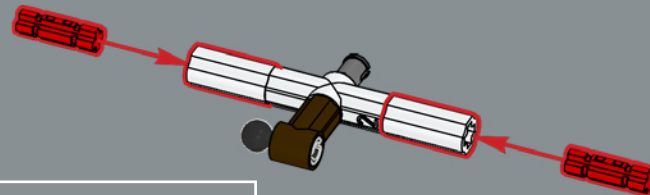

591

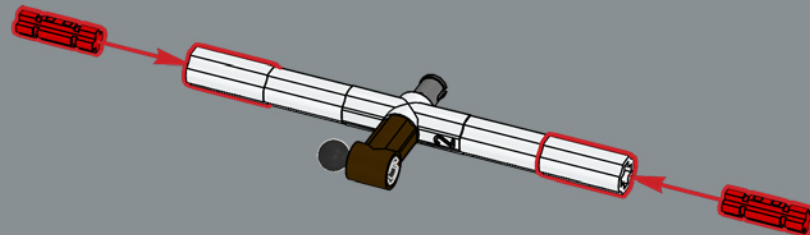

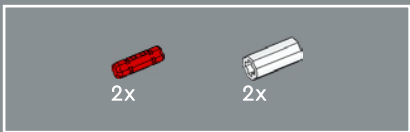

592

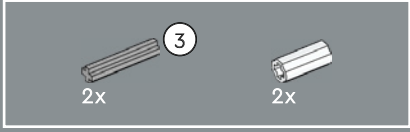
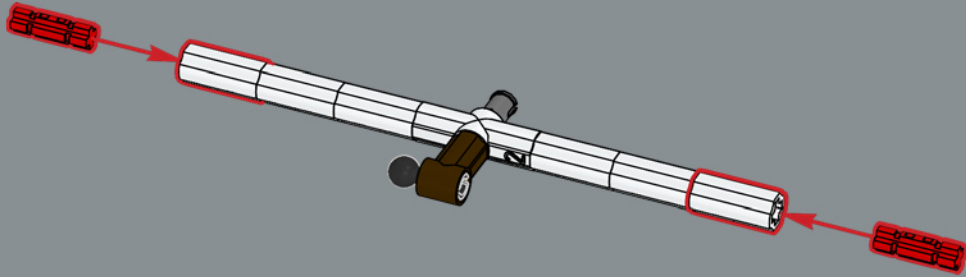

593

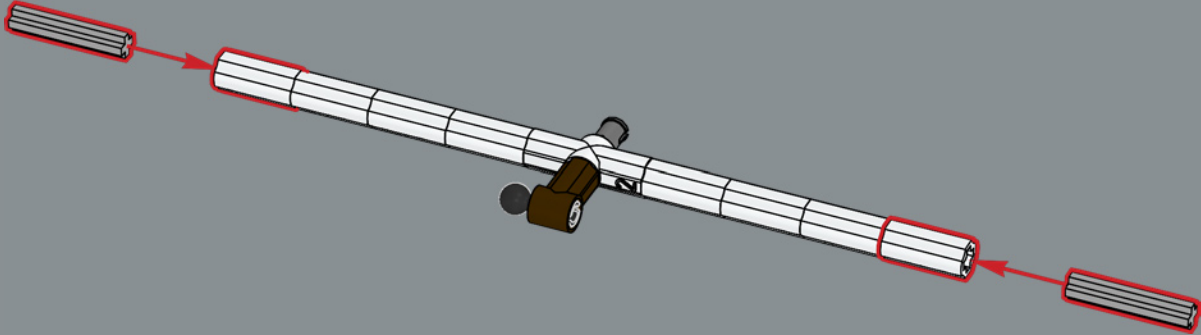

594

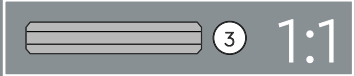
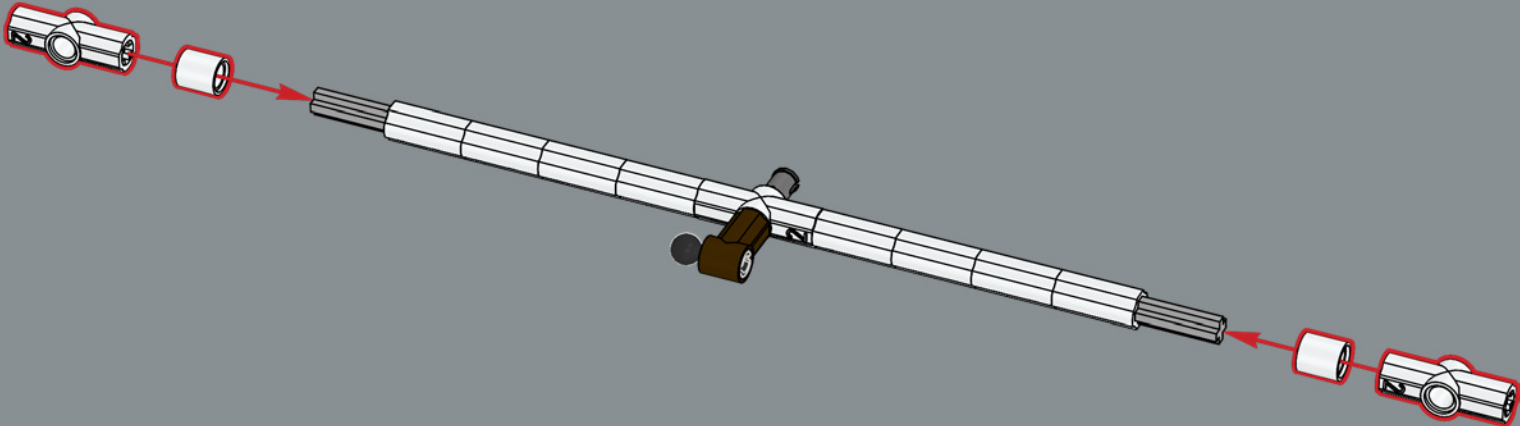





595

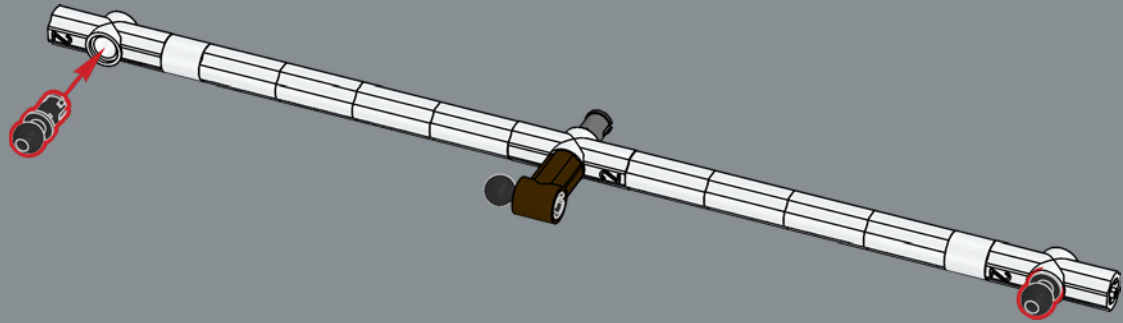

596

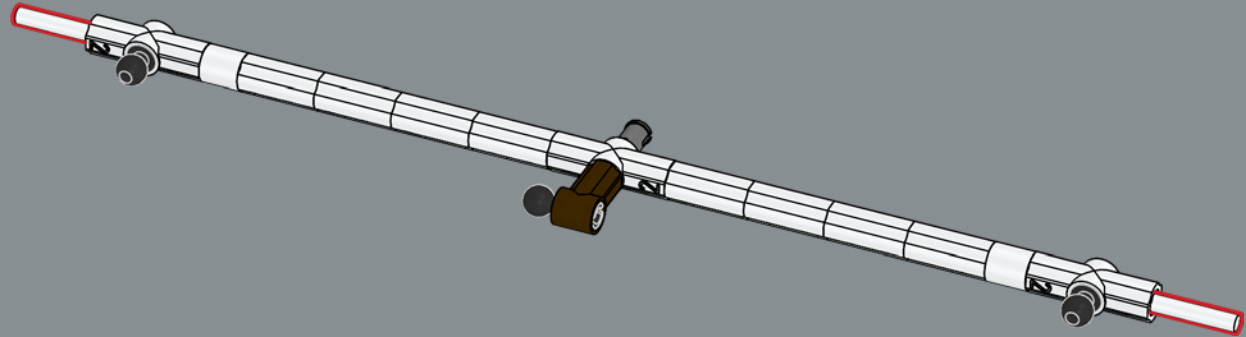

597

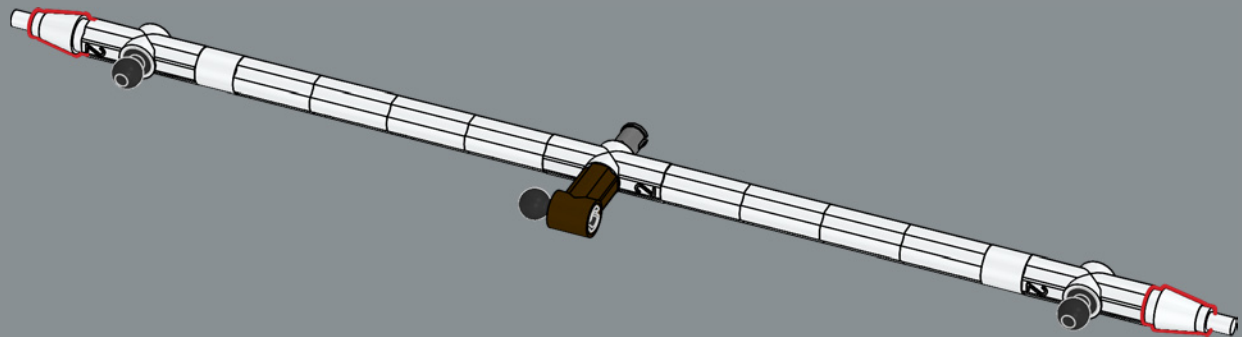

598

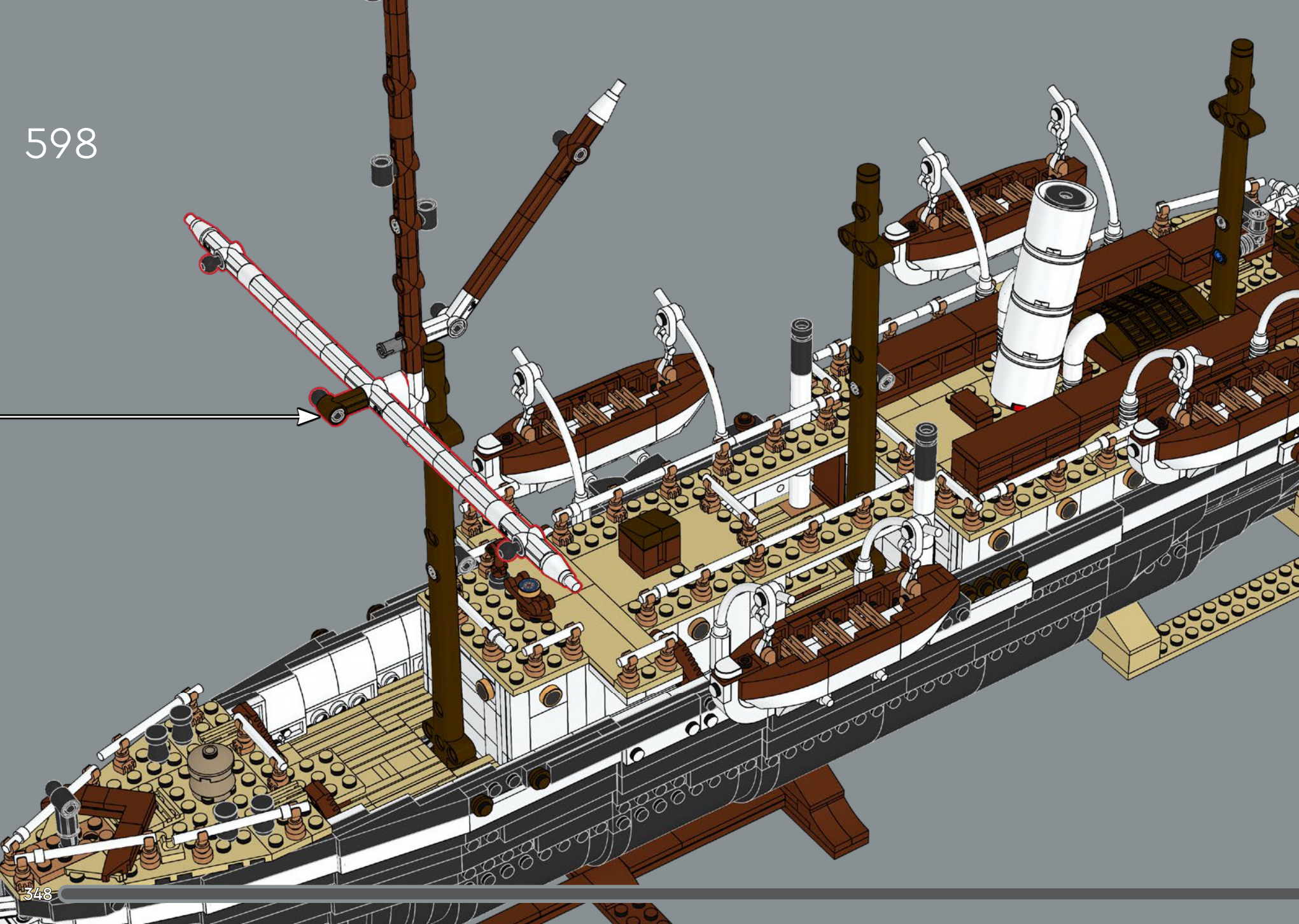





599

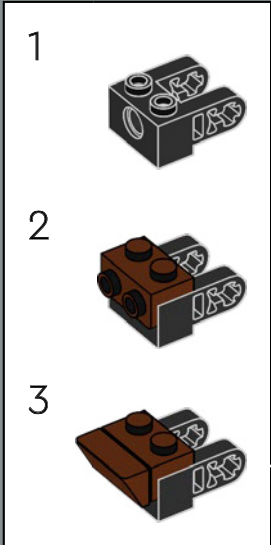



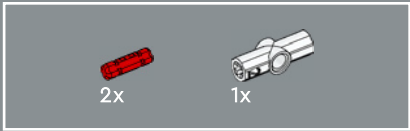
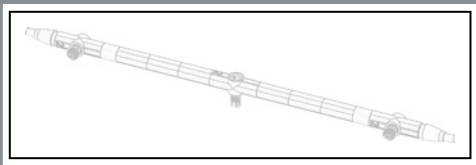

600

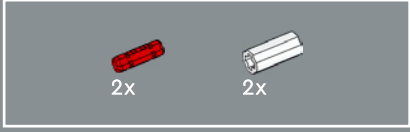
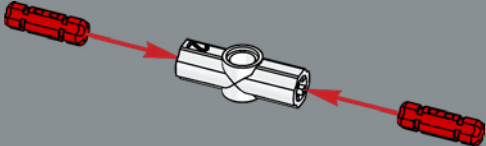

601

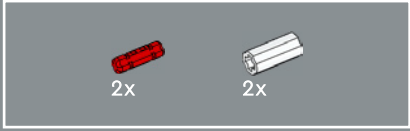
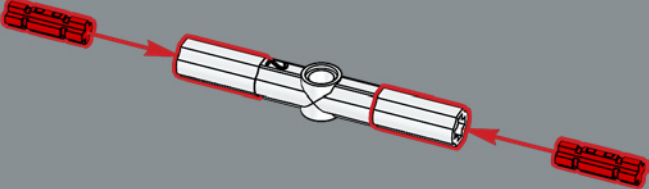

602

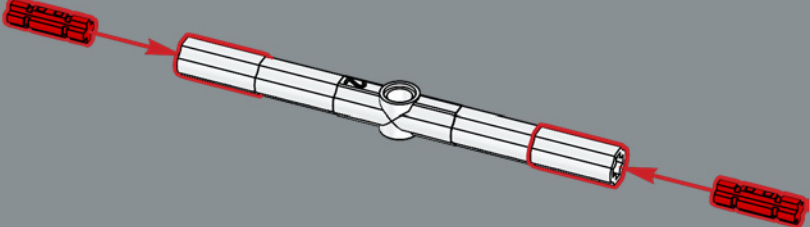

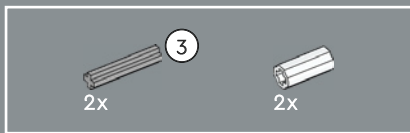

603

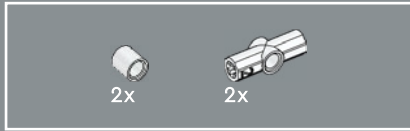
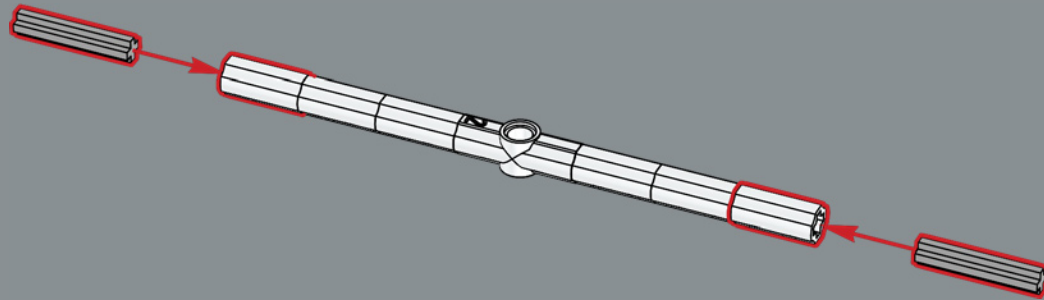

604

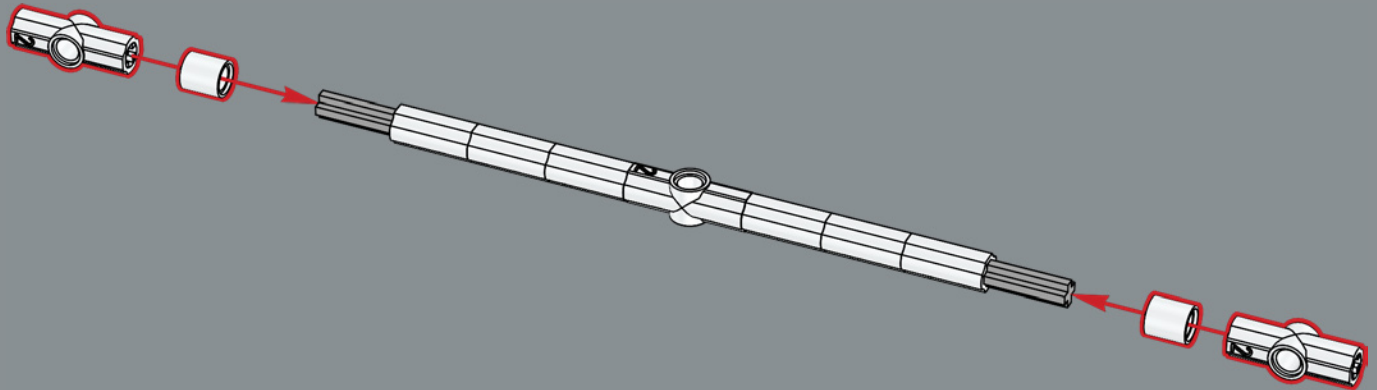

605

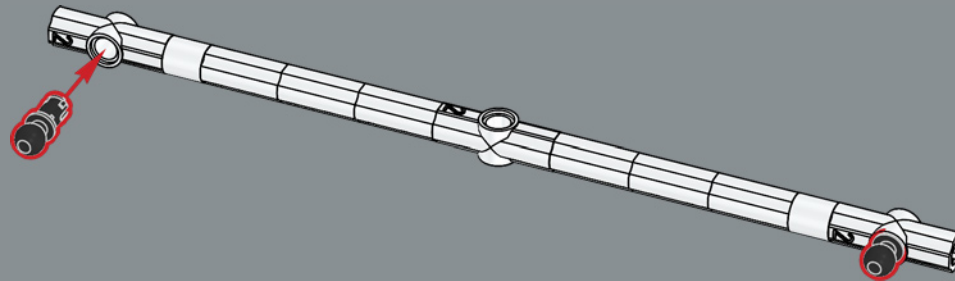



606

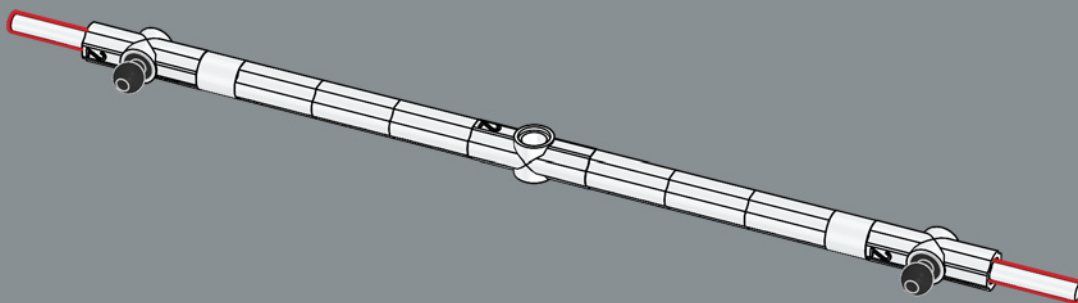

607

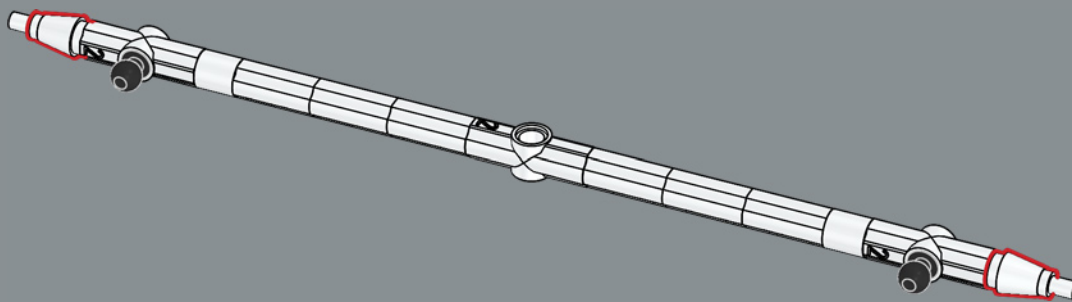

608

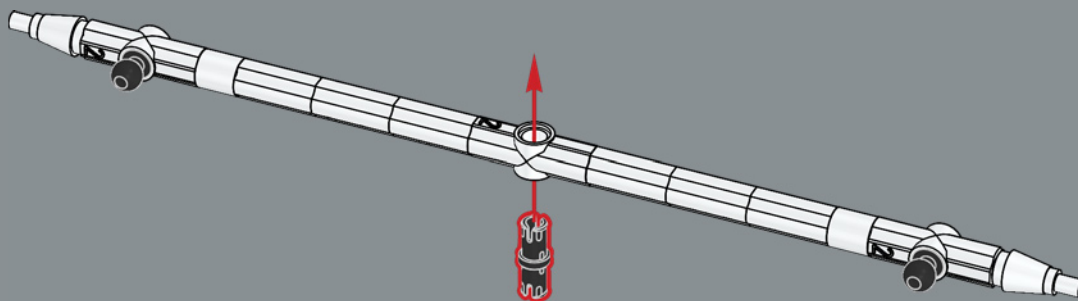



609



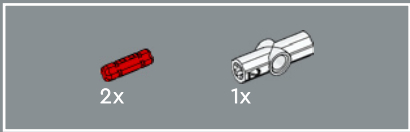
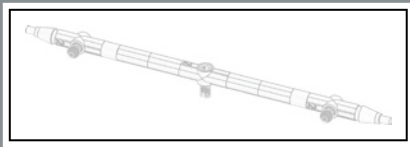

610

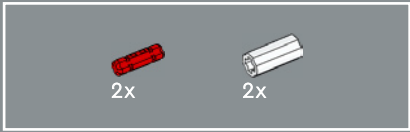
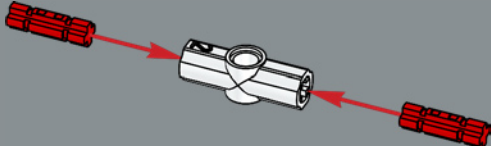

611

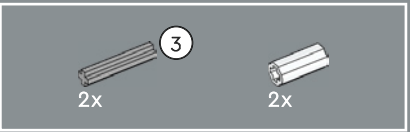
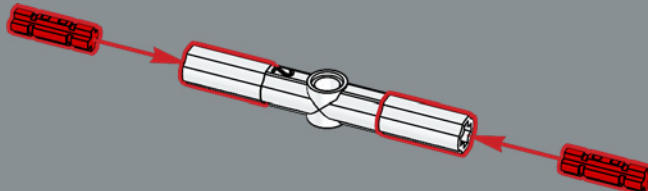

612

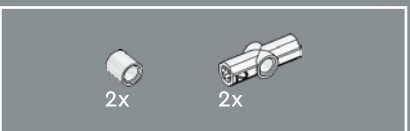
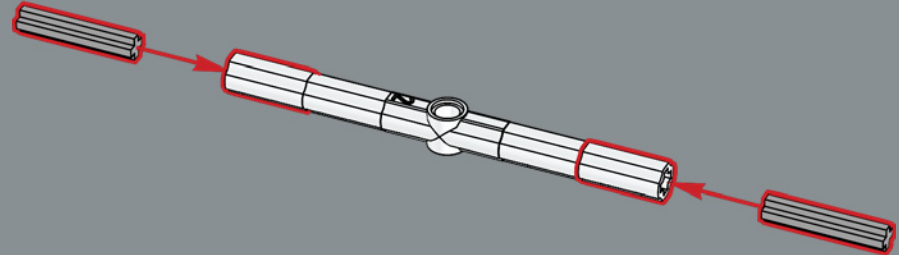

613

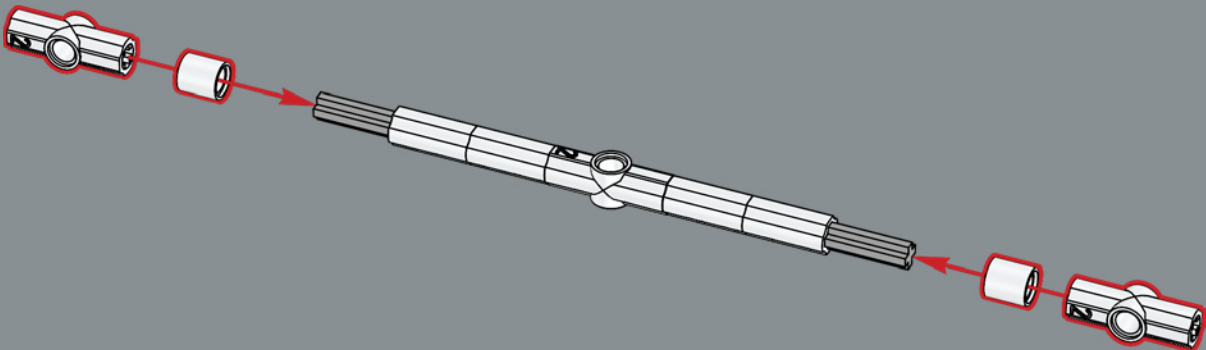



614

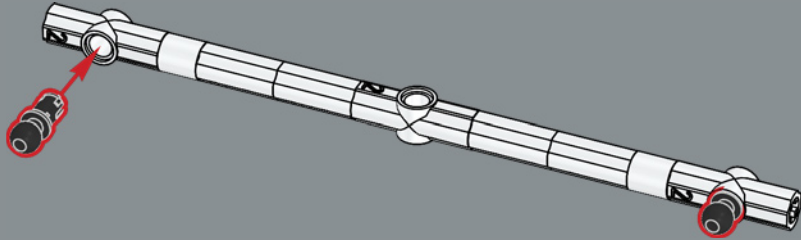

615

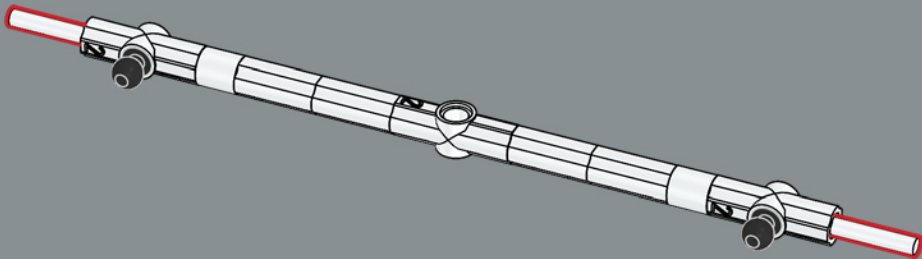

616

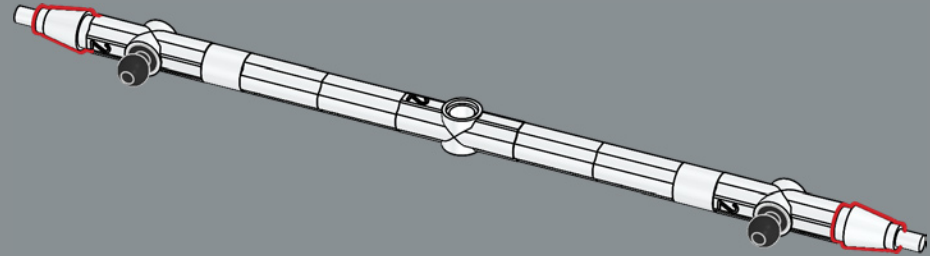

617

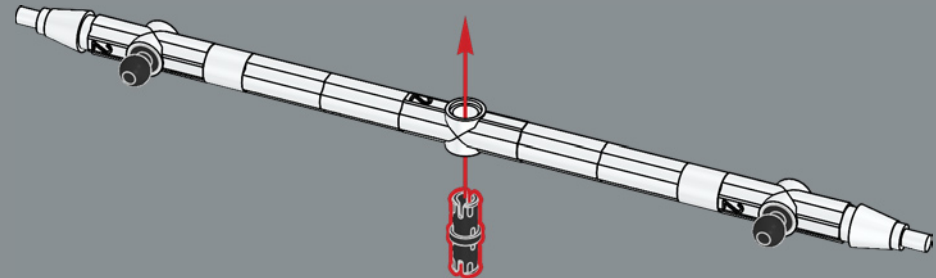



618



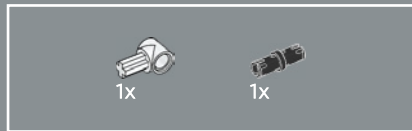
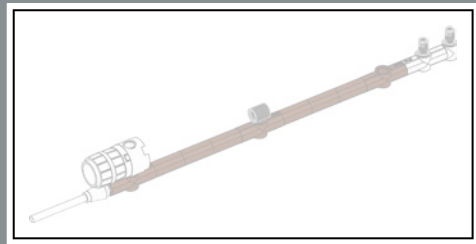

619

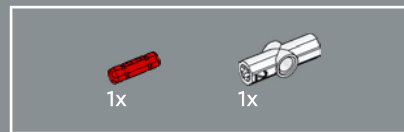
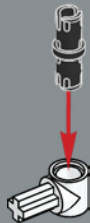

620

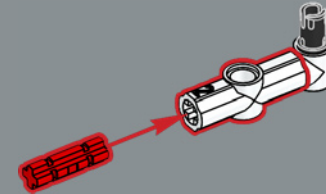

621

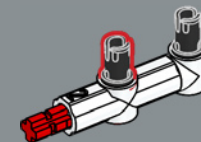

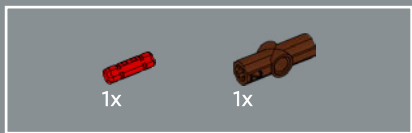

622

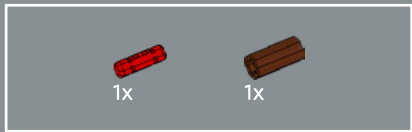
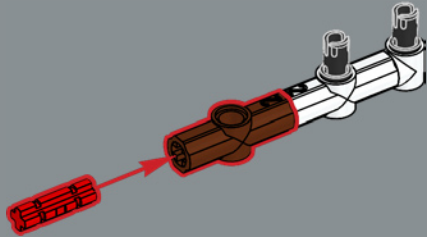

623

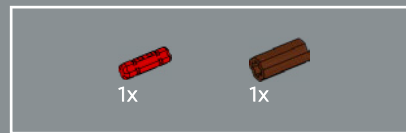
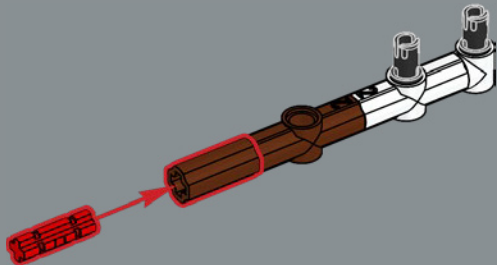

624

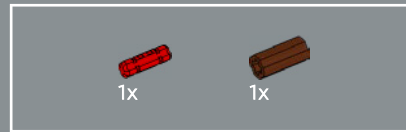
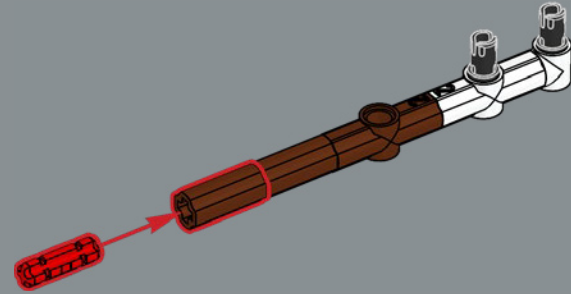

625

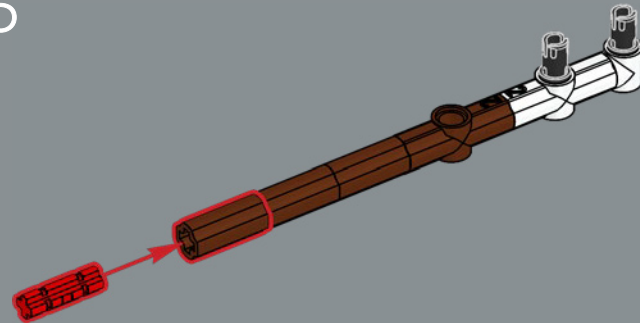



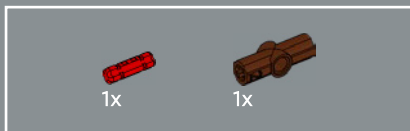

626

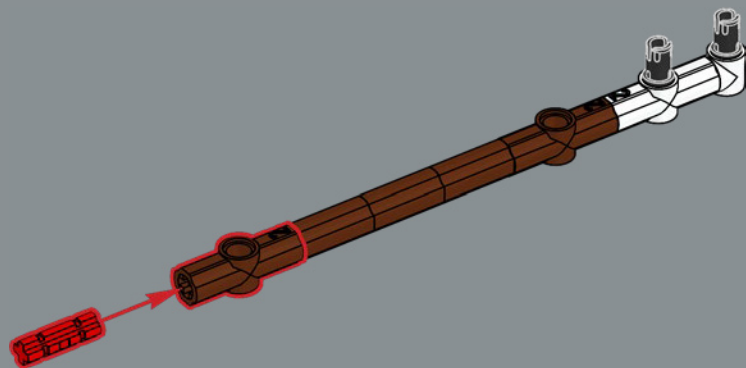

627

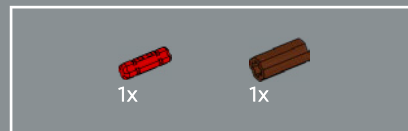
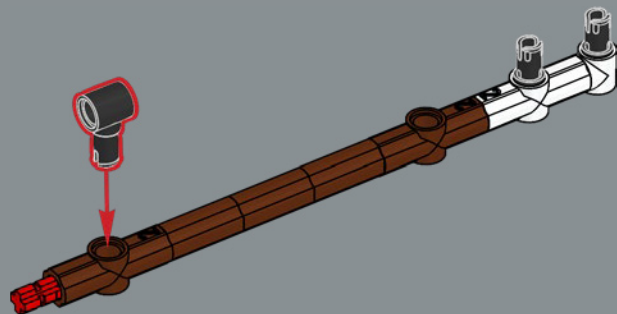

628

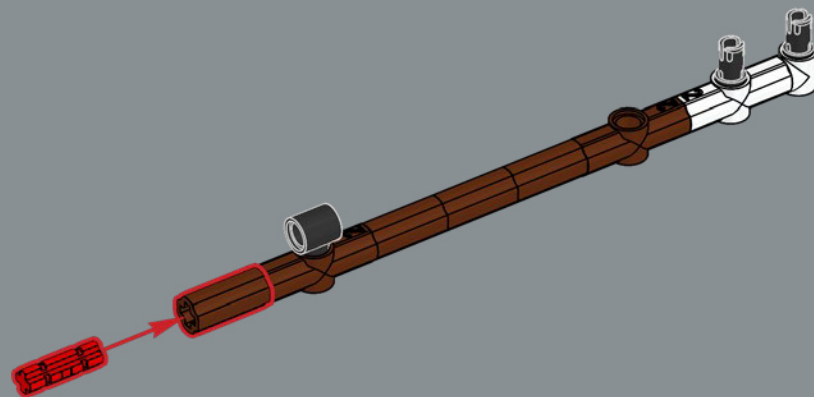

629

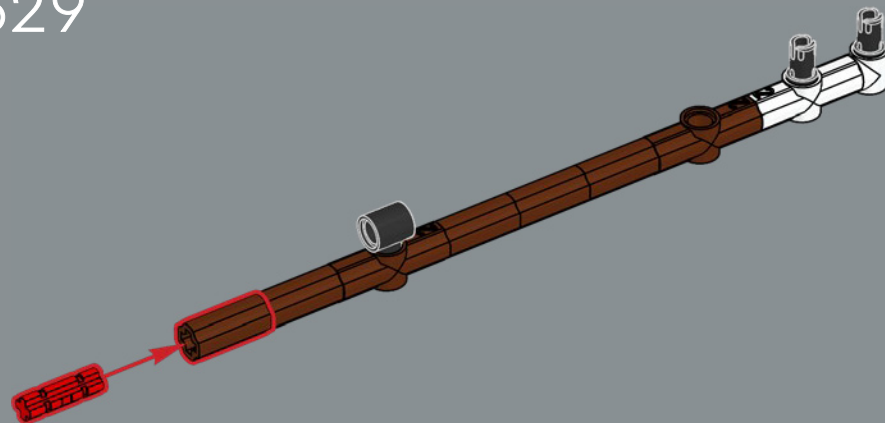

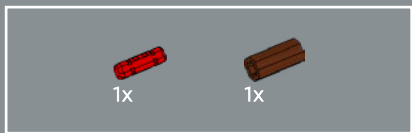

630

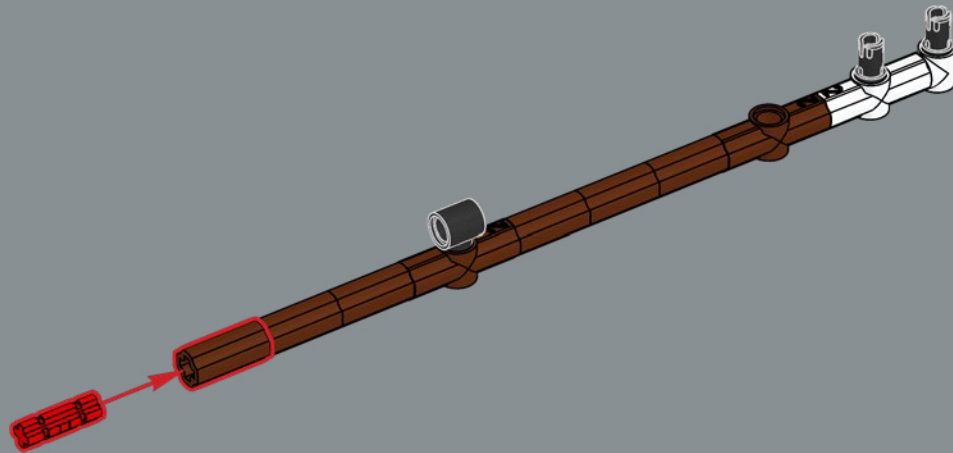

631

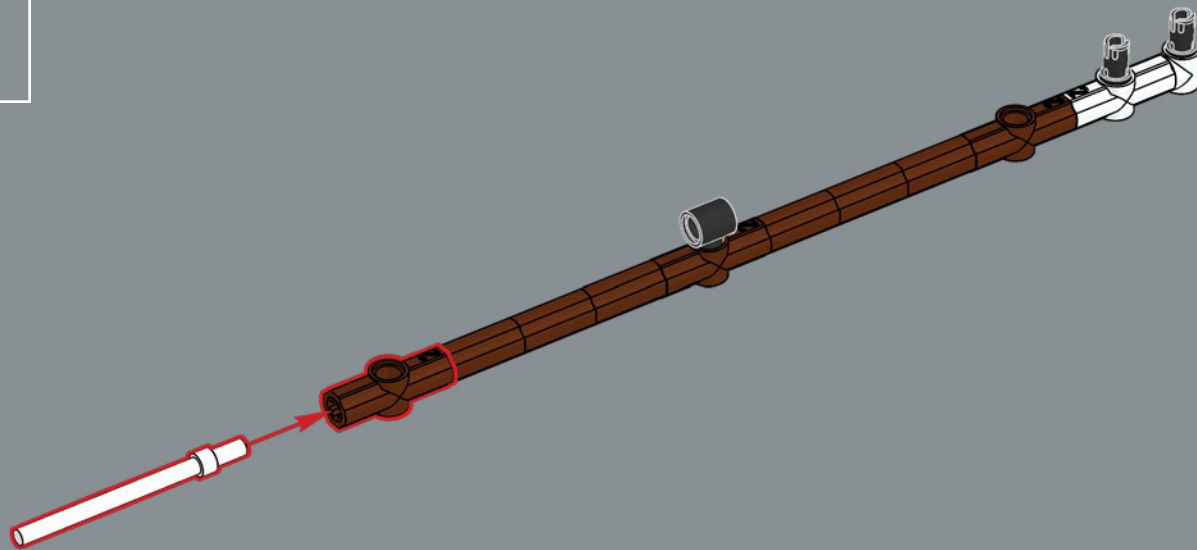



632

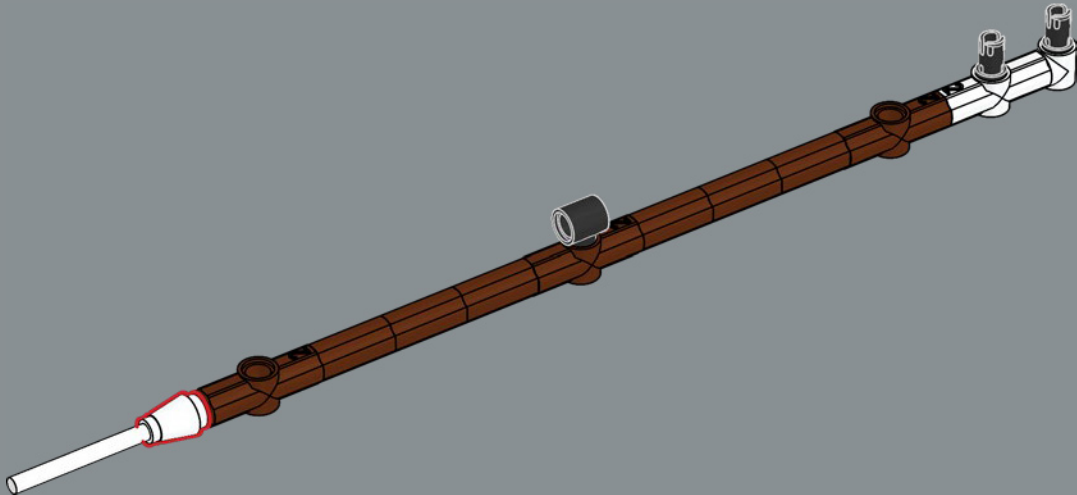

633

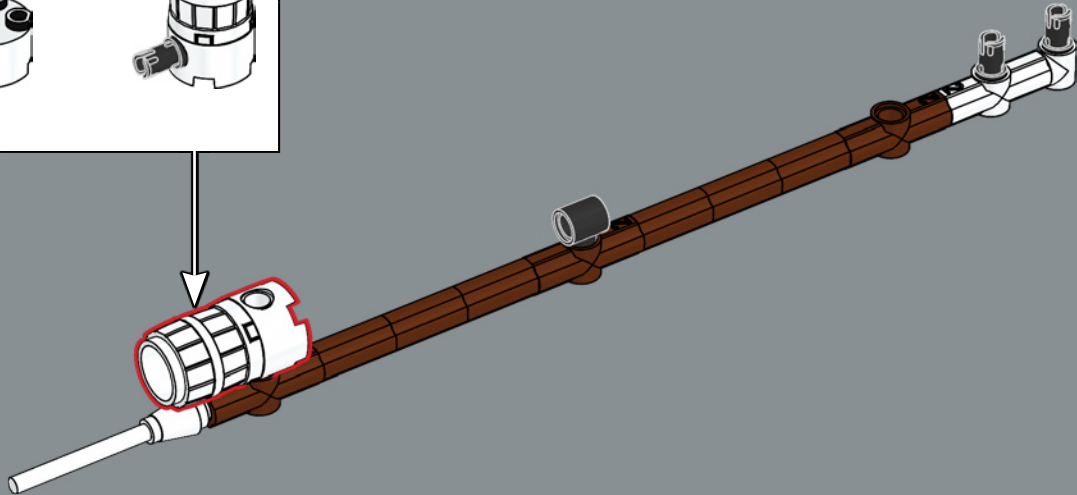
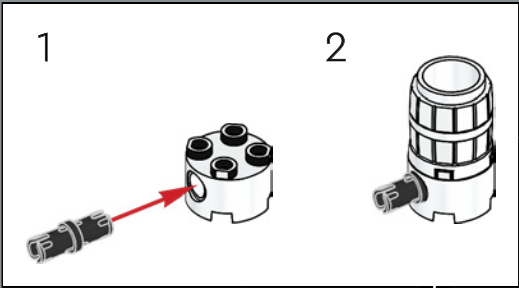



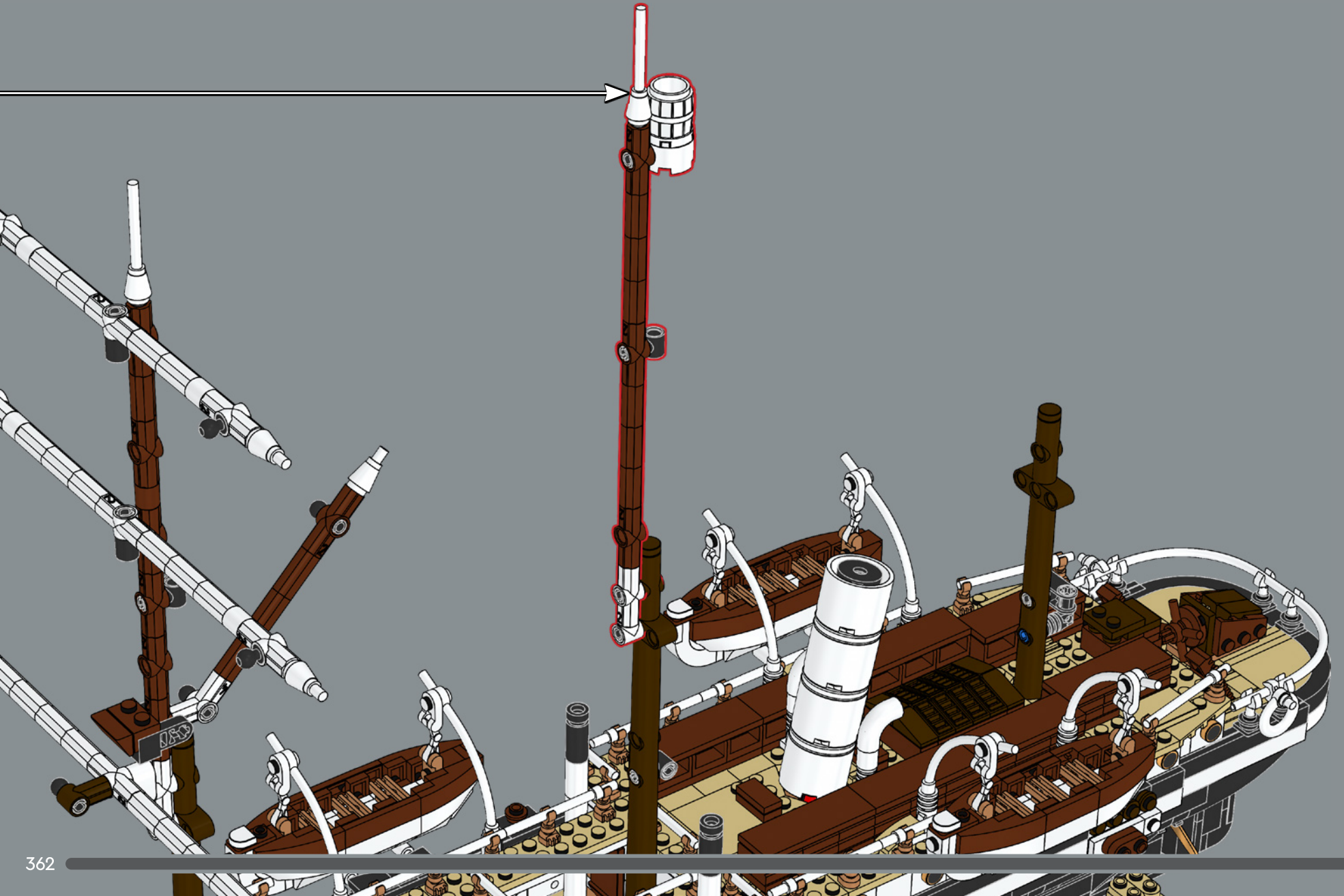

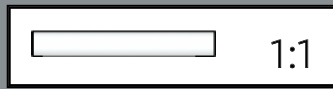
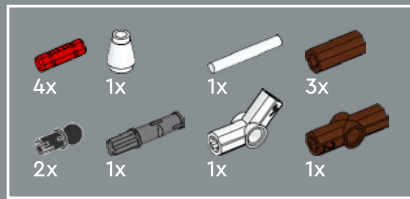

635

1

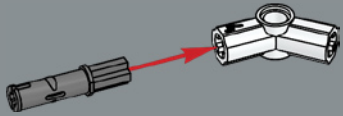

2

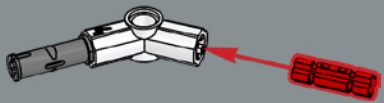

3

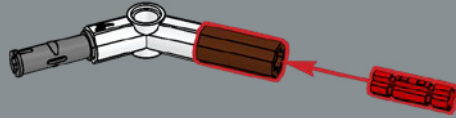

4



5

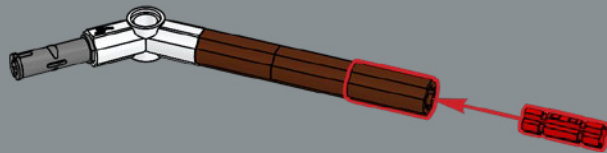

6

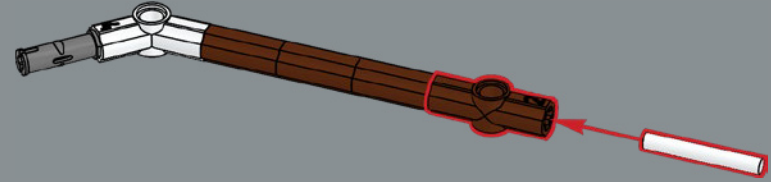

7

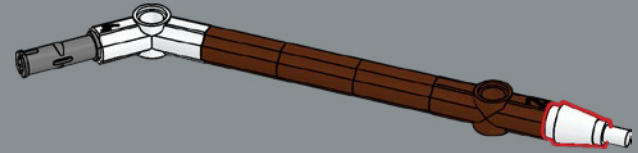

8

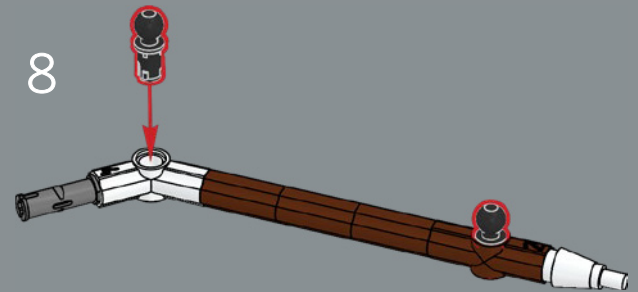







636

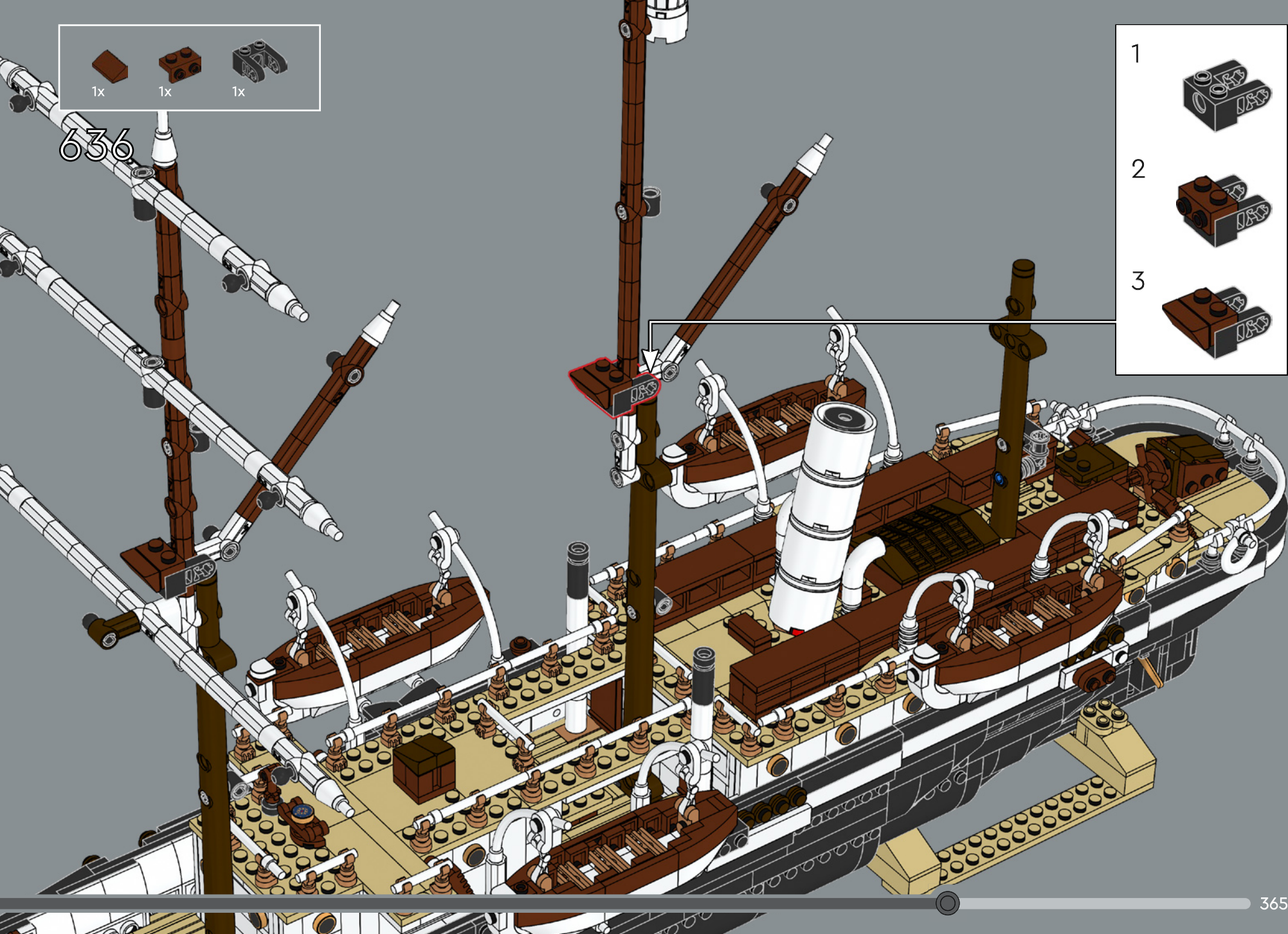
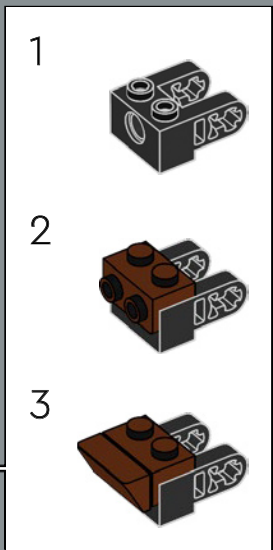

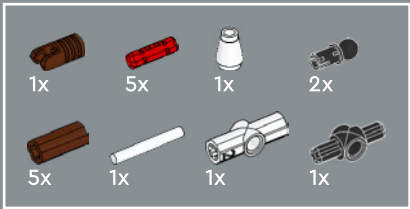

637

1

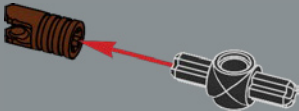

2

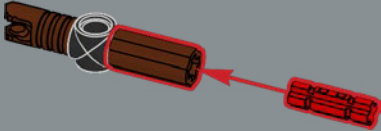

3

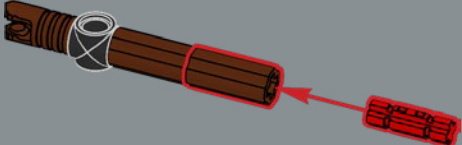

4

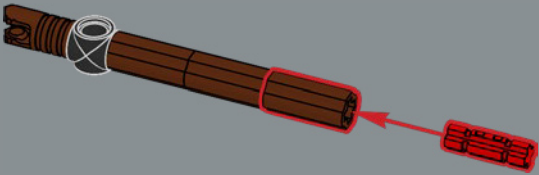

5

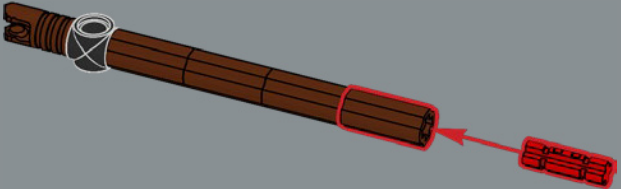

6

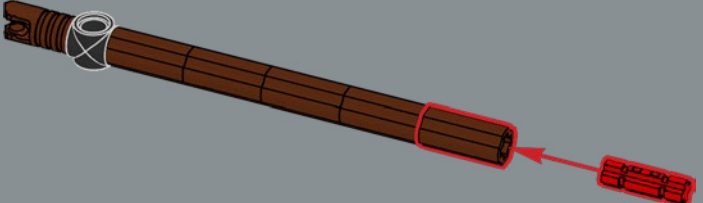



7

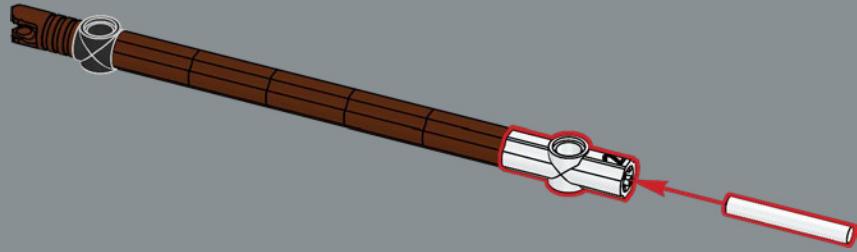

8

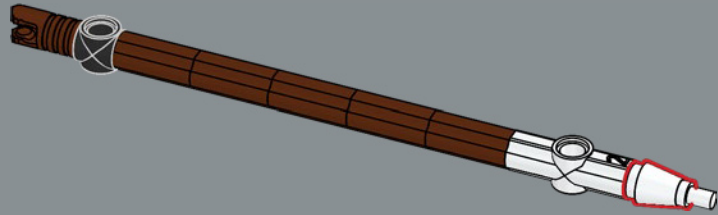

9

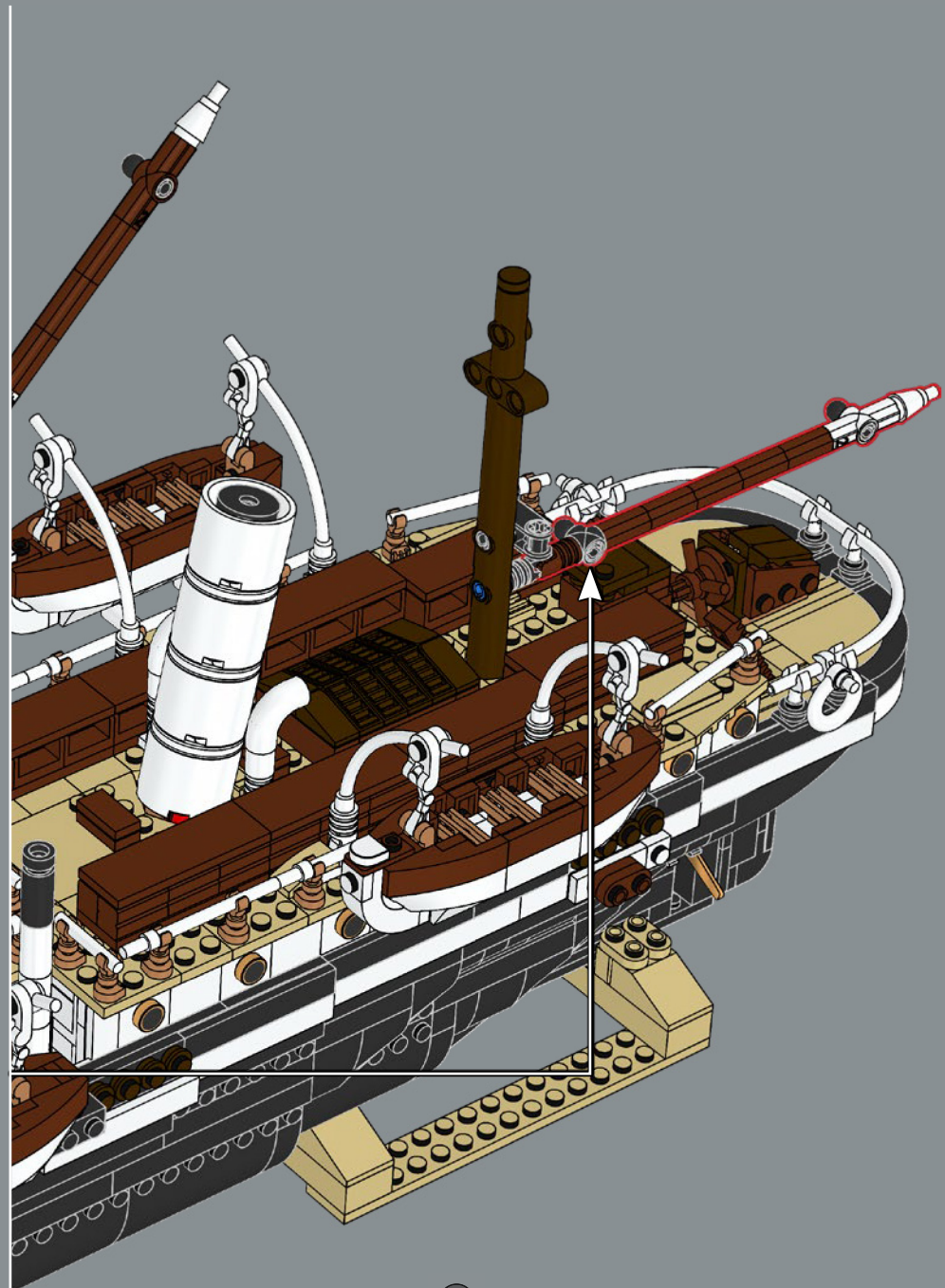
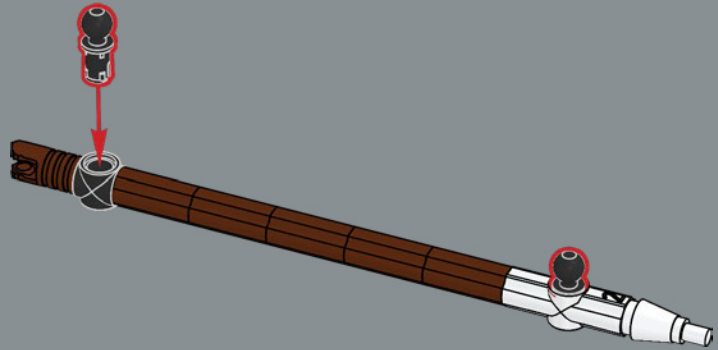



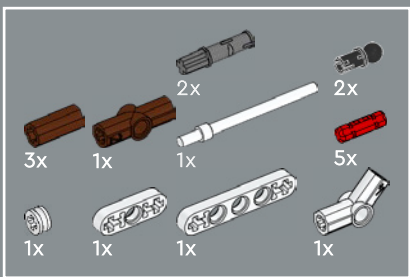

638

1

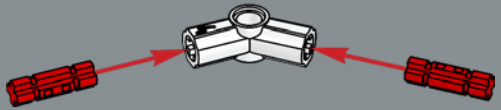

2

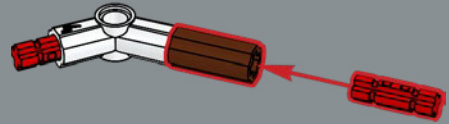

3

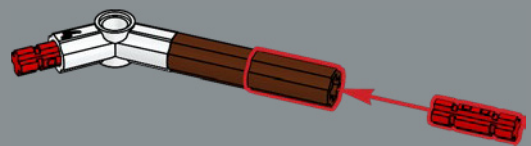

4

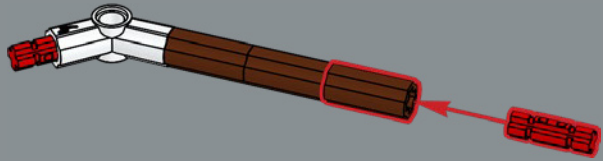

5

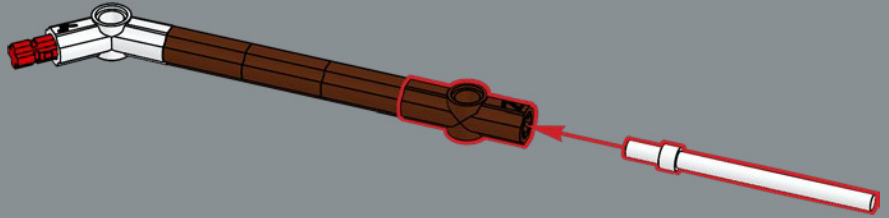

6

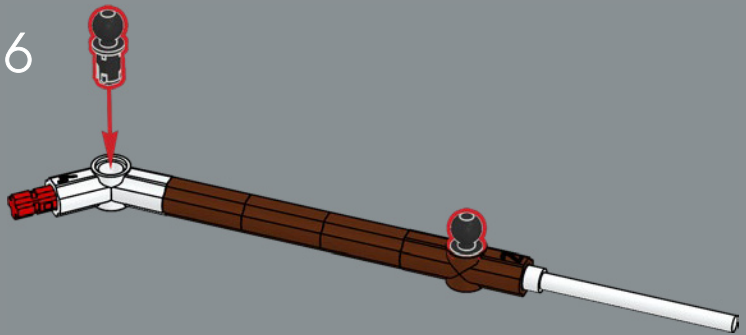

7

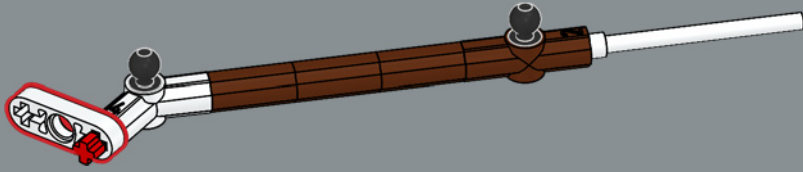

9

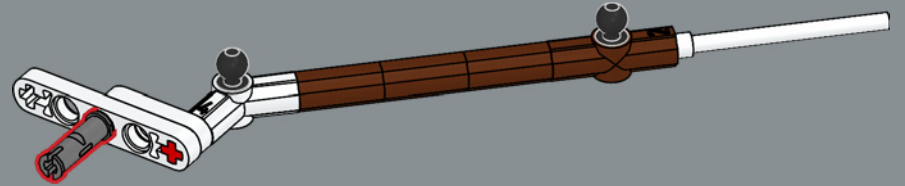

8

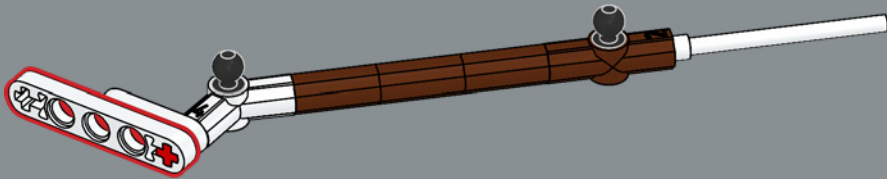

10

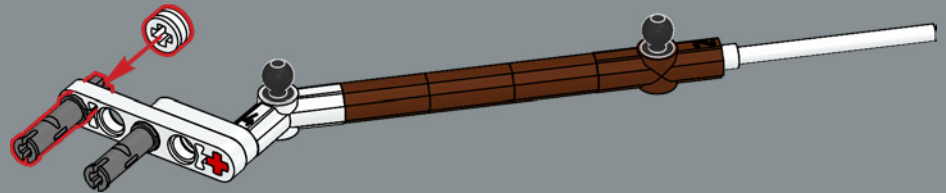

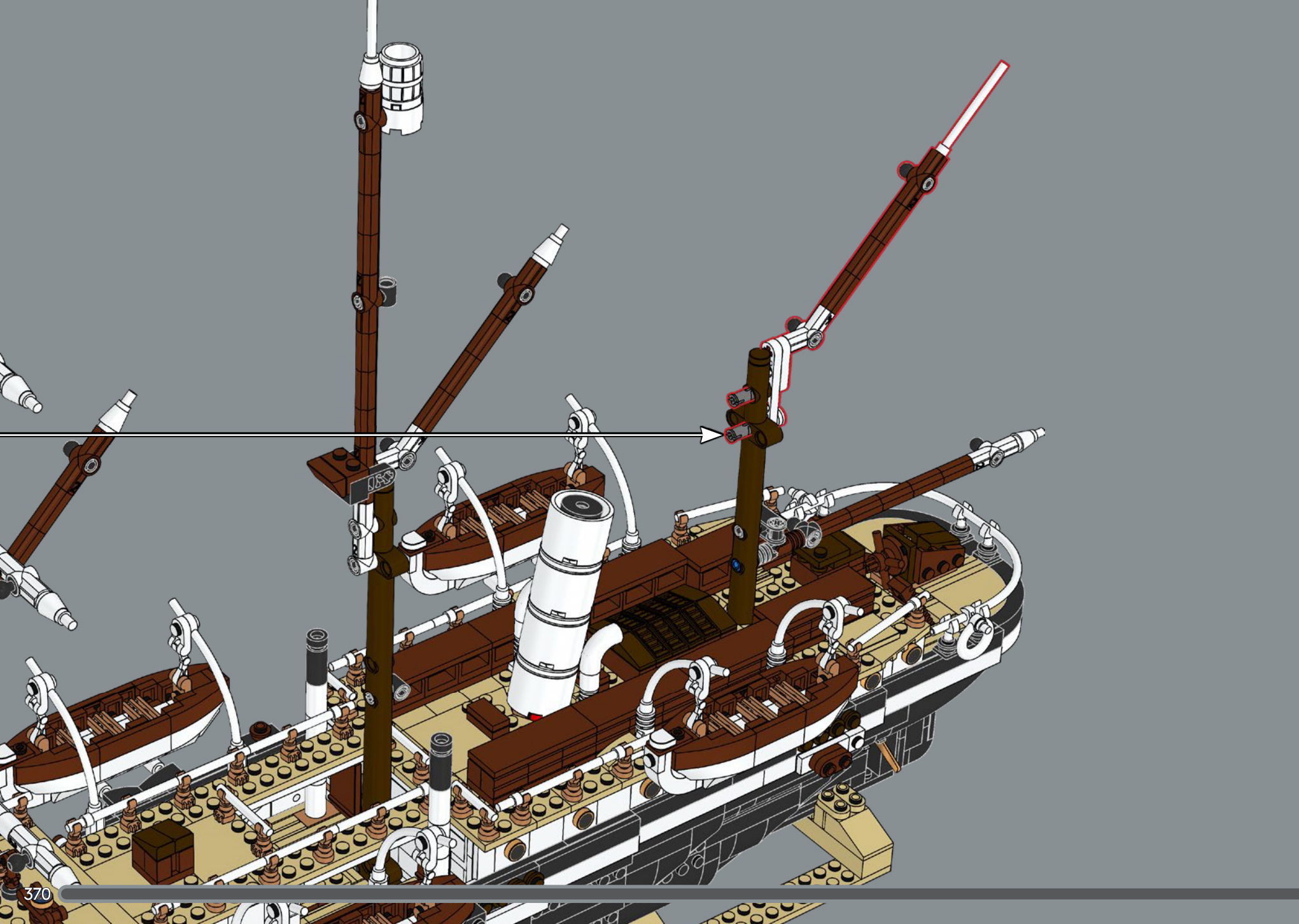



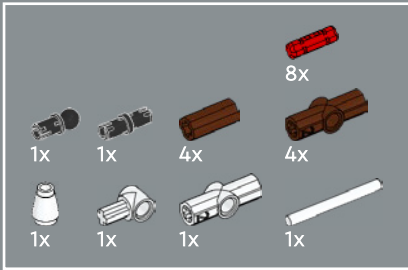
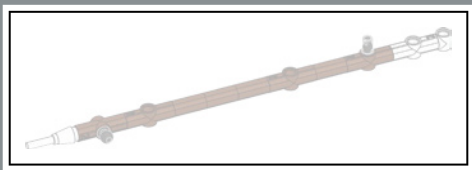

639

1

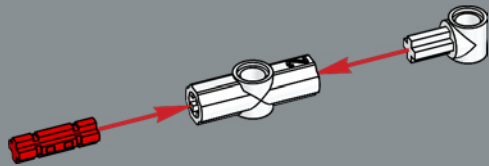

2

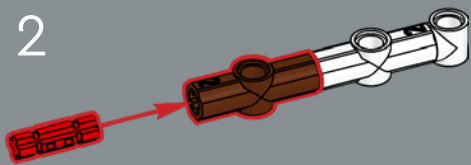

3

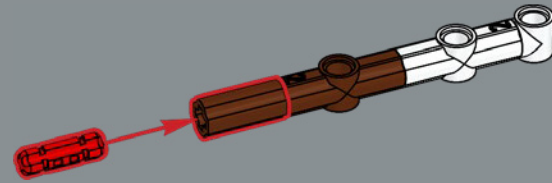

4

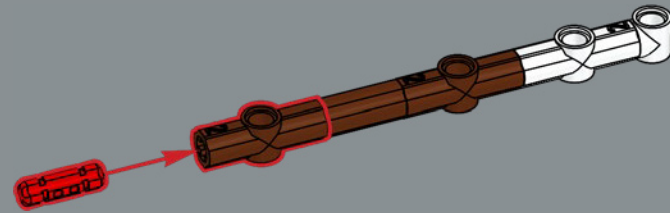

5

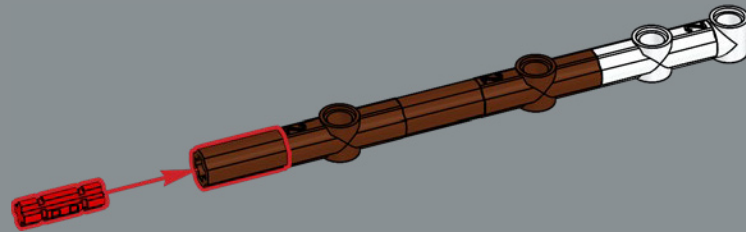

6

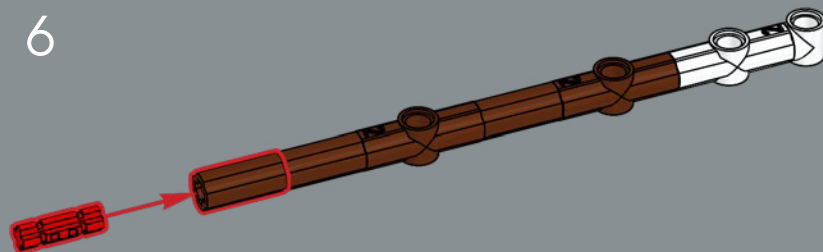

7

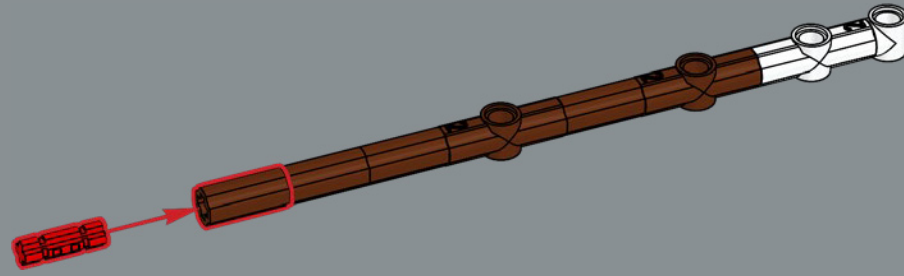

8

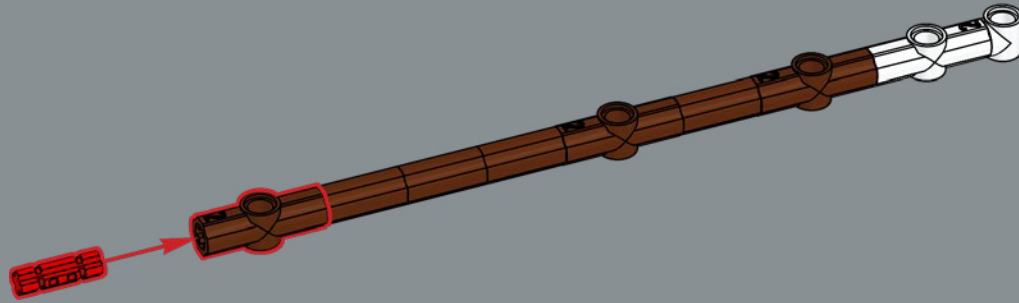

9

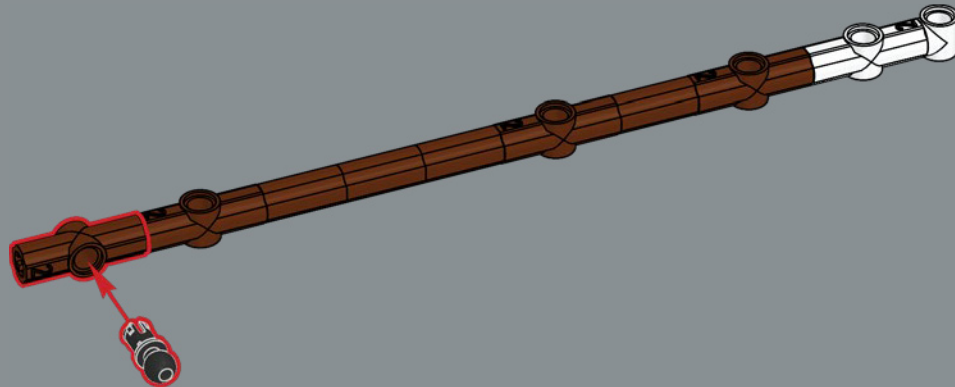

10

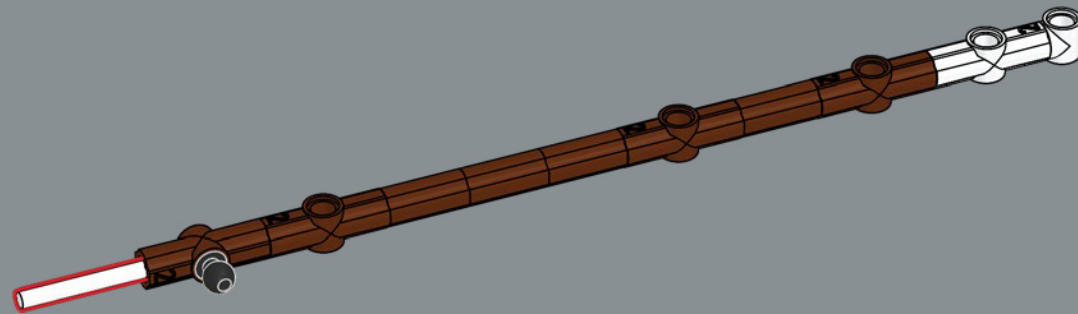

11

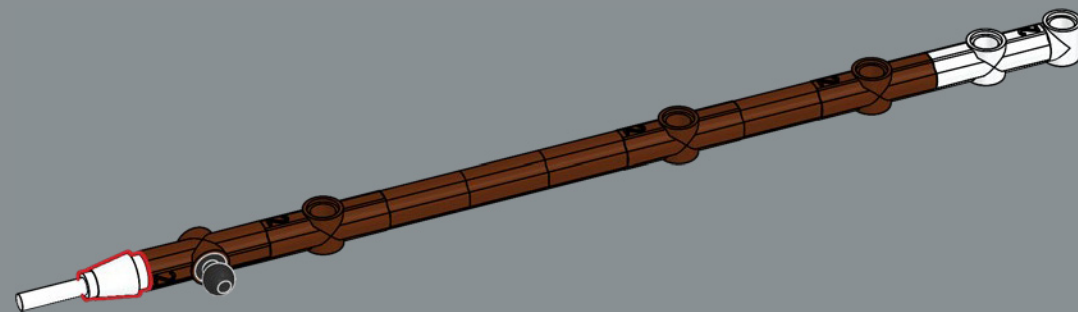

12

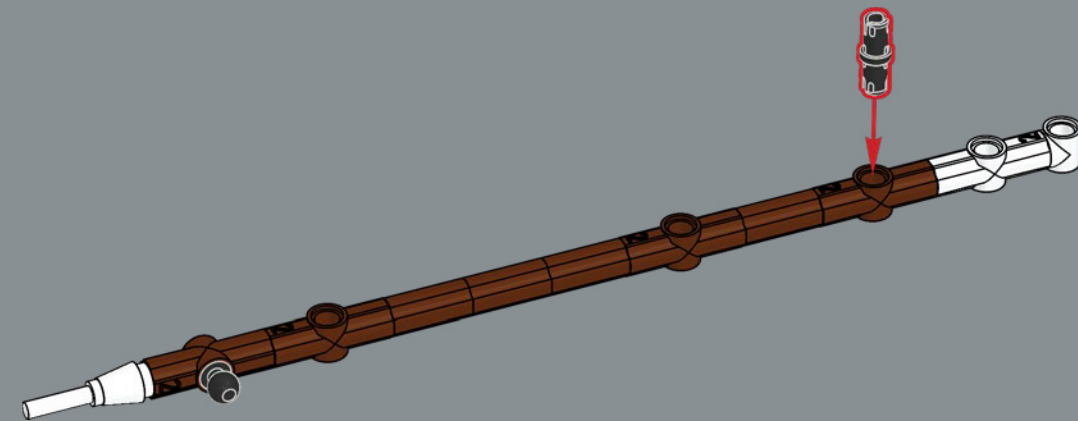







640

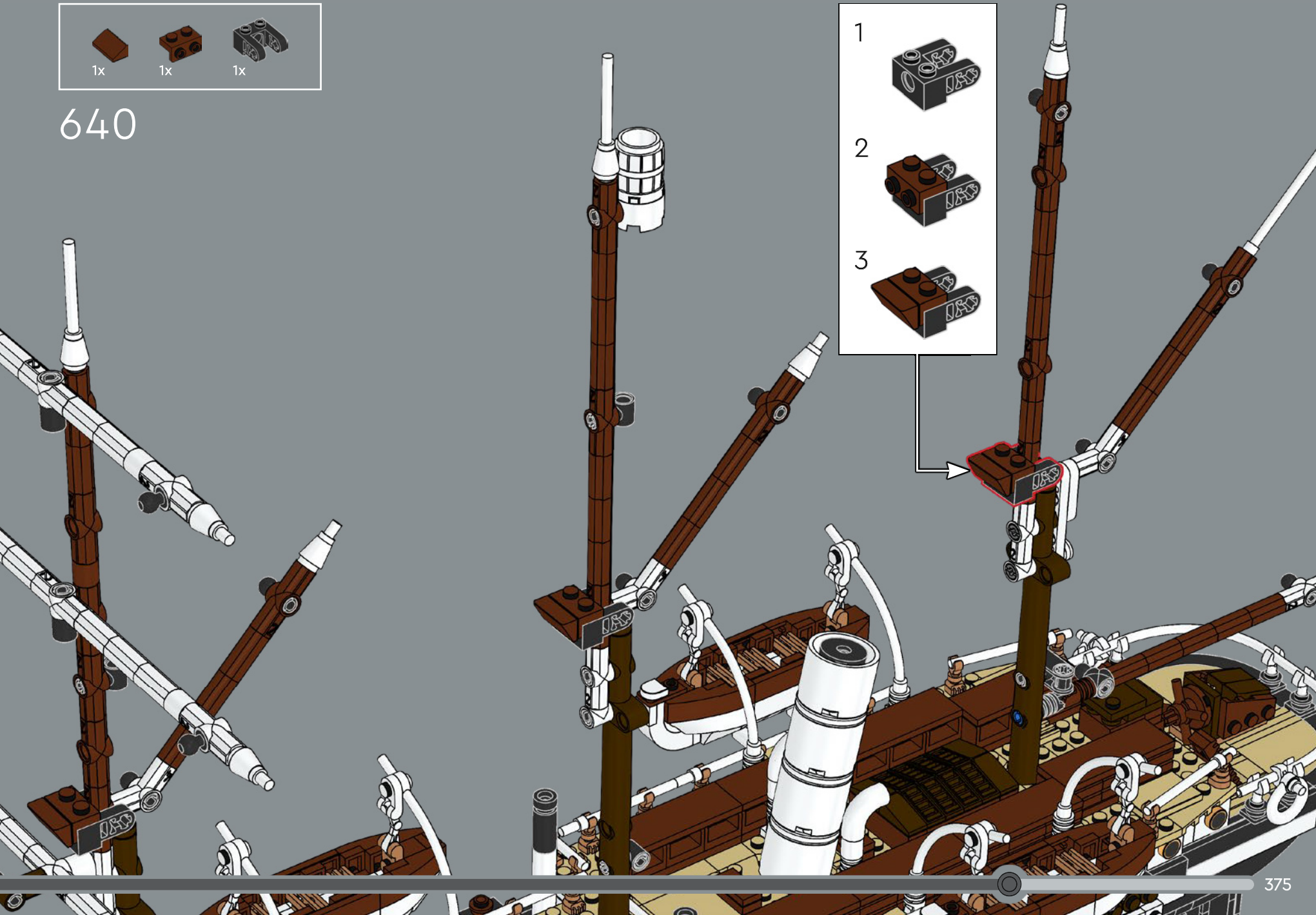
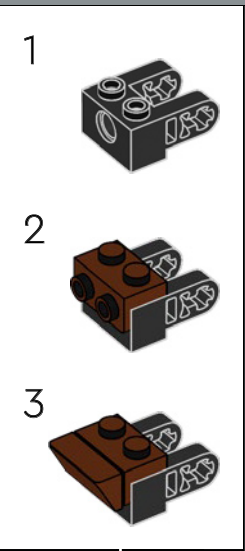

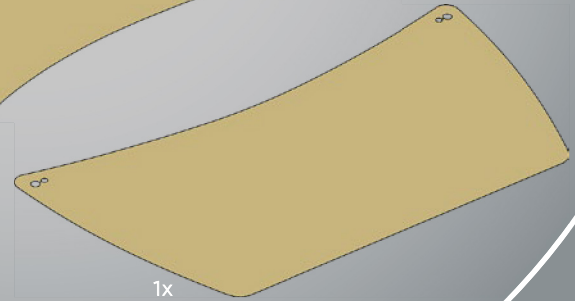
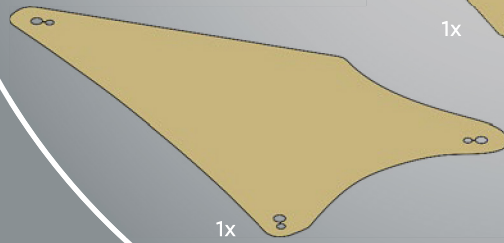
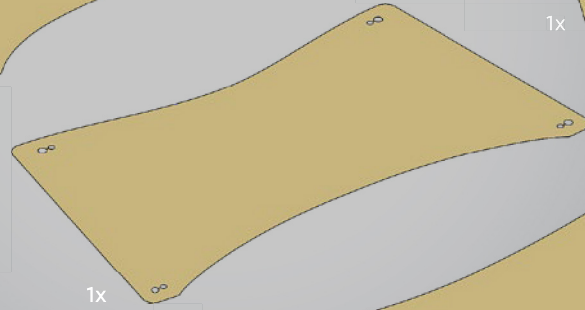
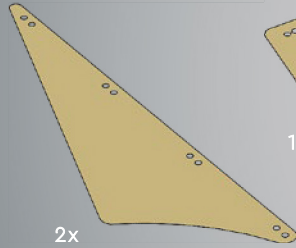
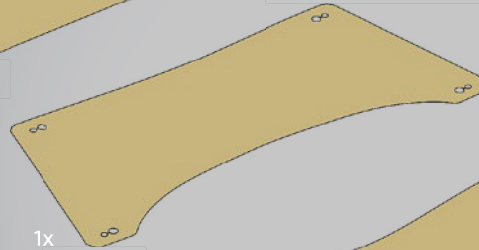
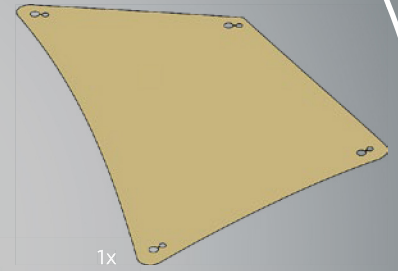
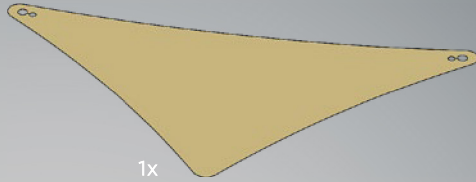
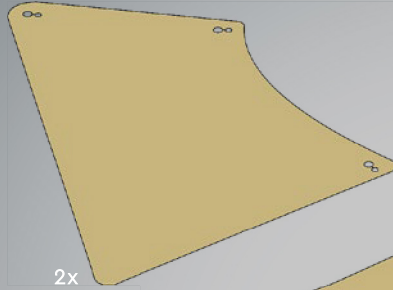
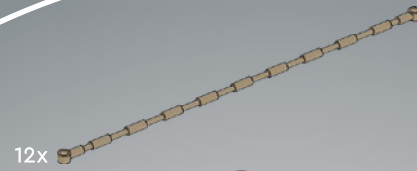
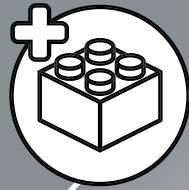





641

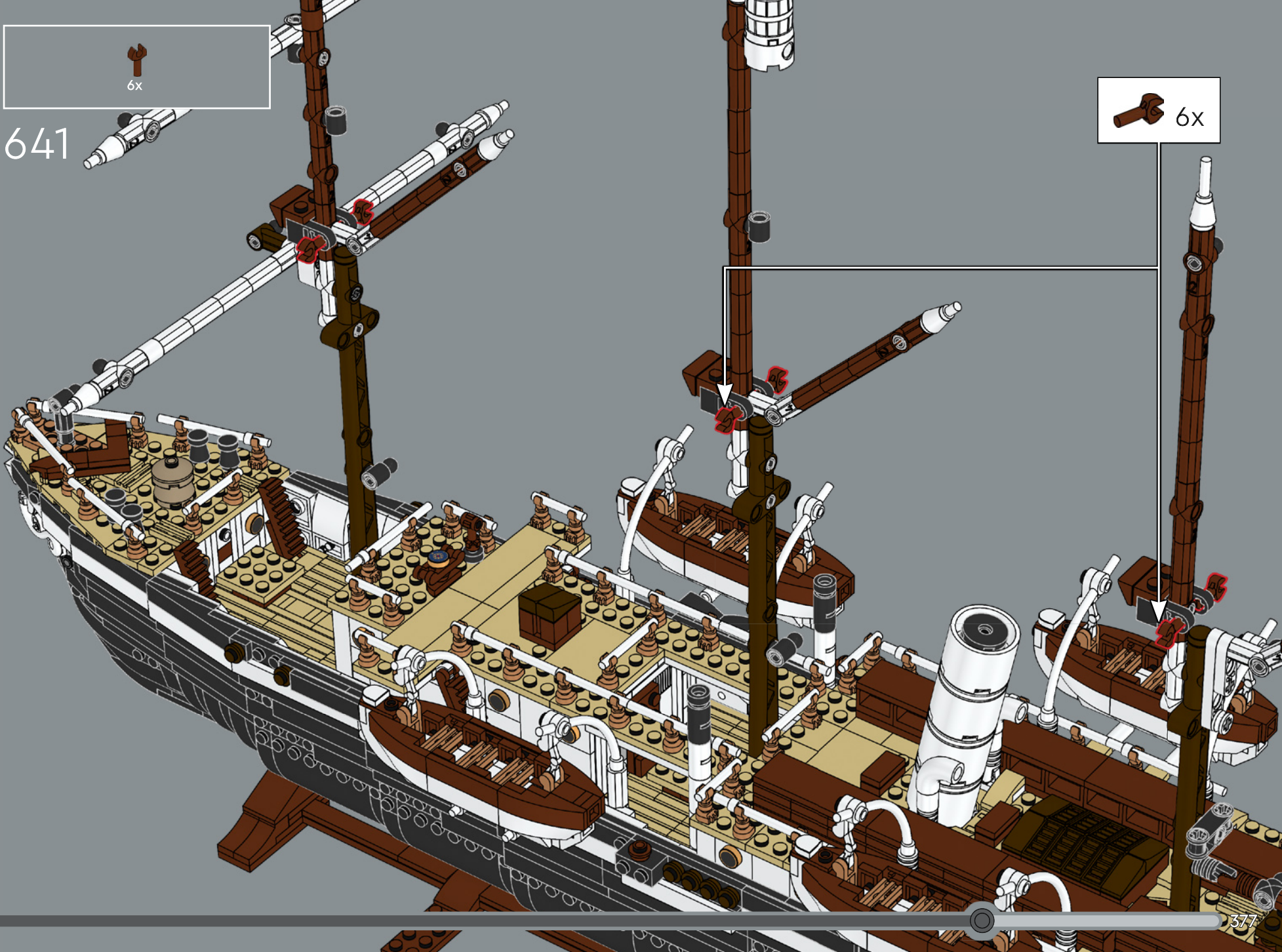
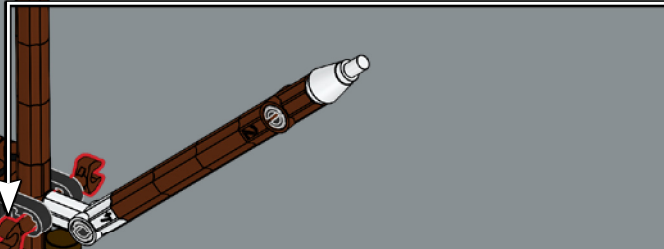

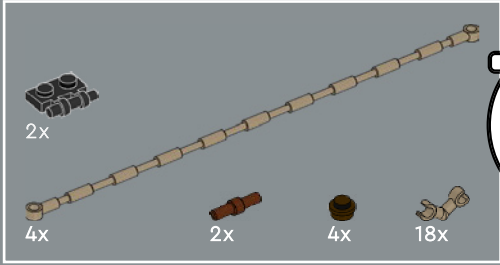
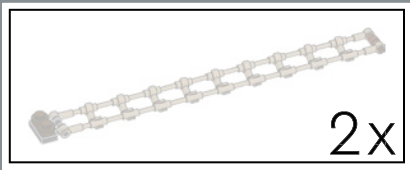

642

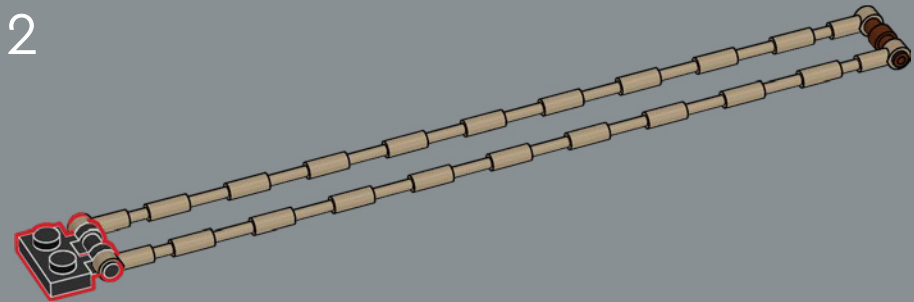
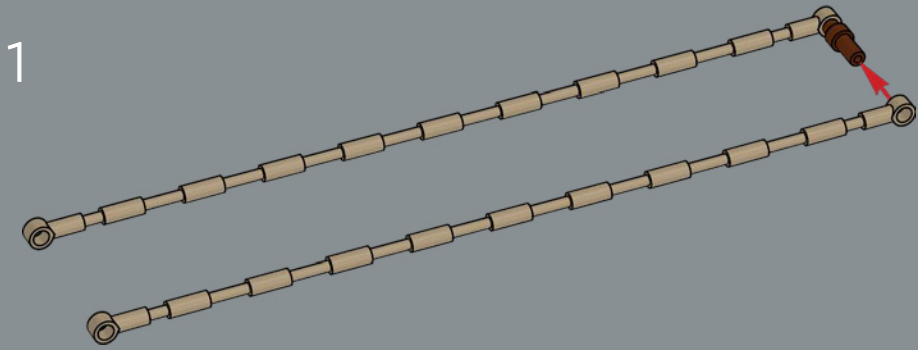

3

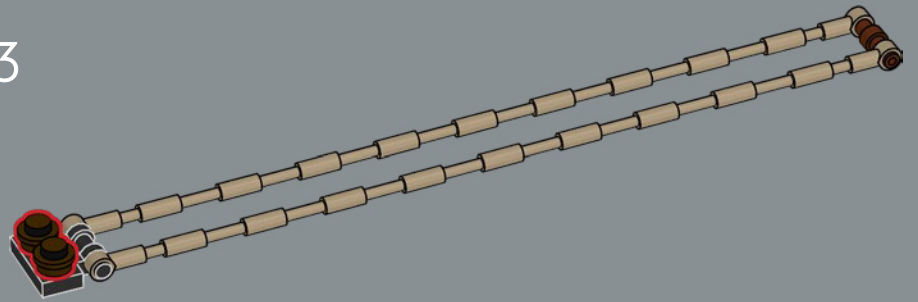

4

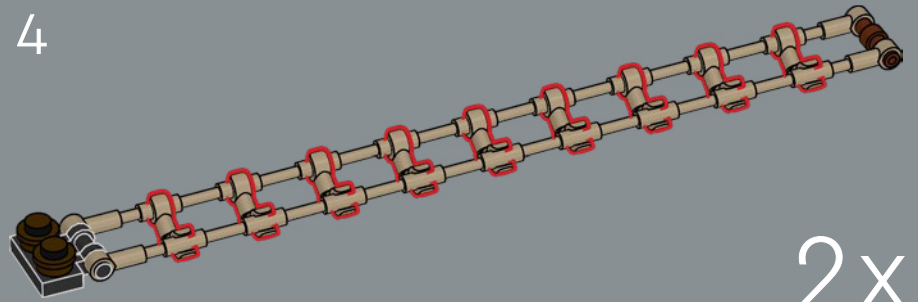





Die Fallreeps wurden in Mittelbraun gefertigt, um das Material von der dunklen Holzkonstruktion des übrigen Schiffs abzusetzen.

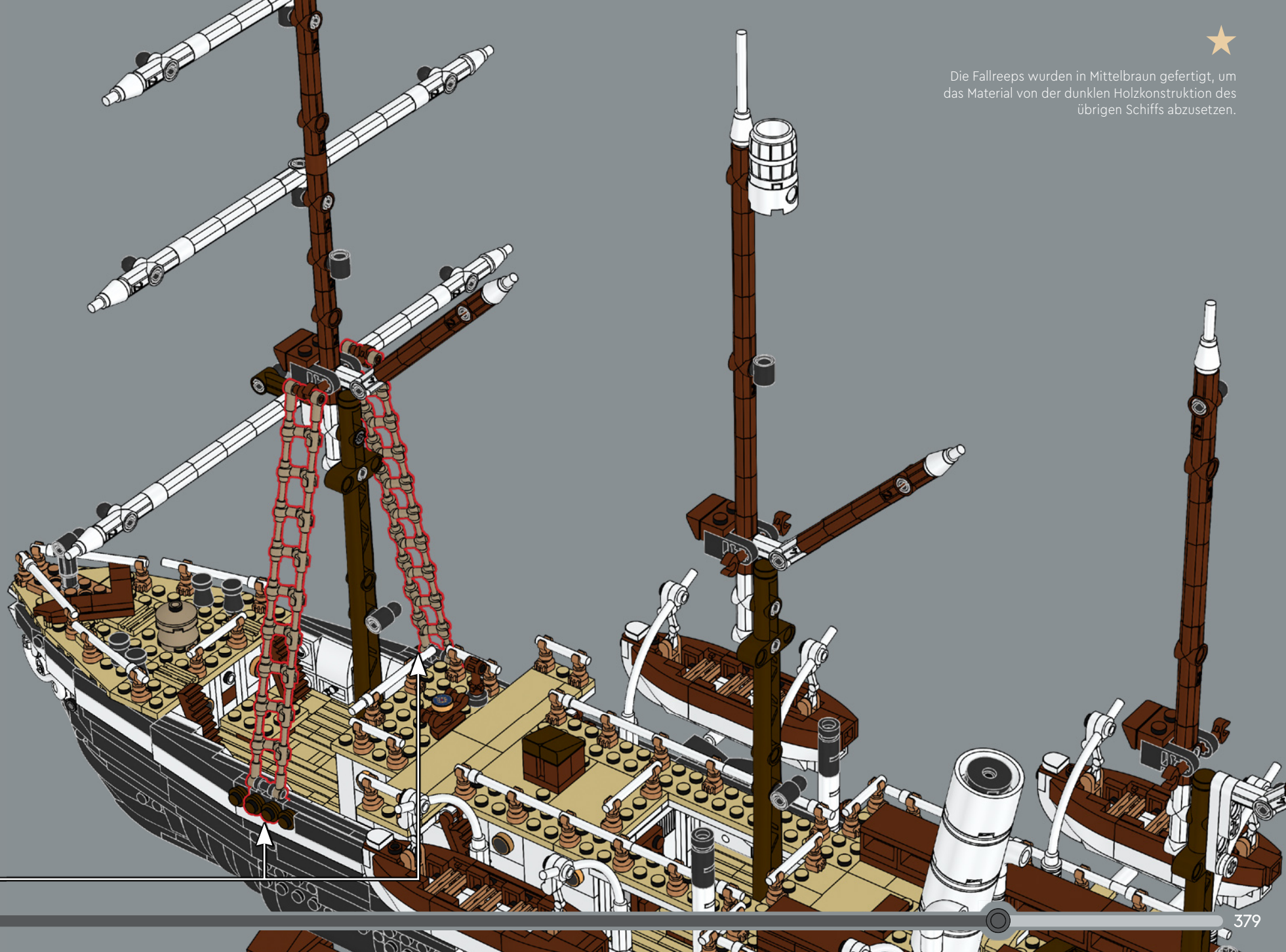



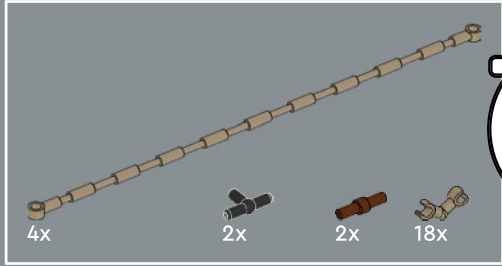
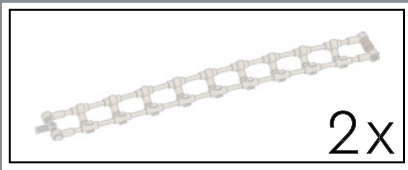

643

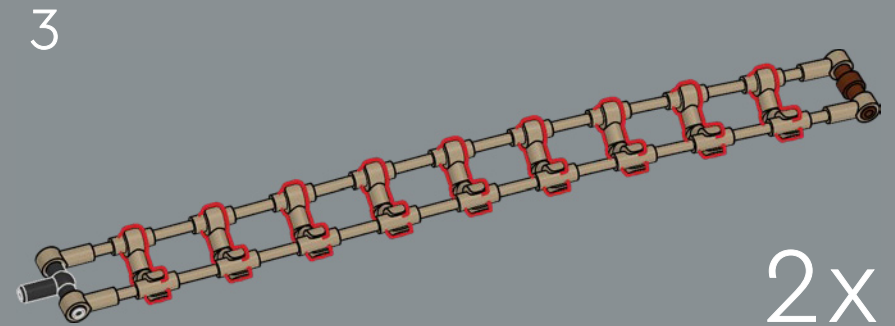
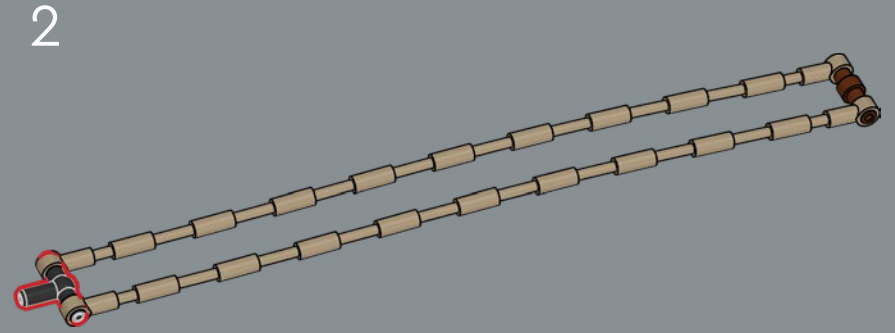
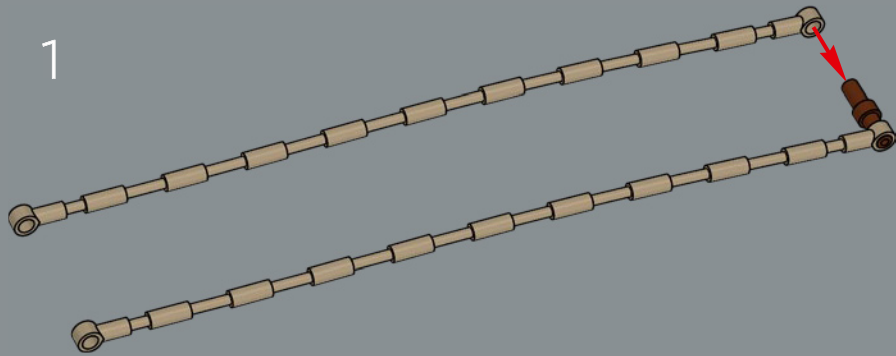

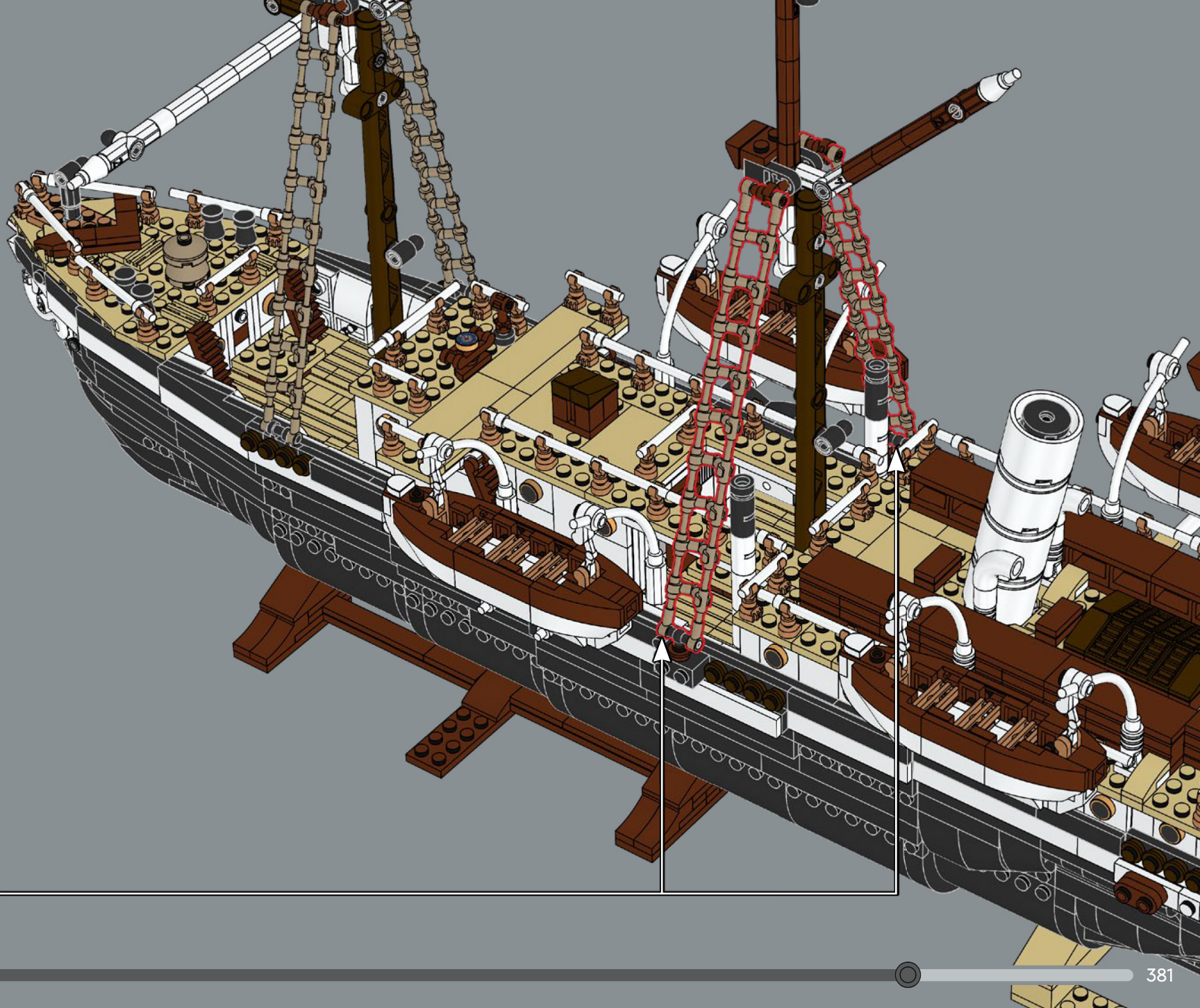

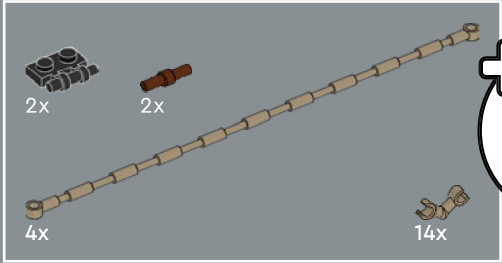
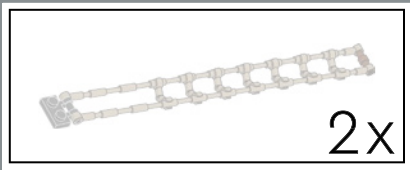

644

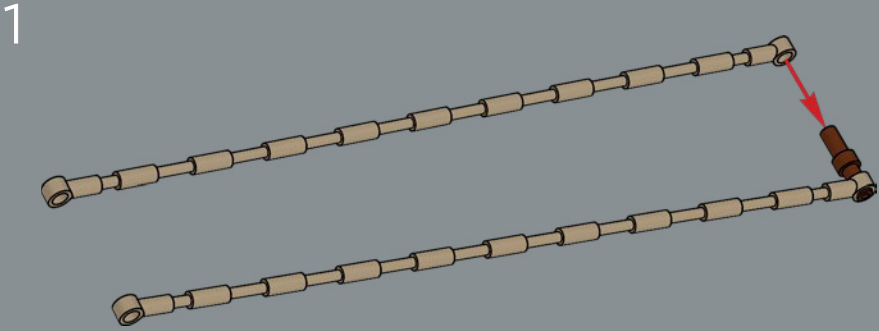

2

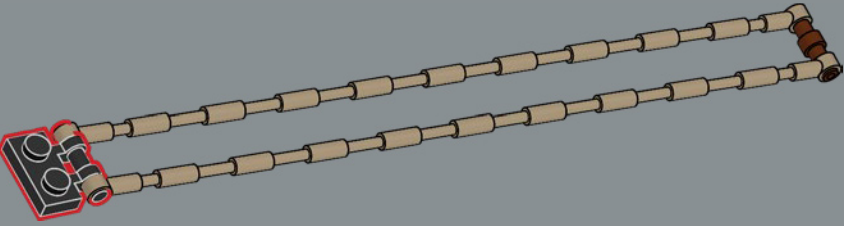

3

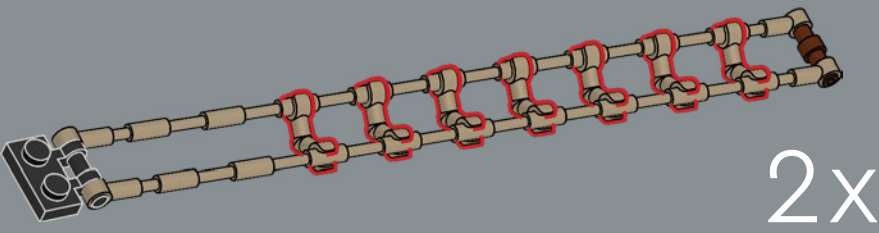



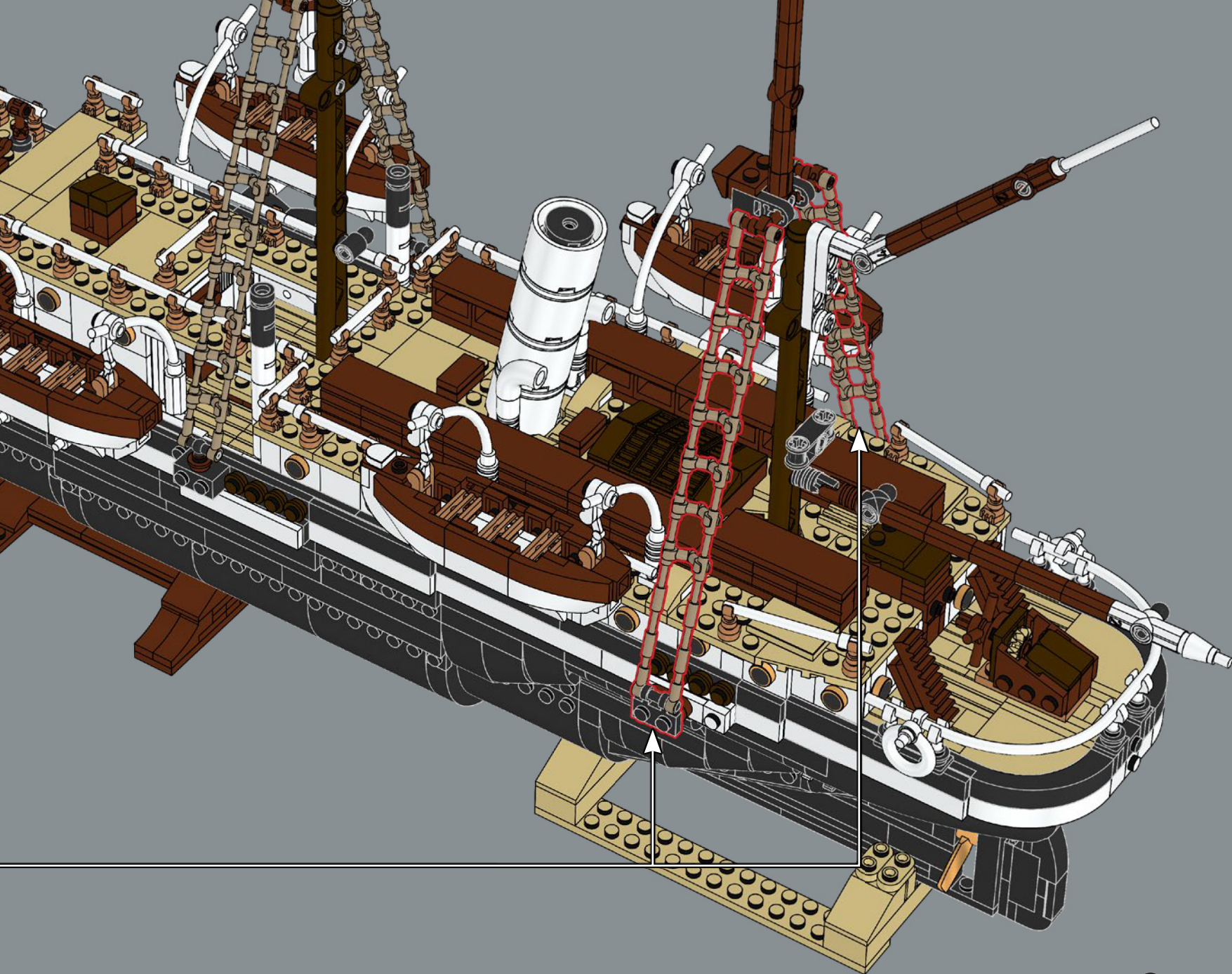



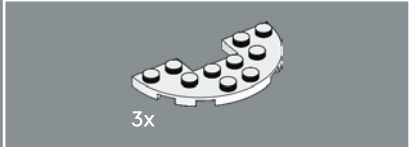

3x

645





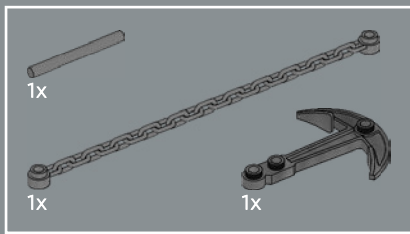

646

1

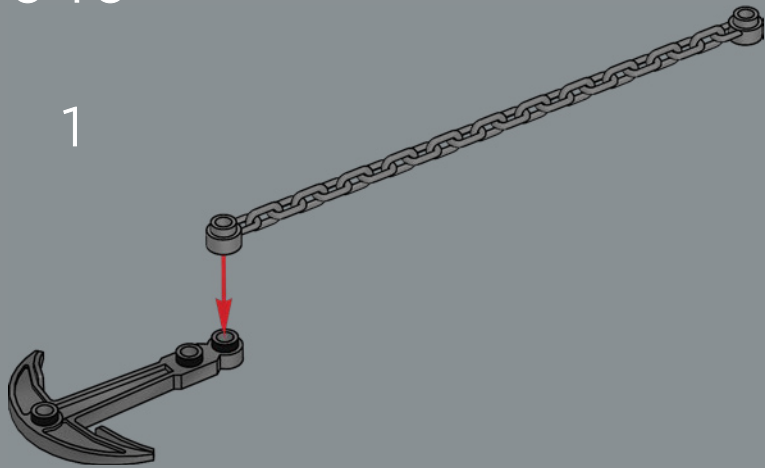

2

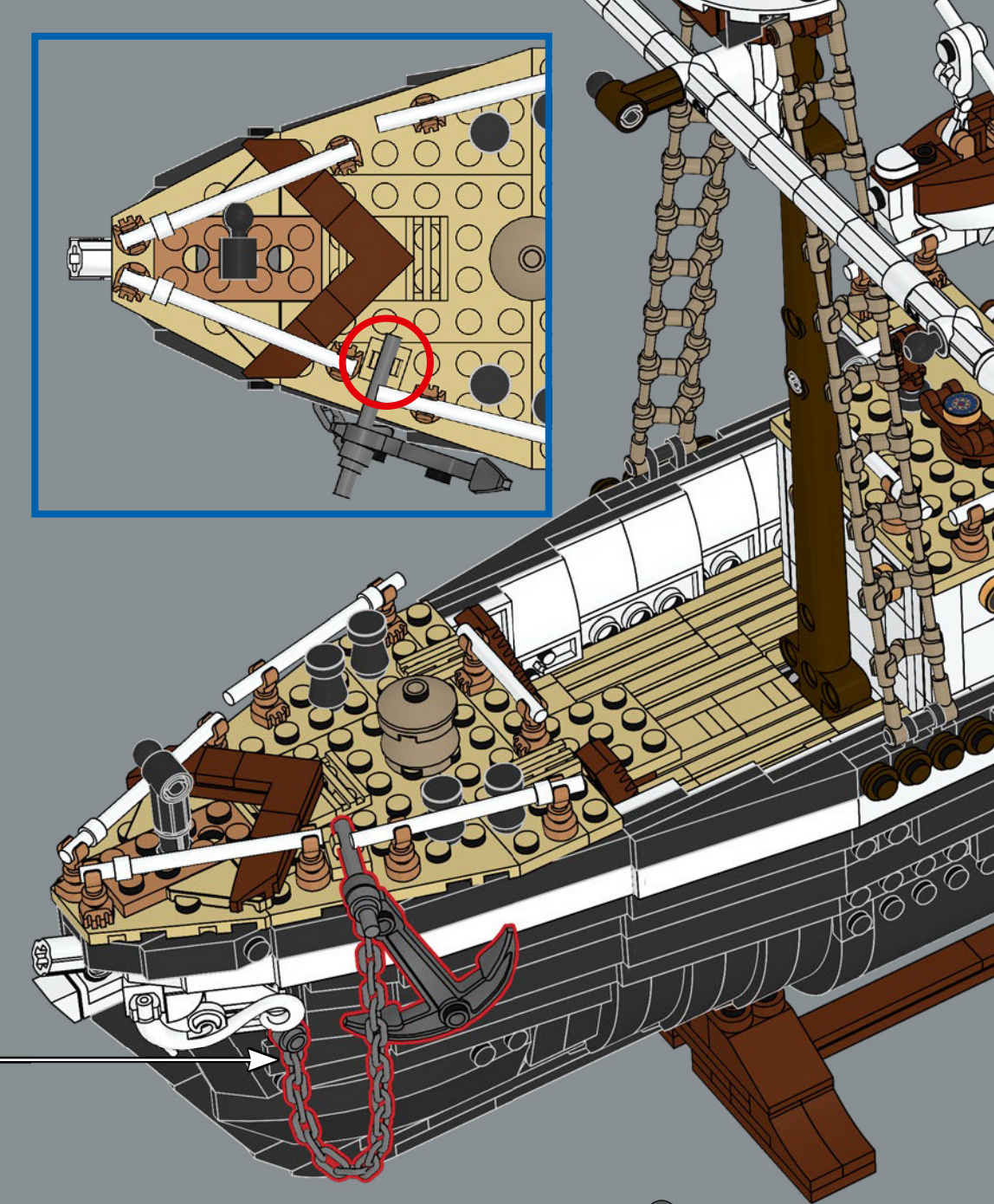
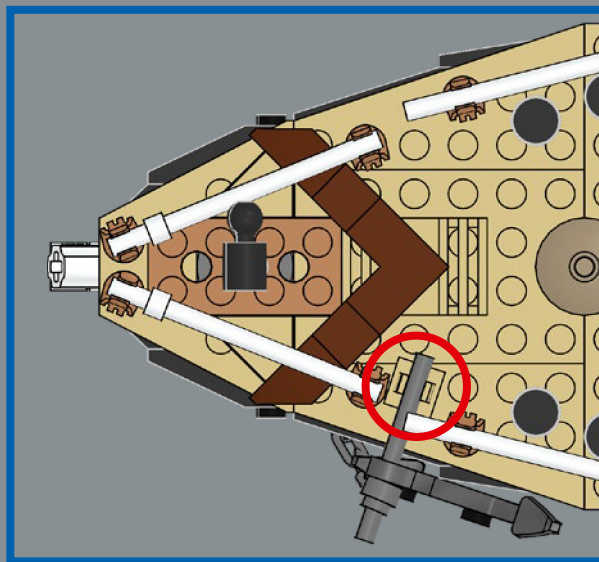
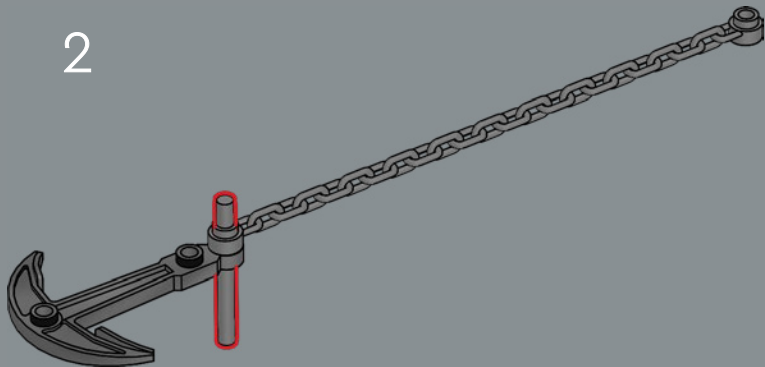



647

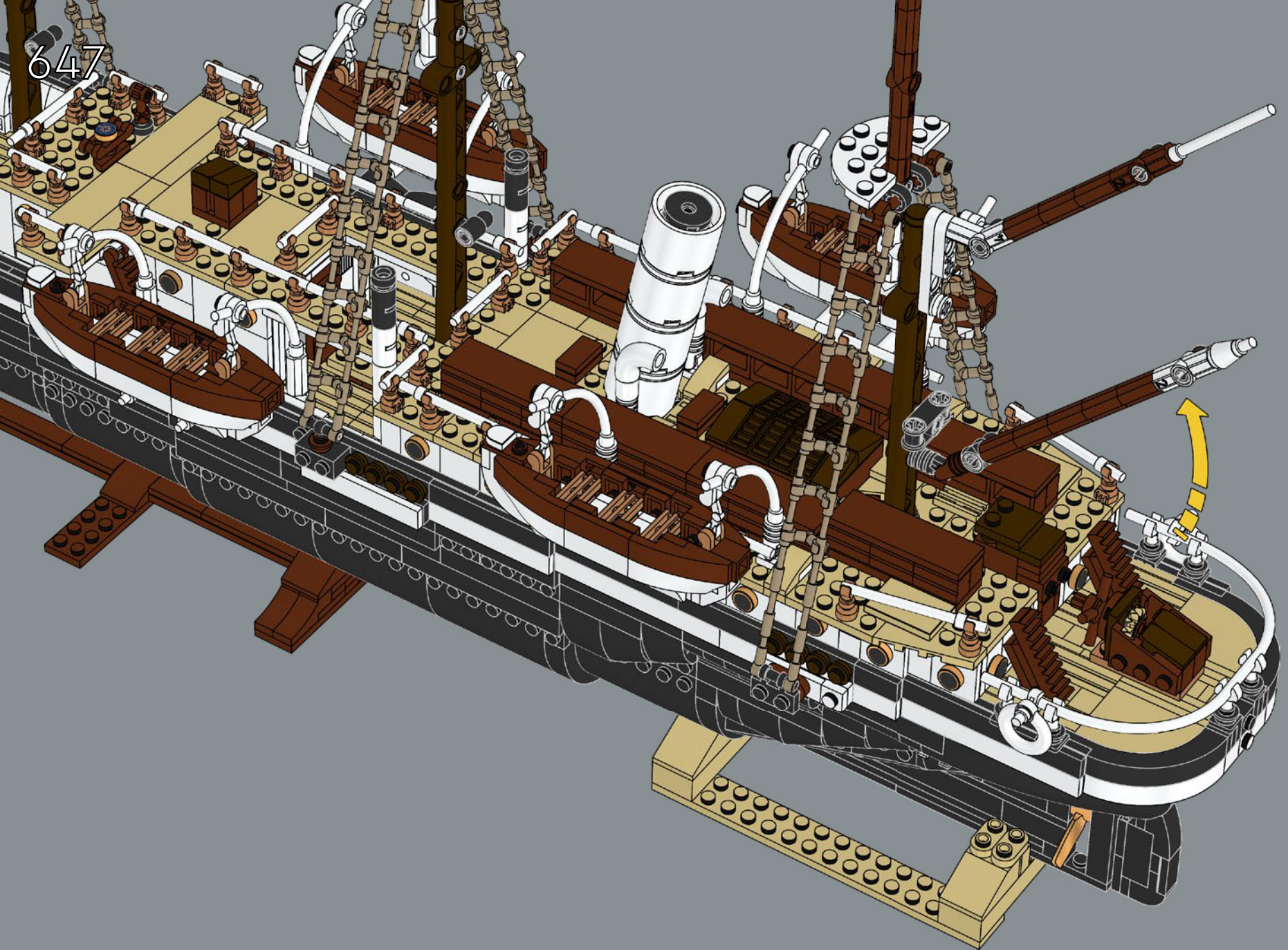



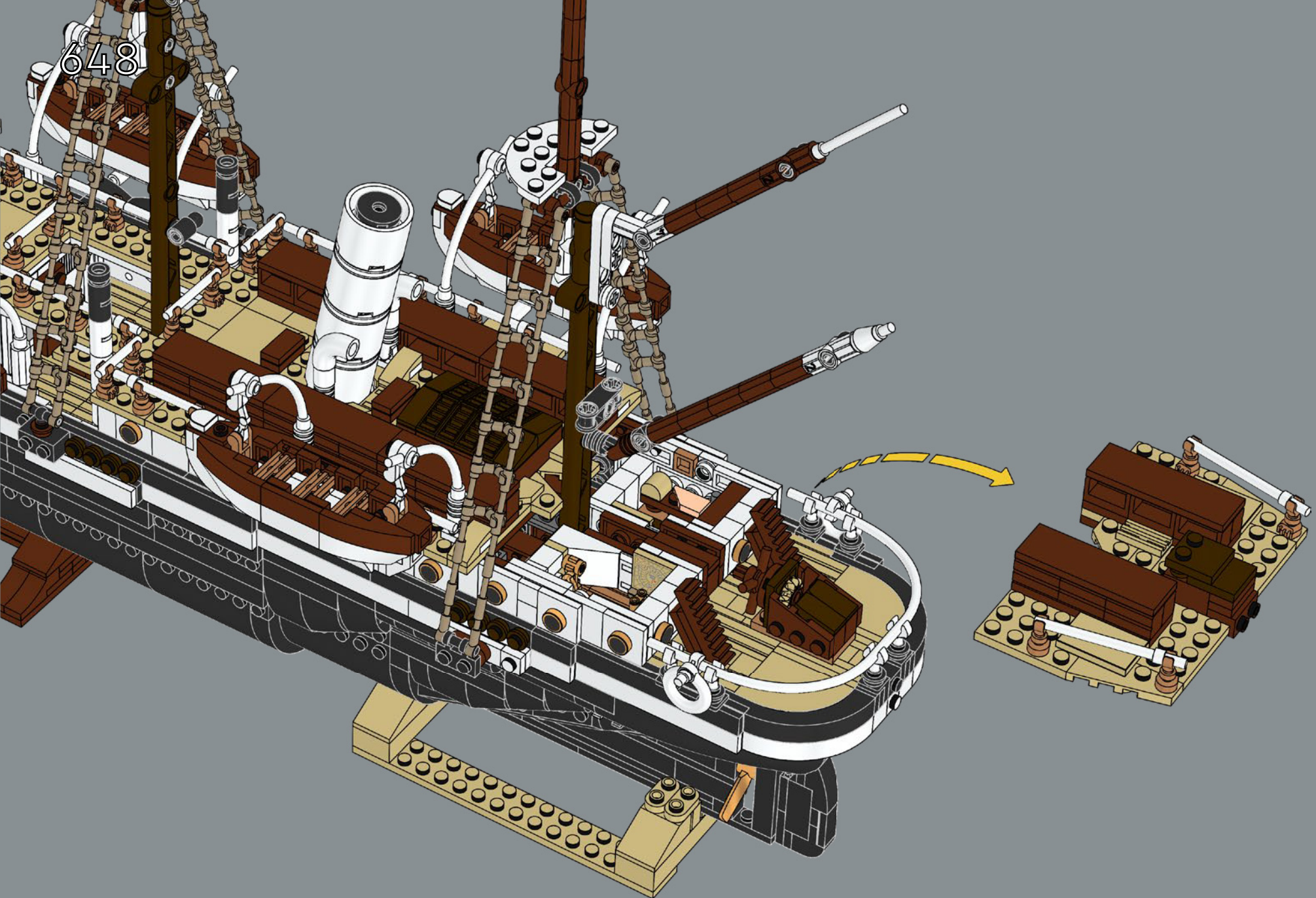

648



649

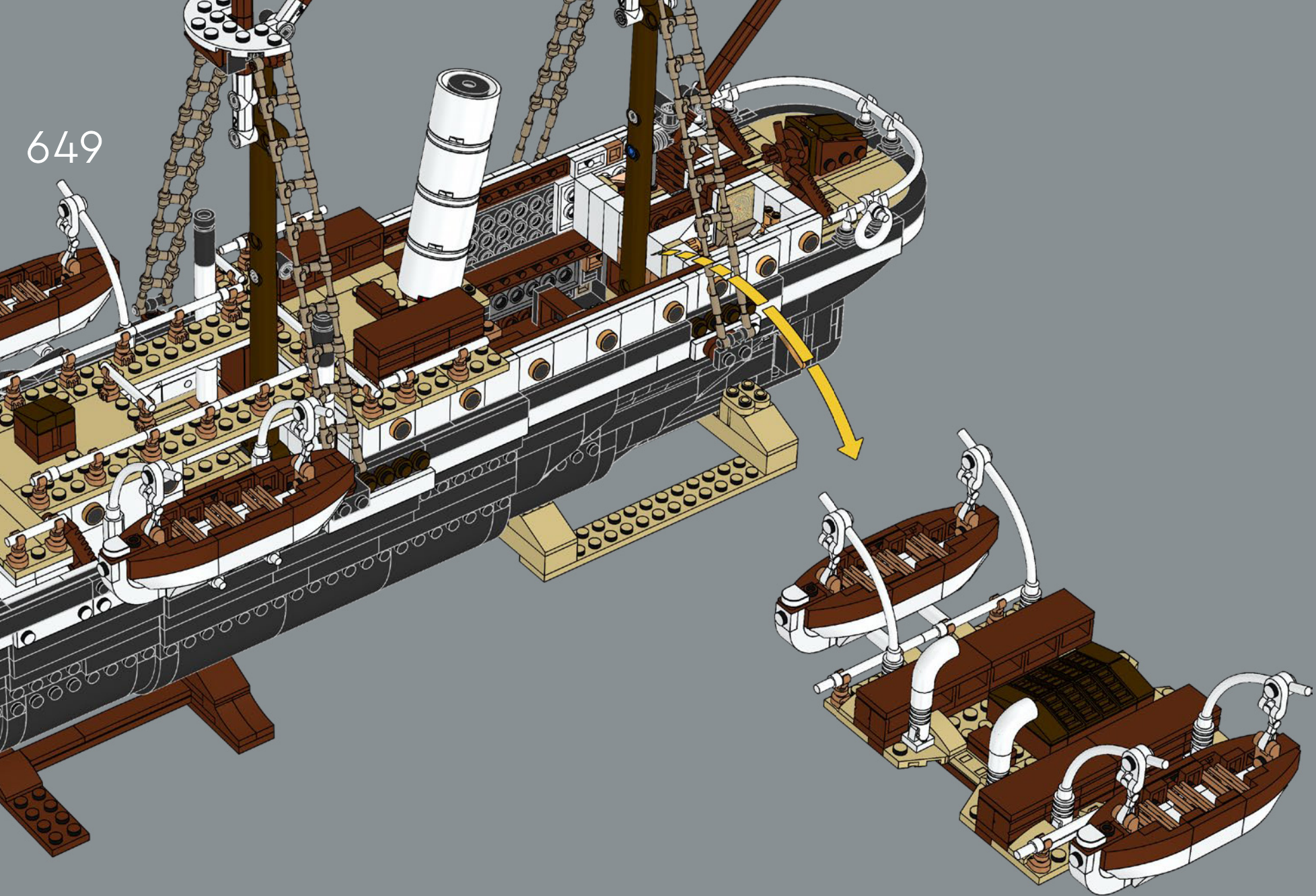



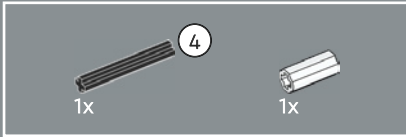
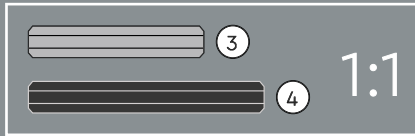
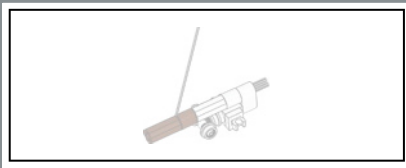

650

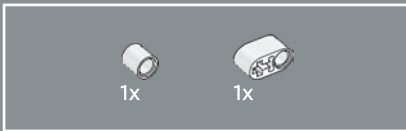
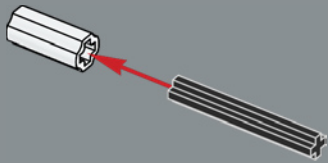

651

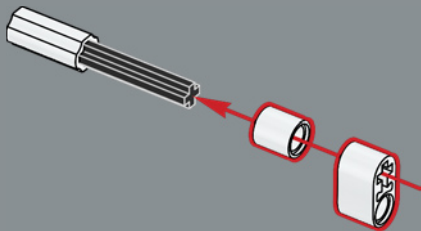

652

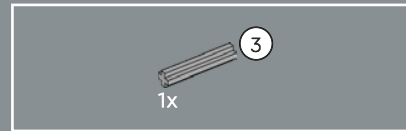
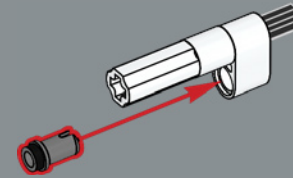

653

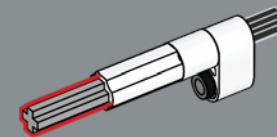

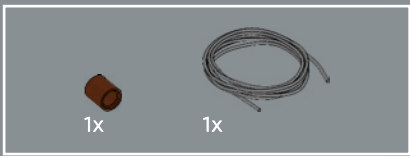

654

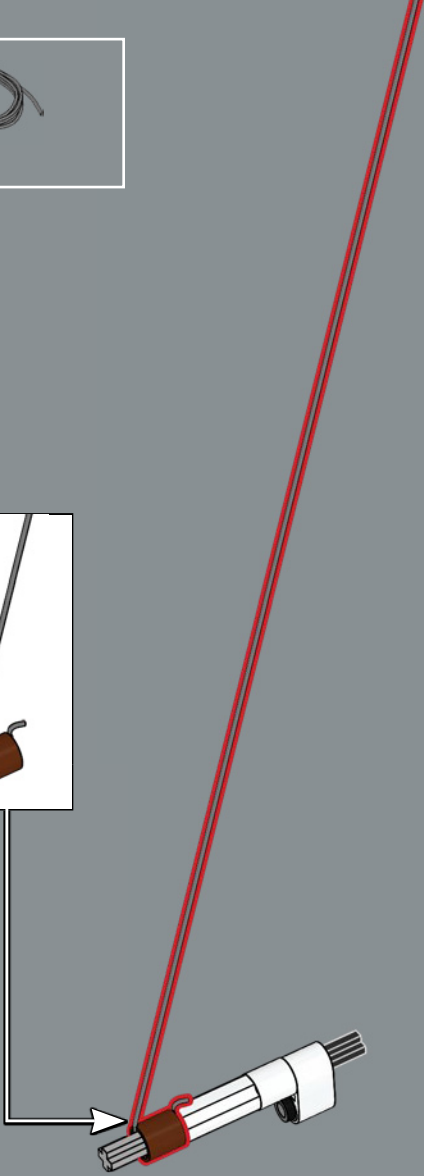
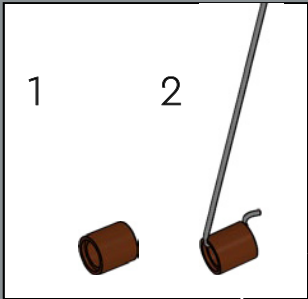

655

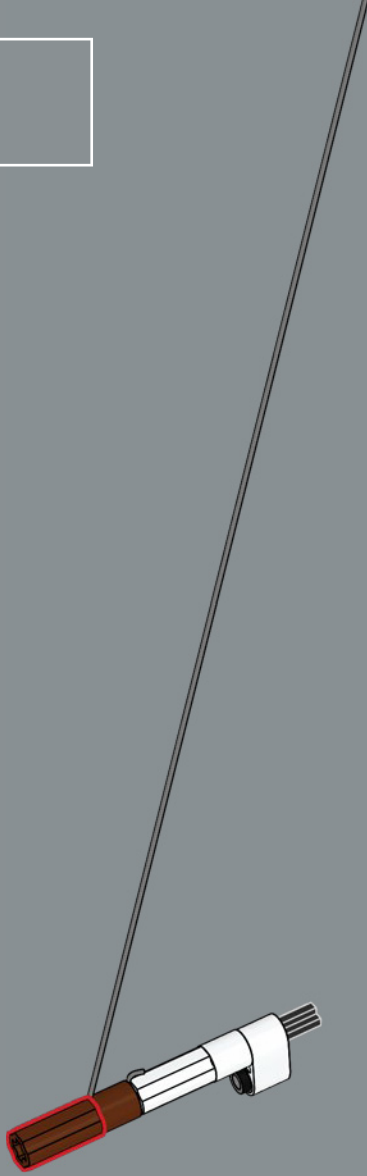

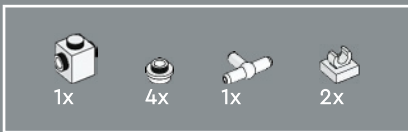

656

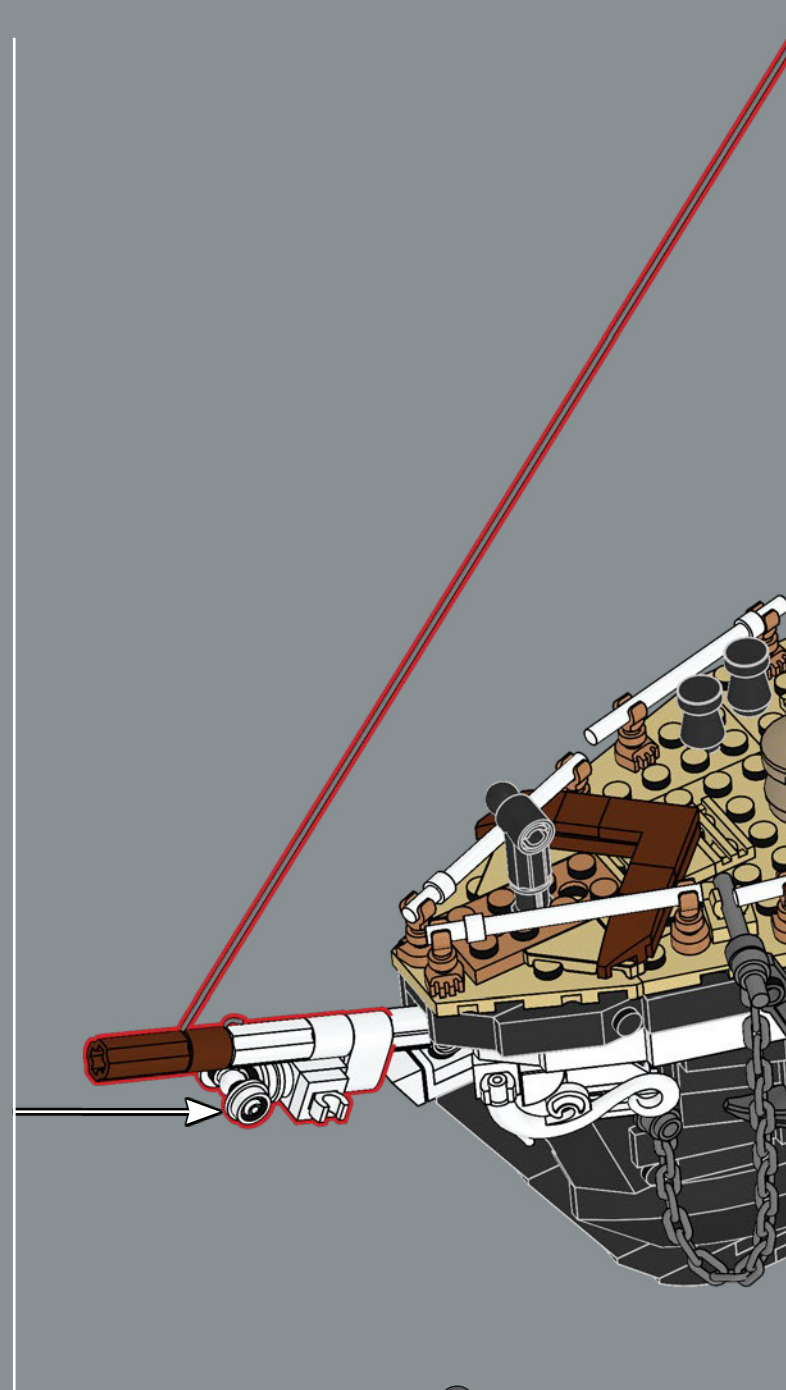
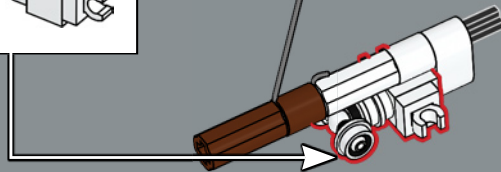
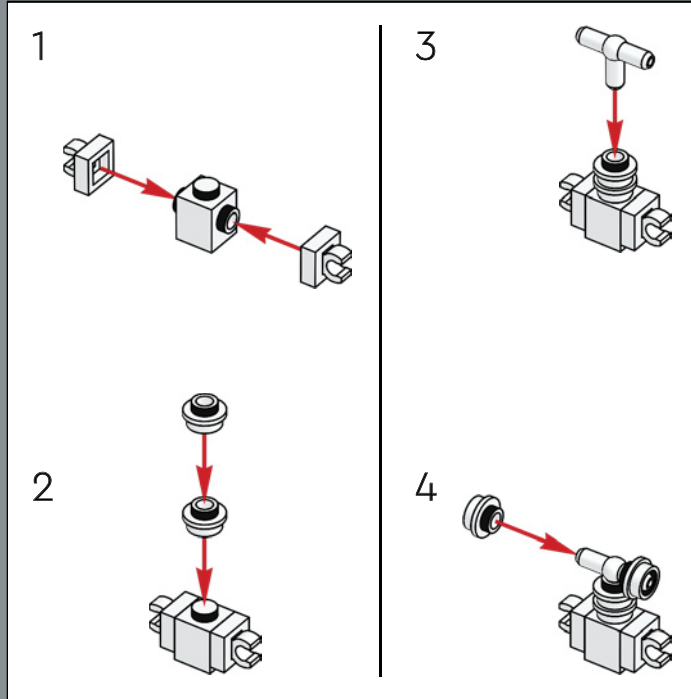





657

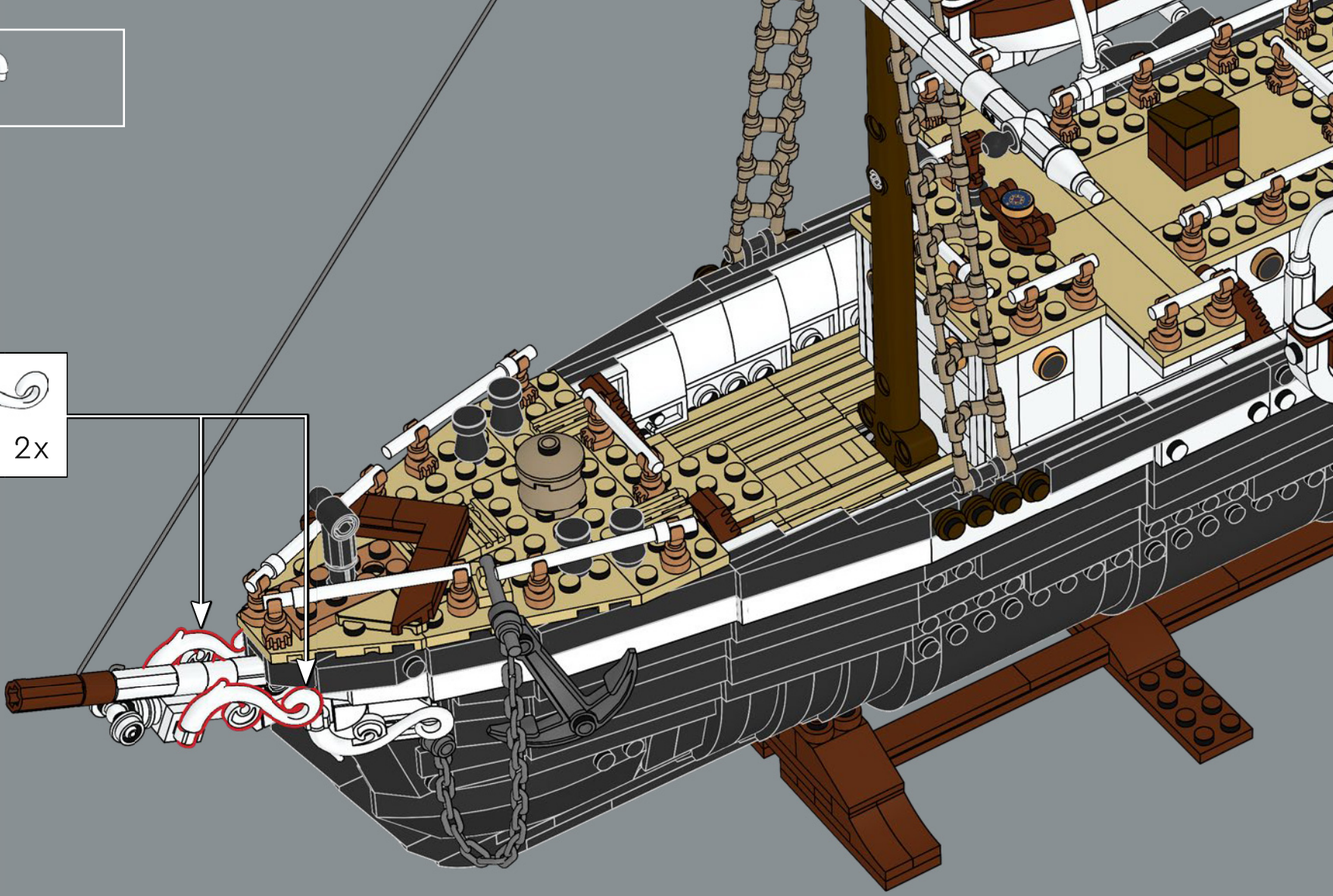
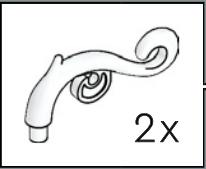

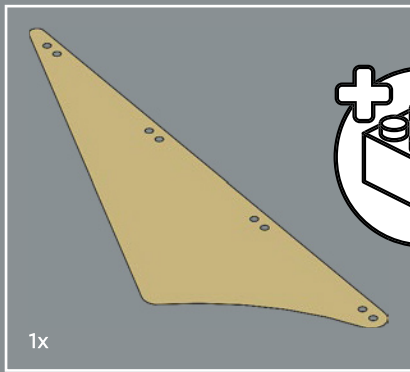

1x

658



LEGO® Stoffe werden in denselben Farben produziert wie die LEGO Steine. Hellbraun wurde als attraktivster und passendster Farbton für die Segel erachtet.

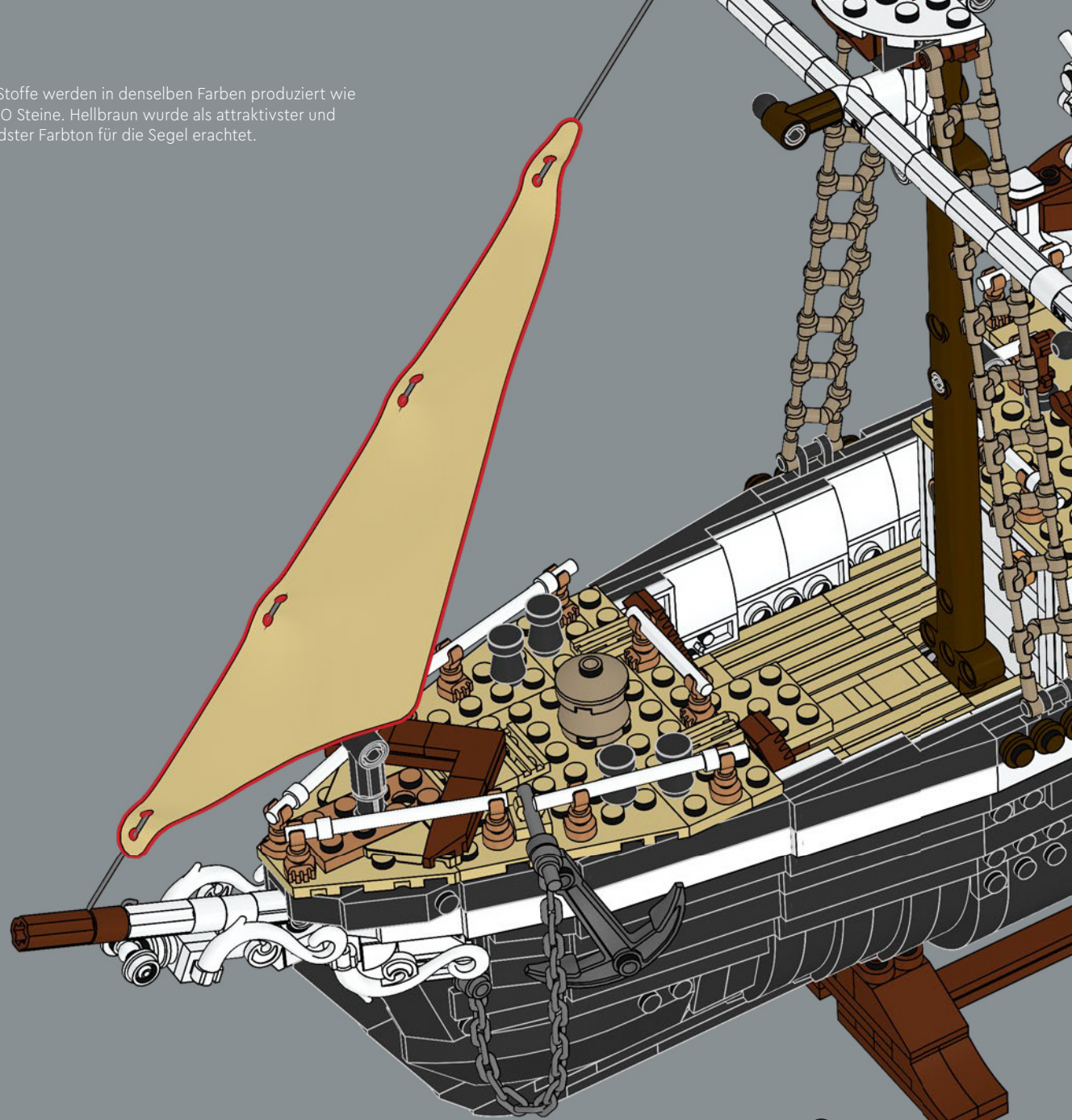



659

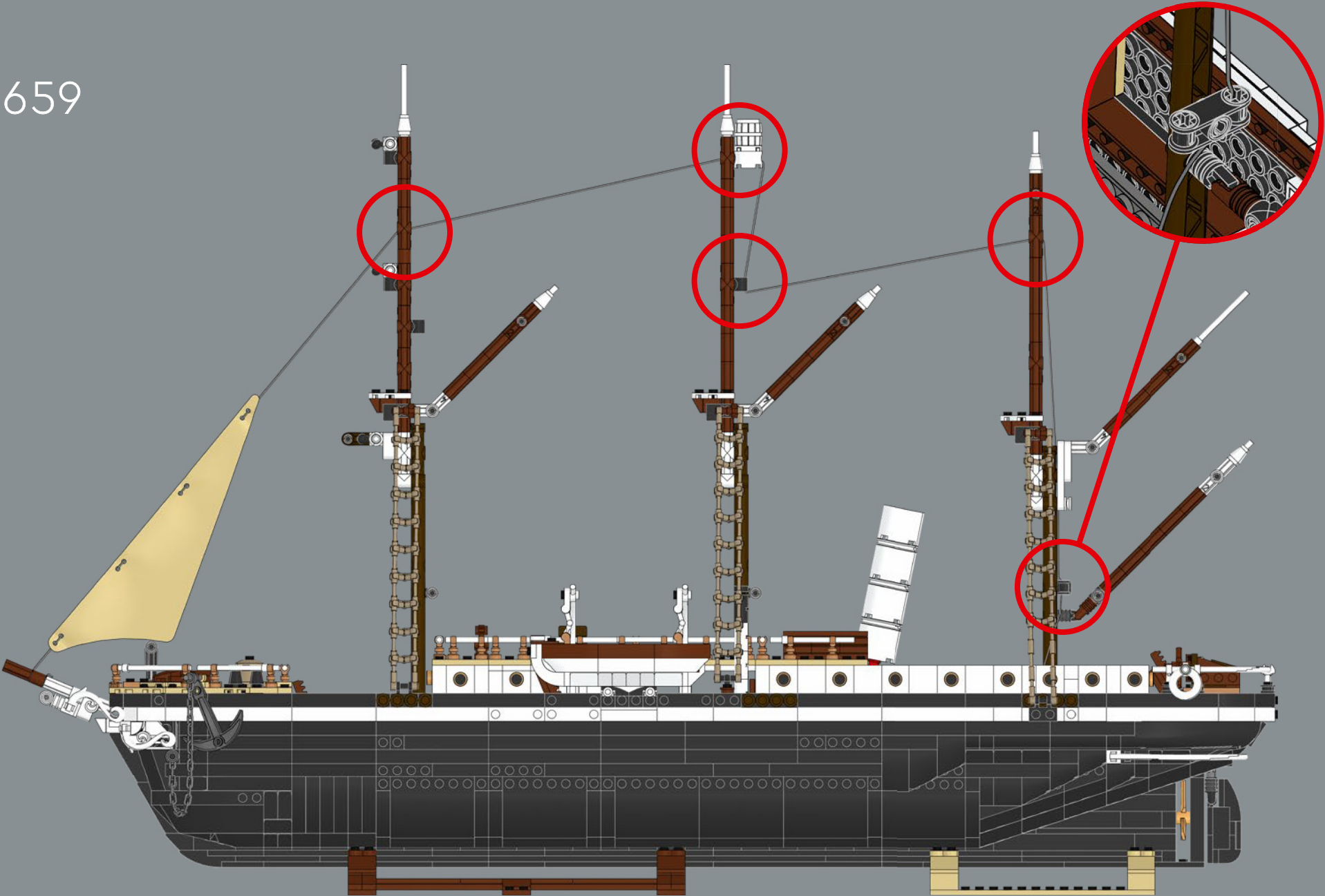



1x



660

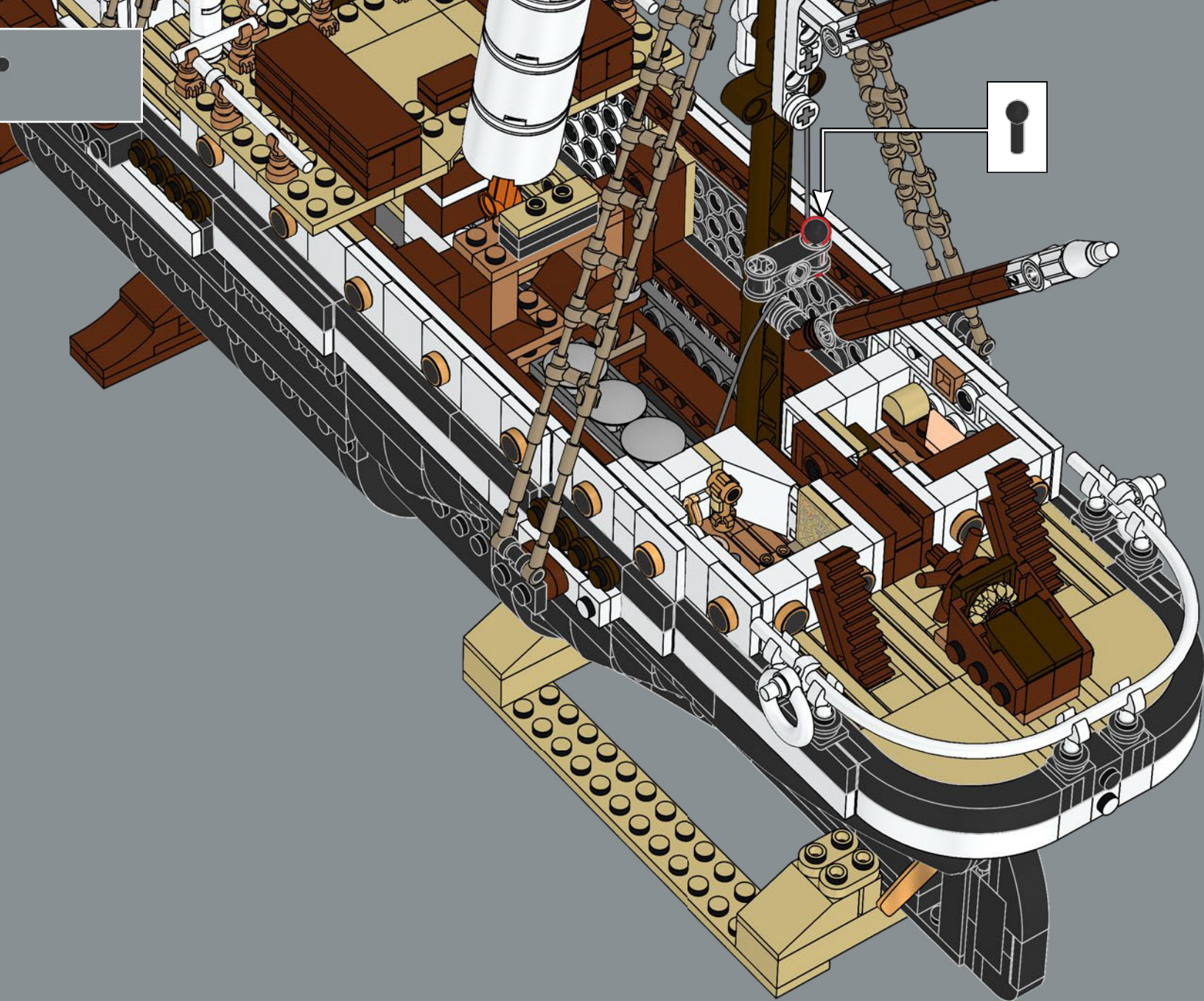

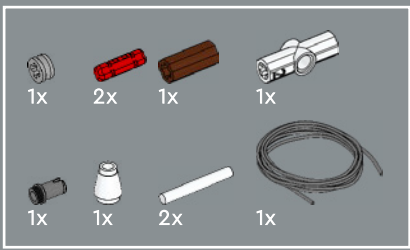

661

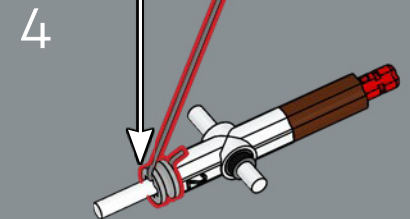
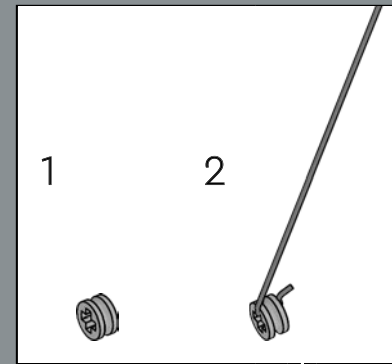
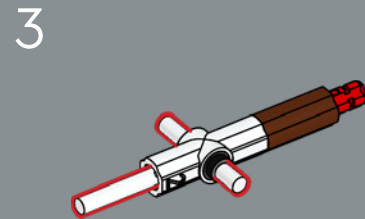
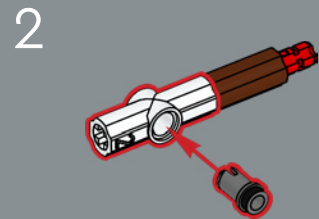
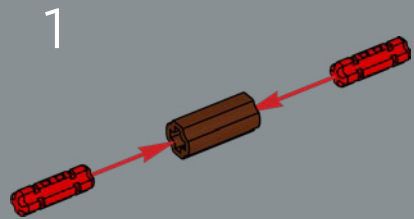

5

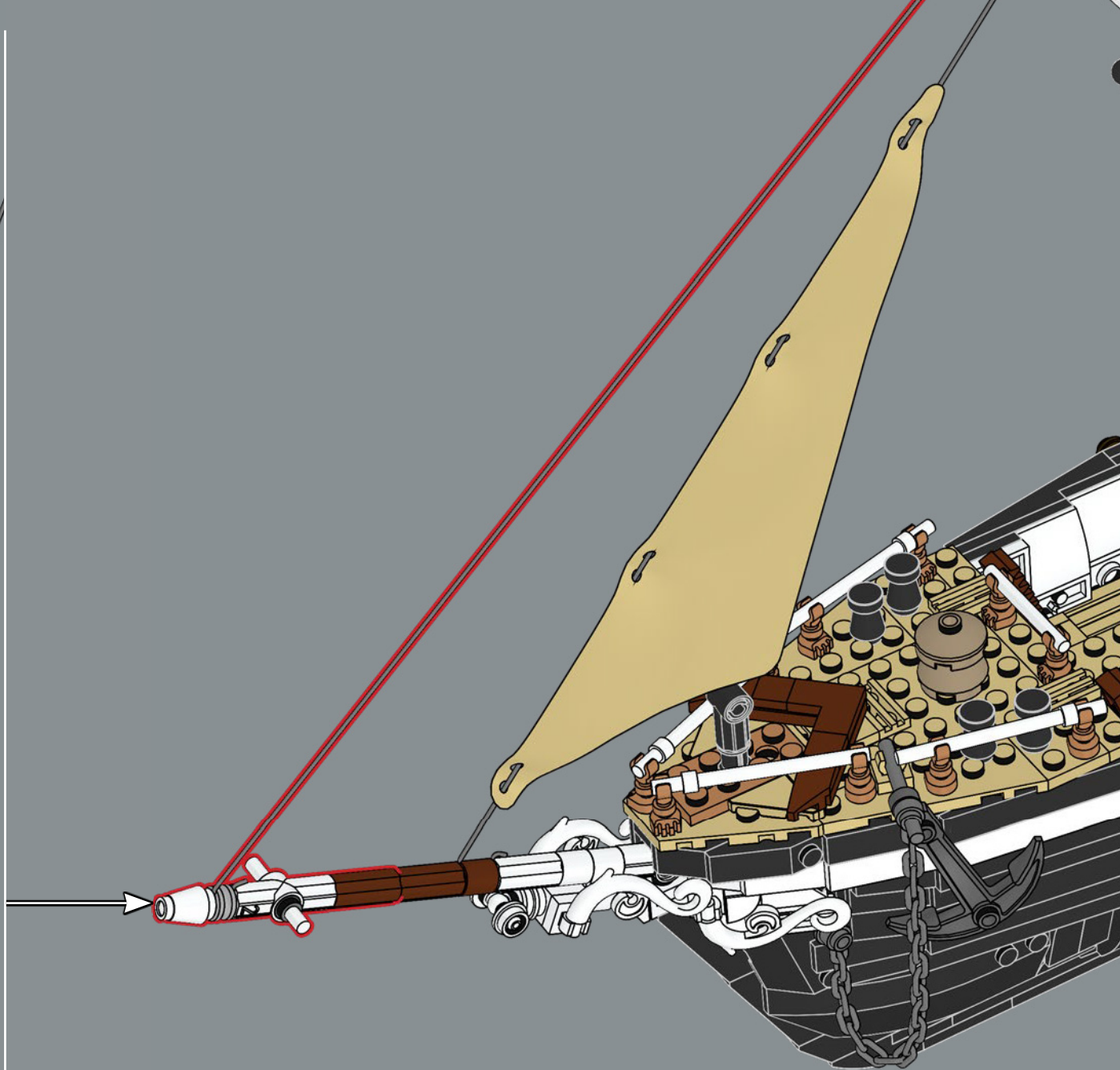
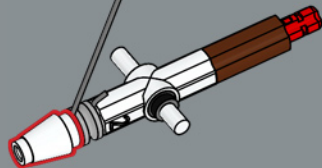



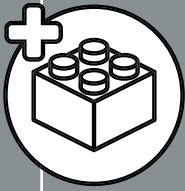
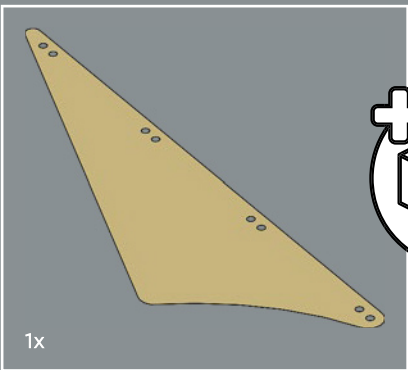

662

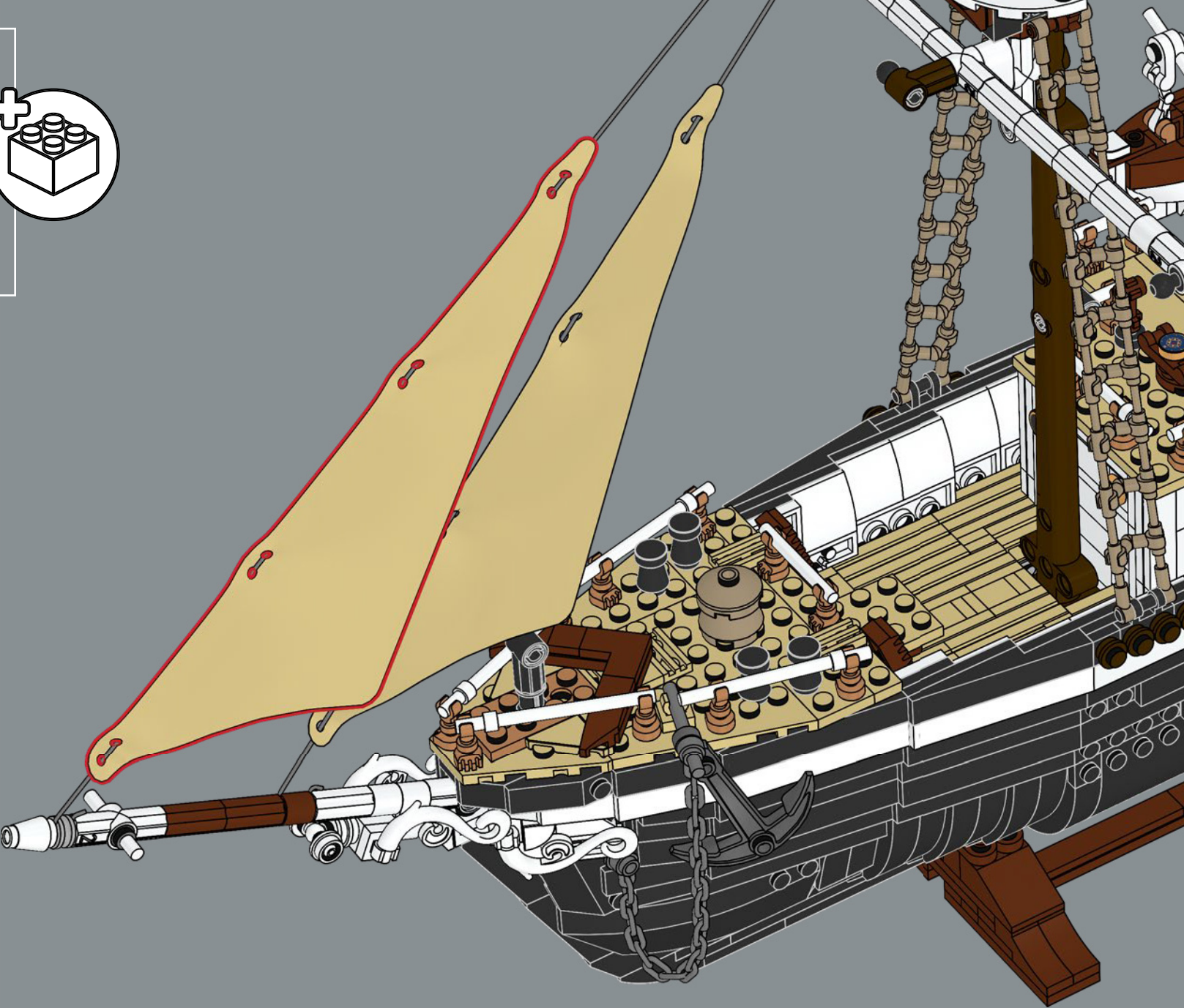

663

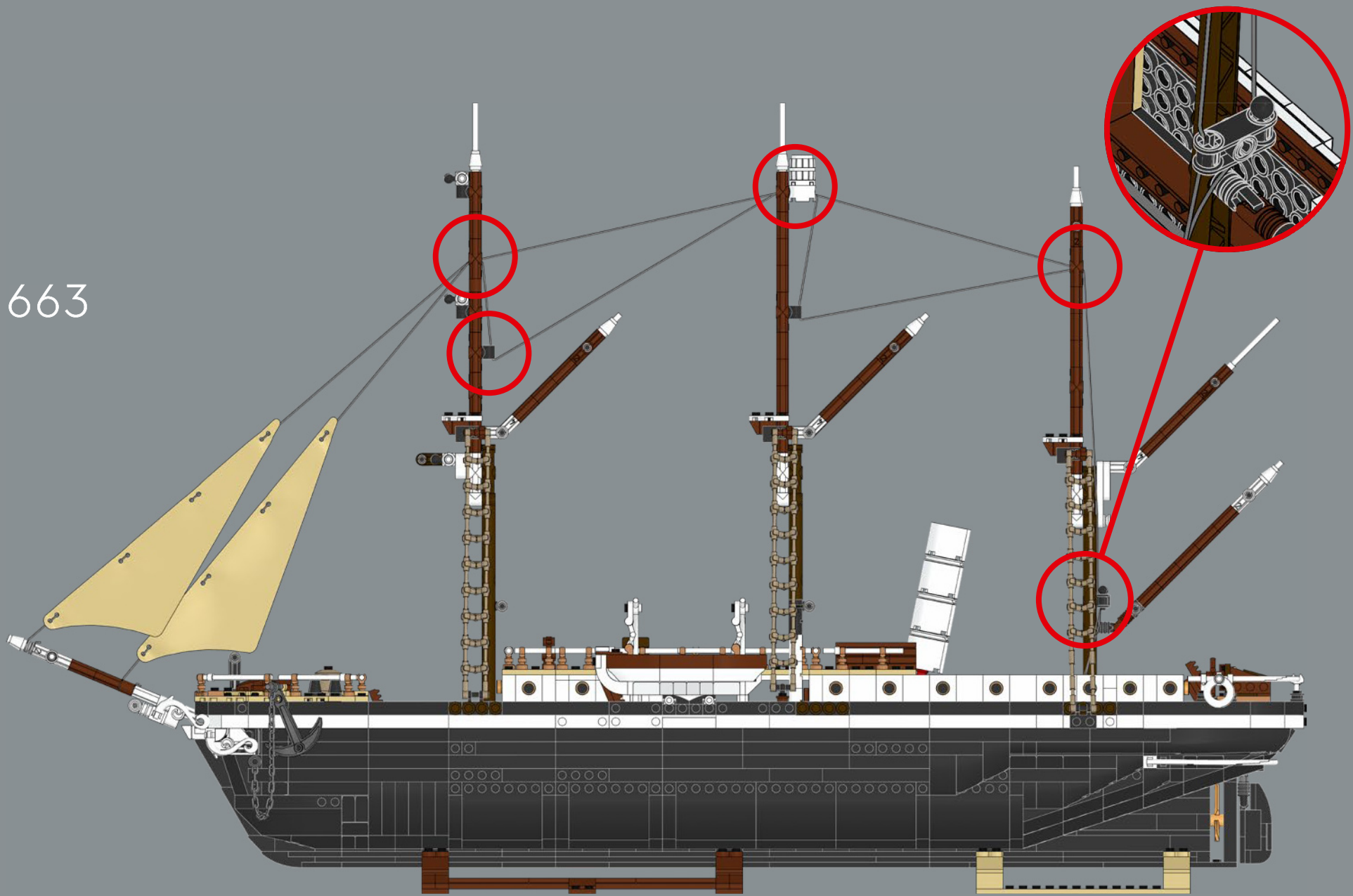





1x

664



LEGO® Schnüre werden heißgeschnitten, damit die Enden nicht ausfransen. Für dieses Modell haben wir eine Lösung ohne Knoten und ohne Schnitte gefunden. Überschüssige Schnur wird um eine Spule gewickelt und unter Deck verstaut.



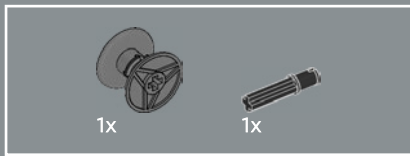

665

1

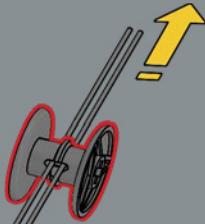

2

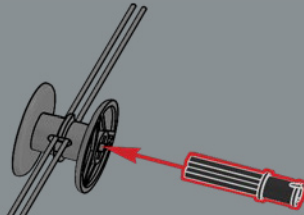

3

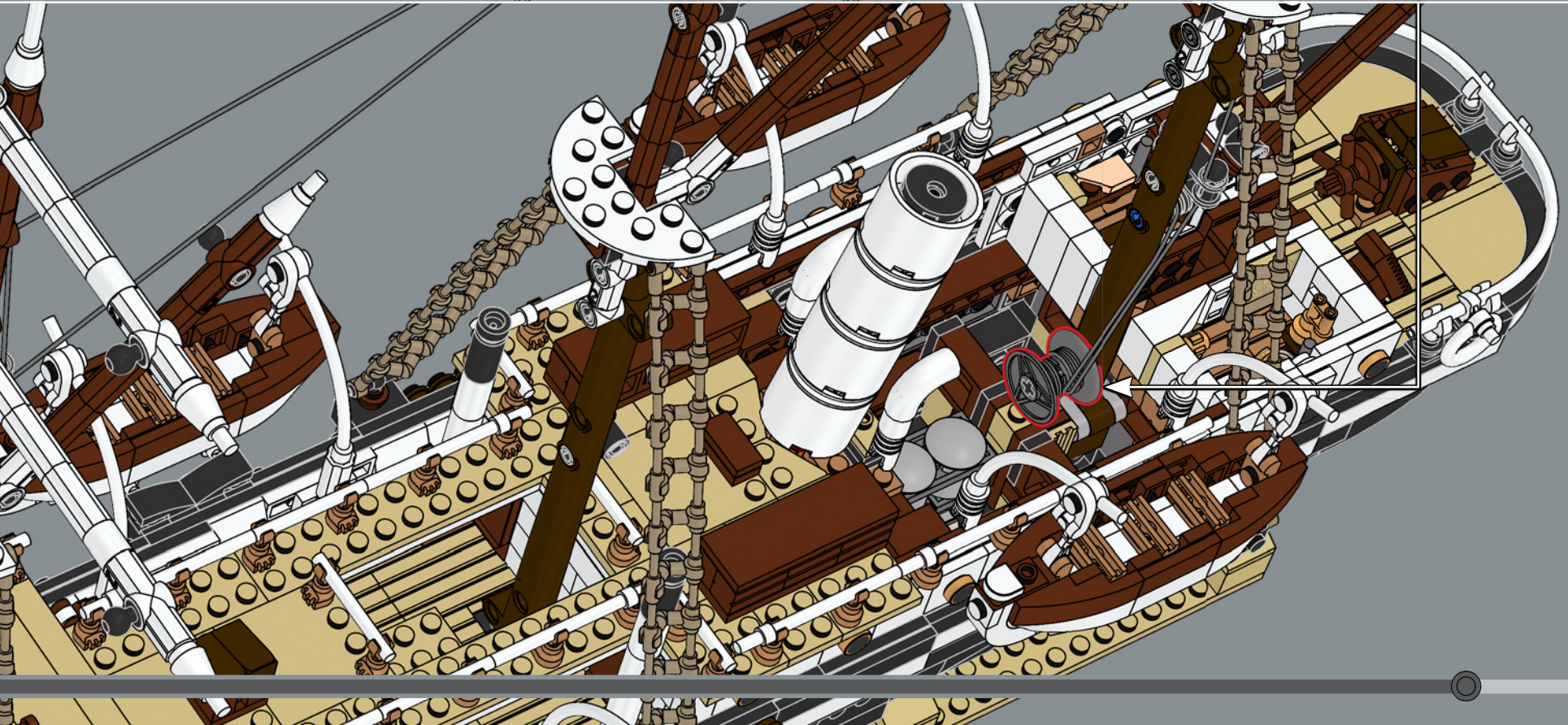
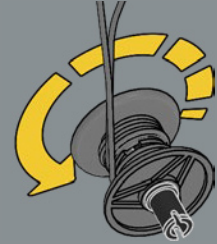



666

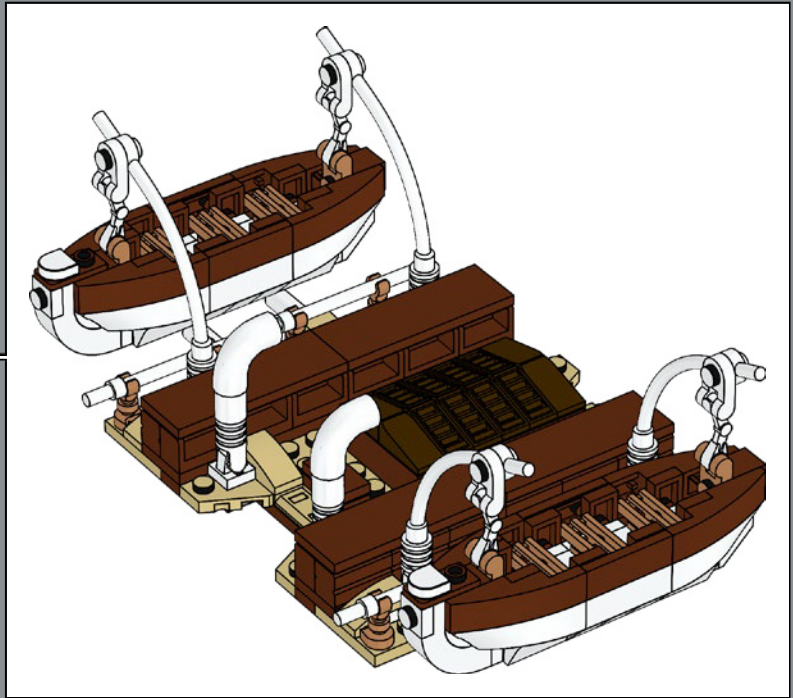
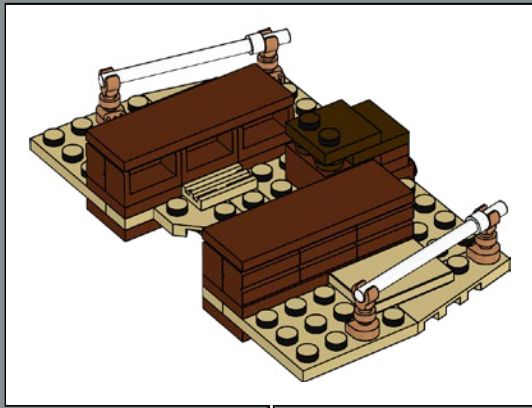
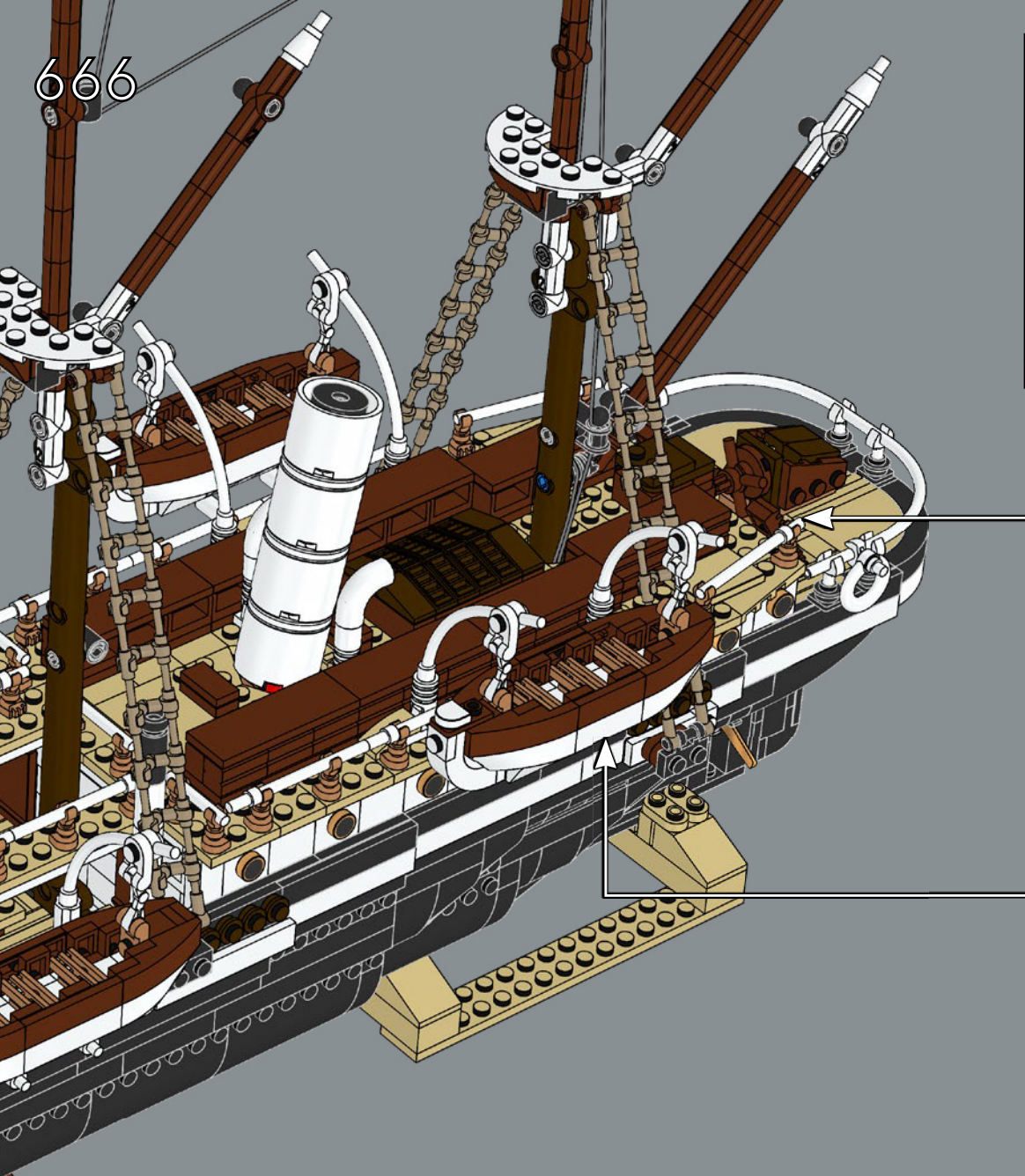



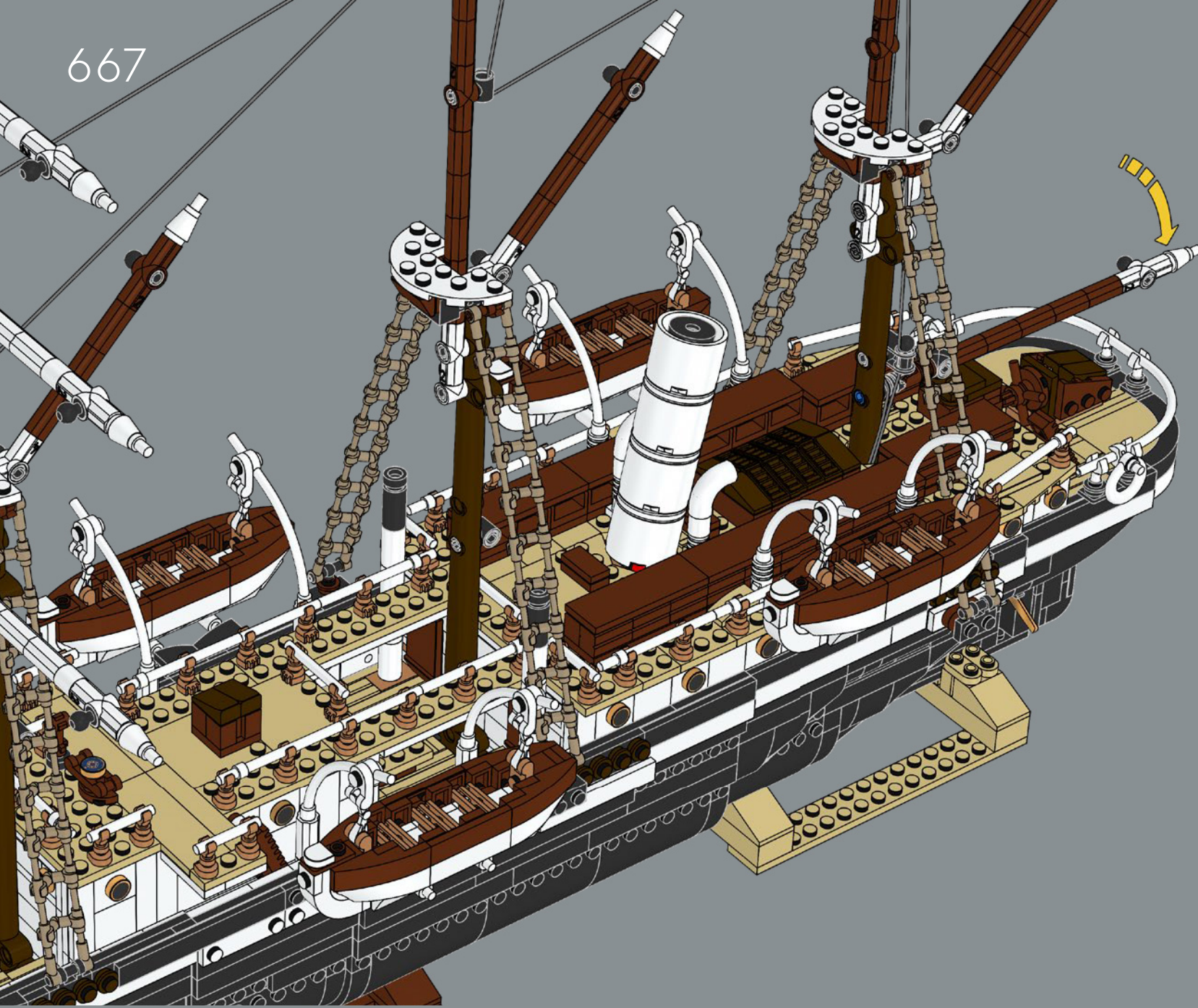



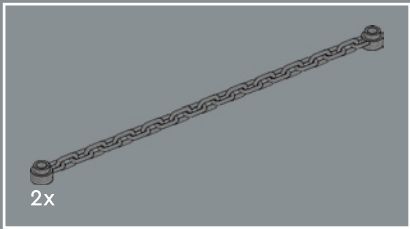

668

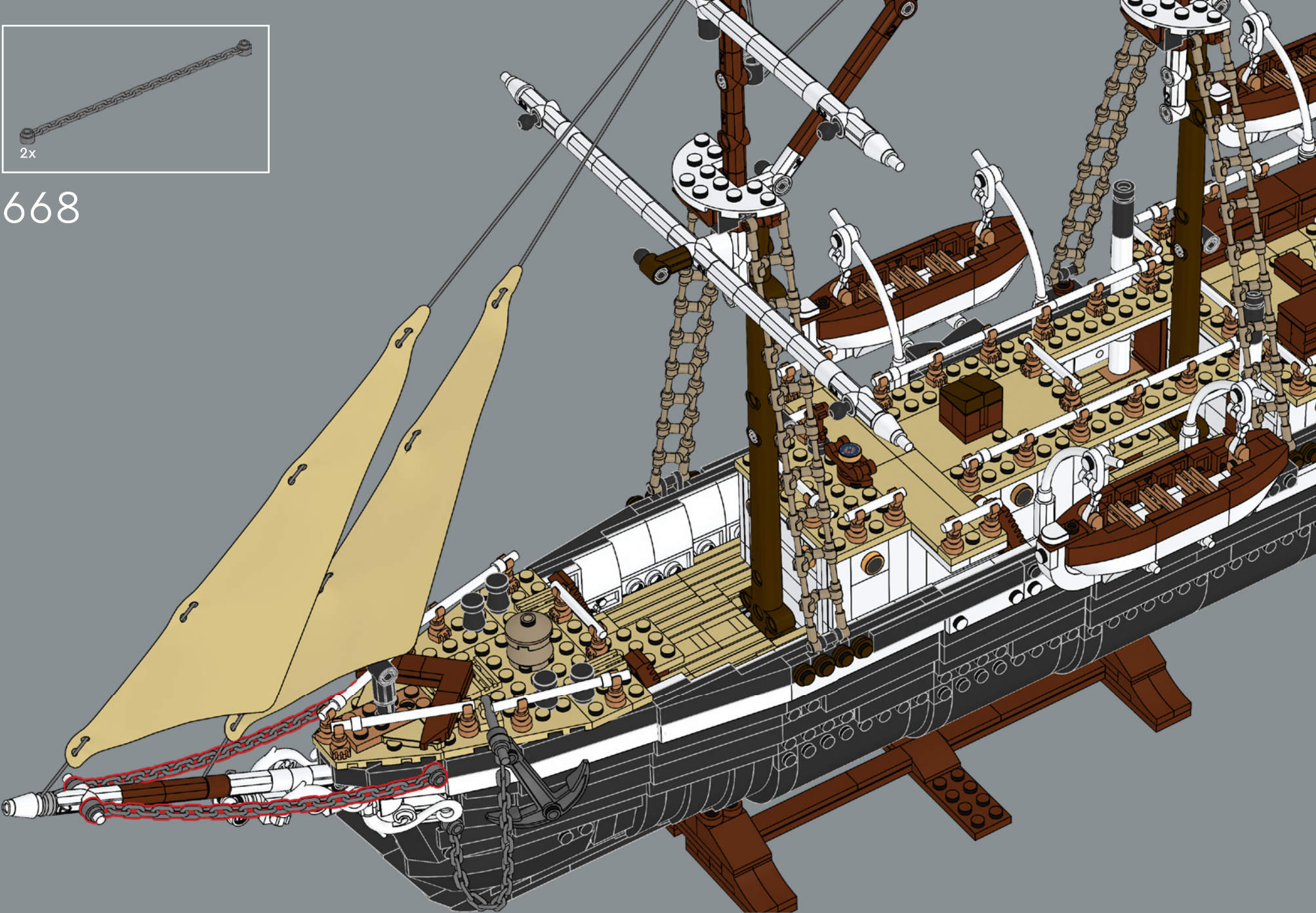



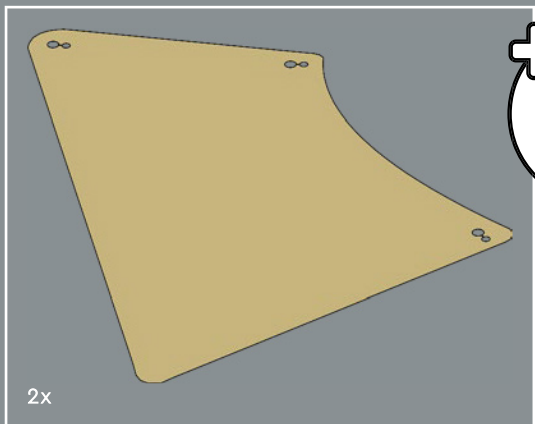

2x

669





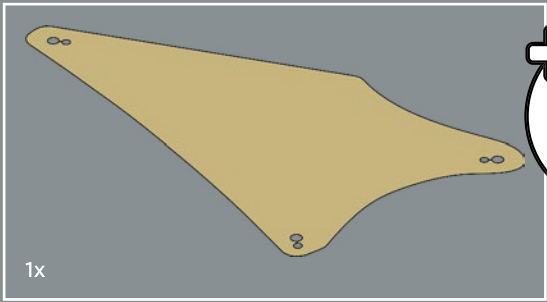

670

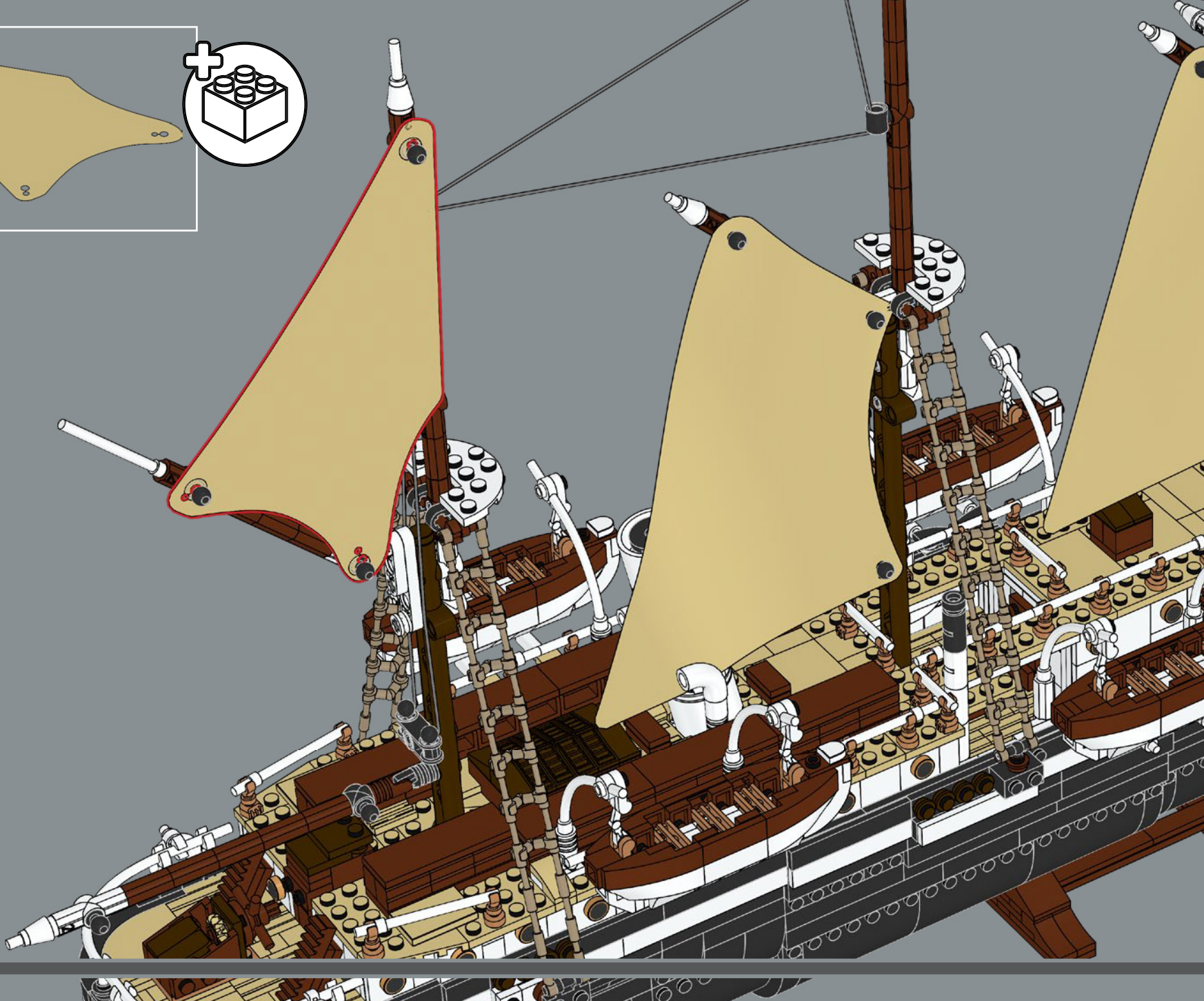





1x

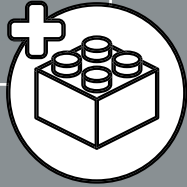

671



Die britische Handelsflagge wird als „Red Ensign“ bezeichnet. Britische Handelsschiffe und die Schiffe von Privatleuten fuhren damals unter dieser „roten Flagge“.

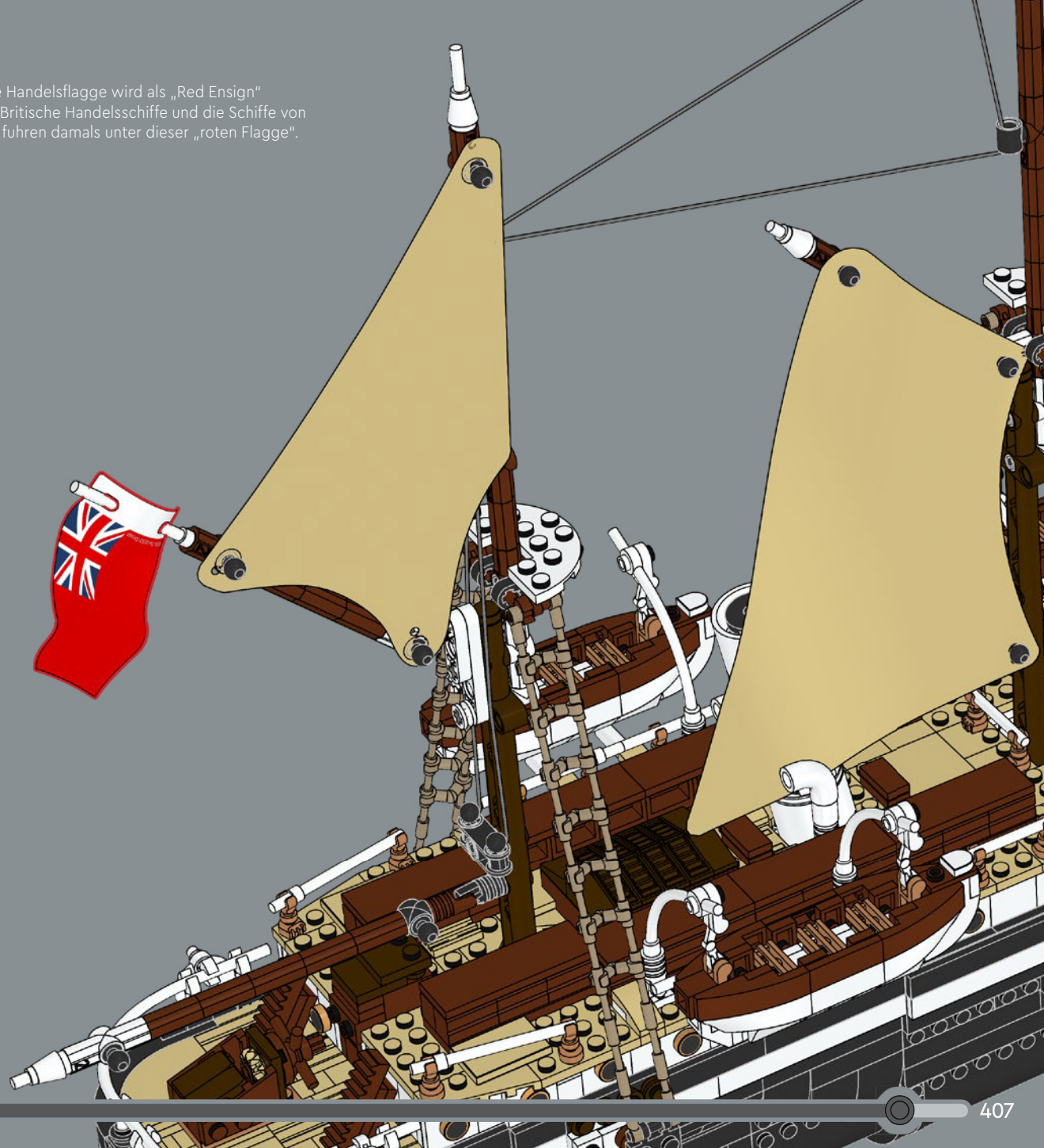

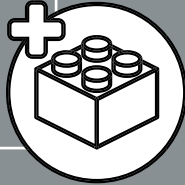
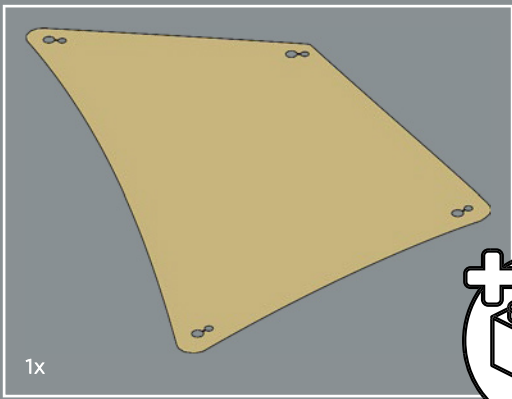

1x

672

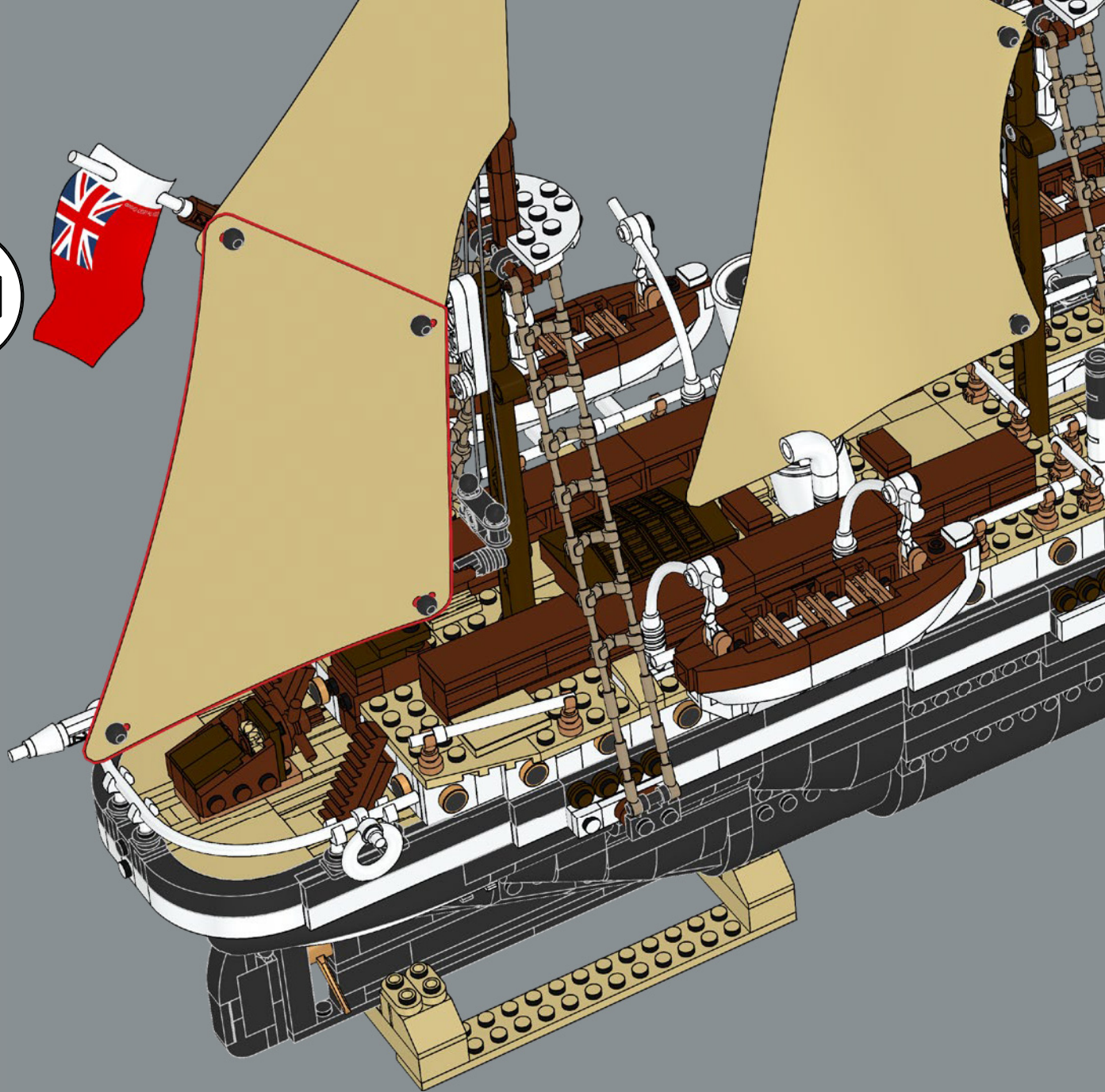



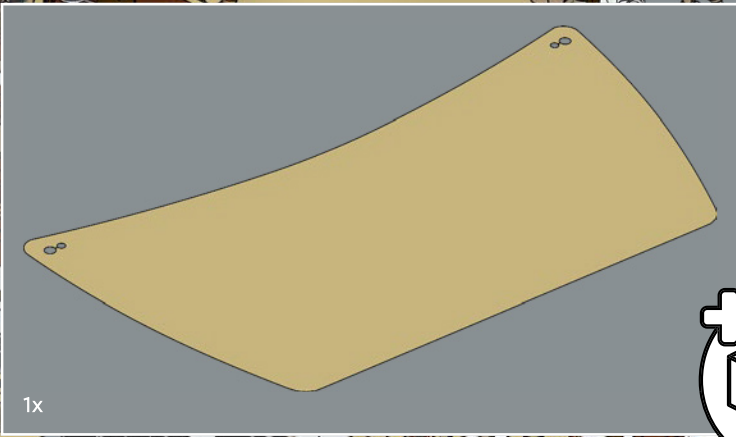
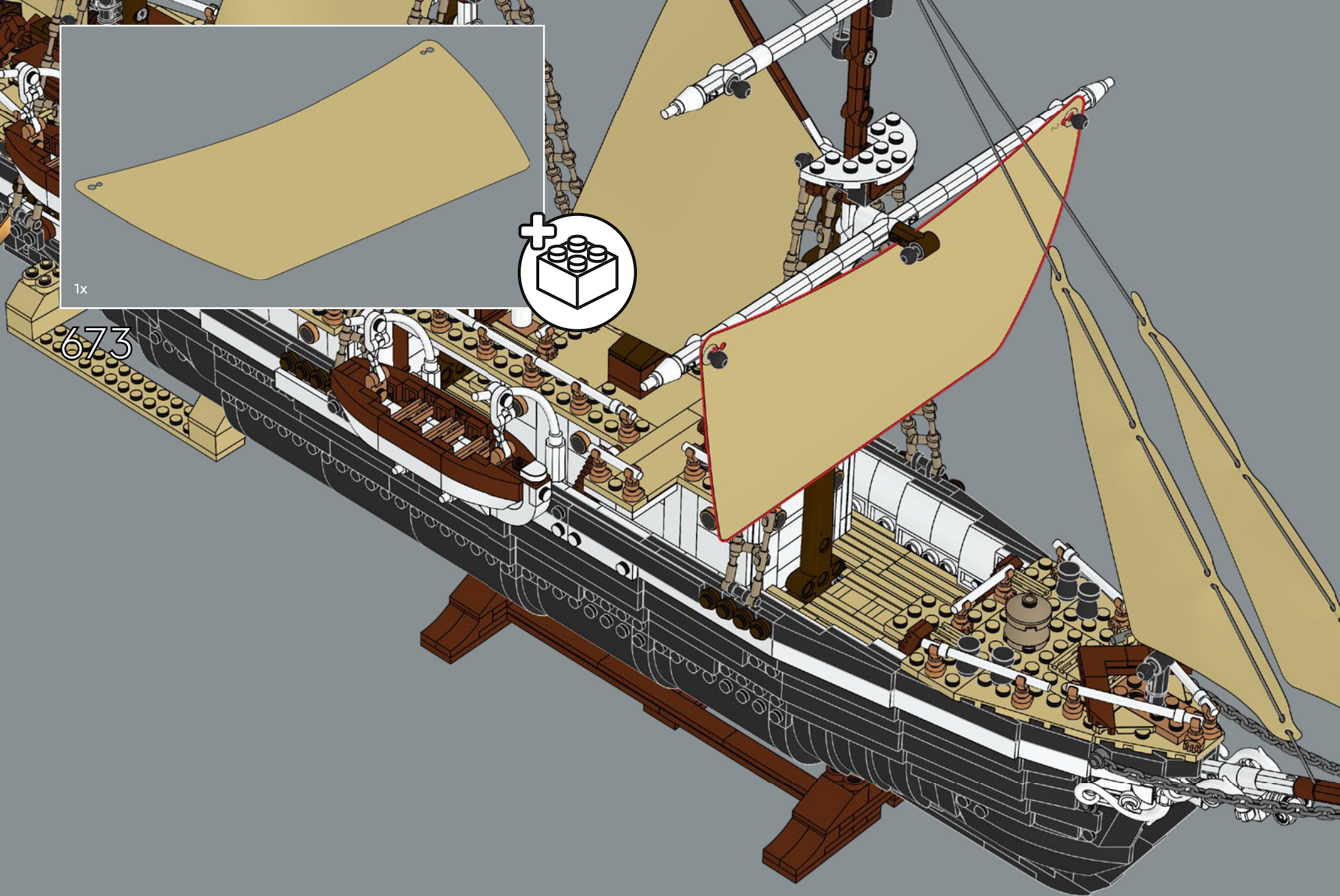

1x

673



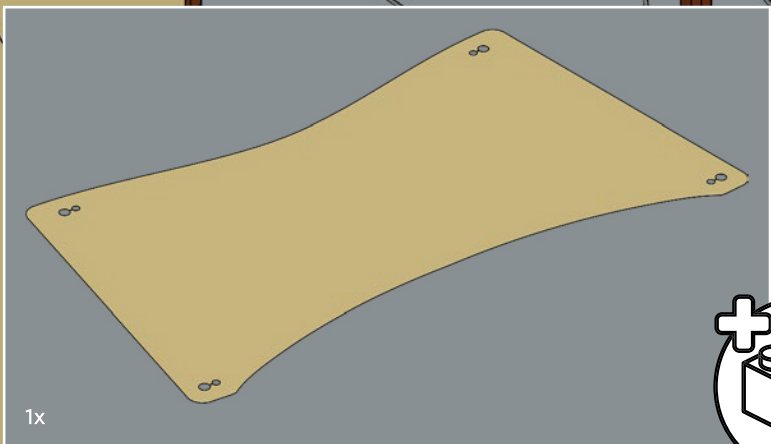

674

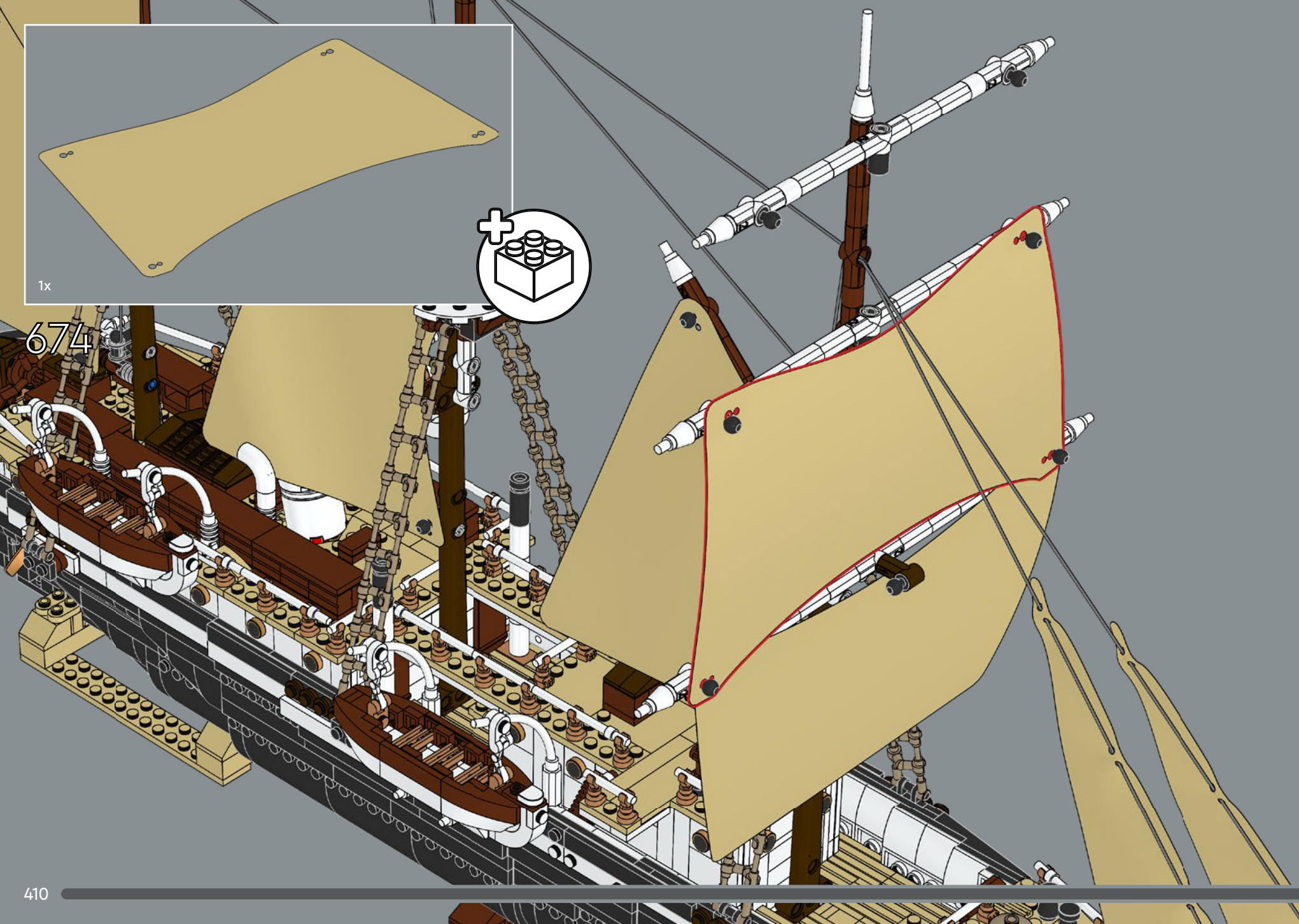



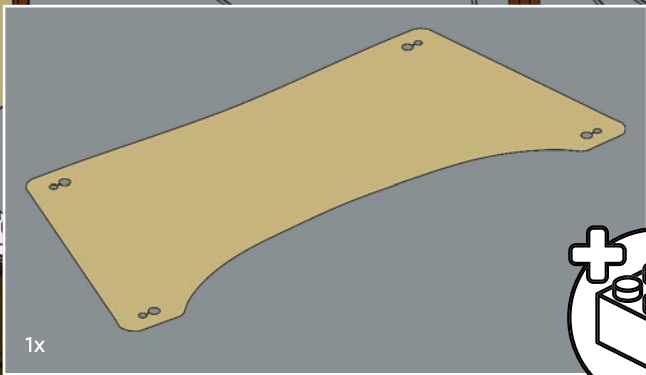

1x

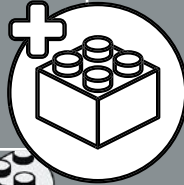

675

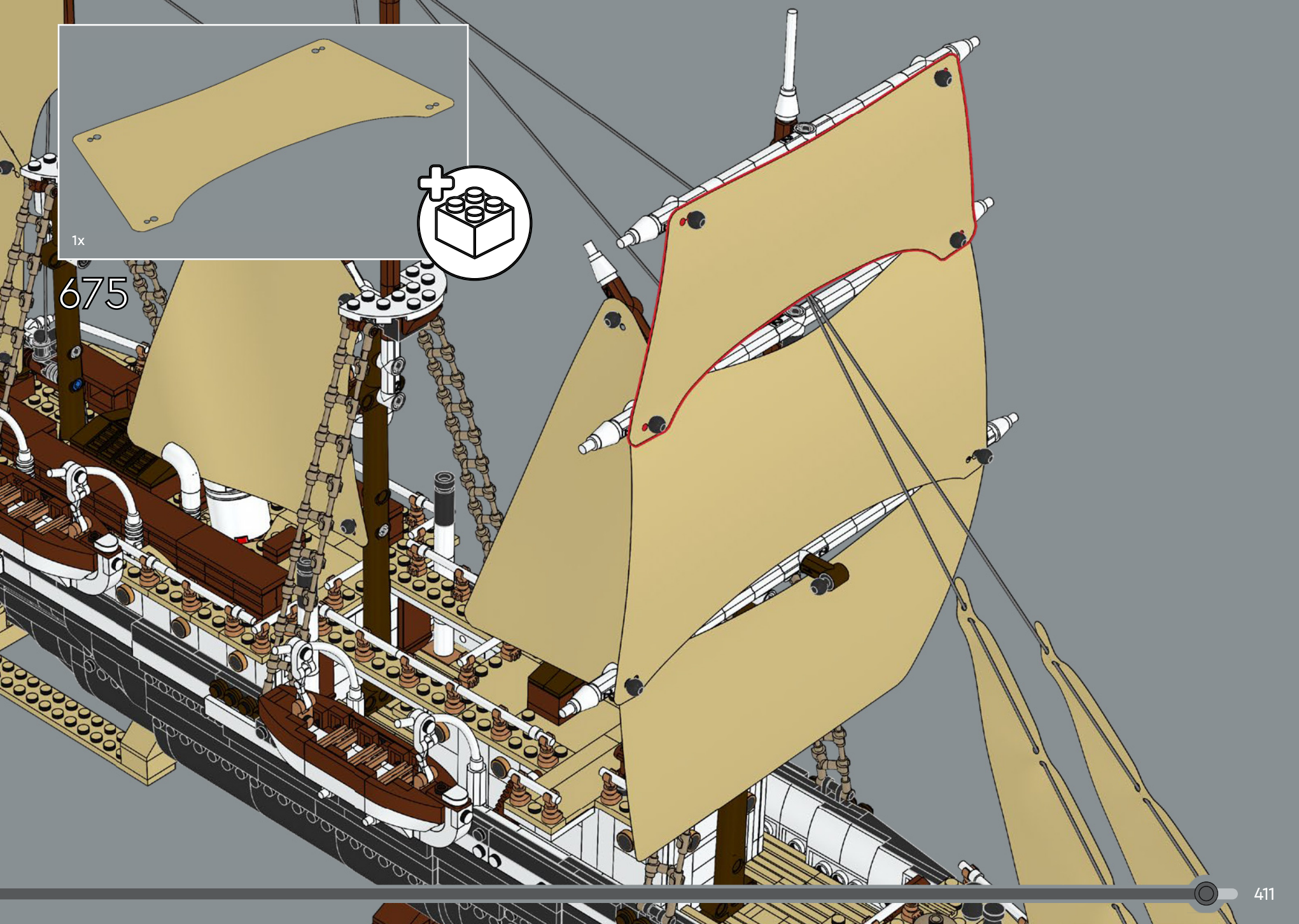



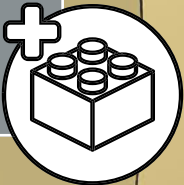
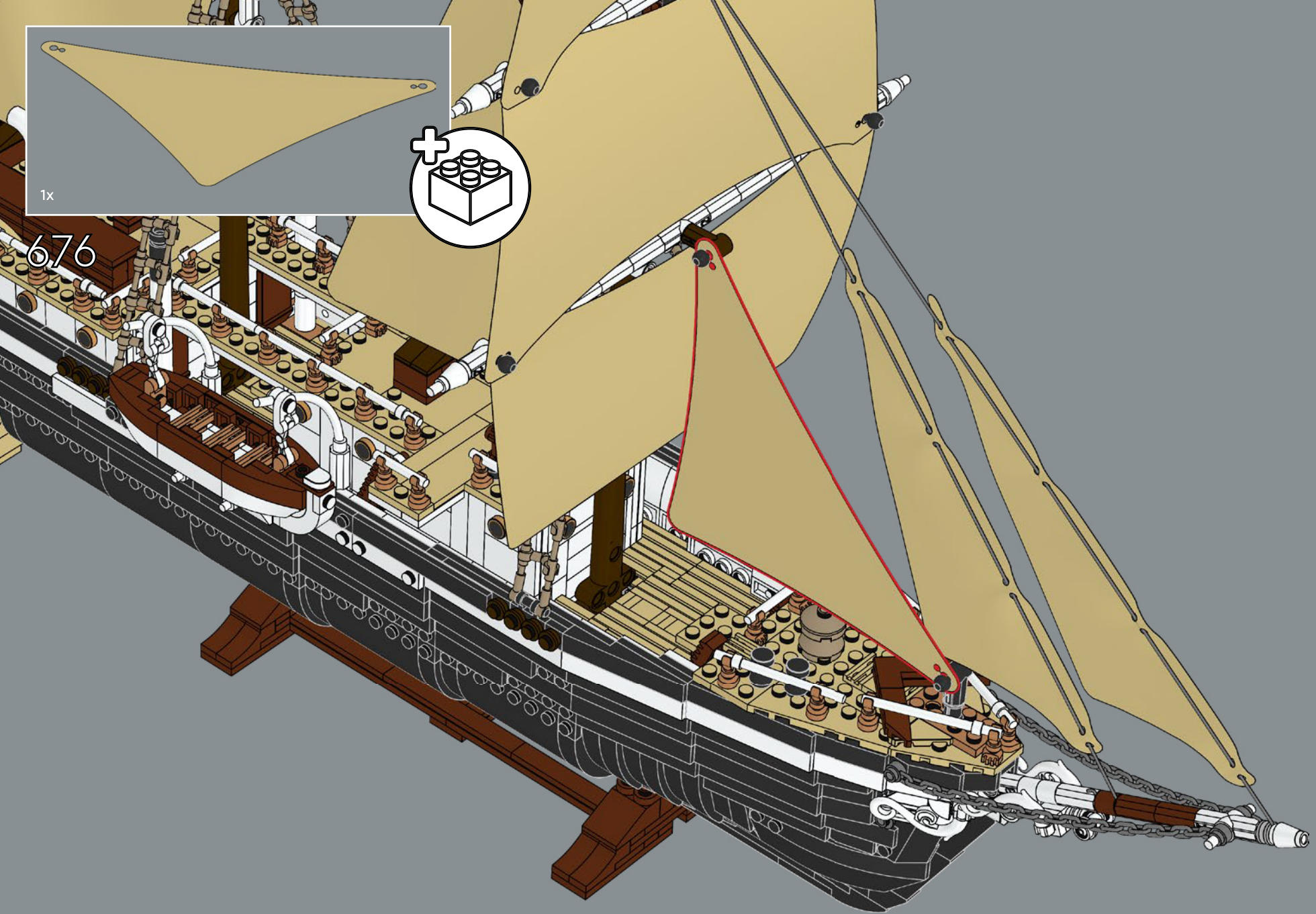

1x

676



677

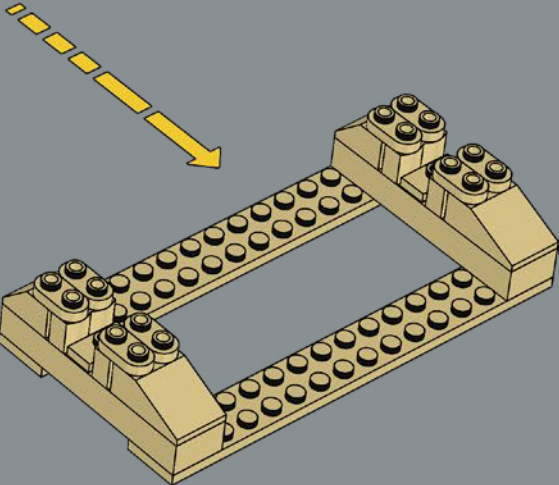
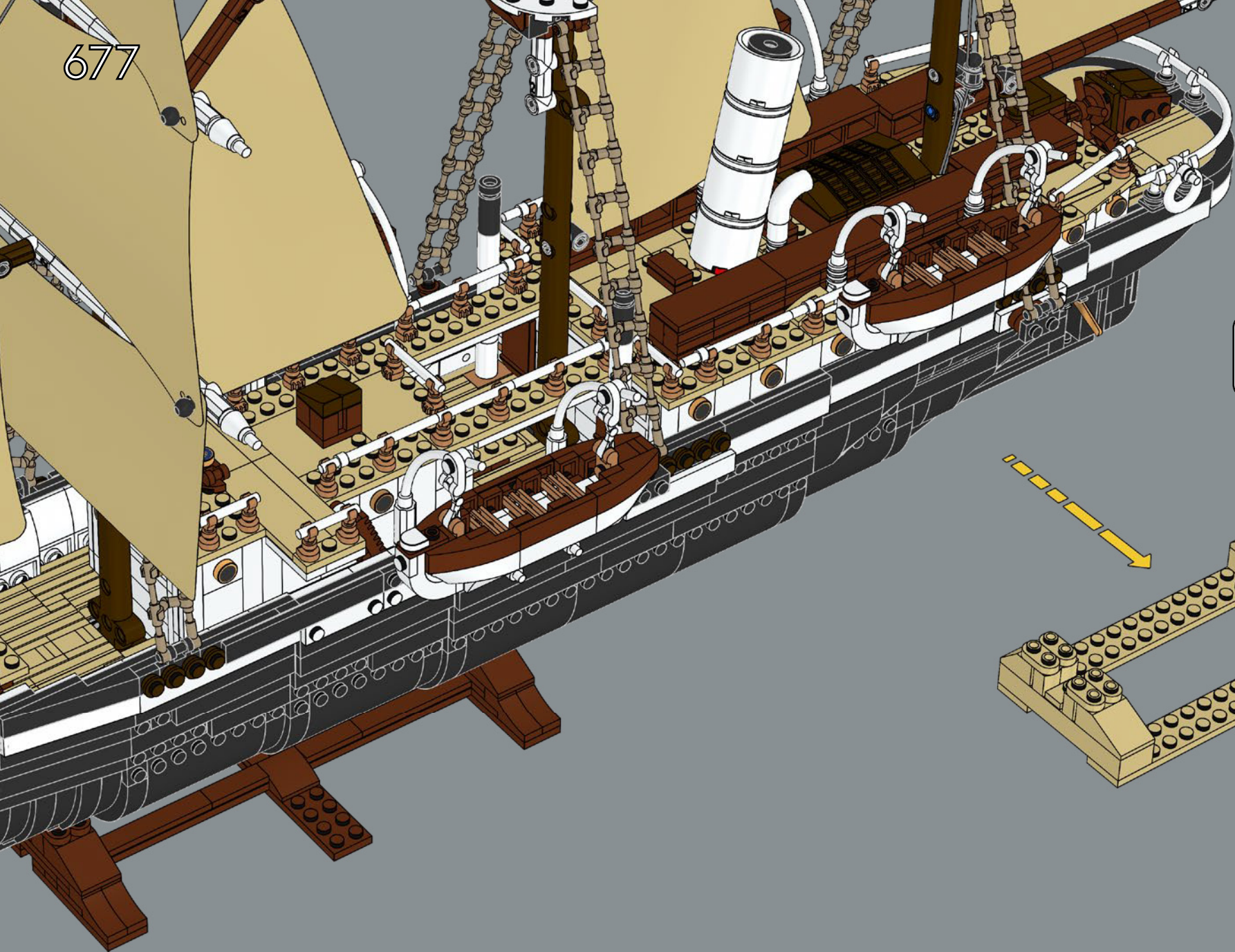



678

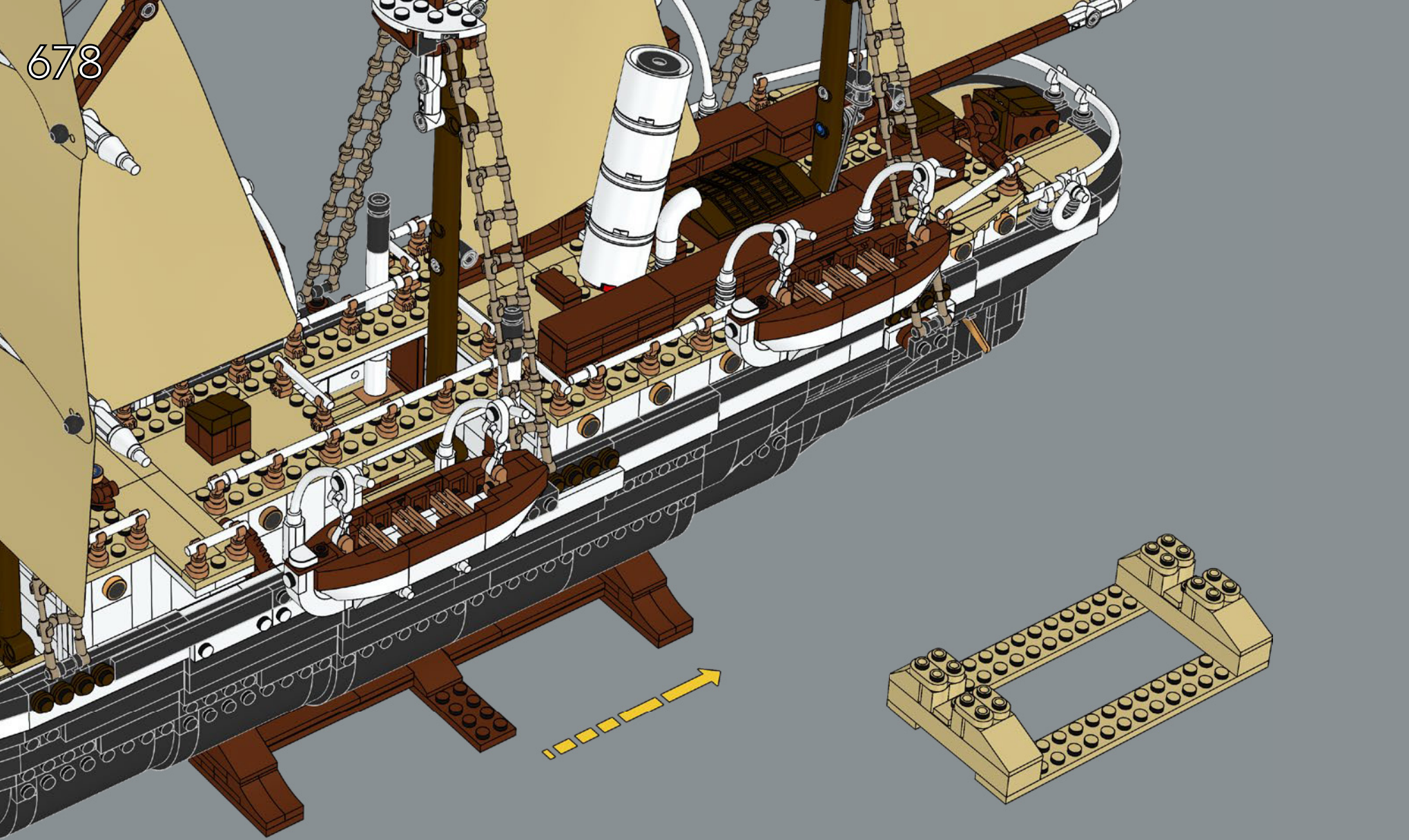

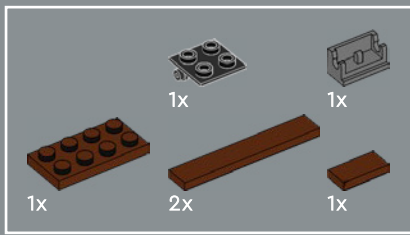

679

1

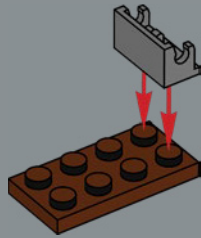

2

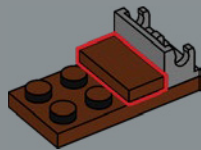

3

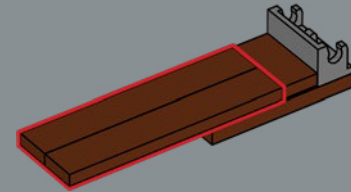

4

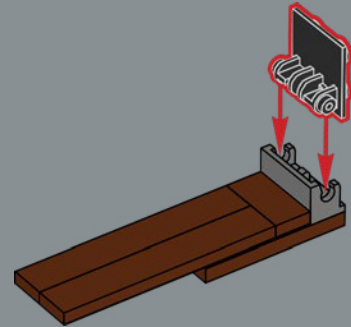

5

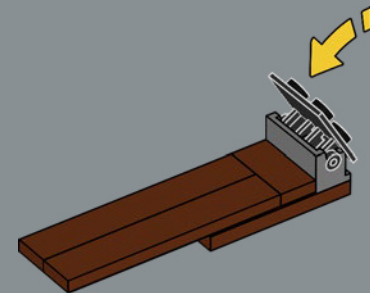



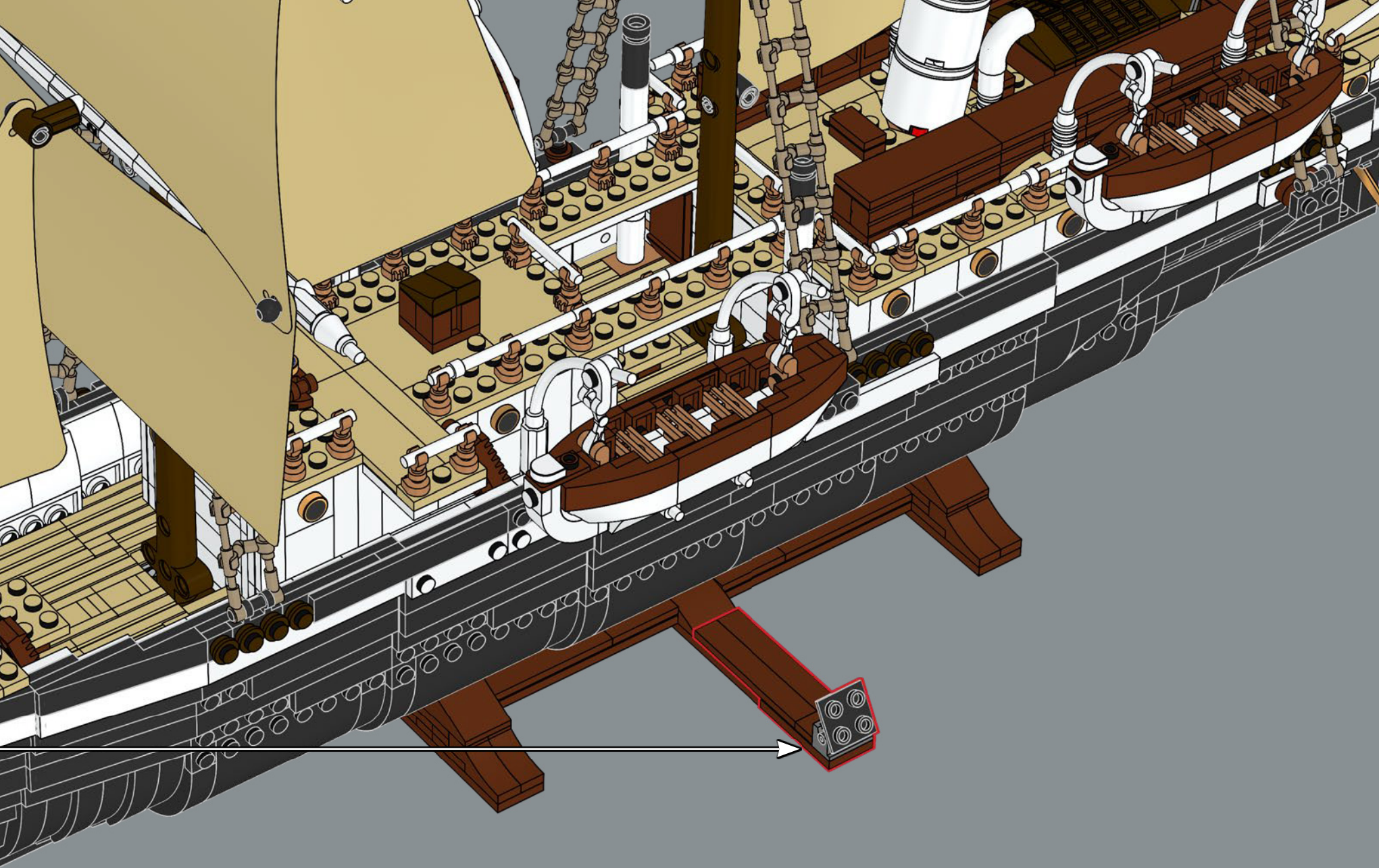



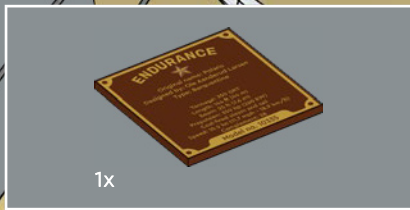

680

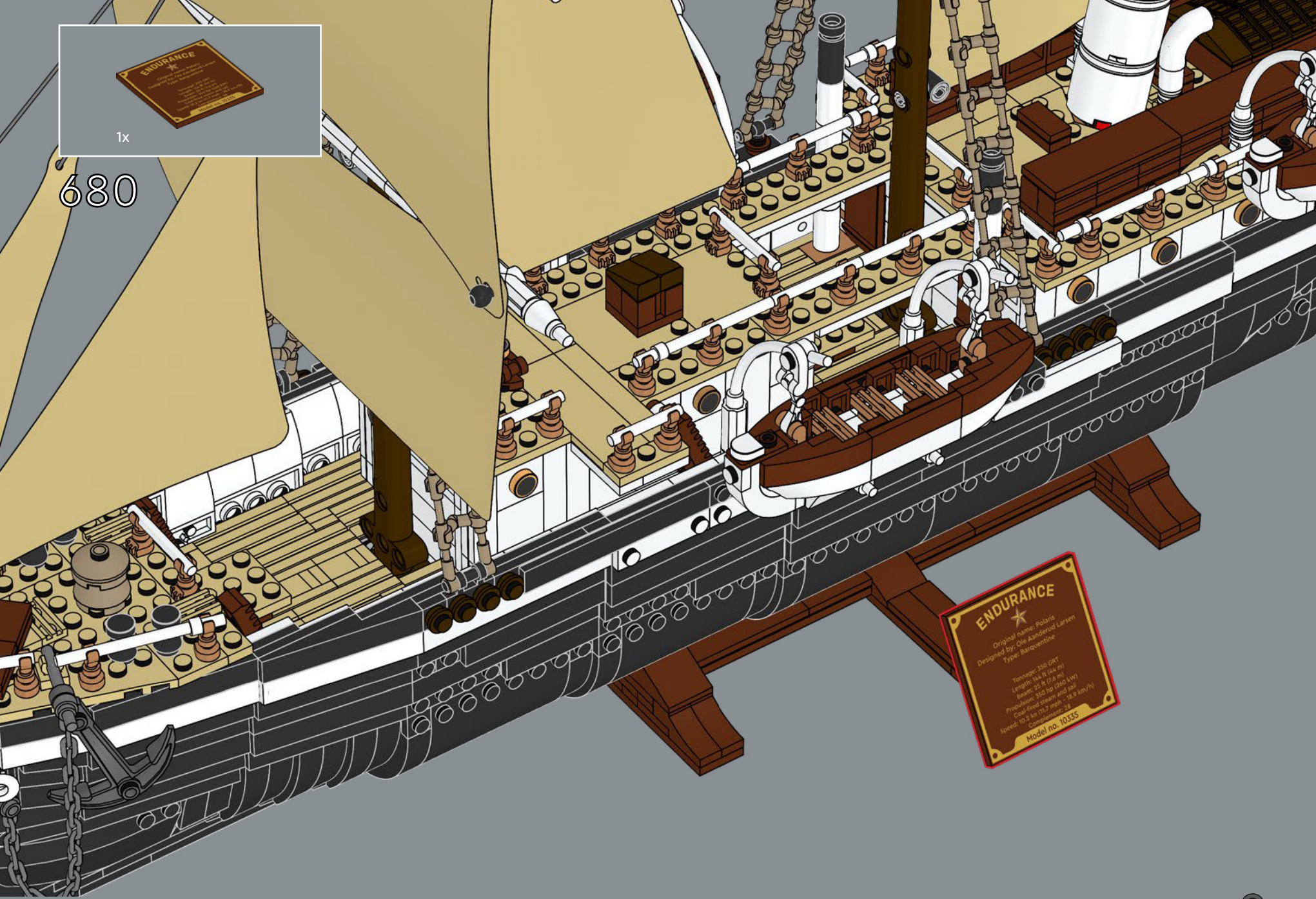



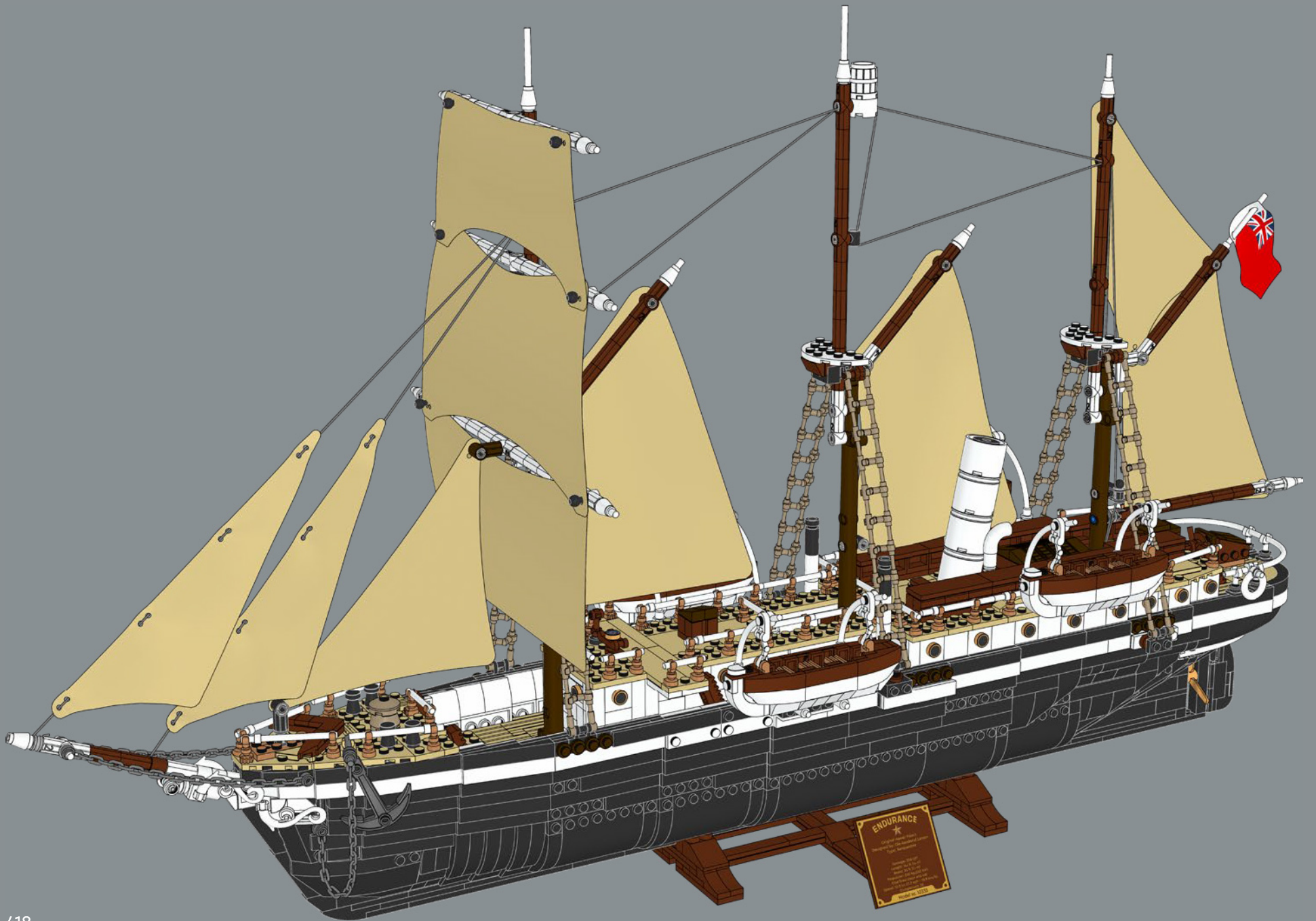



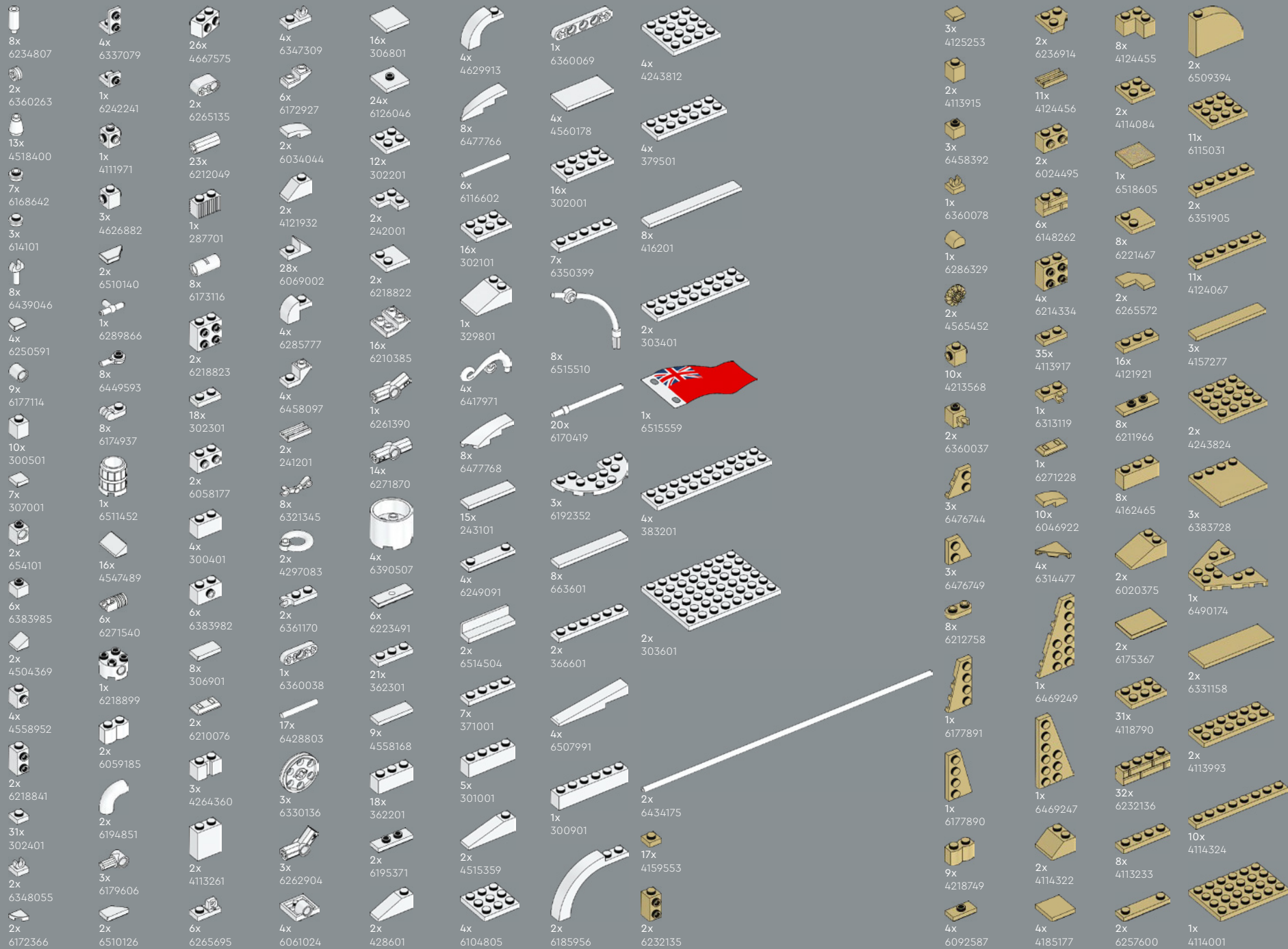

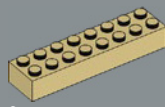

2x  
6037398

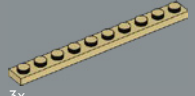

3x  
4143409

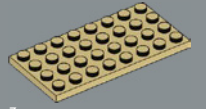

3x  
4509897

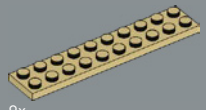

9x  
4249019

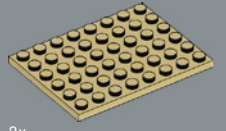

2x  
6070501

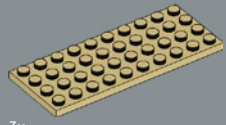

3x  
6037834

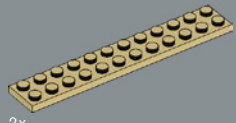

2x  
6093864

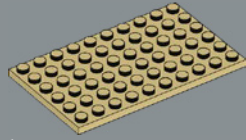

1x  
4624185

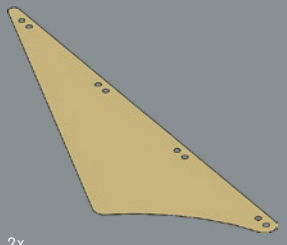

2x  
6509959

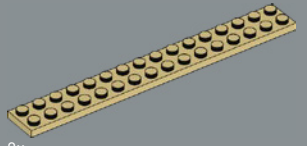

2x  
6030980

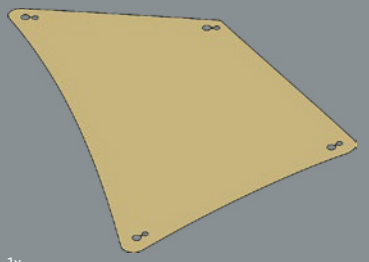

1x  
6509952

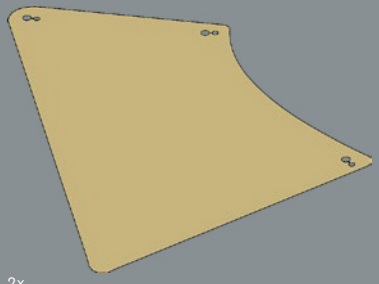

2x  
6509954

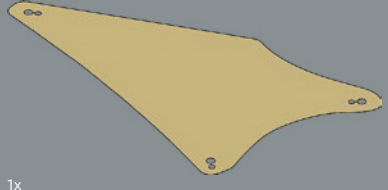

1x  
6509953

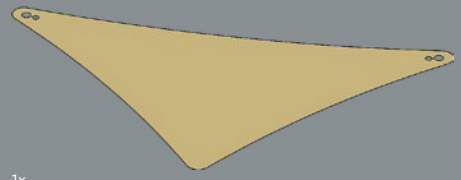

1x  
6509958

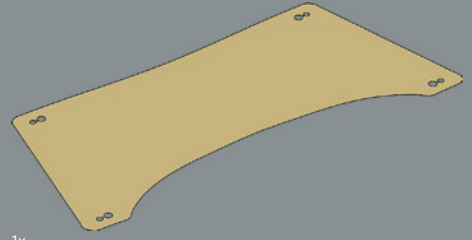

1x  
6509955

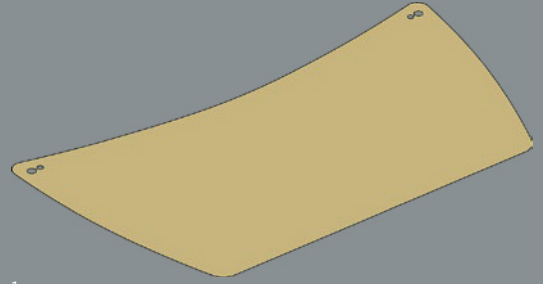

1x  
6509957

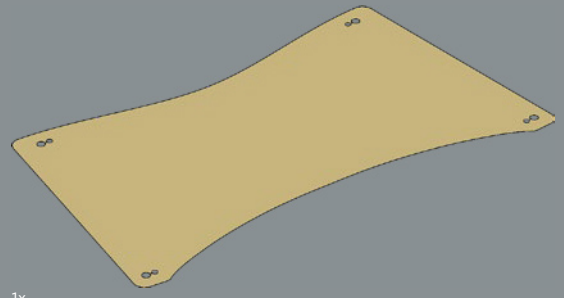

1x  
6509956

2x  
614121

1x  
6271820

64x  
4142865

1x  
6129995



8x  
300121

5x  
4206482

4x  
6271167

4x  
6130007

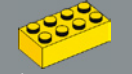

1x  
300124

4x  
6186675

6x  
6168646

4x  
6284070

4x  
4529236

1x  
6332148

1x  
6284699

8x  
407026

4x  
307026

22x  
302426

2x  
4504382

1x  
654126

5x  
6388352

2x  
6335388

1x  
4566308

6x  
6234695

3x  
4214559

2x  
6509664

19x  
6344752

1x  
6141554

2x  
6104209

1x  
6265699

1x  
6141556

2x  
4180536

2x  
4180508

6x  
6513918

10x  
4548180

2x  
6475339

18x  
302326

2x  
6051508

4x  
6477759

9x  
403226

18x  
6279875

1x  
4109810

1x  
6271535

2x  
6195325

1x  
6143850

4x  
6507846

6x  
6282140

1x  
4283260

28x  
4253815

2x  
6173119

7x  
6047276

2x  
6475339

18x  
302326

2x  
393726

1x  
366526

8x  
300426

9x  
6092585

5x  
306926

7x  
6184784

6x  
6069000

2x  
4121966

4x  
4140588

3x  
4283047

3x  
4283046

1x  
6266224

1x  
6396457

8x  
242026

6x  
303926

10x  
302226

2x  
6053077

2x  
6390748

2x  
4567436

3x  
4124096

1x  
6089119

1x  
6276951

14x  
362326

8x  
428626

7x  
362226

5x  
4526931

1x  
4251161

3x  
6517676

2x  
6390749







2x  
4271874



1x  
6511449



2x  
6469351



3x  
4211214



6x  
6055145

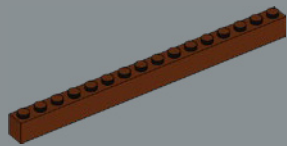

2x  
6258989



[LEGO.com/service](https://www.LEGO.com/service)

1x  
6271165

2x  
6275844

4x  
6225242

6x  
4211476

2x  
4211389

1x  
6329584

1x  
6253856

2x  
6248890

1x  
6227897

1x  
4211807

3x  
4278273

3x  
4211526

1x  
6092956

1x  
4512360

3x  
6066097

4x  
6123809

2x  
6383177

6x  
4211398

1x  
4211470

1x  
6004990

2x  
6360043

10x  
4211387

4x  
4211397

9x  
4211815

1x  
4211536

4x  
4211429

1x  
6381253

6x  
6093058

1x  
4211773

8x  
4211394

8x  
4211425

8x  
4251149

2x  
6178172

2x  
4211522

2x  
6178172

2x  
4211522

2x  
4211522

3

4x  
4211090

6x  
6231765

2x  
6439040

4x  
6395635

3x  
6362259

7x  
6344022

2x  
6388133

1x  
6225494

1x  
4211042

1x  
6115080

1x  
6514456

2x  
6230233

1x  
4211066

3x  
6092572

2x  
6310596

6x  
4210635

11

2x  
6405646

6x  
6015356

2x  
4211133

3x  
6365692

1x  
4239891

1x  
6378143

12x  
4211043

4x  
4211105

8x  
4211001

1x  
4211103

13x  
6039176

2x  
6431485

1x  
4508553

11x  
4211002

55

2x  
4499858

1x  
4211099

2x  
4211114

3x  
6258887

1x  
6510133

32x  
6511448

1x  
6287847

2x  
6186672

1x  
6328909

1x  
6034543

1x  
6490722

32x  
6315780

3x  
6322813

1x  
6332586

8

8x  
6509391

8x  
6509392

1x  
4566688

2x  
6058221

2x  
6347604

1x  
6515036

1x  
6331950

3x  
6258887

1x  
6510133

32x  
6511448

1x  
6287847

2x  
6186672

1x  
6328909

1x  
6034543

1x  
6490722

32x  
6315780

3x  
6322813

1x  
6332586

3x  
6314190

3x  
6457557

4x  
6215606

2x  
6474266

12x  
6324205

2x  
6360035

10x  
4651231

2x  
6192920

22x  
6218360

2x  
6431328

4x  
6411587

2x  
4656783

12x  
6452541

8x  
6167699

1x  
6336665

1x  
6336665

1x  
6336665

4x  
6055309

1x  
6257605

2x  
6489195

31x  
6343854

2x  
6313600

4x  
6208446

1x  
6474270

1x  
6474270

1x  
6474270

1x  
6474270

1x  
6474270

1x  
6474270

1x  
6474270

1x  
6474270

1x  
6474270

1x  
6474270

1x  
6474270

1x  
6474270



# YOU COULD WIN



## YOU COULD WIN

Your feedback will help shape the future development of this product series.

Visit:

## DU KÖNNTEST GEWINNEN

Dein Feedback trägt zur Weiterentwicklung dieser Produktreihe bei.

Geh auf:

## VOUS POURRIEZ GAGNER

Vos commentaires nous aideront à concevoir les futurs produits de cette gamme.

Visitez :

## POTRESTI VINCERE TU

La tua opinione ci aiuterà a migliorare la creazione futura di questa linea di prodotti.

Visita:

## PUEDES GANAR

Tu opinión contribuirá al futuro de esta serie de productos.

Visita:

## 轻松获奖

您的反馈将有助于我们在今后改进本产品系列。

请访问:

---

**[LEGO.com/productfeedback](https://LEGO.com/productfeedback)**

---

You also have the chance to win a LEGO® set.

Terms and conditions apply.\*

Außerdem hast du die Chance, ein LEGO® Set zu gewinnen.

Es gelten die Teilnahmebedingungen.\*

Vous pourriez également gagner un ensemble LEGO®.

Des conditions s'appliquent.\*

Hai anche la possibilità di vincere un set LEGO®.

Termini e condizioni sono applicabili.\*

También tienes la oportunidad de ganar un set LEGO®.

Aplican términos y condiciones.\*

您还有机会赢取乐高®套装。

条款和条件适用。\*

\*[LEGO.com/productfeedback-terms](https://LEGO.com/productfeedback-terms)



LEGO and the LEGO logo are trademarks of the LEGO Group.  
©2024 The LEGO Group.