



10333

THE LORD OF THE RINGS





# SAURON IL GRANDE VI PORGE IL BENVENUTO

La base dei livelli della torre è la sala del trono di Barad-dûr. Se si tira la leva sul pavimento, il trono scivola via per rivelare la camera sul retro con il Palantír e i piani segreti che Sauron ha preparato per le battaglie nella Terra di Mezzo.

Uno studio con biblioteca ospita una rara collezione di libri e pergamene che raccontano migliaia di anni di storia della Terra di Mezzo e di magia oscura. Una scala circonda le librerie per un facile accesso agli scaffali superiori.

Il grande Occhio di Sauron, sempre alla ricerca dell'Unico Anello, aleggia sopra Mordor.

L'occhio si muove verso sinistra, verso destra, in su e in giù, e può essere illuminato con un mattoncino luminoso.



BOCCA DI SAURON

SAURON

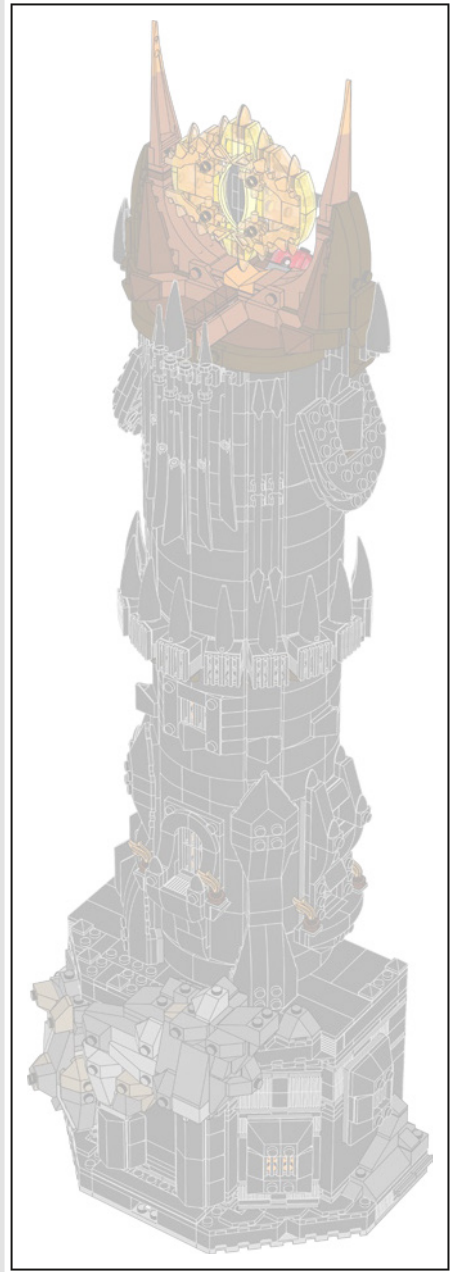

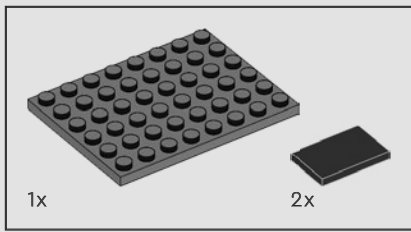

1

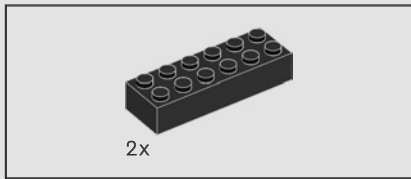
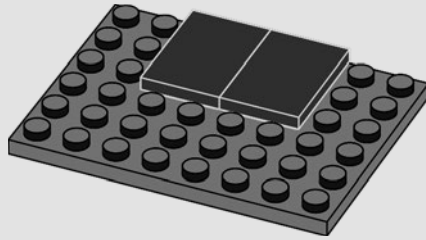

2

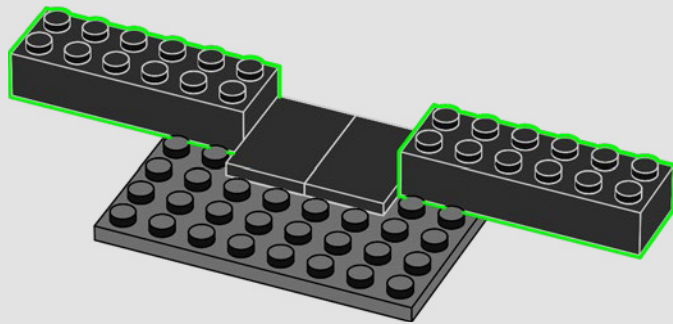

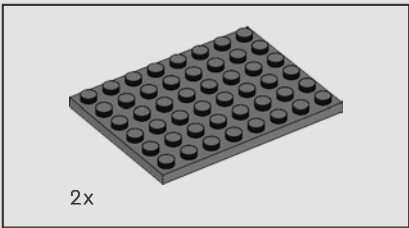

3

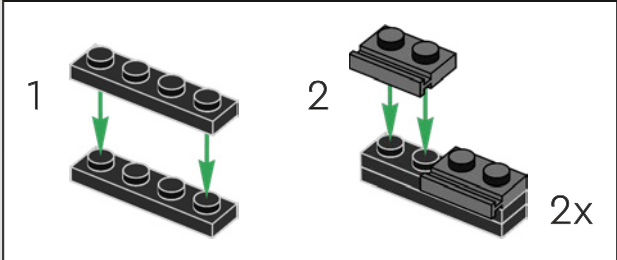
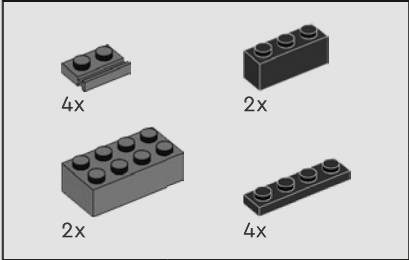
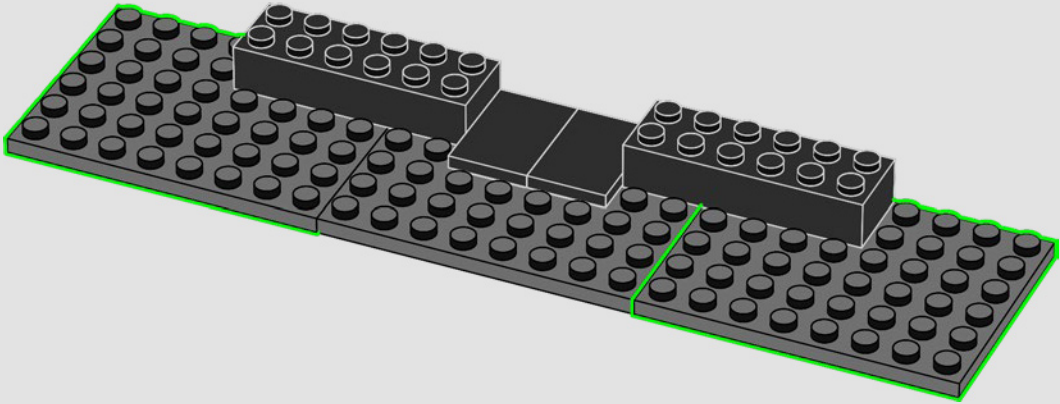

4

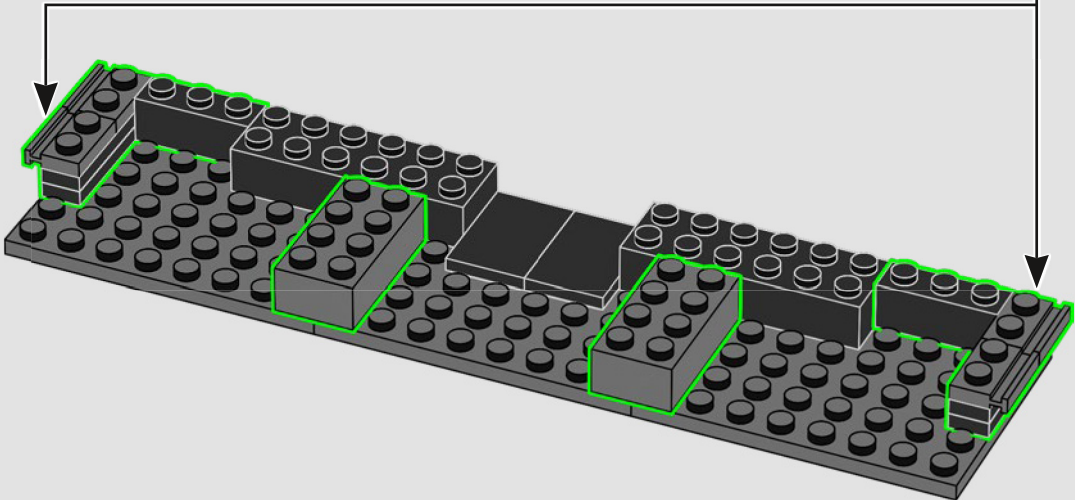

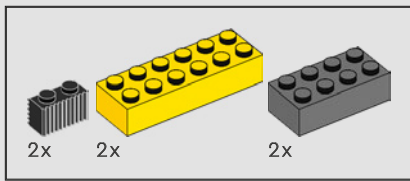

5

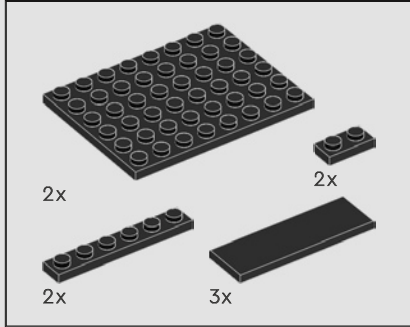
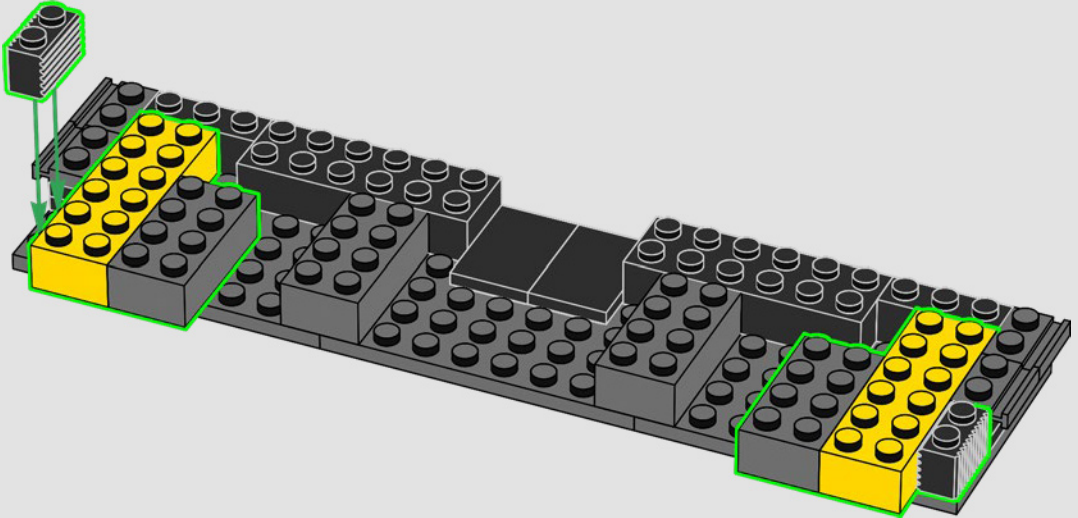

6

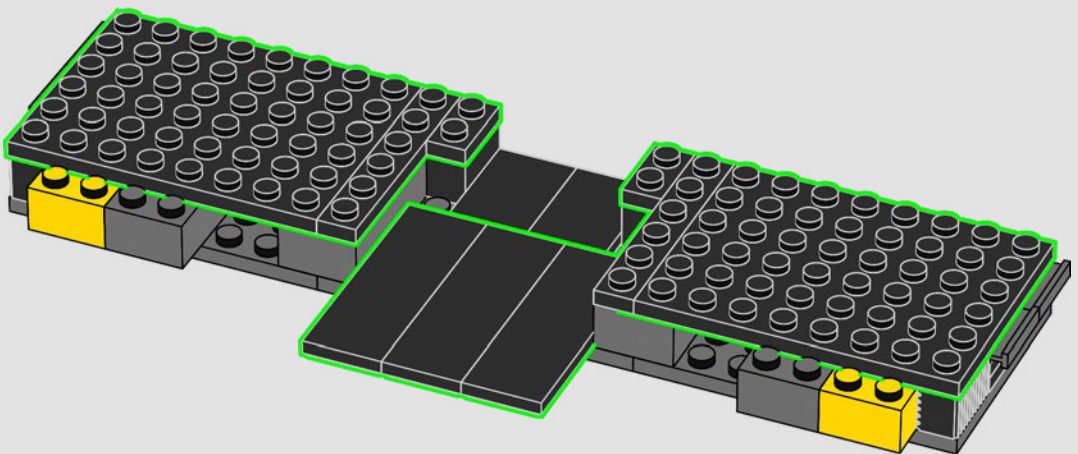

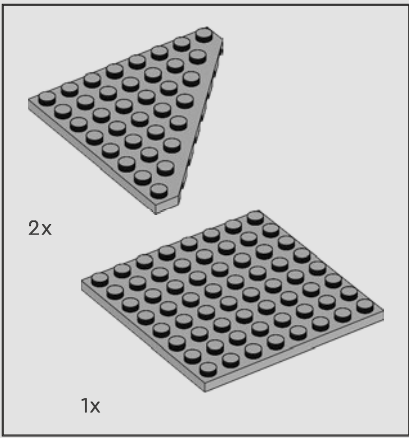

7

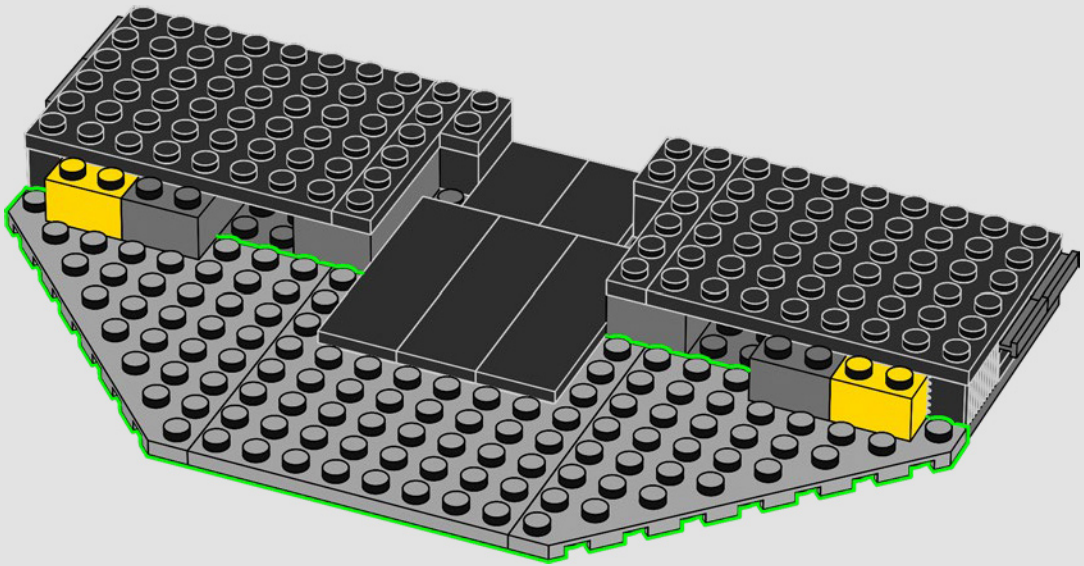

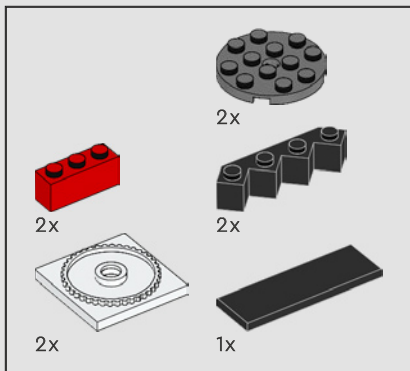

8

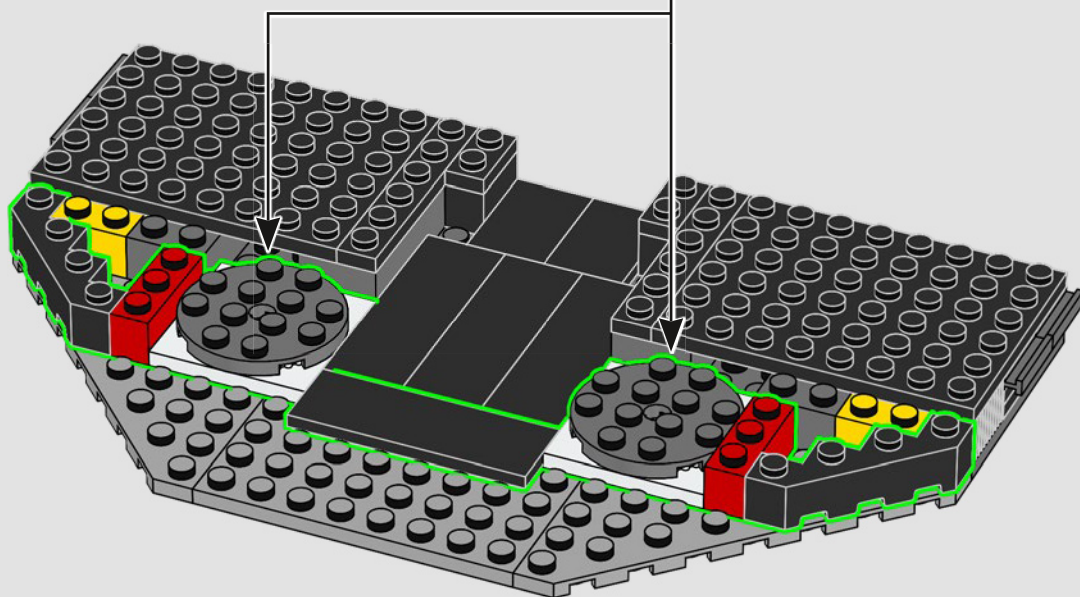
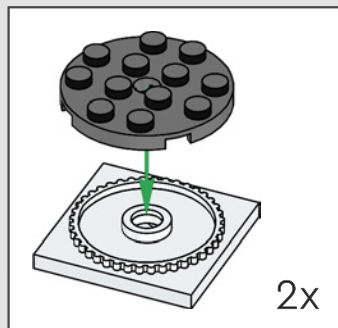

La piattaforma nasconde la funzione principale di questa sezione.





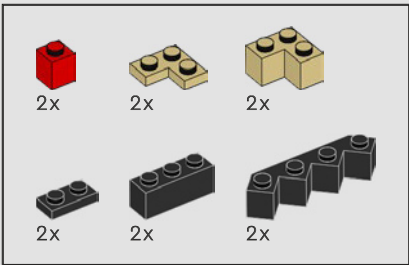

9

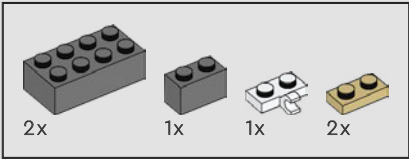
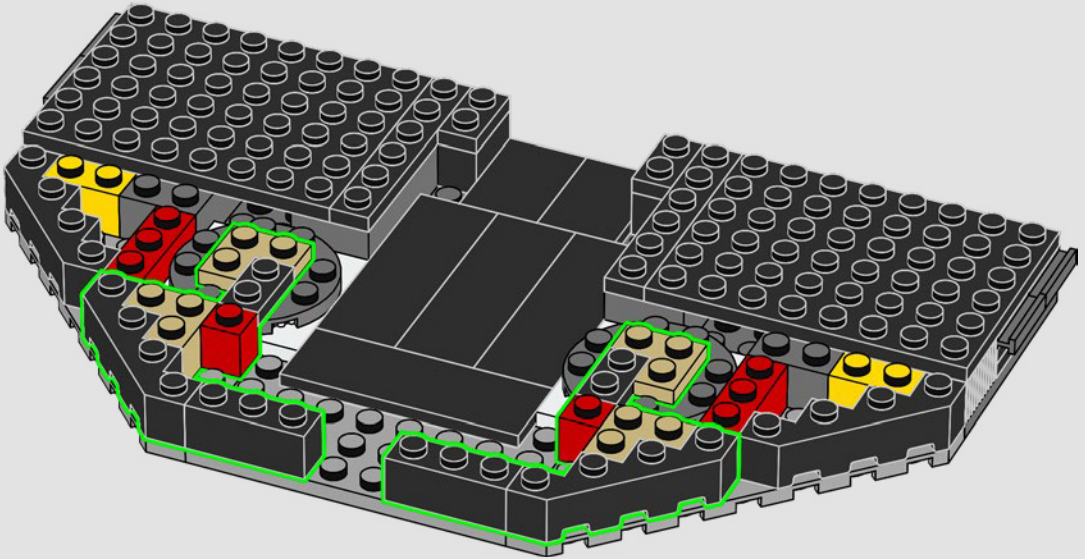

10

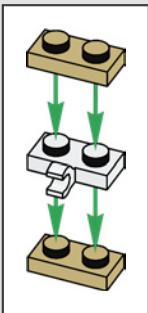
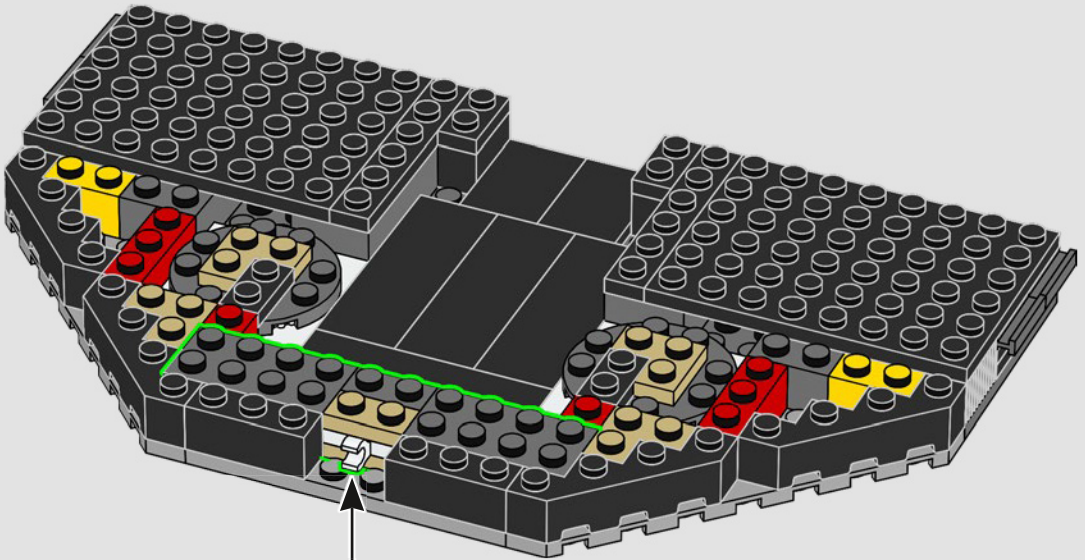

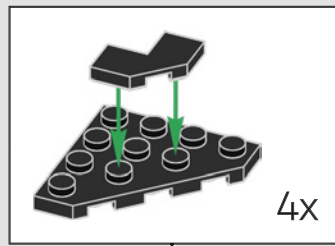
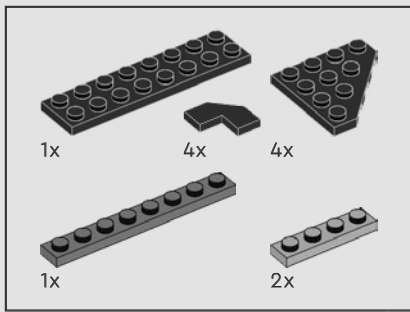

11

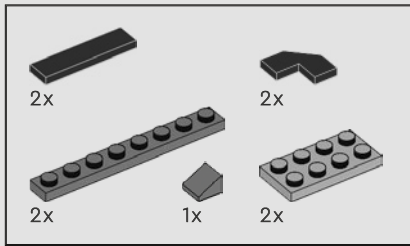
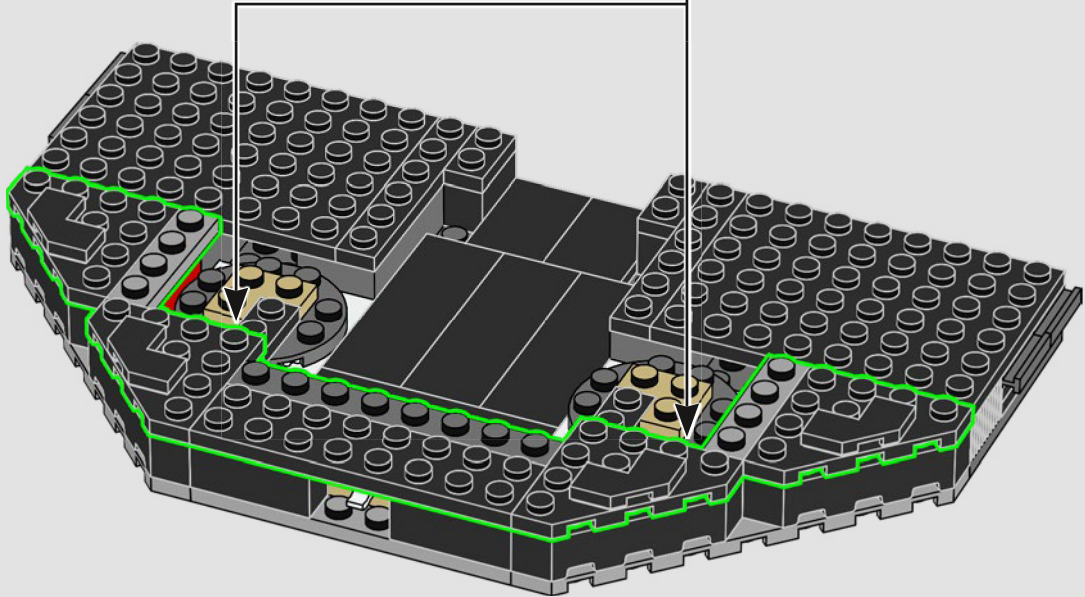

12

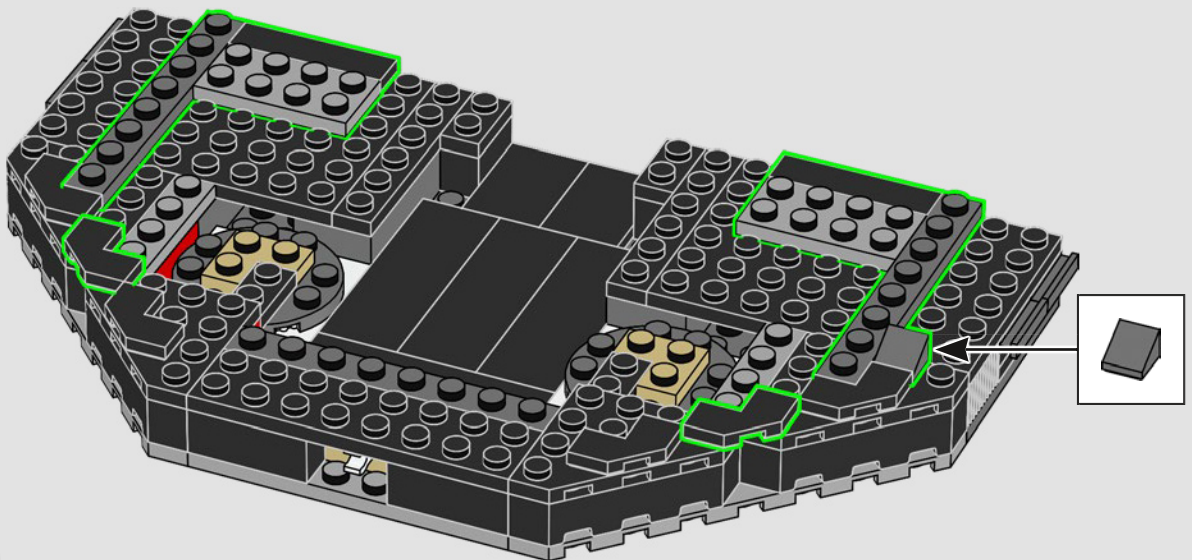

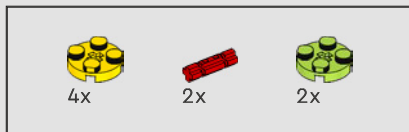

13

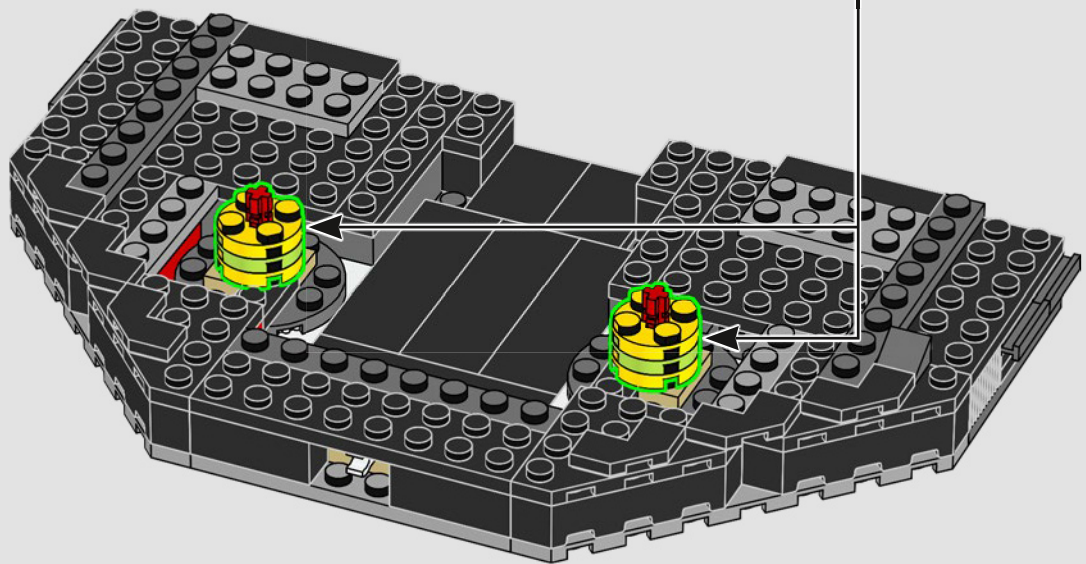
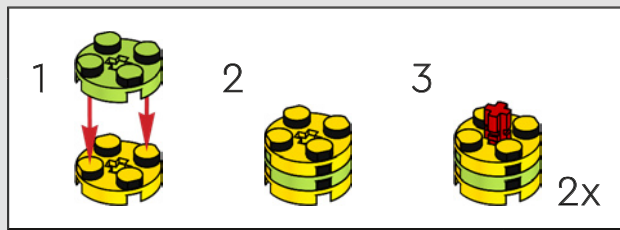

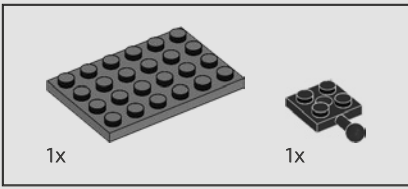

14

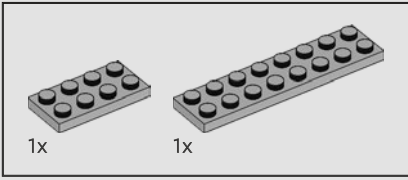
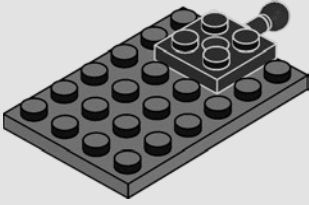

15

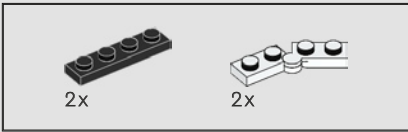
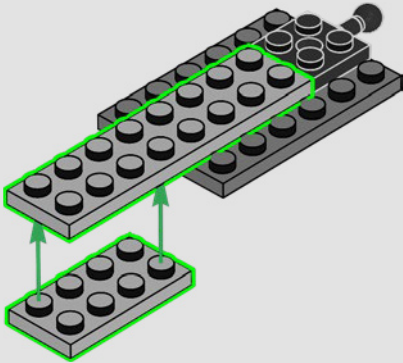

16

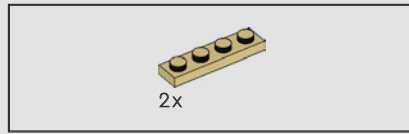
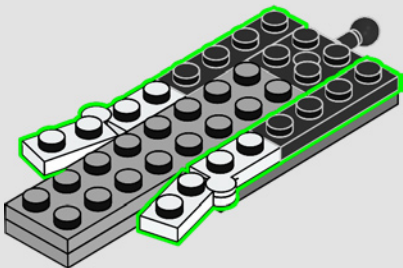

17

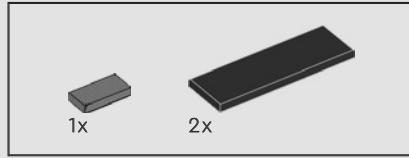
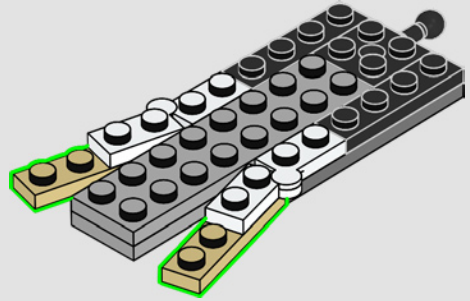

18

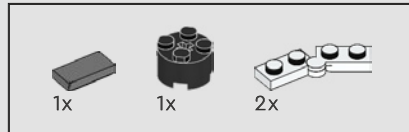
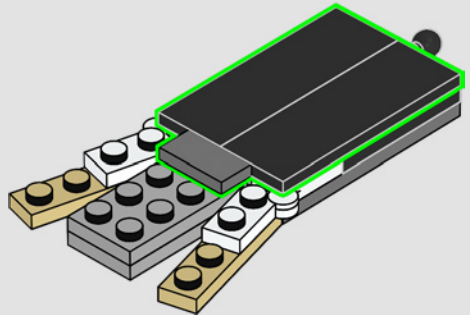

19

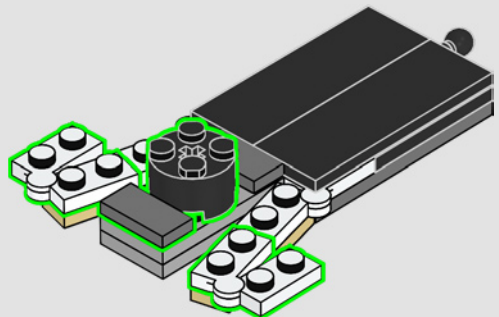

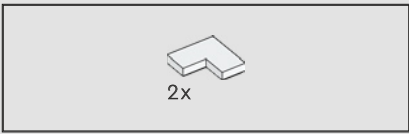

20

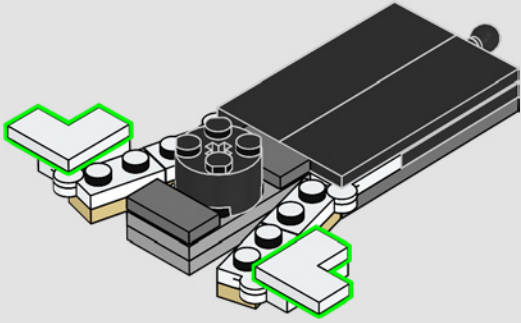

21

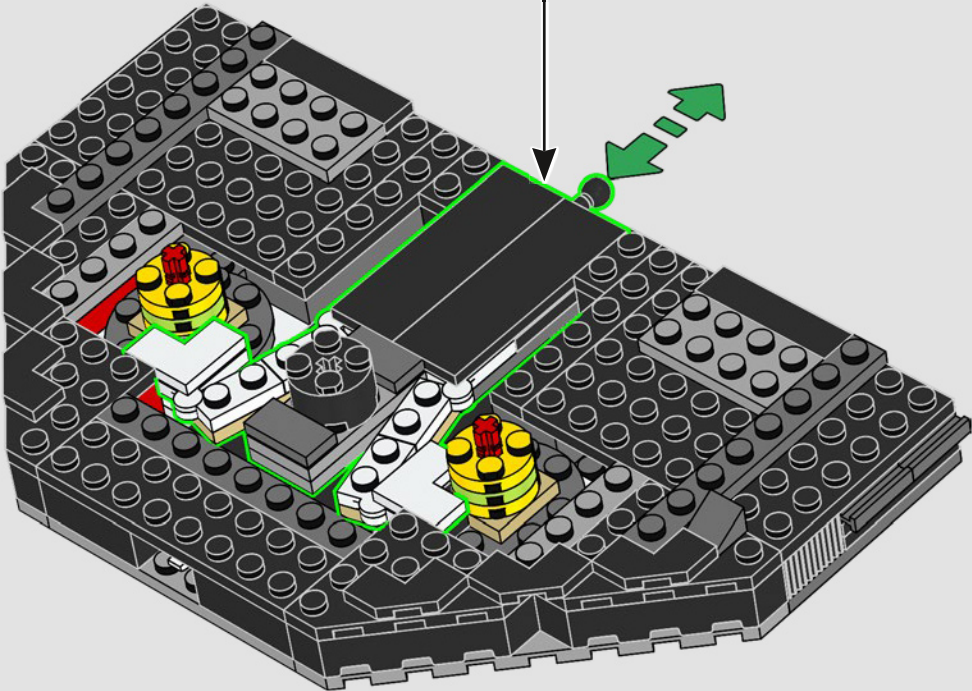

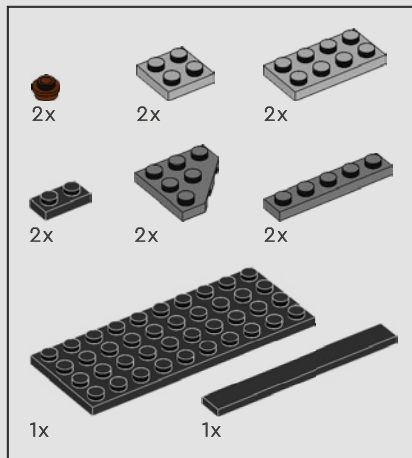

22

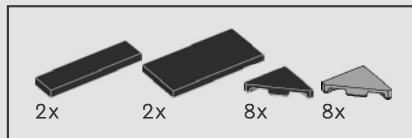
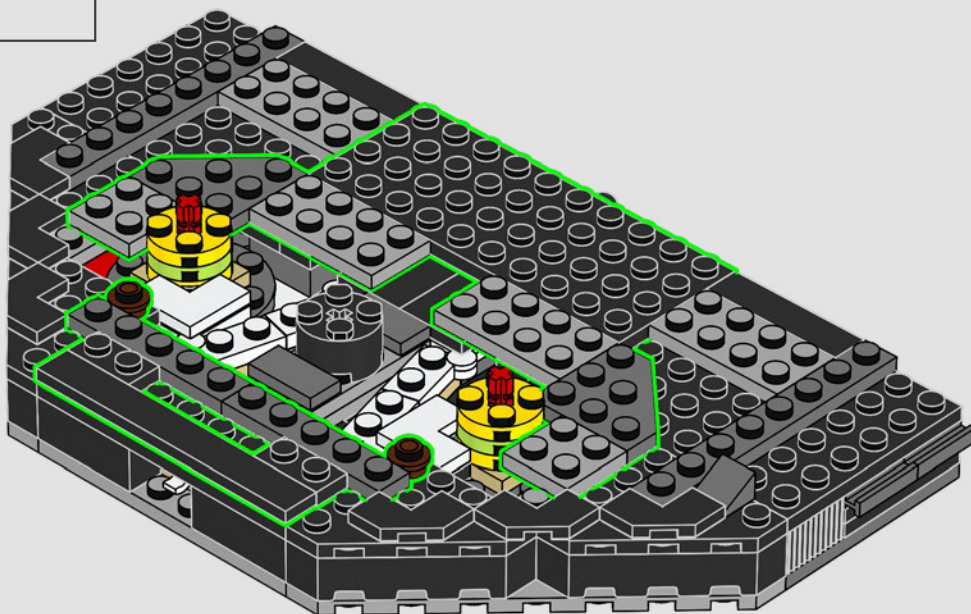

23

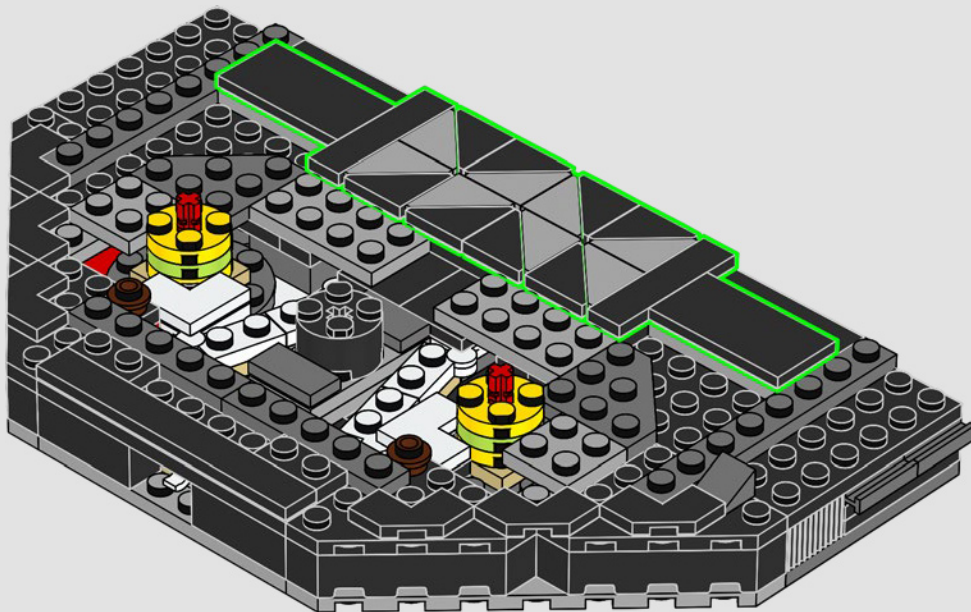

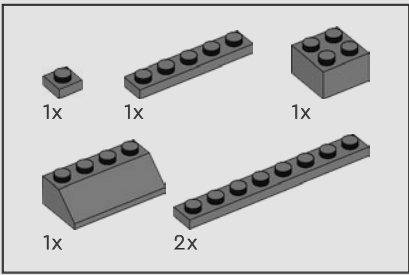

24

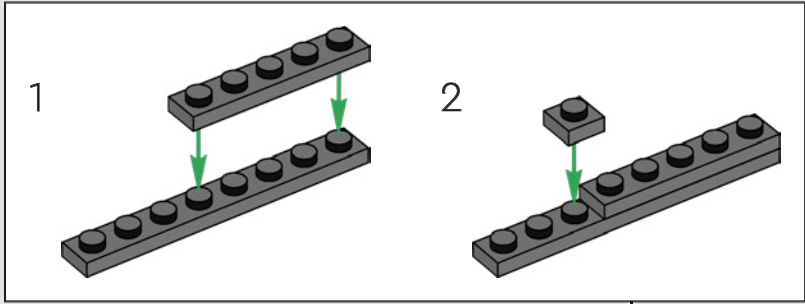
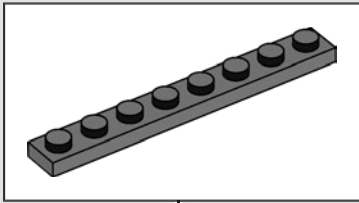

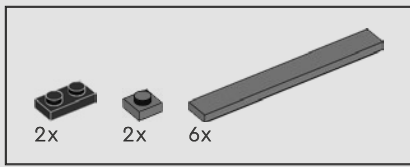

25

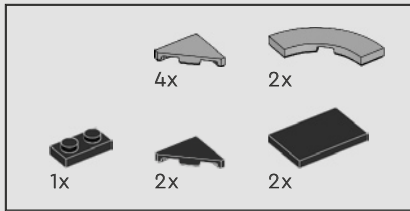
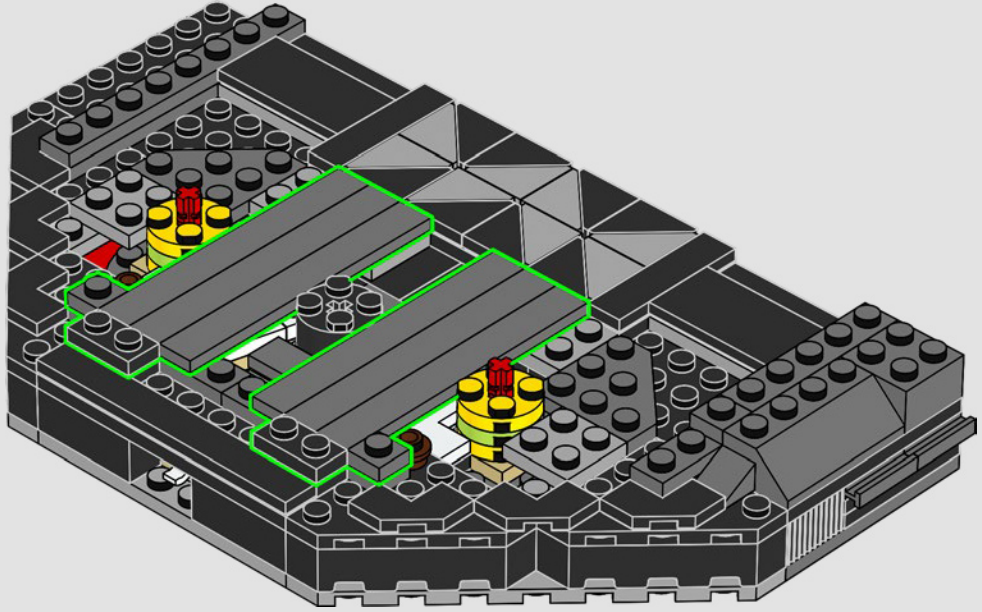

26

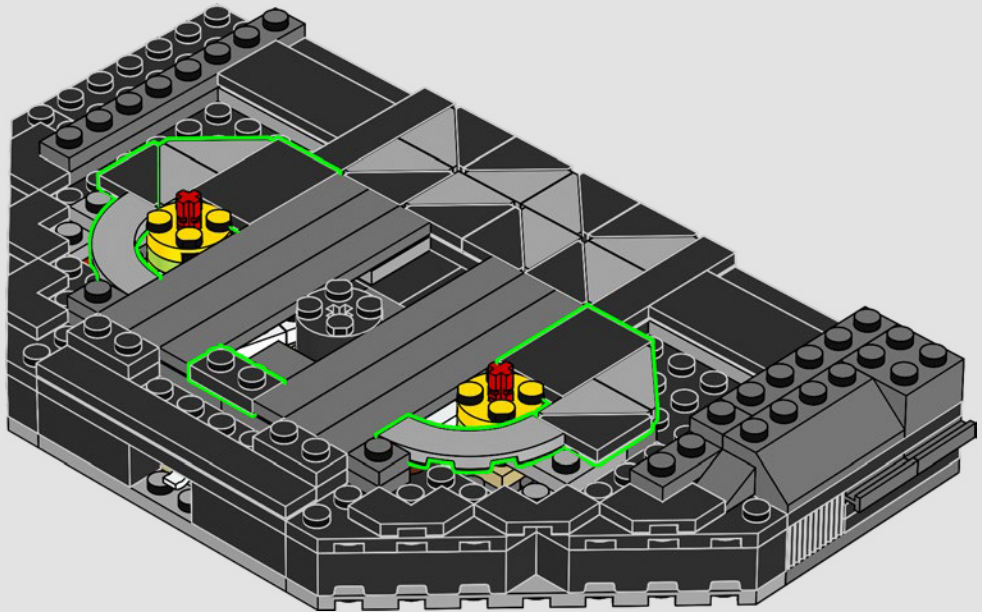



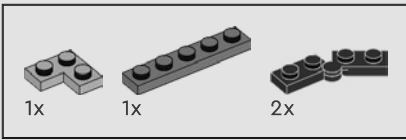

27

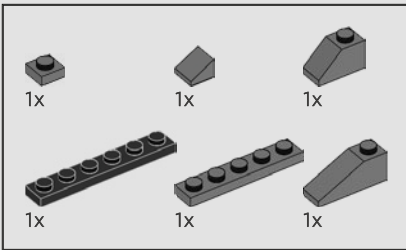
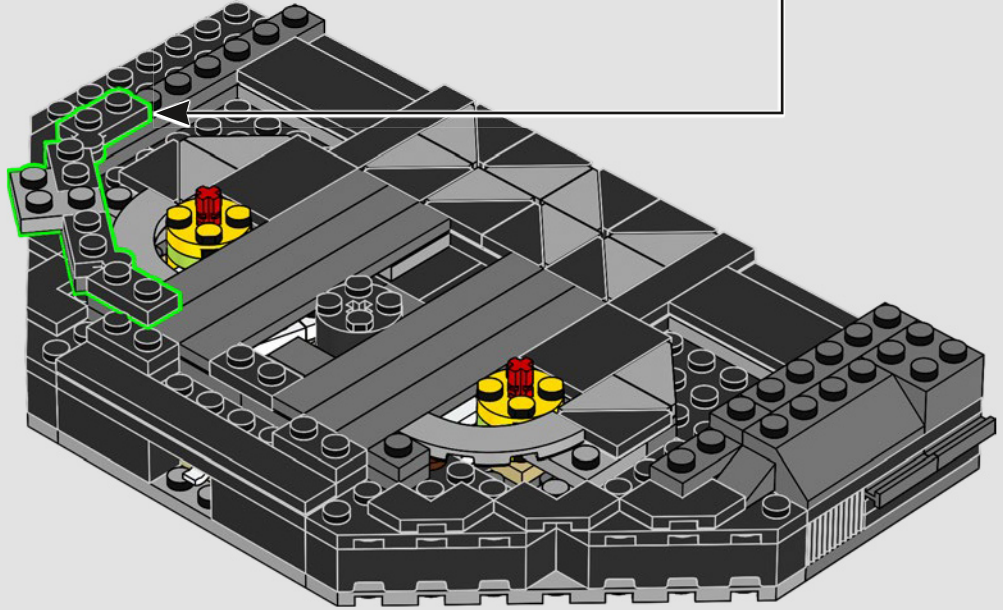
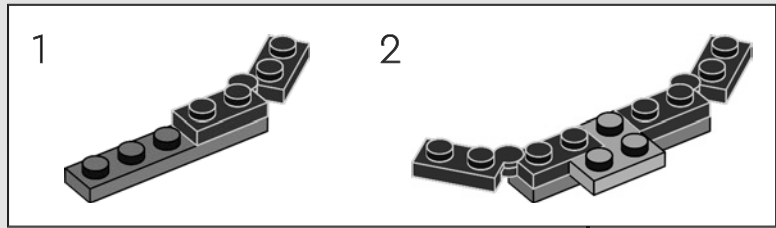

28

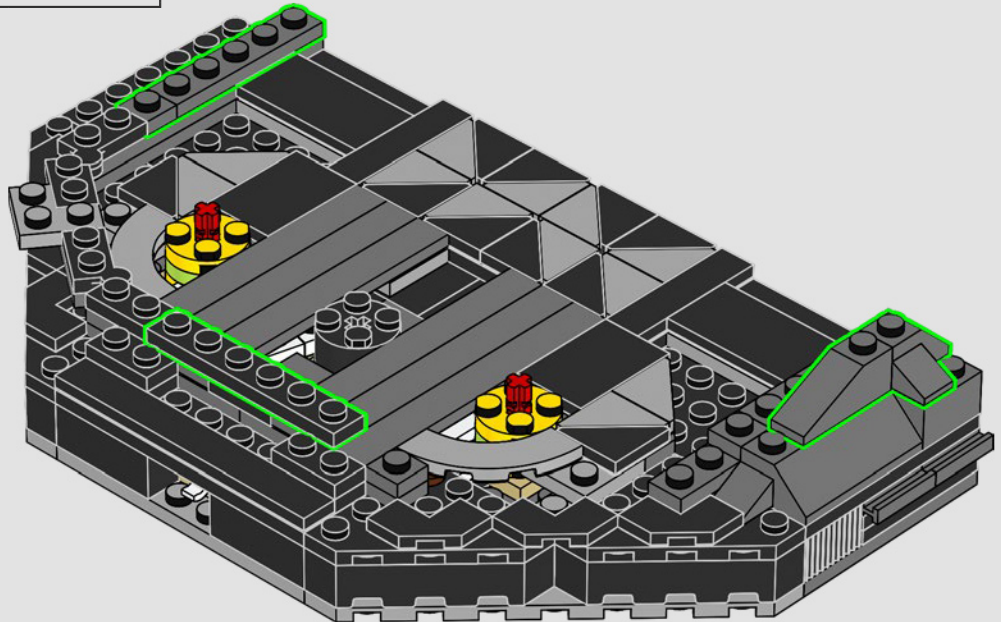

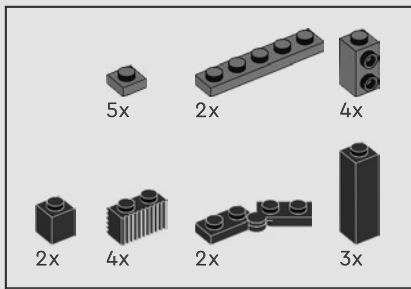

29

1

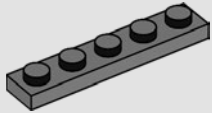

2

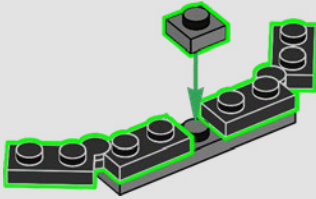

3

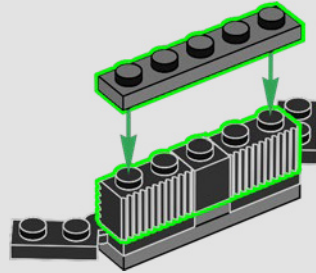

4

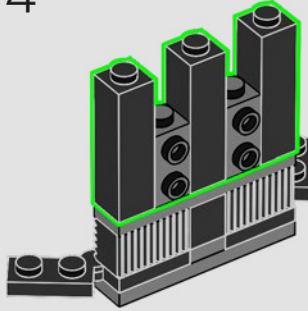

5

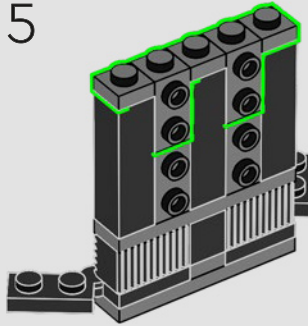

6

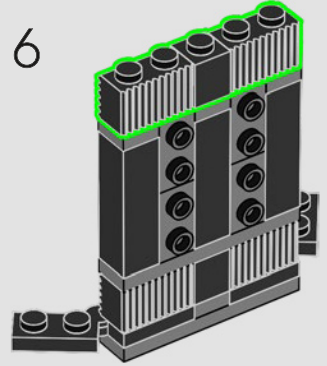

7

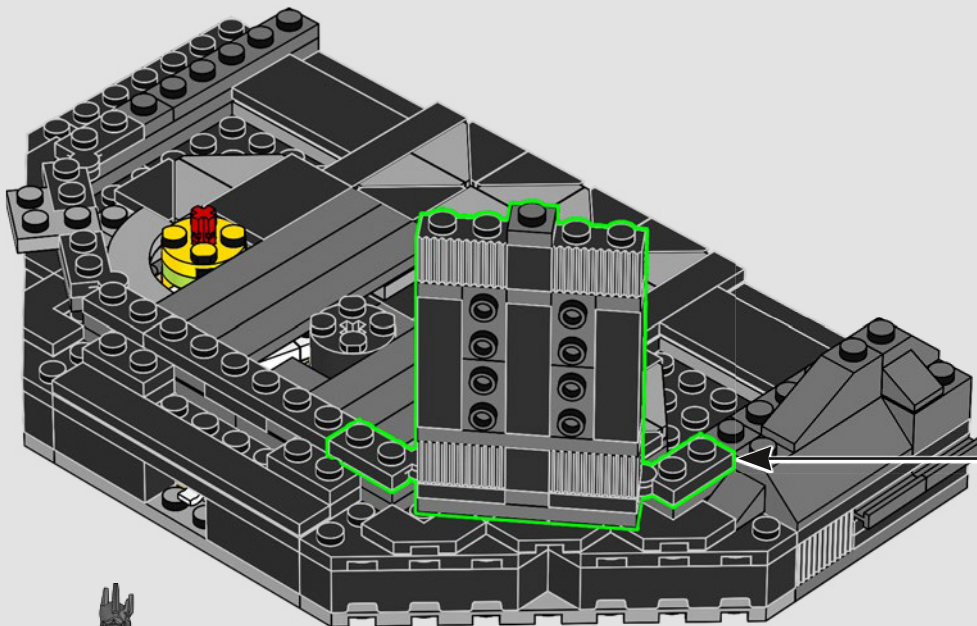
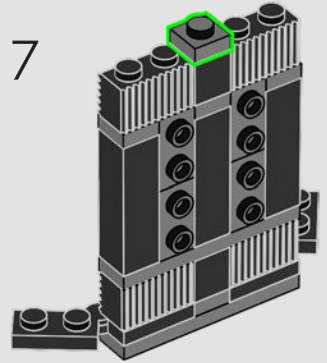

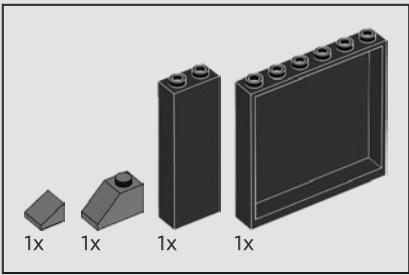

30

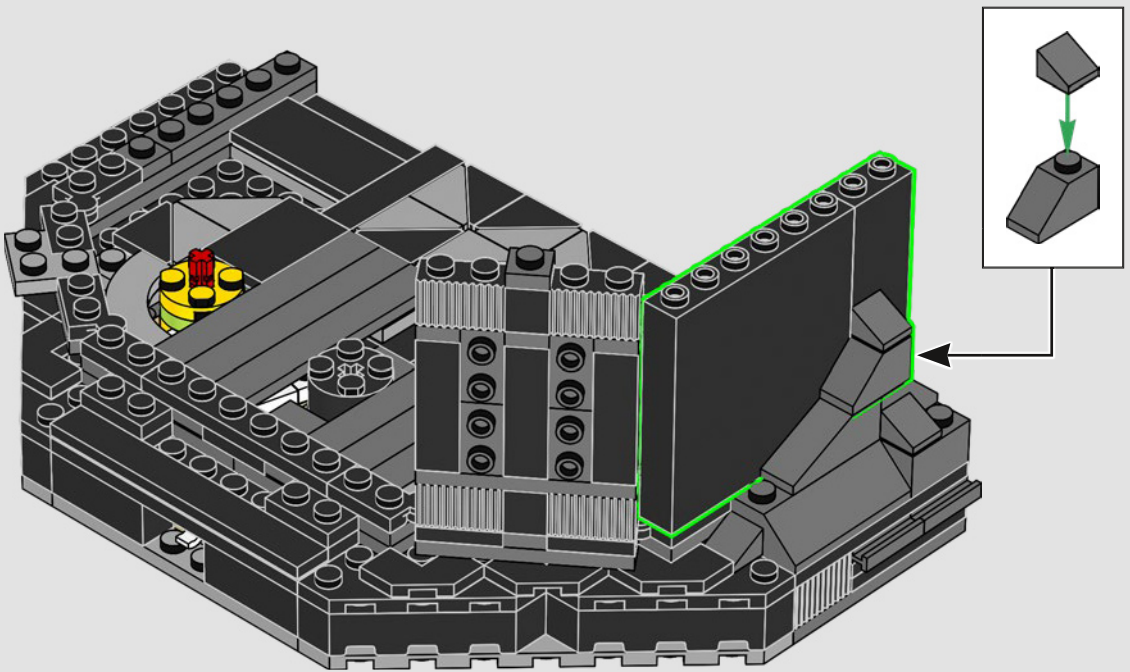

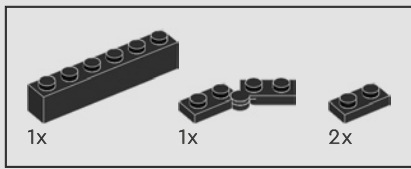

31

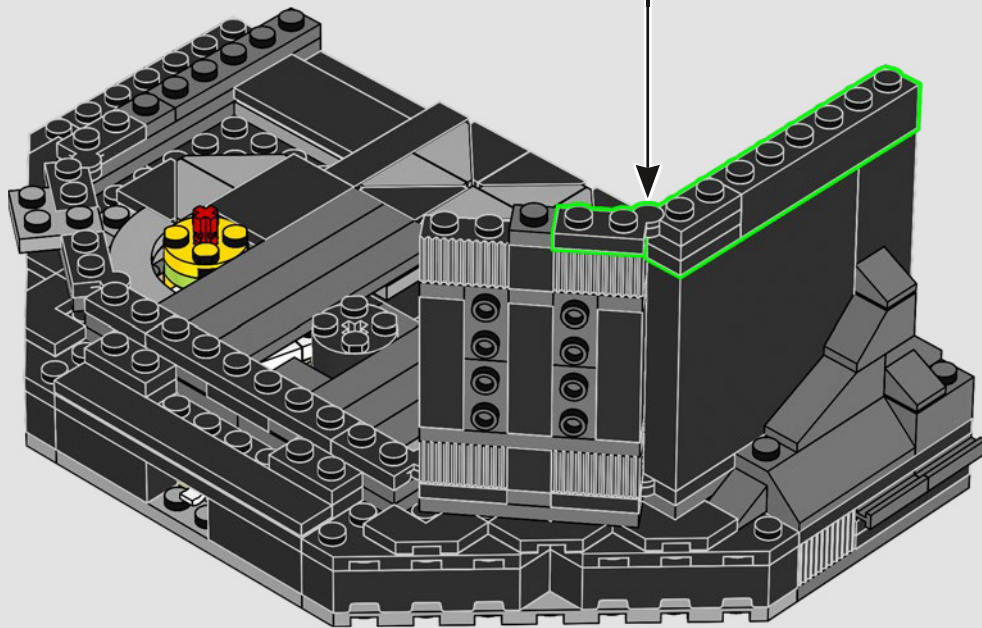
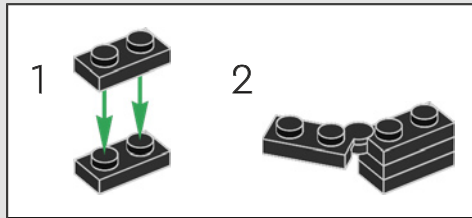

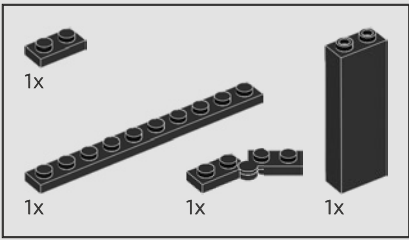

32

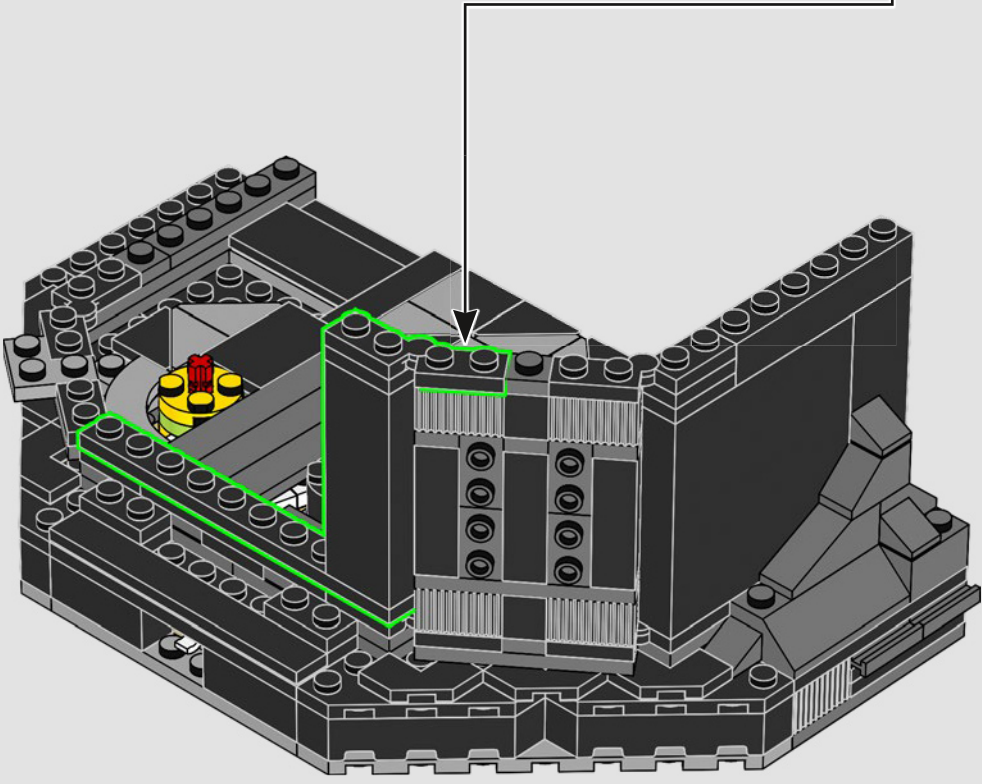
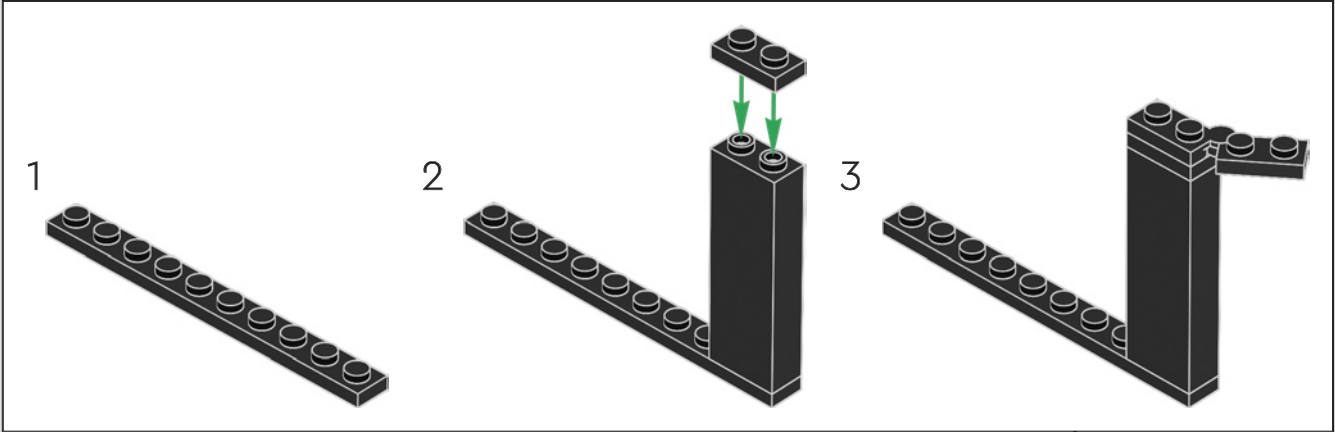

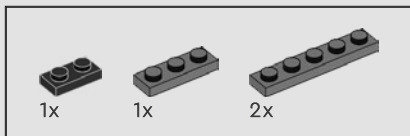

Il design team ha immaginato la sala del trono come uno spazio minimalista, oscuro e minaccioso, con angoli acuti e archi curvi.

33

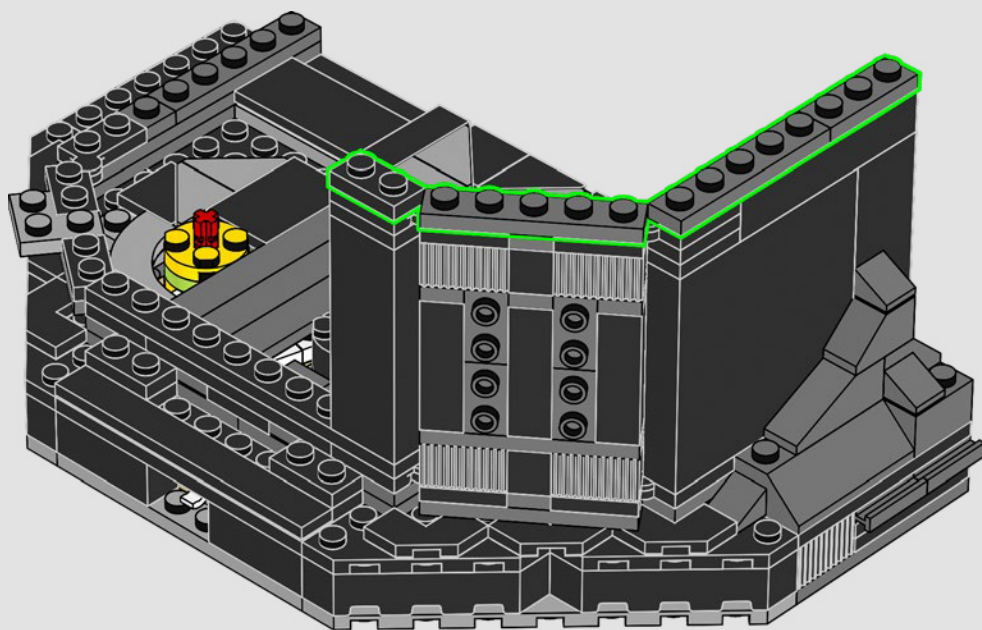

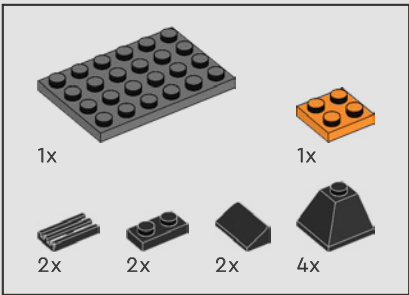

34

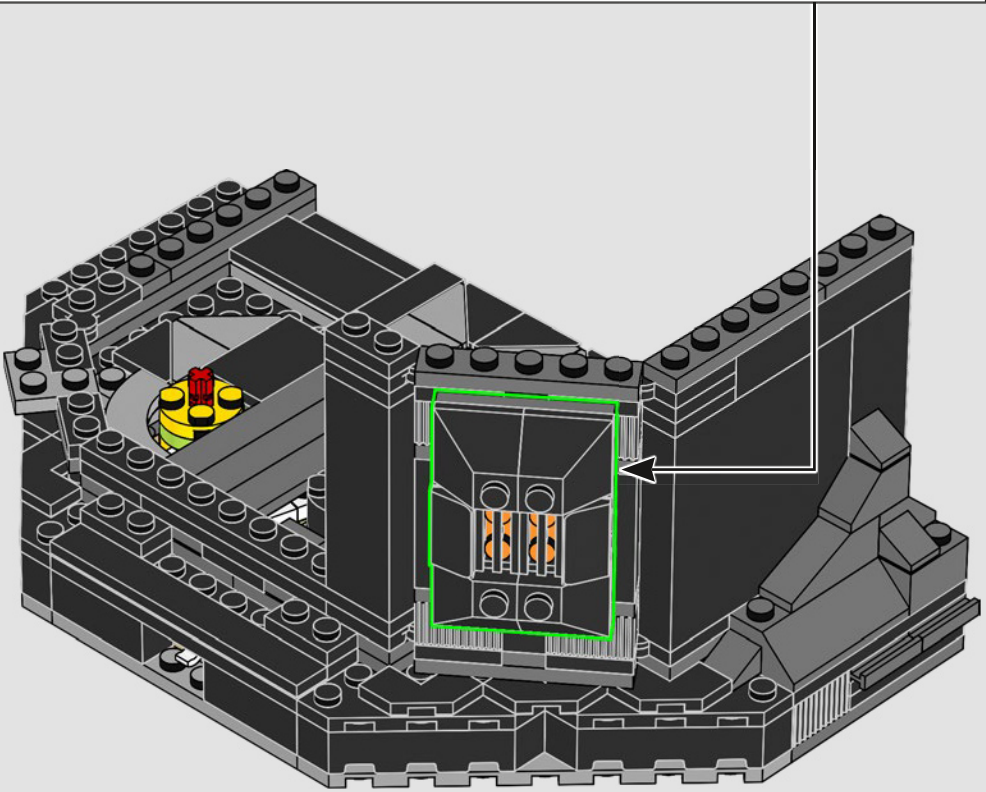
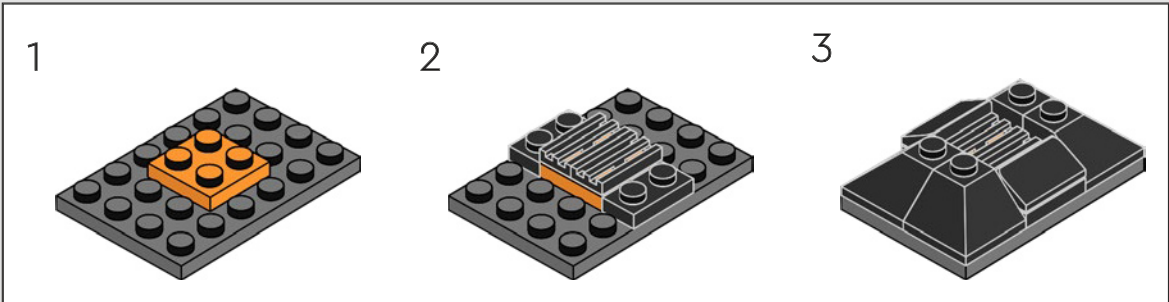

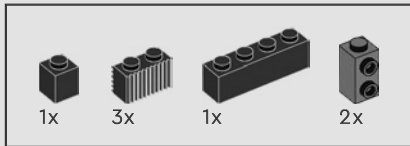

35

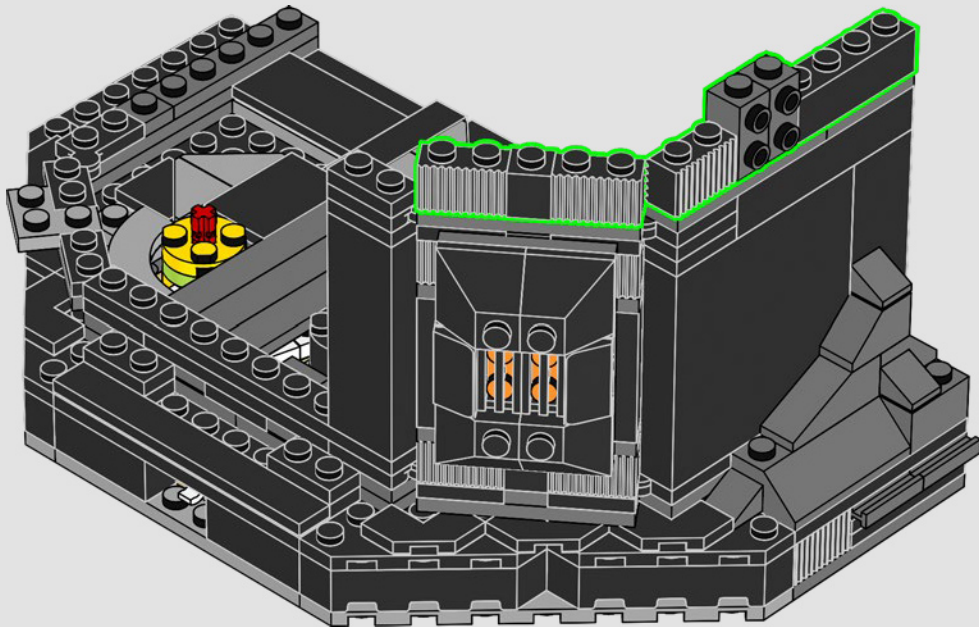



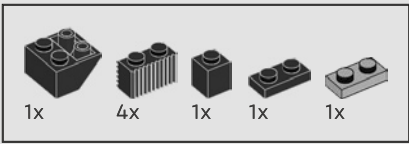

36

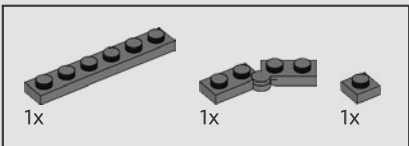
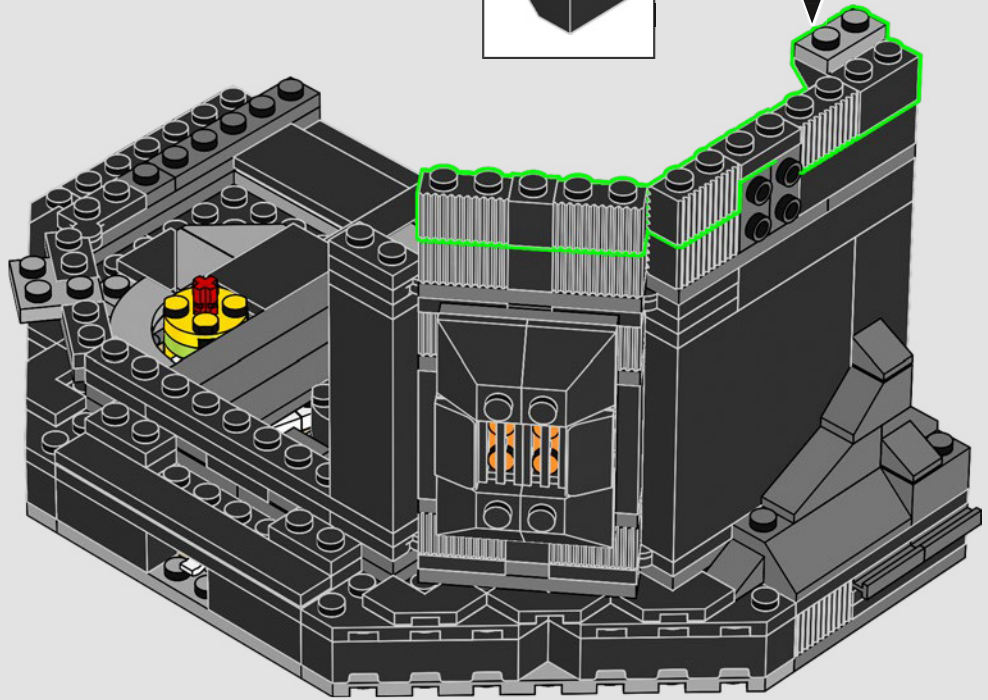
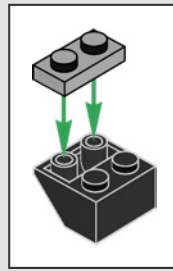

37

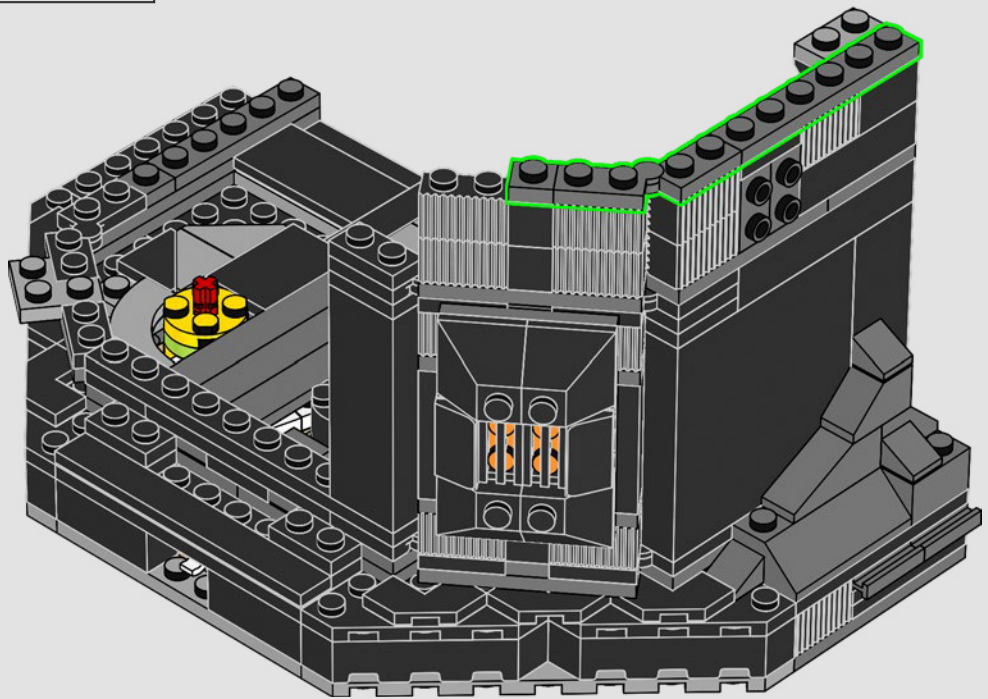

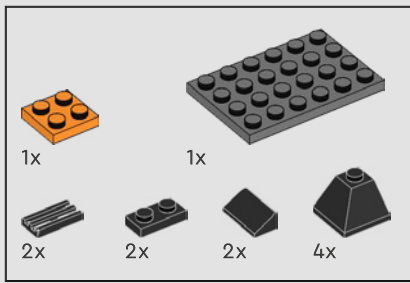

38

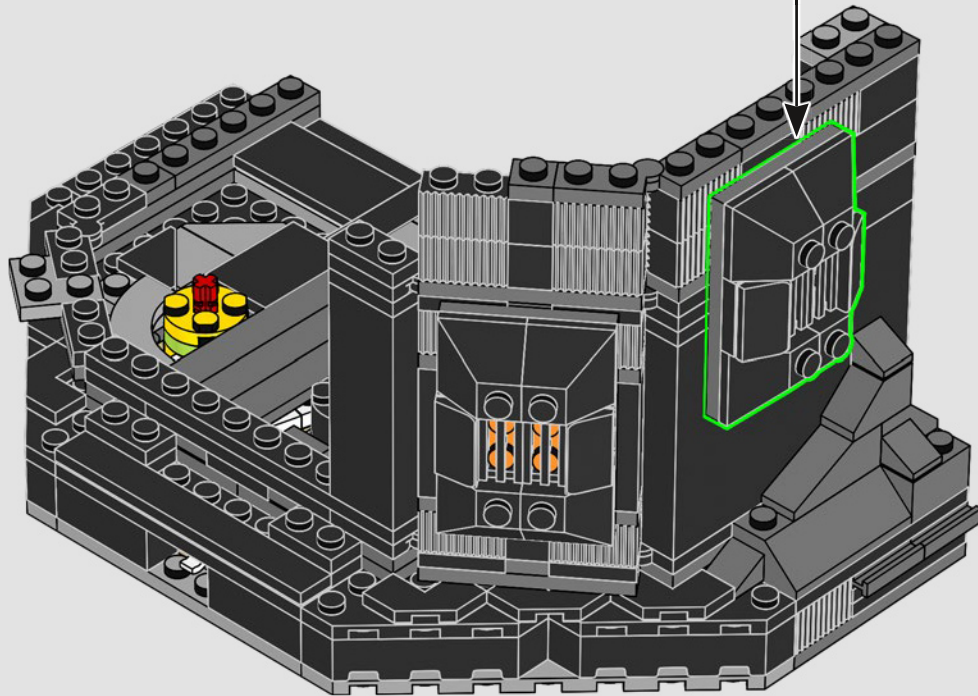
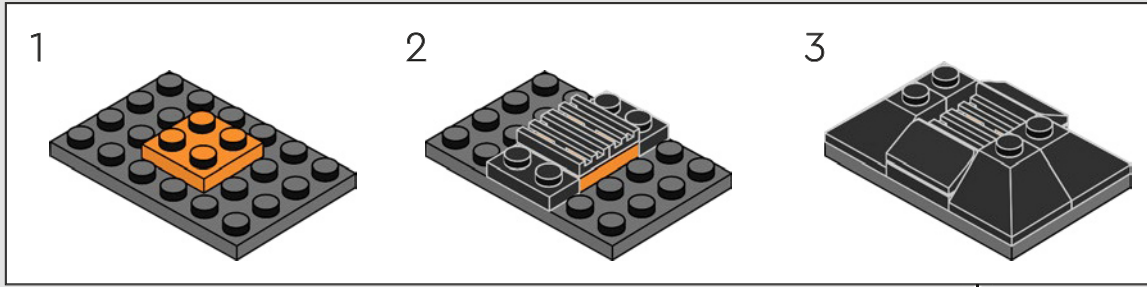

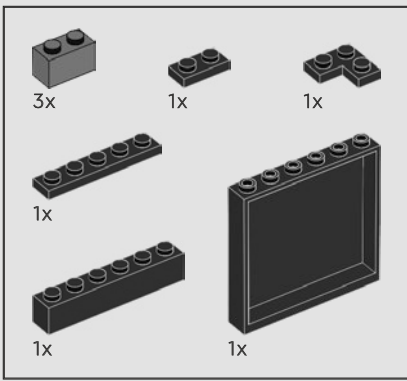

39

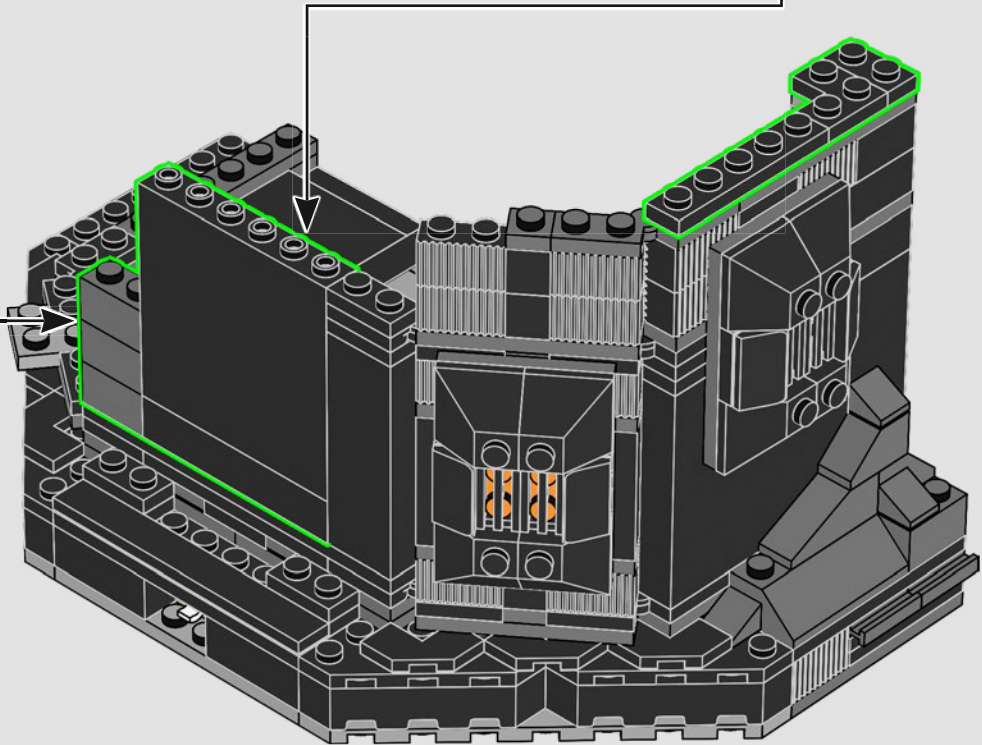
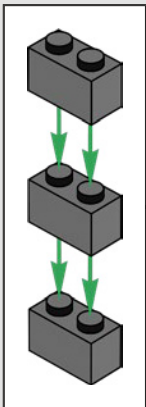
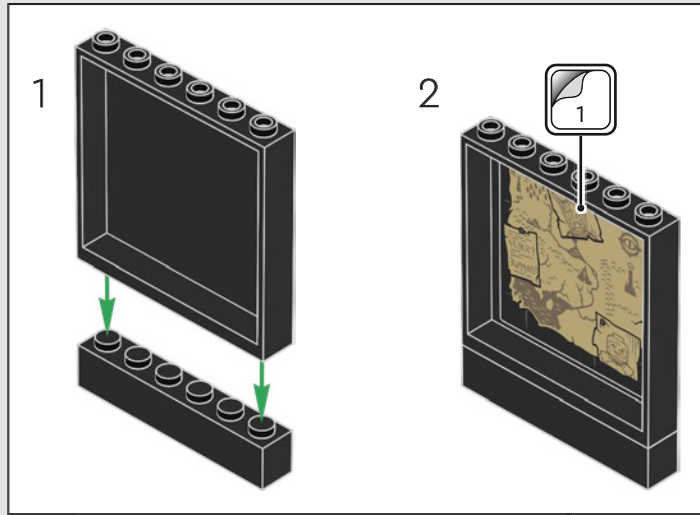

La mappa dietro il trono rivela i piani di battaglia che Sauron segue nella sua missione: conquistare tutta la Terra di Mezzo.



40

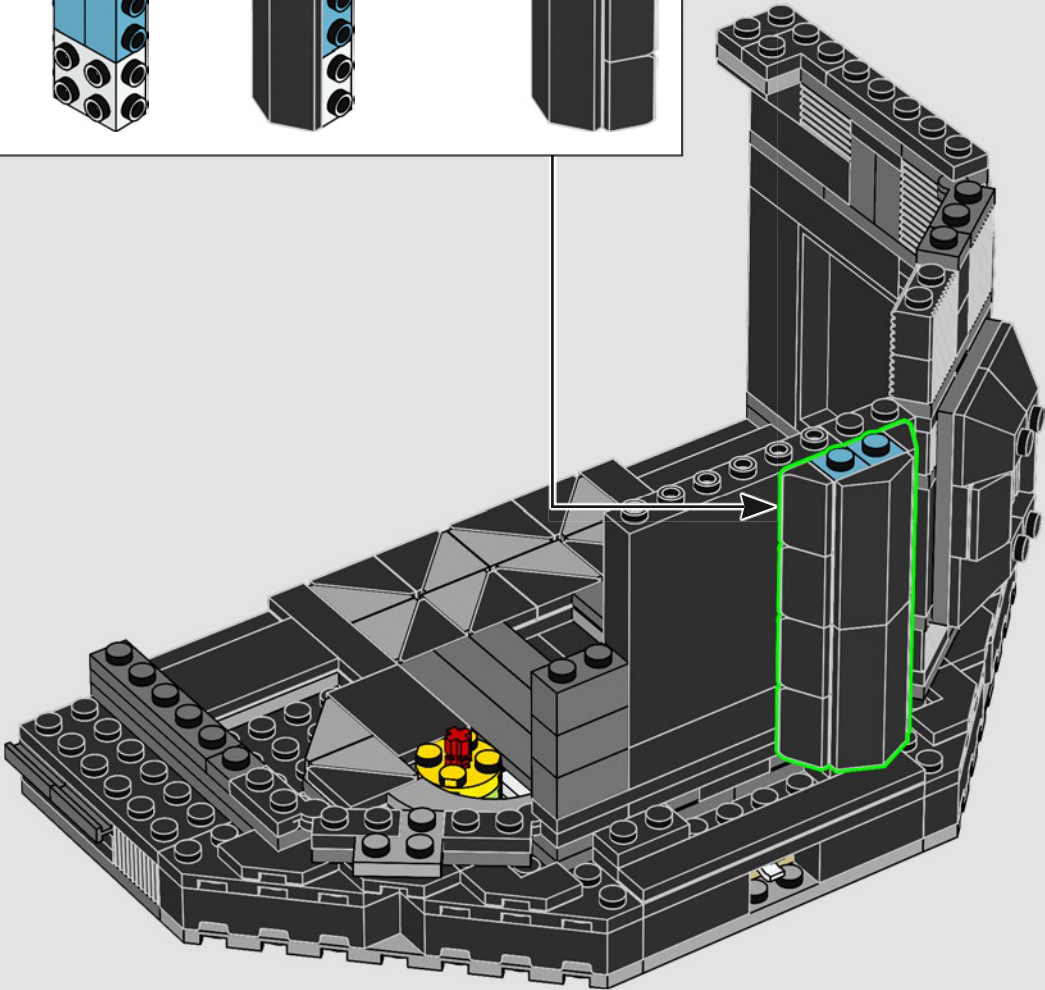
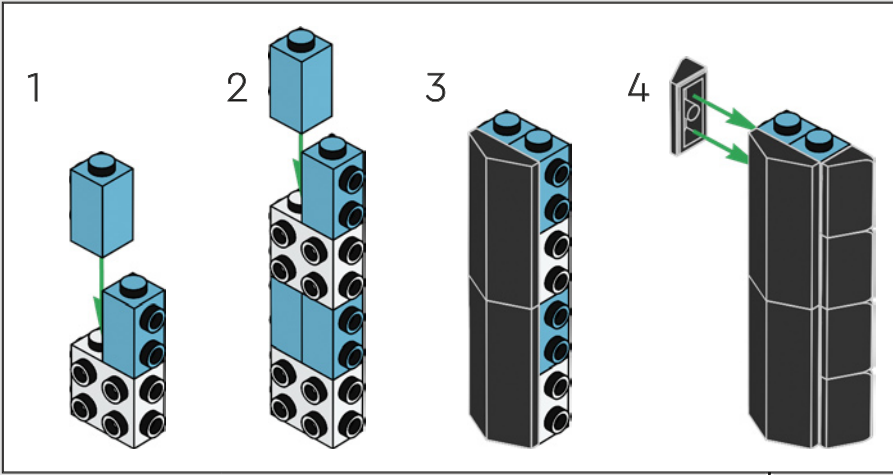

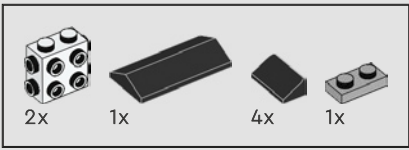

41

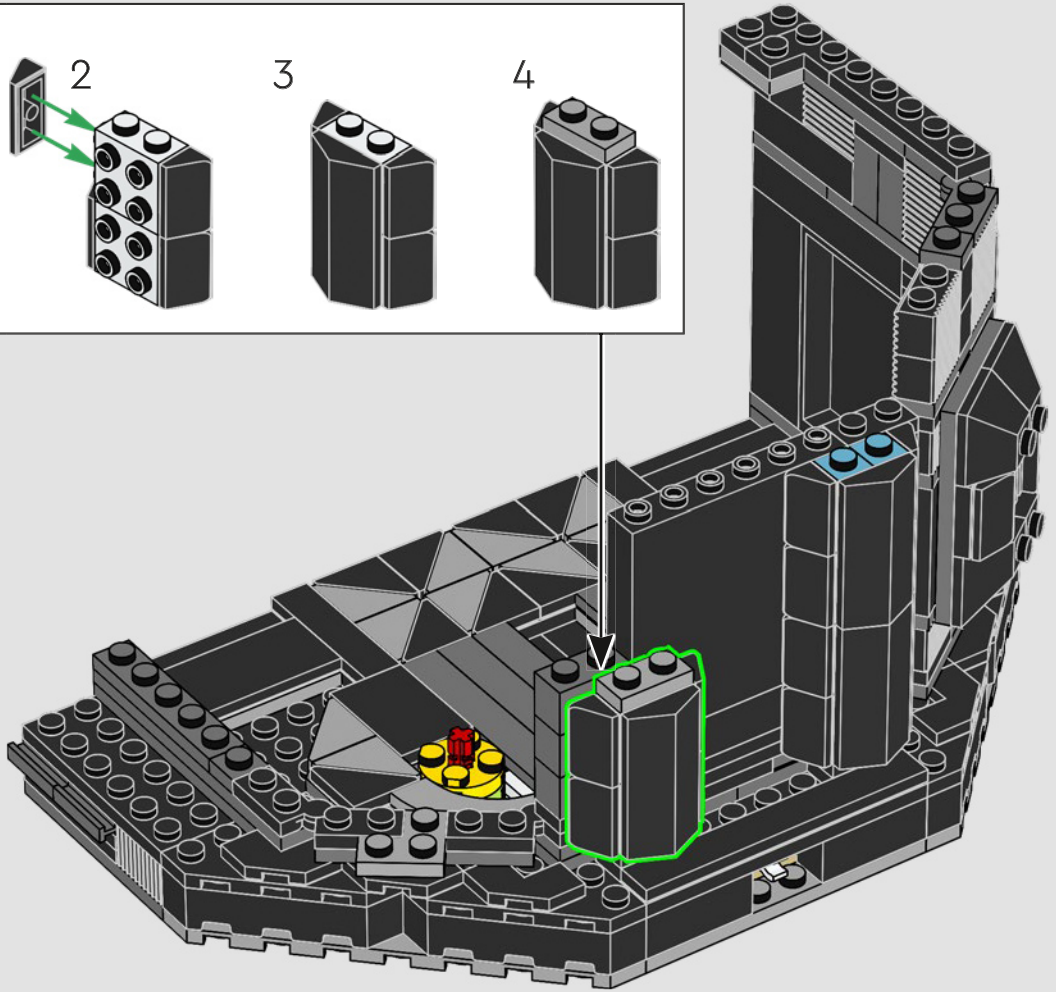
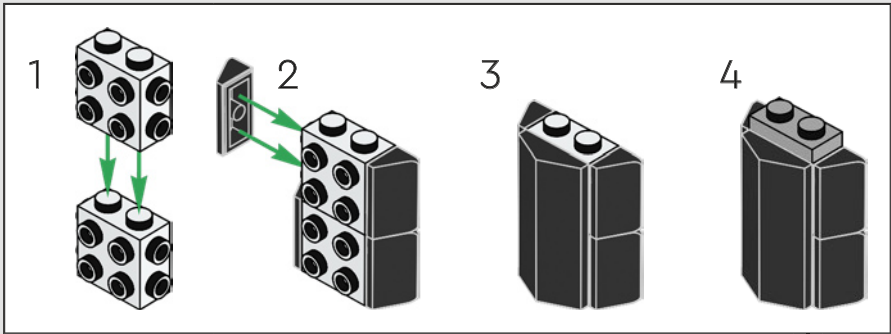

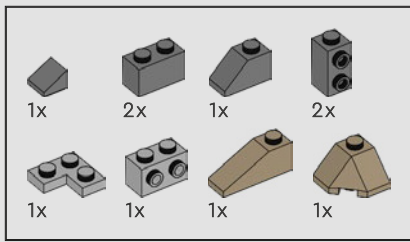

42

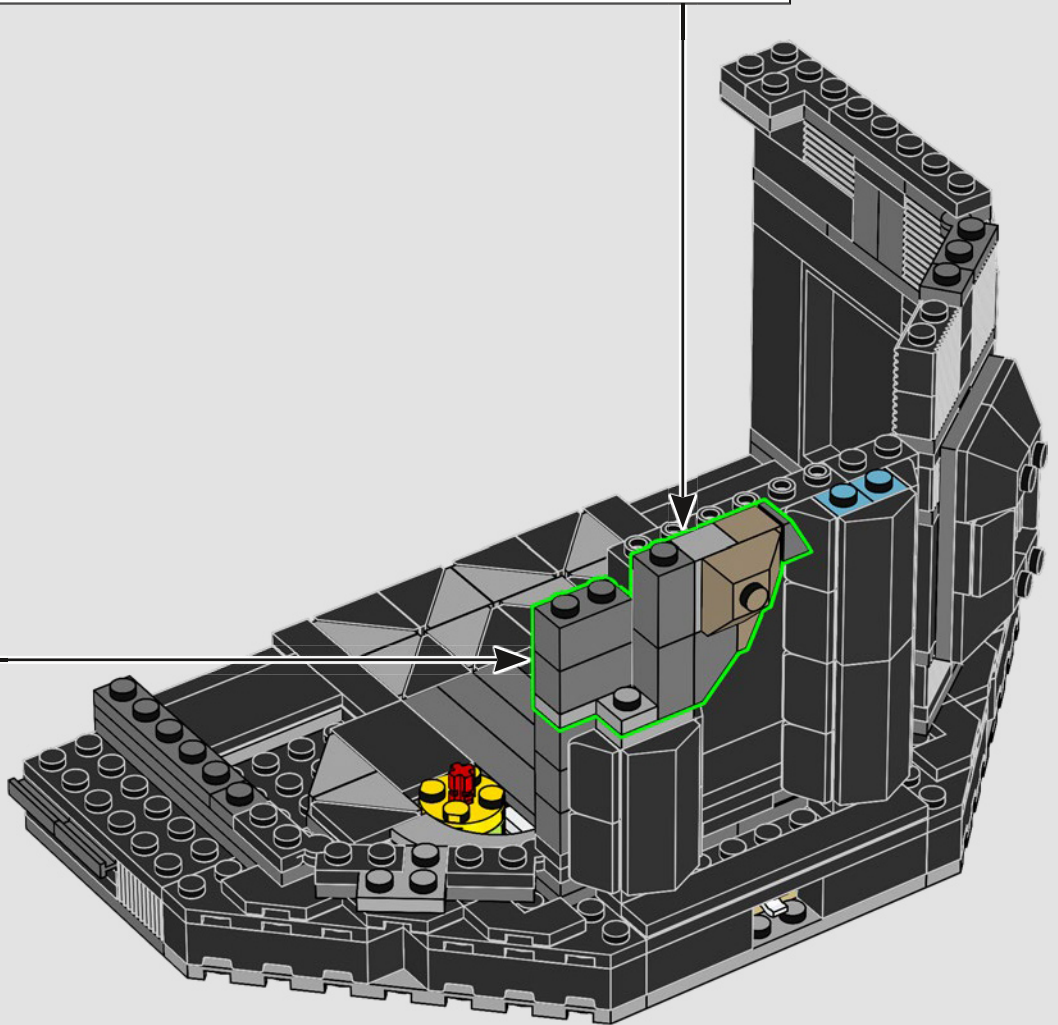
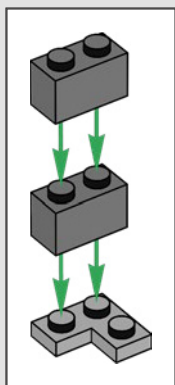
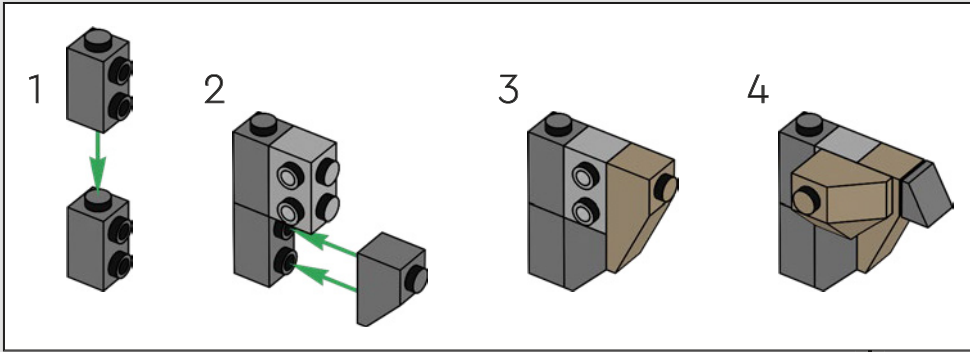

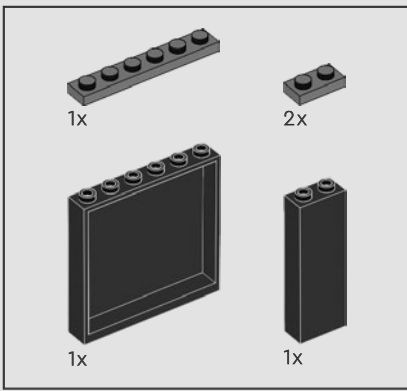

43

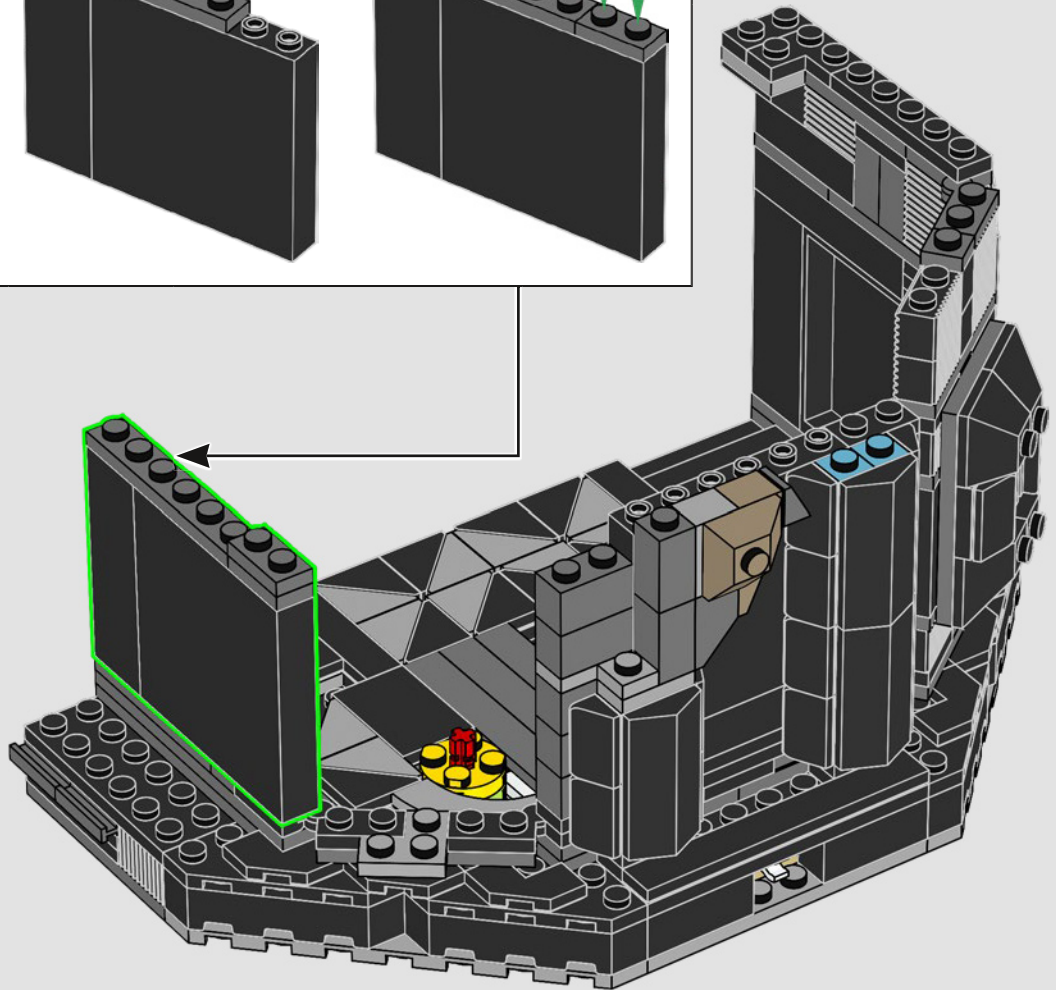
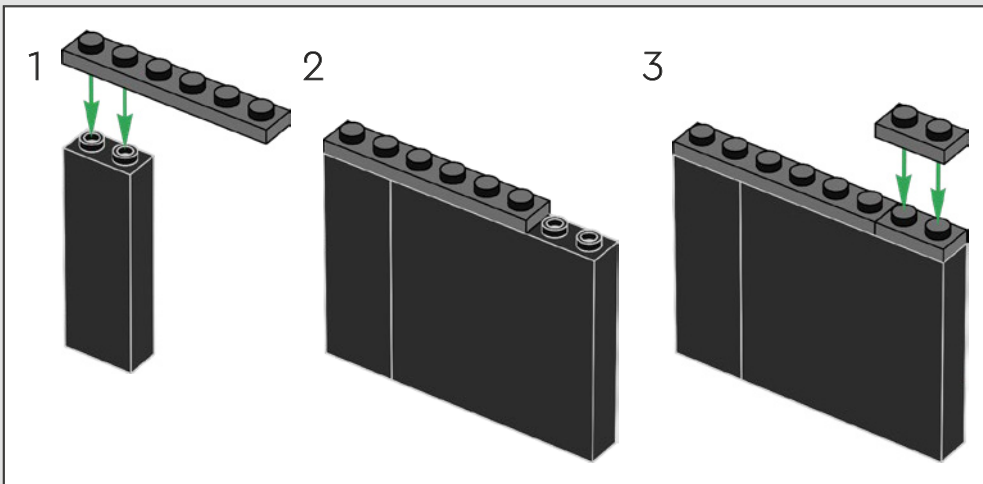

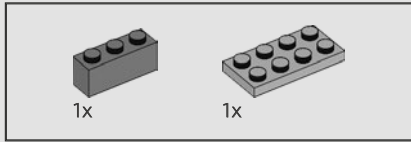
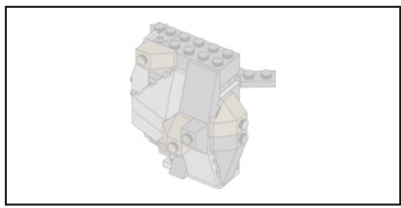

44

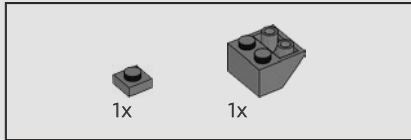
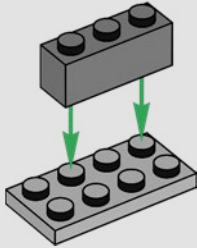

45

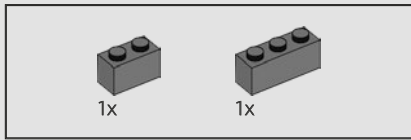
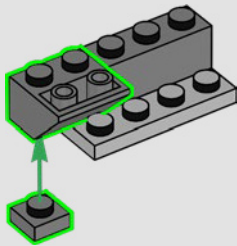

46

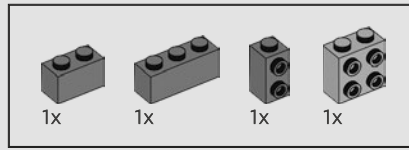
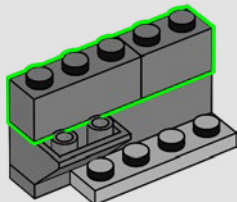

47

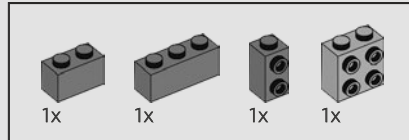
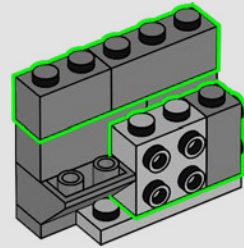

48

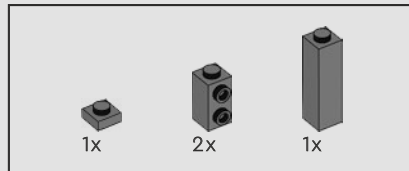
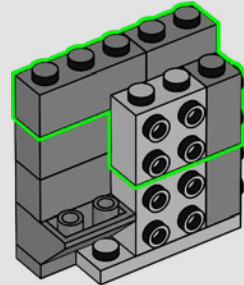

49

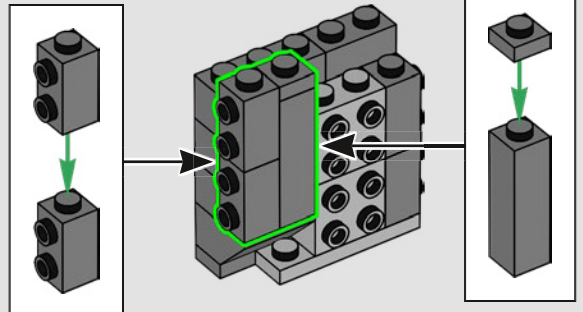



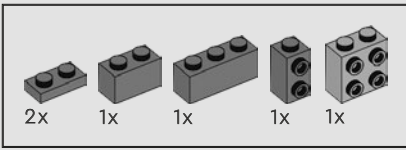

50

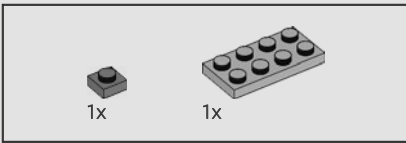
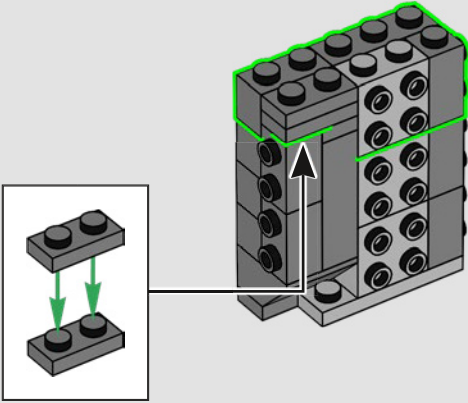

51

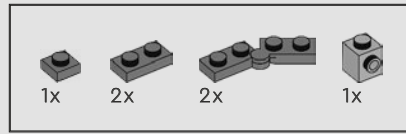
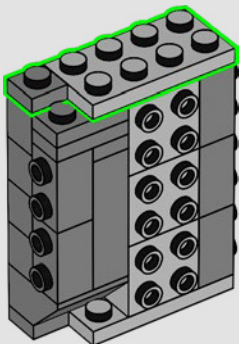

52

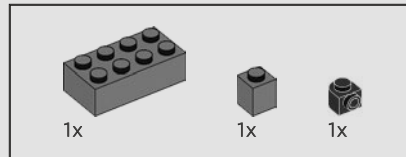
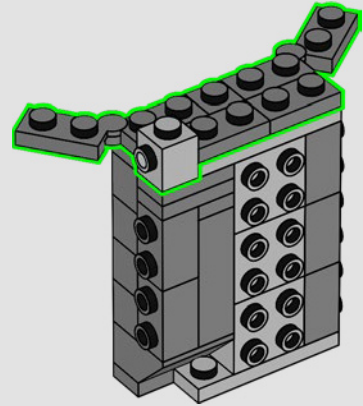

53

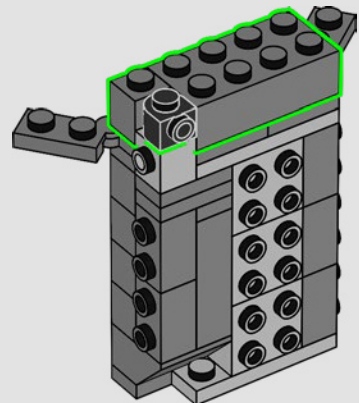

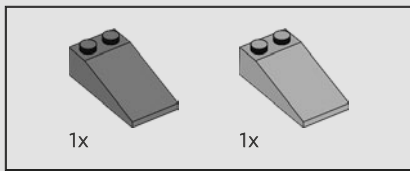

54

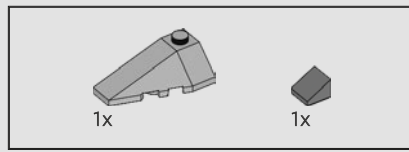
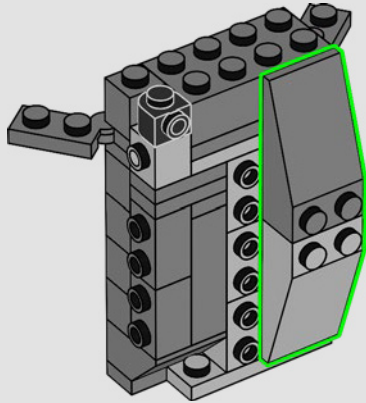

56

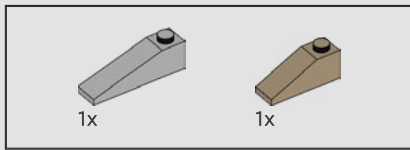
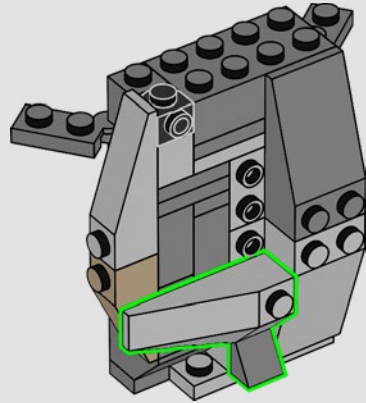

55

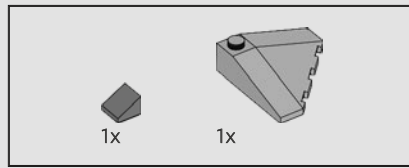
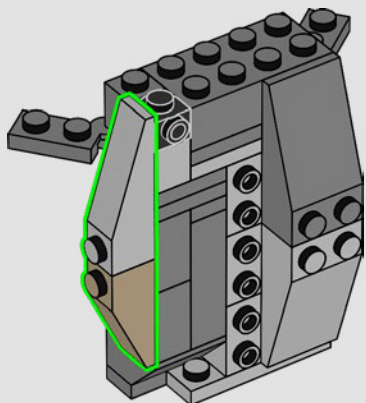

57

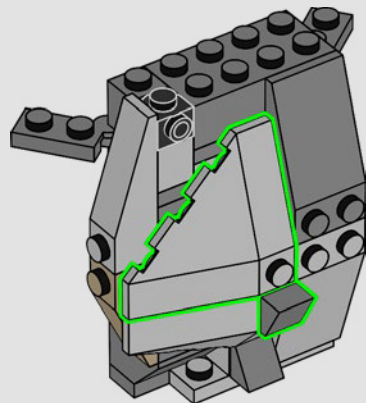

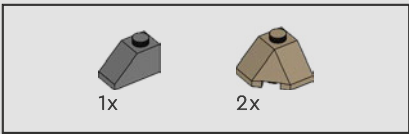

58

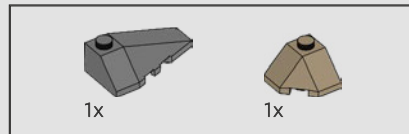
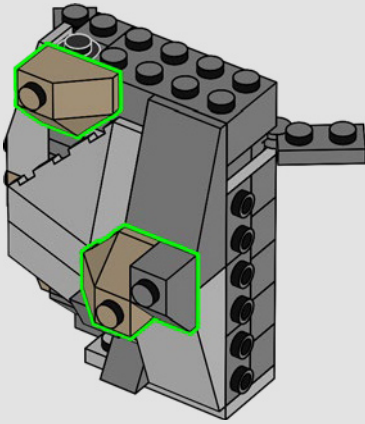

59

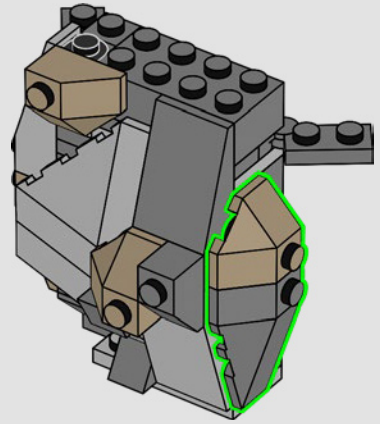

60

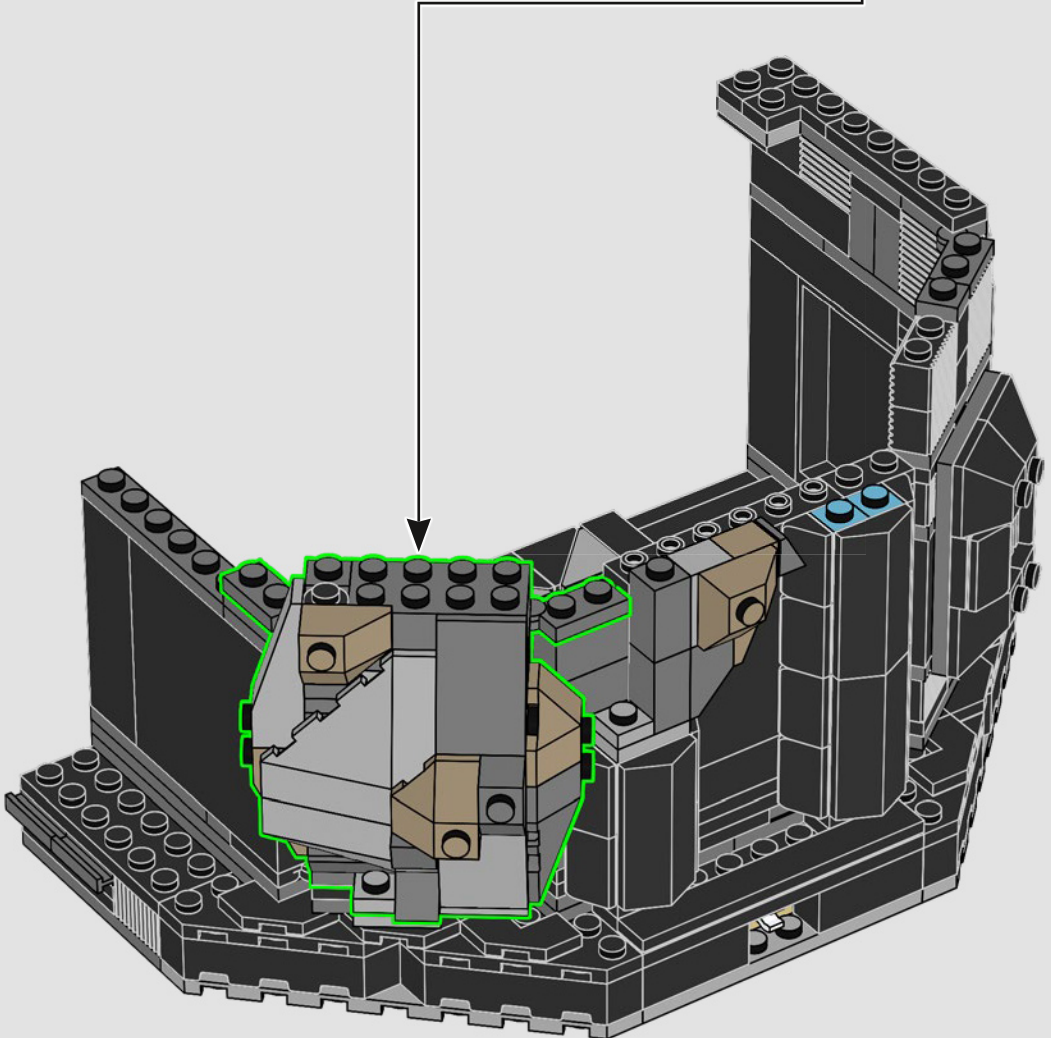

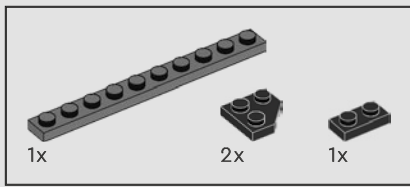

61

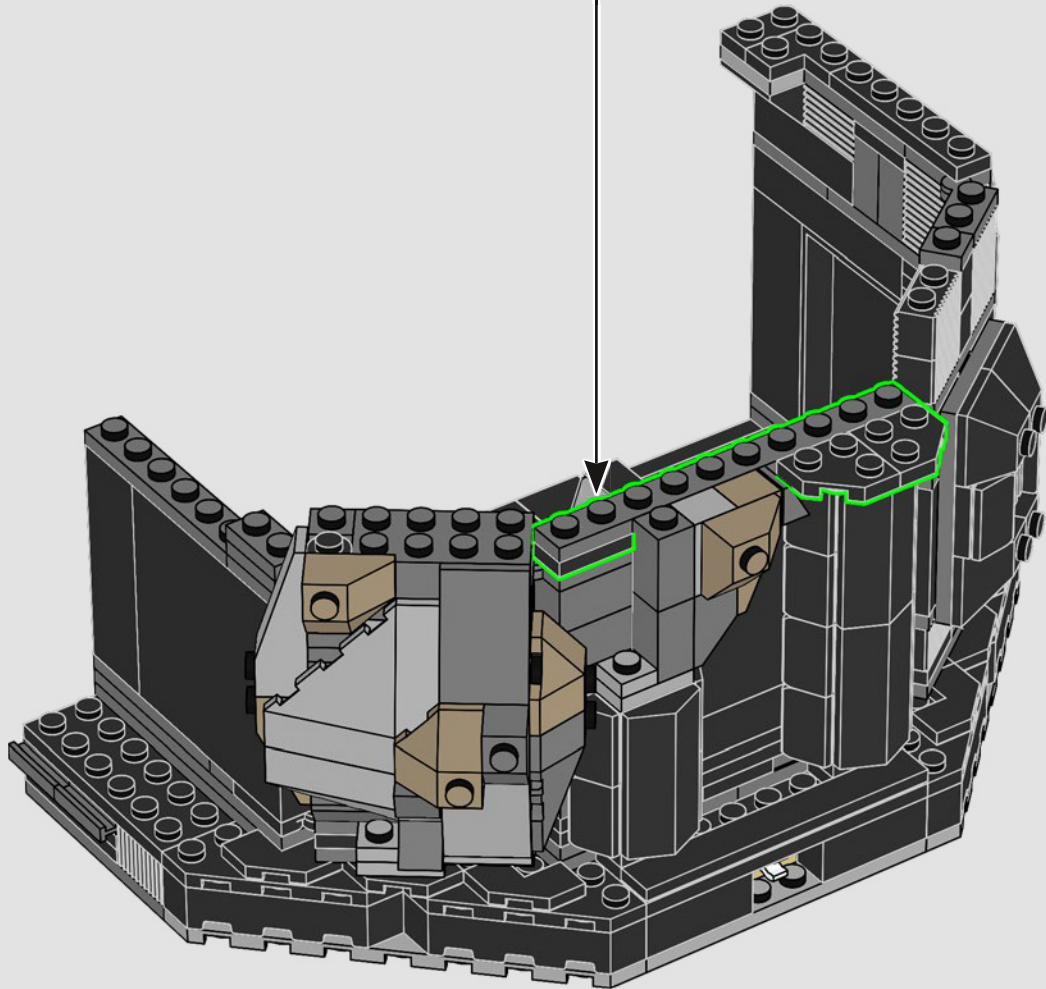
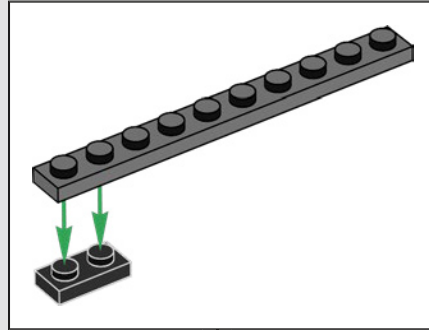



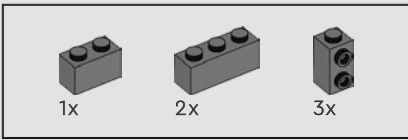

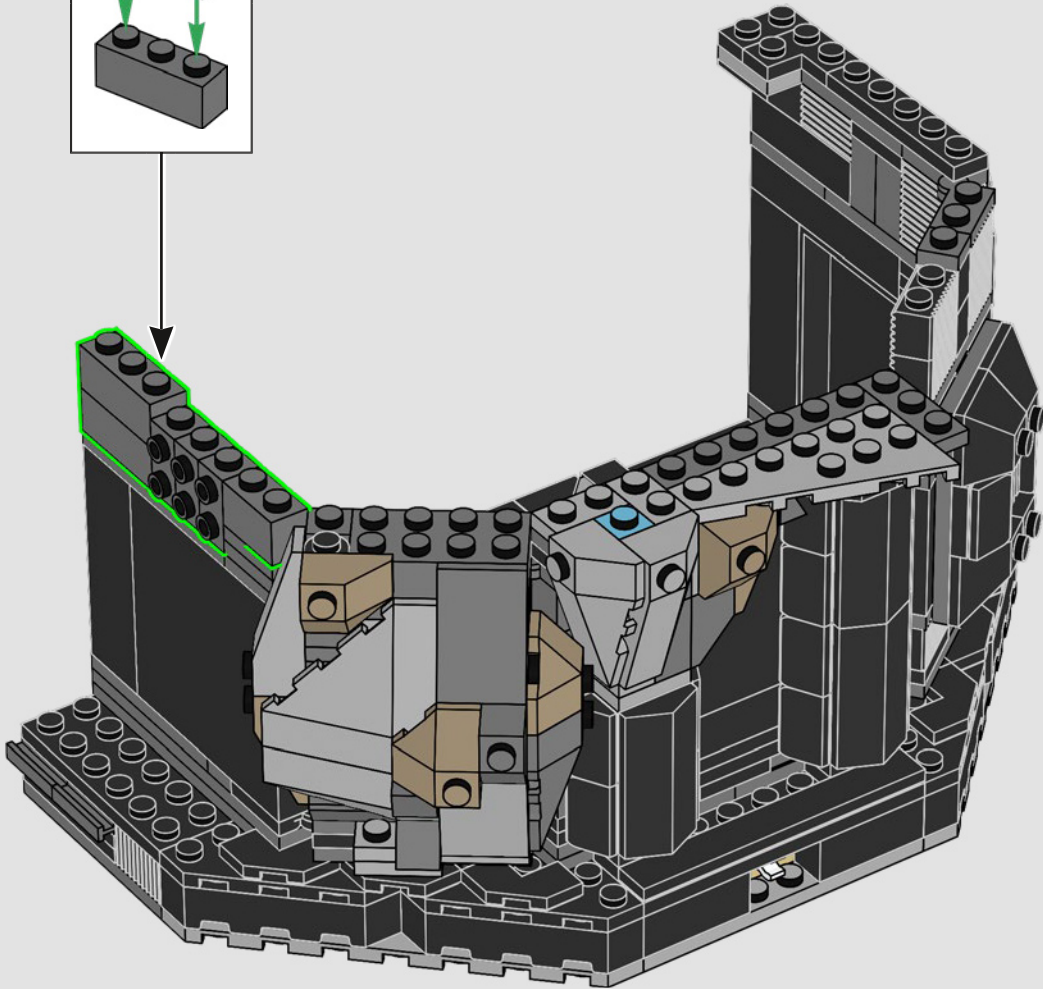
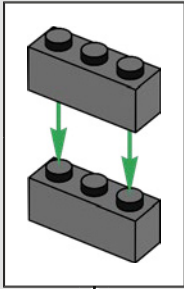

63

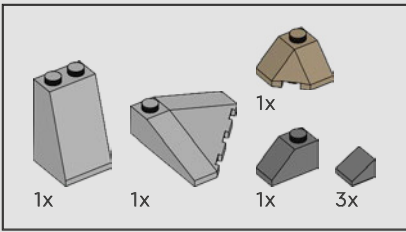

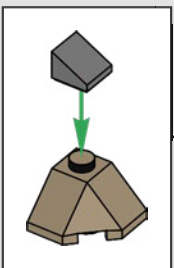
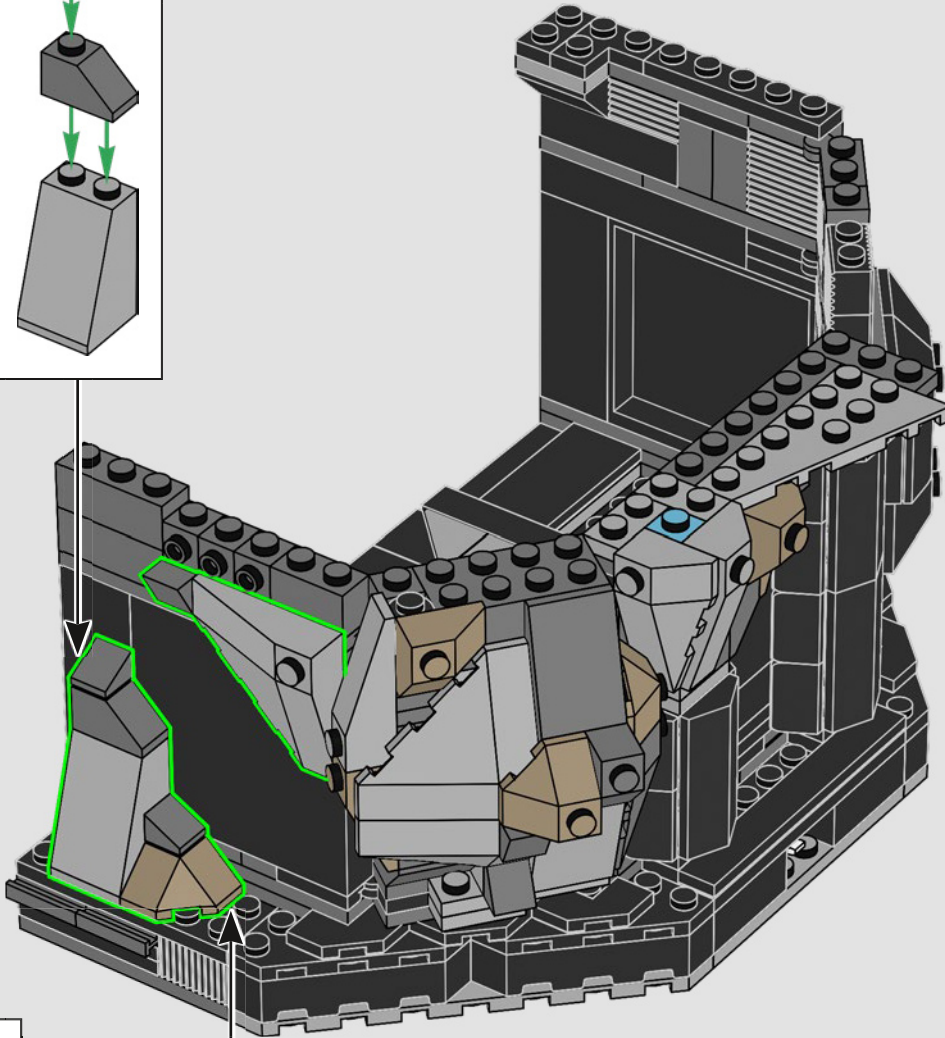
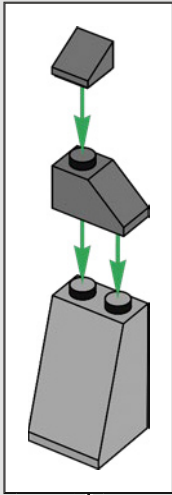

64



  
Costruita sul fianco di una montagna,  
la torre sembra inviolabile.



Questa è la prima volta che Sauron viene presentato sotto forma di minifigure LEGO® e il suo elmo è stato progettato appositamente per questo set.

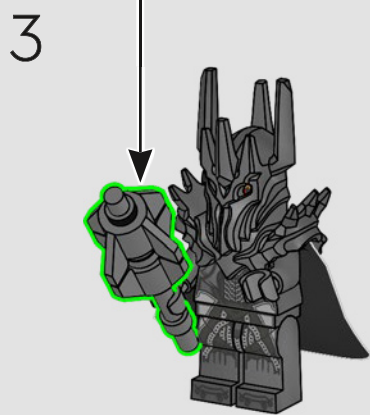
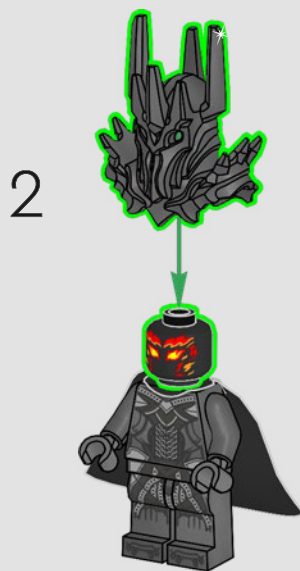
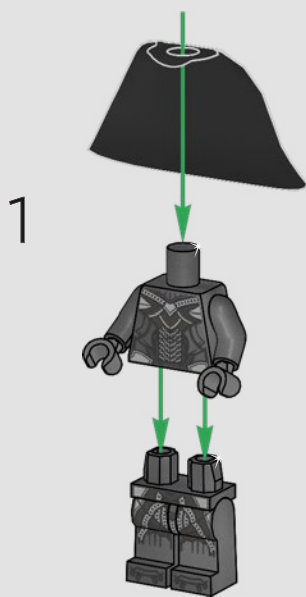
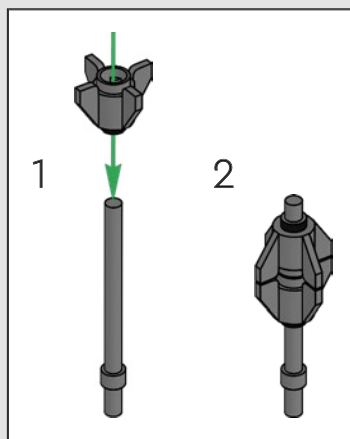



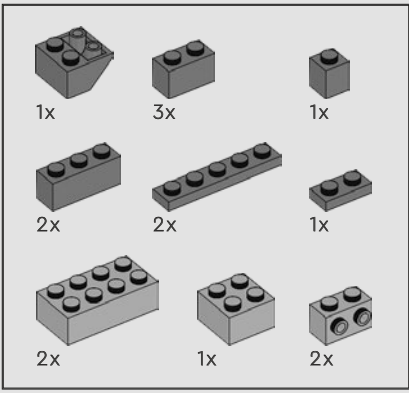

65

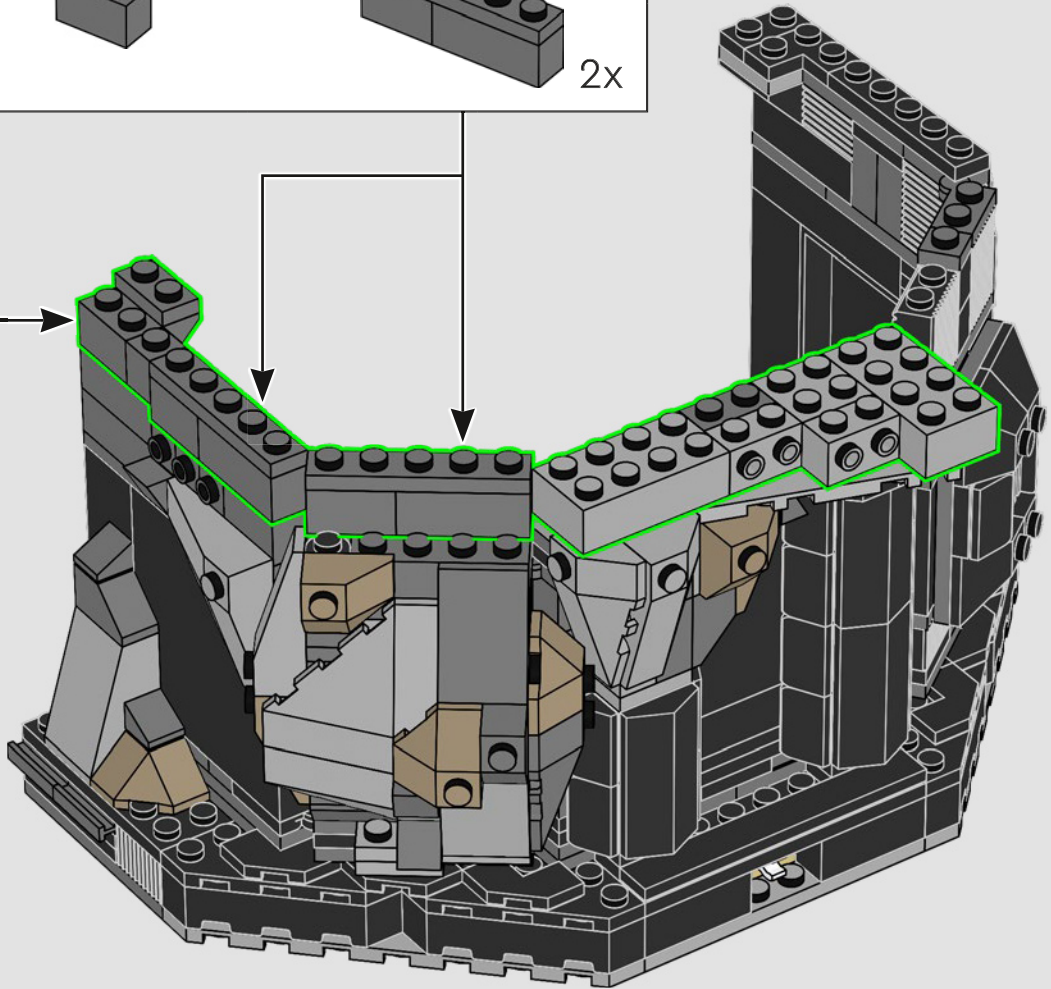
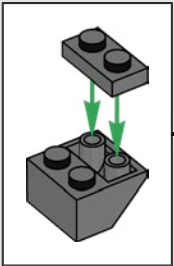
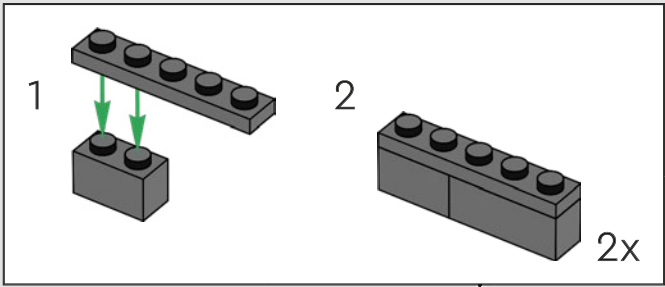

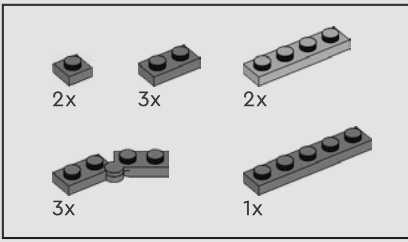

66

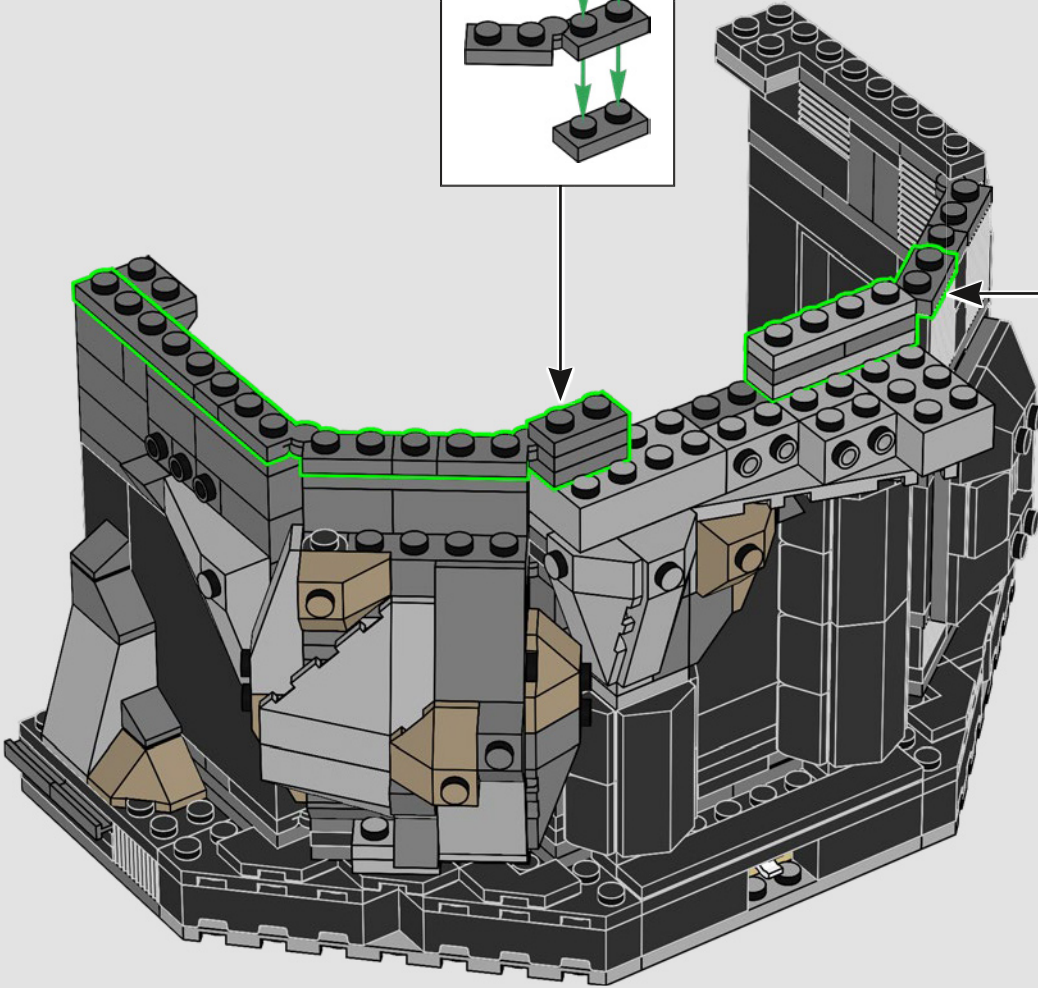
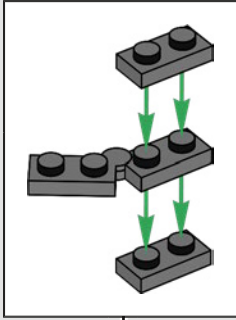
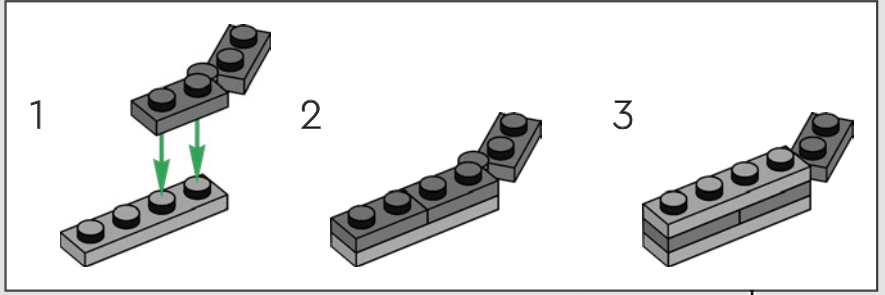



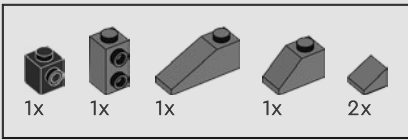

68

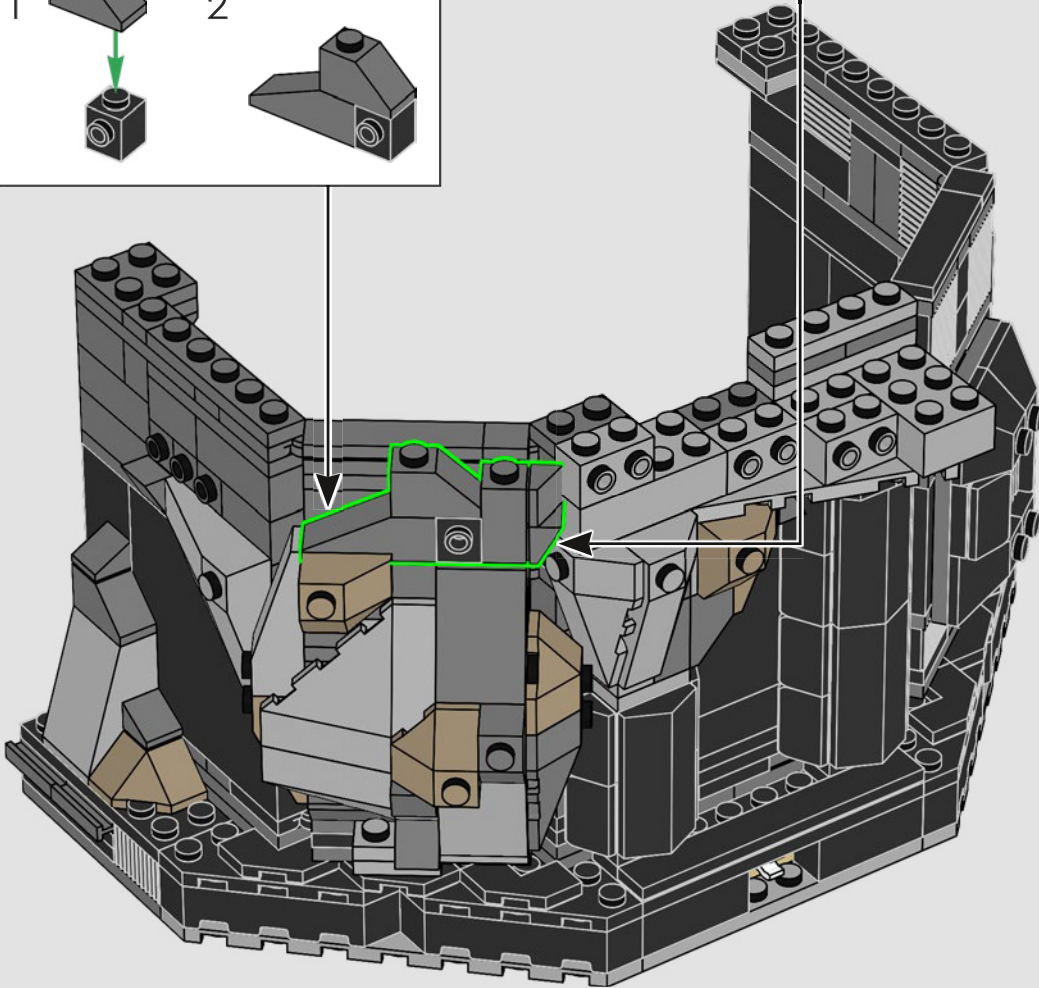
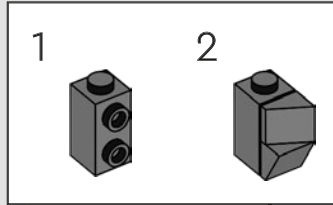
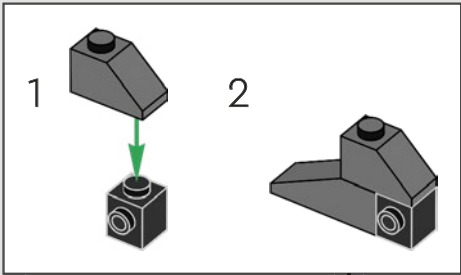

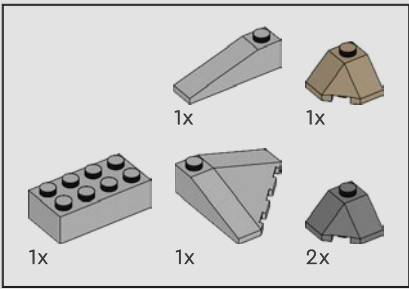

69

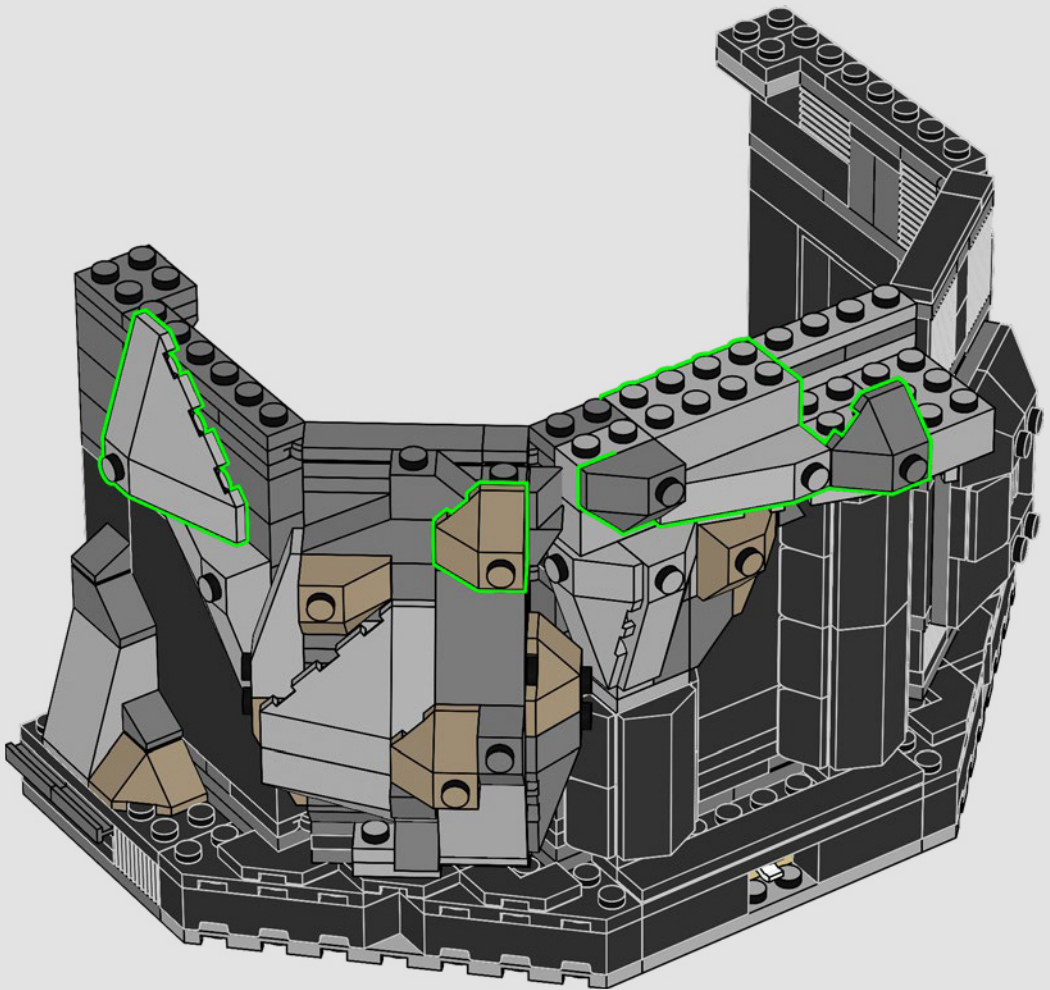

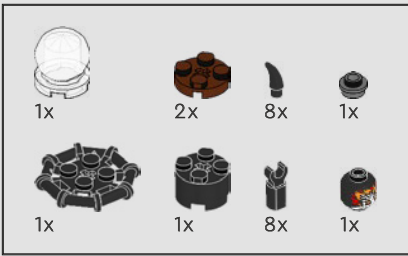

70

1



2

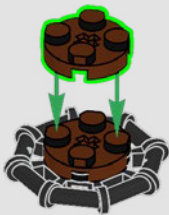

3

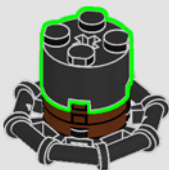

4

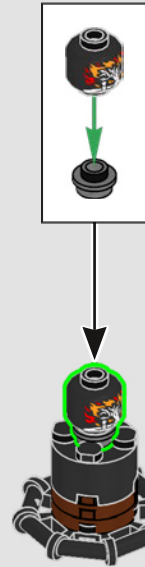

5



6

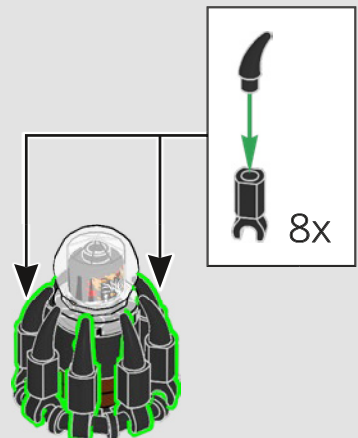



Per questo set è stato realizzato un nuovo pezzo decorato  
- una sfera Palantír che Sauron usa per spiare i suoi nemici  
nella Terra di Mezzo.

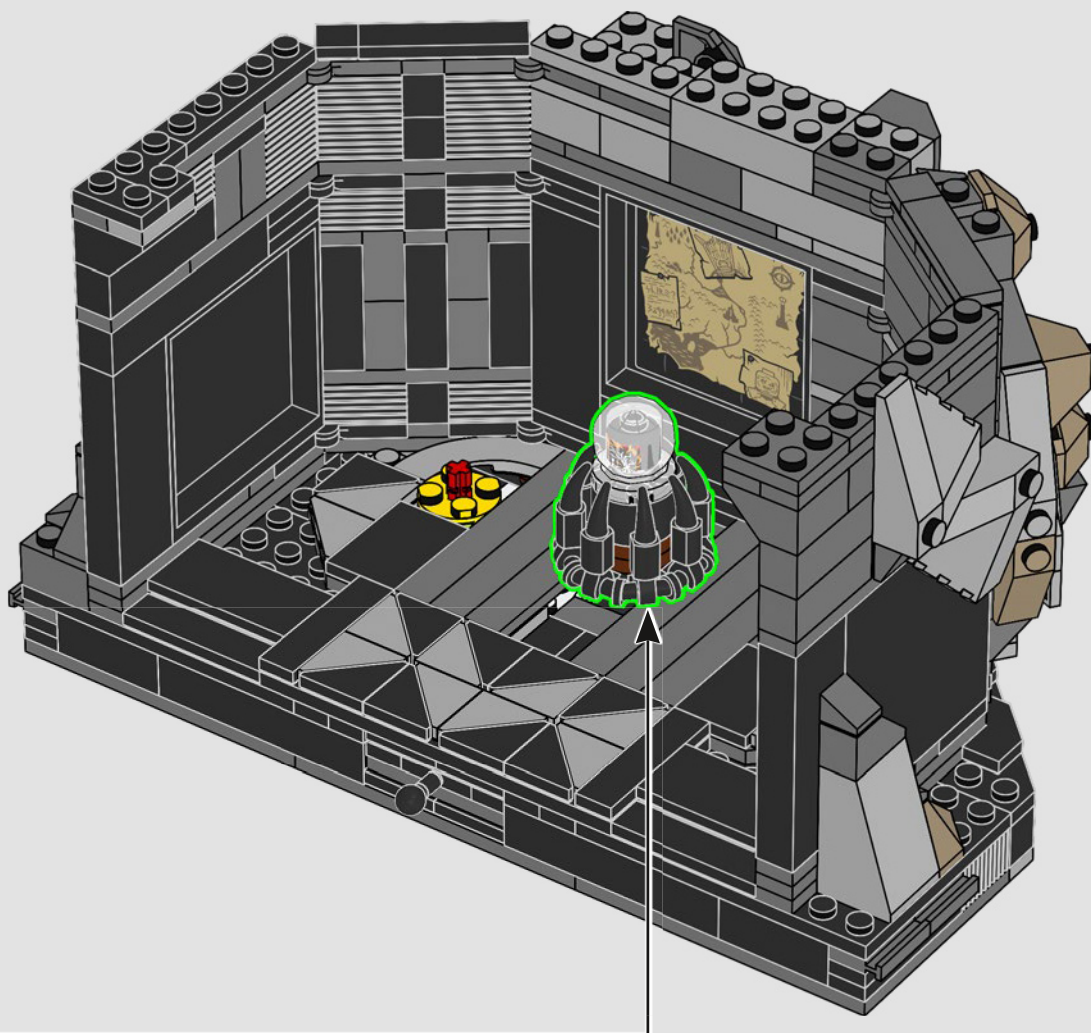

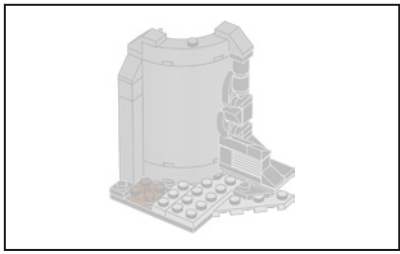

71

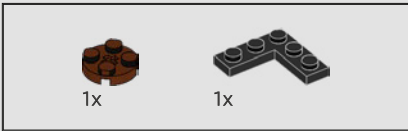
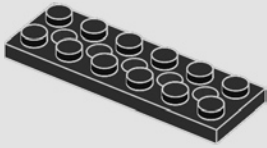

72

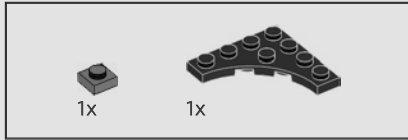
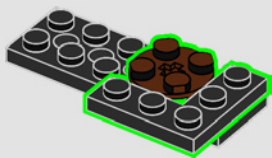

73

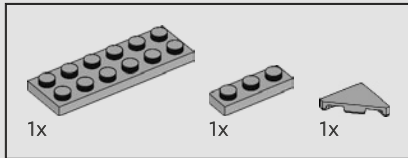
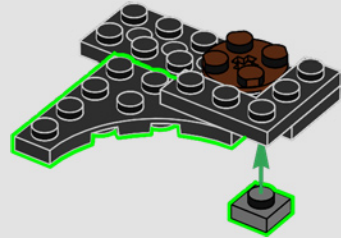

74

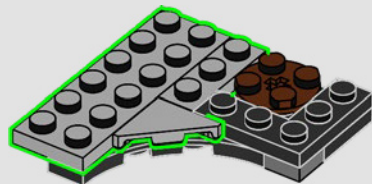



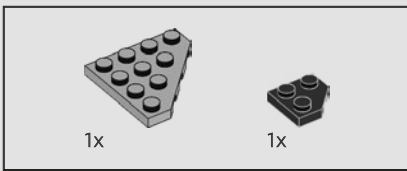

75

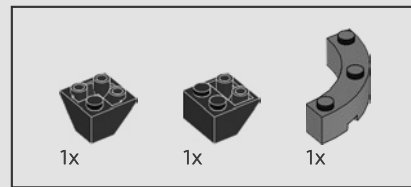
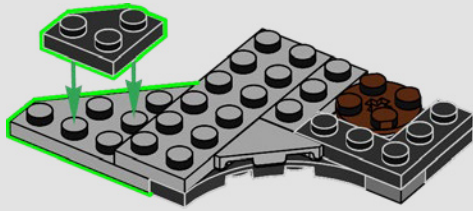

77

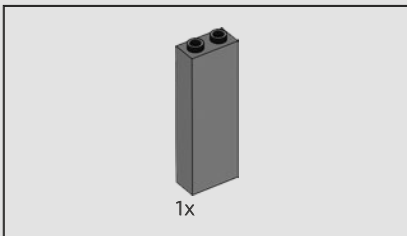
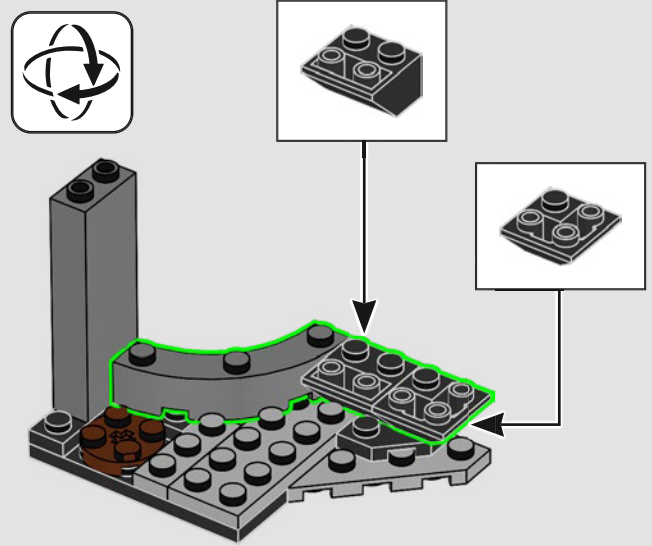

76

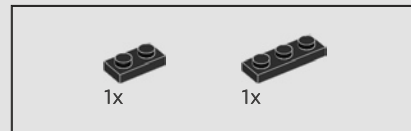
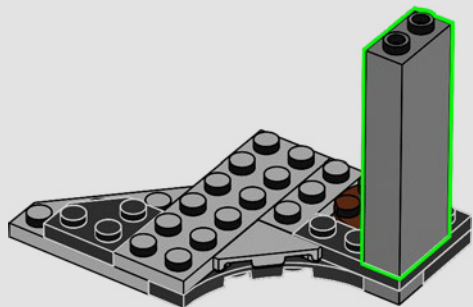

78

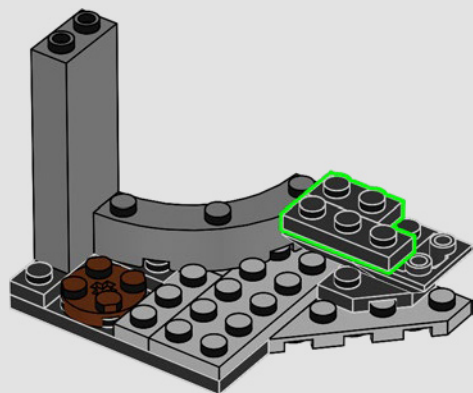

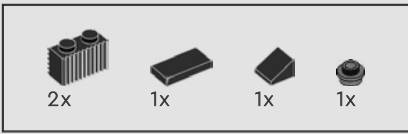

79

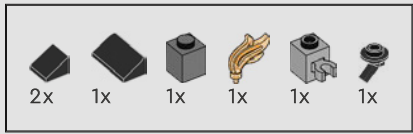
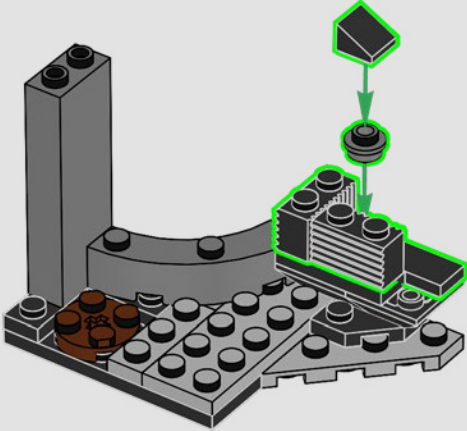

80

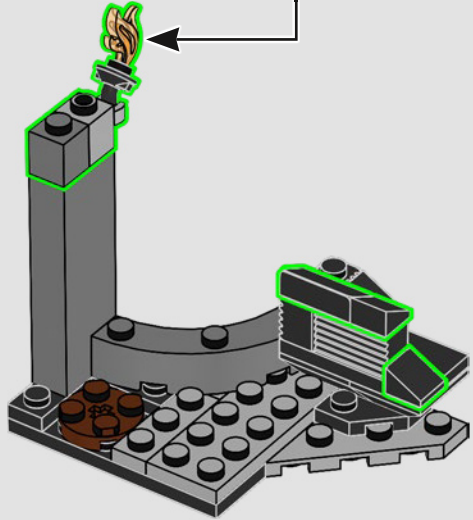
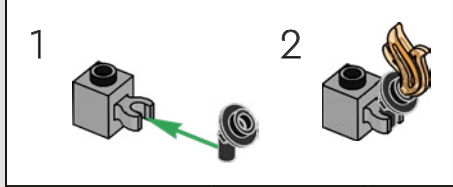

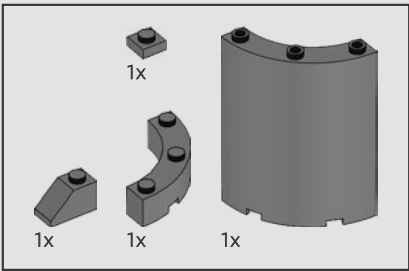

81

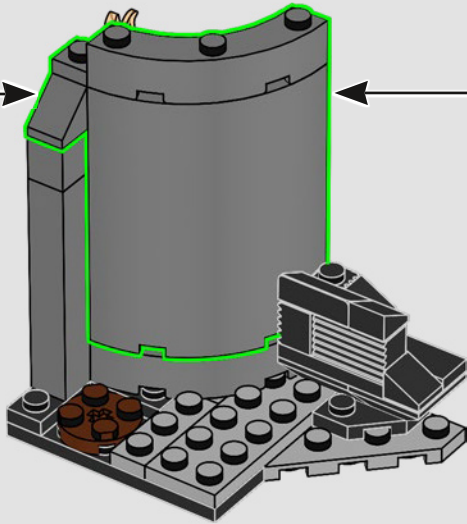
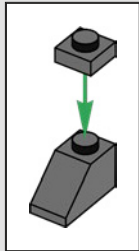
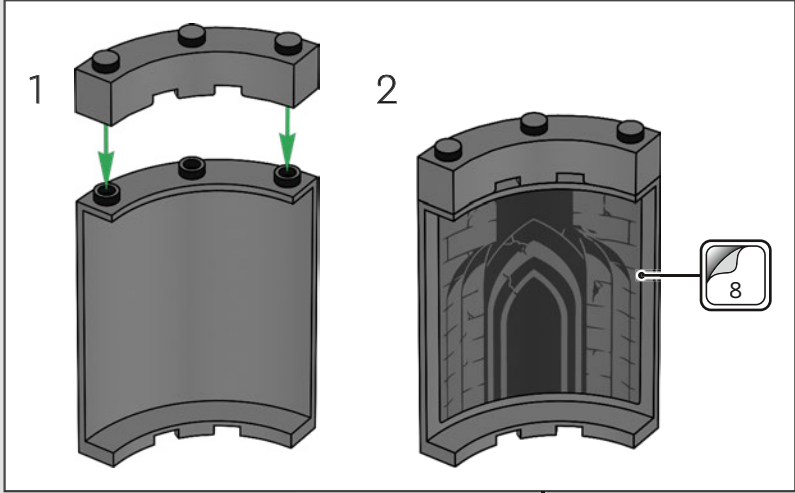

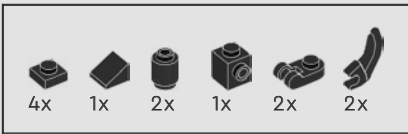

82

1

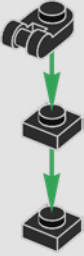

2

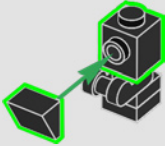

3

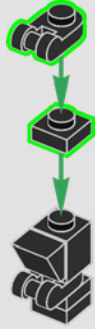

4

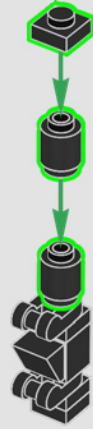

5

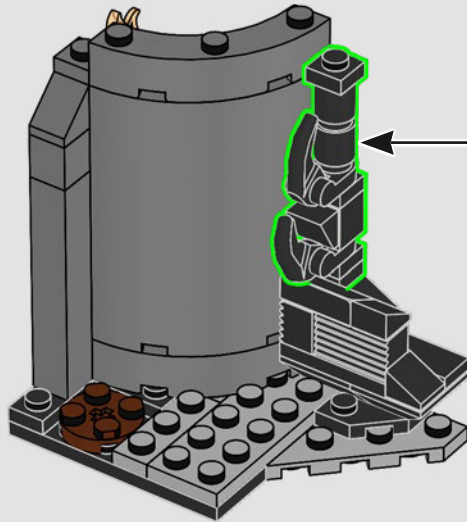

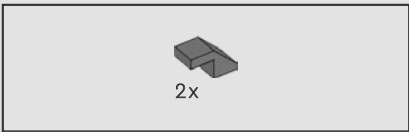

83

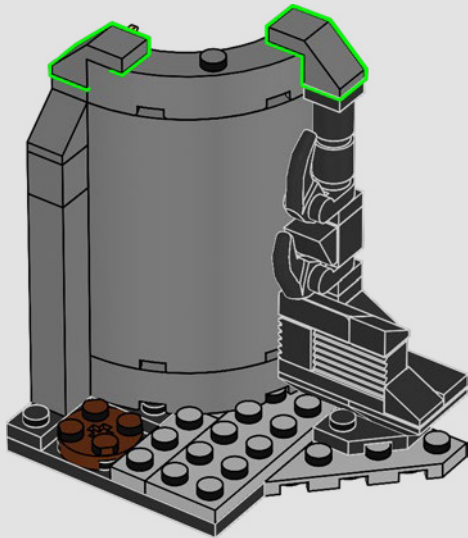

84

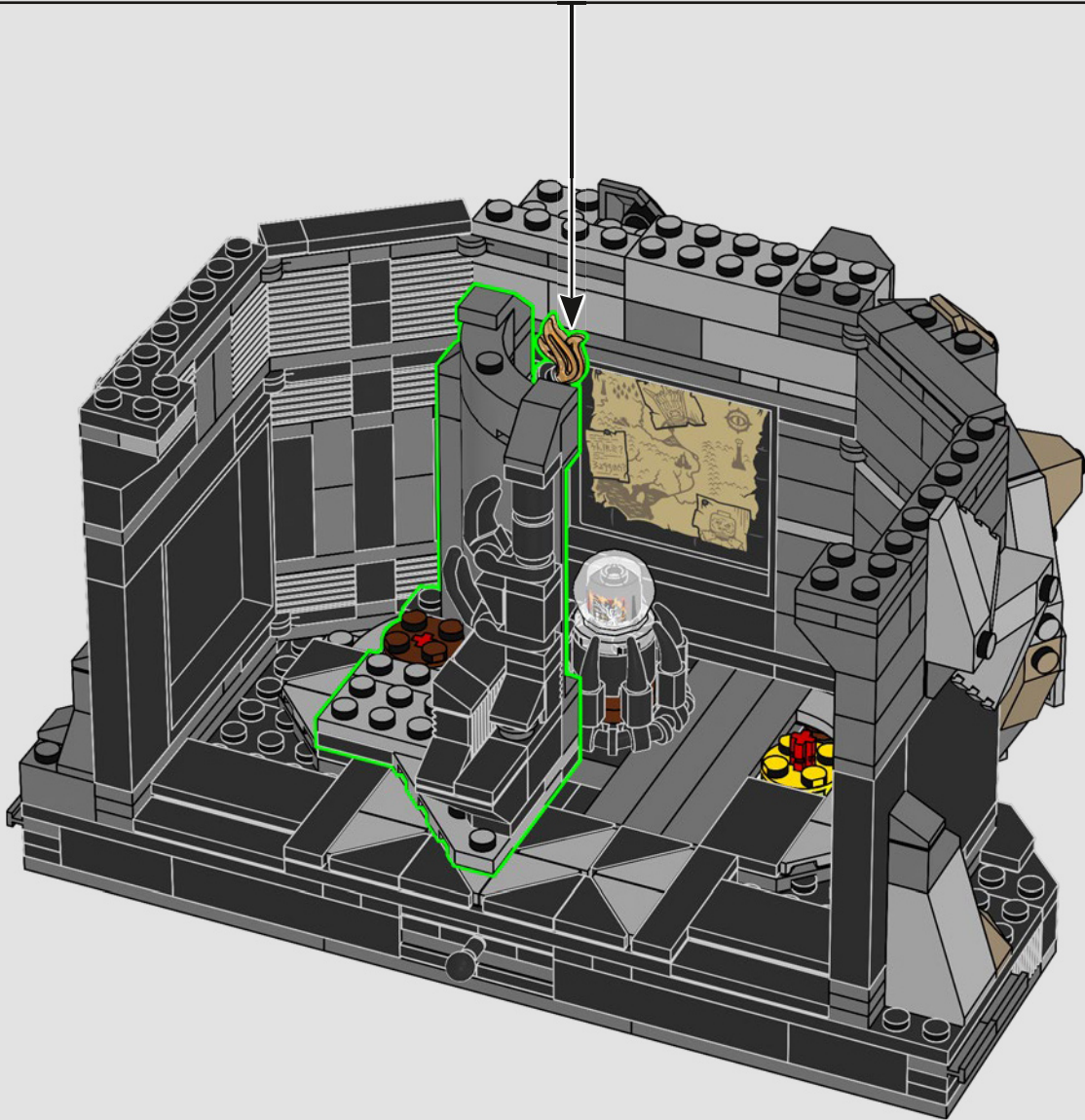

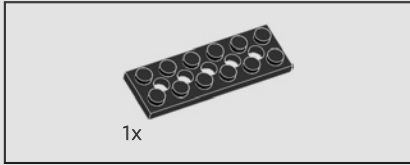
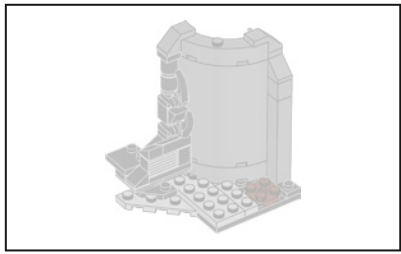

85

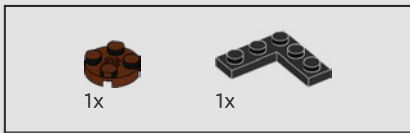
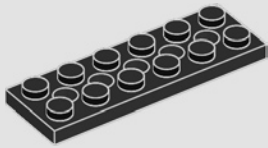

86

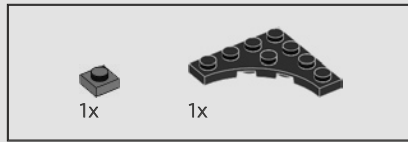
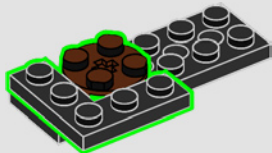

87

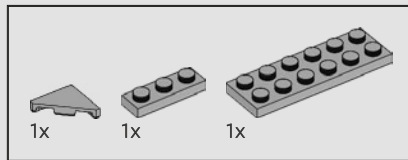
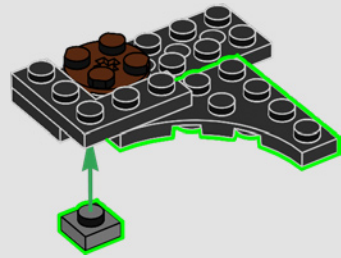

88

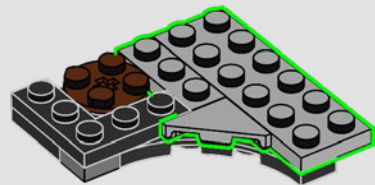

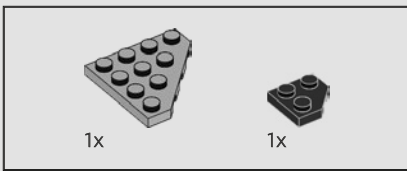

89

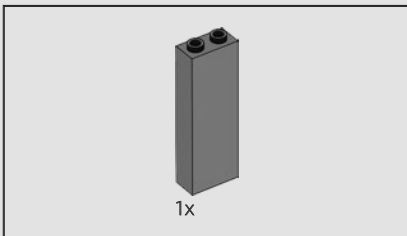
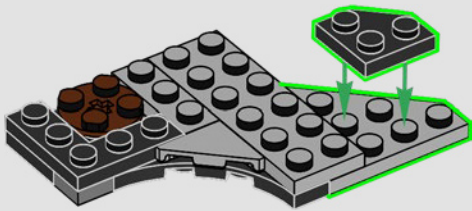

90

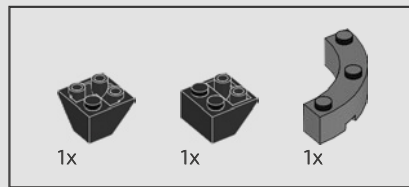
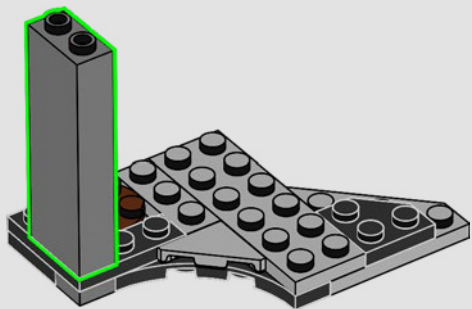

91

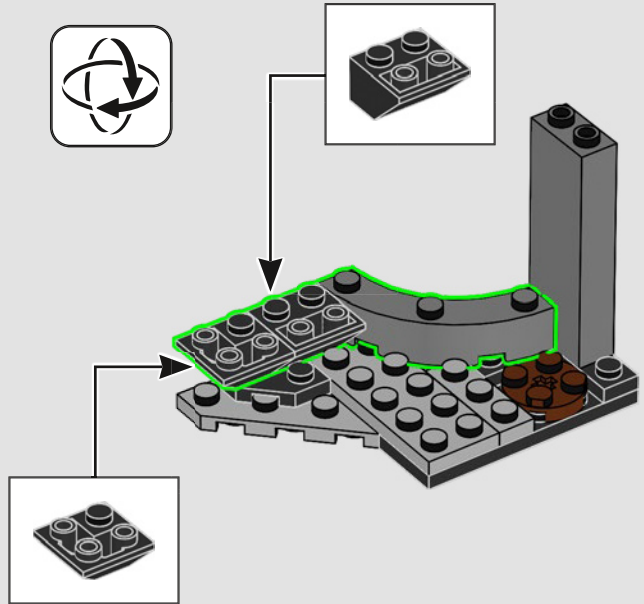

92

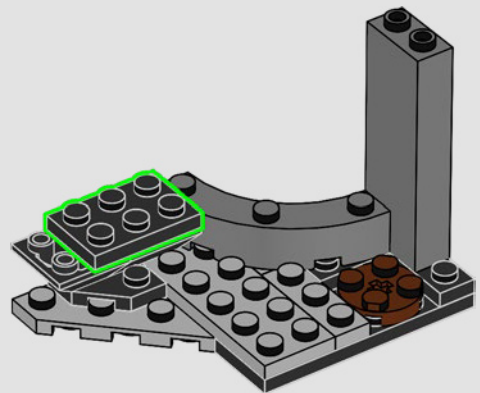



93

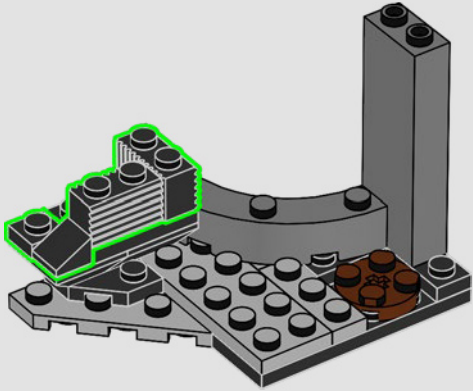

94

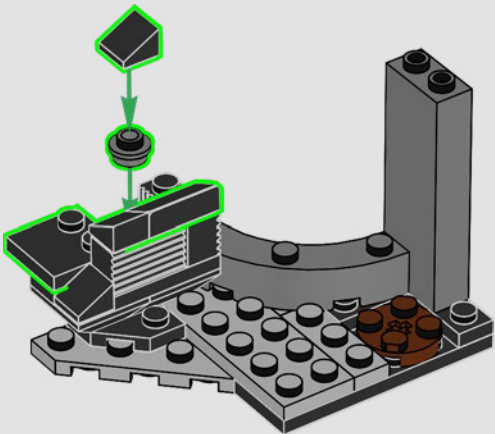

95

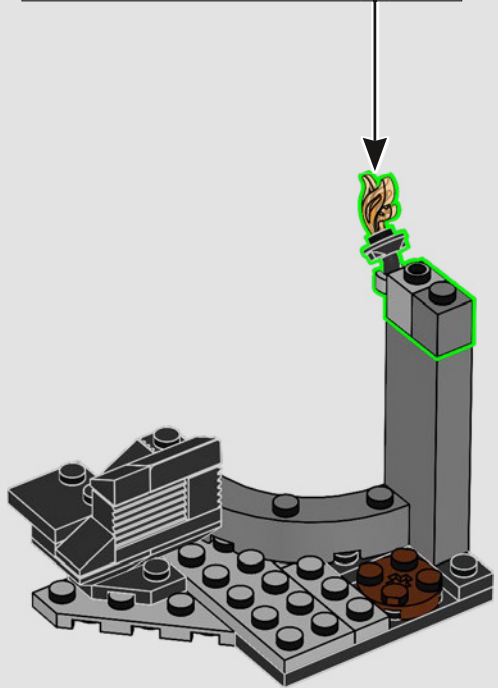
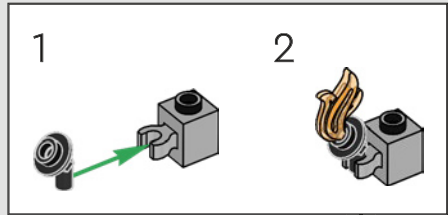



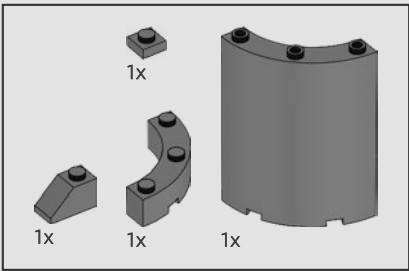

96

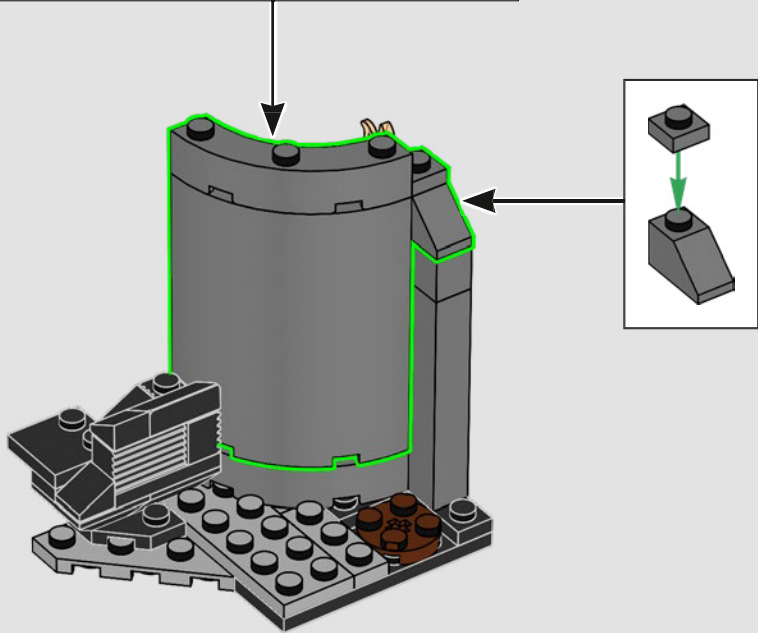
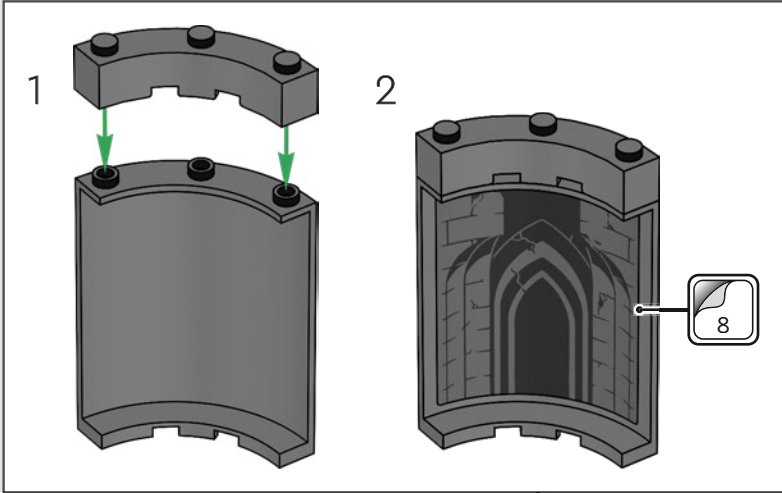



97

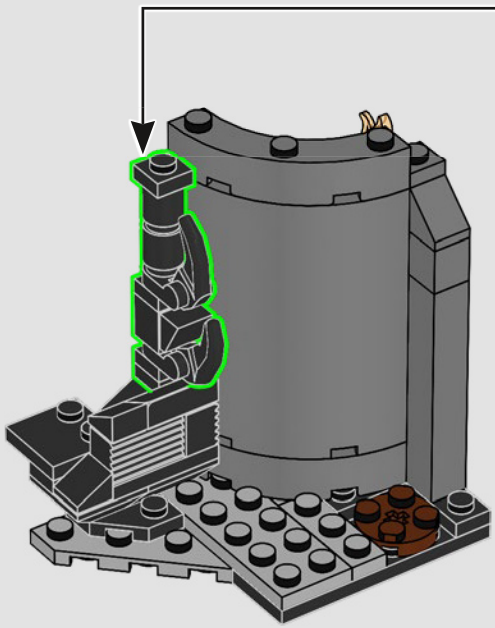
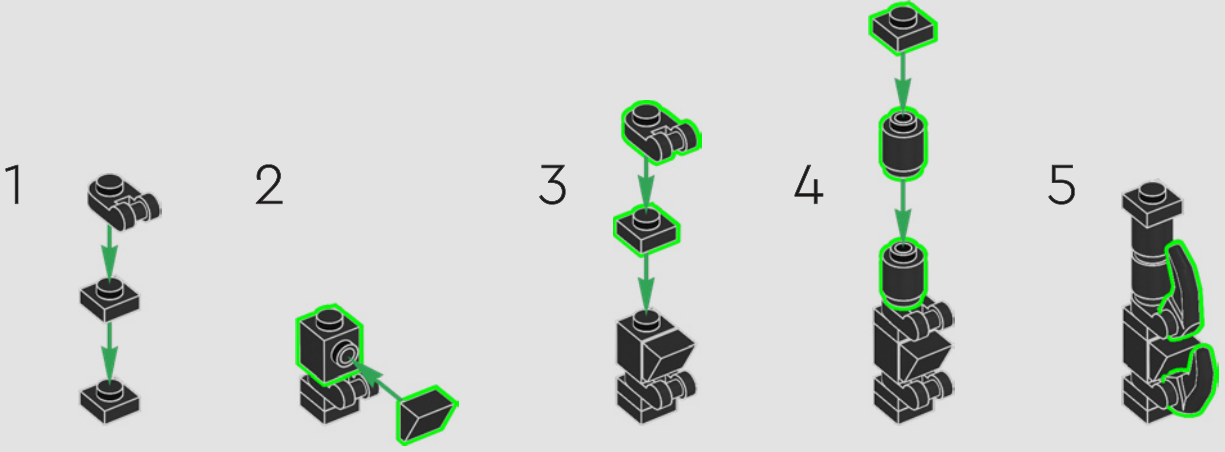

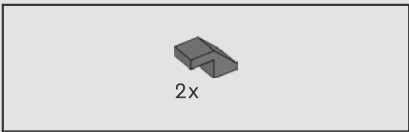

98

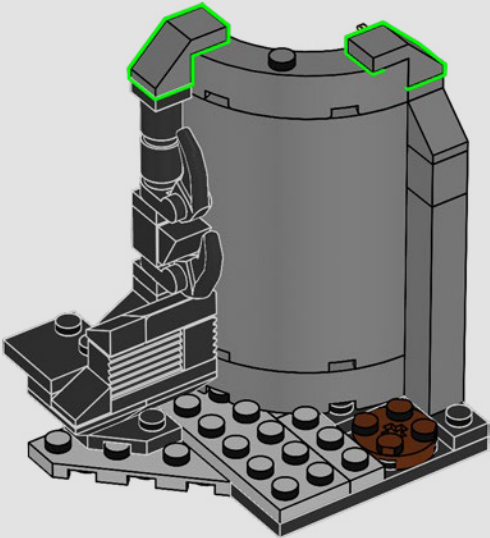

99

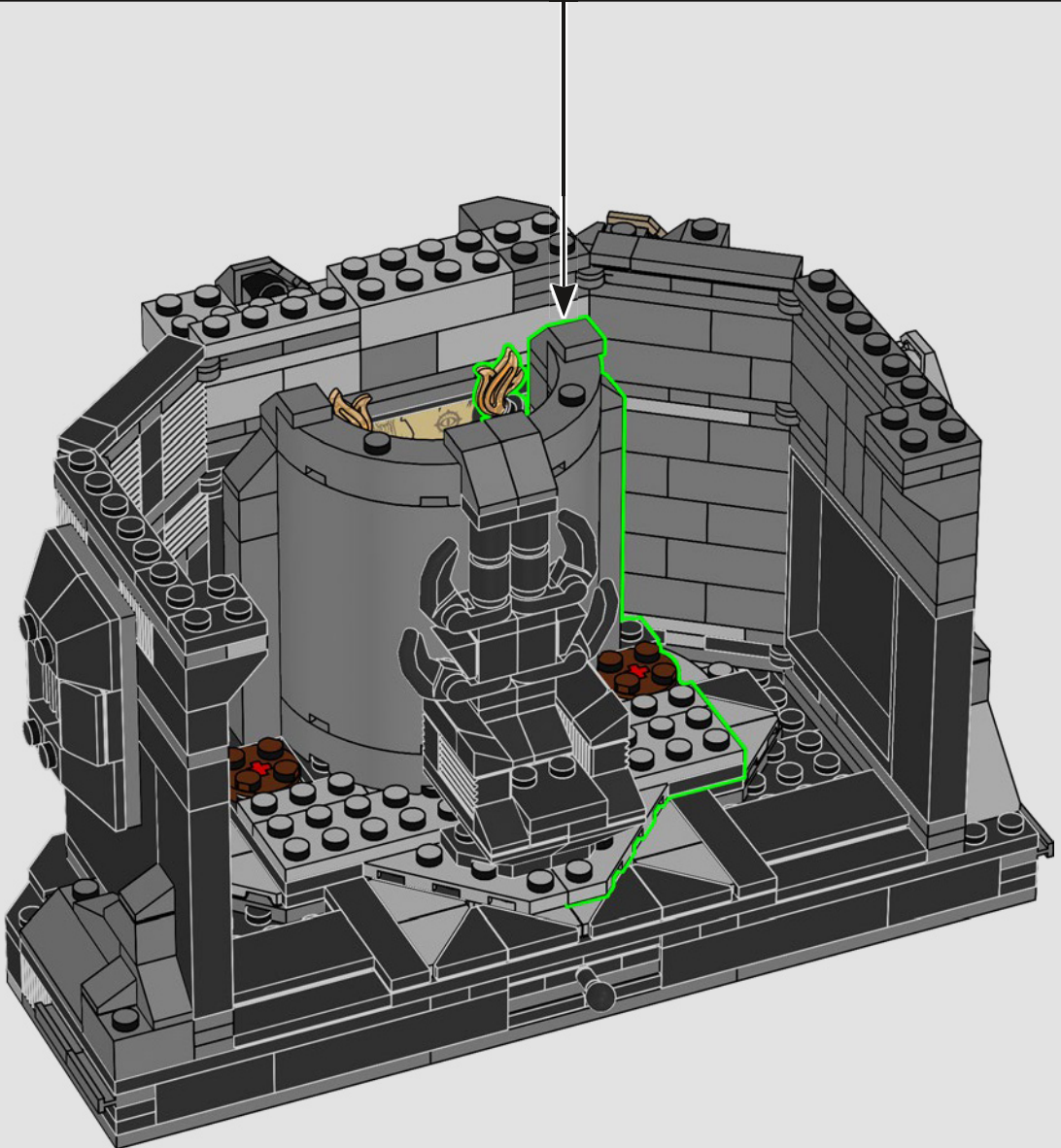

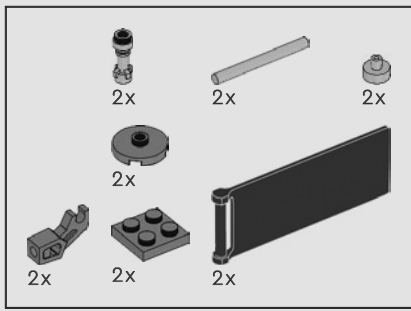

100

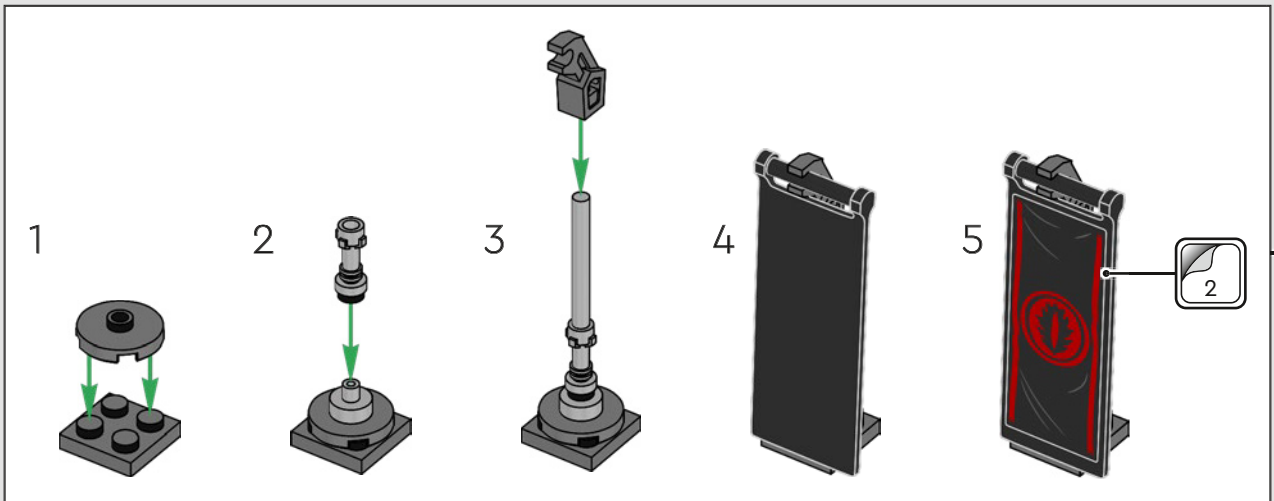
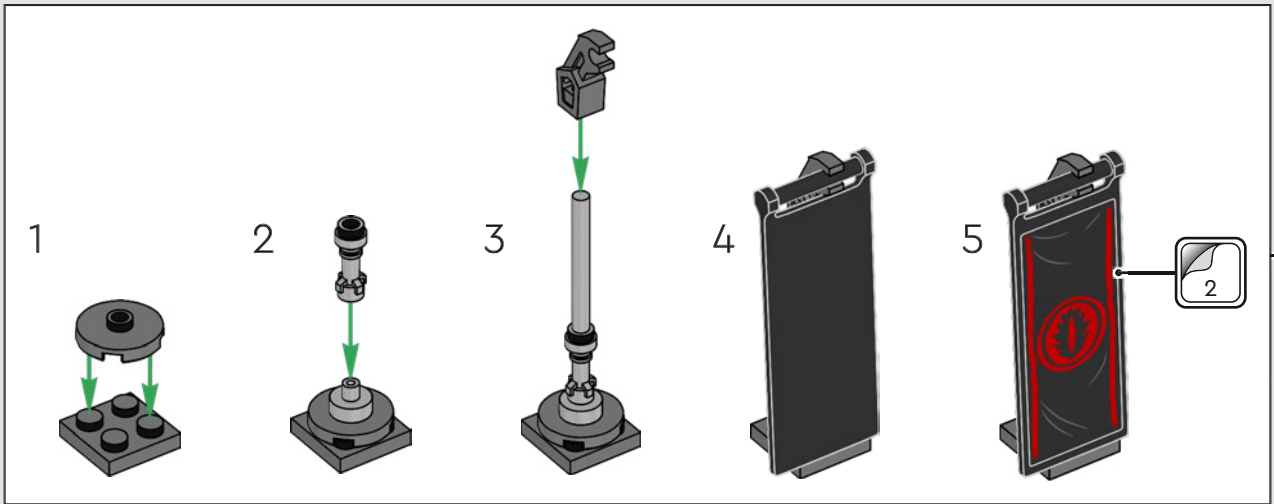

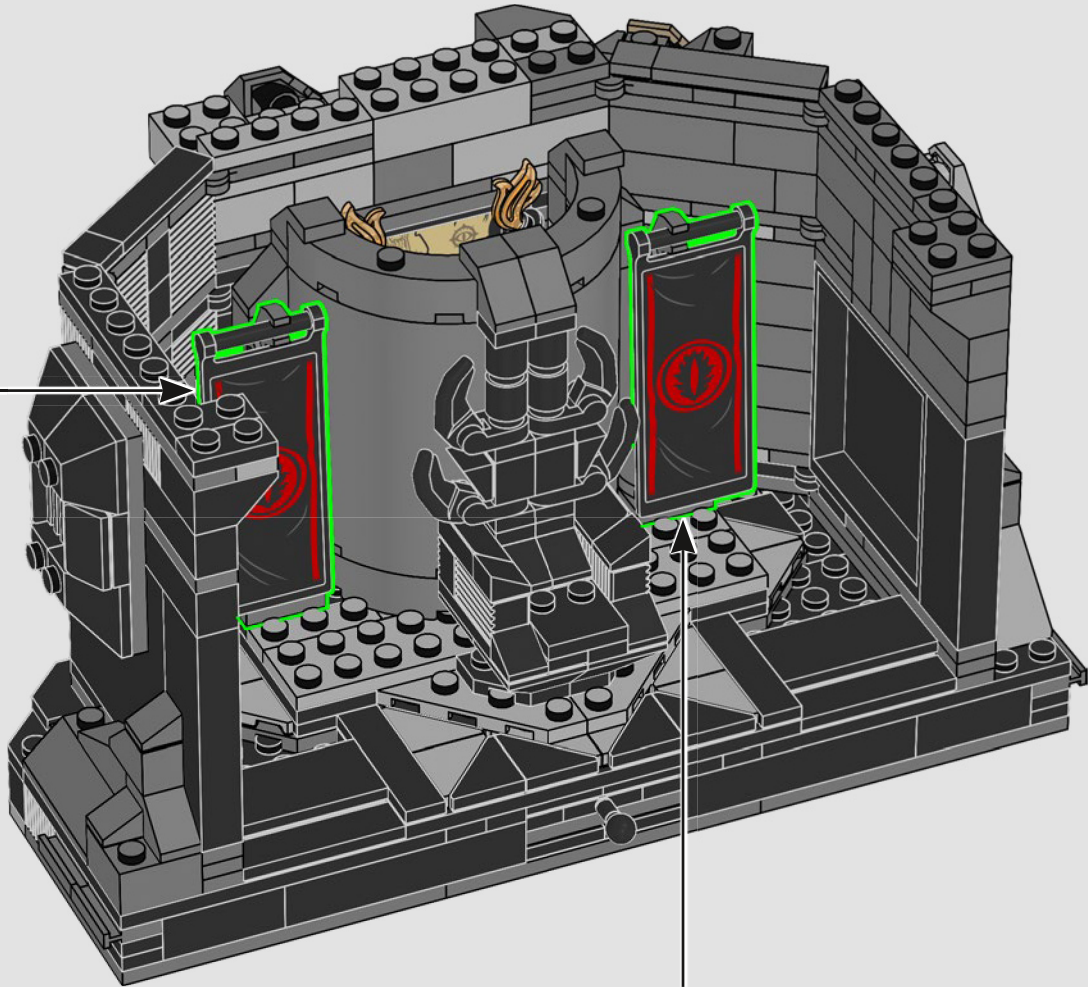

Tirando questa manopola, si rivela la stanza segreta dietro il trono.



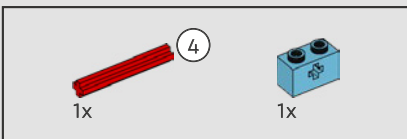
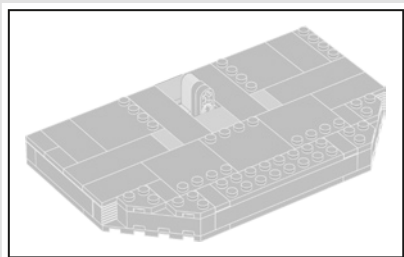

101

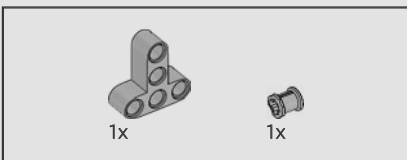
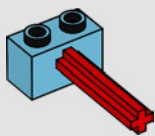

102

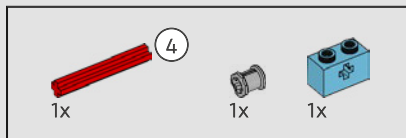
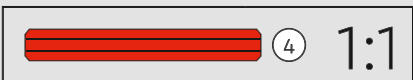
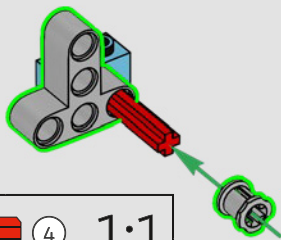

103

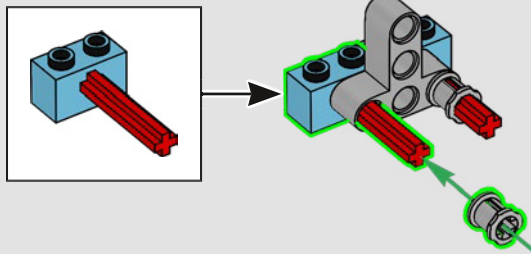

104

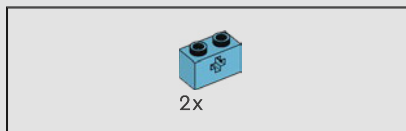
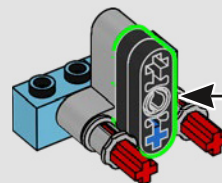
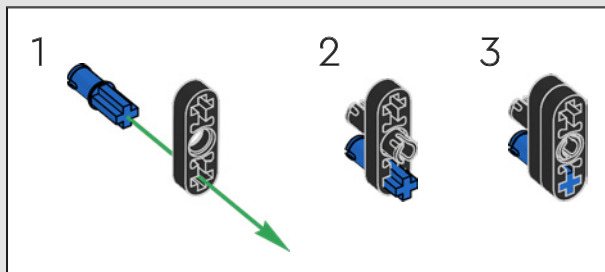

105

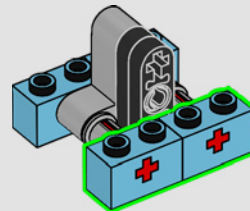

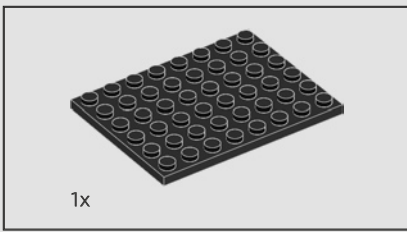

106

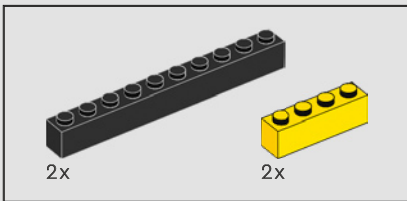
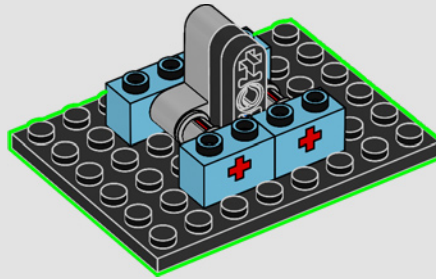

107

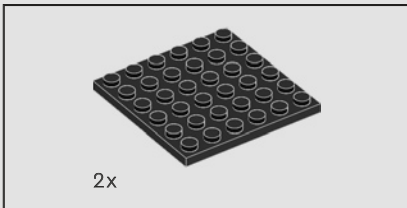
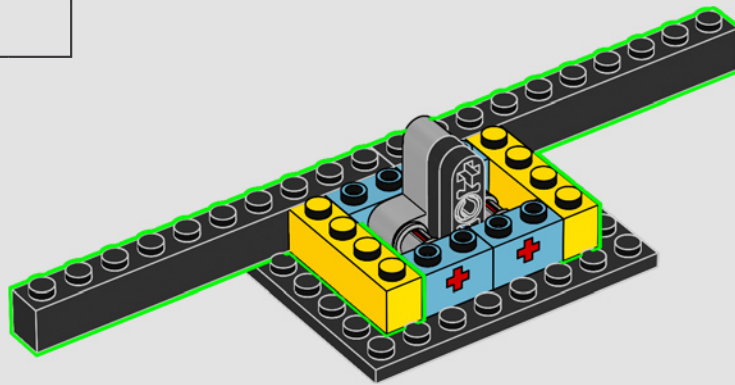

108

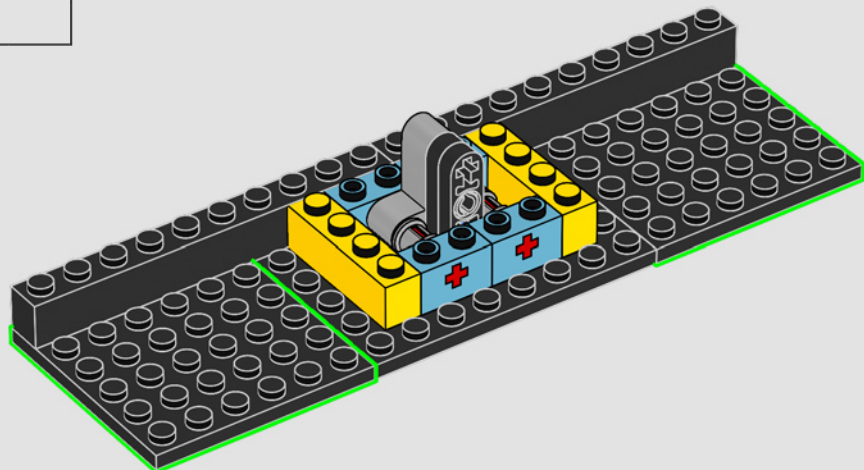

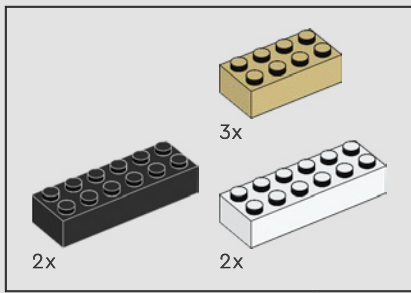

109

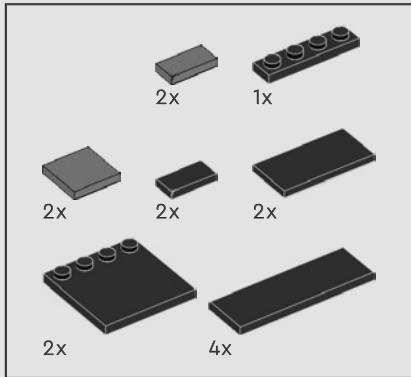
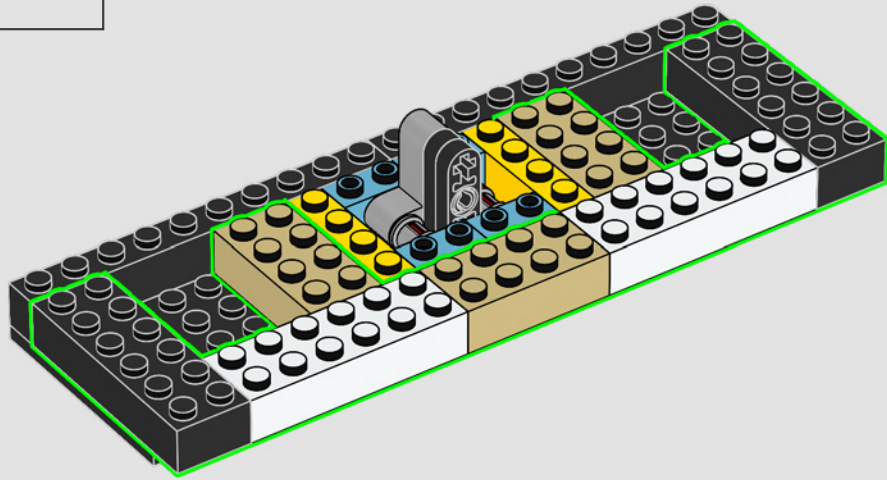

110

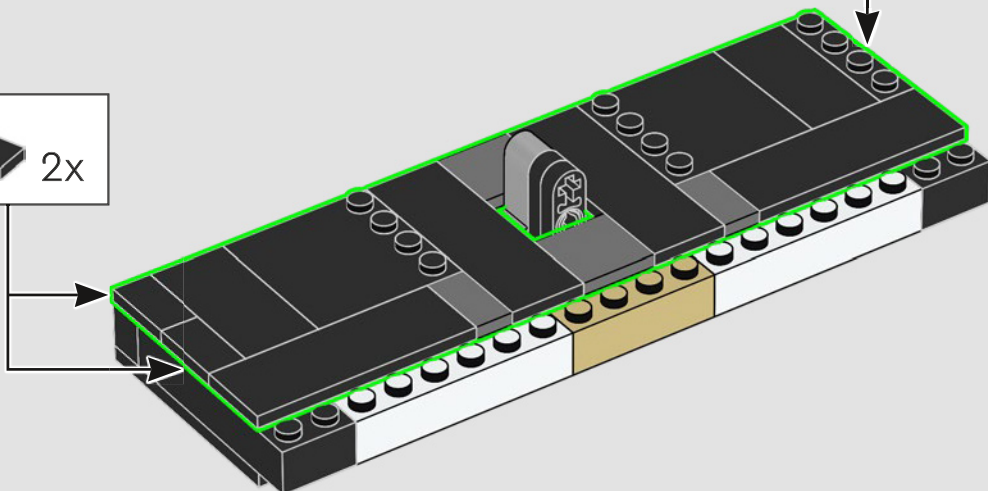
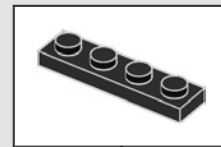



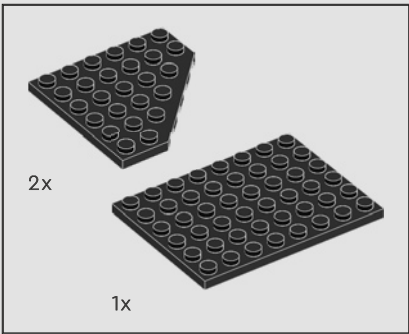

111

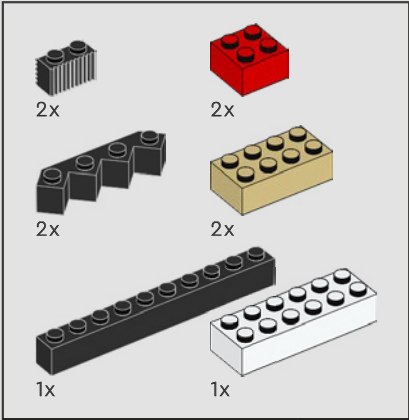
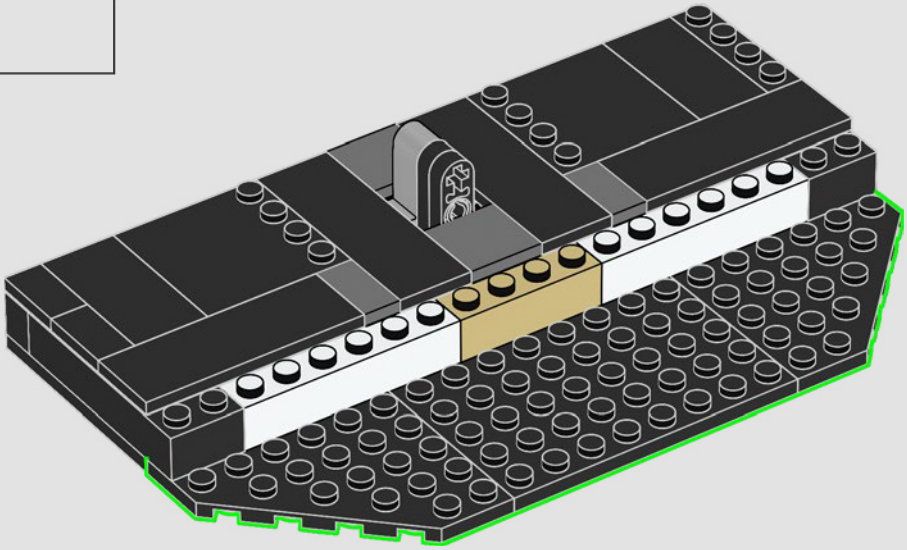

112

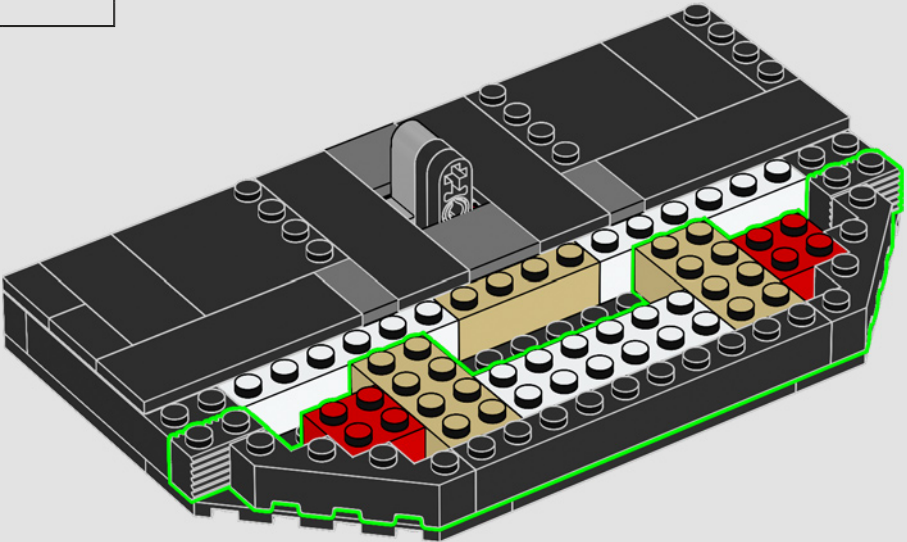

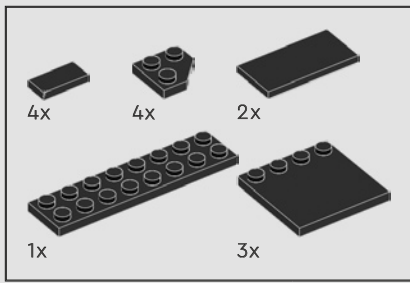

113

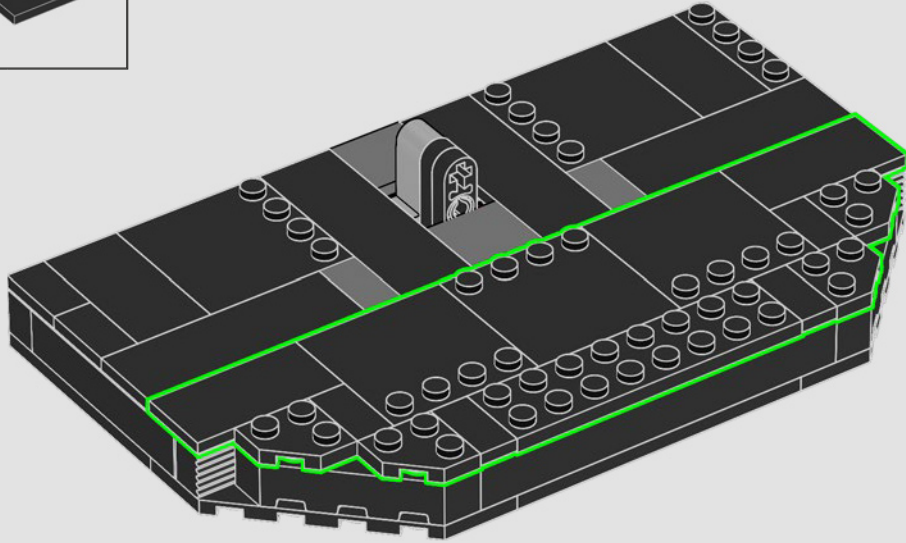

114

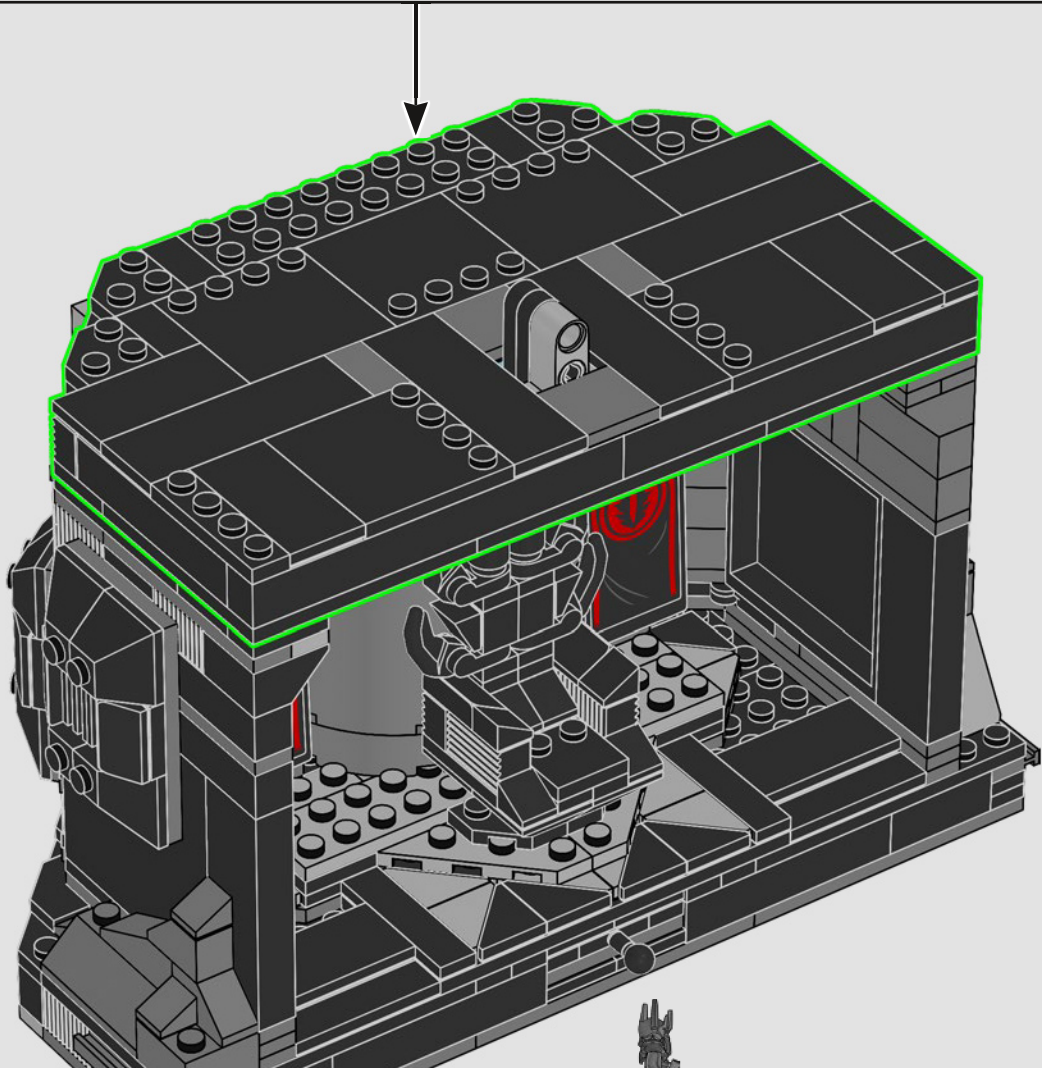

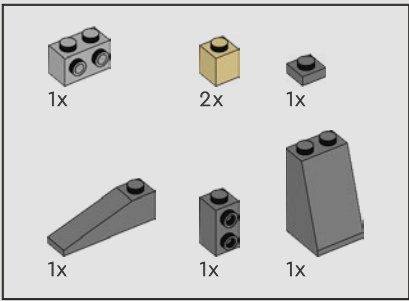

115

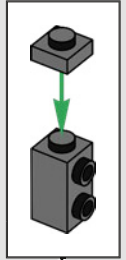
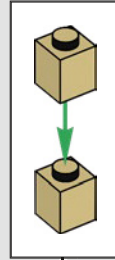
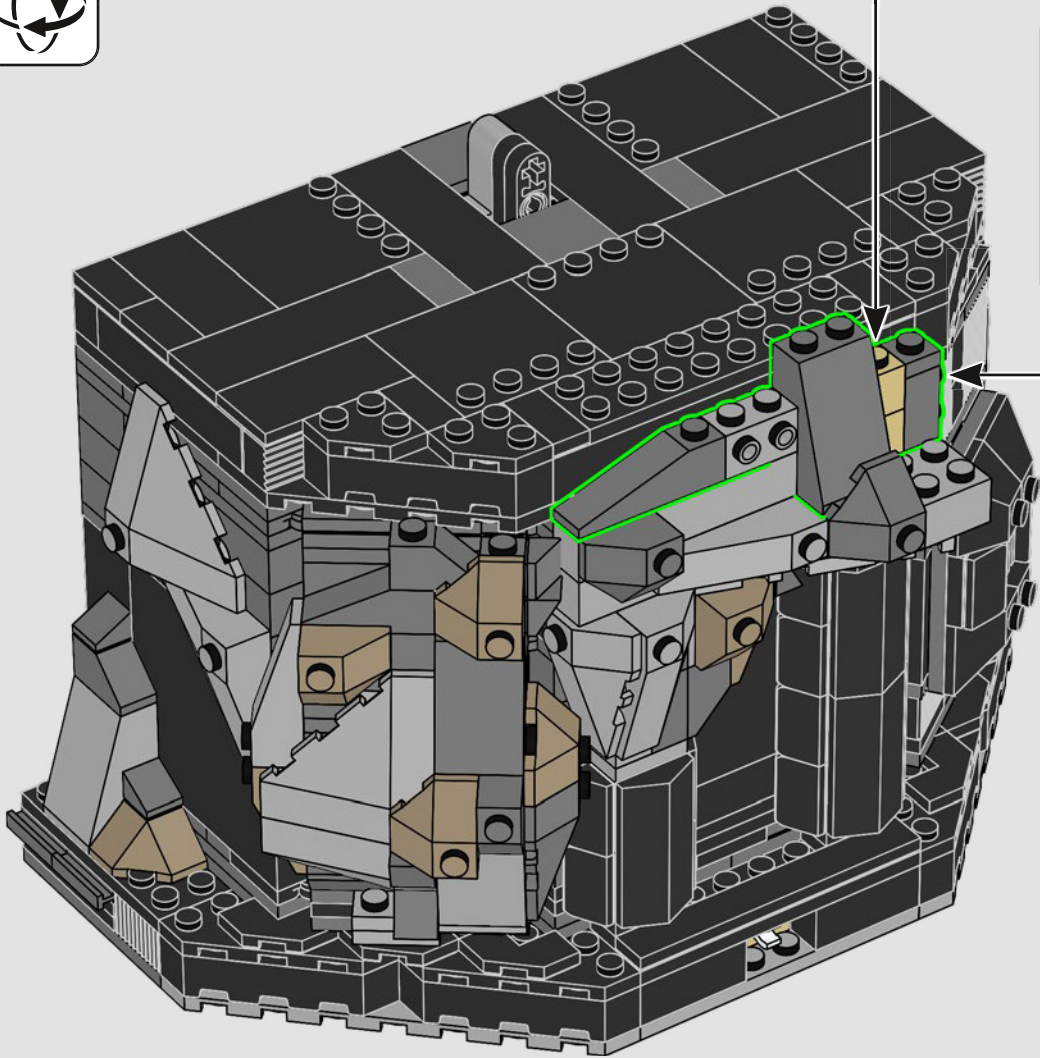

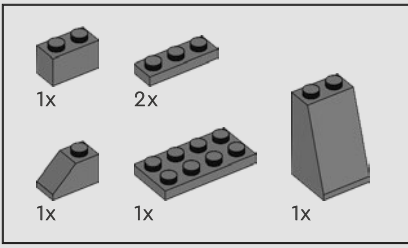

116

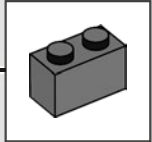
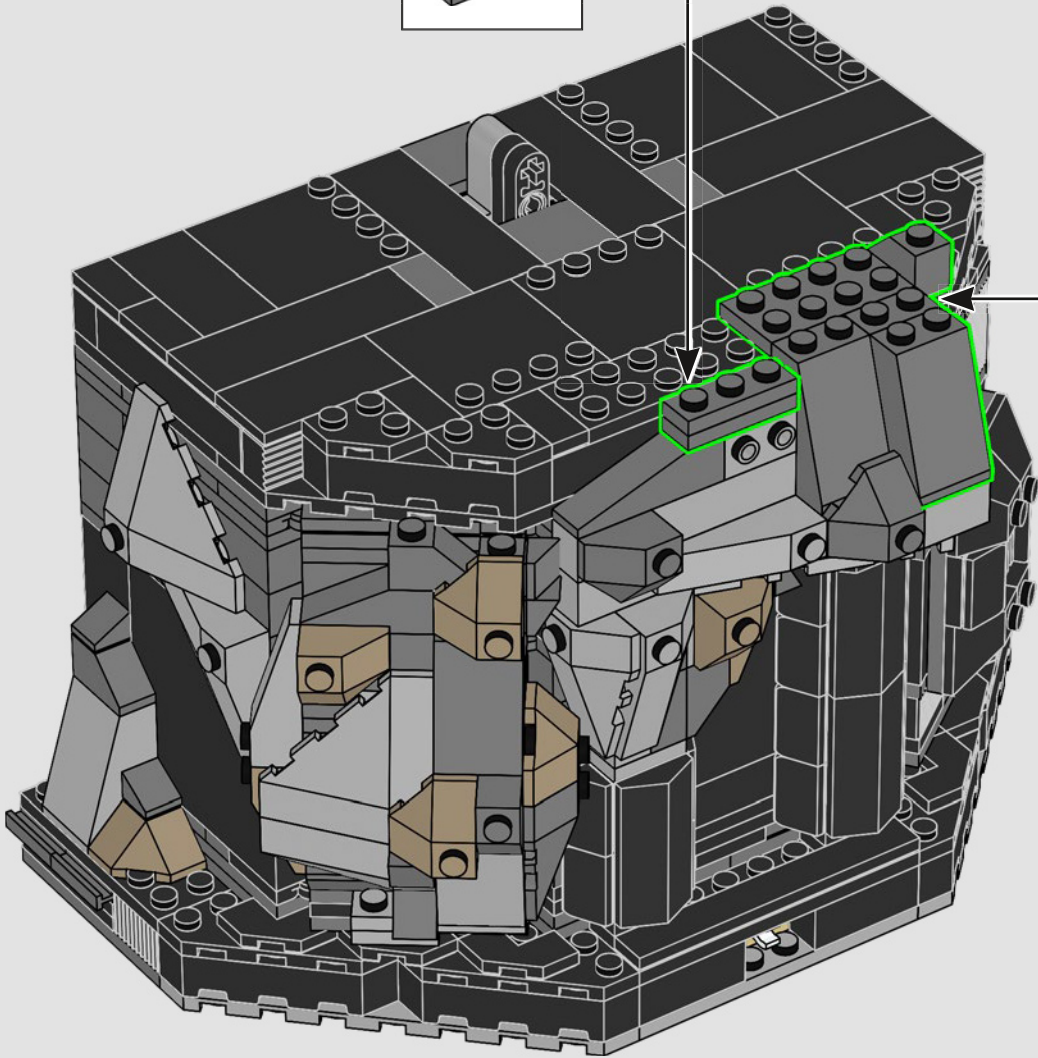
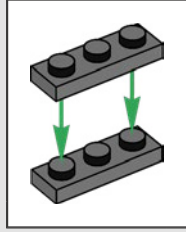

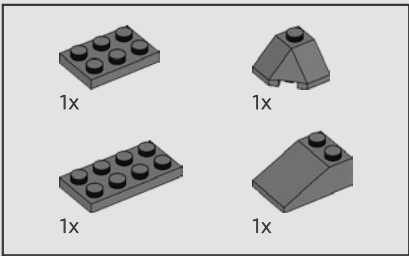

117

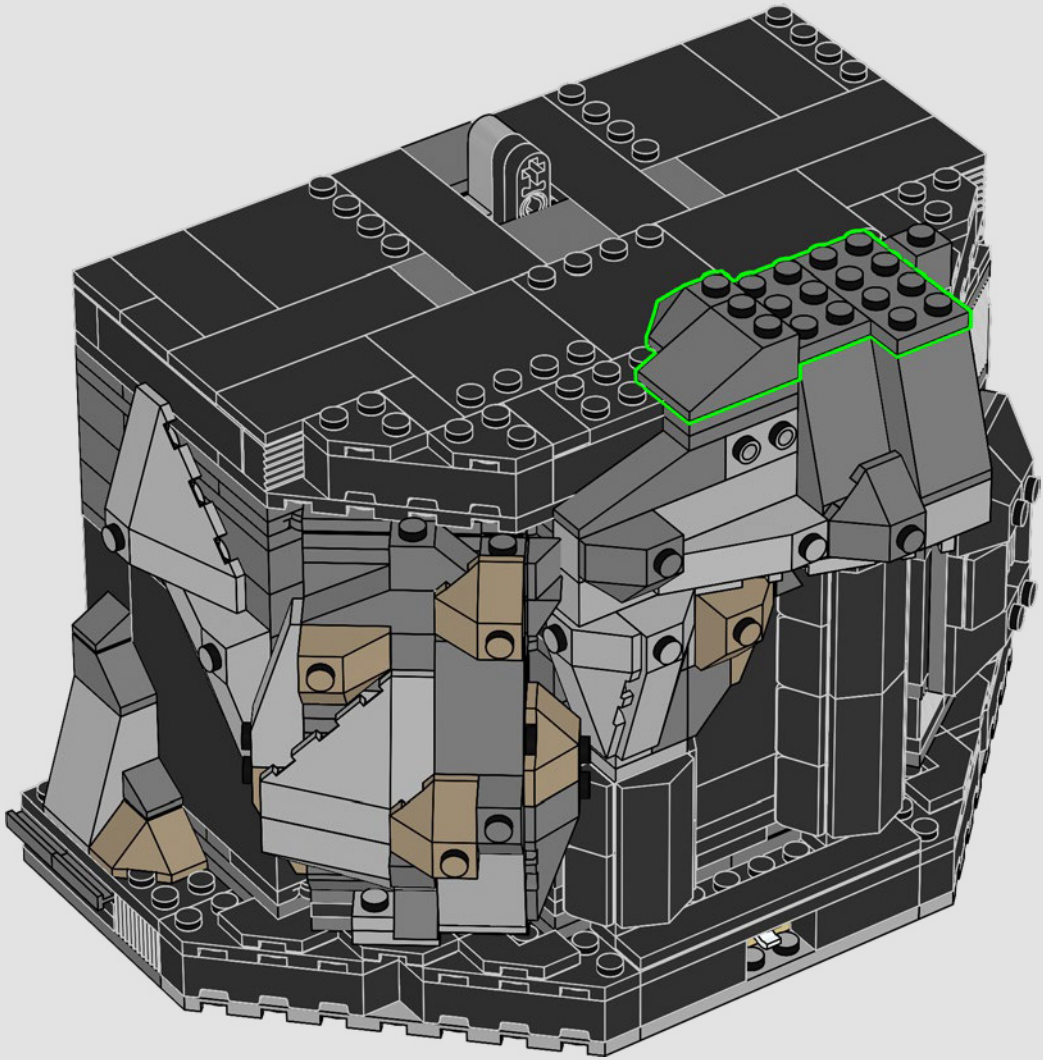

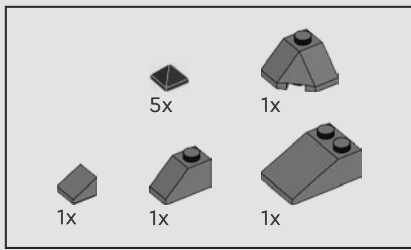

118

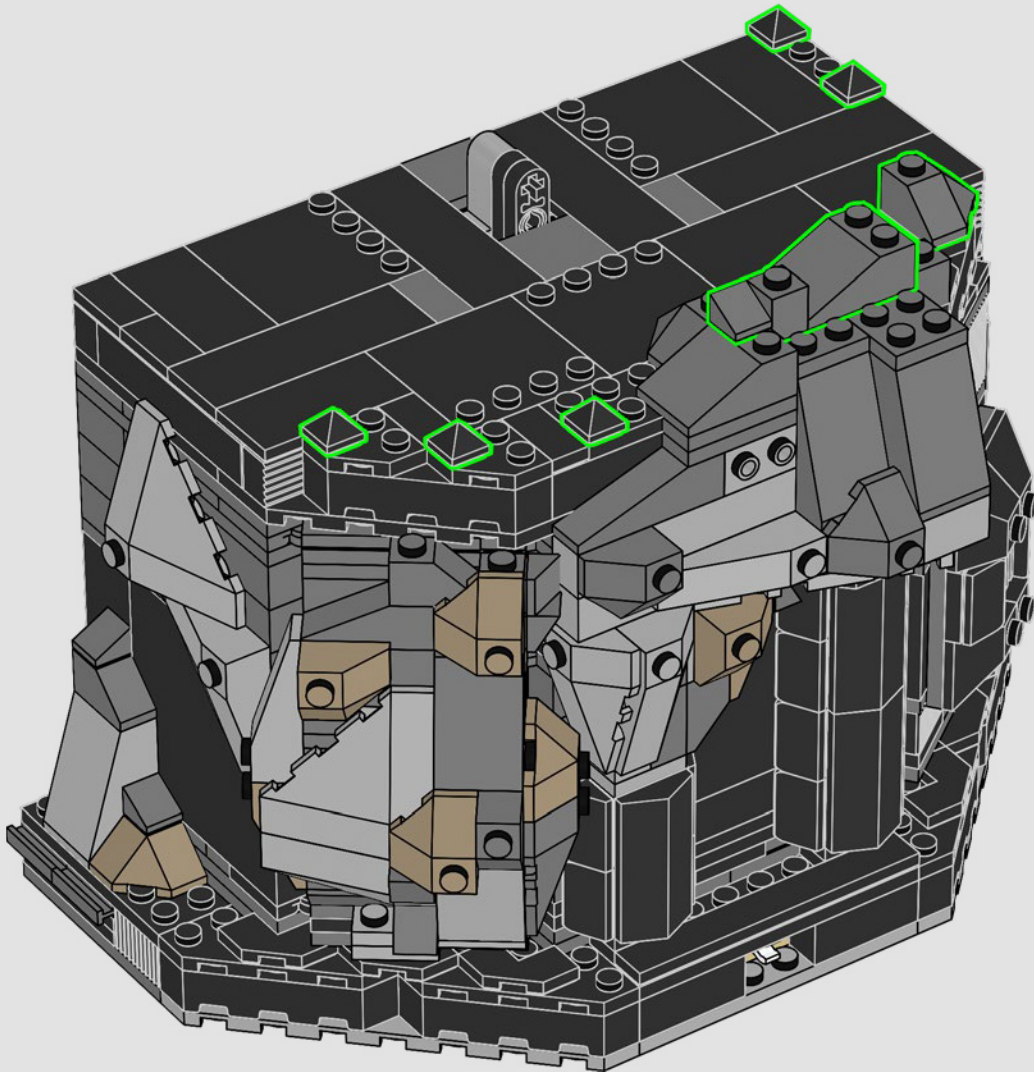

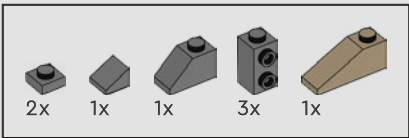

119

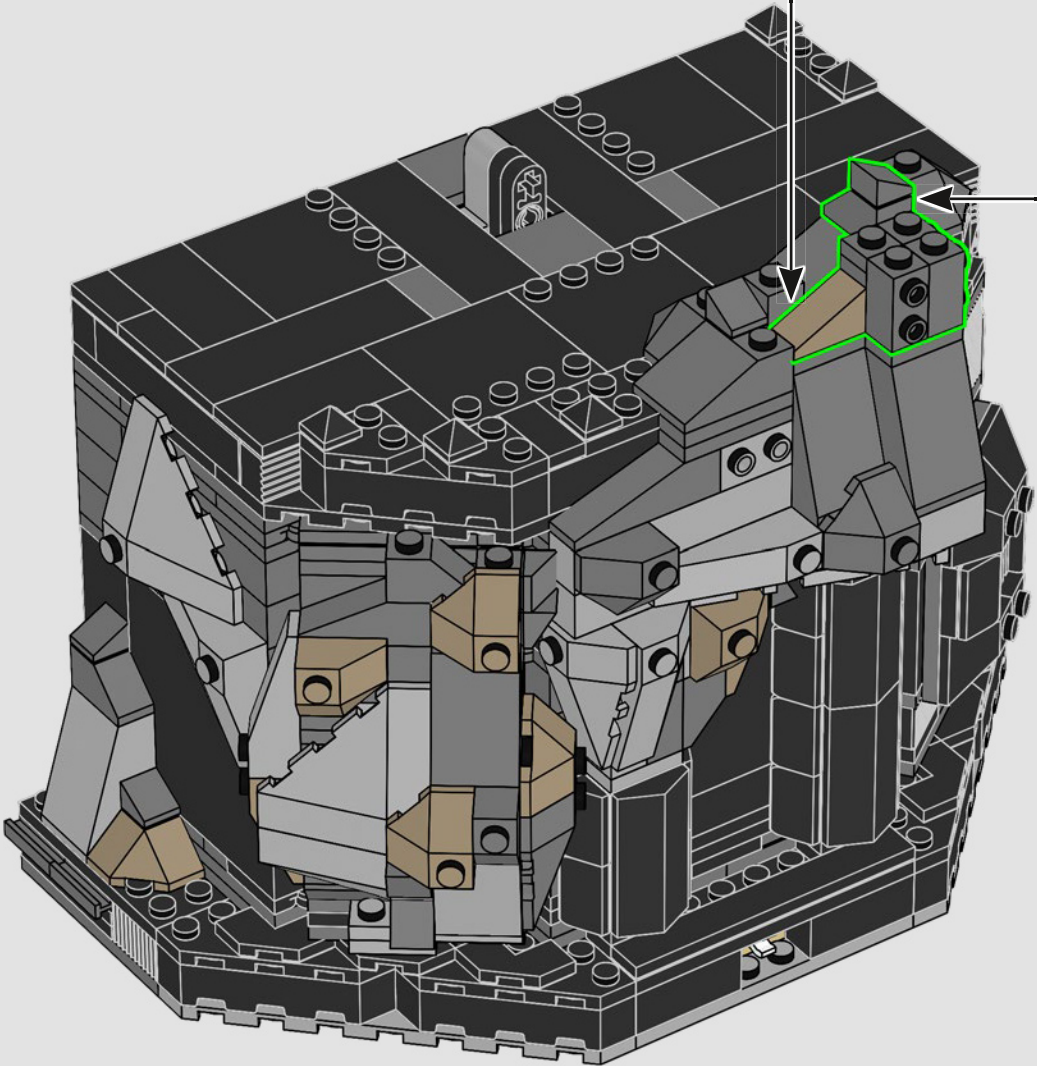
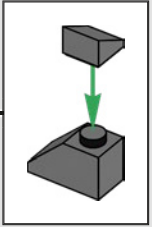
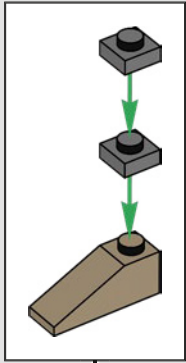

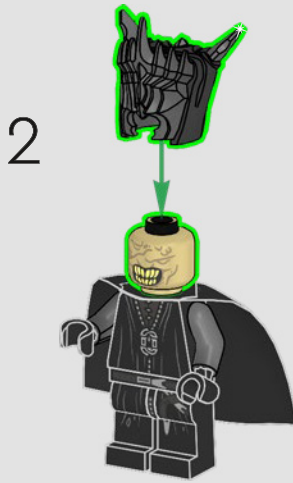
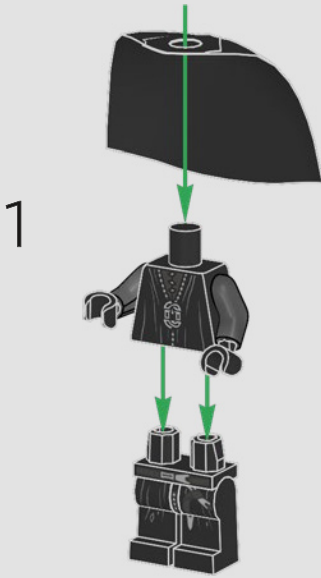



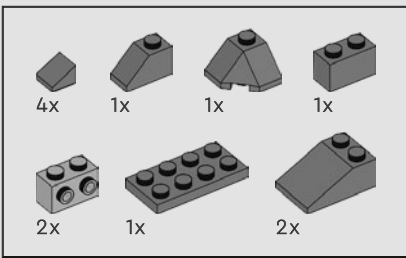

120

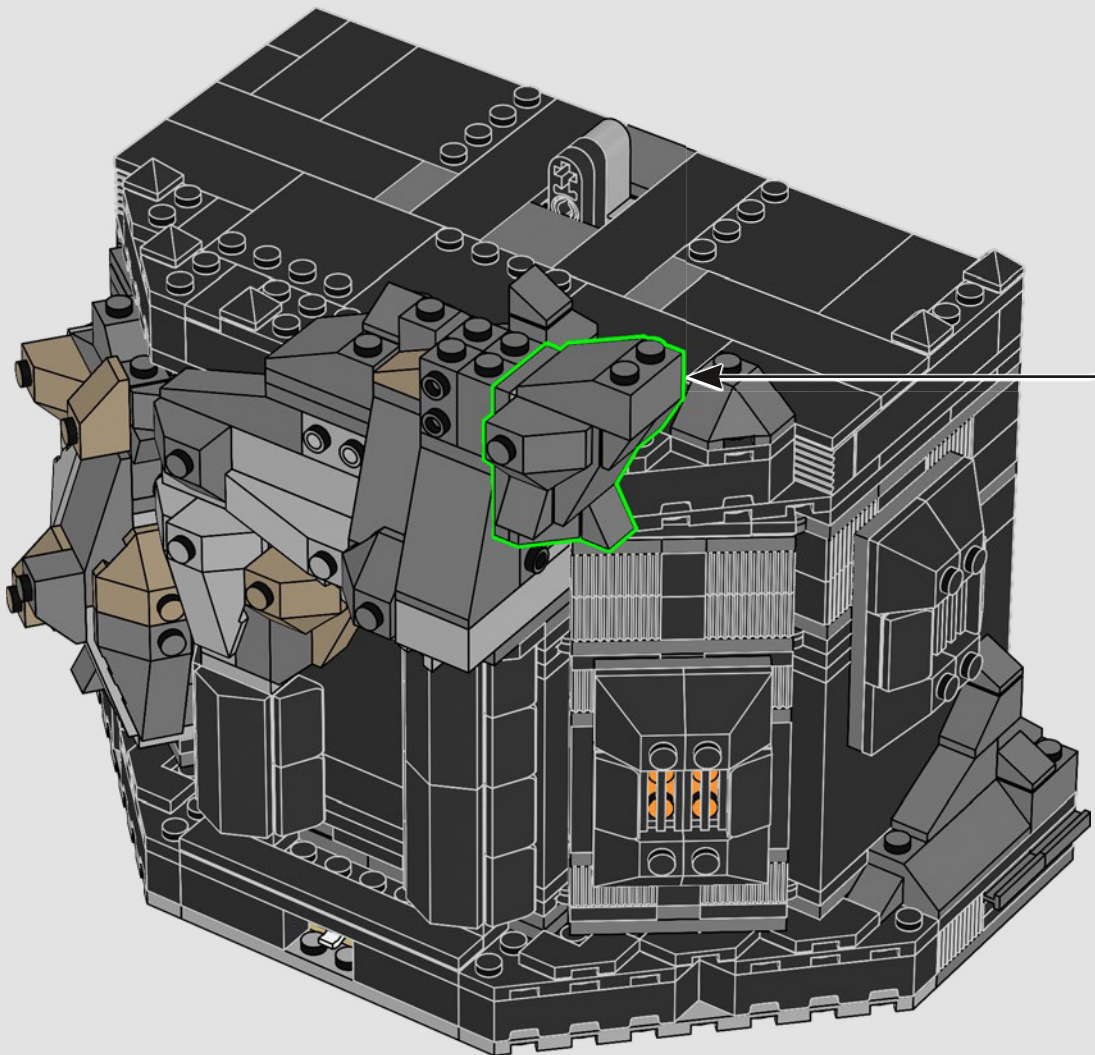
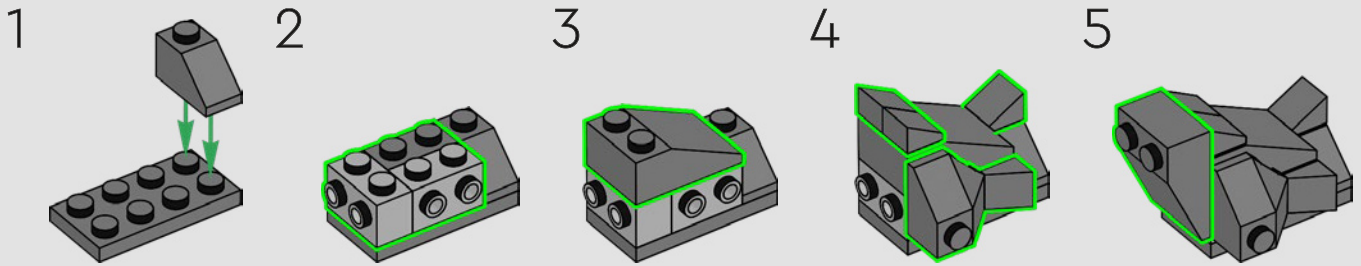

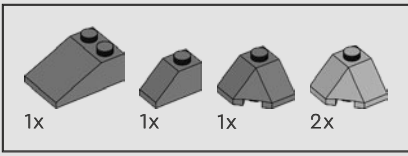

121

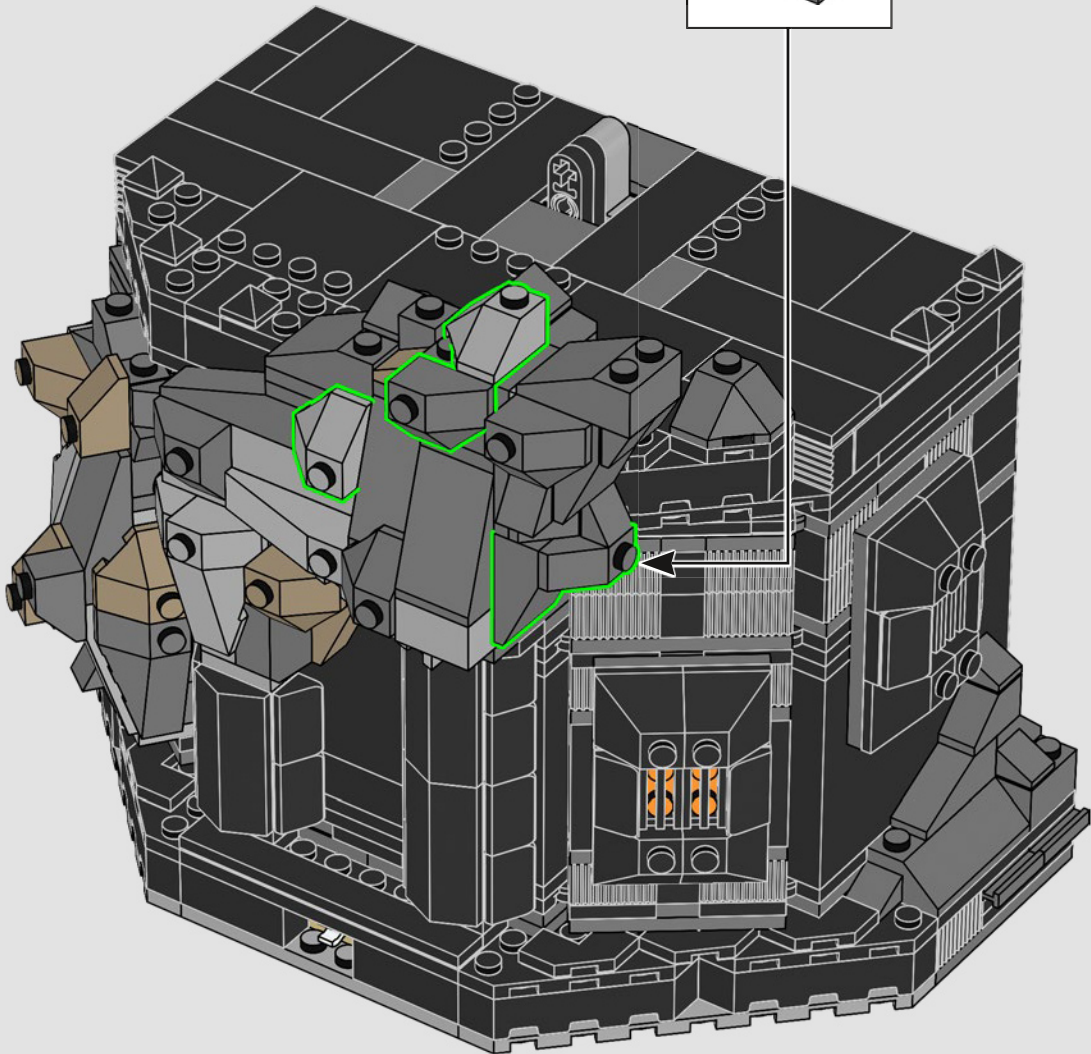
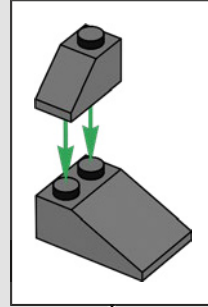

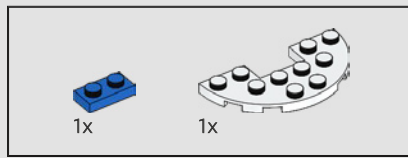
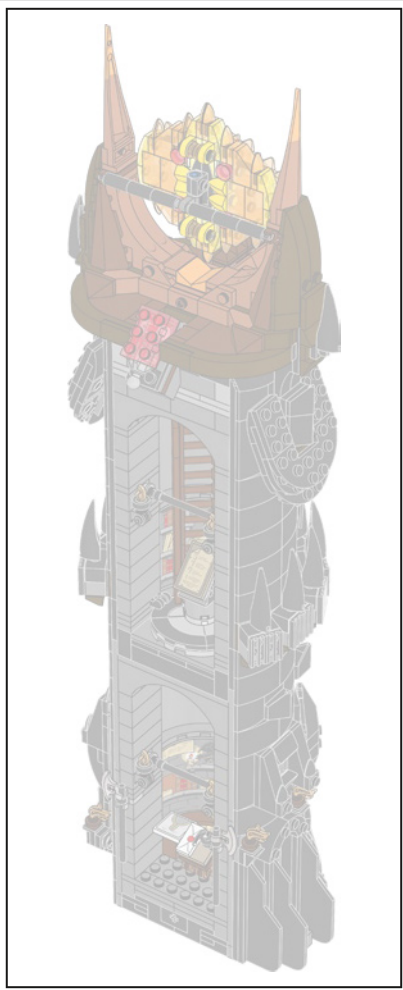

122

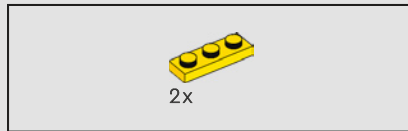
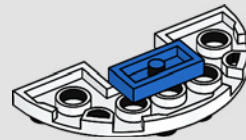

123

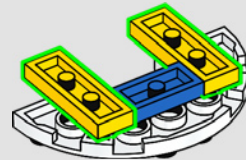

124

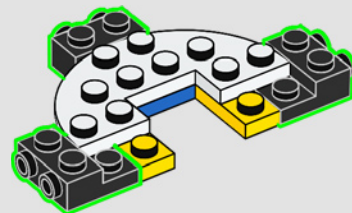

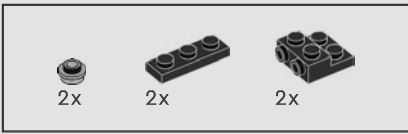

125

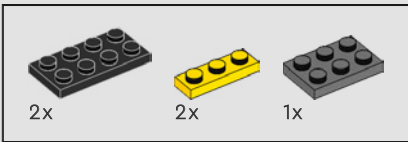
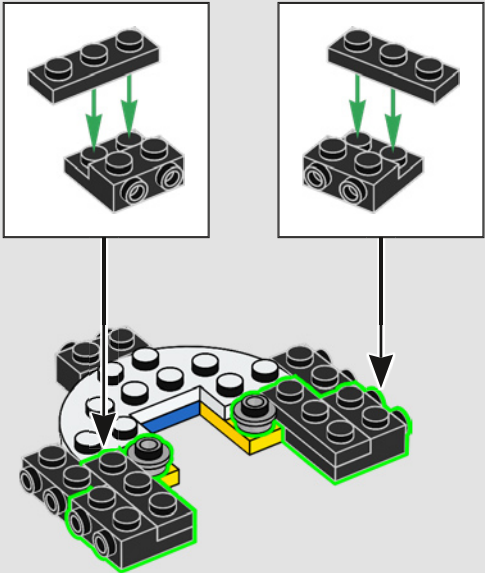

126

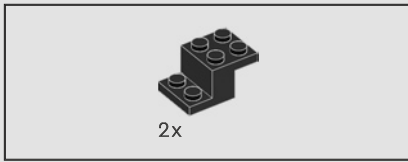
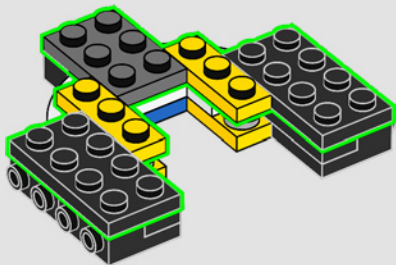

127

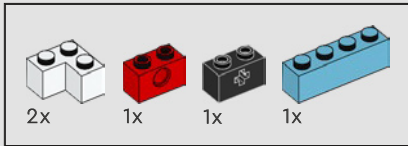
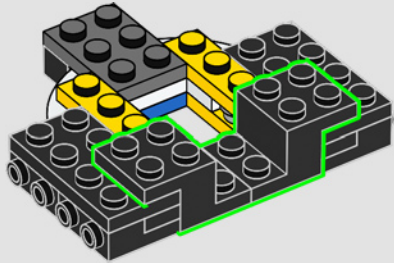

128

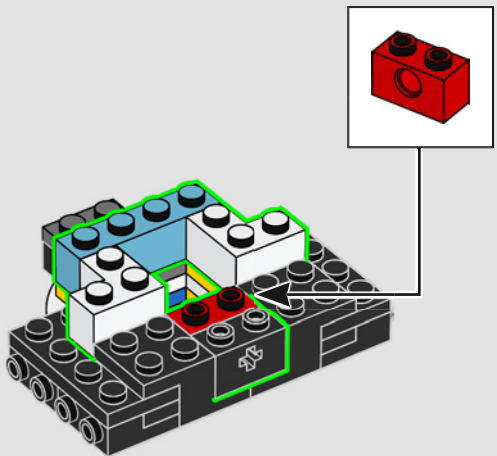

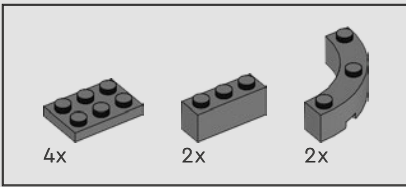

129

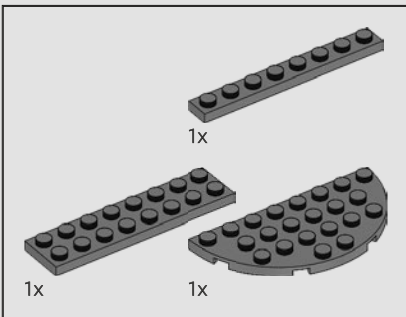
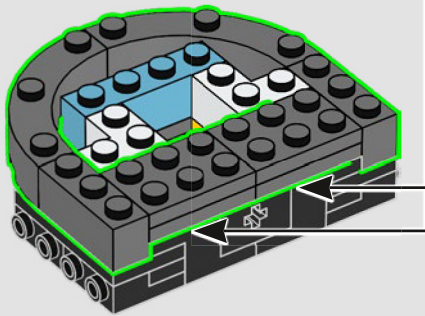
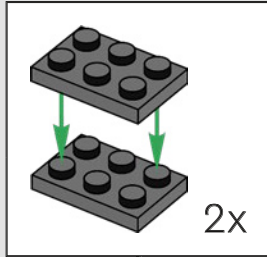

130

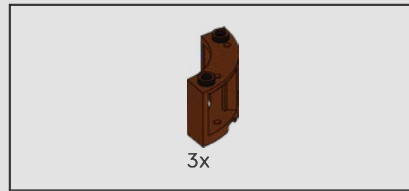
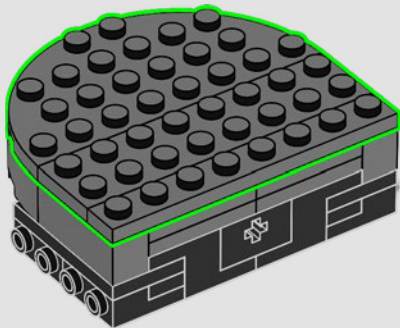

131

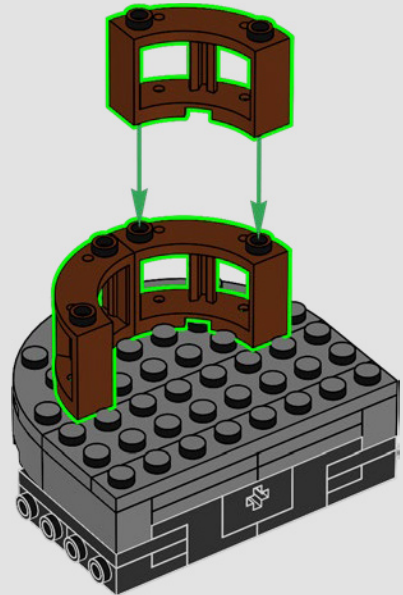

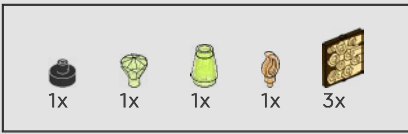

# 132



Gli scaffali nella sala dello studio presentano nuove decorazioni con un elemento inserto finestra e pergamene.

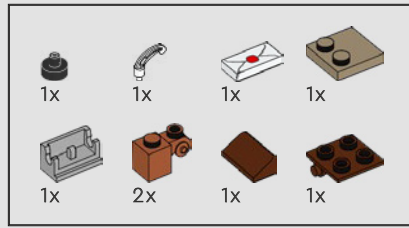
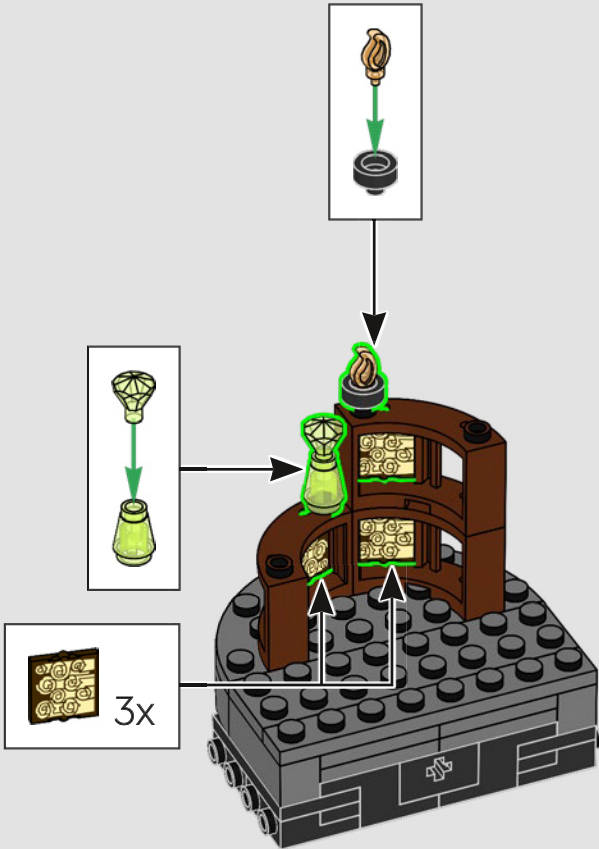

# 133

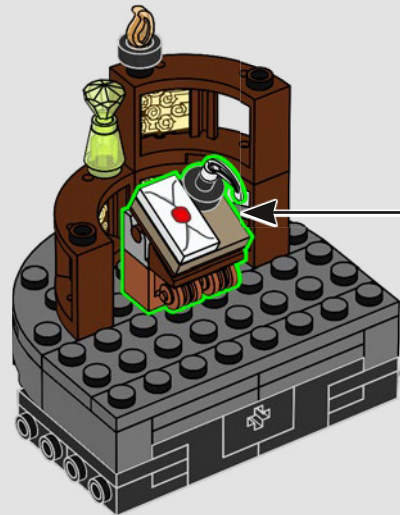
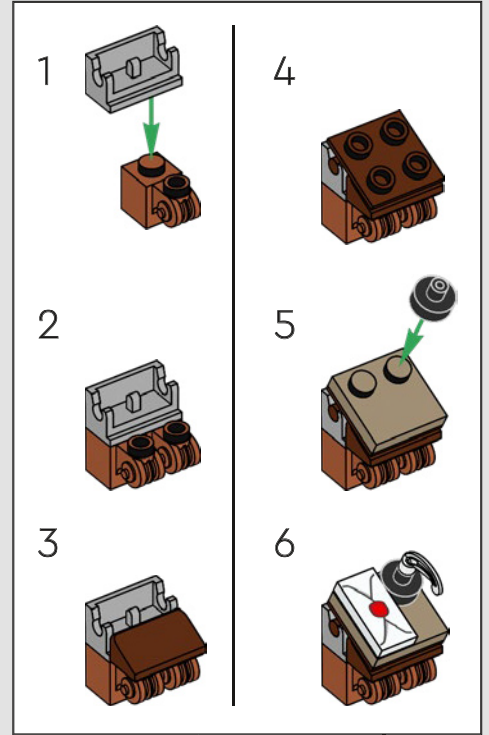

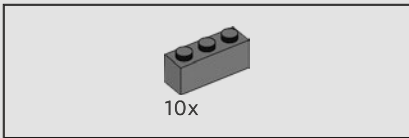

134

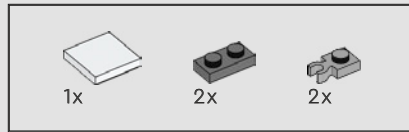
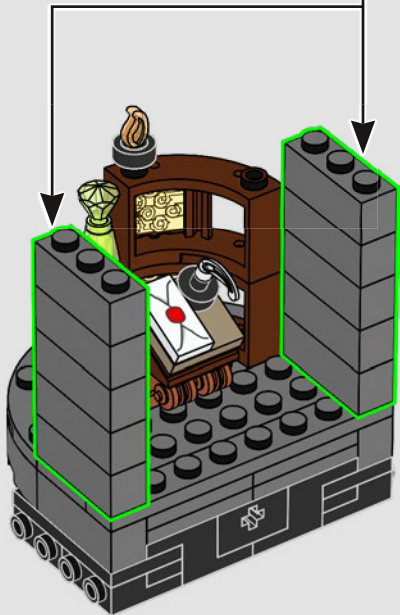
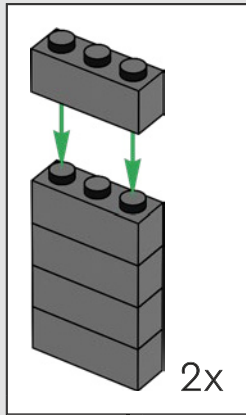

135

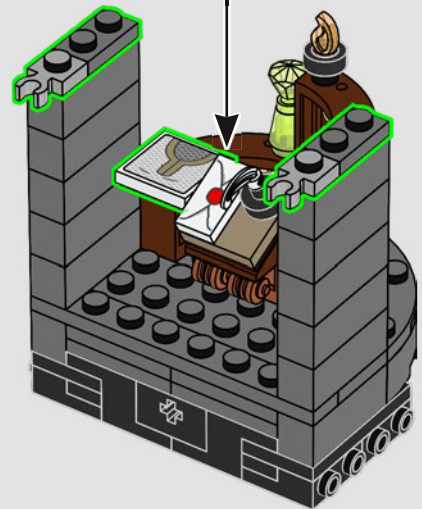
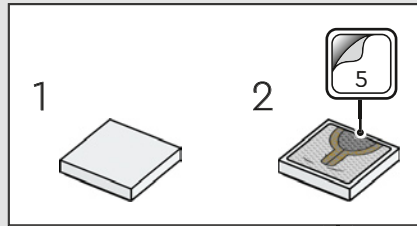

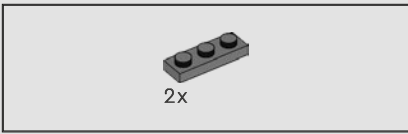

136

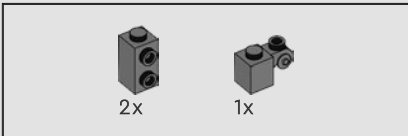
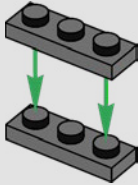

137

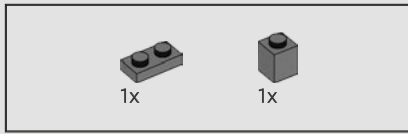
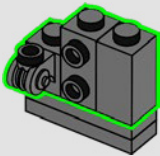

138

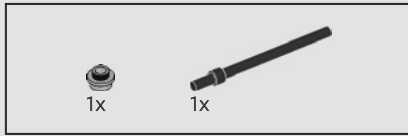
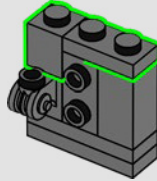

139

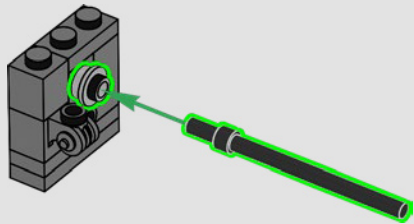





Nelle camere della Bocca di Sauron, è presente una maglia Mithril che Sauron usa per ingannare la Compagnia facendole credere di aver catturato Frodo Baggins.

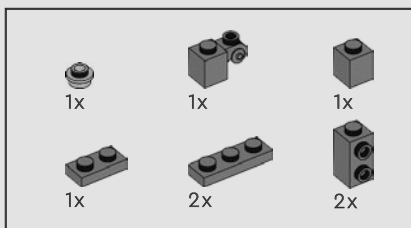

140

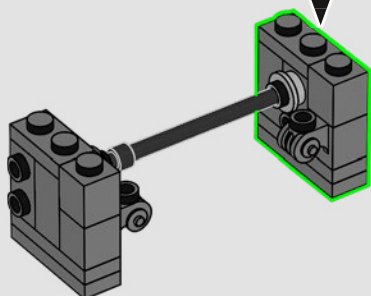
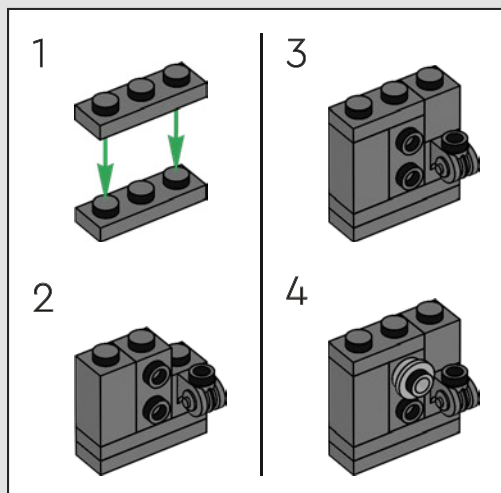

141

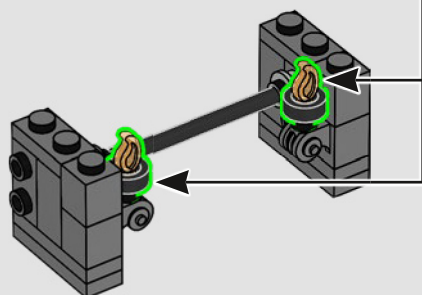
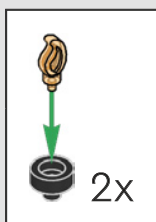

142

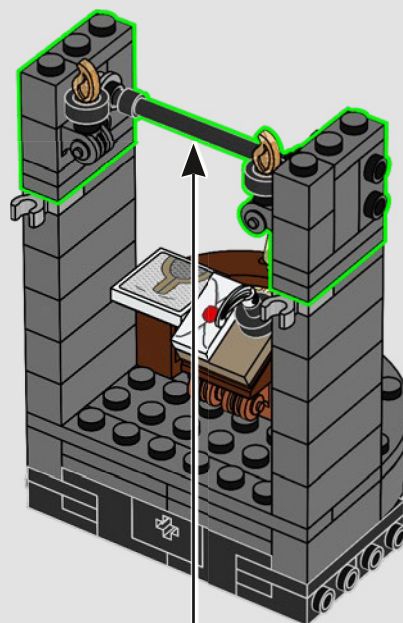

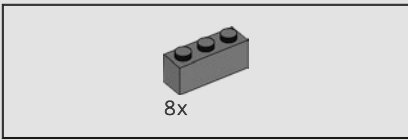

143

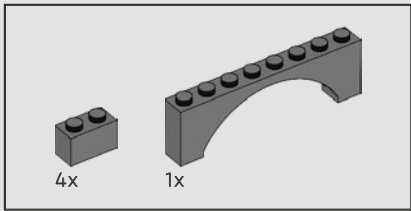
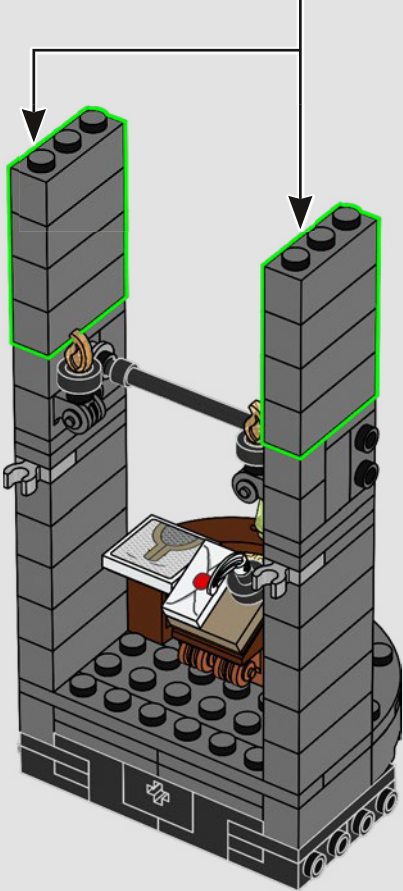
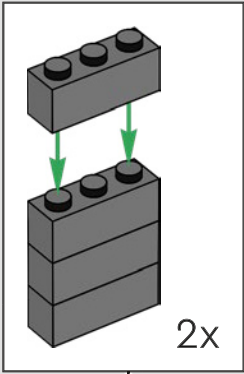

144

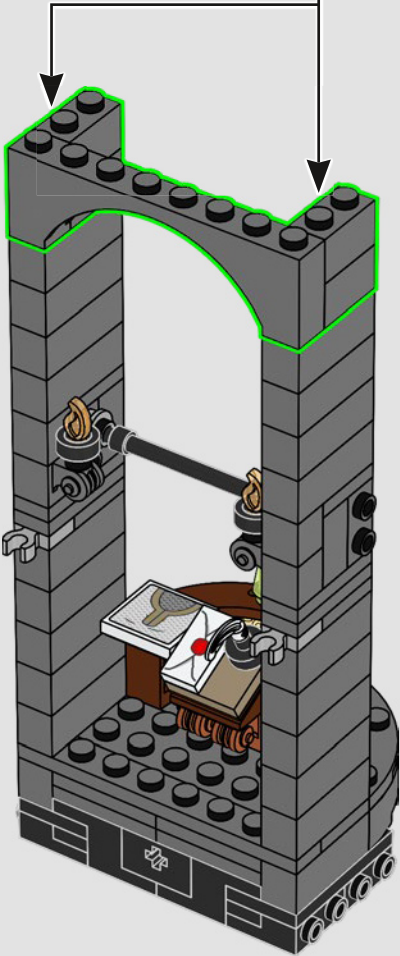
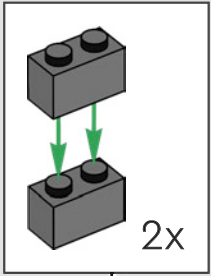

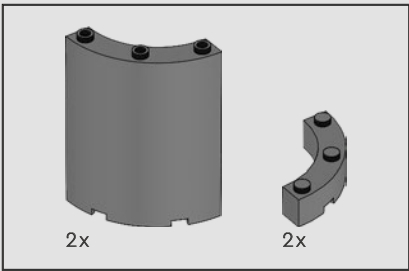

145

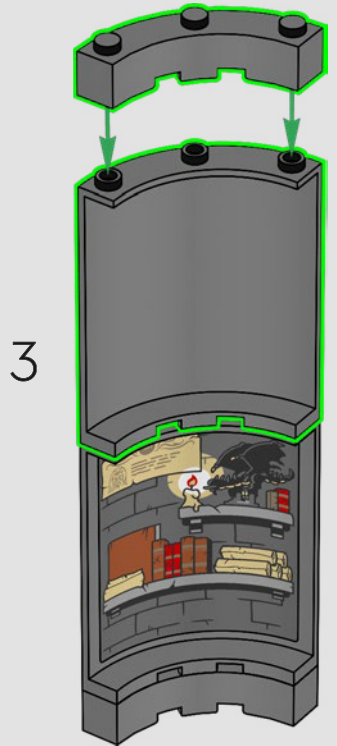
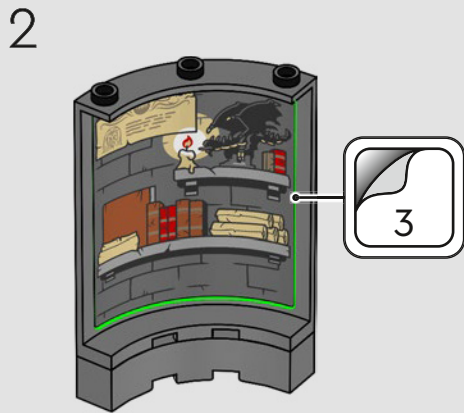
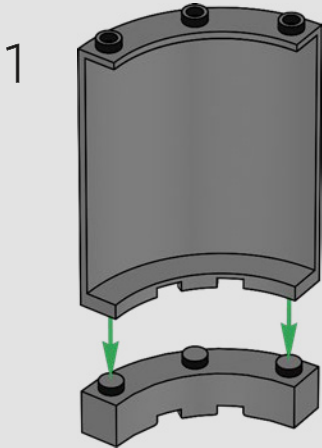

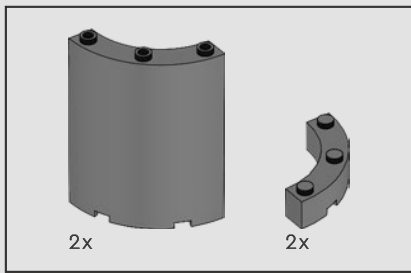

146

1

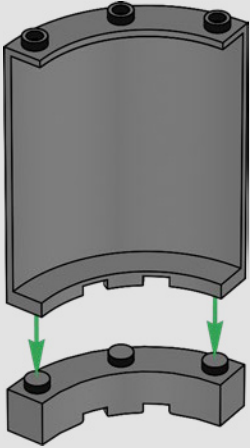

2

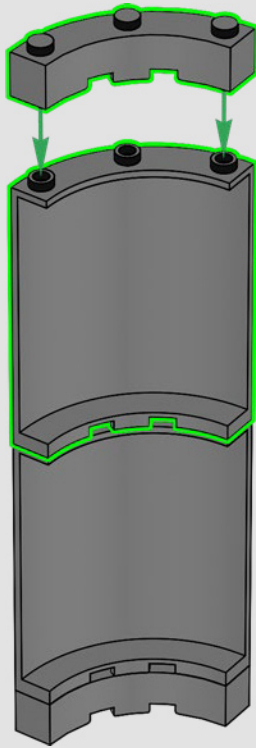

3

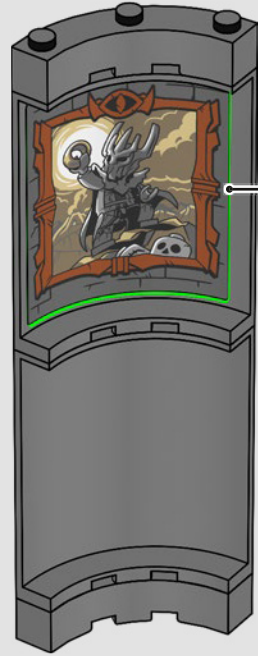



Mentre la Bocca di Sauron si occupa della sua corrispondenza con Isengard, un ritratto di Sauron penzola sopra la sua testa.

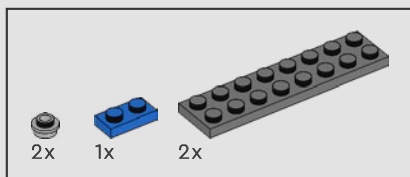

147

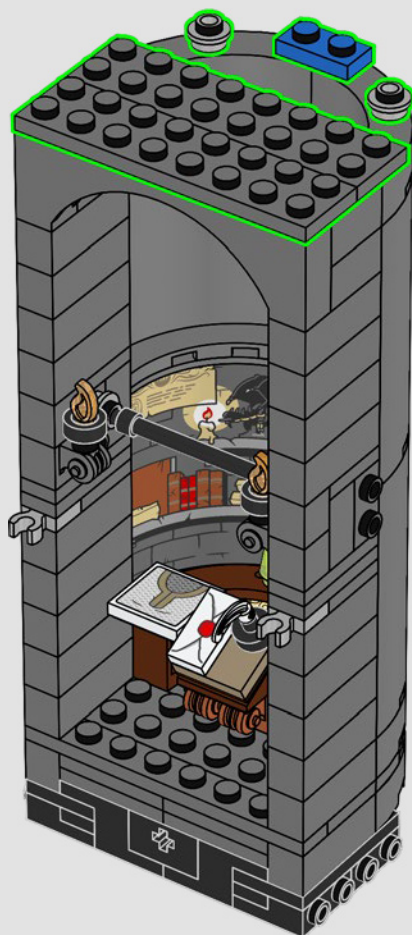

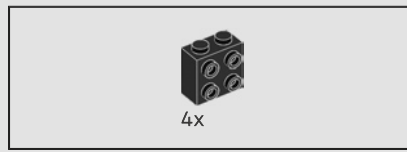

148



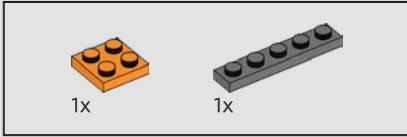
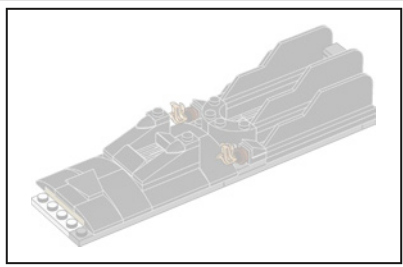

149

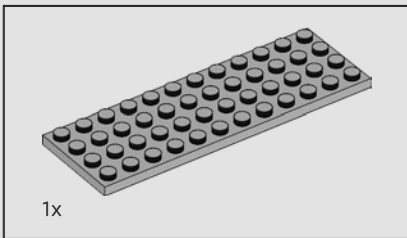
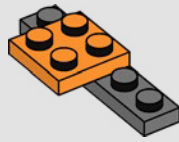

150

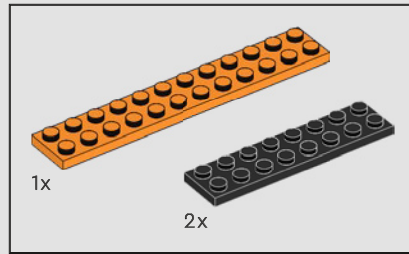
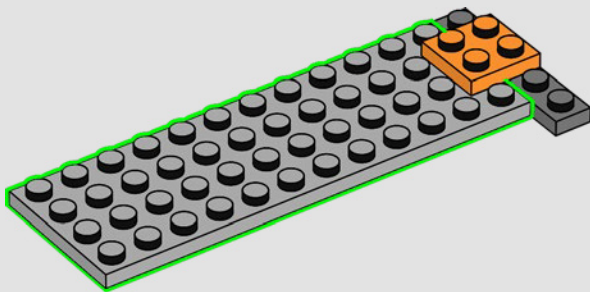

151

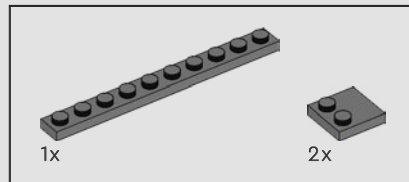
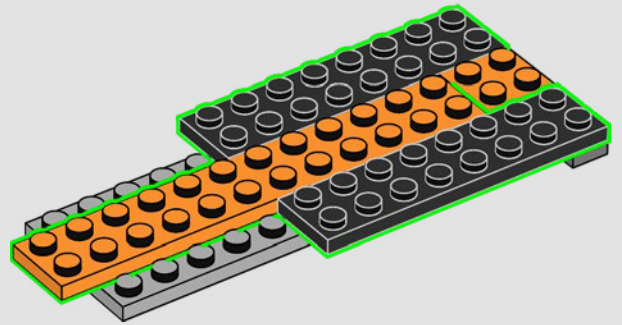

152

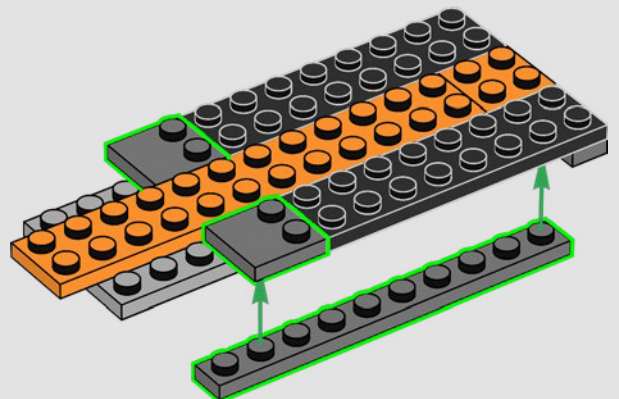

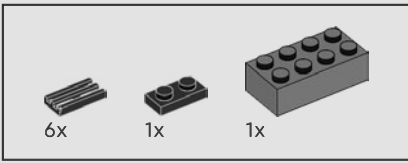

153

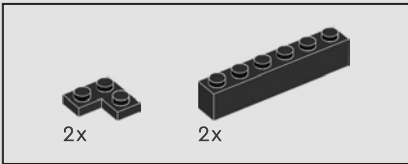
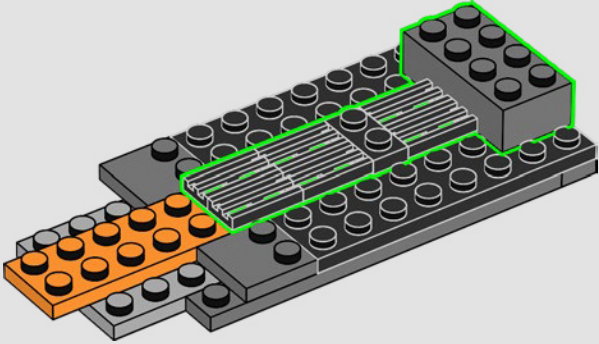

154

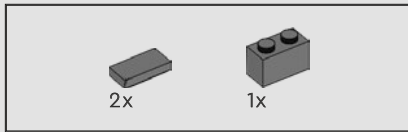
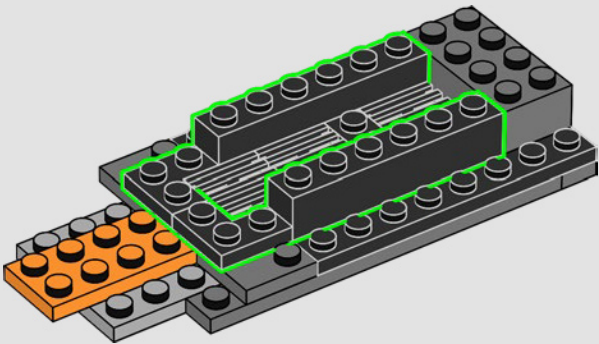

155

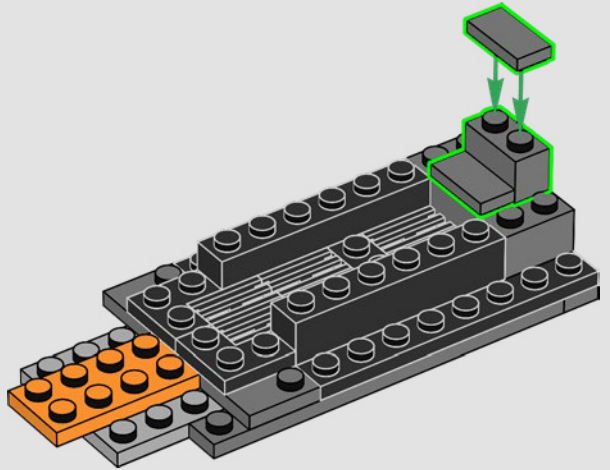



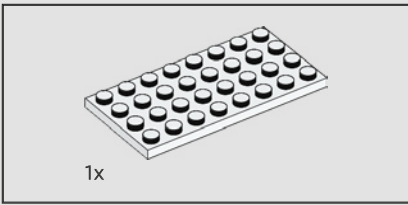

156

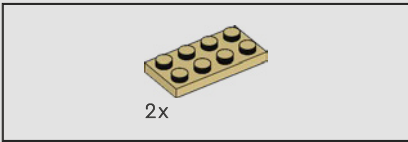
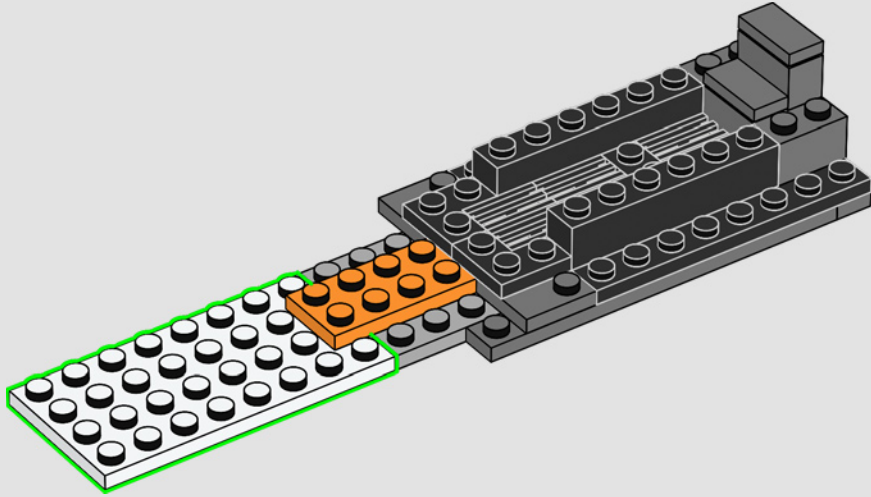

157

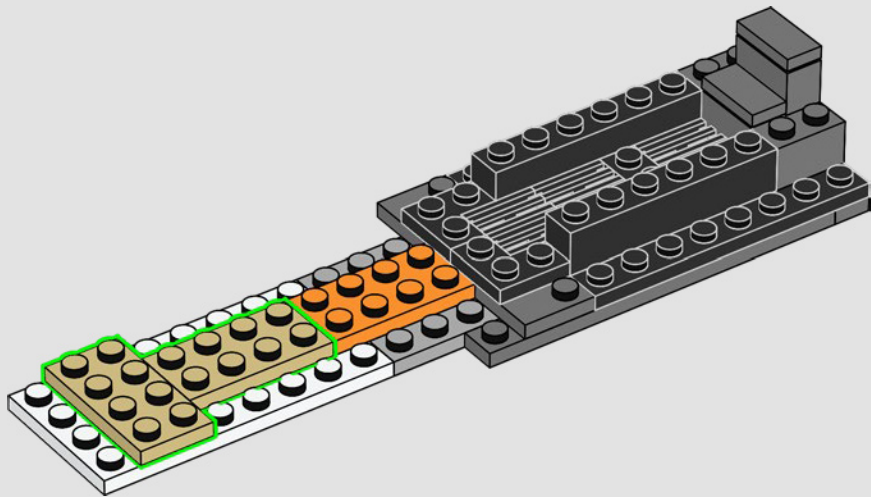

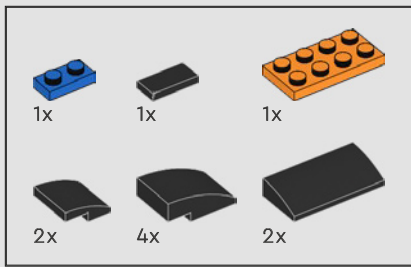

158

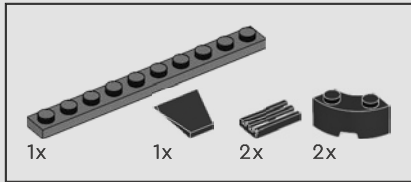
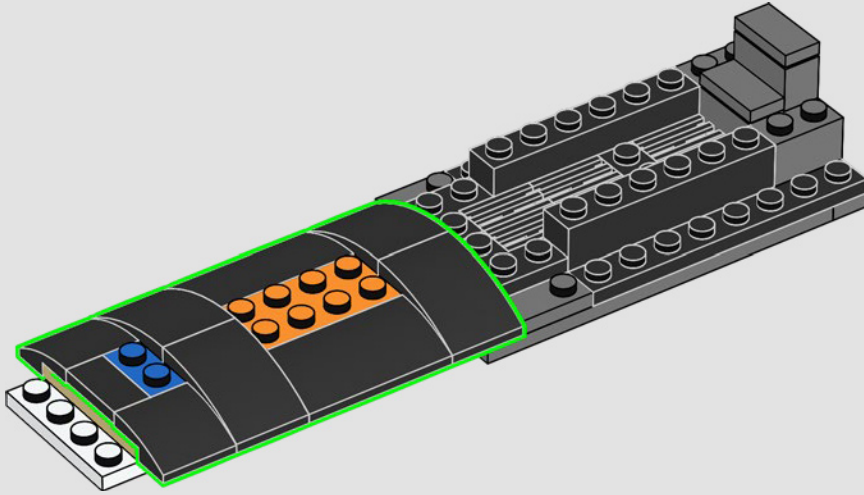

159

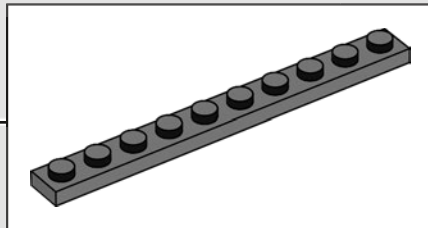
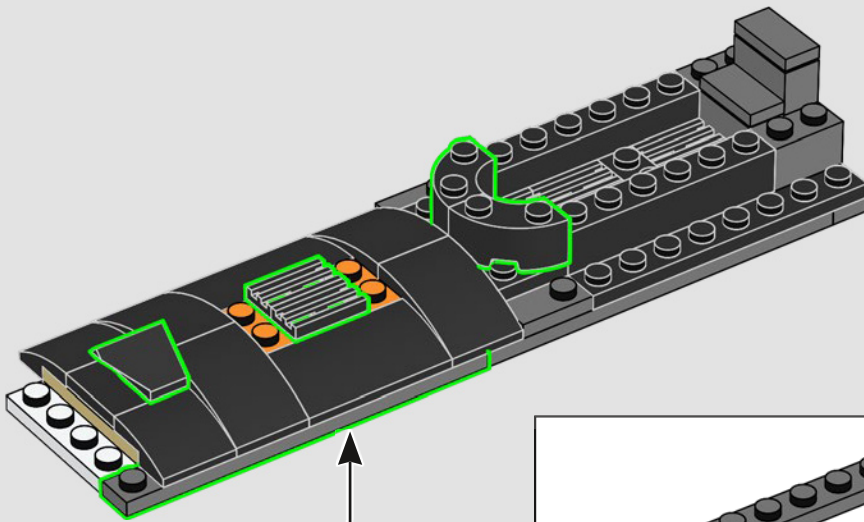

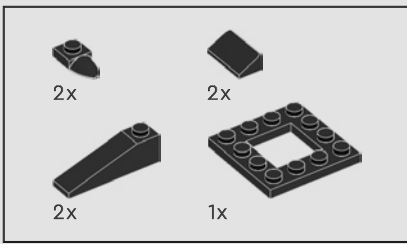

160

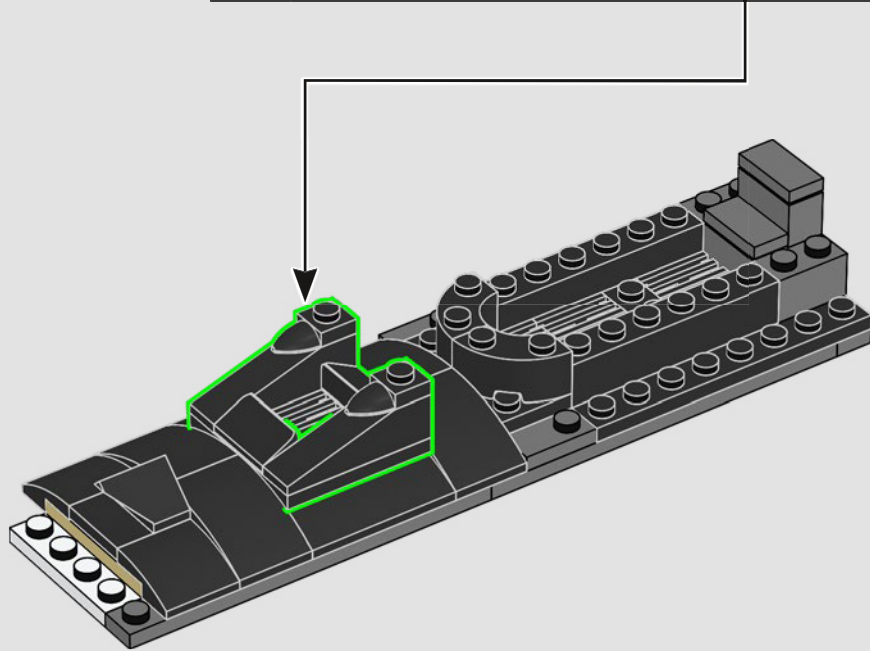
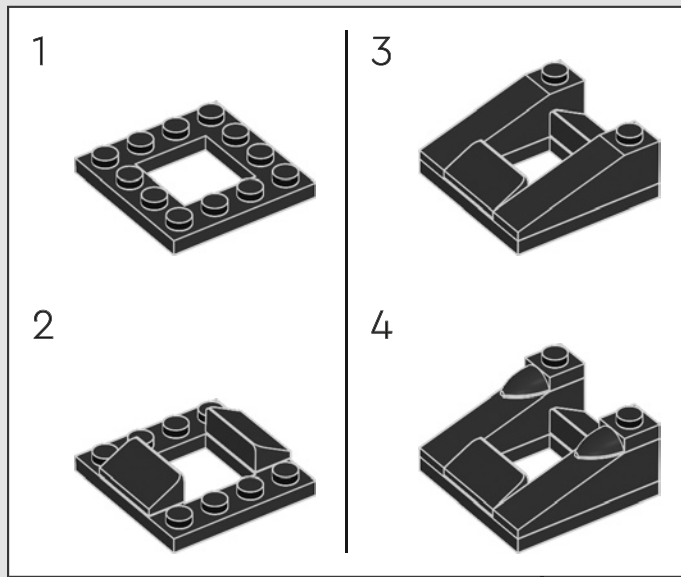



161

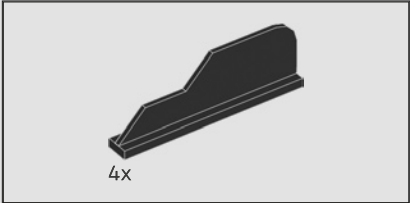
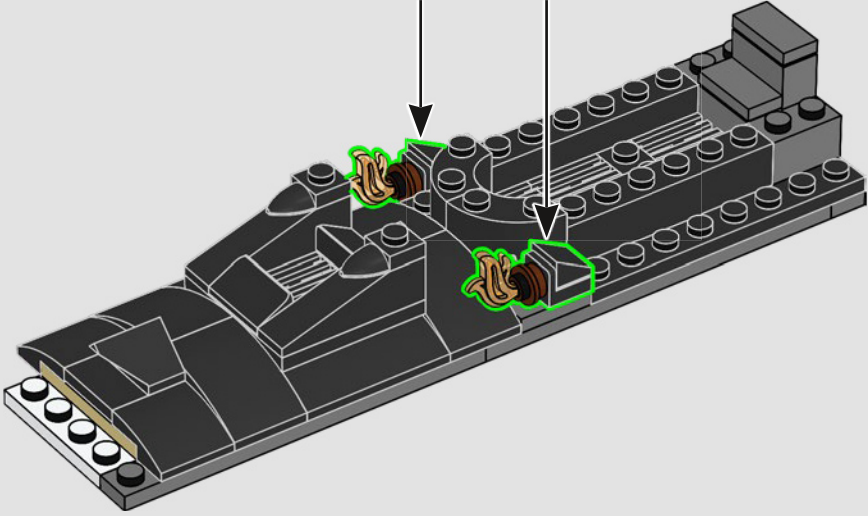
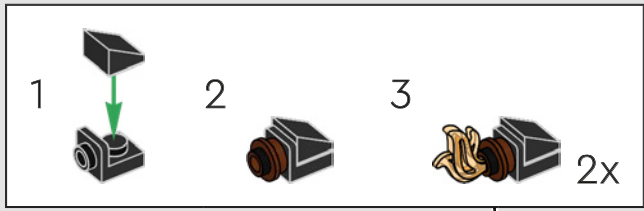

162

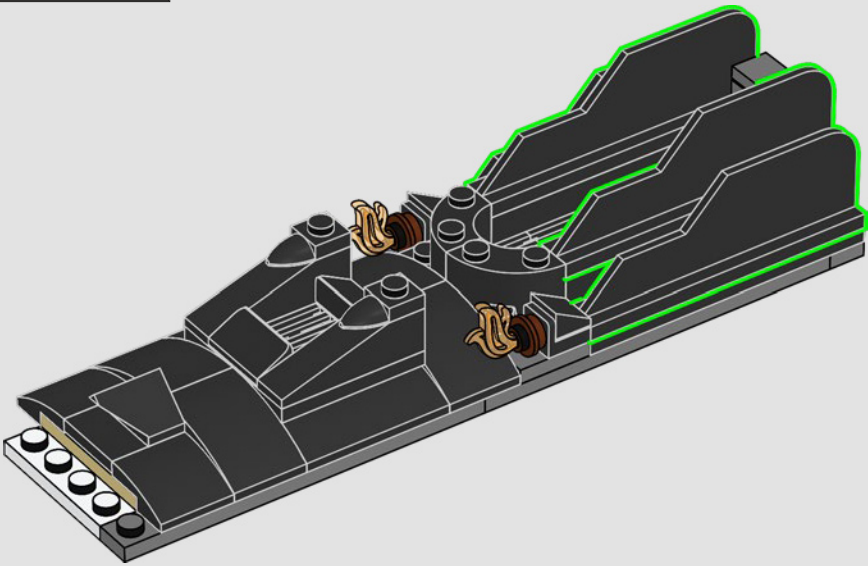



L'elemento timone 1x8 è stato utilizzato per creare la porta all'esterno della camera.

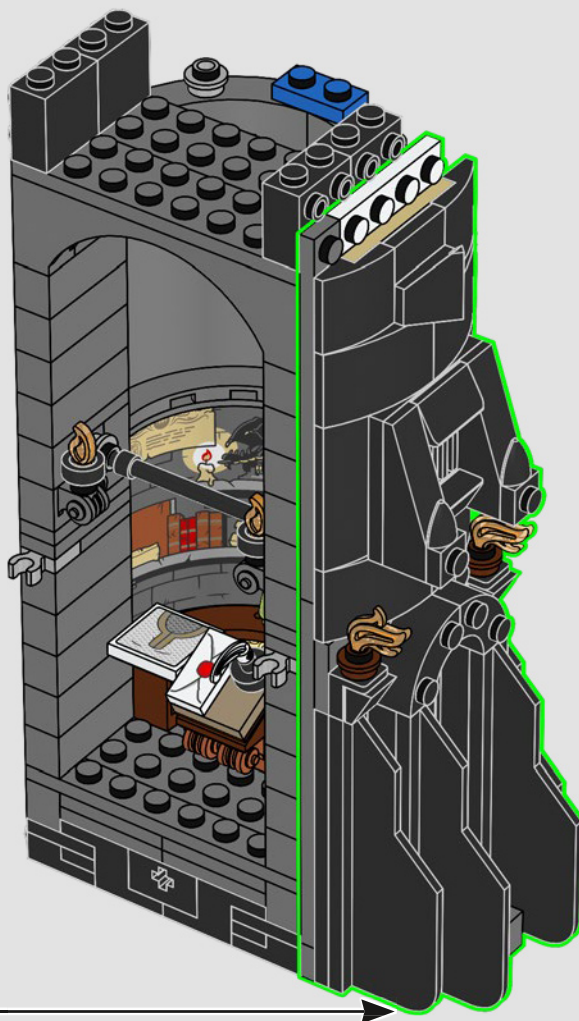

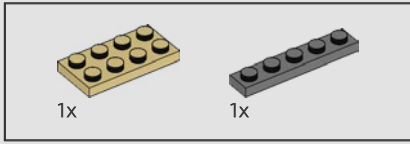
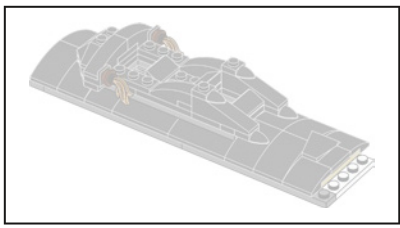

164

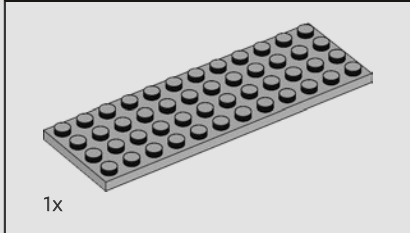
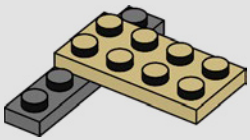

165

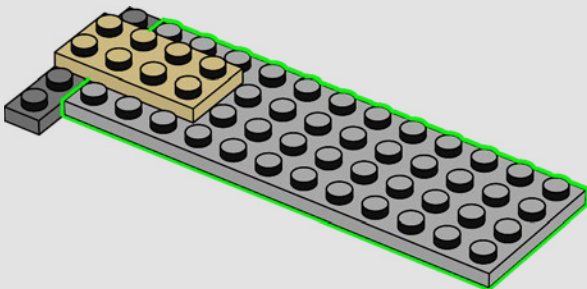

166

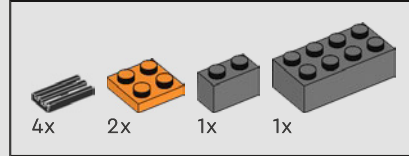
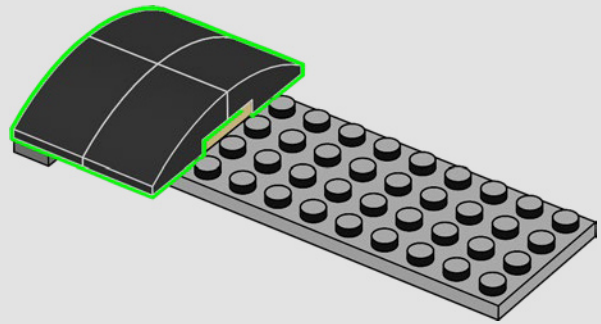

167

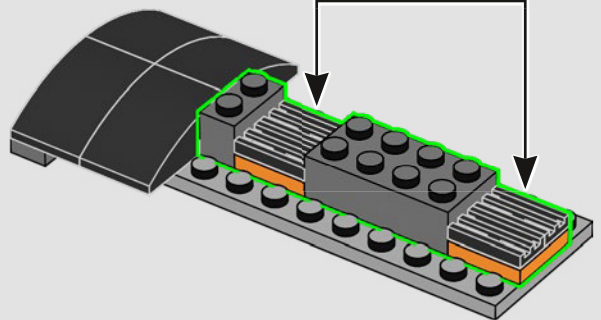
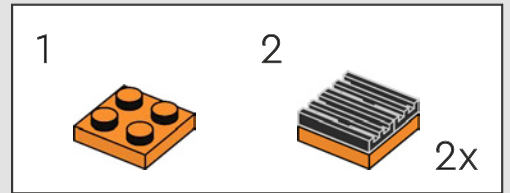

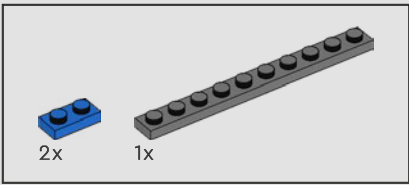

168

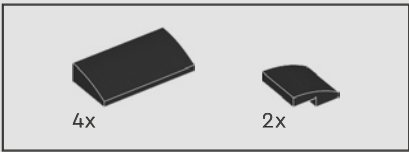
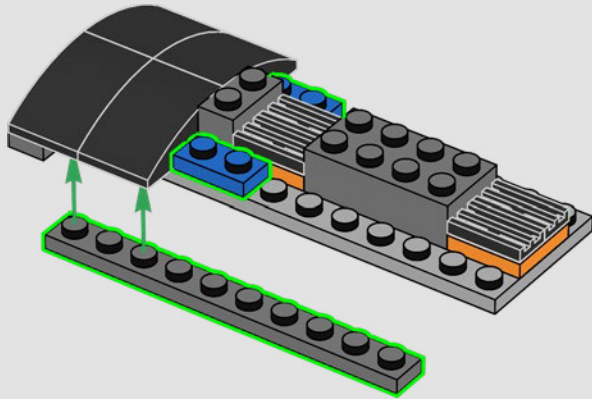

169

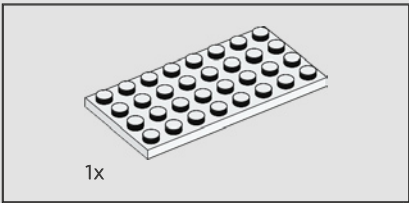
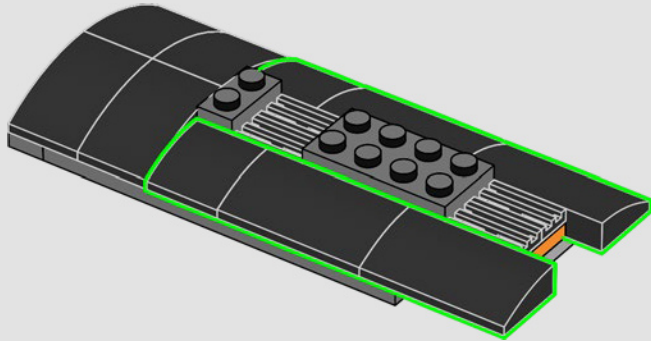

170

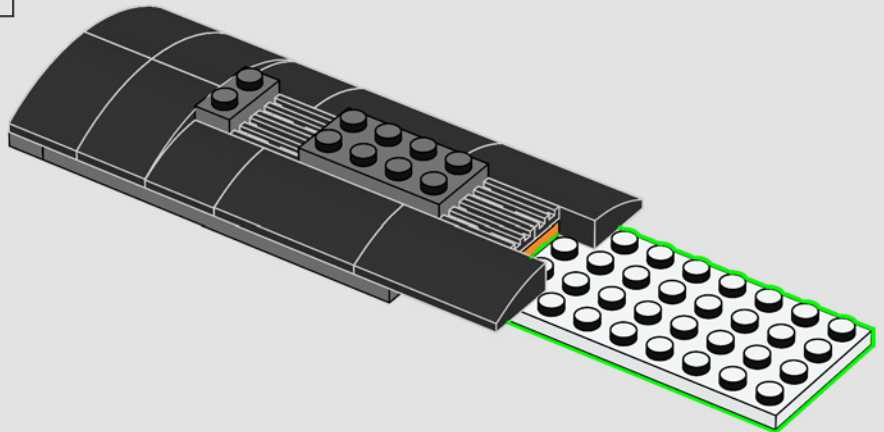

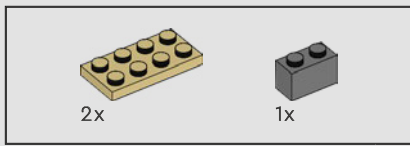

171

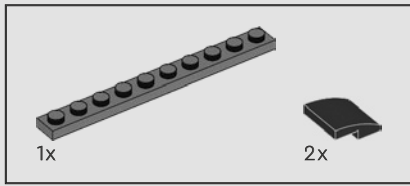
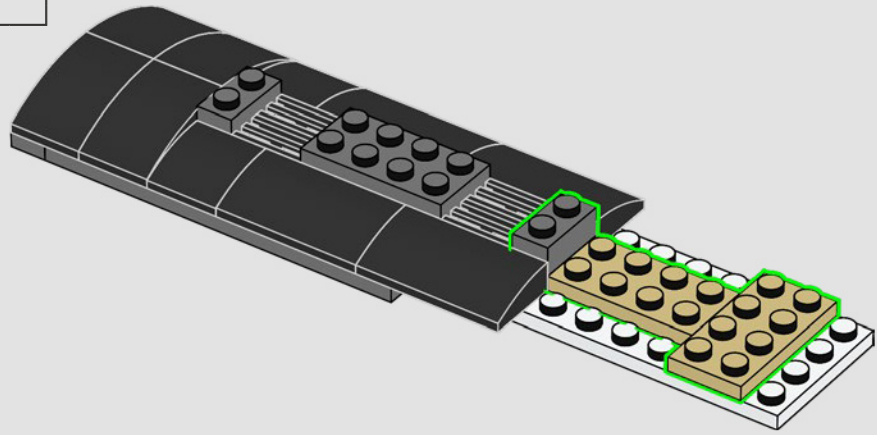

172

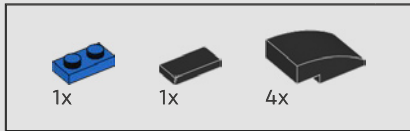
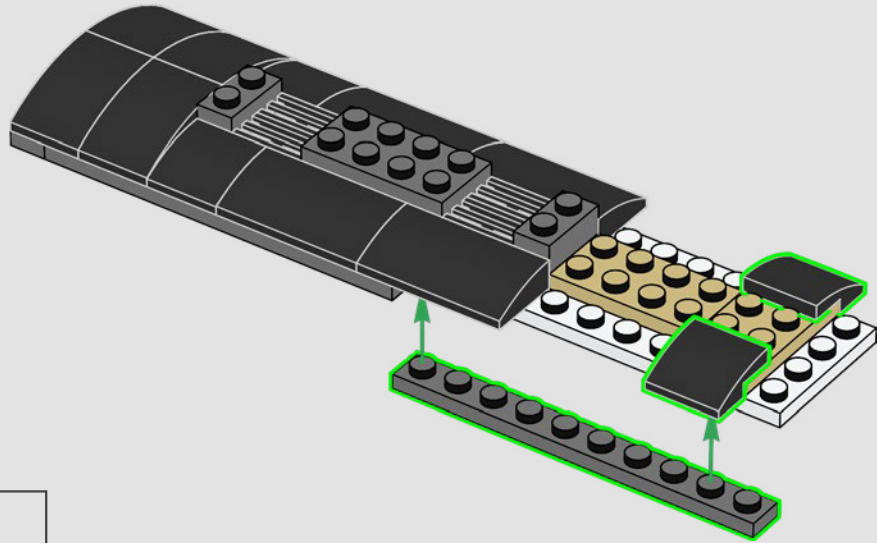

173

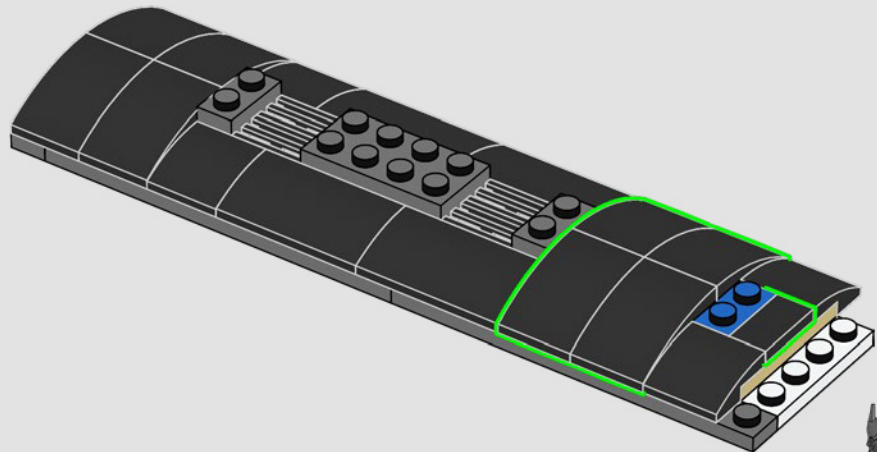



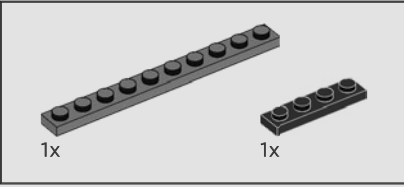
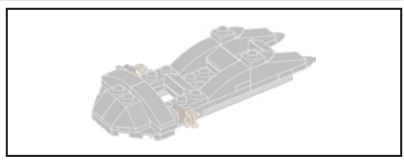

174

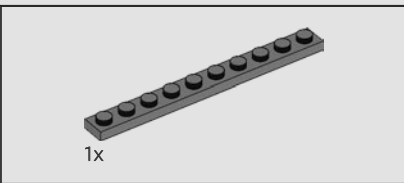
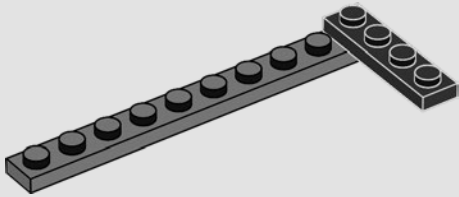

175

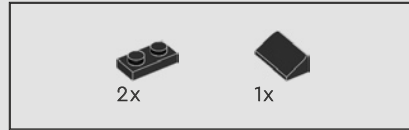
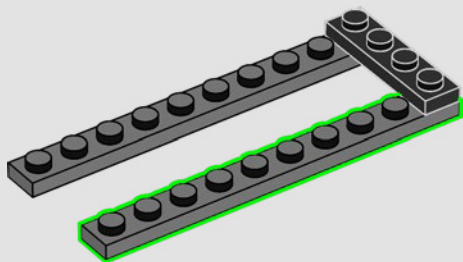

176

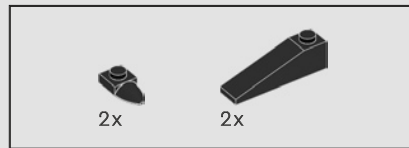
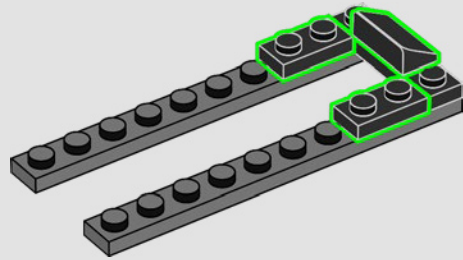

177

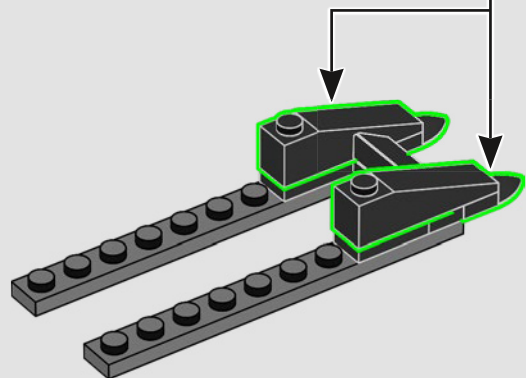
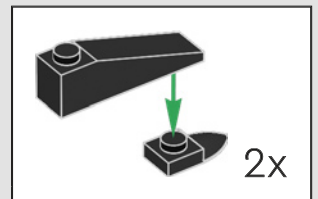



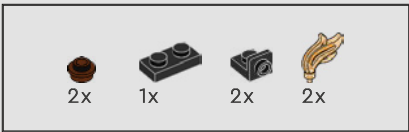

182

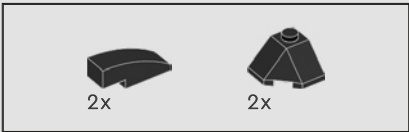
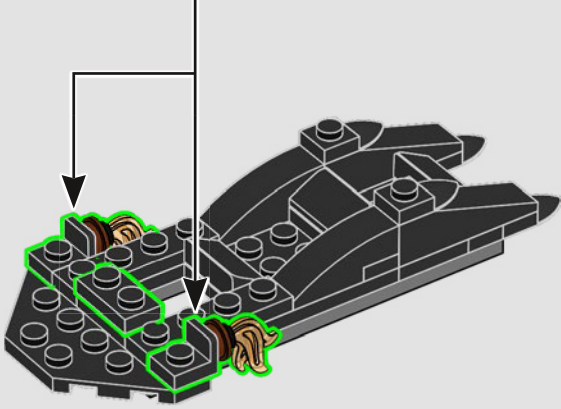
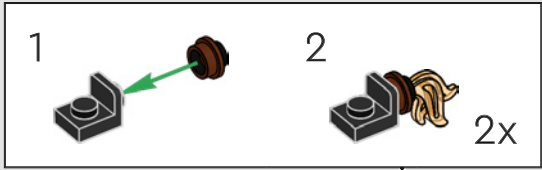

183

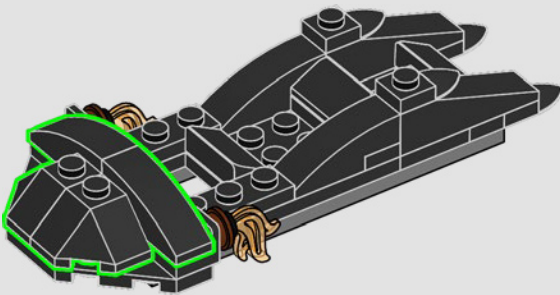

184

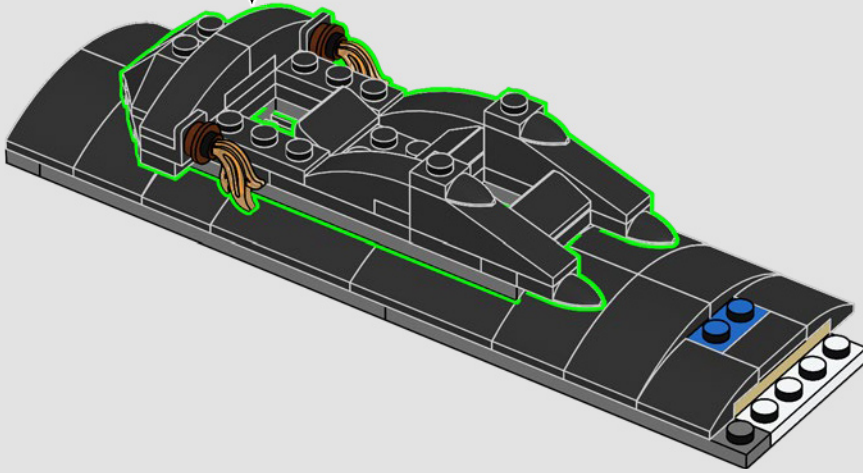

185

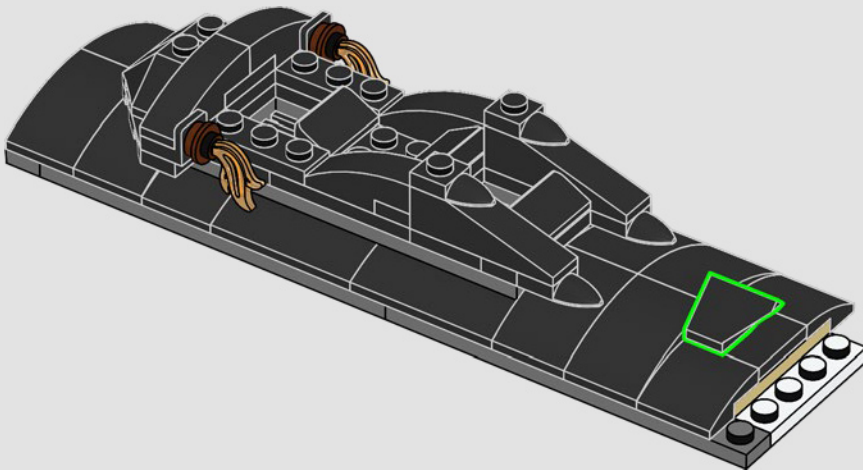

186

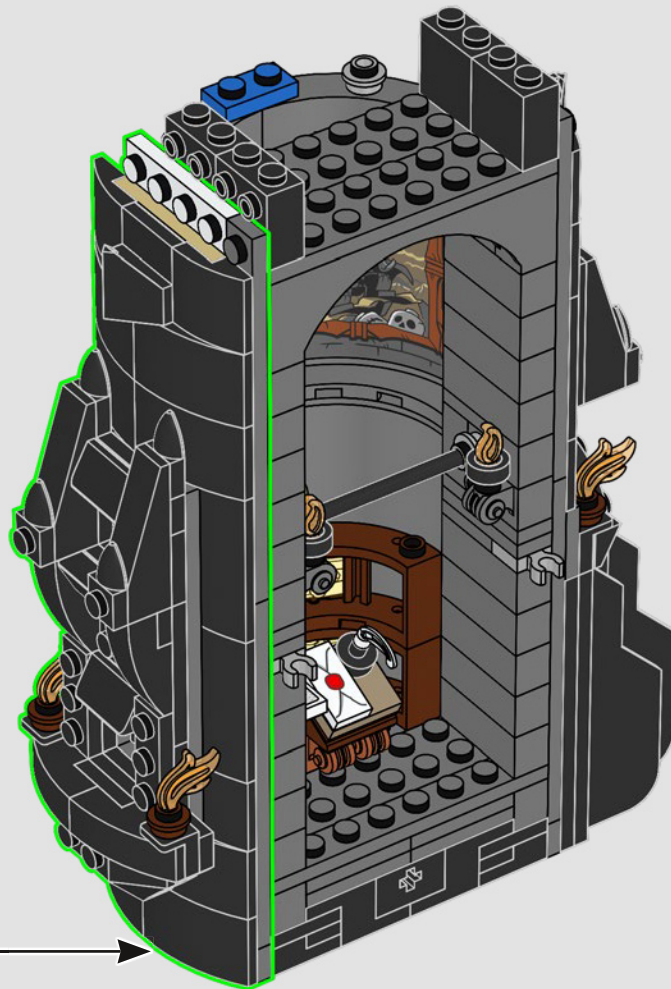



187

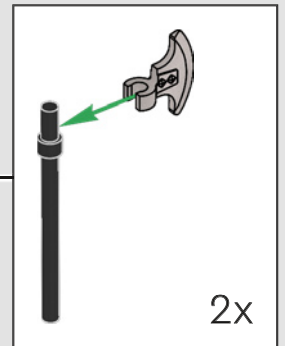
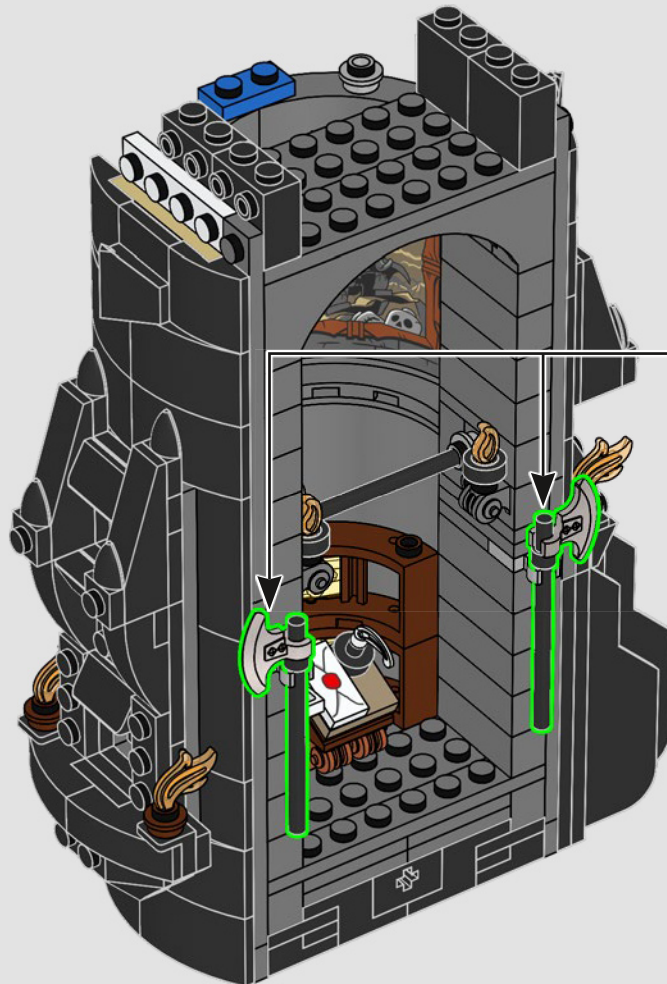

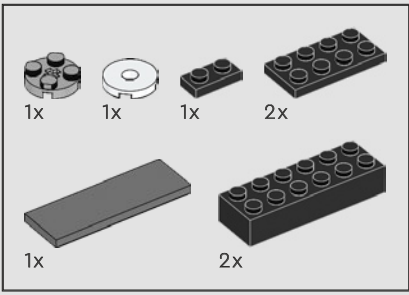

188

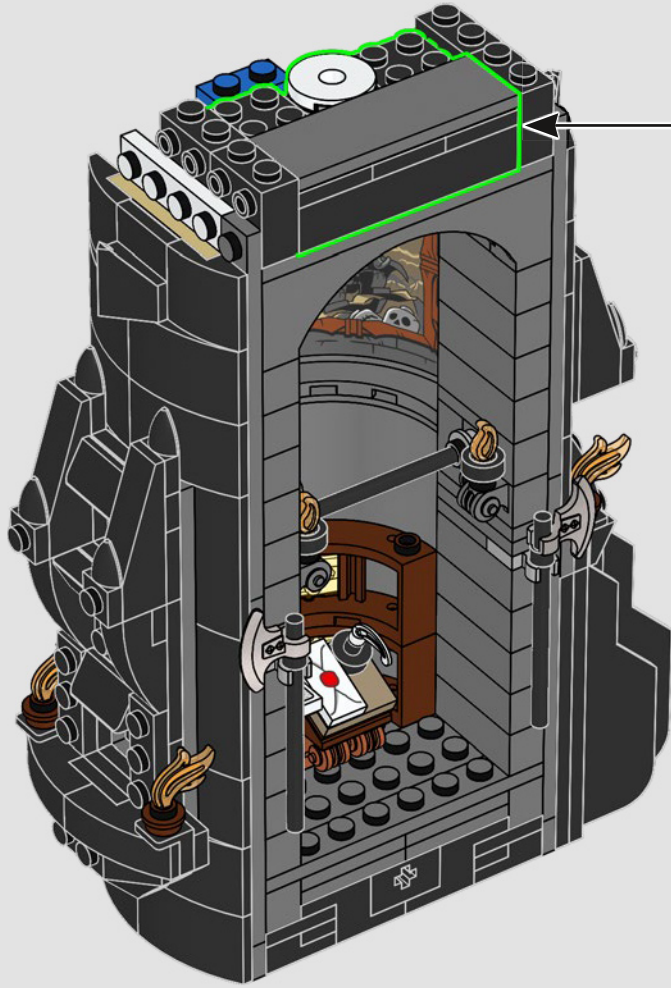
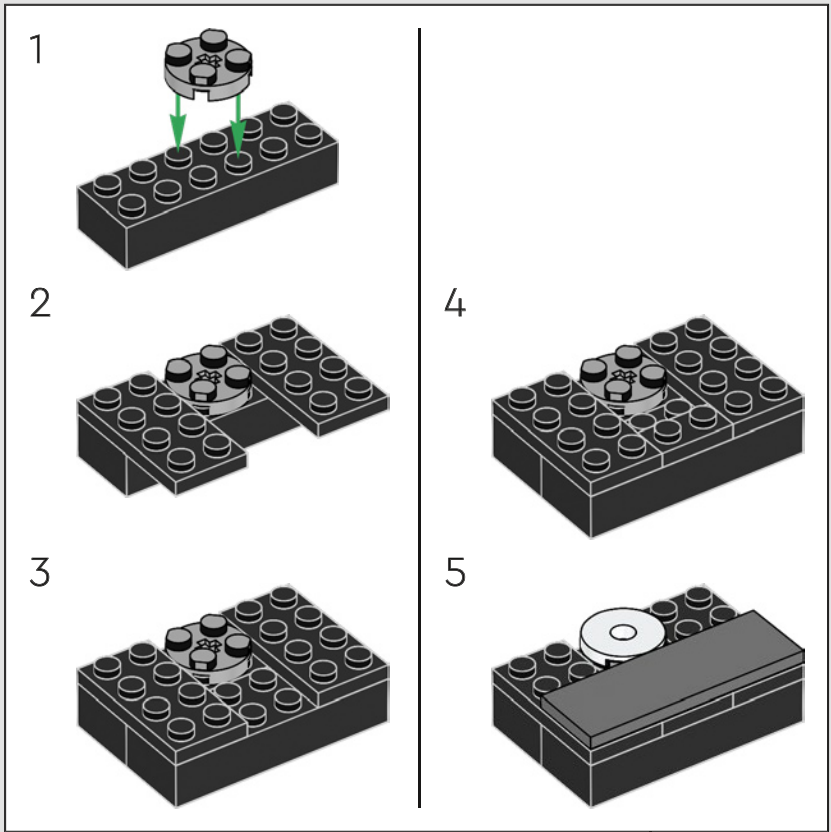



189

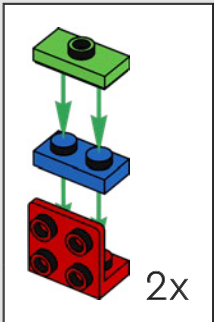
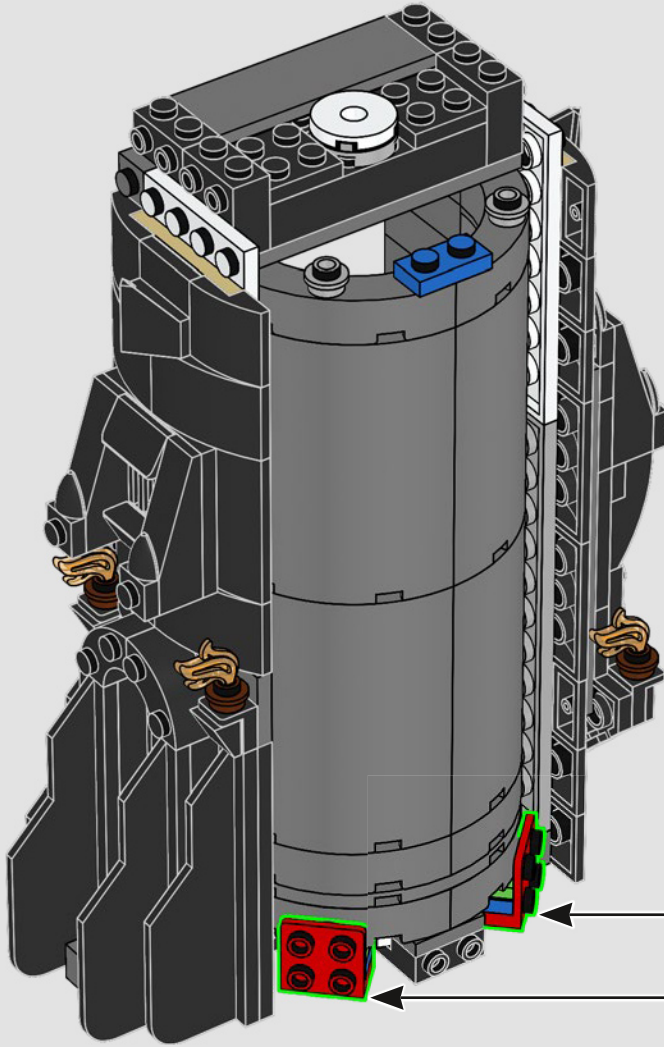



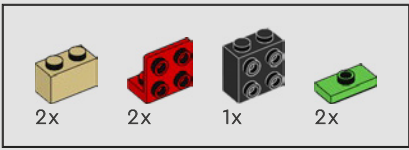

190

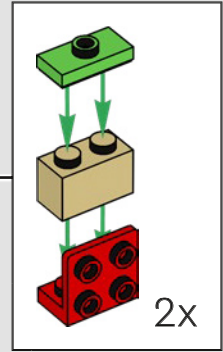
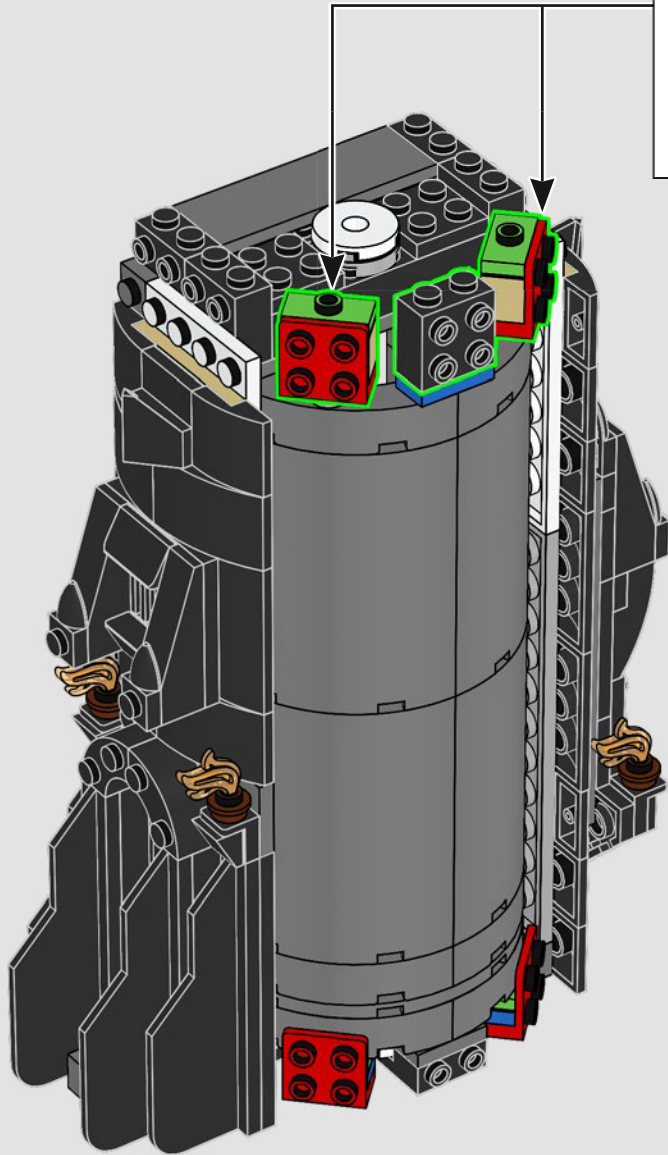

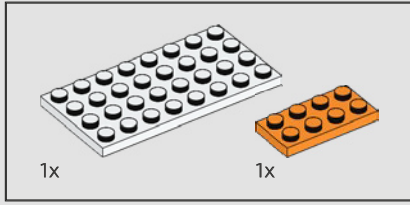
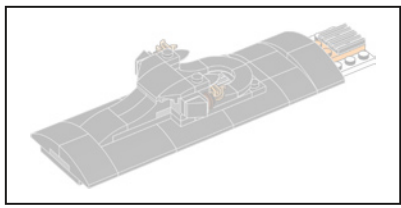

191

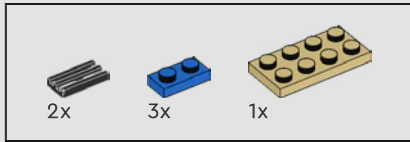
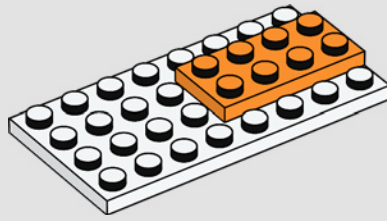

192

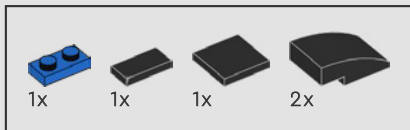
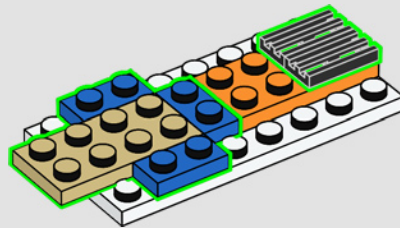

193

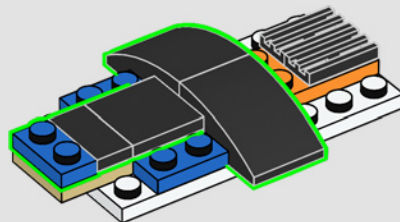

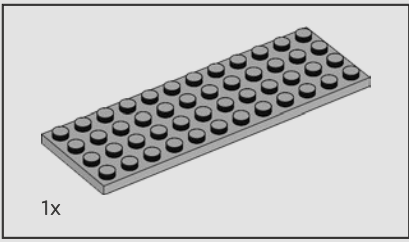

194

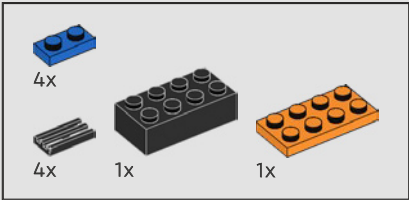
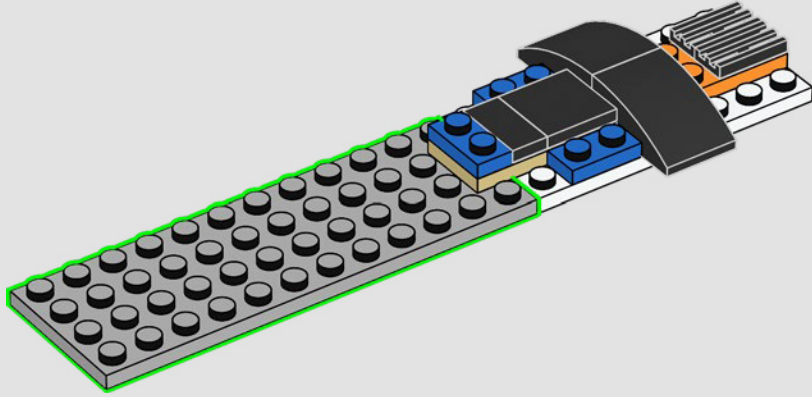

195

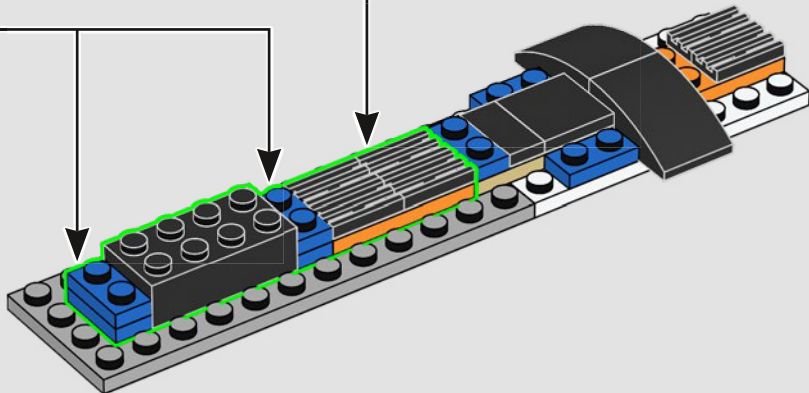
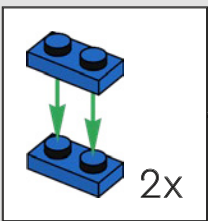
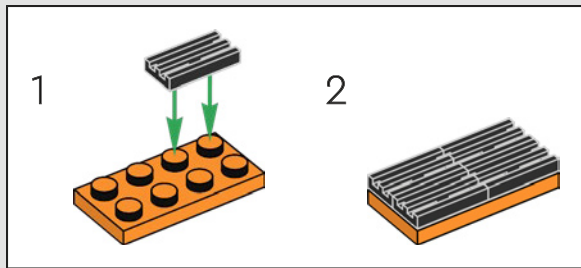

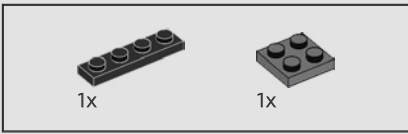

196

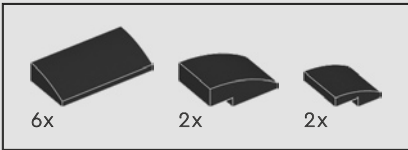
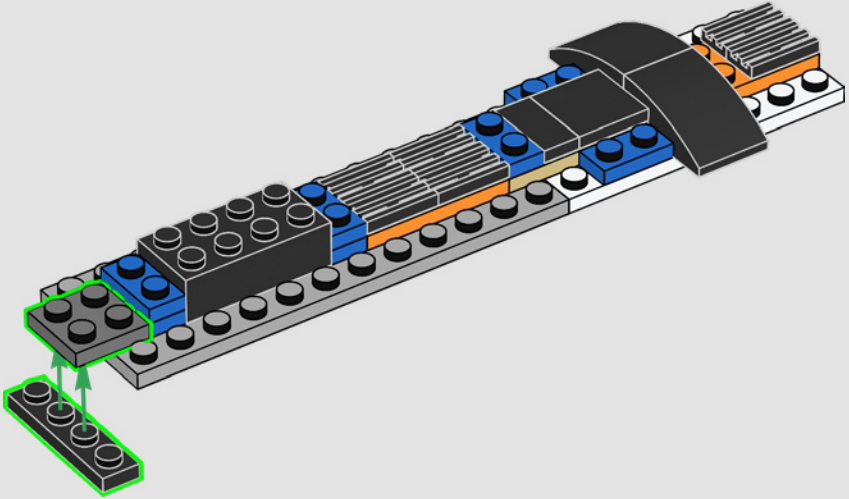

197

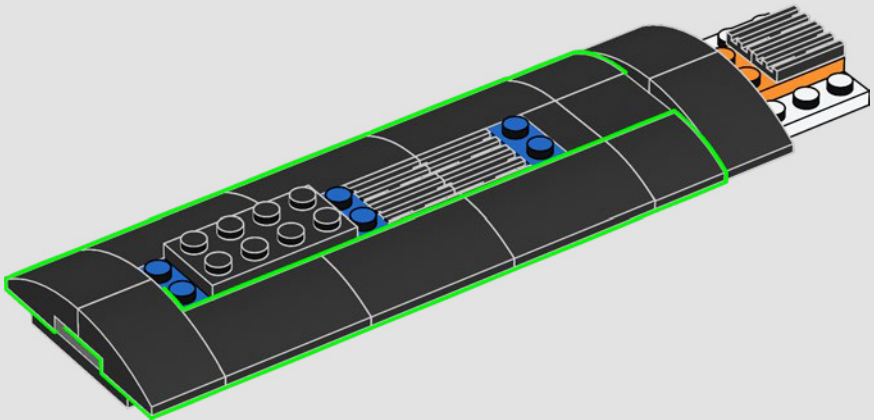

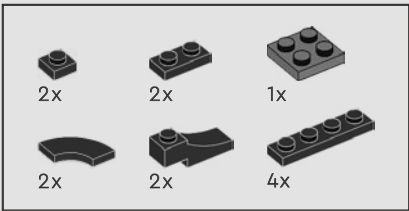

198

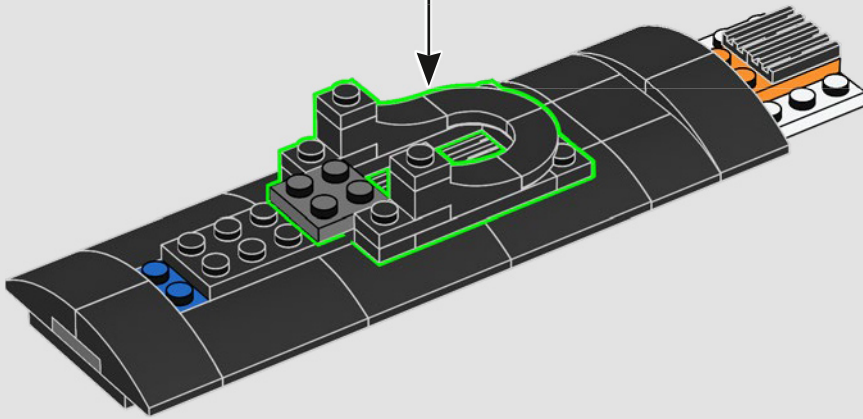
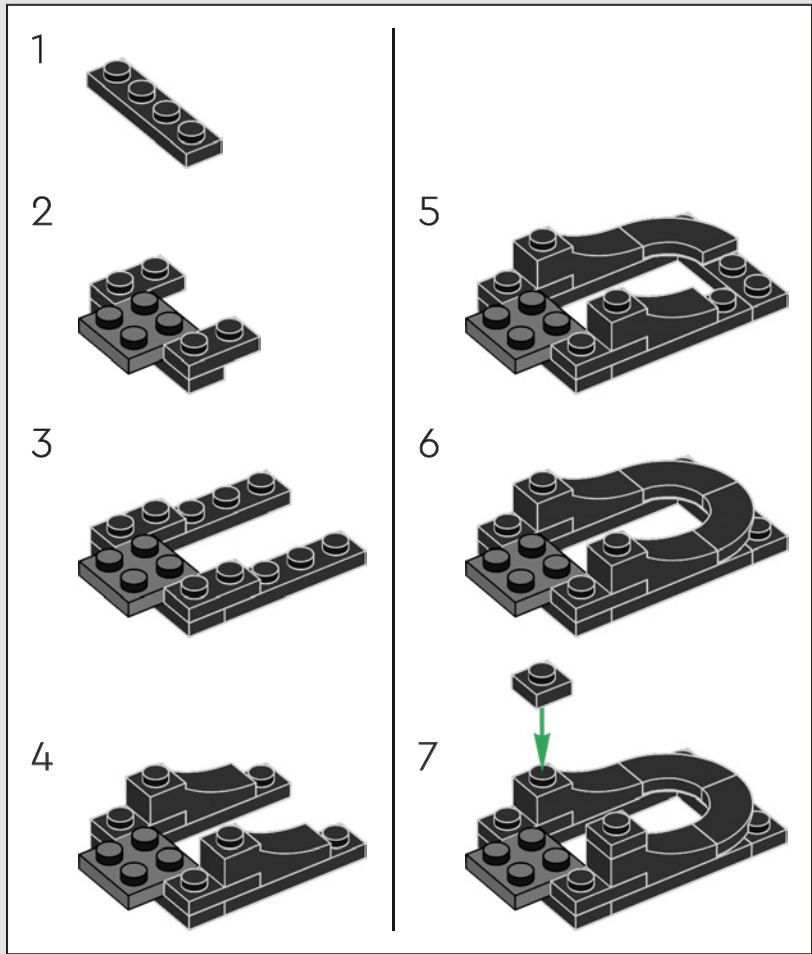

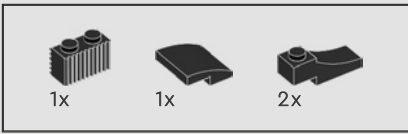

199

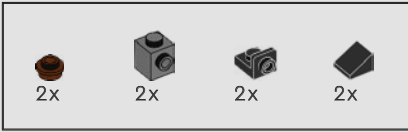
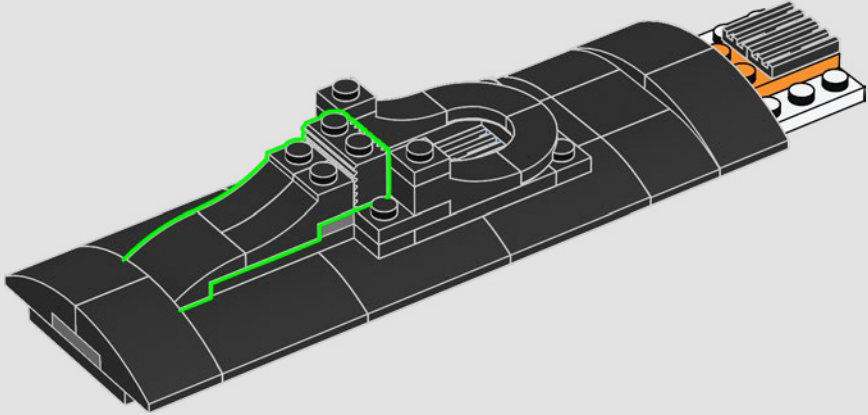

200

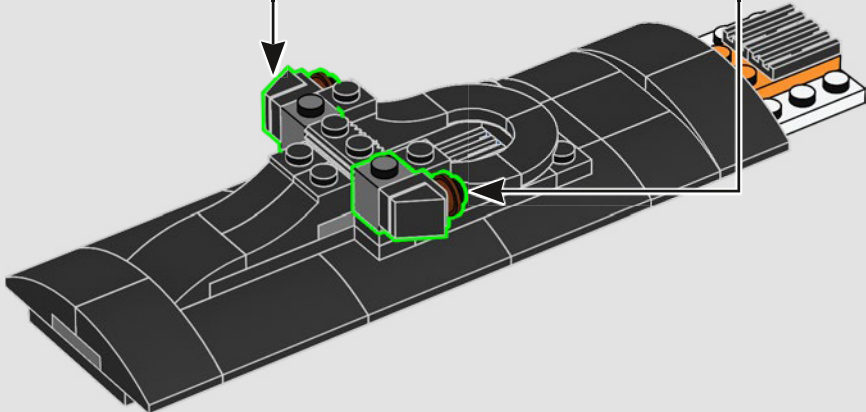
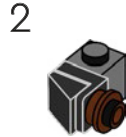
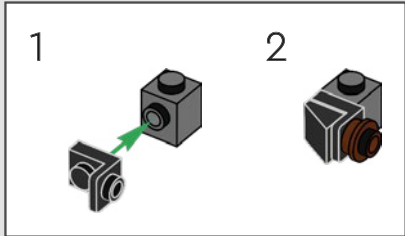
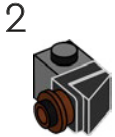
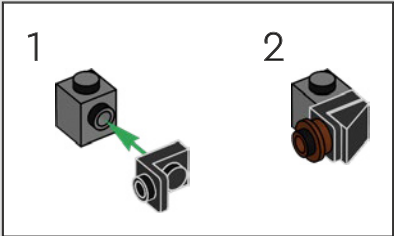



201

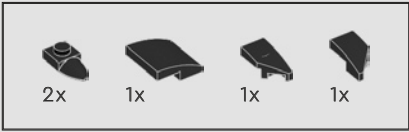
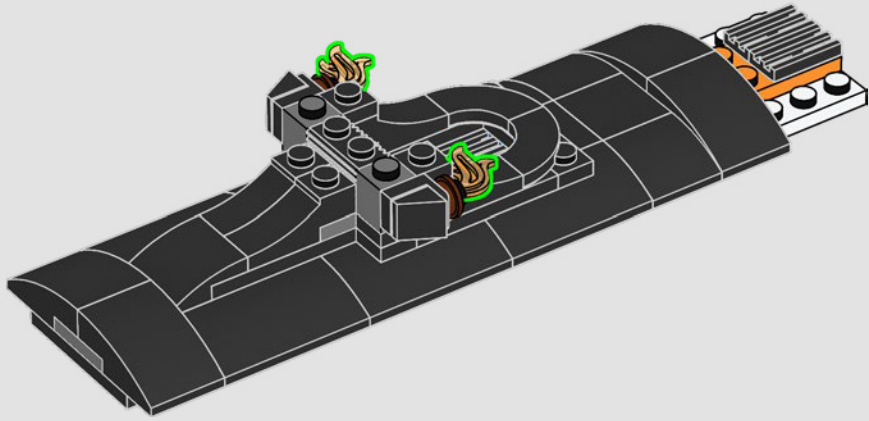

202

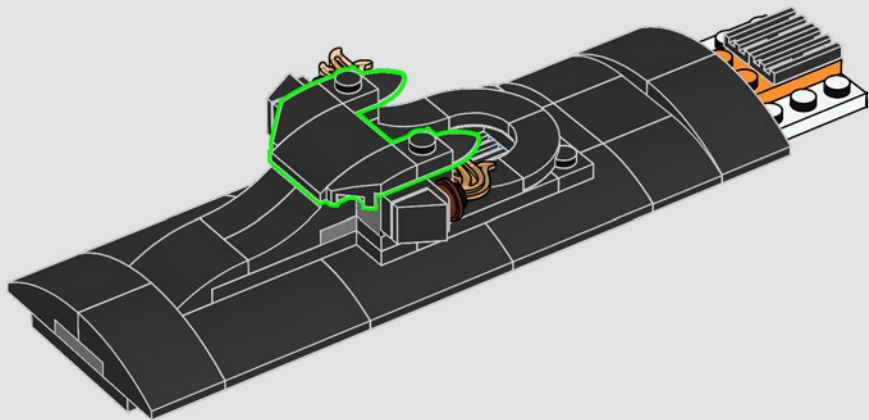

203

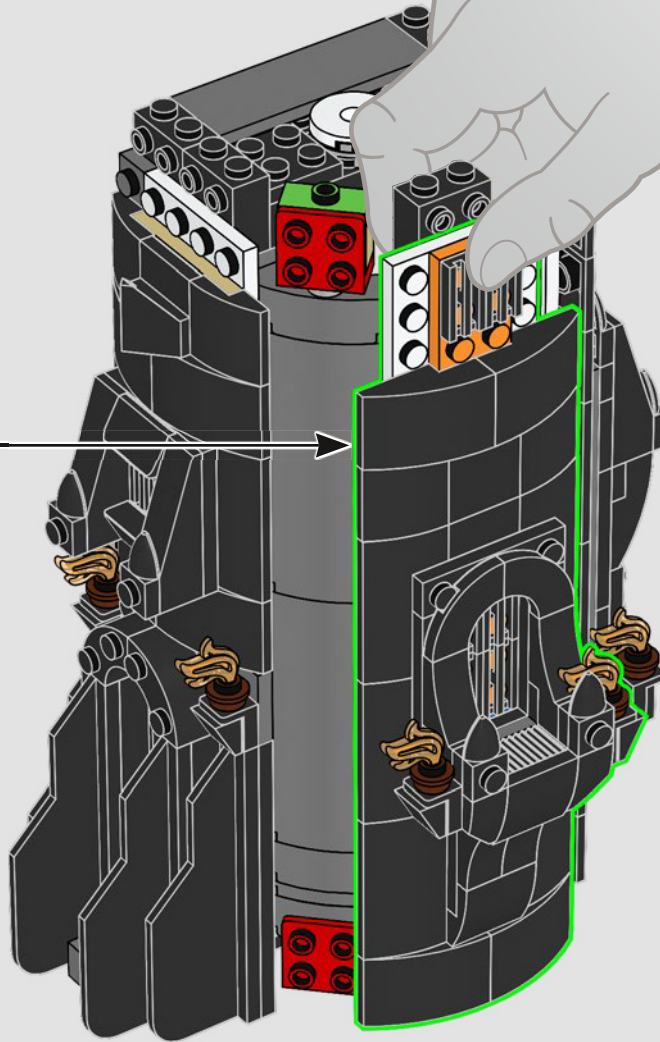



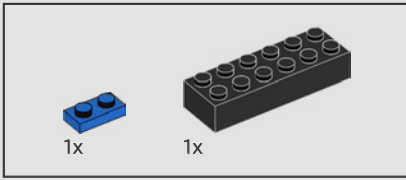
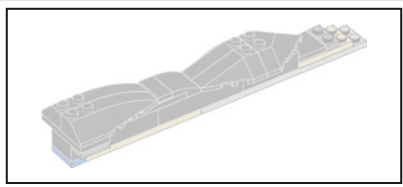

204

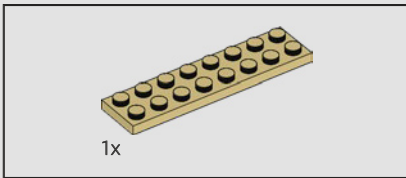
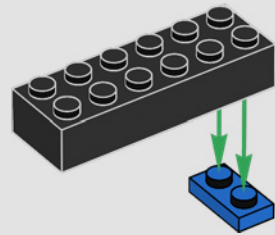

205

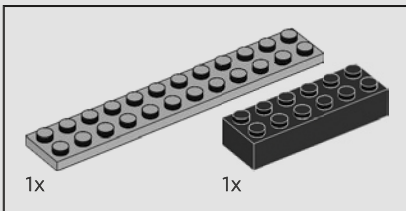
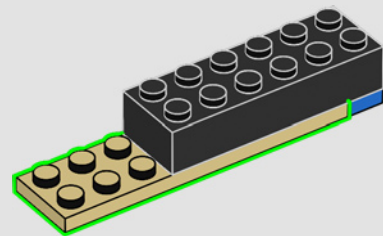

206

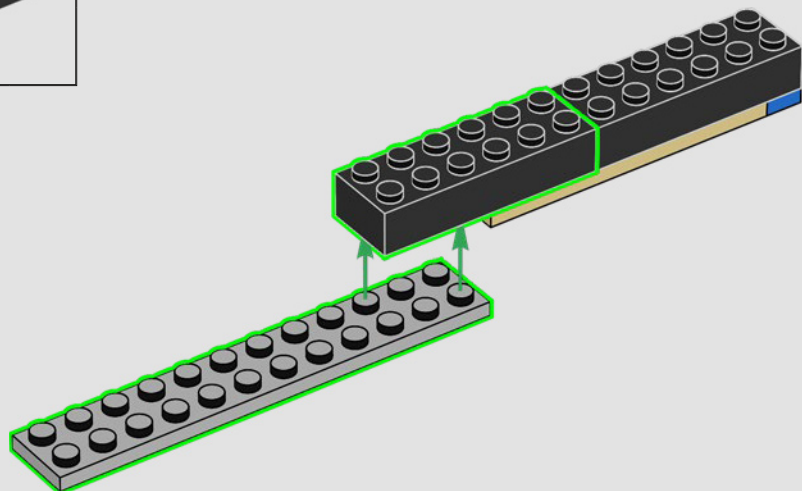

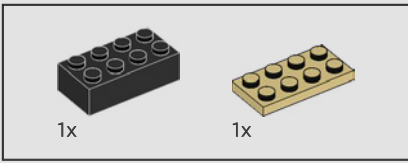

207

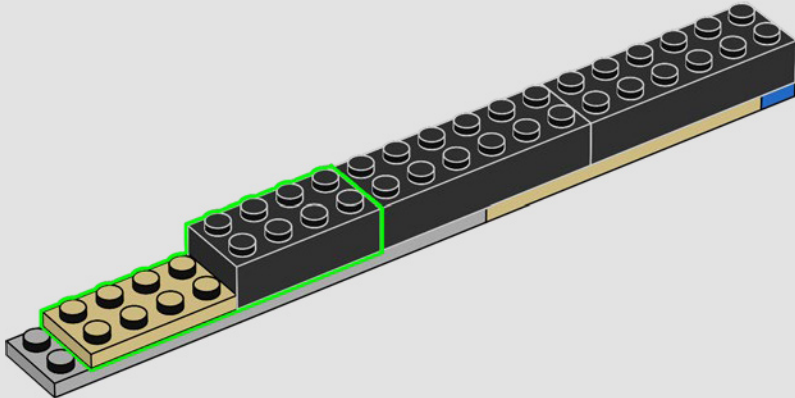

208

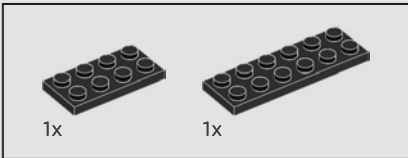
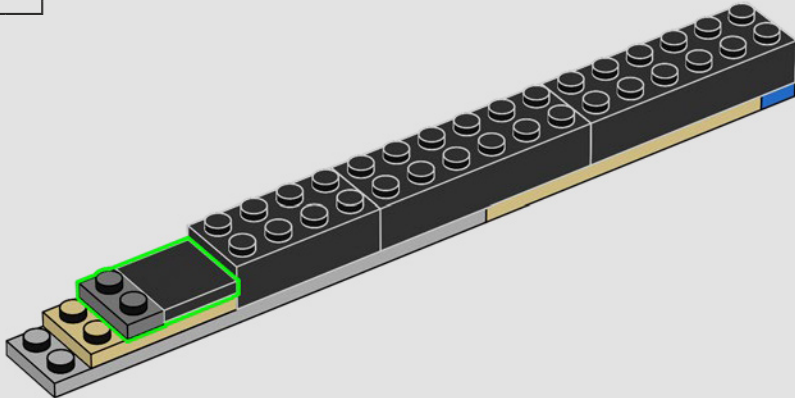

209

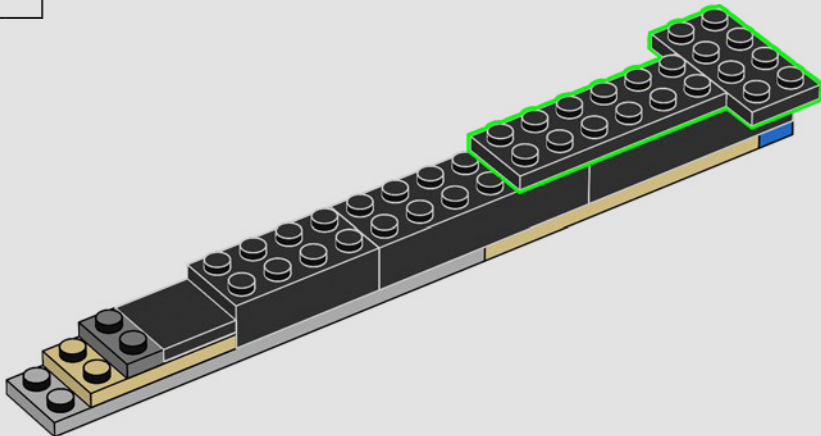

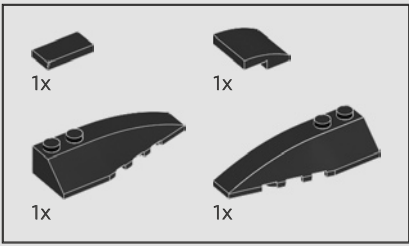

210

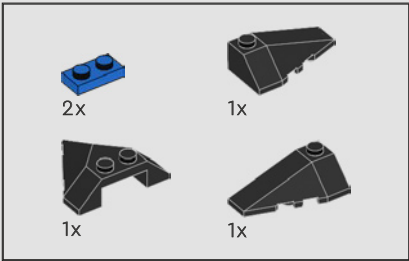
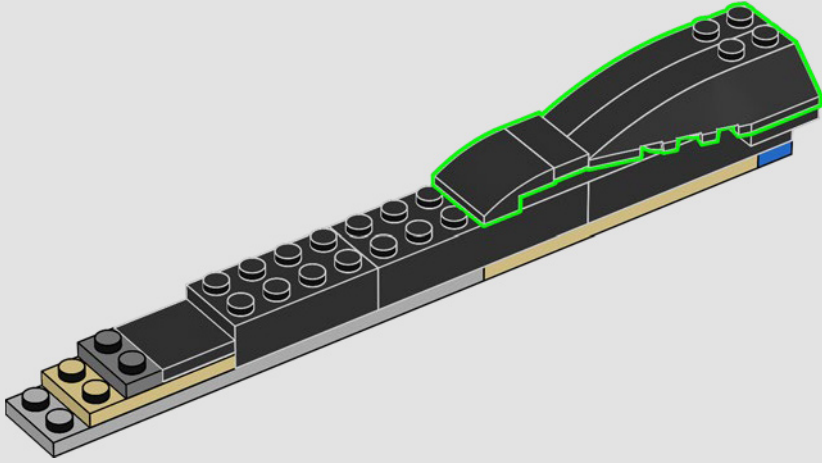

211

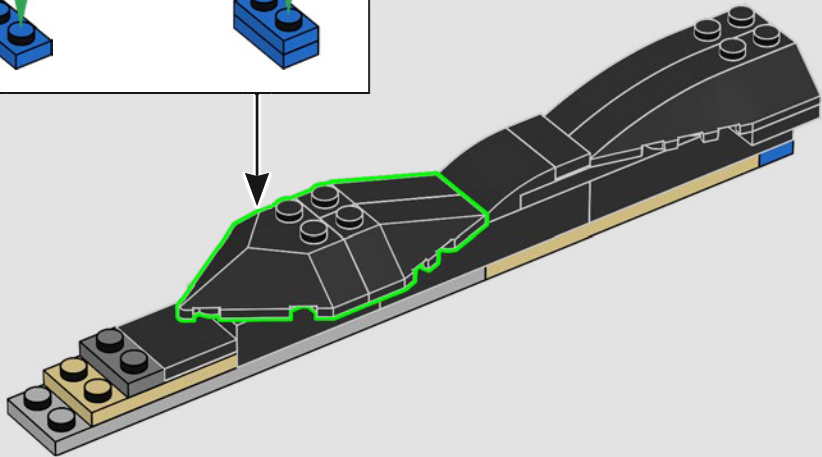
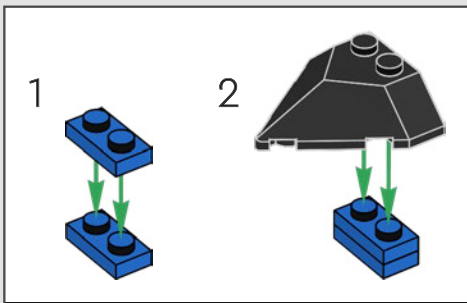

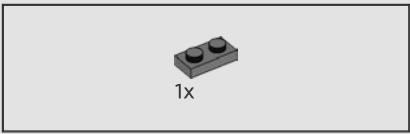

212

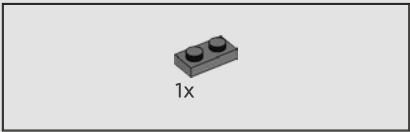
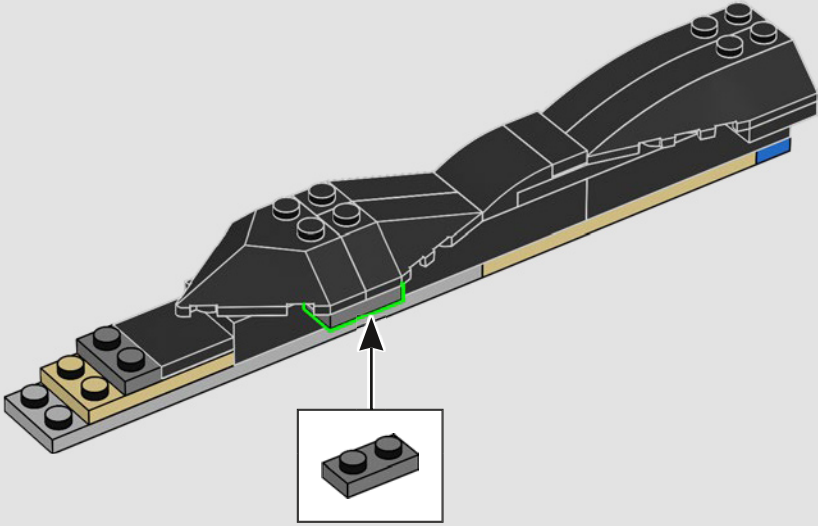

213

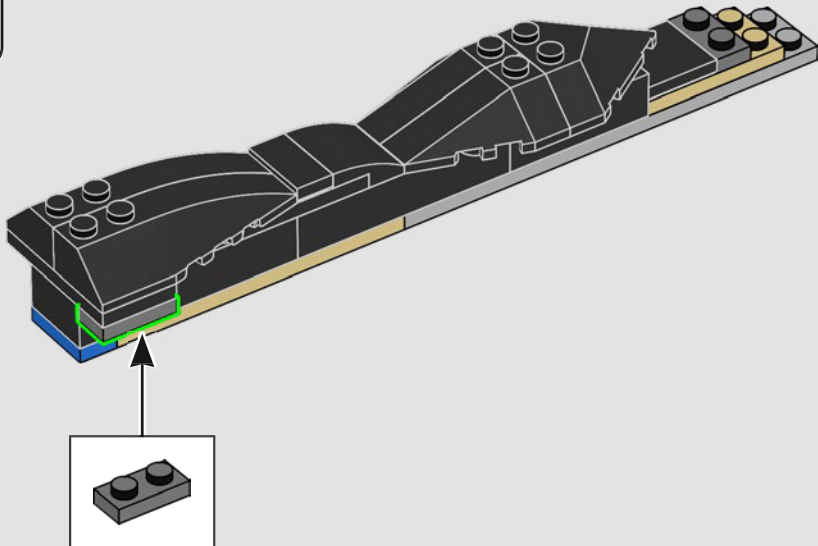

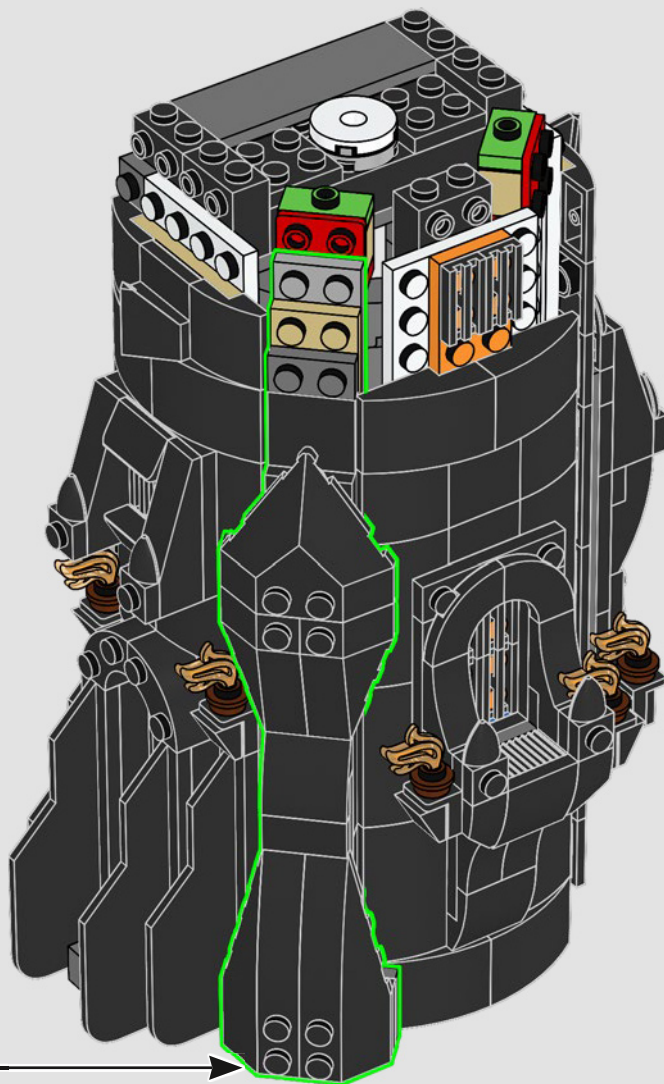

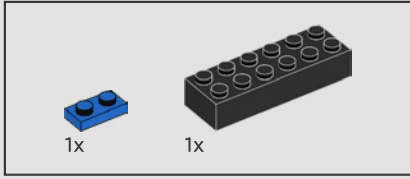
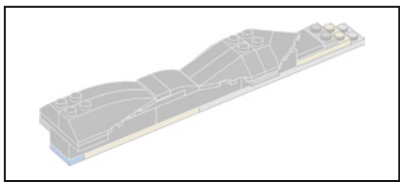

215

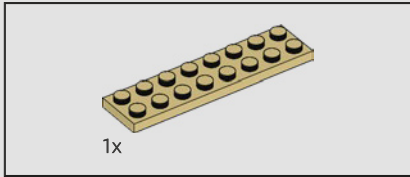
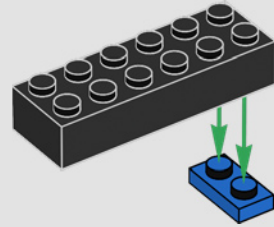

216

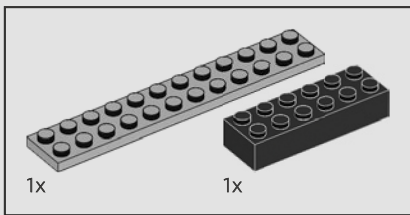
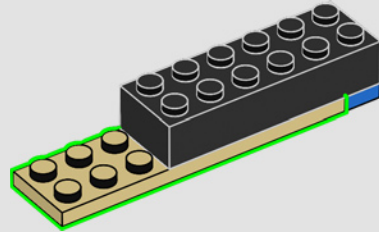

217

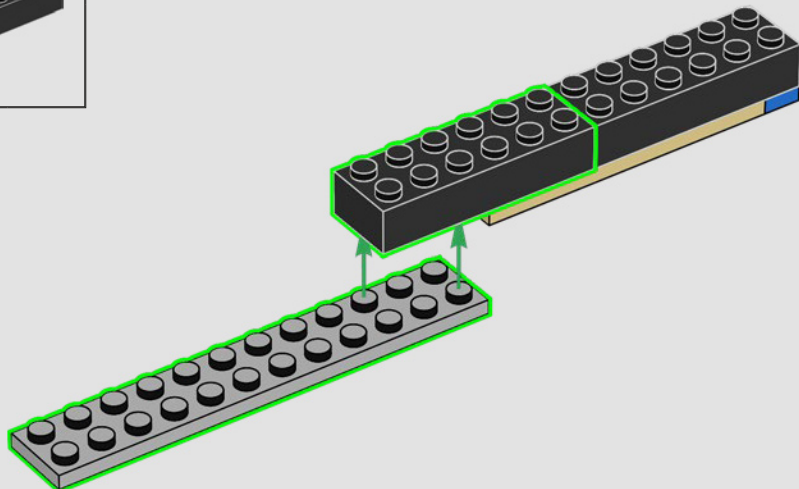

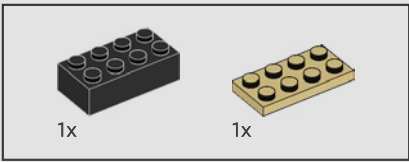

218

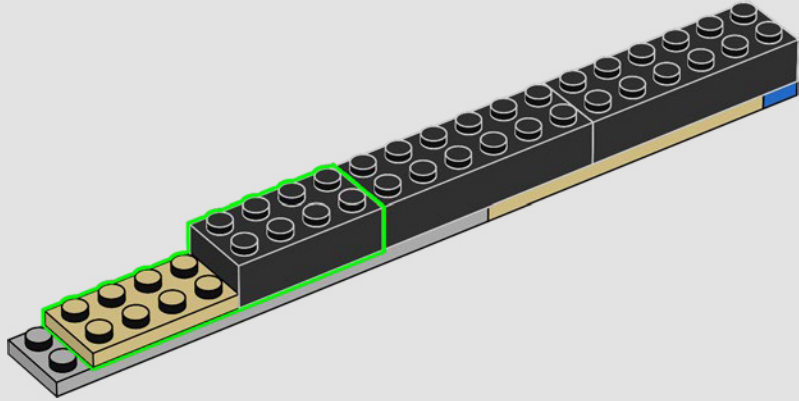

219

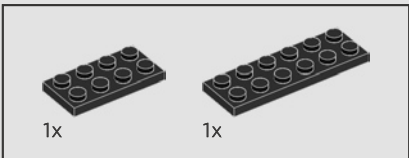
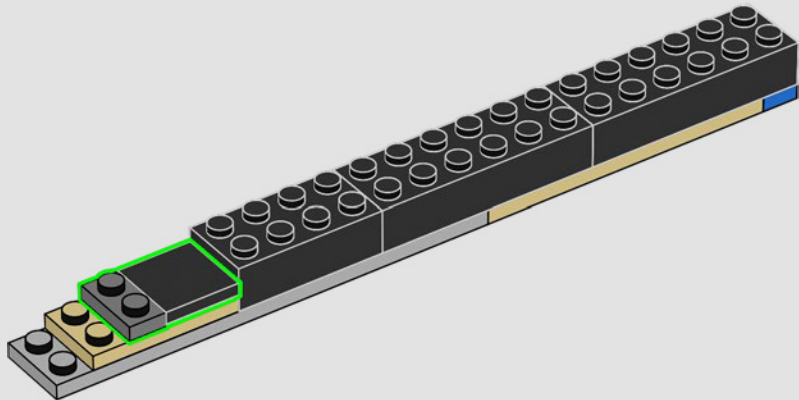

220

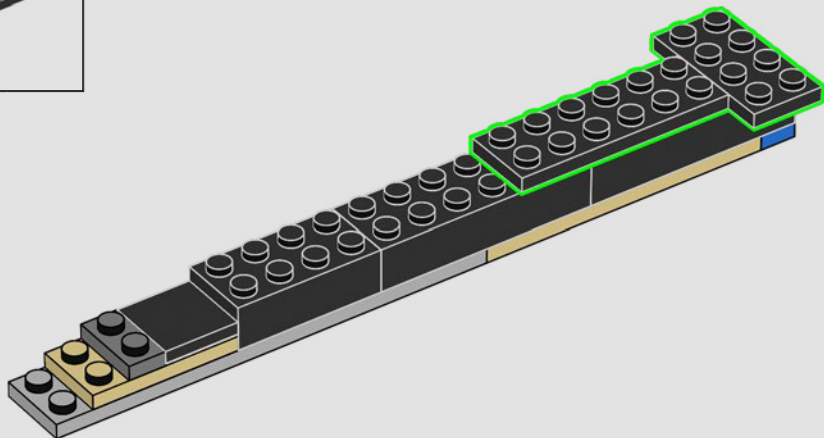

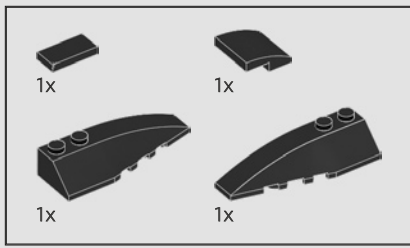

221

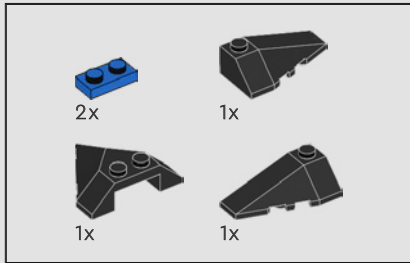
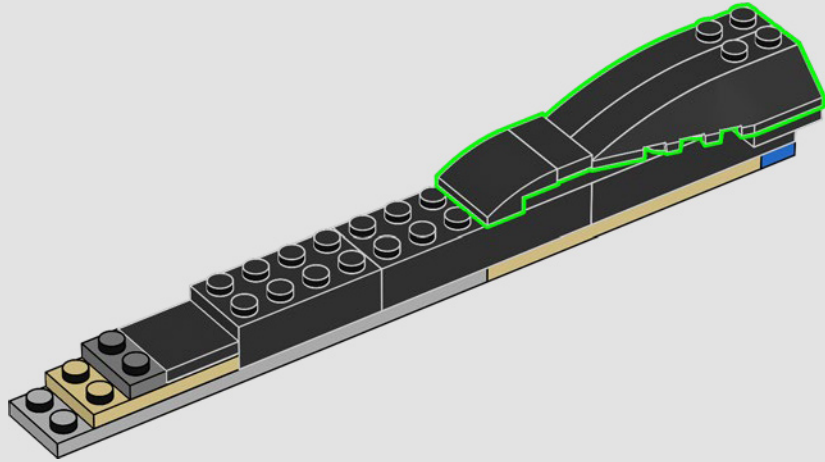

222

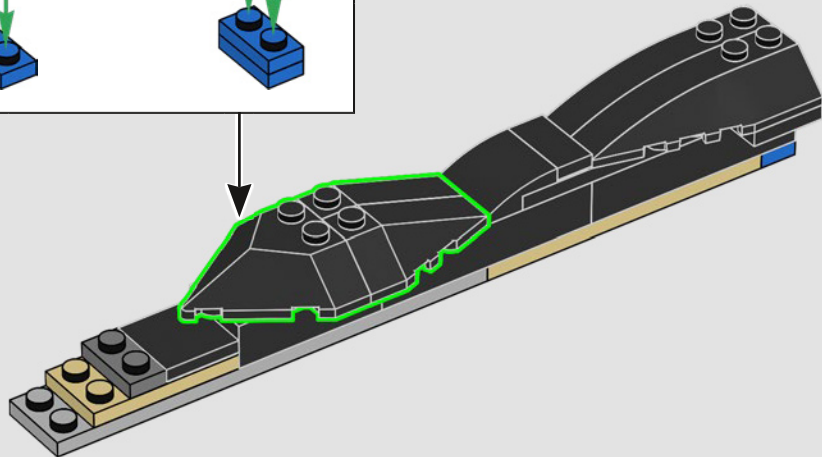
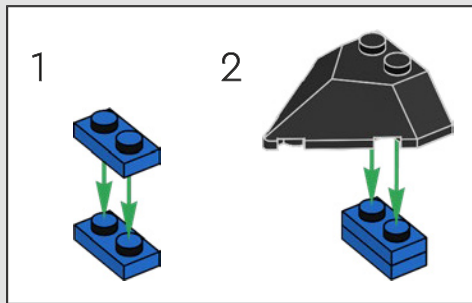



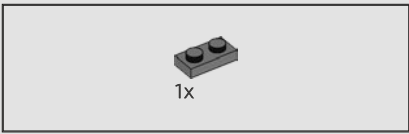

223

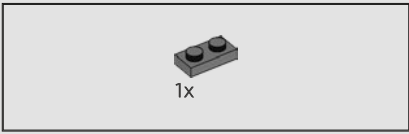
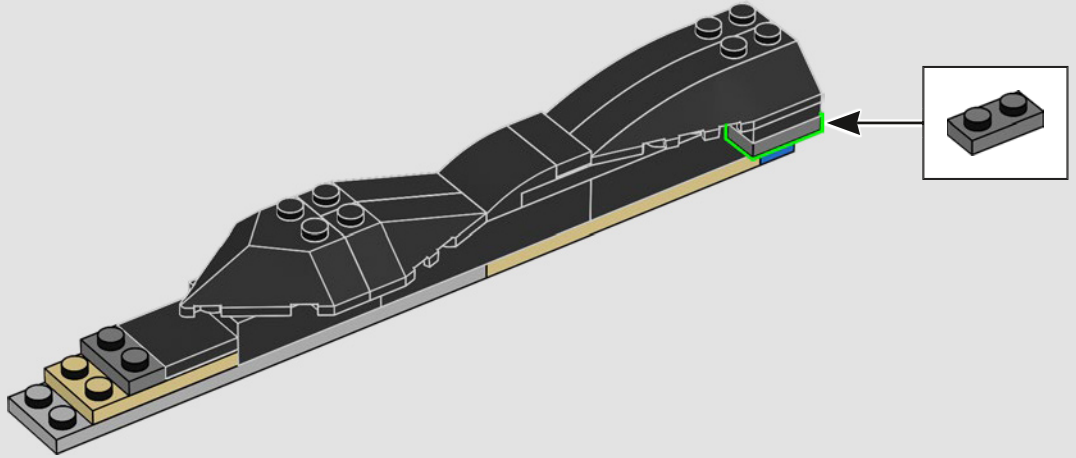

224

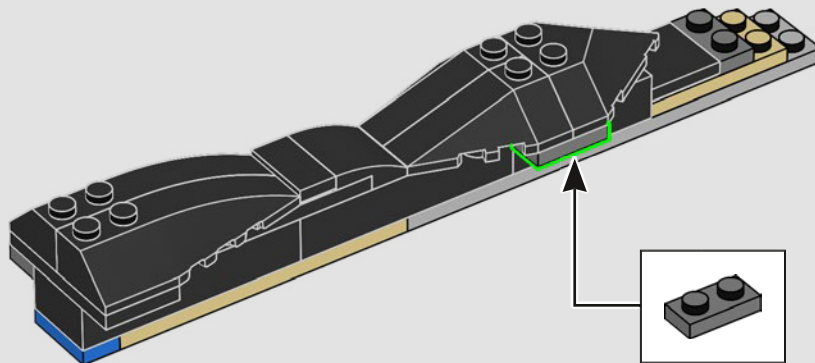



"Vi è qualcuno in mezzo a questa folla con l'autorità di trattare con me? O addirittura il cervello per capirmi?"  
- Bocca di Sauron

225



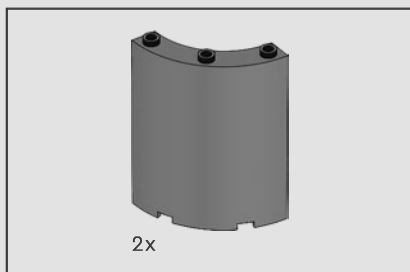

226

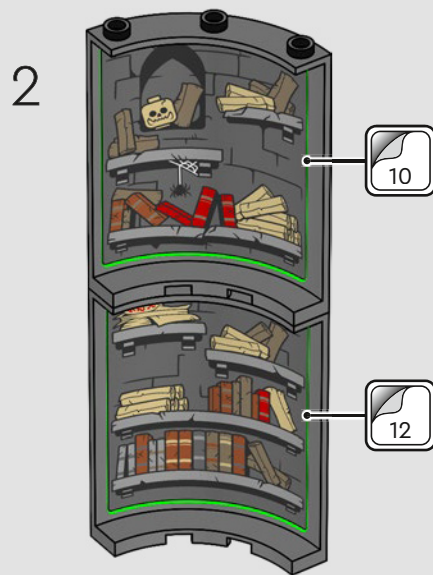
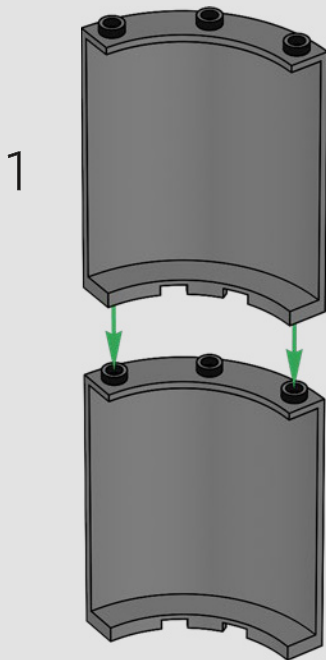



La biblioteca in cima alla torre è la dimora della conoscenza oscura e della magia.

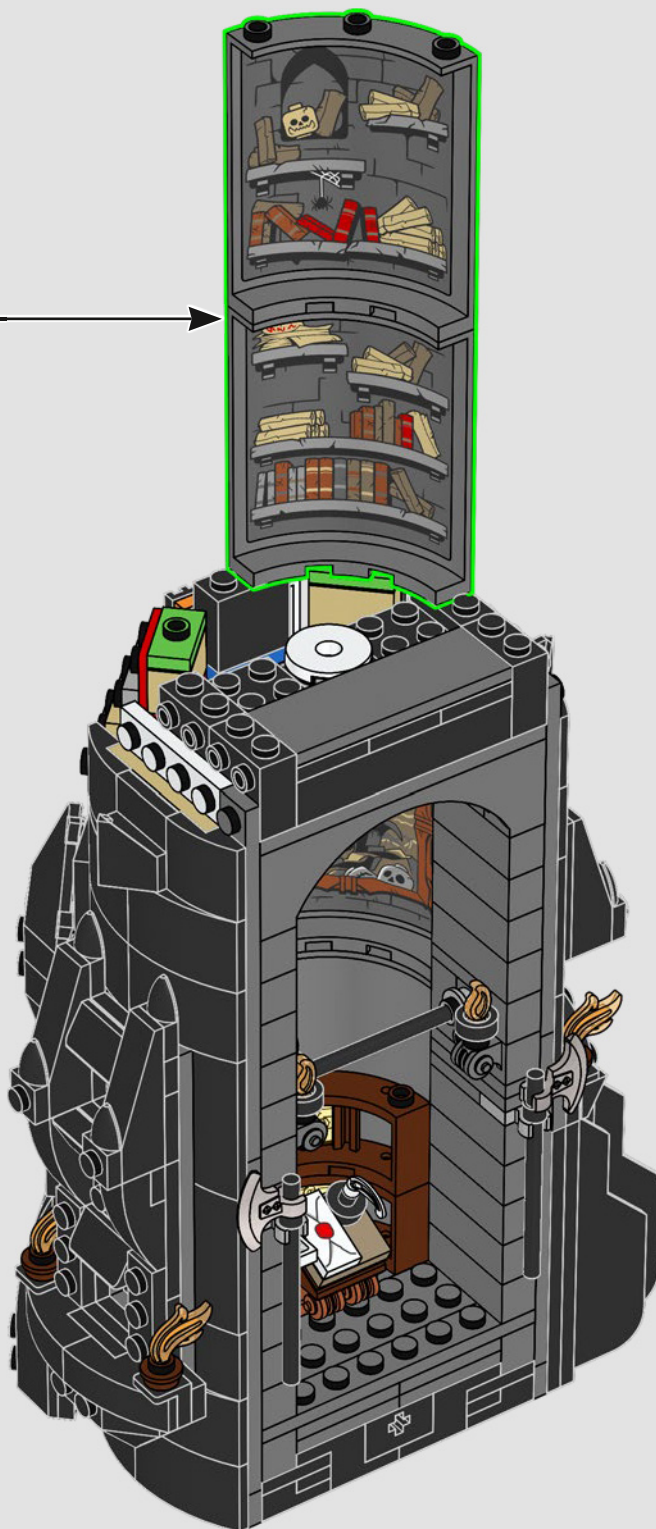

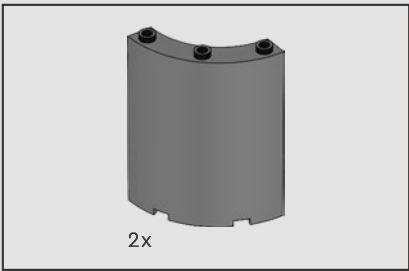

227

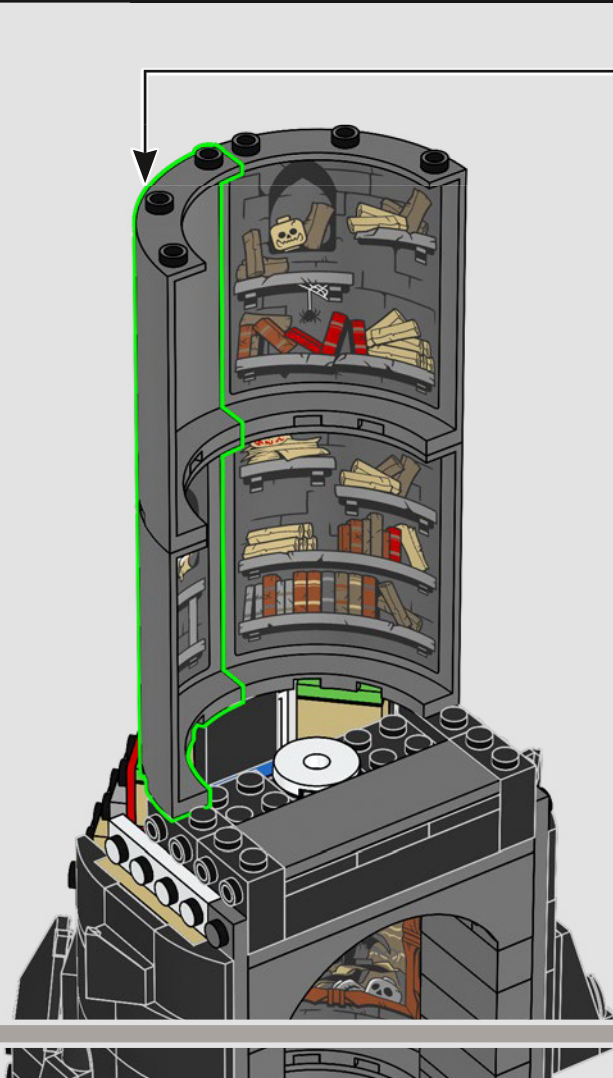
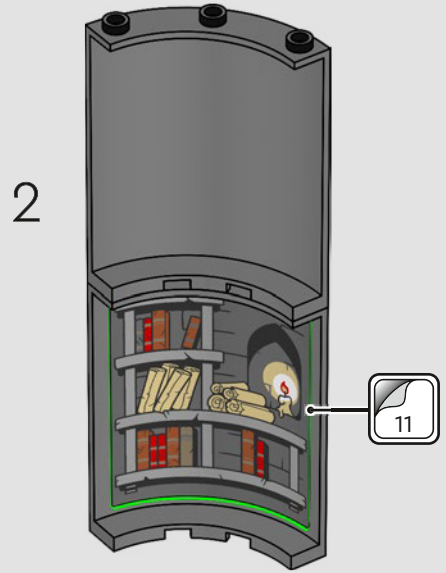
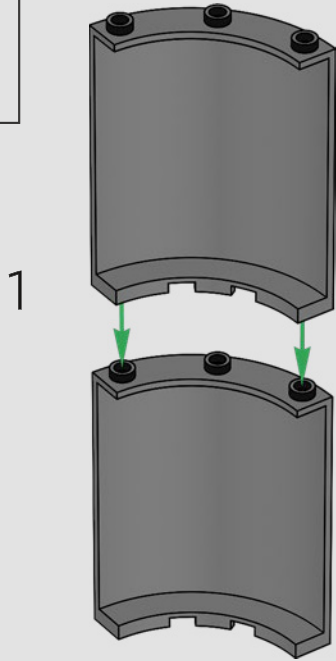

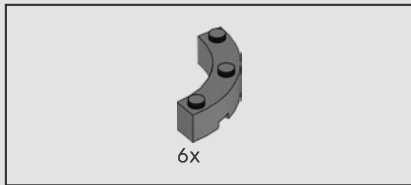

228

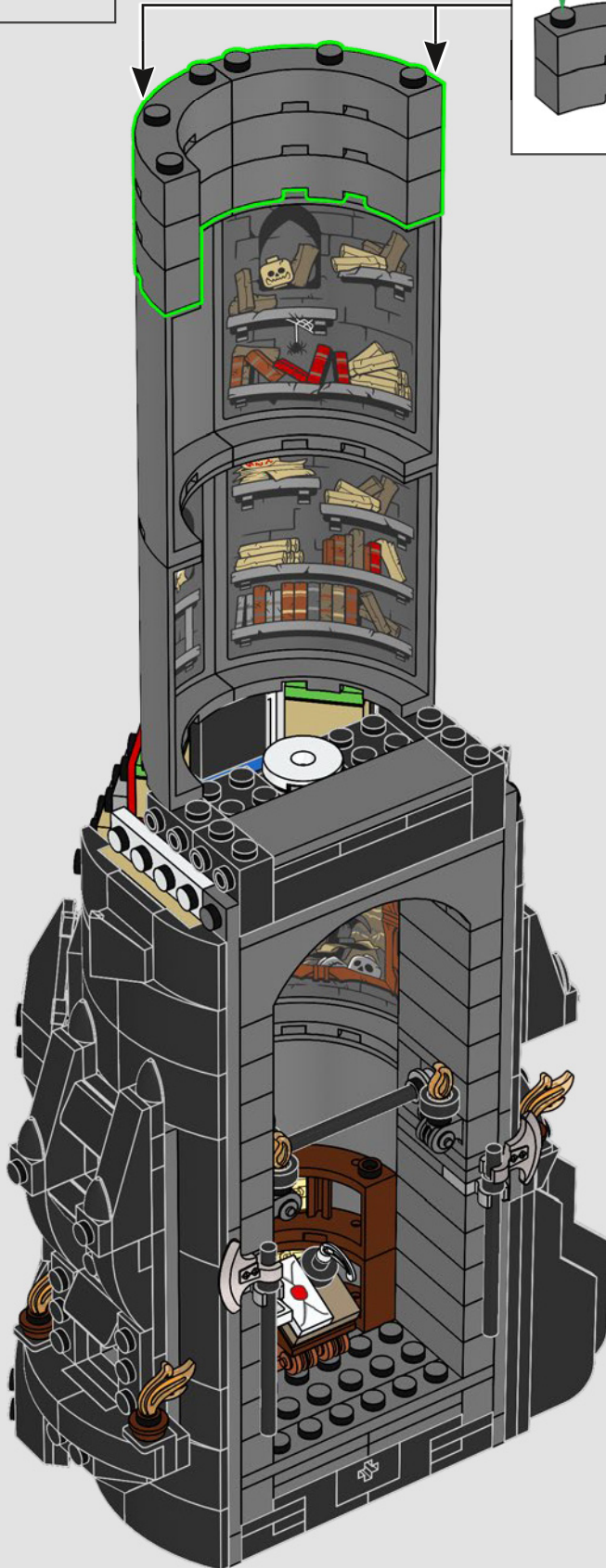
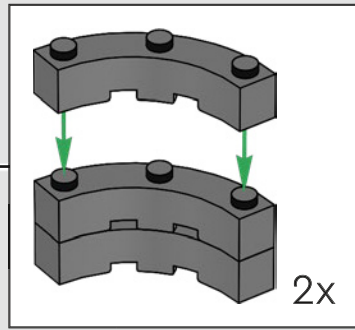

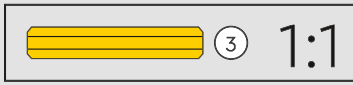
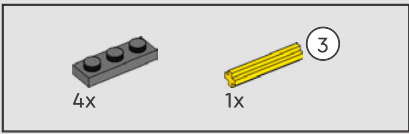

229

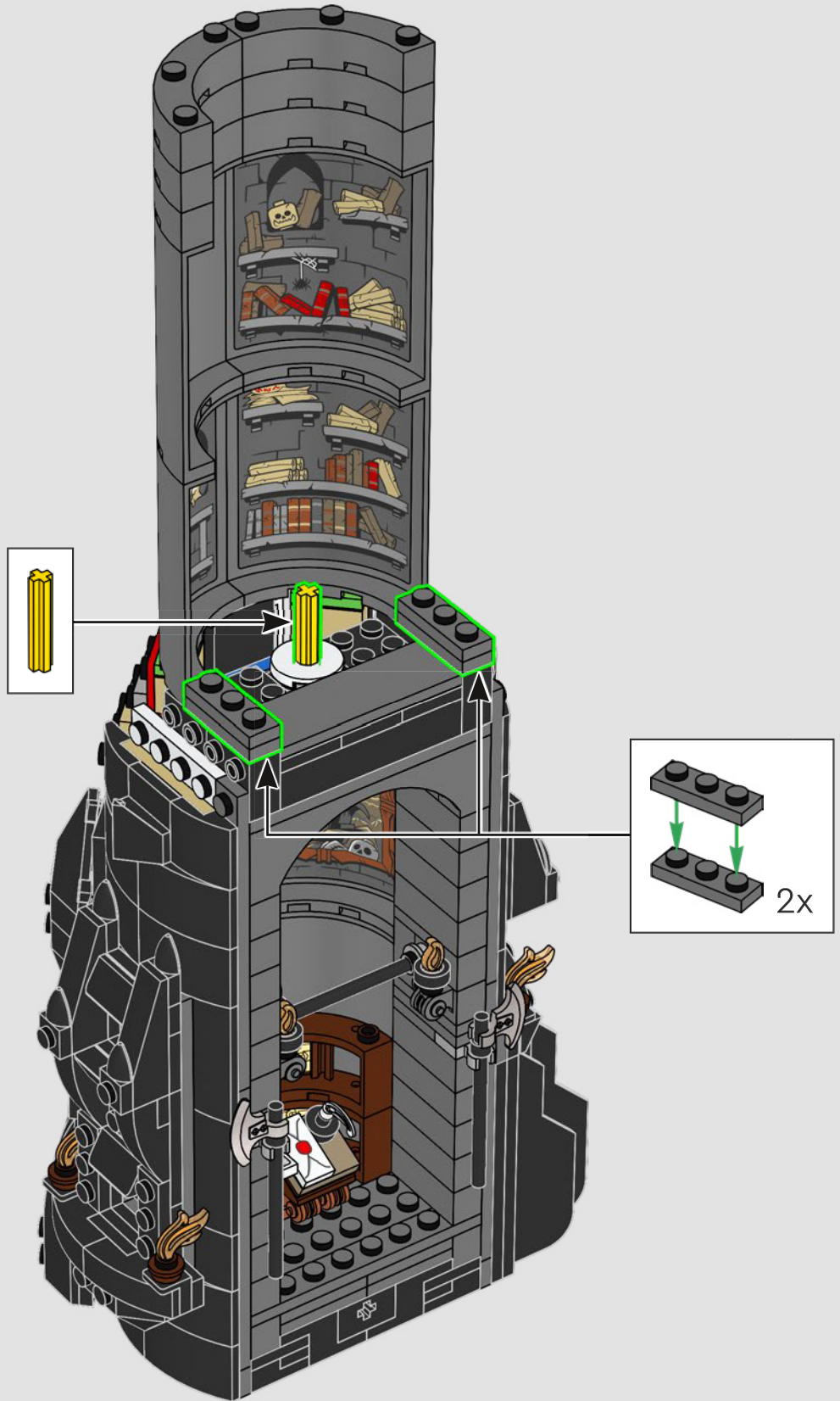





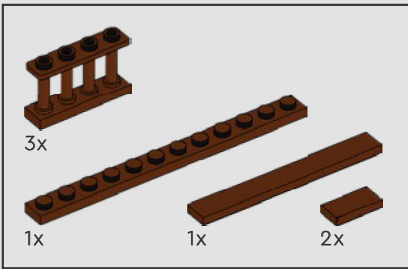

234

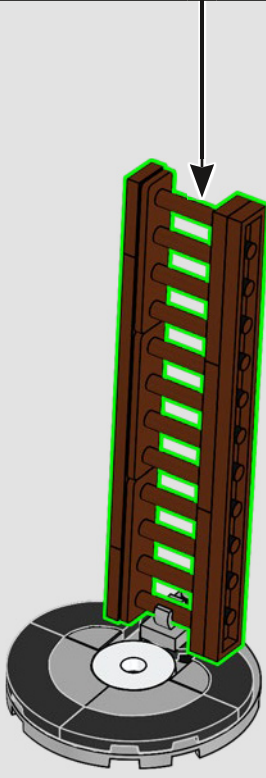
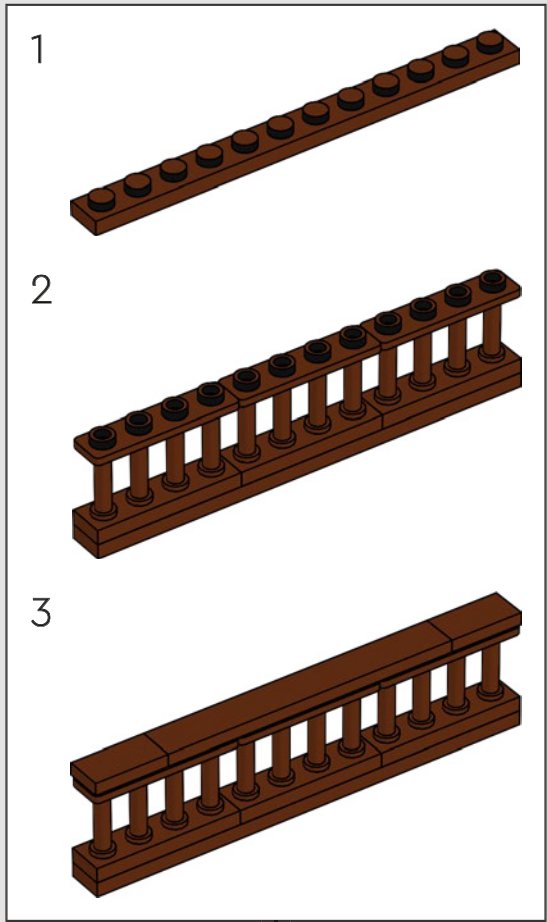

235

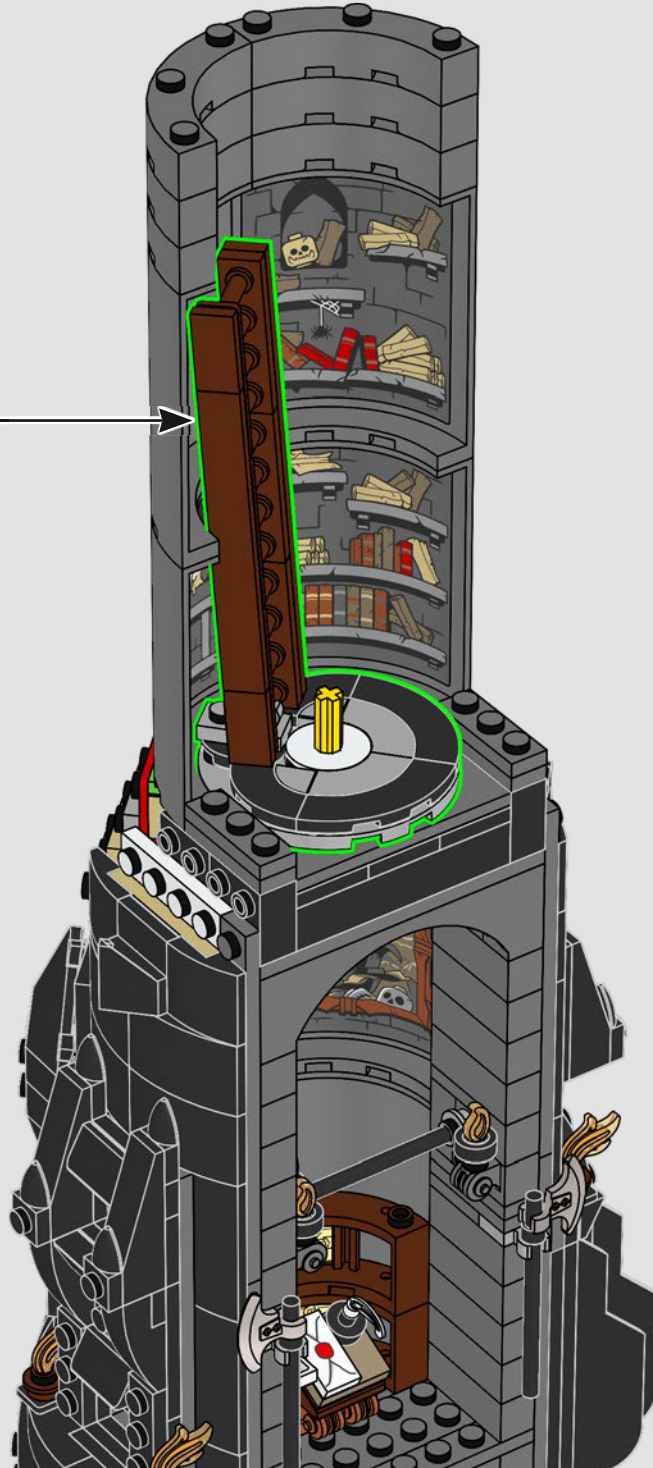

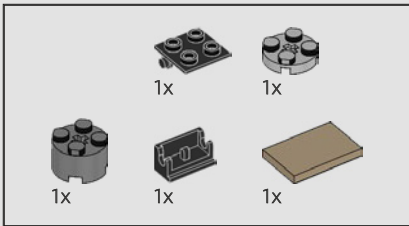

236

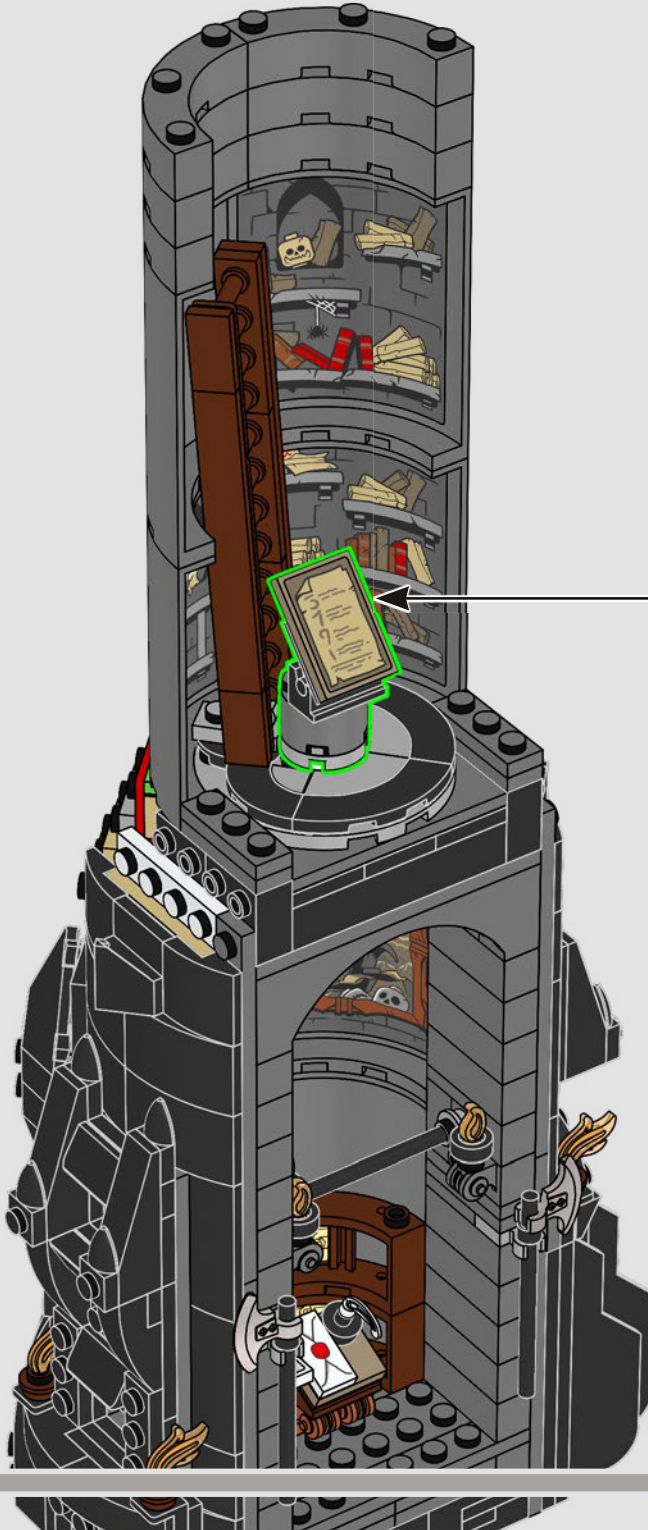
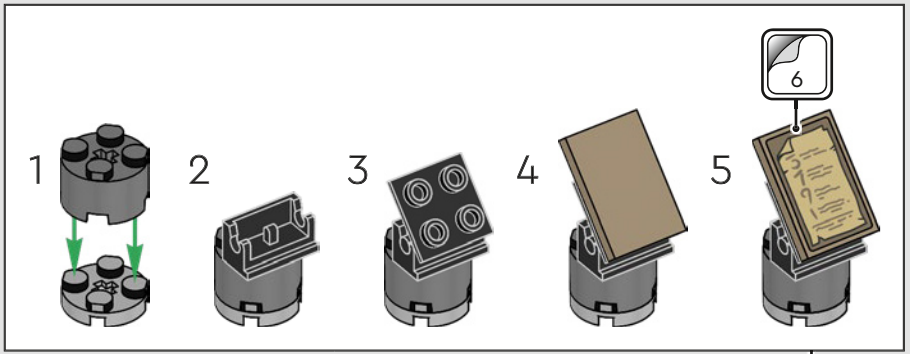



237

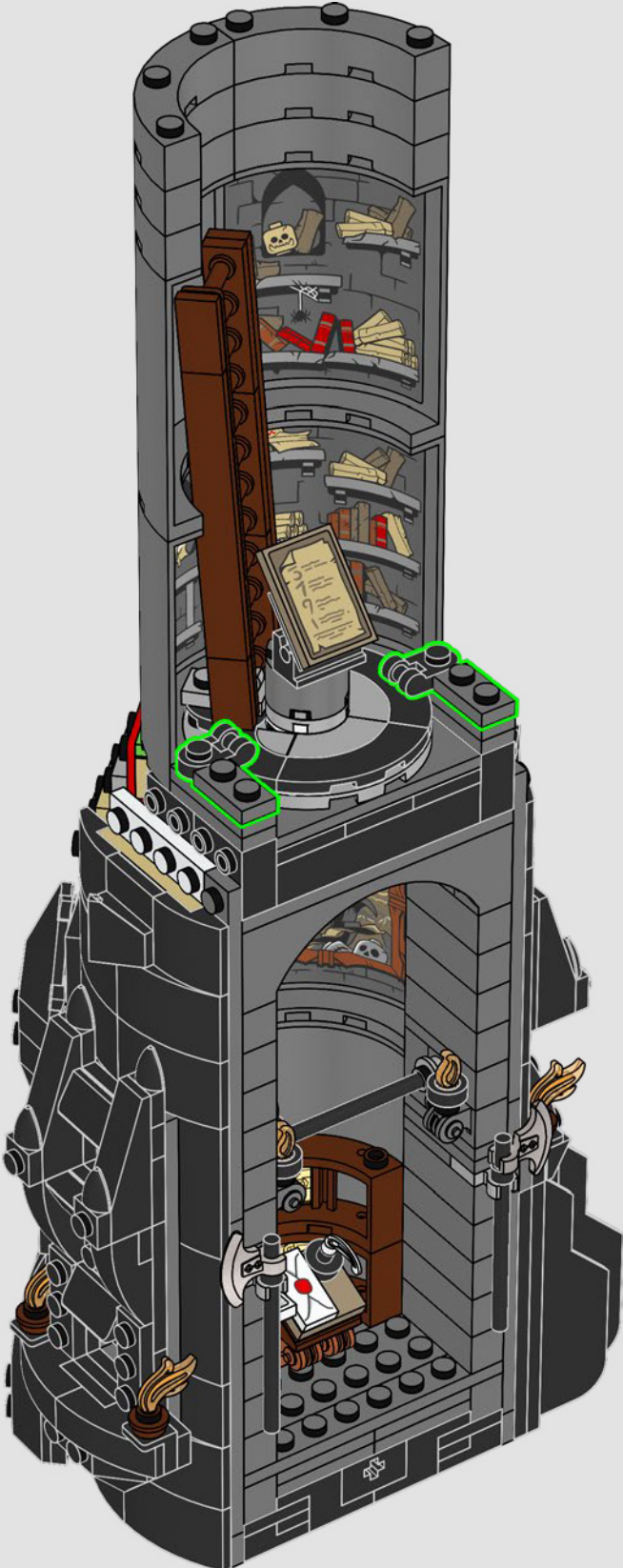

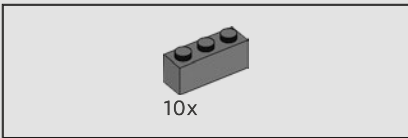

238

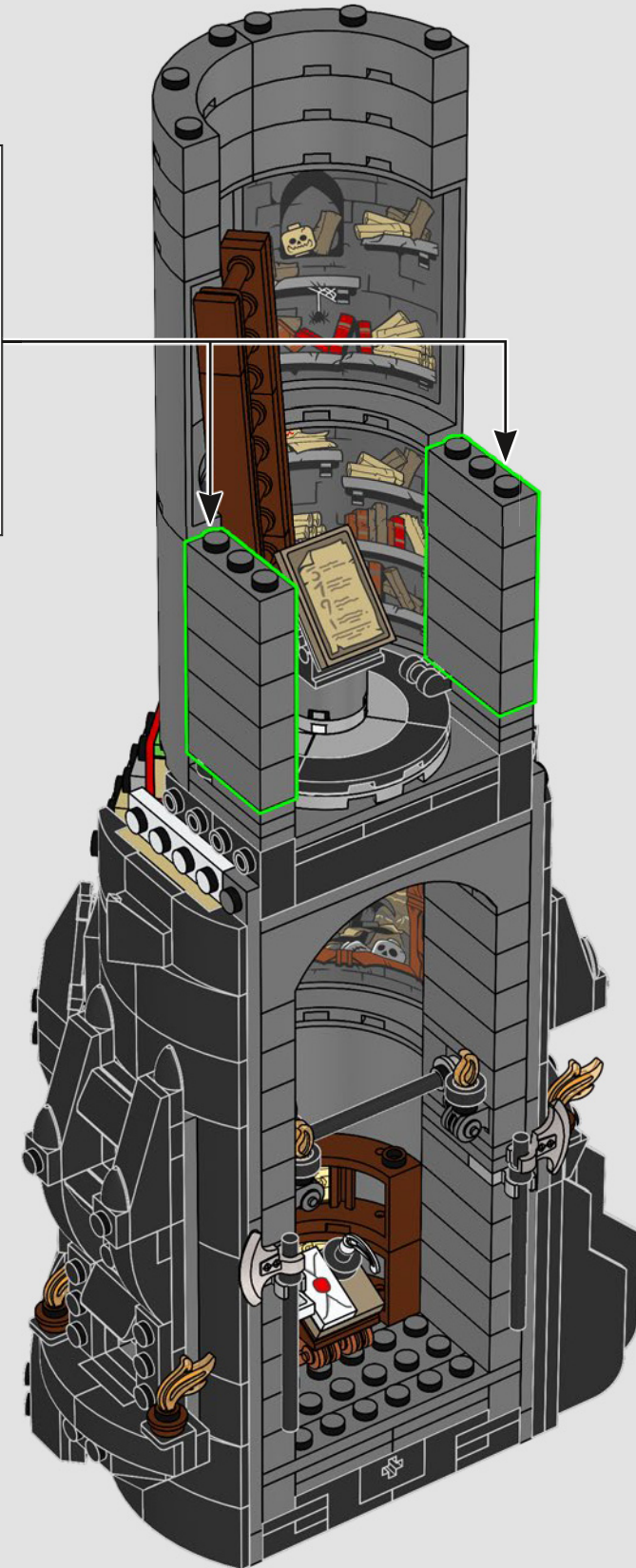
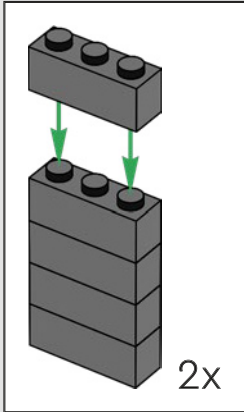

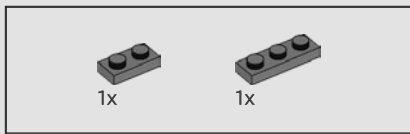

239

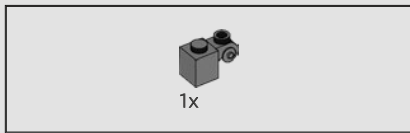
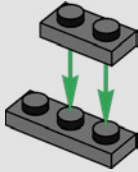

240

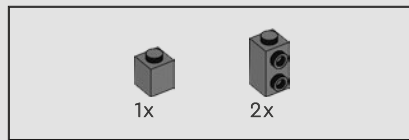
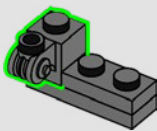

241

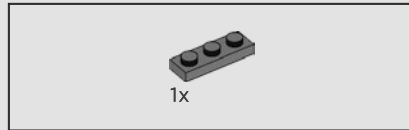
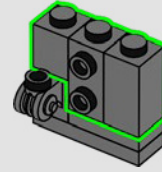

242

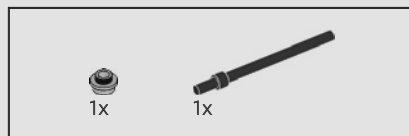
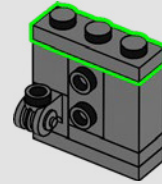

243

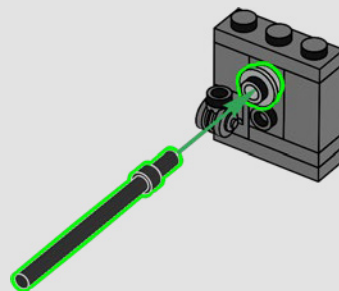

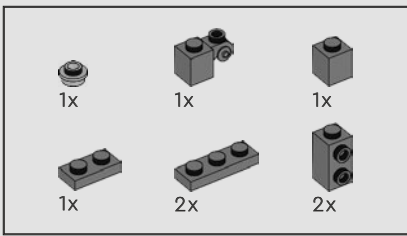

244

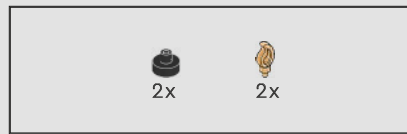
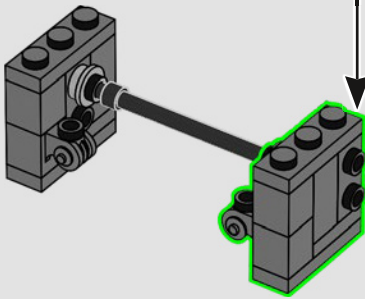
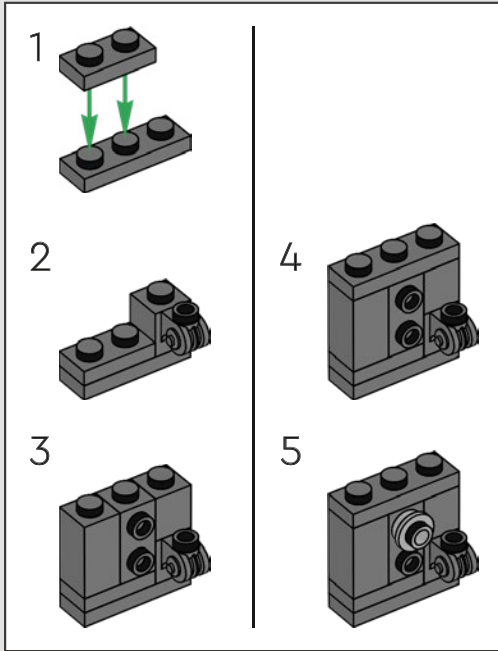

245

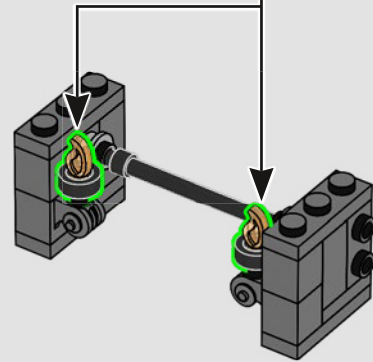
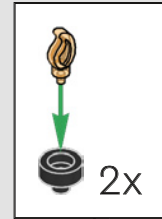

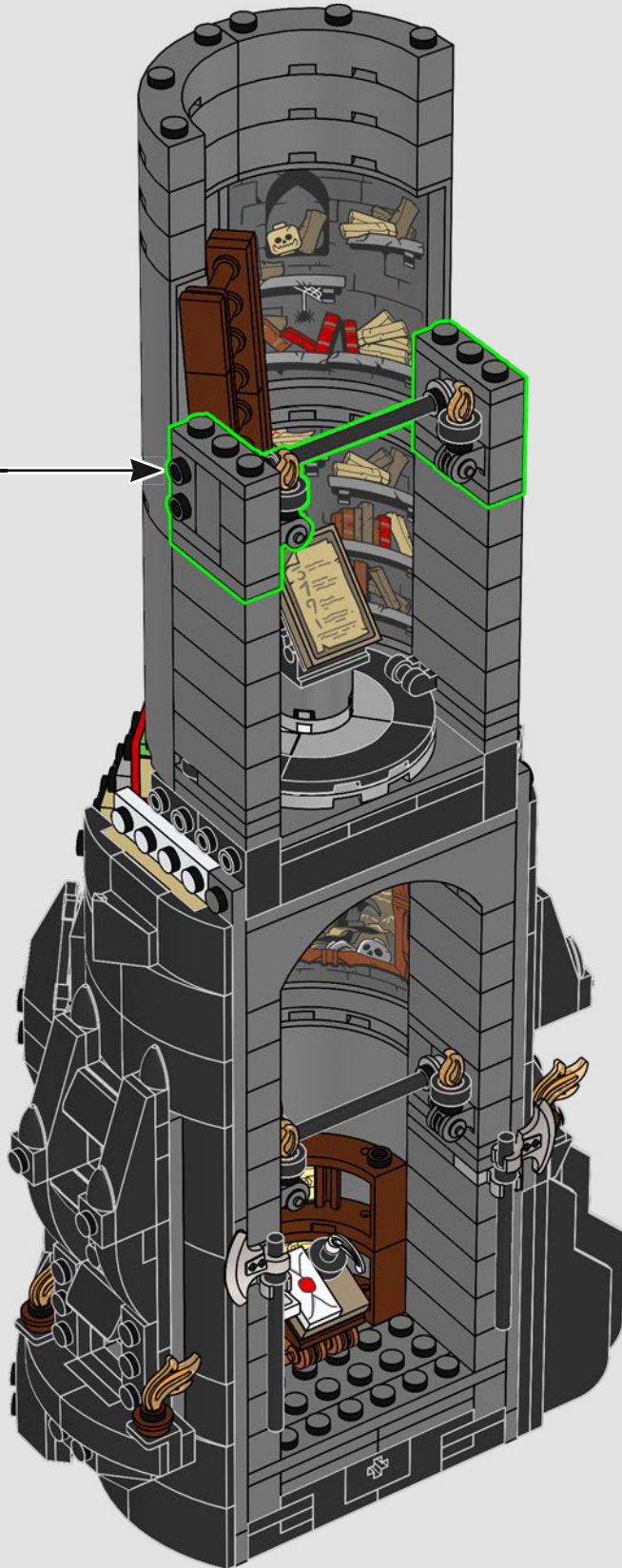



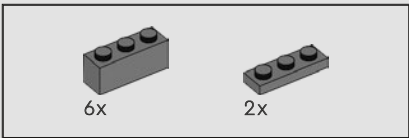

247

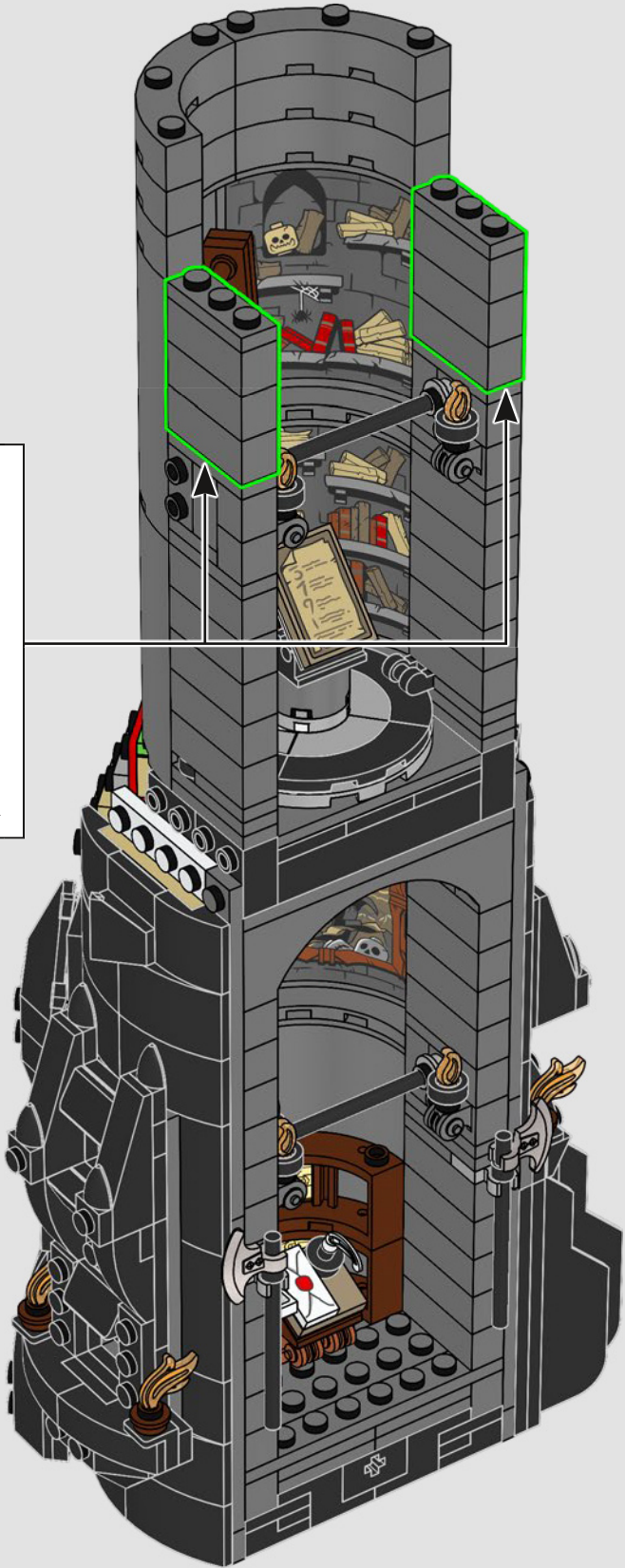
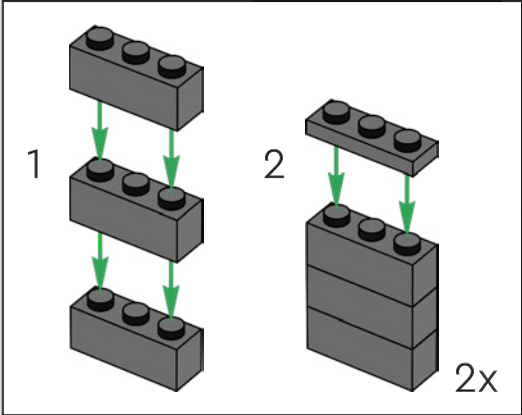

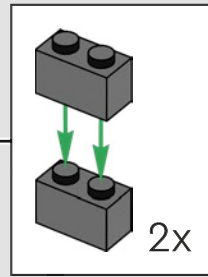
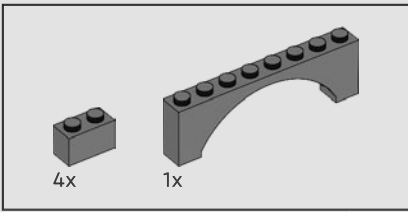

248

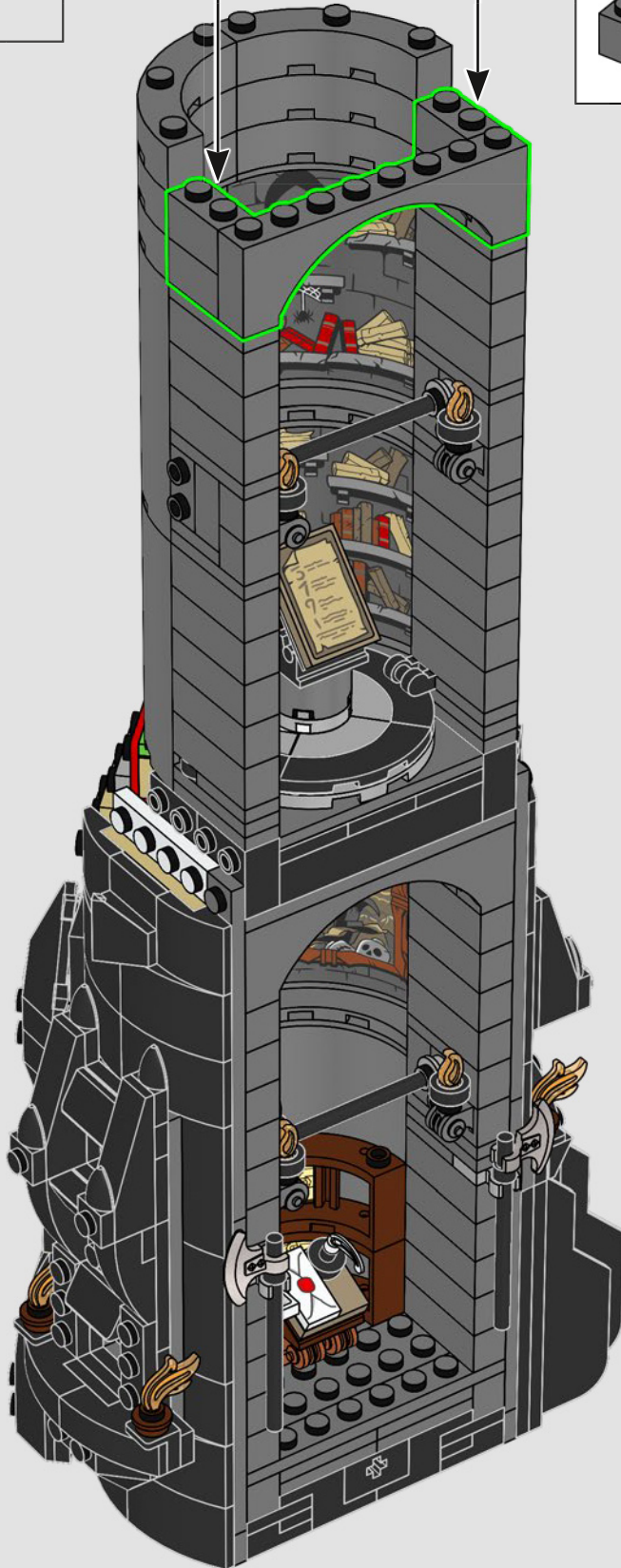

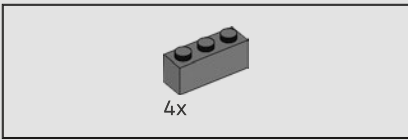

249



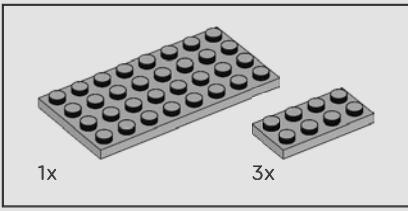

250

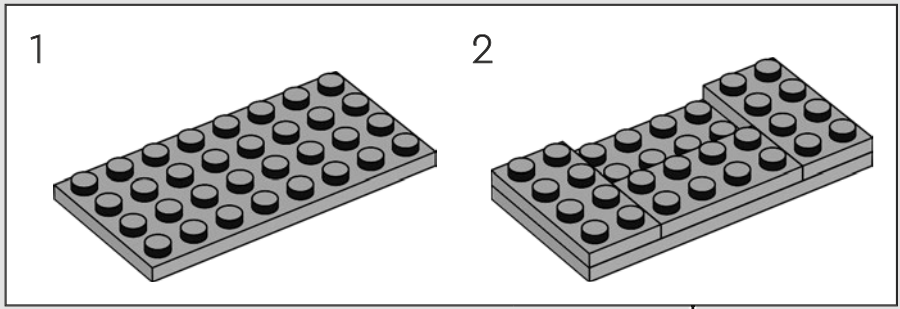



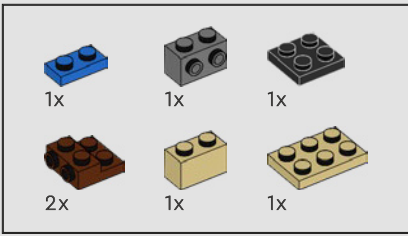

251

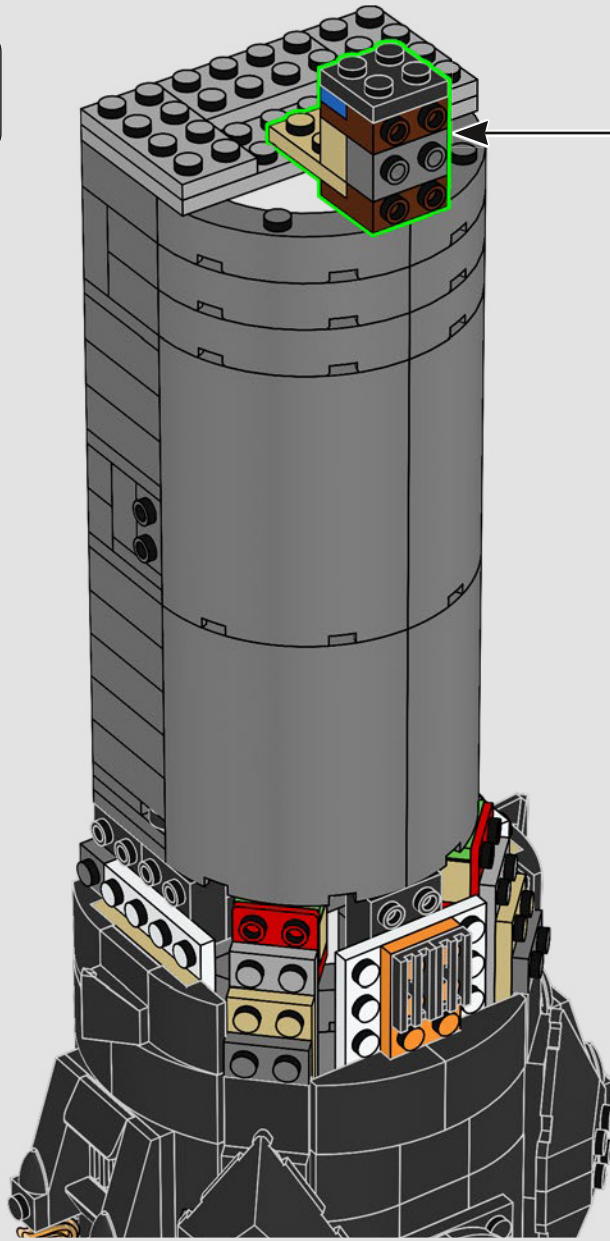
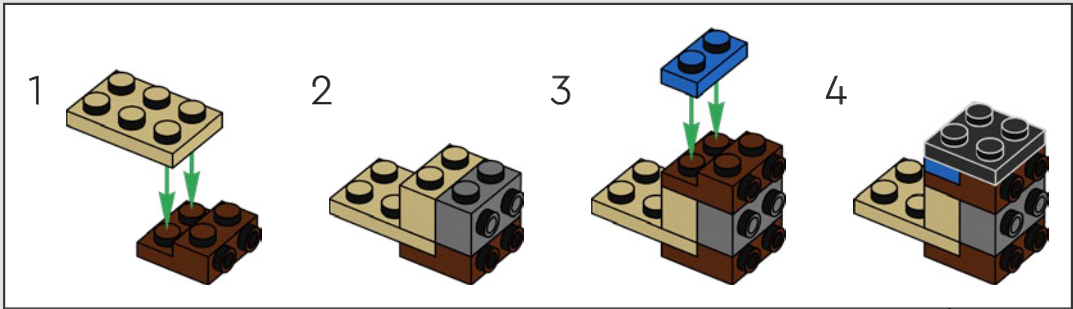

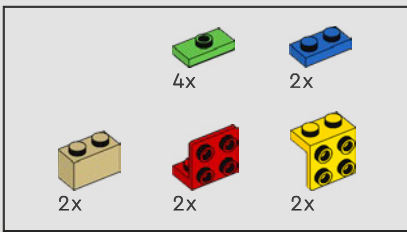

252

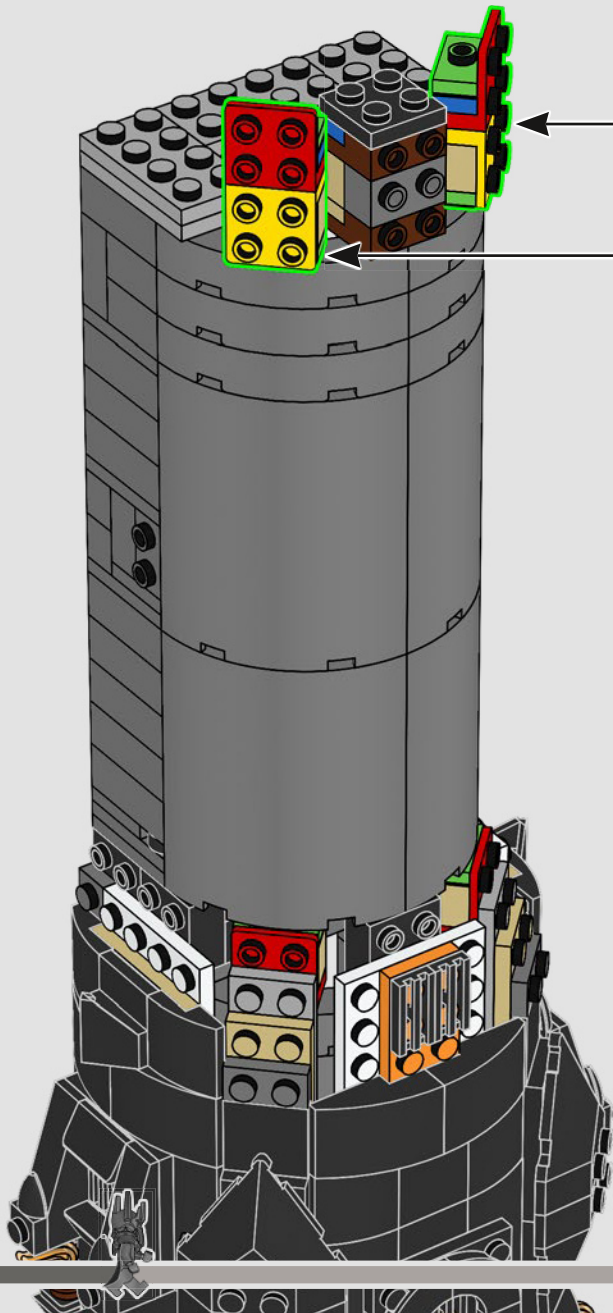
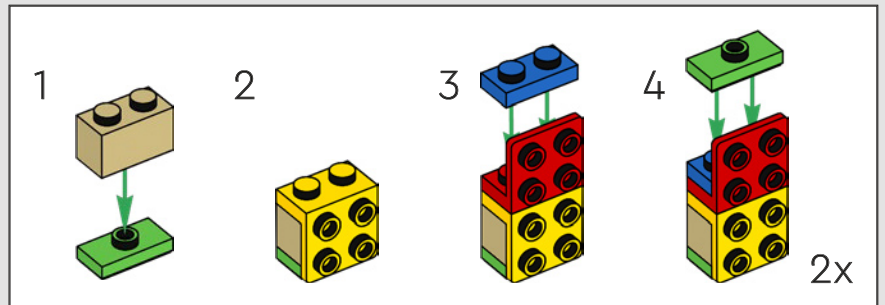

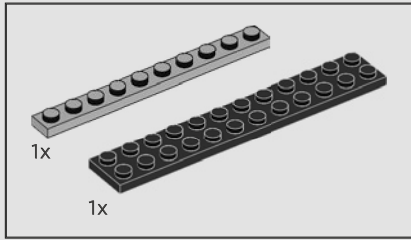
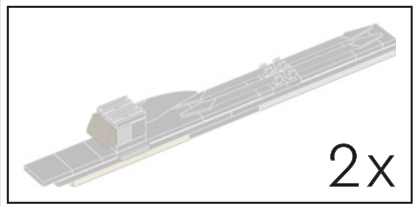

253

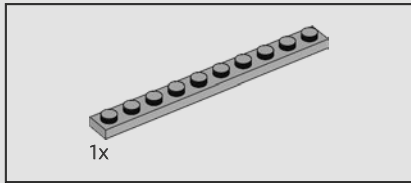
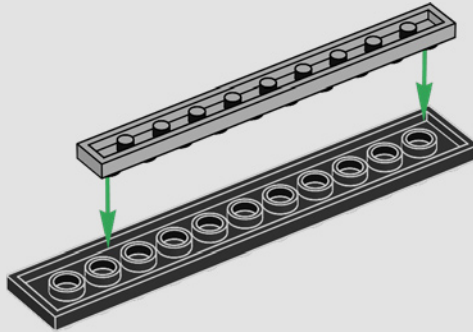

254

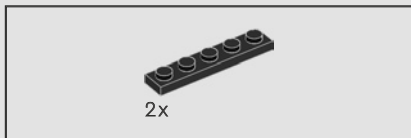
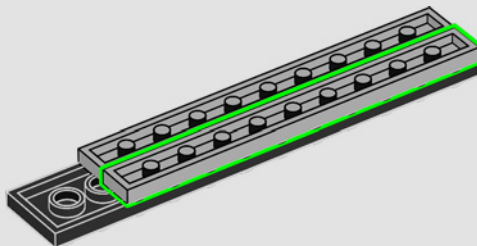

255

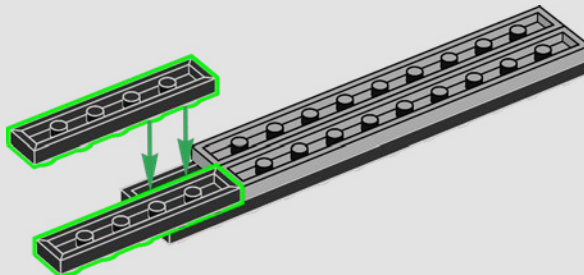



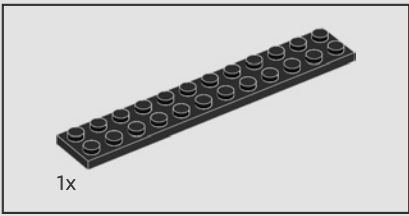

256

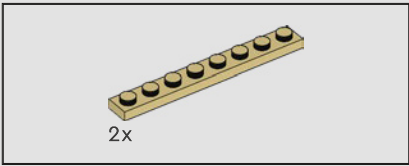
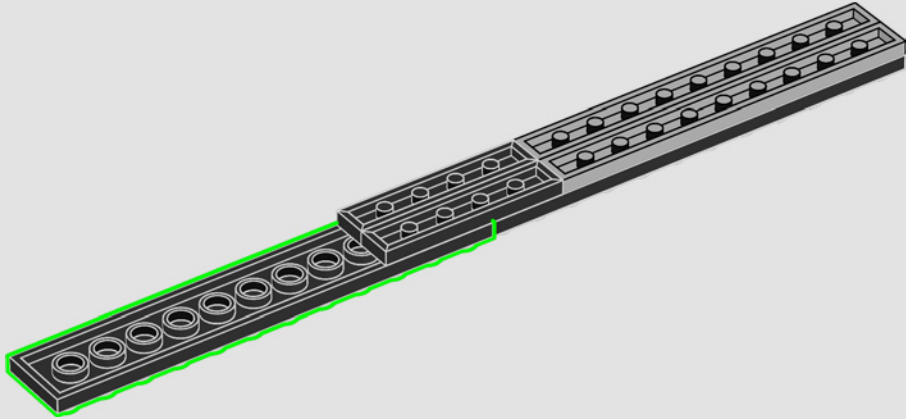

257

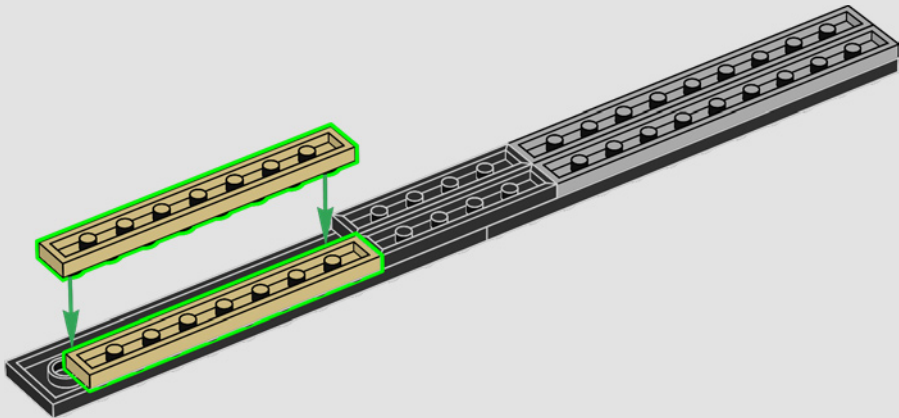

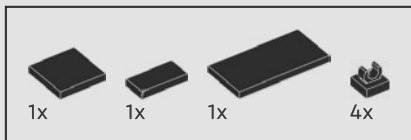

258

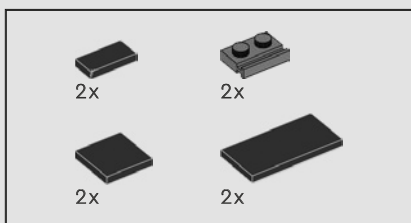
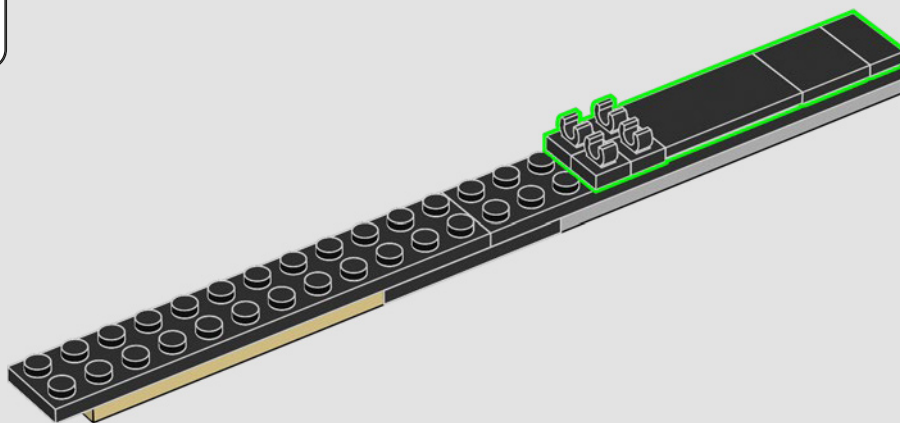

259

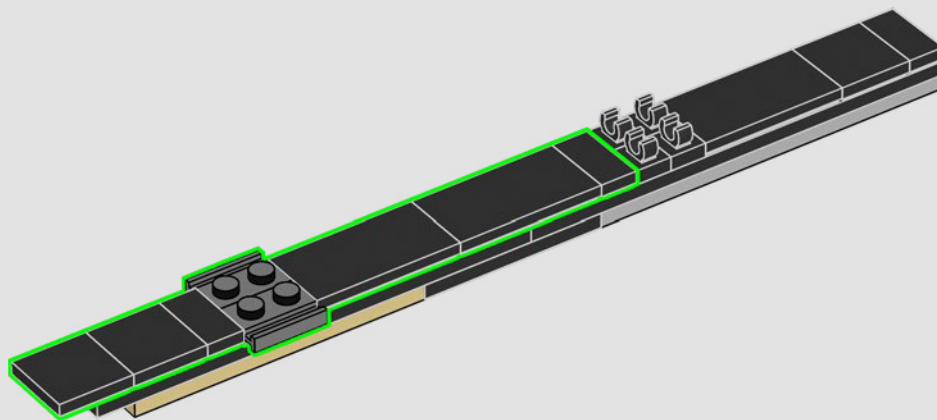

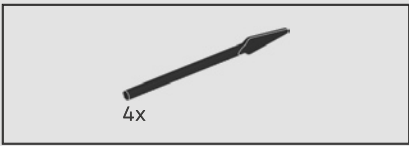

260

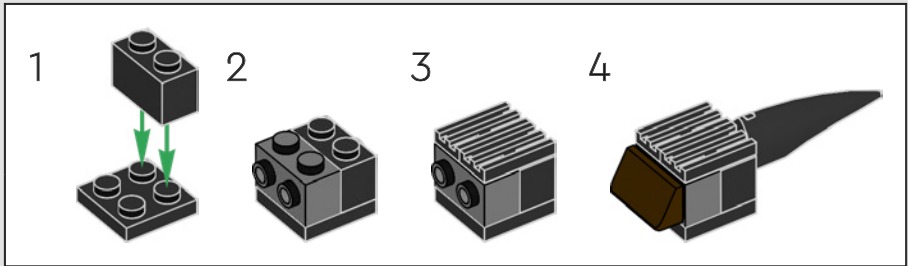
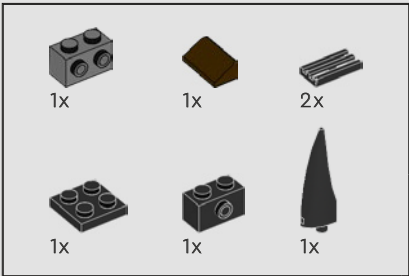
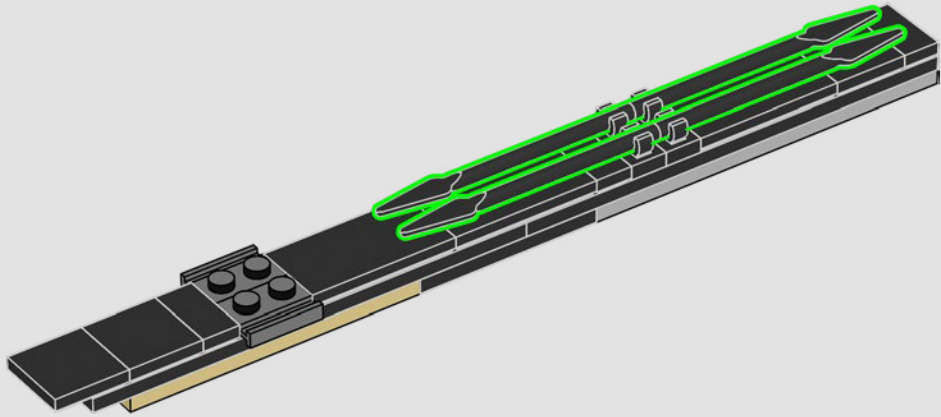

261

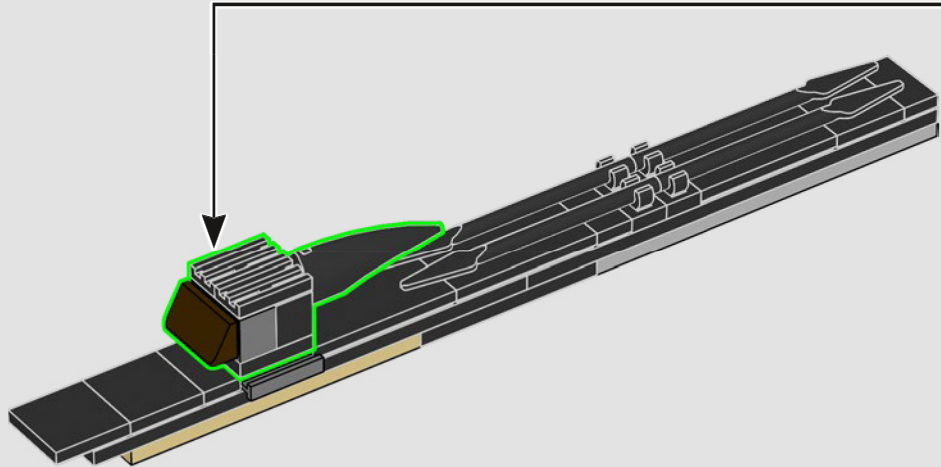

2x





L'elemento lancia è stato ricolorato di nero per questo set.

262

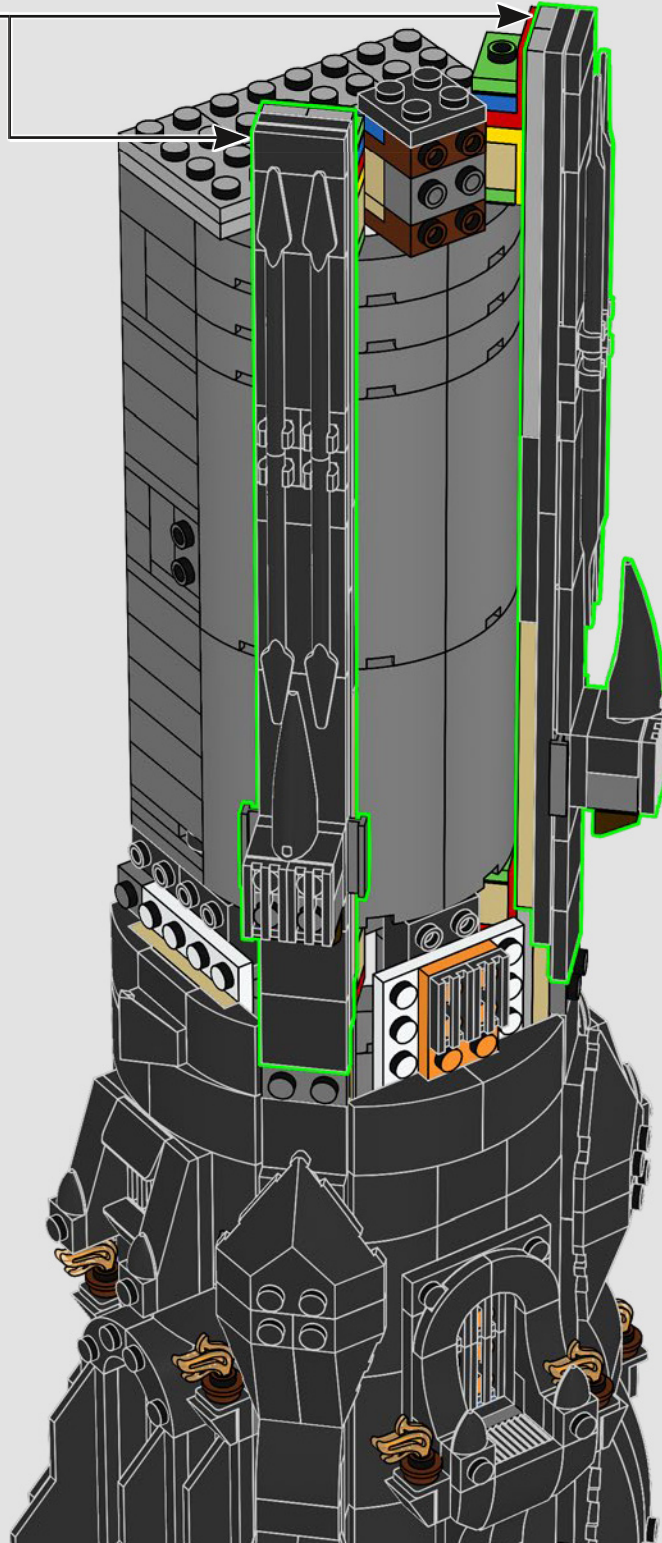



263

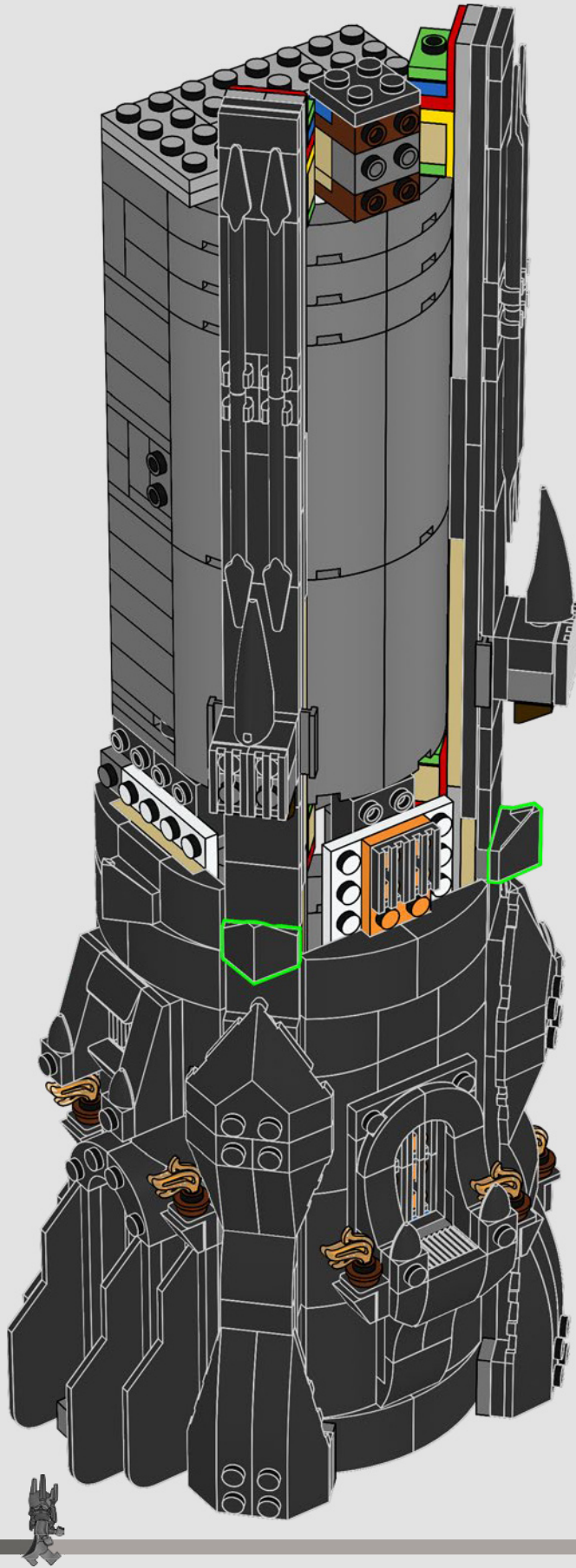

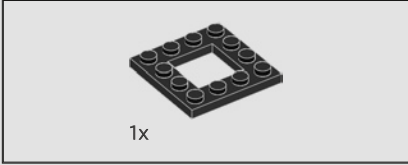
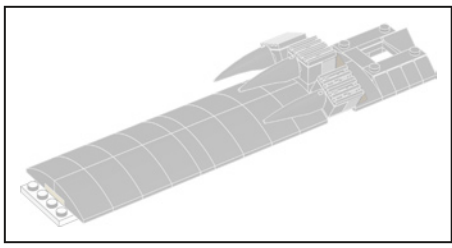

264

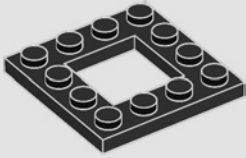

265

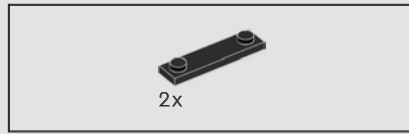
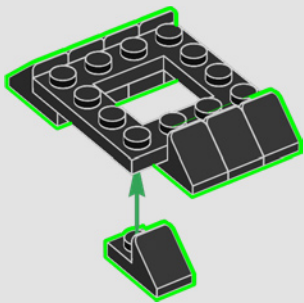

266

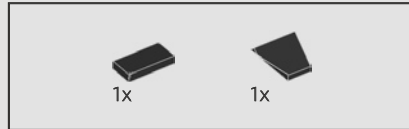
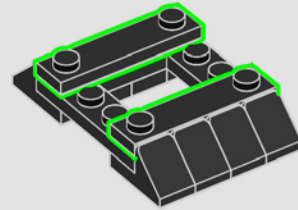

267

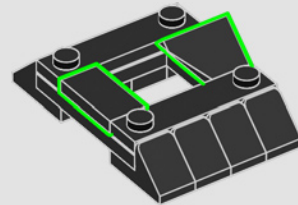

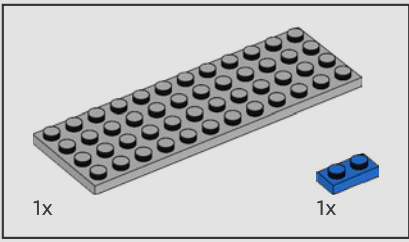

268

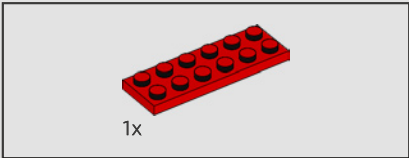
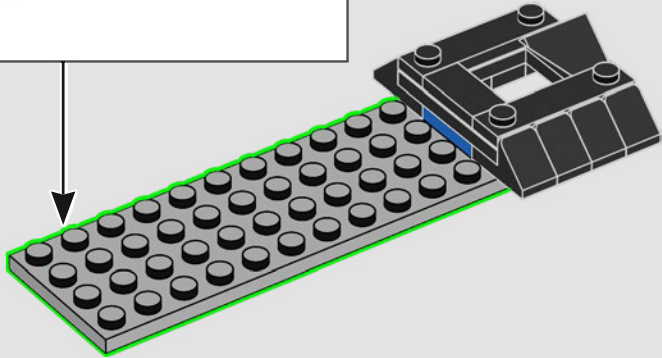
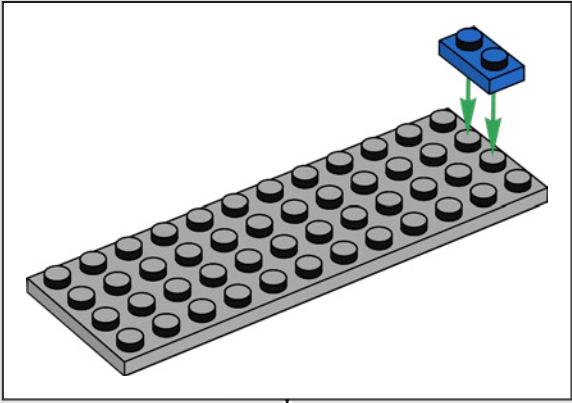

269

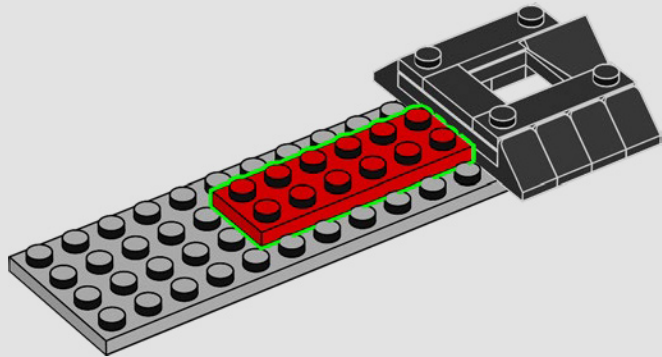

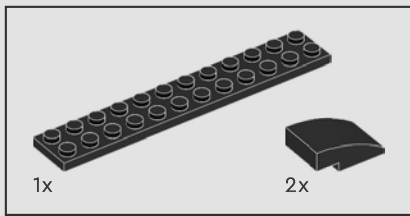

270

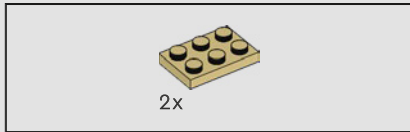
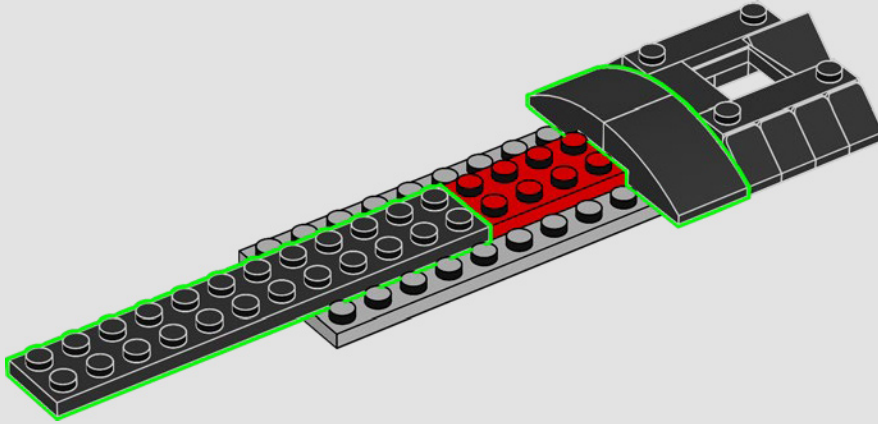

271

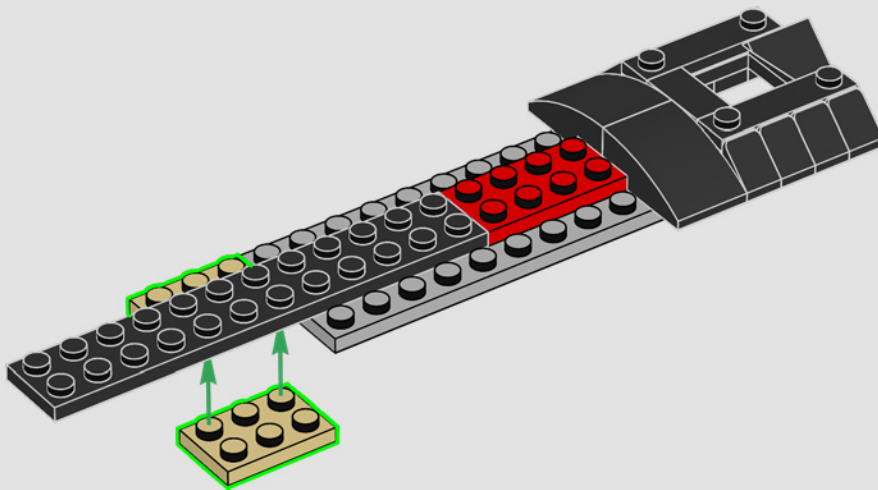



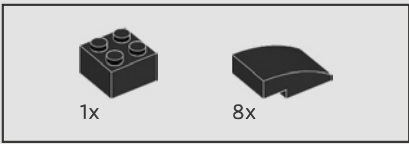

272

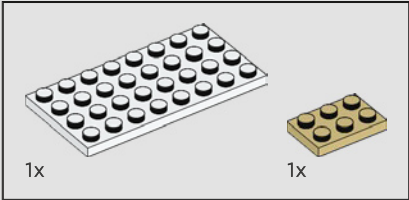
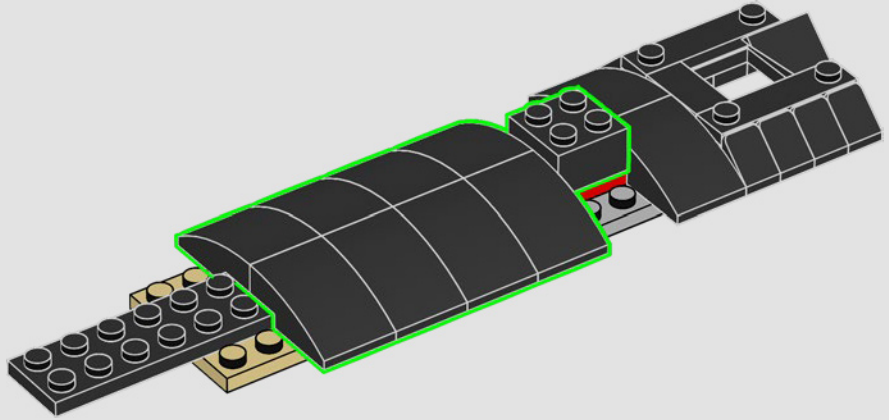

273

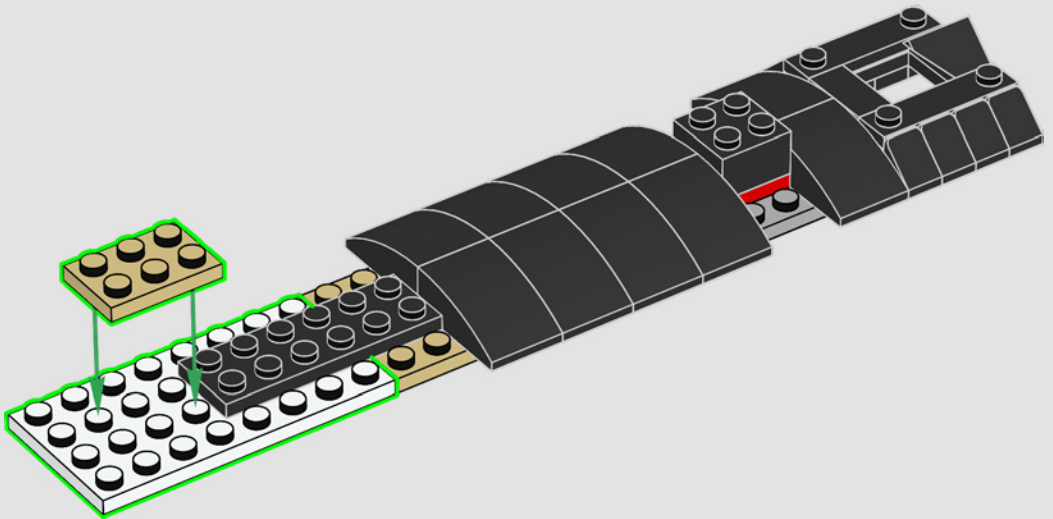

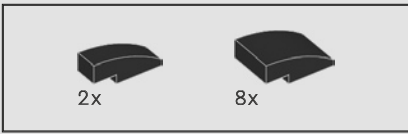

274

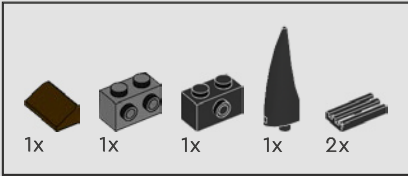
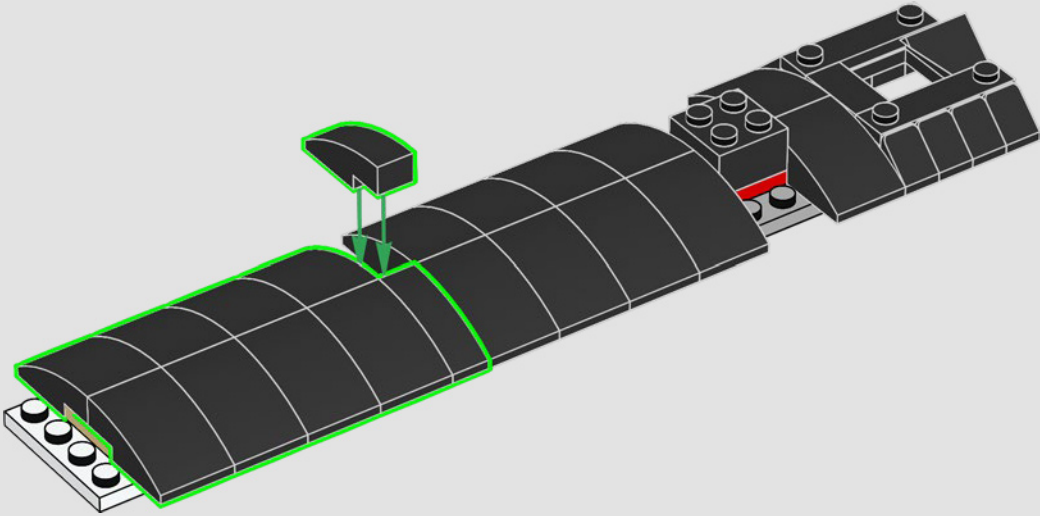

275

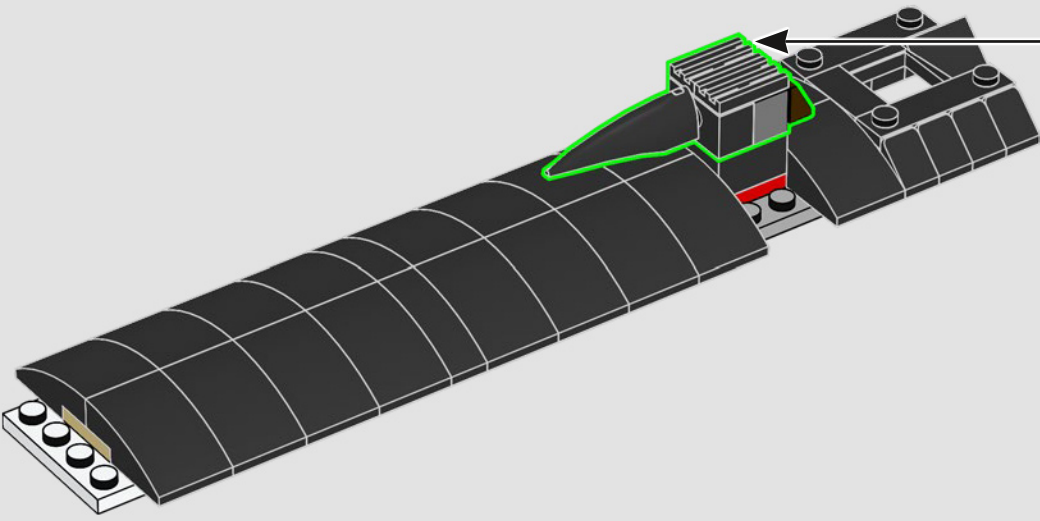
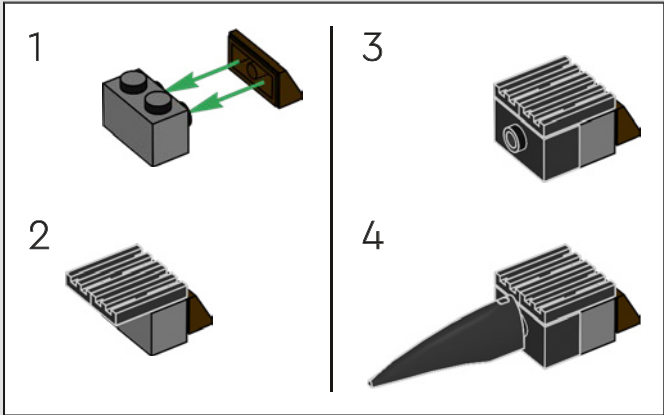

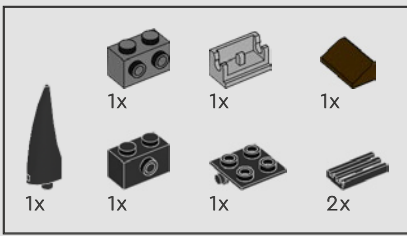

276

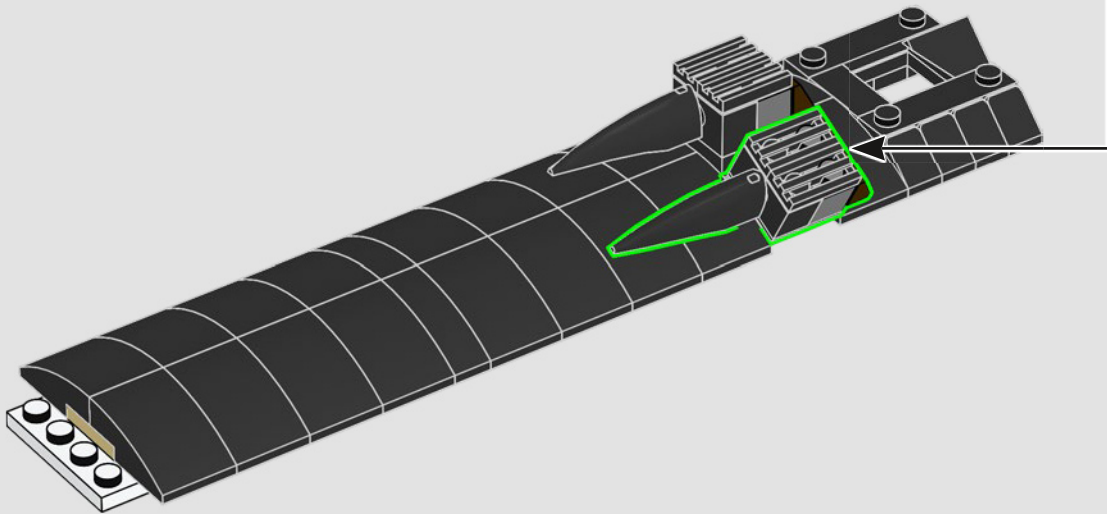
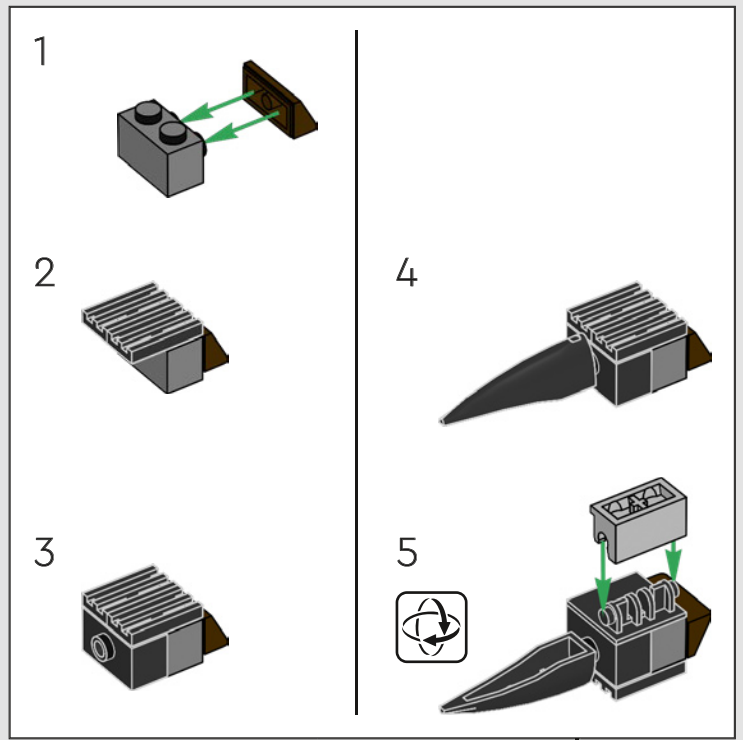

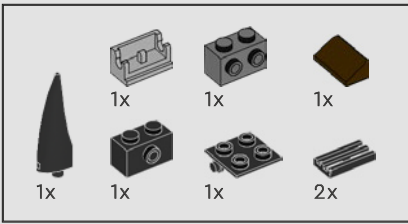

277

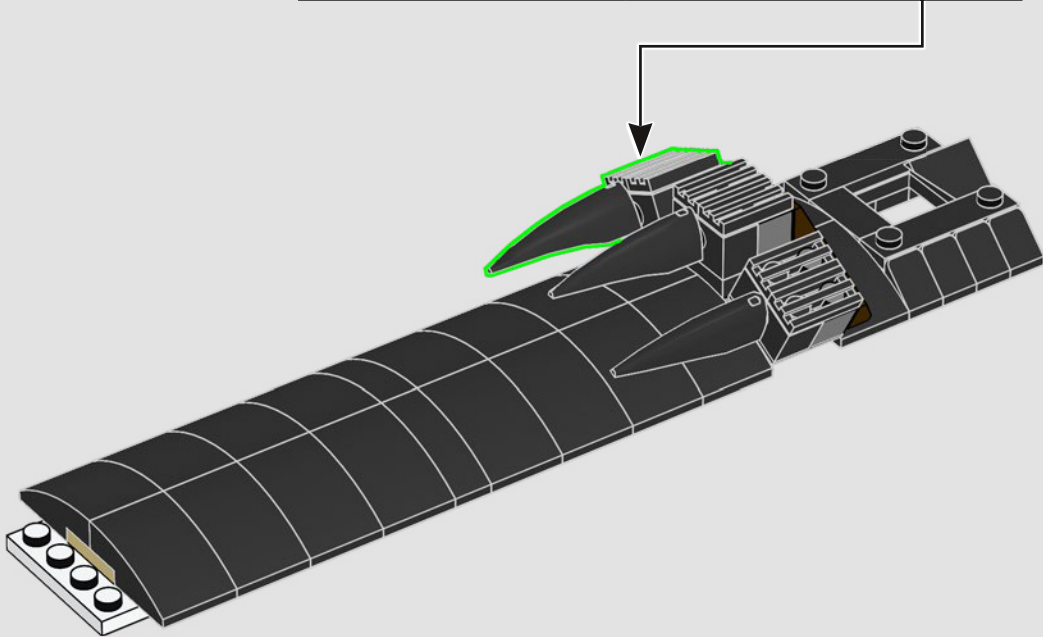
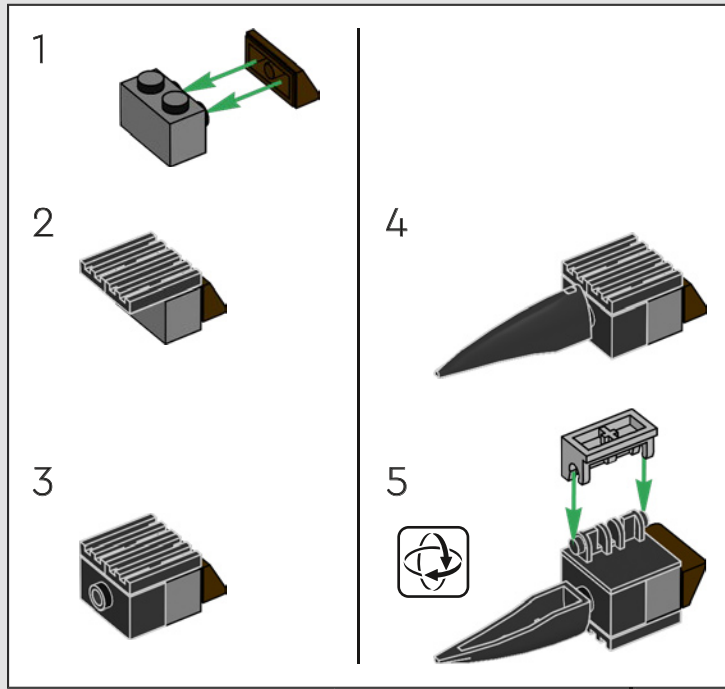

278

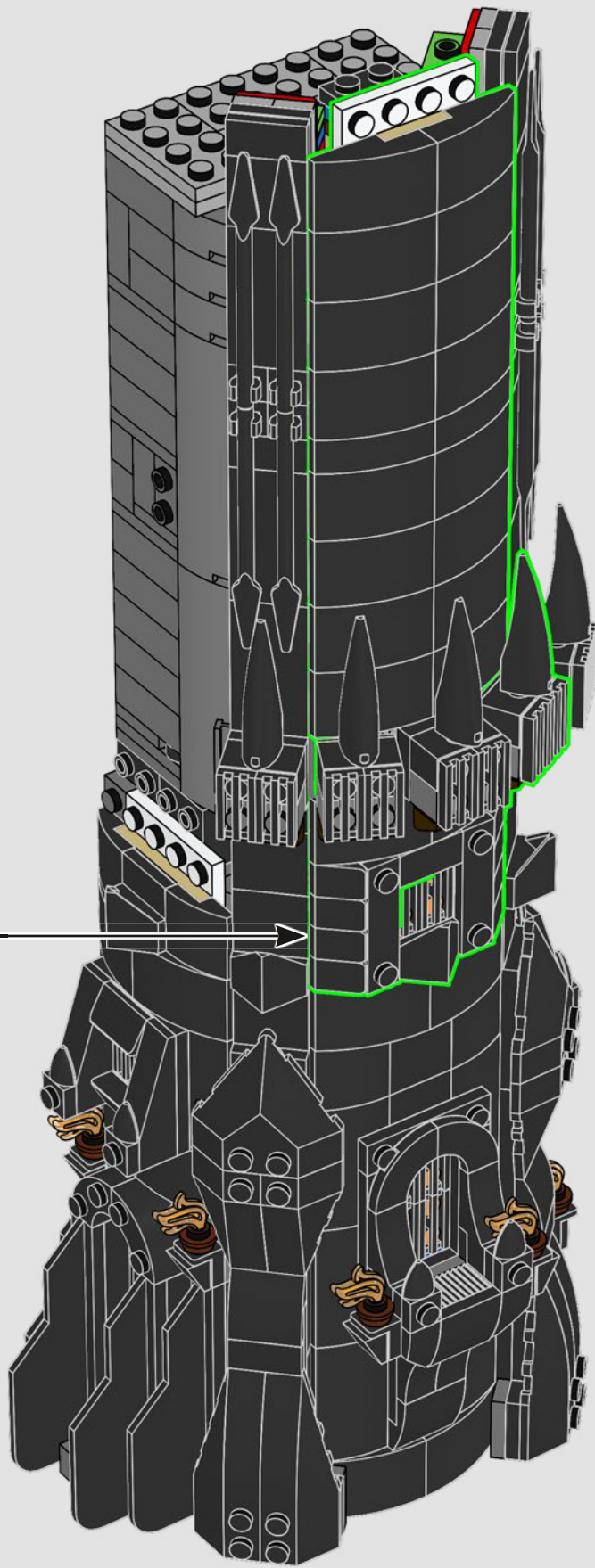

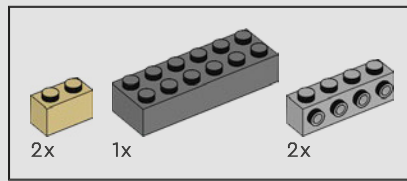

279



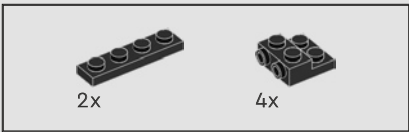

280

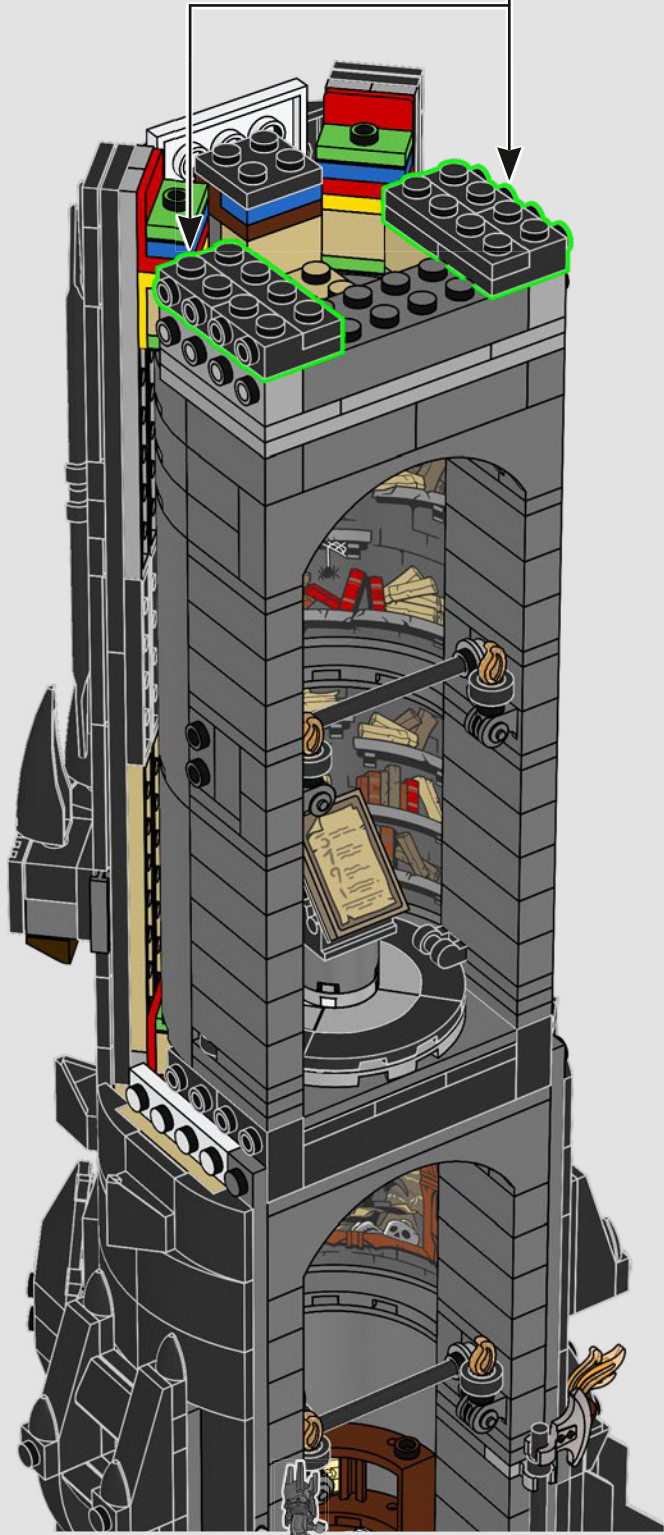
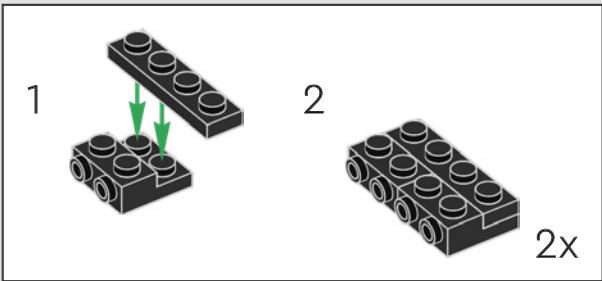

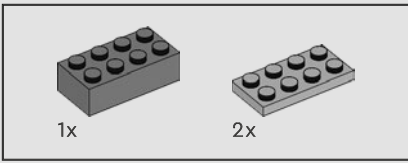

281





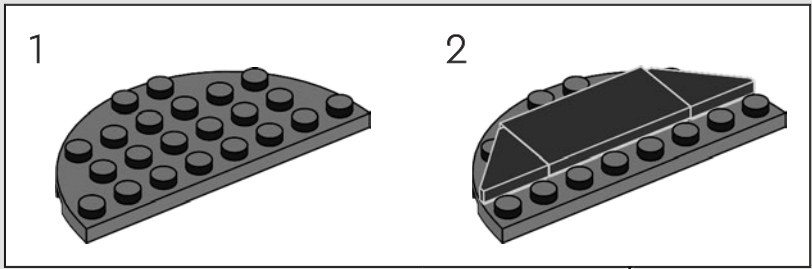
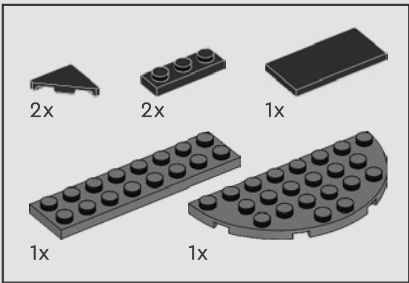

282



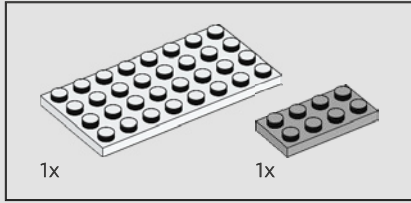
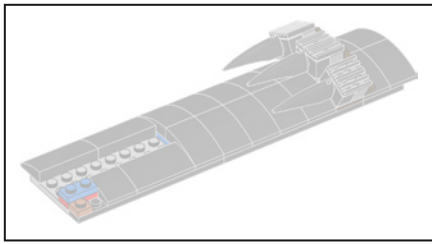

283

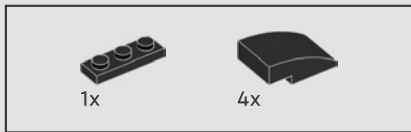
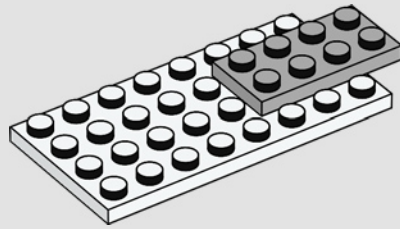

284

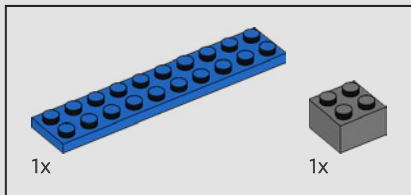
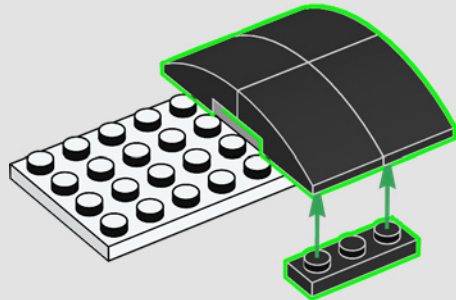

285

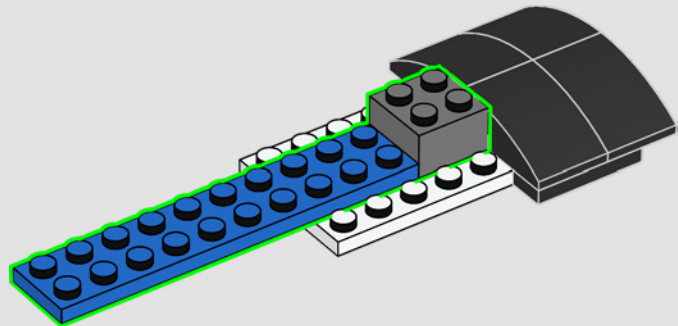



286

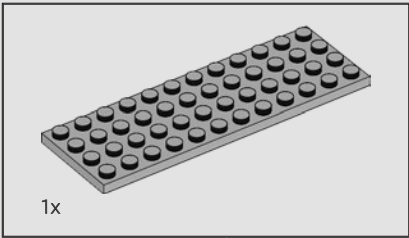
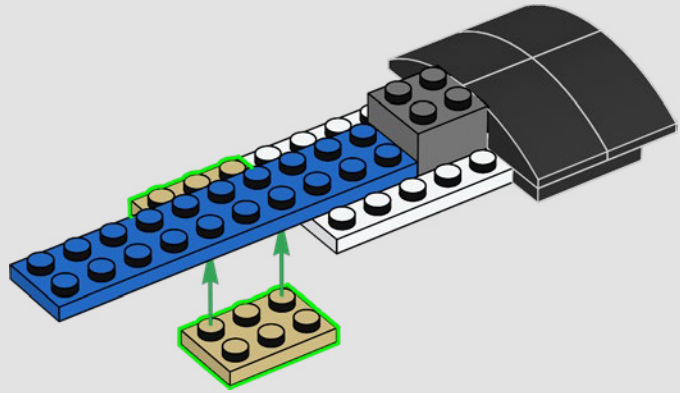

287

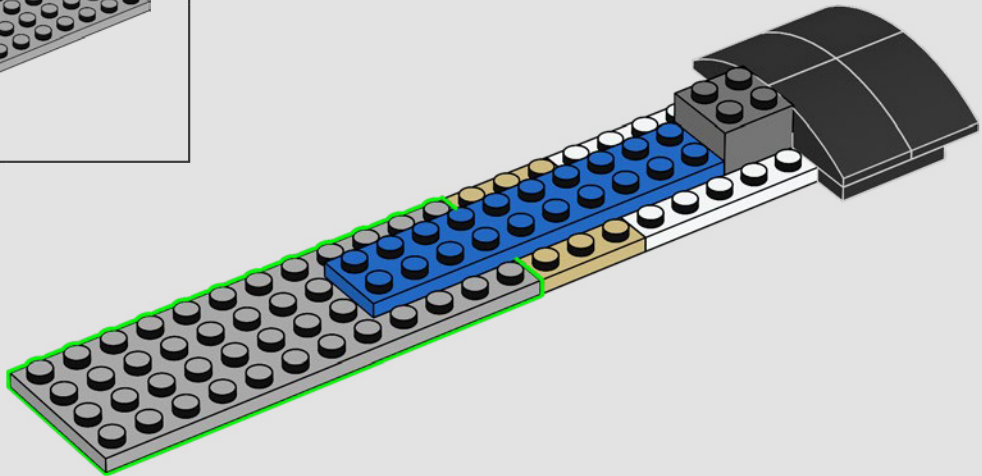

288

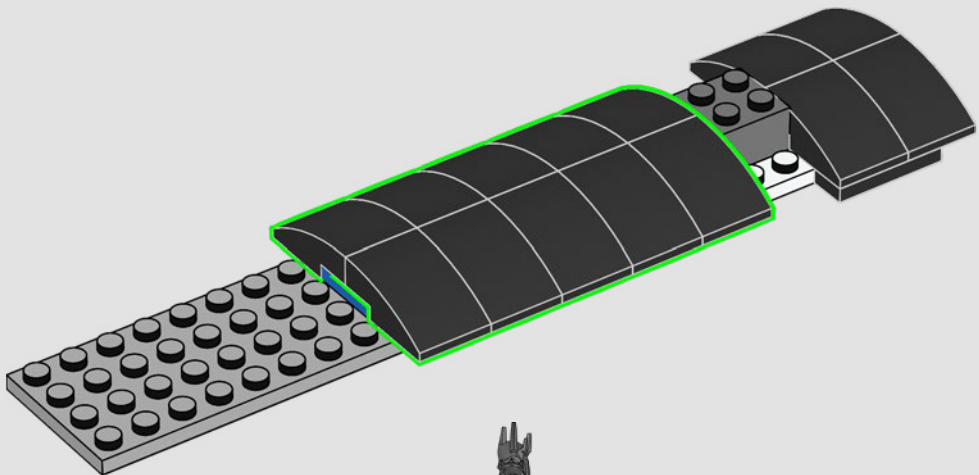

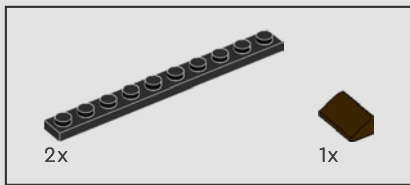

289

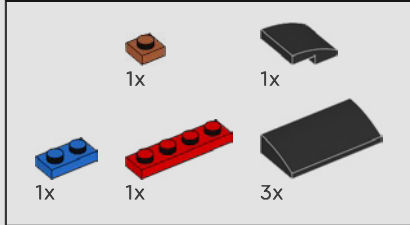
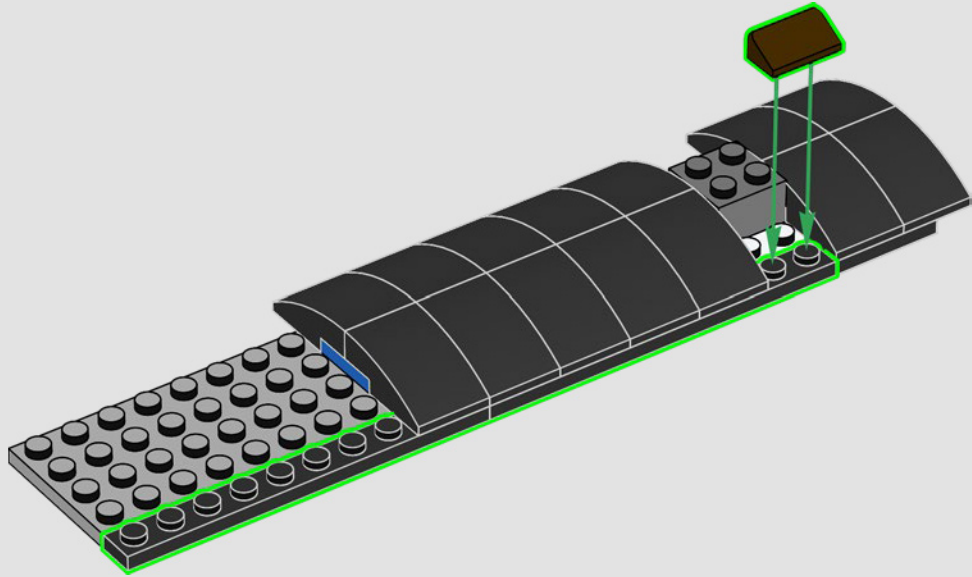

290

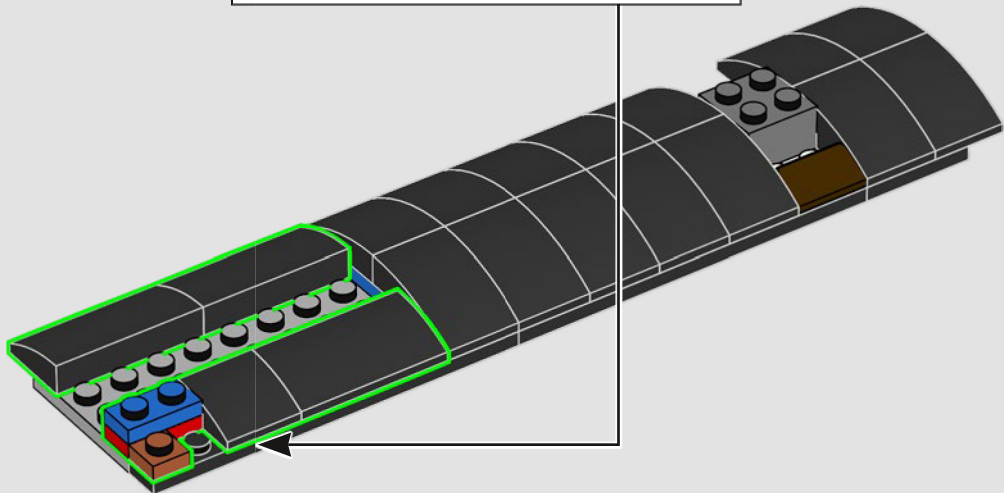
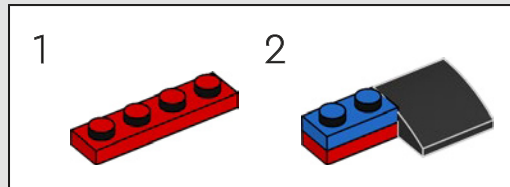

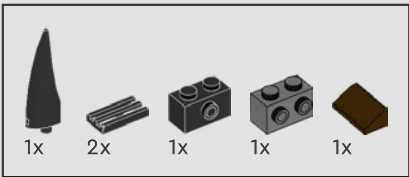

291

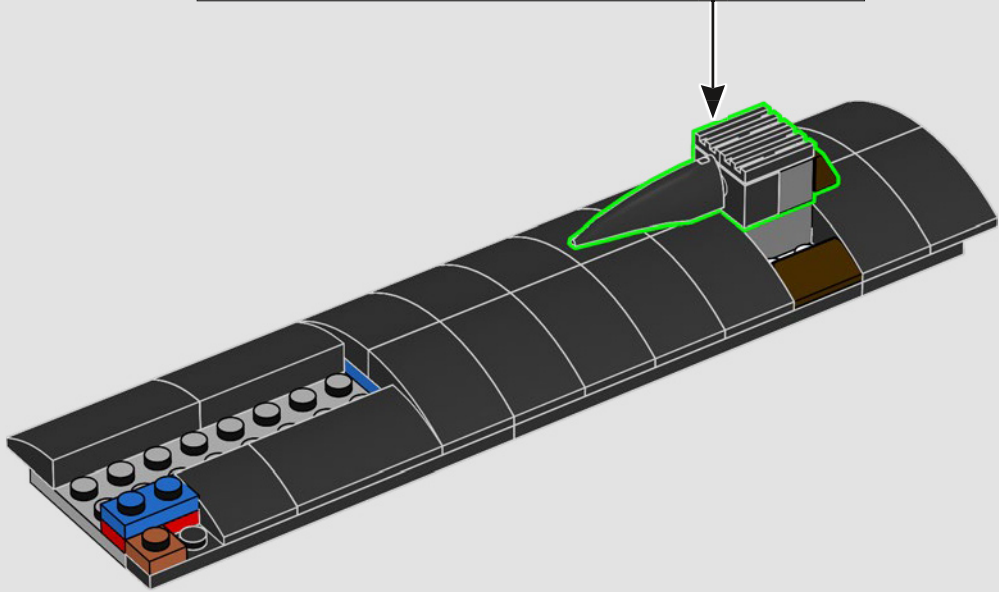
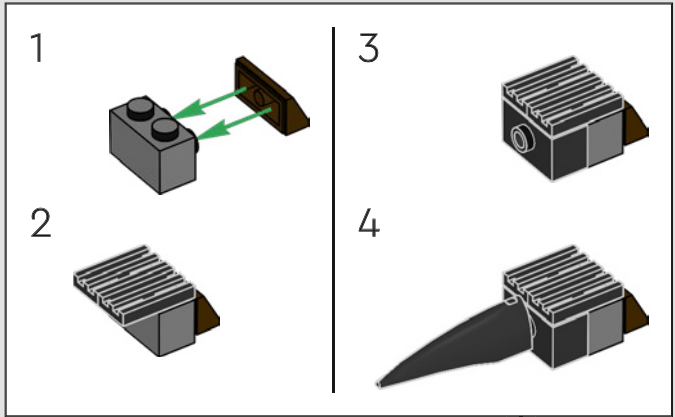

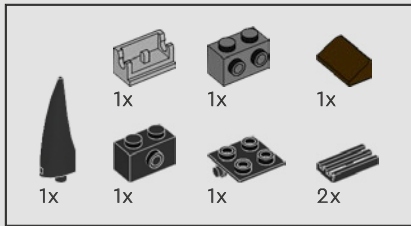

292

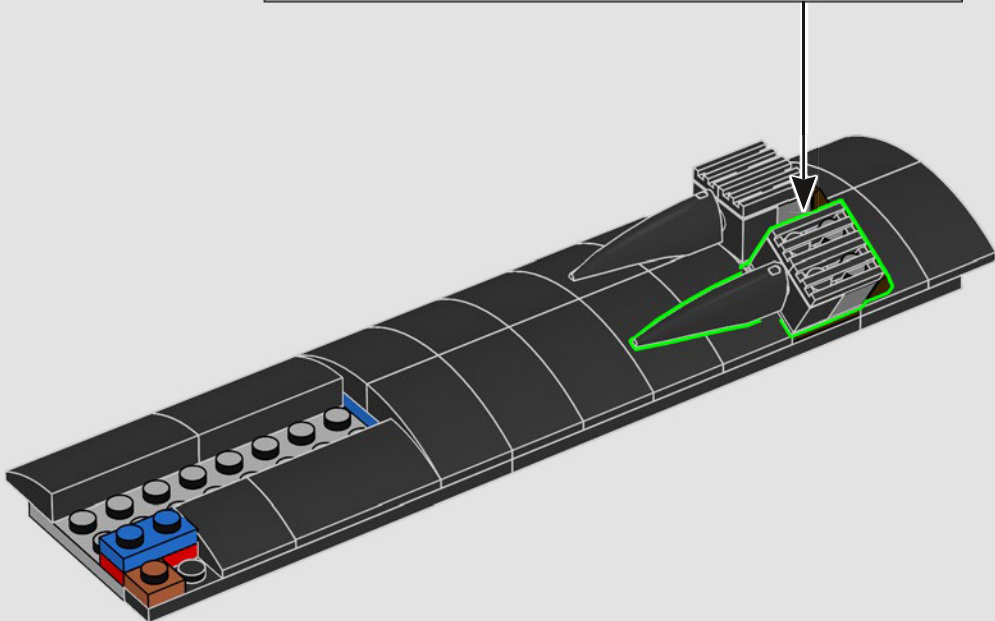
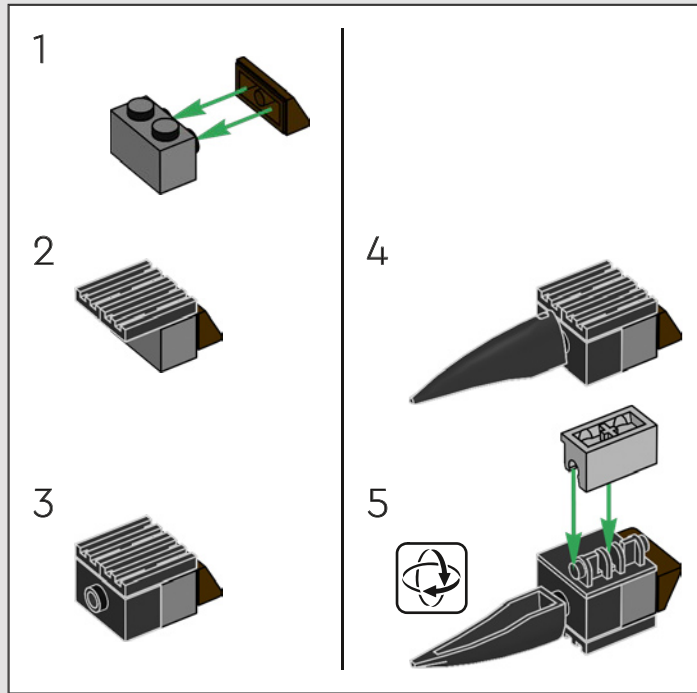

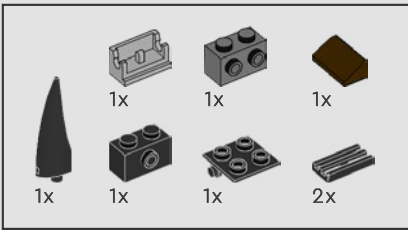

293

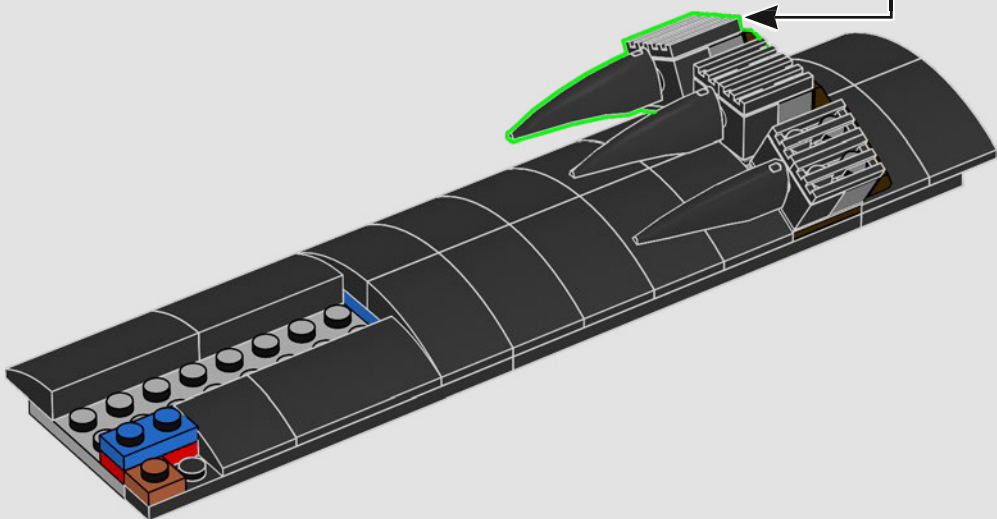
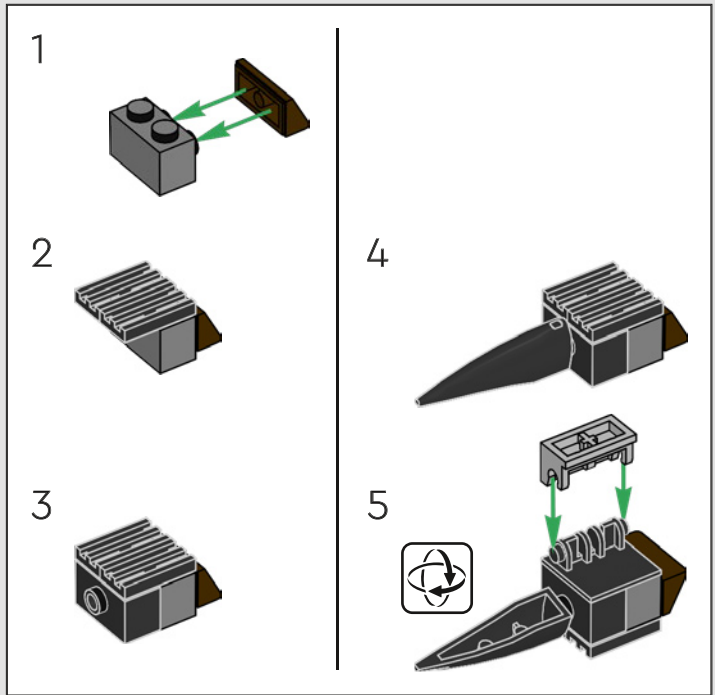

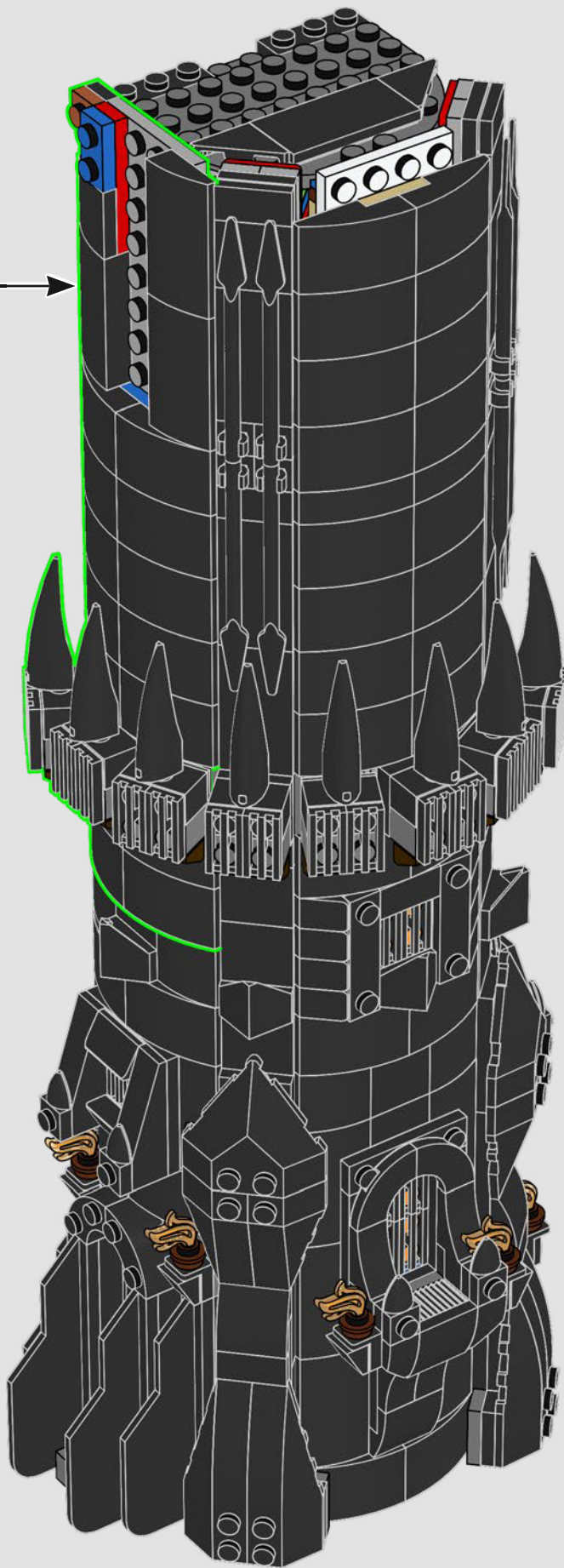

294





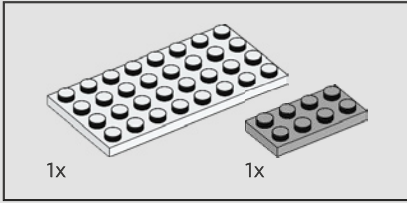
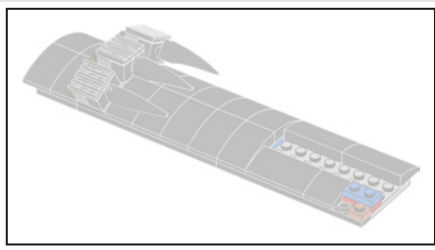

295

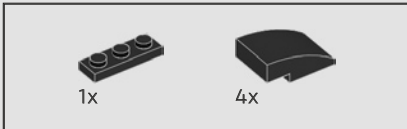
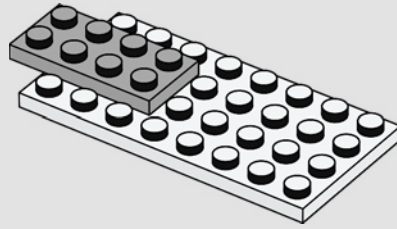

296

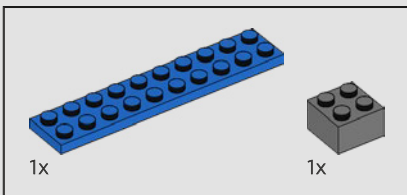
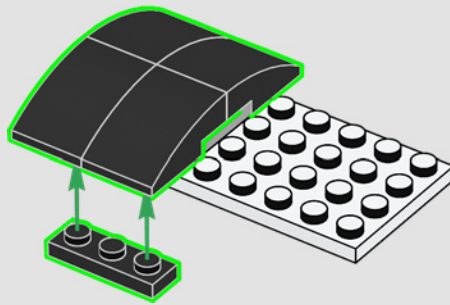

297

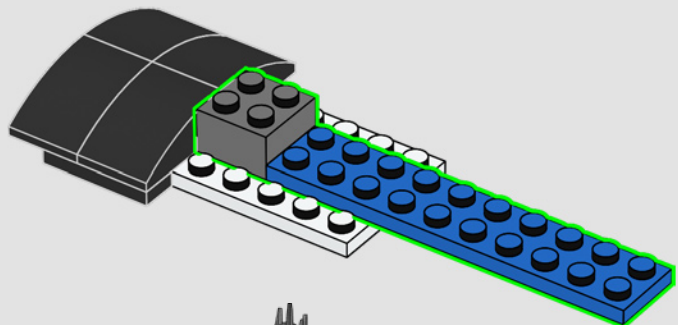

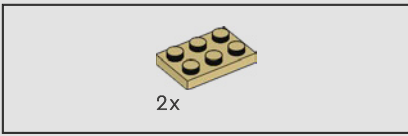

298

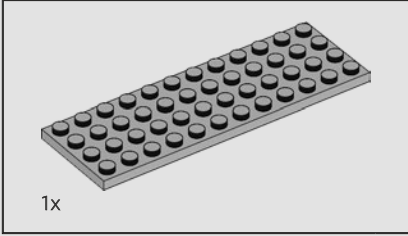
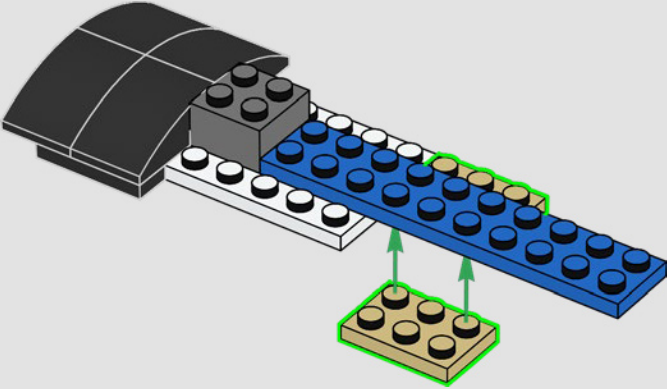

299

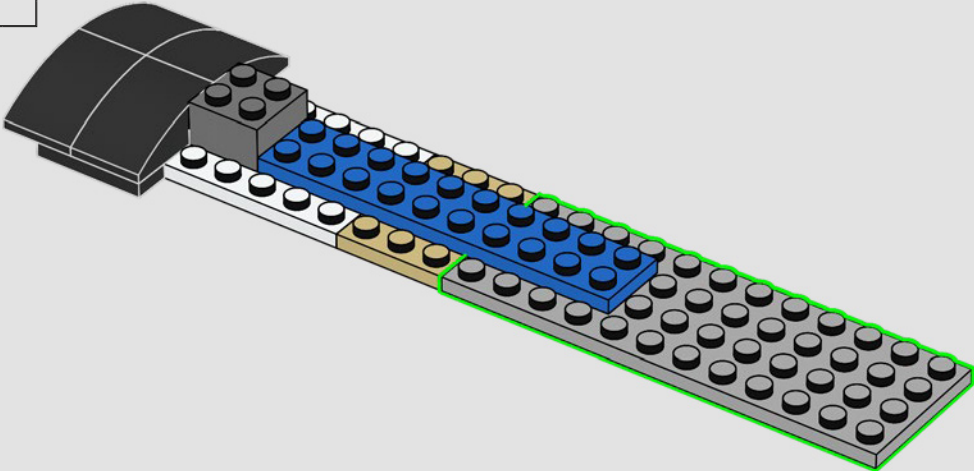

300

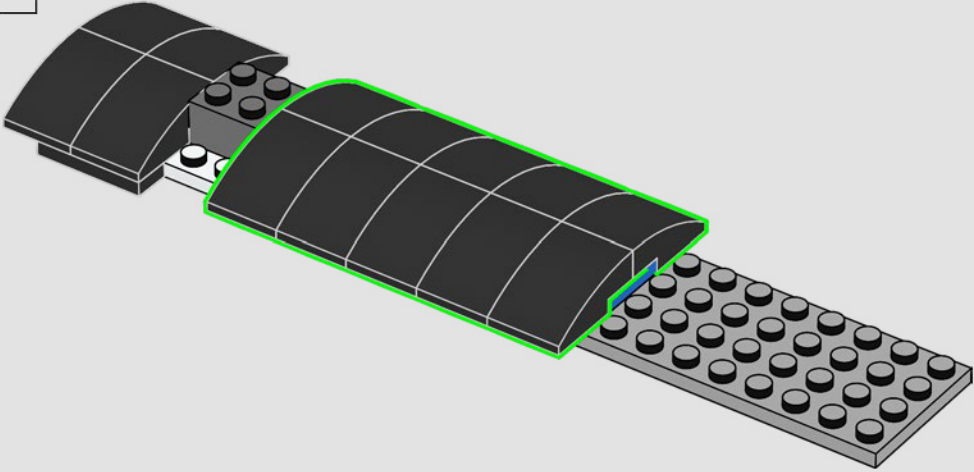

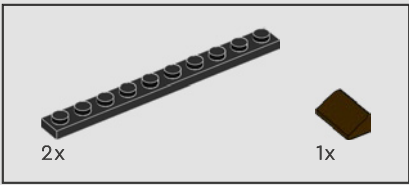

301

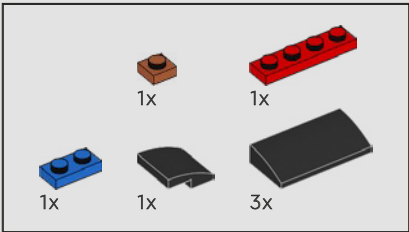
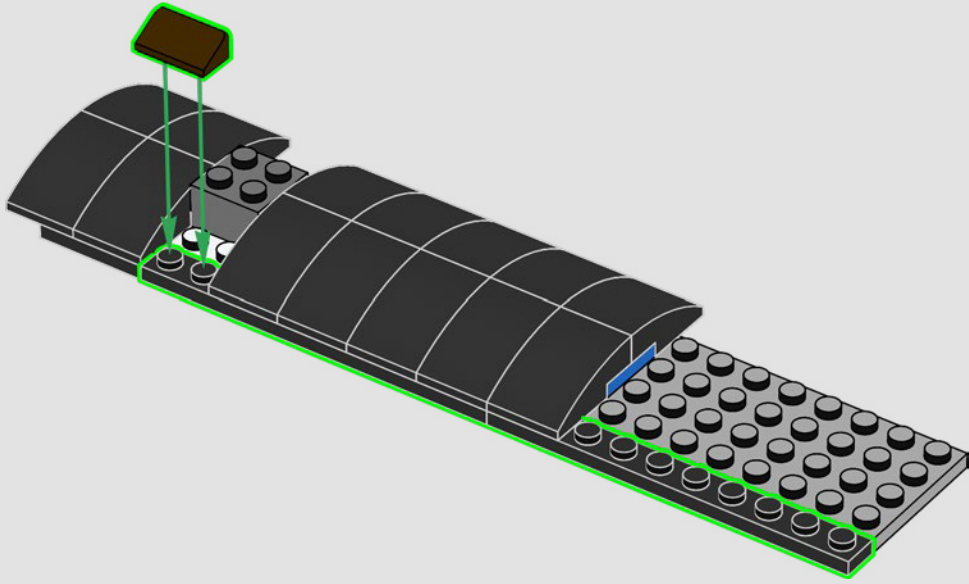

302

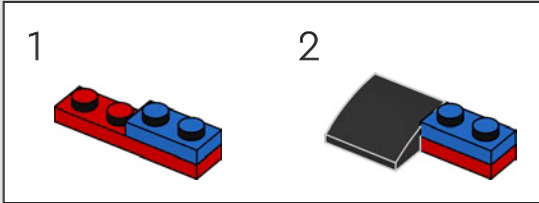
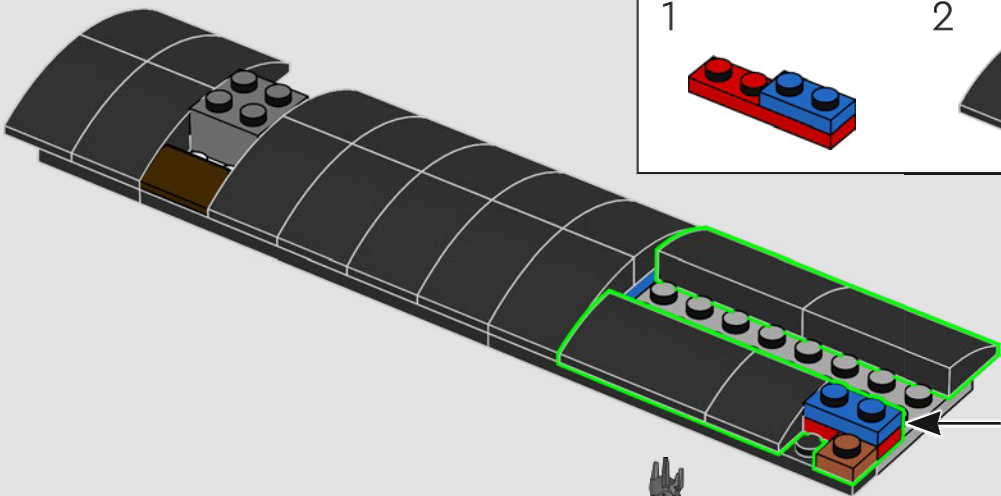

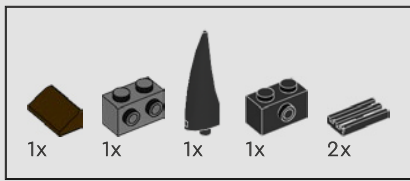

303

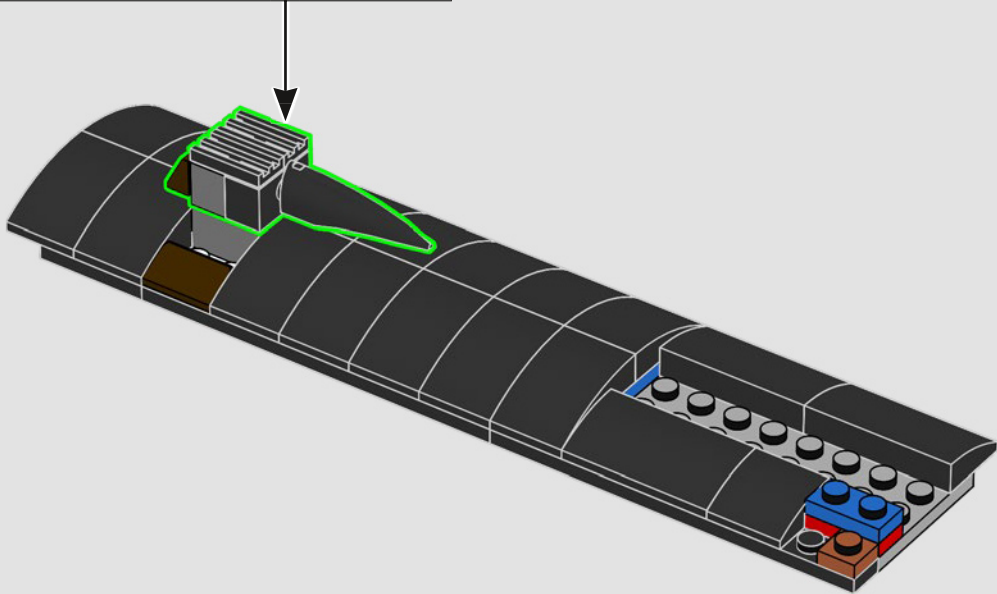
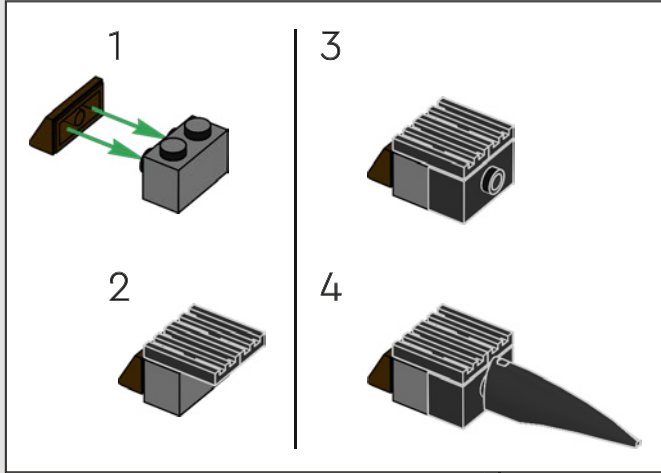

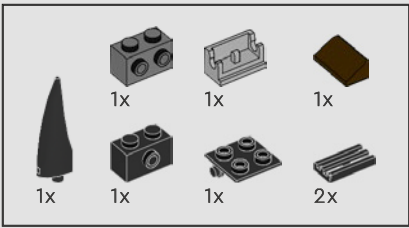

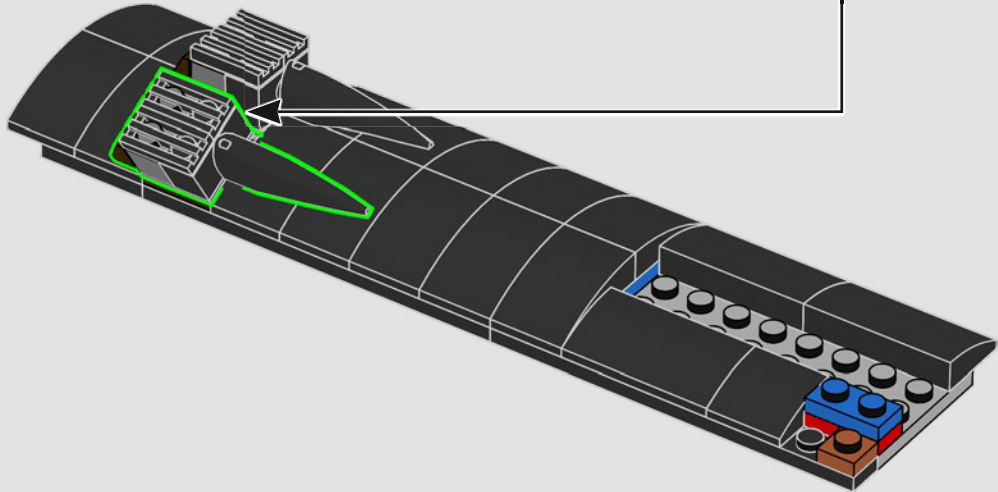
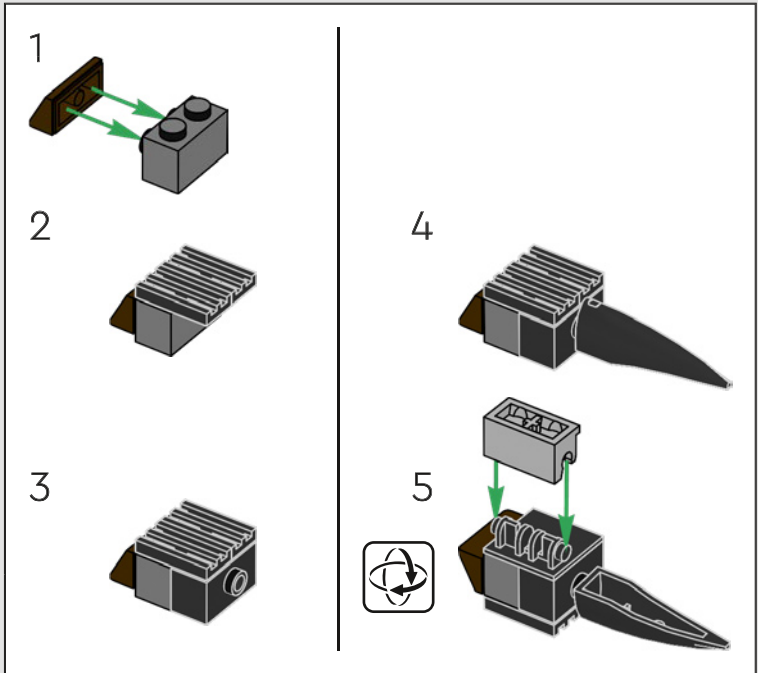

304

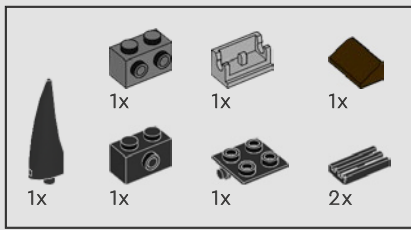

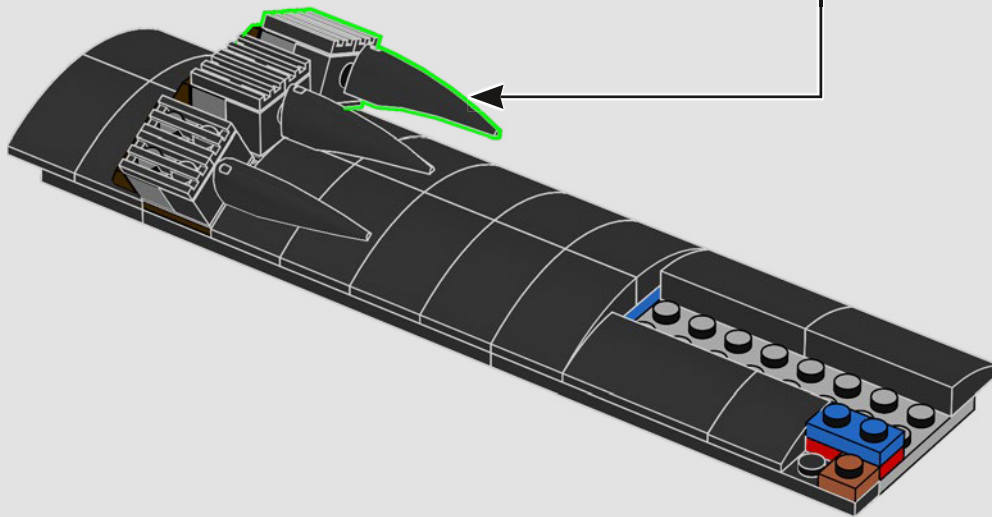
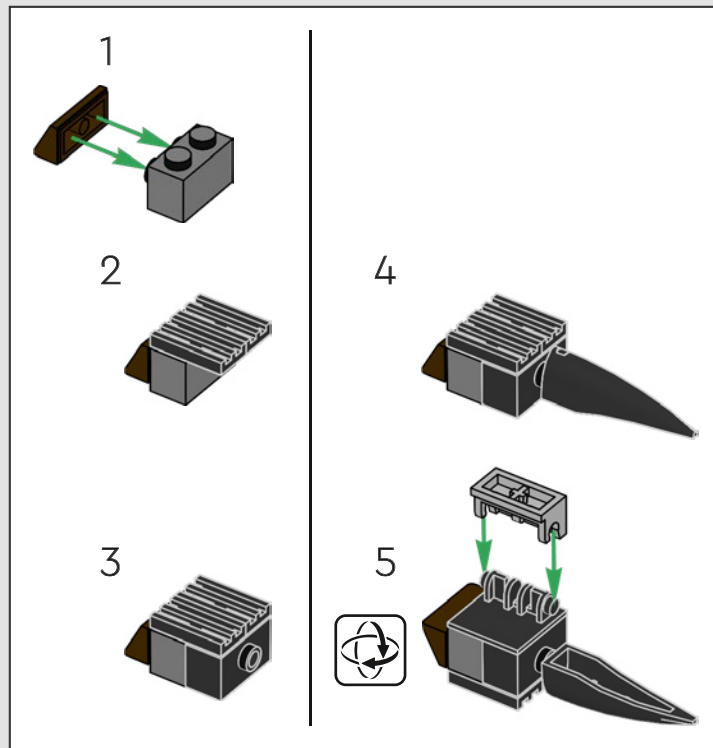

305



 Copie multiple della sezione della torre possono essere impilate insieme con il semplice sistema di costruzione modulare.

306

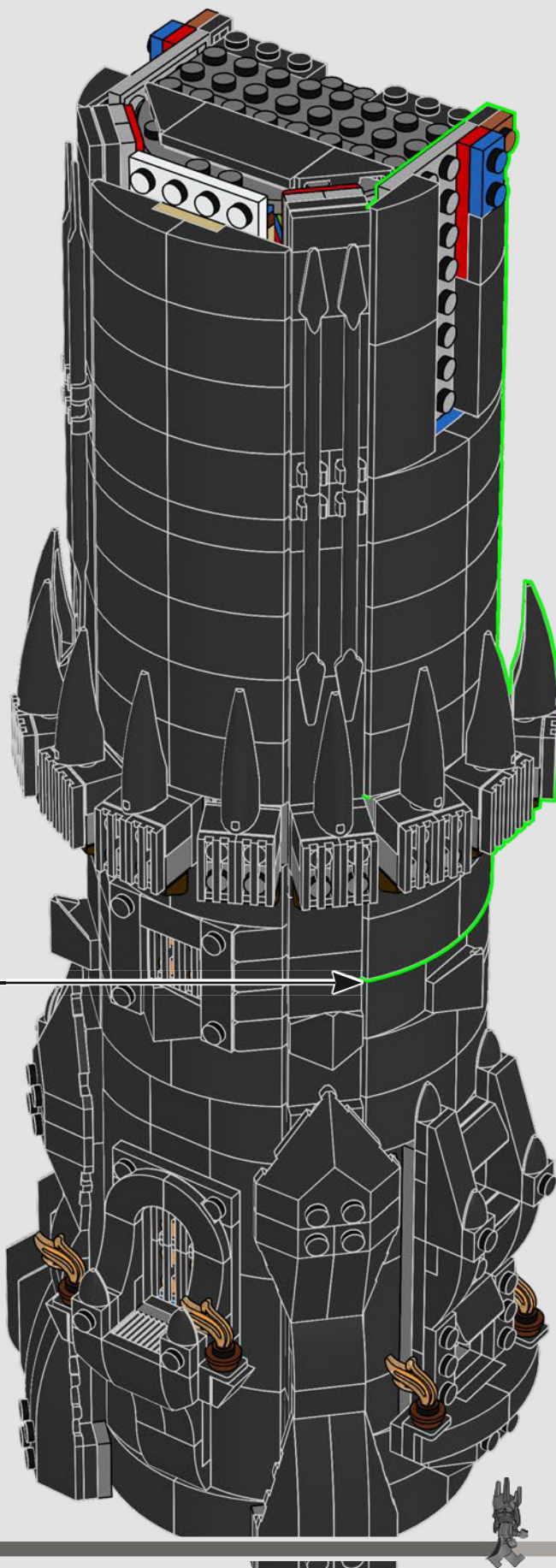

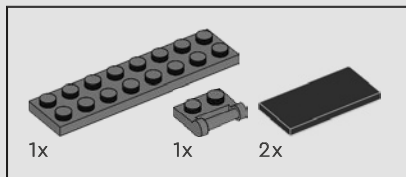

307

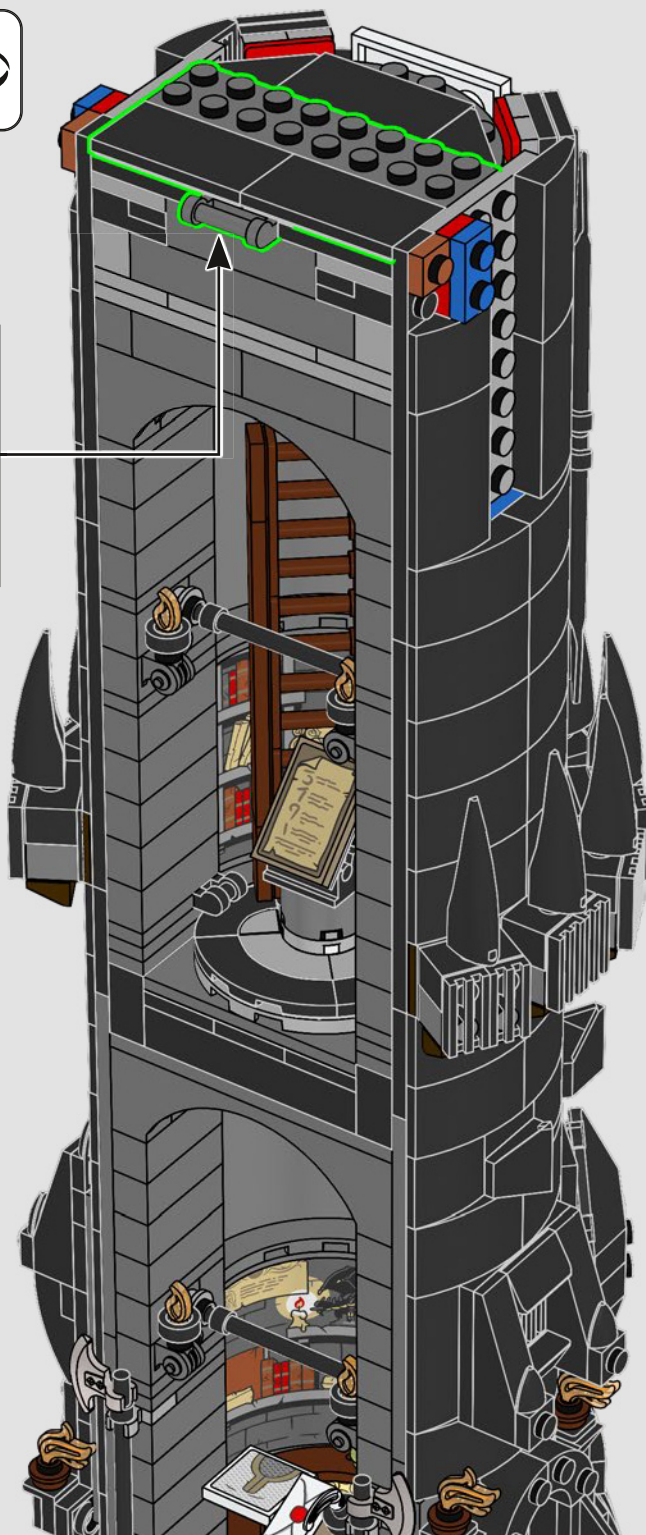
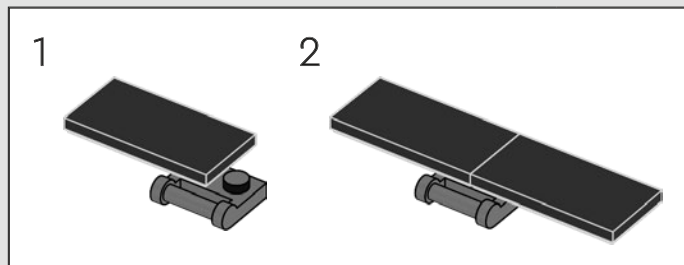



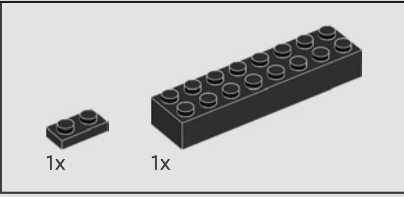
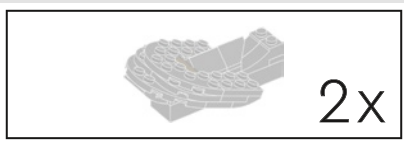

308

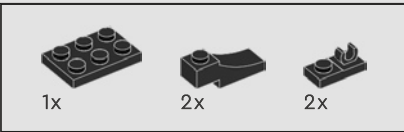
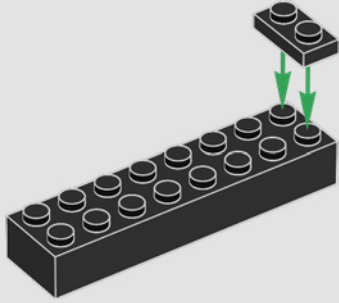

309

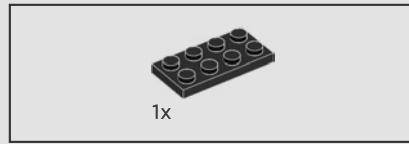
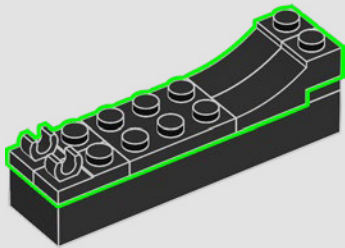

310

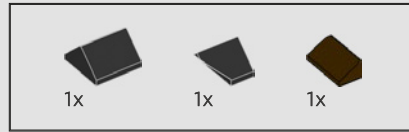
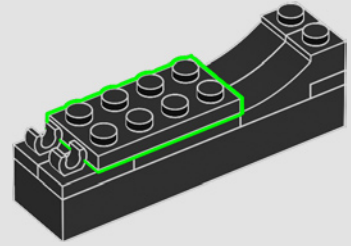

311

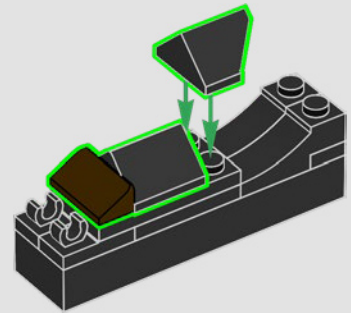

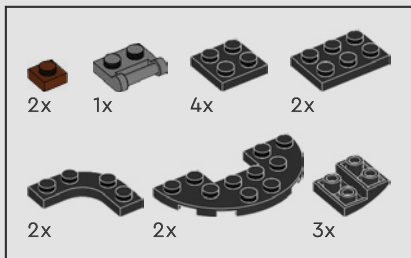

312

1



2

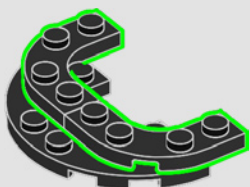

3

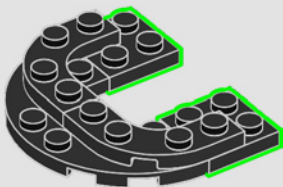

4

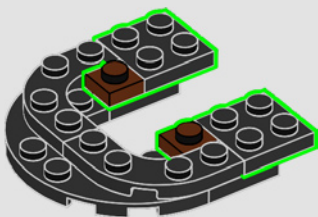

5

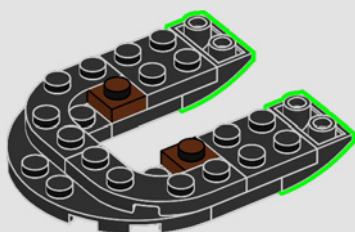

6

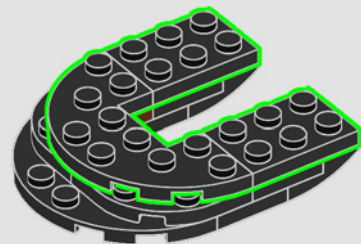

7

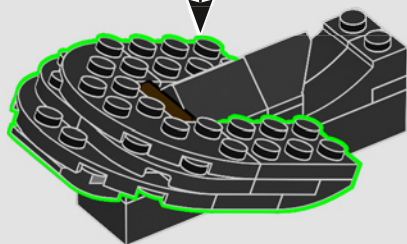
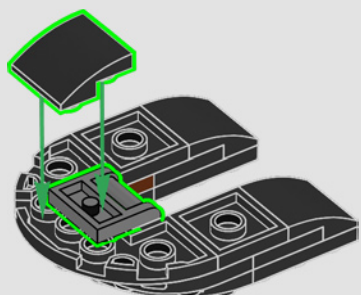

2x

313



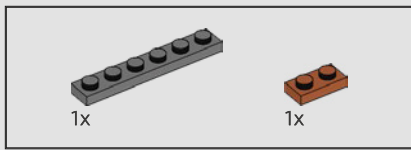

314

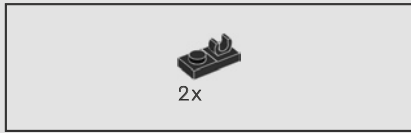
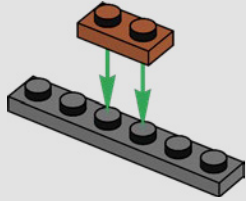

315

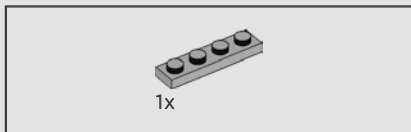
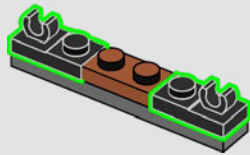

316

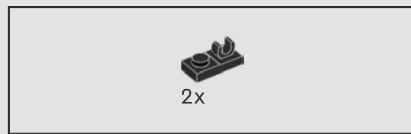
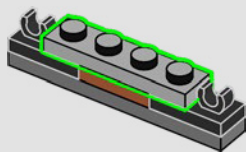

317

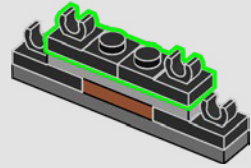

318

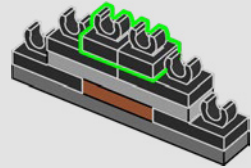

319

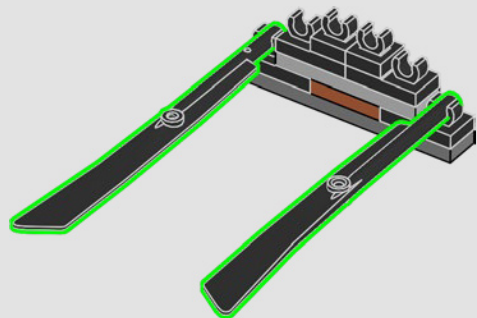

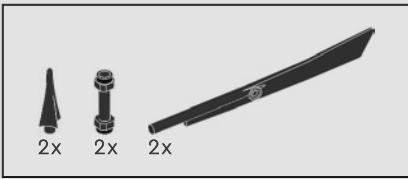

320

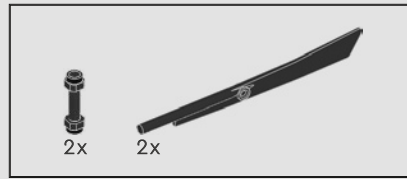
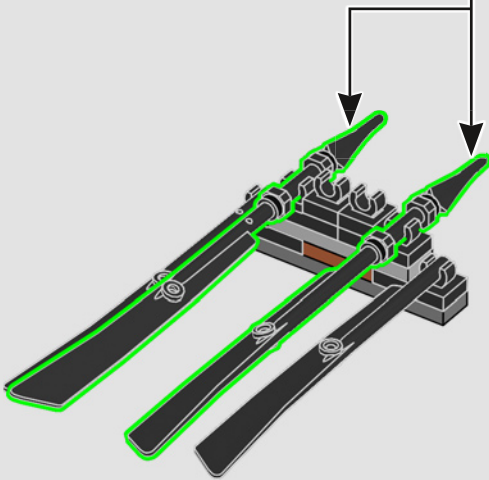
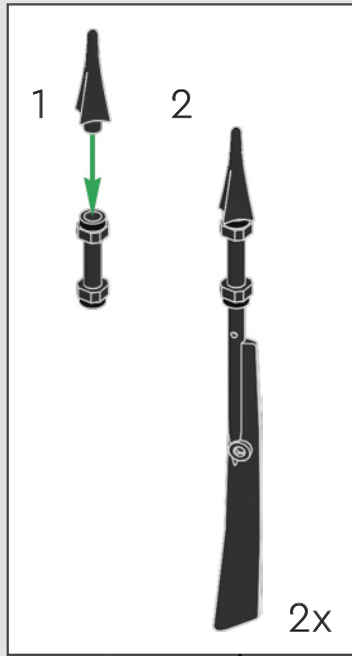

321

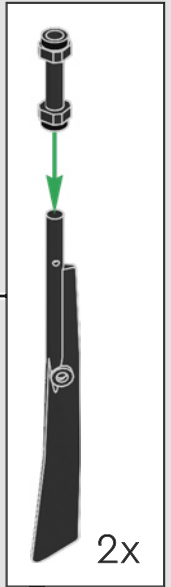
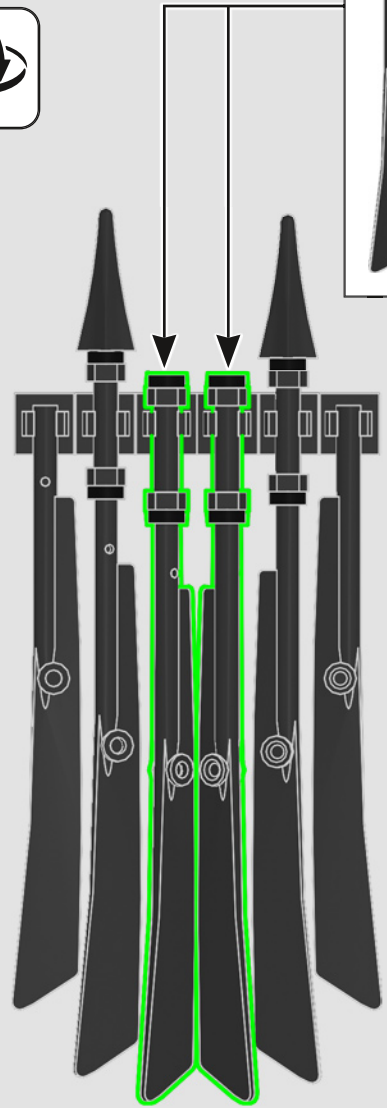



L'elemento lama è stato ricolorato di nero per questo set.



322

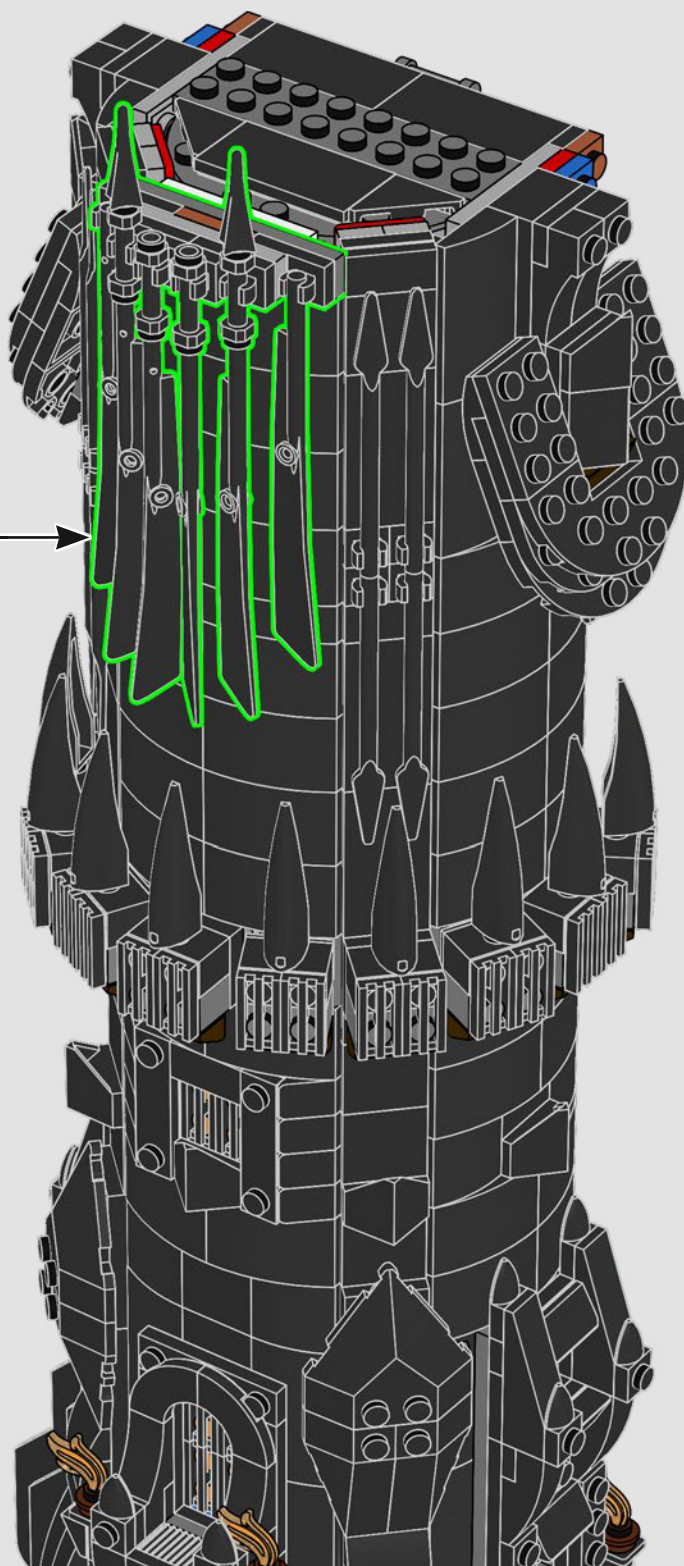

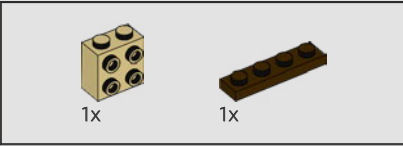
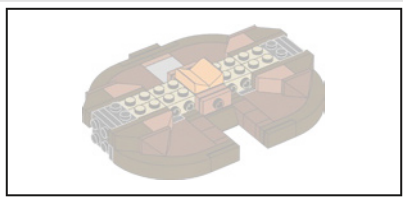

323

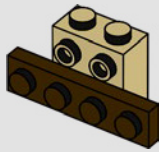

324

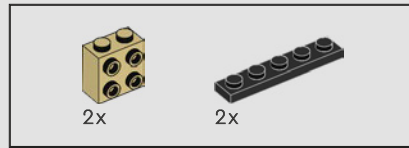
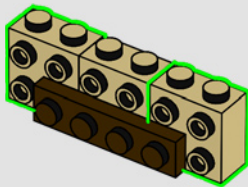

325

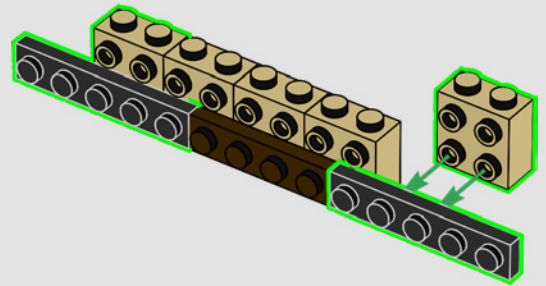

326

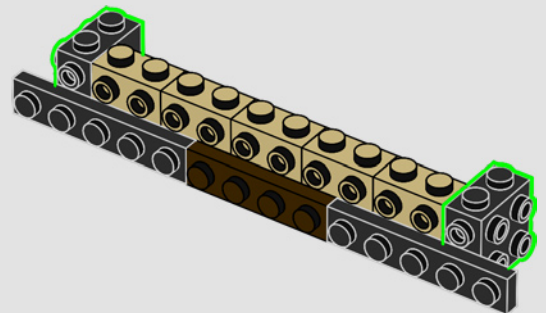

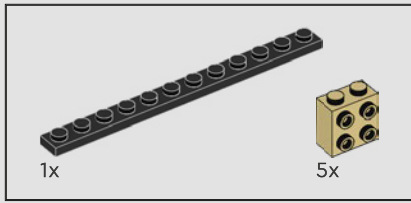

327

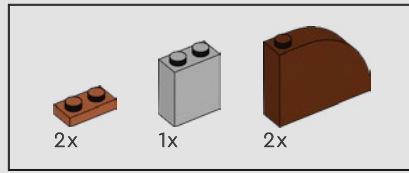
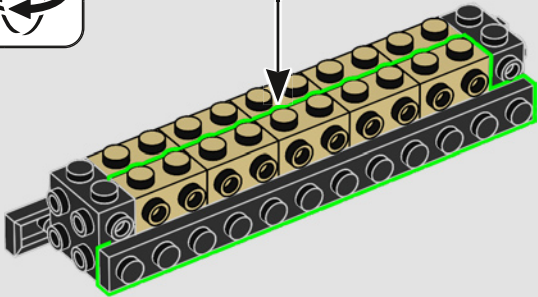
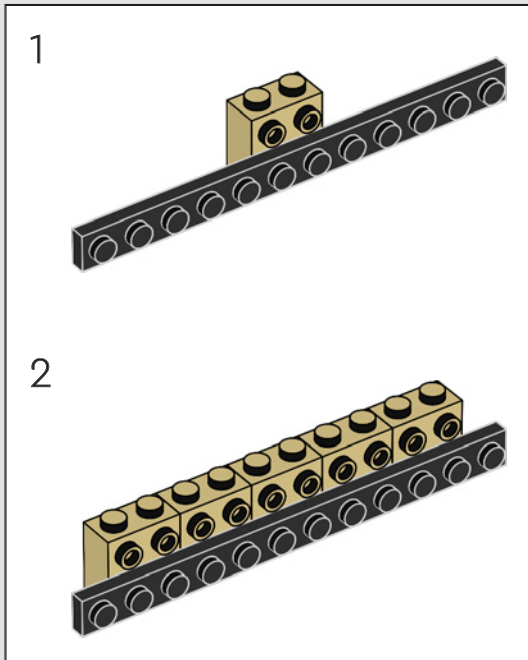

328

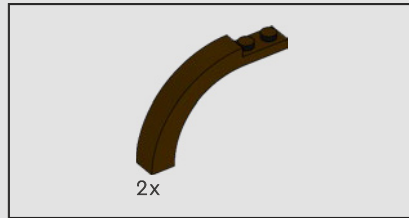
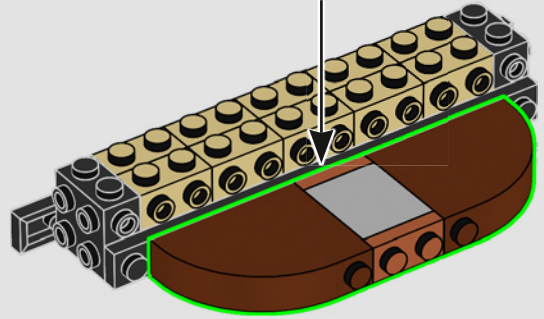
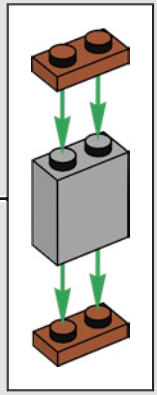

329

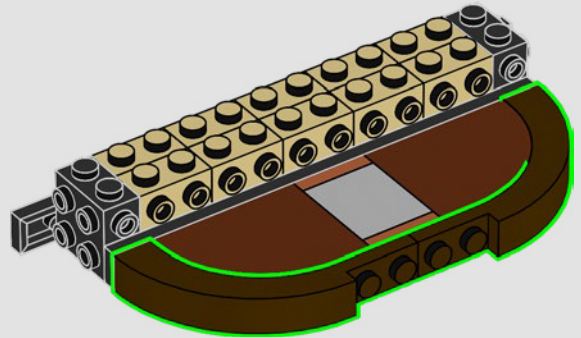



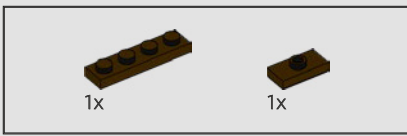

330

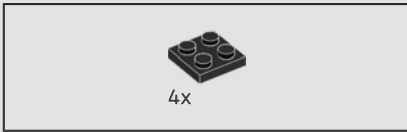
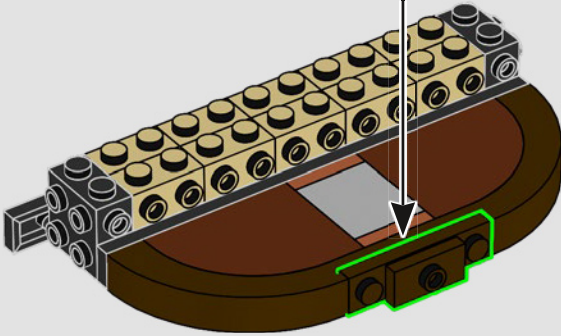
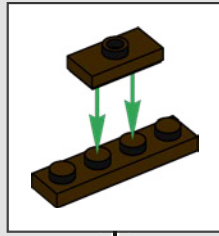

331

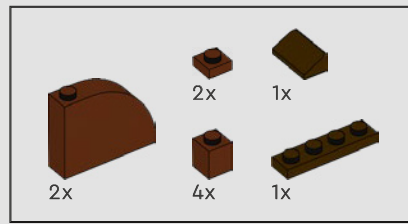
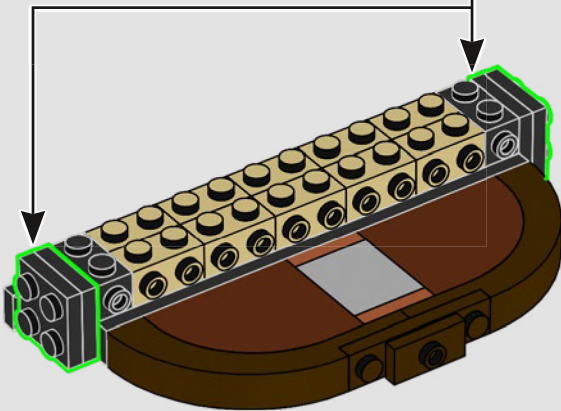
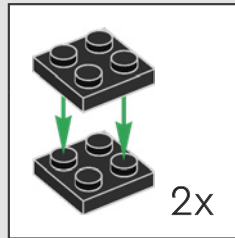

332

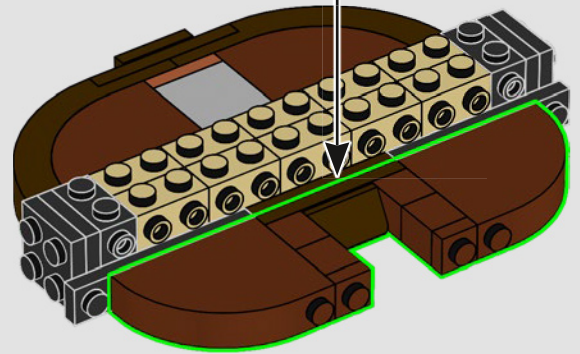
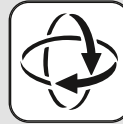
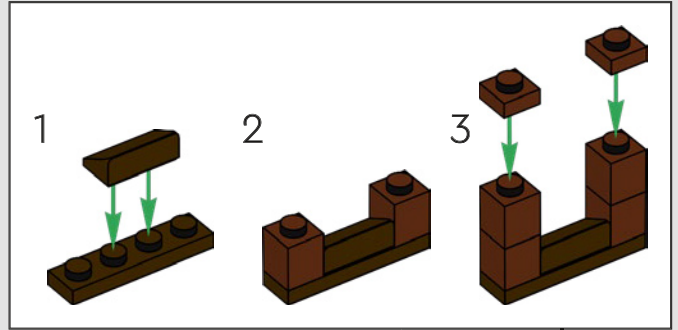

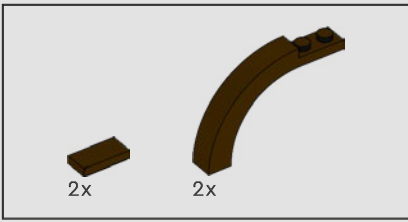

333

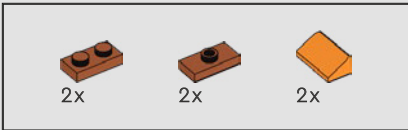
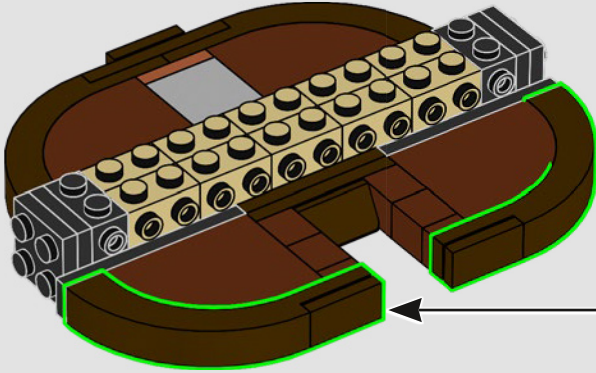
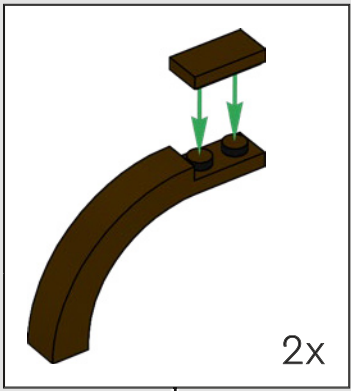

334

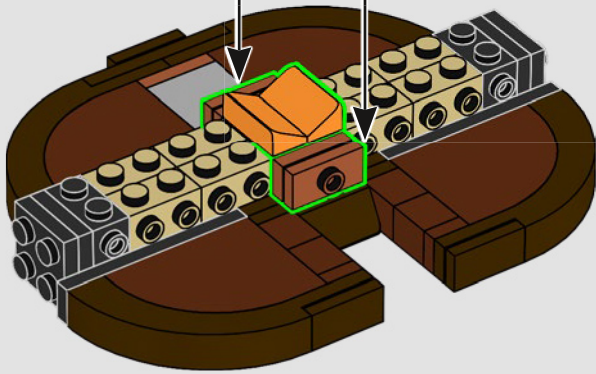
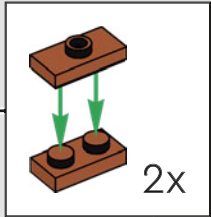

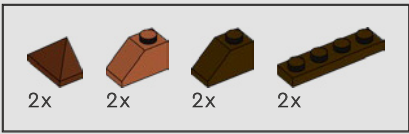

335

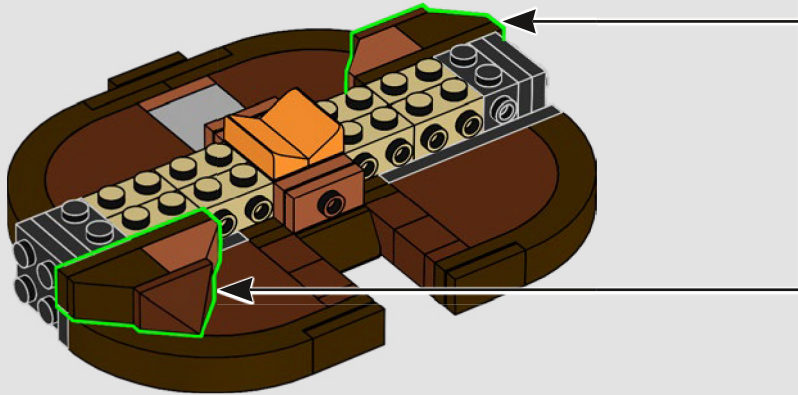
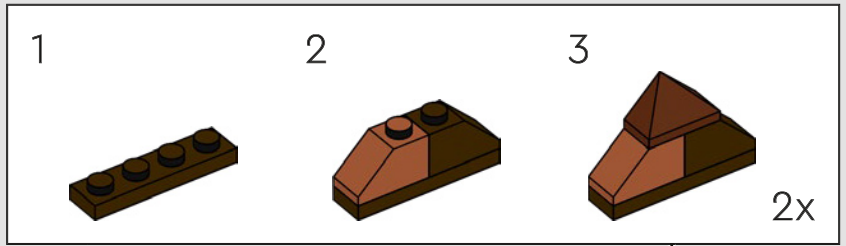

336

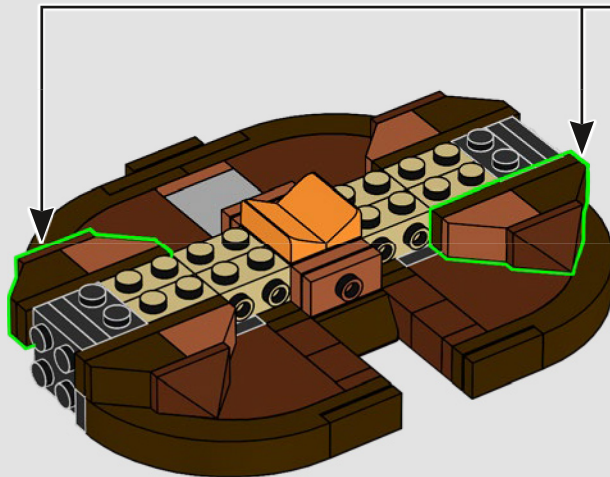
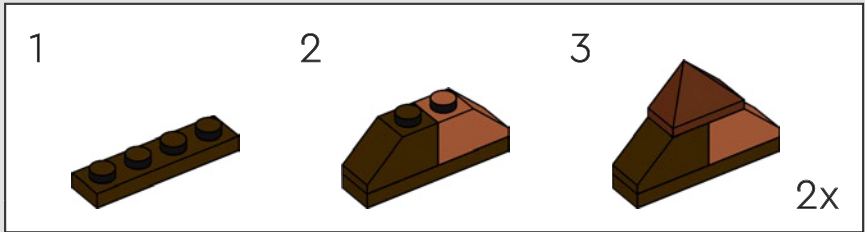

337

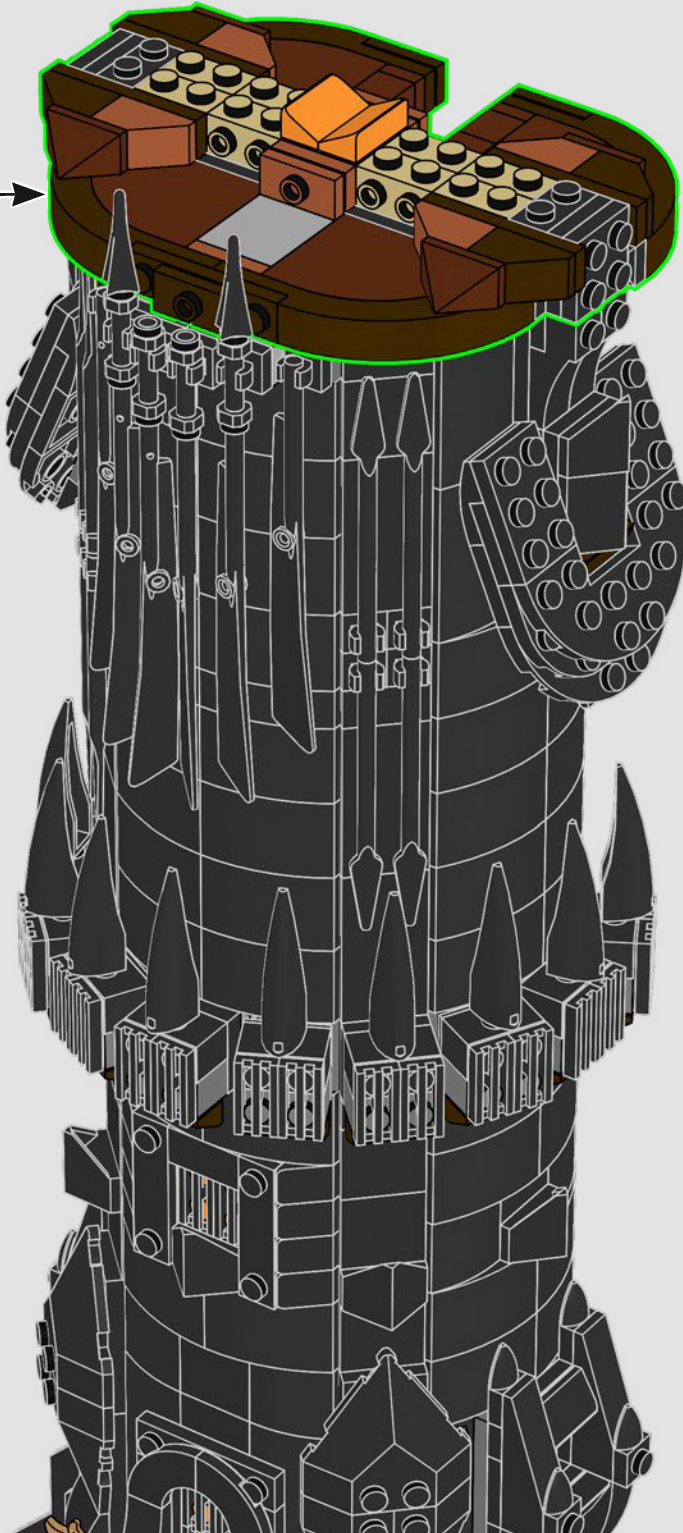

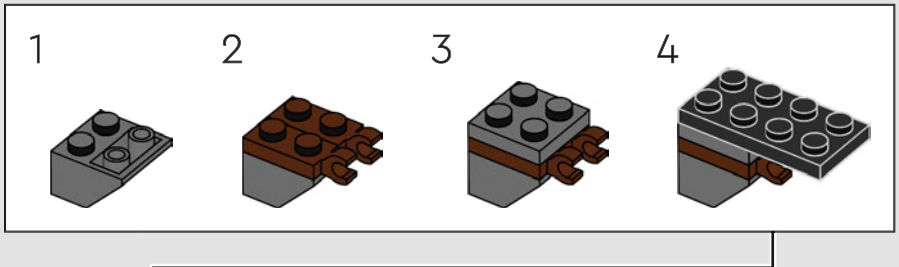
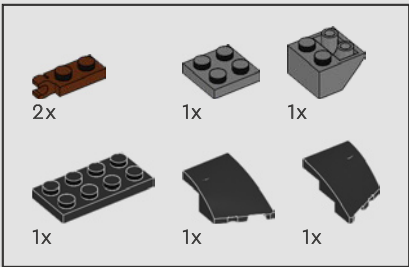

338

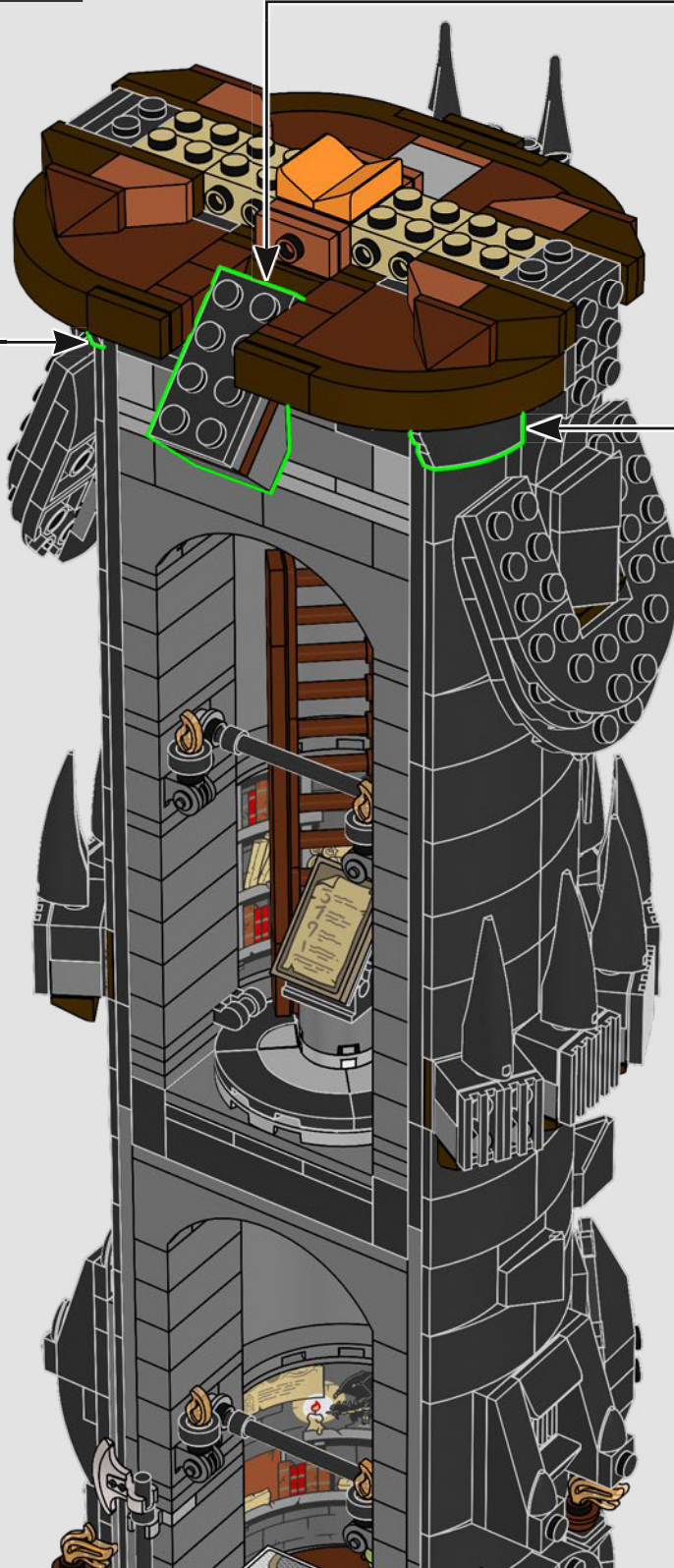

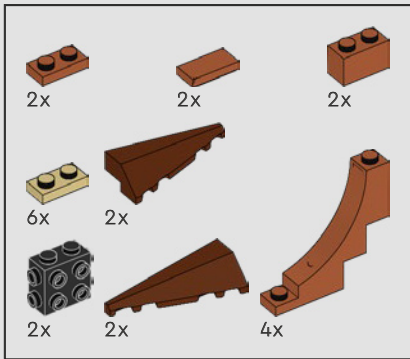
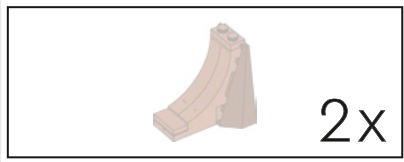

339

1

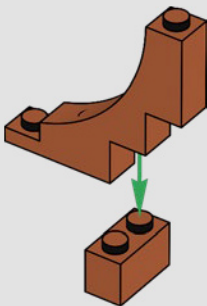

2

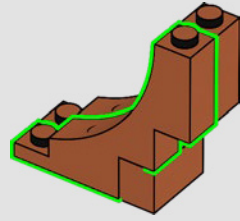

3

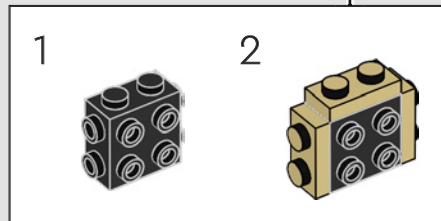
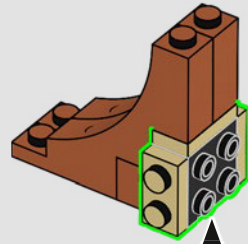

4

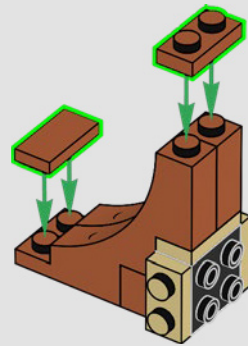

5

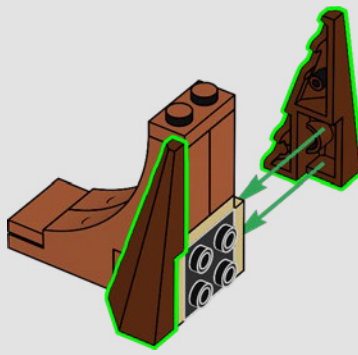

2x

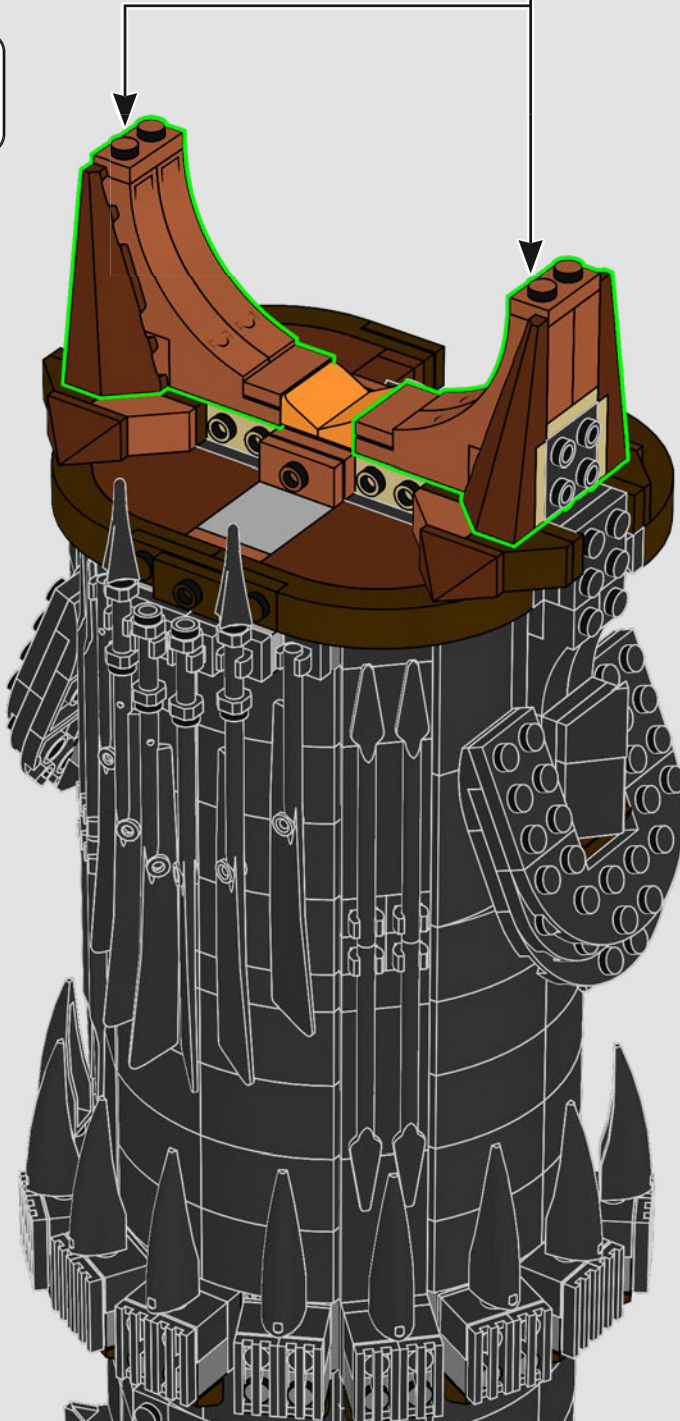

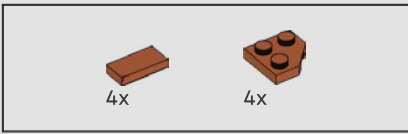

340

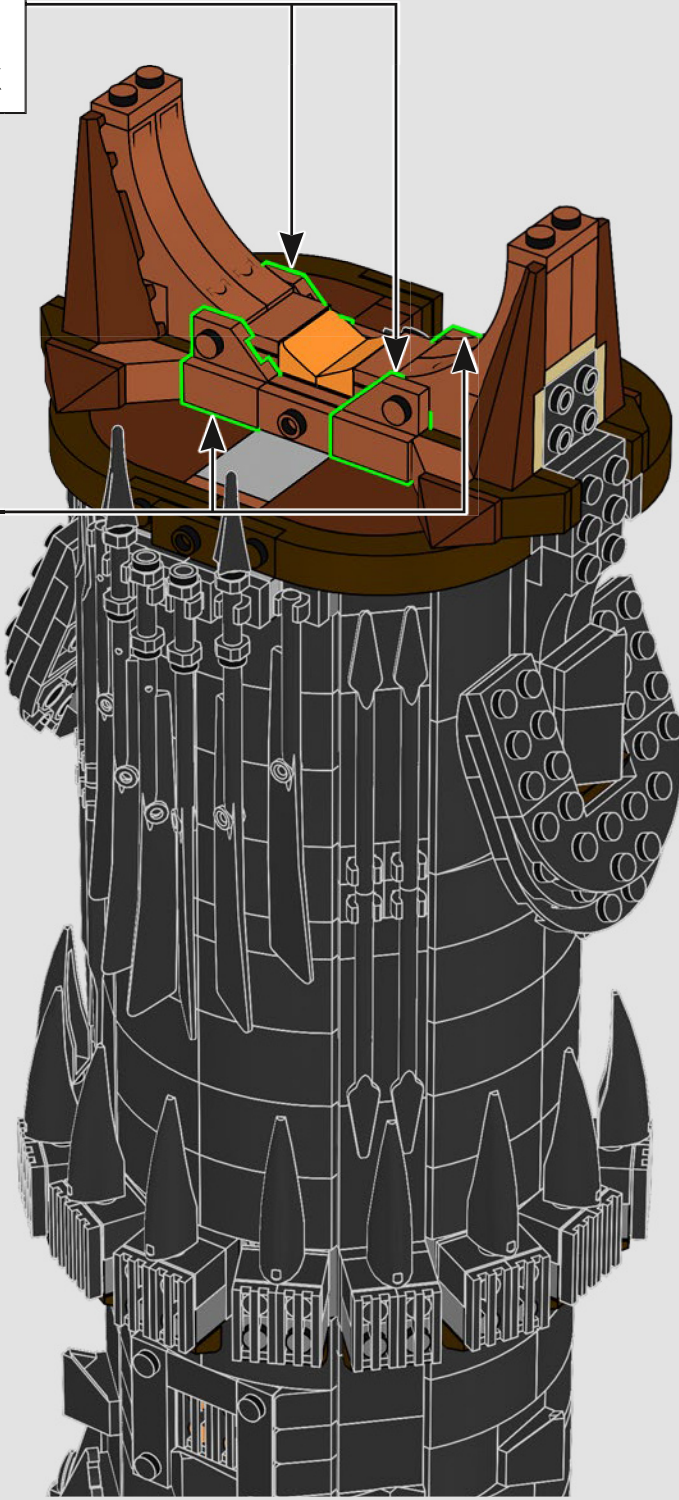
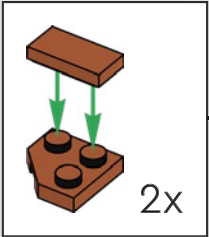
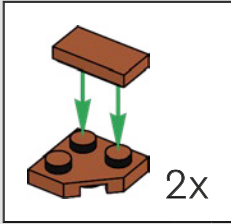



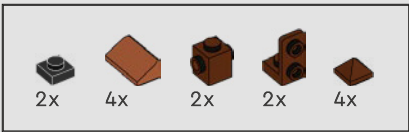

341

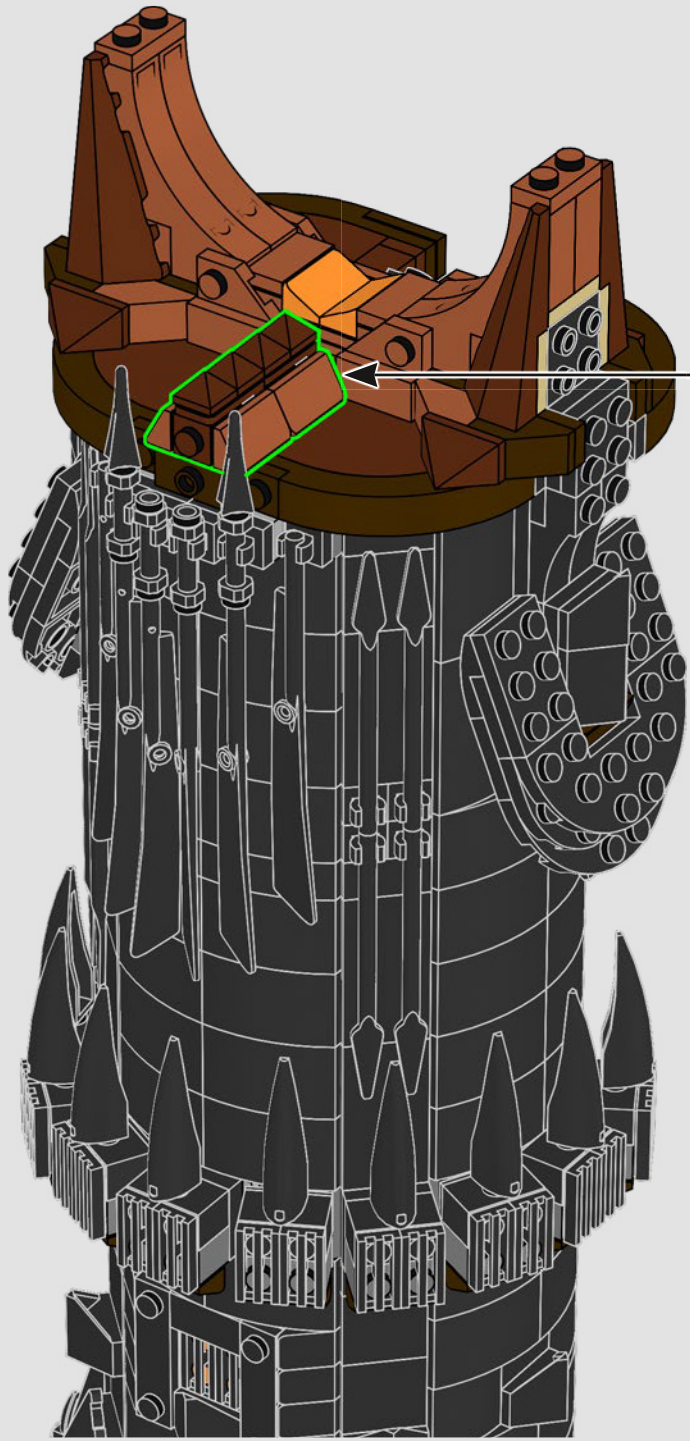
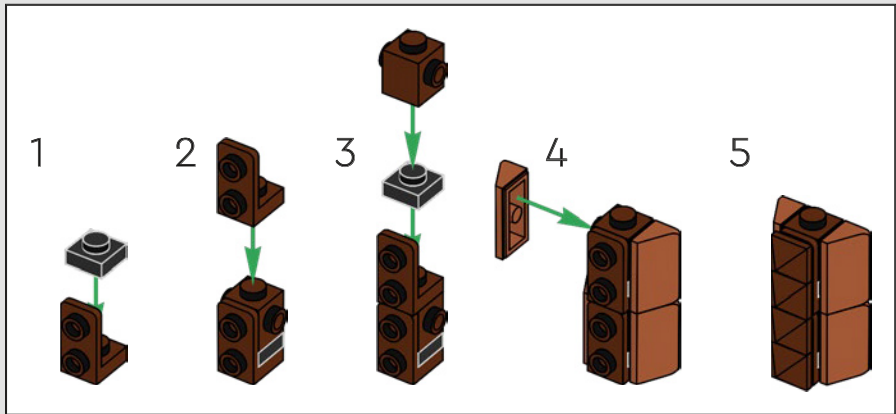

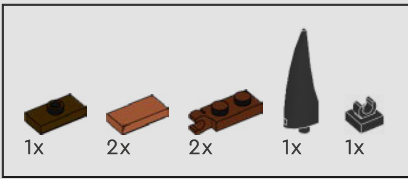

342

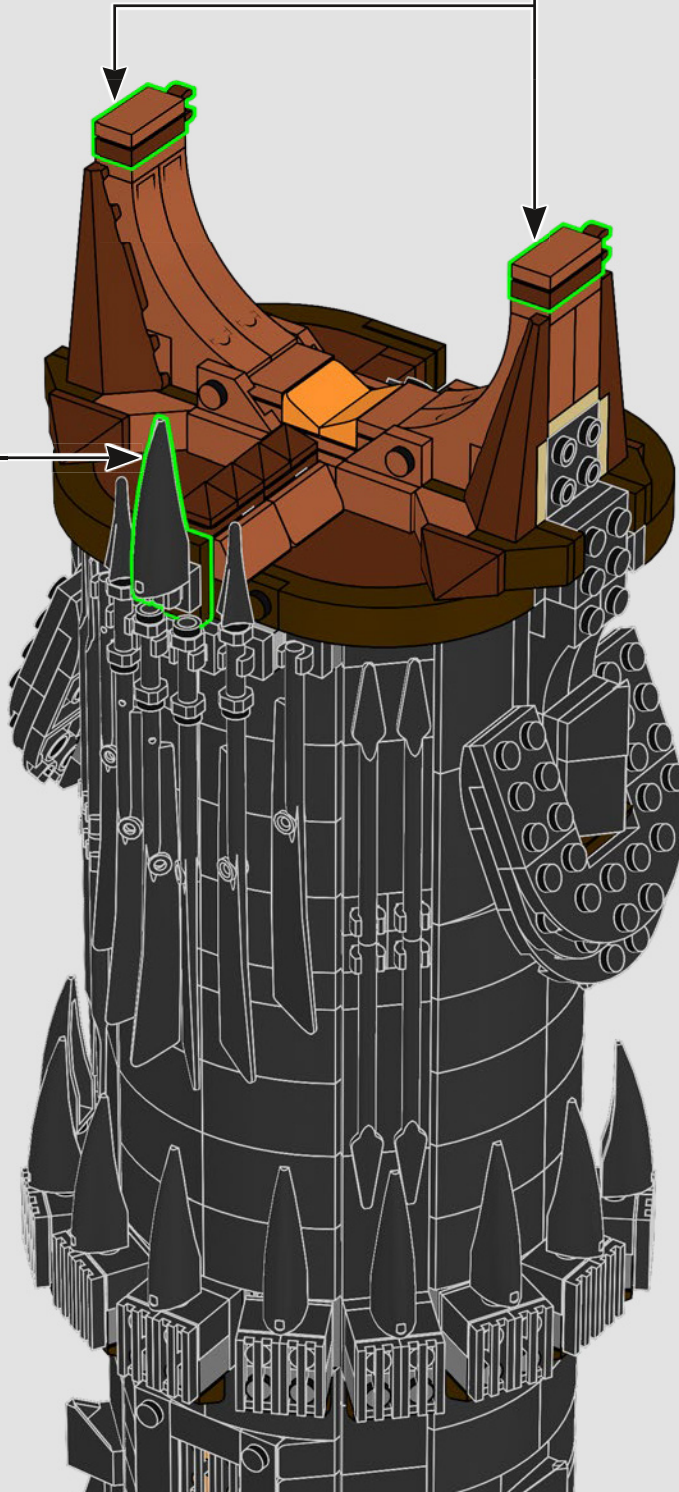
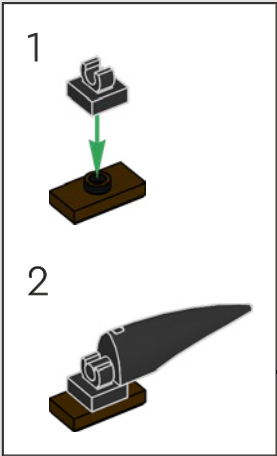
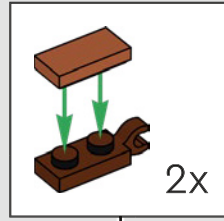

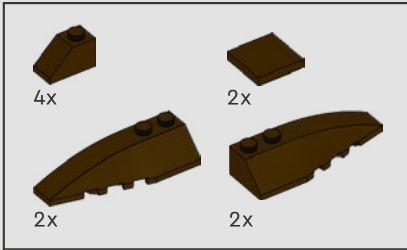
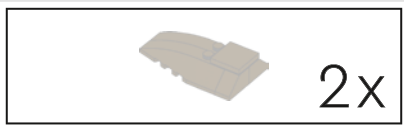

343

1

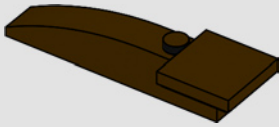

2

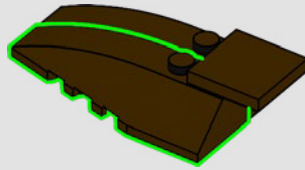

3

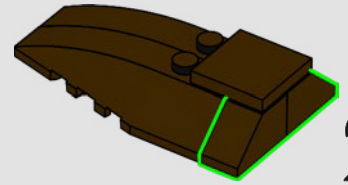

2x

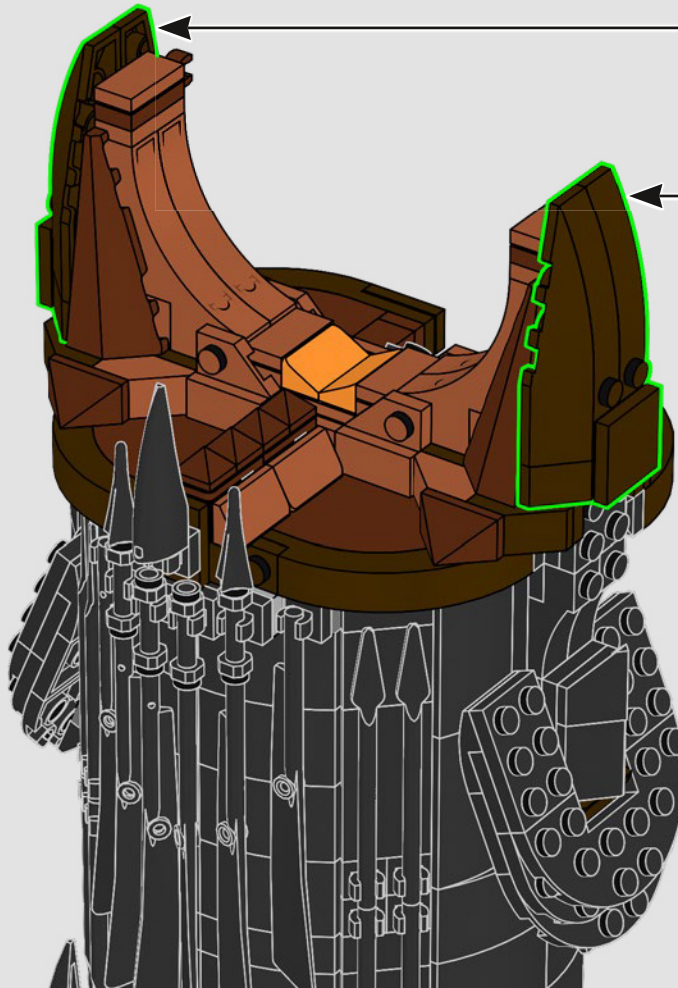

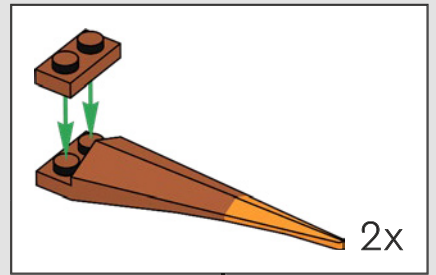
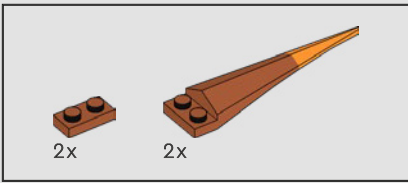

344

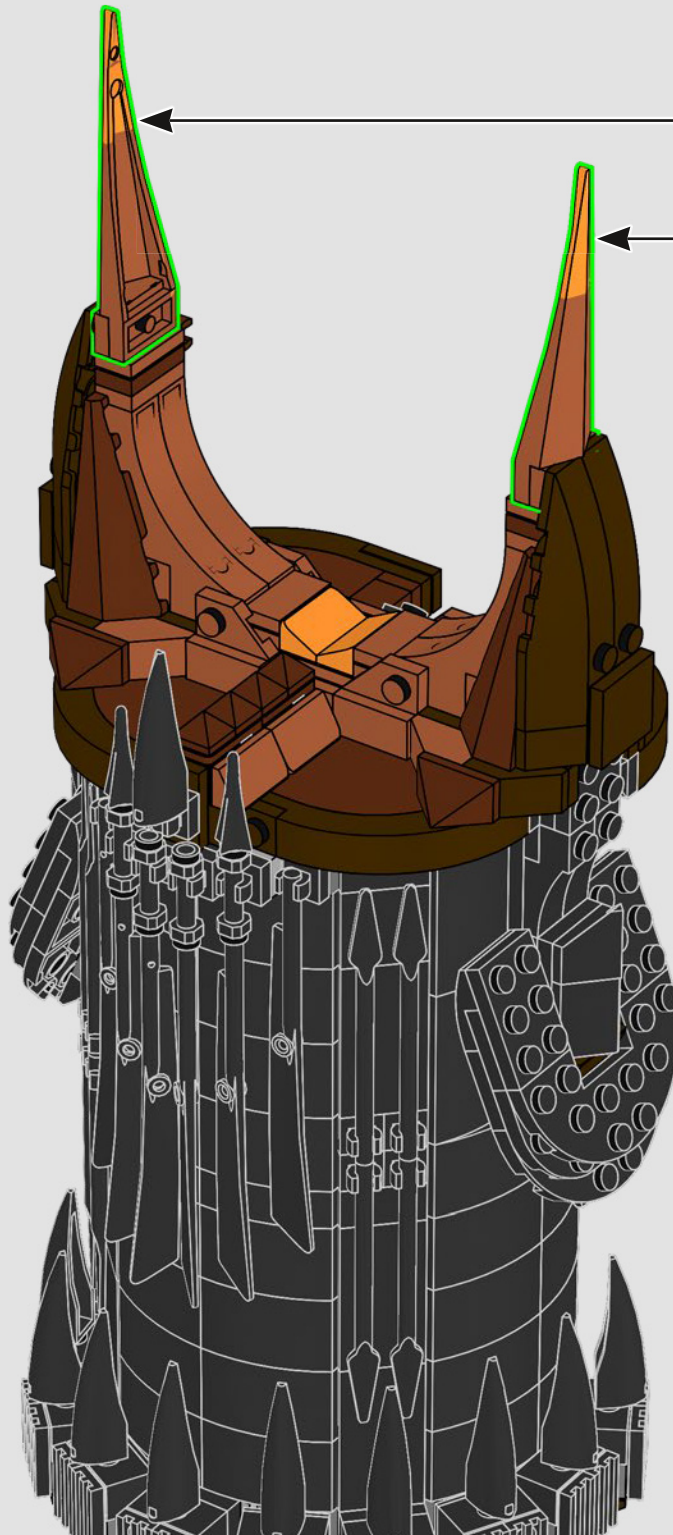

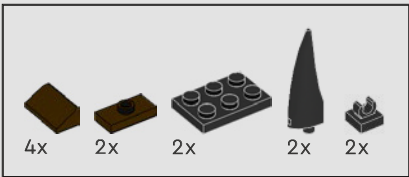

345

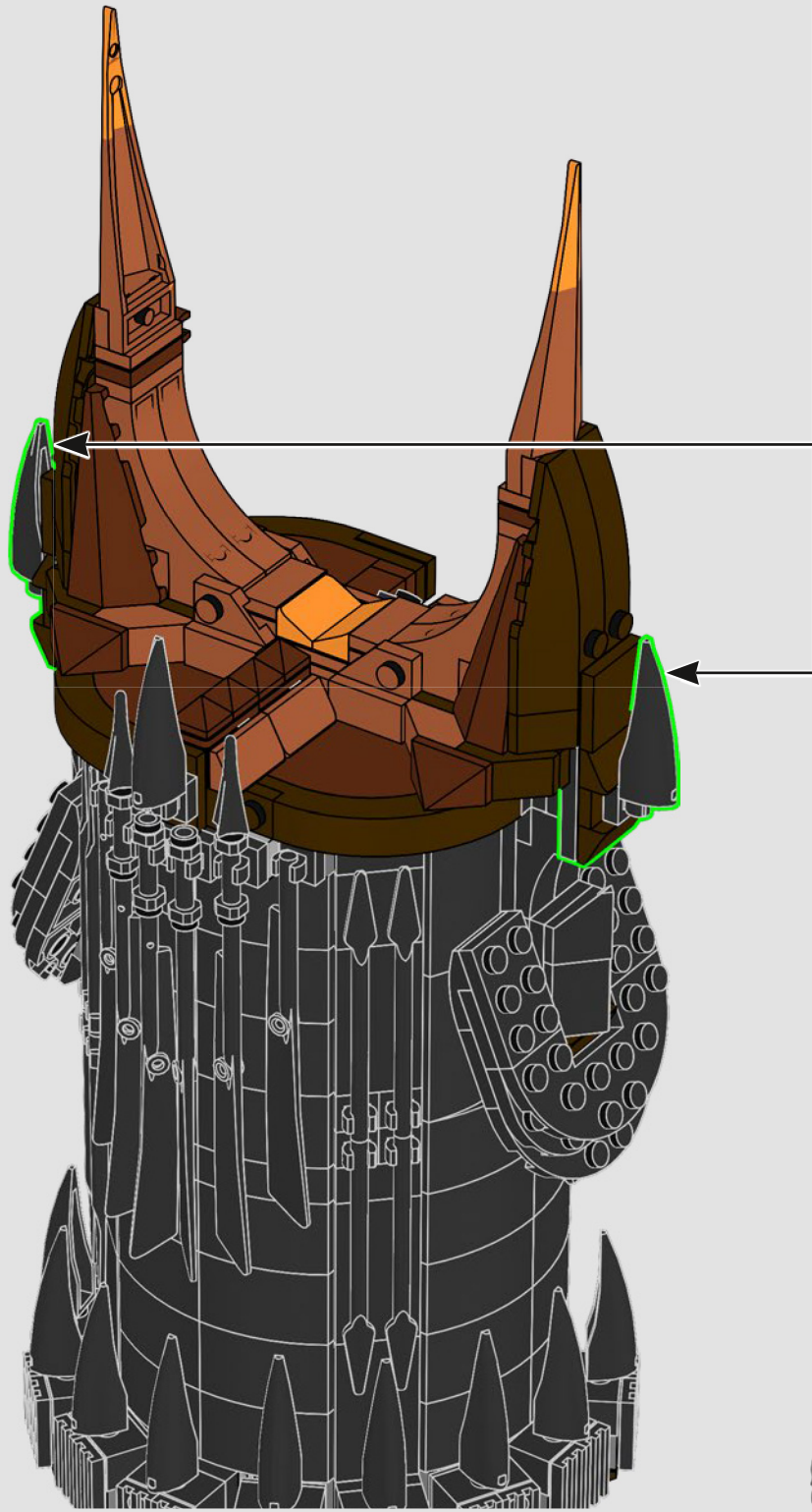
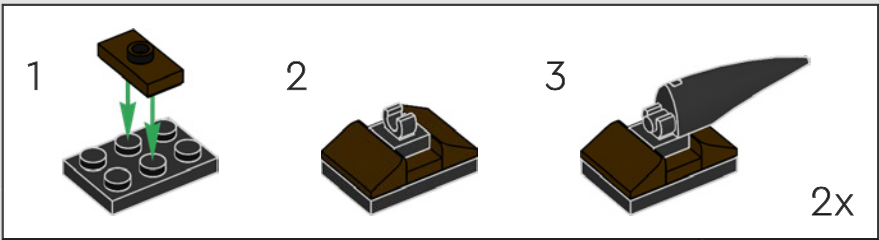



Per creare la forma dell'occhio è stato utilizzato un elemento parafango.

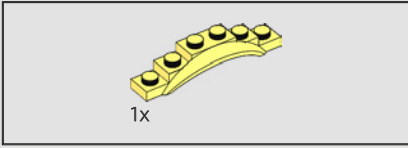
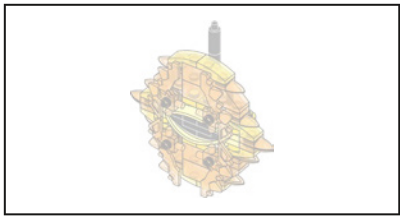

346

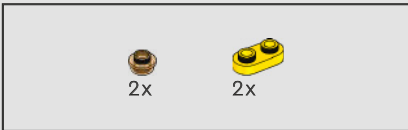
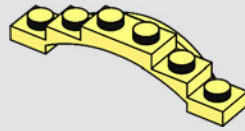

347

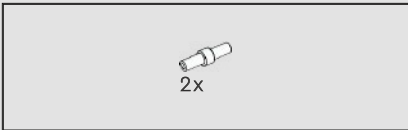
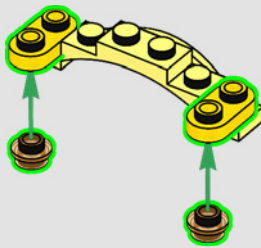

348

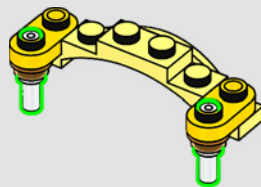

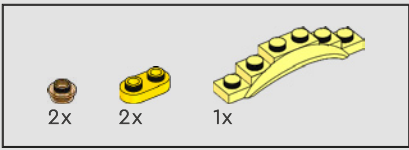

349

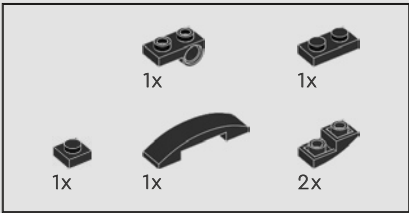
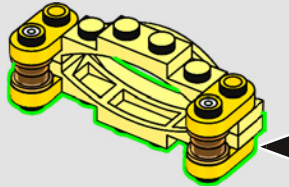
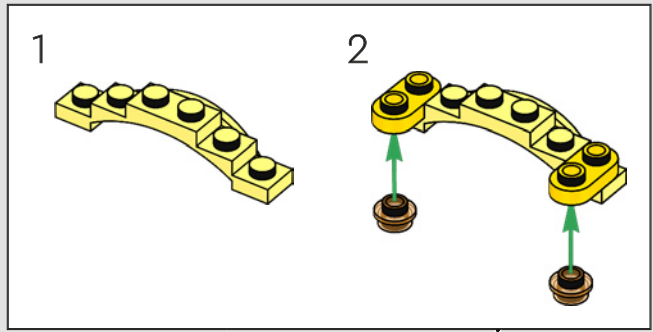

350

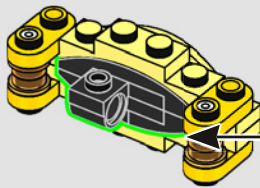
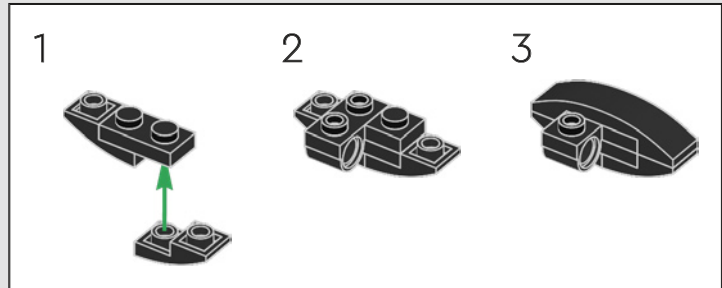

351

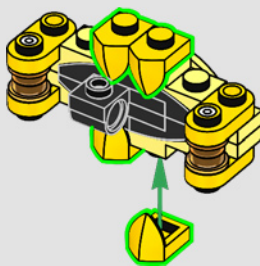

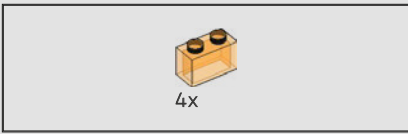

352

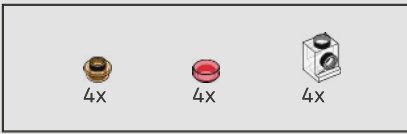
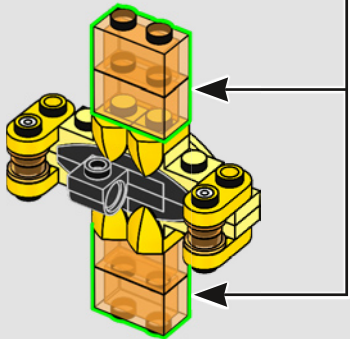
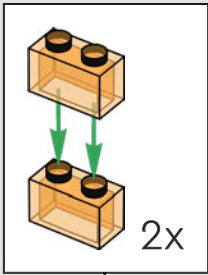

353

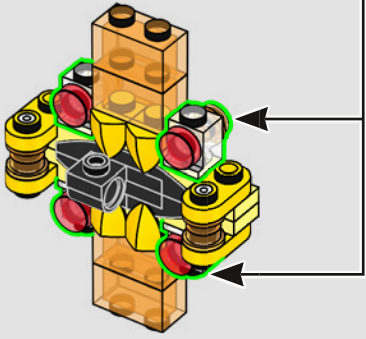
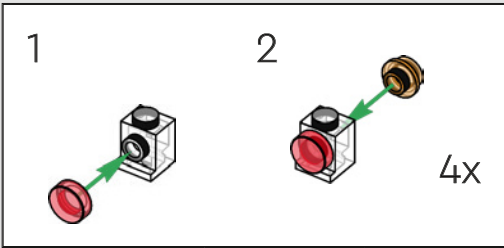



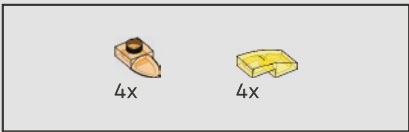

354

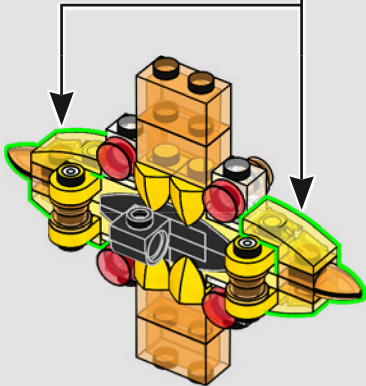
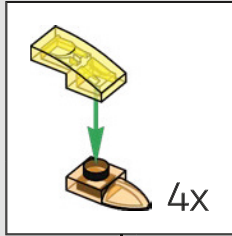

355

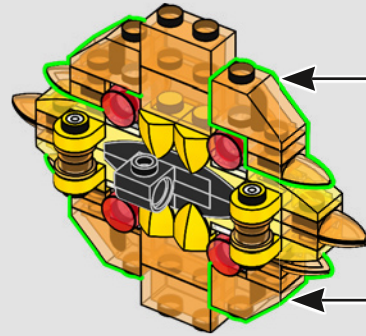
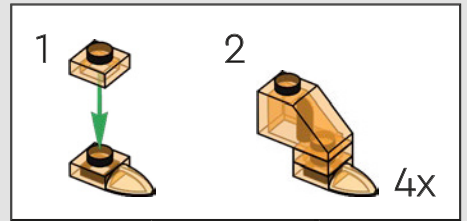

356

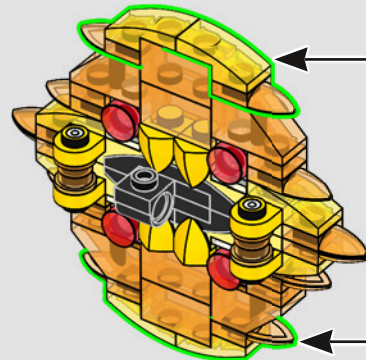
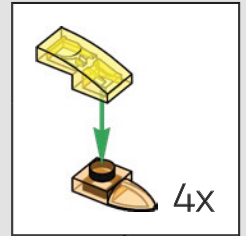



357

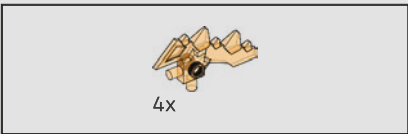
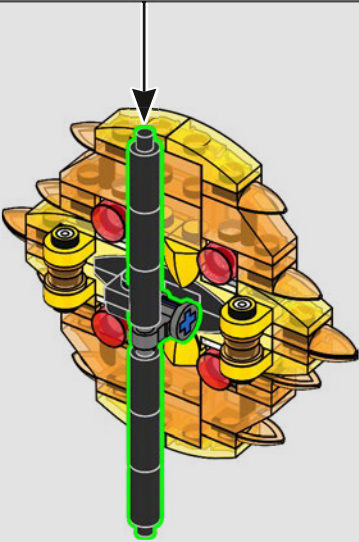
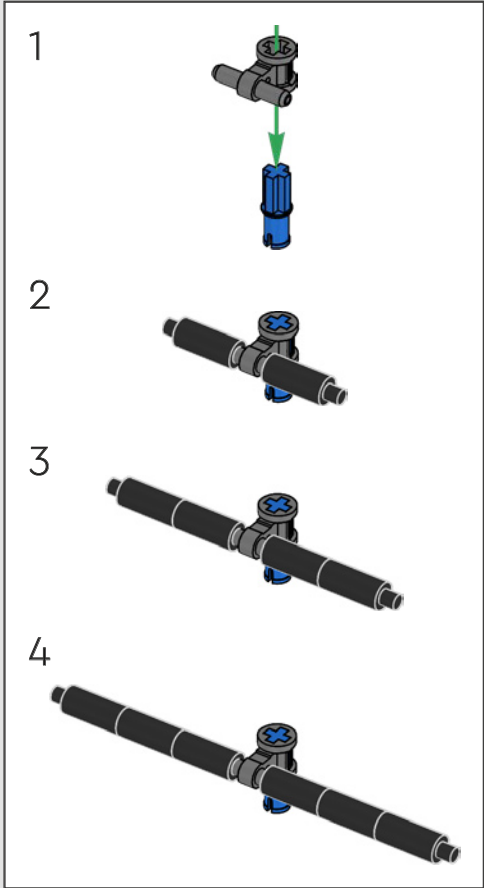

358

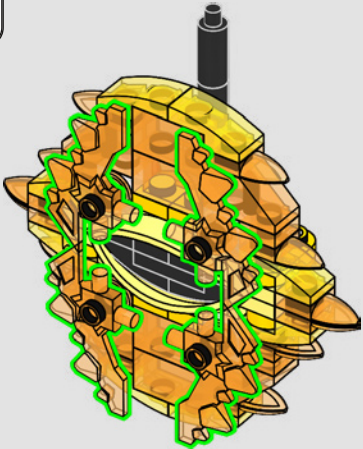



359

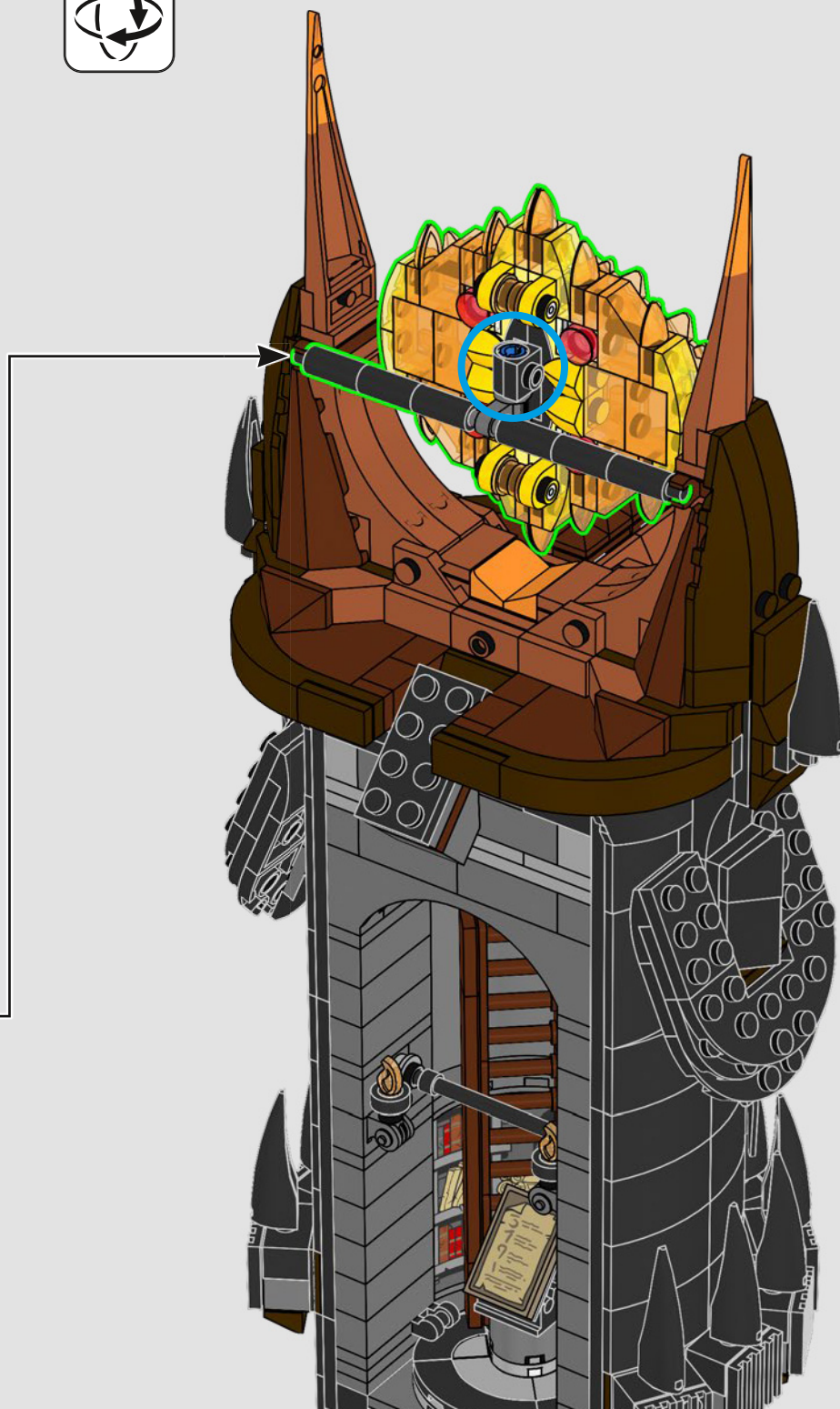

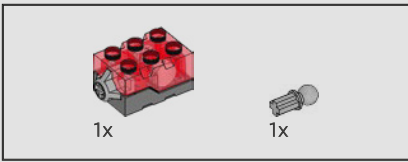

360

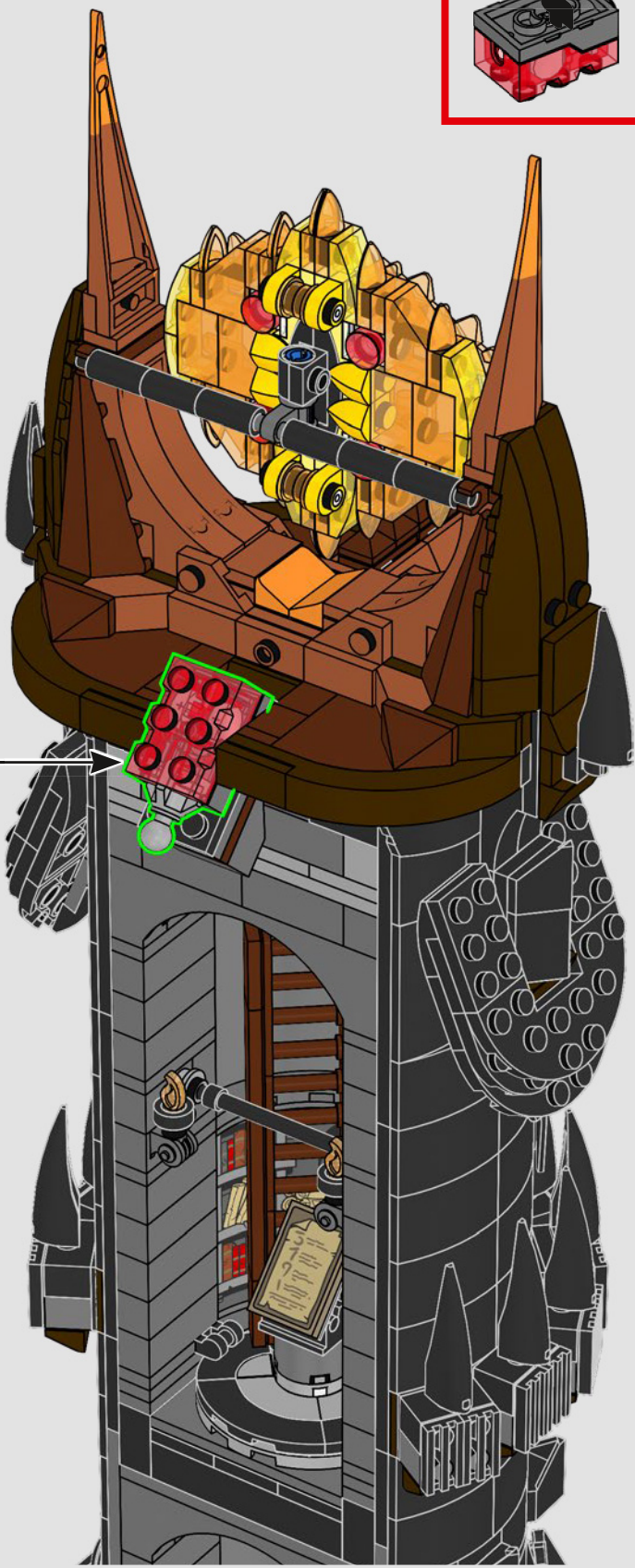
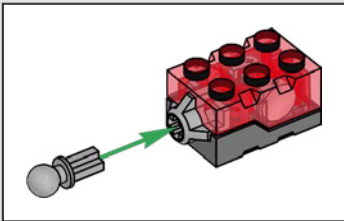
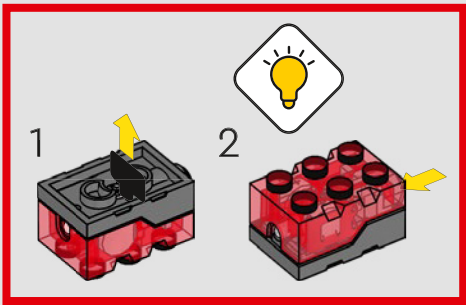

361

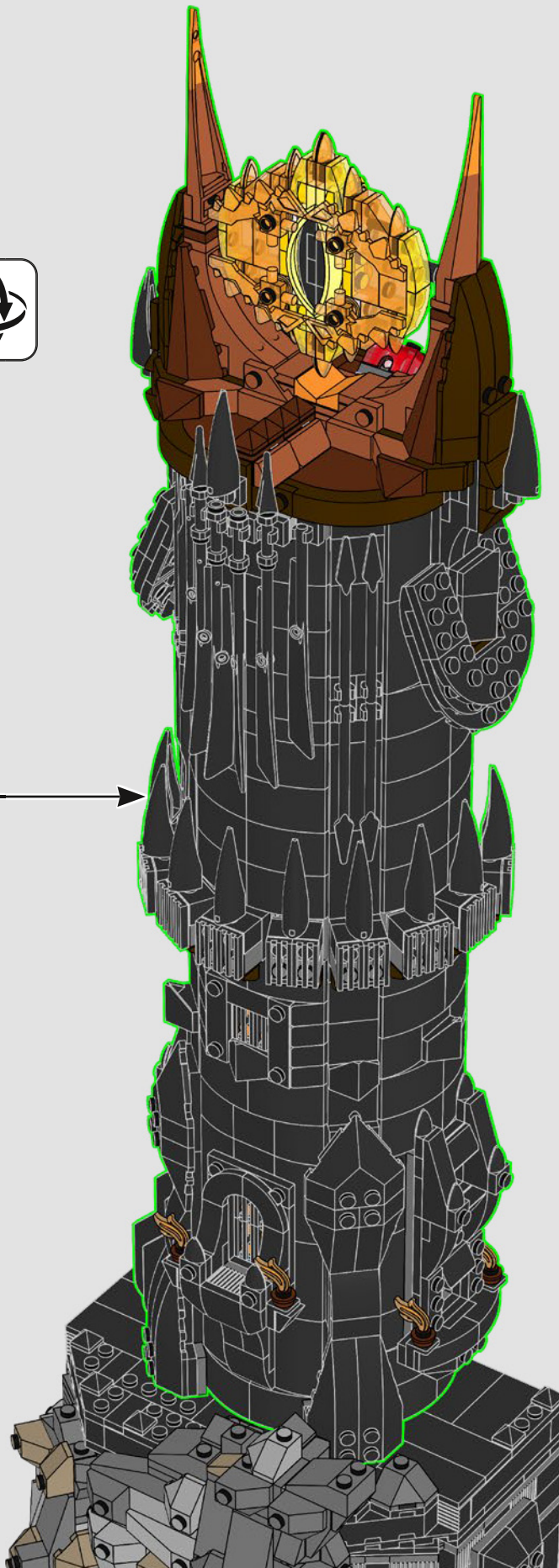

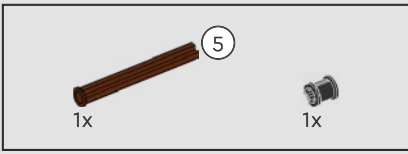

362

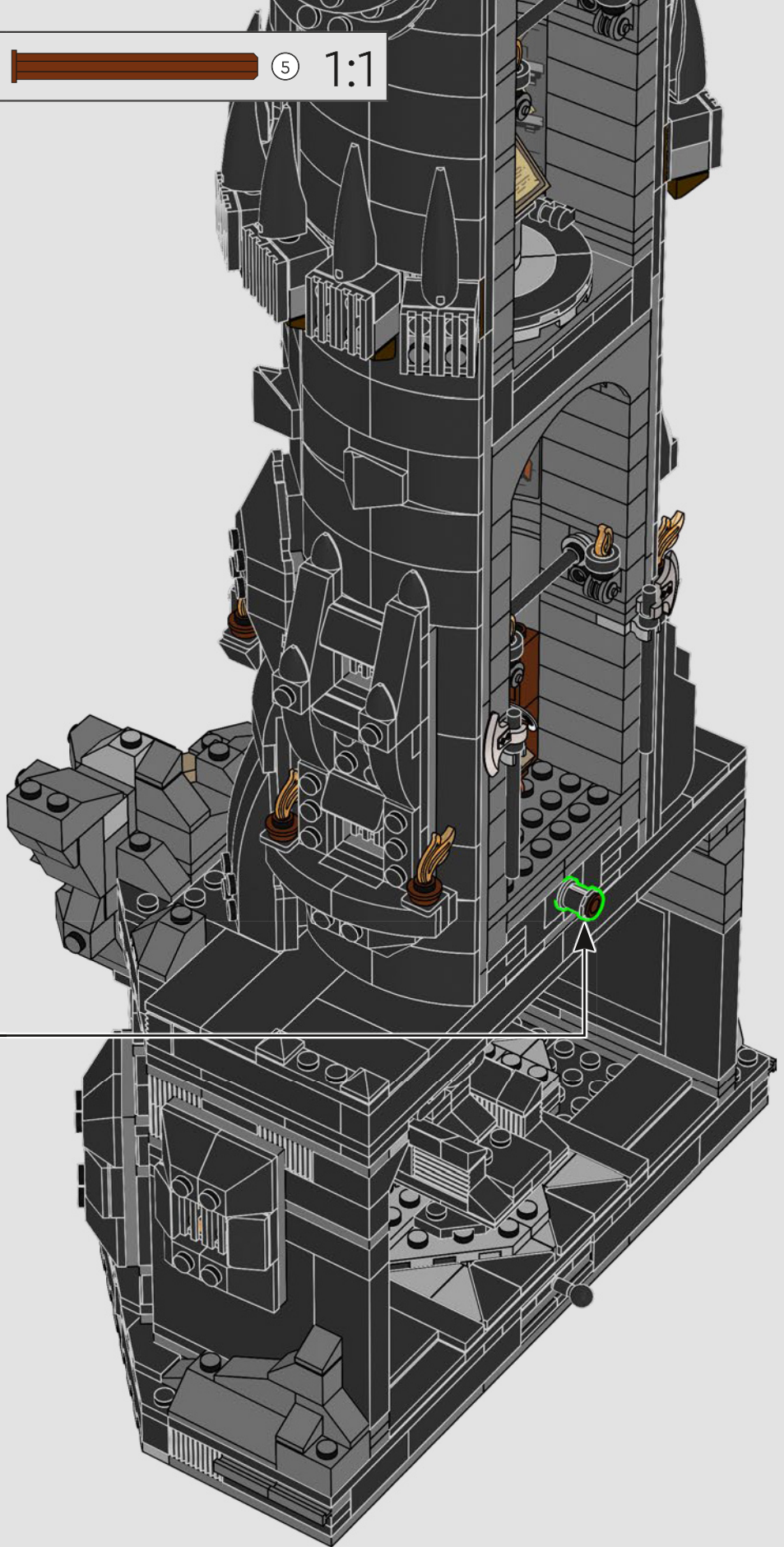
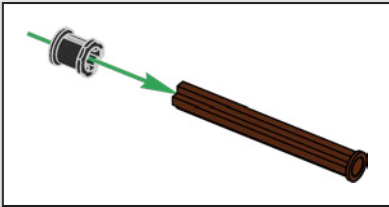

363



"Rinchiuso nella sua fortezza, il Signore di Mordor vede tutto. Il suo sguardo trafigge nuvole, ombre, terra e... carne. Tu sai a cosa mi riferisco, Gandalf. Un grande occhio, senza palpebre, avvolto nelle fiamme" – Saruman



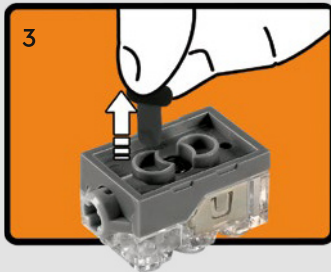
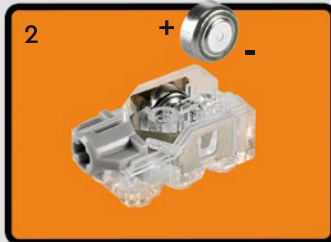

1:1  
2x LR 41 1.5V



**EN****Important information about batteries**

Never use different types of batteries together, or a combination of old and new batteries. Always remove the batteries if the product is not to be used for a long time or if the batteries have run down. Never use damaged batteries. Only use alkaline type batteries. Insert the batteries so that the poles are correctly positioned. Never attempt to recharge non-rechargeable batteries. Never short-circuit the battery holder.

**DE****Wichtige Informationen zu Batterien**

Benutzen Sie niemals unterschiedliche Arten von Batterien oder alte und neue gleichzeitig. Nehmen Sie stets die Batterien heraus, wenn mit dem Modell längere Zeit nicht gespielt wird oder wenn die Batterien leer sind. Verwenden Sie niemals beschädigte Batterien. Verwenden Sie ausschließlich Alkali-Batterien. Achten Sie beim Einsetzen der Batterien auf die richtige Polung. Versuchen Sie unter keinen Umständen, „normale“ Batterien wieder aufzuladen. Schließen Sie das Batteriefach niemals kurz.

**FR****Informations importantes concernant les piles**

Ne jamais utiliser un mélange de différents types de piles, ou de piles neuves et de piles anciennes ou déjà utilisées. Toujours retirer les piles si le produit n'est pas utilisé durant une période prolongée ou si les piles sont vides. Ne jamais utiliser de piles endommagées. N'utiliser que des piles alcalines. En insérant les piles, respecter scrupuleusement le sens d'orientation des pôles (+/-). Ne jamais essayer de recharger des piles non rechargeables. Ne jamais court-circuiter le compartiment des piles.

**IT****Importanti informazioni sulle batterie**

Non usare mai contemporaneamente batterie di tipo diverso o batterie nuove e usate insieme. Rimuovere sempre le batterie qualora il prodotto non venga utilizzato per periodi prolungati, oppure se le batterie sono esauste. Non utilizzare mai batterie danneggiate. Utilizzare solo batterie di tipo alcalino. Inserire le batterie avendo cura che la loro polarità sia corretta. Non tentare mai di ricaricare batterie non ricaricabili. Non cortocircuitare mai il portabatterie.

**NL****Belangrijke informatie over batterijen**

Gebruik nooit verschillende soorten of een combinatie van oude en nieuwe batterijen tegelijkertijd. Verwijder de batterijen altijd als je het product lange tijd niet wilt gebruiken of als batterijen leeg zijn. Gebruik nooit beschadigde batterijen. Gebruik alleen alkalinebatterijen. Plaats de batterijen met de polen in de juiste richting. Probeer nooit niet-oplaadbare batterijen opnieuw op te laden. Laat de batterijhouder nooit kortsluiten.

**ES****Información importante acerca de las pilas**

No use pilas de diferentes tipos ni pilas nuevas y antiguas para alimentar el producto. Extraiga las pilas del producto si este va a permanecer sin uso durante un período prolongado de tiempo o aquellas se han agotado. No use pilas dañadas. Use solo pilas alcalinas. Inserte las pilas de modo que los polos queden situados en las posiciones correctas. No trate de cargar pilas no recargables. No cortocircuite el compartimento de las pilas.

**DA****Vigtige oplysninger om batterier**

Brug aldrig forskellige batterityper sammen eller en kombination af gamle og nye batterier. Fjern altid batterierne, hvis produktet ikke skal bruges i lang tid, eller hvis batterierne er flade. Brug aldrig beskadigede batterier. Brug kun alkaliske batterier. Sæt batterierne i, så polerne vender den rigtige vej. Forsøg aldrig at oplade ikke-genopladelige batterier. Kortslut aldrig batteriholderen.

**IS****Mikilvægar upplýsingar um rafhlöður**

Aldrei skal nota mismunandi gerðir rafhlaðna samtímis, né nýjar og eldri rafhlöður samtímis. Ef ekki á að nota tækið í lengri tíma eða ef rafhlöðurnar eru orðnar tómar skal fjarlægja rafhlöðurnar. Aldrei skal nota rafhlöður sem hafa skemmst. Eingöngu má nota alkaline-rafhlöður. Setja skal rafhlöðurnar í þannig að plús- og mínuskaut þeirra snúi rétt. Aldrei skal reyna að endurhlaða rafhlöður sem ekki eru endurhlaðanlegar. Aldrei ætti að valda skammhlaupi í rafhlöðuhólfinu.

**FI****Tärkeää tietoa paristoista**

Älä koskaan käytä erityyppisiä paristoja yhdessä. Älä myöskään käytä samassa laitteessa sekä vanhoja että uusia paristoja. Poista paristot tuotteesta aina, kun se on pitemmän aikaa käyttämättä, tai kun paristot ovat tyhjentyneet. Älä koskaan käytä viallisia paristoja. Käytä vain alkaliparistoja. Aseta paristot siten, että navat osoittavat oikeaan suuntaan. Älä koskaan aiheuta oikosulkua pariston kosketintien välillä.

**SV****Viktig information om batterier**

Använd aldrig olika sorters batterier samtidigt, och inte heller en kombination av gamla och nya batterier. Ta alltid ur batterierna om produkten inte ska användas under en längre tid eller om batterierna är slut. Använd aldrig skadade batterier. Använd endast alkaliska batterier. Sätt i batterierna så att polerna hamnar i rätt läge. Försök aldrig ladda icke-laddningsbara batterier. Kortslut aldrig batteriutrymmets kontaktytor.

**NO****Viktig informasjon om batterier**

Bruk aldri ulike typer batterier sammen og heller aldri gamle og nye batterier sammen. Ta alltid ut batteriene hvis produktet ikke skal brukes på lang tid, eller hvis batteriene er brukt opp. Bruk aldri skadde batterier. Bruk bare alkaliske batterier. Sett inn batteriene med polene vendt riktig vei. Forsøk aldri å lade opp ikke-oppladbare batterier. Kortslett aldri batteriholderen.

**PT****Informação importante sobre as pilhas**

Nunca use diferentes tipos de pilhas em simultâneo, ou uma combinação de pilhas usadas e novas. Retire sempre as pilhas se o produto não for usado durante muito tempo ou se as pilhas já não tiverem carga. Nunca use pilhas danificadas. Use apenas pilhas alcalinas. Insira as pilhas de forma a que os polos fiquem corretamente posicionados. Nunca tente recarregar pilhas não recarregáveis. Nunca deixe o compartimento das pilhas entrar em curto-circuito.

**EL****Σημαντικές πληροφορίες για τις μπαταρίες**

Μην χρησιμοποιείτε ποτέ διαφορετικούς τύπους μπαταριών μαζί και μην συνδυάζετε παλιές και καινούργιες μπαταρίες. Αφαιρείτε πάντα τις μπαταρίες αν δεν σκοπεύετε να χρησιμοποιήσετε το προϊόν για αρκετό καιρό ή αν οι μπαταρίες έχουν αδειάσει. Ποτέ μην χρησιμοποιείτε μπαταρίες που έχουν φθορές. Χρησιμοποιείτε μόνο αλκαλικές μπαταρίες. Τοποθετήστε τις μπαταρίες με τους πόλους στη σωστή θέση. Μην επιχειρήσετε ποτέ να επαναφορτίσετε μη επαναφορτιζόμενες μπαταρίες. Ποτέ μην βραχυκυκλώνετε τη θήκη των μπαταριών.

## JA

### 電池取扱に関する重要事項

異なるタイプの電池や古い電池を混ぜて使用しないでください。商品を長時間使用しないときや電池が切れたときは、電池を必ず取り外してください。不具合のある電池は絶対に使用しないでください。アルカリタイプの電池のみを使用してください。電極を確認して電池を正しい向きに入れてください。充電式ではない電池は絶対に充電しないでください。電池ホルダをショートさせないでください。

## ZH

### 電池使用注意事項

请勿同时使用不同类型的电池，或把新旧程度不同的电池混合使用。如果产品将有很长时间不会使用，或者电池已经没电，请注意取出电池。切勿使用已破损的电池。仅可使用碱性电池。装入电池时请注意正负极。请勿尝试给非充电电池充电。切勿对电池仓进行短路连接。

## KO

### 배터리 사용 시 주의사항

다른 종류의 배터리를 함께 사용하거나, 새 전지와 오래된 전지를 혼용하지 마세요. 배터리가 방전되었거나 장기간 제품을 작동하지 않을 때에는 반드시 배터리를 분리하세요. 파손된 배터리는 사용하지 마세요. 알칼라인 타입의 배터리만을 사용하세요. 양극과 음극의 위치를 잘 맞춰서 넣으세요. 일반 배터리는 충전해서 사용할 수 없습니다. 배터리 홀더의 접촉부에 배터리를 정확히 끼워서 사용하세요.

## RU

### Необходимая информация об элементах питания

Ни в коем случае не используйте одновременно элементы питания различных типов, а также элементы питания с разным сроком годности. В обязательном порядке вынимайте элементы питания из терминалов в случае, если вы не пользуетесь прибором в течение долгого времени, либо в случае, если в элементах питания закончился заряд. Ни в коем случае не используйте поврежденные элементы питания. Используйте только элементы питания щелочного типа. Установите элементы питания, соблюдая указанную полярность. Ни в коем случае не пытайтесь подзарядить перезаряжаемые элементы питания. Ни в коем случае не пытайтесь замкнуть полюса в устройстве для элементов питания.

## PL

### Ważne informacje dotyczące baterii

Nigdy nie należy stosować razem różnych rodzajów baterii ani stosować równocześnie starych i nowych baterii. Jeżeli produkt nie jest używany przez dłuższy czas lub jeżeli baterie się wyczerpały, należy wyjąć baterie. Nigdy nie należy stosować uszkodzonych baterii. Należy używać wyłącznie baterii alkalicznych. Przy wkładaniu baterii należy zwrócić uwagę na właściwe położenie biegunów. Nigdy nie należy próbować ładowania baterii jednorazowych. Nigdy nie należy doprowadzać do zwarcia w gnieździe baterii.

## CZ

### Důležitá informace o bateriích

Nikdy nepoužívejte najednou různé typy baterií nebo kombinaci starých a nových baterií. Nebude-li se výrobek delší dobu používat nebo jsou-li baterie vybité, vždy je vyjměte z výrobku. Nikdy nepoužívejte poškozené baterie. Používejte pouze alkalické baterie. Baterie instalujte se správnou orientací pólů. Nikdy se nesnažte nabíjet baterie, které nejsou nabíjitelné. Nikdy nezkratujte kontakty v prostoru pro baterie.

## SK

### Dôležitá informácia o batériách

Nikdy nepoužívajte naraz odlišné typy batérií ani nekombinujte staré batérie s novými. Batérie vždy vyberte, ak sa výrobok nebude dlhšie používať, alebo ak sa batérie vybili. Nikdy nepoužívajte poškodené batérie. Používajte iba alkalické batérie. Batérie vkladajte so správnou orientáciou pólů. Nikdy sa nesnažte nabíjať batérie, ktoré nie sú nabíjateľné. Nikdy neskratujte kontakty v priestore pre batérie.

## HU

### Fontos tudnivalók az elemekről

Soha ne használjon különböző típusú elemeket, illetve ne használjon vegyesen új és használt elemeket. Mindig távolítsa el az elemeket, ha a készüléket előre láthatóan hosszabb ideig nem fogják használni, vagy ha az elemek lemerültek. Soha ne használjon megrongálódott elemeket. Csak alkáli elemeket használjon! Az elemeket helyesen helyezze be, a polaritásuknak megfelelően. Soha ne próbálja meg feltölteni a nem tölthető elemeket. Soha ne hozzon létre rövidzárlatot az elemtartó kivezetésein.

## UA

### Необхідна інформація про батарейки

Ніколи не використовуйте одночасно батарейки різних типів або батарейки з різним терміном придатності. Обов'язково вилучайте батарейки з приладу, якщо довго не користуєтесь ним, або якщо в батарейках уже скінчився заряд. Ніколи не використовуйте пошкоджені батарейки. Використовуйте лише лужні батарейки. Вставляйте батарейки, враховуючи задану полярність. У будь-якому випадку не намагайтеся підзарядити батарейки, що не підлягають підзарядці. У будь-якому випадку не намагайтеся зробити коротке замикання в приладі для батарей.

## HR

### Važne obavijesti o bateriji

Nikada nemoj koristiti različite vrste baterija zajedno, isto tako ni kombinaciju starih i novih baterija. Uvijek izvadite baterije ako dugo nećeš koristiti proizvod ili ako su one potrošene. Nikada nemoj koristiti oštećene baterije. Uпотrebļavajte samo alkalne baterije. Umetni baterije pazeci da dobro okreneš polove. Nikada ne pokušavaj puniti baterije koje nisu predviđene za punjenje. Nikada ne izazivaj kratki spoj u držaču baterija.

## SR

### Важне информације о батеријама

Nikada ne koristite različite tipove baterija zajedno niti kombinaciju starih i novih baterija. Uvijek izvadite baterije ako dugo nećeš koristiti proizvod ili ako su one potrošene. Nikada nemoj koristiti oštećene baterije. Uvek izvadite baterije ukoliko proizvod neћete dugo vreme koristiti ili ukoliko su baterije prazne. Nikada ne koristite oštećene baterije. Koristite samo alkalne baterije. Stavite baterije tako da su polovi pravilno pozicionirani. Nikada ne pokušavajte da puniti baterije koje ne mogu da se pune. Nikada ne izazivajte kratak spoj u kuћištu za baterije.

## МК

### Важни информации за батериите

Nikogash ne koristete različiti tipovi baterii zaedno ili kombinaciju od stari i novi baterii. Sekogash odstranuvajte gi bateriite dokolku ne go koristite proizvod podolgo vreme ili dokolku se potrosihile. Nikogash ne koristete oštetenii baterii. Koristete samo alkalnii baterii. Vmetnete gi bateriite taka што точно ke gi namestite polovite. Nikogash ne obiduvajte se da gi polnite bateriite za ednokratna upotreba. Nikogash ne predizvivuvajte kratok spoj na drzhatot za baterii.

## SL

### Pomembne informacije o baterijah

Nikoli ne uporabljajte skupaj različnih baterij ali kombinacije starih in novih baterij. Vedno odstranite baterije, če izdelka dlje časa ne boste uporabljali ali če so iztrošene. Nikoli ne uporabljajte poškodovanih baterij. Uporabljajte le alkalne baterije. Baterije vstavite tako, da so njihovi poli pravilno obrnjeni. Nikoli ne poskušajte polniti baterij, ki niso akumulatorske. Pazite, da ležišč za baterije ne boste spravili v kratek stik.

## RO

### Informații importante despre baterii

Nu folosiți niciodată împreună tipuri diferite de baterii, sau o combinație de baterii vechi și noi. Îndepărtați întotdeauna bateriile dacă produsul nu este folosit timp îndelungat sau dacă bateriile s-au epuizat. Nu folosiți niciodată baterii deteriorate. Utilizați numai baterii de tip alcalin. Introduceți bateriile astfel ca polii să fie poziționați corect. Nu încercați niciodată să reîncărcați baterii nereîncărcabile. Nu scurtcircuitați niciodată suportul bateriei.

## BG

### Важна информация за батериите

Никога не използвайте едновременно различни типове батерии или комбинация от стари и нови батерии. Винаги изваждайте батериите, ако izdelieto няма да се използва продължително време или ако батериите са се изтощили. Никога не използвайте повредени батерии. Използвайте само алкални батерии. Поставете батериите така, че полюсите да са разположени правилно. Никога не опитвайте да зареждате батерии, които не са акумулаторни. Никога не свързвайте на късо контактите на отделението за батериите.

## LV

### Svarīga informācija par baterijām

Nekad vienlaikus nelietojiet dažādu tipu, kā arī vecas un jaunas baterijas. Vienmēr izņemiet baterijas, ja tās ir izlādējušas vai ja produkts ilgāku laiku netiek lietots. Nekad nelietojiet bojātas baterijas. Izmantojiet tikai sārma tipa baterijas. Ievietojot baterijas, ievērojiet pareizu polaritāti. Nekad nemēģiniet uzlādēt baterijas, kas nav uzlādējamās. Nepieļaujiet issavienojumu bateriju nodalījumā.

## ET

### Oluline teave patareide kohta

Ära kunagi kasuta koos erinevat tüüpi patareid, samuti vanu ja uusi patareid. Kui märguandja ei kasutata pika aja jooksul, võta patarei sellest välja. Ära kunagi kasuta kahjustatud patareid. Kasuta ainult leelispatareid. Pane patareid märguandja sisse nii, et pluss- ja miinusklappide asend oleks õige. Ära kunagi proovi akulaadijaga laadida tavalisi patareid. Patareipesa klemmide vahel ei tohi tekkida lühisid.

## LT

### Svarbi informacija apie elementus

Vienu metu nenaudokite skirtingų elementų, taip pat su naujais elementais nenaudokite senų. Jei nenaudosite gaminio ilgesnį laiką arba jei elementai išseko, visuomet išimkite juos iš gaminio. Niekada nenaudokite pažeistų elementų. Naudokite tik šarminius elementus. Elementus dėkite atsižvelgdami į jų poliškumą. Niekada nebandykite įkrauti vienkartinį elementų. Saugokitės, kad elementų įdėkle nesukeltumėte trumpojo jungimo.

## TR

### Piller hakkında önemli bilgiler

Hiçbir zaman farklı tipte pilleri ya da eski pillerle yeni pilleri bir arada kullanmayın. Ürün uzun süre kullanılmayacaksa ya da piller bitmişse, pilleri ürünün içinden çıkarın. Hiçbir zaman zedelenmiş piller kullanmayın. Sadece alkanin piller kullanın. Pilleri kutupları doğru konumda olacak şekilde yerleştirin. Hiçbir zaman, şarj edilebilir olmayan pilleri şarj etmeye çalışmayın. Hiçbir zaman pil kutusuna kısa devre yaptırmayın.

## AR

### معلومات مهمة عن البطاريات

يحظر استخدام أنواع مختلفة من البطاريات معا أو مزيج من البطاريات القديمة و الجديدة. احرص دائما على نزع البطاريات في حال عدم استخدام المنتج لفترة طويلة أو إذا نفذت طاقة البطاريات. تجنب استخدام البطاريات التالفة. لا تستخدم إلا البطاريات القلوية فقط. قم بتكيب البطاريات بحيث تكون الأقطاب في موضعها الصحيح. يحظر إعادة شحن البطاريات غير القابلة لإعادة الشحن. تجنب إحداث دائرة قصر في حامل البطارية.

## ID

### Informasi penting tentang baterai

Jangan gunakan baterai yang jenisnya berlainan, atau mencampur baterai lama dan baterai baru. Lepas baterai jika produk tidak akan digunakan untuk waktu lama atau jika baterai sudah lemah. Jangan gunakan baterai yang rusak. Gunakan hanya baterai alkali. Masukkan baterai dengan posisi kutub yang tepat. Jangan pernah coba mengisi ulang baterai biasa. Jangan pernah membuat arus pendek pada dudukan baterai.

## MS

### Maklumat penting tentang bateri

Jangan guna jenis bateri yang berbeza bersama-sama, atau gabungan bateri baharu dan lama. Tanggalkan bateri jika produk tidak akan digunakan untuk tempoh masa yang lama atau jika bateri telah kehabisan kuasa. Jangan guna bateri yang rosak. Guna bateri jenis alkali sahaja. Selitkan bateri supaya paksi berada pada kedudukan yang betul. Jangan cuba untuk mengecap semula bateri yang tidak boleh dicaskan semula. Jangan pintas litar pemegang bateri.



EN  
WARNING: This product contains a Button or Coin Cell Battery. A swallowed Button or Coin Cell battery can cause internal chemical burns in as little as two hours and lead to death. Dispose of used batteries immediately. Keep new and used batteries away from children. If you think batteries might have been swallowed or placed inside any part of the body, seek immediate medical attention.

DE  
ACHTUNG: Dieses Produkt enthält eine Knopfzellenbatterie. Eine verschluckte Knopfzellenbatterie kann innere chemische Verbrennungen verursachen und in weniger als zwei Stunden zum Tod führen. Entsorge umgehend gebrauchte Batterien. Halte neue und gebrauchte Batterien von Kindern fern. Wenn du glaubst, dass Batterien verschluckt wurden oder sich in einem Körperteil befinden, hole umgehend medizinische Hilfe.

FR  
AVERTISSEMENT : Ce produit contient une pile bouton. L'ingestion d'une pile bouton peut provoquer des brûlures chimiques internes en seulement deux heures et provoquer la mort. Jeter immédiatement les piles usagées. Conserver les piles neuves et usagées hors de portée des enfants. Si vous suspectez l'ingestion d'une pile ou sa présence où que ce soit à l'intérieur du corps, consultez immédiatement un médecin.

IT  
ATTENZIONE: questo prodotto contiene una batteria a bottone. Se inghiottita, una batteria a bottone può causare ustioni chimiche interne in sole due ore, con possibile morte. Smaltire immediatamente le batterie usate. Tenere le batterie nuove e usate lontano dai bambini. Se si pensa che una batteria sia stata inghiottita o inserita in una parte del corpo, rivolgersi immediatamente a un medico.

NL  
WAARSCHUWING: dit product bevat een knoopcelbatterij. Als een knoopcelbatterij wordt ingeslikt, kan deze binnen twee uur chemische brandwonden veroorzaken in het lichaam. Het inslikken van een dergelijke batterij kan zelfs leiden tot overlijden. Gooi gebruikte batterijen onmiddellijk weg. Bewaar nieuwe en gebruikte batterijen buiten bereik van kinderen. Als je denkt dat een kind batterijen heeft ingeslikt of ze in een lichaamsopening heeft gestopt, raadpleeg je direct een arts.

ES  
ADVERTENCIA: Este producto contiene una pila de botón. Ingerir una pila de botón puede dar lugar a quemaduras químicas internas en tan sólo dos horas y provocar la muerte. Las pilas usadas deben desecharse inmediatamente. Mantenga las pilas nuevas y usadas fuera del alcance de los niños. Si sospecha de la ingestión o la introducción de pilas en cualquier parte del cuerpo, busque atención médica inmediatamente.

DA  
ADVARSSEL: Dette produkt indeholder et knap- eller møntcellebatteri. Hvis et knap- eller møntcellebatteri sluges, kan det forårsage indvendige ætsninger på blot to timer og medføre døden. Bortskaf brugte batterier omgående. Hold både nye og brugte batterier uden for børns rækkevidde. Hvis du har mistanke om, at batterierne kan være blevet slugt eller kommet ind i nogen del af kroppen, skal du omgående søge lægehjælp.

IS  
VIÐVÖRUN: Þessi vara inniheldur hnapparaflöðu eða flata raflöðu. Ef hnapparaflaða eða flöt raflaða er gleypt getur hún valdið innvortis efnabruna á innan við tveimur klukkustundum og leitt til dauða. Fargaðu notuðum raflöðum tafarlaust. Geymdu nýjar og notaðar raflöður þar sem börn ná ekki til. Ef þú telur að raflöður hafi verið gleyptar eða á annan hátt komist inn í einhverjum hluta líkamans skaltu tafarlaust leita læknaðstoðar.

FI  
VAROITUS: Tämä tuote sisältää pienen tai isokokaisen nappipariston. Niełtynä pieni tai isokokoinen nappiparisto voi aiheuttaa sisäisiä kemiallisia palovammoja jo kahden tunnin kuluessa ja johtaa kuolemaan. Käytetyt paristot on toimitettava heti keräyspisteeseen. Pidä uudet ja käytetyt paristot poissa lasten ulottuvilta. Jos epäilet jonkun nielaisseen pariston tai laittaneensa pariston kehoonsa, vie hänet välittömästi lääkäriin.

SV  
VARNING: Denna produkt innehåller ett knapp- eller myntcells batteri. Förtäring av ett knapp- eller myntcells batteri kan orsaka inre kemiska brännskador på så kort tid som två timmar och leda till döden. Kassera förbrukade batterier omedelbart. Förvara nya och använda batterier utom räckhåll för barn. Om du tror att batterierna kan ha svalts eller placerats inuti någon del av kroppen, sök omedelbart läkarvård.

NO  
ADVARSSEL: Dette produktet inneholder et knapp- eller myntcellebatteri. Ved svelging kan knapp- eller myntcellebatterier gi kjemisk brannskade innvendig på bare to timer og føre til død. Brukte batterier skal avhendes øyeblikkelig. Nye og brukte batterier skal oppbevares utilgjengelig for barn. Hvis du tror at batterier har blitt svelget eller puttet inn andre steder i kroppen, må du kontakte lege øyeblikkelig.

PT  
AVISO: Este produto contém uma pilha tipo botão ou moeda. Uma pilha tipo botão ou moeda que tenha sido engolidas pode provocar queimaduras químicas internas em menos de duas horas e levar à morte. Elimine as pilhas usadas imediatamente. Mantenha as pilhas novas e usadas fora do alcance das crianças. Se pensa que as pilhas podem ter sido engolidas ou colocadas no interior de alguma parte do corpo, procure de imediato assistência médica.

EL  
ΠΡΟΕΙΔΟΠΟΙΗΣΗ: Αυτό το προϊόν περιέχει μία Στρογγυλή Μπαταρία Μεγέθους Κουμπιού ή Κέρματος. Η κατάποση μιας Στρογγυλής Μπαταρίας Μεγέθους Κουμπιού ή Κέρματος μπορεί να προκαλέσει εσωτερικά χημικά εγκαύματα σε μόλις δύο ώρες και να οδηγήσει σε θάνατο. Πετάξτε αμέσως τις χρησιμοποιημένες μπαταρίες. Κρατήστε τις καινούργιες και τις χρησιμοποιημένες μπαταρίες μακριά από τα παιδιά. Εάν νομίζετε ότι κάποια μπαταρία έχει καταποθεί ή τοποθετηθεί εντός οποιουδήποτε μέρους του σώματος, ζητήστε αμέσως ιατρική βοήθεια.

JA  
警告：本製品には、ボタン型またはコイン型の電池が使用されています。ボタン型またはコイン型電池は誤飲すると2時間以内に体内で科学火傷を起こし、死に至る恐れがあります。使用済みの電池は直ちに廃棄してください。新しい電池および使用済み電池は、どちらもお子様の手の届かないところに保管してください。電池を誤飲した恐れがある、または電池が身体どこかに入った恐れがある場合は、直ちに医師の診察を受けてください。

ZH  
警告：本品内含一颗纽扣电池。吞咽的纽扣电池仅在两小时内就会引起体内化学灼伤并导致死亡！请立即处理使用过的电池。请将新、旧电池放置到儿童接触不到的地方。如果电池被不慎吞下，或被置入身体的任何一个部位，请立即就医！

KO  
경고: 이 제품에는 버튼 또는 코인 셀 배터리가 포함되어 있습니다. 코인 셀 배터리를 삼킬 경우, 빠르면 2시간 이내에 체내에서 화학적 화상이 일어나고 심하면 사망에 이를 수 있습니다. 다 쓴 배터리는 즉시 폐기하십시오. 배터리를 어린이의 손에 닿지 않는 곳에 보관하십시오. 배터리를 삼켰거나 신체 어느 부위에든 들어간 것으로 판단될 경우, 즉각 의사의 도움을 구하십시오.

RU  
ПРЕДОСТЕРЕЖЕНИЕ. Эта игрушка работает от батарейки таблеточного или кнопочного типа. Проглатывание батарейки таблеточного или кнопочного типа может (в течение двух часов) вызвать химические ожоги внутренних органов и привести к летальному исходу. Своевременно утилизируйте использованные батарейки. Храните новые и использованные батарейки в местах, недоступных для детей. Если у вас есть основания полагать, что ребенок проглотил батарейку или она попала внутрь какой-либо части его тела, немедленно обратитесь за медицинской помощью.

PL  
OSTRZEŻENIE: w tym produkcie znajduje się płaska okrągła bateria. Połknięcie takiej baterii może spowodować chemiczne oparzenia wewnętrzne już po dwóch godzinach, a także doprowadzić do śmierci. Gdy bateria się zużyje, należy ją natychmiast zutylizować. Nowe i używane baterie należy przechowywać z dala od dzieci. W przypadku stwierdzenia, że baterie mogły zostać połknięte lub inaczej trafić do organizmu, należy natychmiast poszukać pomocy lekarskiej.



**CZ**  
**VAROVÁNÍ:** Tento výrobek obsahuje knoflíkovou nebo mincovou baterii.  
Spolknutí knoflíkové nebo mincové baterie může během pouhých 2 hodin způsobit vnitřní poleptání sliznice a v některých případech mít za následek smrt. Použité baterie ihned vyjměte a zlikvidujte. Nové i použité baterie uchovávejte mimo dosah dětí. V případě spolknutí či uvlnutí baterie v některé části těla okamžitě vyhledejte lékařskou pomoc.

**SK**  
**UPOZORNENIE:** Tento produkt obsahuje gombíkovú alebo mincovú batériu.  
Prehltnutie gombíkovej alebo mincovej batérie môže spôsobiť vnútorné chemické popálenie už do dvoch hodín a viesť k úmrtiu. Použité batérie ihneď vyhoďte. Nové aj použité batérie uchováajte mimo dosahu detí. Ak si myslíte, že mohli dôjsť k prehltnutiu batérie alebo sa batéria mohla dostať do vnútra ktorejkoľvek časti tela, okamžite vyhľadajte lekársku pomoc.

**HU**  
**FIGYELMEZTETÉS:** Ez a termék gombelemet illetve lapos gombelemet tartalmaz!  
A lenyelt gombelem vagy lapos gombelem akár két óra alatt is belső vegyi sérüléseket okozhat, ami halálhoz vezethet. Az elhasznált elemeket azonnal dobja ki! Az új és a használt elemeket ne adja gyermekek kezébe! Ha úgy gondolja, hogy valaki lenyelt egy elemet, vagy bekerült valakinek valamely testrészébe, akkor azonnal kérjen orvosi segítséget!

**UA**  
**ОБЕРЕЖНО.** Продукт містить мініатюрну батарейку типу «таблетка».  
Якщо проковтнути мініатюрну батарейку, вона може спричинити внутрішні хімічні опіки протягом двох годин і призвести до смерті. Негайно утилізуйте використані батарейки. Зберігайте нові та використані батарейки недосяжними для дітей. Якщо вам здається, що дитина проковтнула батарейку чи вона опинилася в будь-якій частині тіла дитини, негайно зверніться до лікаря.

**HR**  
**UPOZORENJE:** Ovaj proizvod sadrži gumbastu bateriju ili bateriju oblika kovanice.  
Ako se gumbasta baterija ili baterija oblika kovanice proguta, za samo dva sata može uzrokovati unutarnje kemijske opekline i izazvati smrt. Iskoristene baterije odmah odložite u otpad. Čuvajte nove i stare baterije dalje od djece. Ako mislite da je baterija progutana ili je dospjela u bilo koji dijel tijela, odmah zatražite liječničku pomoć.

**SR**  
**УПОЗОРЕЊЕ:** Овај производ садржи дугмасту батерију.  
Прогутана дугмаста батерија може да доведе до интерних хемијских опекотина већ за два сата и доводи до смрти. Одмах одложите искоришћене батерије у отпад. Чувајте нове и искоришћене батерије ван домаћаја деце. Ако мислите да је дошло до гутања батерија или стављања у било који део тела, одмах потражите помоћ лекара.

**MK**  
**ПРЕДУПРЕДУВАЊЕ:** Овој производ содржи батерија тип копче или тип монета.  
Проголтувањето на батерија тип копче или тип монета може да предизвика внатрешно хемиско горење во рок од два часа и да доведе до смрт. Искрлете ги веднаш искористените батери. Држете ги новите и користените батери подалеку од деца. Ако мислите дека е можно батериите да се проголтани или поставени во кој било дел на телото, веднаш побарајте медицинска помош.

**SL**  
**OPOZORILO:** Ta izdelek vsebuje gumbasto baterijo.  
Če oseba požre gumbasto baterijo, lahko to povzroči kemične opekline notranjih organov že v dveh urah po zaužitju. Tovrstne poškodbe lahko vodijo v smrt. Iztrošene baterije takoj zavržite. Pazite, da nove ali iztrošene baterije ne bodo v dosegu otrok. Če menite, da je oseba zaužila baterijo ali si jo vstavila v kateri koli del telesa, takoj poiščite zdravniško pomoč.

**RO**  
**AVERTIZARE:** Acest produs conține o baterie de tip pastilă.  
Înghițirea unei baterii de tip pastilă poate cauza arsuri chimice interne în doar două ore, ducând la deces. Debarasați-vă imediat de bateriile uzate. Nu lăsați bateriile noi și uzate la îndemâna copiilor. Dacă credeți că bateriile ar fi putut fi înghițite sau ar fi putut ajunge în interiorul oricărei părți a corpului, solicitați imediat asistență medicală.

**BG**  
**ПРЕДУПРЕЖДЕНИЕ:** Този продукт съдържа батерия тип „копче“ или „монета“.  
При поглъщане батериите тип „копче“ или „монета“ могат да предизвикат вътрешни химически изгаряния в рамките на по-малко от два часа и да доведат до смърт. Незабавно изхвърляйте използваните батерии. Дръжте новите и стари батерии далеч от деца. Ако смятате, че е възможно батериите да са били погълнати или да са попаднали където и да е вътре в тялото, потърсете незабавно медицинска помощ.

**LV**  
**BRĪDINĀJUMS.** Šim produktam ir pogas jeb monētas tipa akumulators.  
Ja pogas jeb monētas tipa akumulators tiek norīts, tas jau divu stundu laikā var izraisīt iekšējus ķīmiskus apdegumus un izraisīt nāvi. Nekavējoties izlietojiet izlietos akumulatorus. Jaunus un lietotus akumulatorus glabājiet bērniem nepieejamā vietā. Ja uzskatāt, ka akumulators varētu būt norīts vai ievietots kādā ķermeņa daļā, nekavējoties vērsieties pēc medicīniskās palīdzības.

**ET**  
**HOIATUS!** See toode sisaldab nööp- või müntpatareid.  
Alla neelatud nööp- või müntpatareid võib tekitada sisemisi keemilisi põletusi kõigest kahe tunniga ning põhjustada surma. Kõrvaldage kasutatud patareid viivitamatult. Hoidke uusi ja kasutatud patareisid lastele kättesaamatus kohas. Kui arvate, et keegi on patareid alla neelanud või need on sattunud mõnda kehaosasse, pöörduge kohe arsti poole.

**LT**  
**JSPĖJIMAS.** Šiame gaminyje yra sagos arba monetos formos baterija.  
Praryta sagos arba monetos formos baterija gali sukelti vidinius cheminius nudeginimus greičiau nei per dvi valandas ir galiausiai sukelti mirtį. Panaudotas baterijas nedelsiant utižuokite. Naujas ir panaudotas baterijas laikykite atokiau nuo vaikų. Jei manote, kad vaikas galėjo praryti arba įsprauti bateriją sau į kūną, nedelsdami kreipkitės medicininės pagalbos.

**TR**  
**UYARI:** Bu ürün bir düğme pil içerir.  
Yutulmuş pil, iki saat gibi kısa bir sürede iç kimyasal yanıklara neden olabilir ve ölüme yol açabilir. Kullanılmış pilleri derhal atın. Yeni ve kullanılmıř pilleri çocuklardan uzak tutun. Pillerin yutulmuş ya da vücudun başka bir yerine sokulmuş olabileceđini düşünüyörsanız derhal doktora bařurun.

**AR**  
تحذير: يحتوي هذا المنتج على بطارية خلايا قرصية أو بطارية خلايا على شكل عملة.  
قد يؤدي ابتلاع بطارية خلايا قرصية أو بطارية خلايا على شكل عملة إلى حدوث حروق كيميائية داخلية خلال فترة قصيرة لا تتجاوز ساعتين وقد يؤدي إلى الوفاة. يرجى التخلص من البطاريات المستعملة على الفور. مع الاحتفاظ بالبطاريات الجديدة والمستعملة بعيداً عن متناول الأطفال. إذا كنت تعتقد أن البطاريات تم ابتلاعها أو إدخالها إلى أي جزء من أجزاء الجسم، فاطلب المساعدة الطبية على الفور.

**ID**  
**PERINGATAN:** Produk ini berisi Baterai Sel Kancing.  
Baterai Sel Kancing yang tertelan dapat mengakibatkan luka bakar kimiawi dalam tubuh minimal setelah dua jam dan dapat mengakibatkan kematian. Segera buang baterai yang sudah tidak digunakan. Jauhkan baterai baru maupun bekas dari jangkauan anak-anak. Jika Anda curiga baterai telah tertelan atau masuk ke dalam tubuh, segeralah minta bantuan dokter.

**MS**  
**AMARAN:** Produk ini mengandungi Bateri Sel Butang atau Syiling.  
Tertelan bateri Sel Butang atau Syiling boleh mengakibatkan lecuran kimia dalaman dalam tempoh sekurang-kurangnya dua jam dan menyebabkan kematian. Buang bateri terpakai dengan serta-merta. Jauhkan bateri baharu dan terpakai daripada kanak-kanak. Jika anda mendapati bateri mungkin telah ditelan atau termasuk ke dalam mana-mana bahagian badan, dapatkan rawatan perubatan dengan segera.



EN  
Protect the environment by not disposing of this product with your household waste.  
Check with your local authority for recycling advice and facilities. Penalties may apply for improper disposal.

DE  
Schützen Sie die Umwelt und entsorgen Sie dieses Produkt nicht mit Ihrem Hausmüll.  
Informationen zu Recycling-Möglichkeiten erhalten Sie bei den örtlichen Behörden. Bei unsachgemäßer Entsorgung können Strafen verhängt werden.

FR  
Protégez l'environnement : ne jetez pas ce produit avec vos autres déchets ménagers.  
Contactez les autorités locales pour obtenir des informations sur le recyclage et connaître les points de collecte. Des sanctions peuvent être appliquées en cas d'élimination inappropriée.



IT  
Proteggi l'ambiente! Non smaltire questo prodotto con i rifiuti domestici.  
Per consulenza sul riciclaggio dei rifiuti e le strutture di riciclaggio, rivolgersi alle proprie autorità locali. Uno smaltimento improprio può comportare sanzioni.

NL  
Bescherm het milieu: gooi dit product niet samen met het andere huisvuil weg.  
Raadpleeg de plaatselijke instanties voor locaties van milieustations en advies over hergebruik. In geval van onjuiste verwijdering kunnen boetes worden opgelegd.

ES  
Proteja el medio ambiente no deshaciéndose de este producto junto con sus residuos domésticos.  
Solicite asesoramiento e información sobre instalaciones de reciclaje a las autoridades locales. La eliminación inadecuada puede ser objeto de sanciones.

DA  
Beskyt miljøet! Smid ikke dette produkt ud sammen med husholdningsaffaldet.  
Få vejledning om genbrug og genbrugsstationer hos din kommune.  
Ukorrekt bortskaffelse kan medføre bøde eller straf.

IS  
Stuðlið að umhverfisvernd með því að farga þessari vöru ekki með heimilissorpi.  
Leitið upplýsinga um endurvinnslu- og förgunarstaði hjá yfirvöldum á hverjum stað. Viðurlögum kann að vera beitt ef förgun er ekki með réttum hætti.

FI  
Tämä tuote on hävitettävä ympäristöstävällisesti ja erillään muusta talousjätteestä.  
Tietoja kierrätyksestä ja keräyspisteiden sijainnista saat paikkakuntasi teknisestä virastosta. Epäasianmukaisesta hävittämisestä saattaa aiheutua seuraamuksia.

SV  
Skydda miljön genom att inte kasta denna produkt bland ditt hushållsavfall.  
Kontakta din kommun för frågor om återvinning och miljöstationer. Påföljder kan tillkomma för felaktigt avyttring.

NO  
Beskytt miljøet. Ikke kast dette produktet i husholdningsavfallet.  
Kontakt kommunen for veiledning om gjenbruk og miljøstasjoner. Feil avfallshåndtering kan være straffbart.

PT  
Proteja o ambiente não eliminando este produto com o seu lixo doméstico.  
Consulte as autoridades locais para informação sobre reciclagem e sistemas de recolha. Podem ser aplicadas coimas por eliminação inadequada.

EL  
Προστατέψτε το περιβάλλον. Μην πετάτε αυτό το προϊόν μαζί με τα συνηθισμένα οικιακά απορρίμματα.  
Επικοινωνήστε με τις τοπικές αρχές σχετικά με συμβουλές και εγκαταστάσεις ανακύκλωσης. Ενδέχεται να επιβάλλονται κυρώσεις για ακατάλληλη διάθεση απορριμμάτων.

JA  
環境保護のため、本製品は家庭ごみとは別に処分してください。  
リサイクルに関する指示や施設については、お住まいの地方自治体にお問い合わせください。不適切な廃棄を行った場合、罰則が適用されることがあります。

ZH  
注意保护环境，请勿将本产品与生活垃圾一起丢弃处理。  
请咨询当地相关部门，了解与回收相关的设施与建议。  
处理不当可能会导致处罚。

KO  
환경 보호를 위해 이 제품을 생활폐기물과 함께 버리지 마십시오.  
재활용 방법 및 시설에 관한 사항은 현지 관계 당국에 문의하십시오. 부적절하게 폐기할 경우 벌칙이 부과될 수 있습니다.

RU  
Позаботьтесь об окружающей среде: не утилизируйте этот продукт вместе с бытовым мусором.  
Узнайте в органах местного самоуправления правила вторичной переработки и утилизации таких отходов.  
В случае ненадлежащей утилизации могут быть наложены штрафы.

PL  
Aby chronić środowisko naturalne, nie należy wyrzucać tego produktu wraz z odpadkami z gospodarstwa domowego.  
W celu uzyskania wskazówek dotyczących recyklingu oraz adresów zakładów należy skontaktować się z lokalnym urzędem.  
Za nieprzestrzeganie zasad związanych z utylizacją odpadów grożą kary.

CZ  
Nevyhazujte tento produkt do domácího odpadu, chraňte životní prostředí.  
Zjistěte si prosím u místních úřadů možnosti recyklace a dostupná zařízení.  
Nesprávná likvidace může být pokutována.

SK  
Nevyhádzajte tento produkt do domáceho odpadu, chráňte životné prostredie.  
Zistite si na miestnych úradoch možnosti recyklácie a dostupné zariadenia.  
Za nesprávnú likvidáciu môžu byť uložené sankcie.

HU  
Környezetét óvja, ha ettől a terméktől nem a háztartási hulladékkal együtt válik meg.  
Érdeklődjék a lakóhelyéhez közel eső hatóságnál az újrahasznosítás módjáról és lehetőségeiről. A nem megfelelő hulladékelhelyezésért büntetés járhat.

UA  
Допоможіть захистити довкілля: не утилізуйте цей виріб разом із побутовим сміттям.  
Вказівки з утилізації та відомості про пункти прийому з'ясуйте в місцевих компетентних органах. У разі неналежної утилізації можуть застосовуватися штрафи.

HR  
Zaštitite okoliš tako da ovaj proizvod ne odložite u otpad zajedno s kućanskim otpadom.  
Od lokalnih vlasti zatražite savjet ili informacije o pogonima za recikliranje.  
Moguća je kazna za nepropisno zbrinjavanje.

SR  
Zaštitite životnu sredinu tako što nećete da odlažete ovaj proizvod sa kućnim otpadom.  
Raspitajte se kod lokalnog nadležnog organa o načinu reciklaže i o sabirnom centru. U slučaju nepravilnog odlaganja u otpad, mogu biti izrečene kazne.

МК

Заштитете ја околината така што нема да се ослободите од производот со домашниот отпад.  
Консултирајте се со локалните власти да да дознаете за советите и објектите за рециклирање. Возможно е да бидат применети казни за неправилно исфрлање.

SL

Zaščitite okolje! Okolje varujte tako, da tega izdelka ne zavržete skupaj z gospodinjstvi odpadki.  
Pri krajevni upravi preverite, kakšne možnosti in kateri obrati za recikliranje obstajajo v vaši okolici. Za nepravilno odlaganje odpadkov vas lahko doleti kazen.

RO

Protejați mediul înconjurător și nu vă debarasați de acest produs împreună cu deșeurile menajere.  
Consultați autoritățile locale pentru îndrumări și facilități de reciclare. Dezafectarea necorespunzătoare poate atrage sancțiuni.

BG

Защитете околната среда и не изхвърляйте този продукт заедно с битовите си отпадъци.  
Свържете се с местните власти относно съвети и съоръжения за рециклиране. Възможно е да има глоби за неправилно изхвърляне.

LV

Lai saudzētu vidi, neizmetiet šo izstrādājumu kopā ar sadzīves atkritumiem.  
Vērsieties vietējās varas iestādēs, lai noskaidrotu, kur un kā tas nododams pārstrādei. Par neatbilstošu likvidēšanu var tikt piemērots sods.

ET

Keskkonda saate kaitsta nii, et ei kõrvalda seda toodet koos olmejäätmetega.  
Nõuandeid toote taaskasutusse võtmise ja ümbertöötlemispunktide kohta saate asjaomaselt kohalikul asutuselt.  
Nõuetele mittevastav kasutuselt kõrvaldamine võib kaasa tuua trahvid.

LT

Saugokite aplinką: nemeskite šio produkto kartu su buitinėmis atliekomis.  
Atsižvelkite į savo vietos valdžios rekomendacijas dėl pakartotinio panaudojimo ir sąlygas. Už netinkamą šalinimą gali būti taikomos baudos.

TR

Bu ürünü, evsel atıklarla birlikte atmayarak çevreyi koruyun.  
Gerİ dönüşüm tavsiyeleri ve tesisler hakkında bilgi için yerel yönetimle iletişİm kurun. Uygunsuz atılması durumunda cezalar uygulanabilir.

AR

احم البيئة بعدم التخلص من هذا المنتج مع المخلفات المنزلية.  
استشر السلطة المحلية لديك للحصول على نصح بخصوص إعادة تدوير المخلفات ومراقبه.  
قد يتم تطبيق عقوبات على التخلص غير السليم.

ID

Jagalah lingkungan dengan tidak membuang produk ini bersama sampah rumah tangga Anda.  
Periksa peraturan pemerintah setempat tentang saran dan fasilitas daur ulang. Pembuangan yang tidak sesuai ketentuan dapat dikenakan denda.

MS

Lindungi alam sekitar dengan tidak melupuskan produk ini bersama sisa isi rumah anda.  
Rujuk pihak berkuasa tempatan anda tentang nasihat dan kemudahan kitar semula. Penalti boleh dikenakan untuk pelupusan yang tidak wajar.

- EN Please retain the leaflet and packaging as they contain important information
- DE Broschüre und Verpackung bitte aufbewahren, sie enthalten wichtige Informationen
- FR Veuillez conserver le dépliant et l'emballage, car ils contiennent des informations importantes
- IT Conserva l'opuscolo e la confezione in quanto contengono informazioni importanti
- NL Bewaar a.u.b. de folder en verpakking: die bevatten belangrijke informatie
- ES Conserve el folleto y el embalaje; contienen información importante
- DA Gem hæftet og emballagen, da de indeholder vigtige oplysninger
- IS Geymið bæklinginn og umbúðirnar þar sem þau innihalda mikilvægar upplýsingar
- FI Säilytä esite ja pakkaus, koska ne sisältävät tärkeää tietoa
- SV Spara broschyren och förpackningen eftersom de innehåller viktig information
- NO Heftet og emballasjen inneholder viktig informasjon og skal beholdes
- PT Por favor guarde o folheto e a embalagem, pois contém informação importante
- EL Κρατήστε το φυλλάδιο και τη συσκευασία γιατί περιέχουν σημαντικές πληροφορίες
- JA 説明書とパッケージには重要な情報が含まれていますので保管しておいてください
- ZH 说明书和包装均包含重要信息, 请妥善保存
- KO 중요한 정보가 담겨 있으므로 리플릿과 포장을 보관해주세요
- RU Пожалуйста, сохраните эту брошюру и упаковку, поскольку они содержат важную информацию
- PL Prosimy zachować ulotkę i opakowanie, ponieważ zawierają one ważne informacje
- CZ Ponechte si prosím leták i obal, neboť obsahují důležitě informace
- SK Ponechajte si prosím leták aj obal, pretože obsahujú dôležité informácie
- HU Kérjük, őrizze meg a szórólapot és a csomagolást, mert fontos tudnivalókat tartalmaznak
- UA Будь ласка, зберігайте вкладиш та упаковку, оскільки вони містять важливу інформацію
- HR Spremite letak i ambalažu jer sadrže važne obavijesti
- SR Molimo da sačuvate uputstvo i pakovanje jer se na njima nalaze važne informacije
- MK Чувајте ги брошурата и амбалажата бидејќи содржат важна информација
- SL Prosimo, da brošurico in embalažo shranite, saj vključujeta pomembne informacije
- RO Vă rugăm să păstrați prospectul și ambalajul întrucât conțin informații importante
- BG Запазете листовката и опаковката, тъй като съдържат важна информация
- LV Lūdzu, saglabājiet bukletu un iepakojumu, jo uz tā ir norādīta svarīga informācija
- ET Hoidke infoleht ja pakend alles, sest nendele on märgitud oluline teave
- LT Išsaugokite informacinį lapelį ir pakuotę, nes ant jų pateikiama svarbi informacija
- TR Önemli bilgiler içerdiği için broşürü ve ambalajı saklayın
- AR الرجاء الاحتفاظ بالنشرة والغلاف لاحتوائهما على معلومات هامة
- ID Harap simpan brosur dan kemasan ini karena berisi informasi penting
- MS Sila simpan risalah dan pembungkusan kerana ia mengandungi maklumat penting

LEGO System A/S  
Aastvej 1  
DK-7190 Billund





2x 6240495  
1x 6406415  
21x 6446788  
1x 4651445  
4x 6360202  
3x 6357680  
2x 6326680  
2x 6310185  
2x 474001  
3x 6313115  
3x 300401  
1x 6299836  
4x 6312480  
1x 6359891  
8x 6218822  
2x 235701  
2x 6058329  
1x 306801  
3x 6289797  
1x 300201  
4x 6497109  
1x 4600307

1x 6192352  
9x 389401  
2x 4611927  
13x 4181142  
6x 303501  
1x 6324176  
3x 4529237  
1x 6484310  
1x 6484313  
2x 4113915  
4x 4666579  
2x 6490029  
10x 6024495  
18x 4113917  
2x 6313119  
7x 4109995  
10x 6214334  
2x 4205107  
5x 6313611  
1x 4185177

2x 4124455  
2x 4114077  
1x 6486727  
8x 4118790  
2x 4113233  
5x 4114319  
8x 4114309  
3x 4181134  
8x 4114324  
1x 6037398  
2x 4113988  
5x 300521  
2x 6144805  
1x 6097192  
9x 4142865  
7x 300421  
1x 370021  
6x 6001806

2x 300321  
8x 6209519  
2x 362221  
5x 6129995  
2x 371021  
4x 6416443  
1x 379521  
1x 370221  
2x 6078594  
3x 4206482  
33x 302323  
6x 6299413  
3x 302223  
1x 300923  
2x 383223  
4x 6047218  
4x 6248971  
4x 403224  
2x 300424

2x 6117938  
2x 235724  
1x 6130007  
4x 362324  
4x 301024  
2x 6130008  
3x 300924  
1x 366624  
2x 4181143  
18x 6270103  
6x 6290456  
5x 6331084  
2x 6269965  
11x 6315887  
2x 6321194  
21x 306226  
12x 6186675  
2x 6510193  
39x 6424674  
1x 6484307

1x 6332148  
1x 6484325  
14x 6213729  
1x 459926  
12x 6065496  
22x 6172383  
3x 6228987  
49x 4504382  
61x 302426  
10x 300526  
5x 6312449  
4x 307026  
3x 4558954  
12x 6420198  
13x 6335388  
1x 6181720  
16x 6234695  
6x 6335317  
1x 6299338  
68x 4273590  
10x 6433936  
5x 4177431

2x 6344752  
7x 6141554  
2x 6104209  
8x 6141556  
2x 6438919  
6x 6210270  
3x 4180536  
2x 4180508  
11x 4161332  
11x 4160869  
8x 6157554  
1x 6181713  
34x 4548180  
5x 6279875  
9x 403226  
1x 452926  
4x 6143850  
5x 6195325  
2x 614326  
1x 6484312  
172x 287726

35x 4220539	13x 245426	3x 6425507	1x 6492539	1x 6192309	2x 4629921	14x 6208787	2x 6037390
18x 6174243	4x 6016172	8x 4189064	1x 4521681	2x 6408603	4x 6138405	14x 379526	1x 6435265
97x 302326	4x 6308883	2x 6403373	1x 6390749	2x 6439175	5x 366626	16x 4181144	6x 6475345
12x 6228588	25x 4107761	7x 4124096	2x 6394879	2x 6434275	2x 663626	10x 6318582	2x 395826
2x 6338799	4x 6250020	4x 6191630	28x 302126	6x 6325190	20x 300926	8x 6475344	6x 447726
18x 6475339	28x 6214807	1x 6192346	62x 6147790	29x 6416444	1x 4525078	2x 4106977	3x 611126
31x 306926	3x 6346535	2x 4567436	2x 6395375	1x 4525078	41x 4529155	2x 4160130	1x 303526
19x 6267487	1x 6234806	6x 6211476	4x 6162892	7x 6475341	29x 4560182	2x 639200	5x 383226
5x 6275806	2x 6331723	2x 4584274	2x 300226	18x 4587844	2x 6058118	2x 6170702	4x 303626
8x 6347310	3x 6093525	24x 6469445	1x 6018805	13x 302026	1x 6335646	8x 416226	9x 4514845
44x 241226	43x 302226	7x 6313508	1x 6018805	3x 300126	6x 4243819	5x 300826	3x 303026
1x 393726	21x 242026	2x 6267045	58x 371026	2x 6040297	5x 617926	7x 346026	2x 6302830
1x 6178922	10x 300326	1x 6448318	8x 243126	1x 6495964	2x 6501118	4x 6438920	2x 6302830
13x 6069000	4x 235726	12x 6038531	25x 301026	17x 6350415	2x 6179660	15x 303426	18x 244526
26x 6047276	16x 4163373	29x 362326	2x 6254045	6x 6039347	4x 6170421		
12x 366526	2x 6176768	4x 4558170	4x 4160025				
6x 4121966	14x 6053077	7x 362226	3x 4613153				
1x 6092585	1x 6390748	6x 4251161	6x 4515362				
4x 6147050	9x 306826	14x 6328095	2x 6040298				
	6x 6166859	2x 6199908					

6x 6104342  
8x 6186012  
1x 6417953  
3x 6360331  
4x 6188477  
2x 6429032  
30x 4570877  
20x 4614158  
8x 4579659  
16x 6069259  
12x 6228840  
2x 6092602  
19x 6186423  
1x 6253417  
8x 6212081  
3x 6248859  
7x 4615606  
4x 6186007  
6x 6340118  
1x 6359717  
1x 6223040

6x 6074892  
21x 6058089  
9x 4535928  
4x 6475346  
4x 6000743  
1x 6253418  
3x 6219673  
2x 6475349  
2x 6351327  
1x 6247798  
4x 6244796  
1x 6507889  
4x 6258607  
42x 6251290  
2x 6245272  
13x 6252045  
15x 6240211  
48x 6508250

2x 6274742  
1x 6240225  
2x 6068996  
1x 6424015  
1x 4177932  
5x 4159007  
4x 4125278  
3x 4118782  
4x 4158355  
5x 6221691  
4x 6264183  
5x 6424454  
6x 6382505  
1x 6313826

23x 6040126  
3x 6001824  
2x 6055172  
8x 4549436  
2x 6093064  
10x 4521914  
15x 4528604  
1x 4496699  
10x 4530678  
2x 6452010  
2x 6210495  
2x 6497102  
2x 6000852  
23x 6331865  
1x 6310830  
2x 4255416  
2x 6396392  
8x 6015454  
1x 6015452  
1x 6435308  
1x 6328307

11x 6001822  
1x 6175927  
1x 4507047  
2x 6015424  
1x 4550329  
1x 4530712  
5x 6357747  
8x 6174023  
8x 6240550  
1x 6245265  
4x 6252040  
15x 6314353  
12x 6237278  
16x 6507935  
4x 6466832  
4x 6483809  
63x 6484052  
1x 6097511  
55x 6215659  
2x 6186673  
1x 4626196

35x 4221744  
40x 4211242  
4x 6256734  
8x 6348057  
5x 6329114  
2x 6341553  
2x 6253167  
2x 6325717  
3x 6343651  
21x 6035291  
4x 6452539  
8x 4211159  
1x 6102360  
4x 4211180  
7x 6475343  
9x 4223303  
58x 4211150  
1x 6186045  
9x 6092590  
2x 4211252  
11x 4211151  
1x 6151461

1x 6248854  
5x 6338135  
5x 4211257  
2x 6196221  
5x 4565394  
6x 6221608  
2x 6425510  
1x 6167644  
2x 6470170  
1x 6135494  
10x 6055086  
9x 4211195  
1x 6433883  
4x 4216668  
1x 4211225  
1x 4211190  
4x 6475335  
3x 6066114  
1x 6257604

3



5

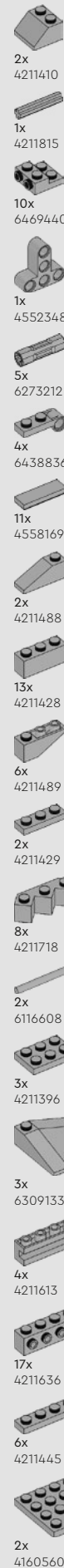
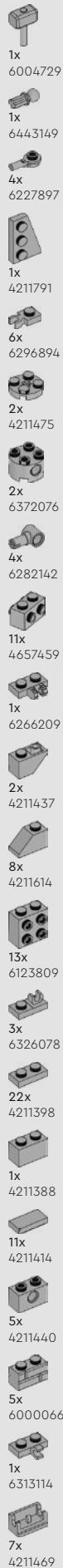
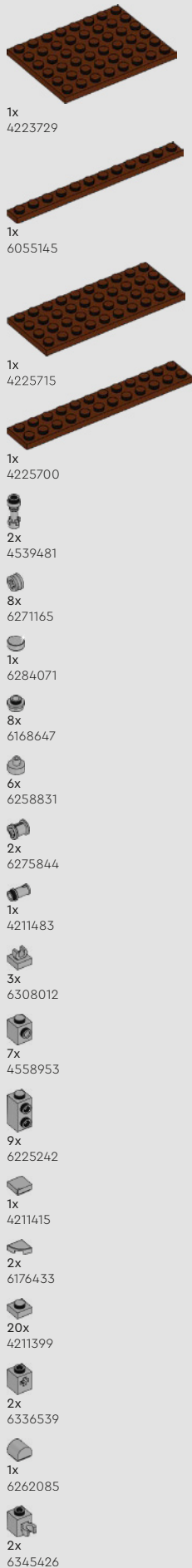

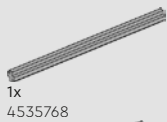

1x  
4535768

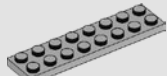

1x  
4211406



7x  
4251149



1x  
4211407



2x  
4514846

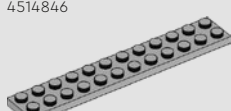

3x  
4211360

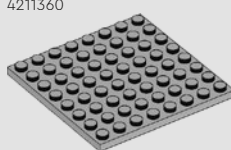

1x  
4166618

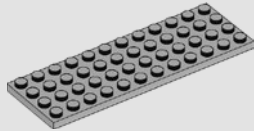

6x  
4211401

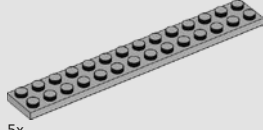

5x  
4662161



4x  
6399780



1x  
6434871



8x  
6314378



8x  
6336970



6x  
6231765



26x  
4211098



43x  
4210719



50x  
6228923



6x  
4210848



23x  
4504378



1x  
6396489



2x  
4558955



10x  
4210700



1x  
6245283



2x  
6331222



1x  
6265669



4x  
6221607



2x  
4210788



2x  
4210872



2x  
4210869



3x  
4249139



2x  
6115080



4x  
6388131



10x  
4516546



2x  
6276870



18x  
4211052



2x  
6435267



45x  
4211088



1x  
6092572



11x  
4211096



19x  
4211135



6x  
6029948



12x  
6230233



4x  
6168776



1x  
4221745



2x  
6039479



1x  
6176400



4x  
6164073



1x  
6342558



2x  
4211075



16x  
6452530



2x  
6319332



4x  
6000606



5x  
6117972



1x  
6308045



14x  
6314192



8x  
4543086



1x  
4586562



3x  
6146321



2x  
4529727



5x  
4211055



9x  
4211060



9x  
4211000



14x  
4211094



5x  
4211109



12x  
6126083



2x  
4210635



2x  
6309059



6x  
6227909



2x  
6000853



1x  
6236949



5x  
6344820



1x  
6271876



2x  
4210751



27x  
4211133



6x  
4211045



3x  
4568734



56x  
4211104



2x  
4652259



18x  
4210897



7x  
6378143



17x  
4211043



9x  
4211106



5x  
4210728



26x  
4211001



14x  
4211103



2x  
4648256



1x  
4211053



1x  
4535930



1x  
4210867



2x  
4210637



2x  
4528323



95x  
4211063



6x  
4210639



12x  
6416526



26x  
4211085



2x  
6307616



23x  
4211065



1x  
4560184



1x  
4211127



15x  
6413109



1x  
4508553



1x  
6311445



6x  
6170420



2x  
4211100



19x  
4211056



1x  
4509911



5x  
4243831



10x  
4221749



20x  
4210875



8x  
4211002



7x  
6321746



2x  
6262023

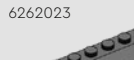

5x  
4211099

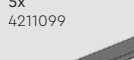

8x  
4211008

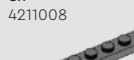

6x  
4210998

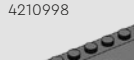

2x  
6313652

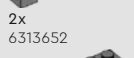

11x  
4211115



2x  
6141856



5x  
4210997

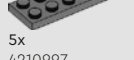

1x  
6311001



7x  
4257526



2x  
4211061



1x  
4210678



5x  
4210794



5x  
6133611

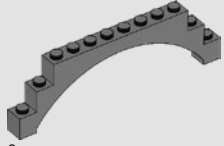

2x  
6311438



1x  
4211067



14x  
4211114

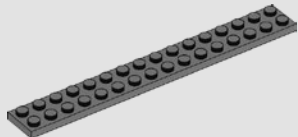

7x  
4210796



2x  
6314224

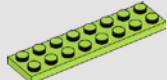

8x  
6440107

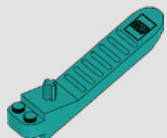

1x  
6254100



 [LEGO.com/service](https://www.lego.com/service)



2x  
6476004



1x  
6337628



1x  
6247800



1x  
6421827



1x  
6383857



2x  
4505990



3x  
6484327



1x  
6417951



59x  
6127366



1x  
6278987



6x  
4623298



2x  
6492894



2x  
6417974



30x  
6058257



8x  
4518557



4x  
6404033



2x  
4566688



8x  
6046943



2x  
6179803



6x  
6167928



2x  
6505863



2x  
4623775



7x  
6252667



4x  
6266292



2x  
6475338



2x  
6484316



46x  
6167690



10x  
6057986



2x  
6422082



6x  
6215606



1x  
6417963



2x  
6365629



1x  
6368592



21x  
6058135



4x  
6218360



1x  
6401021



3x  
6426722



5x  
4569382



2x  
6186400



5x  
6177535



1x  
6058085



34x  
6452538



3x  
6192922



5x  
6403913



2x  
6347842



4x  
6135191



3x  
6295464

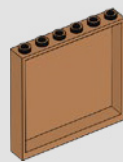

2x  
6313598

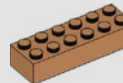

7x  
6350413



1x  
6351288



2x  
6361354



2x  
6107389



1x  
6363149



2x  
6363145



4x  
4625146



1x  
4611885



1x  
6093532



1x  
6429475



2x  
6020990



1x  
6078442



1x  
4611883



4x  
6484323



1x  
6484309



2x  
6484320



1x  
6484315



2x  
6492688



1x  
6492705



1x  
6492771



1x  
6492757



1x  
6480538



5x  
6264145



1x  
6471829



2x  
6484326



3x  
6208447



1x  
6484324



1x  
6486726



1x  
6492167



1x  
6420725



1x  
6009771



21x  
6481909



2x  
6484318



6x  
6465292



6x  
6322830



1x  
6036238



1x  
6480538



1x  
6036238



1x  
6036238



1x  
6036238



1x  
6036238



1x  
6036238



1x  
6036238



# YOU COULD WIN

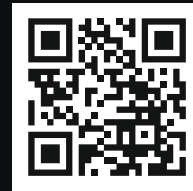

## YOU COULD WIN

Your feedback will help shape the future development of this product series.

Visit:

## DU KÖNNTEST GEWINNEN

Dein Feedback trägt zur Weiterentwicklung dieser Produktreihe bei.

Geh auf:

## VOUS POURRIEZ GAGNER

Vos commentaires nous aideront à concevoir les futurs produits de cette gamme.

Visitez :

## POTRESTI VINCERE TU

La tua opinione ci aiuterà a migliorare la creazione futura di questa linea di prodotti.

Visita:

## PUEDES GANAR

Tu opinión contribuirá al futuro de esta serie de productos.

Visita:

## 轻松获奖

您的反馈将有助于我们在今后改进本产品系列。

请访问:

---

# LEGO.com/productfeedback

---

You also have the chance to win a LEGO® set.

Terms and conditions apply.\*

Außerdem hast du die Chance, ein LEGO® Set zu gewinnen.

Es gelten die Teilnahmebedingungen.\*

Vous pourriez également gagner un ensemble LEGO®.

Des conditions s'appliquent.\*

Hai anche la possibilità di vincere un set LEGO®.

Termini e condizioni sono applicabili.\*

También tienes la oportunidad de ganar un set LEGO®.

Aplican términos y condiciones.\*

您还有机会赢取乐高®套装。

条款和条件适用。\*

\*LEGO.com/productfeedback-terms



LEGO and the LEGO logo are trademarks of the LEGO Group. ©2024 The LEGO Group.



NEW LINE CINEMA

© New Line Productions Inc. All rights reserved.  
THE LORD OF THE RINGS TRILOGY and all names  
of the characters, items, events, and places therein  
are ™ of Middle-earth Enterprises, LLC under license  
to New Line Productions, Inc. (s24)