

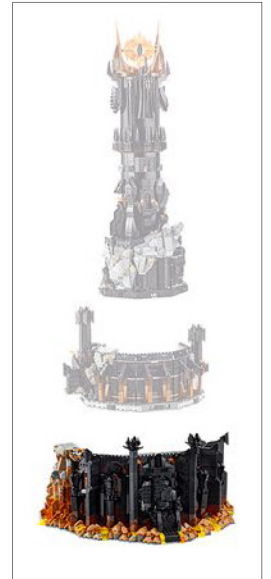

10333



THE LORD OF THE RINGS





LEGO.com/sustainable-packaging



FR
**DONNEZ
OU
RECYCLEZ**



ASSOCIATION

OU



MAGASIN

OU



DÉCHÈTERIE

Adresses sur quefairedemesdechets.fr



BUILDER



Apple and the Apple logo are trademarks of Apple Inc., registered in the U.S. and other countries and regions. App Store is a service mark of Apple Inc. Google Play and the Google Play logo are trademarks of Google LLC. Tencent and the Tencent logo are trademarks of Tencent Inc.

LEGO.com/devicecheck



LEGO® Builder

"Es él. El Ojo".

- Frodo Bolsón



LA TORRE OSCURA

 En la trilogía de *El señor de los anillos*, el momento en el que, por casualidad, Frodo Bolsón coloca el Anillo Único en su dedo nos permite vislumbrar por primera vez el poder de Barad-dûr™. Una encarnación del Señor Oscuro Sauron™, el Ojo de la macabra fortaleza atraviesa los negros cielos de Mordor™ y penetra en la mente de Frodo en una visión espeluznante. Con el paso de los siglos, Sauron ha adquirido la fuerza necesaria para apoderarse de toda la Tierra Media. Apoyado en el poder del Anillo Único, Sauron y, por extensión, su fortaleza, son prácticamente indestructibles mientras el Anillo exista.

Los heroicos Hobbits™ se unen a la Comunidad del Anillo en una ardua travesía para destruir el Anillo en el corazón de Mordor. Mientras Samsagaz Gamyi conduce a Frodo por el tramo final hasta un pasaje situado en la ladera del Monte del Destino, un frenético Gollum™ intenta detenerlos y termina por perecer en el fuego junto con su tesoro. Barad-dûr, Sauron y su ejército de Orcos se desintegran en un colapso de dimensiones cataclísmicas.

Inspirado en el enigmático monumento, este modelo recrea notables detalles y ofrece una visión única de los acontecimientos que podrían haber ocurrido entre bastidores en Mordor.

IMPRESIONES DE LA COMUNIDAD DE DISEÑO DE LEGO®

👁️ "Nuestro viaje LEGO® a la Tierra Media comenzó con una serie de modelos centrados en *El señor de los anillos* y *El hobbit* lanzados en 2012-2014, y en 2023 acompañamos a la Comunidad del Anillo hasta Rivendel (set 10316). En esta ocasión, nos adentramos más que nunca en el corazón de Mordor™ para asomarnos a la guarida del Señor Oscuro, y es la primera vez que sacamos el personaje de Sauron™ en formato de minifigura LEGO.

Para los fans de las novelas y películas de la saga *El señor de los anillos*, Barad-dûr™ representa uno de los lugares más emblemáticos de la Tierra Media. En la gran pantalla, apenas logramos ver de cerca la torre completa o su interior, lo que nos permitió experimentar con diferentes escenas e ideas. El modelo es bastante grande, así que lo dividimos en secciones que hacen posible una mejor experiencia de construcción y facilitan su manejo.

Las tonalidades de esta recreación son muy oscuras, por lo que decidimos añadir gradientes de color en su estructura a fin de crear la ilusión de reflejos del resplandor de la lava. En la plataforma superior, el centro de atención es el Ojo de Sauron™, que también está dotado de movimiento. El modelo cuenta con múltiples funciones que incluyen desde la apertura de las puertas delanteras y la escalera giratoria de la biblioteca hasta secciones ocultas, accesorios sorpresa y secretos de la Torre Oscura. Esperamos que los fans tanto de los sets LEGO como de *El señor de los anillos* disfruten mucho explorando este formidable símbolo de Mordor™.

Antica Bracarov
Modelista sénior de LEGO®



*Antica Bracnov,
modelista sénior de LEGO®*

LA FORJA Y LAS MAZMORRAS

 Tu modelo LEGO® Barad-dûr™ está dividido en varios niveles modulares. A nivel del suelo, puedes girar un mando situado en el lado izquierdo de la torre para abrir y cerrar las puertas principales e internarte en la forja y las mazmorras. Los tristes restos de un desafortunado intruso cuelgan dramáticamente sobre la lava líquida y advierten a los visitantes inoportunos del destino que les espera si se cruzan con el Señor Oscuro.

En la siguiente cámara, los Orcos se preparan para los próximos asedios a la Tierra Media. En el río de fuego que fluye por las mazmorras desde el Monte del Destino se forjan, afilan y ajustan escudos, cascos, herramientas, hombreras y lanzas.

En el otro extremo de la mazmorra, Gollum™ se oculta en un pequeño recoveco. Un rincón secreto de la cueva está ocupado por una araña gigante. Es imposible saber si Gollum la colocó allí para que le hiciera compañía o para librarse de ella. Cuando los Hobbits™ llegan al final de su travesía, el conocimiento de primera mano de Gollum de los escondrijos más oscuros de Mordor™ ayuda a Frodo Bolsón y a Samsagaz Gamyi a evitar ser detectados mientras se escabullen por territorio enemigo.





*"¿A qué está esperando?
¡Solo tiene que soltarlo!"*

- Samsagaz Gamyi



GOLLUM™



FRODO BOLSÓN



SAMSAGAZ GAMYI



ORCO

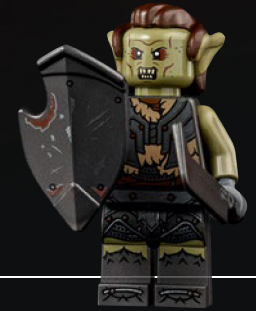

ORCO



 Frodo Bolsón atraviesa penosamente las escarpadas tierras de Mordor™ en su aventura para destruir el Anillo Único en el fuego del Monte del Destino.

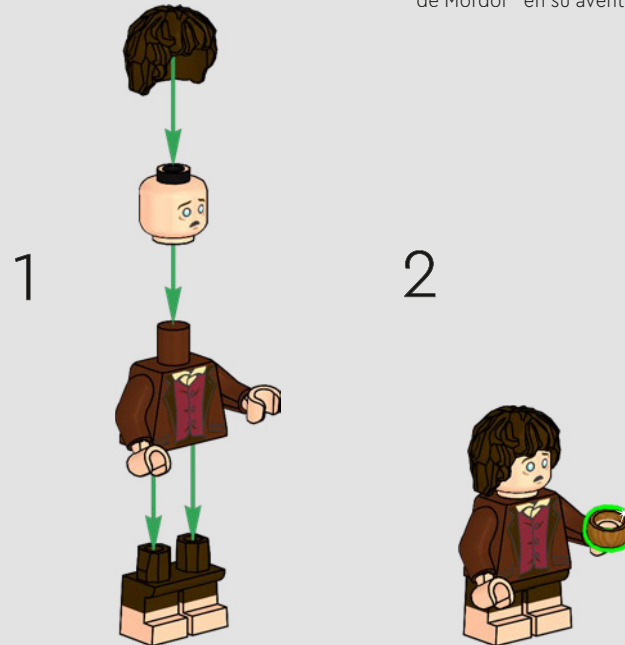
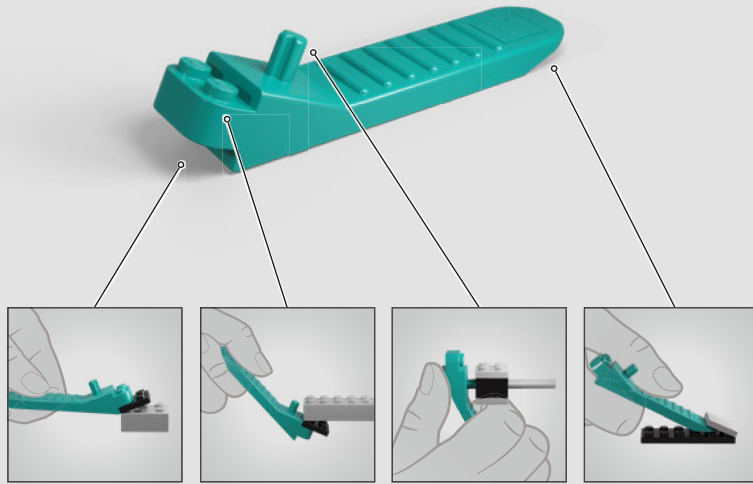

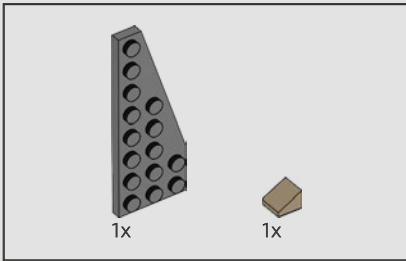
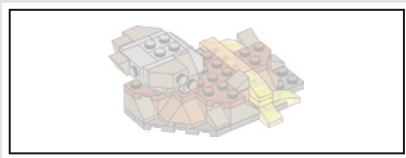

1

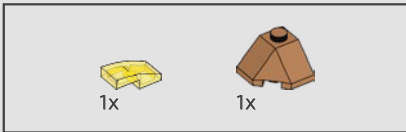
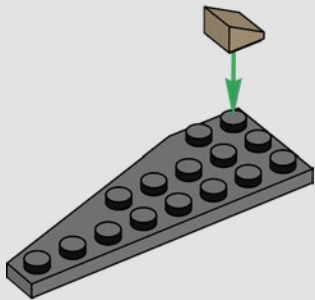

2

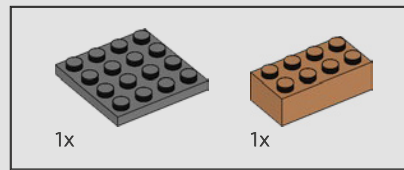
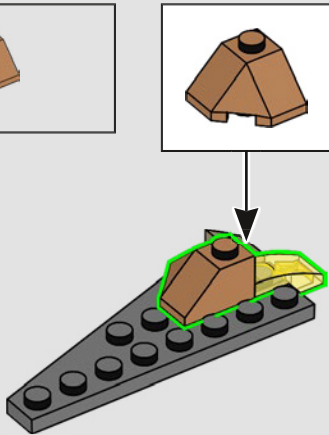

3

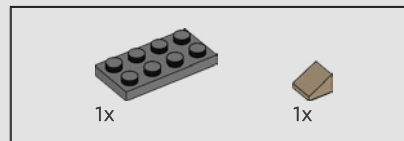
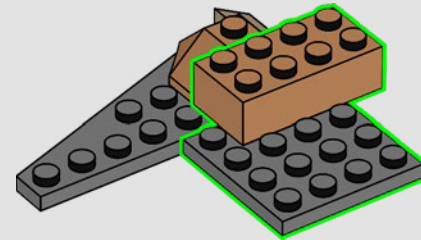

4

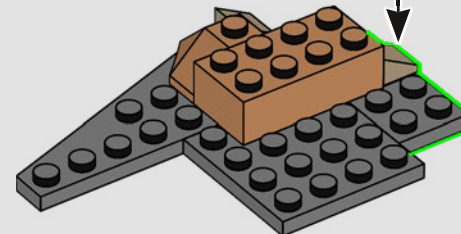
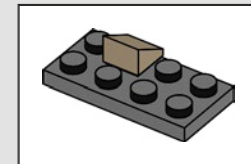

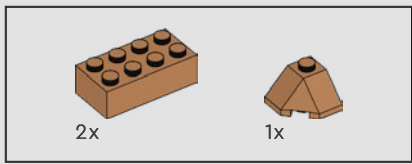

5

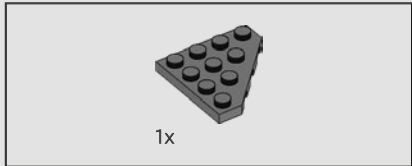
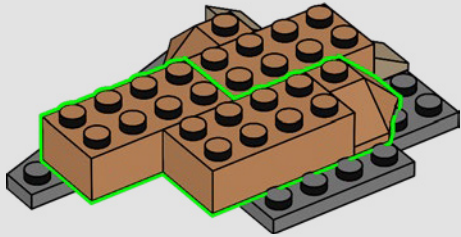

6

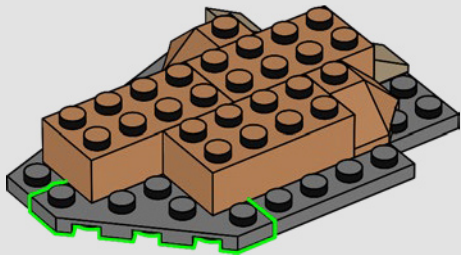

7

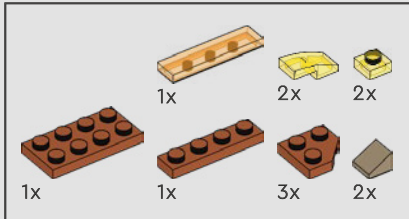
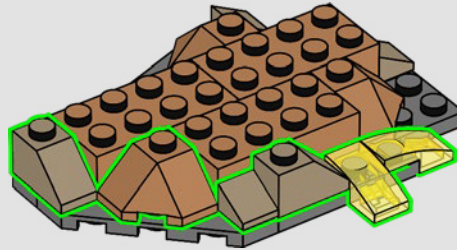

8

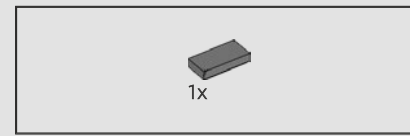
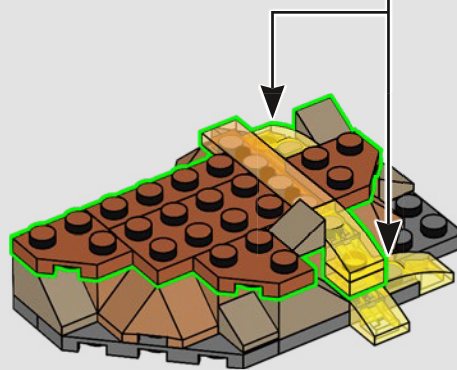
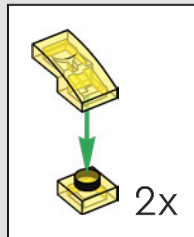

9

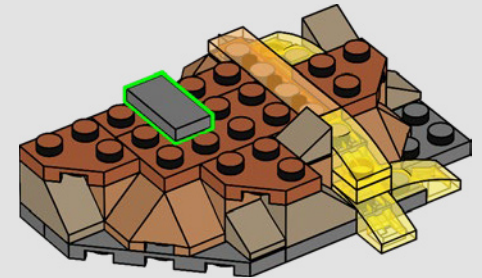

La cubierta LEGO® plana 1x4 en color naranja transparente se fabricó por primera vez en dicha tonalidad para este modelo. Hay 63 en el set.



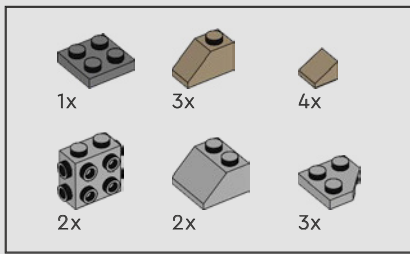

10

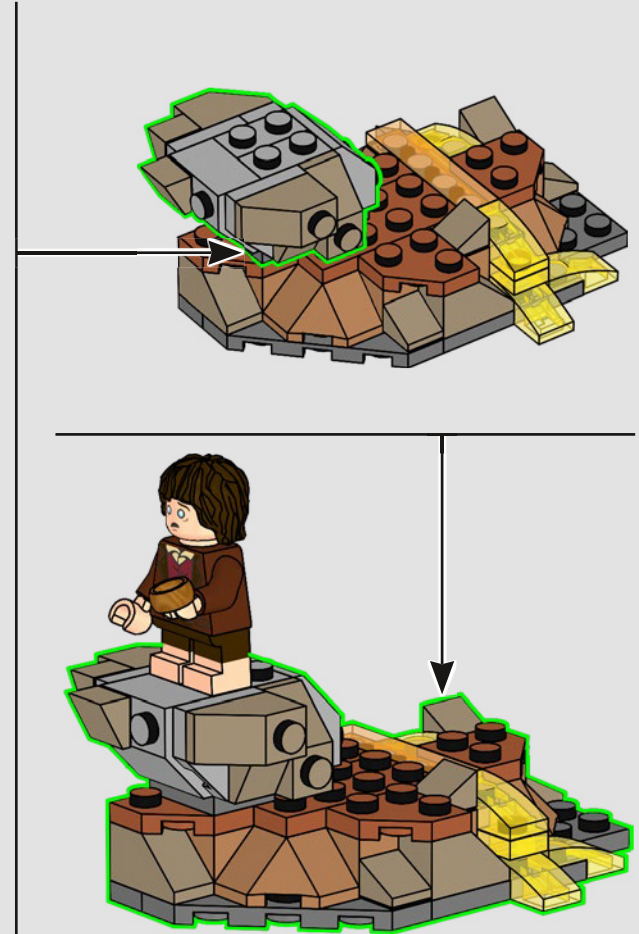
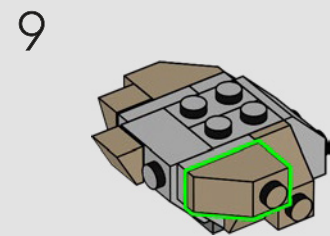
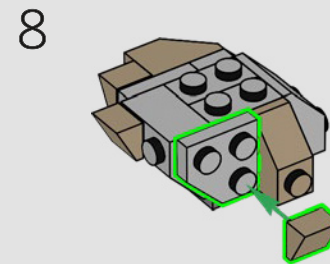
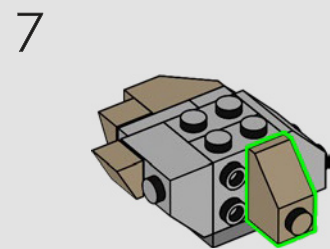
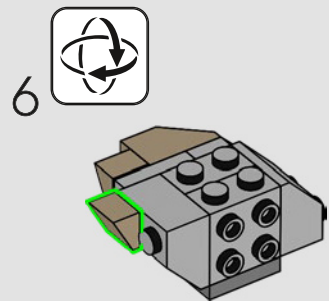
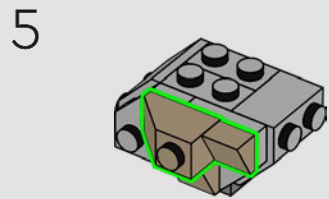
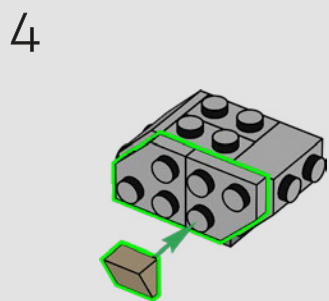
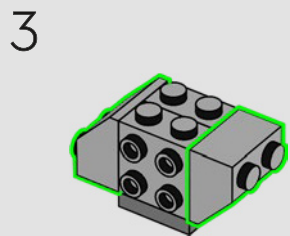
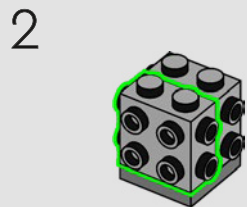
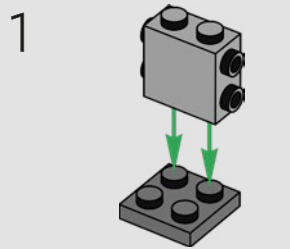

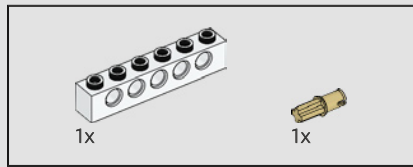
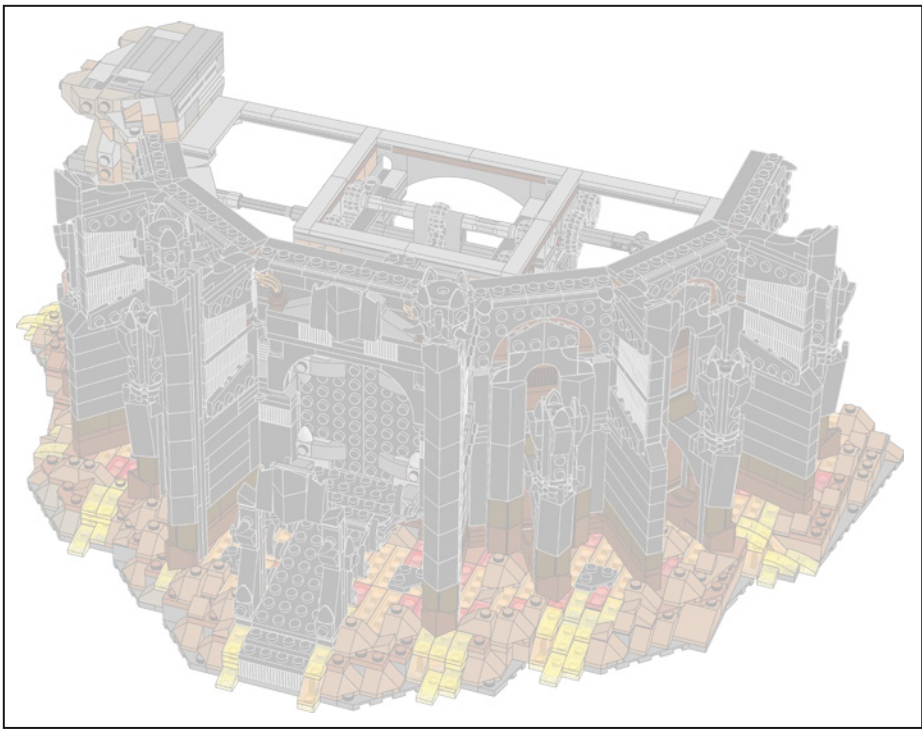

2

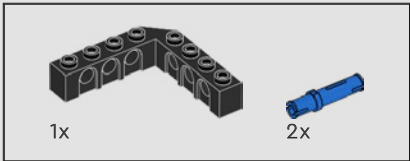
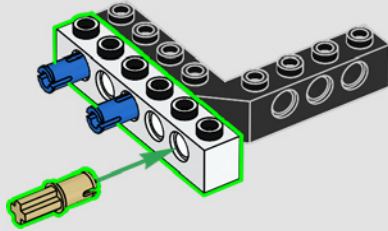

1

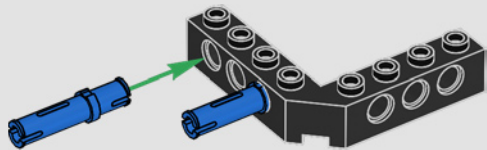

3

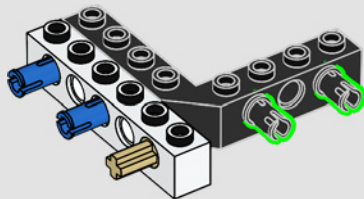

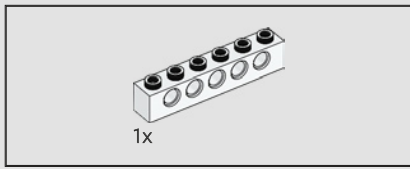

4

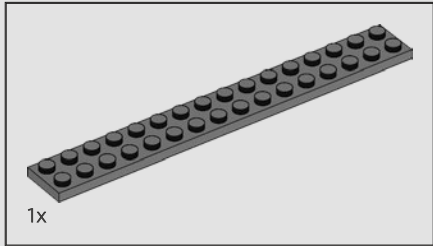
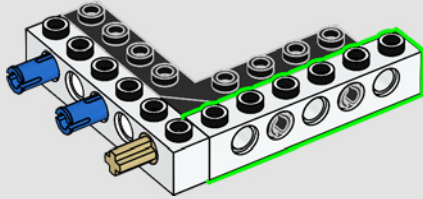

5

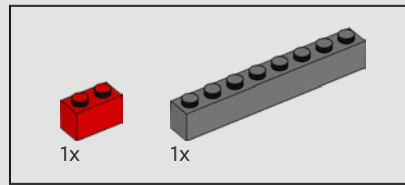
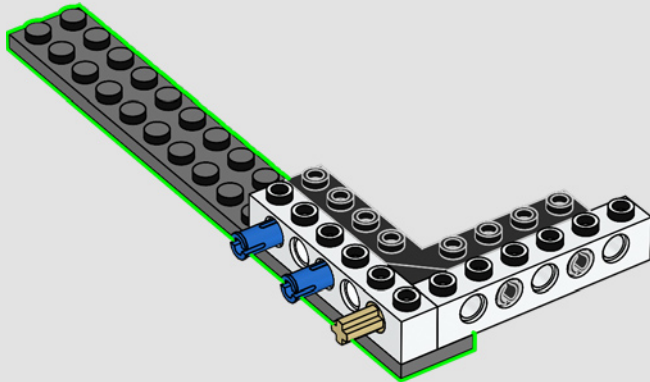

6

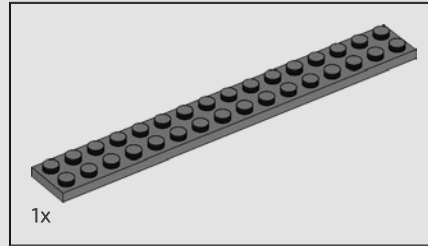
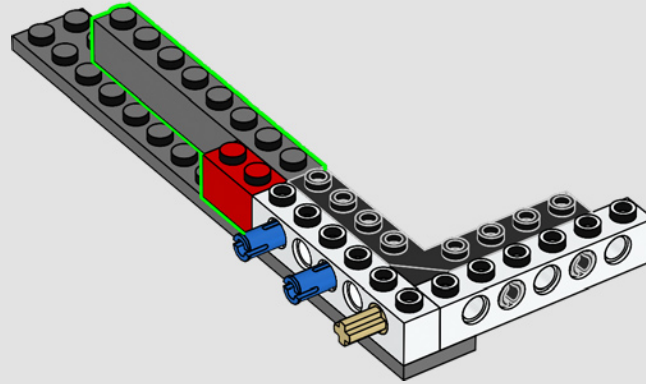

7

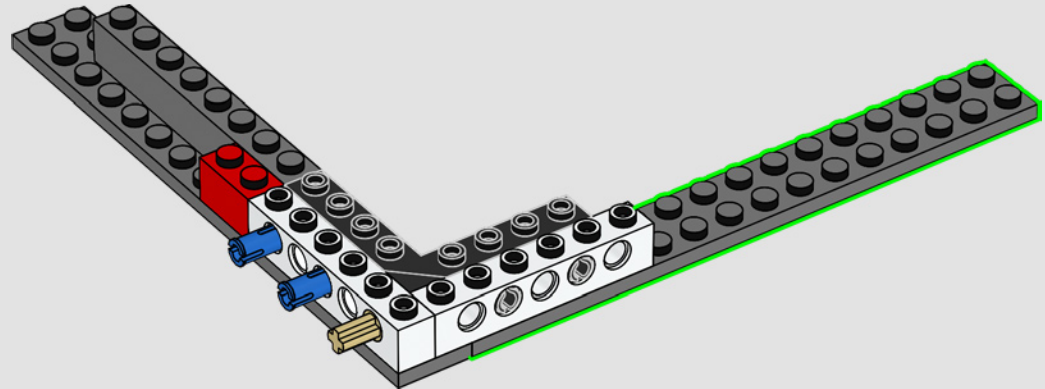

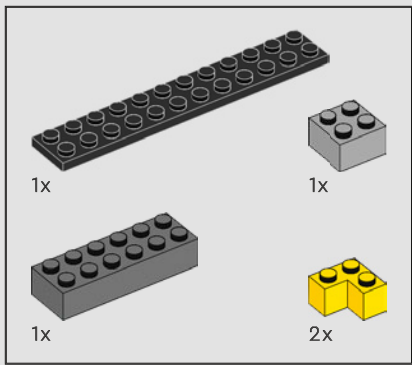

8

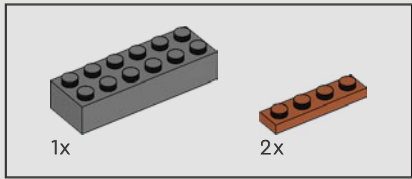
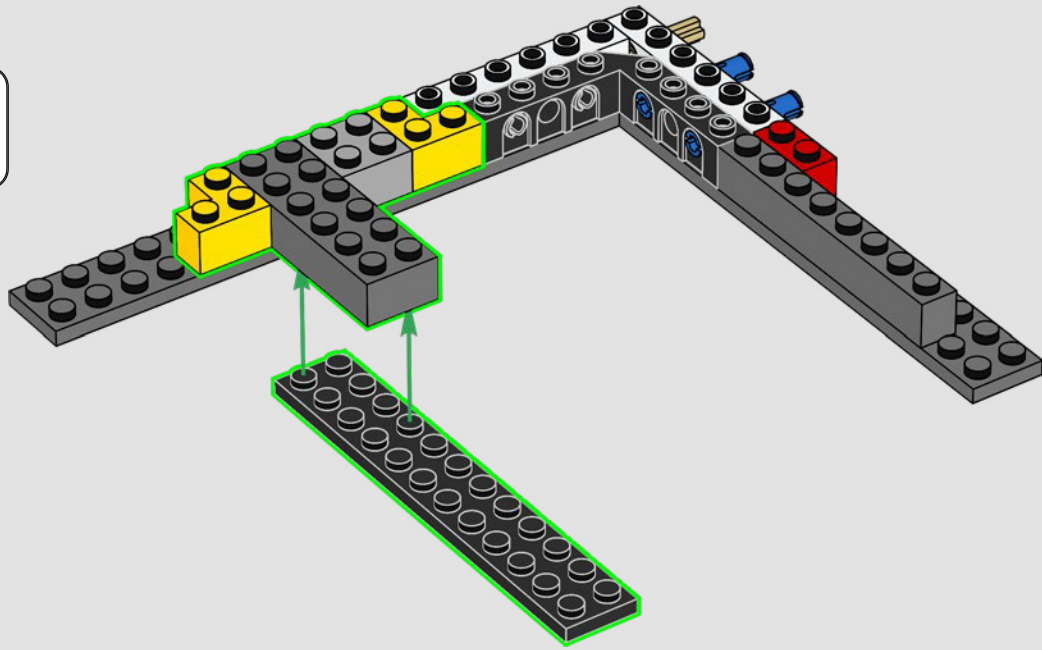

9

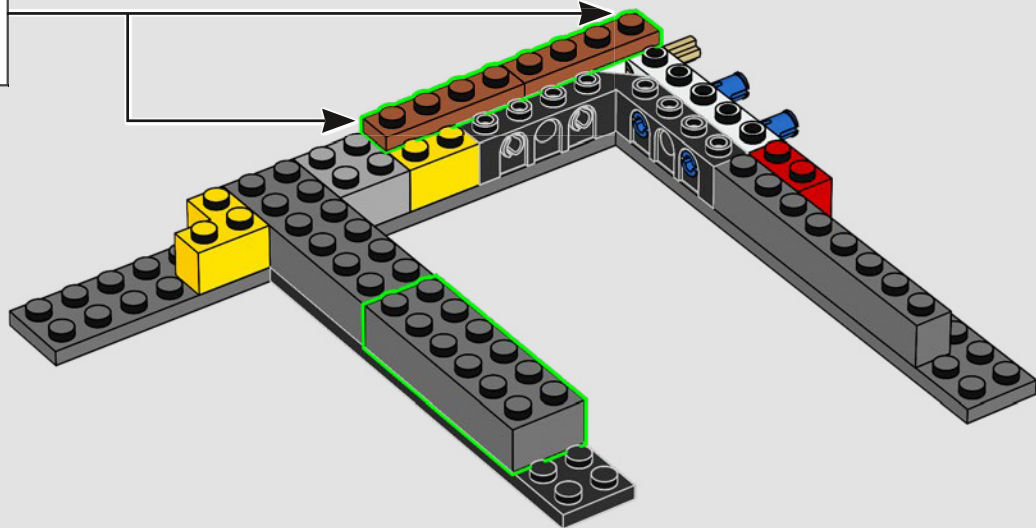
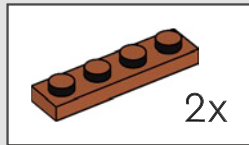

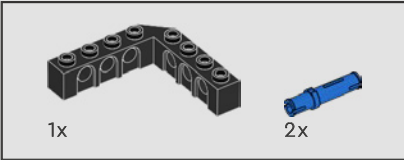
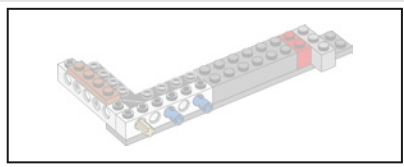

10

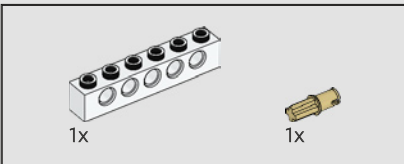
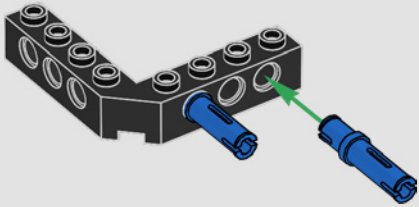

11

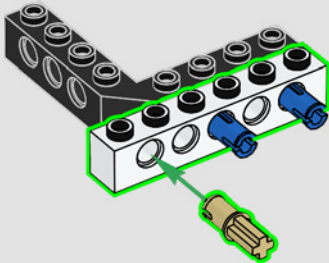

12

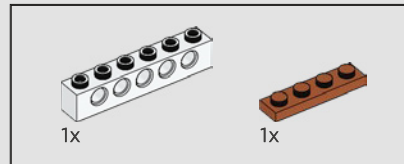
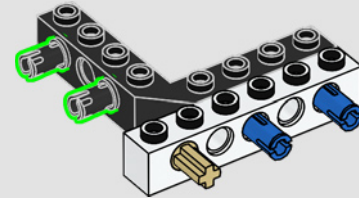

13

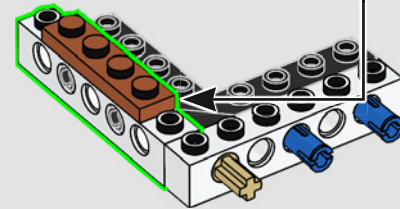
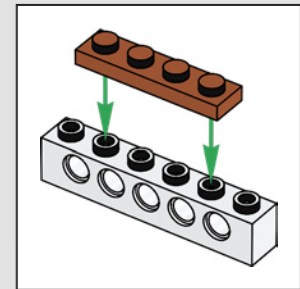

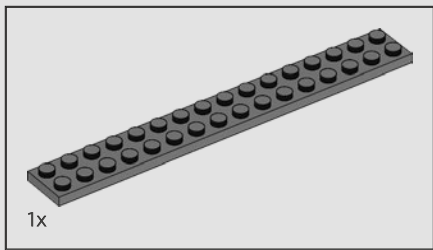

14

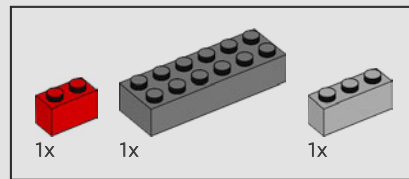
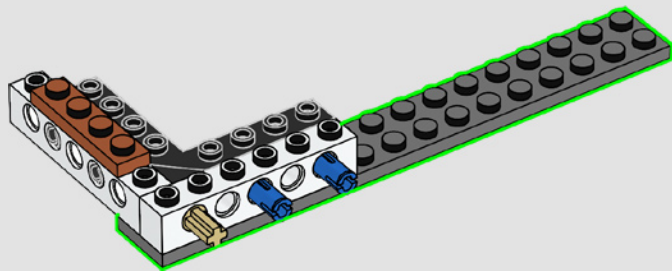

15

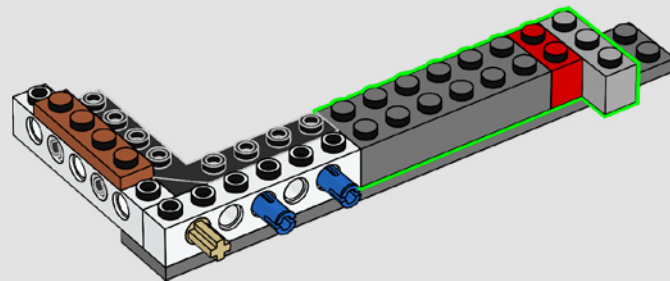

16

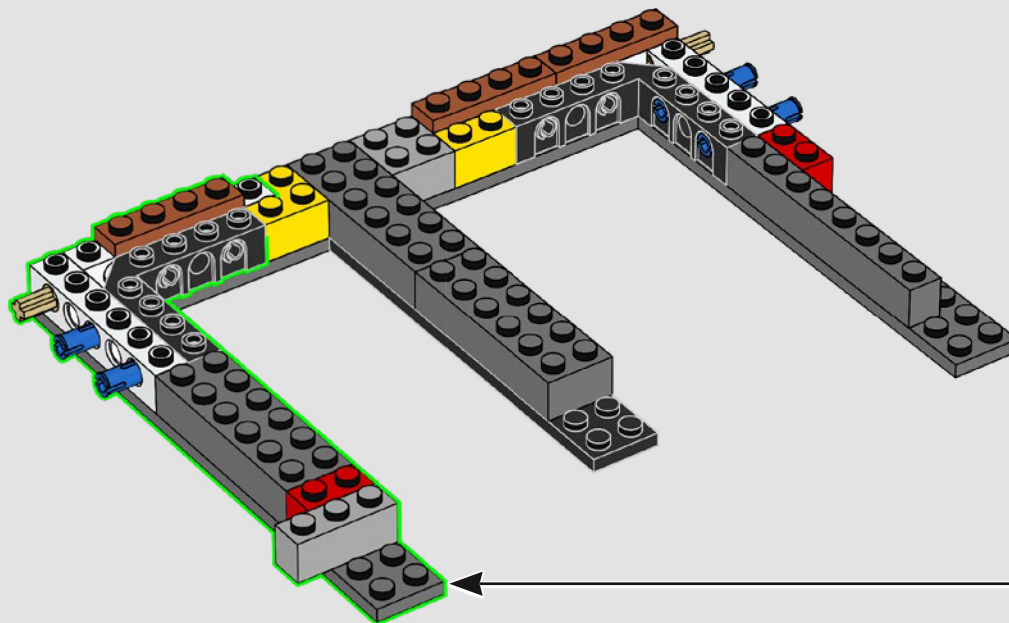

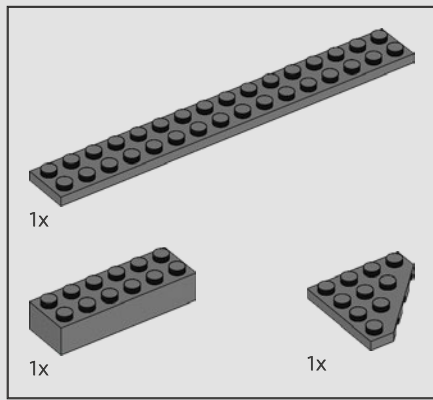

17

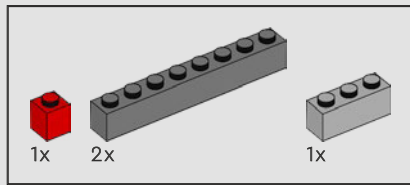
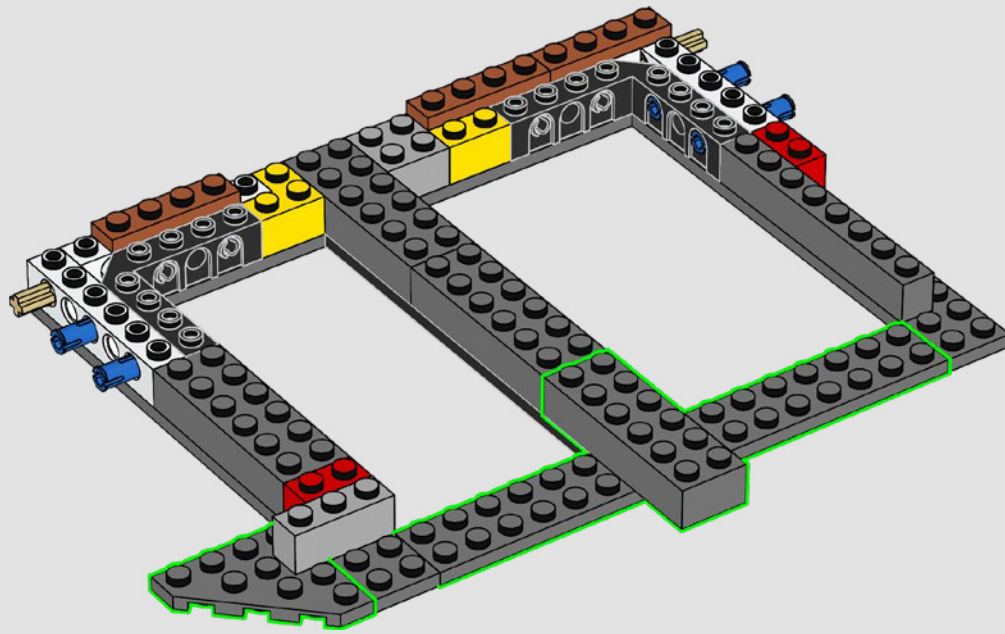

18

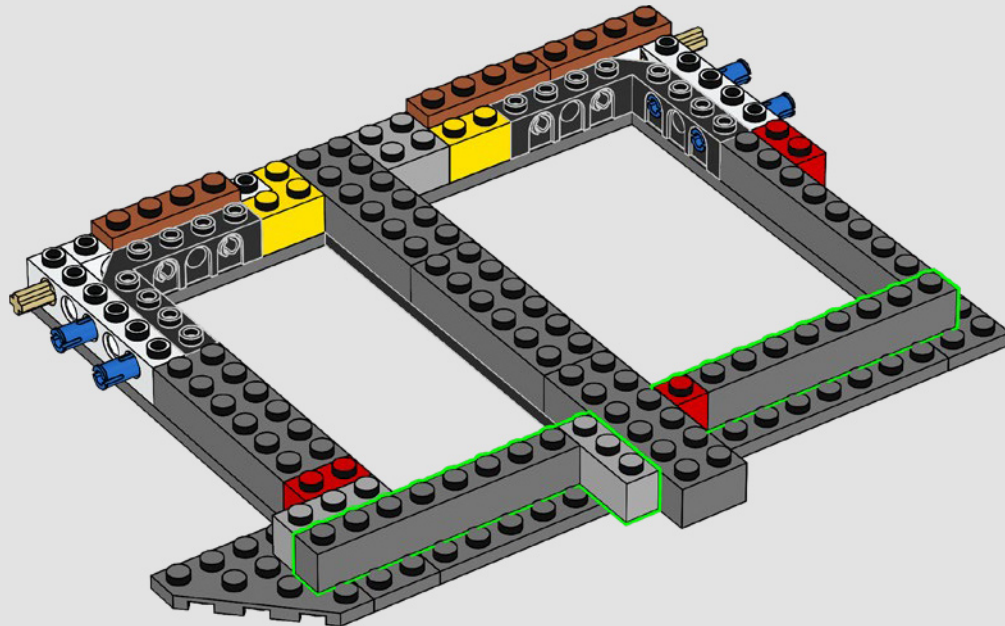

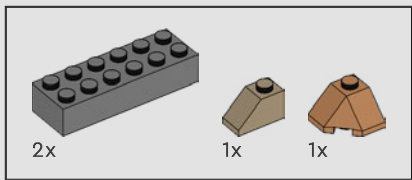

19

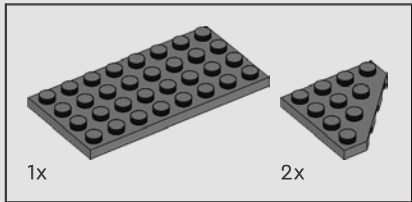
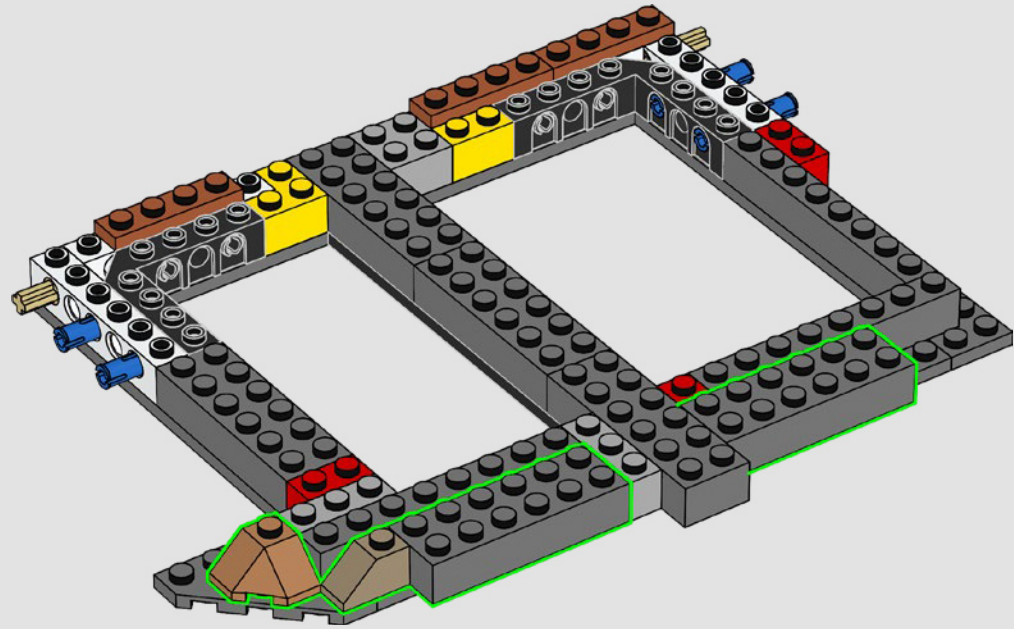

20

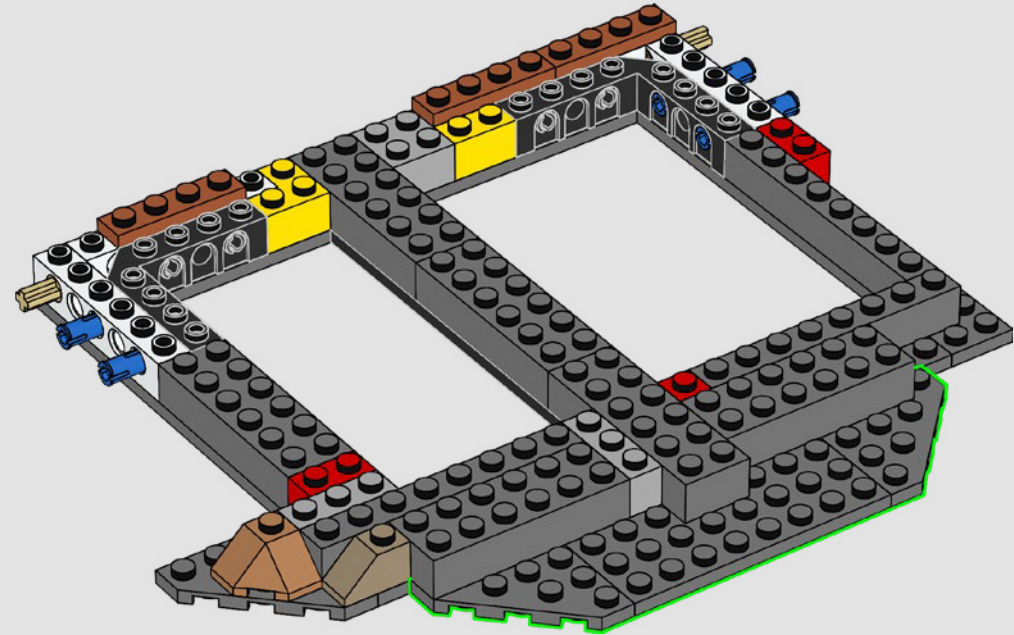

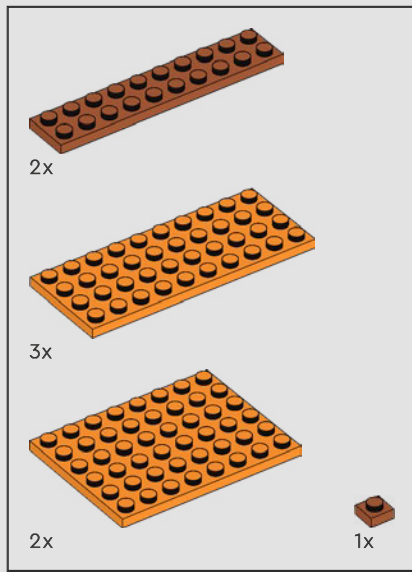

21

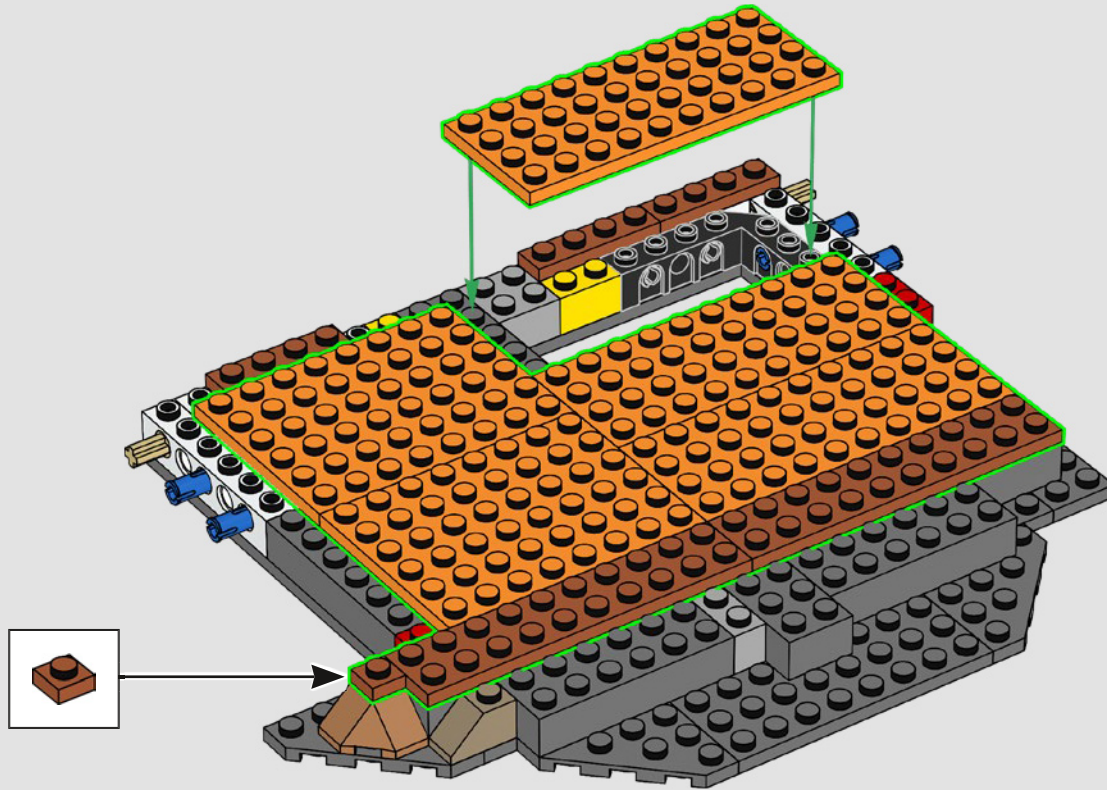

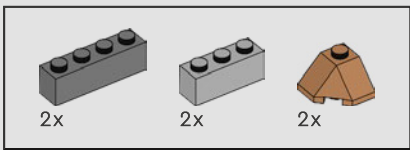

22

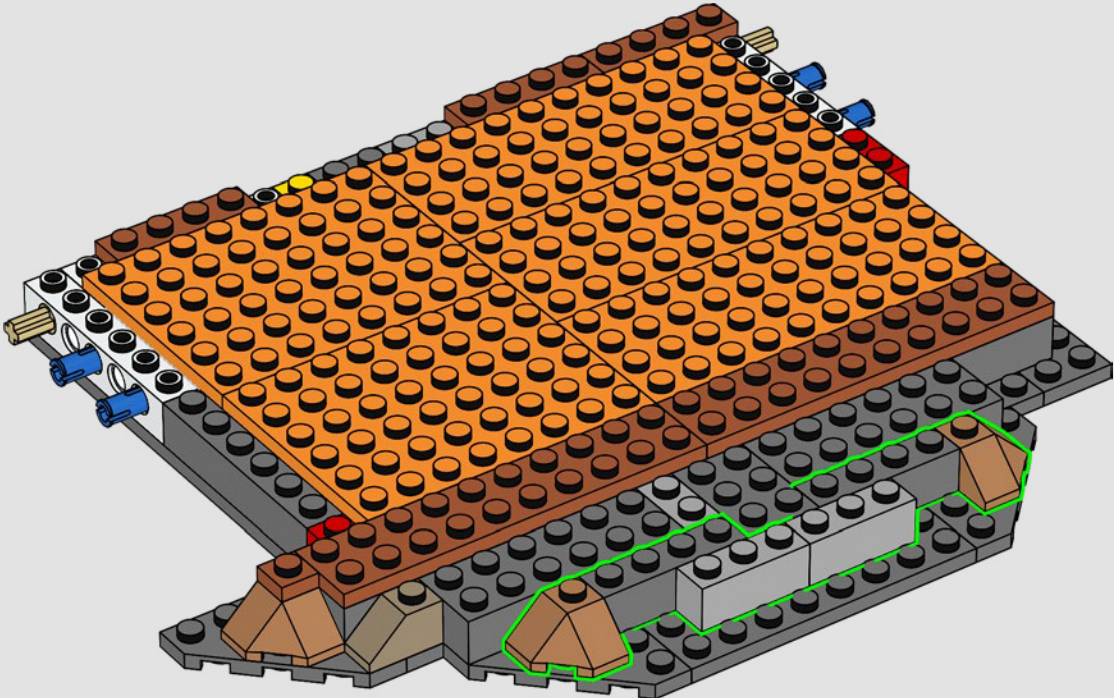

El frasco de Galadriel™ que sostiene Samsagaz Gamyi fue originalmente un regalo de ella a Frodo Bolsón. Después de que Frodo lo perdiera durante su encuentro con Ella-Laraña, Sam derrotó a esta y lo recuperó.

1

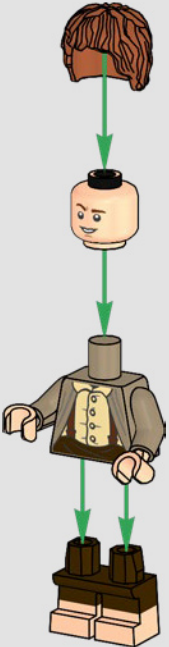

2





23

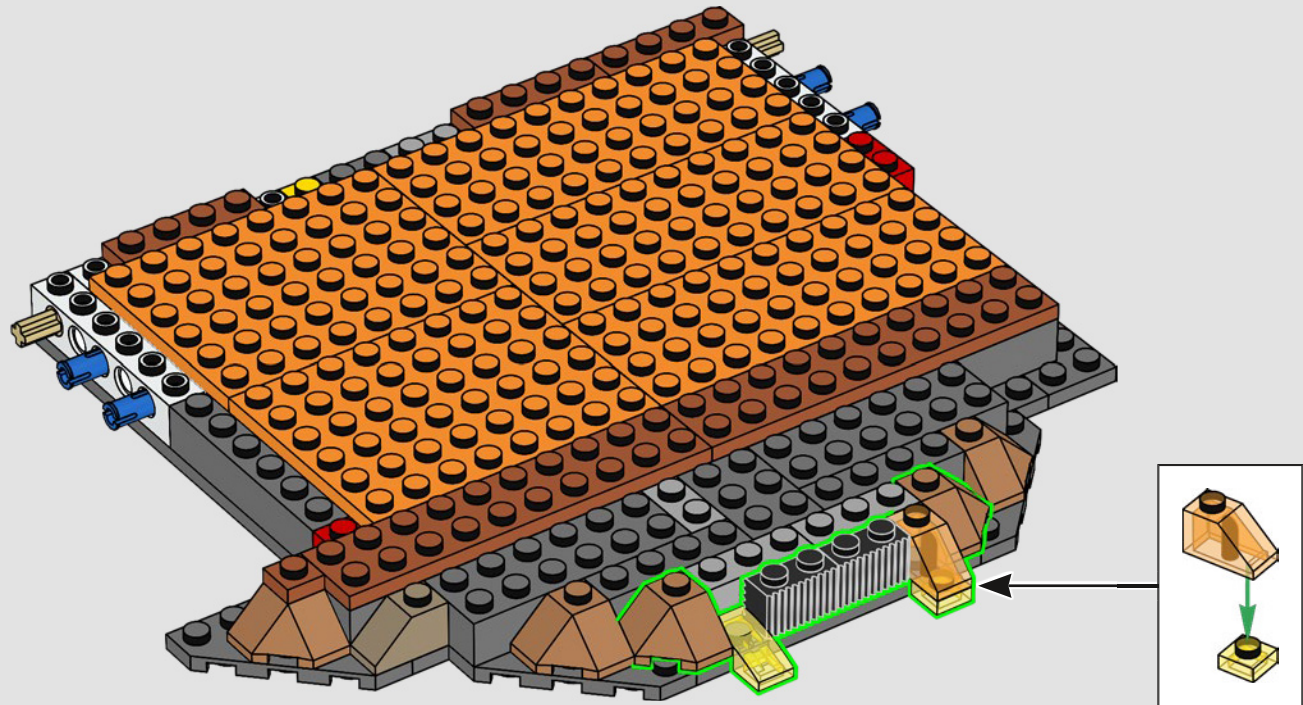

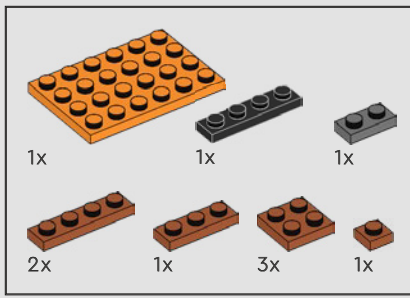

24

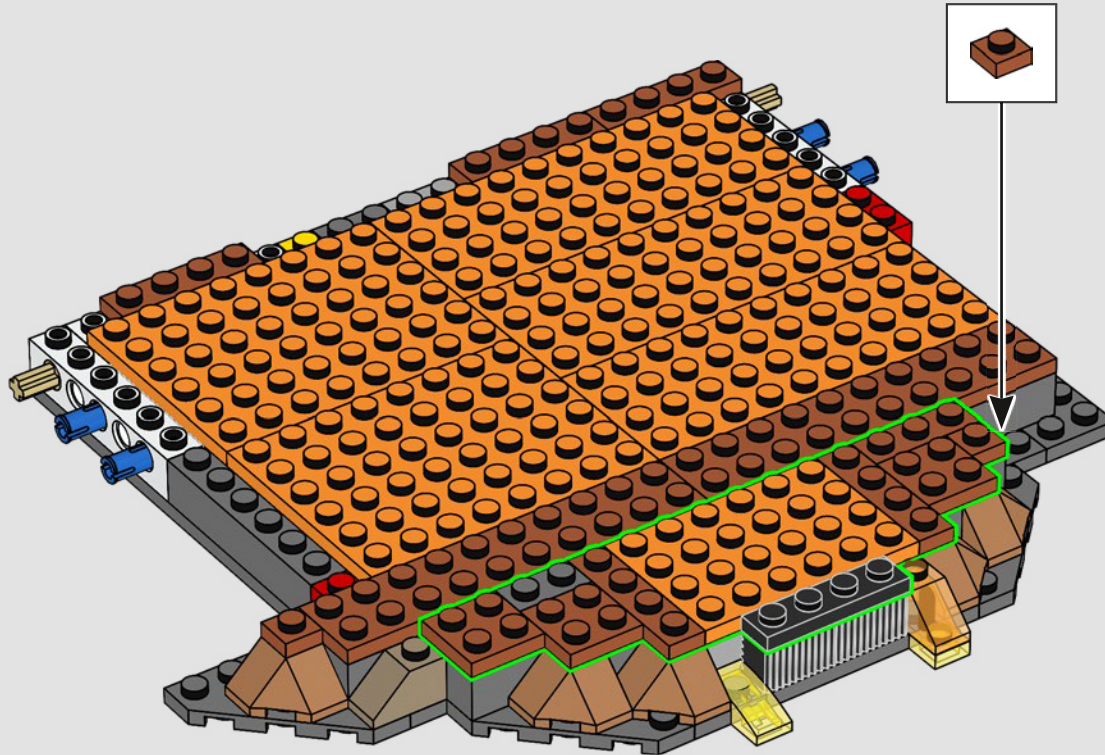

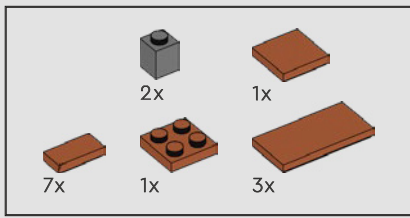

25

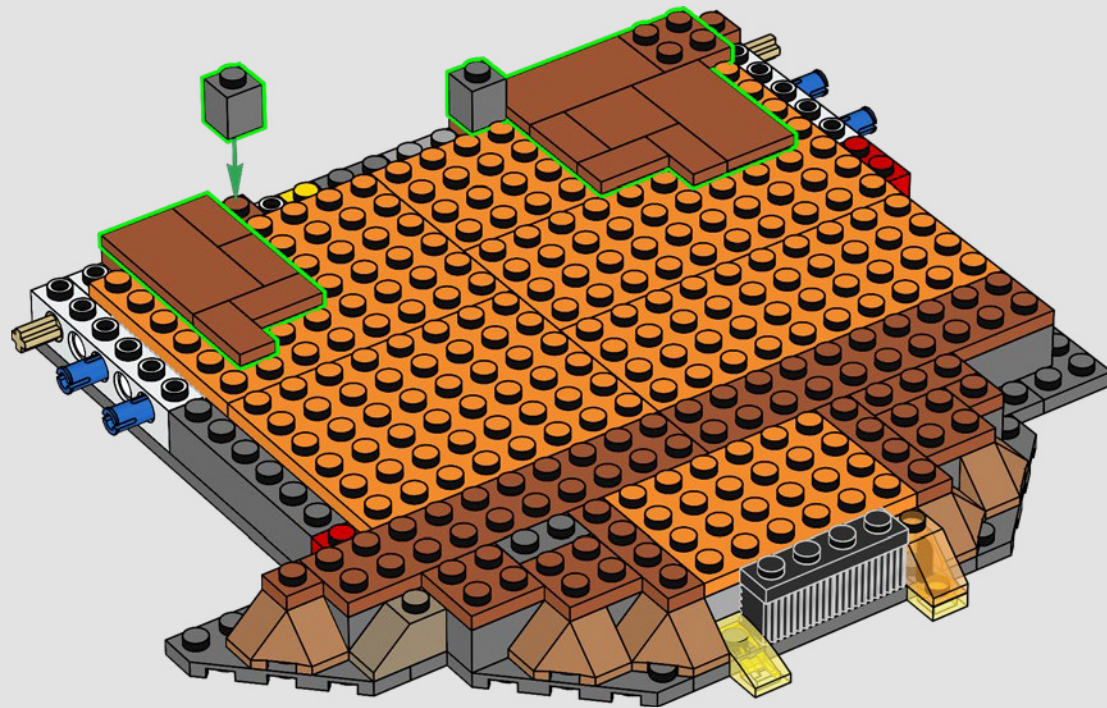

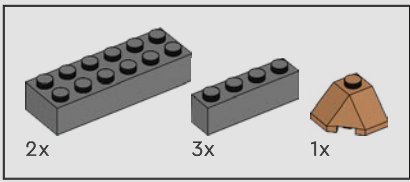

26

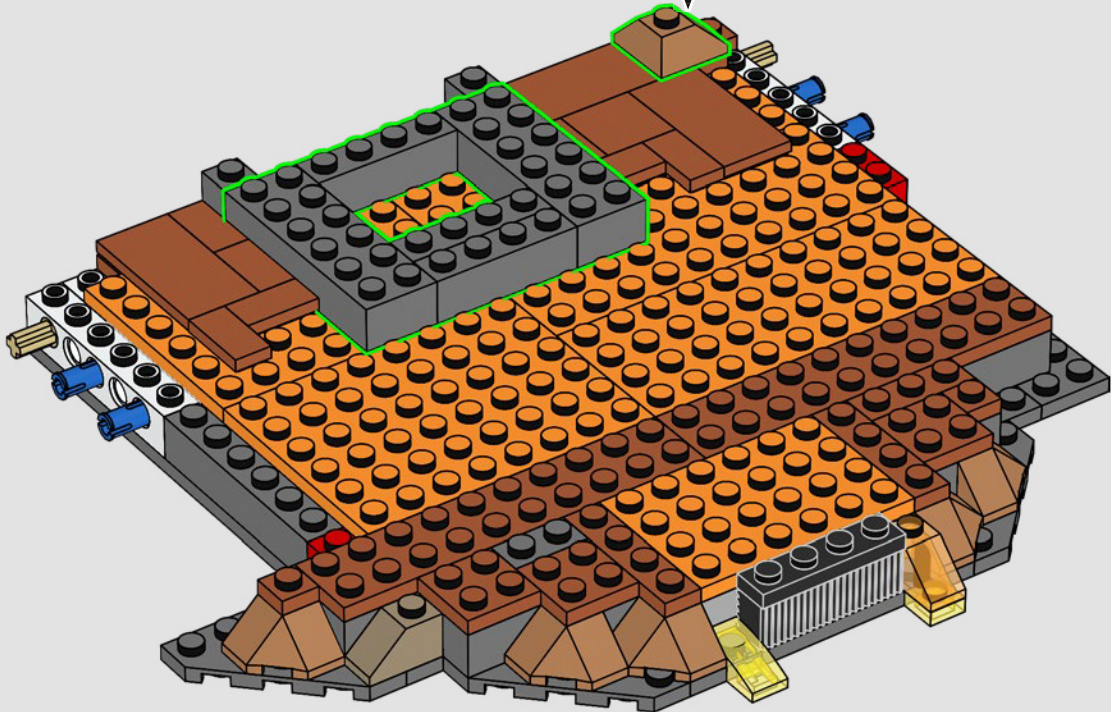

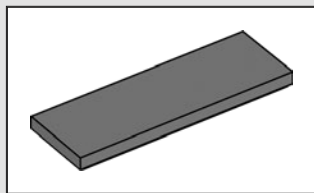
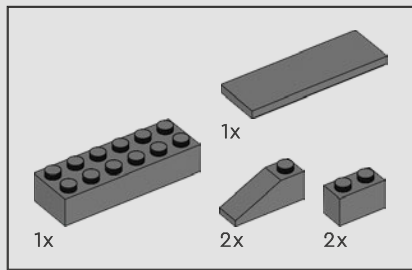

27

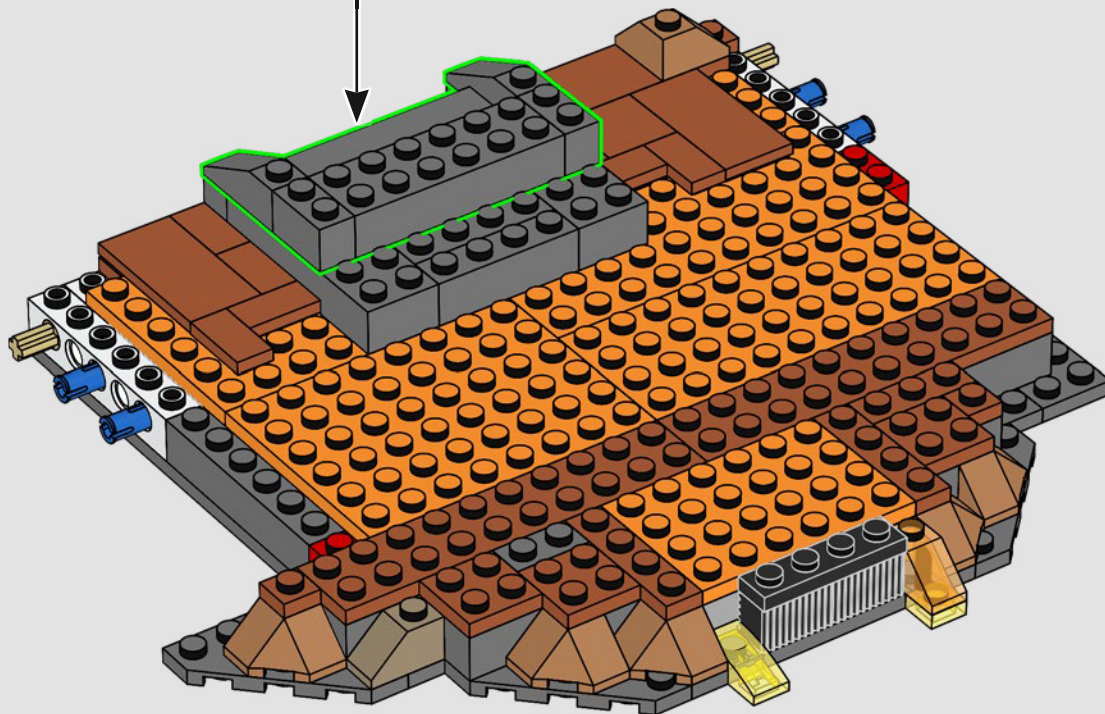

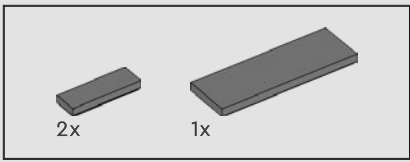

28

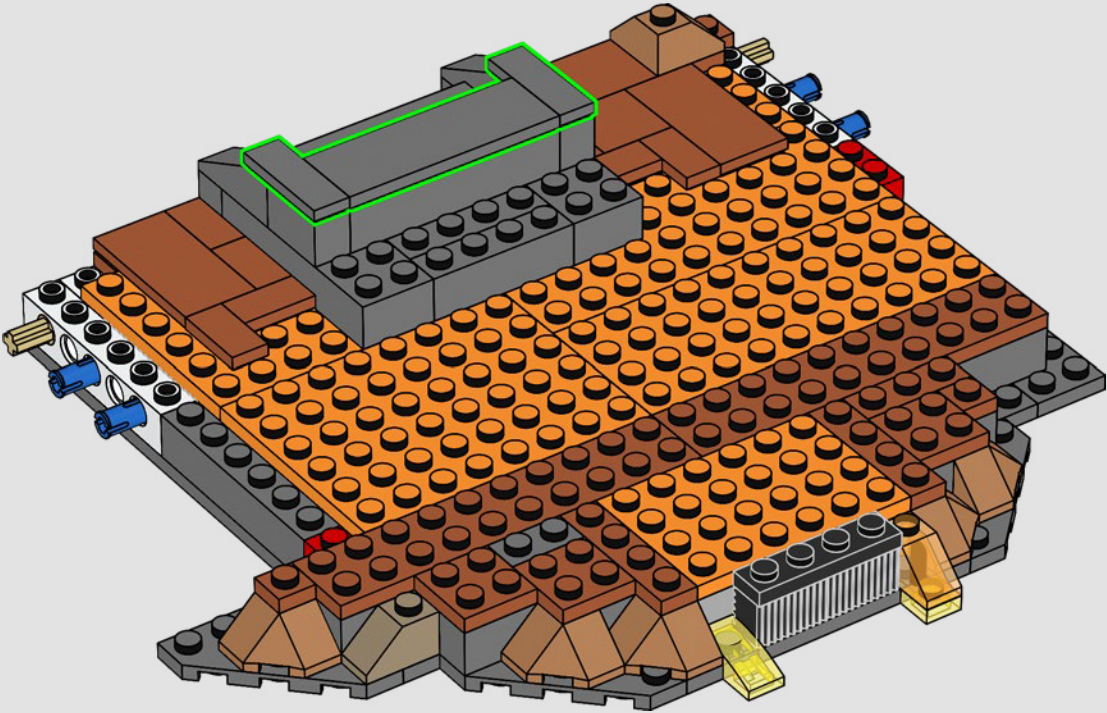

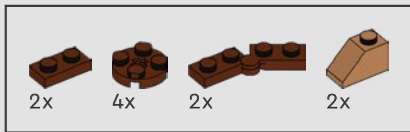

29

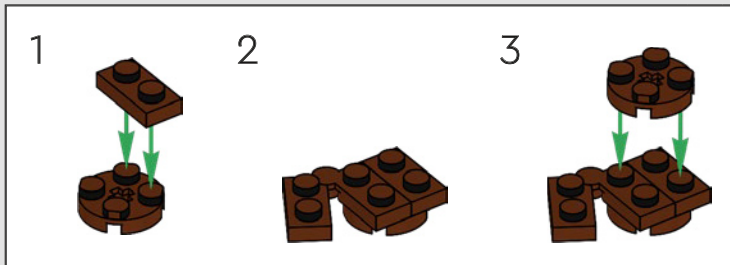
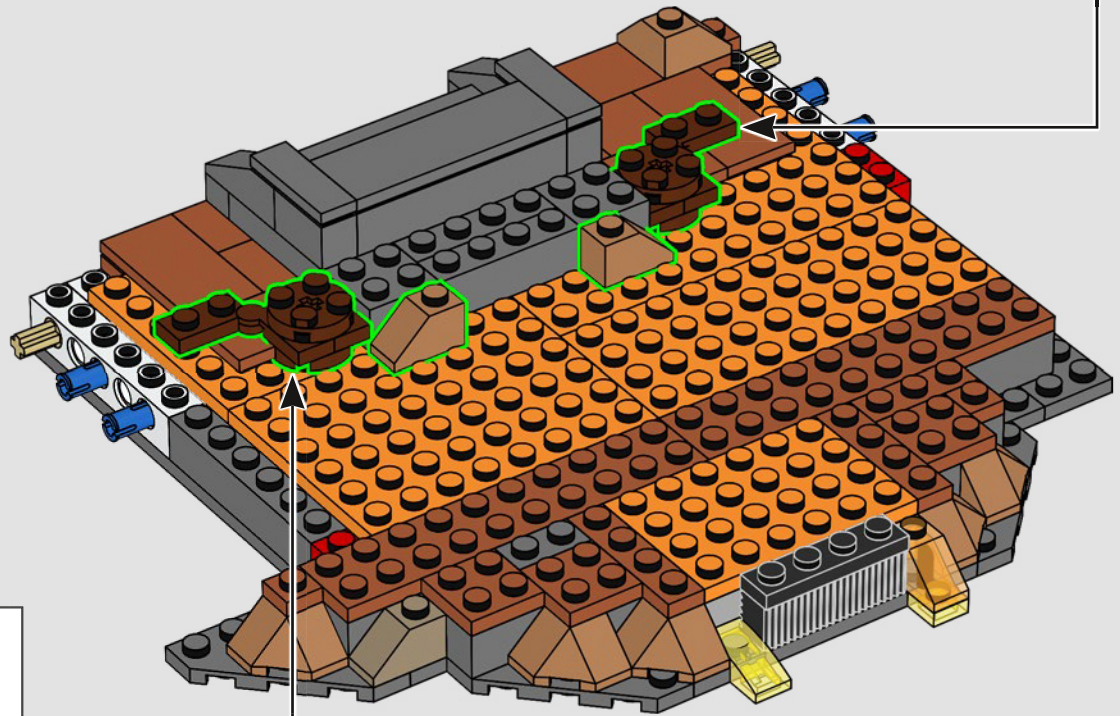
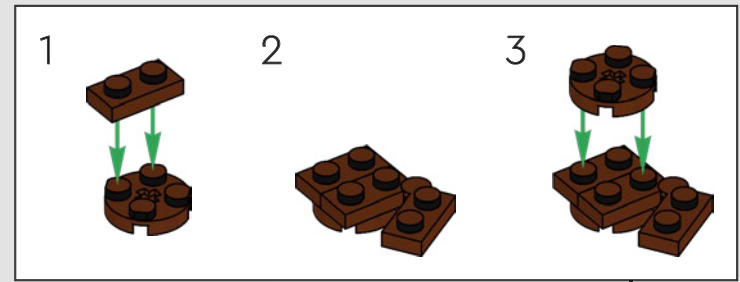

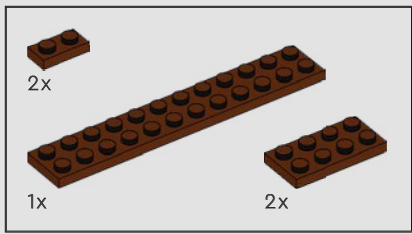

30

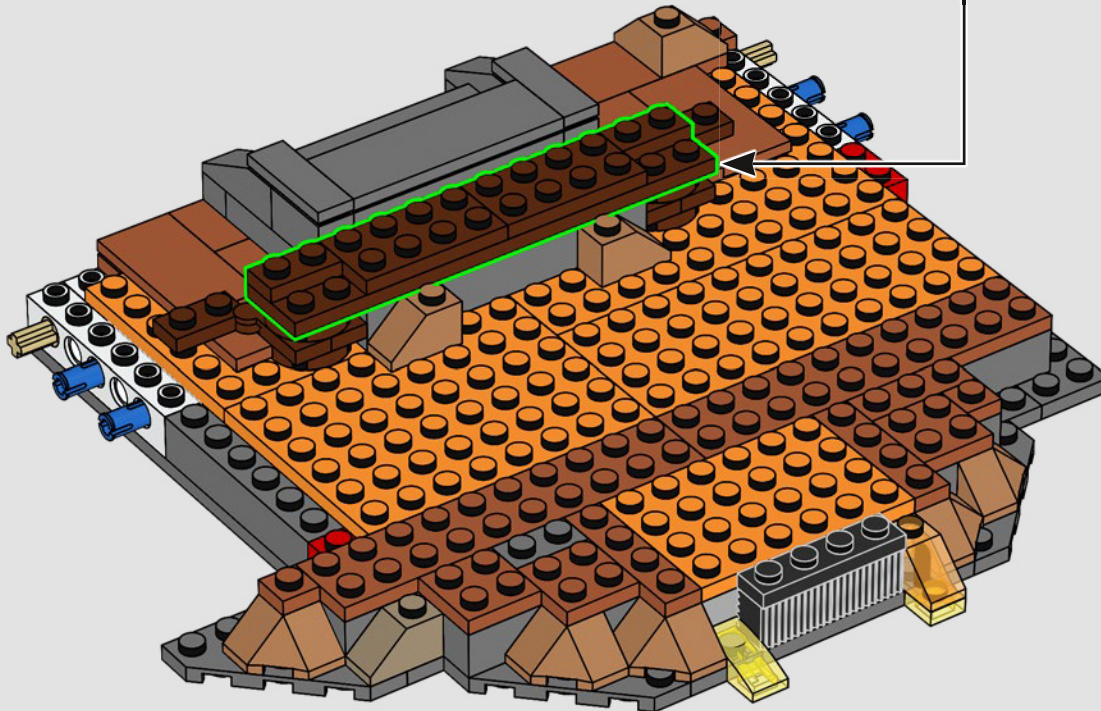
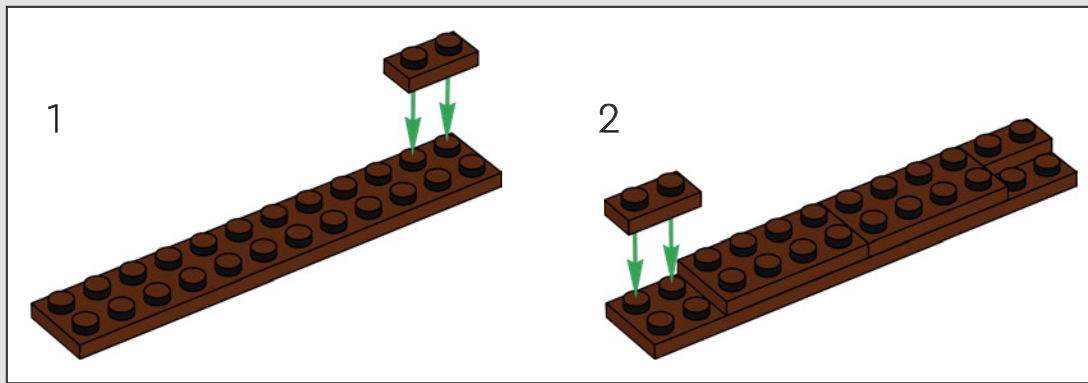

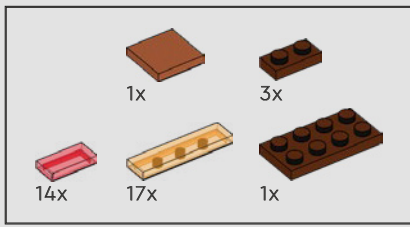

31

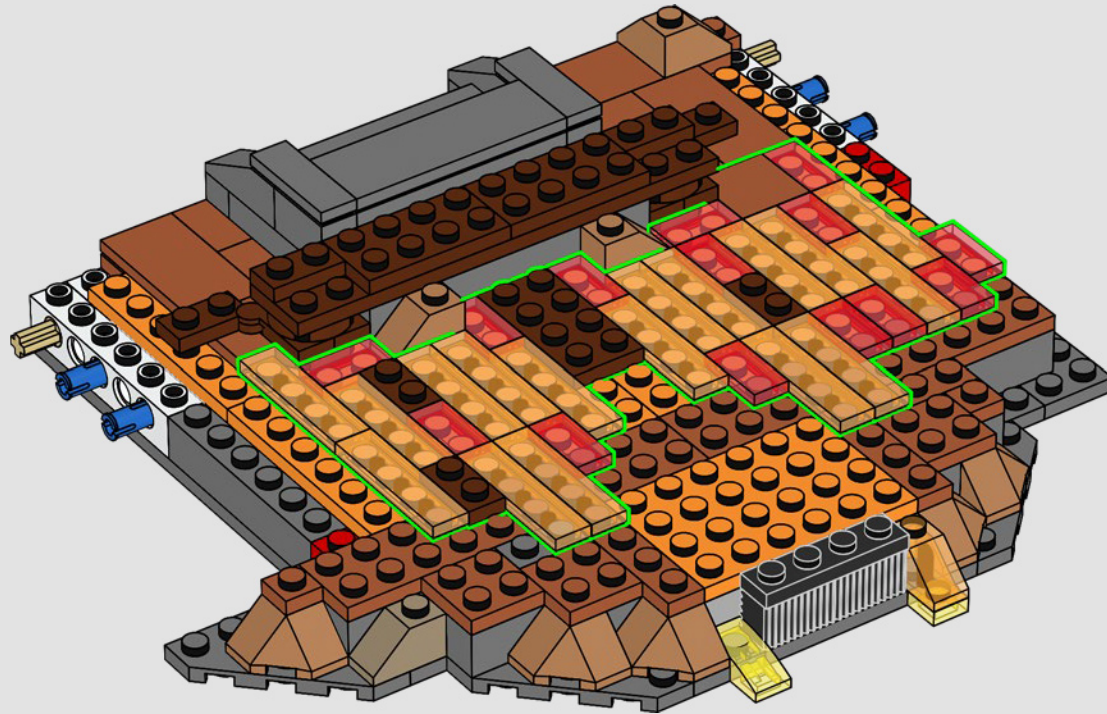

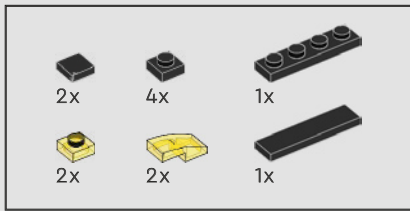

33

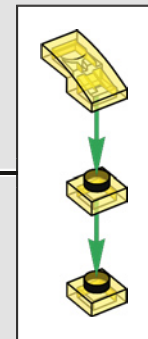
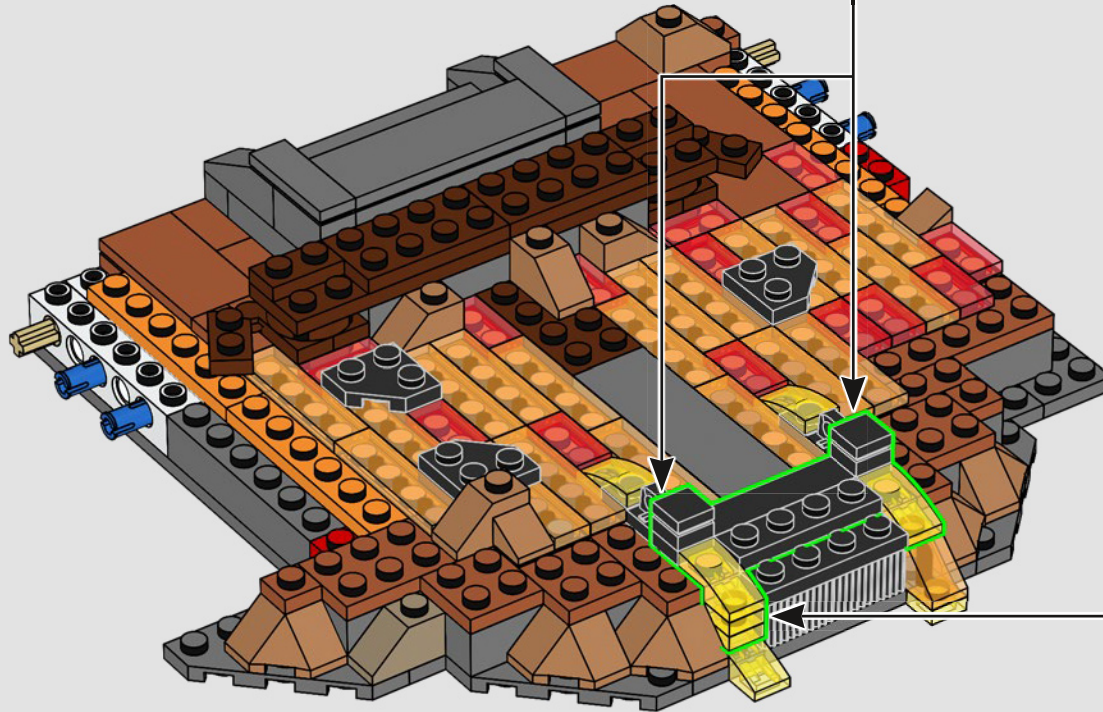
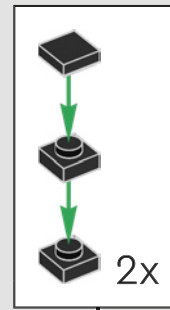



34

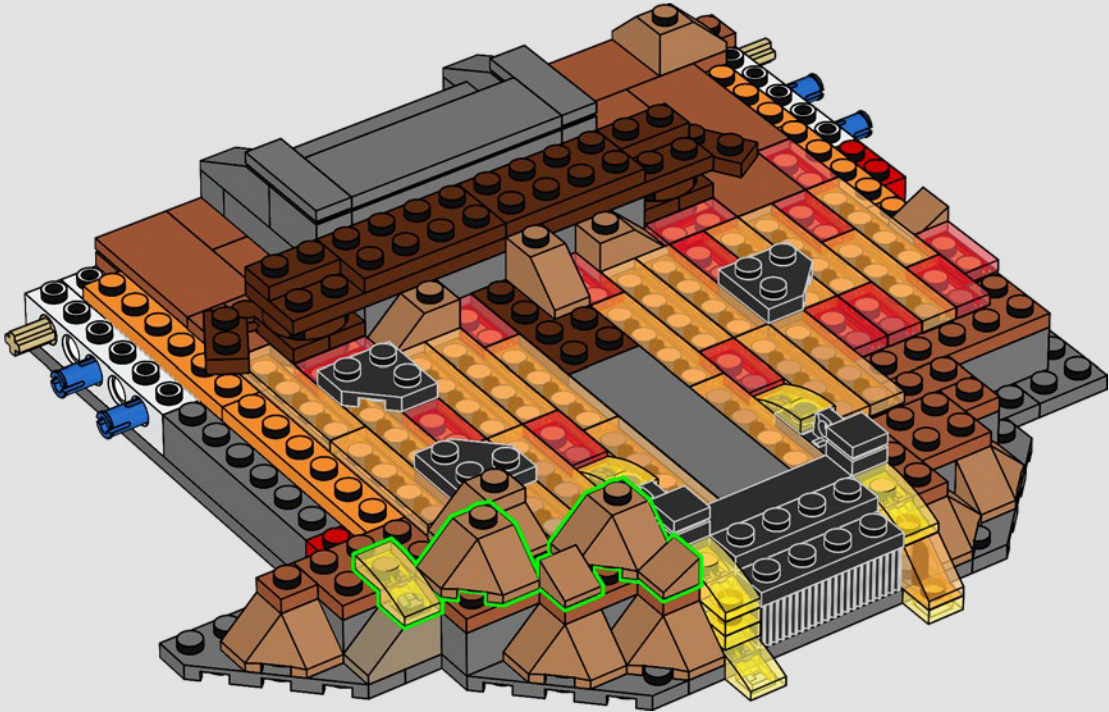

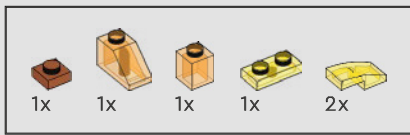

35

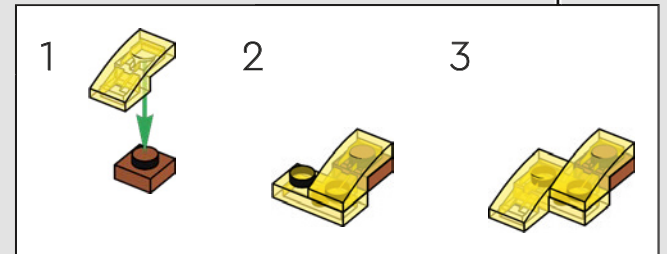
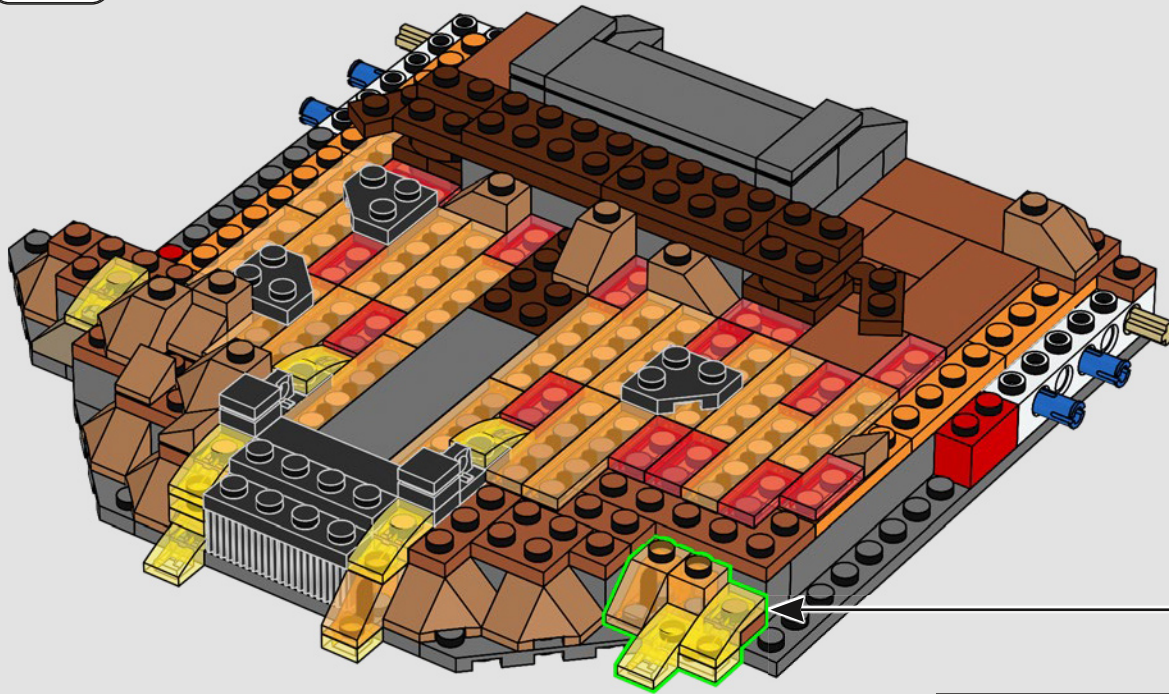



El terreno rocoso que rodea la Torre Oscura presenta varios colores. Las rocas más cercanas a la lava tienen tonos más cálidos, mientras que las más alejadas lucen más oscuras y frías.

36

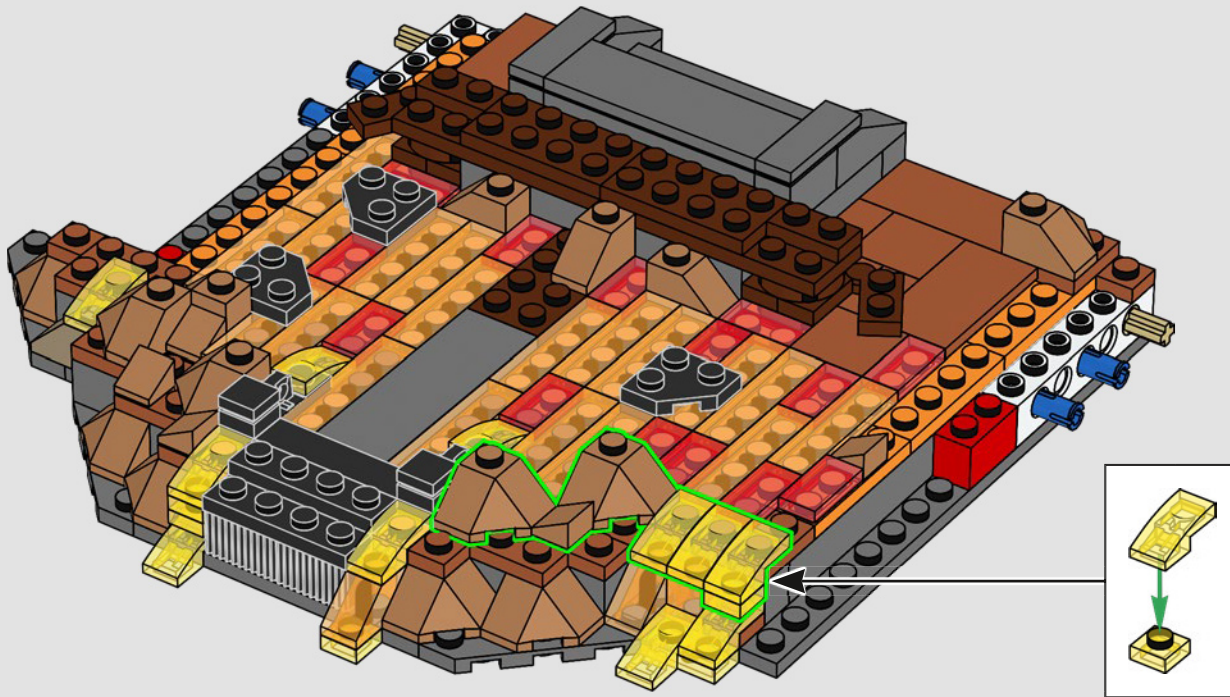

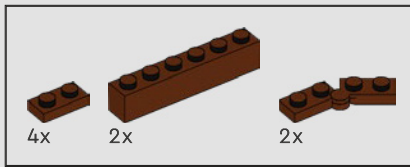

37

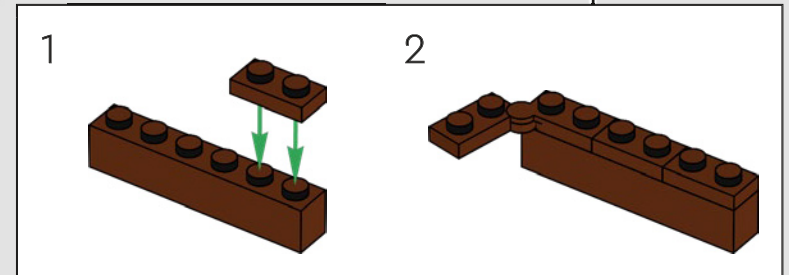
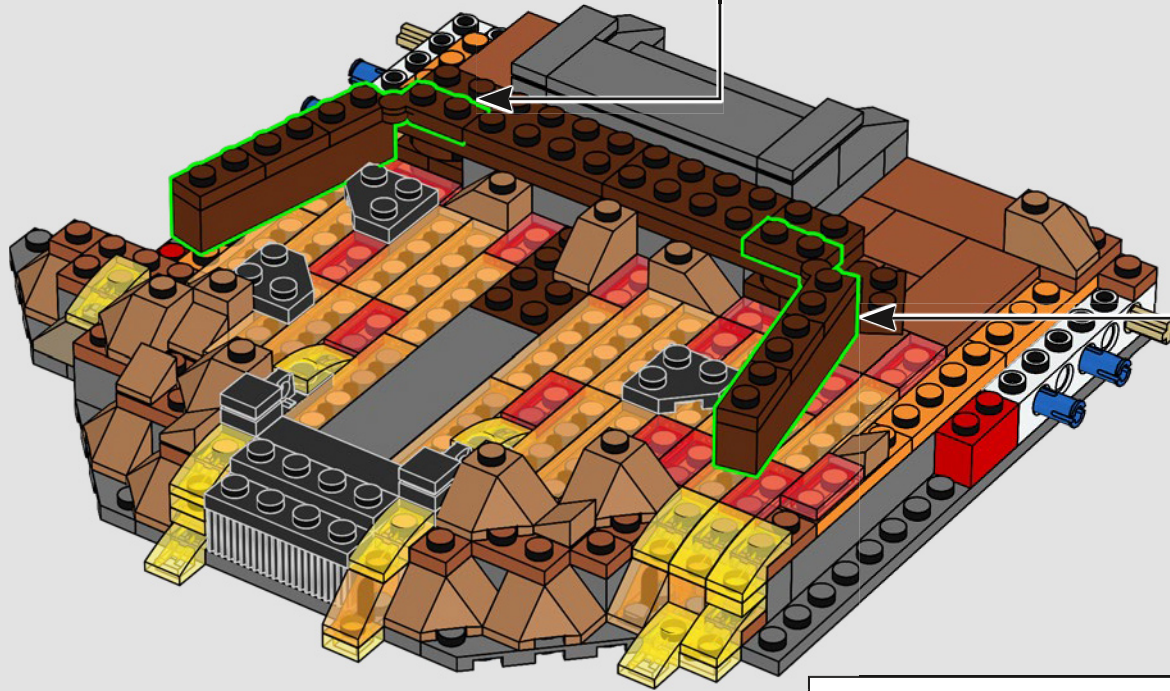
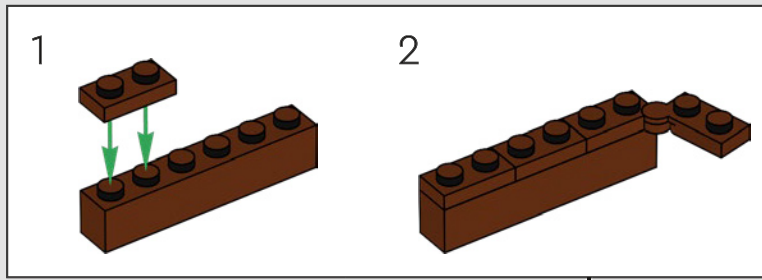

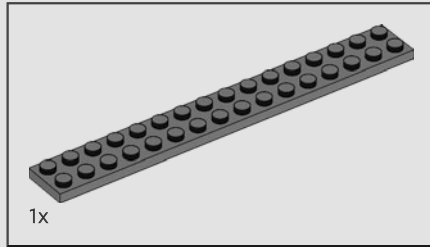
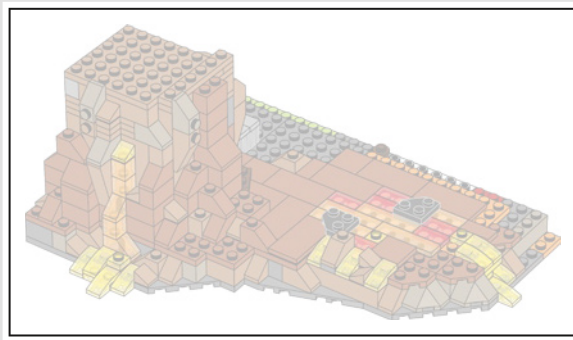

38

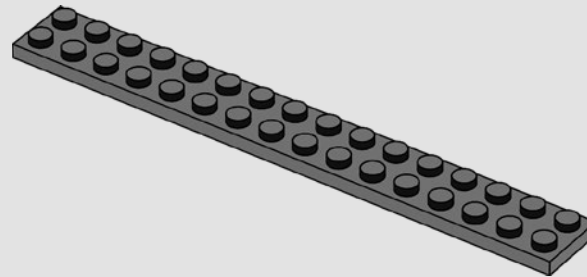

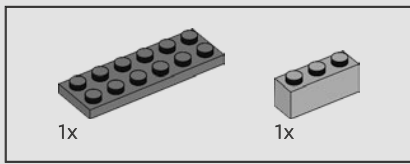

39

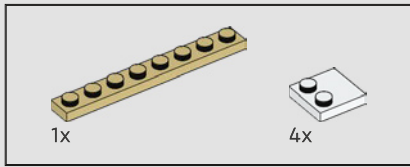
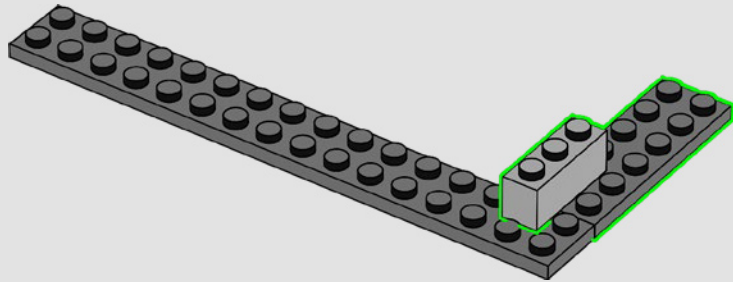

40

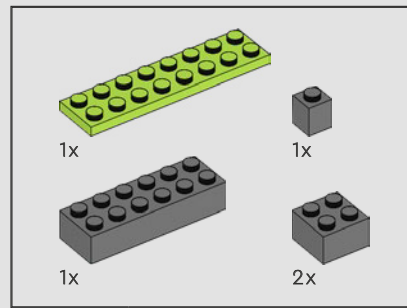
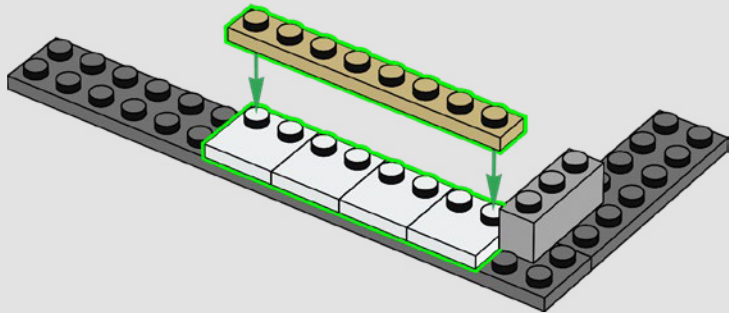

41

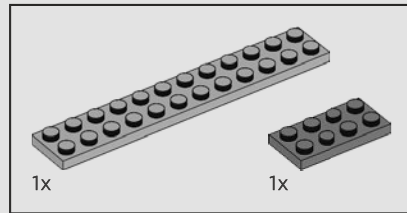
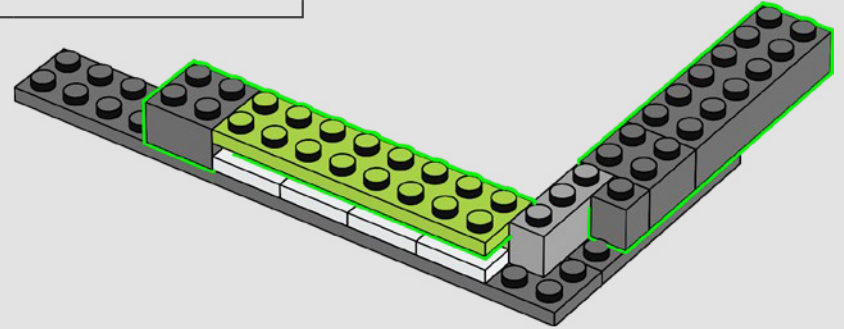

42

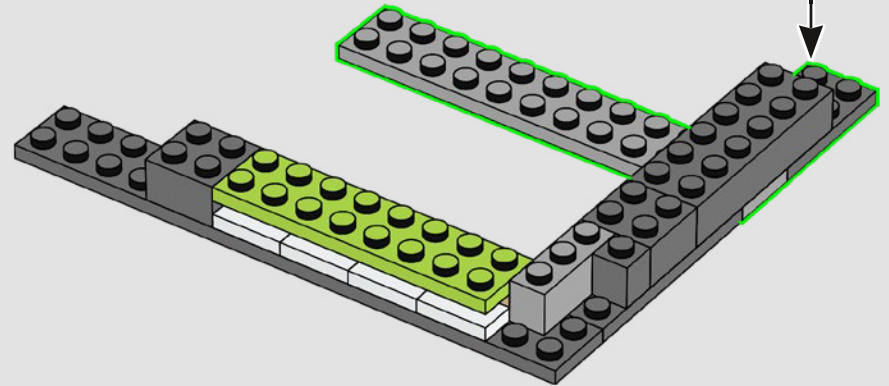

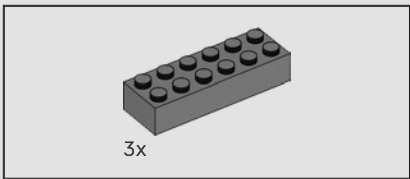

43

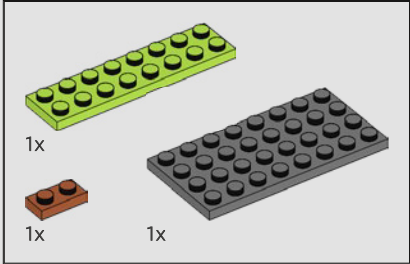
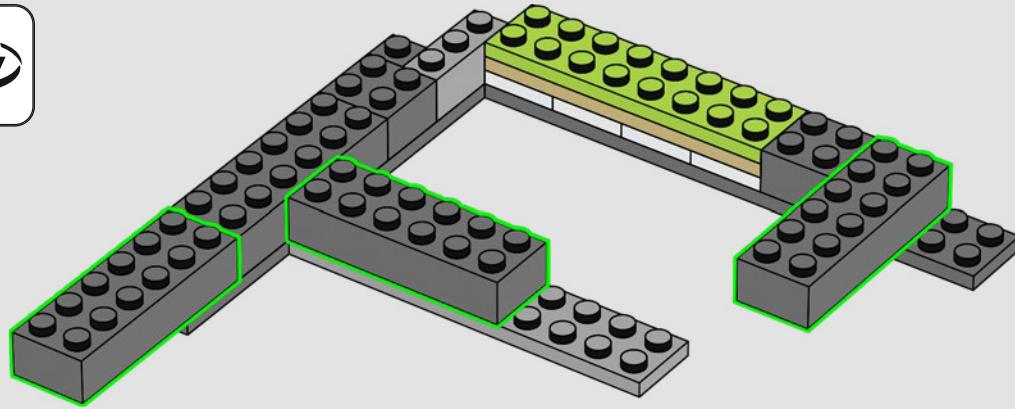

44

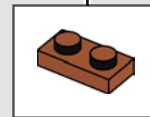
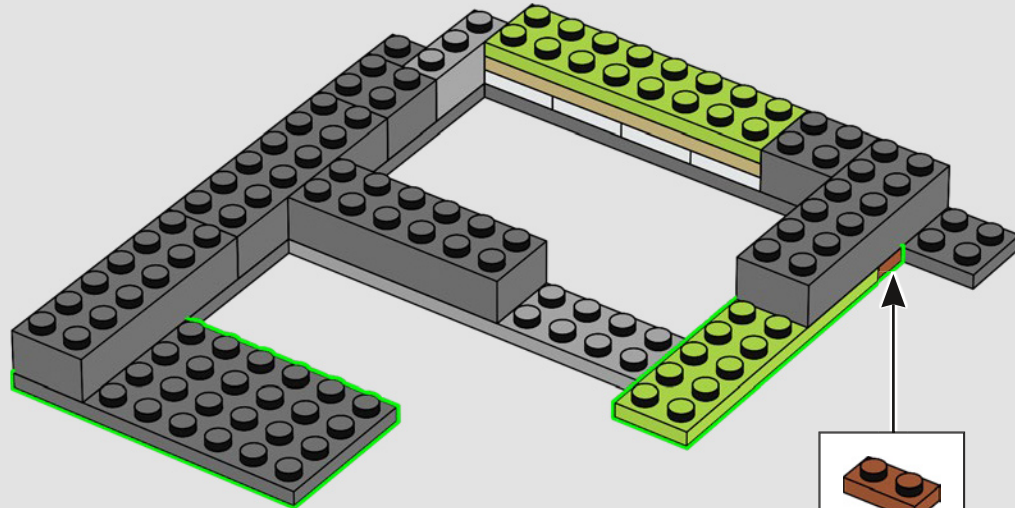

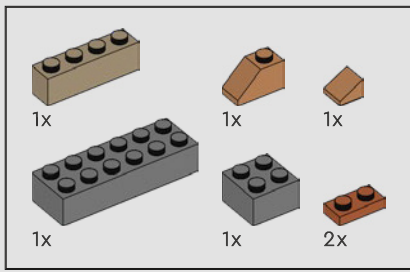

45

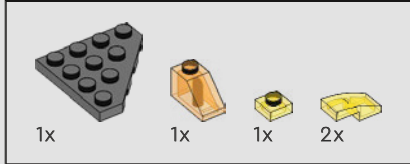
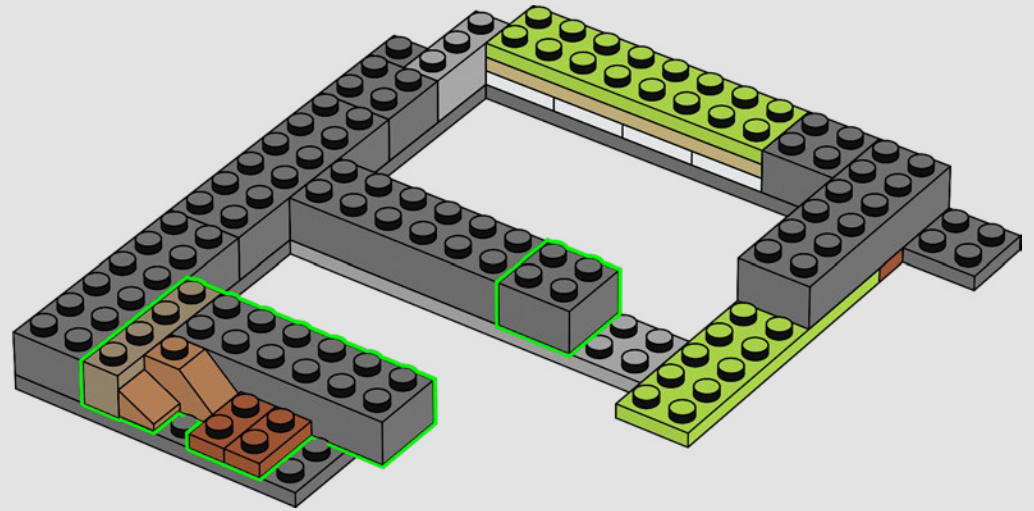

46

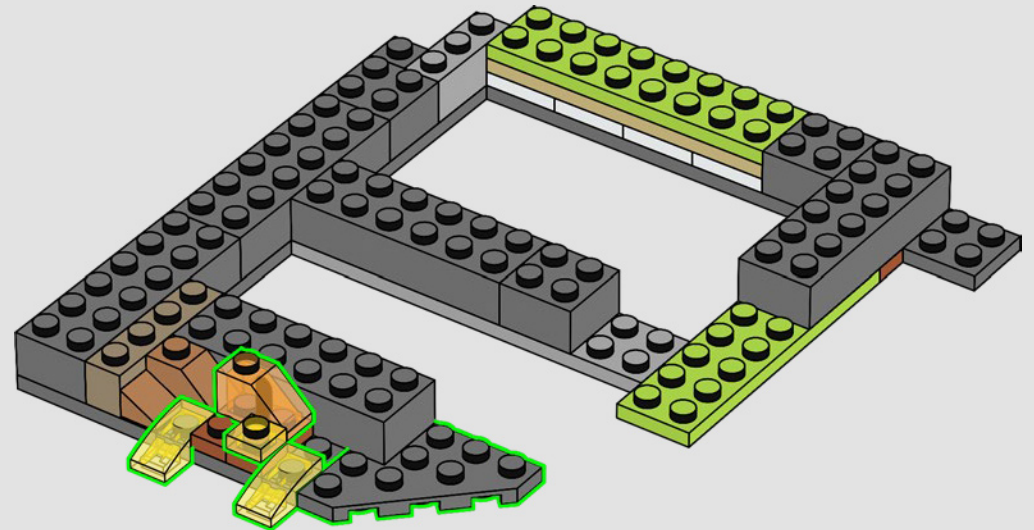

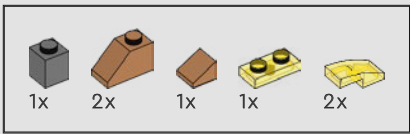

47

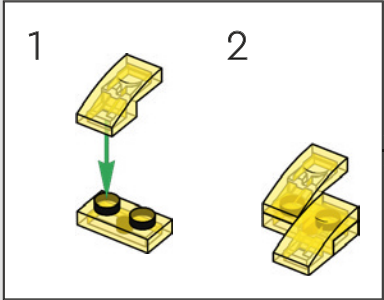
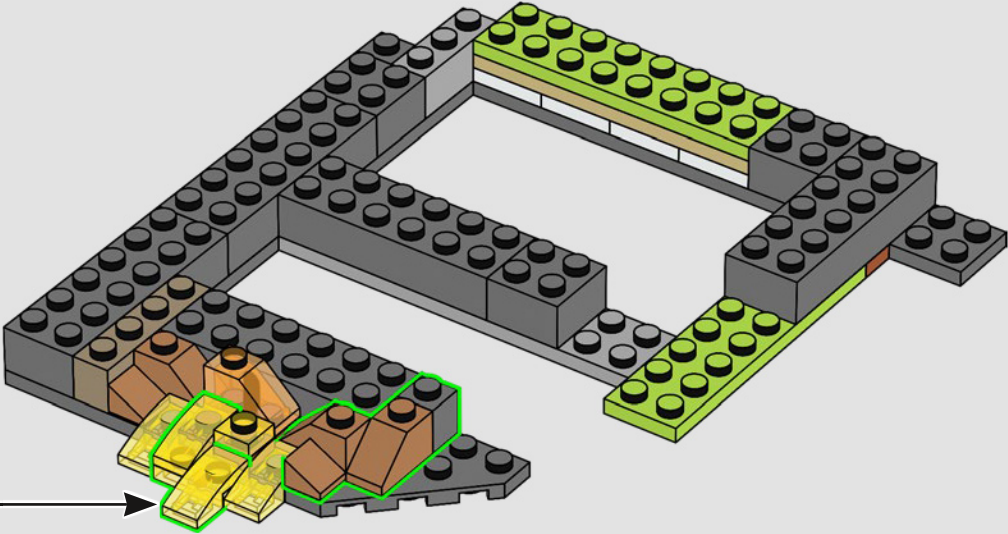

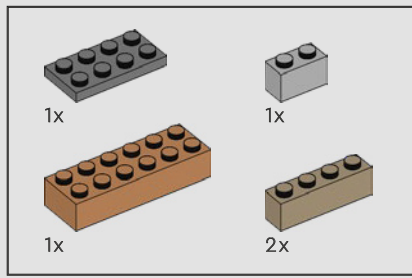

48

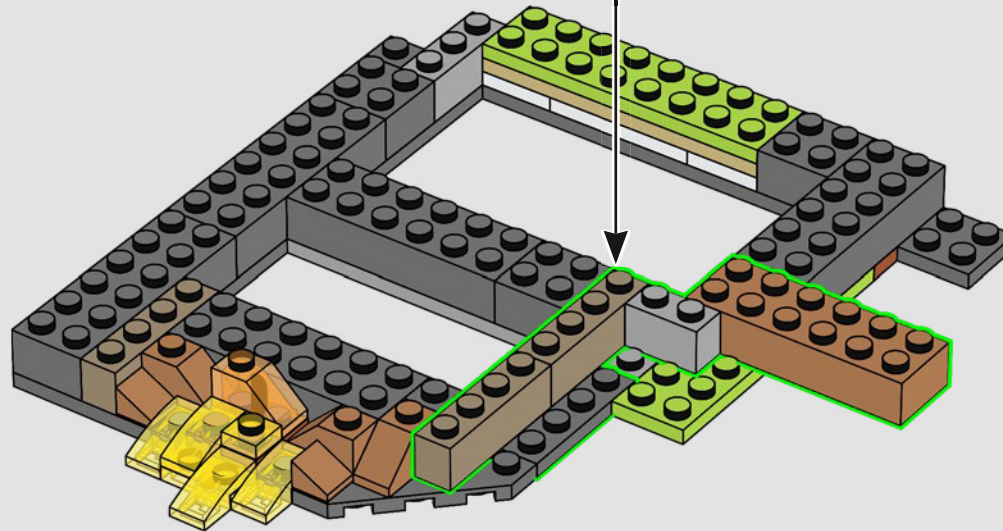
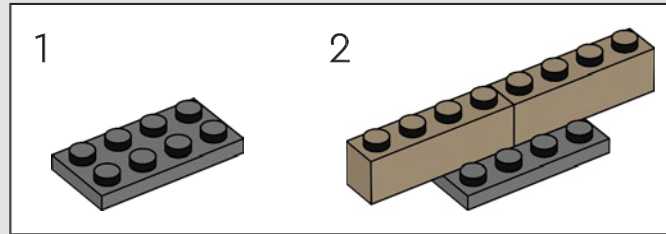

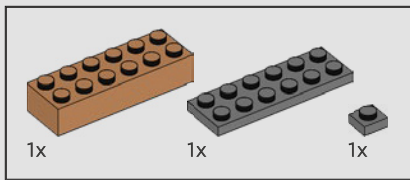

49

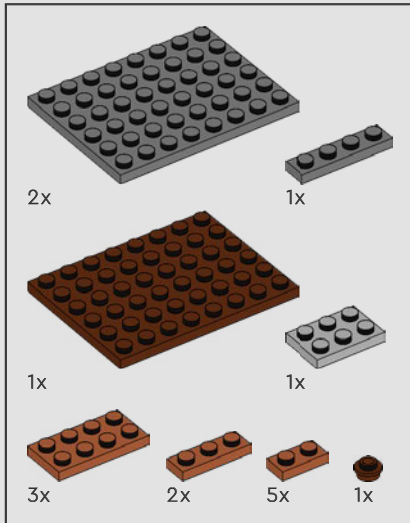
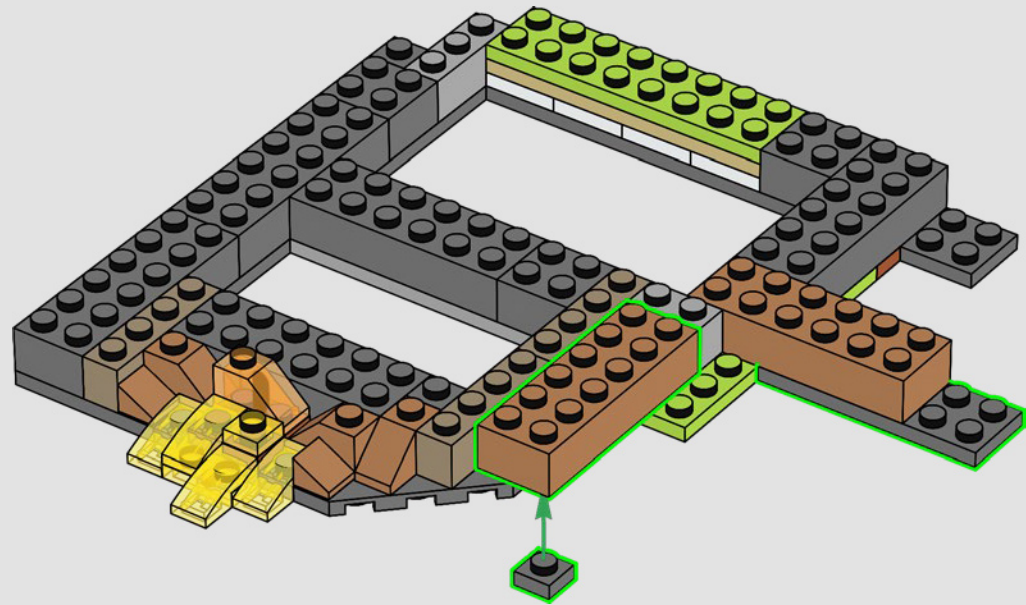

50



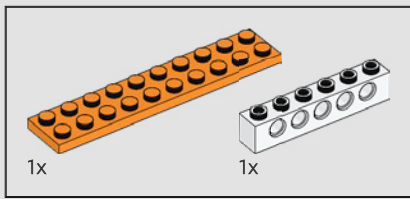

51

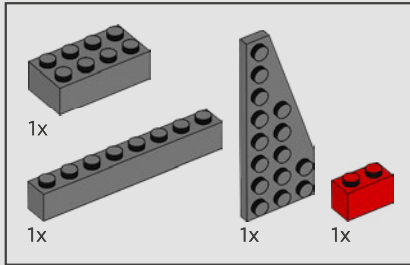
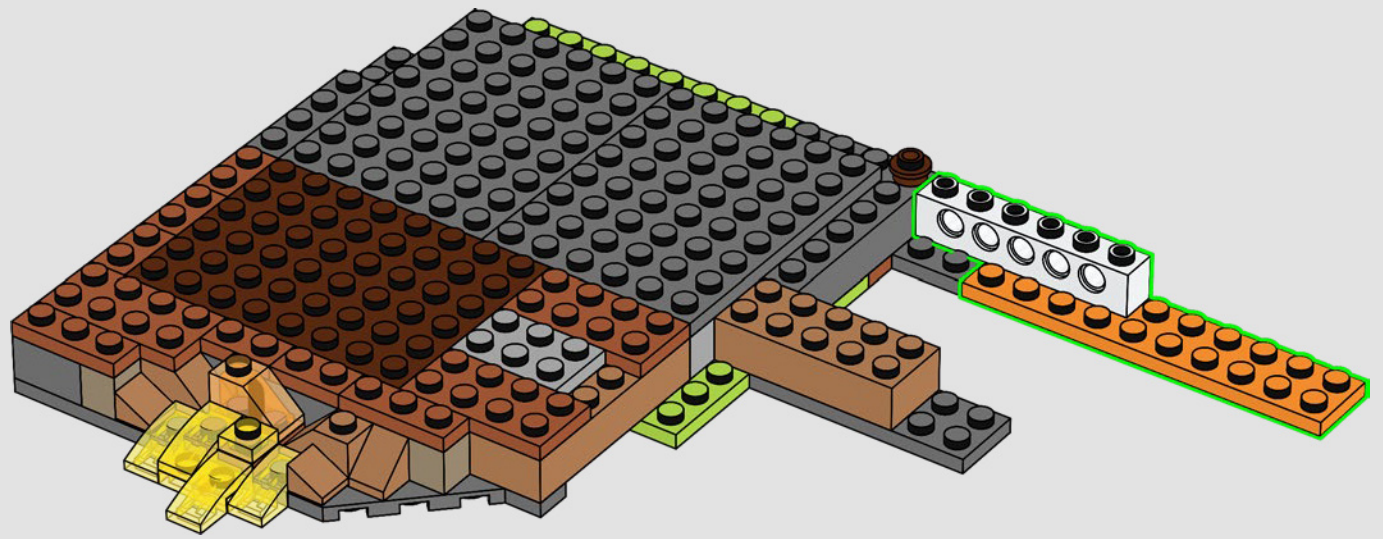

52

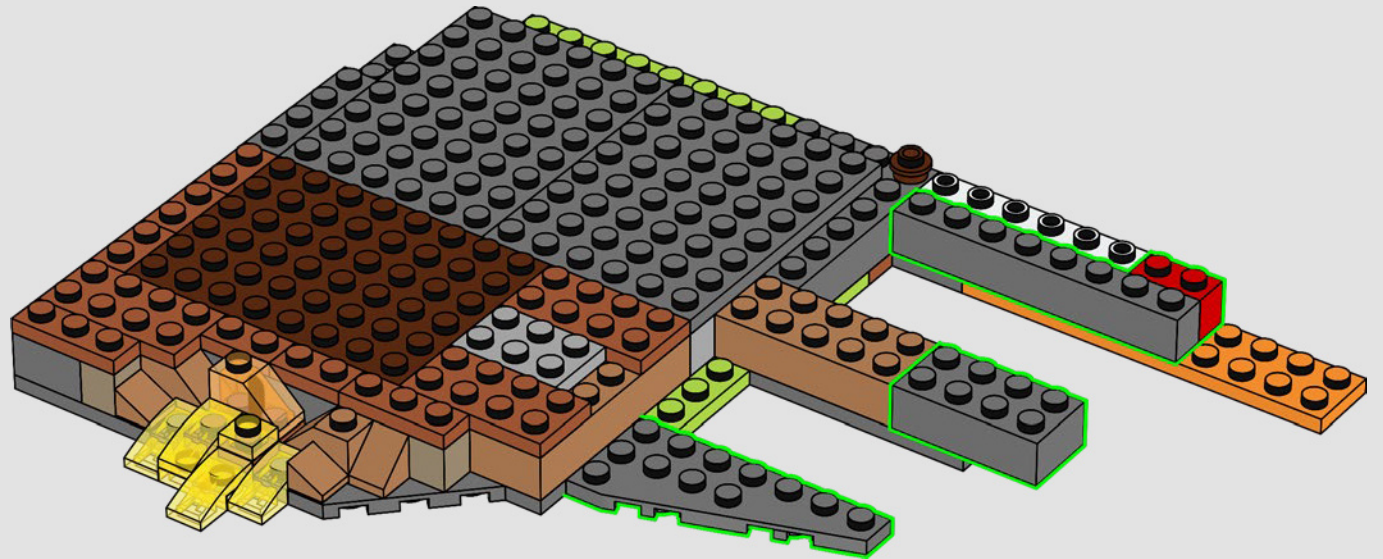



Haciéndose pasar por Orcos, Frodo Bolsón y Samsagaz Gamyi tardaron cerca de diez días en atravesar el hostil territorio de Mordor™ para llegar al Monte del Destino.

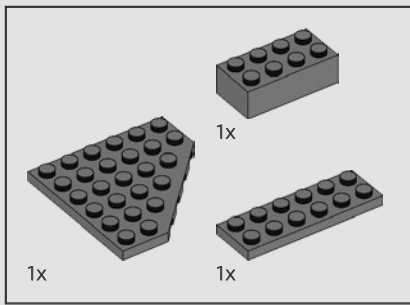

53

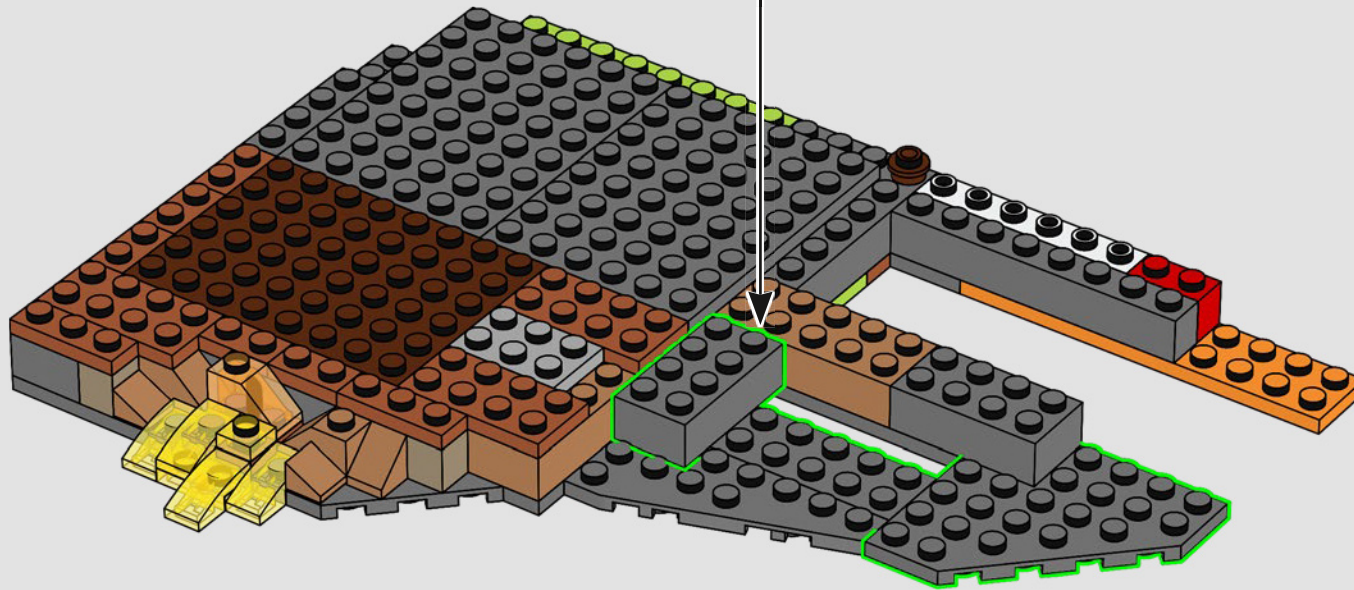
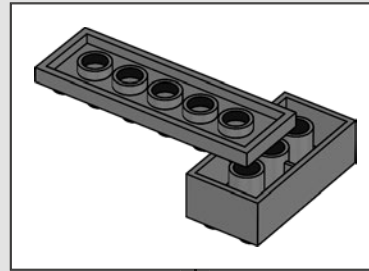

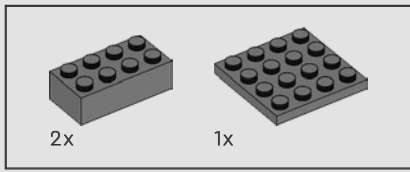

54

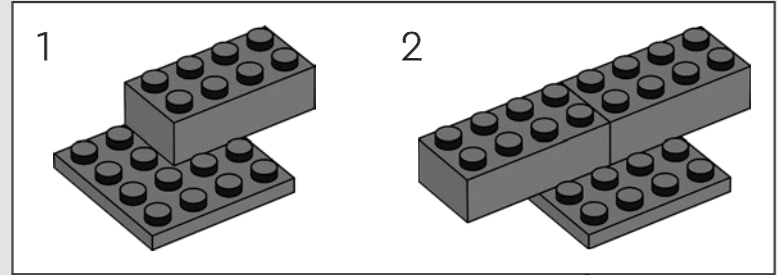

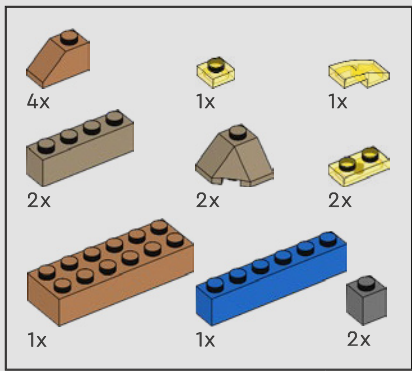

55



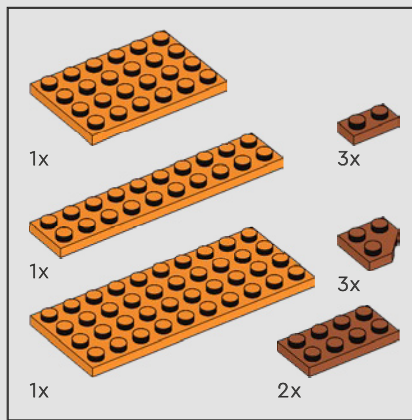

56

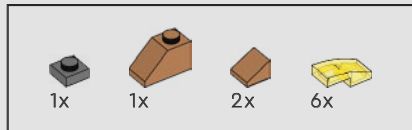
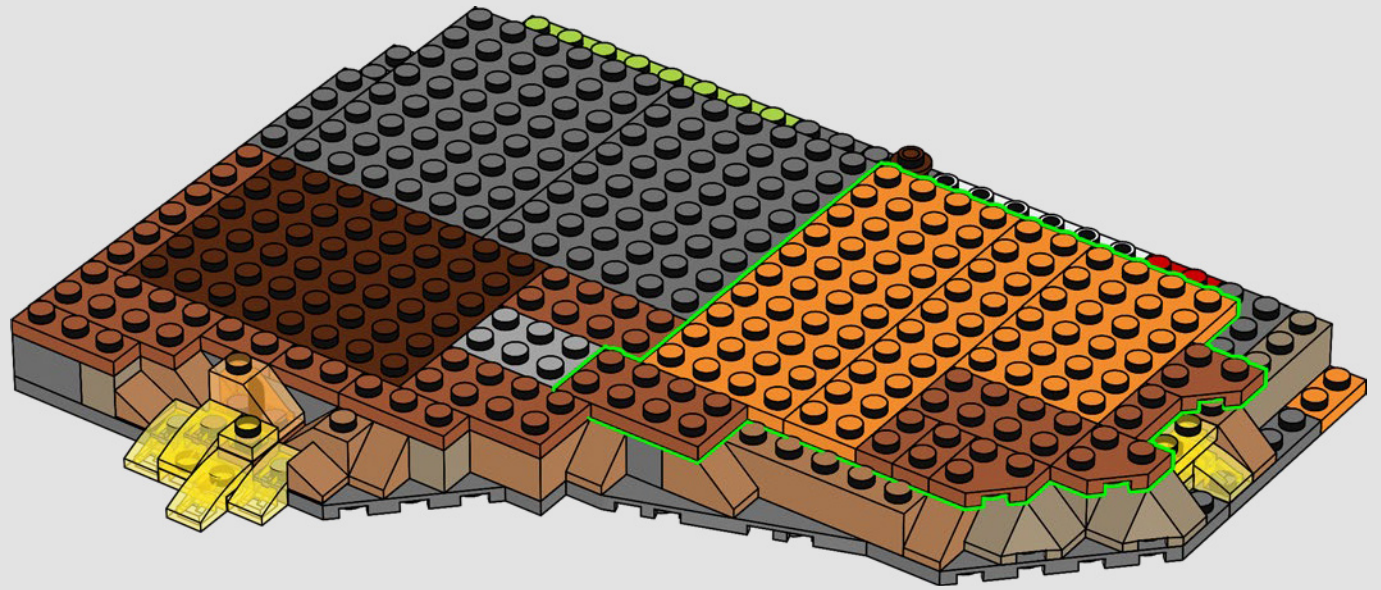

57

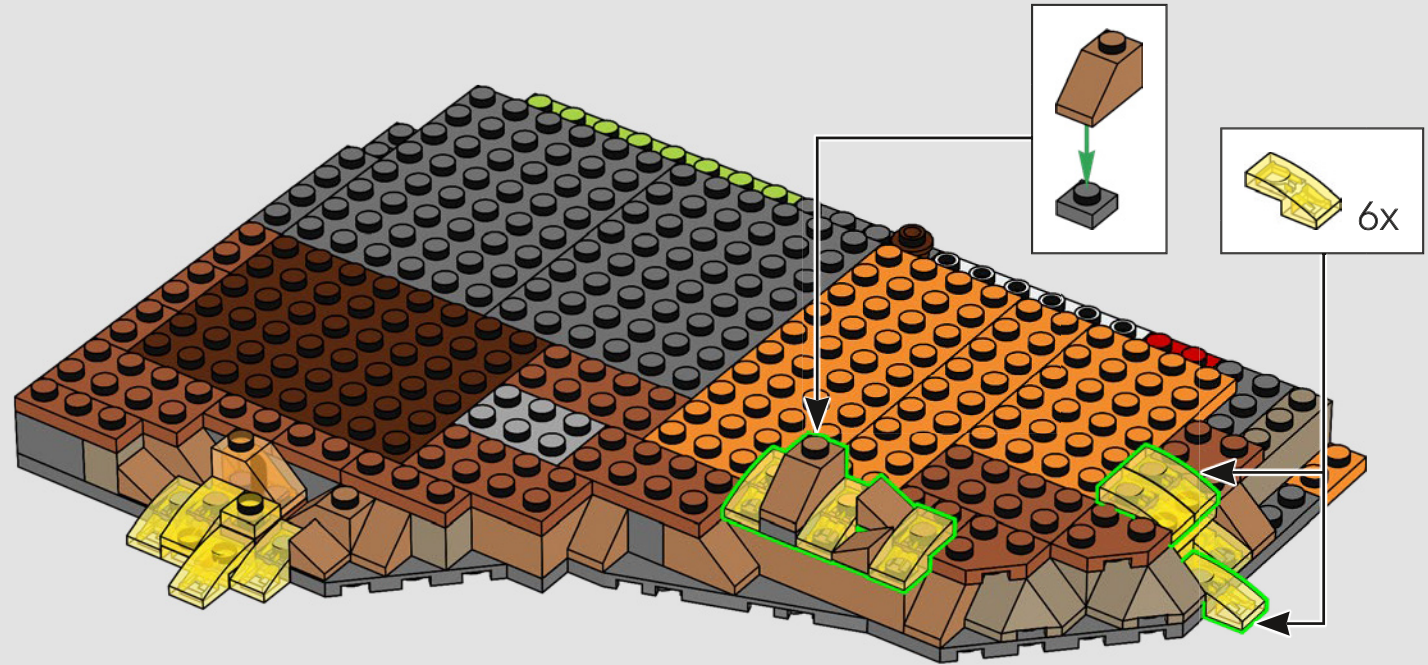



La minifigura de Gollum™ se rediseñó para este set y cuenta con una nueva decoración facial.

1



2



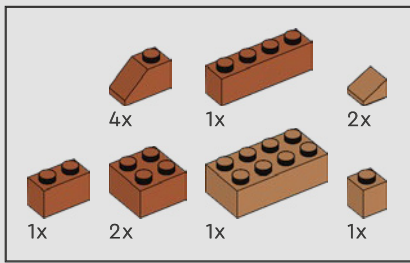

58

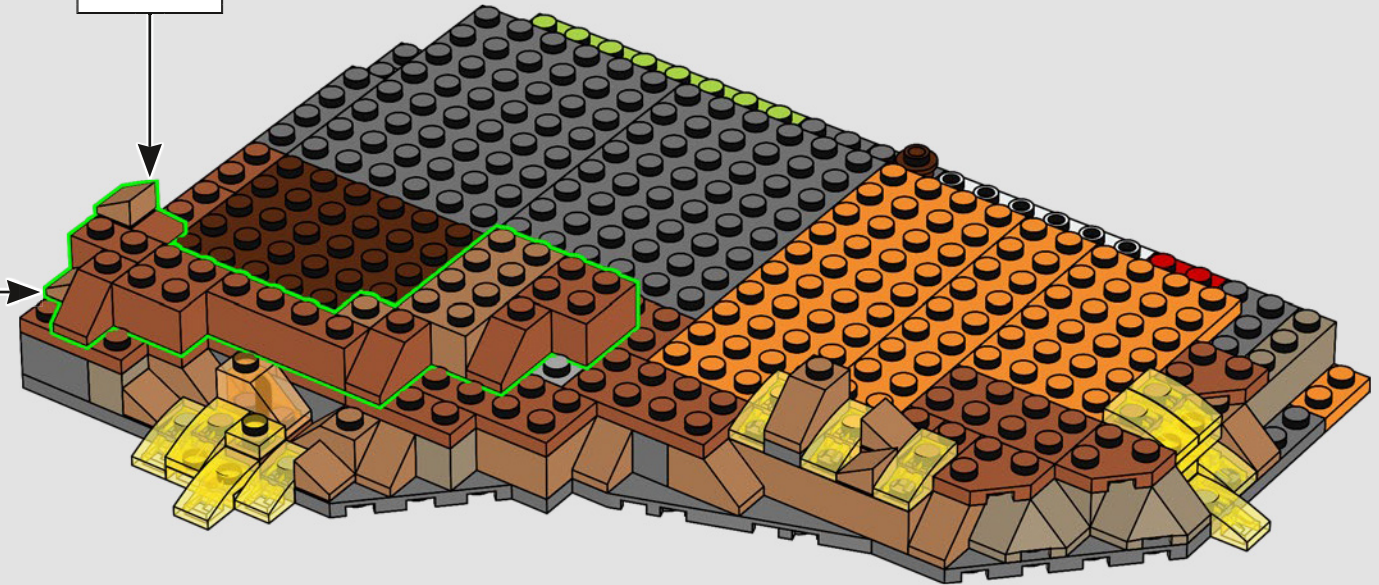
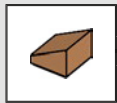
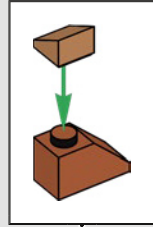

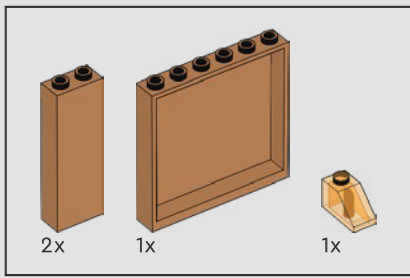

60

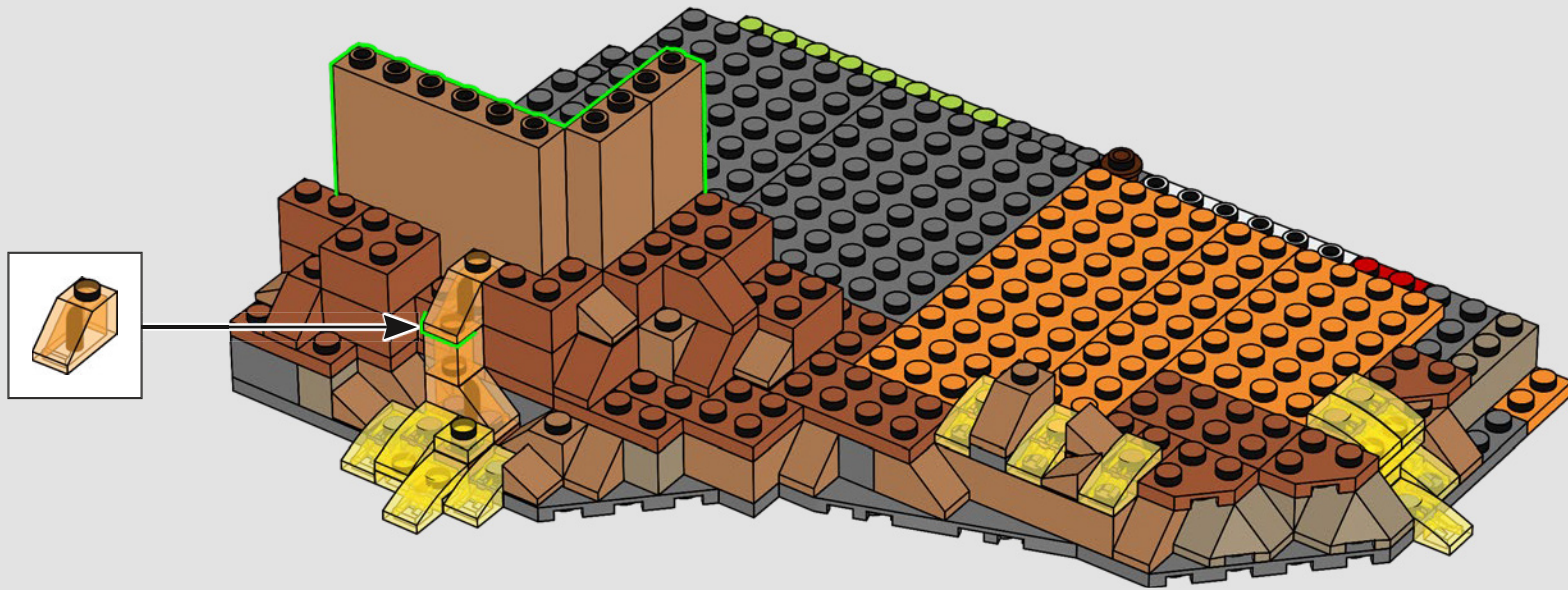

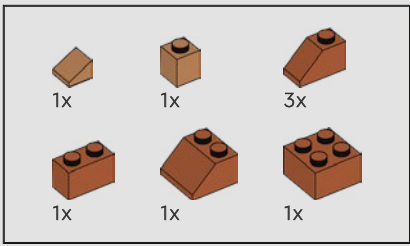

61

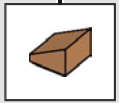
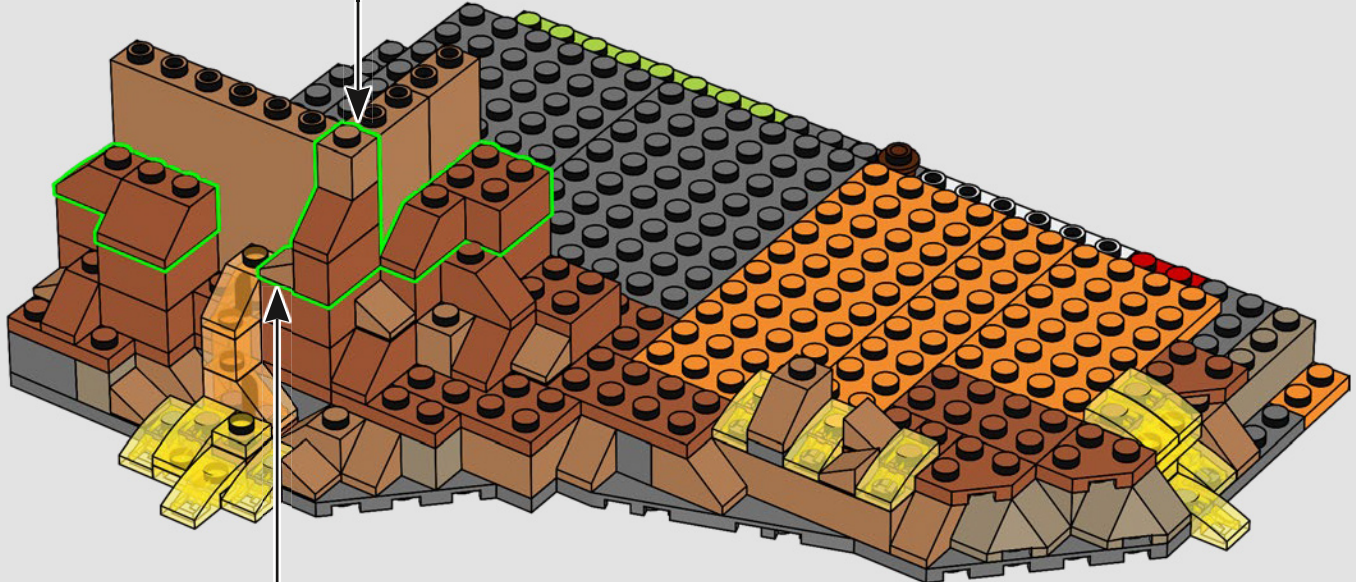
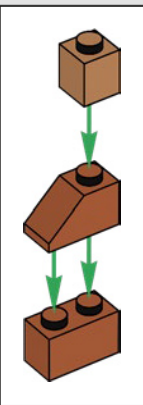

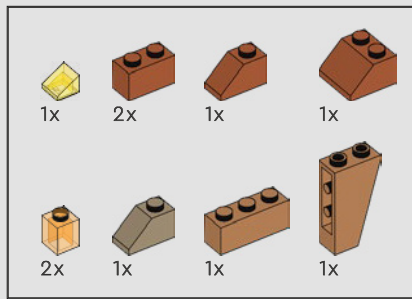

62

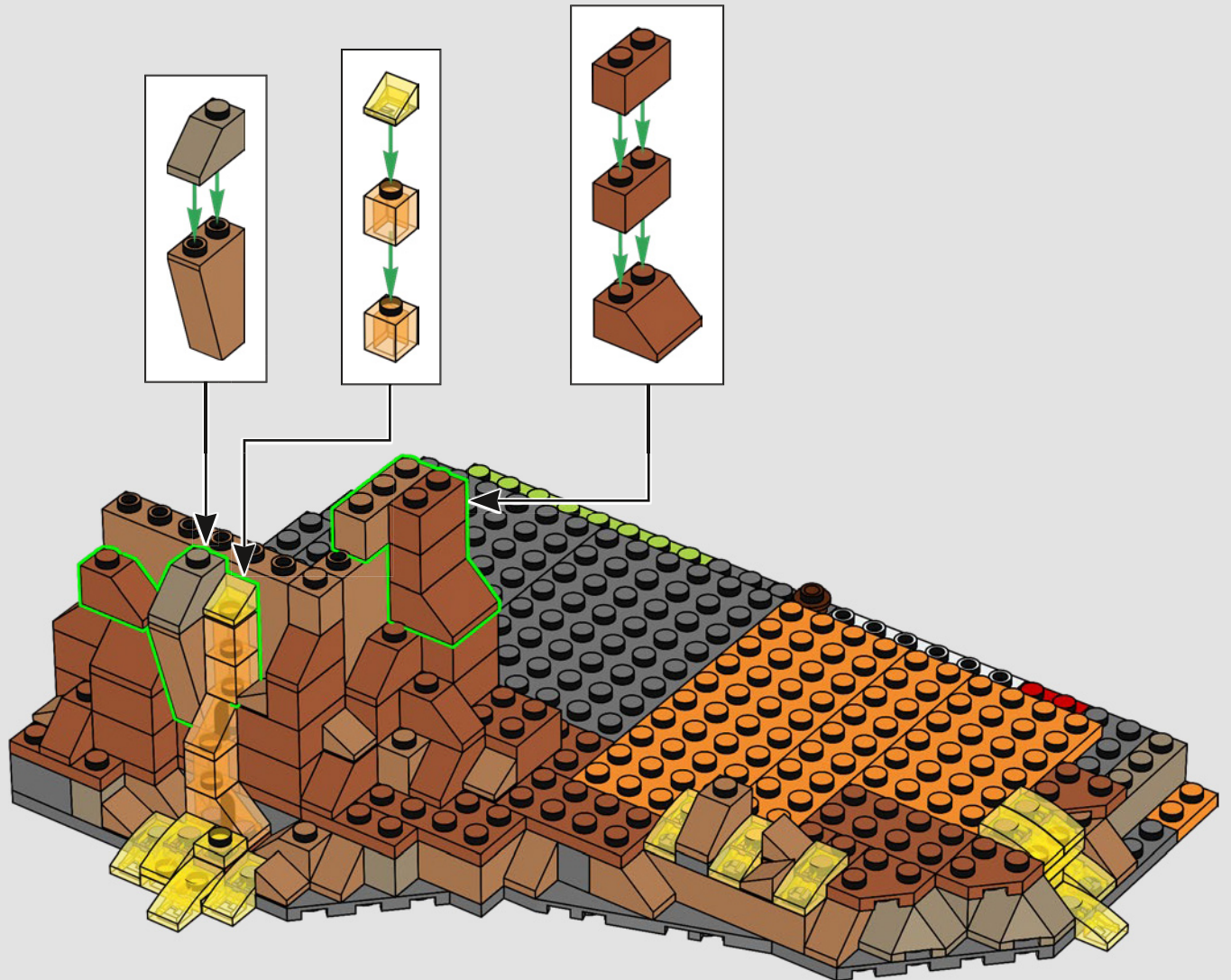

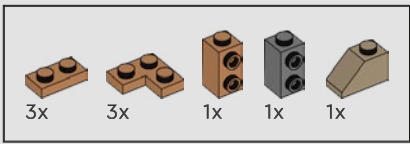

63

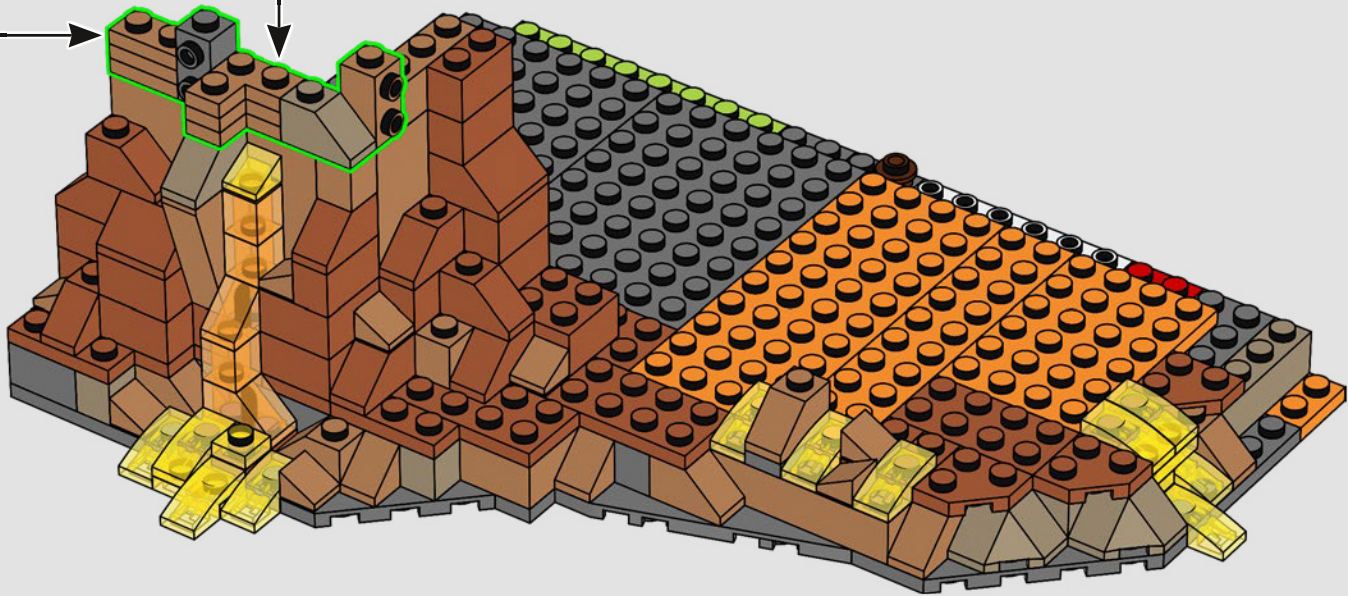
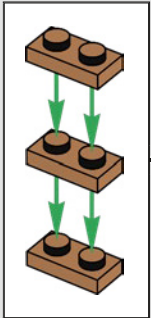
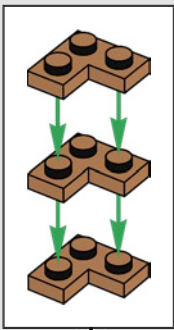

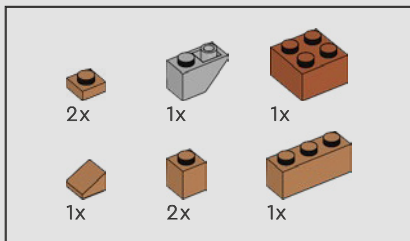

64

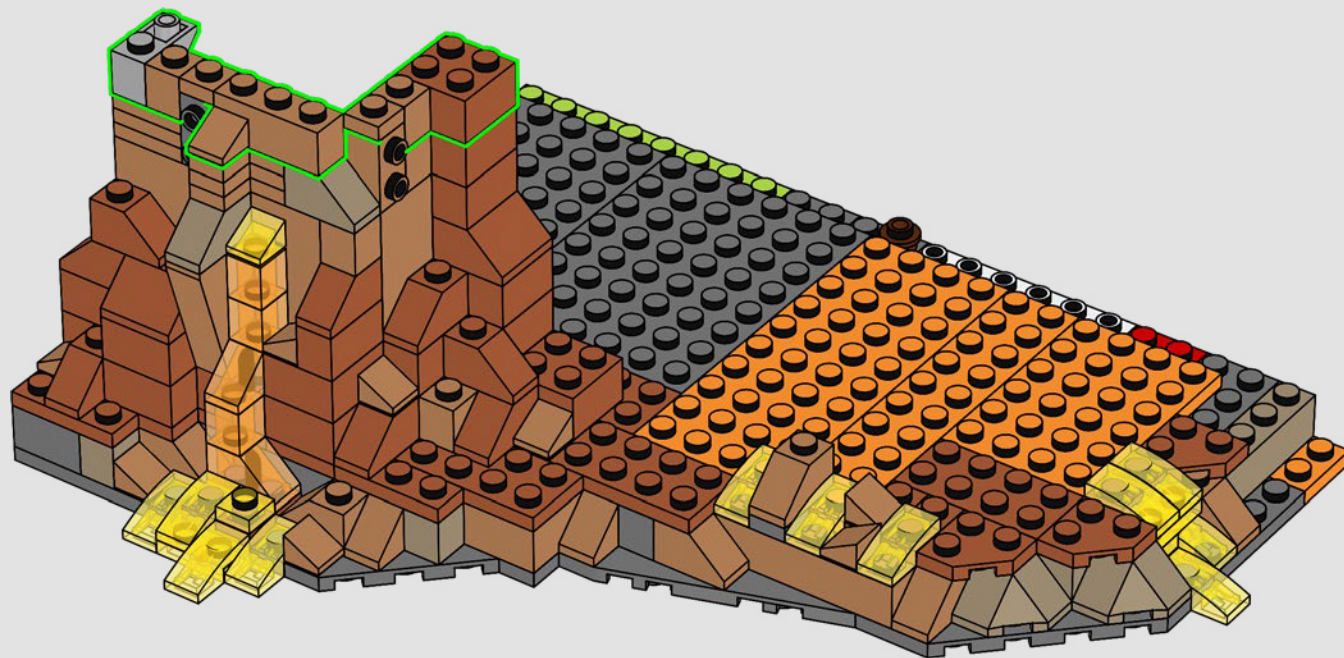

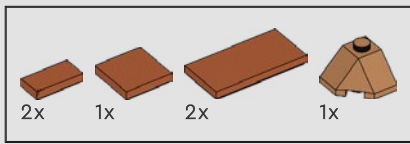

66

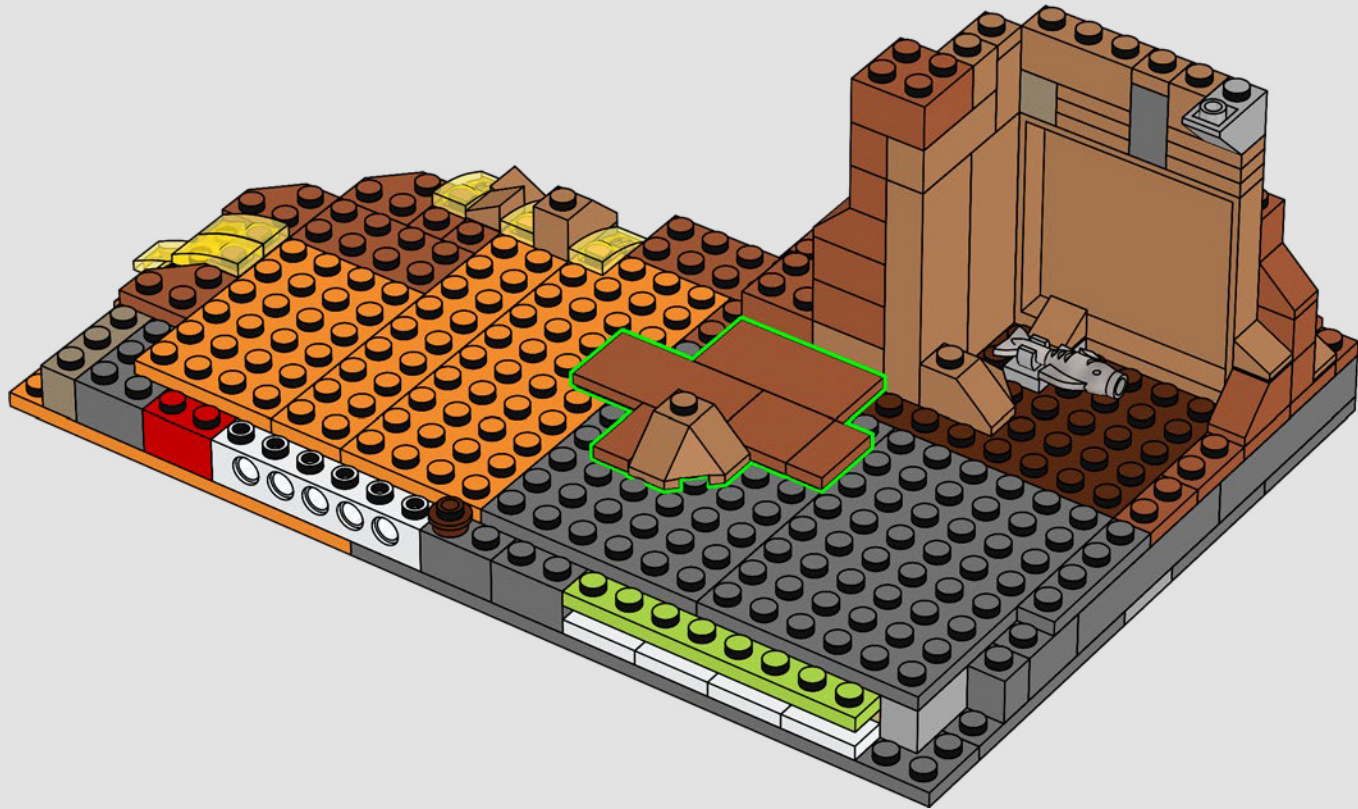

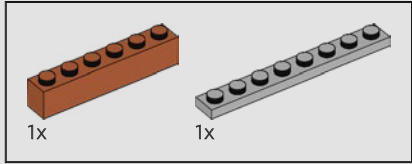
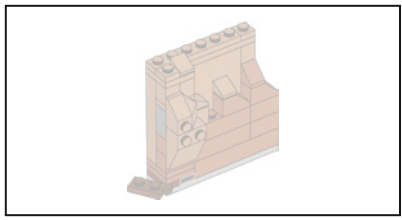

67

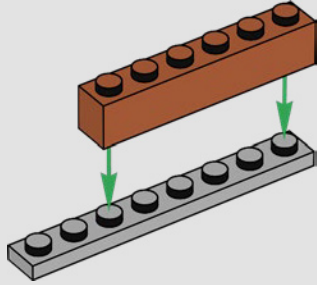

68

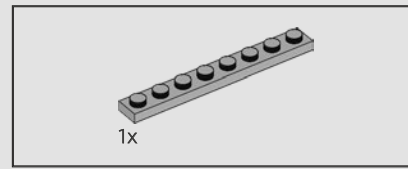
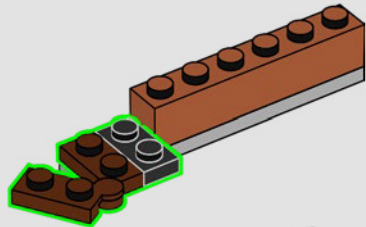

69

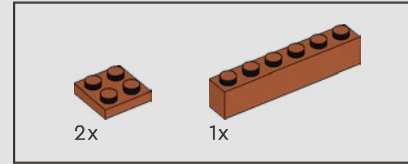
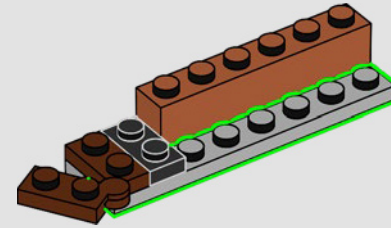

70

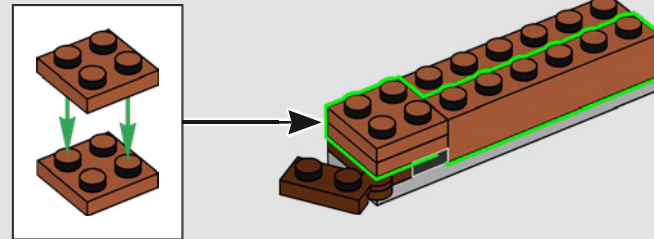

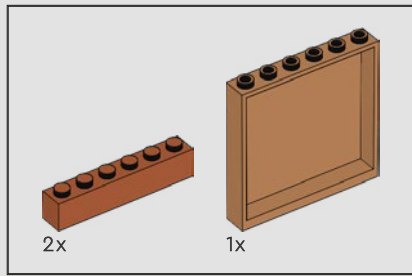

71

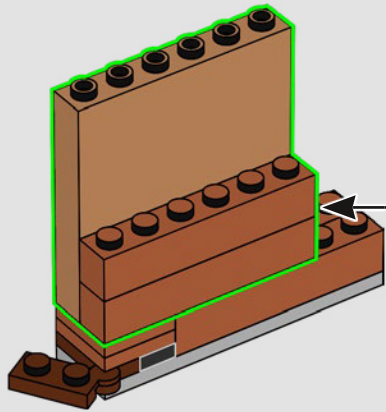
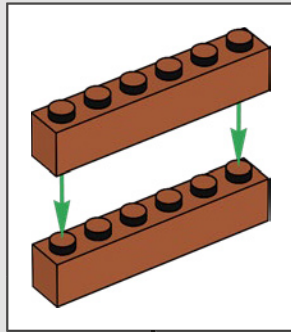

72

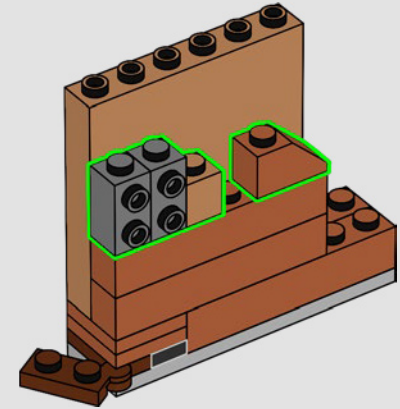

73

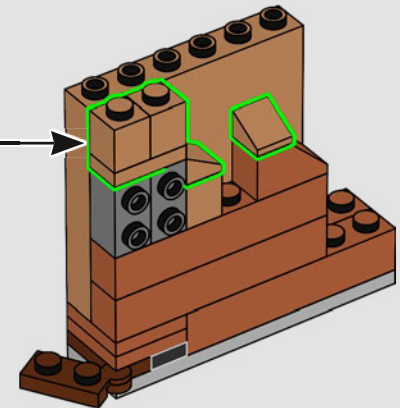
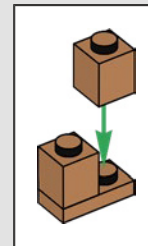

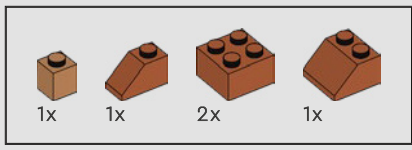

74

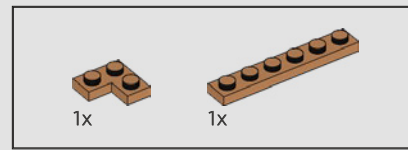
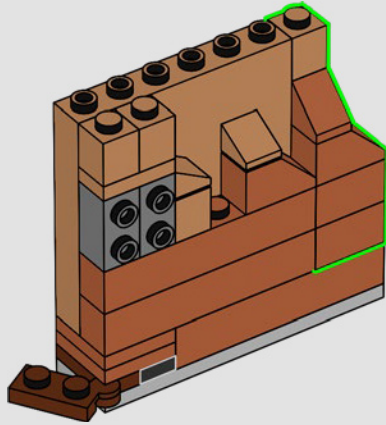
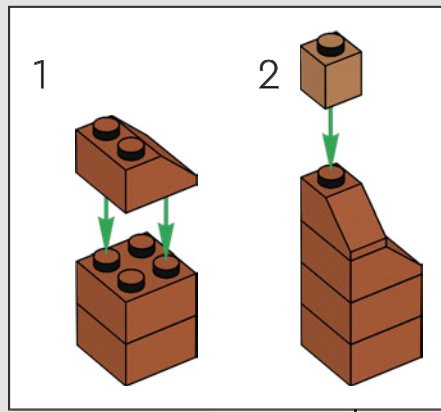

75

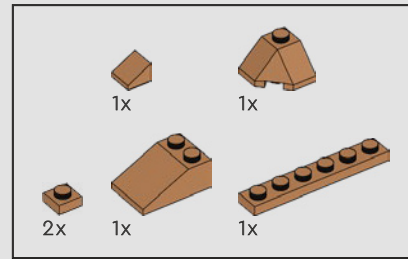
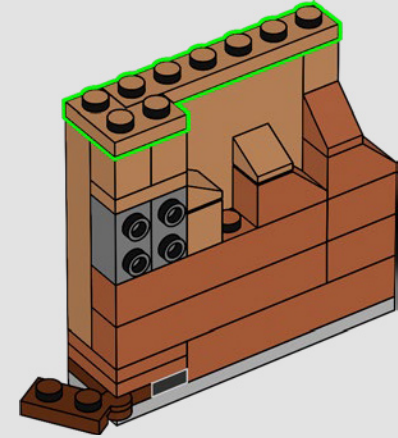

76

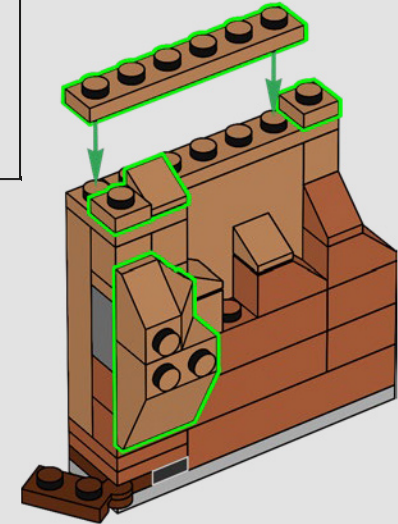

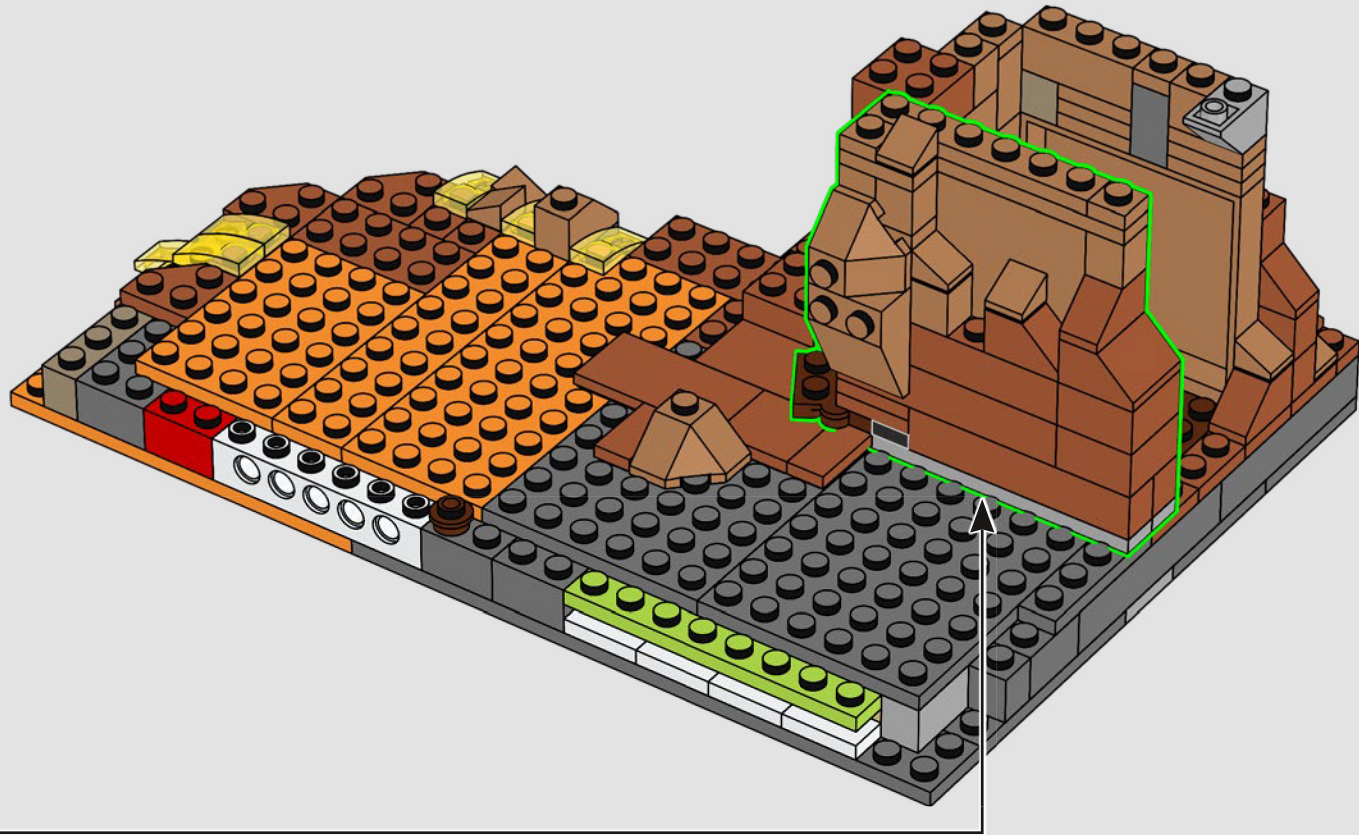

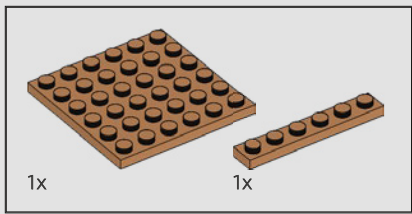

78

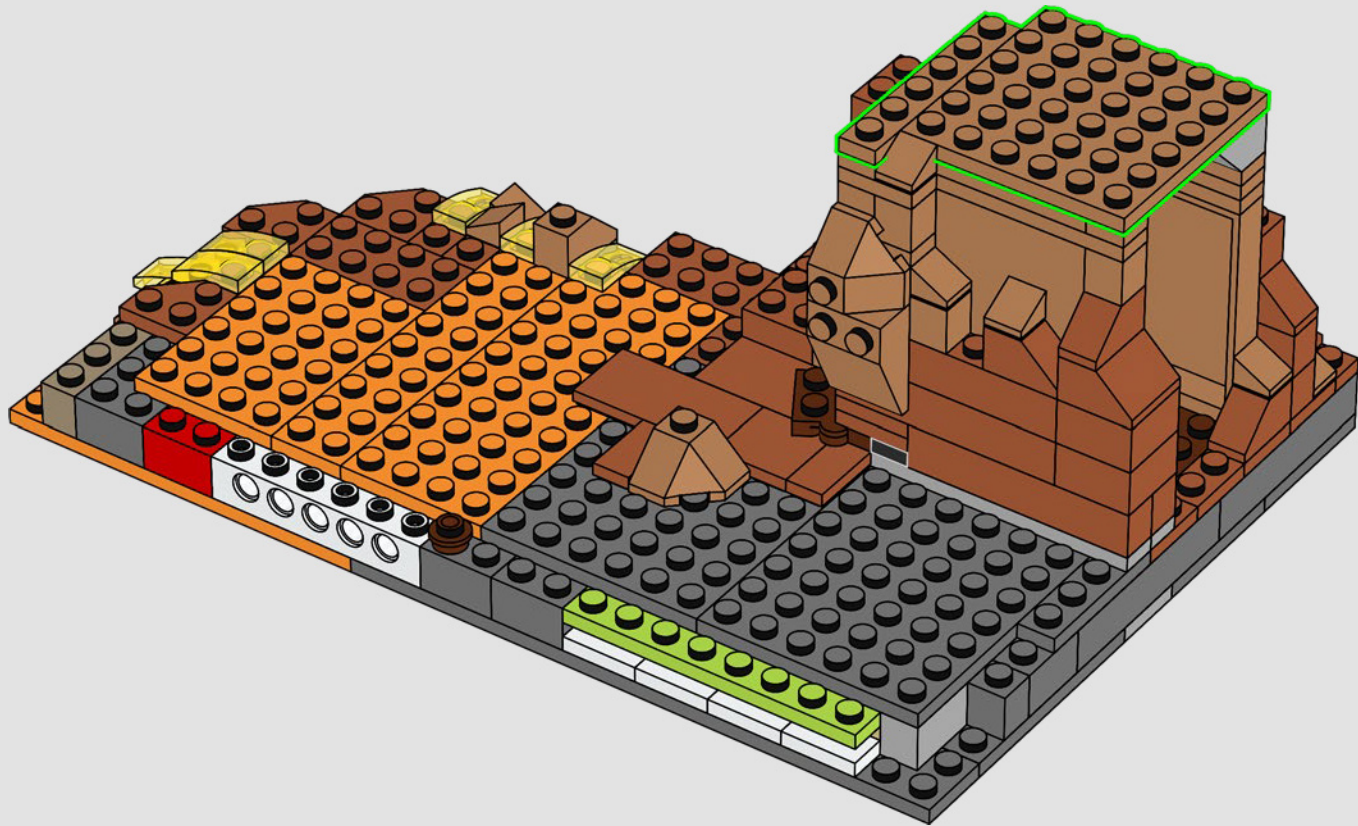

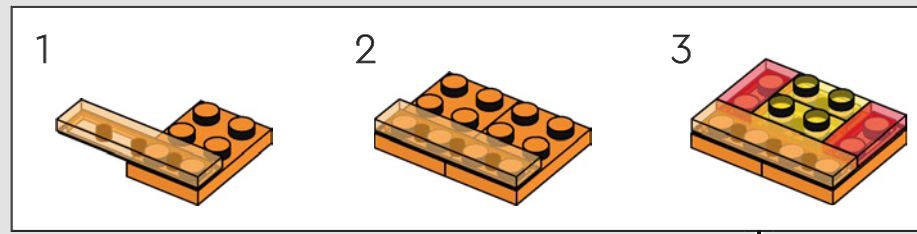
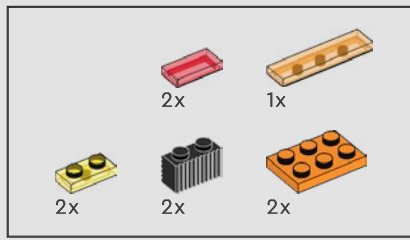

79

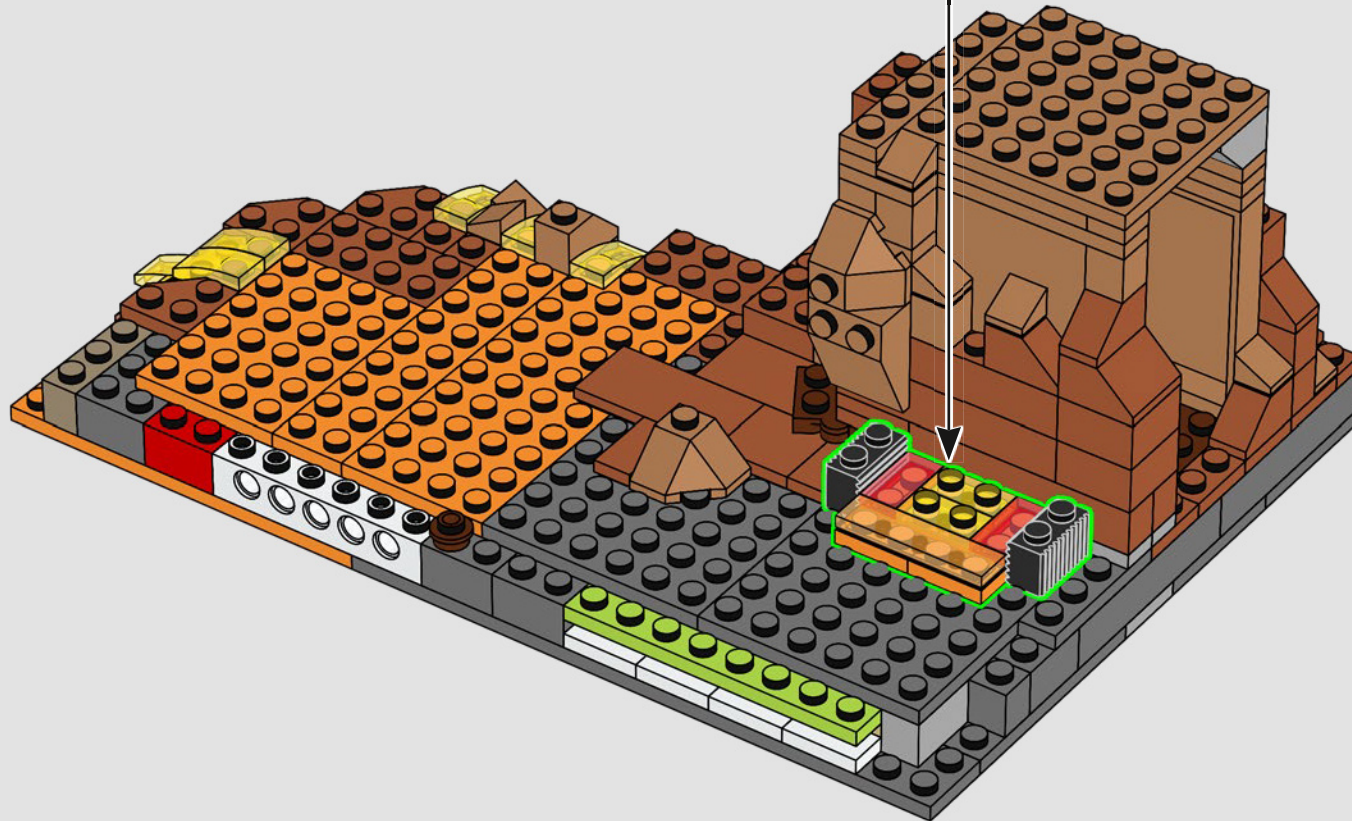

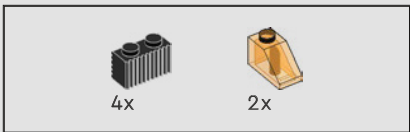

80

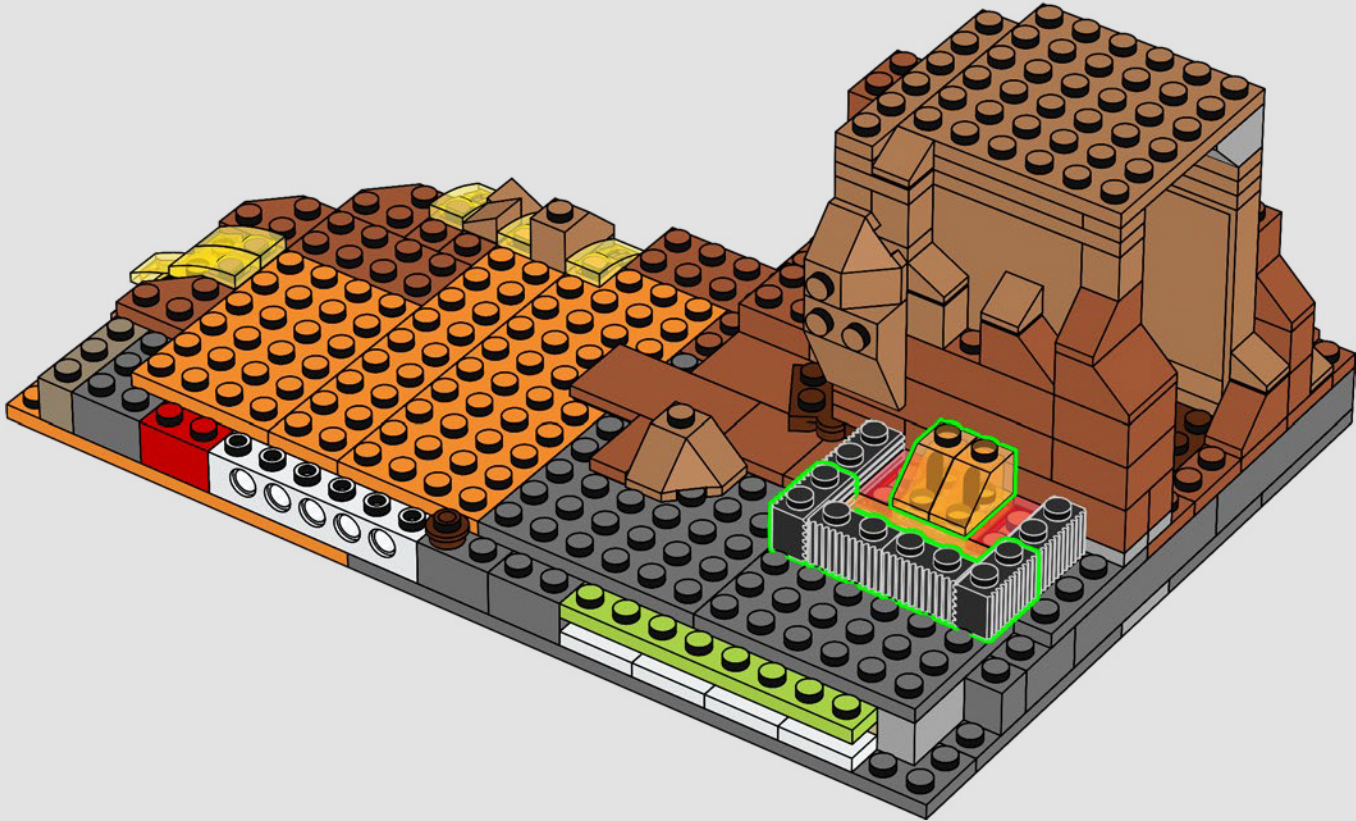

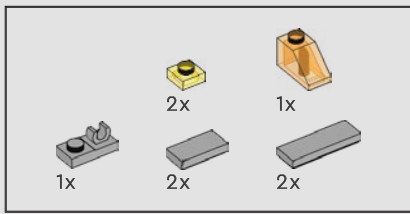

81

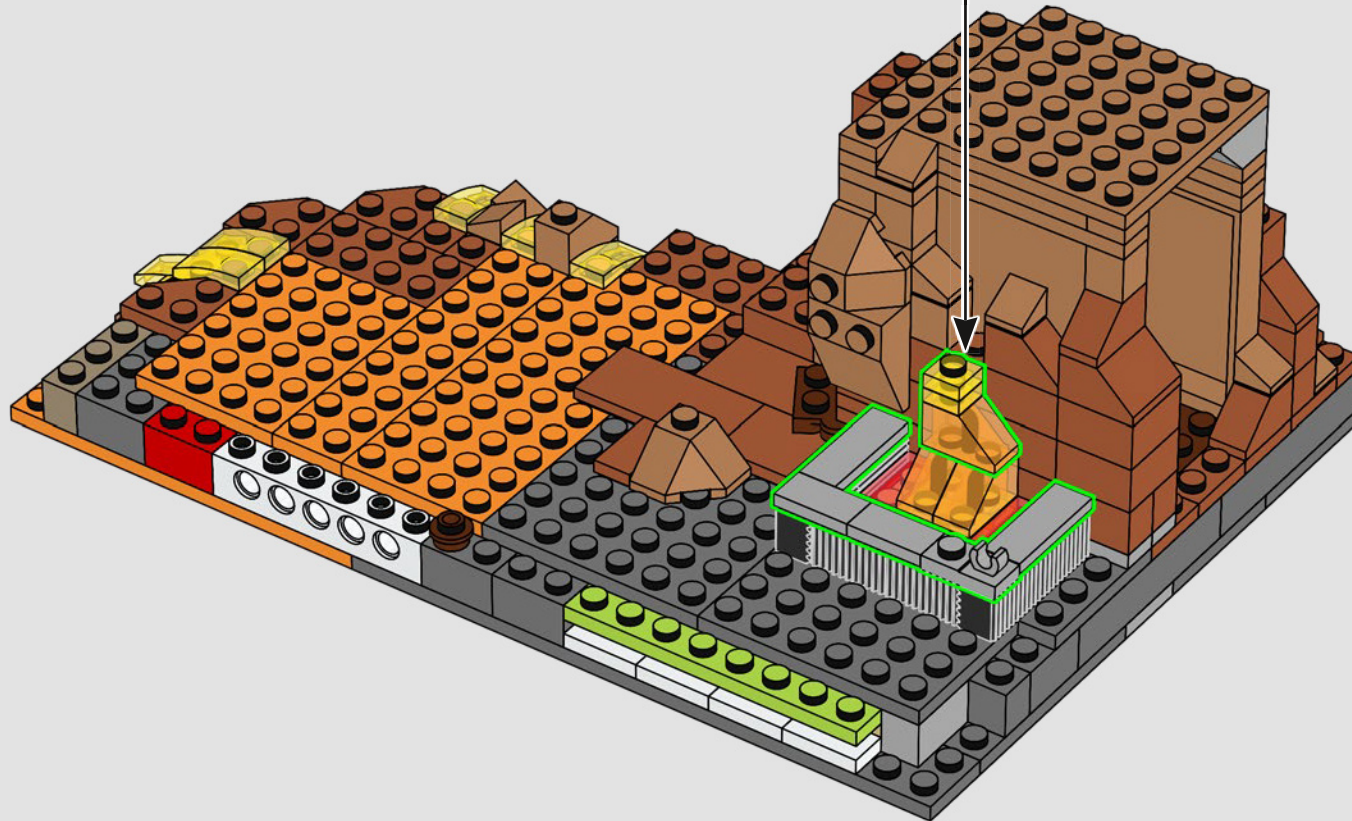
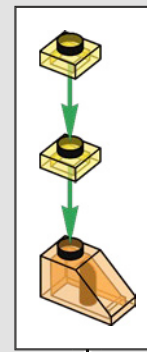



82

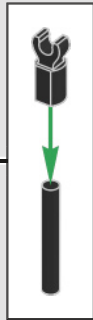
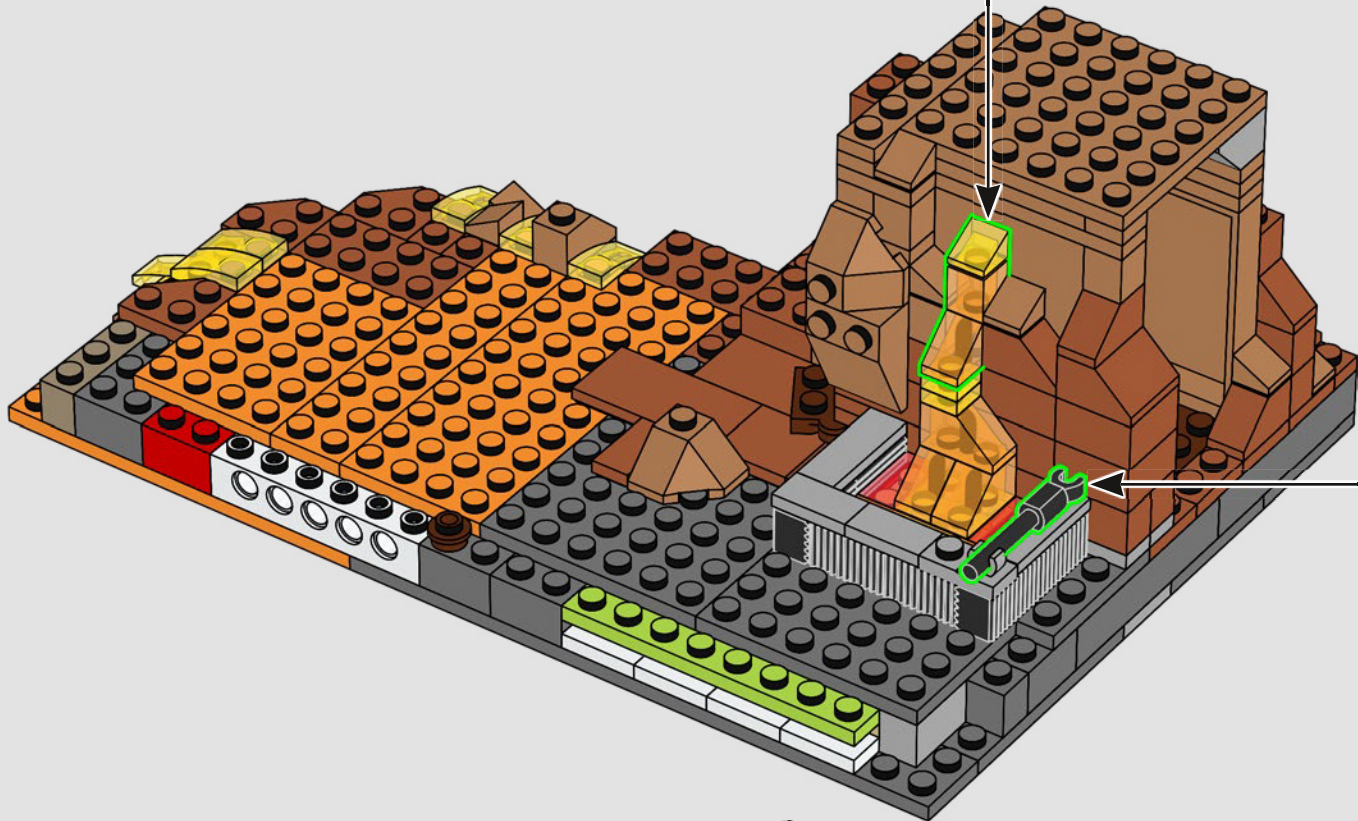
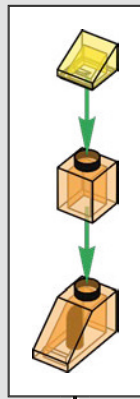

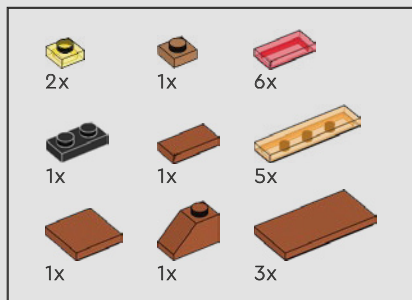

83

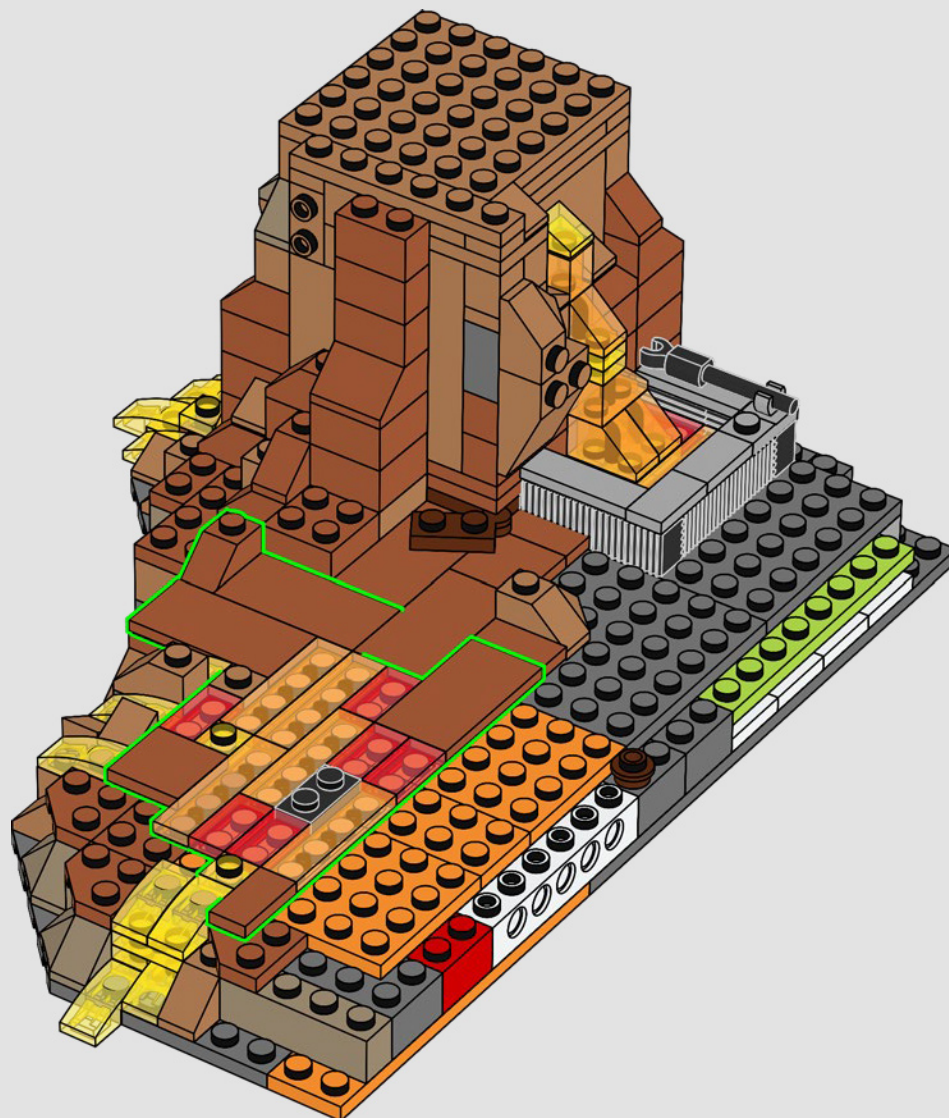

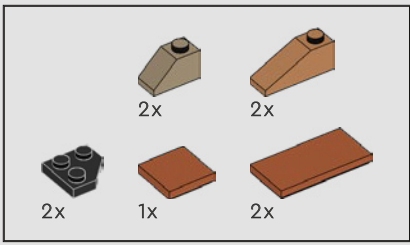

84

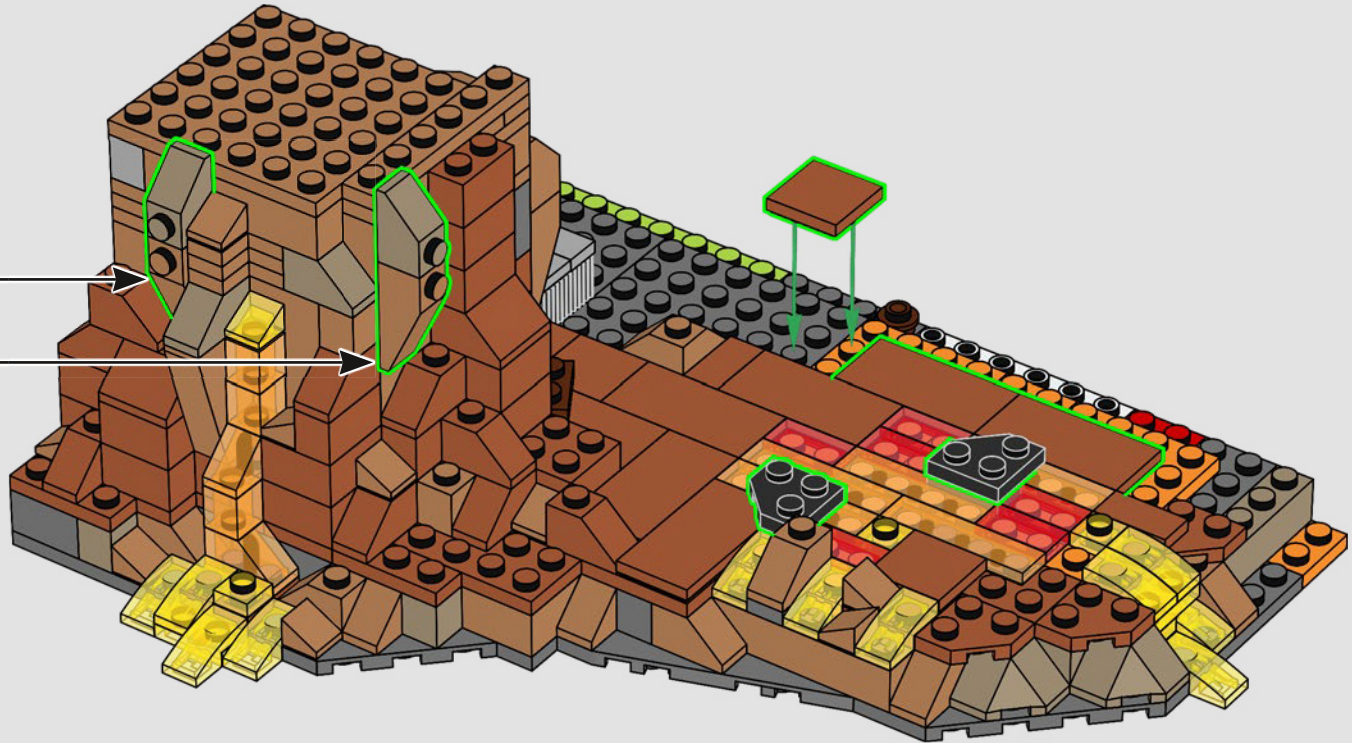
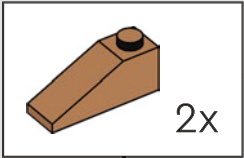

85

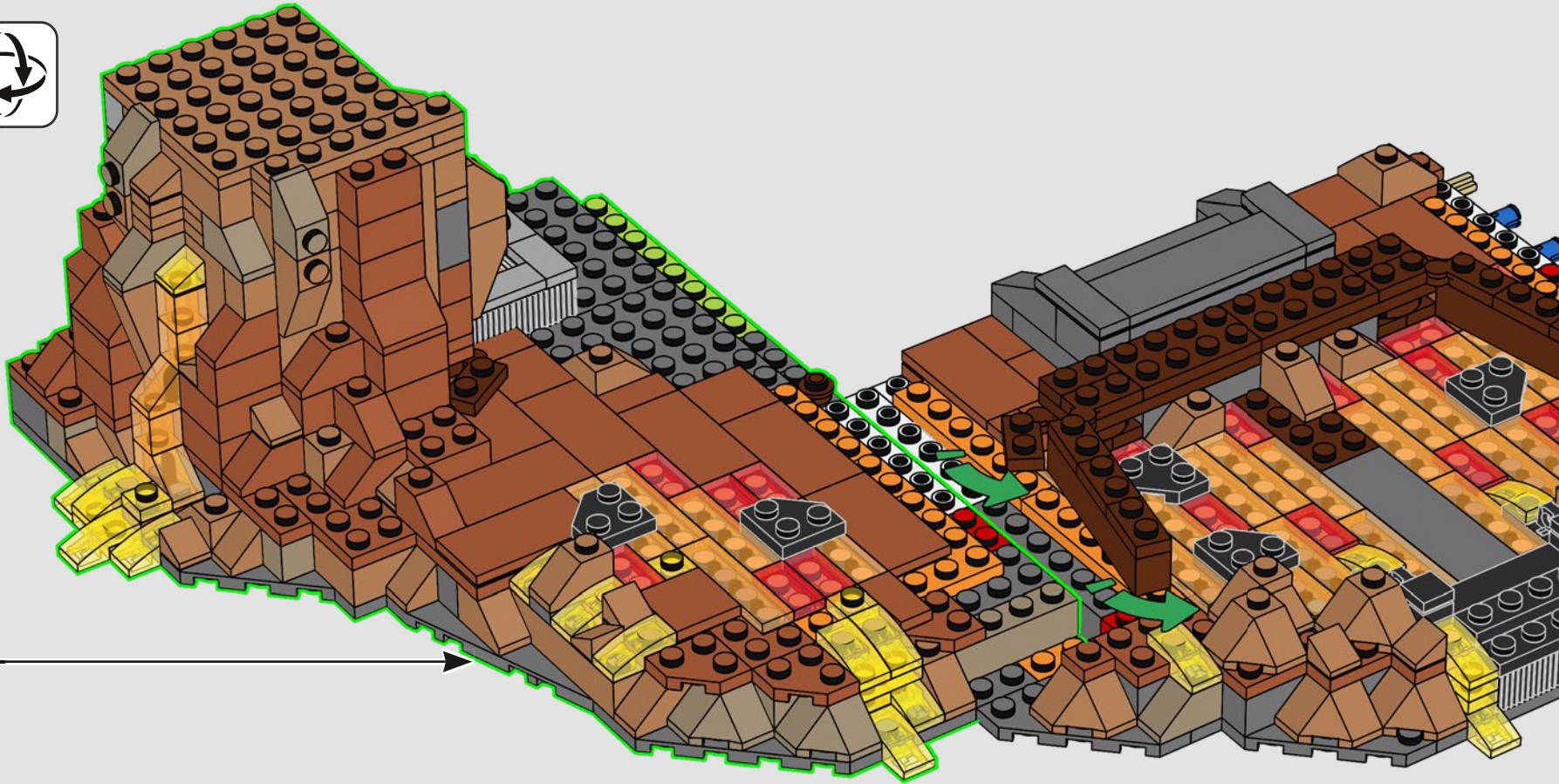

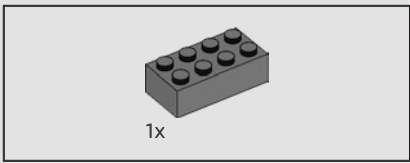

86

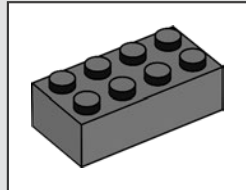
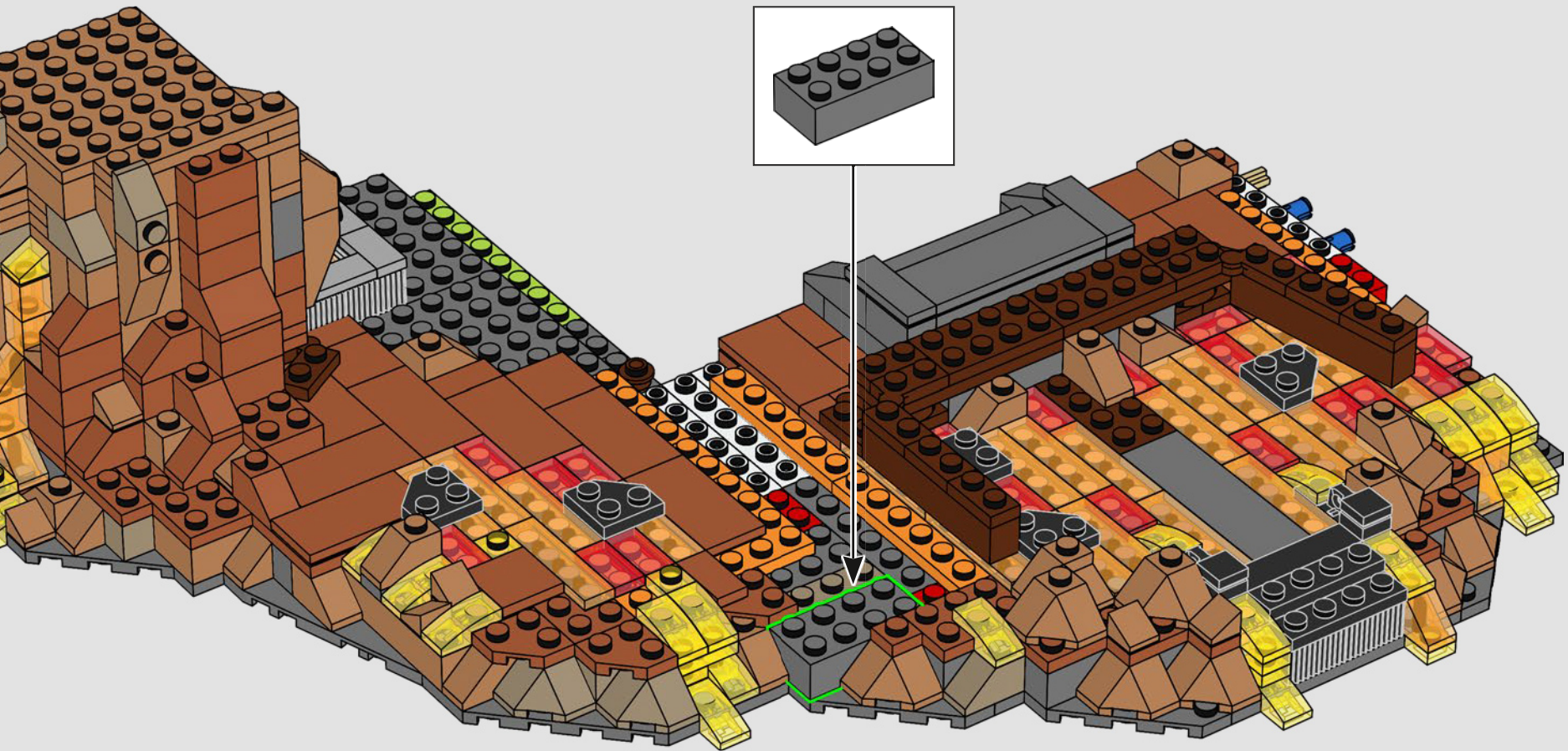

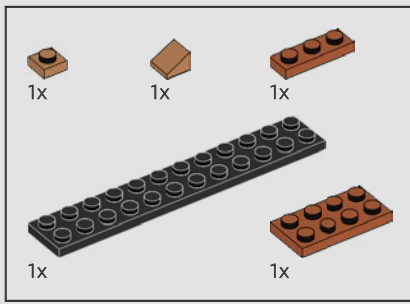

87

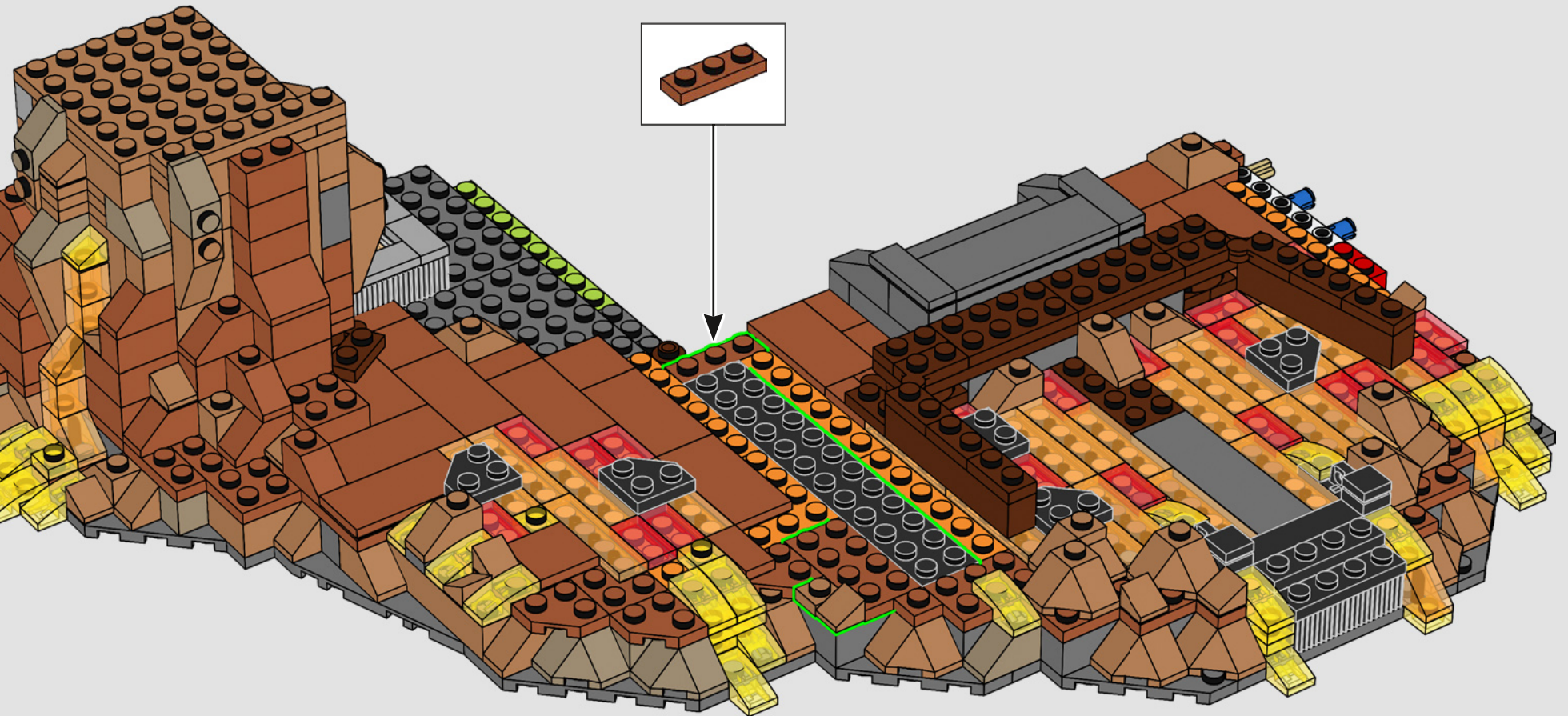



"Para que el bien reine en este mundo, señor Frodo. Se puede luchar por eso".
Samsagaz Gamyi

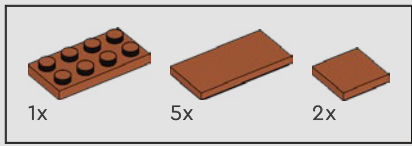

88

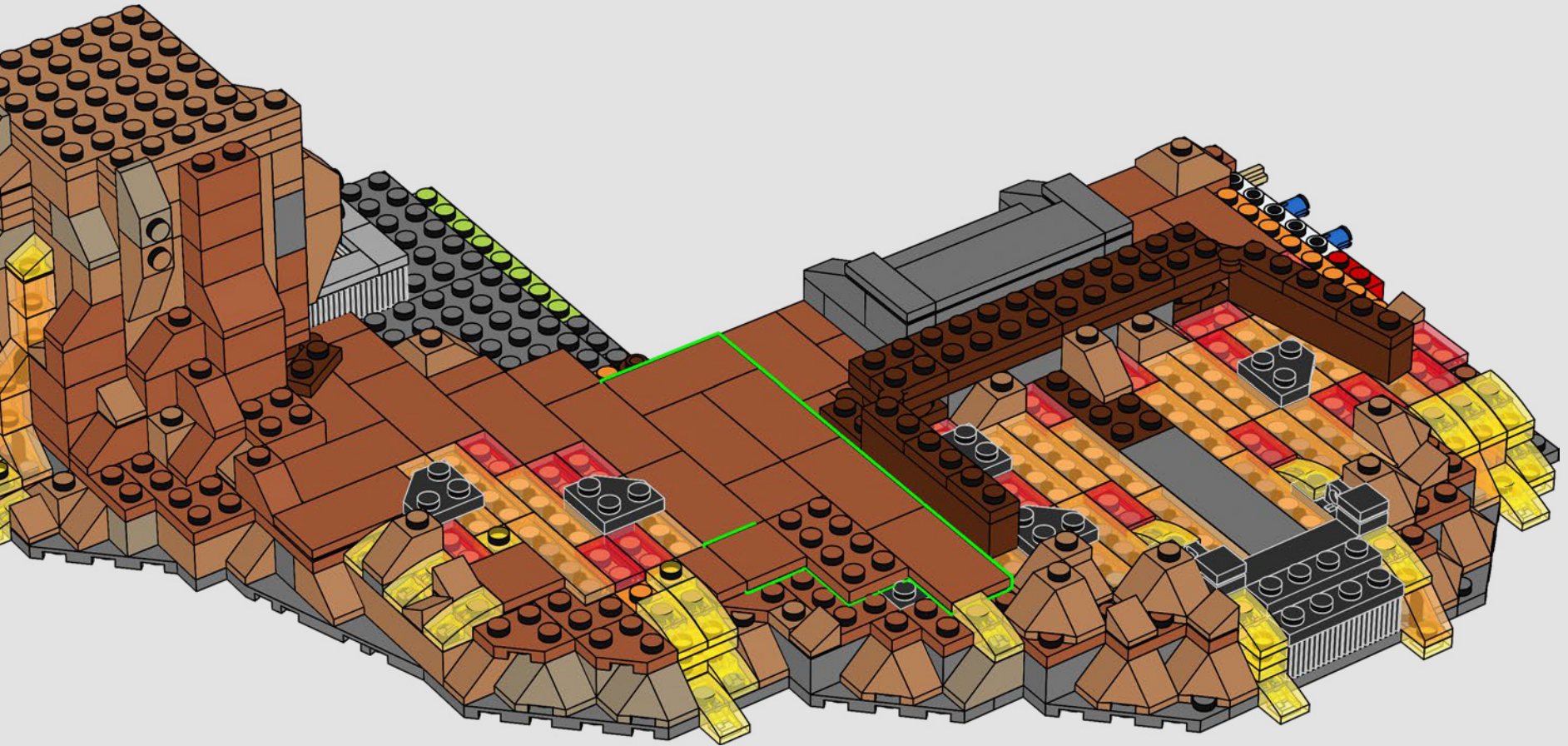

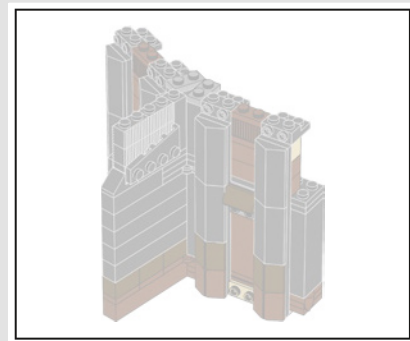

89

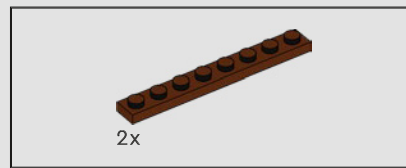
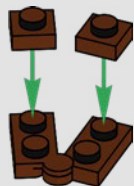

90

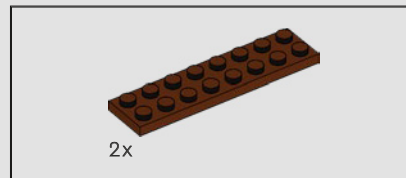
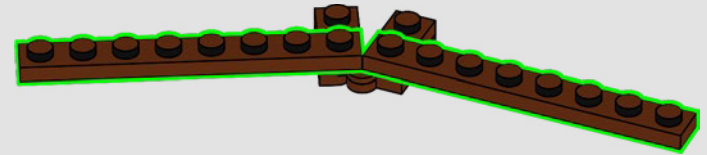

91

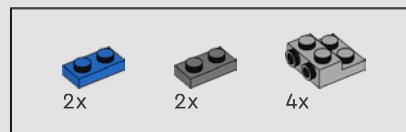
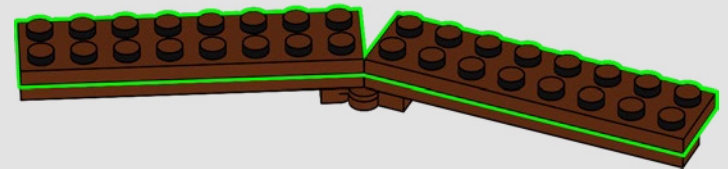

92

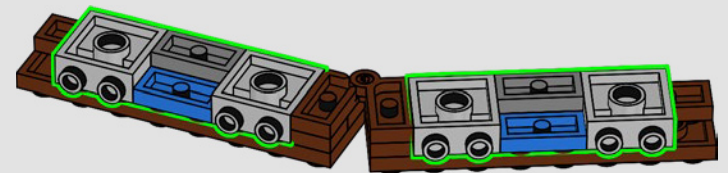



93



94

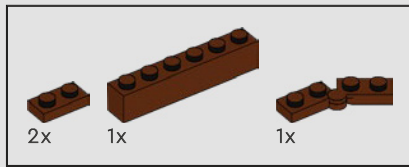
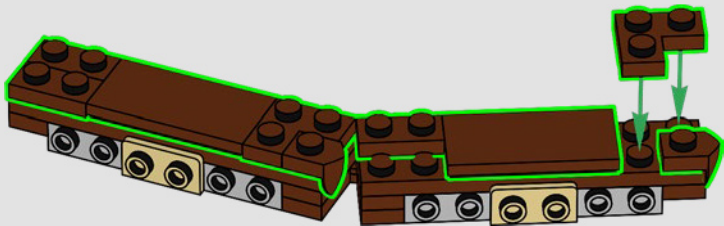

95

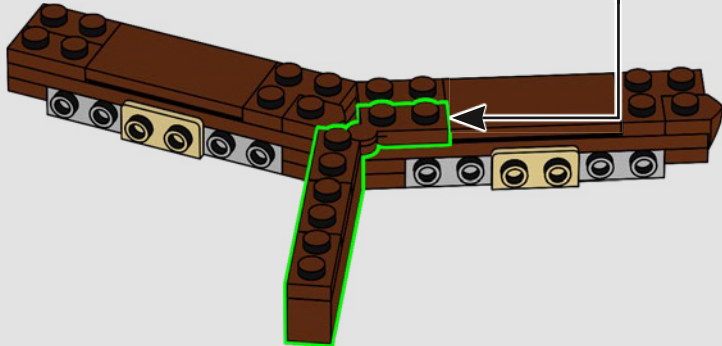
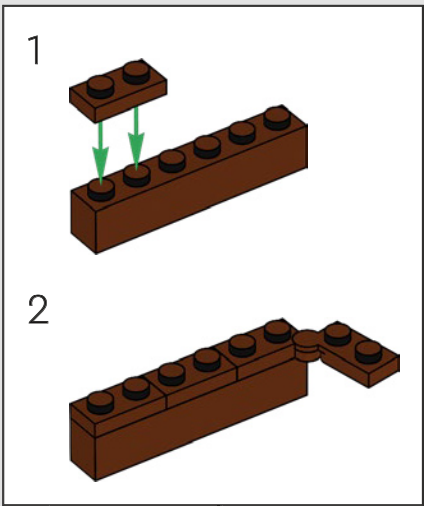

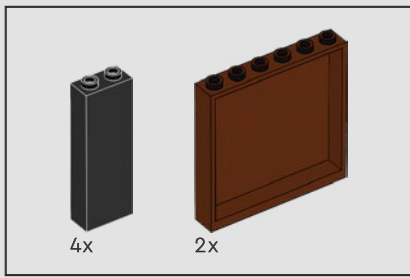

96

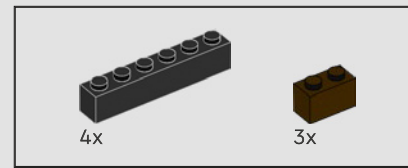
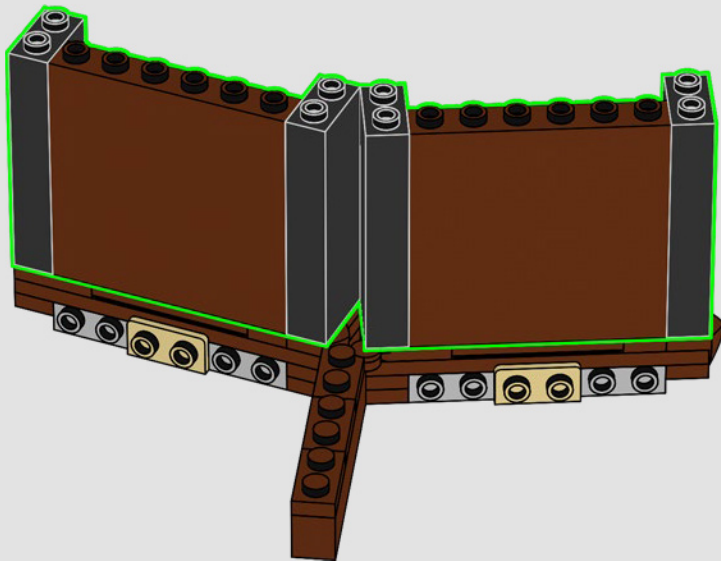

97

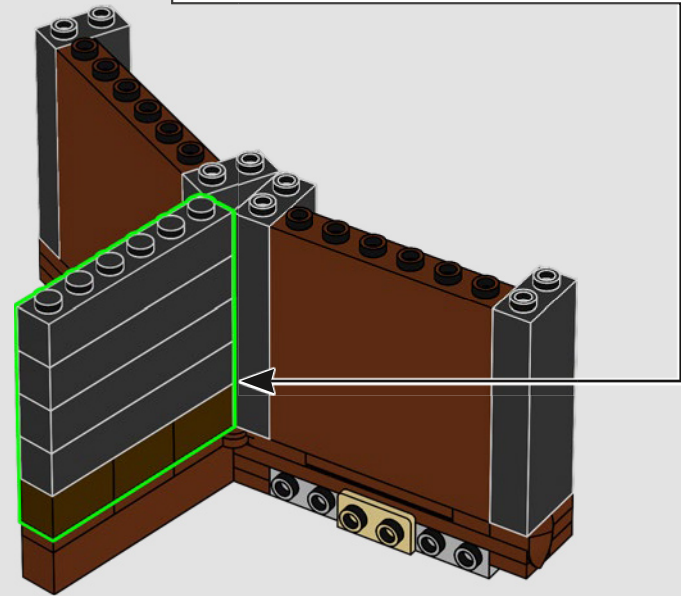
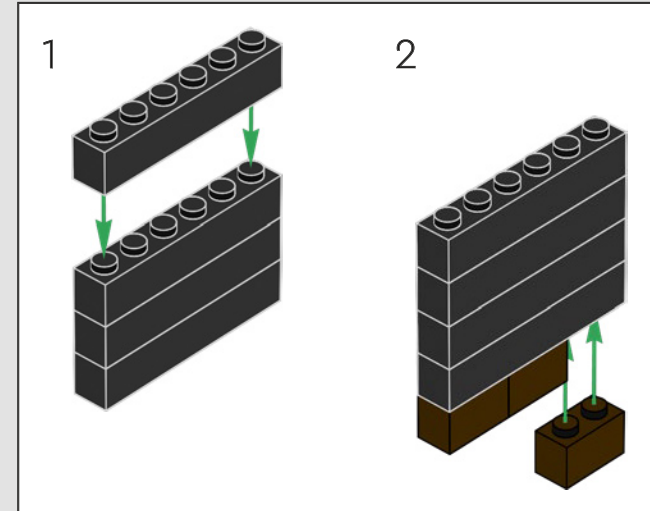

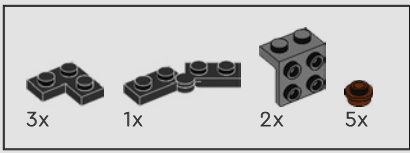

98

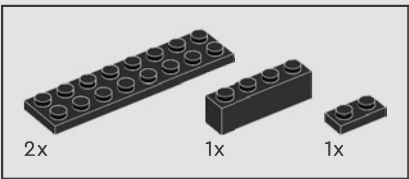
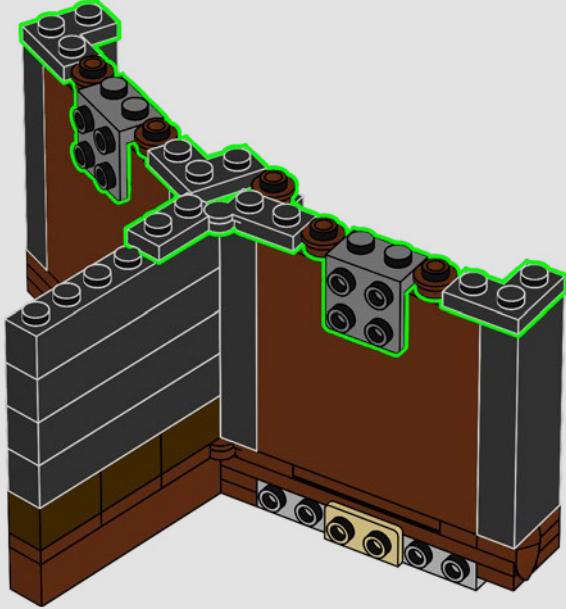

99

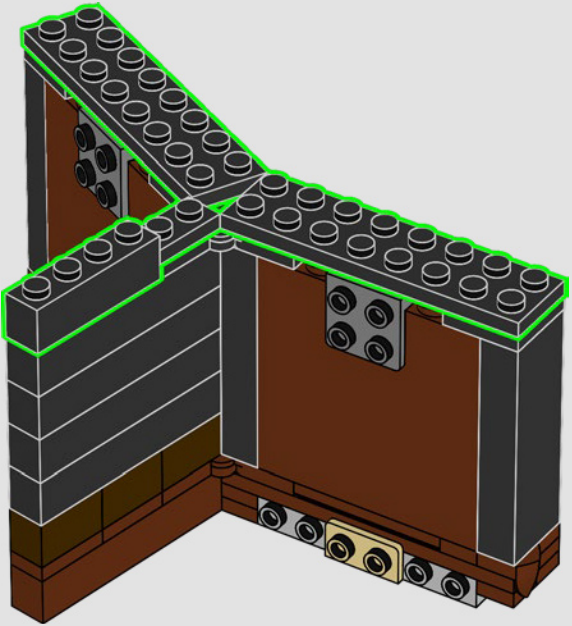

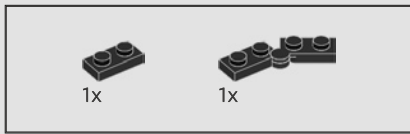

100

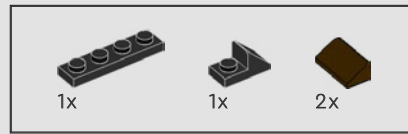
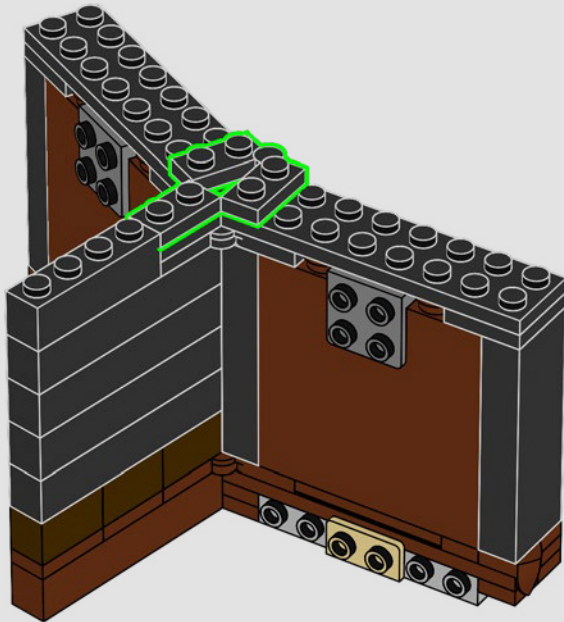

101

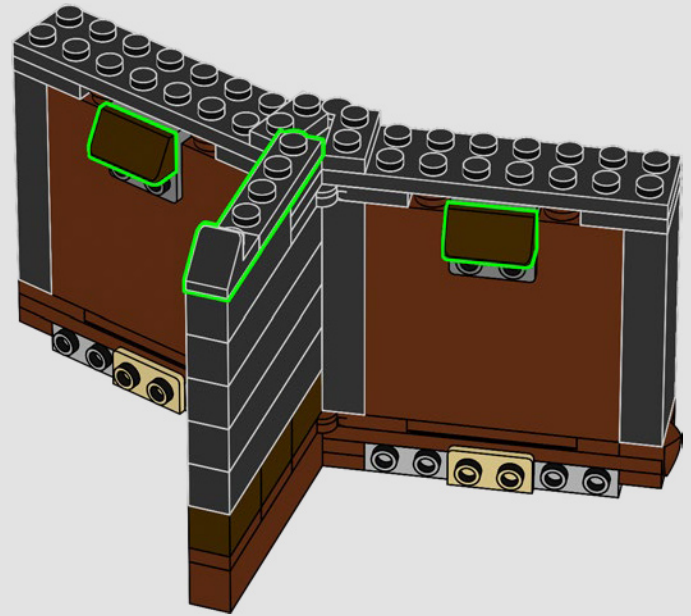

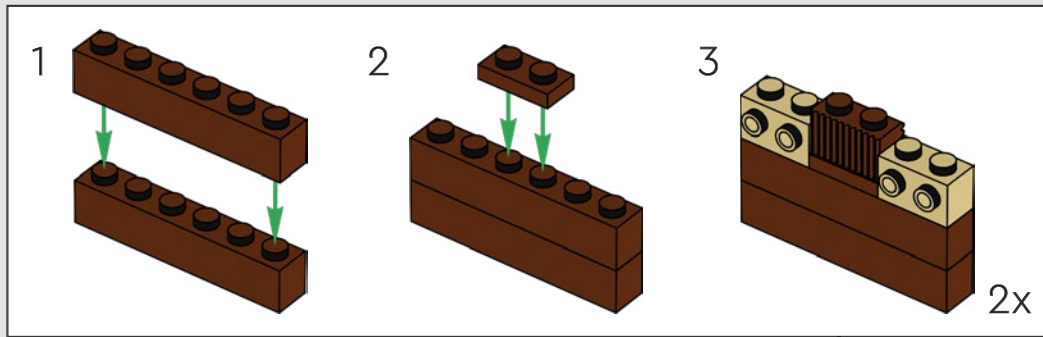
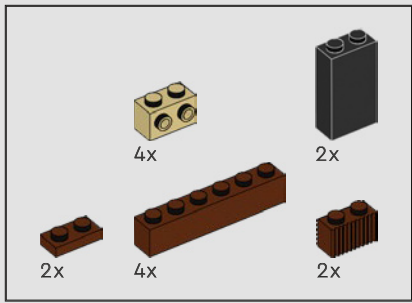

102

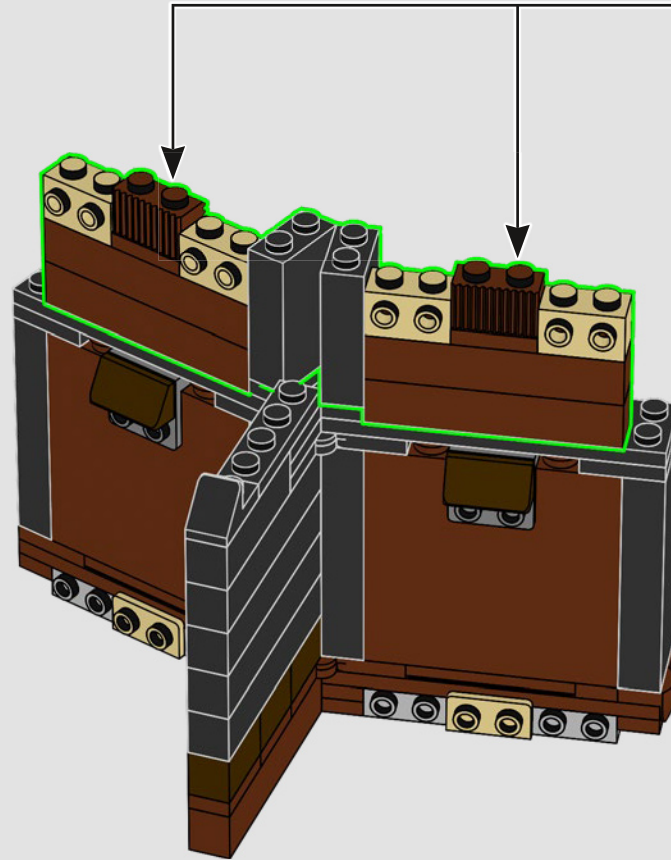

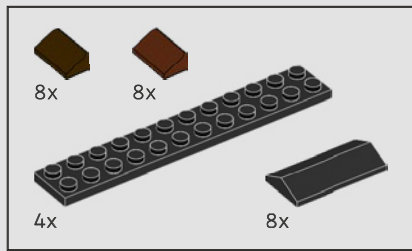

103

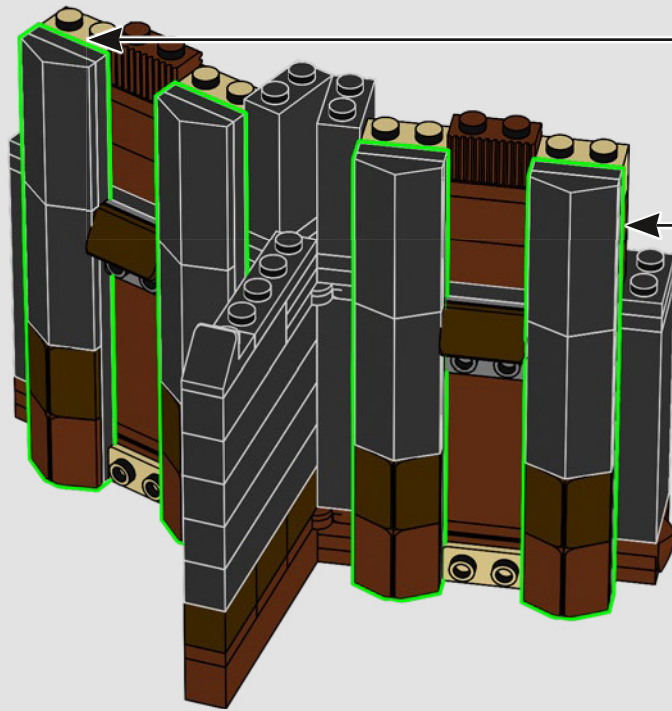
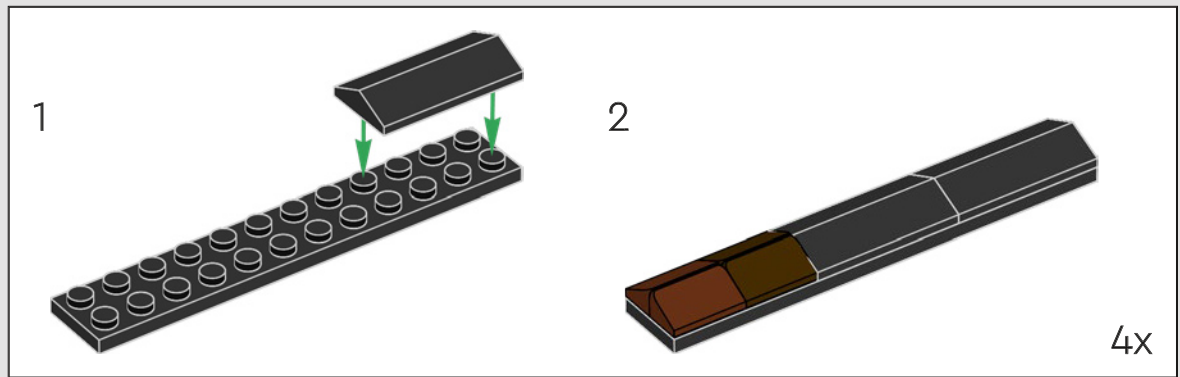



"No se entra así como así en Mordor, especialmente más allá de los impenetrables y altos muros de la fortaleza de Sauron". Boromir™

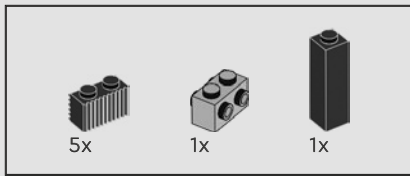

104

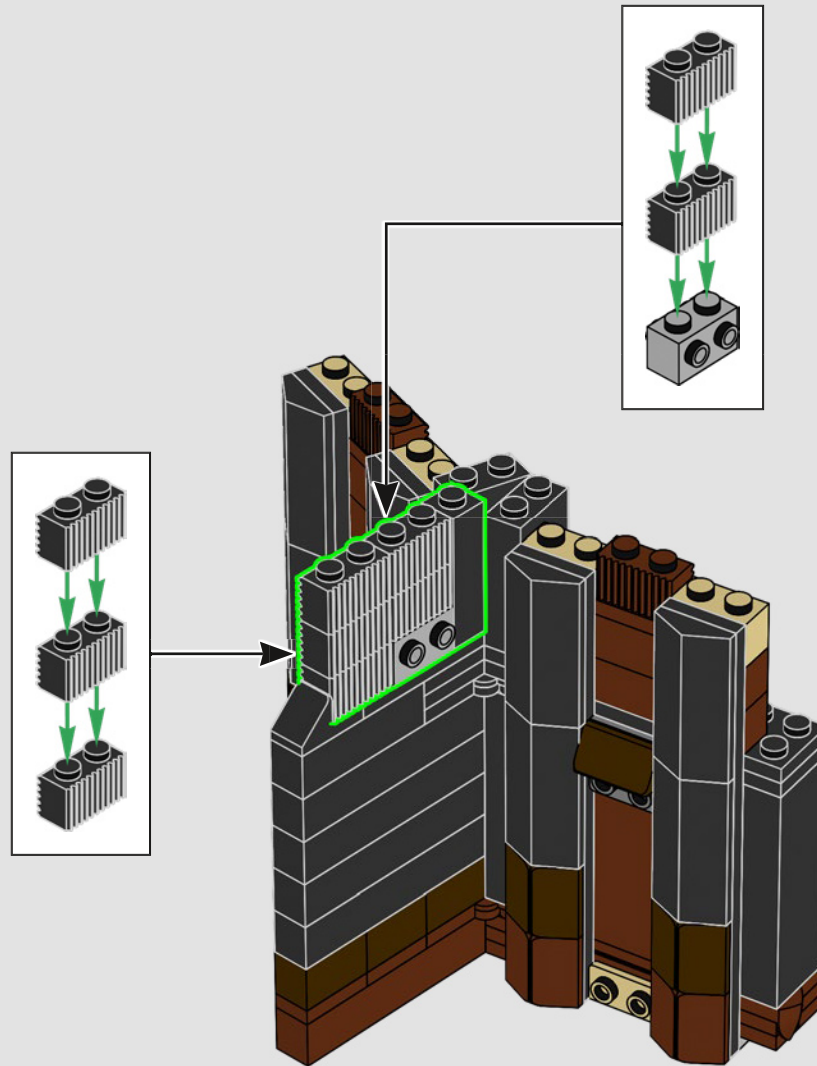

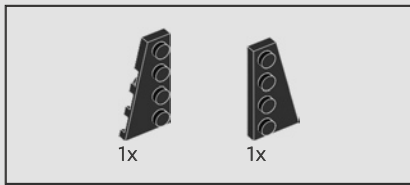

105

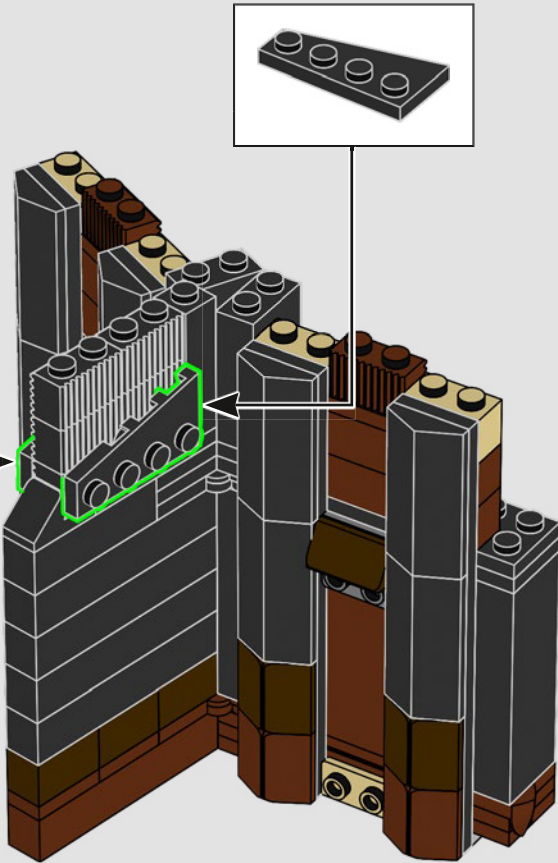
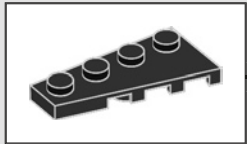

106

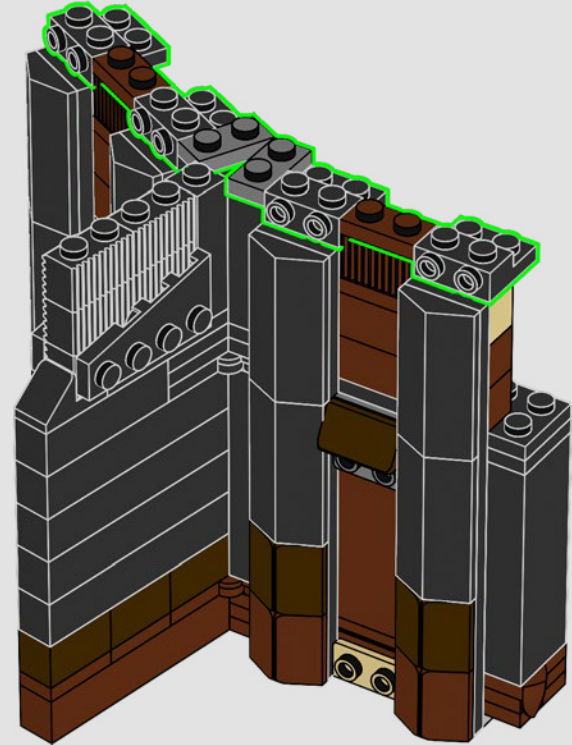

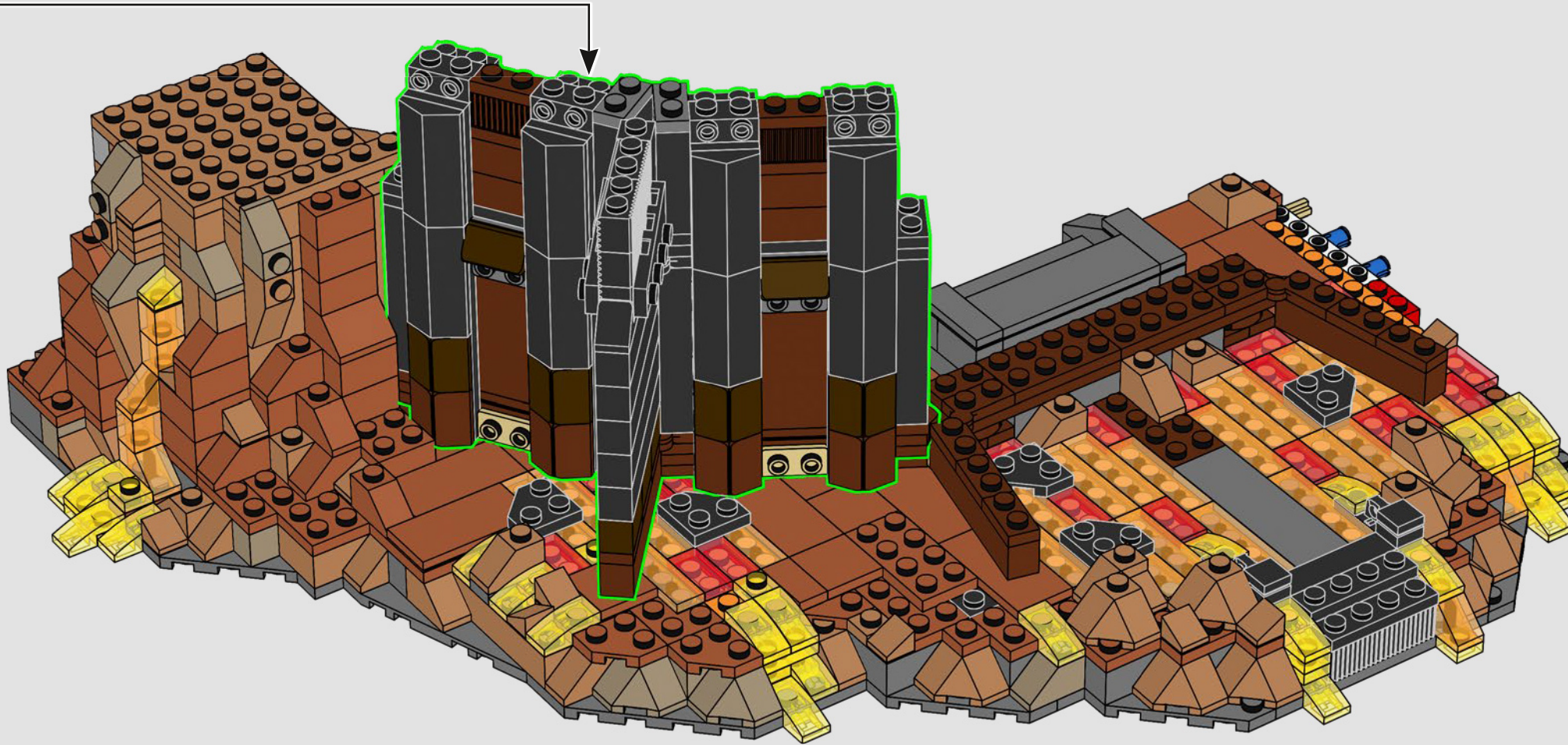

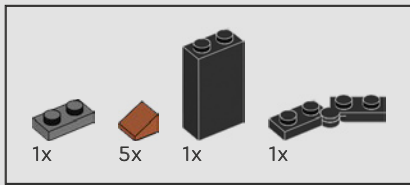

108

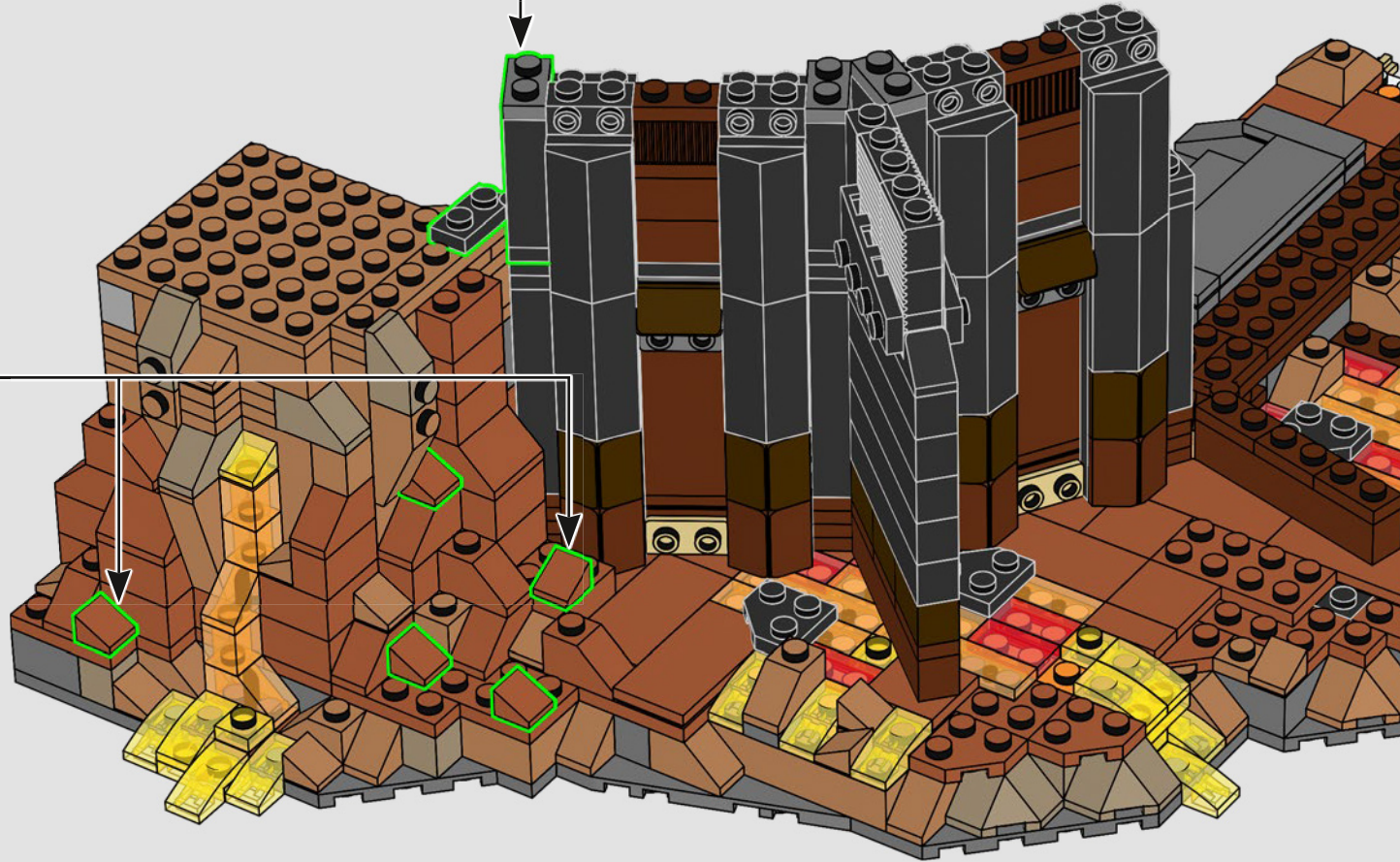
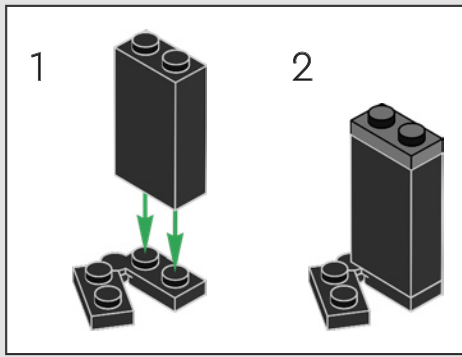



109

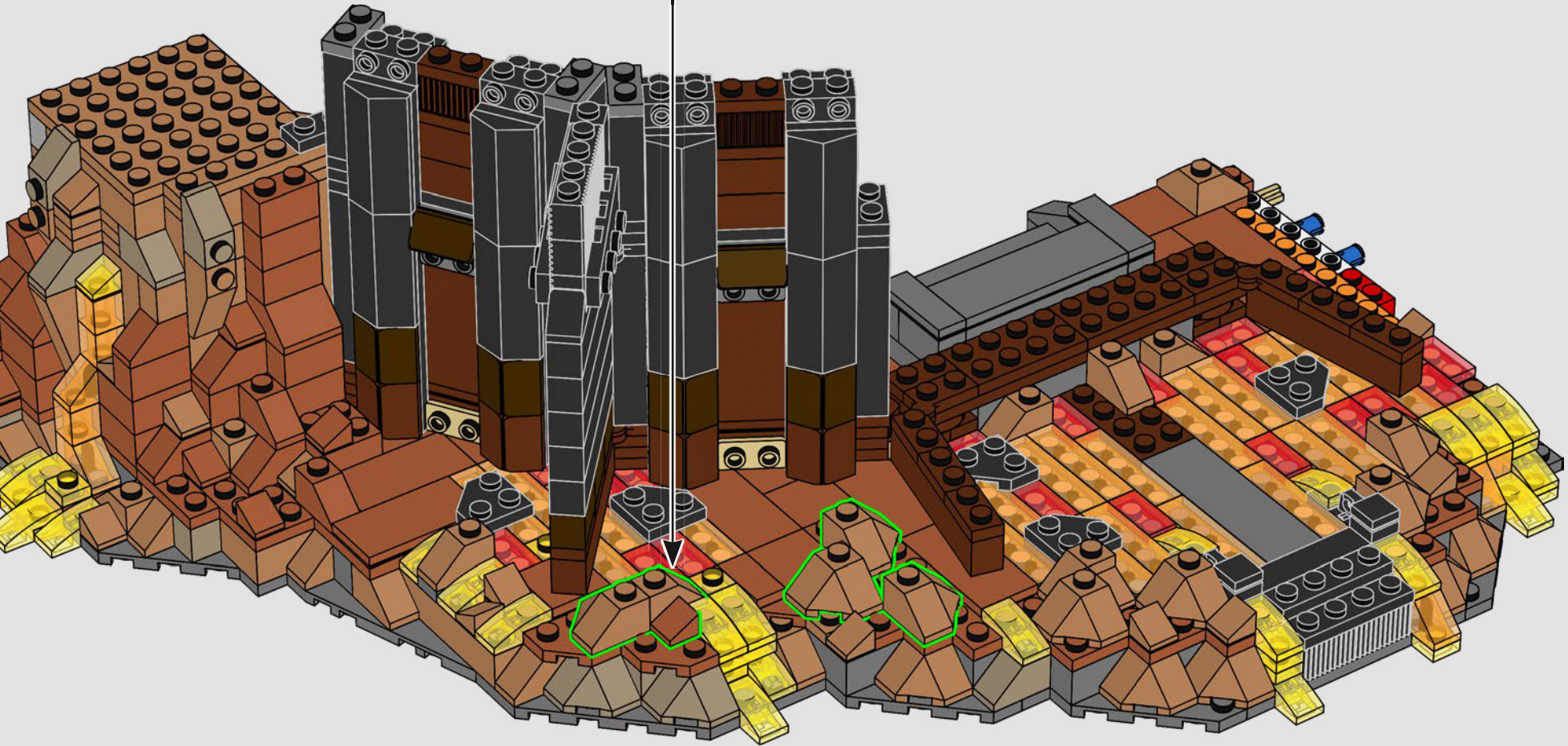
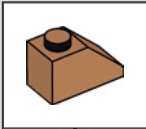

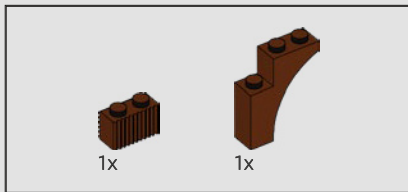
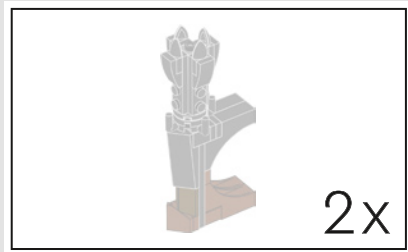

110

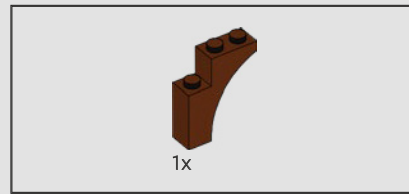
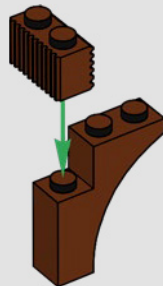

111

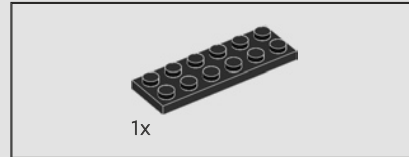
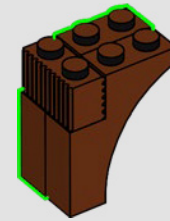

112

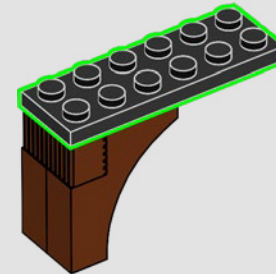



113

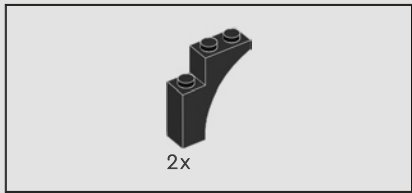
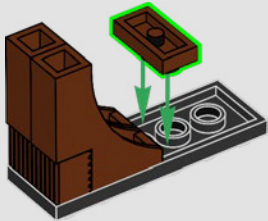

114

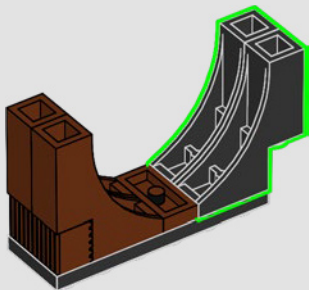

115

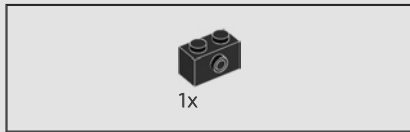
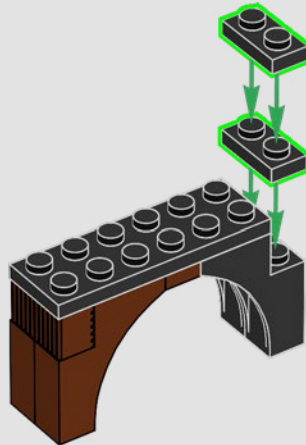

116

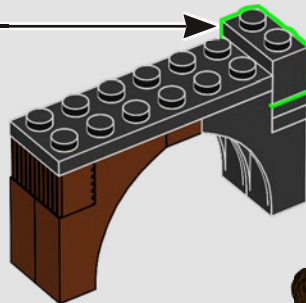
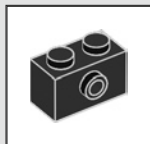

117

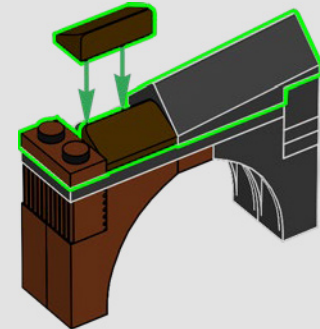

118

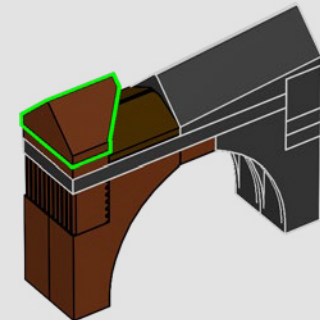

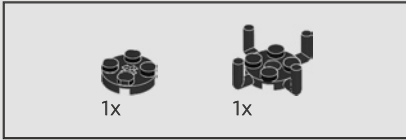

119

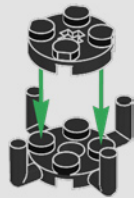

120

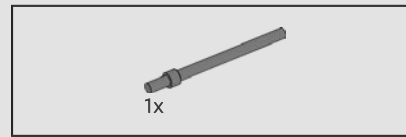
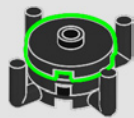

121

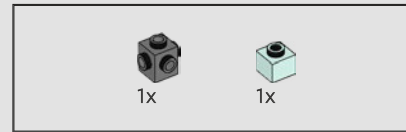
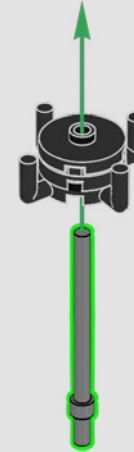

122

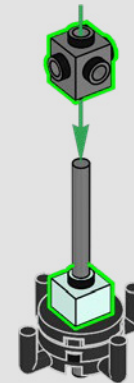



123

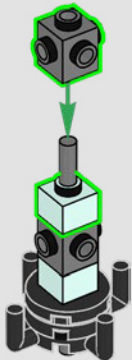

124

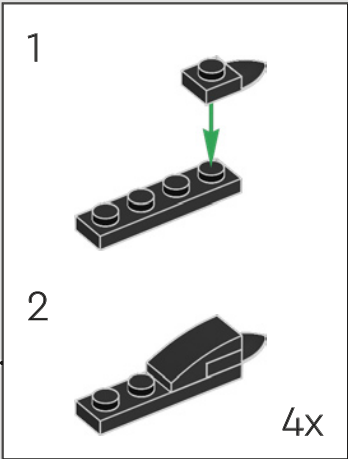

125

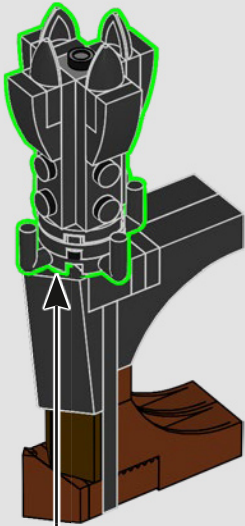

2x





El gradiente de color confiere a la arquitectura oscura y puntiaguda de la torre un aspecto majestuoso y dinámico.

126

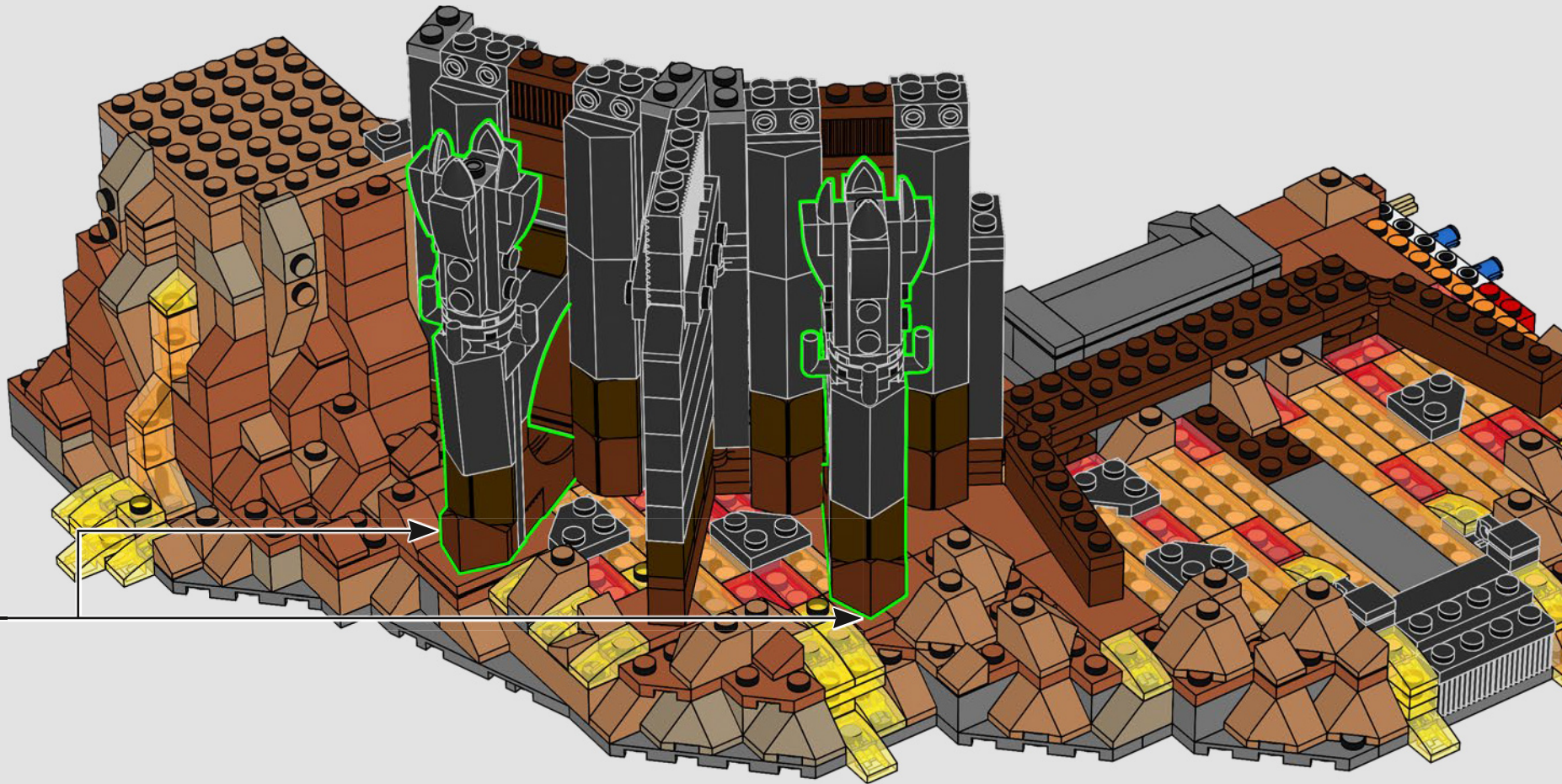

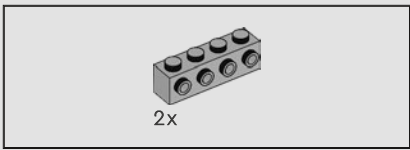

127

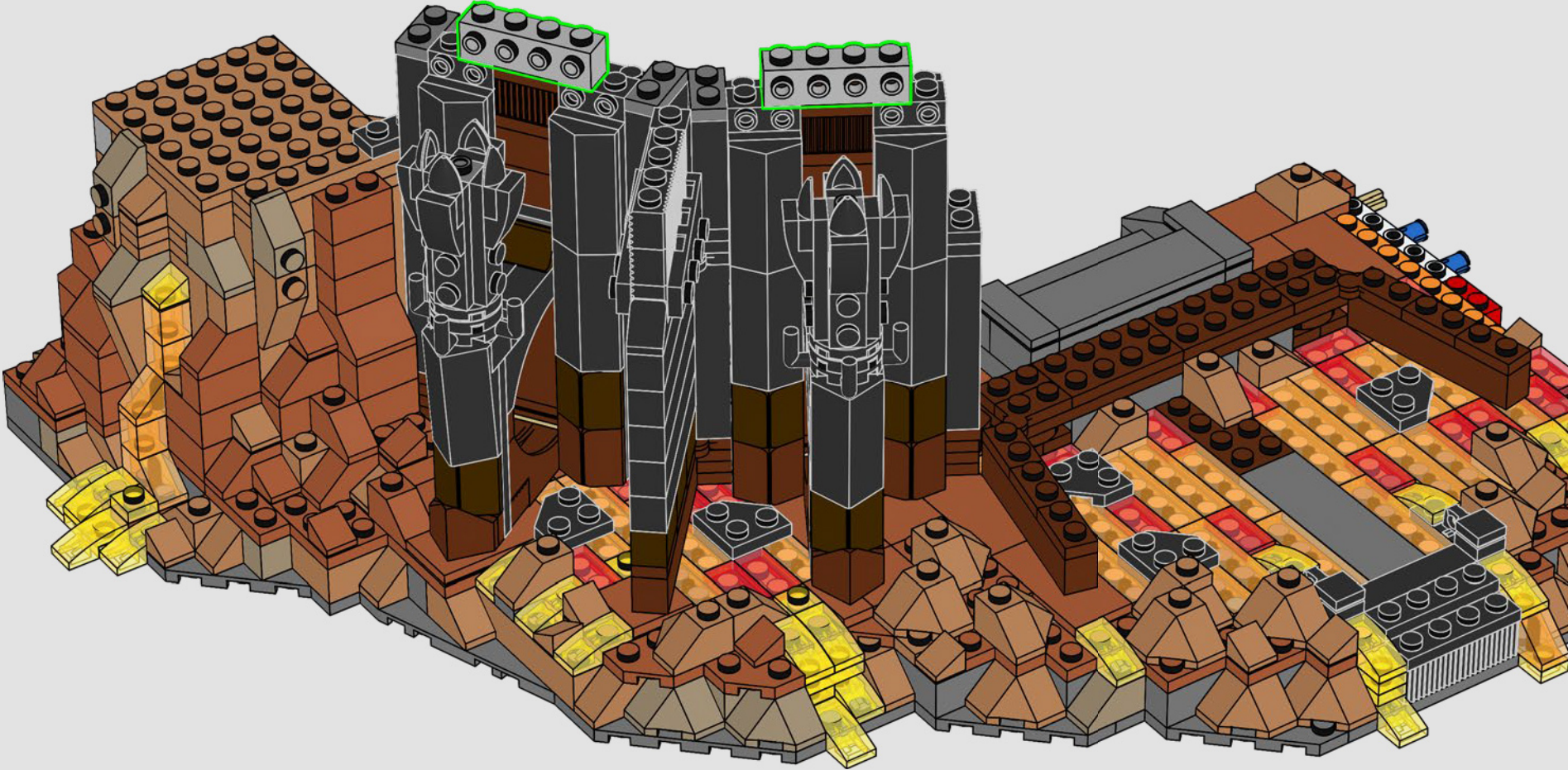

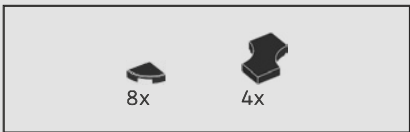

128

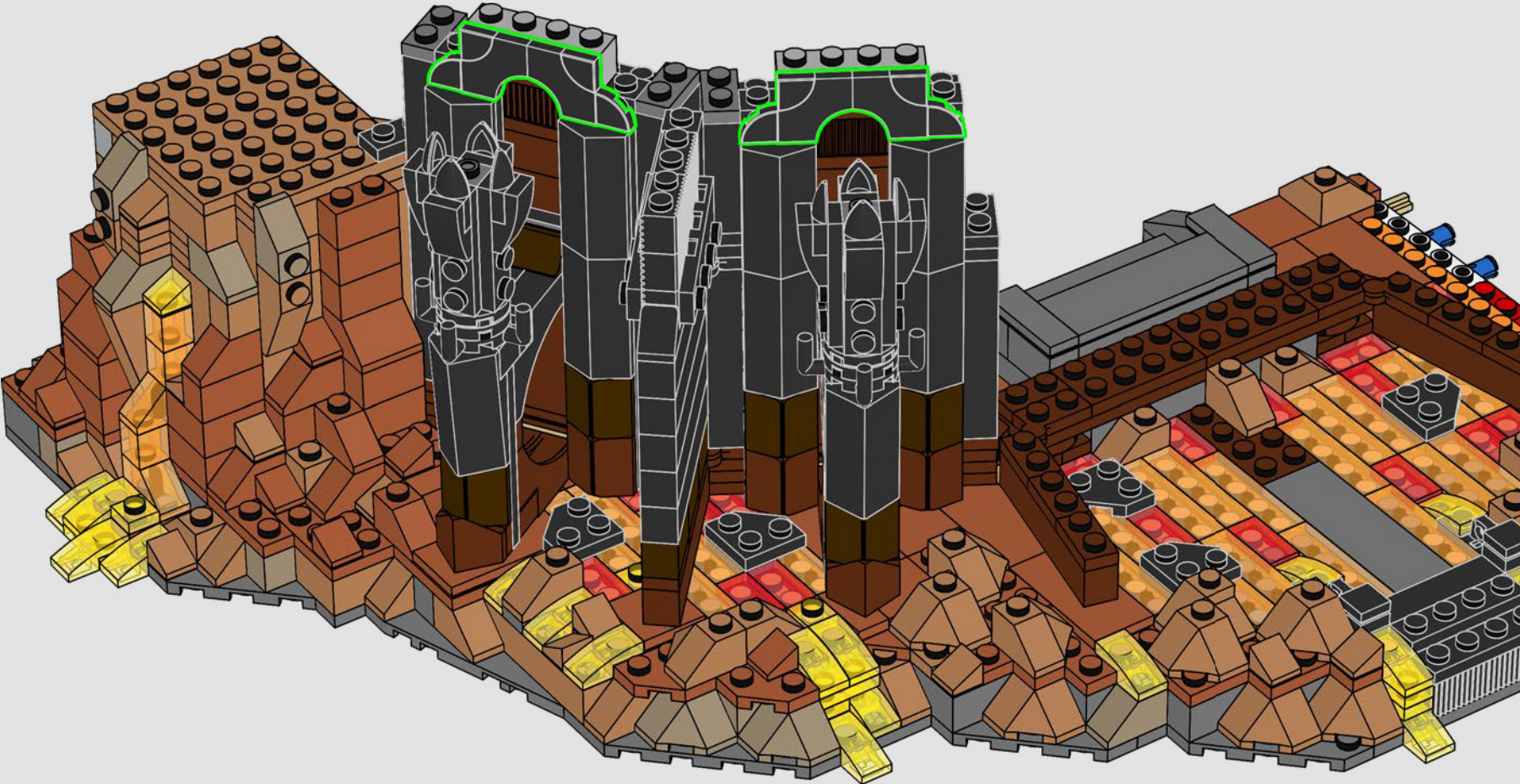

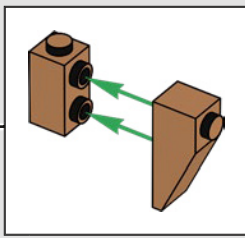
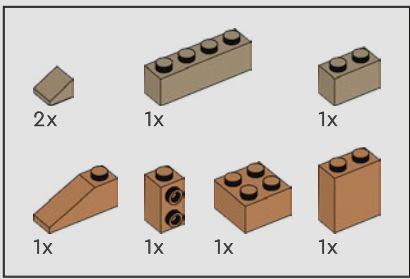

129

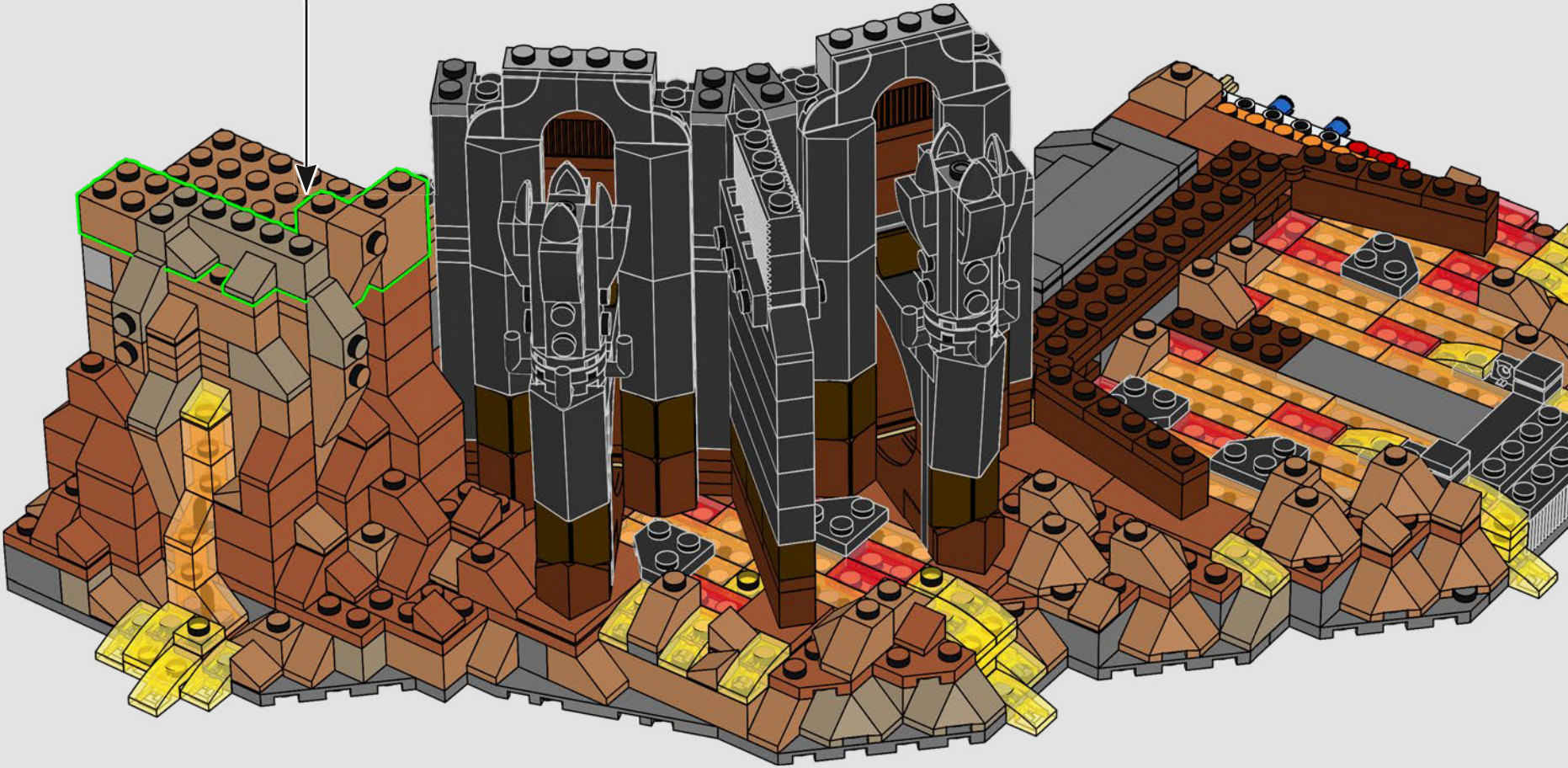

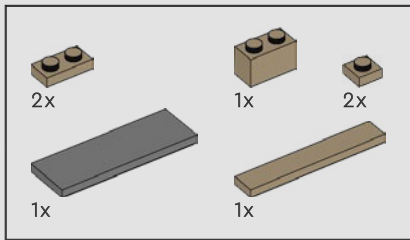

130

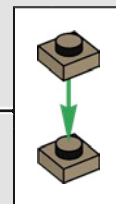
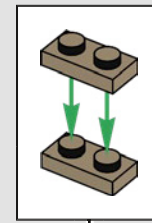

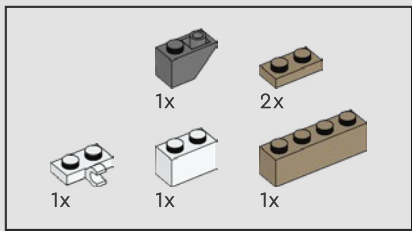

131

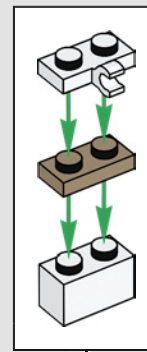

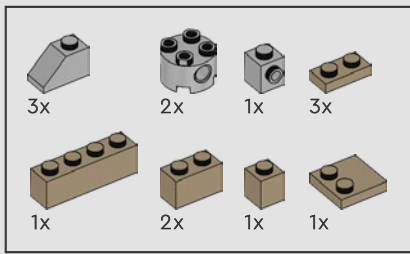

132

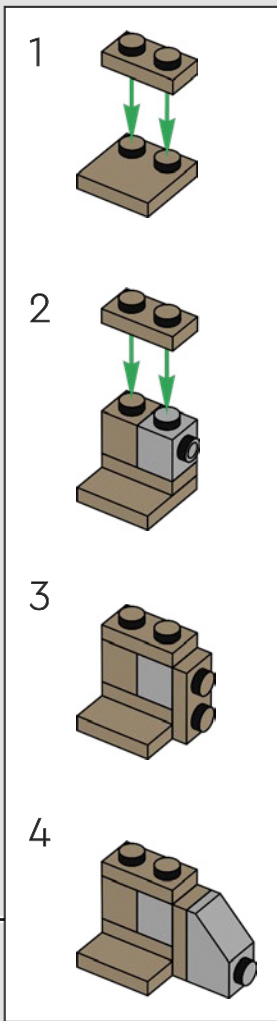
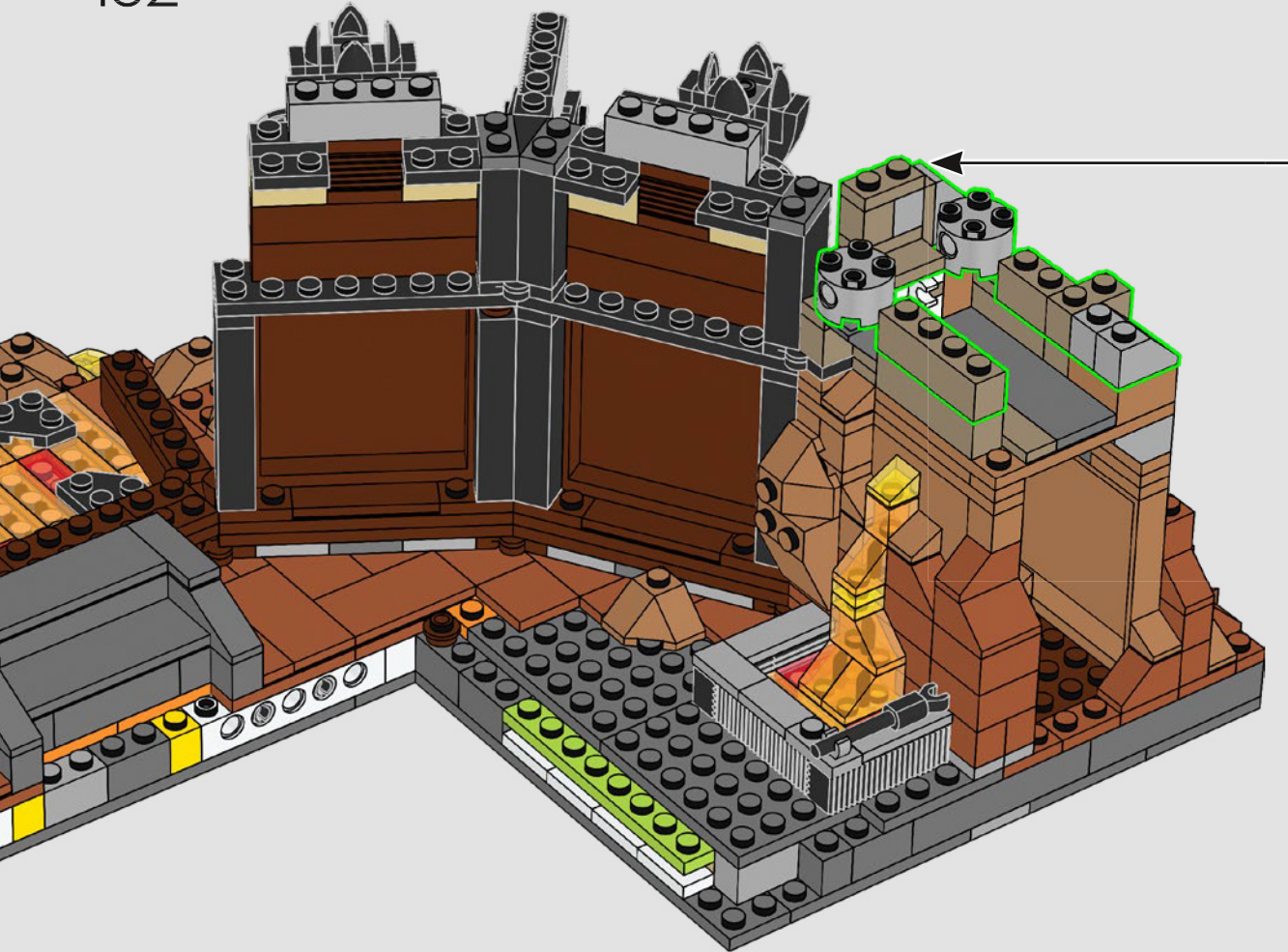

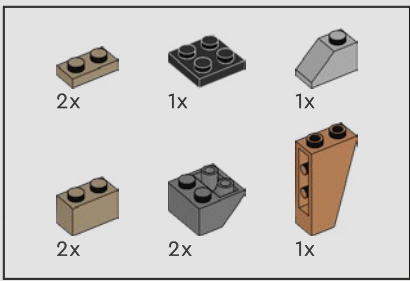

133

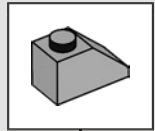

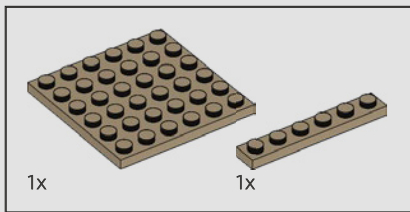

134



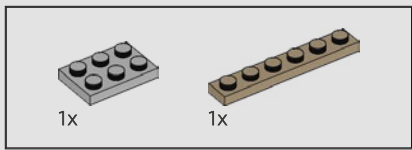

135

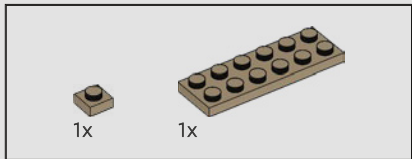
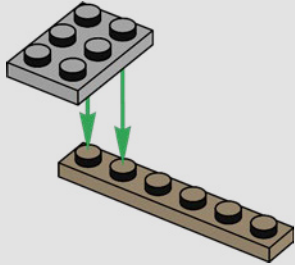

136

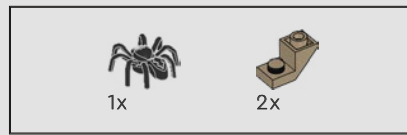
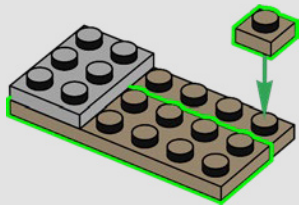

137

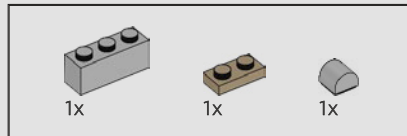
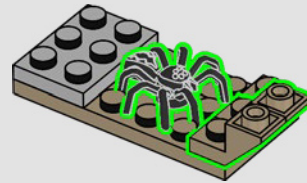

138

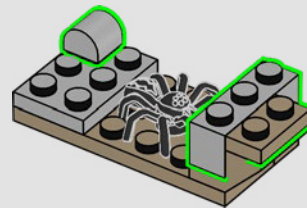

139

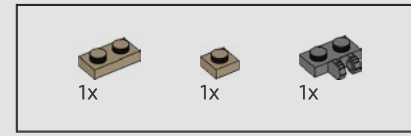
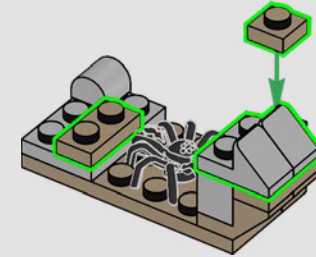

140

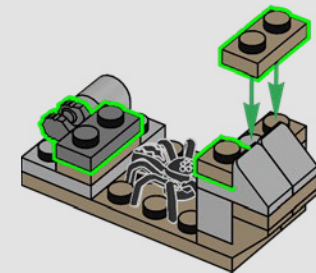

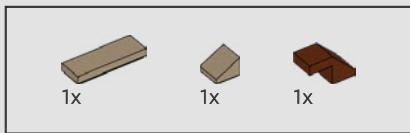

141

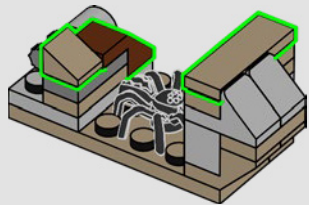

142

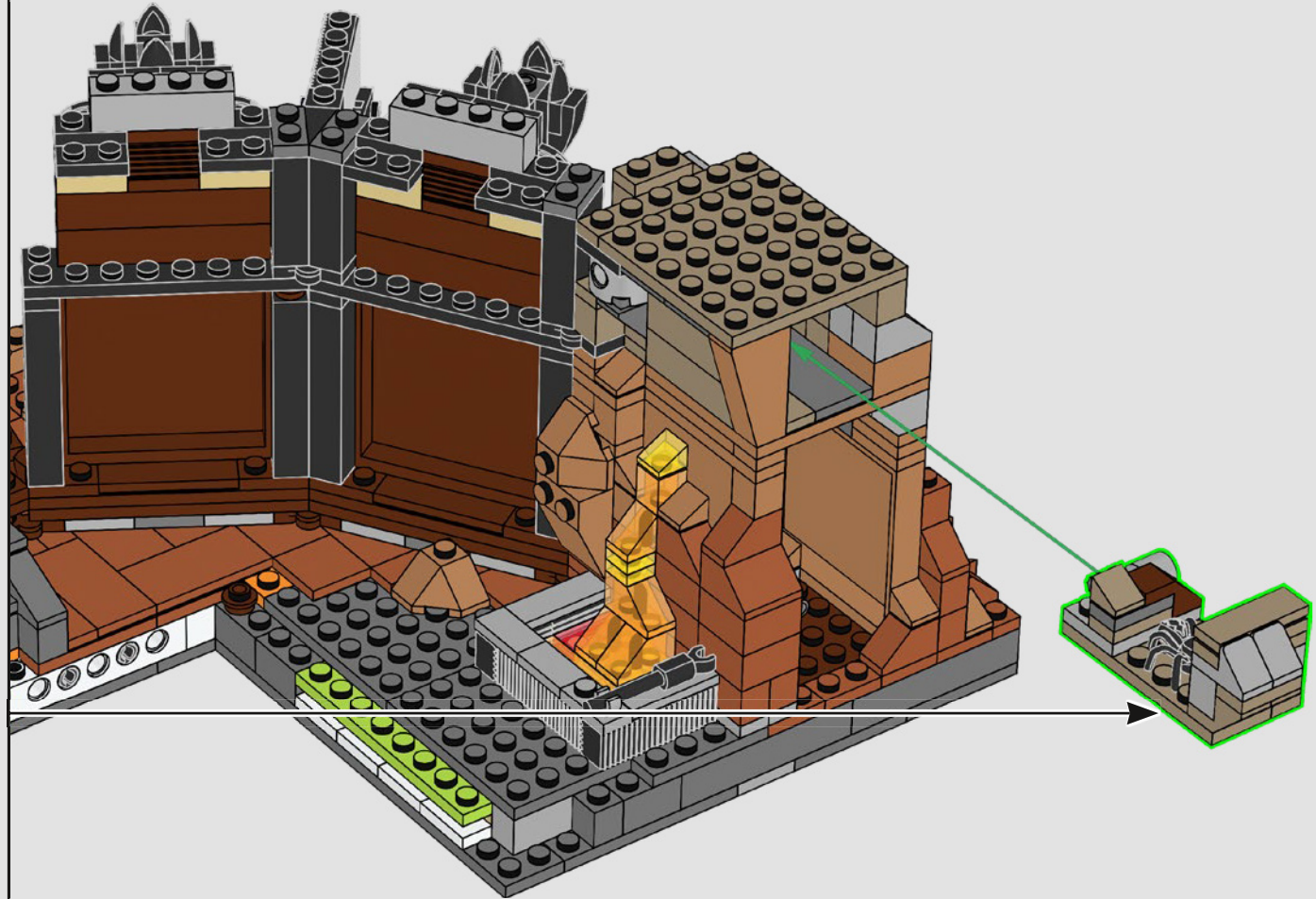

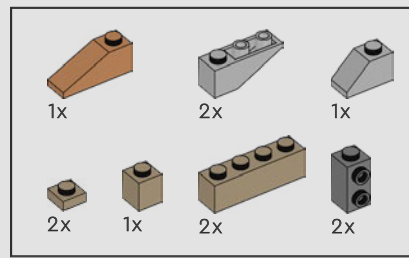

143

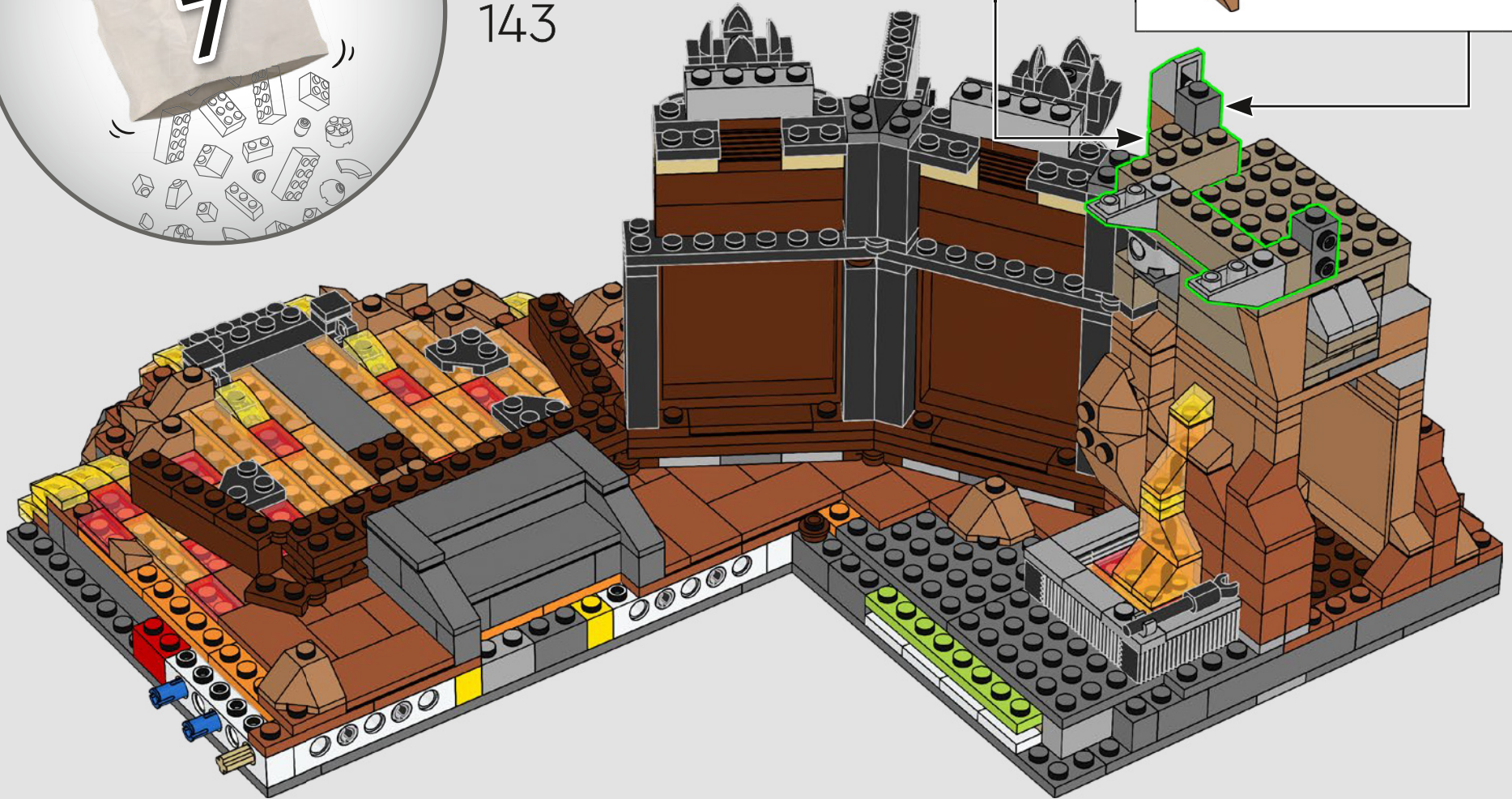
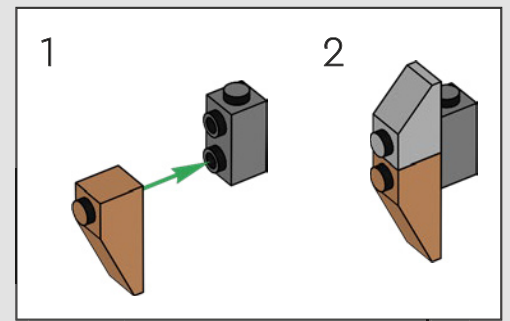
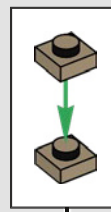

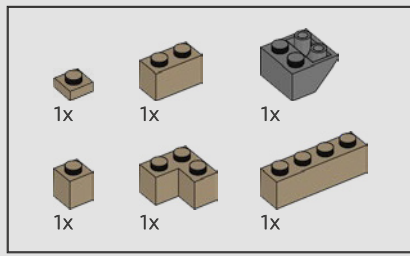

144



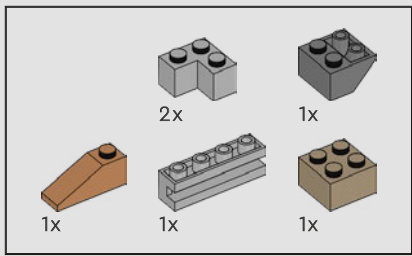

145

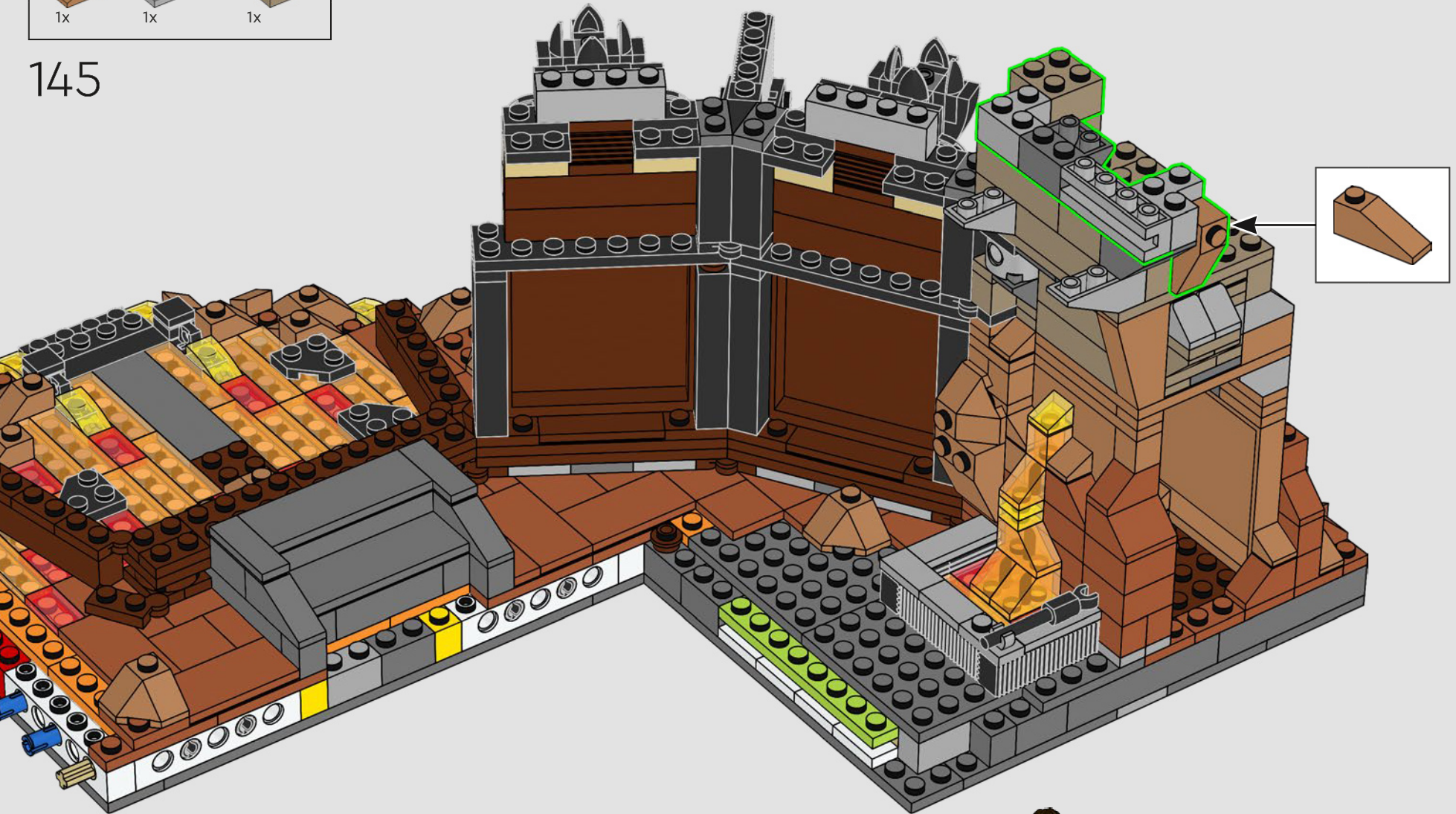

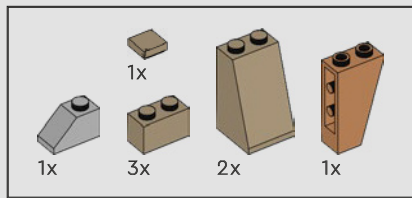

146

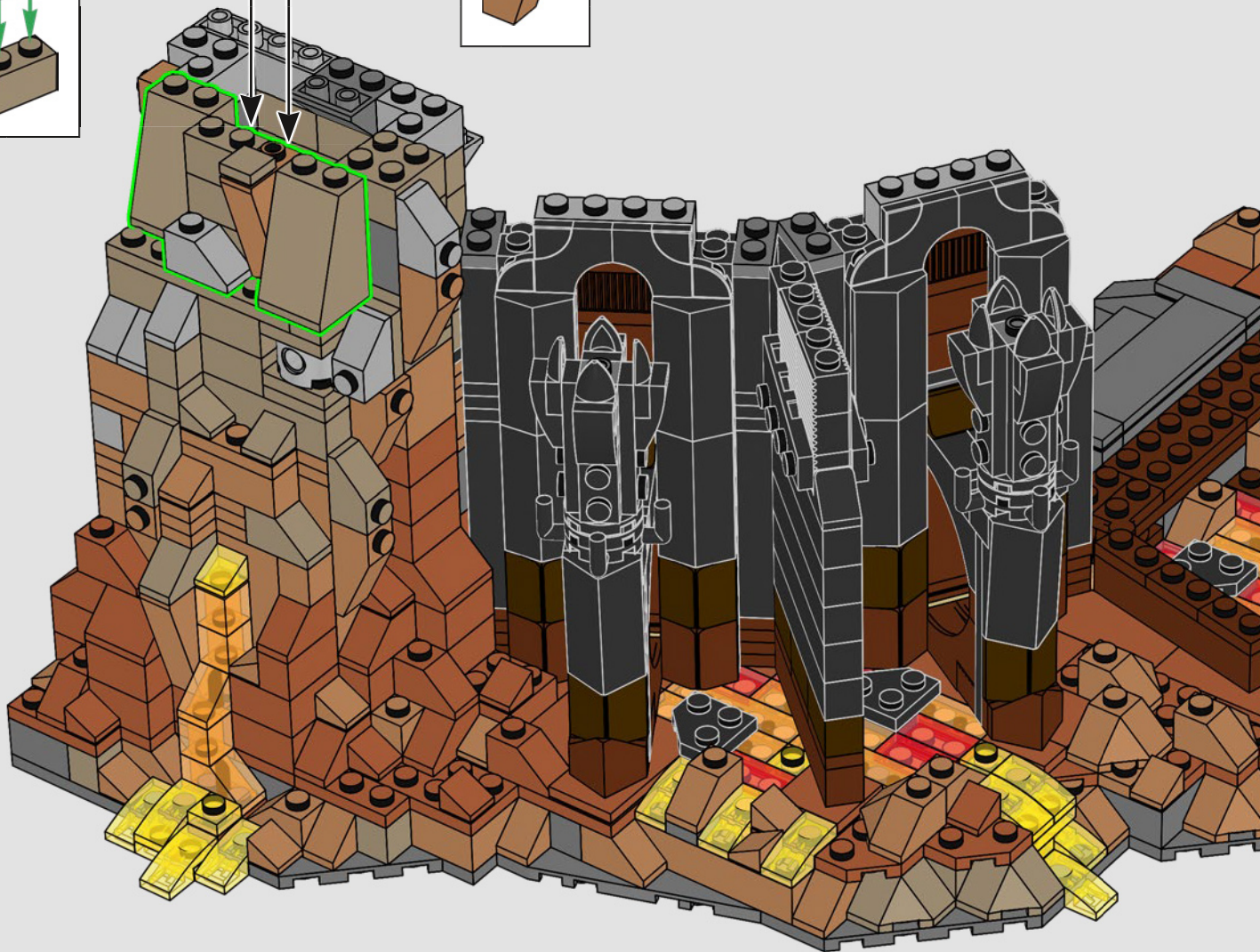
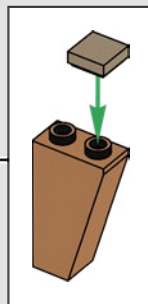
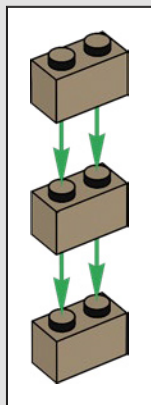

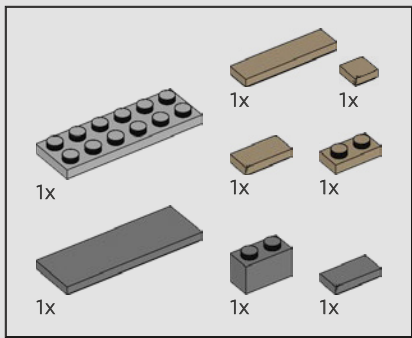

147

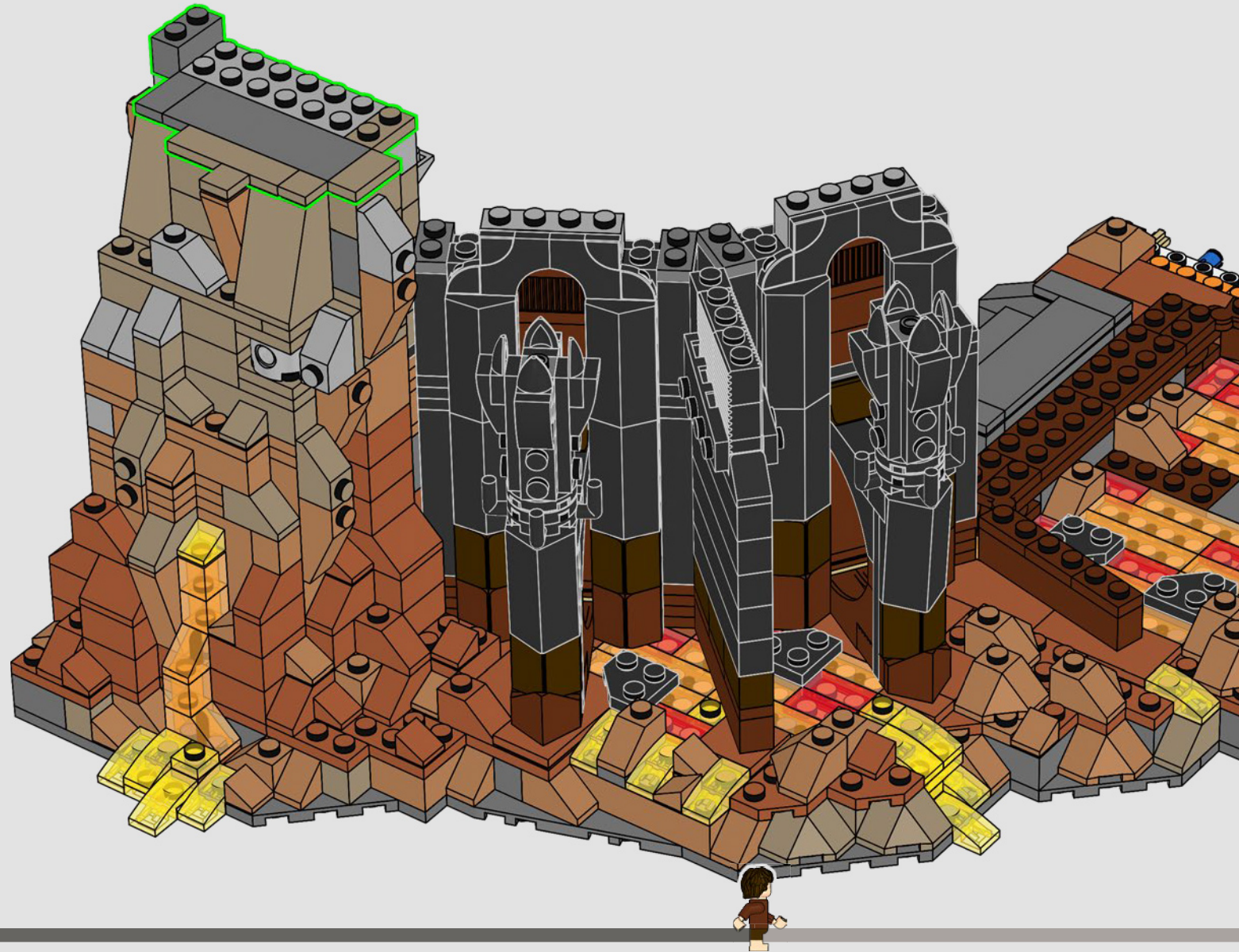

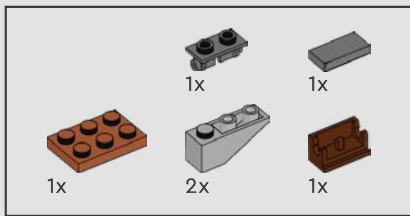

148

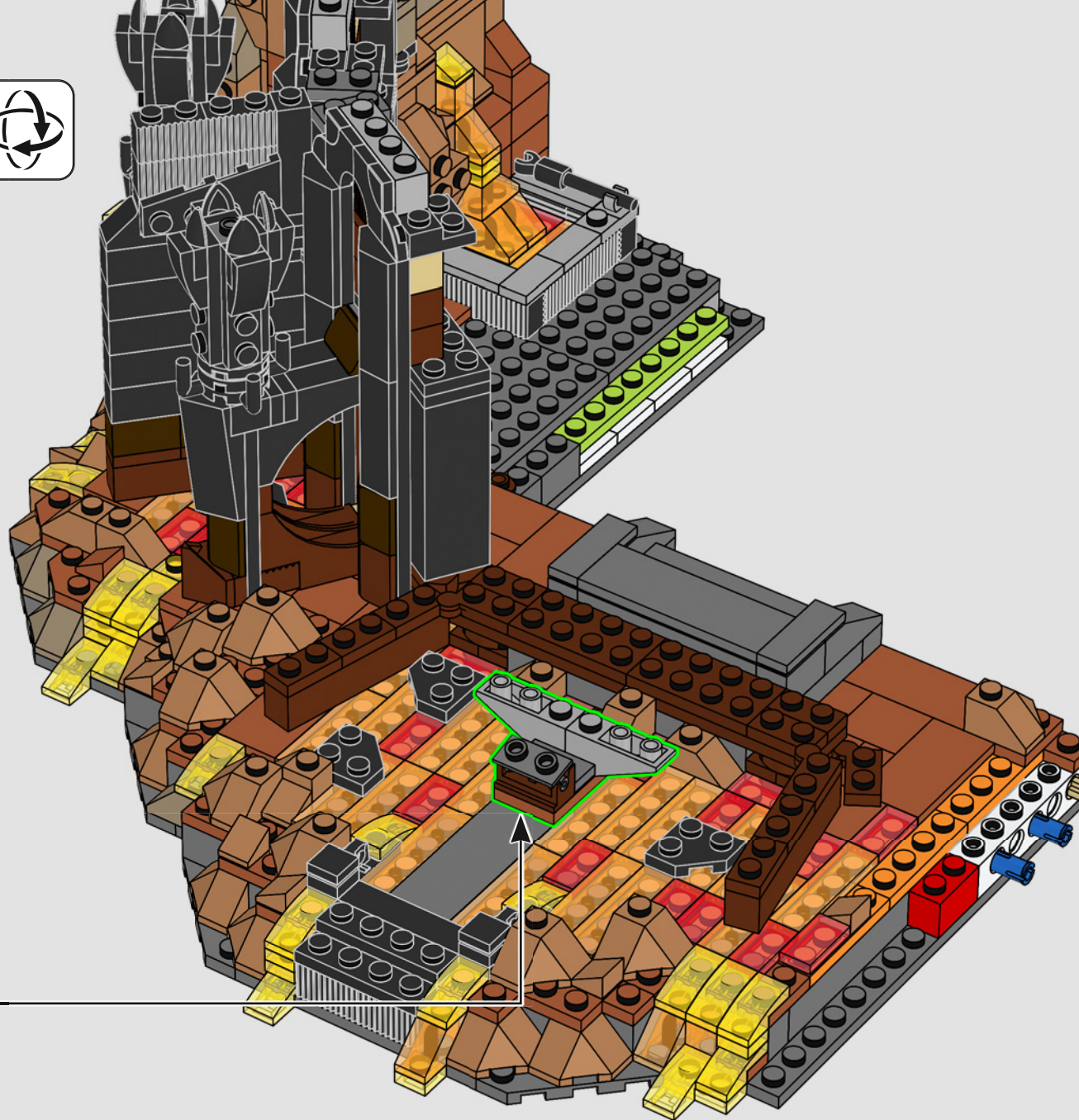
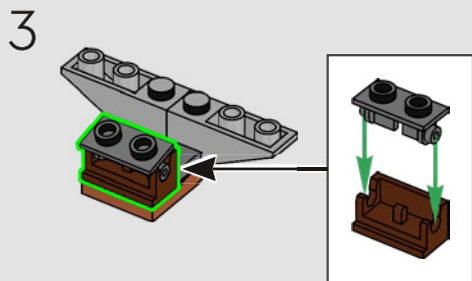
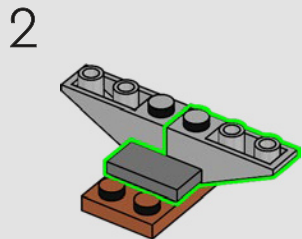
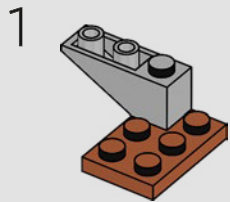

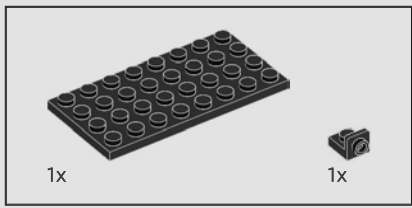

149

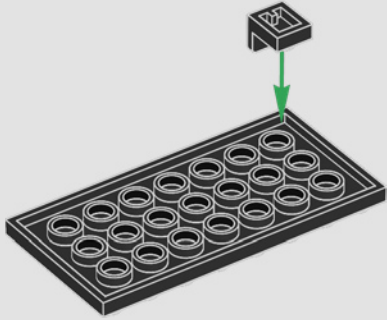

150

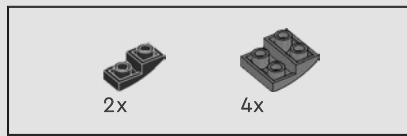
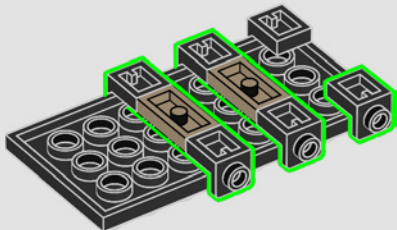

151

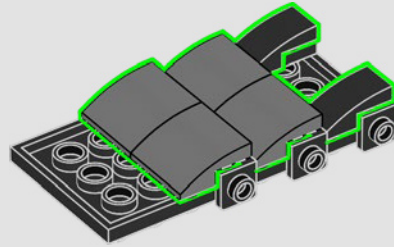

152

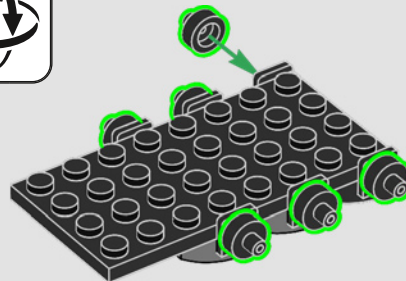

153

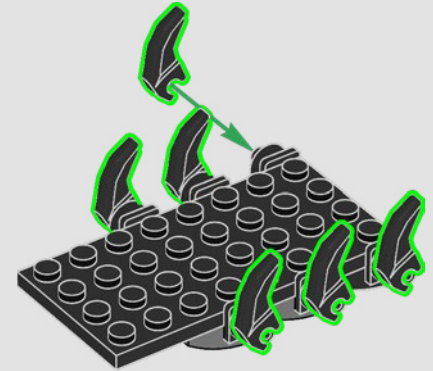

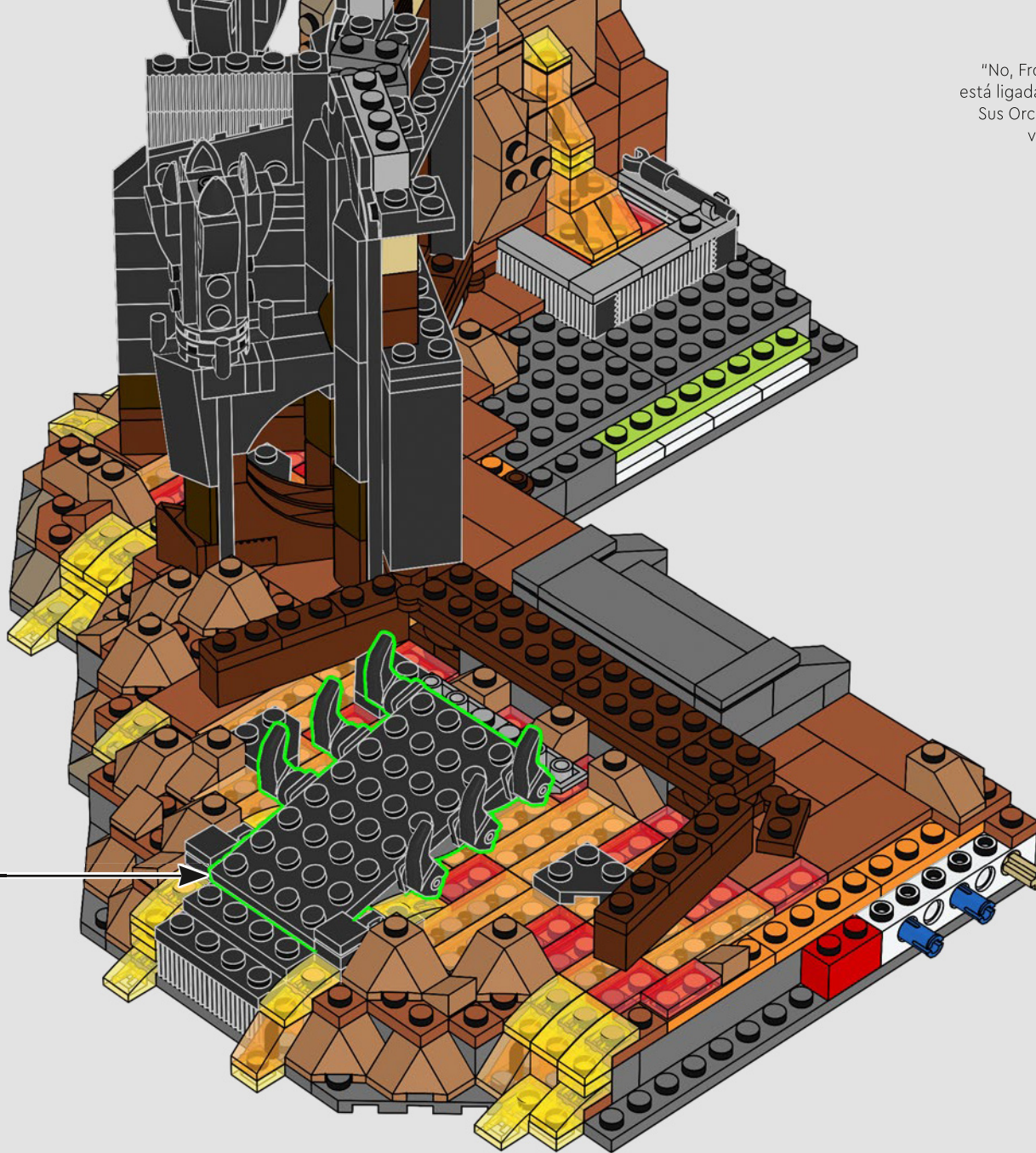

"No, Frodo. El espíritu de Sauron perduró. Su fuerza vital está ligada al Anillo y el Anillo sobrevivió. Sauron ha vuelto. Sus Orcos se han multiplicado. Su fortaleza de Barad-dûr vuelve a erguirse en la tierra de Mordor". Gandalf™

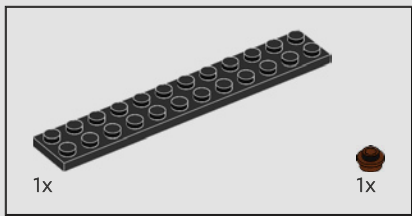

155

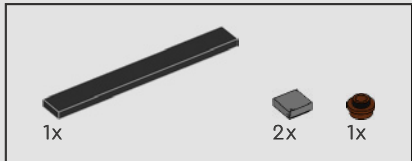
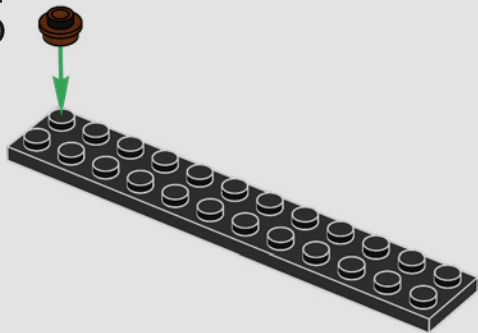

156

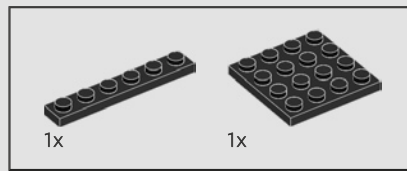
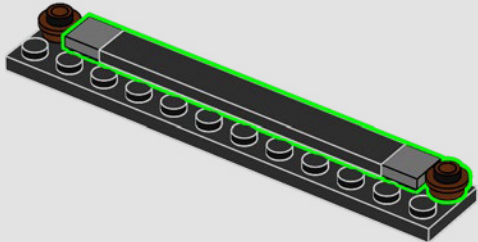

157

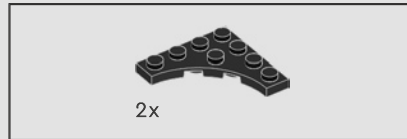
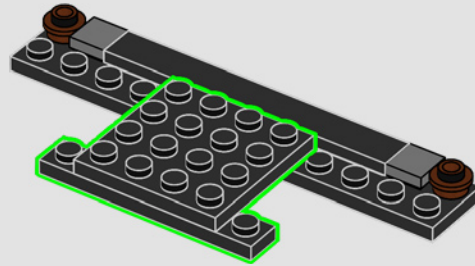

158

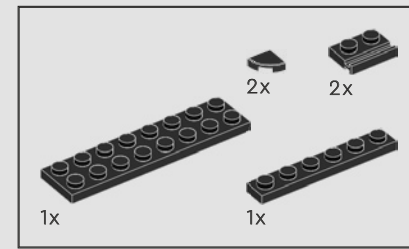
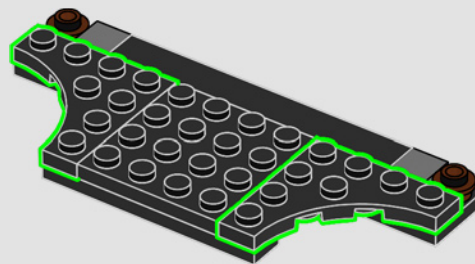

159

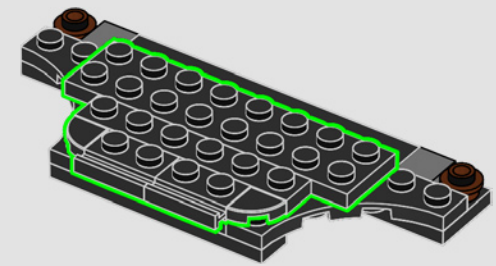

160

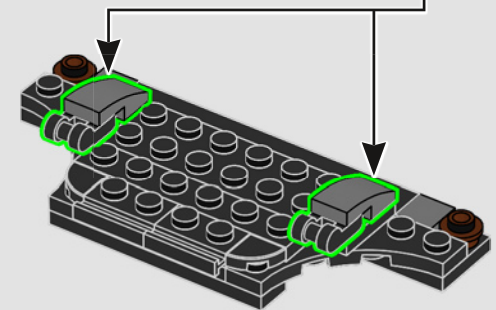
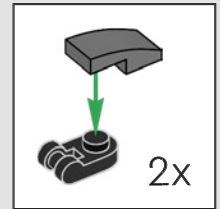



161

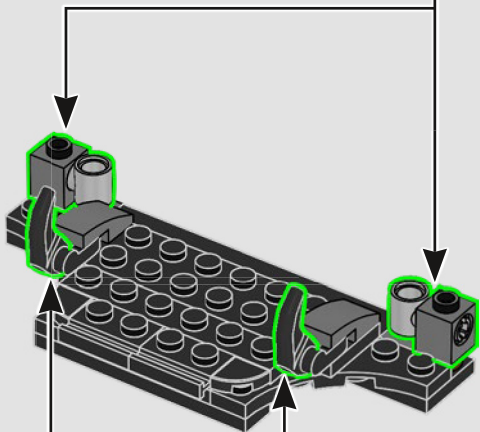
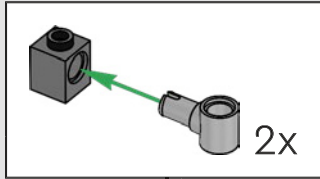

162

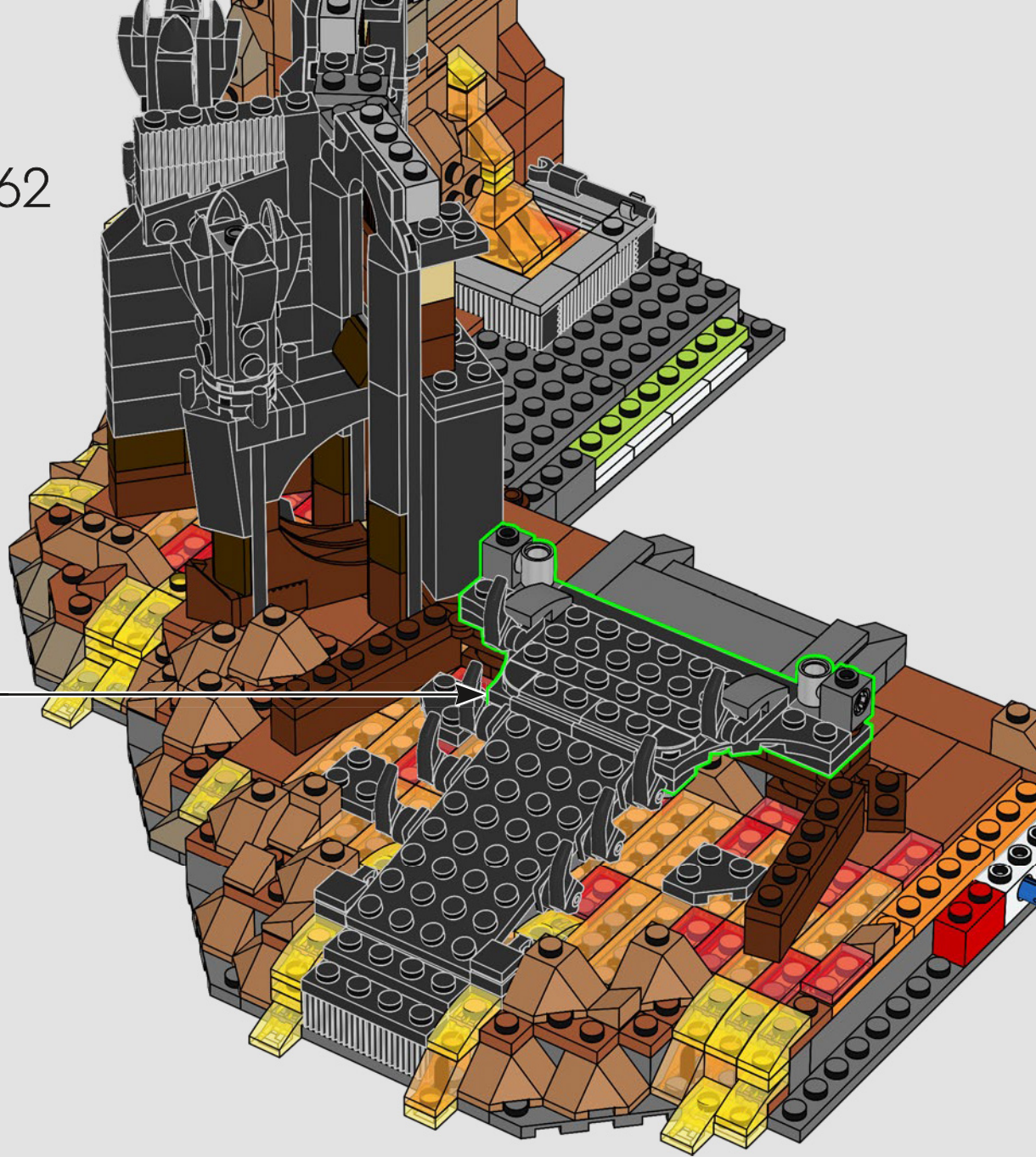

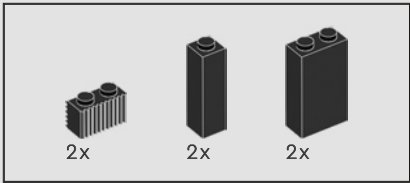

163

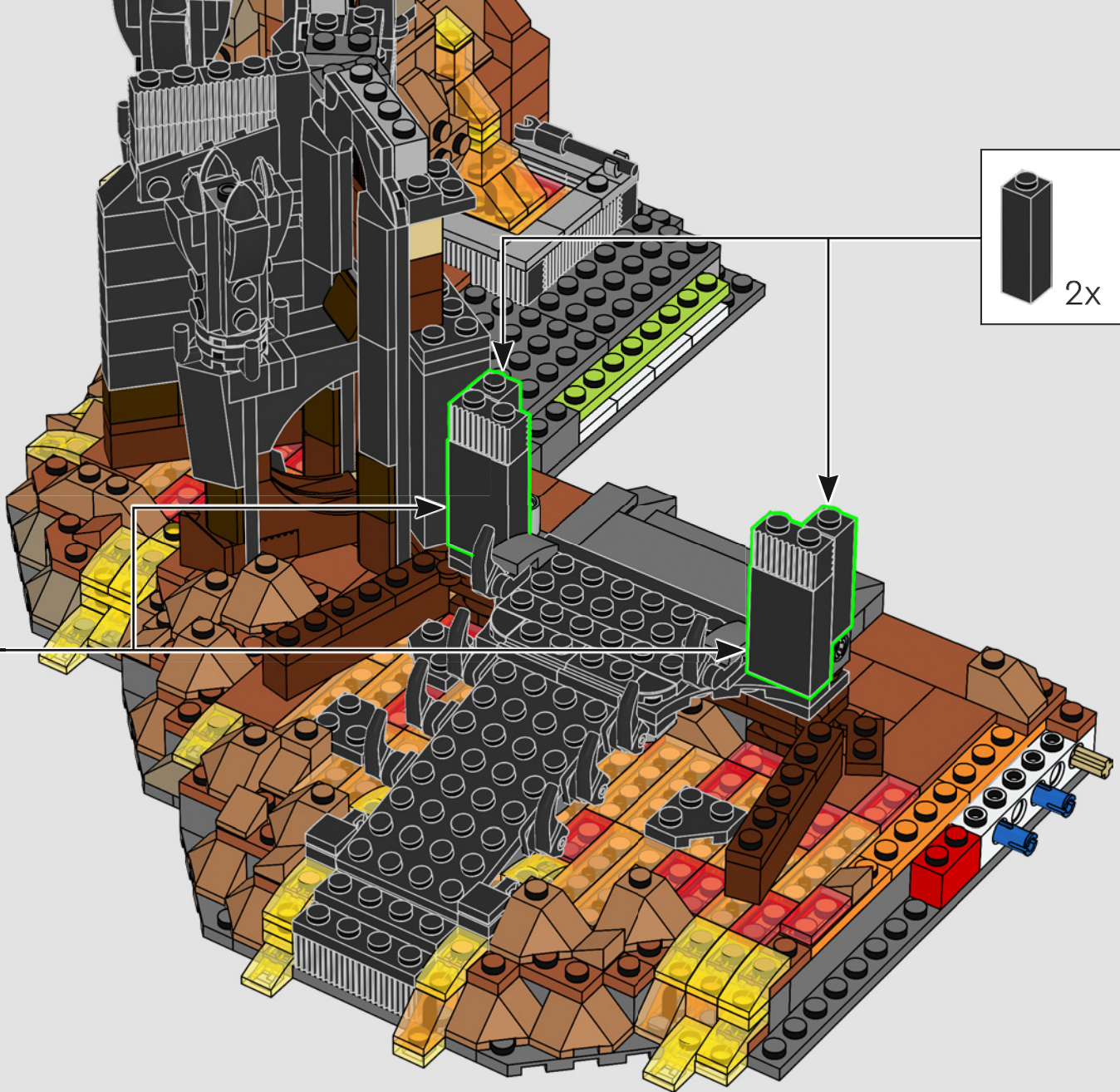
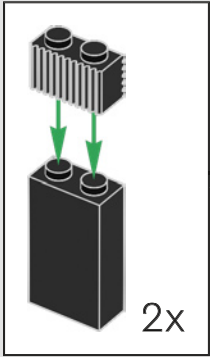
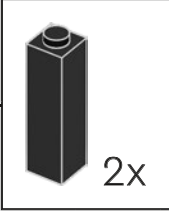

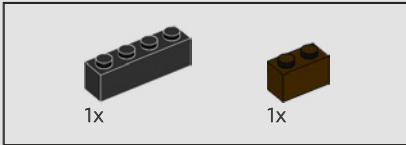
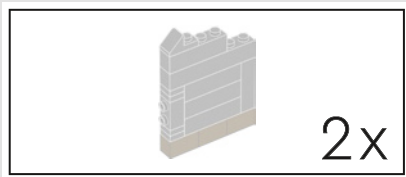

164

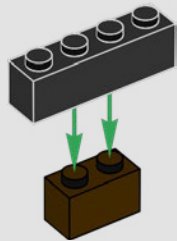

165

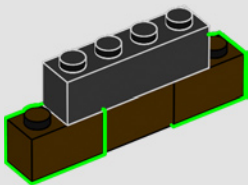

166

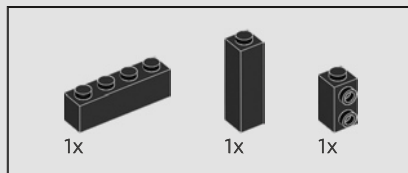
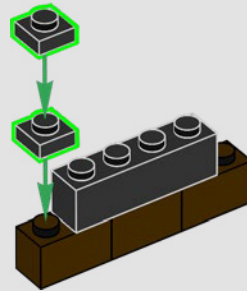

167

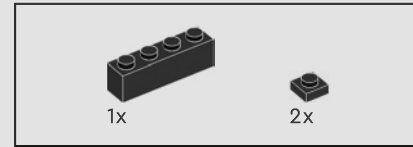
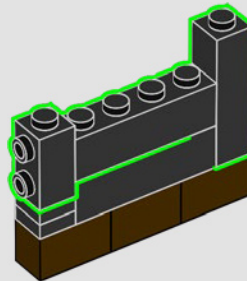

168

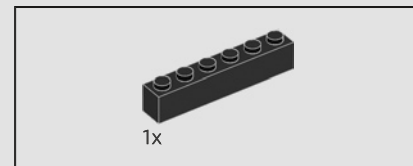
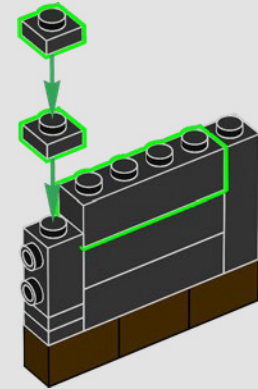

169

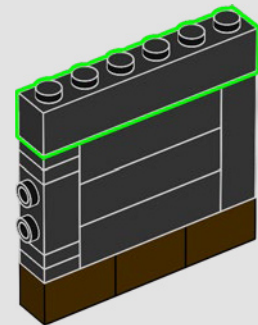

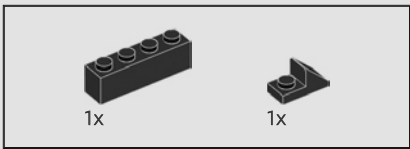

170

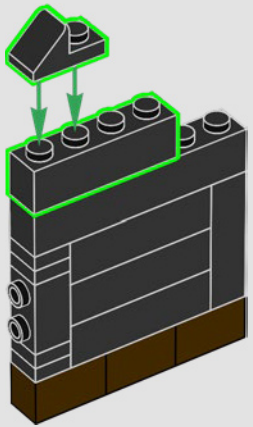

2x

171

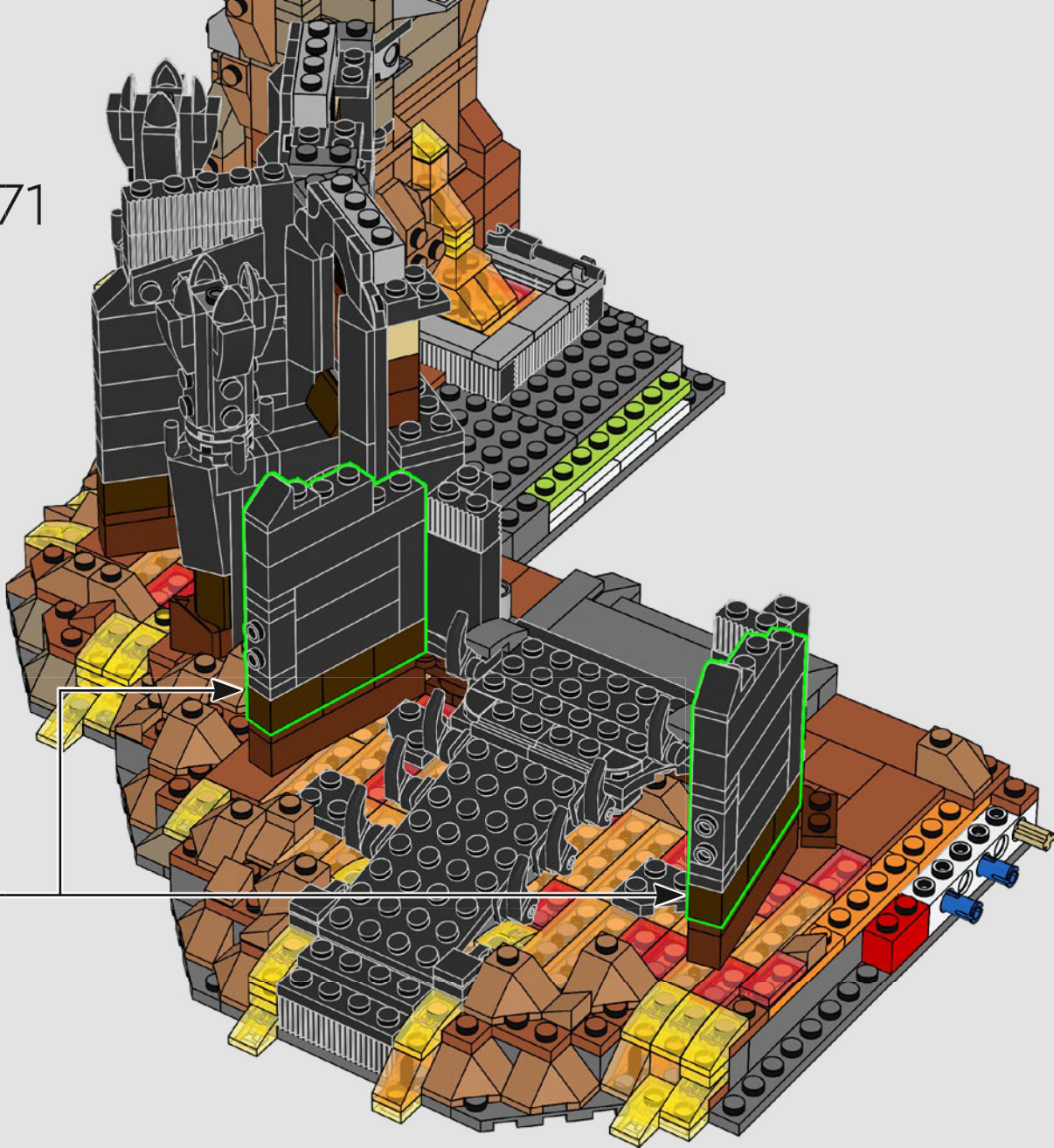

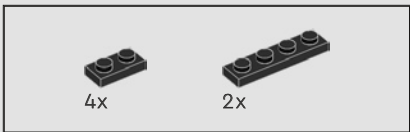

173

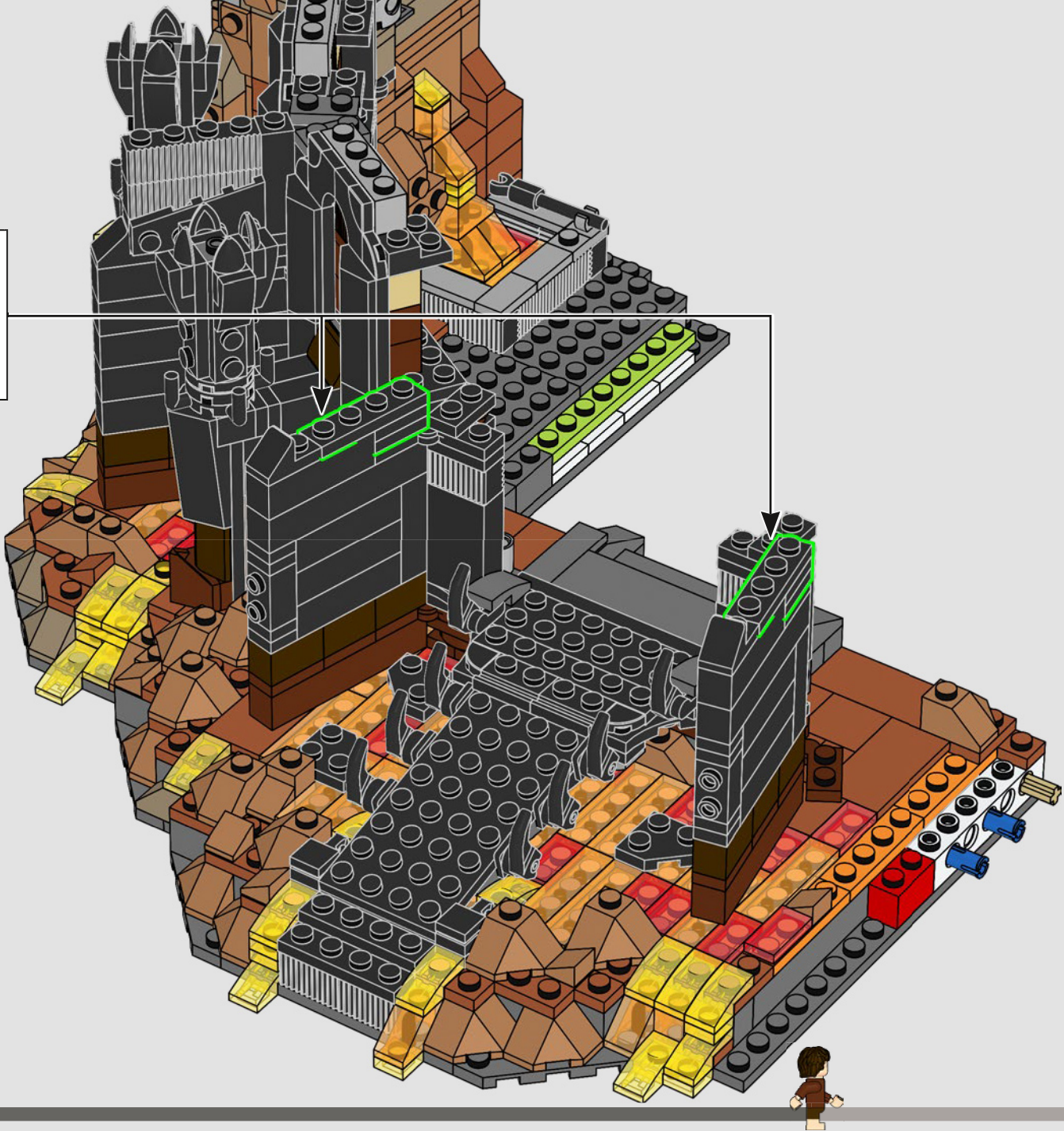
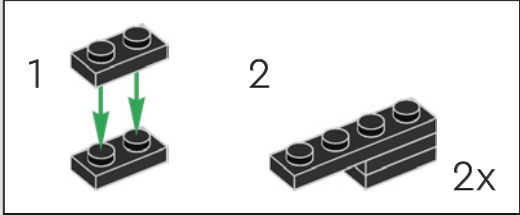

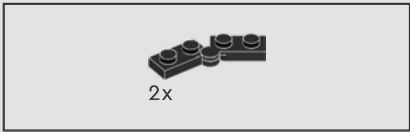

174

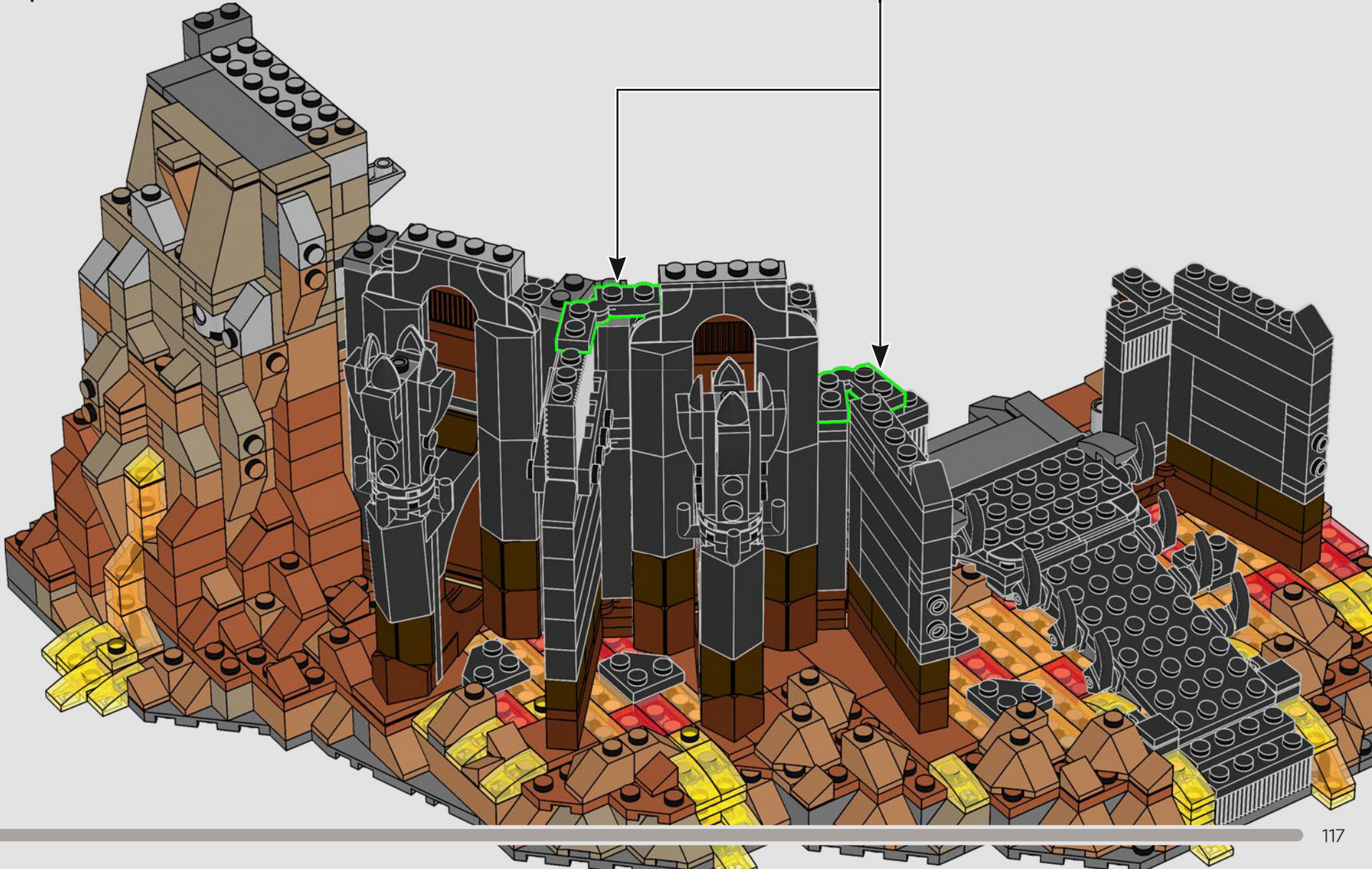
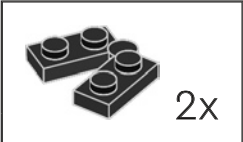

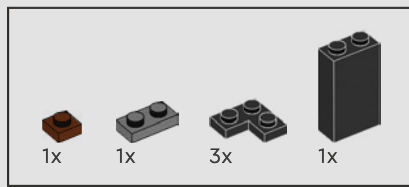

175

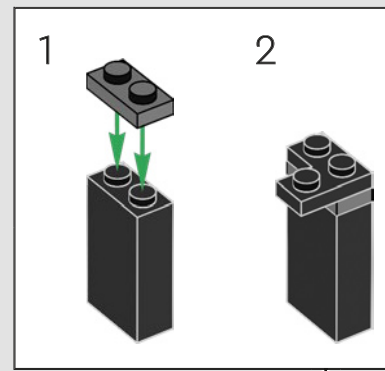

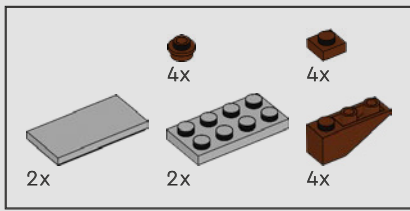

176

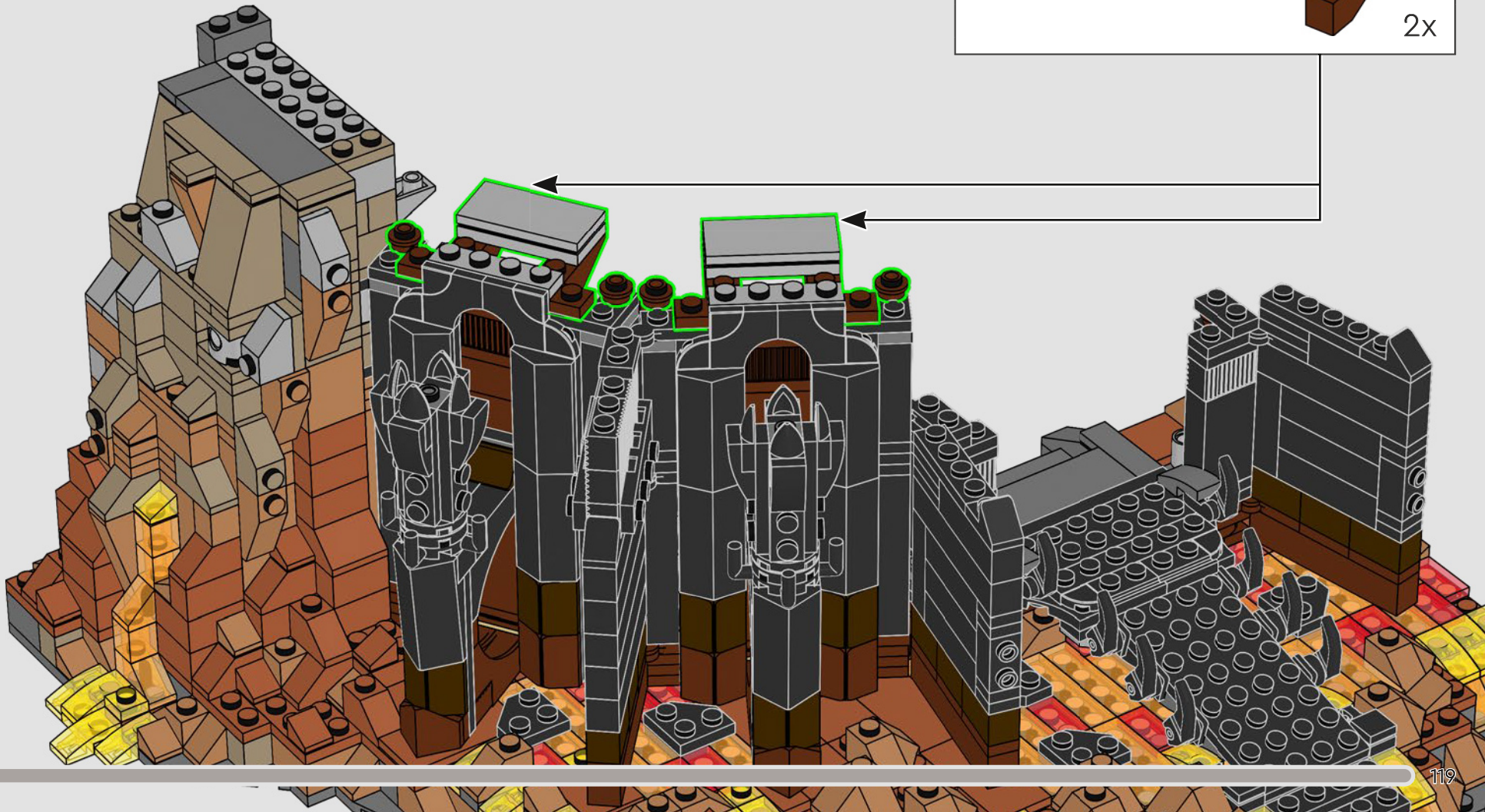
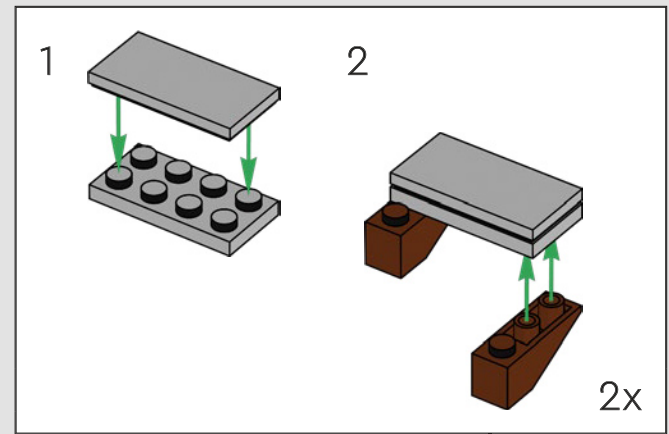

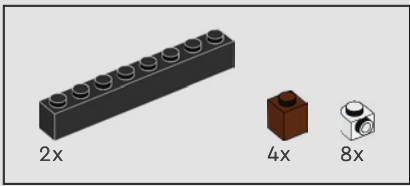

177

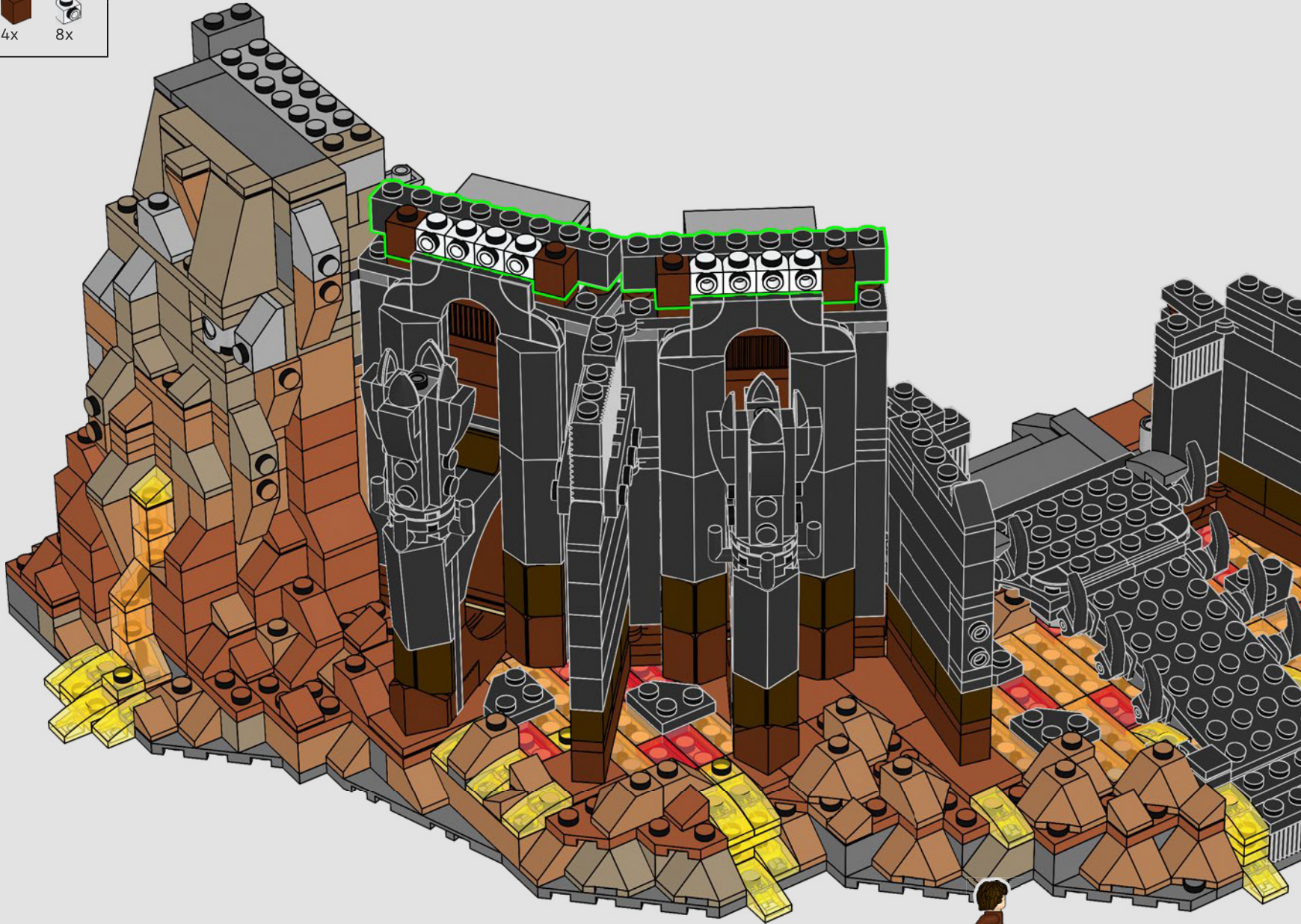

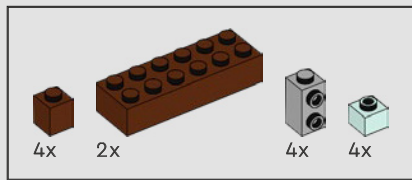

178

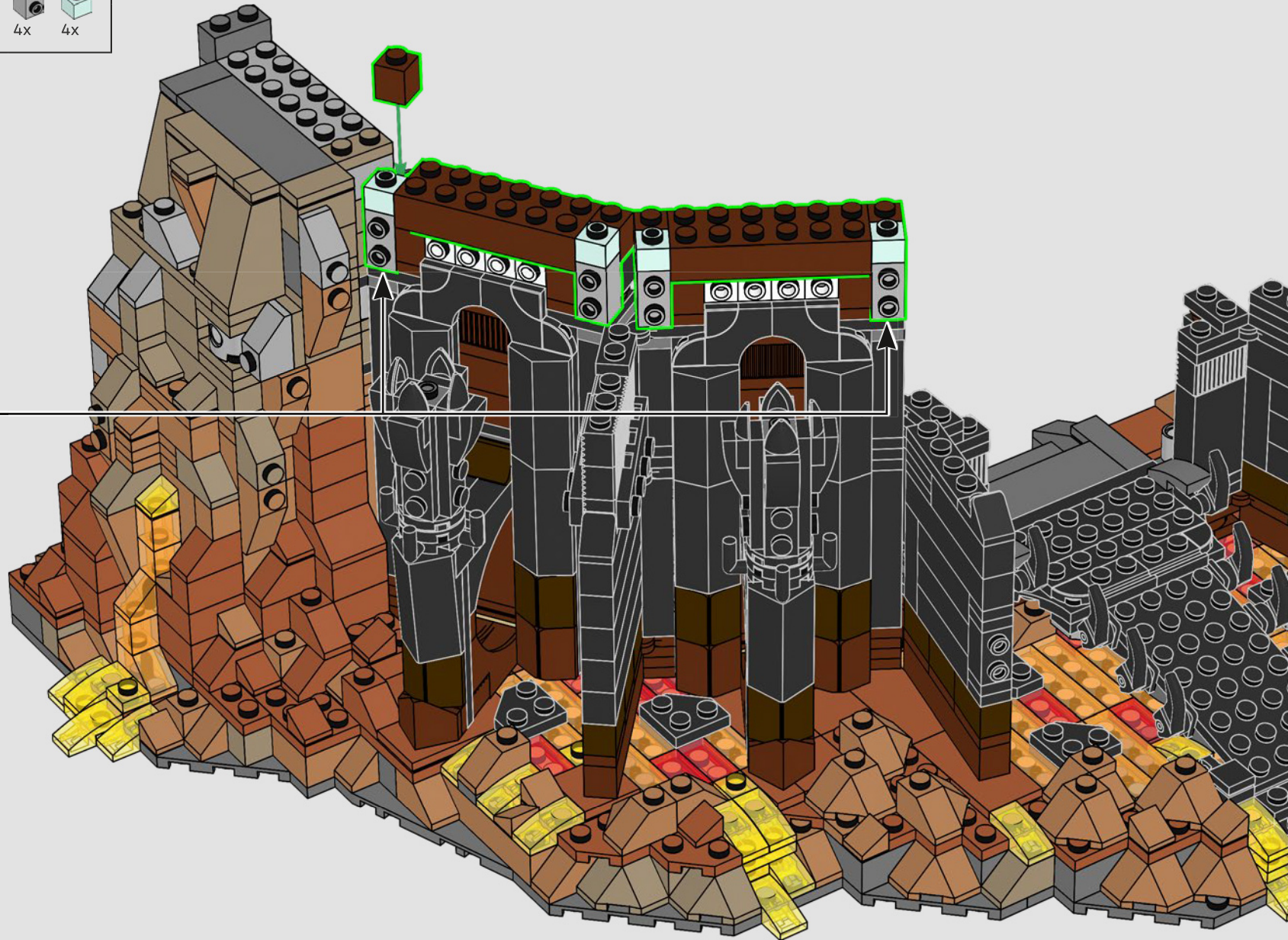
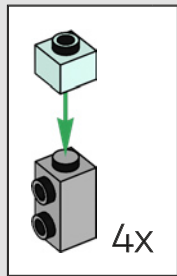

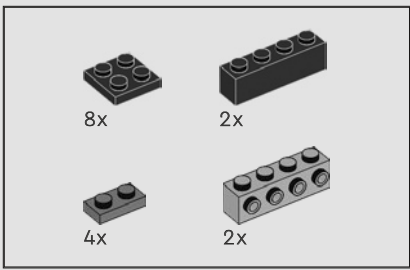

179

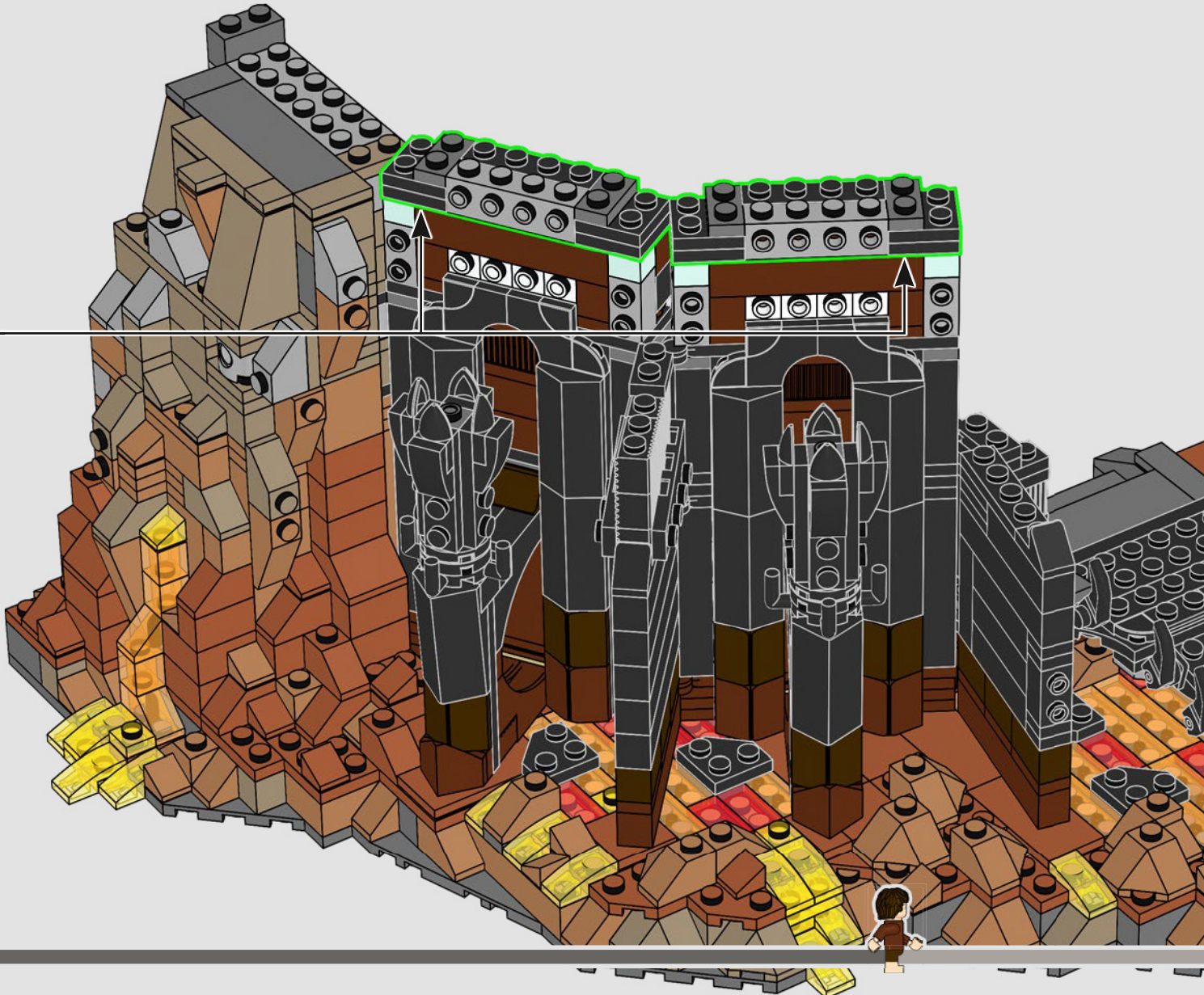
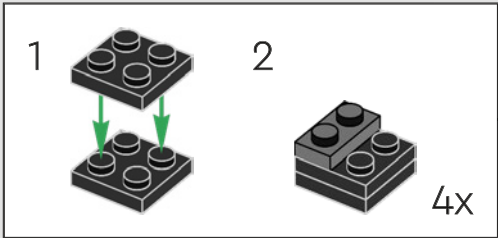

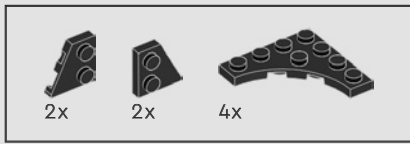

180

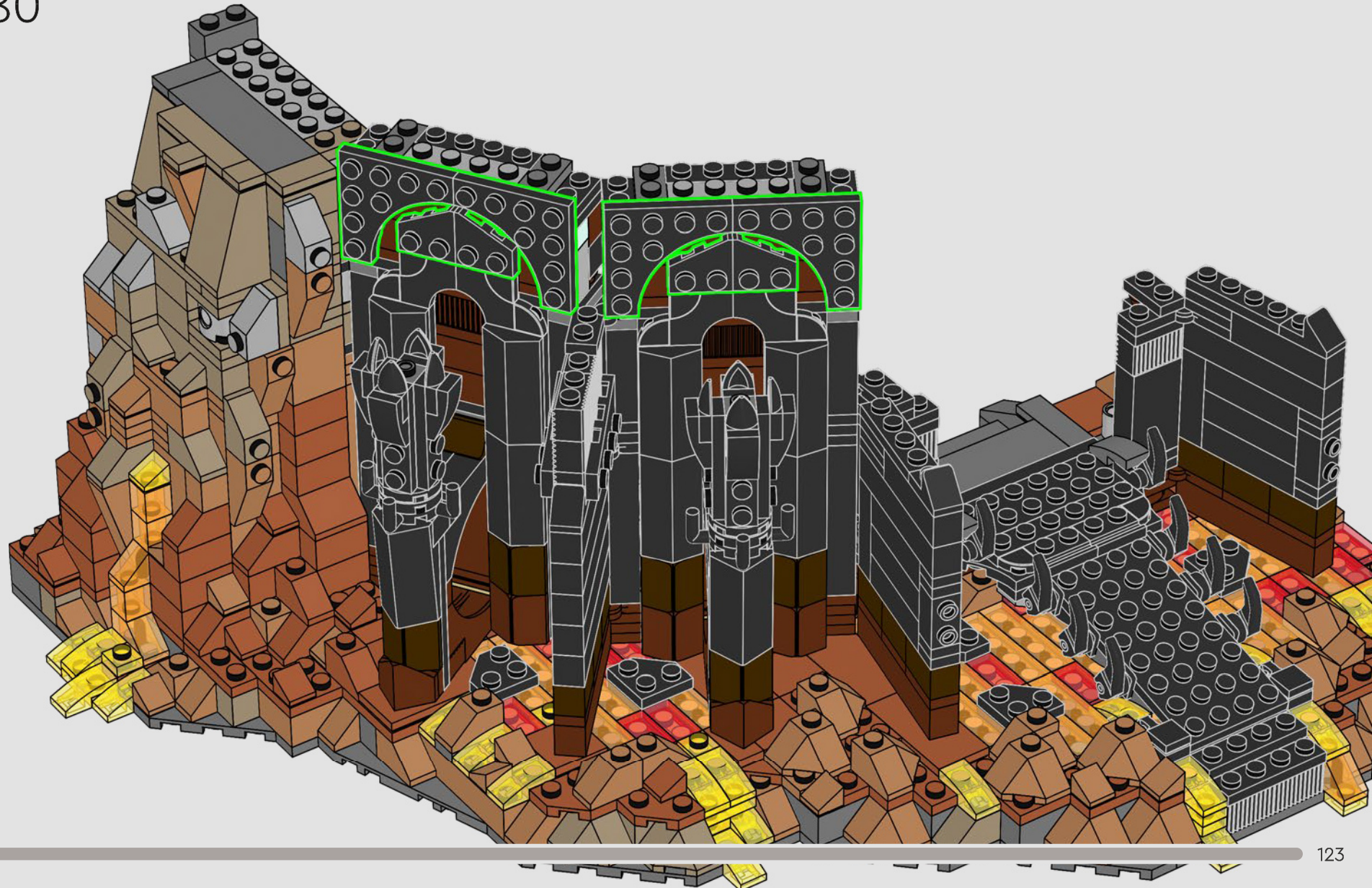

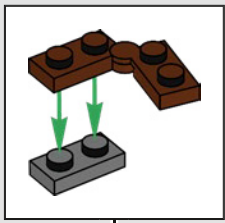
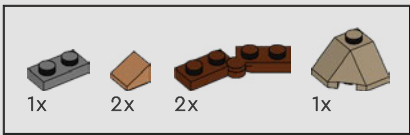

181

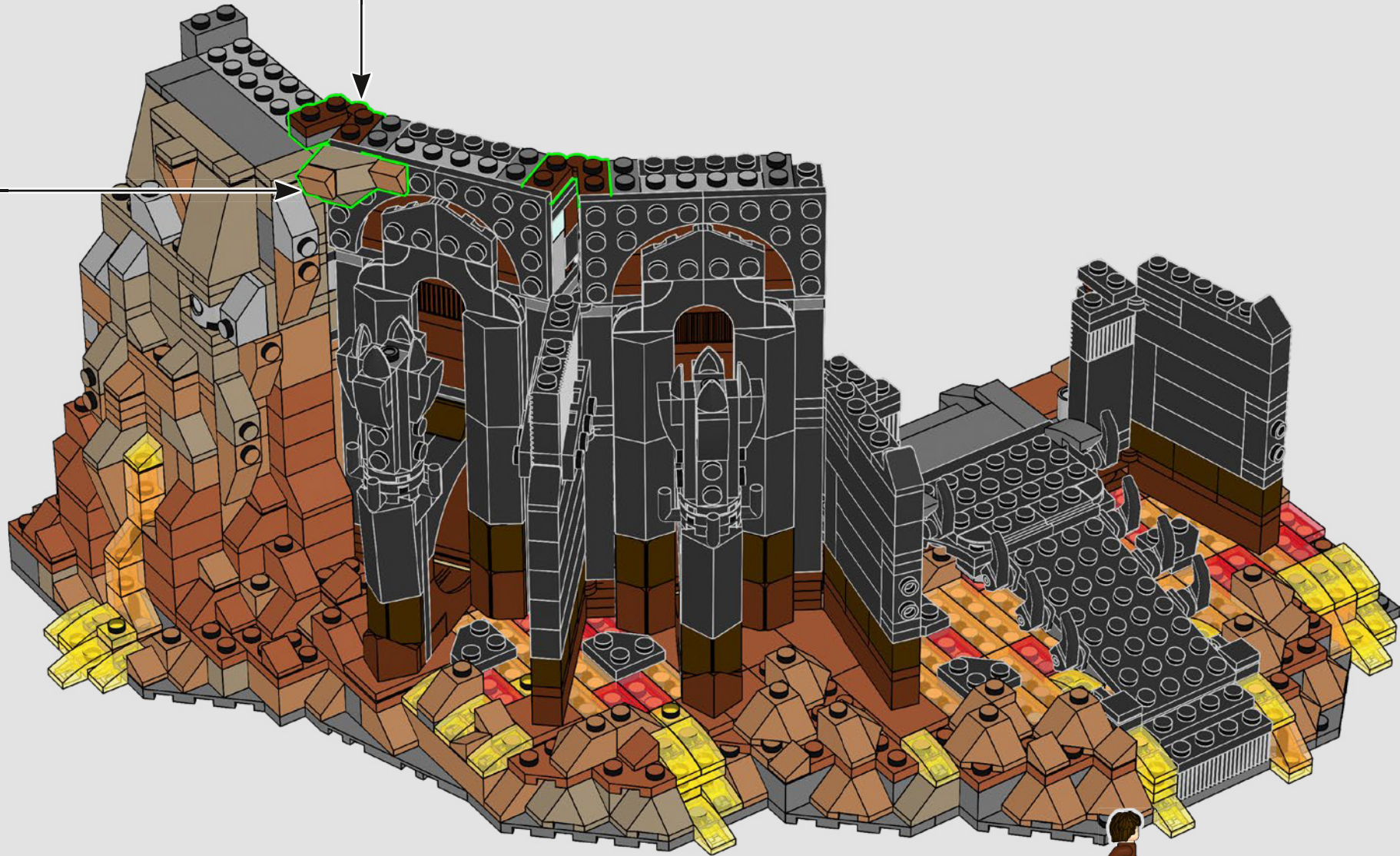
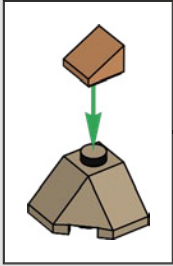



182

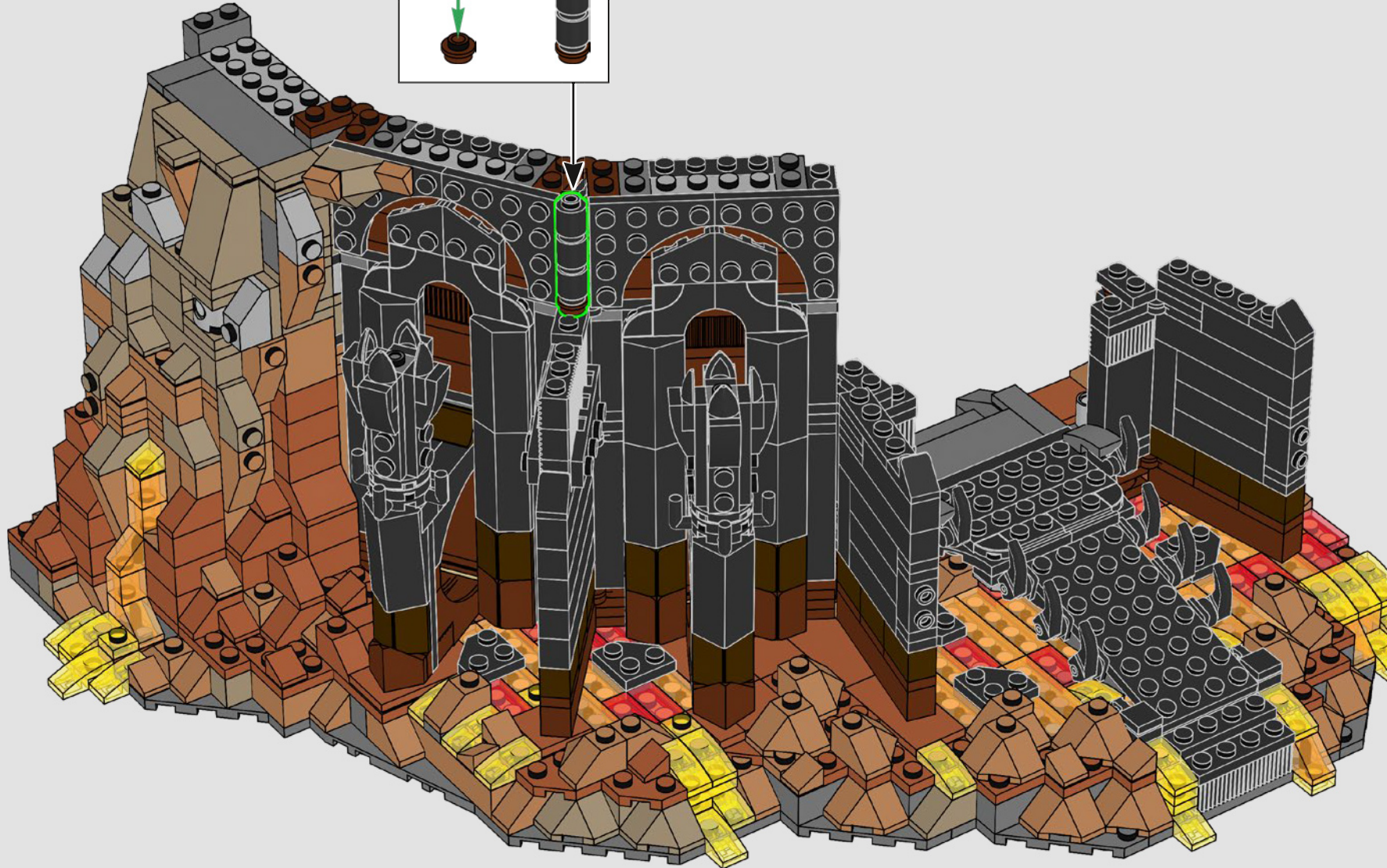
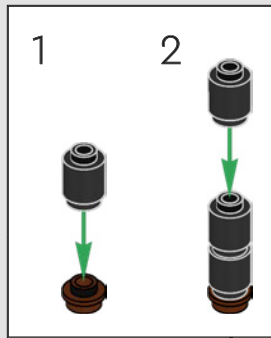



183

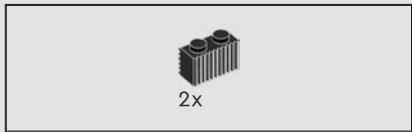
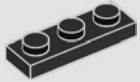

184

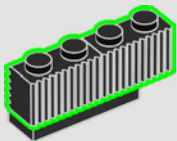

185

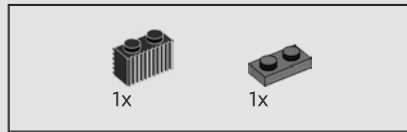
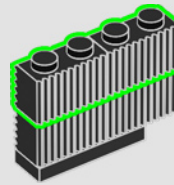

186

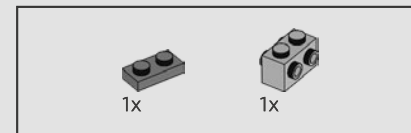
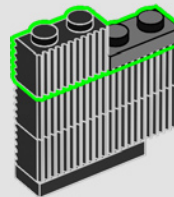

187

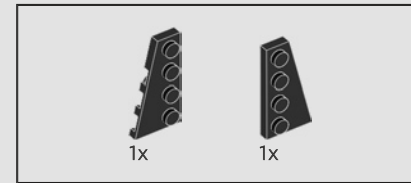
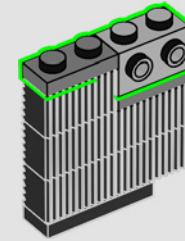

188

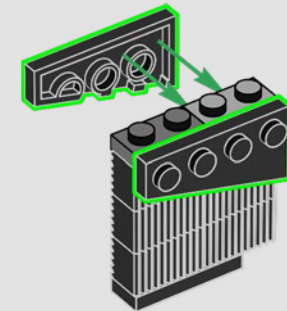



189

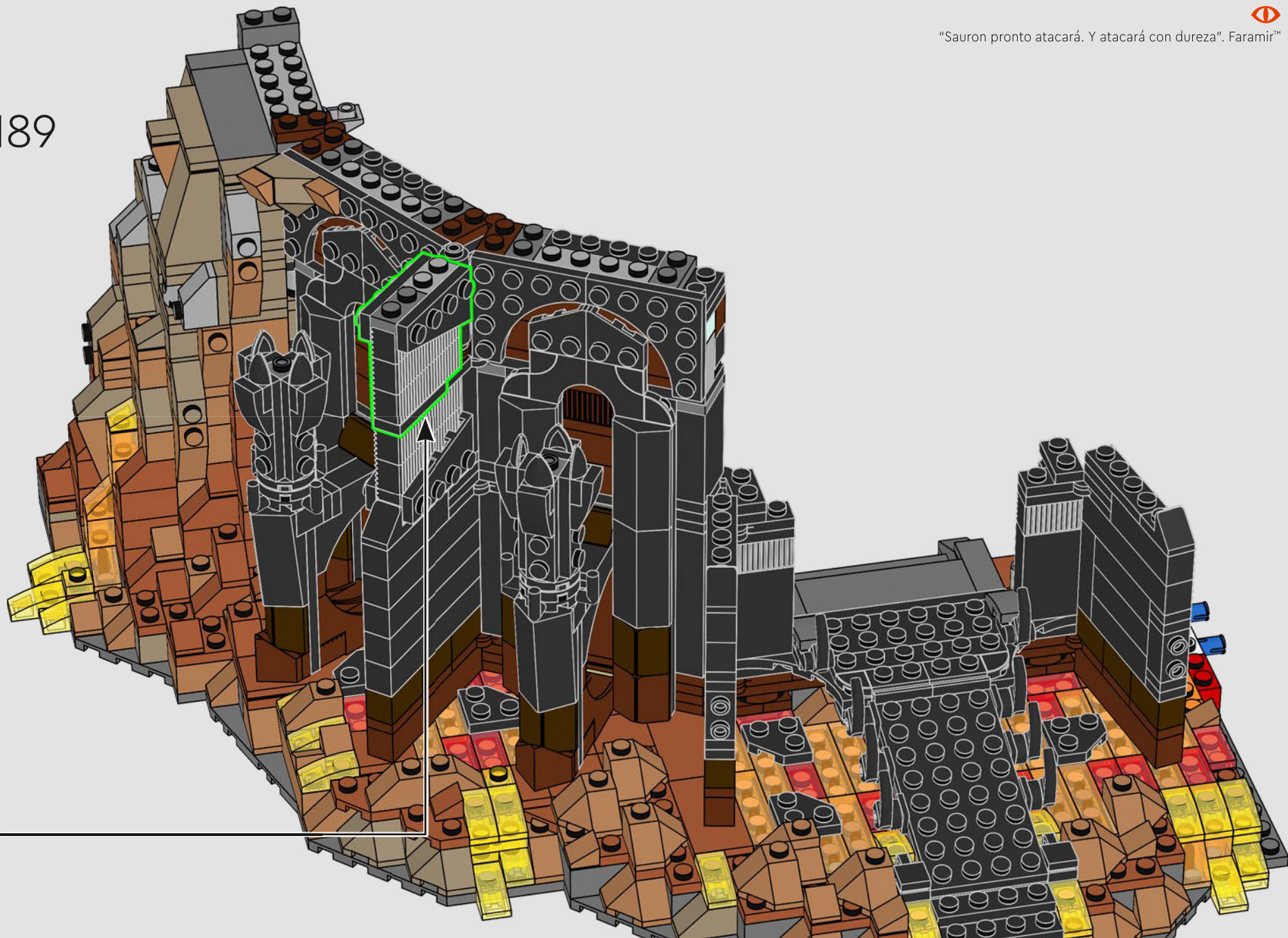

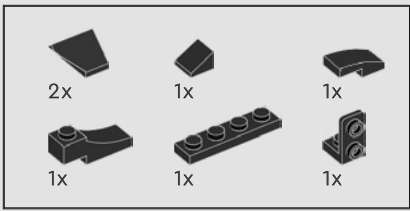

190

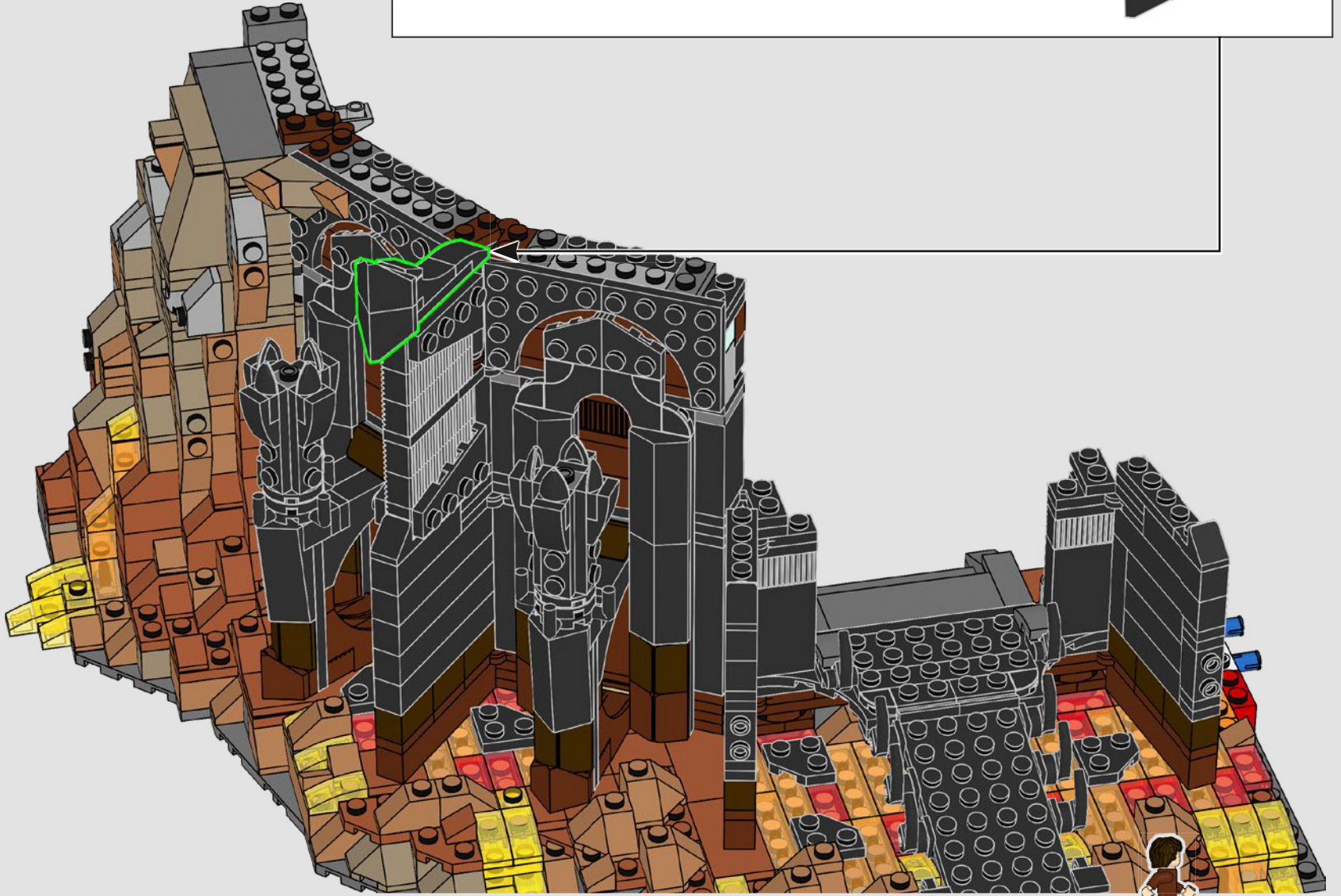
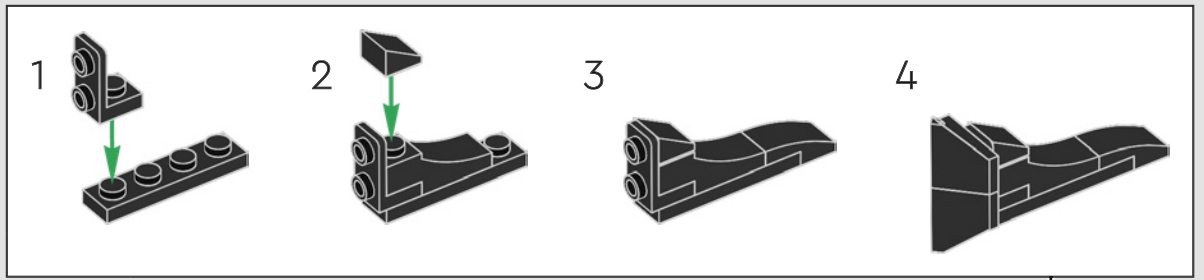

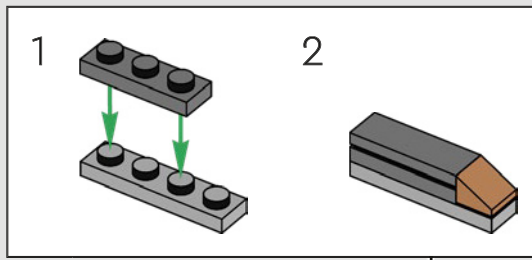
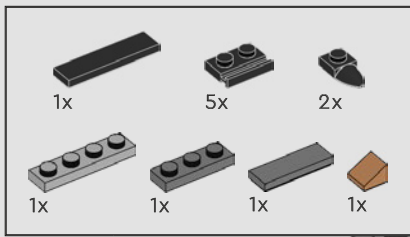

191

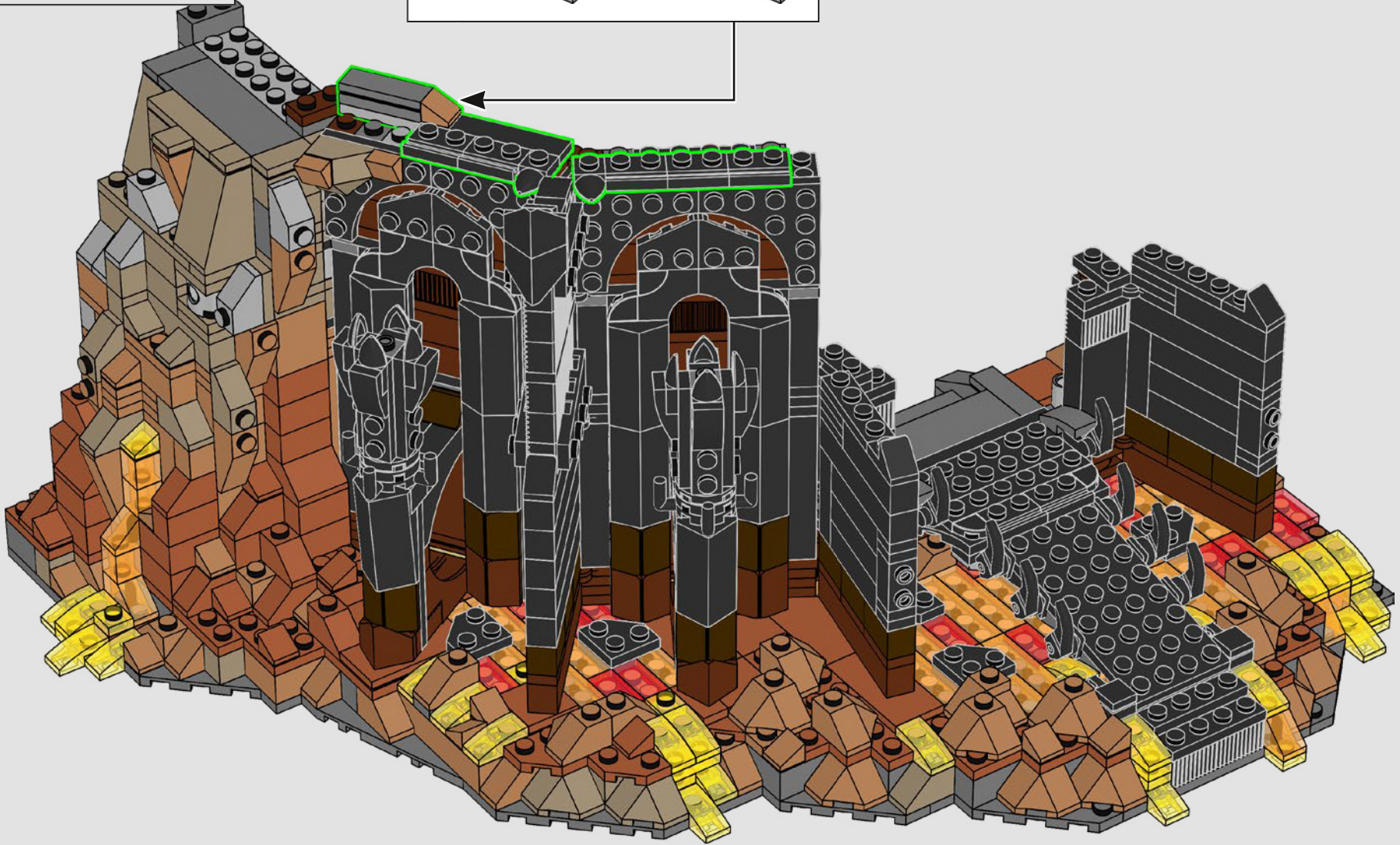

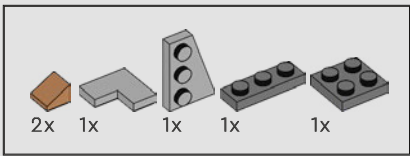

192

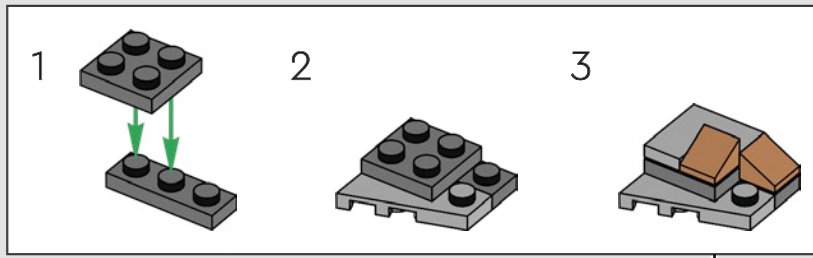

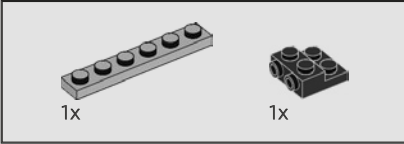
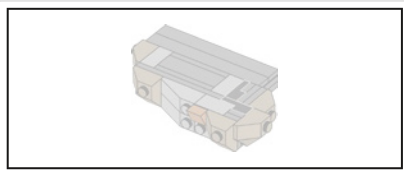

193

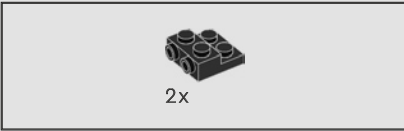
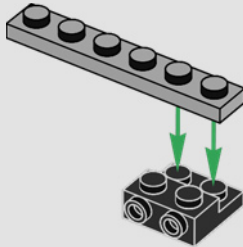

194

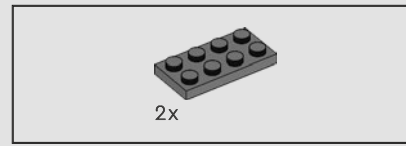
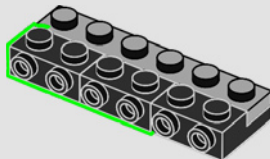

195

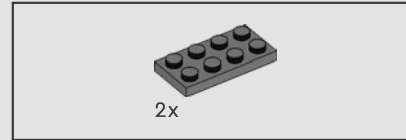
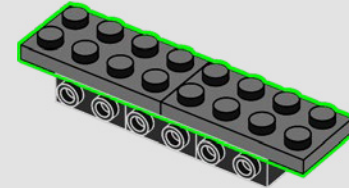

196

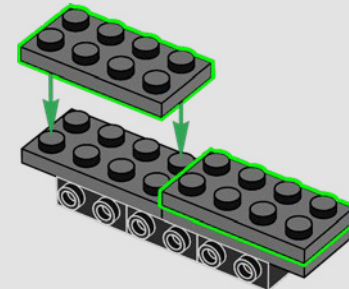

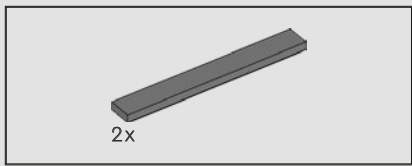

197

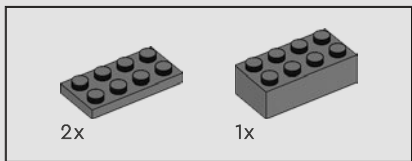
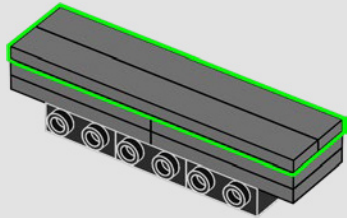

198

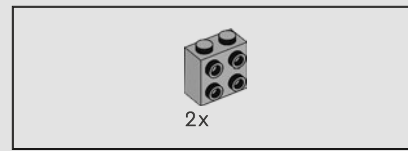
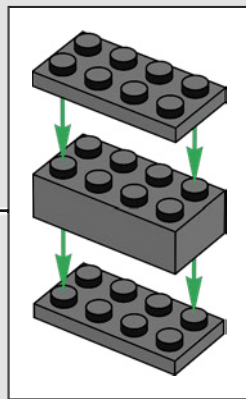
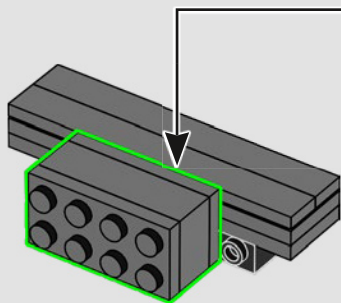

199

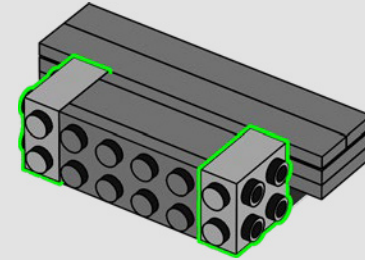

200

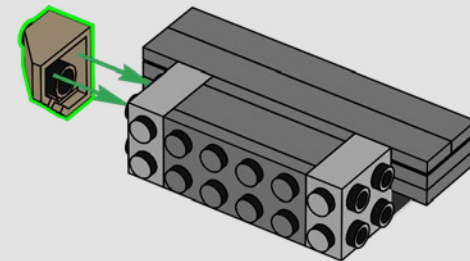

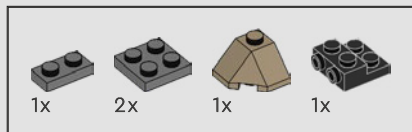

201

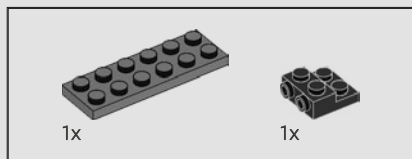
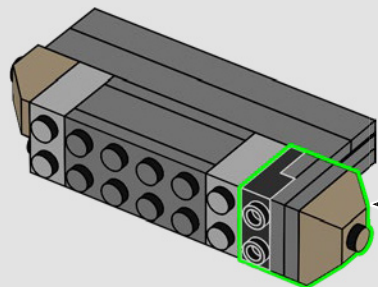
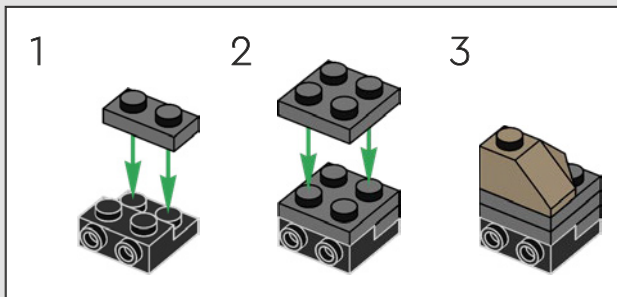

202

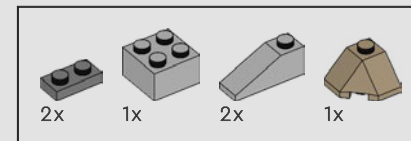
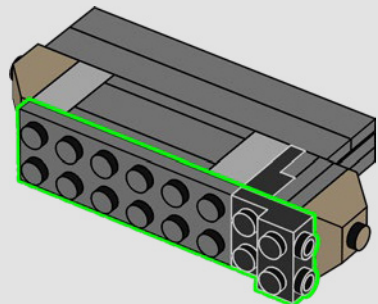

203

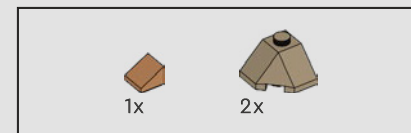
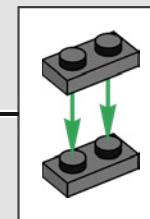
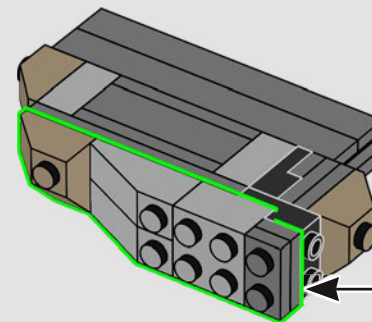

204

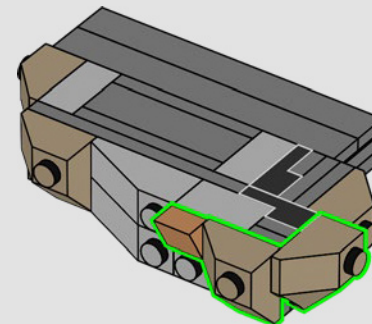

205

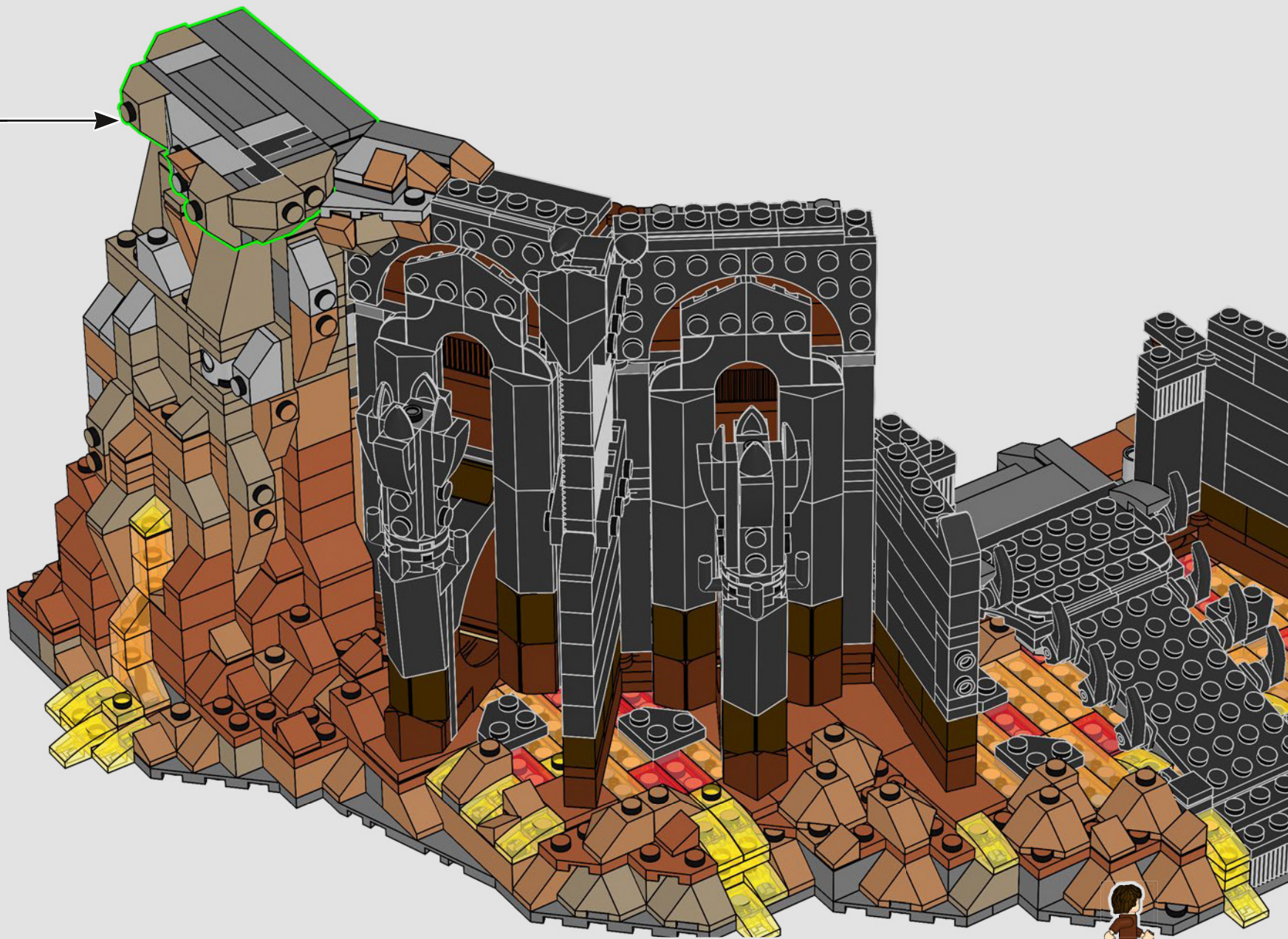

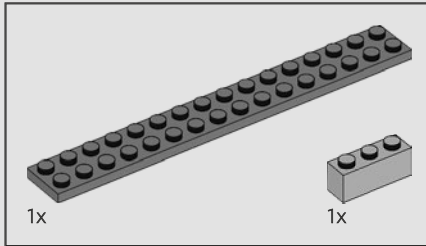
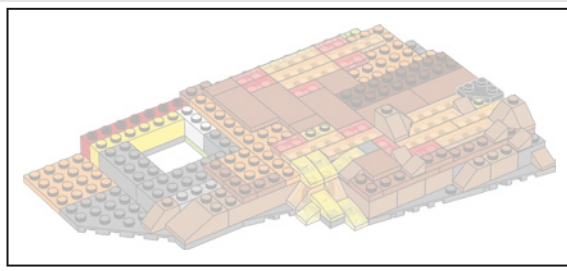

206

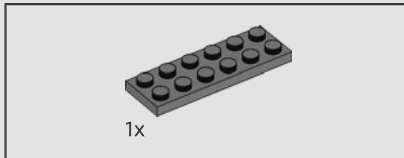
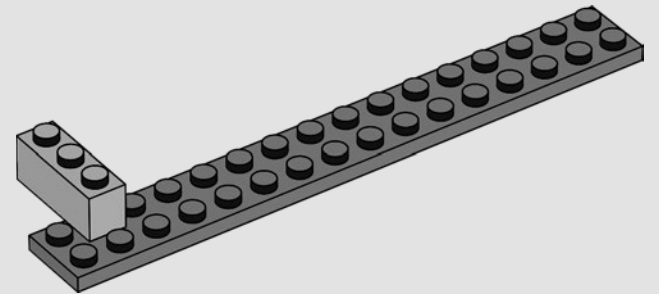

207

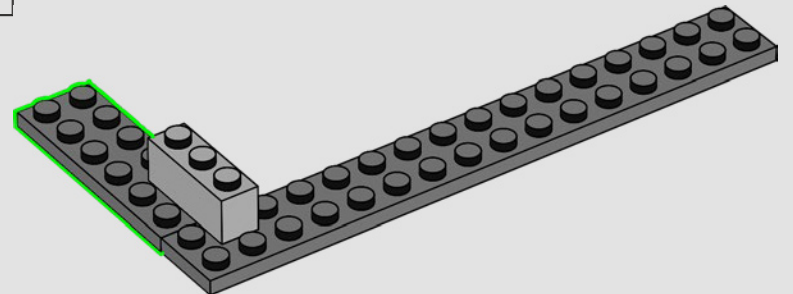

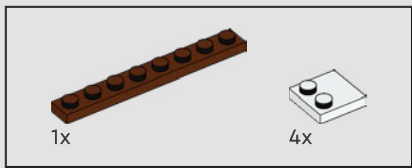

208

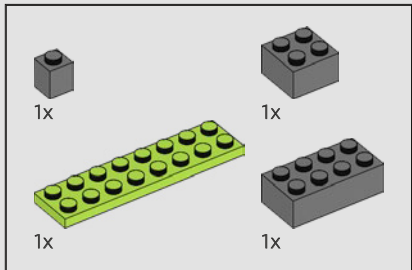
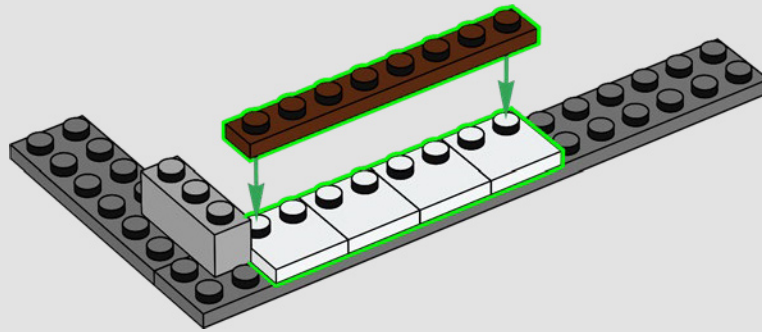

209

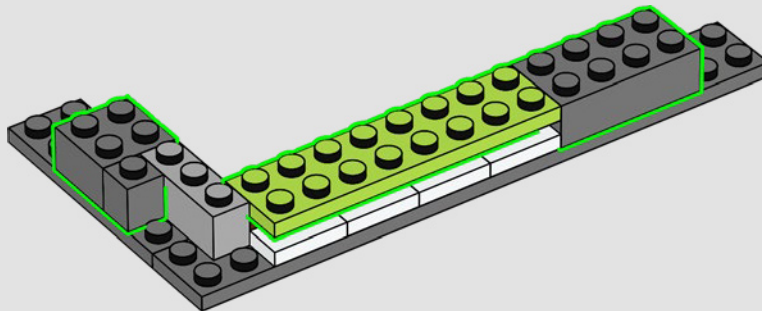

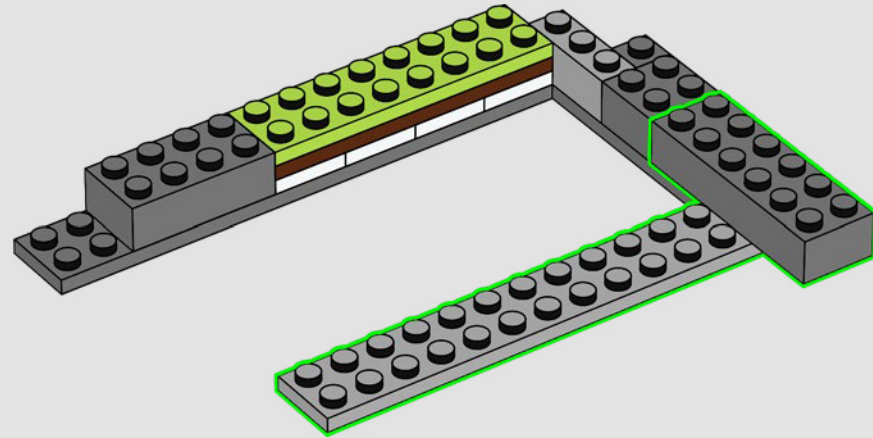
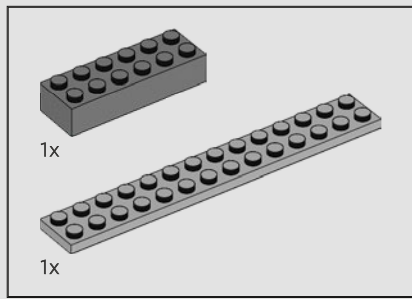

210

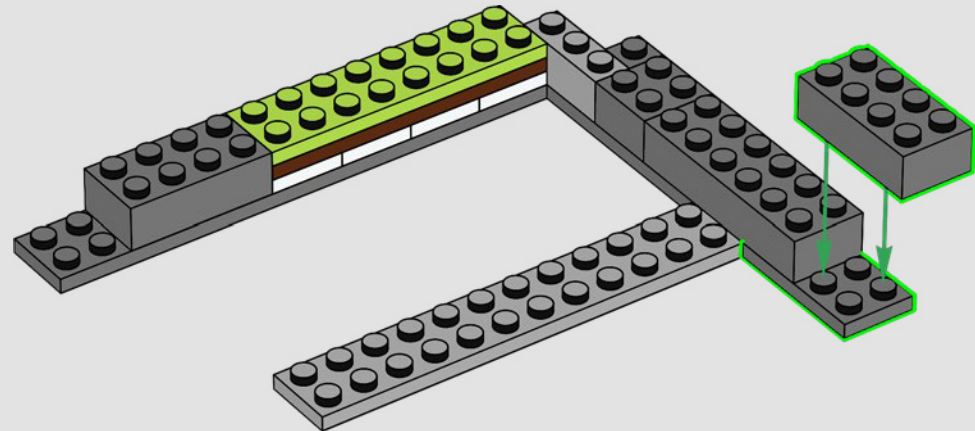
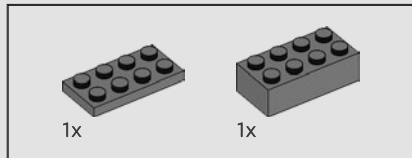

211

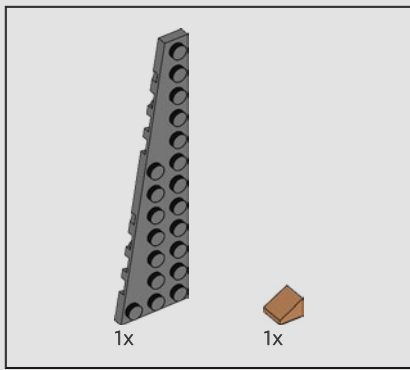

212

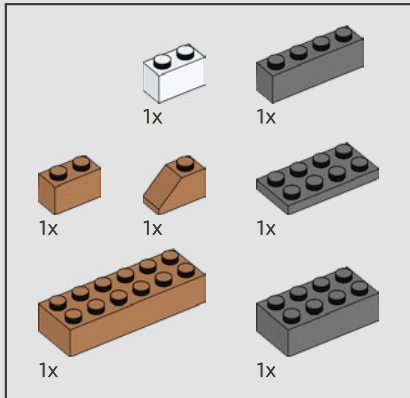
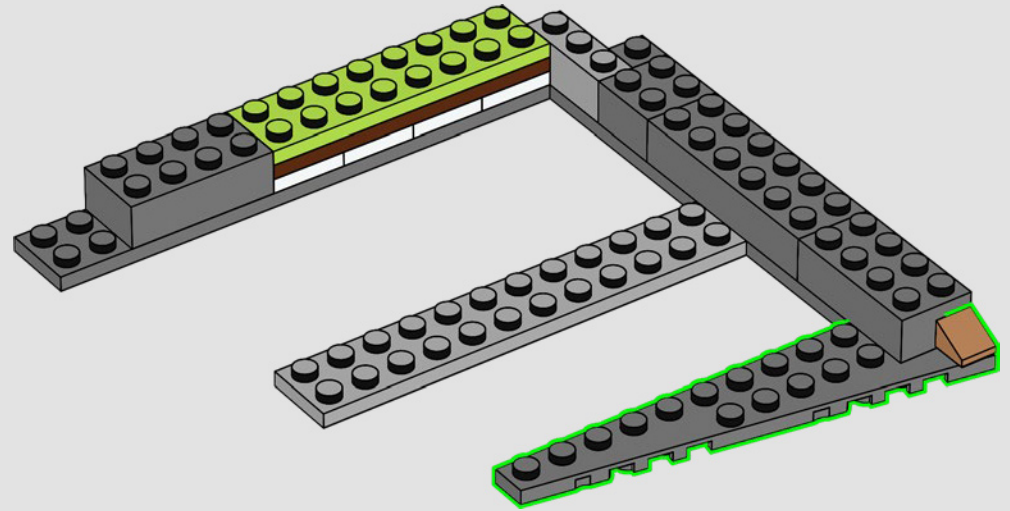

213

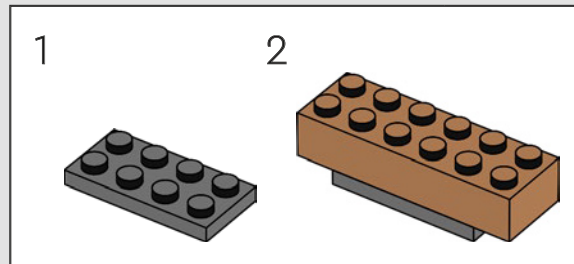
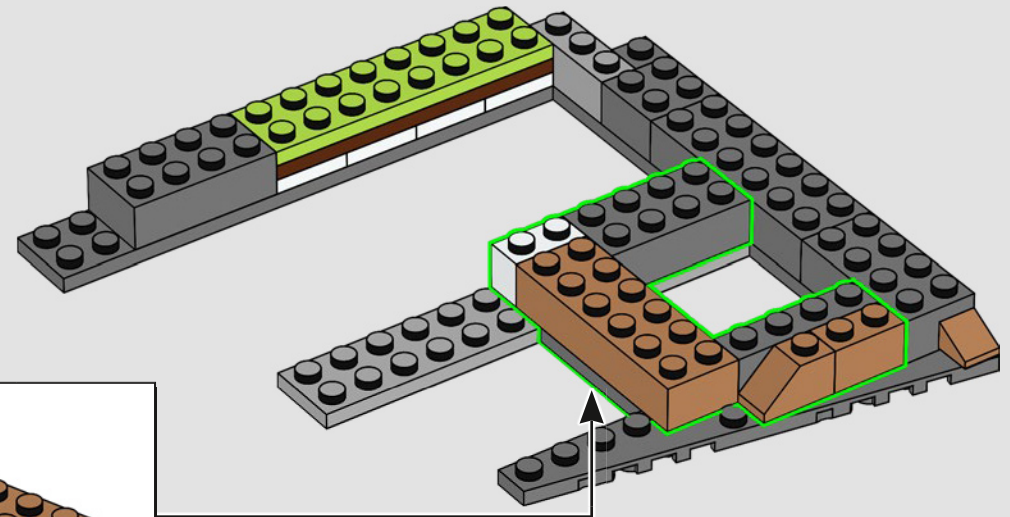

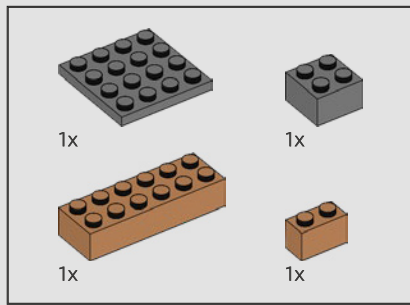

214

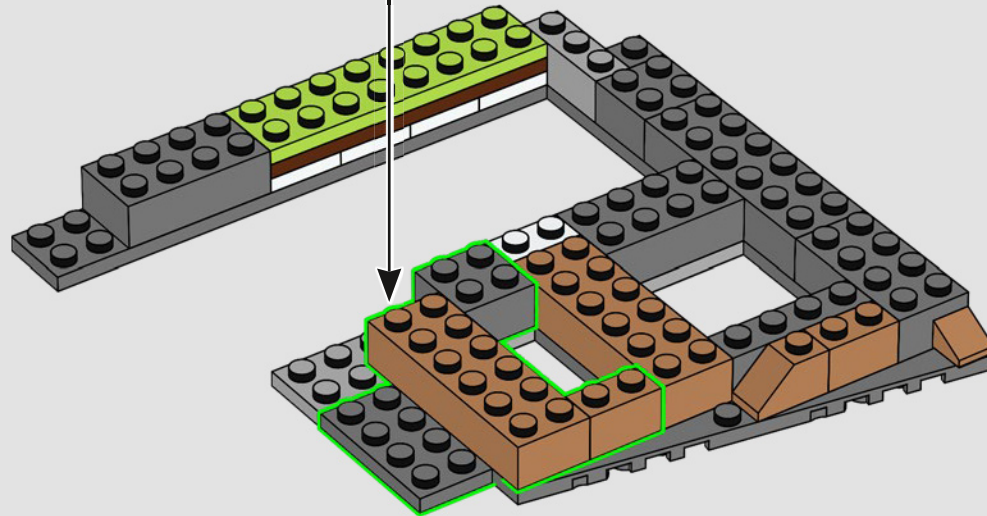
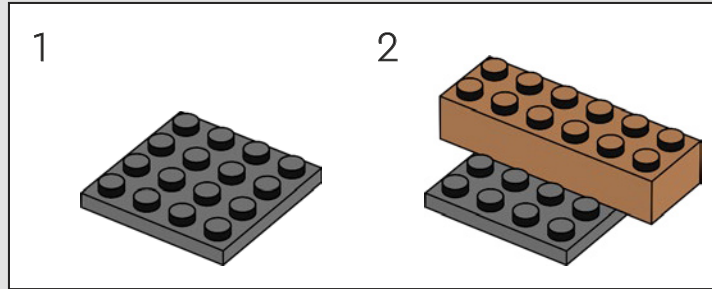

Ya que la fortaleza se construyó usando el poder del Anillo Único, sus cimientos no pueden destruirse mientras este exista.

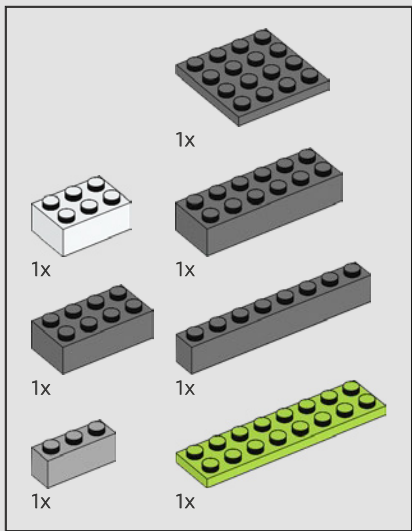

215

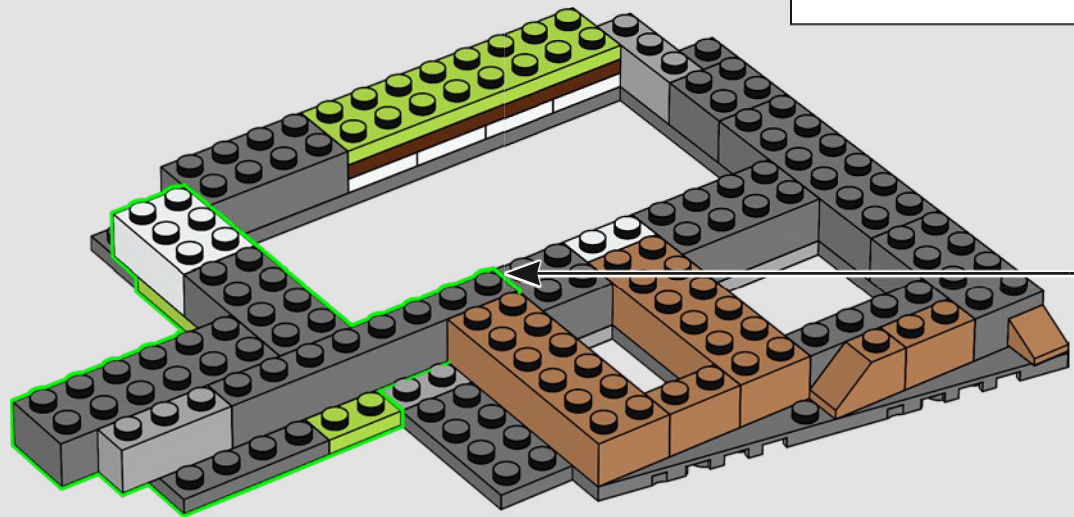
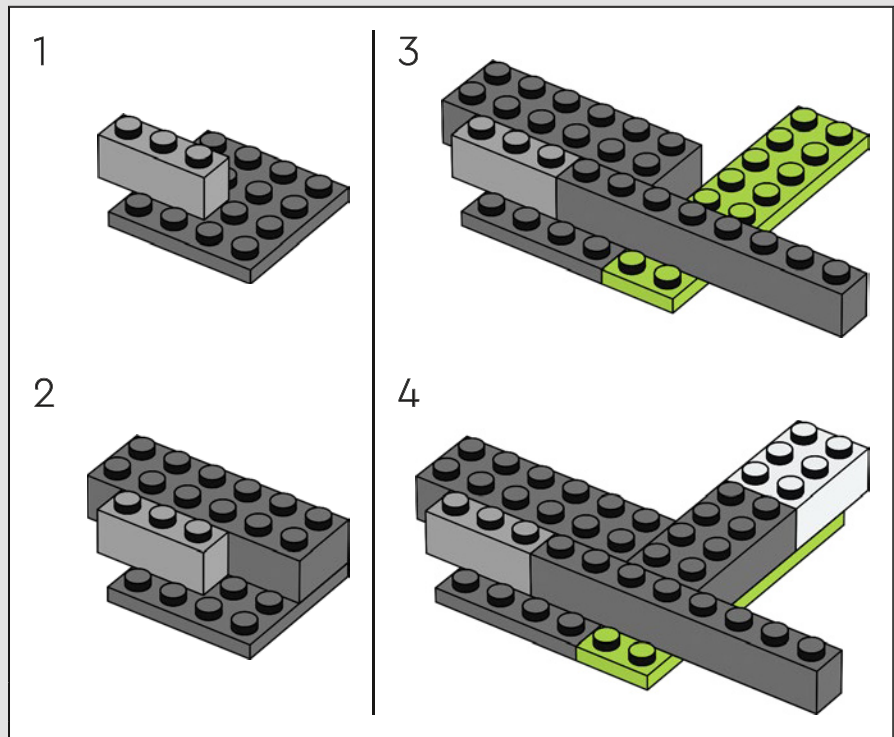

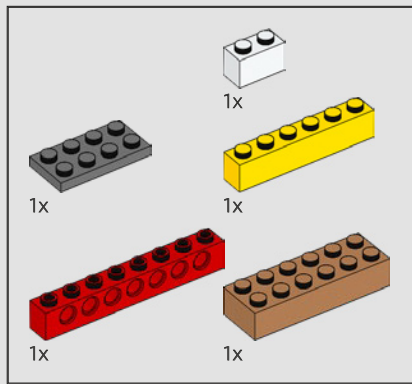

216

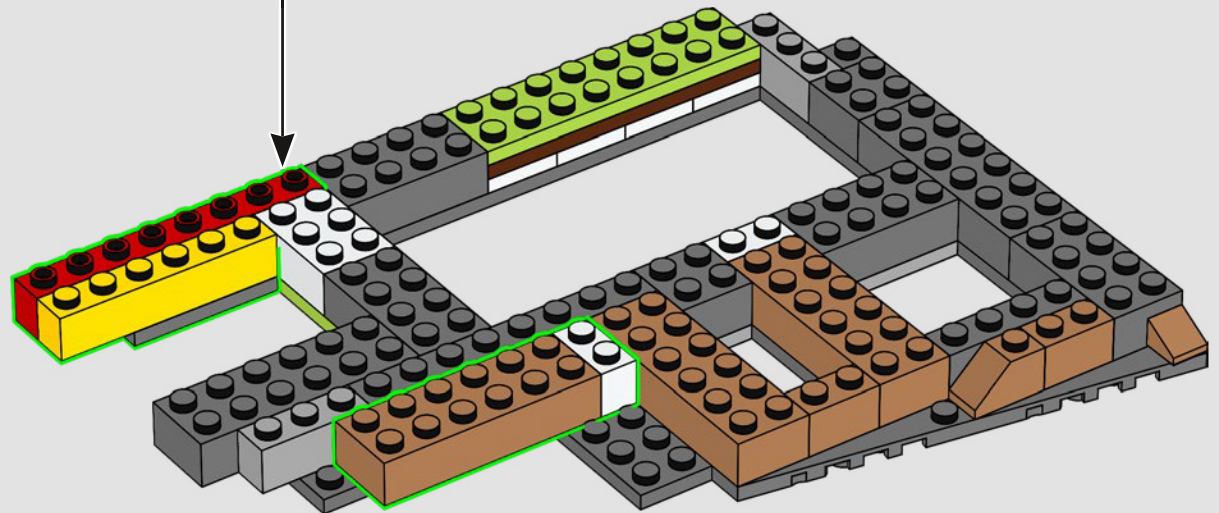
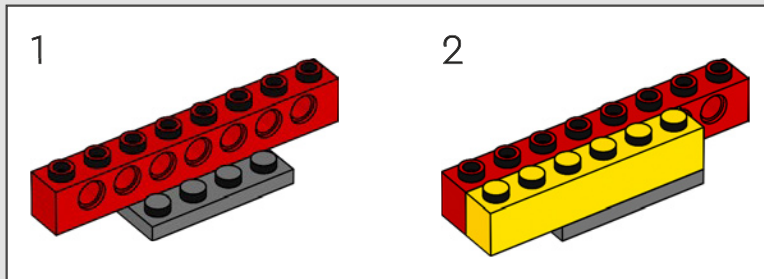

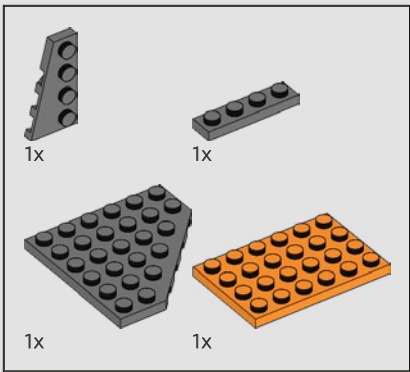

217

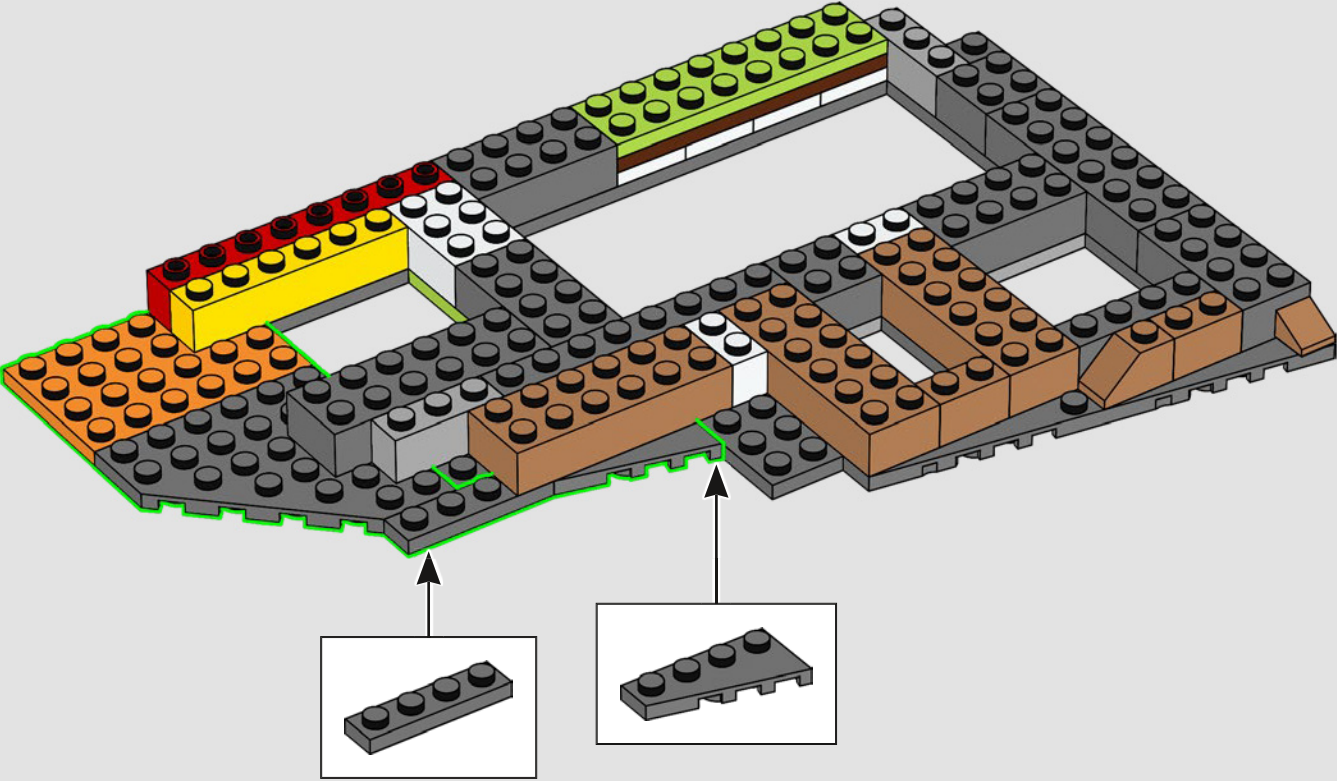

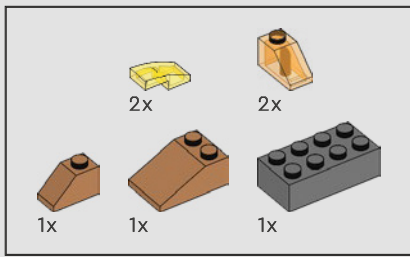

218

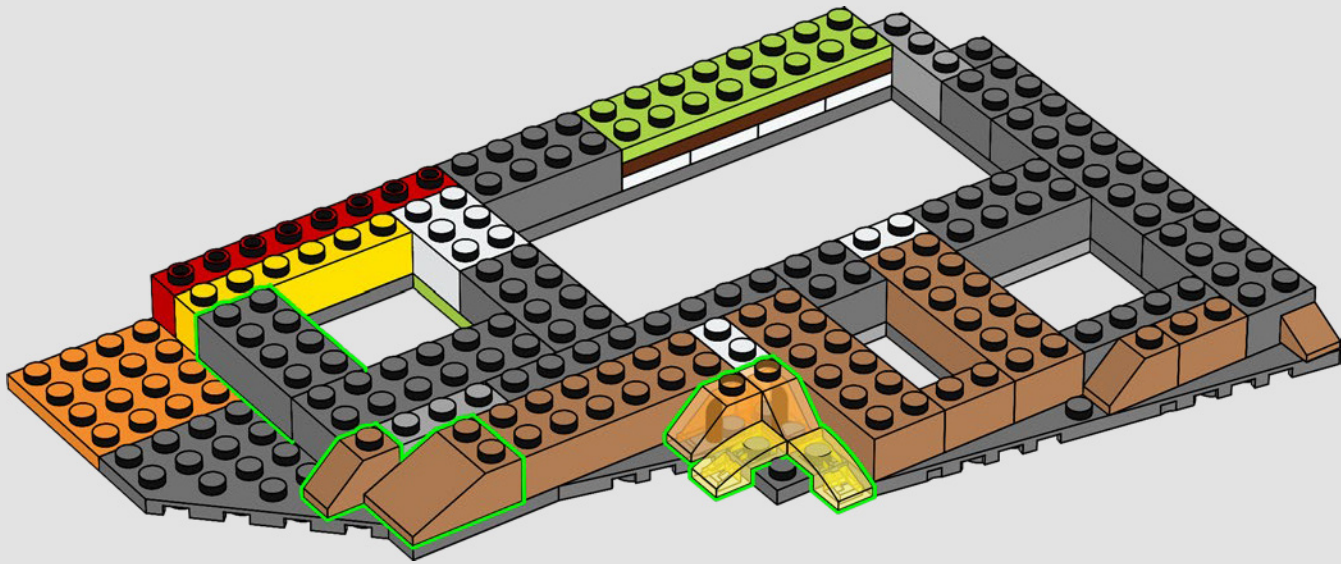

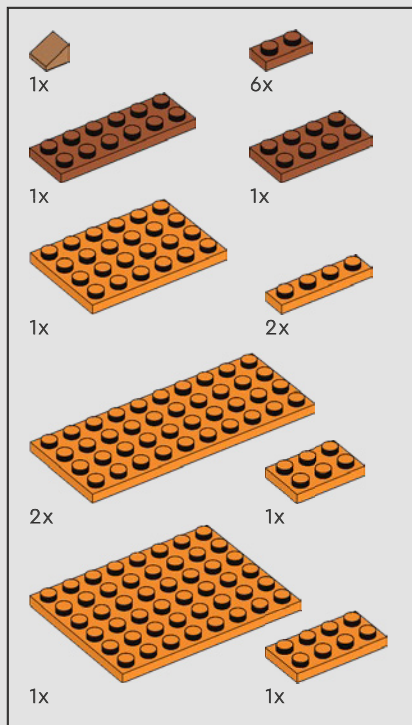

219

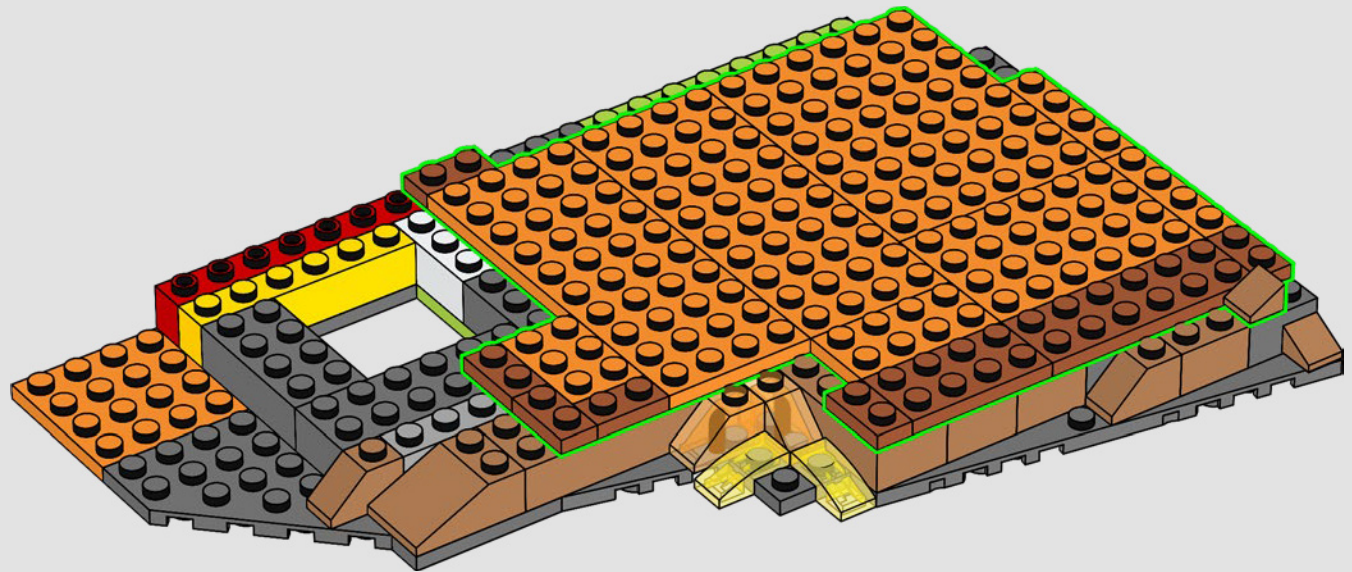

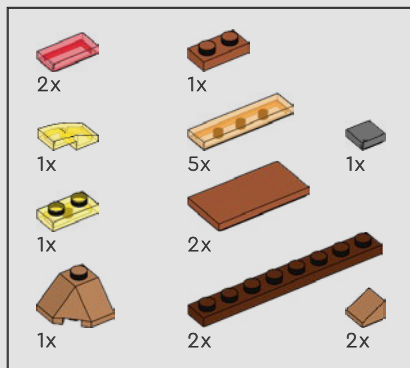

220

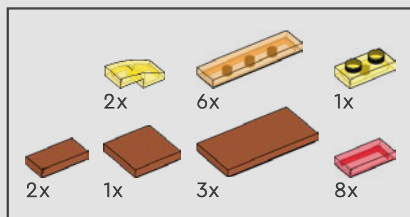
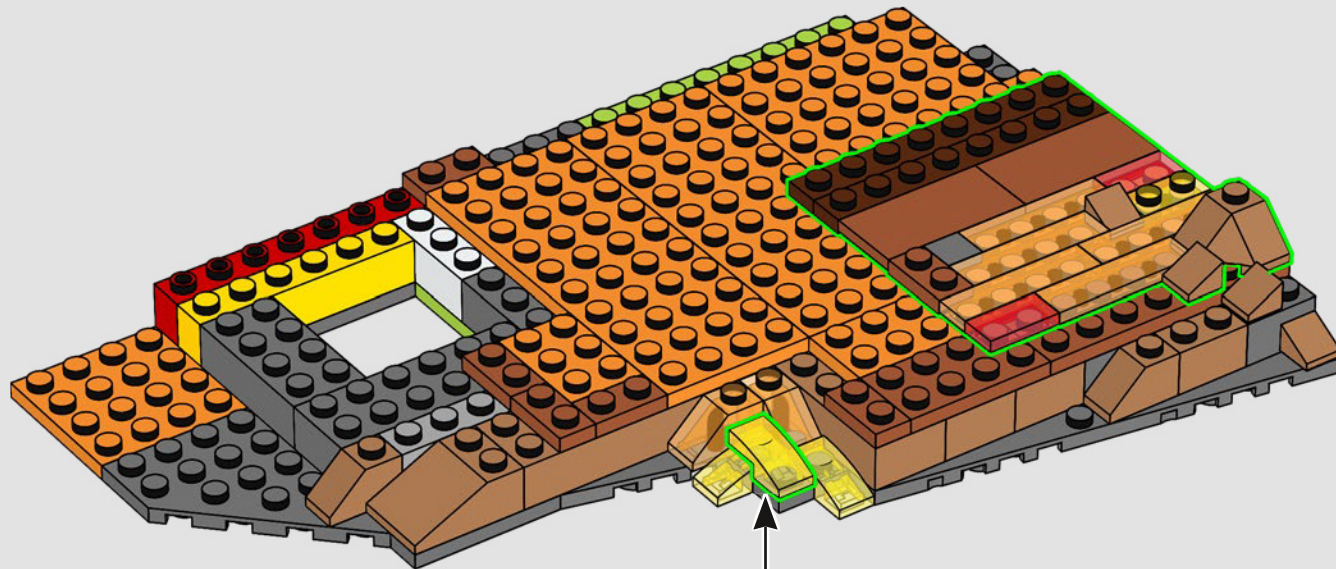

221

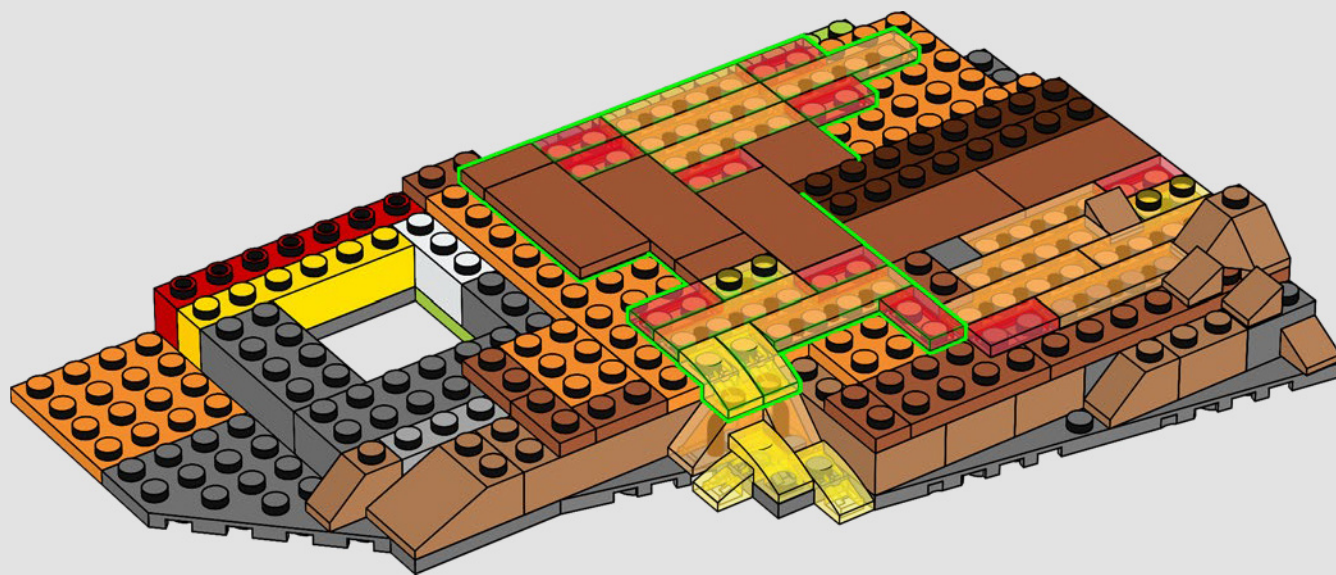



222

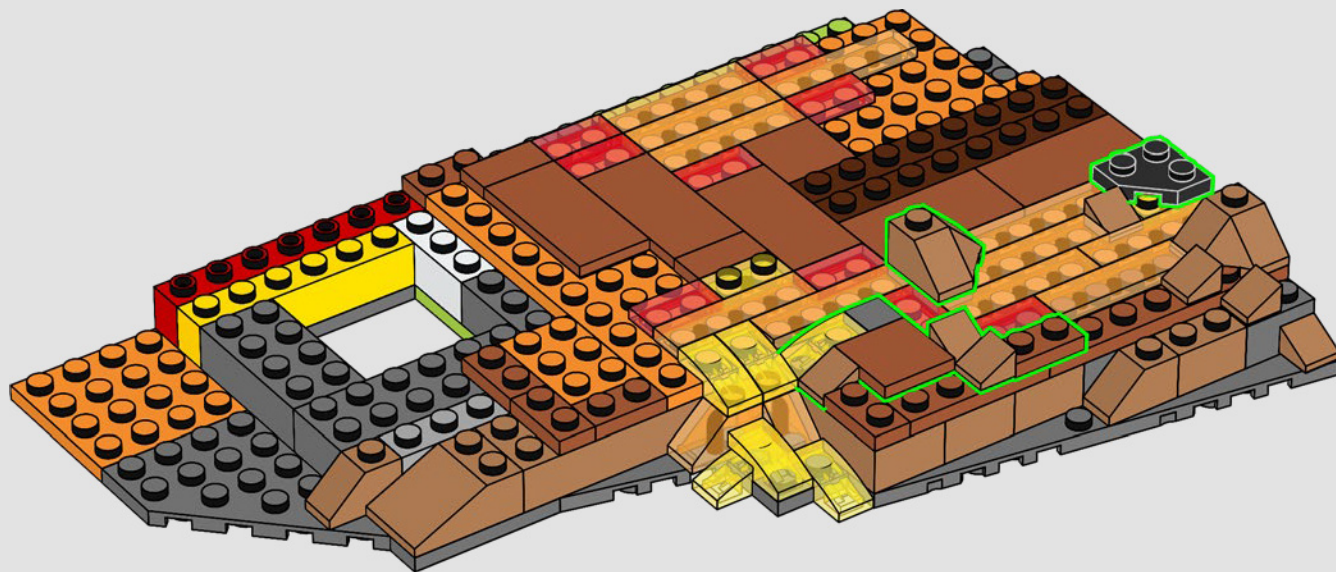

223



La robusta base del modelo se dividió en cuatro secciones para dar fluidez a la construcción, hacer que sea más sencillo orientarse y simplificar el seguimiento del proceso.

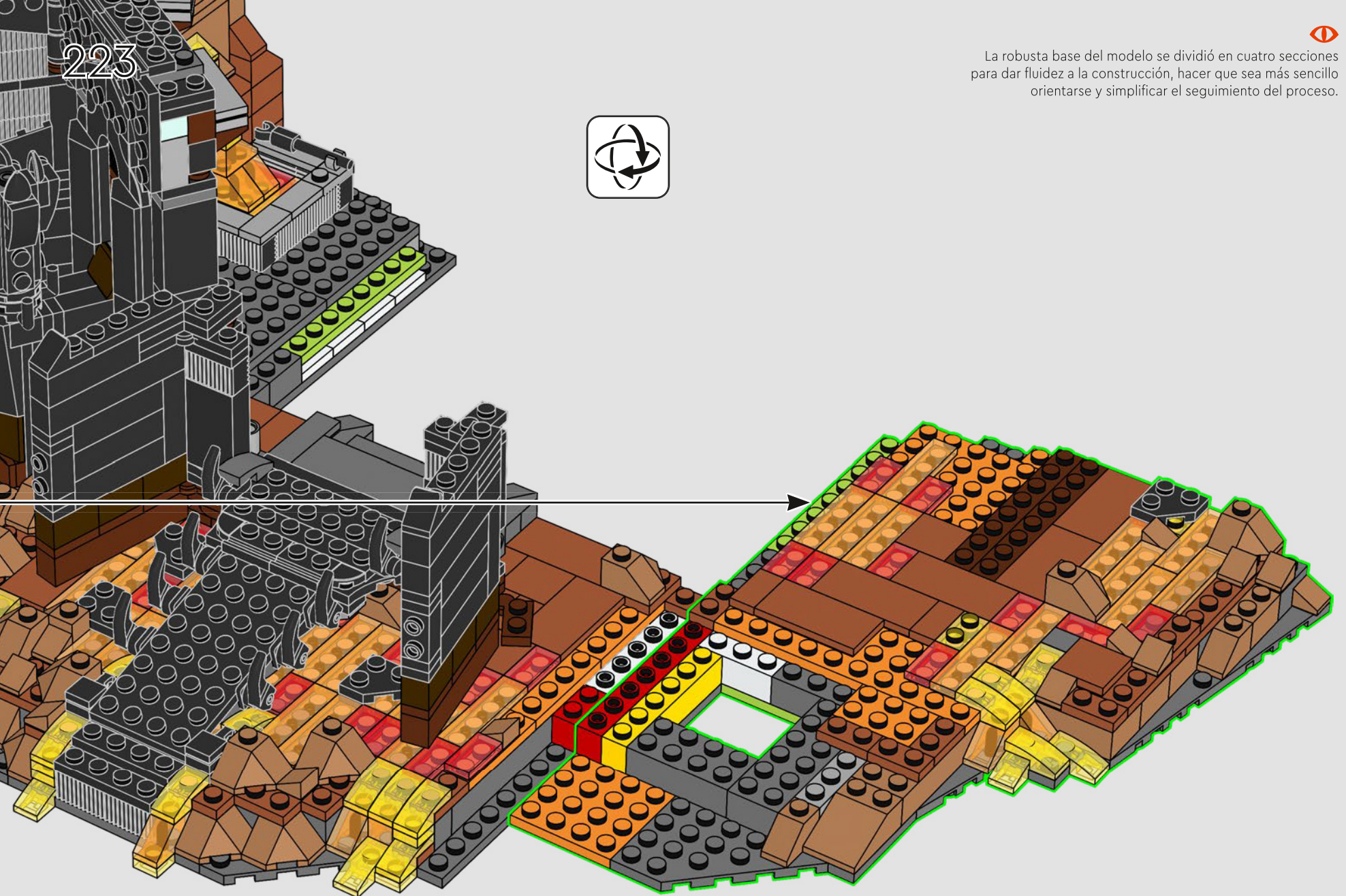

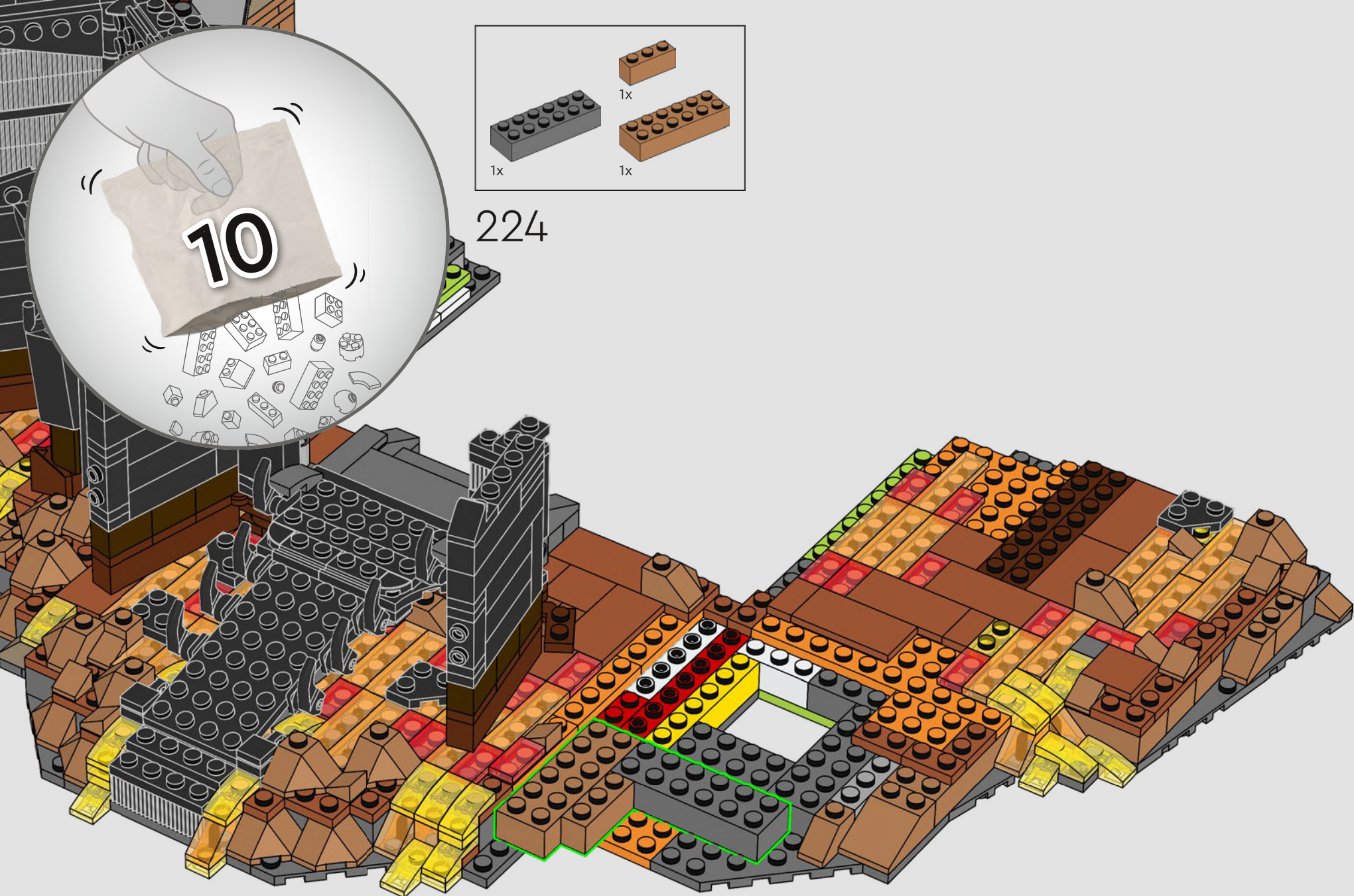

10

224

1x

1x

1x

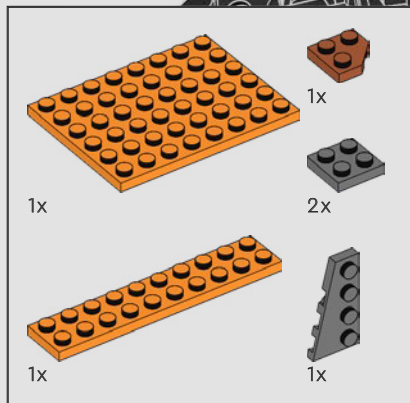

225

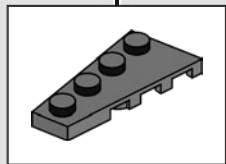
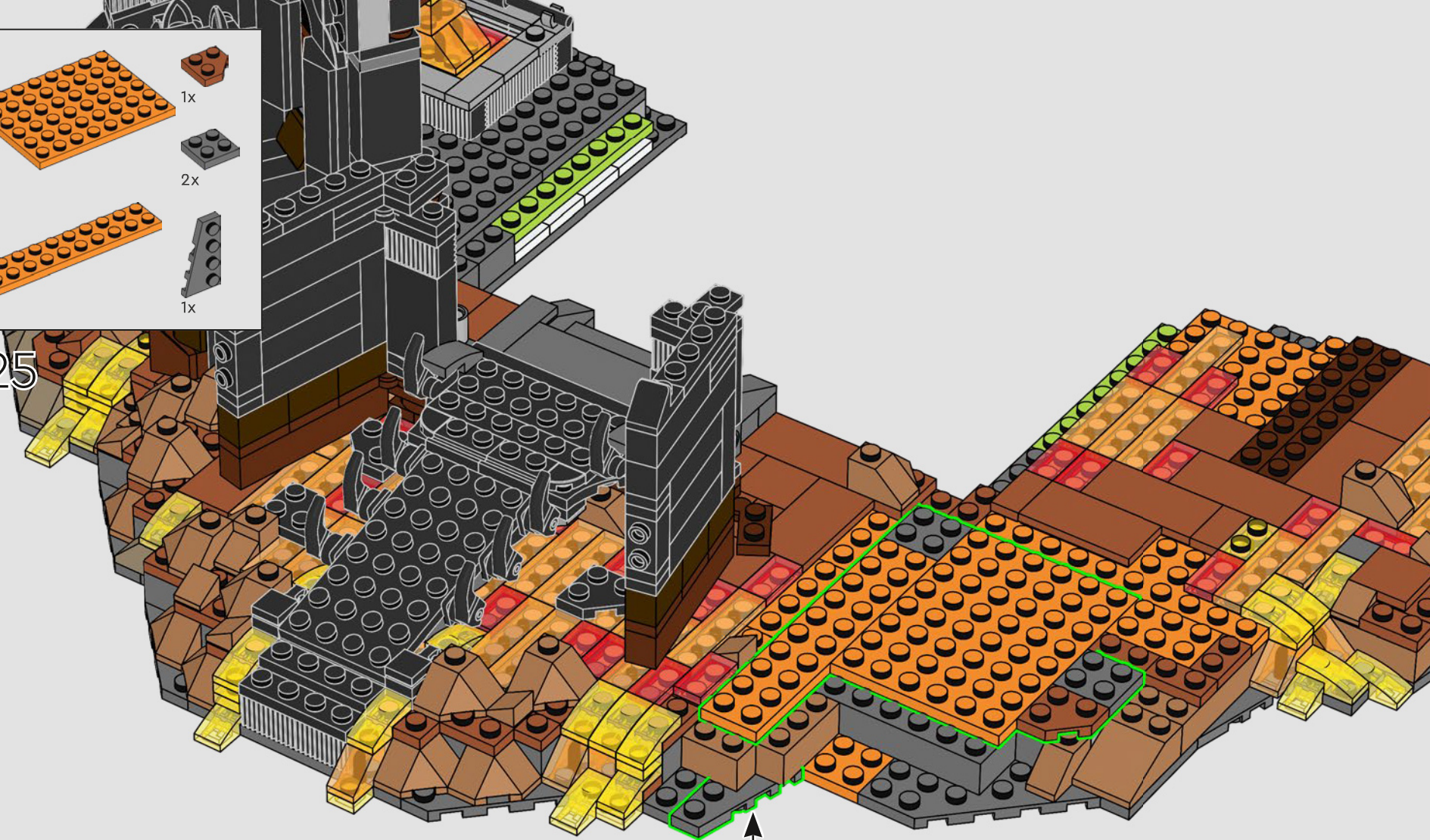



226

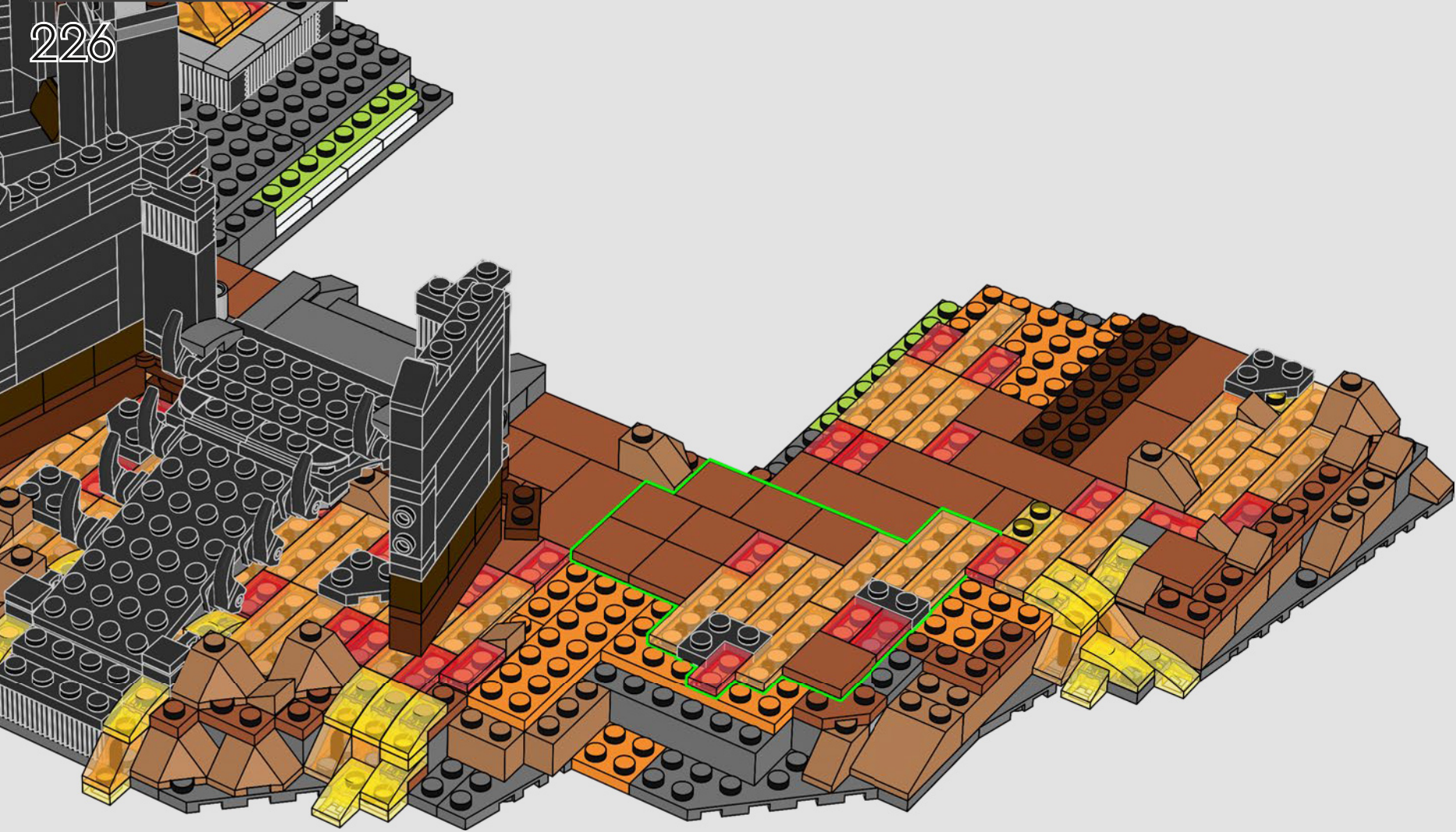

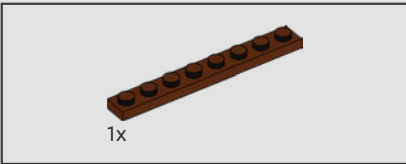
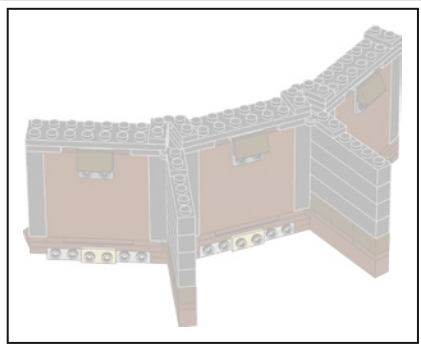

227

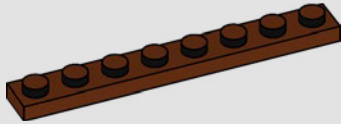

228

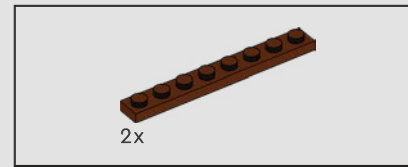
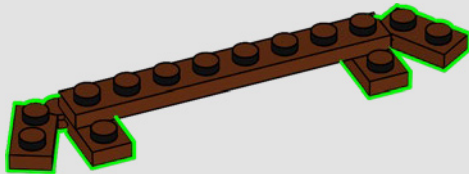

229

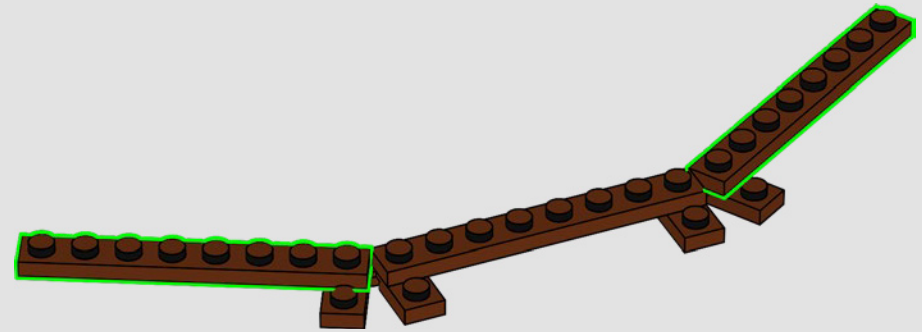

230

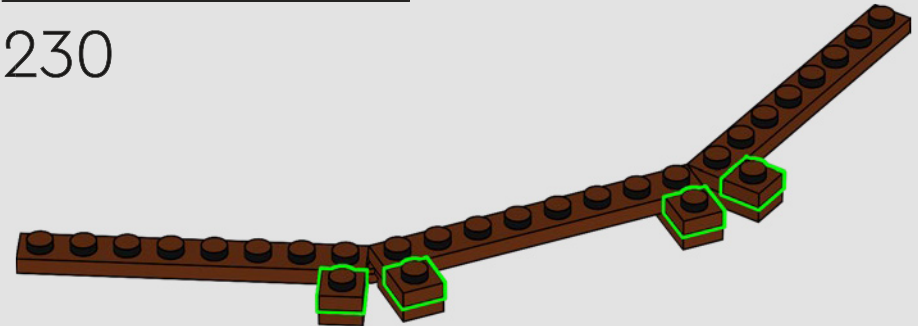

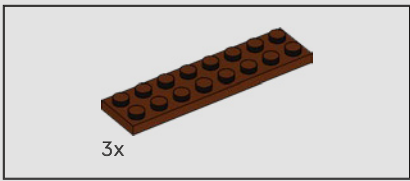

231

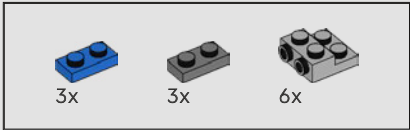
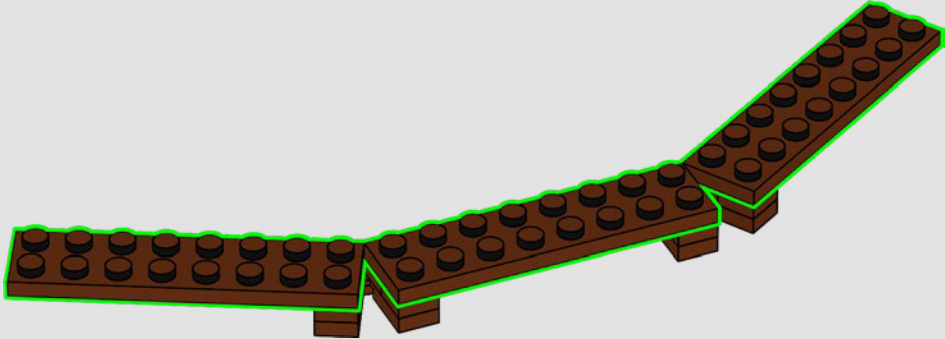

232

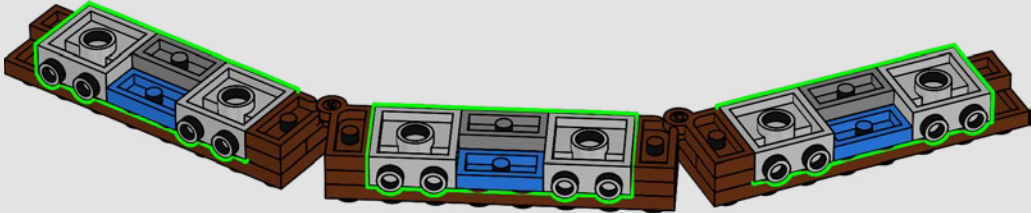



233

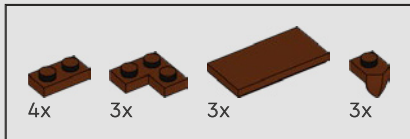
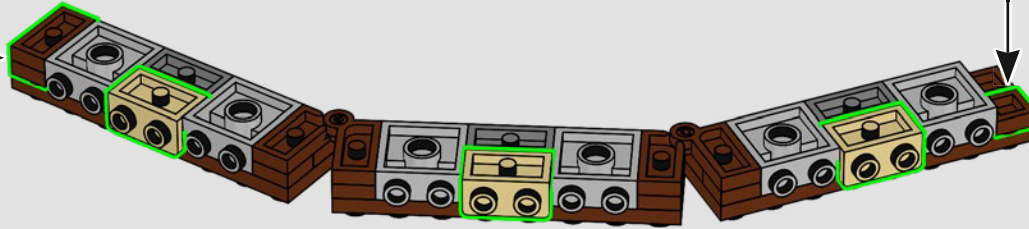
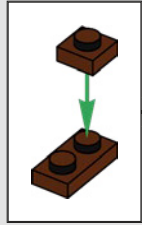

234

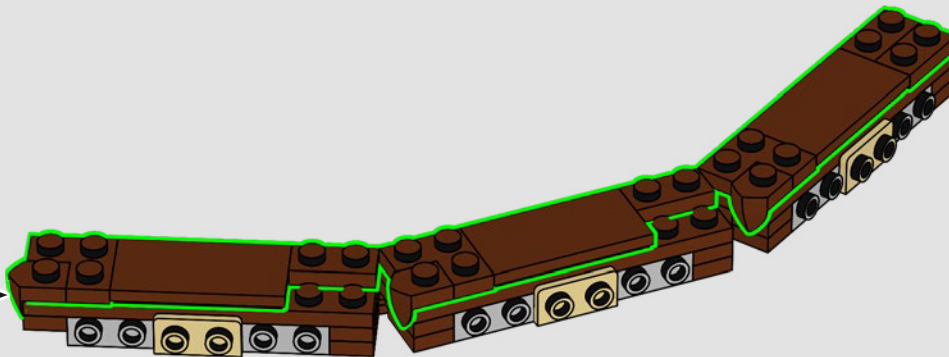

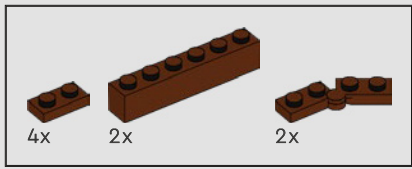

235

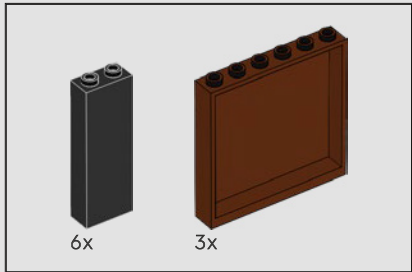
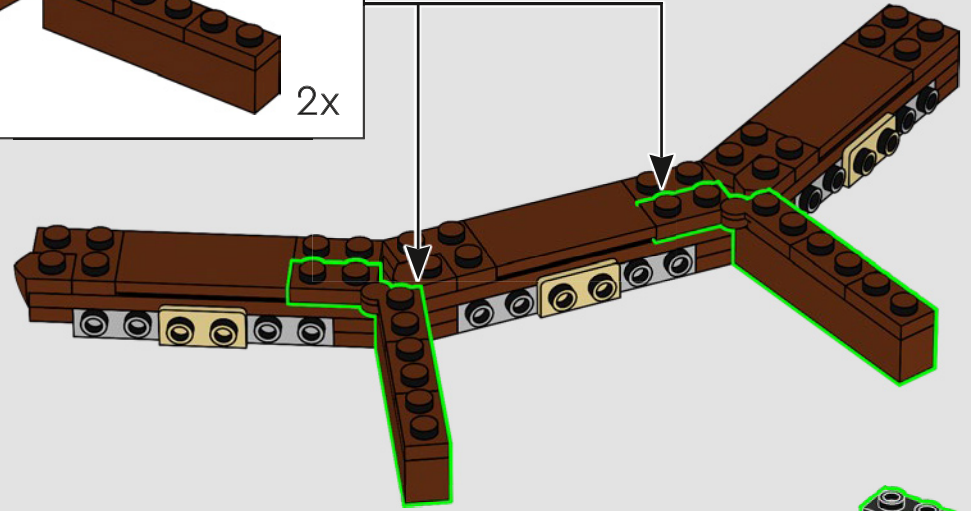
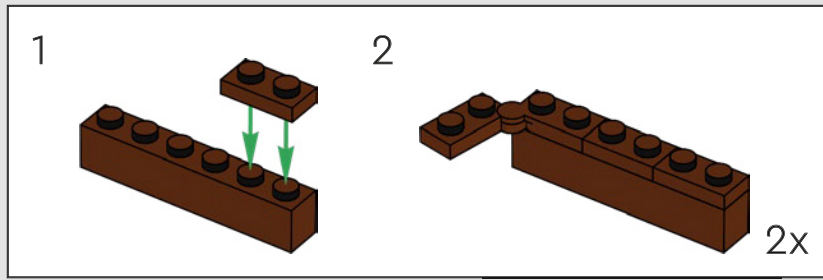

236

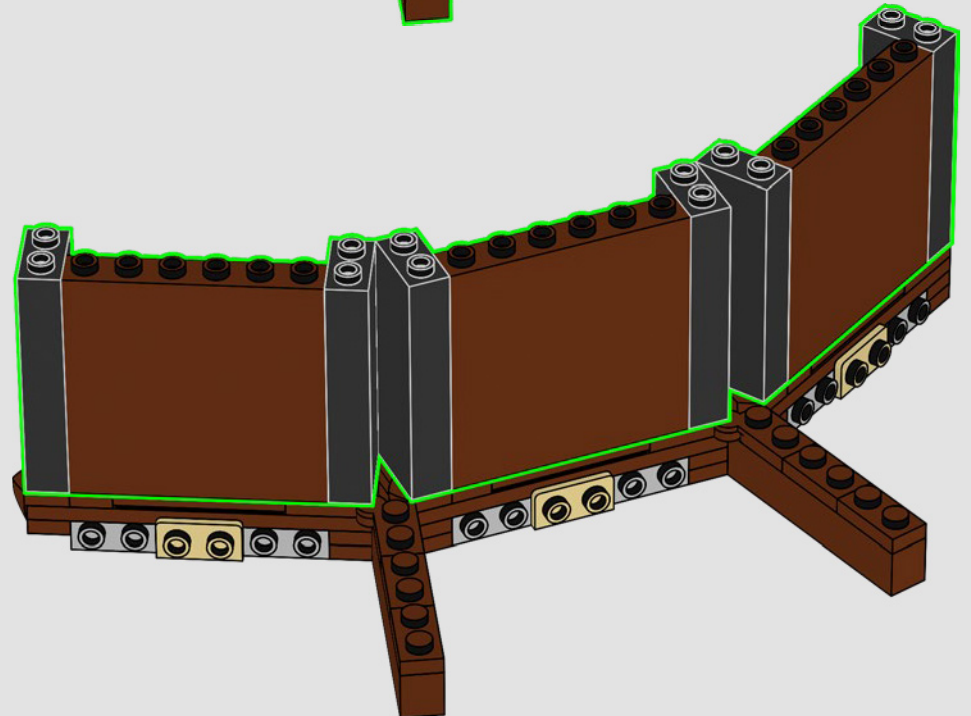

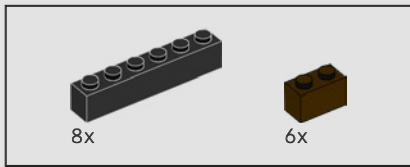

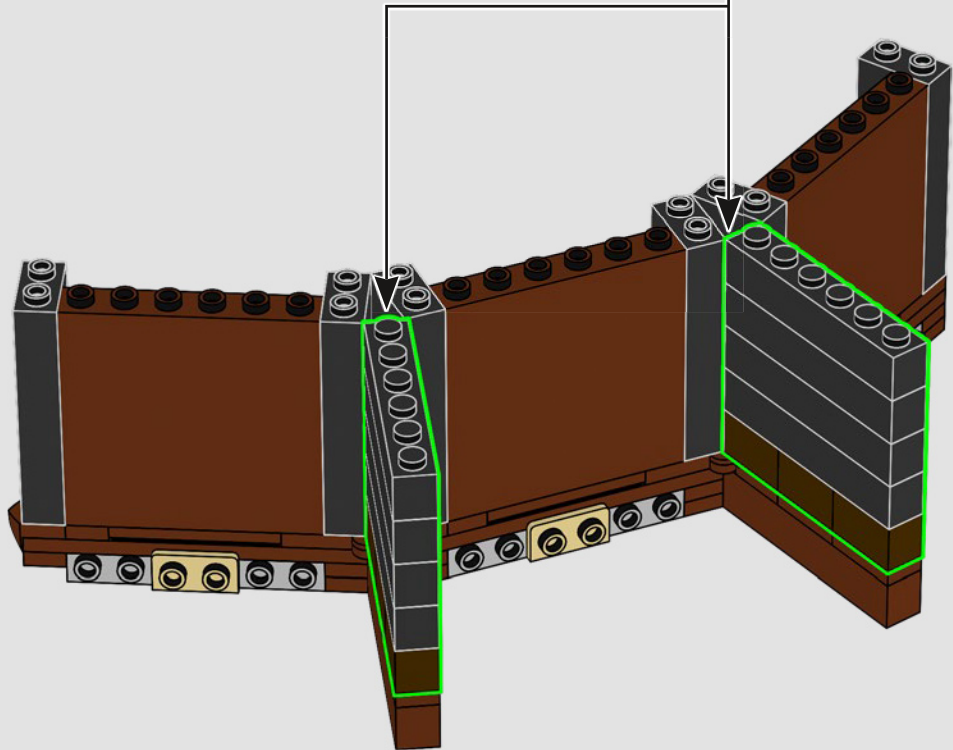
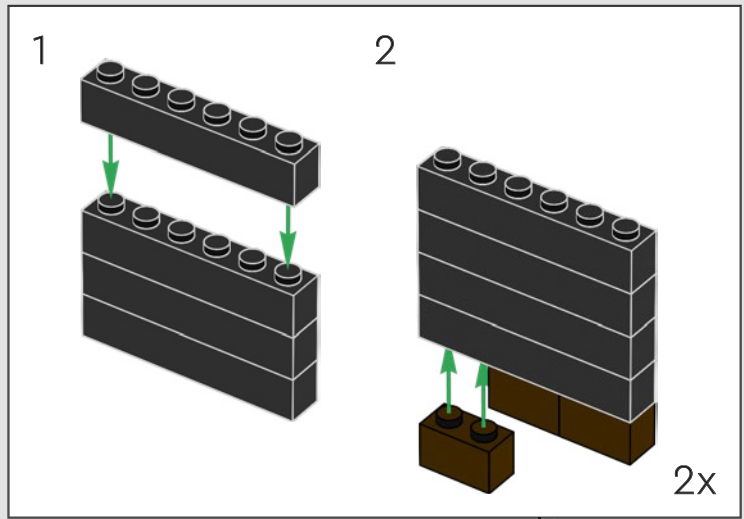

237

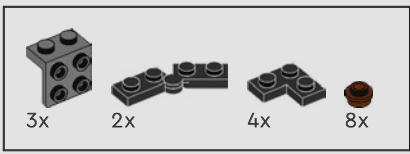

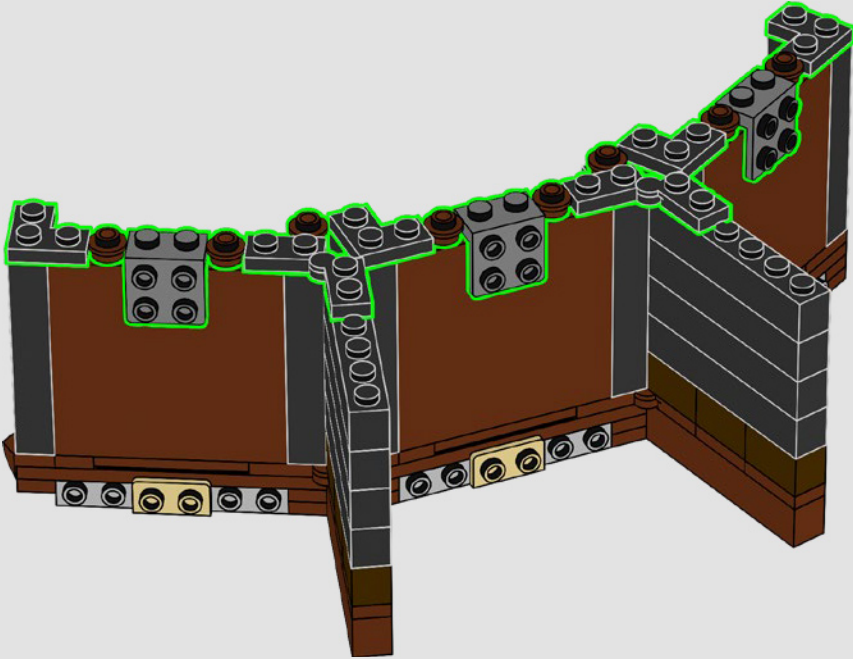

238



 El modelo utiliza elementos abisagrados para crear la singular forma de la fortaleza. Cada planta se ha diseñado utilizando distintos ángulos.

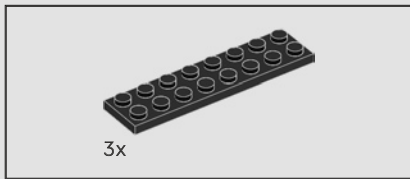

239

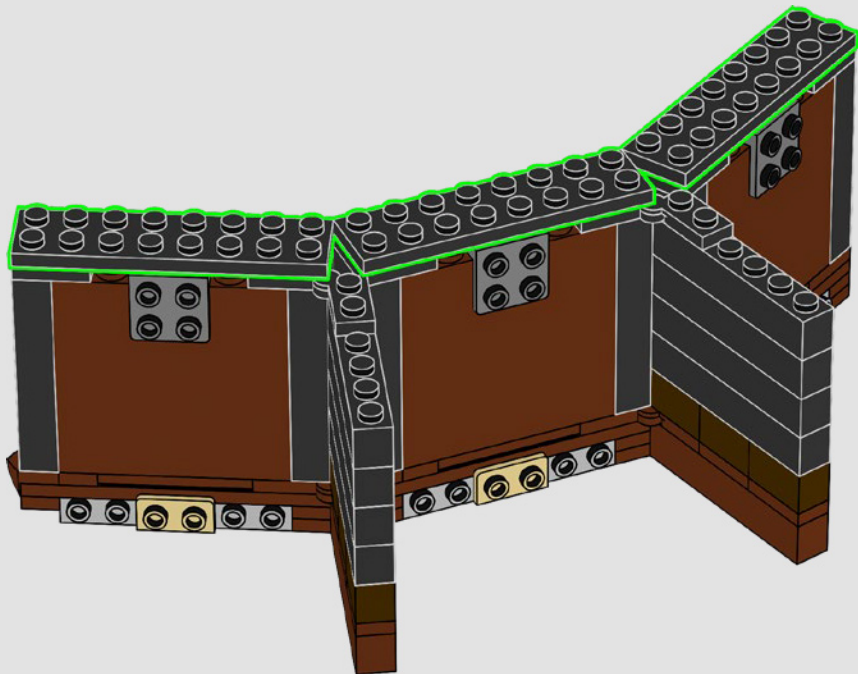

240

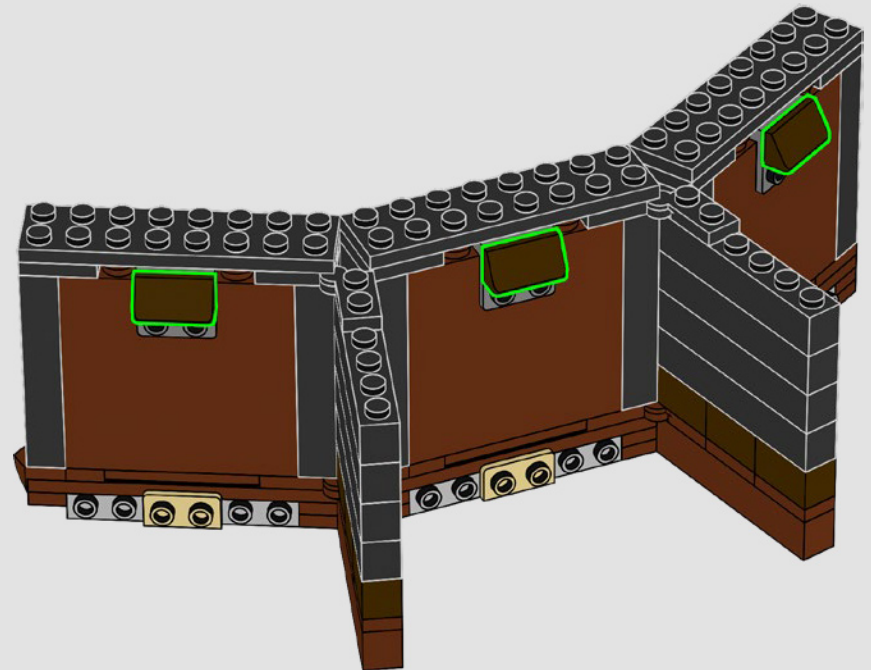



241

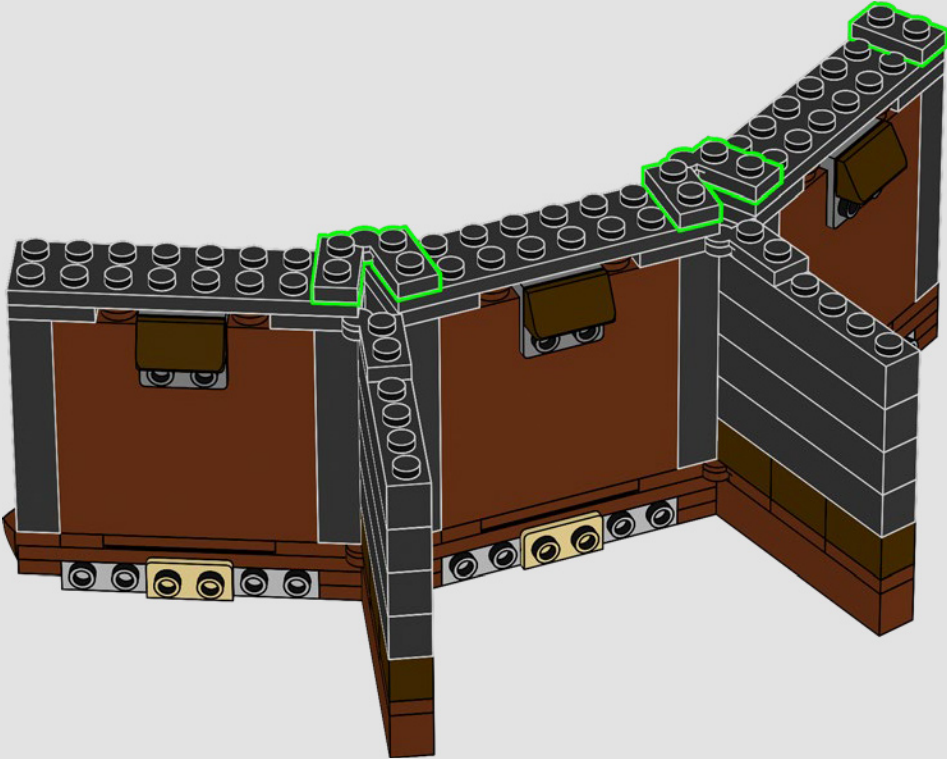



242

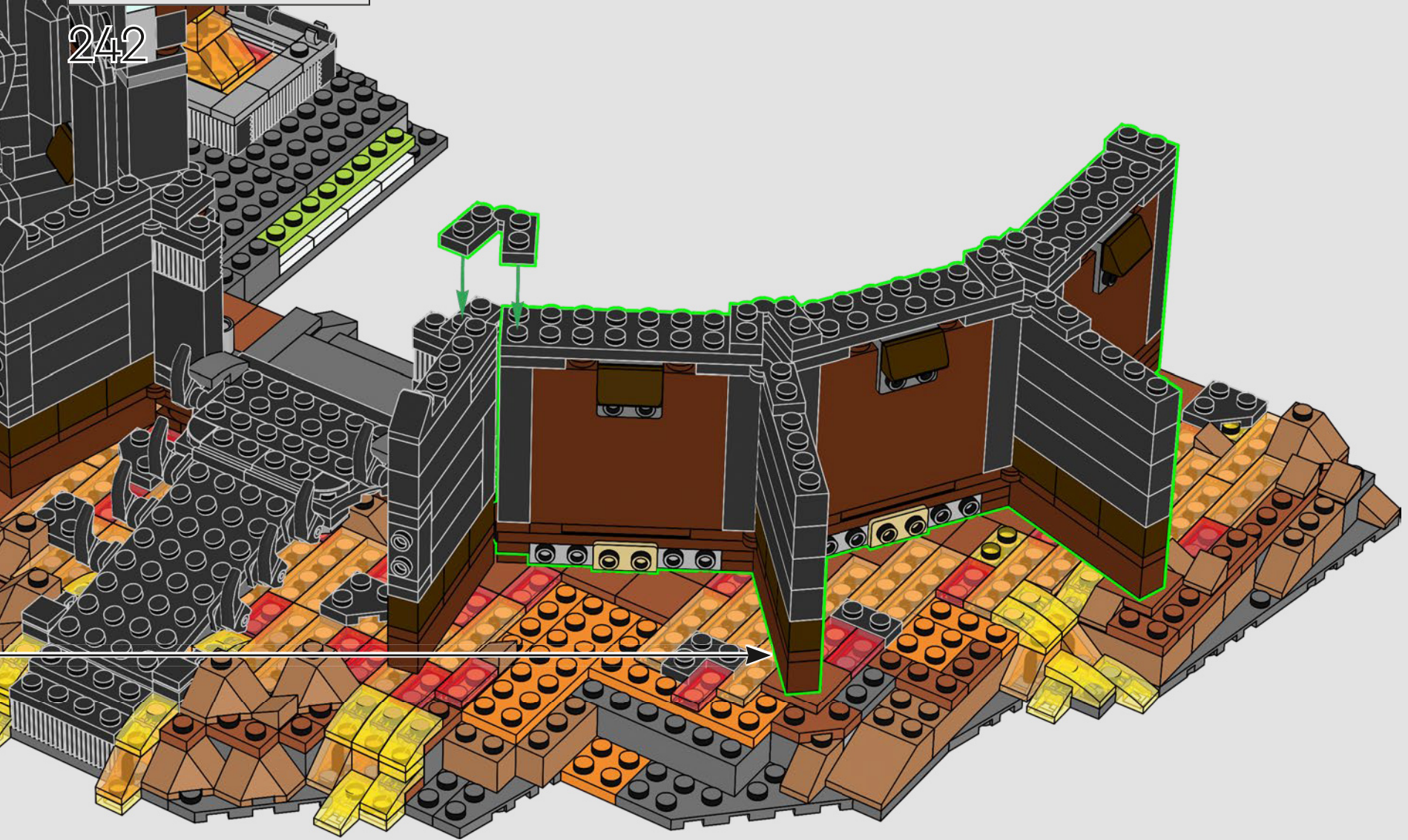



- | | | |
|----|----|----|
| | | |
| 1x | 2x | 1x |
| | | |
| 1x | 1x | 1x |

243

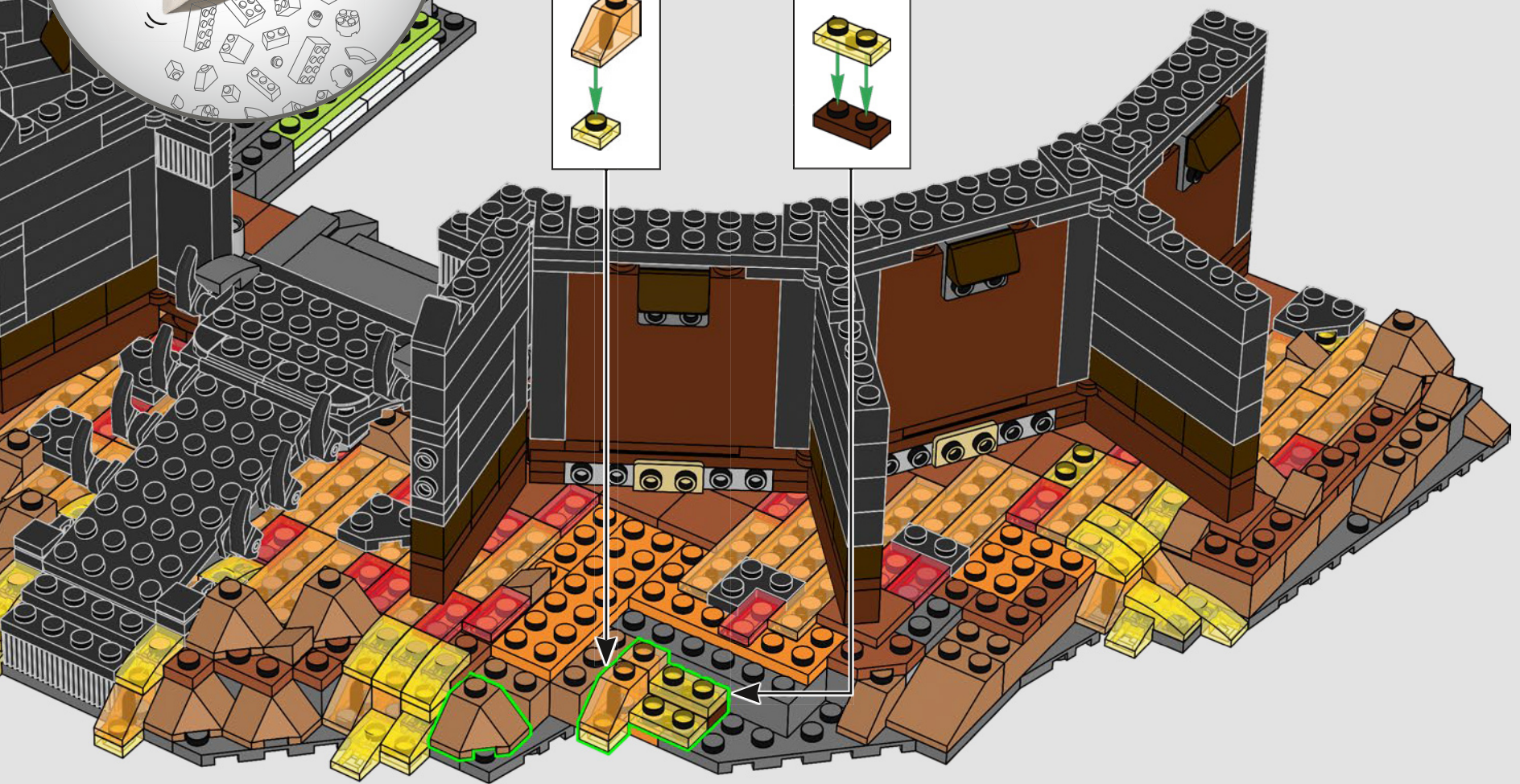
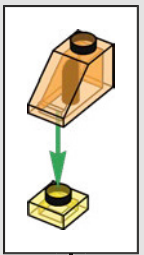

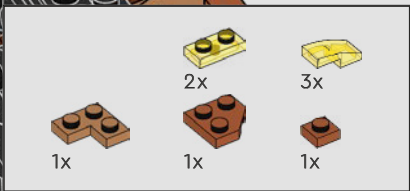

244

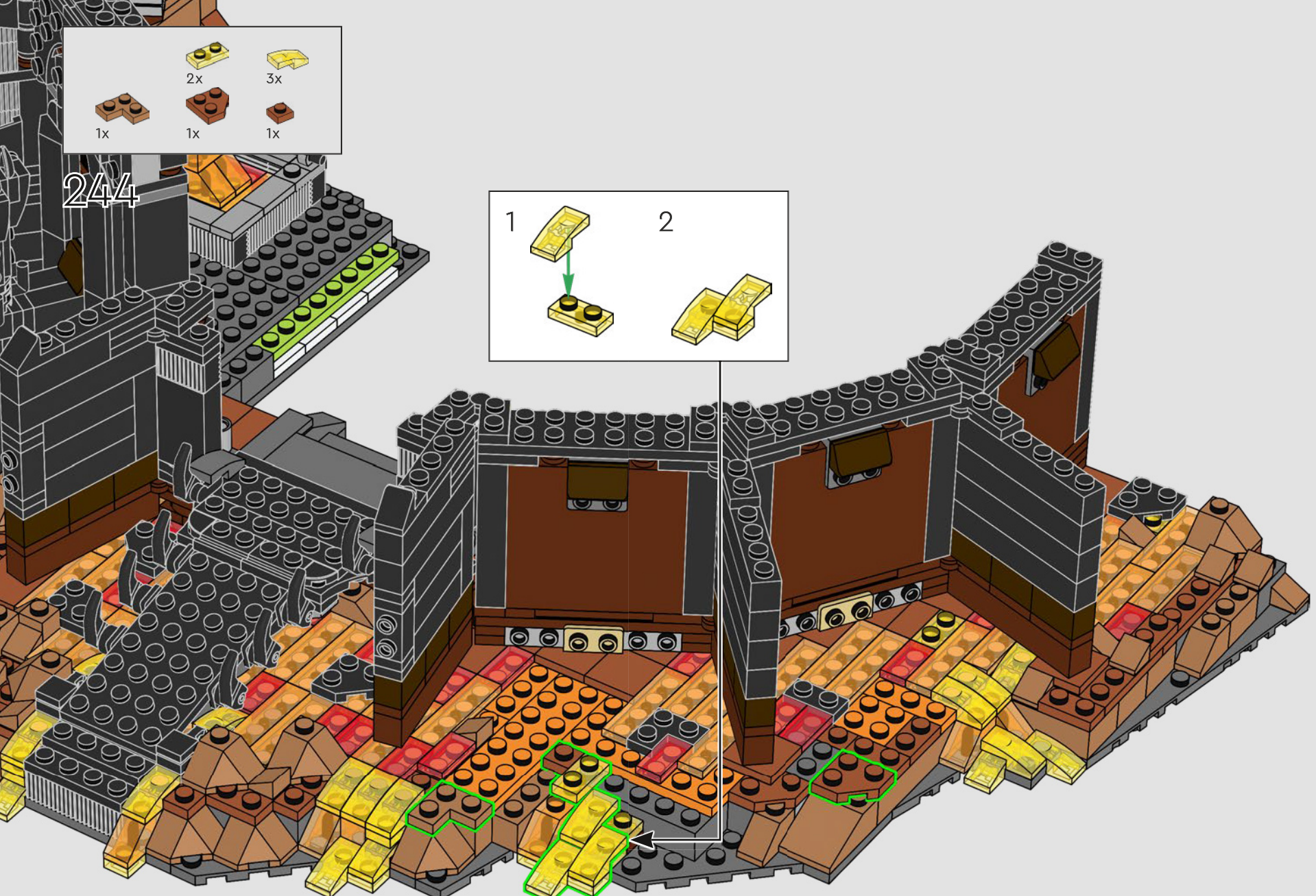
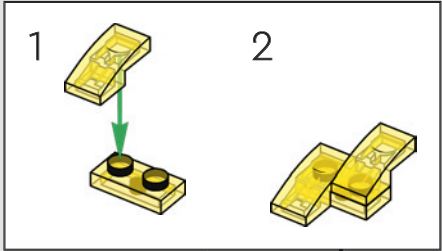

245

1x	1x	4x	
2x	2x	4x	2x
1x	2x	1x	1x

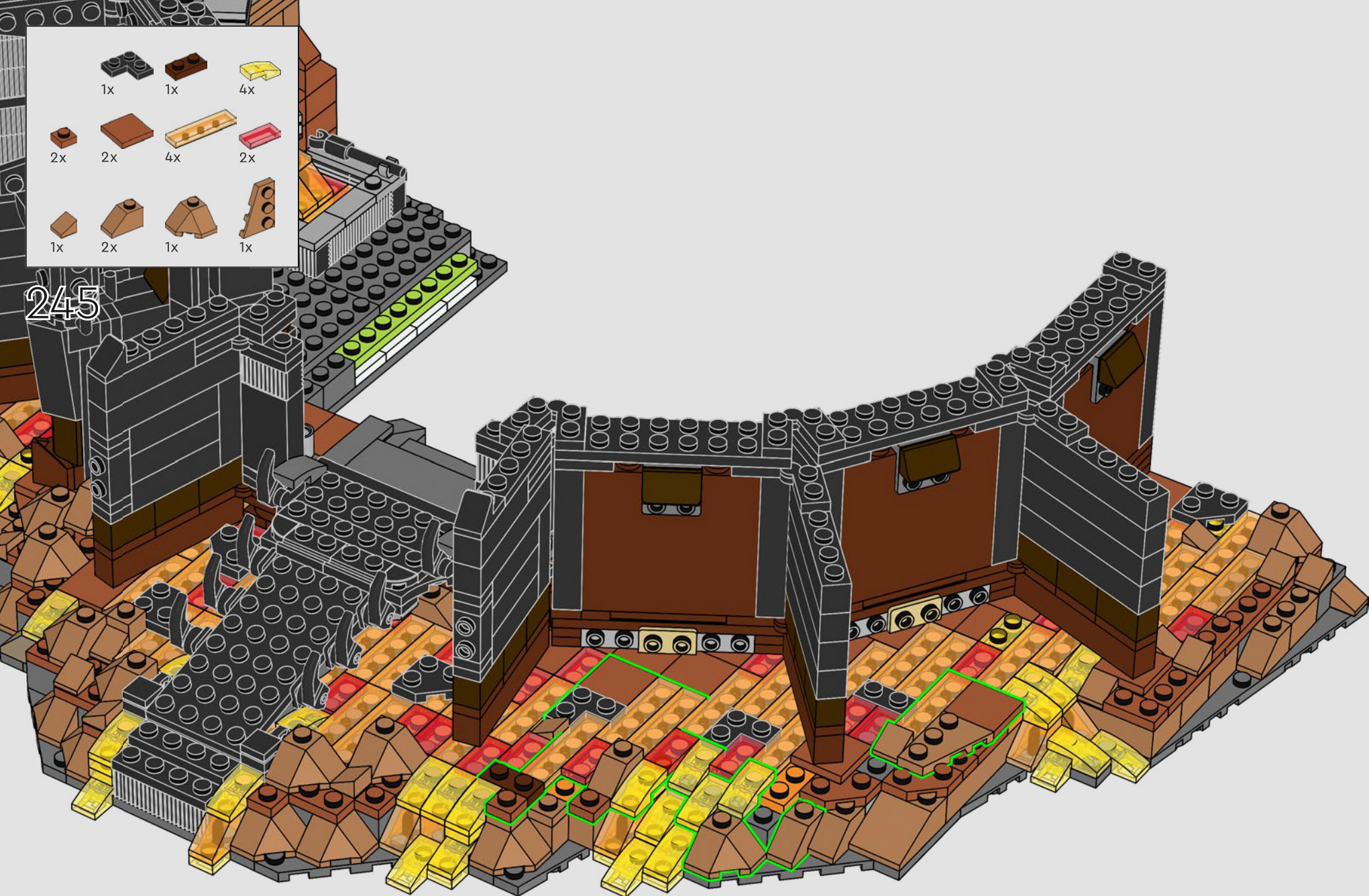



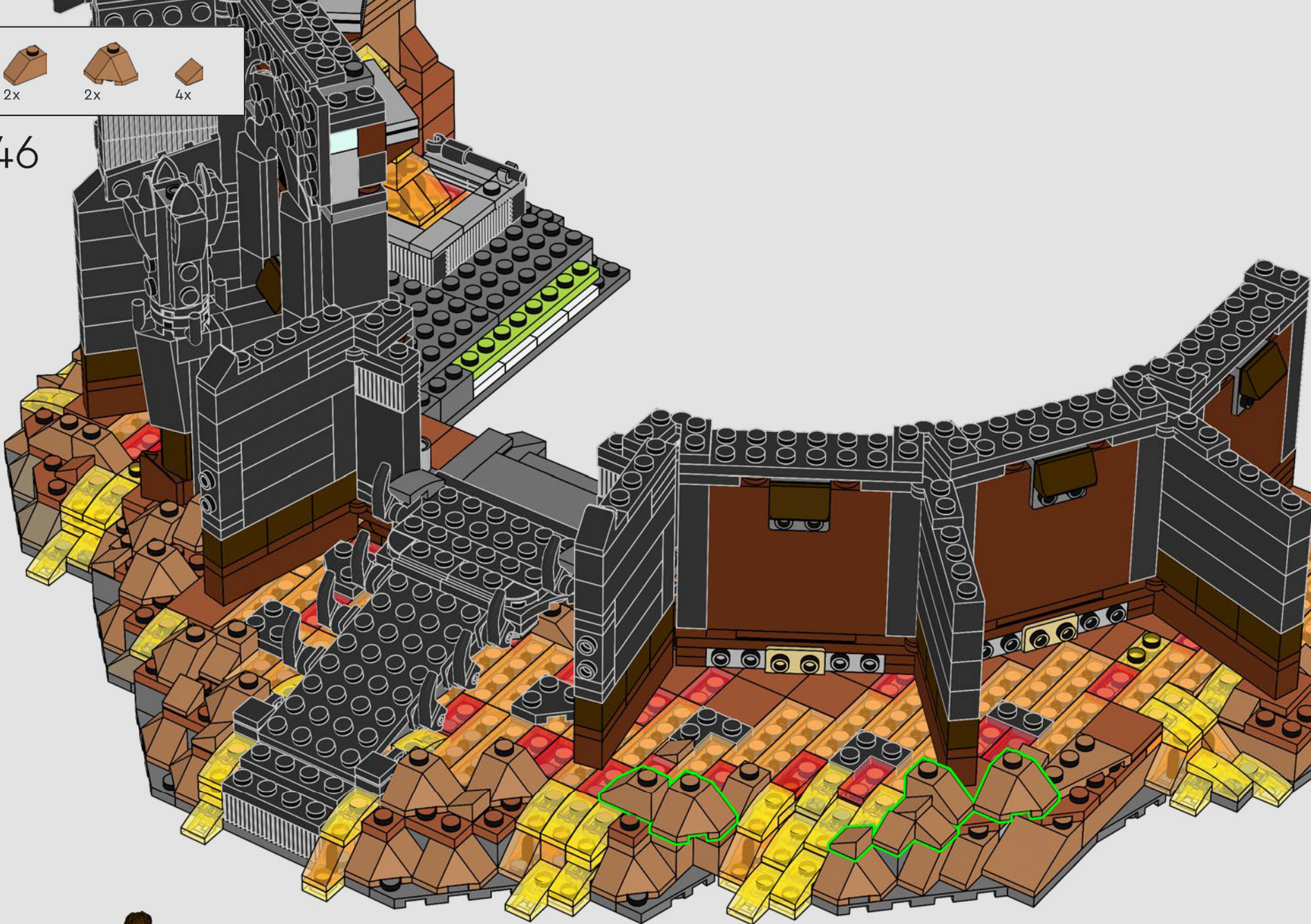

246

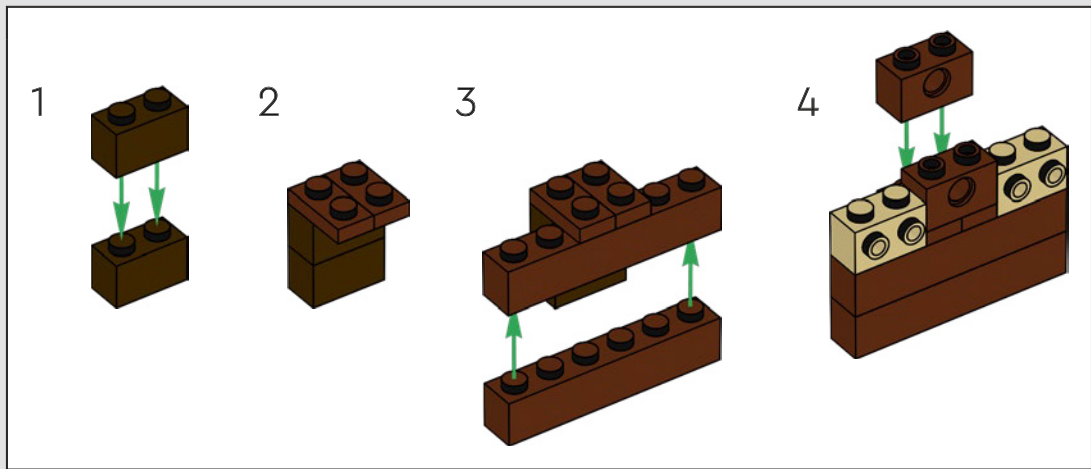
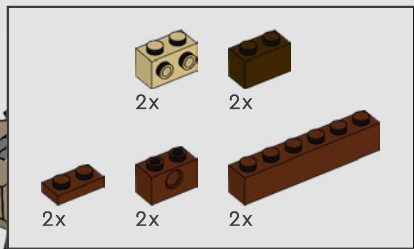

247



 *Barad-dûr*[™] significa 'torre oscura' en sindarin, una de las lenguas élficas.

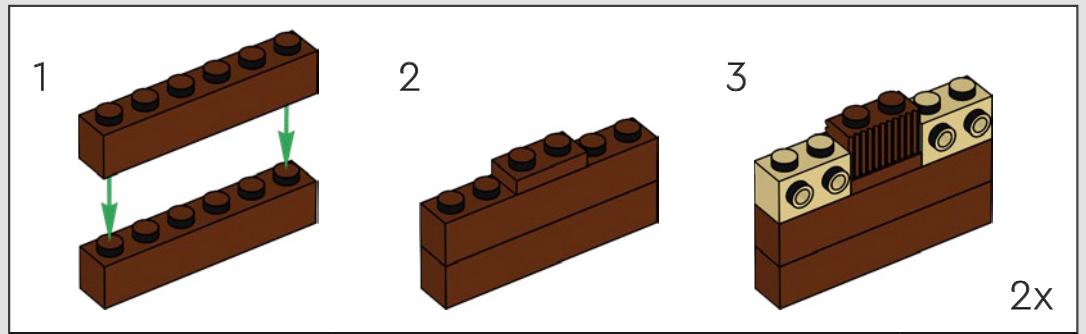
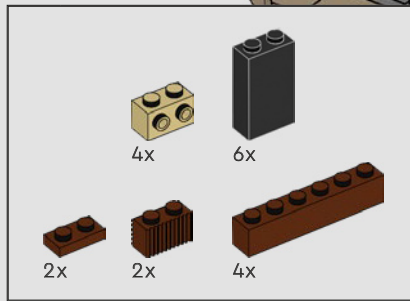

248

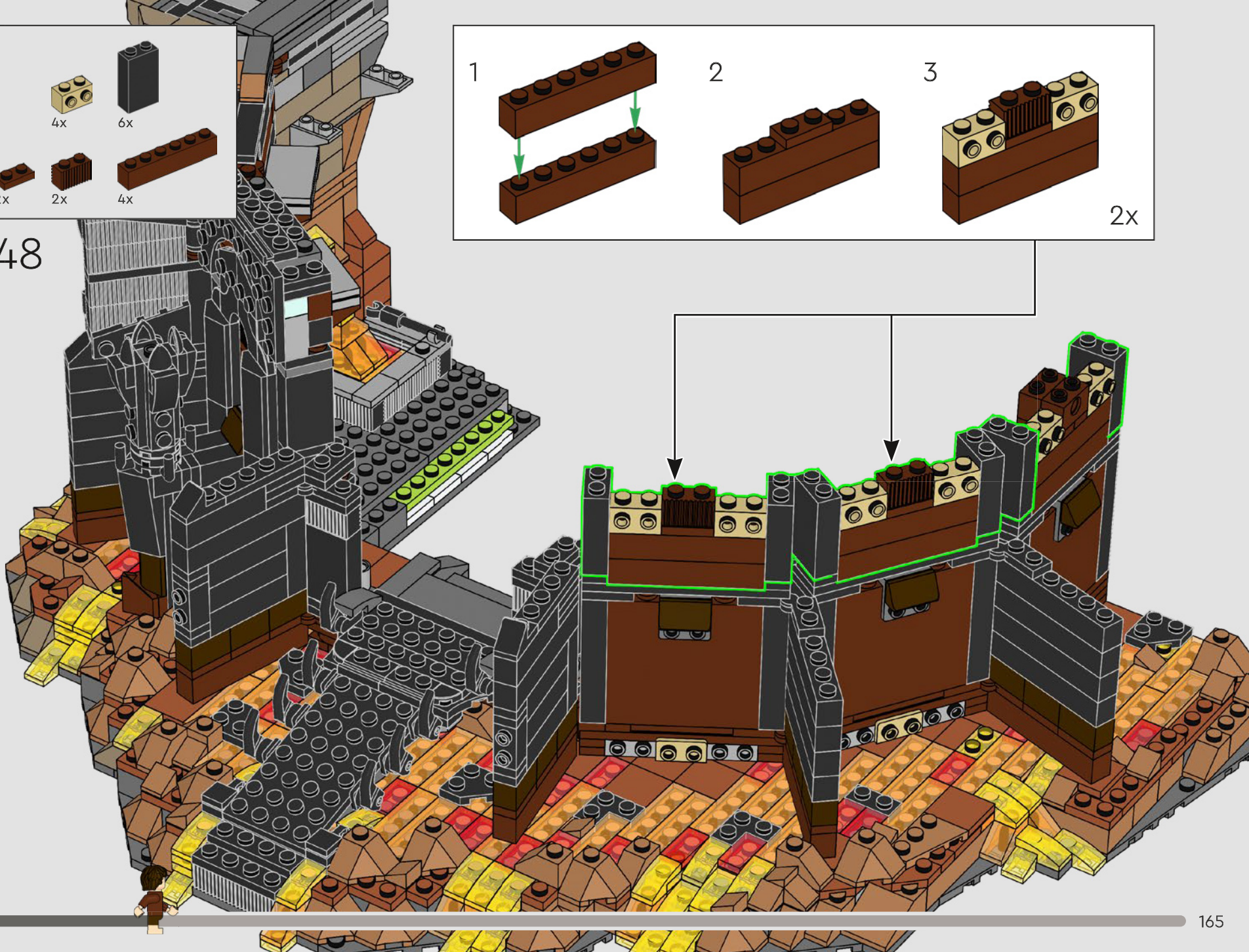

249

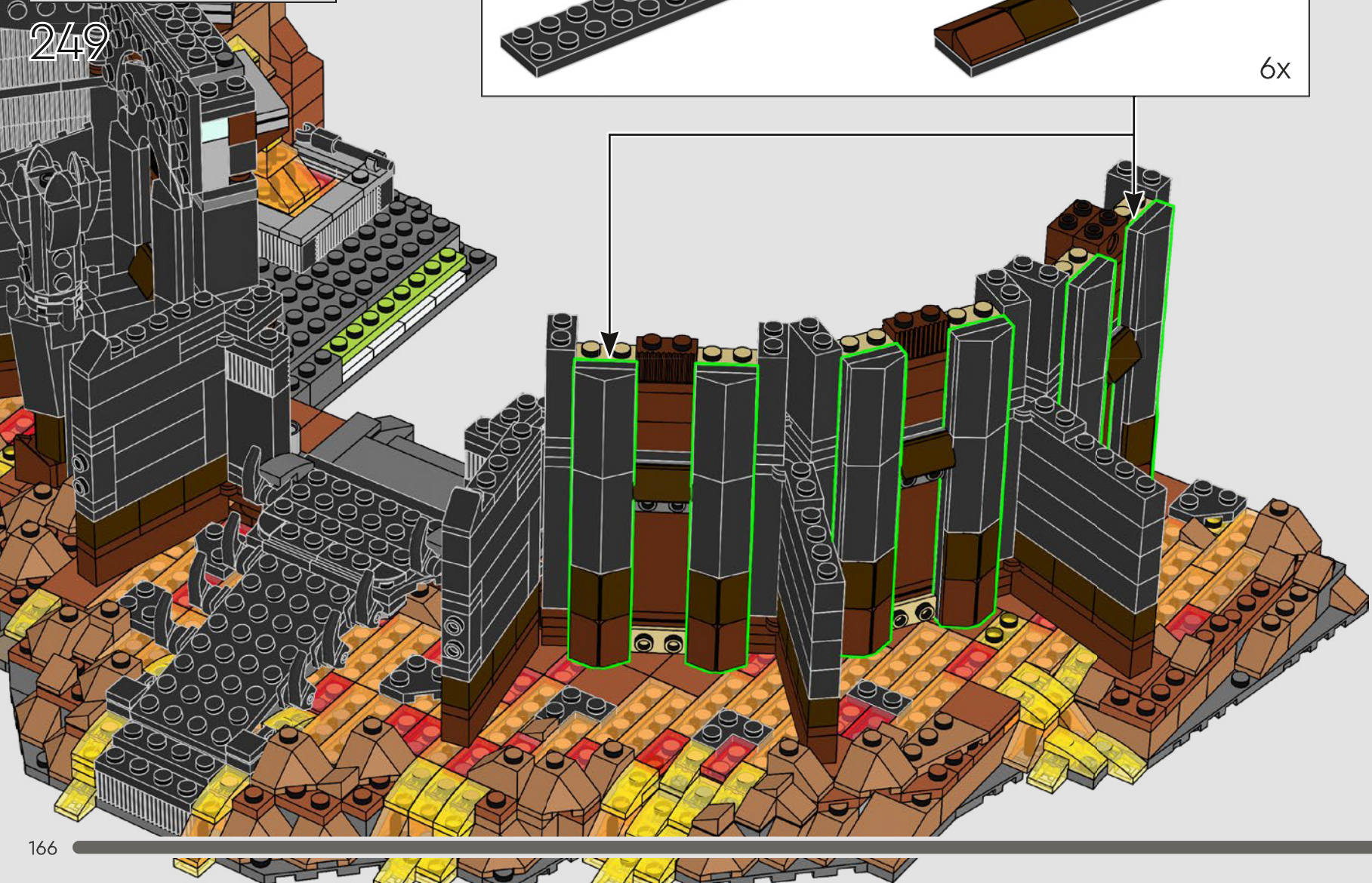
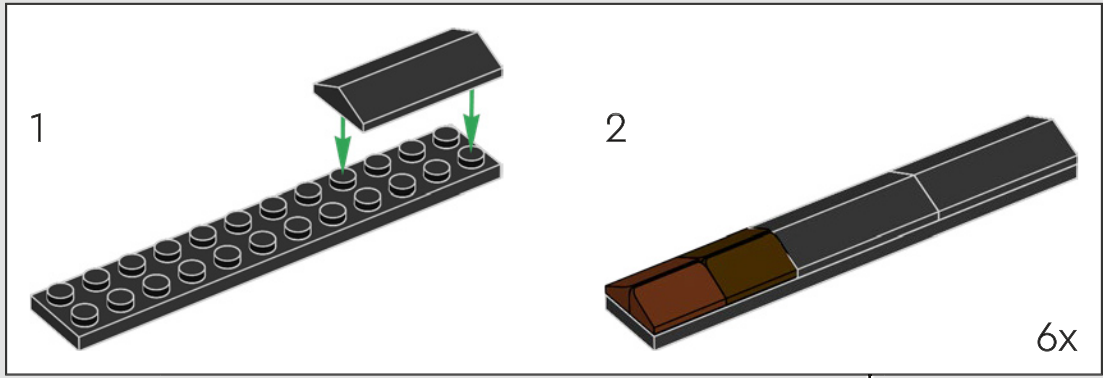
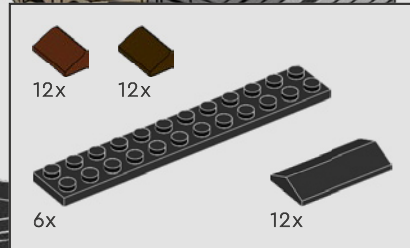

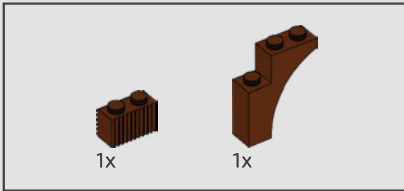
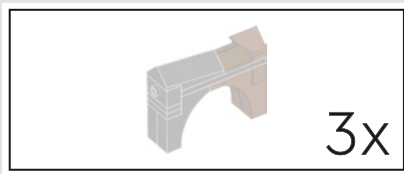

250

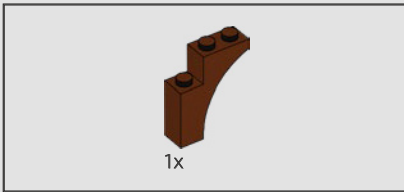
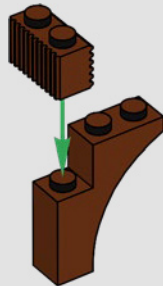

251

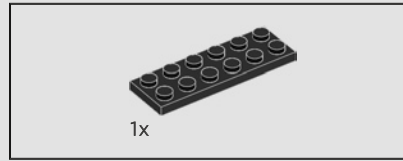
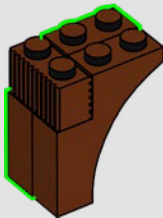

252

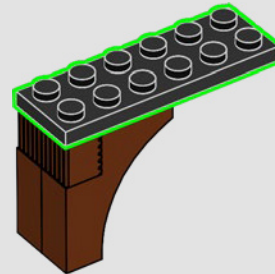

253

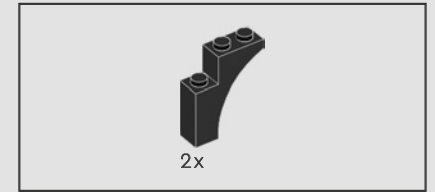
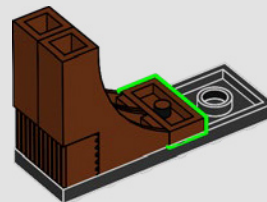

254

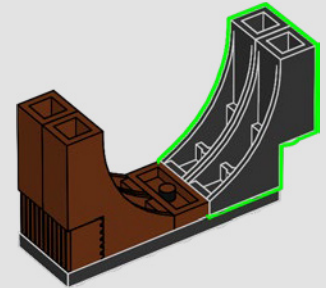



2x

255

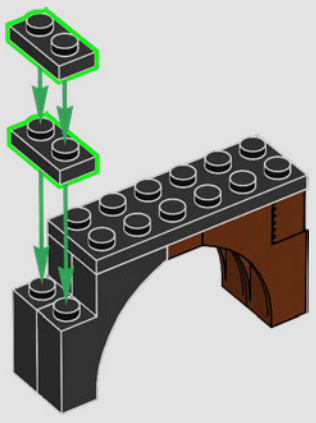

1x

256

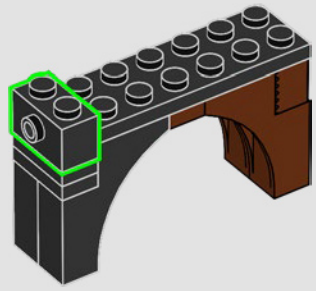

1x

2x

1x

257

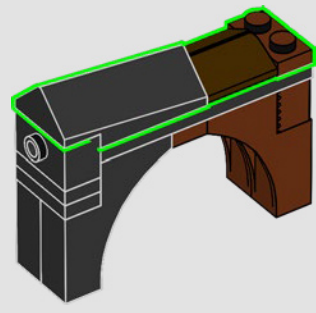

1x

258

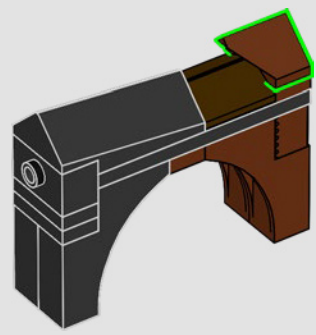

3x

259

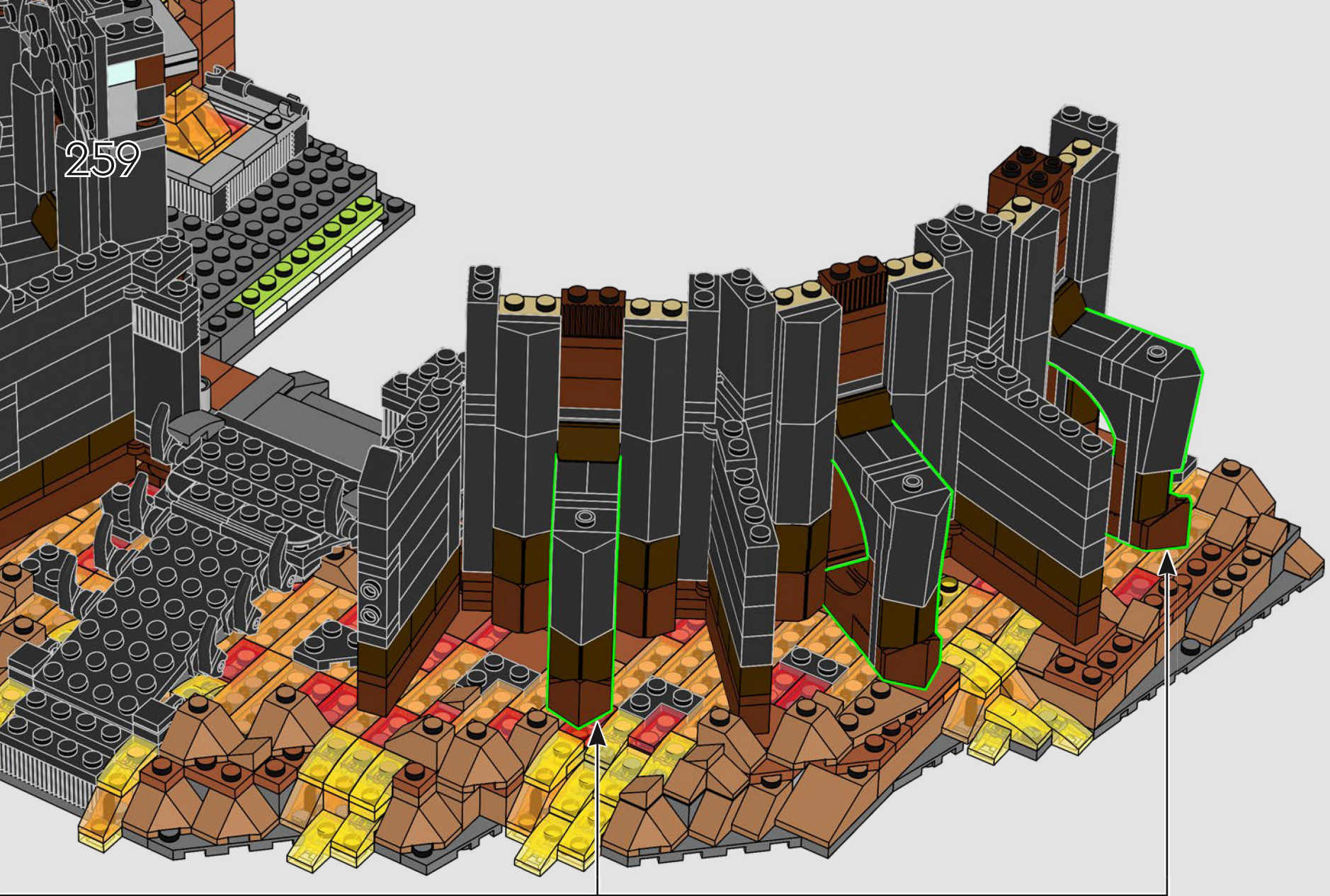

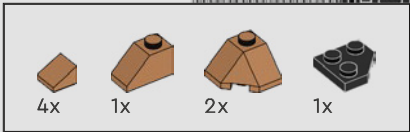

260

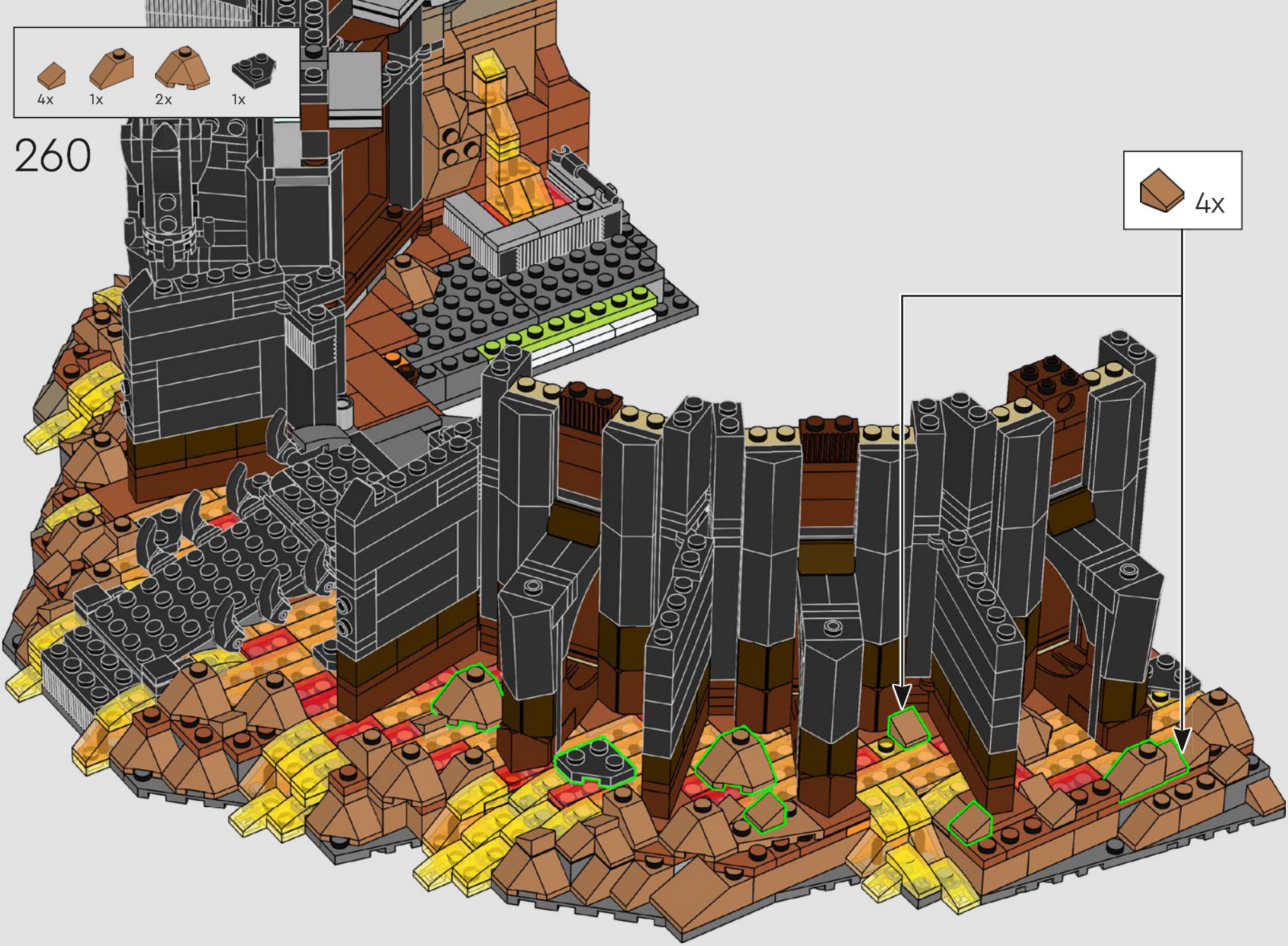

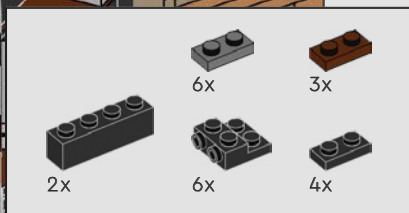

261

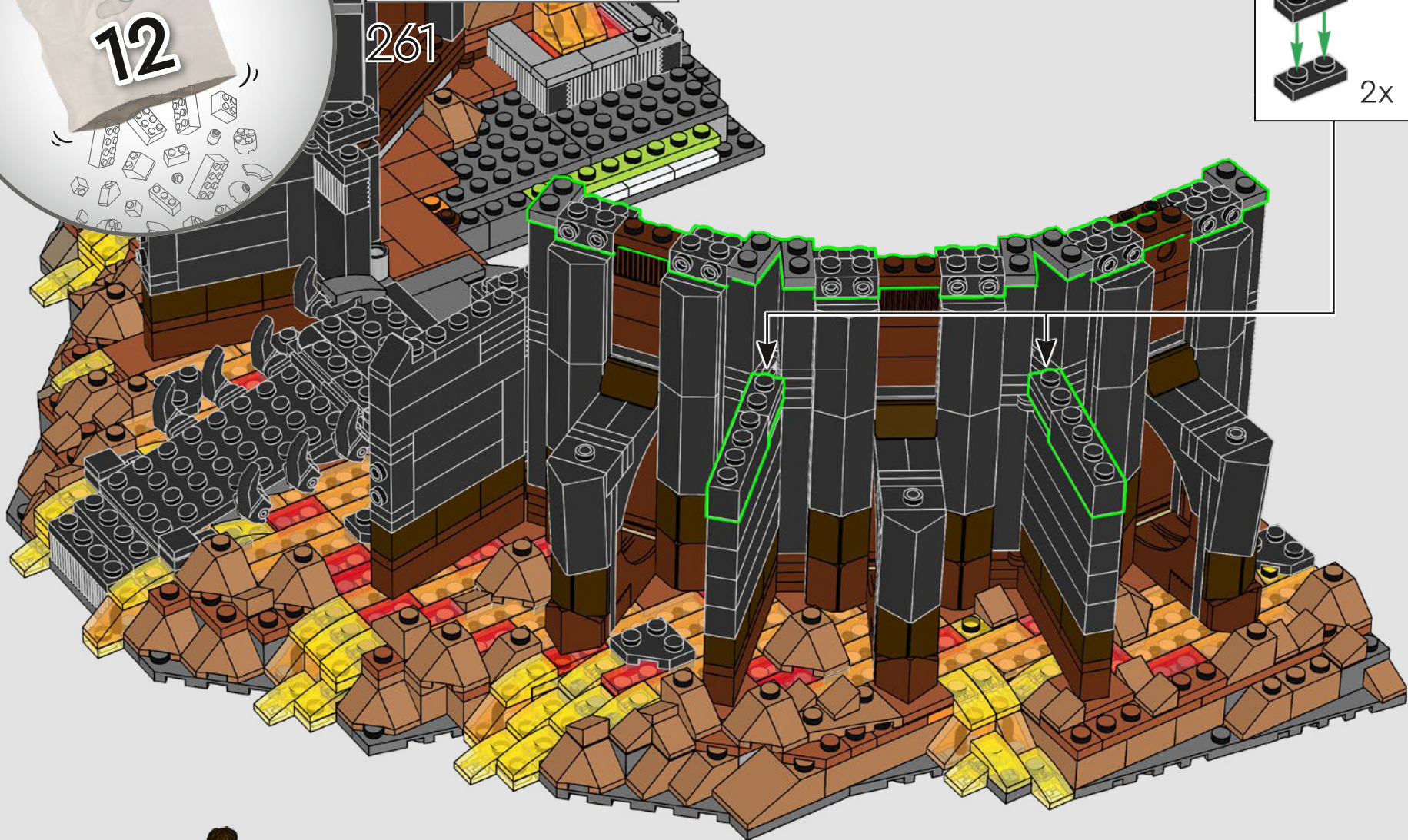
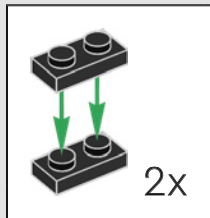

2x 4x 3x

262

2x

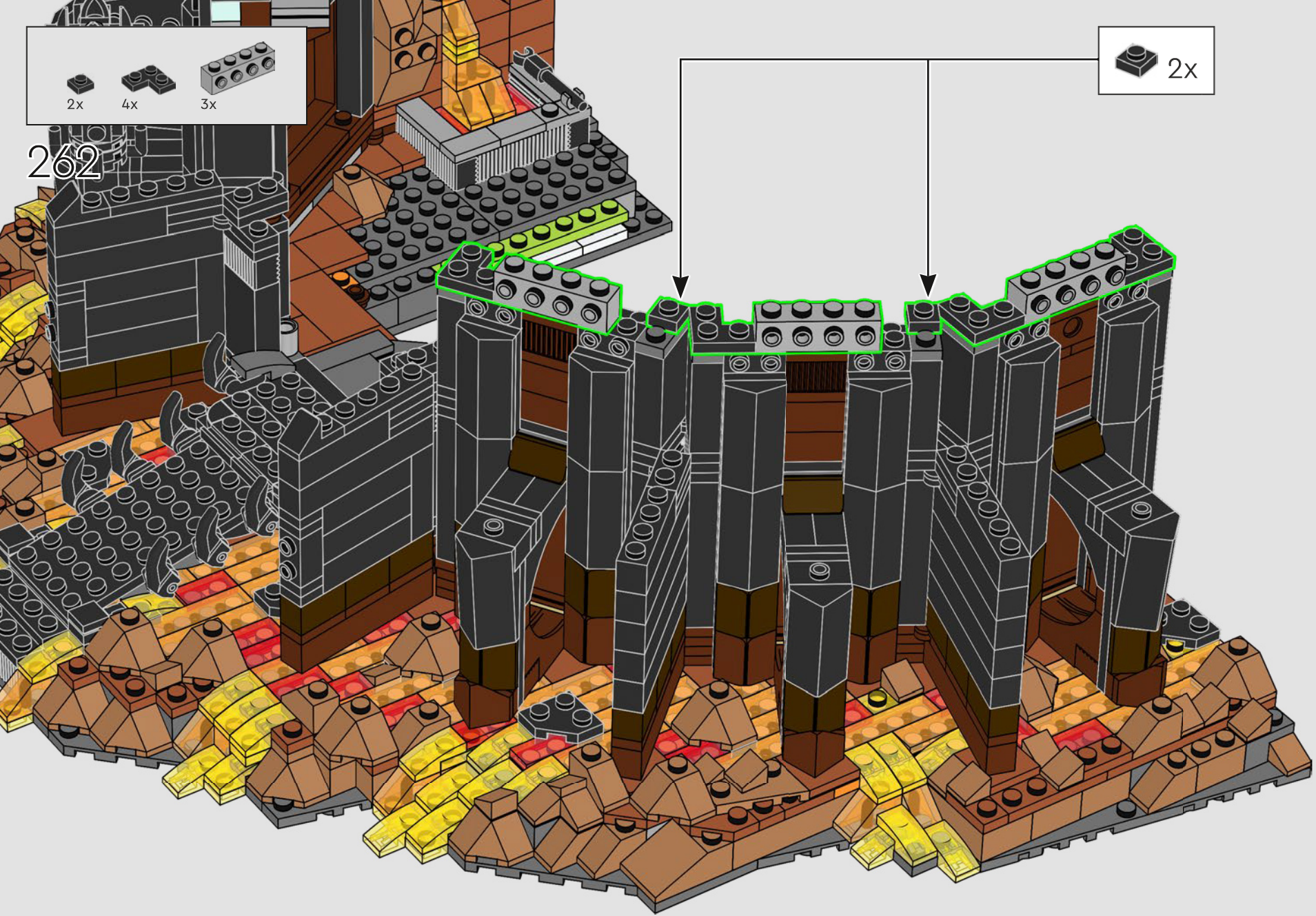

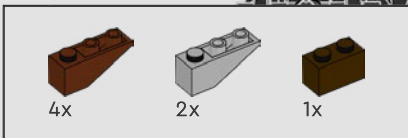

263



12x  6x 

264

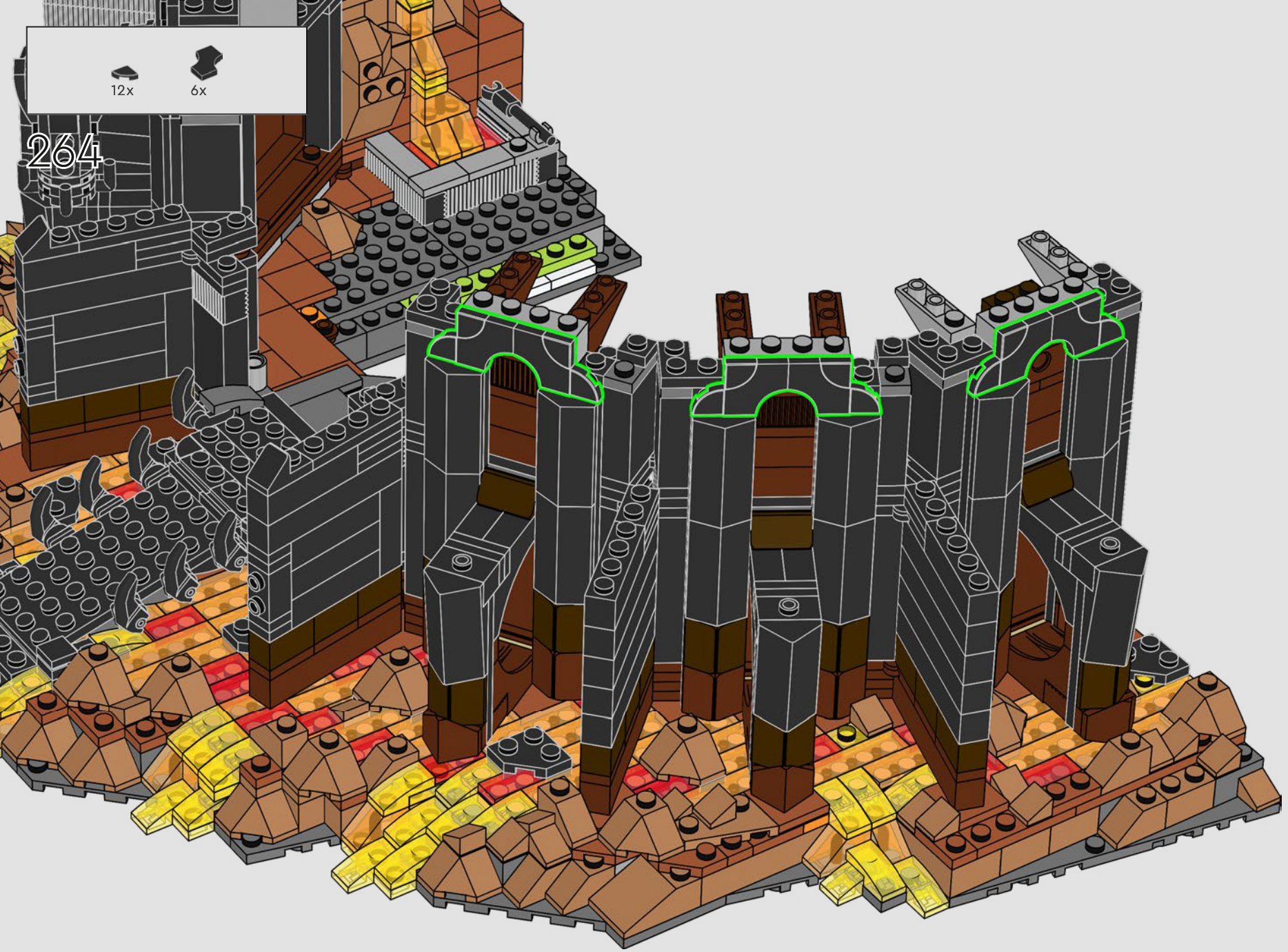

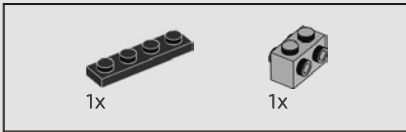
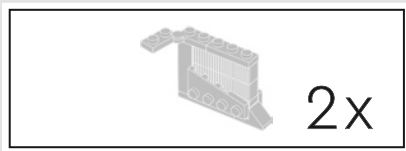

265

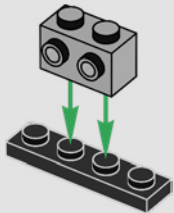

266

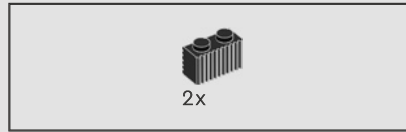
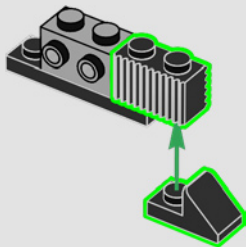

267

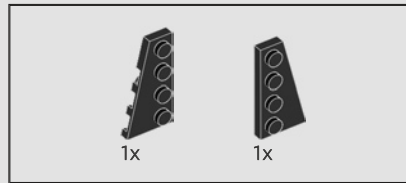
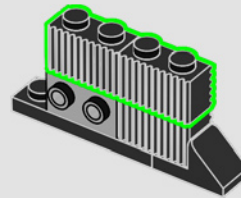

268

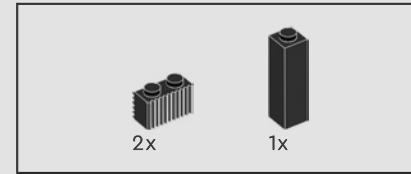
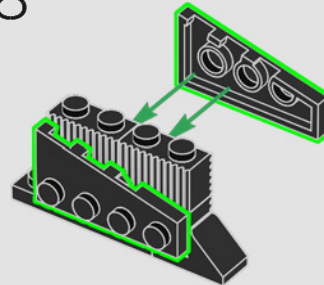

269

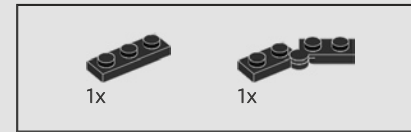
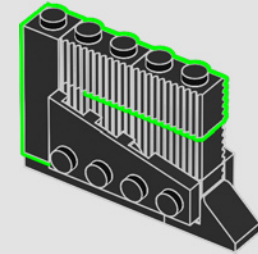

270

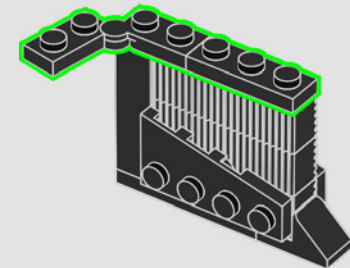

2x

Con una altura estimada de más de 914 m, Barad-dûr™ es la estructura más prominente de la Tierra Media. Su construcción duró más de 600 años.

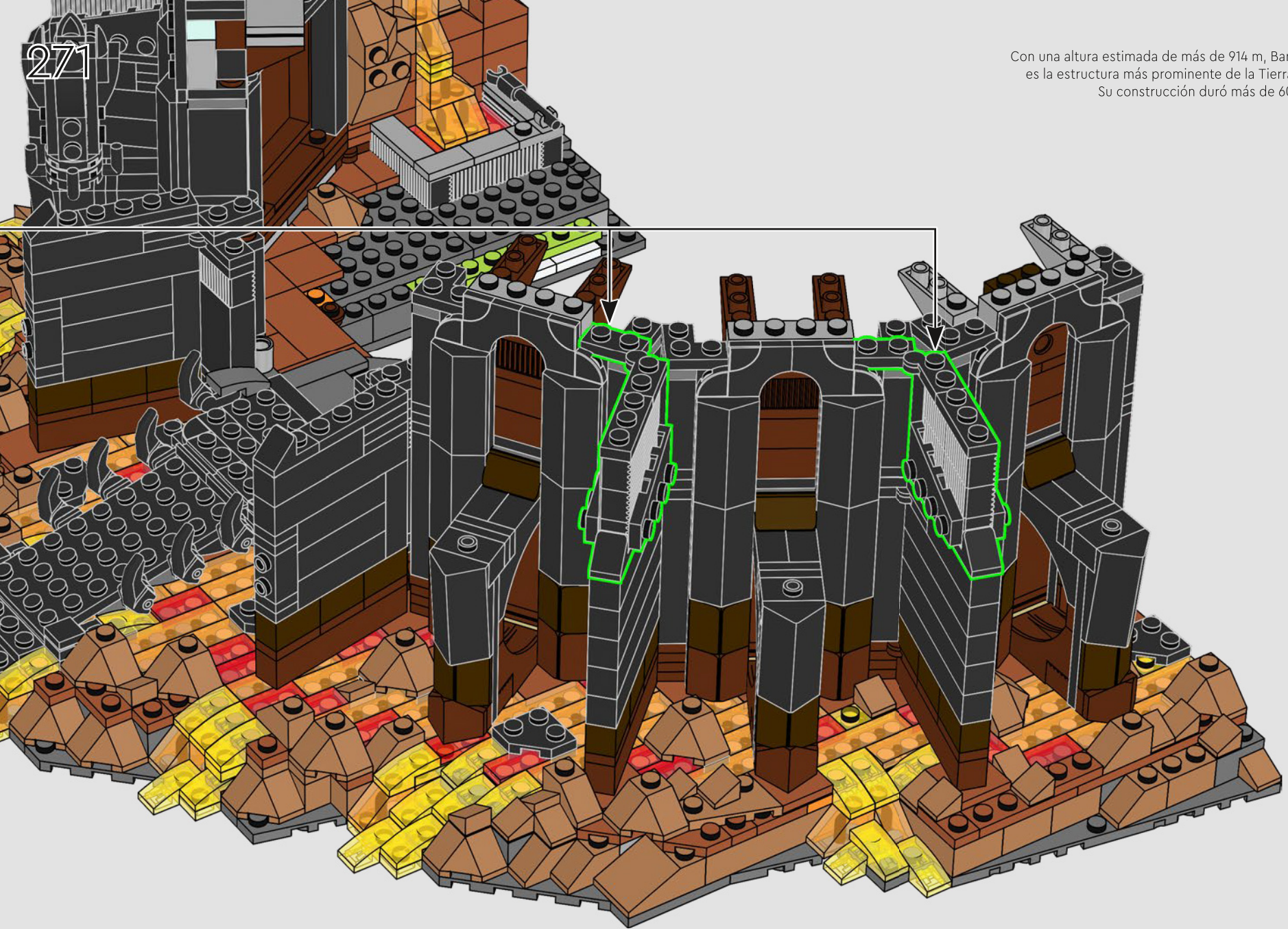

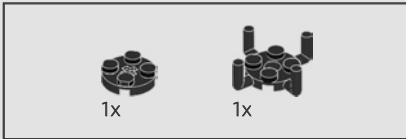
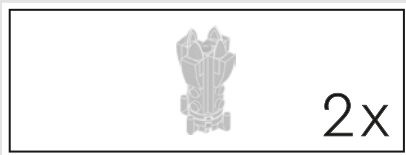

272

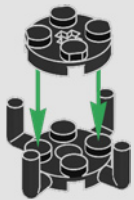

273

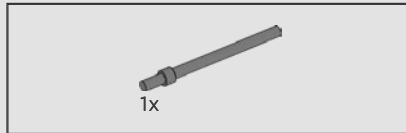

274

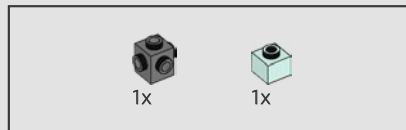
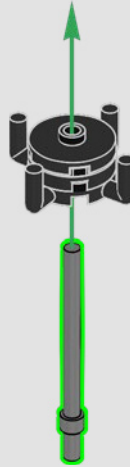

275

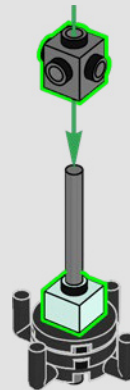

276

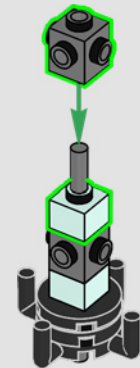

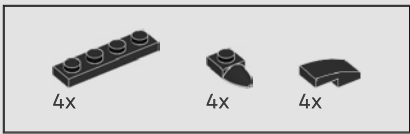

277

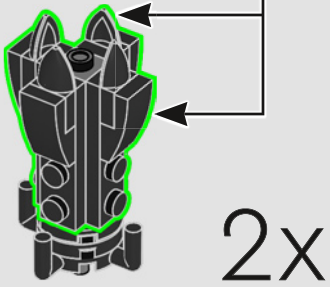
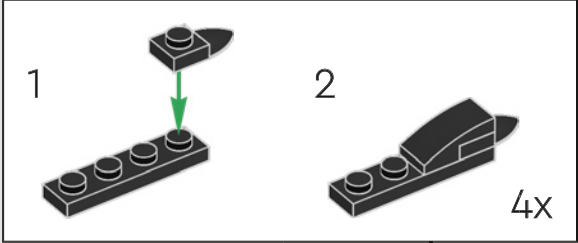

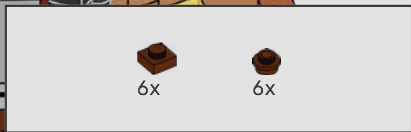

279

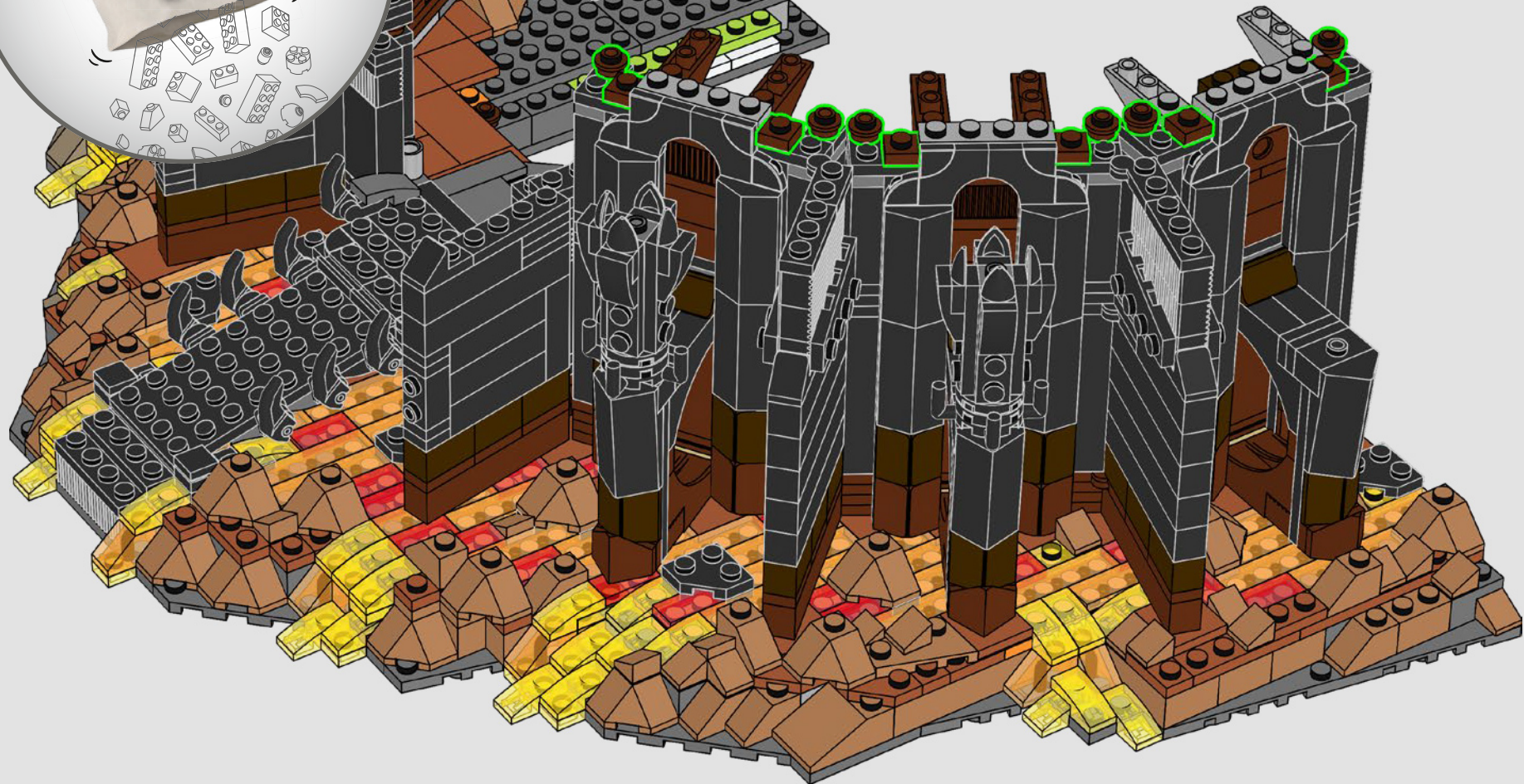

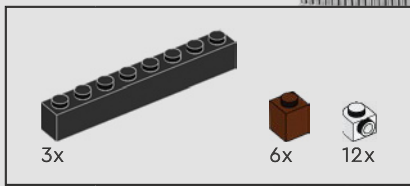

280

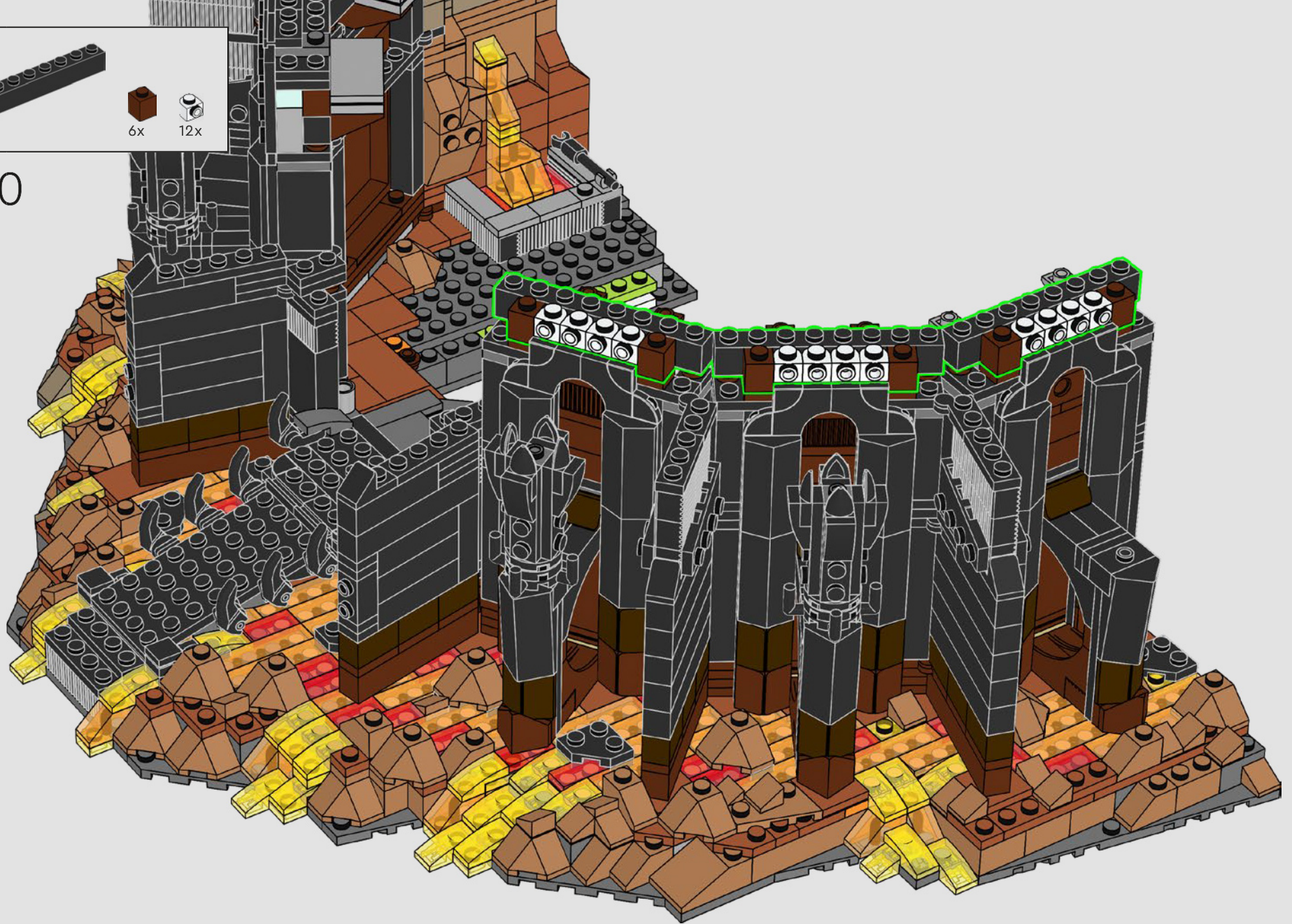

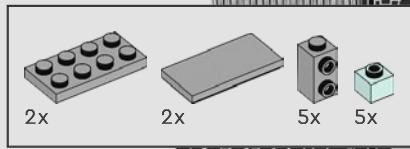

281

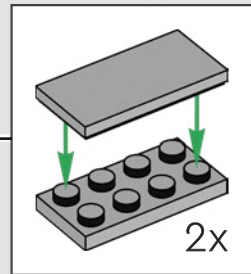
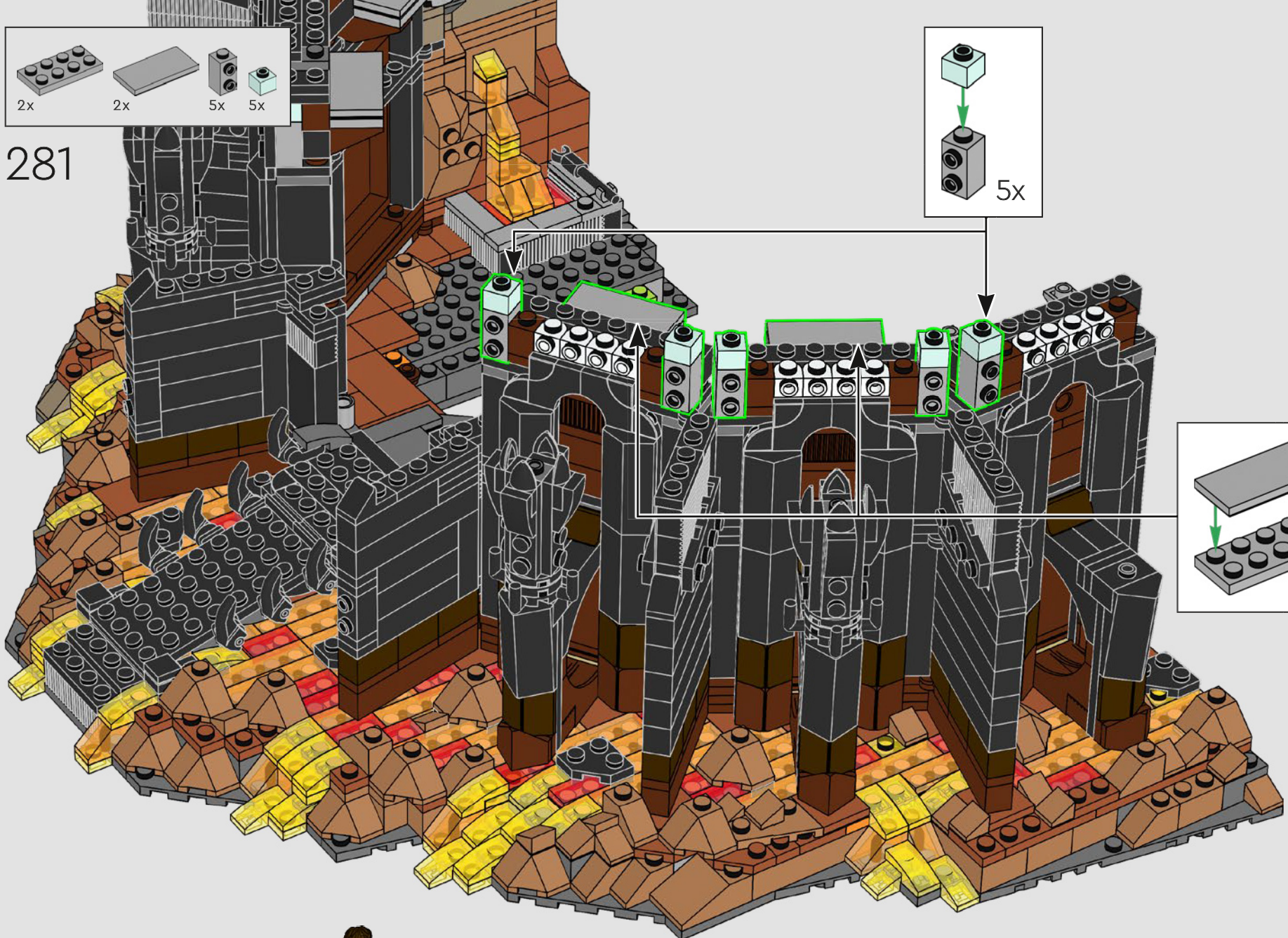
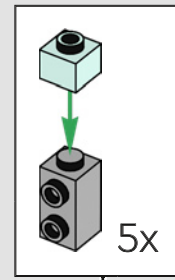

282

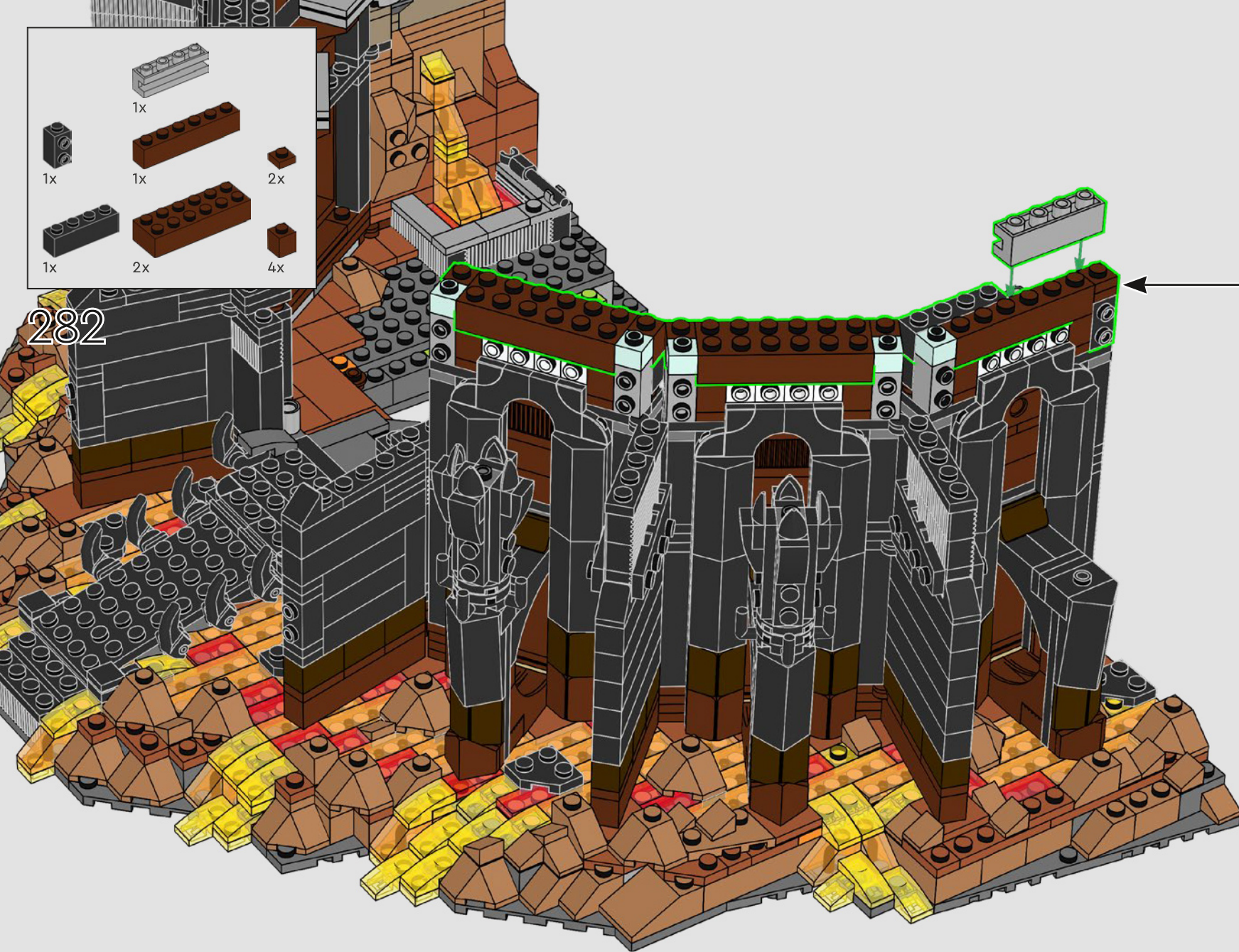
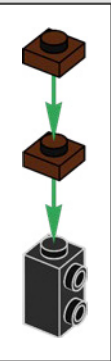
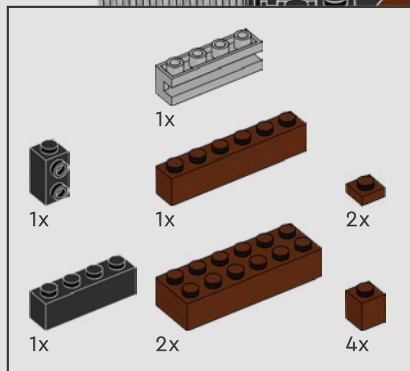

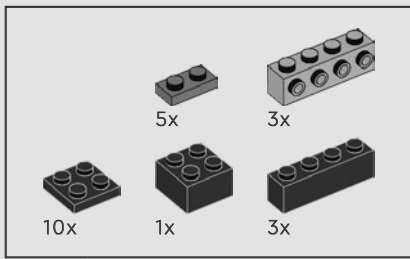

283

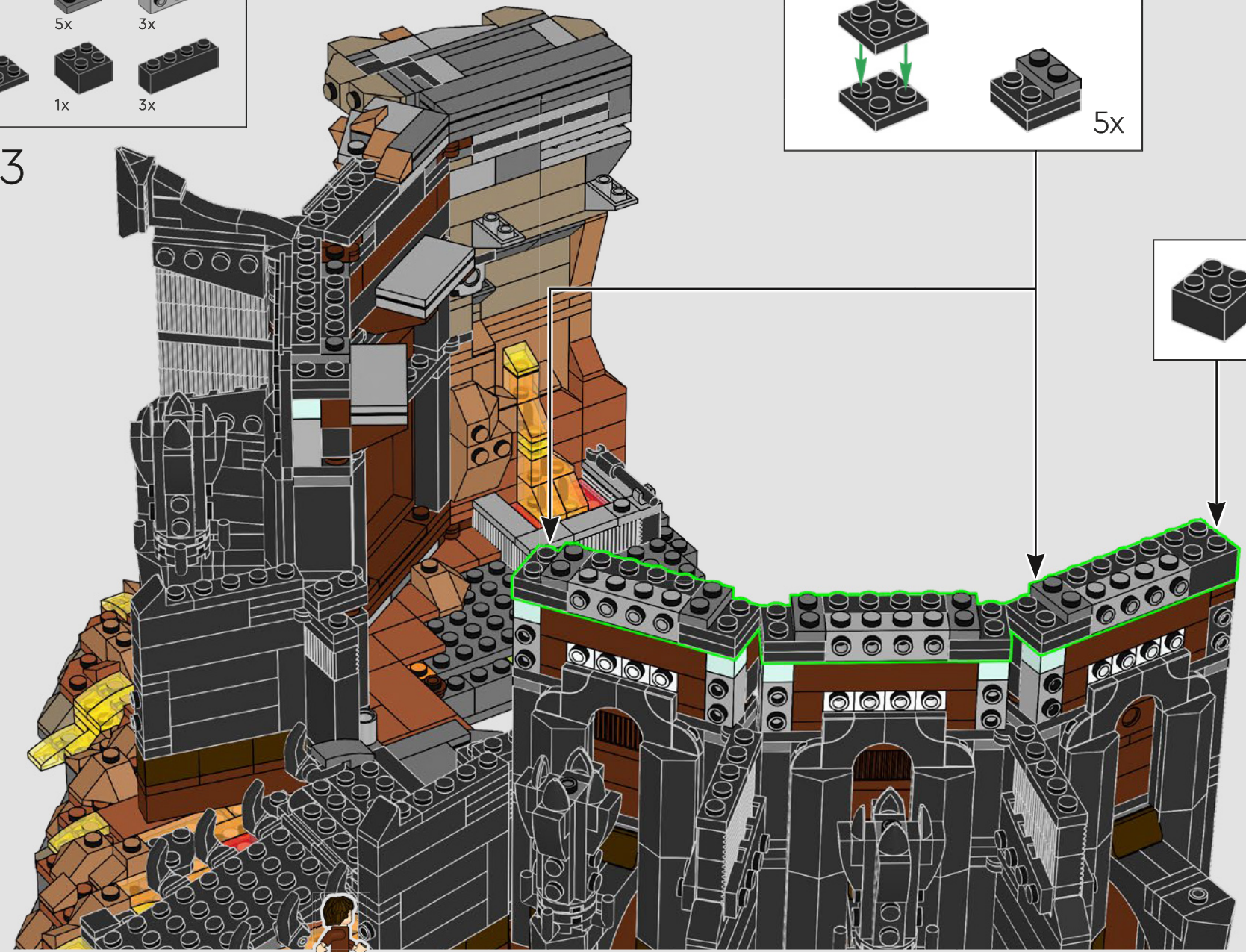
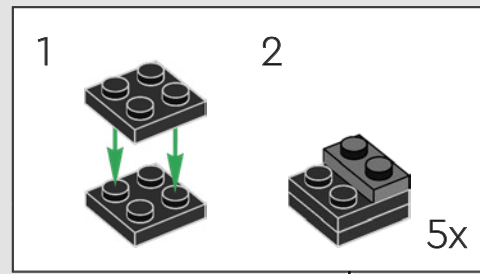

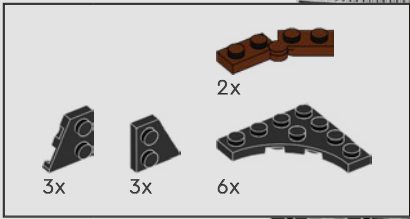

284

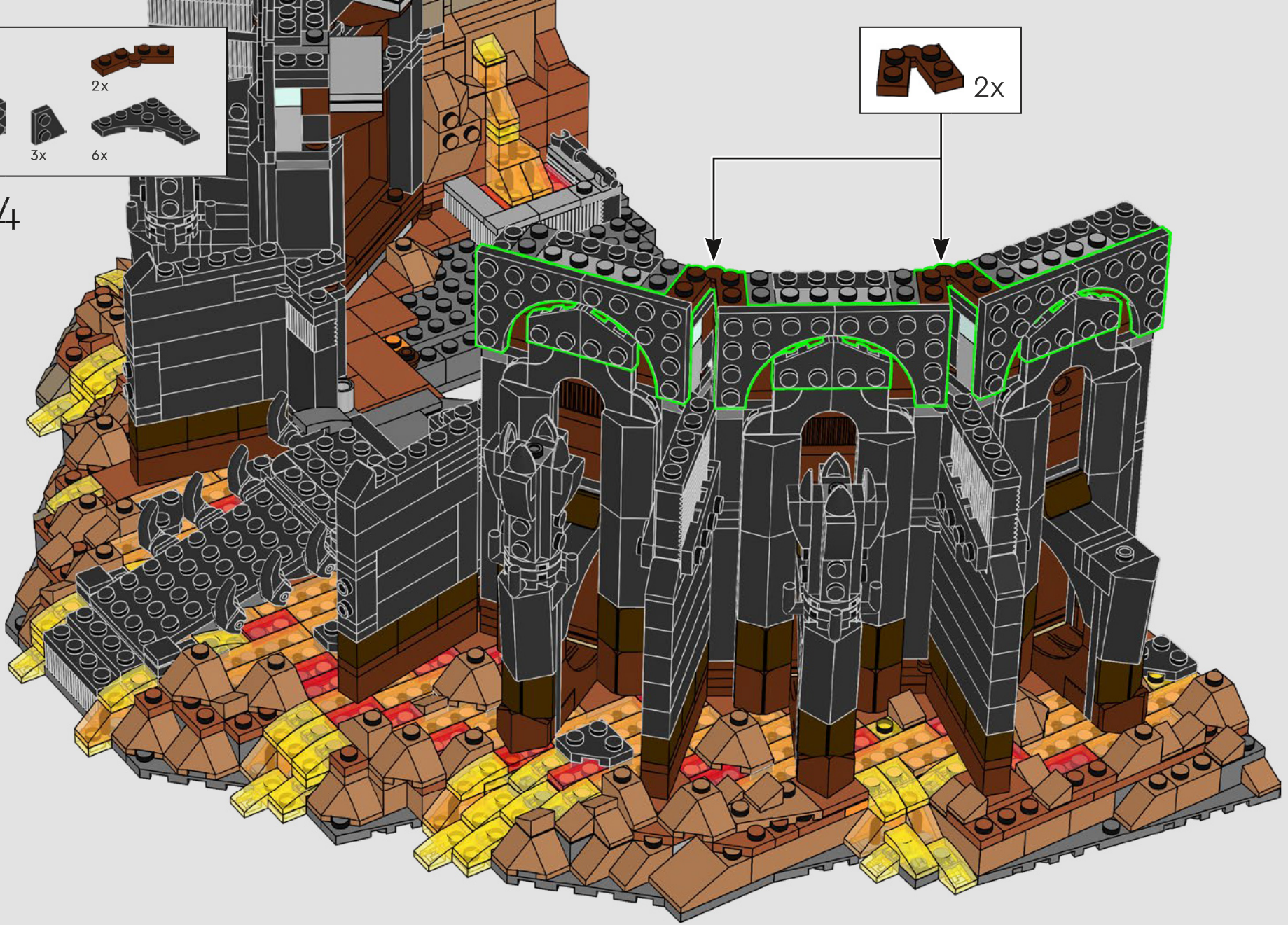

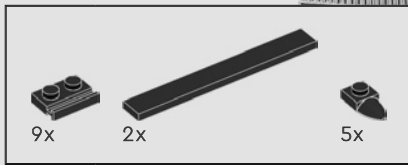



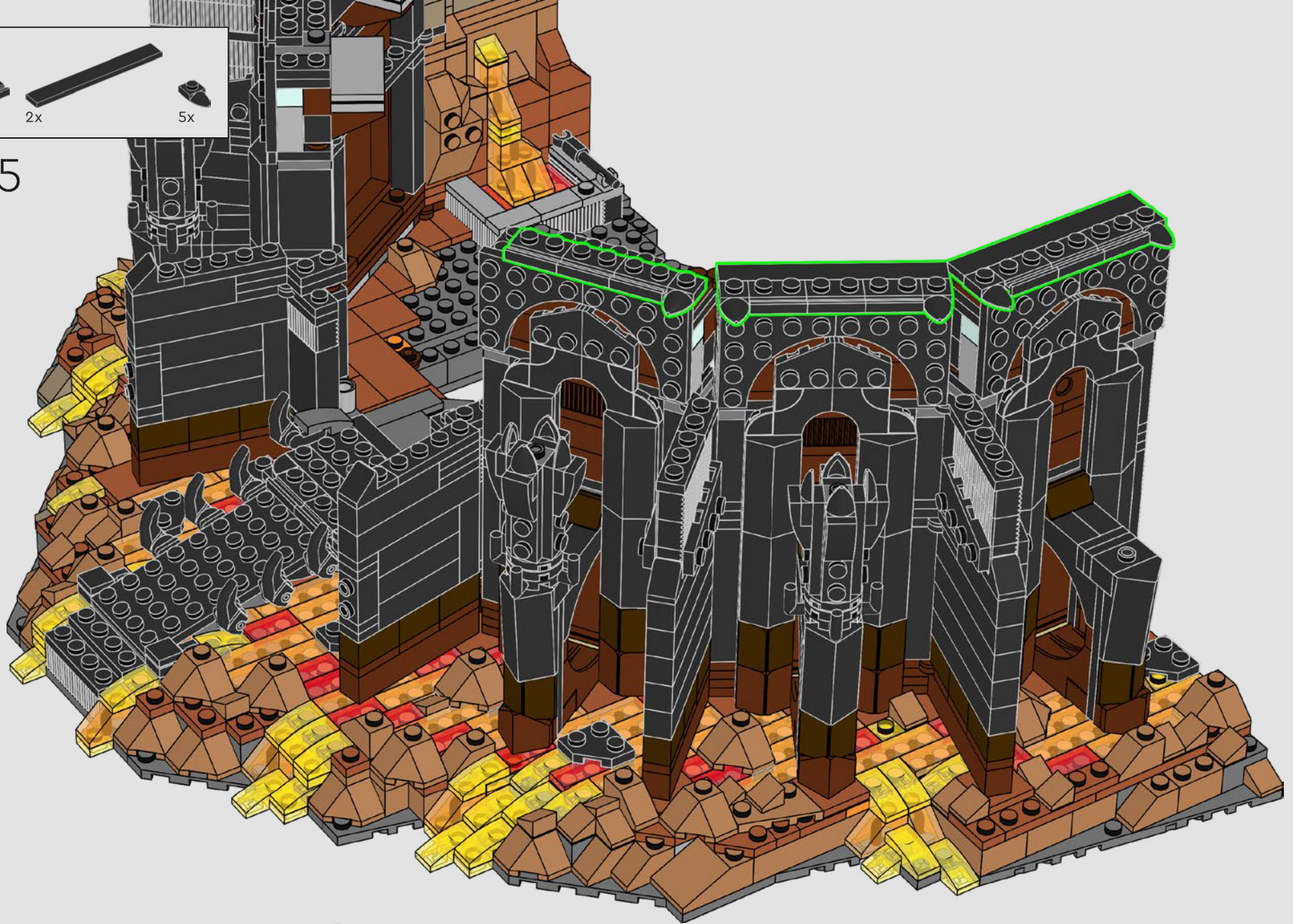

285



6x  2x 

286

1  
2    2x

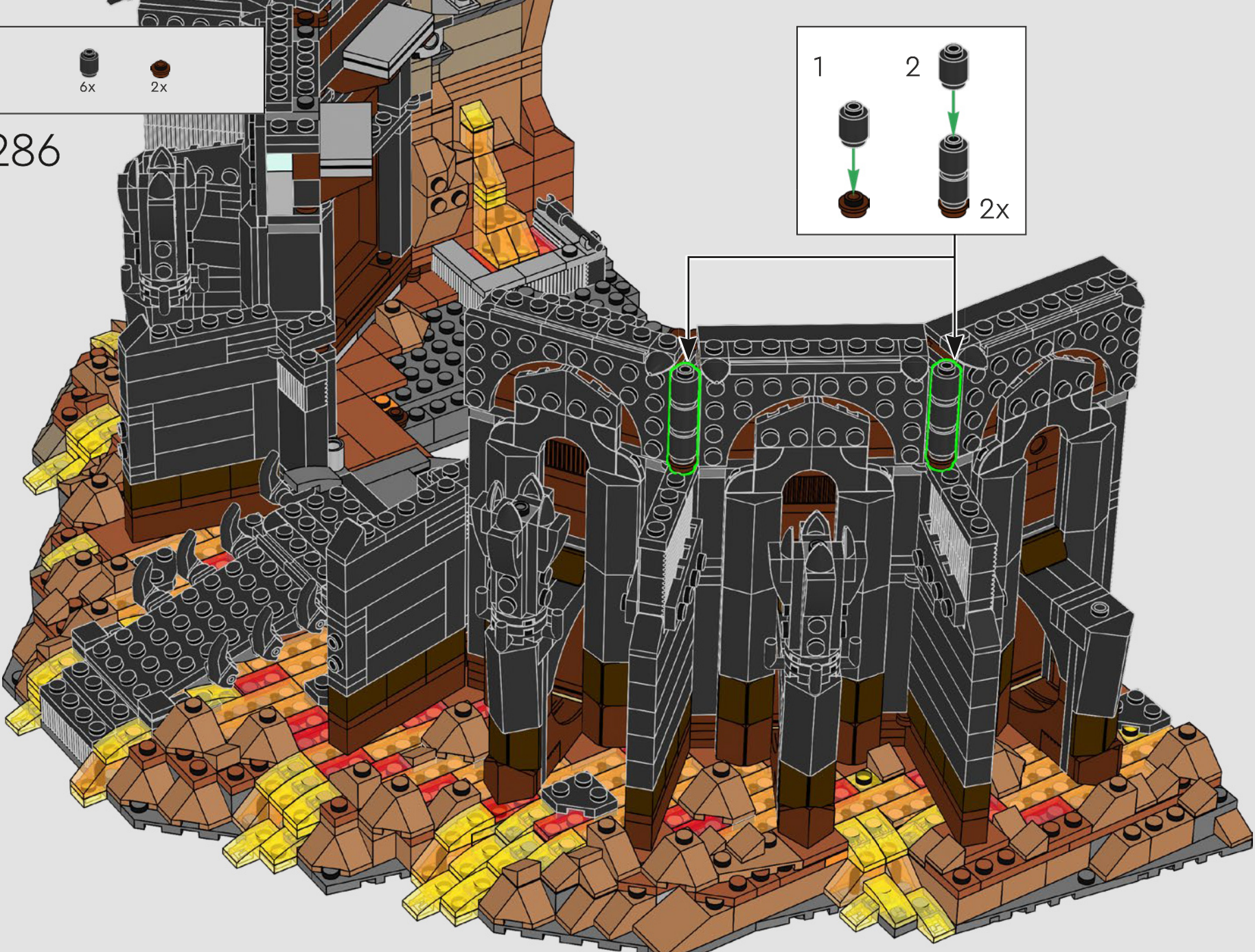



Se utilizaron 172 ladrillos negros 1x2 perfilados para crear los muros con textura de la torre.

287



10x



2x



4x

1

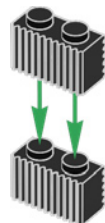

2

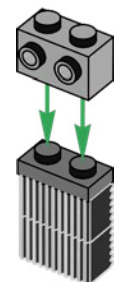

2x

1

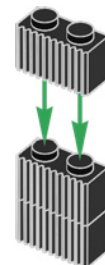

2

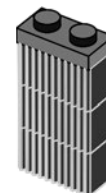

2x

288

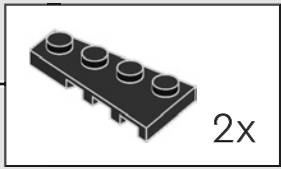
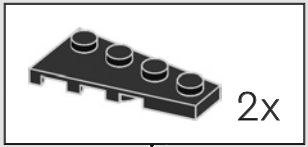

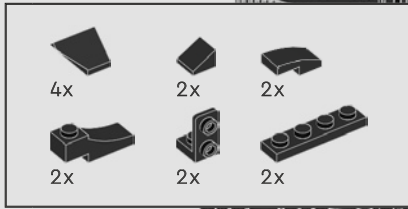

289

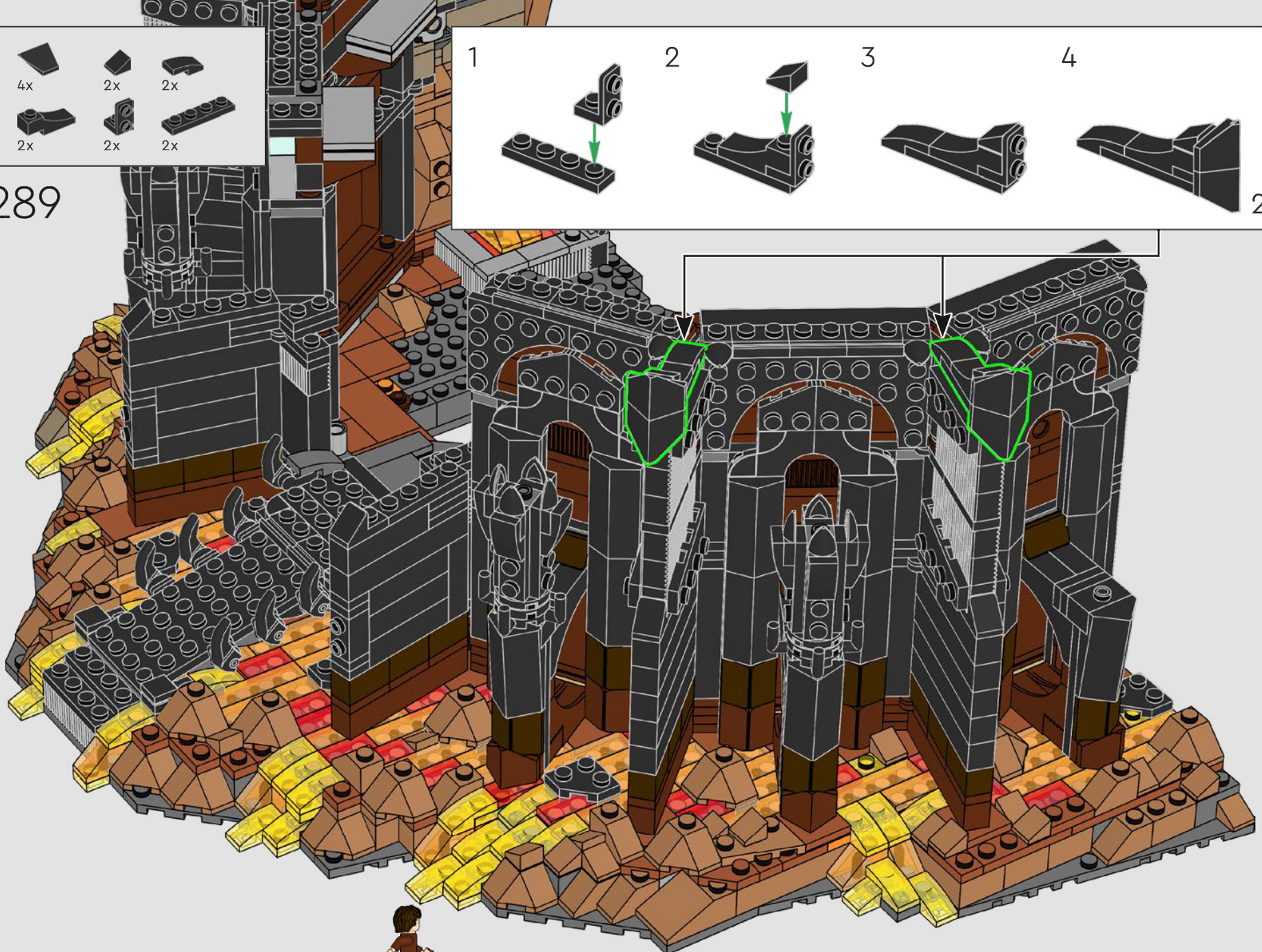
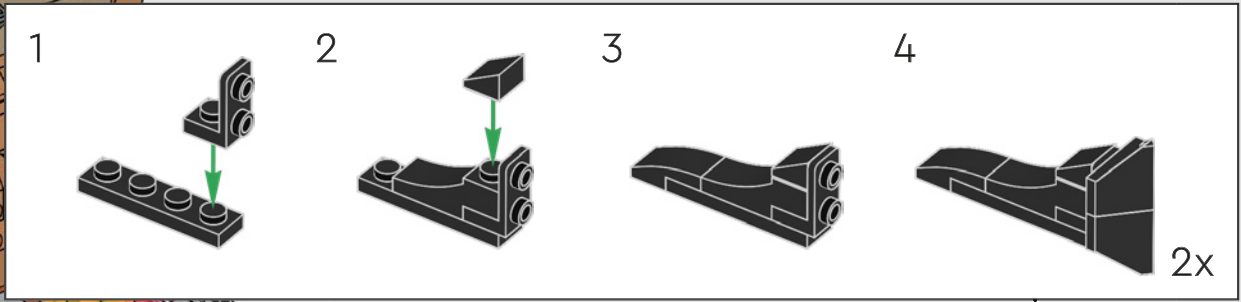

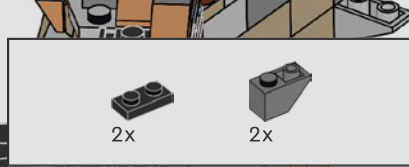
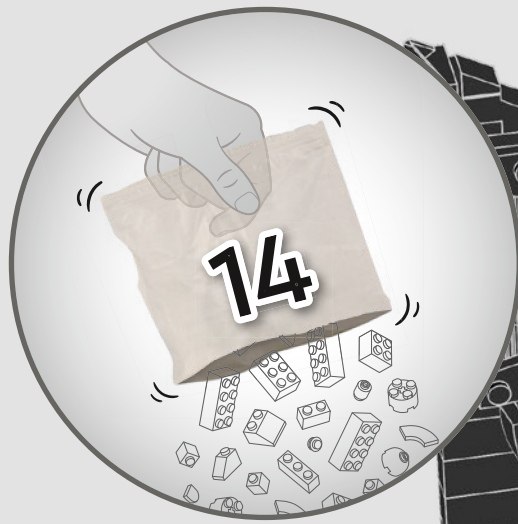

290

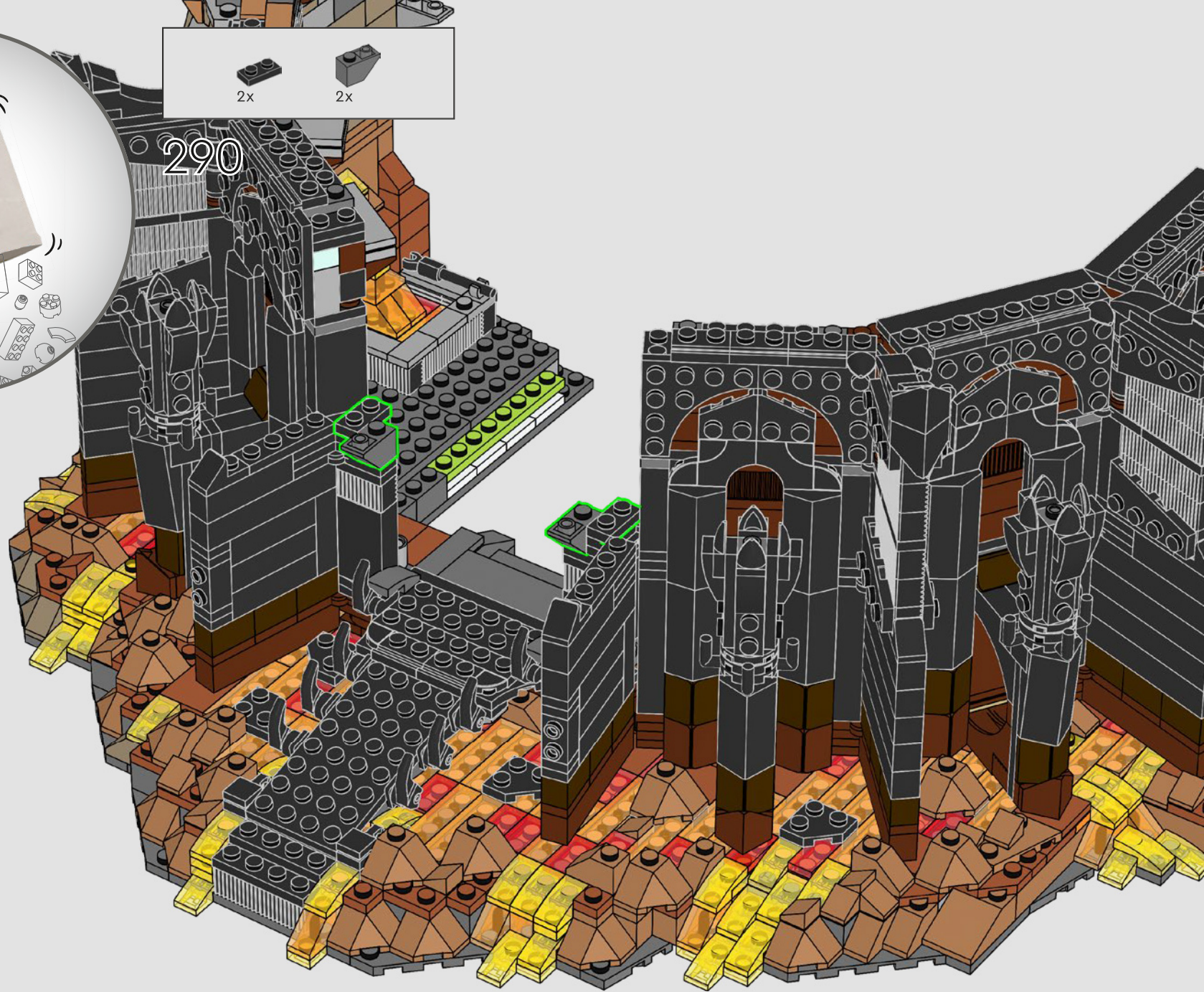

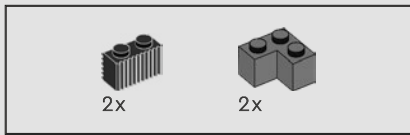

291

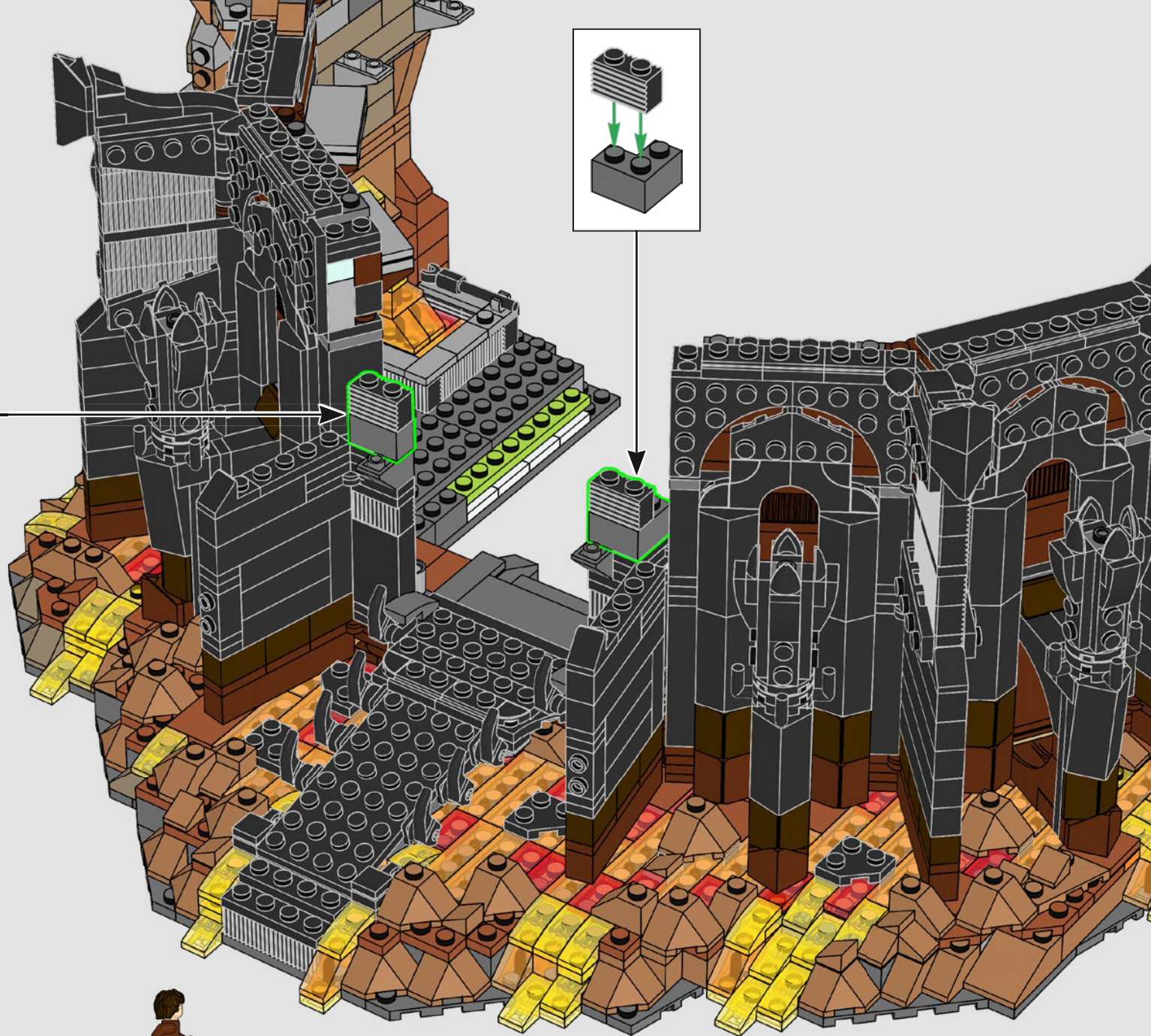
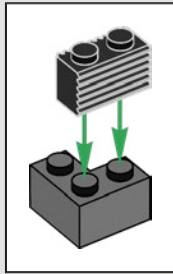

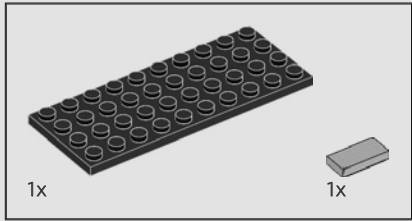
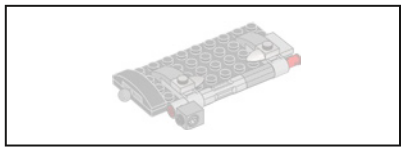

292

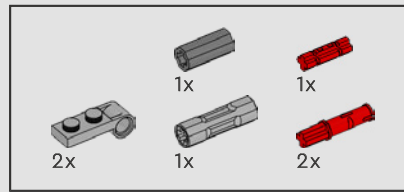
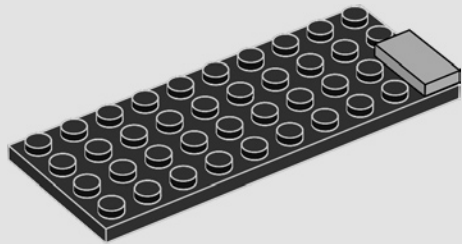

293

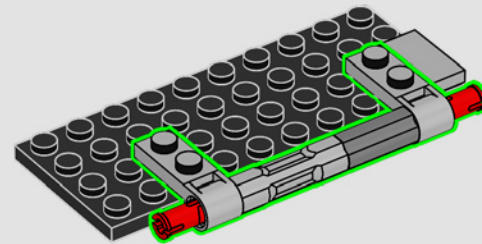
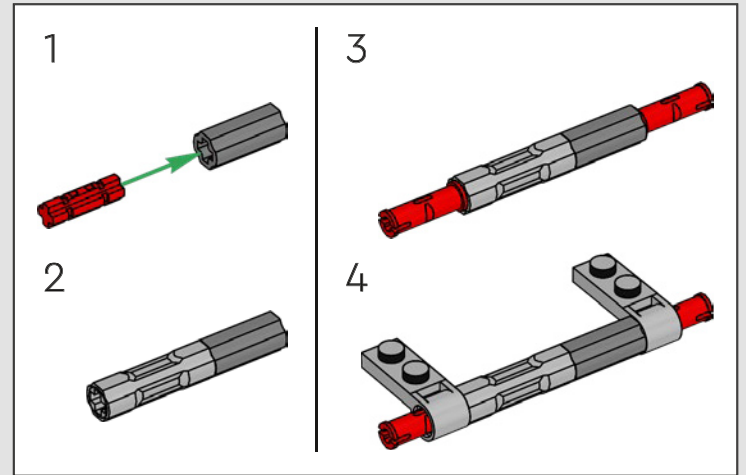

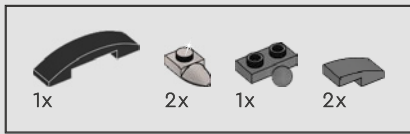

294

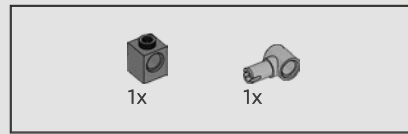
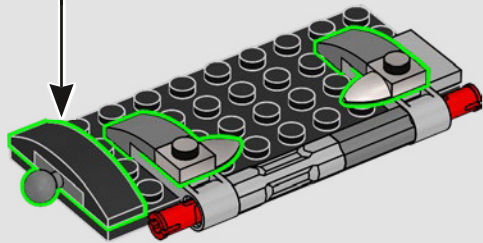
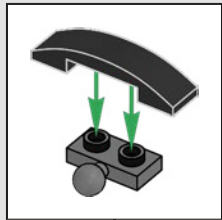

295

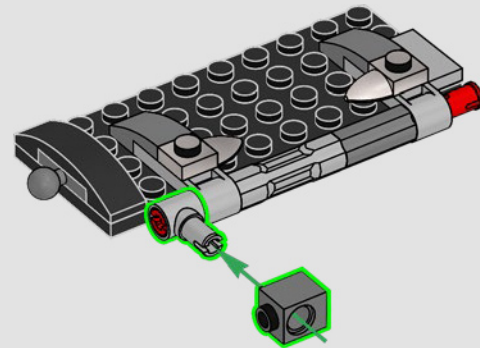

296



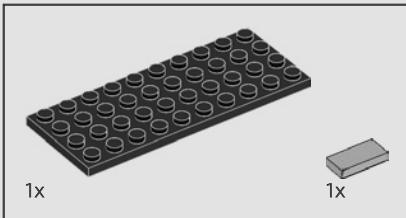
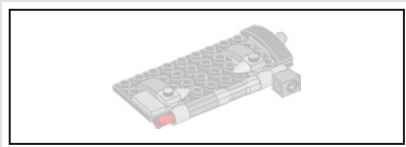

297

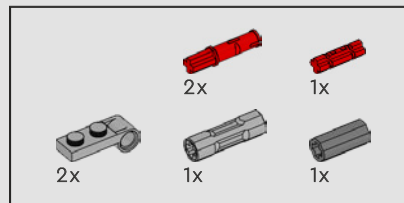
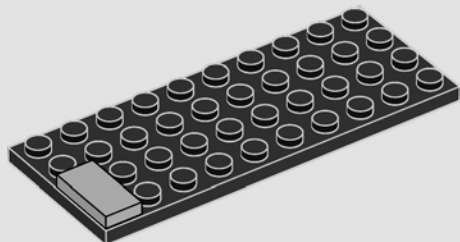

298

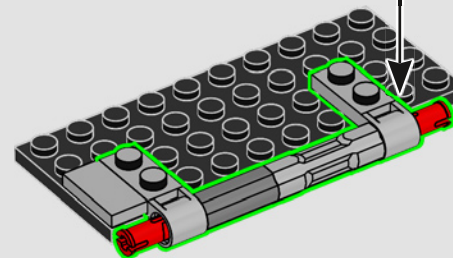
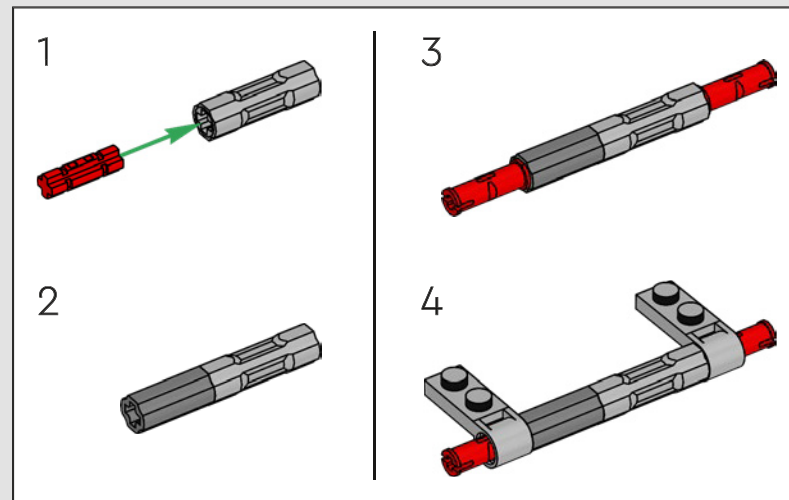

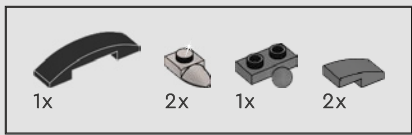

299

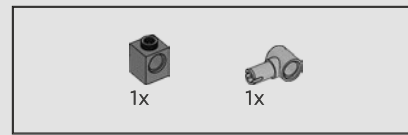
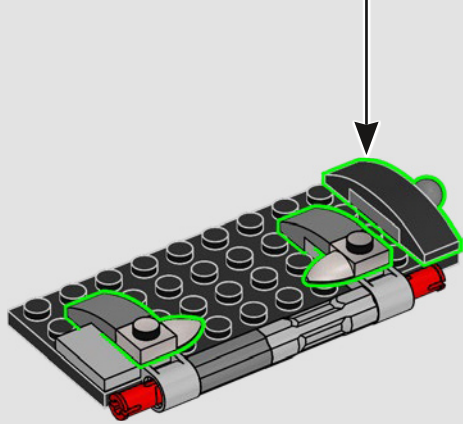
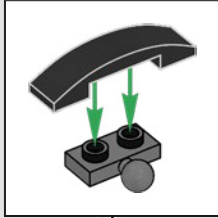

300

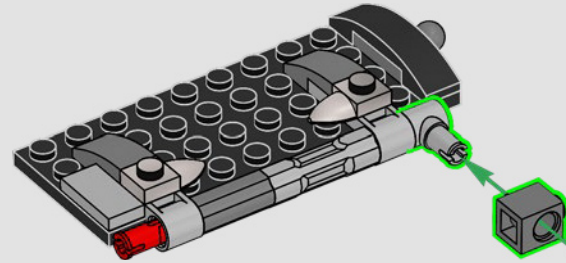

301

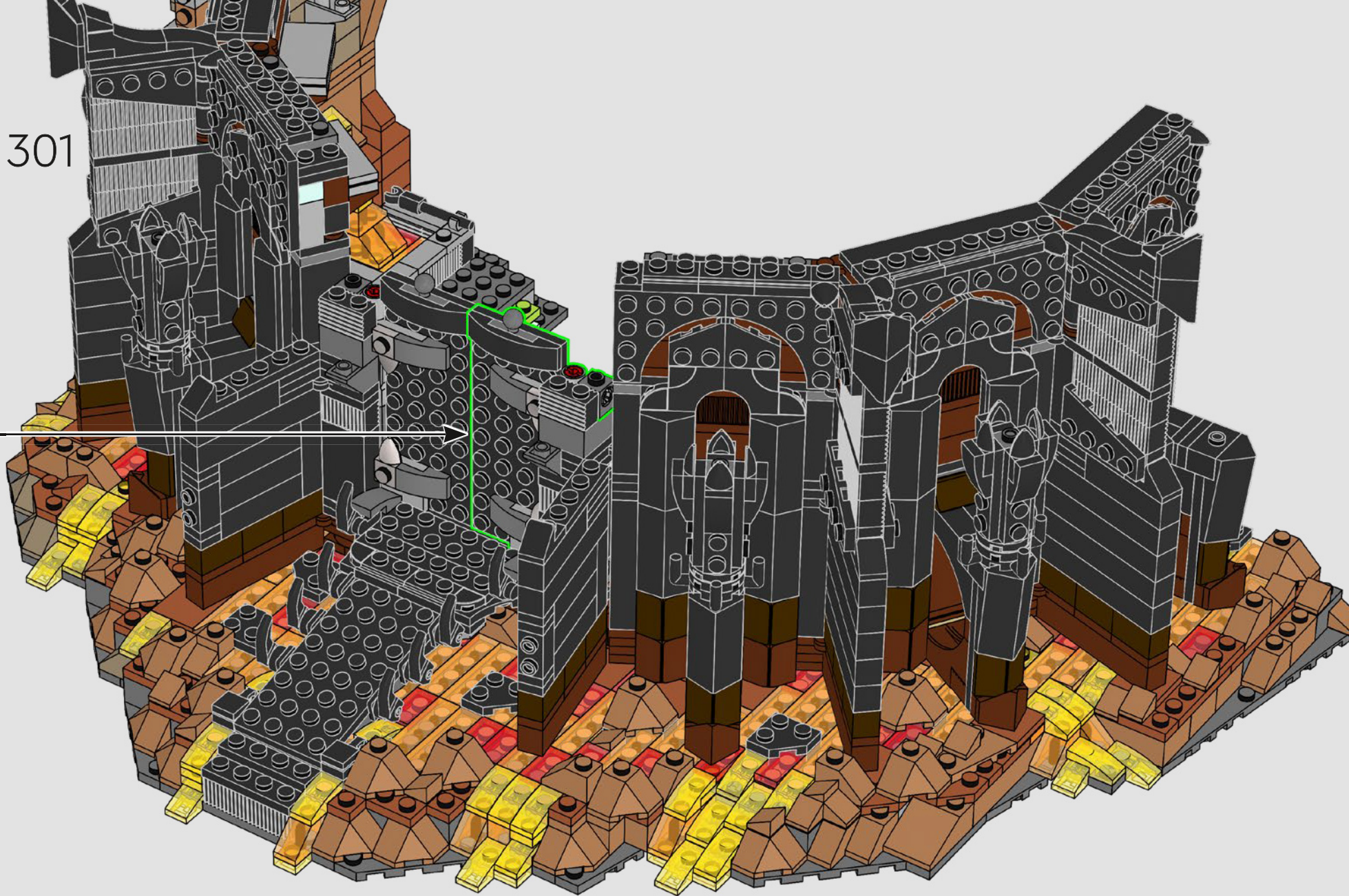

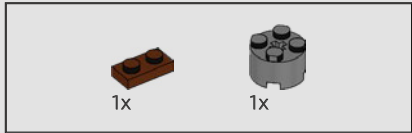
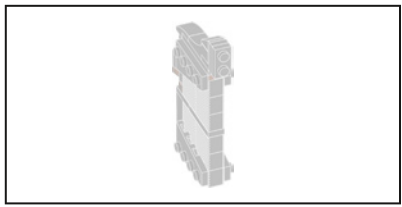

302

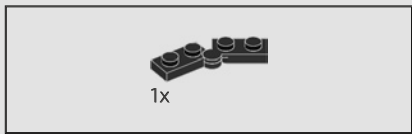
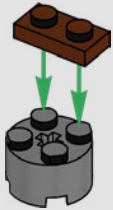

303

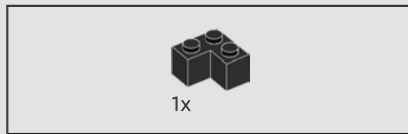
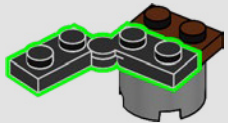

304

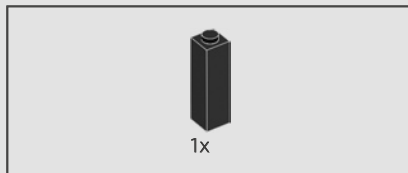
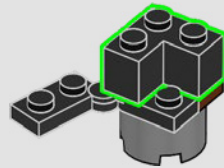

305

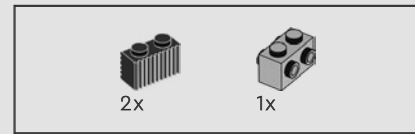
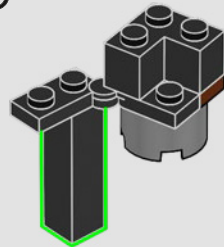

306

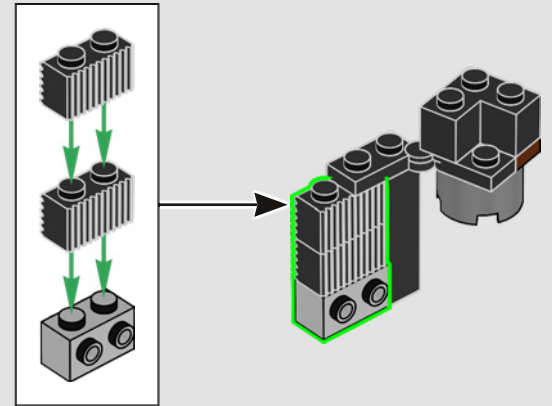

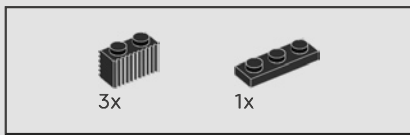

307

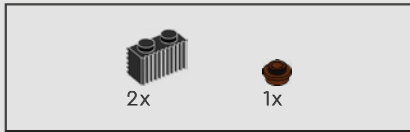
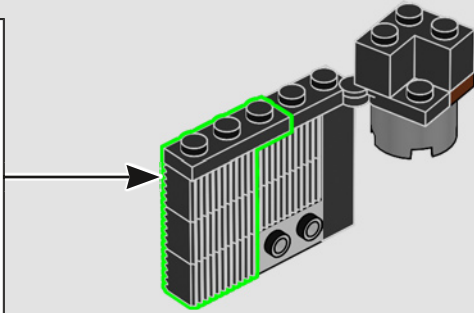
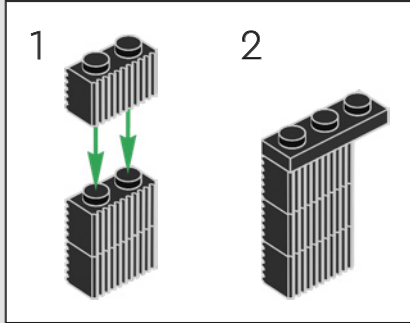

308

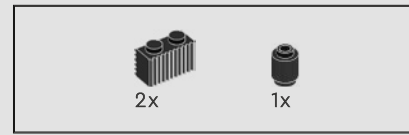
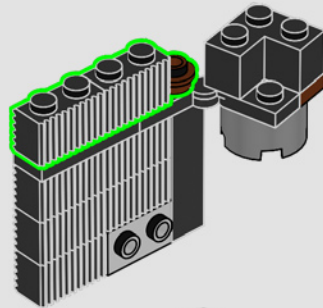

309

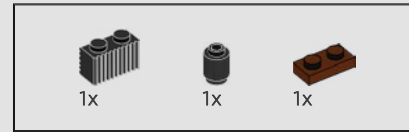
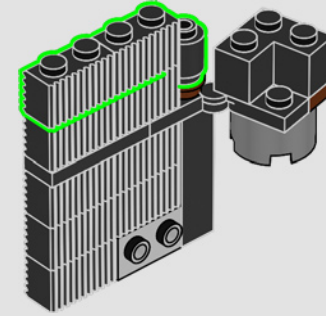

310

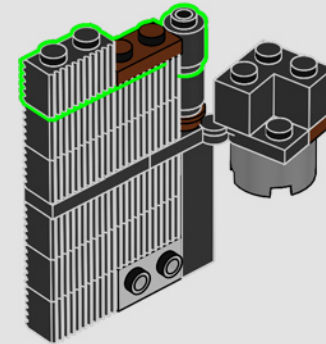



311

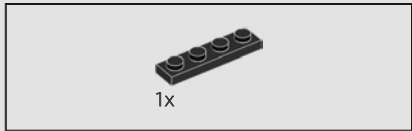
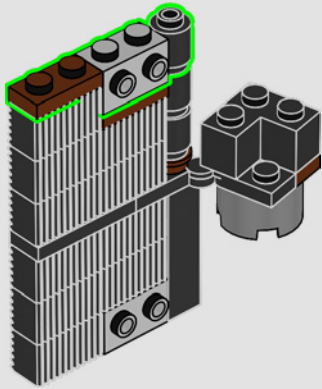

312

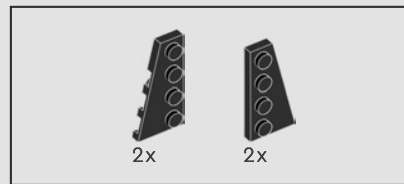
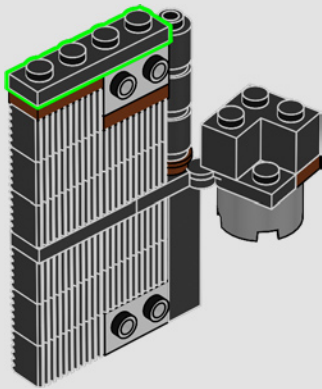

313

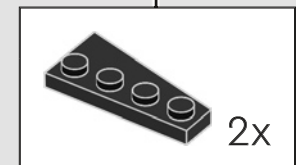
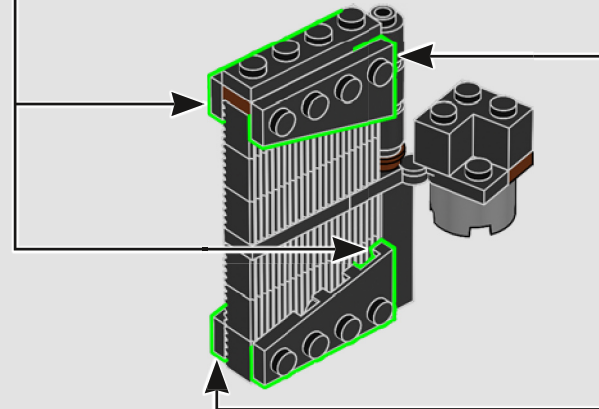
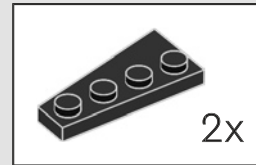



314

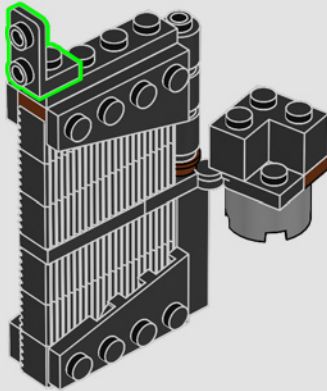

315

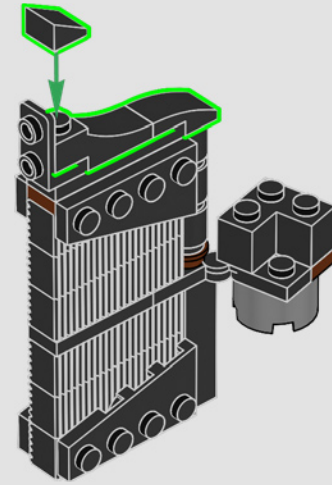

316

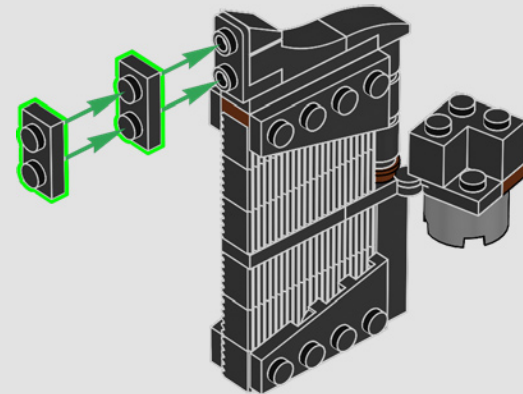



Fue Gollum™ quien reveló a Sauron™ que el Anillo Único había resurgido en la Comarca, en posesión de un Hobbit™ de apellido Bolsón.

317

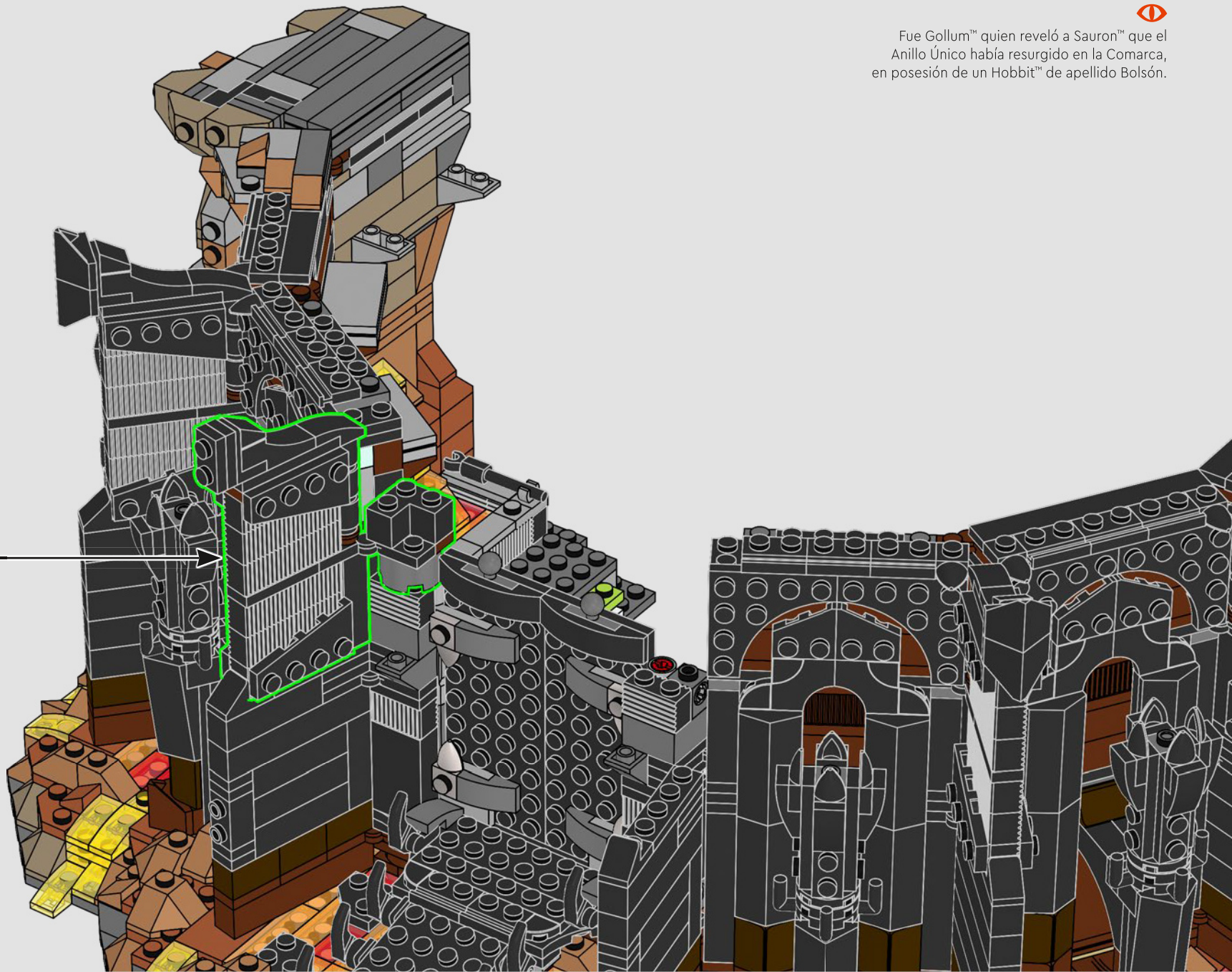

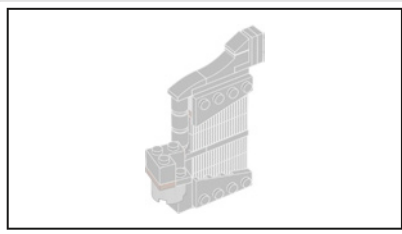

318

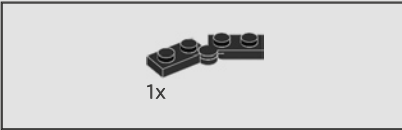
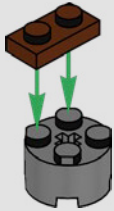

319

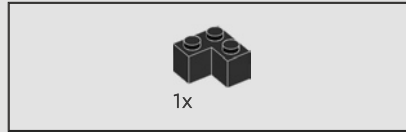
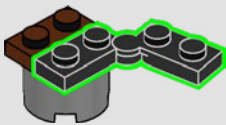

320

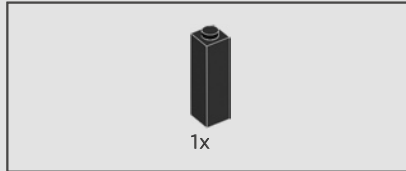
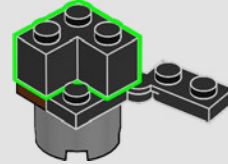

321

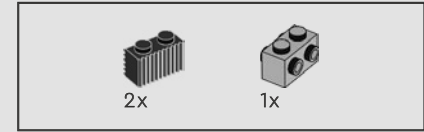
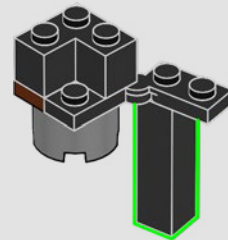

322

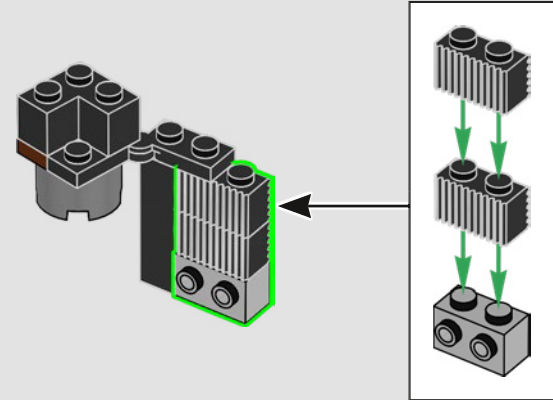

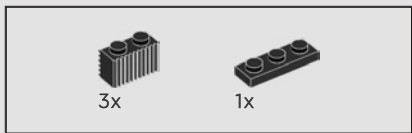

323

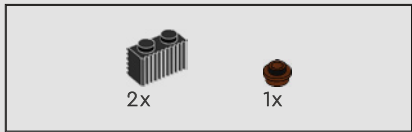
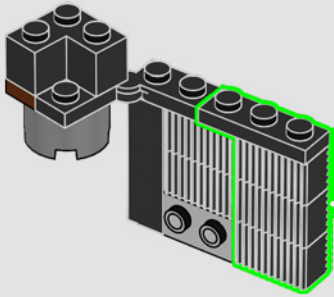
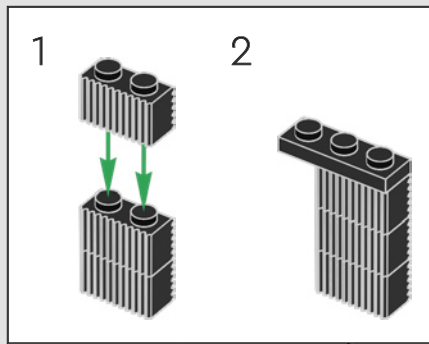

324

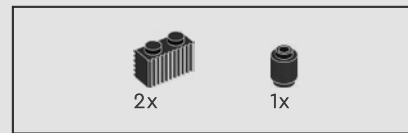
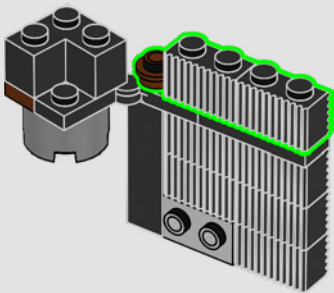

325

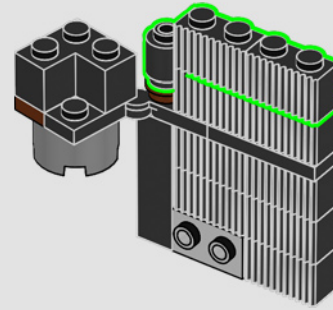

326

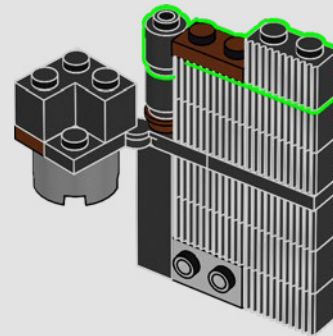



327

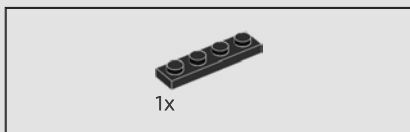
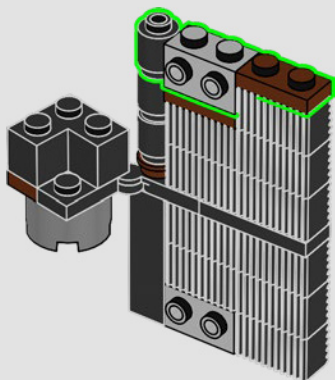

328

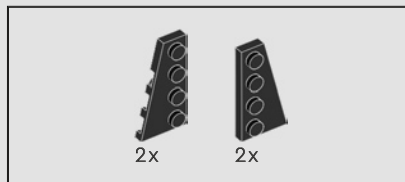
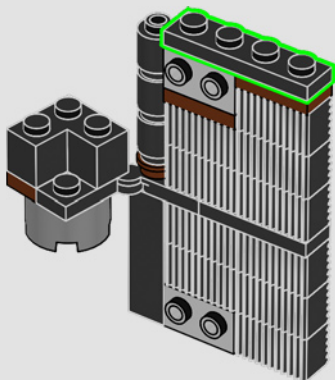

329

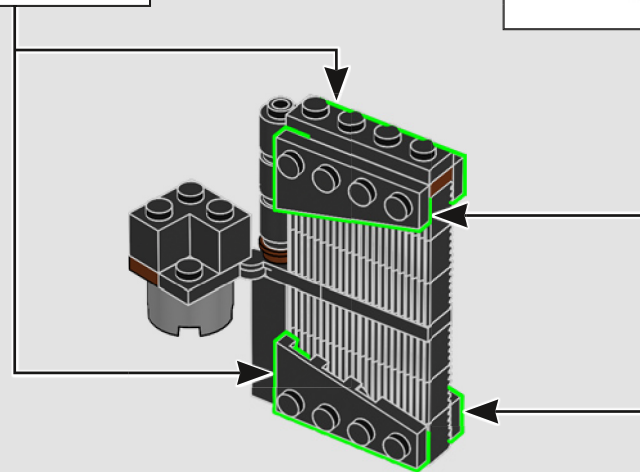
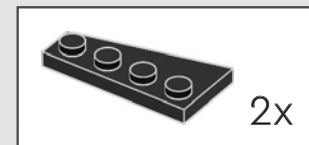
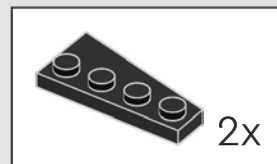



1x

330

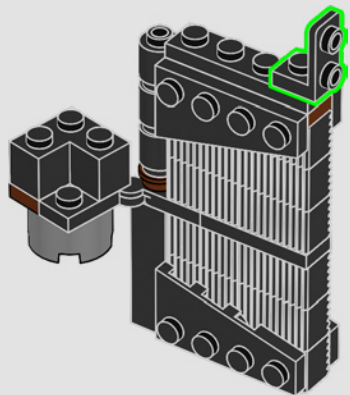

1x



1x



1x

331

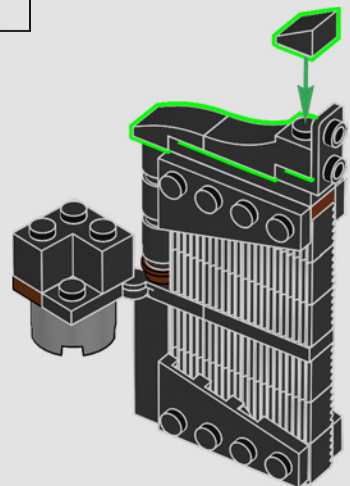

2x

332

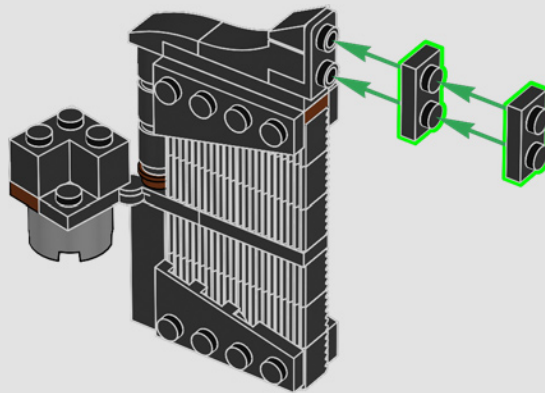

333

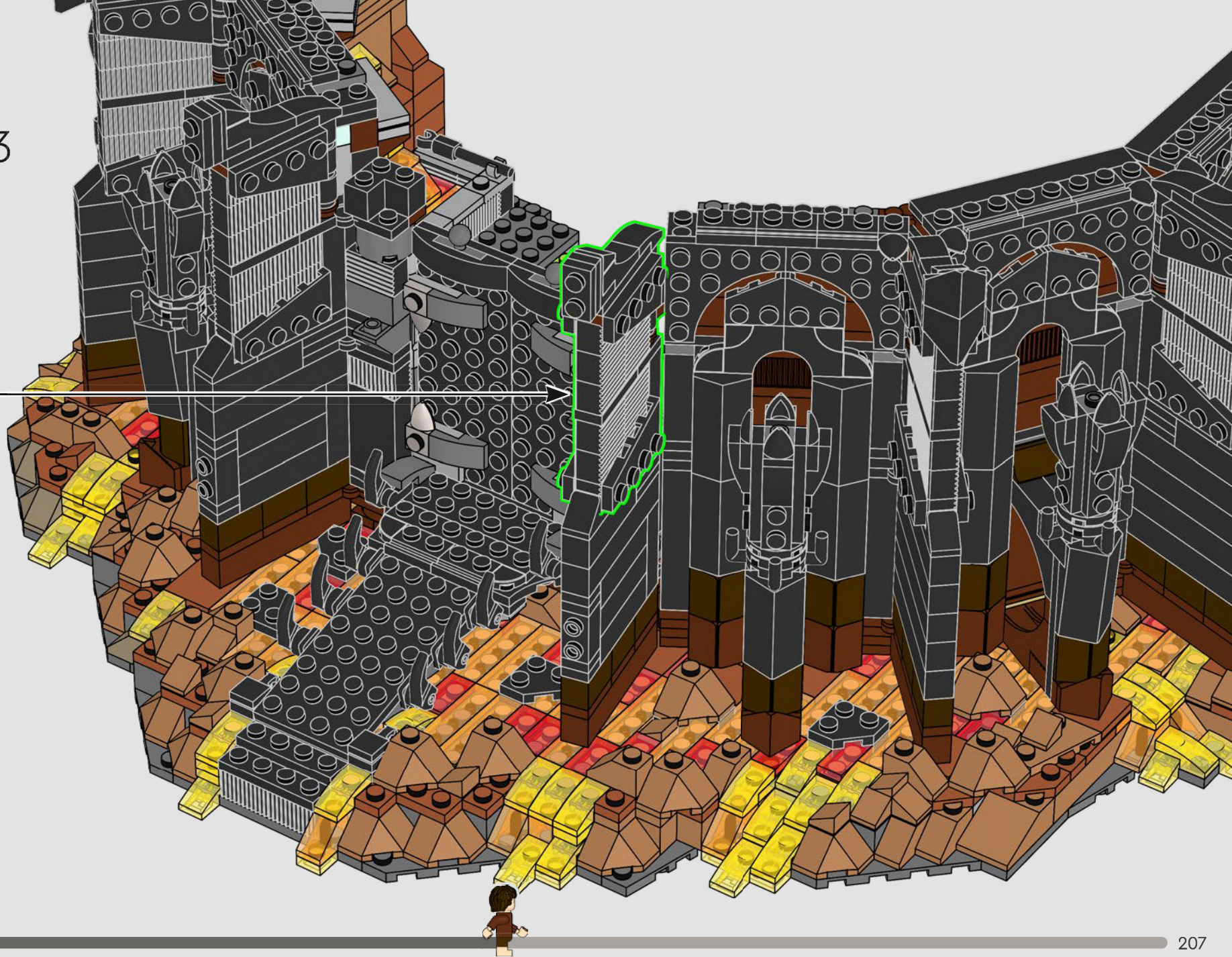

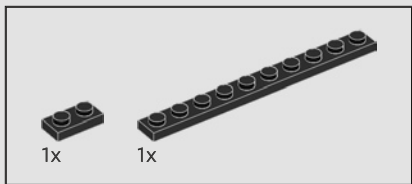

334

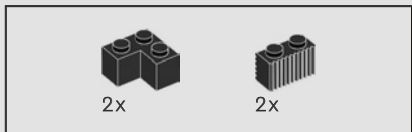
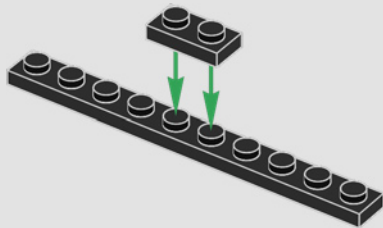

335

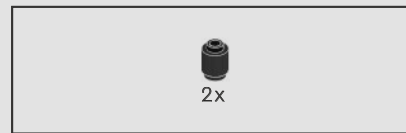
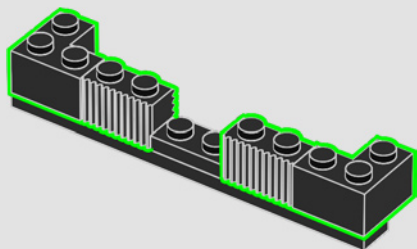

336

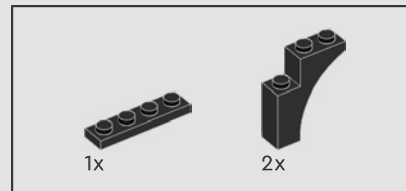
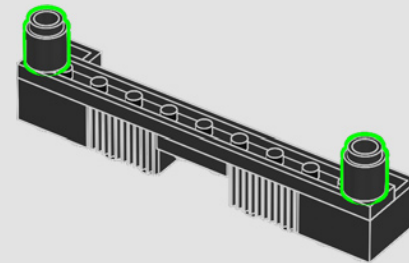

337

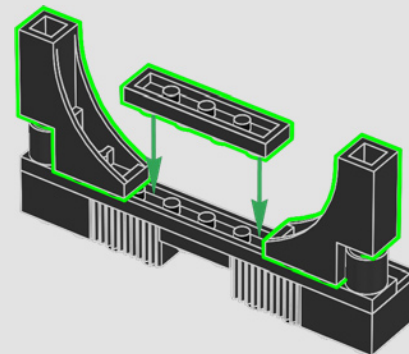

338

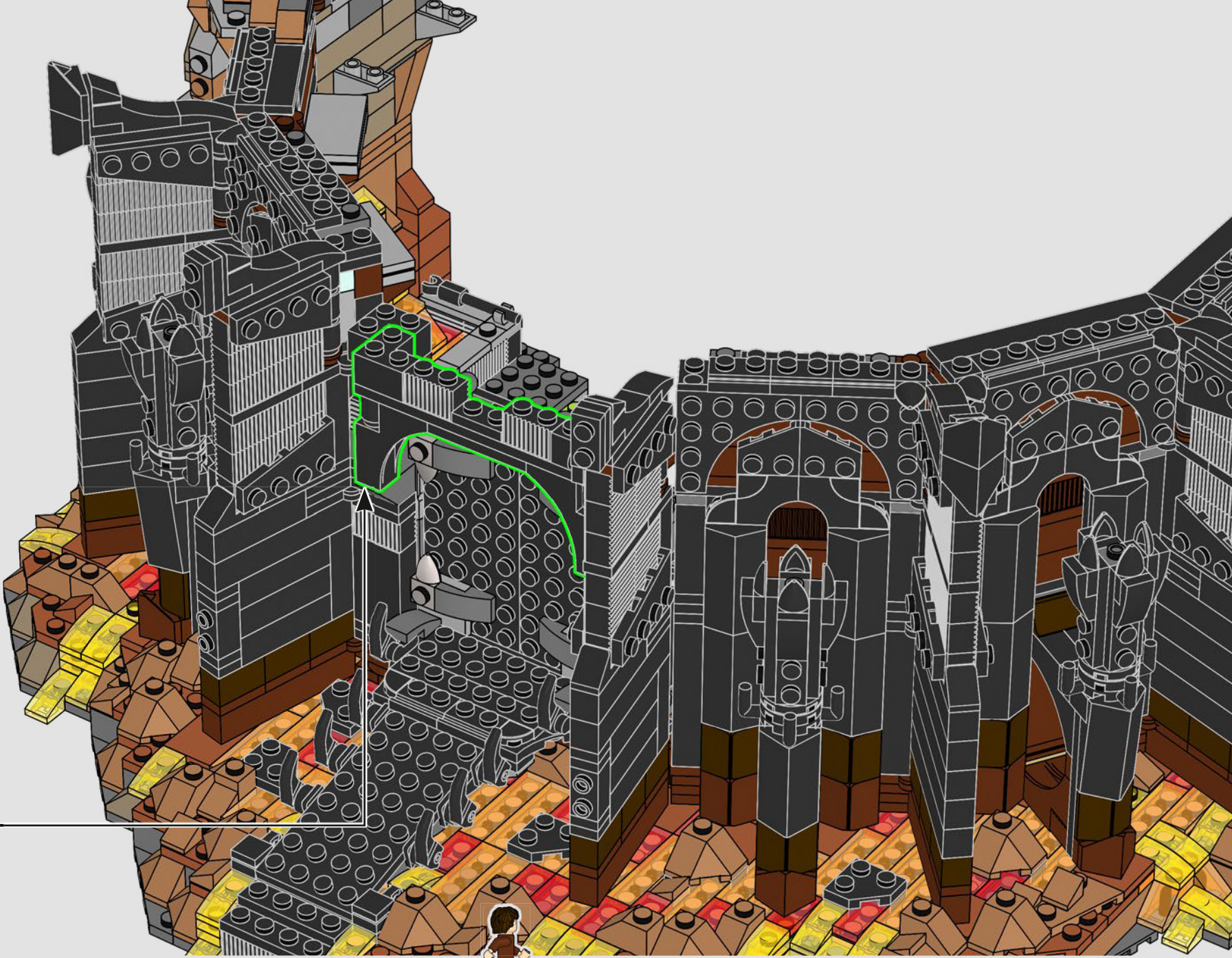

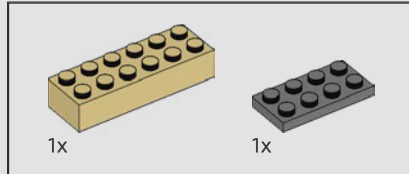
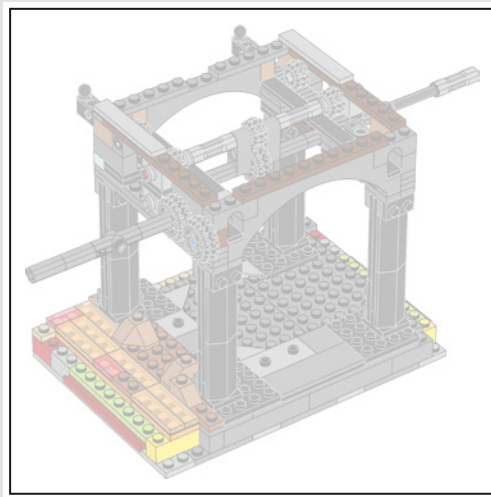

339

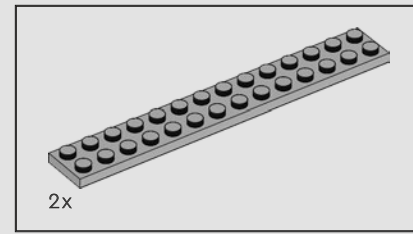
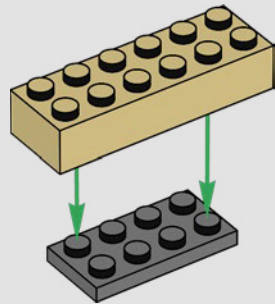

340

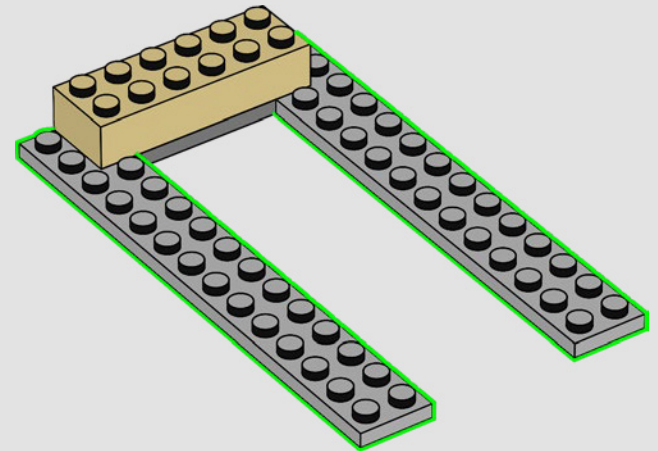

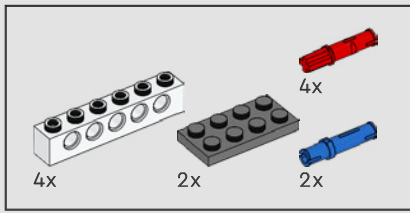

341

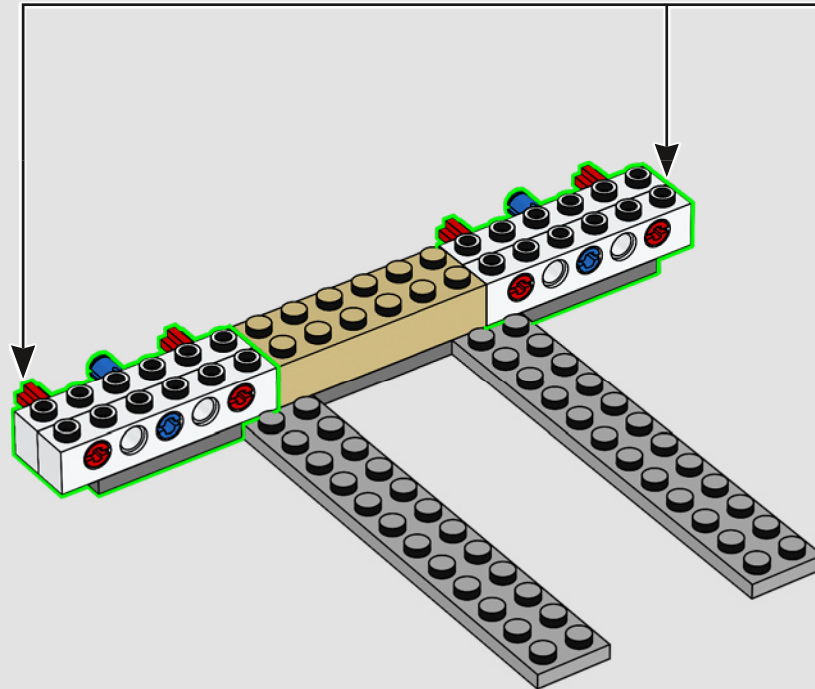
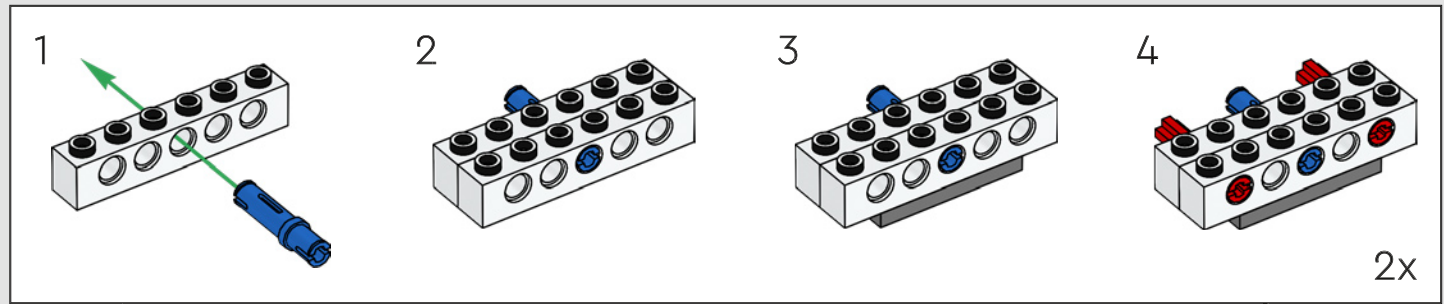

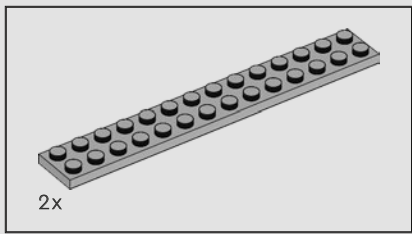

342

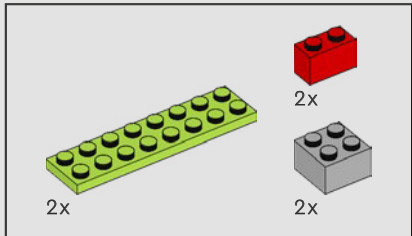
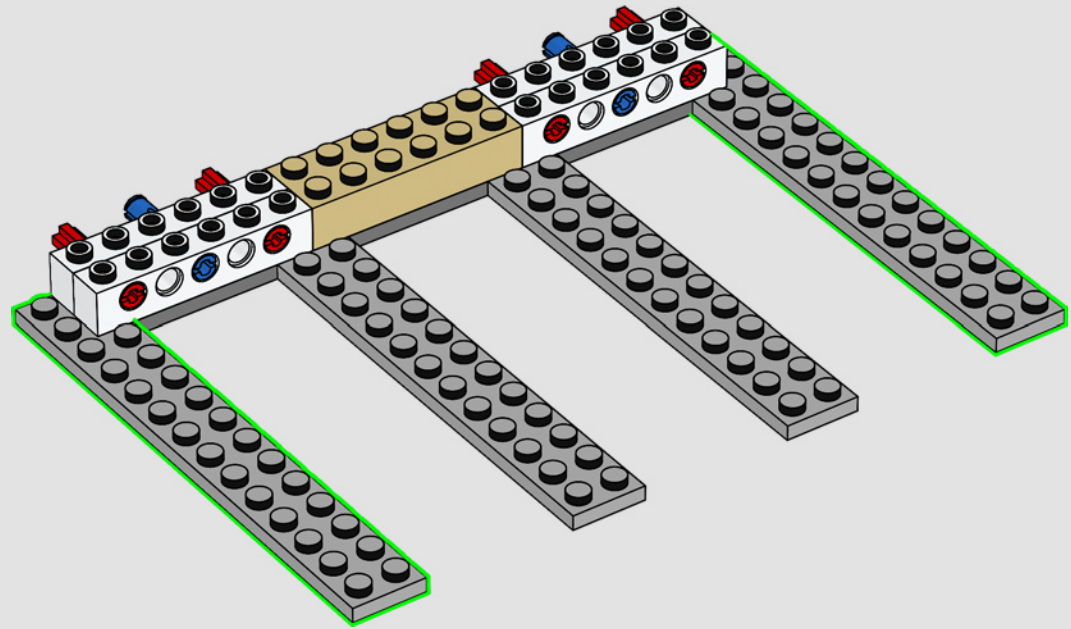

343

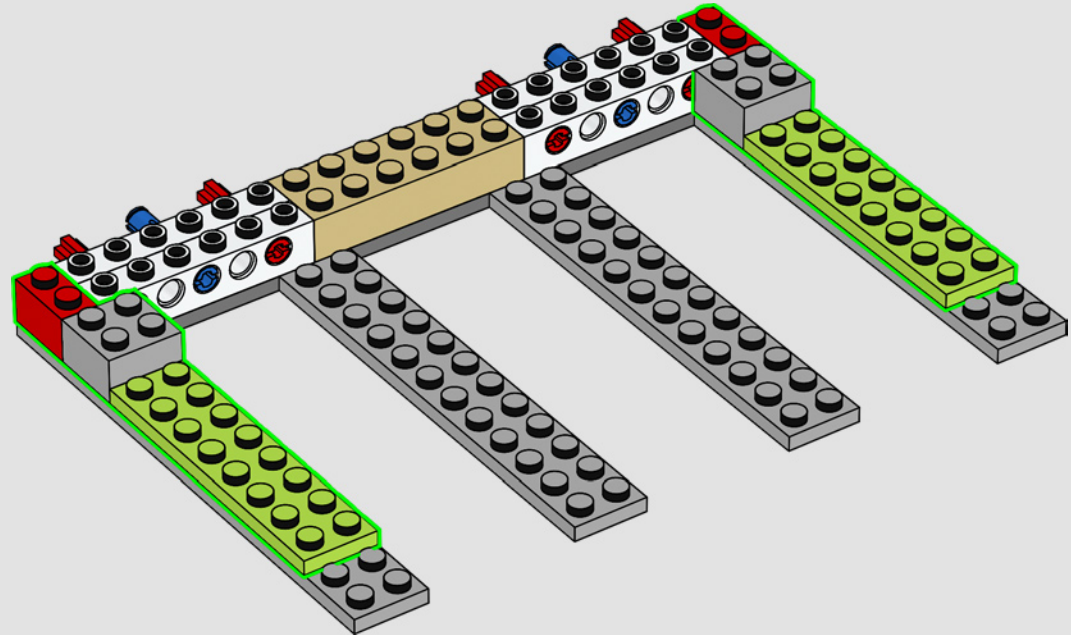

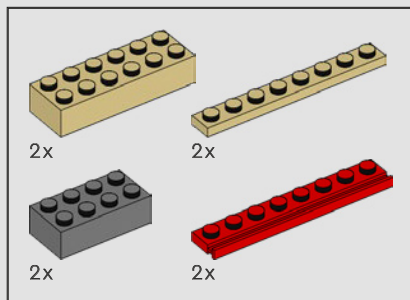

344

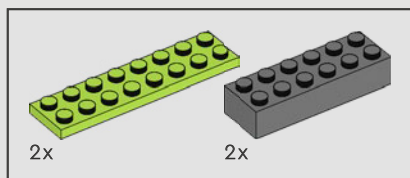
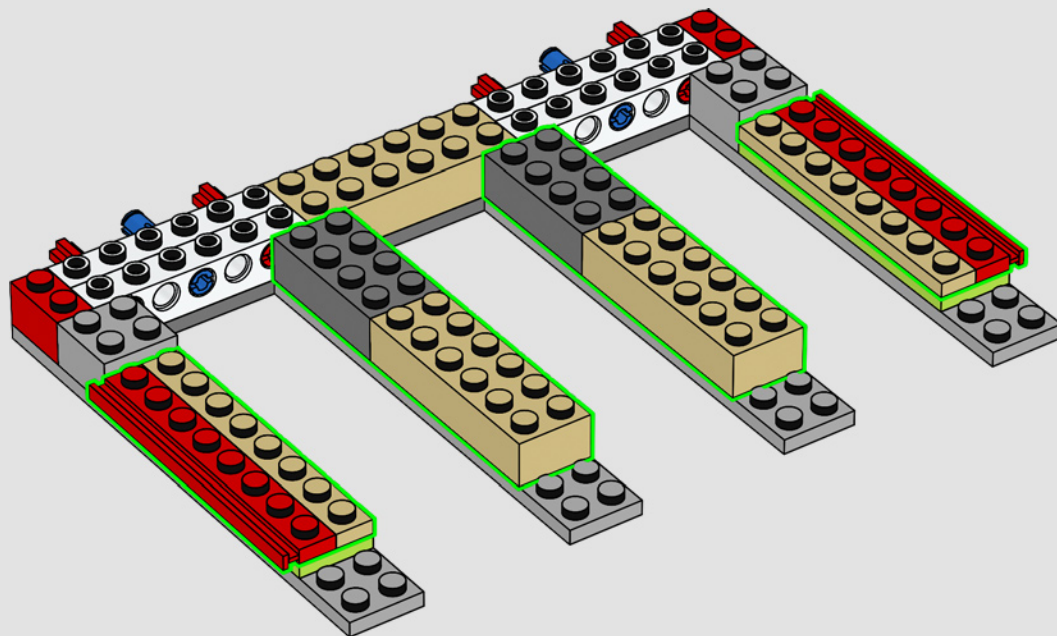

345

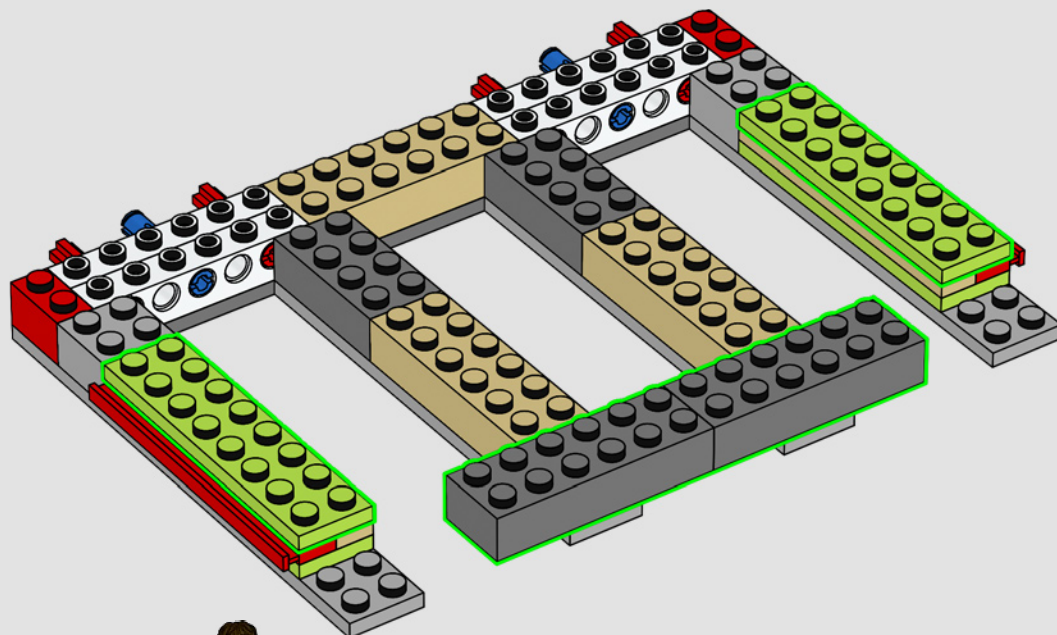

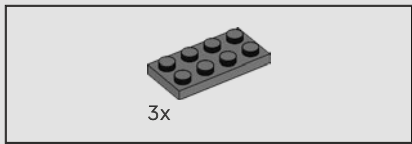

346

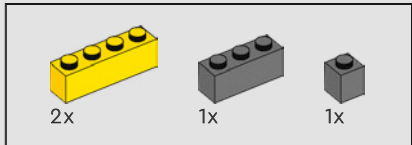
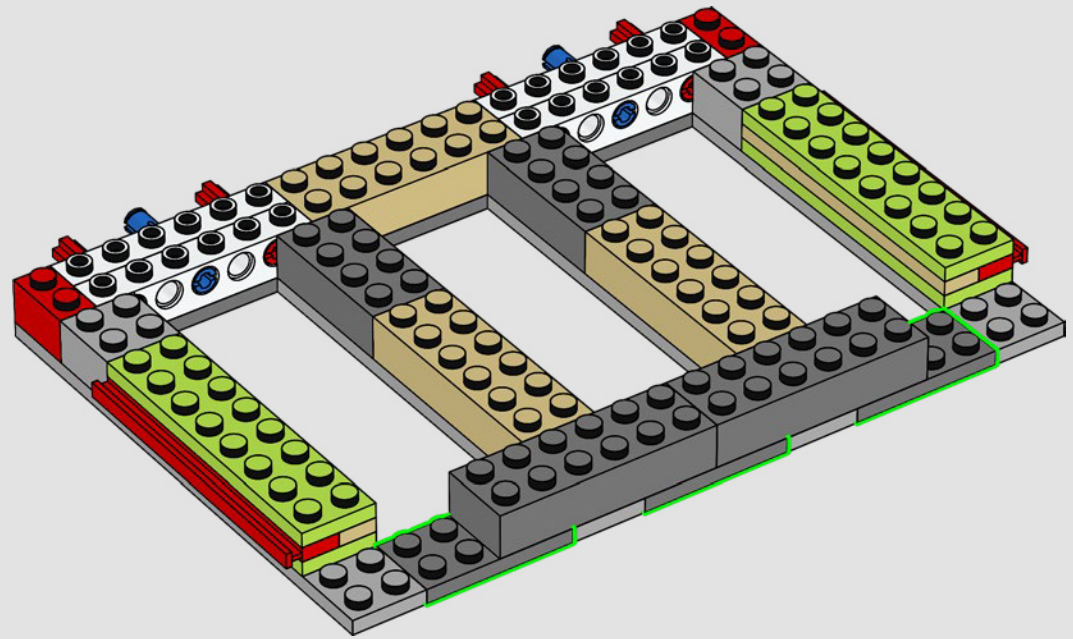

347

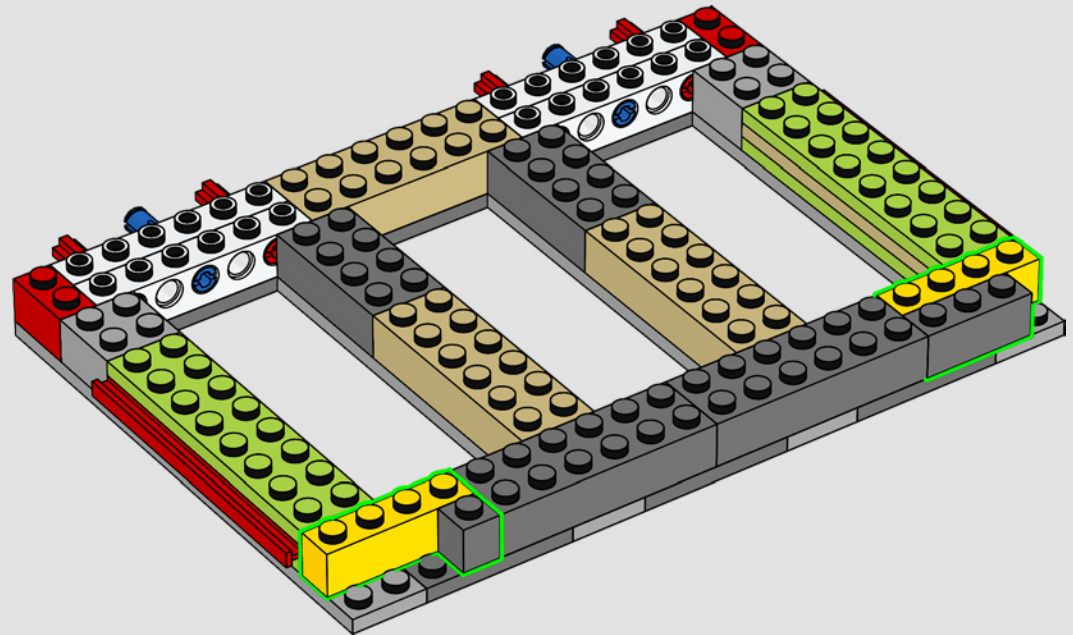

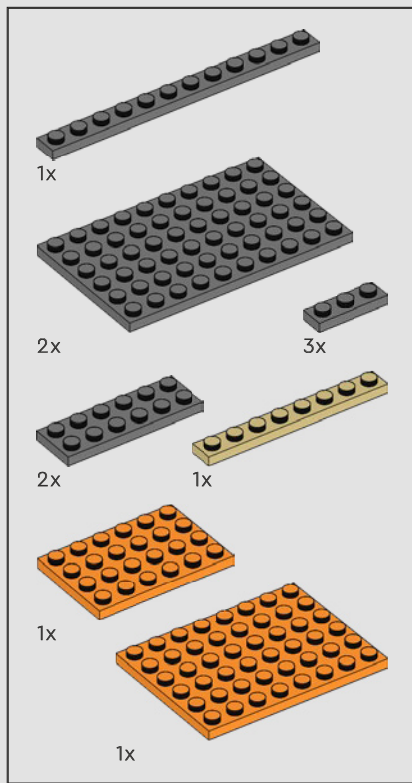

348

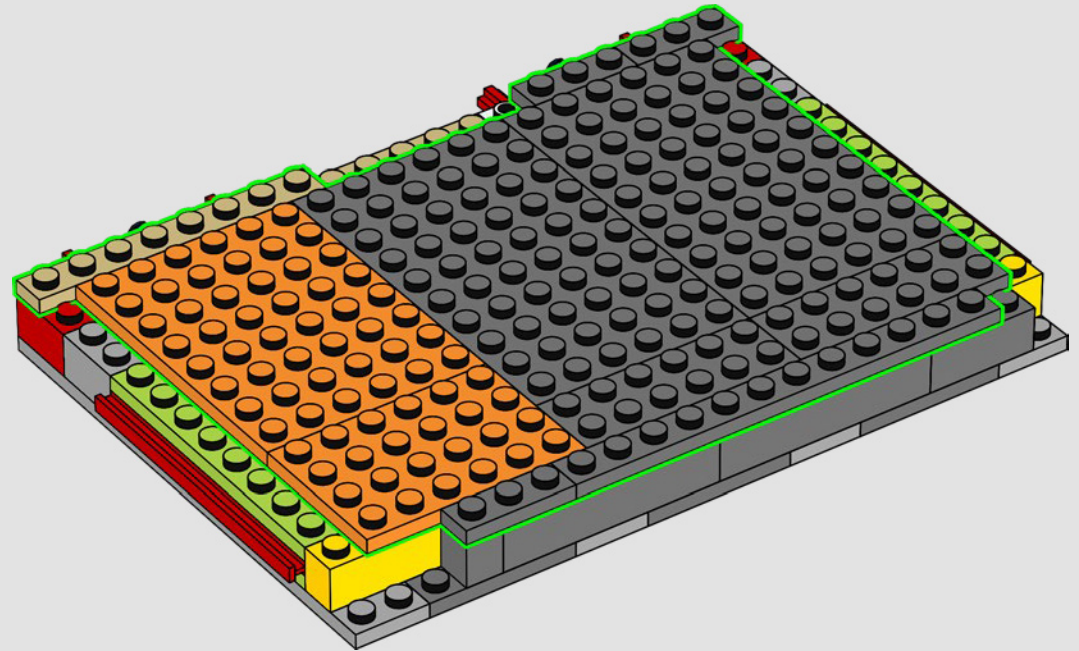

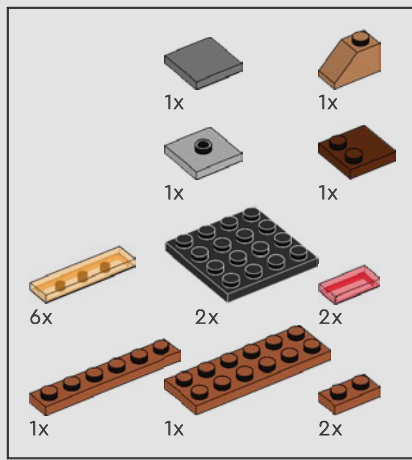

349

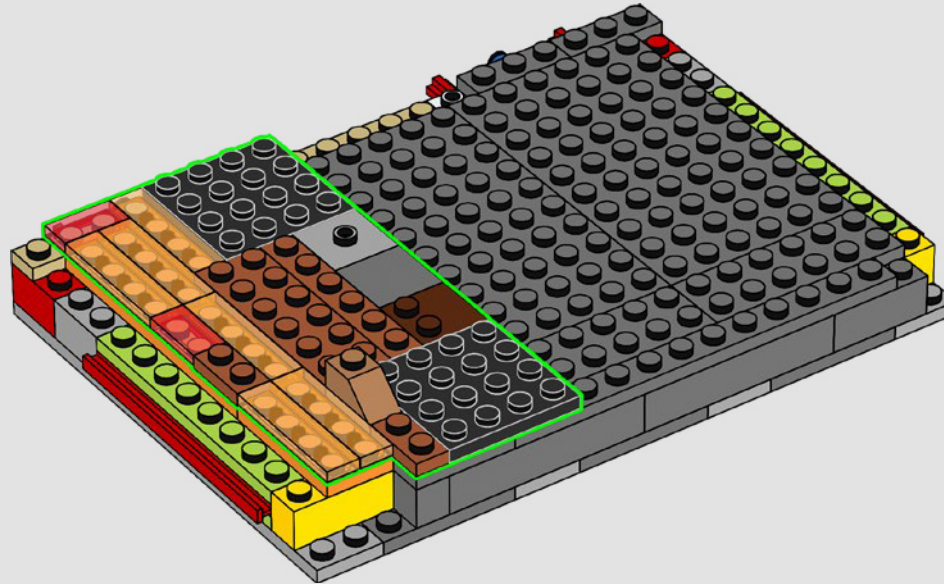

Para tener la mejor visibilidad posible del avance durante el proceso de construcción, esta sección se monta por separado y luego se coloca en el centro del modelo y se fija en su lugar.

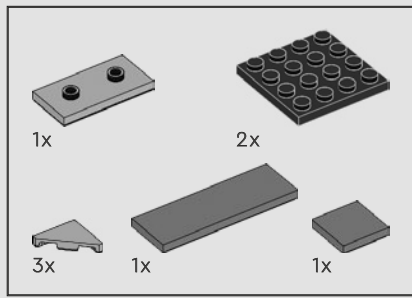

350

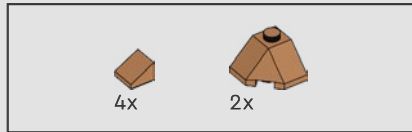
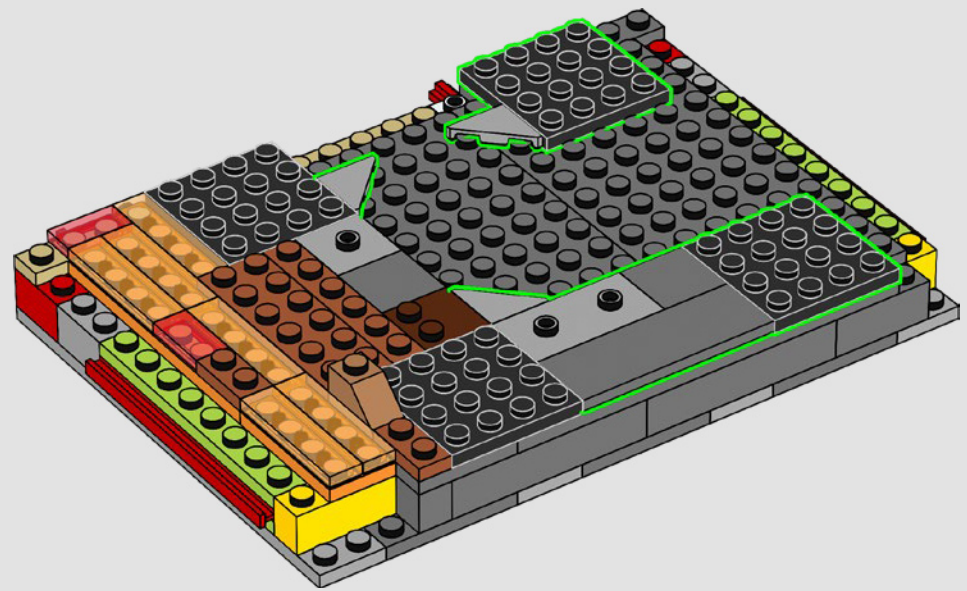

351

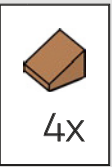
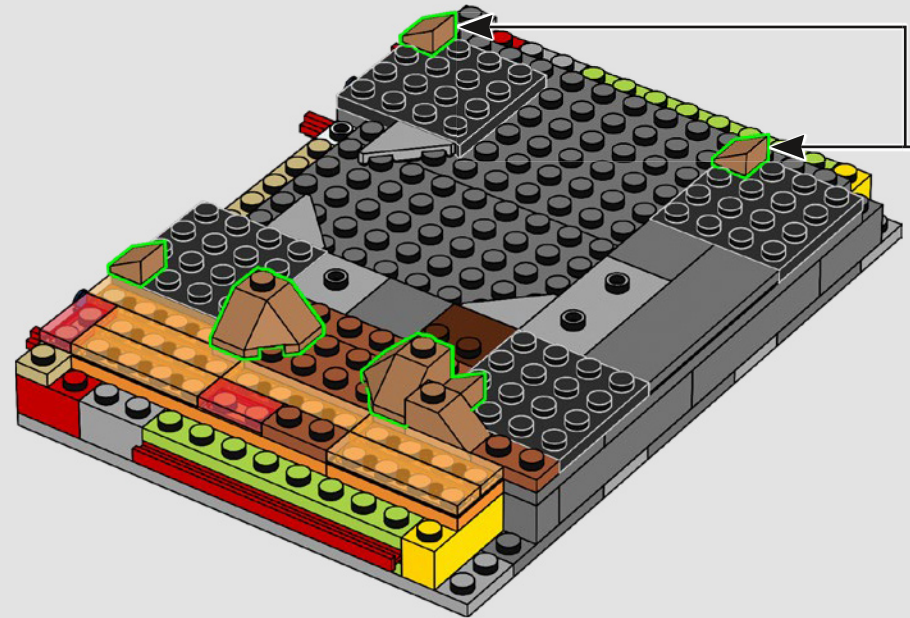

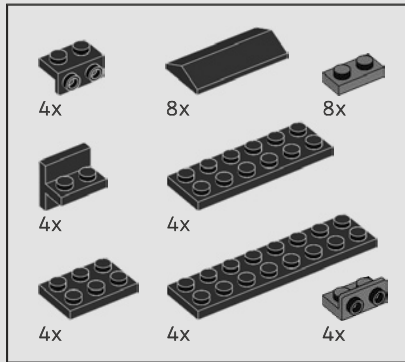
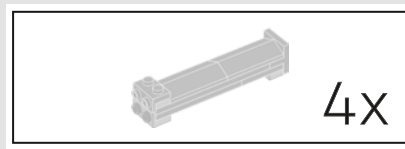

352

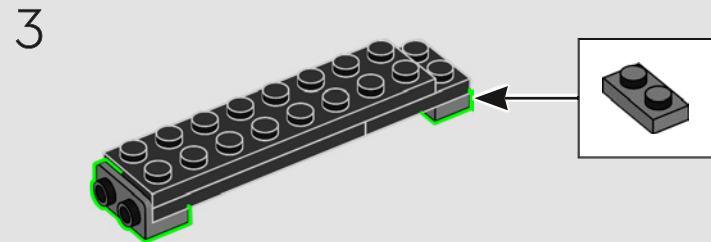
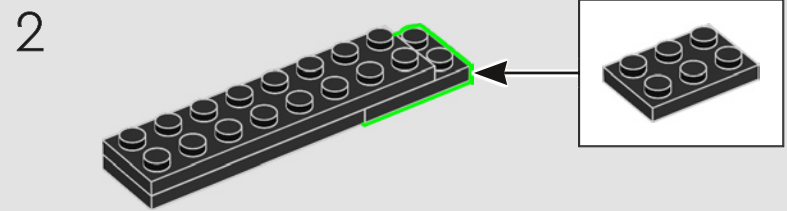
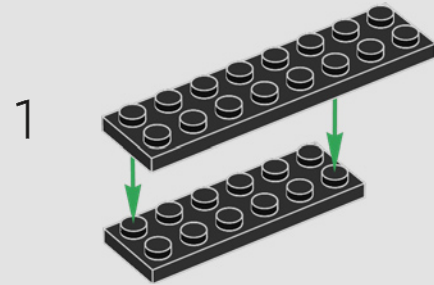

4

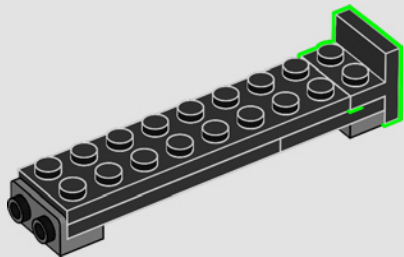

5

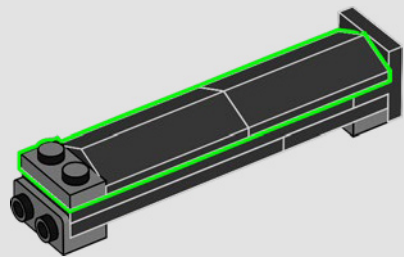

6

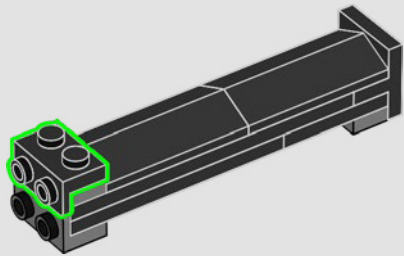

4x

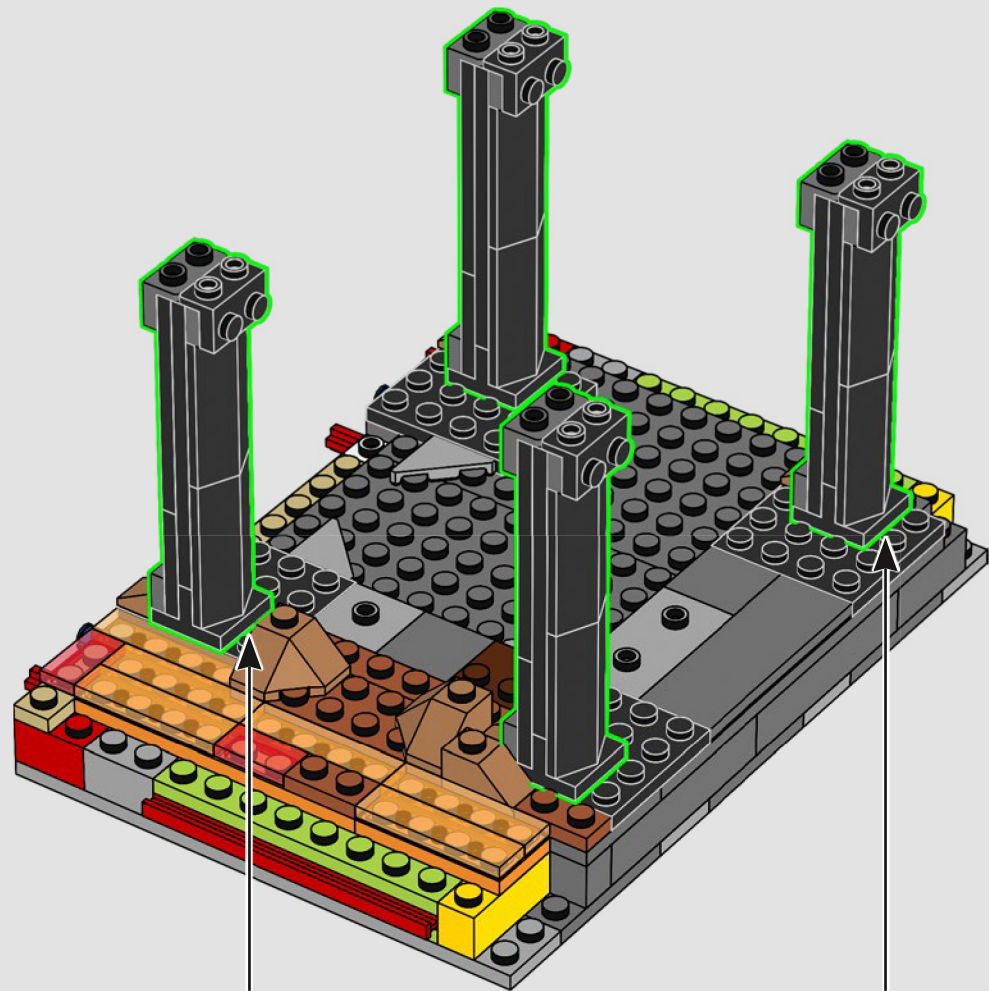

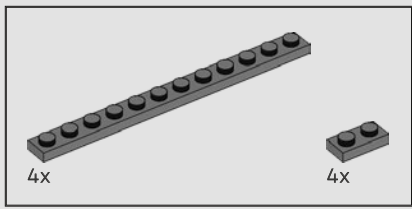

353

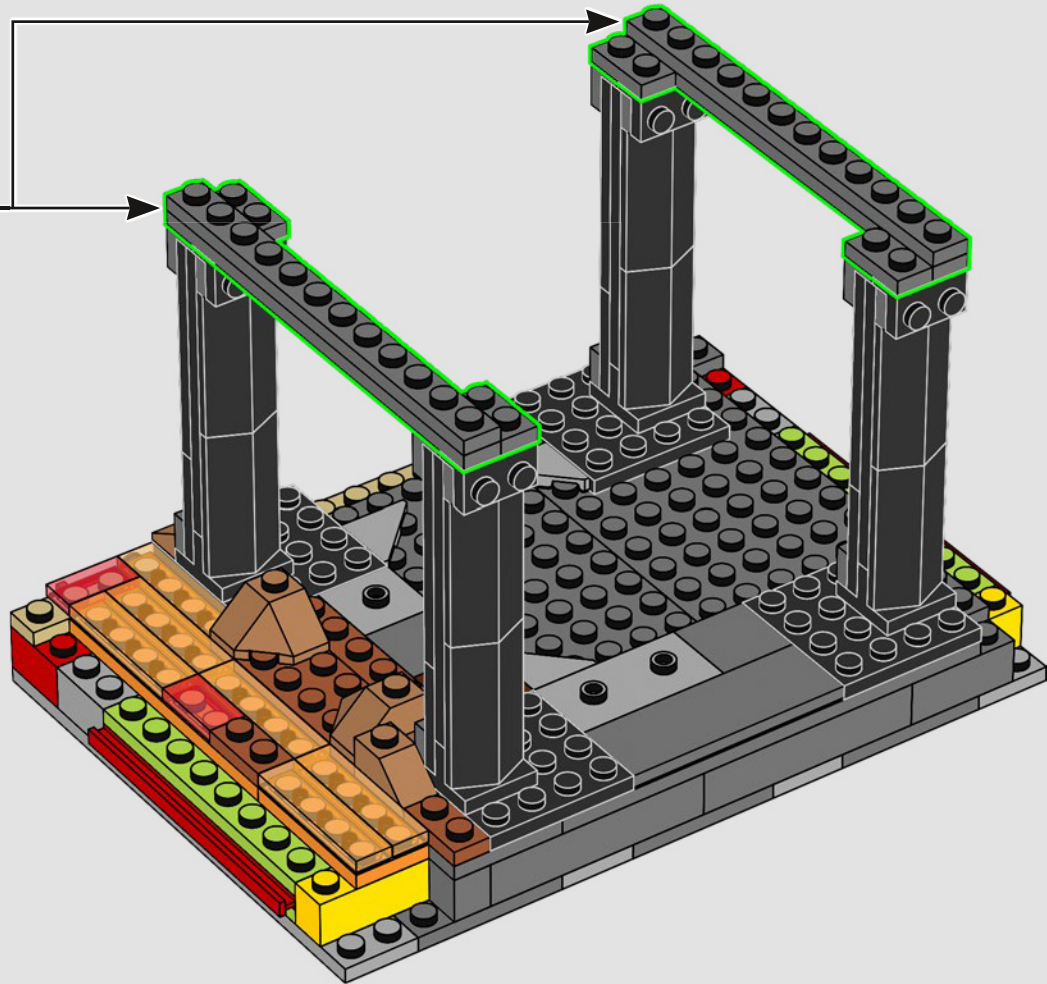
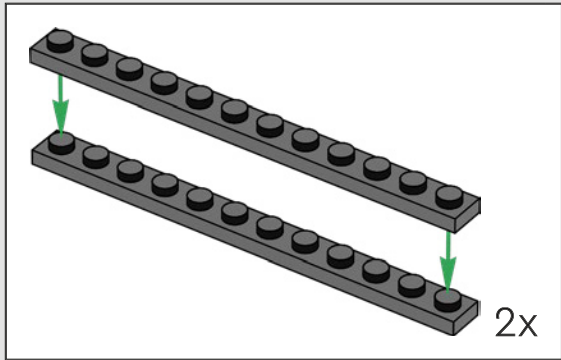

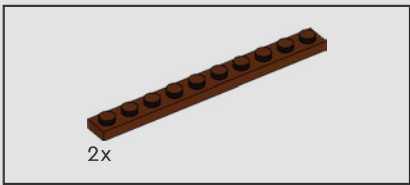

354

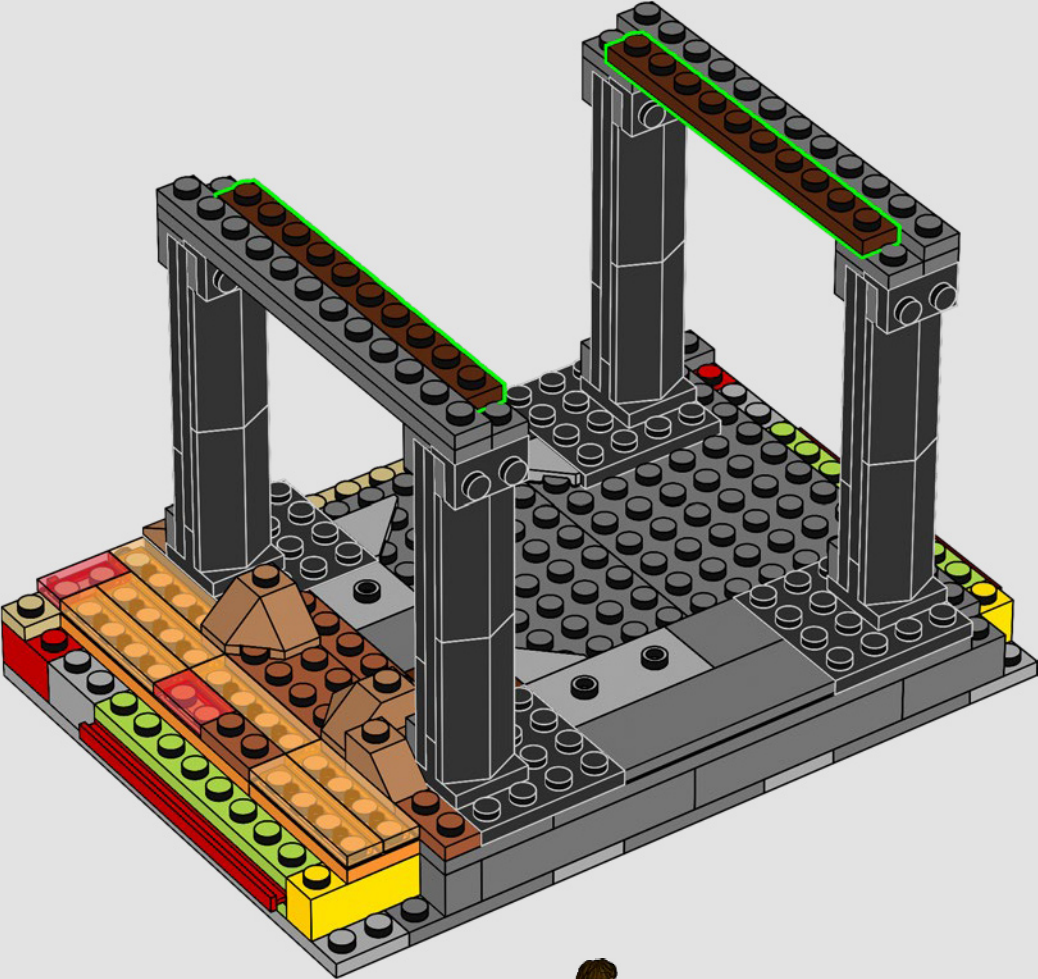

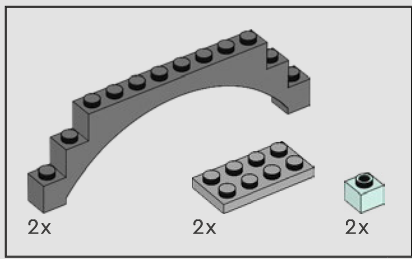

355

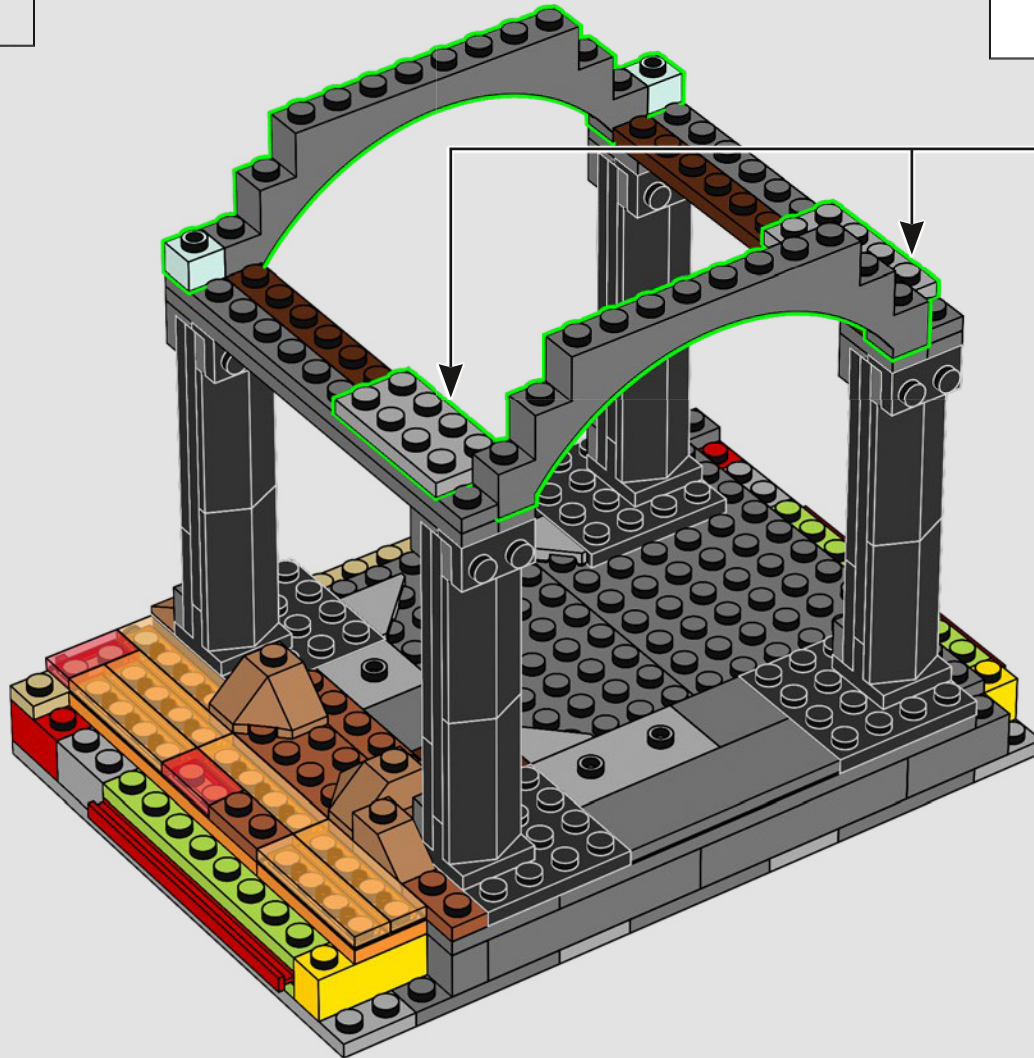
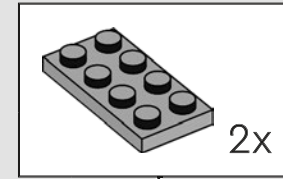

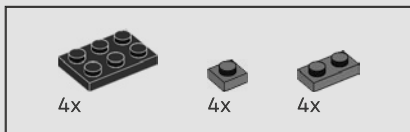

356

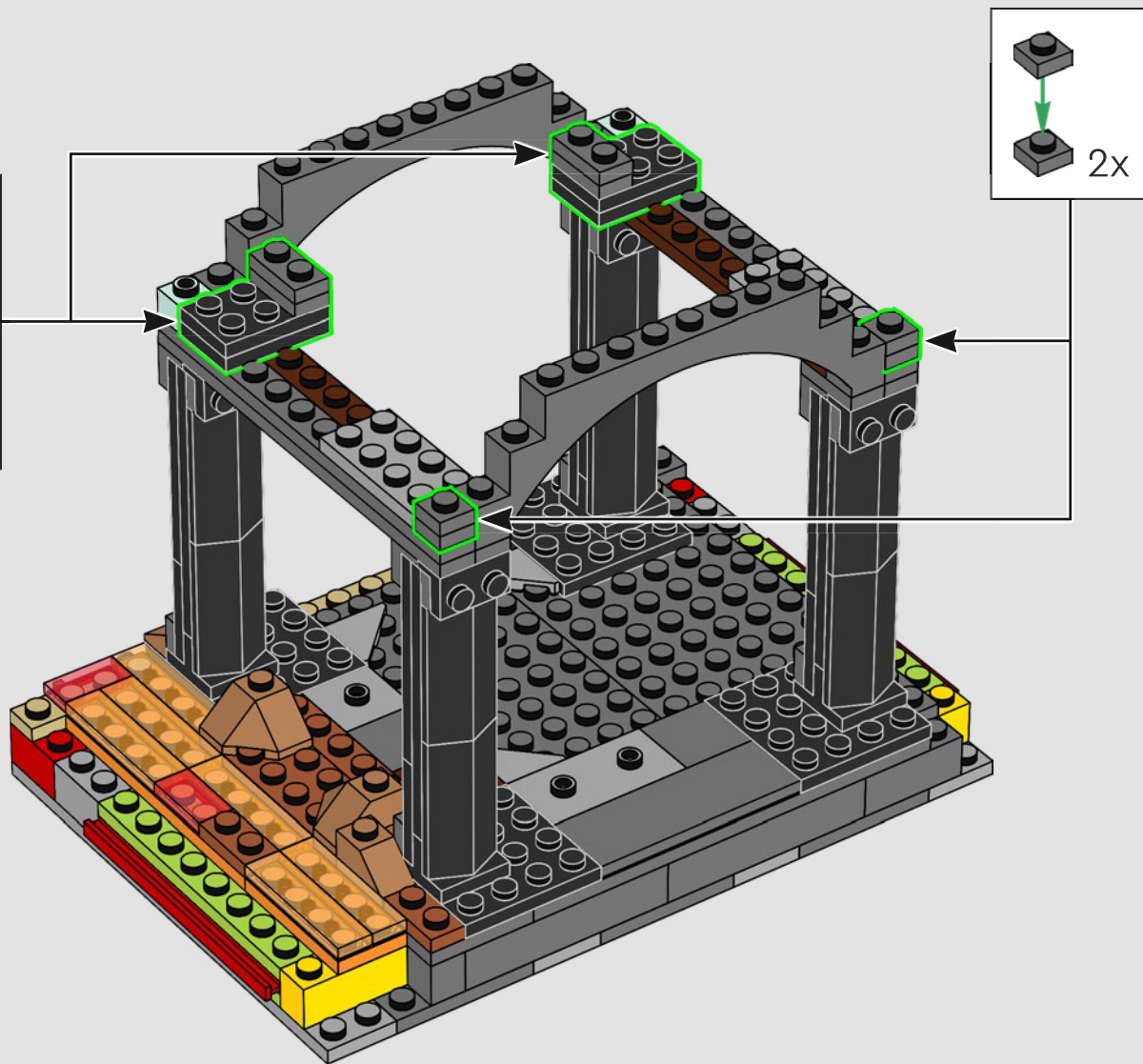
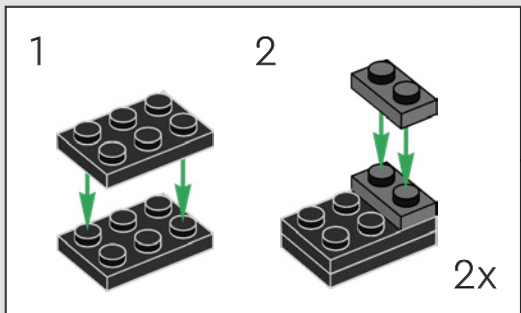

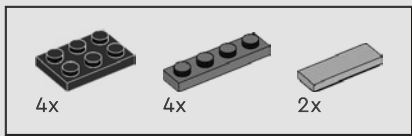

357

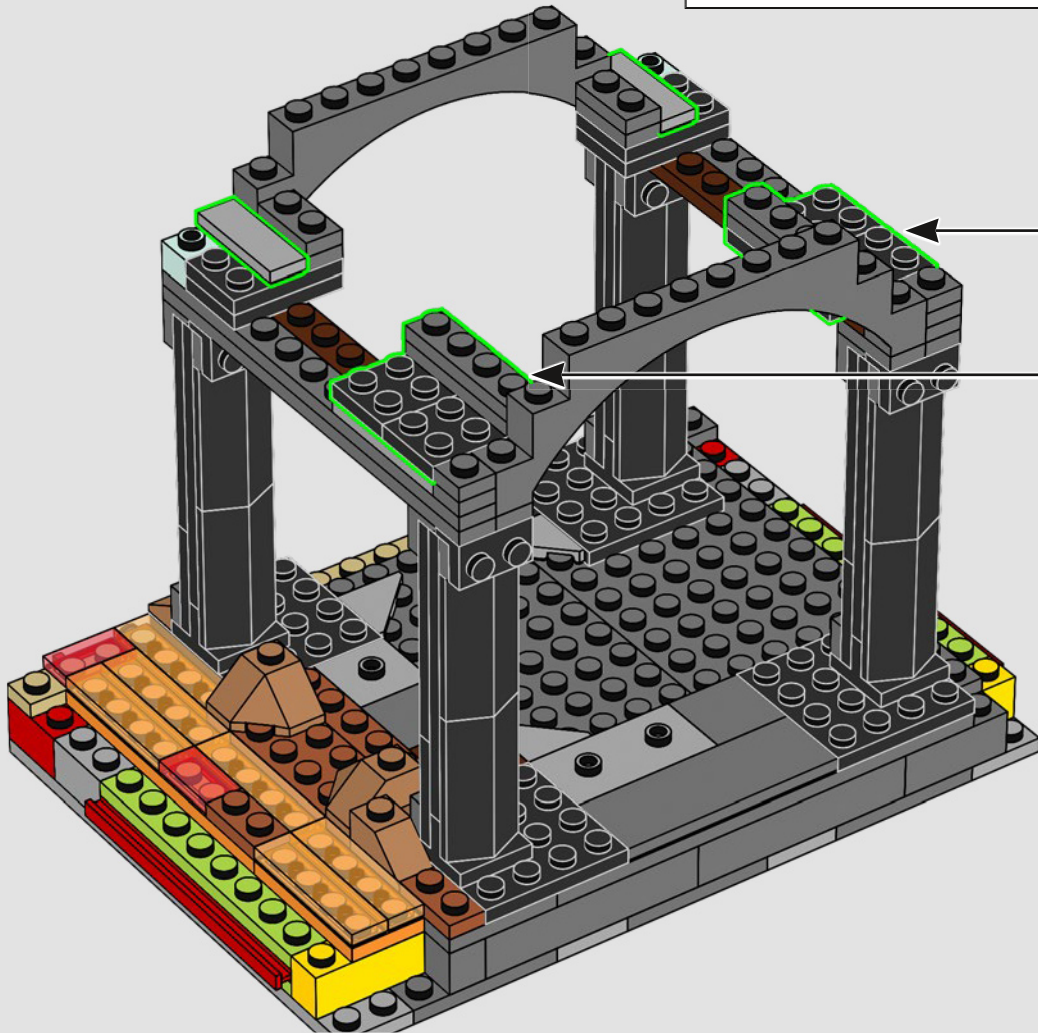
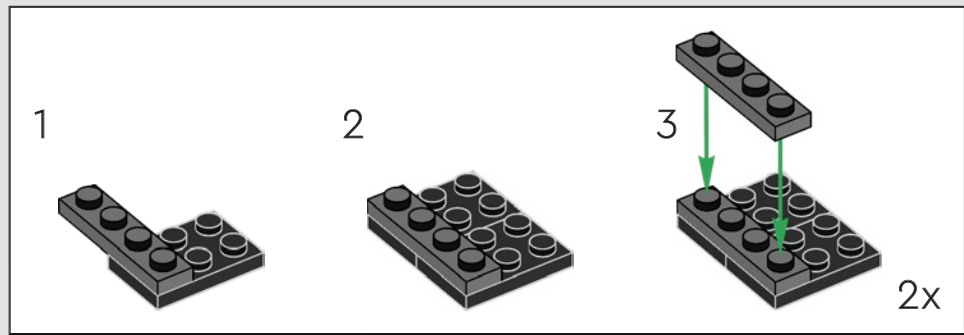

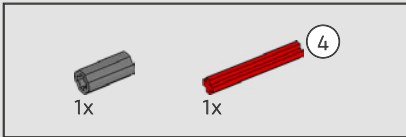
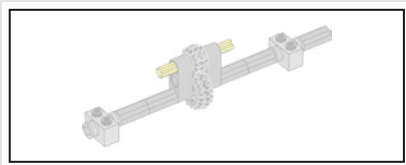

358

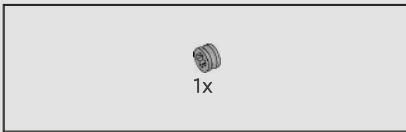
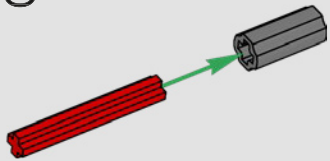

359

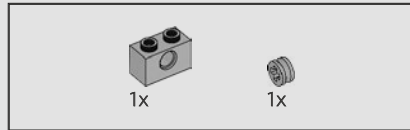
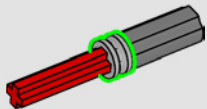

360

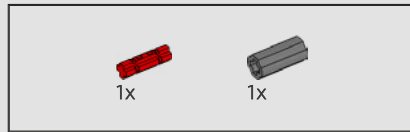
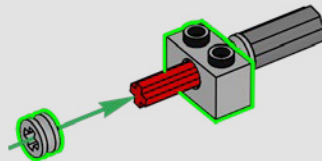

361

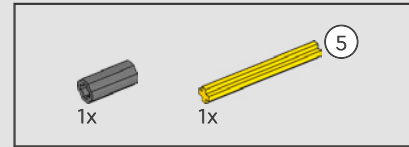
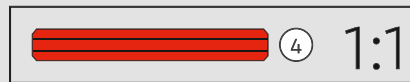
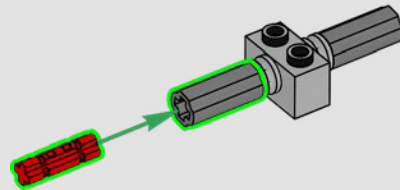

362

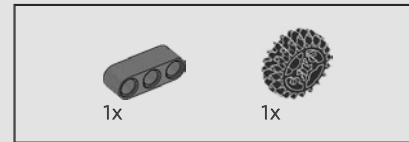
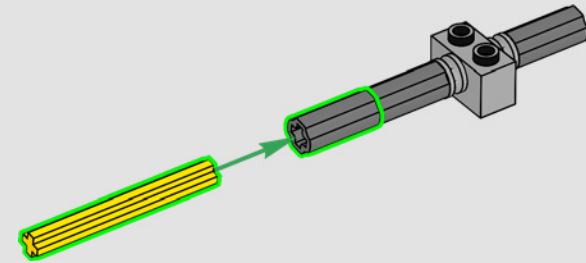

363

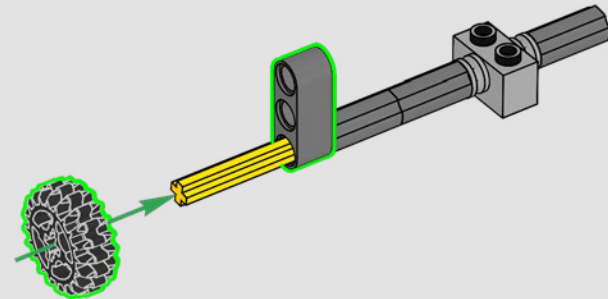

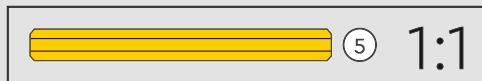
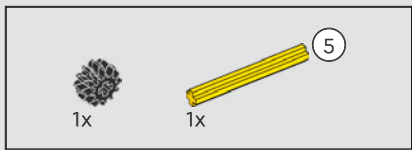

364

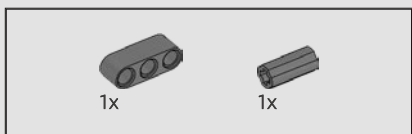
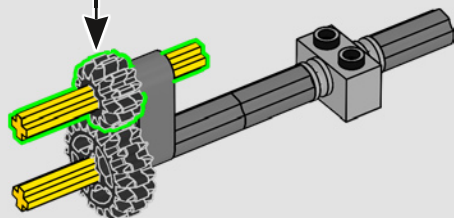
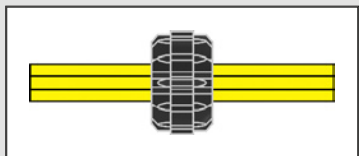

365

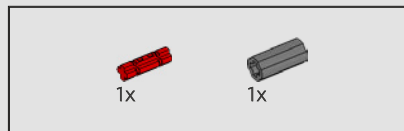
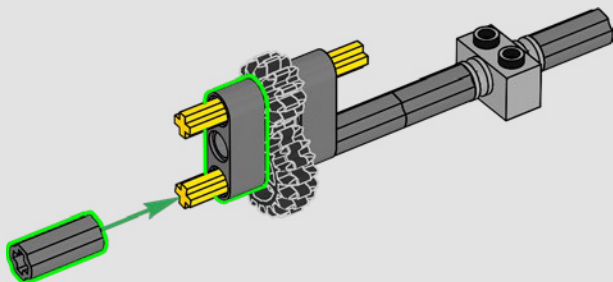

366

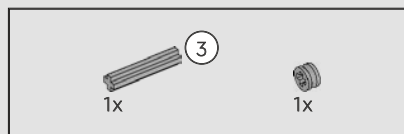
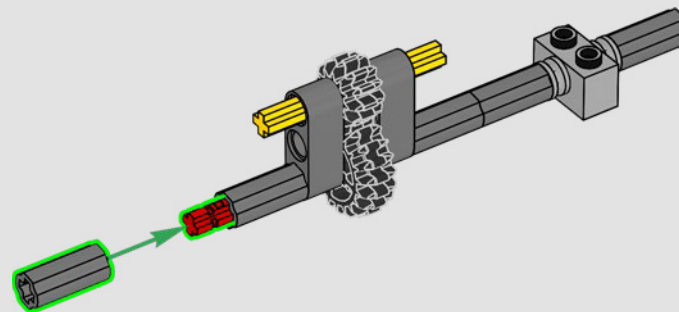

367

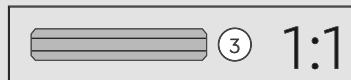
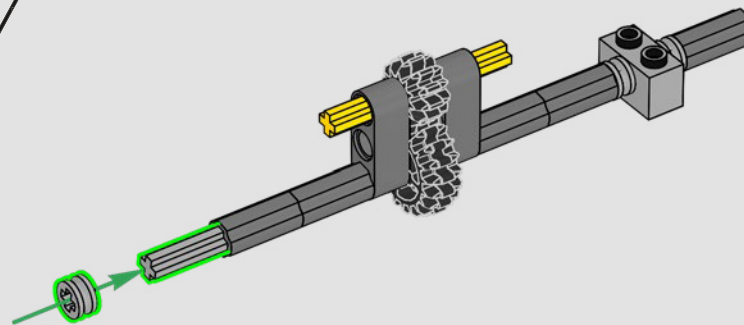

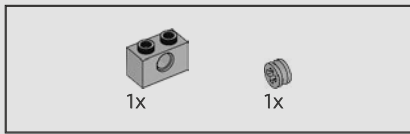

368

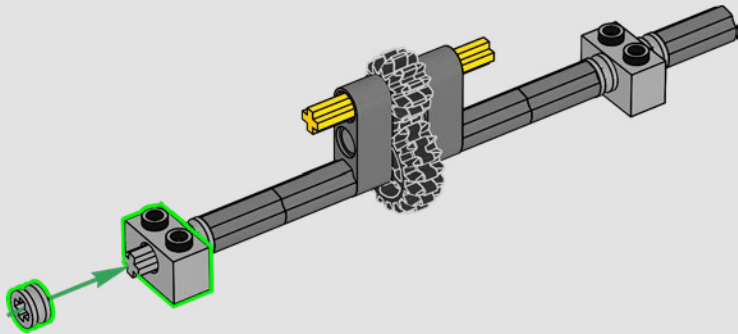

369

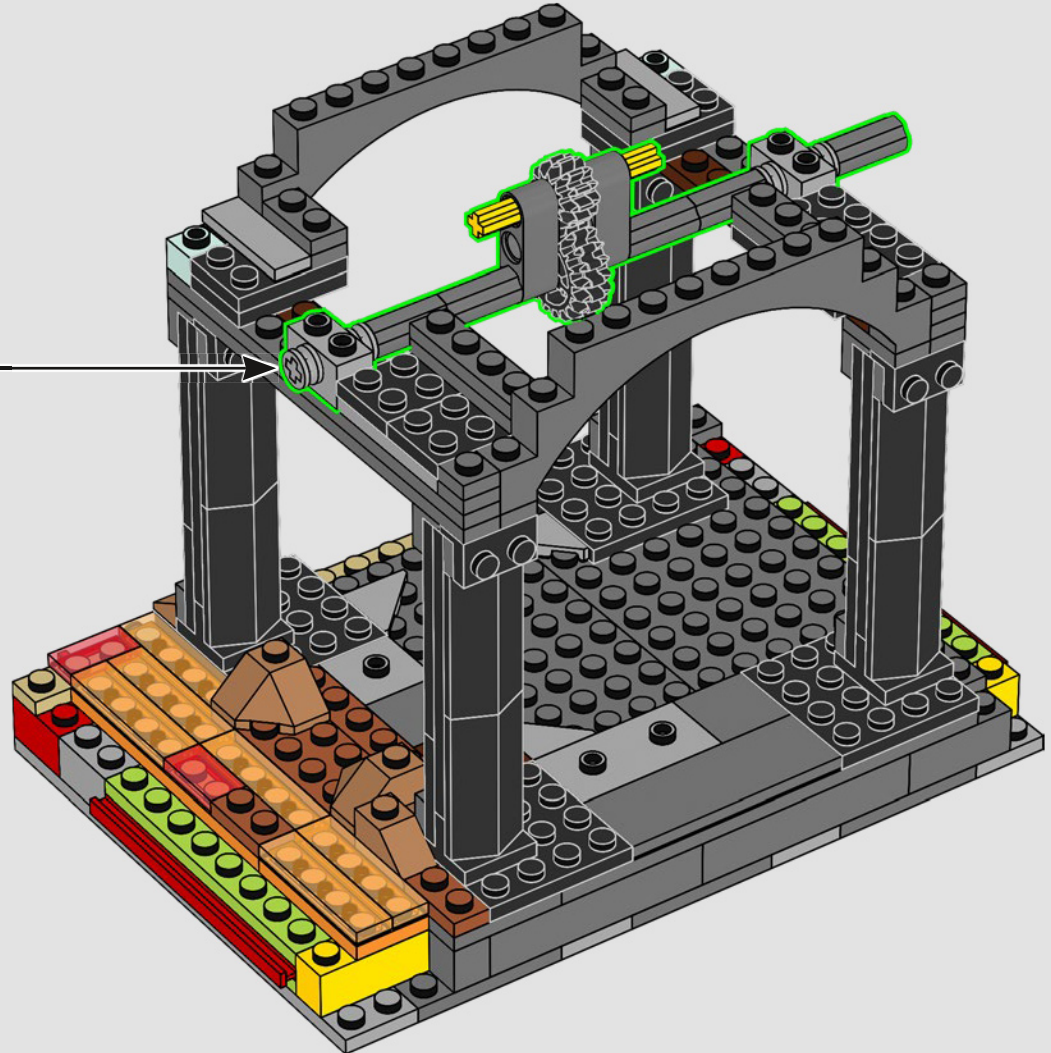

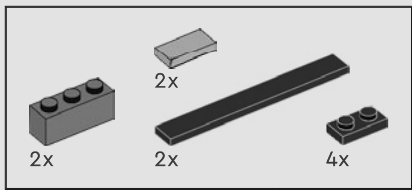

370

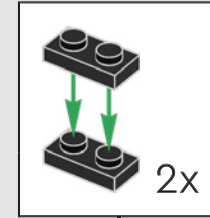
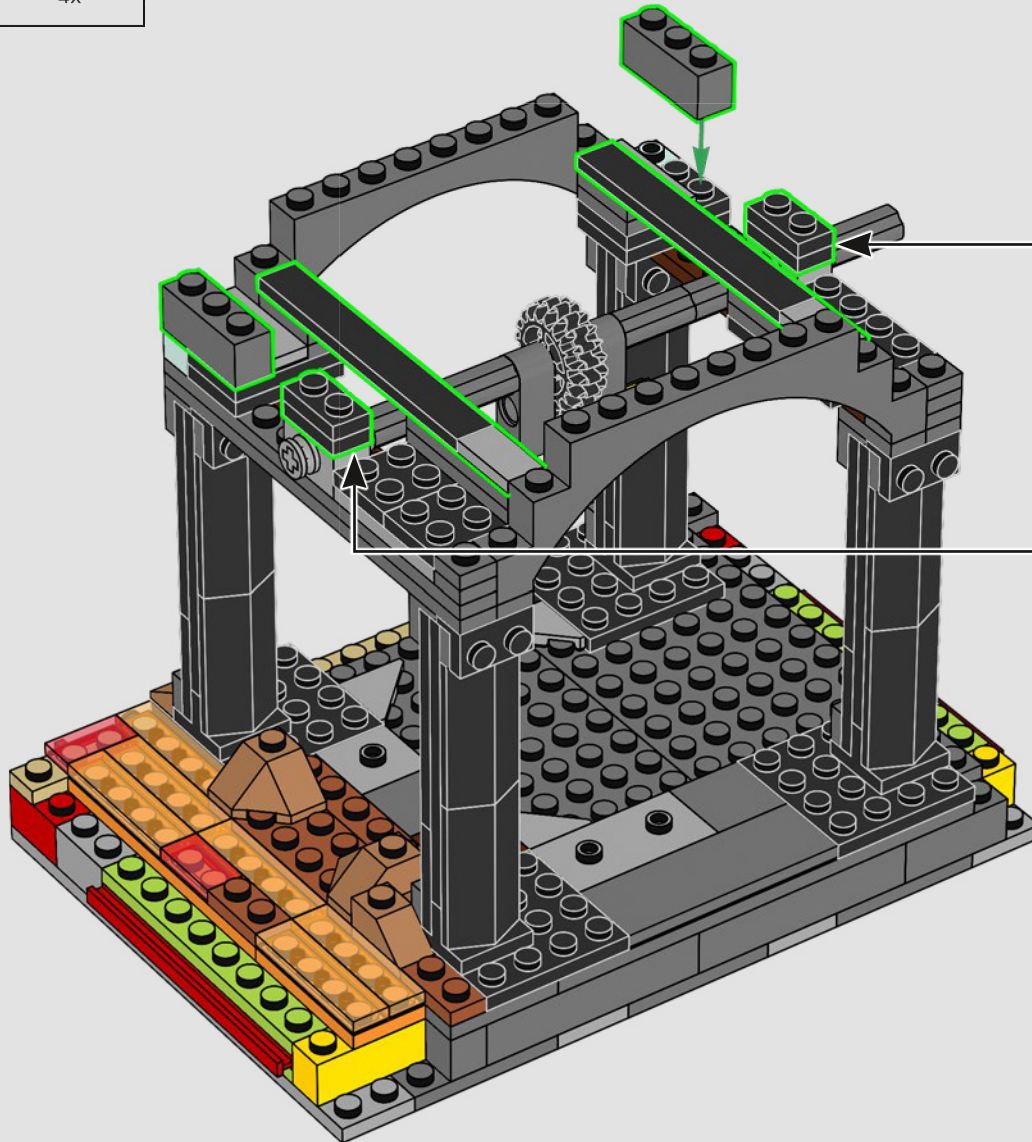

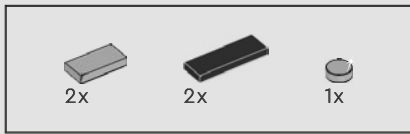

371

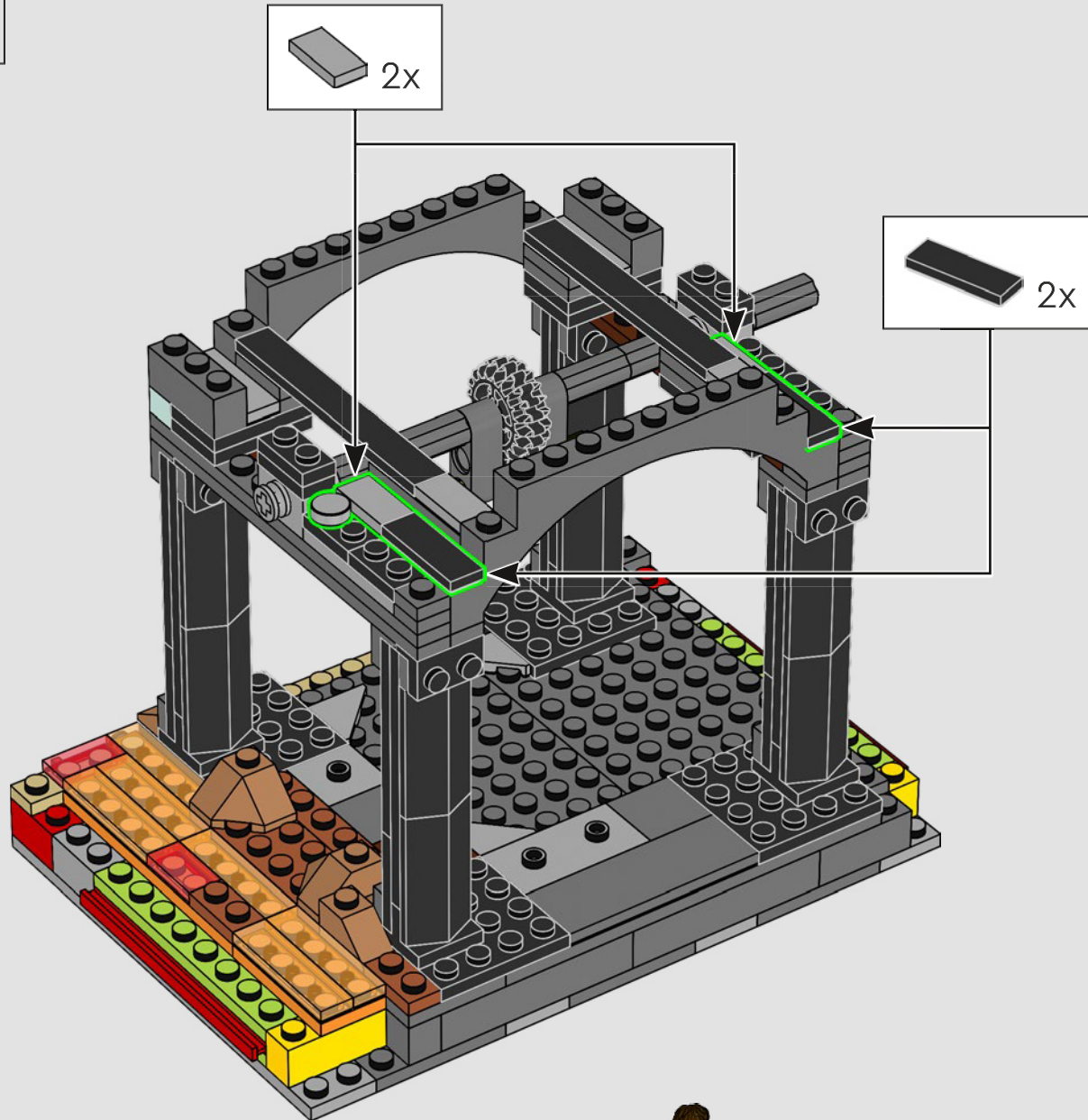

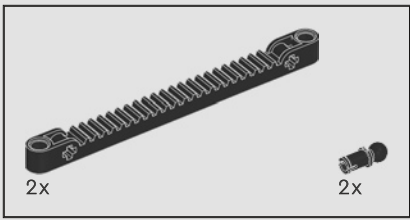

372

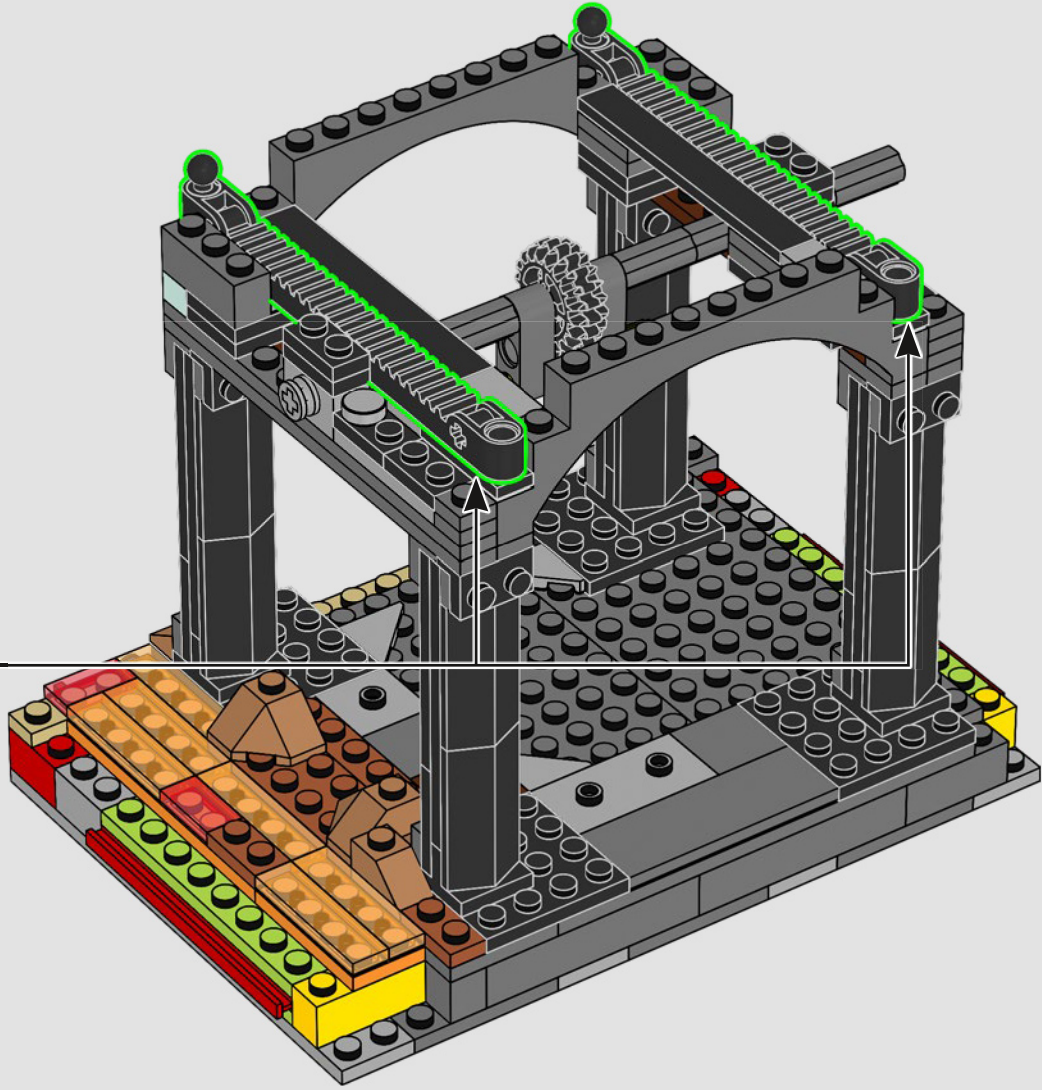
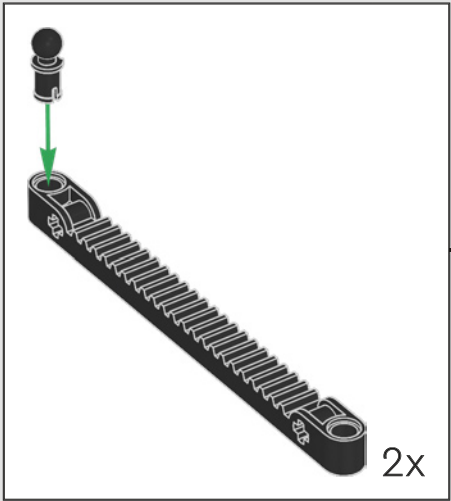

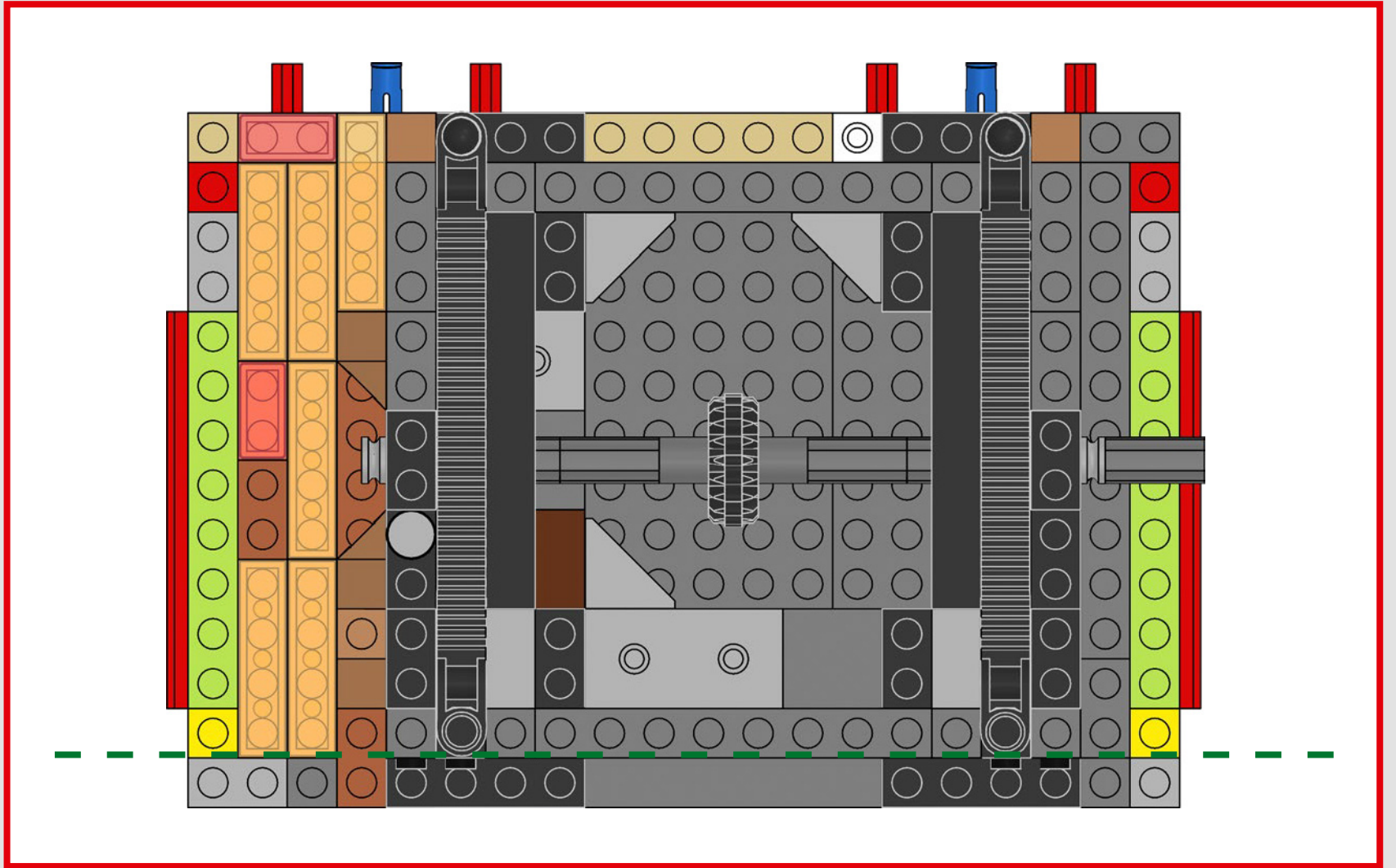



373

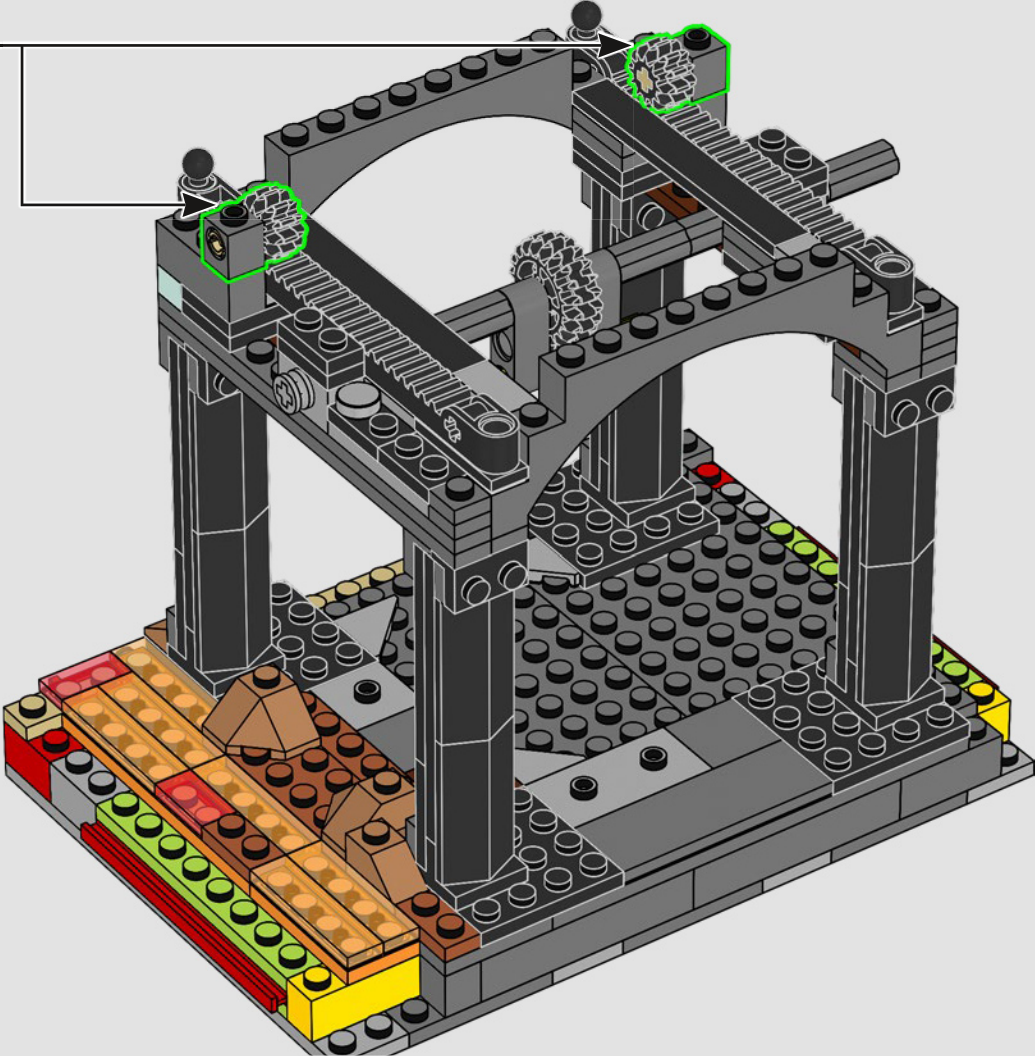
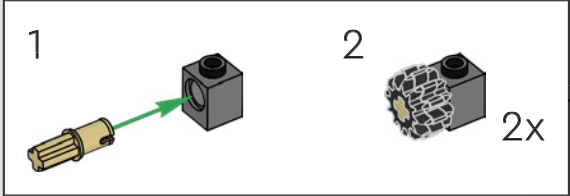

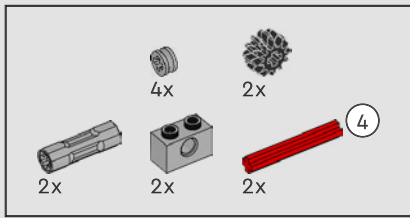

374

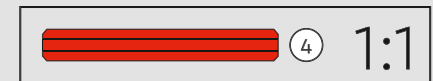
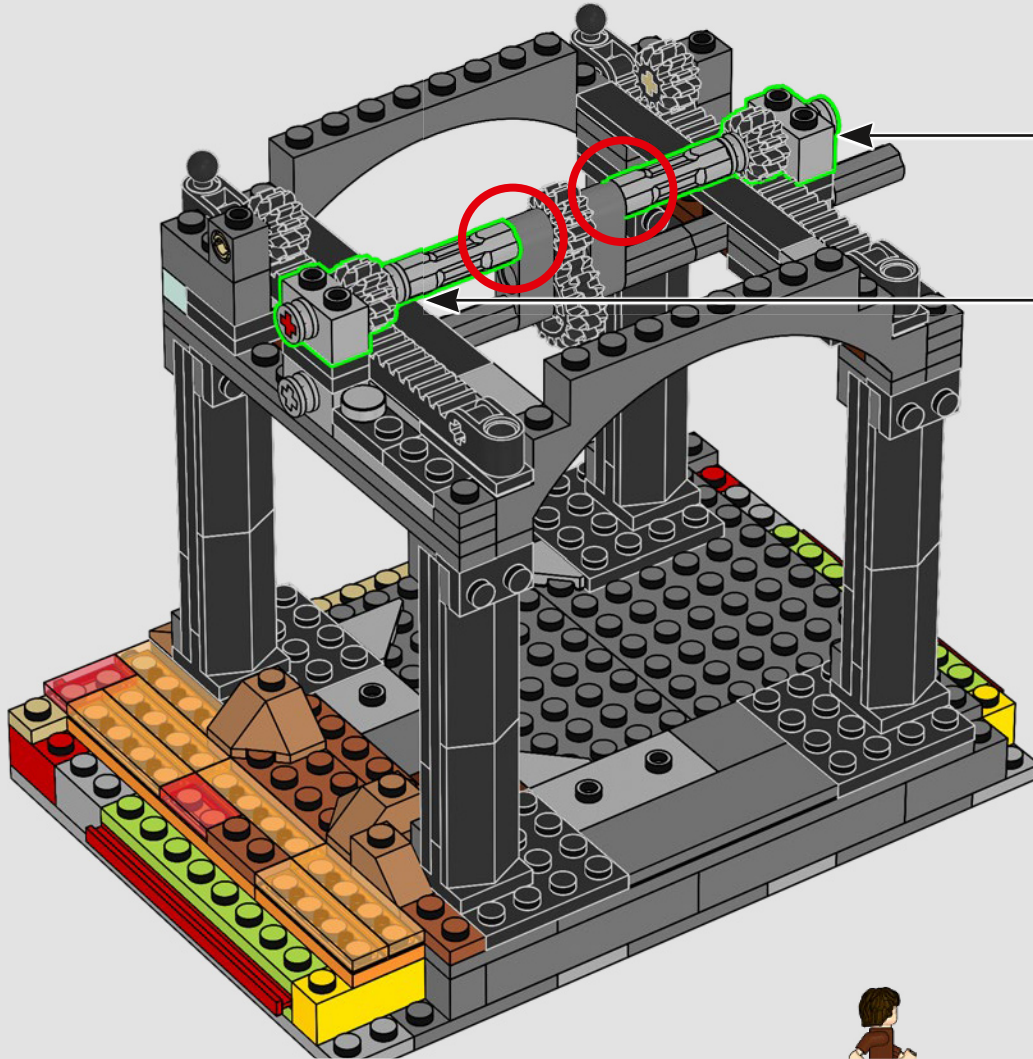
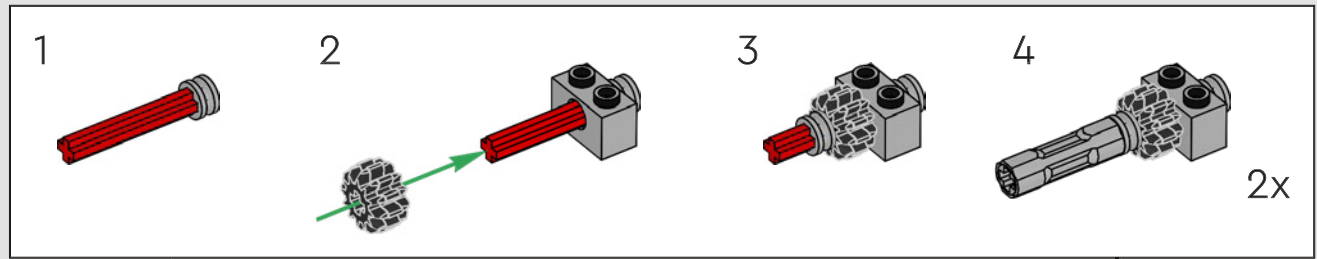

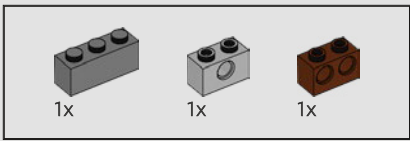

375

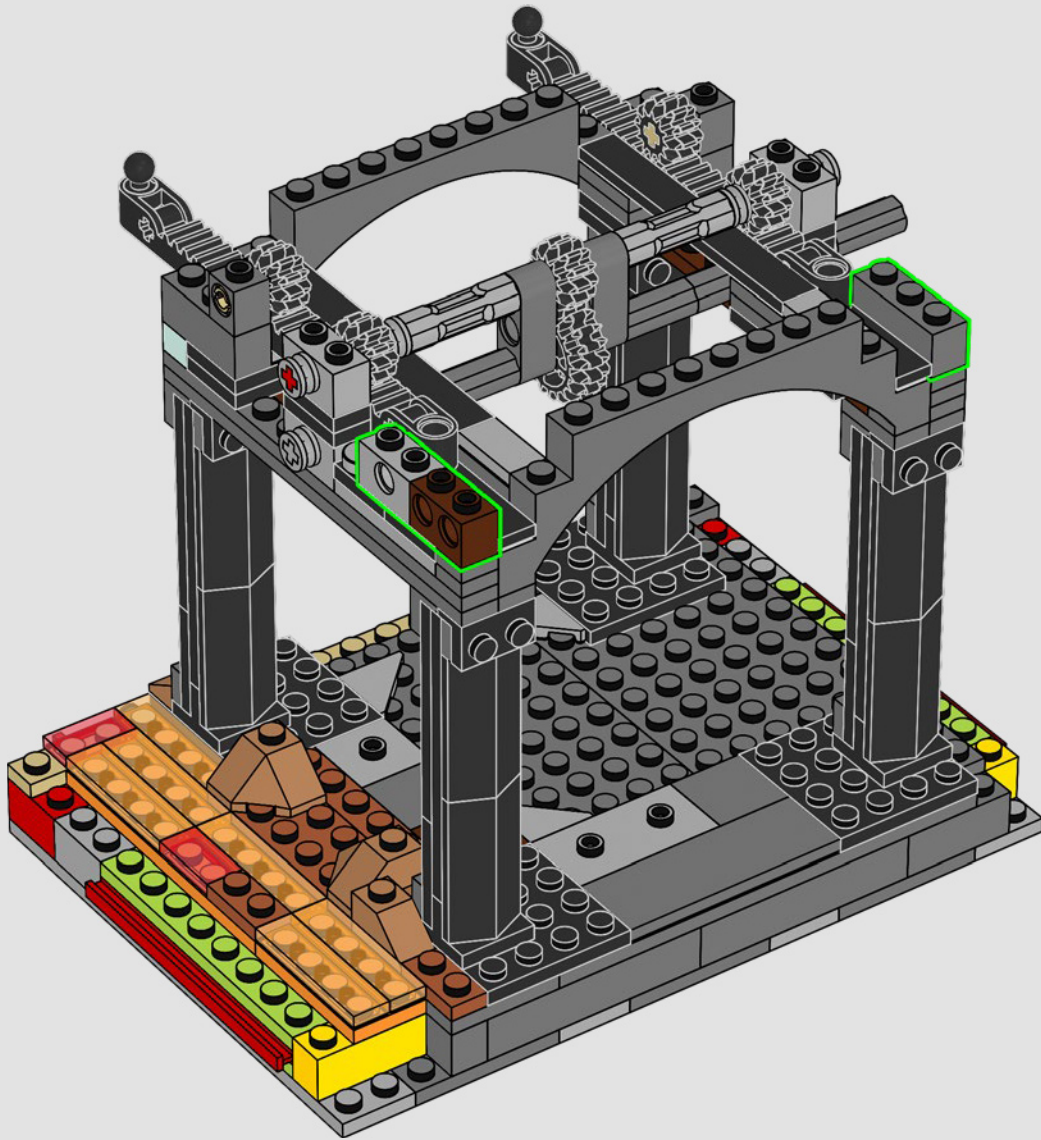

Se ha utilizado un mecanismo sencillo pero eficaz para abrir las puertas principales de la fortaleza.



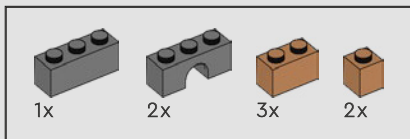

376

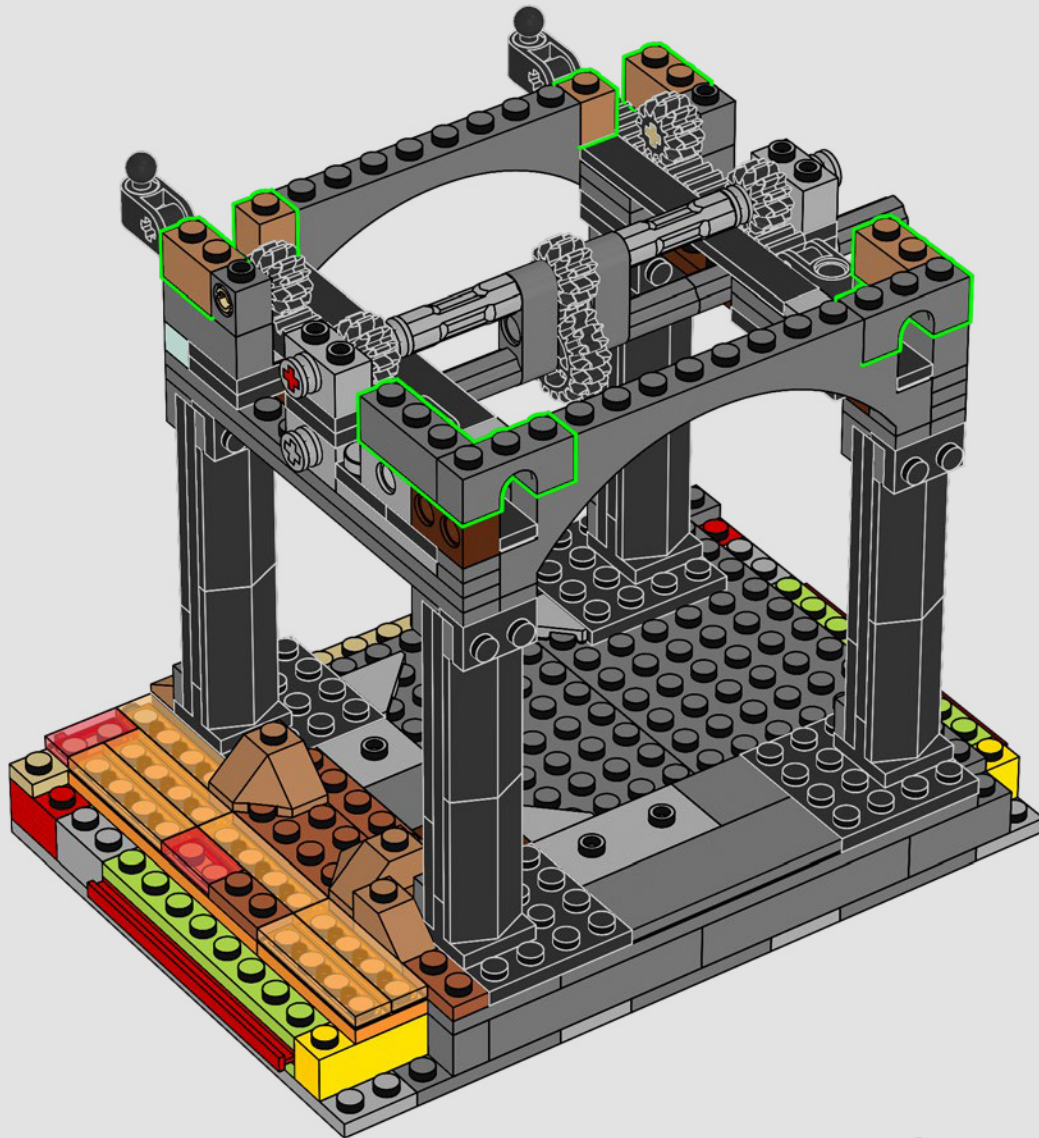

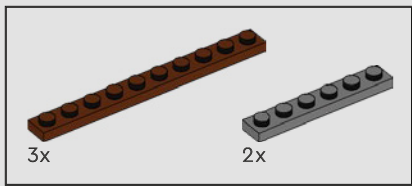

377

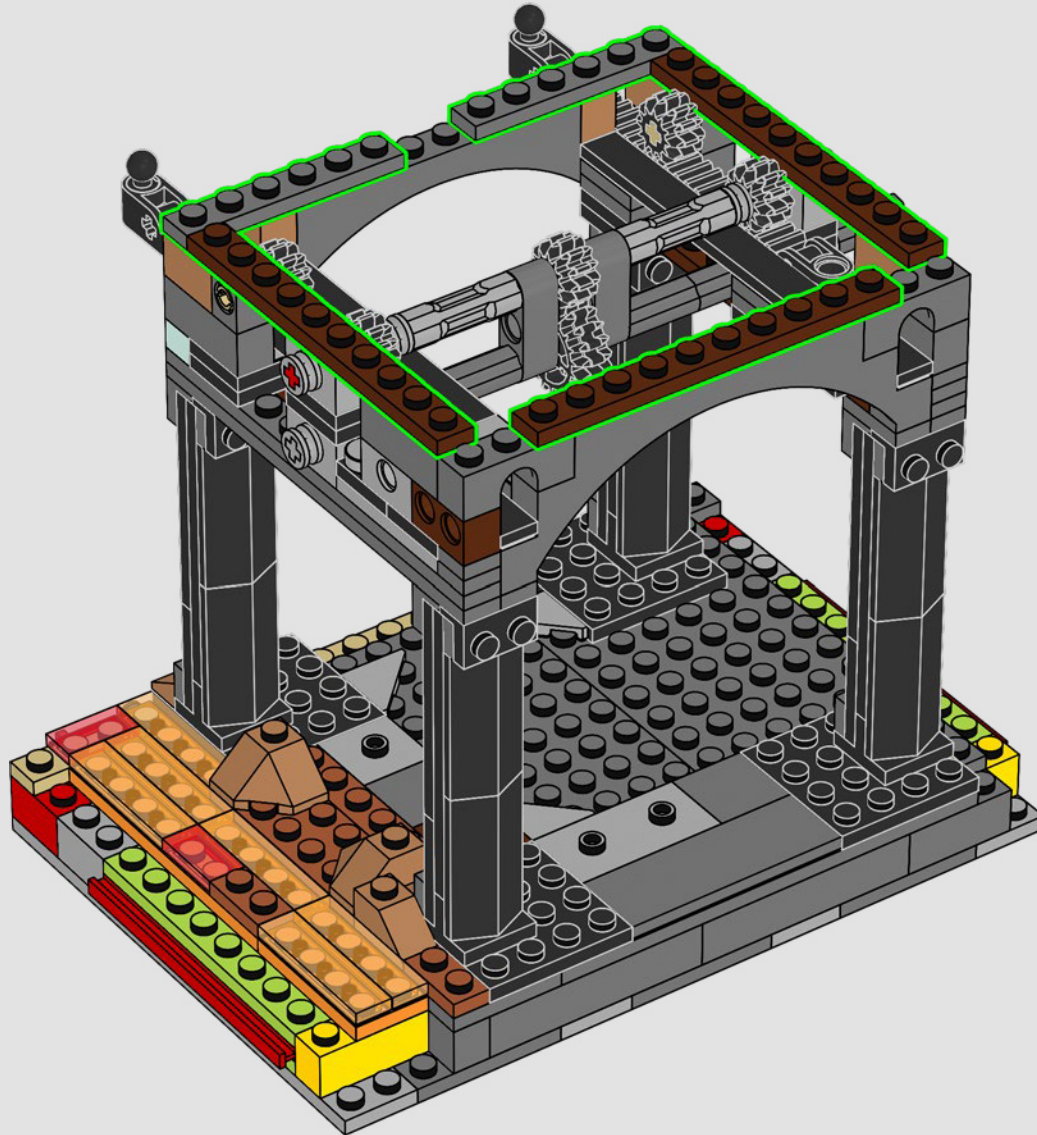

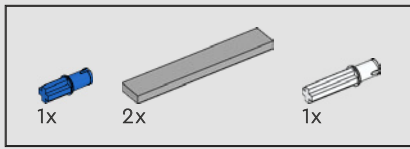

378

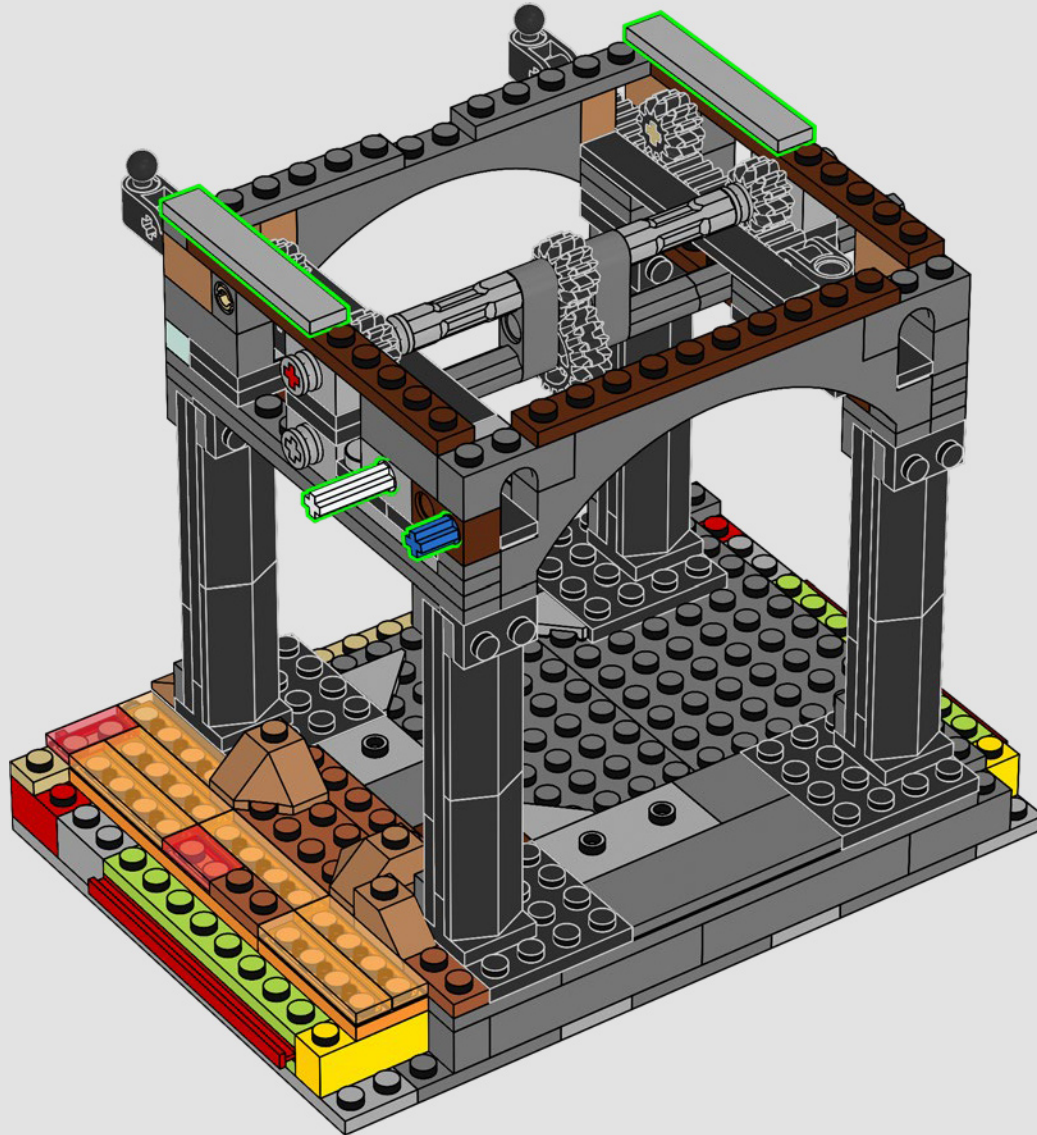



2x

379

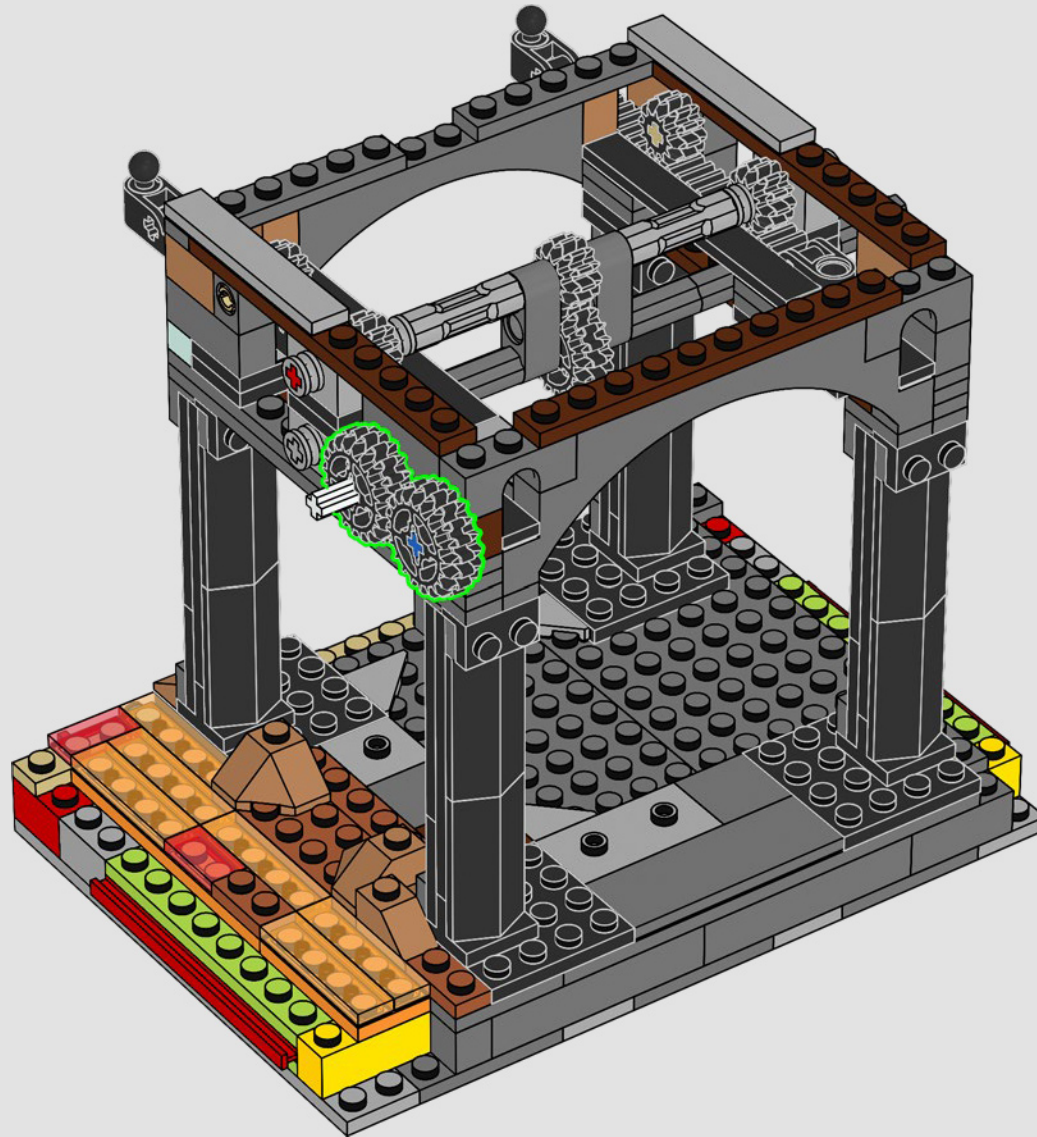

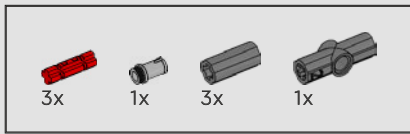

380

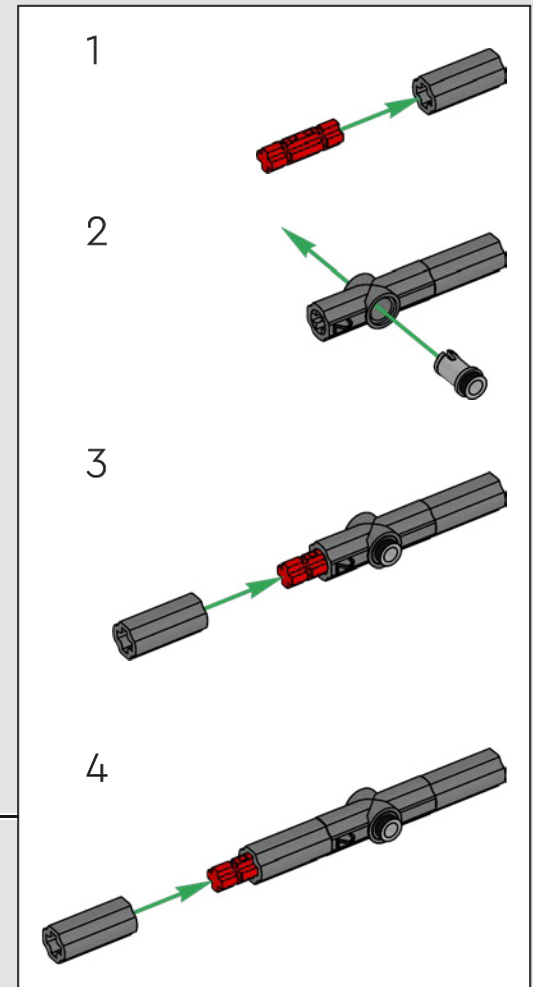
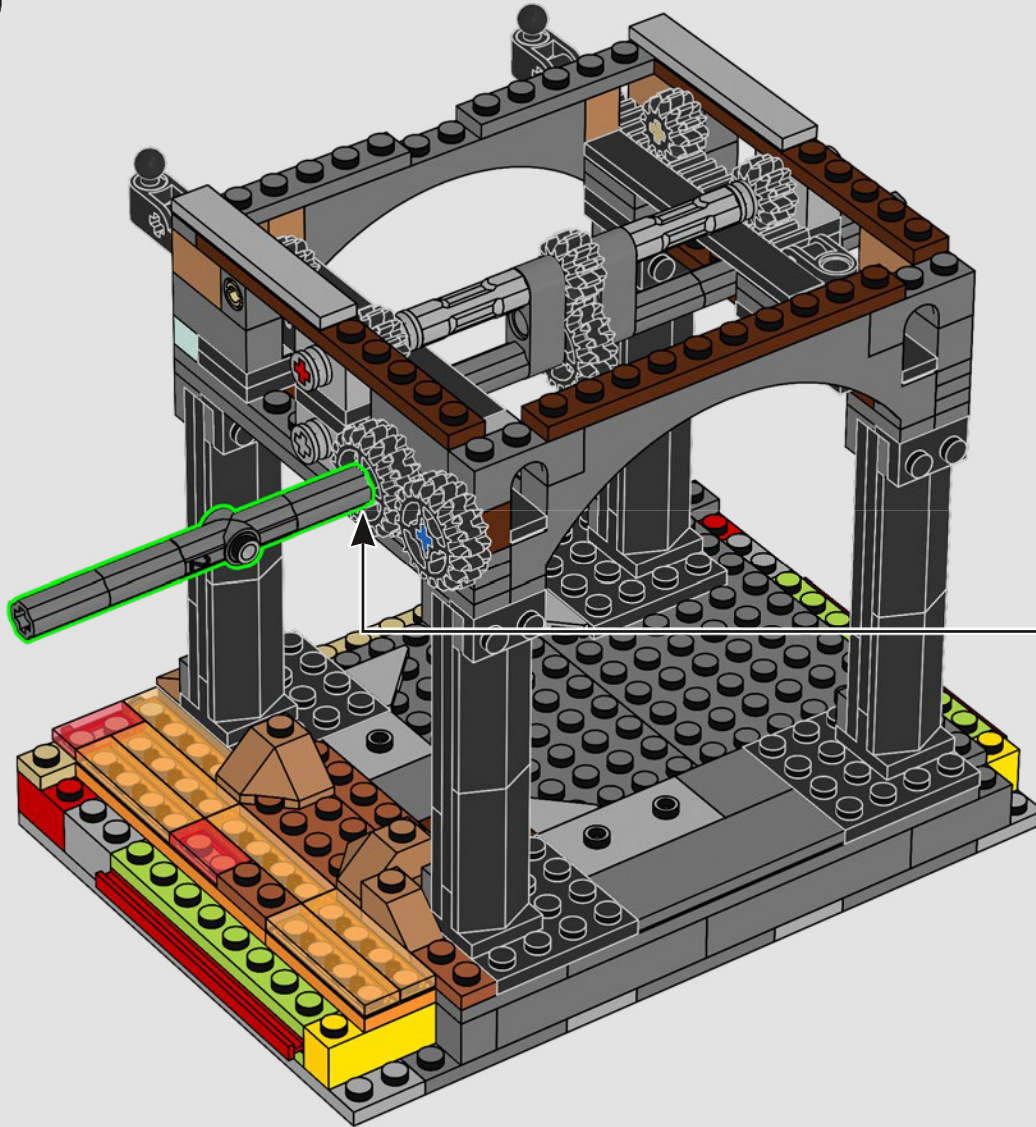

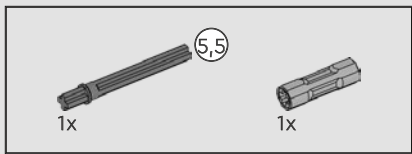

381

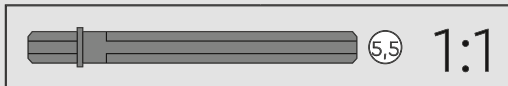
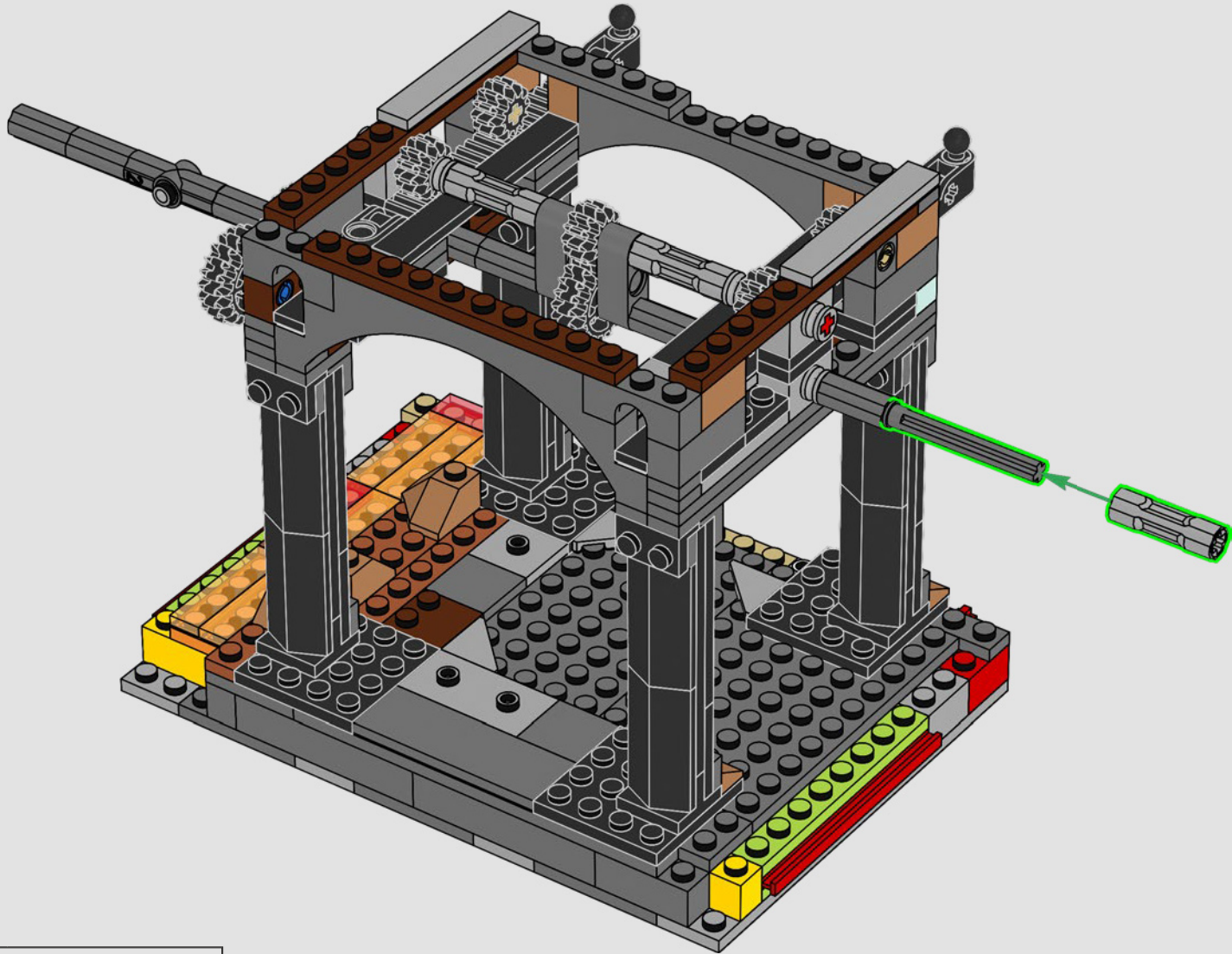

382

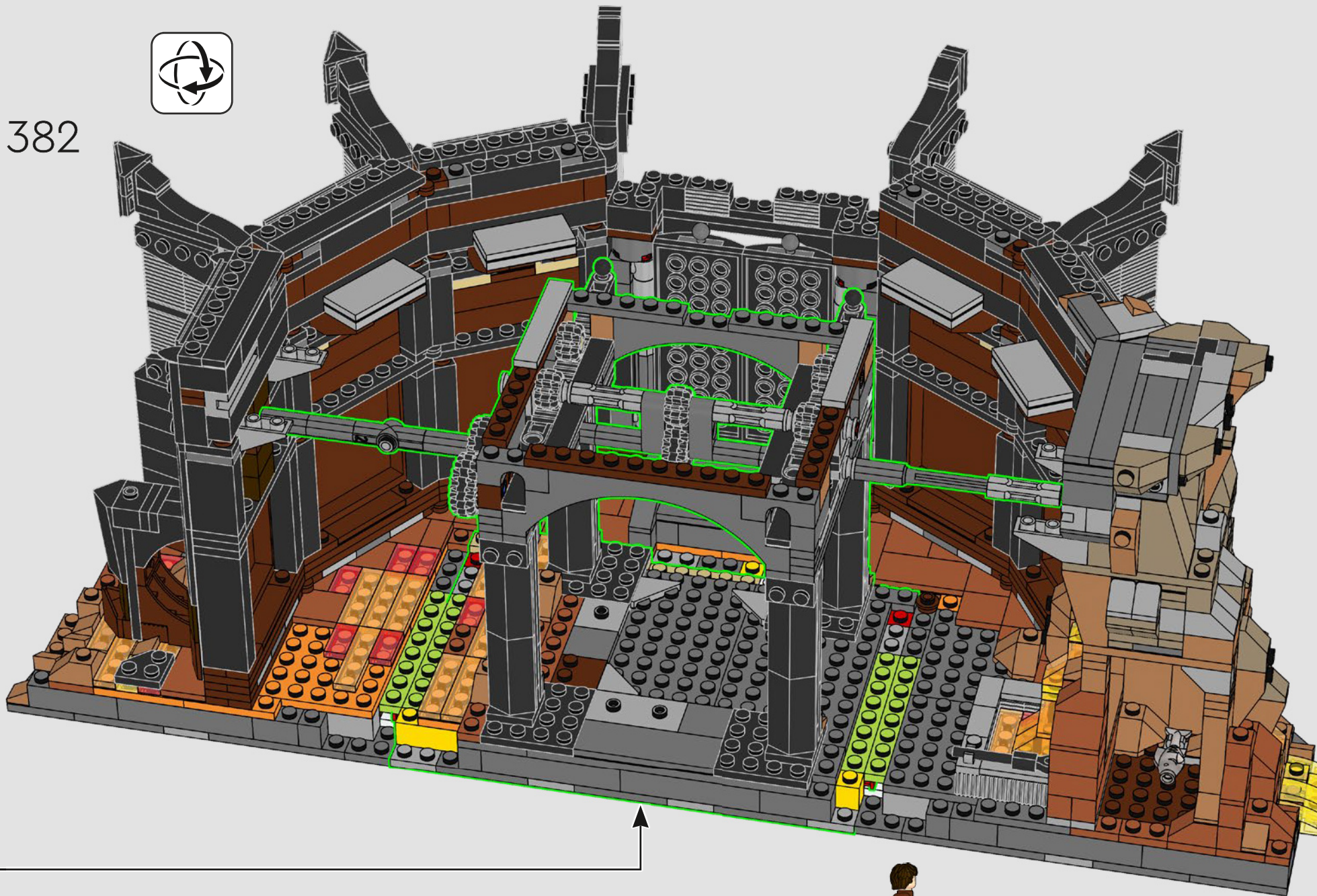

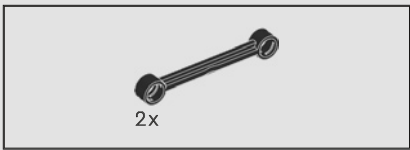

383

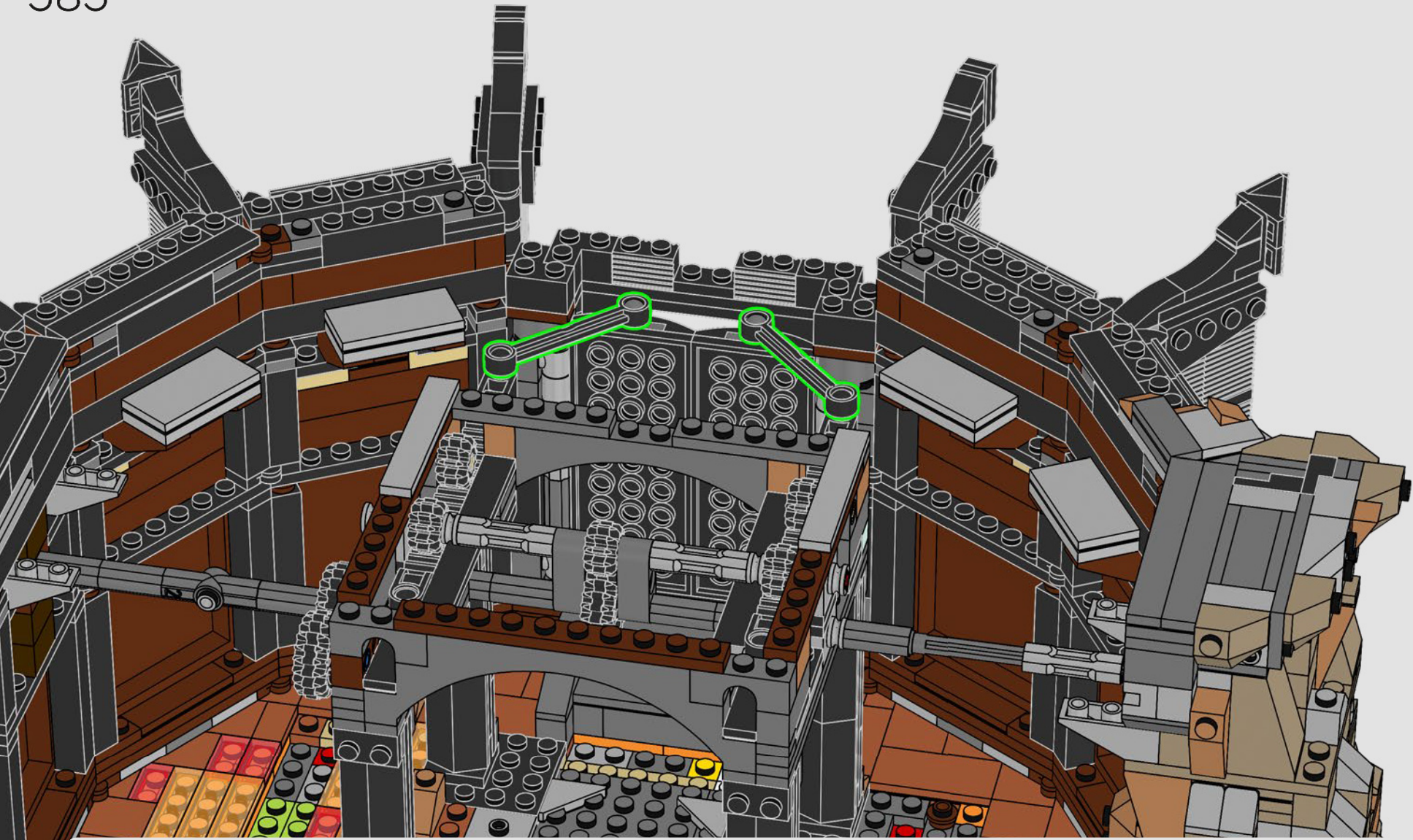



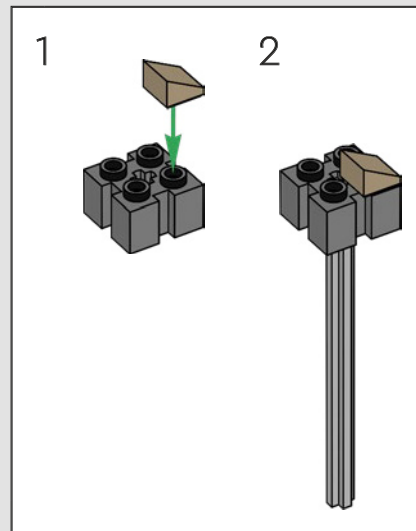
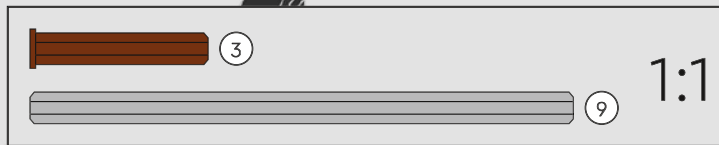
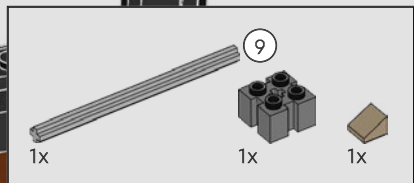

384

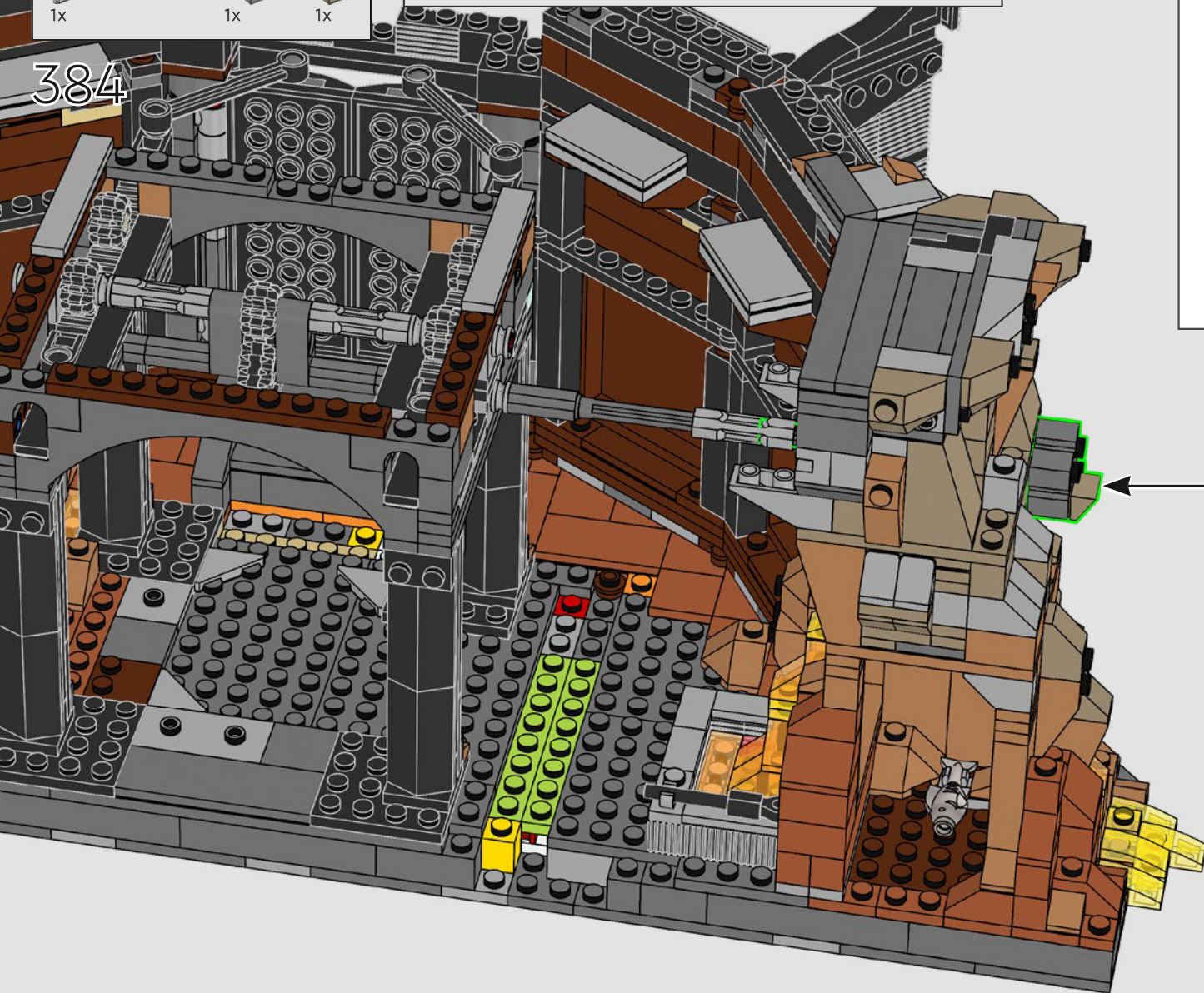

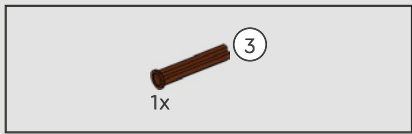

Las puertas principales se abren girando este mando que parece una roca.

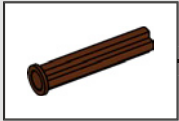

385

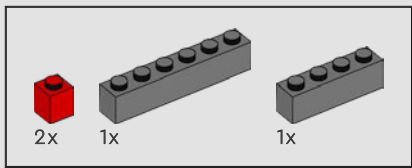



386

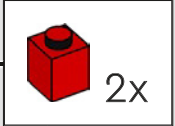
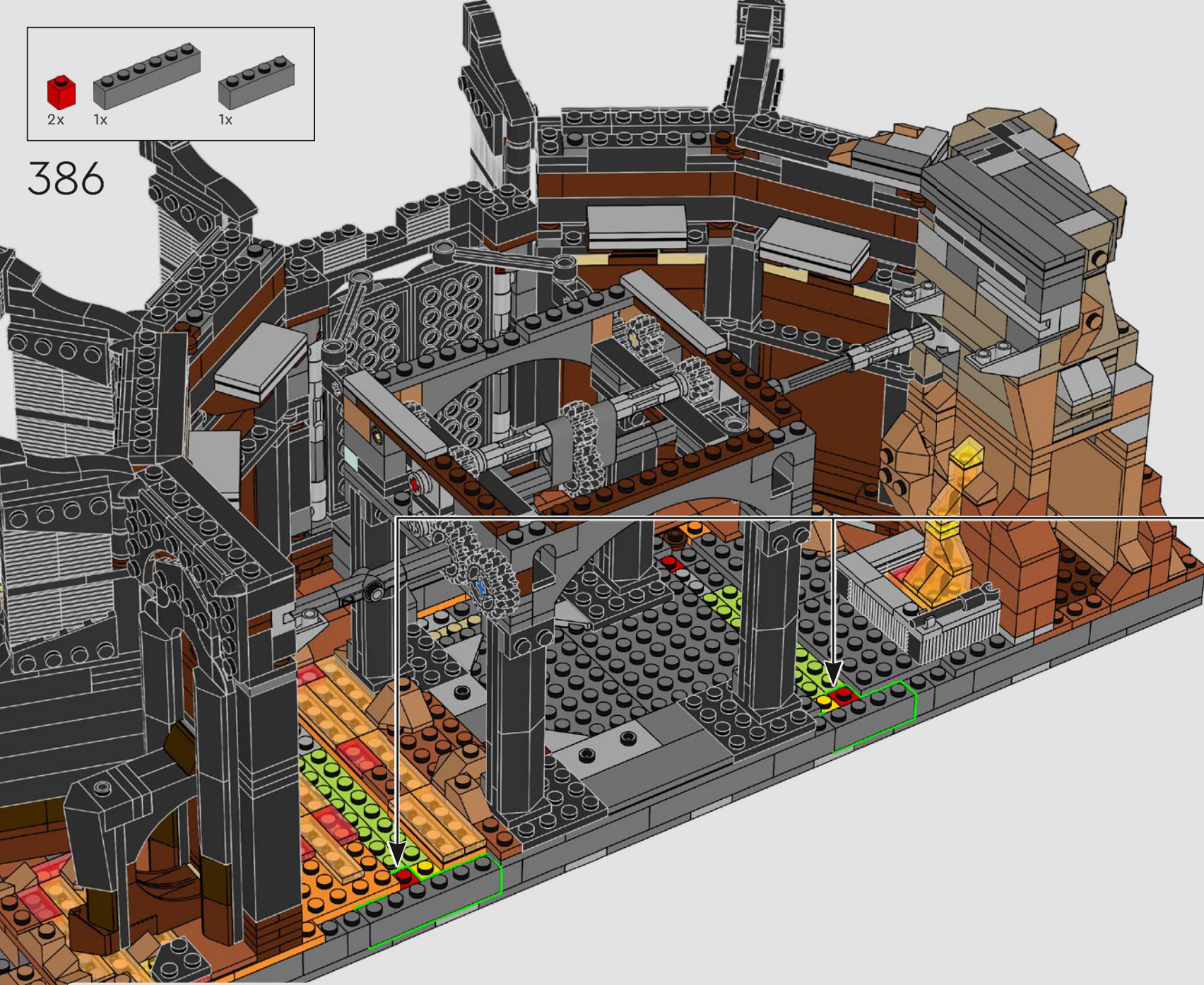

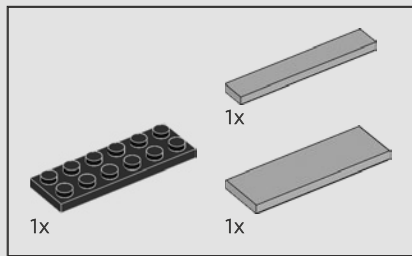

387

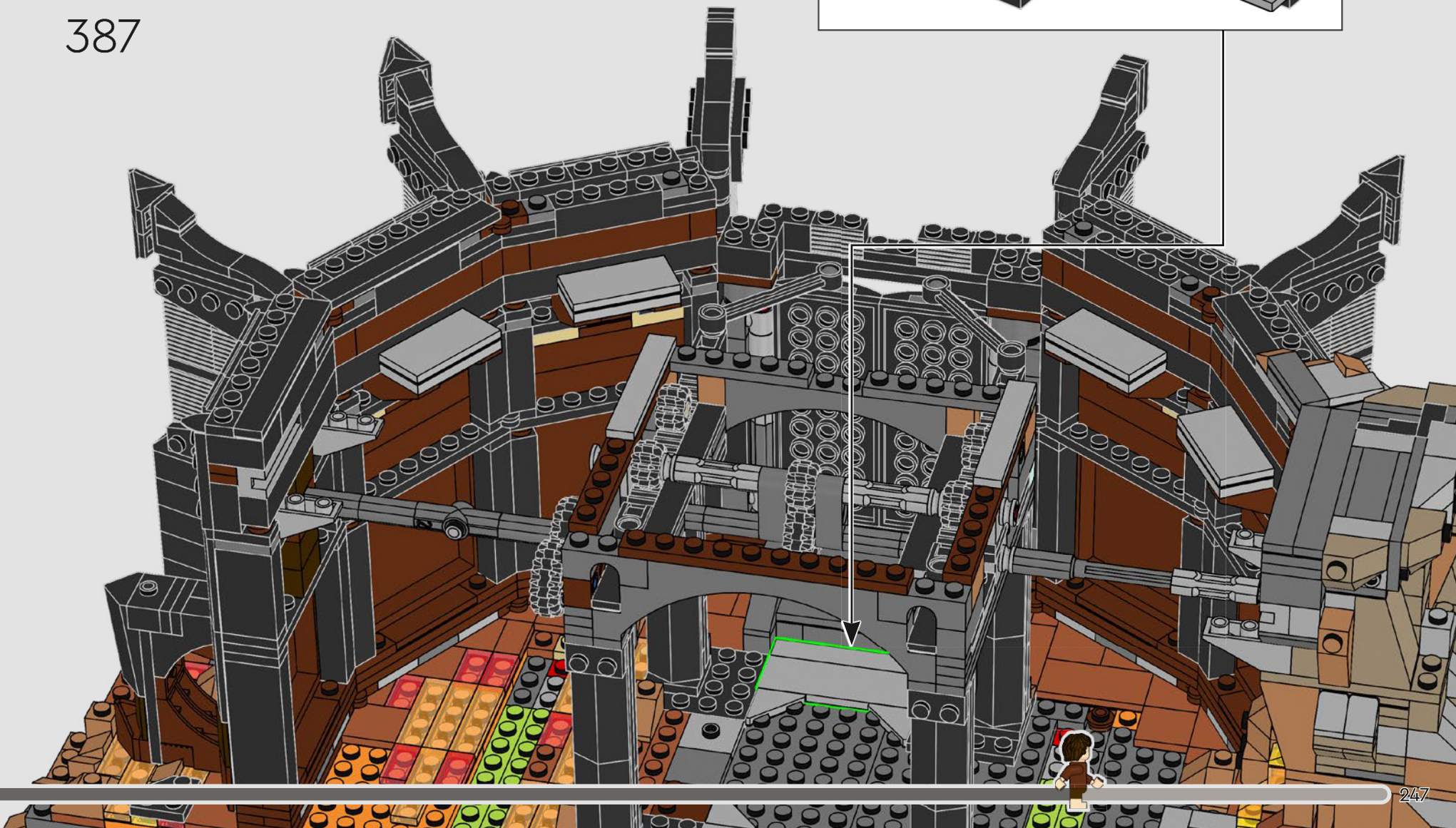
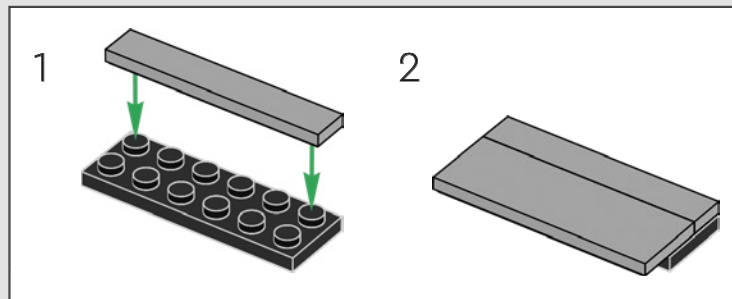

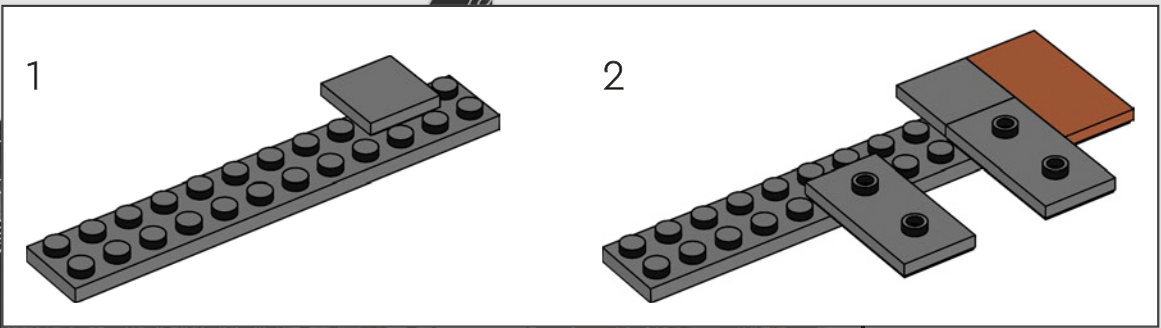
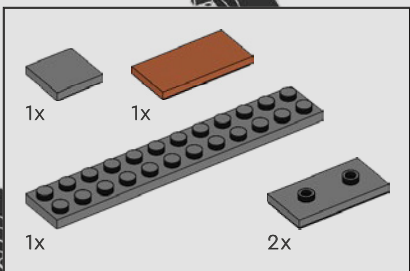

388

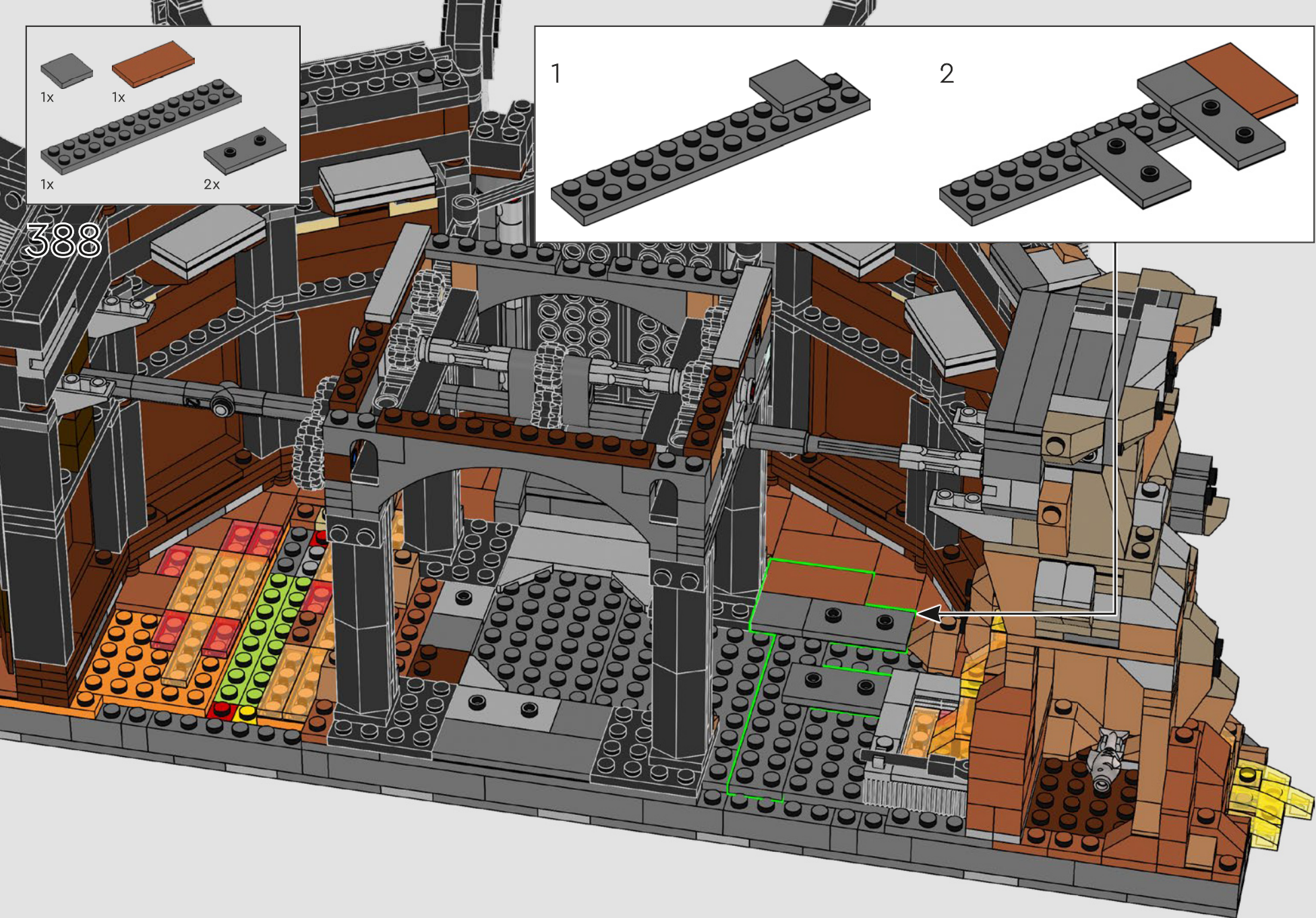

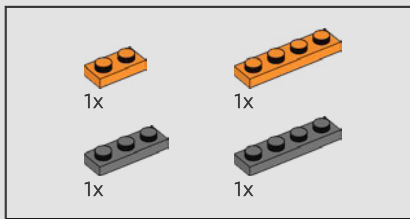

389

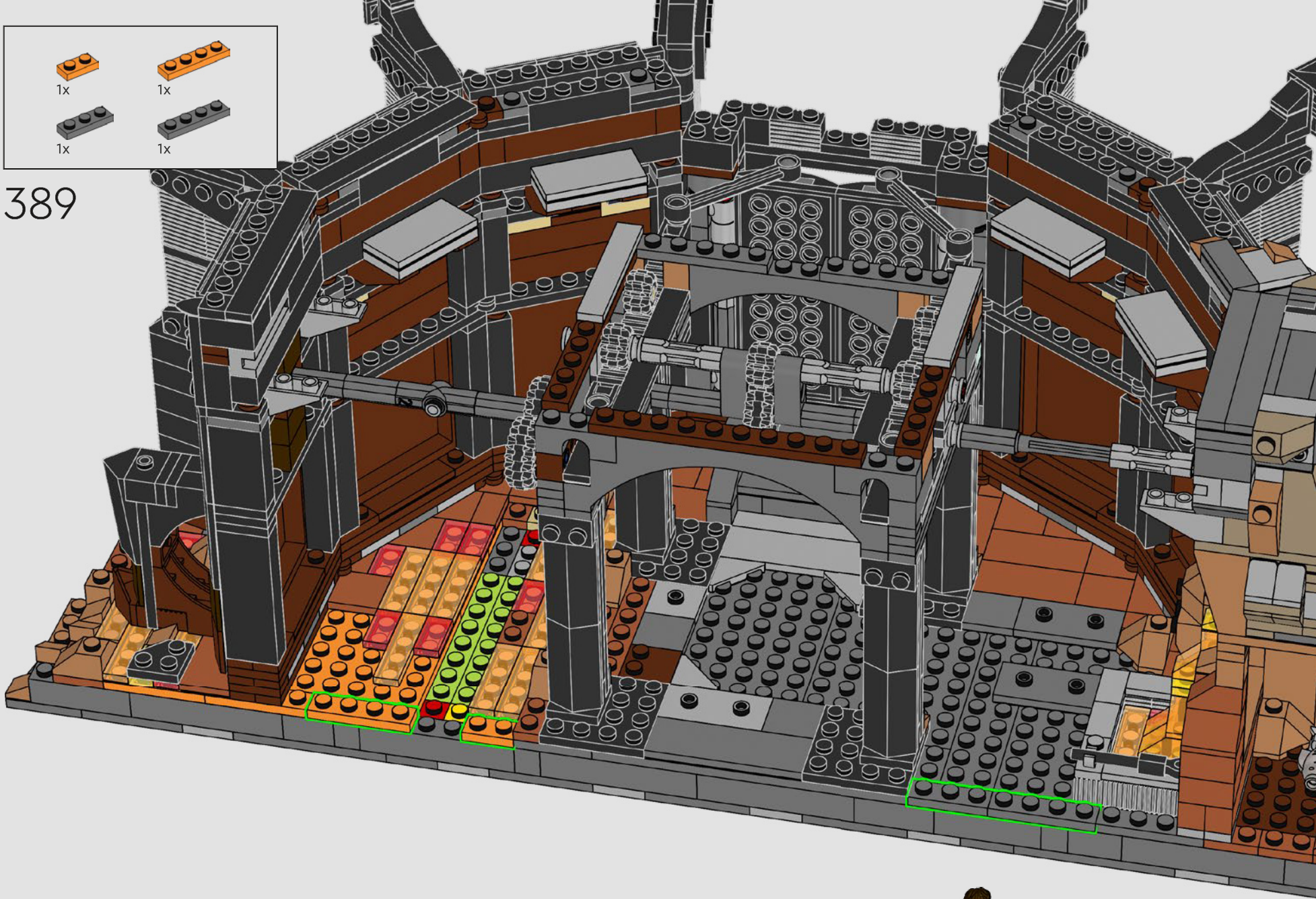

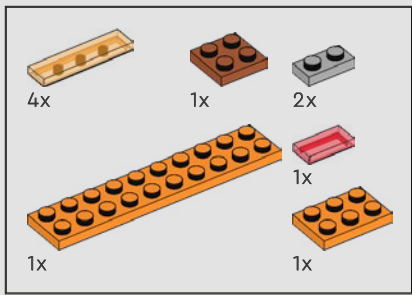

390

1

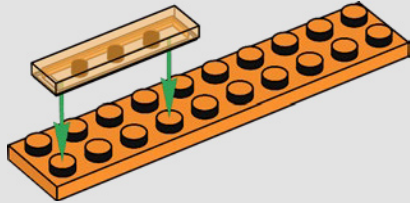

2

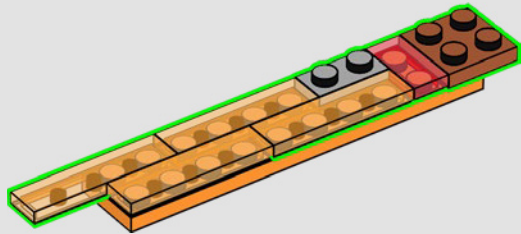

3

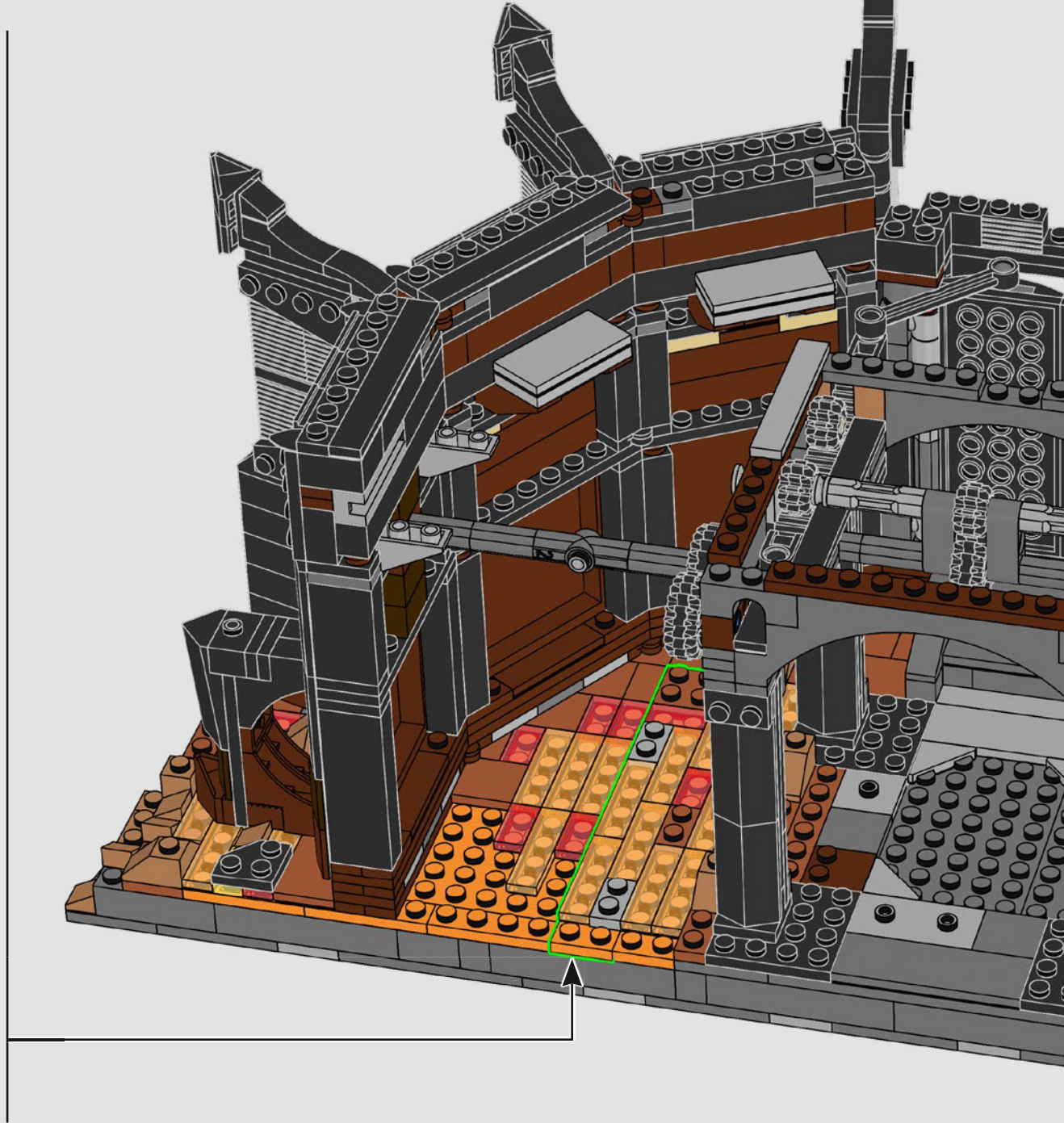
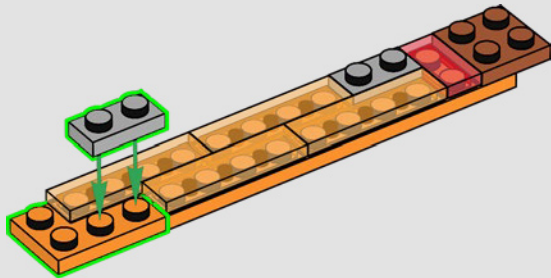

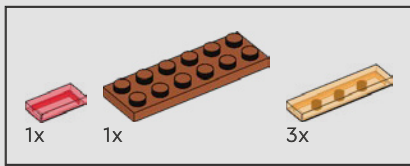

391

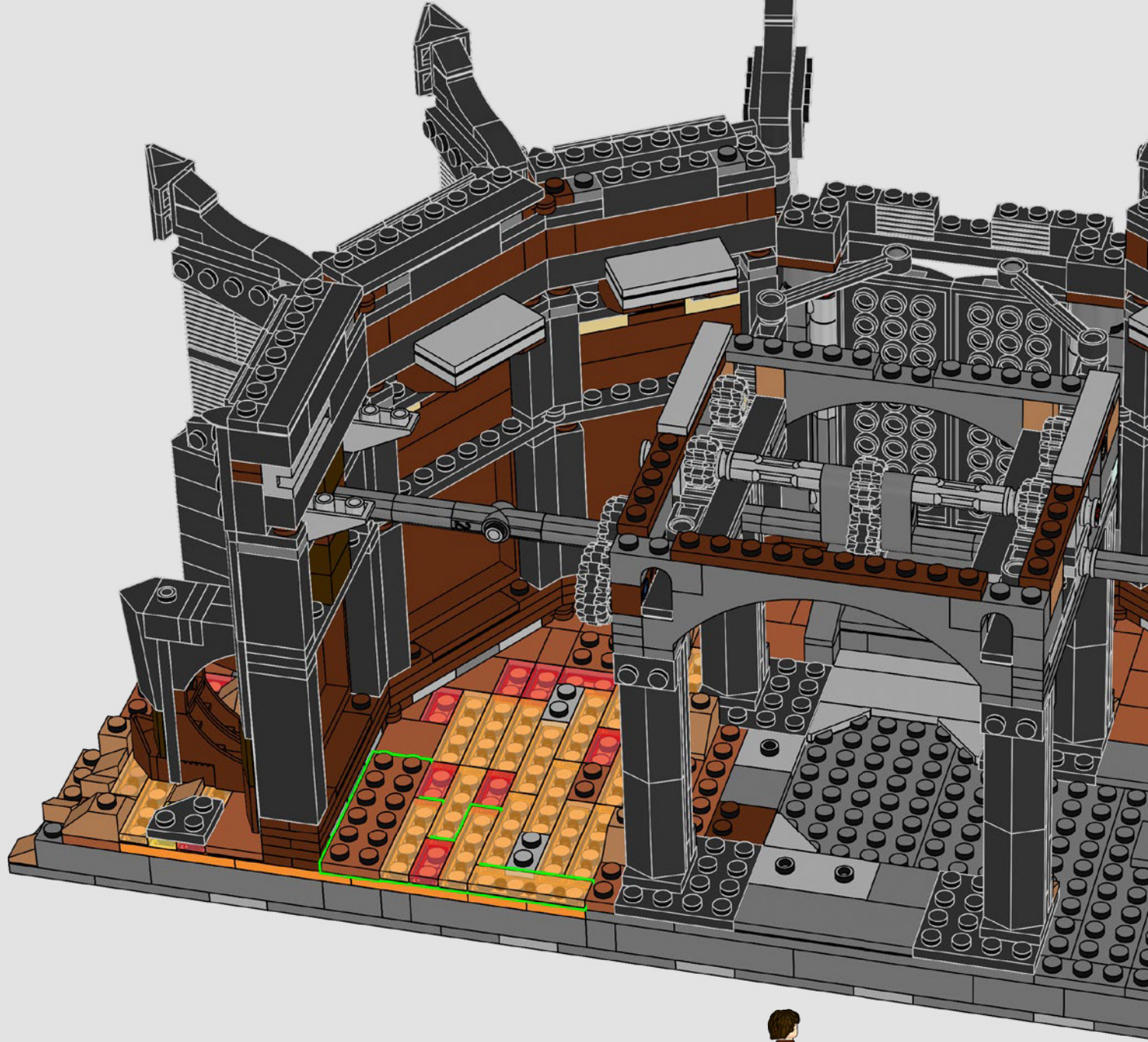



392



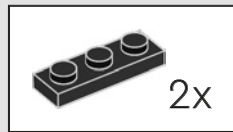
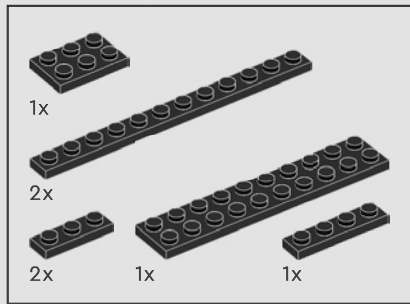

393

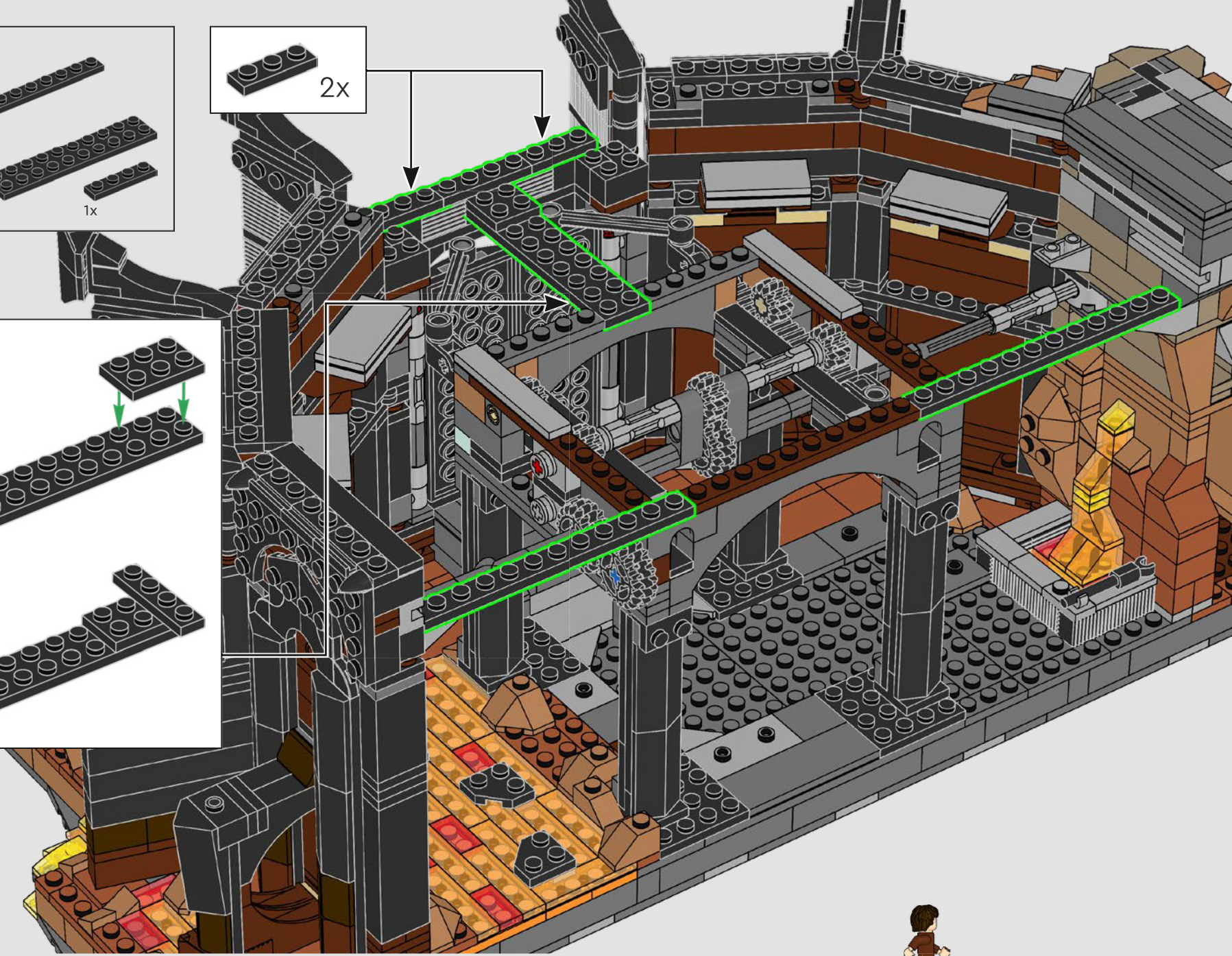
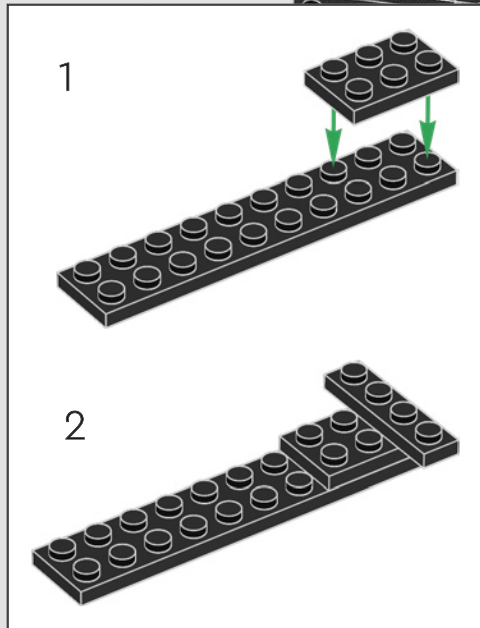

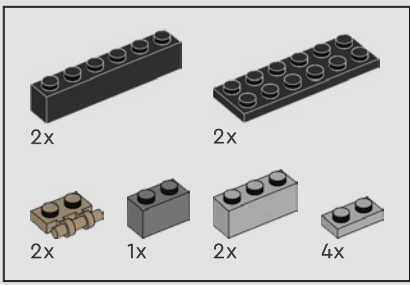

394 1

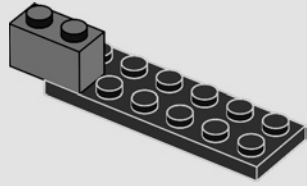

3

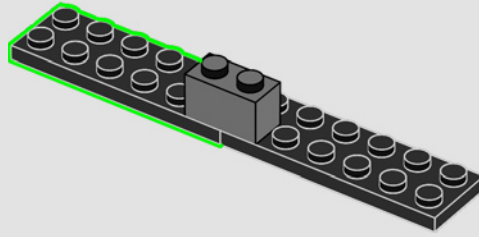

2

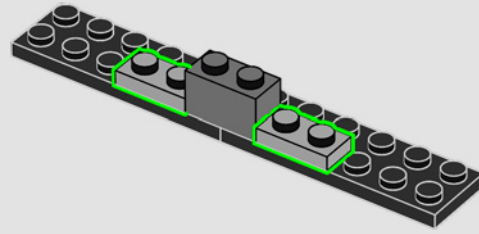

4

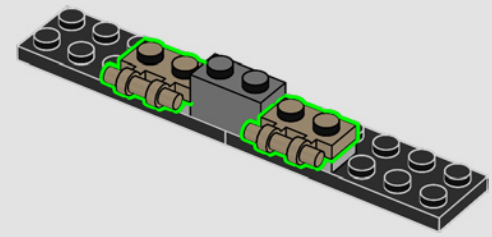

5

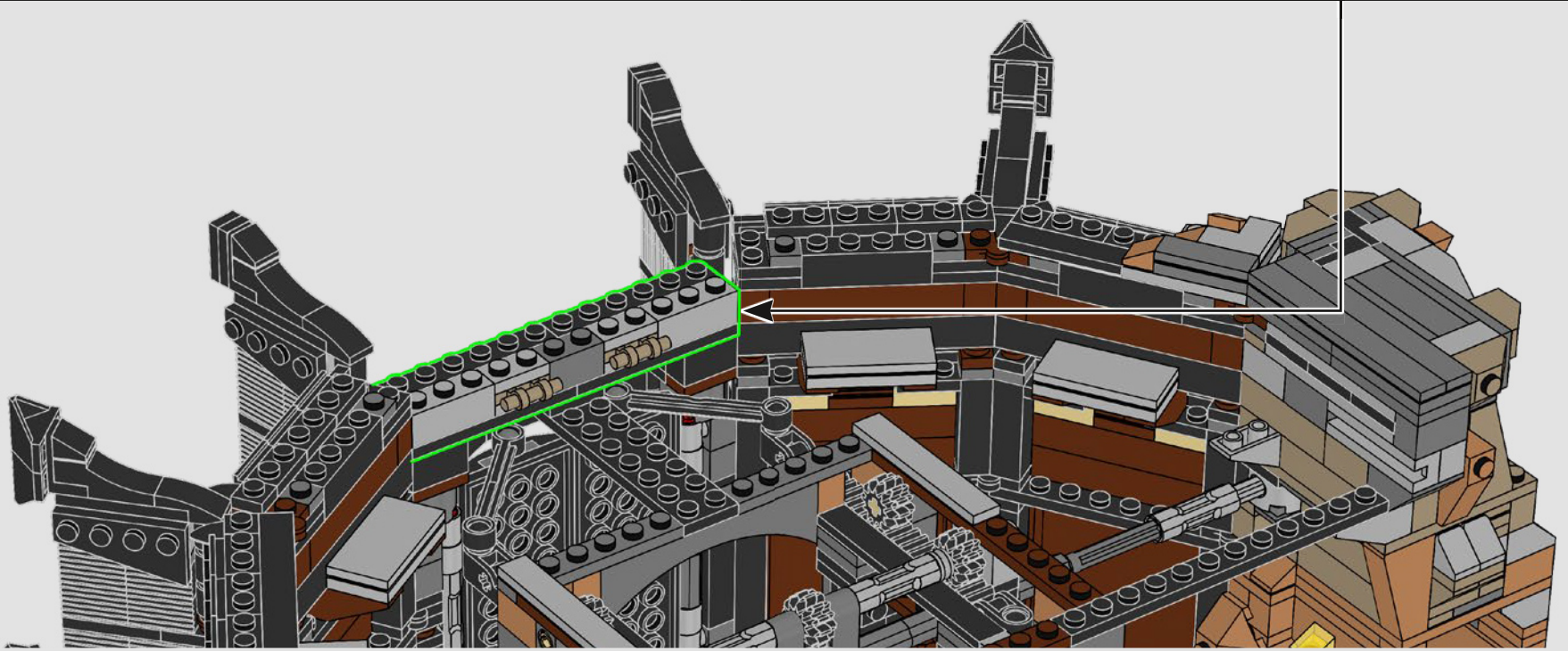
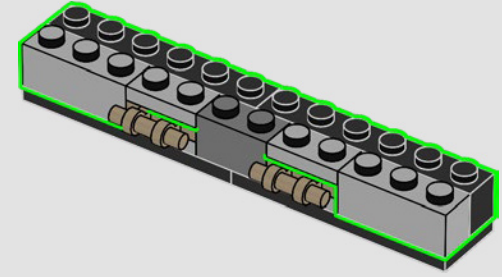

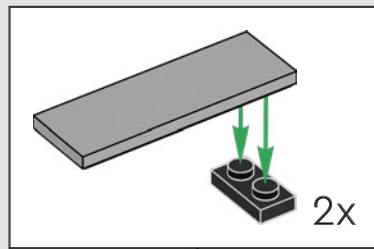
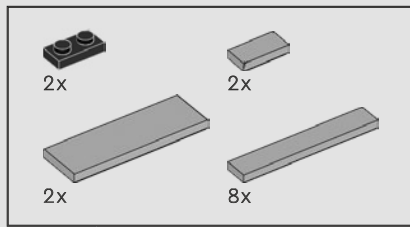

395

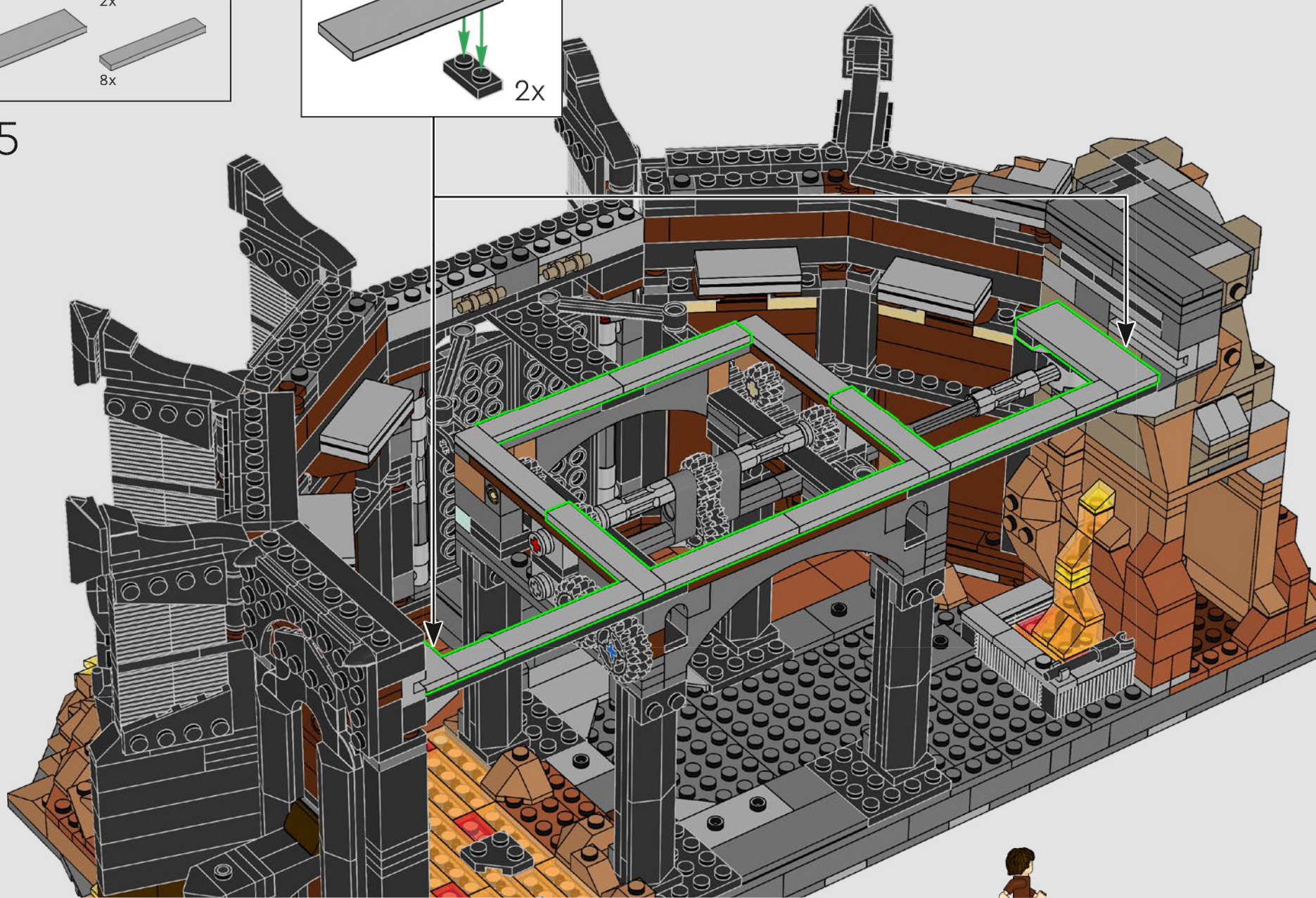

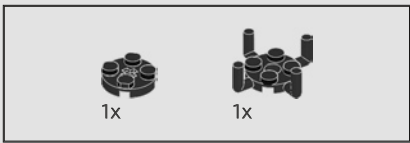

396

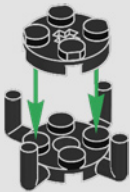

397

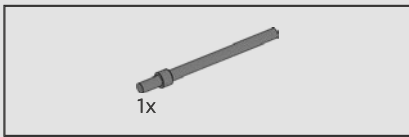

398

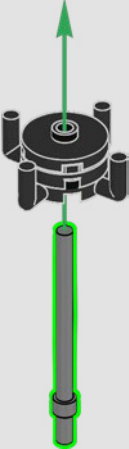

399

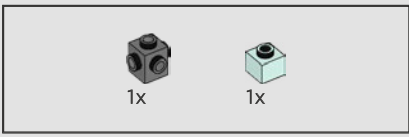
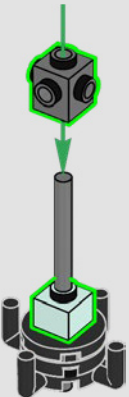

400

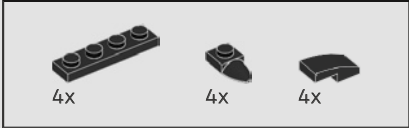
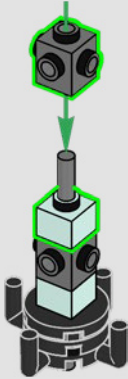

401

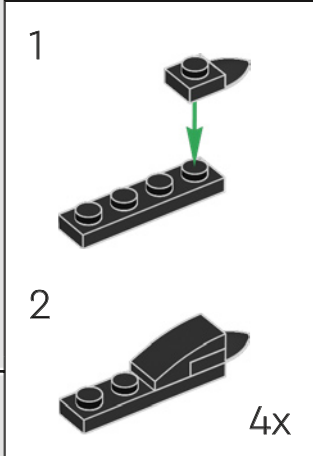
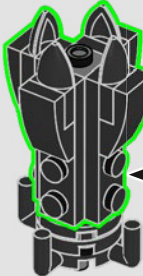

402

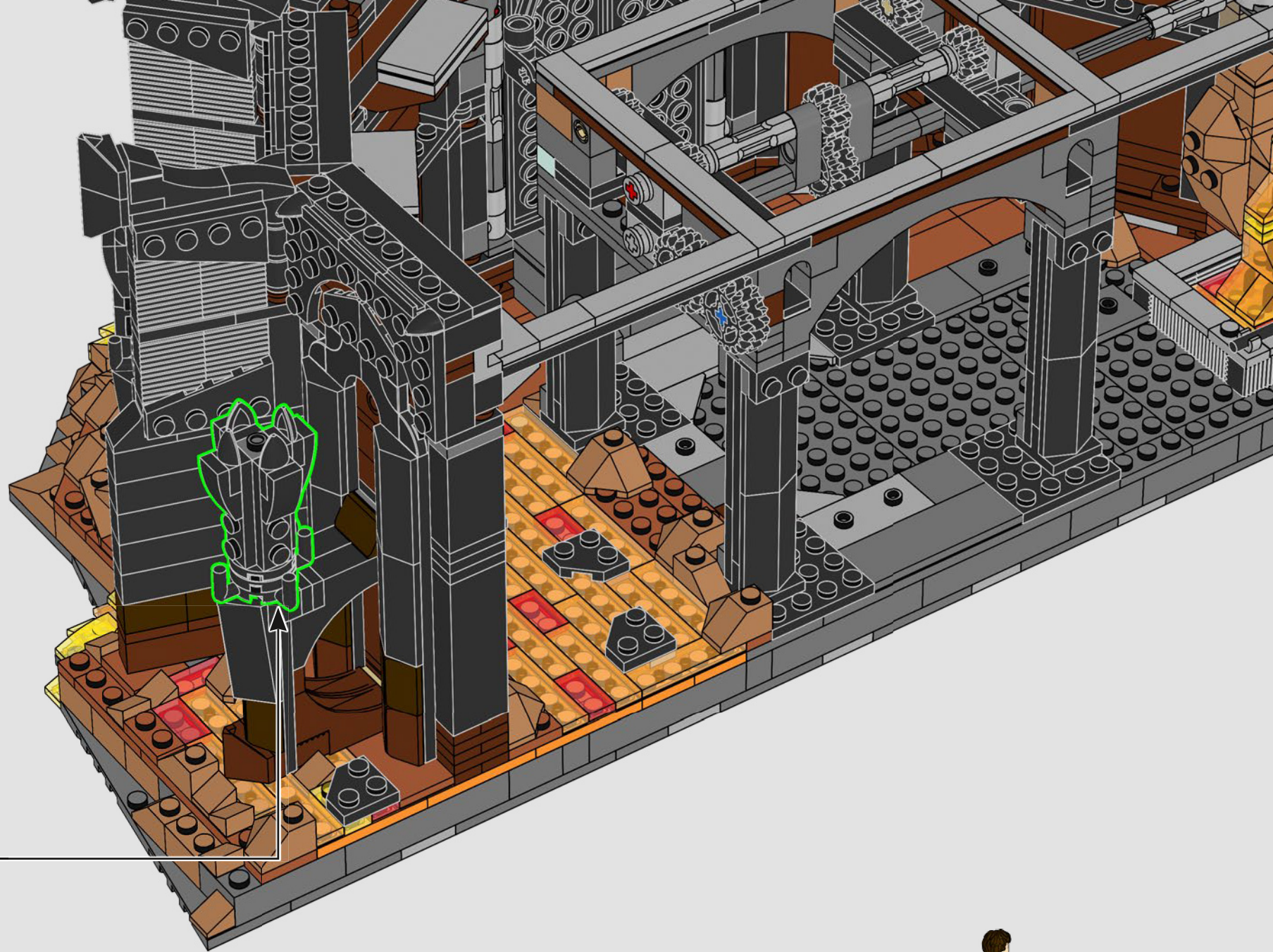



Con motivo de este modelo, se creó un nuevo paquete familiar de cascos que contiene cuatro diseños diferentes.

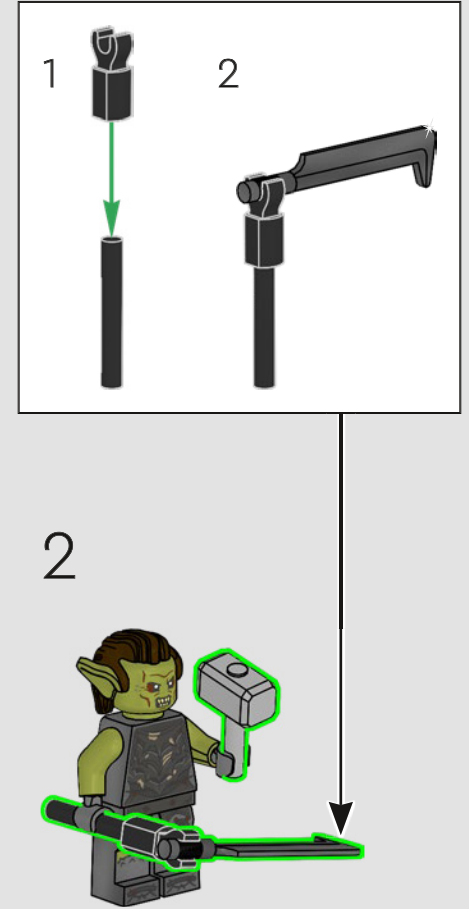
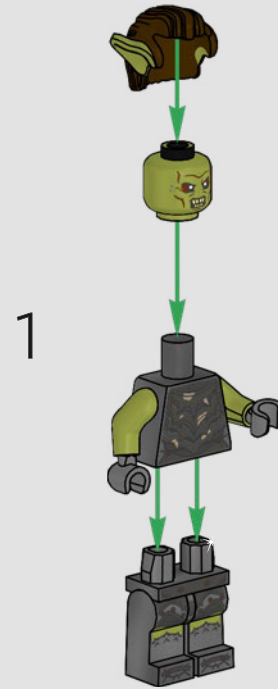
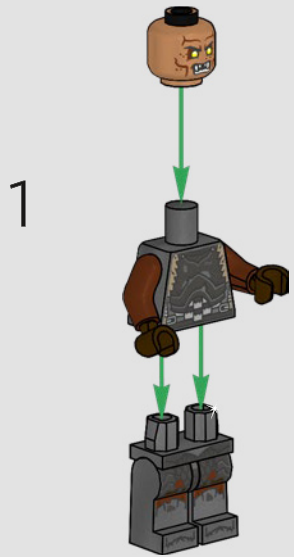

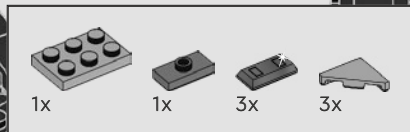

403

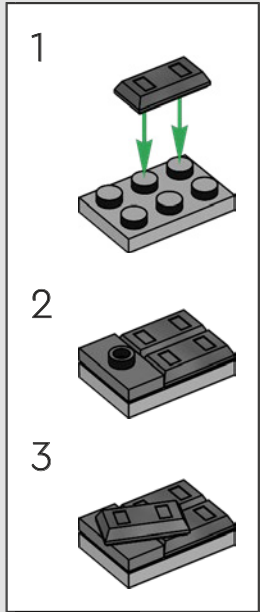
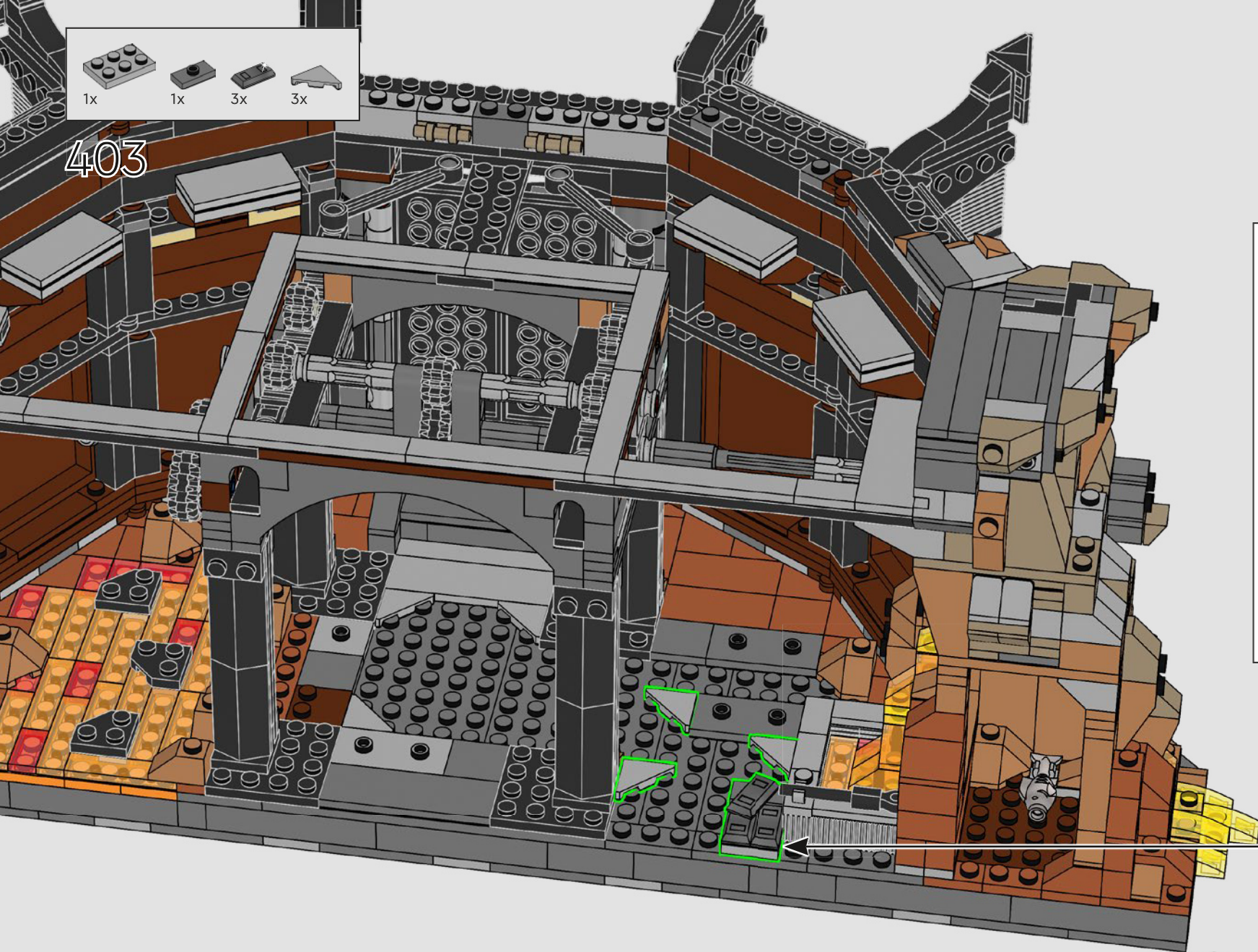

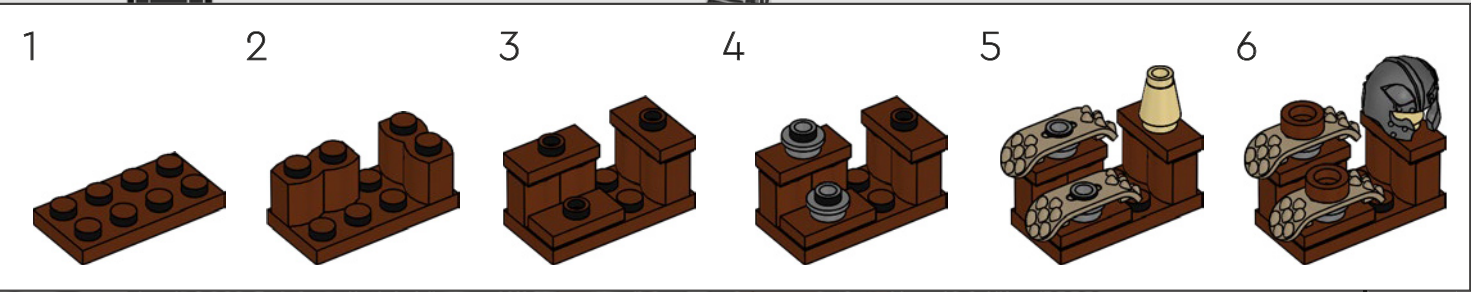
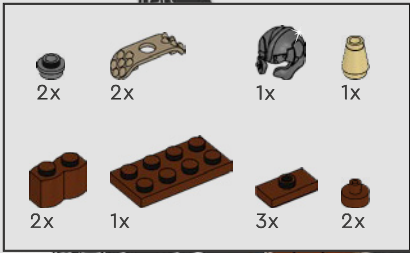

404



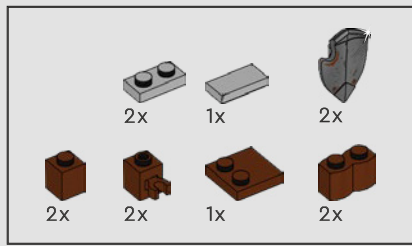

405

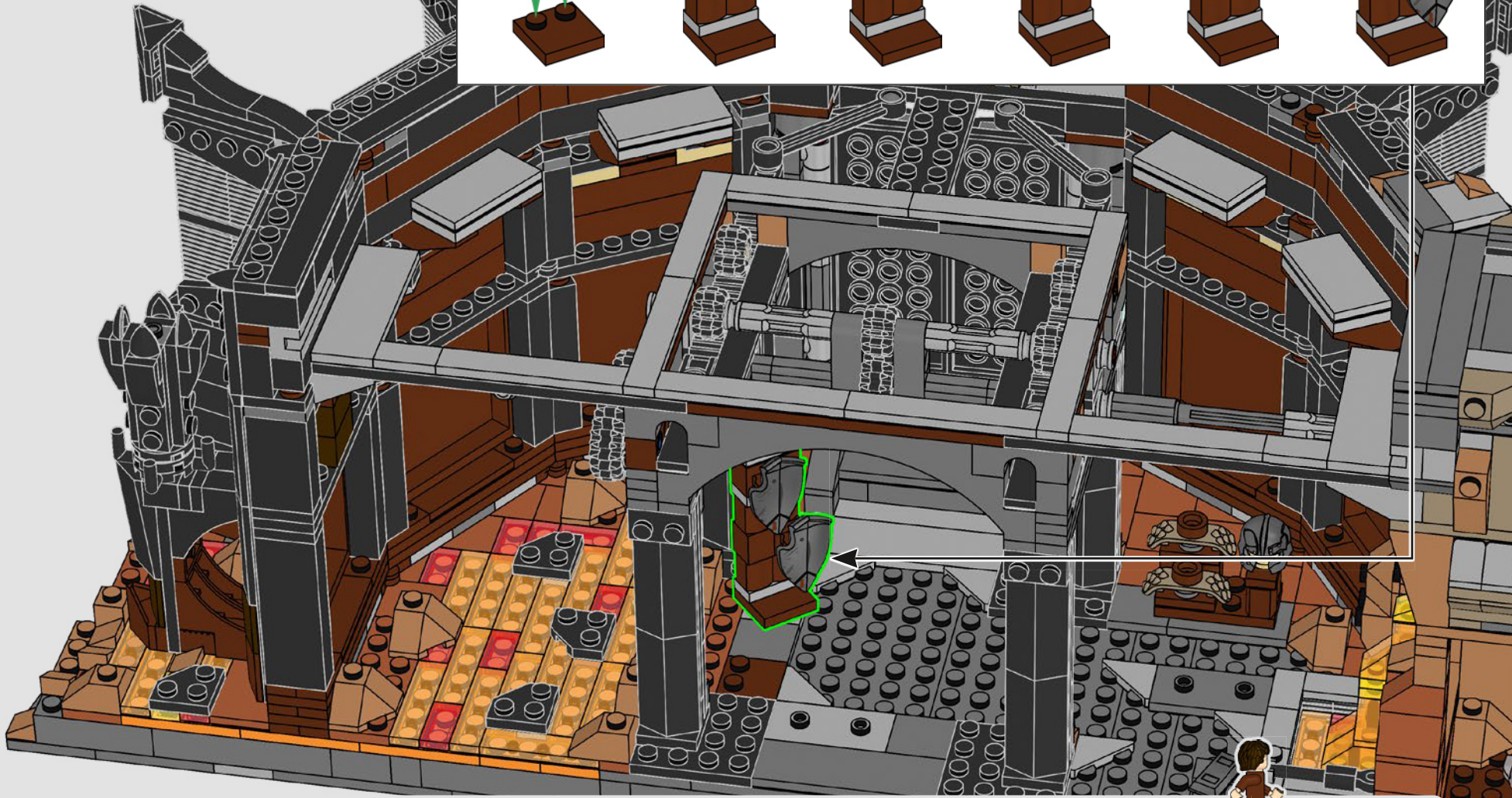
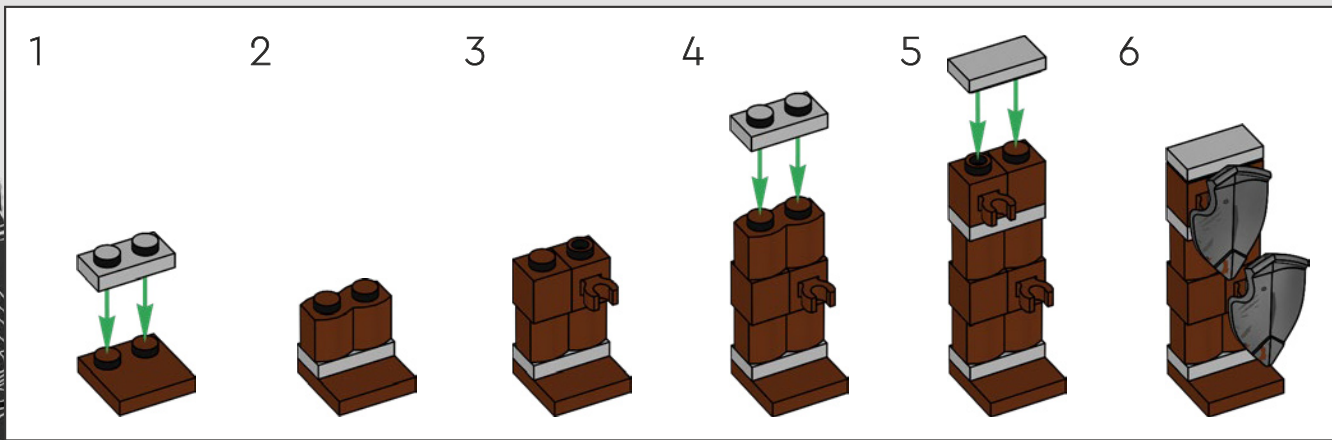



406

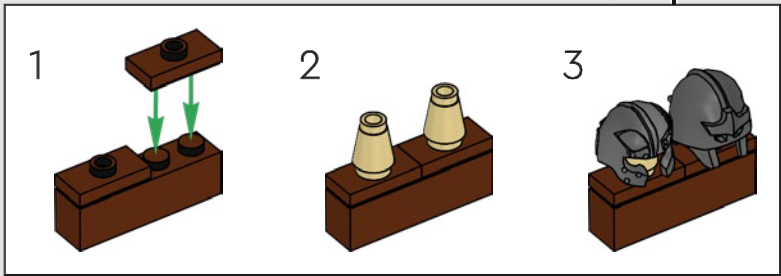
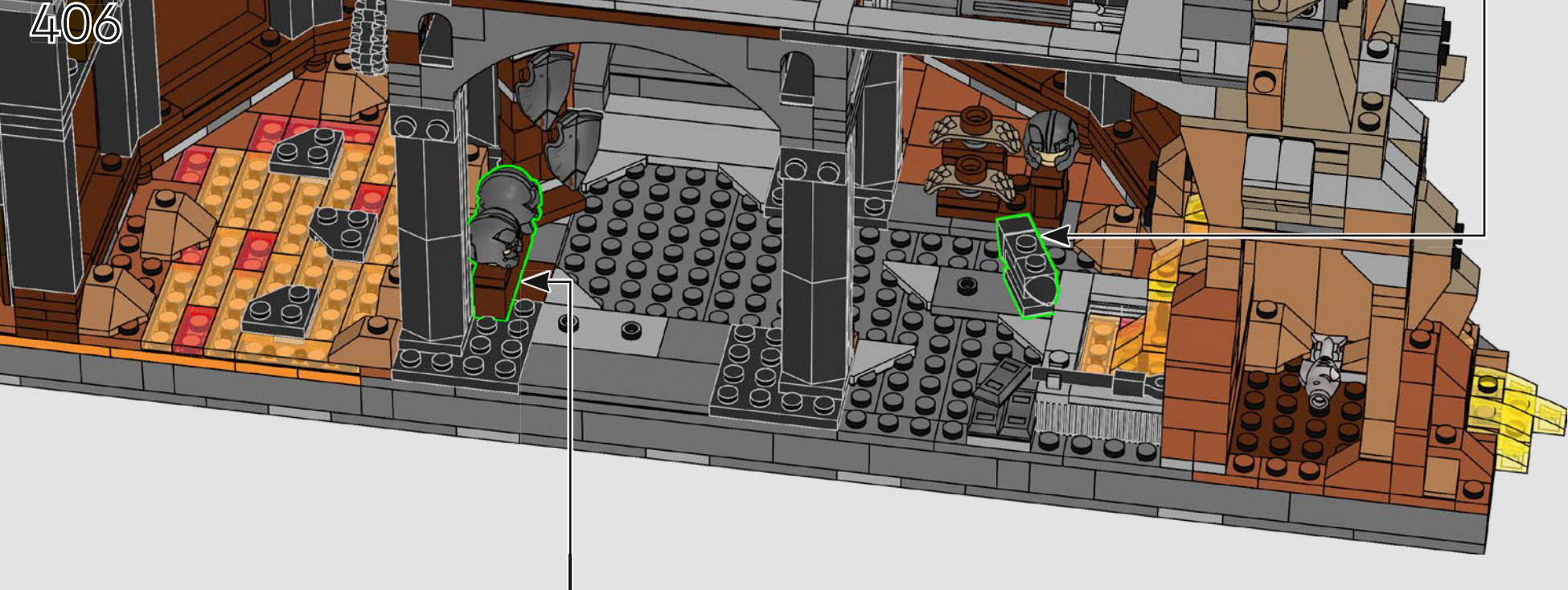
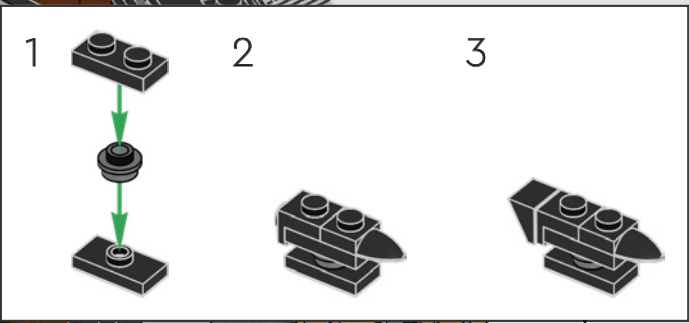

Para atravesar Mordor™ sin ser descubiertos, Frodo Bolsón y Samsagaz Gamyi se pusieron cascos de Orcos.



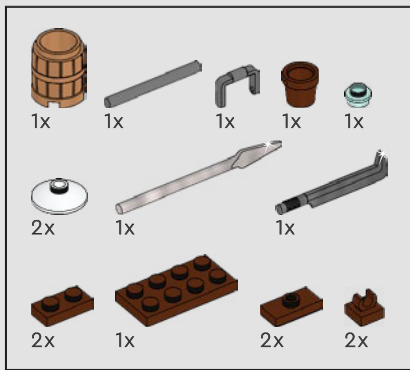

407

1



2

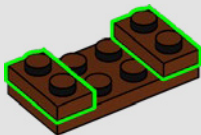

3

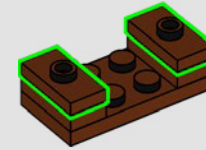

4

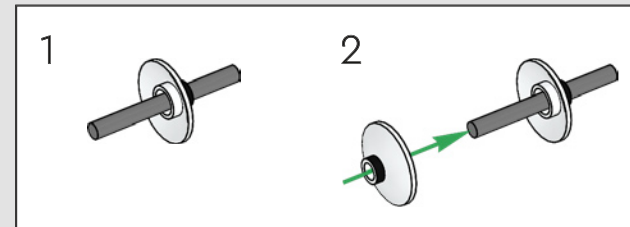
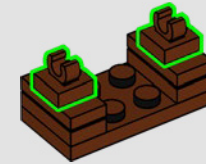

5

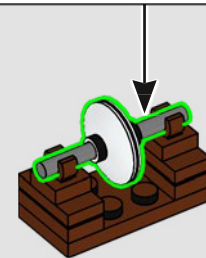

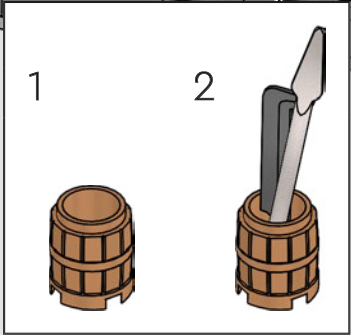
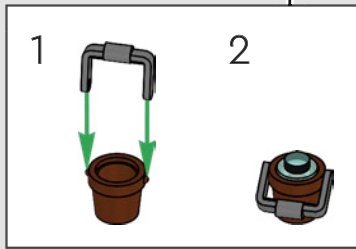
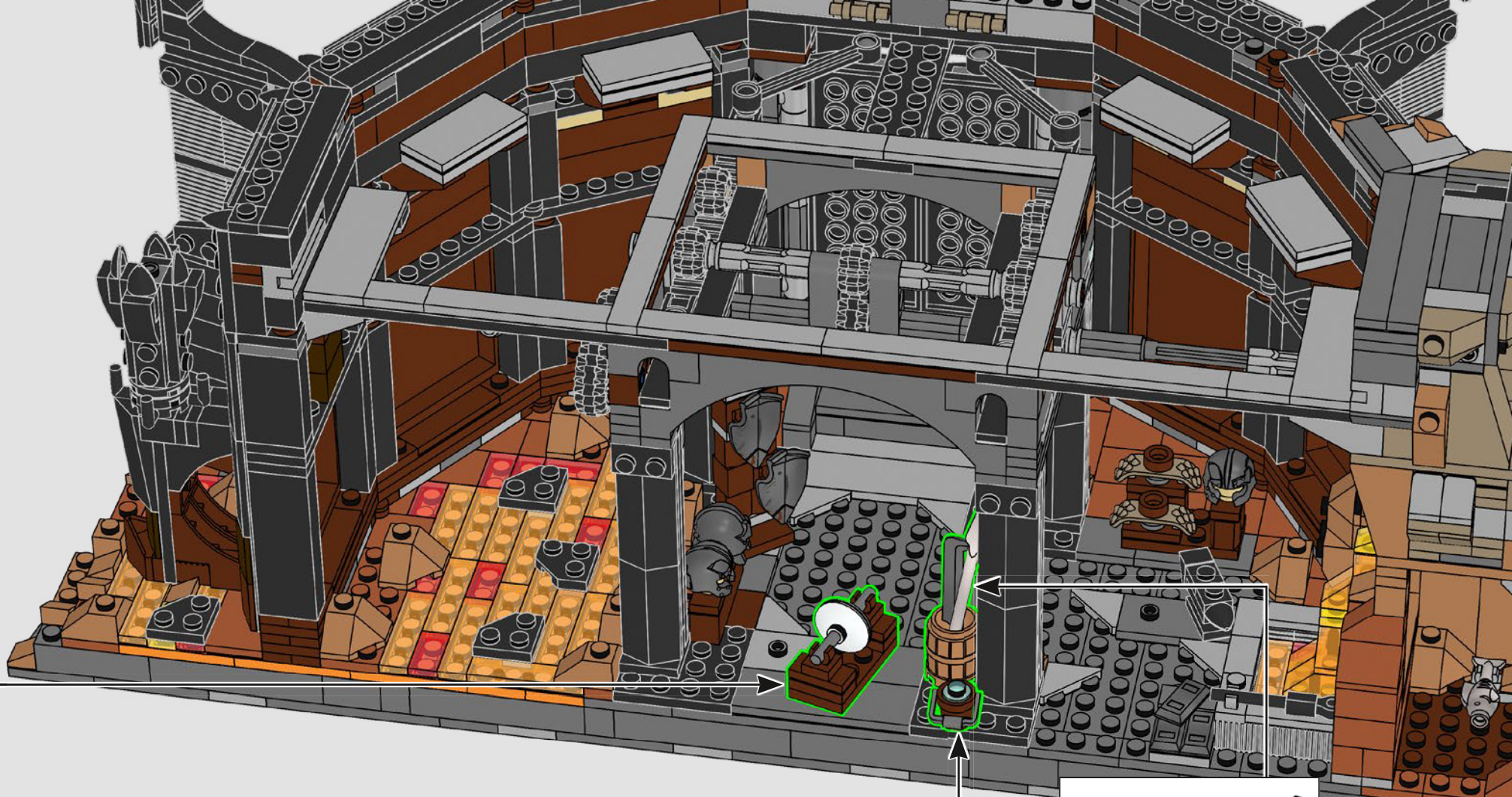

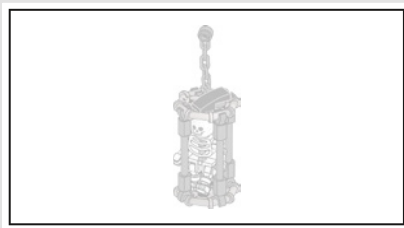

408



409

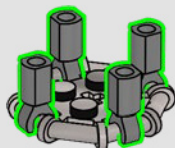

410

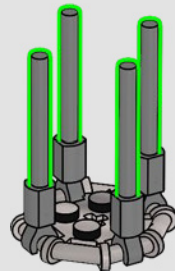

411

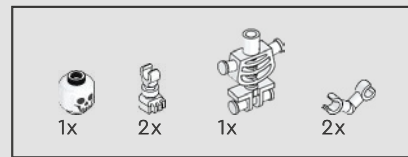
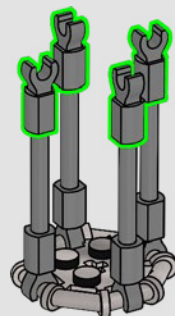

412

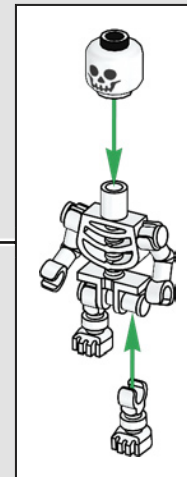
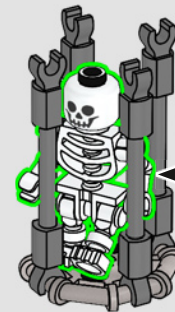

413

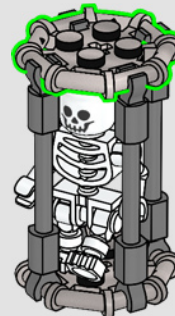

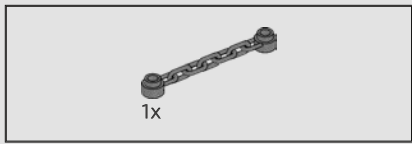

414

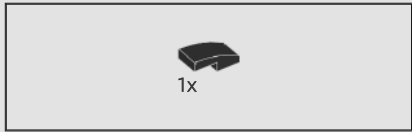
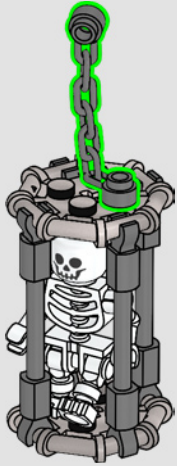

415

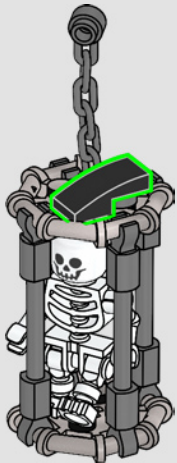

416

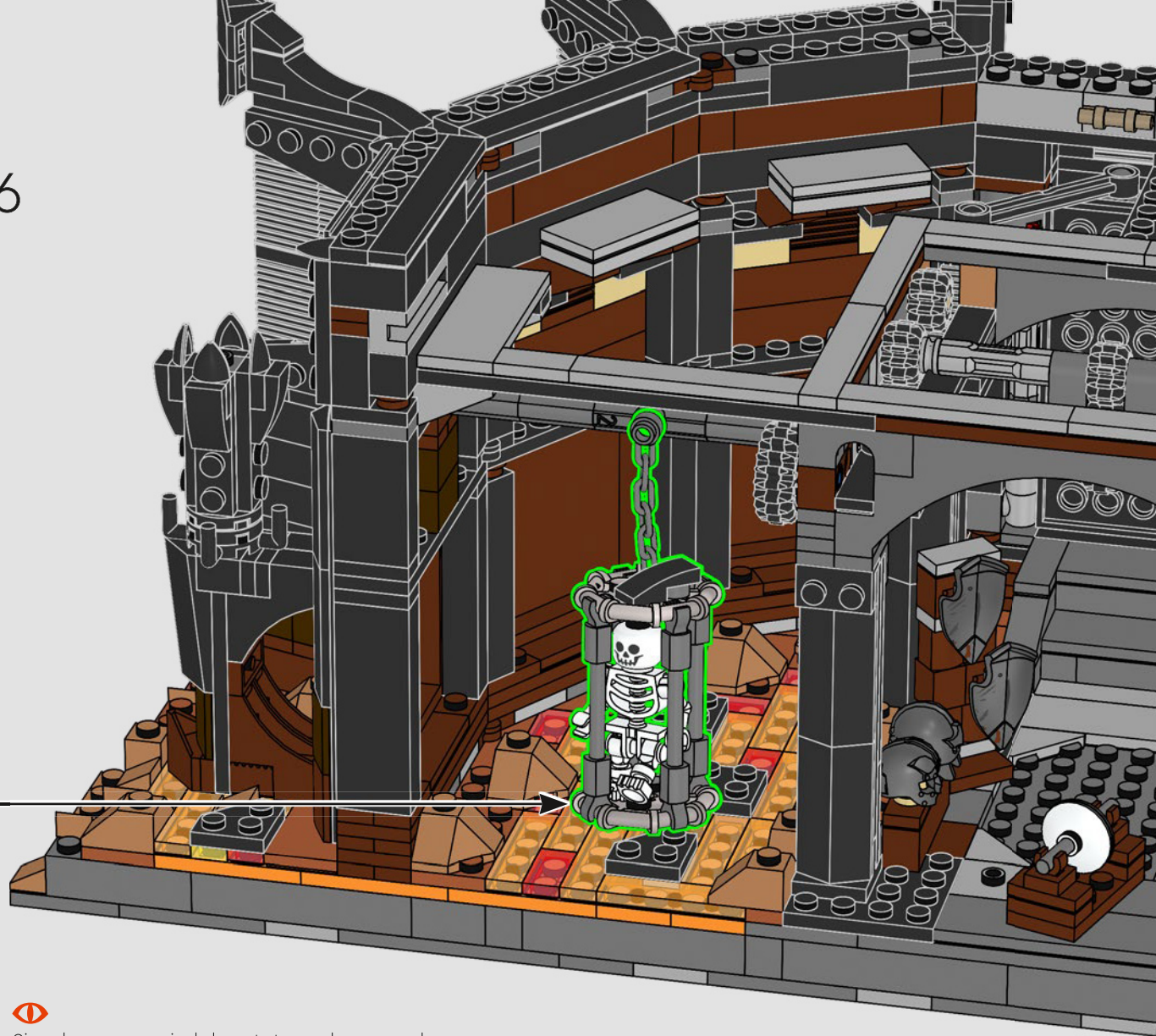

Girar el gran engranaje de la parte trasera hace que suba o baje la jaula que cuelga peligrosamente sobre el pozo de lava.



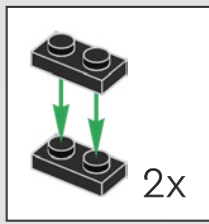
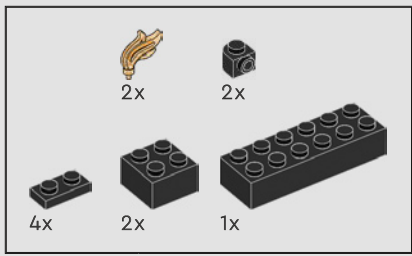

417

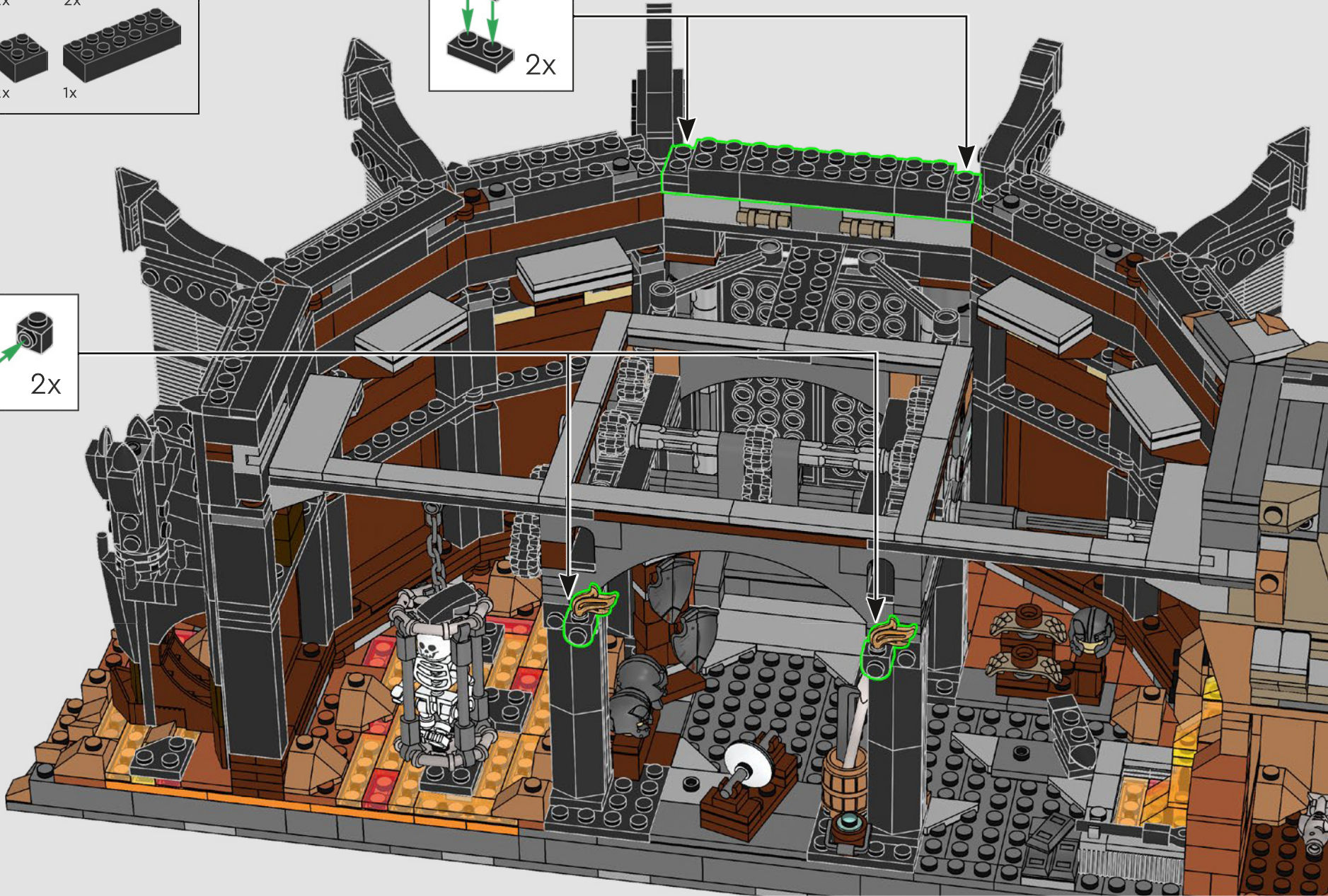
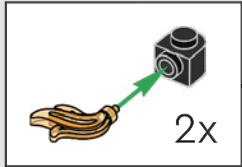

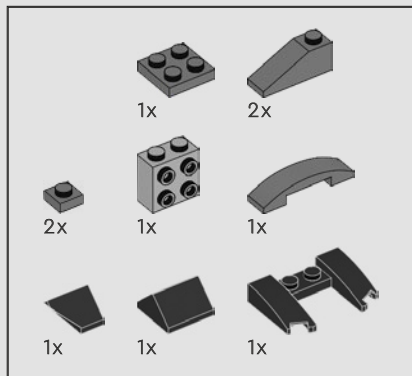

418

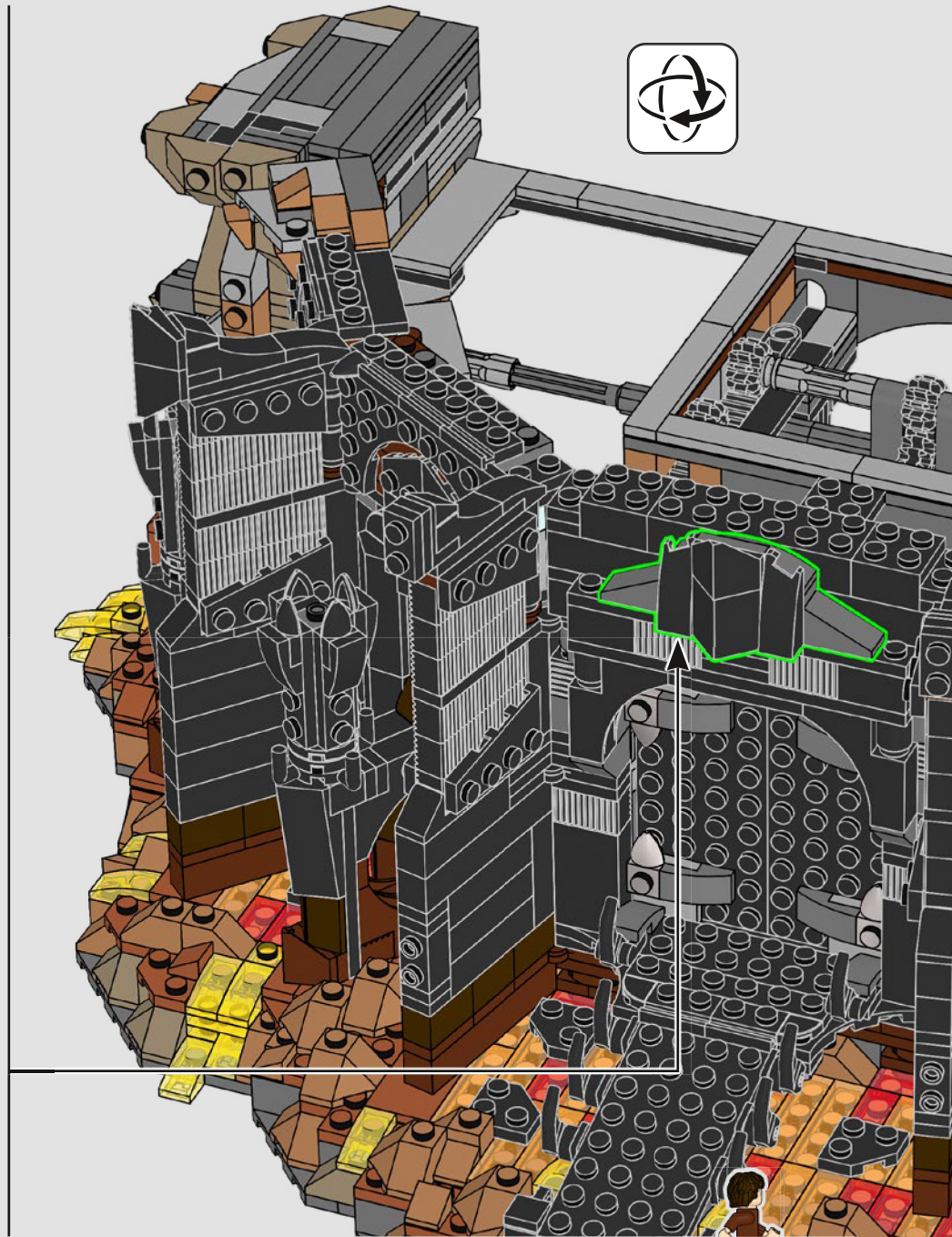
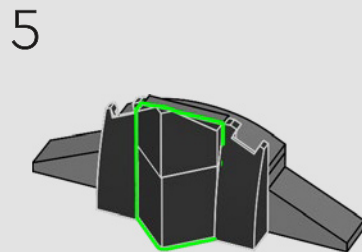
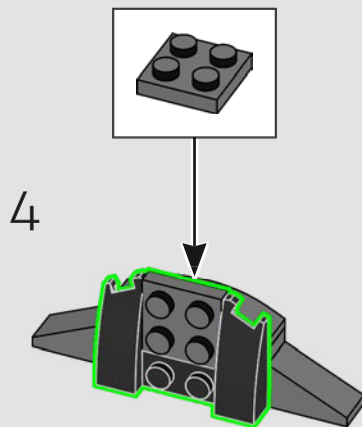
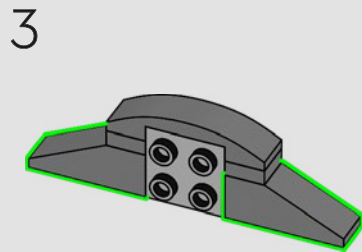
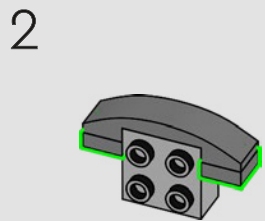
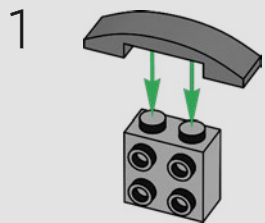

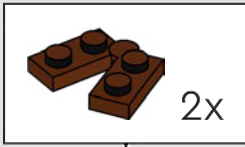

419

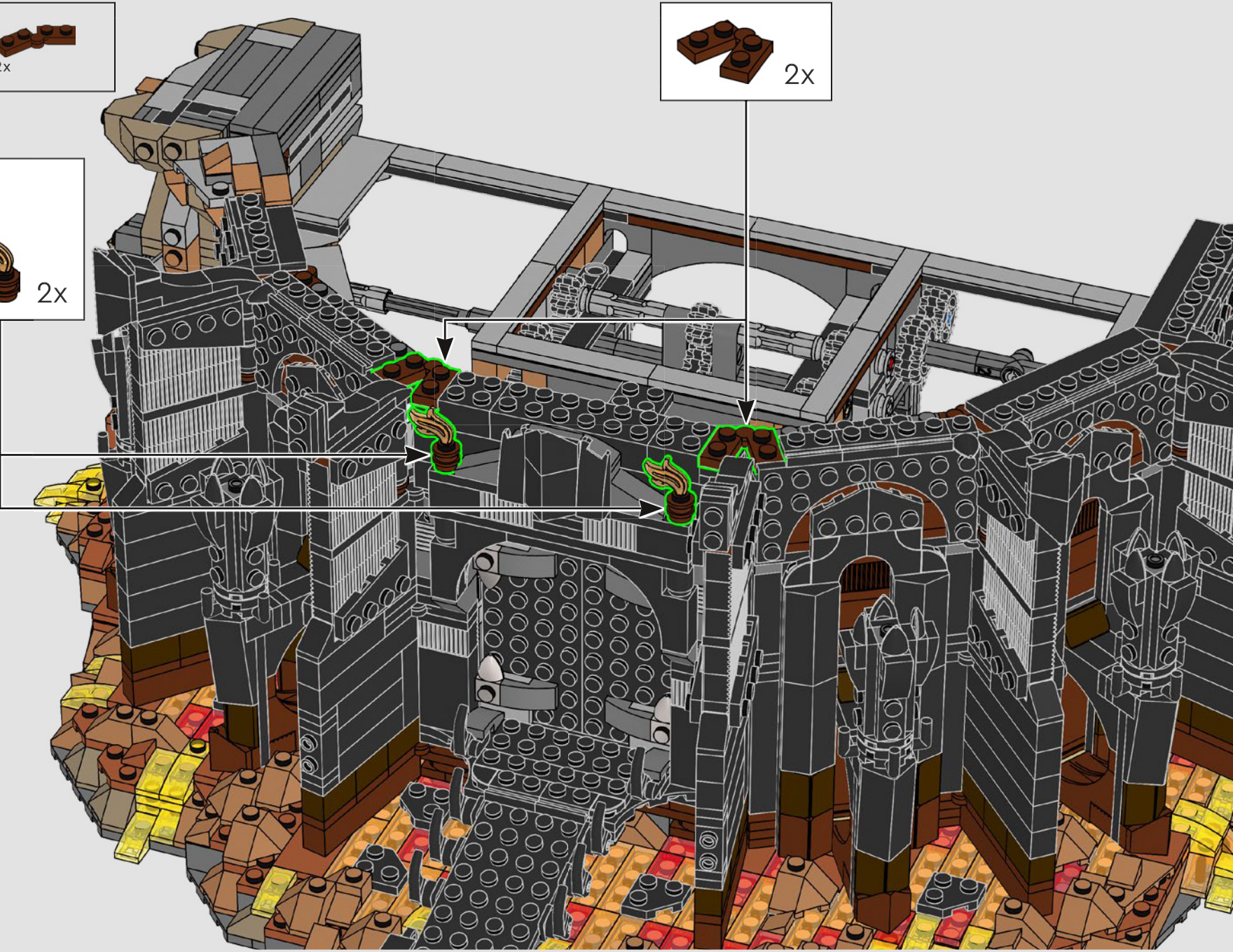
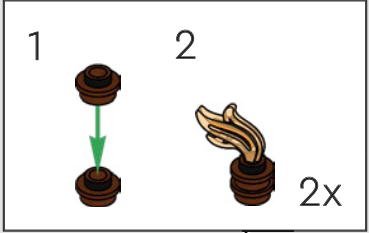

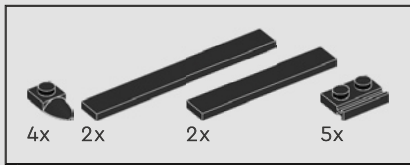

420

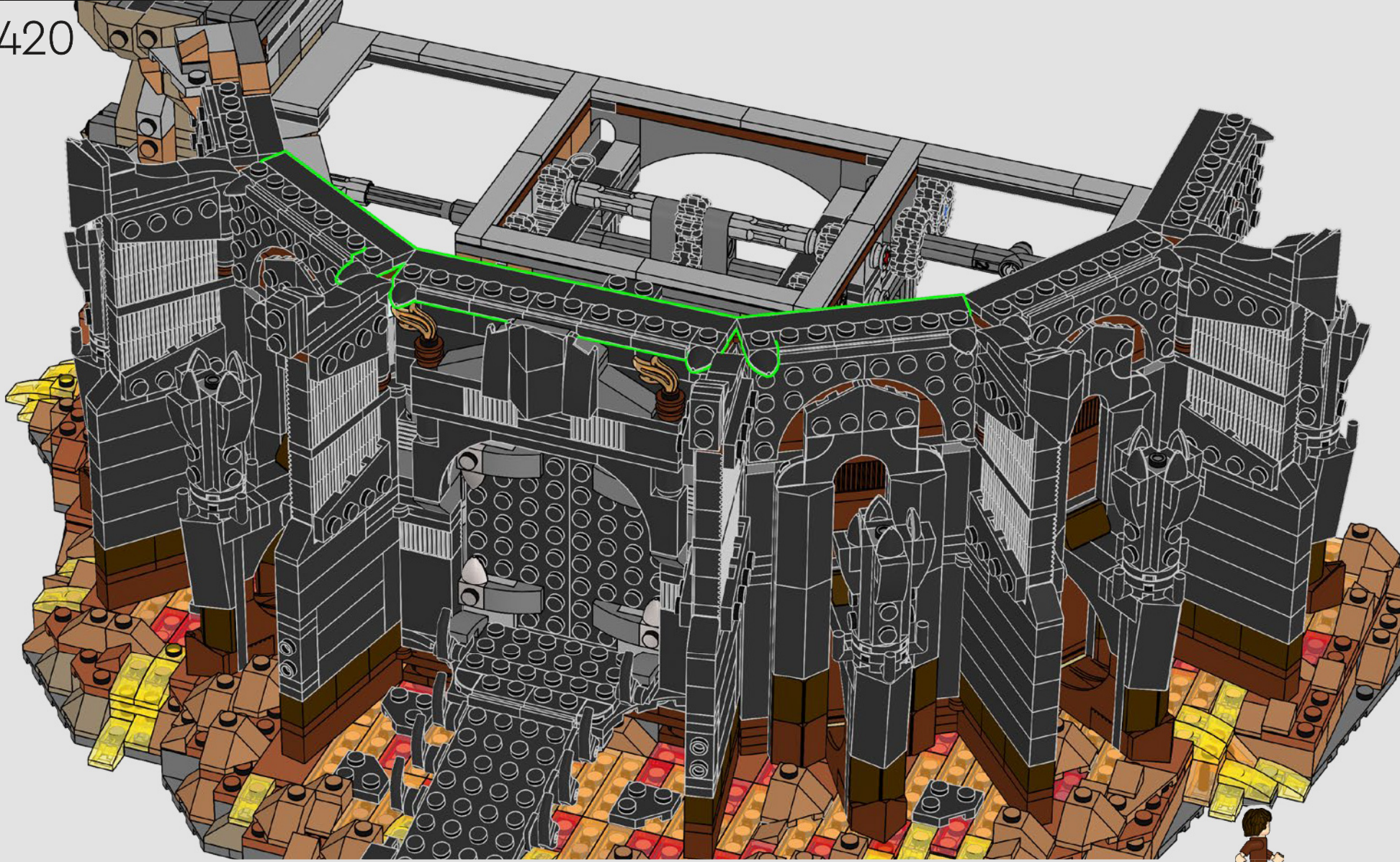

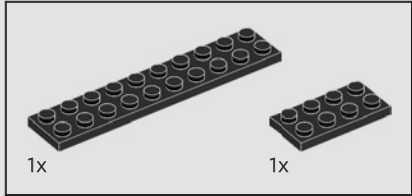
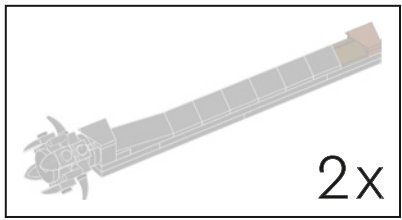

421

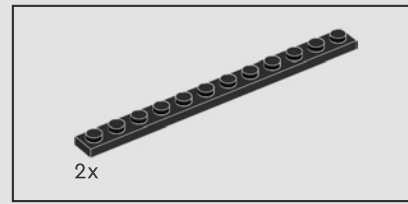
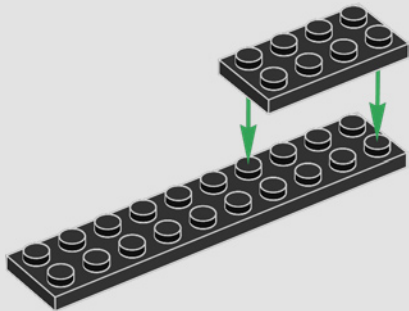

422

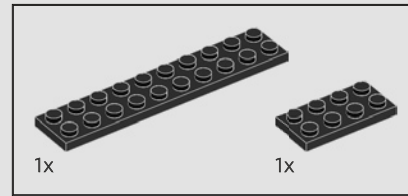
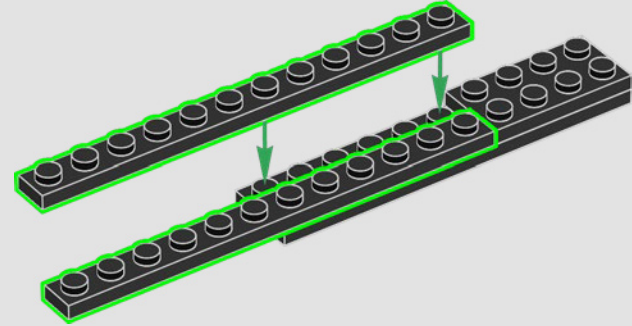

423

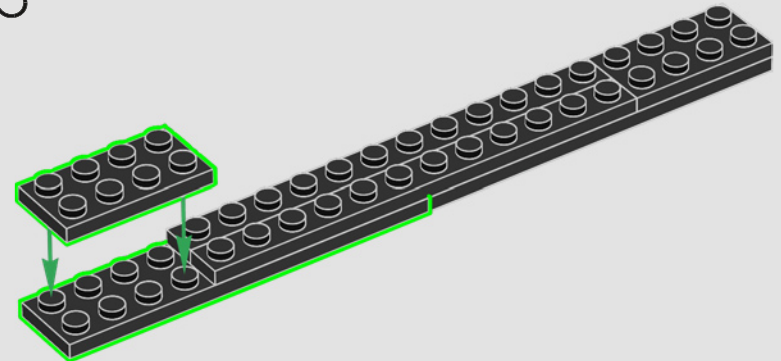

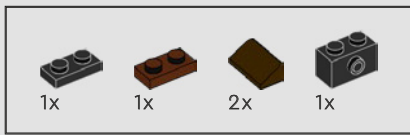

424

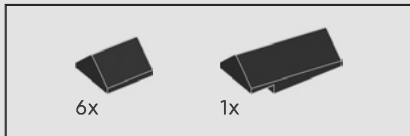
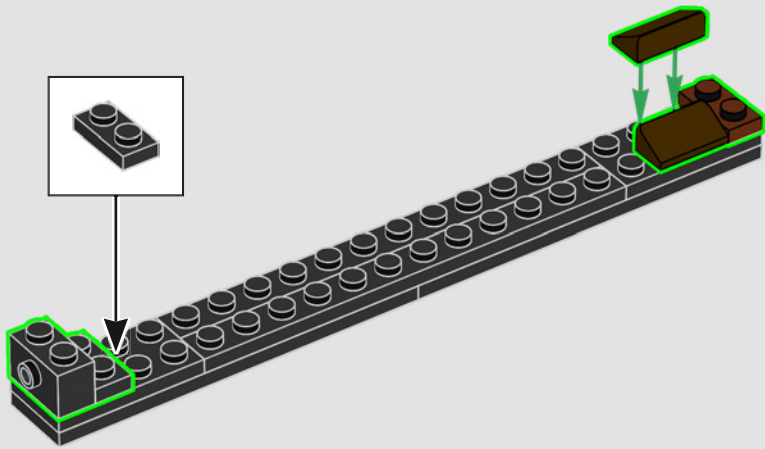

425

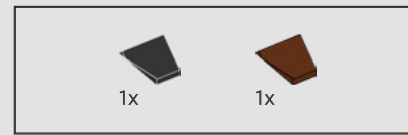
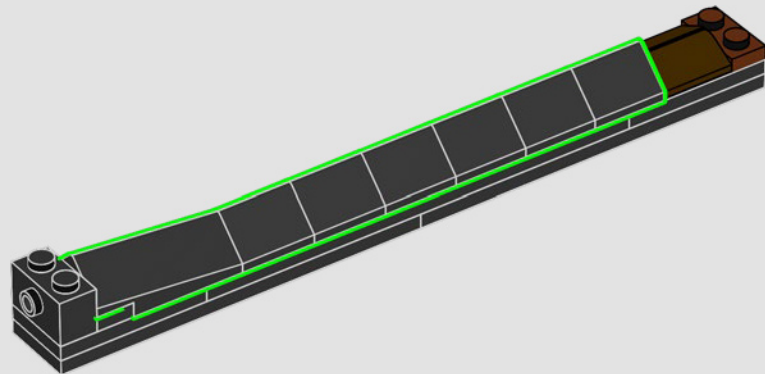

426

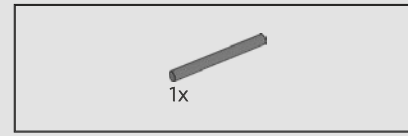
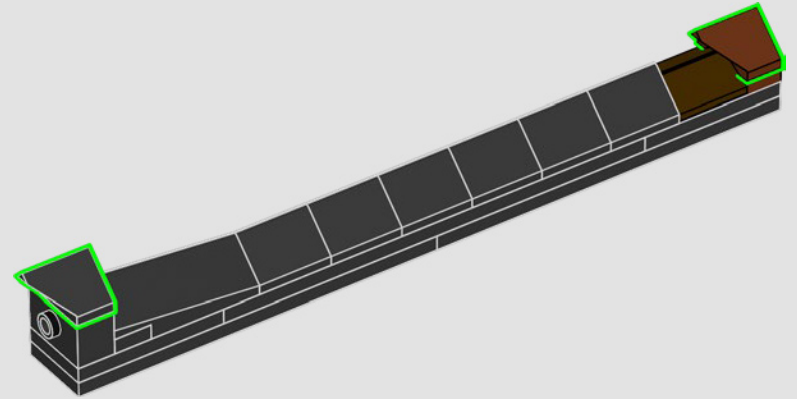

427

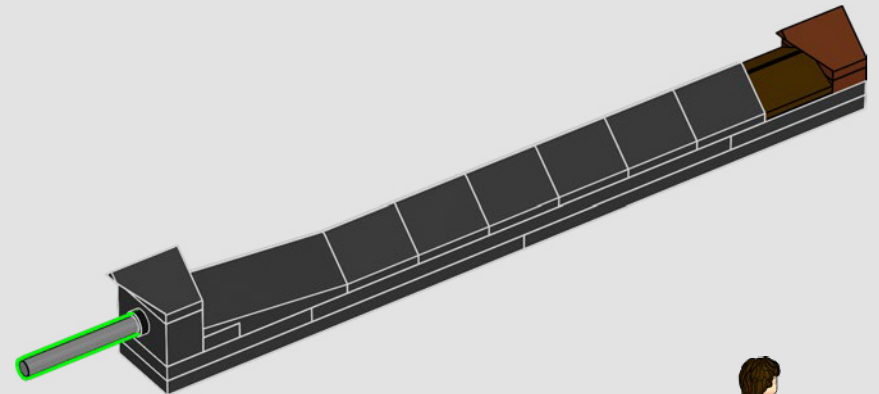

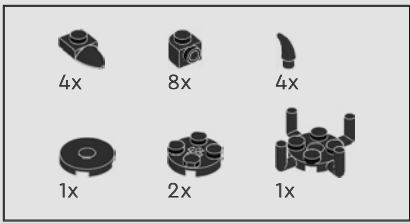

428

1



3



5

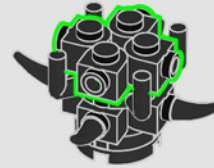

2

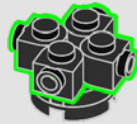

4

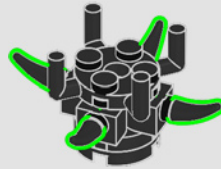

6

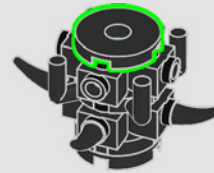

7

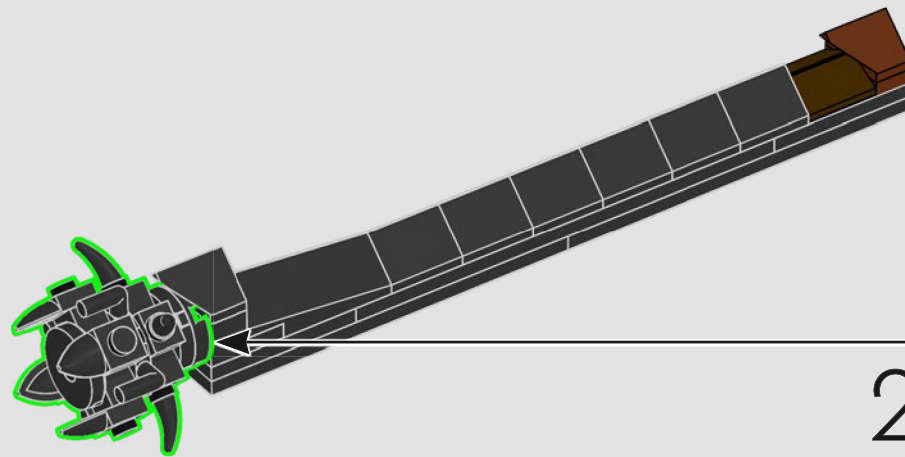

2x

429

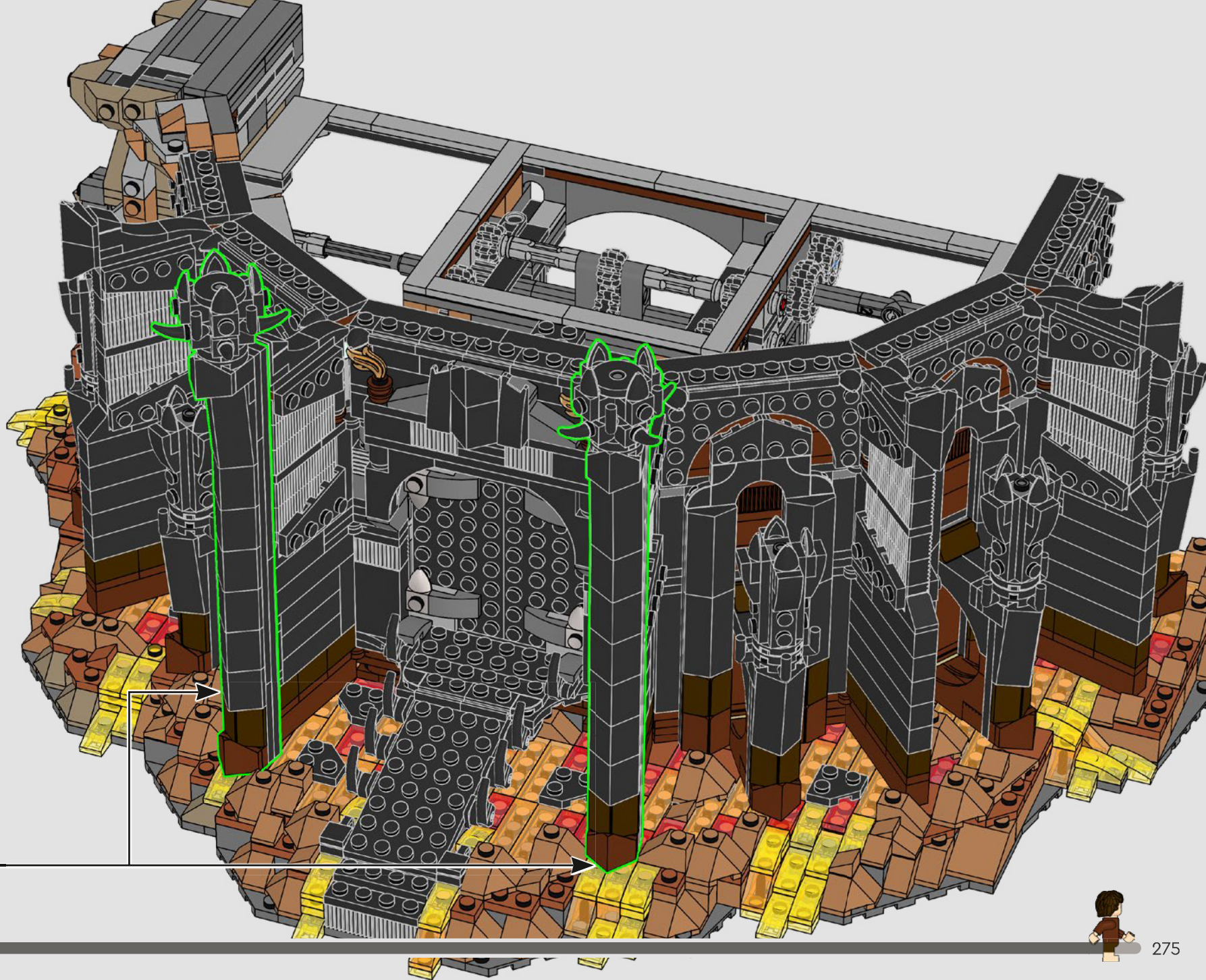

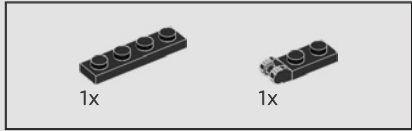
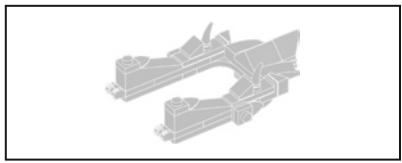

430

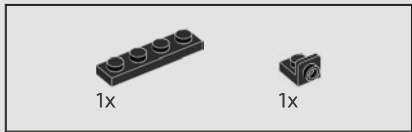
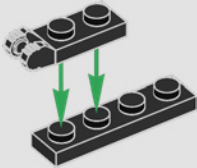

431

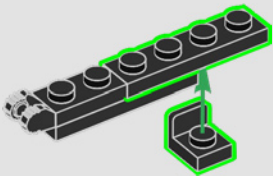

432

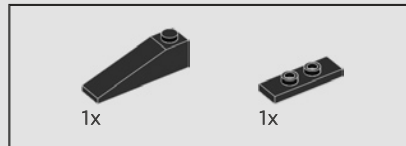
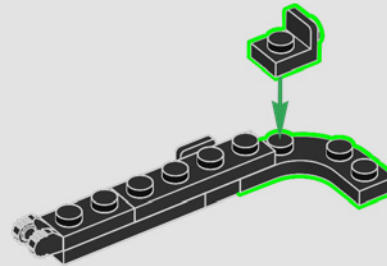

433

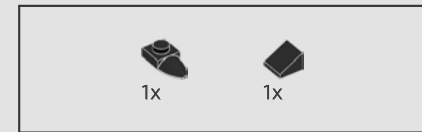
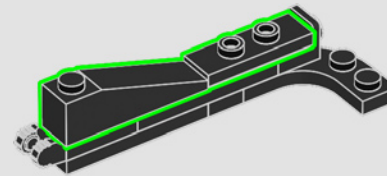

434

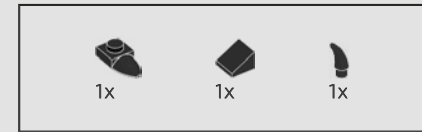
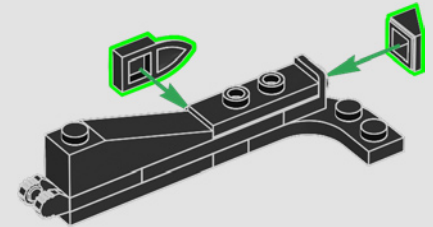

435

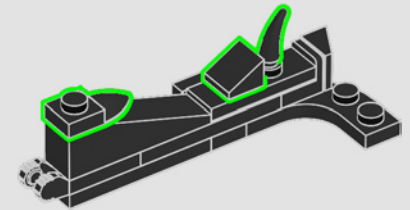

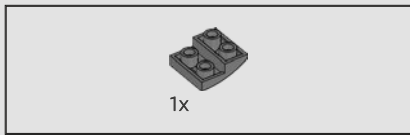

436

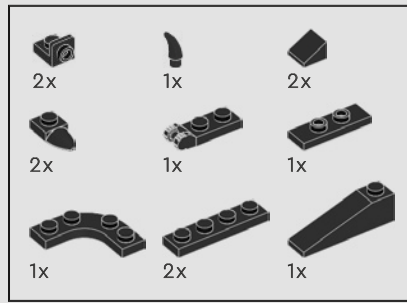
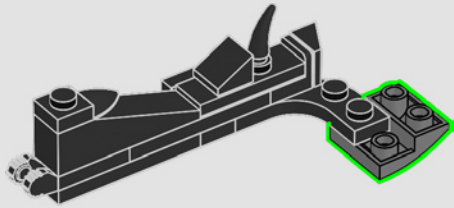

437

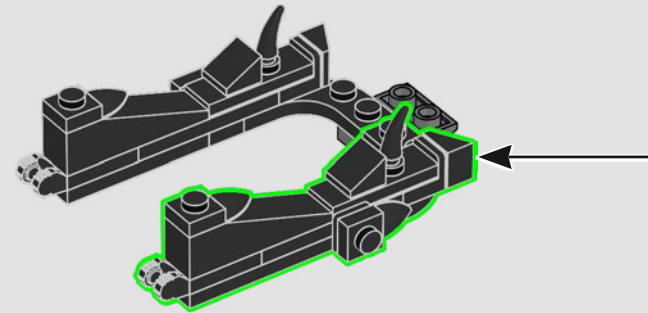
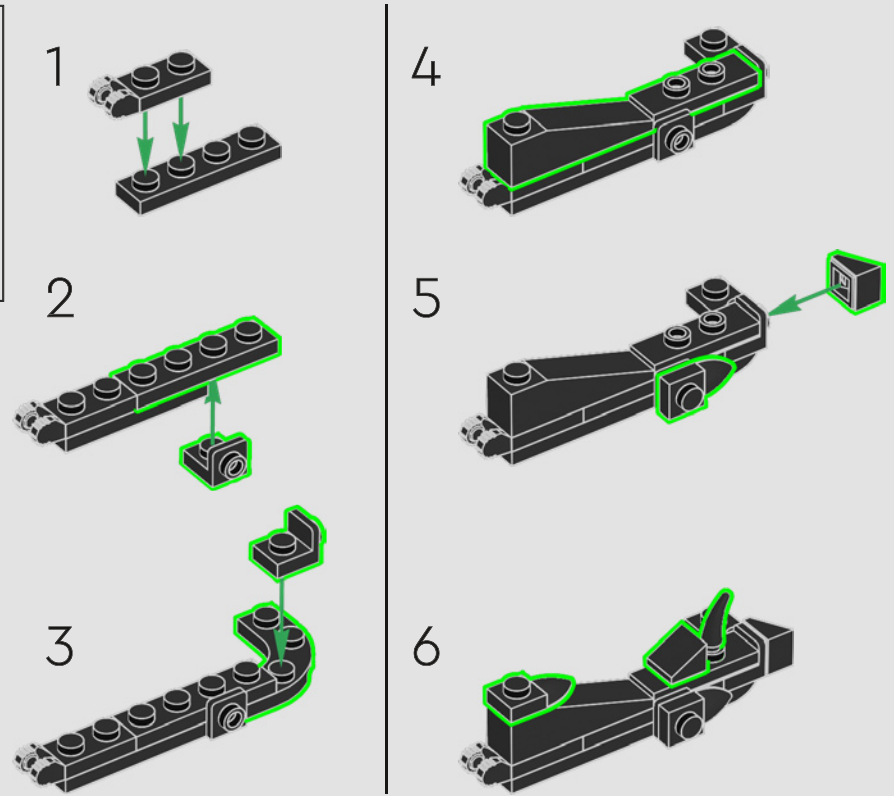

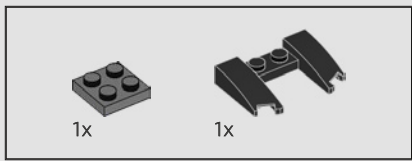

438

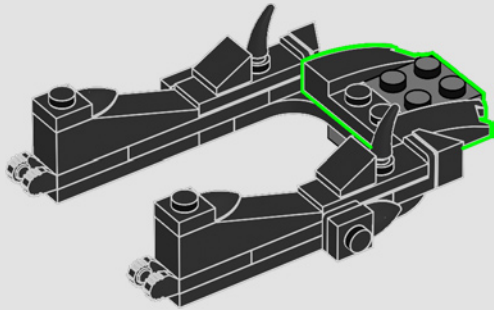

439

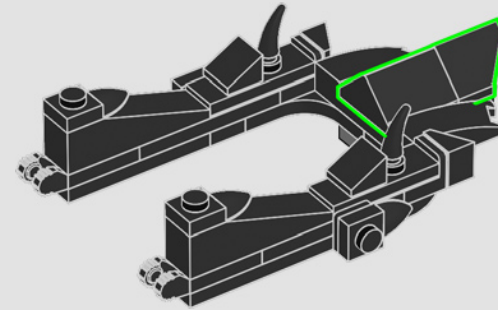

440

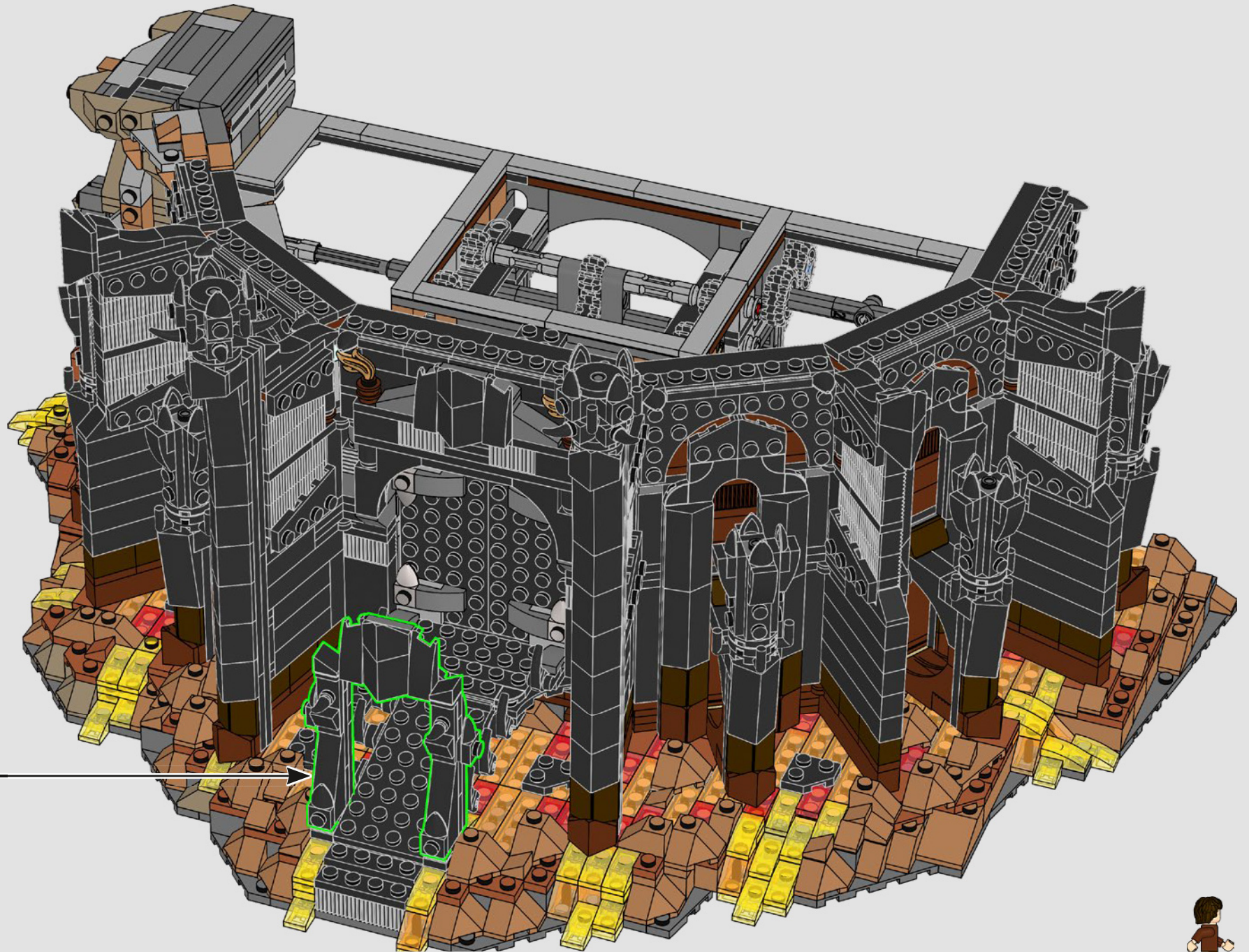



LEGO and the LEGO logo are trademarks of the LEGO Group. ©2024 The LEGO Group.



© New Line Productions Inc. All rights reserved.
THE LORD OF THE RINGS TRILOGY and all names
of the characters, items, events, and places therein
are ™ of Middle-earth Enterprises, LLC under license
to New Line Productions, Inc. (s24)