



10333

THE LORD OF THE RINGS





SAURON DER GROSSE WÜNSCHT EUCH WILLKOMMEN

Am Fuß des Turms befindet sich der Thronsaal des Barad-dûr™. Zieh den Hebel im Boden, um den Thron hinausgleiten zu lassen und die Kammer dahinter mit dem Palantír und Saurons Geheimplänen für die Schlachten in Mittelerde preiszugeben.

Ein Studierzimmer mit Bibliothek beherbergt eine seltene Kollektion aus Büchern und Schriftrollen mit einer Chronik der Tausende Jahre umfassenden Geschichte und dunklen Magie von Mittelerde. Eine Leiter umkreist die Bücherregale, um auch an die obersten Bücher zu gelangen.

Über Mordor™ schwebt das Auge Saurons in ständiger Ausschau nach dem Einen Ring. Das Auge bewegt sich nach links und rechts, oben und unten, und lässt sich mit einem Lichtstein erleuchten.



SAURONS MUND

SAURON™

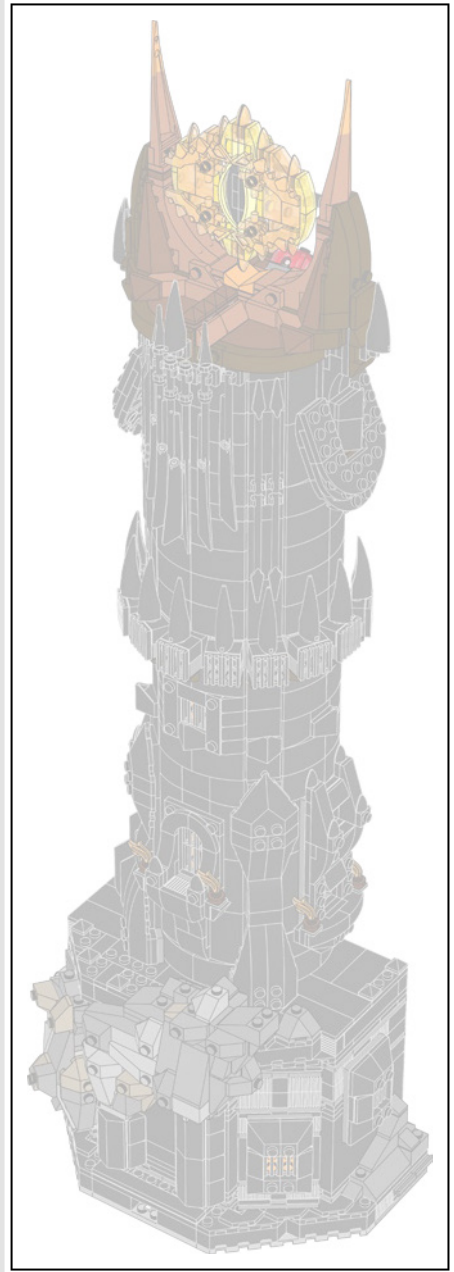

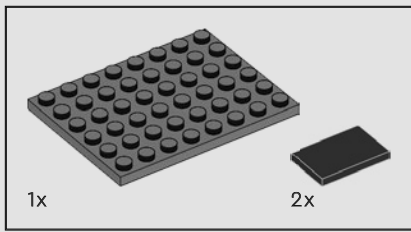

1

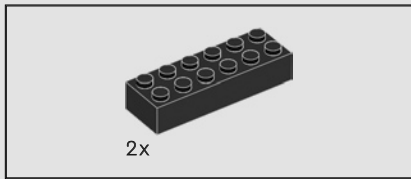
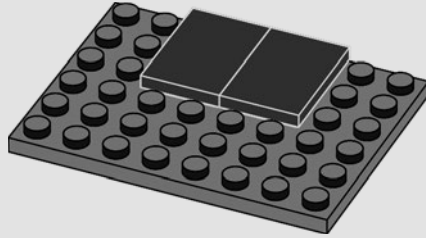

2

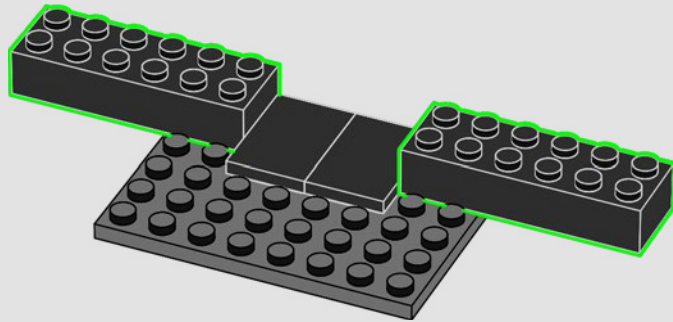

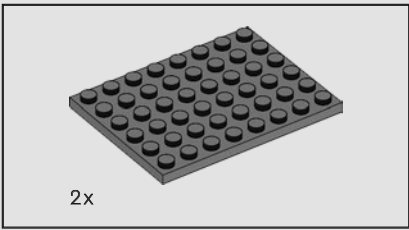

3

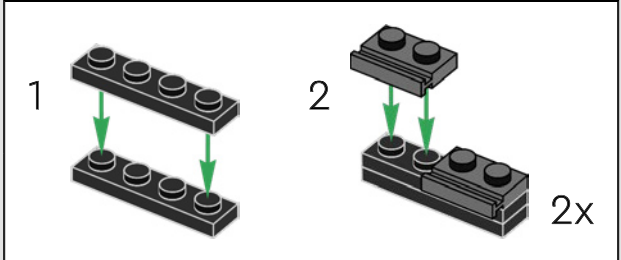
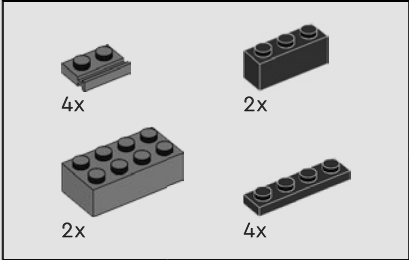
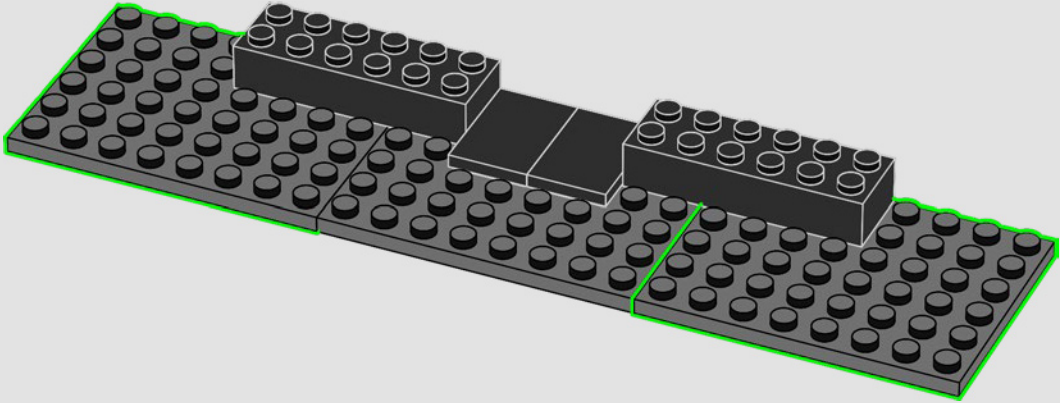

4

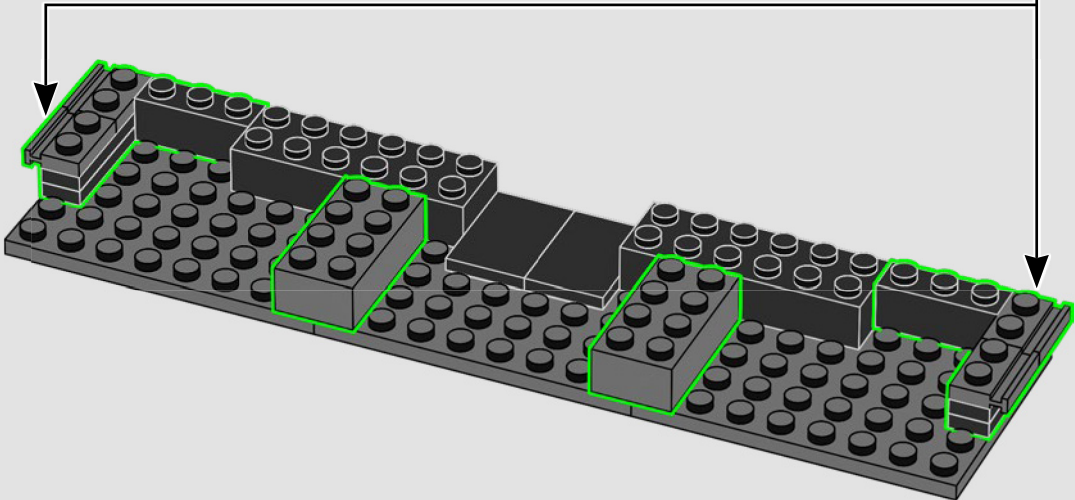

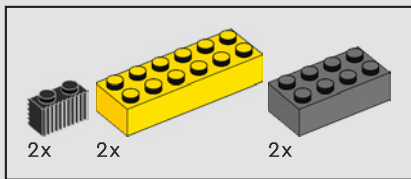

5

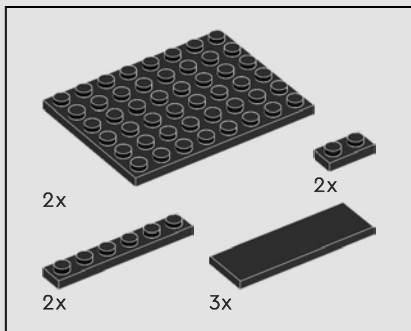
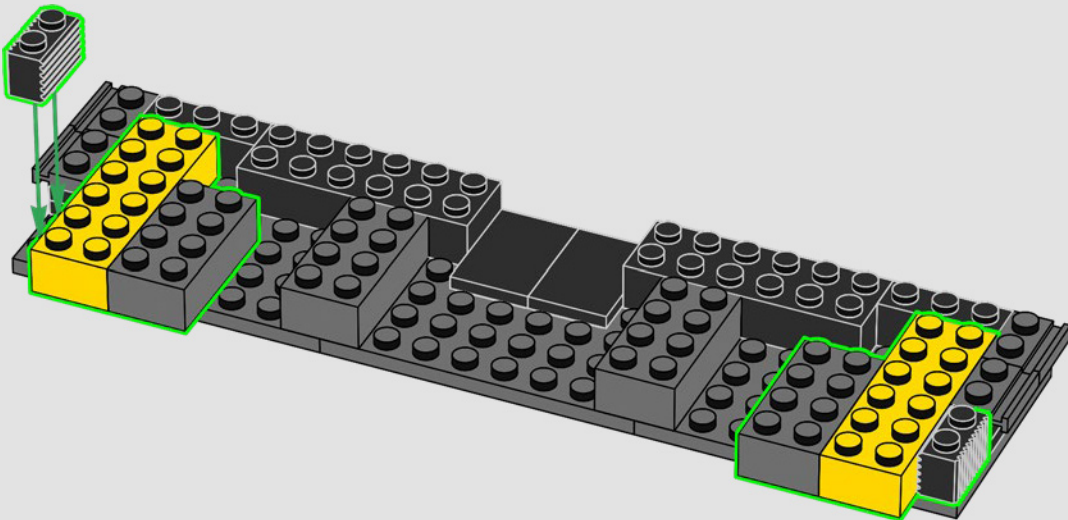

6

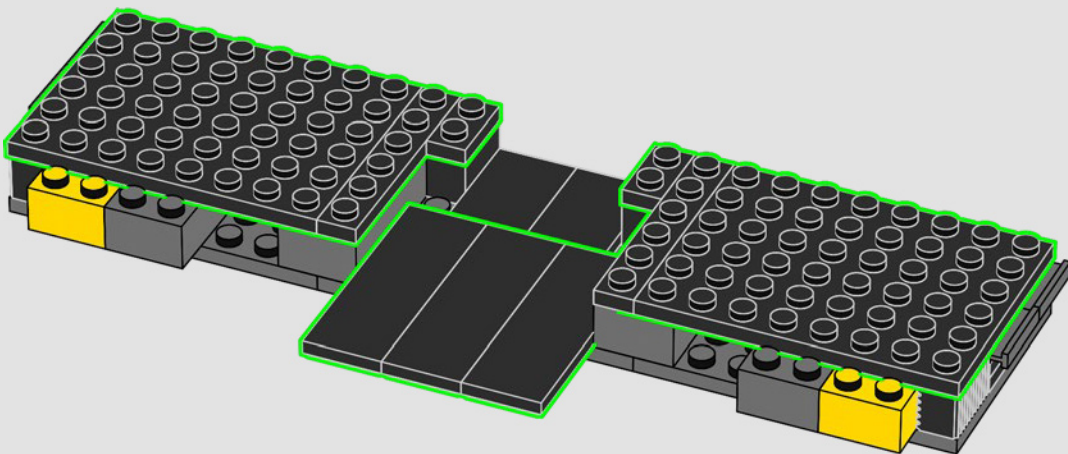

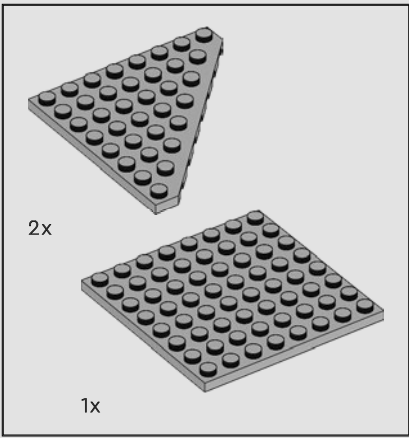

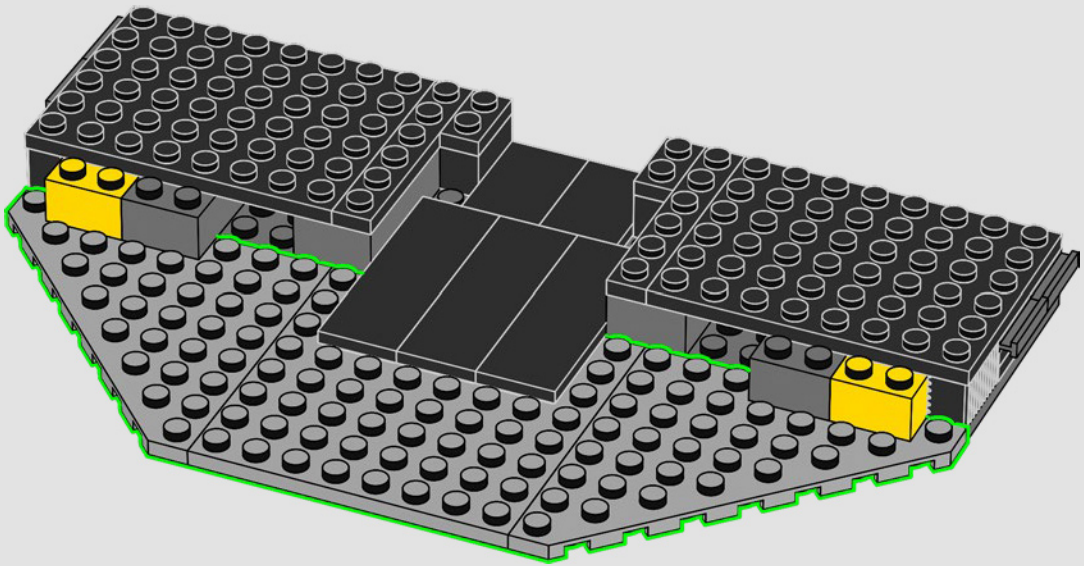

7

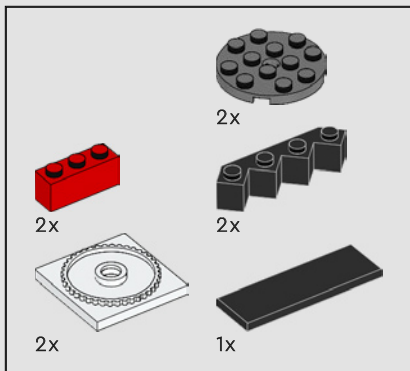

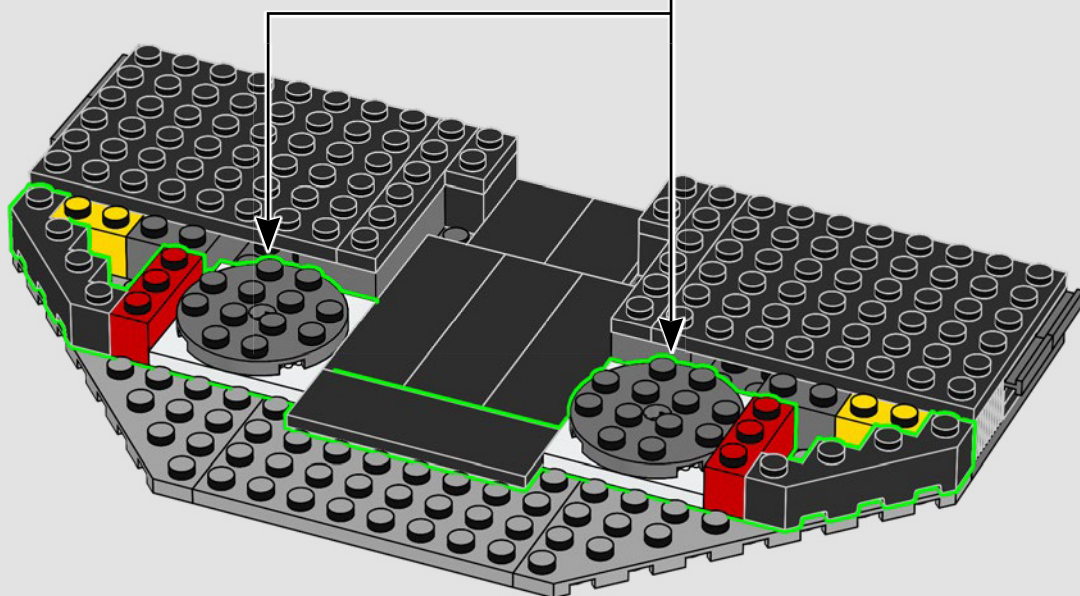
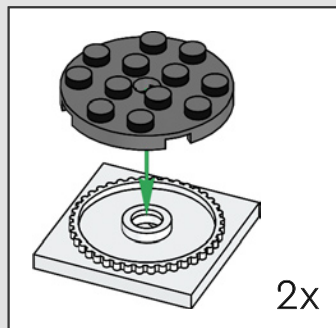

8



Die Plattform verdeckt die Hauptfunktion dieses Segments. 



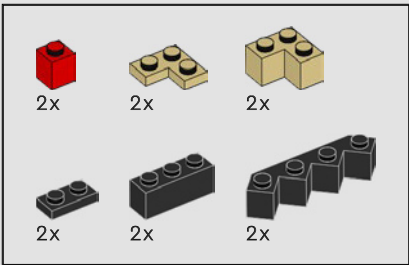

9

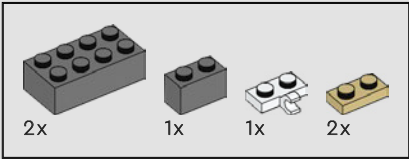
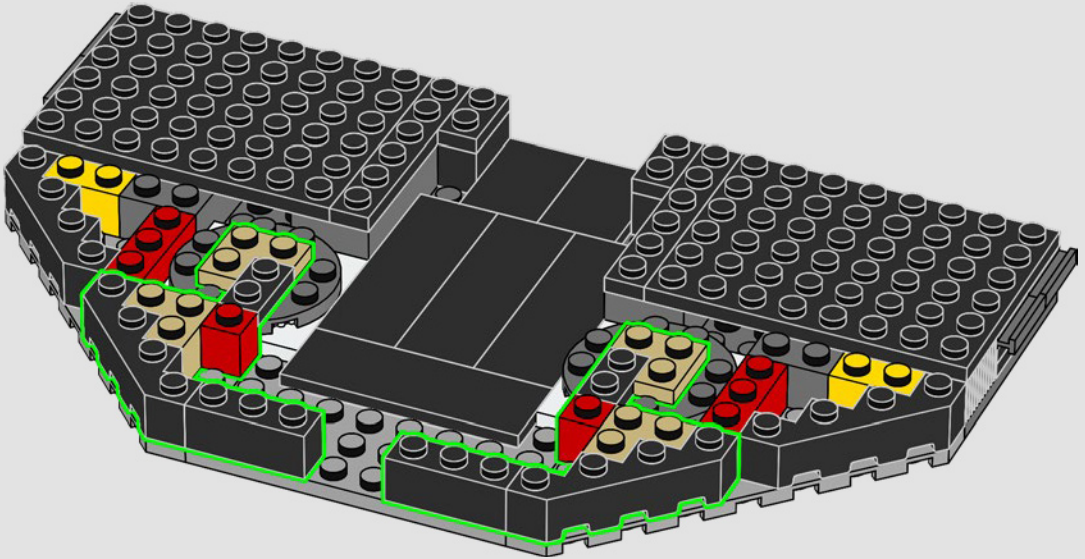

10

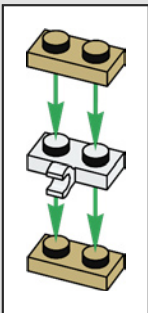
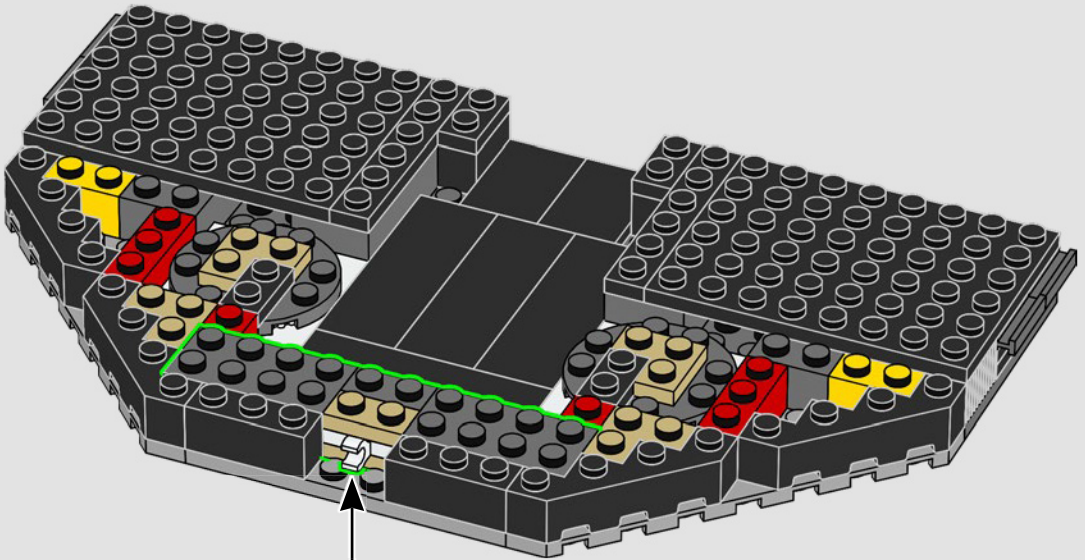

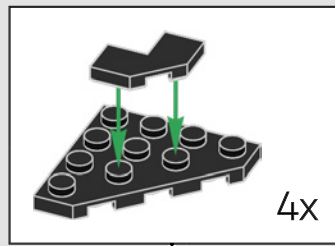
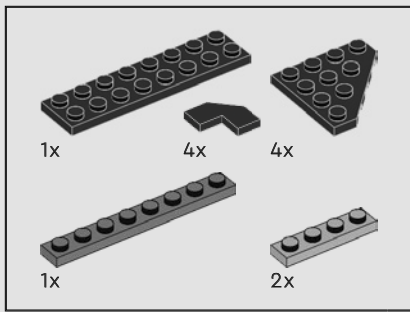

11

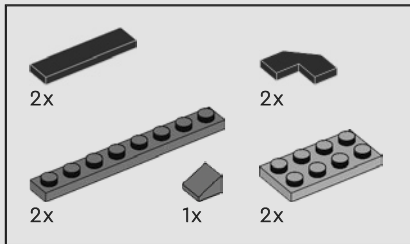
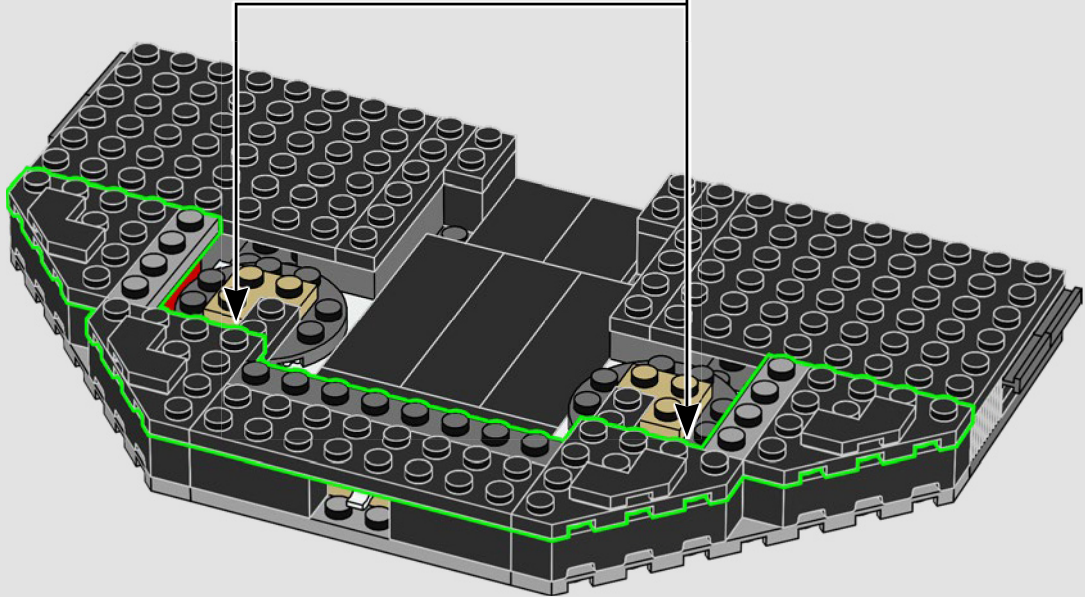

12

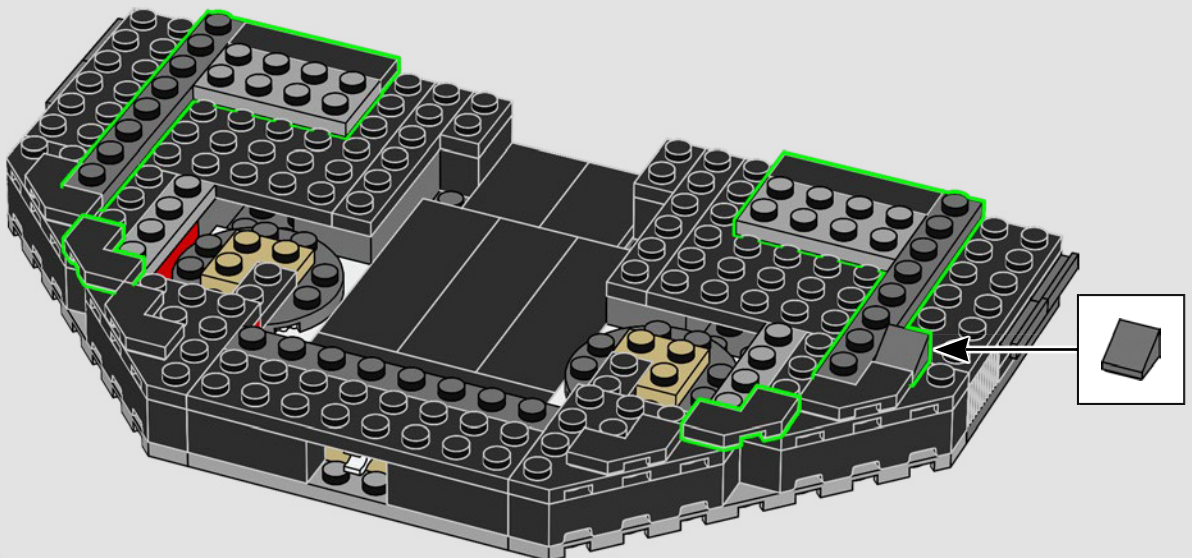

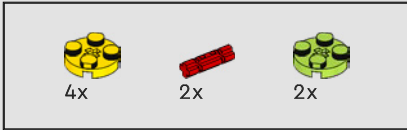

13

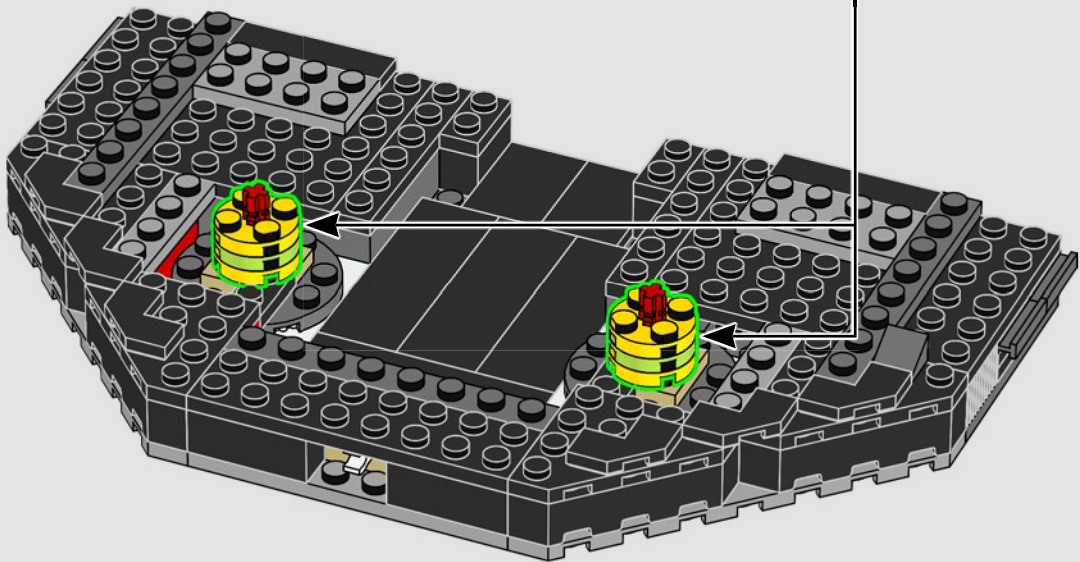
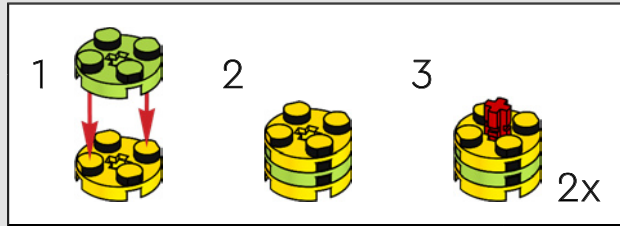

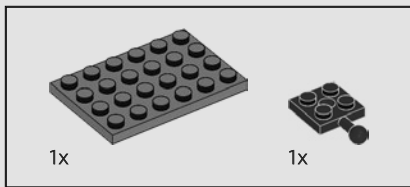

14

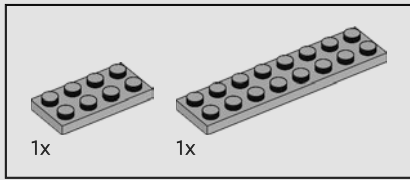
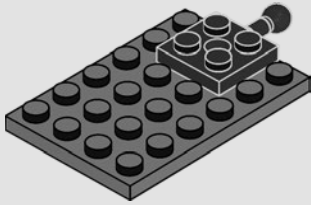

15

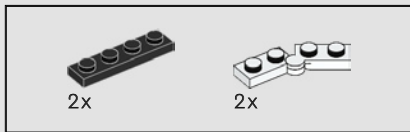
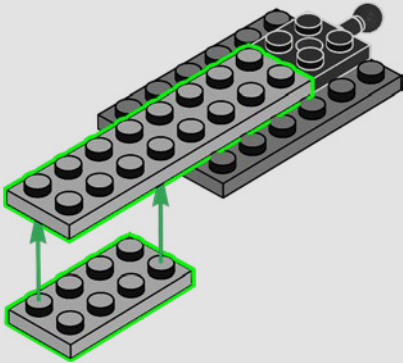

16

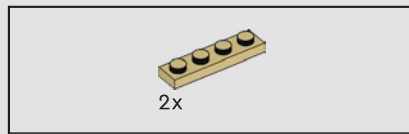
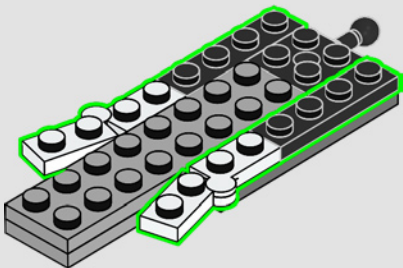

17

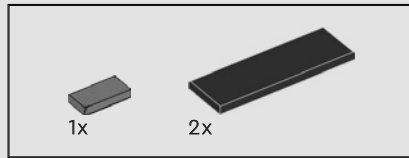
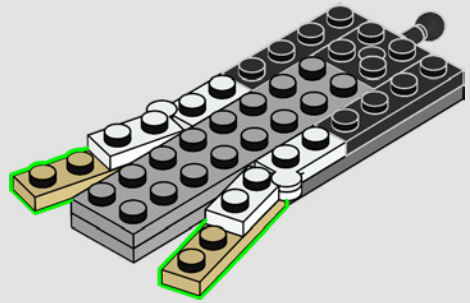

18

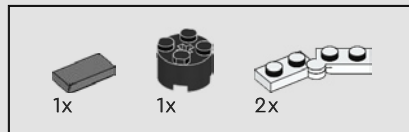
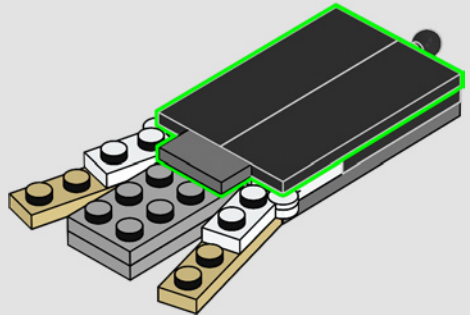

19

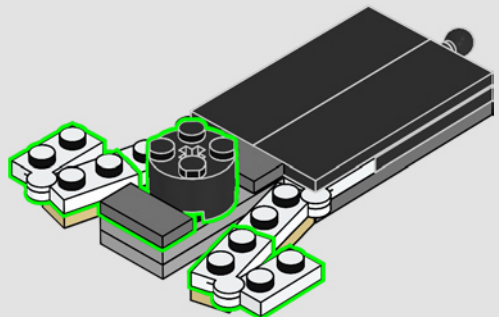

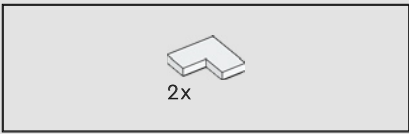

20

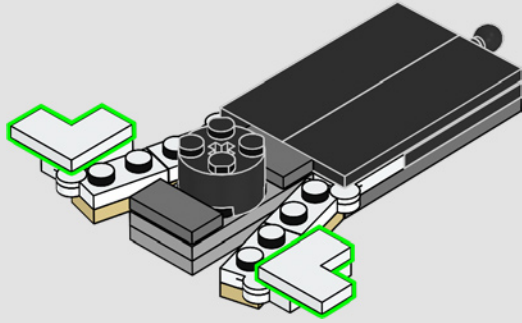

21

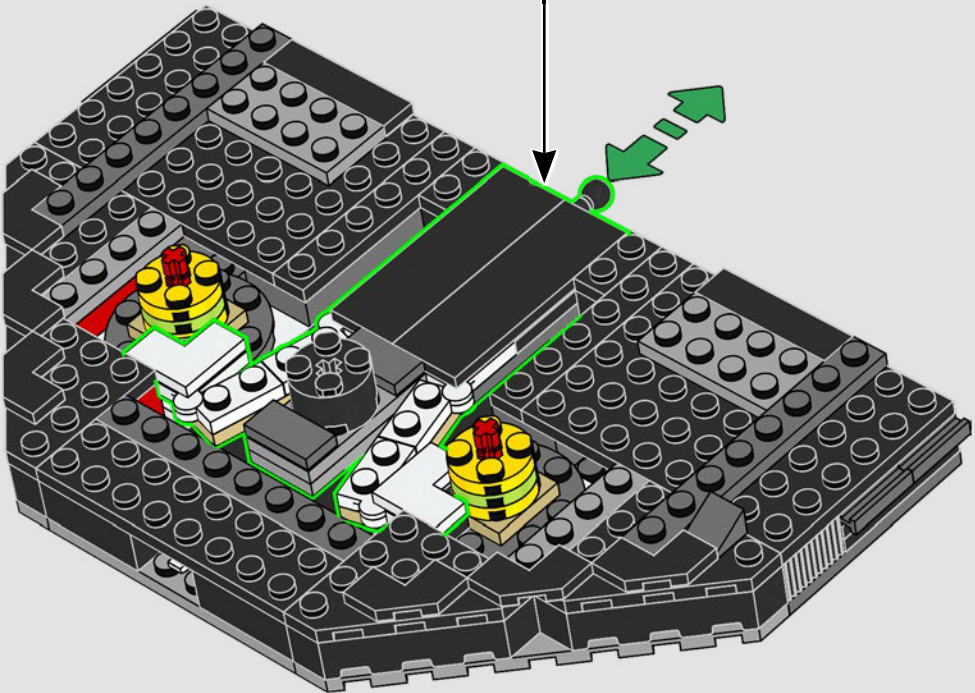

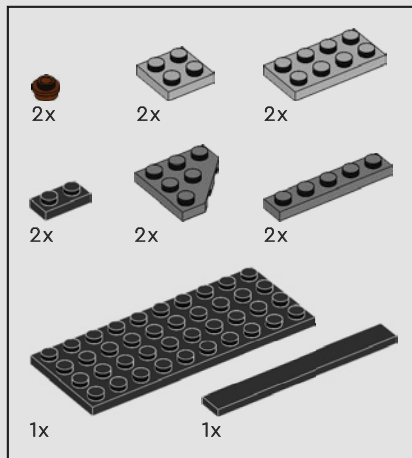

22

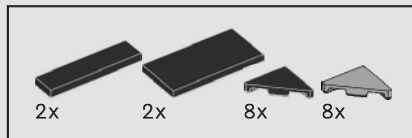
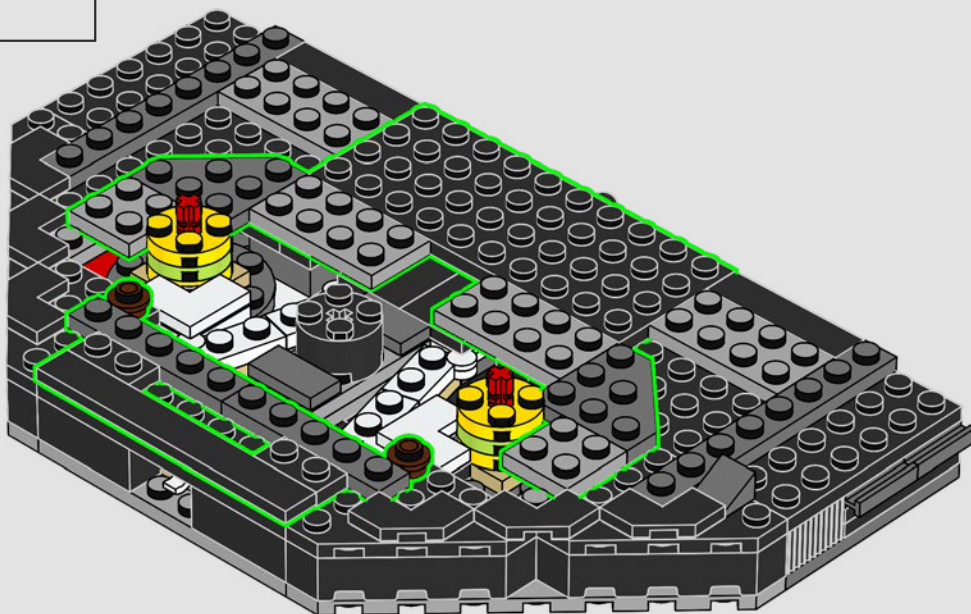

23

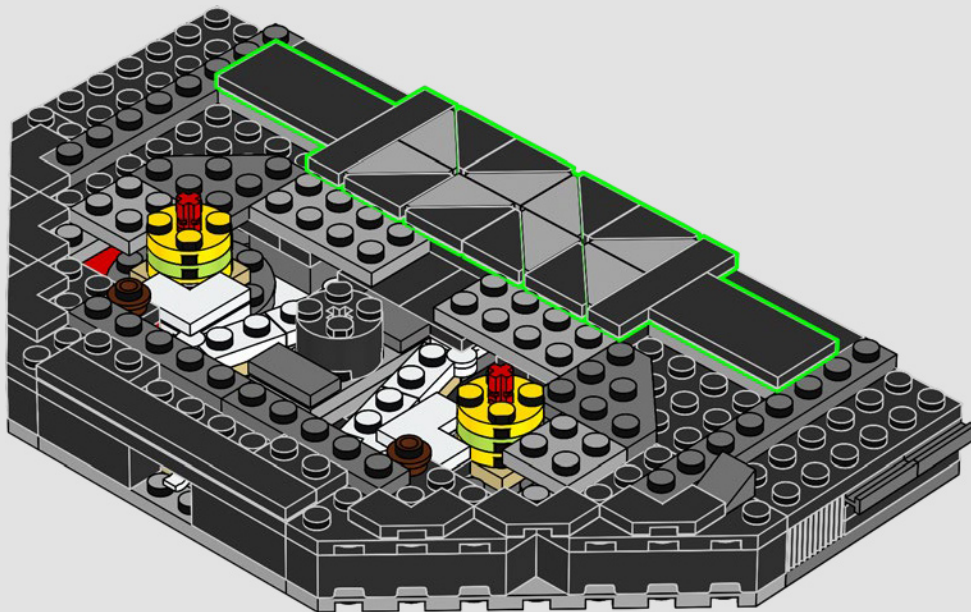

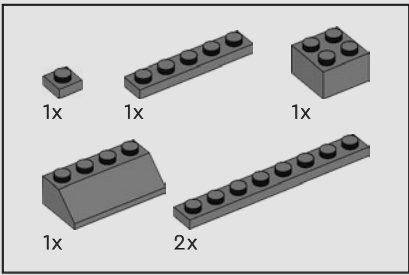

24

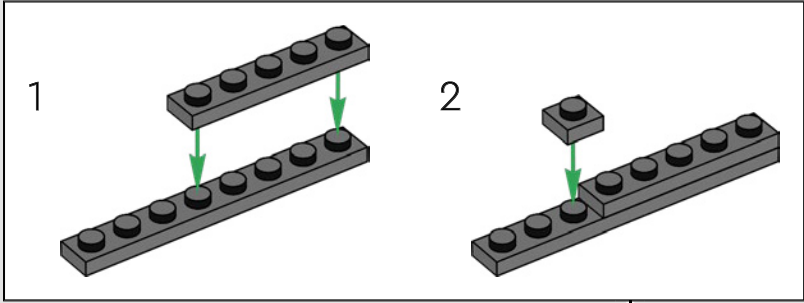
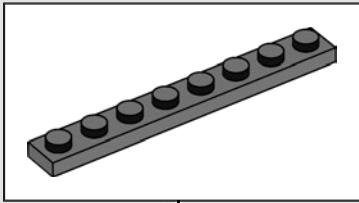

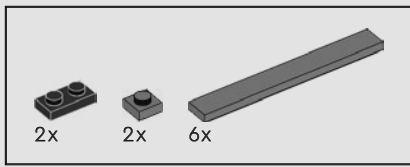

25

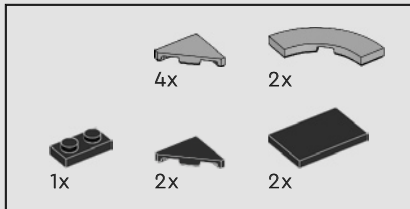
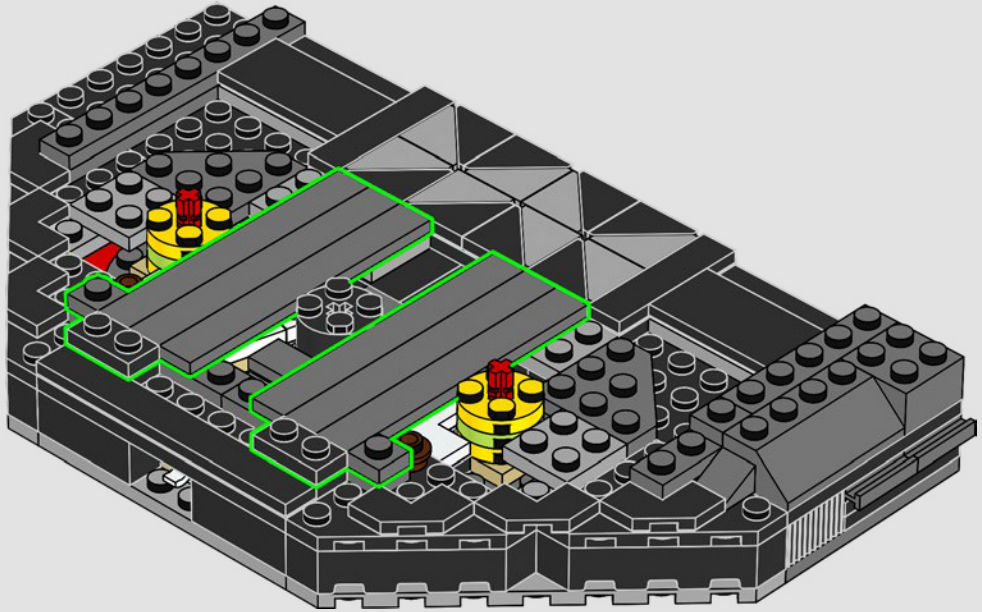

26

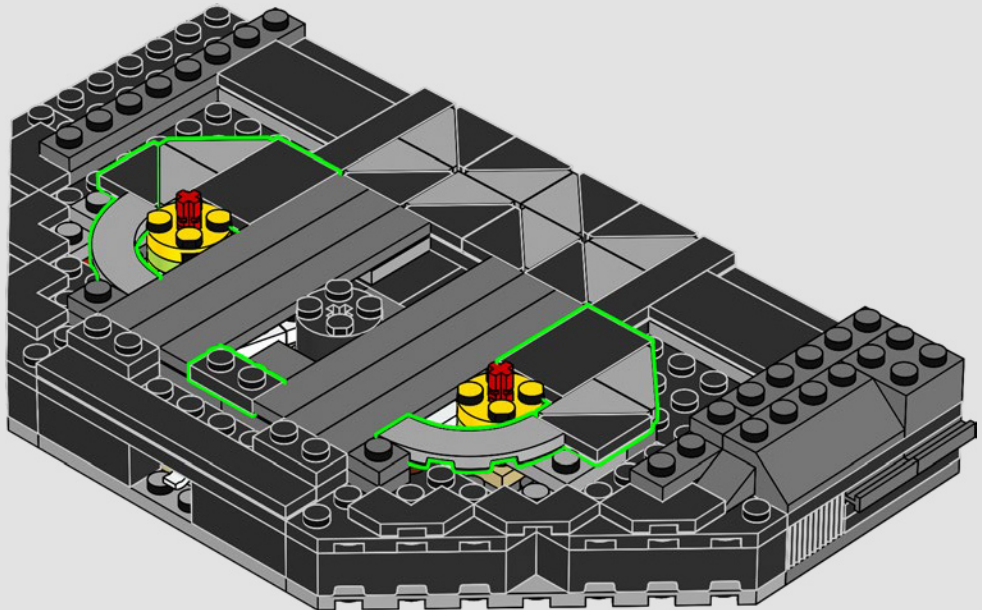

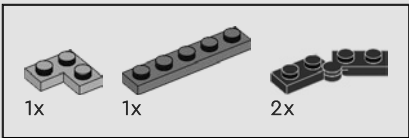

27

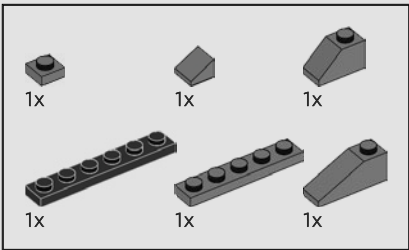
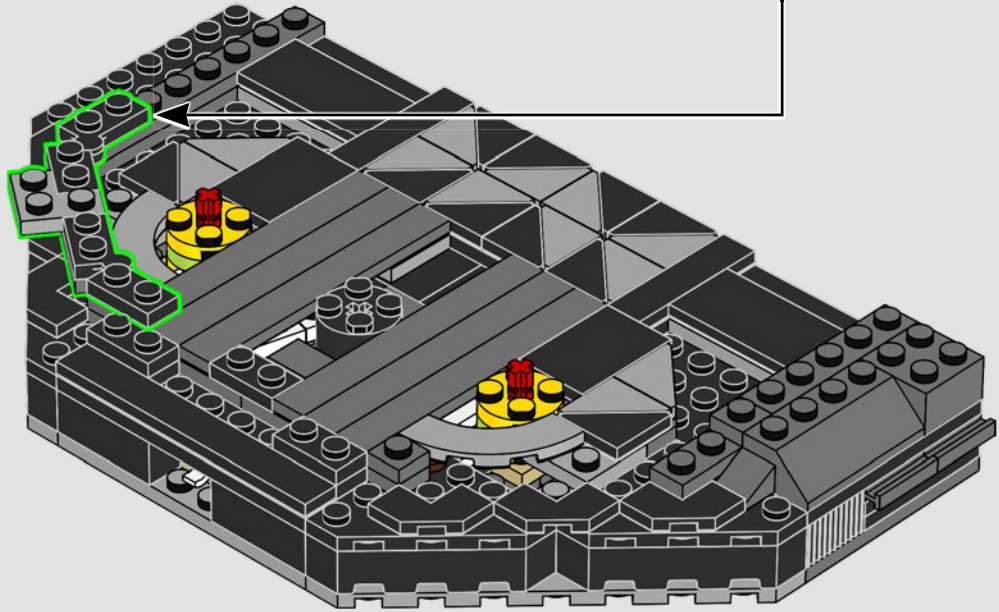
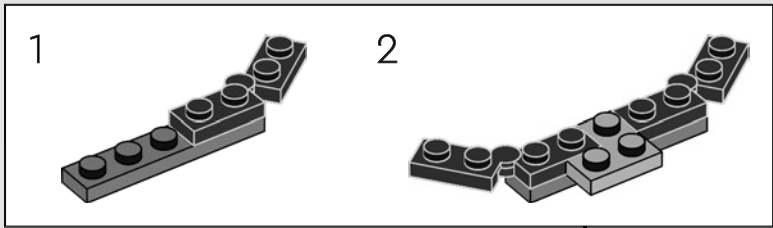

28

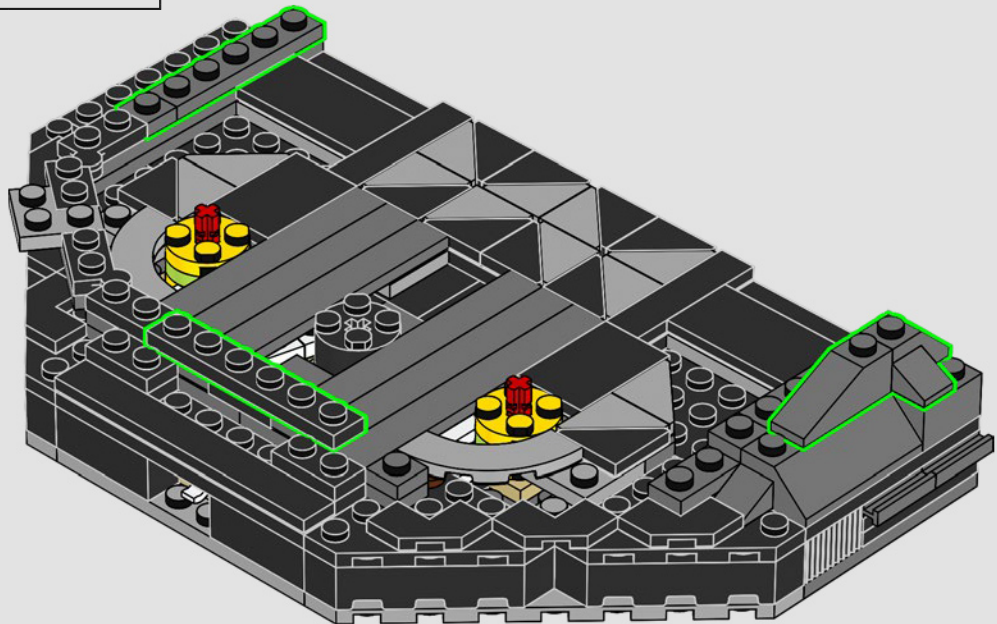

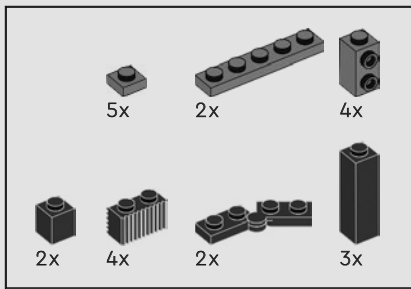

29

1

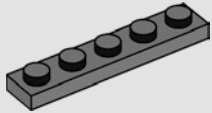

2

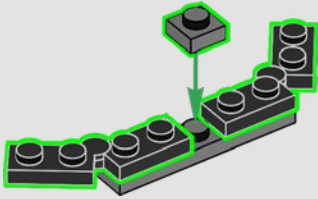

3

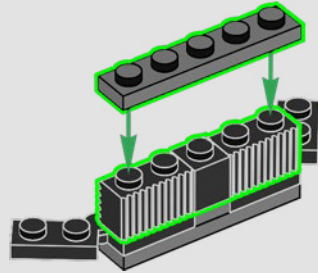

4

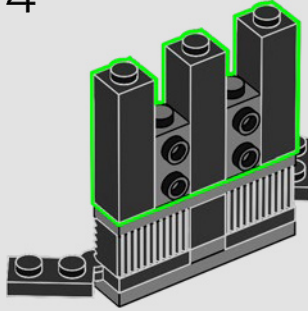

5

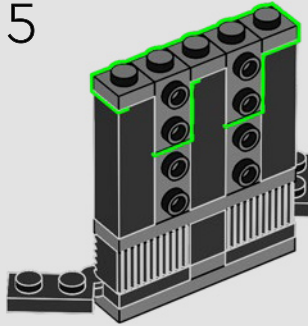

6

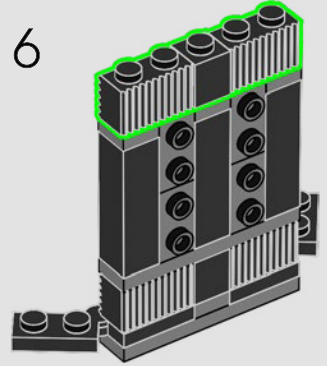

7

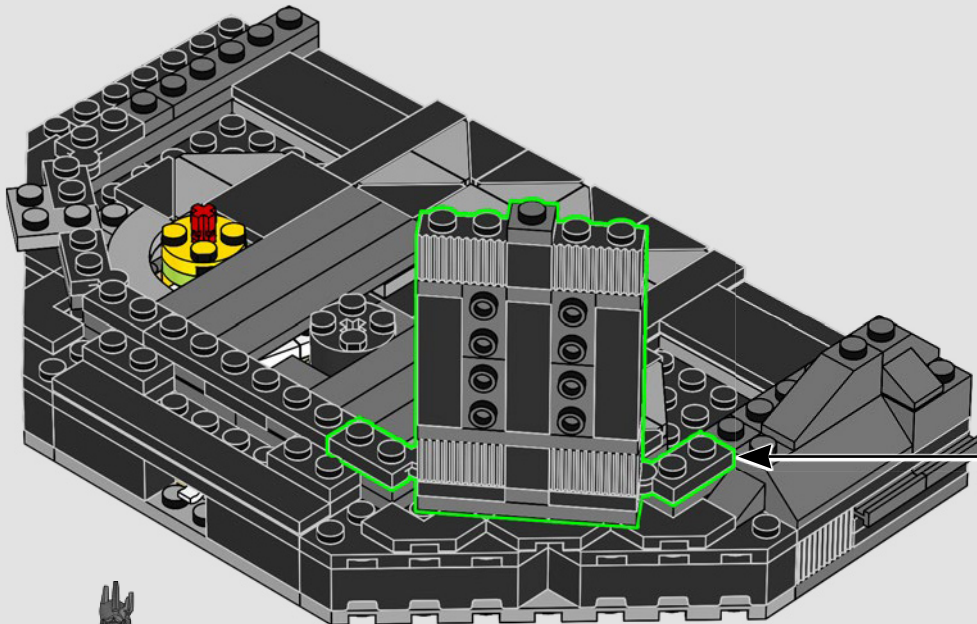
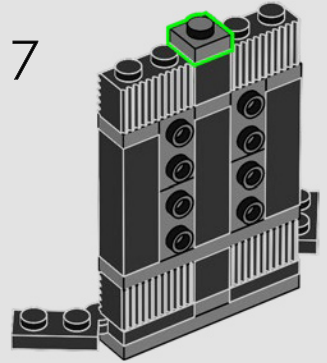

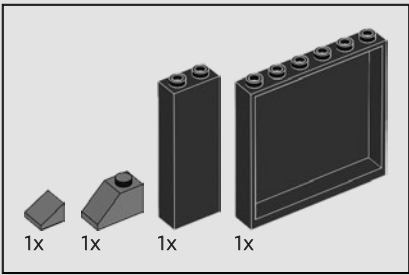

30

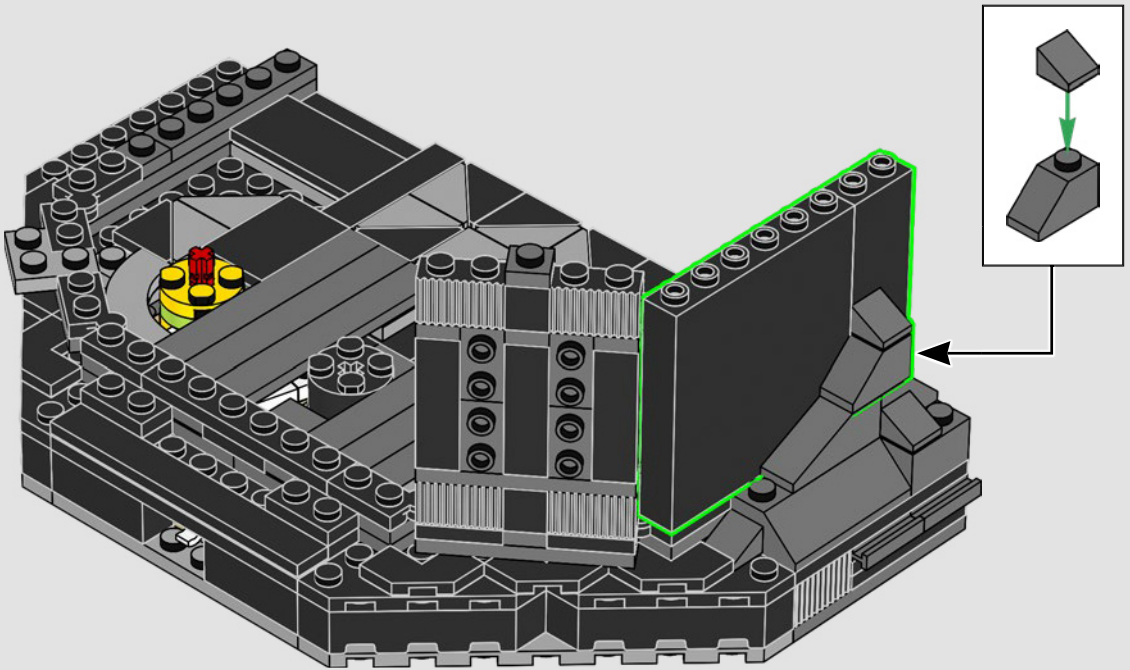

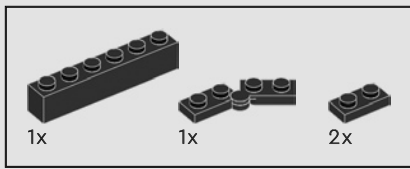

31

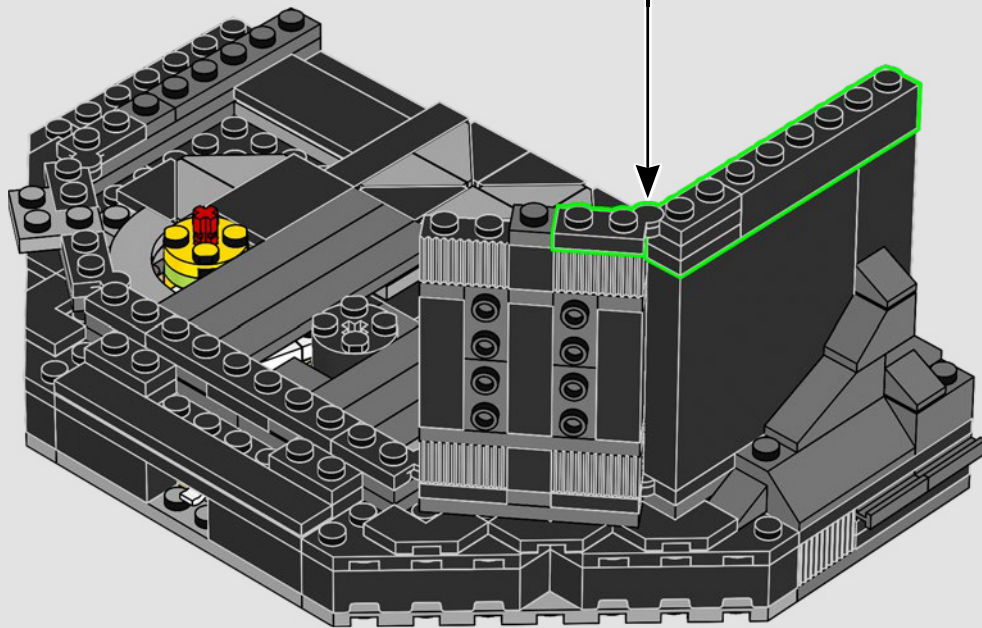
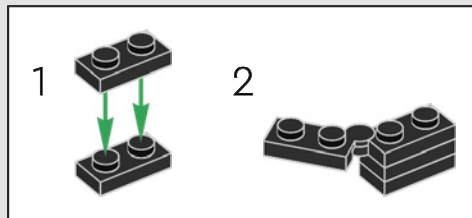

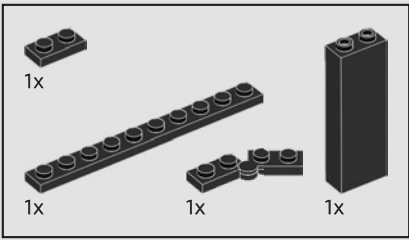

32

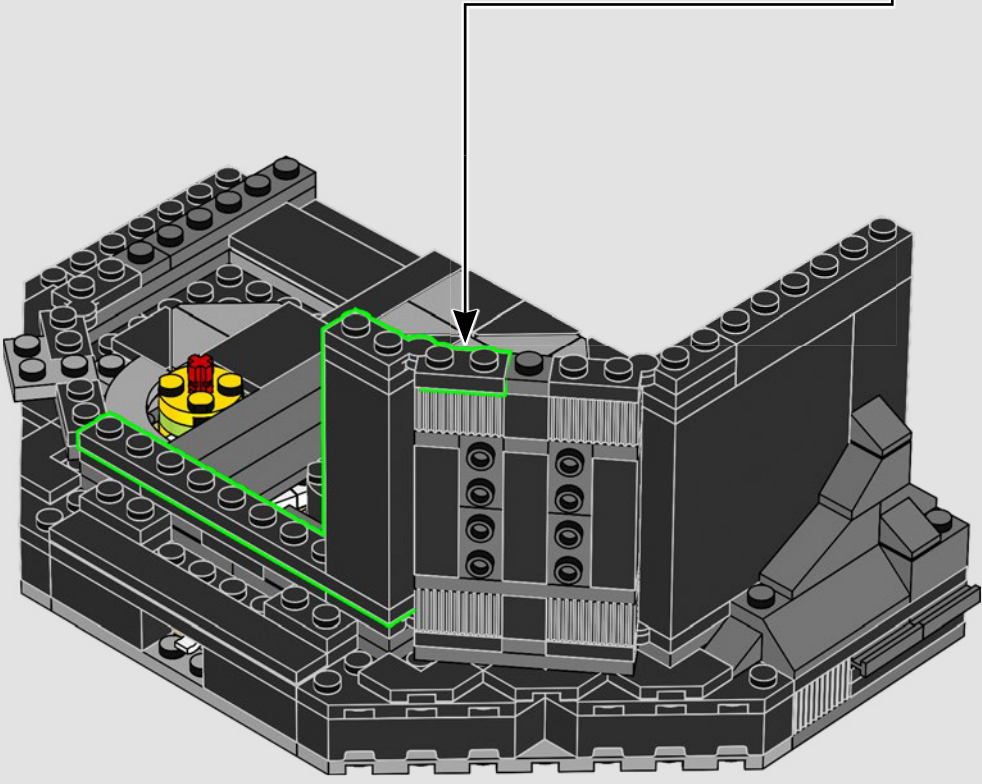
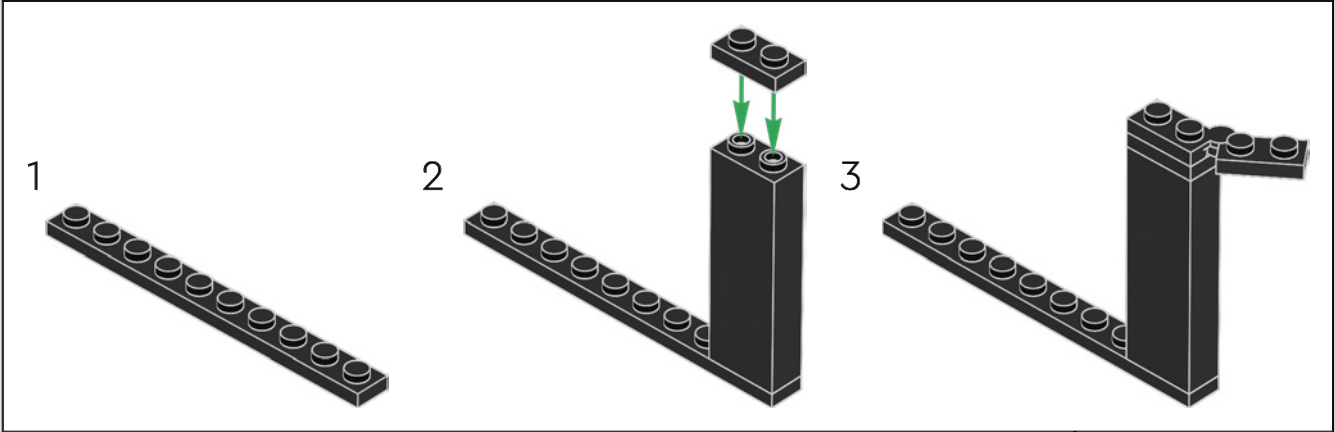

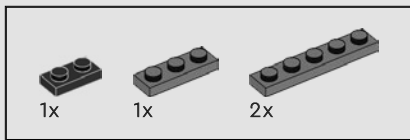

Das Designteam hat den Thronsaal als minimalistischen, dunklen und bedrohlichen Raum konzipiert, in dem es sowohl spitze Winkel als auch geschwungene Bögen gibt.

33

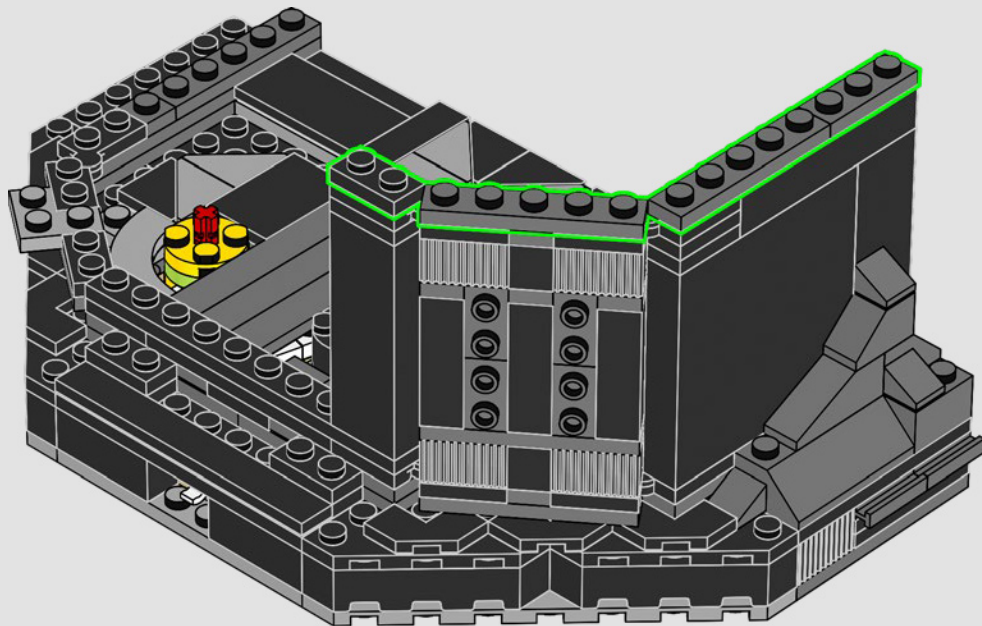

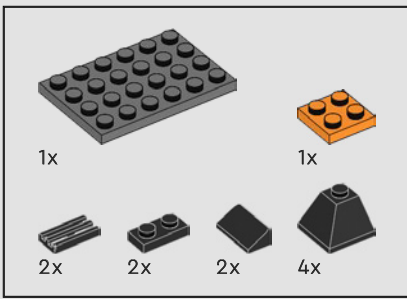

34

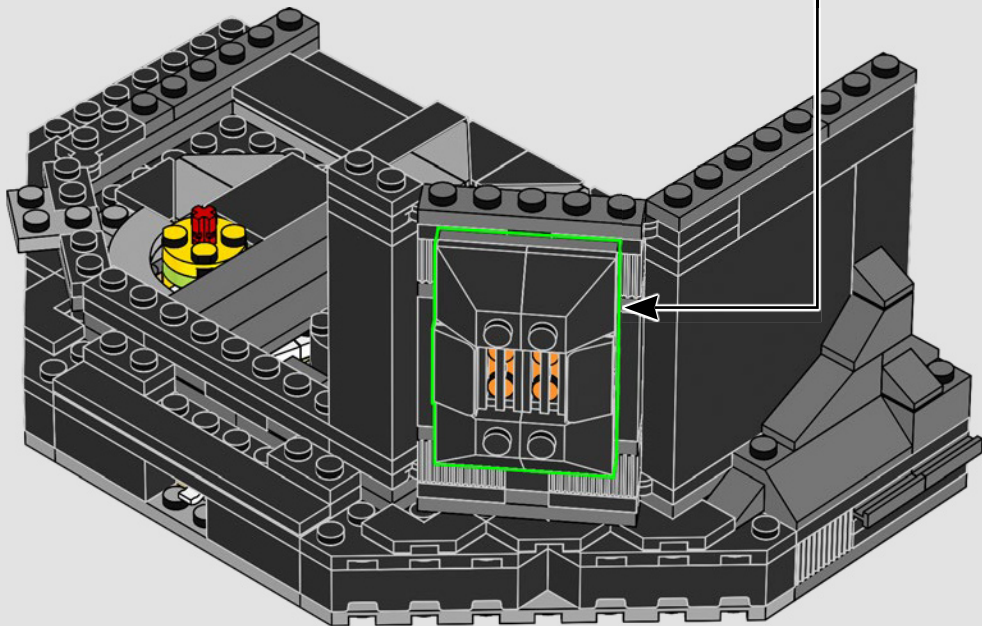
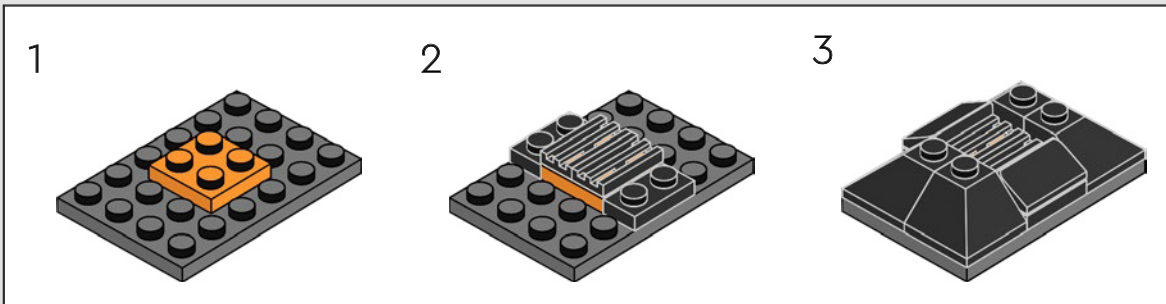

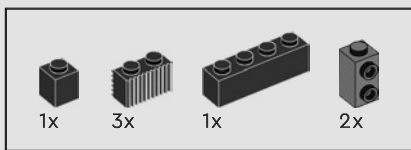

35

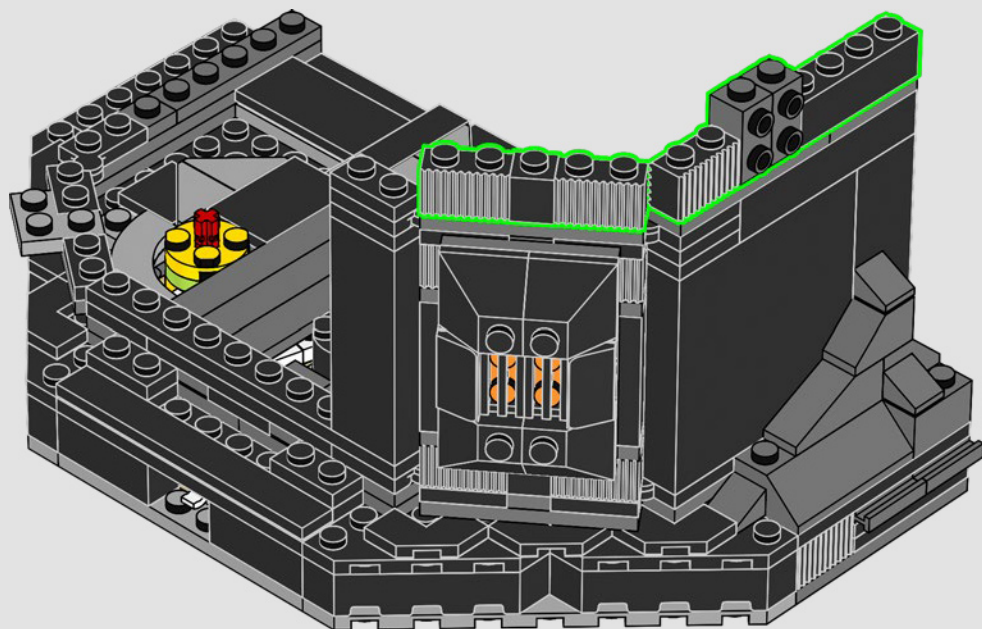

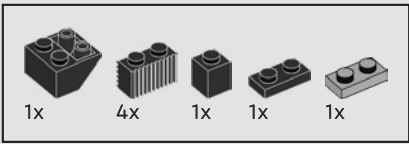

36

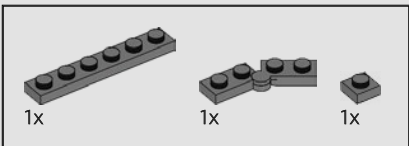
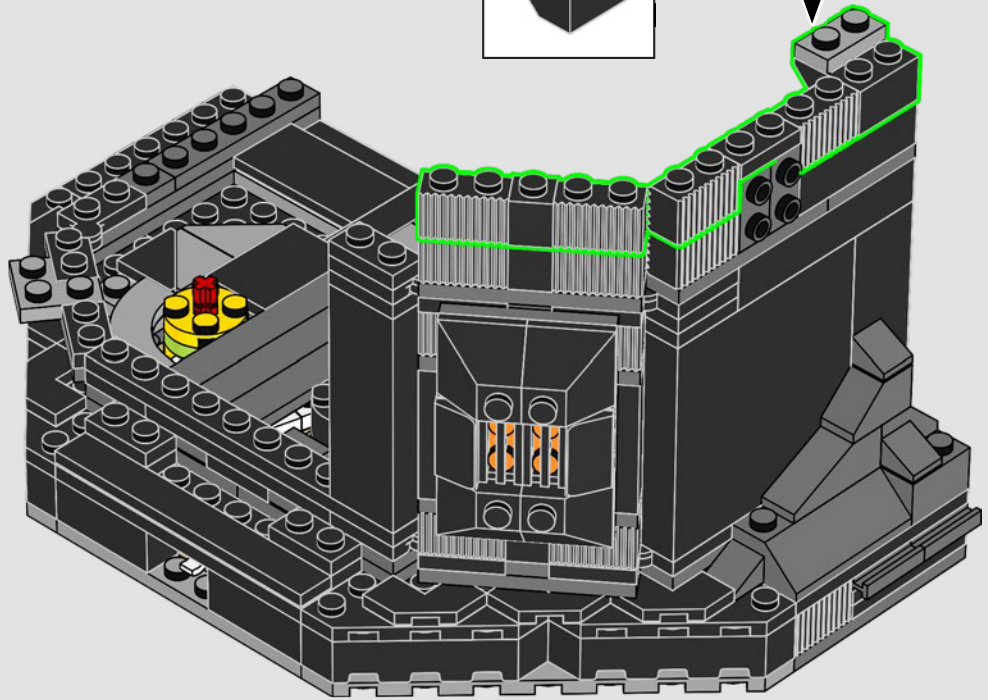
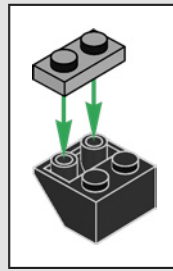

37

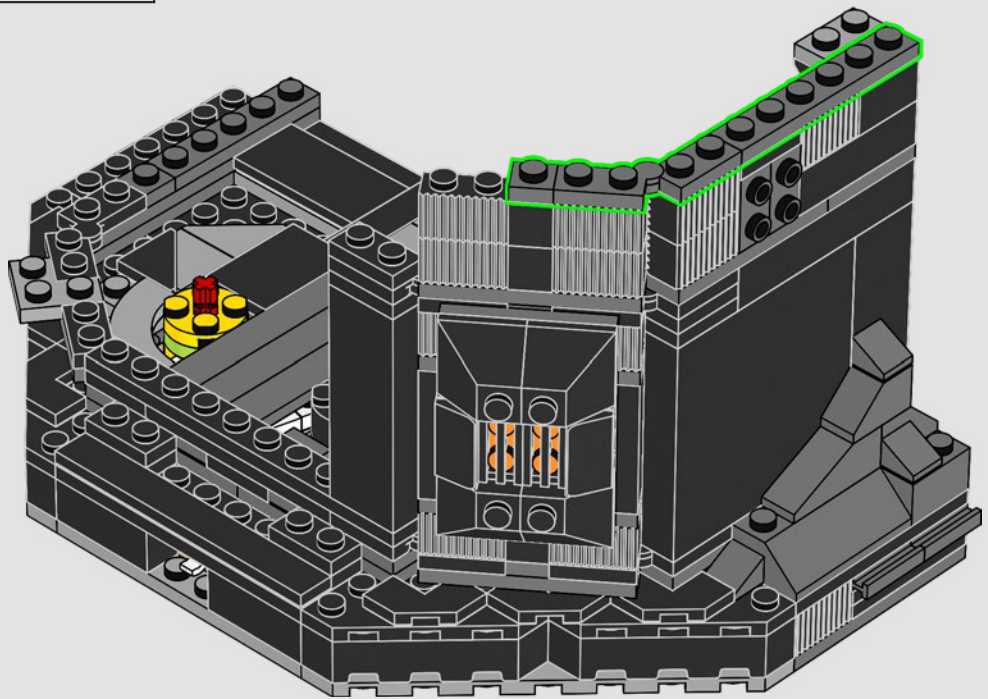

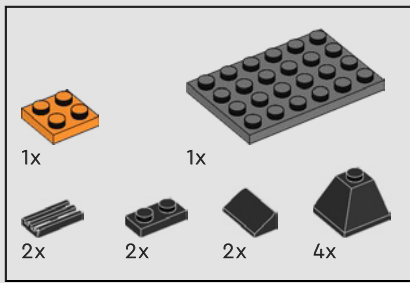

38

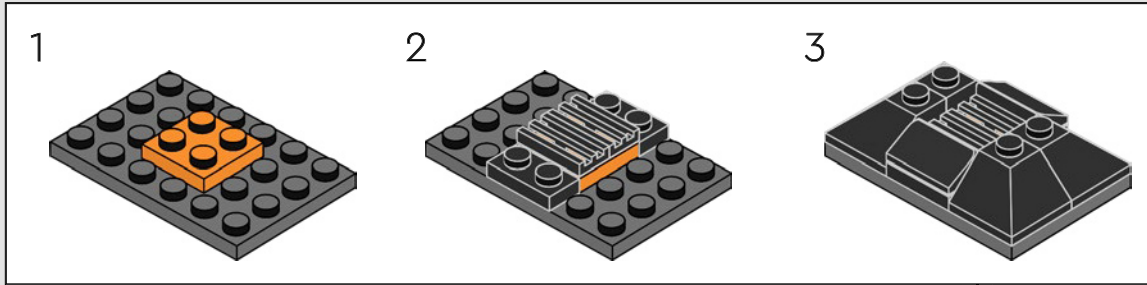

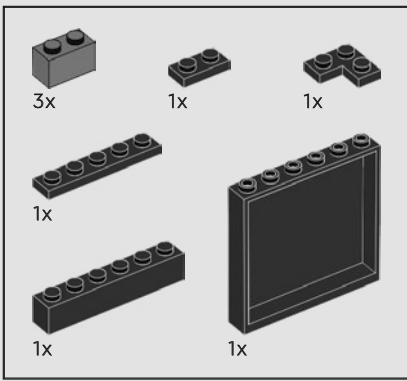

39

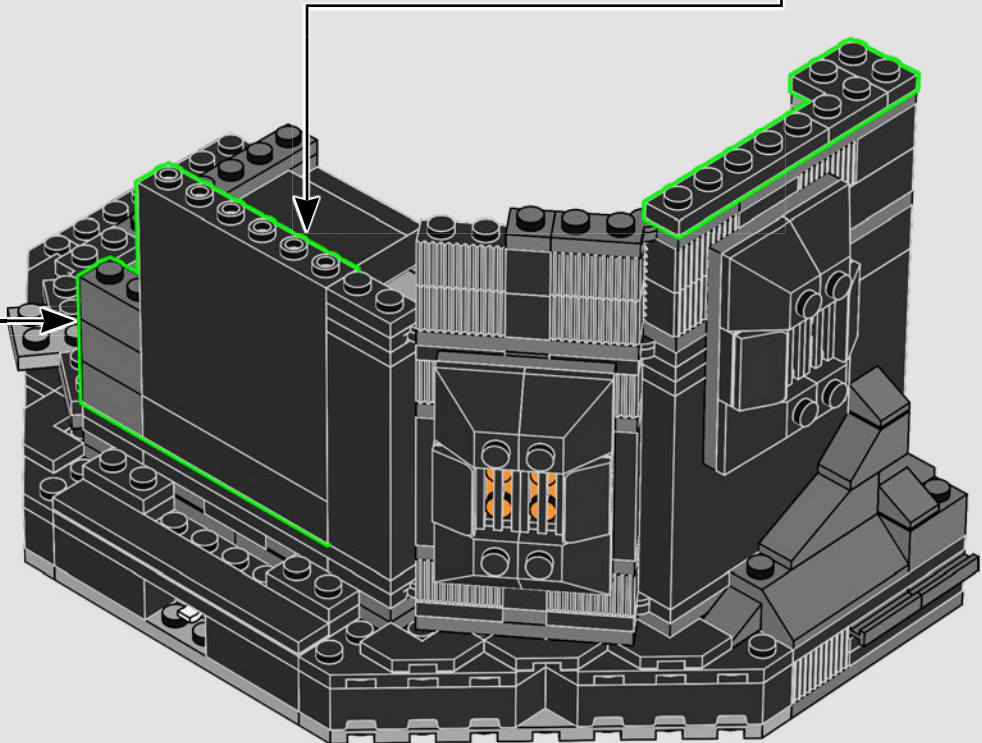
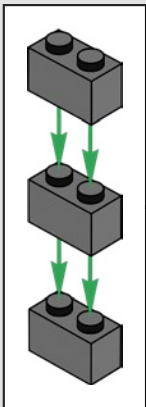
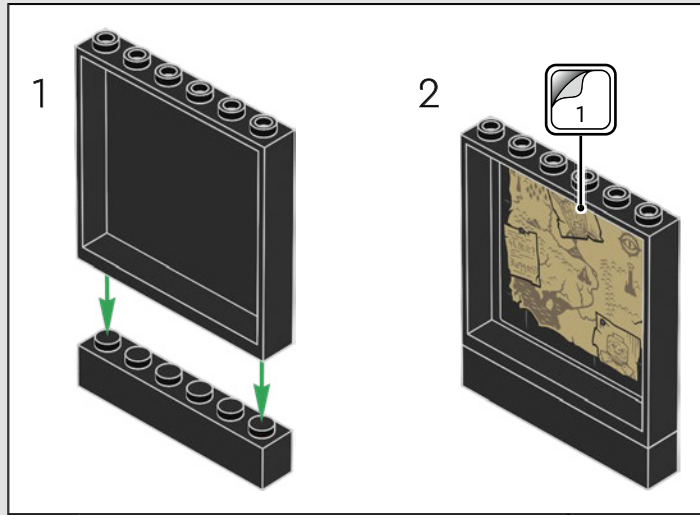

Die Karte hinter dem Thron gibt die Schlachtpläne preis, die Sauron™ verfolgt, um ganz Mittelerde zu erobern.





40

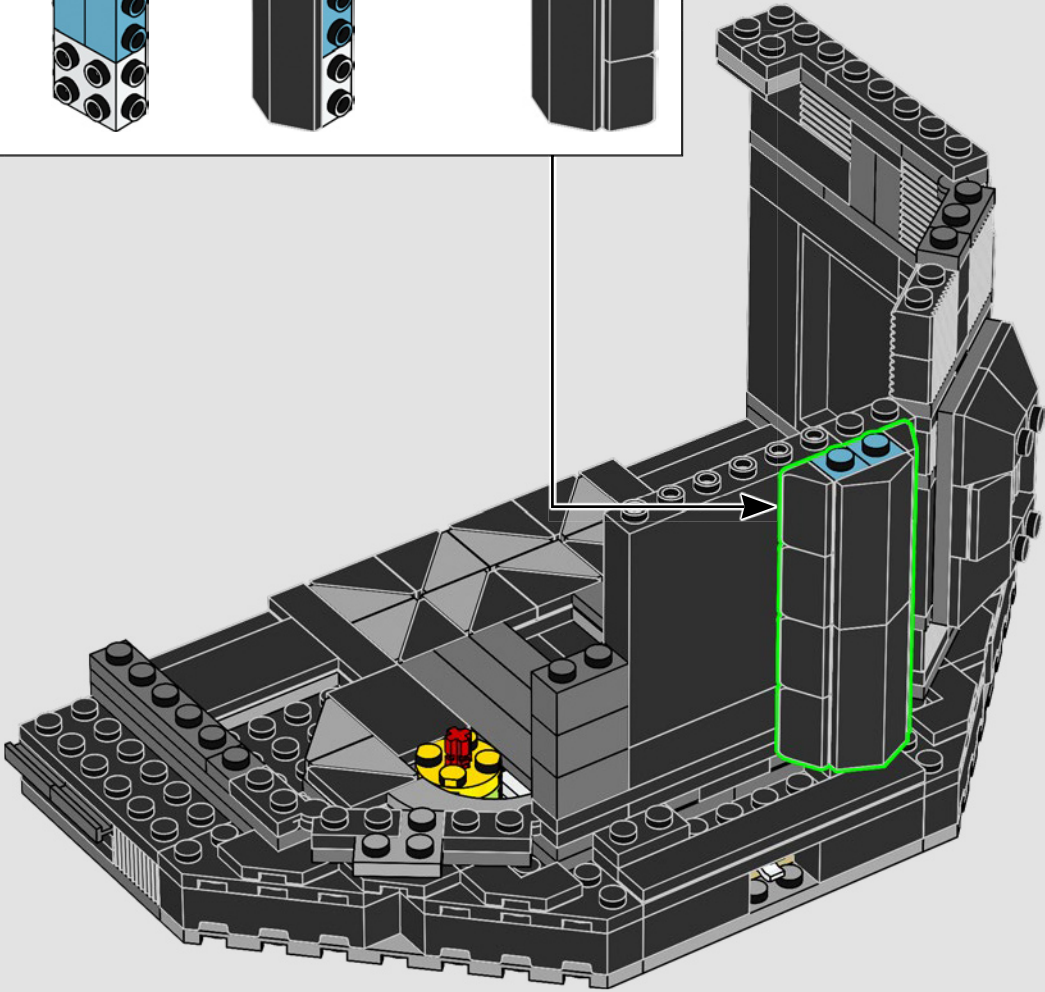
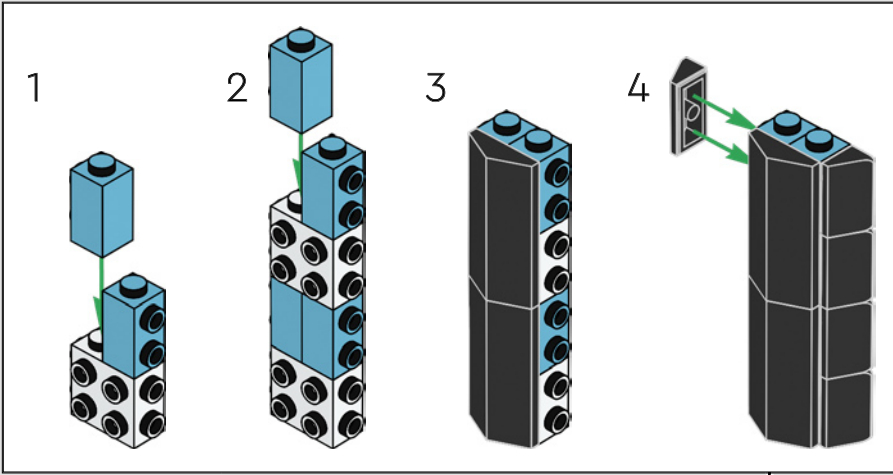

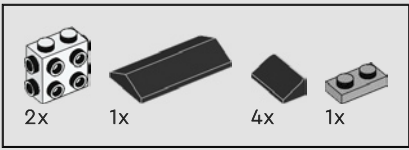

41

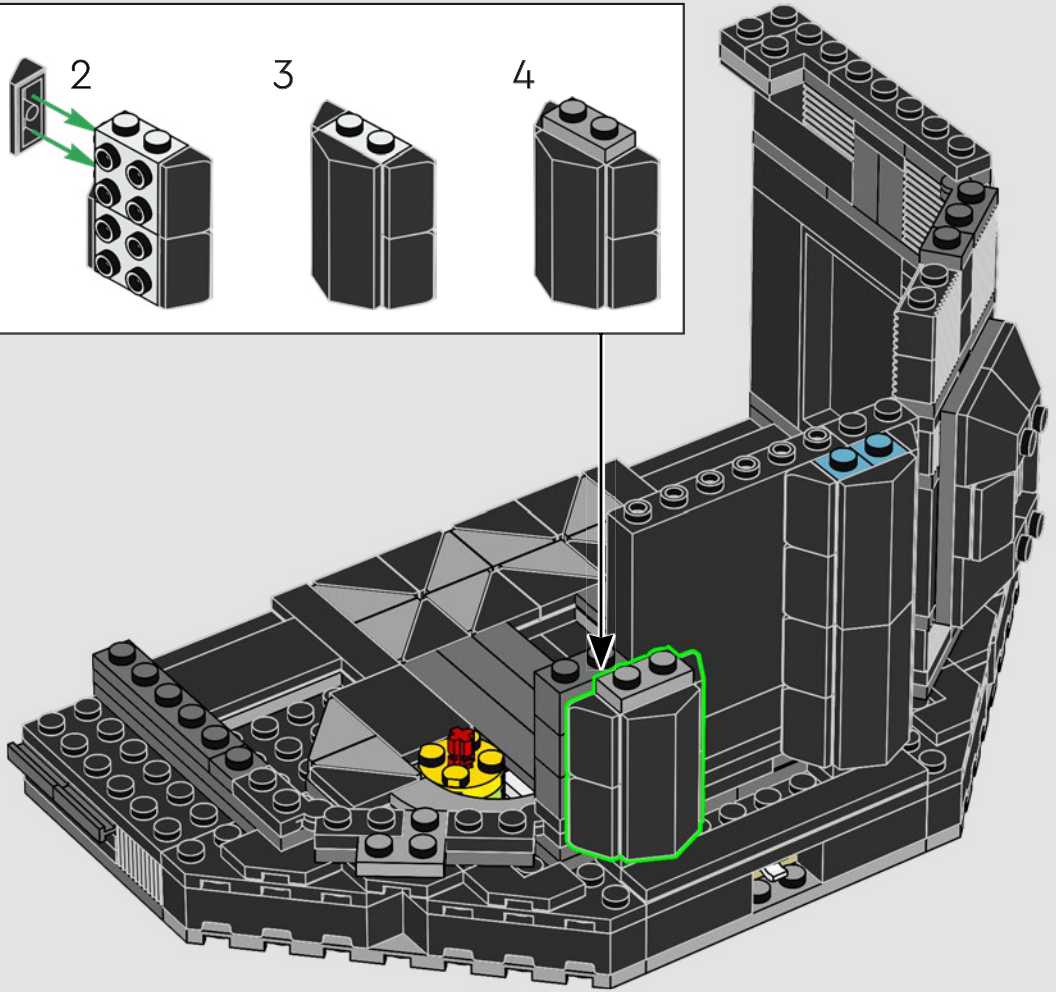
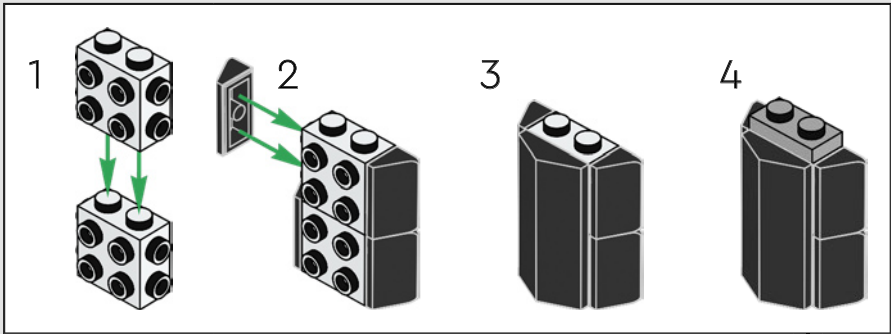

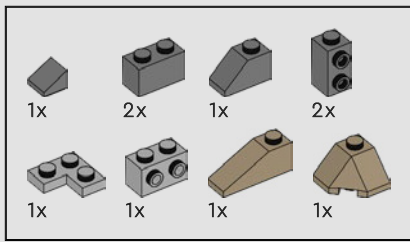

42

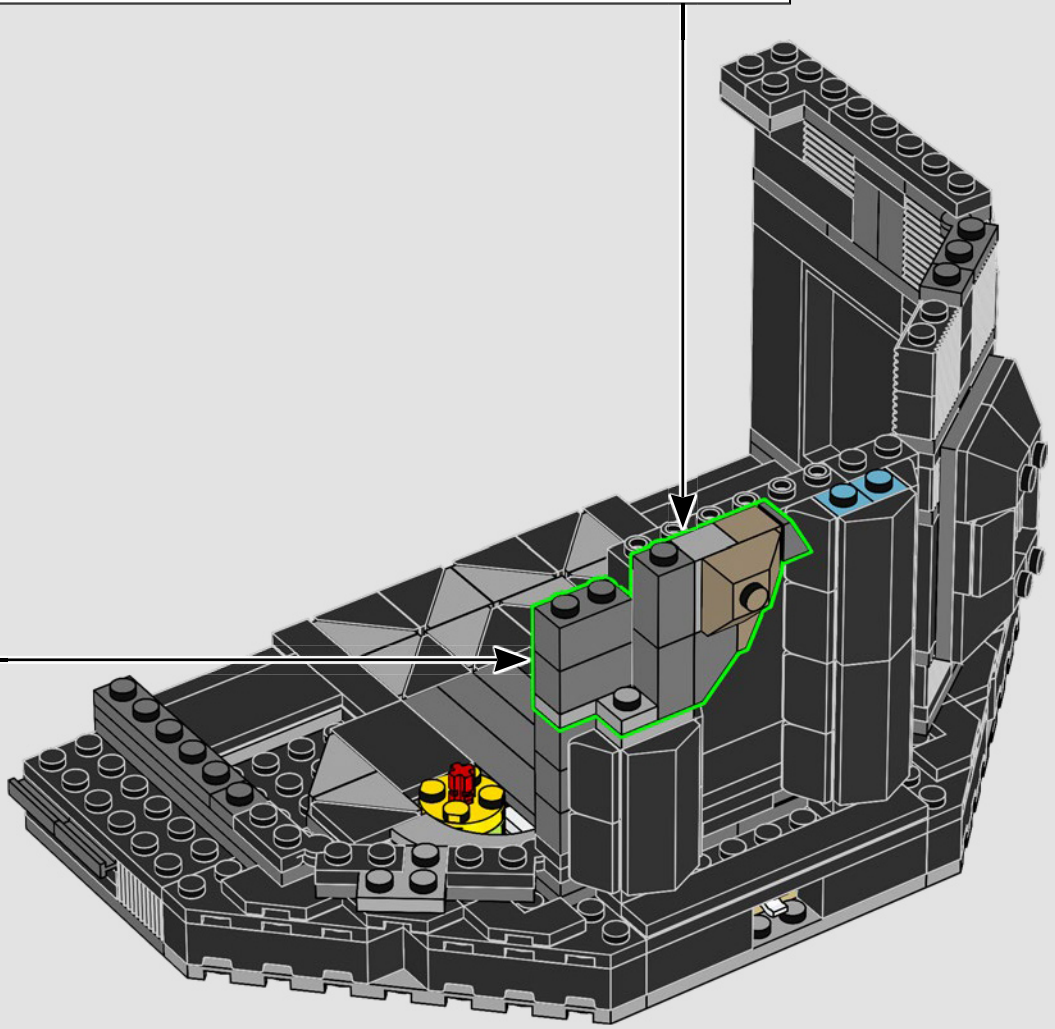
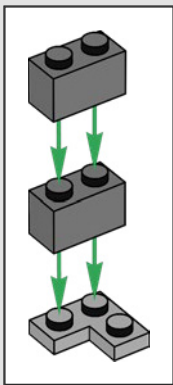
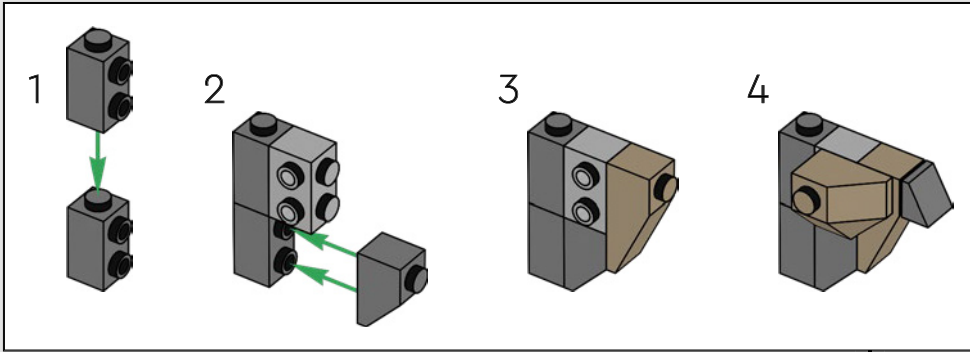

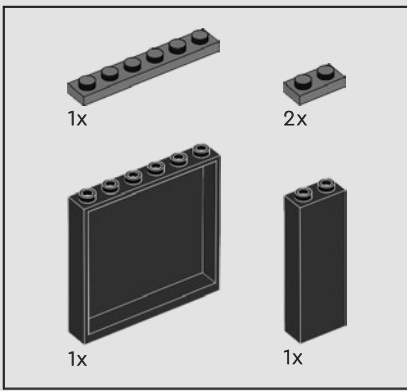

43

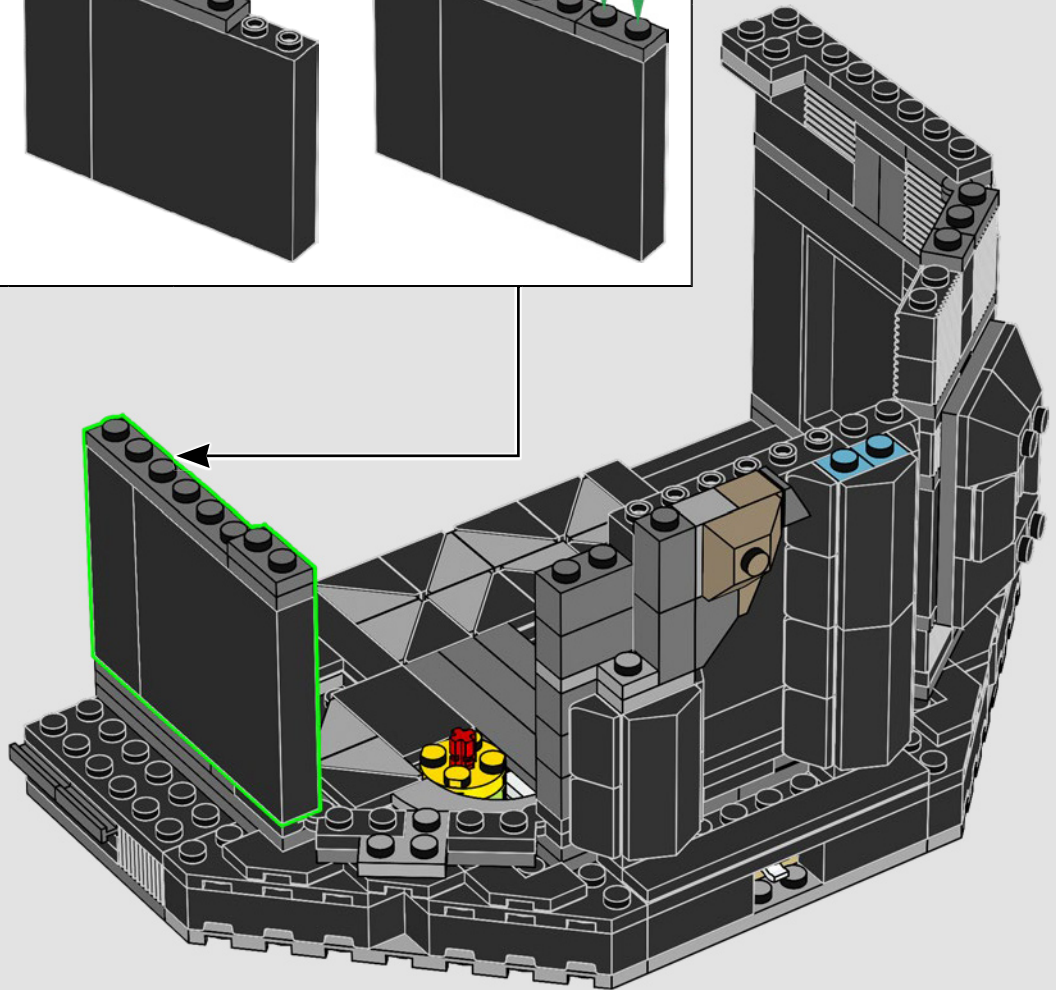
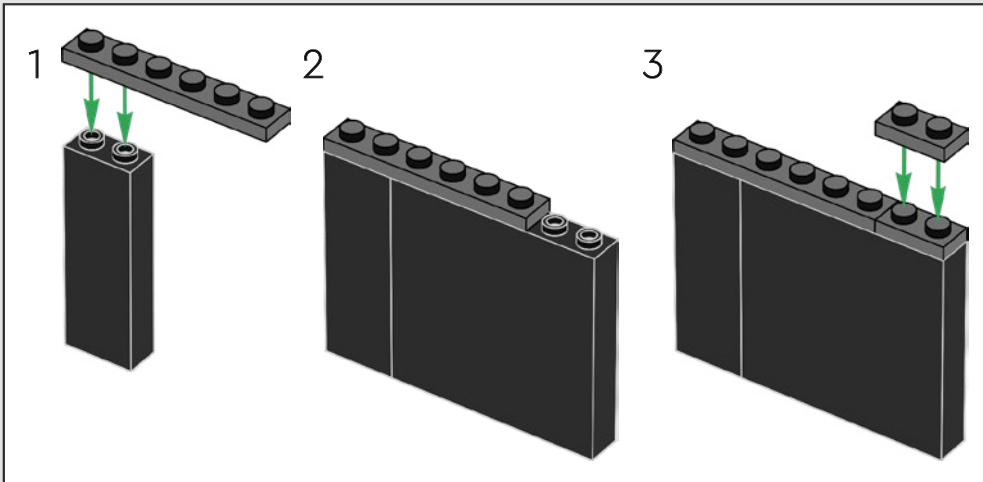

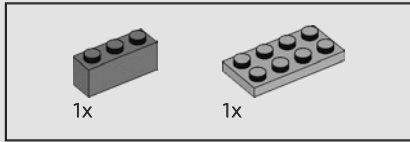
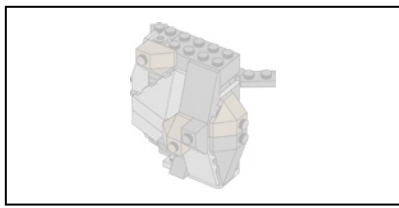

44

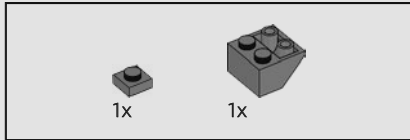
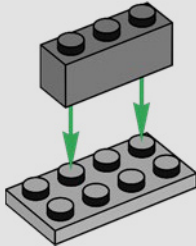

45

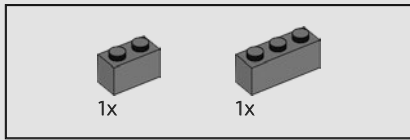
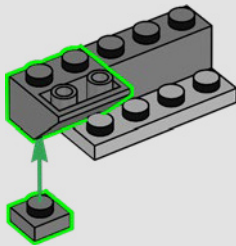

46

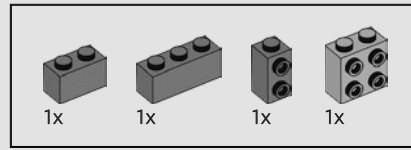
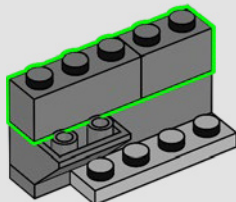

47

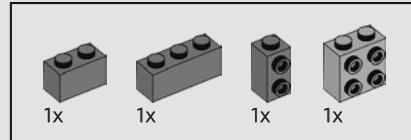
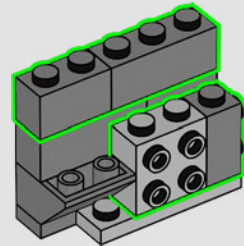

48

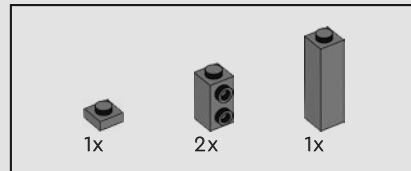
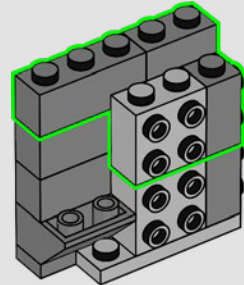

49

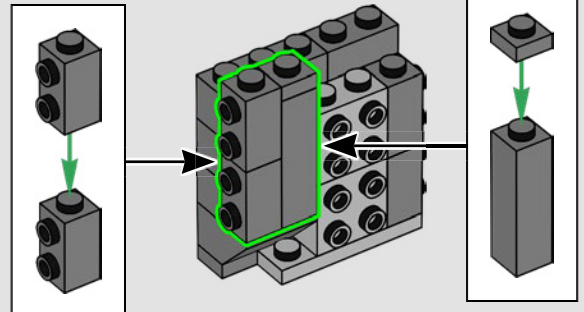

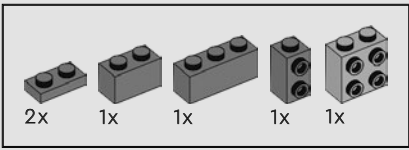

50

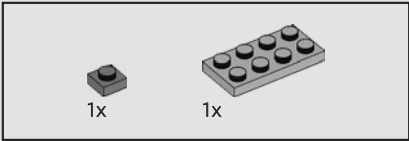
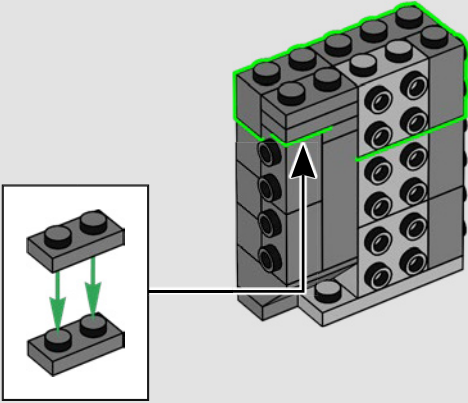

51

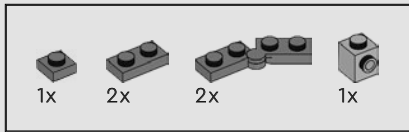
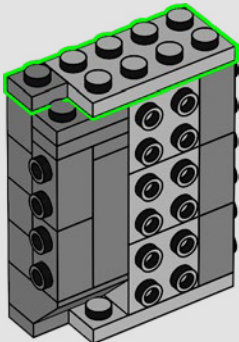

52

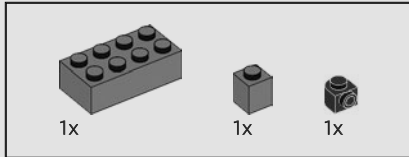
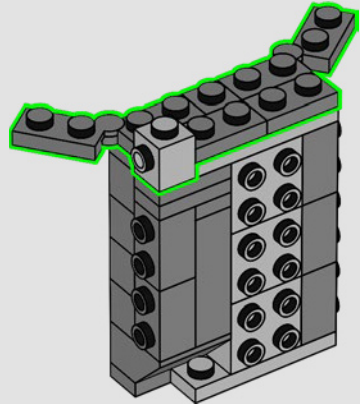

53

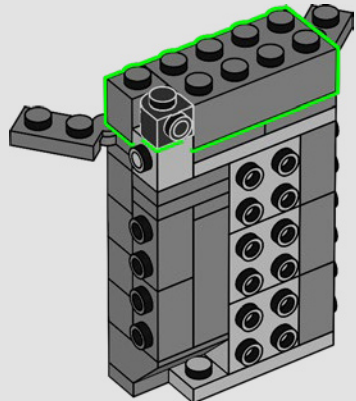

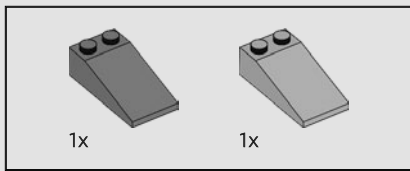

54

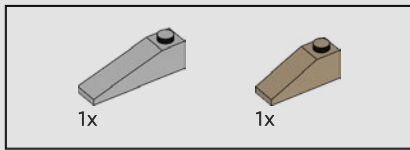
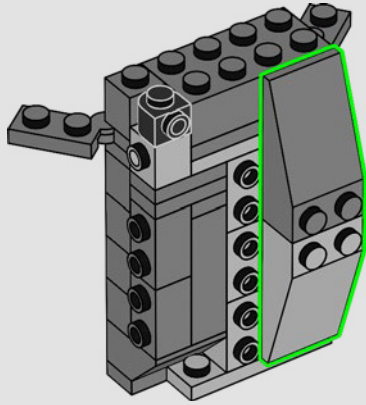

55

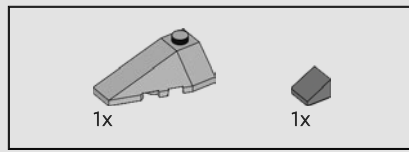
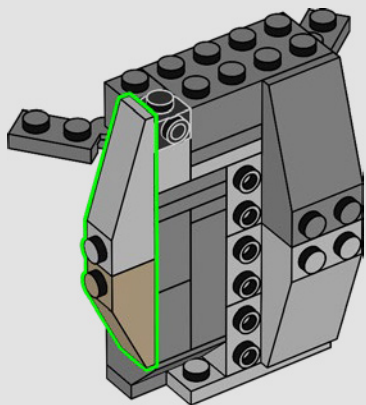

56

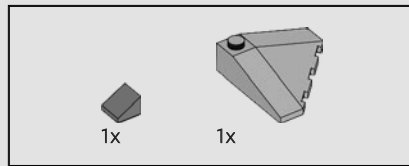
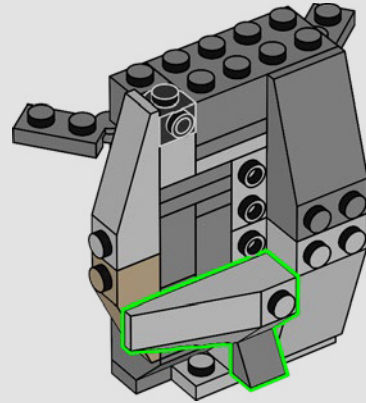

57

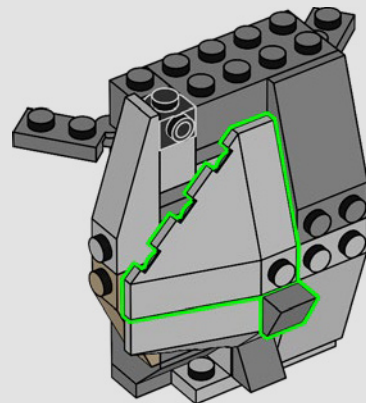

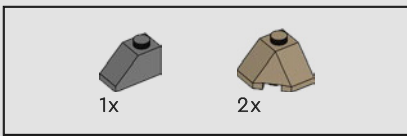

58

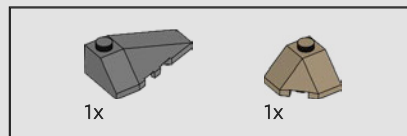
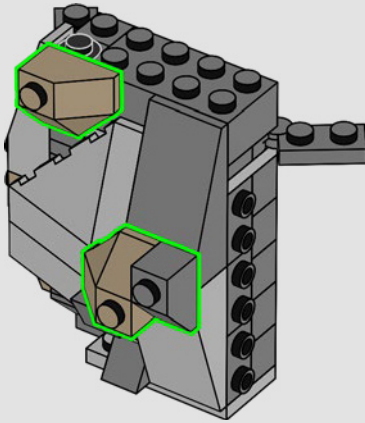

59

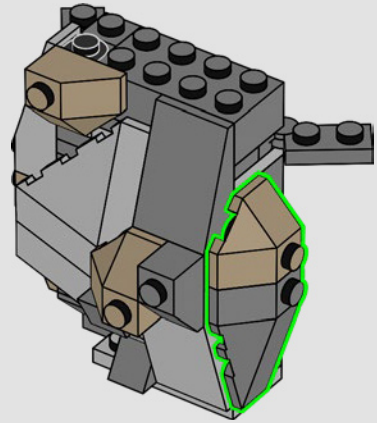

60

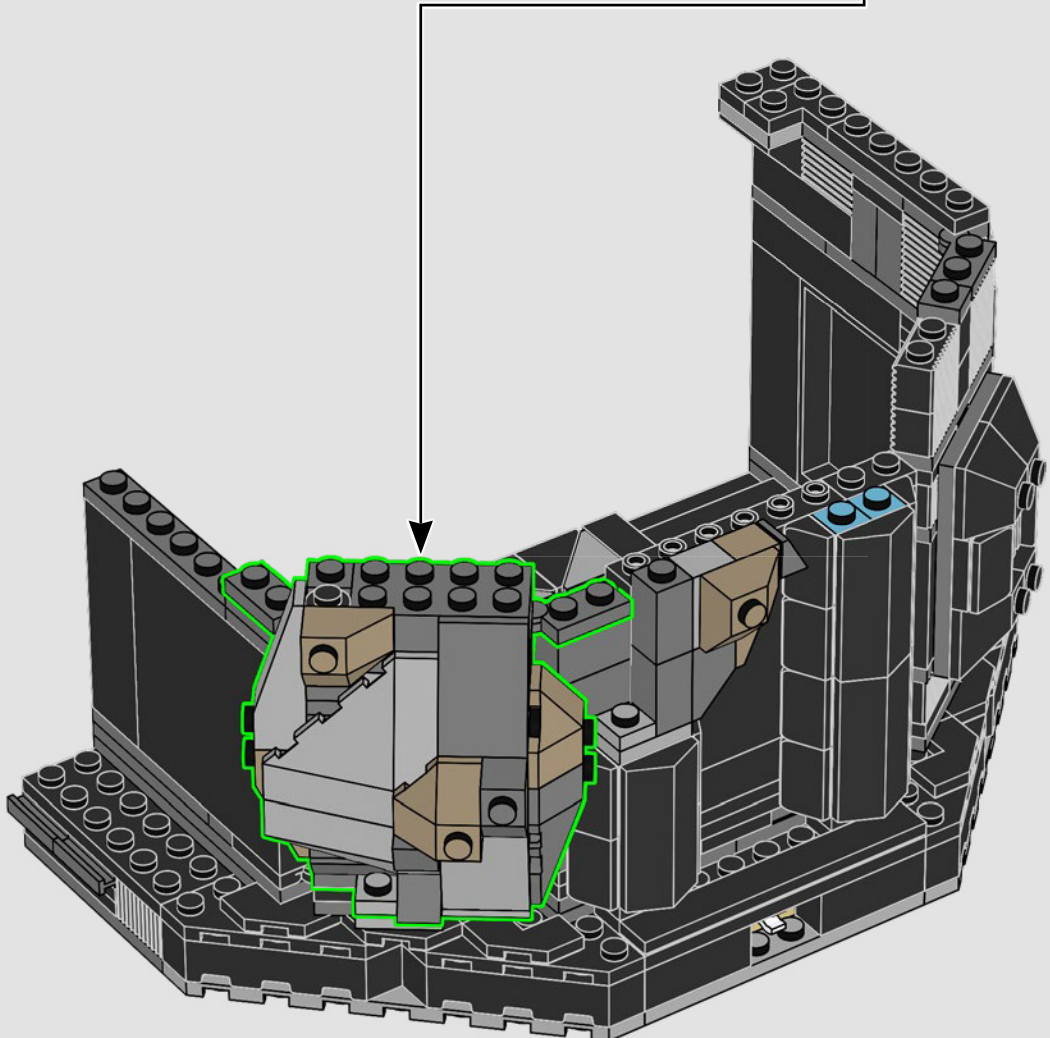

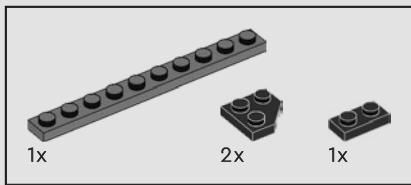

61

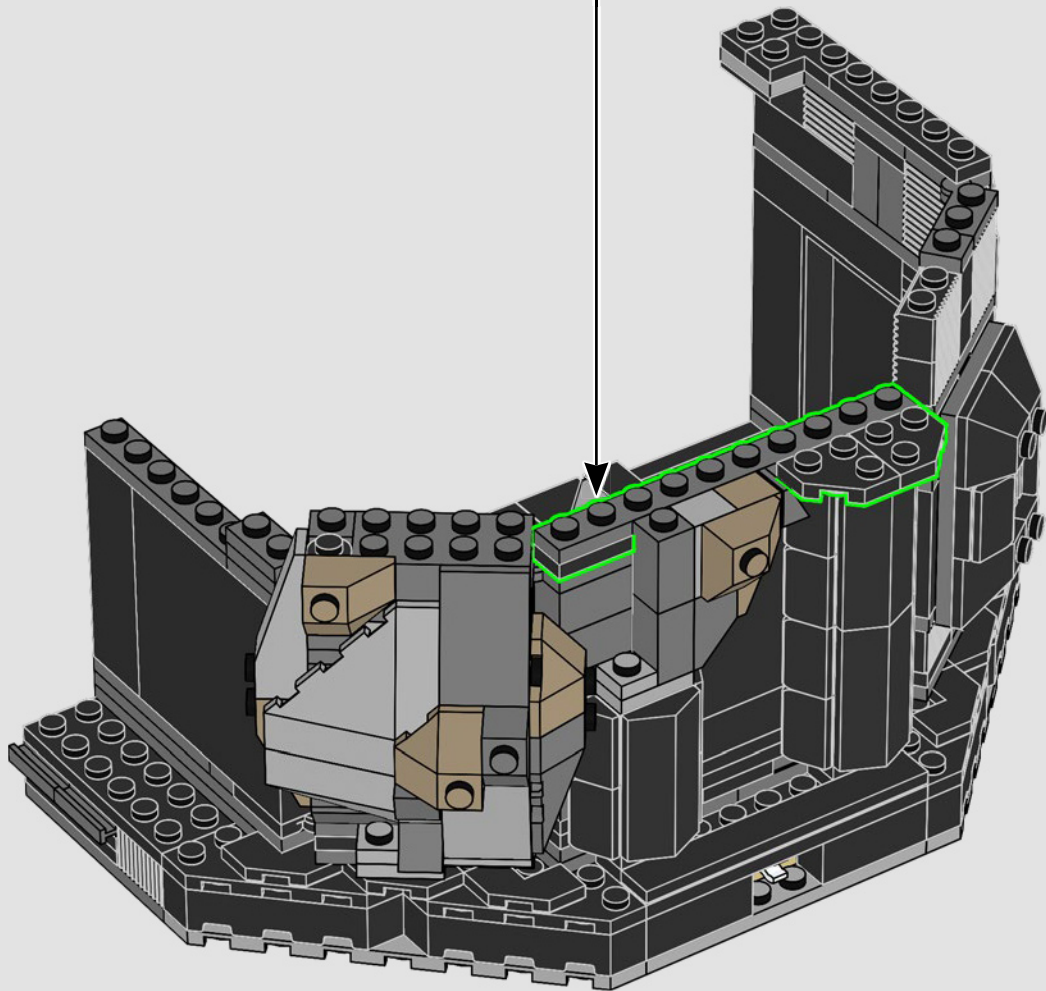
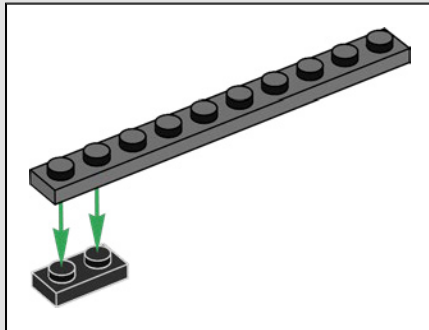

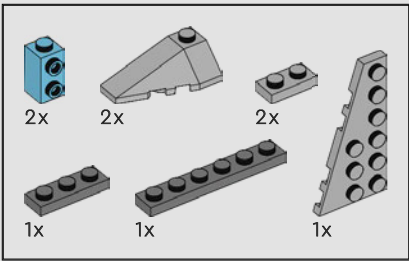

62

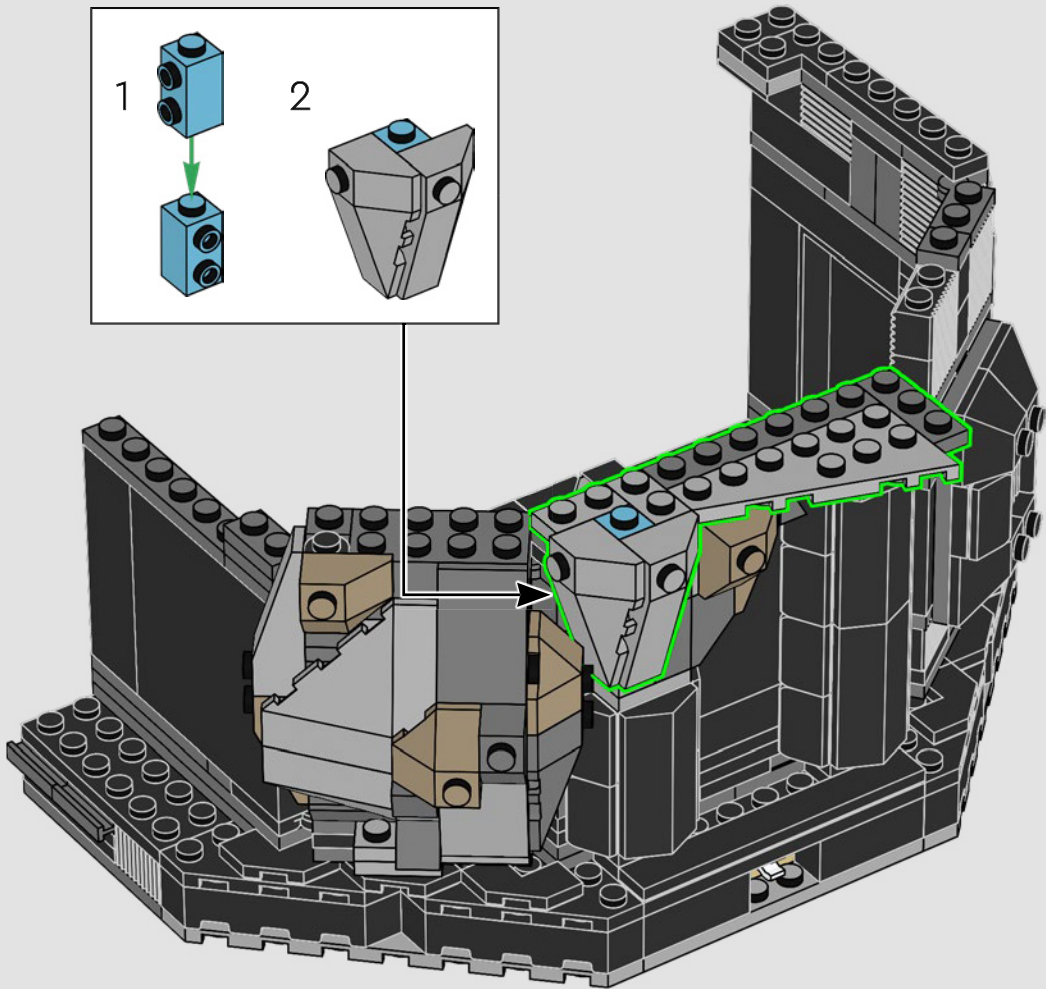

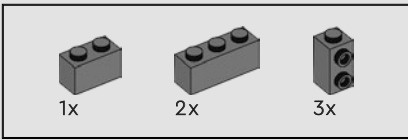

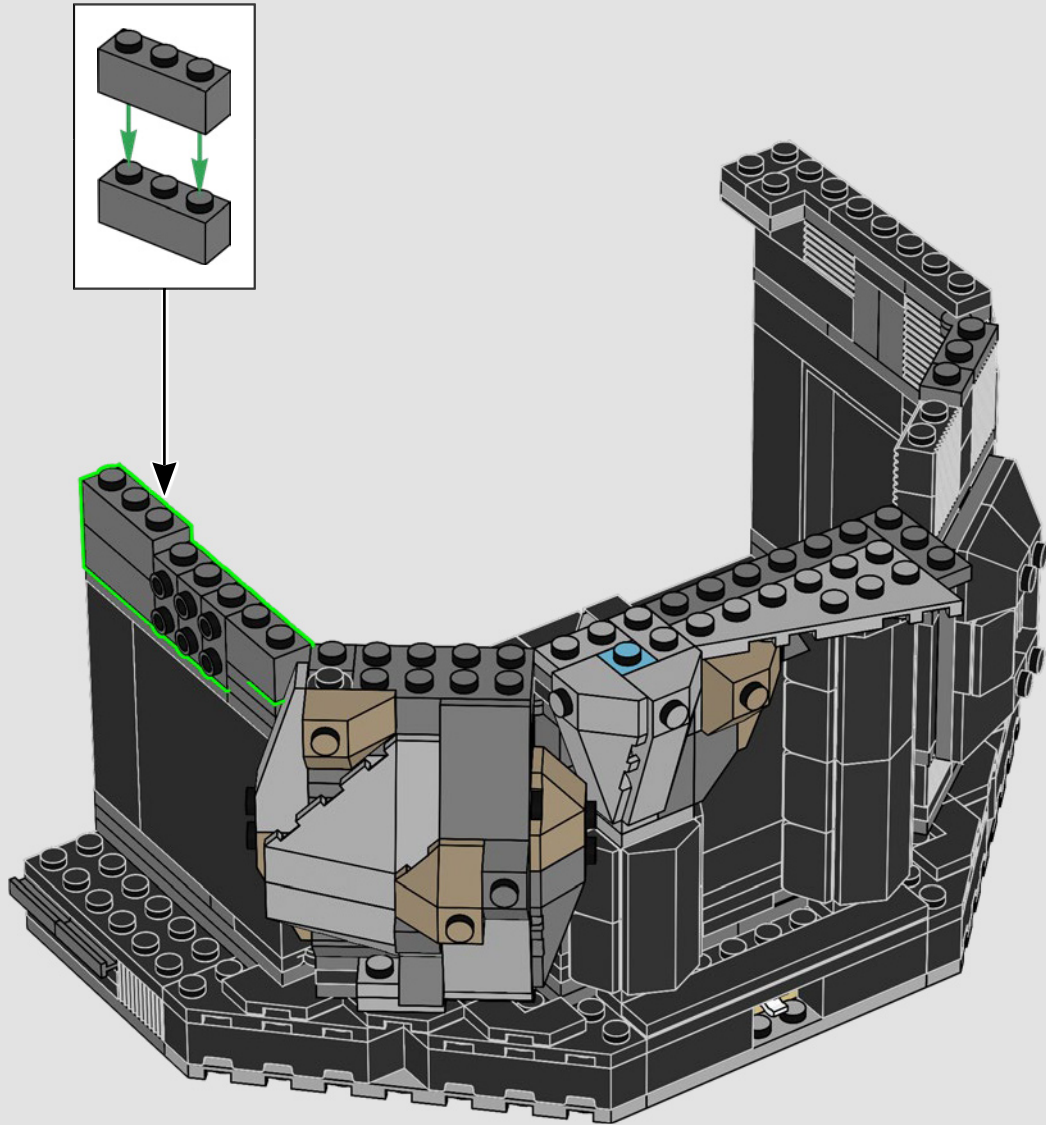

63

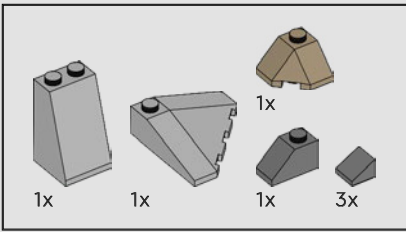

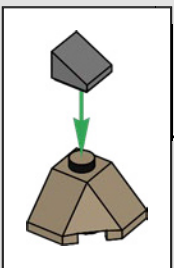
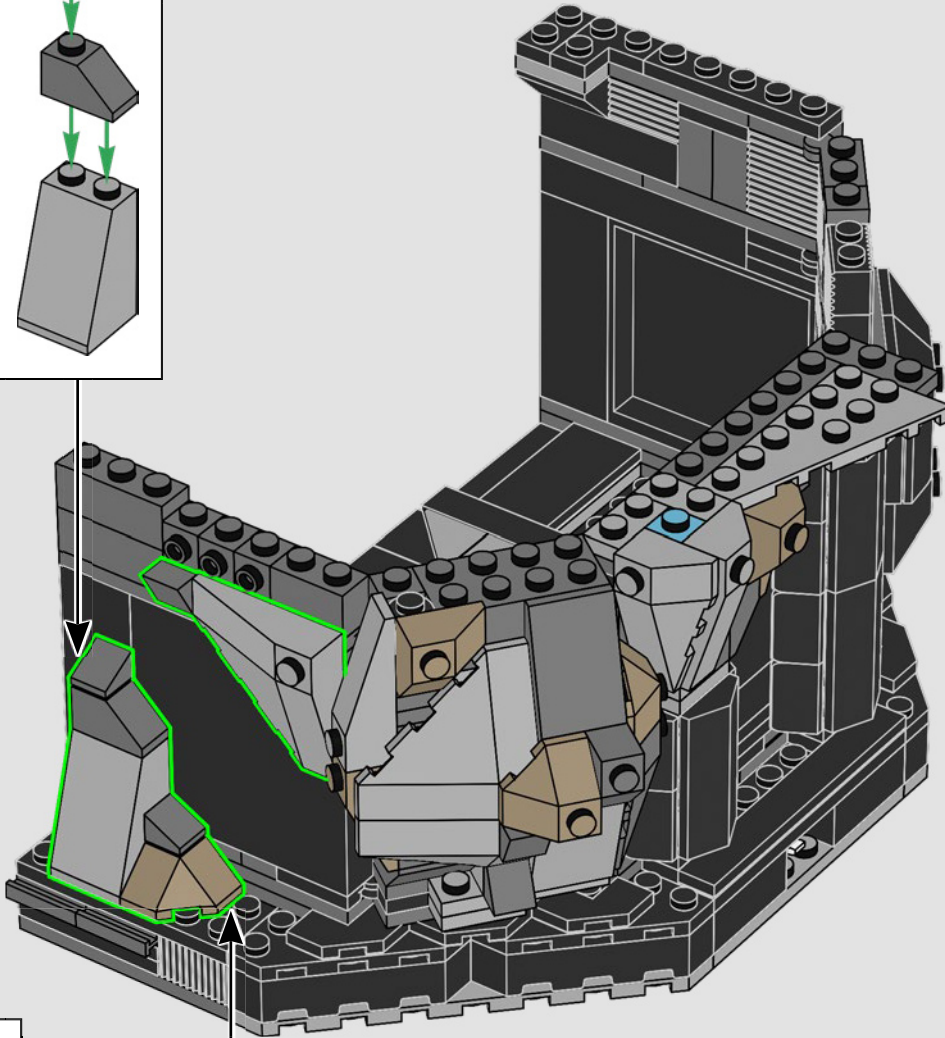
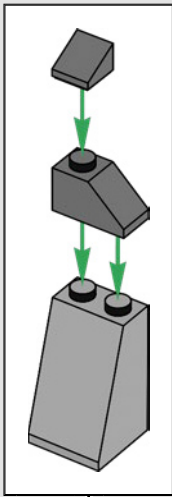

64



 Der in die Flanke eines Bergs eingebettete Turm scheint uneinnehmbar zu sein.



Sauron™ wird in diesem Set zum ersten Mal als LEGO® Minifigur eingeführt. Sein Helm wurde eigens für dieses Set entworfen.

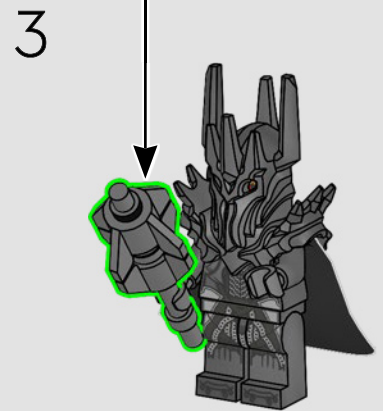
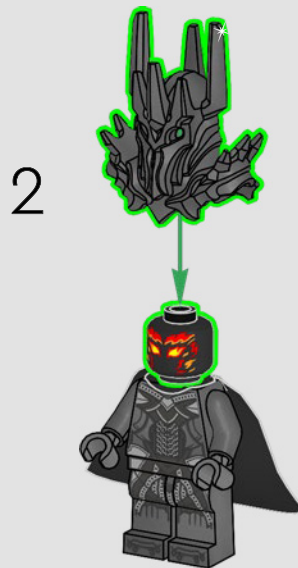
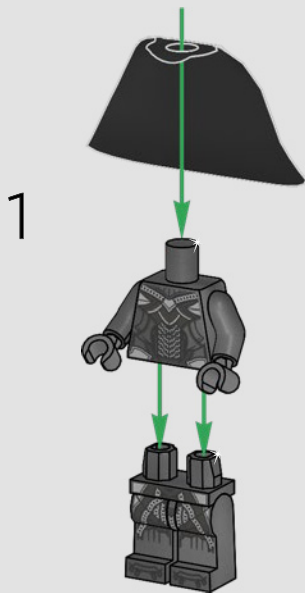
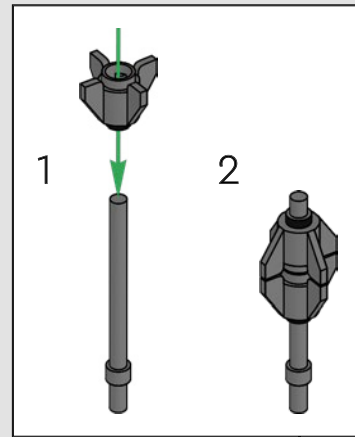

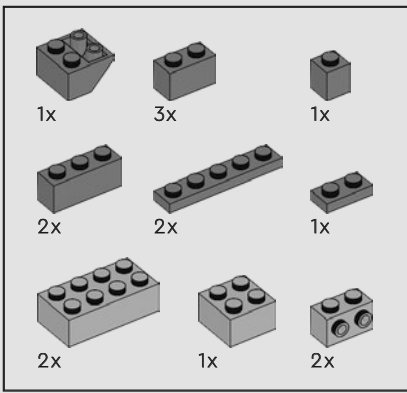

65

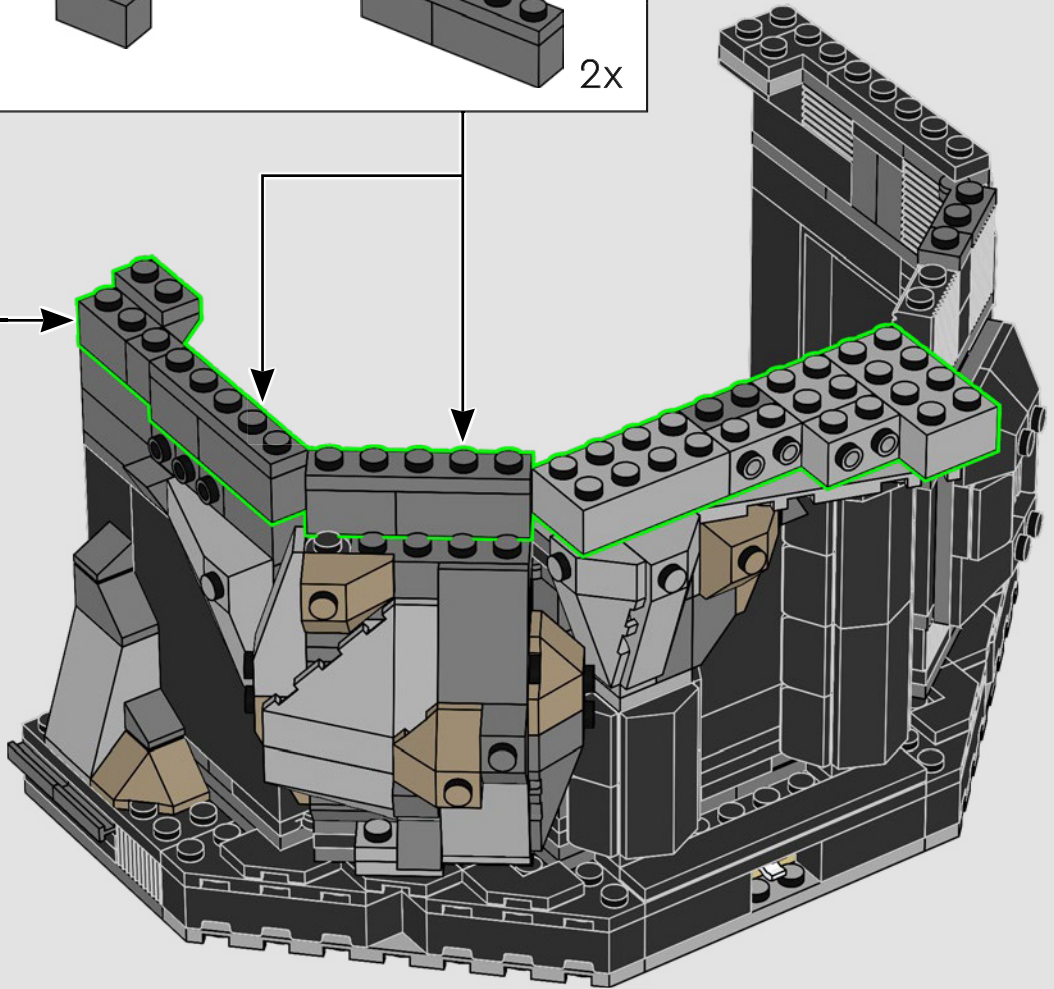
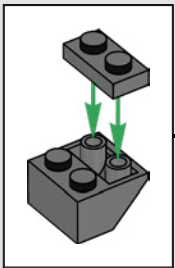
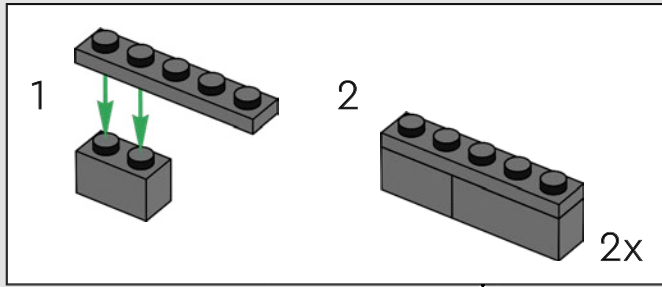

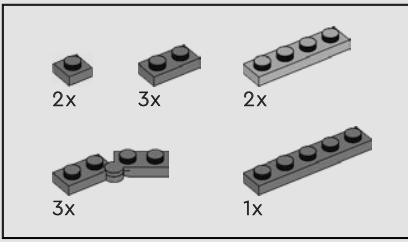

66

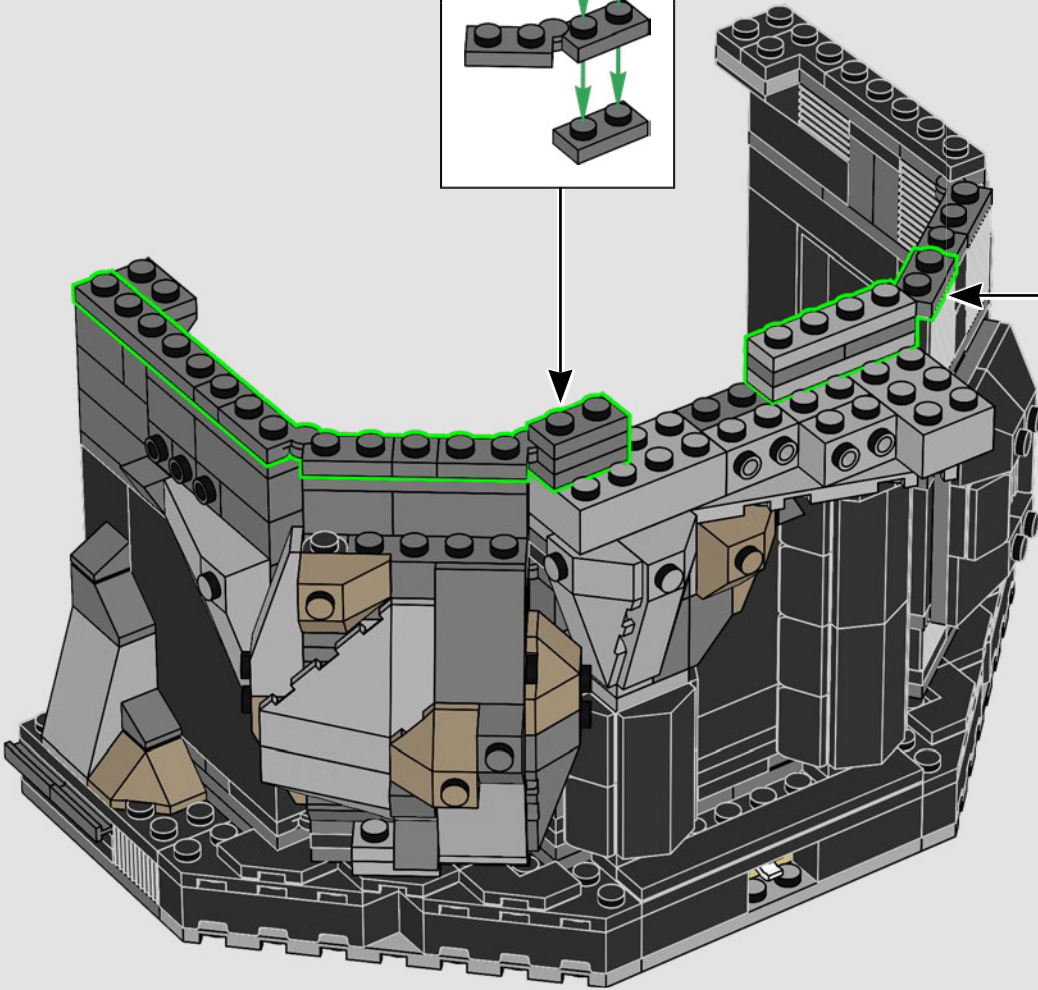
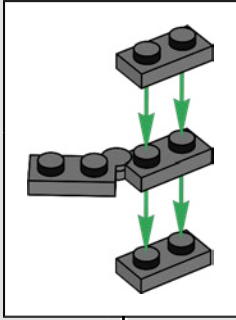
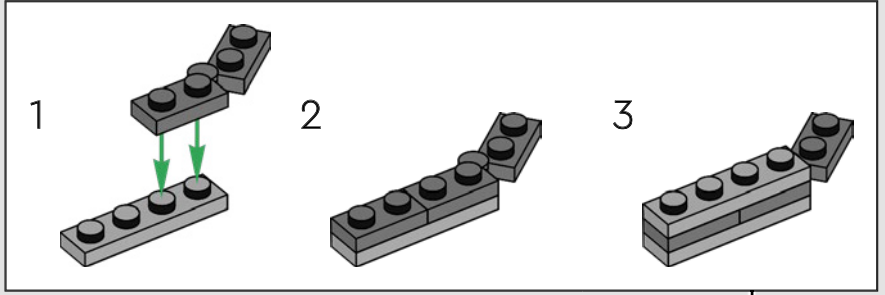

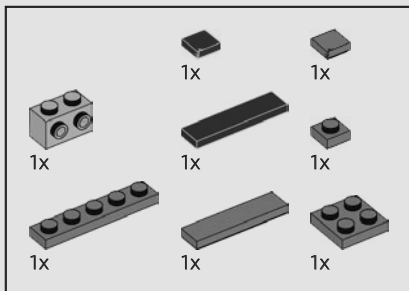

67

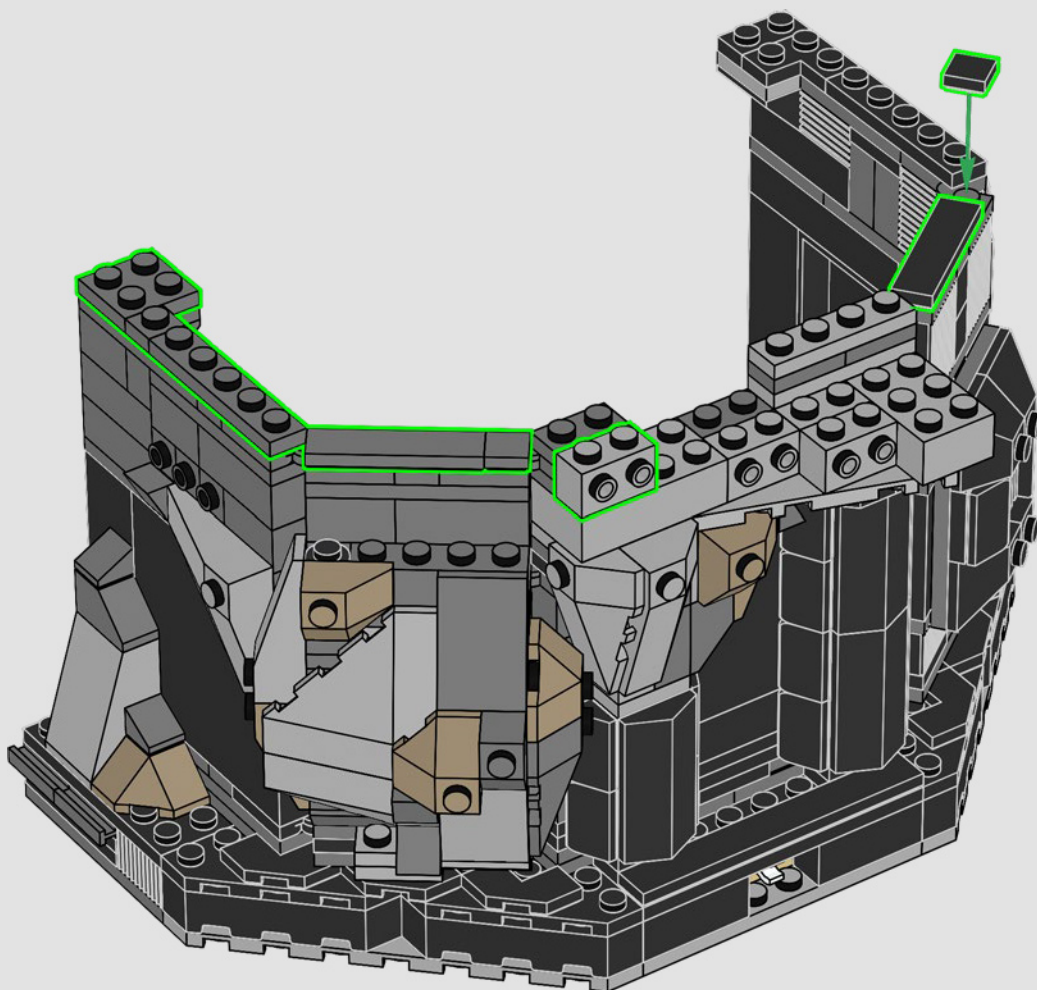

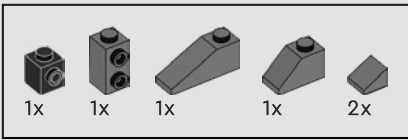

68

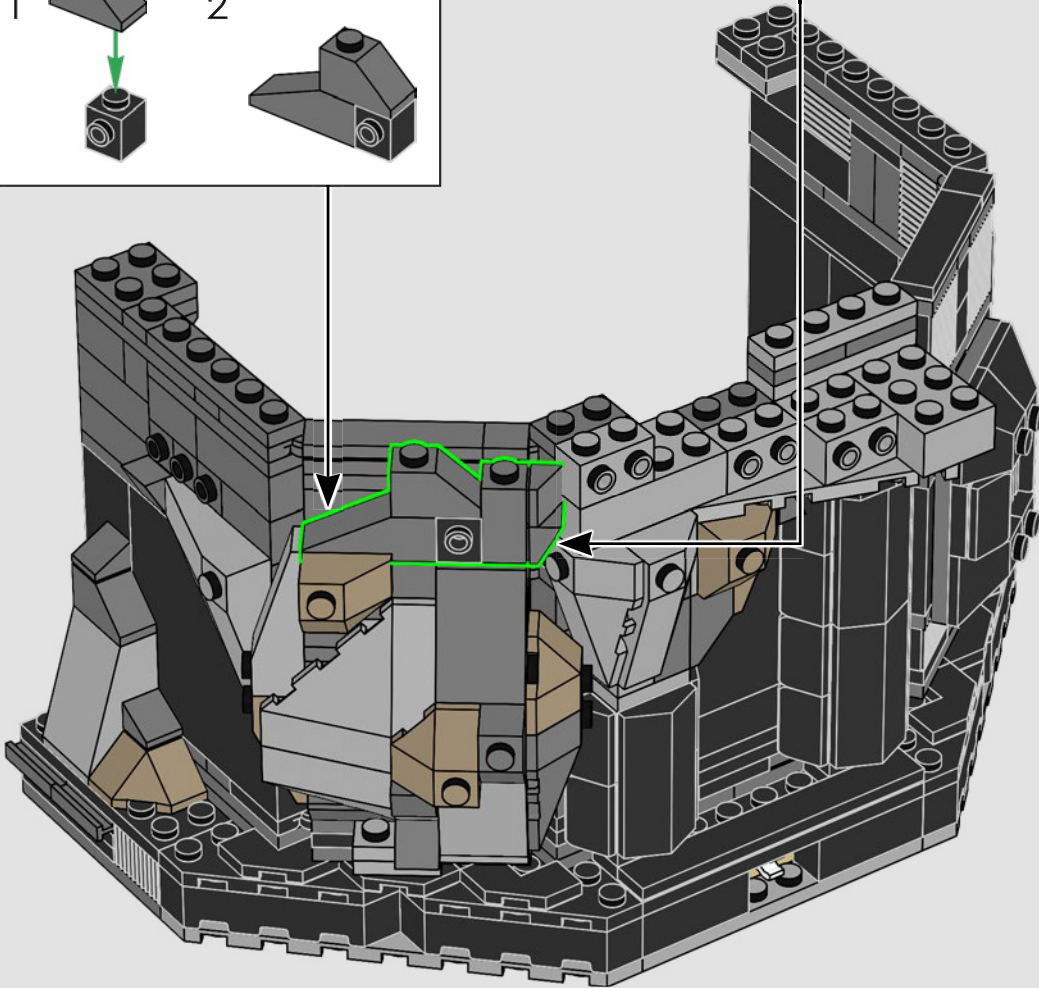
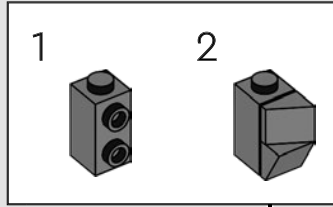
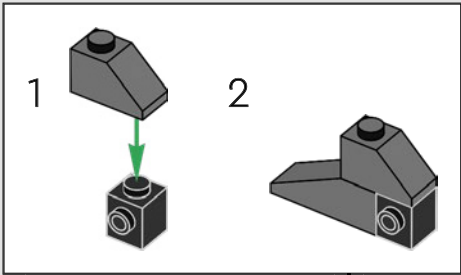

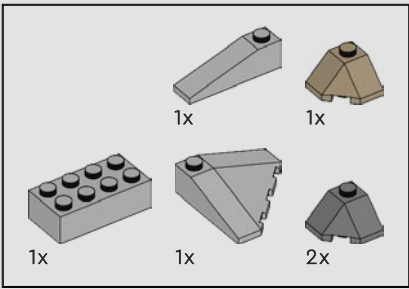

69

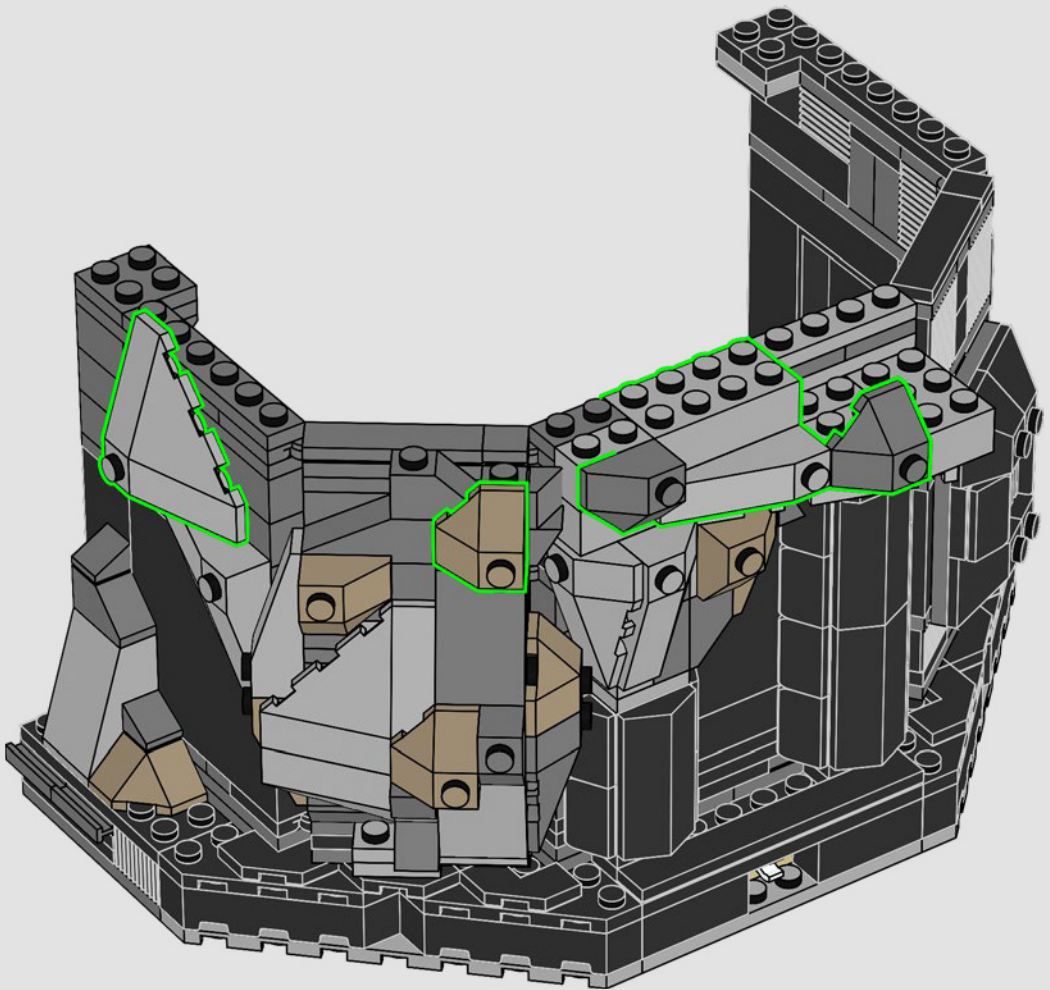

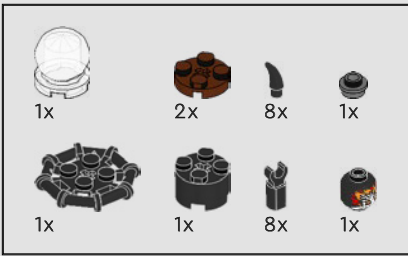

70

1



2

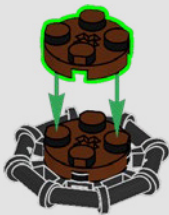

3

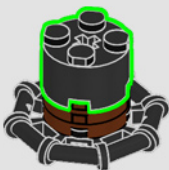

4

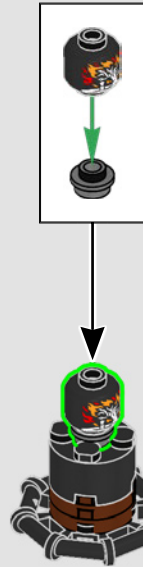

5



6

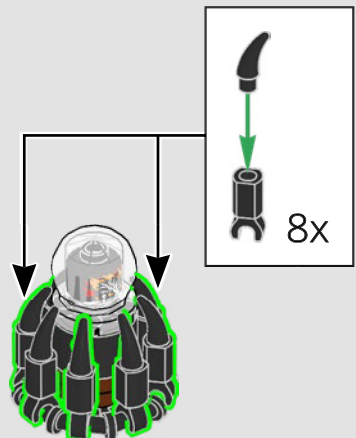



Für dieses Set wurde ein neues bedrucktes Teil angefertigt
– ein Palantír-Reichsapfel, den Sauron™ benutzt, um seine
Feinde überall in Mittelerde auszuspionieren.

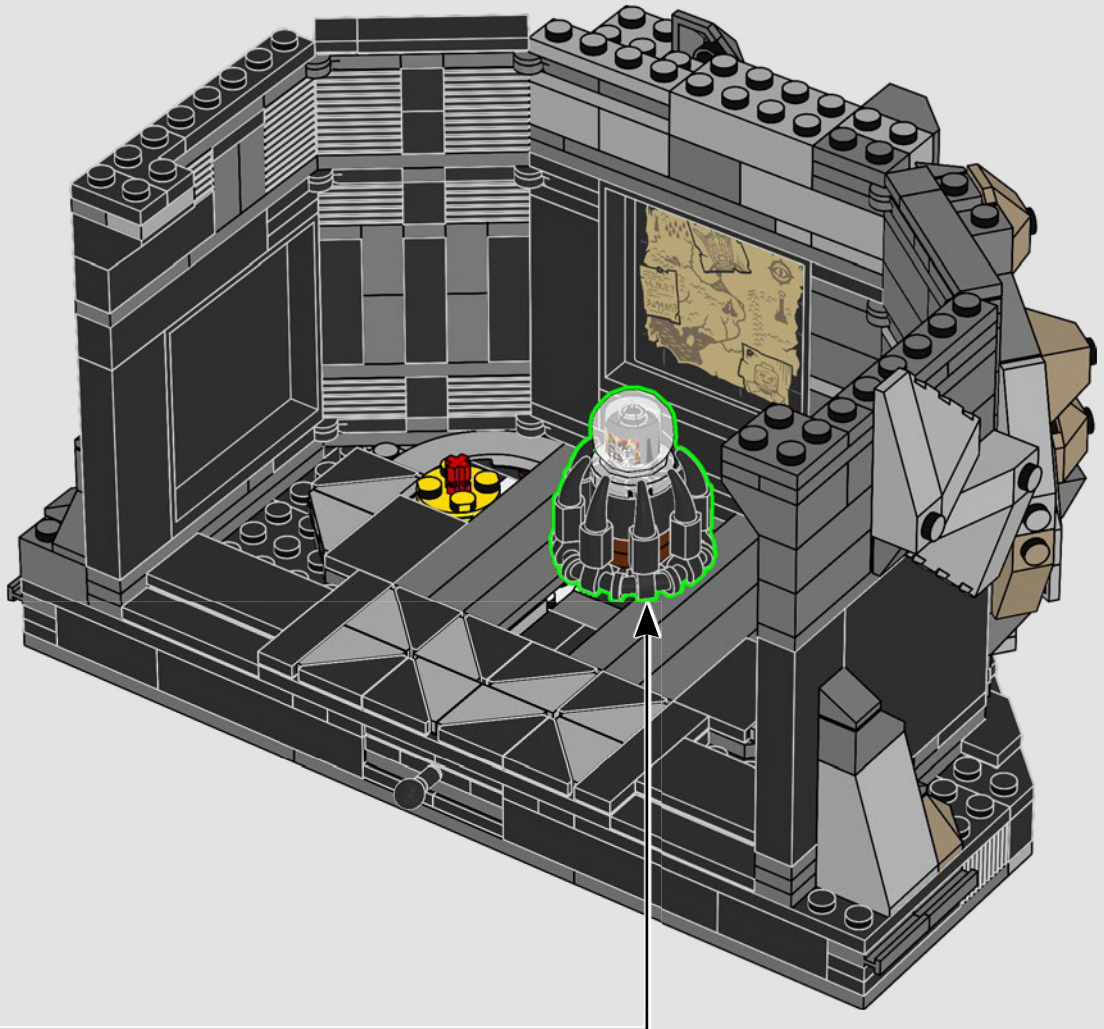

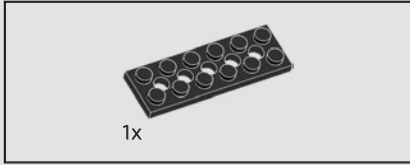
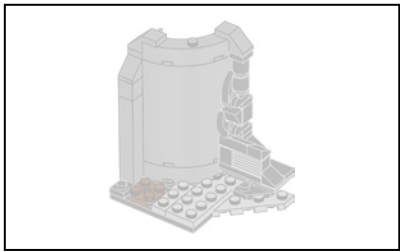

71

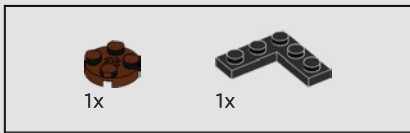
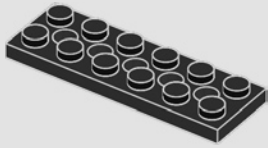

72

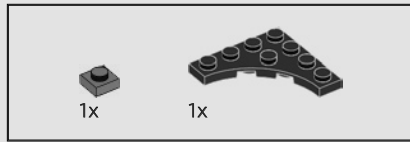
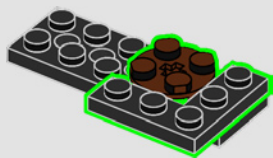

73

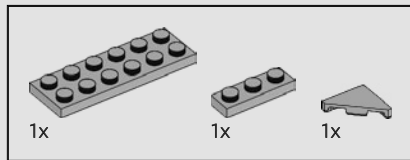
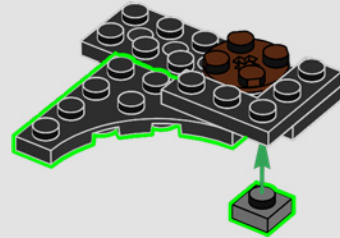

74

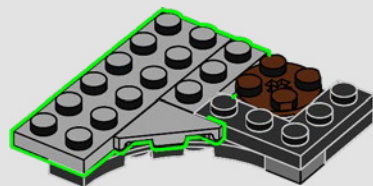

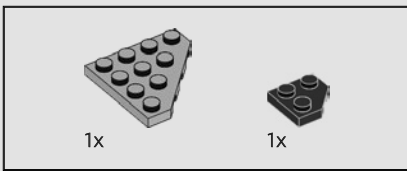

75

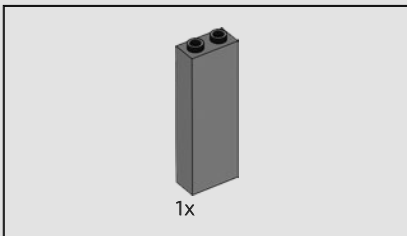
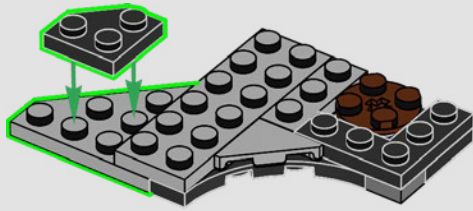

76

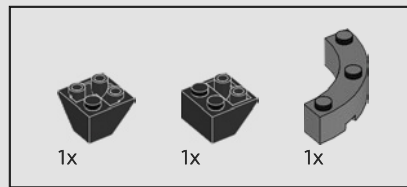
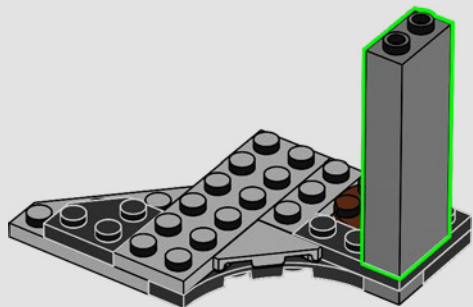

77

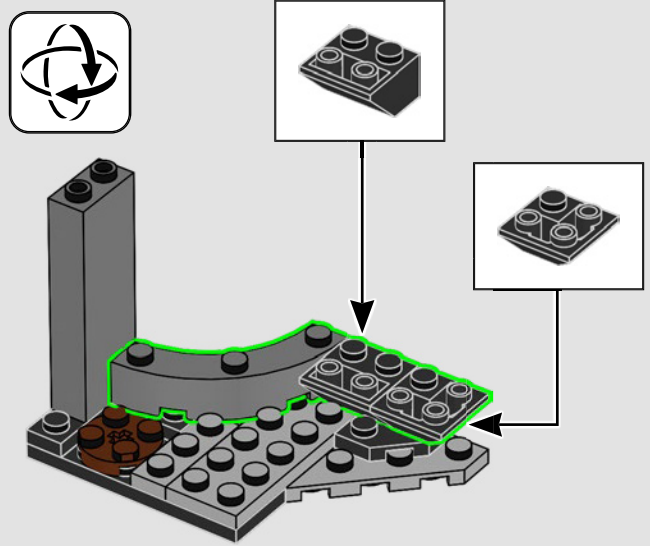

78

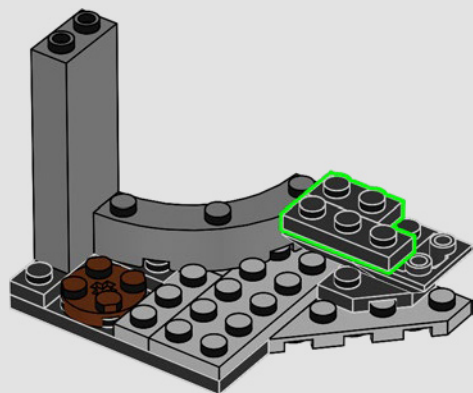

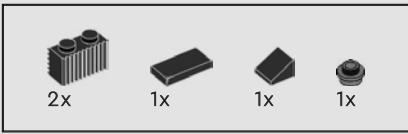

79

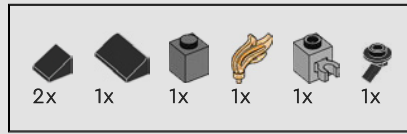
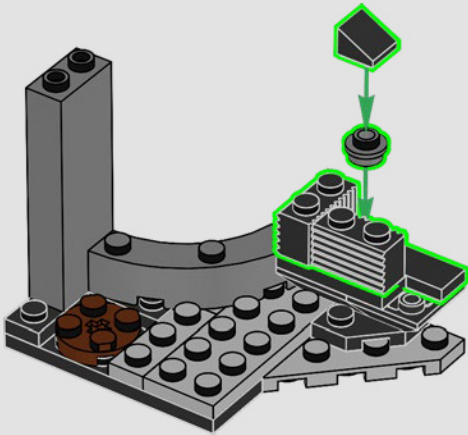

80

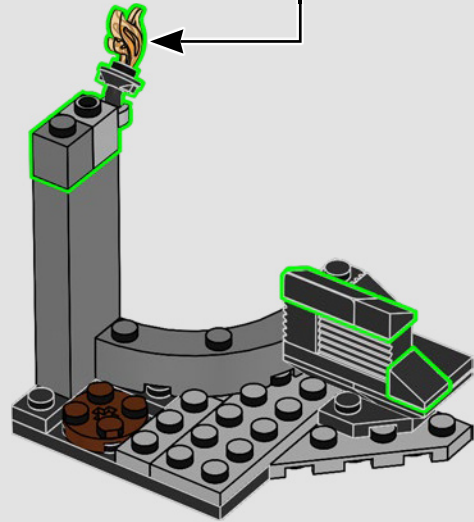
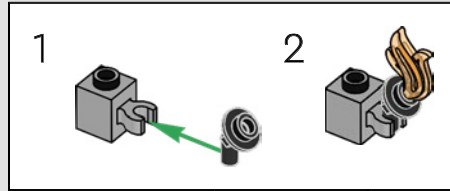

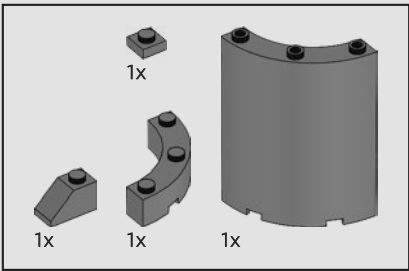

81

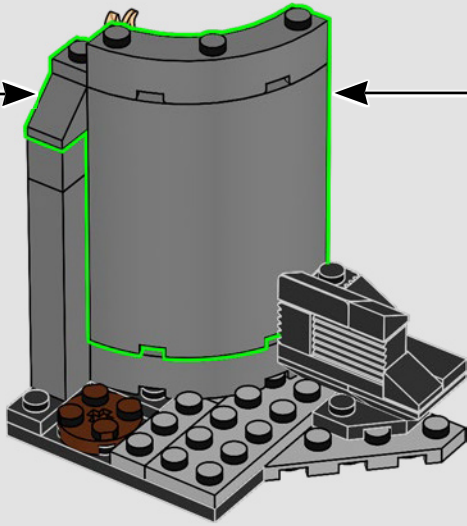
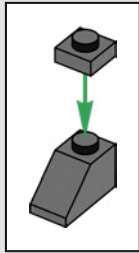
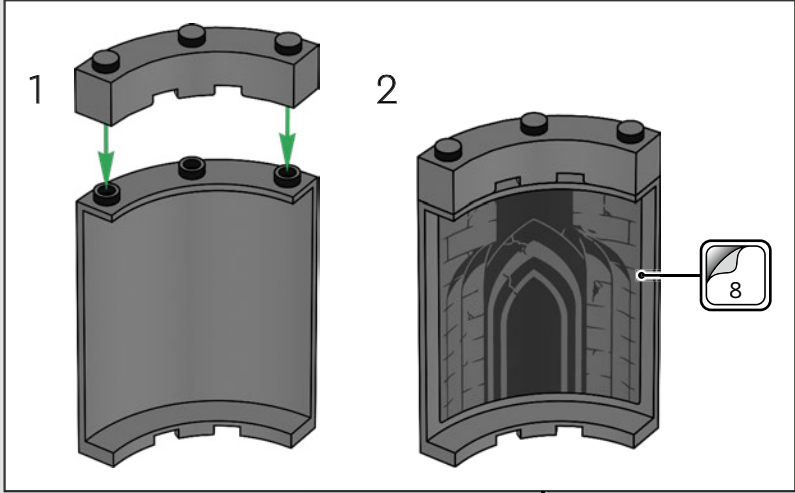

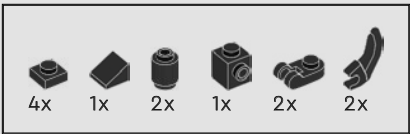

82

1

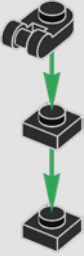

2

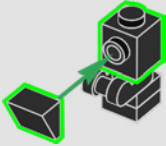

3

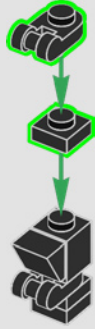

4

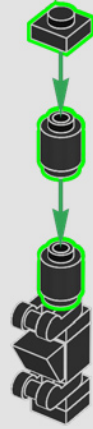

5

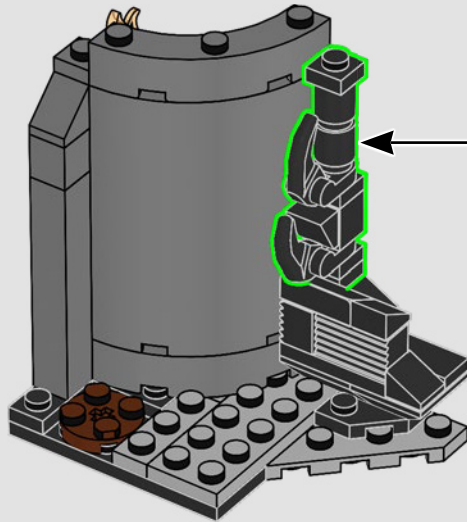

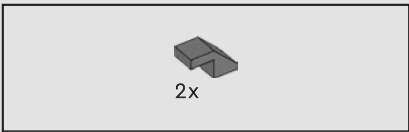

83

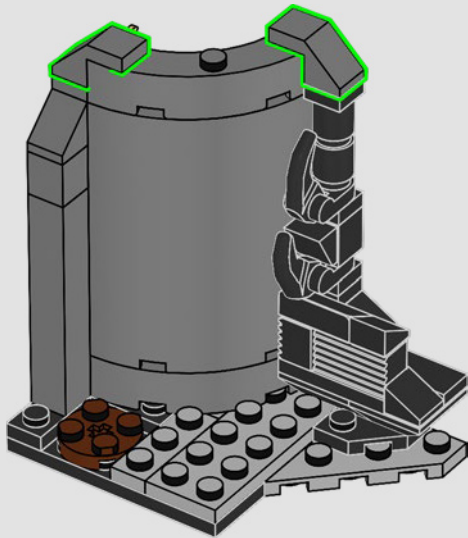

84

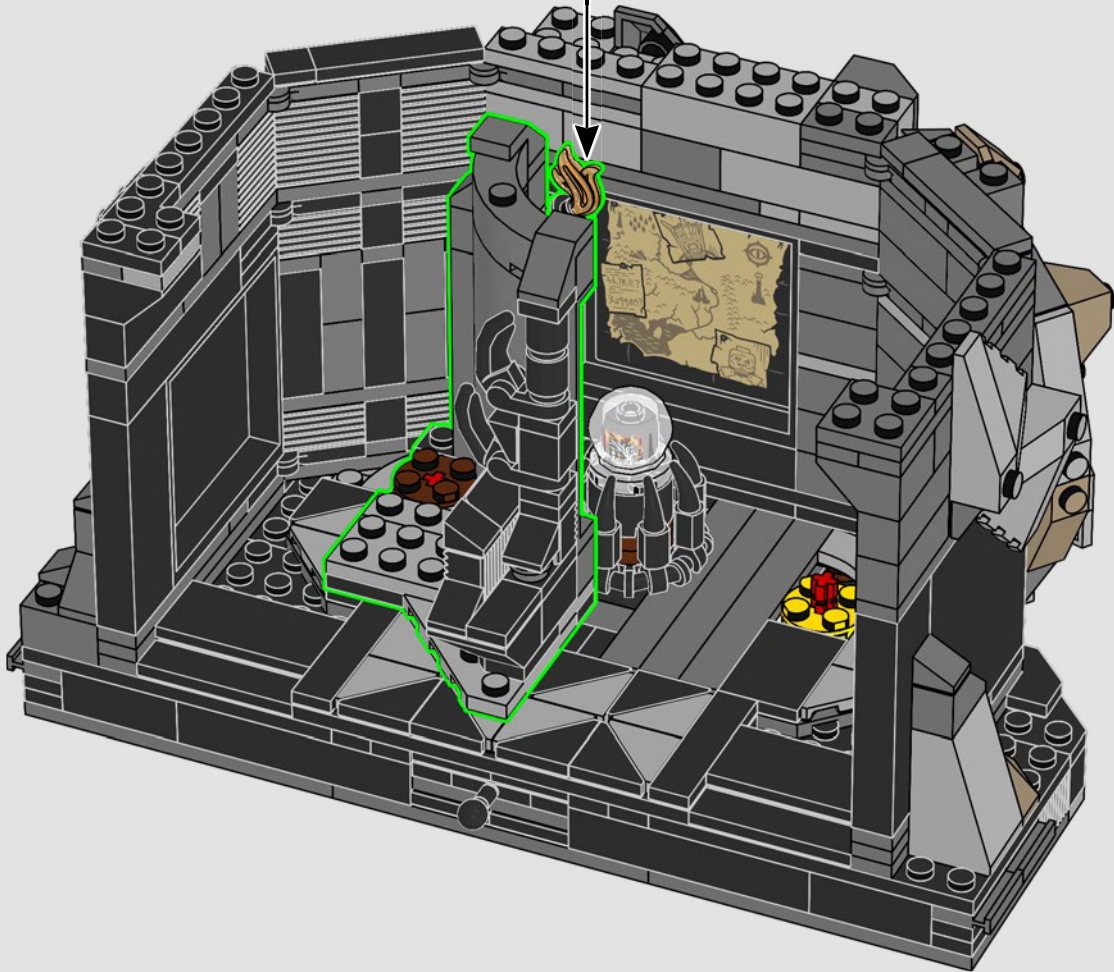

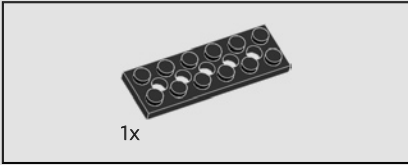
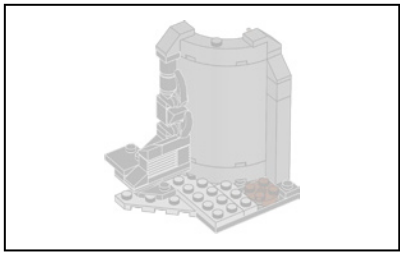

85

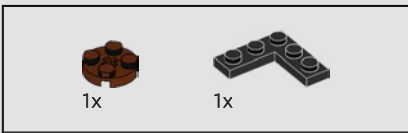
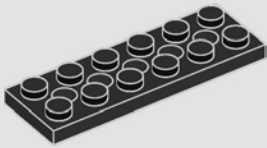

86

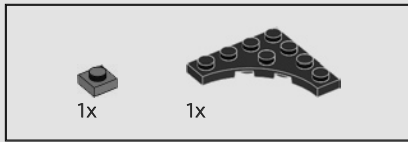
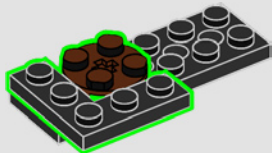

87

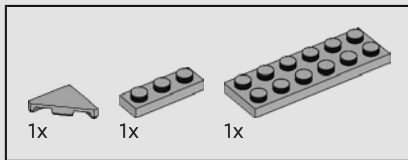
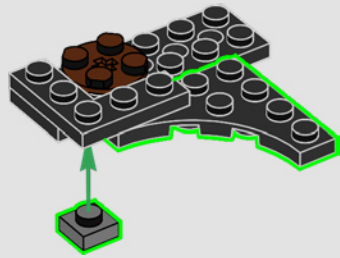

88

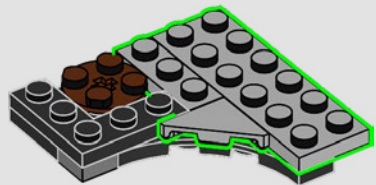

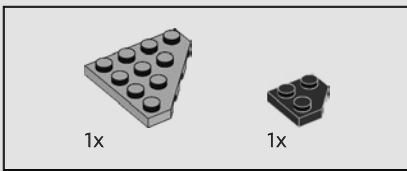

89

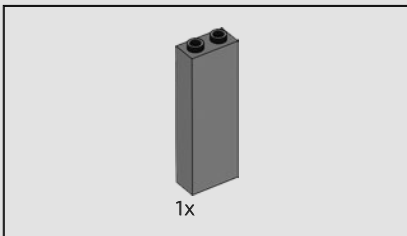
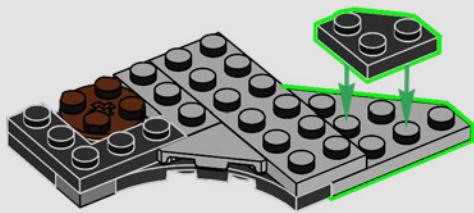

90

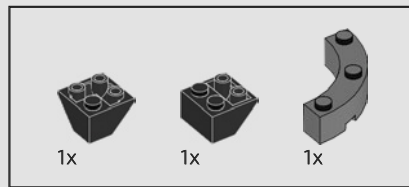
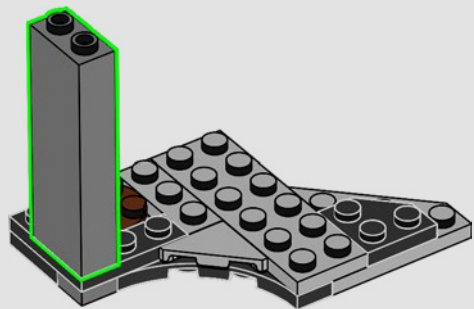

91

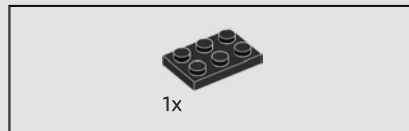
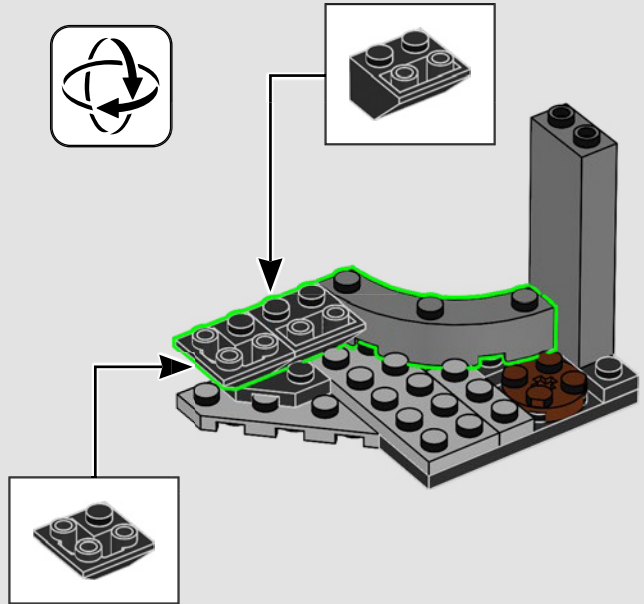

92

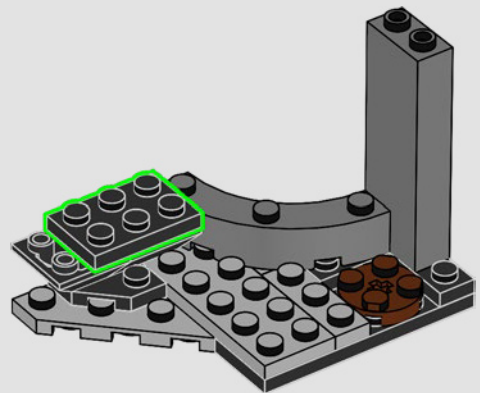



93

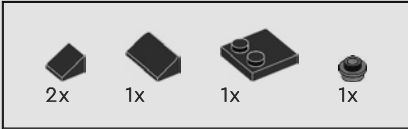
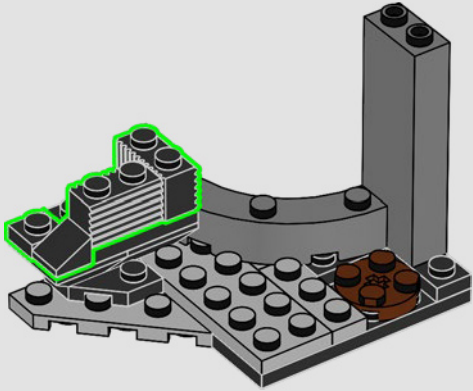

94

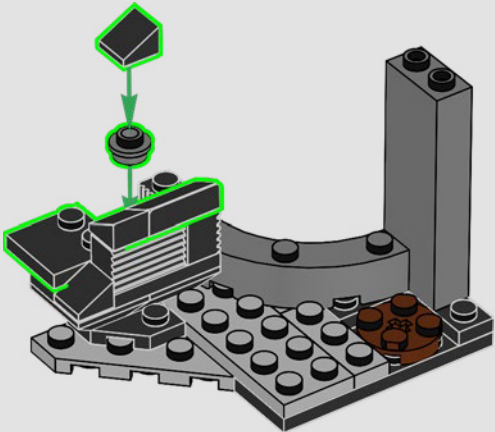

95

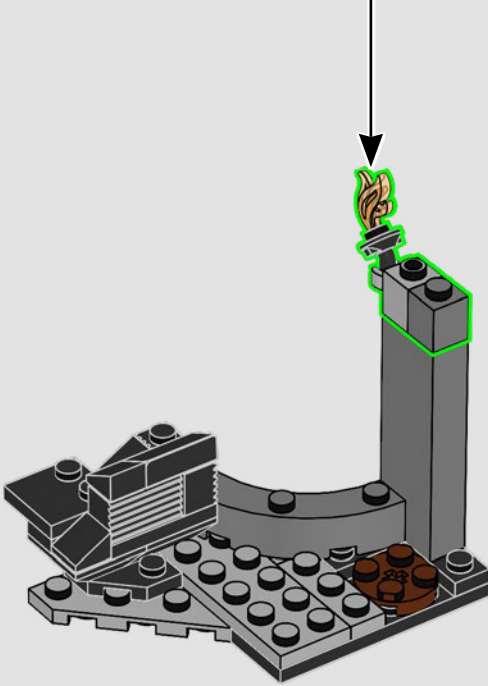
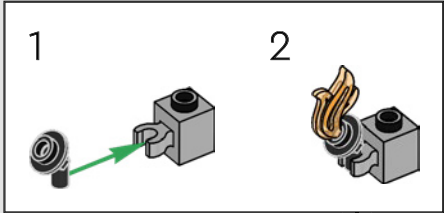

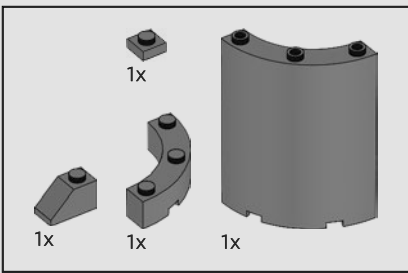

96

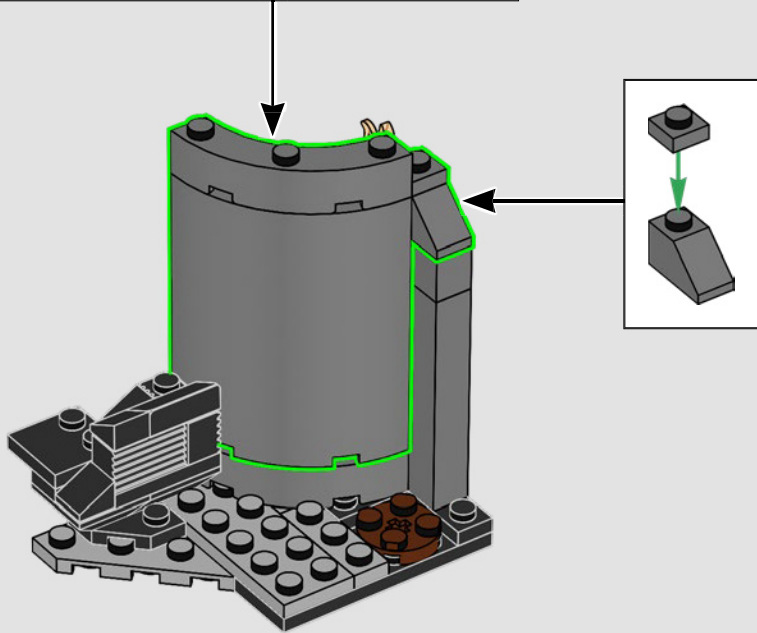
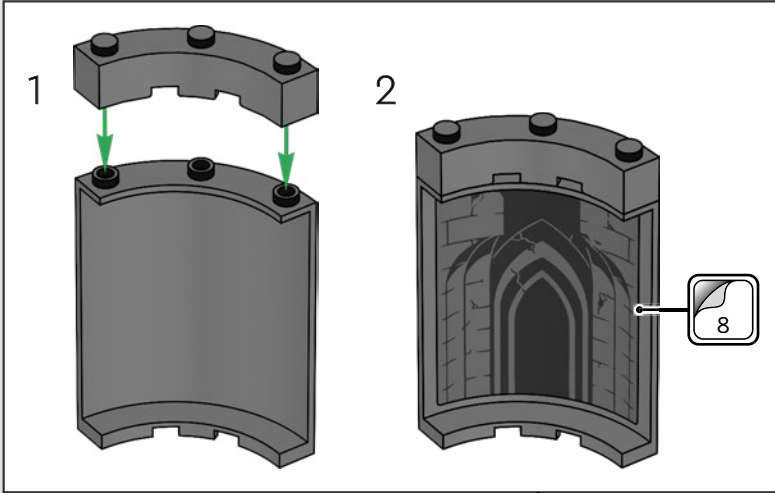

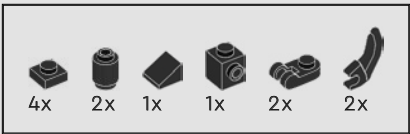

97

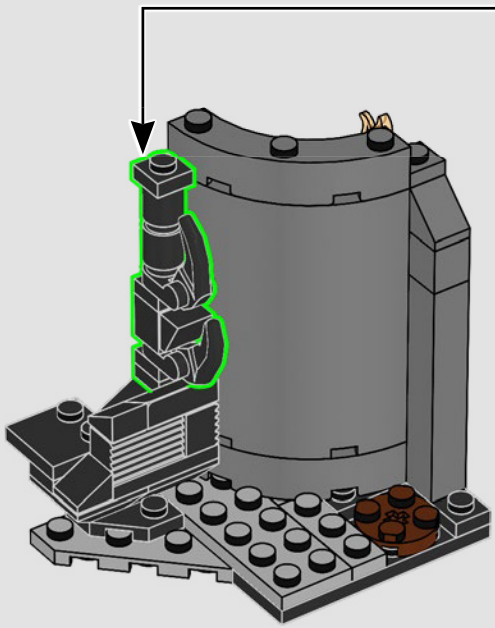
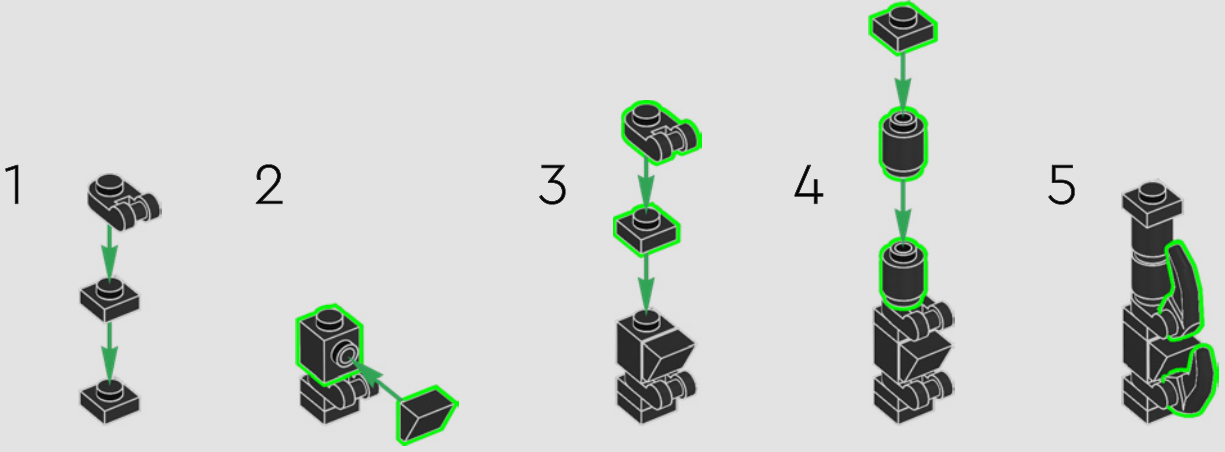

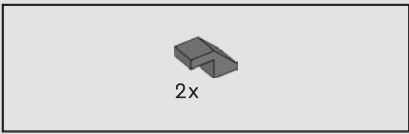

98

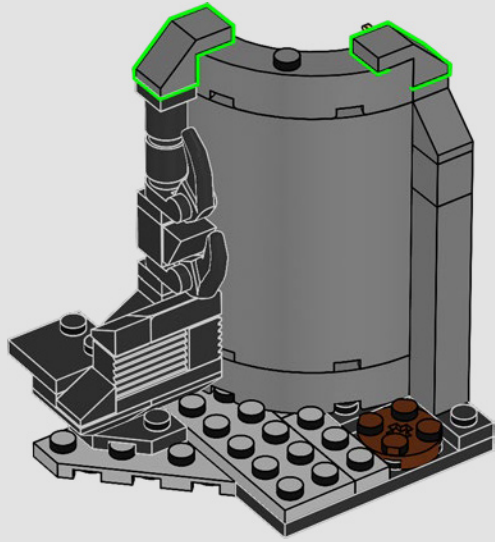

99

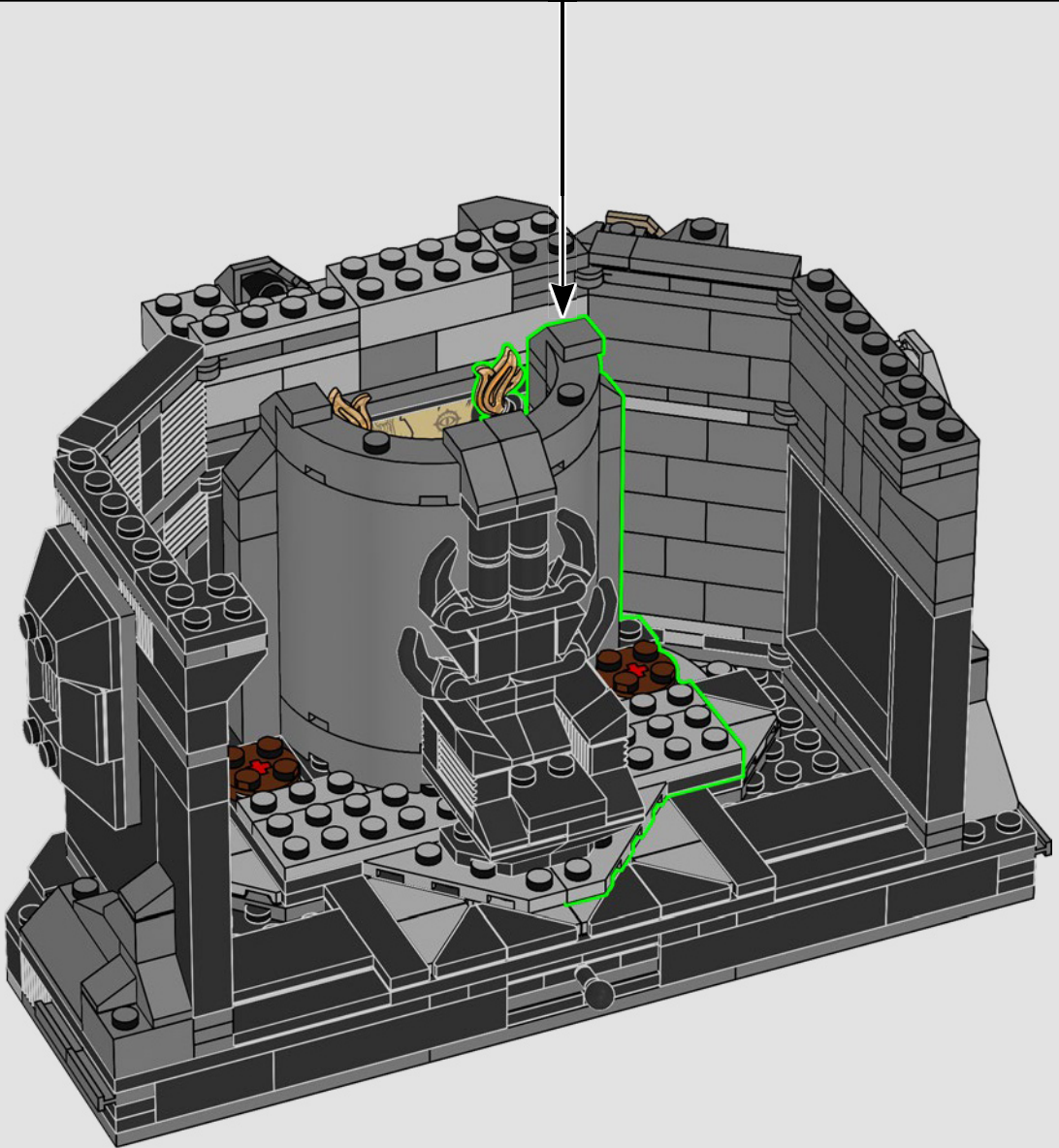

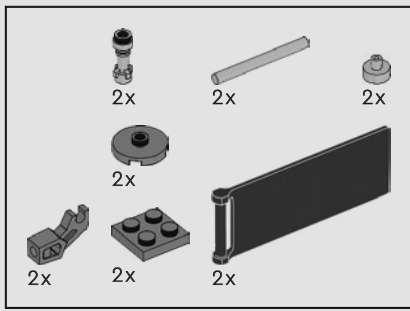

100

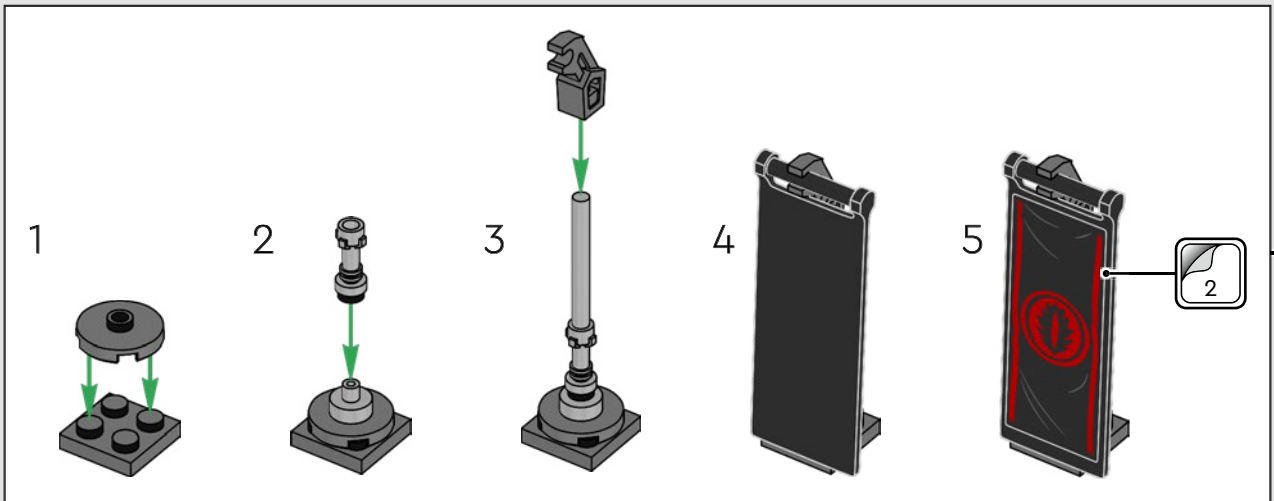
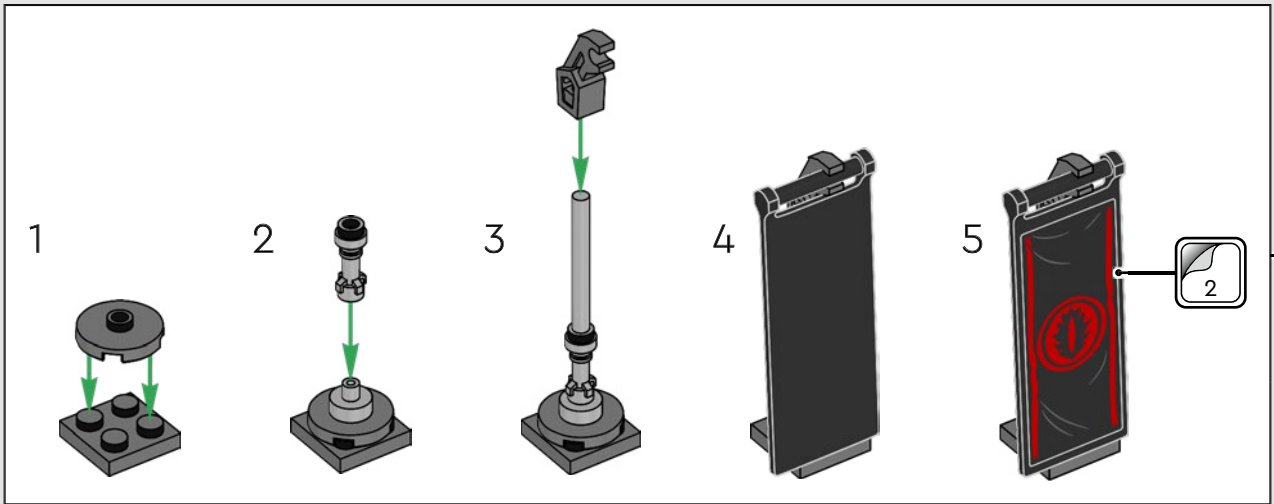

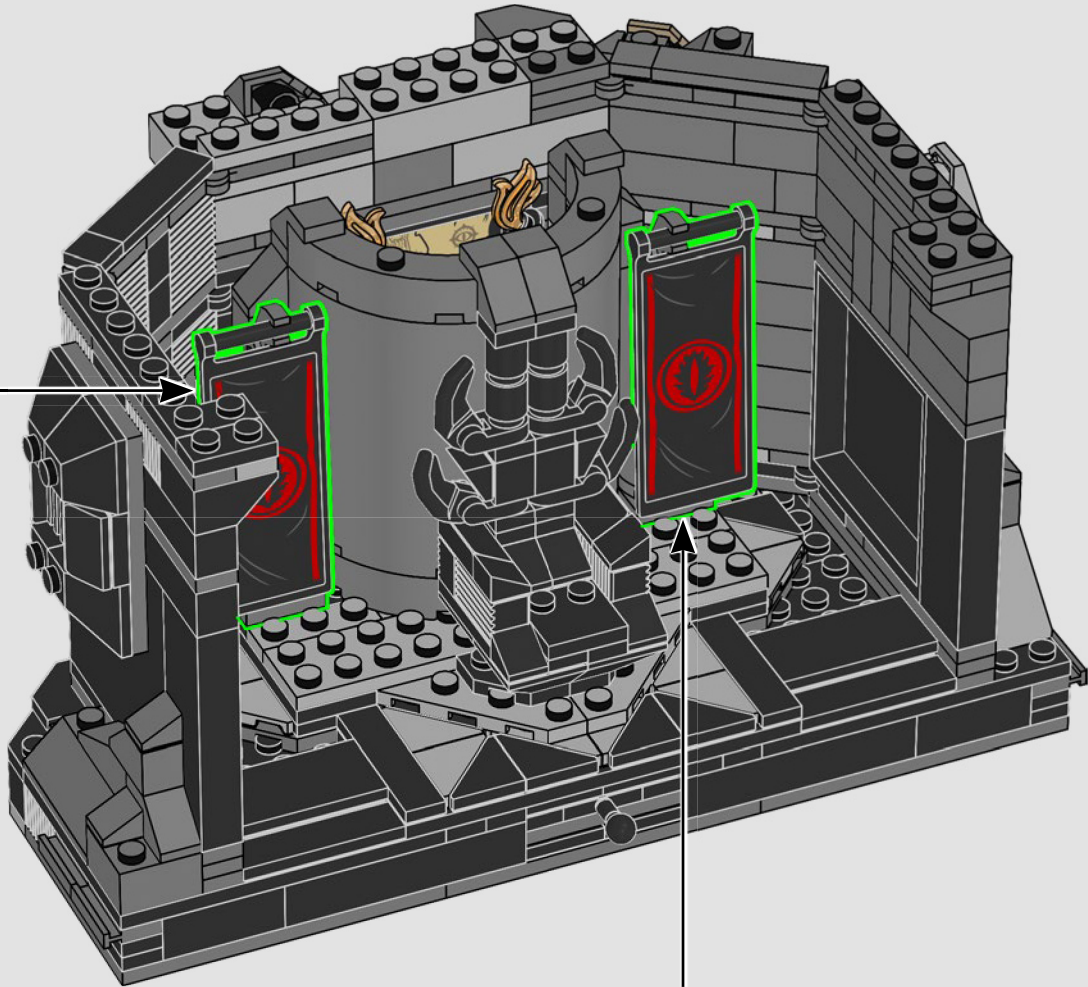

 Wenn man an diesem Knauf zieht, kommt die Geheimkammer hinter dem Thron zum Vorschein.

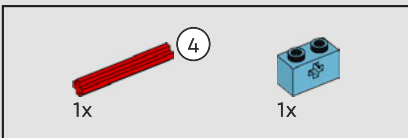
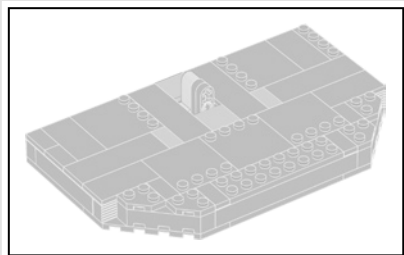

101

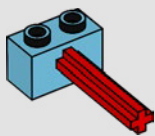

102

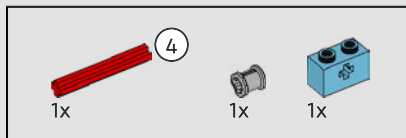
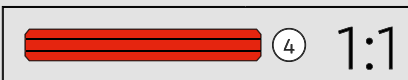
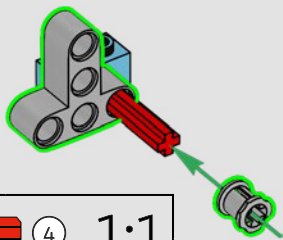

103

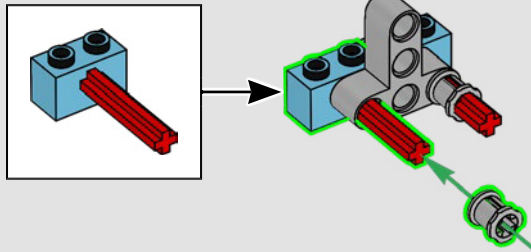

104

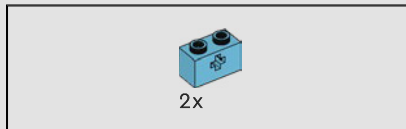
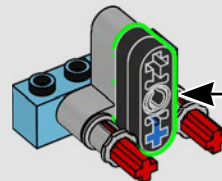
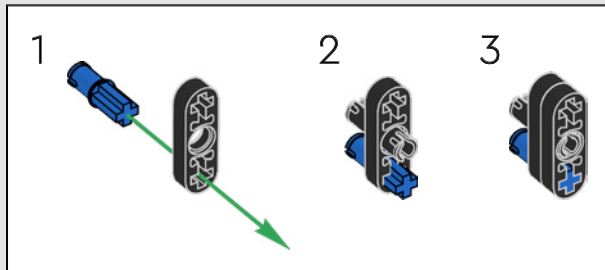

105

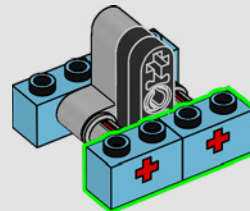

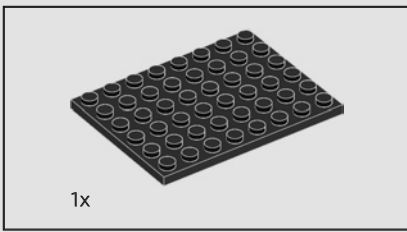

106

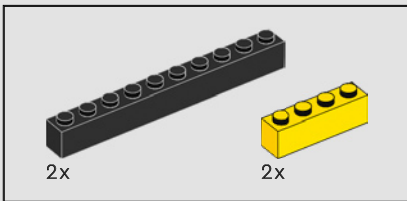
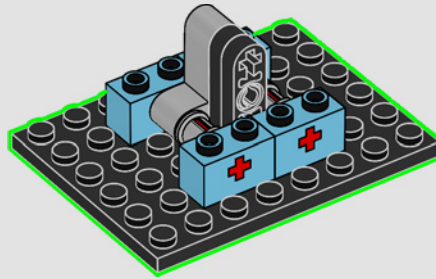

107

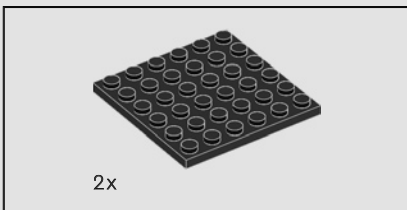
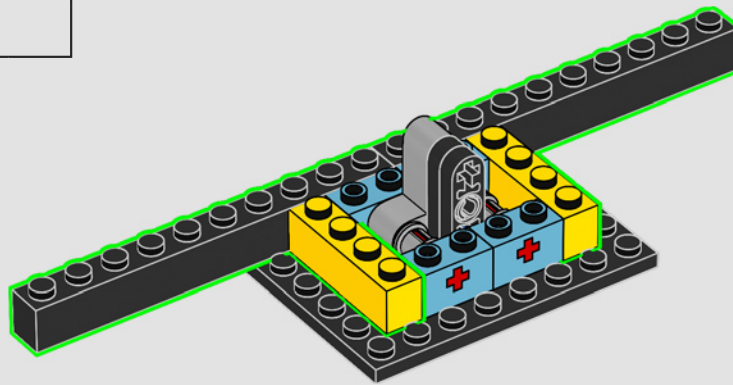

108

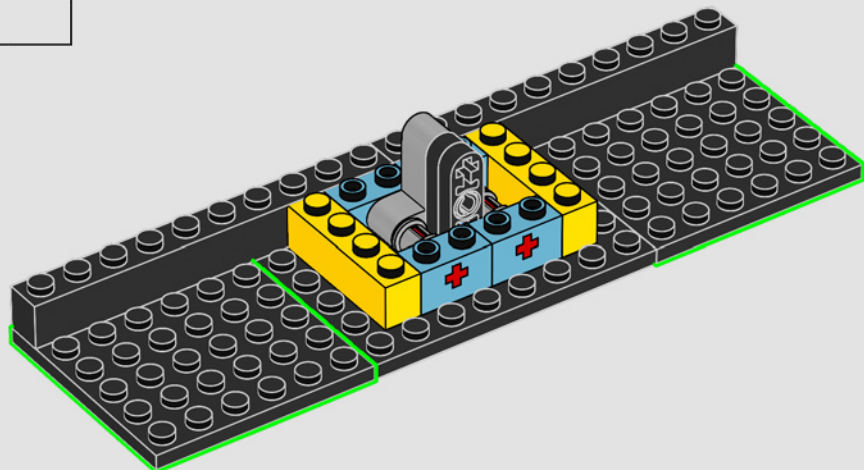

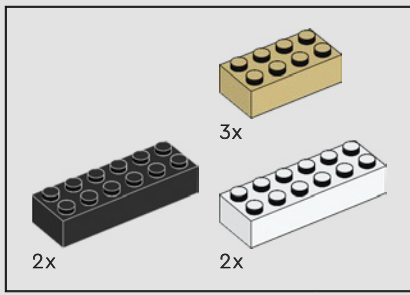

109

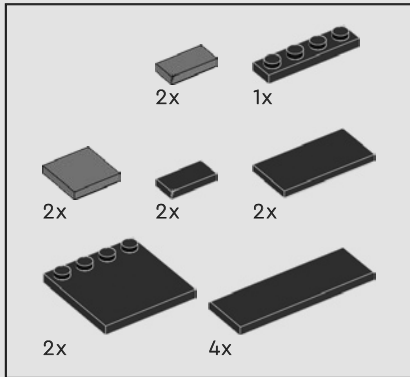
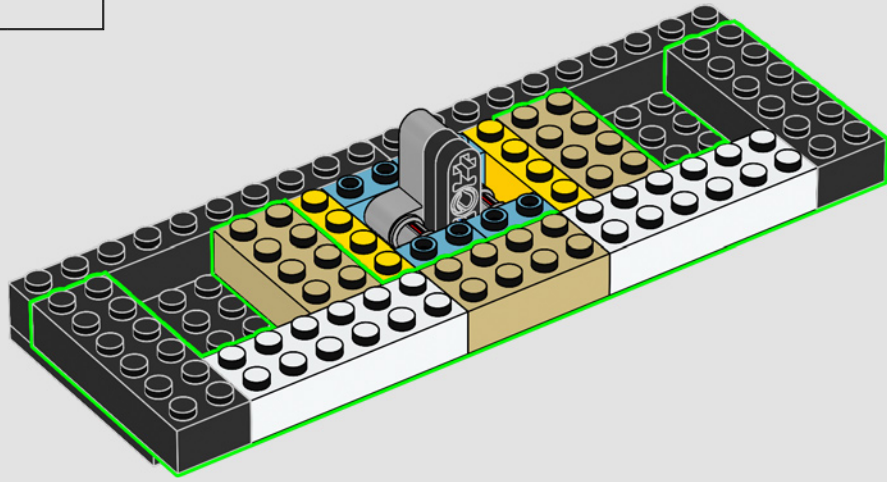

110

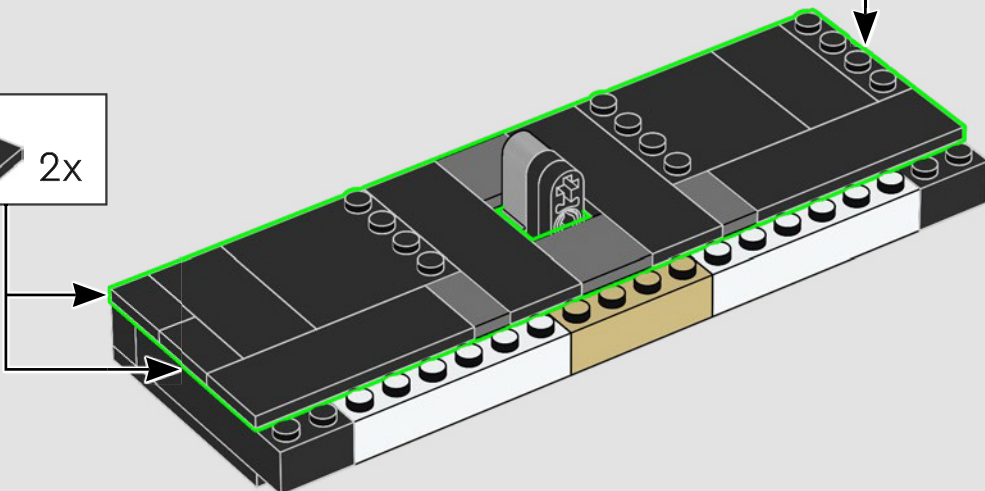
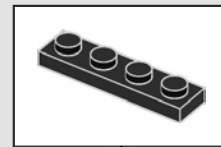

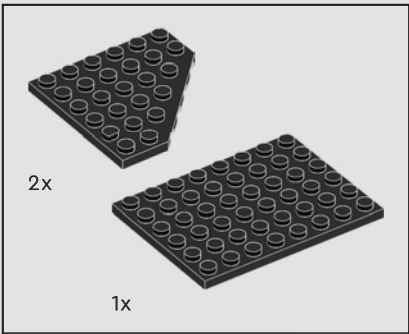

111

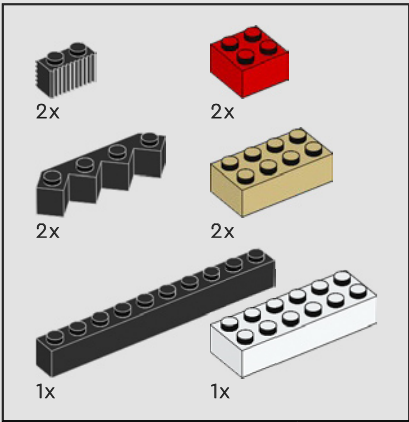
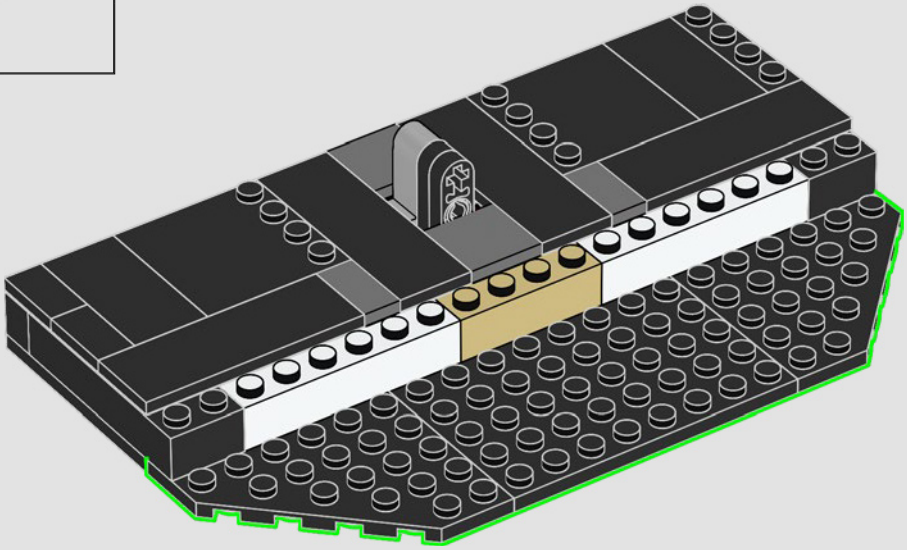

112

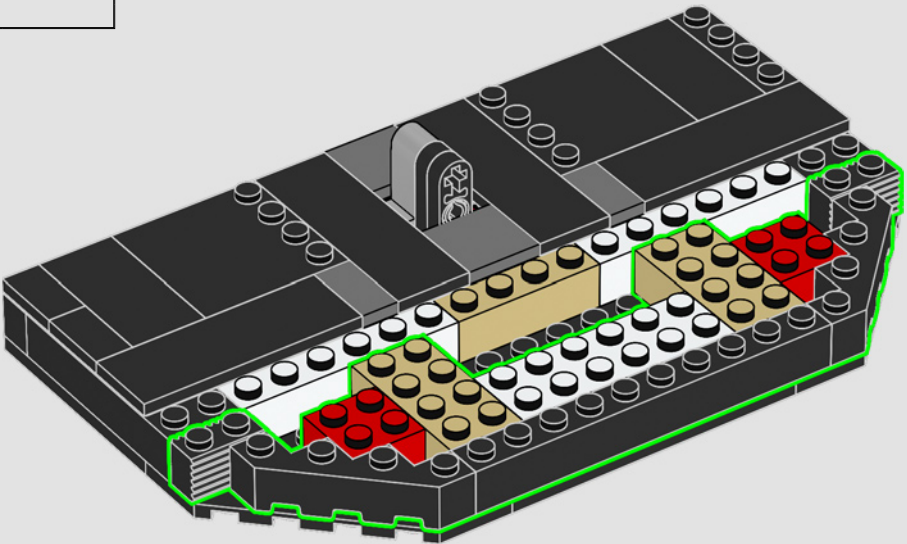

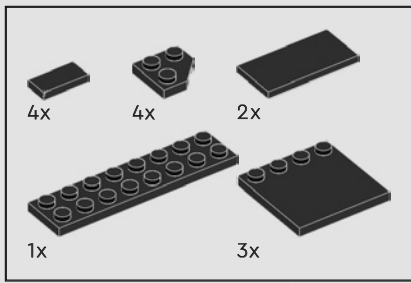

113

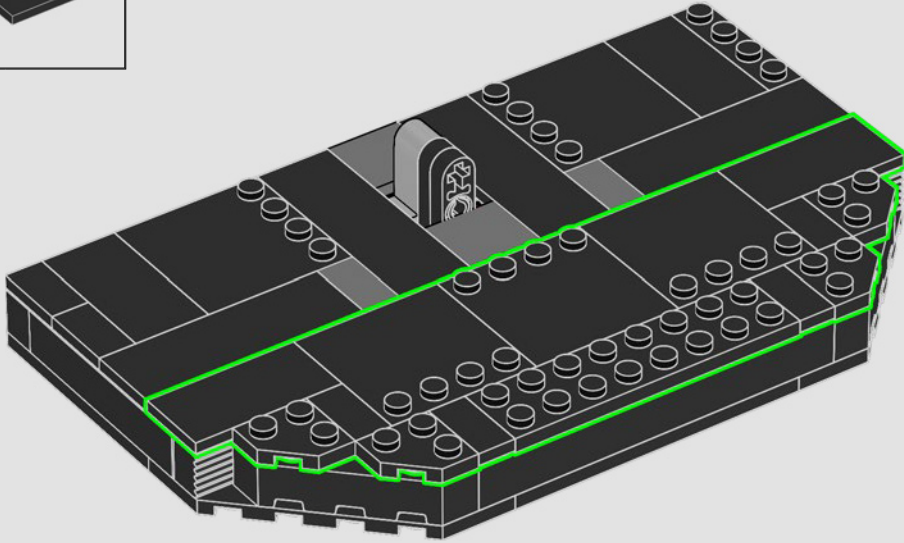

114

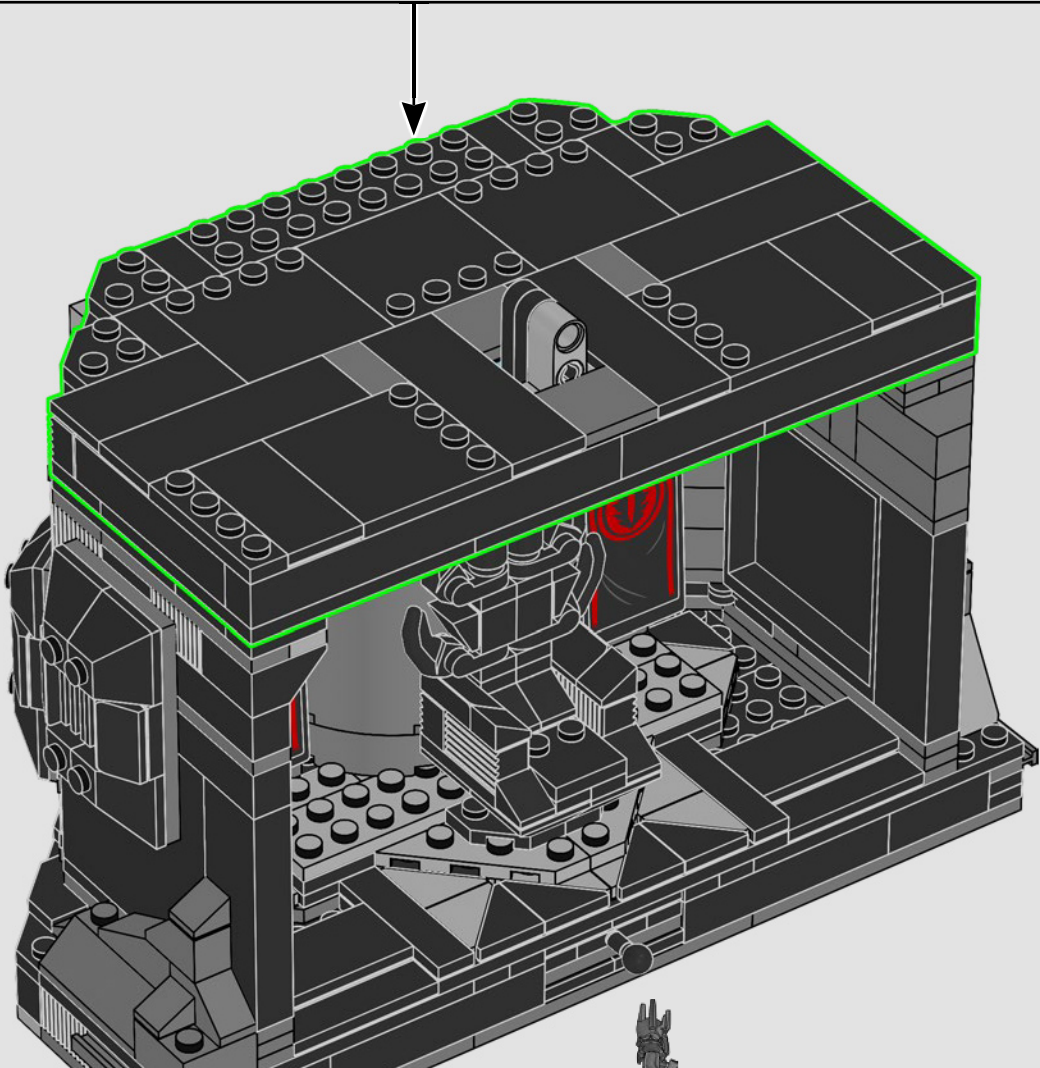

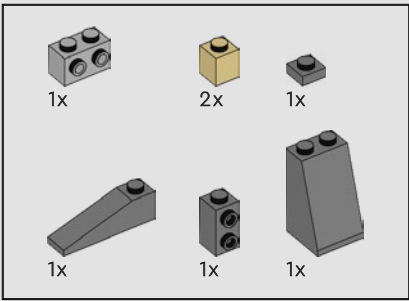

115

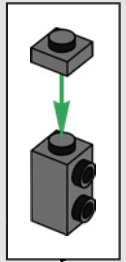
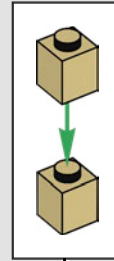
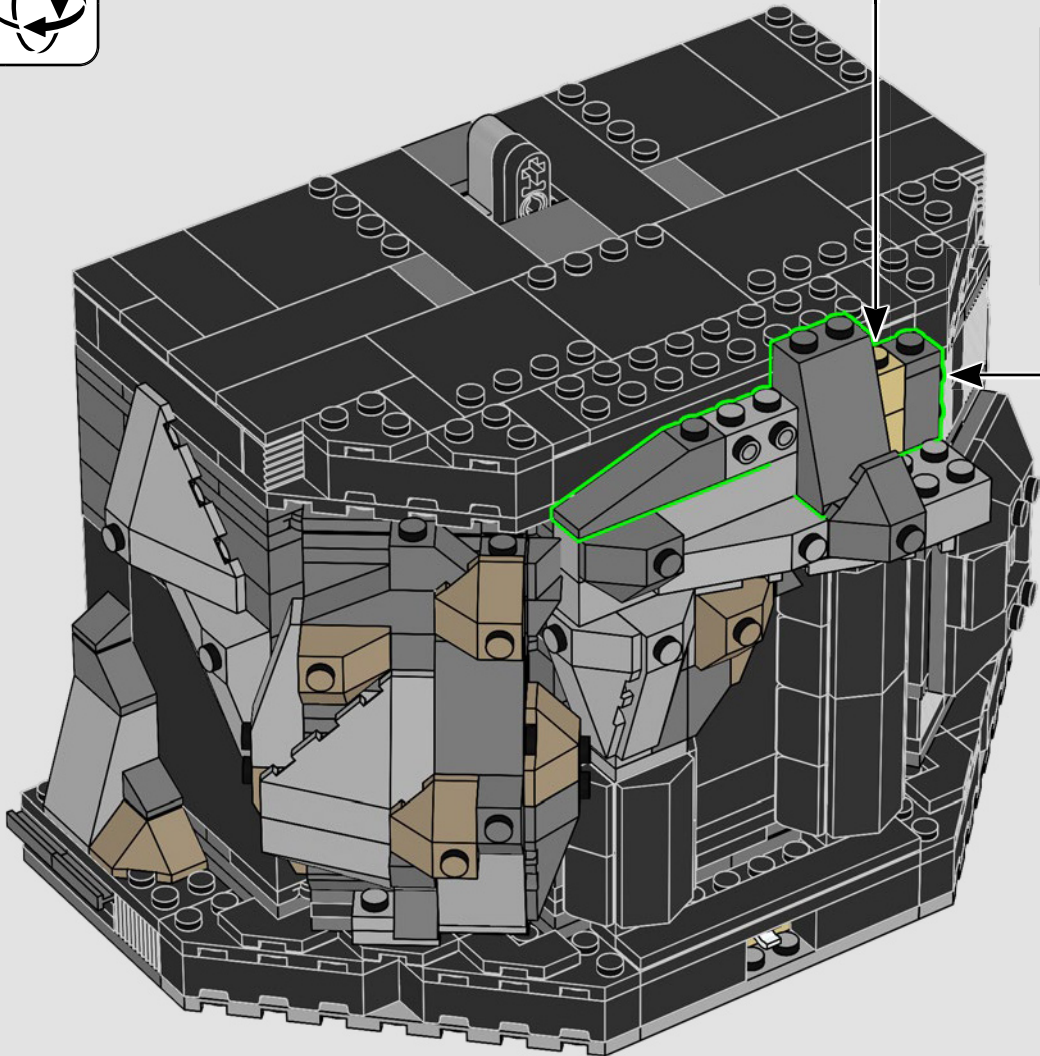

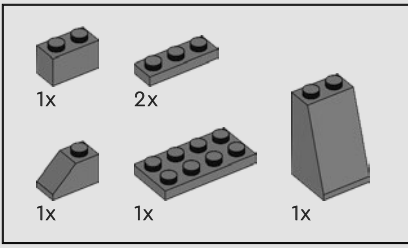

116

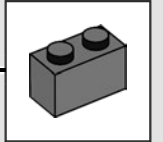
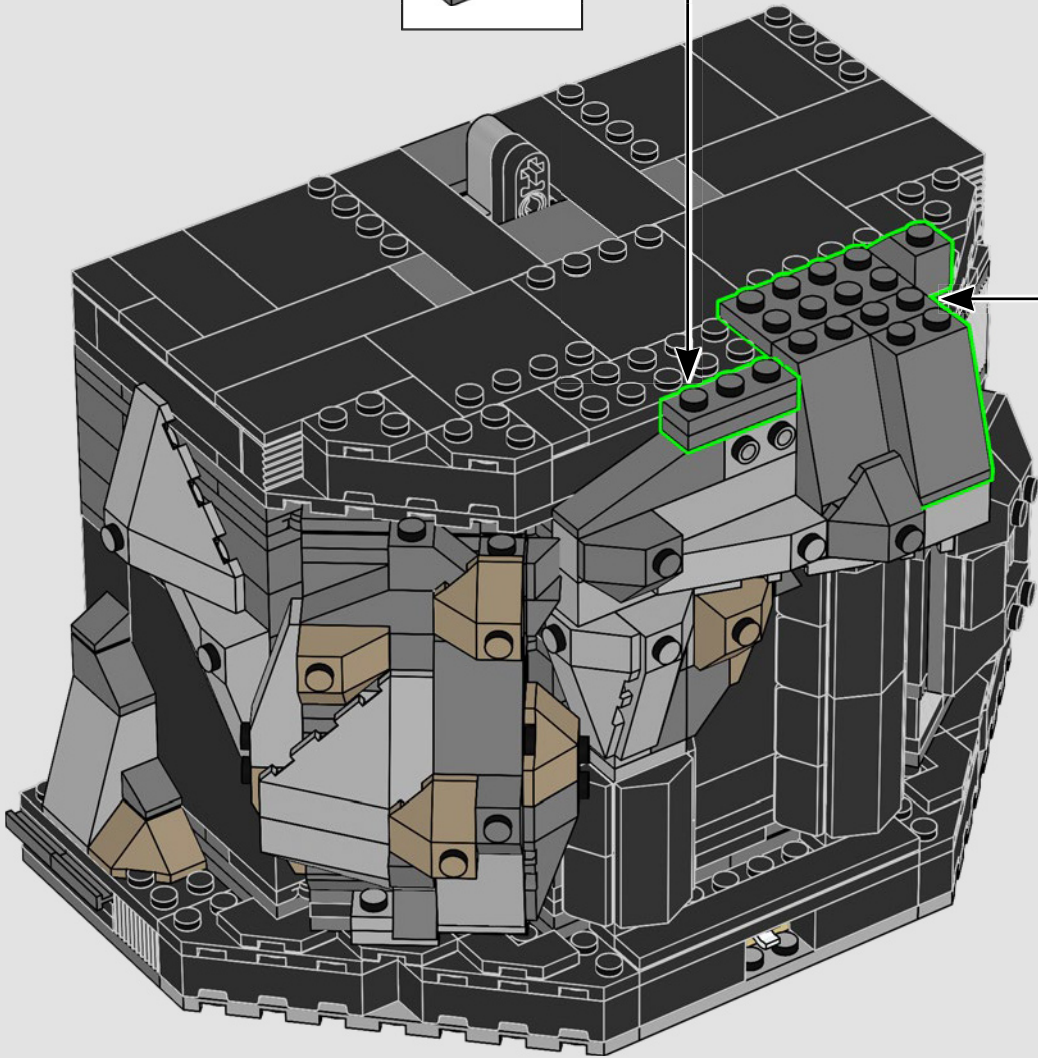
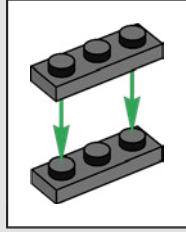

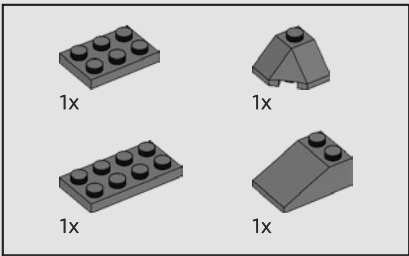

117

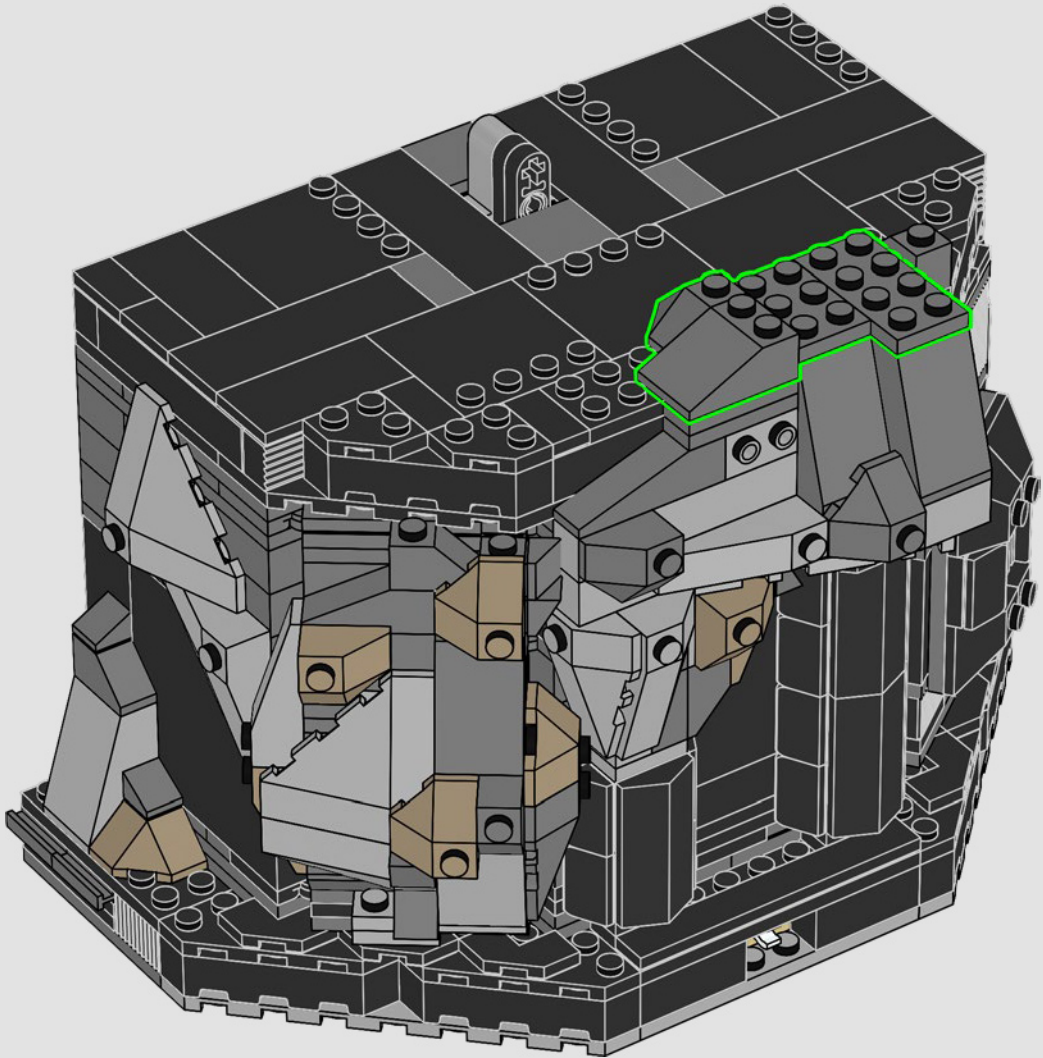

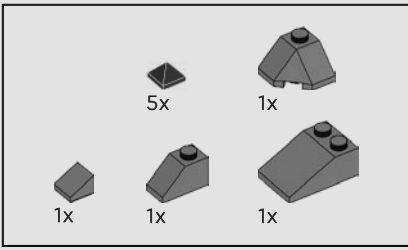

118

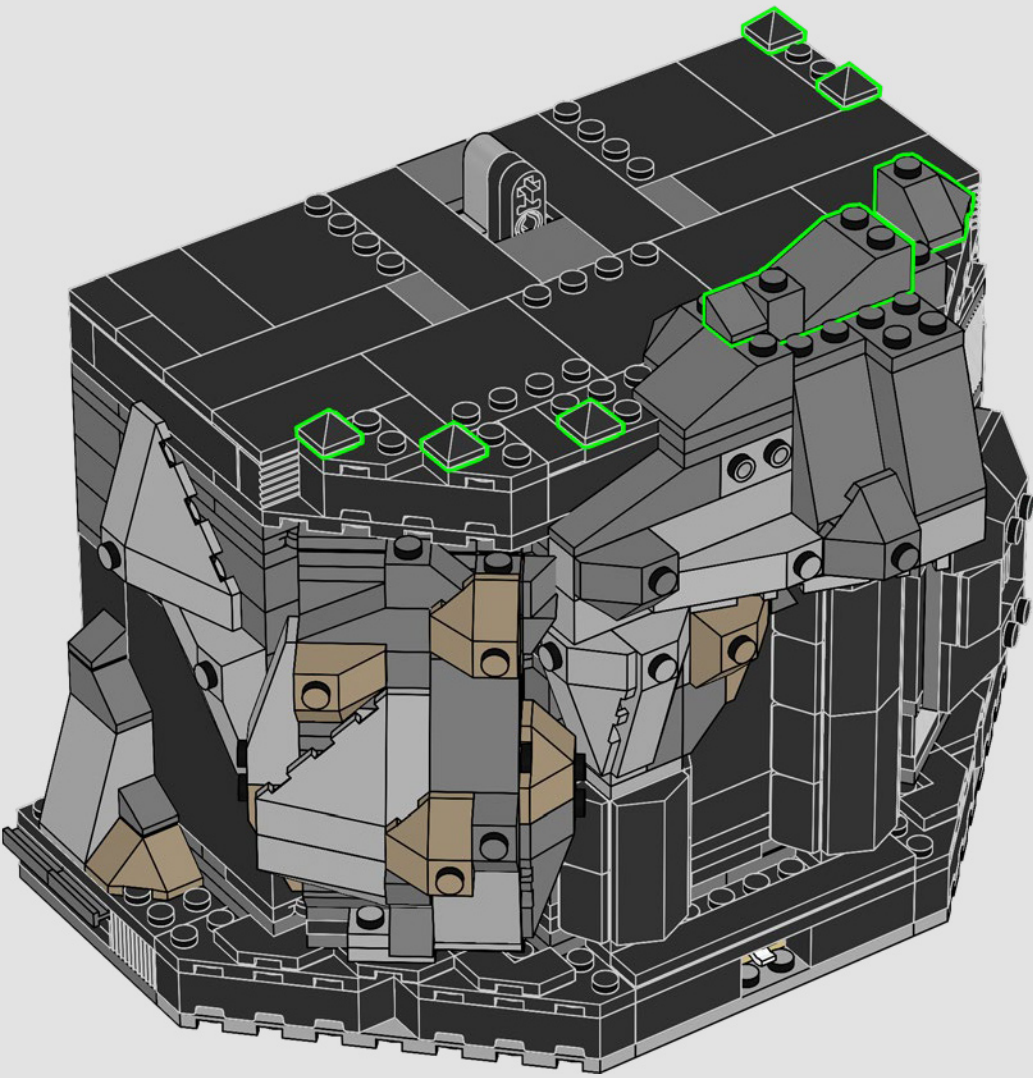

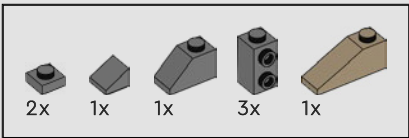

119

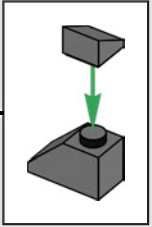
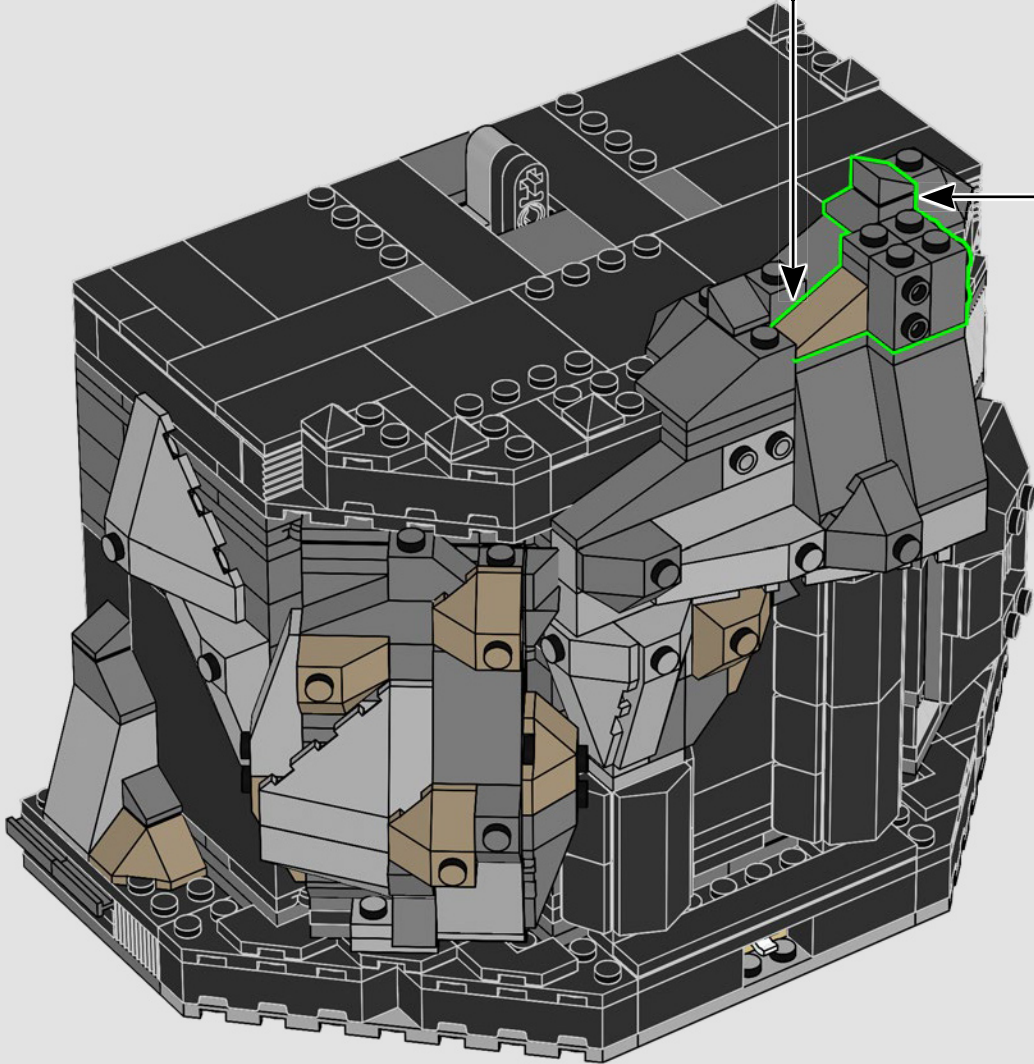
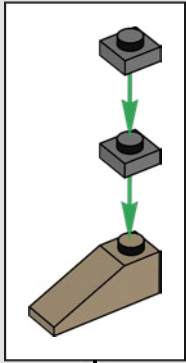

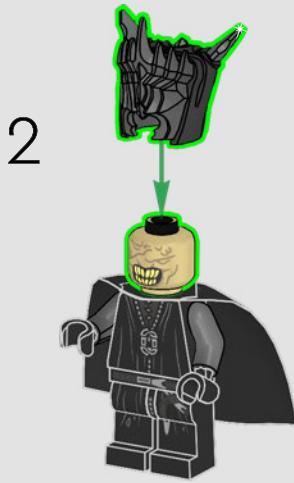
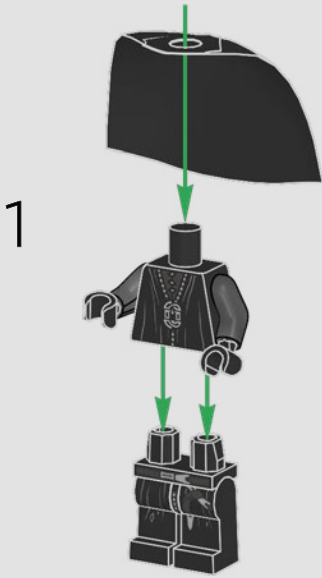

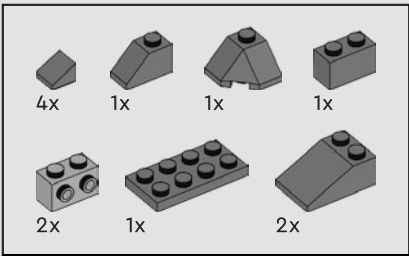

120

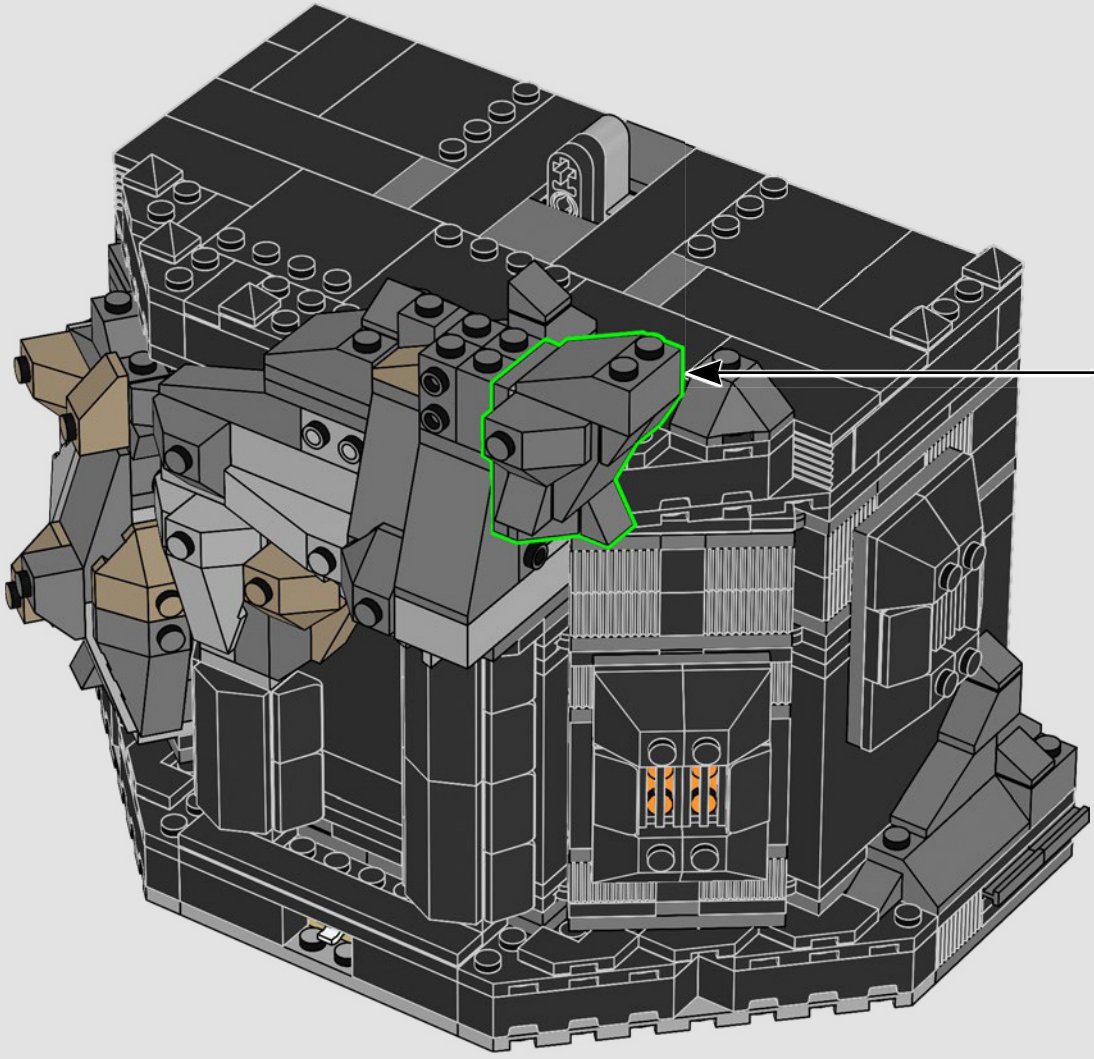
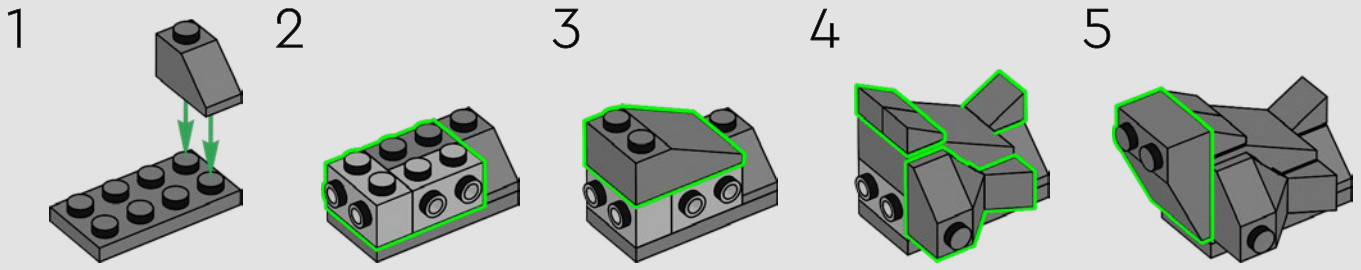

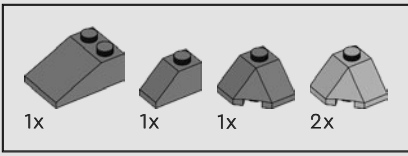

121

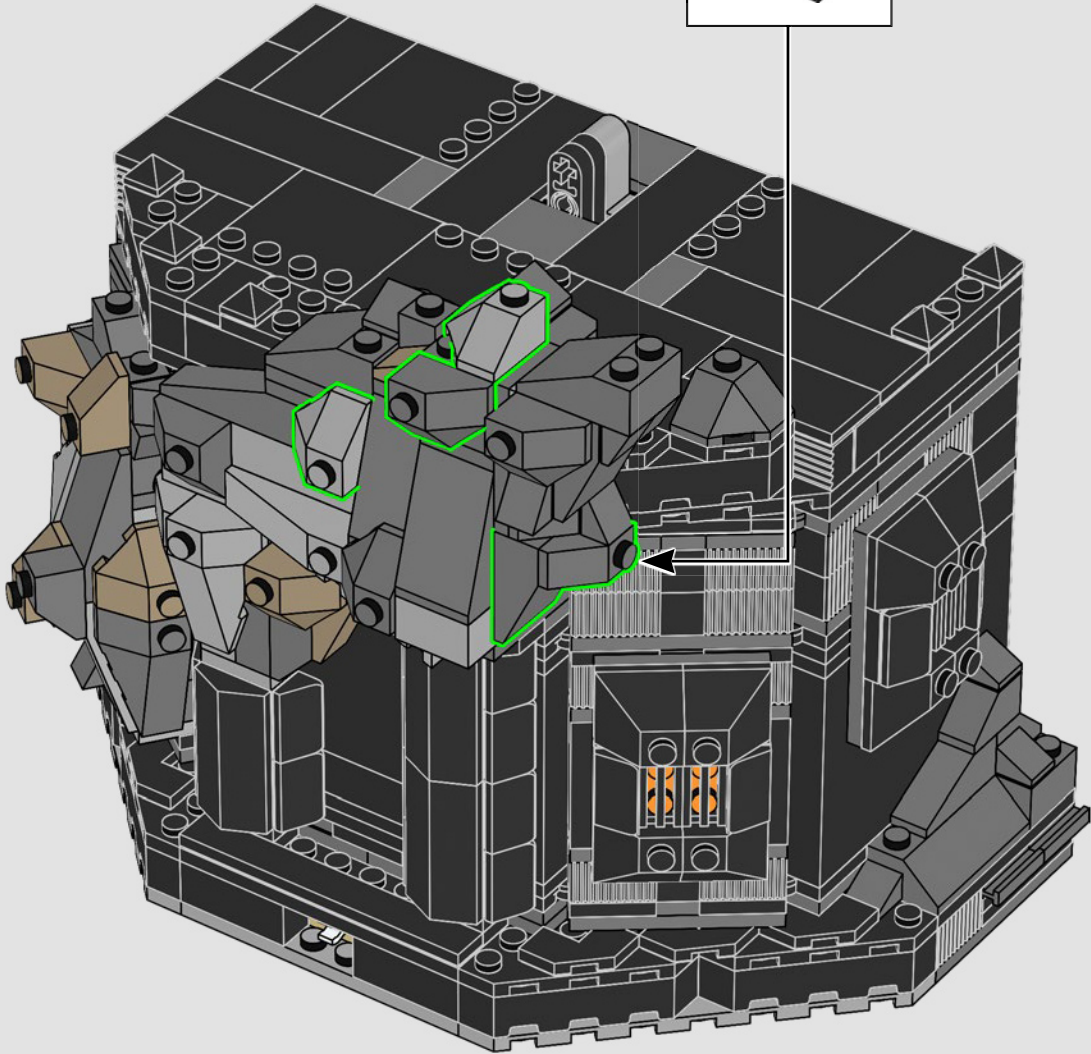
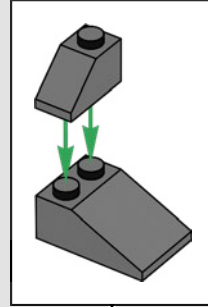

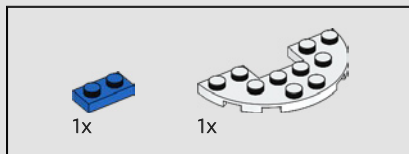
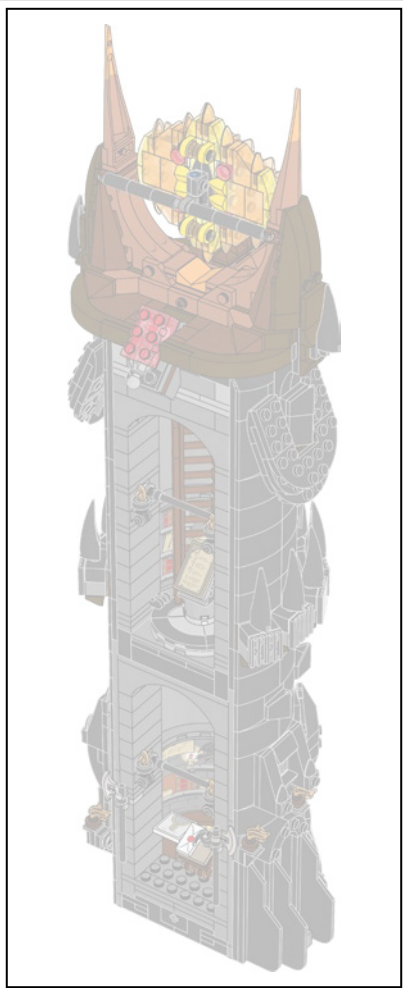

122

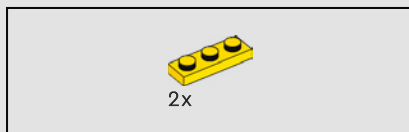
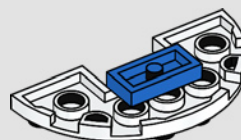

123

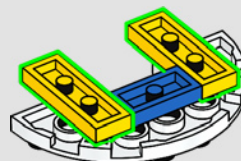

124

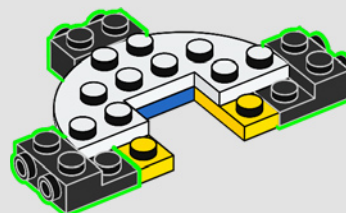

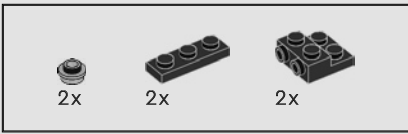

125

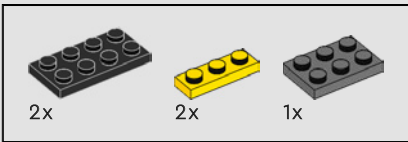
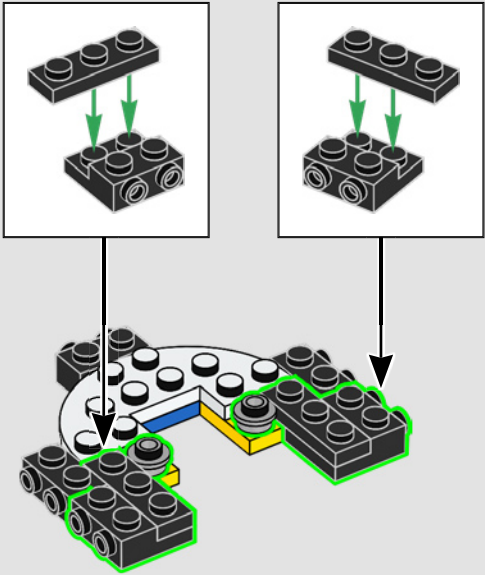

126

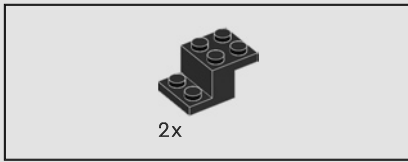
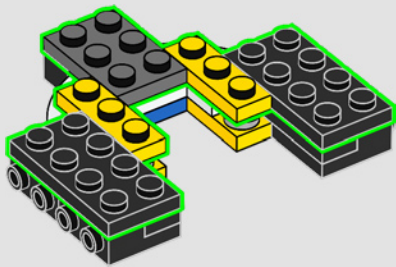

127

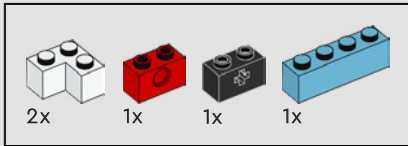
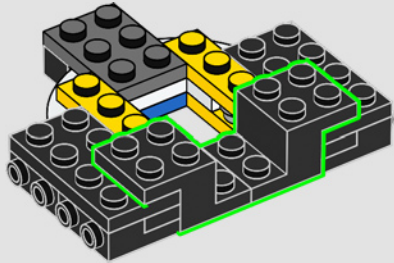

128

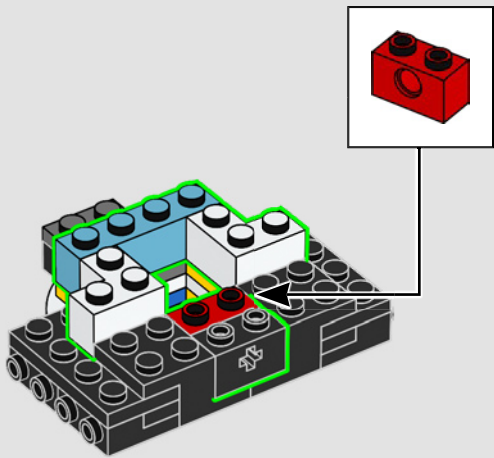

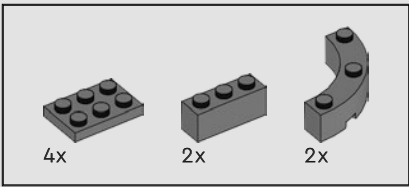

129

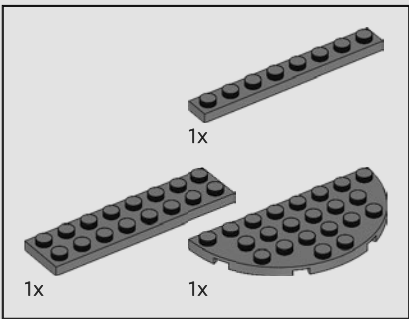
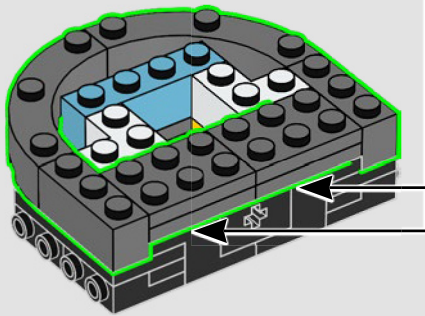
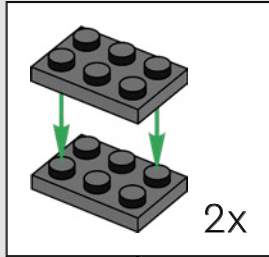

130

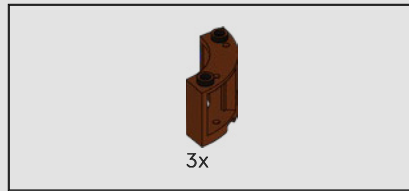
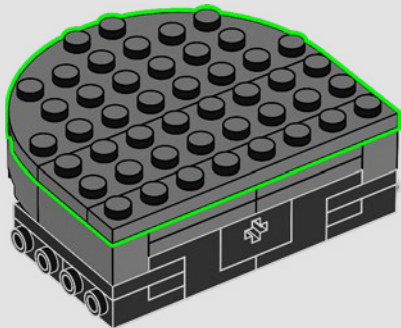

131

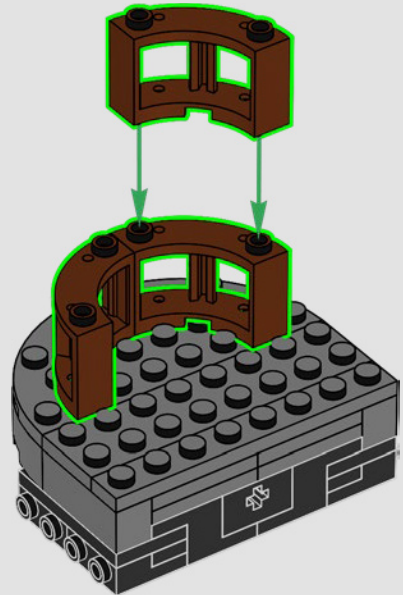

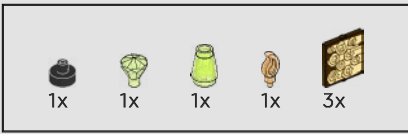

132



Die Bücherregale im Studierzimmer sind mit neuen Deko-Elementen verziert, die eingesetzte Fenster und Schriftrollen darstellen.

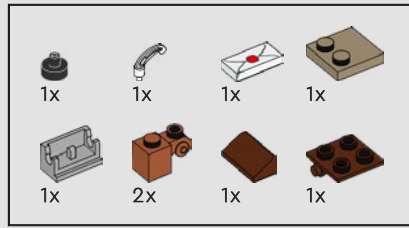
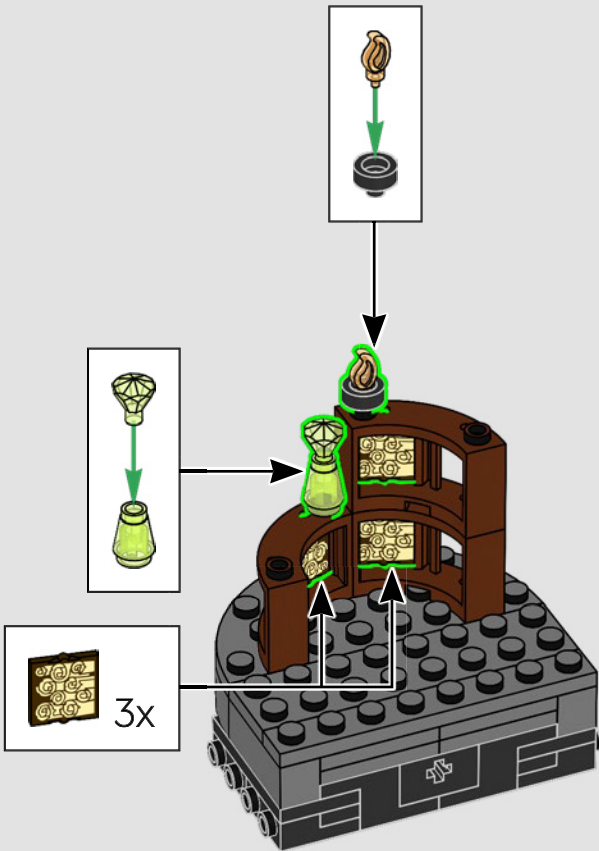

133

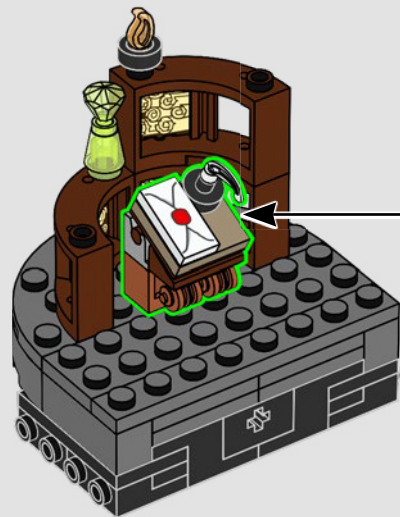
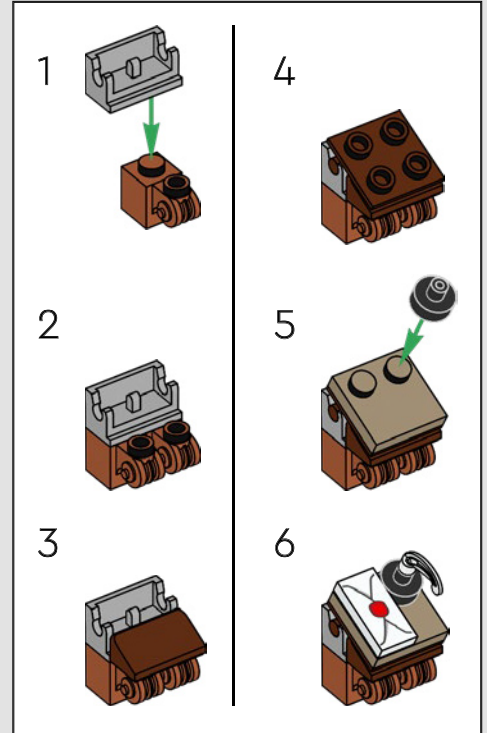

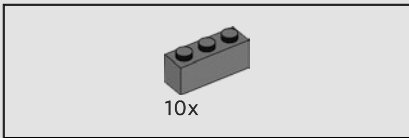

134

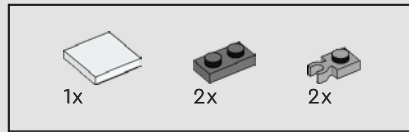
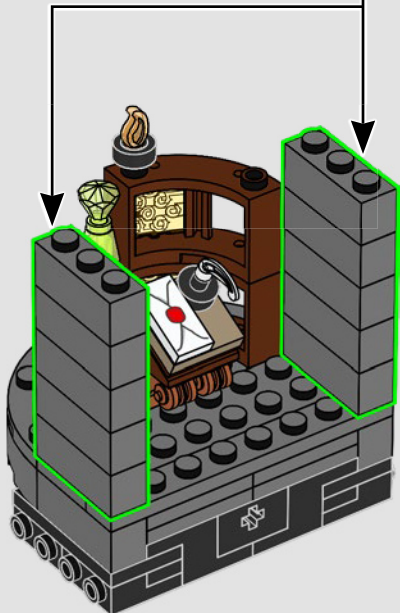
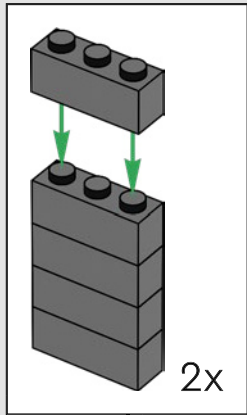

135

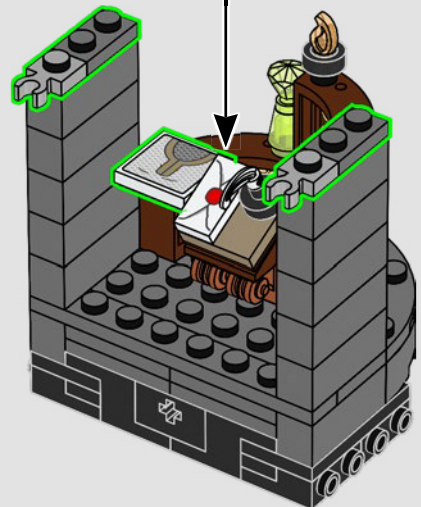
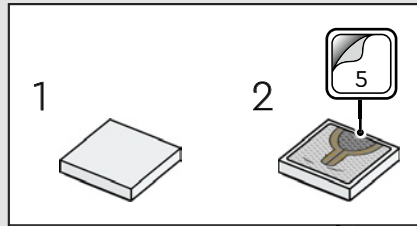

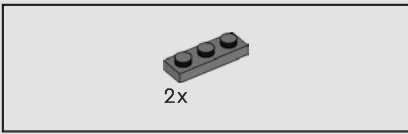

136

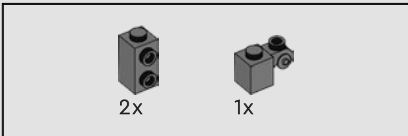
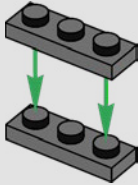

137

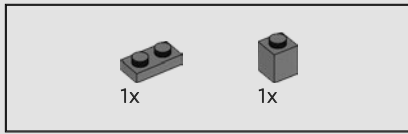
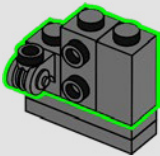

138

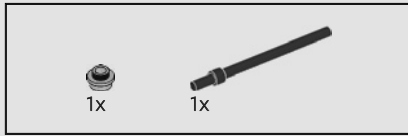
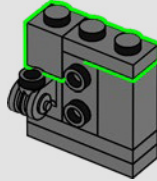

139

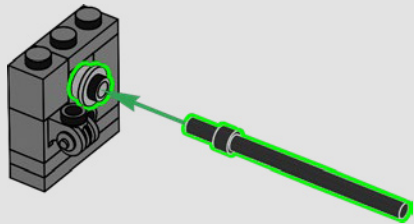
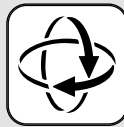



In den Kammern von Saurons Mund befindet sich ein Mithril-Hemd, das er benutzt, um die Gefährten glauben zu lassen, er hätte Frodo Beutlin gefangen genommen.

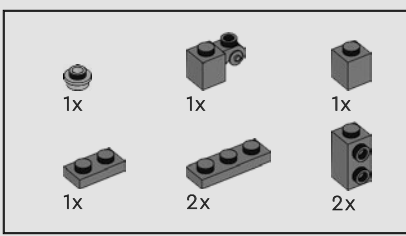

140

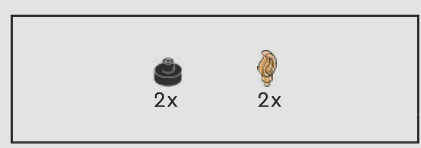
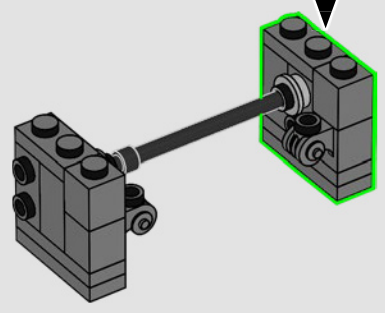
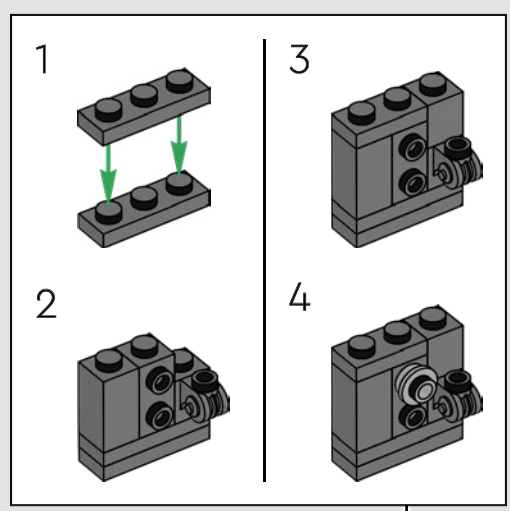

141

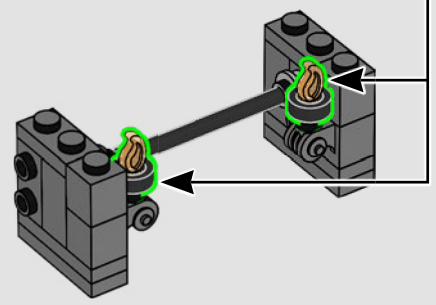
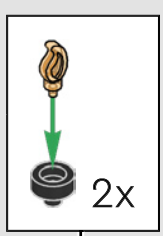

142

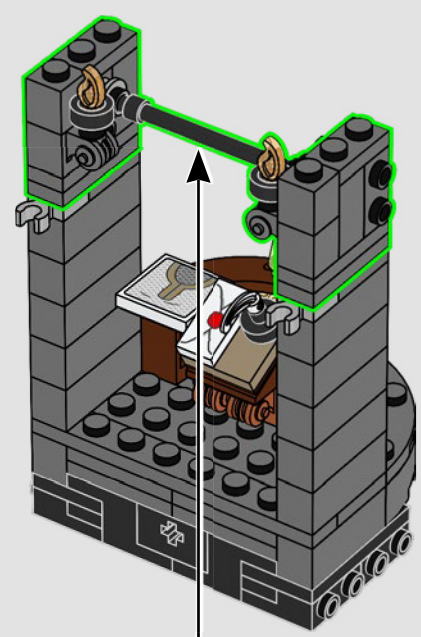

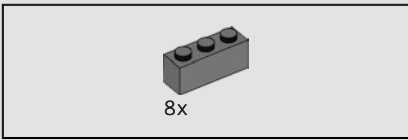

143

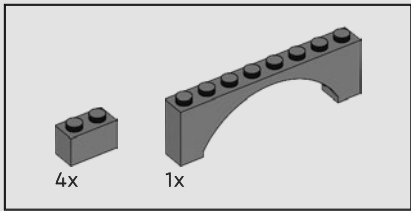
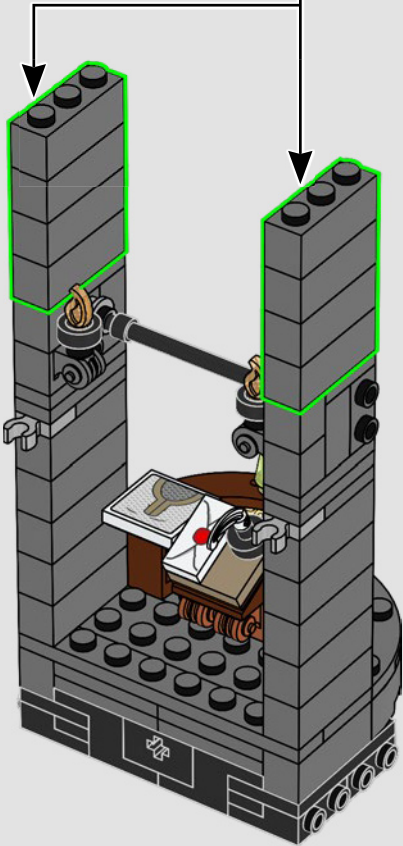
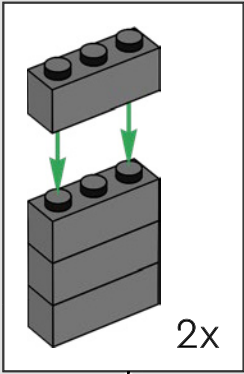

144

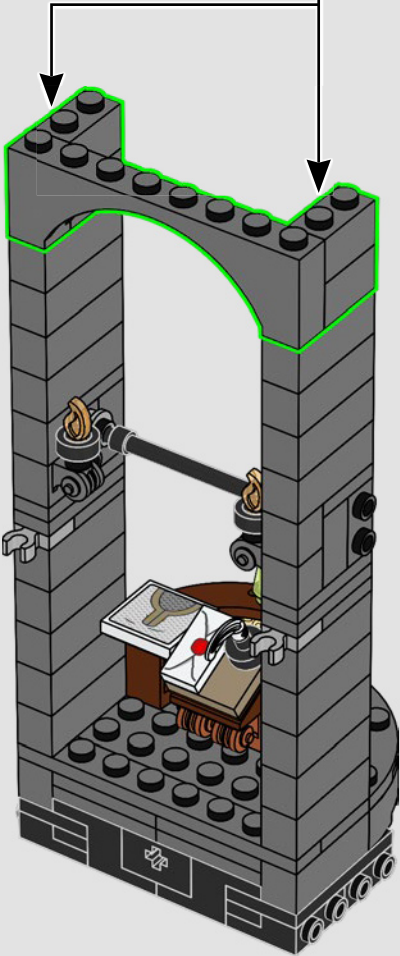
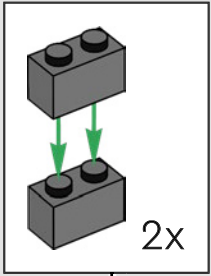

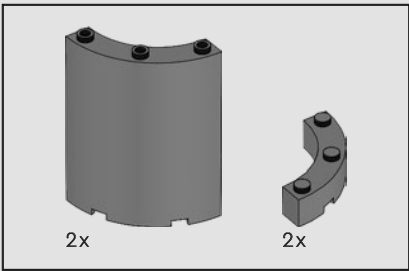

145

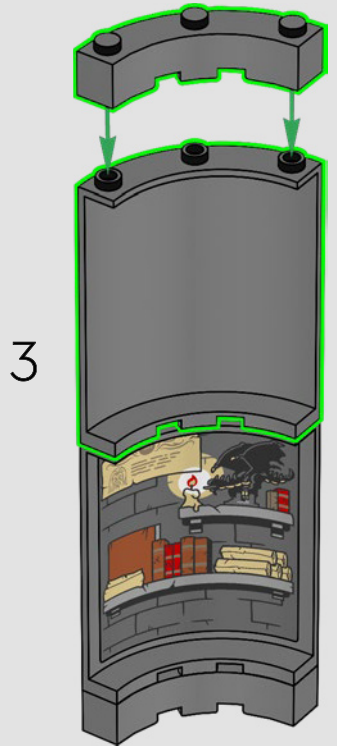
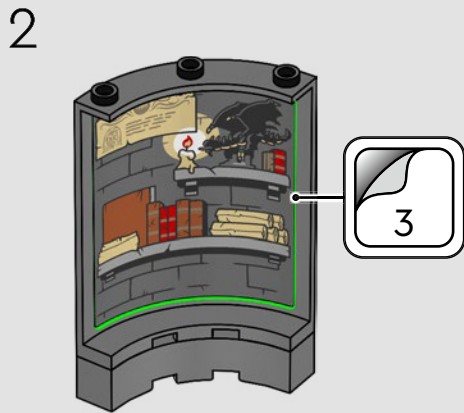
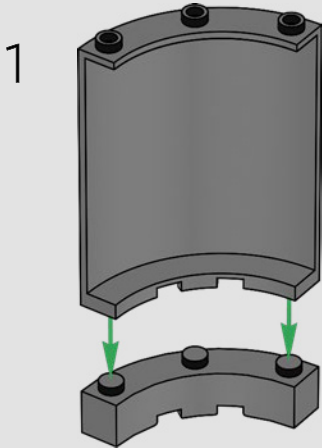

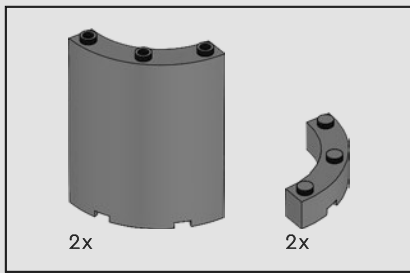

146

1

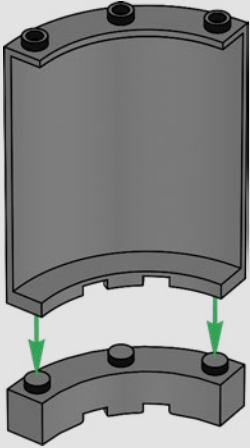

2

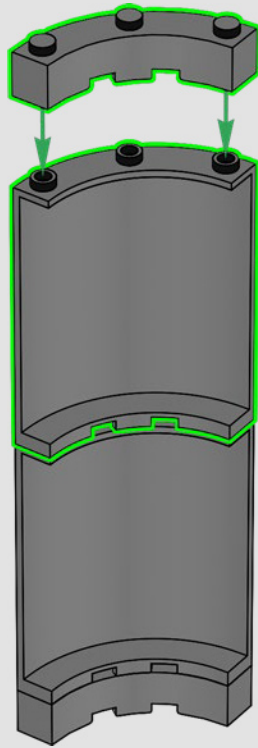

3

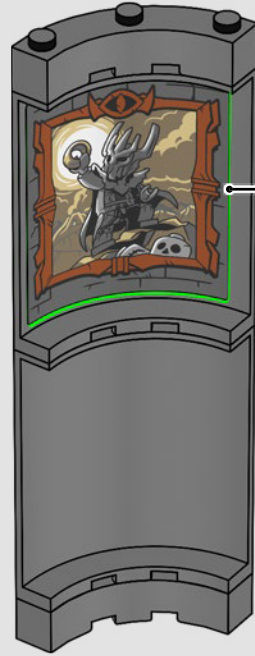



Während Saurons Mund an seinem Schriftwechsel mit Isengard sitzt, hängt über ihm ein Porträt von Sauron™.

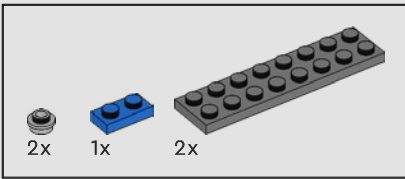

147

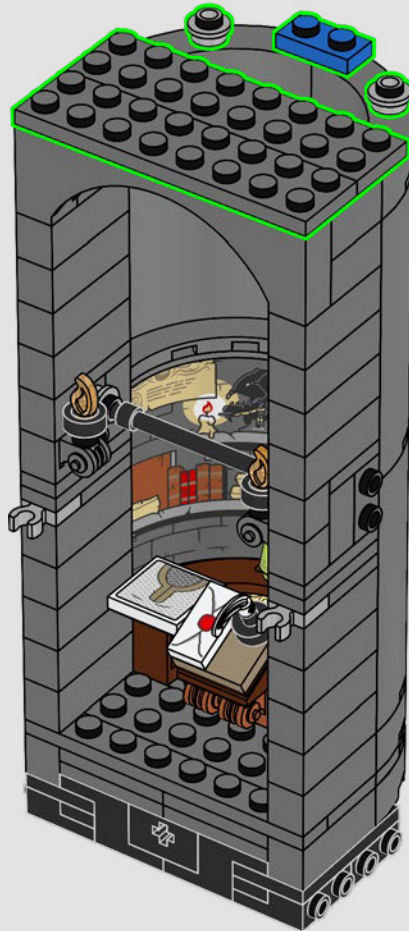

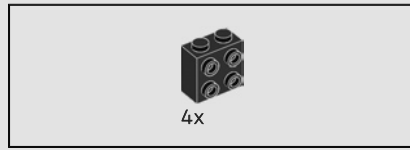

148



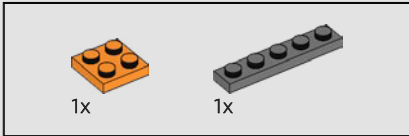
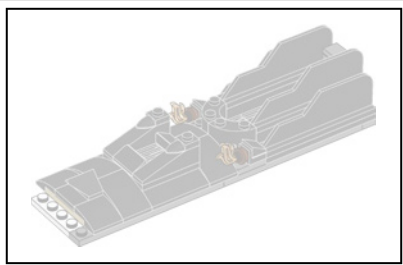

149

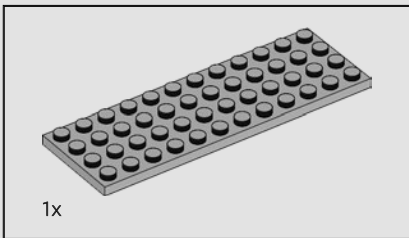
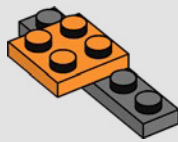

150

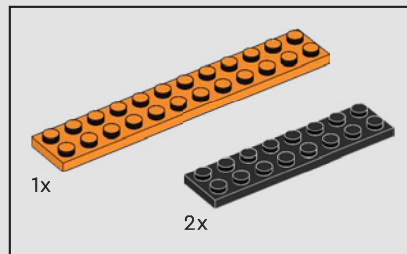
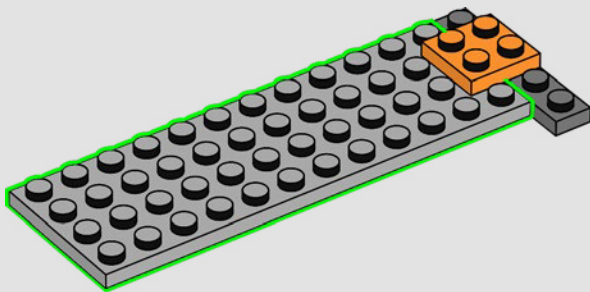

151

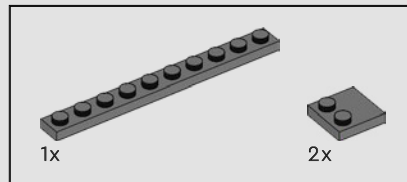
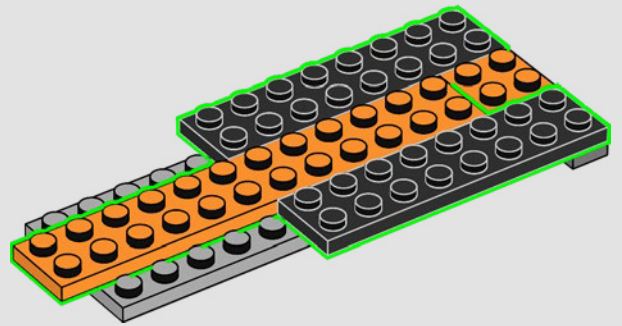

152

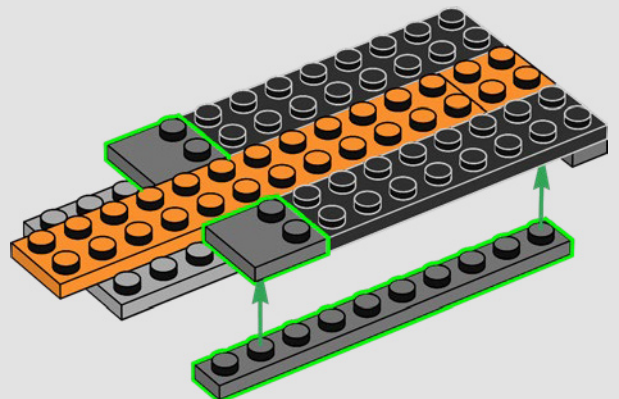

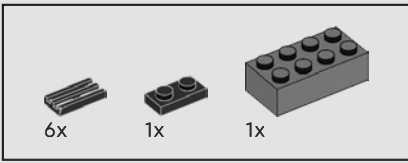

153

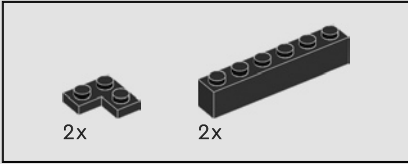
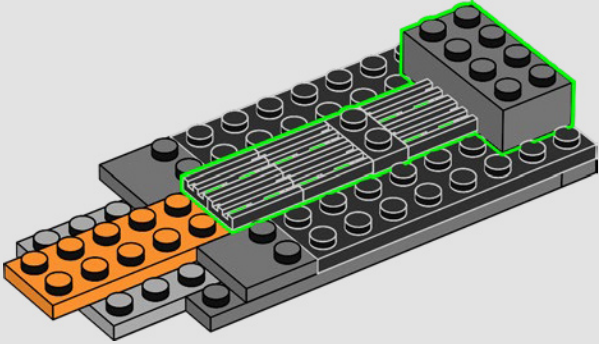

154

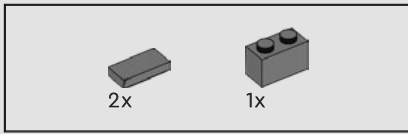
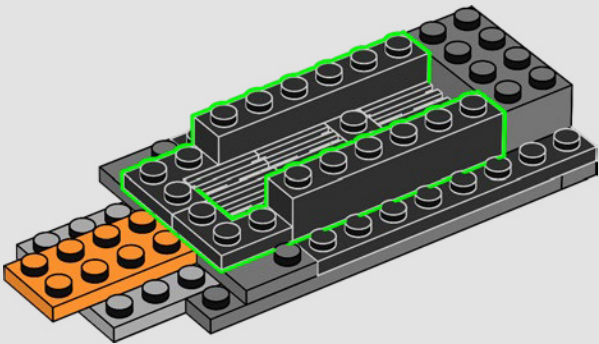

155

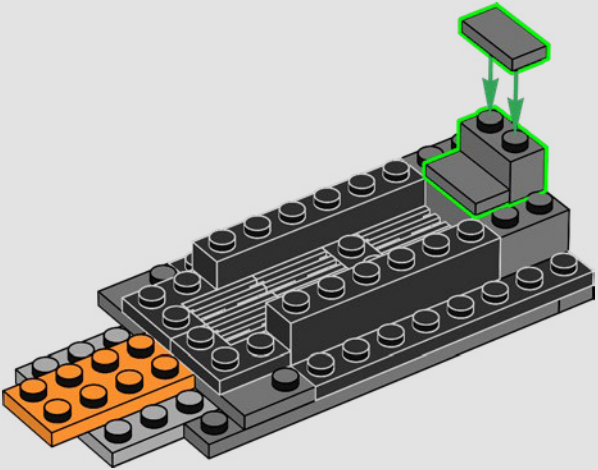

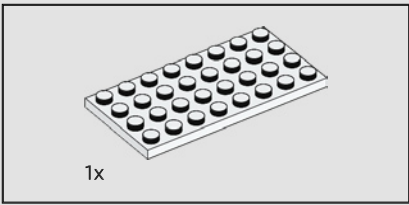

156

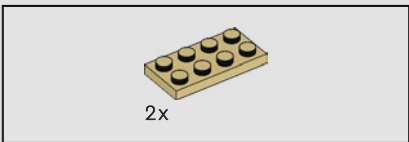
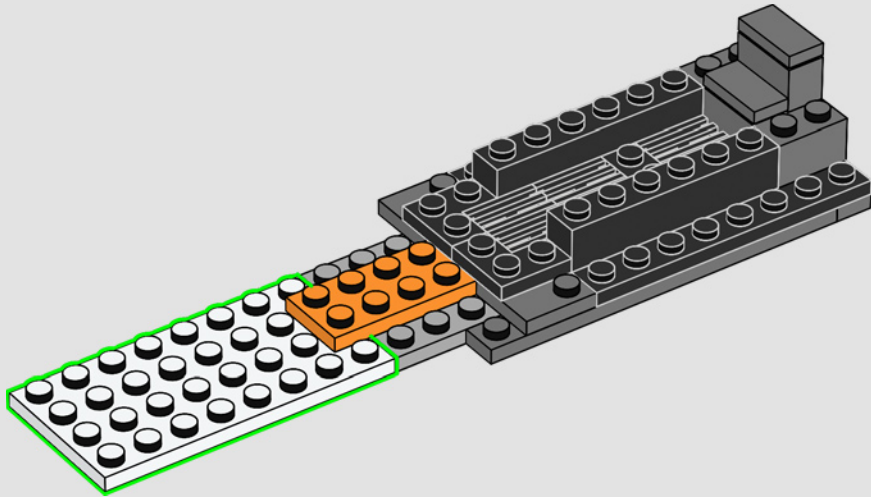

157

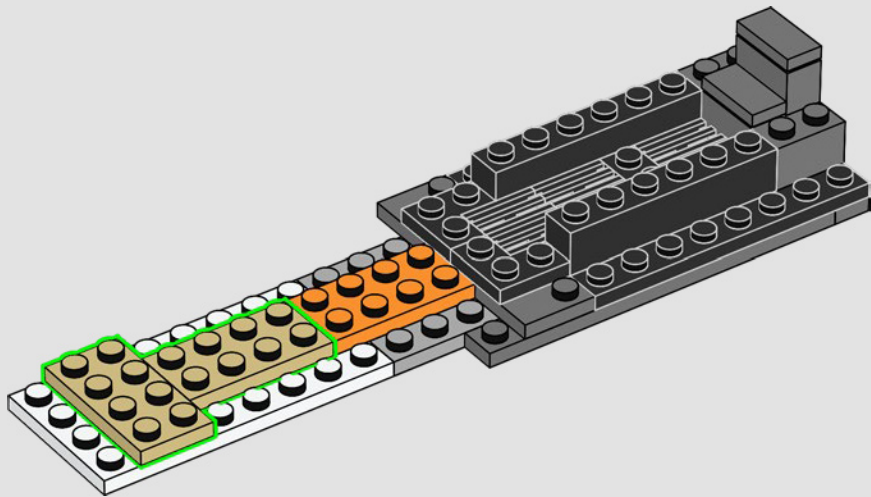

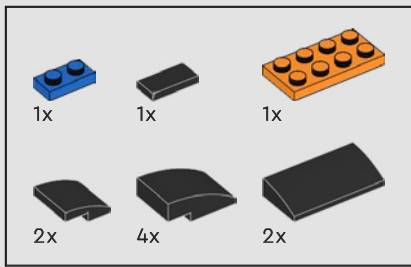

158

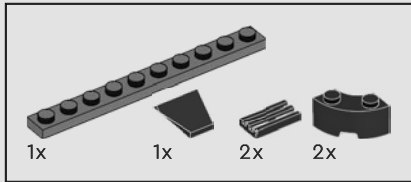
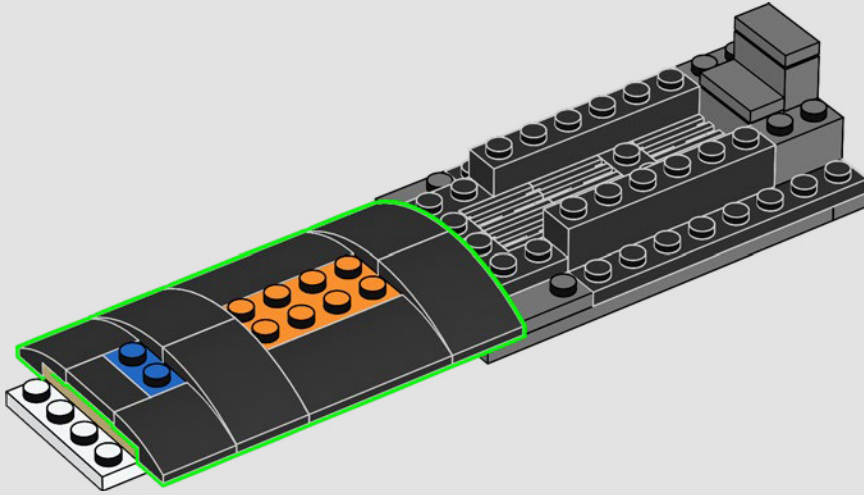

159

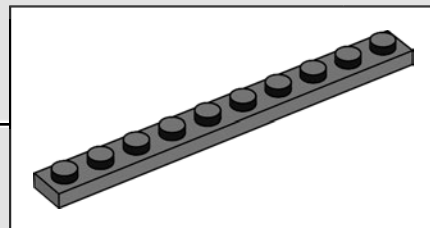
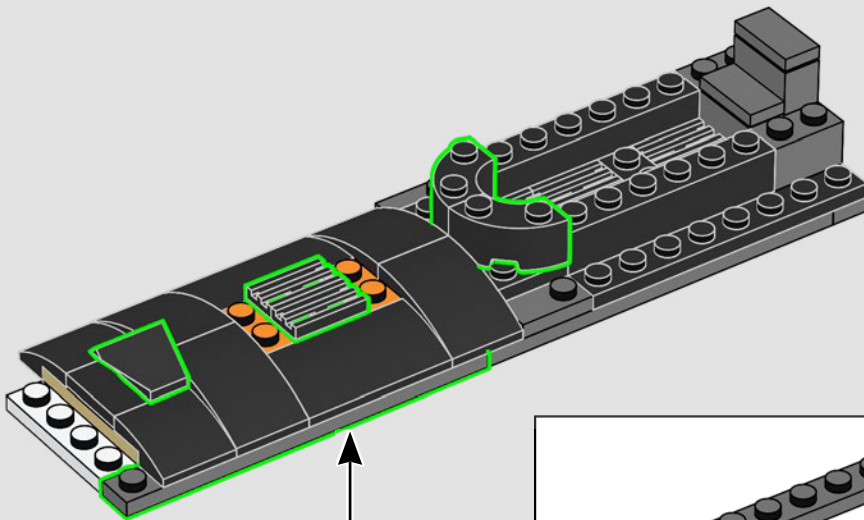

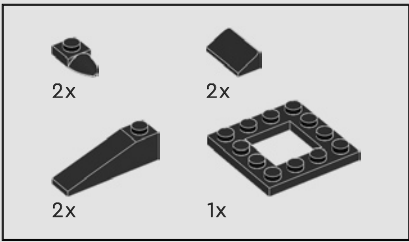

160

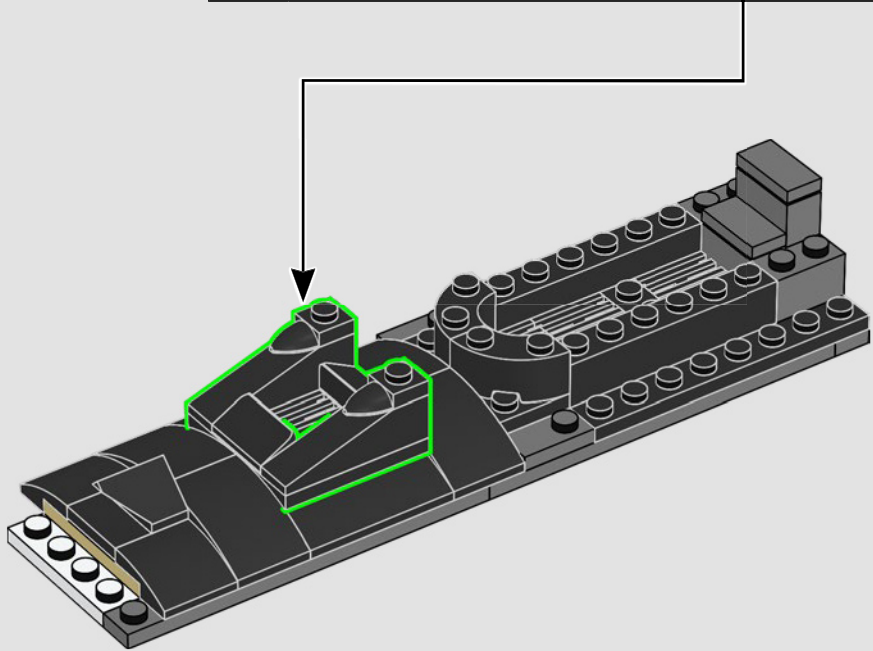
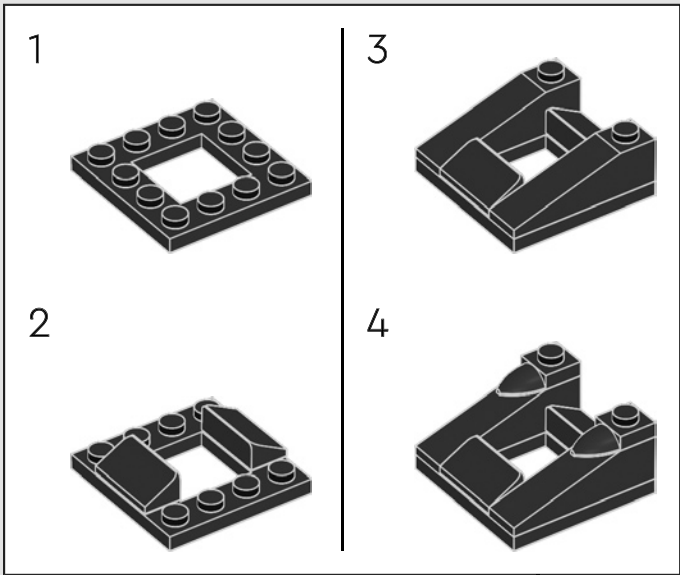



161

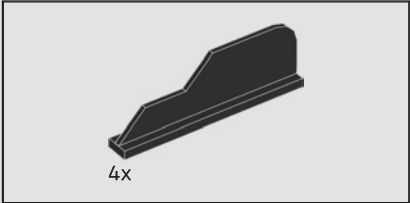
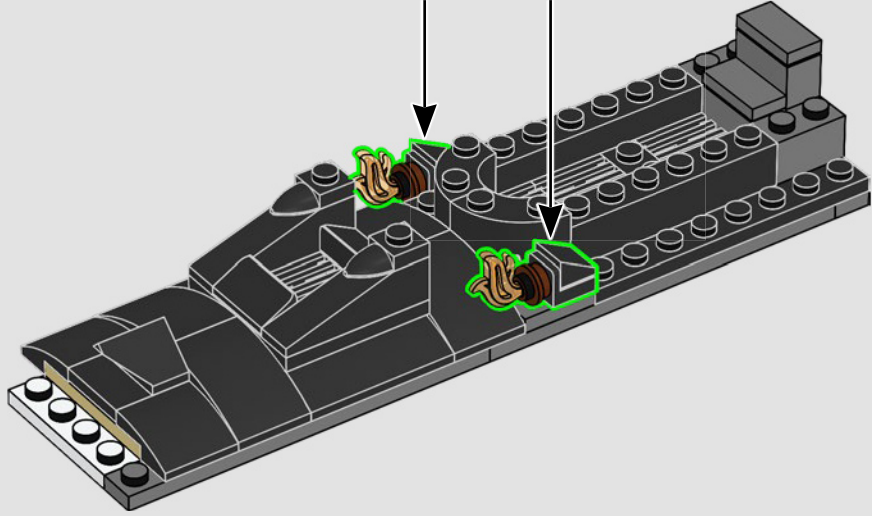
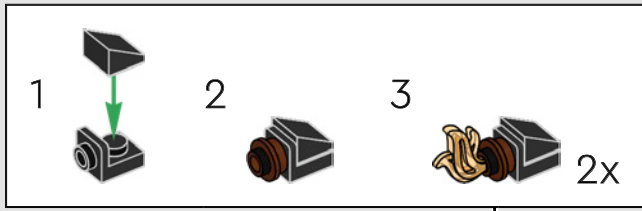

162

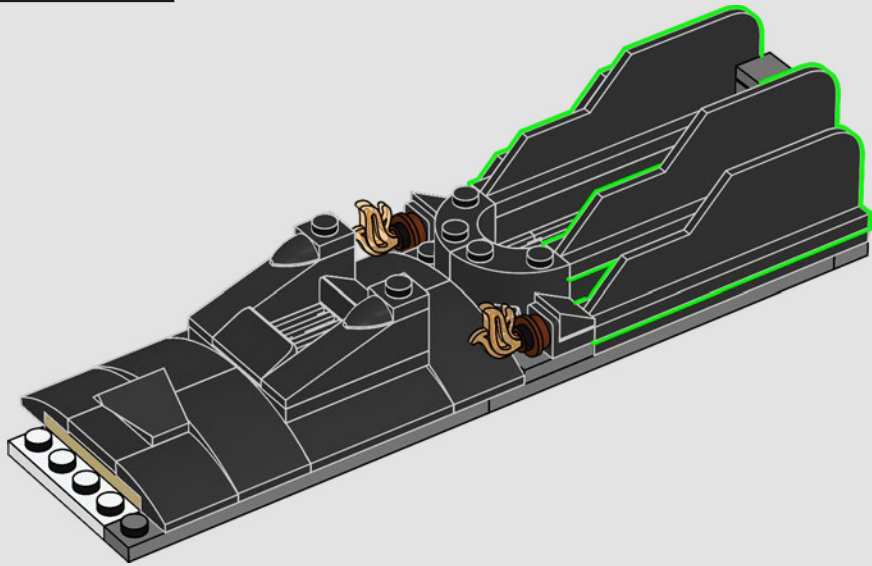



Das 1x8 Ruderelement wurde umfunktioniert, um die Tür an der Außenseite der Kammer darzustellen.

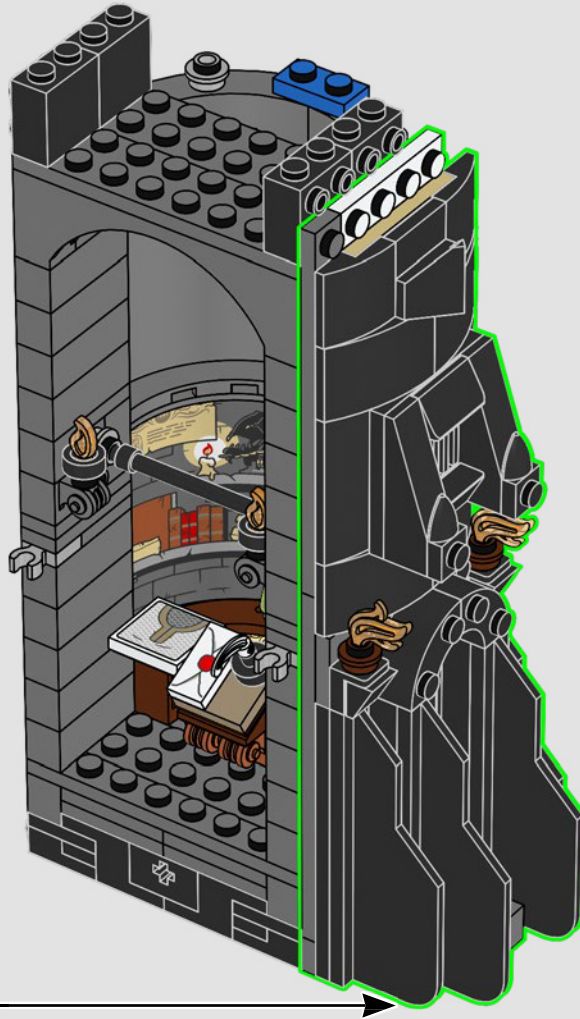

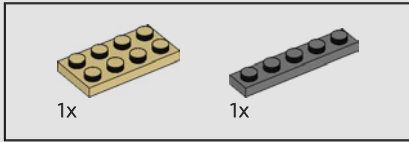
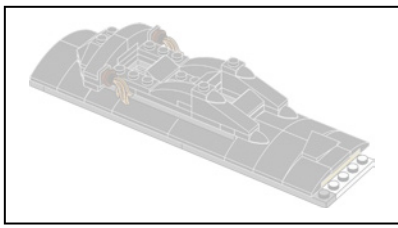

164

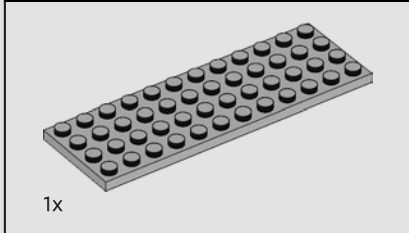
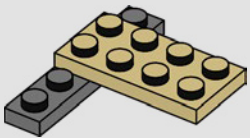

165

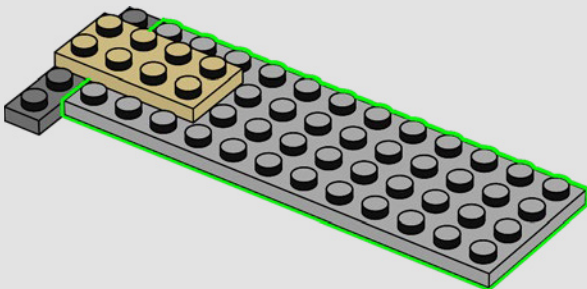

166

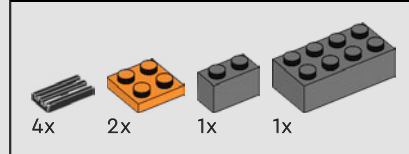
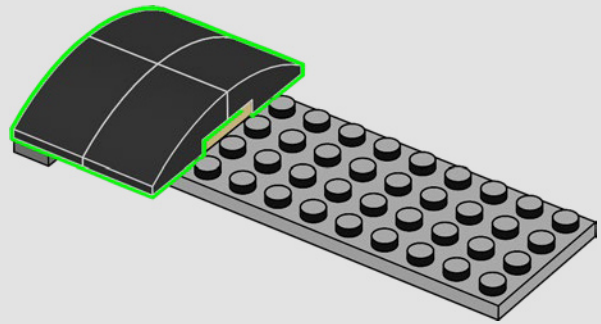

167

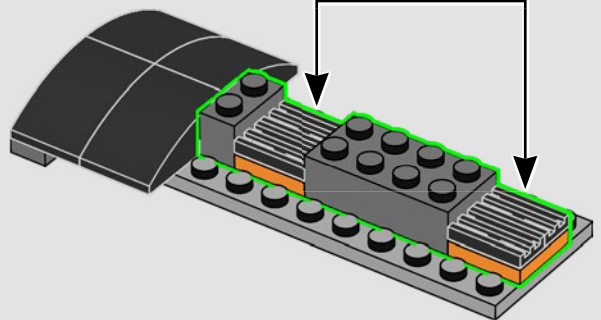
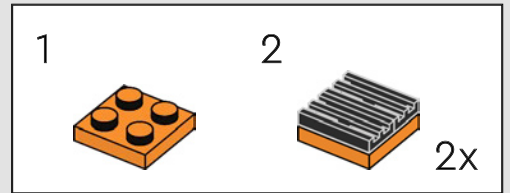

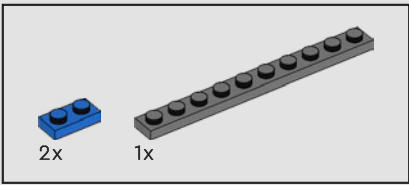

168

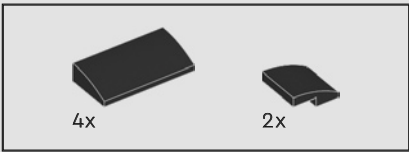
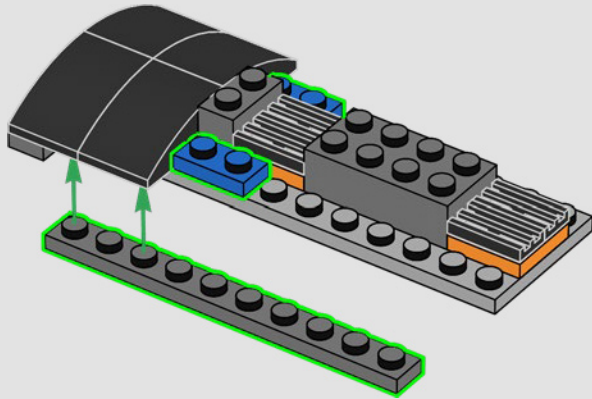

169

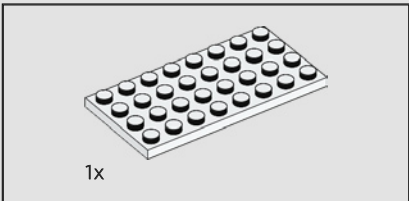
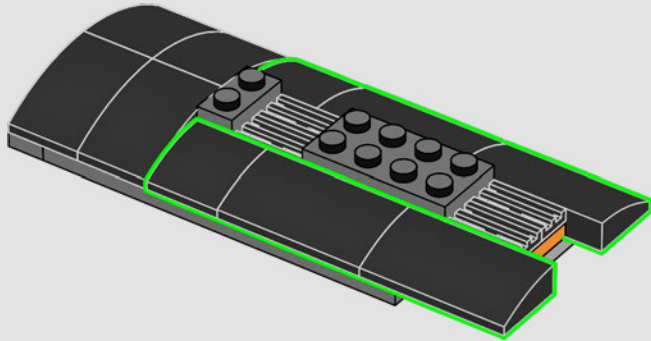

170

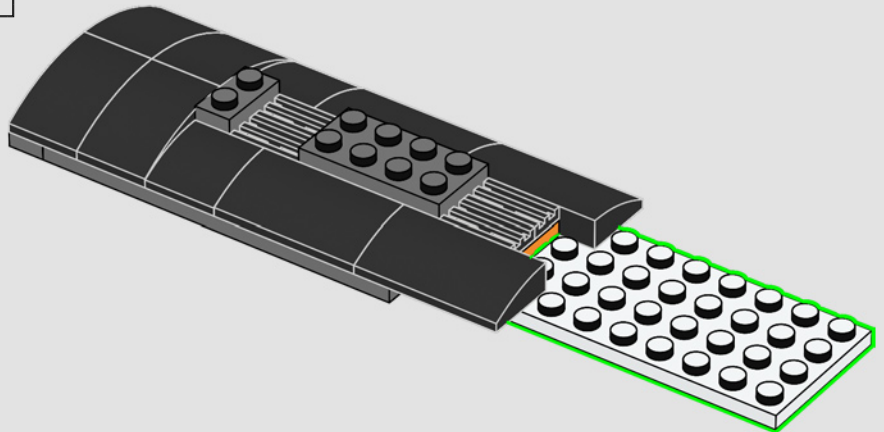

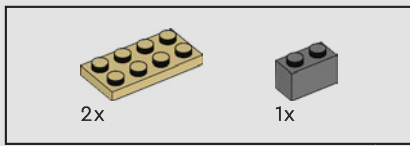

171

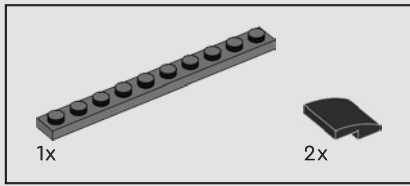
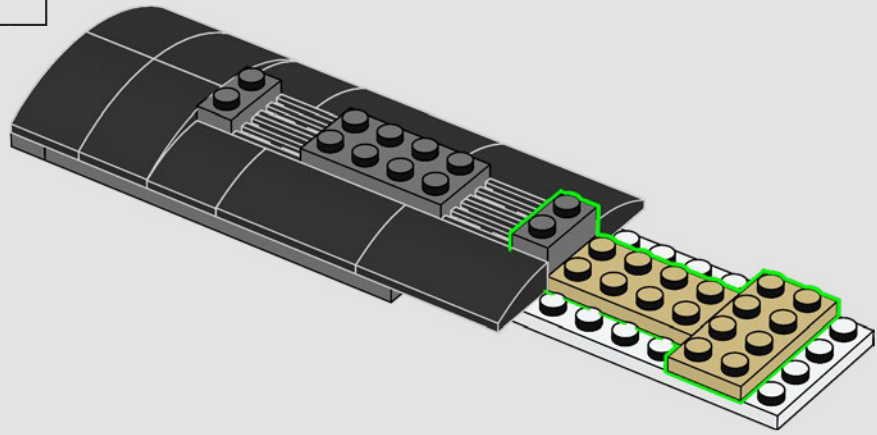

172

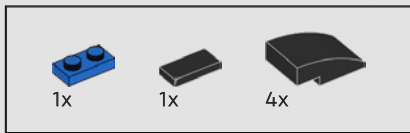
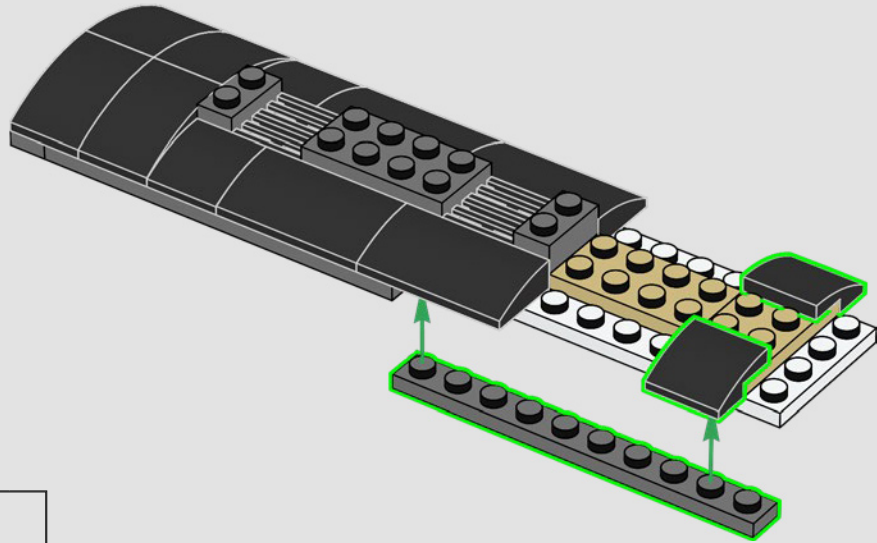

173

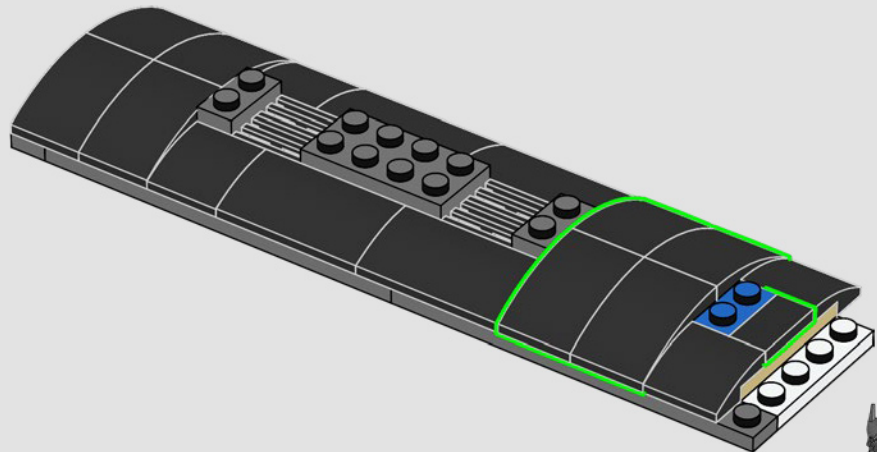

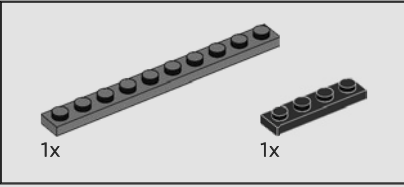
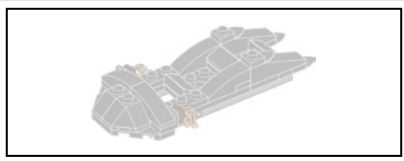

174

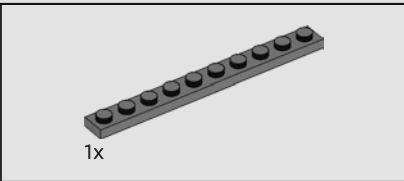
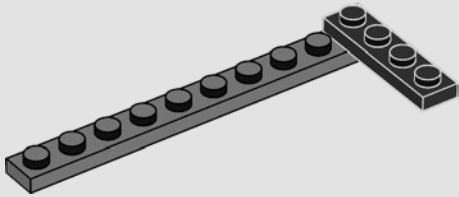

175

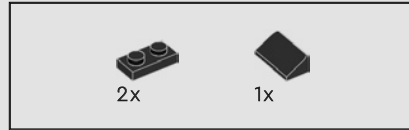
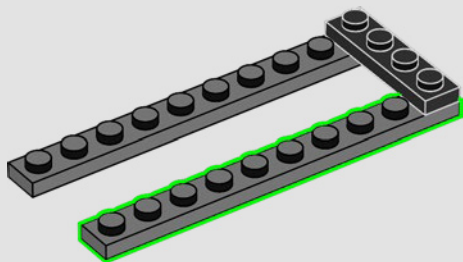

176

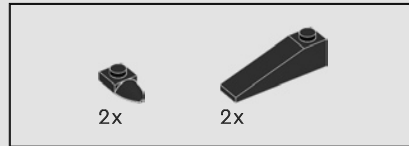
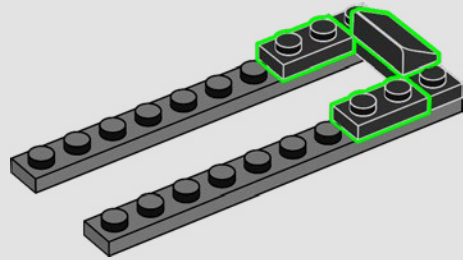

177

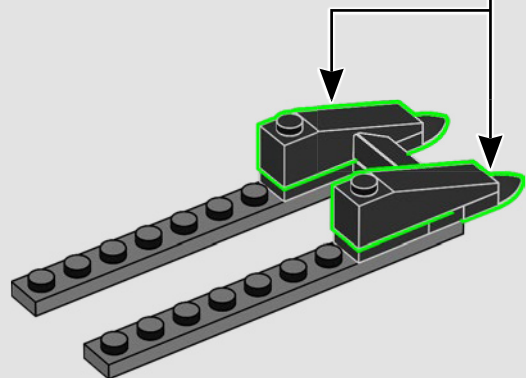
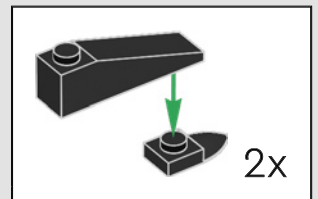

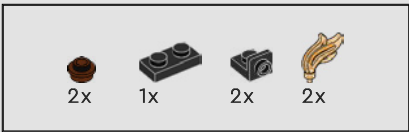

182

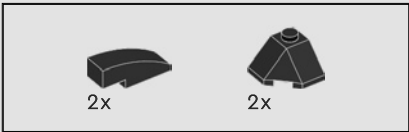
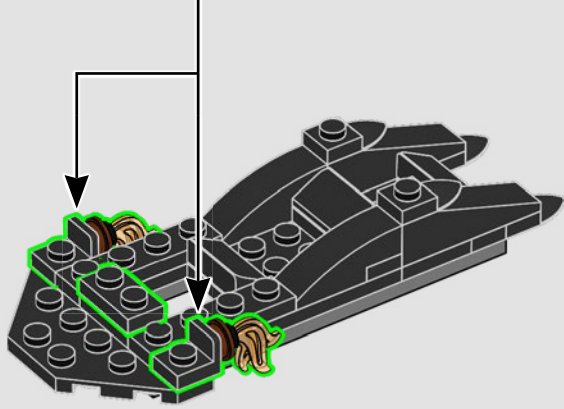
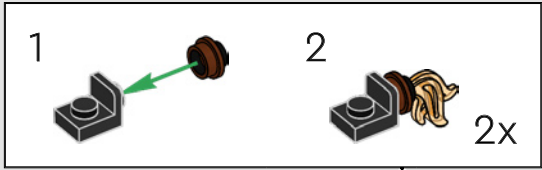

183

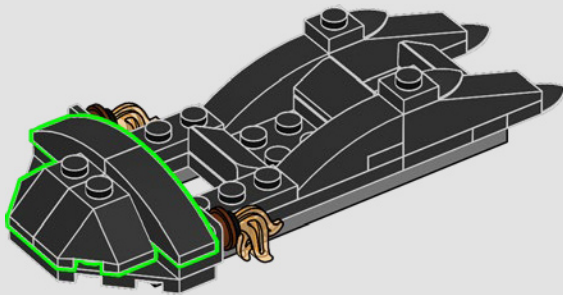

184

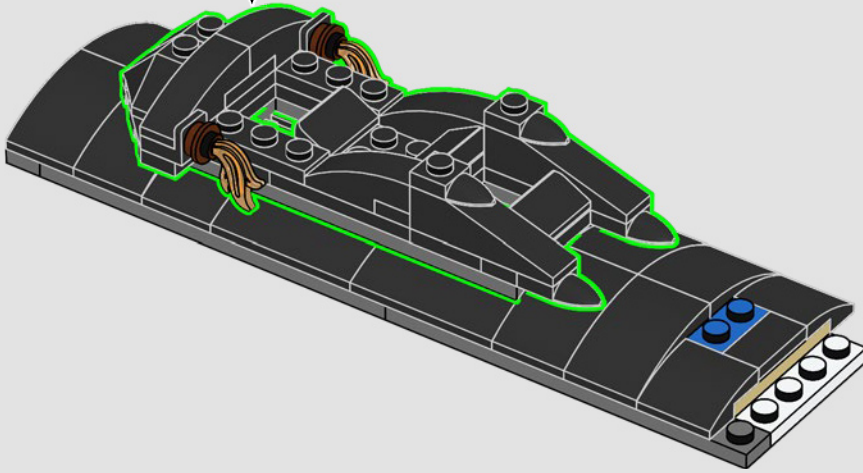

185

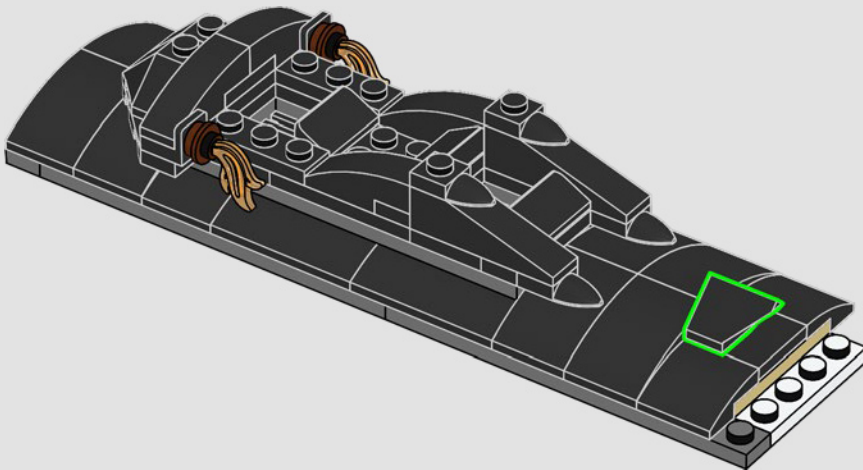

186

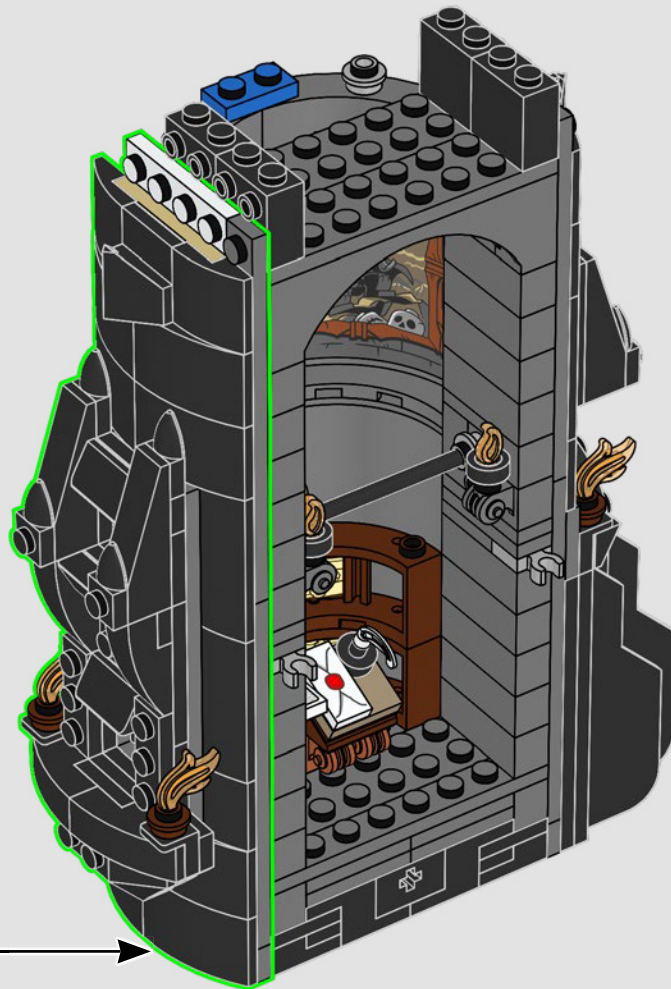



187

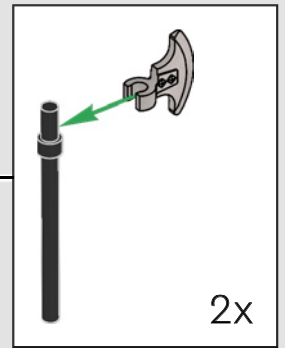
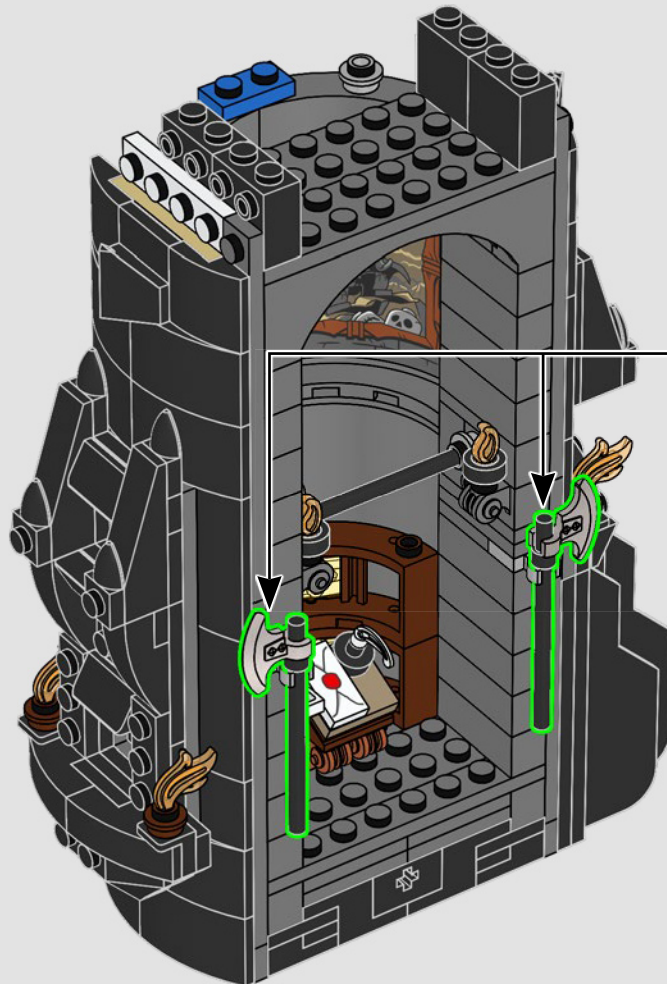

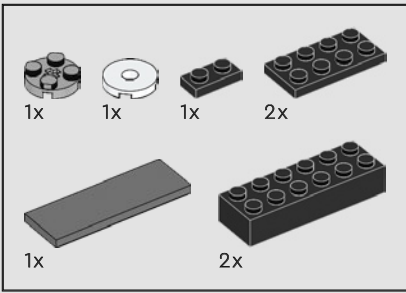

188

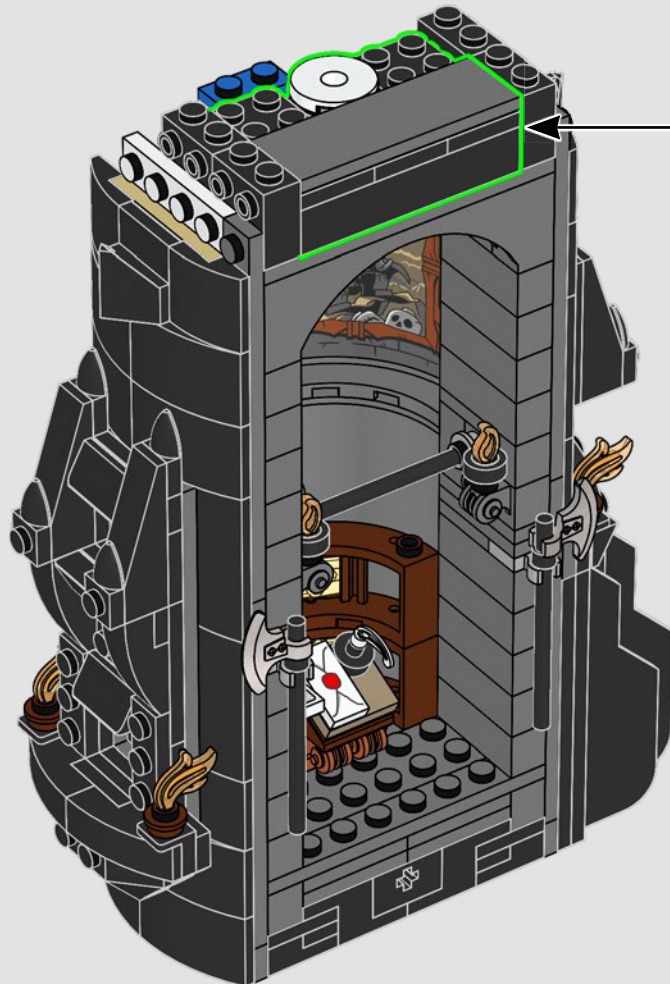
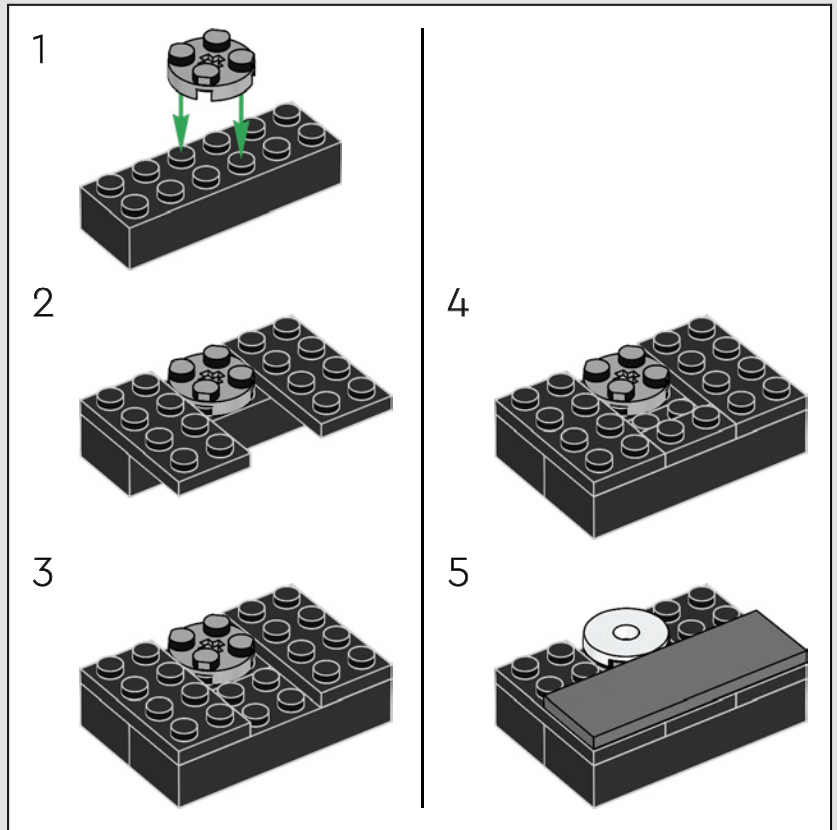



189

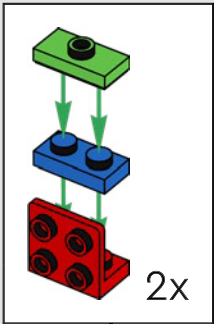
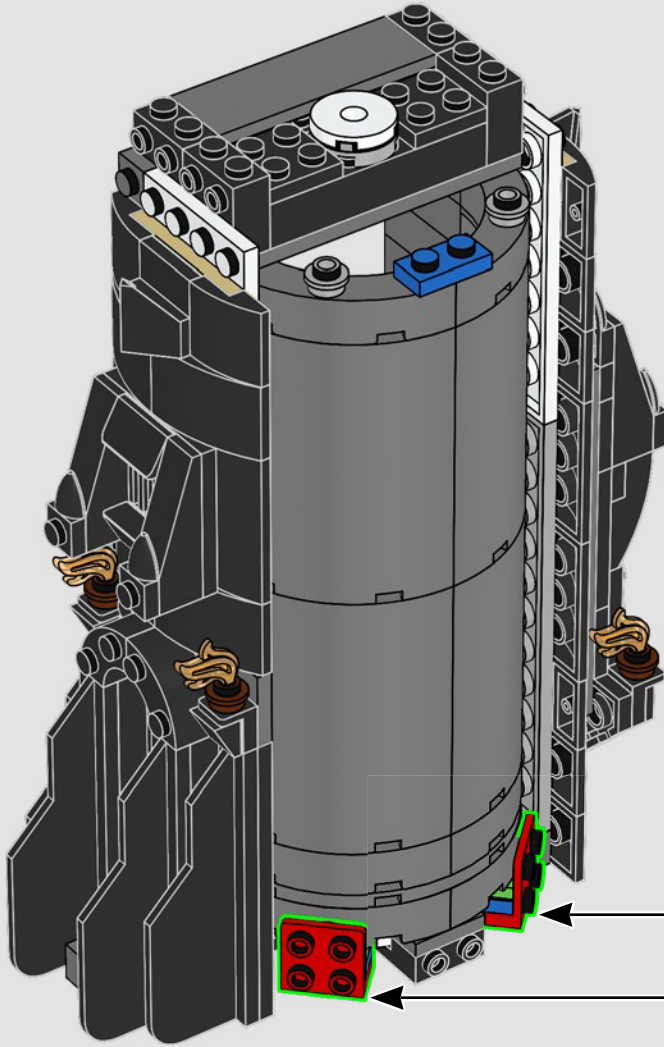

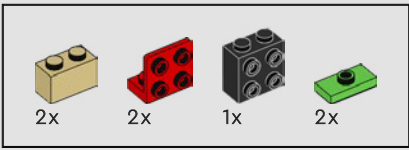

190

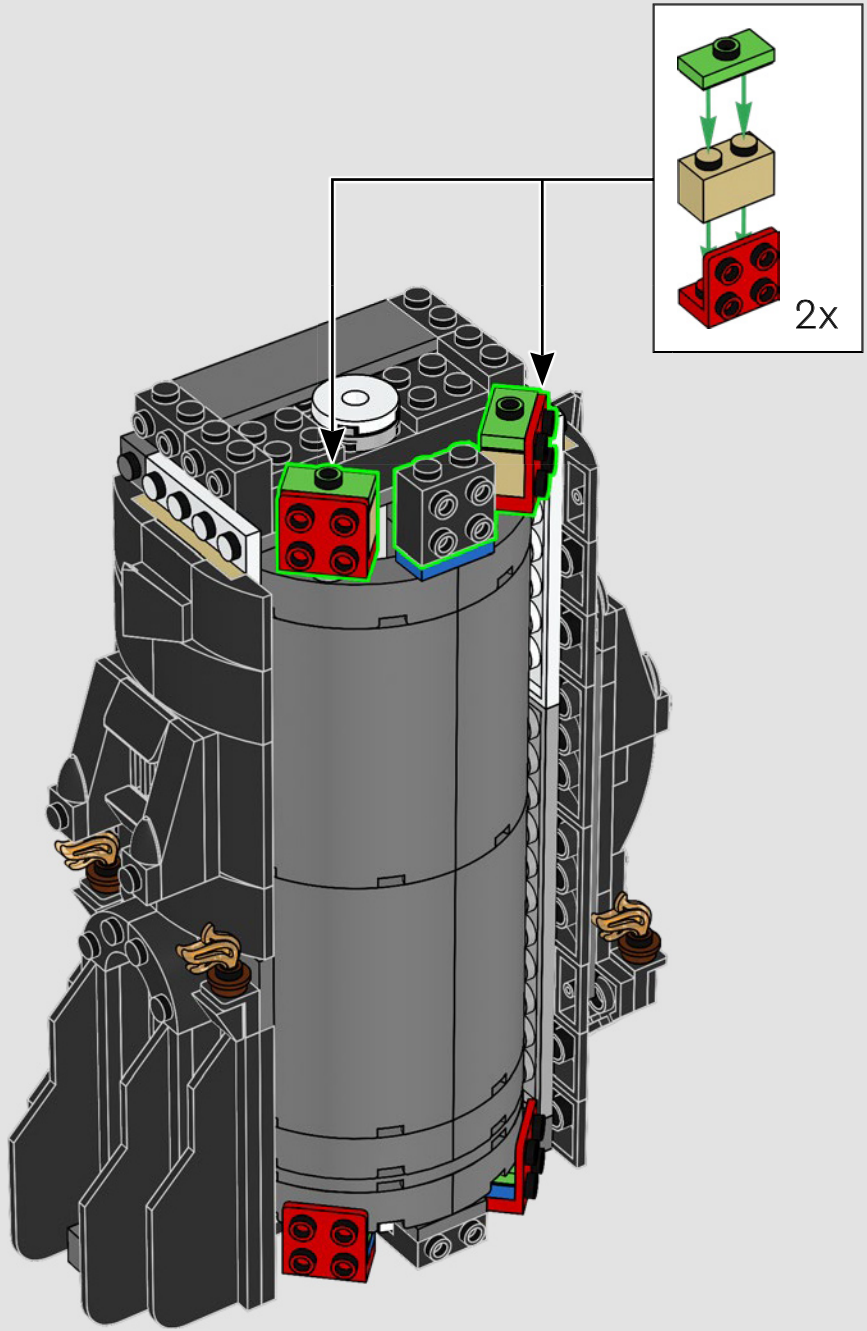

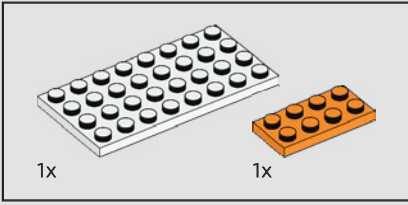
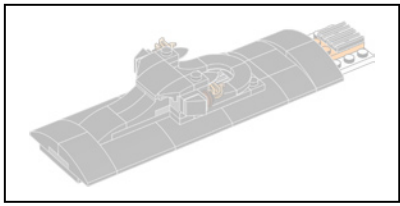

191

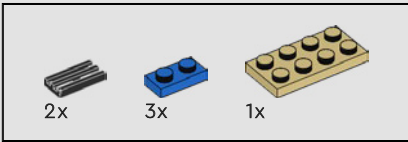
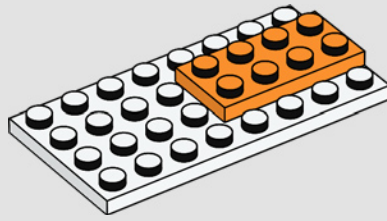

192

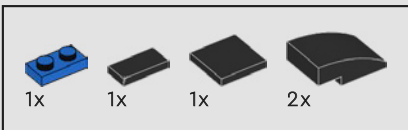
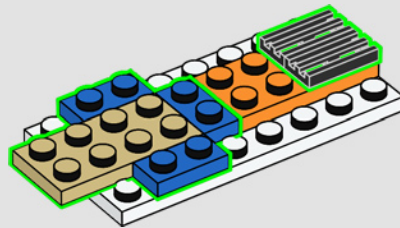

193

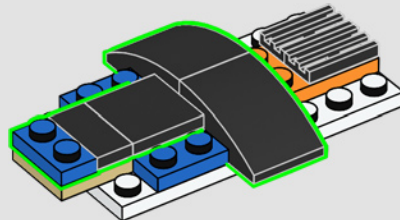

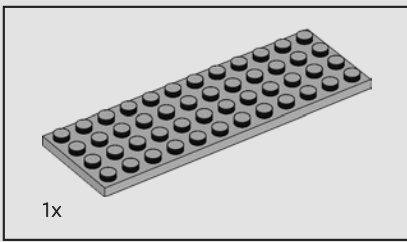

194

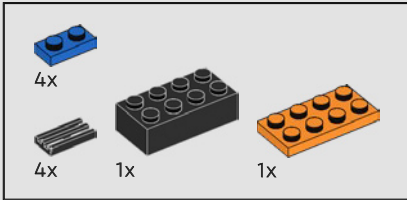
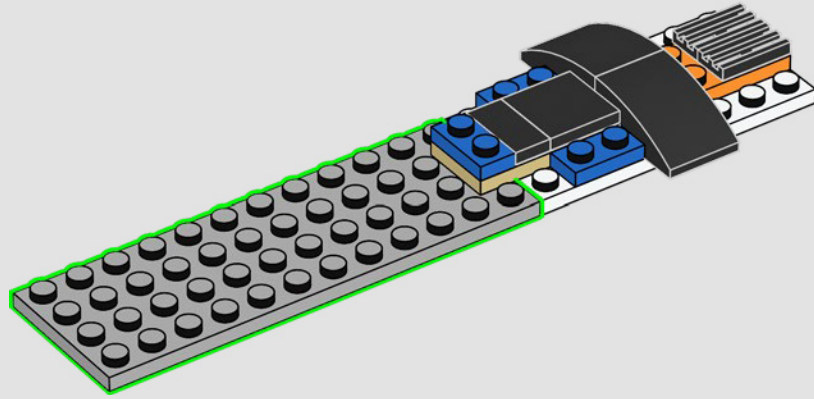

195

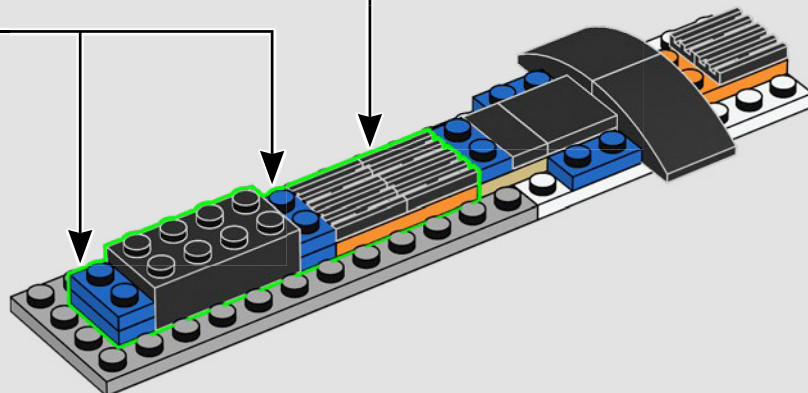
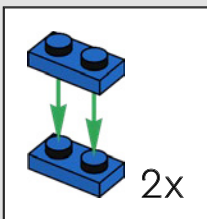
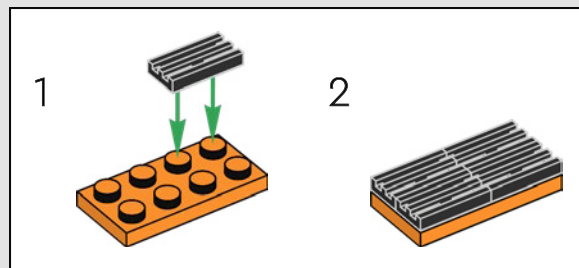

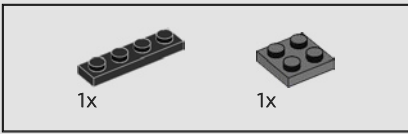

196

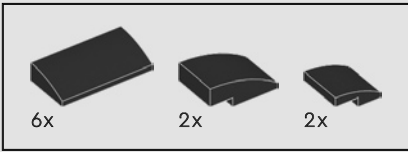
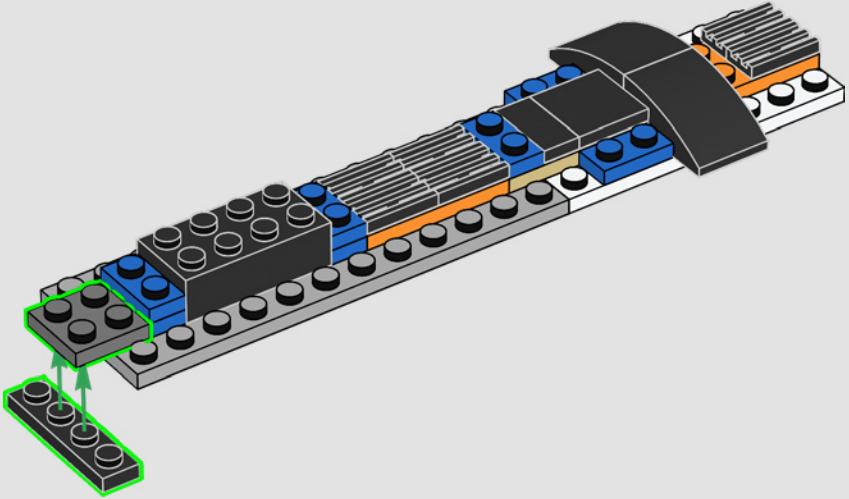

197

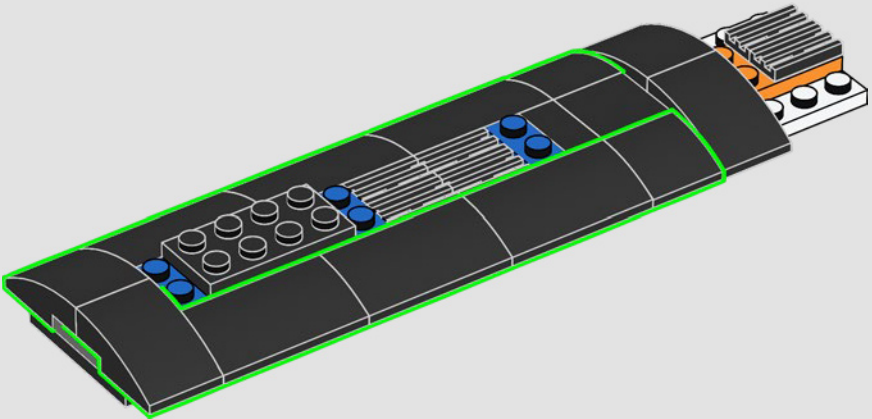

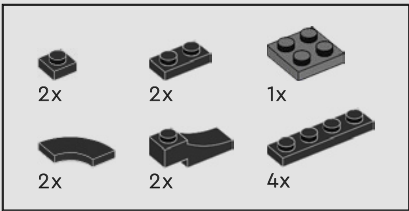

198

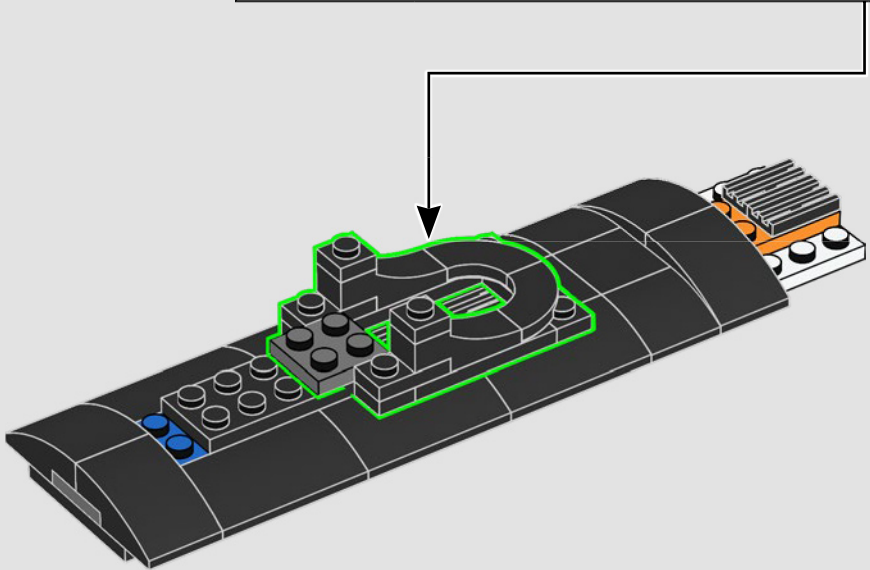
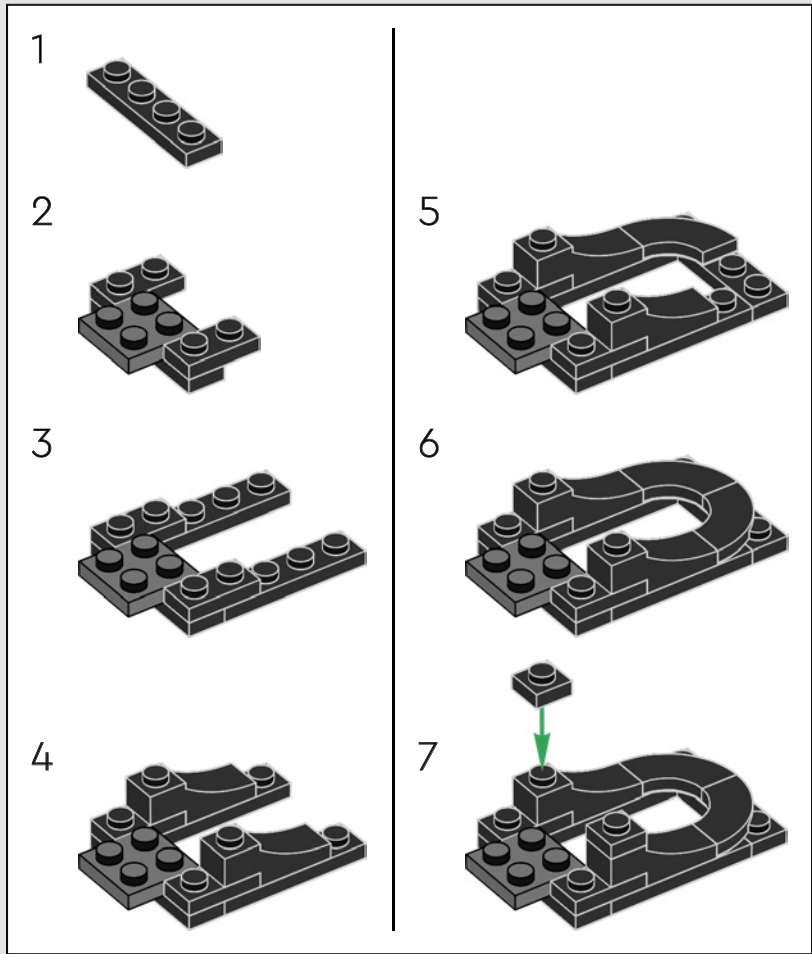

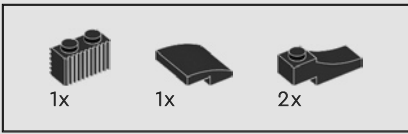

199

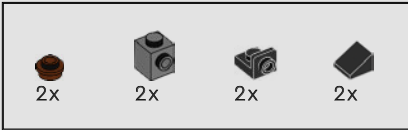
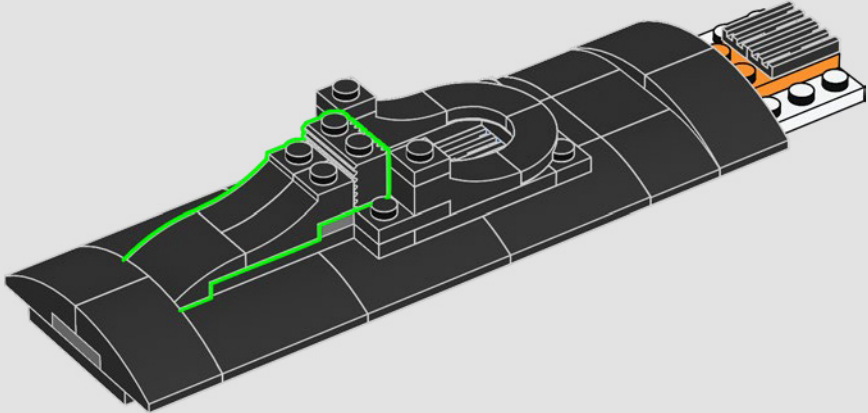

200

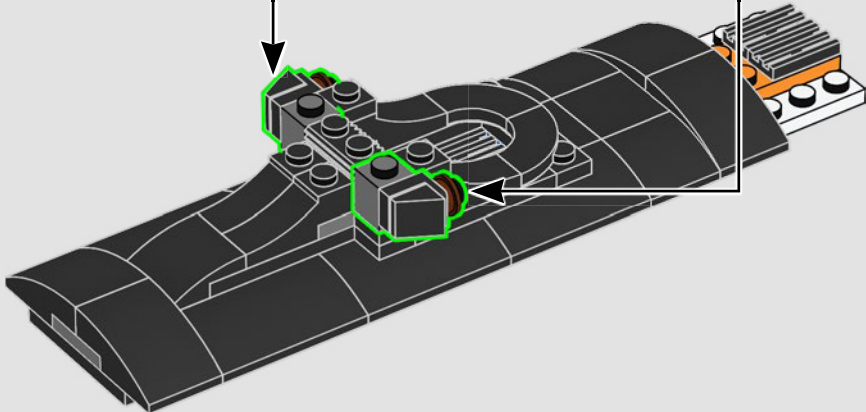
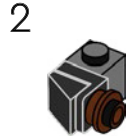
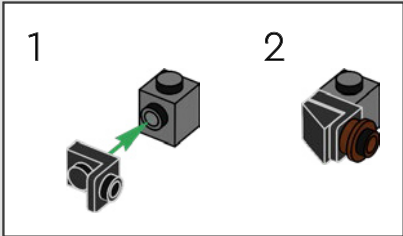
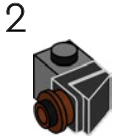
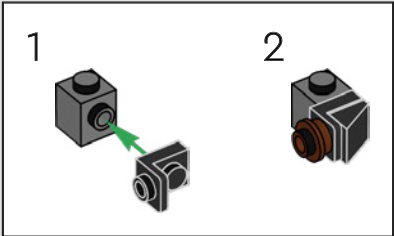



201

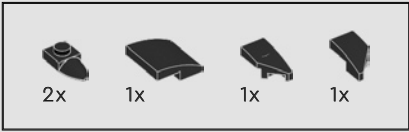
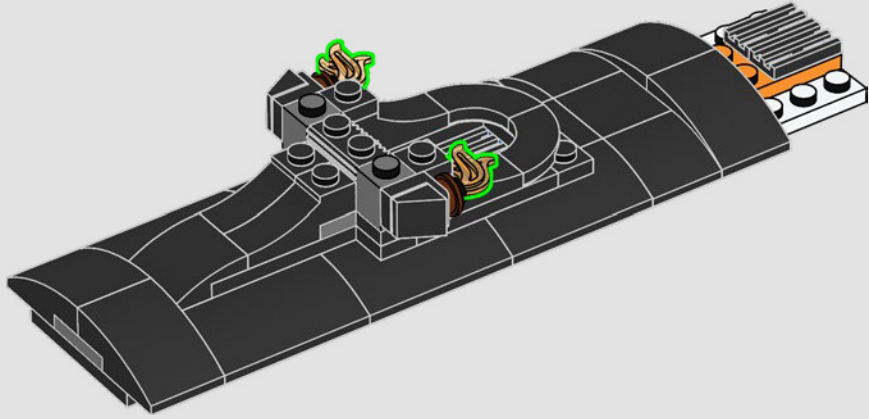

202

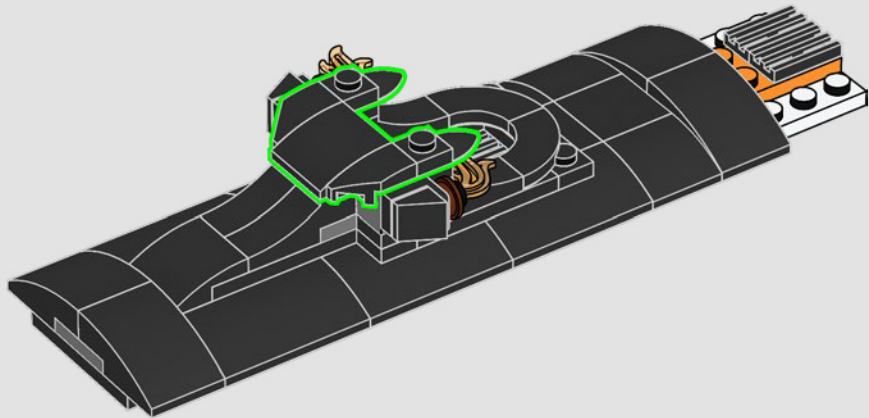

203

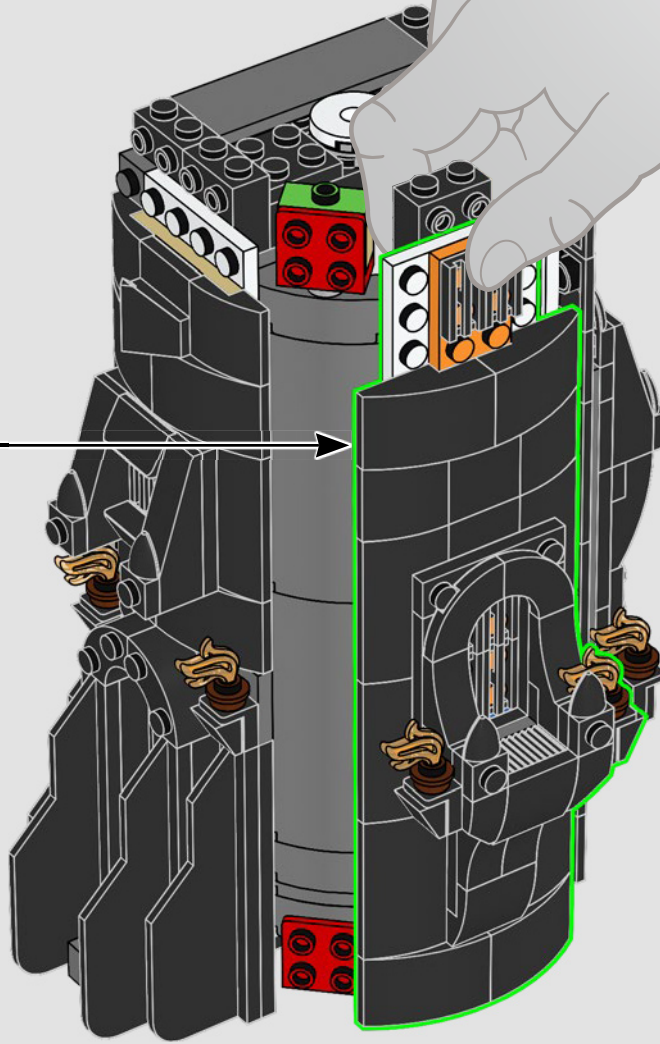

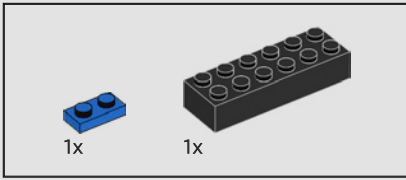
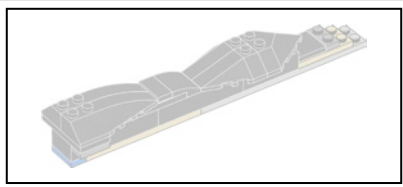

204

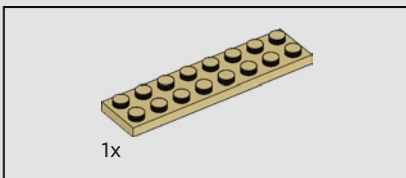
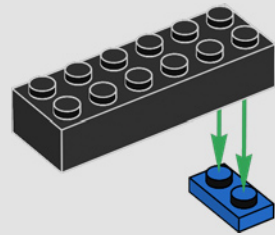

205

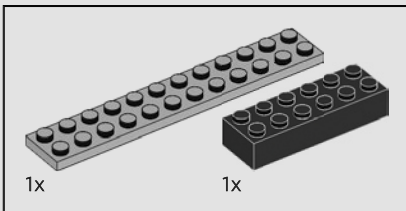
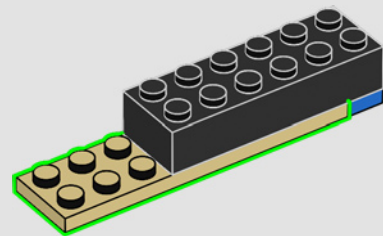

206

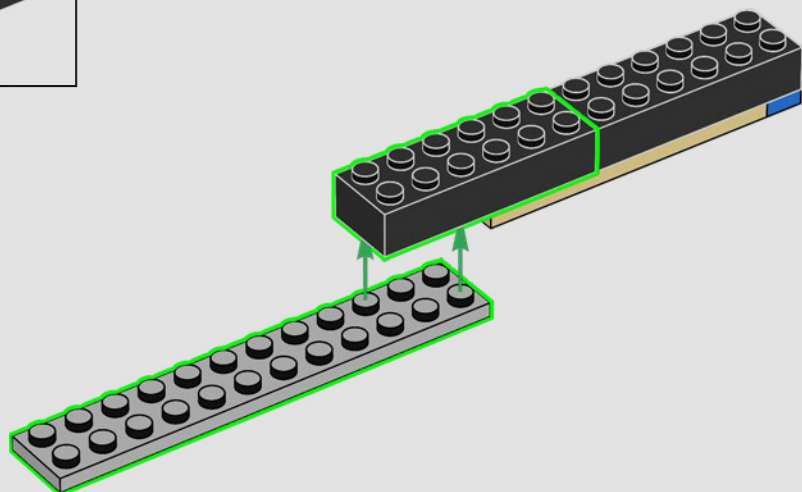

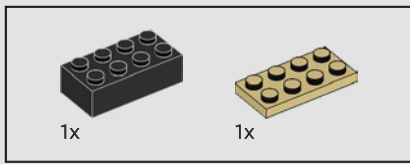

207

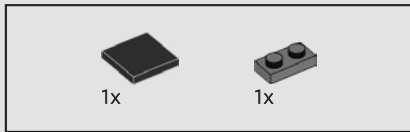
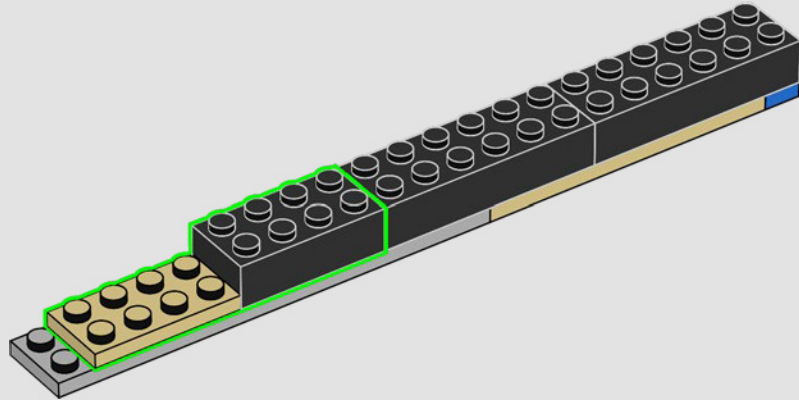

208

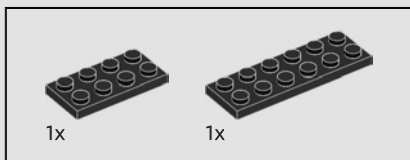
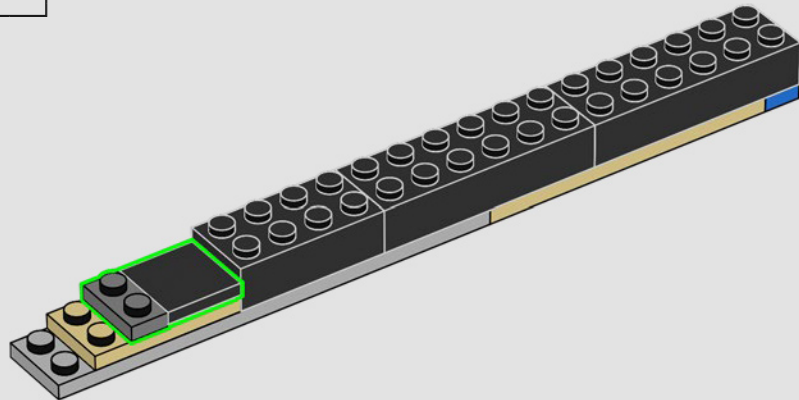

209

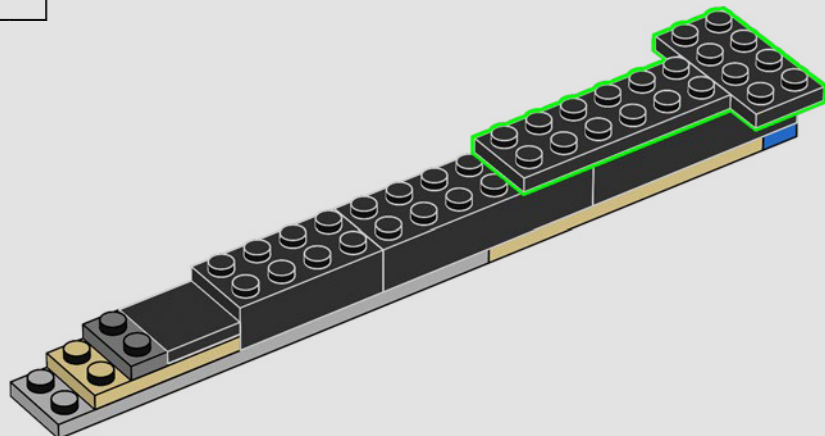

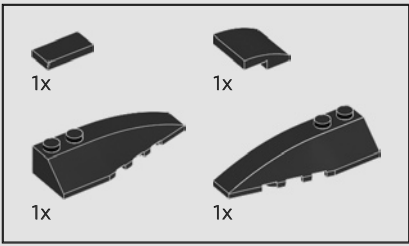

210

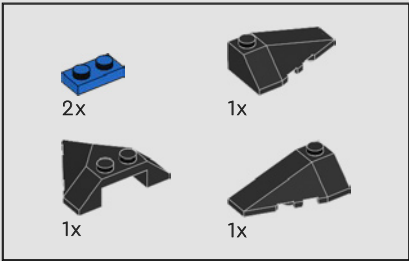
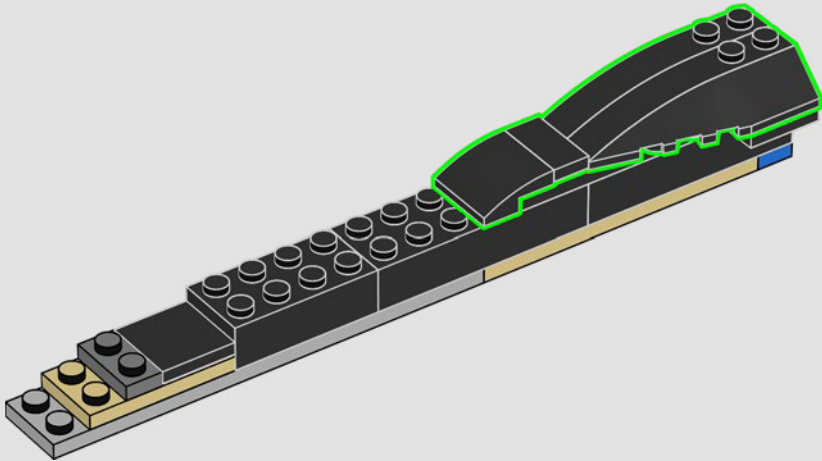

211

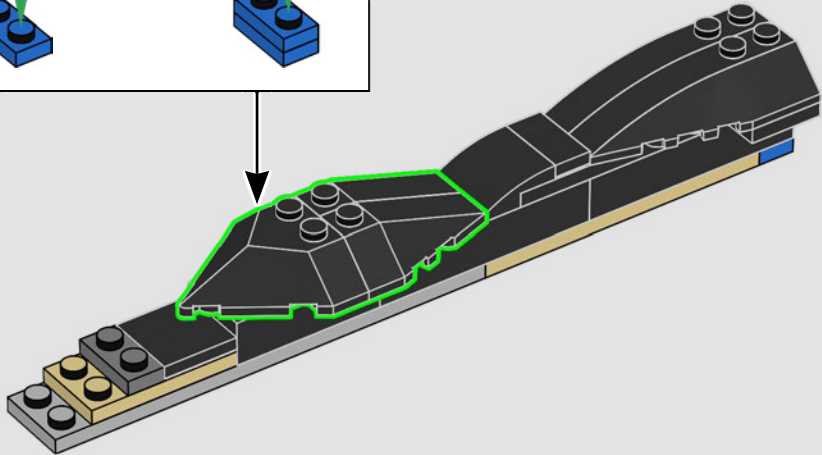
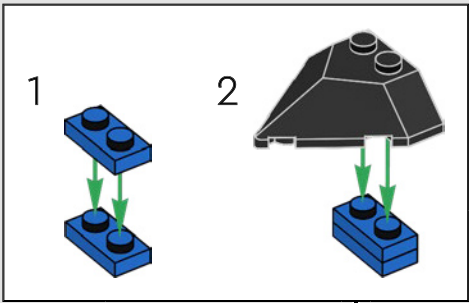

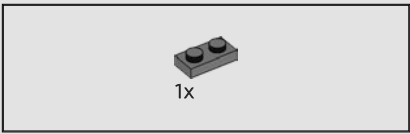

212

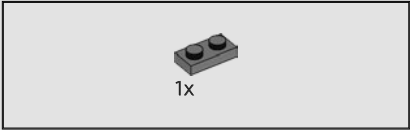
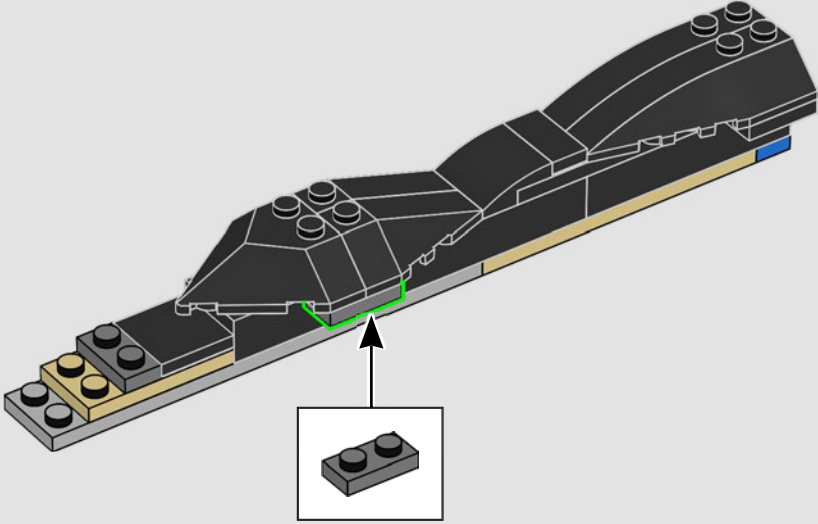

213

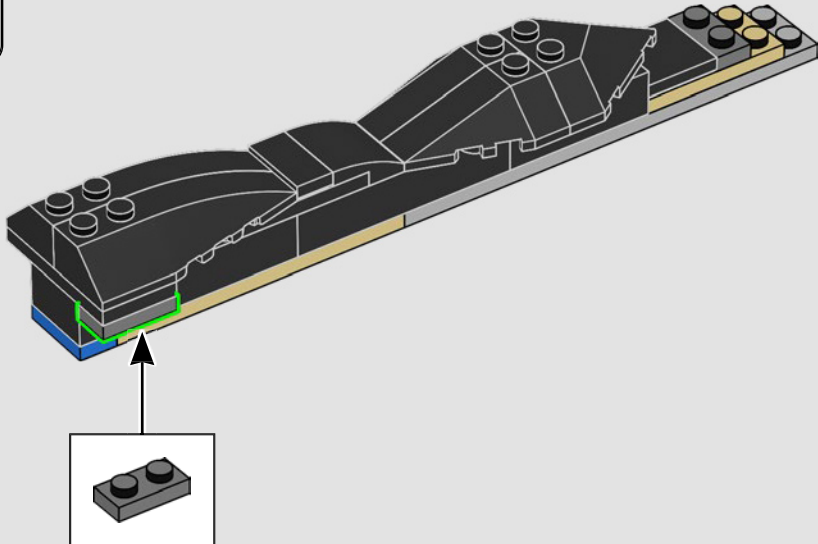

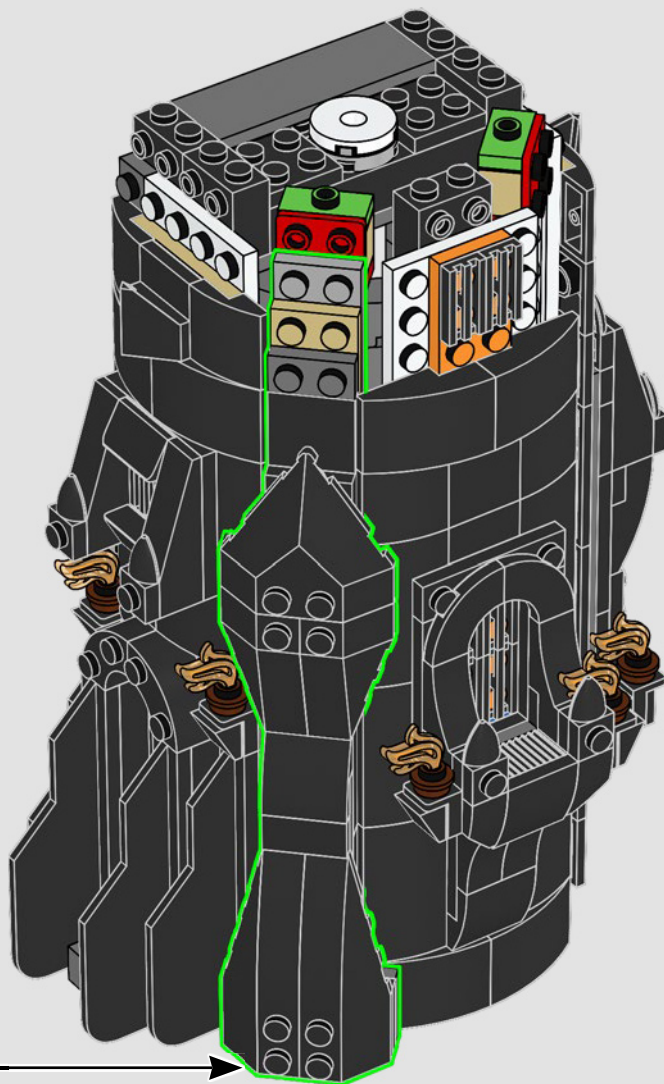

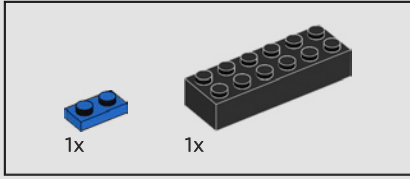
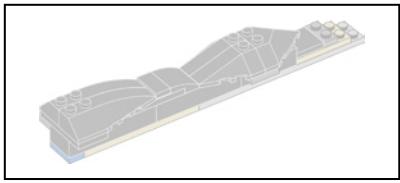

215

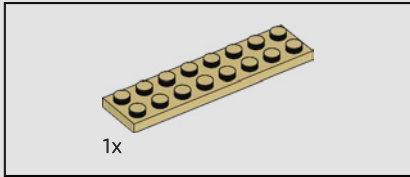
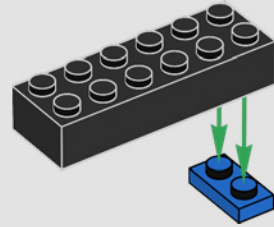

216

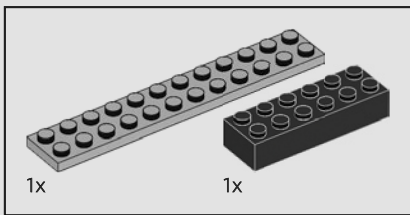
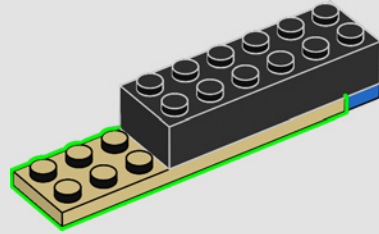

217

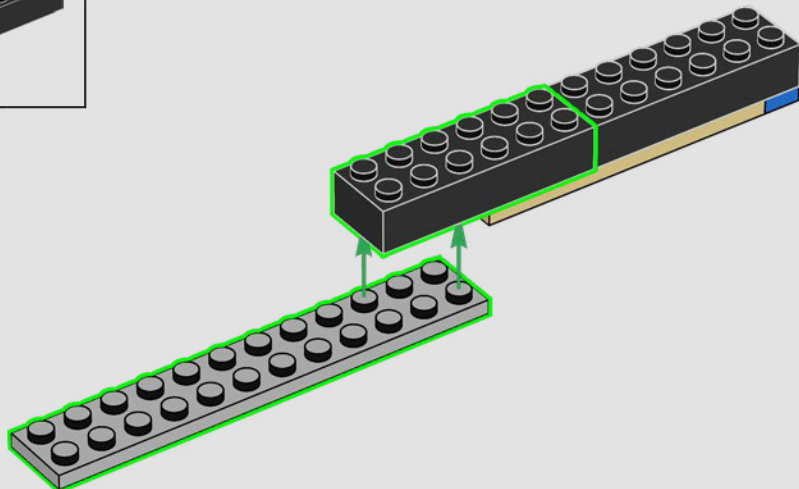

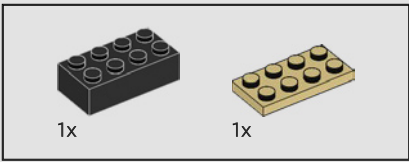

218

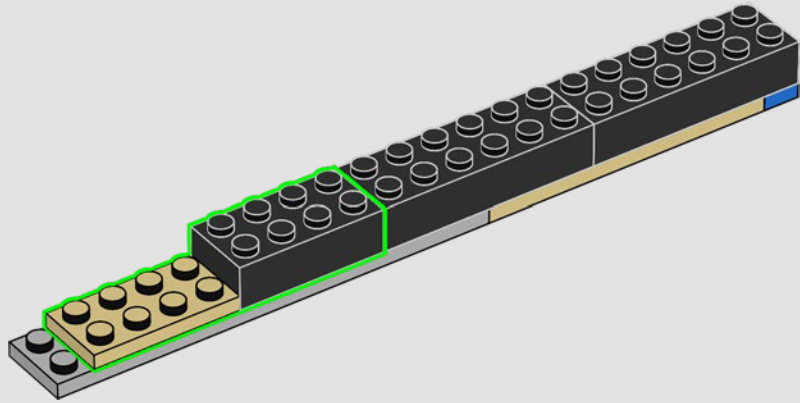

219

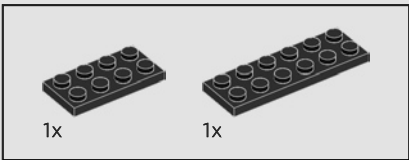
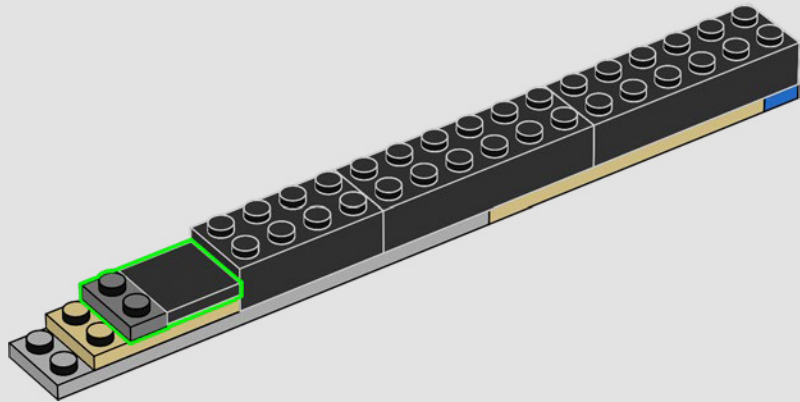

220

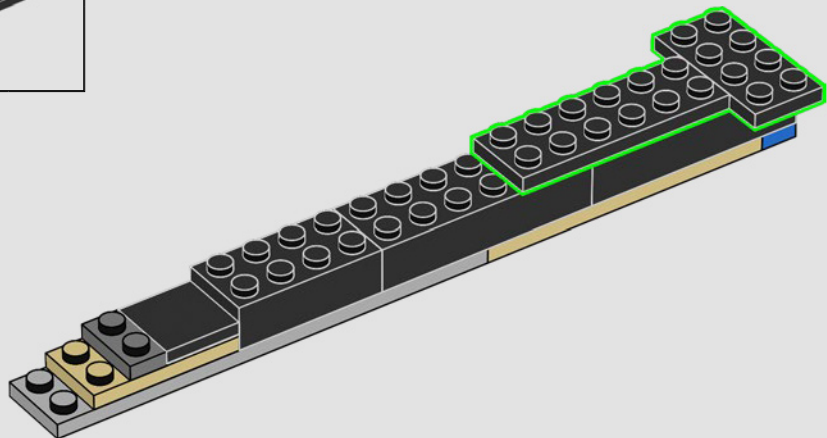

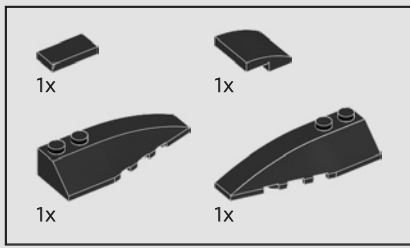

221

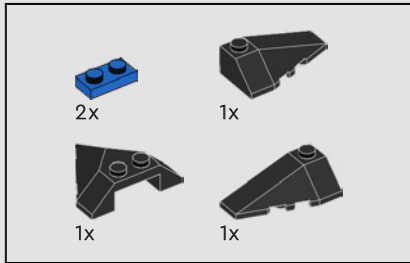
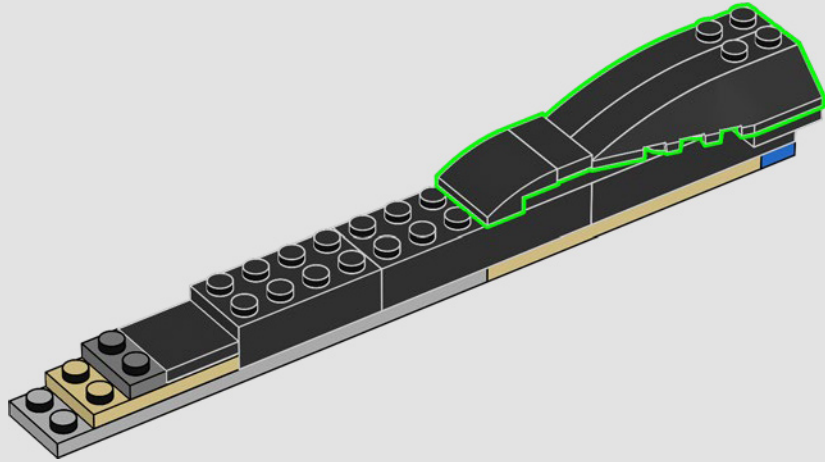

222

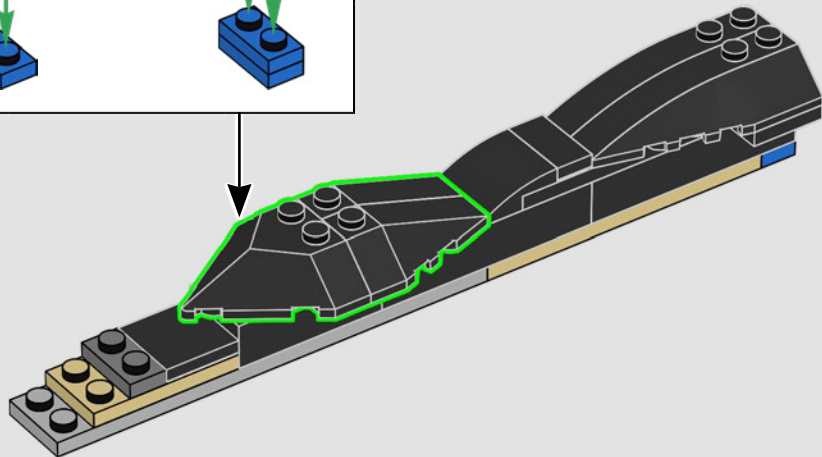
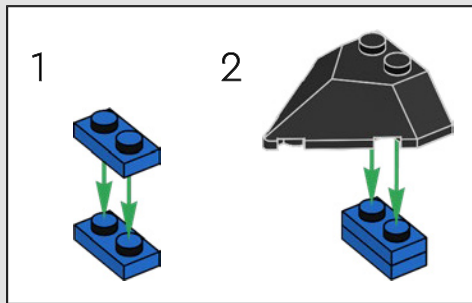

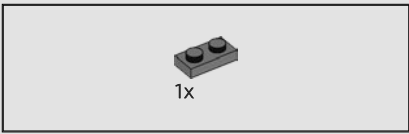

223

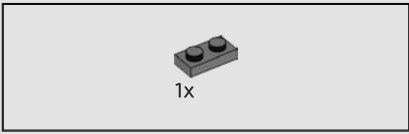
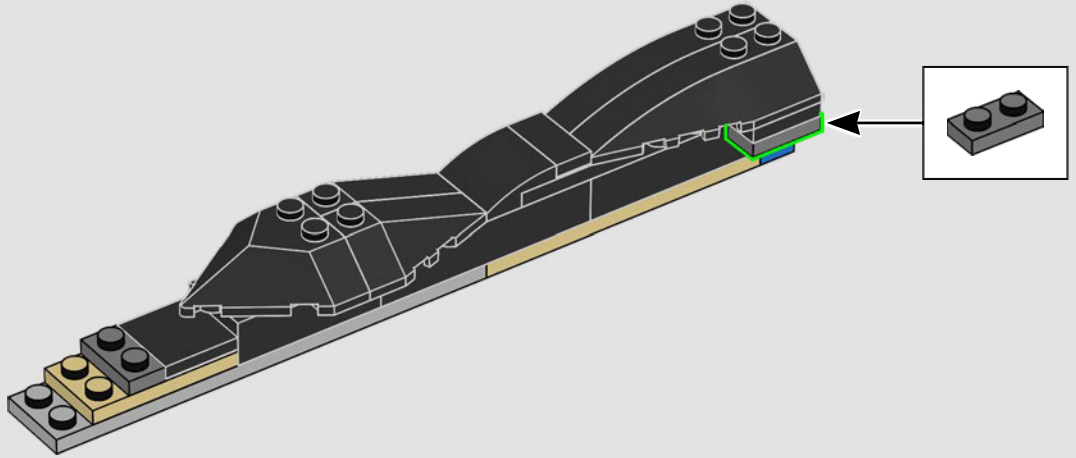

224

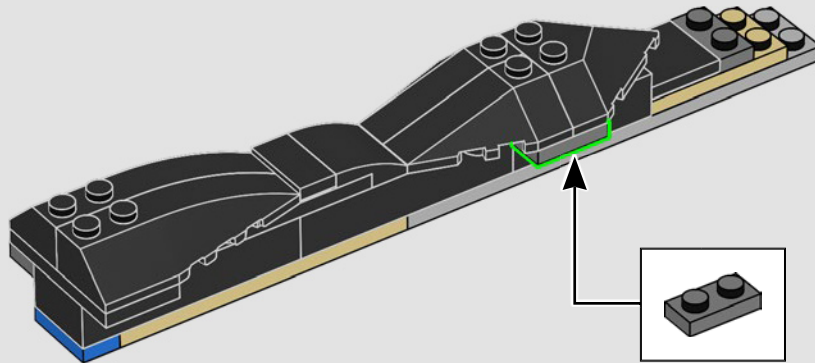



„Ist hier einer in diesem Haufen, der ermächtigt ist,
mit mir zu verhandeln?“ – Saurons Mund

225

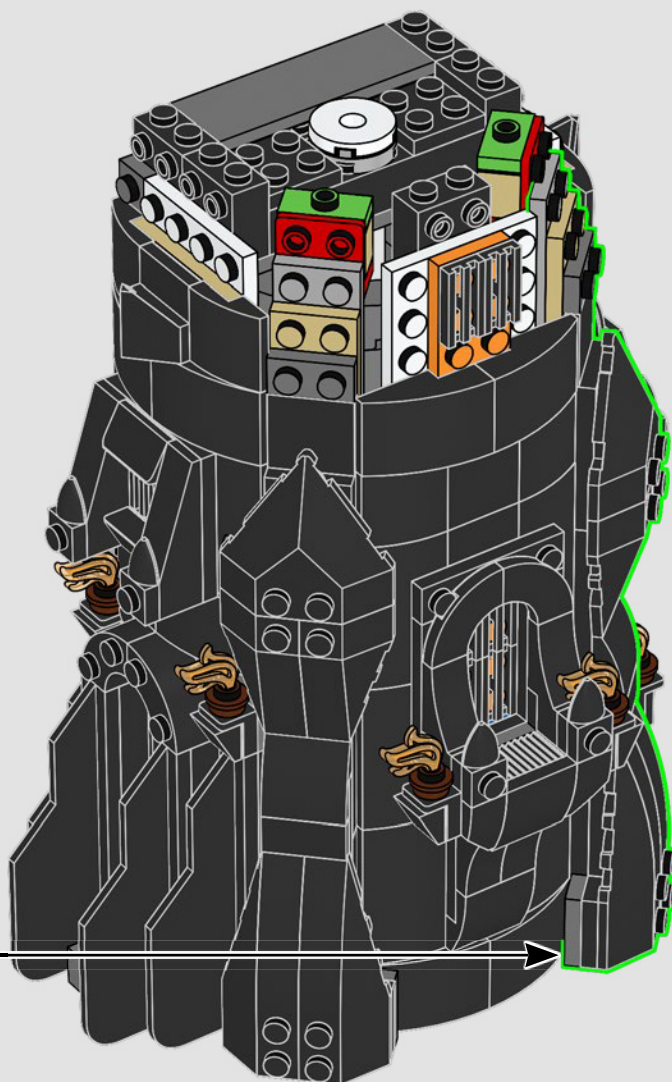

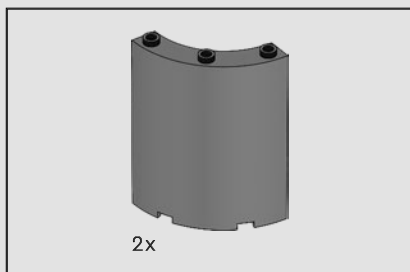

226

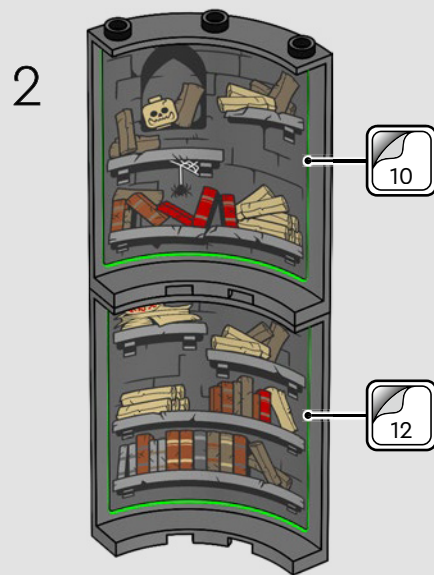
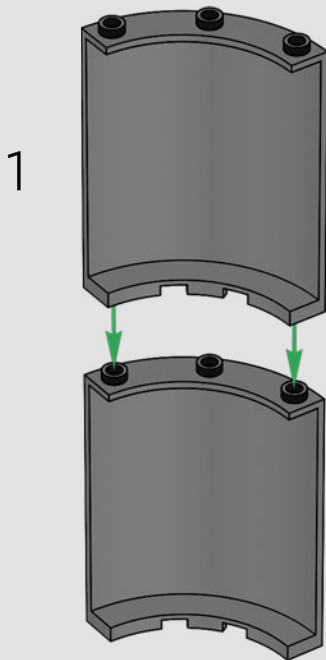



Die Bibliothek ganz oben im Turm beherbergt dunkles Wissen und dunkle Magie.

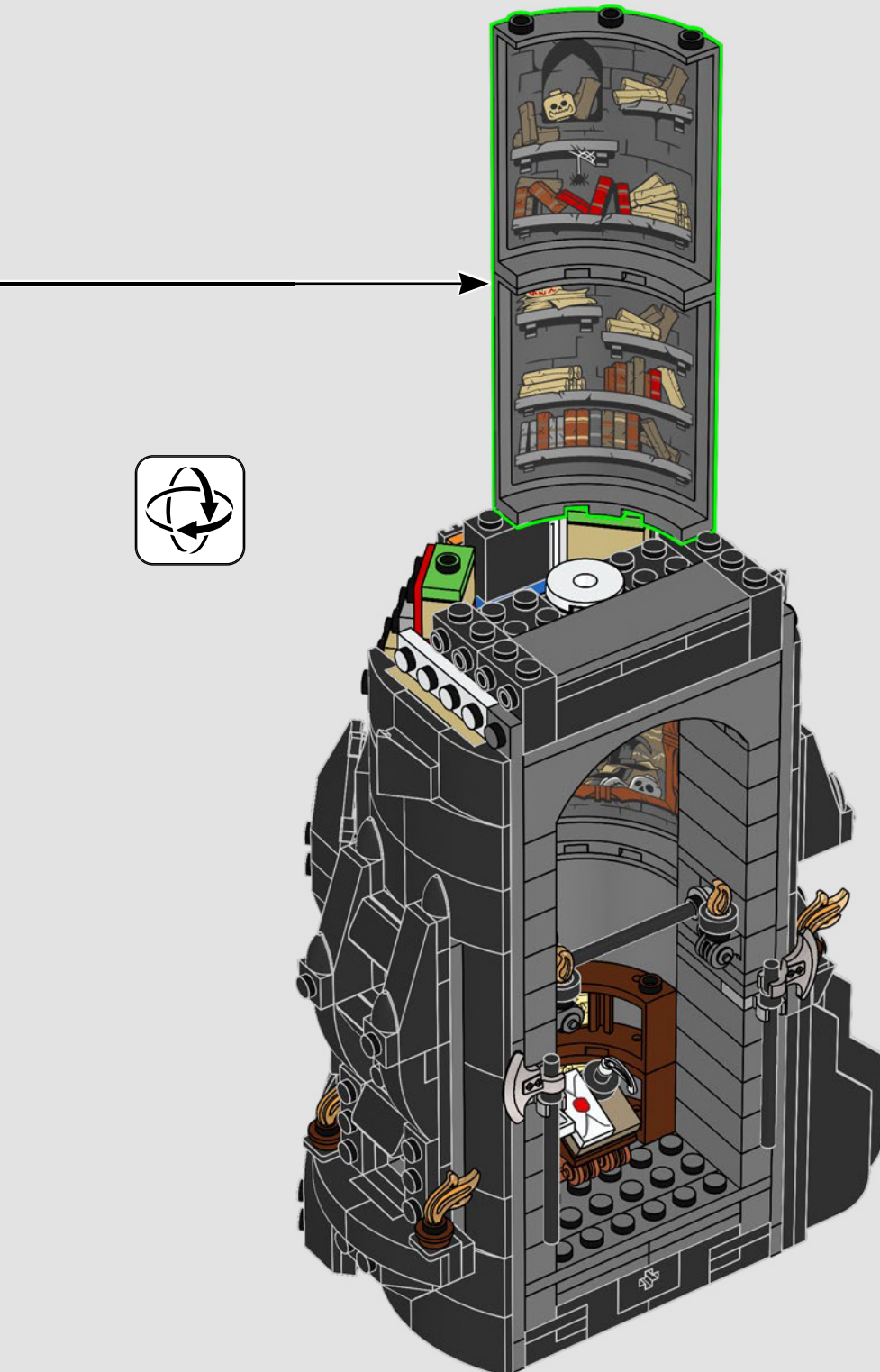

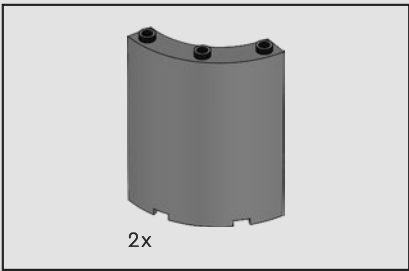

227

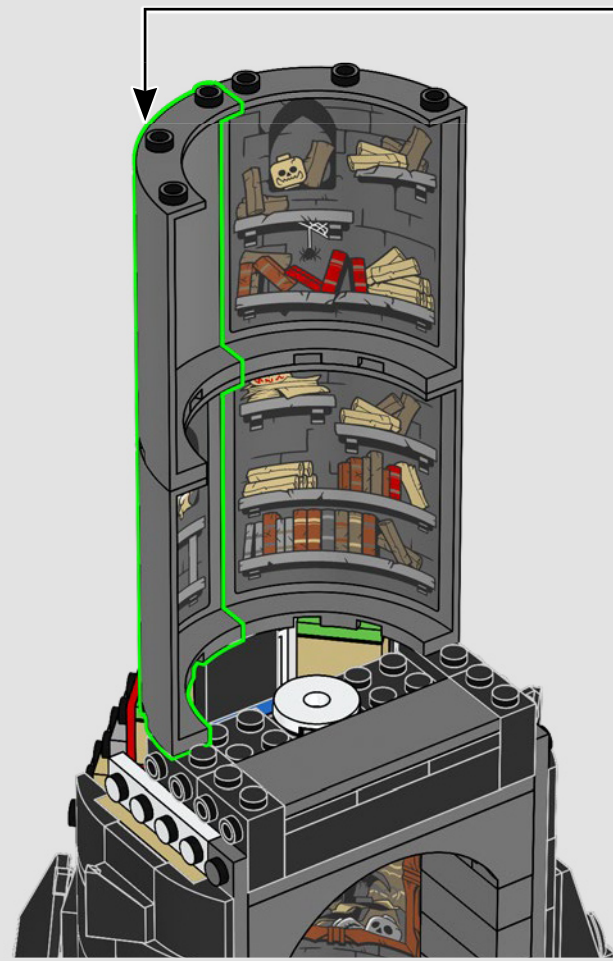
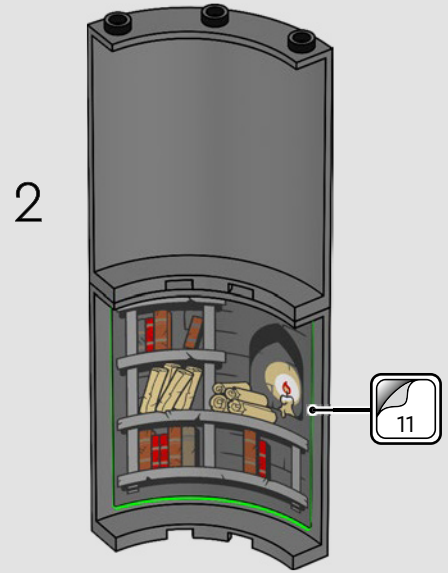
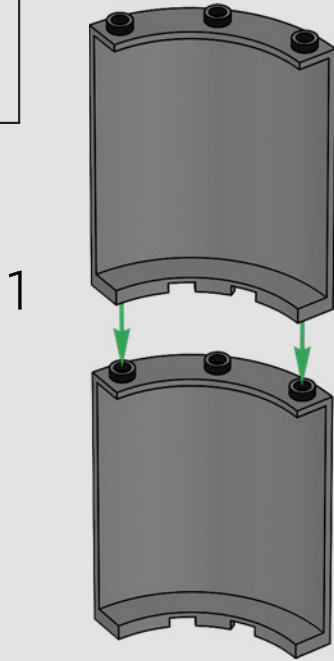

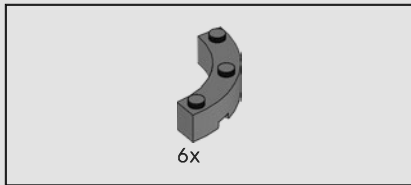

228

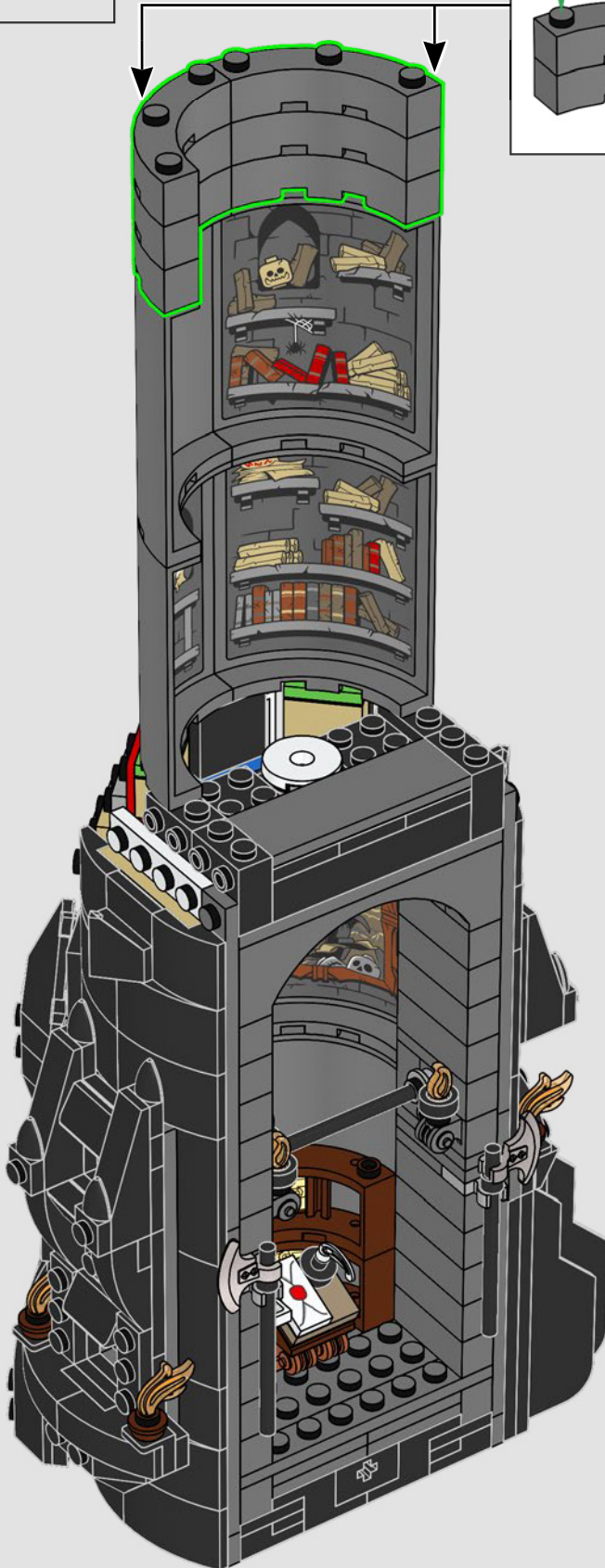
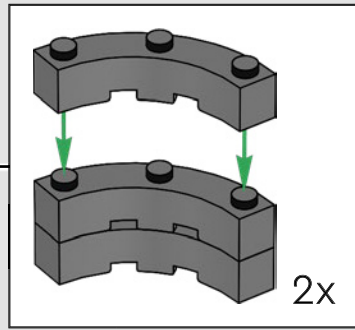

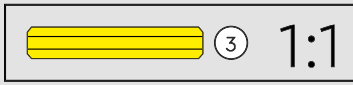
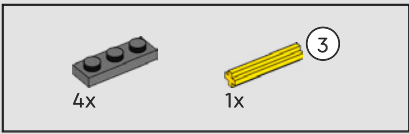

229

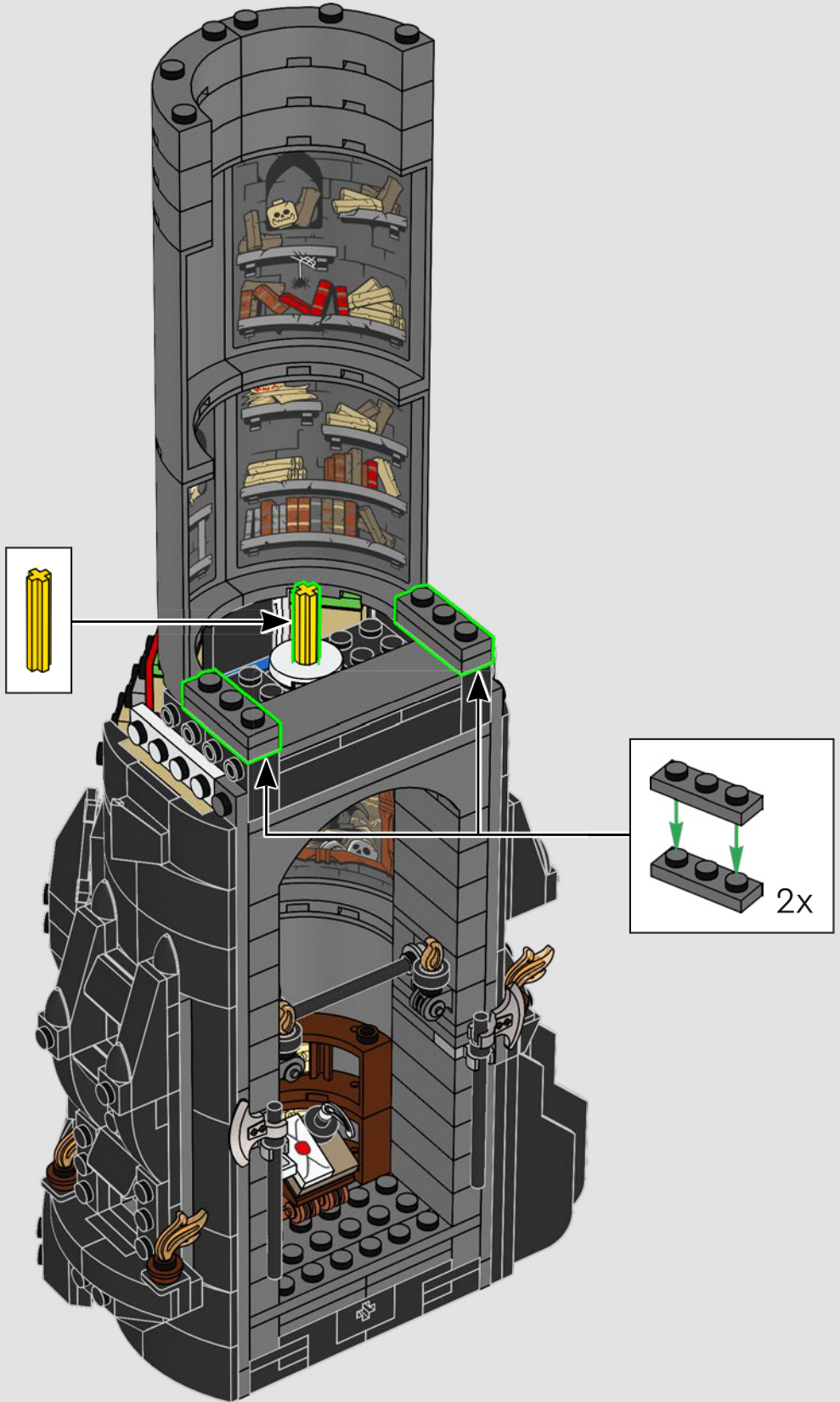

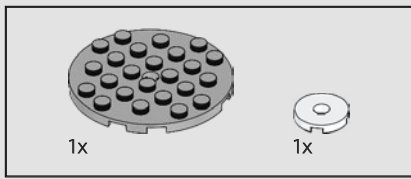

230

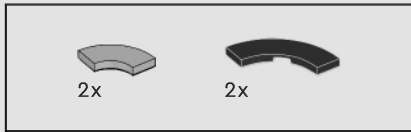
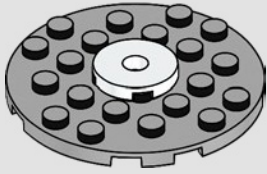

231

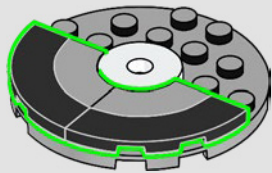

232

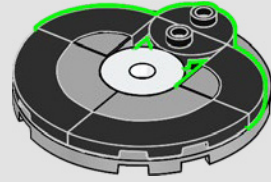

233

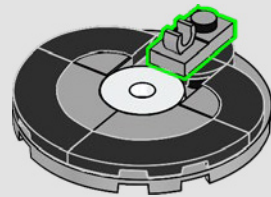

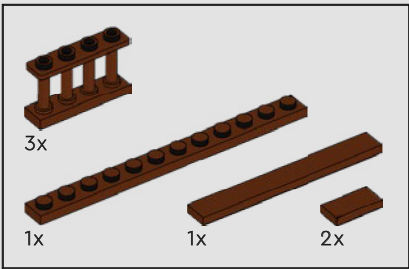

234

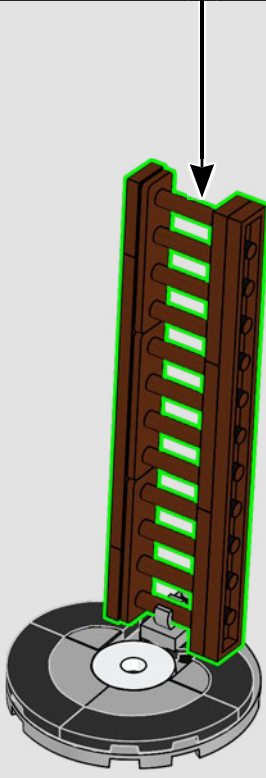
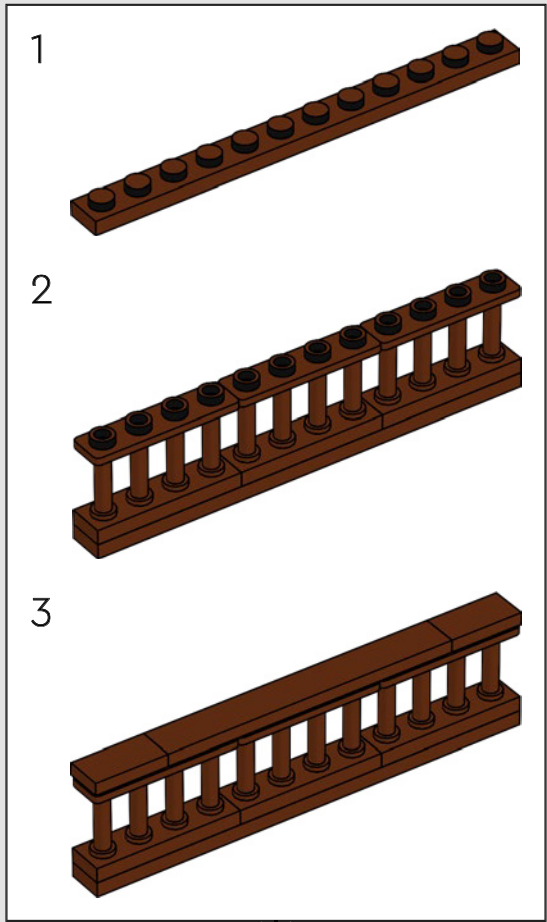

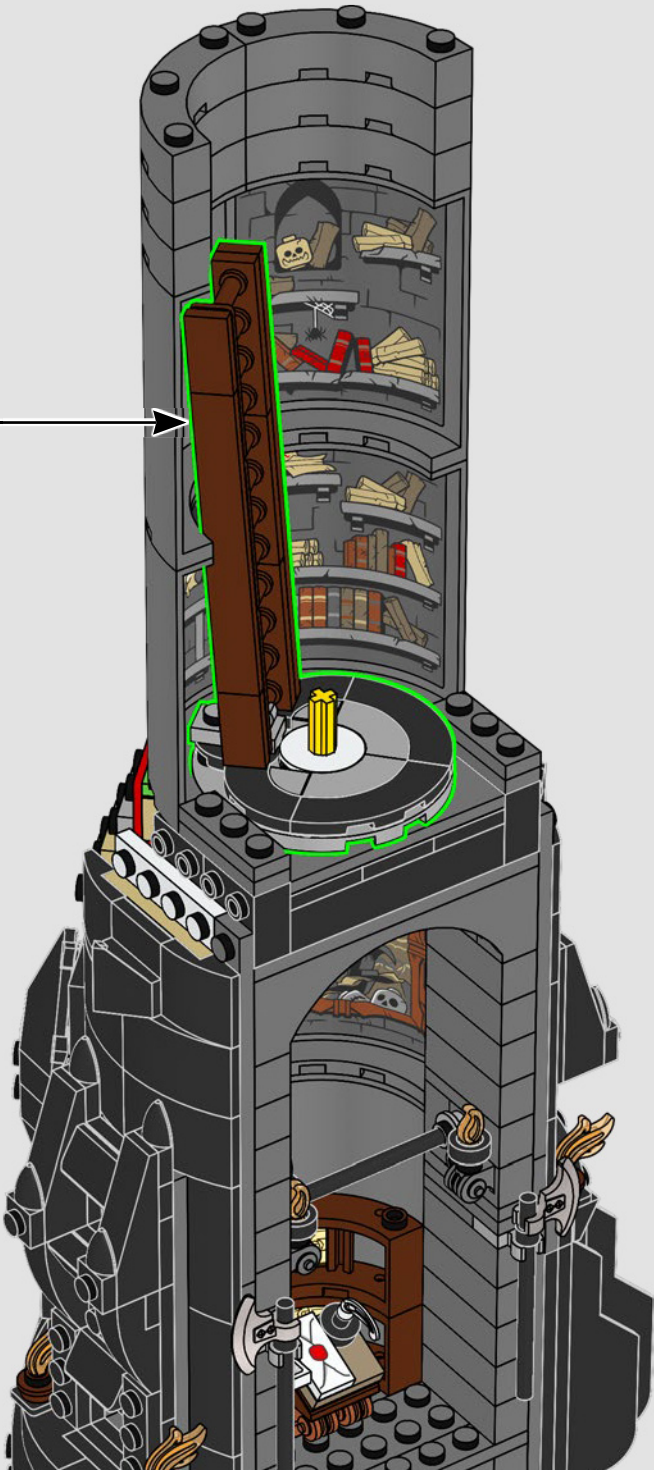

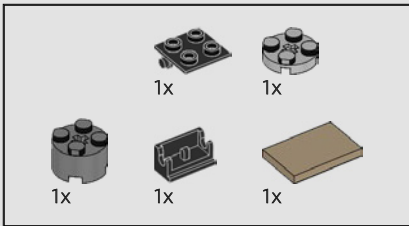

236

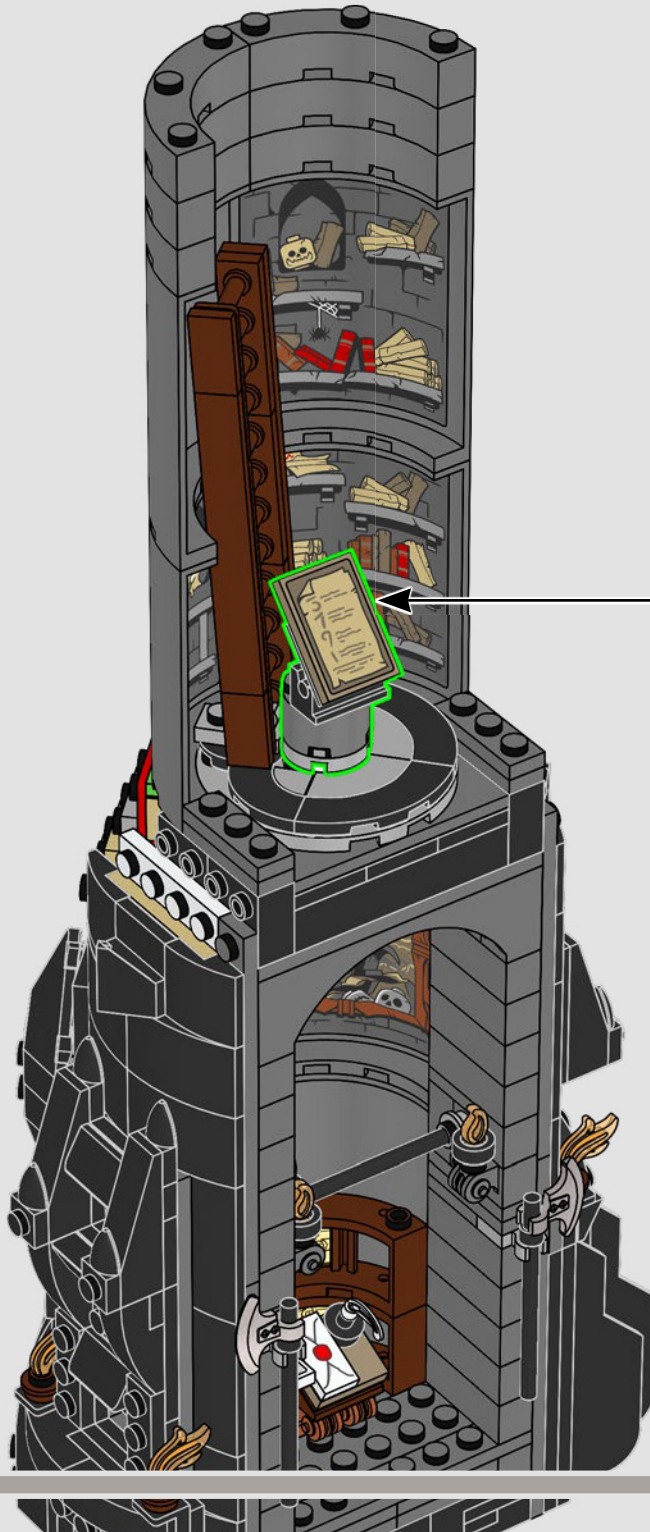
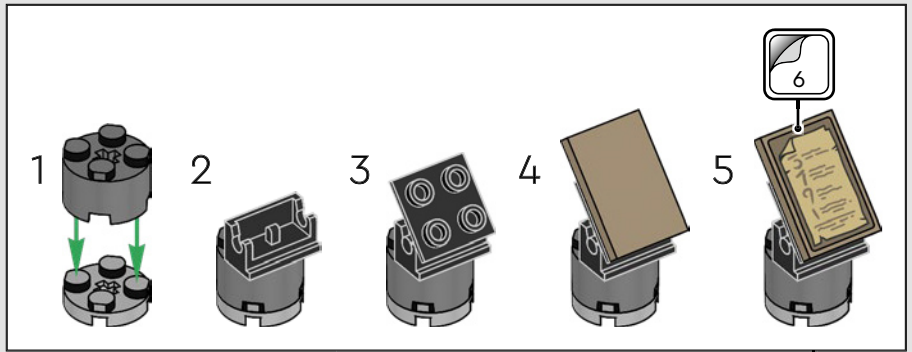



237

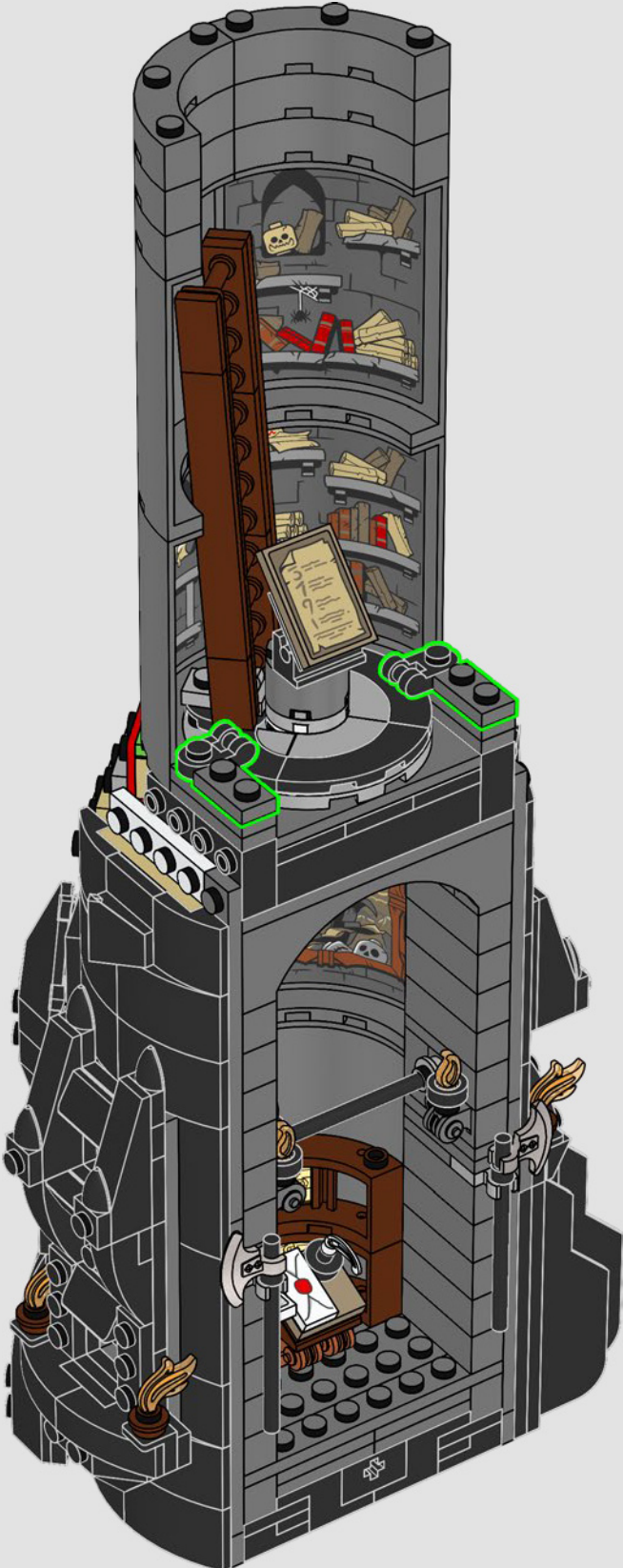

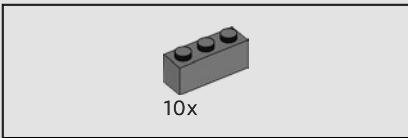

238

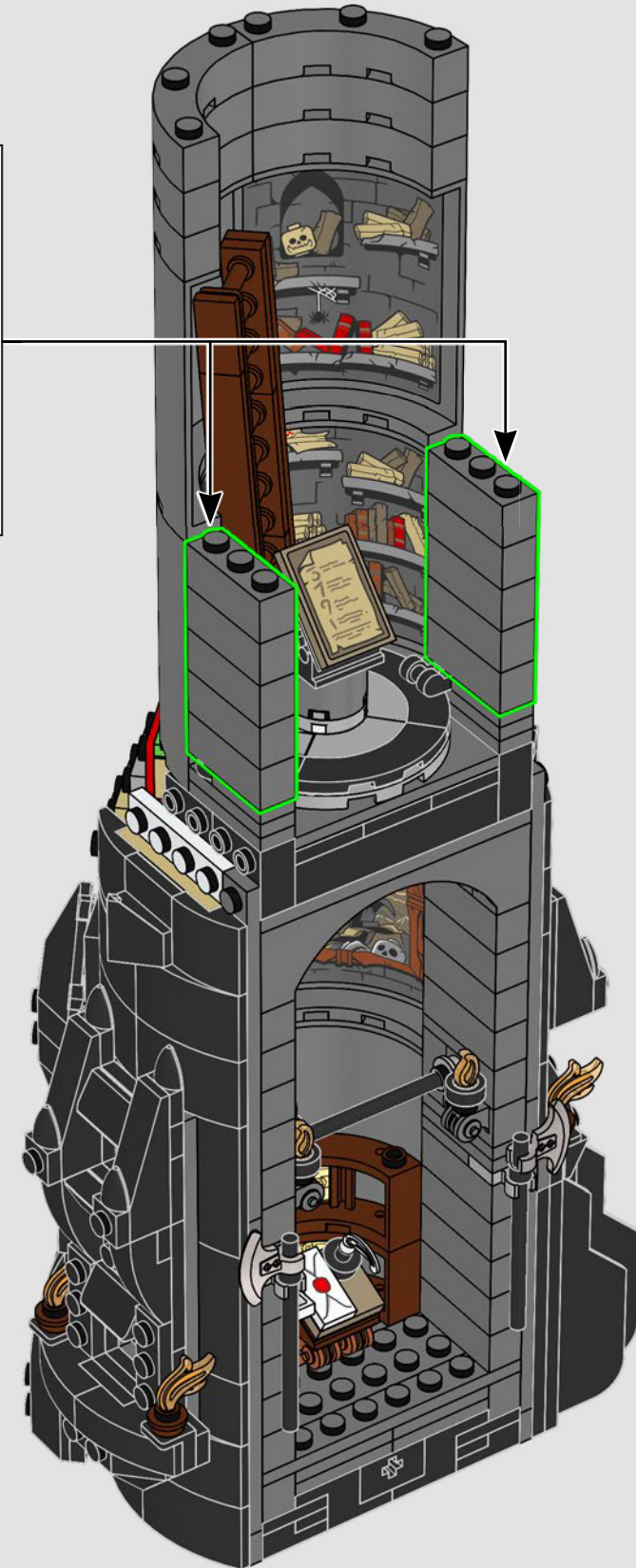
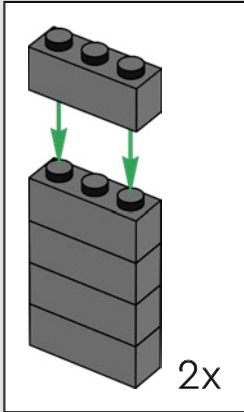

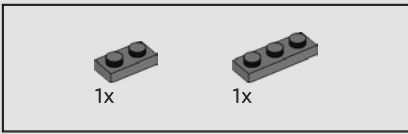

239

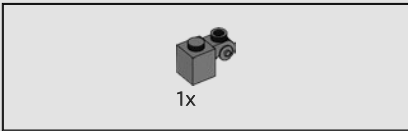
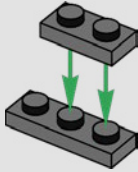

240

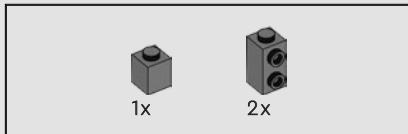
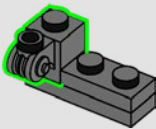

241

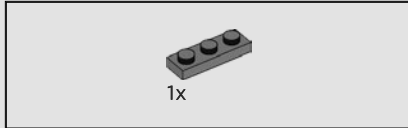
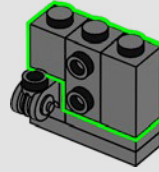

242

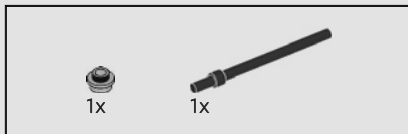
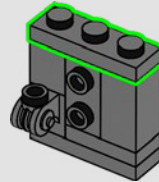

243

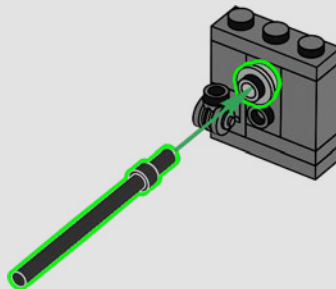

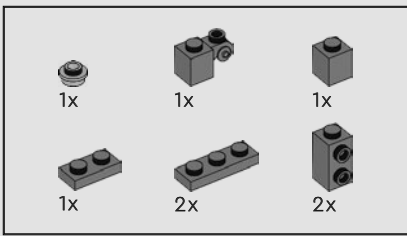

244

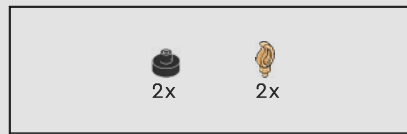
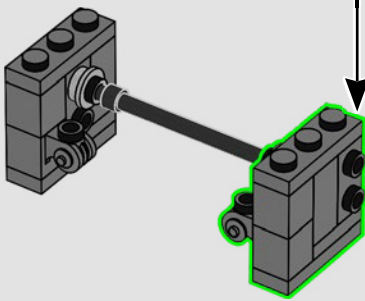
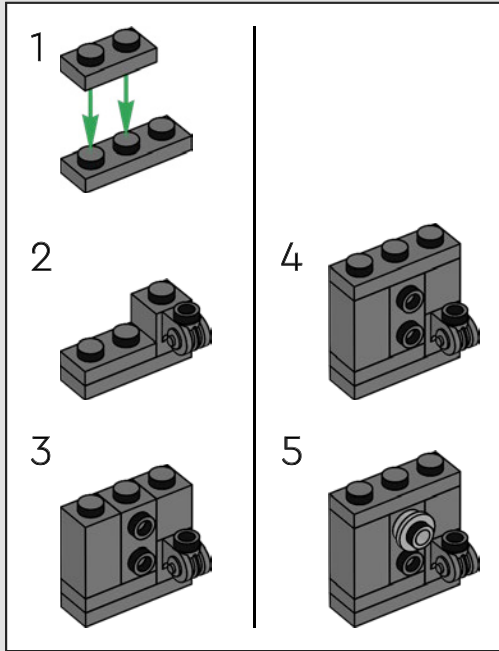

245

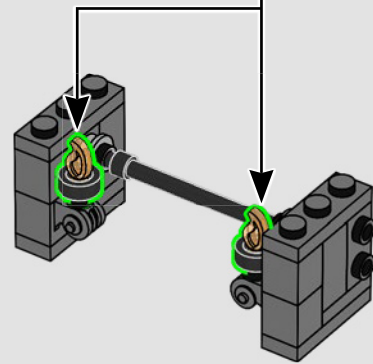
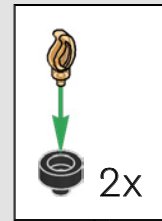

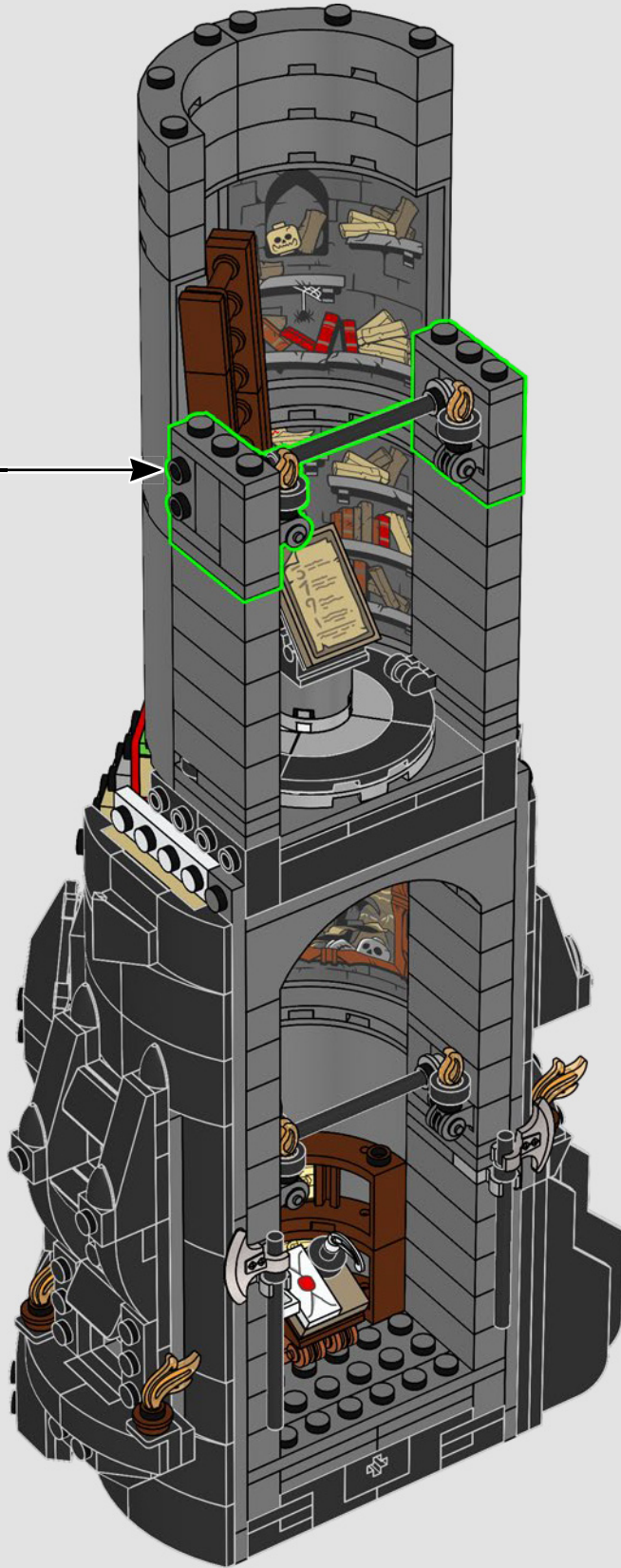

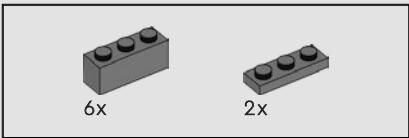

247

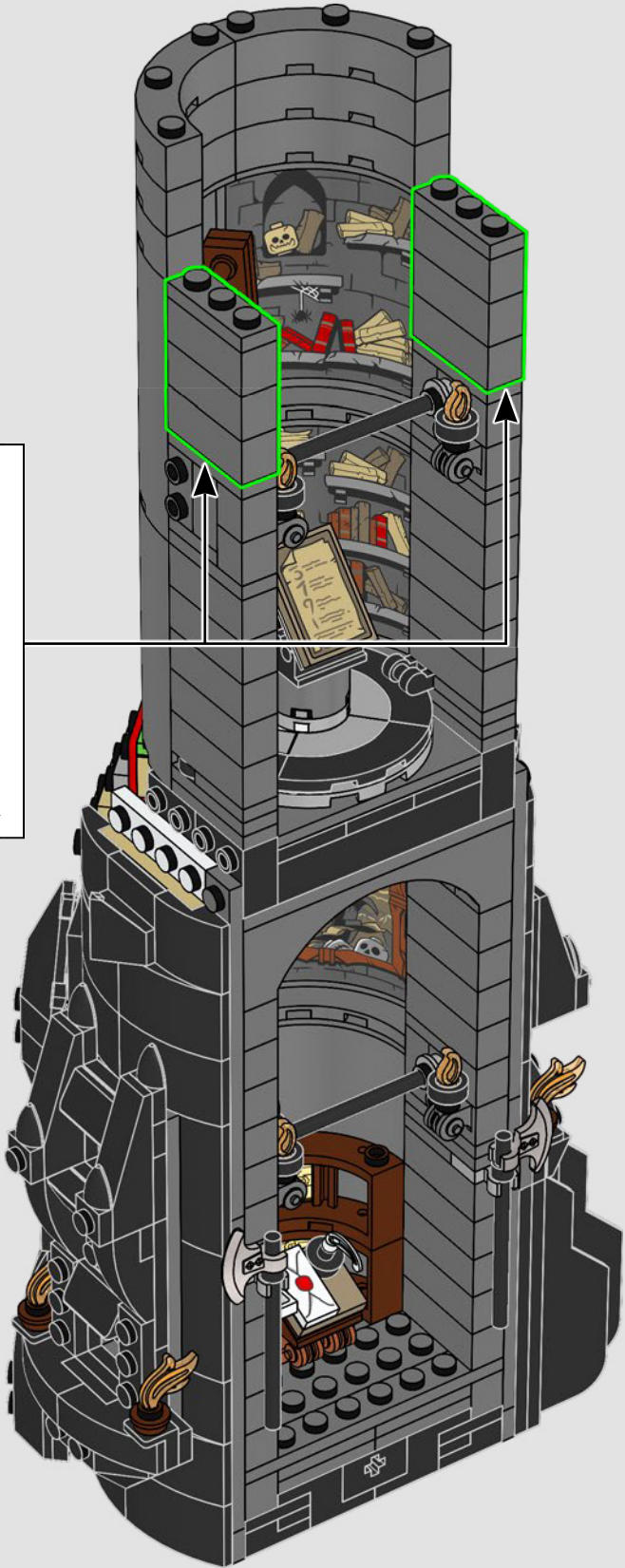
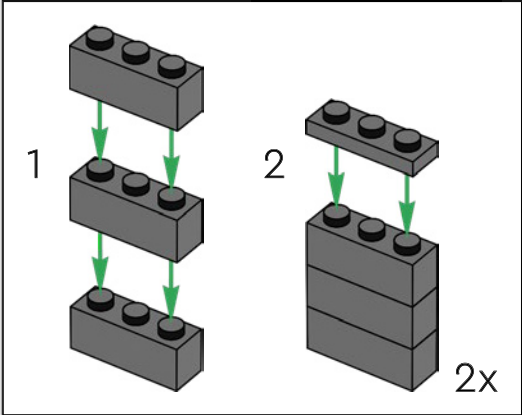

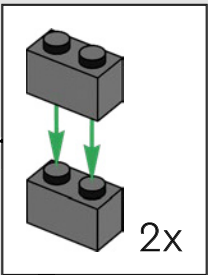
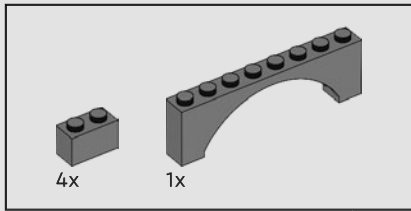

248



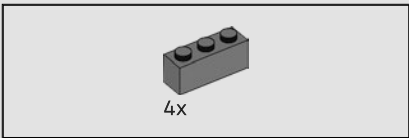

249



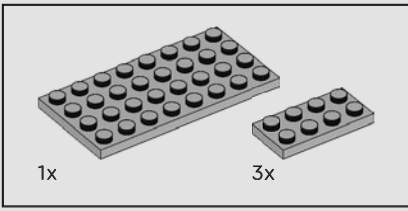

250

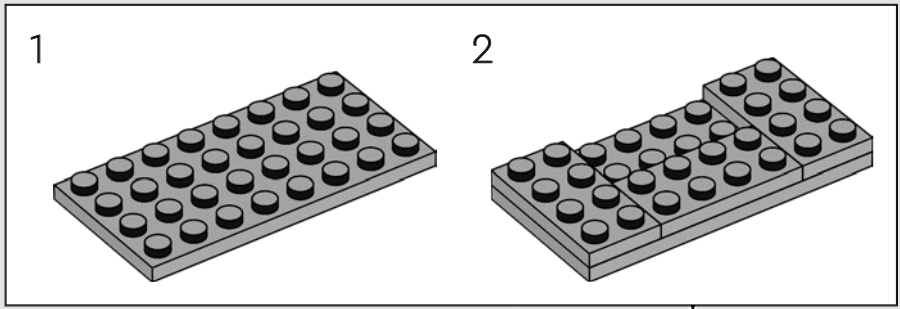



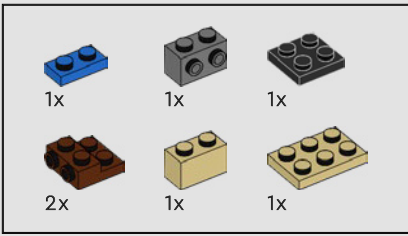

251

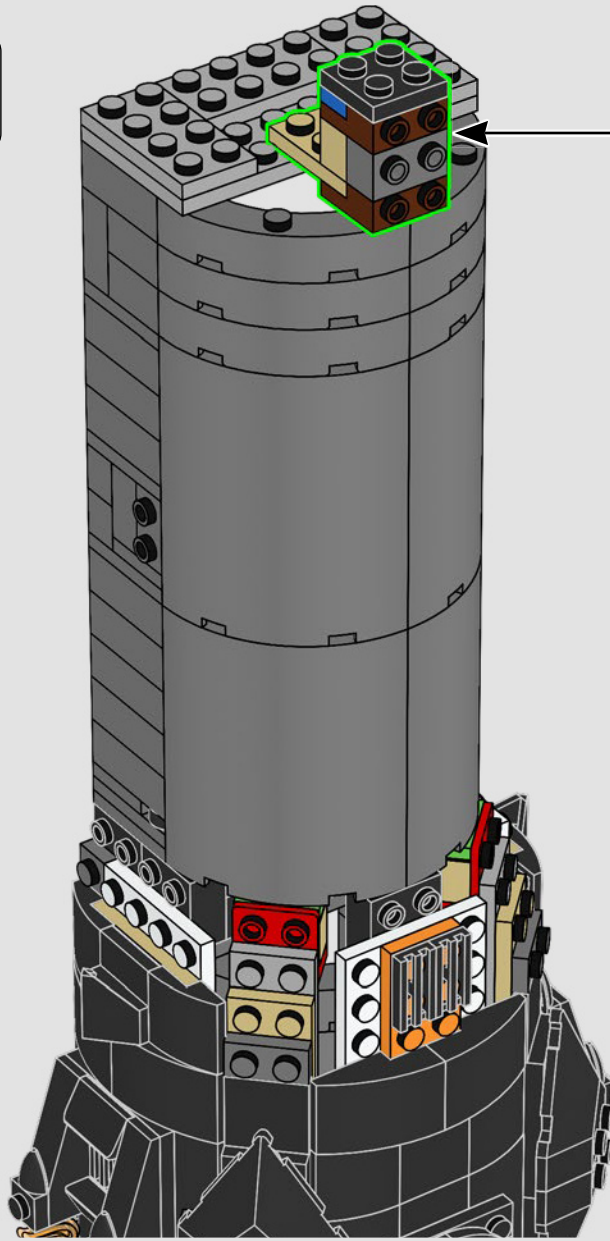
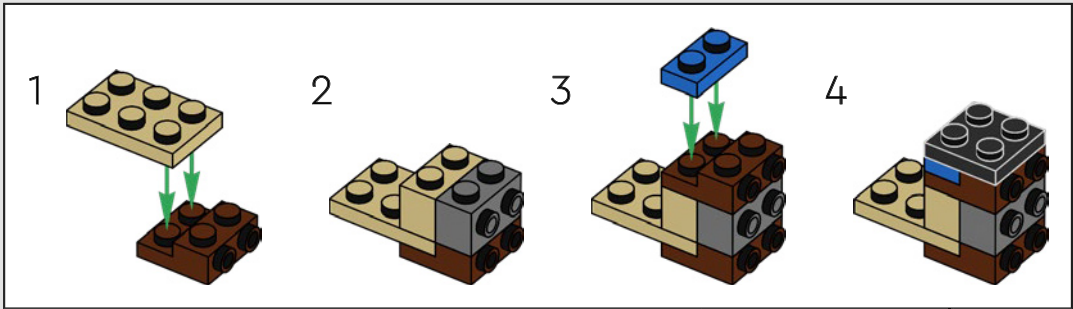

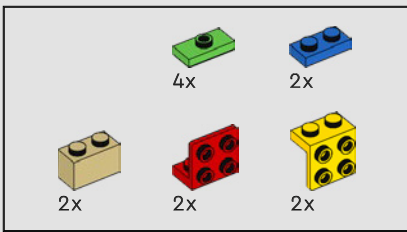

252

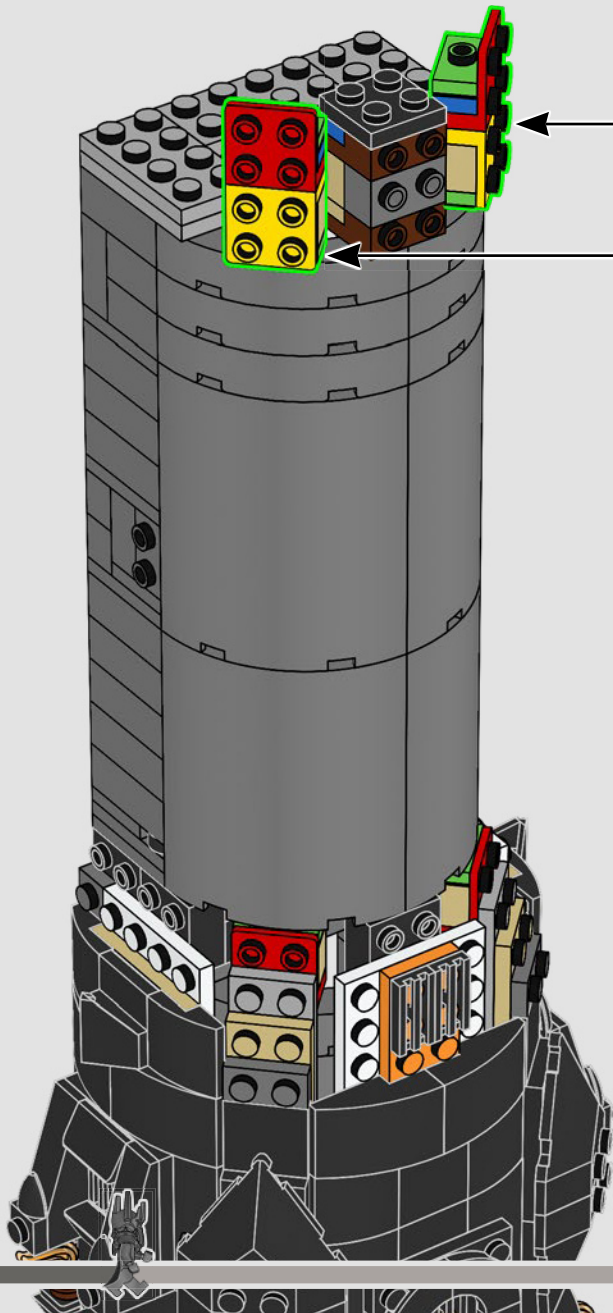
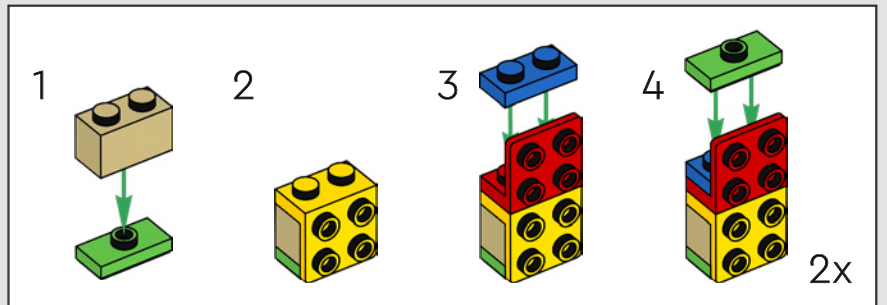

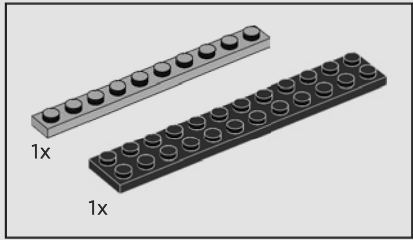
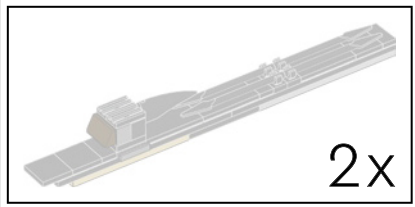

253

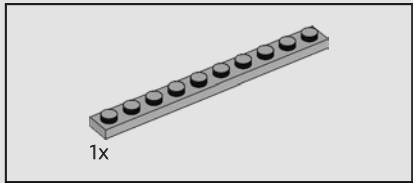
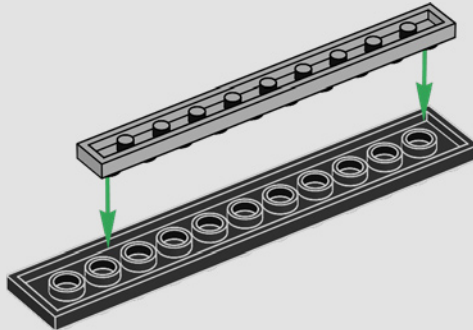

254

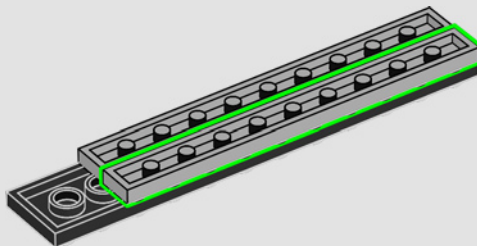

255

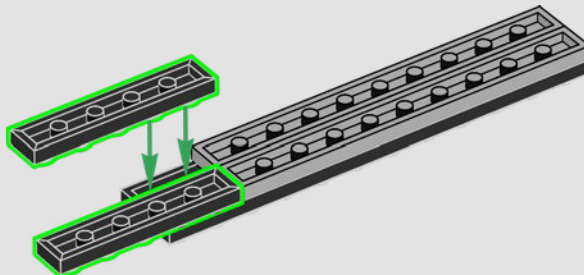

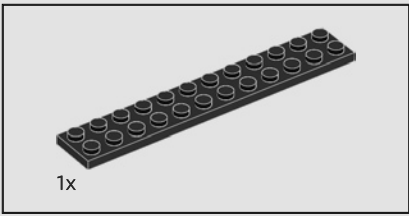

256

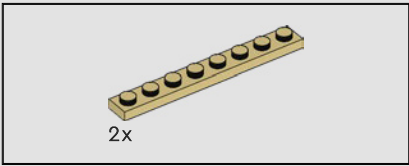
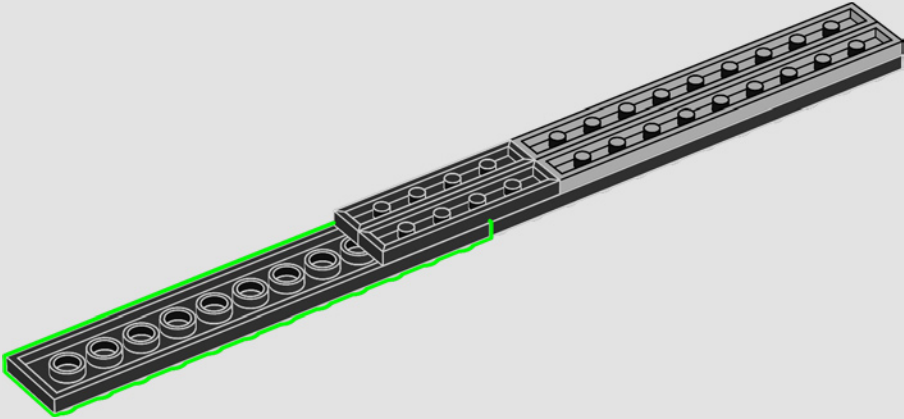

257

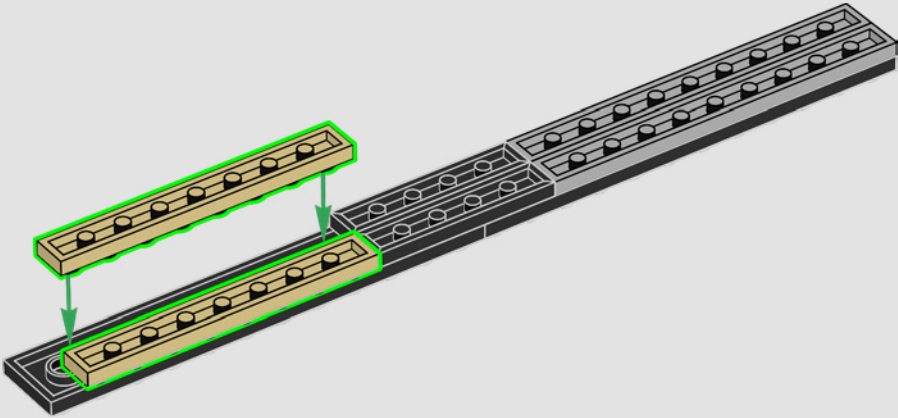

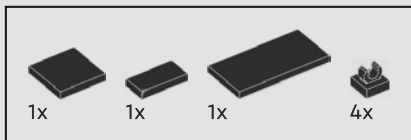

258

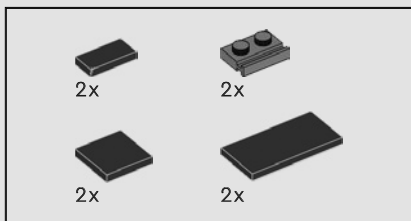
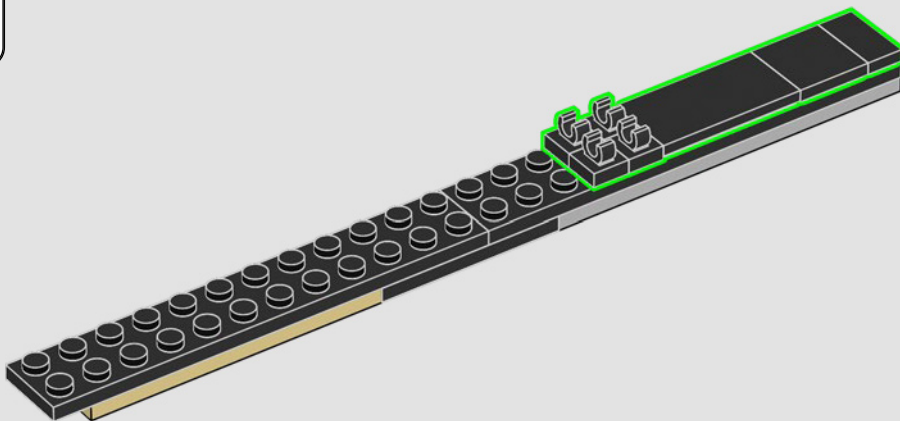

259

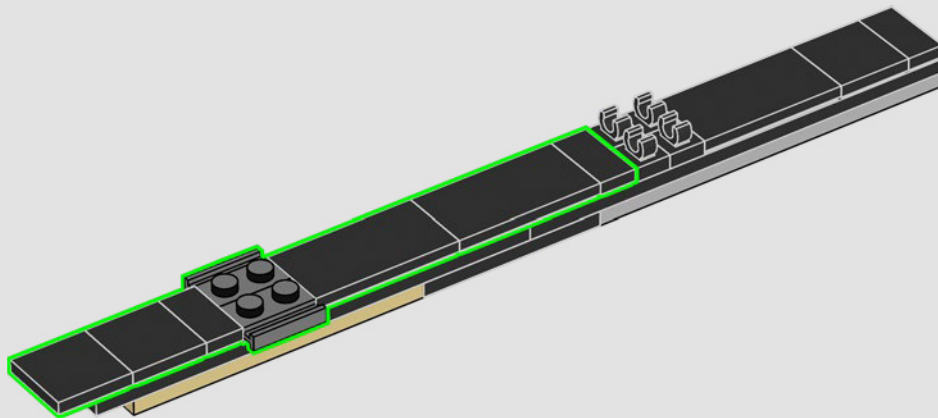

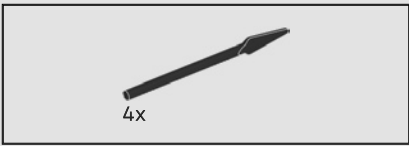

260

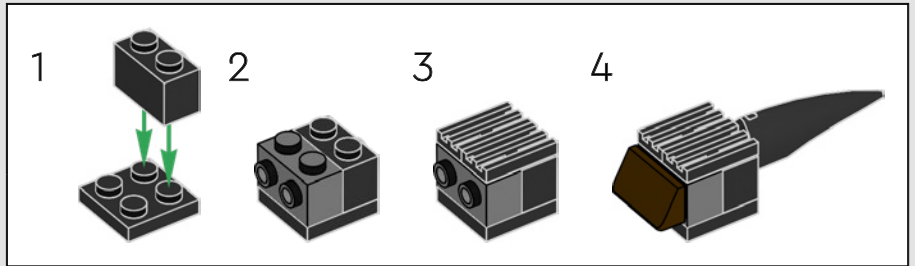
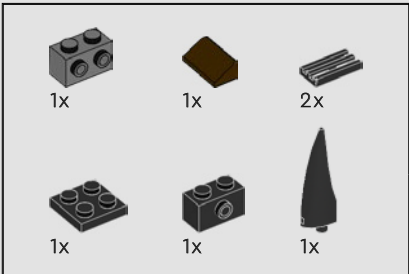
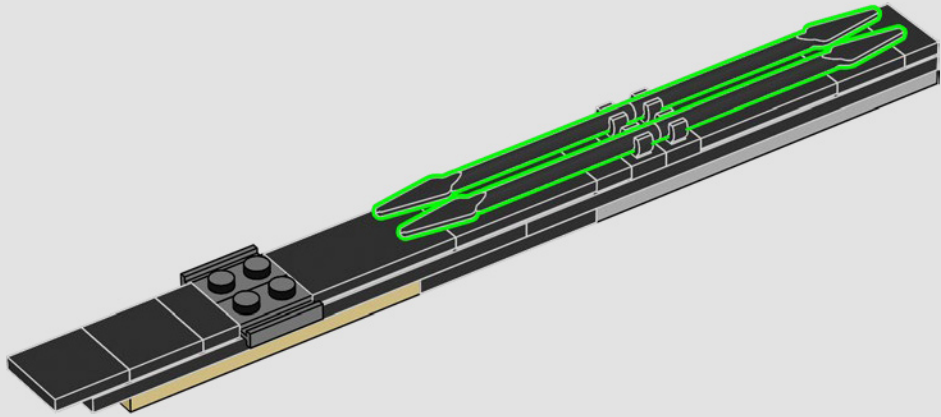

261

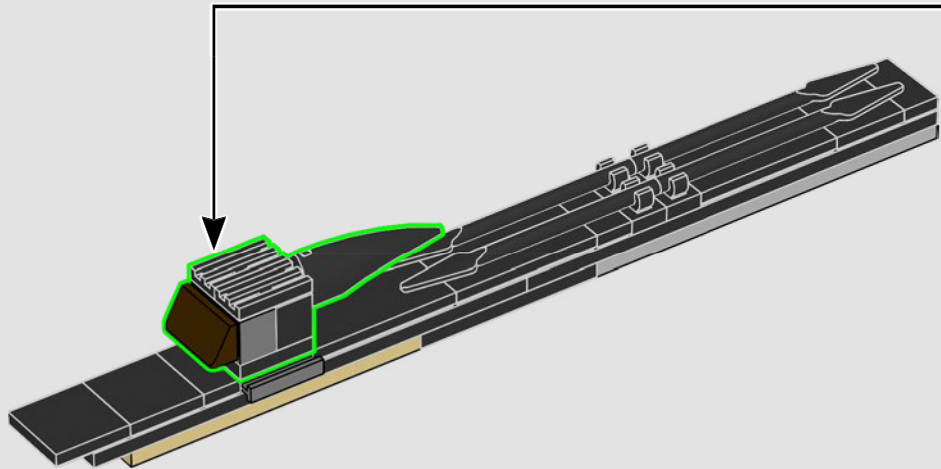

2x





Für dieses Set wurde der Speer schwarz umgefärbt.

262

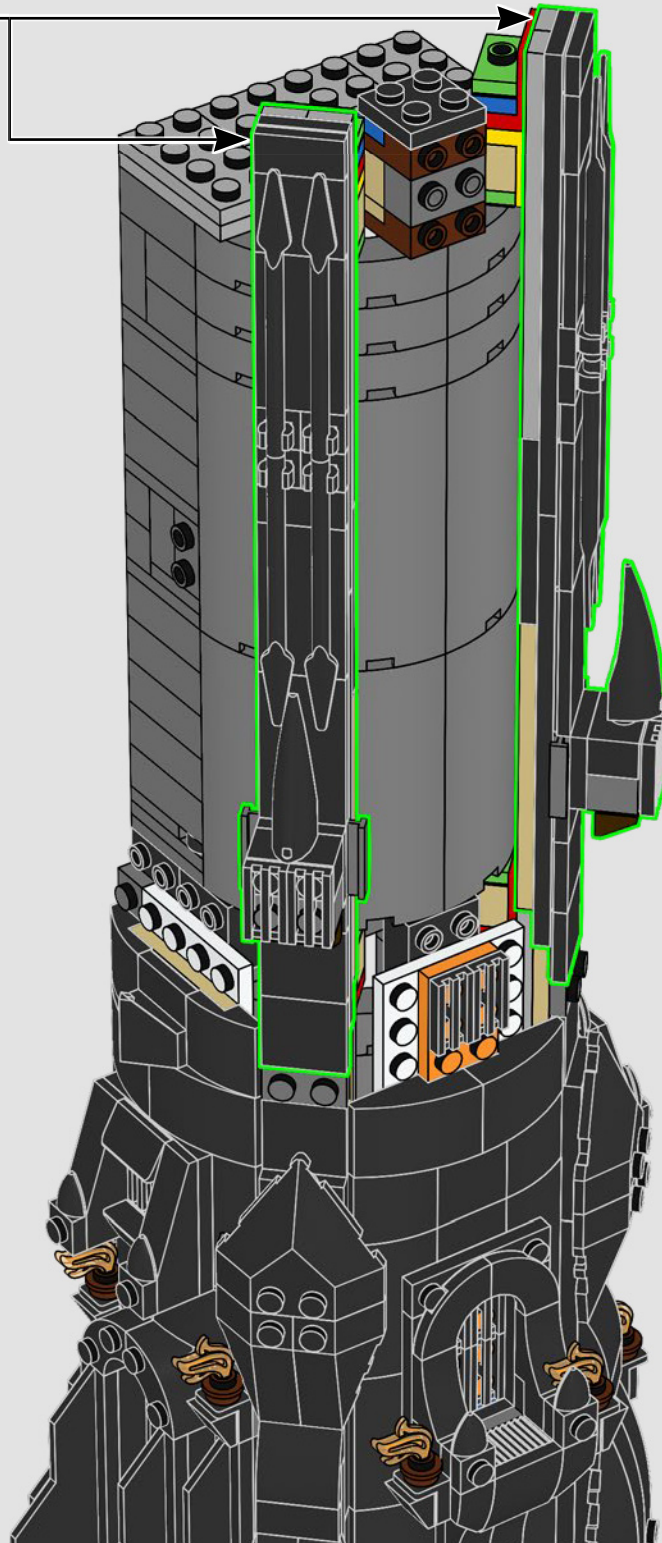



263

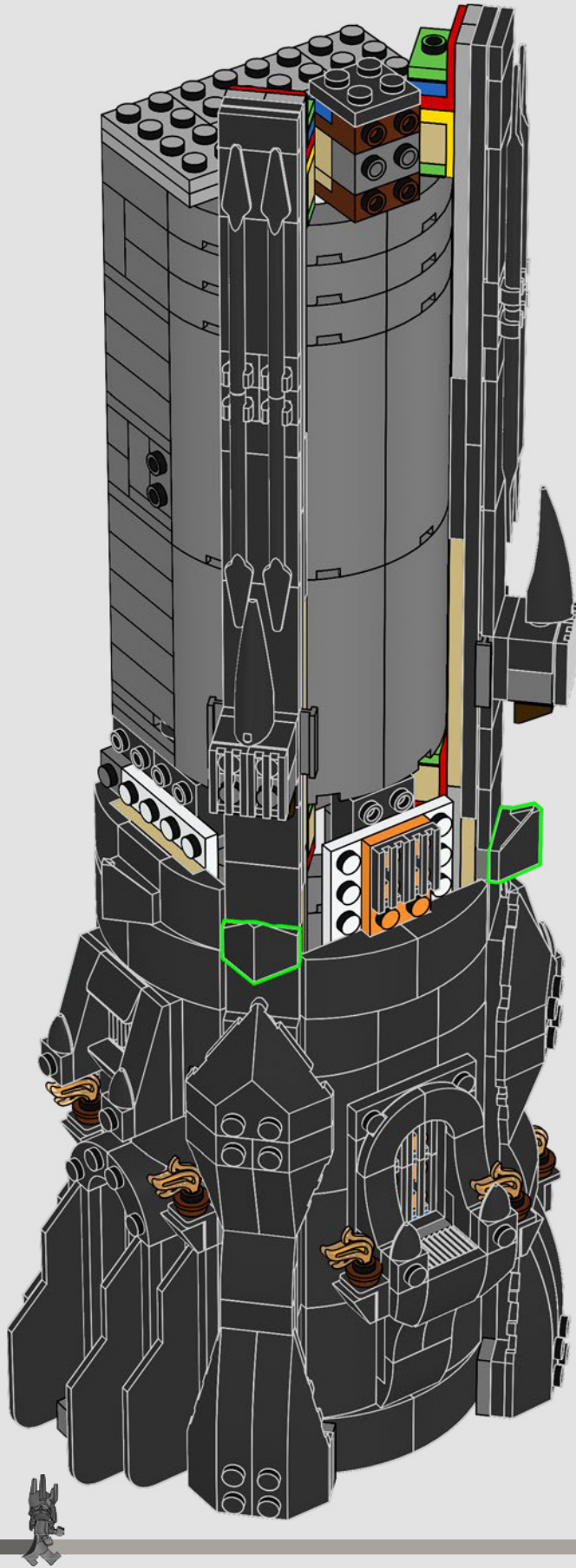

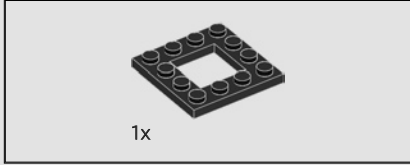
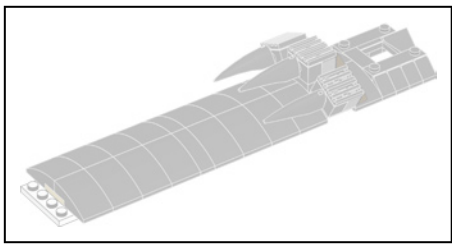

264

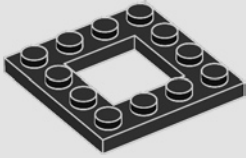

265

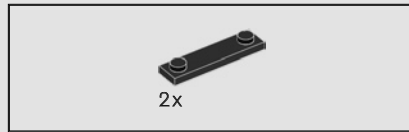
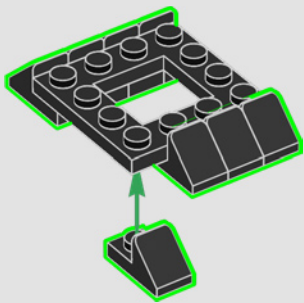

266

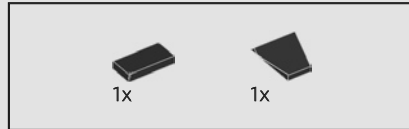
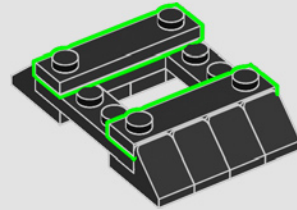

267

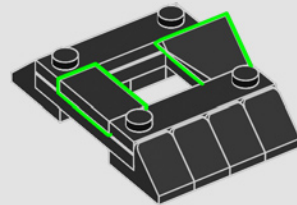

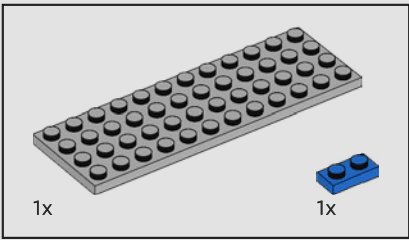

268

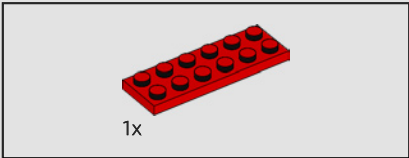
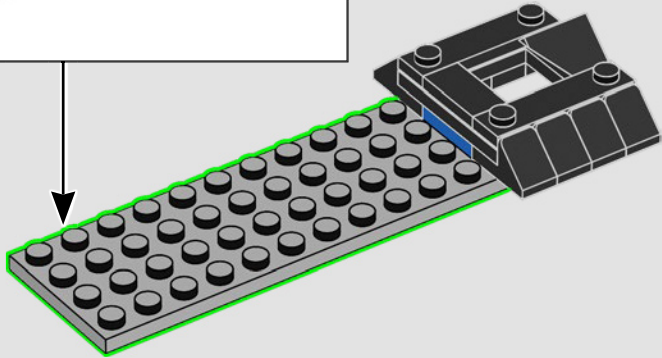
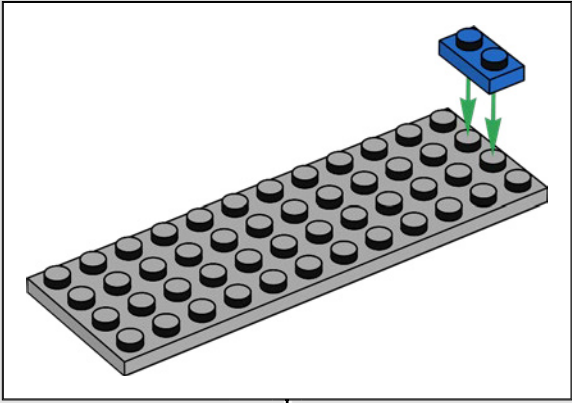

269

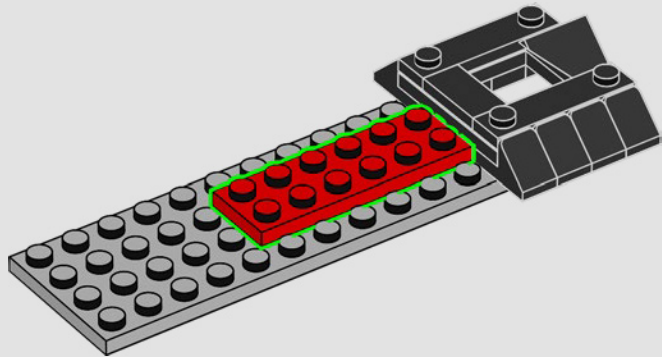

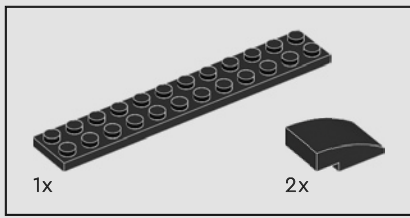

270

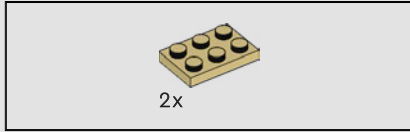
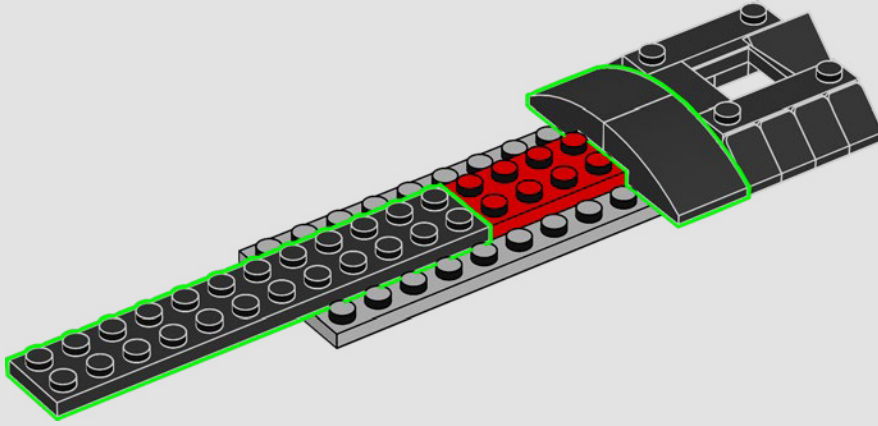

271

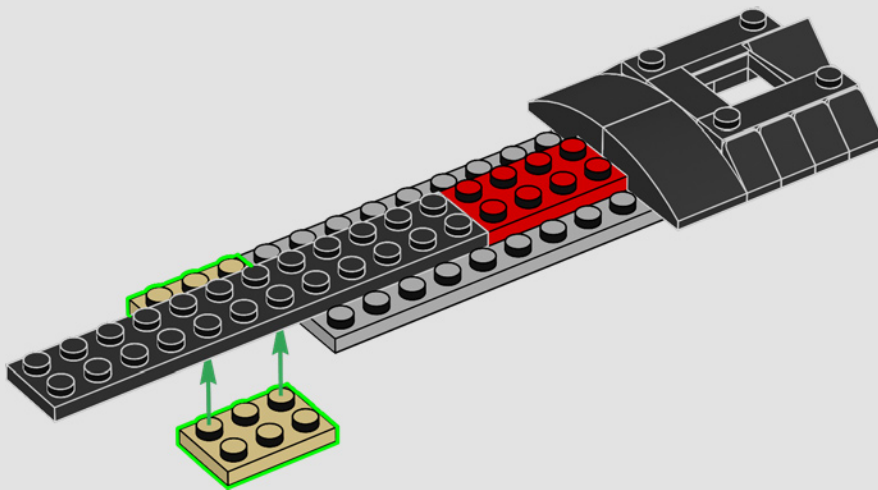

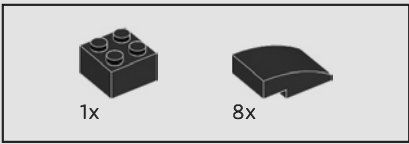

272

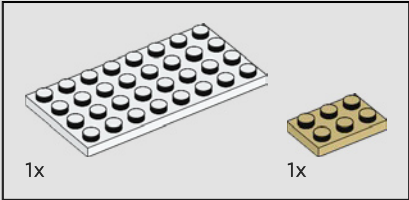
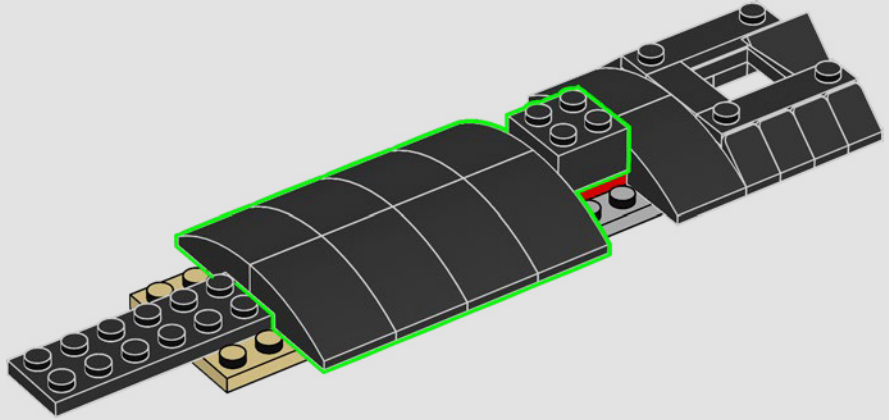

273

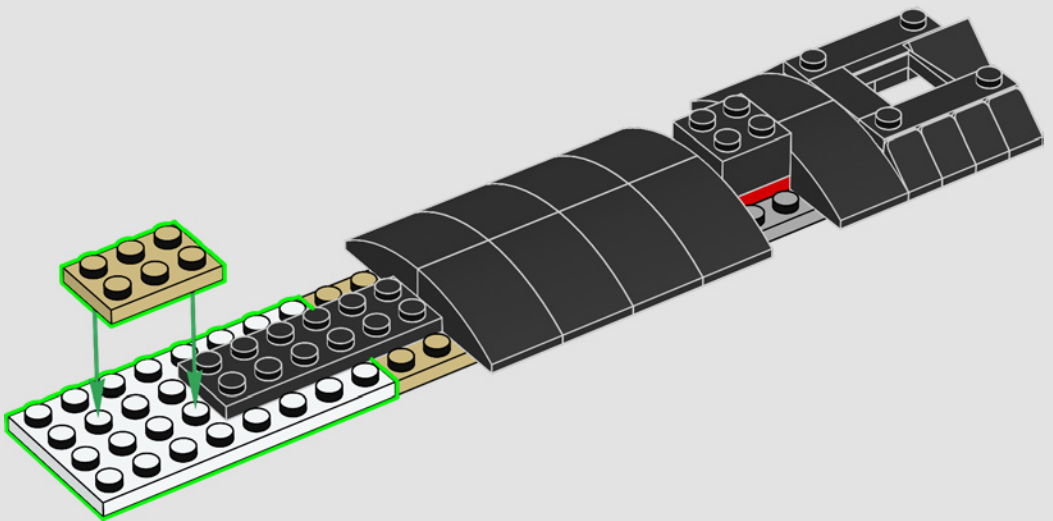

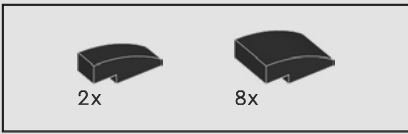

274

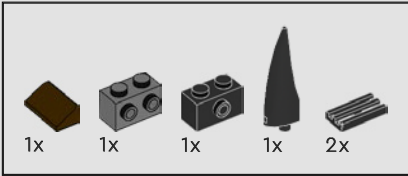
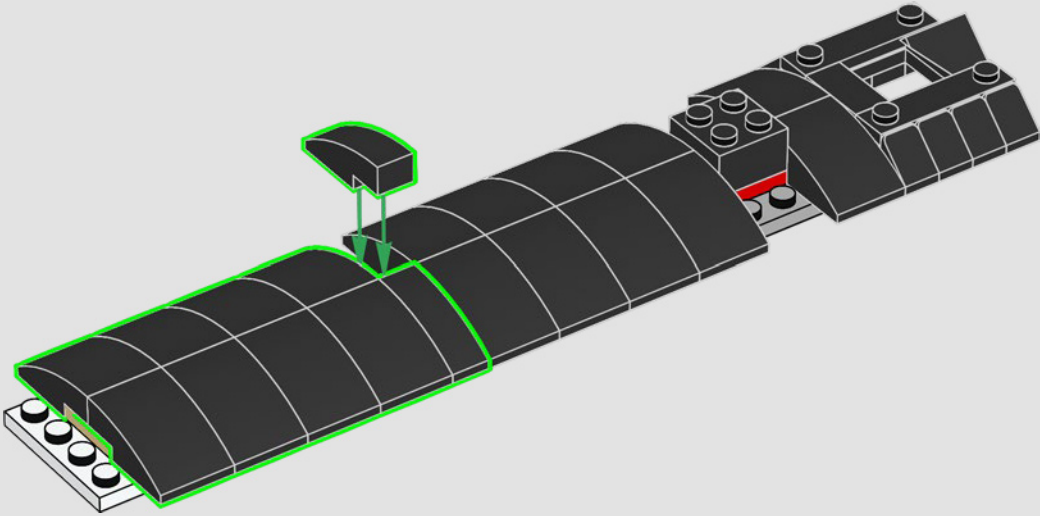

275

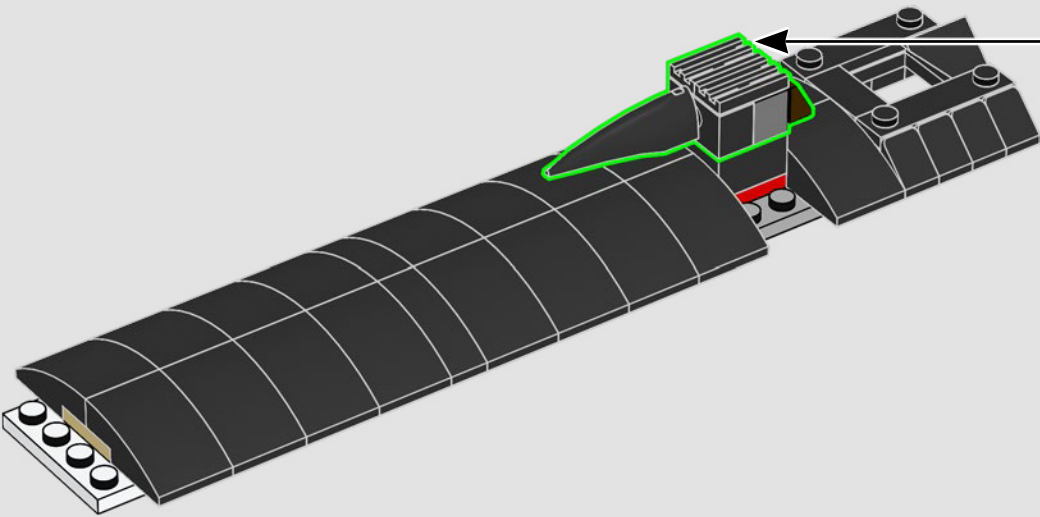
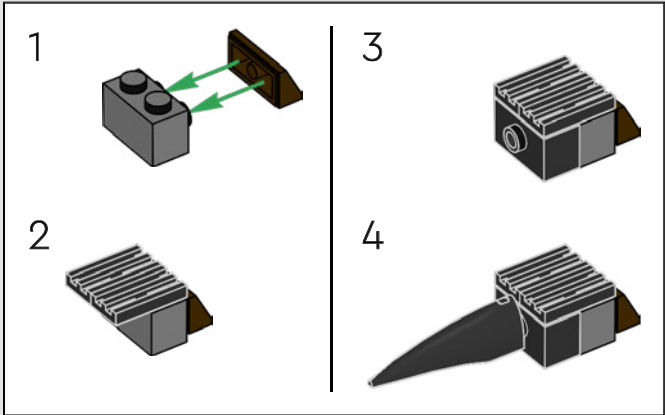

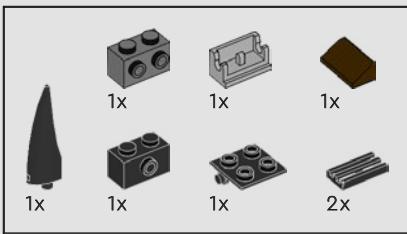

276

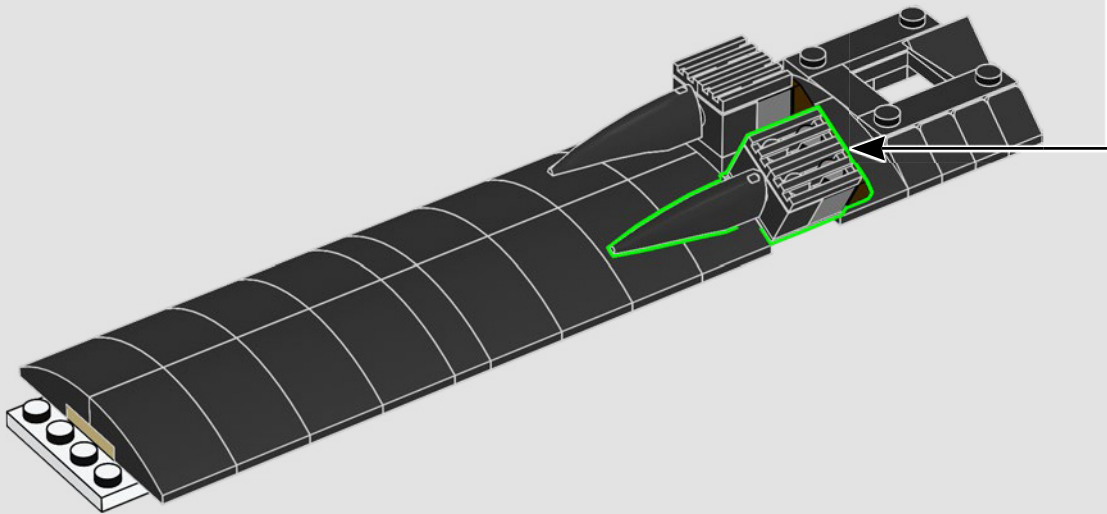
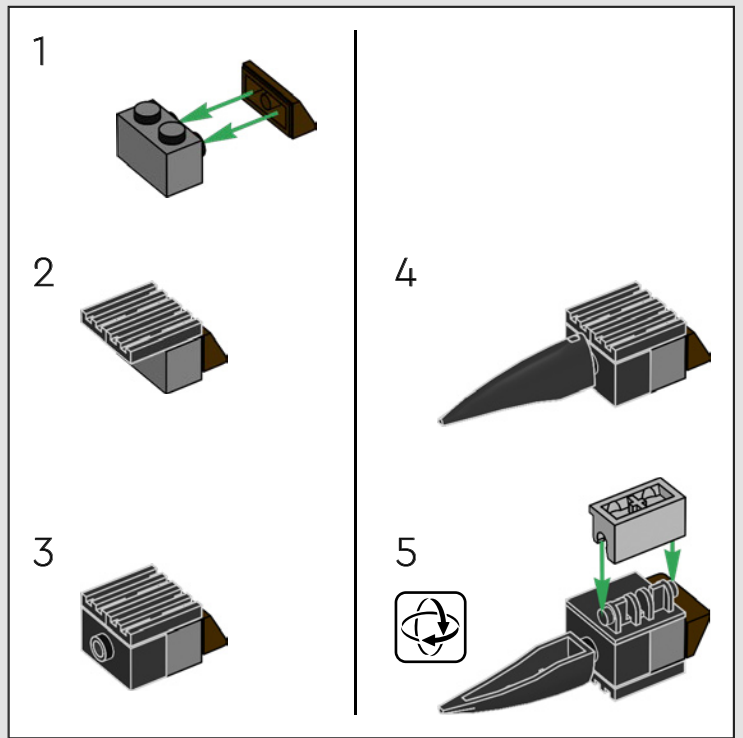

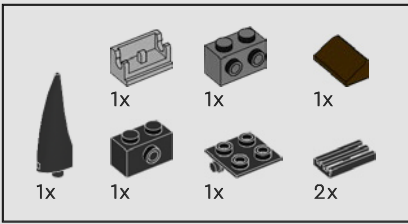

277

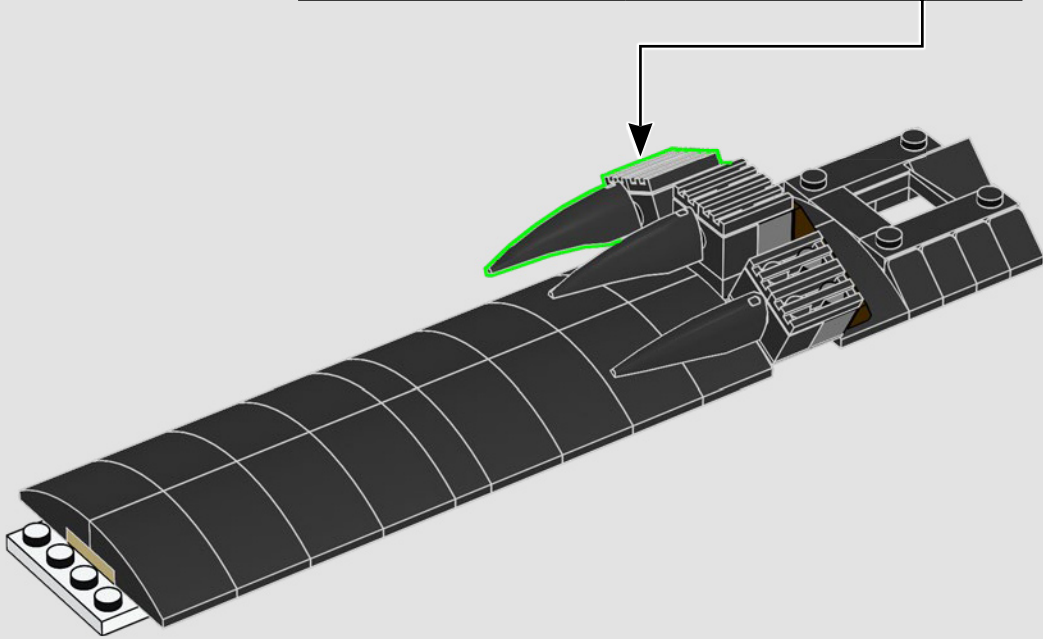
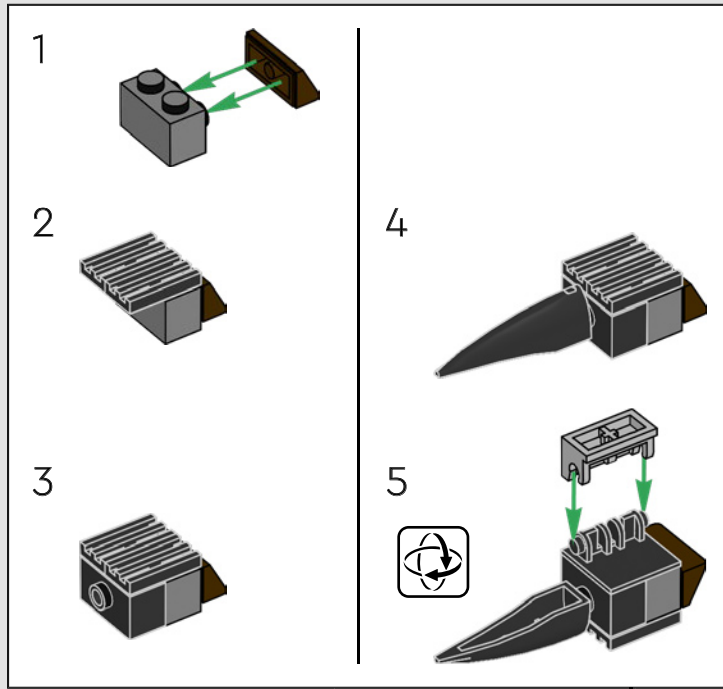

278

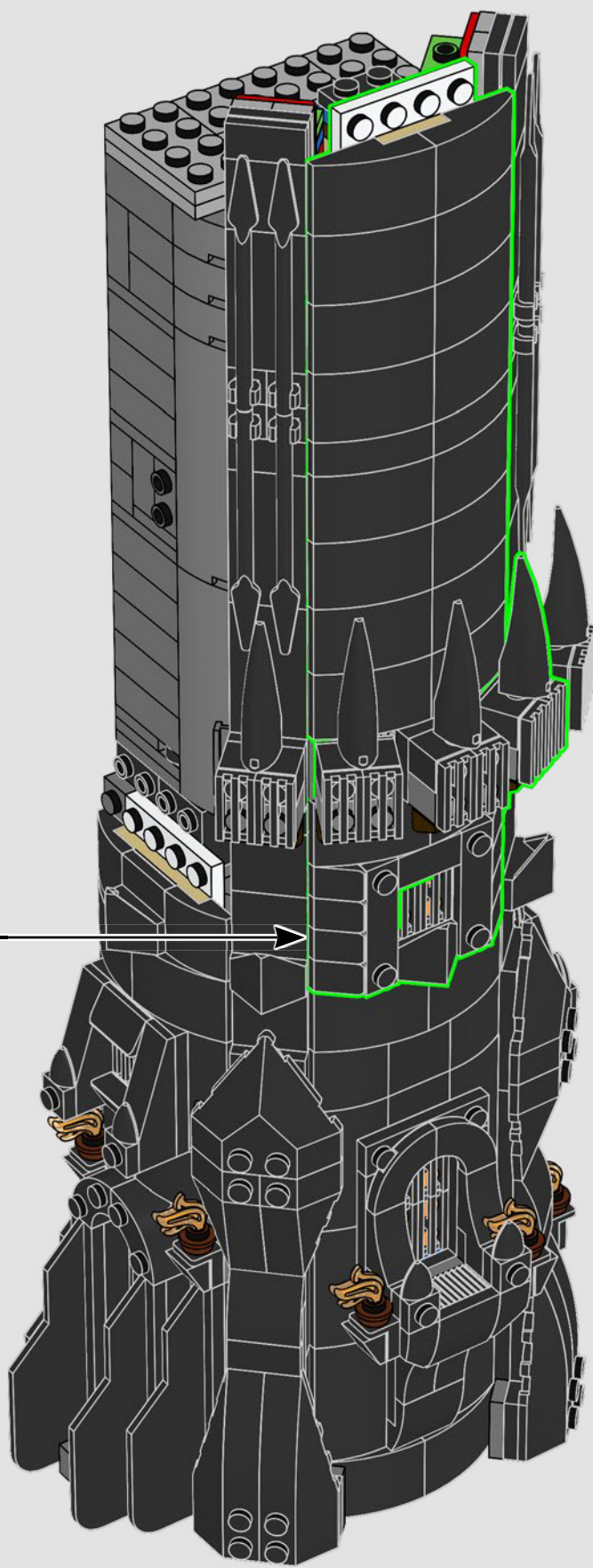

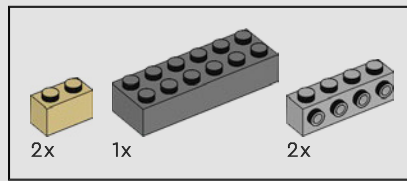

279

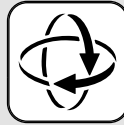

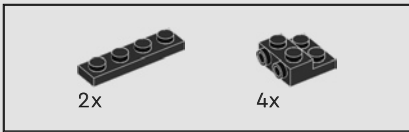

280

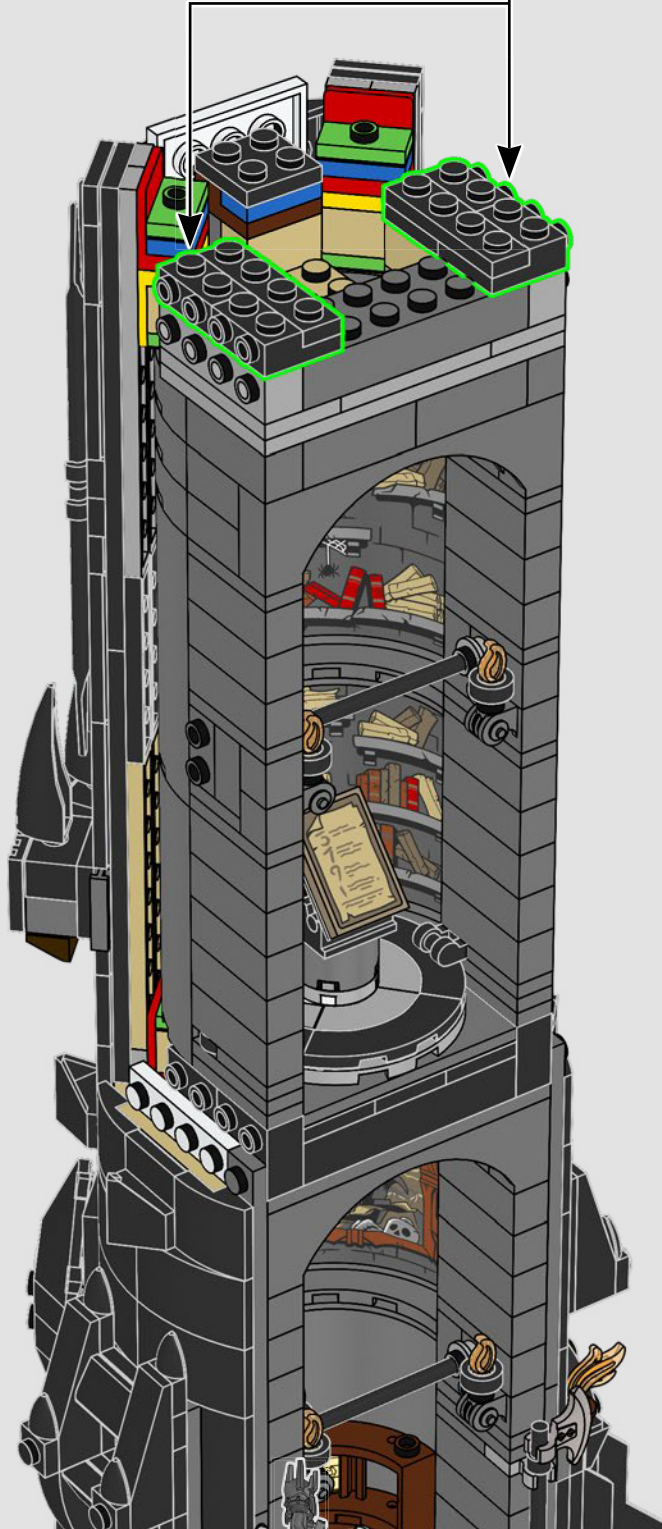
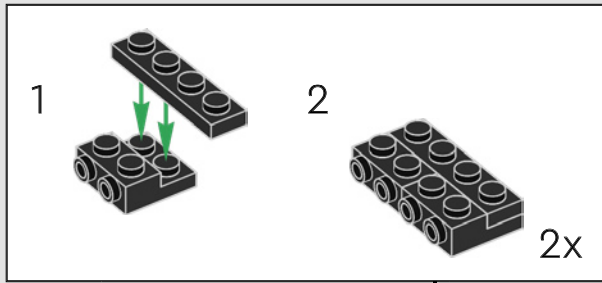

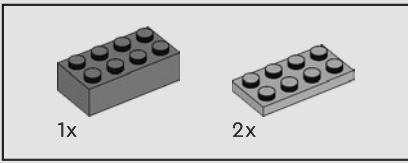

281

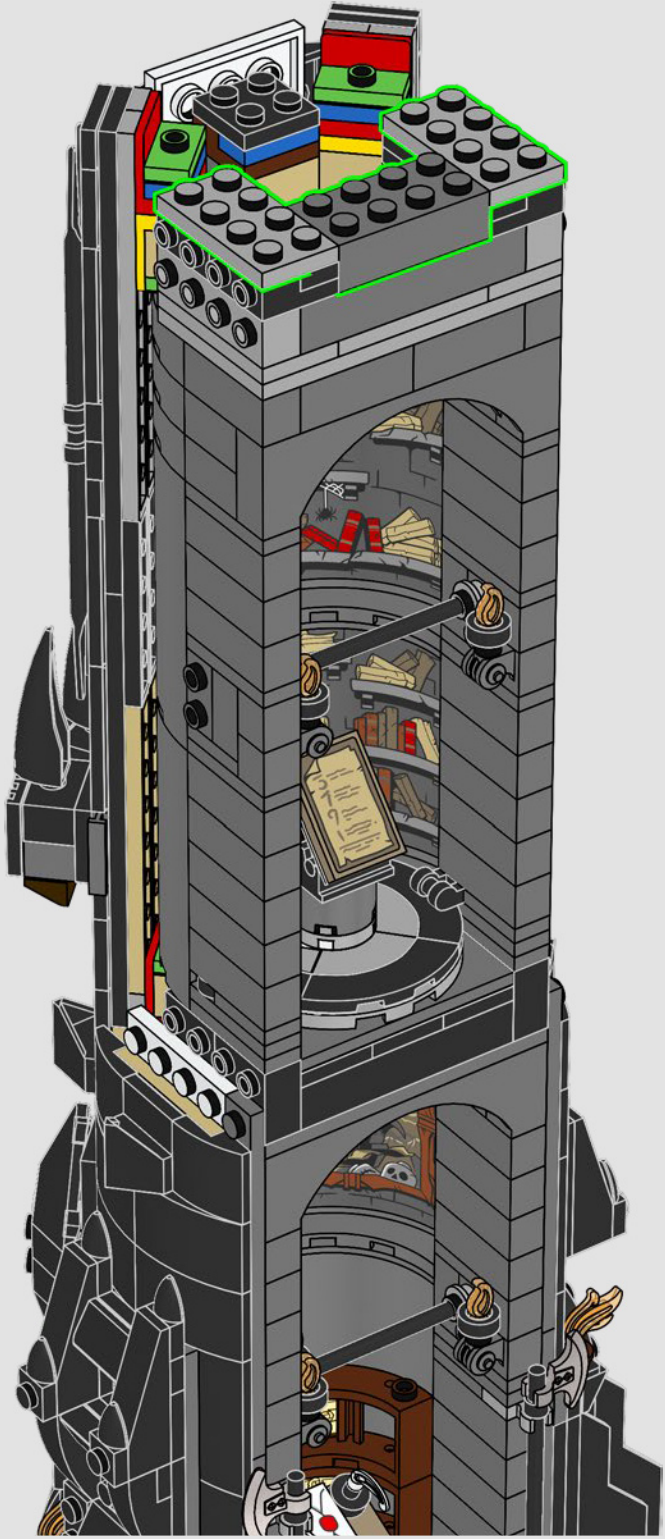

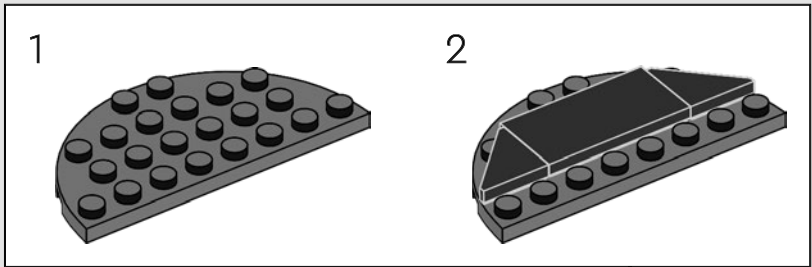
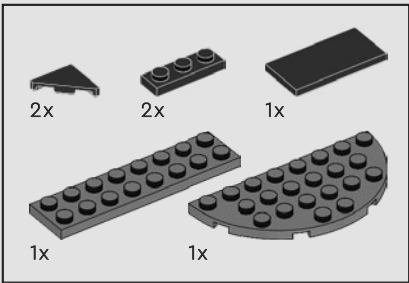

282



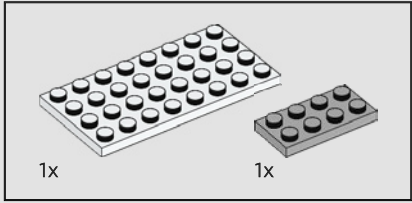
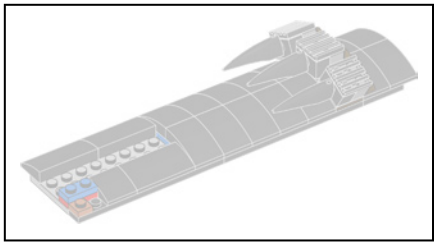

283

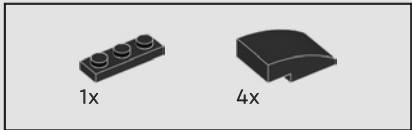
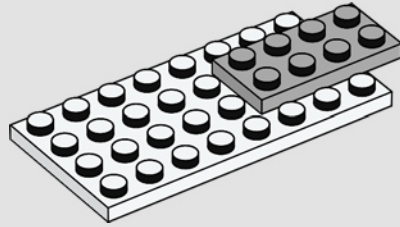

284

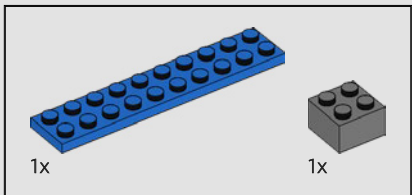
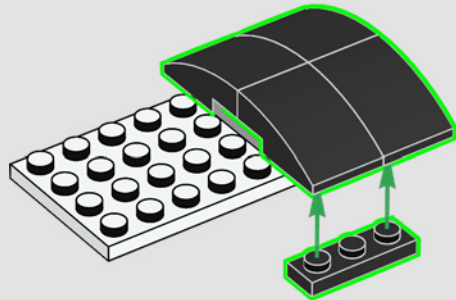

285

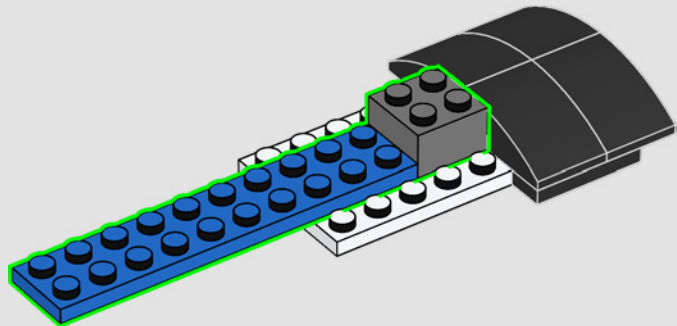



286

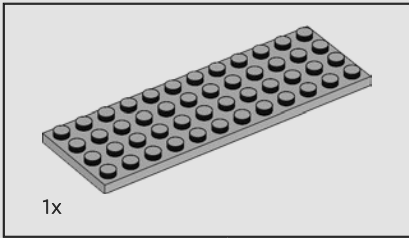
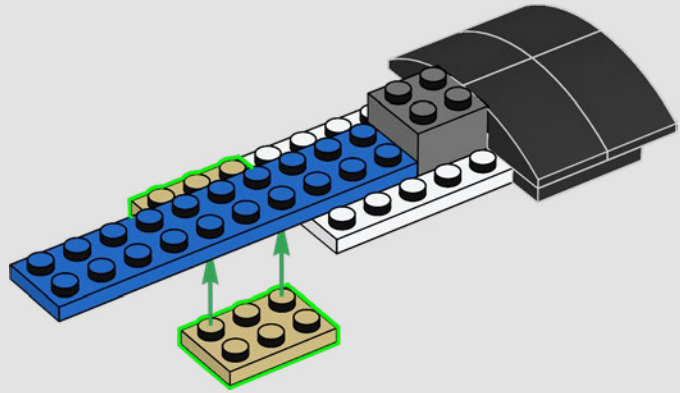

287

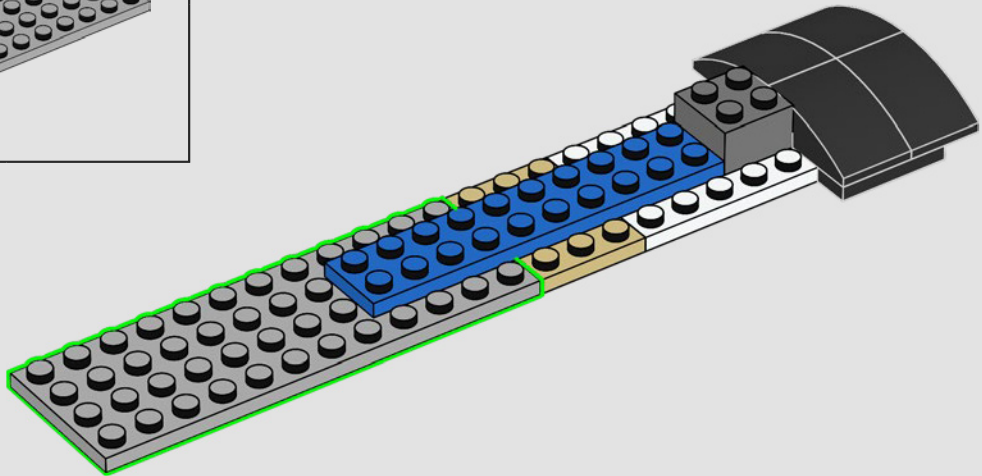

288

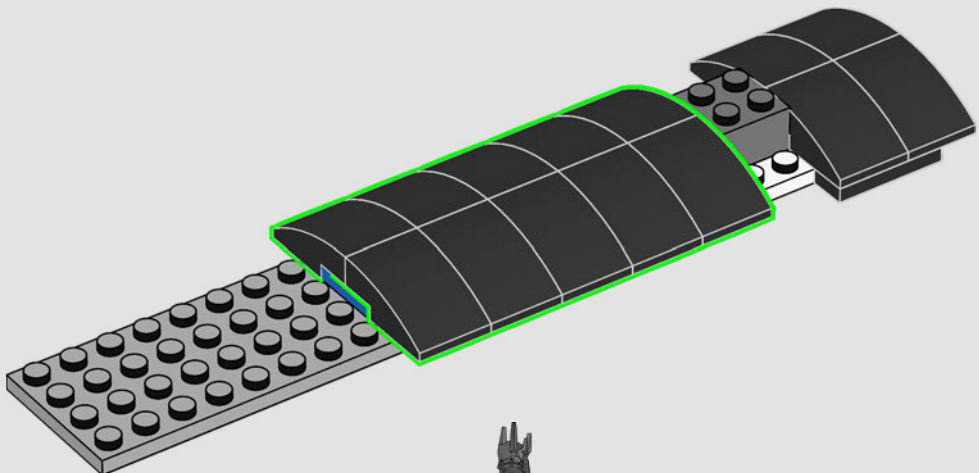

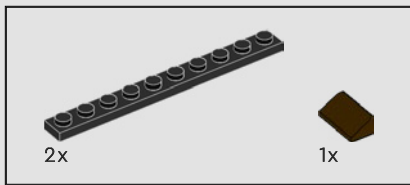

289

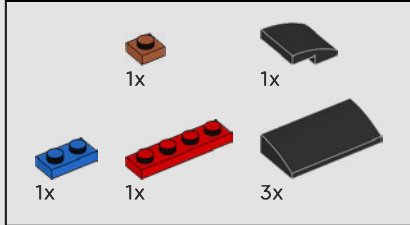
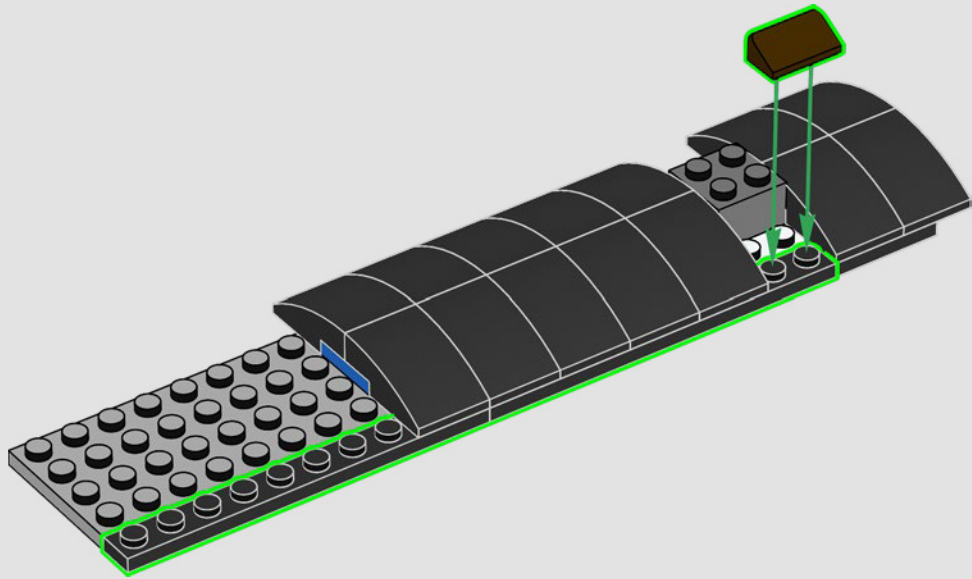

290

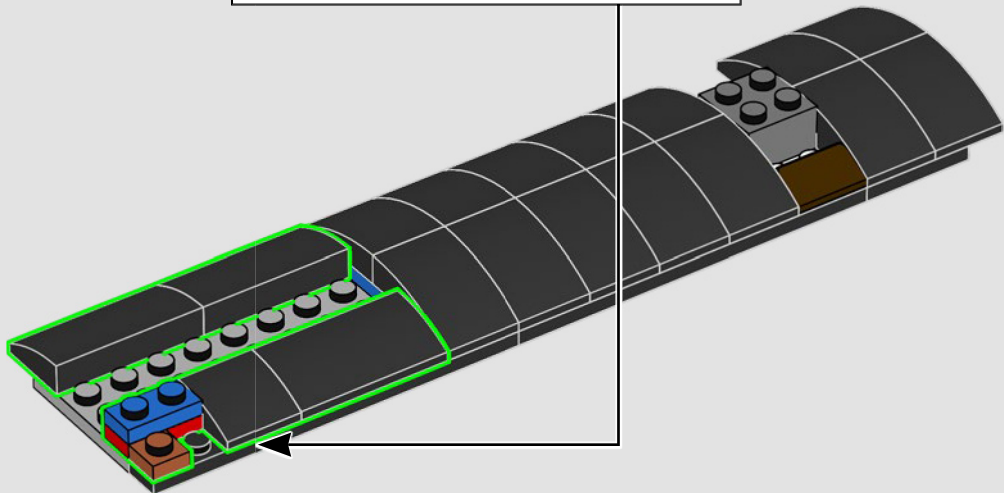
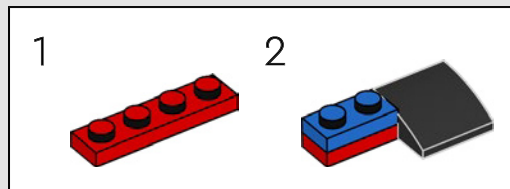

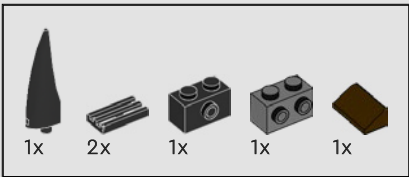

291

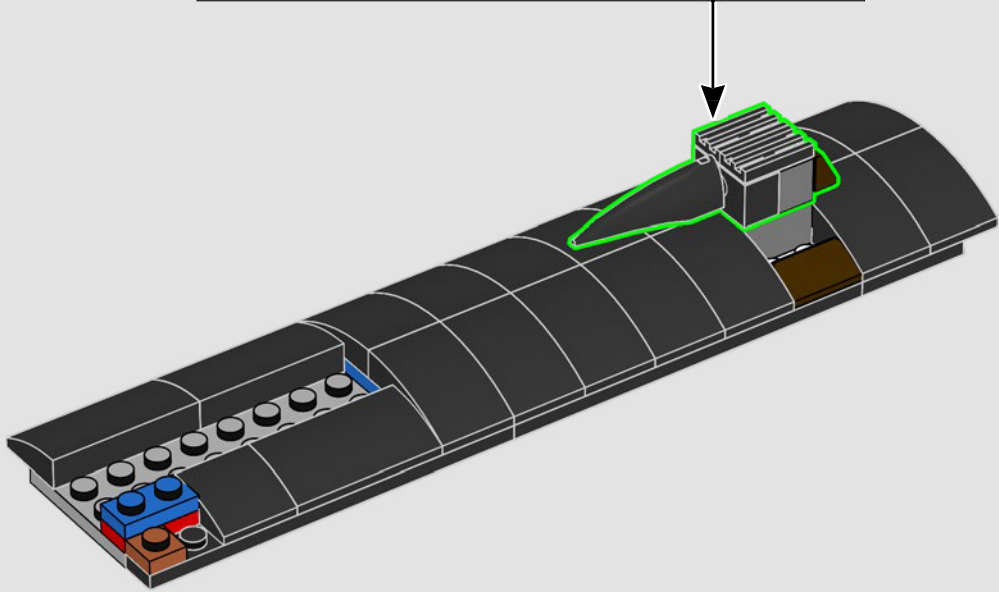
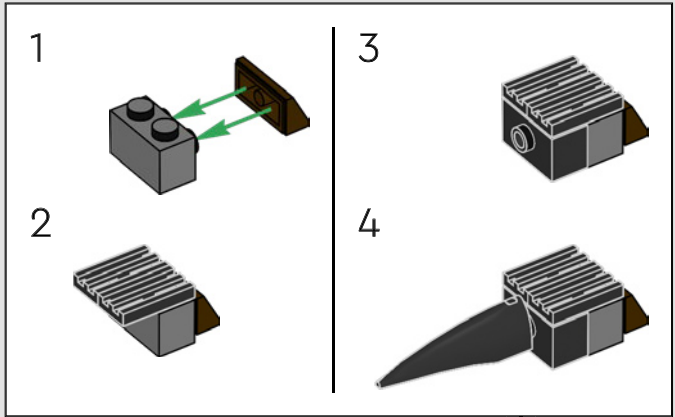

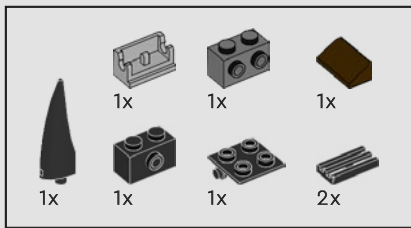

292

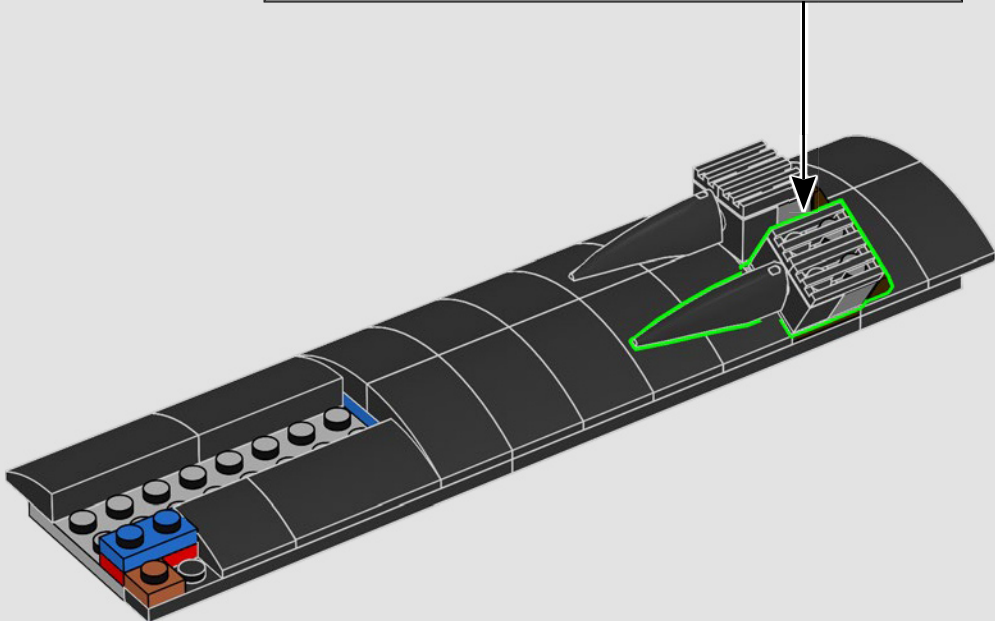
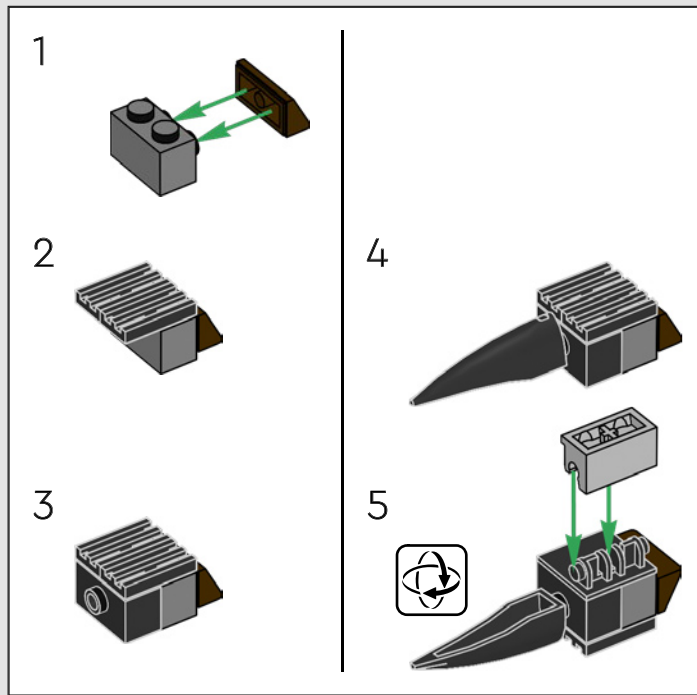

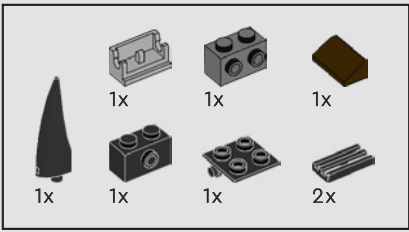

293

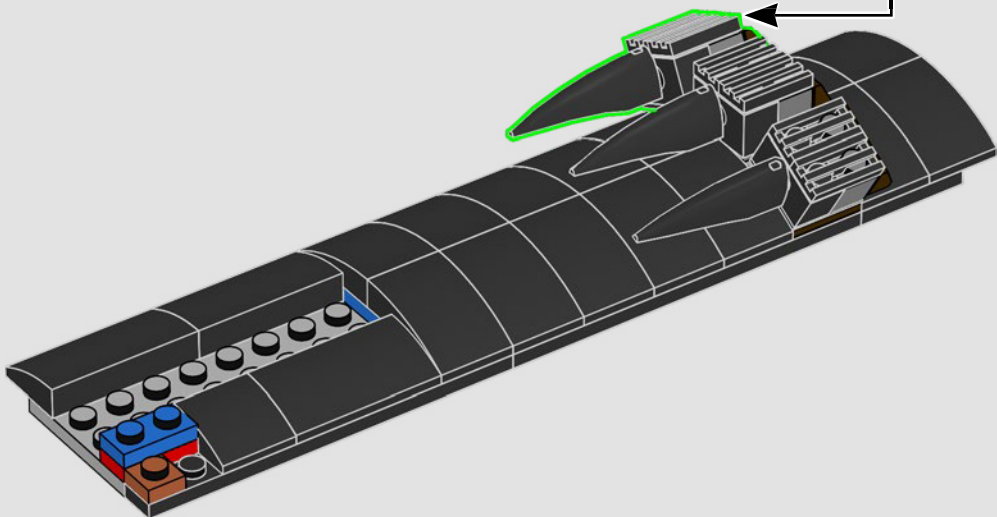
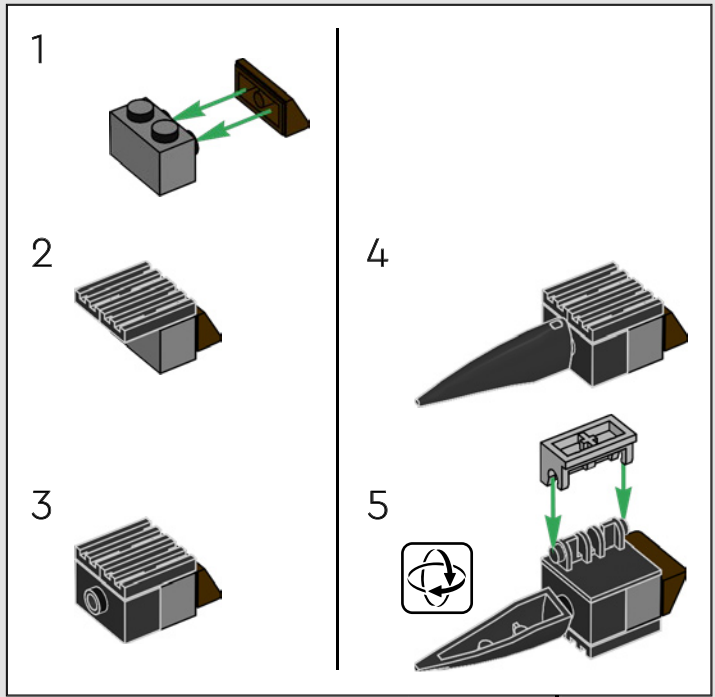

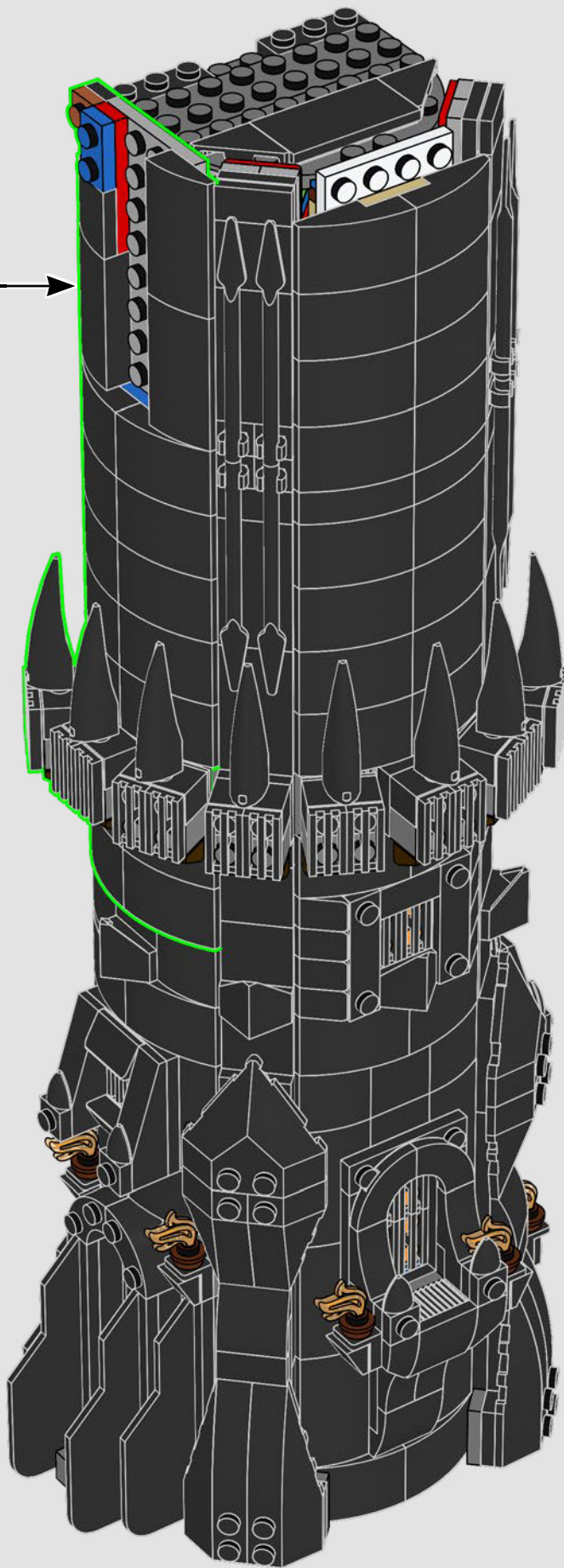

294



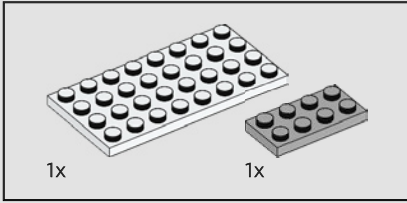
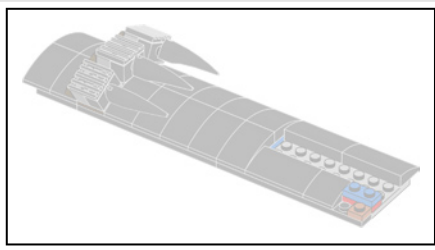

295

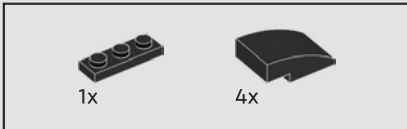
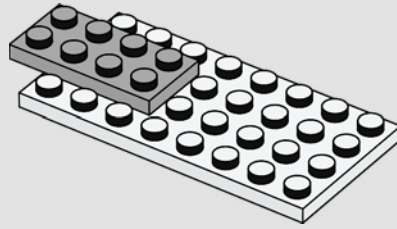

296

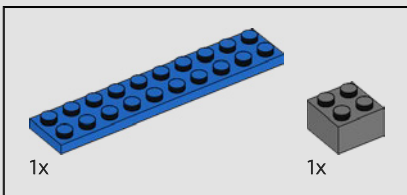
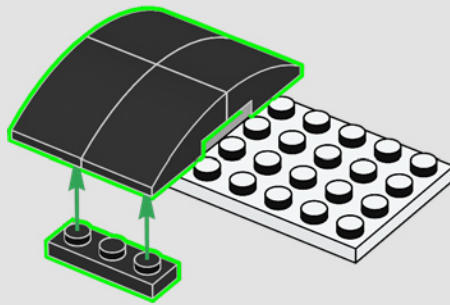

297

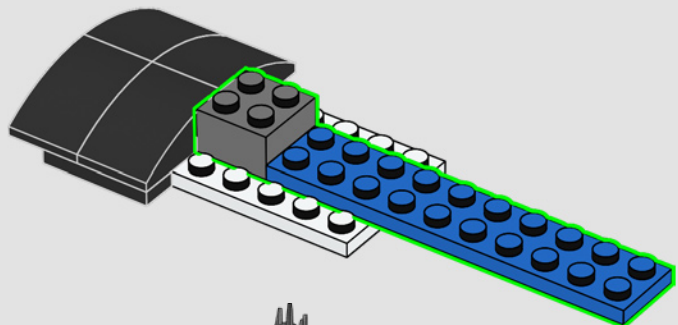

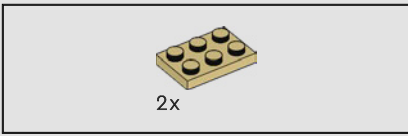

298

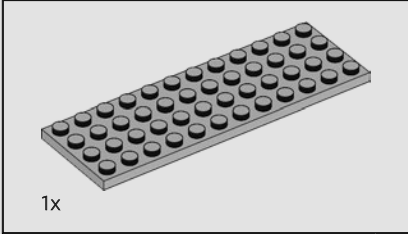
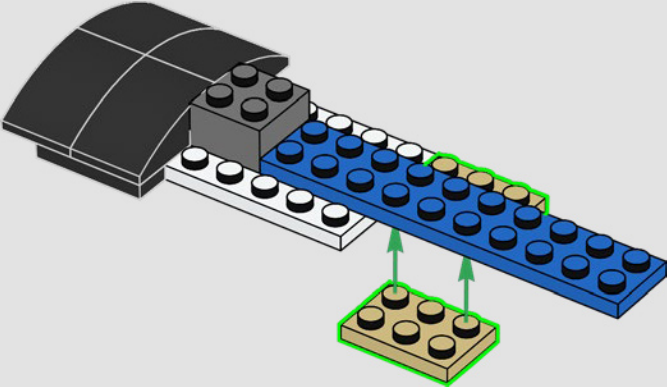

299

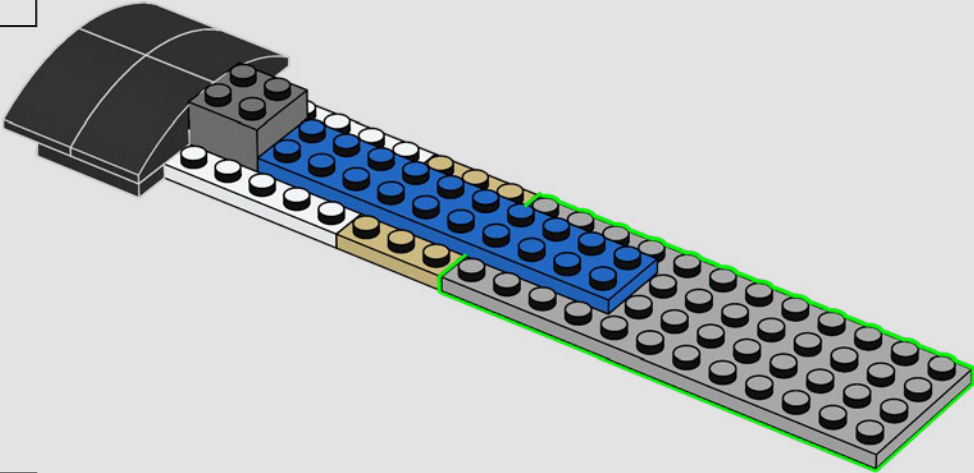

300

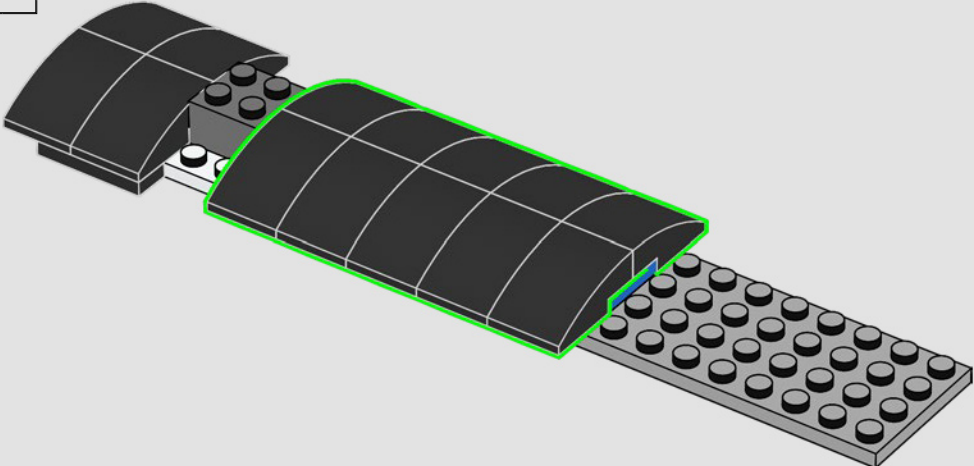

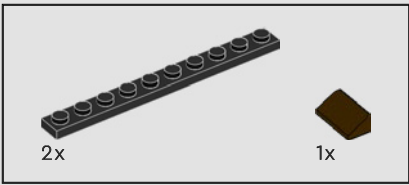

301

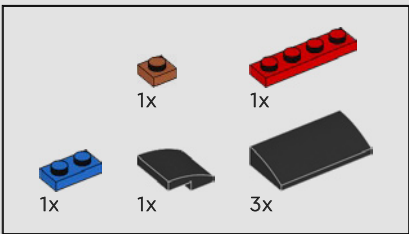
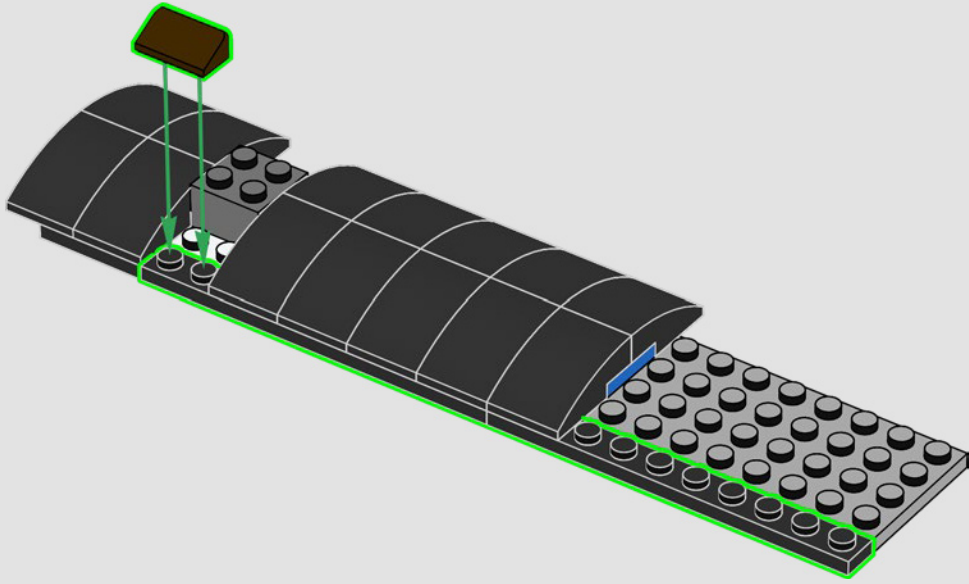

302

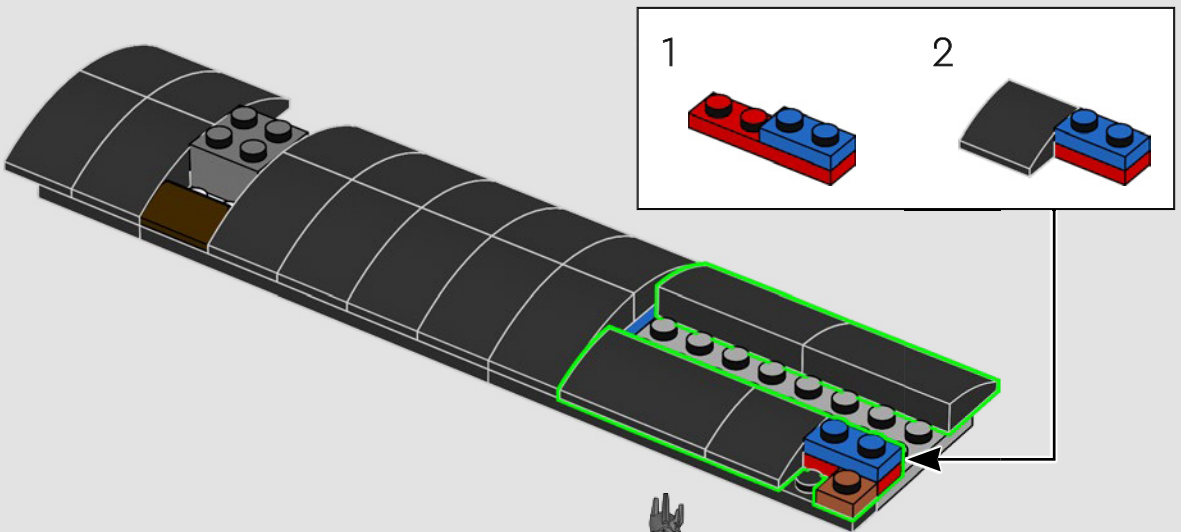

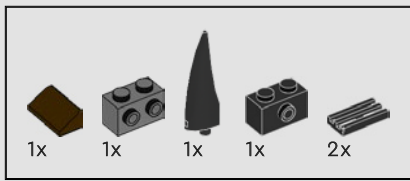

303

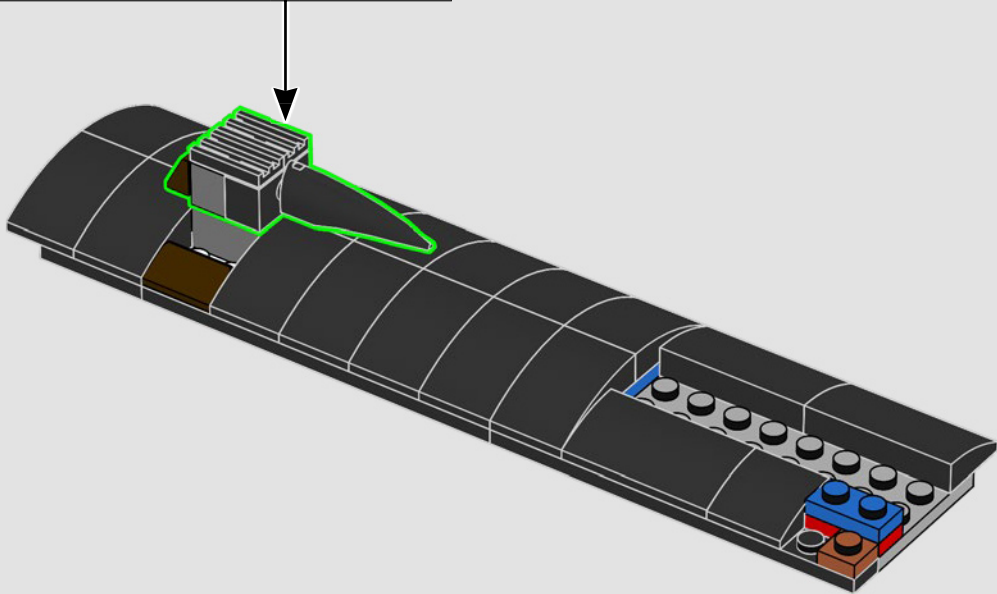
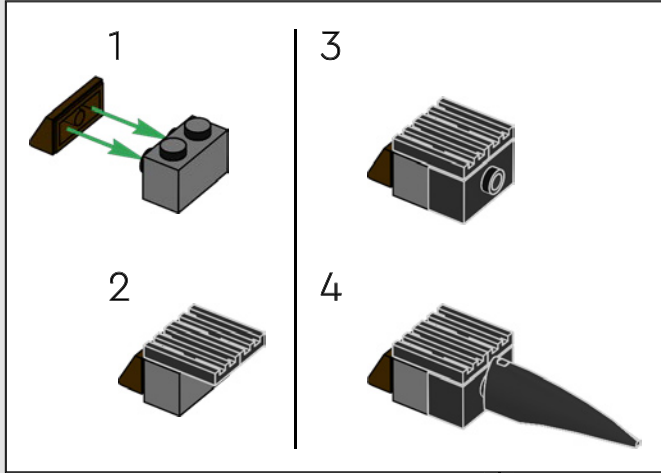

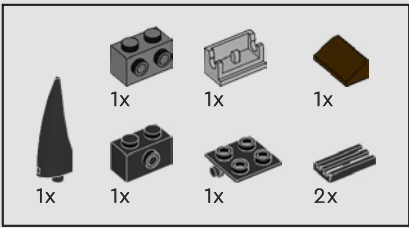

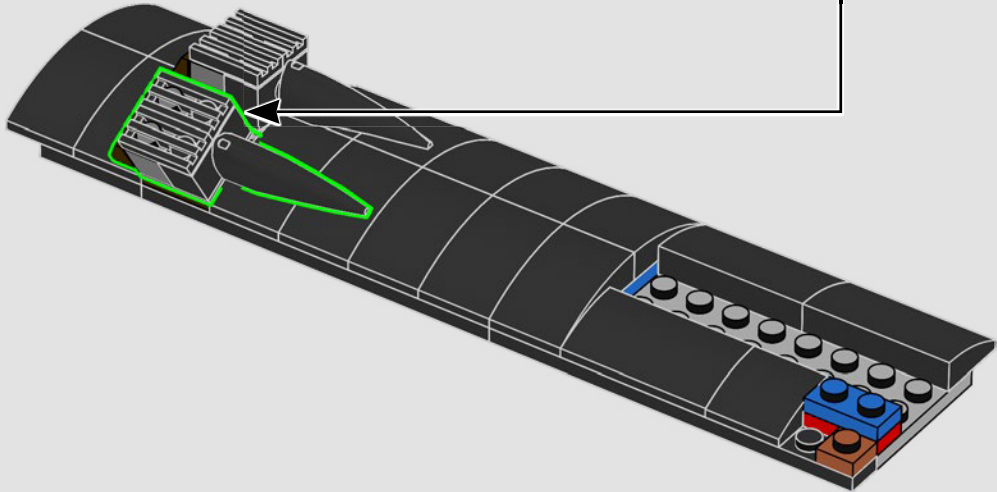
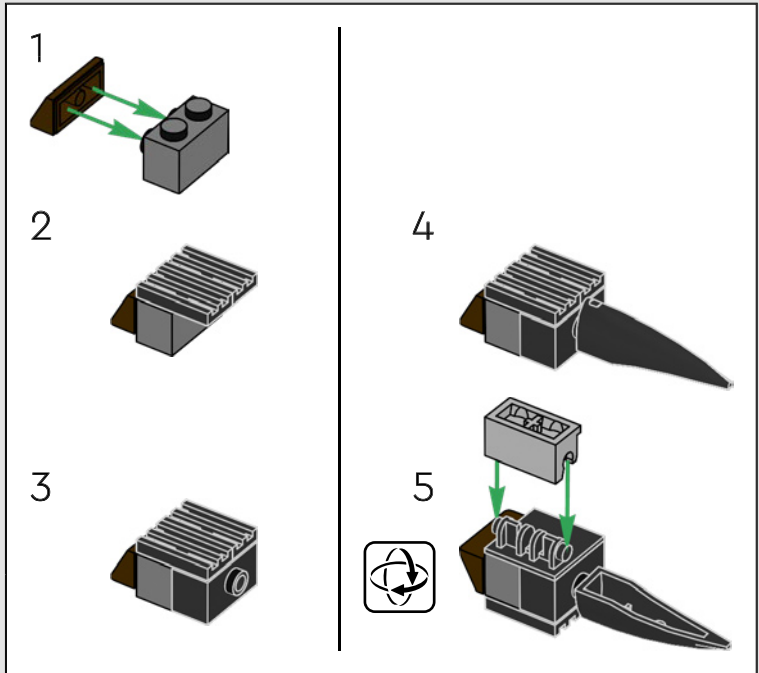

304

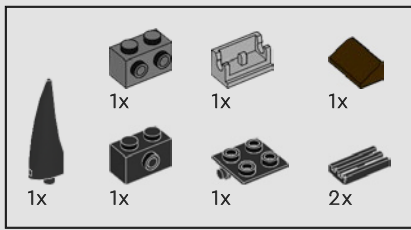

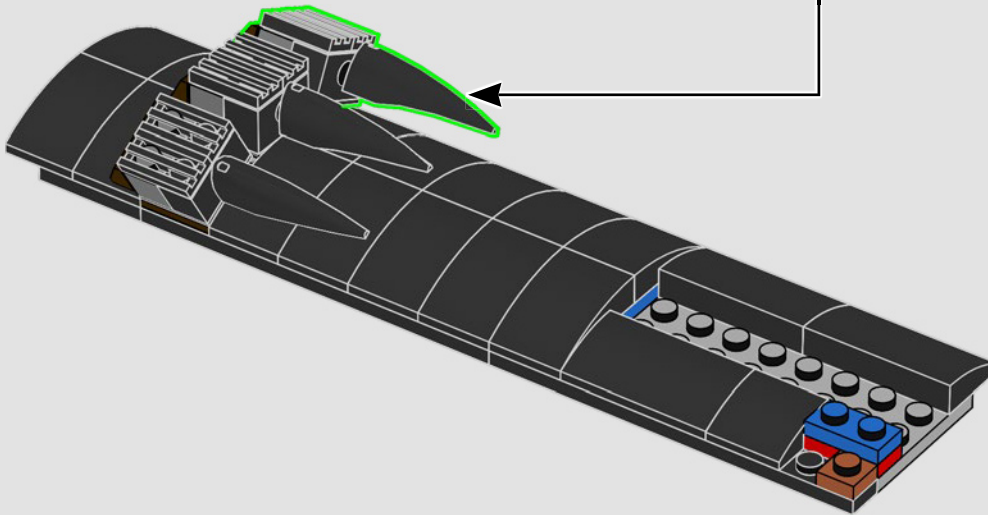
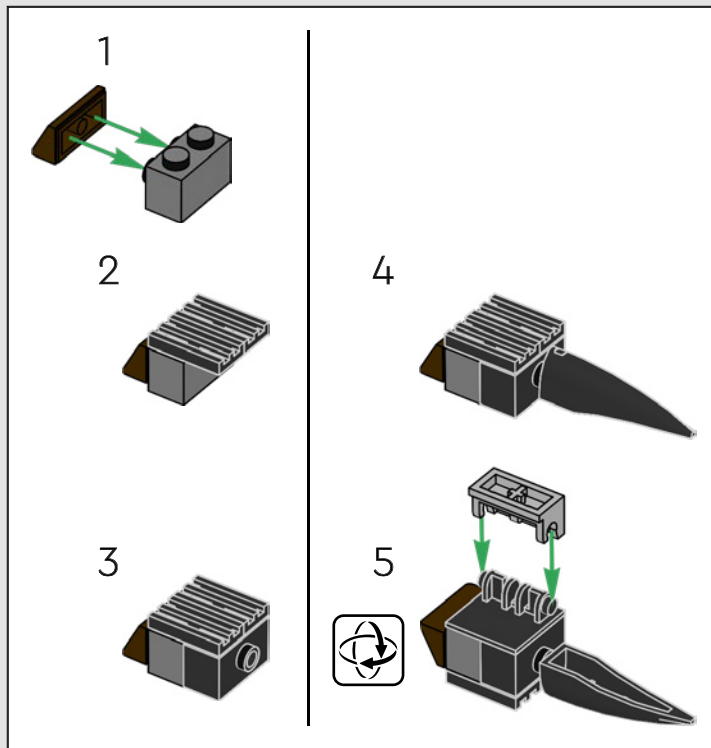

305



Mehrere identische Segmente des Turms lassen sich dank des modularen Bausystems mühelos zusammenstecken. 

306

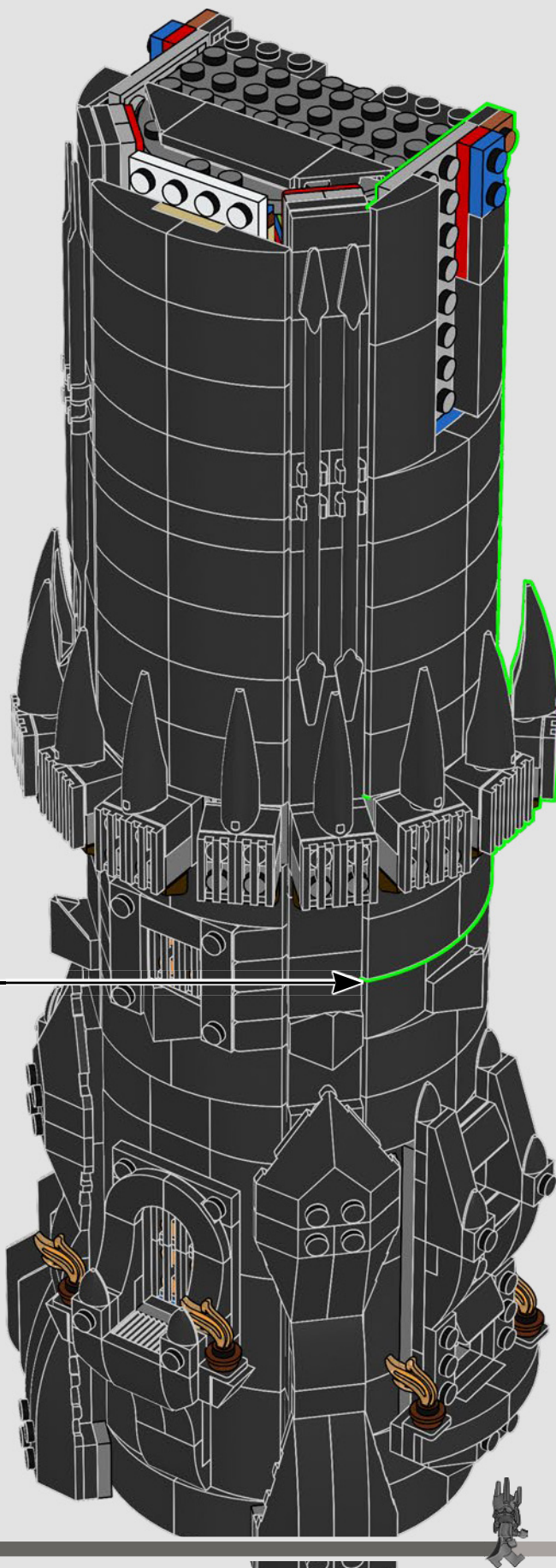

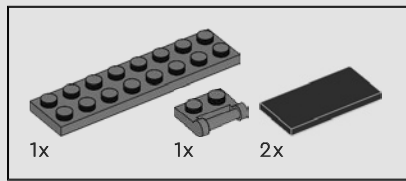

307

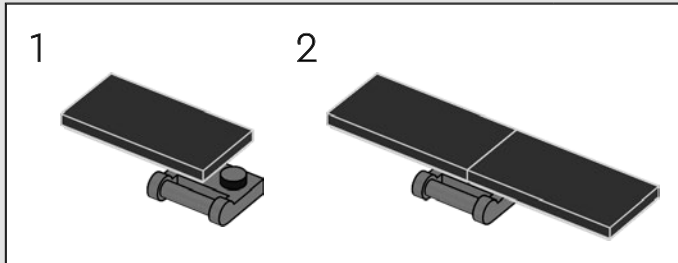

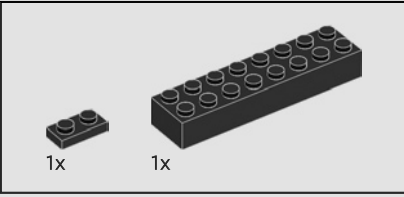
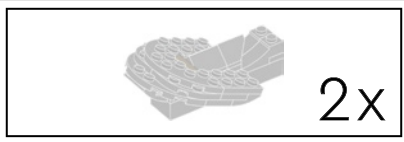

308

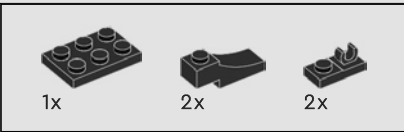
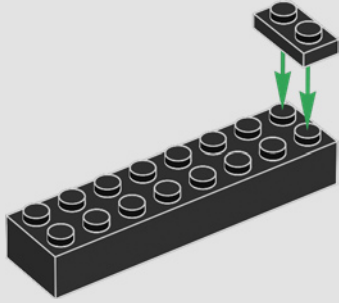

309

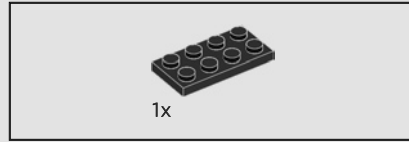
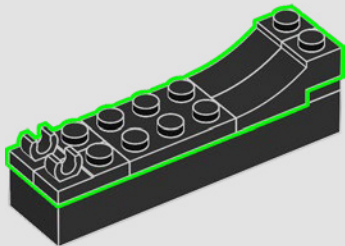

310

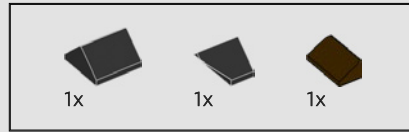
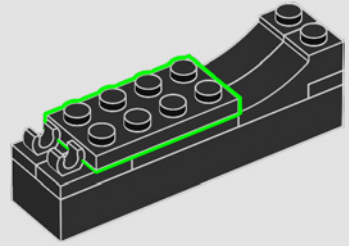

311

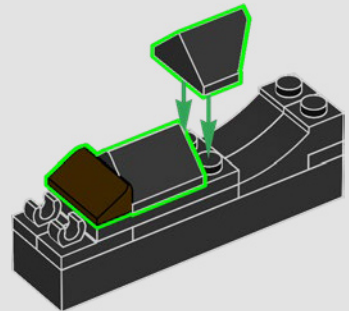

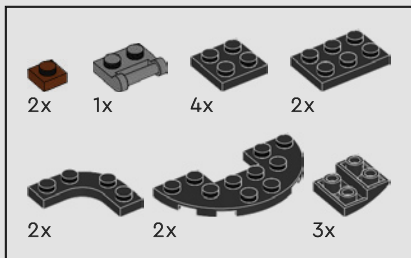

312

1



2

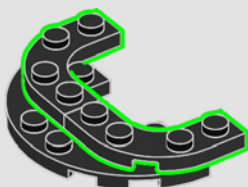

3

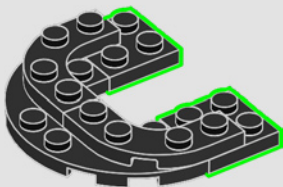

4

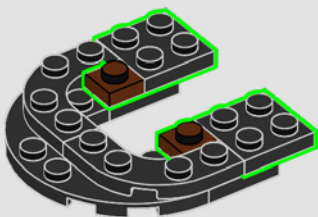

5

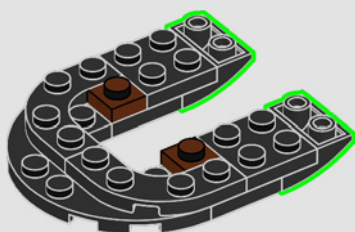

6

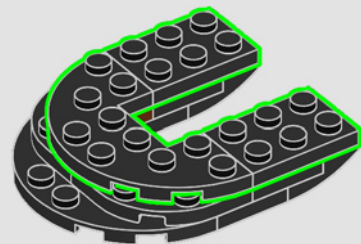

7

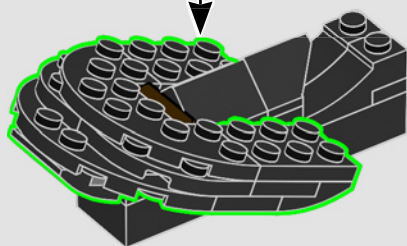
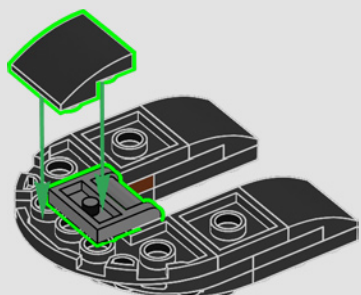

2x

313



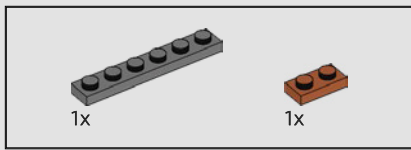

314

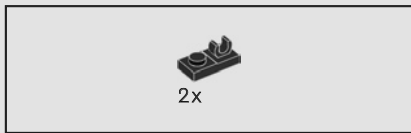
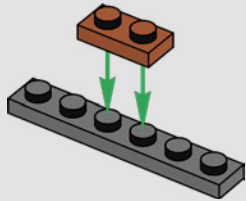

315

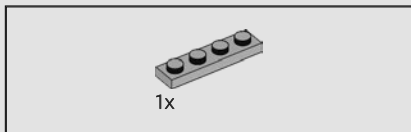
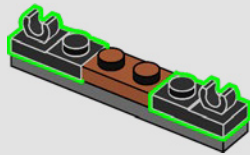

316

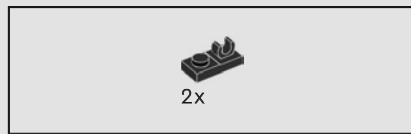
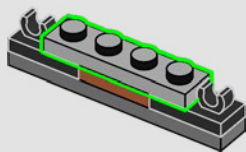

317

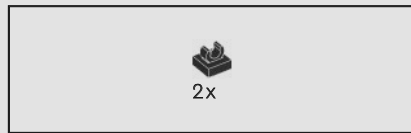
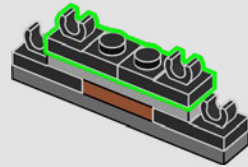

318

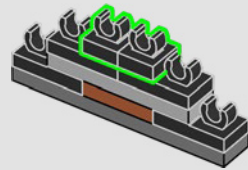

319

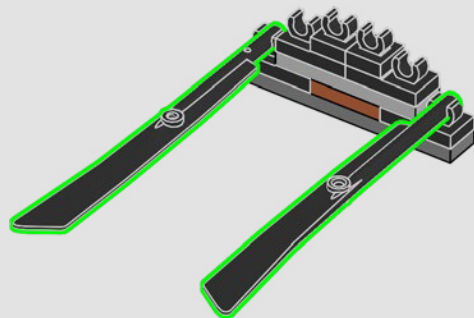

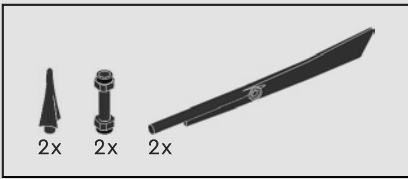

320

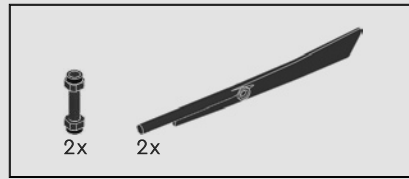
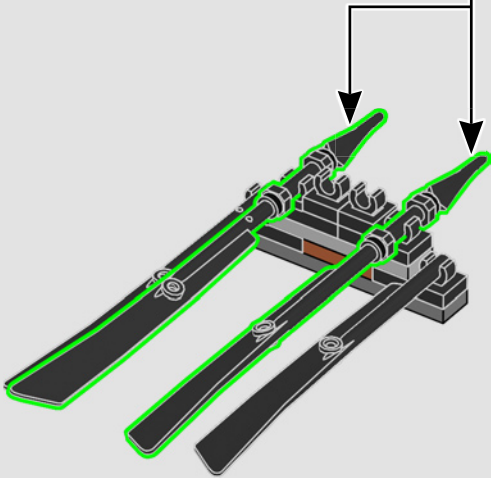

321

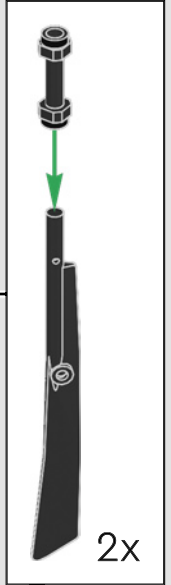
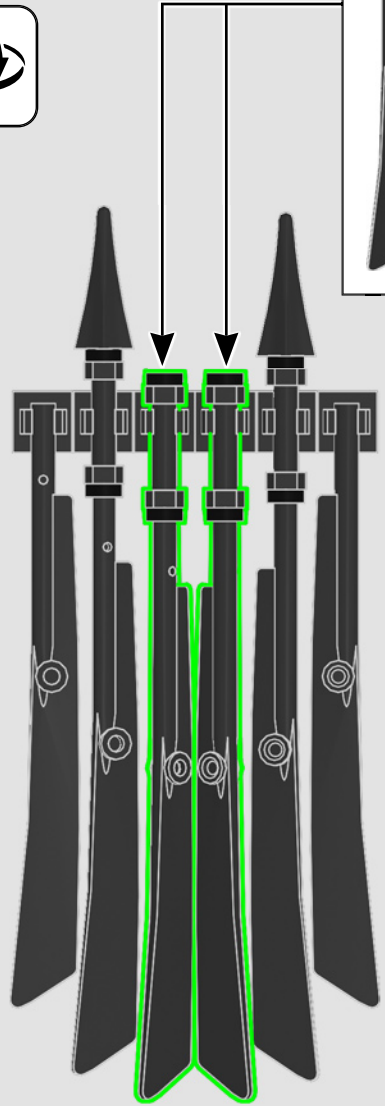
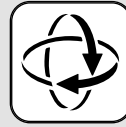



Für dieses Set wurde die Klinge schwarz umgefärbt.



322

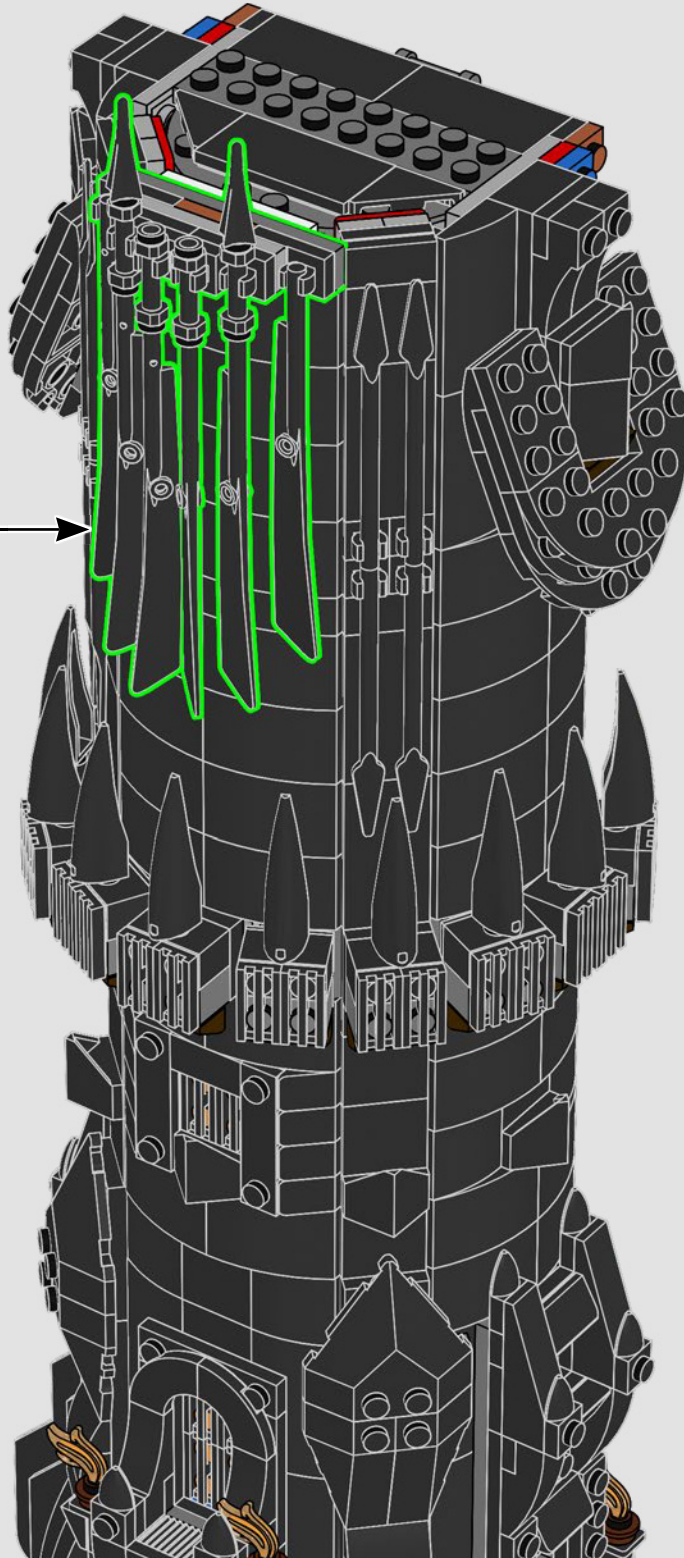

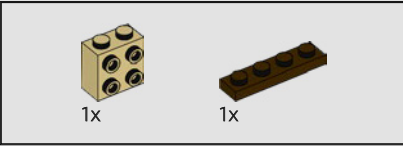
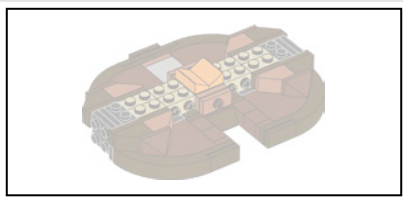

323

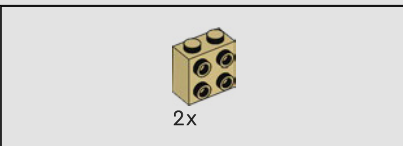
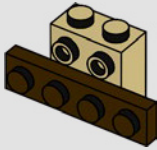

324

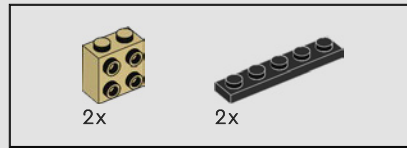
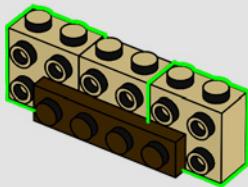

325

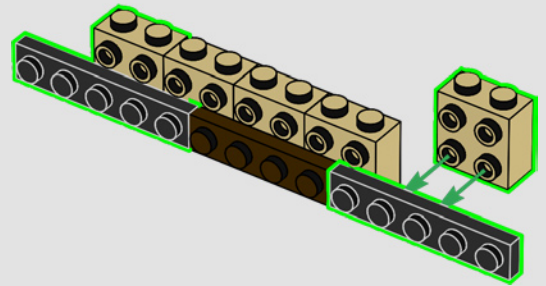

326

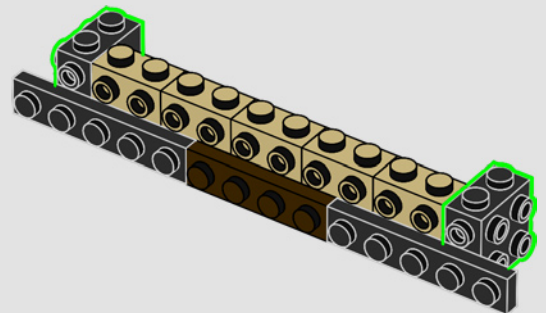

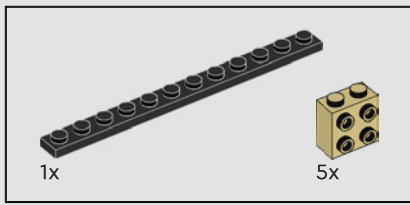

327

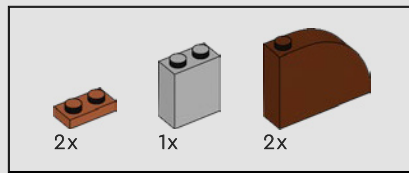
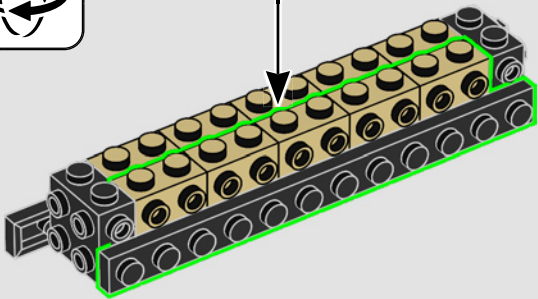
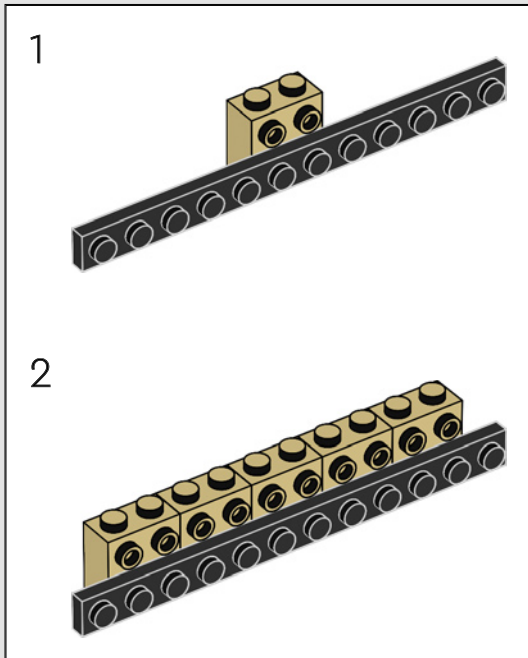

328

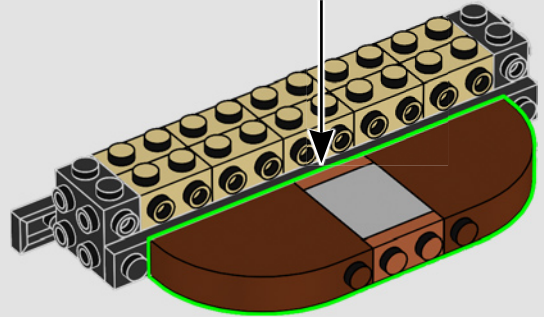
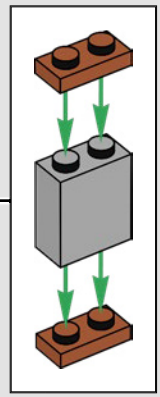

329

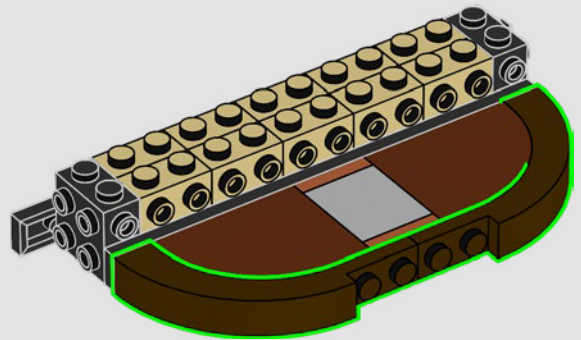

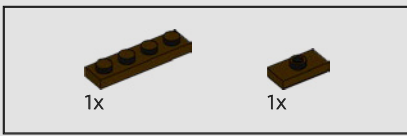

330

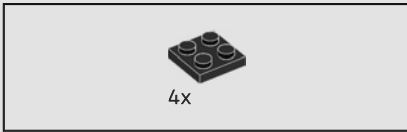
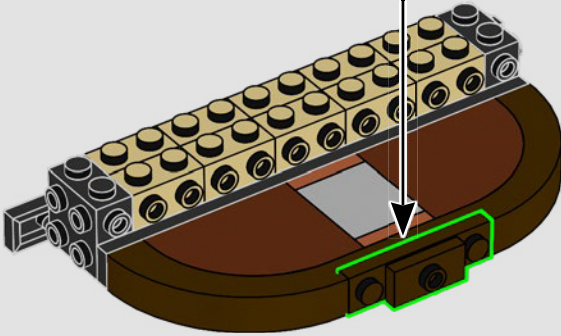
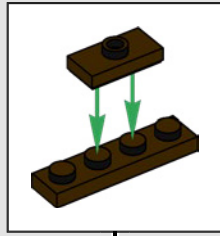

331

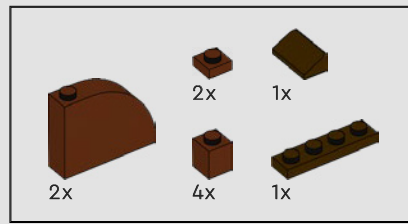
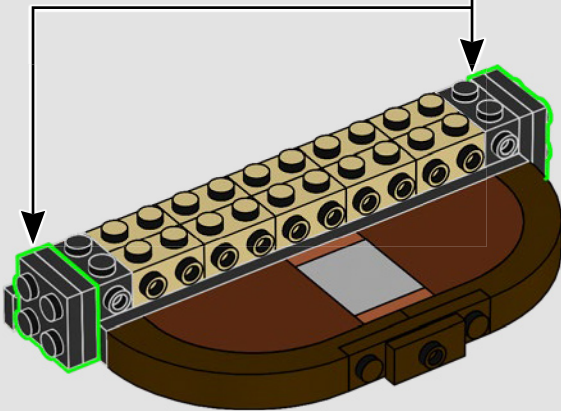
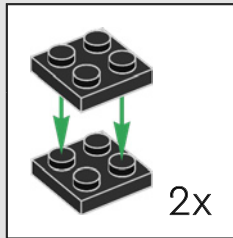

332

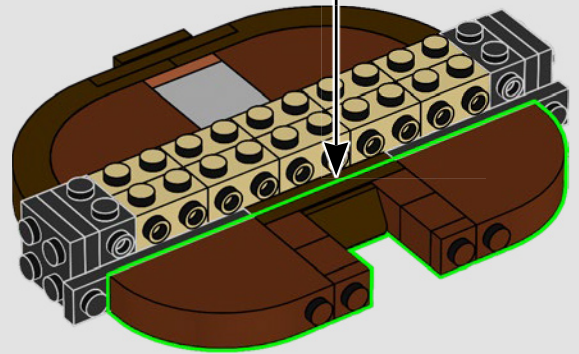
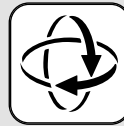
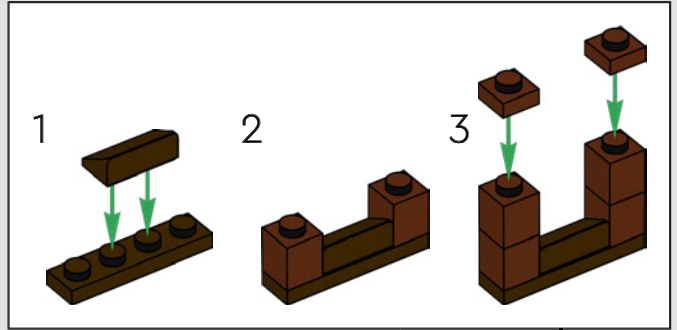

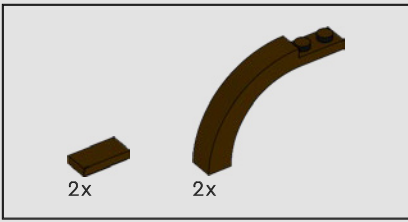

333

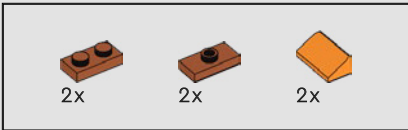
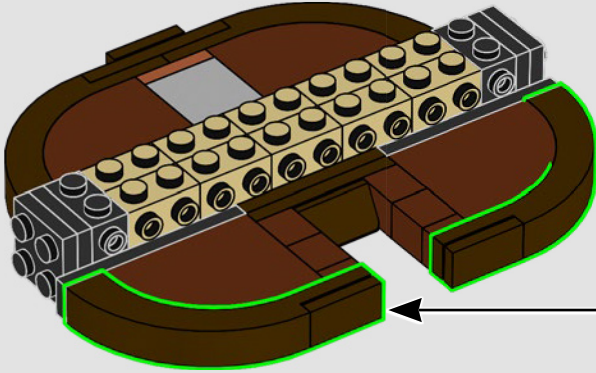
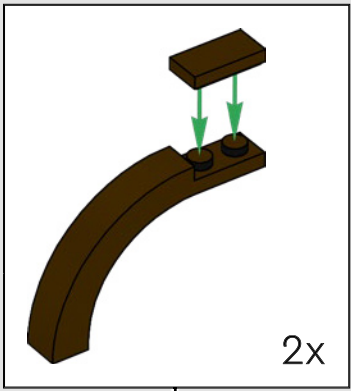

334

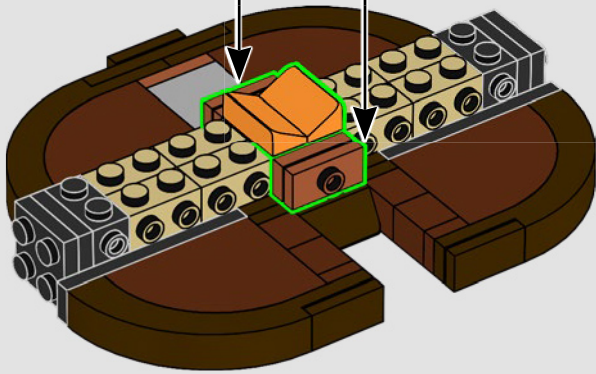
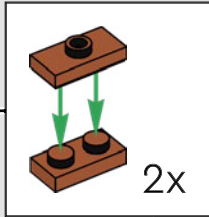

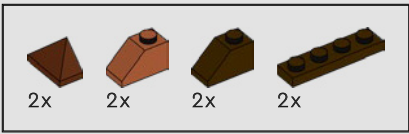

335

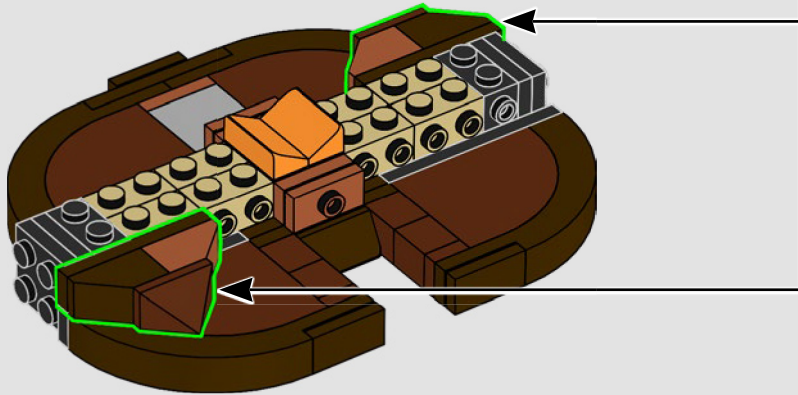
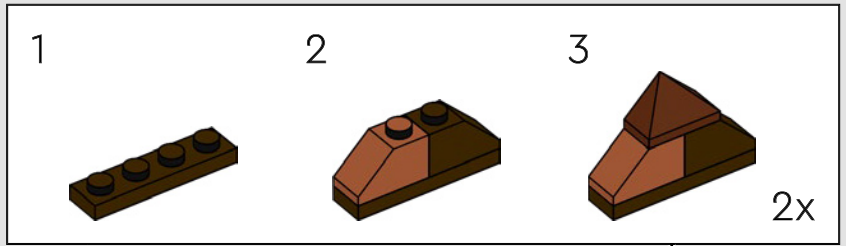

336

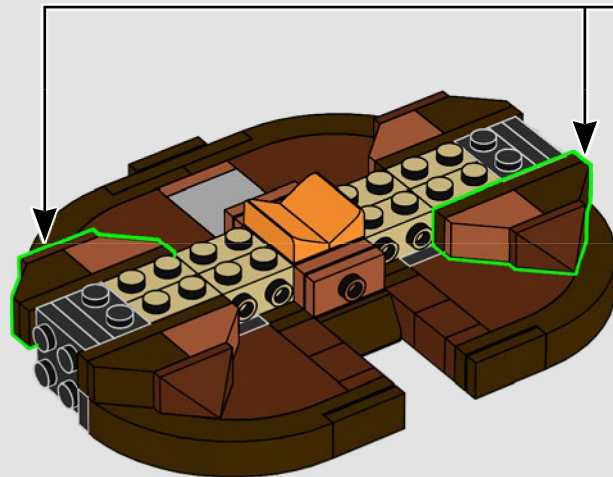
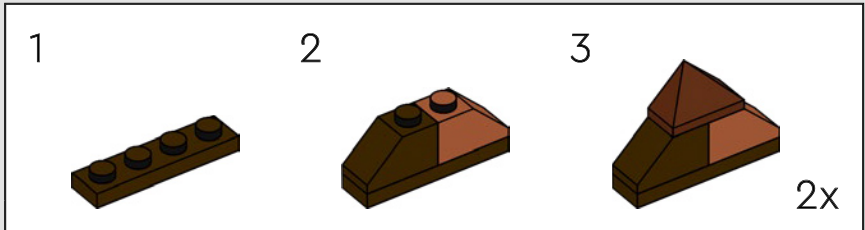

337

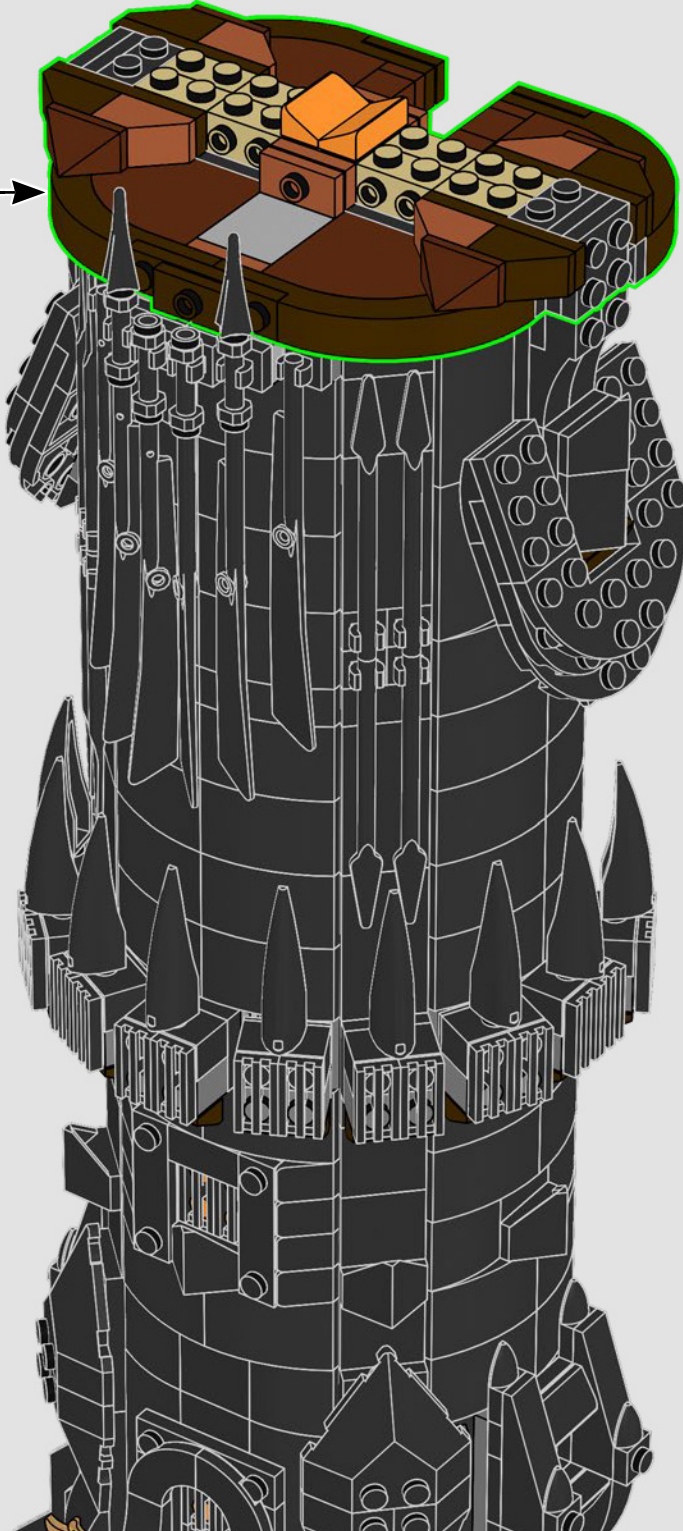

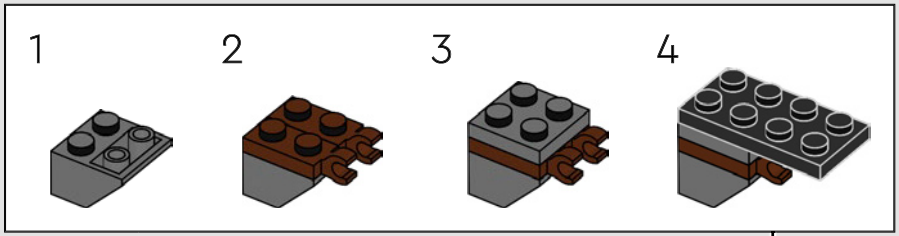
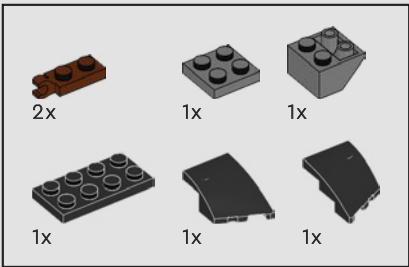

338

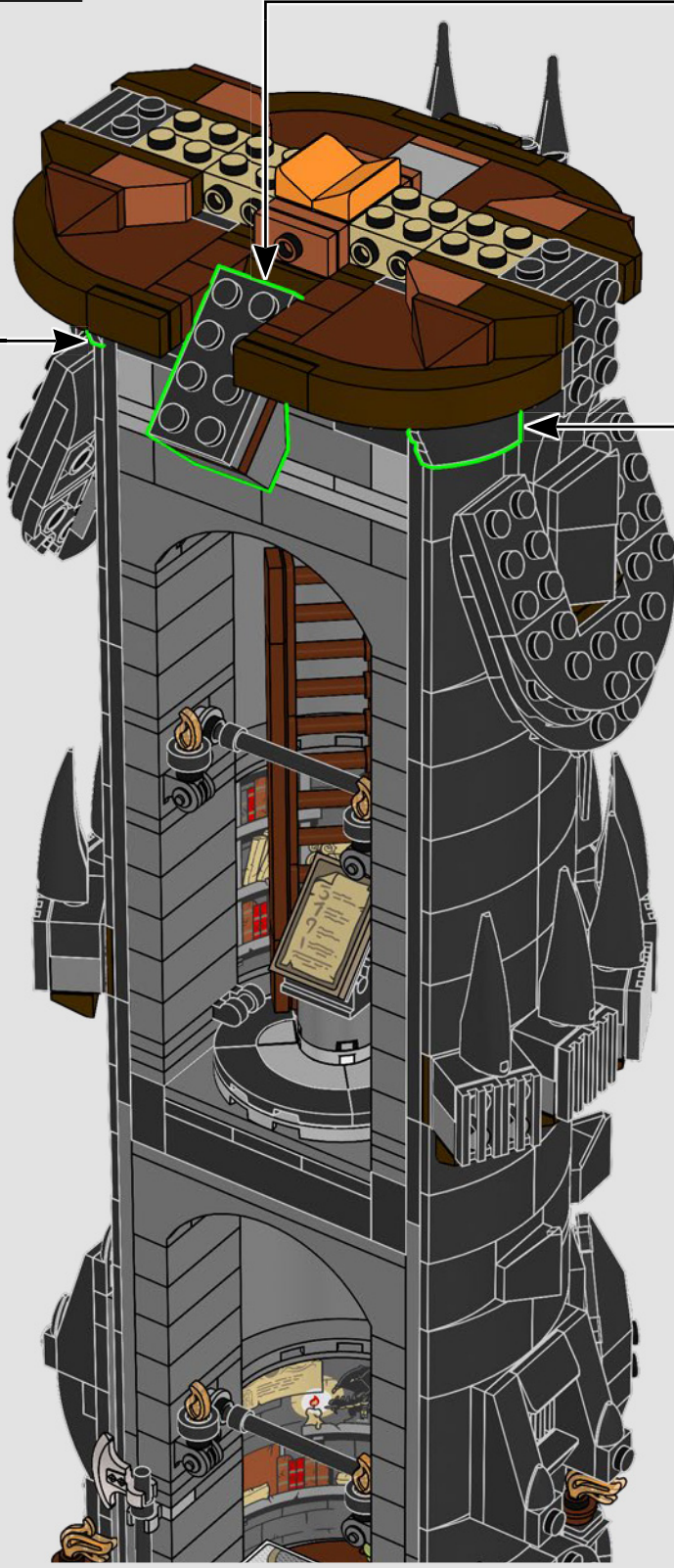

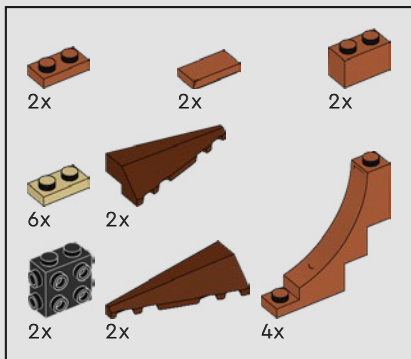

339

1

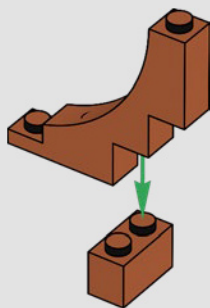

2

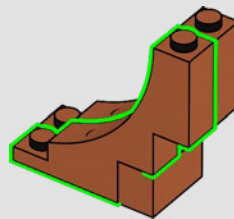

3

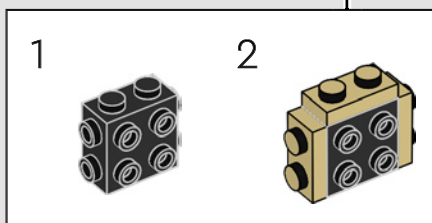
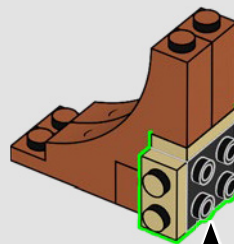

4

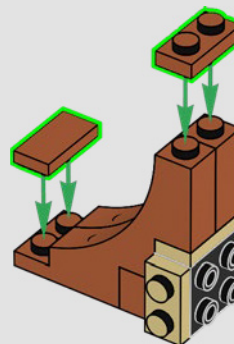

5

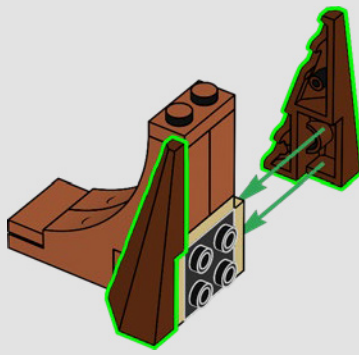

2x

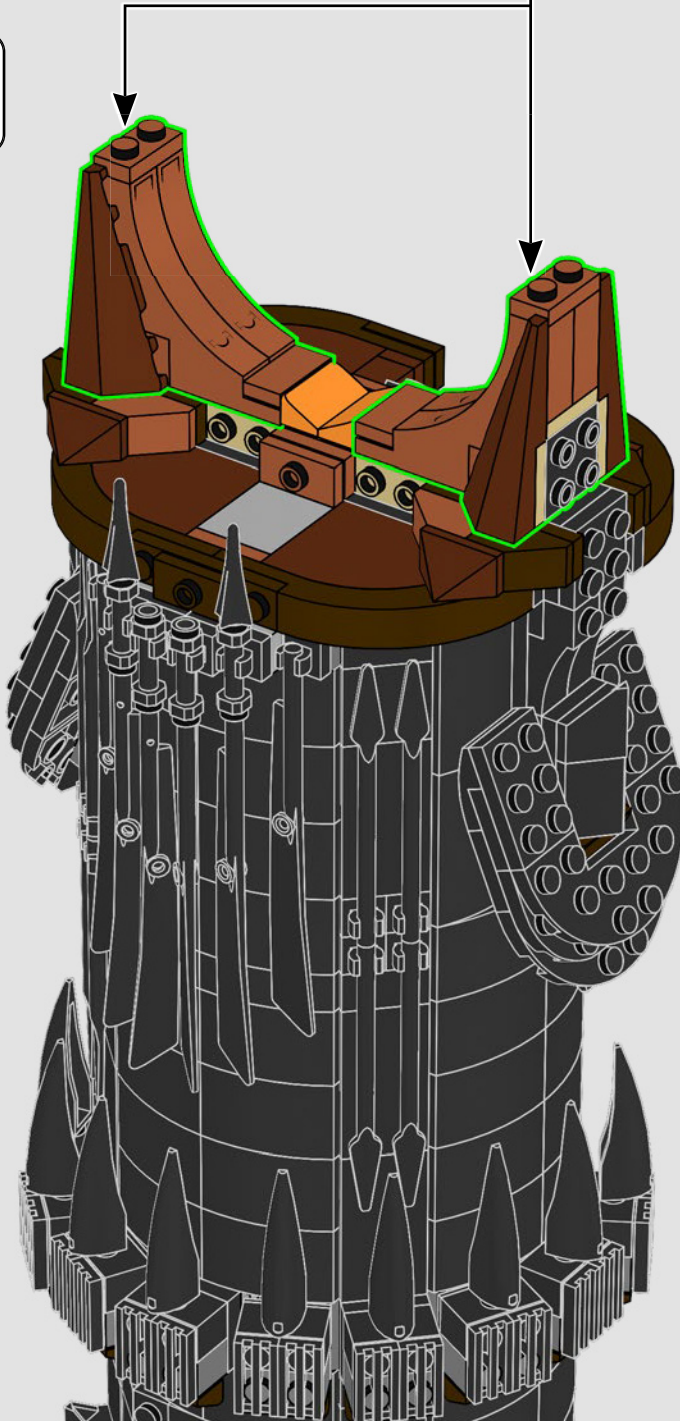

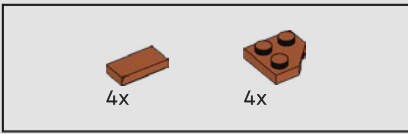

340

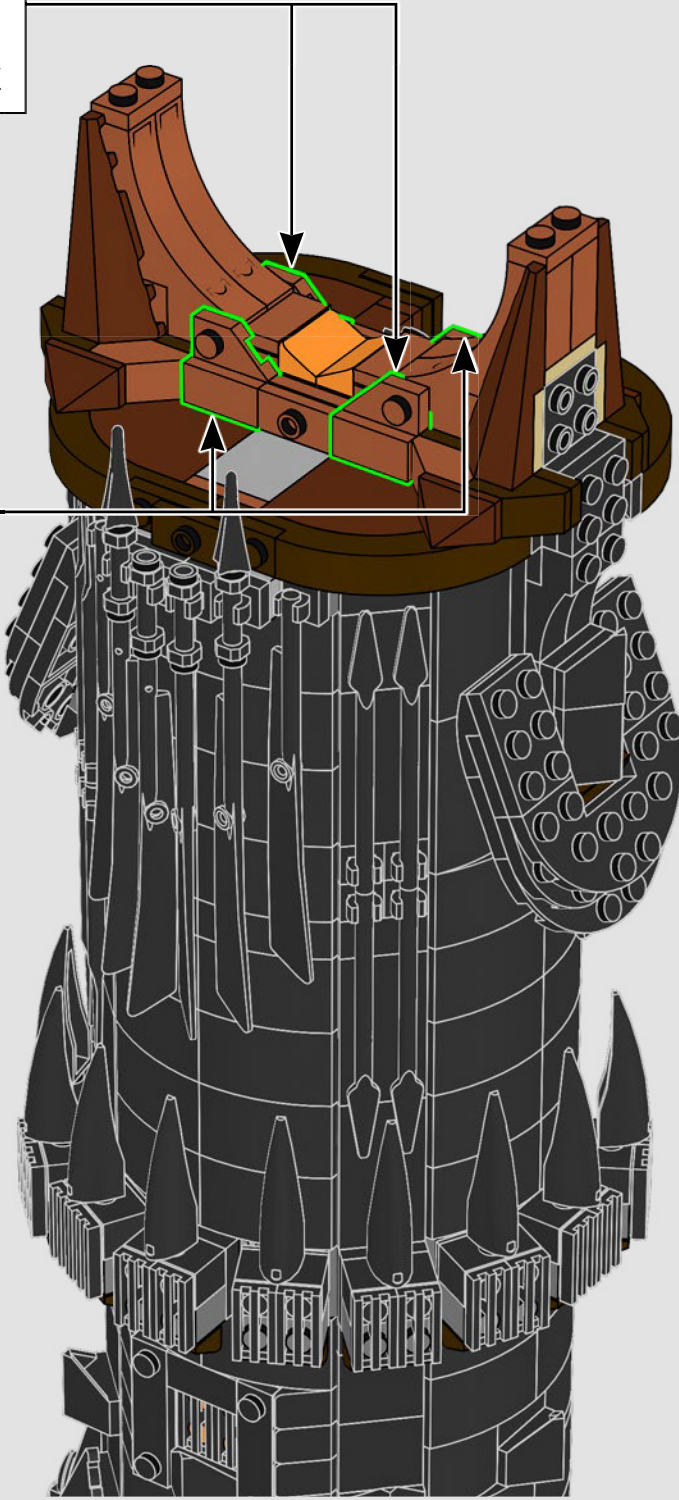
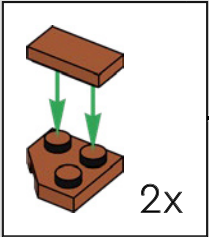
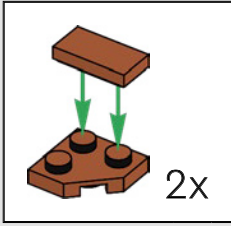

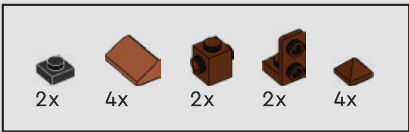

341

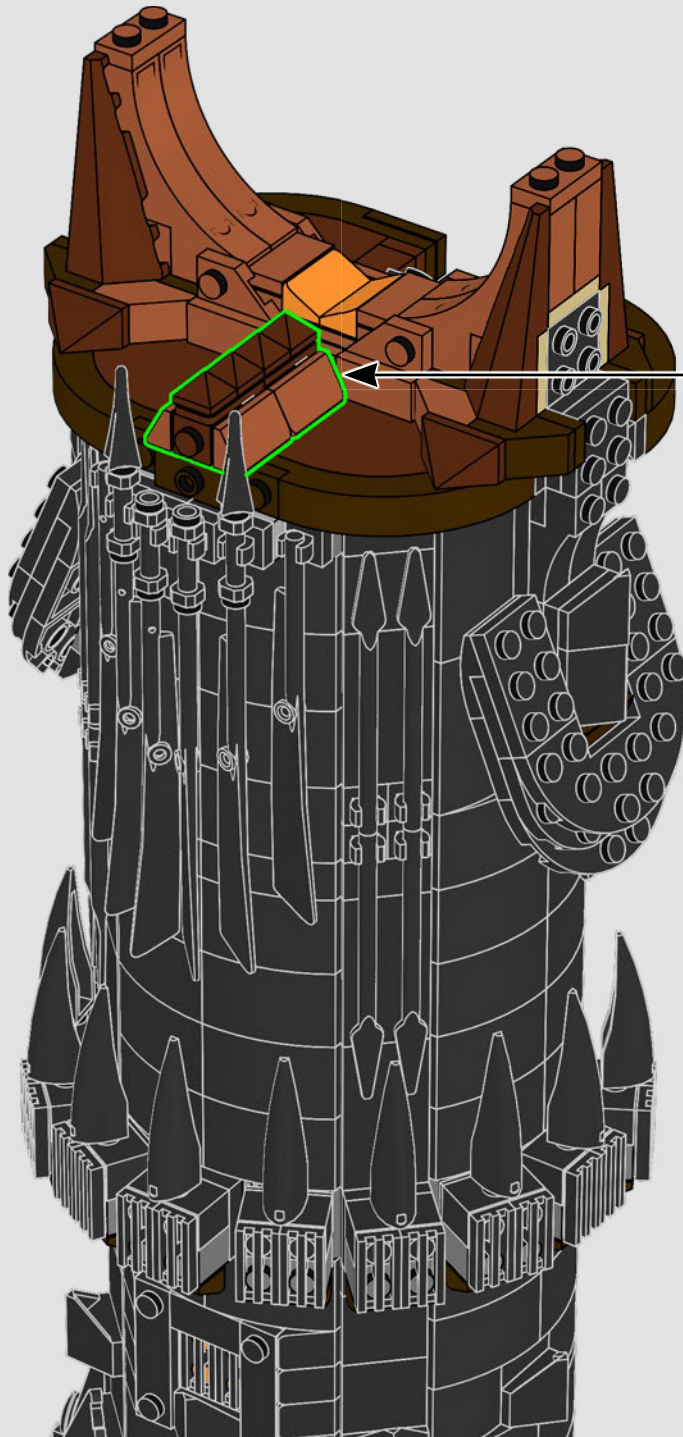
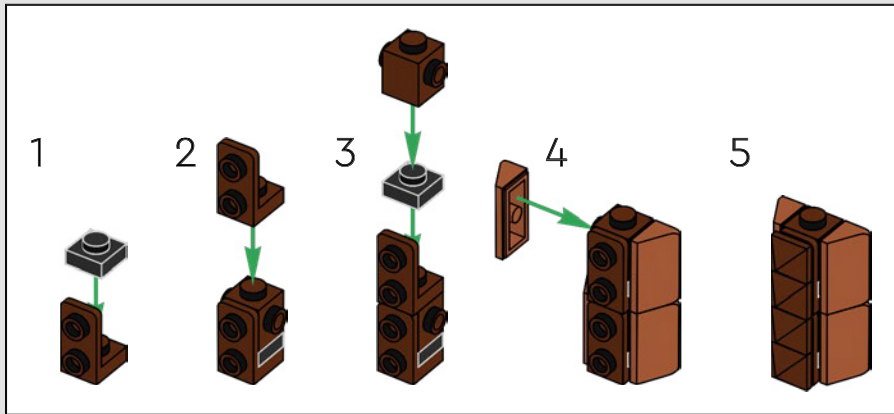

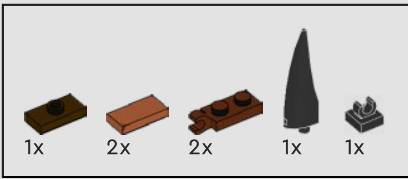

342

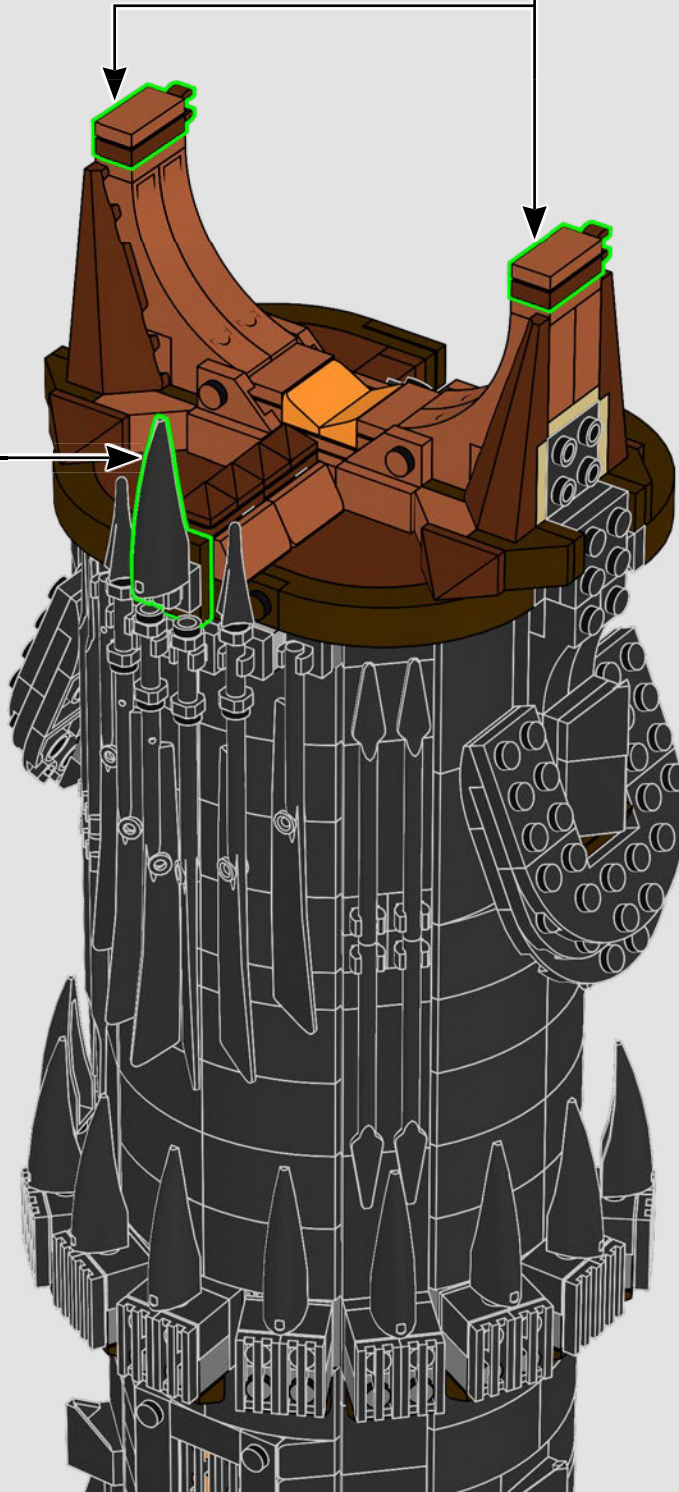
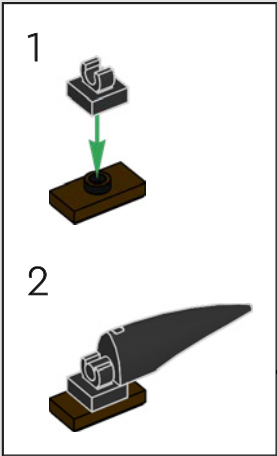
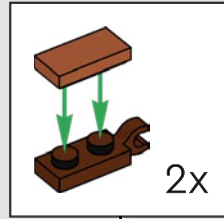

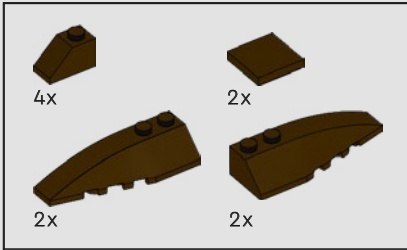
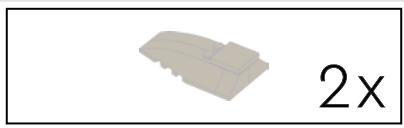

343

1

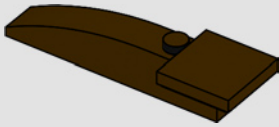

2

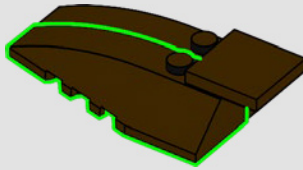

3

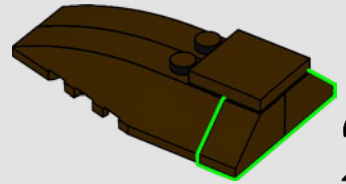

2x

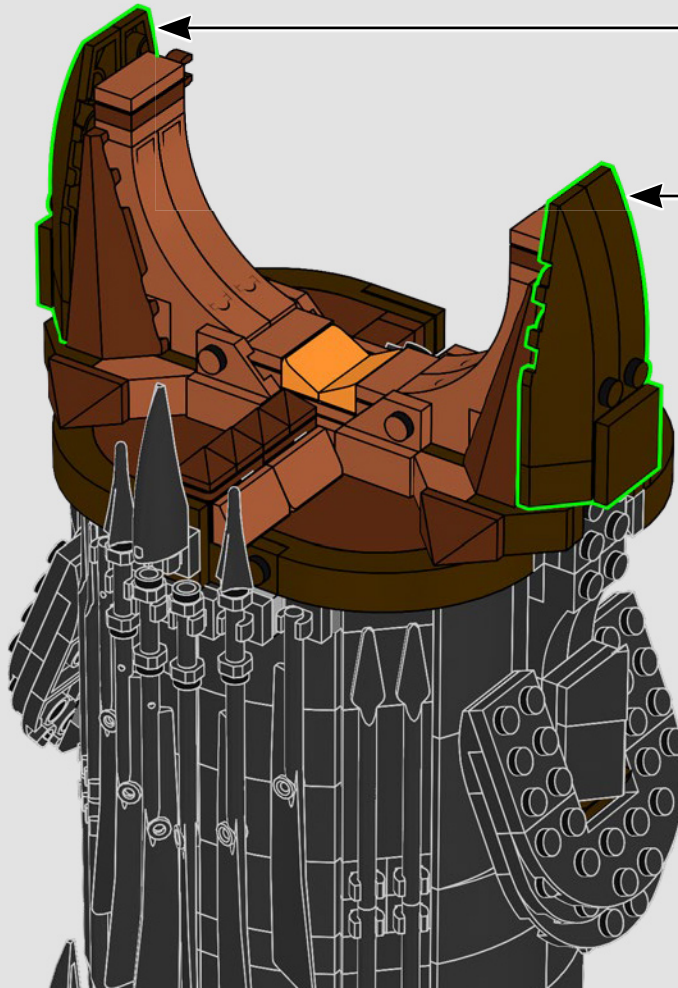

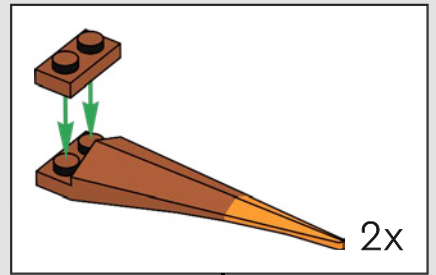
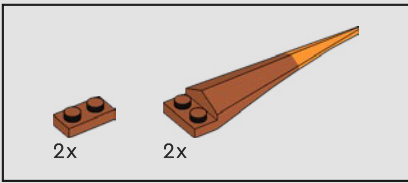

344

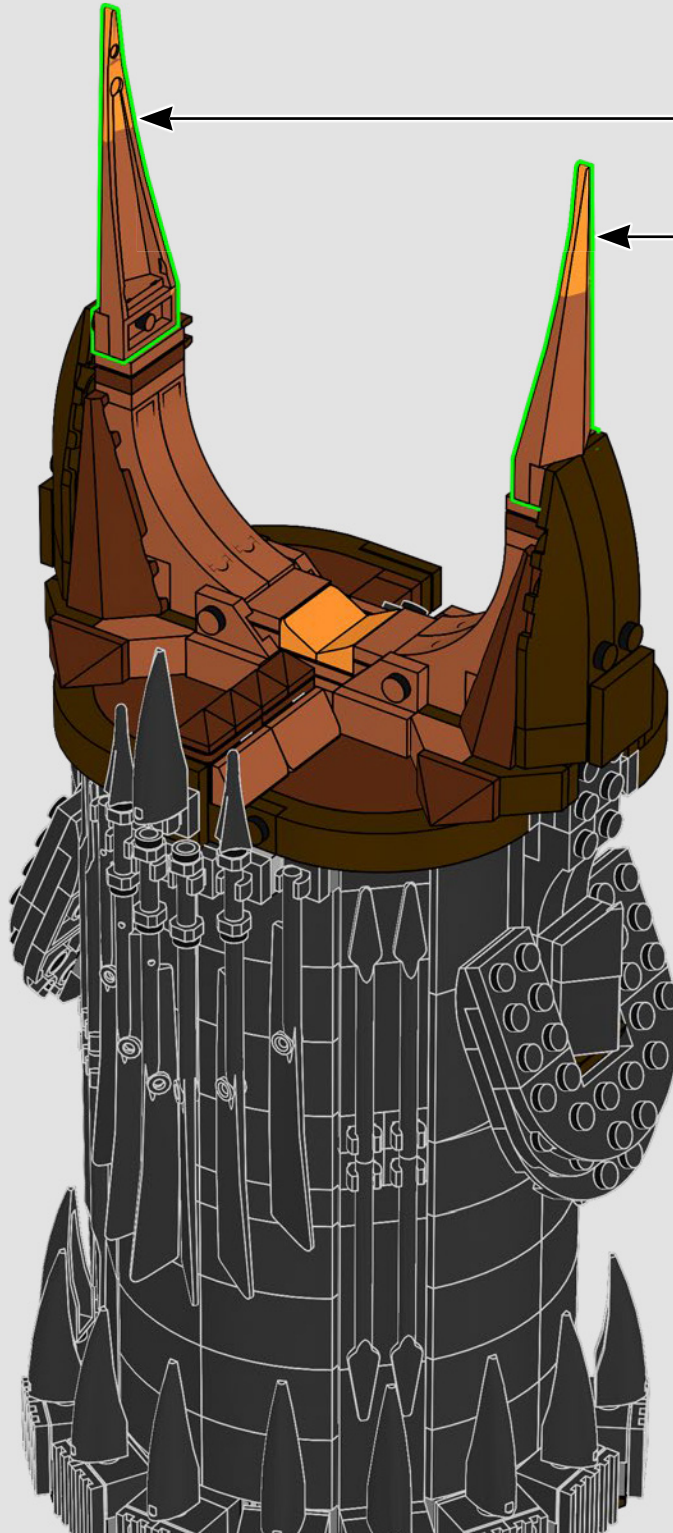

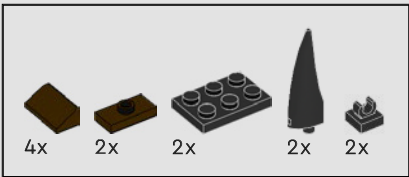

345

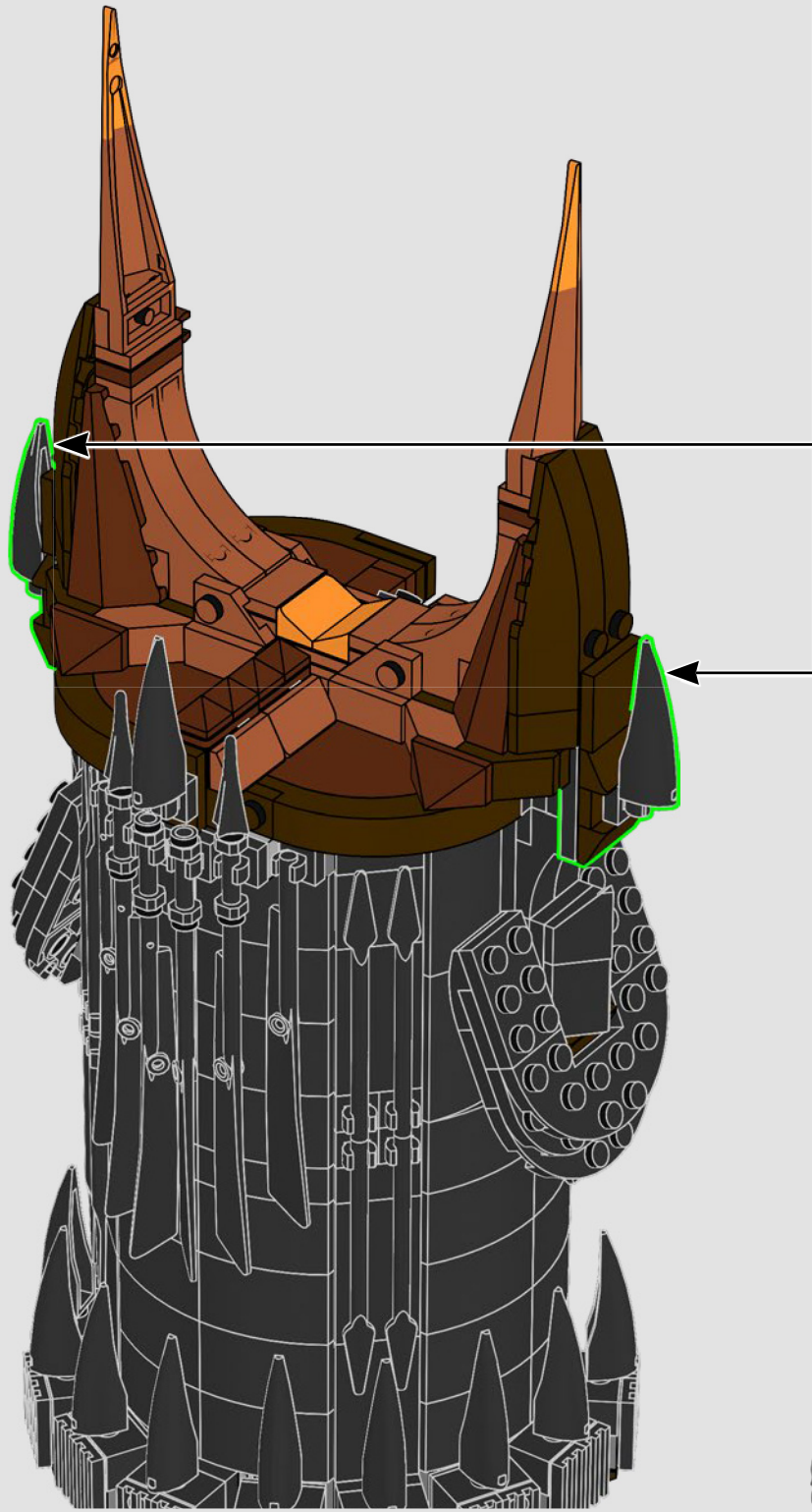
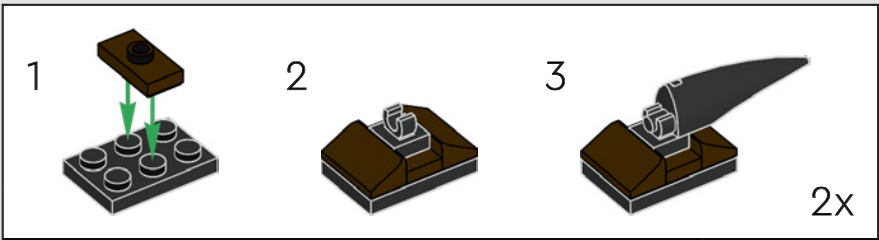



Mit einem Kotflügel ließ sich die Form des Auges nachbilden.

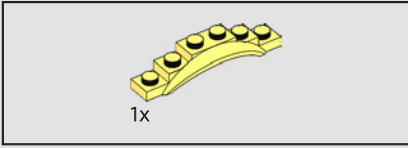
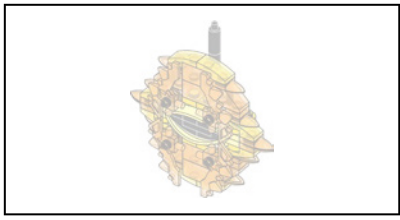

346

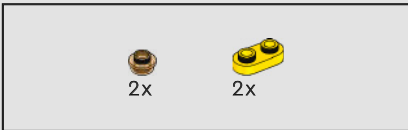
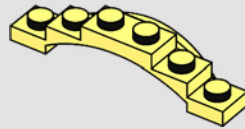

347

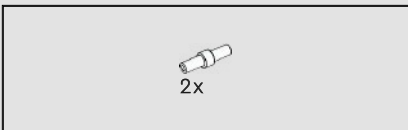
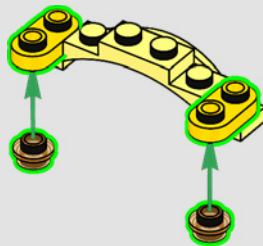

348

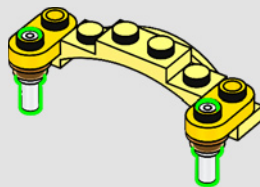

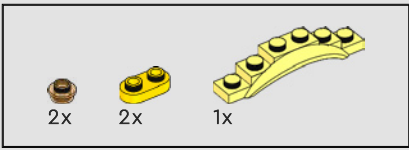

349

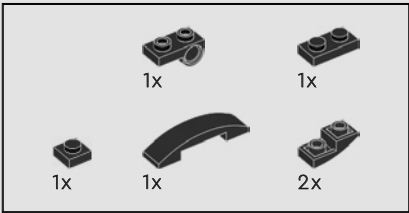
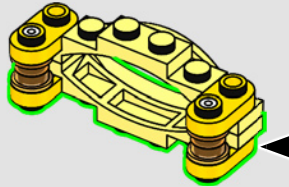
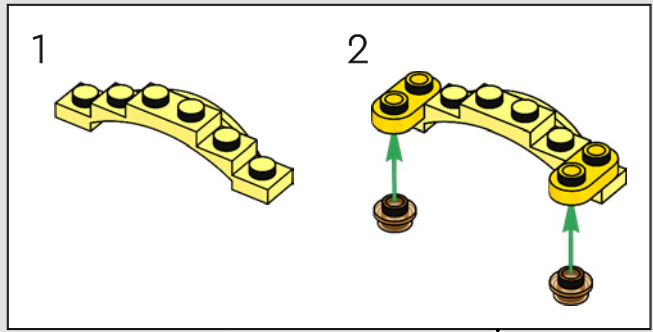

350

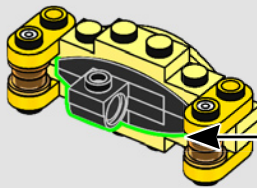
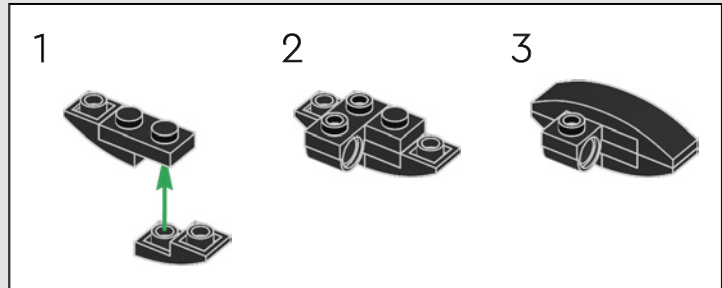

351

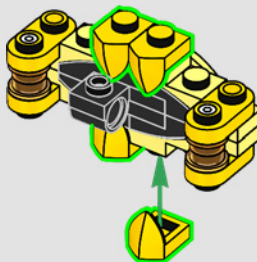

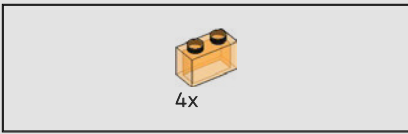

352

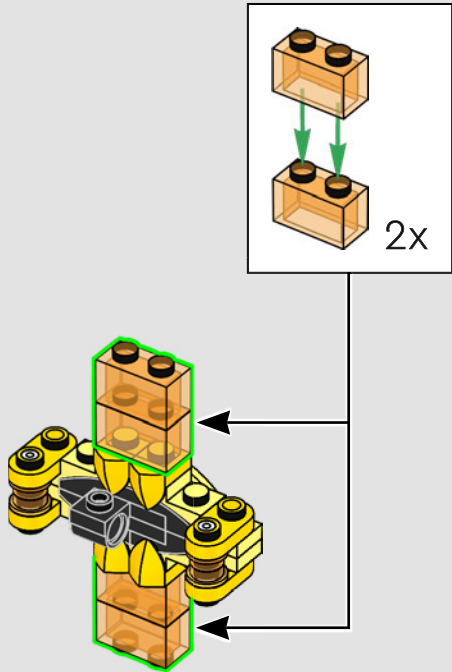

353

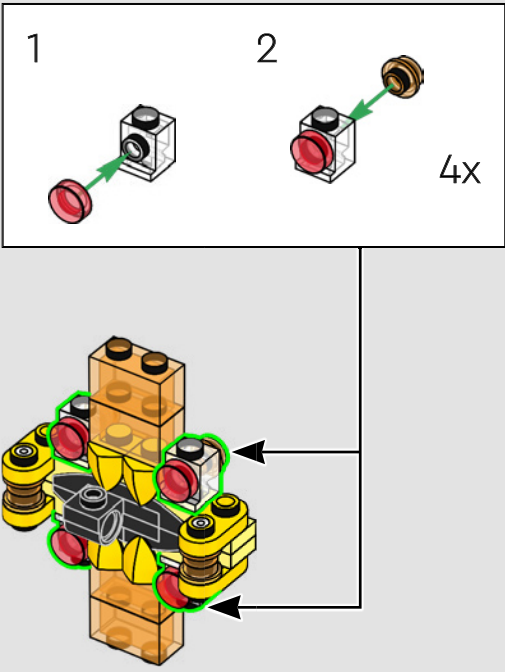

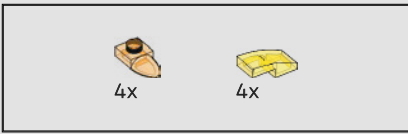

354

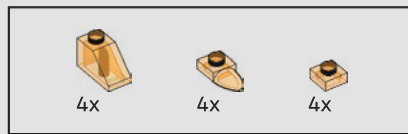
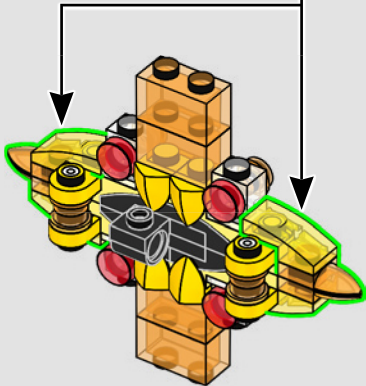
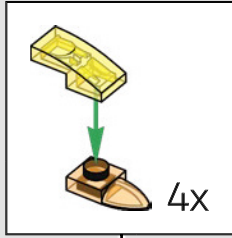

355

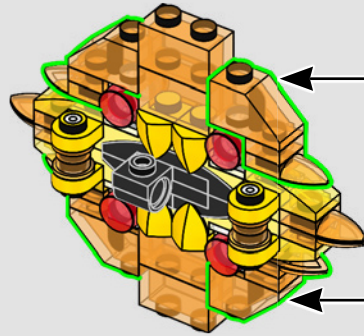
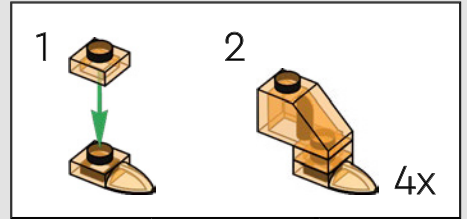

356

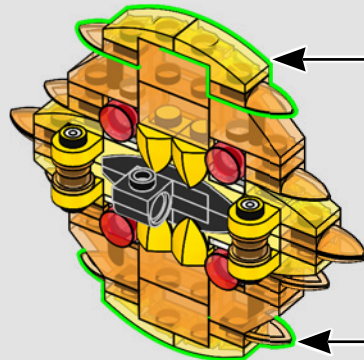
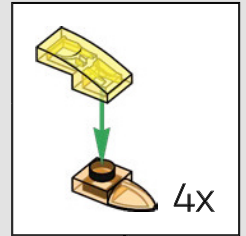



357

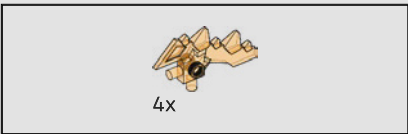
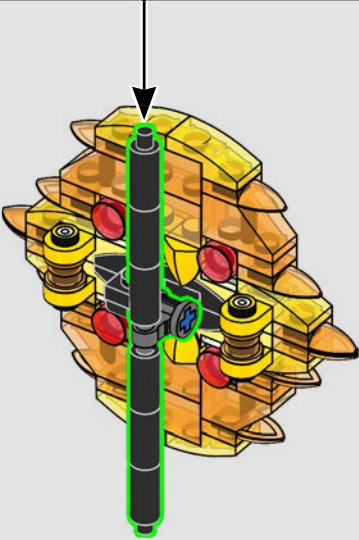
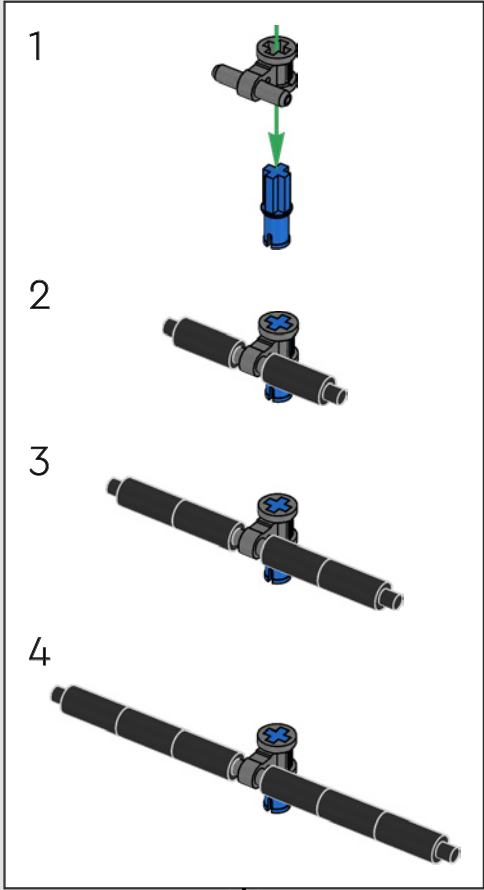

358

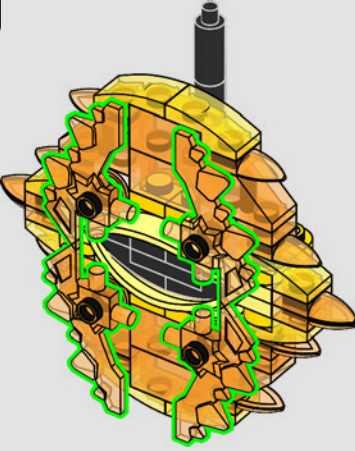



359

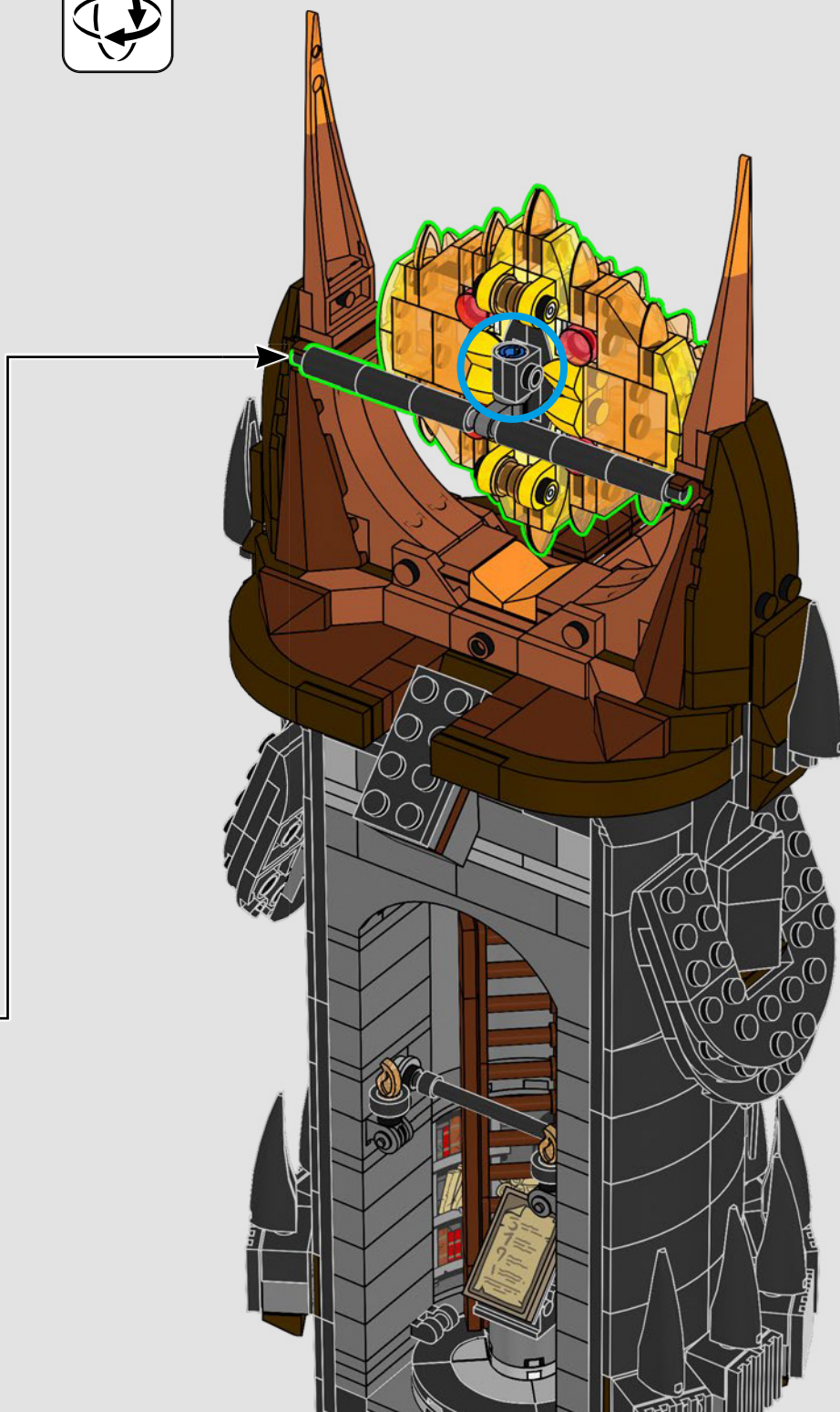

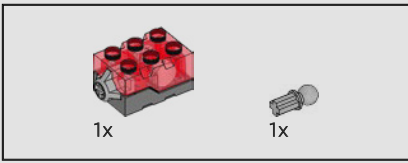

360

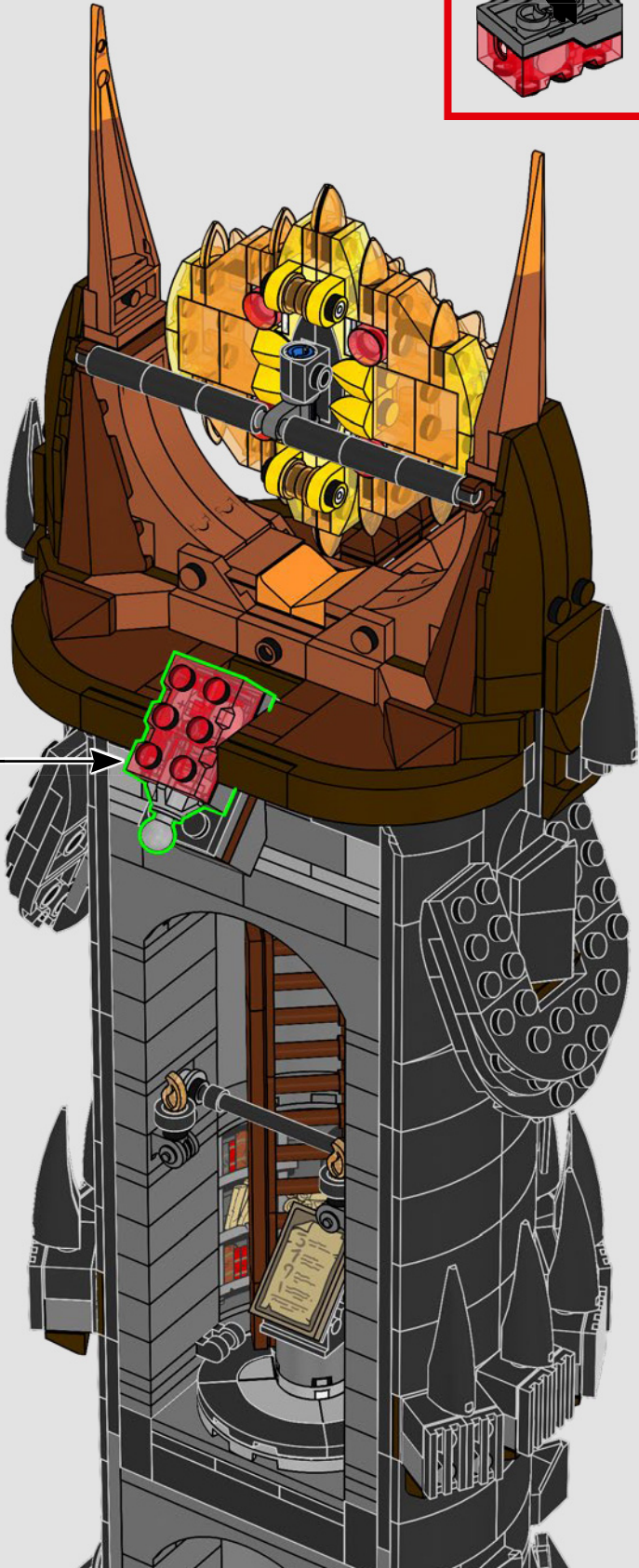
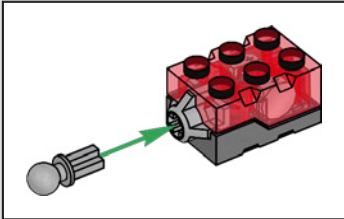
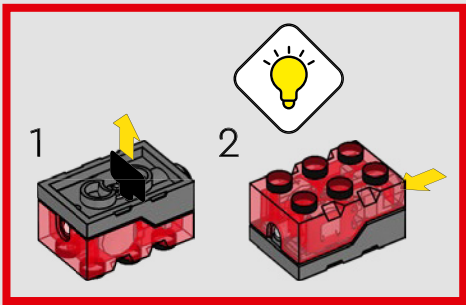

361

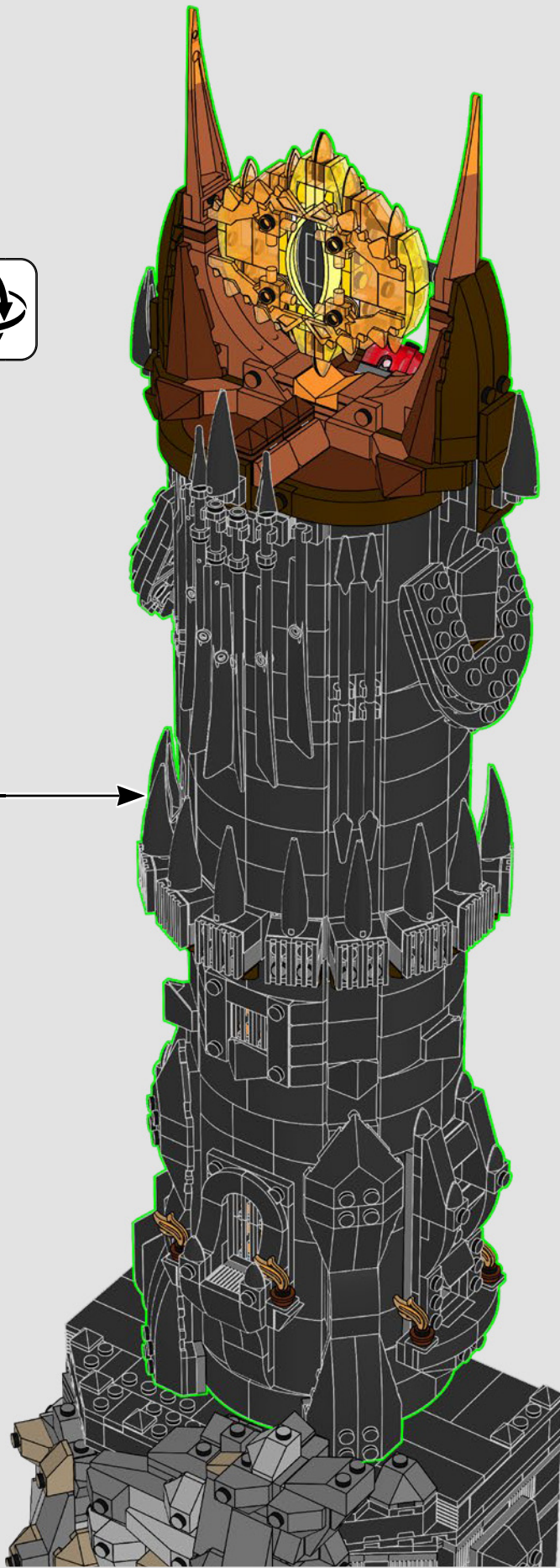

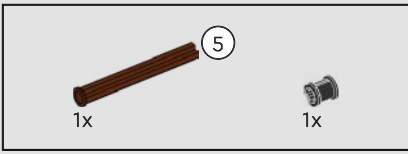

362

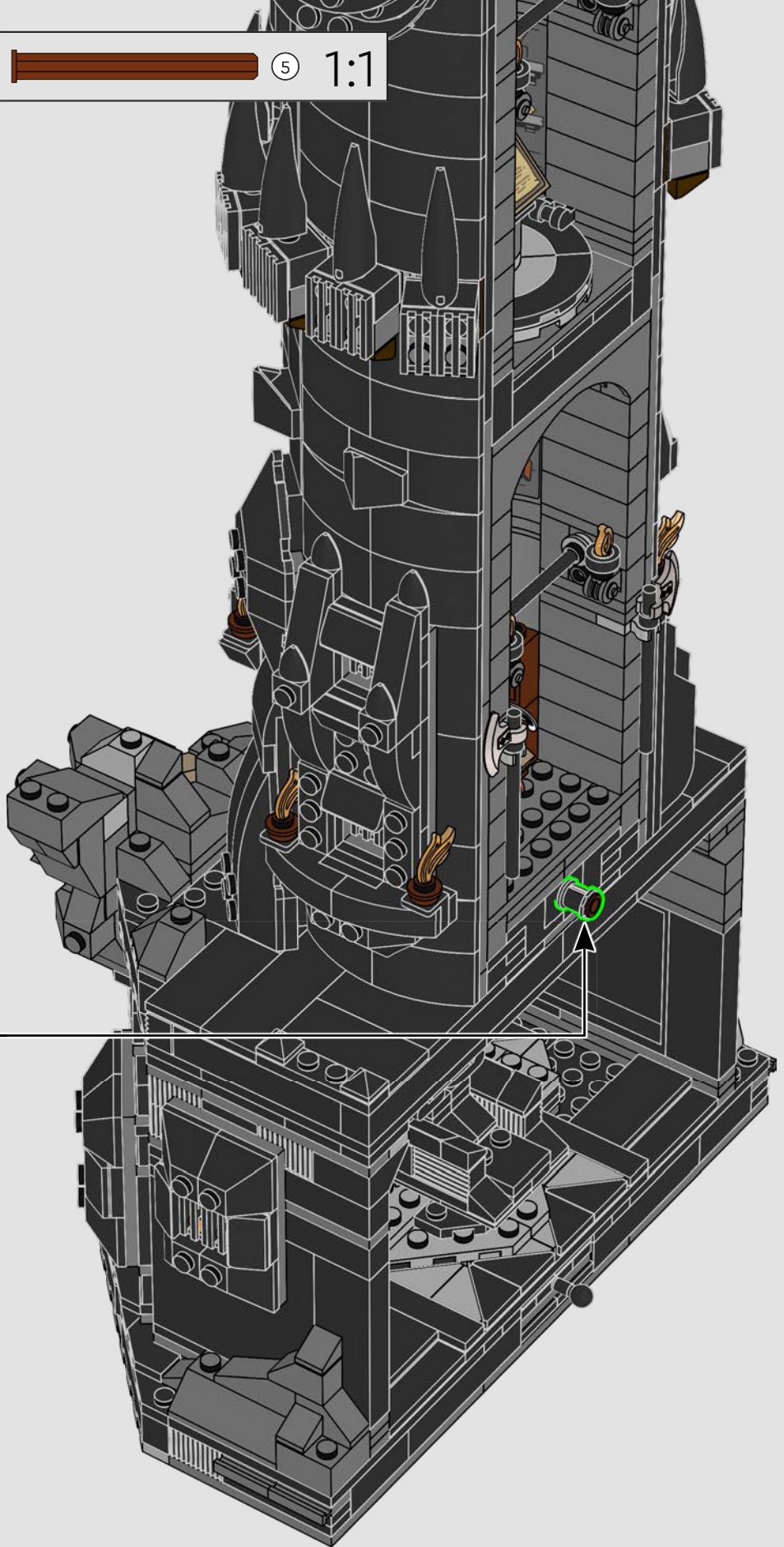
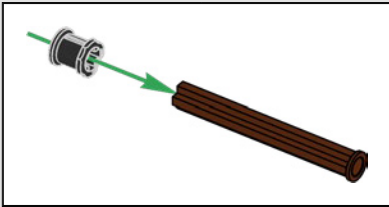
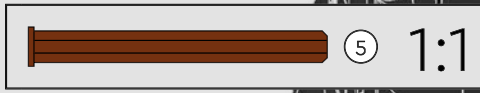

363

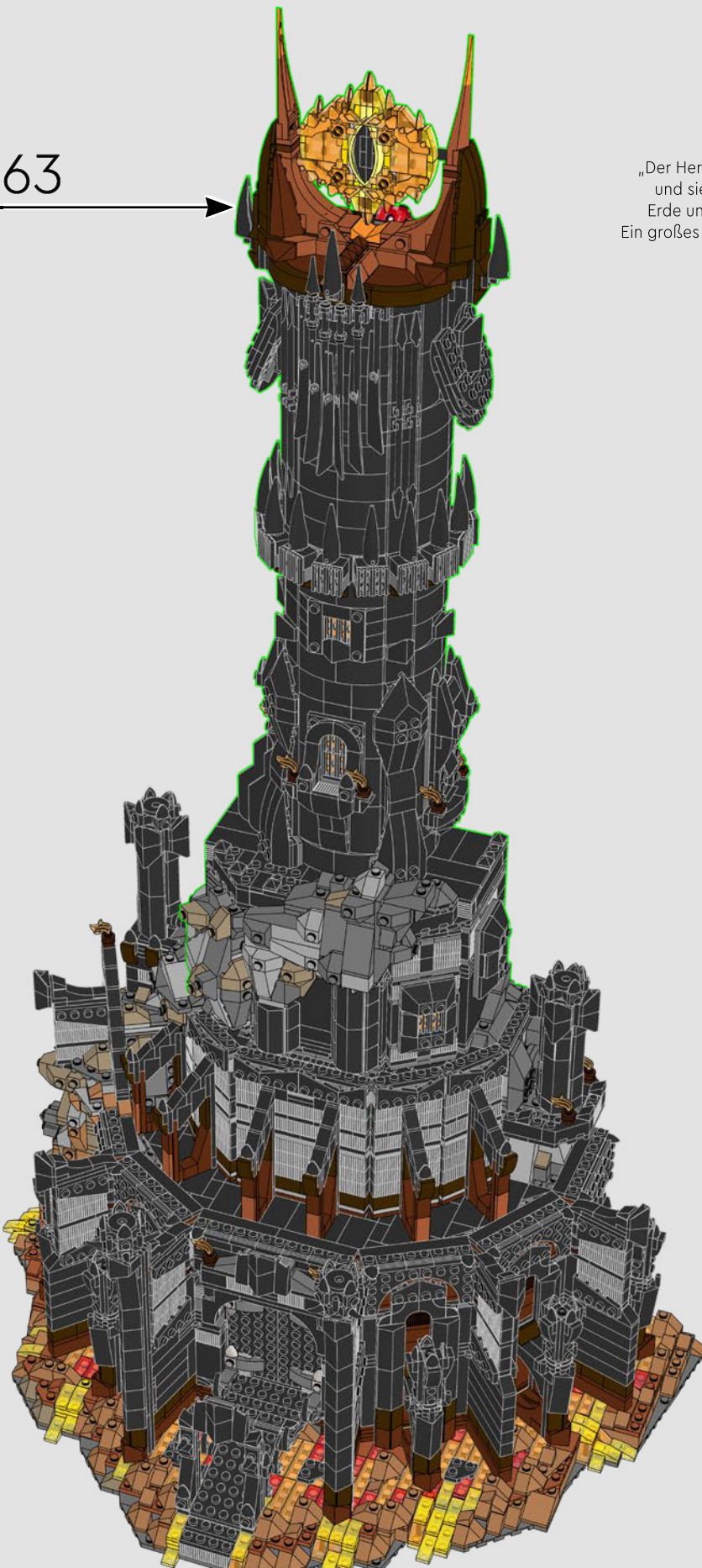

„Der Herr von Mordor hält sich in seiner Festung versteckt und sieht alles! Sein Blick durchbohrt Wolken, Schatten, Erde und Fleisch. Du weißt, wovon ich spreche, Gandalf? Ein großes Auge, lidlos, umrandet von Flammen.“ – Saruman



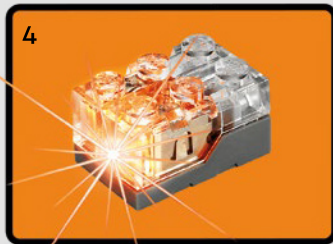
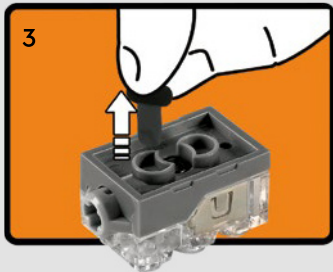

1:1
2x LR 41 1.5V

BG

Важна информация за батериите

Никога не използвайте едновременно различни типове батерии или комбинация от стари и нови батерии. Винаги изваждайте батериите, ако izdelieto няма да се използва продължително време или ако батериите са се изтощили. Никога не използвайте повредени батерии. Използвайте само алкални батерии. Поставете батериите така, че полюсите да са разположени правилно. Никога не опитвайте да зареждате батерии, които не са акумулаторни. Никога не свързвайте на късо контактите на отделението за батериите.

LV

Svarīga informācija par baterijām

Nekad vienlaikus nelietojiet dažādu tipu, kā arī vecas un jaunas baterijas. Vienmēr izņemiet baterijas, ja tās ir izlādējušas vai ja produkts ilgāku laiku netiek lietots. Nekad nelietojiet bojātas baterijas. Izmantojiet tikai sārna tipa baterijas. Ievietojot baterijas, ievērojiet pareizu polaritāti. Nekad nemēģiniet uzlādēt baterijas, kas nav uzlādējamās. Nepieļaujiet issavienojumu bateriju nodalījumā.

ET

Oluline teave patareide kohta

Ära kunagi kasuta koos erinevat tüüpi patareid, samuti vanu ja uusi patareid. Kui märguandja ei kasutata pika aja jooksul, võta patarei sellest välja. Ära kunagi kasuta kahjustatud patareid. Kasuta ainult leelispatareid. Pane patareid märguandja sisse nii, et pluss- ja miinusklemmi asend oleks õige. Ära kunagi proovi akulaadijaga laadida tavalisi patareid. Patareipesa klemmide vahel ei tohi tekkida lühist.

LT

Svarbi informacija apie elementus

Vienu metu nenaudokite skirtingų elementų, taip pat su naujais elementais nenaudokite senų. Jei nenaudosite gaminio ilgesnį laiką arba jei elementai išseko, visuomet išimkite juos iš gaminio. Niekada nenaudokite pažeistų elementų. Naudokite tik šarminius elementus. Elementus dėkite atsižvelgdami į jų poliškumą. Niekada nebandykite įkrauti vienkartinį elementų. Saugokitės, kad elementų įdėkle nesukeltumėte trumpojo jungimo.

TR

Piller hakkında önemli bilgiler

Hiçbir zaman farklı tipte pilleri ya da eski pillerle yeni pilleri bir arada kullanmayın. Ürün uzun süre kullanılmayacaksa ya da piller bitmişse, pilleri ürünün içinden çıkarın. Hiçbir zaman zedelenmiş piller kullanmayın. Sadece alkanin piller kullanın. Pilleri kutupları doğru konumda olacak şekilde yerleştirin. Hiçbir zaman, şarj edilebilir olmayan pilleri şarj etmeye çalışmayın. Hiçbir zaman pil kutusuna kısa devre yaptırmayın.

AR

معلومات مهمة عن البطاريات

يحظر استخدام أنواع مختلفة من البطاريات معا أو مزيج من البطاريات القديمة و الجديدة. احرص دائما على نزع البطاريات في حال عدم استخدام المنتج لفترة طويلة أو إذا نفذت طاقة البطاريات. تجنب استخدام البطاريات التالفة. لا تستخدم إلا البطاريات القلوية فقط. قم بتكيب البطاريات بحيث تكون الأقطاب في موضعها الصحيح. يحظر إعادة شحن البطاريات غير القابلة لإعادة الشحن. تجنب إحداث دائرة قصر في حامل البطارية.

ID

Informasi penting tentang baterai

Jangan gunakan baterai yang jenisnya berlainan, atau mencampur baterai lama dan baterai baru. Lepas baterai jika produk tidak akan digunakan untuk waktu lama atau jika baterai sudah lemah. Jangan gunakan baterai yang rusak. Gunakan hanya baterai alkali. Masukkan baterai dengan posisi kutub yang tepat. Jangan pernah coba mengisi ulang baterai biasa. Jangan pernah membuat arus pendek pada dudukan baterai.

MS

Maklumat penting tentang bateri

Jangan guna jenis bateri yang berbeza bersama-sama, atau gabungan bateri baharu dan lama. Tanggalkan bateri jika produk tidak akan digunakan untuk tempoh masa yang lama atau jika bateri telah kehabisan kuasa. Jangan guna bateri yang rosak. Guna bateri jenis alkali sahaja. Selitkan bateri supaya paksi berada pada kedudukan yang betul. Jangan cuba untuk mengecap semula bateri yang tidak boleh dicaskan semula. Jangan pintas litar pemegang bateri.



EN
Protect the environment by not disposing of this product with your household waste.
Check with your local authority for recycling advice and facilities. Penalties may apply for improper disposal.

DE
Schützen Sie die Umwelt und entsorgen Sie dieses Produkt nicht mit Ihrem Hausmüll.
Informationen zu Recycling-Möglichkeiten erhalten Sie bei den örtlichen Behörden. Bei unsachgemäßer Entsorgung können Strafen verhängt werden.

FR
Protégez l'environnement : ne jetez pas ce produit avec vos autres déchets ménagers.
Contactez les autorités locales pour obtenir des informations sur le recyclage et connaître les points de collecte. Des sanctions peuvent être appliquées en cas d'élimination inappropriée.



IT
Proteggi l'ambiente! Non smaltire questo prodotto con i rifiuti domestici.
Per consulenza sul riciclaggio dei rifiuti e le strutture di riciclaggio, rivolgerti alle proprie autorità locali. Uno smaltimento improprio può comportare sanzioni.

NL
Bescherm het milieu: gooi dit product niet samen met het andere huisvuil weg.
Raadpleeg de plaatselijke instanties voor locaties van milieustations en advies over hergebruik. In geval van onjuiste verwijdering kunnen boetes worden opgelegd.

ES
Proteja el medio ambiente no deshaciéndose de este producto junto con sus residuos domésticos.
Solicite asesoramiento e información sobre instalaciones de reciclaje a las autoridades locales. La eliminación inadecuada puede ser objeto de sanciones.

DA
Beskyt miljøet! Smid ikke dette produkt ud sammen med husholdningsaffaldet.
Få vejledning om genbrug og genbrugsstationer hos din kommune.
Ukorrekt bortskaffelse kan medføre bøde eller straf.

IS
Stuðlið að umhverfisvernd með því að farga þessari vöru ekki með heimilissorpi.
Leitið upplýsinga um endurvinnslu- og förgunarstaði hjá yfirvöldum á hverjum stað. Viðurlögum kann að vera beitt ef förgun er ekki með réttum hætti.

FI
Tämä tuote on hävitettävä ympäristöstävällisesti ja erillään muusta talousjättestä.
Tietoja kierrätyksestä ja keräyspisteiden sijainnista saat paikkakuntasi teknisestä virastosta. Epäasianmukaisesta hävittämisestä saattaa aiheutua seuraamuksia.

SV
Skydda miljön genom att inte kasta denna produkt bland ditt hushållsavfall.
Kontakta din kommun för frågor om återvinning och miljöstationer. Påföljden kan tillkomma för felaktigt avyttring.

NO
Beskytt miljøet. Ikke kast dette produktet i husholdningsavfallet.
Kontakt kommunen for veiledning om gjenbruk og miljøstasjoner. Feil avfallshåndtering kan være straffbart.

PT
Proteja o ambiente não eliminando este produto com o seu lixo doméstico.
Consulte as autoridades locais para informação sobre reciclagem e sistemas de recolha. Podem ser aplicadas coimas por eliminação inadequada.

EL
Προστατέψτε το περιβάλλον. Μην πετάτε αυτό το προϊόν μαζί με τα συνηθισμένα οικιακά απορρίμματα.
Επικοινωνήστε με τις τοπικές αρχές σχετικά με συμβουλές και εγκαταστάσεις ανακύκλωσης. Ενδέχεται να επιβάλλονται κυρώσεις για ακατάλληλη διάθεση απορριμμάτων.

JA
環境保護のため、本製品は家庭ごみとは別に処分してください。
リサイクルに関する指示や施設については、お住まいの地方自治体にお問い合わせください。不適切な廃棄を行った場合、罰則が適用されることがあります。

ZH
注意保护环境，请勿将本产品与生活垃圾一起丢弃处理。
请咨询当地相关部门，了解与回收相关的设施与建议。
处理不当可能会导致处罚。

KO
환경 보호를 위해 이 제품을 생활폐기물과 함께 버리지 마십시오.
재활용 방법 및 시설에 관한 사항은 현지 관계 당국에 문의하십시오. 부적절하게 폐기할 경우 벌칙이 부과될 수 있습니다.

RU
Позаботьтесь об окружающей среде: не утилизируйте этот продукт вместе с бытовым мусором.
Узнайте в органах местного самоуправления правила вторичной переработки и утилизации таких отходов.
В случае ненадлежащей утилизации могут быть наложены штрафы.

PL
Aby chronić środowisko naturalne, nie należy wyrzucać tego produktu wraz z odpadkami z gospodarstwa domowego.
W celu uzyskania wskazówek dotyczących recyklingu oraz adresów zakładów należy skontaktować się z lokalnym urzędem.
Za nieprzestrzeganie zasad związanych z utylizacją odpadów grożą kary.

CZ
Nevyhadzujte tento produkt do domácího odpadu, chraňte životní prostředí.
Zjistěte si prosím u místních úřadů možnosti recyklace a dostupná zařízení.
Nesprávná likvidace může být pokutována.

SK
Nevyhadzujte tento produkt do domáceho odpadu, chraňte životné prostredie.
Zistite si na miestnych úradoch možnosti recyklácie a dostupné zariadenia.
Za nesprávnu likvidáciu môžu byť uložené sankcie.

HU
Környezetét óvja, ha ettől a terméktől nem a háztartási hulladékkal együtt várlik meg.
Érdeklődjék a lakóhelyéhez közel eső hatóságnál az újrahasznosítás módjáról és lehetőségeiről. A nem megfelelő hulladékelhelyezésért büntetés járhat.

UA
Допоможіть захистити довкілля: не утилізуйте цей виріб разом із побутовим сміттям.
Вказівки з утилізації та відомості про пункти прийому з'ясуйте в місцевих компетентних органах. У разі неналежної утилізації можуть застосовуватися штрафи.

HR
Zaštite okoliš tako da ovaj proizvod ne odložite u otpad zajedno s kućanskim otpadom.
Od lokalnih vlasti zatražite savjet ili informacije o pogonima za recikliranje.
Moguće je kazna za nepropisno zbrinjavanje.

SR
Zaštite životnu sredinu tako što nećete da odlažete ovaj proizvod sa kućnim otpadom.
Raspitajte se kod lokalnog nadležnog organa o načinu reciklaže i o sabirnom centru. U slučaju nepravilnog odlaganja u otpad, mogu biti izrečene kazne.

МК

Заштитете ја околината така што нема да се ослободите од производот со домашниот отпад.
Консултирајте се со локалните власти да да дознаете за советите и објектите за рециклирање. Возможно е да бидат применети казни за неправилно исфрлање.

SL

Zaščitite okolje! Okolje varujte tako, da tega izdelka ne zavržete skupaj z gospodinjstvi odpadki.
Pri krajevni upravi preverite, kakšne možnosti in kateri obrati za recikliranje obstajajo v vaši okolici. Za nepravilno odlaganje odpadkov vas lahko doleti kazen.

RO

Protejați mediul înconjurător și nu vă debarasați de acest produs împreună cu deșeurile menajere.
Consultați autoritățile locale pentru îndrumări și facilități de reciclare. Dezafectarea necorespunzătoare poate atrage sancțiuni.

BG

Защитете околната среда и не изхвърляйте този продукт заедно с битовите си отпадъци.
Свържете се с местните власти относно съвети и съоръжения за рециклиране. Възможно е да има глоби за неправилно изхвърляне.

LV

Lai saudzētu vidi, neizmetiet šo izstrādājumu kopā ar sadzīves atkritumiem.
Vērsieties vietējās varas iestādēs, lai noskaidrotu, kur un kā tas nododams pārstrādei. Par neatbilstošu likvidēšanu var tikt piemērots sods.

ET

Keskkonda saate kaitsta nii, et ei kõrvalda seda toodet koos olmejäätmetega.
Nõuandeid toote taaskasutusse võtmise ja ümbertöötlemispunktide kohta saate asjaomaselt kohalikul asutuselt.
Nõuetele mittevastav kasutuselt kõrvaldamine võib kaasa tuua trahvid.

LT

Saugokite aplinką: nemeskite šio produkto kartu su buitinėmis atliekomis.
Atsižvelkite į savo vietos valdžios rekomendacijas dėl pakartotinio panaudojimo ir sąlygas. Už netinkamą šalinimą gali būti taikomos baudos.

TR

Bu ürünü, evsel atıklarla birlikte atmayarak çevreyi koruyun.
Gerî dönüşüm tavsiyeleri ve tesisler hakkında bilgi için yerel yönetimle iletişîm kurun. Uygunsuz atılması durumunda cezalar uygulanabilir.

AR

احم البيئة بعدم التخلص من هذا المنتج مع المخلفات المنزلية.
استشر السلطة المحلية لديك للحصول على نصح بخصوص إعادة تدوير المخلفات ومراقفه.
قد يتم تطبيق عقوبات على التخلص غير السليم.

ID

Jagalah lingkungan dengan tidak membuang produk ini bersama sampah rumah tangga Anda.
Periksa peraturan pemerintah setempat tentang saran dan fasilitas daur ulang. Pembuangan yang tidak sesuai ketentuan dapat dikenakan denda.

MS

Lindungi alam sekitar dengan tidak melupuskan produk ini bersama sisa isi rumah anda.
Rujuk pihak berkuasa tempatan anda tentang nasihat dan kemudahan kitar semula. Penalti boleh dikenakan untuk pelupusan yang tidak wajar.

- EN Please retain the leaflet and packaging as they contain important information
- DE Broschüre und Verpackung bitte aufbewahren, sie enthalten wichtige Informationen
- FR Veuillez conserver le dépliant et l'emballage, car ils contiennent des informations importantes
- IT Conserva l'opuscolo e la confezione in quanto contengono informazioni importanti
- NL Bewaar a.u.b. de folder en verpakking: die bevatten belangrijke informatie
- ES Conserve el folleto y el embalaje; contienen información importante
- DA Gem hæftet og emballagen, da de indeholder vigtige oplysninger
- IS Geymið bæklinginn og umbúðirnar þar sem þau innihalda mikilvægar upplýsingar
- FI Säilytä esite ja pakkaus, koska ne sisältävät tärkeää tietoa
- SV Spara broschyren och förpackningen eftersom de innehåller viktig information
- NO Heftet og emballasjen inneholder viktig informasjon og skal beholdes
- PT Por favor guarde o folheto e a embalagem, pois contém informação importante
- EL Κρατήστε το φυλλάδιο και τη συσκευασία γιατί περιέχουν σημαντικές πληροφορίες
- JA 説明書とパッケージには重要な情報が含まれていますので保管しておいてください
- ZH 说明书和包装均包含重要信息, 请妥善保存
- KO 중요한 정보가 담겨 있으므로 리플릿과 포장을 보관해두세요
- RU Пожалуйста, сохраните эту брошюру и упаковку, поскольку они содержат важную информацию
- PL Prosimy zachować ulotkę i opakowanie, ponieważ zawierają one ważne informacje
- CZ Ponechte si prosím leták i obal, neboť obsahují důležitě informace
- SK Ponechajte si prosím leták aj obal, pretože obsahujú dôležité informácie
- HU Kérjük, őrizze meg a szórólapot és a csomagolást, mert fontos tudnivalókat tartalmaznak
- UA Будь ласка, зберігайте вкладиш та упаковку, оскільки вони містять важливу інформацію
- HR Spremite letak i ambalažu jer sadrže važne obavijesti
- SR Molimo da sačuvate uputstvo i pakovanje jer se na njima nalaze važne informacije
- MK Чувајте ги брошурата и амбалажата бидејќи содржат важна информација
- SL Prosimo, da brošurico in embalažo shranite, saj vključujeta pomembne informacije
- RO Vă rugăm să păstrați prospectul și ambalajul întrucât conțin informații importante
- BG Запазете листовката и опаковката, тъй като съдържат важна информация
- LV Lūdzu, saglabājiet bukletu un iepakojumu, jo uz tā ir norādīta svarīga informācija
- ET Hoidke infoleht ja pakend alles, sest nendele on märgitud oluline teave
- LT Išsaugokite informacinį lapelį ir pakuotę, nes ant jų pateikiama svarbi informacija
- TR Önemli bilgiler içerdiği için broşürü ve ambalajı saklayın
- AR الرجاء الاحتفاظ بالنشرة والغلاف لاحتوائهما على معلومات هامة
- ID Harap simpan brosur dan kemasan ini karena berisi informasi penting
- MS Sila simpan risalah dan pembungkusan kerana ia mengandungi maklumat penting

LEGO System A/S
Aastvej 1
DK-7190 Billund



2x 6240495
1x 6406415
21x 6446788
1x 4651445
4x 6360202
3x 6357680
2x 6326680
2x 6310185
2x 474001
3x 6313115
3x 300401
1x 6299836
4x 6312480
1x 6359891
8x 6218822
2x 235701
2x 6058329
1x 306801
3x 6289797
1x 300201
4x 6497109
1x 4600307

1x 6192352
9x 389401
2x 4611927
13x 4181142
6x 303501
1x 6324176
3x 4529237
1x 6484310
1x 6484313
2x 4113915
4x 4666579
2x 6490029
10x 6024495
18x 4113917
2x 6313119
7x 4109995
10x 6214334
2x 4205107
5x 6313611
1x 4185177

2x 4124455
2x 4114077
1x 6486727
8x 4118790
2x 4113233
5x 4114319
8x 4114309
3x 4181134
8x 4114324
1x 6037398
2x 4113988
5x 300521
2x 6144805
1x 6097192
9x 4142865
7x 300421
1x 370021
6x 6001806

2x 300321
8x 6209519
2x 362221
5x 6129995
2x 371021
4x 6416443
1x 379521
1x 370221
2x 6078594
3x 4206482
33x 302323
6x 6299413
3x 302223
1x 300923
2x 383223
4x 6047218
4x 6248971
4x 403224
2x 300424

2x 6117938
2x 235724
1x 6130007
4x 362324
4x 301024
2x 6130008
3x 300924
1x 366624
2x 4181143
18x 6270103
6x 6290456
5x 6331084
2x 6269965
11x 6315887
2x 6321194
21x 306226
12x 6186675
2x 6510193
39x 6424674
1x 6484307

1x 6332148
1x 6484325
14x 6213729
1x 459926
12x 6065496
22x 6172383
3x 6228987
49x 4504382
61x 302426
10x 300526
5x 6312449
4x 307026
3x 4558954
12x 6420198
13x 6335388
1x 6181720
16x 6234695
6x 6335317
1x 6299338
68x 4273590
10x 6433936
5x 4177431

2x 6344752
7x 6141554
2x 6104209
8x 6141556
2x 6438919
6x 6210270
3x 4180536
2x 4180508
11x 4161332
11x 4160869
8x 6157554
1x 6181713
34x 4548180
5x 6279875
9x 403226
1x 452926
4x 6143850
5x 6195325
2x 614326
1x 6484312
172x 287726

35x 4220539	13x 245426	3x 6425507	1x 6492539	1x 6192309	2x 4629921	14x 6208787	2x 6037390
18x 6174243	18x 245426	8x 4189064	1x 4521681	2x 6408603	4x 6138405	14x 379526	1x 6435265
97x 302326	4x 6016172	2x 6403373	1x 6390749	2x 6439175	5x 366626	16x 4181144	6x 6475345
12x 6228588	4x 6308883	7x 4124096	2x 6394879	2x 6434275	2x 663626	10x 6318582	2x 395826
2x 6338799	25x 4107761	4x 6191630	28x 302126	6x 6325190	2x 663626	8x 6475344	6x 447726
18x 6475339	4x 6250020	1x 6192346	62x 6147790	29x 6416444	20x 300926	2x 4106977	3x 611126
31x 306926	28x 6214807	2x 4567436	2x 6395375	1x 4525078	1x 241926	2x 4160130	1x 303526
19x 6267487	3x 6346535	6x 6211476	4x 6162892	41x 4529155	3x 4513539	2x 3200126	5x 383226
5x 6275806	1x 6234806	2x 4584274	2x 300226	7x 6475341	2x 6058118	2x 6339200	4x 303626
8x 6347310	2x 6331723	24x 6469445	1x 6018805	29x 4560182	1x 6335646	8x 416226	9x 4514845
44x 241226	3x 6093525	7x 6313508	58x 371026	18x 4587844	6x 4243819	5x 300826	3x 303026
1x 393726	43x 302226	2x 6267045	8x 243126	13x 302026	6x 4243819	7x 346026	2x 6302830
1x 6178922	21x 242026	1x 6448318	25x 301026	3x 300126	5x 617926	4x 6438920	18x 244526
13x 6069000	10x 300326	12x 6038531	2x 6254045	2x 6040297	2x 6501118	2x 6179660	
26x 6047276	4x 235726	29x 362326	4x 4160025	1x 6495964	2x 6179660	4x 6170421	
12x 366526	16x 4163373	4x 4558170	3x 4613153	17x 6350415	4x 6170421		
6x 4121966	2x 6176768	7x 362226	6x 4251161	6x 4515362	15x 303426		
1x 6092585	14x 6053077	6x 4251161	14x 6328095	2x 6040298			
4x 6147050	1x 6390748	6x 4251161	2x 6199908				
	9x 306826	14x 6328095					
	6x 6166859	2x 6199908					

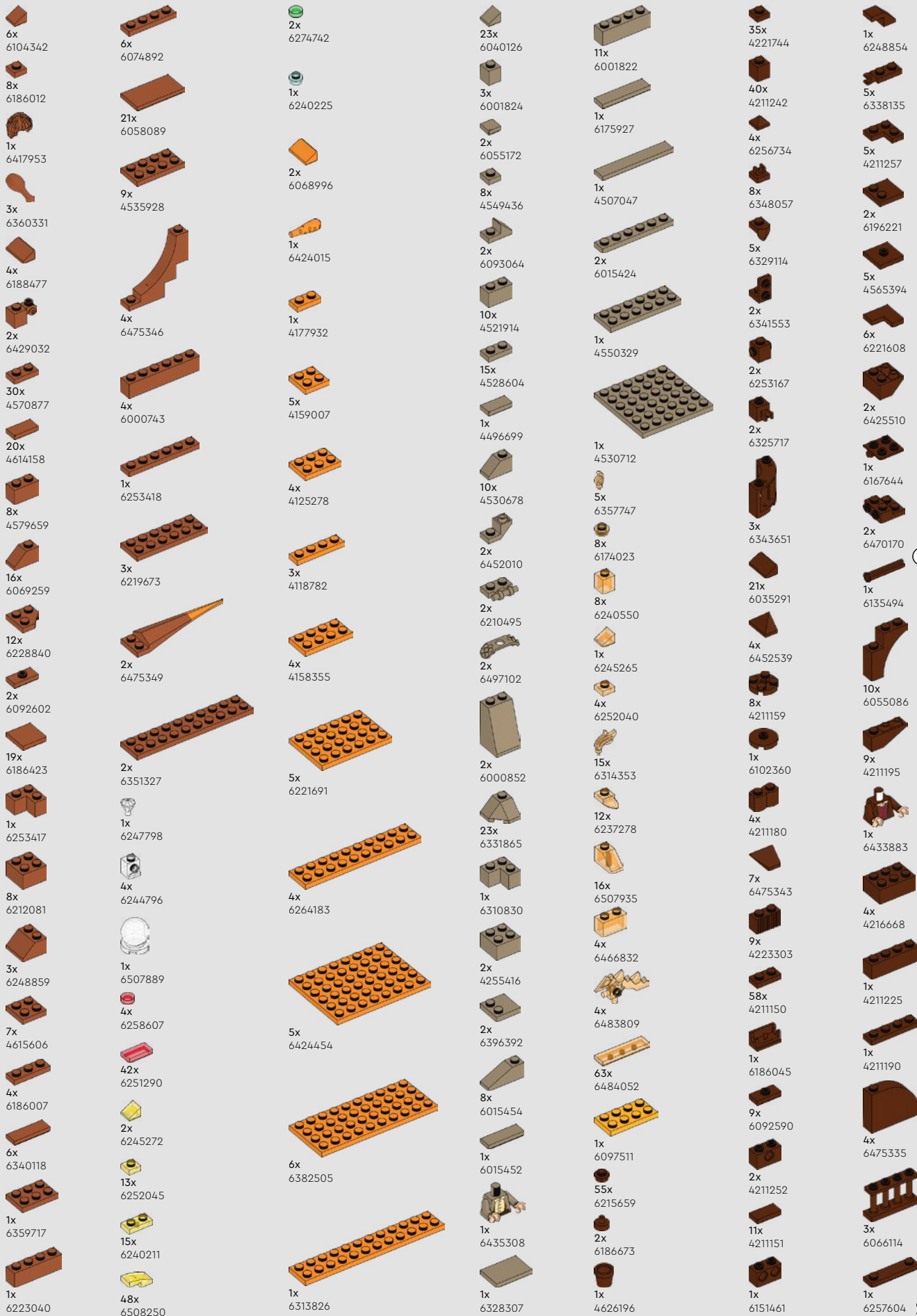

3



5

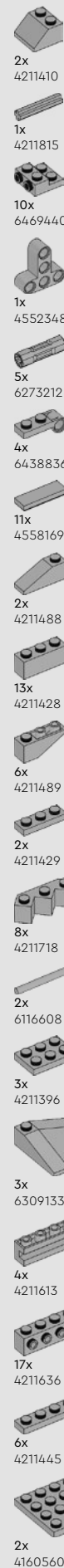
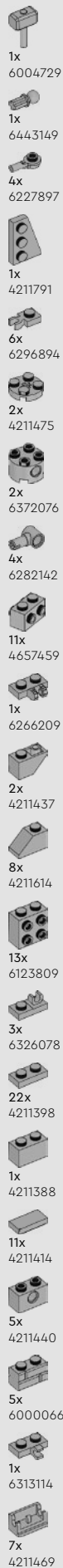
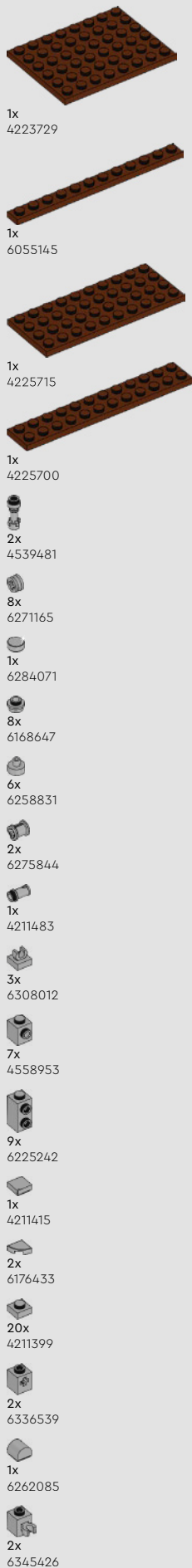

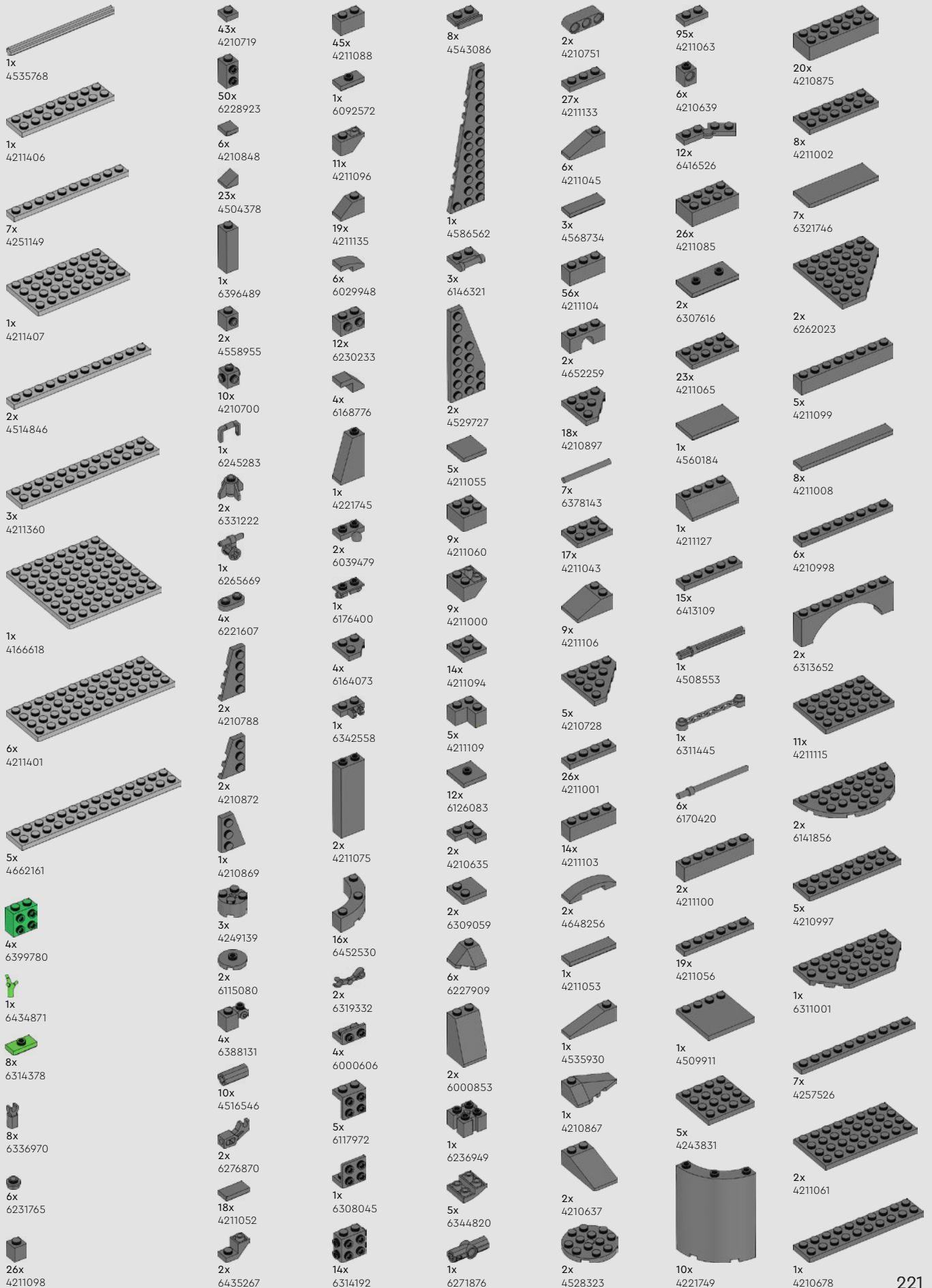



YOU COULD WIN



YOU COULD WIN

Your feedback will help shape the future development of this product series.

Visit:

DU KÖNNTEST GEWINNEN

Dein Feedback trägt zur Weiterentwicklung dieser Produktreihe bei.

Geh auf:

VOUS POURRIEZ GAGNER

Vos commentaires nous aideront à concevoir les futurs produits de cette gamme.

Visitez :

POTRESTI VINCERE TU

La tua opinione ci aiuterà a migliorare la creazione futura di questa linea di prodotti.

Visita:

PUEDES GANAR

Tu opinión contribuirá al futuro de esta serie de productos.

Visita:

轻松获奖

您的反馈将有助于我们在今后改进本产品系列。

请访问:

LEGO.com/productfeedback

You also have the chance to win a LEGO® set.

Terms and conditions apply.*

Außerdem hast du die Chance, ein LEGO® Set zu gewinnen.

Es gelten die Teilnahmebedingungen.*

Vous pourriez également gagner un ensemble LEGO®.

Des conditions s'appliquent.*

Hai anche la possibilità di vincere un set LEGO®.

Termini e condizioni sono applicabili.*

También tienes la oportunidad de ganar un set LEGO®.

Aplican términos y condiciones.*

您还有机会赢取乐高®套装。

条款和条件适用。*

*LEGO.com/productfeedback-terms



LEGO and the LEGO logo are trademarks of the LEGO Group. ©2024 The LEGO Group.



NEW LINE CINEMA

© New Line Productions Inc. All rights reserved.
THE LORD OF THE RINGS TRILOGY and all names
of the characters, items, events, and places therein
are ™ of Middle-earth Enterprises, LLC under license
to New Line Productions, Inc. (s24)