

# THE MAGAZINE



LEGO TROLLS WORLD TOUR



LEGO MINECRAFT™



MAX COMICS

JAN - MAR | 2020



# GET READY FOR LEGO® LEGACY!

**LEGO** LEGACY  
HEROES UNBOXED

COMING  
SOON!

Classic minifigures and sets come to life in the new mobile game LEGO® Legacy: Heroes Unboxed! Assemble a team of famous minifigure heroes for action-packed battles against some of the worst villains in LEGO history.

Play solo or team up for online multiplayer action. Train your heroes, unlock awesome abilities and rediscover amazing minifigures.



**Build Your Own Team!**

The LEGO® Legacy minifigures have an important mission, and we need YOU to choose which five minifigures are the best ones to carry it out. **Tick boxes for each minifigure you choose for your team.**

### YOUR MISSION:

- Sail to a pirate island.
- Climb to the top of a snowy mountain.
- Cast magic spells to enter a secret cave.
- Slip past the guardian dragon by making him laugh.
- Put out the Eternal Fire inside.

<input type="checkbox"/>	<input type="checkbox"/>	<input type="checkbox"/>	<input type="checkbox"/>	<input type="checkbox"/>	<input type="checkbox"/>
Firefighter Ash	Miner Clay	Yeti	Nya	Clockwork Robot	Private LaQuay
<input type="checkbox"/>	<input type="checkbox"/>	<input type="checkbox"/>	<input type="checkbox"/>	<input type="checkbox"/>	<input type="checkbox"/>
Captain Redbeard	Jester Gogo	Poppy	Princess Verda	Princess Argenta	Willa the Witch
<input type="checkbox"/>	<input type="checkbox"/>	<input type="checkbox"/>	<input type="checkbox"/>	<input type="checkbox"/>	<input type="checkbox"/>
Gorwell	Darwin	Chef	Cactus Girl	Hiker	Spaceman Reed

RATING PENDING  
COTE EN ATTENTE  
RP  
ESRB

Visit [esrb.org](http://esrb.org) for rating information  
Visiter [esrb.org](http://esrb.org) pour les classifications

©2020 Gameloft.™ & ©2020 The LEGO Group. All Rights Reserved. Apple and the Apple logo are trademarks of Apple Inc., registered in the U.S. and other countries. App Store is a service mark of Apple Inc., registered in the U.S. and other countries. Google Play and the Google Play logo are trademarks of Google LLC. Microsoft, Windows and the Windows Store are trademarks of the Microsoft group of companies.

# WELCOME TO ISSUE 1, 2020!



HI, IT'S MAX!

THIS IS SO EMBARRASSING. I WAS ALL SET TO TELL YOU ABOUT WHAT AN EXCITING FIRST ISSUE OF 2020 THIS IS GOING TO BE. WE'VE GOT ALL-NEW STUFF LIKE LEGO® FRIENDS, NEW HIDDEN SIDE EXCITEMENT, AWESOME LEGO CREATOR SETS ... BUT NOW THEY HAVE DISAPPEARED!

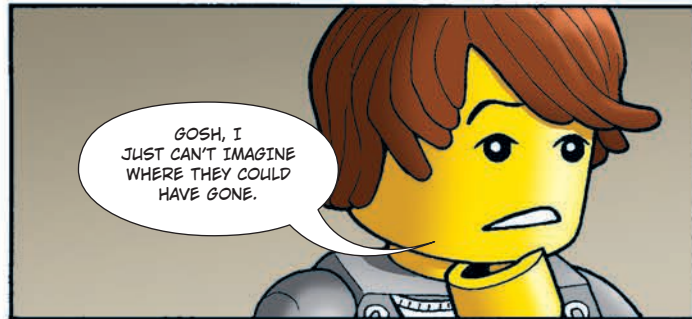

GOSH, I JUST CAN'T IMAGINE WHERE THEY COULD HAVE GONE.



OH! THERE THEY ARE ... UMMM ... FLOATING ... IN THE AIR ...

MAYBE I SHOULD CALL SOMEONE? OOPS! I HIT THE HIDDEN SIDE APP BY MISTAKE!



AHA! I SHOULD HAVE KNOWN!

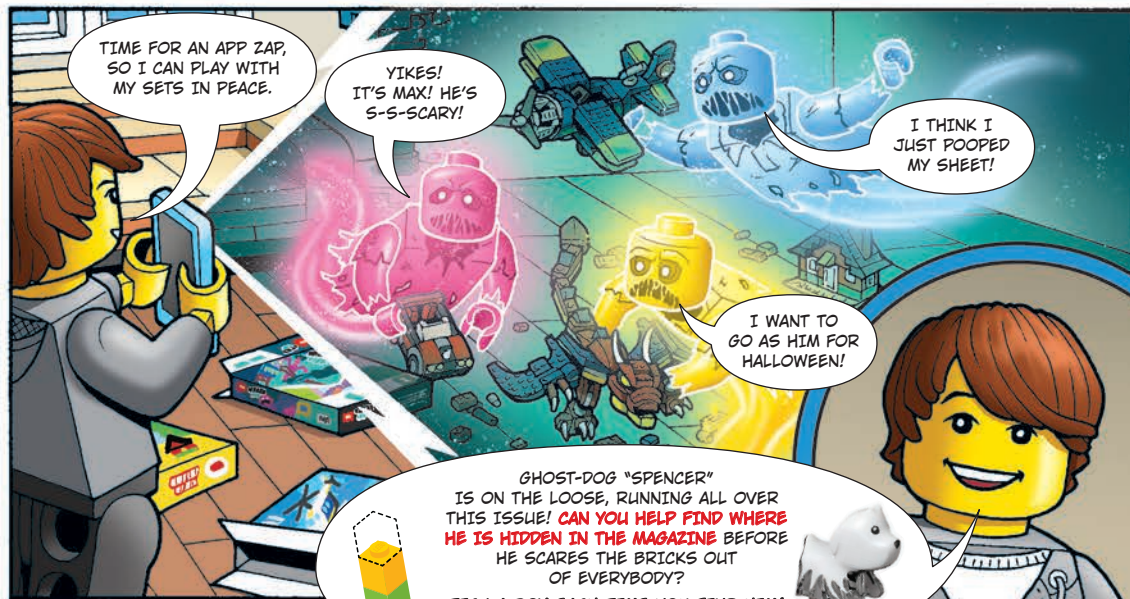

TIME FOR AN APP ZAP, SO I CAN PLAY WITH MY SETS IN PEACE.

YIKES! IT'S MAX! HE'S S-S-SCARY!

I THINK I JUST POOPED MY SHEET!

I WANT TO GO AS HIM FOR HALLOWEEN!

GHOST-DOG "SPENCER" IS ON THE LOOSE, RUNNING ALL OVER THIS ISSUE! **CAN YOU HELP FIND WHERE HE IS HIDDEN IN THE MAGAZINE** BEFORE HE SCARES THE BRICKS OUT OF EVERYBODY?

TICK A BOX EACH TIME YOU FIND HIM!

## LOOK!

Look for these icons on activity pages. They will tell you if the activity is easy, hard, or somewhere in between. Try them all and see how you do! **If you get stuck, the answers can be found on page 27!**



**LEVEL 1**  
Easy



**LEVEL 2**  
Somewhere in between



**LEVEL 3**  
Hard



### LEGO® Life Magazine

For information about LEGO® Life visit [LEGO.com/life](http://LEGO.com/life)

For questions about your membership visit [LEGO.com/service](http://LEGO.com/service)



### LEGO Life Magazine

PO Box 3384  
Slough SL1 0BJ  
00800 5346 5555



### LEGO Life Australia

Locked bag 2240  
North Ryde BC, NSW, 1670  
Freecall 1800 823757



### LEGO Life New Zealand

Suite 5.2, 27 Gillies Avenue  
Newmarket, Auckland, 1023  
Freecall 0800 480 381

# PANDA PANDEMONIUM!



Alex is bringing a treat for one of the newest mobs in the Minecraft™ game: pandas! These adorable black and white creatures appear in bamboo jungle biomes and are rarer than other jungle mobs. **How much do you know about Minecraft pandas?**



Not all pandas included in set.



## TAKE THE QUIZ!

- 1.** Pandas will follow anyone who is carrying:

  - A. A shovel
  - B. Lava
  - C. Bamboo
  - D. Melons
- 2.** Which of these is a favourite food of pandas in Minecraft™?

  - A. Pumpkins
  - B. Sugar cane
  - C. Cactus
  - D. Cake
- 3.** Baby pandas sometimes make their parents jump by doing this:

  - A. Sneezing
  - B. Roaring
  - C. Sleeping
  - D. Rolling around
- 4.** The slowest land mob in Minecraft is:

  - A. Normal pandas
  - B. Playful pandas
  - C. Worried pandas
  - D. Lazy pandas

# HIDDEN SIDE SECRET FILES

We uncovered some of the mysteries of the town of Newbury, its ghosts and the young heroes trying to drive out the spirits and save the day. **Read on... IF YOU DARE!**

Why do ghosts ride lifts?  
To raise their spirits!



**JACK**

- New to Newbury
- Loves making videos and ghost hunting
- Best friends with Parker
- Sometimes gets distracted by vlogging while on a ghost-hunting mission

What kind of streets do ghosts live on?



**EL FUEGO**

Dead ends!

- Used to be the school grounds-keeper and a stunt-man
- Died and came back as a ghost
- Now he can do the craziest, most dangerous stunts without ever getting hurt

Why are ghosts like your mattress?  
They both wear sheets!



**PARKER**

- Loves ghost hunting and is super good at it
- Best friends with Jack
- Likes uncovering secrets and solving mysteries
- Very dedicated to her work

Why was the ghost such a bad liar?  
You could see right through him!



**J.B.**

- Invented the app Jack and Parker use to hunt ghosts
- Skilled inventor
- Drives a bus she calls "Sweet Sally"
- Enjoys designing new vehicles

What kind of room will you never find in a ghost's house?  
A living room!



**SPENCER**

- Jack's ghost dog
- Moves back and forth between Sides as he chooses
- Will always show up if promised bacon

**FIND THE HIDDEN MESSAGE!**  
Jack and Parker have sent you a secret message!  
Here's how to find it: 1. Cross out all the A's  
2. Cross out all the U's  
3. Cross out all the S's

A U H S A E U S Y A U S U A  
A A U S D A O S S N U A T A S  
G A U S A E U H A T S S A A S  
A G S L U O S A O S M A E S D



Need help? Answers can be found on page 27.



# MULTIPLAYER MADNESS ON THE HIDDEN SIDE!

Adventures on the Hidden Side now have twice as much action and fun! Invite your friends to join the app as a ghost hunter or a ghost. Will you banish the ghost back to its home dimension, or be gloomed forever?

Parker and Jack have discovered a ghostly roller-coaster ... but the ghosts have discovered them too! Take on a friend in this board game and see who can make it to the end of the track first, ghost hunter or ghost!

## DIRECTIONS:

1. Youngest player goes first.
2. Choose your path – green for ghost or red for ghost hunter.
3. Roll a dice and move that number of spaces.
4. Follow any instructions on the space you land on.
5. First one to reach the end of the roller coaster track is the winner!



WHY DIDN'T THE  
GHOST GO TO THE PARTY?

HE HAD NO BODY  
TO GO WITH!



Remember to take  
Spencer for a walk  
when you get home.  
**ROLL AGAIN.**

Uploading  
your new video.  
**LOSE ONE TURN.**

Maybe they  
should call it a  
"roller-ghoster"?  
**ROLL AGAIN.**



WHAT DO  
BABY GHOSTS WEAR?  
PILLOWCASES!

Glooming  
you go.  
**ADVANCE  
ONE SPACE.**

Nothing like  
a good fright!  
**ROLL AGAIN  
AND JUMP  
THE TRACK!**



**END**



**HIDDEN  
SIDE**

Looking at the clown head was a mistake.  
**GO BACK ONE SPACE.**



Forgot your phone!  
**GO BACK TWO SPACES.**

No brakes on this coaster!  
**ADVANCE TWO SPACES.**

Got a ghost with the app!  
**ROLL AGAIN AND JUMP THE TRACK!**

**HUNTER**

**START**

**GHOST**

Can't decide who to scare next.  
**LOSE ONE TURN!**

LESS JOKING,  
MORE ZAPPING!



Today, the clown-coaster - tomorrow, all of Newbury!  
**ADVANCE ONE SPACE.**

Better dodge the app!  
**GO BACK ONE SPACE.**



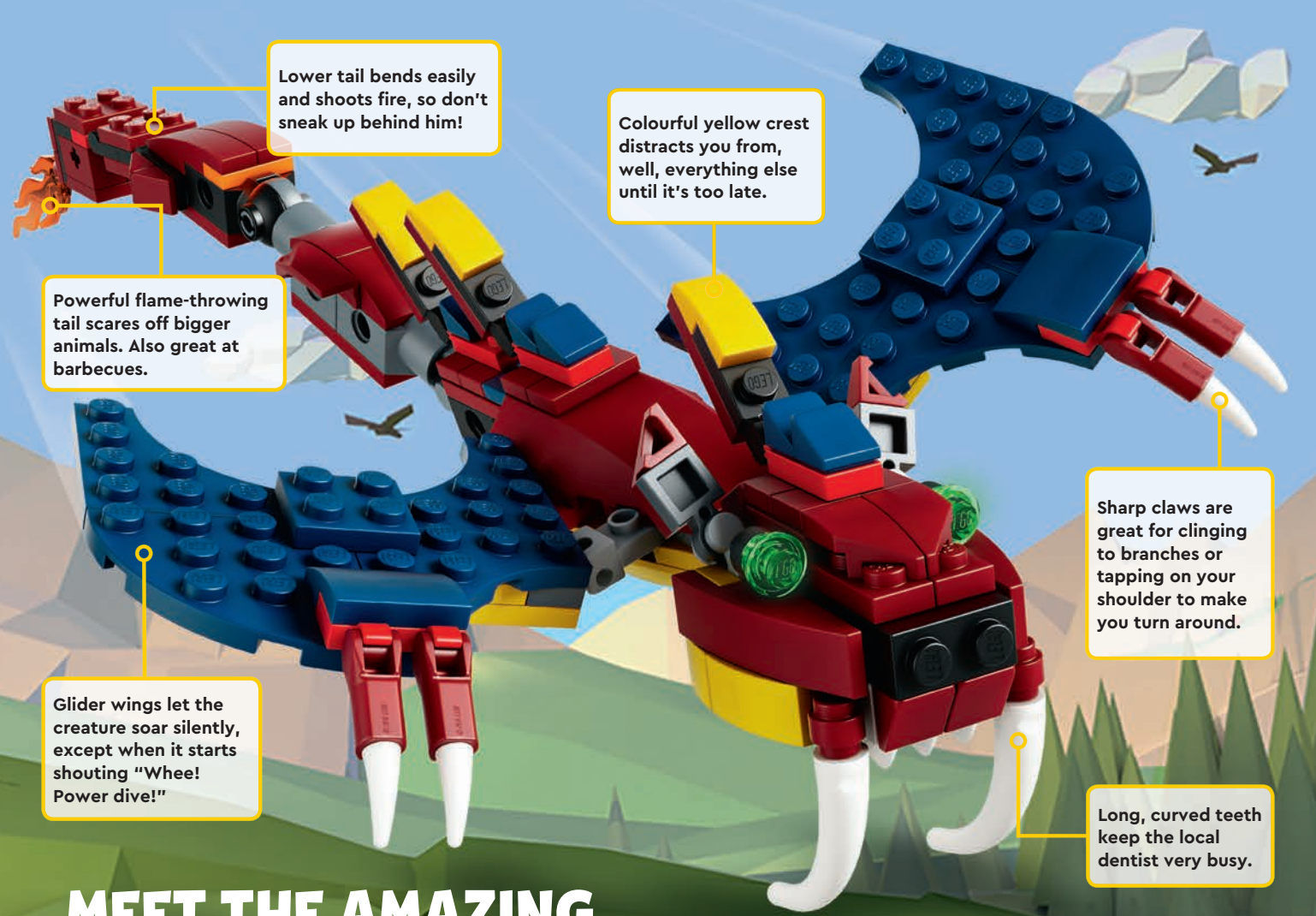

Lower tail bends easily and shoots fire, so don't sneak up behind him!

Colourful yellow crest distracts you from, well, everything else until it's too late.

Powerful flame-throwing tail scares off bigger animals. Also great at barbecues.

Sharp claws are great for clinging to branches or tapping on your shoulder to make you turn around.

Glider wings let the creature soar silently, except when it starts shouting "Whee! Power dive!"

Long, curved teeth keep the local dentist very busy.

# MEET THE AMAZING SABRE-TOOTHED FIRE FLYER!

**LEGO** CREATOR 3-in-1

We took three models – the Sneaky Scorpion, Sabre-Toothed Tiger and the Fire-Breathing Dragon and mashed them up together! What we got was a brand new creature that your parents wouldn't want flying around the house or hiding in your sock drawer. In other words ... it's awesome!

**What would you make with these models?** \_\_\_\_\_



**Sneaky Scorpion**



**Sabre-Toothed Tiger**



**Fire-Breathing Dragon**





# DO YOU DARE ENTER PRIME EMPIRE?

The mysterious appearance of the legendary video game Prime Empire has gamers excited in NINJAGO® City. Everybody's lining up to play, eager for the chance to test their skills. But one by one, players are disappearing...

**It's all fun and games until you reach Level 13.**

# TOO MANY STARFIGHTERS!

The First Order is trying to trick the Resistance by creating fake X-wing Starfighters™! Two of the Starfighters on this page are real and the rest are part of the First Order deception.



Can you spot the two X-wings that are identical?

1



2



3



4



5



6



# RECRUITMENT DRIVE!



Both the First Order and the Resistance are looking for skilled pilots!  
But which side should you fly for? **Take the quiz and find out!**



## WOULD YOU RATHER...?

Start out hunting womp rats

**OR**

Start out flying TIE Fighters™

Have an autographed picture of Rey

**OR**

Have a Kylo Ren™ poster in your room

Get discounts at Resistance bases

**OR**

Stock up on First Order gear

Be outnumbered and fight on

**OR**

Be just one more pilot in a huge fleet

Fight to protect freedom in the galaxy

**OR**

Fight to take away freedom in the galaxy

Be friends with Rey, Poe and Finn

**OR**

Hang out with Sith™ Lords

Have your other ship be a Y-wing™

**OR**

Have your other ship be a Star Destroyer™



If you have more **BLUE** answers, head for your nearest Resistance base.



If you have more **RED** answers, the First Order wants you!



# LEGO® HOUSE

## THE WORLD'S BEST PLAYDATE!

It's the best playdate ever! LEGO® House is packed with fun for the whole family and so many ways to play. Check out the awesome Experience Zones and get ready to build!



HI, IT'S MAX!  
I JUST GOT BACK FROM  
A TRIP TO BILLUND, DENMARK  
TO SEE THE AWESOME LEGO® HOUSE!  
IT'S A LEGO FAN'S ULTIMATE VACATION  
DESTINATION, AND I'M GOING TO  
TELL YOU ALL ABOUT IT!



### Tree of Creativity



One of the largest LEGO builds ever constructed!

### Masterpiece Gallery



Amazing LEGO models built by fans!

### LEGO® Brick Builder



A cascading waterfall of LEGO elements!

### Red Zone

Build whatever you can imagine with LEGO® System and DUPLO® bricks!

### Yellow Zone

Build fish, flowers, insects and more!



### Blue Zone

Build robots, vehicles and much more!

### Green Zone

Create minifigures and make your own LEGO movie!

### World Explorer



Discover a world of LEGO minifigures!

### Fish Designer



Build your own LEGO fish, scan it and then release it into the huge aquarium!

# FRIENDSHIP CUBED!

Can you finish the story?

Your LEGO® Friends now have their own play cubes! Each one is a mini-version of their favourite place, full of plenty of fun and accessories. Open them for play and then stack them up. Plus you can meet the Friends' secret pets. (See the story below!)

**NEW!**

LEGO Friends™



## MYSTERY OF THE MISSING PETS!

Olivia was hard at work in her lab. "This will be the best batch of slime I ever made!" she said. "Not too sticky, not too oozy. I can't wait to show my friends!"

Scooping up a handful of slime, she turned to see her pet's reaction to

it. But he was gone! Olivia looked everywhere. Worried, she called Andrea, Emma, Stephanie and Mia.

"My pet has vanished too," said Mia.

"So has mine," said Stephanie.

Emma and Andrea said the same.

Where could all the pets have gone?

"Let's all use our special talents to find our missing pets," said Olivia. "Here we go!"

**Where do you think the Friends' favourite pets have gone? How will Olivia and the rest find them?**



**Write the end to this story!**



# DISCOVER THE WORLD OF TROLLS!

Poppy and her friends have a big job ahead of them. They have to unite all six tribes and keep Queen Barb from wiping out any music she doesn't like. Help Poppy out by doing the puzzles and activities below!



Need help?  
Answers can be found on page 27.



**Where's Tiny Diamond?**

Tiny Diamond has wandered off and got lost. Can you spot him on this page?

## What Kind of Music is Playing?

The six Trolls tribes all like their own kind of music. Take this true-or-false quiz and see what you know about different music styles.

- 1. Classical music is usually played in dance clubs.**  
a) True  
b) False
- 2. "Pop" is short for "popular music."**  
a) True  
b) False
- 3. Another name for country music is "heavy metal."**  
a) True  
b) False
- 4. Electronic dance music is also called EDM for short.**  
a) True  
b) False
- 5. Jazz, funk and blues are all styles of music.**  
a) True  
b) False



DREAMWORKS  
**Trolls**  
WORLD TOUR

**NEW!**

### Draw Your Own Troll Hair!

This adorable Troll is missing something important: hair! Draw a head of hair and colour it in (any colour you choose!) to make this Troll complete.

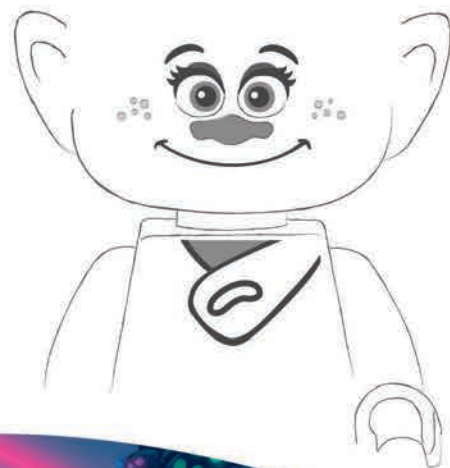

DreamWorks Trolls  
World Tour ©  
2020 DreamWorks  
Animation LLC. All  
Rights Reserved.

# CHOOSE YOUR OWN LEGO® CITY POLICE ADVENTURE!

Snake Rattler has robbed the jewellery store, a prisoner has escaped, and a safe full of money has been stolen! How will you and Lt. Duke DeTain catch the crooks?



## DIRECTIONS:

1. Choose how you will chase the crooks. Pick Option 1 or 2.
2. Follow the directions on the spaces or use the arrows to change where you are on the board.
3. **No dice required!**

Yikes! Crooks blocked the street with garbage bins!

Chase the crooks through narrow streets!

**1**

Chase in the high-speed police car.



**2**

Take off in the heavy-lift helicopter.

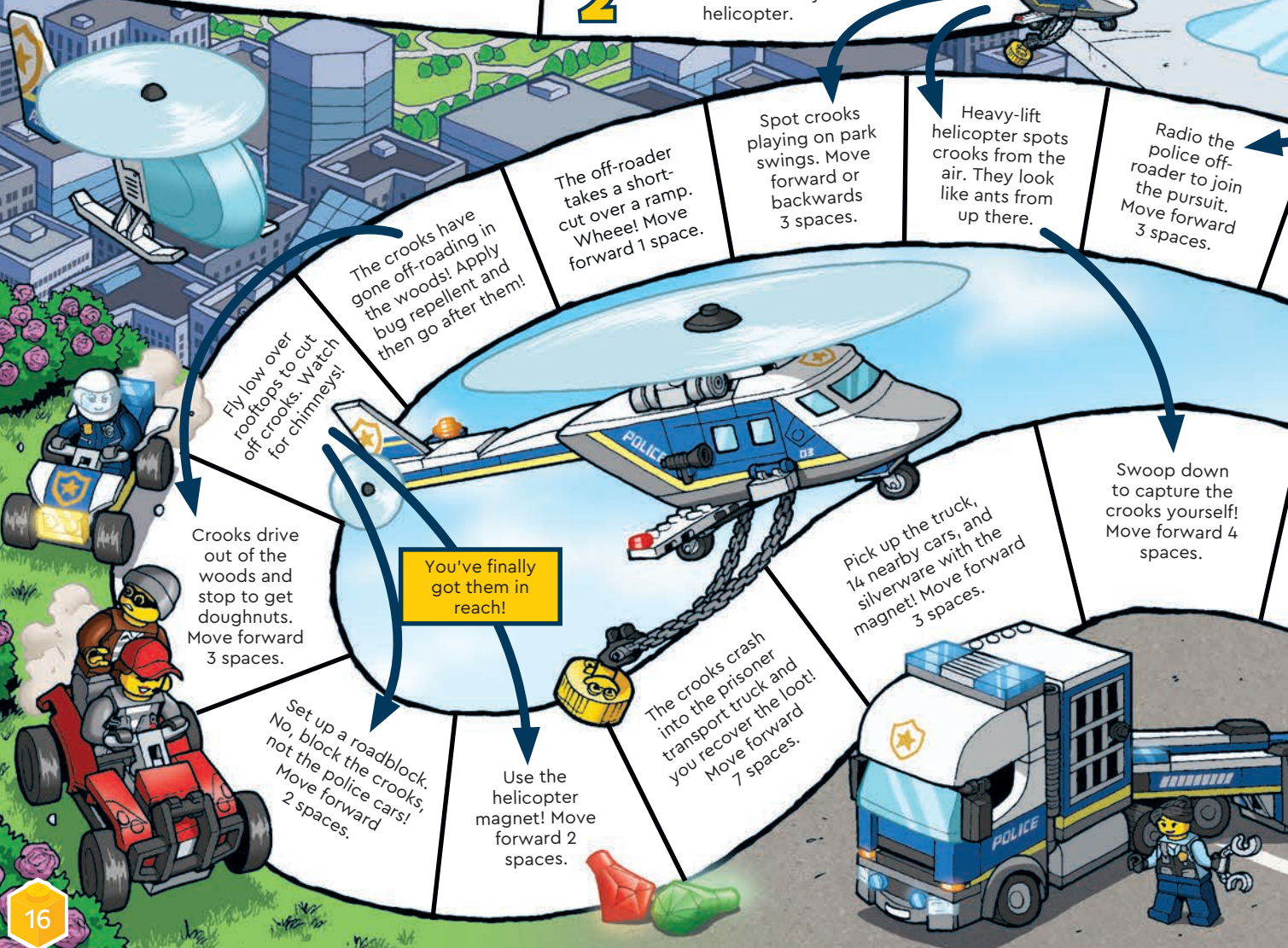



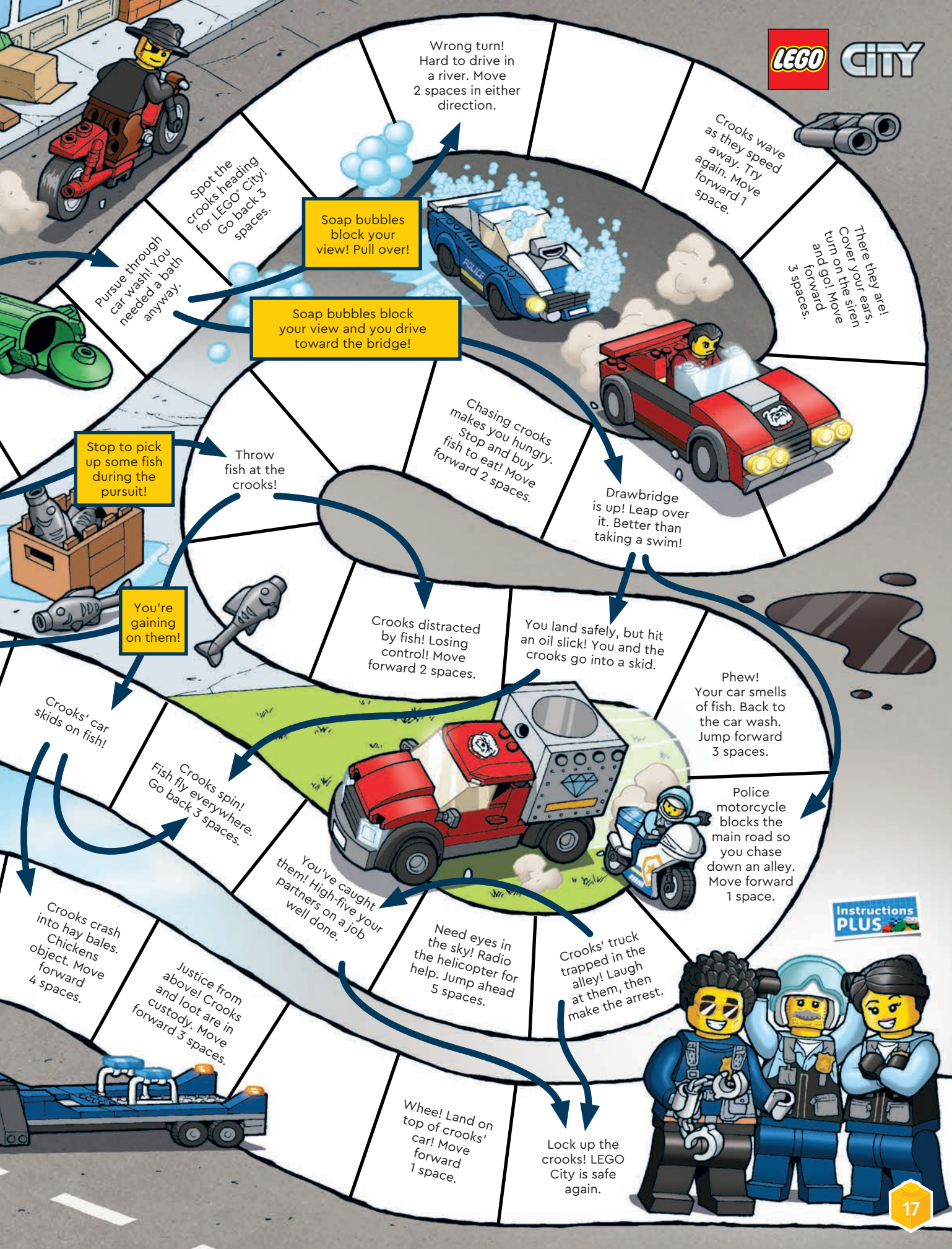

Wrong turn!  
Hard to drive in  
a river. Move  
2 spaces in either  
direction.

Crooks wave  
as they speed  
away. Try  
again. Move  
forward 1  
space.

There they are!  
Cover your ears!  
Turn on the siren  
and go! Move  
forward  
3 spaces.

Spot the  
crooks heading  
for LEGO City!  
Go back 3  
spaces.

Soap bubbles  
block your  
view! Pull over!

Soap bubbles block  
your view and you drive  
toward the bridge!

Pursue through  
car wash! You  
needed a bath  
anyway.

Chasing crooks  
makes you hungry.  
Stop and buy  
fish to eat! Move  
forward 2 spaces.

Drawbridge  
is up! Leap over  
it. Better than  
taking a swim!

Stop to pick  
up some fish  
during the  
pursuit!

Throw  
fish at the  
crooks!

You're  
gaining  
on them!

Crooks distracted  
by fish! Losing  
control! Move  
forward 2 spaces.

You land safely, but hit  
an oil slick! You and the  
crooks go into a skid.

Phew!  
Your car smells  
of fish. Back to  
the car wash.  
Jump forward  
3 spaces.

Crooks' car  
skids on fish!

Crooks spin!  
Fish fly everywhere.  
Go back 3 spaces.

Police  
motorcycle  
blocks the  
main road so  
you chase  
down an alley.  
Move forward  
1 space.

You've caught  
them! High-five your  
partners on a job  
well done.

Need eyes in  
the sky! Radio  
the helicopter for  
help. Jump ahead  
5 spaces.

Crooks' truck  
trapped in the  
alley! Laugh  
at them, then  
make the arrest.

Crooks crash  
into hay bales.  
Chickens  
object. Move  
forward  
4 spaces.

Justice from  
above! Crooks  
and loot are in  
custody. Move  
forward 3 spaces.

Whee! Land on  
top of crooks'  
car! Move  
forward  
1 space.

Lock up the  
crooks! LEGO  
City is safe  
again.

**Instructions PLUS**



# THE GREAT CAKE CONTEST!

Instructions PLUS

WELCOME TO THE HEARTLAKE BAKE-OFF, THE NEW BAKING COMPETITION SHOW THAT PROMISES A SWEET REWARD TO THE CAKE CHAMPION!



MMMM, I CAN TASTE THAT CHOCOLATE-COVERED FISH NOW!

“Let’s meet our first contestant, Stephanie,” said the TV host.

“I’ve been baking for years,” said Stephanie. “So I know my way around a cupcake. I’m ready to compete and win!”

“And taking on Stephanie today will be David!”

“I’m new to baking, but I love it,” said David. “So I’ll just try my best!”

The host spun the wheel to discover what treat the bakers would have to create.



“The wheel says ... fish cake with chocolate frosting!”

Stephanie got right to work. She put all her ingredients in order, checked the recipe and started making her batter. She was sure she would take home the prize!

David was going a little more slowly to make sure he didn’t make any big mistakes. He was still mixing his batter when Stephanie was already frying her fish!



CHOCOLATE. FISH. WHO THOUGHT THIS WAS A GOOD IDEA?



She had moved onto making her frosting when David smelled something funny. Stephanie had forgotten to flip her fish over and it was starting to burn!

**“Look out!” he said.  
“Your fish!”**

Stephanie saw the trouble right away and fixed it. “Wow,” she said to herself. “He helped me even though we are competing against each other.”

Later, David took his cake out of the oven and got ready to frost it. Stephanie knew if she didn't say anything, she would be sure to win. “But I don't want to win that way,” she thought.

**“David, put your cake in the freezer first,” she said. “It will make it easier to frost.”**

Finally, the cakes were done. Neither Stephanie nor David tasted their creations. Chocolate-covered trout isn't anyone's idea of a good time.

**“Time's up!” said the host. “Let's see who won!”**



**LEGO Friends**

# CREATE YOUR OWN CUPCAKE!

If you were on this baking show and had to make your own cupcakes, what special ingredients would you include?

**Circle all the ones below that you would use. Plus you can write in your own secret ingredient below!**

- |                 |                  |
|-----------------|------------------|
| Chocolate chips | Milk             |
| Walnuts         | Pickles          |
| Blueberries     | Cream cheese     |
| Lemon           | Swiss cheese     |
| Tuna fish       | Sweaty socks     |
| Hot sauce       | Brownie pieces   |
| Flour           | Bacon            |
| Fairy dust      | Tomatoes         |
| Unicorn poop    | Ice cream        |
| Caramel         | Baking powder    |
| Nut butter      | Marshmallows     |
| Spare ribs      | Sprinkles        |
| Cucumbers       | Brussels sprouts |
| Jam             | Vanilla          |
| Banana          | Coconut          |
| Eggs            | Sugar            |
| Sardines        |                  |

My Secret Ingredient:

---

## Who Is the Bake-Off Champion? You Decide!



Head to the **LEGO Life app** and vote in the special LEGO Friends Bake-Off poll for who you think should take home the prize! Will it be Stephanie or David? **Vote today!** Then go build your own LEGO cake and see what you can make!

# Cool Creations

## HI, MAX HERE!

Thanks to everybody who submitted their creation. We just wish we had room to show them all!

Ask a grown-up to go to [LEGO.com/life](https://www.lego.com/life) and select **"Magazine"** to find out how you can send us a photo of your model. Rebuild LEGO® models your own way or create something totally new!



 **KNIGHT'S CASTLE**  
Maebh, age 5, Denmark



 **MOBILE PRISON**  
Sophia, age 6, Germany



 **NINJA FORTRESS**  
Jaiden, age 9, Canada



 **EXCURSION SHIP**  
Erik, age 7, and Freya, age 6, Germany



 **REMEMBER THE ALAMO**  
Daniel, age 11, Gabriel, age 9,  
and Isabel, age 7, USA

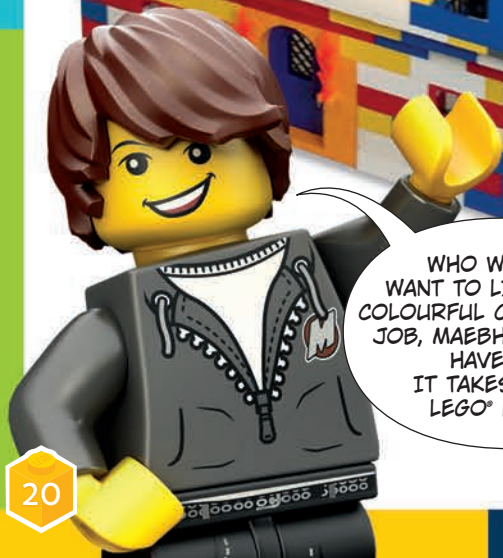

WHO WOULDN'T WANT TO LIVE IN THIS COLOURFUL CASTLE? GREAT JOB, MAEBH, YOU REALLY HAVE WHAT IT TAKES TO BE A LEGO® LEGEND!



TRIPLE JET STAR PLANE  
Max, age 5, United Kingdom



MINI GRAND SIERRA HOTEL  
Bryce, age 7, USA



# Rebuild the world



JUSTIN, age 9, Netherlands



THE DREAM TREE HOUSE  
Anneke, age 8, New Zealand



RUMBLE ON MAIN STREET  
George, age 9, Ireland



FIRE CUP  
Ollie, age 7, Australia



OUR HOME  
Wannes, age 9, Belgium



MY IMAGINARY WORLD  
Melanie, age 9, and Elodie, age 5, Canada



EAGLE  
David, age 6, Germany



ULTRA-STEALTH TANK  
Kai, age 8, France

# OUR STORY BEGINS ...

Every LEGO® | Disney Princess™ storybook has an incredible story. If you were writing the story of Ariel or any of her friends, what would happen?

Get a paper and pencil and write or draw your own Little Mermaid story!



COLLECT ALL BOOKS!



Ariel Belle Frozen II Mulan



© Disney



## TAKE THIS QUIZ!

See how well you know Princess Ariel!



### Disney Little Mermaid Quiz!

1. Ariel traded her voice to Ursula for red hair.
2. Ariel saved Prince Eric during a terrible storm.
3. Ariel collects things from the surface world.
4. Ariel's best friend is an octopus named Flounder.

TRUE FALSE

<input type="checkbox"/>	<input type="checkbox"/>
<input type="checkbox"/>	<input type="checkbox"/>
<input type="checkbox"/>	<input type="checkbox"/>
<input type="checkbox"/>	<input type="checkbox"/>

Need help? Answers can be found on page 27.

## WELCOME PARTY!

The newest LEGO® Minifigures come from the world of DC Comics! We got them together for a welcome party and asked them to come up with the funniest jokes they could!



# GET READY FOR THE BOAT RACE!



The race boat is on its way to the big race!  
 Find all the words on the list in this word search puzzle and then head for the finish line!

ANCHOR CHAMPION CREW ENGINE HULL  
 STEERING RACEBOAT WATER SPEED

R G I J H U L L E R J L  
 A N C H O R Y D O D N K  
 C E J G N I R E E T S A  
 E N N L W I H E B J B C  
 B G C H A M P I O N  
 O I R T T S  
 A N E F E O  
 T E W F R L  
 S E Z Q G M



Need help? Answers can be found on page 27.



LEGO minifigures™



All DC characters and elements © & TM DC Comics (s20)



# BUILD THESE AMAZING BIRDS!

Add these colourful birds to your home decorations. You can build this penguin and toucan using pieces from your LEGO® collection. Don't worry about matching the colours. Use whatever colour bricks you like!

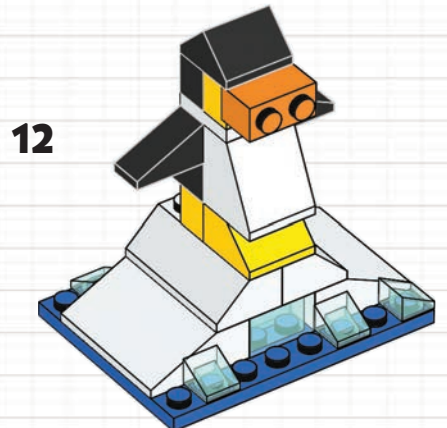
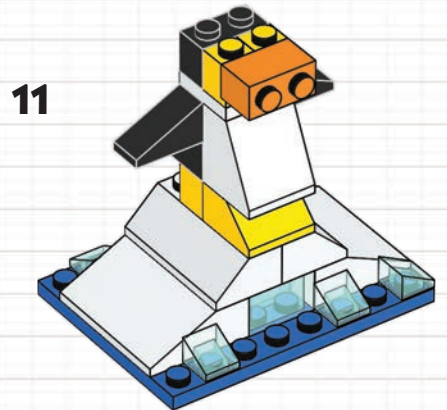
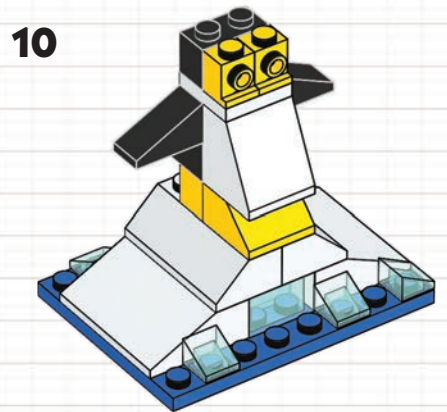
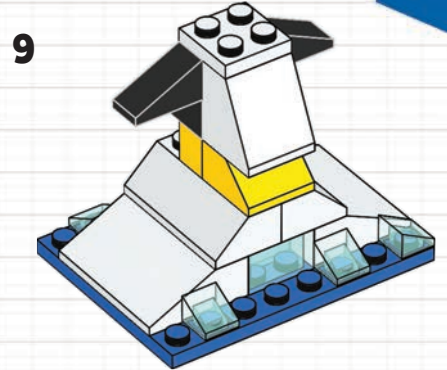
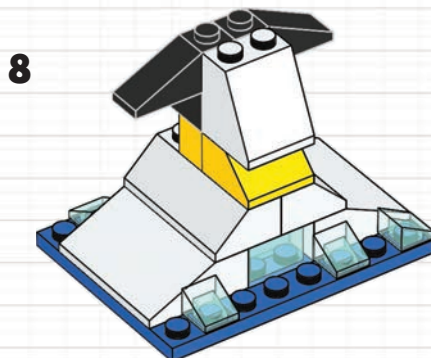
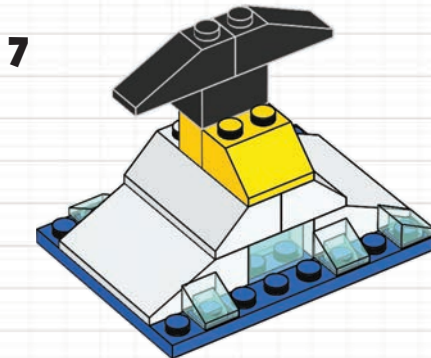
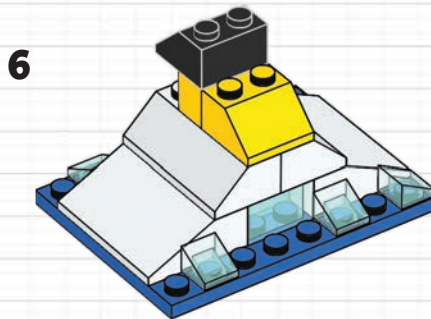
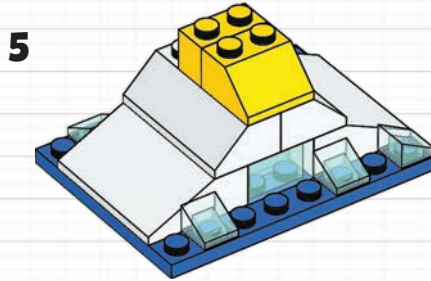
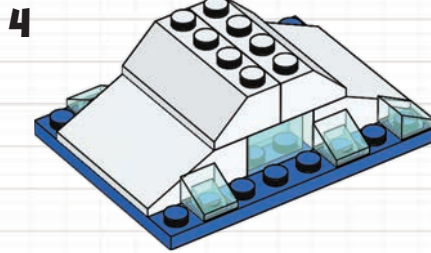
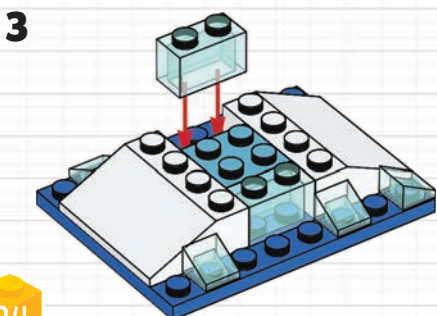
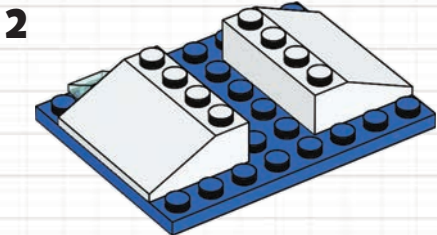
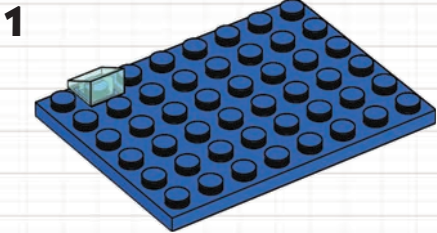



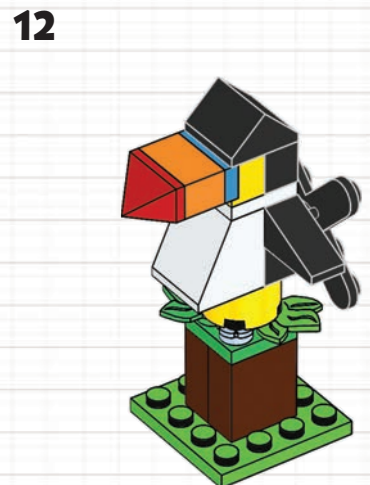
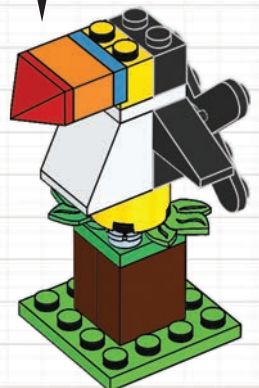
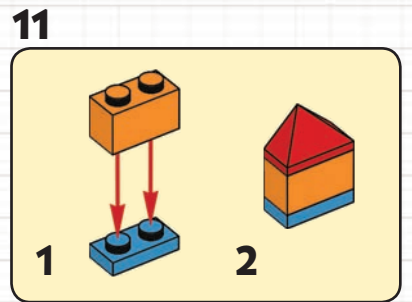
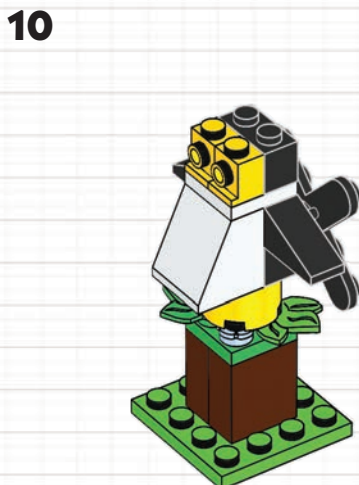
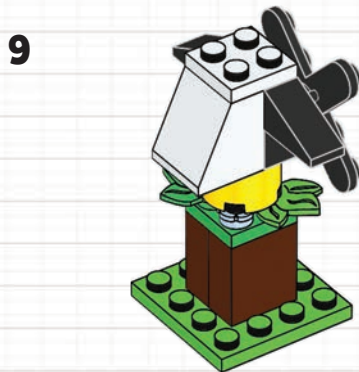
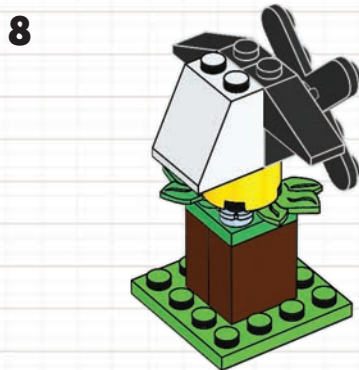
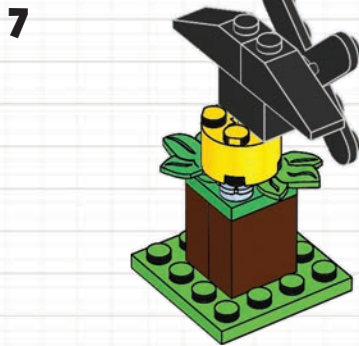
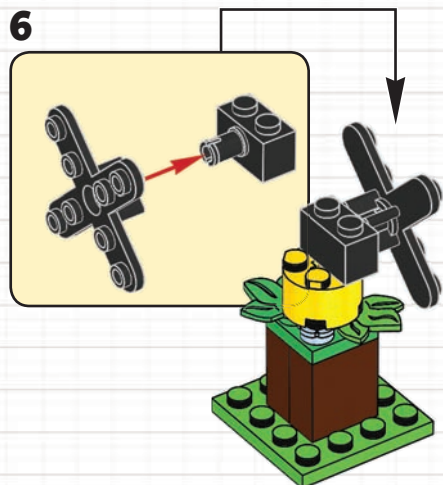
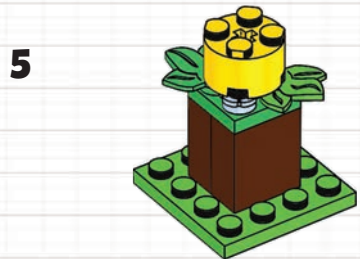
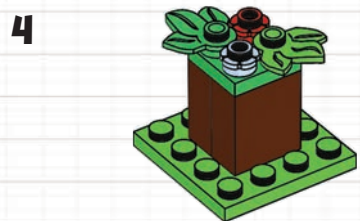
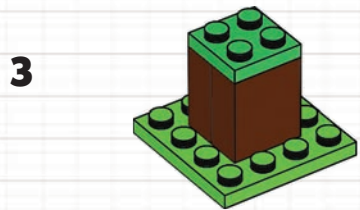
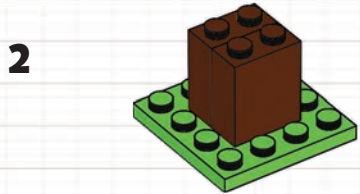
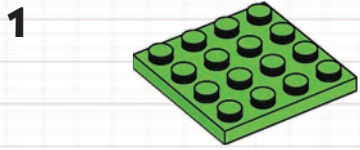

# YOUR STUFF HERE!

COOL LIBRARY. THERE AREN'T ANY G-G-G-GHOSTS HERE, ARE THERE? NOT THAT I'M NERVOUS OR ANYTHING ...

HEY, THERE ARE LOTS OF REASONS TO VISIT THE LIBRARY BESIDES GHOST-HUNTING. WE CAN LEARN ABOUT HISTORY, MYTHS AND LEGENDS, ALL KINDS OF STUFF WE NEED TO DO OUR JOB.

WELL, THERE IS ONE FRIGHTENING THING HERE. GHOSTS NEVER RETURN THEIR BOOKS ON TIME!



## TO DO!

- Send in letters, drawings and photos of LEGO® builds or favourite jokes. You might see them on this page in a future issue!
- Ask a parent/guardian to download the submission form from [LEGO.com/magazine](http://LEGO.com/magazine). Then email it along with your letter, drawing, etc. to me. See the download form for the email address.

### Spooky or Not?

Here I am with Jack and Parker at the Newbury Library. They were kind of scared to visit here, but I told them I would protect them. You know how brave I am!

### Hi Members!

CHECK OUT THIS AMAZING UNI-TURTLE BUILD BY LEGO® LIFE MEMBER "DUCHESSGOOFY BANANA". IT TOOK A LOT OF IMAGINATION TO CREATE SOMETHING SO COLOURFUL AND FUN! WE'RE ALWAYS LOOKING FOR COOL MODELS ON THE LEGO LIFE APP THAT WE CAN FEATURE IN THE MAGAZINE, SO UPLOAD YOUR MODELS, SHARE WITH YOUR FRIENDS, AND MAYBE WE'LL SEE YOUR BUILD HERE ONE DAY!



DuchessGoofyBanana

**MAX**

**Which outfit should Max wear to his friend's costume party?**

**Choose your favourite!**



**1. Hawaiian Max**



**2. Scuba Max**



**3. Mermaid Max**



**4. Surfin' Max**

**VOTE NOW!**  
in the LEGO® Life app.  
#Polls Group

Don't have the LEGO® Life app yet? You can download it today for FREE from one of the app stores and sign in with your LEGO ID.



Apple and the Apple logo are trademarks of Apple Inc., registered in the U.S. and other countries. App Store is a service mark of Apple Inc. Google Play is a trademark of Google Inc.

ChairmanDizzyWithurt

ColonelMelodicUrchin

ProfessorFunBed

PrincessSpikyWizard

**ANSWERS**

**Welcome: Page 3**

**Pg 1** **Pg 3**

**Pg 5** **Pg 7**

**Pg 13** **Pg 25** **Pg 26**

**LEGO® Minecraft™: Page 4**  
1. C 3. A  
2. D 4. D

**LEGO Hidden Side: Page 5**  
Hey Don't Get Gloomed

**LEGO Trolls World Tour: Pages 14-15**  
1. F 3. F 5. T  
2. T 4. T

**LEGO Star Wars™: Pages 10-11**

**LEGO City: Page 23**

**LEGO | Disney Princess™: Page 22**  
1. F 3. T  
2. T 4. F

R	G	I	J	H	U	L	L	E	R	J	L
A	N	C	H	O	R	Y	D	O	D	N	K
C	E	J	G	N	I	R	E	E	T	S	A
E	N	N	L	W	I	H	E	B	J	B	C
B	G	C	H	A	M	P	I	O	N		
O	I	R	T	T	S						
A	N	E	F	E	O						
T	E	W	F	R	L						
S	E	Z	Q	G	M						

Next issue of LEGO® Life Magazine out in April!

