



# BRICK HEADZ

40383



 [LEGO.com/brickheadz](https://www.lego.com/brickheadz)



MARIÉE NOVA BRIDE



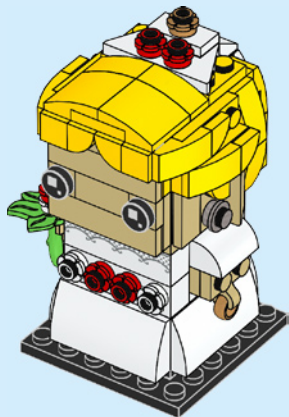
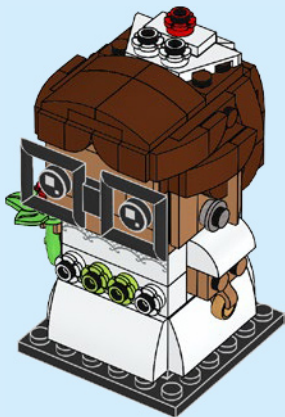
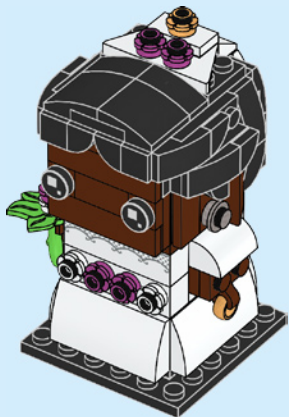



2x

1

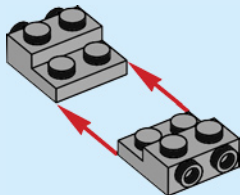

4



1x

2

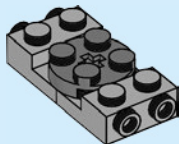

2x

3

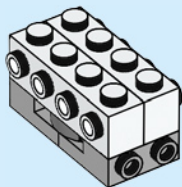



2x



4x

# 4

1

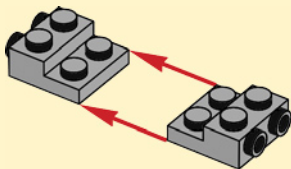

2

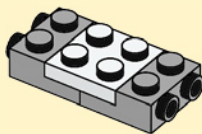

2x

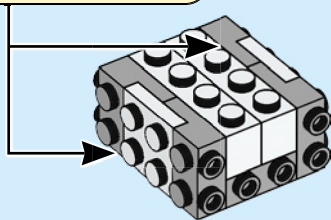

6

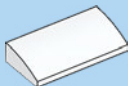

3x

5

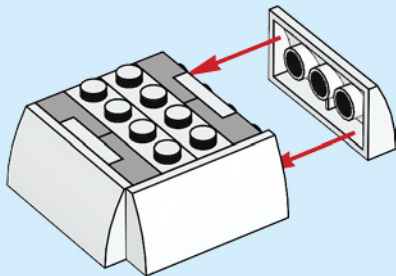

2x

6

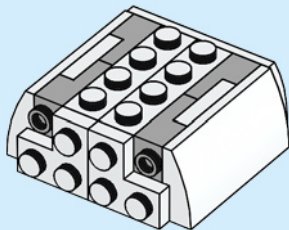

7



1x



1x

7

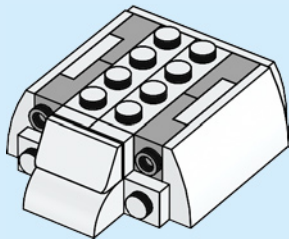

8



2x

8

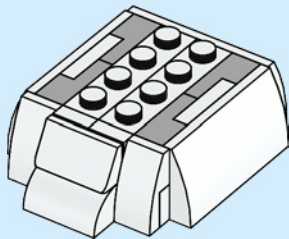





2x



1x

9

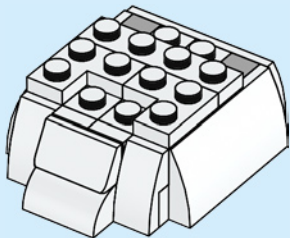

1x

10

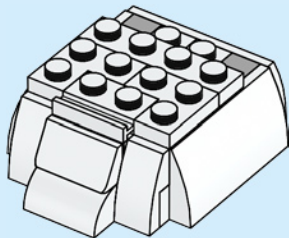



2x



1x

# 11

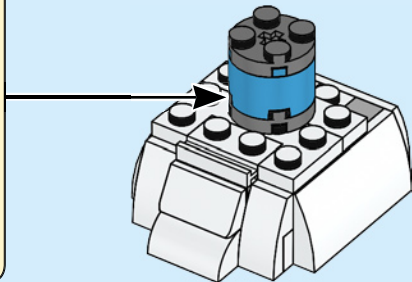
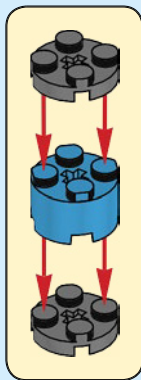



3x

12

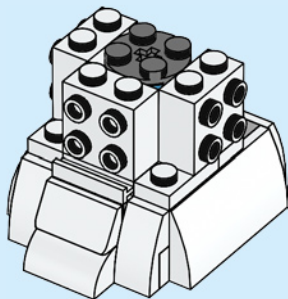



2x



4x

# 13



2x

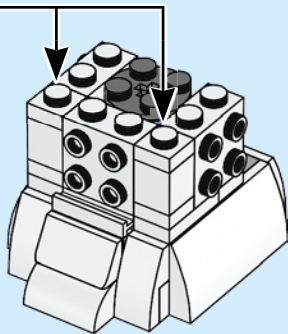



2x



1x

# 14

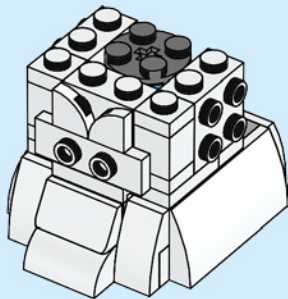



2x

15

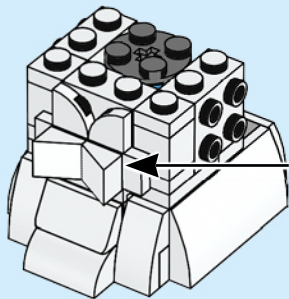

14

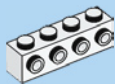

1x



1x

16

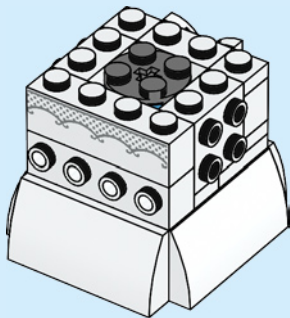

2x

17

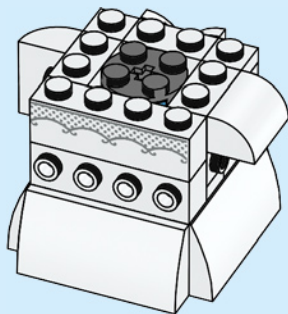

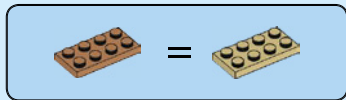
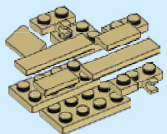
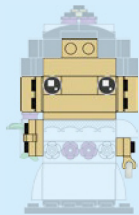
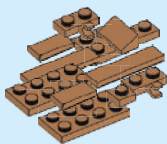
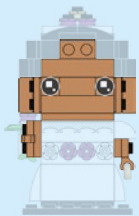





2x

18

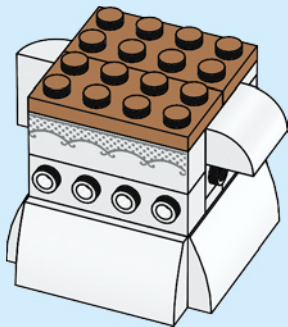



2x



2x

# 19

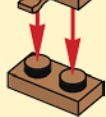

2x

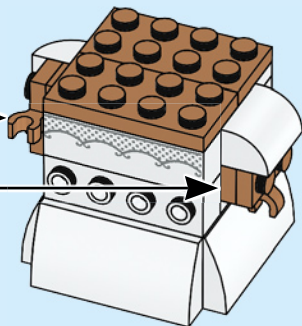

18



1x

20

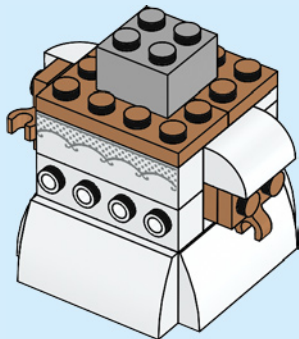

6x

21

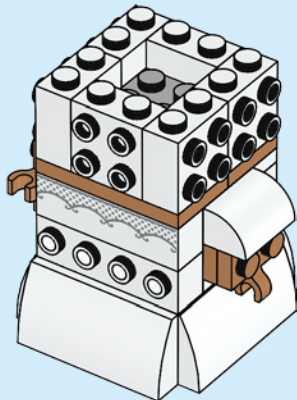



1x



1x



1x

# 22

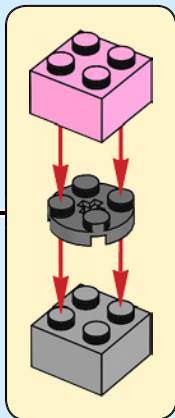
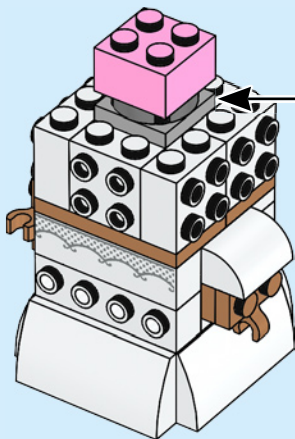



6x

23

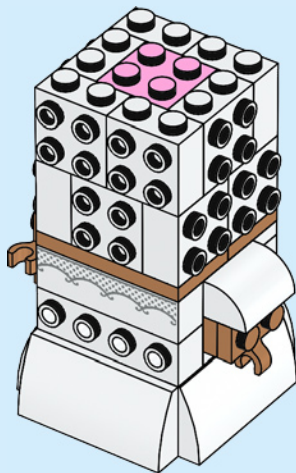

1x

24

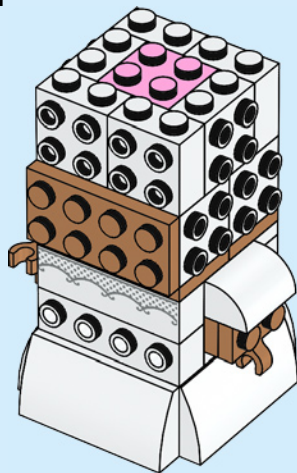

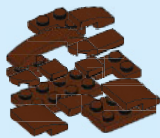
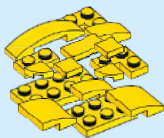
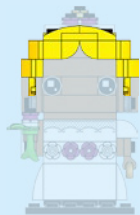
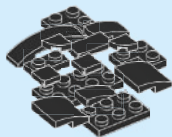

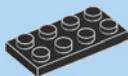

1x

25

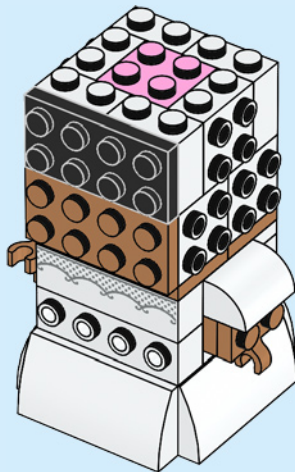

1x



1x



2x

26

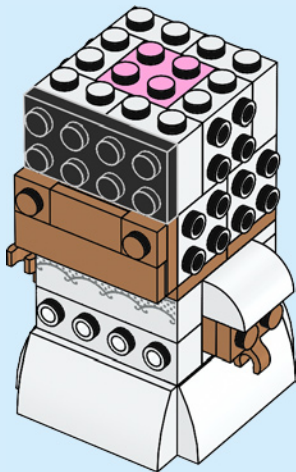



2x



1x



1x

# 27

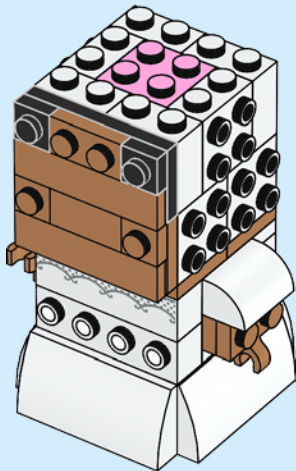





2x



2x



2x



1x



1x

# 28

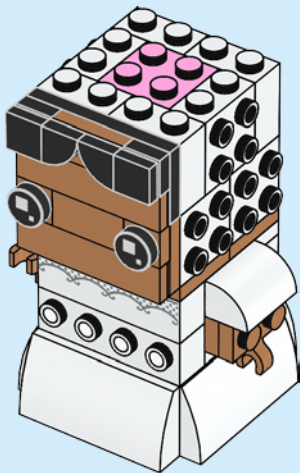

# 29

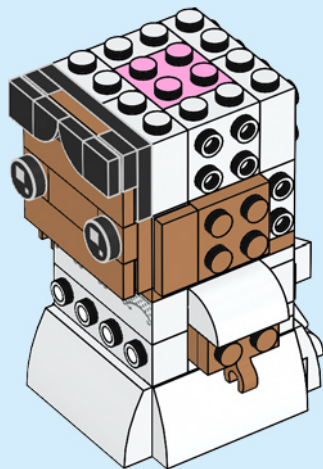

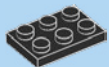

1x



1x



1x

# 30

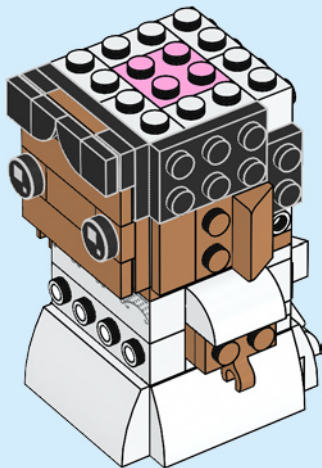



1x



2x



1x

# 31

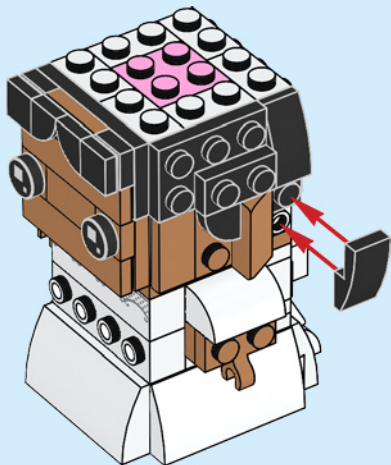

2x



2x

# 32

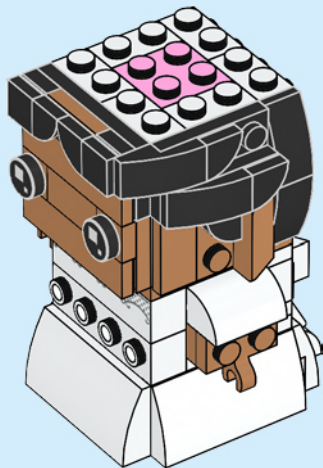



1x



1x

# 33

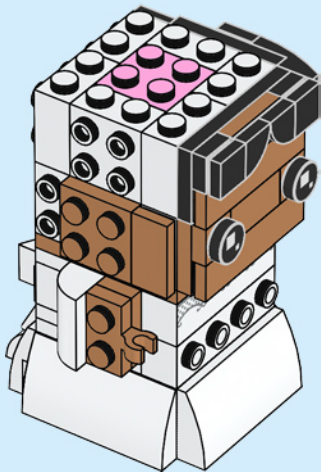

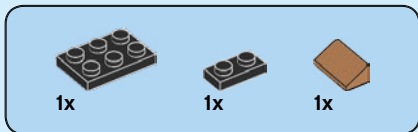

# 34

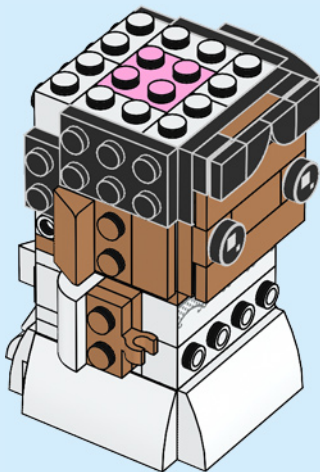



1x



2x



1x

# 35

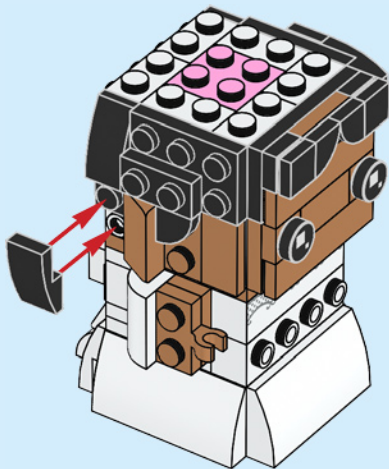

30



2x



2x

# 36

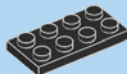
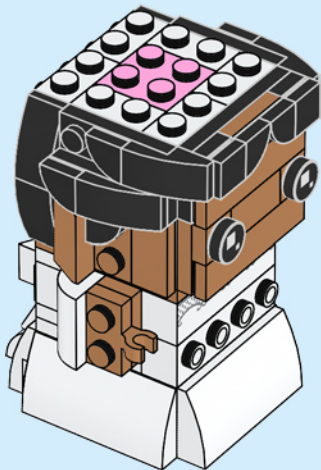

1x

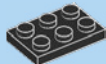

1x

# 37

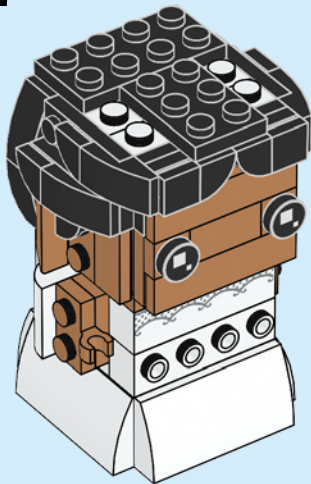



2x



2x

# 38

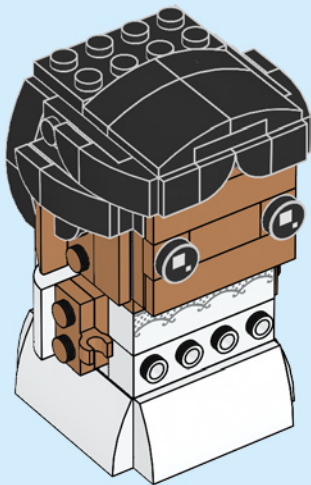

32



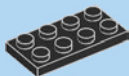

1x



2x

# 39

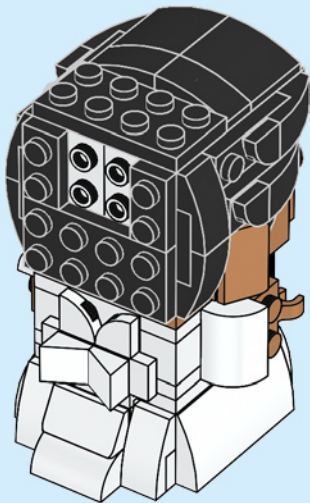



1x



1x

# 40

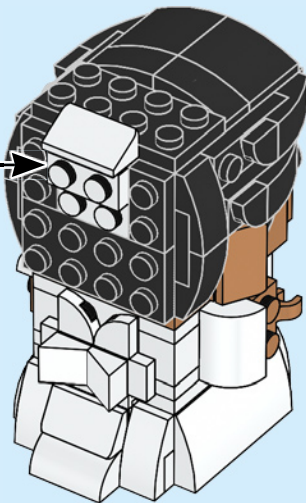
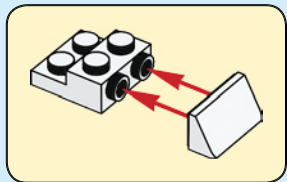



2x

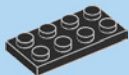

1x

41

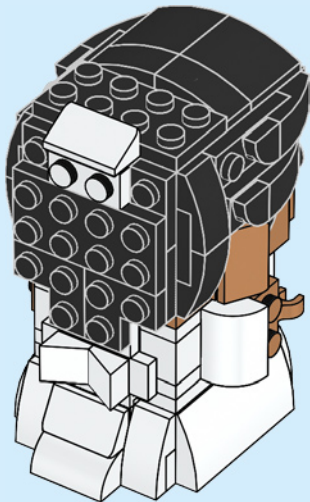

2x



2x

42

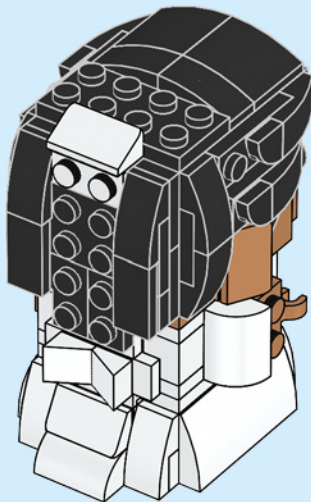



2x

43

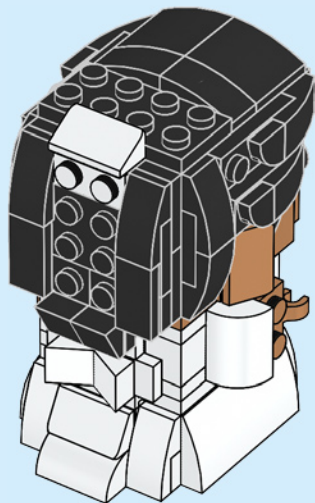



1x



2x



2x

# 44

1

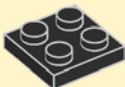

2

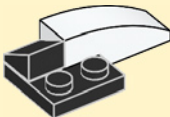

3

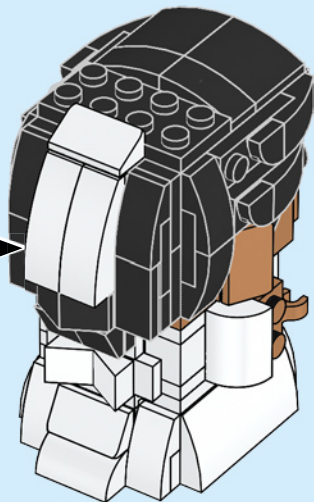
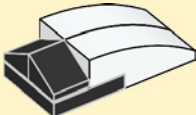



1x



1x

# 45

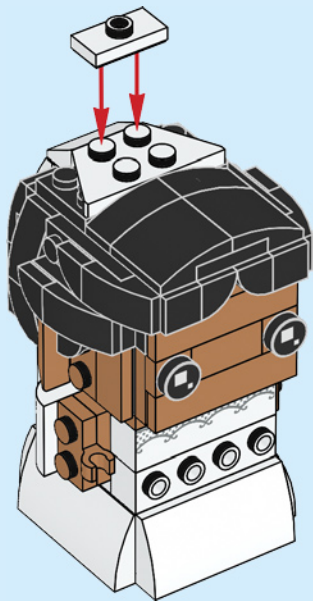

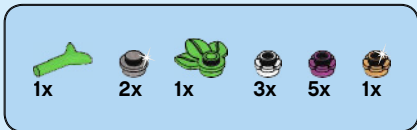

# 46

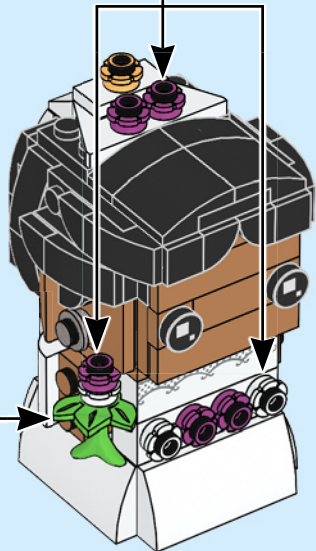
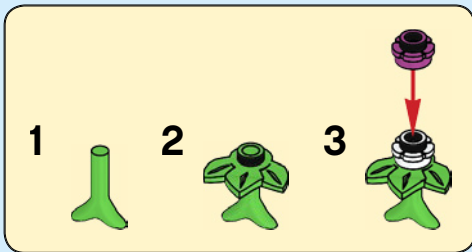

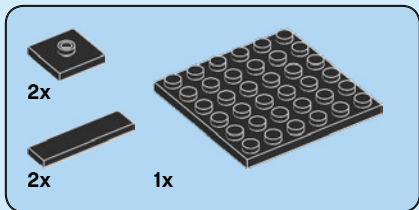

47

1

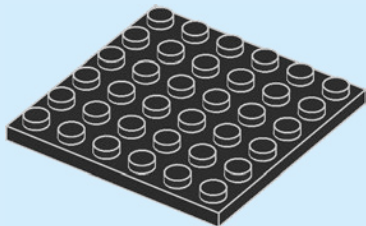

2

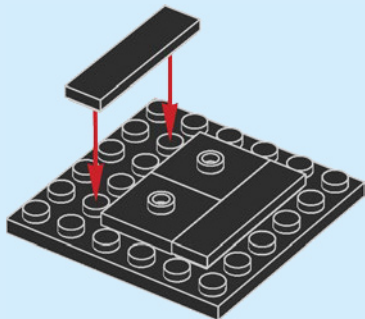



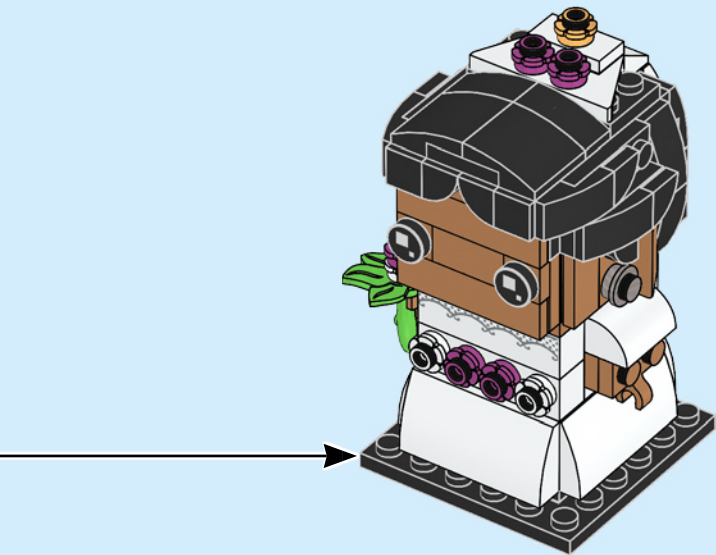



1x

48

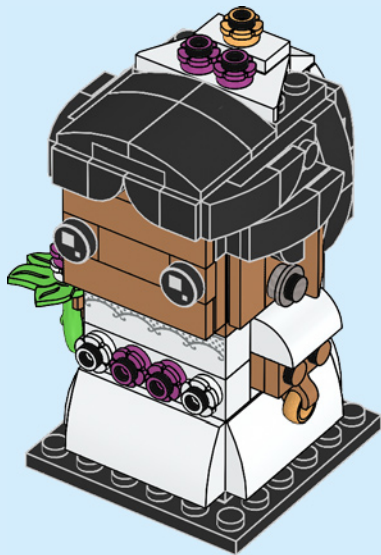

42

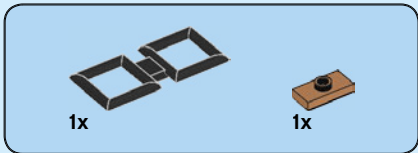

1

1

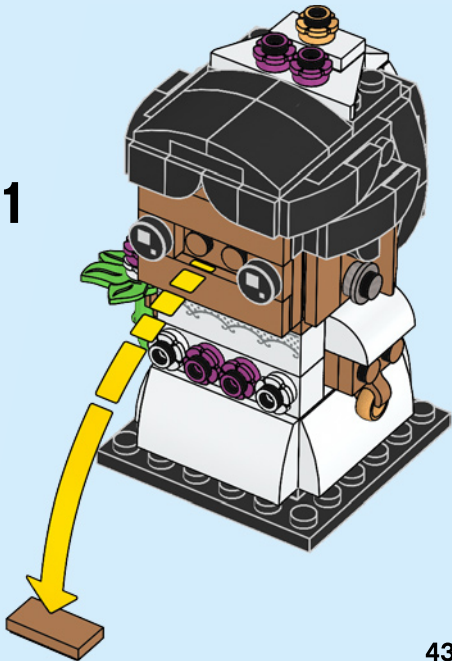

2

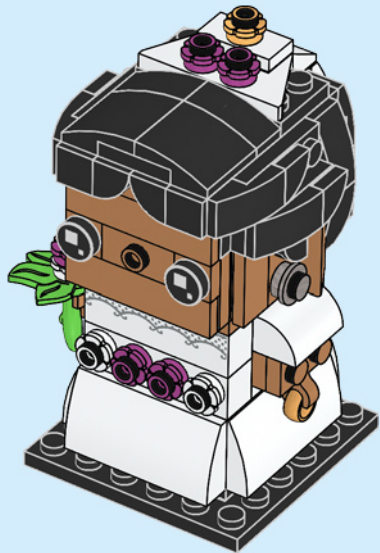

44

3

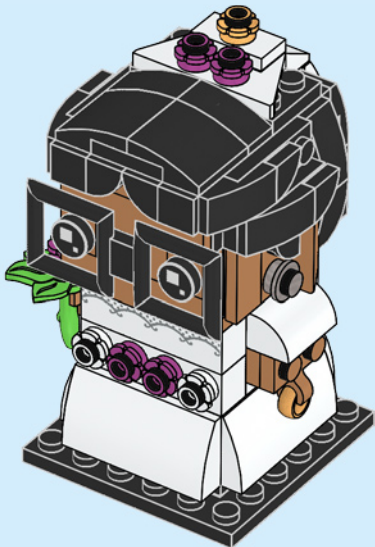



# BRICK 'HEADZ



MARIÉ NOVIO GROOM





8x  
6149677



2x  
4221744



2x  
4211288



4x  
4504376



2x  
6146858



12x  
6069984



6x  
4211150



1x  
6092590



3x  
4211151



2x  
6185998



2x  
6035291



2x  
4216695



2x  
4211257



3x  
4211189



2x  
4211194



4x  
4211186



2x  
4211387



6x  
4654577



1x  
4550359



1x  
6182261



1x  
4119479



5x  
6209692



5x  
6209682



2x  
6177349



4x  
4211042



1x  
6009771



5x  
6209691



2x  
6215606



3x  
6021997



2x  
6293458



3x  
6218360



1x  
6292154



2x  
6218358



2x  
6056383



2x  
6102998



3x  
6093494



2x  
6258098



2x  
4599538



1x  
6229071



2x  
4619520



2x  
6051507



**Customer Service**

**Kundenservice**

**Service Consommateurs**

**Servicio Al Consumidor**

**LEGO.com/service or dial**



**: 00800 5346 5555**

**: 1-800-422-5346**

# WIN

GO TO [WWW.LEGO.COM/PRODUCTFEEDBACK](http://WWW.LEGO.COM/PRODUCTFEEDBACK) AND  
GIVE US YOUR SHORT **FEEDBACK** ABOUT THIS  
LEGO® SET FOR A CHANCE TO WIN  
A COOL LEGO PRIZE.

Terms & Conditions apply



## [LEGO.com/productfeedback](http://LEGO.com/productfeedback)

### GEWINNE

Erzähle uns auf  
[www.LEGO.com/productfeedback](http://www.LEGO.com/productfeedback)

etwas über die Erfahrungen, die du  
mit diesem LEGO® Set gemacht hast,  
und sichere dir die Chance auf einen  
coolen LEGO Preis!

Es gelten die Teilnahmebedingungen

### GAGNE

Rends-toi sur  
[www.LEGO.com/productfeedback](http://www.LEGO.com/productfeedback)

et donne-nous quelques commen-  
taires sur ce produit LEGO® pour  
avoir une chance de gagner un  
prix LEGO !

Voir Conditions Générales

### GANAN

Visita  
[www.LEGO.com/productfeedback](http://www.LEGO.com/productfeedback)

y envíanos tu opinión acerca de este  
set LEGO®, ¡Participarás en el sorteo  
de un premio LEGO!

Términos y Condiciones aplicables

### 获取奖品

登录  
[www.LEGO.com/productfeedback](http://www.LEGO.com/productfeedback)

给出关于此乐高®套装的简短反  
馈，就有机会获得炫酷乐高奖品

《条款及条件》适用

LEGO and the LEGO logo are trademarks of the/sont des marques de commerce du/  
son marcas registradas de LEGO Group. ©2020 The LEGO Group.

6310601