



CLASSIC

10717



 [LEGO.com/classic](https://www.lego.com/classic)



WARNING:
CHOKING HAZARD.
Small parts. Not for
children under 3 years.





AVERTISSEMENT : RISQUE D'ÉTOUFFEMENT.

Contient des petites pièces. Ne convient pas aux enfants de moins de 3 ans.



ADVERTENCIA: PELIGRO DE ASFIXIA.

No recomendado para niños menores de 3 años. Contiene piezas pequeñas.

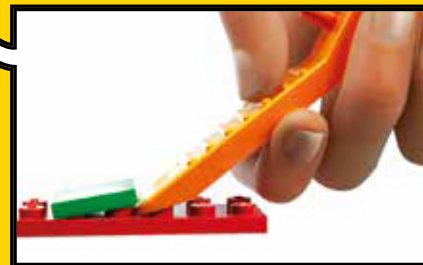
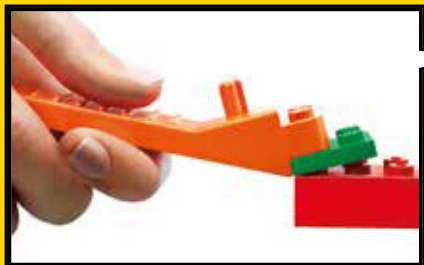
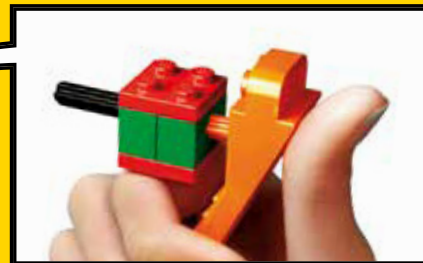
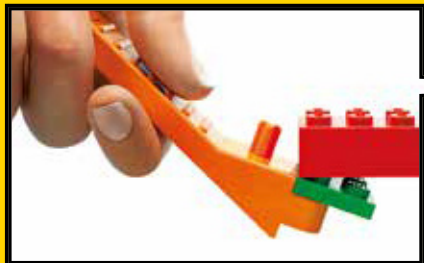

[LEGO.com/brickseparator](https://www.LEGO.com/brickseparator)



Easy Building
Construction facile
Construcción fácil



Medium Building
Construction intermédiaire
Construcción intermedia



Advanced Building
Construction avancée
Construcción avanzada

p./pag.
6



p./pag.
14



p./pag.
22



p./pag.
30



p./pag.
38



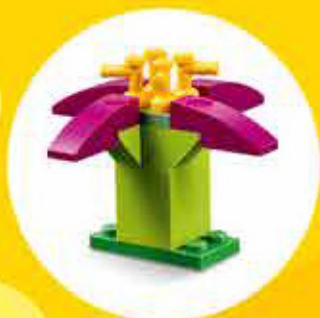



[LEGO.com/classic](https://www.lego.com/classic)

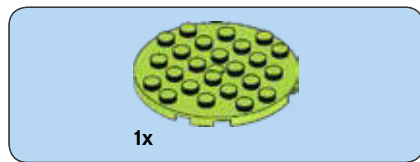



1

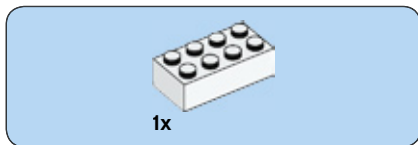



2

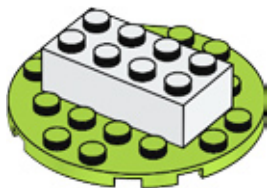

3

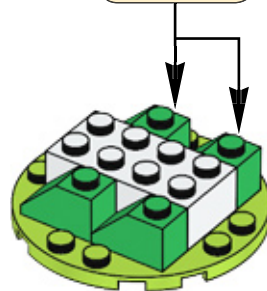

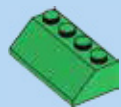

1x

4

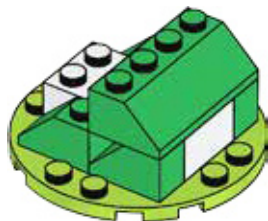

8



2x

5

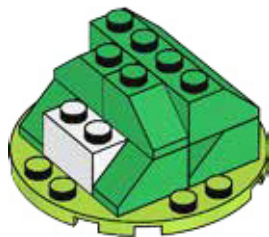

1x

6

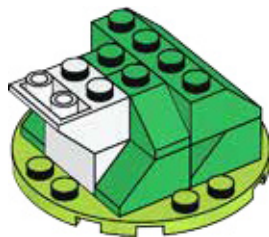



1x

7

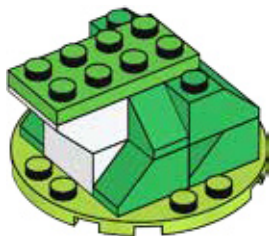



2x

8

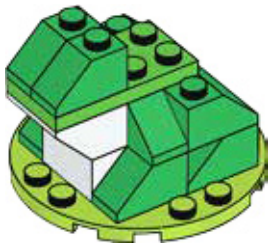

2x



2x

9

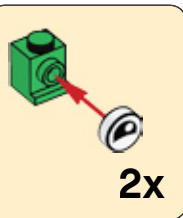

2x

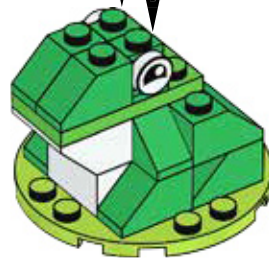



1x

10

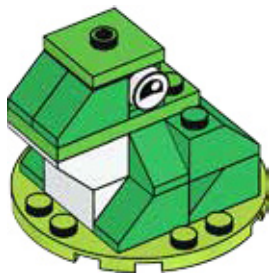



11

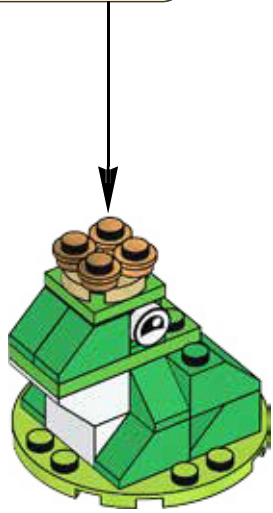

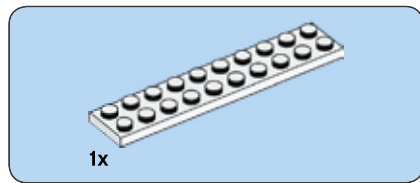

1

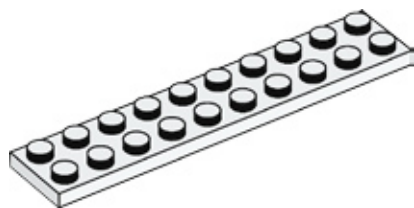



1x



1x

2

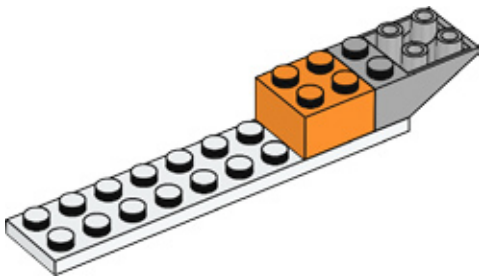



2x

3

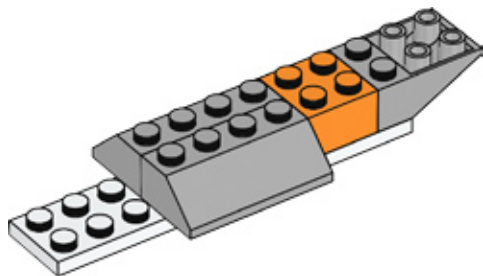

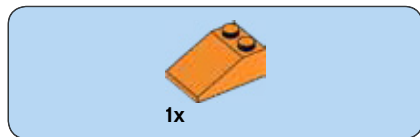

4

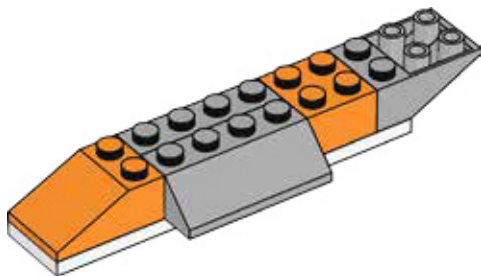

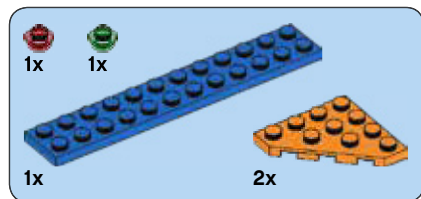

5

1



2

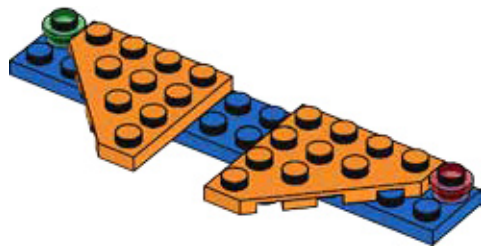

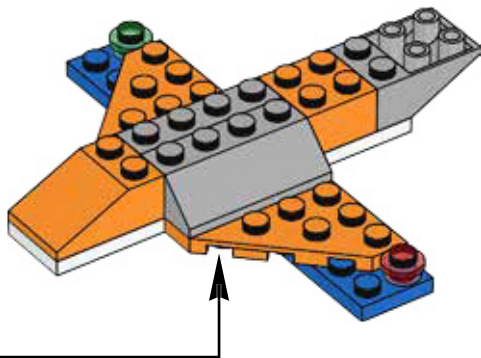

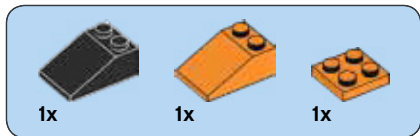

6

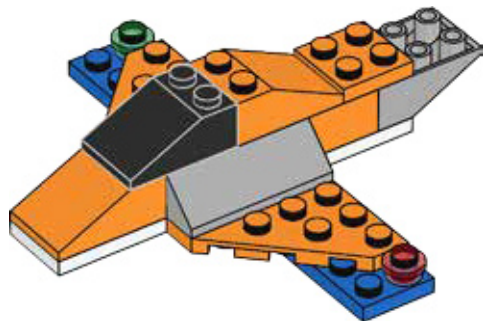

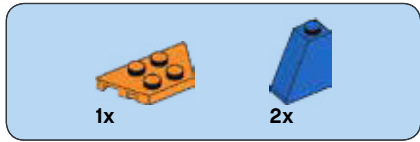

7

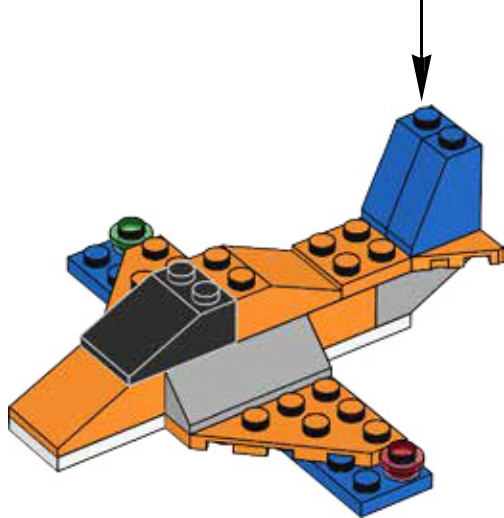
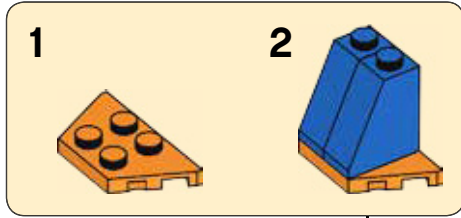

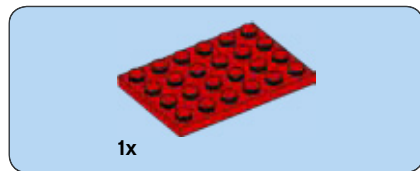

1



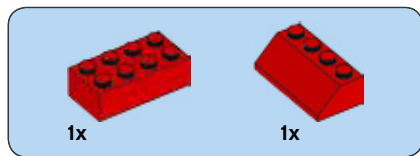

2

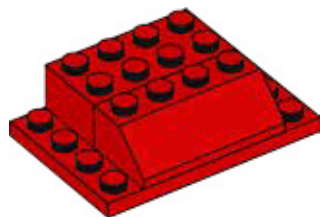

3

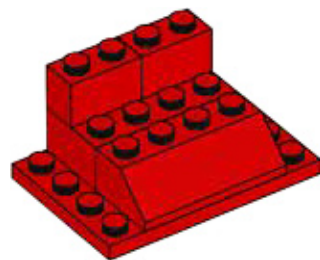



4

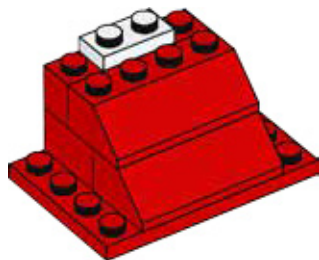

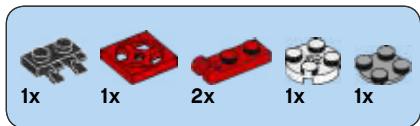

5

1



2

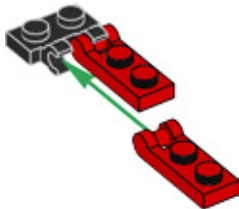

3

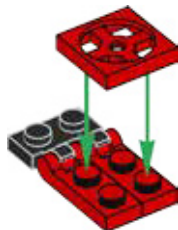

4

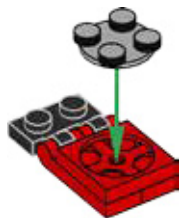

5



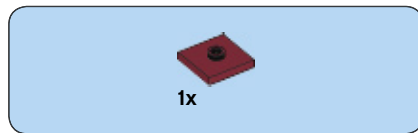
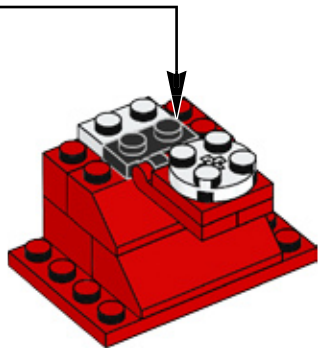

6

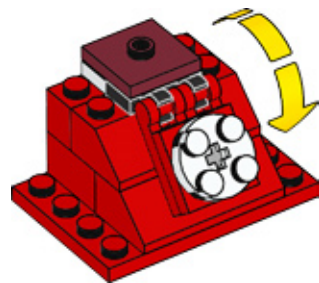

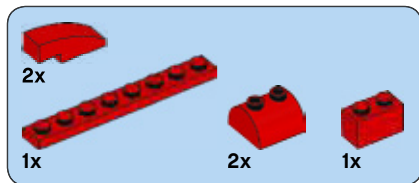

7

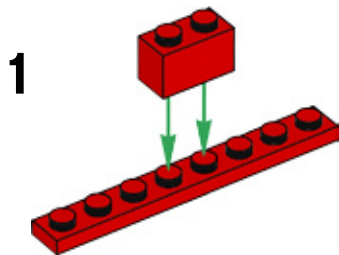

2

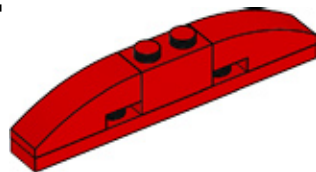

3

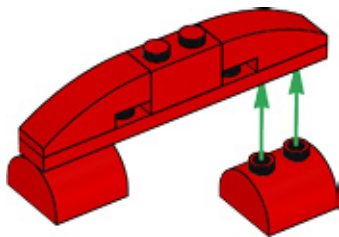

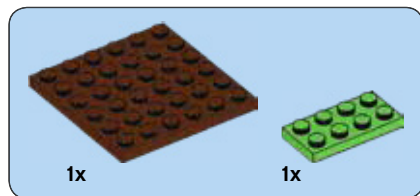

1

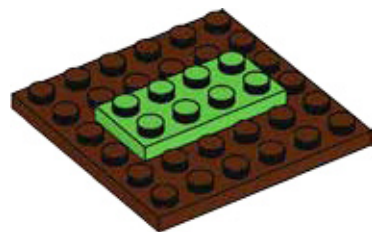

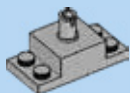

1x

2



2x

3





4x

4

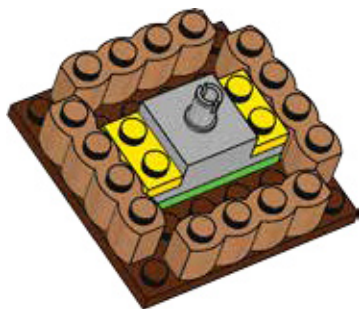

3x



1x

5

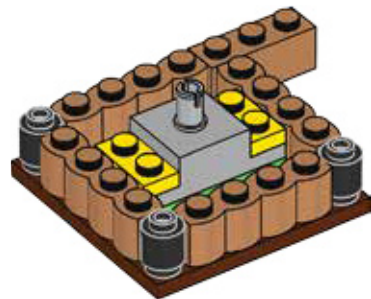



4x

6

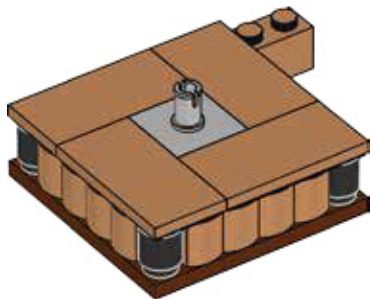

1x

7

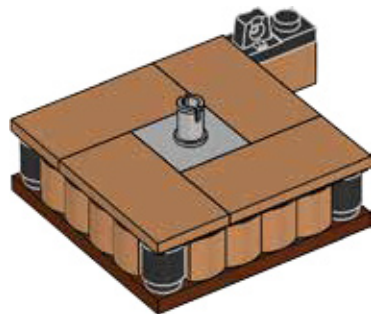

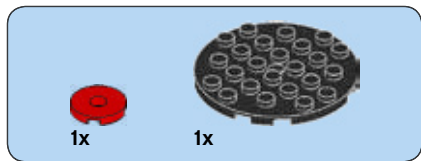

8

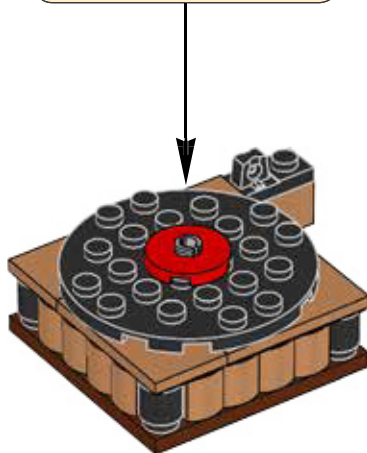
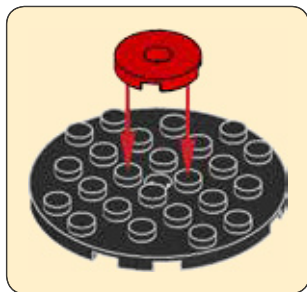



9

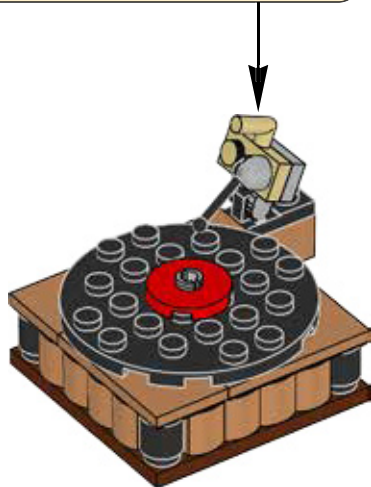
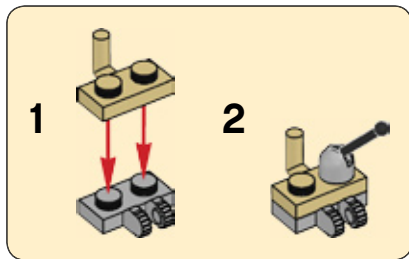



10

1



2



3

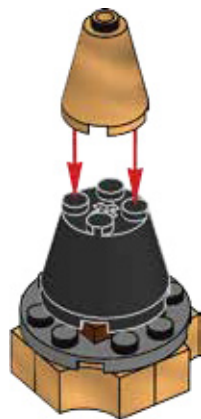

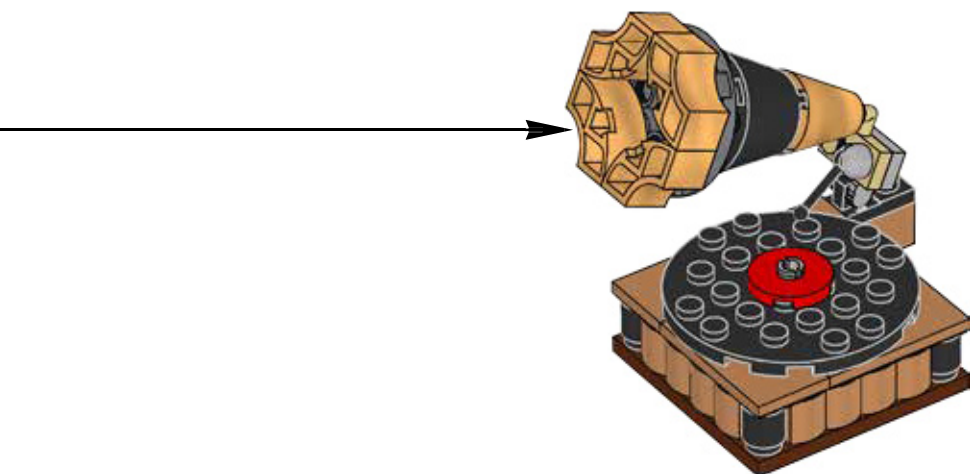

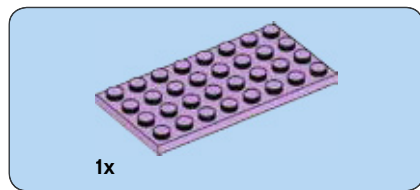

1

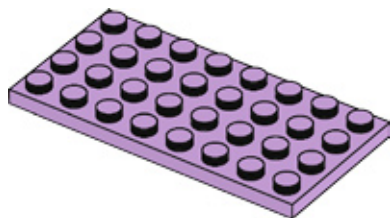

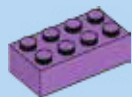

3x

2

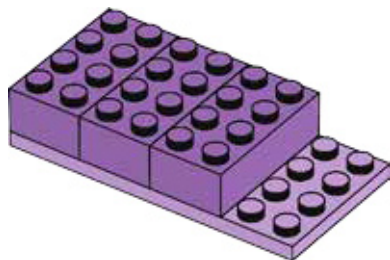

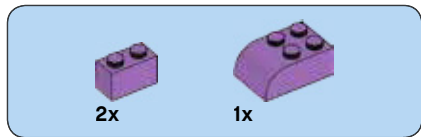

3

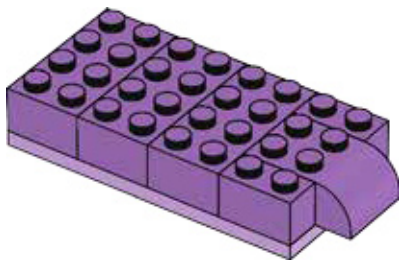

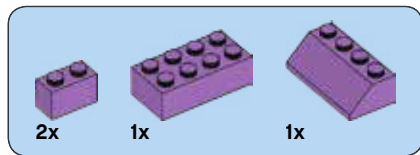

4

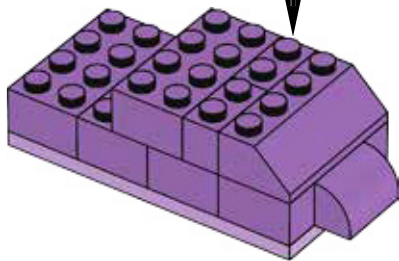
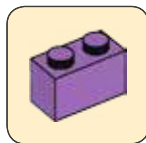

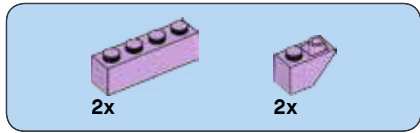

5

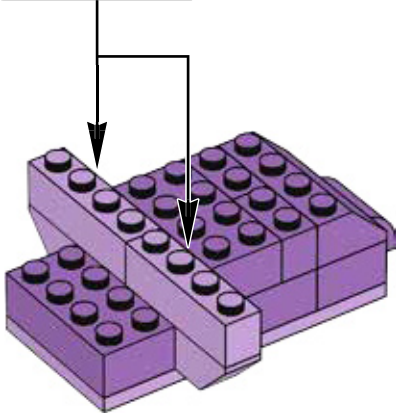
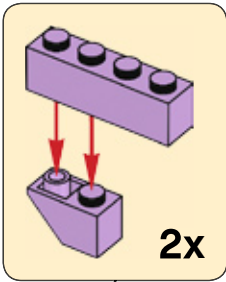



2x



2x

6

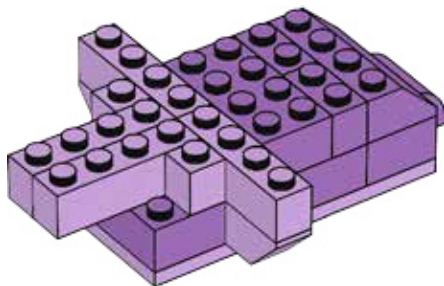

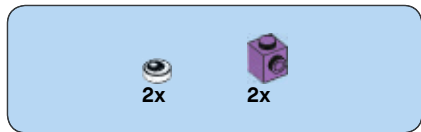

7

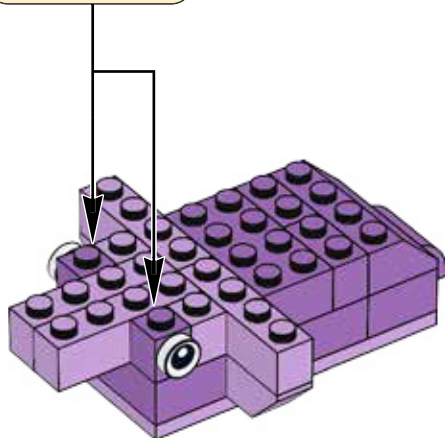
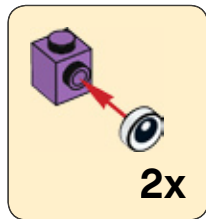



2x



1x

8

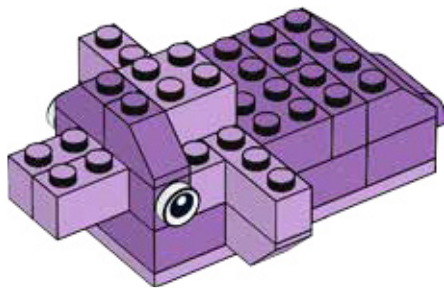



1x

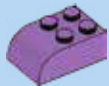

2x

9

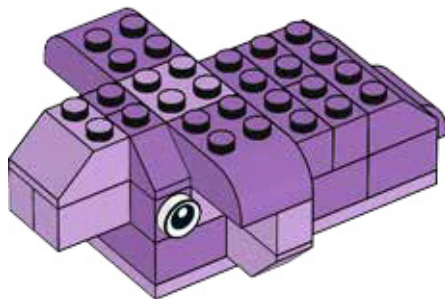



12x

10

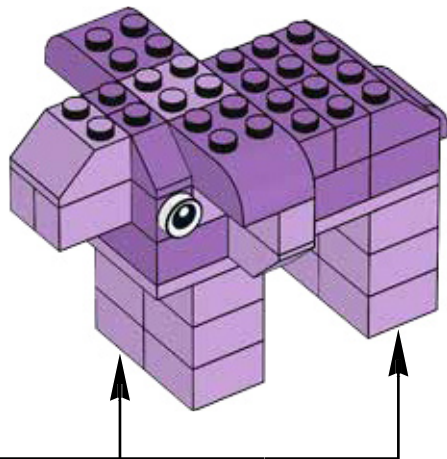
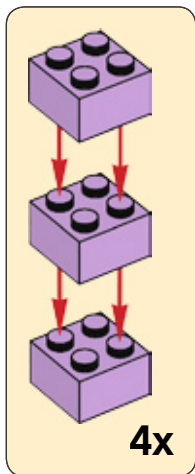

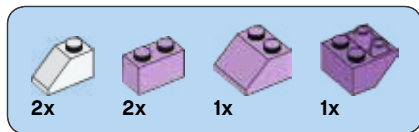

11

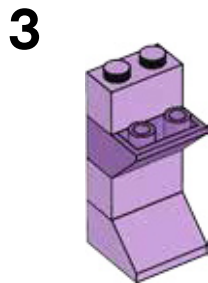
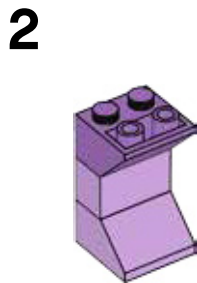
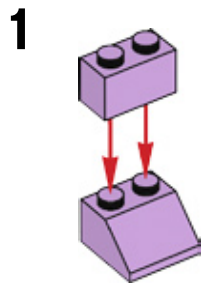

4

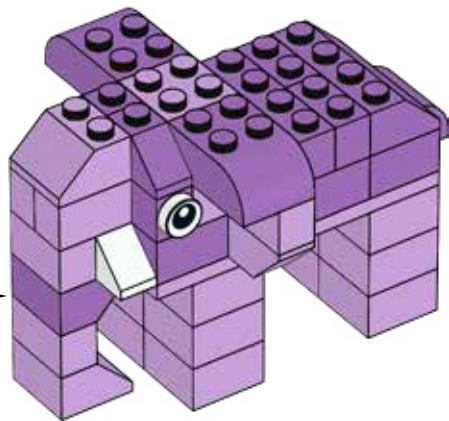
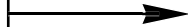
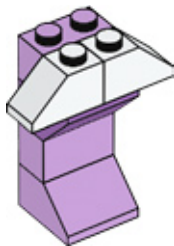

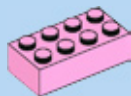

1x

12

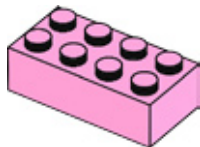



2x

13

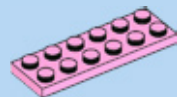
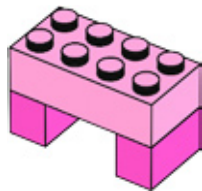

1x

14

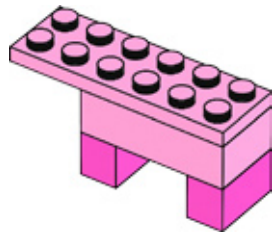



2x



2x

15



2x

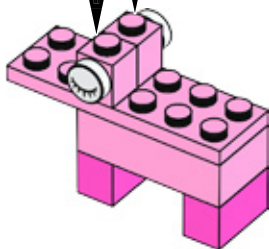



1x



1x

16

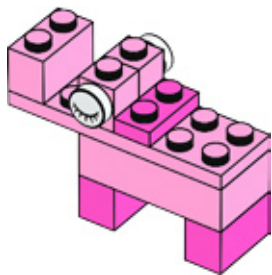

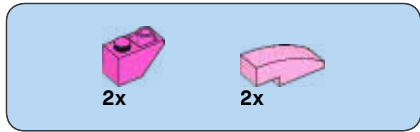

17

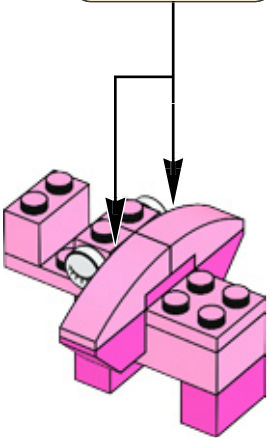
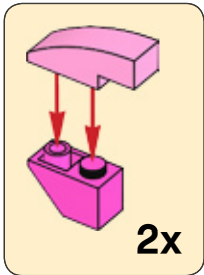

18

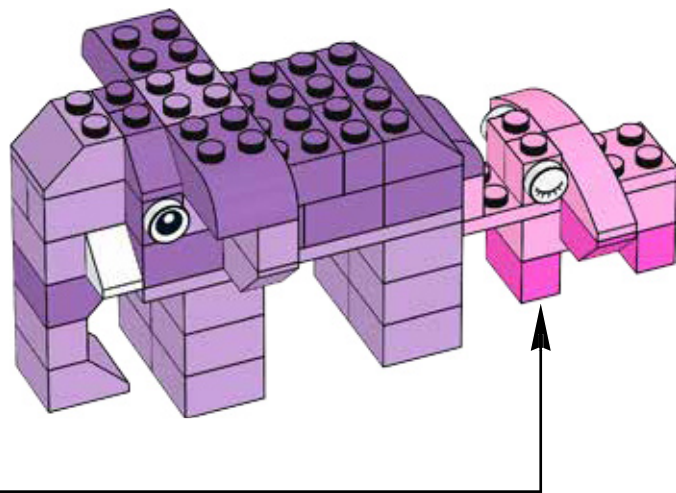

what will you build to help the baby elephant cross the river?
Que construiras-tu pour aider le bébé éléphant à traverser la rivière ?
¿Qué puedes construir para ayudar al bebé elefante a cruzar el río?





10698



10696



10700



10714



10713



10701





















CREATOR™

3 IN 1



31077

 **8x**
30620
 **4x**
6099548
 **4x**
6029156
 **4x**
6097402
 **4x**
6194809
 **4x**
4558952
 **4x**
4170457
 **4x**
403201
 **4x**
362201
 **4x**
4547489
 **8x**
302301
 **8x**
300401
 **6x**
446001
 **2x**
6153776
 **4x**
4121932
 **8x**
300301
 **4x**
366001
 **4x**
362201
 **1x**
4541956

 **3x**
4530590

 **4x**
302001

 **8x**
300101

 **2x**
4181142

 **1x**
383201

 **1x**
4514842

 **1x**
4168072

 **6x**
4118793

 **4x**
4140562

 **4x**
4125220

 **36x**
4109995

 **4x**
4655257

 **20x**
4162465

 **4x**
4118790

 **4x**
4500453

 **8x**
4159739

 **2x**
4550323

 **3x**
4114309

 **3x**
4112982

 **4x**
4529234

 **8x**
300521

 **2x**
6102138

 **16x**
300421

 **2x**
370021

 **4x**
4121934

 **2x**
368021

 **4x**
4521852

 **4x**
4515365

 **8x**
362221

 **4x**
362321

 **4x**
4251162

 **8x**
303721

 **4x**
300121

 **2x**
346021

 **2x**
303221

 **4x**
459923

 **8x**
300523

 **4x**
6189189

 **4x**
6055065

 **8x**
366523







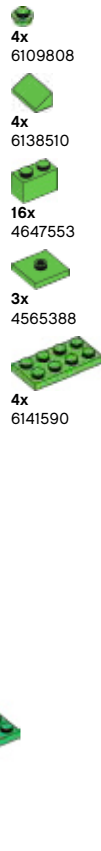
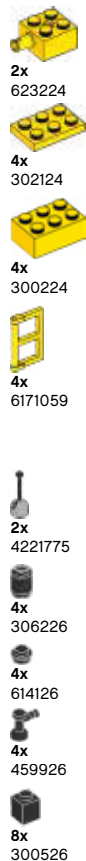
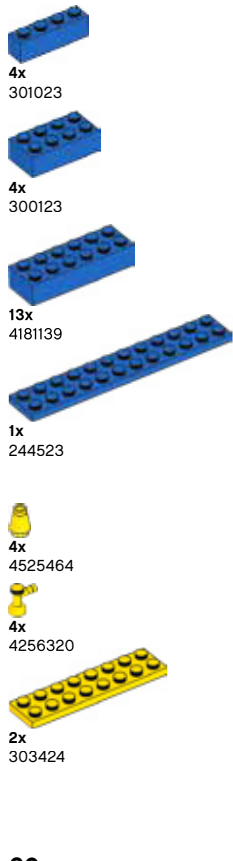

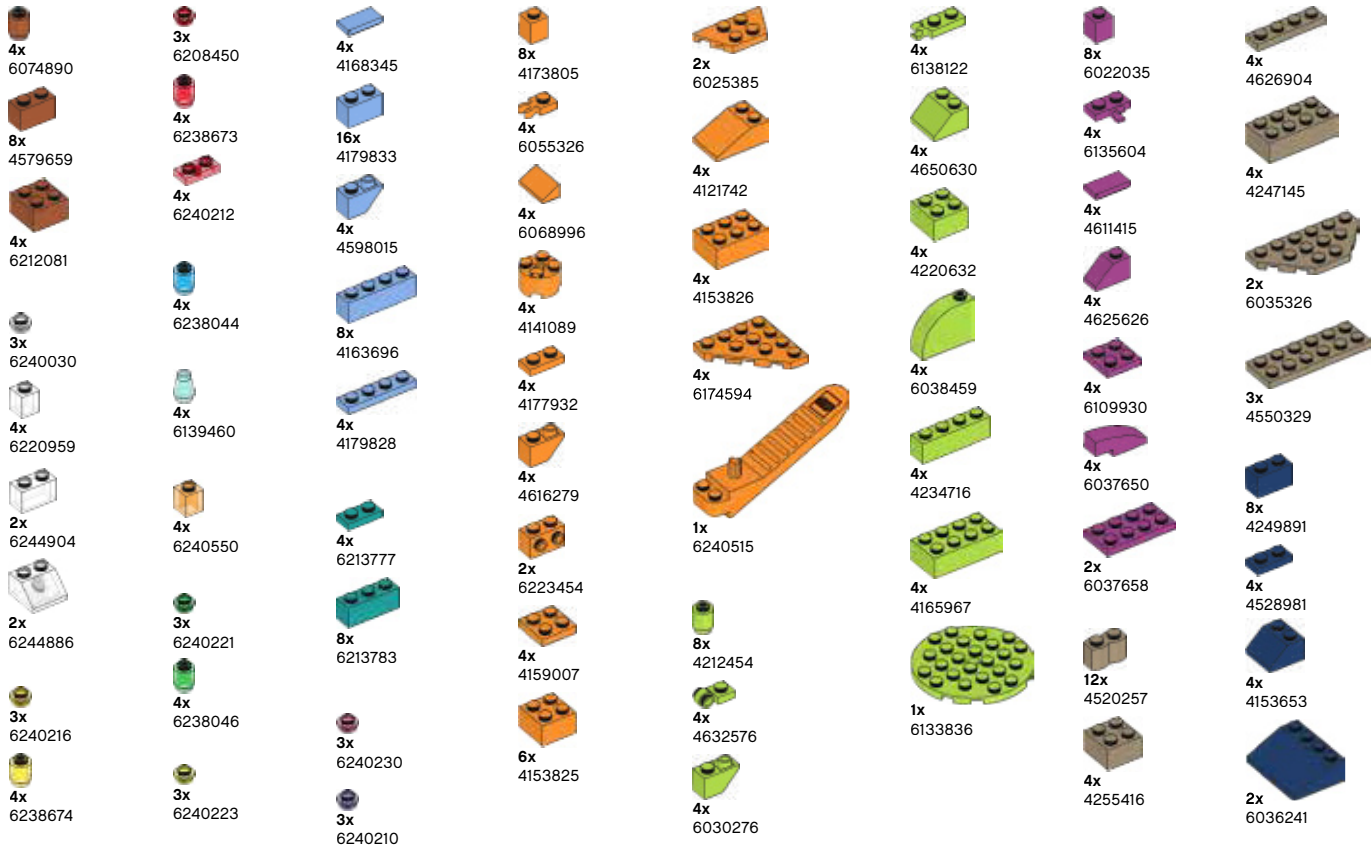























































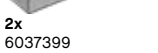







 **4x**
4514398

 **4x**
302123

 **4x**
300223





 8x 4245570	 8x 4541376	 4x 6122504	 4x 4529242	 4x 4216668	 12x 4211389	 2x 4211570	 4x 4529240
 4x 6003331	 4x 4541506	 4x 6170916	 3x 4216581	 2x 6153594	 2x 4540203	 4x 4211394	 3x 4210633
 4x 6214611	 4x 4539097	 4x 6061688	 4x 4223303	 4x 6096217	 4x 4617170	 2x 4211409	 8x 4558955
 4x 4616578	 4x 4613761	 4x 6022064	 4x 6069984	 4x 4538252	 4x 6000066	 1x 4211666	 4x 4210636
 4x 6186823	 4x 4609925	 4x 6200073	 4x 4629736	 1x 4217848	 4x 4515341	 2x 4618874	 8x 4211063
 4x 6075624	 4x 4539104	 4x 6100027	 4x 4211149	 2x 6096716	 4x 4211350	 2x 6037399	 4x 4211043
 4x 6100234	 4x 6004938	 4x 6182777	 4x 4216695	 12x 4211221	 4x 6198932	 2x 6037399	 2x 4528323
 3x 6240227	 8x 6004943	 4x 6132418	 12x 4211221	 4x 6022032	 4x 4645397	 4x 6022105	 4x 4211085
	 4x 6151671		 2x 6050918	 4x 6192270	 2x 4211504	 4x 6092677	 4x 6036232
	 8x 6036851		 4x 4211220		 8x 4211386		

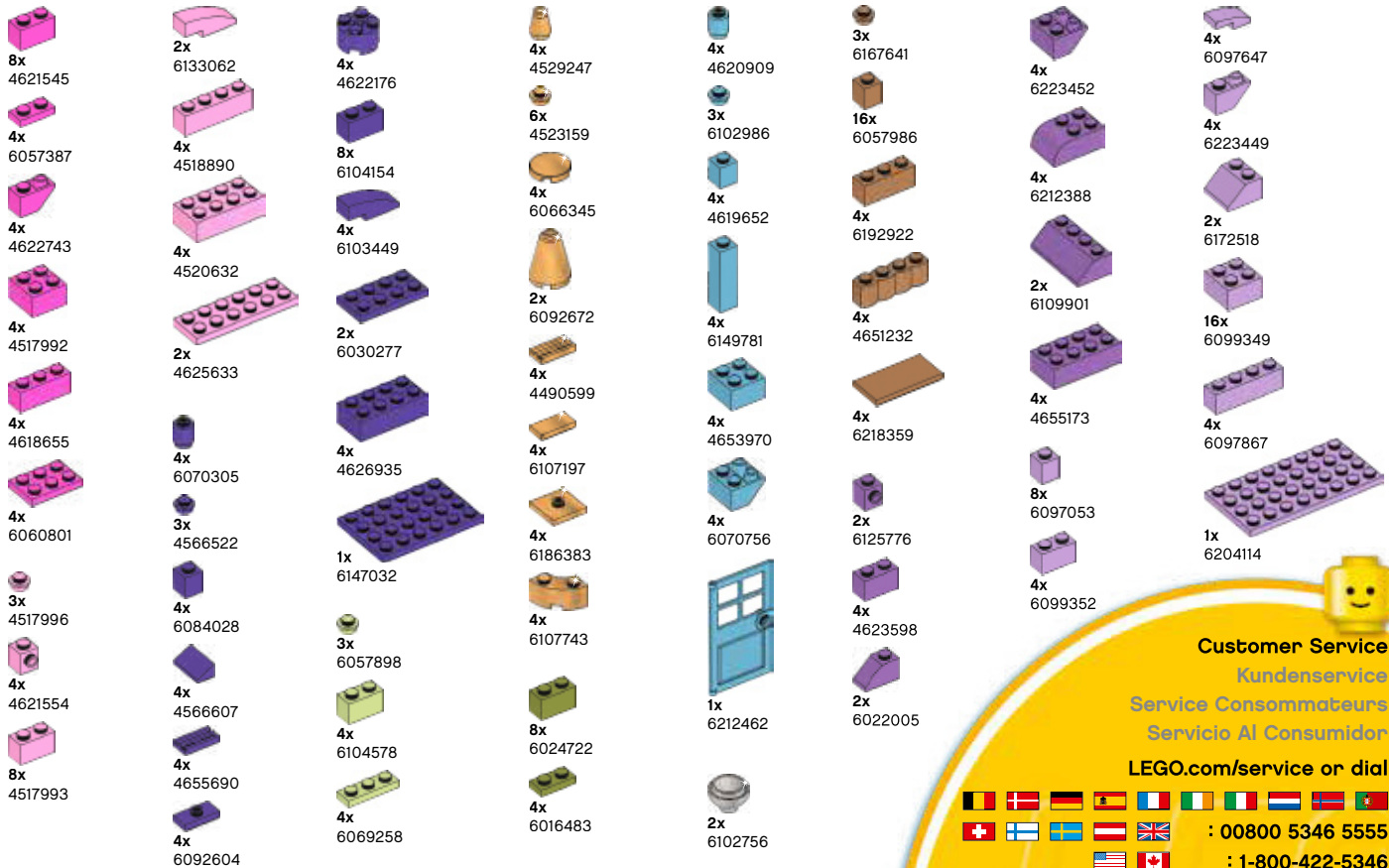

Customer Service
Kundenservice
Service Consommateurs
Servicio Al Consumidor
LEGO.com/service or dial



WIN

GO TO WWW.LEGO.COM/PRODUCTFEEDBACK AND
GIVE US YOUR SHORT **FEEDBACK** ABOUT THIS
LEGO® SET FOR A CHANCE TO WIN
A COOL LEGO PRIZE.

Terms & Conditions apply

LEGO.com/productfeedback



GEWINNE

Erzähle uns auf
www.LEGO.com/productfeedback

etwas über die Erfahrungen, die du mit
diesem LEGO® Set gemacht hast, und
sichere dir die Chance auf einen coolen
LEGO Preis!

Es gelten die Teilnahmebedingungen

GAGNE

Rends-toi sur
www.LEGO.com/productfeedback

et donne-nous quelques commentaires sur
ce produit LEGO® pour avoir une chance
de gagner un prix LEGO !

Voir Conditions Générales

GANAN

Visita
www.LEGO.com/productfeedback

y envíanos tu opinión acerca de este set
LEGO®. ¡Participarás en el sorteo de un
premio LEGO!

Términos y Condiciones aplicables

获取奖品

登录
www.LEGO.com/productfeedback

给出关于此乐高®套装的简短反馈，
就有机会获得炫酷乐高奖品

《条款及条件》适用

LEGO and the LEGO logo are trademarks of the/son des marques de commerce du/son marcas registradas de LEGO Group. ©2018 The LEGO Group.

6242581