



# ELVES

41194



 [LEGO.com/elves](http://LEGO.com/elves)



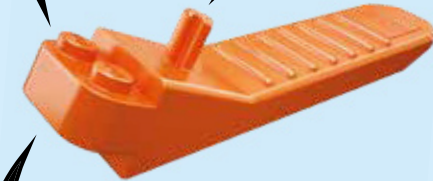
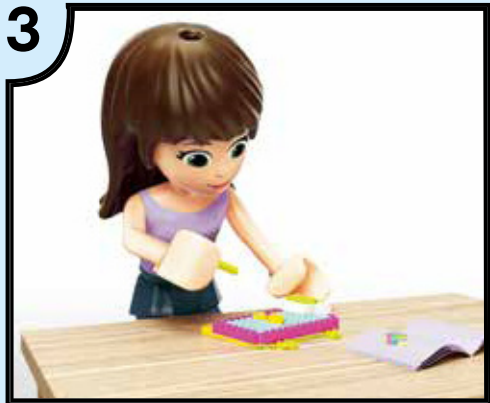
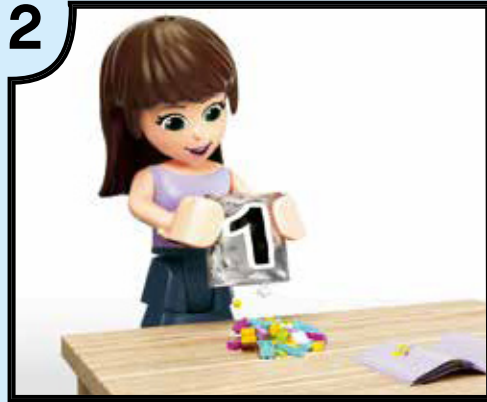
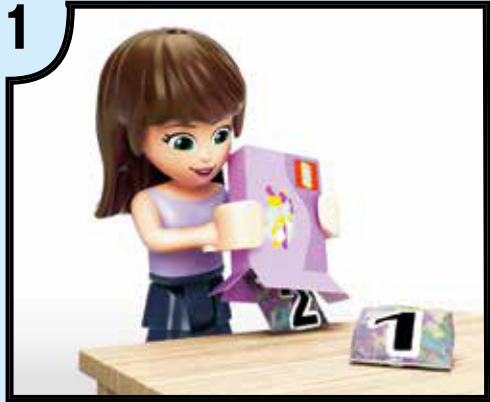

[LEGO.com/brickseparator](https://www.lego.com/brickseparator)

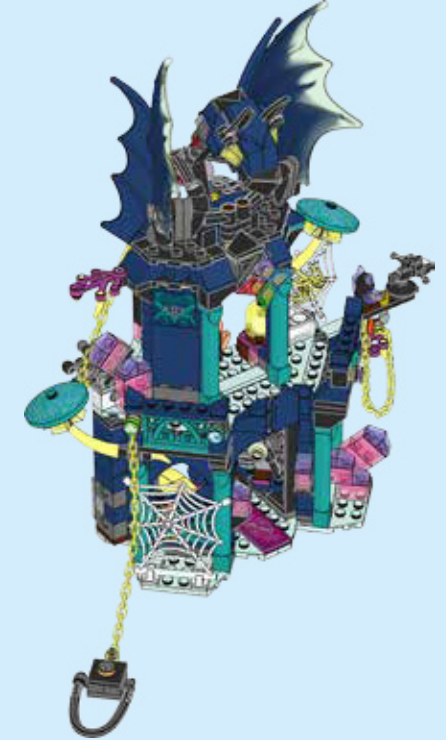
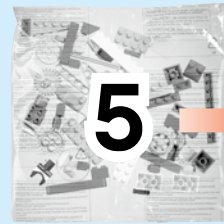
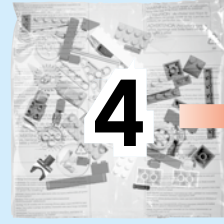
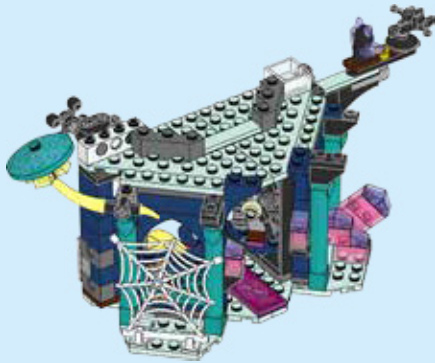
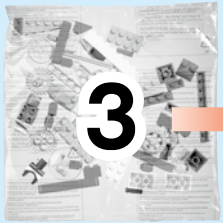
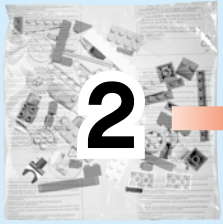
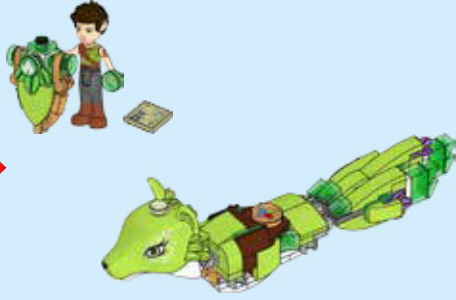

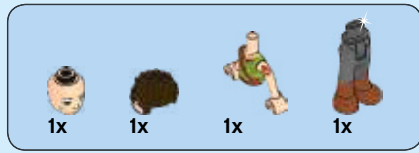
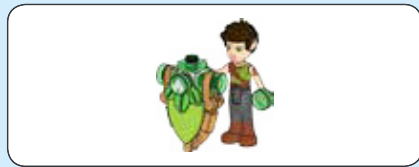
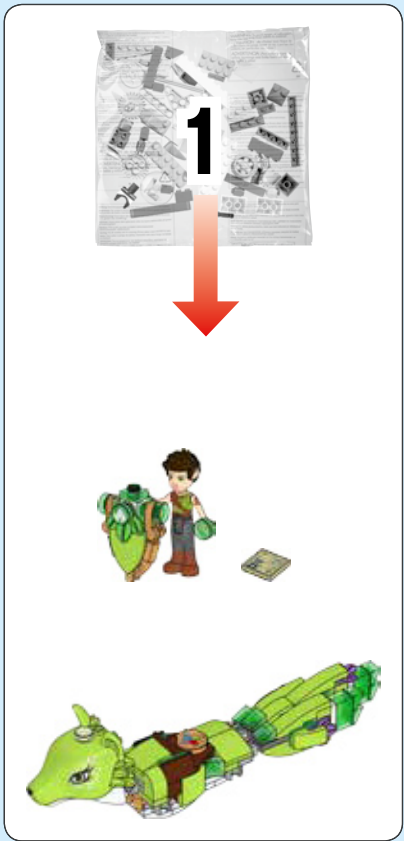

1





4

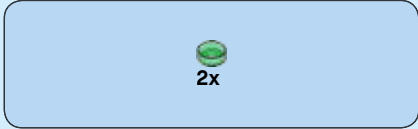
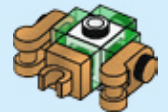

5

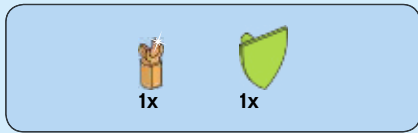
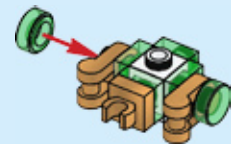

6

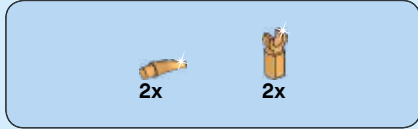
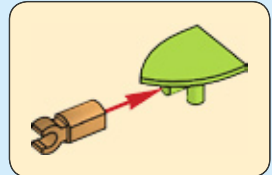

7

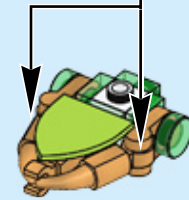
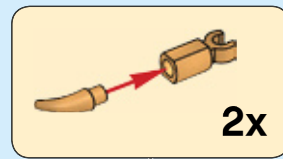

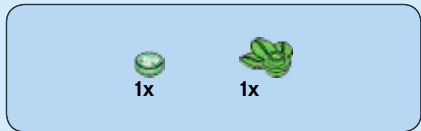

8

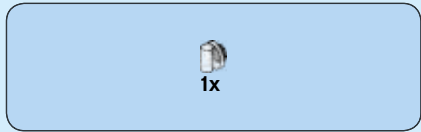
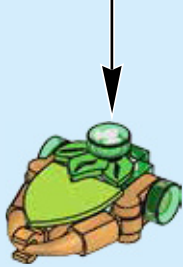
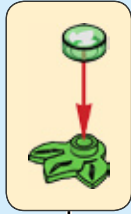

9

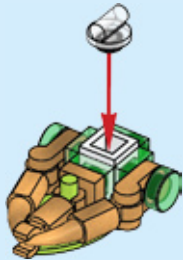
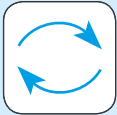

10

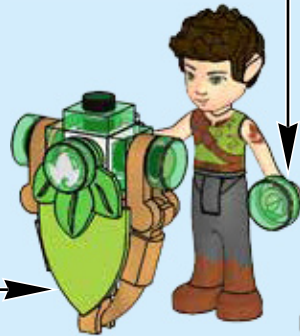

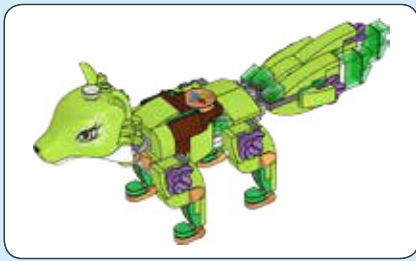

1



2

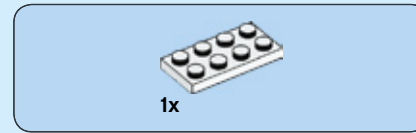
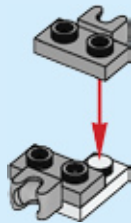

3

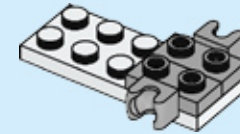

4

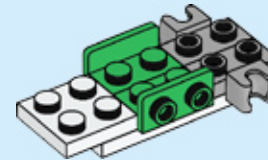



5

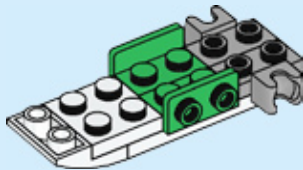

6

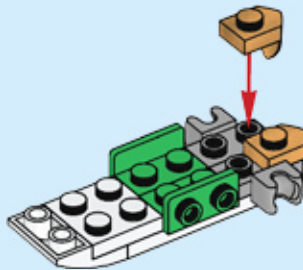

7

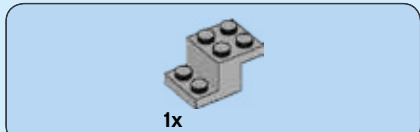
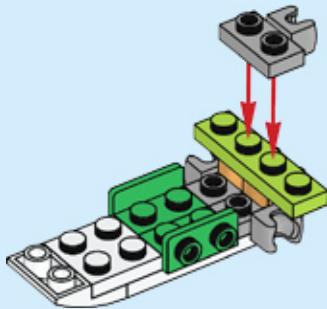

8

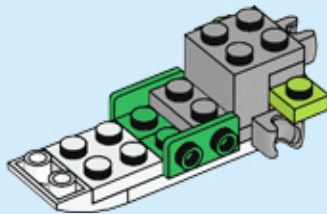





2x

9

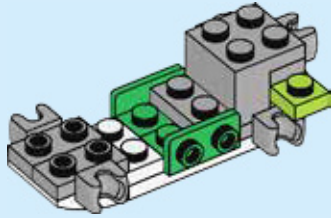

1x

10

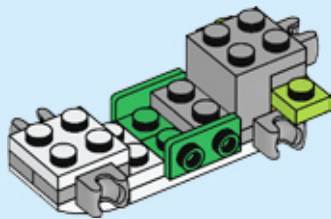

1x



2x

11

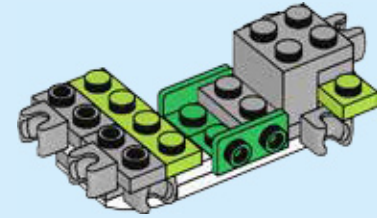

1x



1x

12

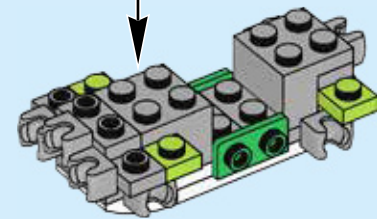
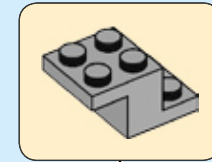



2x

13

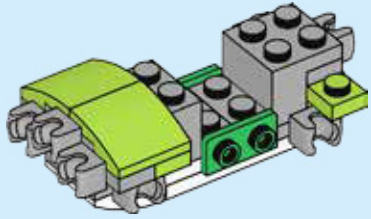

1x

14

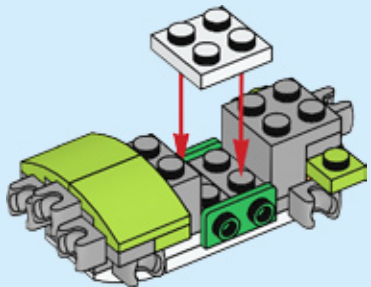

1x

15

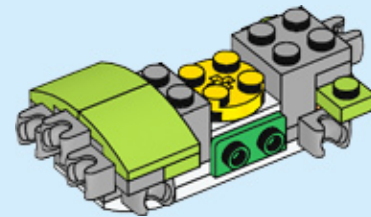

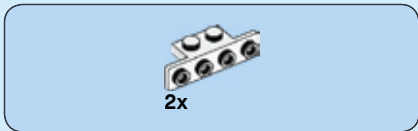

16

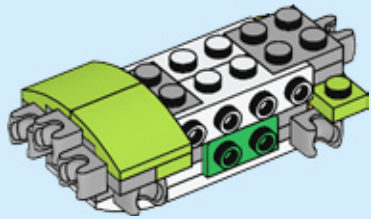

17

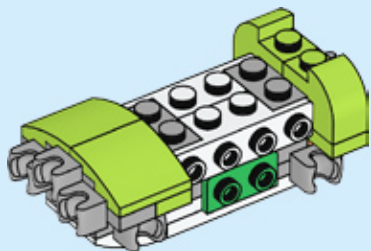

18

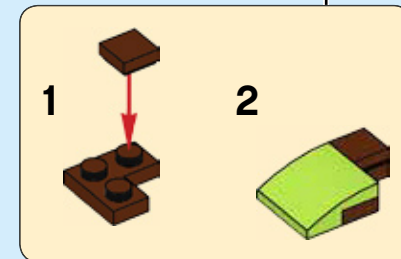
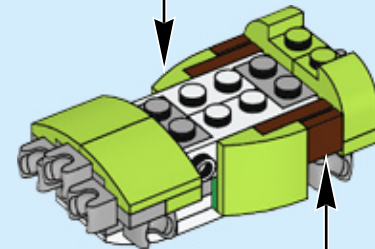
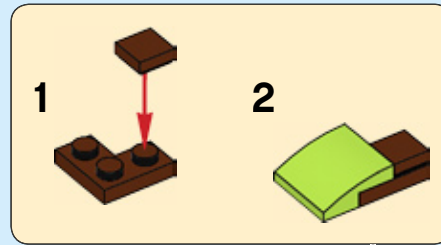



2x

19

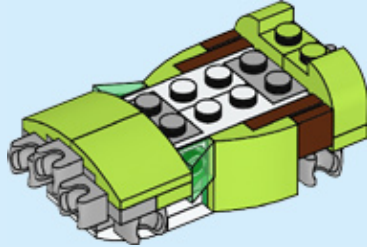

2x



2x

20

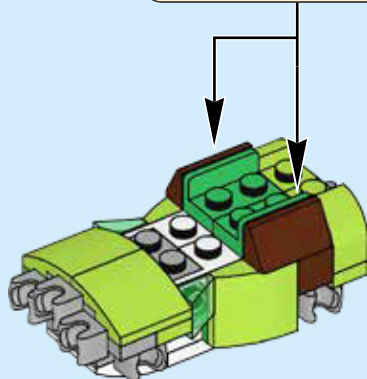
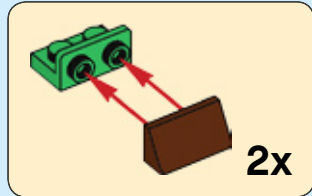

1x

21

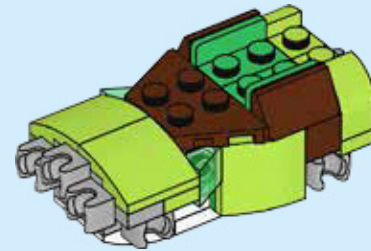



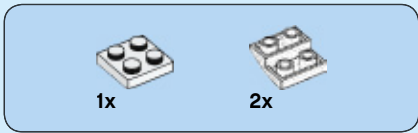

22

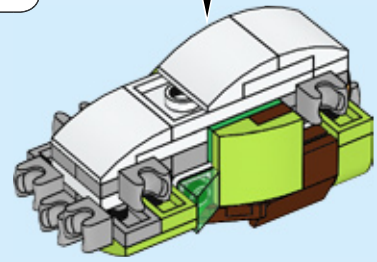
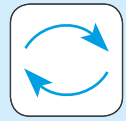
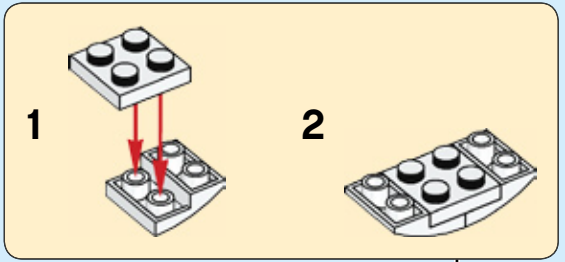

23

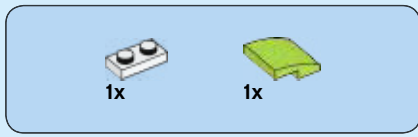
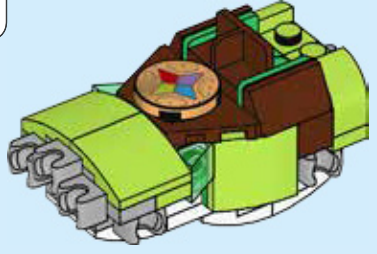
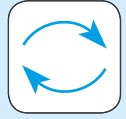

24

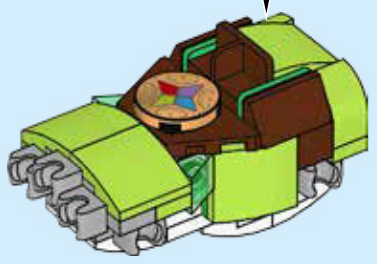
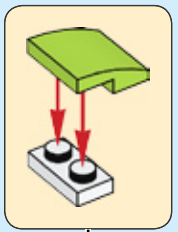



1x

25

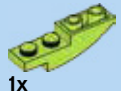

1x

26



1x



1x

27

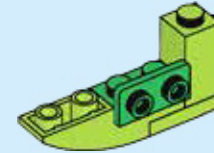

1x



1x

28

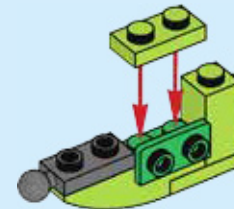



1x

# 29

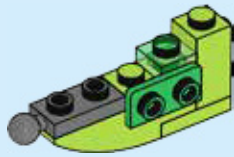

1x



1x

# 30

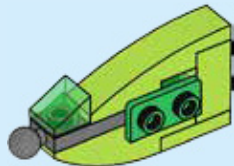

1x



1x



2x

# 31

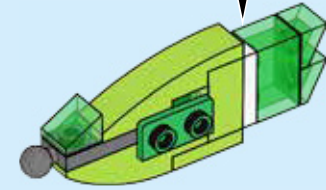
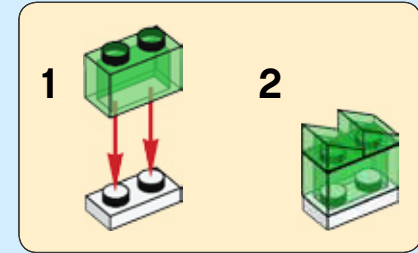

1x



1x

# 32

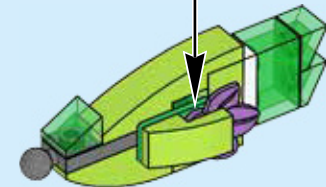
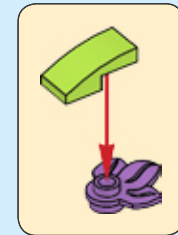

33

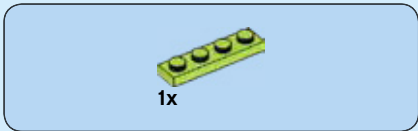
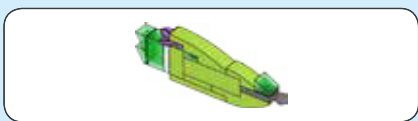
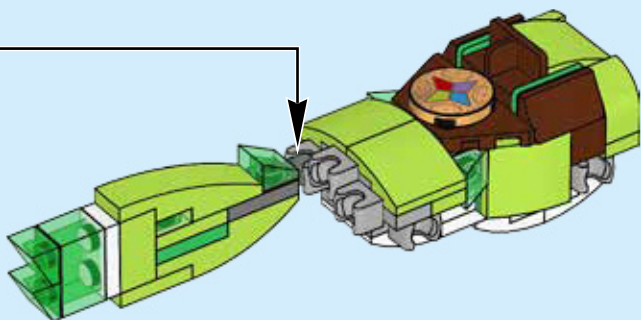

34

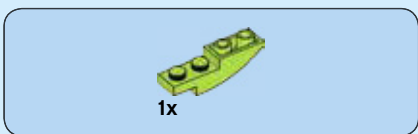
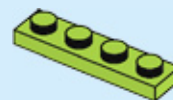

35

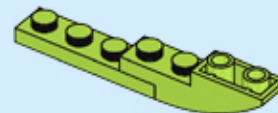





36

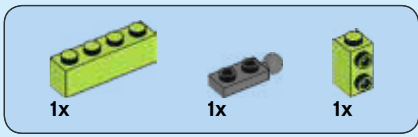
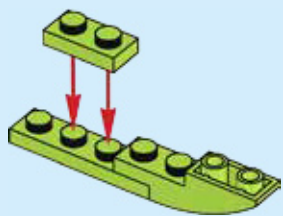

37

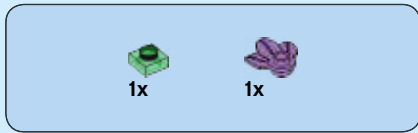
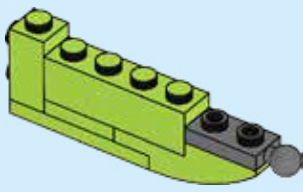

38

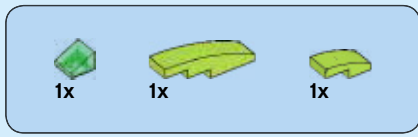
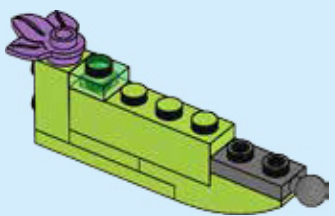

39

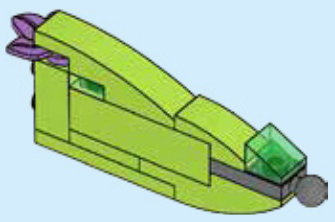



40

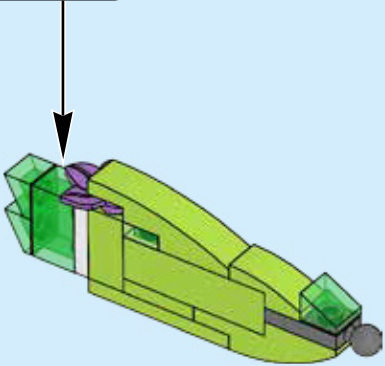
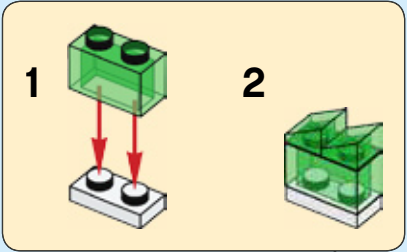

41

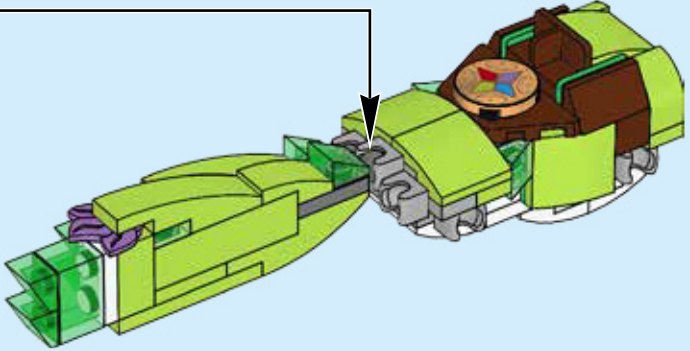

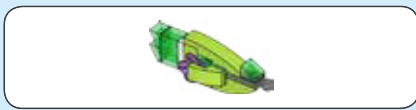

42

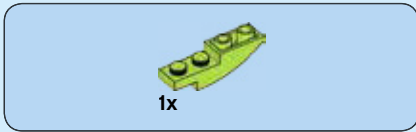

43



44

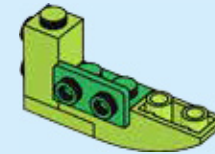

45

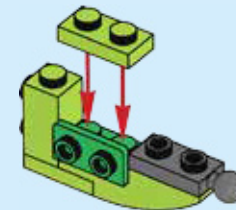



1x

# 46

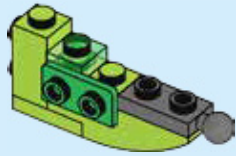

1x



1x

# 47

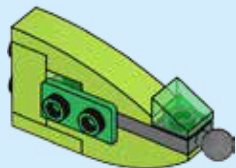

1x



1x



2x

# 48

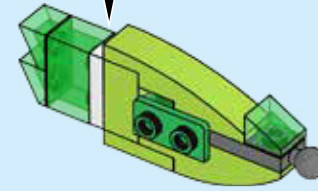
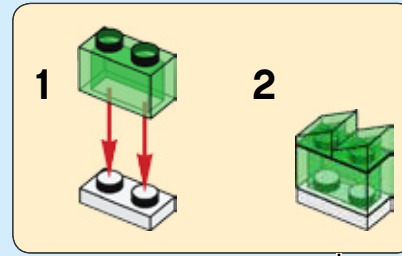

1x



1x

# 49

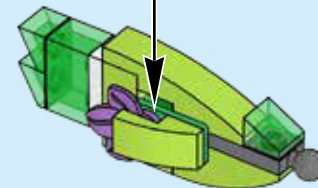
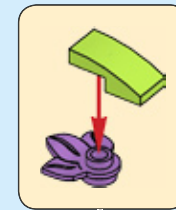



50

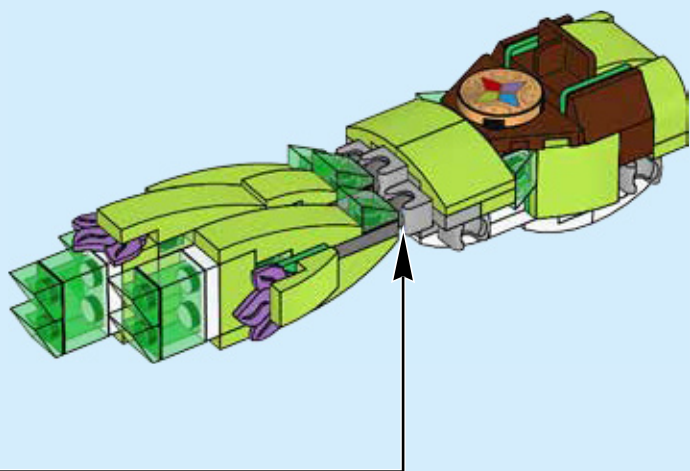

51

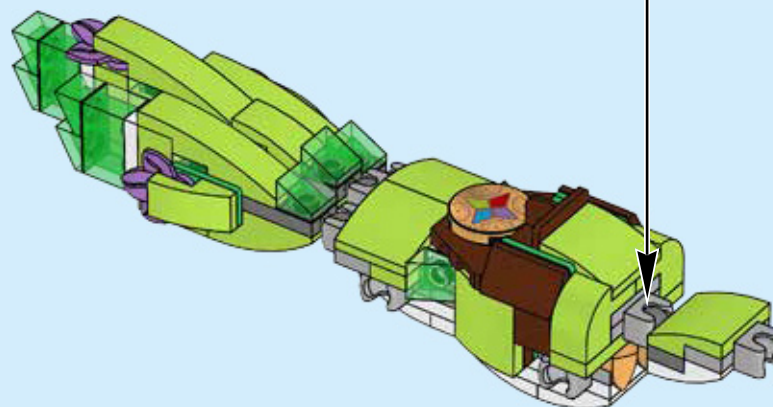
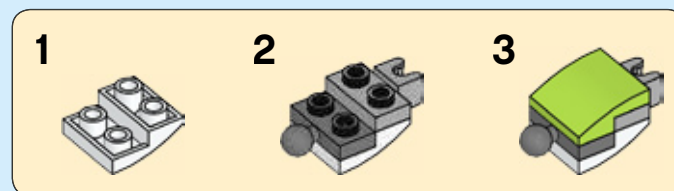

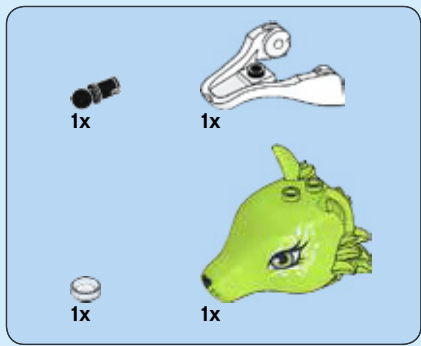

52

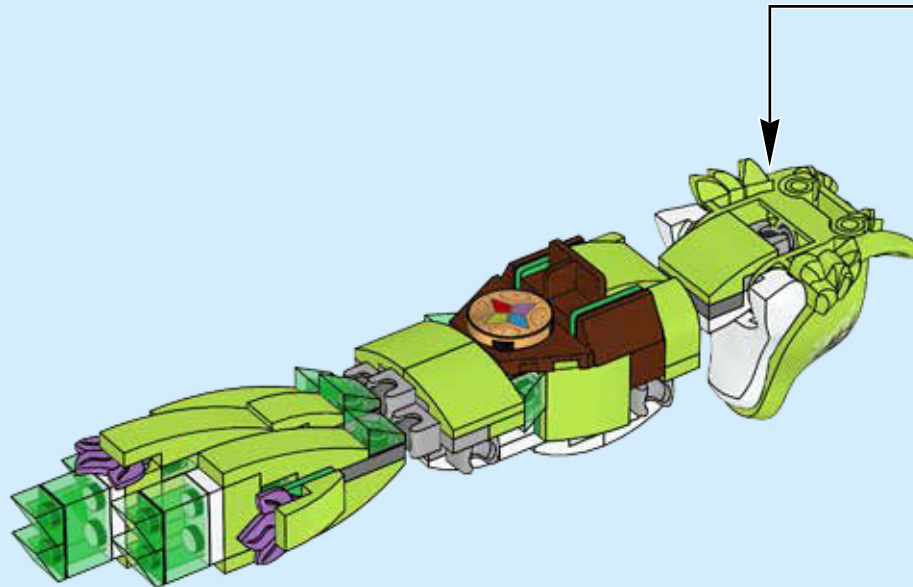
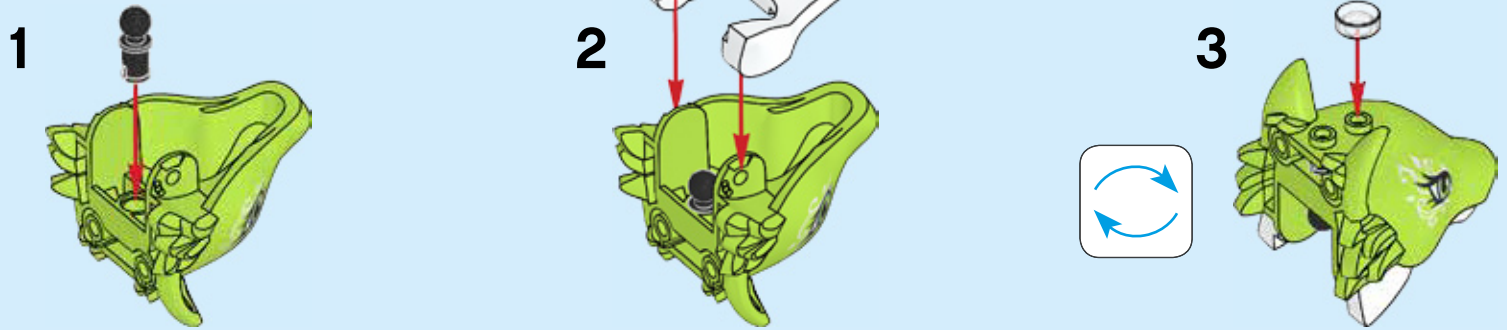



**53**

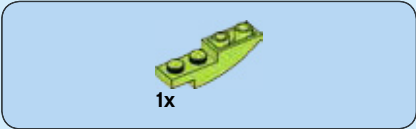

**54**





1x

55

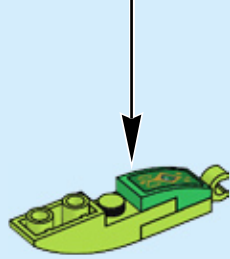
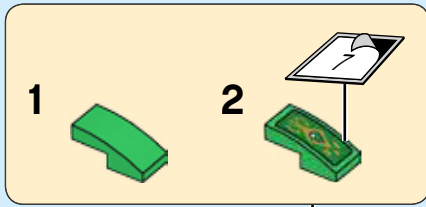

1x



1x

56



1x



1x

57



1x

58

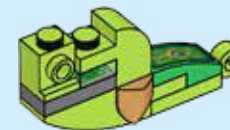



59

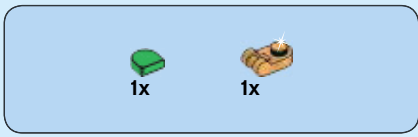
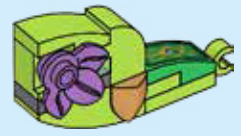

60

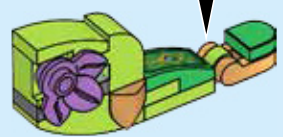
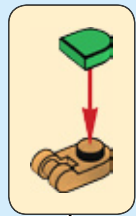

2x

61

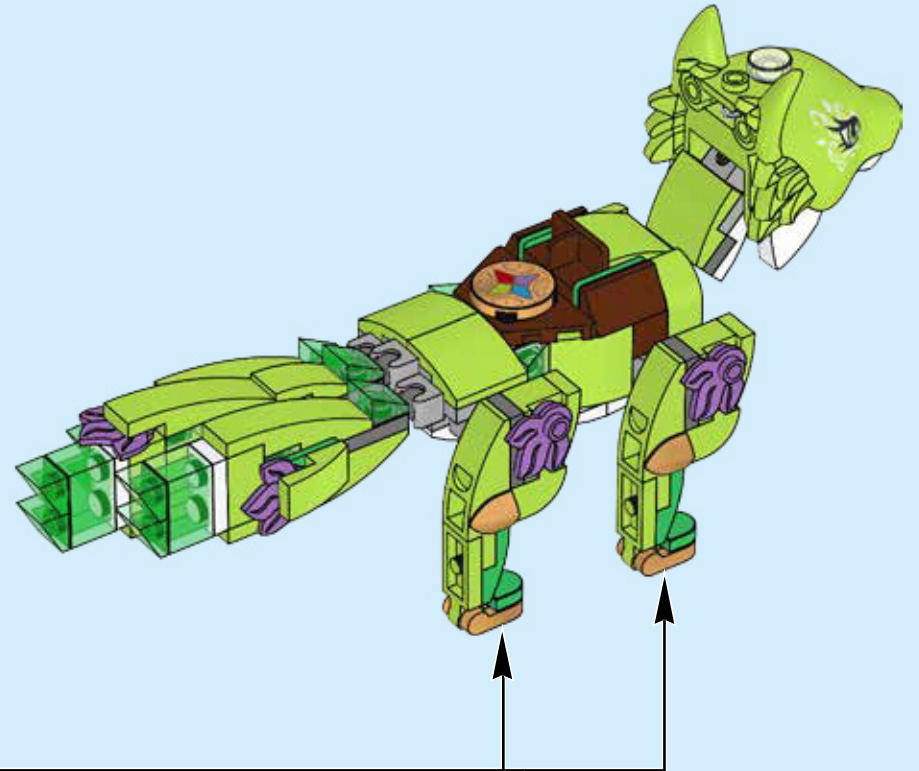



62

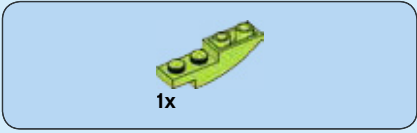

63

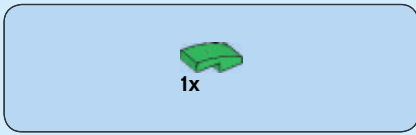

64

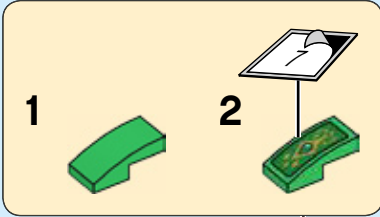

65







66

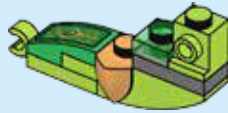

67

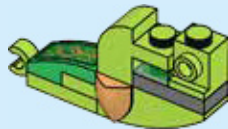

68

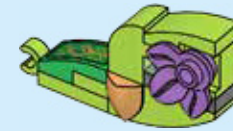

69

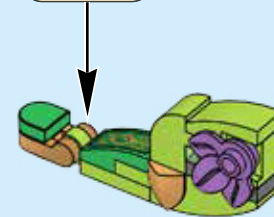
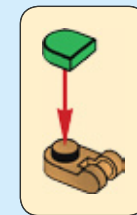

2x

70

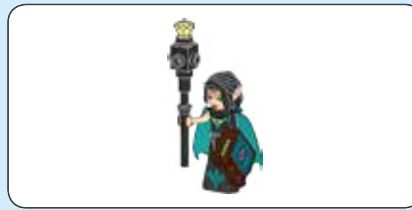
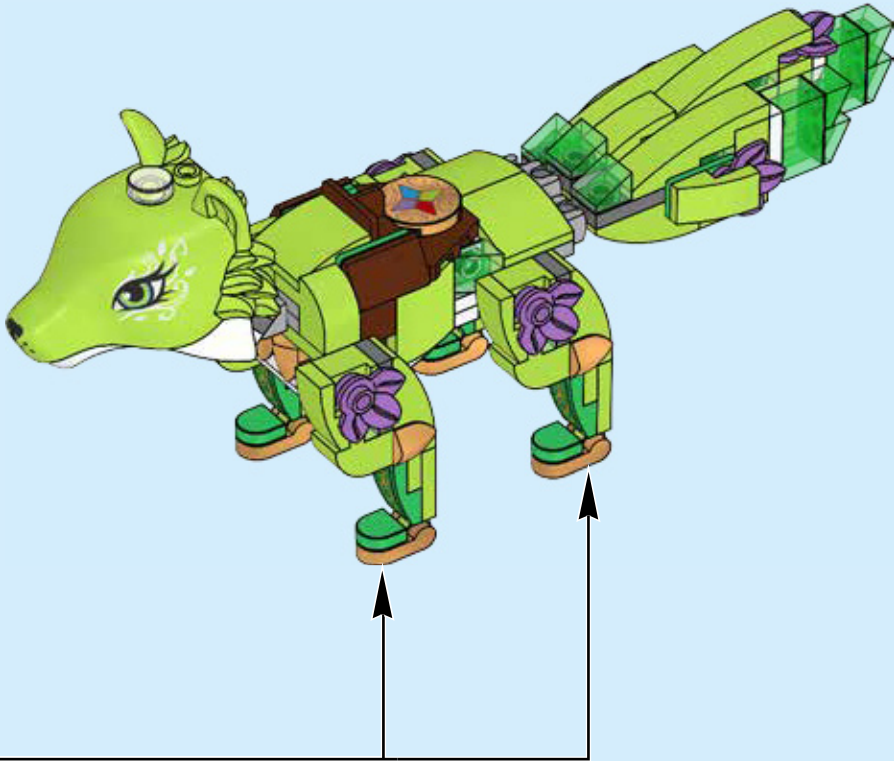

1





2

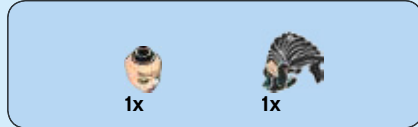

3



4

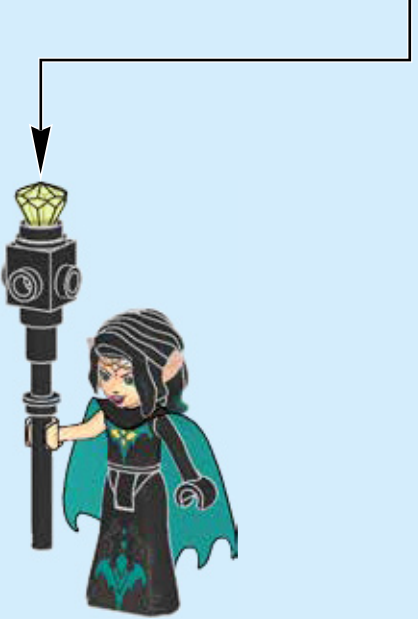
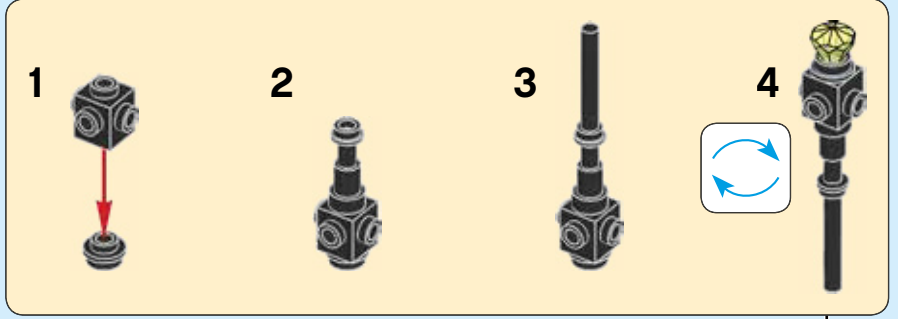

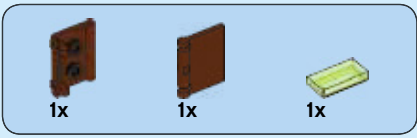

5

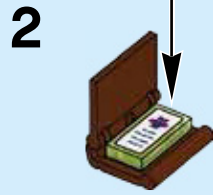
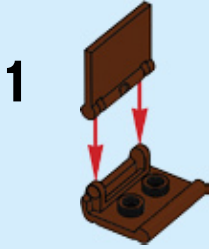
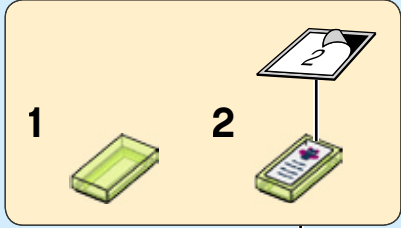

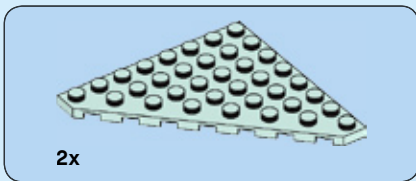
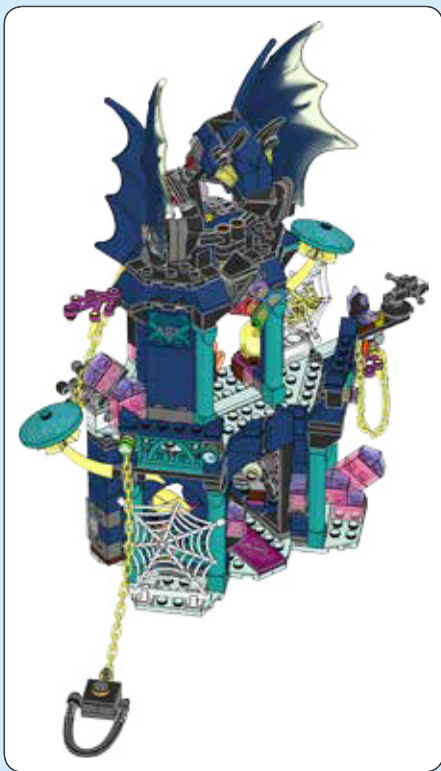

1

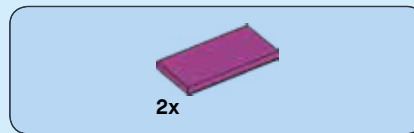
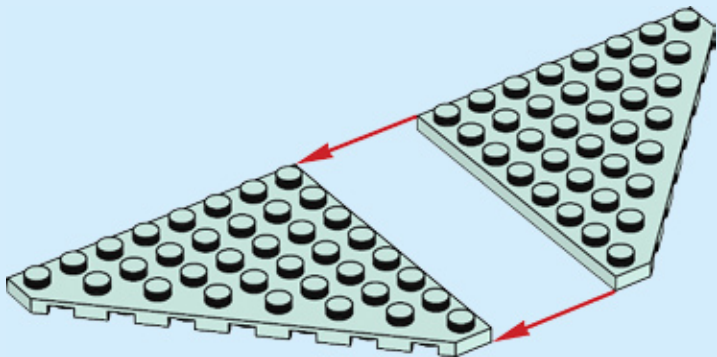

2

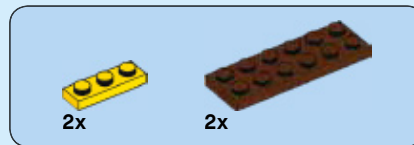
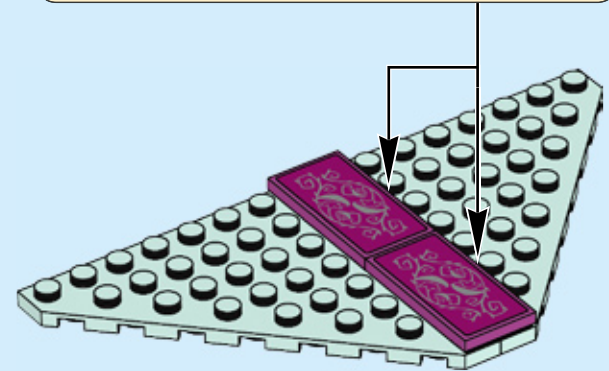
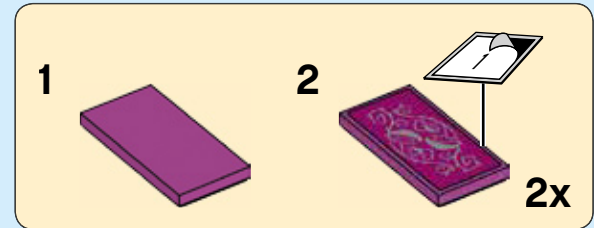

3

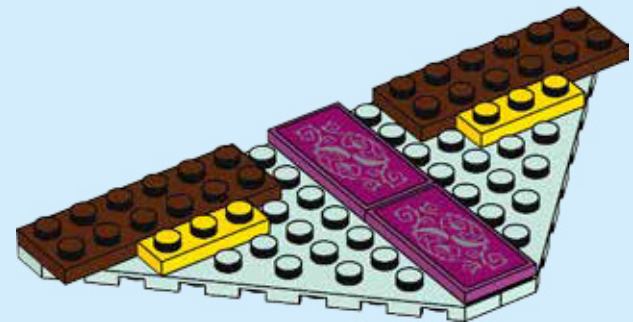

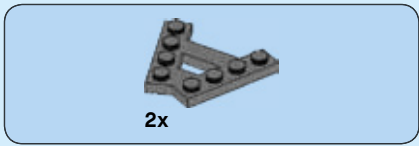

4

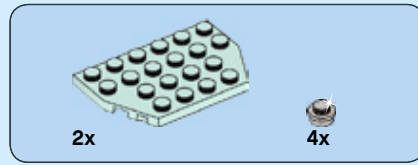
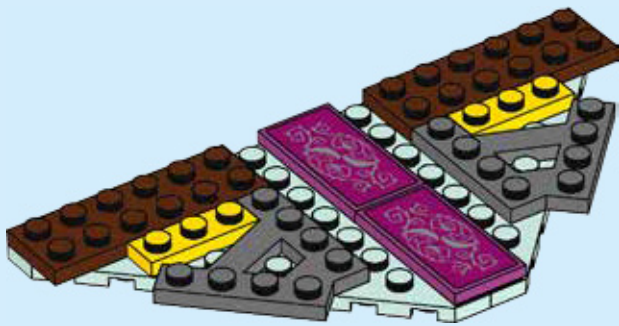

5

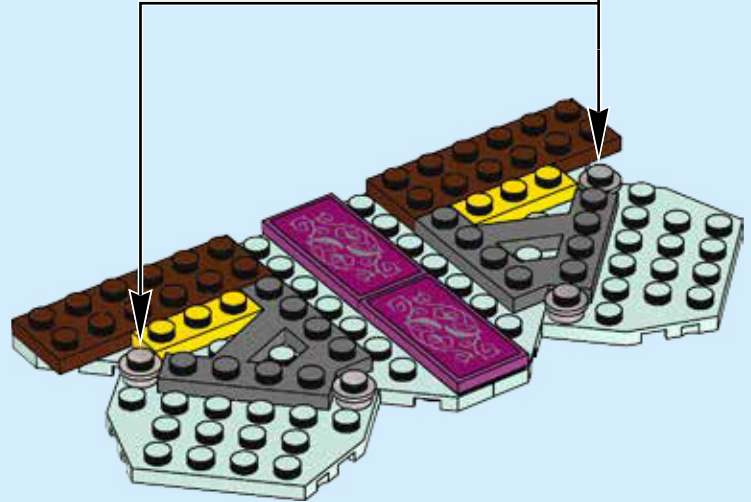
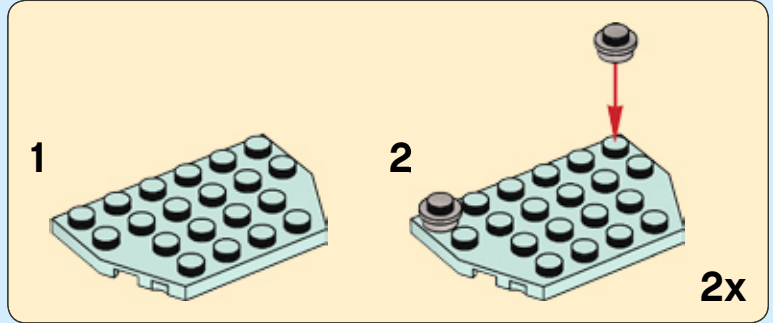



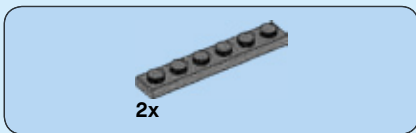

6

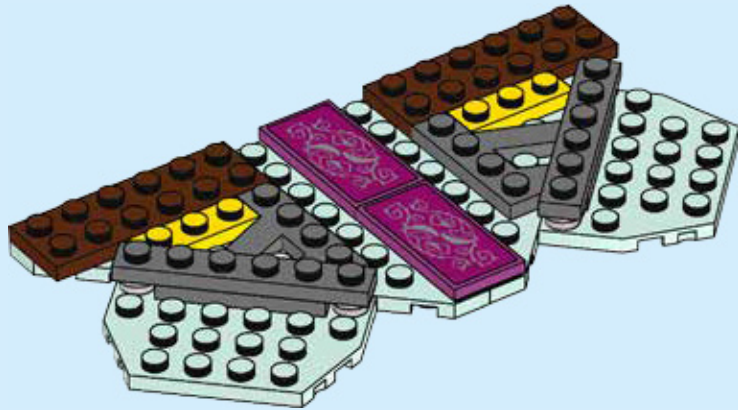

7

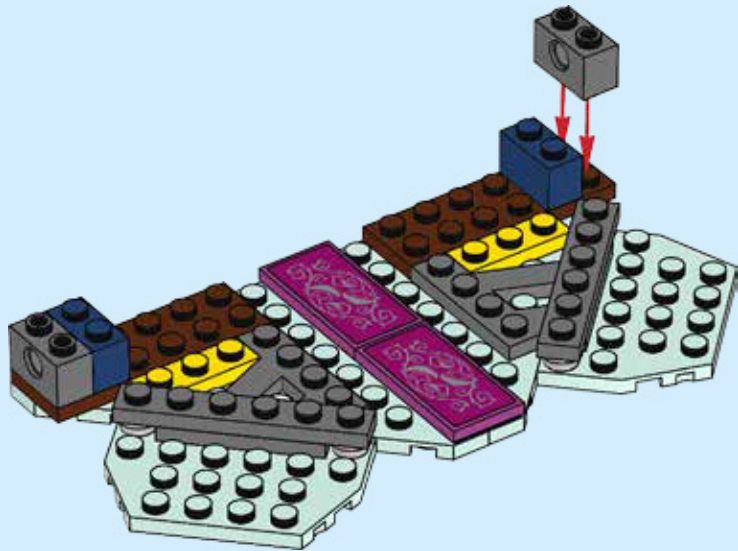

8

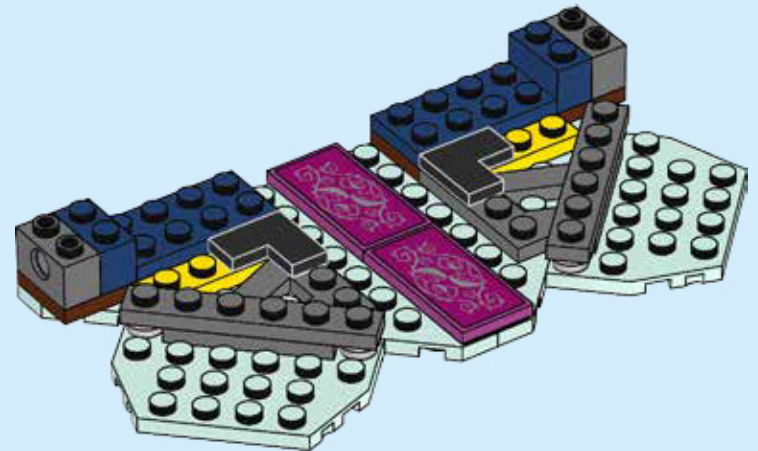



9

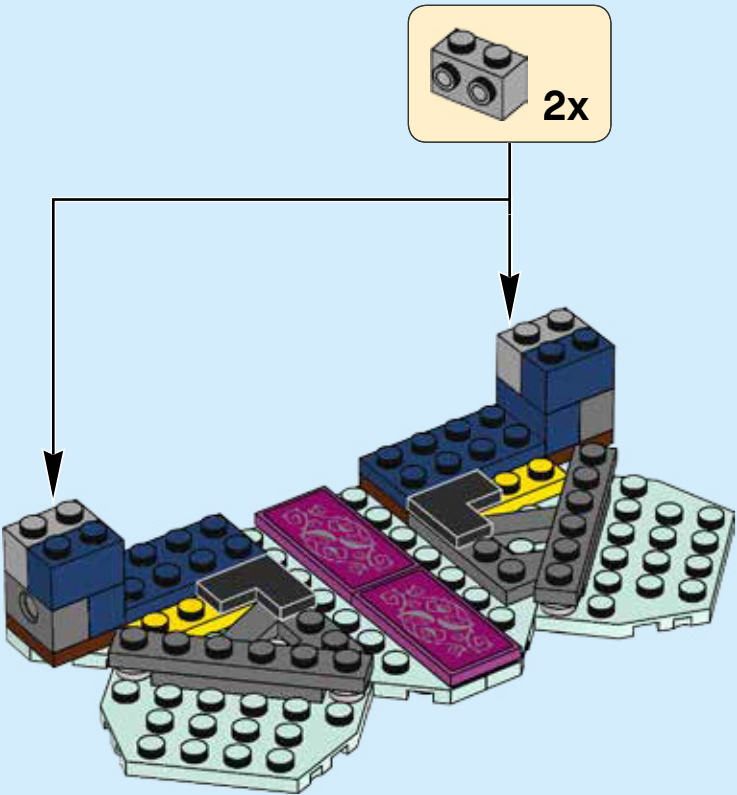

10

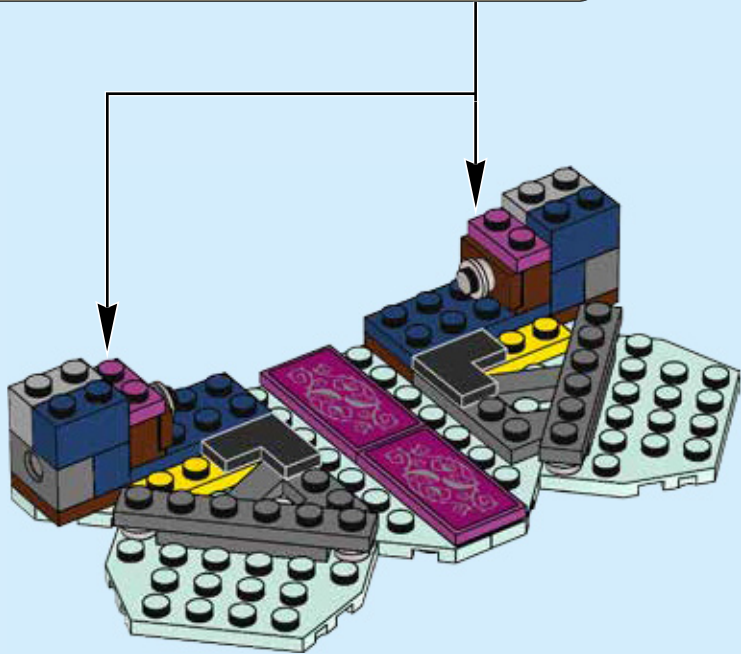
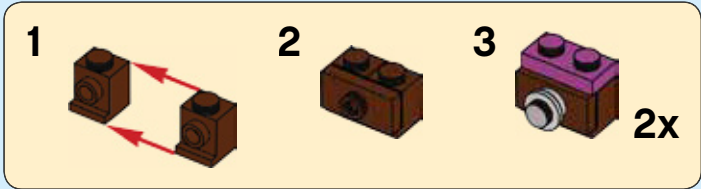



11

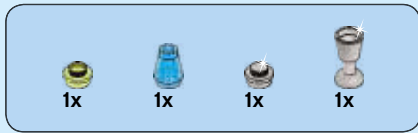
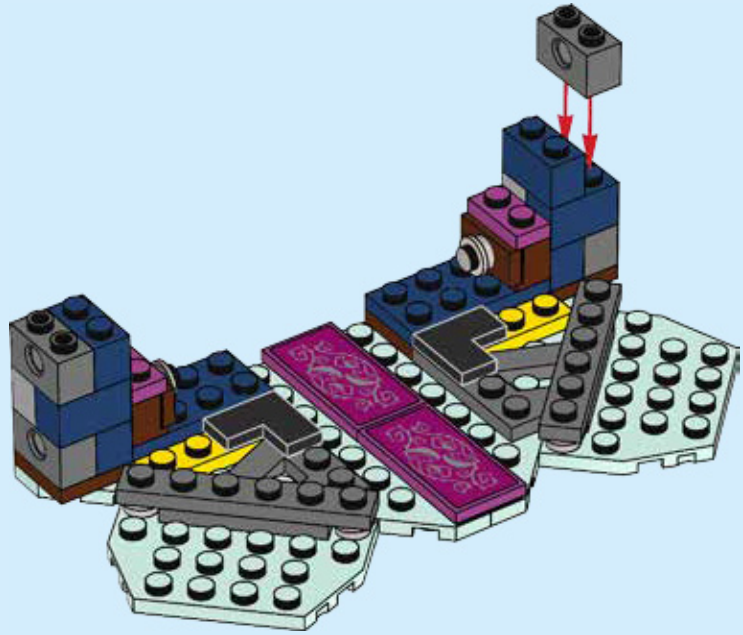

12

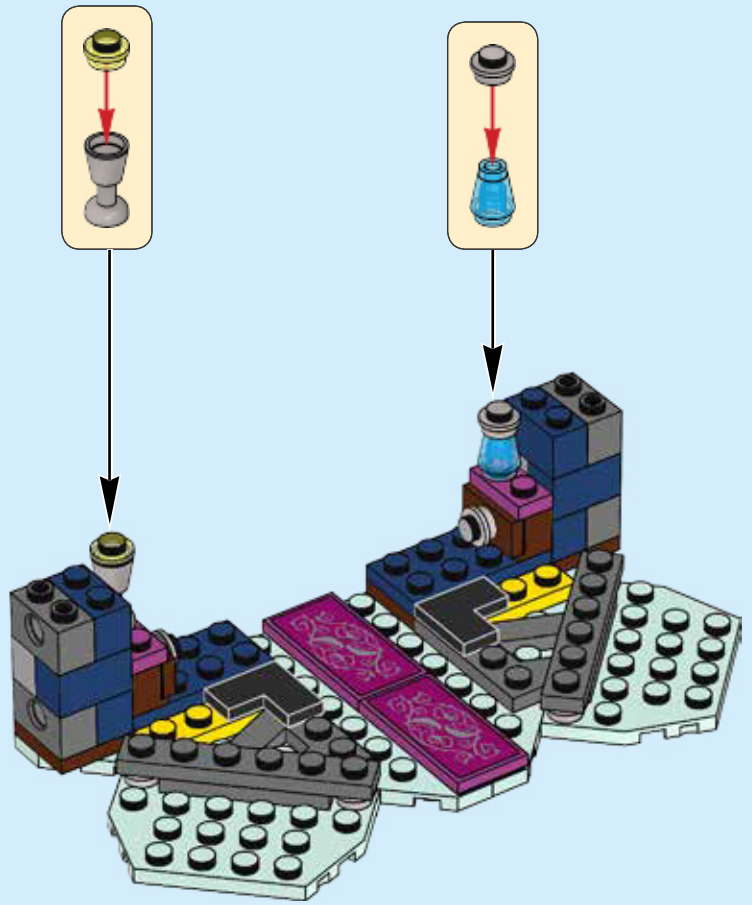

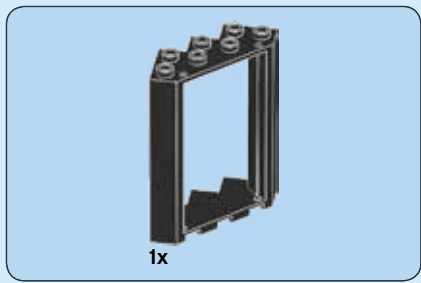

13

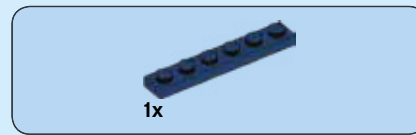
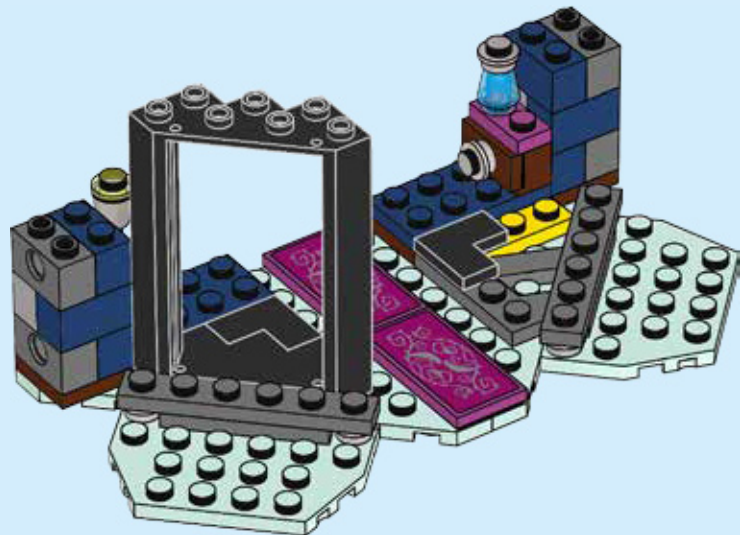

14

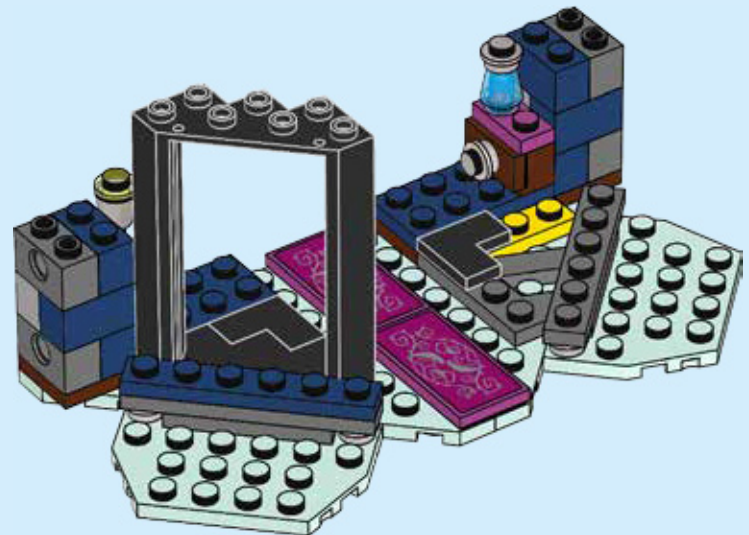



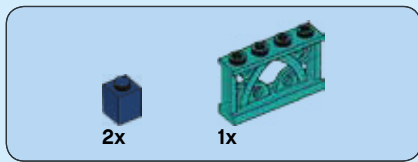

15

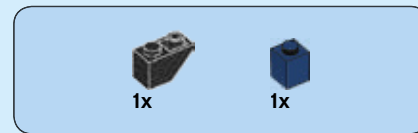
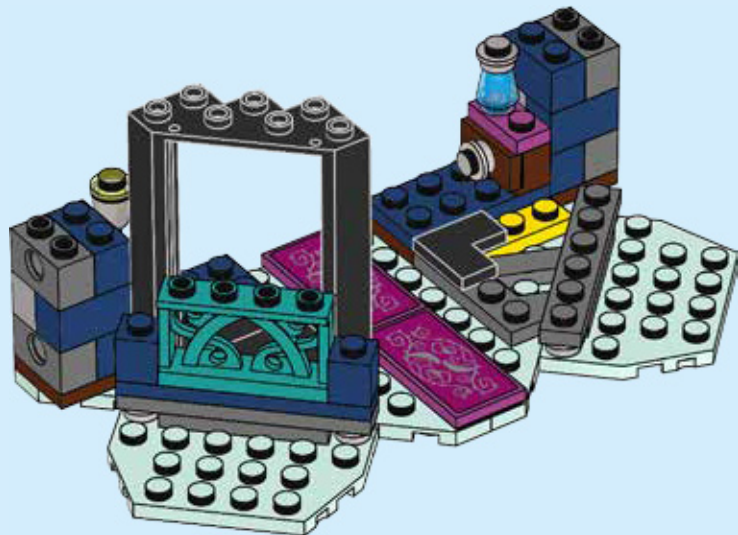

16

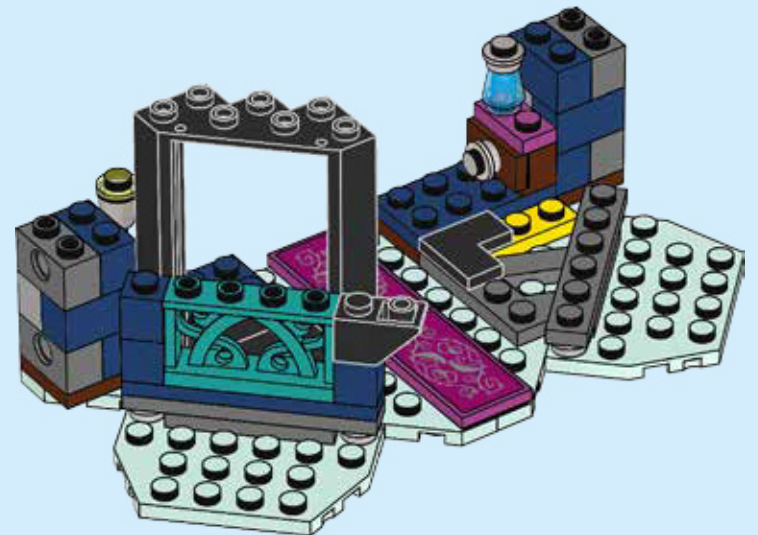

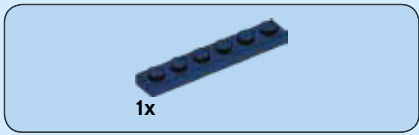

17

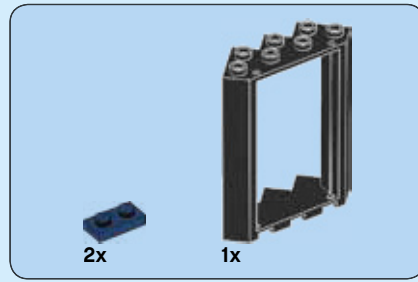
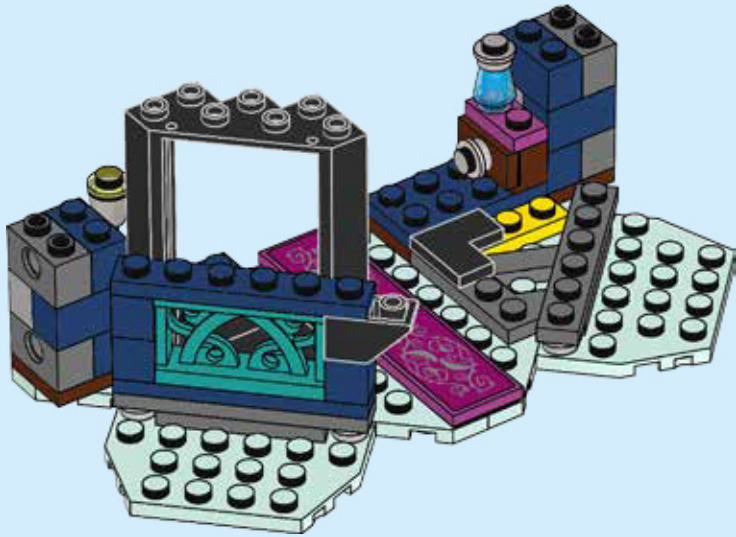

18

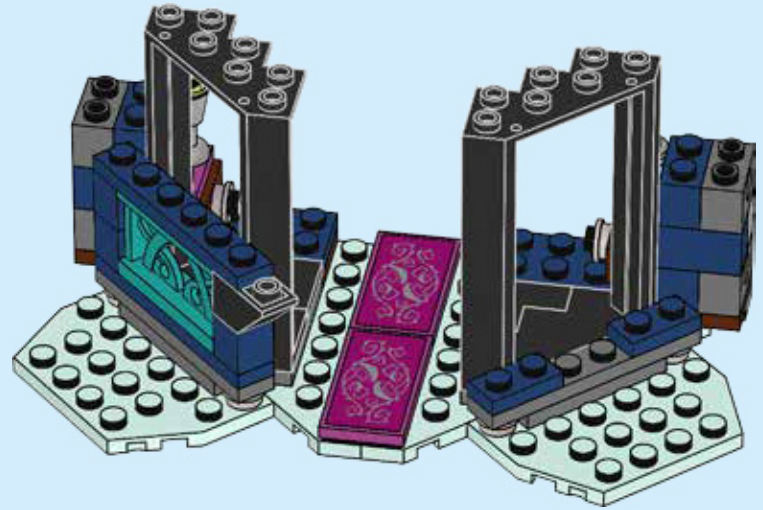





19

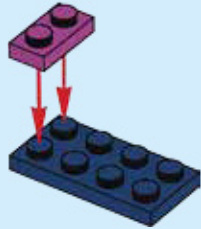

20

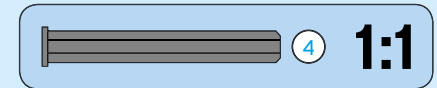
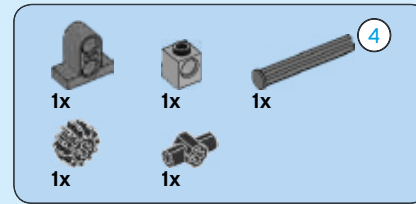

21

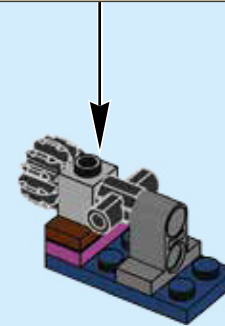
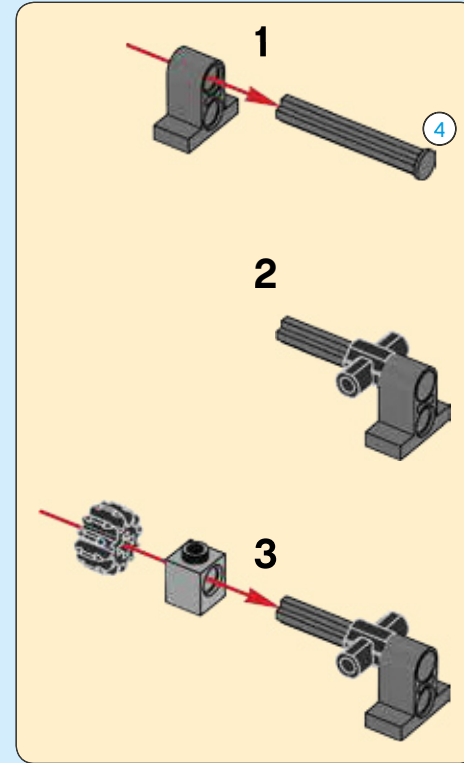



# 22

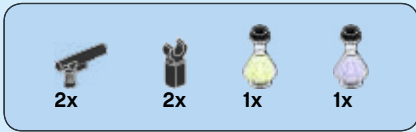
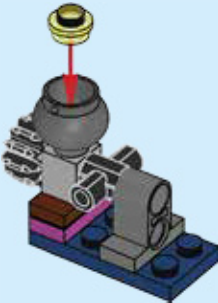

# 23

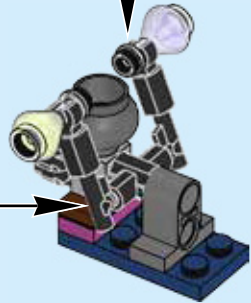
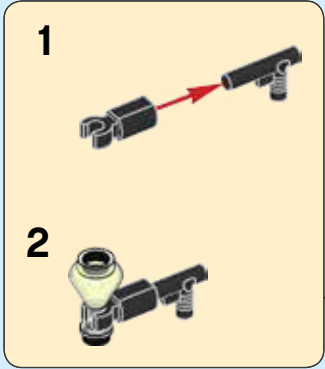
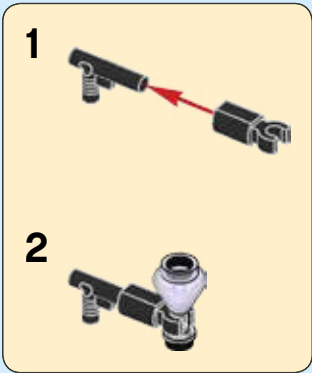

# 24

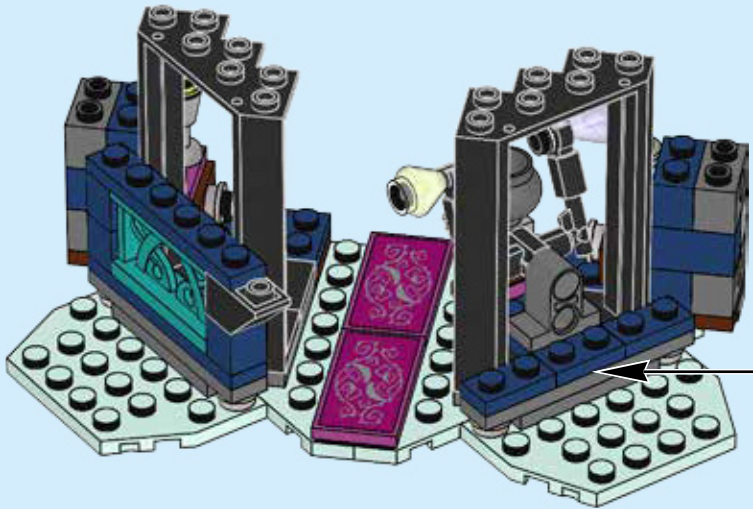

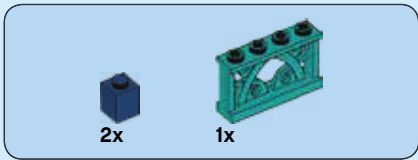

25

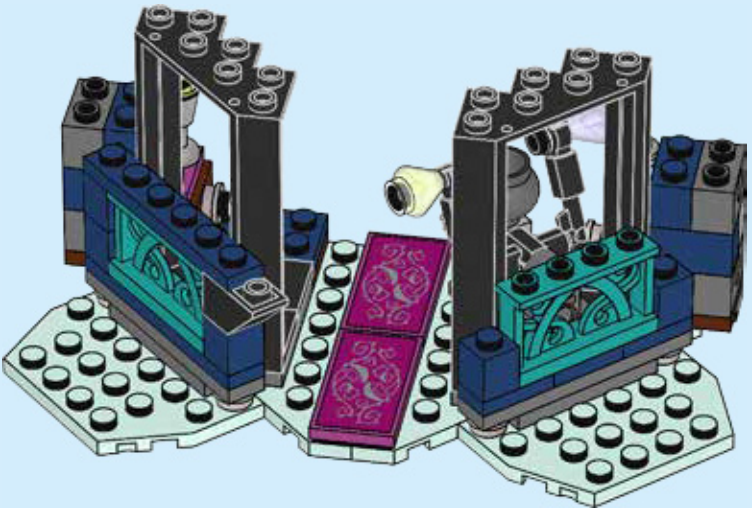

26

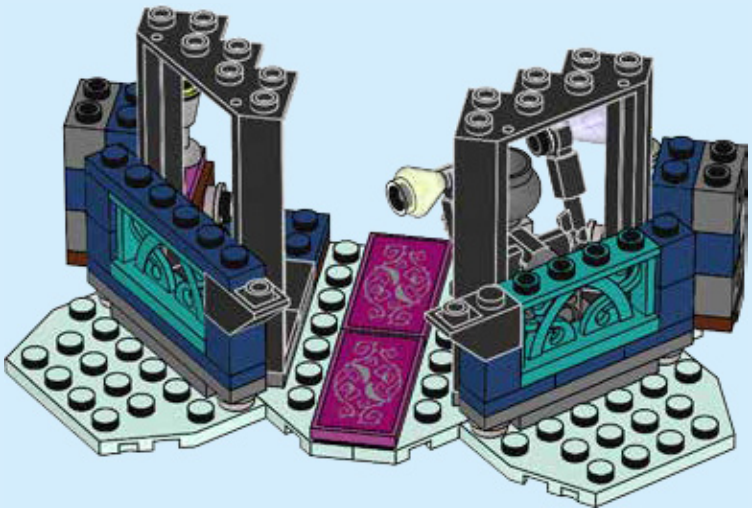

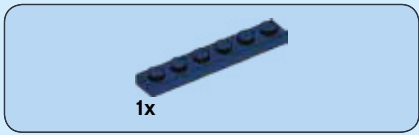

27

1x

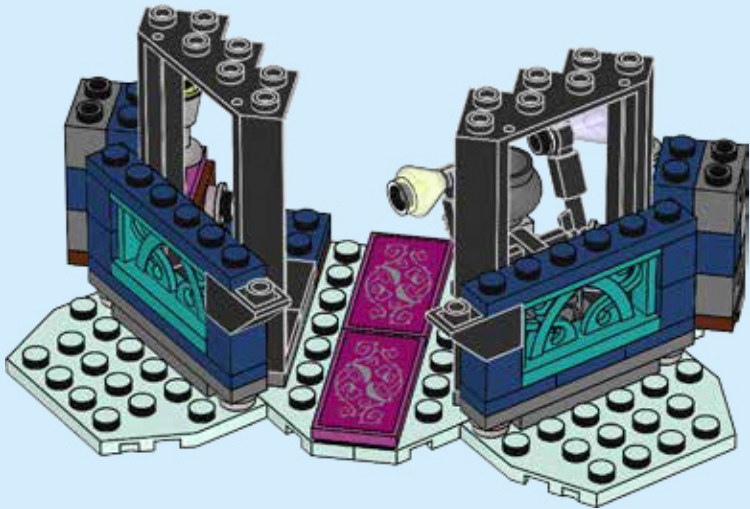

28

2x

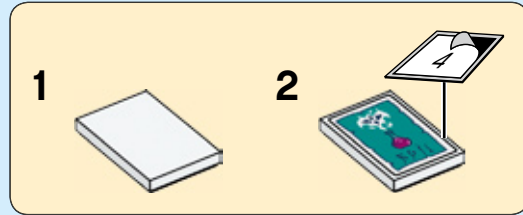
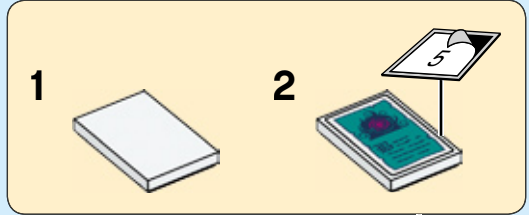
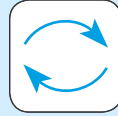



29

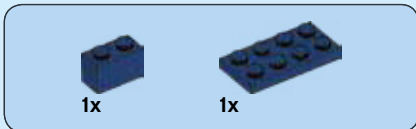

30

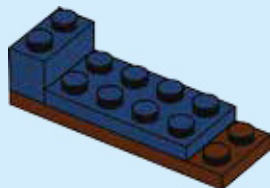

31

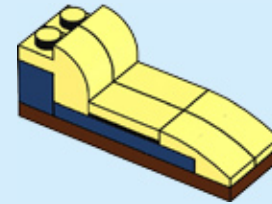

32

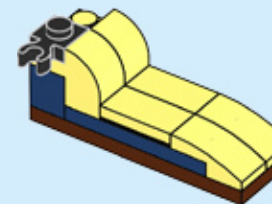

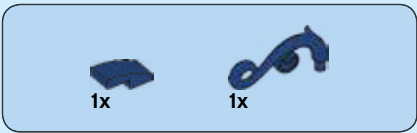

33

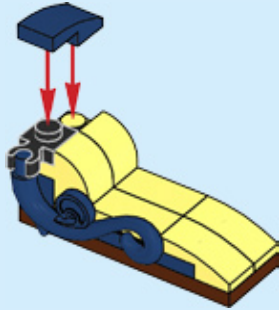

34

