

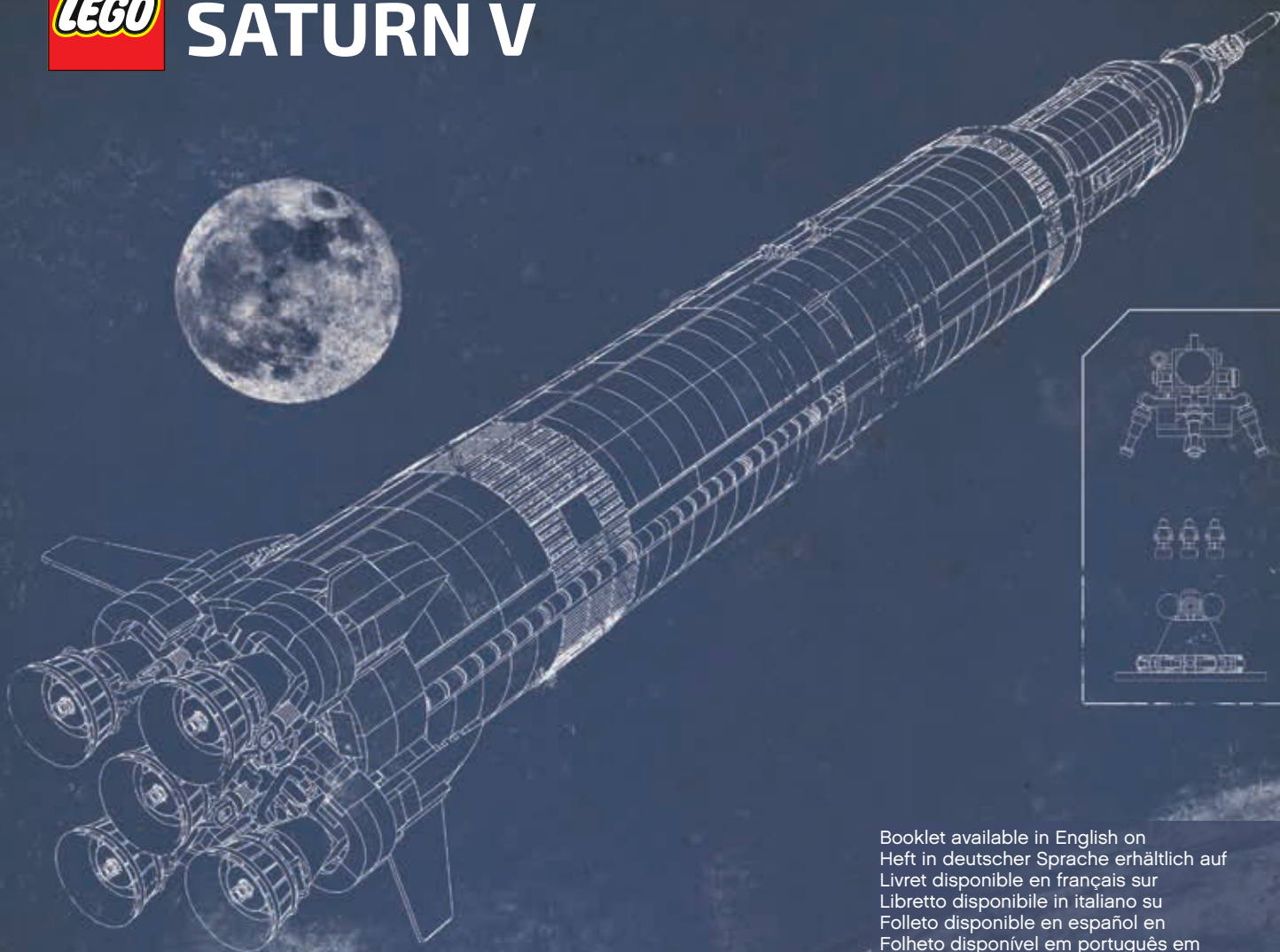

NASA APOLLO  
**SATURN V**



Booklet available in English on  
Heft in deutscher Sprache erhältlich auf  
Livret disponible en français sur  
Libretto disponibile in italiano su  
Folleto disponible en español en  
Folheto disponível em português em  
A füzet magyarul ezen a honlapon olvasható  
如需中文版手册, 请访问 [LEGO.com/ideas](http://LEGO.com/ideas)

# SATURN V BUILDING INSTRUCTIONS

- 21309 -



# The Apollo Program

On May 25, 1961, President John F. Kennedy challenged his country to safely send and return an American to the Moon before the end of the decade. NASA met that challenge with the Apollo program. It would be the first time human beings left Earth orbit and visited another world. The Apollo program played a crucial role in space exploration and made it possible to explore more distant worlds further in the future.

The Apollo program consisted of 11 spaceflights. The first two missions, Apollo 7 and 9, were Earth-orbiting missions used to test the Command and Lunar Modules. The next two, Apollo 8 and 10, tested various components while orbiting the Moon, also taking photographs of the lunar surface. While Apollo 13 did not land on the moon due to a malfunction, a total of six other missions did and returned with a wealth of scientific data and almost 881.8 lbs (400 kilos) of lunar samples.

The first manned mission to the moon was Apollo 8. It circled around the moon on Christmas Eve in 1968. Just over six months later on July 20, 1969, the world witnessed one of the most astounding technological achievements of the 20th century when a NASA astronaut on Apollo 11 became the first human to set foot on the Moon.

The Apollo 11 mission lasted 195 hours, 18 minutes and 35 seconds - about 36 minutes longer than planned. After lunar orbit insertion, the Command Module (CM) and Lunar Module (LM) separated. While one crewmember remained in the CM, which orbited the Moon, the other two astronauts made the historic journey to the lunar surface in the LM. After exploring the surface and setting up experiments for 21 hours and 36 minutes, the astronauts returned safely to the CM and began the journey back to Earth.



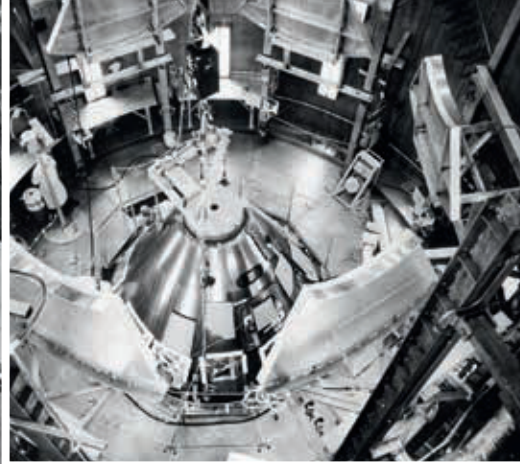

The Saturn V moves at one mile per hour  
down the crawlerway toward pad 39A >>

Workers prepare the S-IC first stage  
in the transfer aisle of the Vehicle  
Assembly Building >

Photographers film the Apollo 11 rollout >

Pre-flight training <

Kennedy Space Center technicians >>  
inspect the LRV.

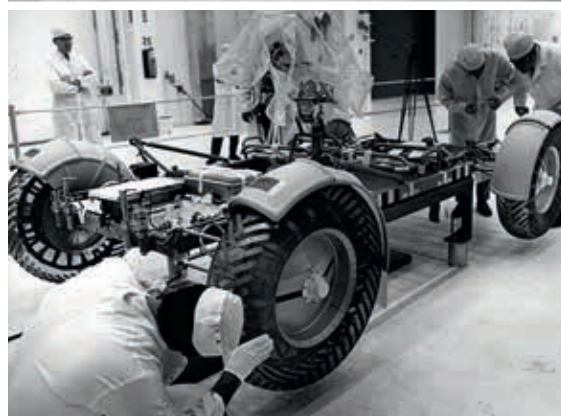
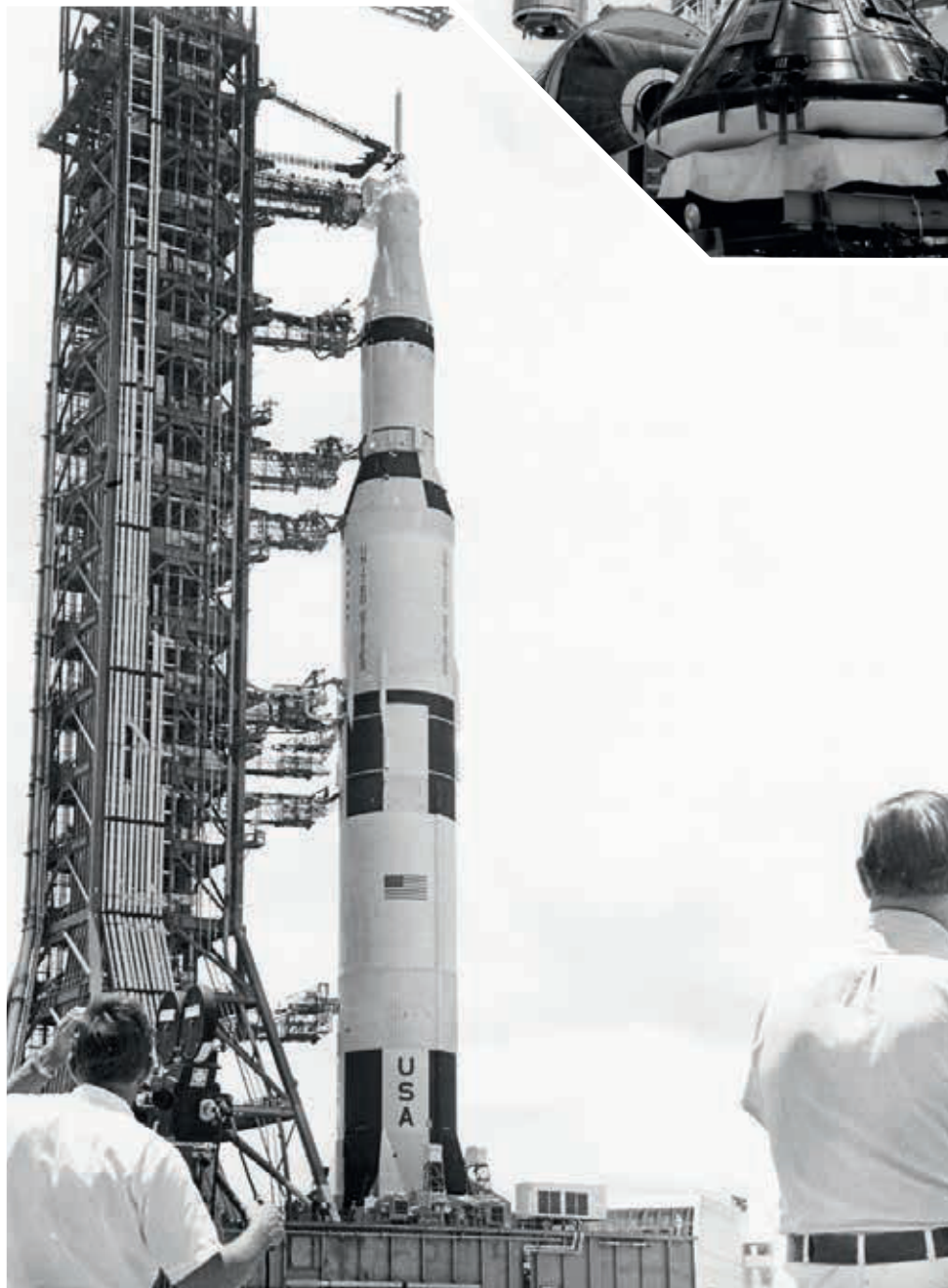

# Saturn V

Saturn V was the most powerful rocket that had ever flown successfully and was used in the Apollo program in the 1960s and 1970s. The rocket was 363 ft. (111 m) tall and weighed 6.2 million lbs (2.8 million kilos) when fully fueled for liftoff. The Saturn V used for the later Apollo missions had three stages. Each stage would burn its engines until it was out of fuel and would then separate from the rocket. The engines on the next stage would fire, and the rocket would continue into space. The first stage had the most powerful engines, since it had the challenging task of lifting the fully fueled rocket off the ground. The first stage lifted the rocket to an altitude of about 42 miles (68 km). The second stage carried it from there almost into orbit. The third stage placed the Apollo spacecraft into Earth orbit and pushed it toward the moon.



The S-II second stage is moved into position for mating with the S-IC first stage



Mating of the Apollo 11 spacecraft to the Saturn V launch vehicle

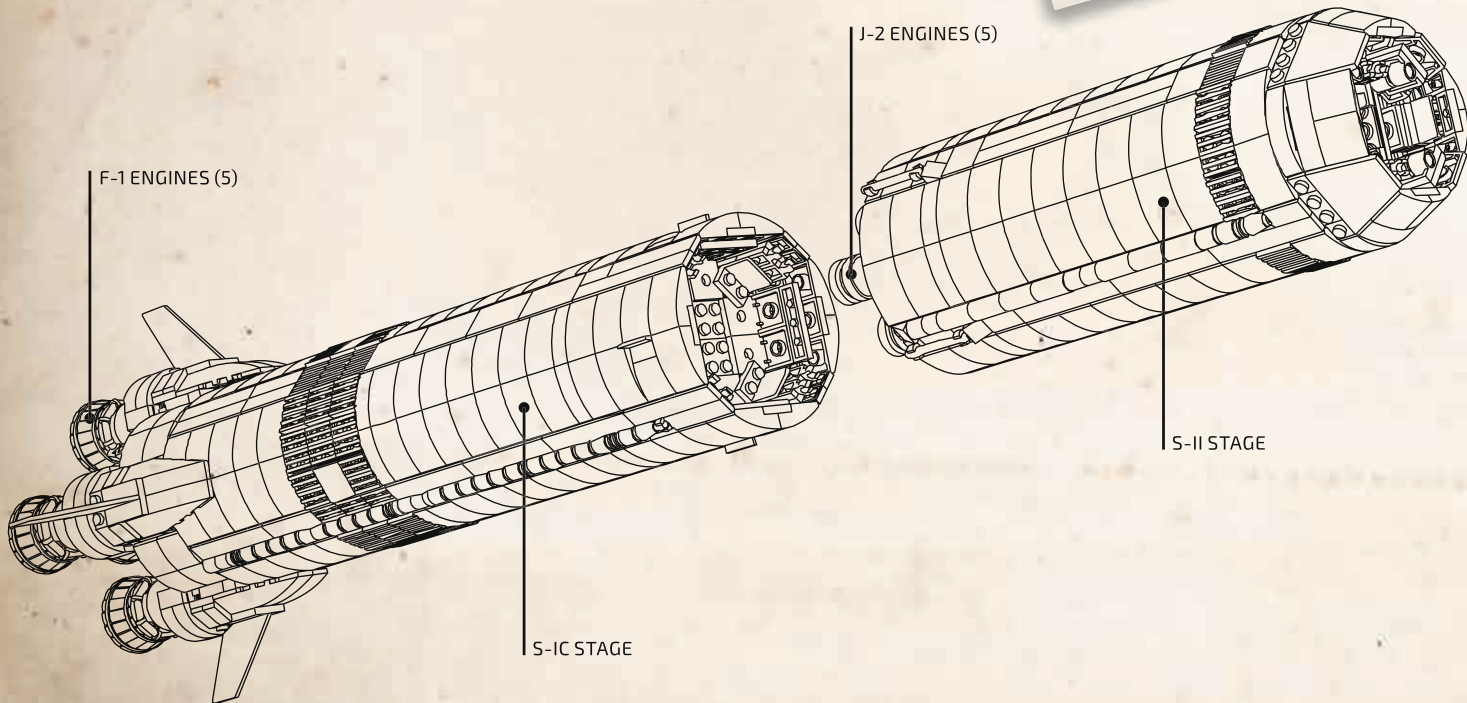

The Apollo 11 CSM being moved from work stand for mating

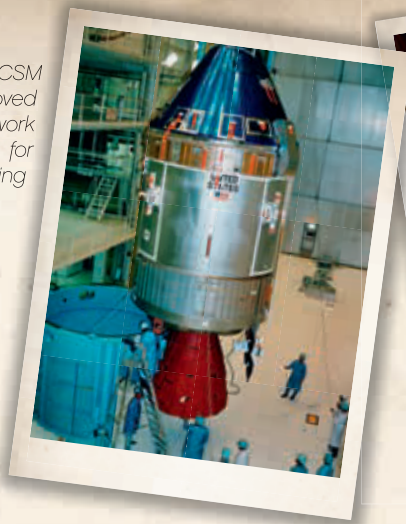

Lunar Module 5 ascent stage in Final Assembly area on overhead hoist

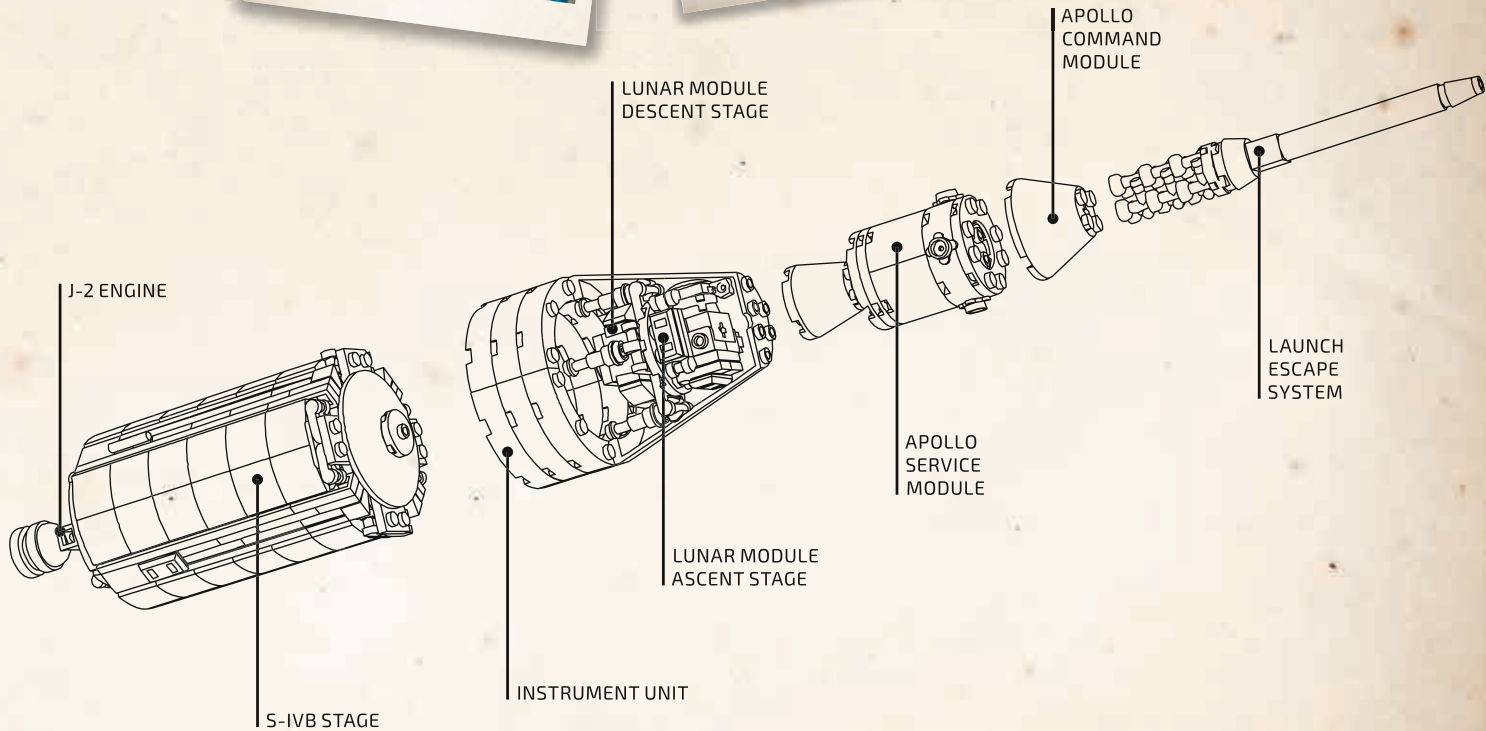

## Transposition, docking, and extraction

Shortly after the trans-lunar injection maneuver that placed the Apollo spacecraft on its trajectory towards the Moon, the transposition and docking maneuver would be performed. This involved an astronaut separating the Apollo Command/Service Module (CSM) spacecraft from the adapter which fastened it to its launch vehicle upper stage, turning it around, and docking its nose to the Apollo Lunar Module (LM), then pulling the combined spacecraft away from the upper stage.



The Command/Service Module (CSM) separates from the adapter.



The CSM then turns around in preparation for docking with the Lunar Module (LM)



After docking, the CSM pulls the LM away from the launch vehicle's upper stage

# Journey to the Moon

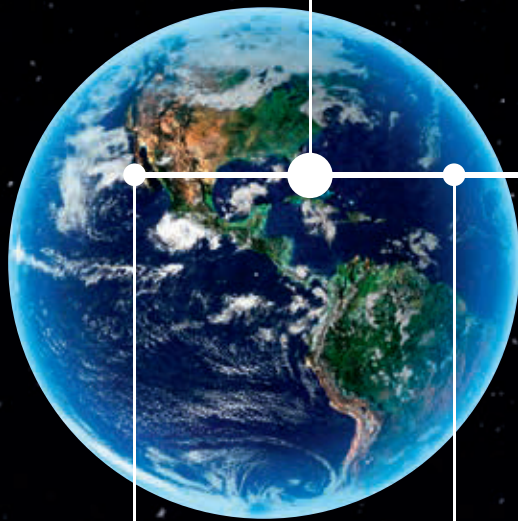
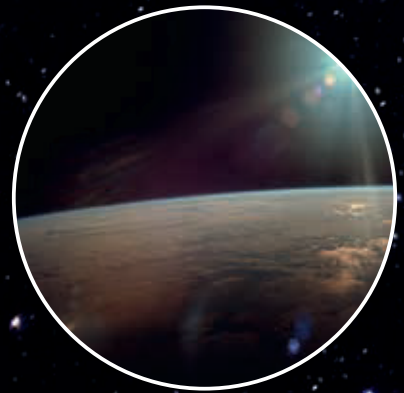

LIFTOFF

LAUNCH ESCAPE  
TOWER JETTISON.

S-IVB 2ND ENGINE  
IGNITION

CSM DOCKING WITH  
LM/S-IVB.

S-IVB ENGINE CUTOFF.

CSM SEPARATION  
FROM LM ADAPTER.

TRANSLUNAR  
INJECTION "GO"  
DECISION.

CSM 180°  
TURNAROUND.

S-II/S-IVB  
SEPARATION.  
S-IV ENGINE IGNITION.

S-IVB ENGINE CUTOFF.

APOLLO SATURN V  
ROLLS OUT OF THE  
MASSIVE VEHICLE  
ASSEMBLY BUILDING

THE FIRST STAGE  
FALLS AWAY AS THE  
S-II STAGE IGNITES



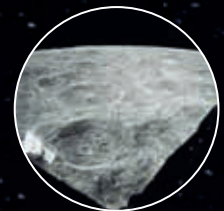
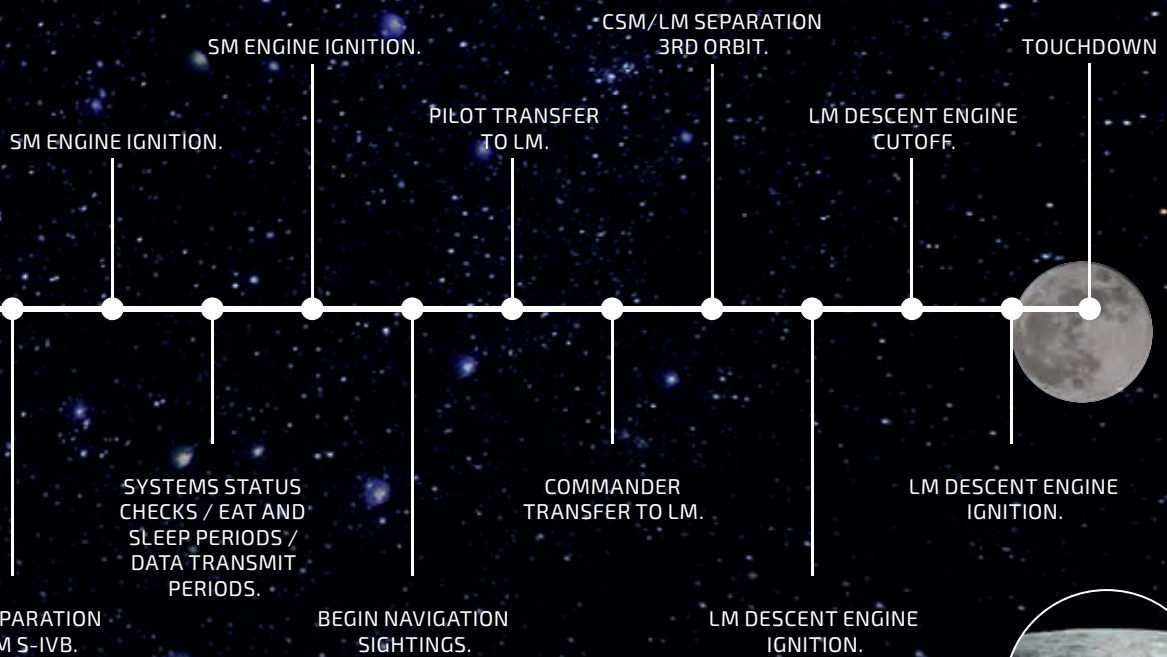

# Fan designers

With a shared passion for both space exploration and LEGO® building, Valérie Roche (aka Whatsuptoday) and Felix Stiessen (aka Saabfan) worked closely together to create their impressive Apollo 11 Mission model for LEGO Ideas.

*"The most challenging part was the Lunar Landing module. I (Felix) tried building it as small as possible (I wanted it to fit in the half-cone parts as seen in the model) while still looking good and accurate. After that, we began building the rocket around it. We also tried to make the rocket as sound as possible, so Valérie included pillars and beams inside for structural integrity."*

*"It actually took quite a long time to finish the whole model. There were often times when one*

*of us just abandoned the project for a few weeks and came back to it later; however, thanks to the fact that it is a collaborative project, it was always the case that one of us continued making progress on the project and re-motivated the other. All in all, we would say it took us about a year to complete."*

*"We were surprised (and happy, of course) when we learned our model would be the latest one in the LEGO Ideas series. What we like about the LEGO Ideas platform is the feedback and support you get from the community. It's great to reply to comments, read suggestions and improve your model in the updates. Of course, the chance of designing your own LEGO set is also really cool!"*

Felix Stiessen



Valérie Roche

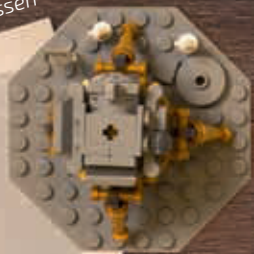





Carl Thomas Merriam (left)  
Michael Psiaki (middle)  
Austin William Carlson (right)

## LEGO® designers

Michael Psiaki, Carl Thomas Merriam and Austin William Carlson are all full-time LEGO® designers and avid space enthusiasts, so this was a project they very much wanted to be a part of. As Michael explains:

*"We were actually not asked. I was so excited when I heard that the project was potentially going to happen, and told Carl about it because I knew he was also a space fanatic. We decided it would be really cool to work together since it is such a big model, so we approached the Ideas team about helping to develop the product."*

*"We were amazed by how big the actual model was and how it was able to separate into all of the different stages and components. This was very difficult to implement in our final design, since we needed to make sure that the rocket was strong enough when connected together, but also easy to separate."*



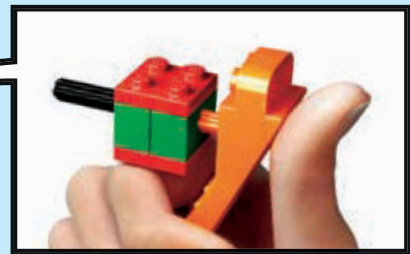
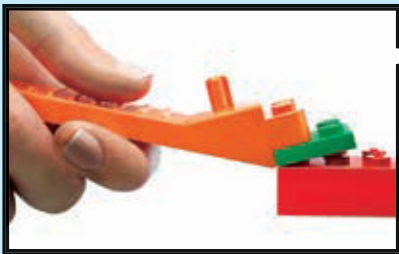

[LEGO.com/brickseparator](https://LEGO.com/brickseparator)

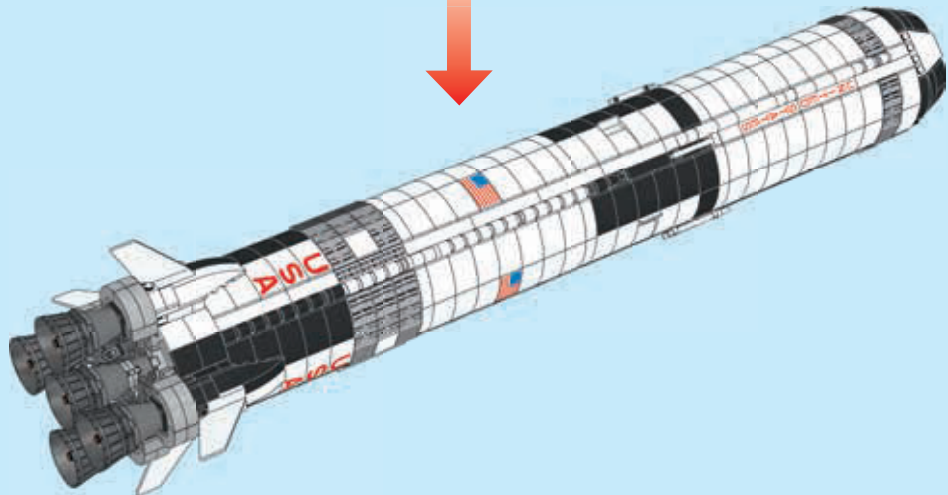
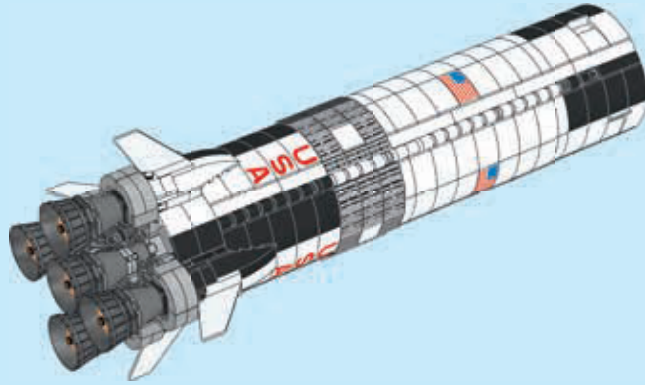

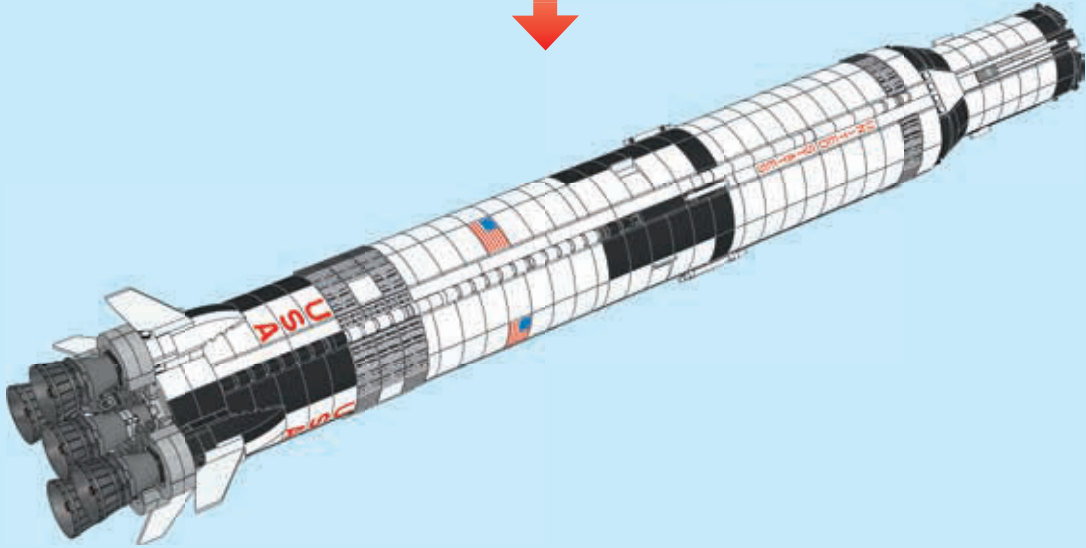

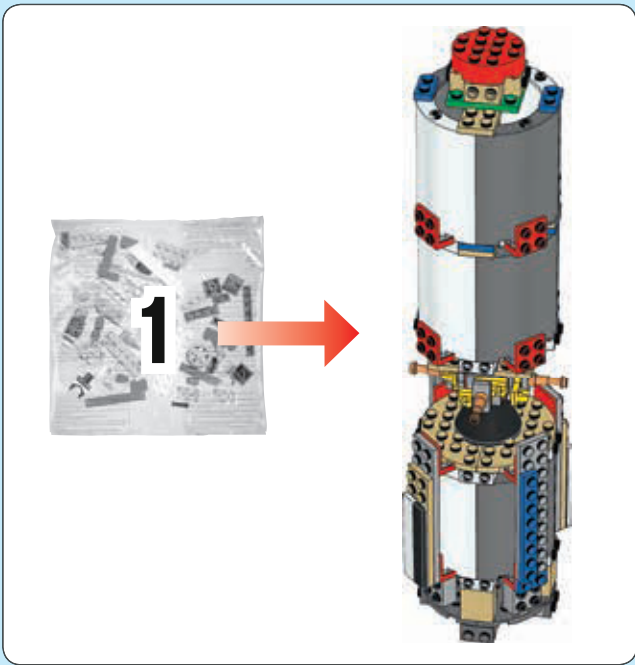

1

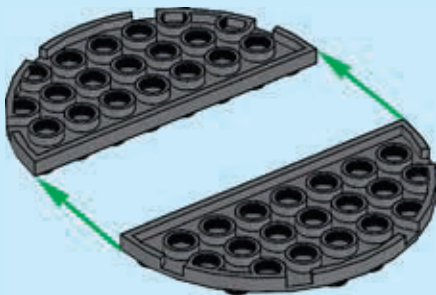

2

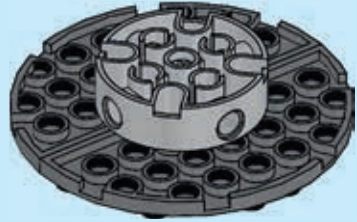

3

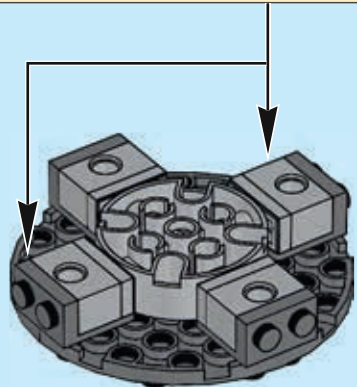
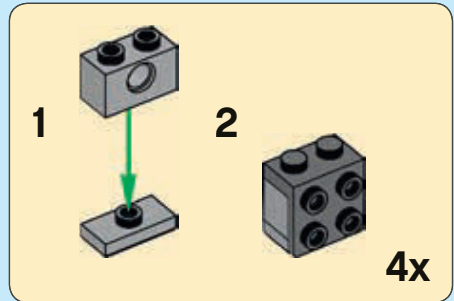



4

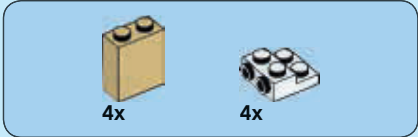
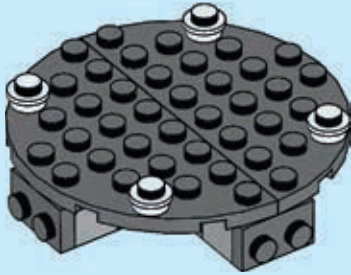
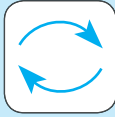

5

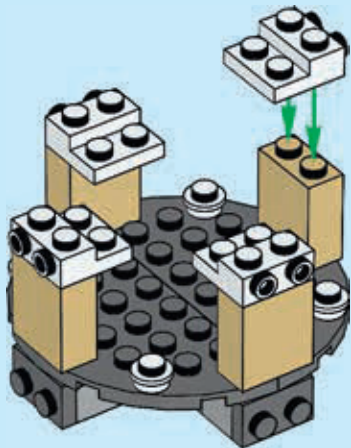

6

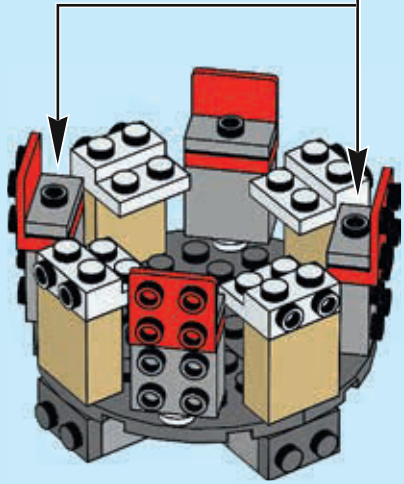
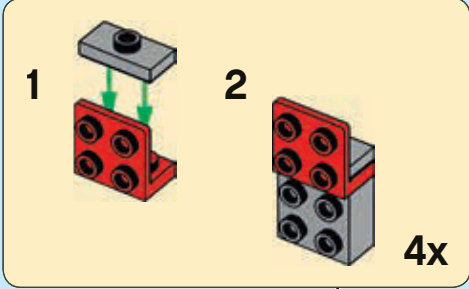

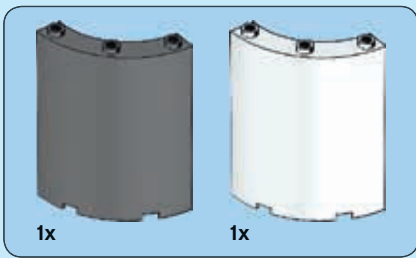

7

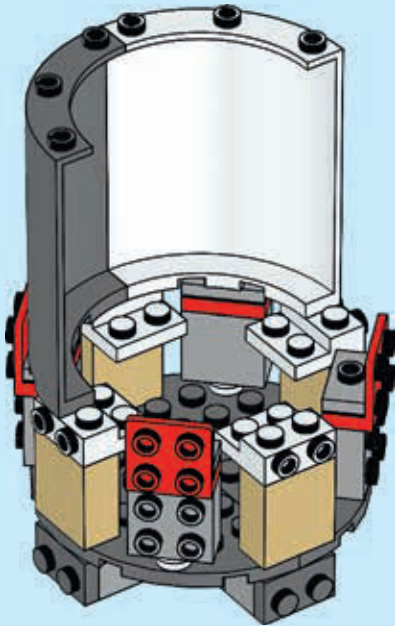

8

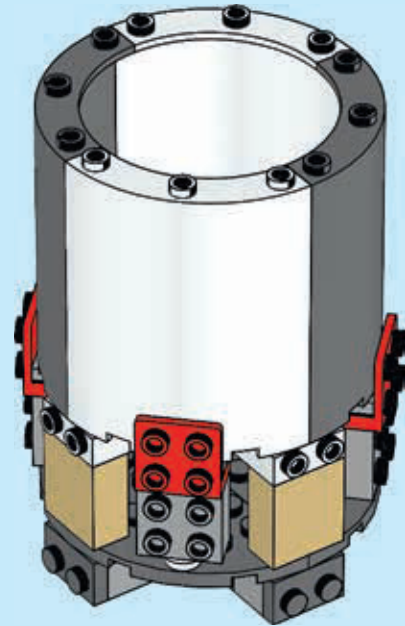



9

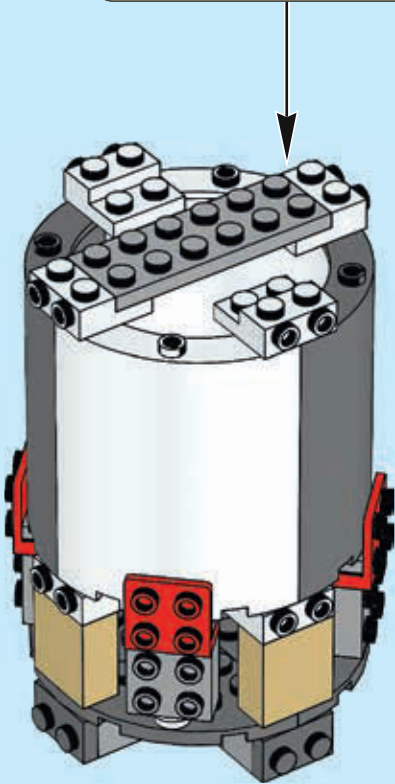
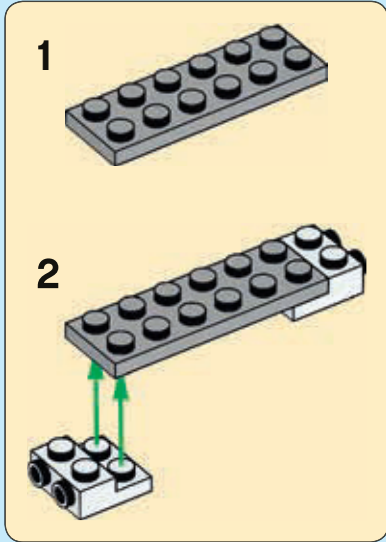

10

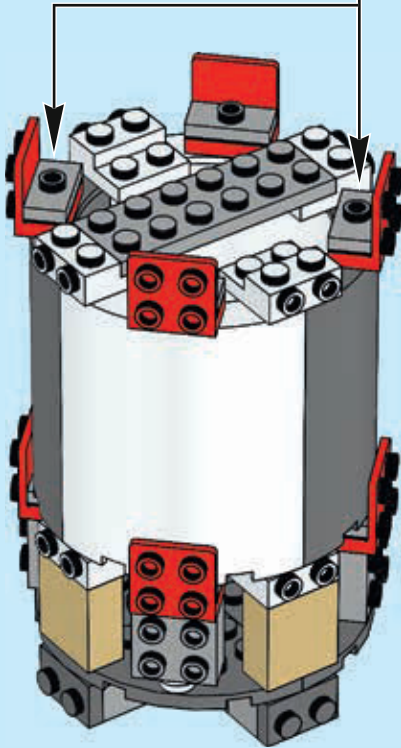
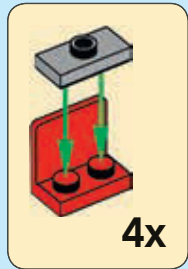



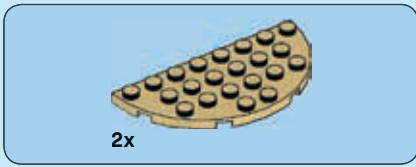

11

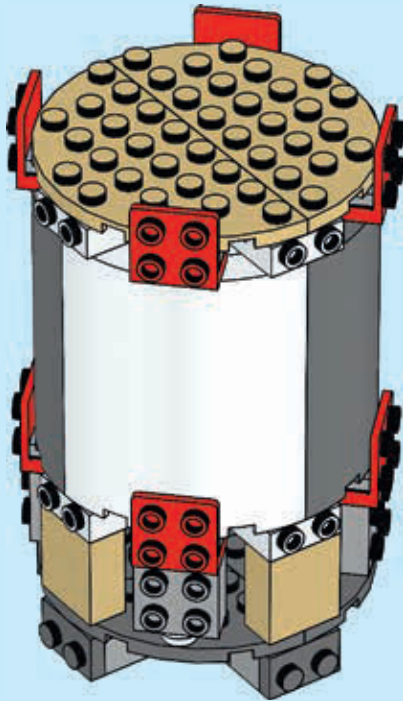

12

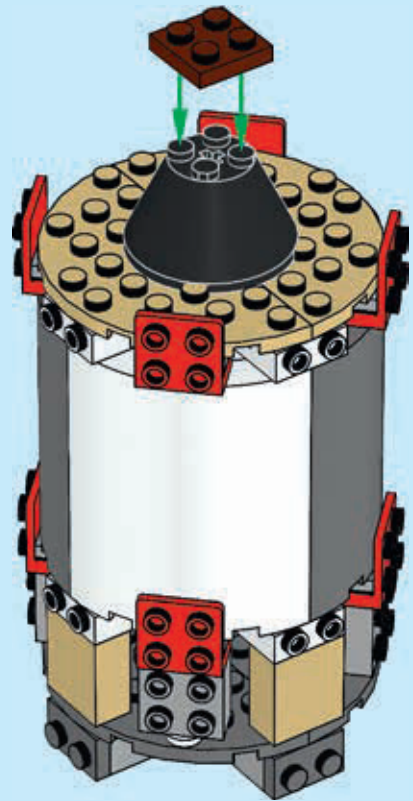



# 13

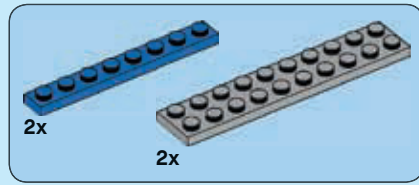
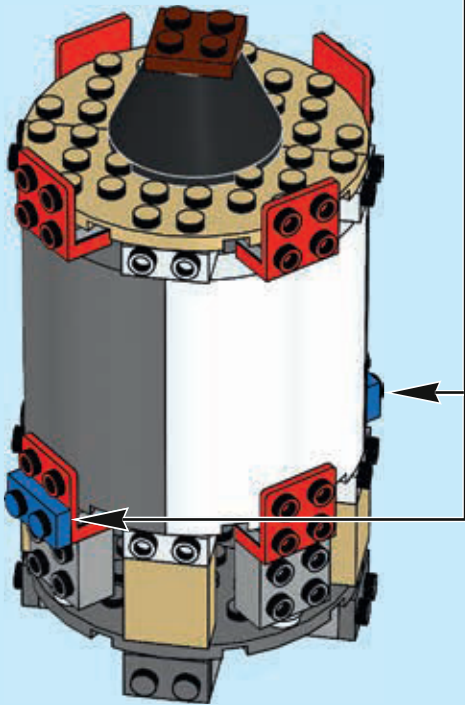
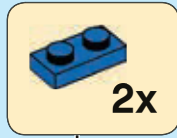

# 14

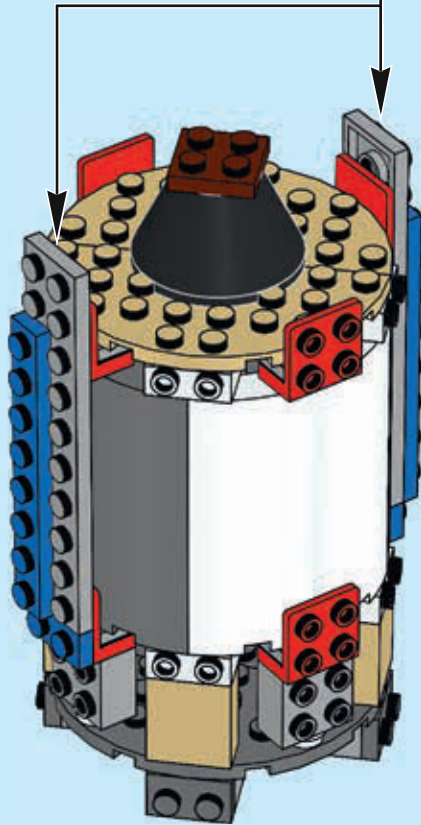
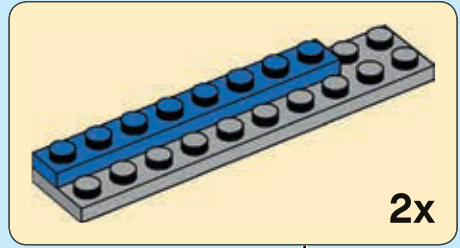

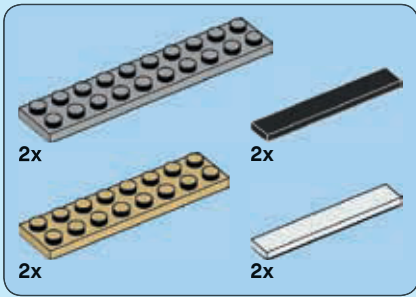

# 15

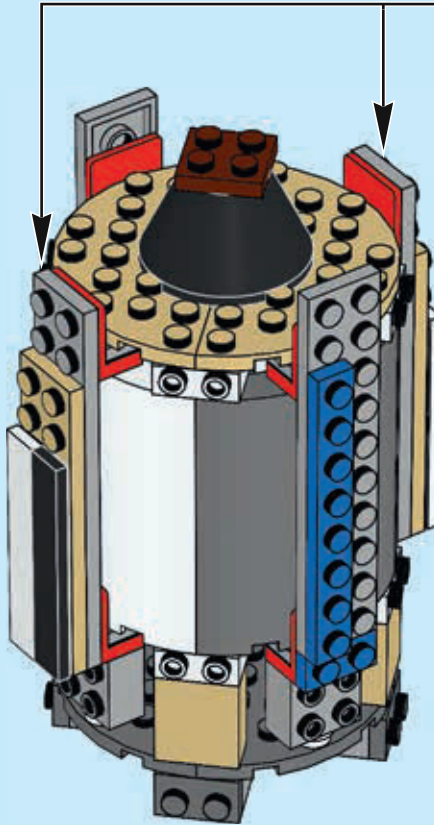
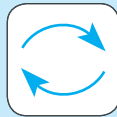
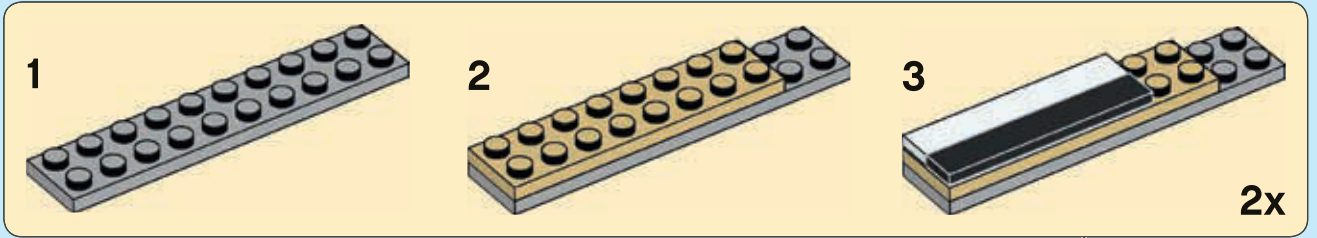



2x

16

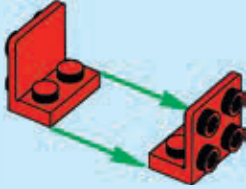

1x

17



2x

18



8x

19

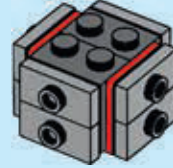

8x

20

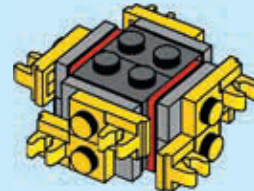

4x

21

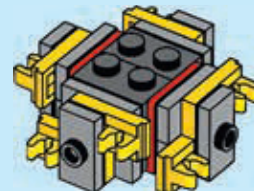

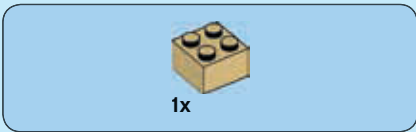

1x

22

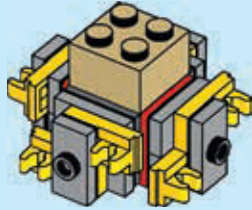

23

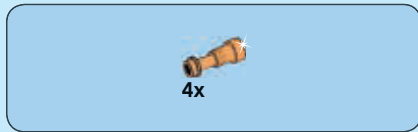
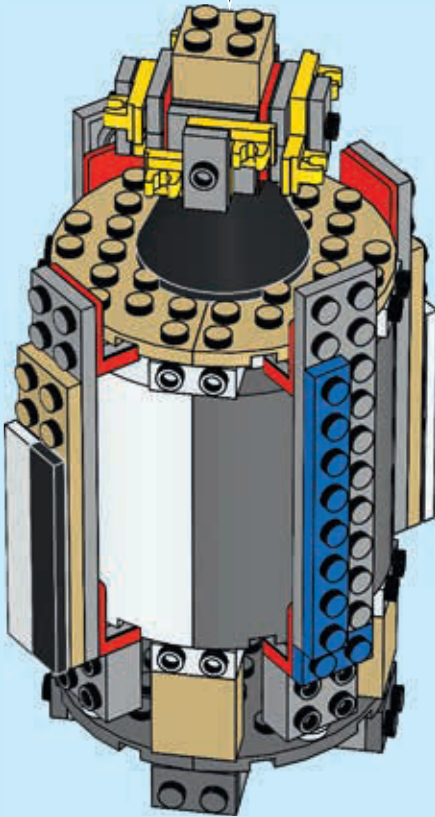

4x

24

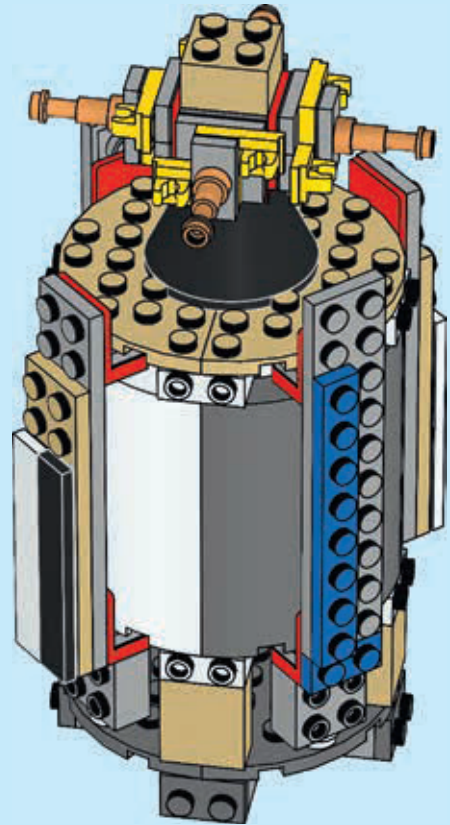

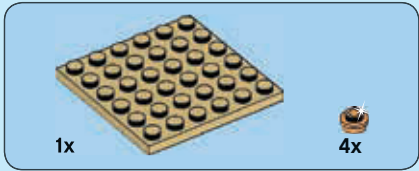

25

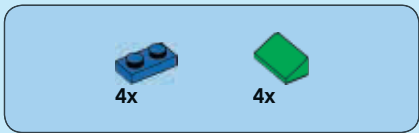
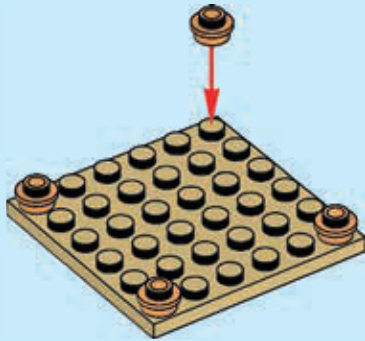

26

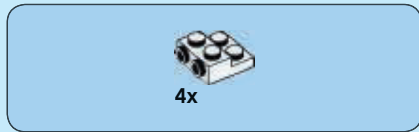
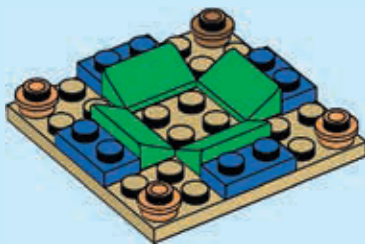

27

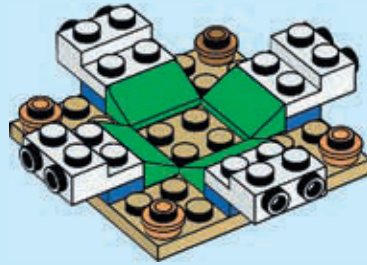

28

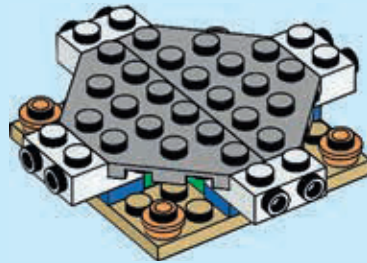

29

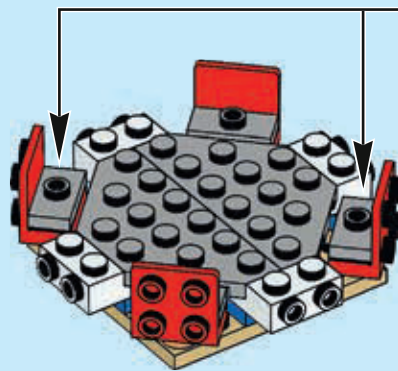
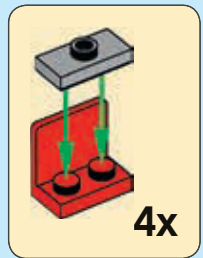



30

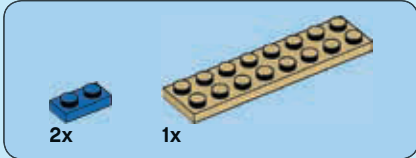
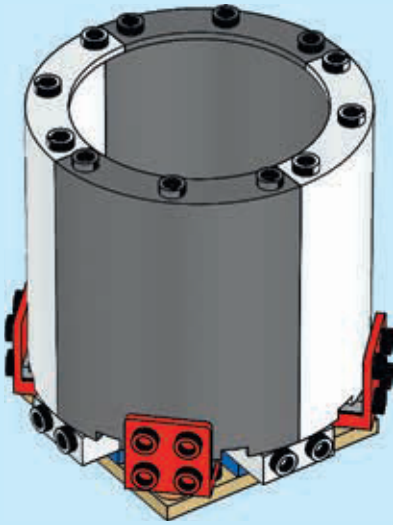

31

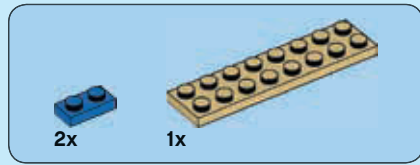
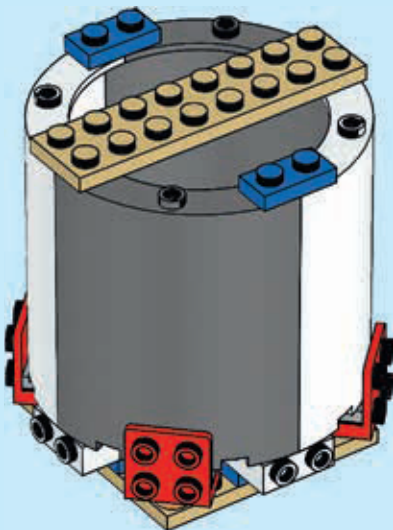

32

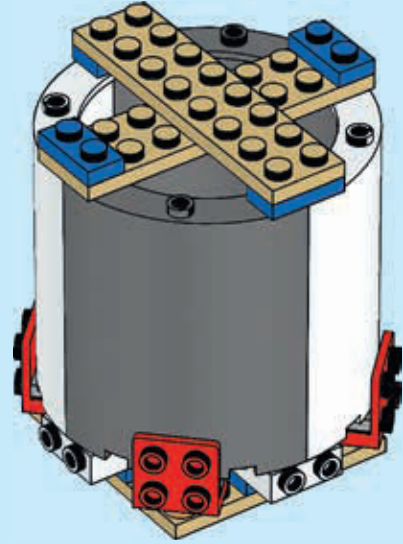

33

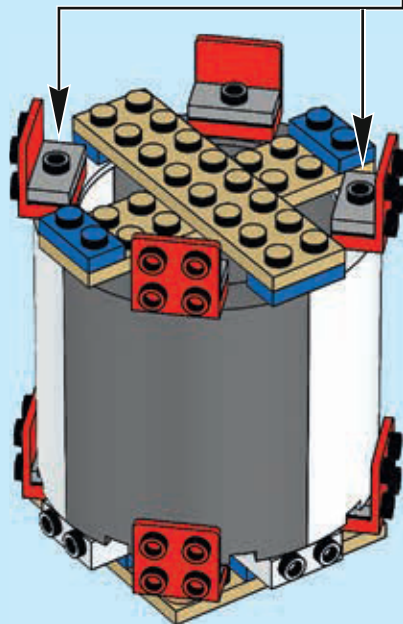
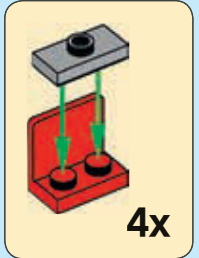



34

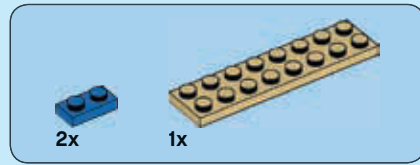
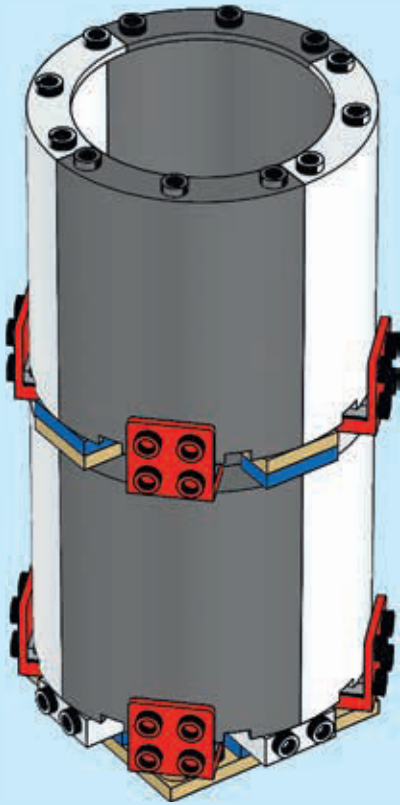

35

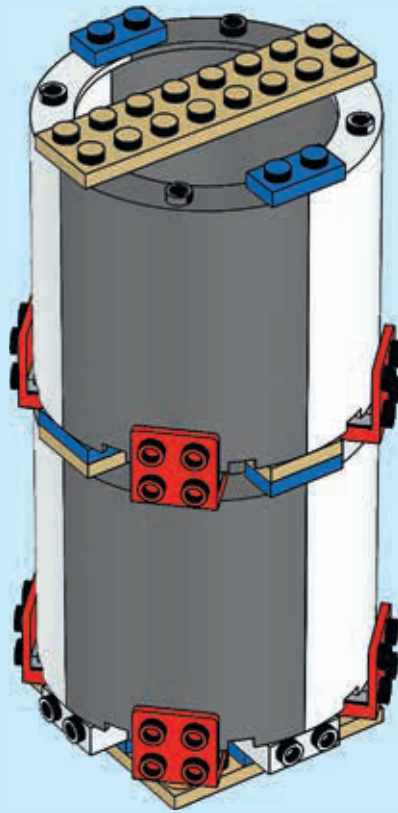



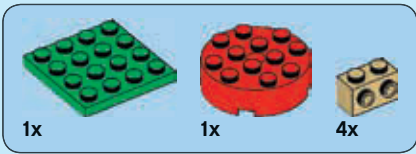

# 36

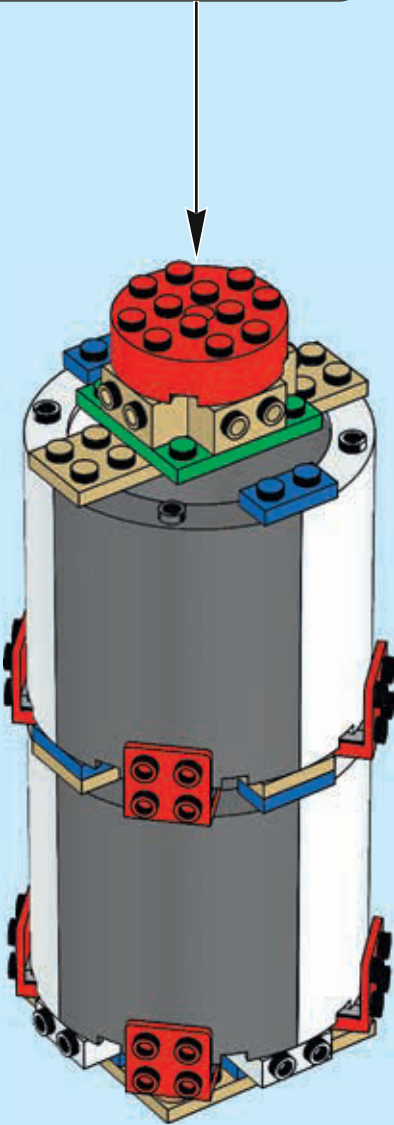
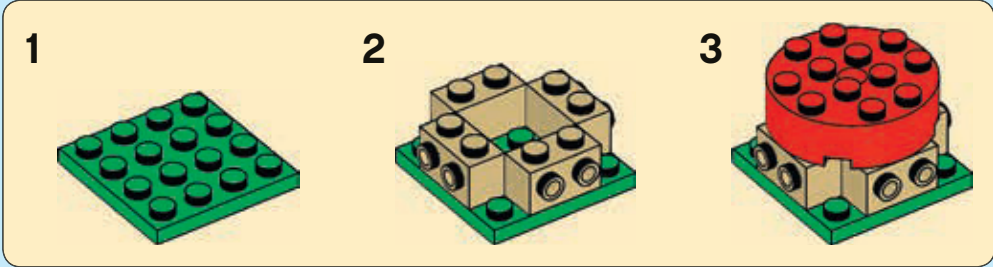

37

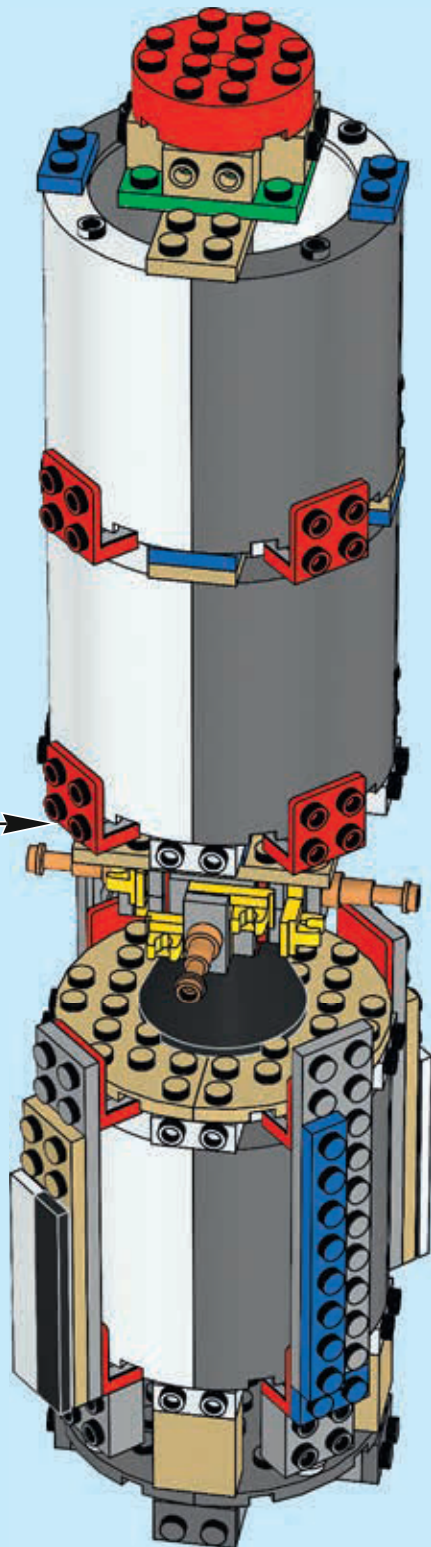

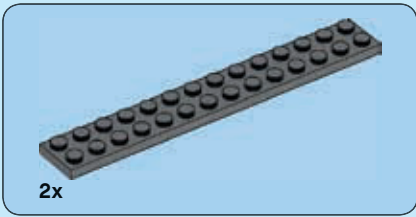
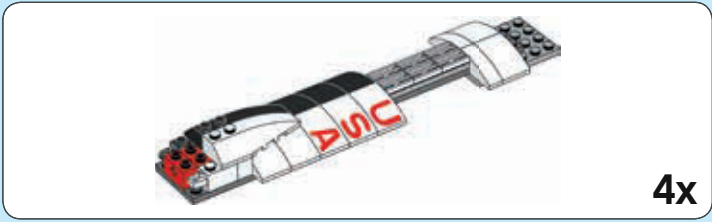
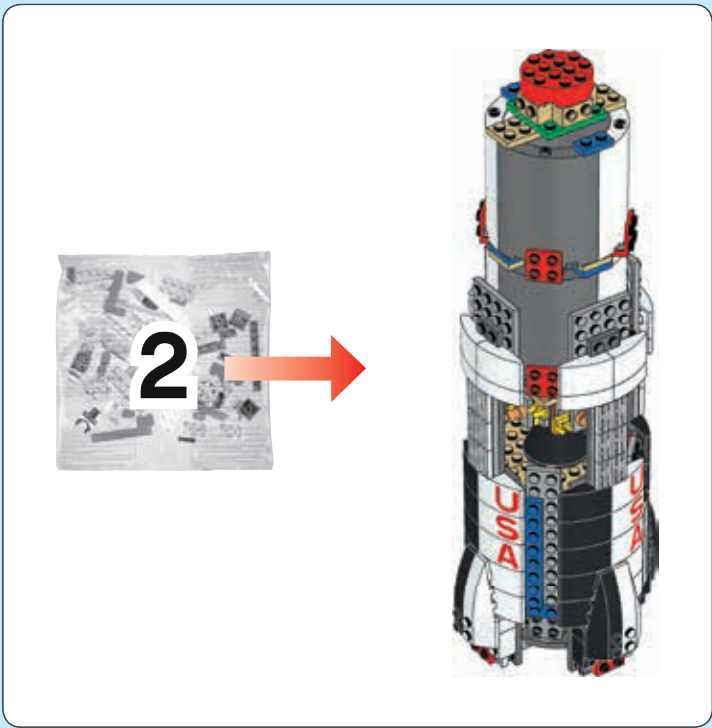

38

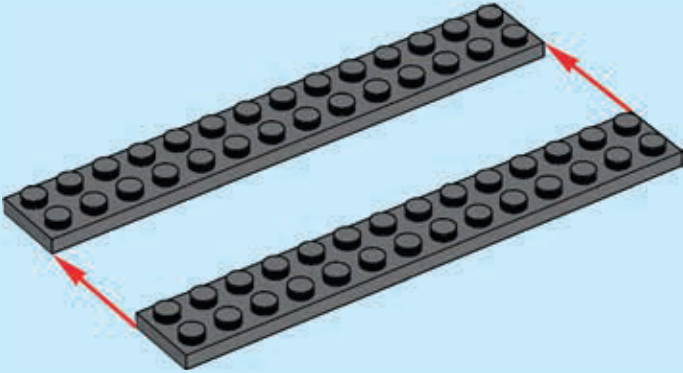

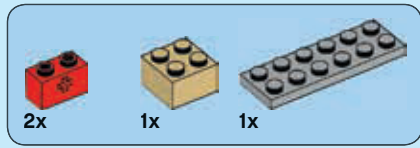

39

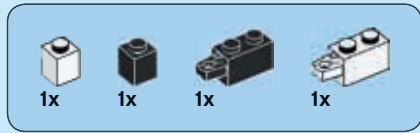
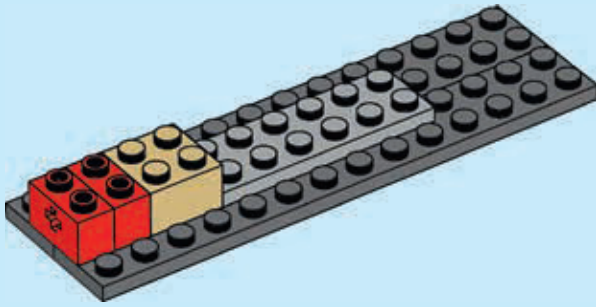

40

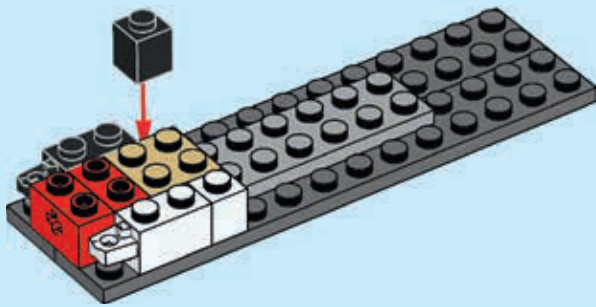

41

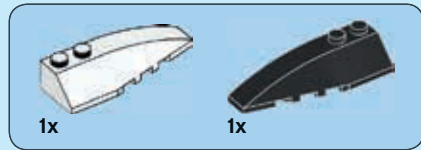
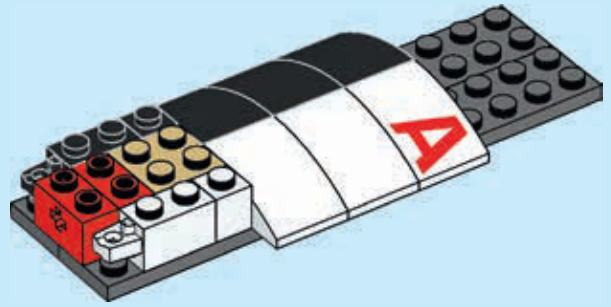

42

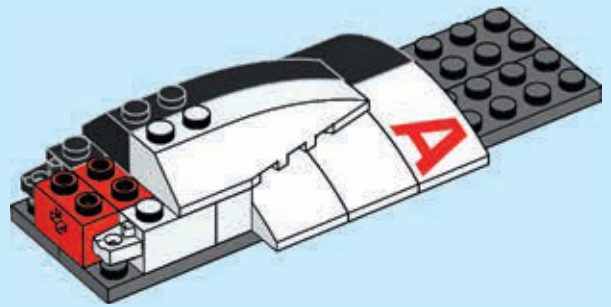

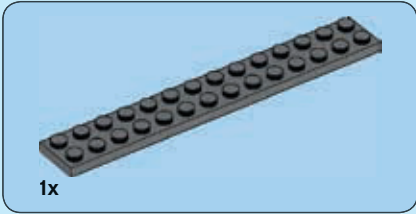

43

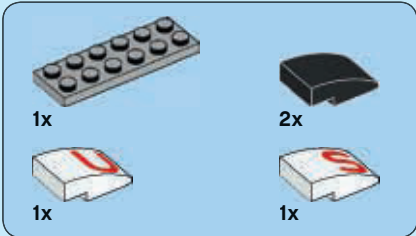
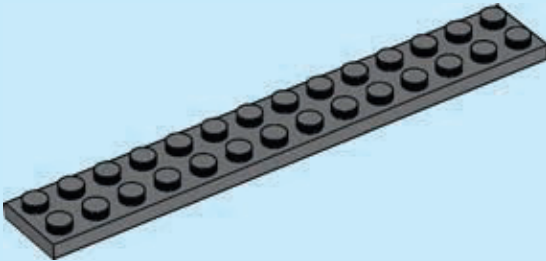

44

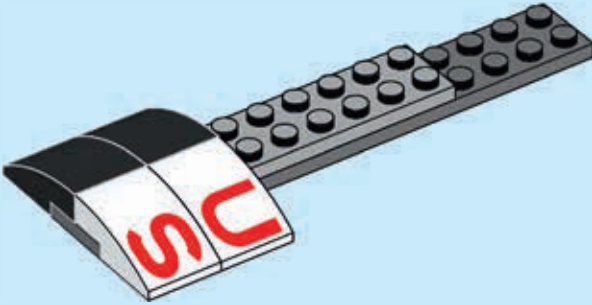



6x

45

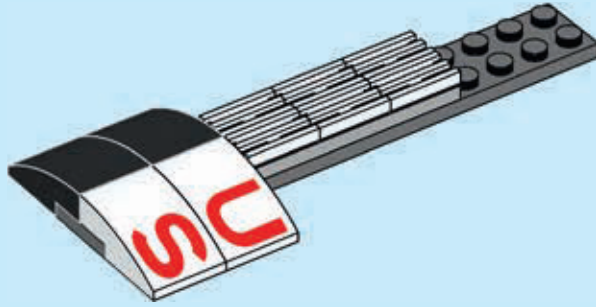

1x

46

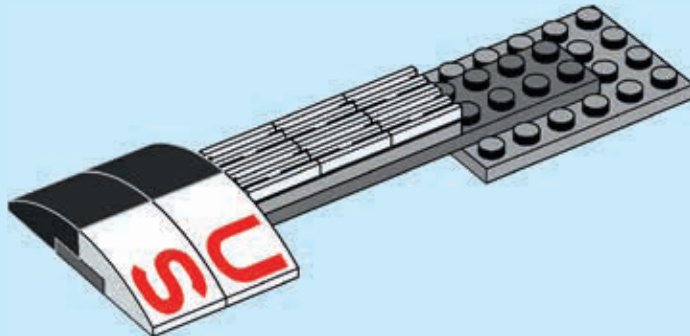

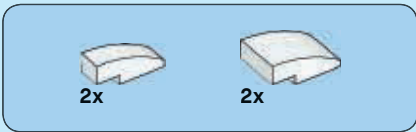

47

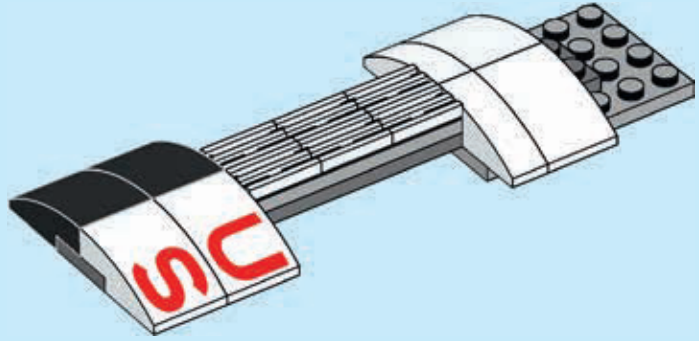

48

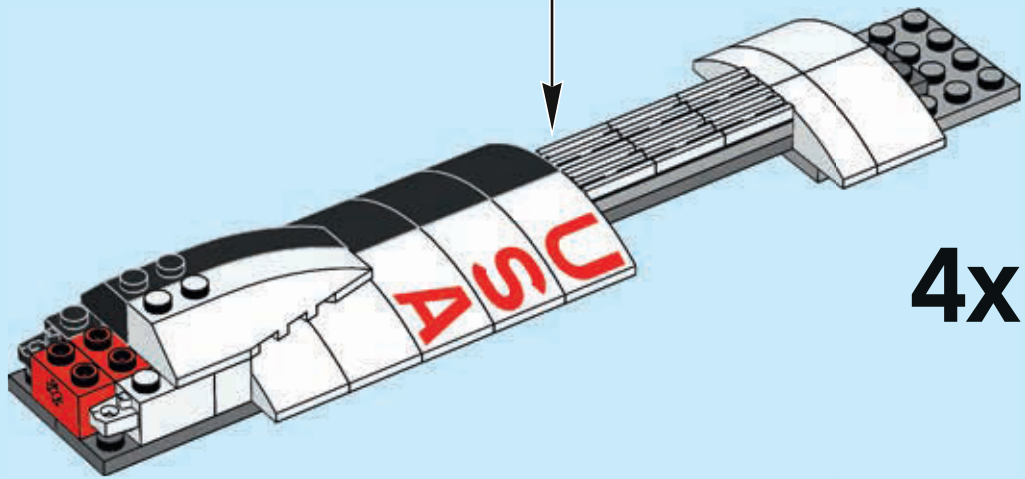

49

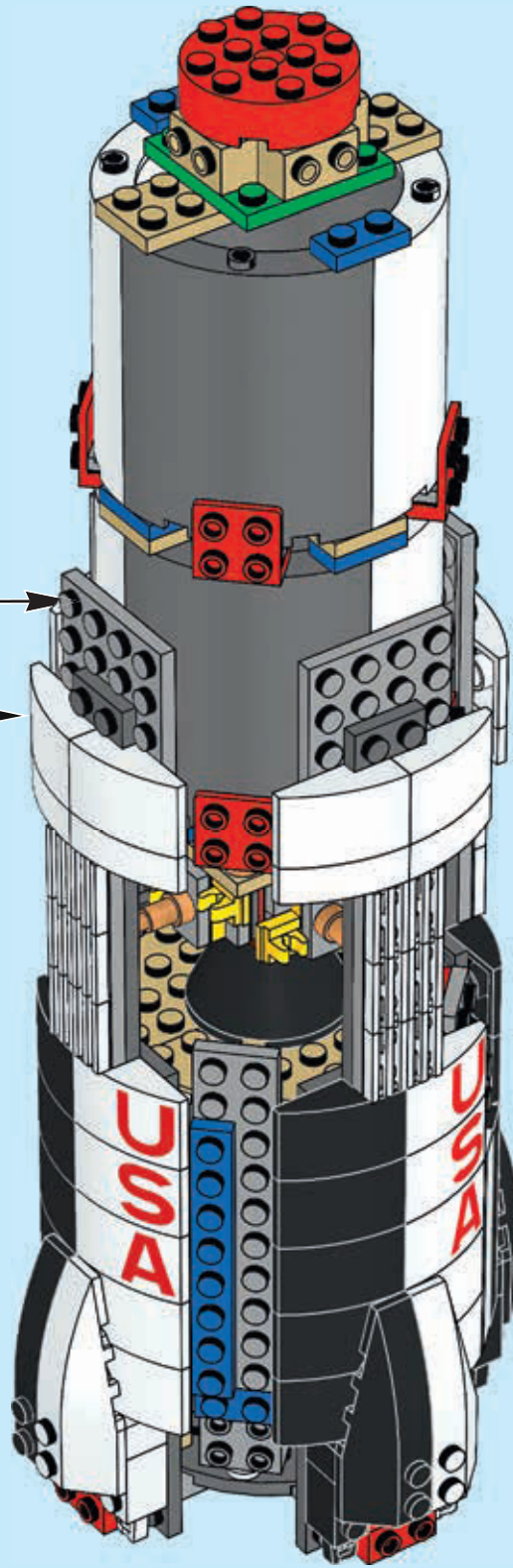



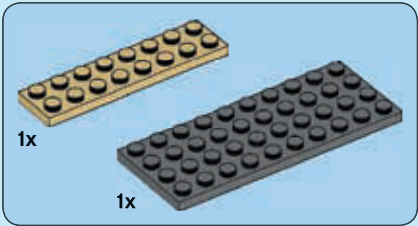
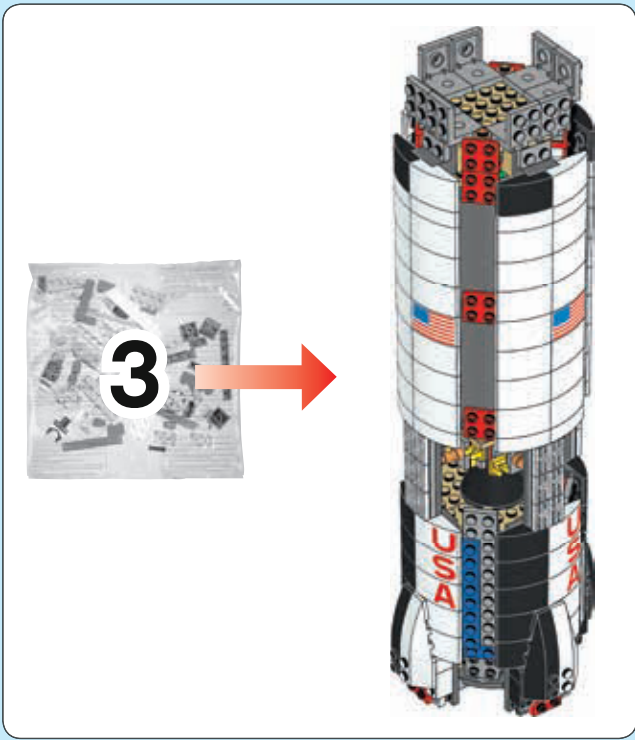

50

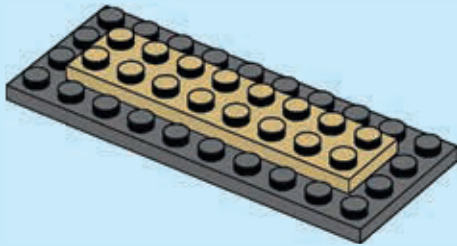

51

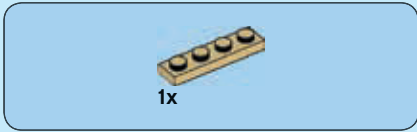
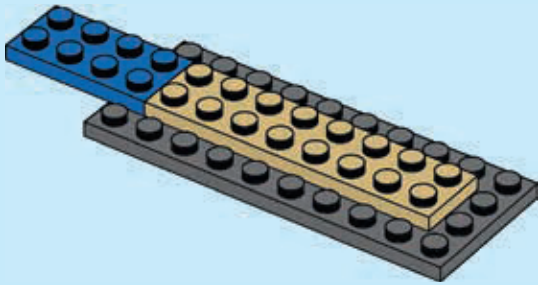

52

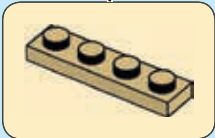
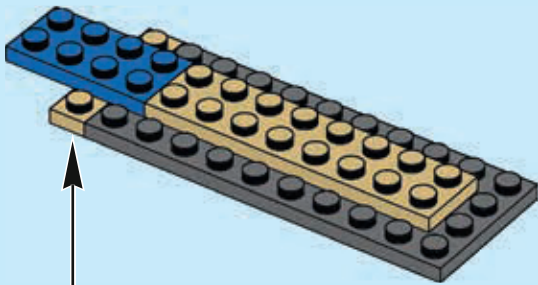



2x

53

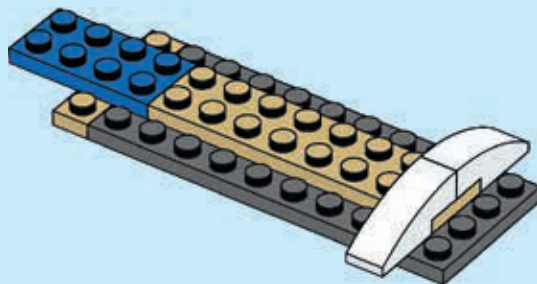

9x



1x

54

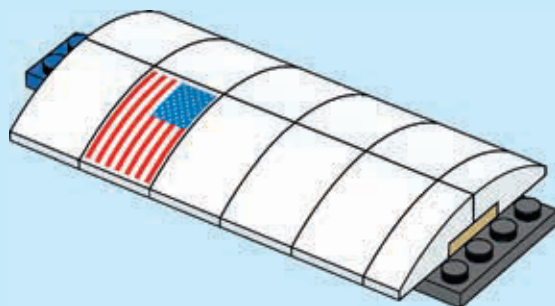

4x

55

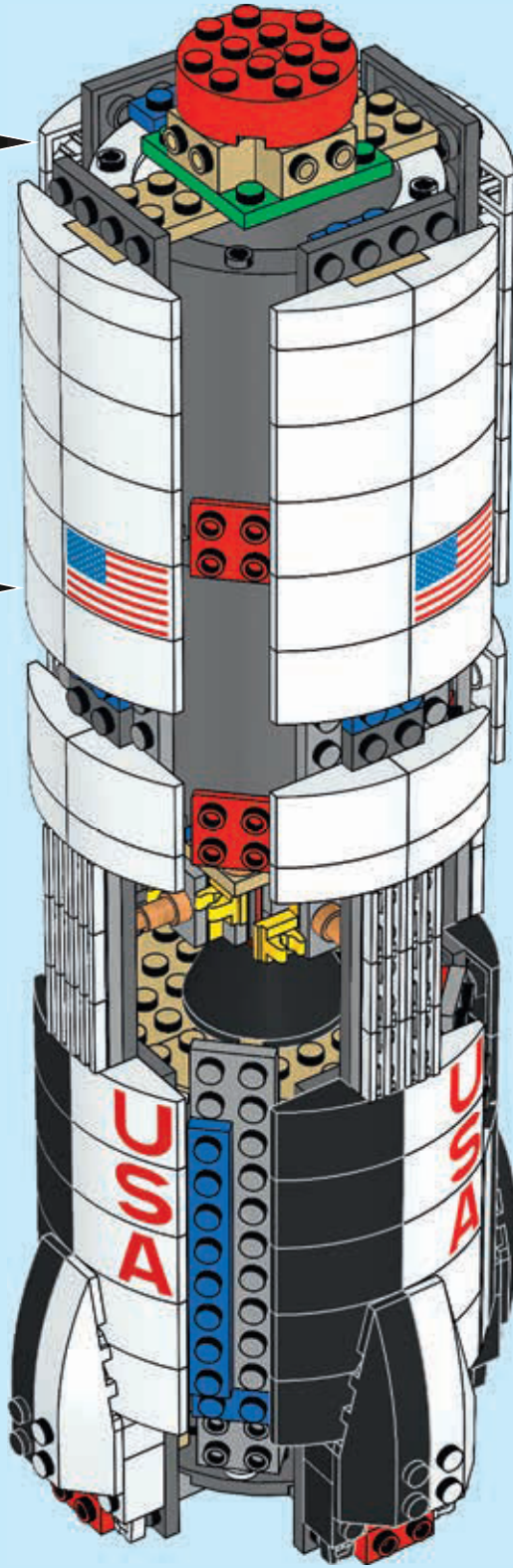

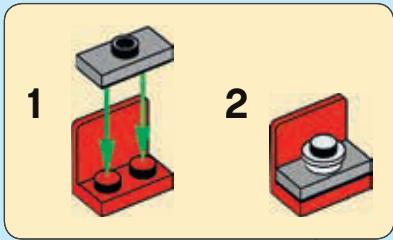

56

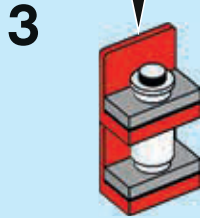
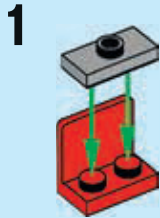

4x

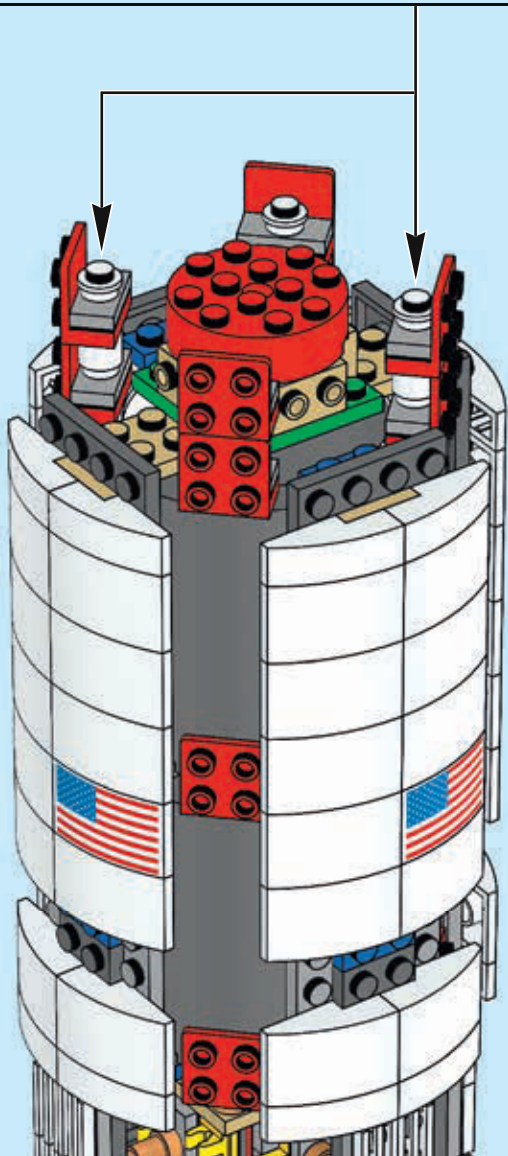



# 57

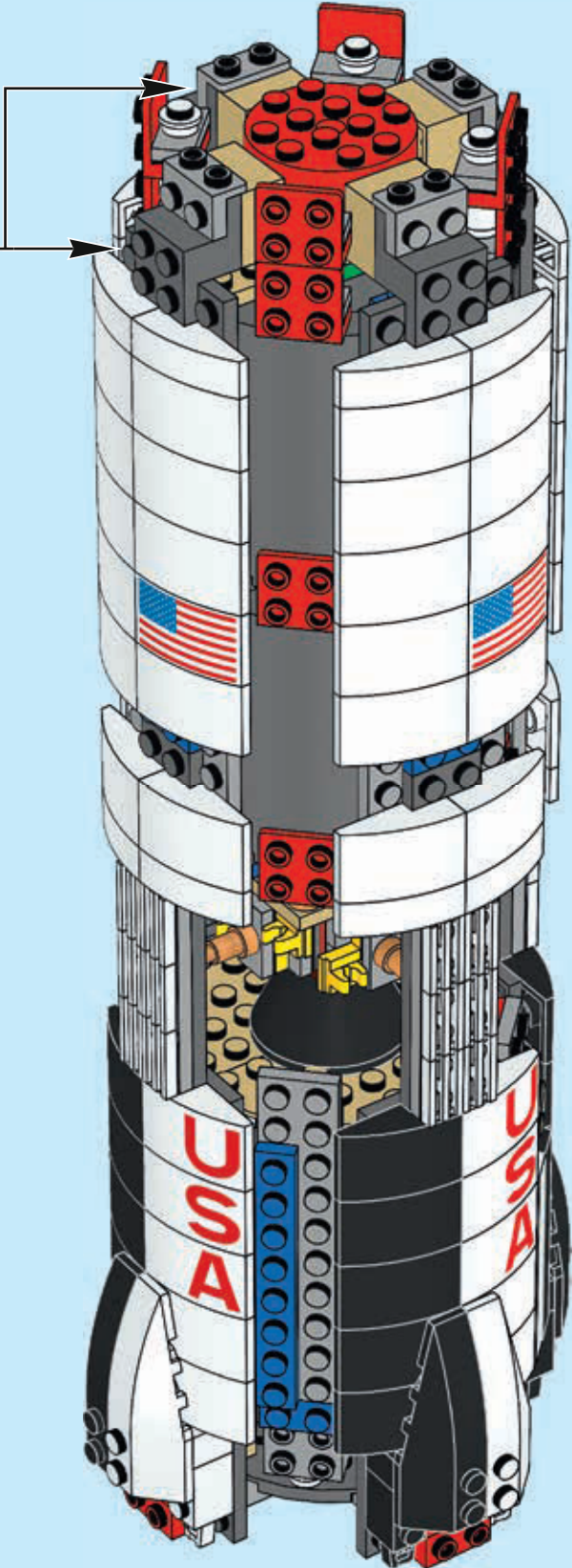
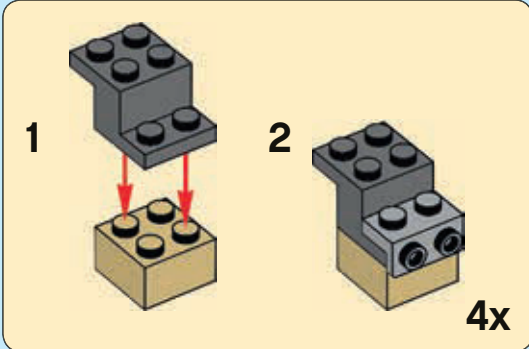

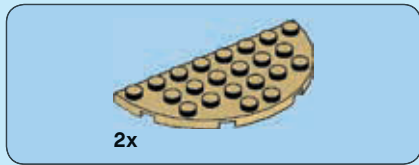

58

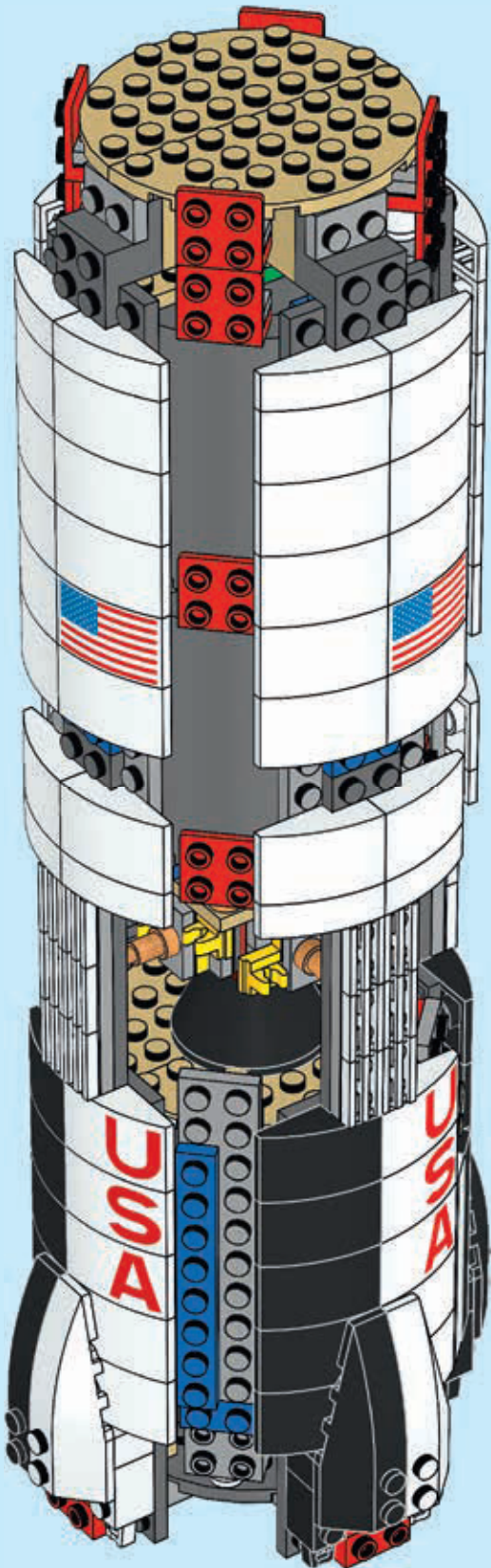

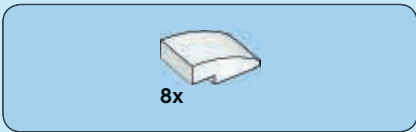

59

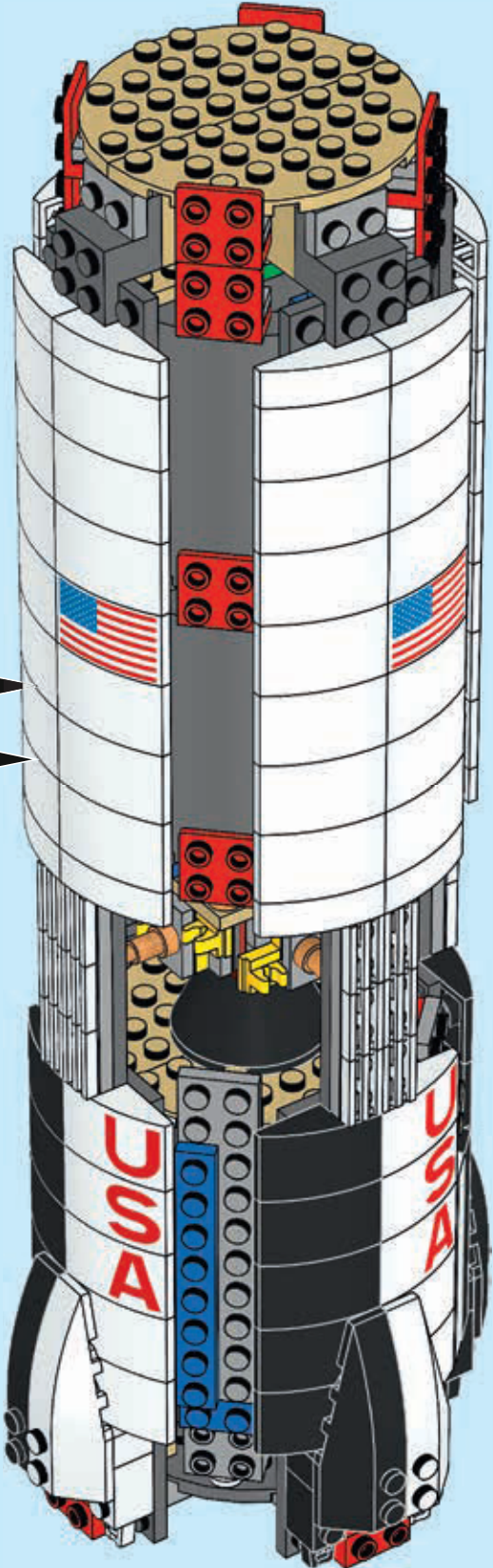
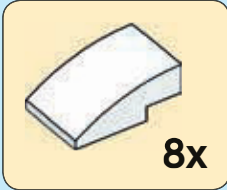



60

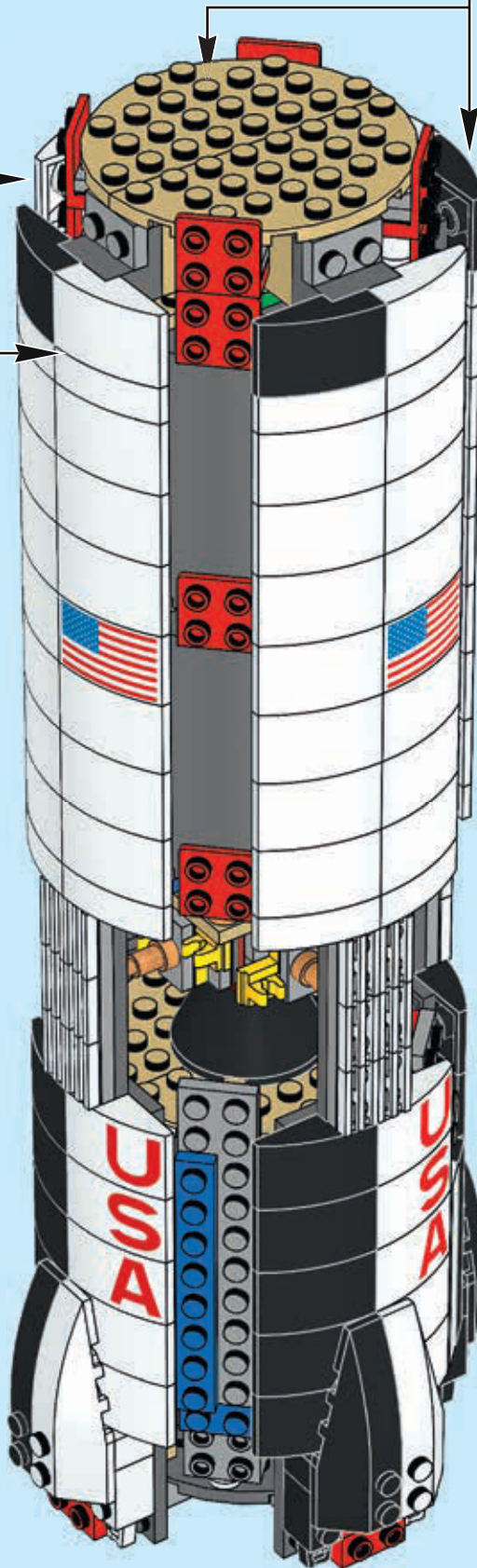





4x

61

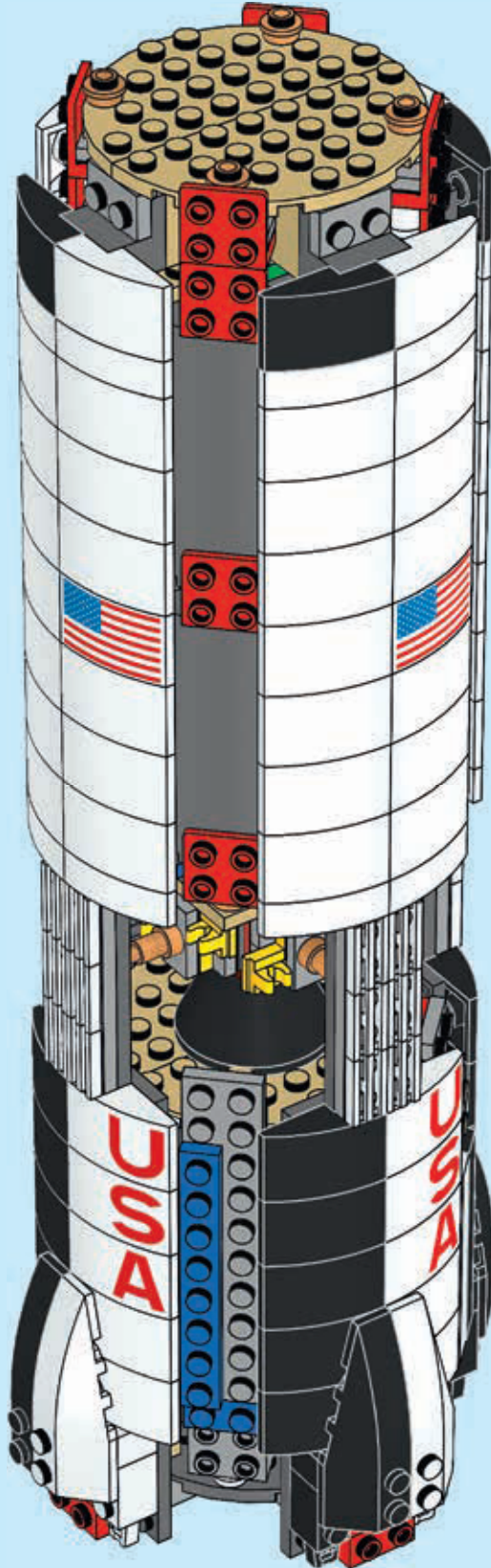



8x

62

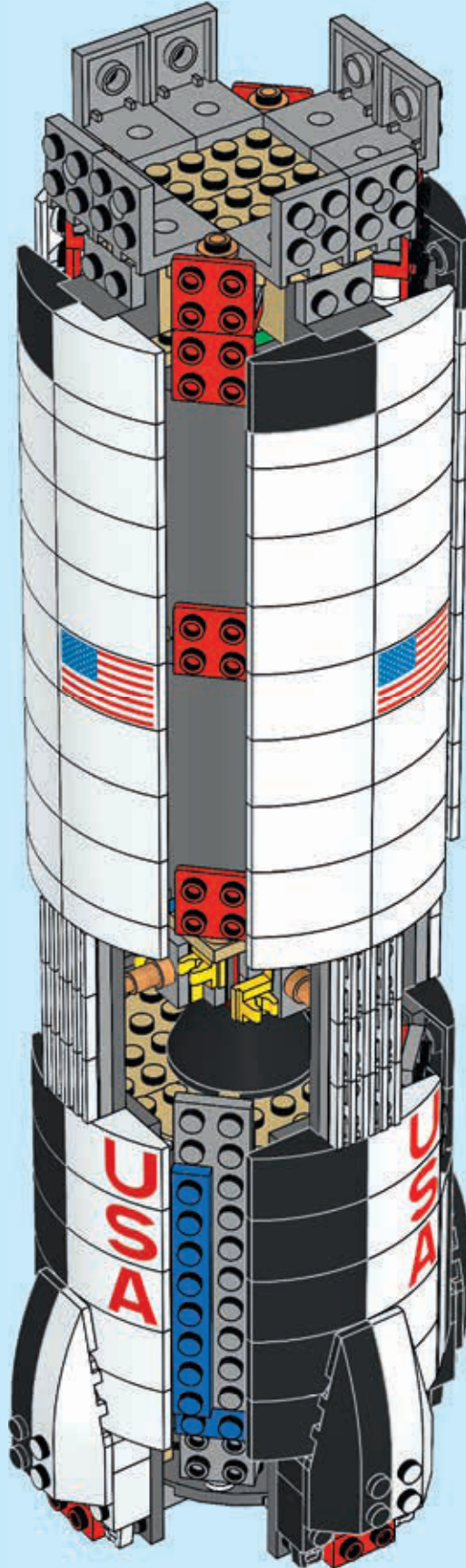



4

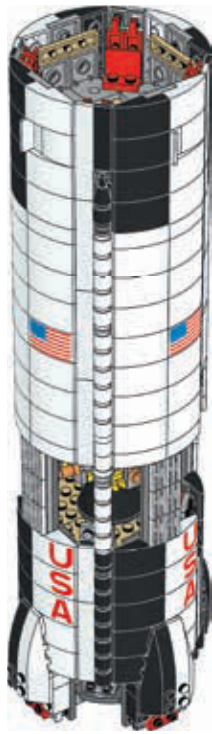

4x

63

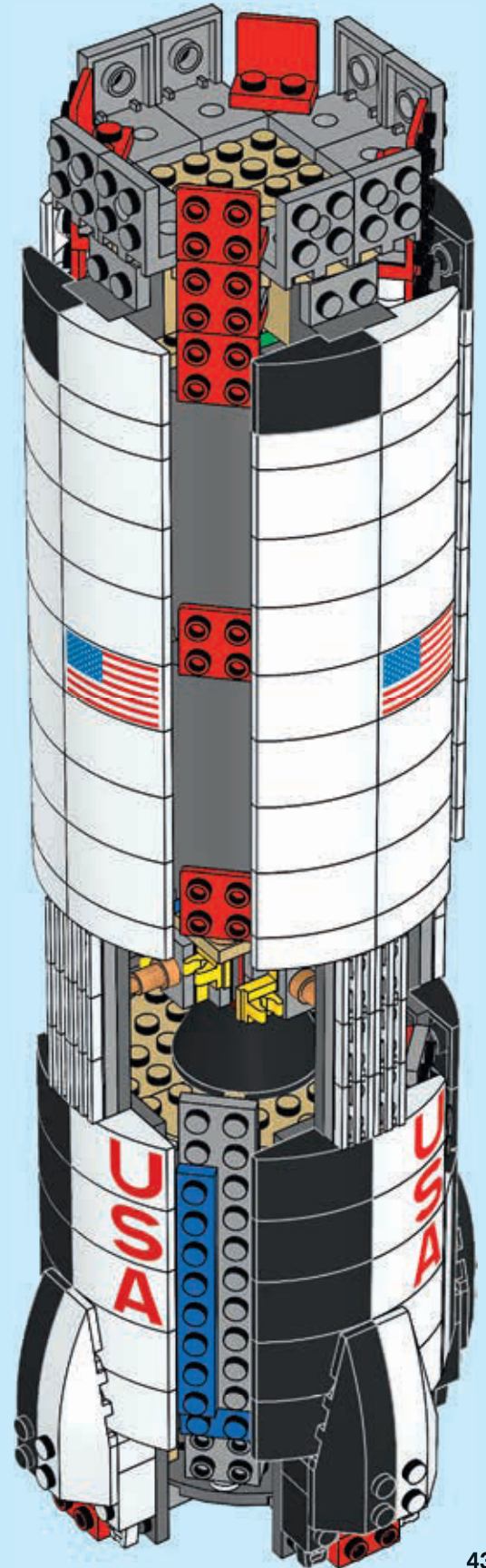

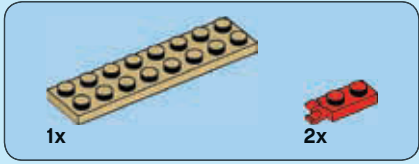

64

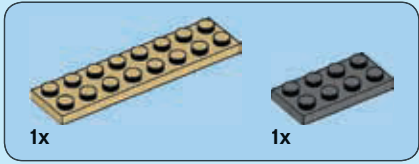
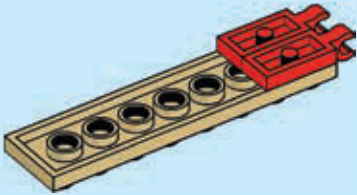

65

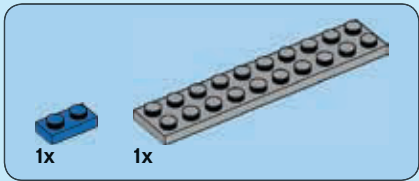
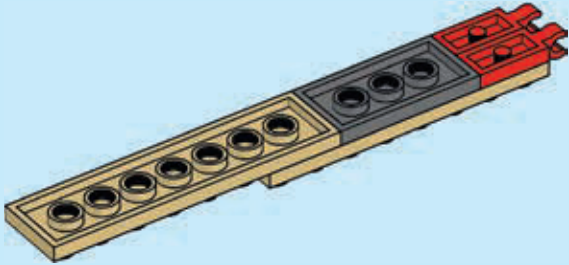

66

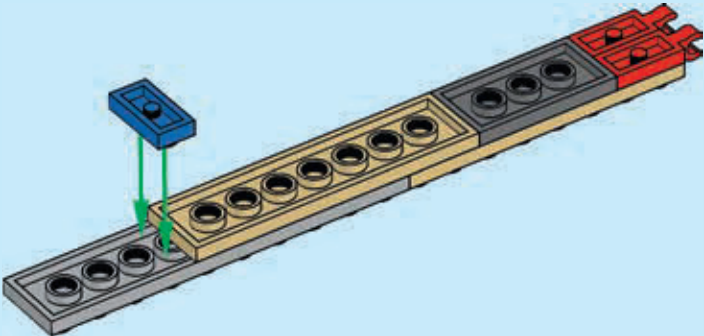

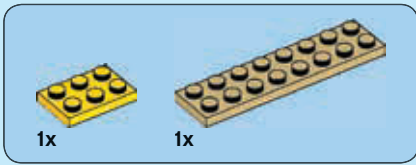

67

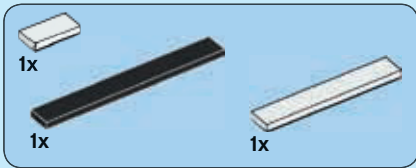
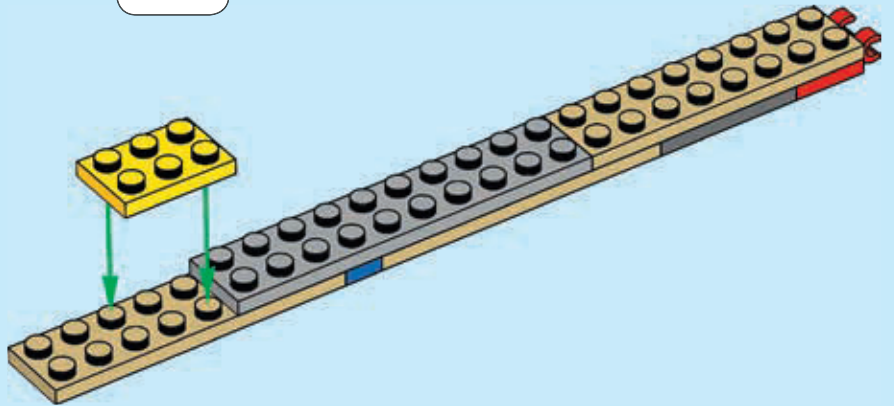

68

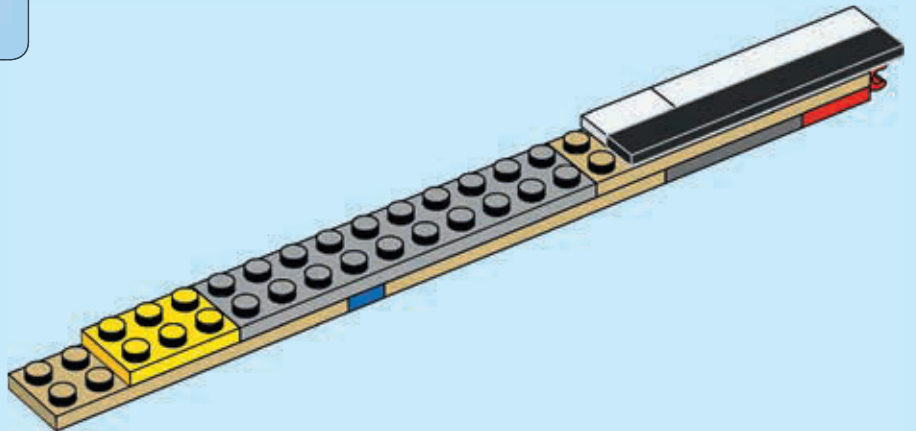

69

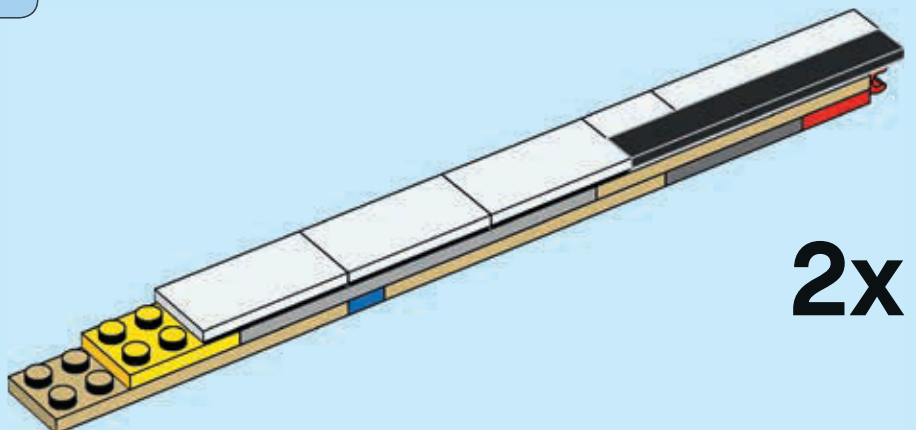

2x

70

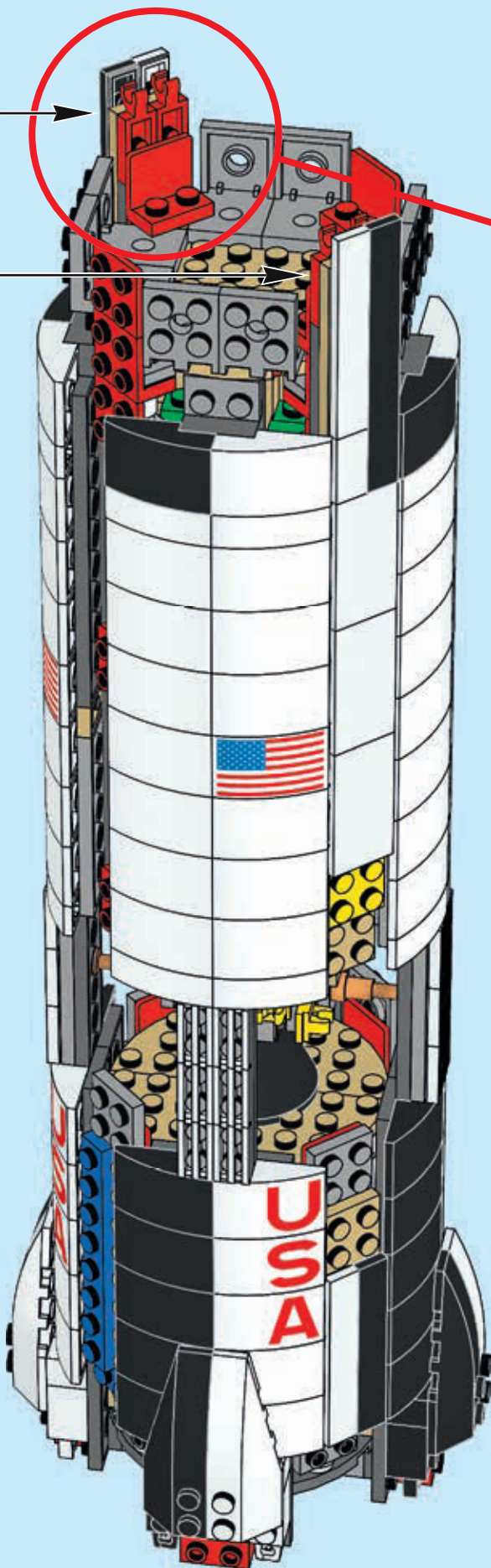

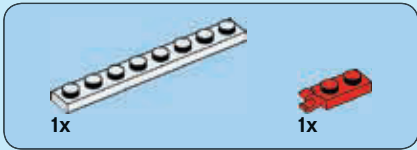
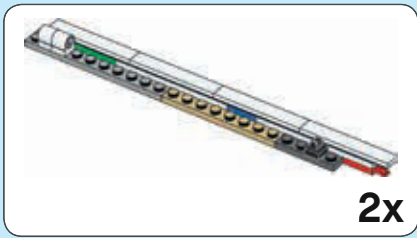

71

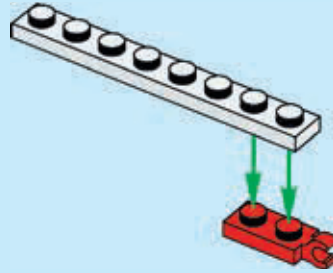

72

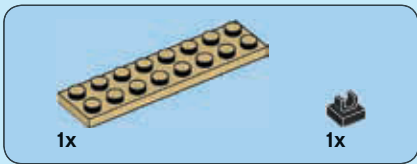
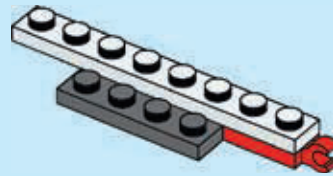

73

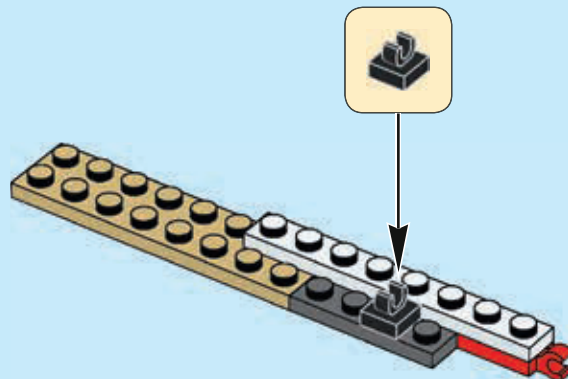

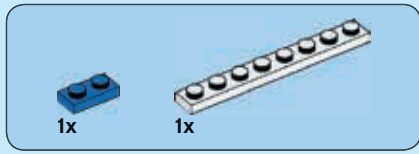

74

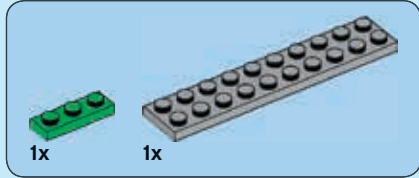
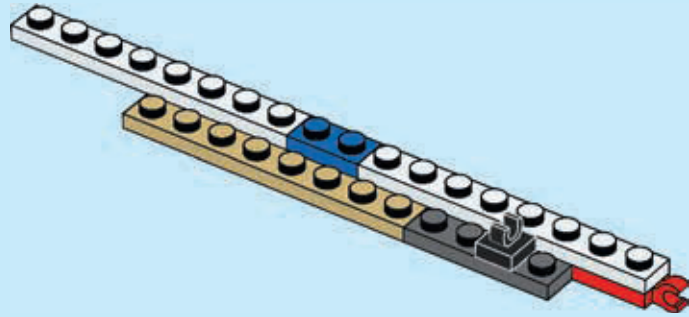

75

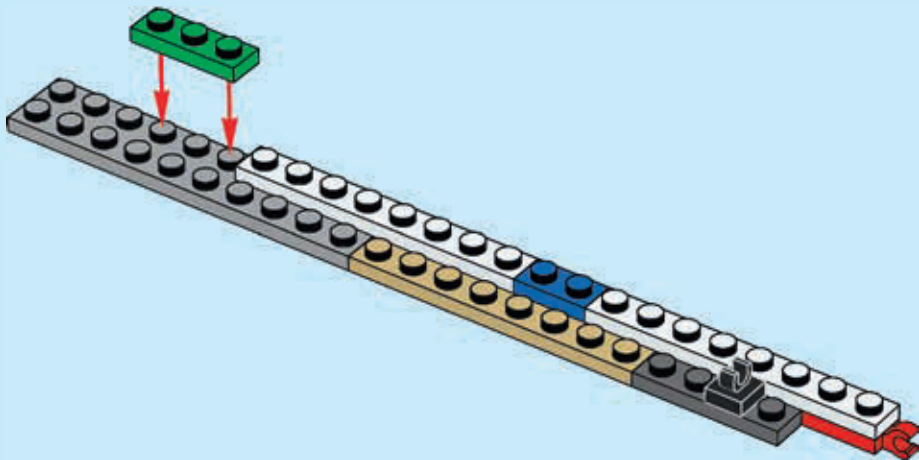





76

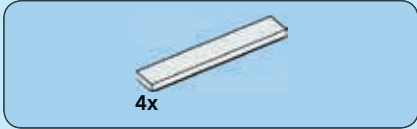
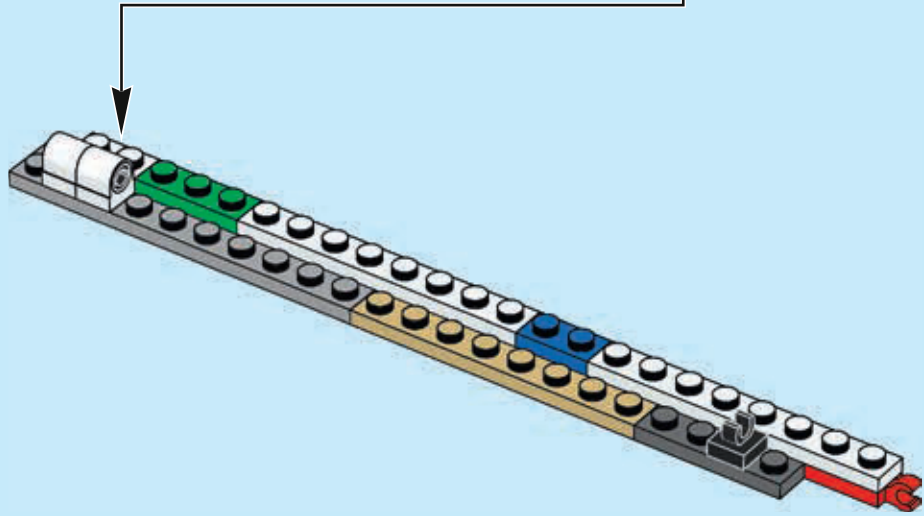

77

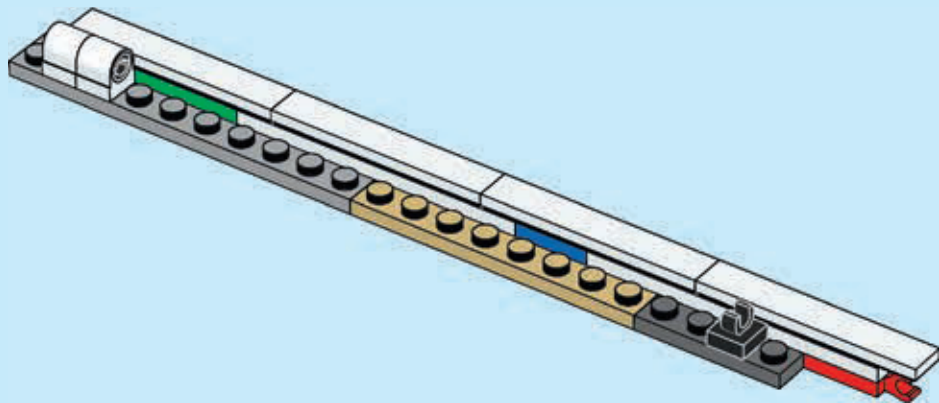

2x

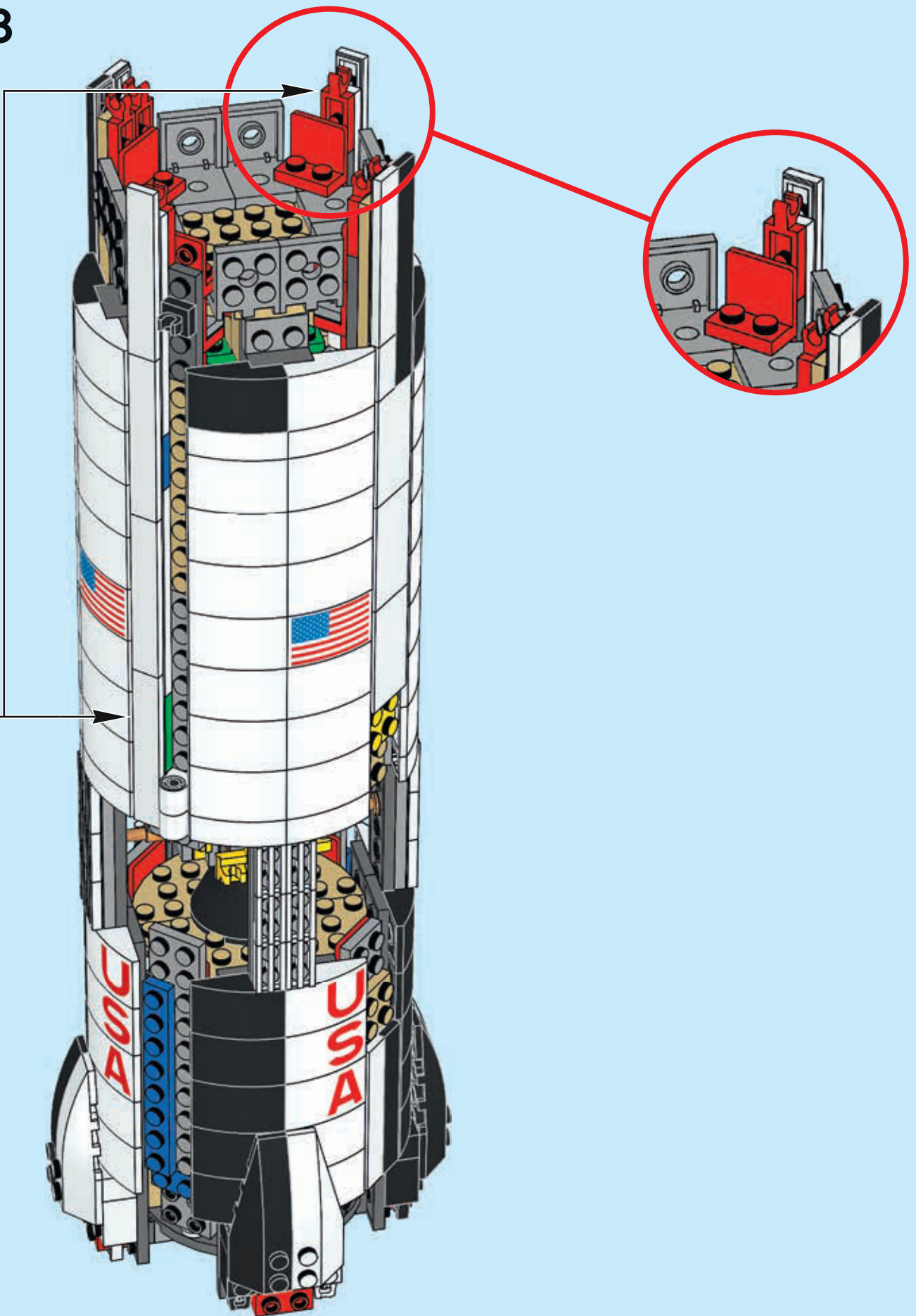



79

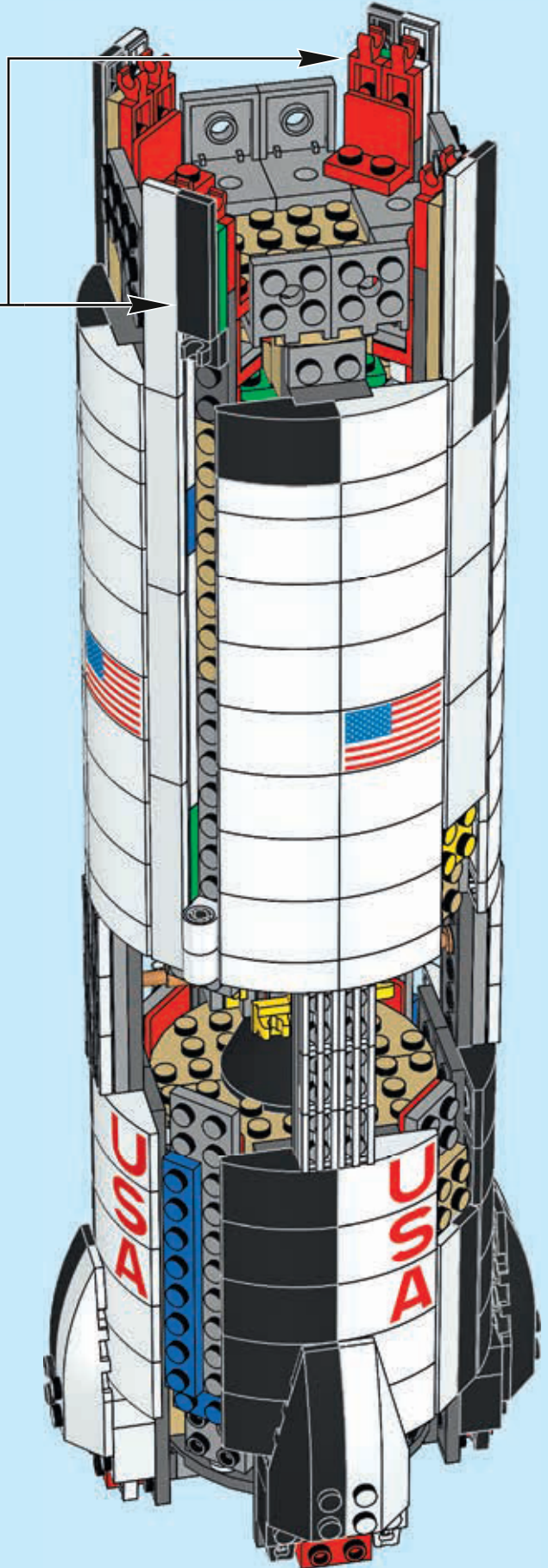
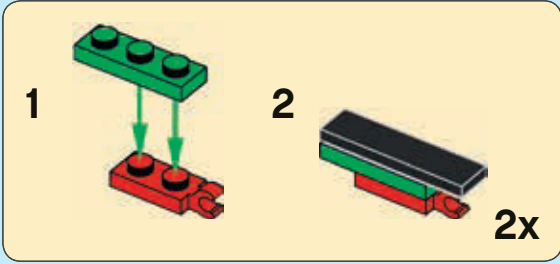

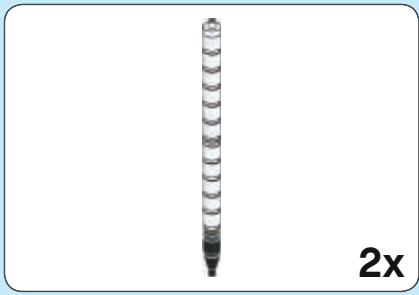

2x



1x

1x

80



2x

81

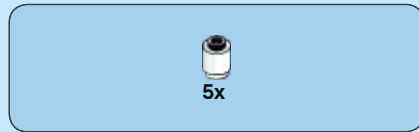

5x

82



1x

83





6x

84



1x

85



2x

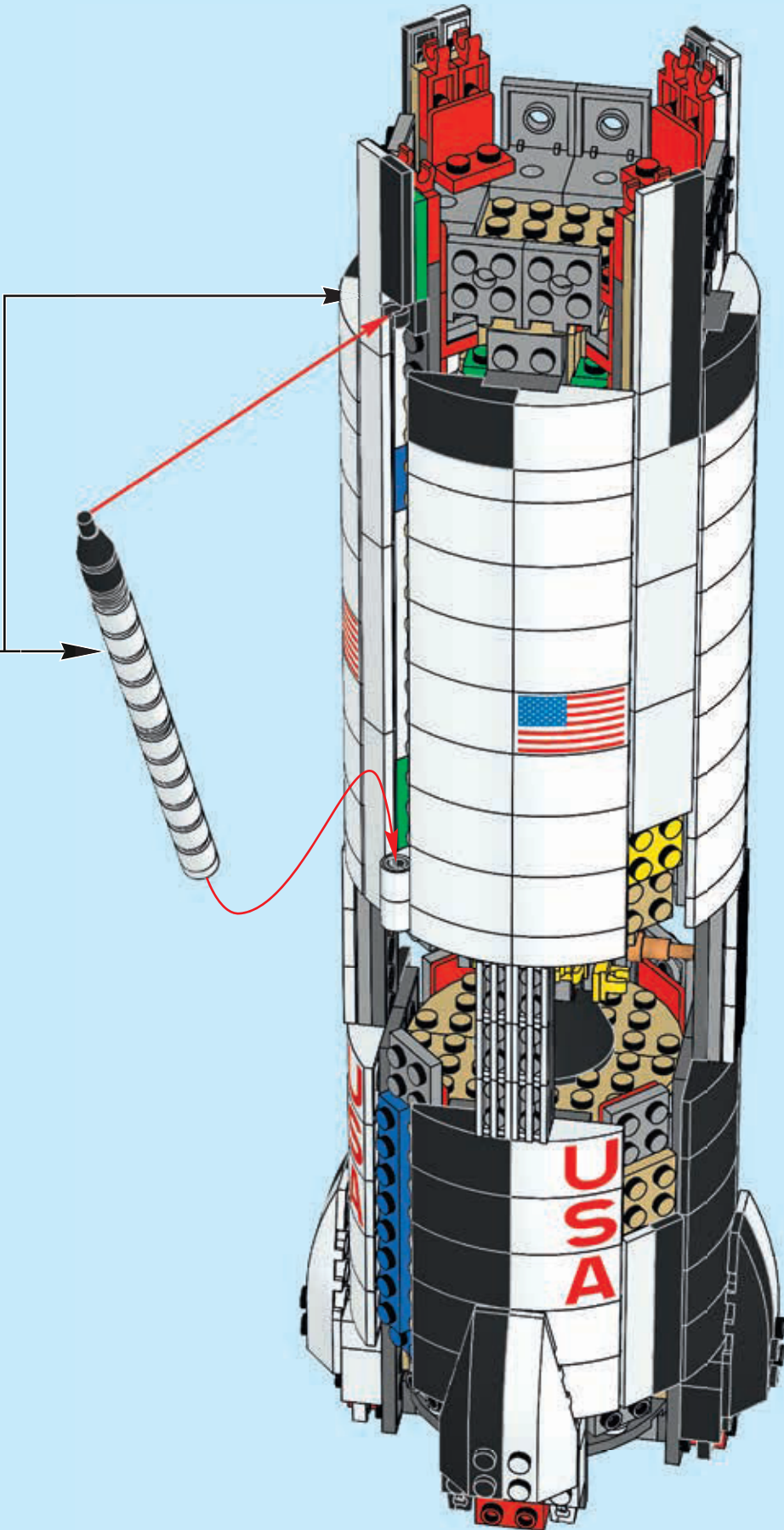

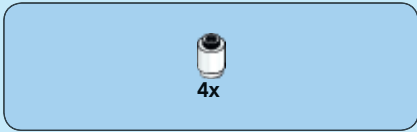

87

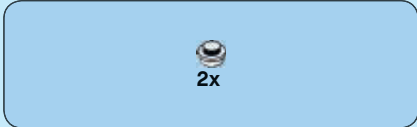

88

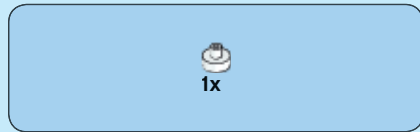

89

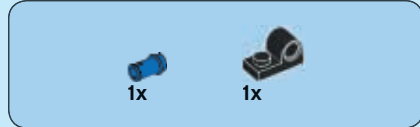

90

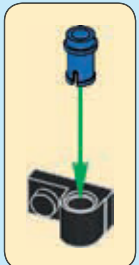

2x

91

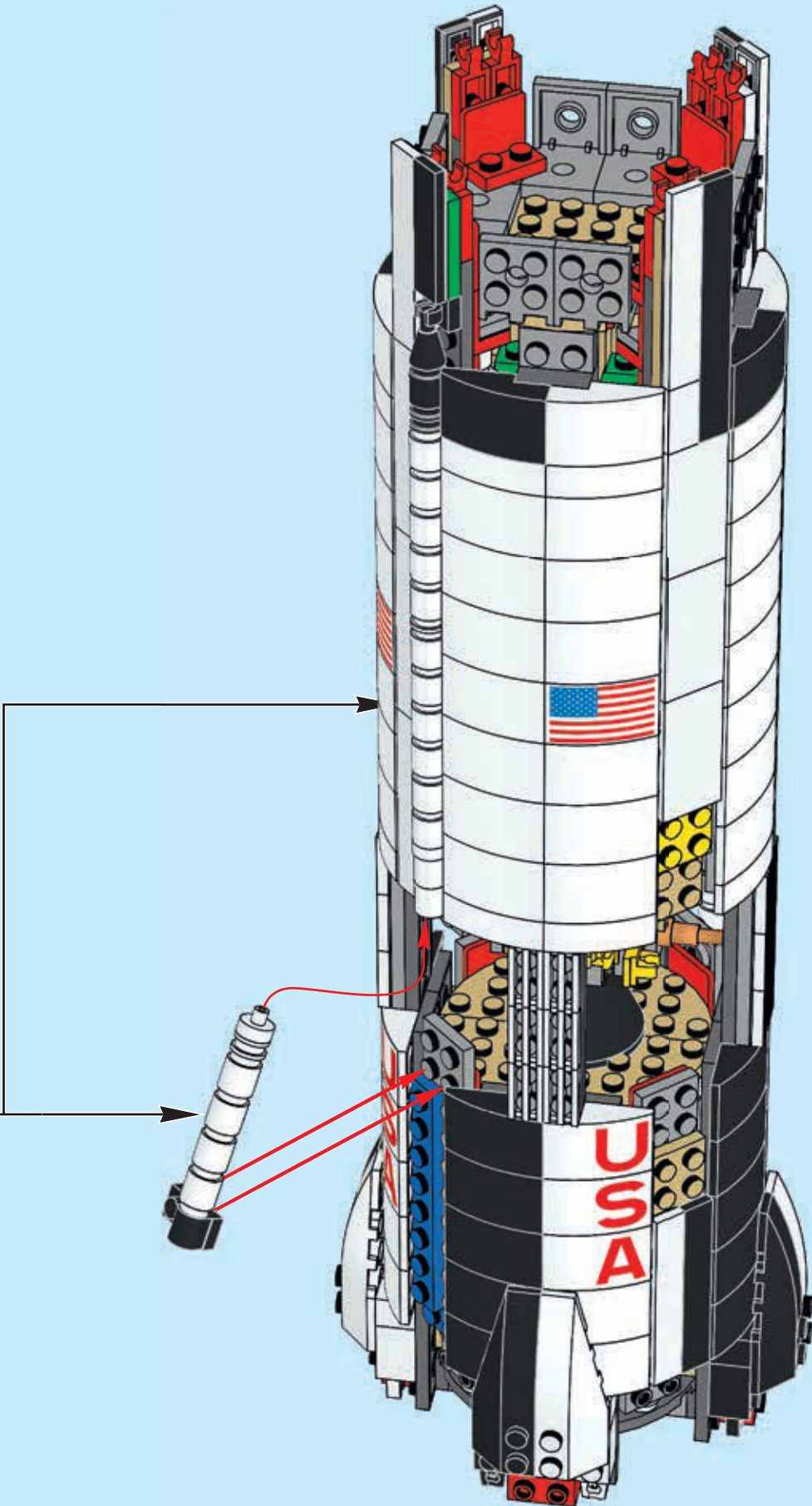



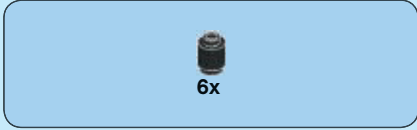

92



93



94

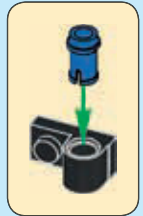

2x

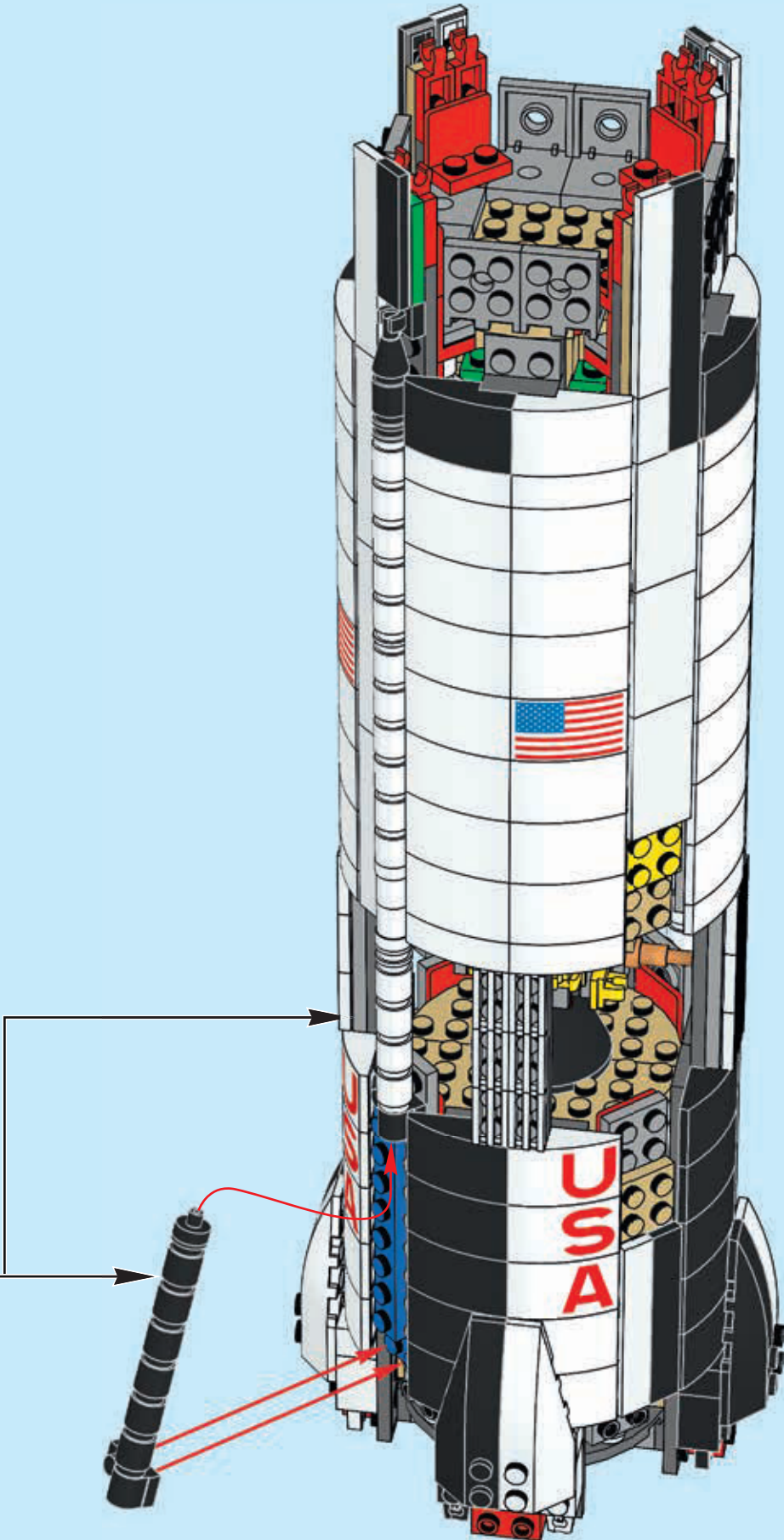

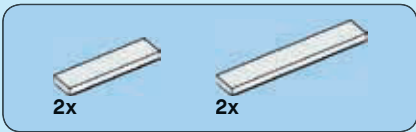

96

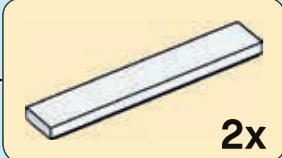
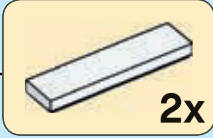
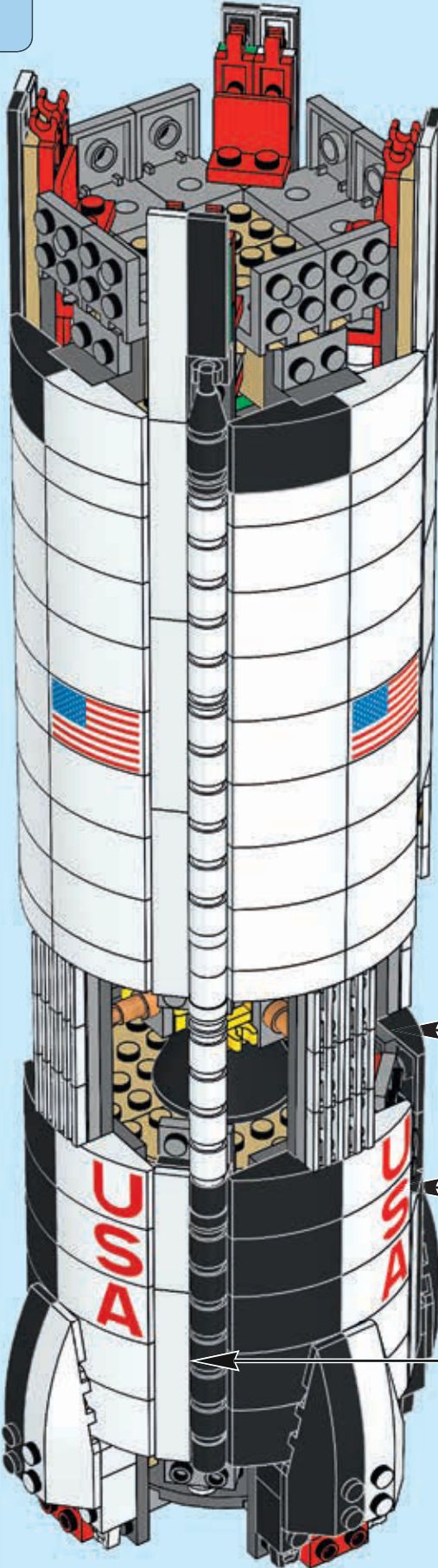



4x



1x

97

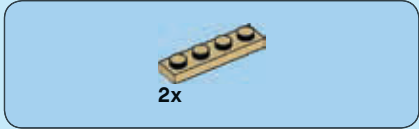

2x

98

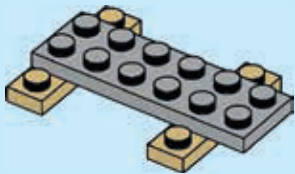

3x

99

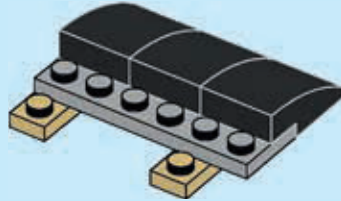

2x

1x

100

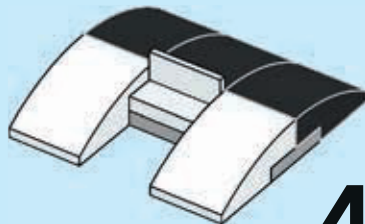

4x

101

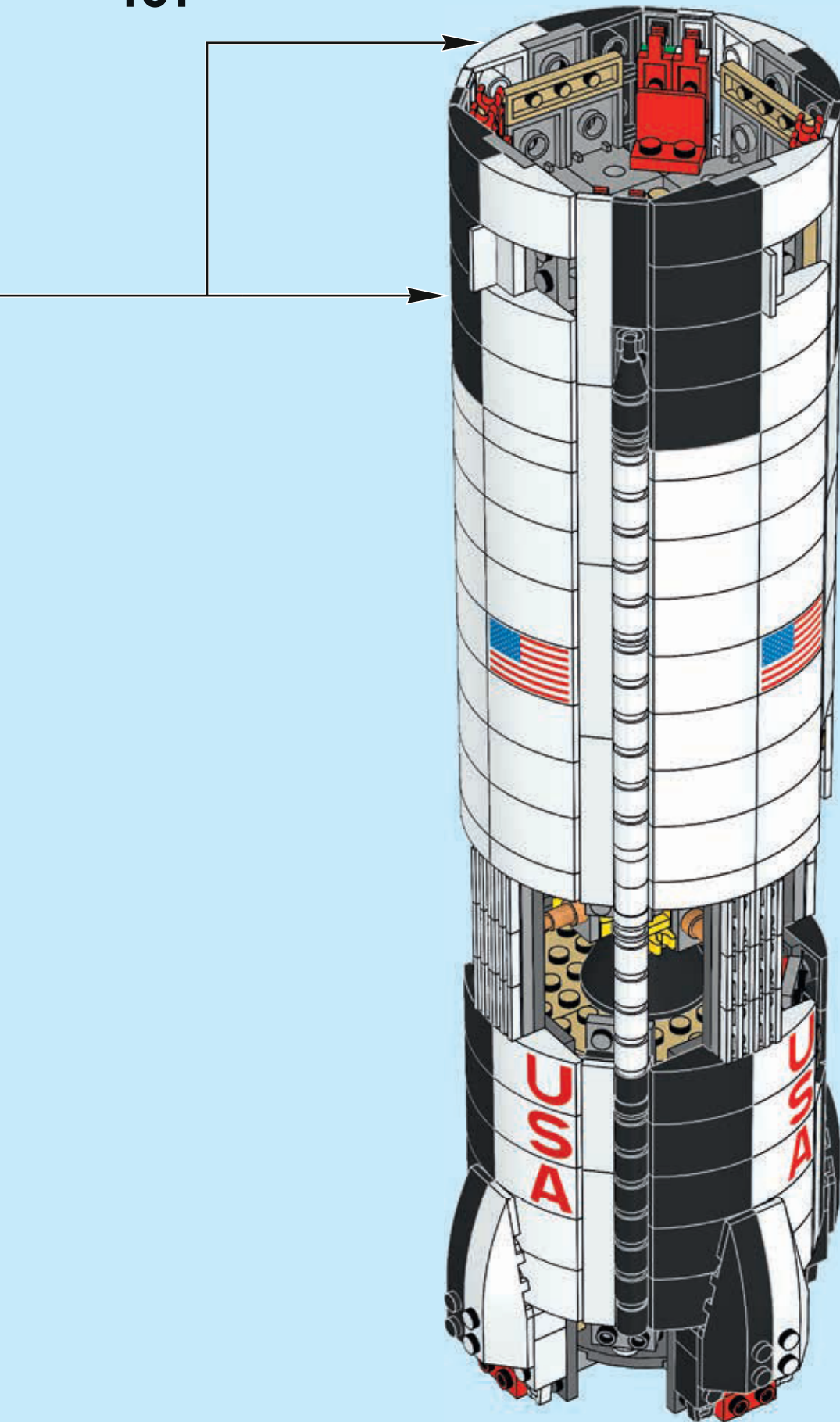



4x



4x

102

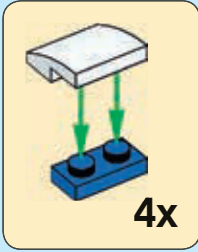

4x

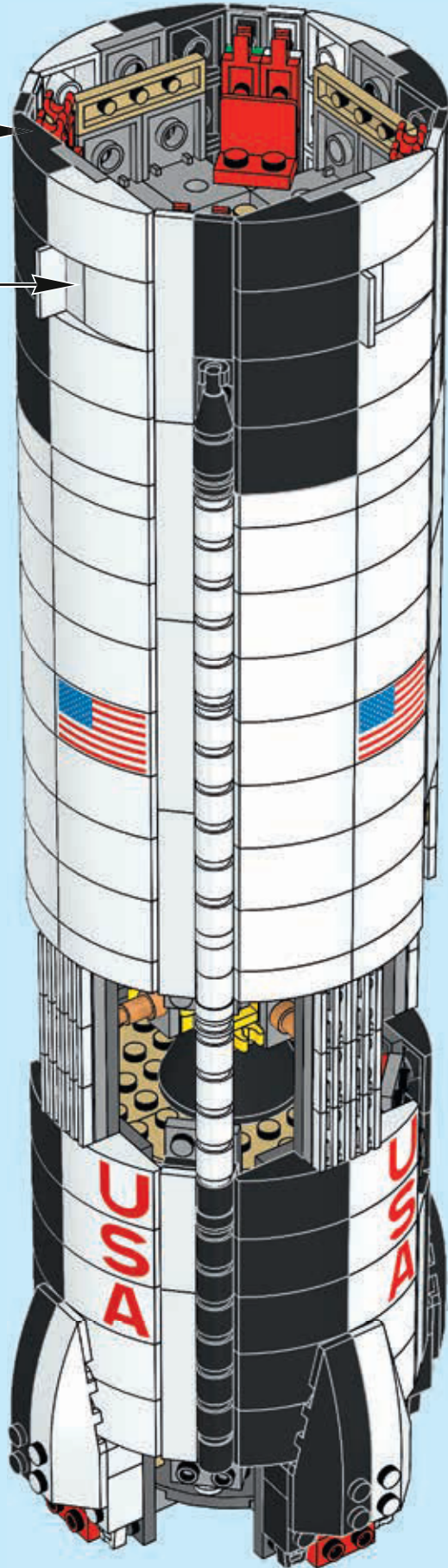

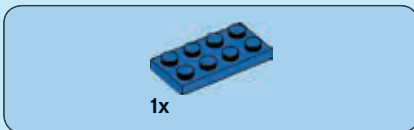
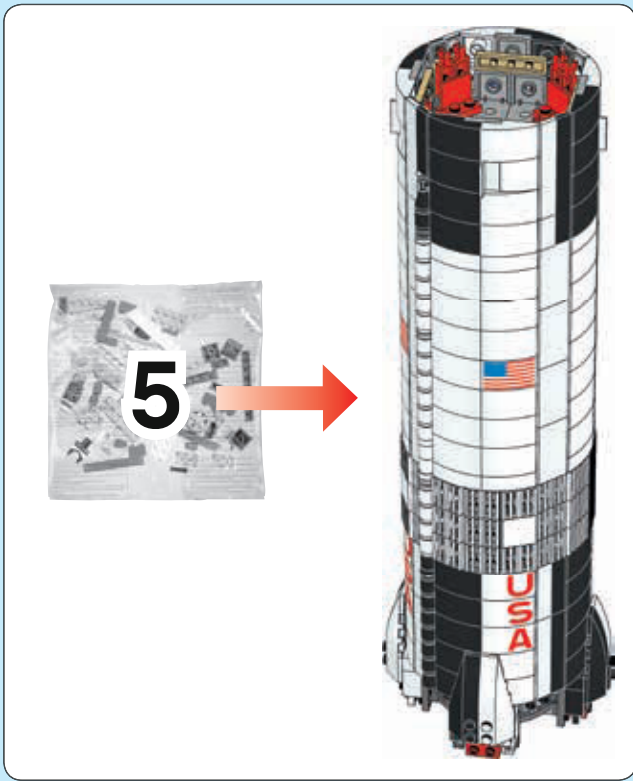

103



104



105

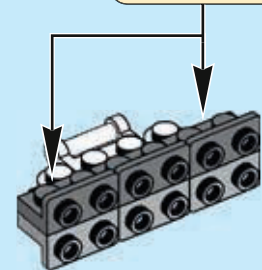
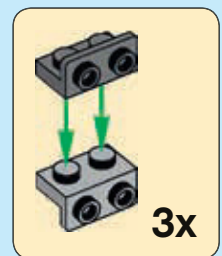



2x

106

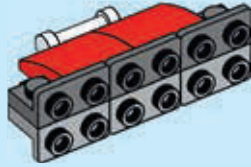

4x



1x

107

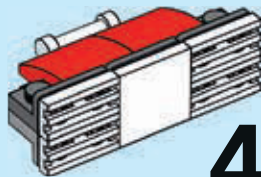

4x



108

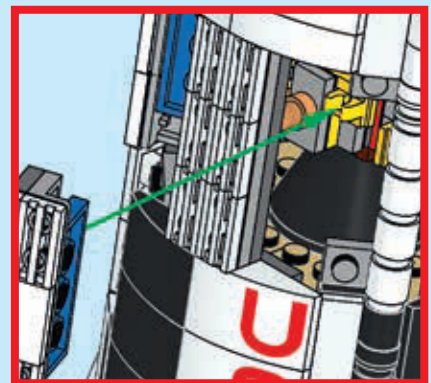
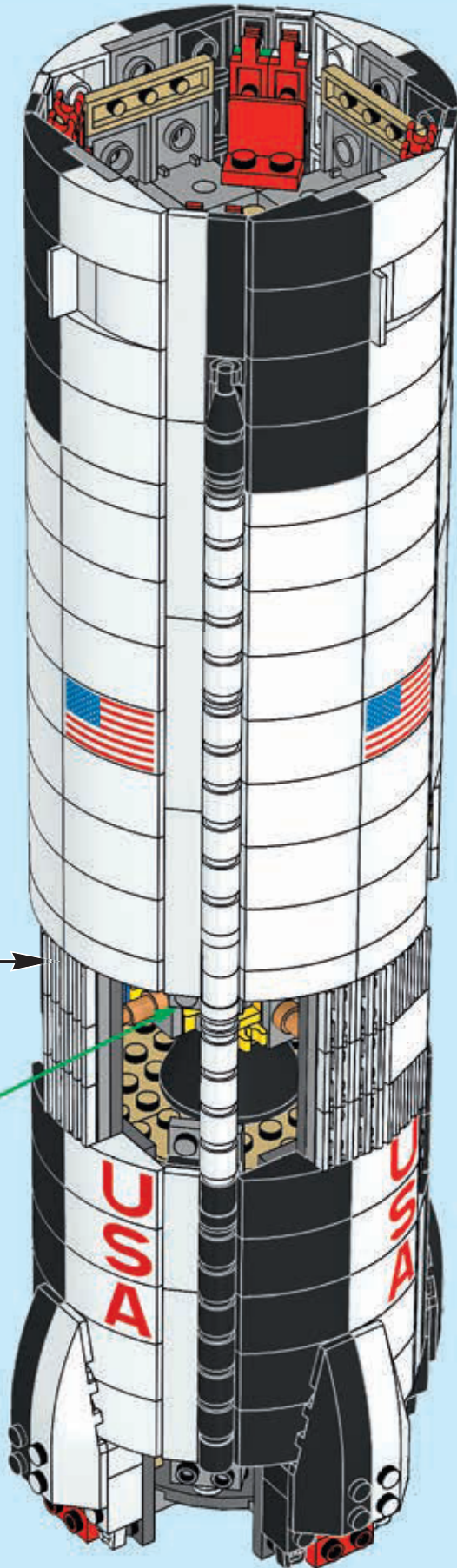



109



110

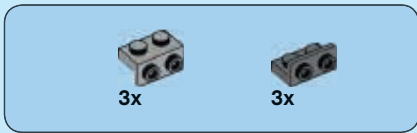

111

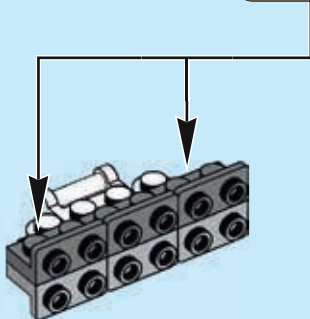
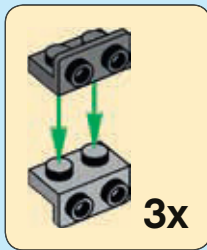

112

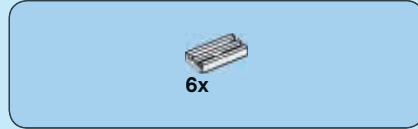
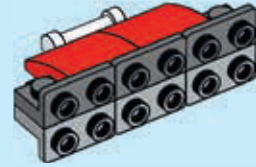

113

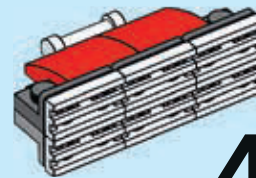

4x

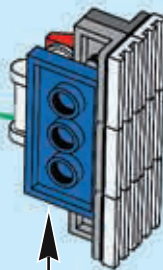
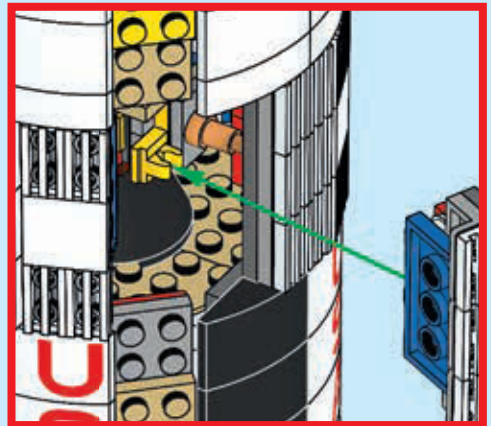
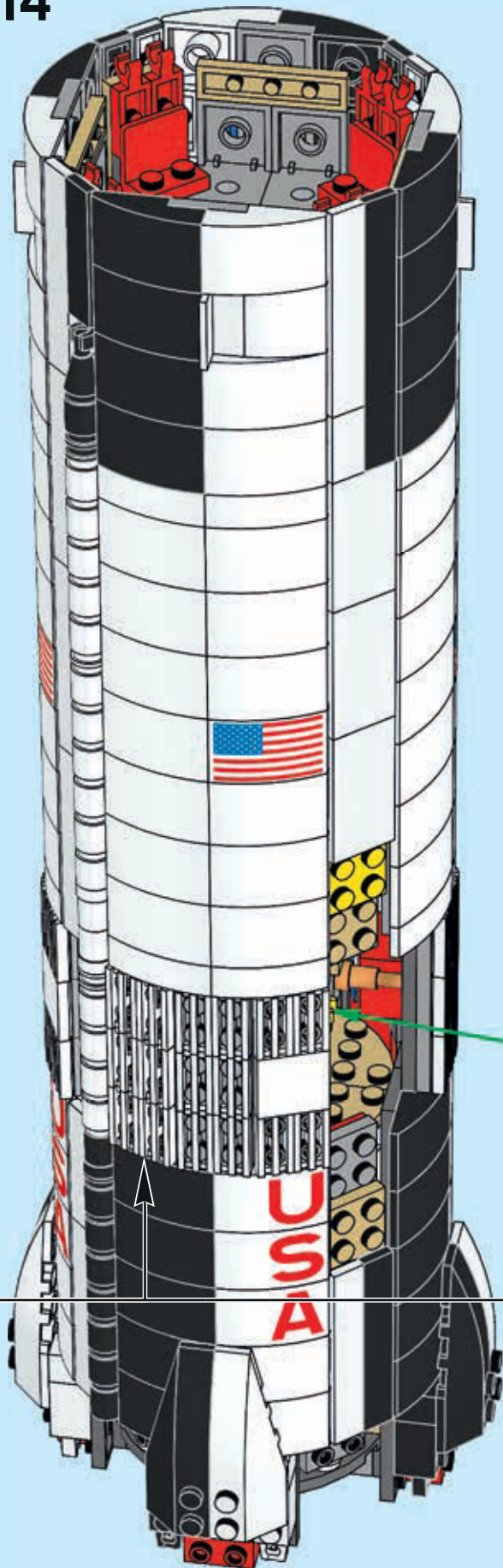

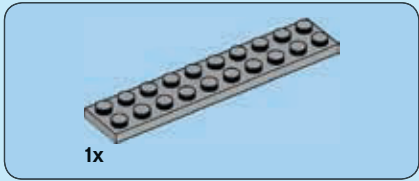

115

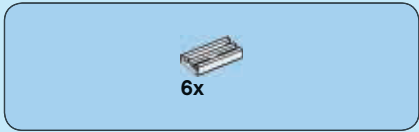
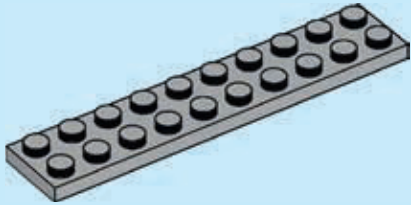

116

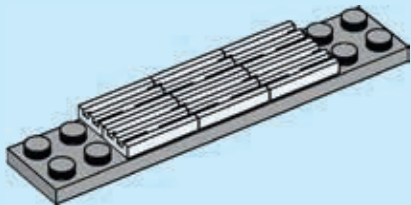

117

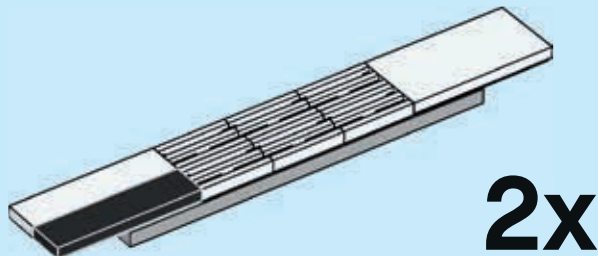

118

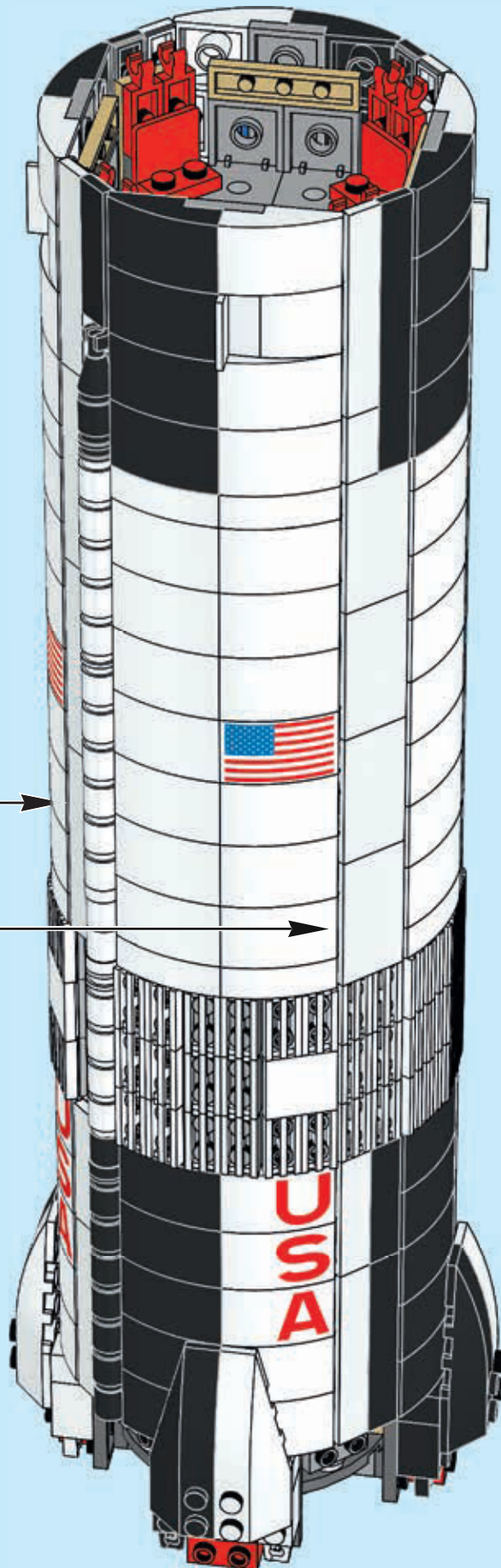

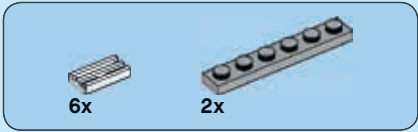

119

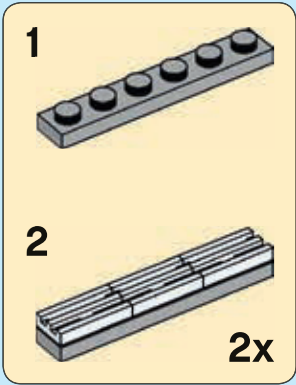
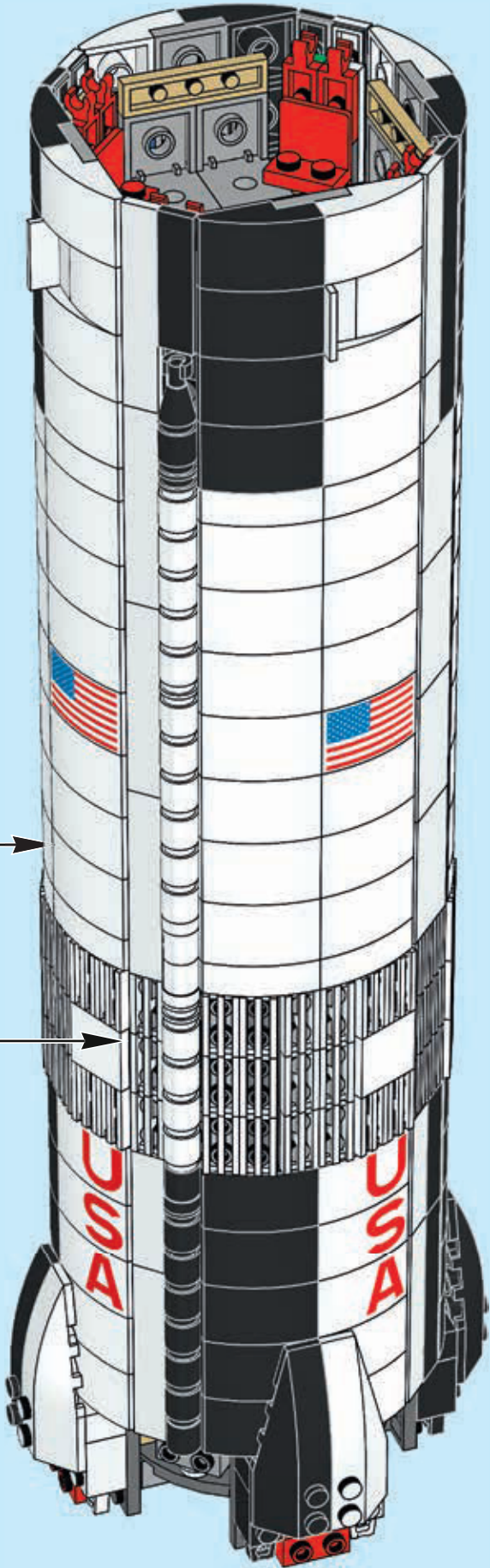

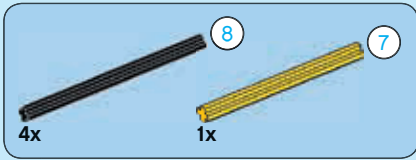
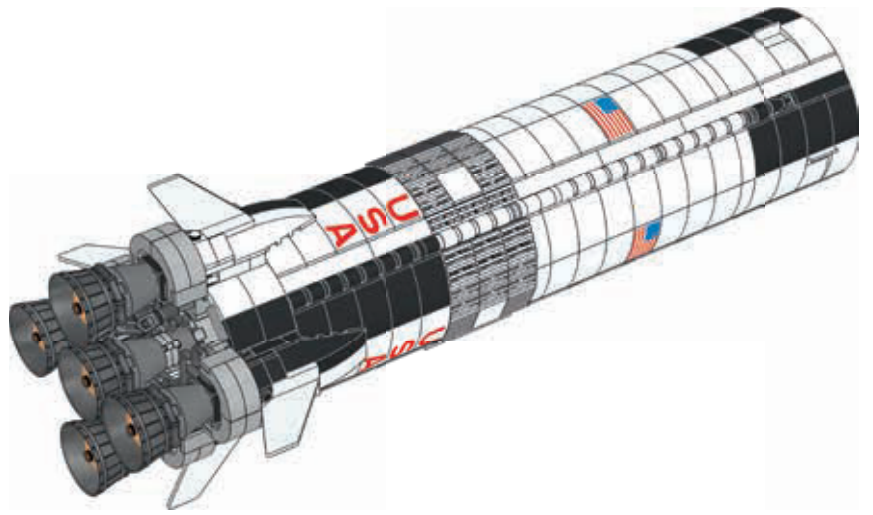

120

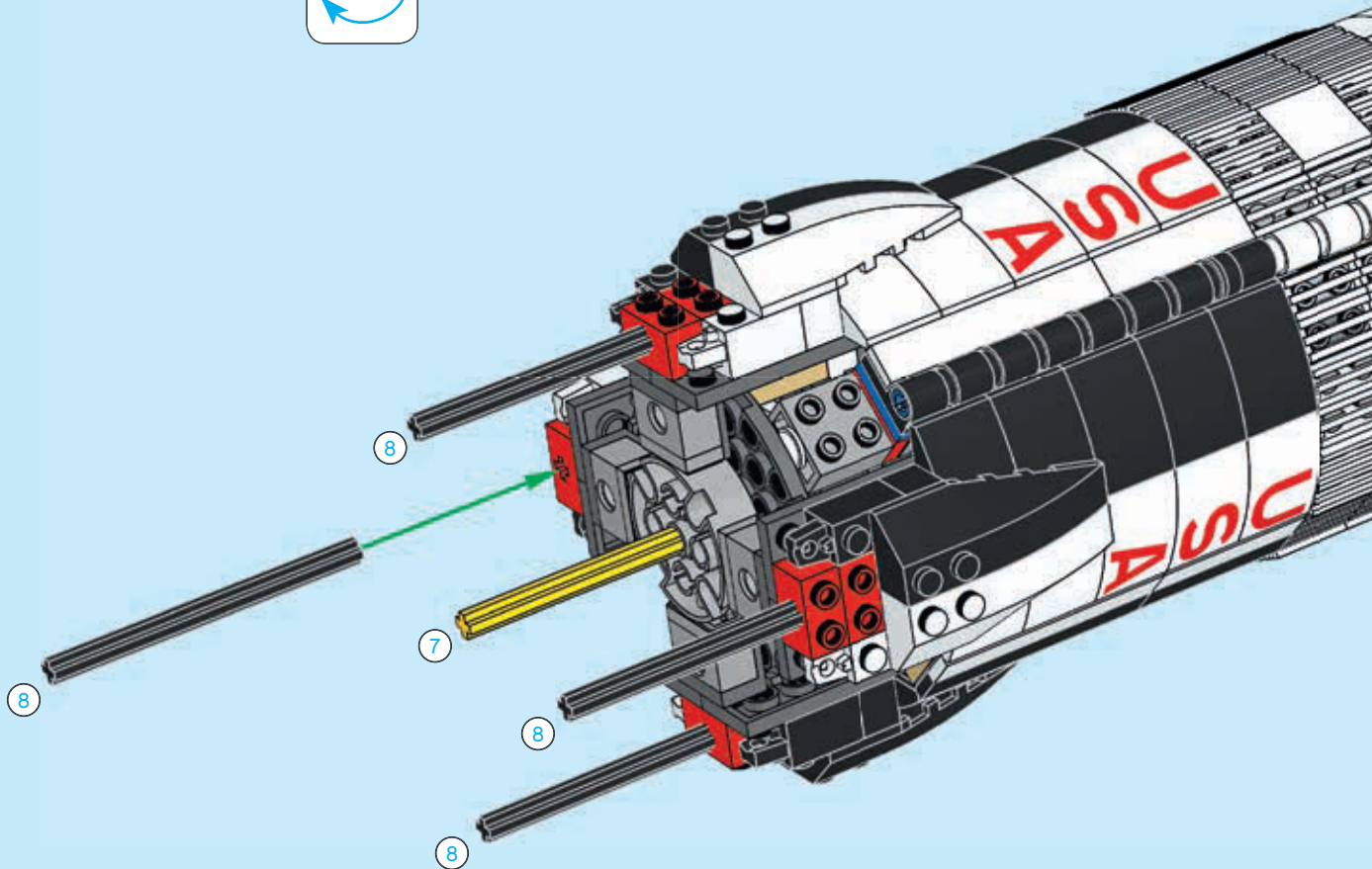

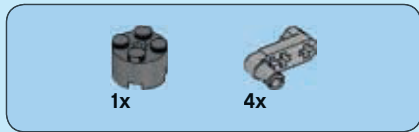

121

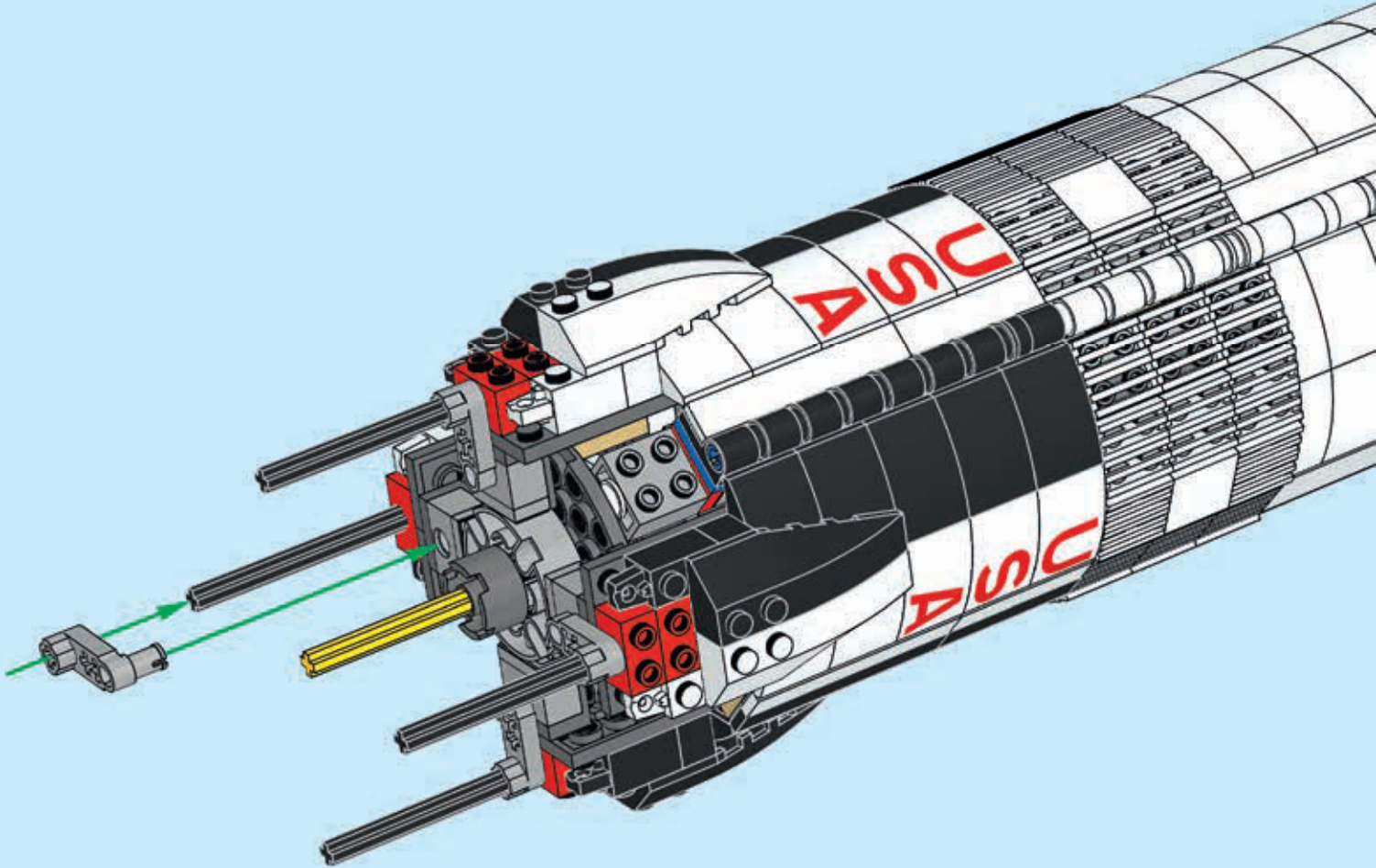





122

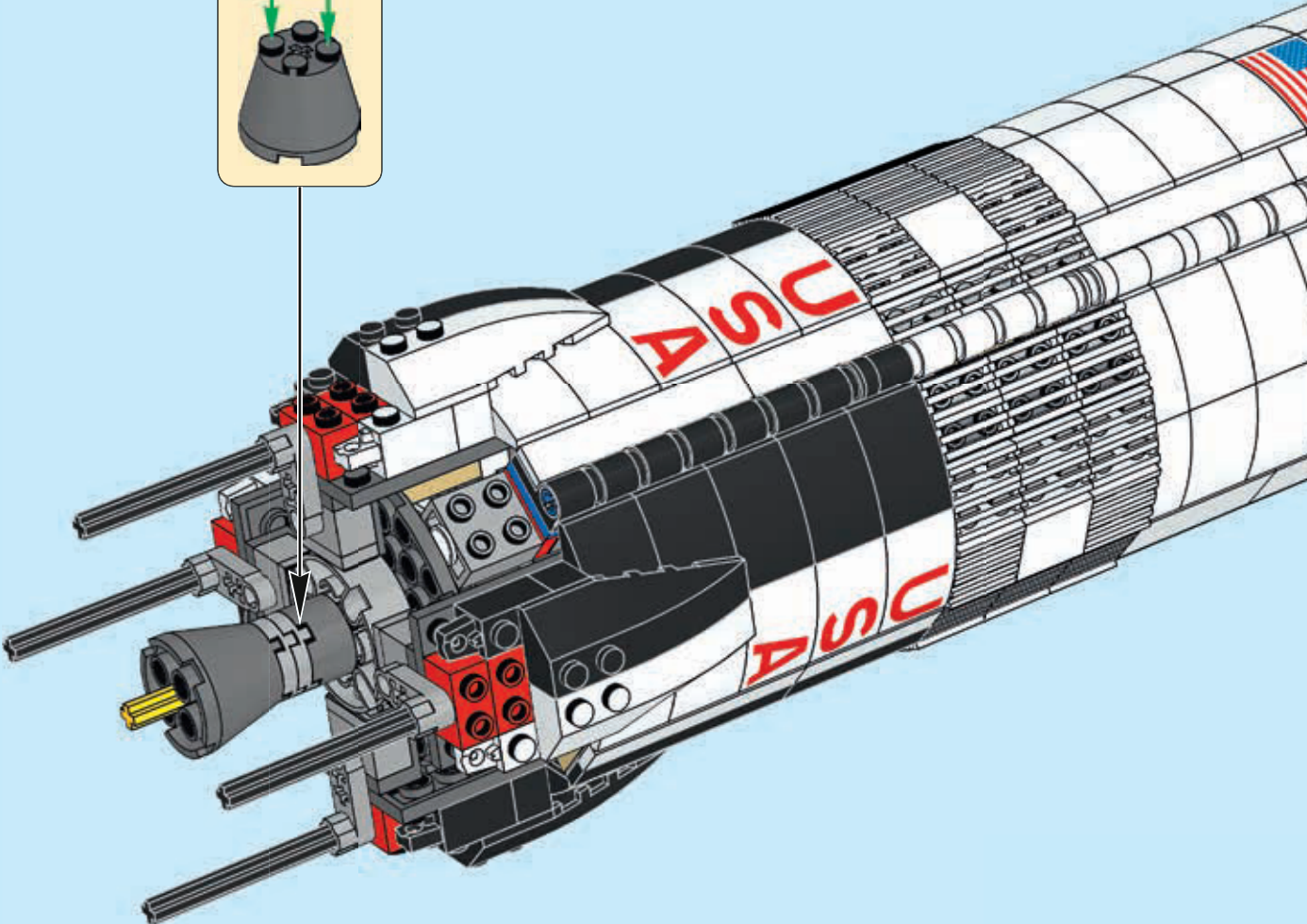
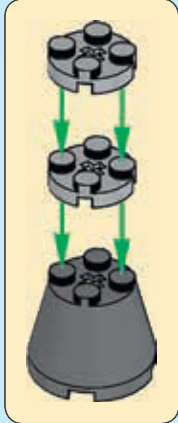



# 123

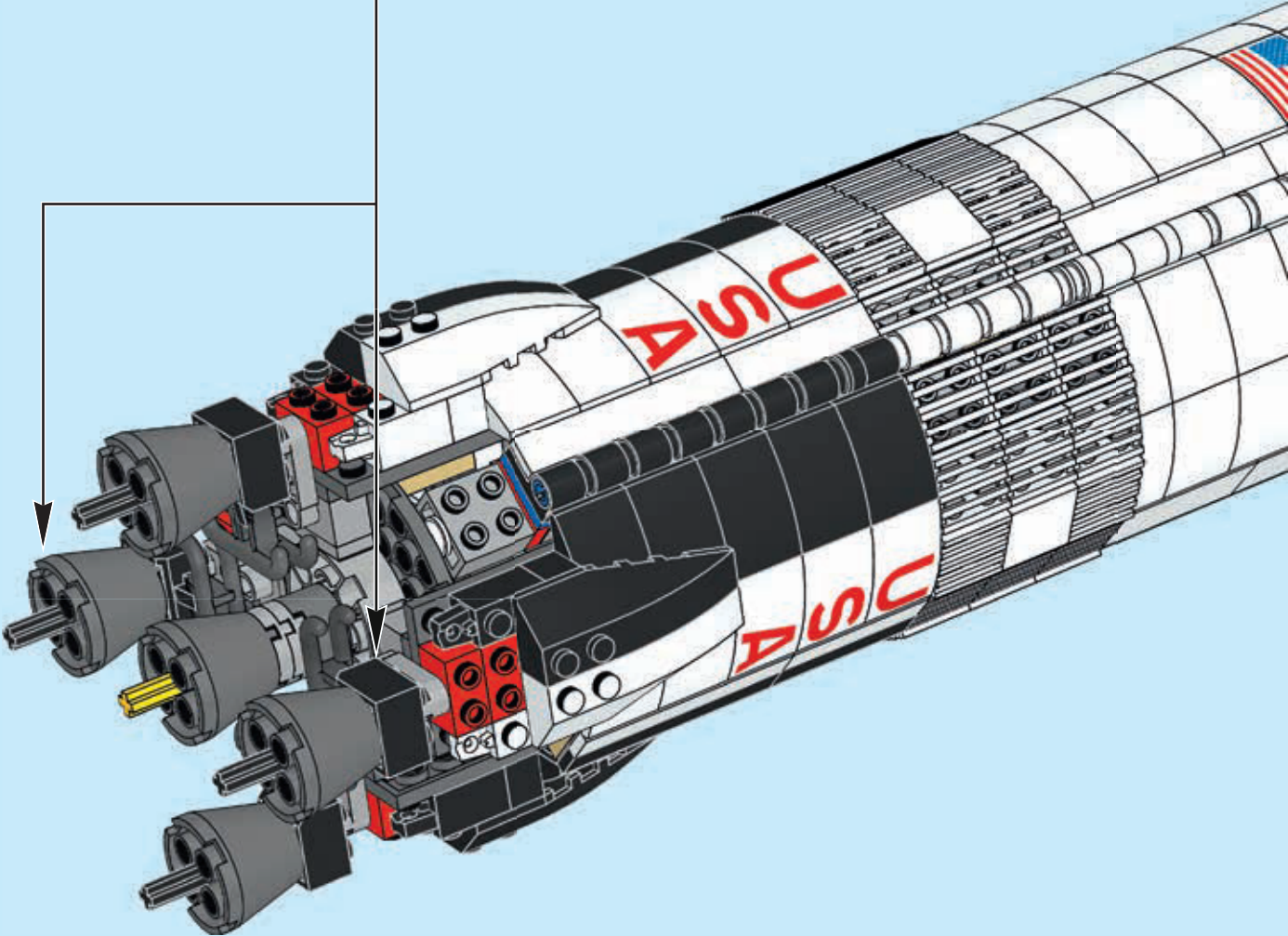
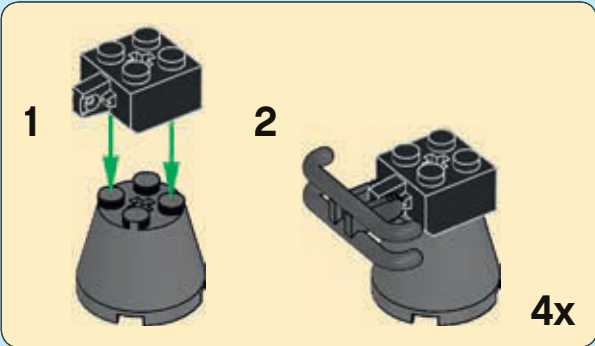



# 124

1

2

3

4

5x

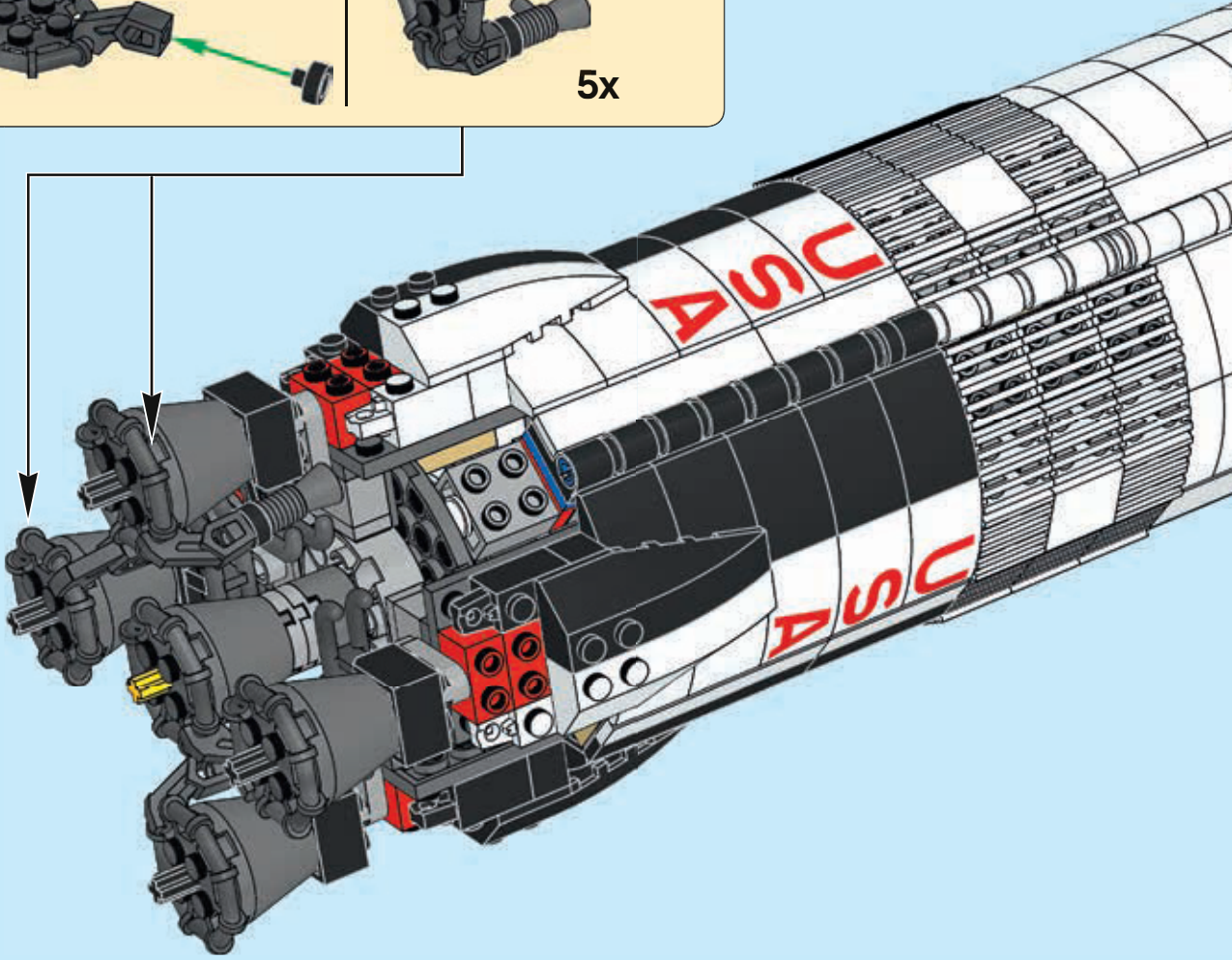



125

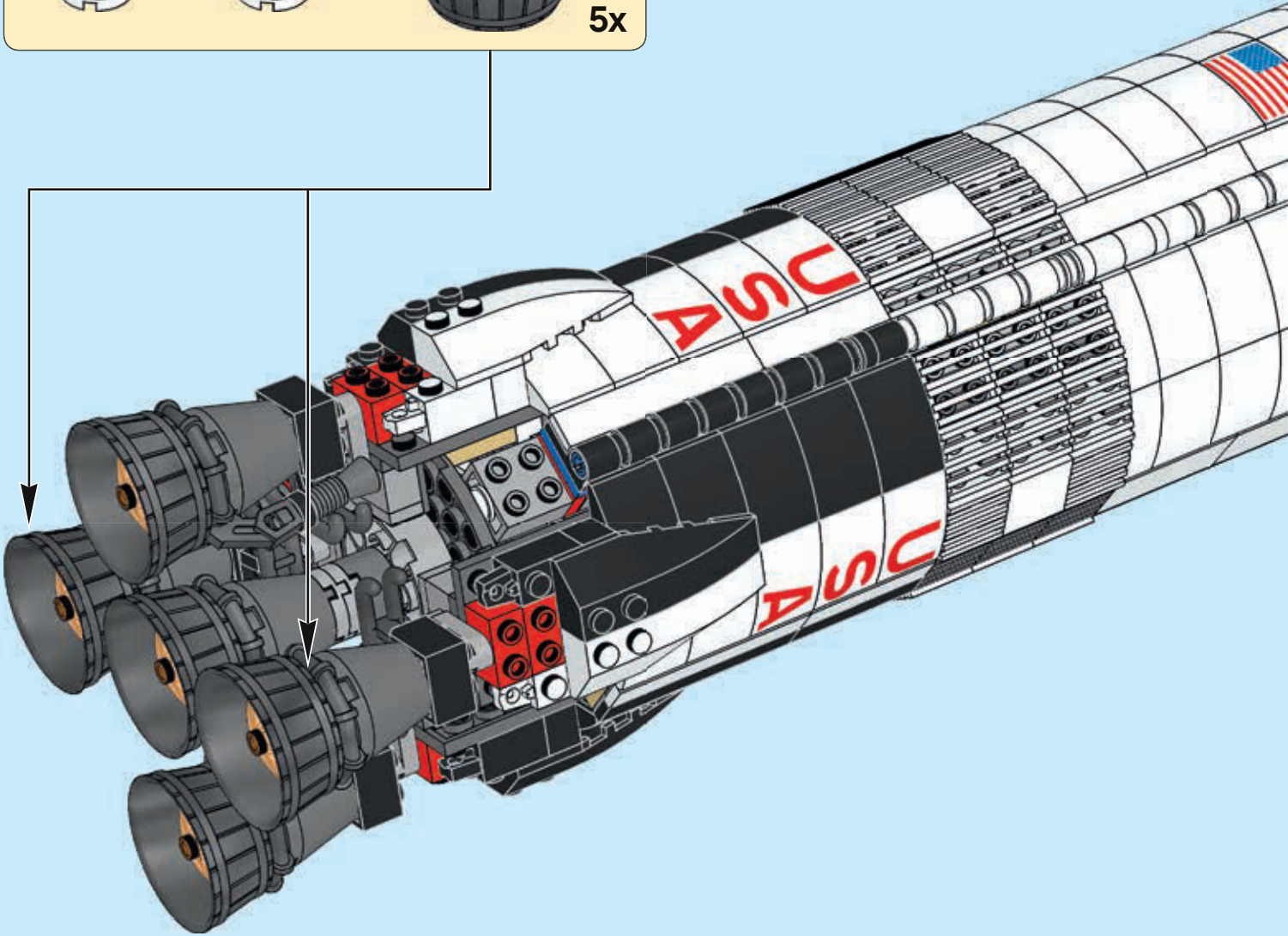
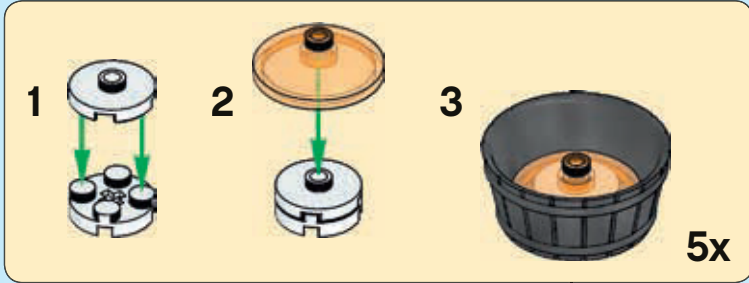

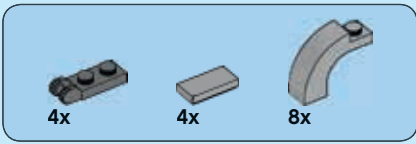

# 126

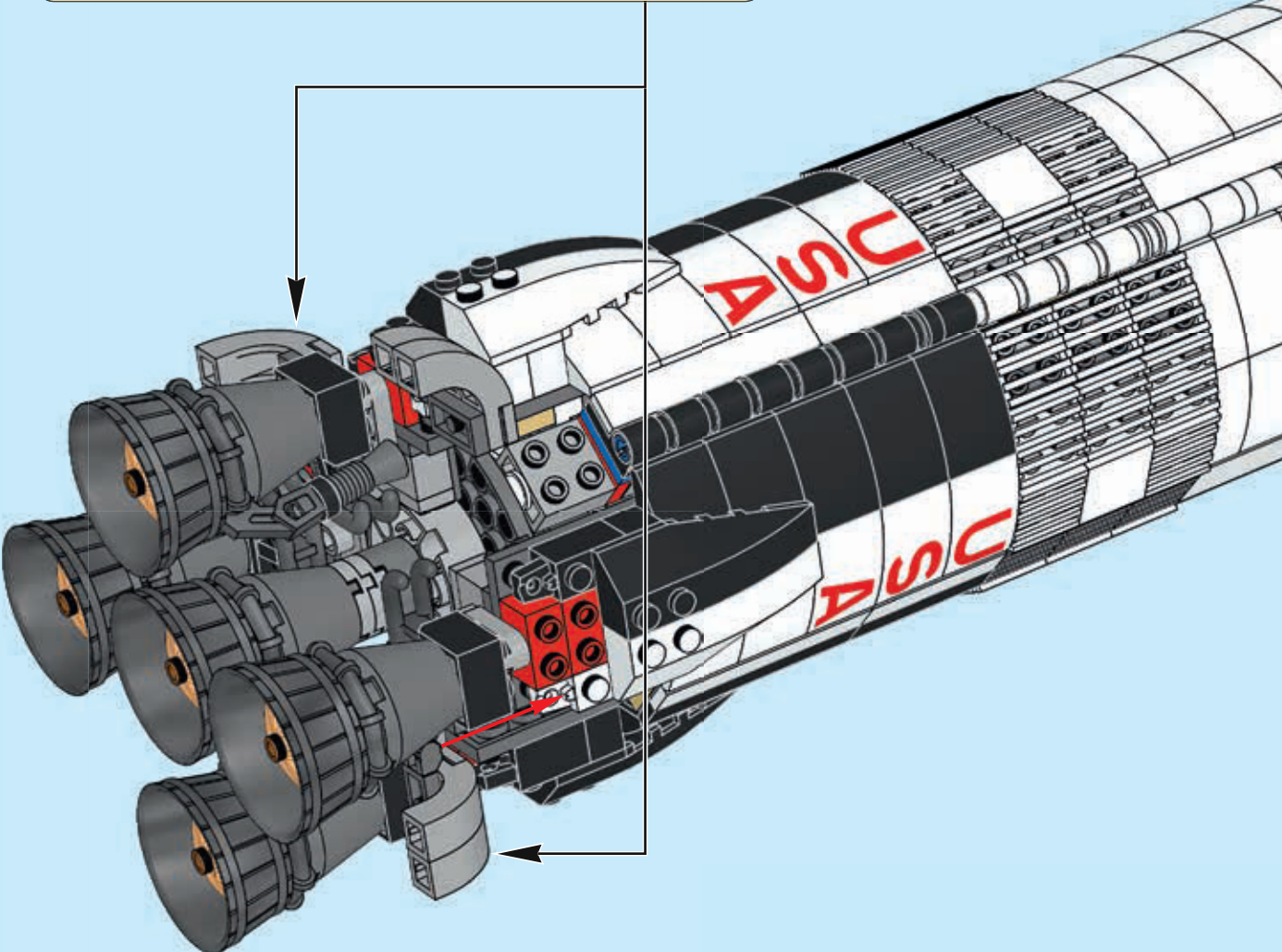
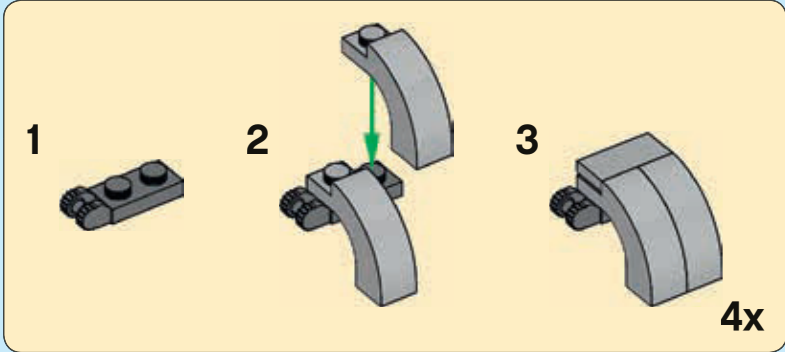

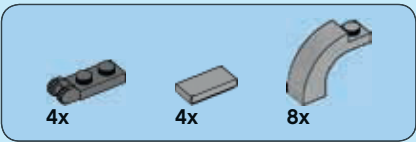

# 127

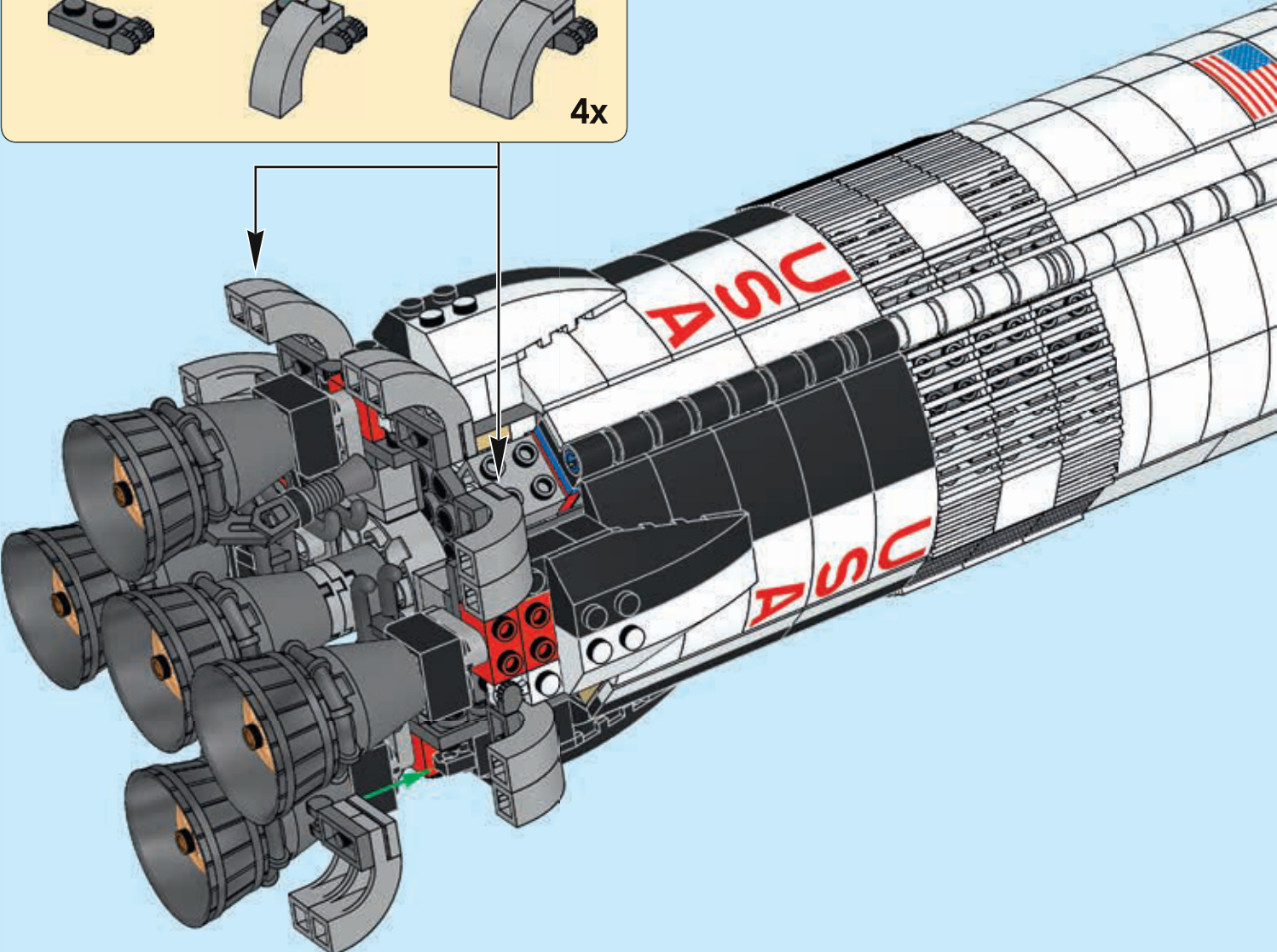
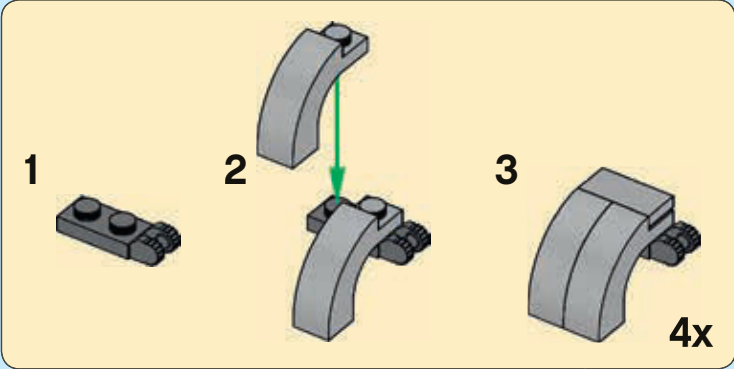

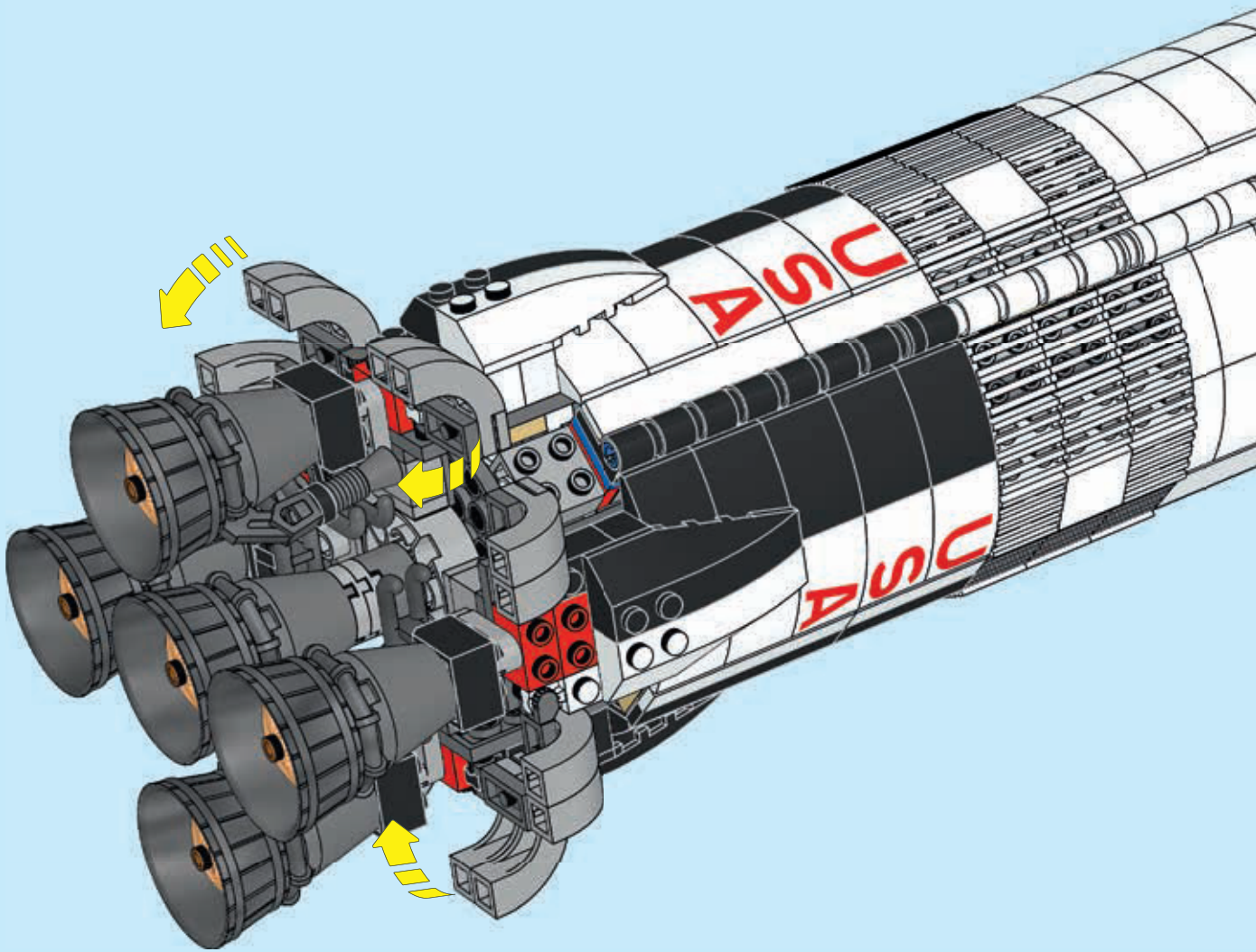



129



130



131



132



4x



133

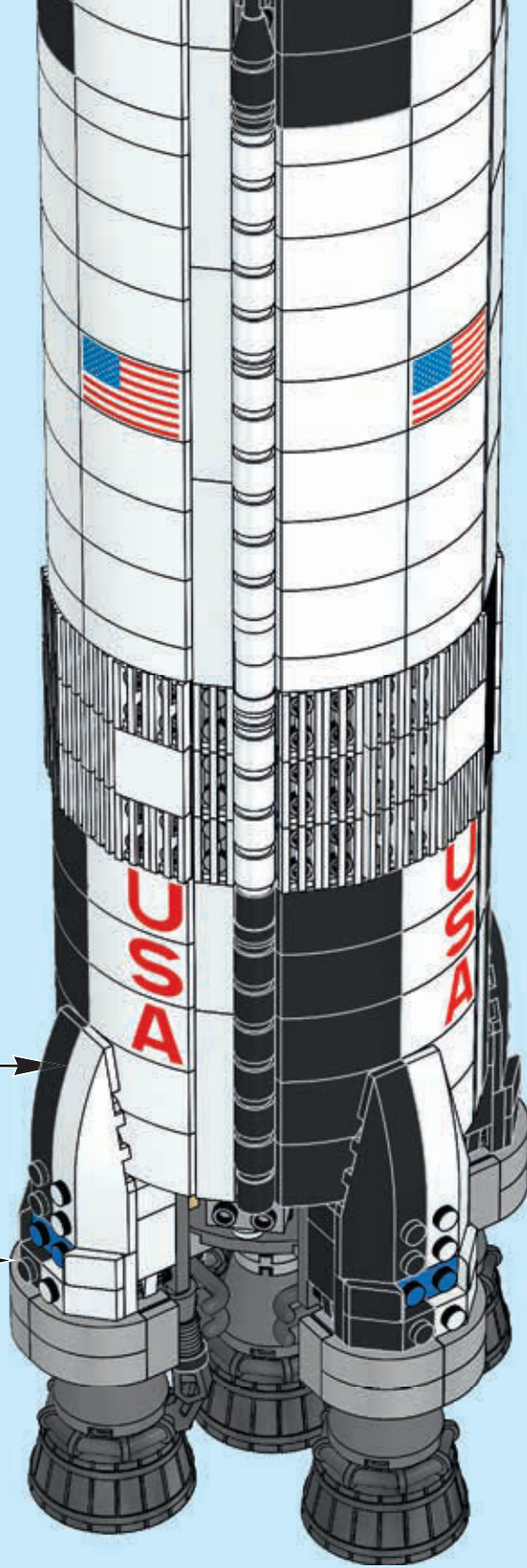

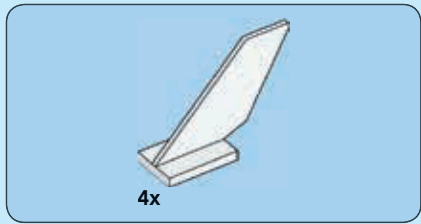

134

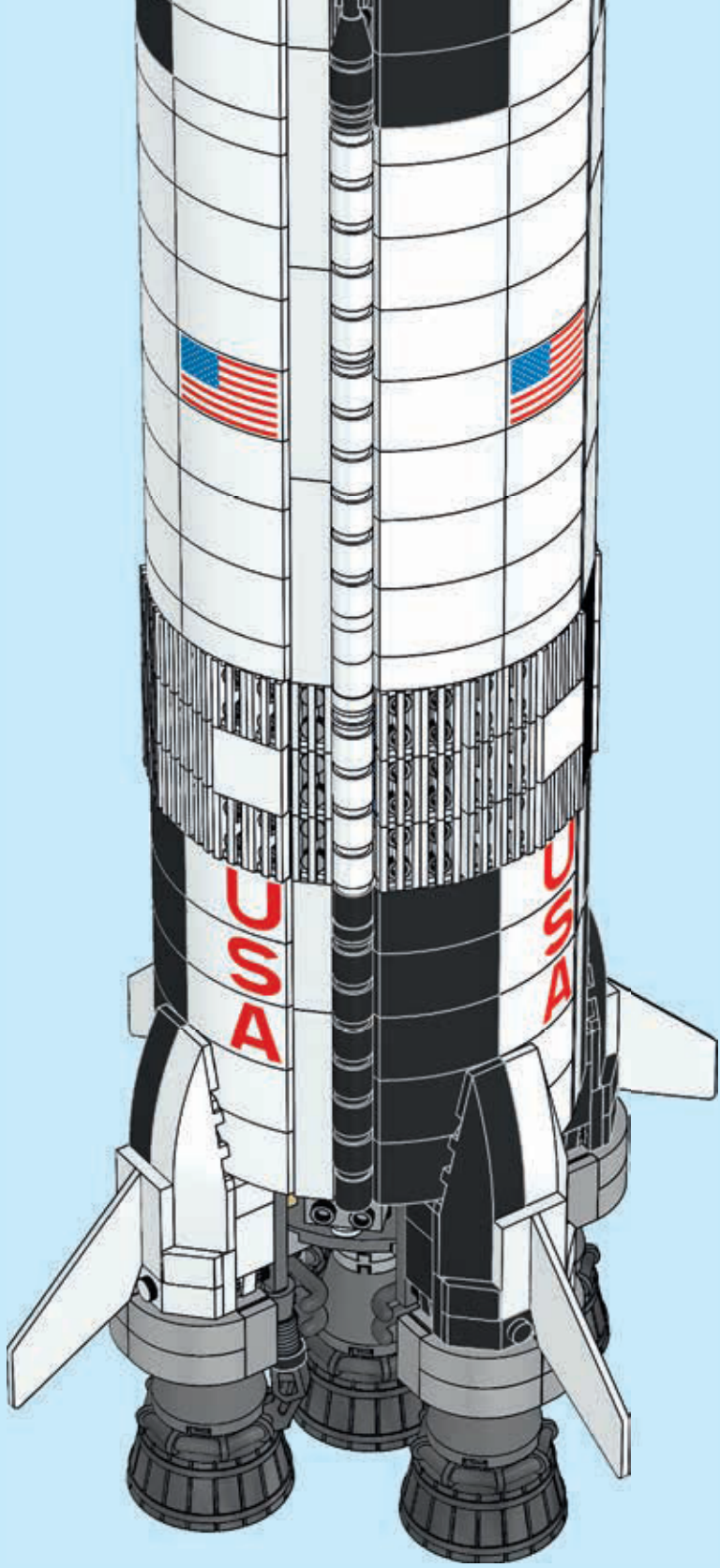

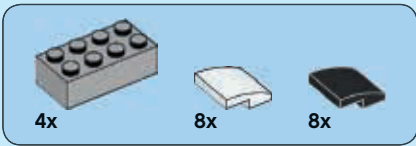

# 135

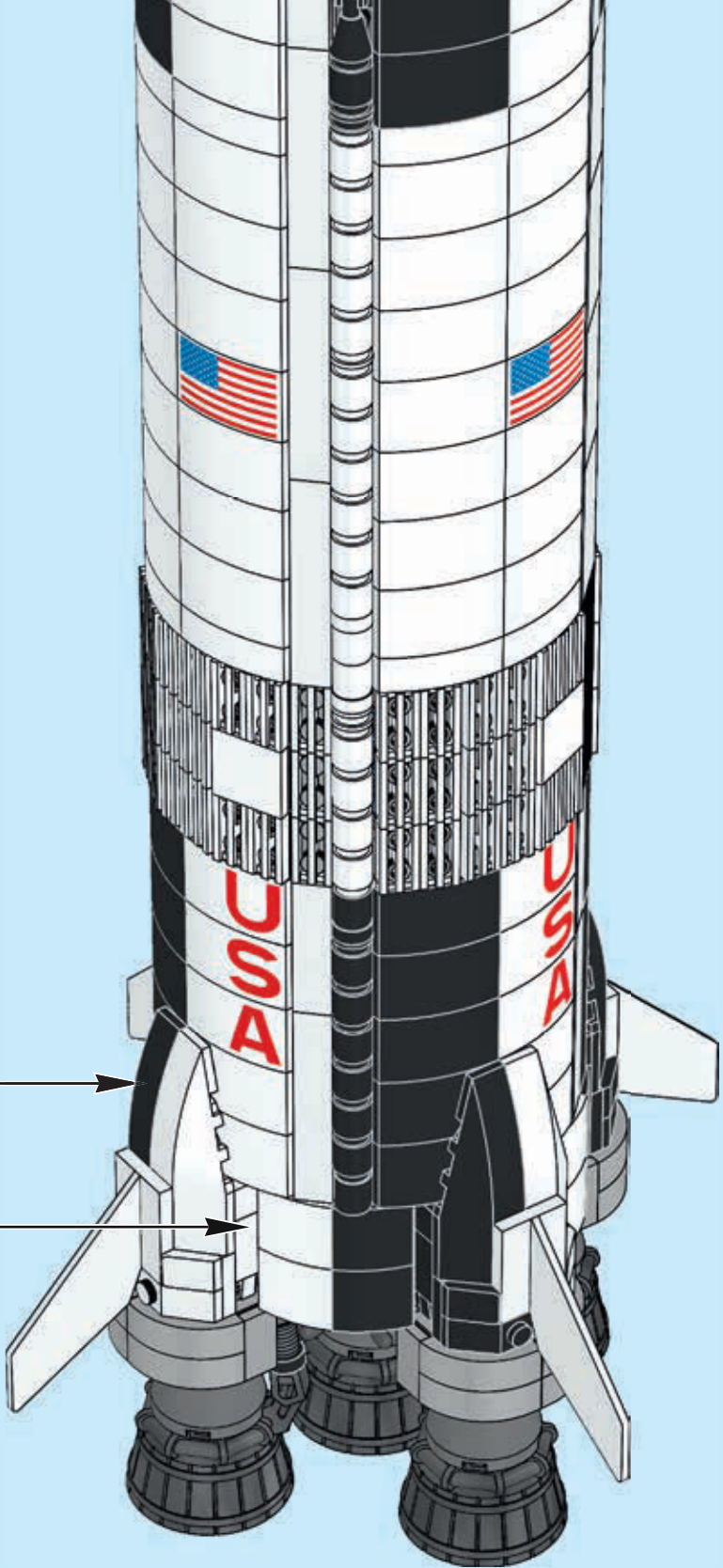
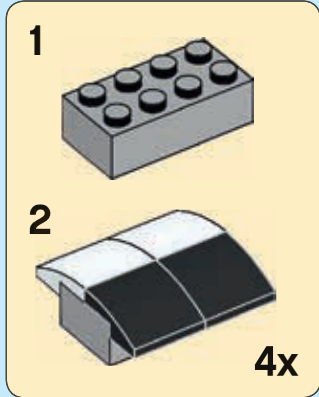

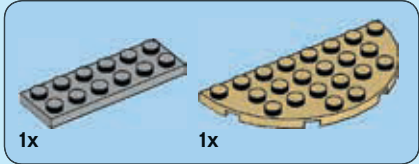
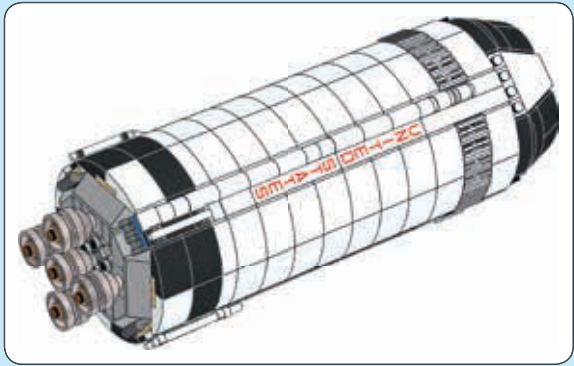
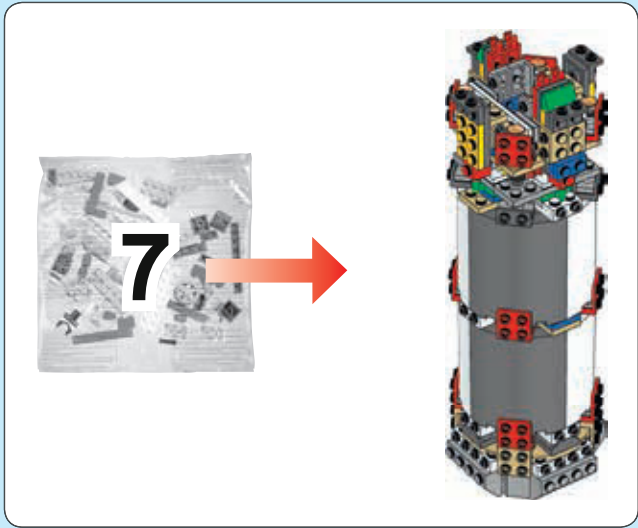

136

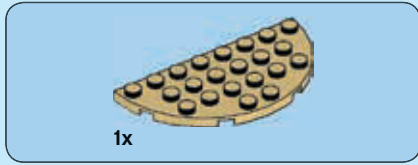
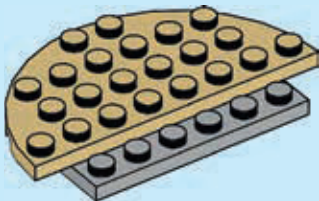

137

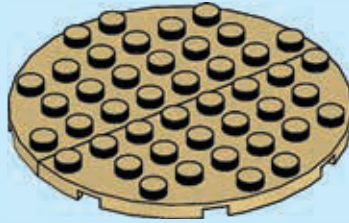

138

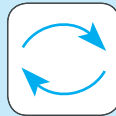



8x

# 139

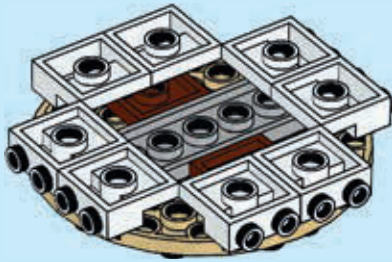

4x



4x

# 140

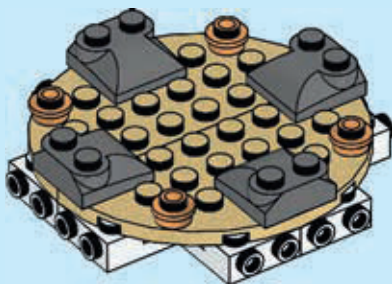
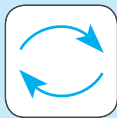

4x

# 141

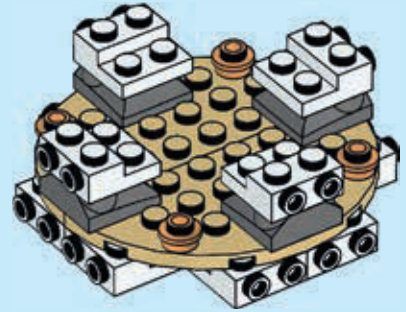

4x



4x



4x

# 142

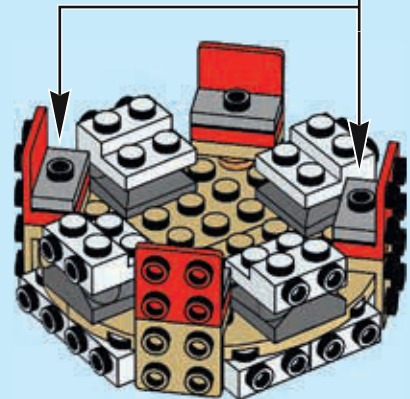
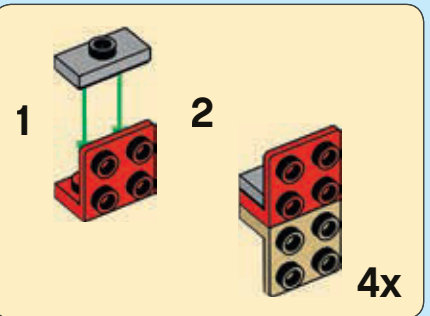



143

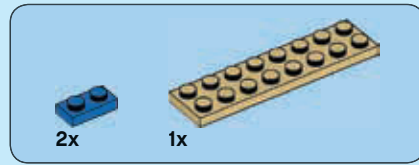
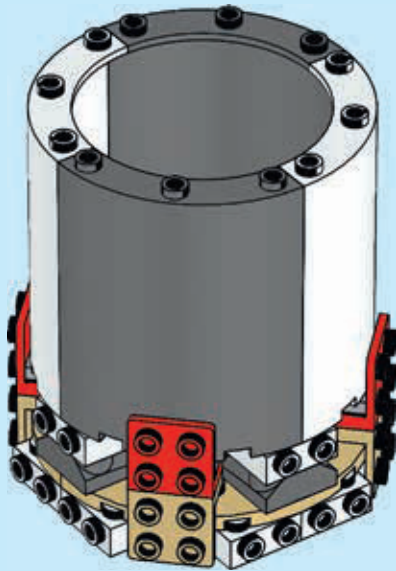

144

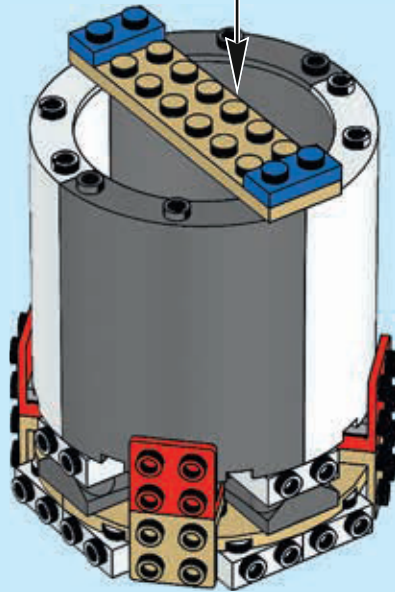
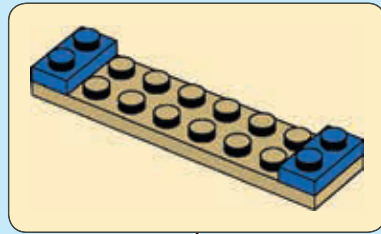



145

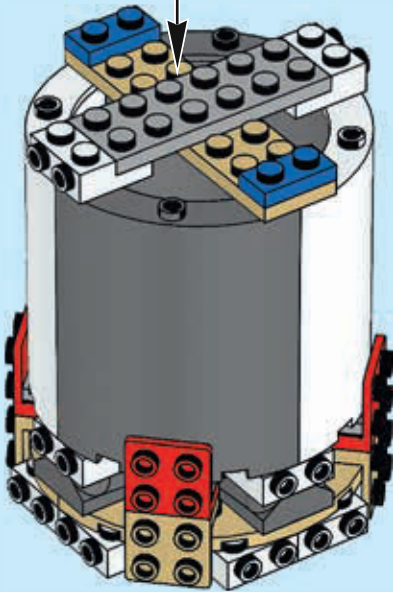
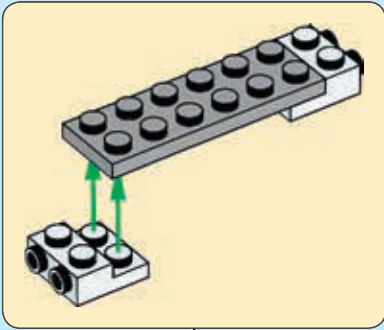

146

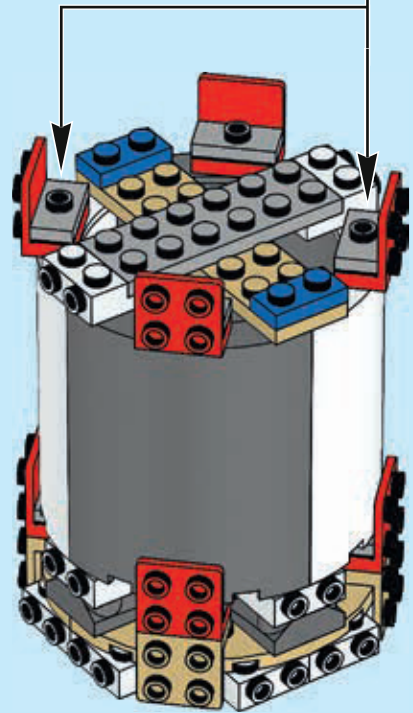
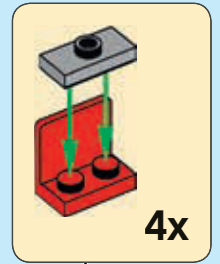



147

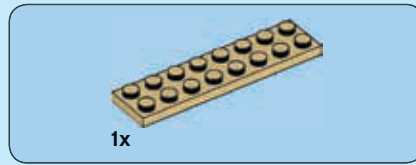
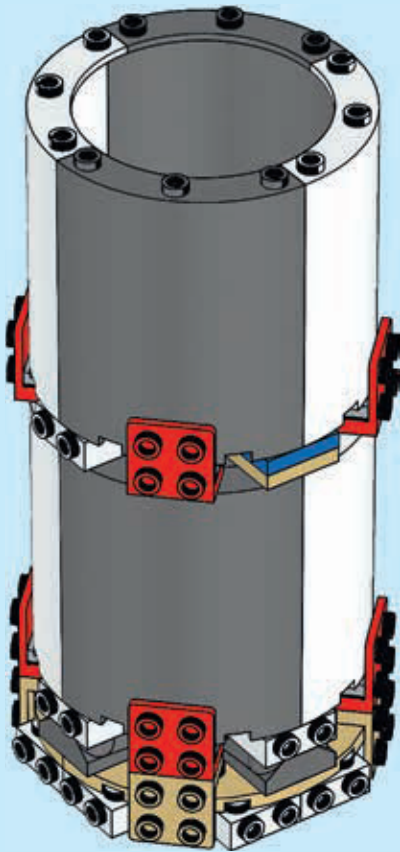

148

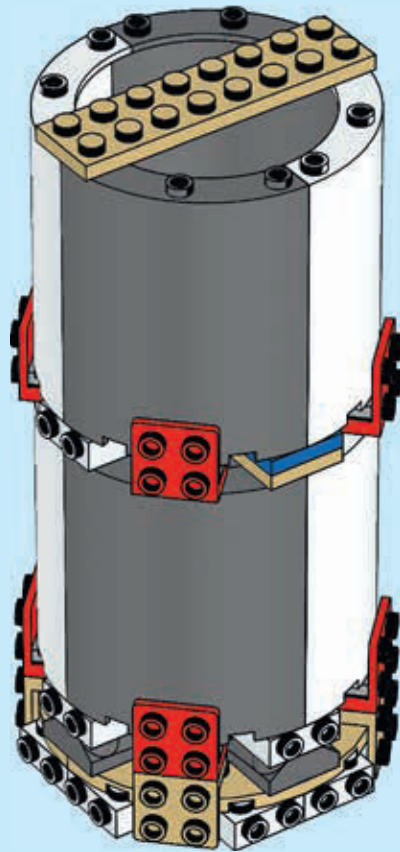



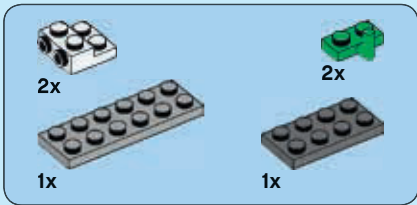

149

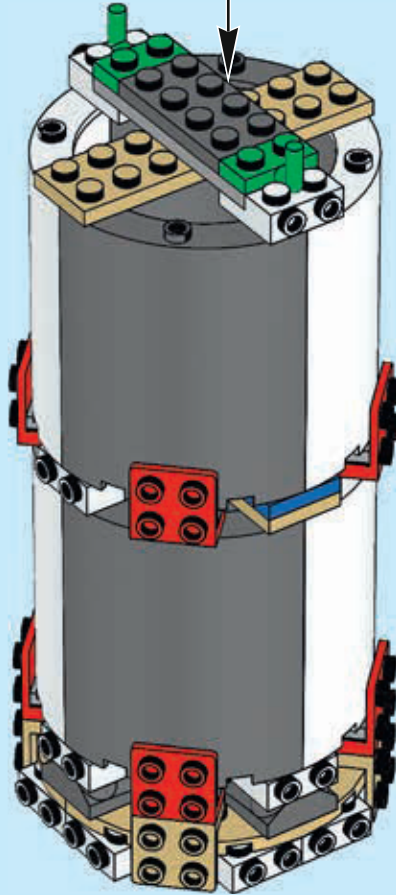
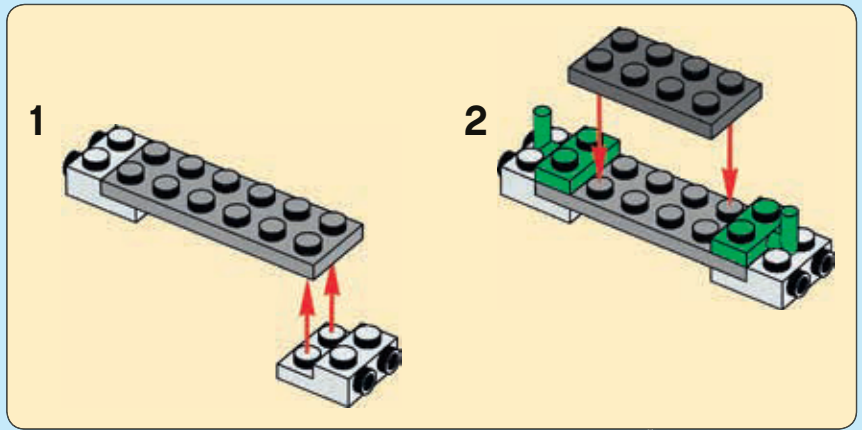

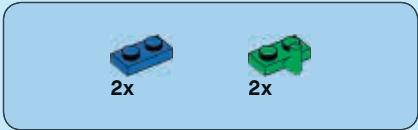

# 150

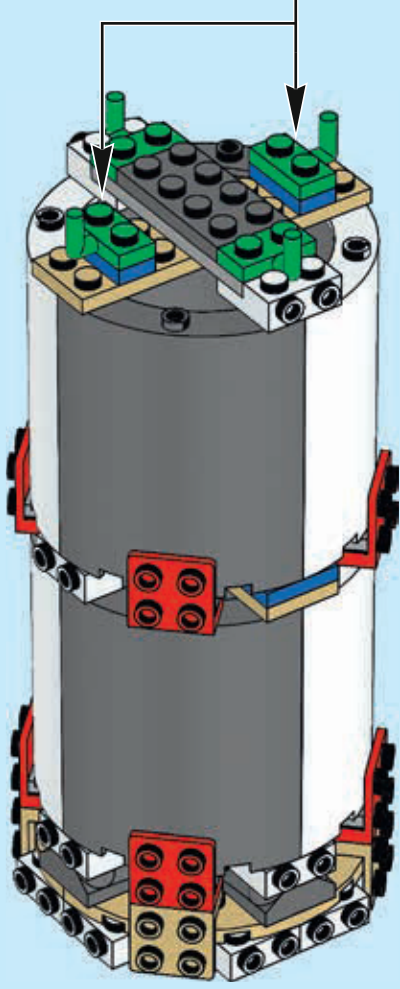
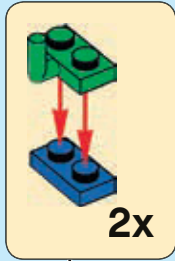

# 151

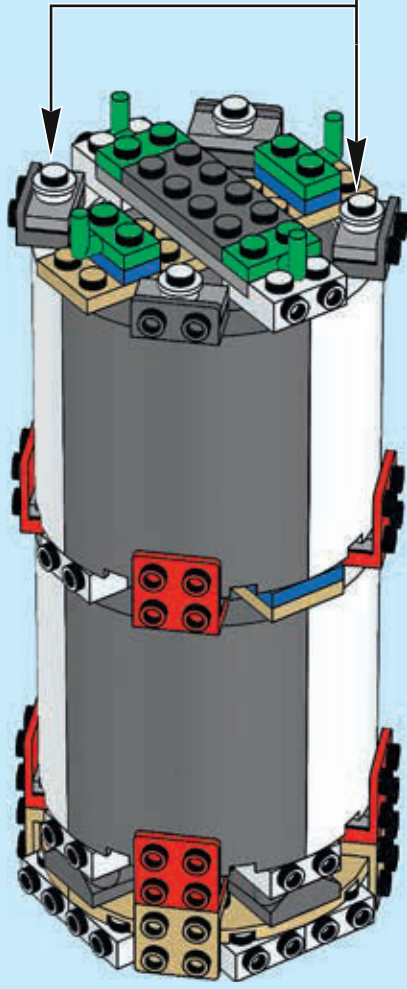
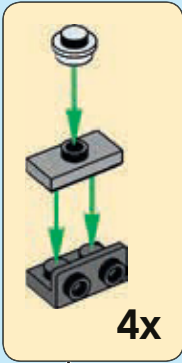



152

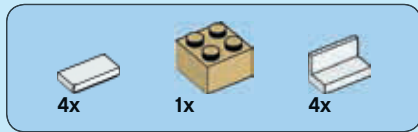
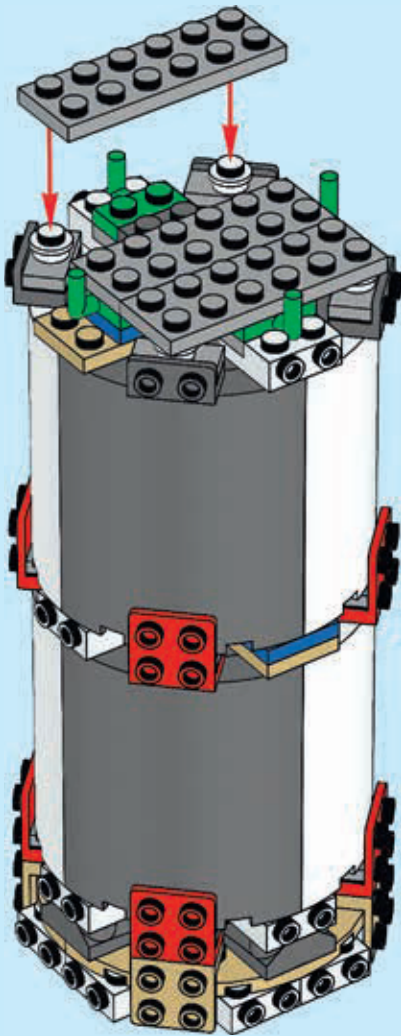

153

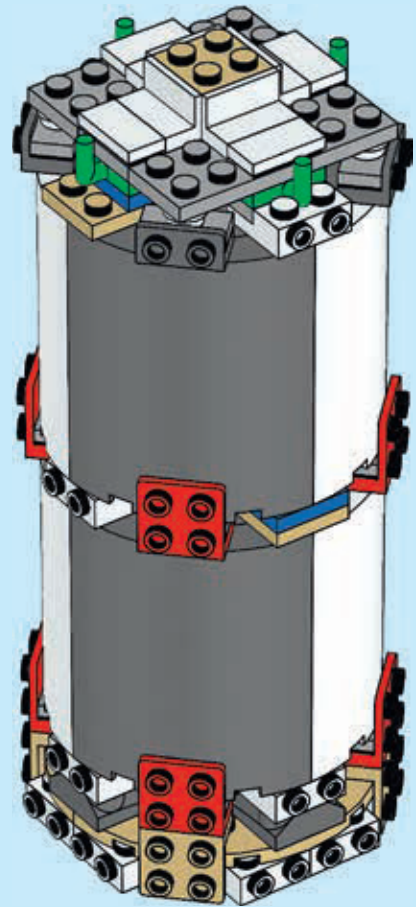



1x

154

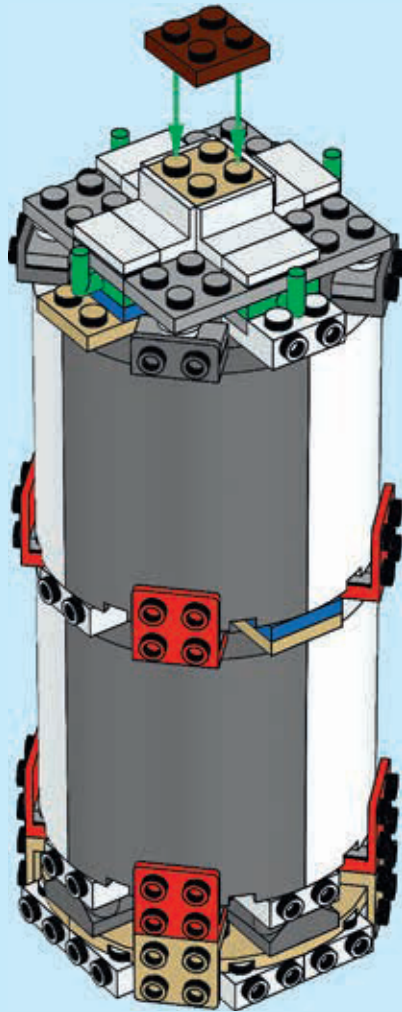



4x



8x



4x



4x



4x

# 155

1



2



3



4



4x

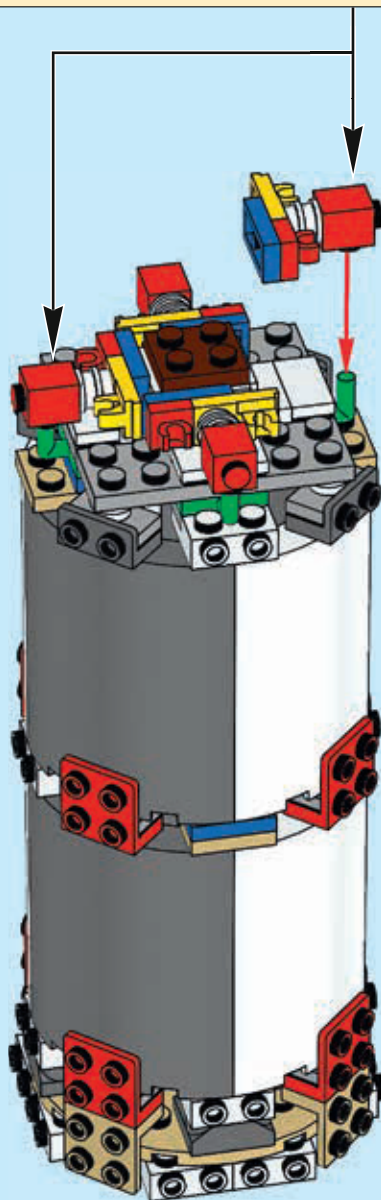



4x



4x

# 156

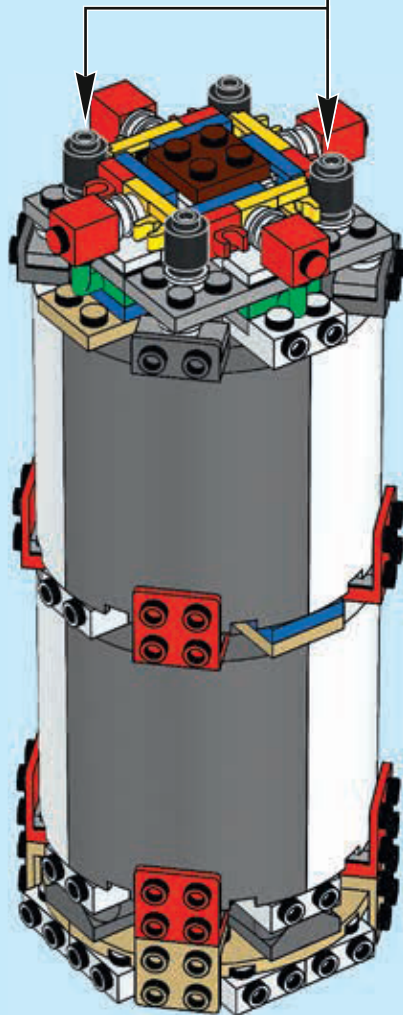

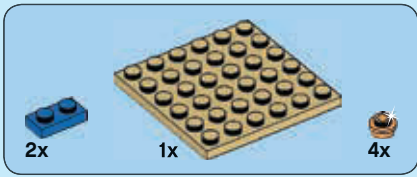

# 157

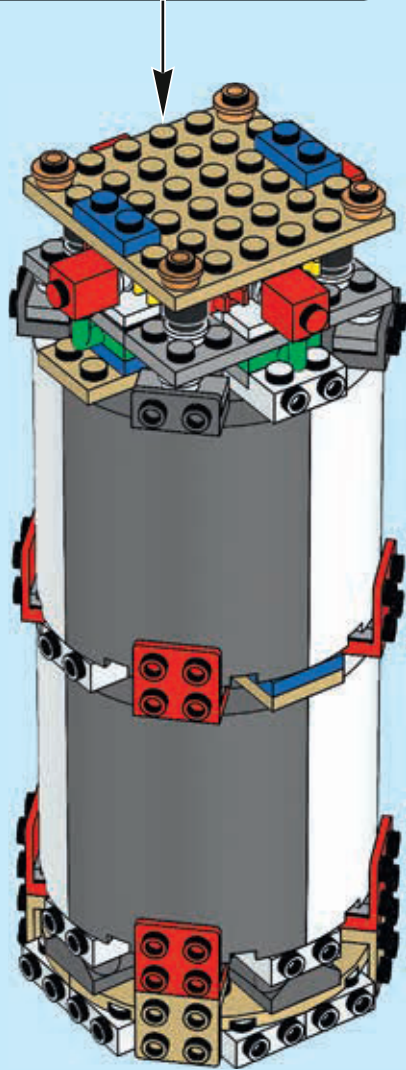
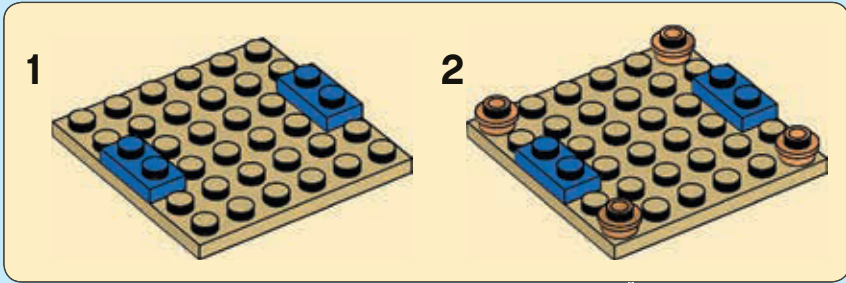



2x



1x

158



2x

159



1x

160

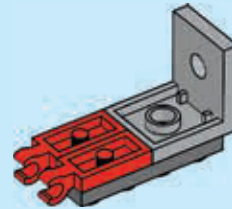

1x



2x

161

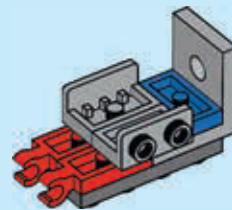





162

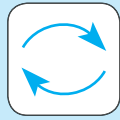

163

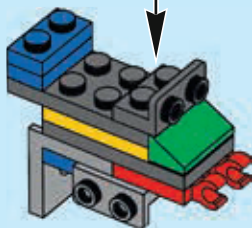
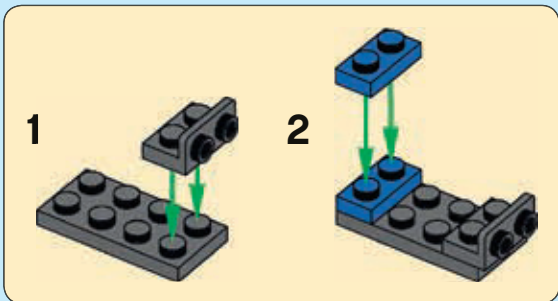

164

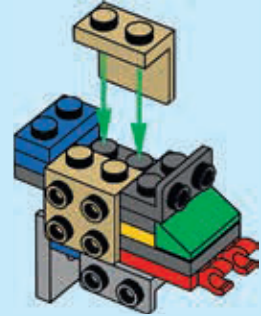

165

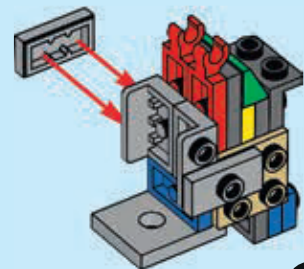
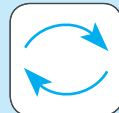

2x

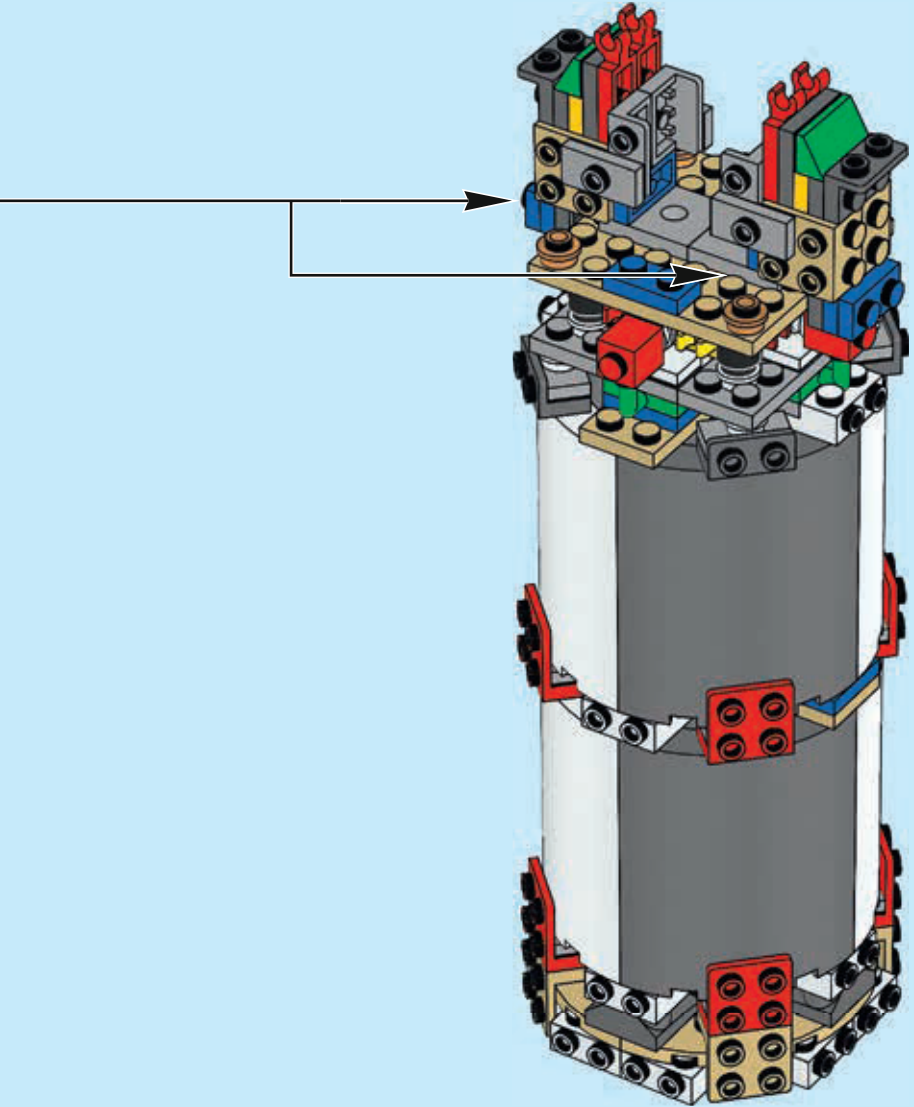

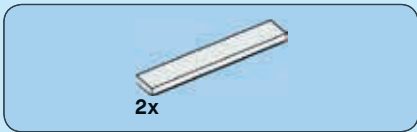

167

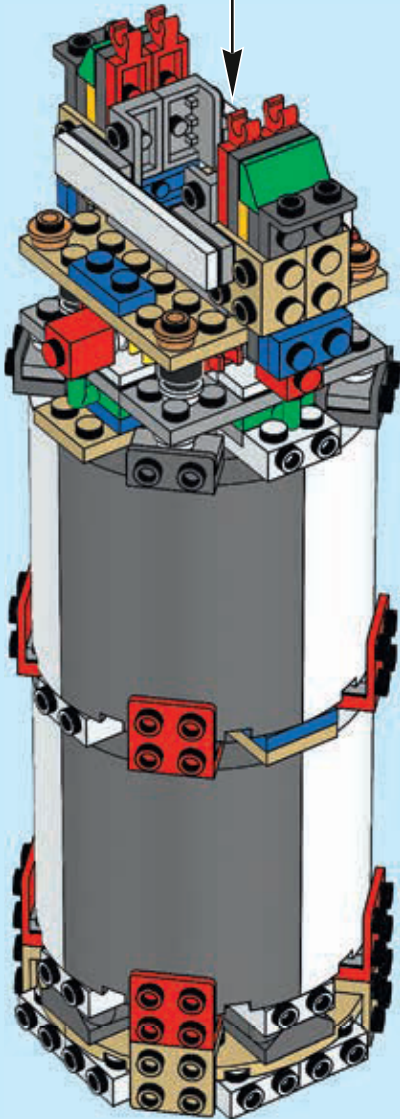
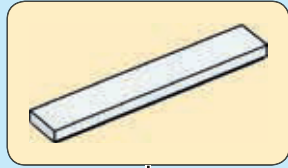

168

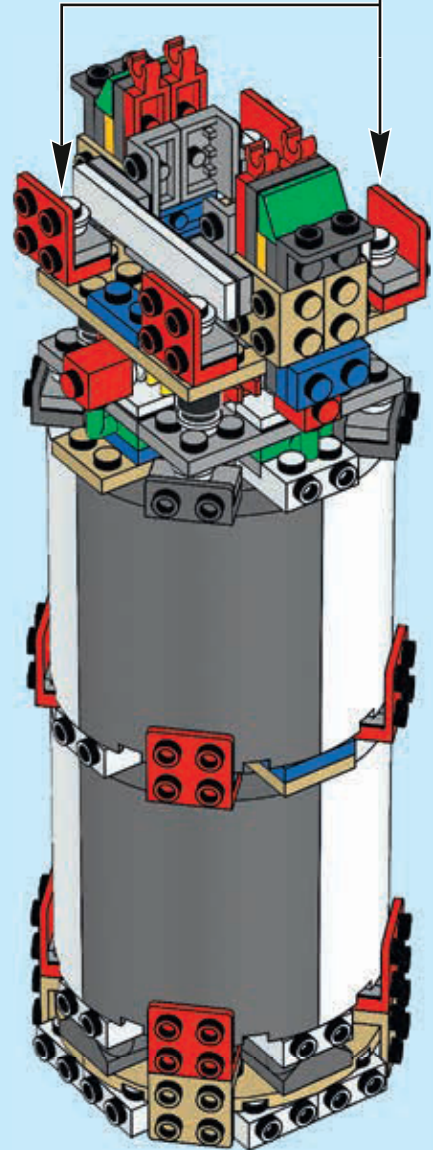
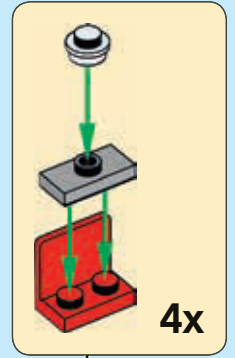



# 169

1



2



3

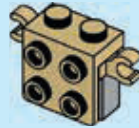

4

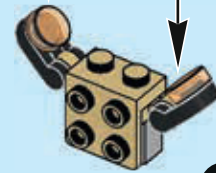

2x

# 170

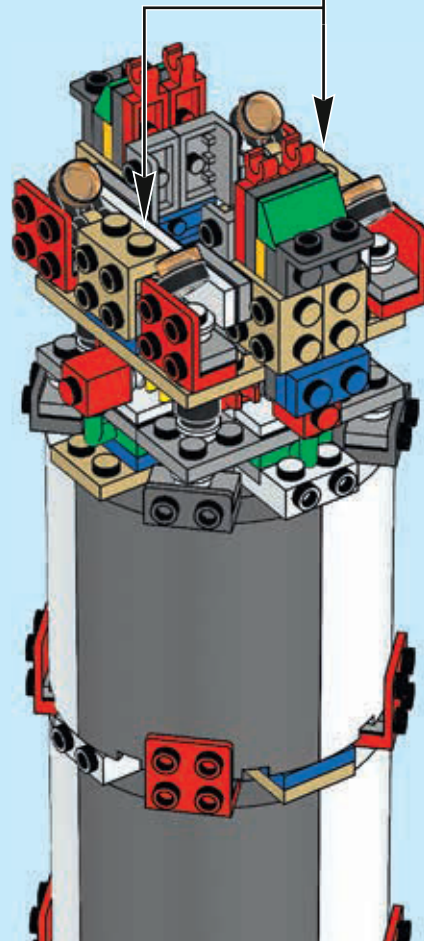

171

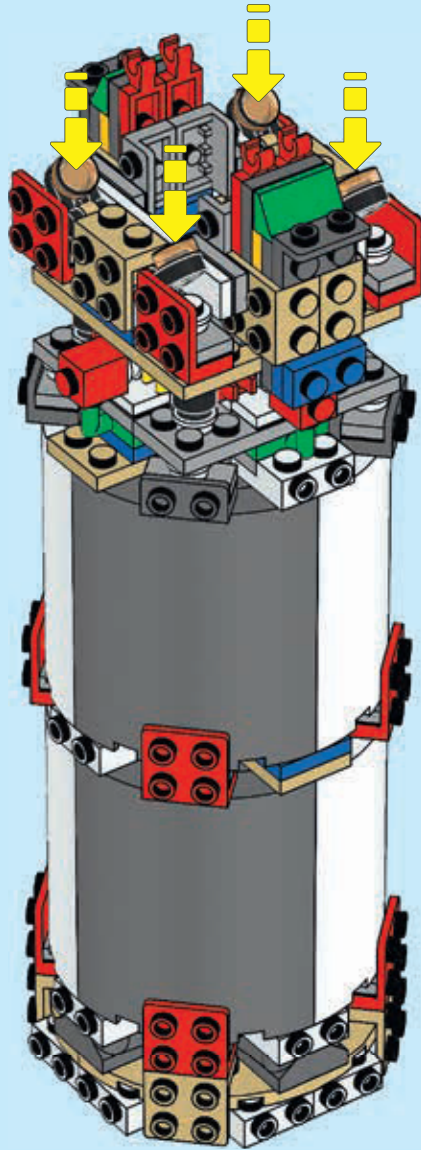



172

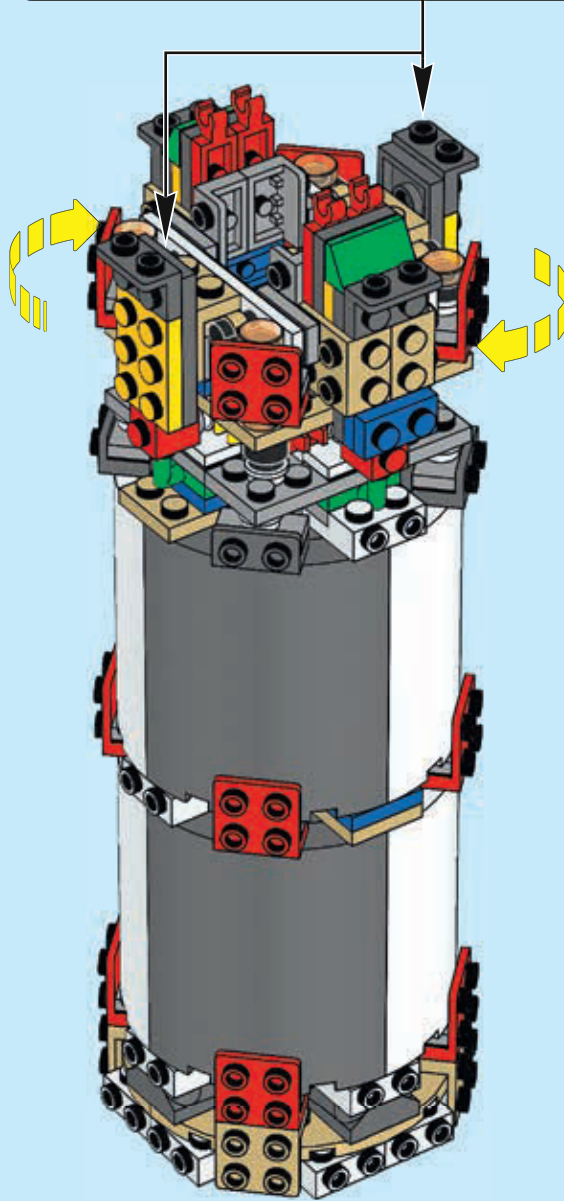



173

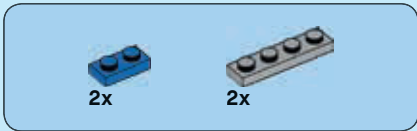

174



175



176

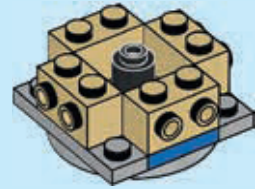

177

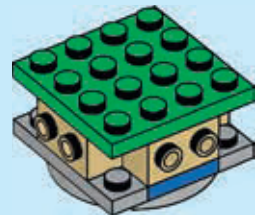

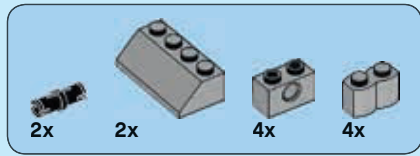

# 178

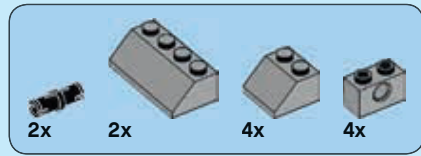
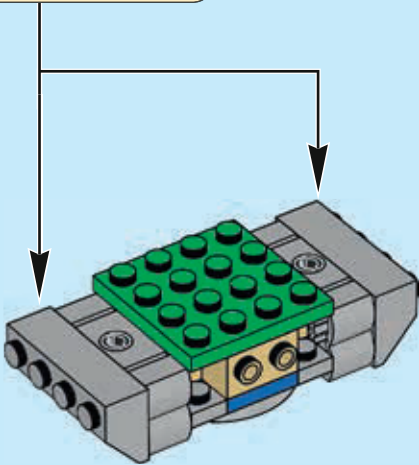
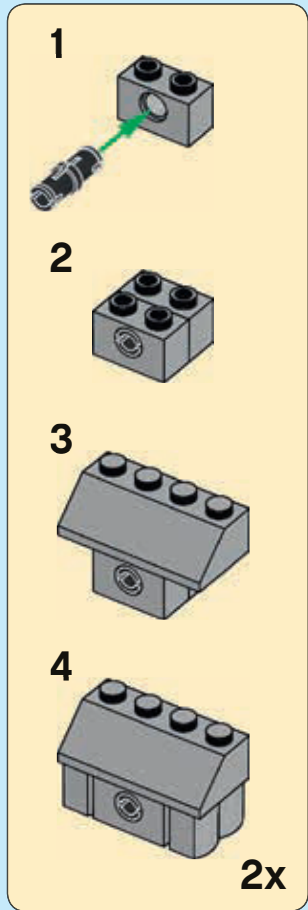

# 179

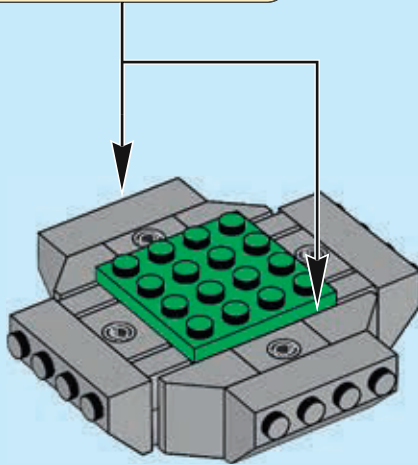
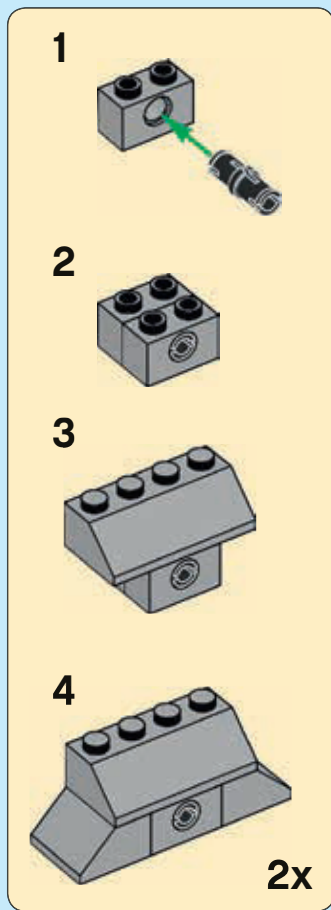



180

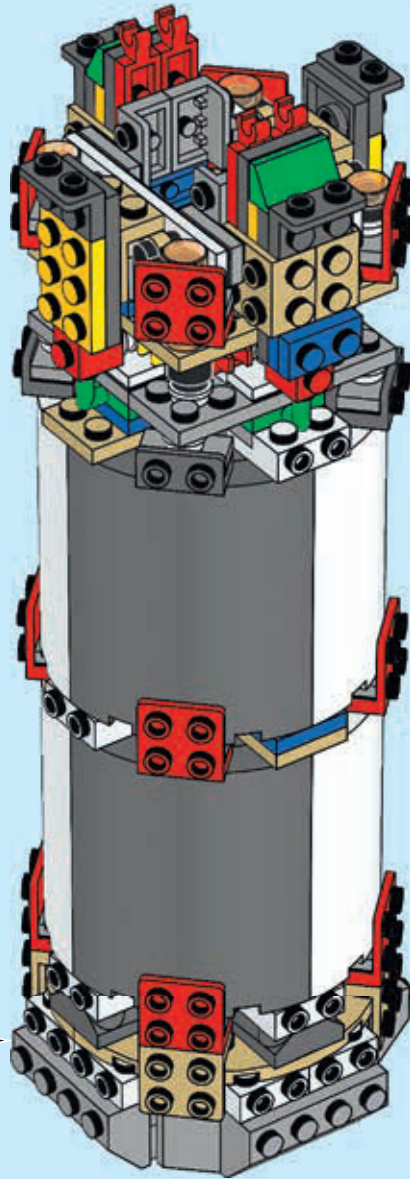

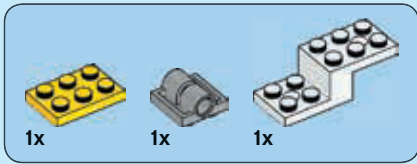
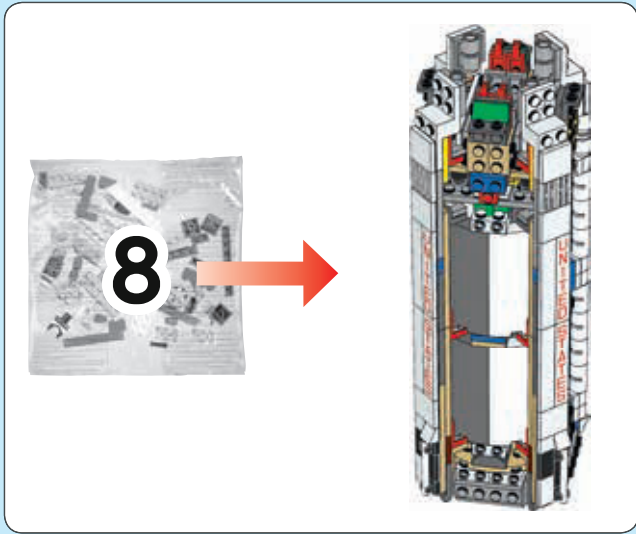

# 181

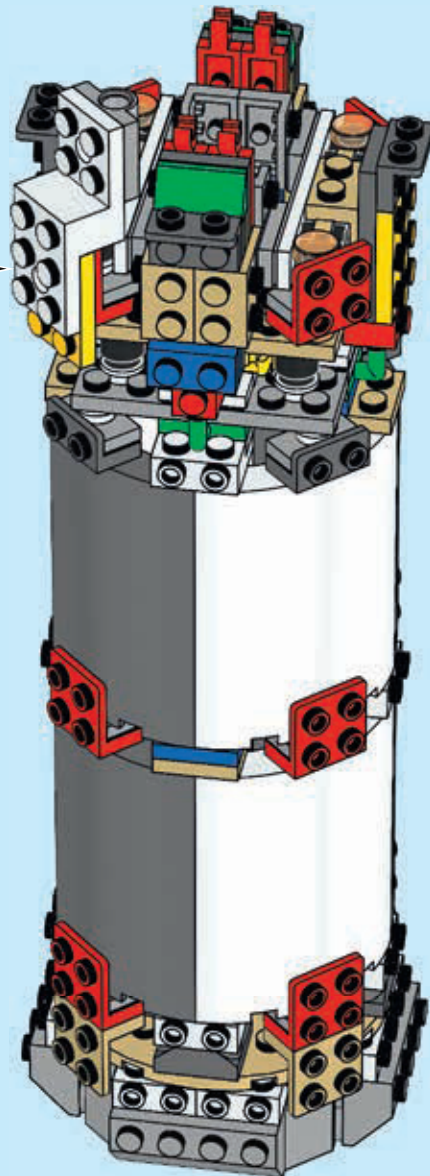
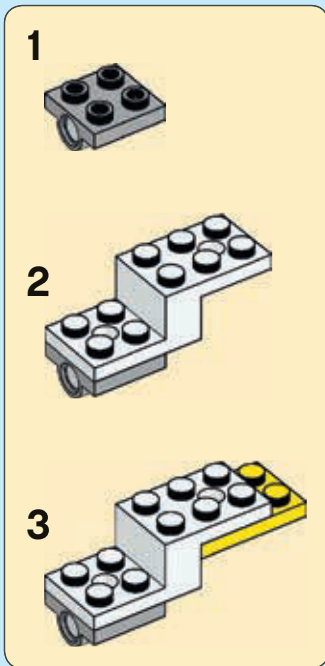

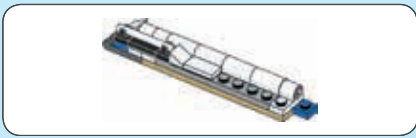

182



183

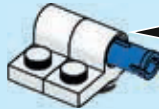
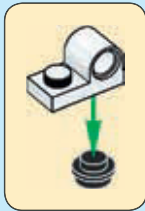

184

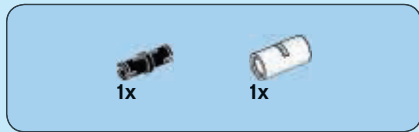
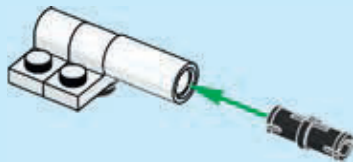

185

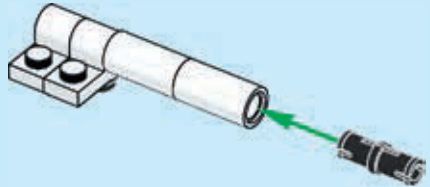

186

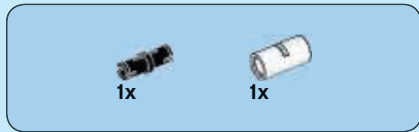
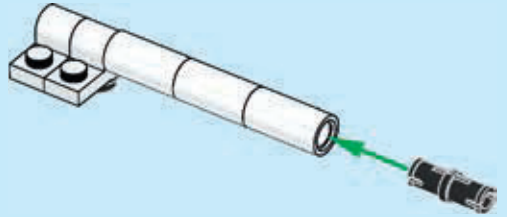

187

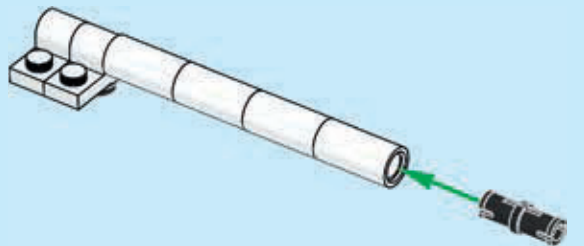



188

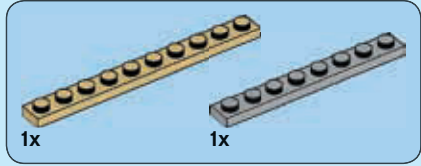
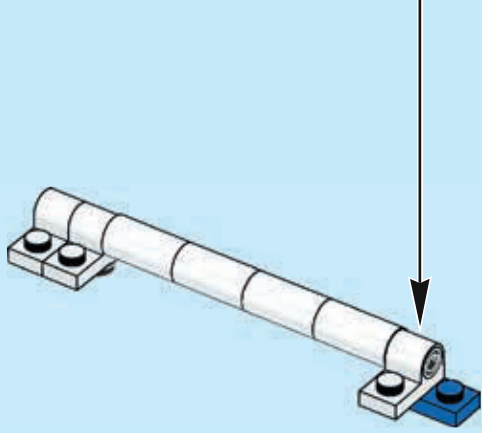

189

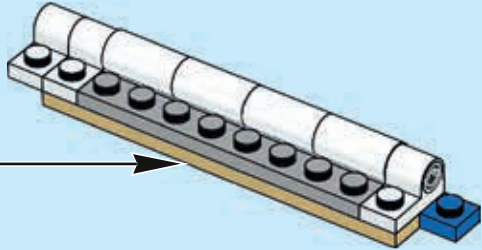
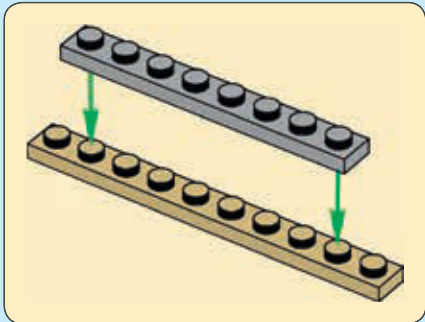



# 190

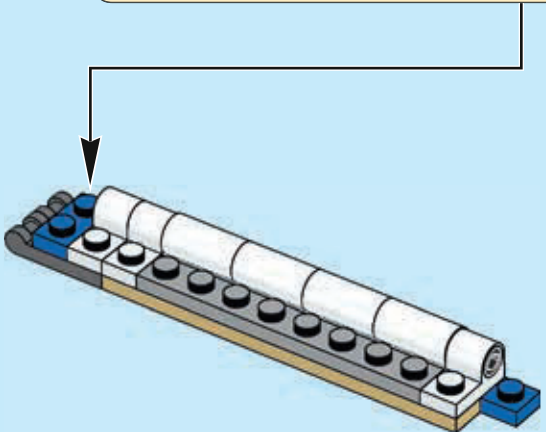
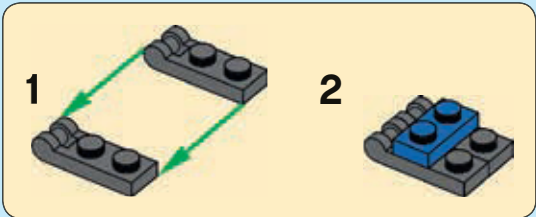

# 191

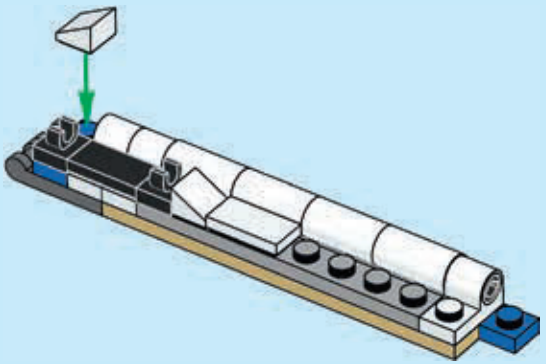



192

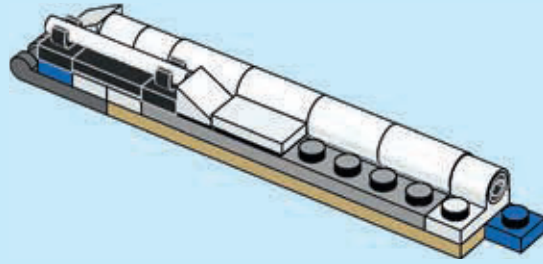

193

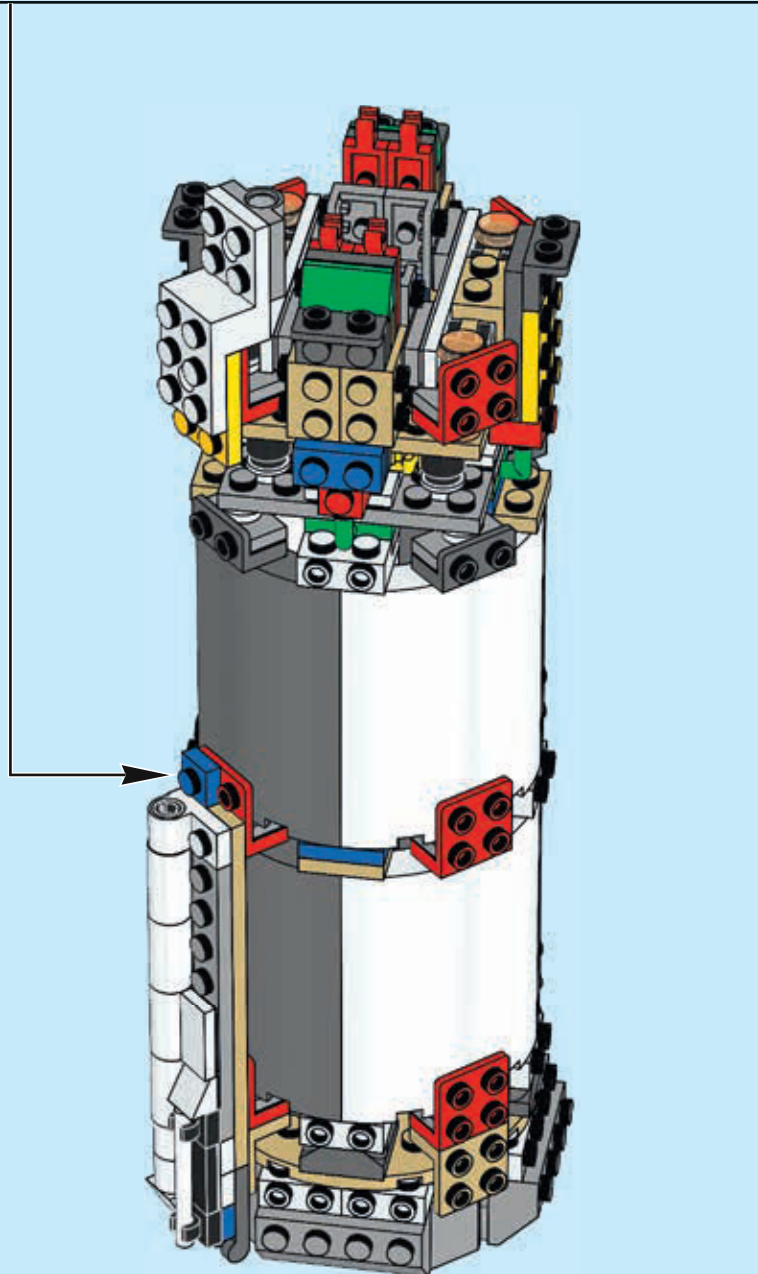



194

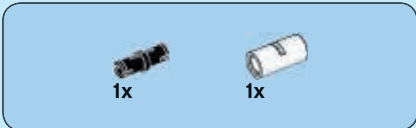

195

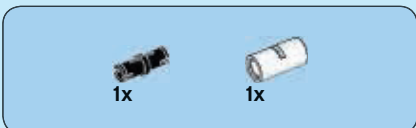
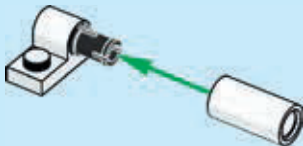

196

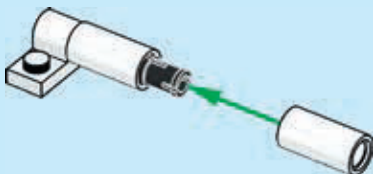

197

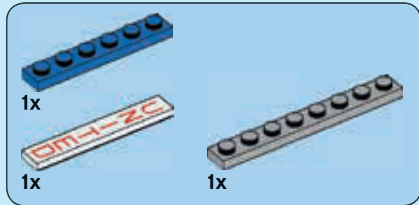

198

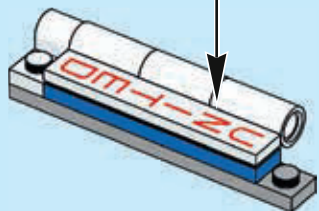
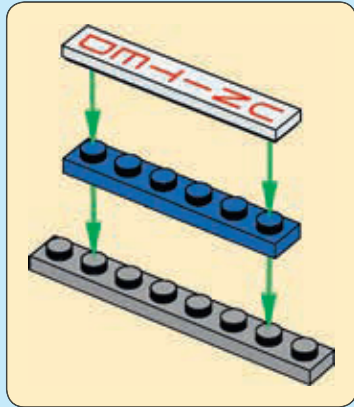

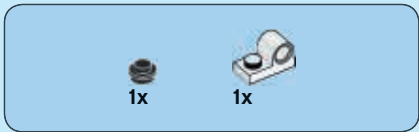

199

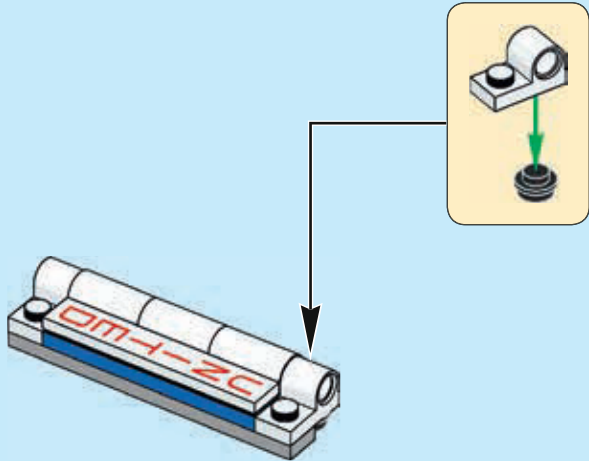

200

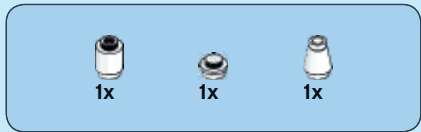
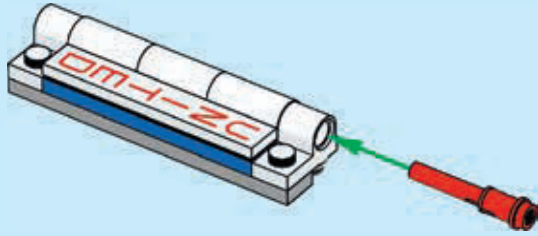

201

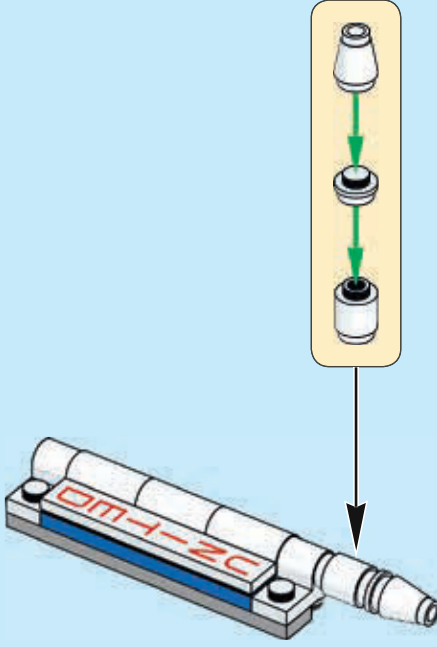



202

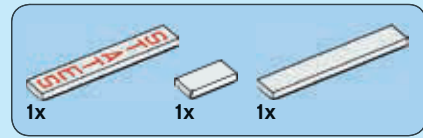
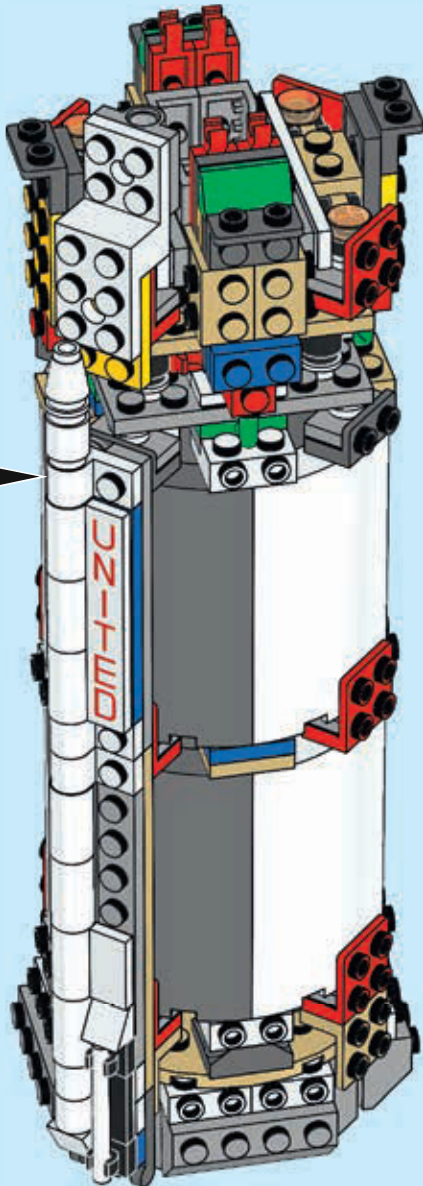

203

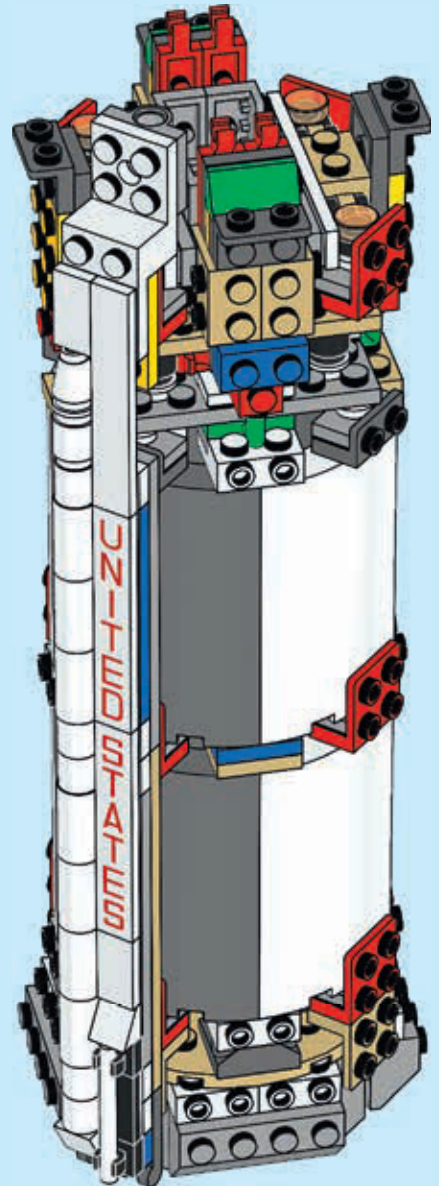

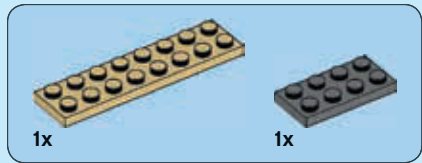

204

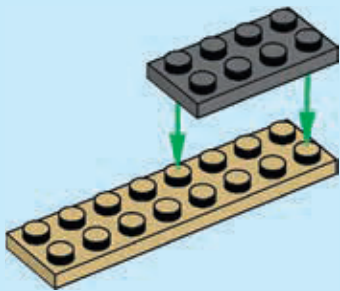

205

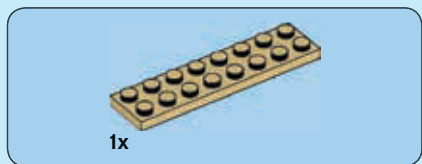
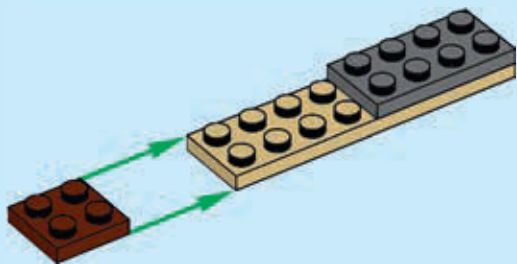

206

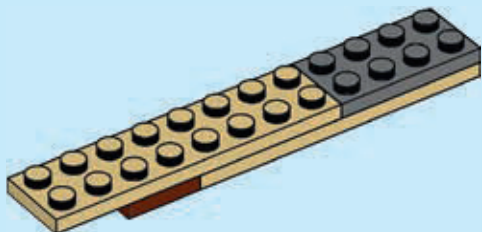

207

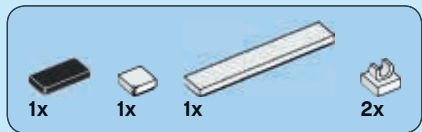
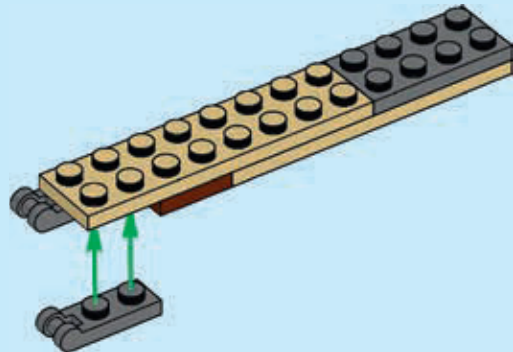

208

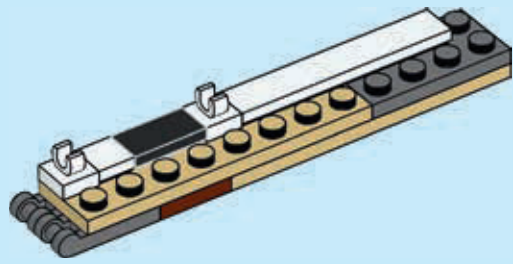

209

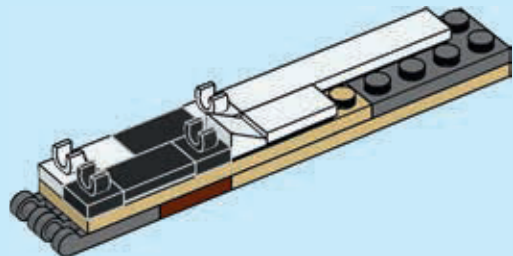

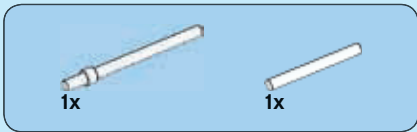

210

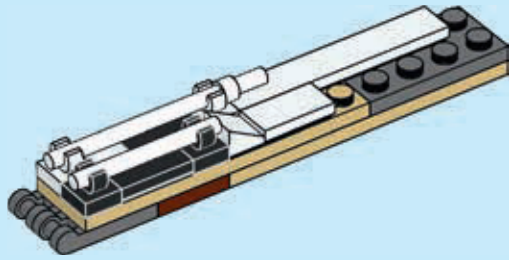

211

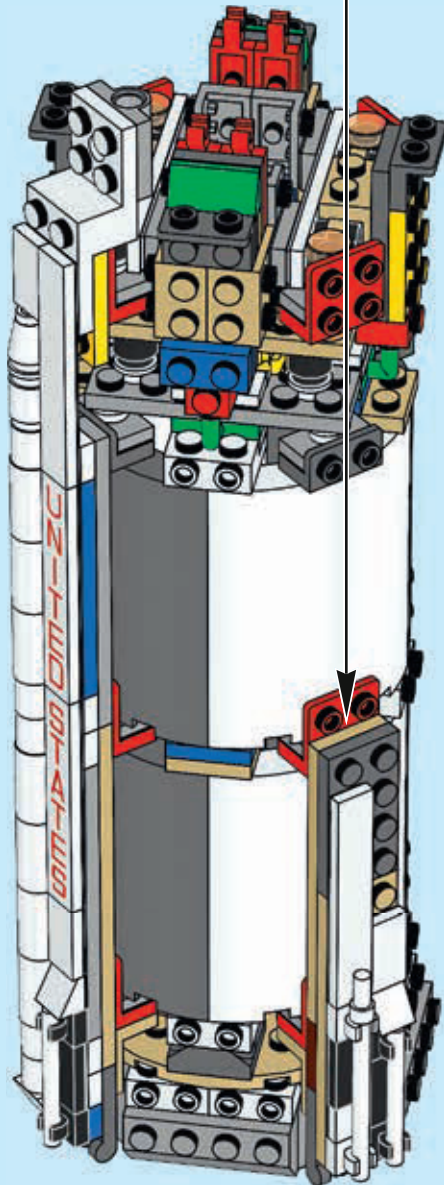

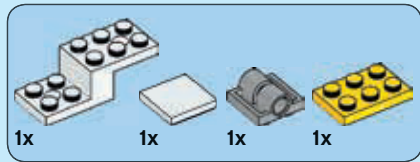

# 212

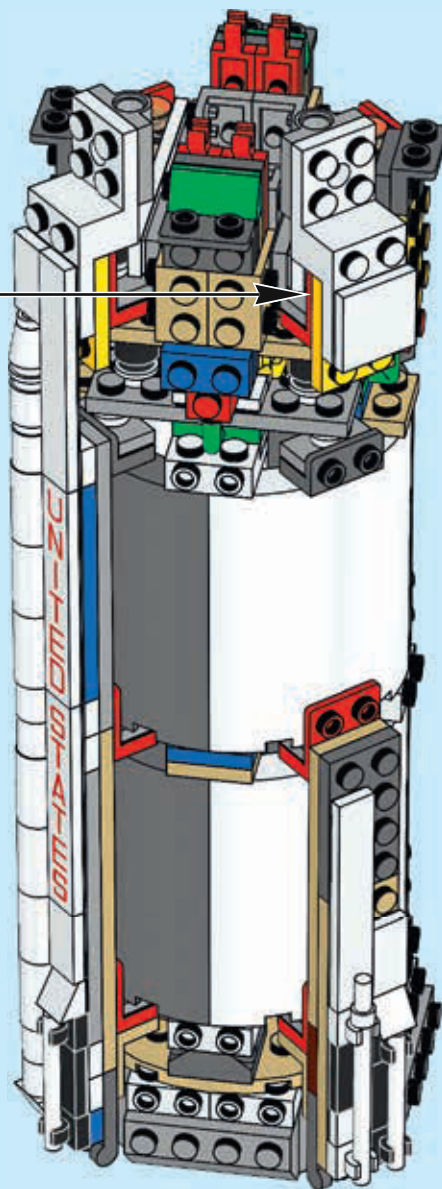
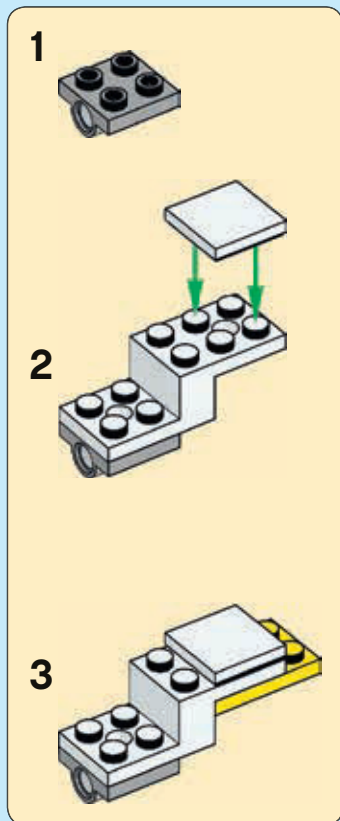

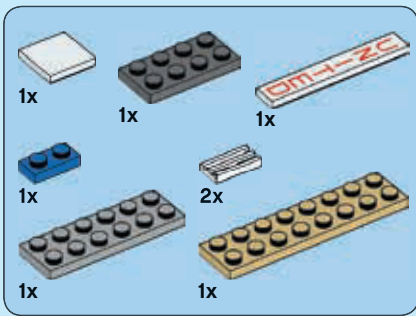

# 213

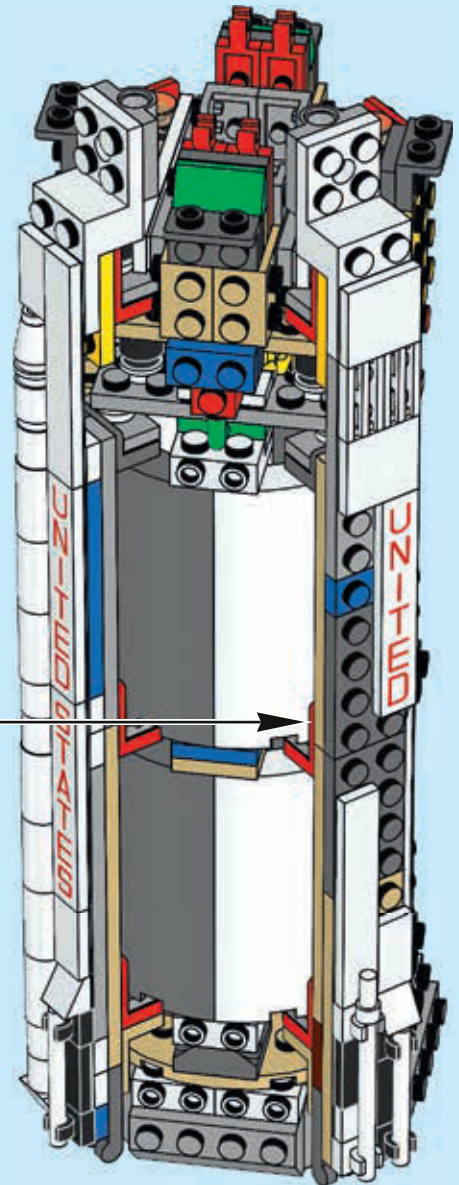
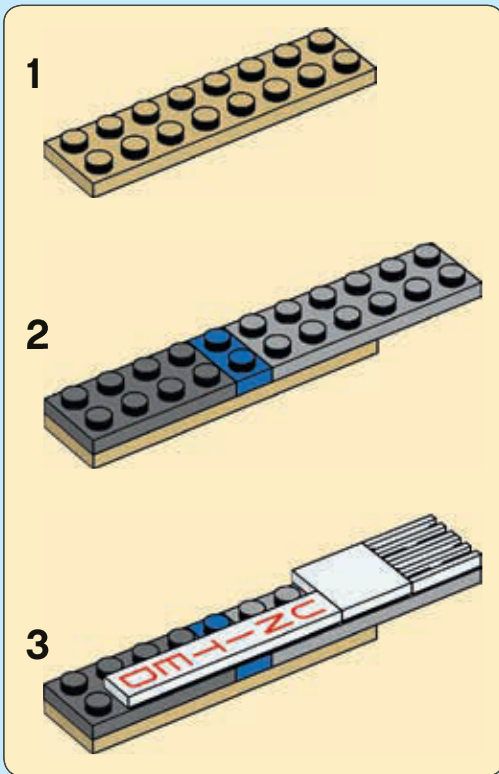

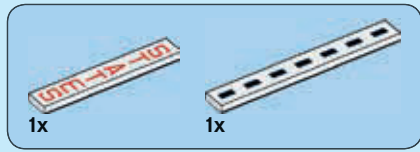

214

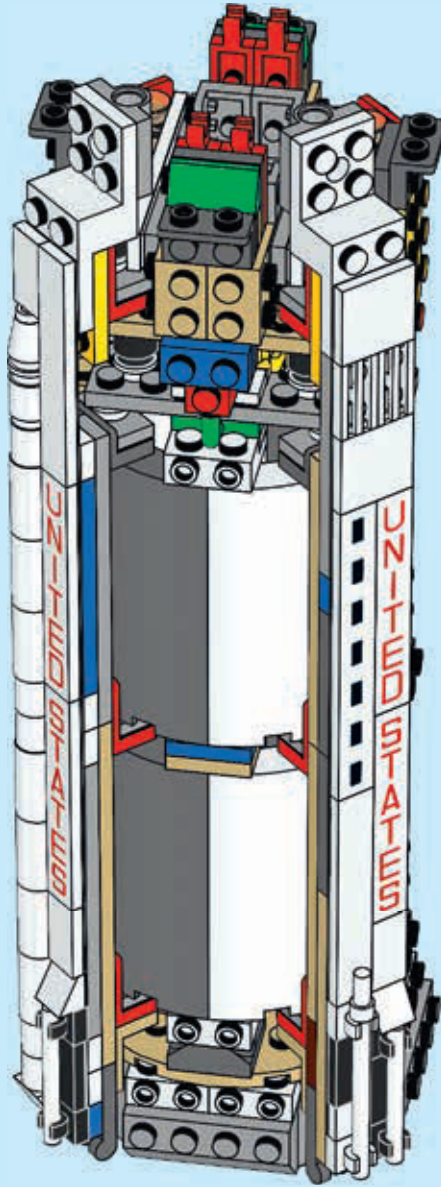

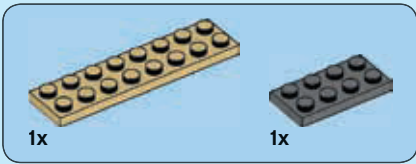

215

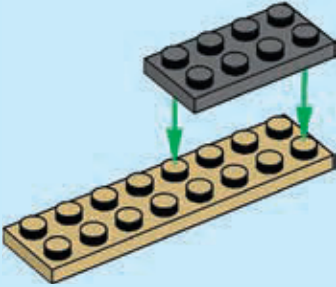

216

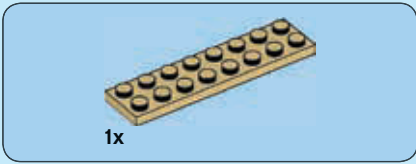
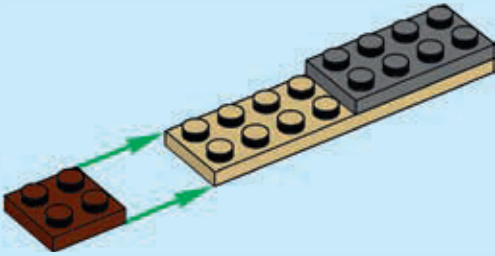

217

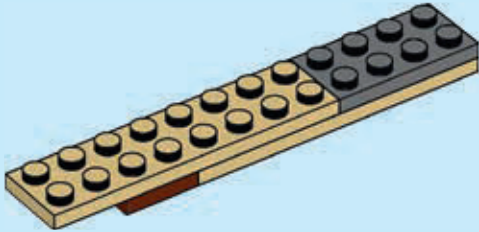

218

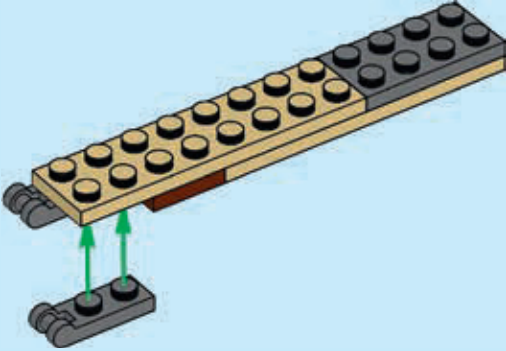

219

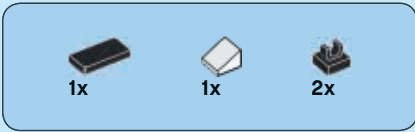
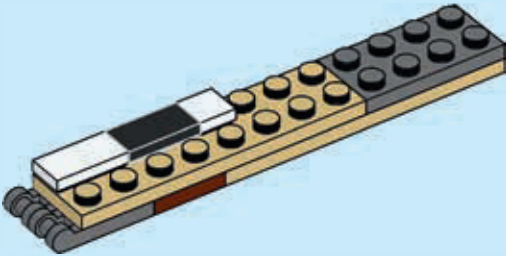

220

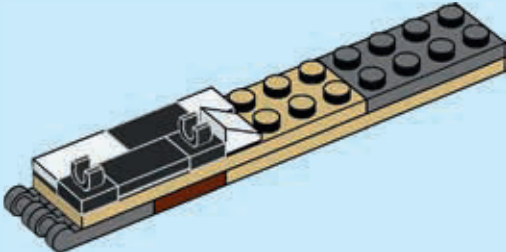

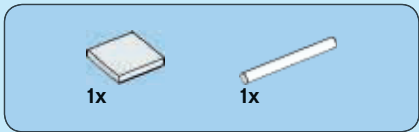

221

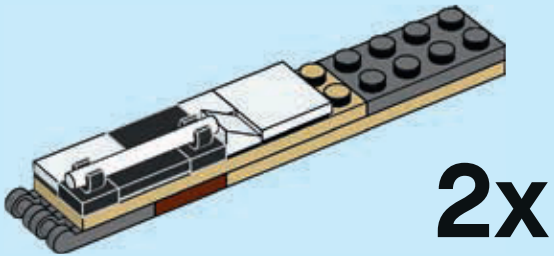

222

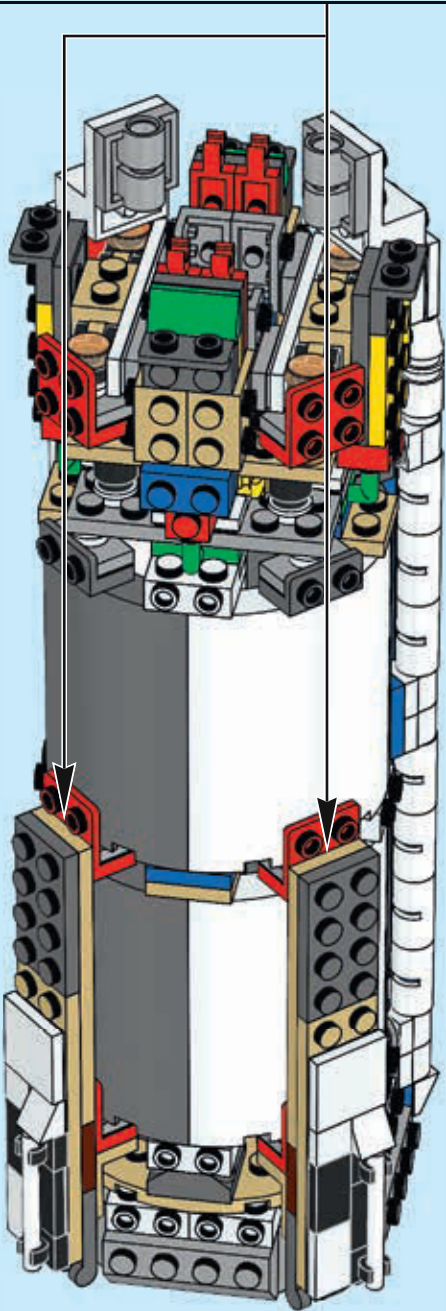



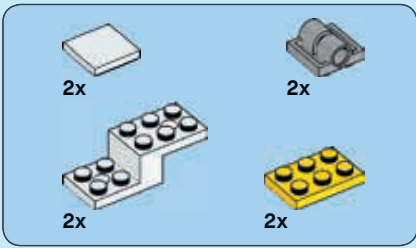

# 223

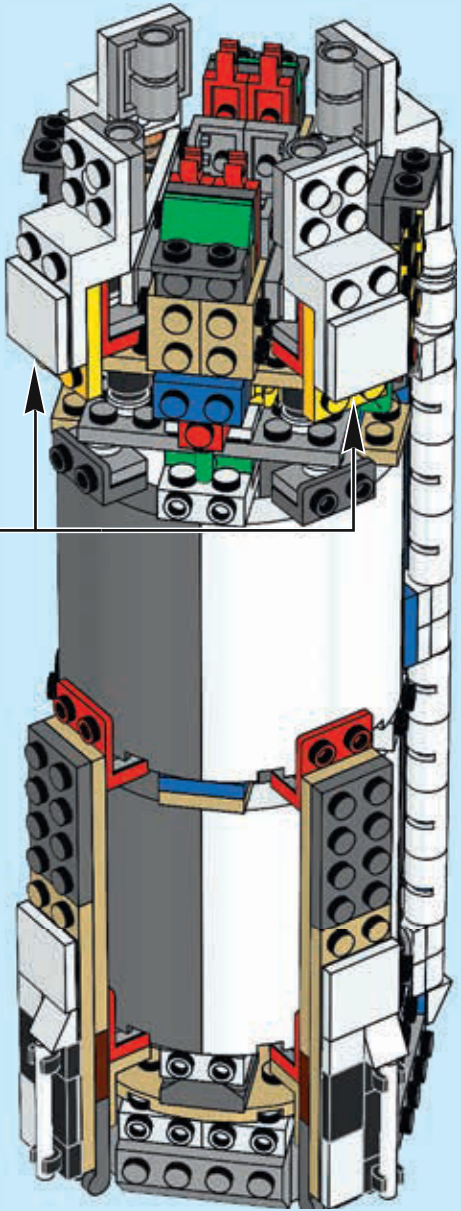
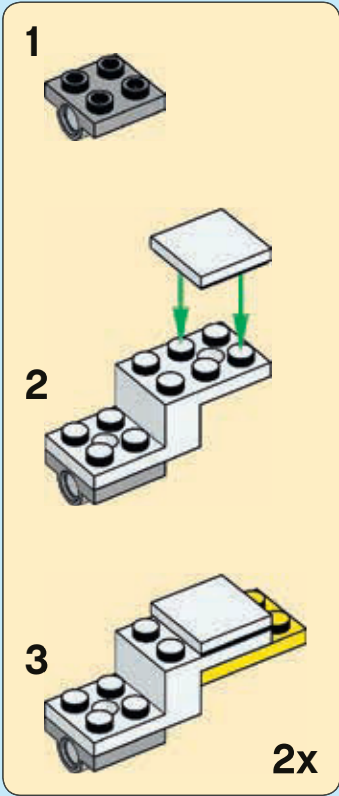

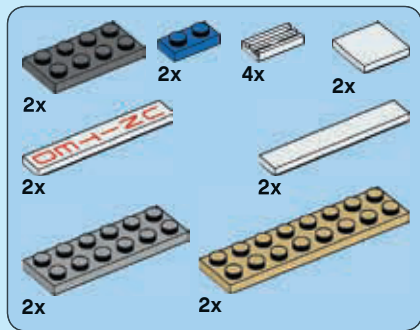

# 224

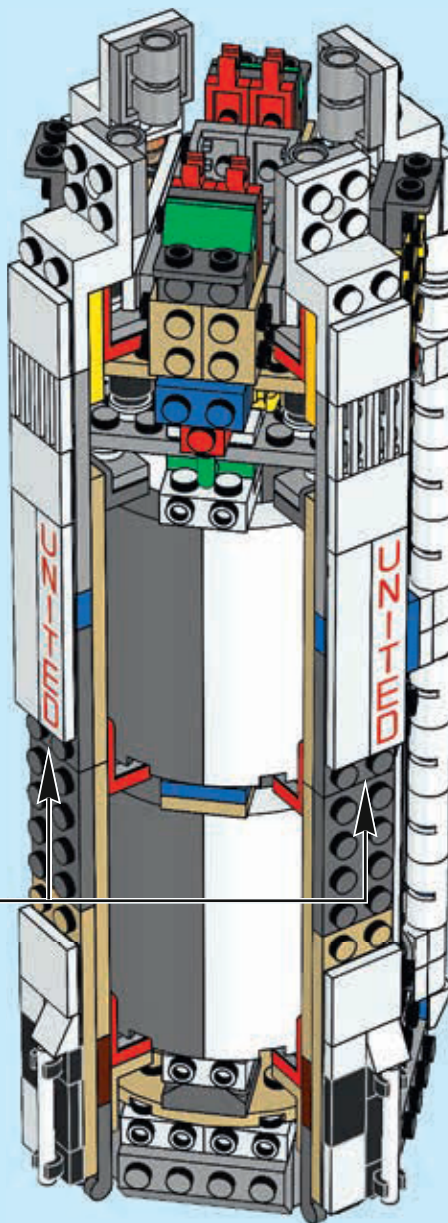
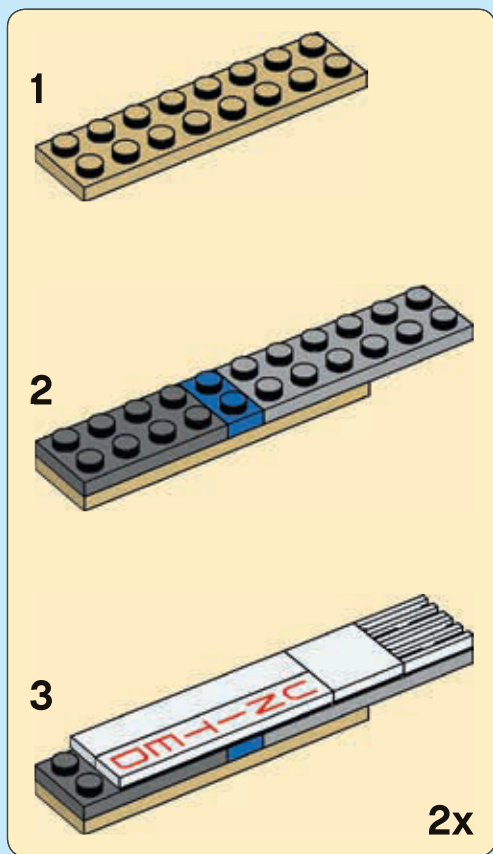

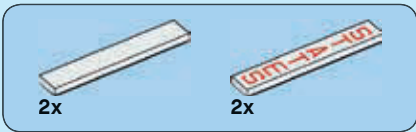

225

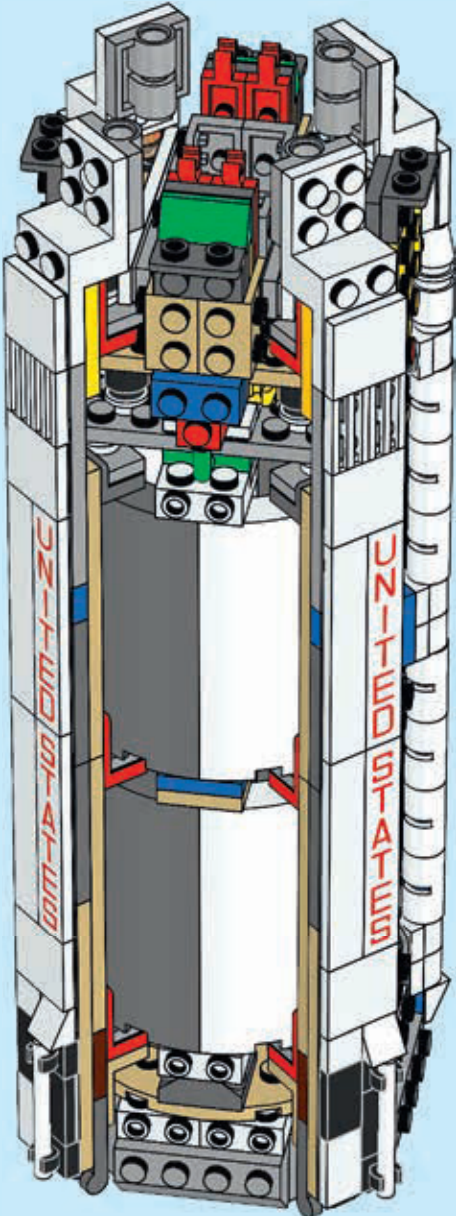

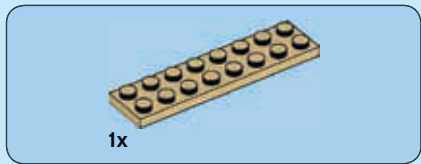
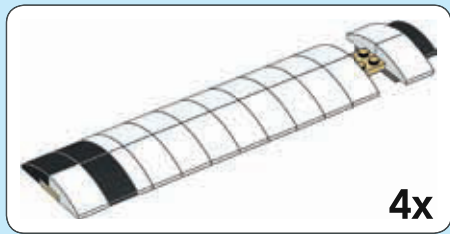
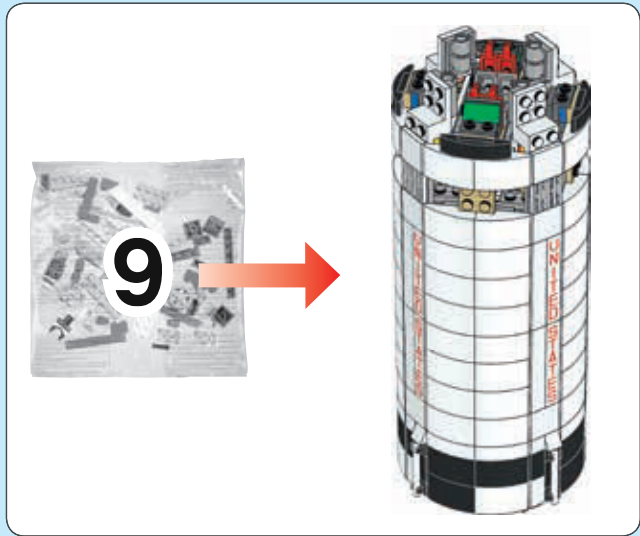

226

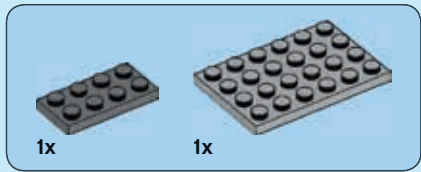
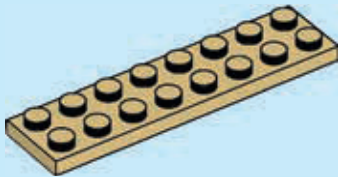

227

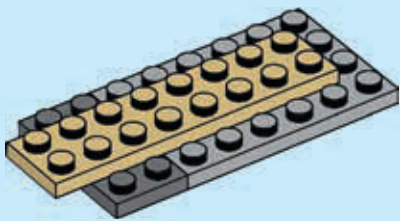

228

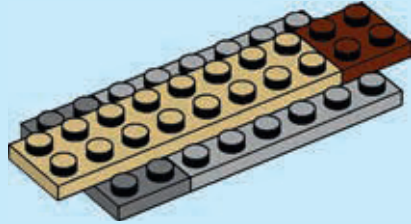

229

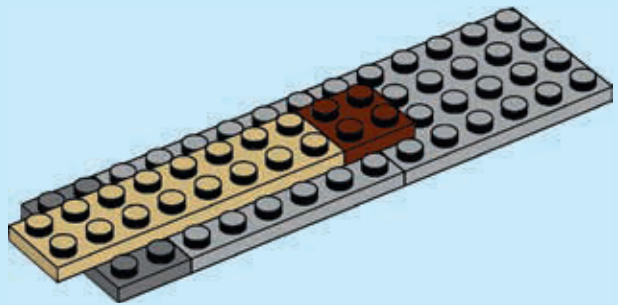

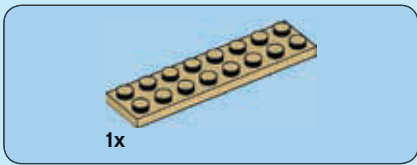

**230**

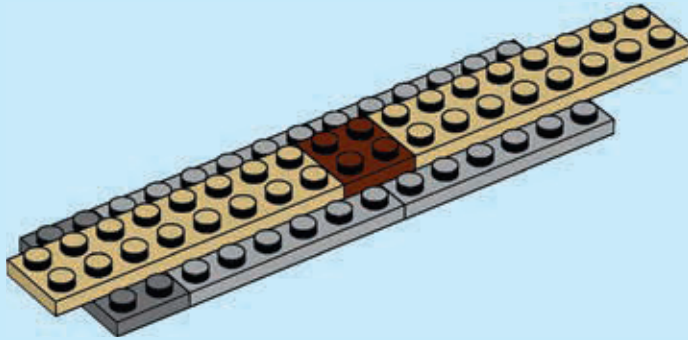

**231**

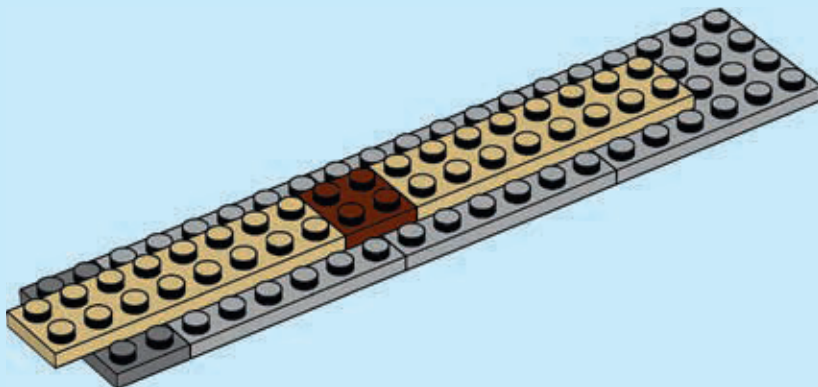

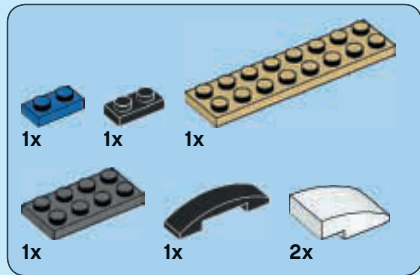

232

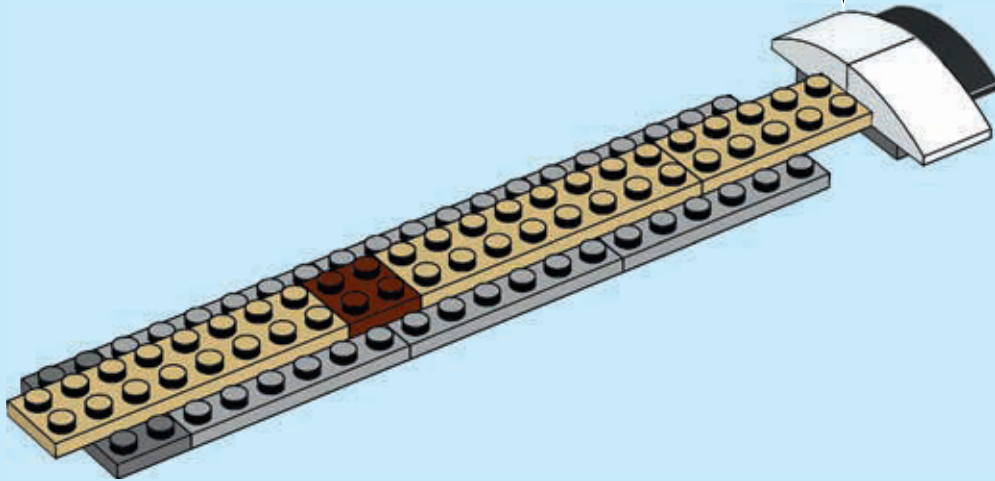
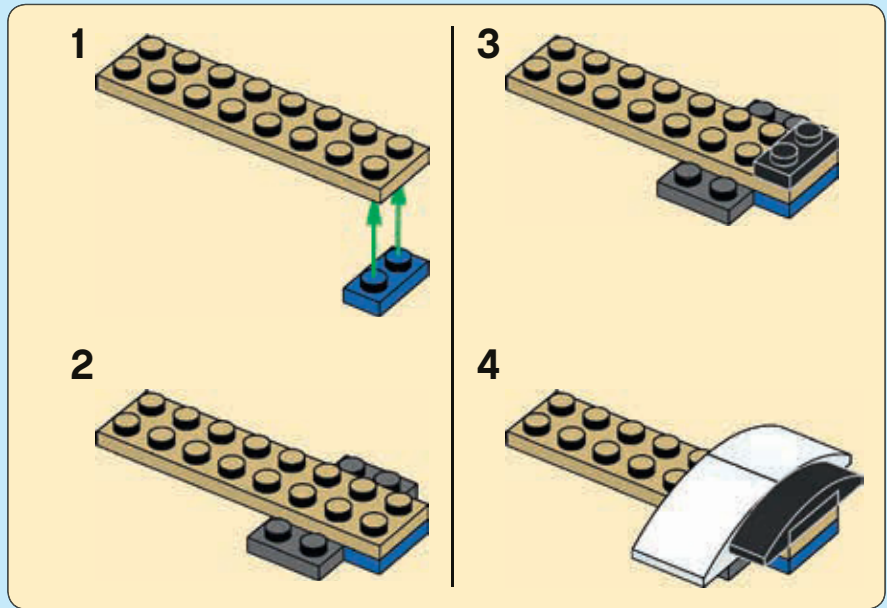

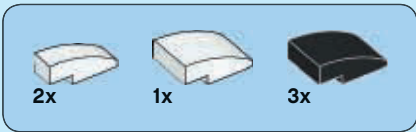

233

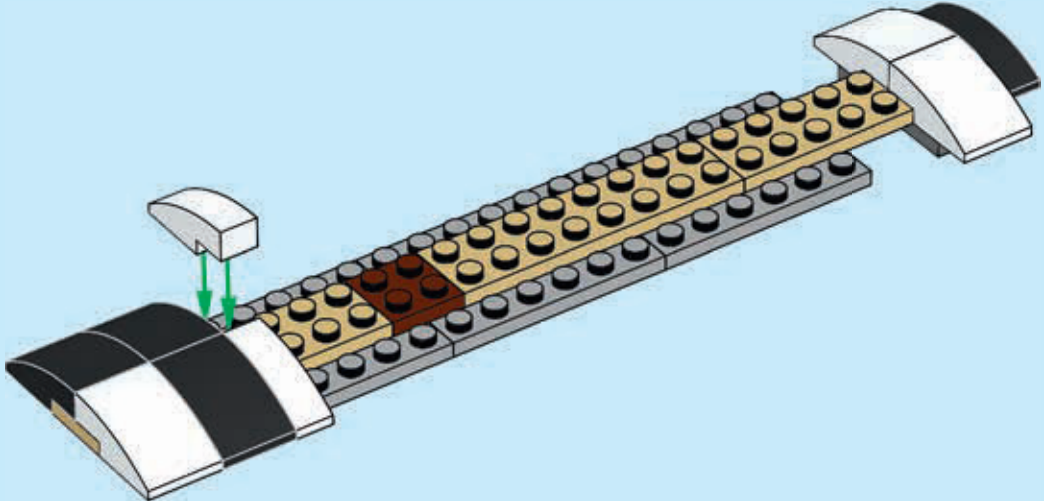

234

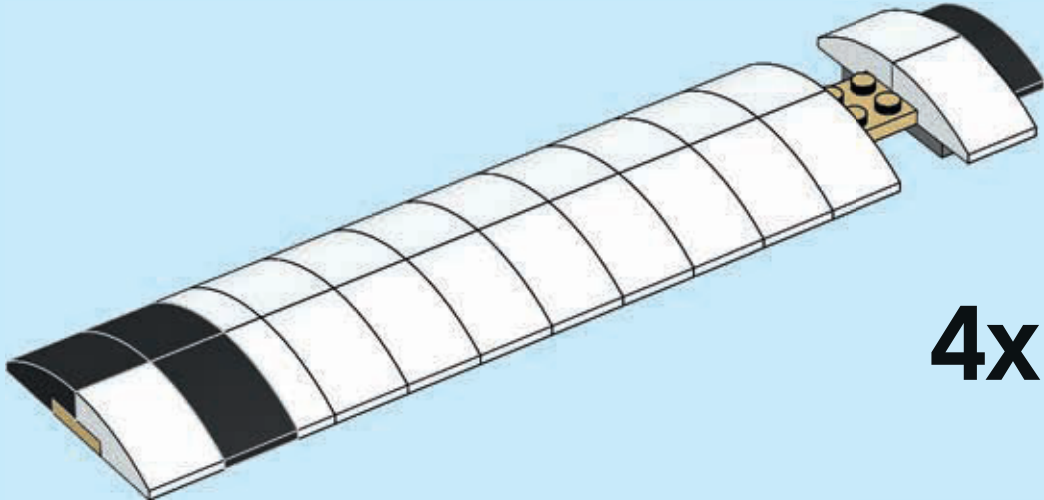

4x

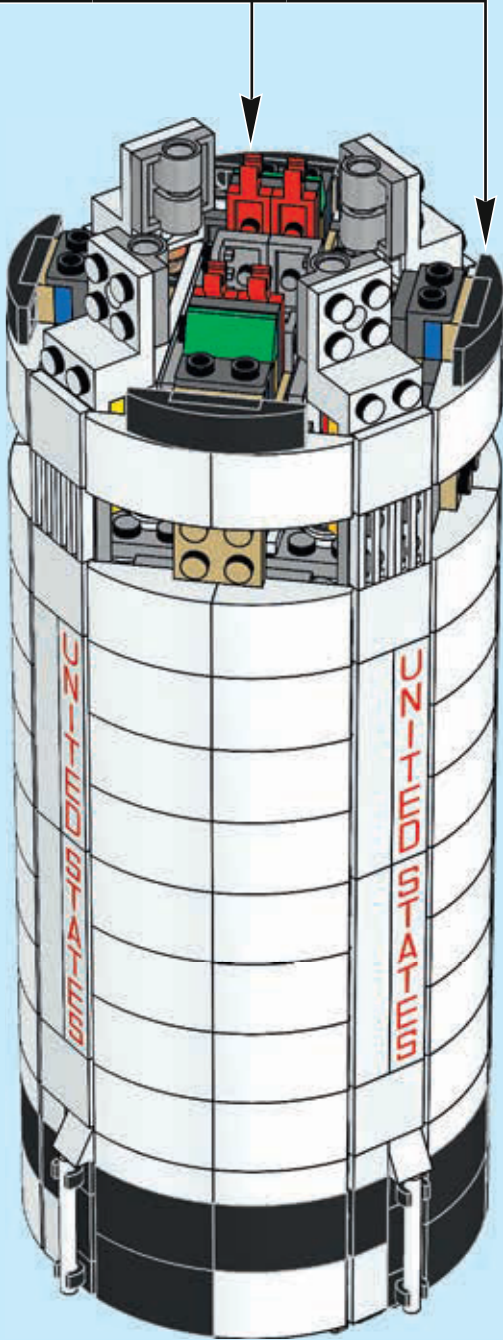



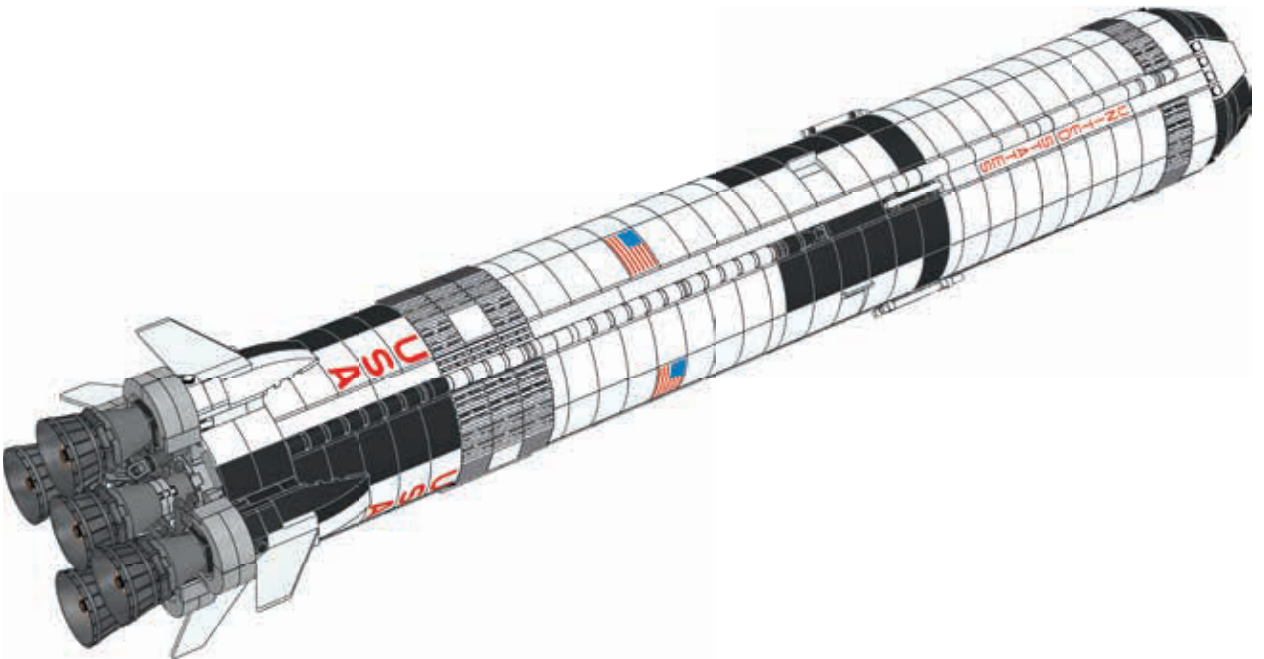



# 236

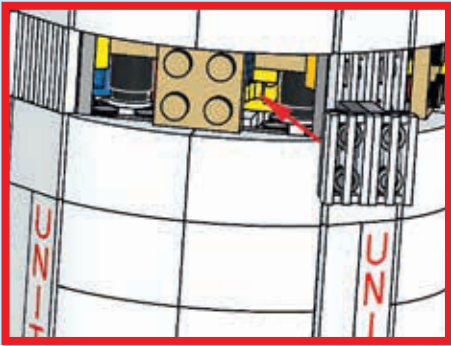
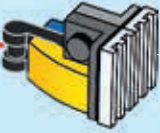
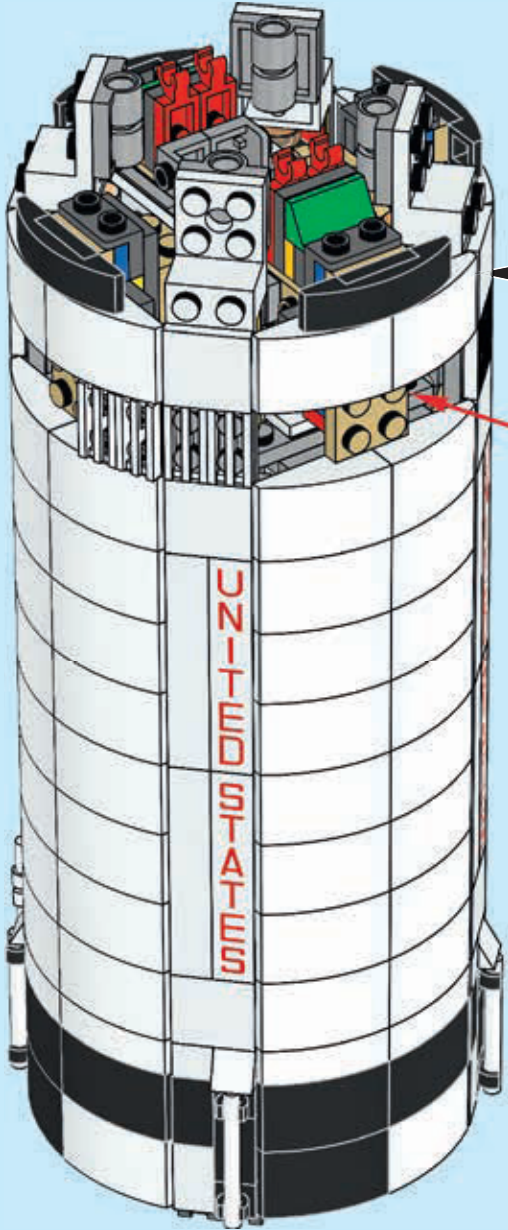
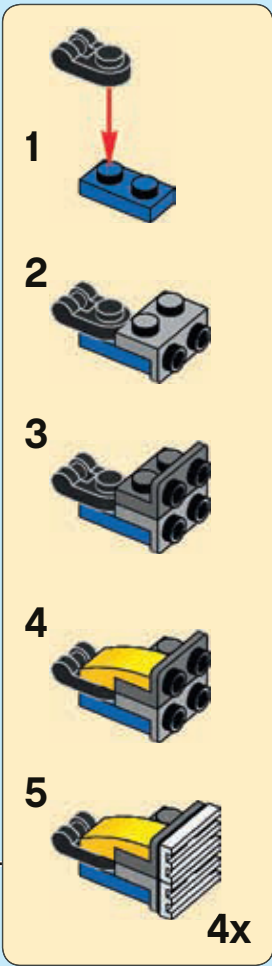

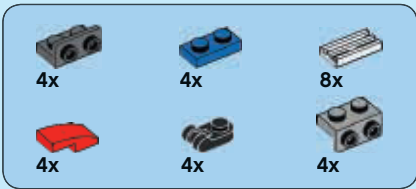

237

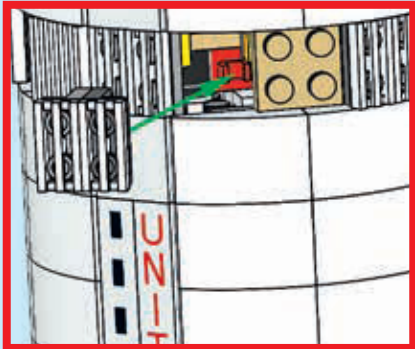
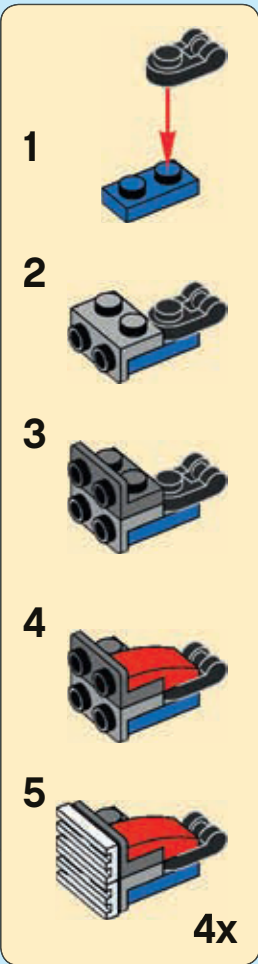
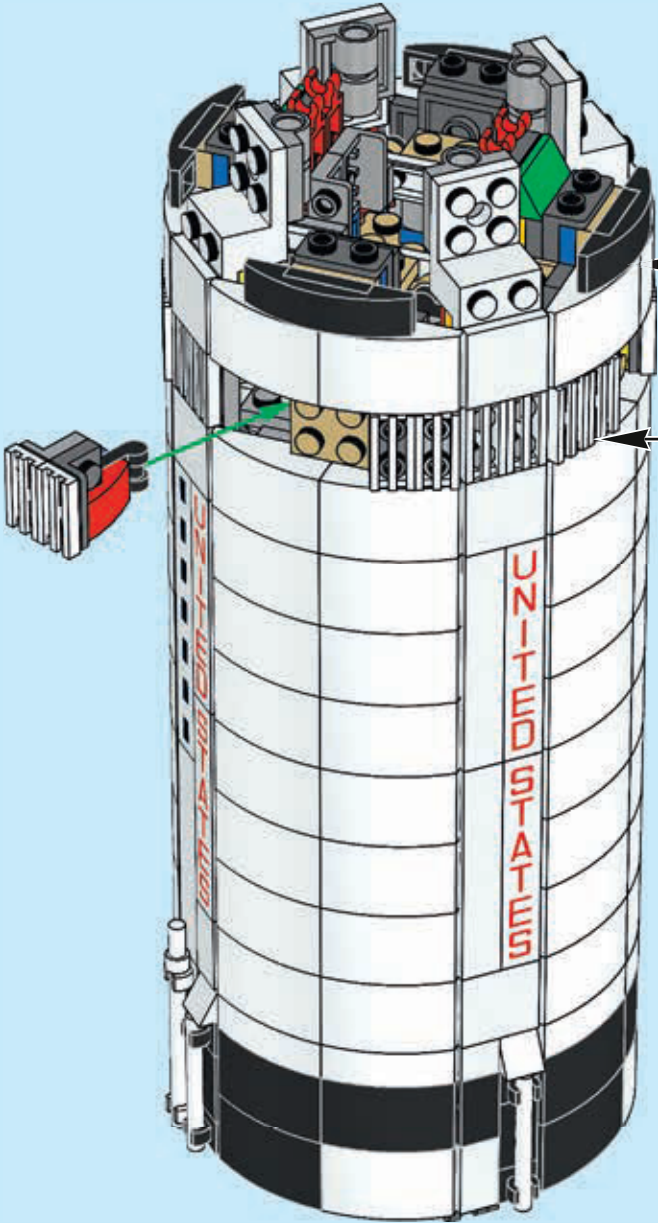



238

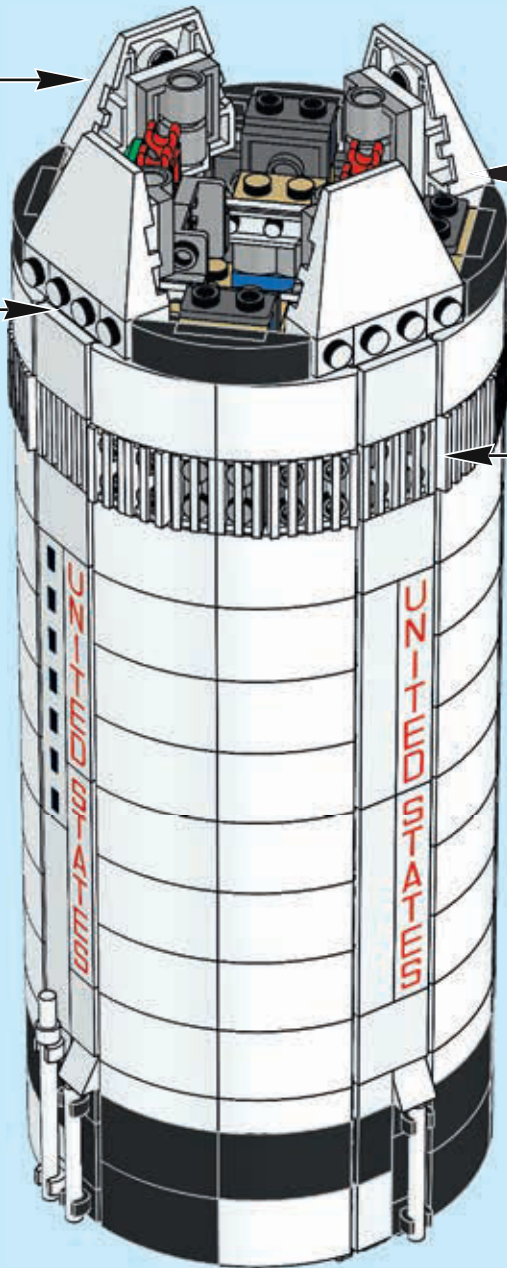
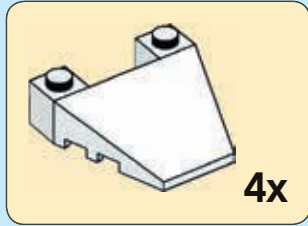
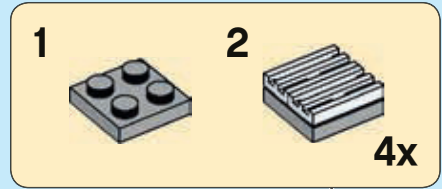



4x



4x

# 239

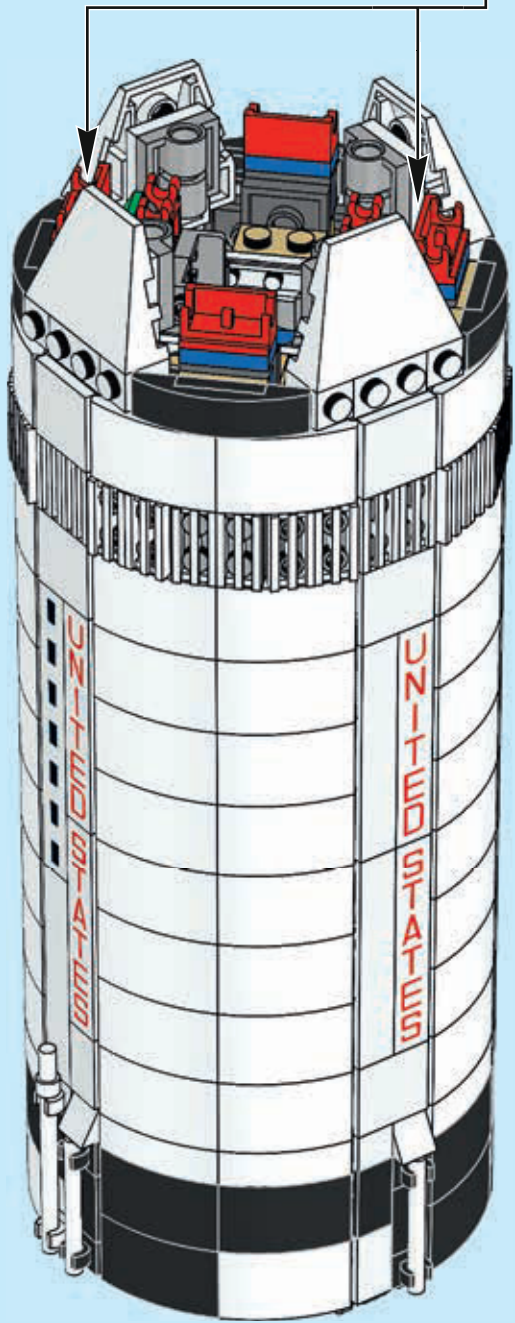
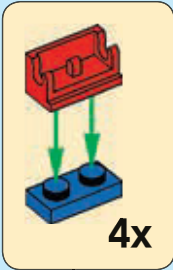

4x



4x

# 240

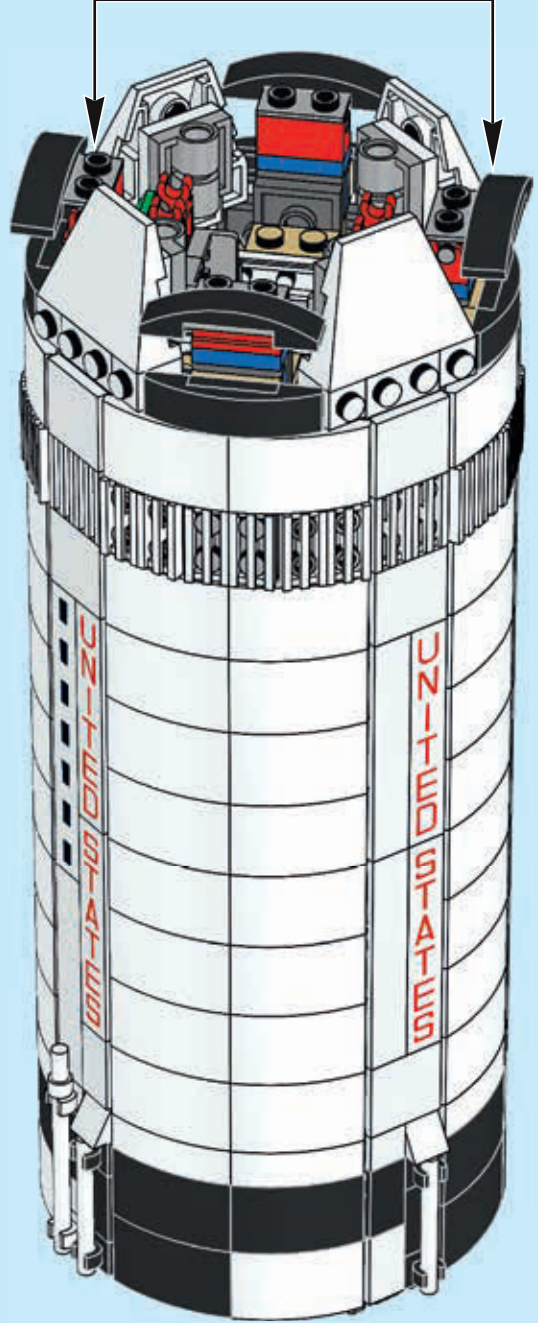
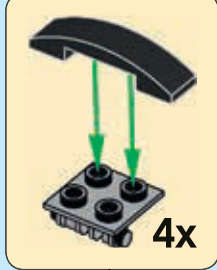



241

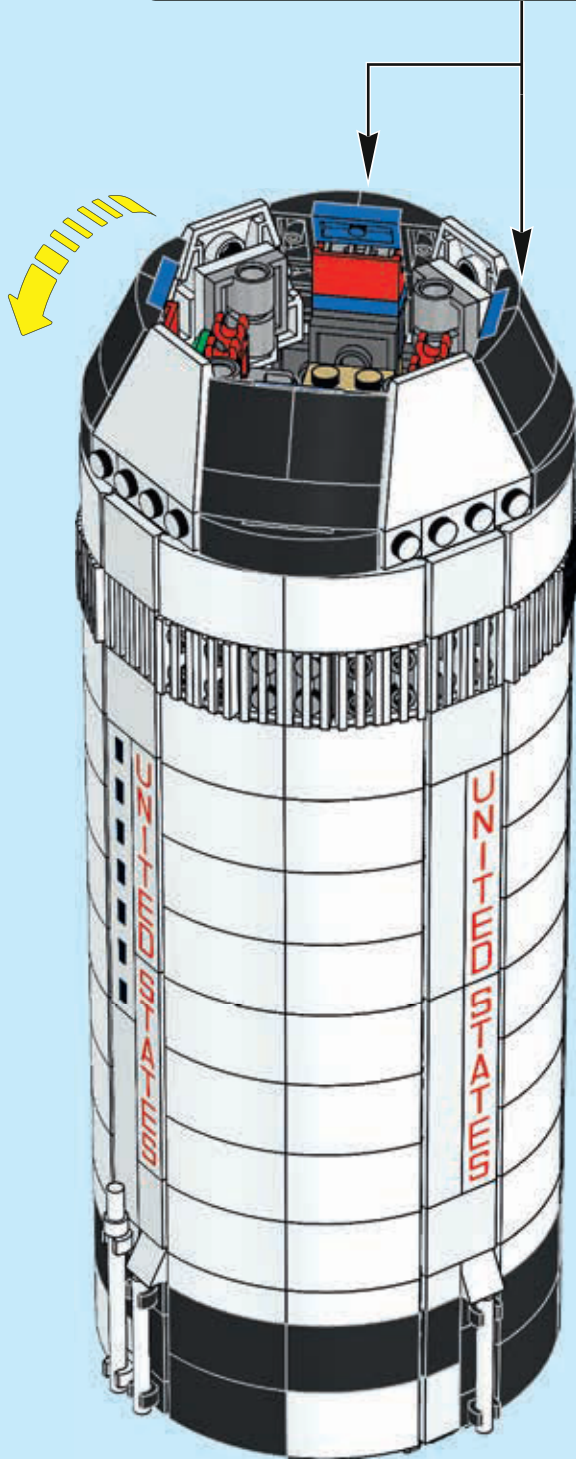
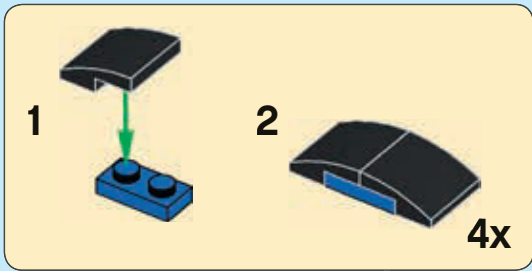



242

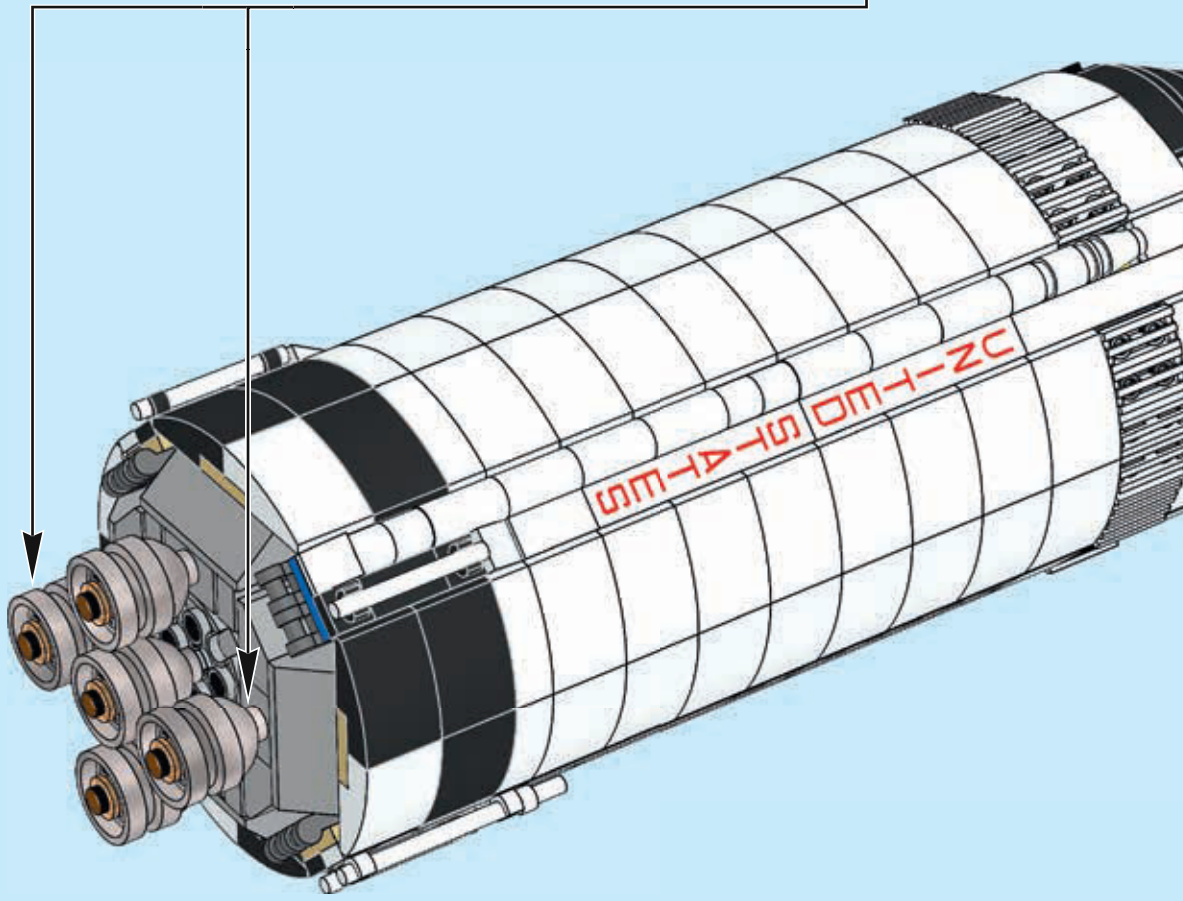
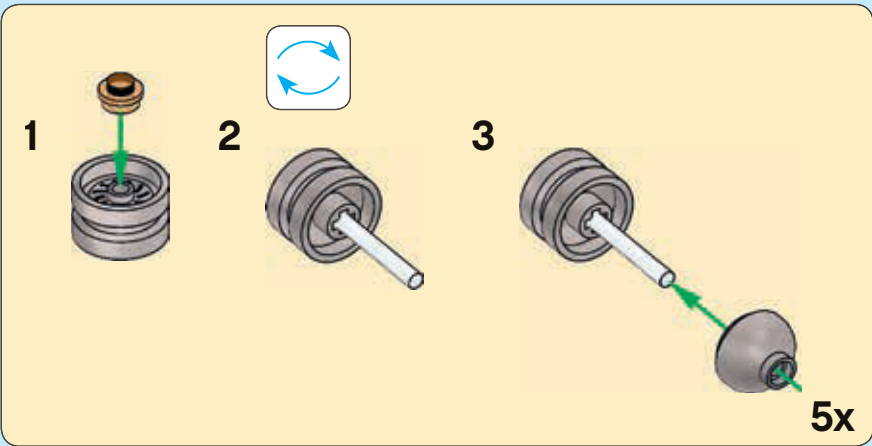

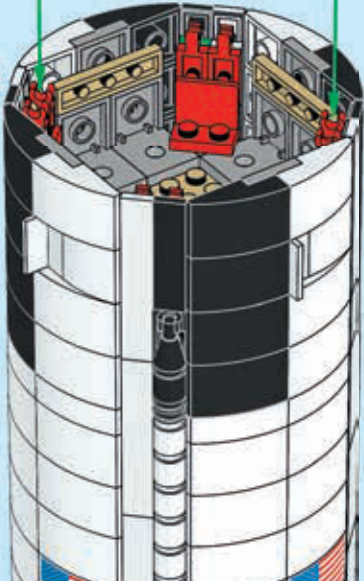
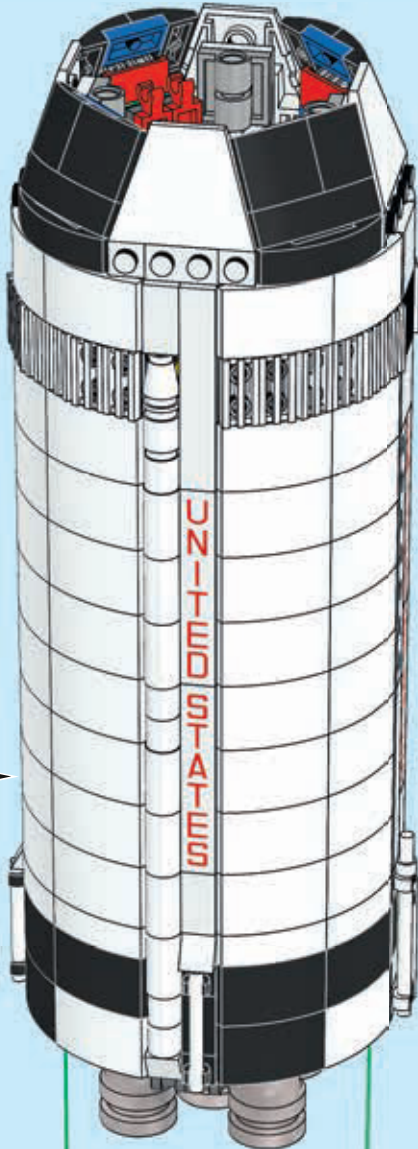



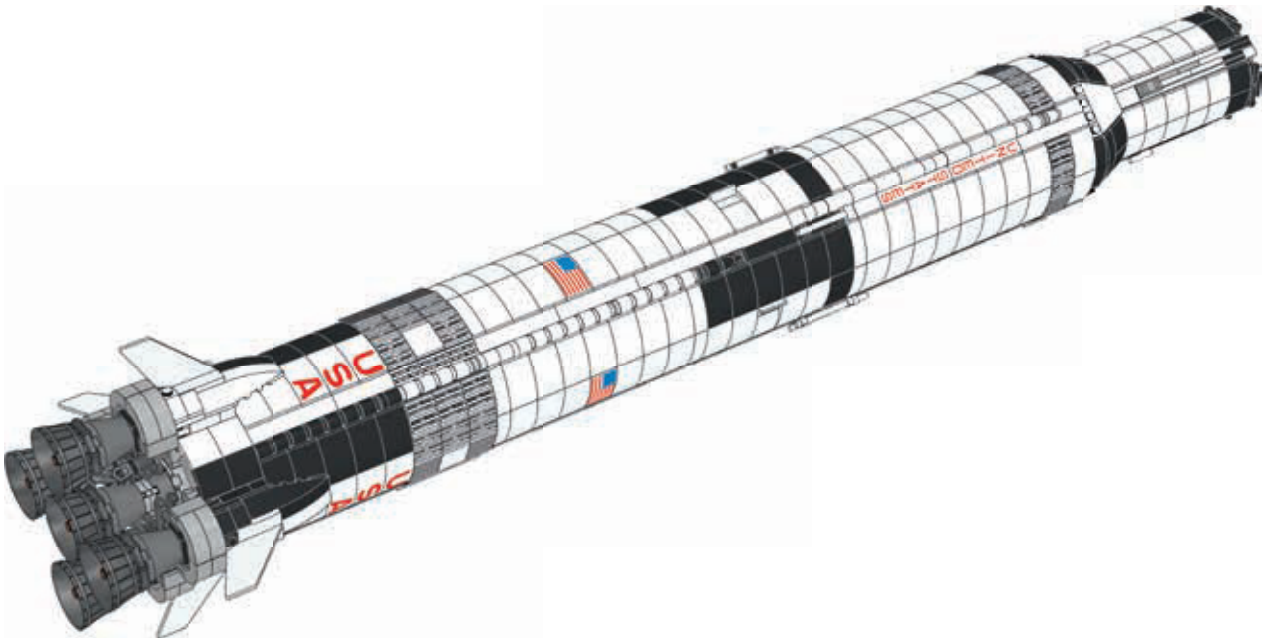

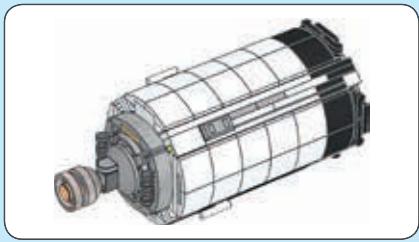

244



245

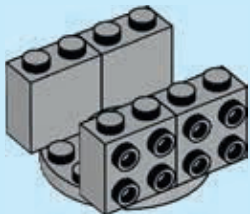

246

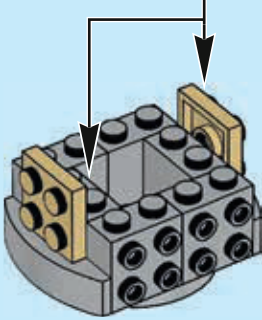
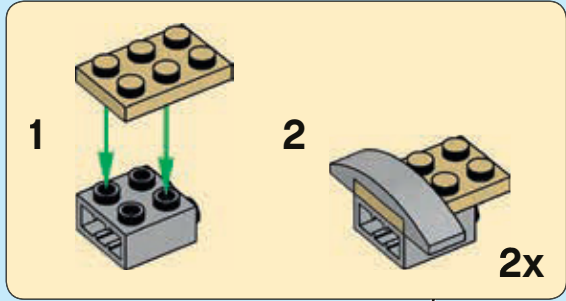

247

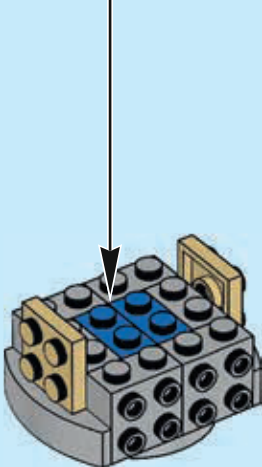
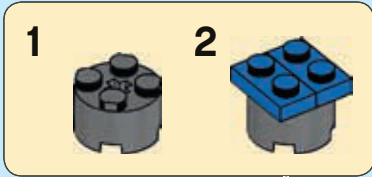

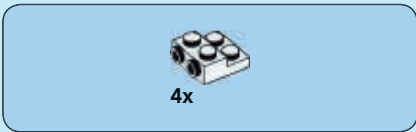

248

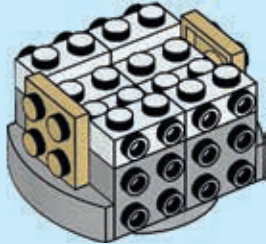

249

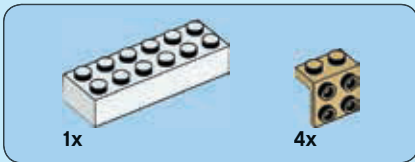
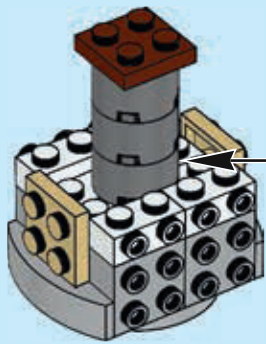
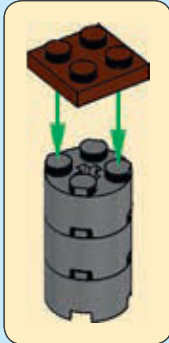

250

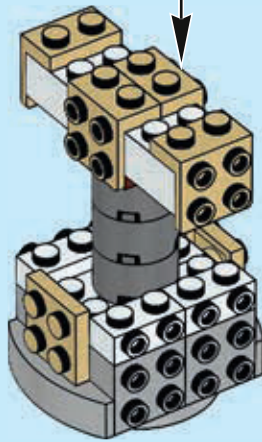
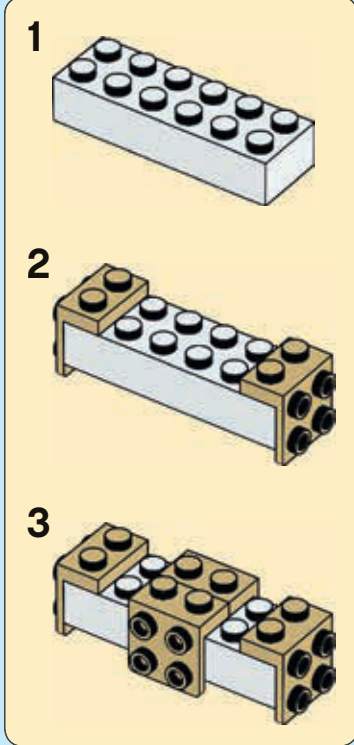



# 251

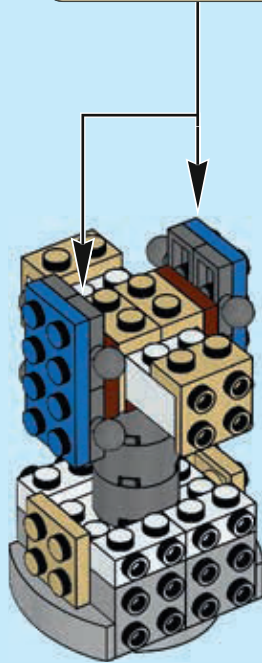
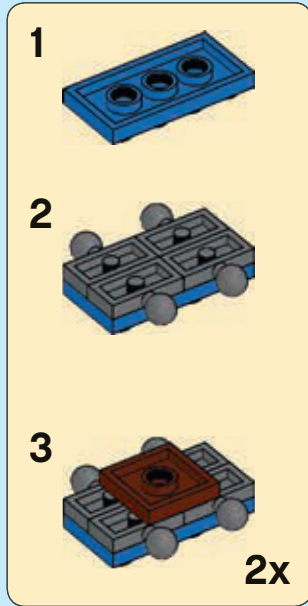

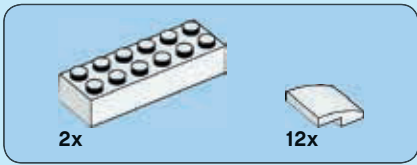

# 252

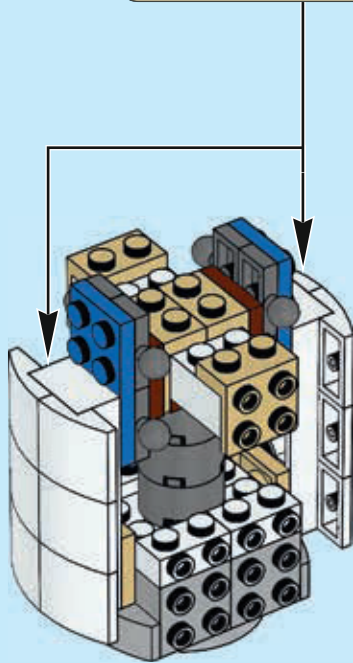
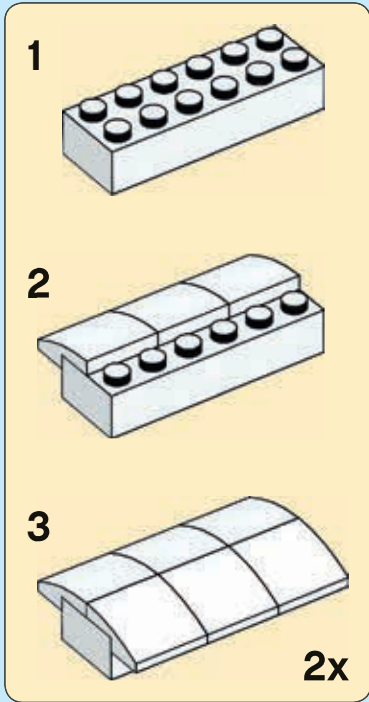

# 253

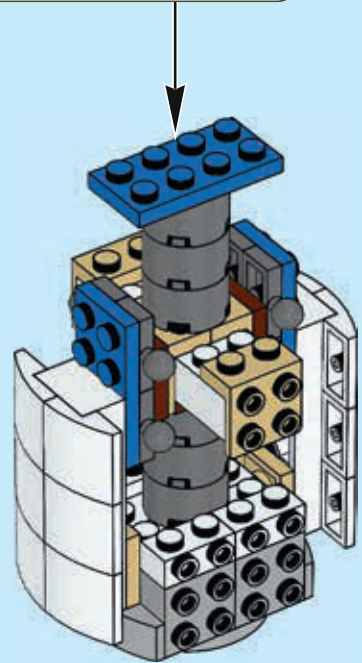
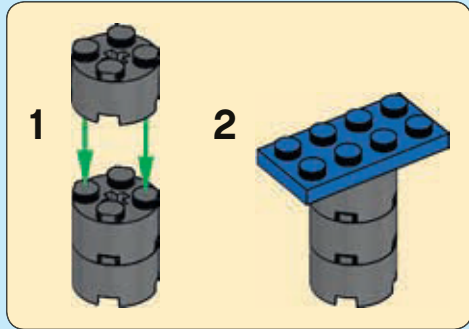



254

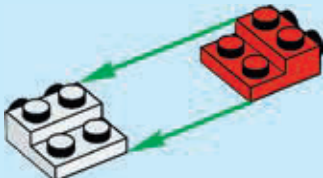

255



256



257

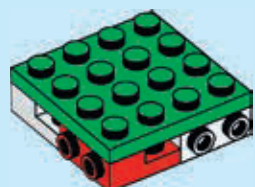



258

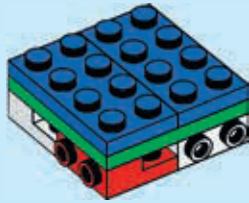

259

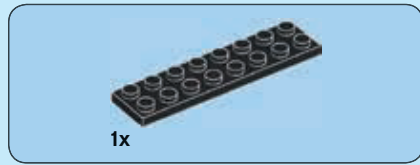
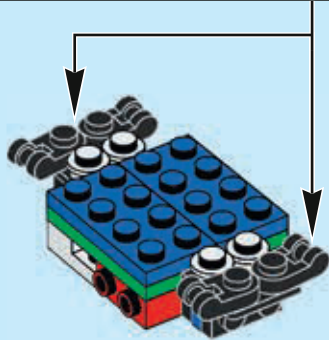
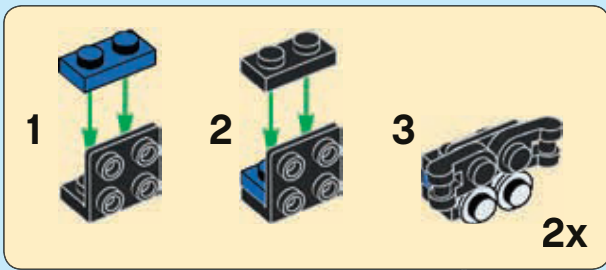

260

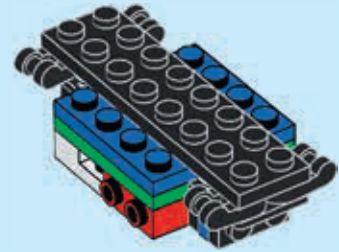

261

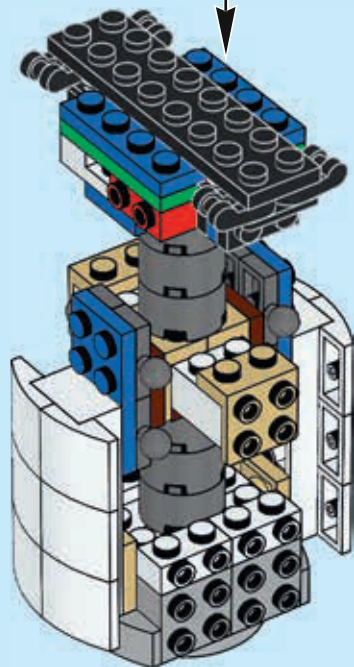

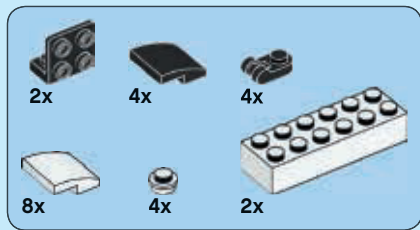

# 262

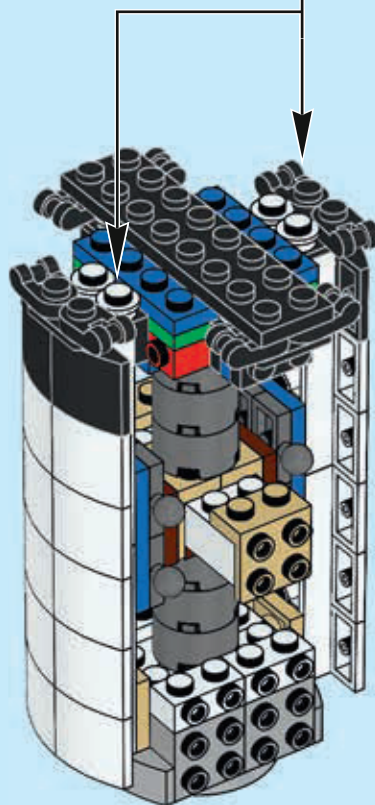
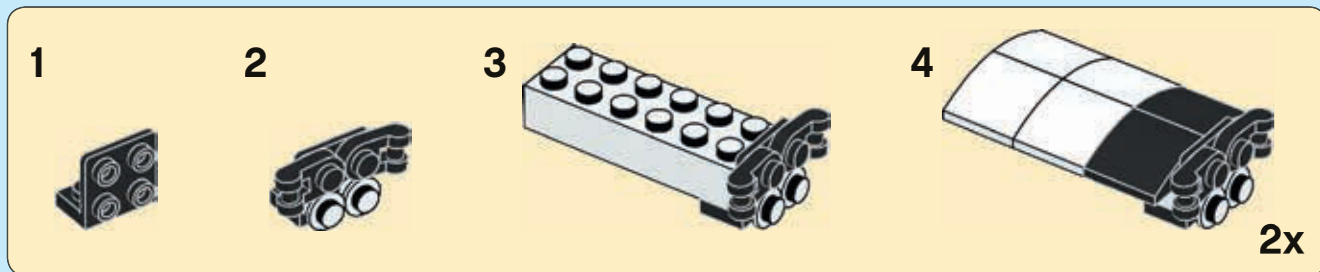





263

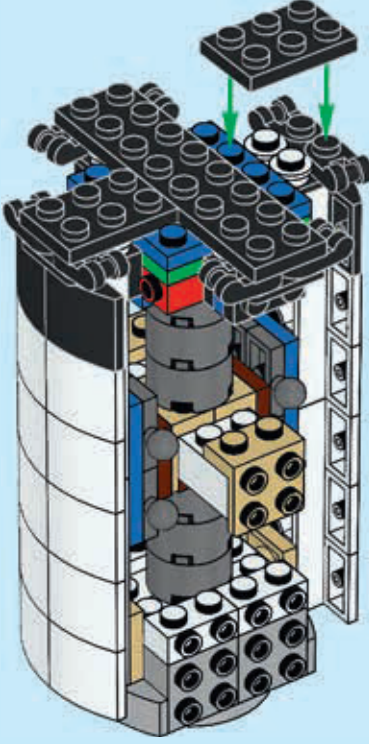

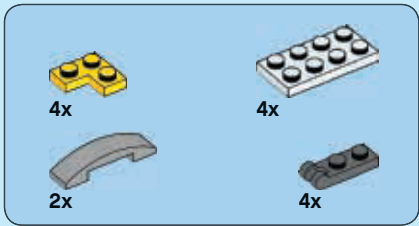

# 264

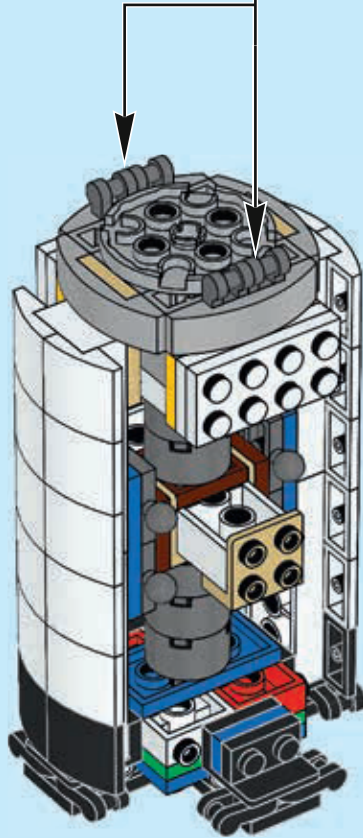
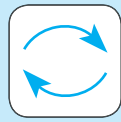
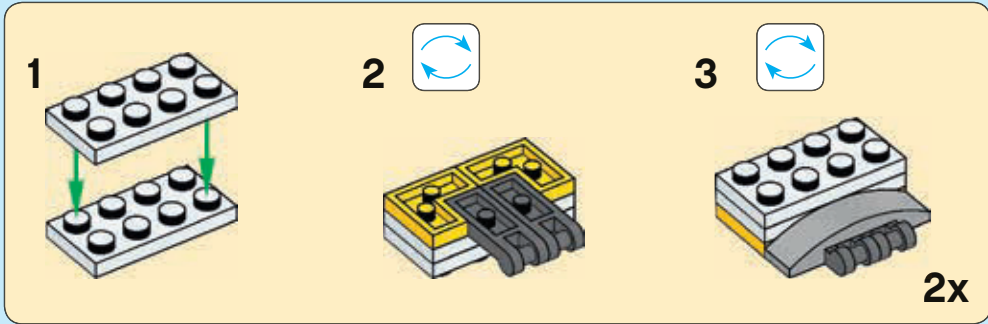

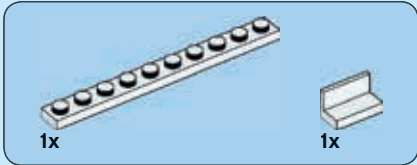

## 265

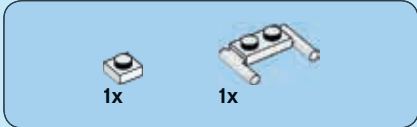
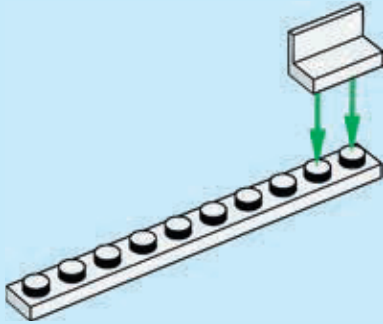

## 266

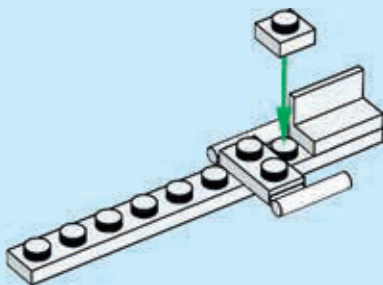

## 267

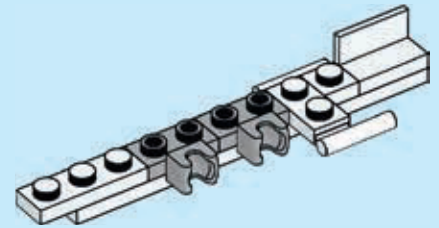

## 268

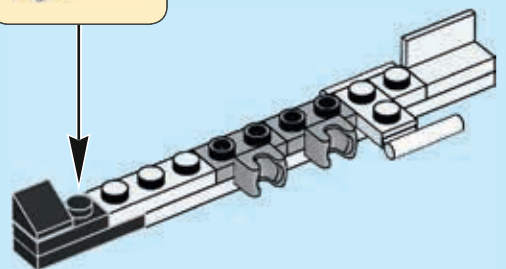
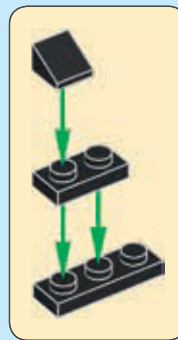

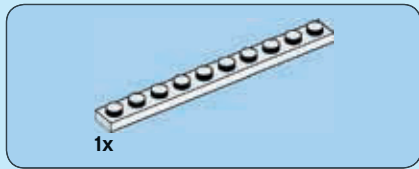

269

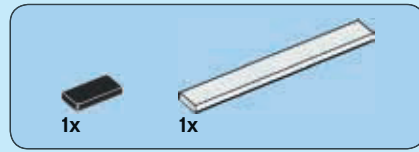
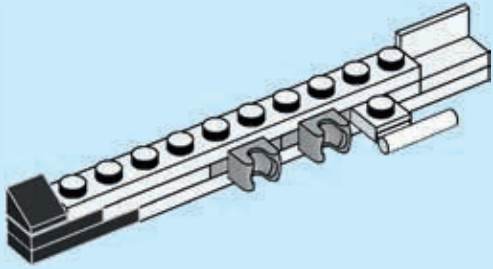

270

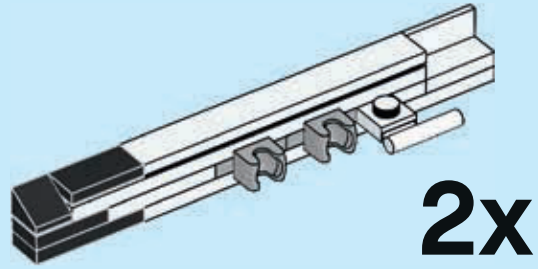

271

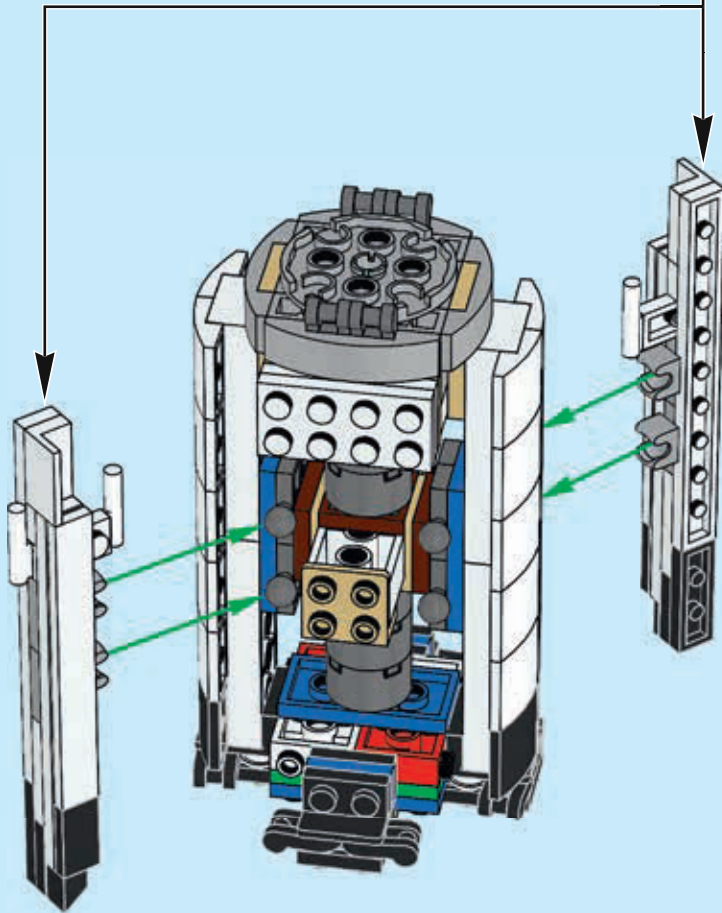

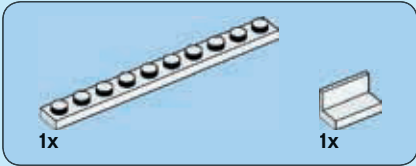

# 272

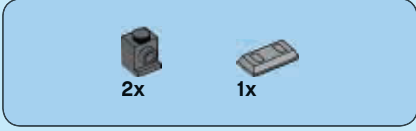
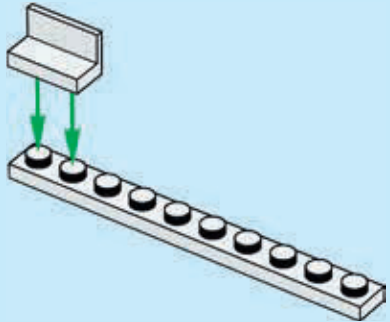

# 273

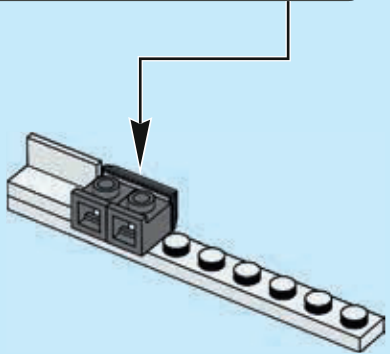
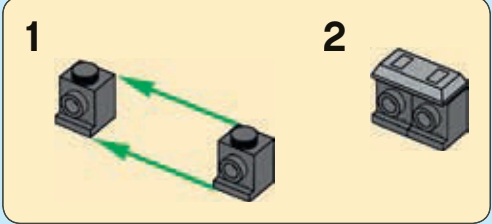

# 274

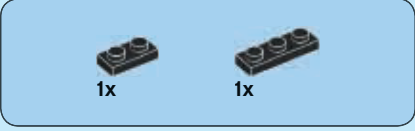
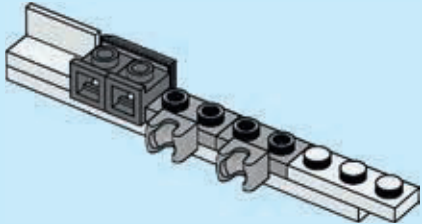

# 275

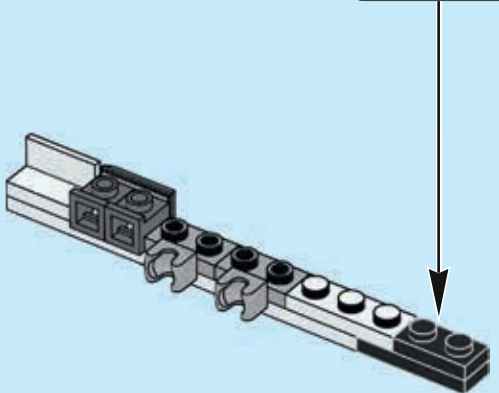
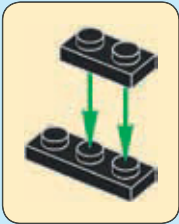



276

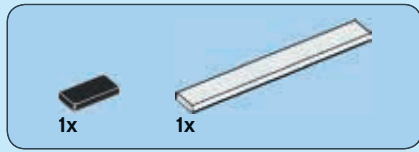
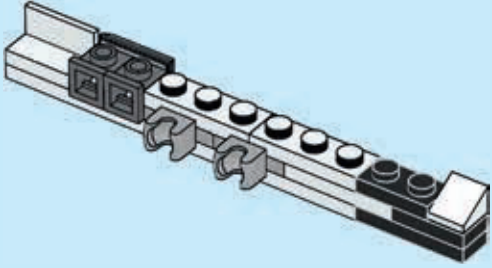

277

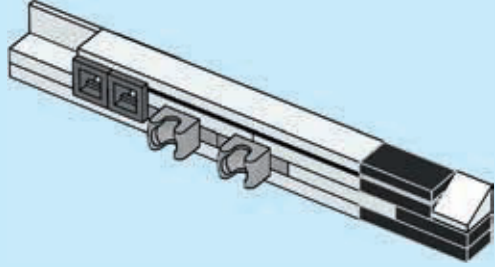

2x

278

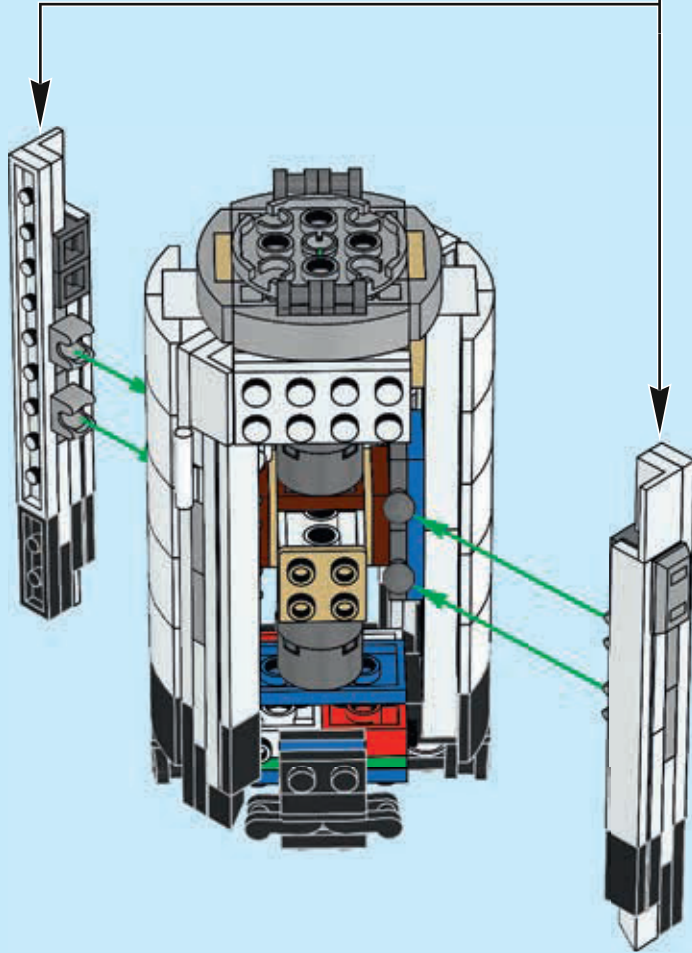

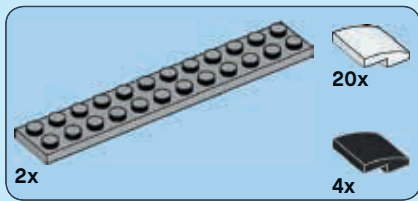

279

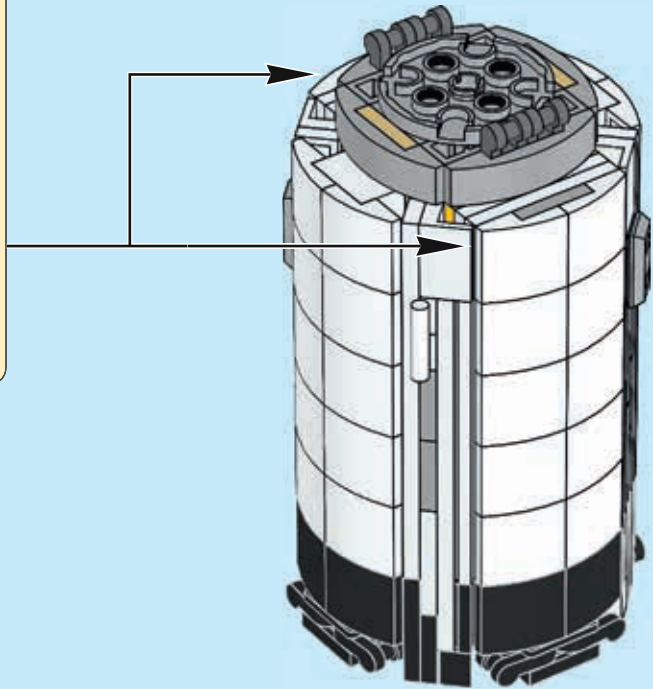
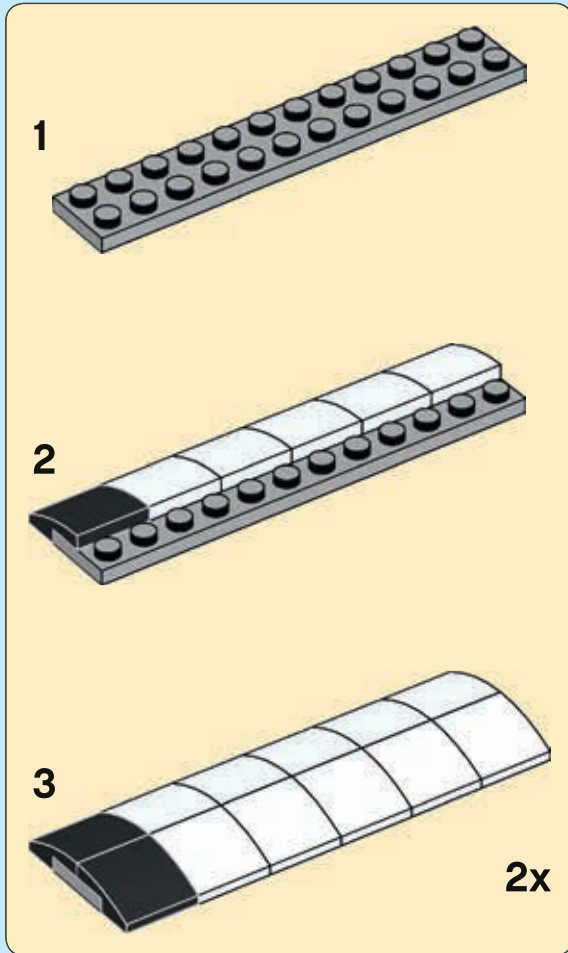



280

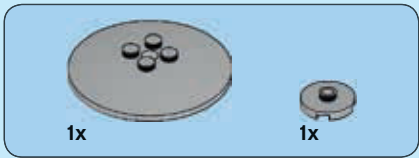
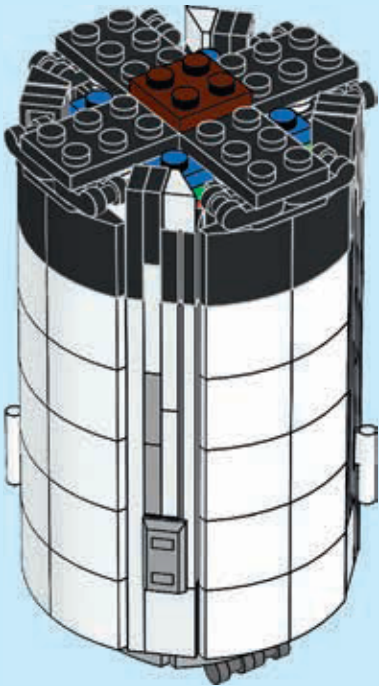

281

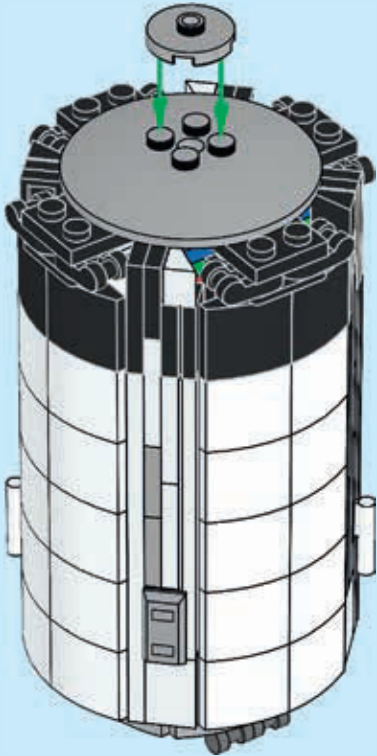



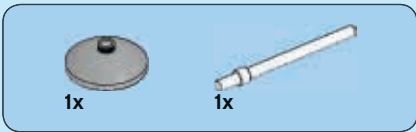

282

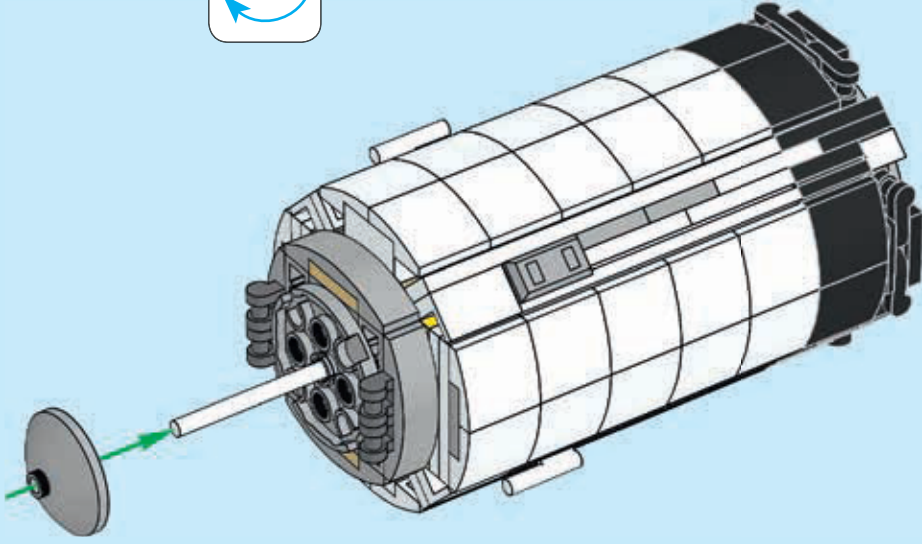
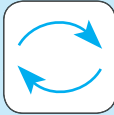

283

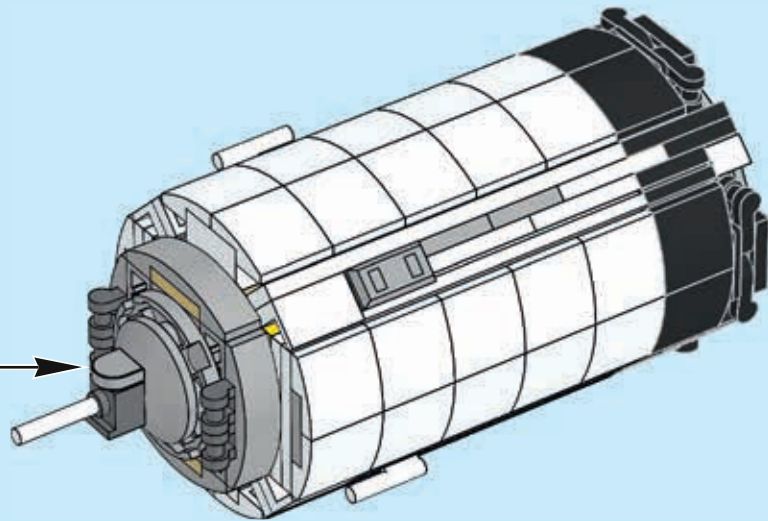
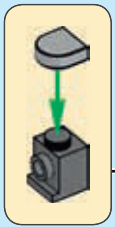



1x

**284**

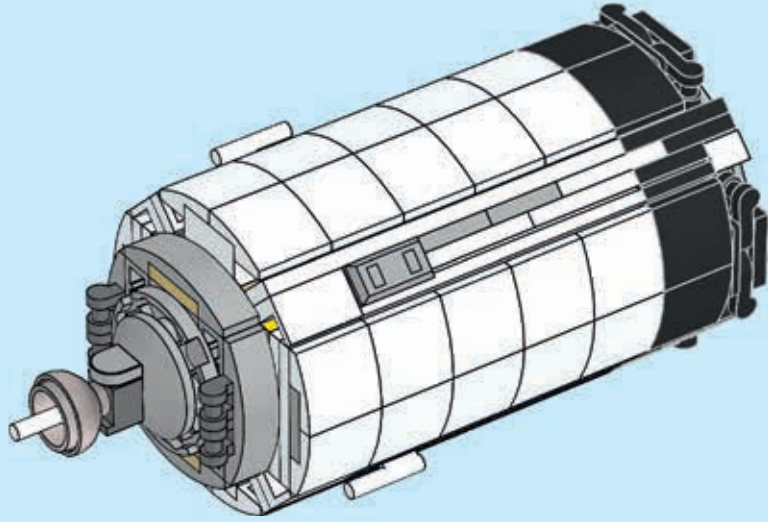

1x



1x

**285**

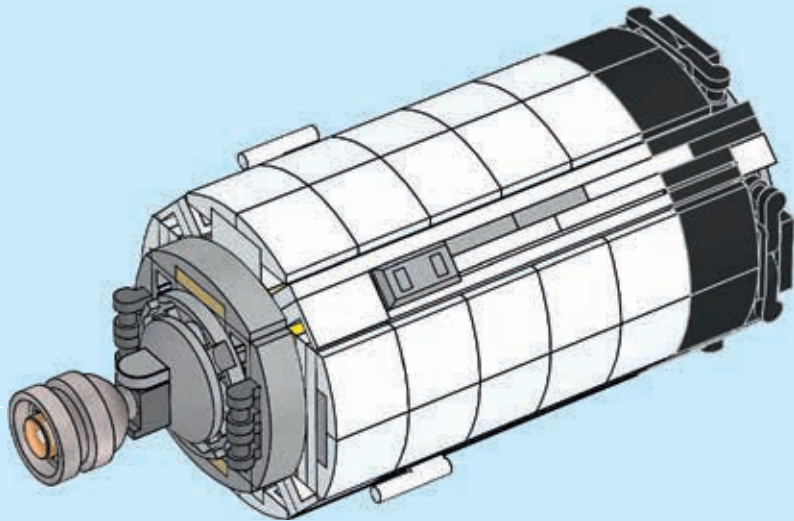

286

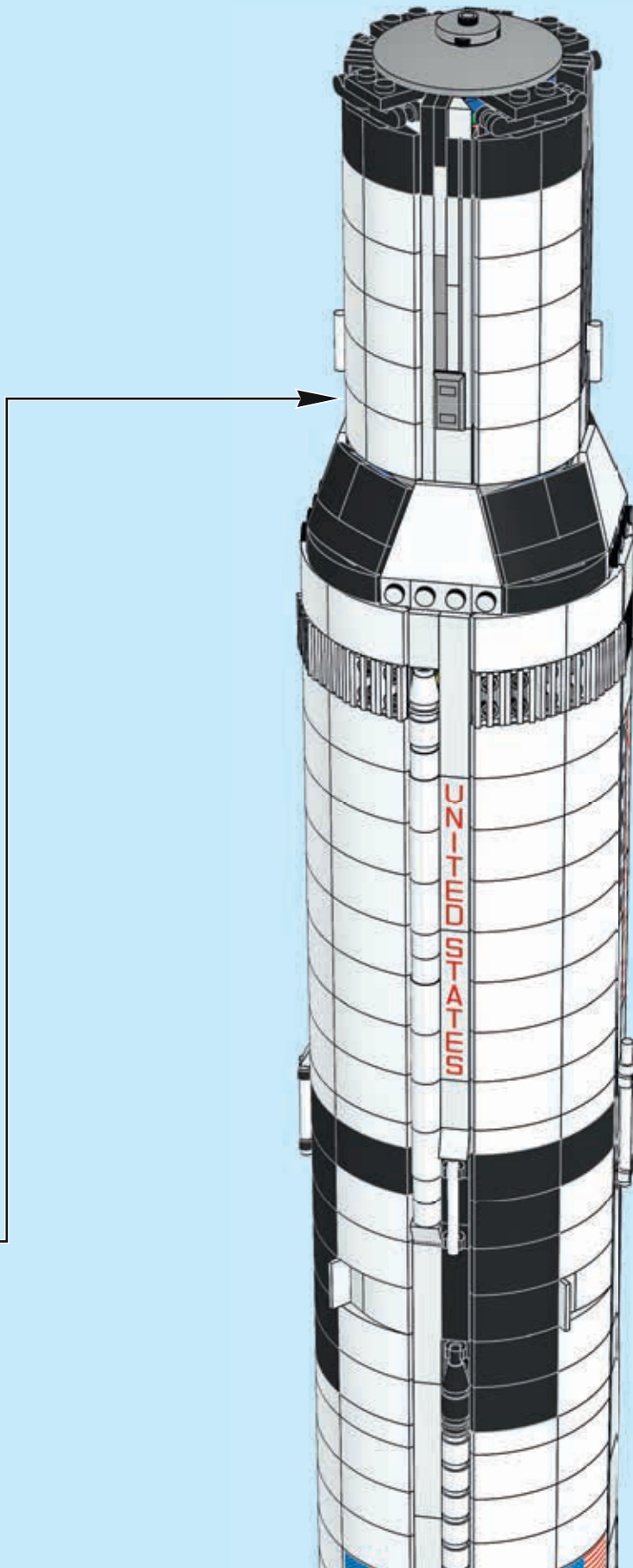



12



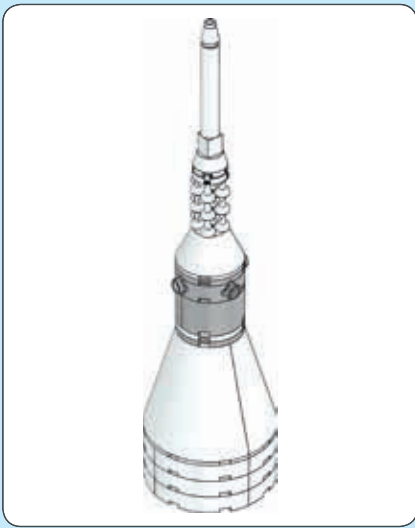

**287**

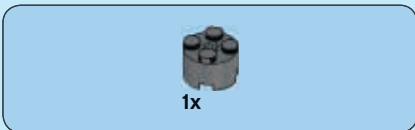

**288**

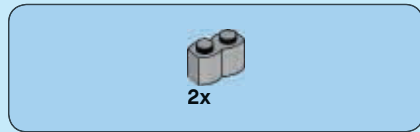

**289**

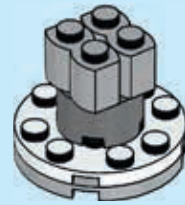

**290**

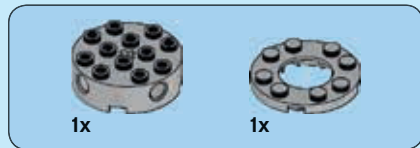

**291**



4x

292

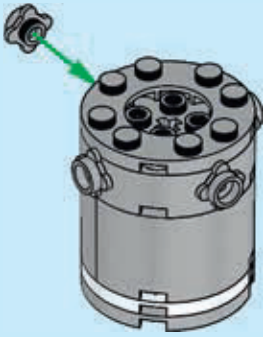

293

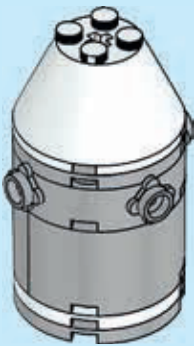

12x

294

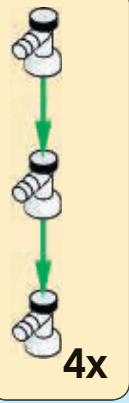
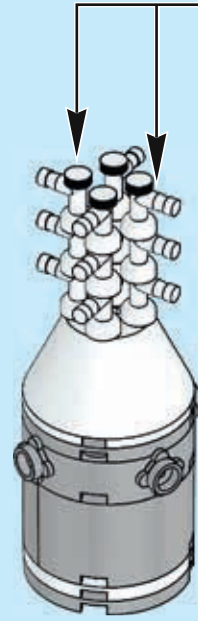

1x

295



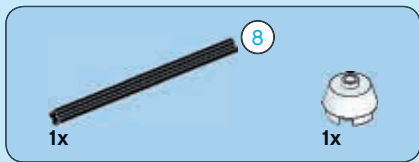

296

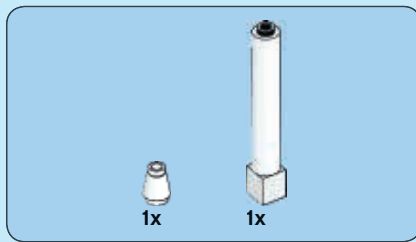
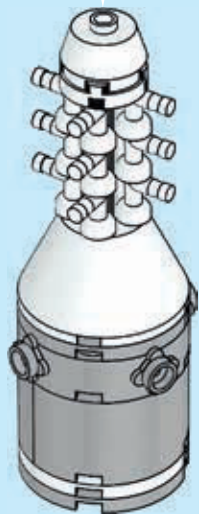
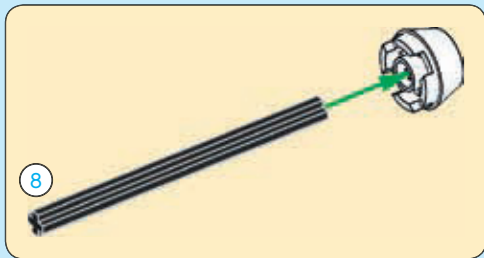

297

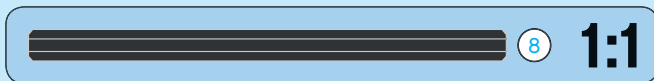
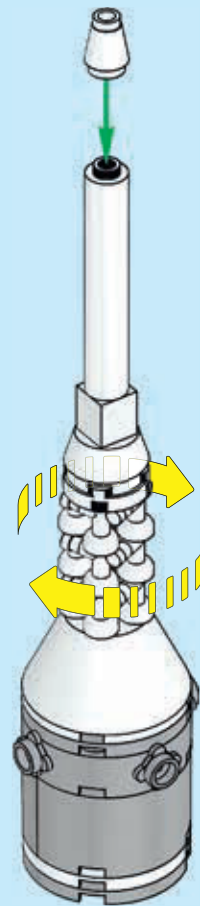

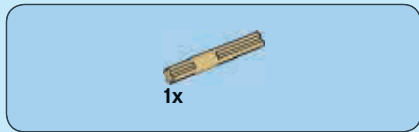

298

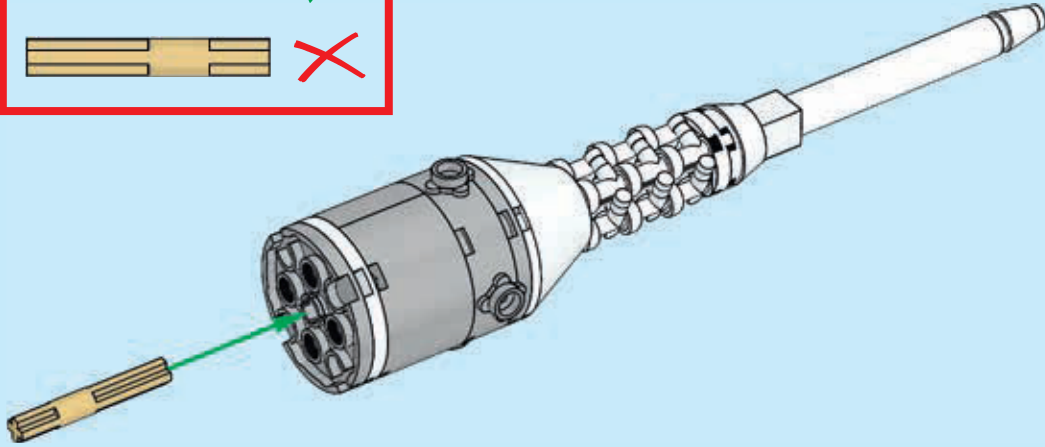
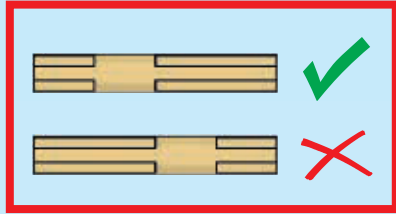
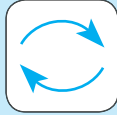

299

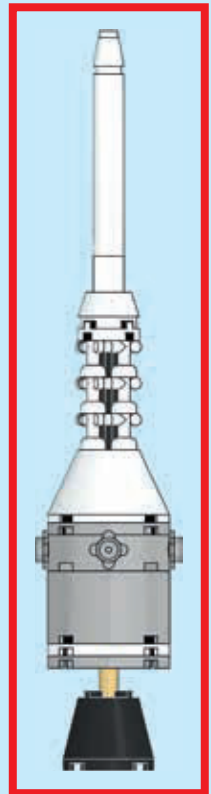
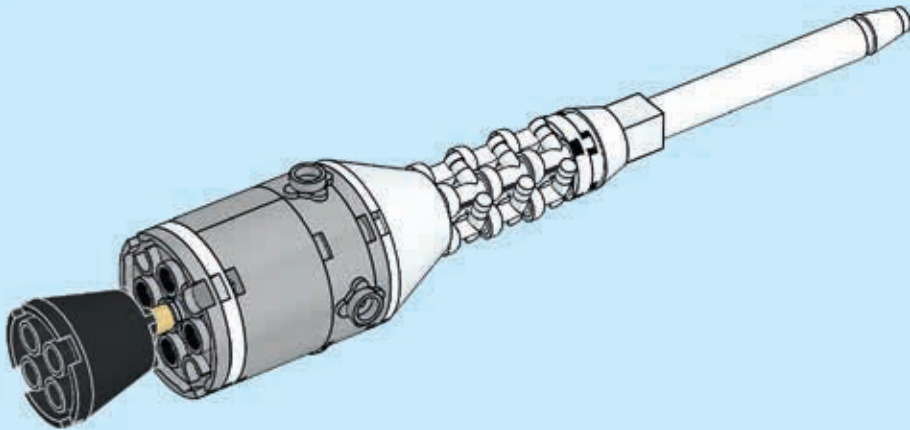



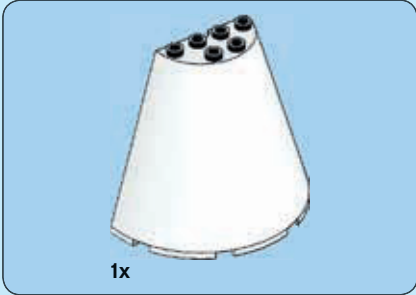

**300**

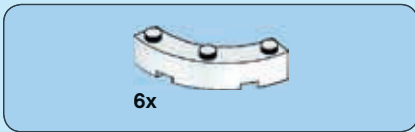
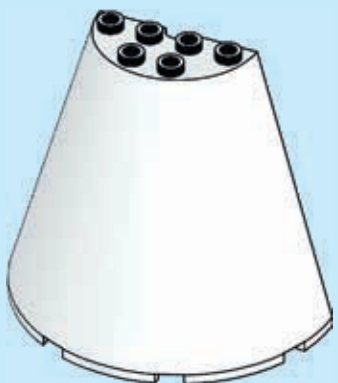

**301**

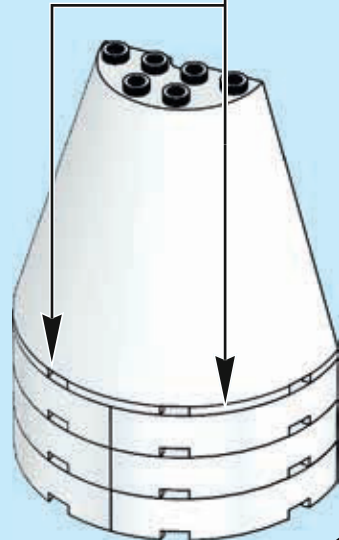
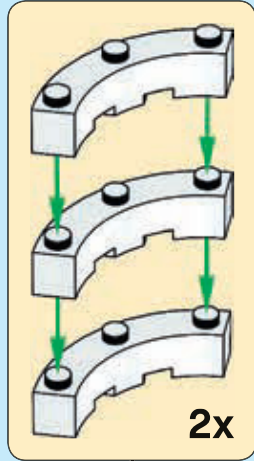

**2x**

302

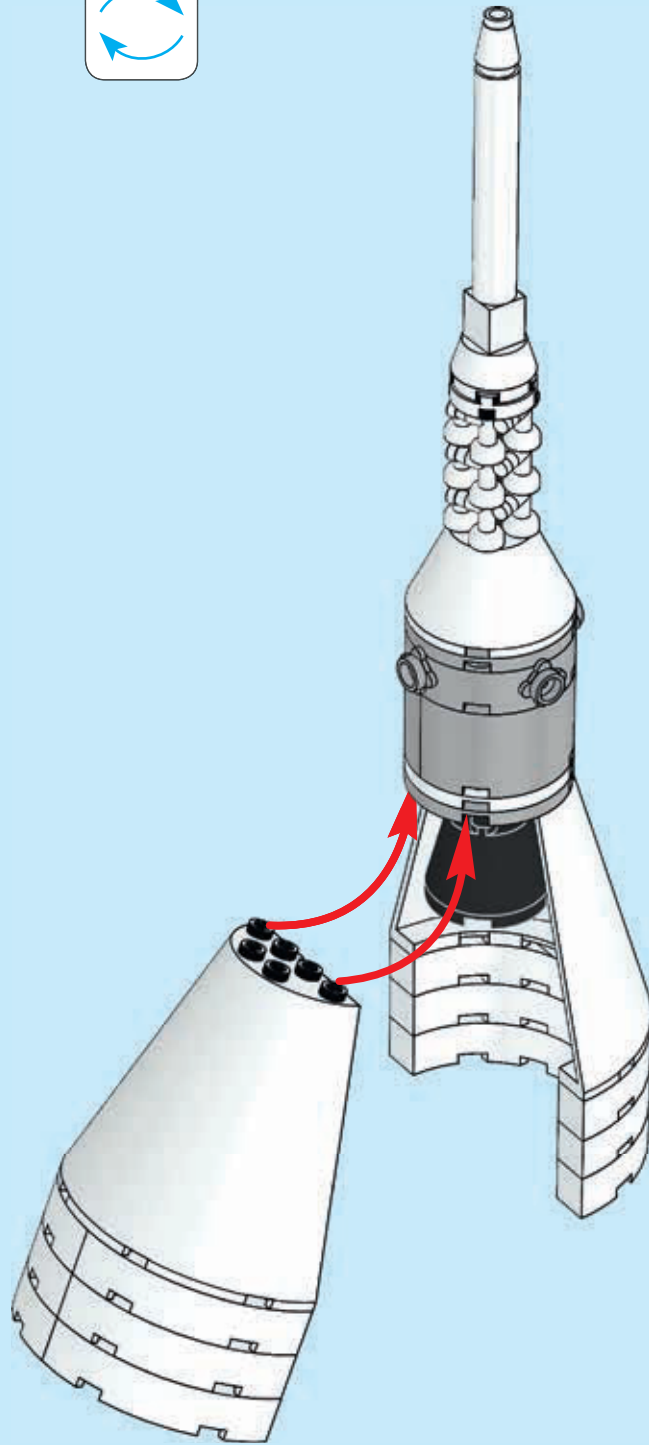
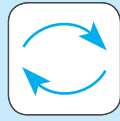

303

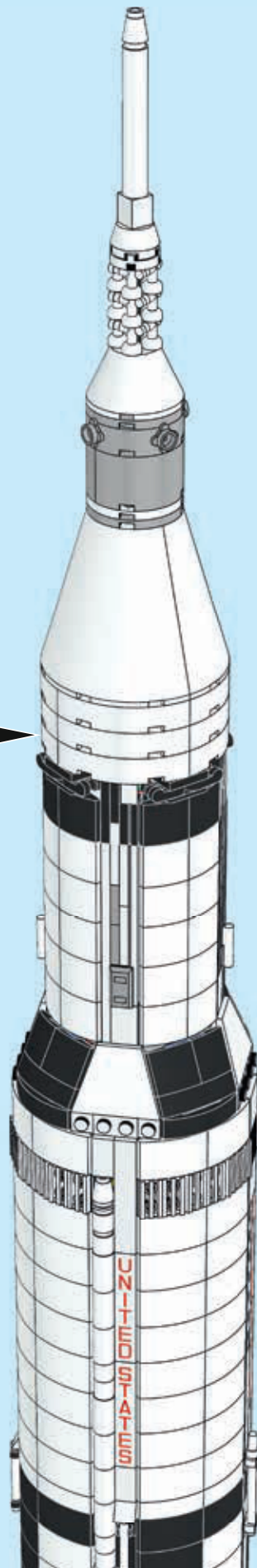

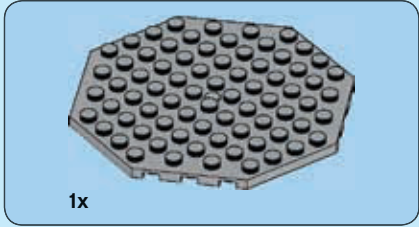
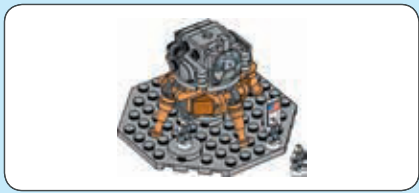

# 304

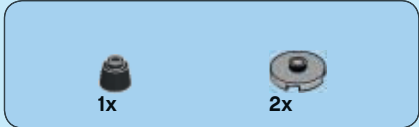
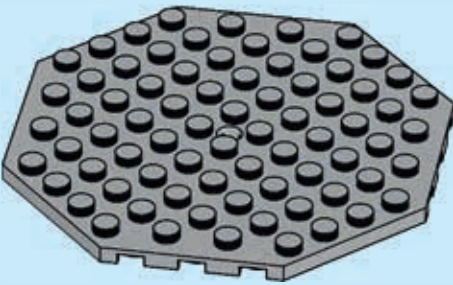

# 305

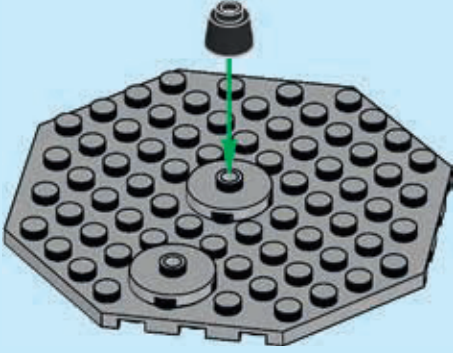



306

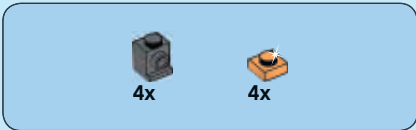

307

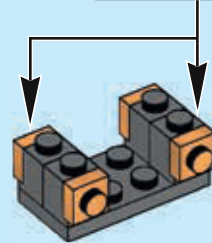
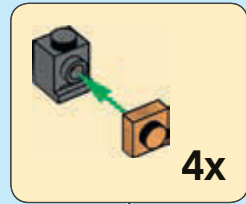

308

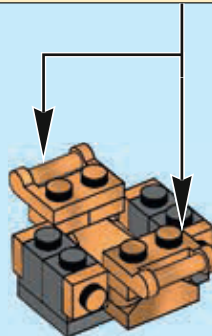
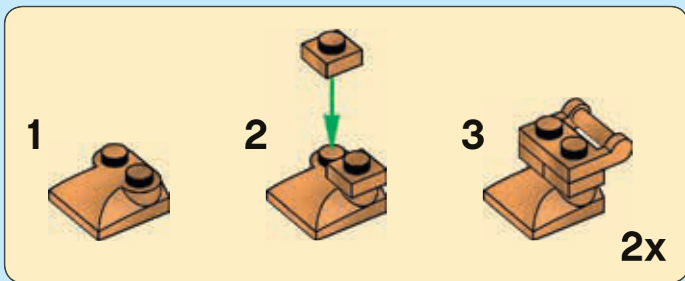



2x

# 309

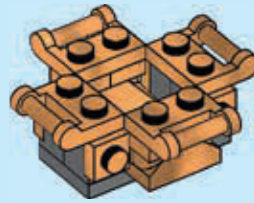

2x



1x

# 310

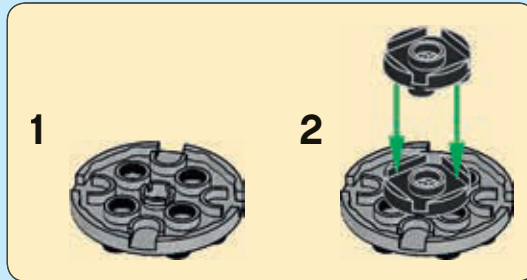

4x

# 311



4x

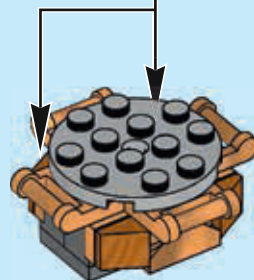

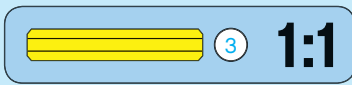
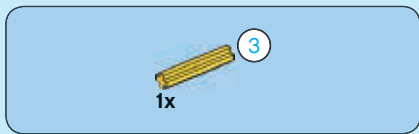

312

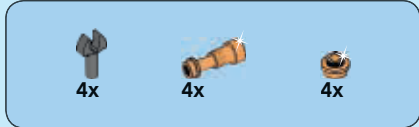

313

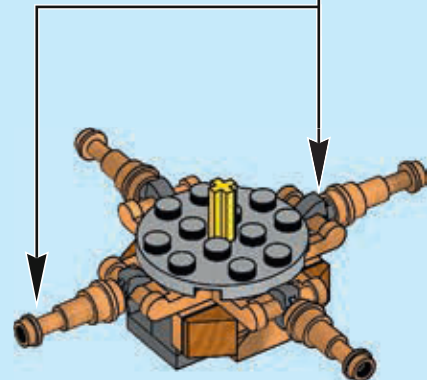
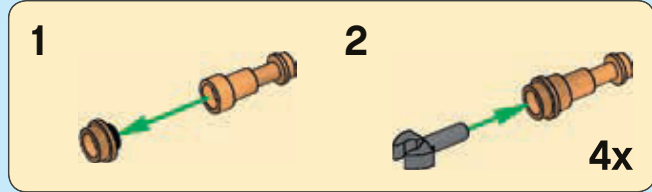



314

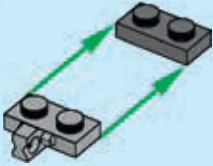

315

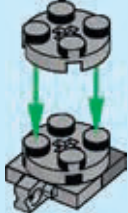

316

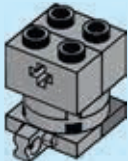

317

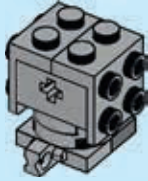

318

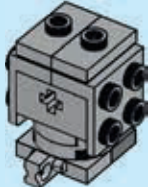

319

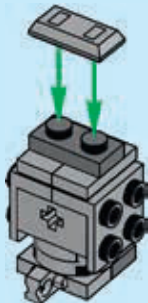





# 320

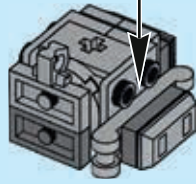
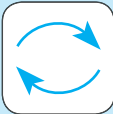
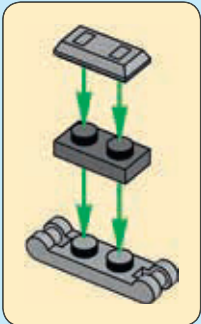

# 321

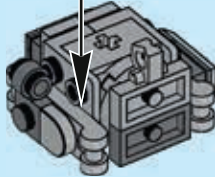
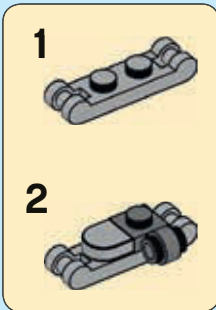

# 322

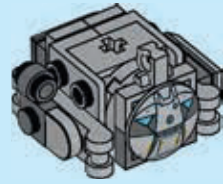

# 323

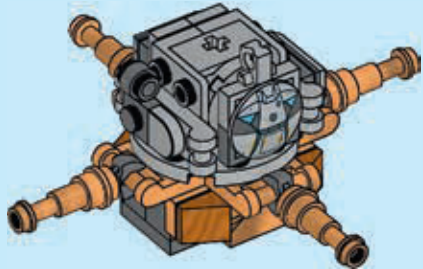

# 324

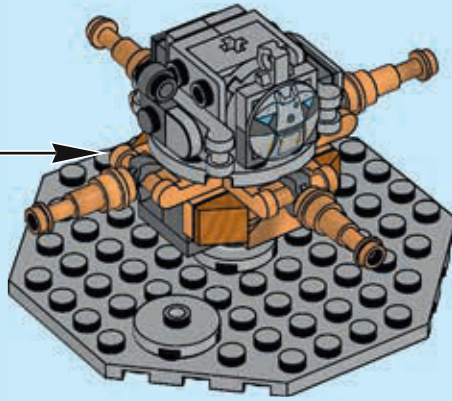

1x



3x

# 325

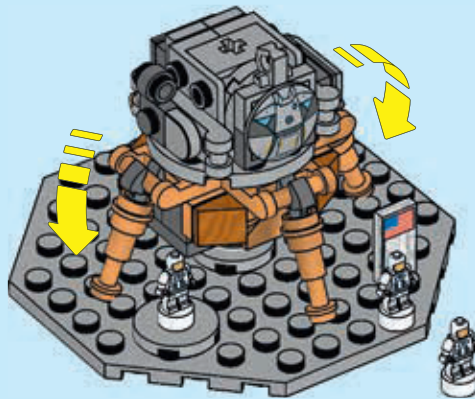

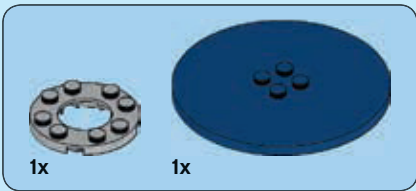

326

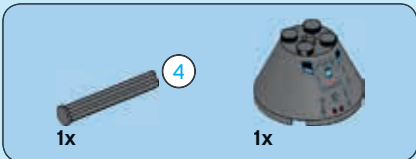

327

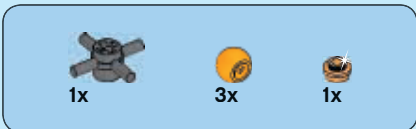
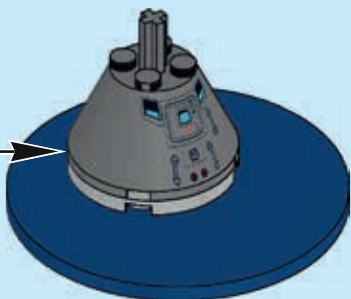
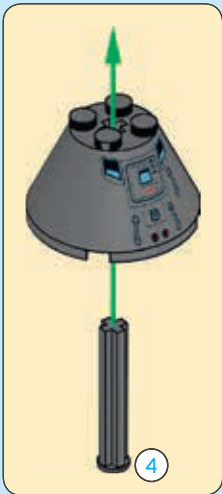

328

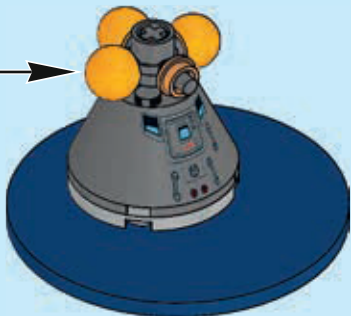
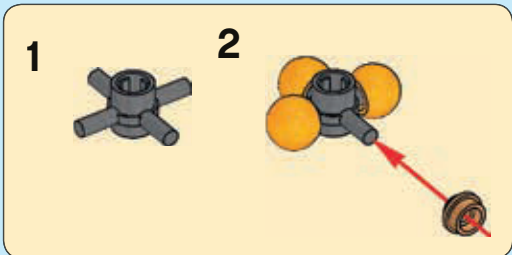



8x

# 329

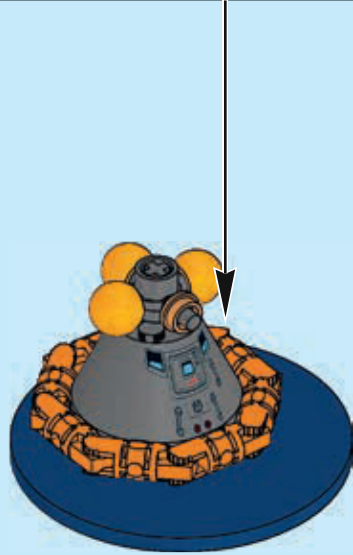
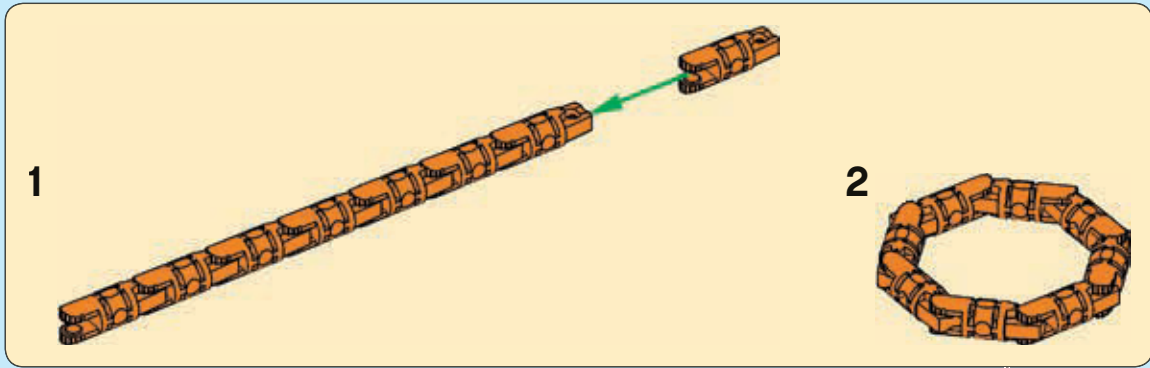

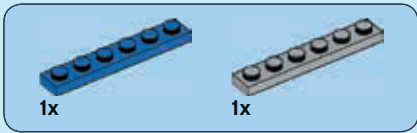
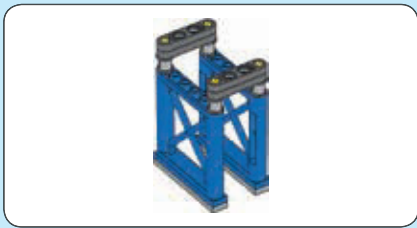

330

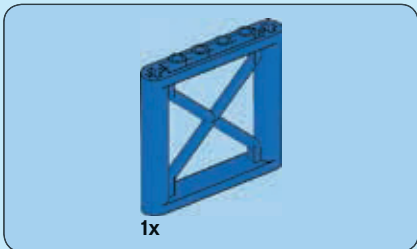
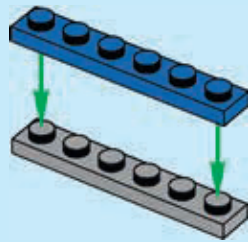

331

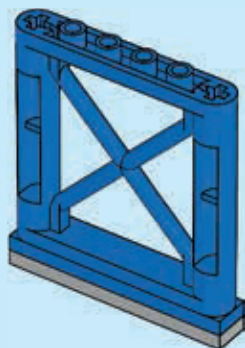

332

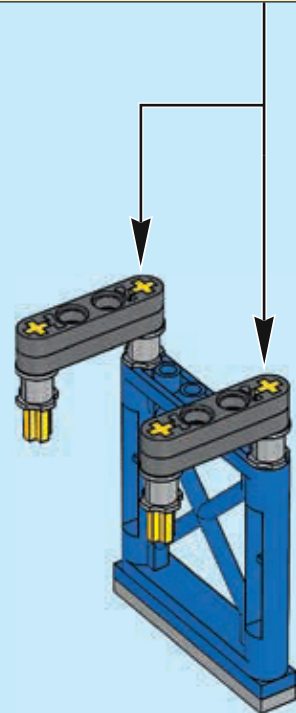
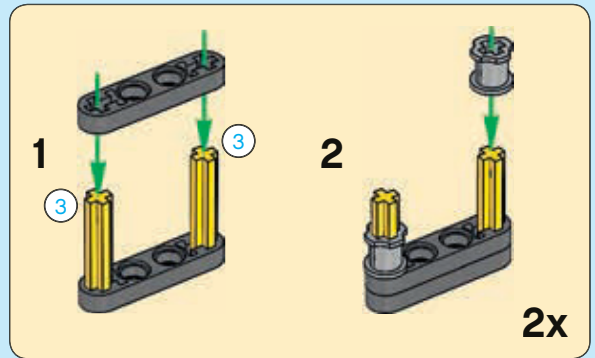
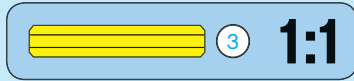

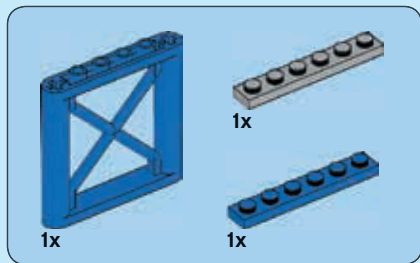

333

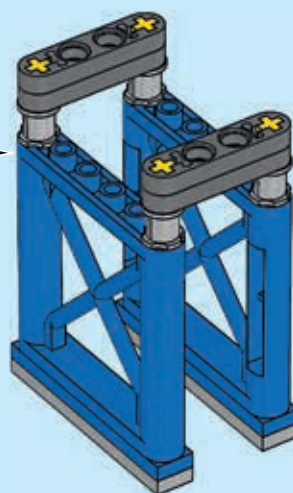
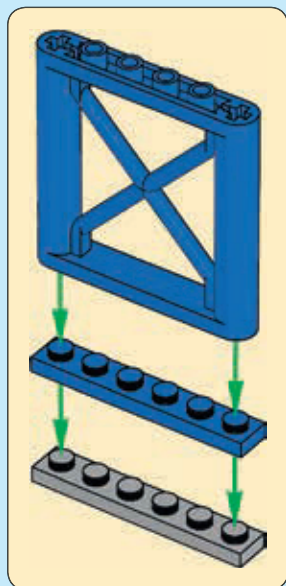

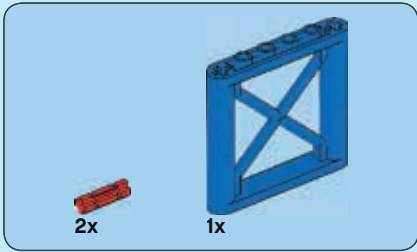

334

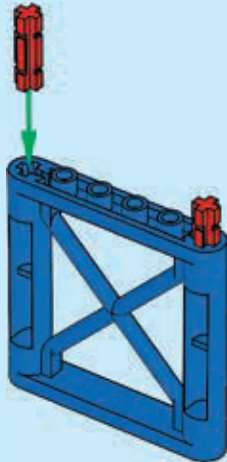

335

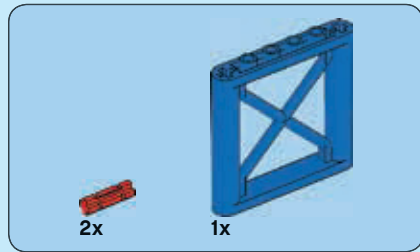
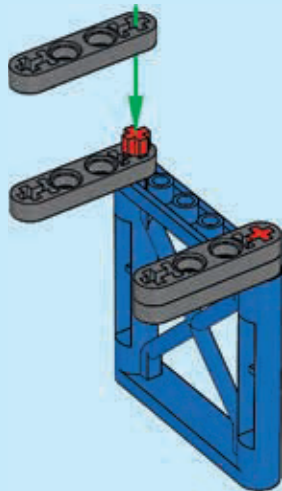

336

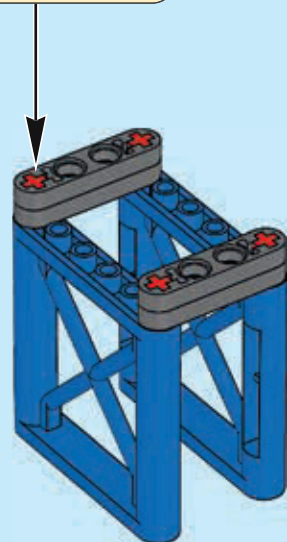
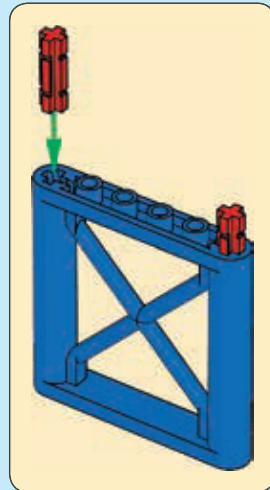

2x  
175

337





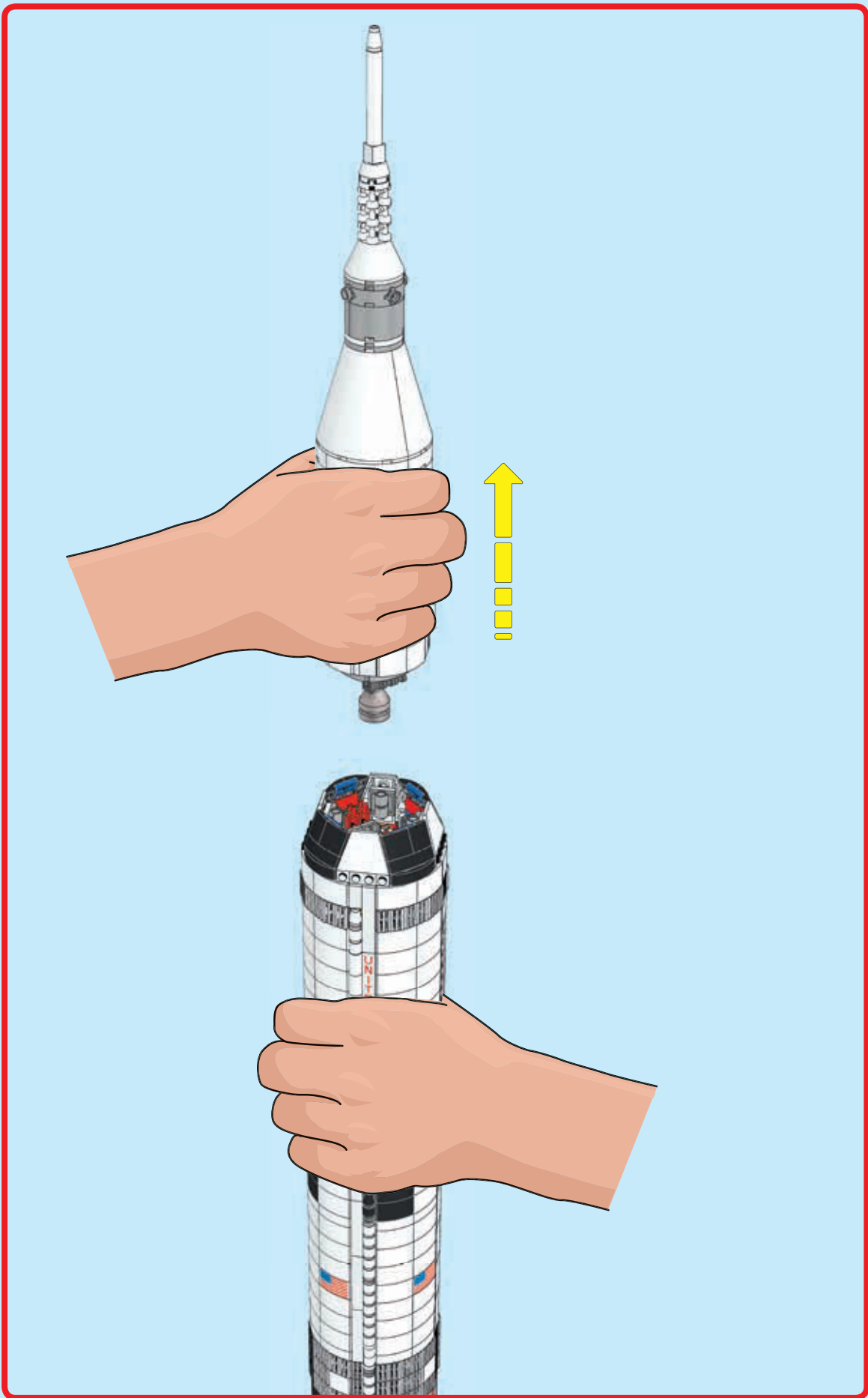

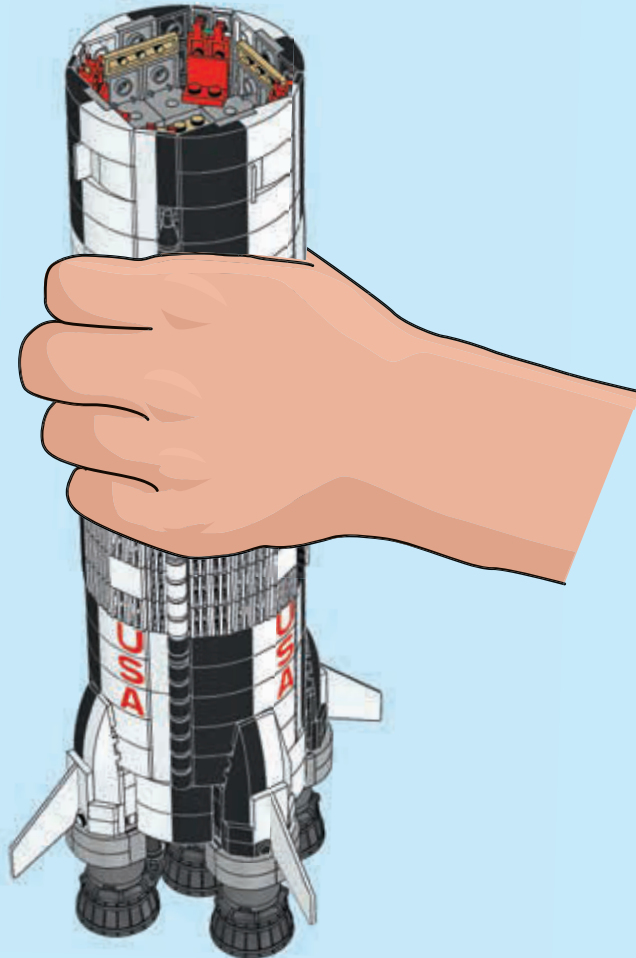
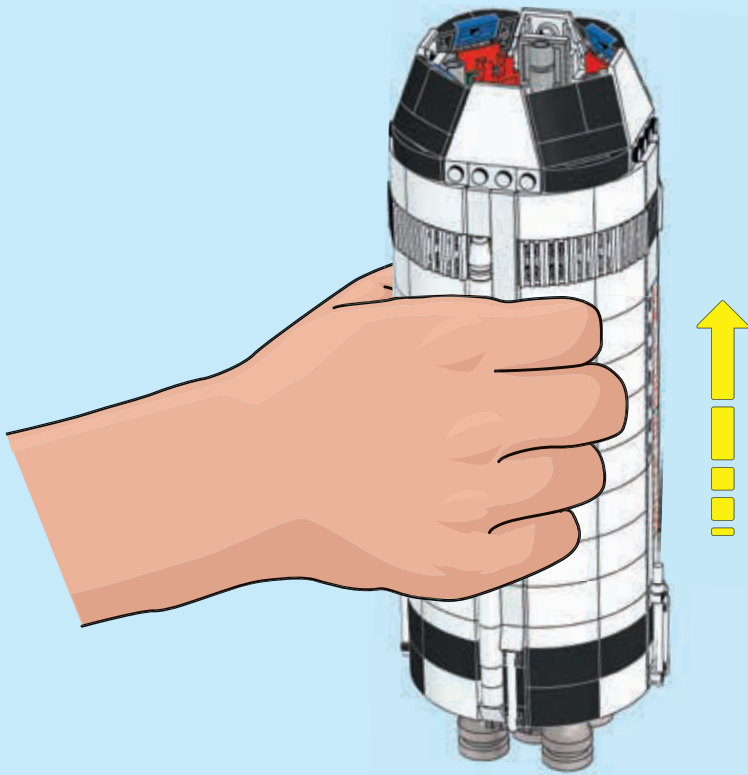

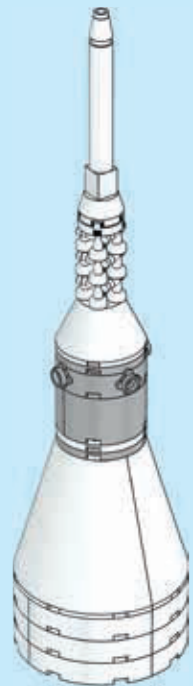
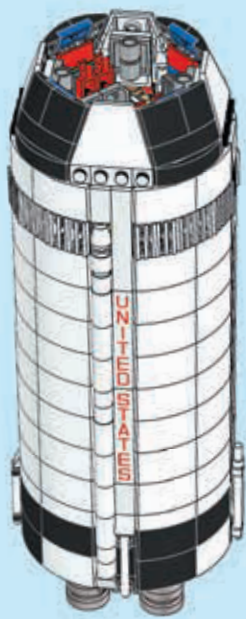
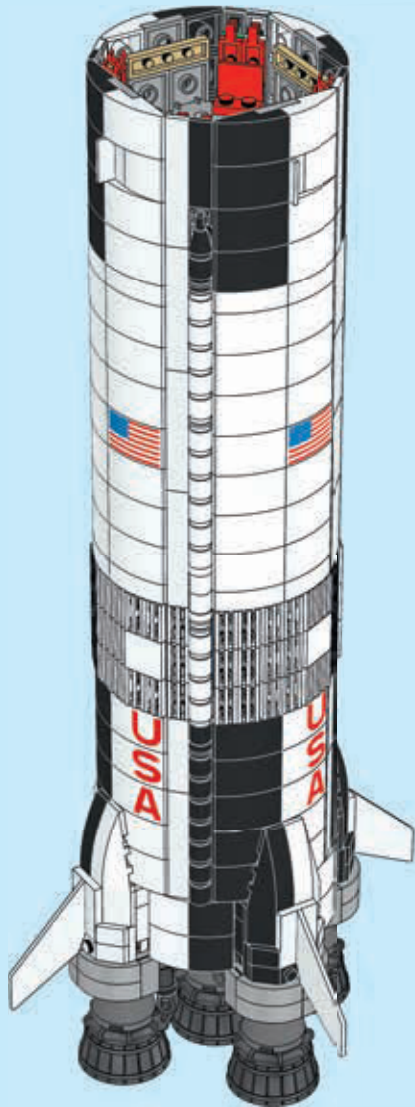

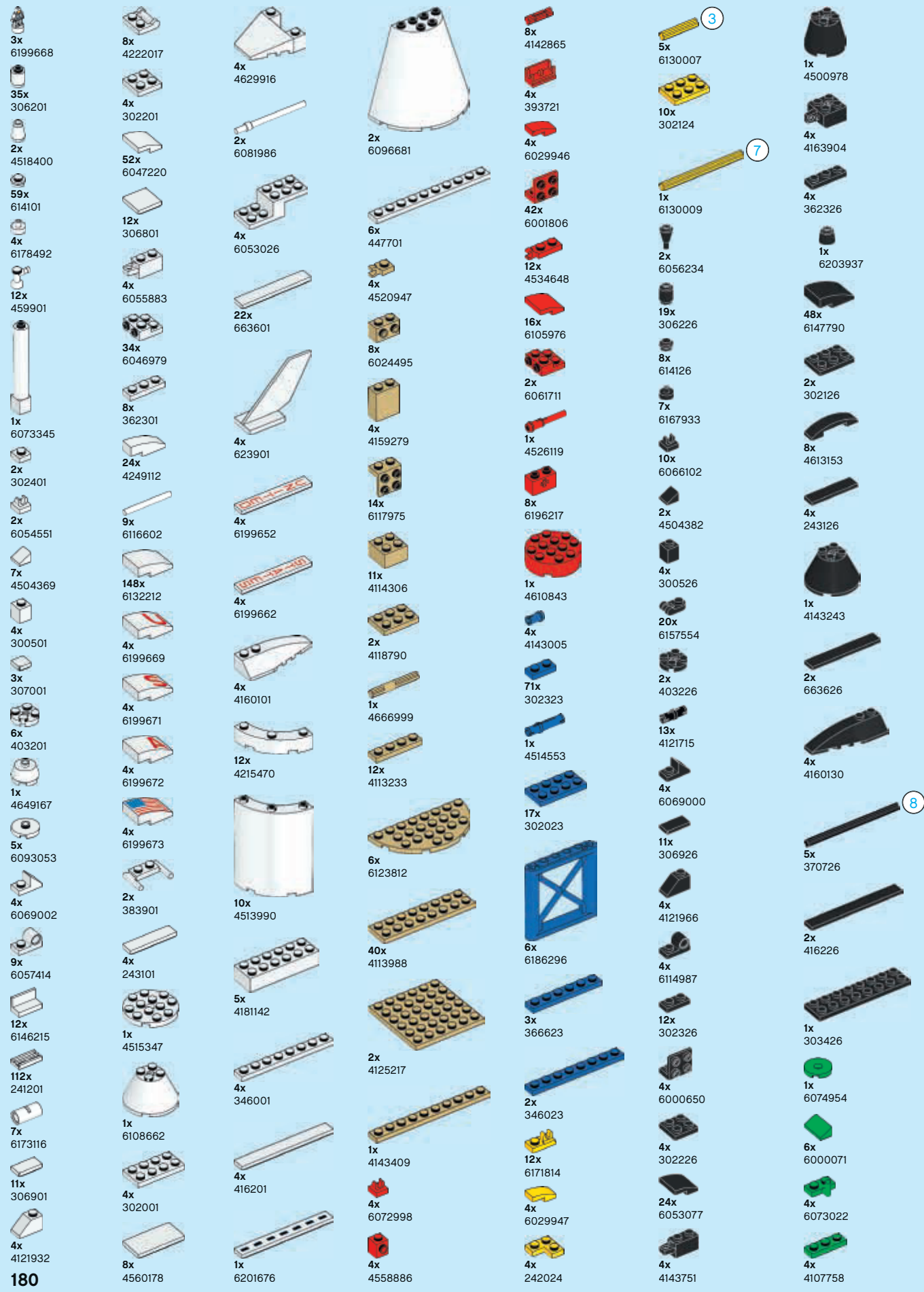

3x 6199668  
 35x 306201  
 2x 4518400  
 59x 614101  
 4x 6178492  
 12x 459901  
 1x 6073345  
 2x 302401  
 2x 6054551  
 7x 4504369  
 4x 300501  
 3x 307001  
 6x 403201  
 1x 4649167  
 5x 6093053  
 4x 6069002  
 9x 6057414  
 12x 6146215  
 112x 241201  
 7x 6173116  
 11x 306901  
 4x 4121932

8x 4222017  
 4x 302201  
 52x 6047220  
 12x 306801  
 4x 6055883  
 34x 6046979  
 8x 362301  
 24x 4249112  
 9x 6116602  
 148x 6132212  
 4x 6199669  
 4x 6199671  
 4x 6199672  
 4x 6199673  
 2x 383901  
 4x 243101  
 1x 4515347  
 1x 6108662  
 4x 302001  
 8x 4560178

4x 4629916  
 2x 6081986  
 4x 6053026  
 22x 663601  
 4x 623901  
 4x 6199652  
 4x 6199662  
 4x 4160101  
 12x 4215470  
 10x 4513990  
 4x 243101  
 5x 4181142  
 4x 346001  
 4x 416201  
 1x 6201676

2x 6096681  
 6x 447701  
 4x 4520947  
 8x 6024495  
 4x 4159279  
 14x 6117975  
 11x 4114306  
 2x 4118790  
 1x 4666999  
 12x 4113233  
 6x 6123812  
 40x 4113988  
 2x 4125217  
 1x 4143409  
 4x 6072998  
 4x 4558886

8x 4142865  
 4x 393721  
 4x 6029946  
 42x 6001806  
 12x 4534648  
 16x 6105976  
 2x 6061711  
 1x 4526119  
 8x 6196217  
 1x 4610843  
 4x 4143005  
 71x 302323  
 1x 4514553  
 17x 302023  
 6x 6186296  
 3x 366623  
 2x 346023  
 12x 6171814  
 4x 6029947  
 4x 242024

5x 6130007  
 10x 302124  
 1x 6130009  
 2x 6056234  
 19x 306226  
 8x 614126  
 7x 6167933  
 10x 6066102  
 2x 4504382  
 4x 300526  
 20x 6157554  
 2x 403226  
 13x 4121715  
 4x 6069000  
 11x 306926  
 4x 4121966  
 4x 6114987  
 12x 302326  
 4x 6000650  
 4x 302226  
 24x 6053077  
 4x 4143751

1x 4500978  
 4x 4163904  
 4x 362326  
 1x 6203937  
 48x 6147790  
 2x 302126  
 8x 4613153  
 4x 243126  
 1x 4143243  
 2x 663626  
 4x 4160130  
 5x 370726  
 2x 416226  
 1x 303426  
 1x 6074954  
 6x 6000071  
 4x 6073022  
 4x 4107758



3x  
4243821



1x  
6199664



8x  
6200047



1x  
4654448



1x  
6200046



5x  
4222960



5x  
4646865



5x  
6185735



3x  
6071608



16x  
4216695



2x  
6151688



4x  
6182167



4x  
4211622



4x  
4211475



1x  
6199828



8x  
4550325



4x  
6183782



1x  
4211814



62x  
6066097



8x  
6043656



8x  
4211414



4x  
6134378



12x  
4211440



10x  
6123809



2x  
6117967



40x  
4654582



4x  
4563045



4x  
4211376



4x  
4211397



4x  
4211410



4x  
4211881



10x  
6019212



1x  
6070564



16x  
4625619



2x  
6206249



2x  
6093058



2x  
6134782



4x  
4622803



2x  
4211445



4x  
4211409



4x  
4515351



2x  
6028015



2x  
4211527



4x  
4211385



2x  
4211352



4x  
4211438



1x  
4211796



22x  
4211452



2x  
4211425



16x  
4211404



10x  
4211462



1x  
6034493



2x  
4211360



4x  
4289542



9x  
4211044



9x  
4249139



1x  
4632574



8x  
6039479



3x  
4211063



5x  
4210698



6x  
6117972



40x  
6000606



1x  
4222192



4x  
4218696



8x  
4210884



12x  
4521187



5x  
6201630



12x  
4210749



4x  
6099909



1x  
6083620



1x  
6199823



26x  
4211065



10x  
4221749



2x  
6141856



4x  
4211122



12x  
6000970



21x  
6141499



8x  
6069887



8x  
4538126



4x  
4585493



2x  
4286597



6x  
6102756



6x  
6102594



6x  
6102594



5x  
6008484



4x  
6200049



5x  
6197967



5x  
6197966



4x  
6191668

4



Customer Service

Kundenservice

Service Consommateurs

Servicio Al Consumidor

LEGO.com/service or dial



: 00800 5346 5555

: 1-800-422-5346



# IDEAS

LEGO® REVIEW  
LEGO® PRÜFUNG  
EXAMEN PAR LEGO®  
REVIEW LEGO®  
REVISIÓN DE LEGO®  
AVALIAÇÃO LEGO®  
LEGO® VÉLEMÉNYEZÉS  
乐高®评论

SHARE YOUR IDEA  
TEILE DEINE IDEE  
PARTAGE TON IDÉE  
CONDIVIDI LA TUA IDEA  
COMPARTE TU IDEA  
PARTILHA A TUA IDEIA  
TEDD KÖZZÉ AZ ÖTLETED  
分享您的观点

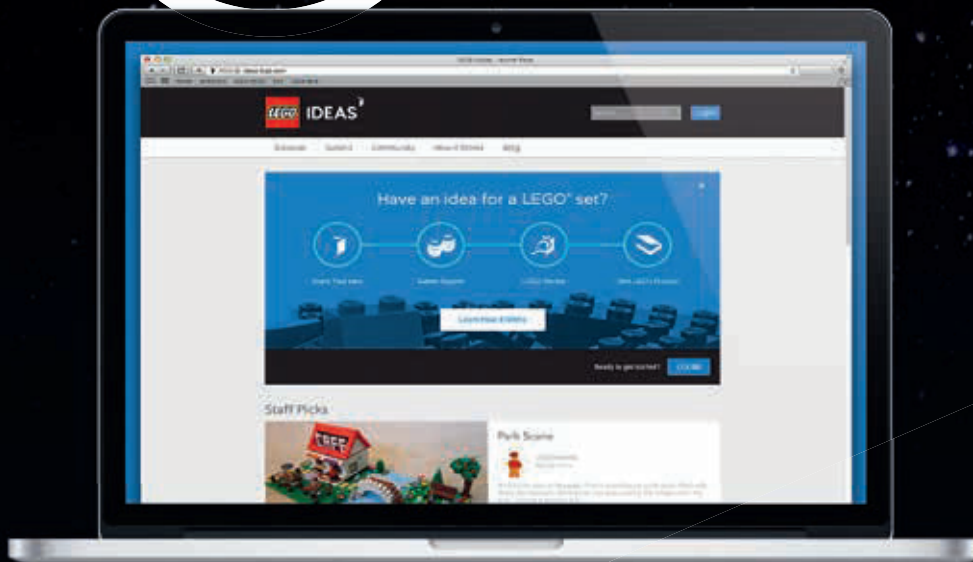
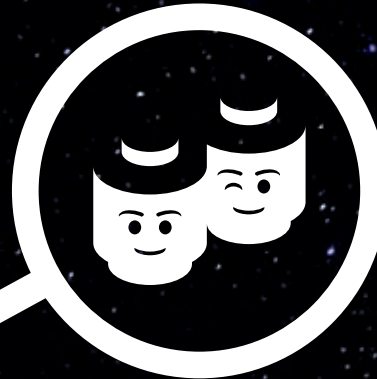

GATHER SUPPORT  
HOL' DIR UNTERSTÜTZUNG  
RASSEMBLE DES VOTES  
CHIEDI DI ESSERE SUPPORTATO  
GANA APOYOS  
OBTÉM APOIO  
SZEREZZ TÁMOGATÁST  
获得更多支持

NEW LEGO® PRODUCT  
NEUES LEGO® PRODUKT  
NOUVEAU PRODUIT LEGO®  
NUOVO PRODOTTO LEGO®  
NUEVO PRODUCTO LEGO®  
NOVO PRODUTO LEGO®  
ÚJ LEGO® TERMÉK  
新的乐高®产品



[LEGO.COM/IDEAS](https://www.lego.com/ideas)



# IDEAS

## Do you like this LEGO® Ideas set?

The LEGO® Group would like your opinion on the new product you have just purchased. Your feedback will help shape the future development of this product series. Please visit:

[LEGO.com/productsurvey](http://LEGO.com/productsurvey)



By completing our short feedback survey, you will be automatically entered into a drawing to win a LEGO® prize. See website for official rules and details. Open to all countries where not prohibited.