



# duplo



**MAVILLE**

**MI CIUDAD**



**10841**  
LEGO.com/DUPL0



 duplo



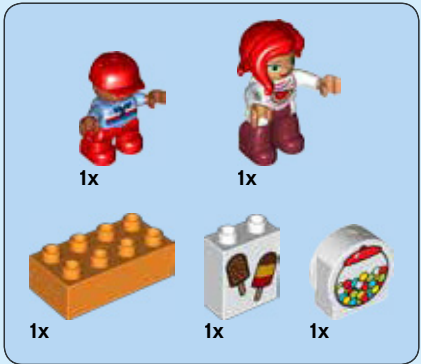

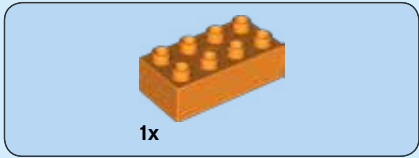

1

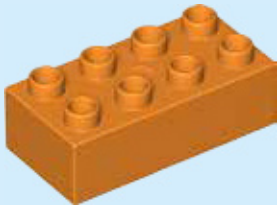

4

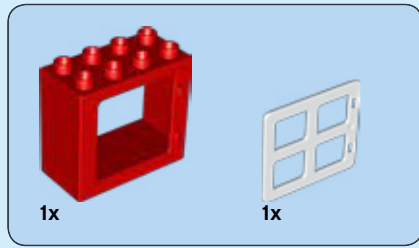

2

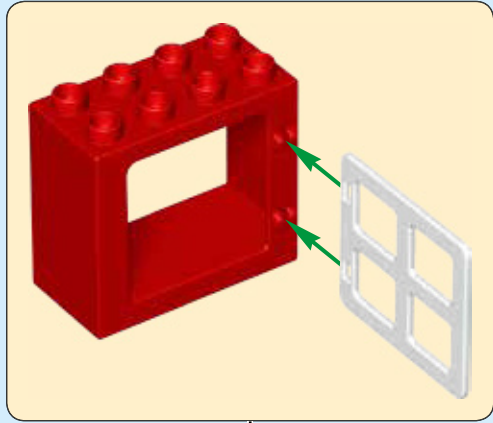

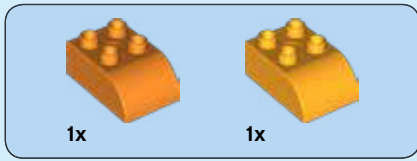

3

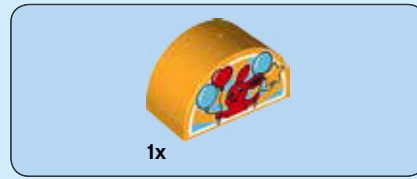
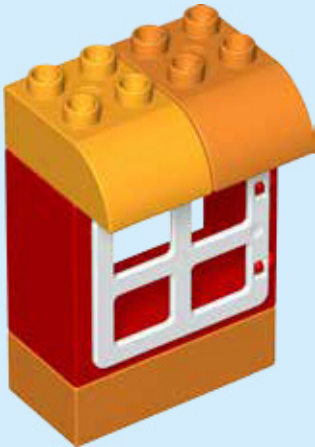

4



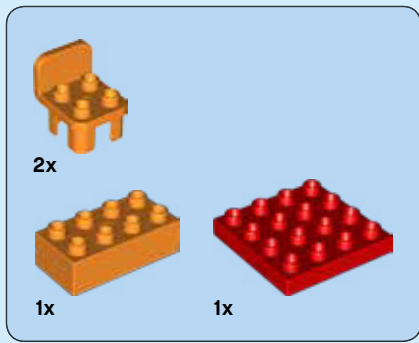

1

1

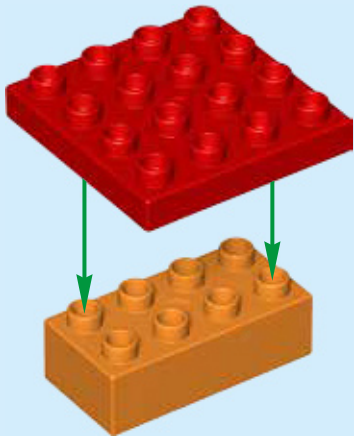

2

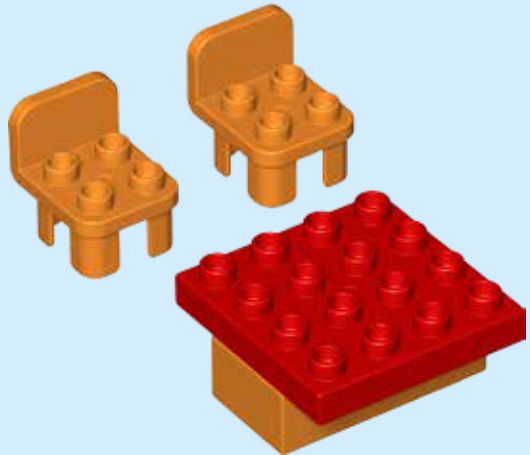

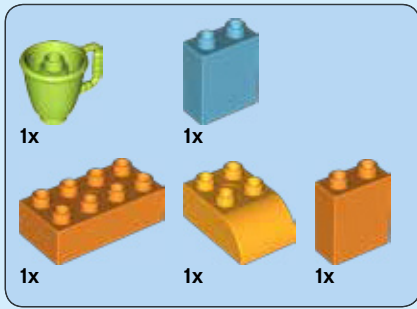

2

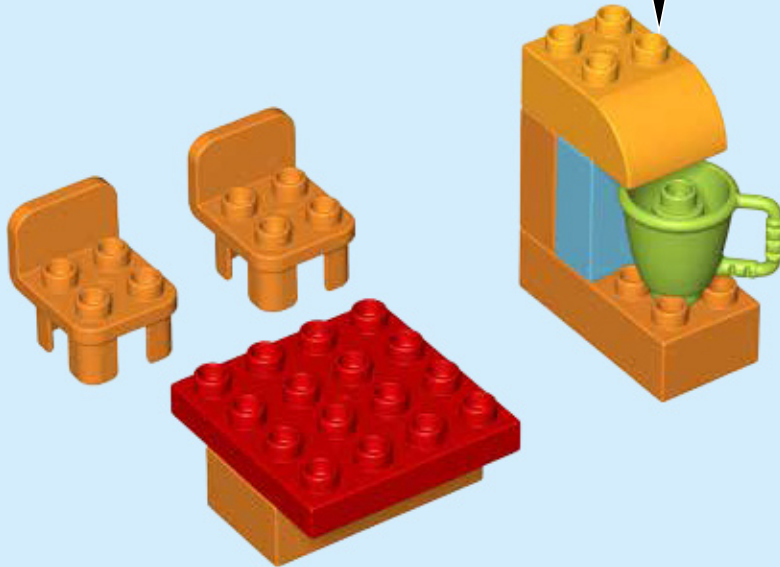
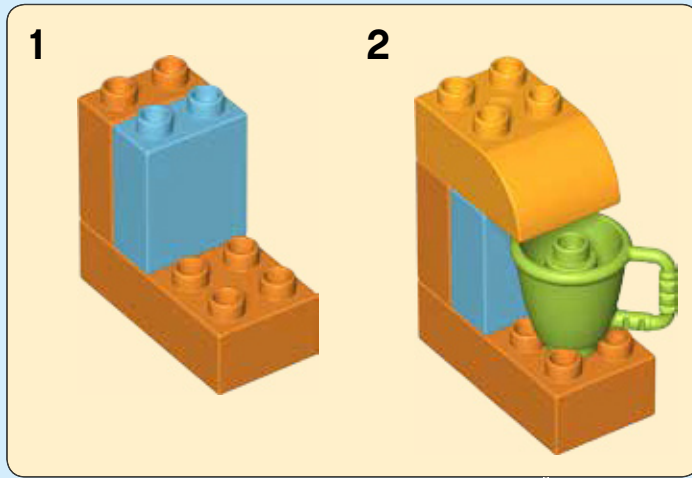

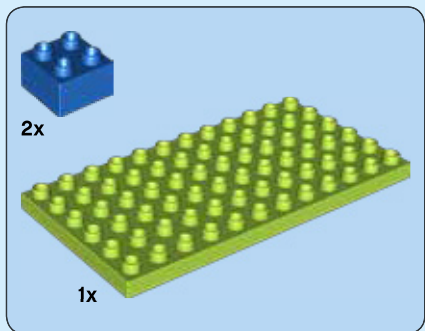

1

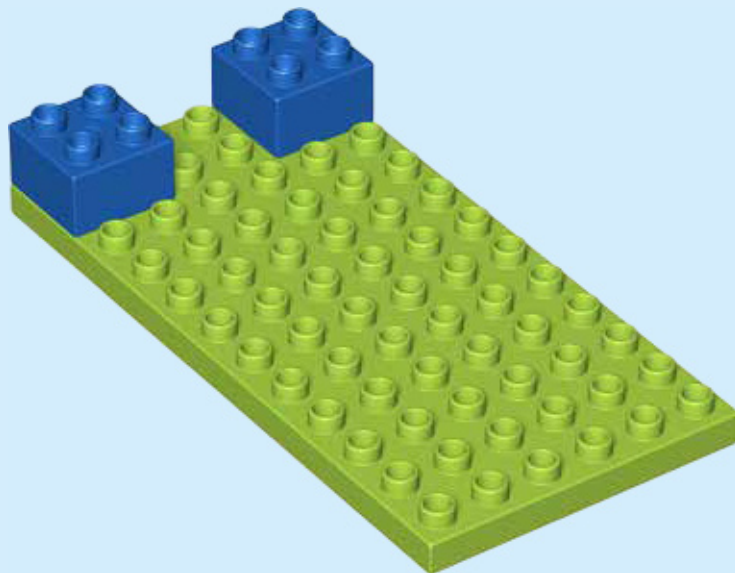



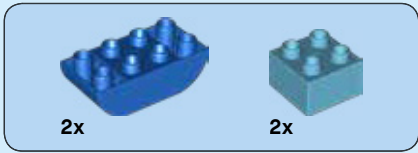

2

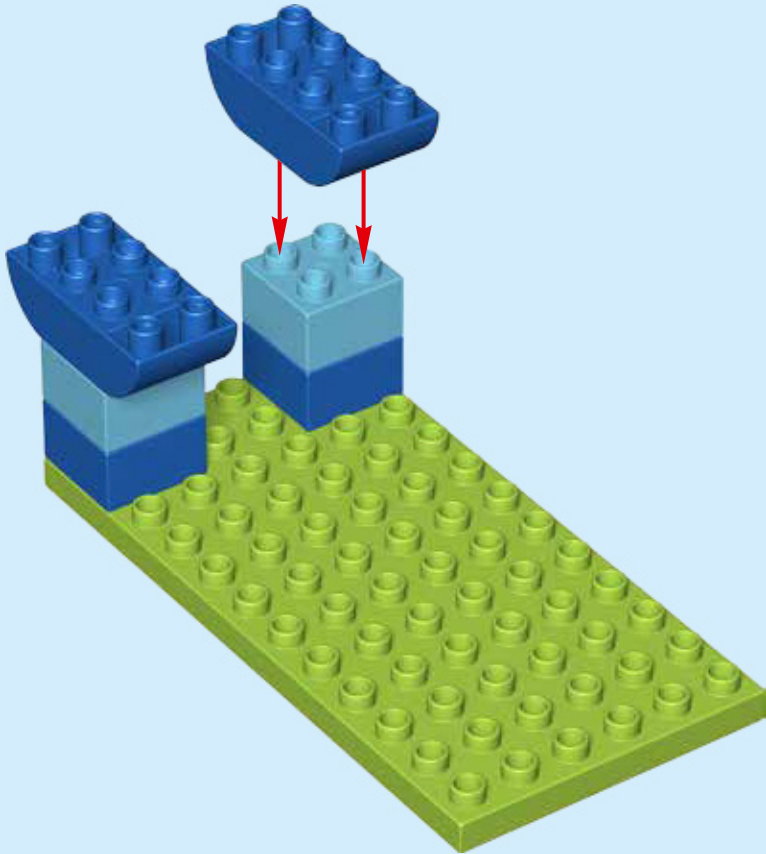

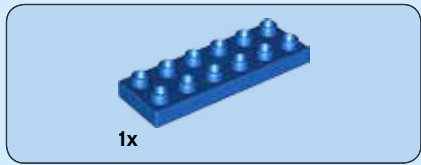

**3**

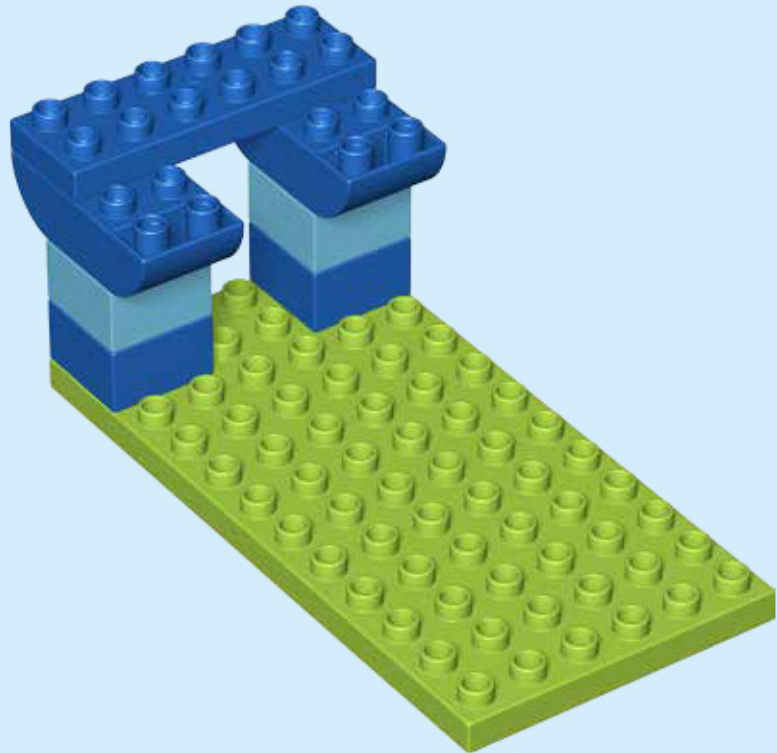

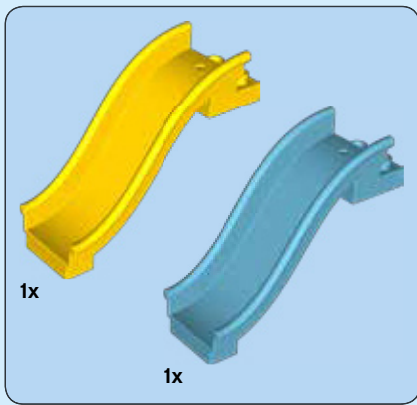

4

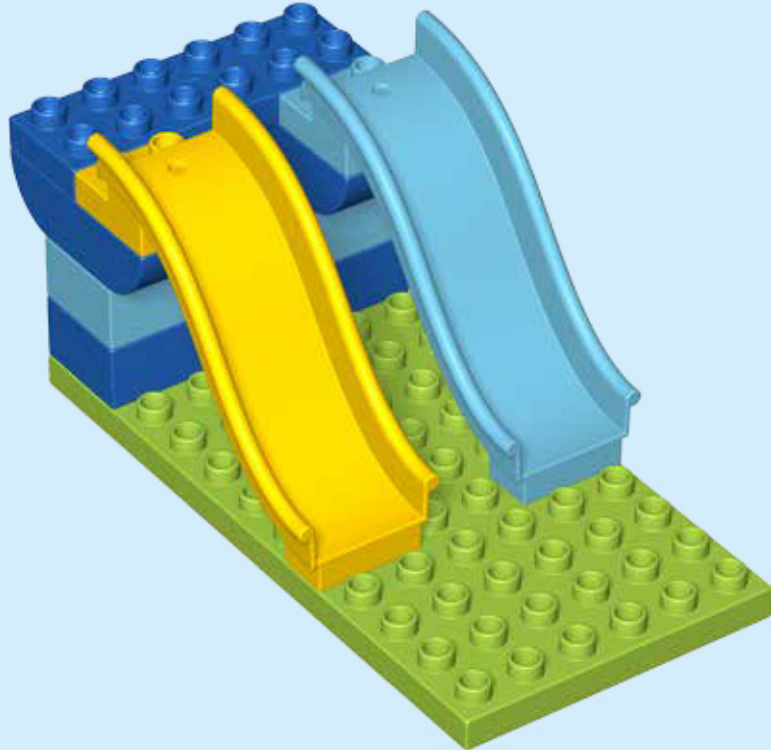

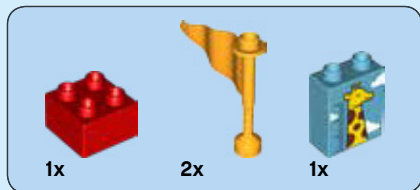

5

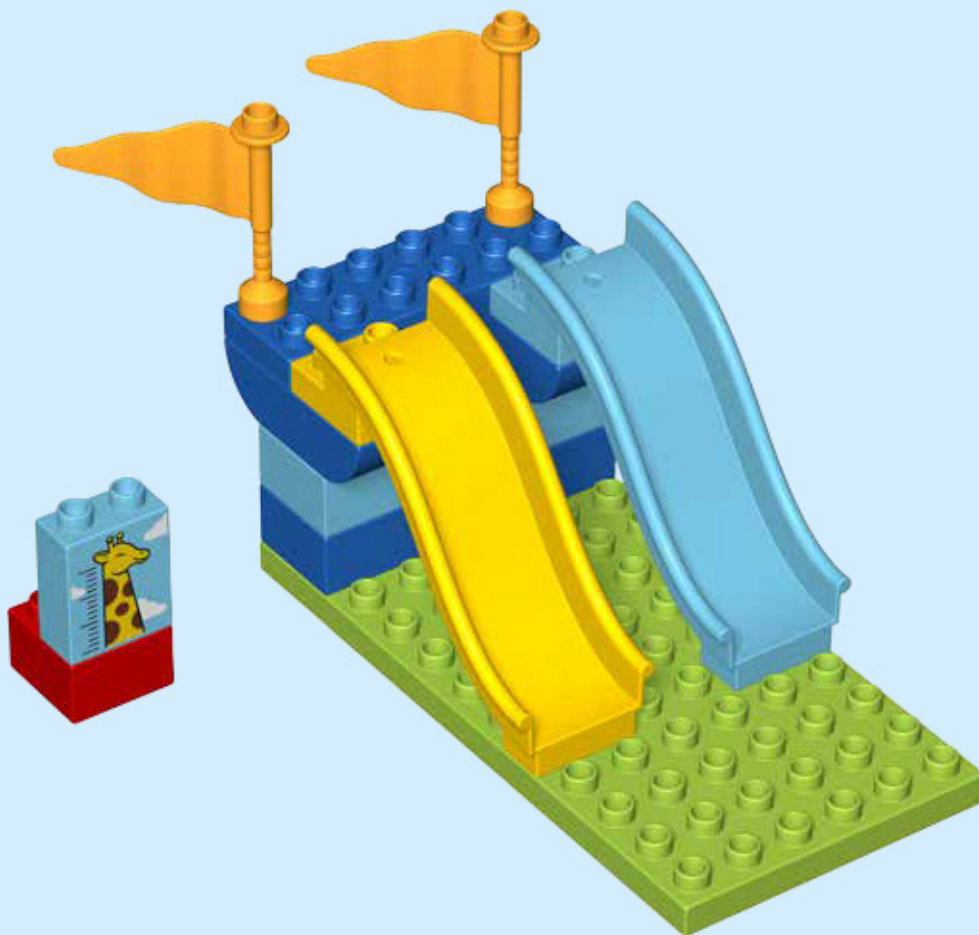



6



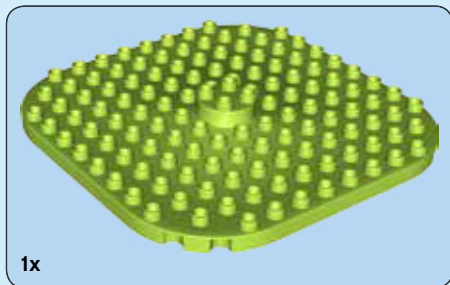

1x

**1**

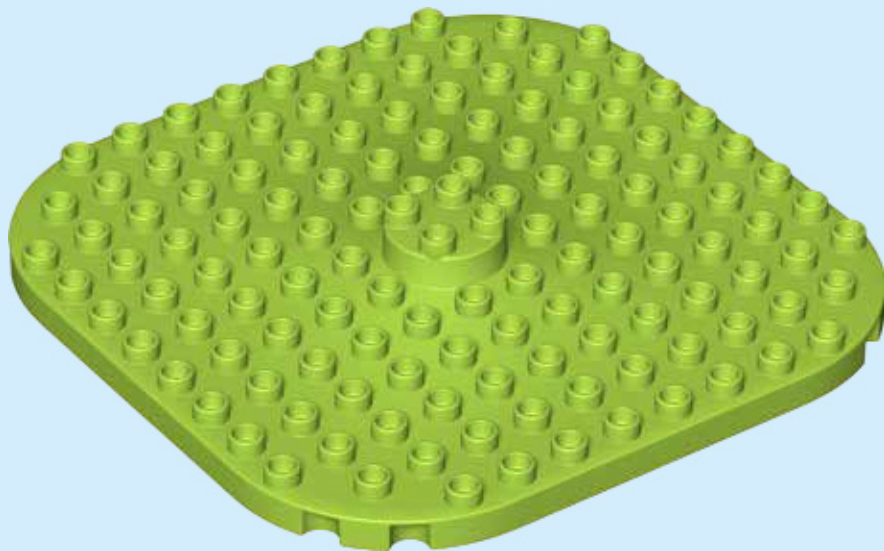

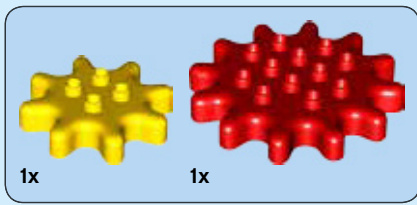

2

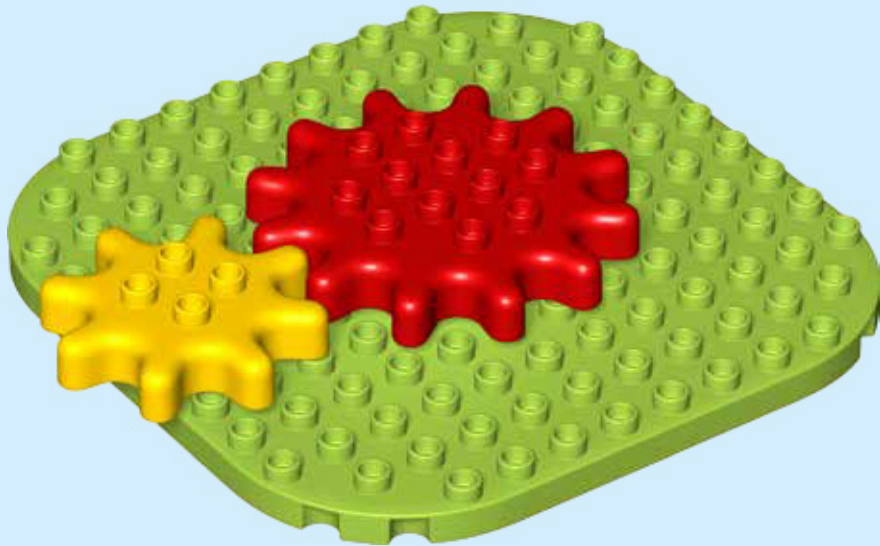

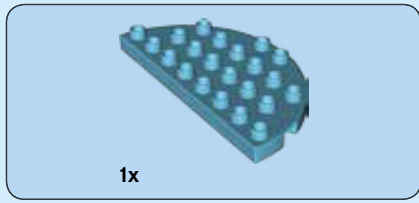

3

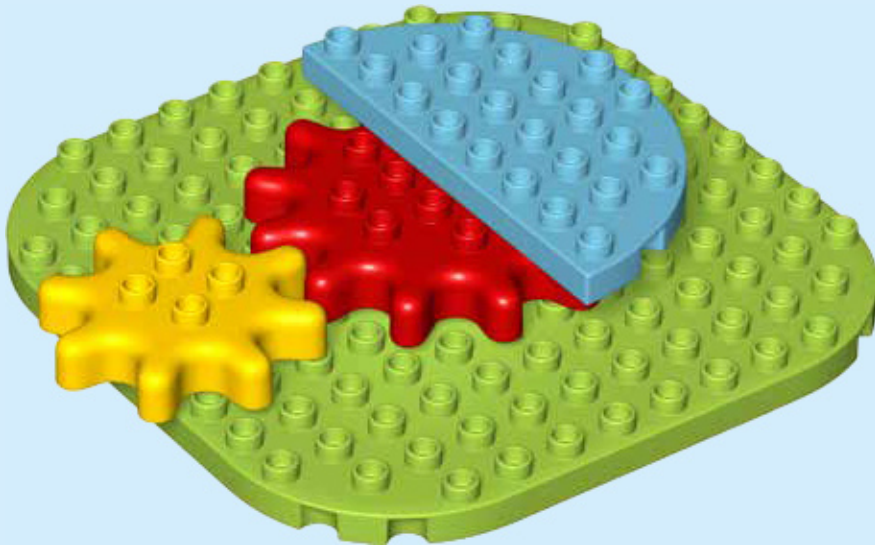



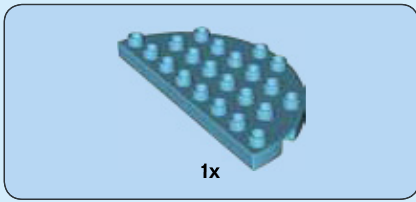

4

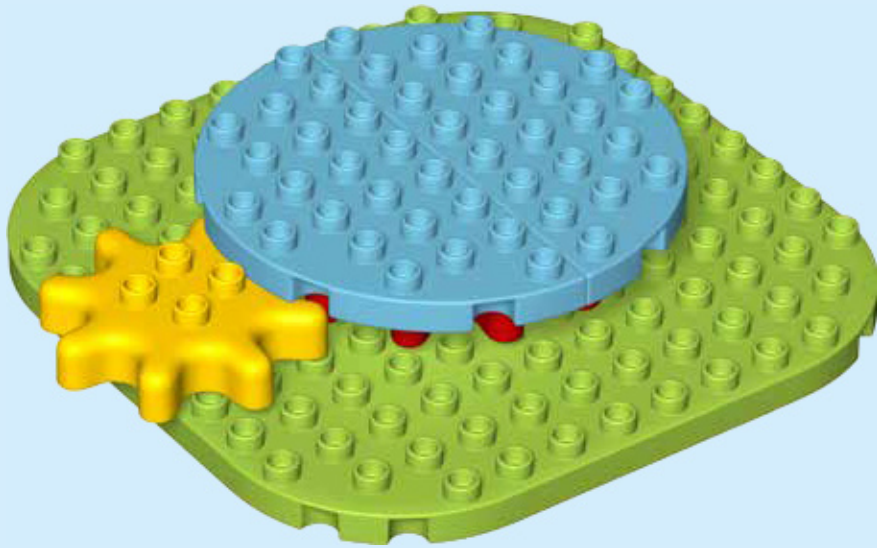

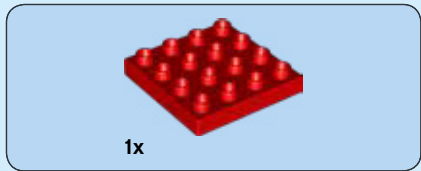

5

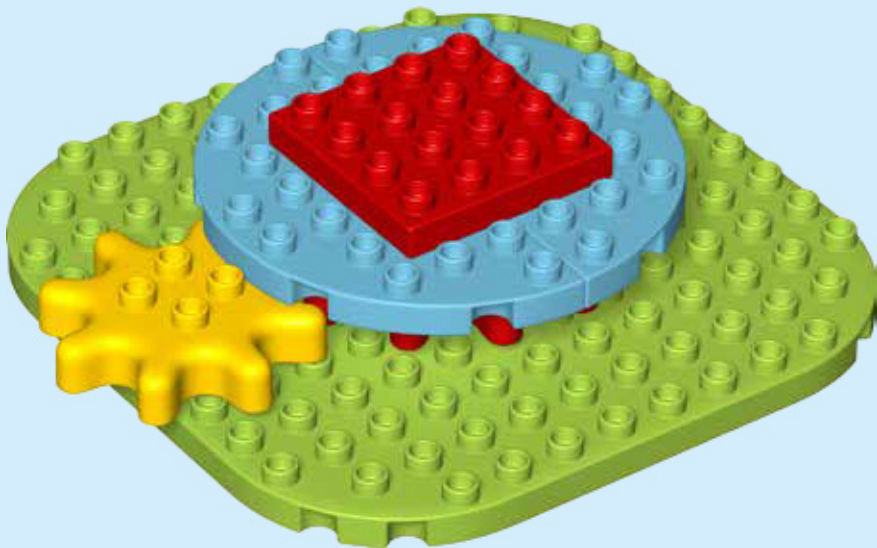

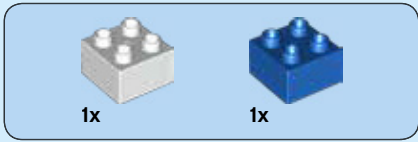

6

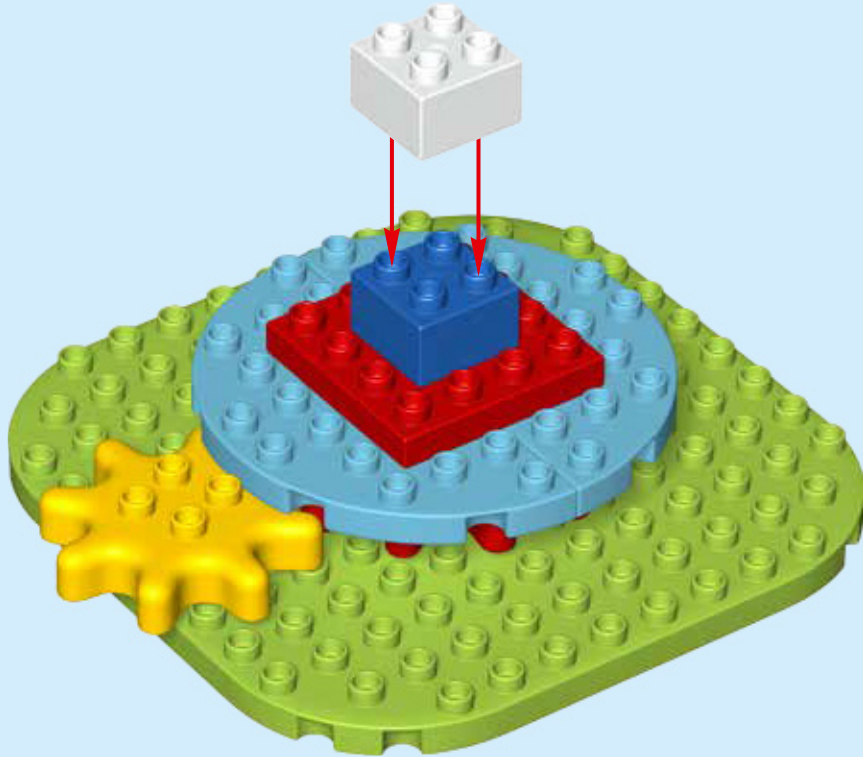



7

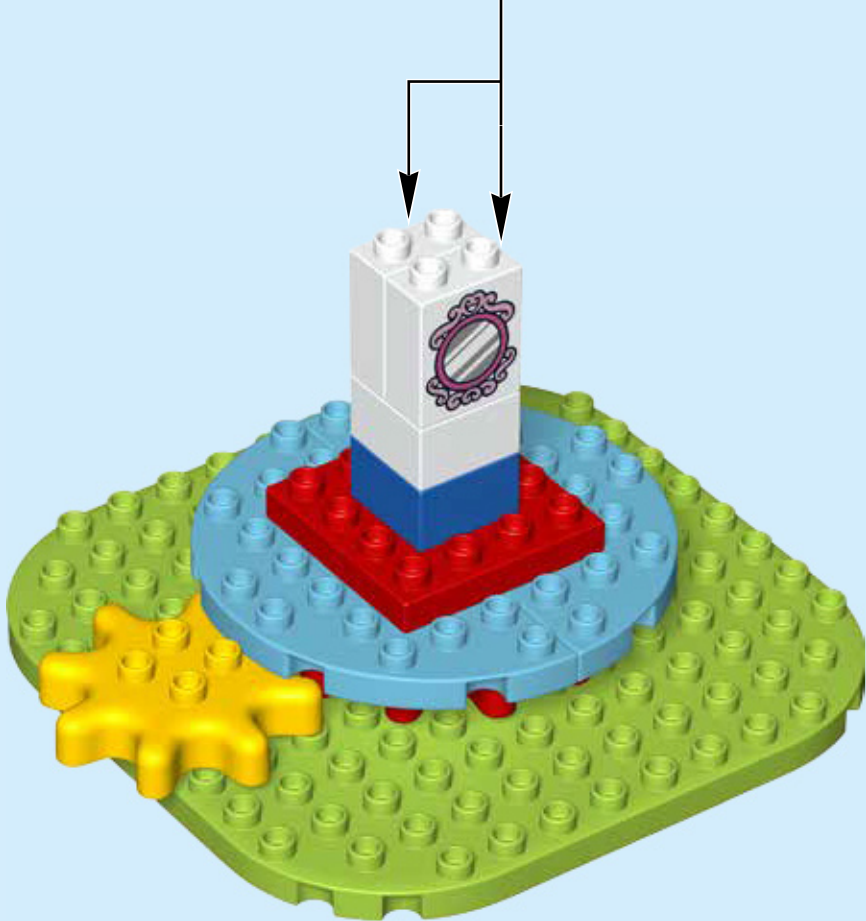

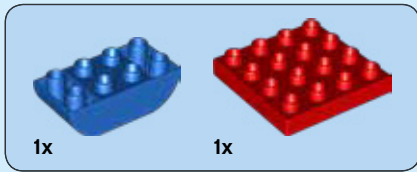

8

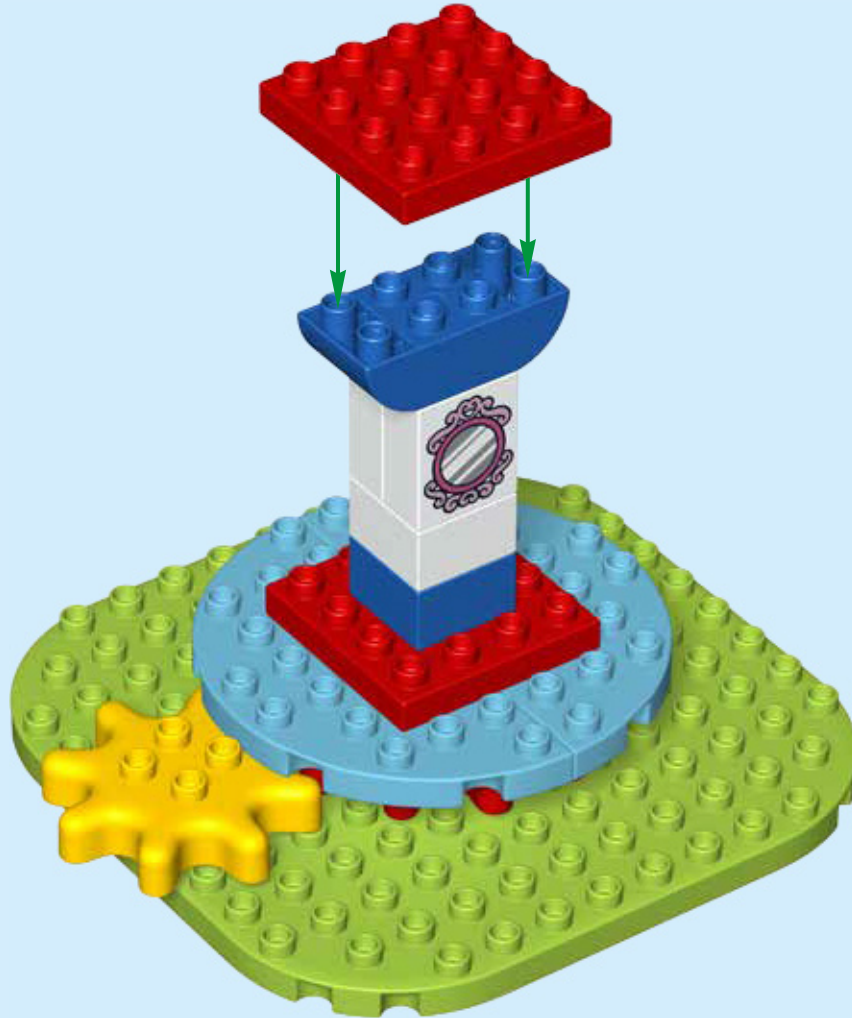

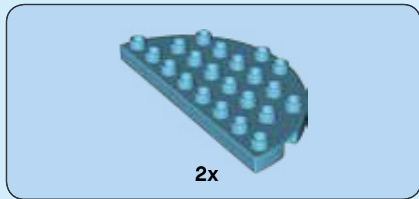

9





10



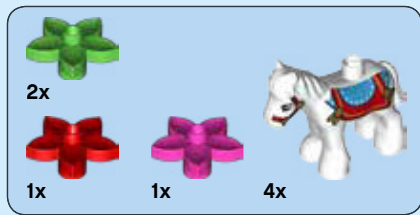

11

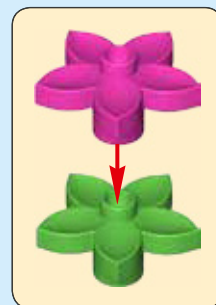
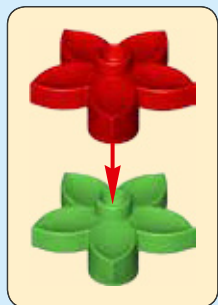







 duplo

The word "duplo" is written in a yellow, rounded, bubbly font with a black outline. A small red fish icon is positioned above the letter 'o'.

LEGO

duplo





**MY FIRST LEGO® DUPLO® SETS**  
**MES PREMIERS ENSEMBLES LEGO® DUPLO®**  
**MIS PRIMEROS SETS LEGO® DUPLO®**

Ages/edades  
**1½-3**



10818



10845



10816



10847



**APPRENDIS  
 A COMPTER**

**APRENDE  
 A CONTAR**



**FAVORITE CHARACTERS**  
**PERSONNAGES PRÉFÉRÉS**  
**PERSONAJES FAVORITOS**

Ages/edades  
**2-5**



10846



10856



10857

© Disney/Pixar; rights in underlying vehicles are the property of third parties, as applicable: FIAT™; Mack™.



© Disney



10844

**MINNIE**

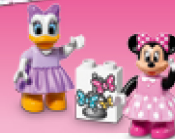

MY LEGO® DUPLO® TOWN  
MA VILLE LEGO® DUPLO®  
MI CIUDAD LEGO® DUPLO®



MA VILLE

MI CIUDAD

Âges/edades  
2-5

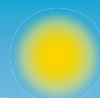

10834



10835



10525



10507



MOTOR  
SOUNDS

MOTEUR  
et  
SONS

MOTOR  
y  
SONIDOS

The fun continues!  
L'amusement continue !  
¡La diversión continúa!

FACILE À CONSTRUIRE

FÁCIL DE CONSTRUIR

EASY TO BUILD

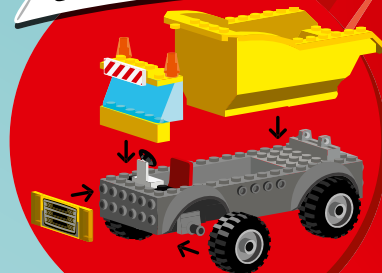

LEGO

JUNIORS

LEGO

duplo



1½-5



4-7

LEGO.com/juniors



**INSPIRATION & ACTIVITIES**  
**IDÉES ET ACTIVITÉS**  
**IDEAS Y ACTIVIDADES**



[pinterest.com/LEGO/LEGO-DUPLO](https://pinterest.com/LEGO/LEGO-DUPLO)

#LEGODUPLO

[facebook.com/LEGODUPLO](https://facebook.com/LEGODUPLO)

[LEGO.com/DUPLO](https://LEGO.com/DUPLO)

**FREE APP**  
**APPLI GRATUITE**  
**APP GRATIS**

The LEGO Group



Our games are available for download for both Android and iOS.

Nos jeux peuvent être téléchargés sur les appareils Android et iOS.

Nuestros juegos están disponibles para dispositivos Android e iOS.

Customer Service  
 Kundenservice  
 Service Consommateurs  
 Servicio Al Consumidor

[LEGO.com/service](https://LEGO.com/service) or dial

: 00800 5346 5555

: 1-800-422-5346

# win

Go to  
[www.LEGO.com/productfeedback](http://www.LEGO.com/productfeedback)  
and give us your short  
**feedback** about this LEGO® DUPLO®  
set for a chance to win  
a cool LEGO prize

Terms & Conditions apply



## LEGO.com/productfeedback

### GEWINNE

Erzähle uns auf  
[www.LEGO.com/productfeedback](http://www.LEGO.com/productfeedback)

etwas über die Erfahrungen, die du mit  
diesem LEGO® Set gemacht hast, und  
sichere dir die Chance auf einen coolen  
LEGO Preis!

Es gelten die Teilnahmebedingungen

### GAGNE

Rends-toi sur  
[www.LEGO.com/productfeedback](http://www.LEGO.com/productfeedback)

et donne-nous quelques commentaires  
sur ce produit LEGO® pour avoir une  
chance de gagner un prix LEGO !

Voir Conditions Générales

### GANA

Visita  
[www.LEGO.com/productfeedback](http://www.LEGO.com/productfeedback)

y envíanos tu opinión acerca de este set  
LEGO®. ¡Participarás en el sorteo de un  
premio LEGO!

Términos y Condiciones aplicables

### 获取奖品

登录  
[www.LEGO.com/productfeedback](http://www.LEGO.com/productfeedback)

给出关于此乐高®套装的简短反馈，  
就有机会获得炫酷乐高奖品

《条款及条件》适用

LEGO, the LEGO logo, DUPLO and the DUPLO logo are trademarks of the/son des marques de commerce du/son marcas registradas de LEGO Group. ©2017 The LEGO Group.

6204396