



# SCOOBY-DOO!

75902



[LEGO.com/scoobydoo](https://www.LEGO.com/scoobydoo)





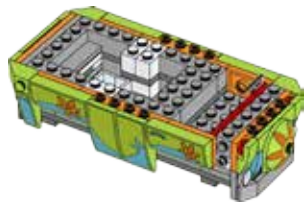

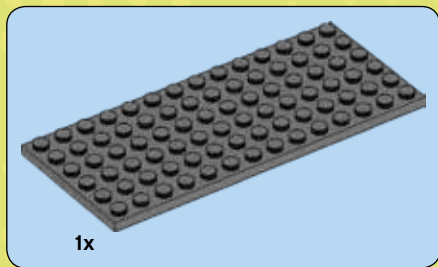

1

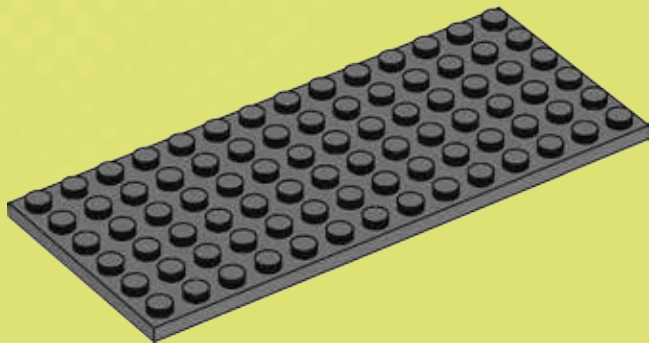



2

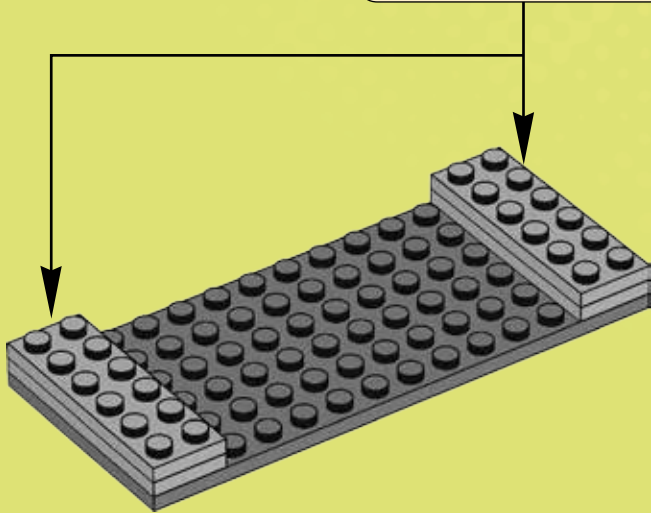
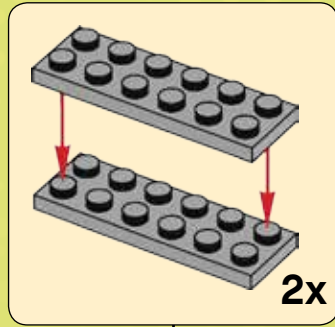



2x

3

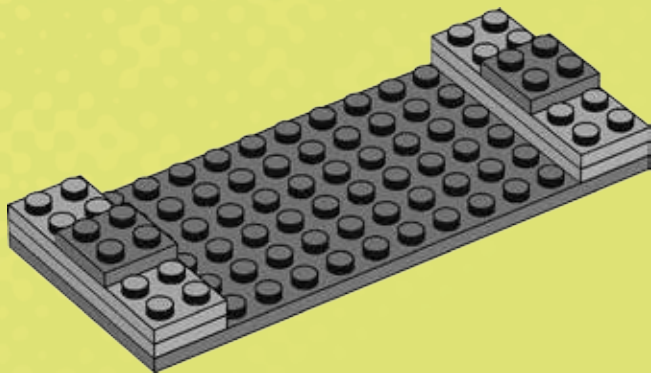



4x

4

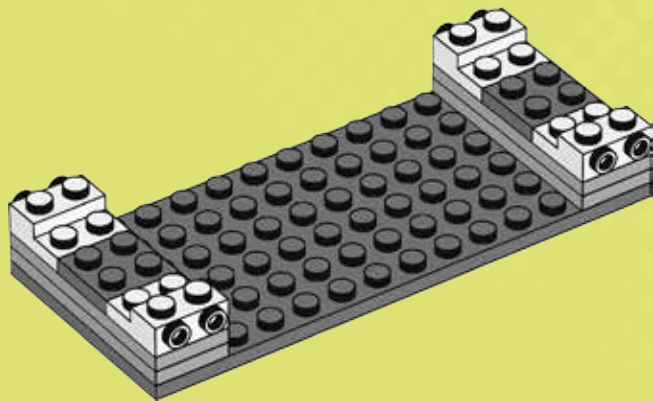



2x

5

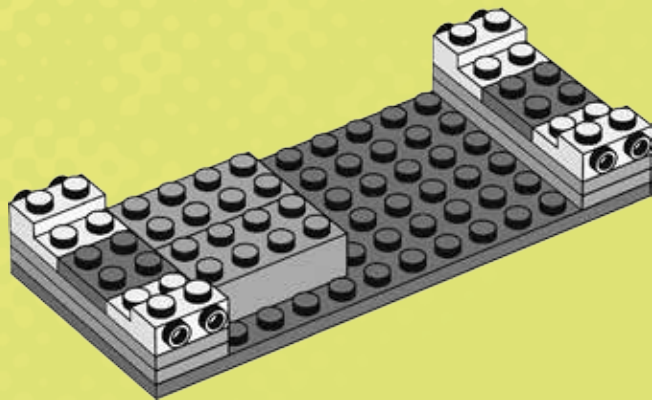



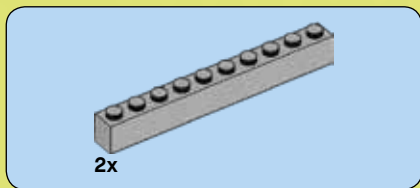

6

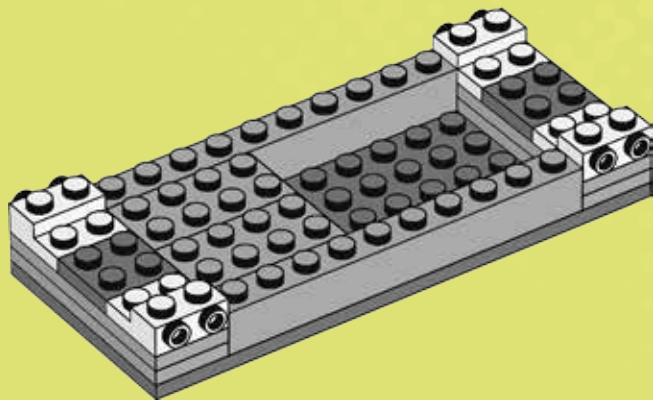



4x

7

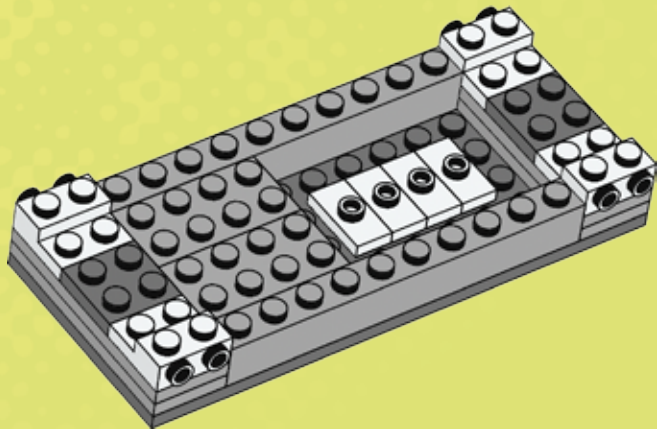



2x

8

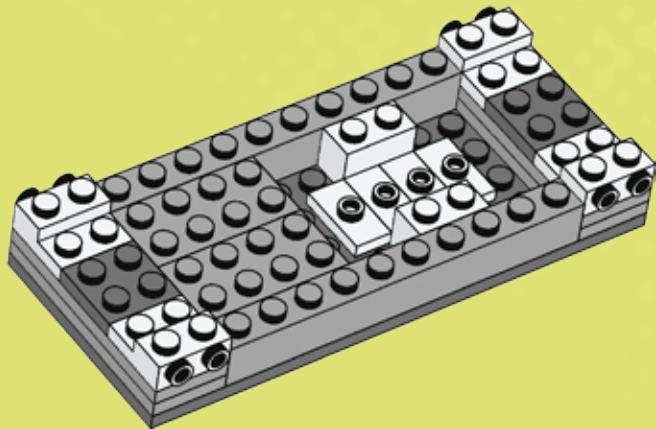



1x



2x

9

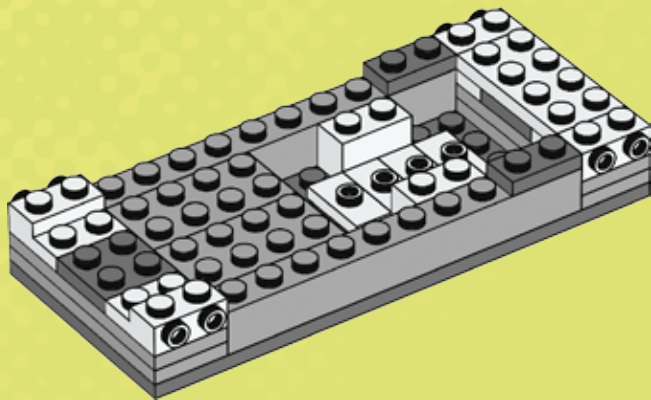



2x



2x

# 10

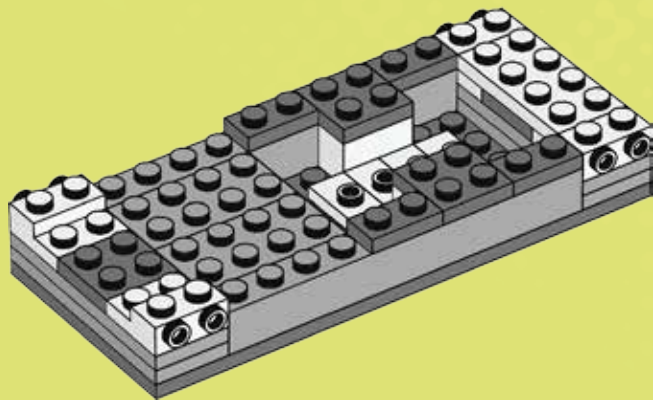



2x



1x

# 11

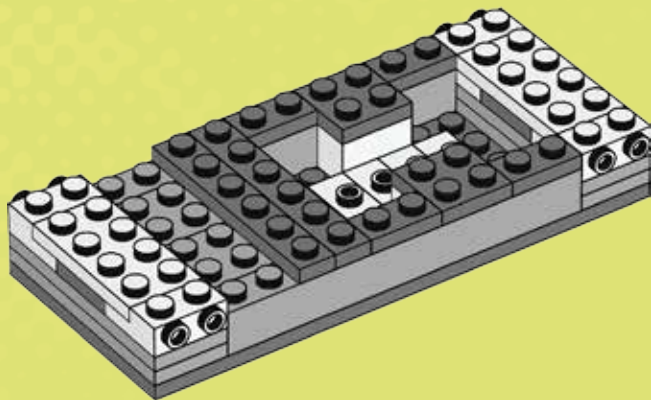

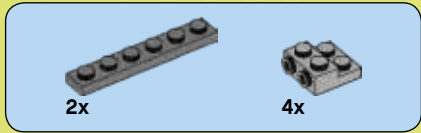

12

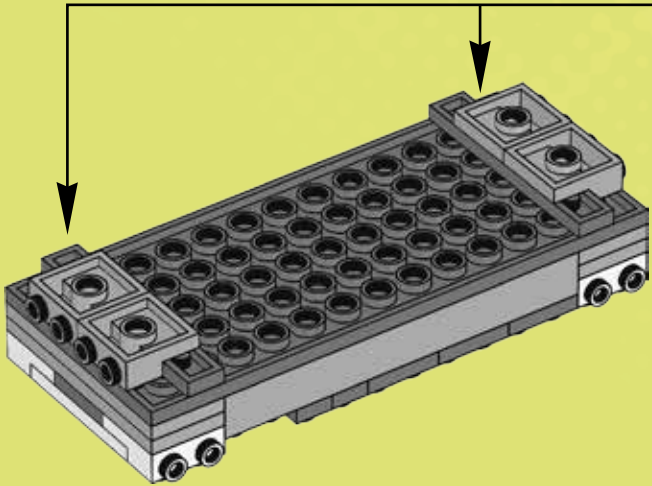
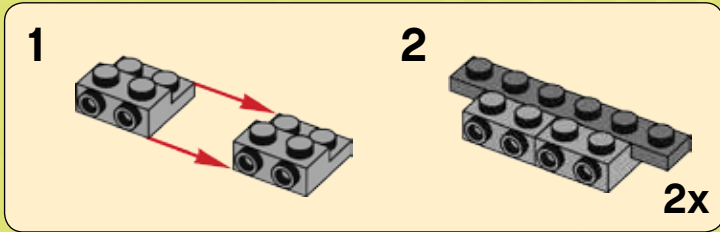



1x



1x

# 13

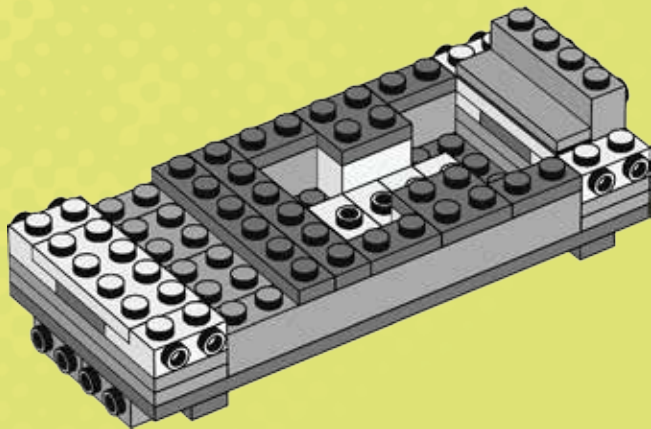





2x

# 14

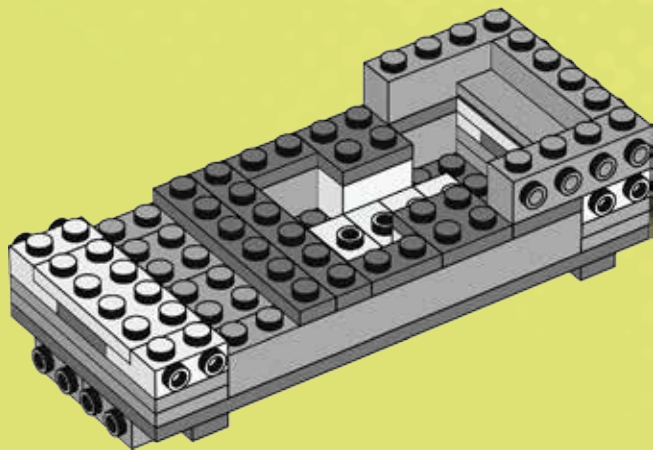



3x



2x

# 15

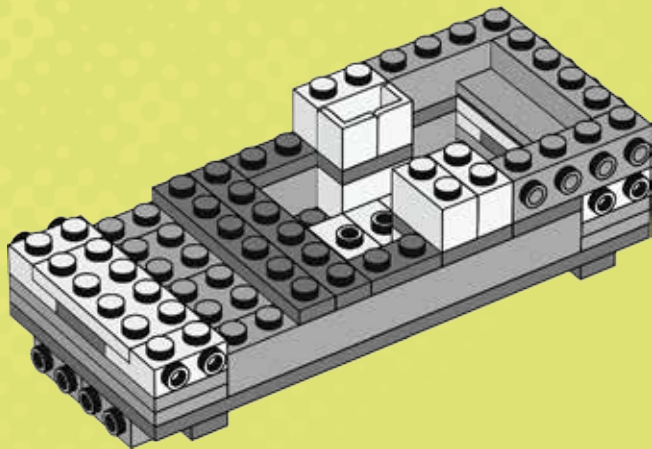



1x



2x

# 16

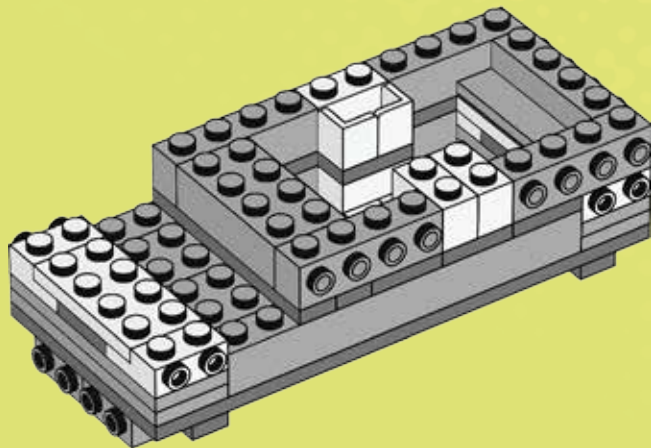



1x



1x

# 17

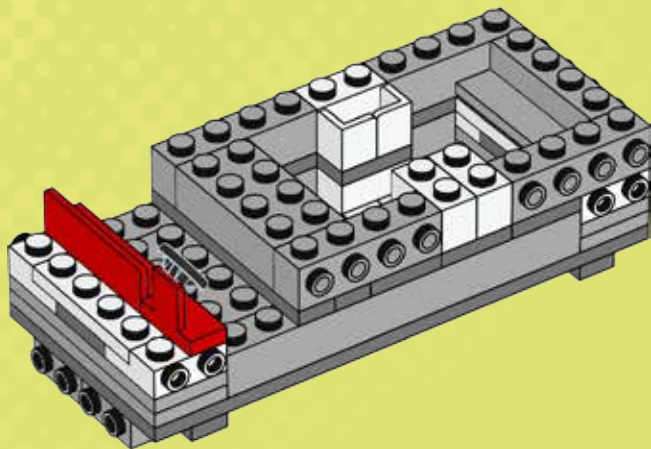



1x



2x

# 18

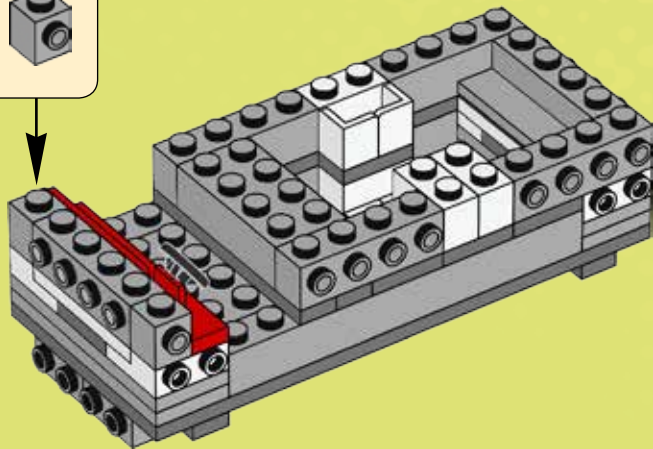

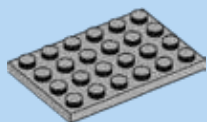

1x

1



1x

2

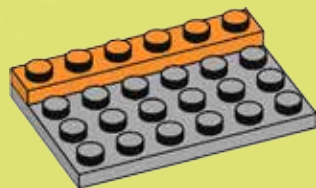

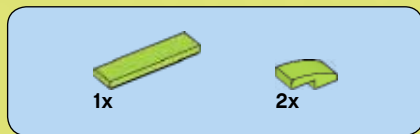

3



4

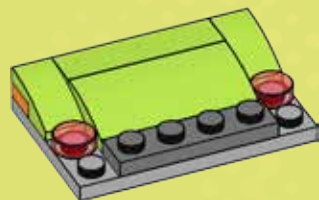



1x



2x

5

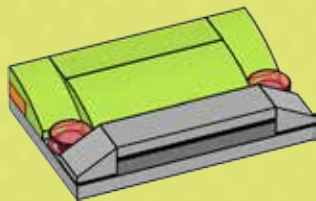



19

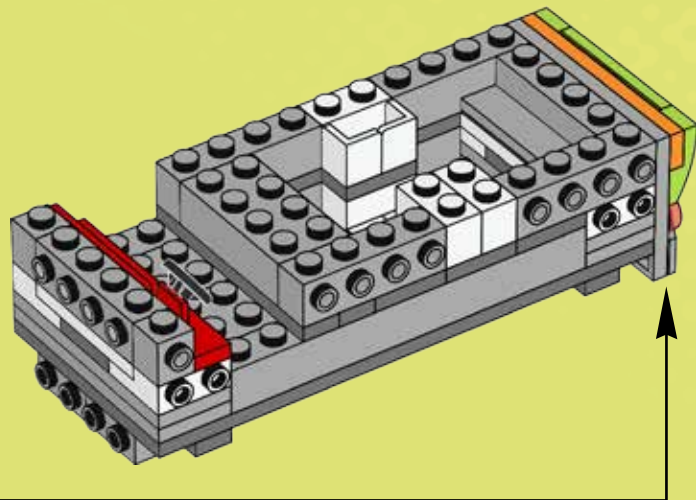

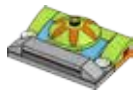

1x

1

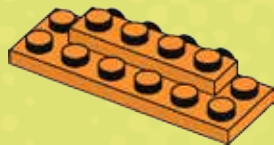

4x



1x

2





1x



2x

3

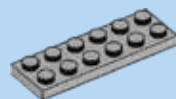
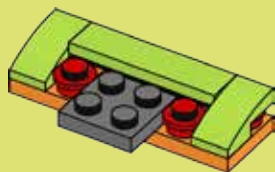

1x

4

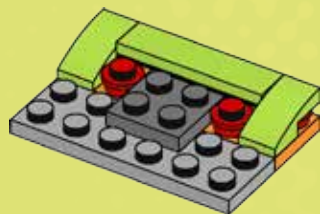



2x



2x

5



1x



1x



1x

6

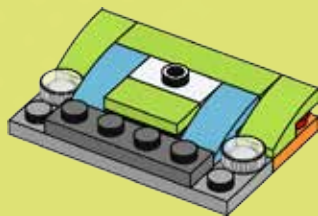

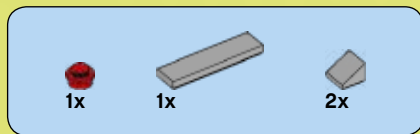

7

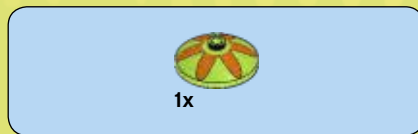
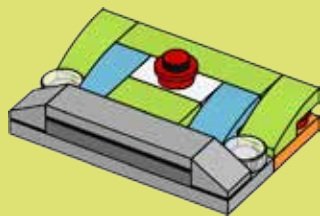

8

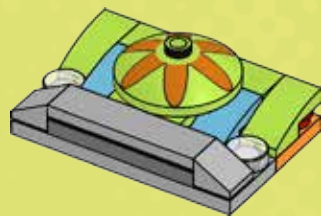

20

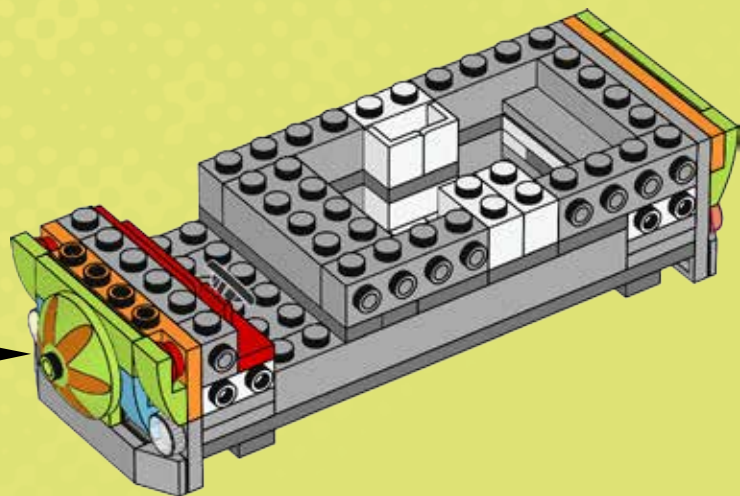

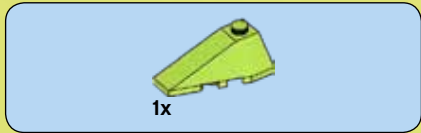

21

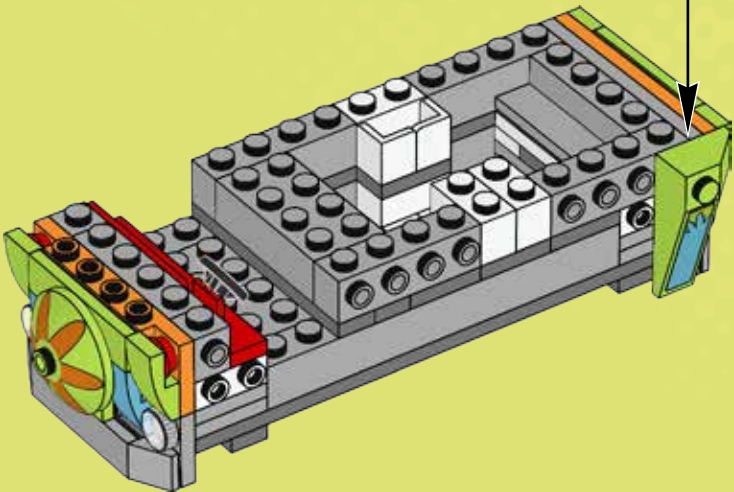
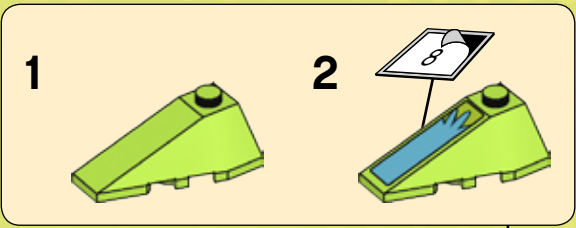

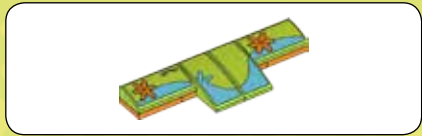

1

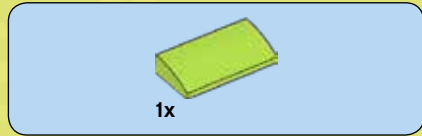

2

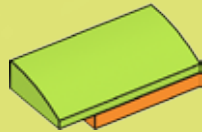





1x

3

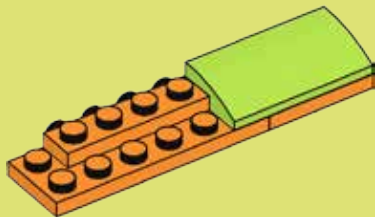

2x

4

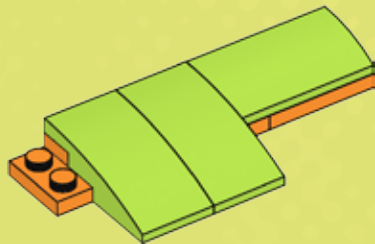



1x

5

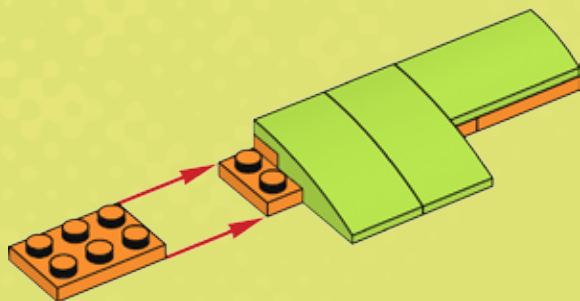

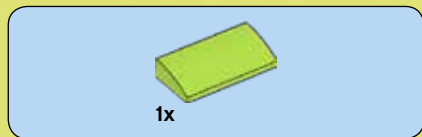

6

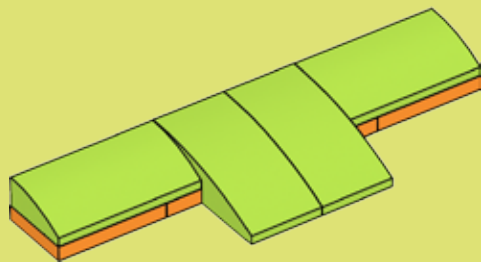

7

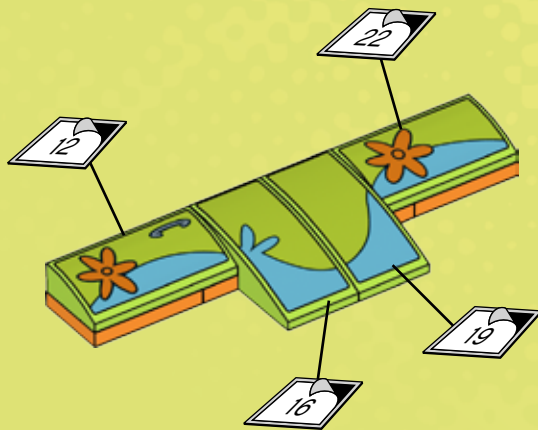

22

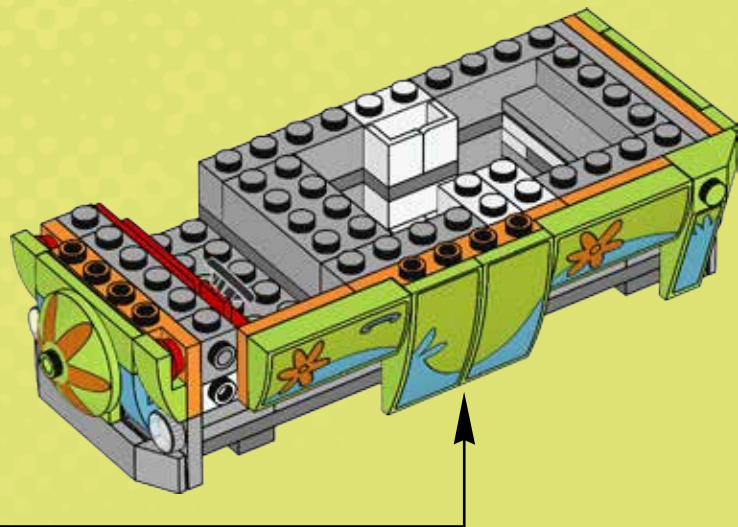



1x

# 23

1

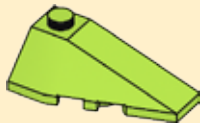

2

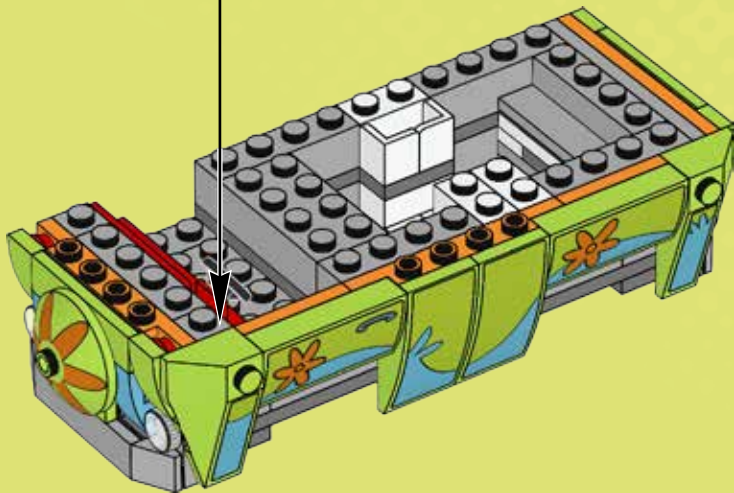



1x

24



1

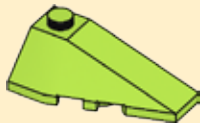

2

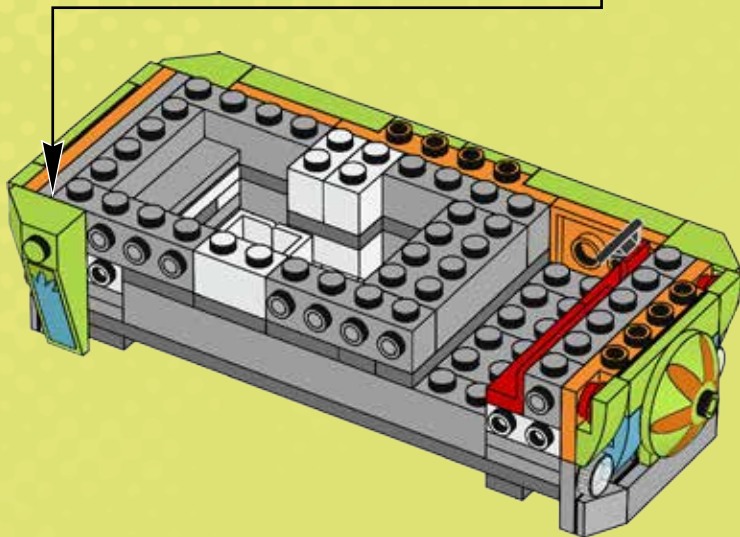

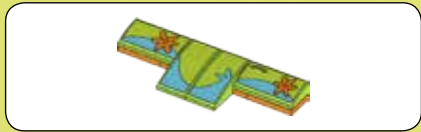

1

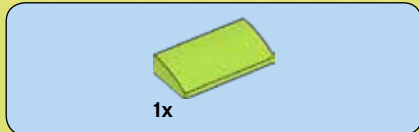

2





1x

3

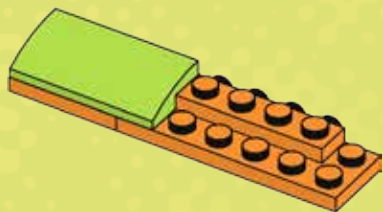

2x

4

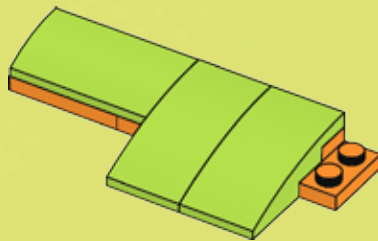





1x

5

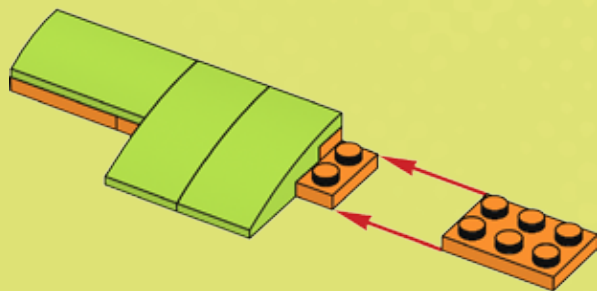

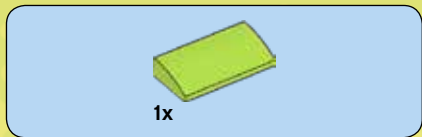

6

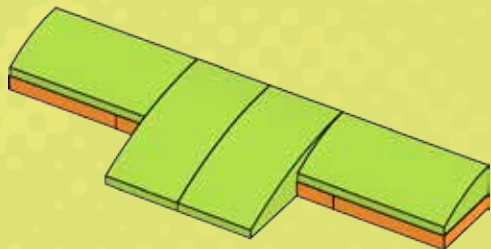

7

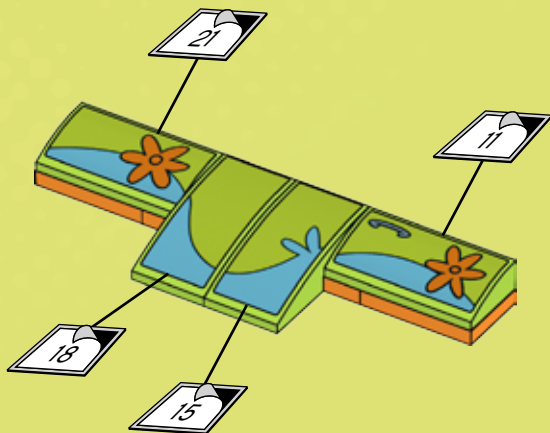

25

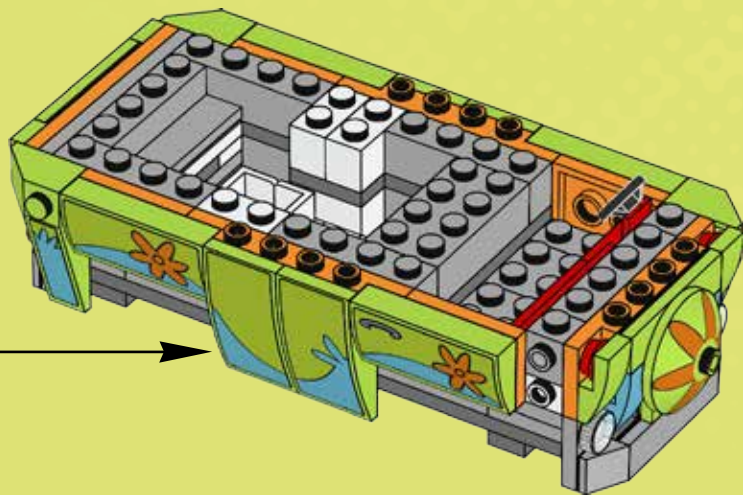

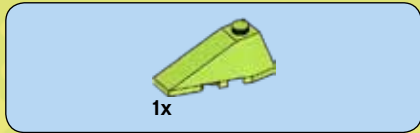

26

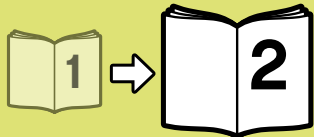
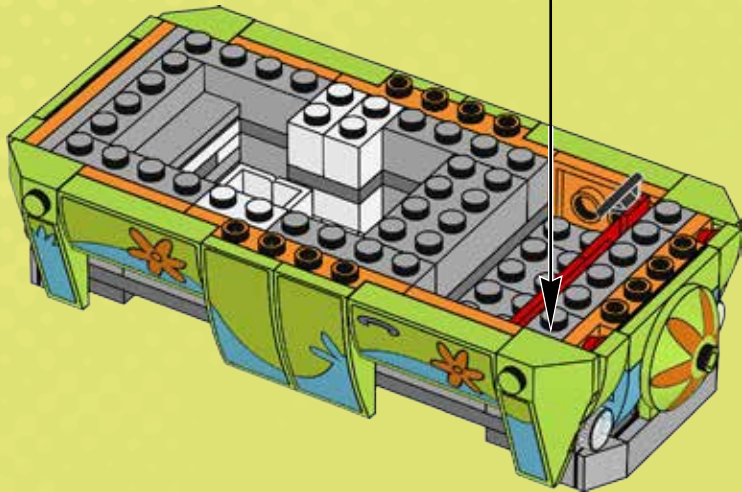
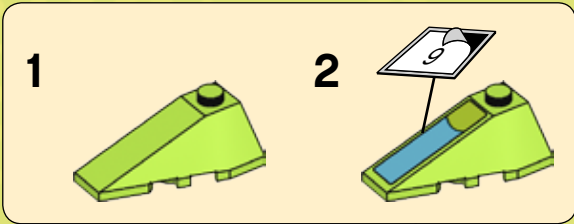



# SCOOBY-DOO!

WE'VE GOT A MYSTERY TO SOLVE  
WIR MÜSSEN EIN GEHEIMNIS LÜFTEN  
NOUS AVONS UN MYSTÈRE À RESOLVER  
TENEMOS UN MISTERIO QUE RESOLVER  
TEMOS UM MISTERIO PARA RESOLVER  
MÁIS VAN EGY MEGOLDÁSRA VÁRO REJTELKÜNK

75900



75901



75902



75903



75904



[LEGO.COM/scoobydoo](http://LEGO.COM/scoobydoo)





*More spooky fun at  
Noch mehr Gruselspaß auf  
Plus d'amusement effrayant sur  
Màs diversión tenebrosa en  
Mais diversão arrepiante em  
További rémisztő móka itt  
**LEGO.com/scoobydoo***



**SCOOBY-DOO!**

Apple, the Apple logo, iPad, iPhone and iPod touch are trademarks of Apple Inc.  
Google Play is a trademark of Google Inc.



**LEGO**

DC COMICS  
**SUPER  
HEROES**

76034

**SUPER  
JUMPER**



76035



BATMAN and all related characters and elements are trademarks of and © DC Comics.



WB SHIELD: TM & © Warner Bros. Entertainment Inc. (s15)

# WIN

GO TO [WWW.LEGO.COM/PRODUCTFEEDBACK](http://WWW.LEGO.COM/PRODUCTFEEDBACK) AND  
GIVE US YOUR SHORT **FEEDBACK** ABOUT THIS  
LEGO® SET FOR A CHANCE TO WIN  
A COOL LEGO PRIZE.



## LEGO.com/productfeedback

### GEWINNE



Erzähle uns auf  
[www.LEGO.com/productfeedback](http://www.LEGO.com/productfeedback)

etwas über die Erfahrungen, die du mit  
diesem LEGO® Set gemacht hast, und  
sichere dir die Chance auf einen coolen  
LEGO Preis!

### GAGNE



Rends-toi sur  
[www.LEGO.com/productfeedback](http://www.LEGO.com/productfeedback)

et donne-nous quelques commentaires  
sur ce produit LEGO® pour avoir une  
chance de gagner un prix LEGO !

### GANAN



Visita  
[www.LEGO.com/productfeedback](http://www.LEGO.com/productfeedback)

y envíanos tu opinión acerca de este set  
LEGO®. ¡Participarás en el sorteo de un  
premio LEGO!

### 获取奖品



登录  
[www.LEGO.com/productfeedback](http://www.LEGO.com/productfeedback)

给出关于此乐高®套装的简短反馈，  
就有机会获得炫酷乐高奖品

LEGO and the LEGO logo are trademarks of the LEGO Group. ©2015 The LEGO Group.



TM & © Hanna-Barbera.  
WB SHIELD: TM & © Warner Bros. Entertainment Inc.  
(s15)

6134997