



9483



 **WARNING: CHOKING HAZARD.**
Small parts. Not for children under 3 years.

1

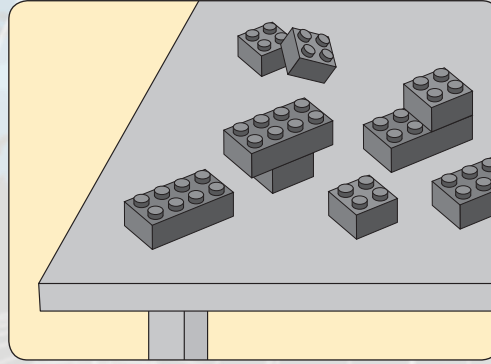
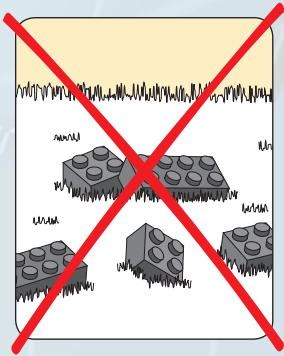

2

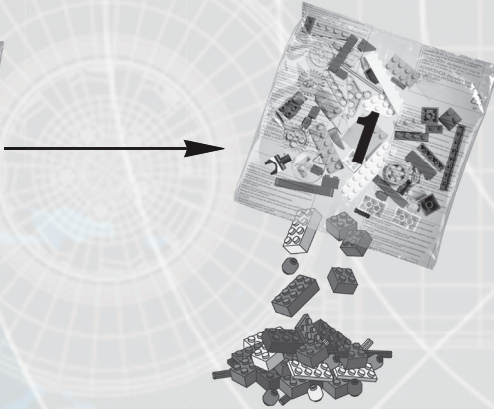

2

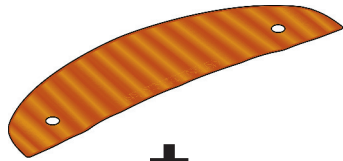

+

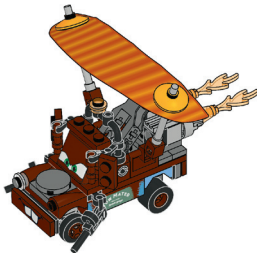

1x

1

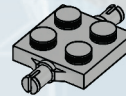

AVERTISSEMENT : RISQUE D'ÉTOUFFEMENT.

Contient des petites pièces. Ne convient pas aux enfants de moins de 3 ans.



ADVERTENCIA: PELIGRO DE ASFIXIA.

No recomendado para niños menores de 3 años. Contiene piezas pequeñas.

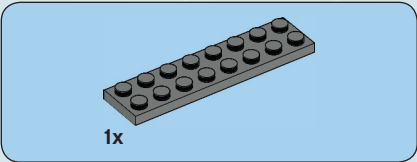

2

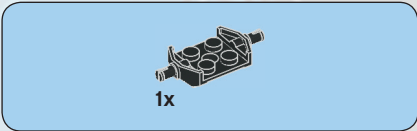
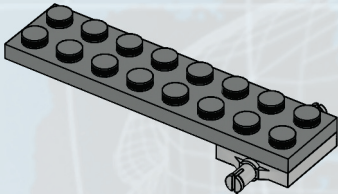

3

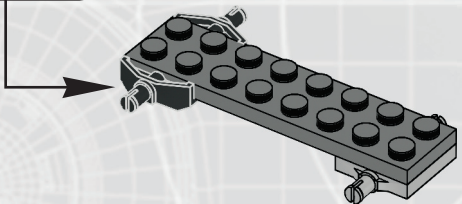

4

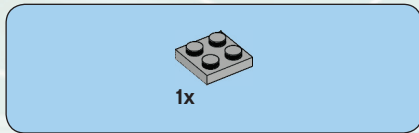

4

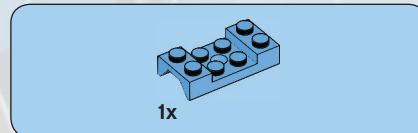
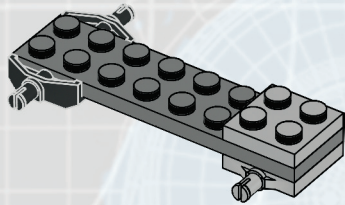

5

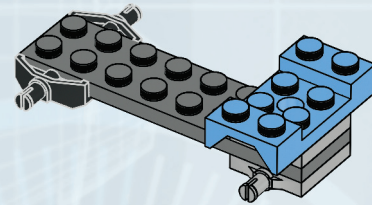

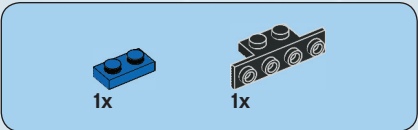

6

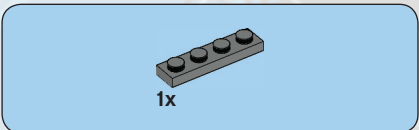
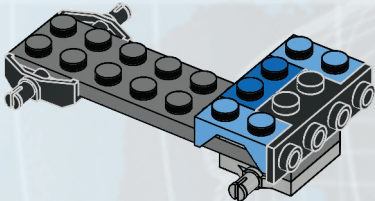

7

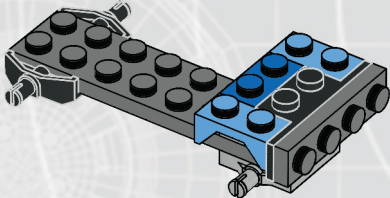
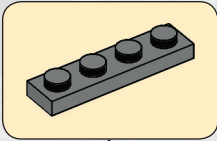



8

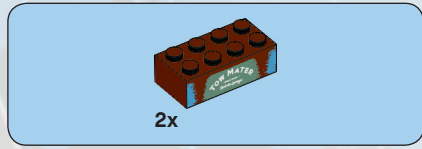
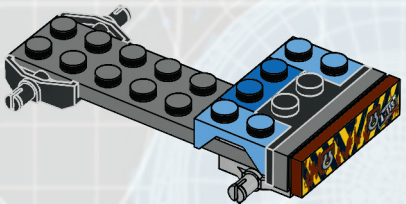

9

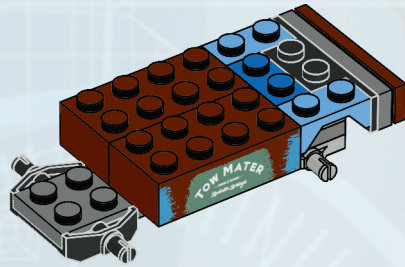



1x

10

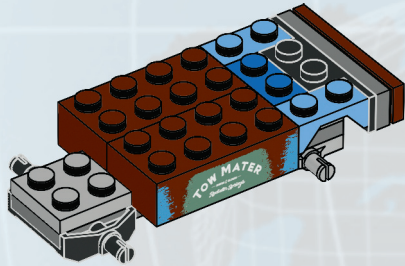

8



1x



1x

11

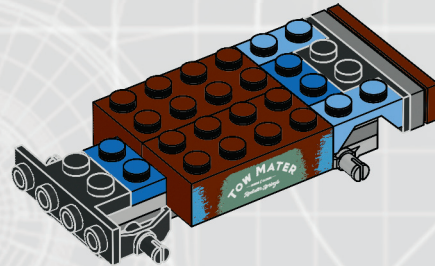

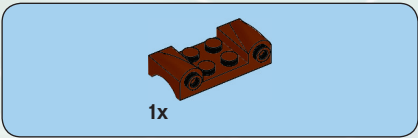

12

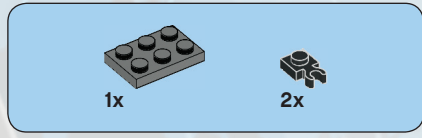
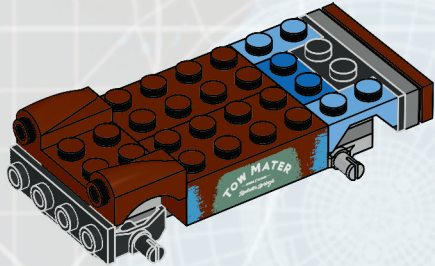

13

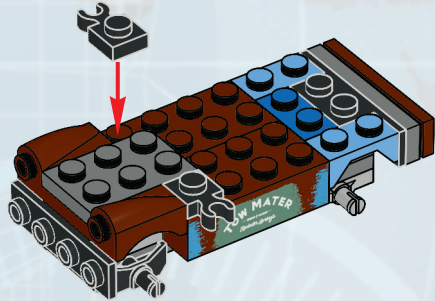

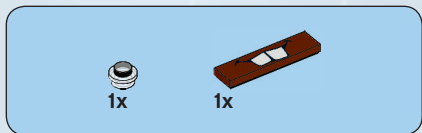

14

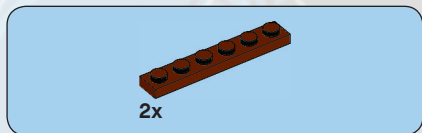
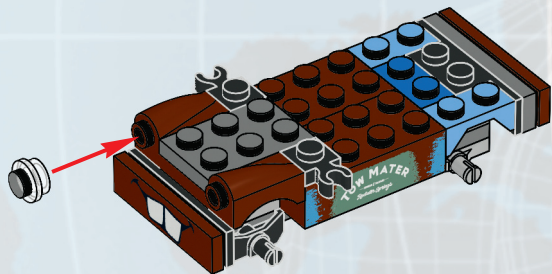

15

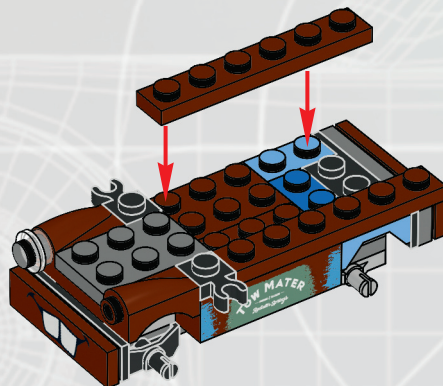

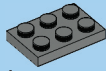

1x

16

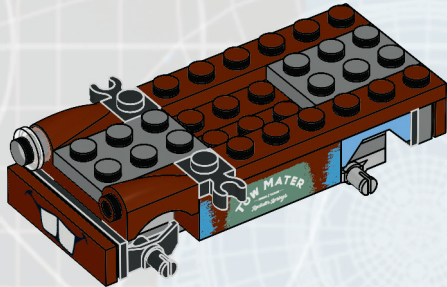

4x

17

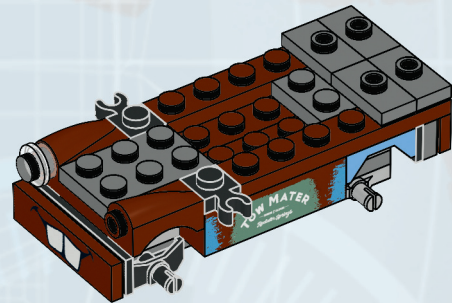

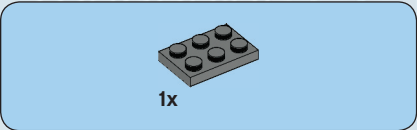
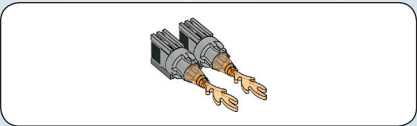

1

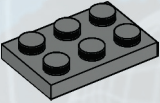

2

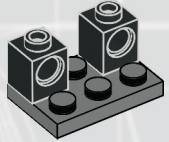

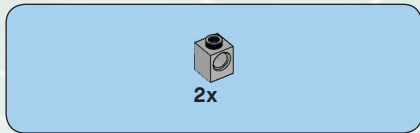

3

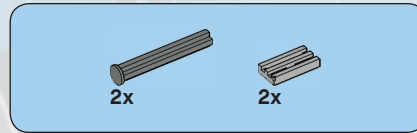
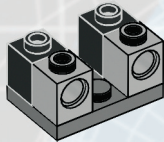

4

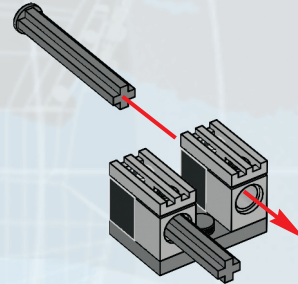

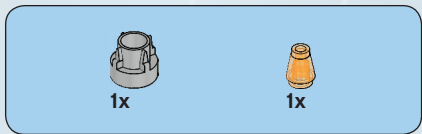

5

waypoint

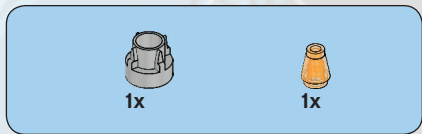
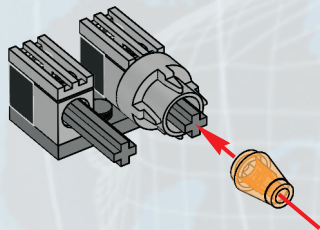

6

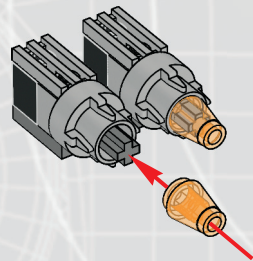

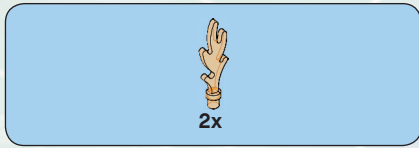

7

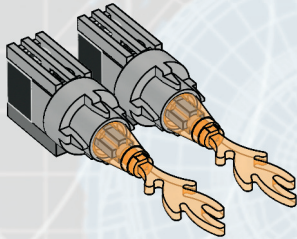

target
acquired

18

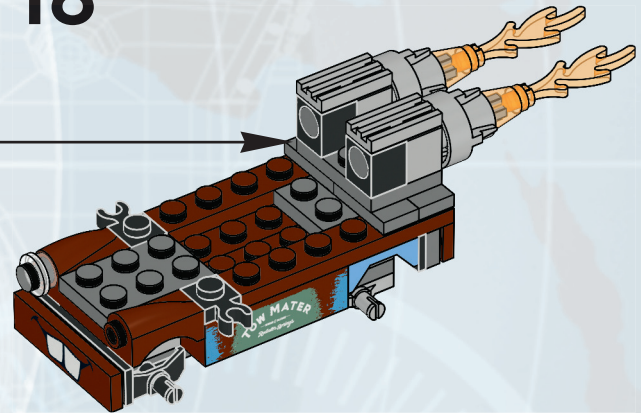

15



19

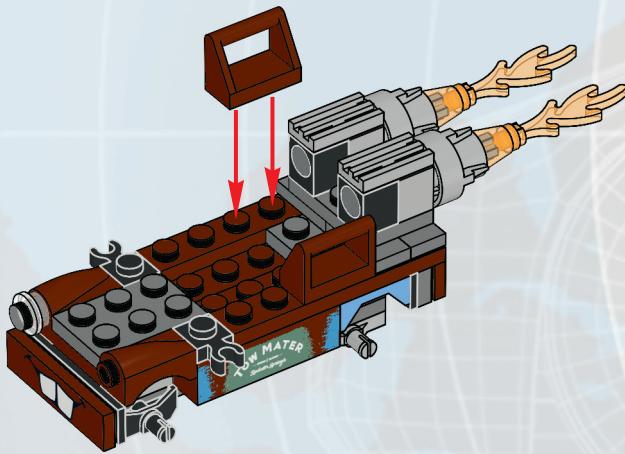

16

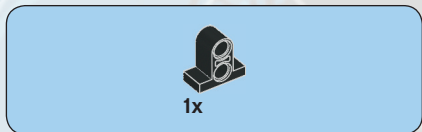

20

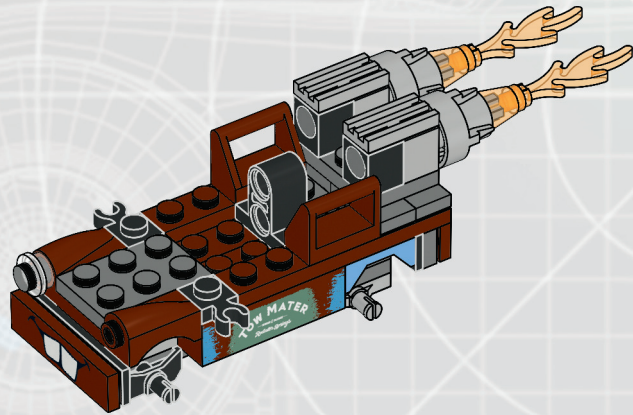

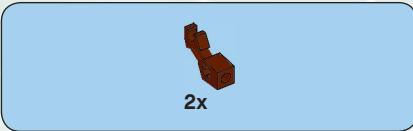

21

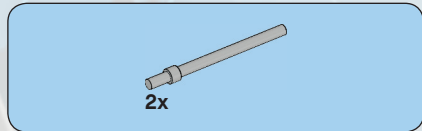
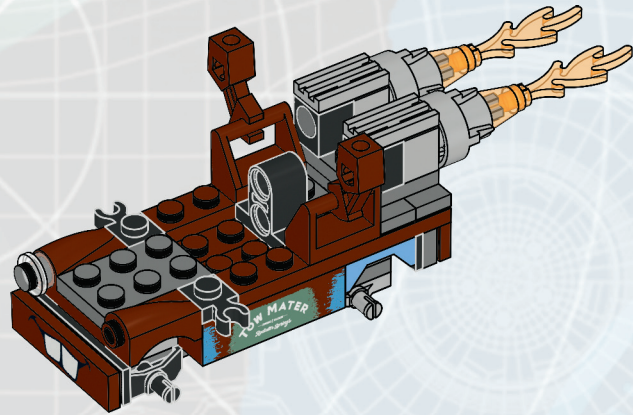

22

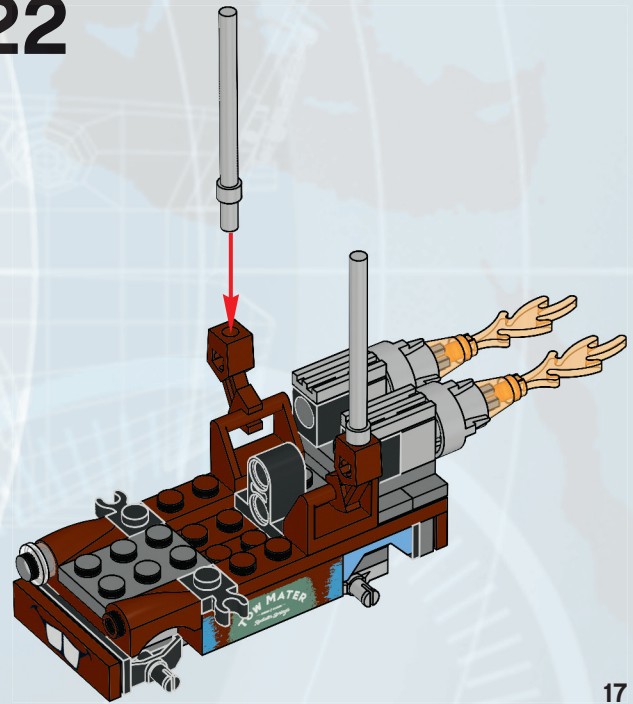

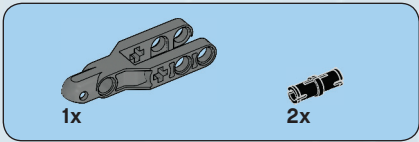

1

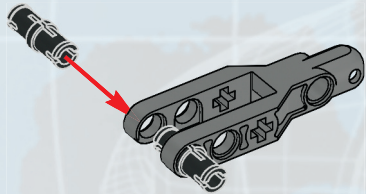

2

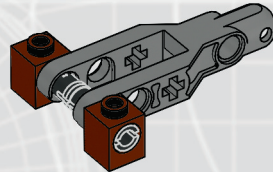

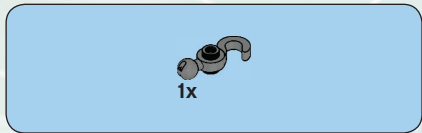

3

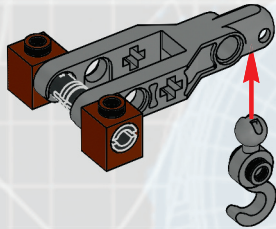

23

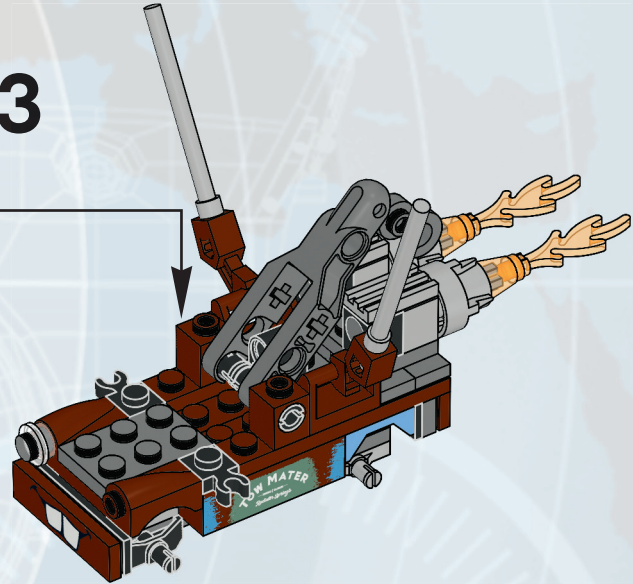

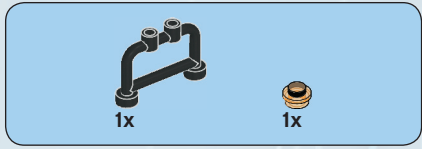

24

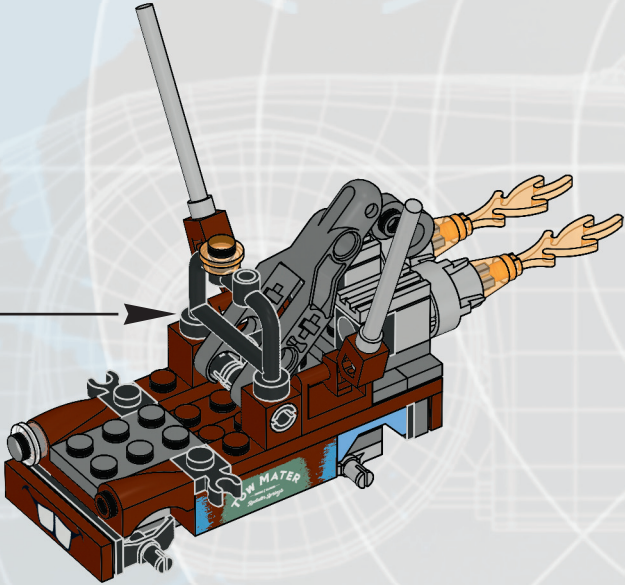
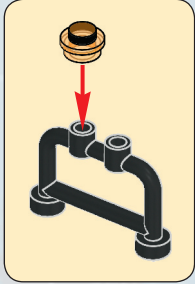

20



25

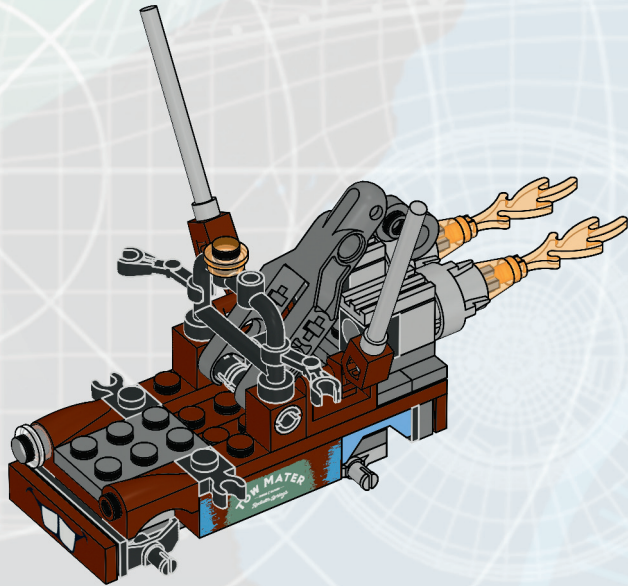

26

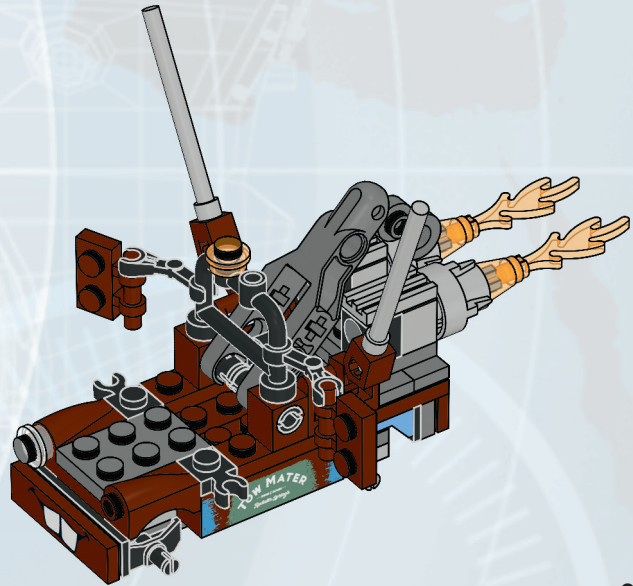

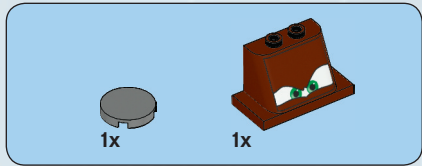

27

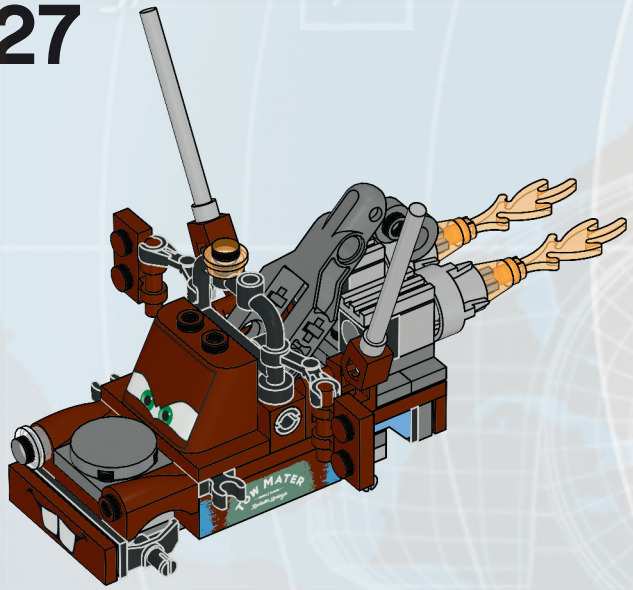

22



28

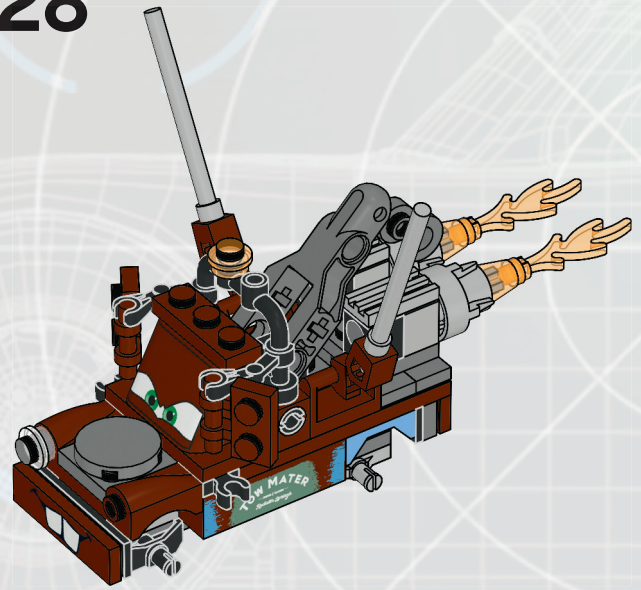

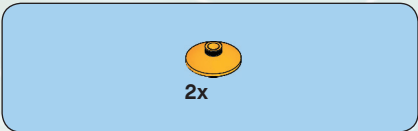

29

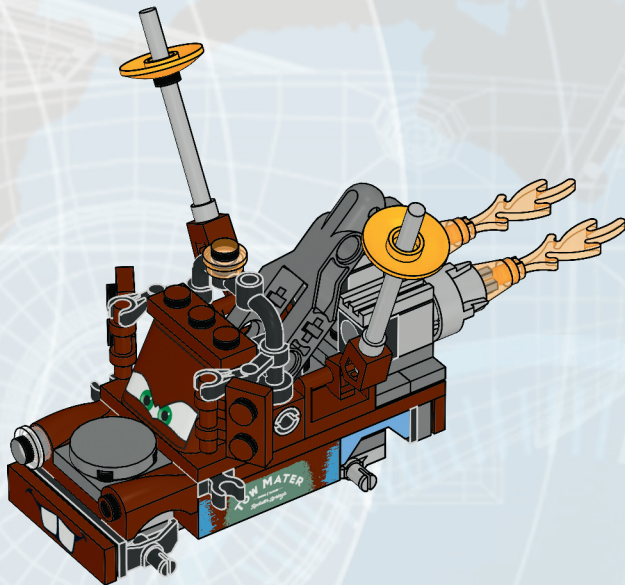

point 2
target acquired

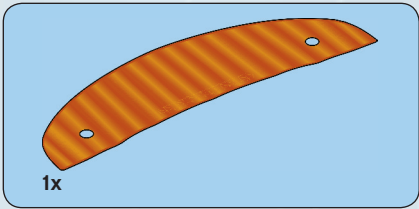

30

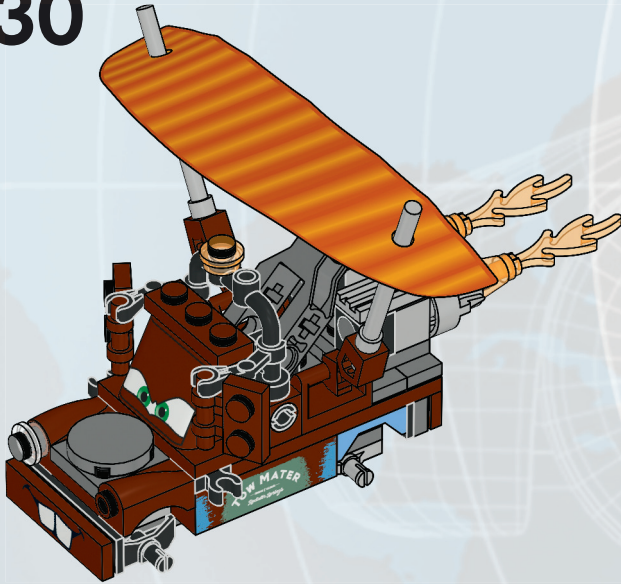

31

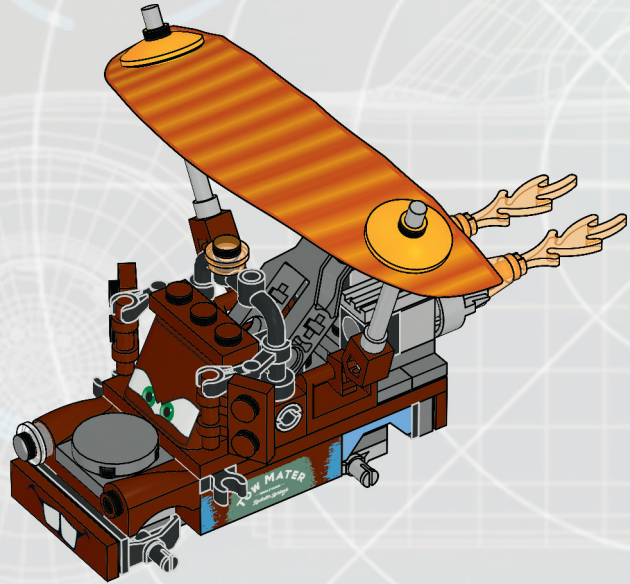



2x



2x

32



2x

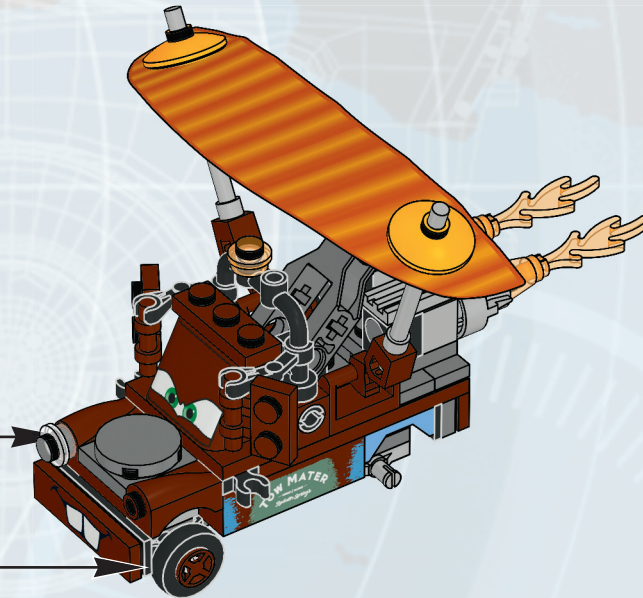



33

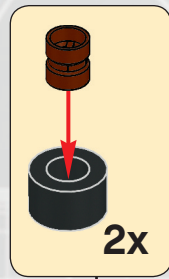
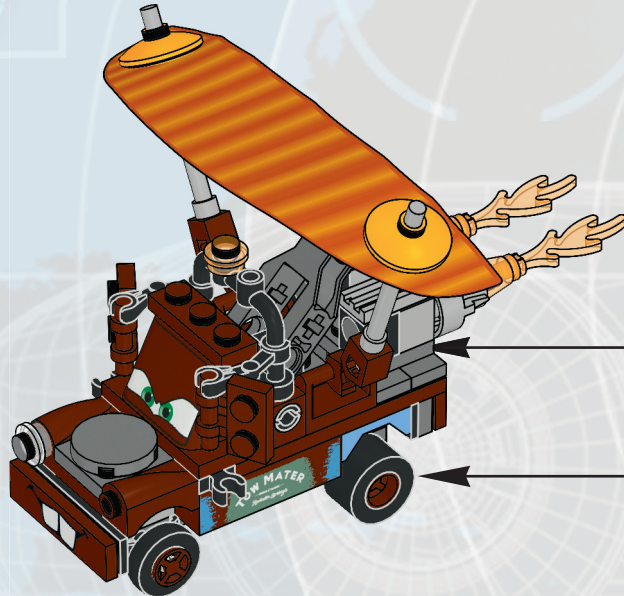



2x

34

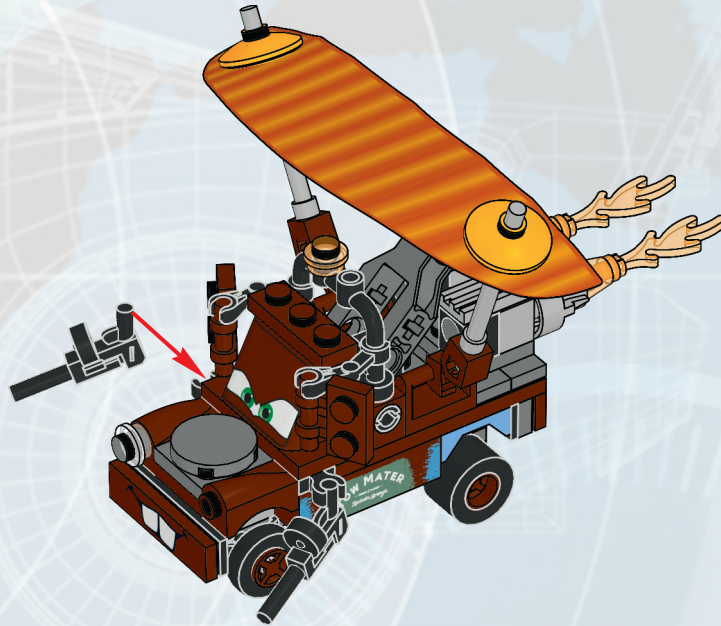

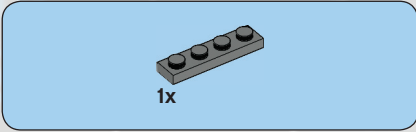
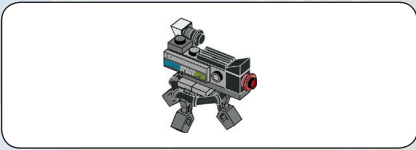
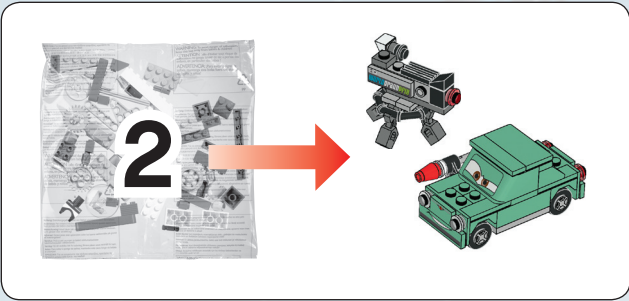

1

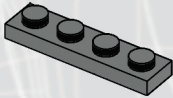



2

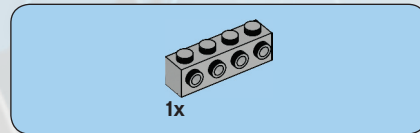
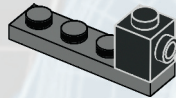

3

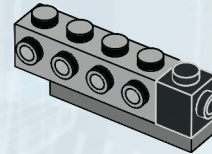

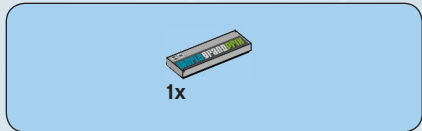

4

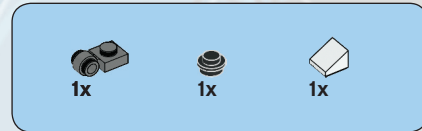
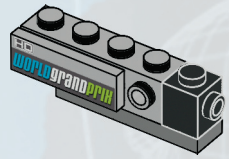

5

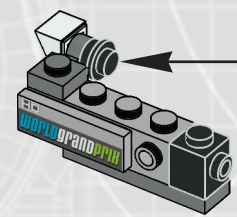
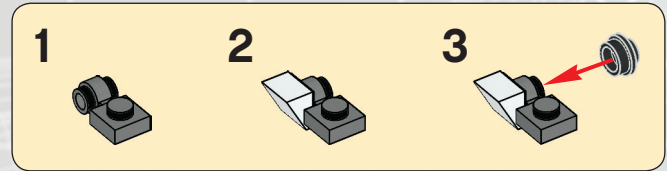



1x



1x

6

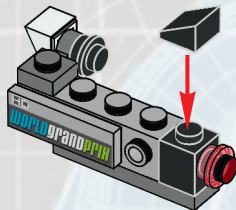

1x

7

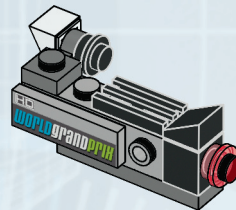



8

1



2

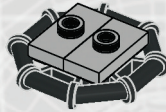

3

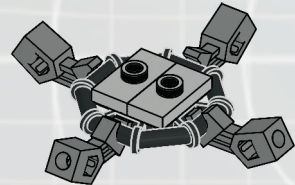

waypoint 2

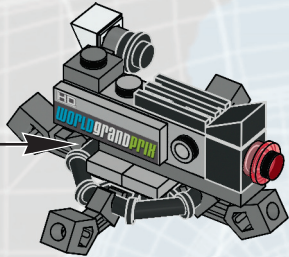

target acquired

9

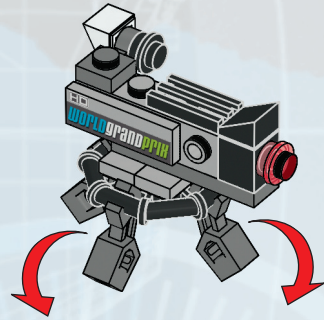

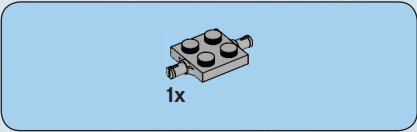
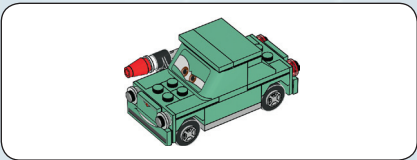

1

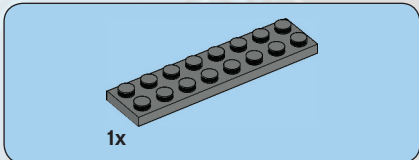
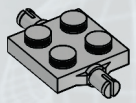

2

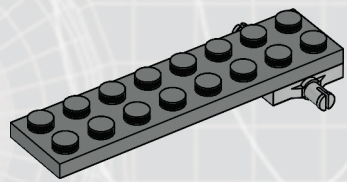

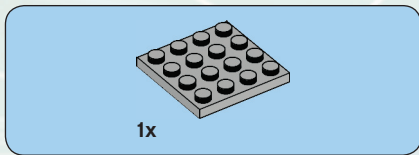

3

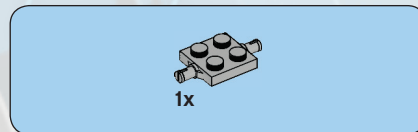
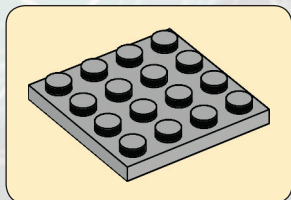

4

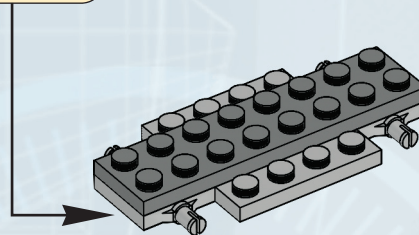
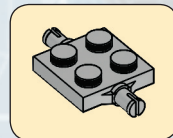

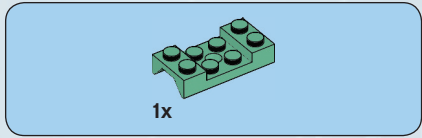

5

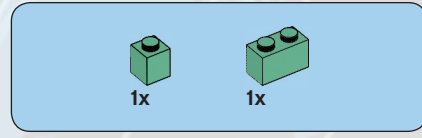
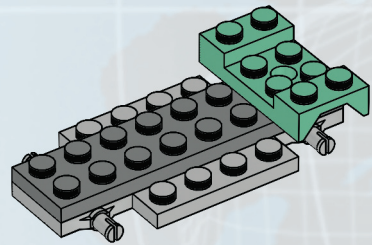

6

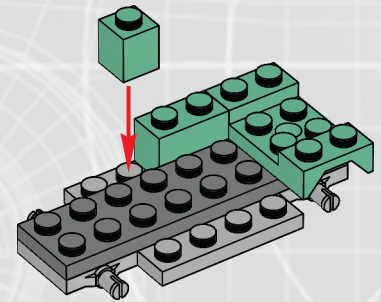

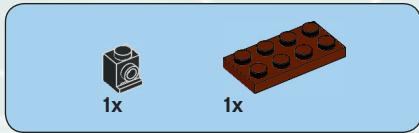

7

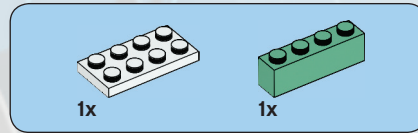
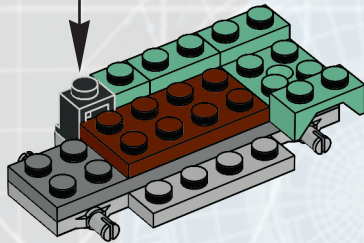

8

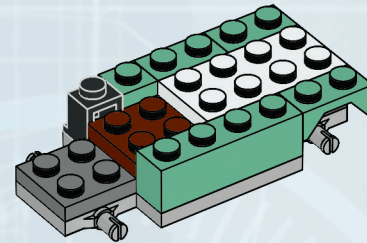

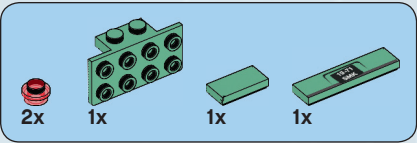

9

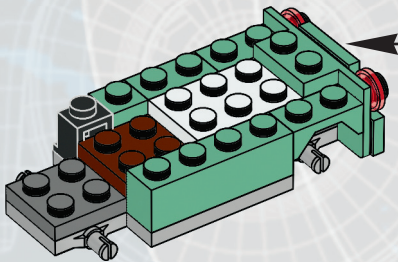
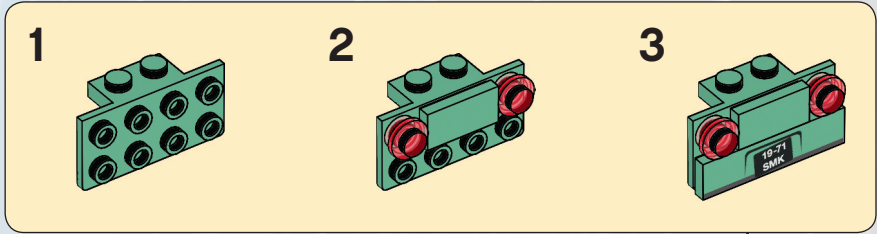

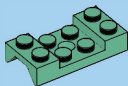

1x

10

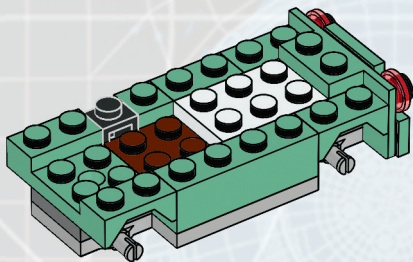

1x

11

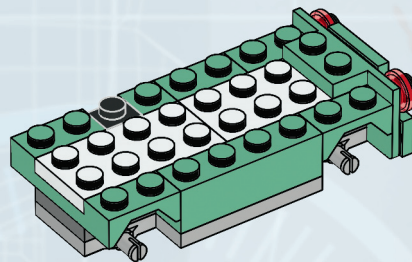

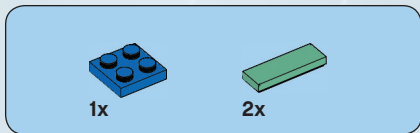

12

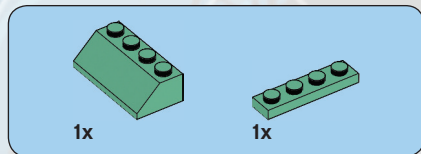
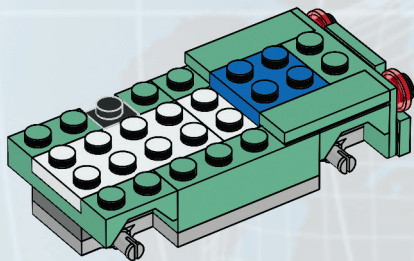

13

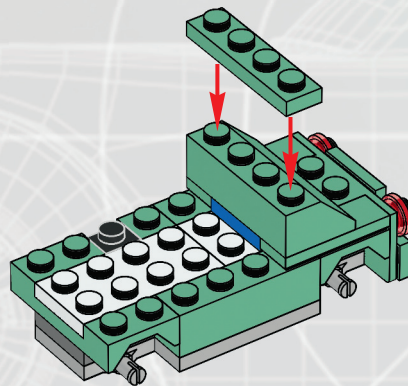

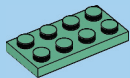

1x

14

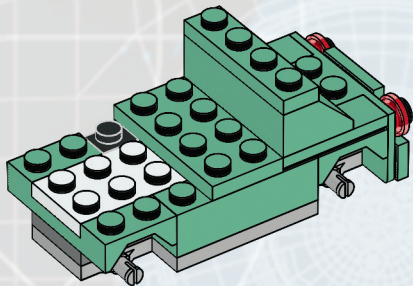

2x



2x

15

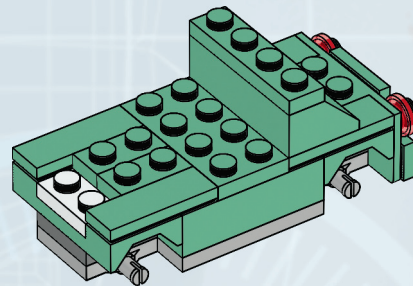

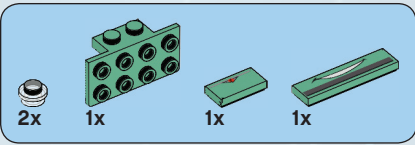

16

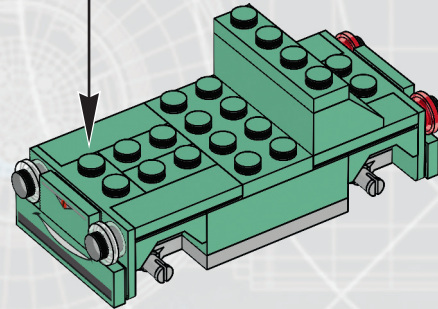
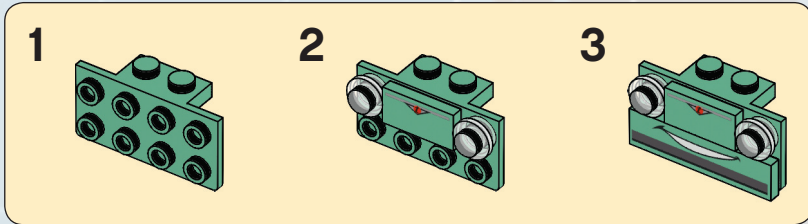

42

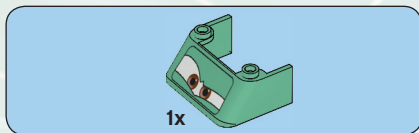

17

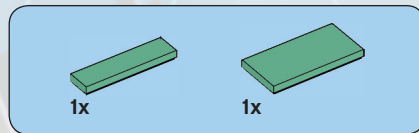
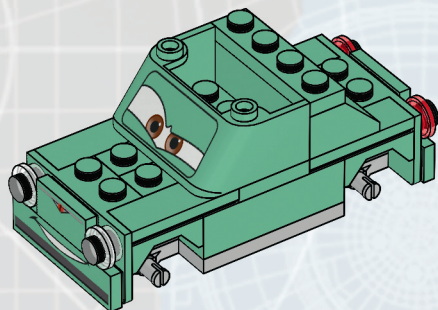

18

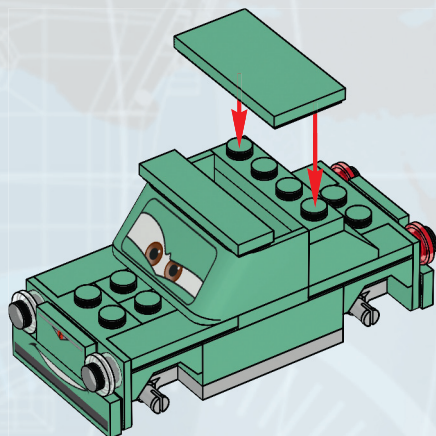



19

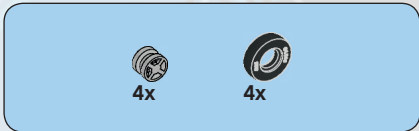
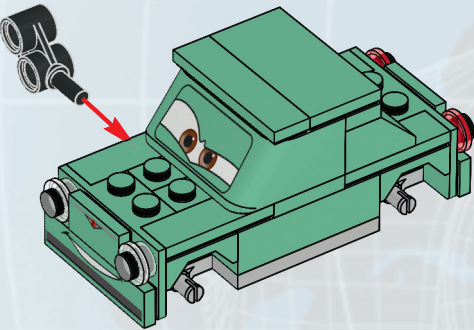

20

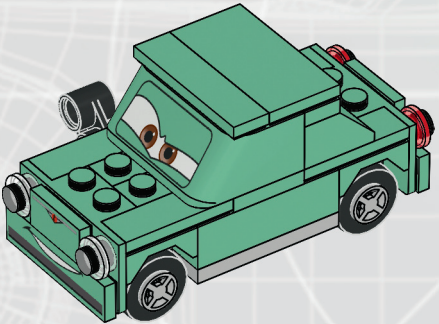

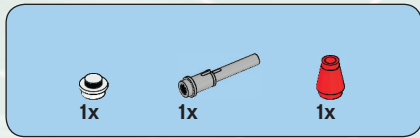

21

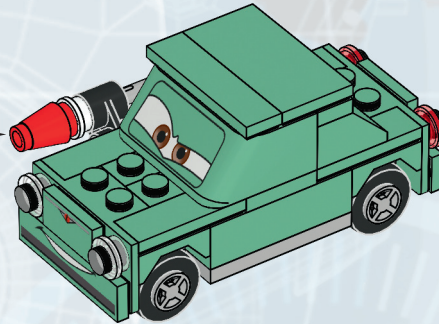
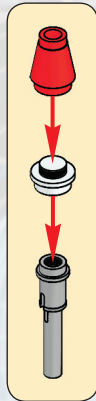

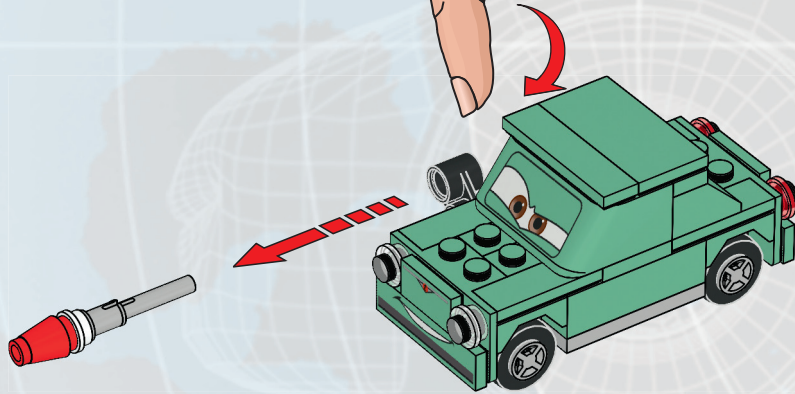

1x
4504369

2x
654126

2x
4223247

1x
4654964

1x
4633698

1x
4633072

2x
302001

1x
4504382

2x
4549989

1x
4558954

1x
4521948

1x
4616710

1x
4654926

1x
614101

2x
4550017

2x
4508215

1x
4514342

1x
4616581

1x
4616578

1x
4616588

1x
4529234

1x
241226

6x
4516843

1x
408326

1x
4521947

2x
4616576

2x
4625234

2x
302323

1x
4144024

1x
615726

3x
3005740

2x
4655080

1x
4654923

1x
4633693

1x
302223

2x
4282746

1x
4562148

1x
4616698

1x
4654927

4x
4655077

1x
4654928

1x
407026

1x
614126

2x
4121715



2x
4567338



2x
4616701



2x
4620075



2x
4626929

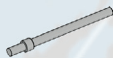

2x
4538098



2x
4278756



2x
4210997



1x
4222960



1x
4211152



2x
4617030



2x
4620534



4x
4211506



2x
4211350



4x
4626927



2x
4261397



1x
4211186



1x
4616707



2x
4620537



3x
4211504



2x
4211451



1x
4212529



4x
4657863



2x
4221590



1x
4620530



1x
4654808



1x
4211636



1x
4654929



2x
4211001



Customer Service
Kundenservice
Service Consommateurs
Servicio Al Consumidor
www.lego.com/service or dial



00800 5346 5555 :

1-800-422-5346 :



1x
4613134



2x
4211535



3x
3005741



3x
4211043



1x
4620079



2x
4211397



1x
4632574



1x
4523398



1x
4243797



1x
4520320



4x
4211119



2x
4560177

2011



8639



8423, 8639, 8679



8426



8487



8200, 8487



8487



8206, 8484, 8679



8206, 8679



8487



8424



8639



8423, 8679



8638



8638



8487



8638



8638



8638

2011



8201, 8487



8639



8639



8486



8426, 8639



8639



8426



8638



8486



8679



8679



8679



8679



8424

2012



9486



9485



9486



9481



9480



9483



9484



9485



9479



9484



9486



9483



9486



9485



9486



9485



9478



WIN!

Go to www.LEGOsurvey.com/product
to fill out a survey for a chance
to win a cool LEGO® Product.

No purchase necessary.

Open to all residents where not prohibited.

www.LEGOsurvey.com/product

GEWINNE!

Nimm an der Umfrage auf www.LEGOsurvey.com/product teil und hab die Chance ein cooles LEGO® Produkt zu gewinnen!
Die Teilnahme am Gewinnspiel führt zu keinerlei Kaufverpflichtungen. Teilnahme in allen nicht ausgeschlossenen Ländern möglich.

WIN!

Ga naar www.LEGOsurvey.com/product, vul een enquêteformulier in en maak kans op een cool LEGO® product.
Geen aankoopverplichting. Iedereen mag deelnemen, uitgezonderd ingezetenden van landen waar een enquêteverbod geldt.

GAGNE!

Visite www.LEGOsurvey.com/product pour répondre à un questionnaire et avoir une chance de gagner un produit LEGO® très cool!
Aucune obligation d'achat.
Ouvert à tous les résidents des pays autorisés.

当てよう!

www.LEGOsurvey.com/product にアクセスして、アンケートにご記入ください。
当選者にはレゴ®製品を差し上げます。
お買い上げの必要はありません。
禁止されていない限り、すべての皆様にご利用いただけます。



www.LEGO.com

6003660

LEGO and the LEGO logo are trademarks of the/sont des marques de commerce de/son marcas registradas de LEGO Group. ©2012 The LEGO Group. © Disney/Pixar