



# CITY

7287



 **WARNING: CHOKING HAZARD.**  
Toy contains small parts and a small ball.  
Not for children under 3 years.



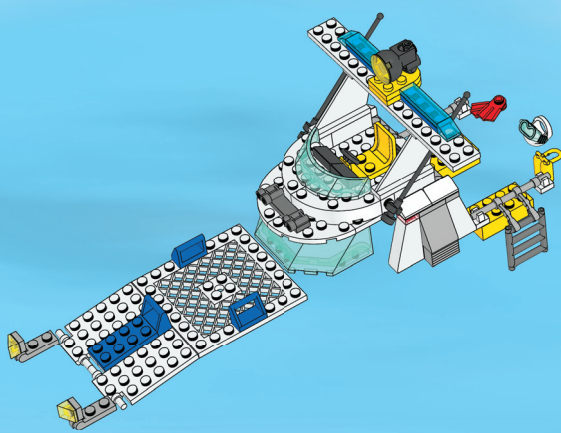
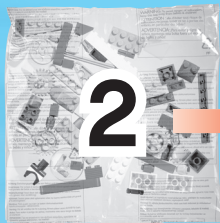
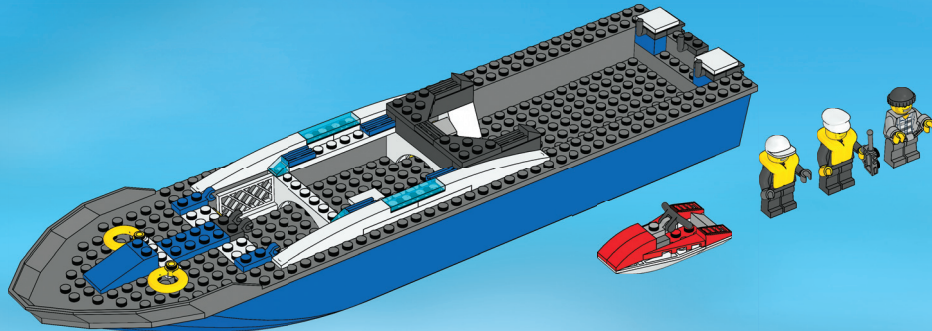

1

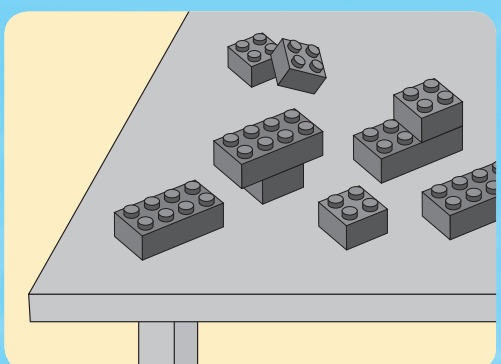
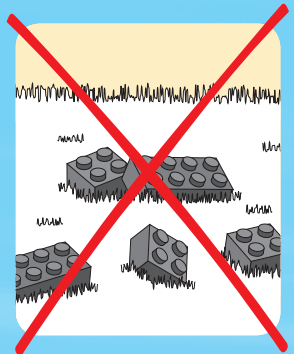

2



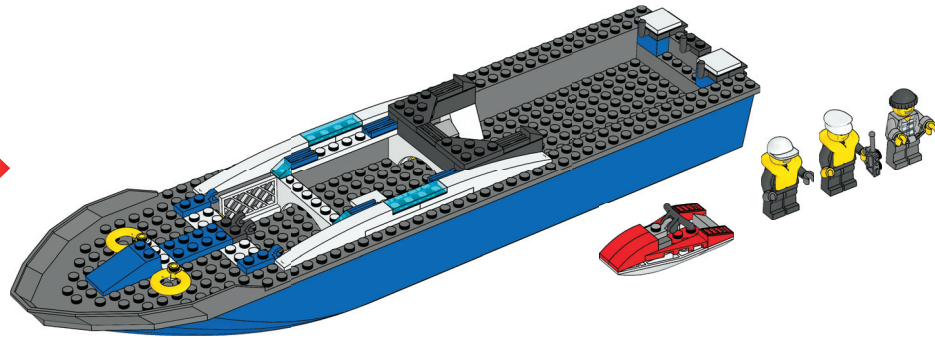

3

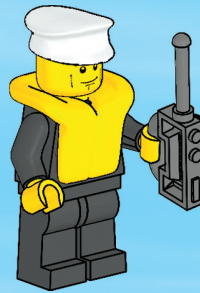
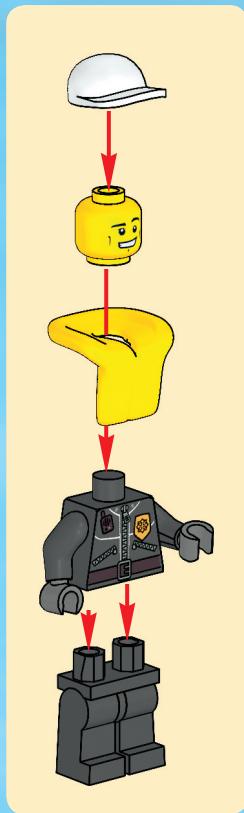

- ⚠ **AVERTISSEMENT : RISQUE D'ÉTOUFFEMENT.**  
Le jouet contient des petites pièces ainsi qu'une petite boule.  
Il ne convient pas aux enfants de moins de 3 ans.
- ⚠ **ADVERTENCIA: PELIGRO DE ASFIXIA.**  
Juguete que contiene partes pequeñas y una pelota pequeña.  
No recomendado para niños menores de 3 años.

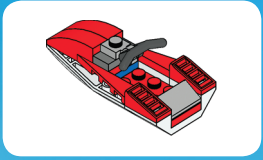

1

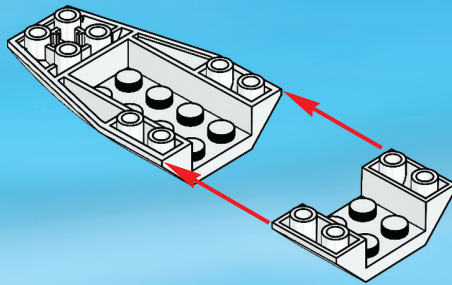

2

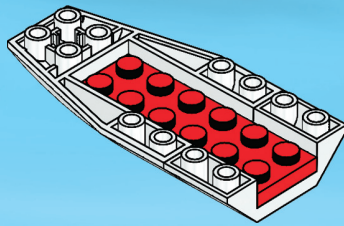

3

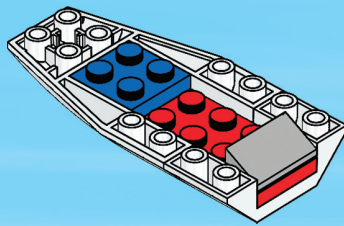

4

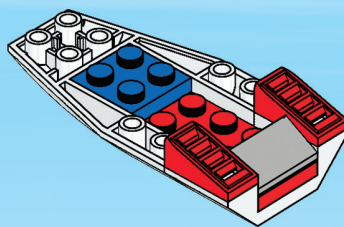



5

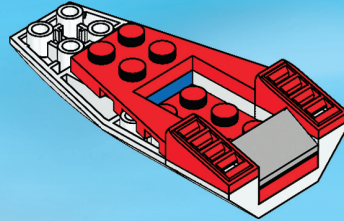

6

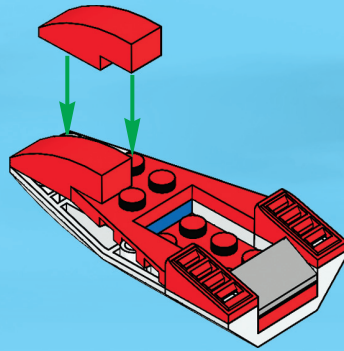

7

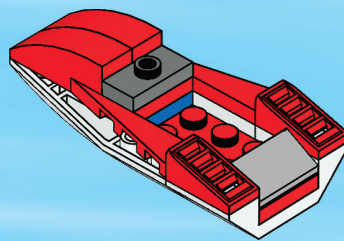

8

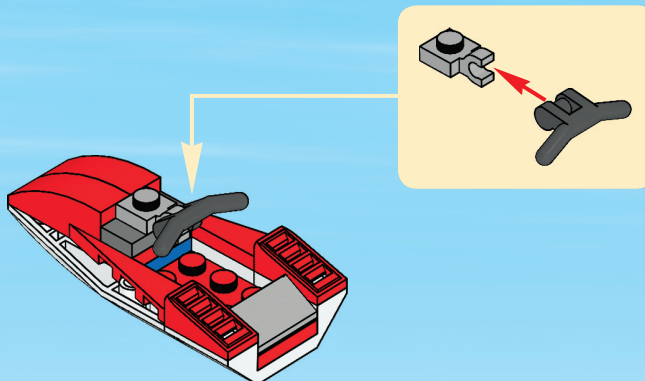

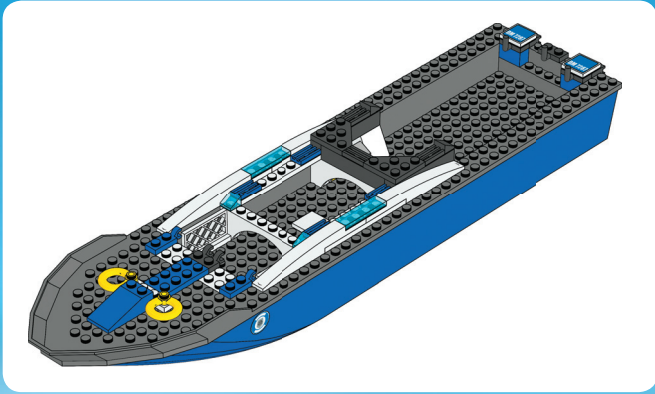

1

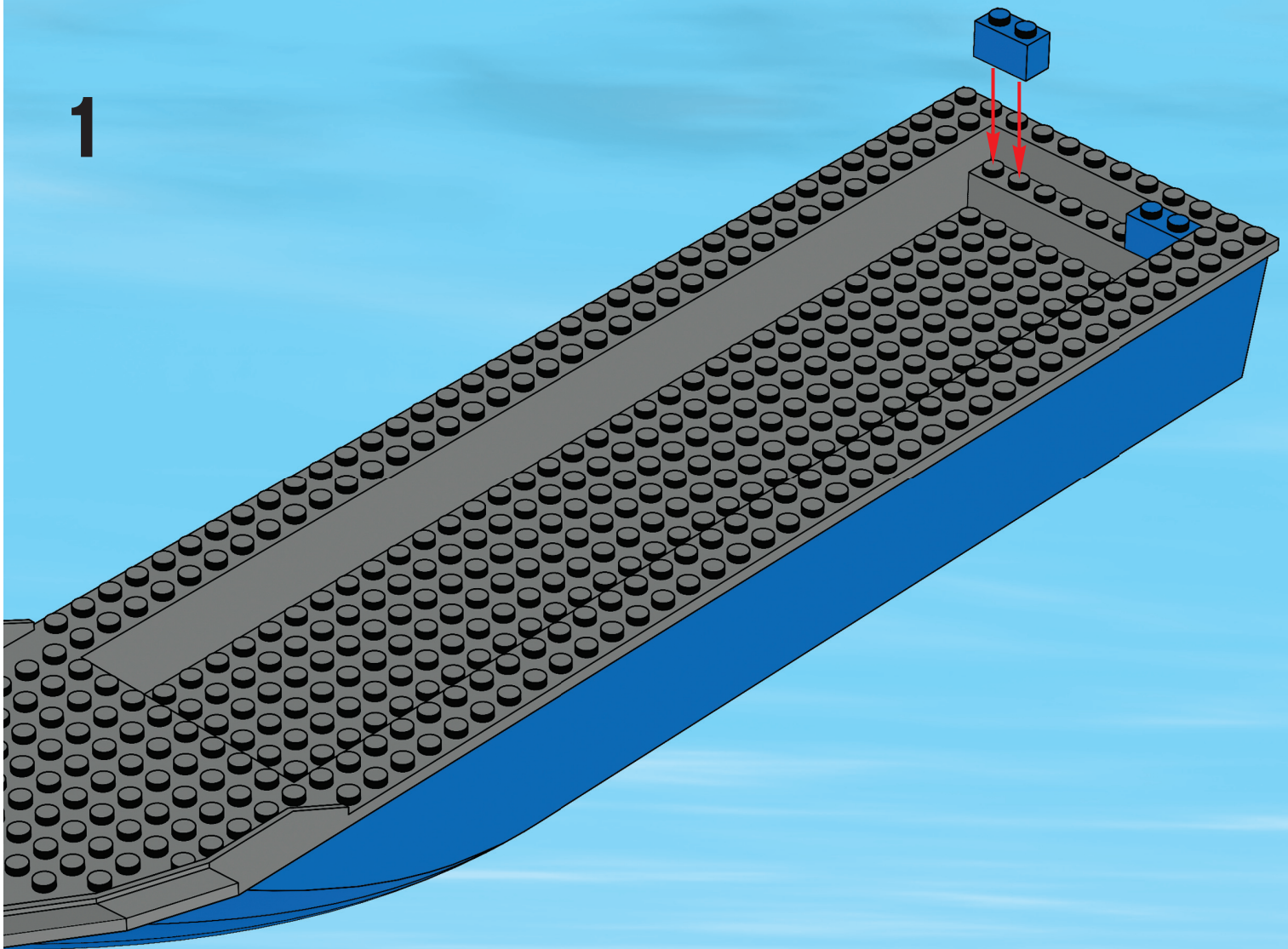

6





2

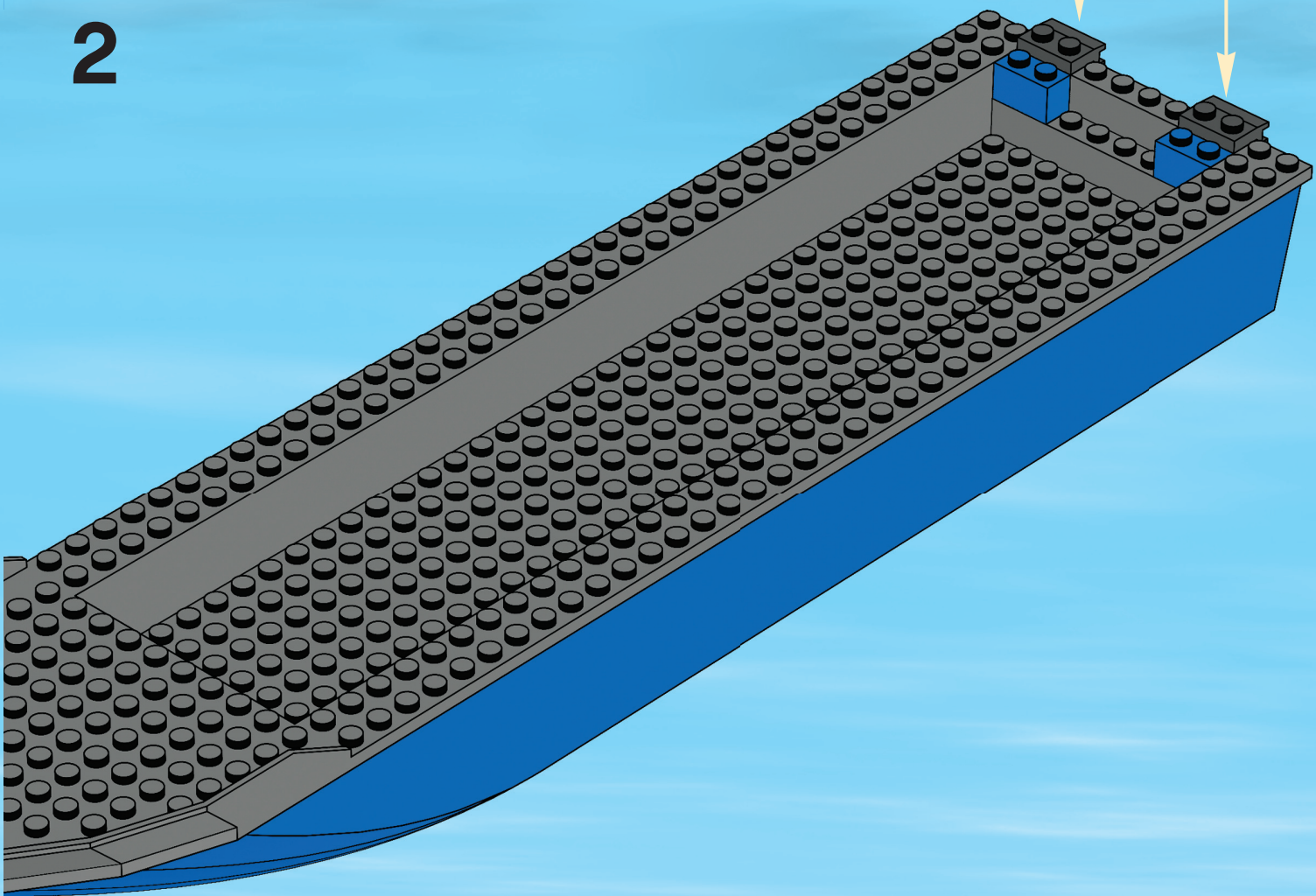
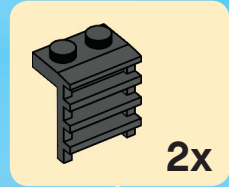



3

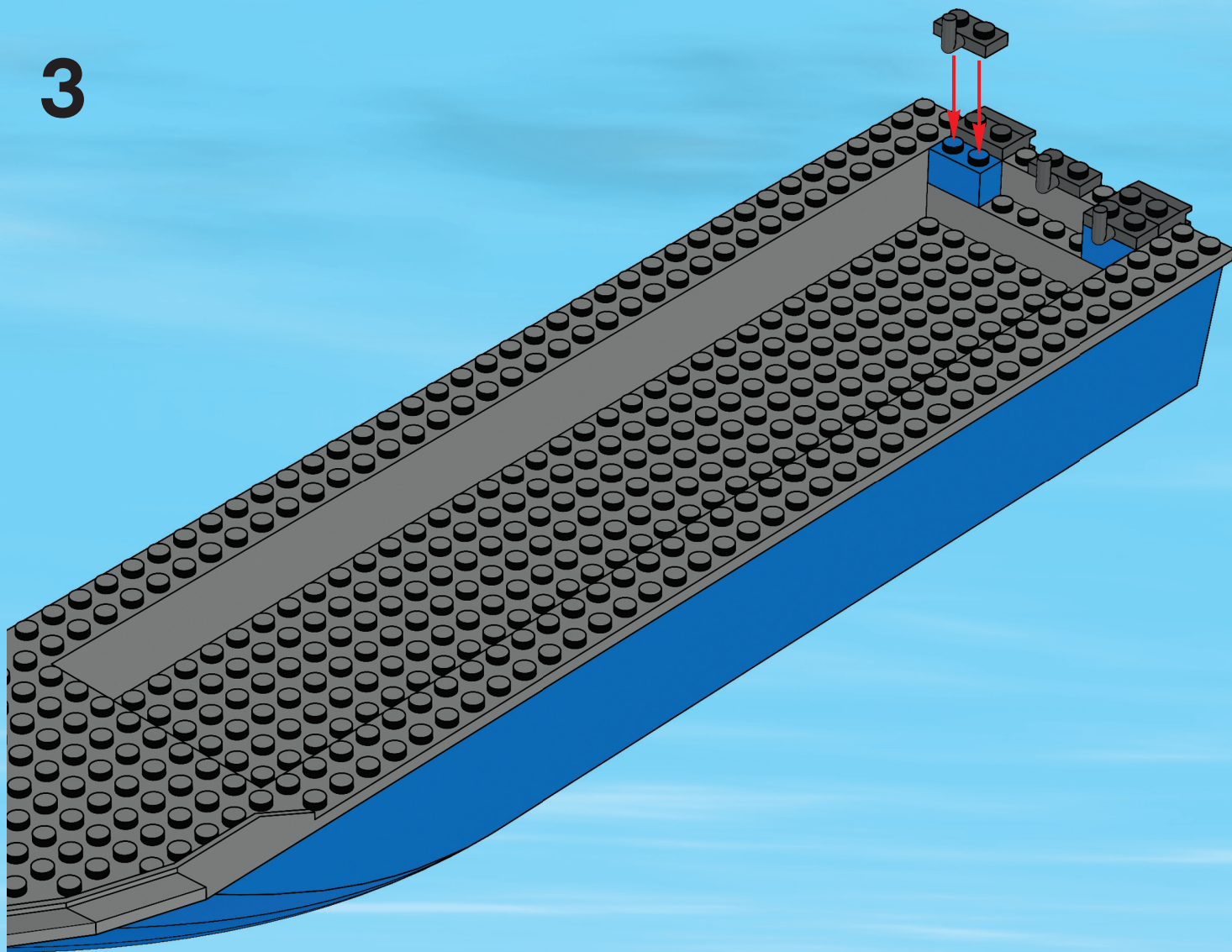

8







4

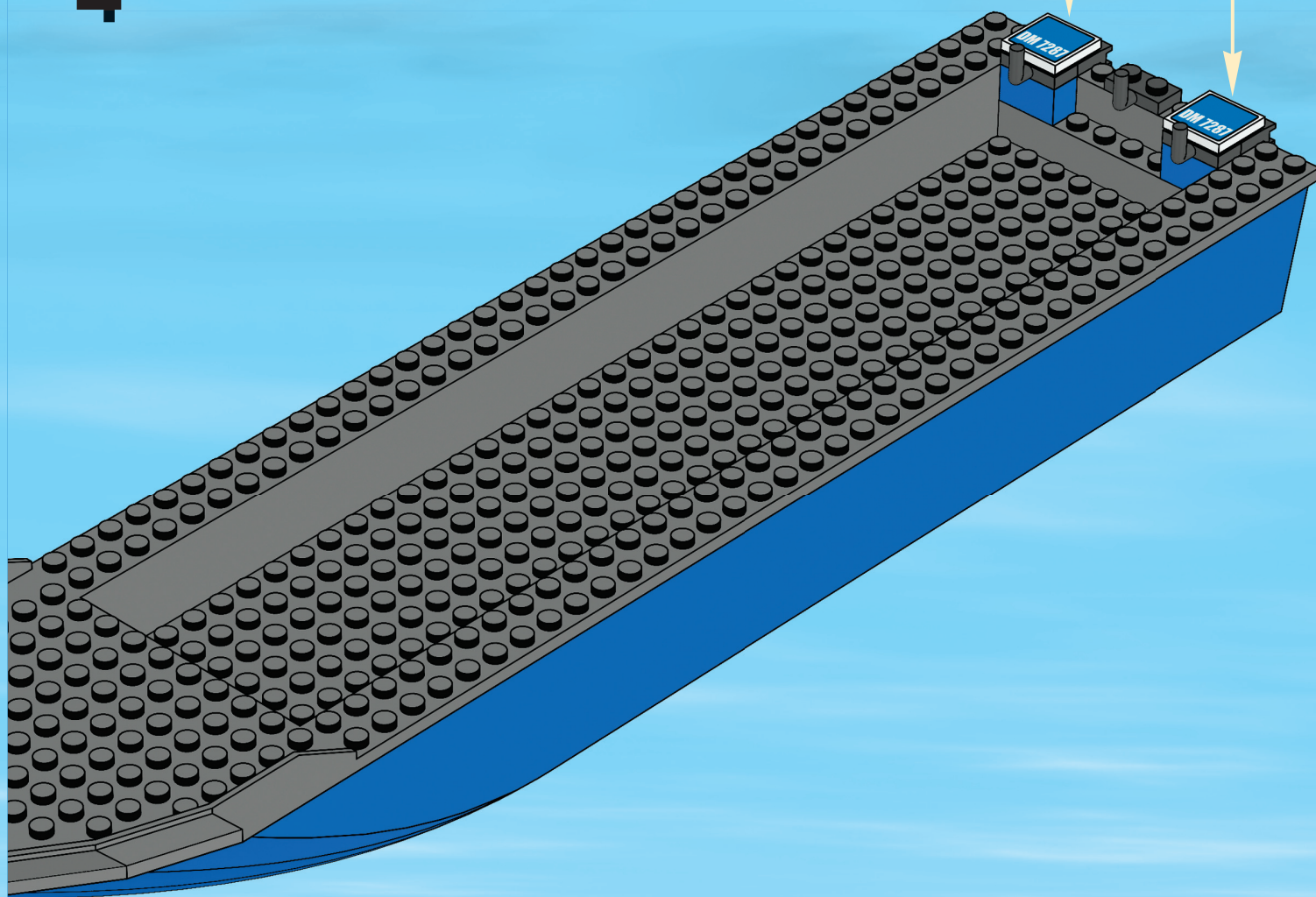
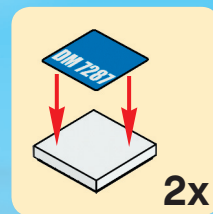



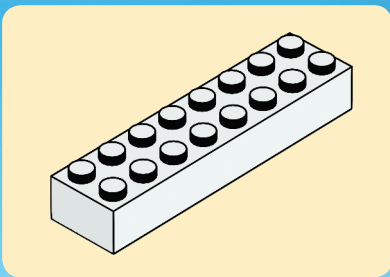

6

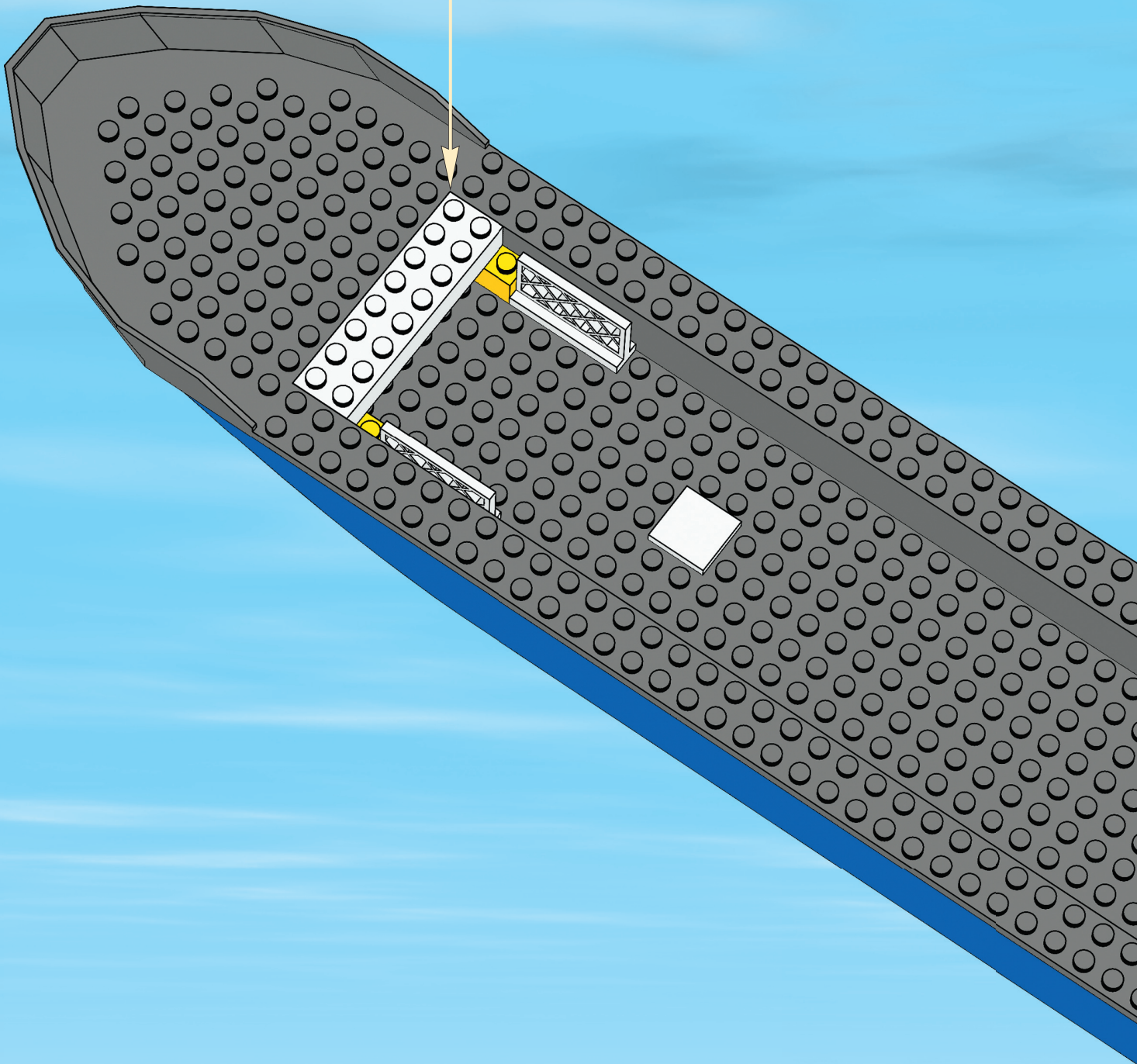



7

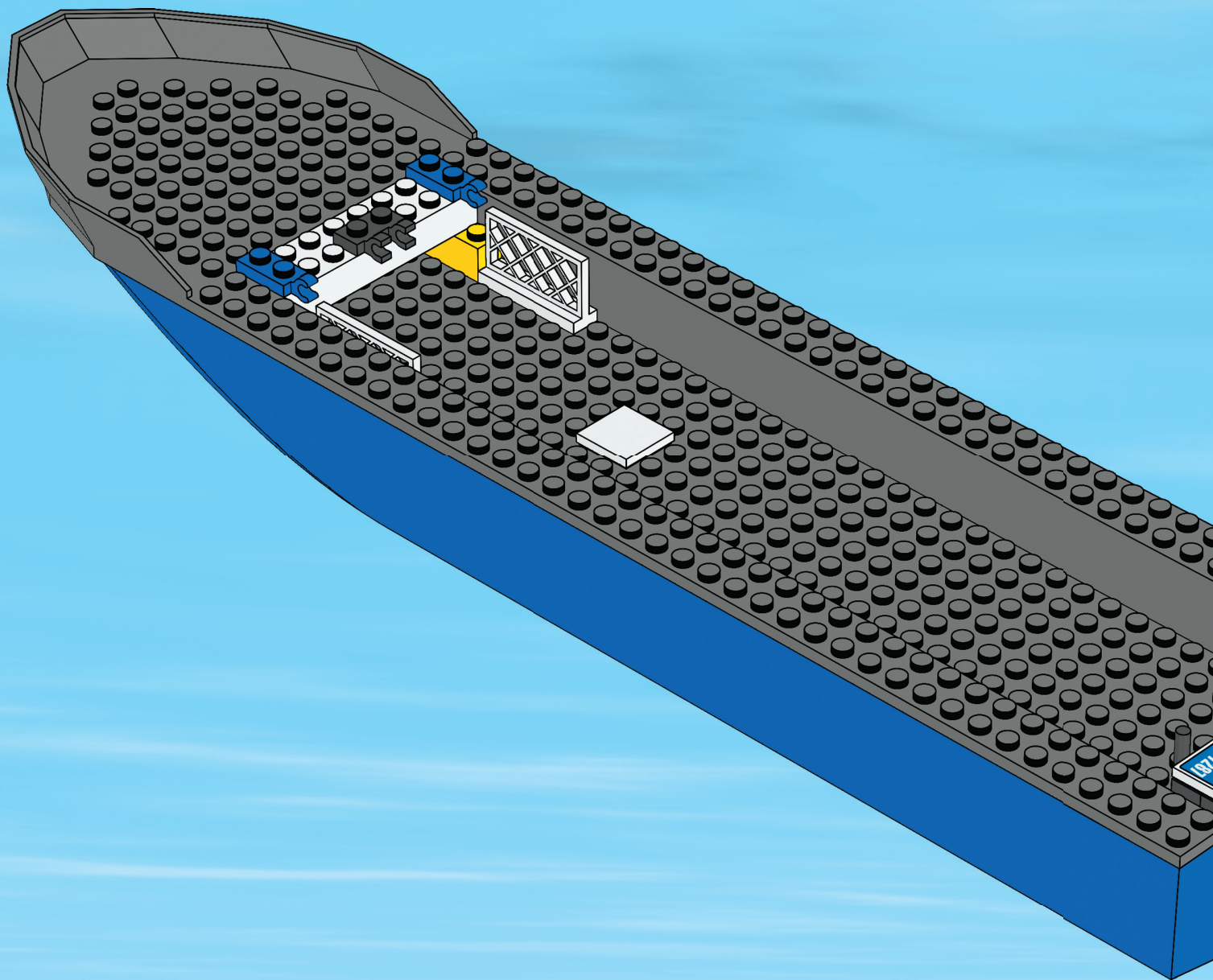



8

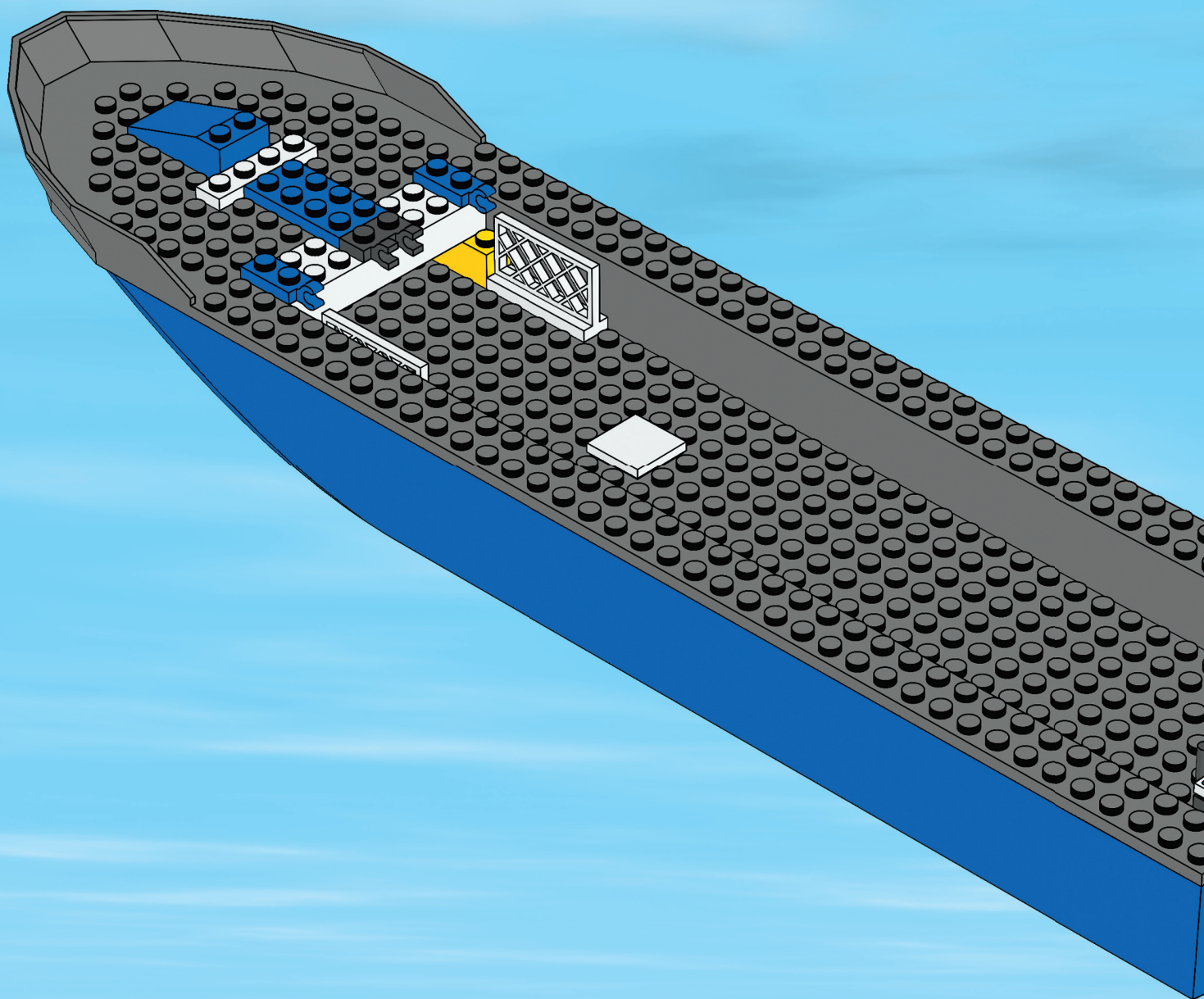



9

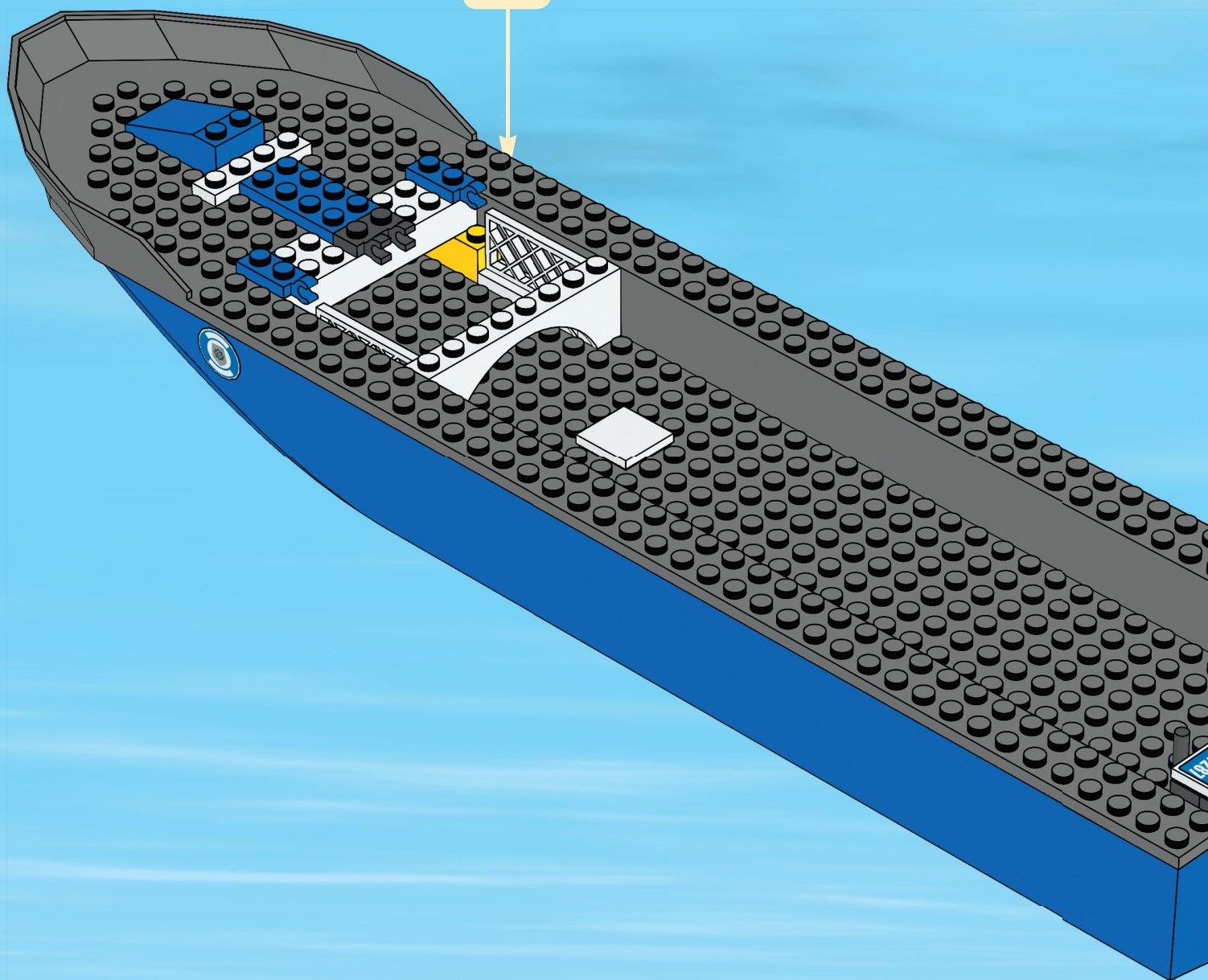



10

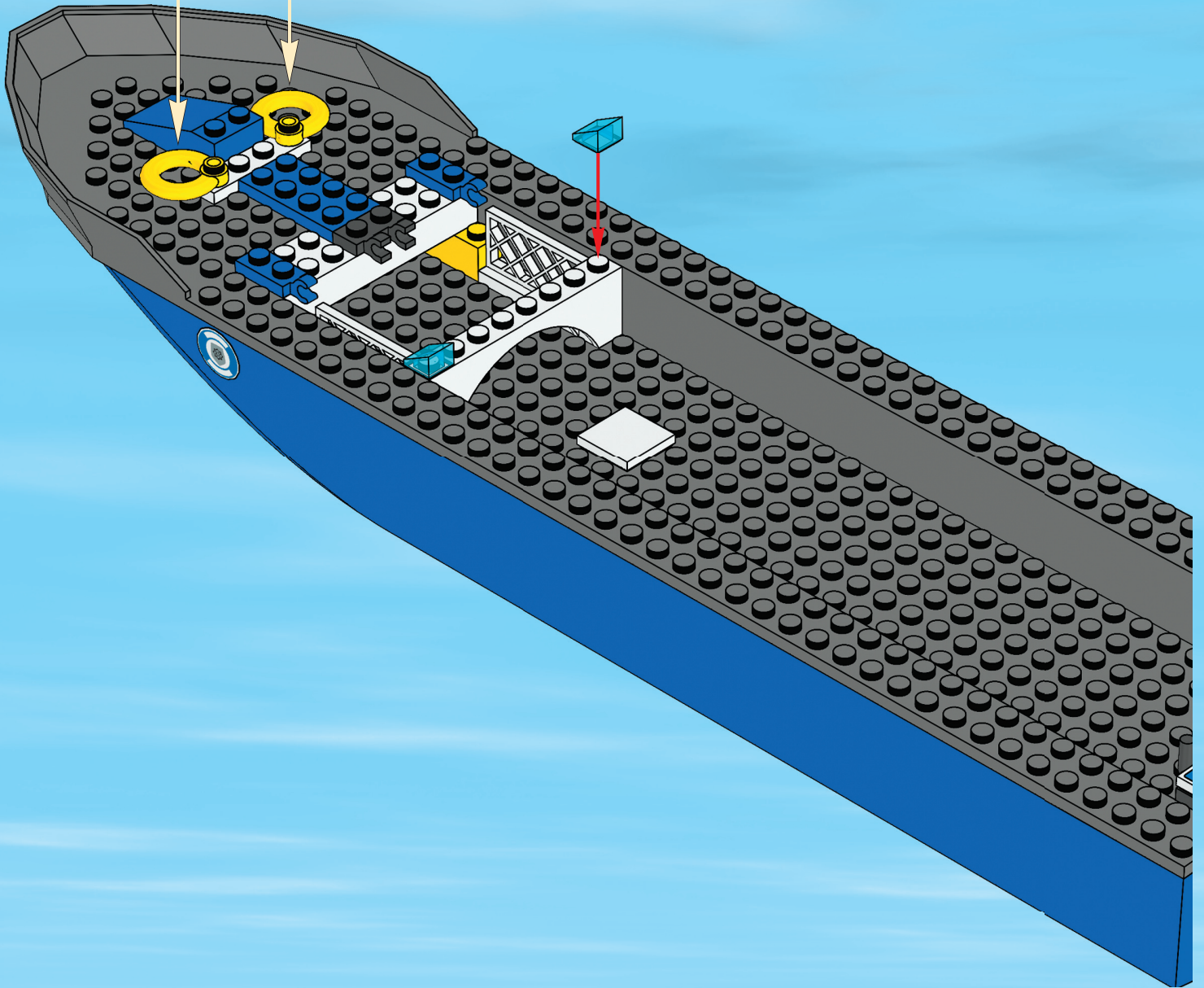

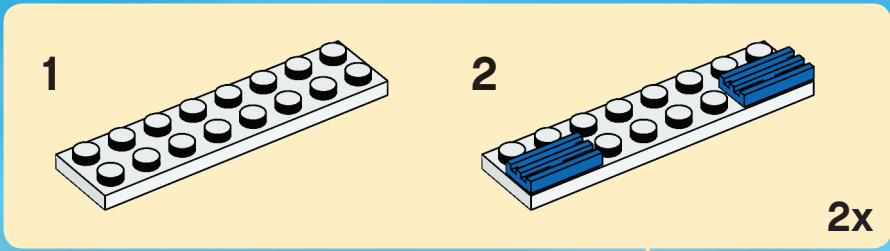

11

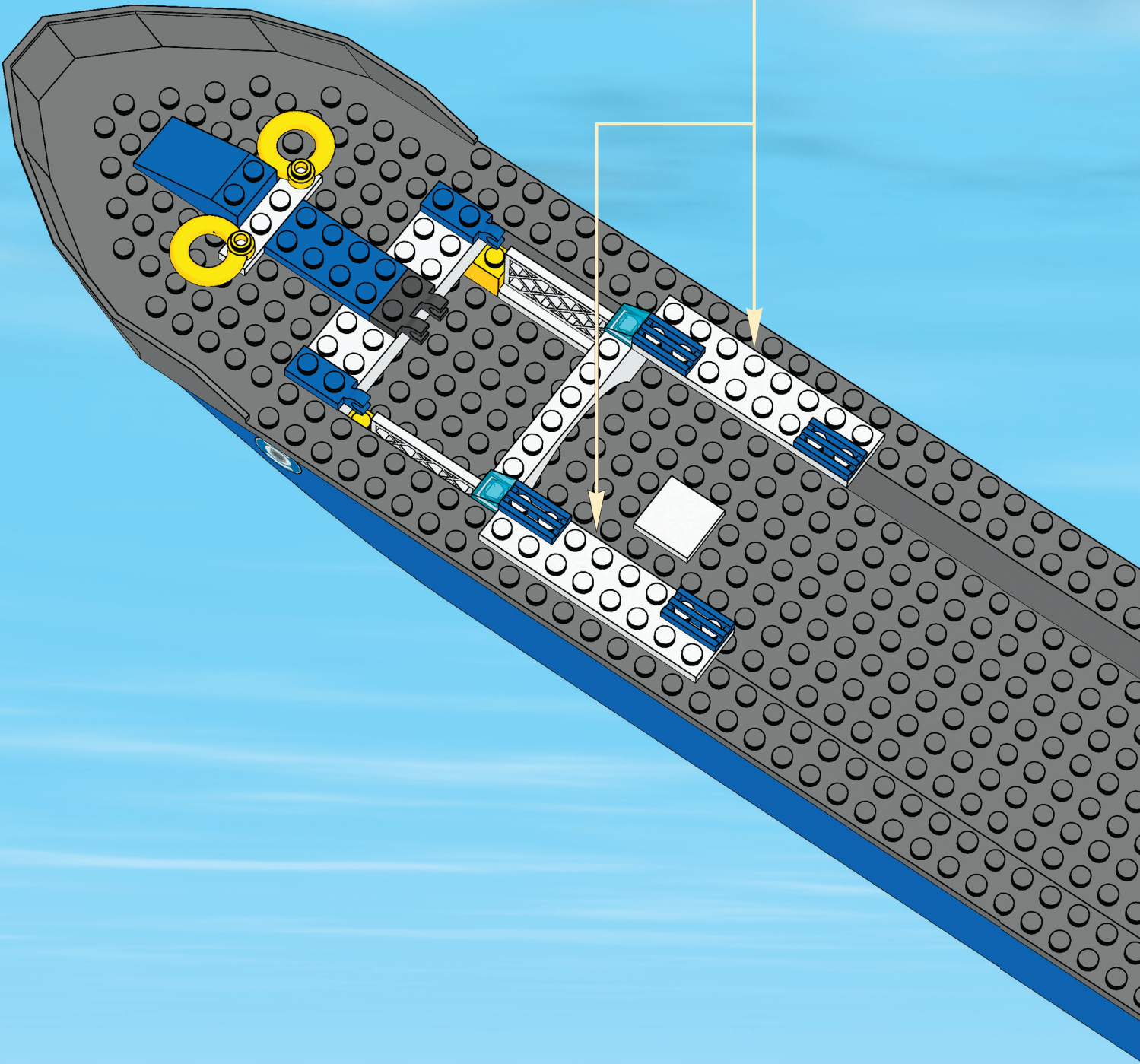



12

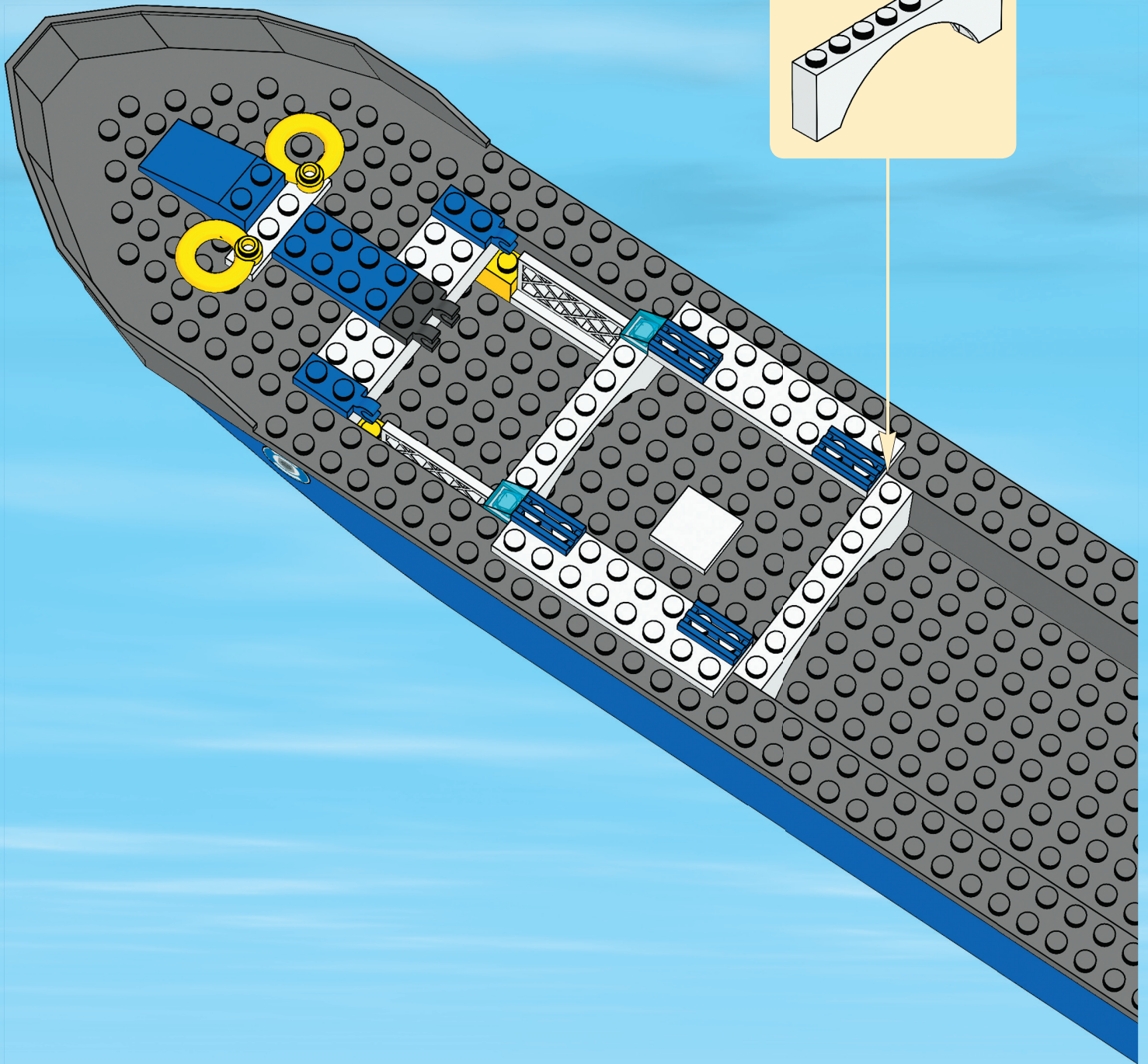



13

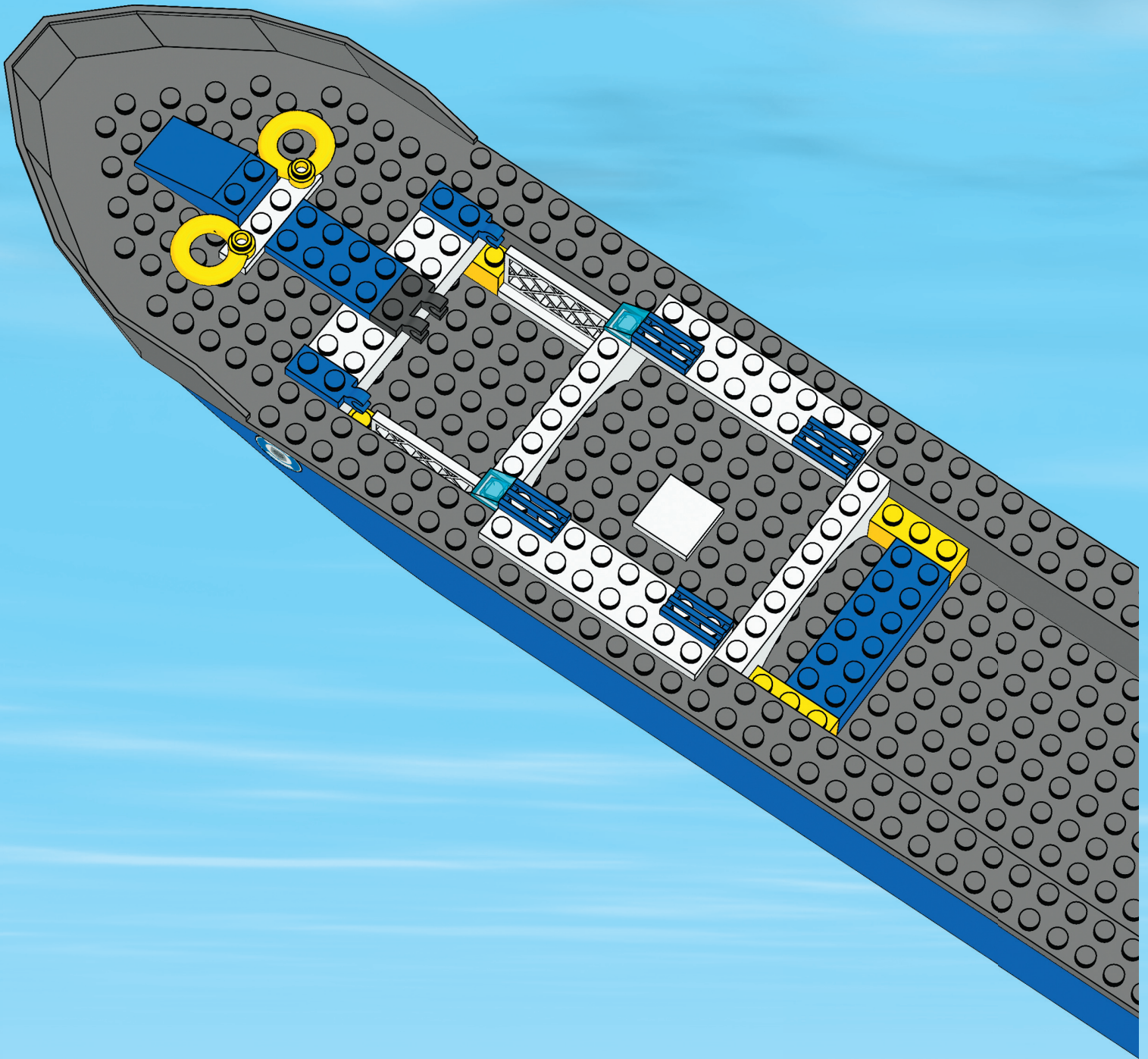

18



14

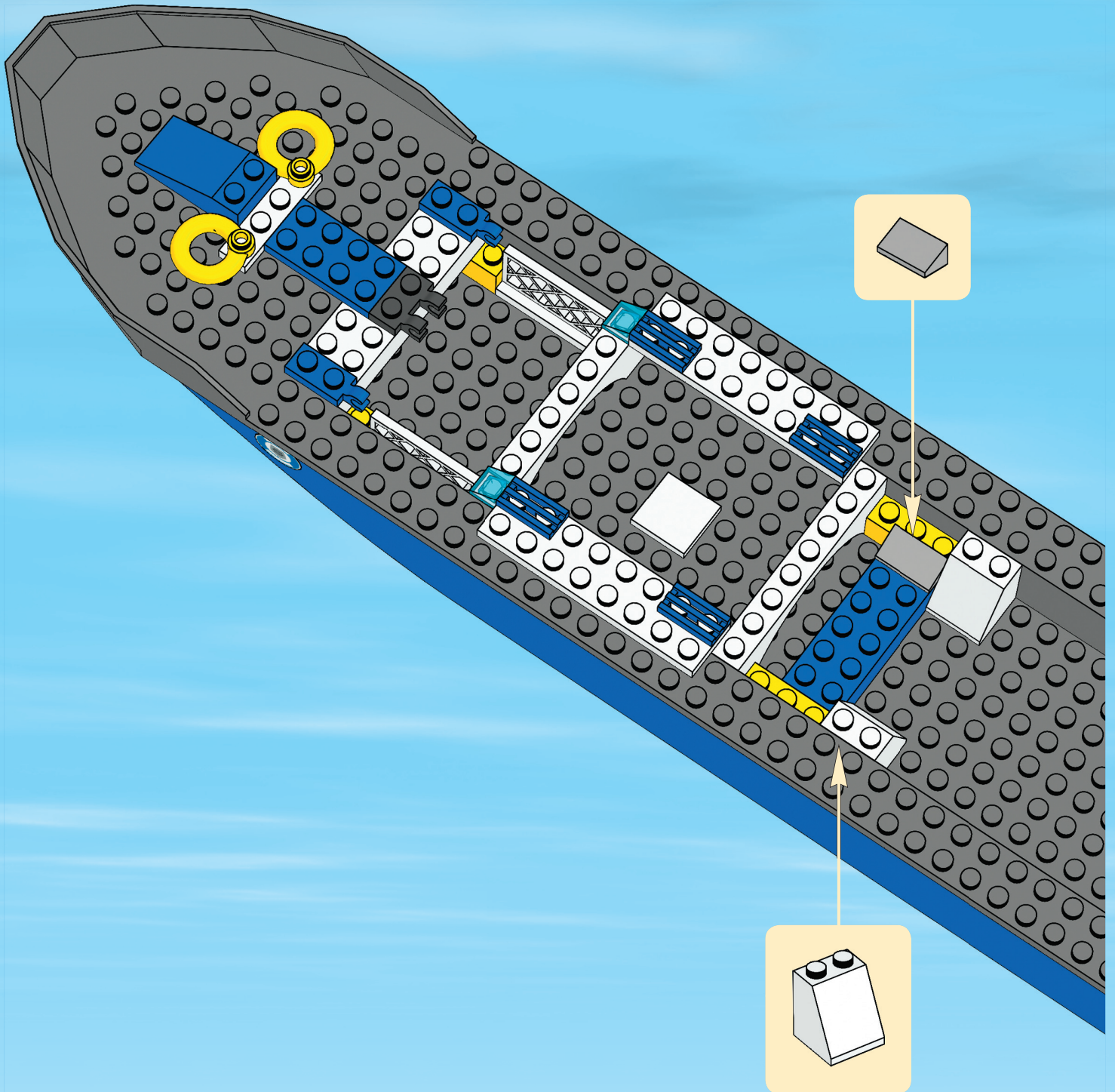

15

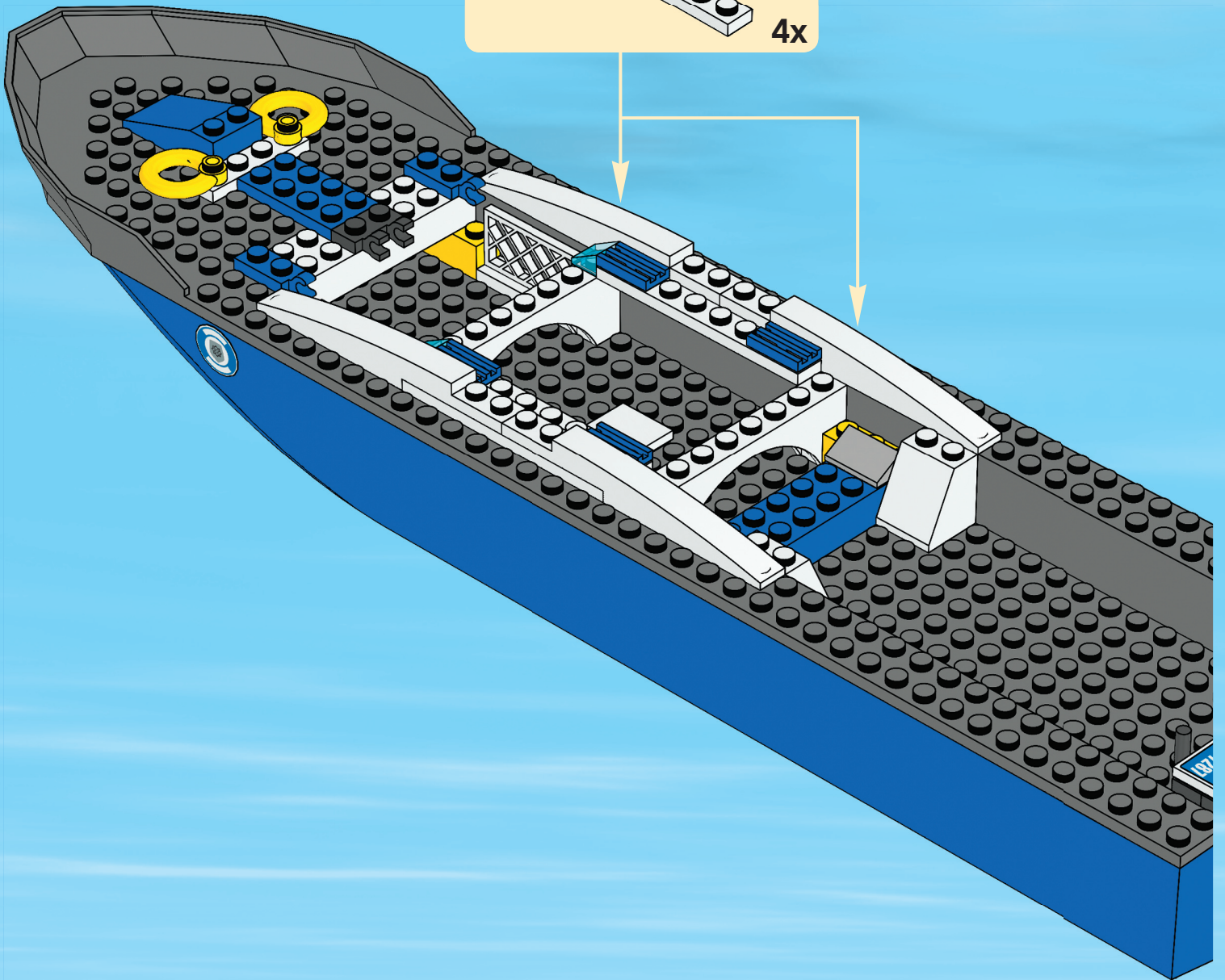
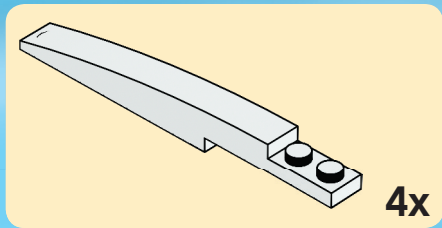



16

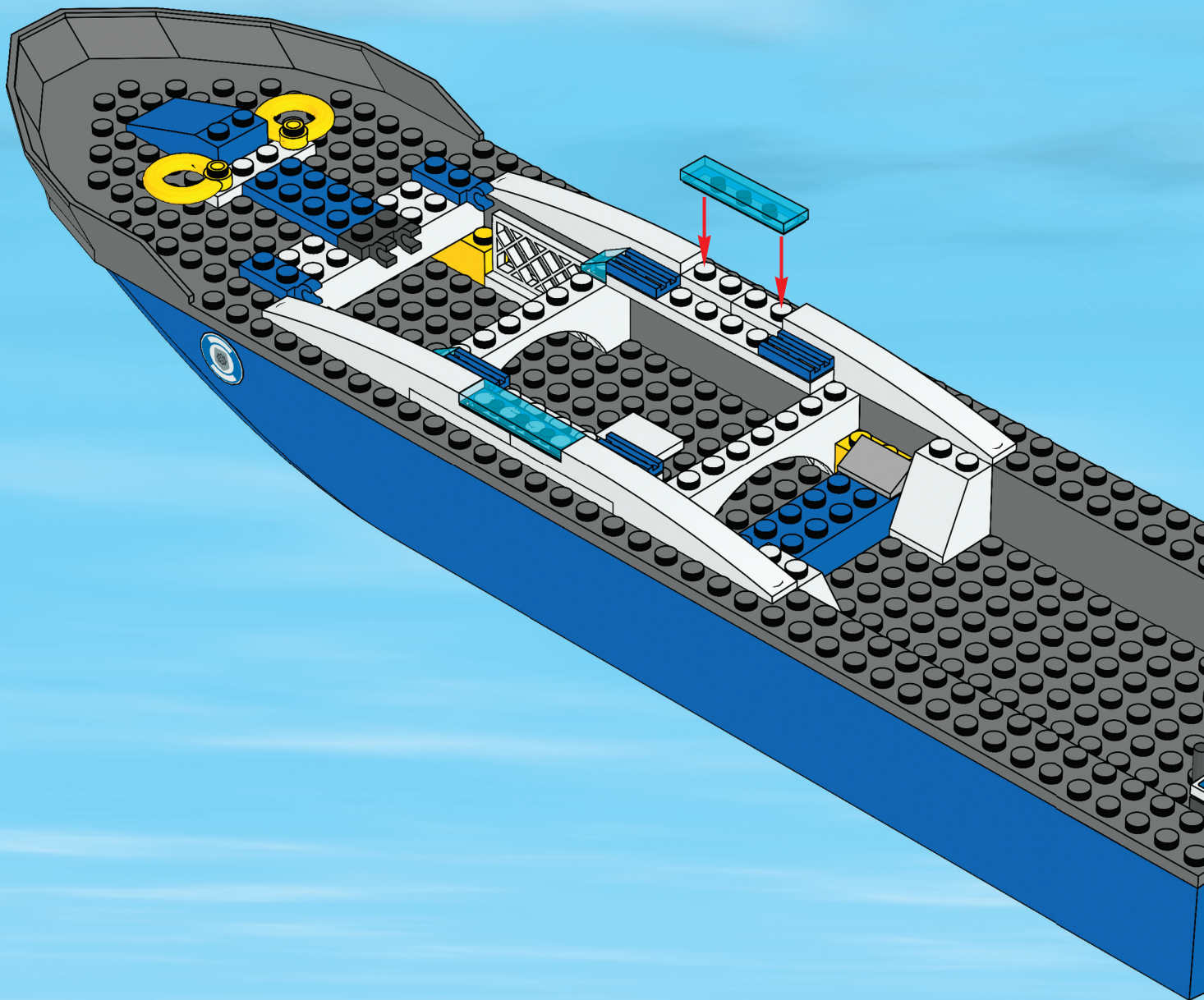



17

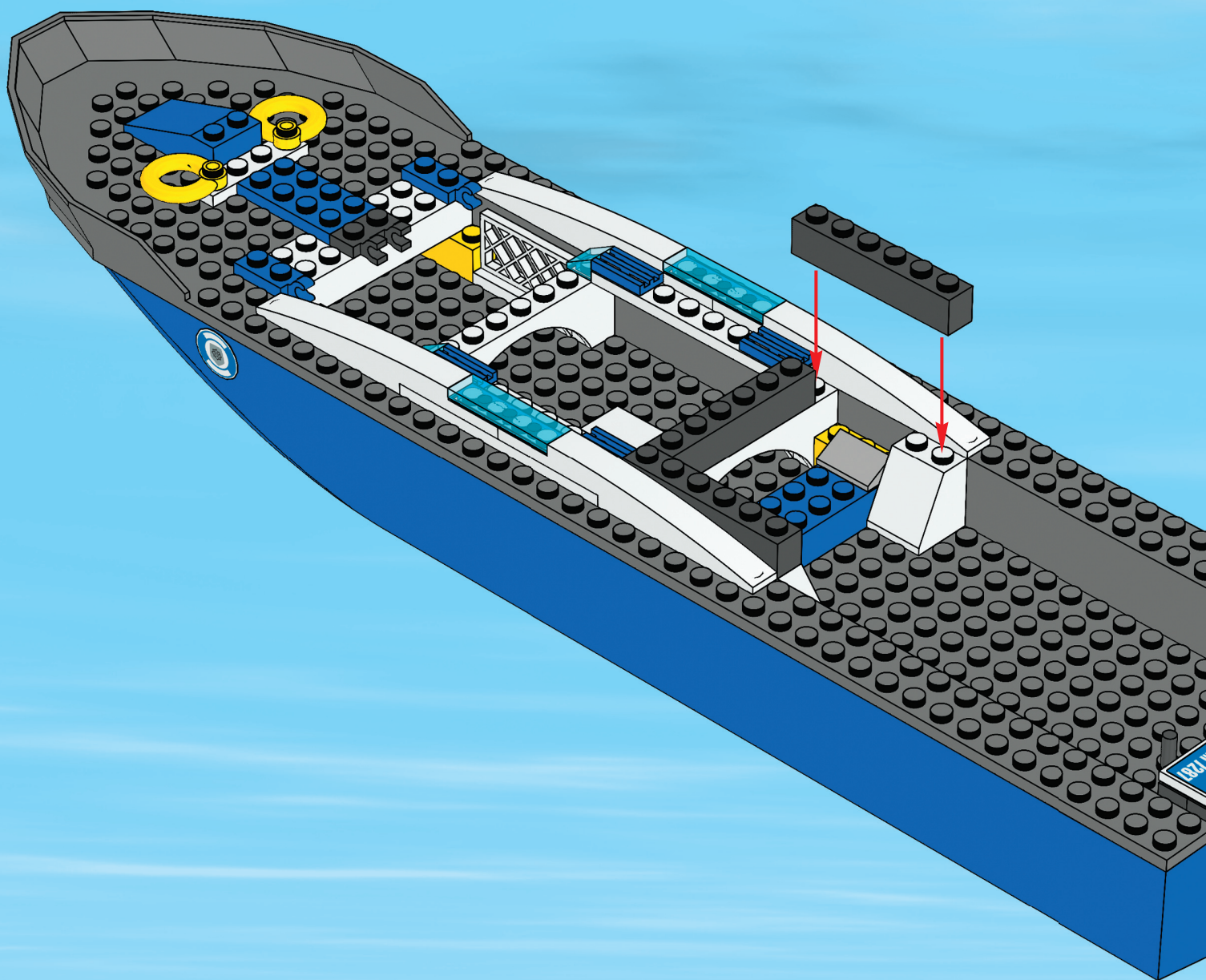

22





18

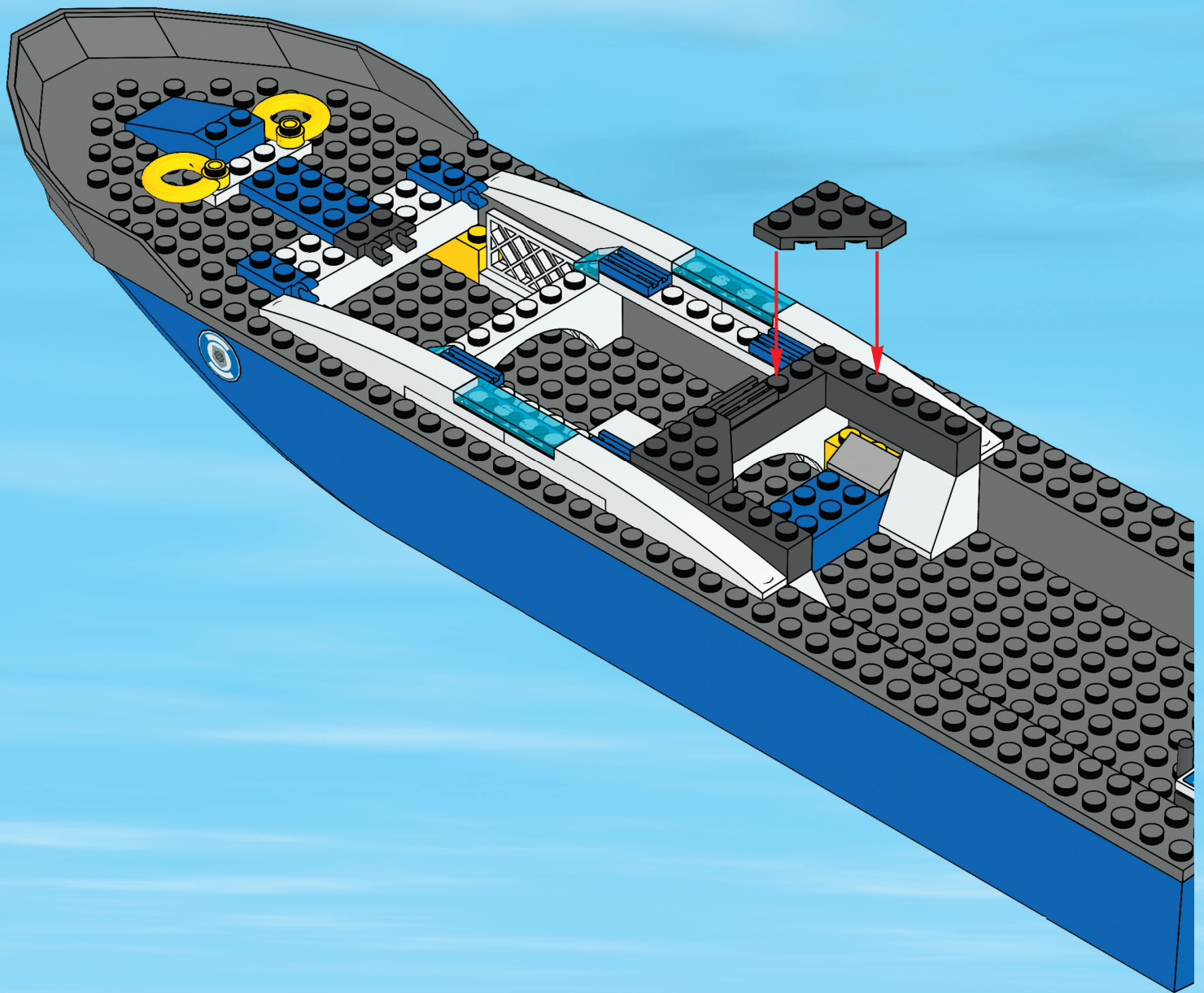



19

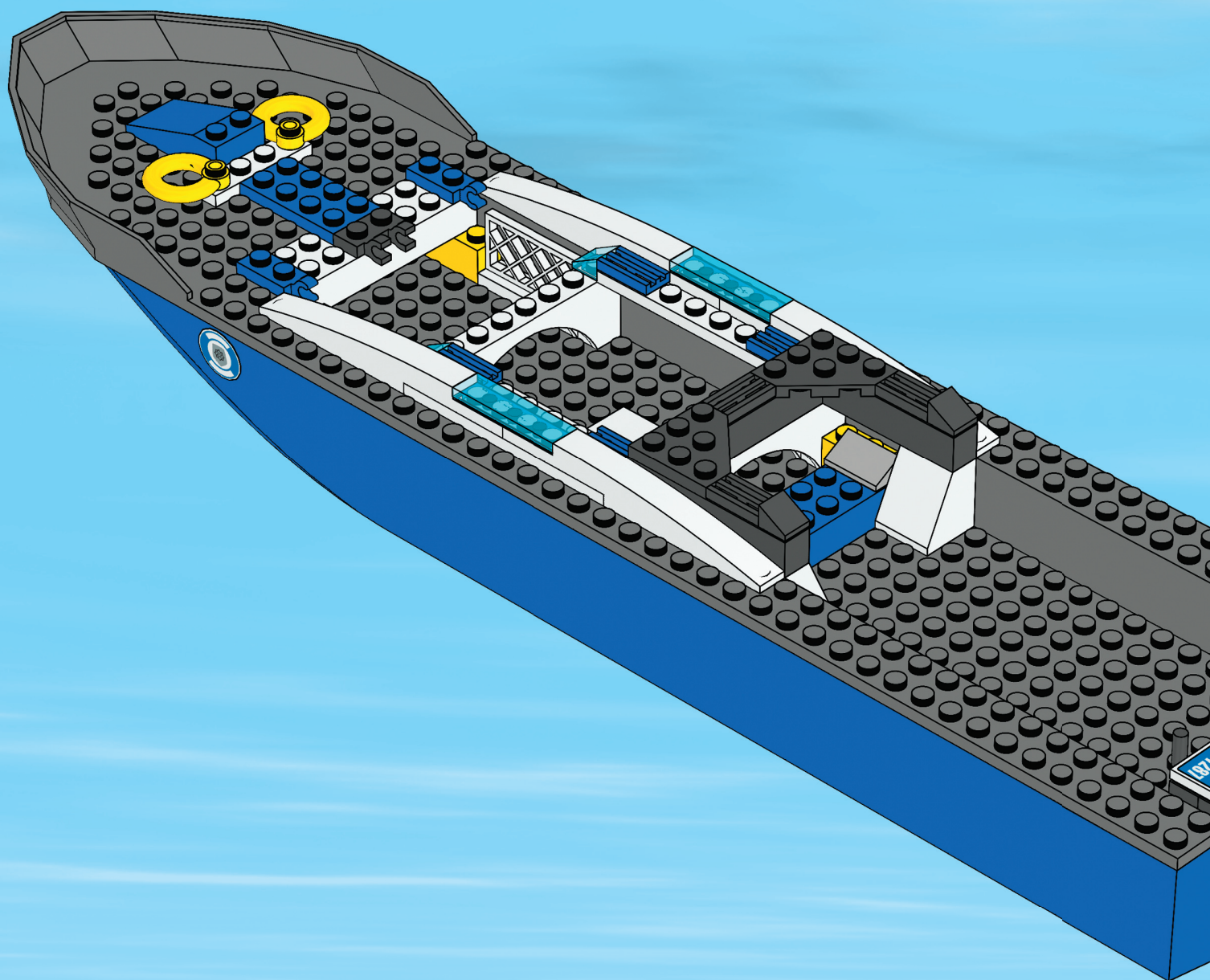

24





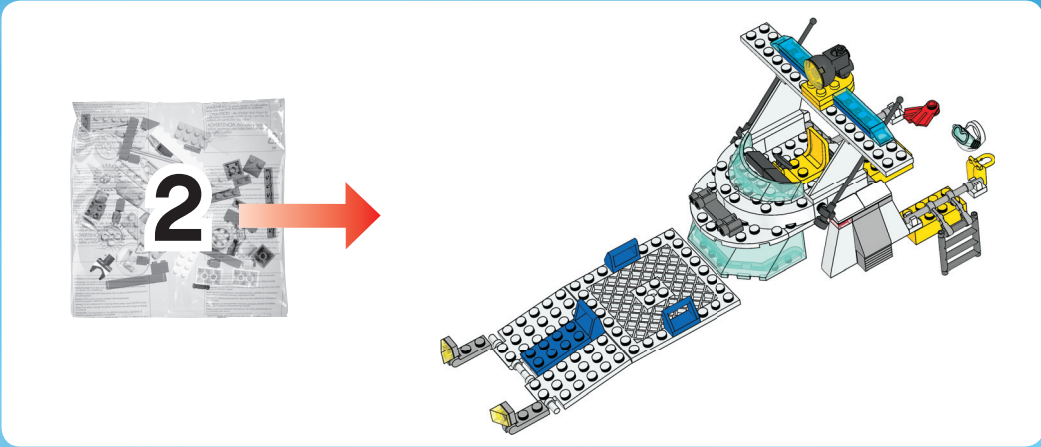

20

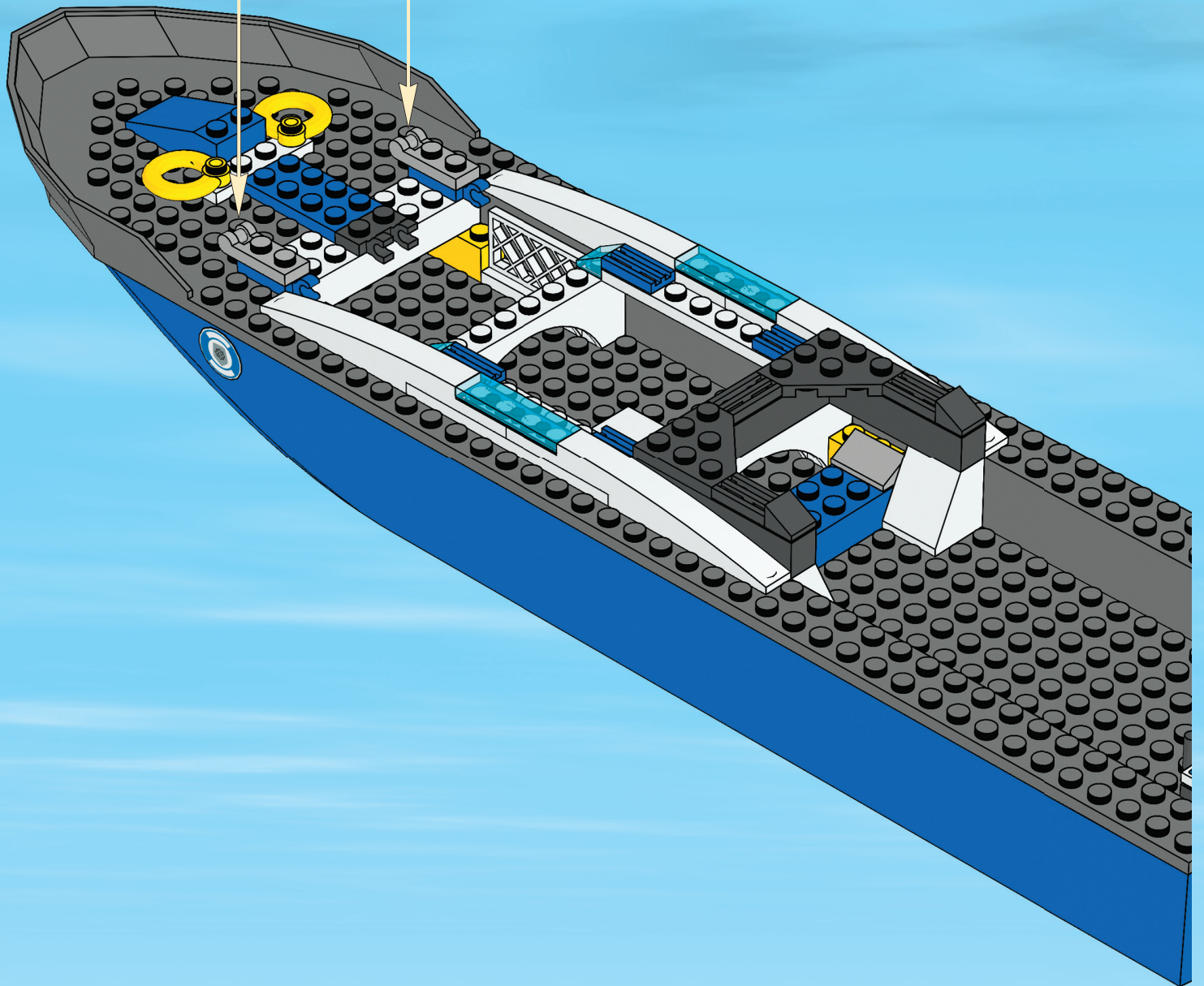
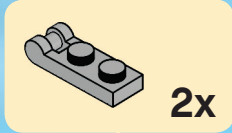



21

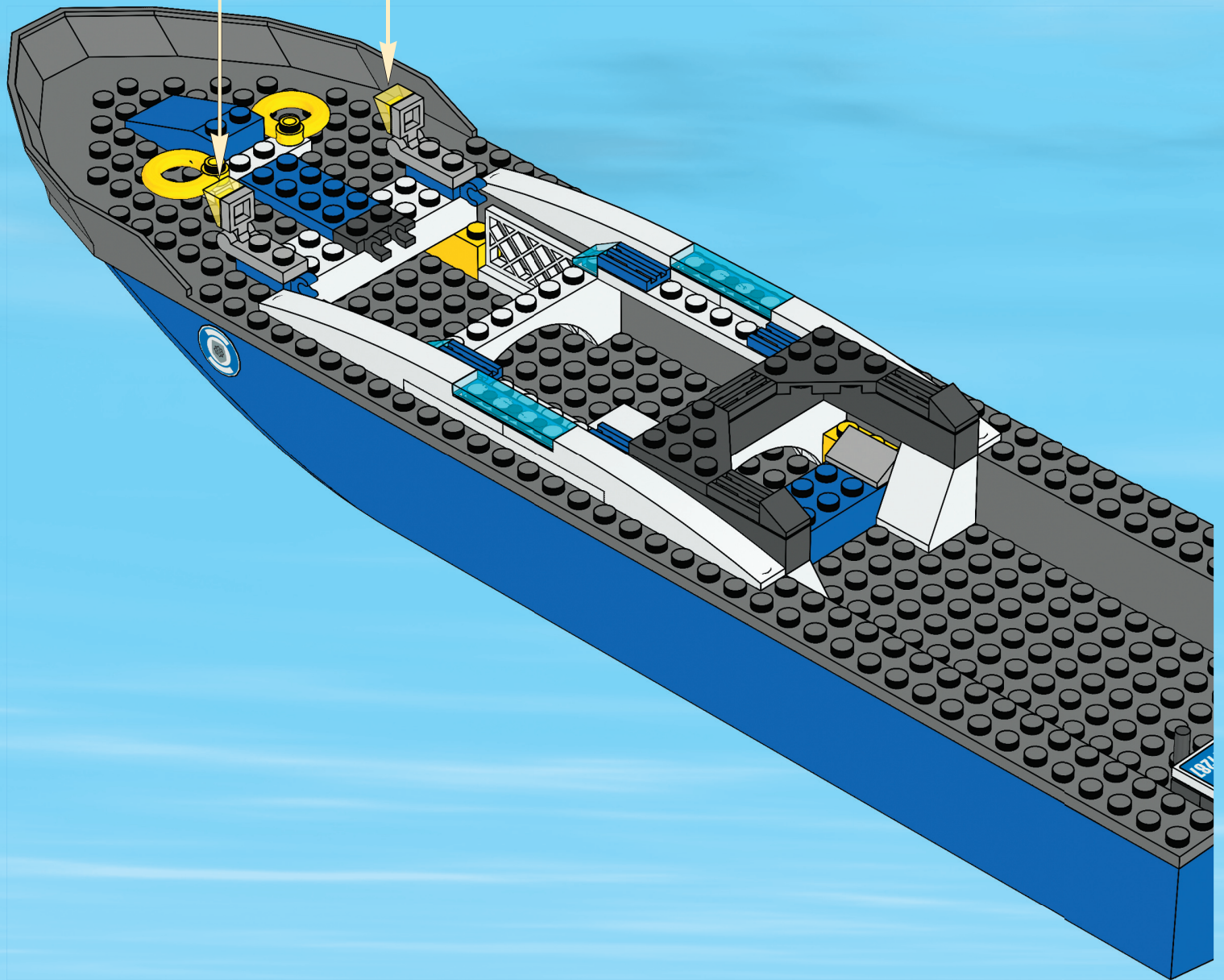
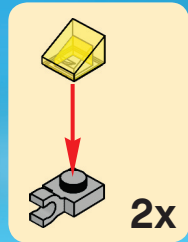

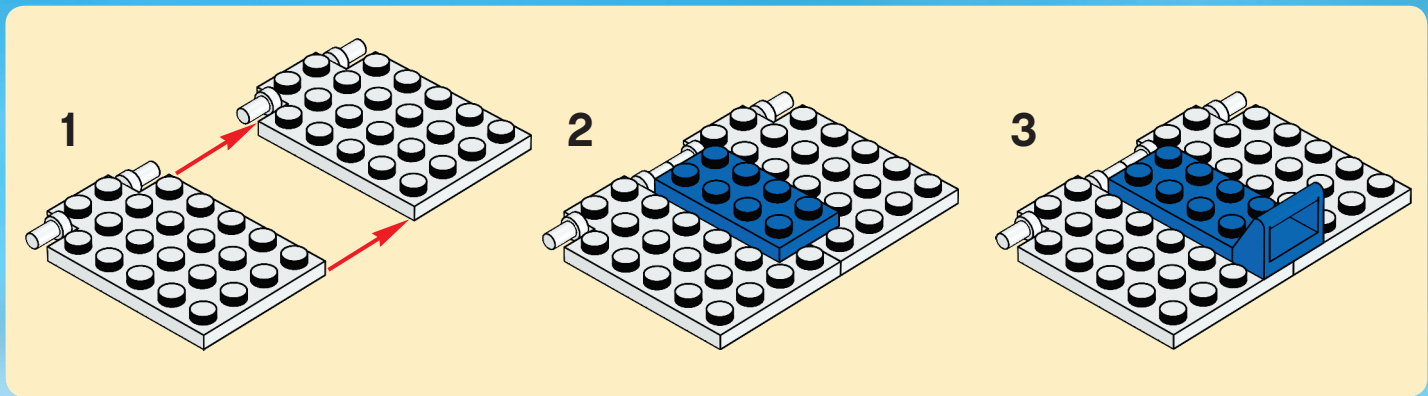

22

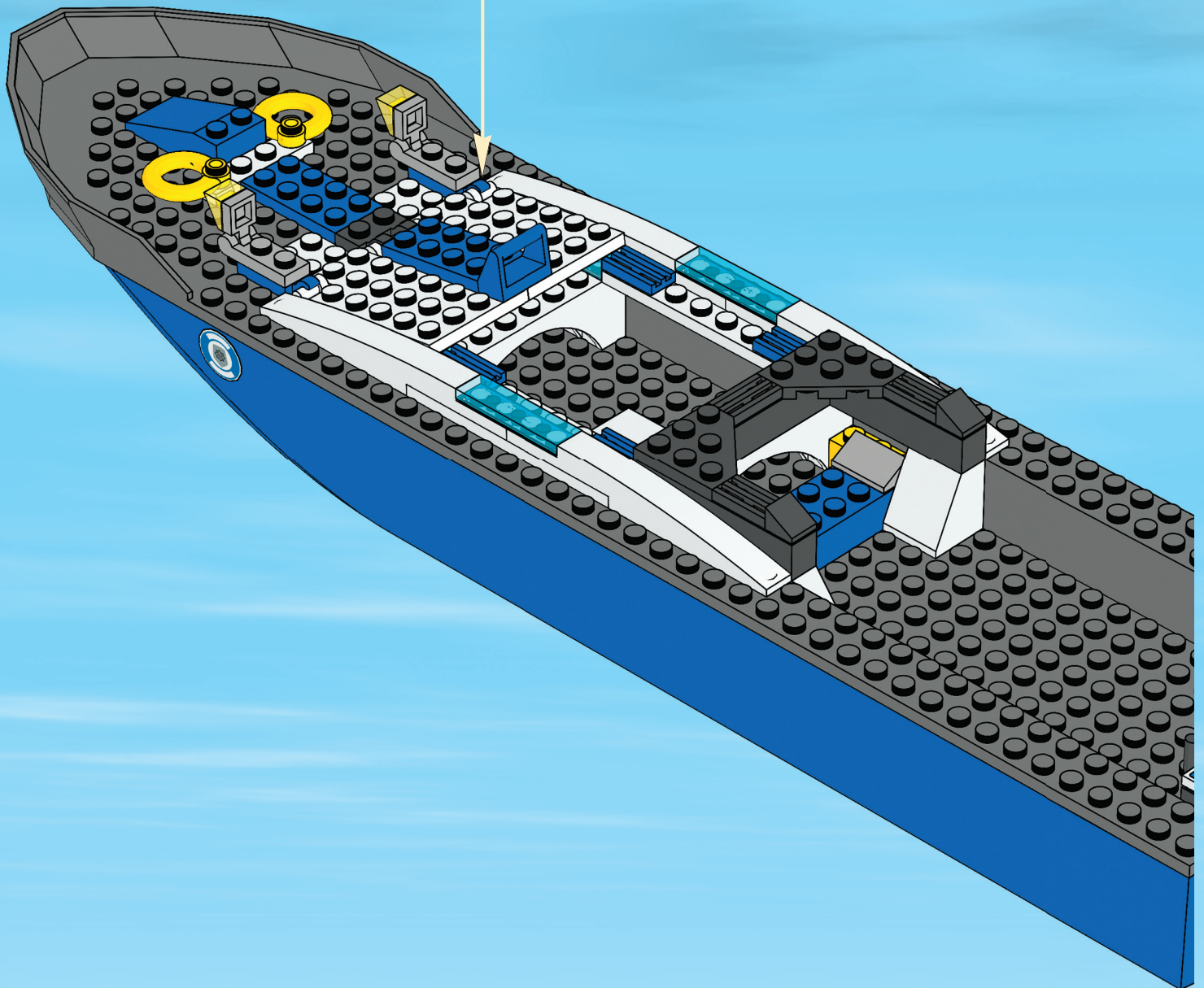



23

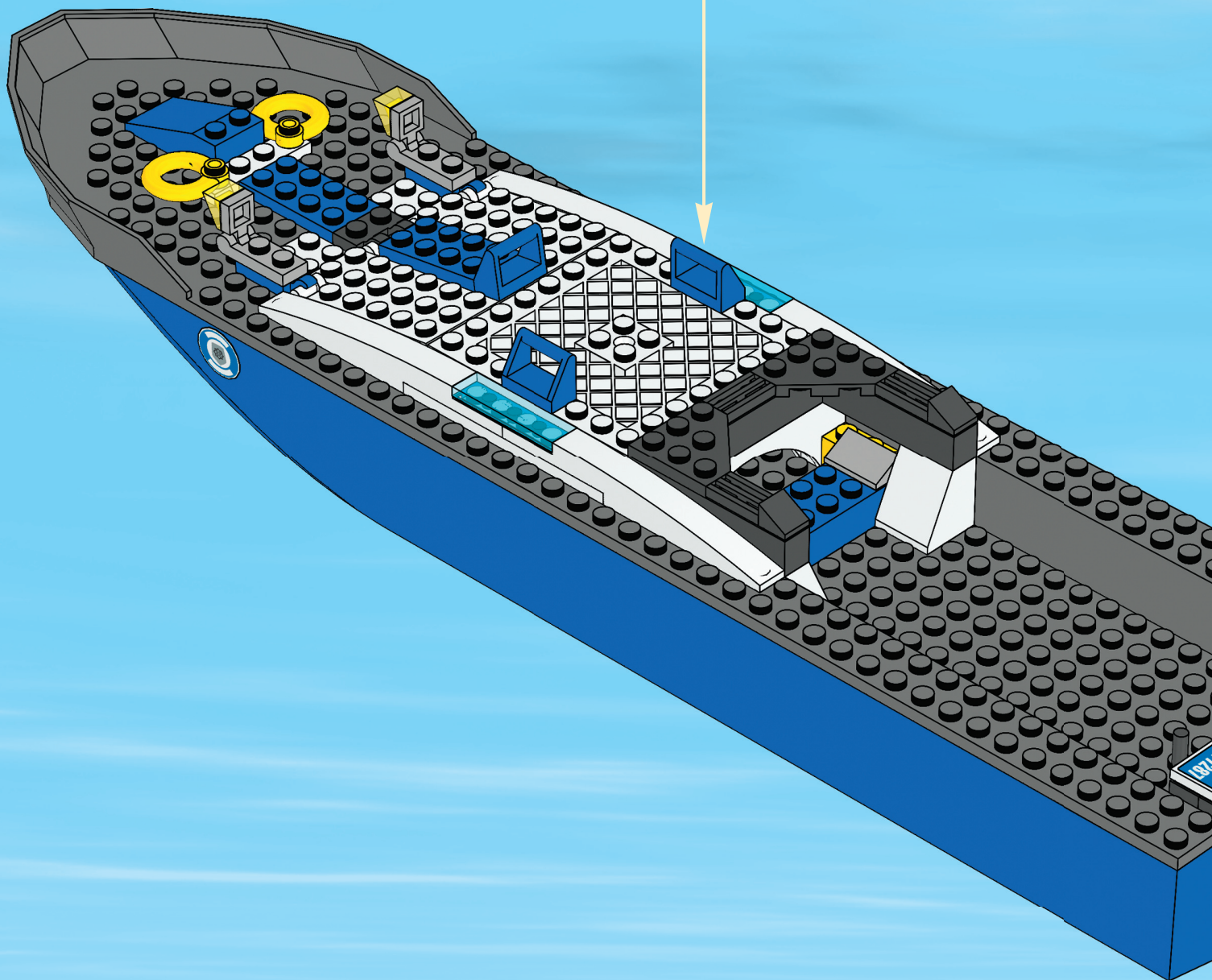
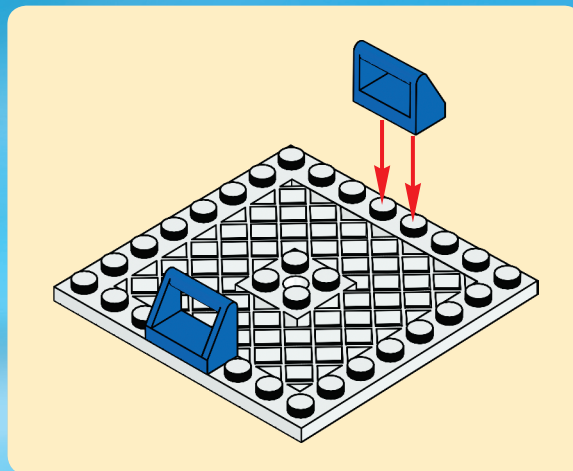



24

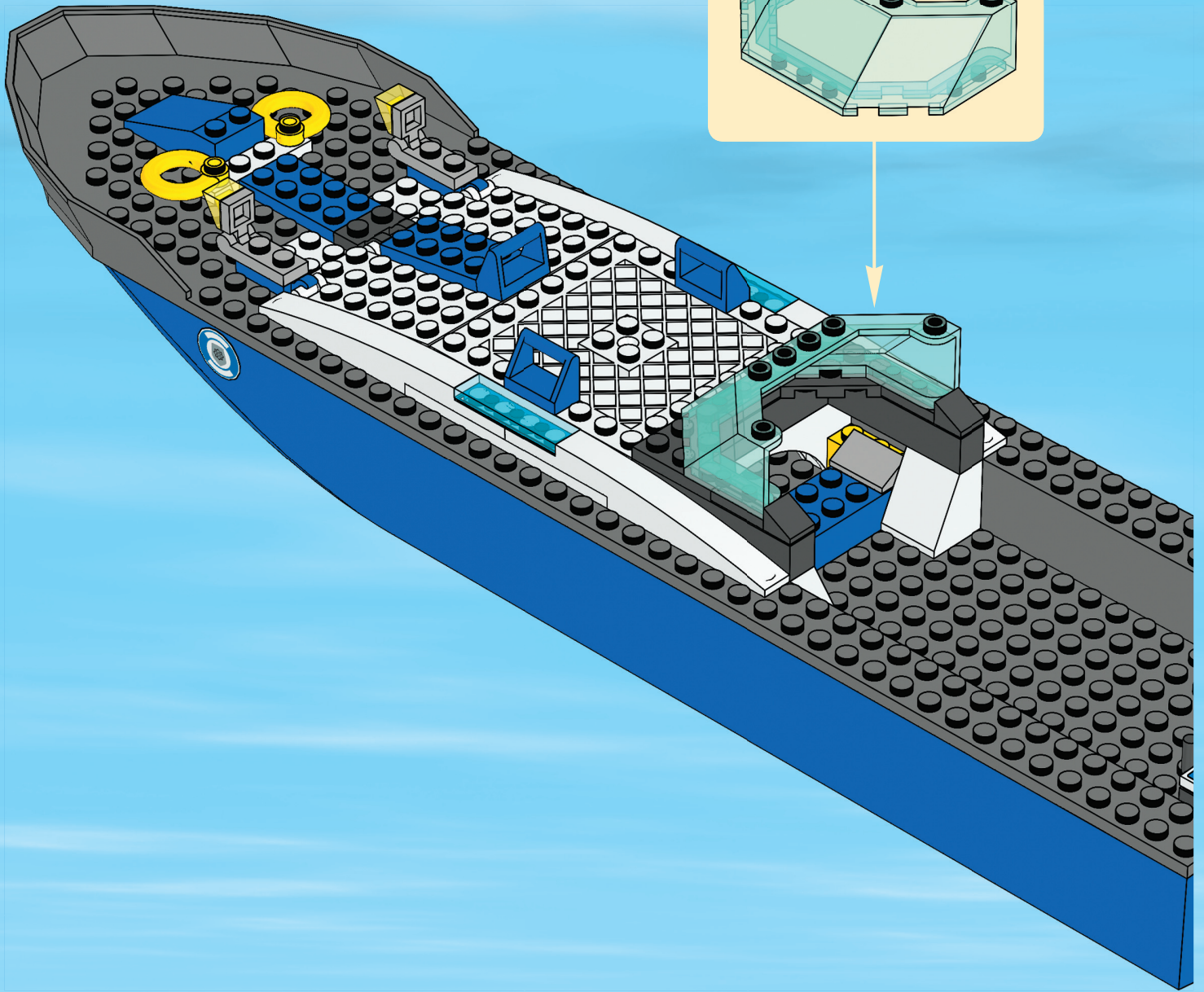
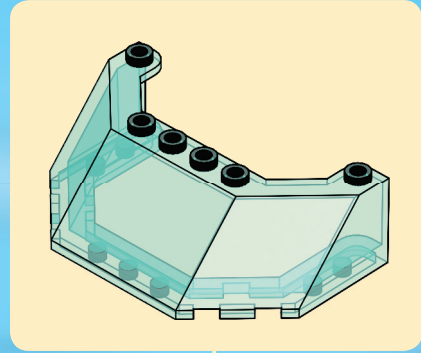

25

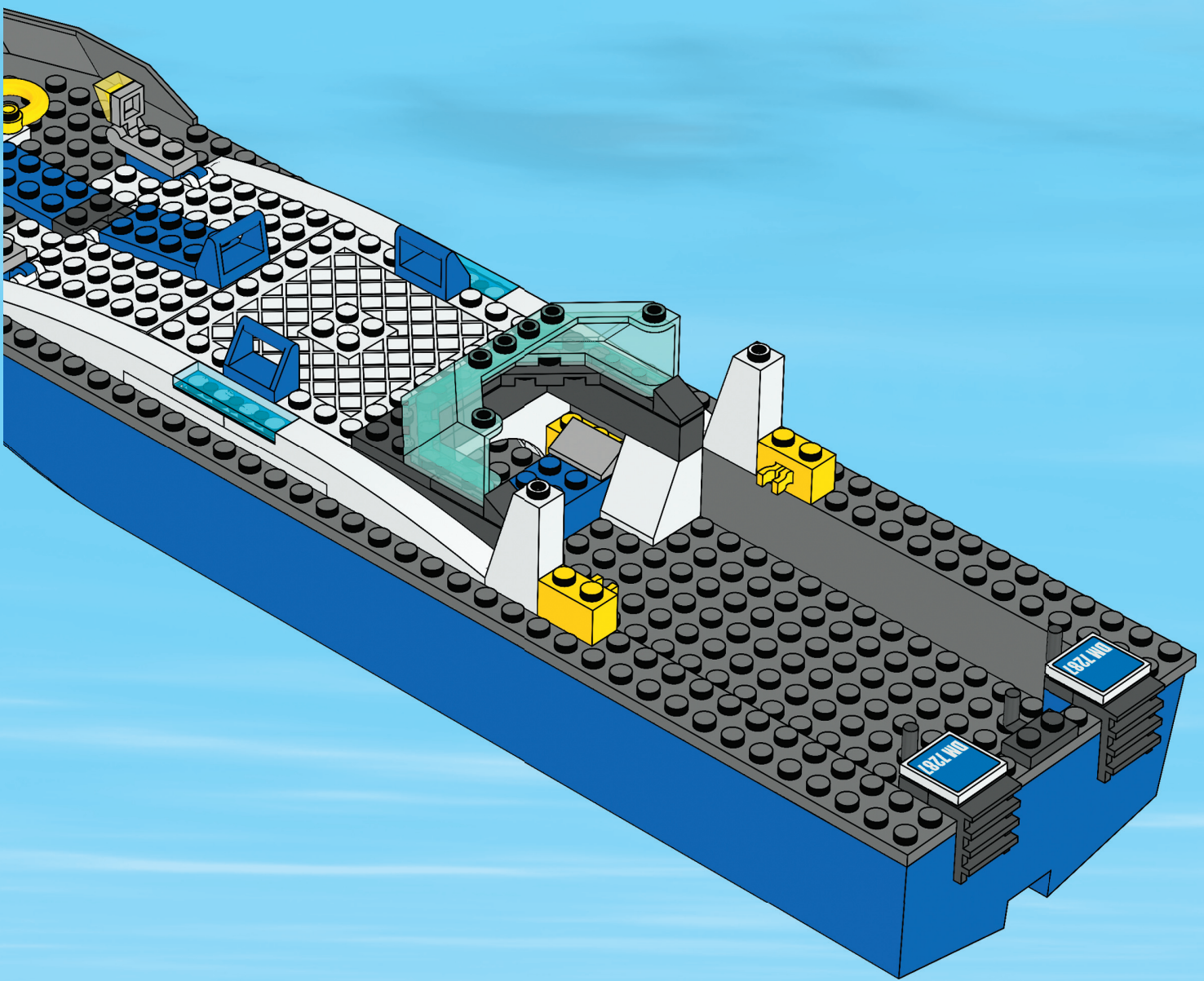

30

26

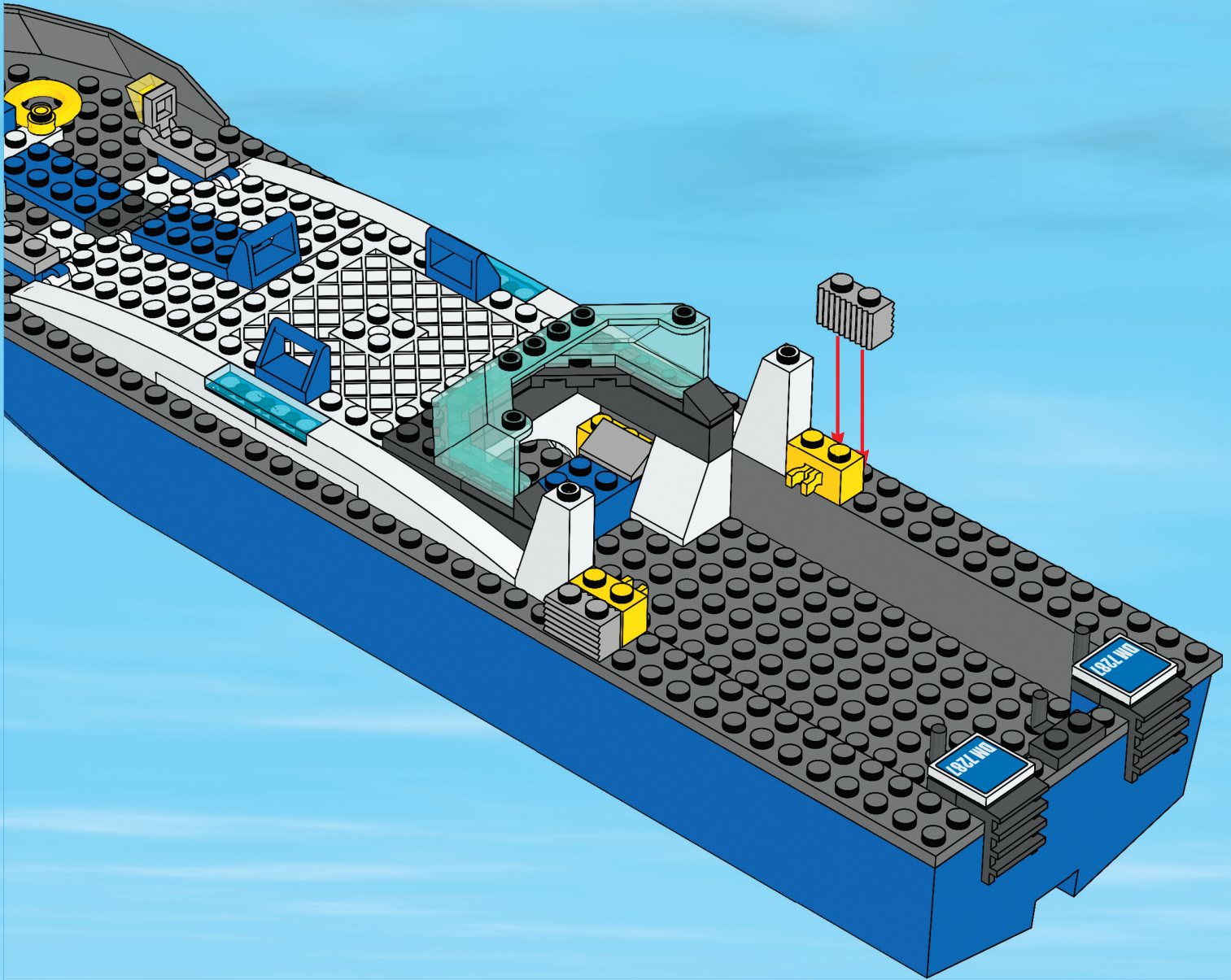







28

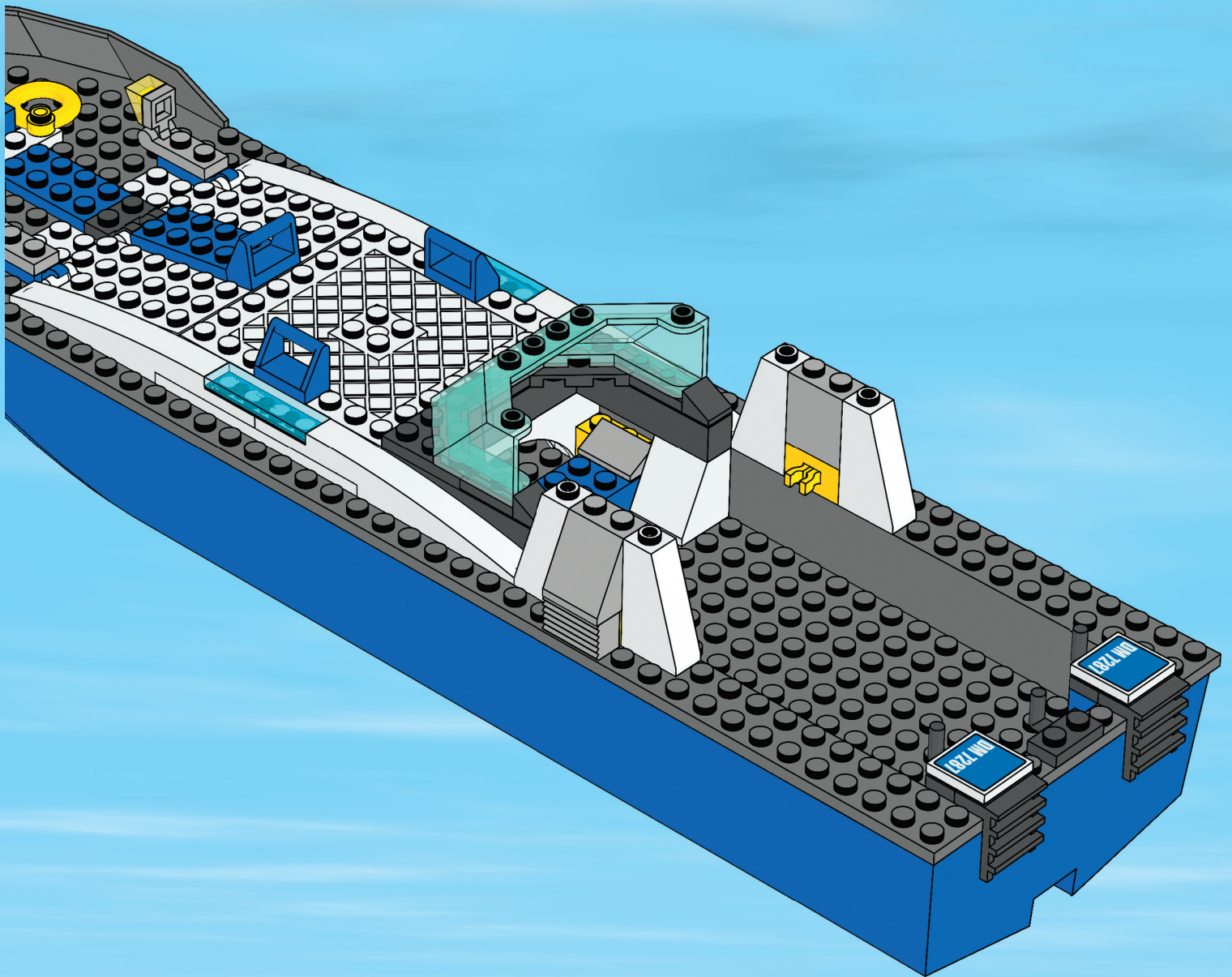

29

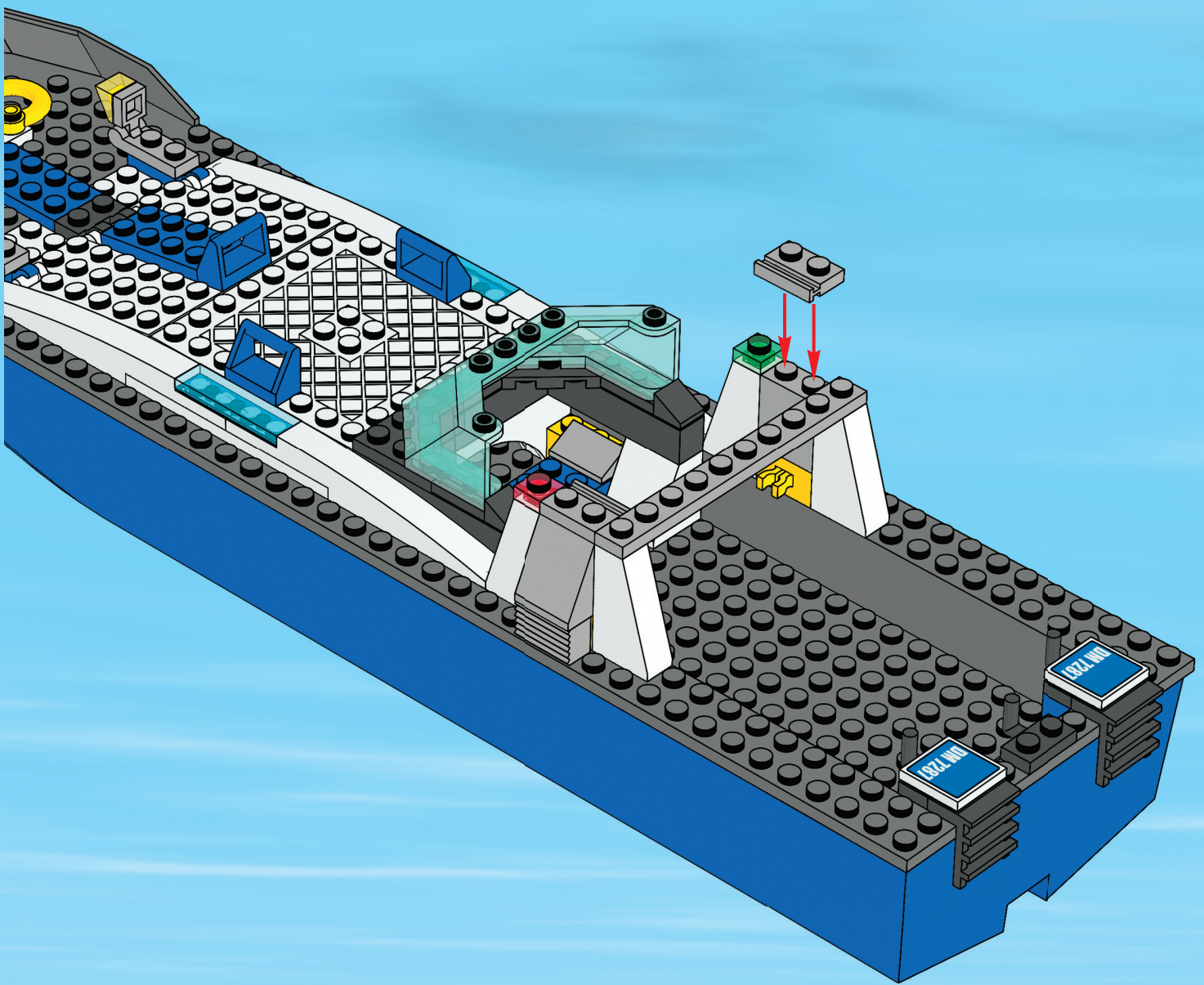

34



30

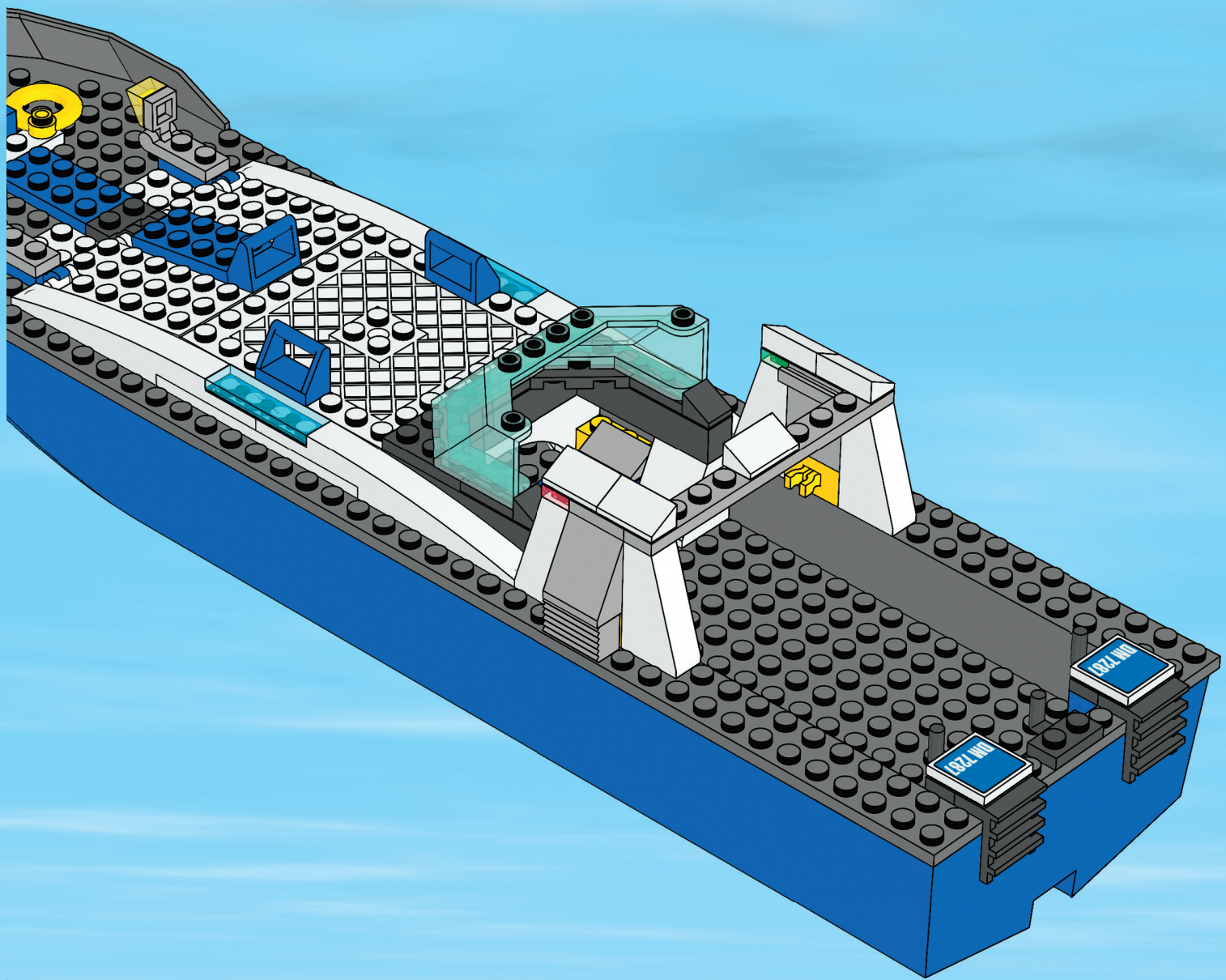

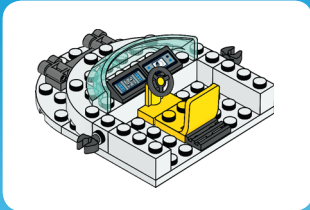

1

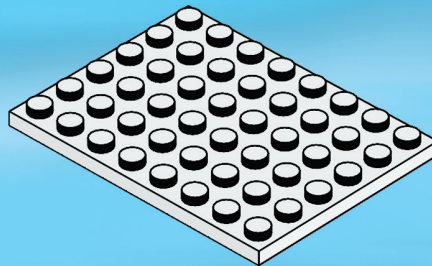

2

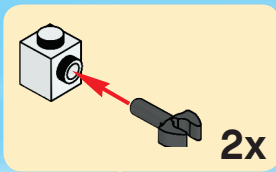
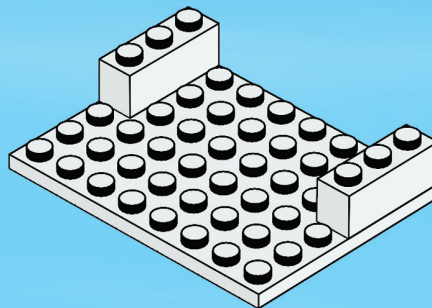

3

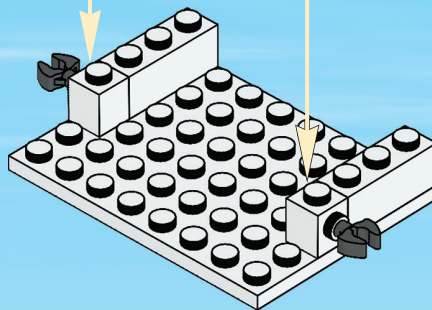



4

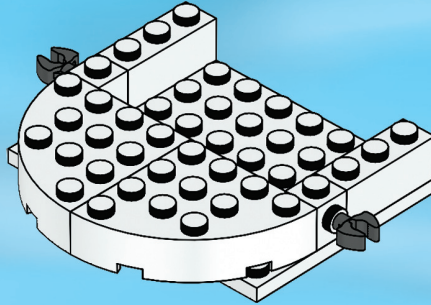

5

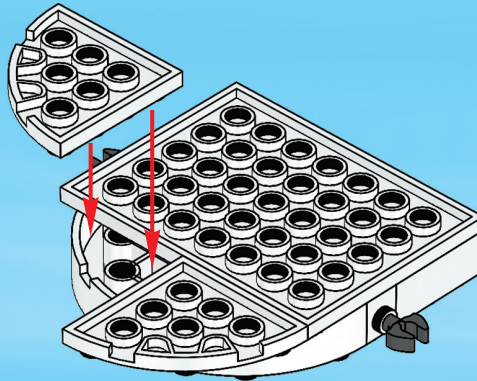

6

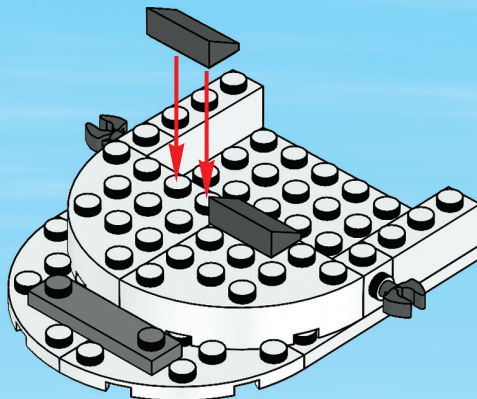



7

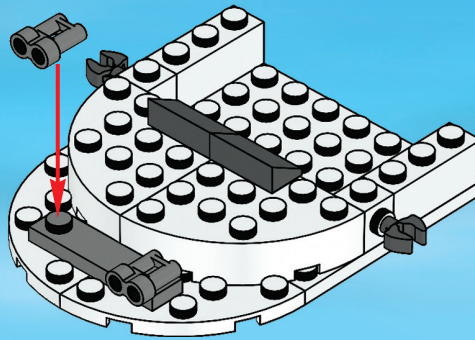

8

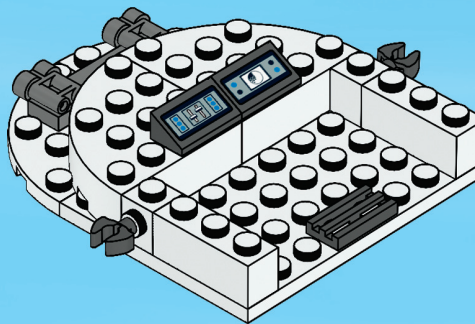

9

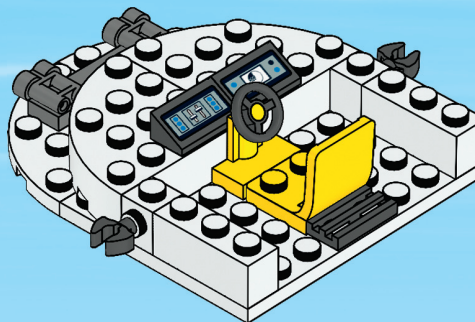



10

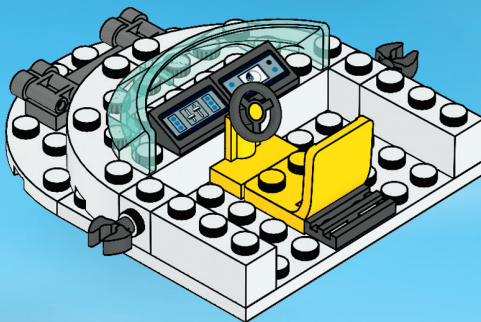

31

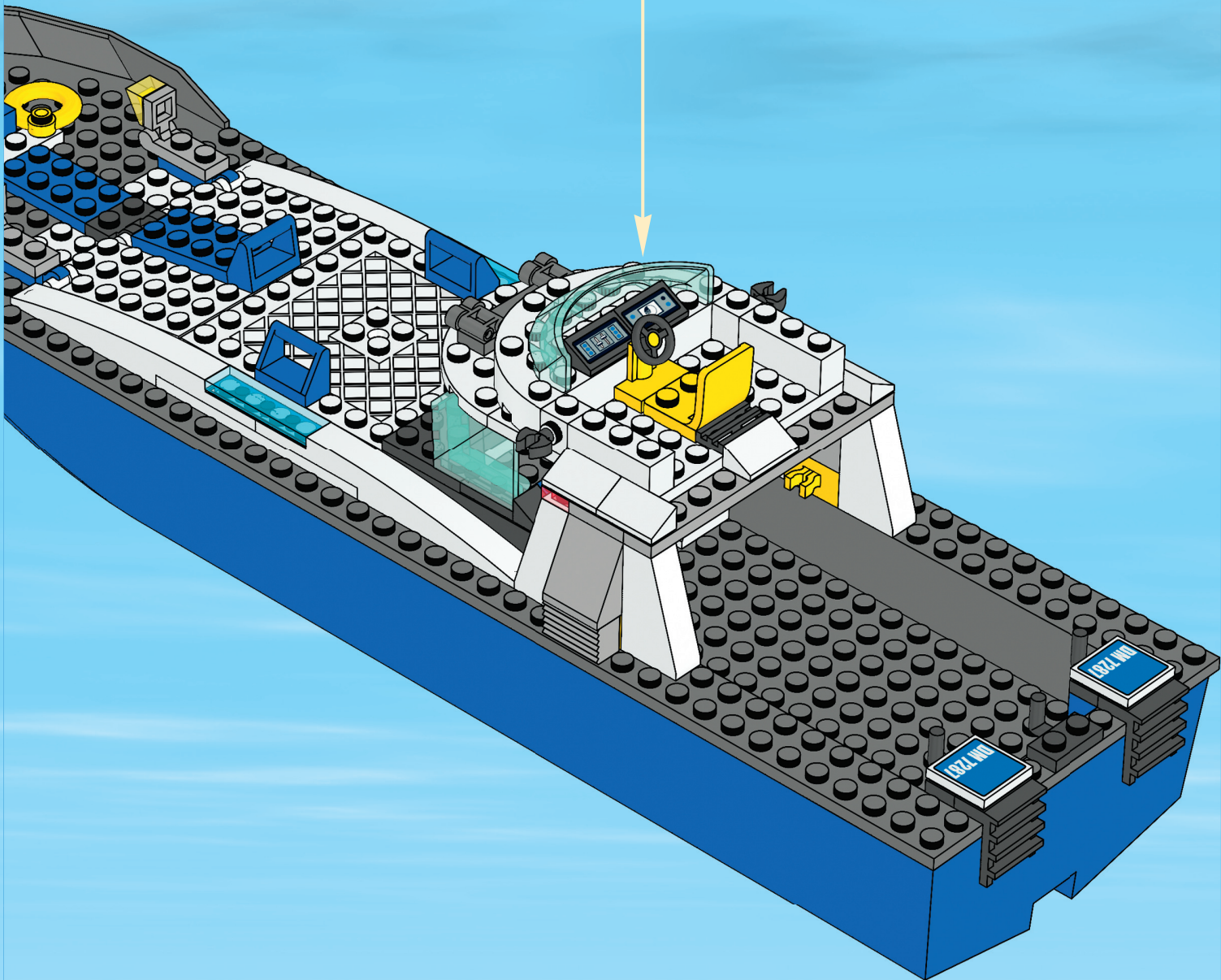

32

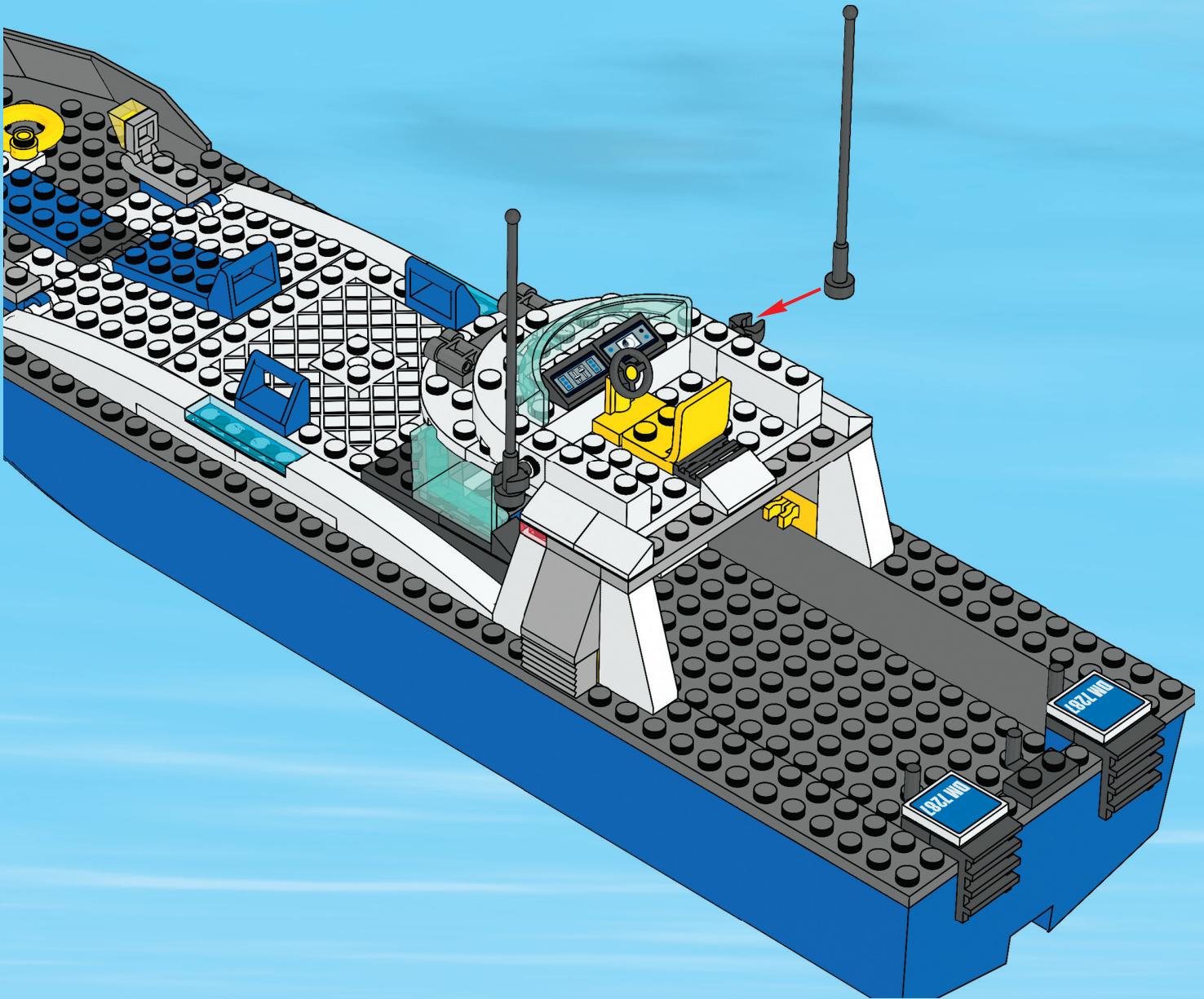





33

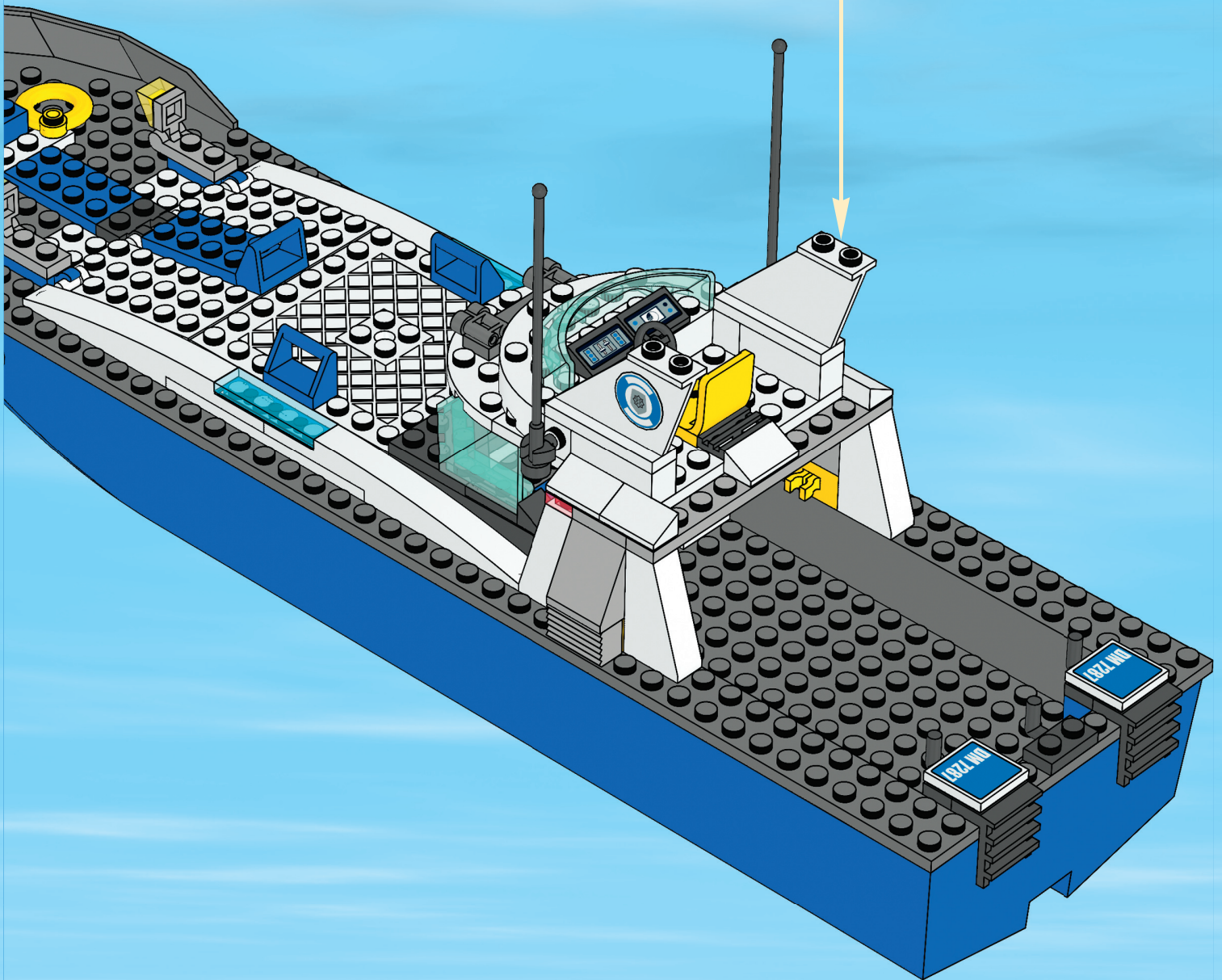
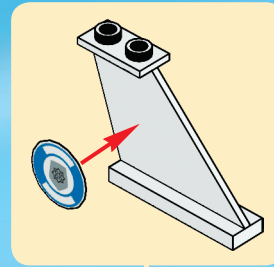

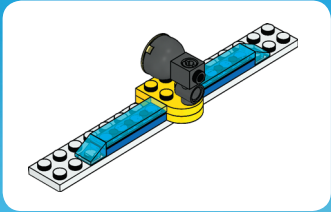

1

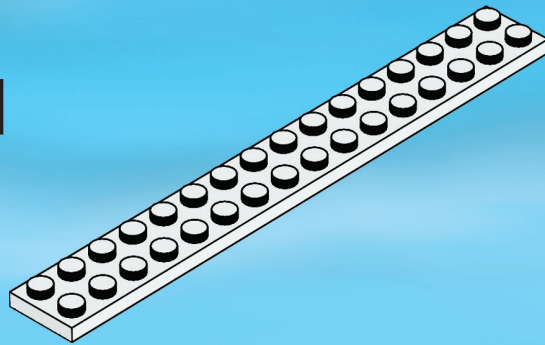

2

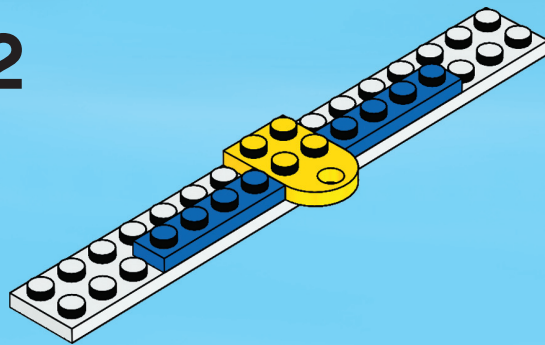

3

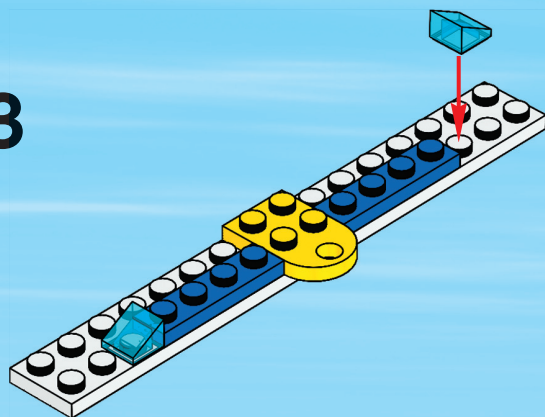

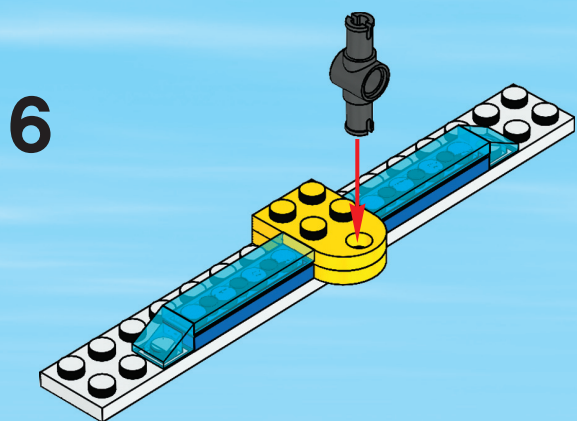
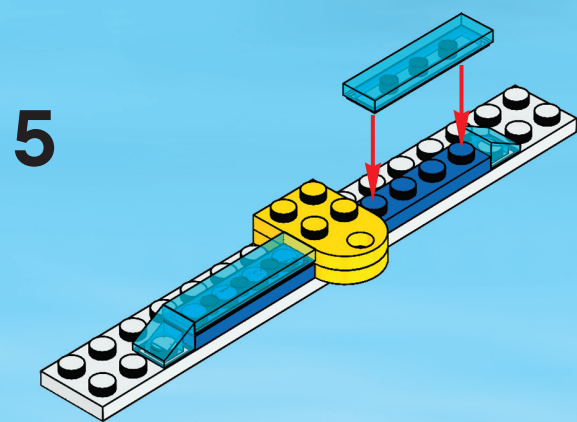
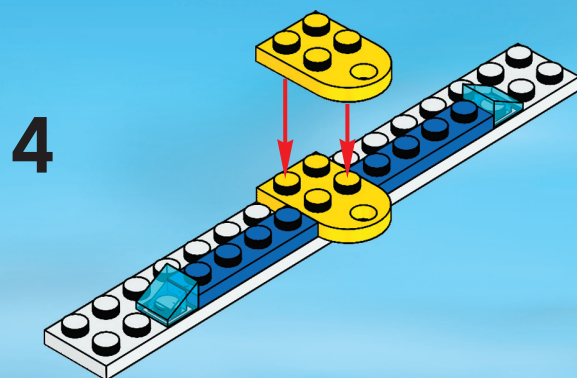



6

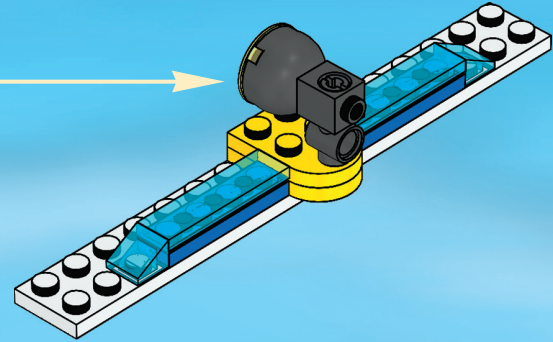
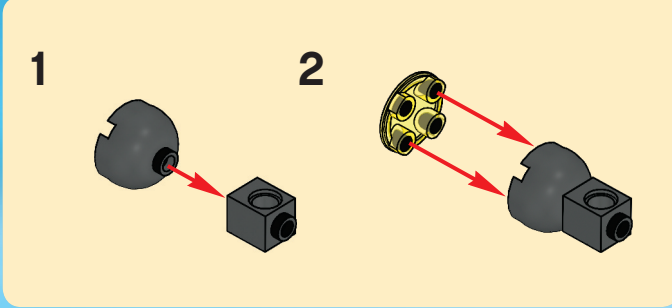

34

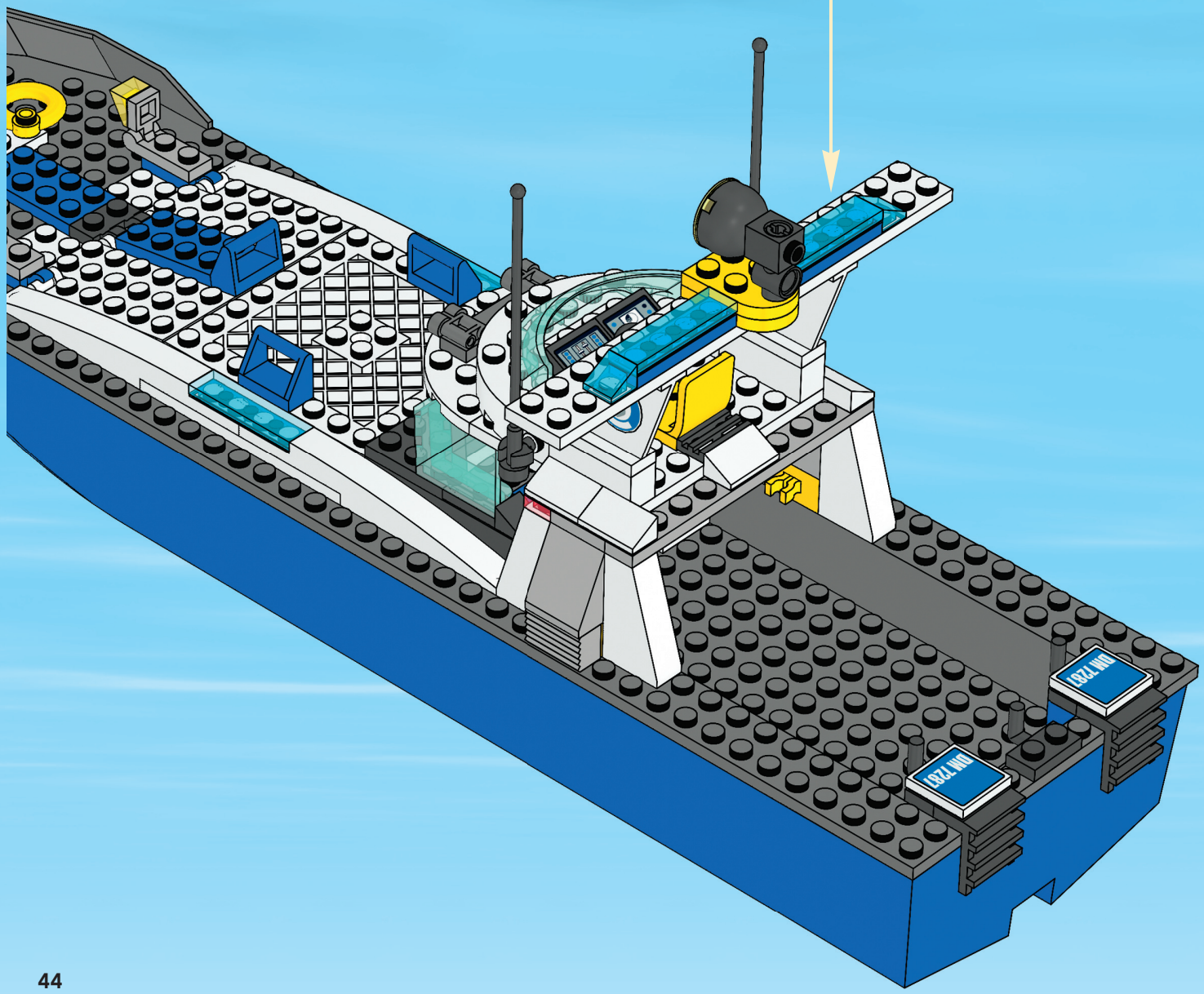

35

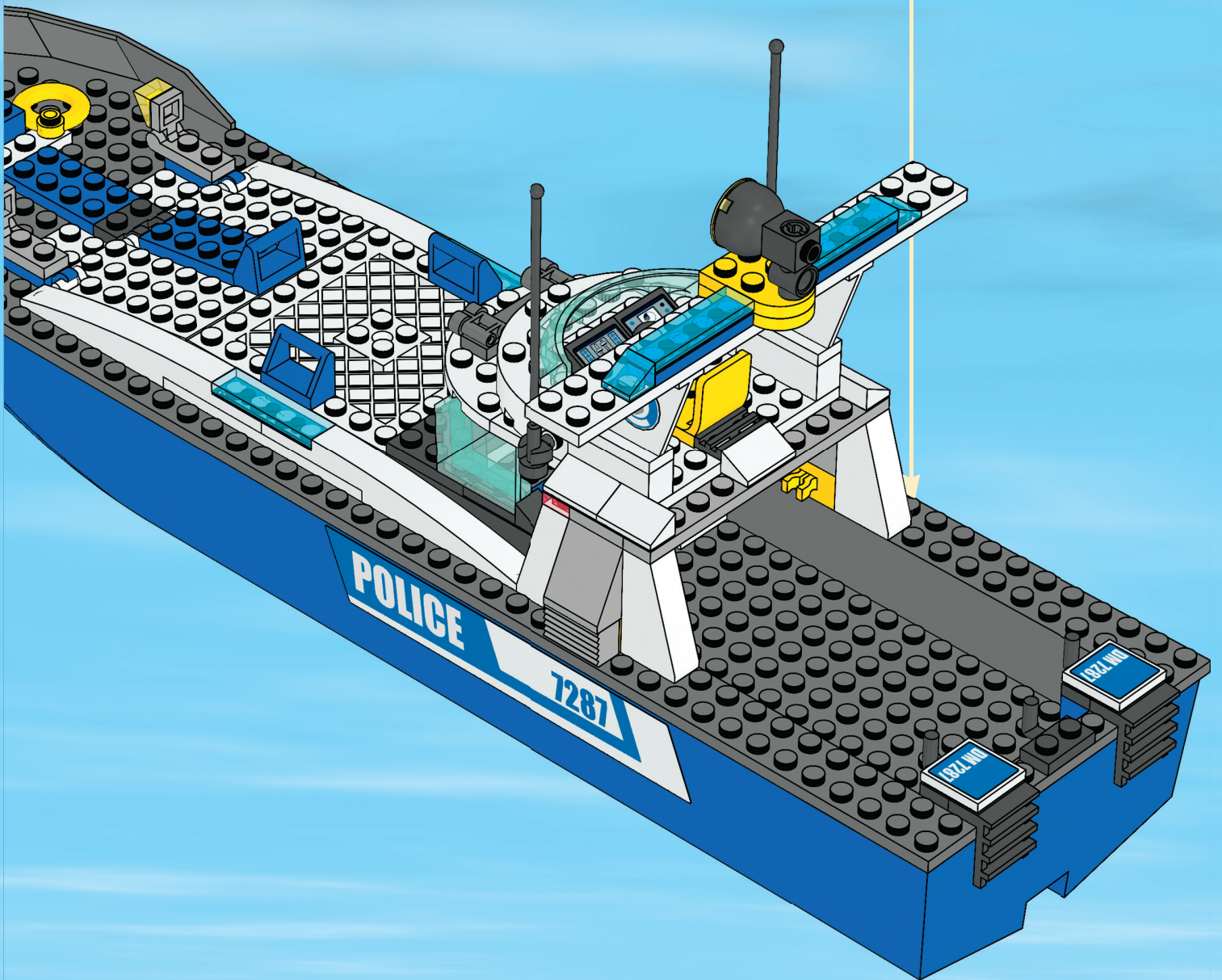
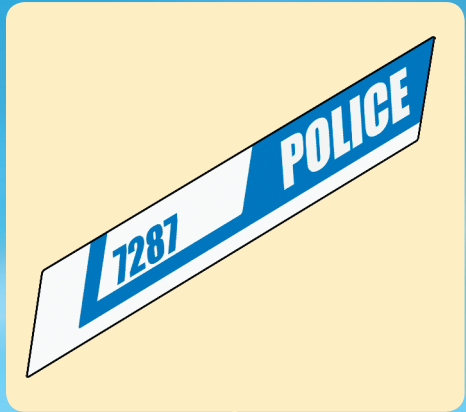

36

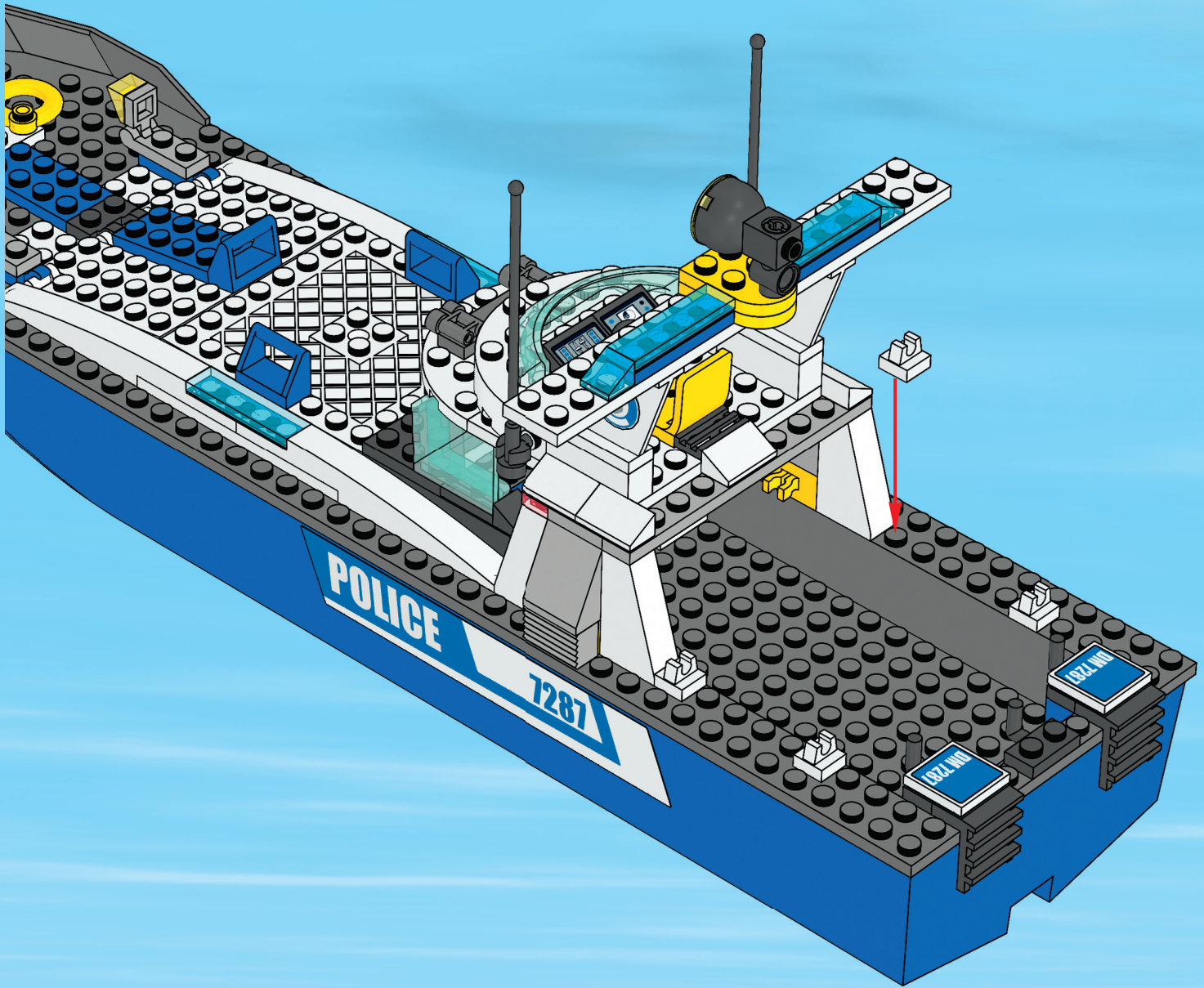

46

37

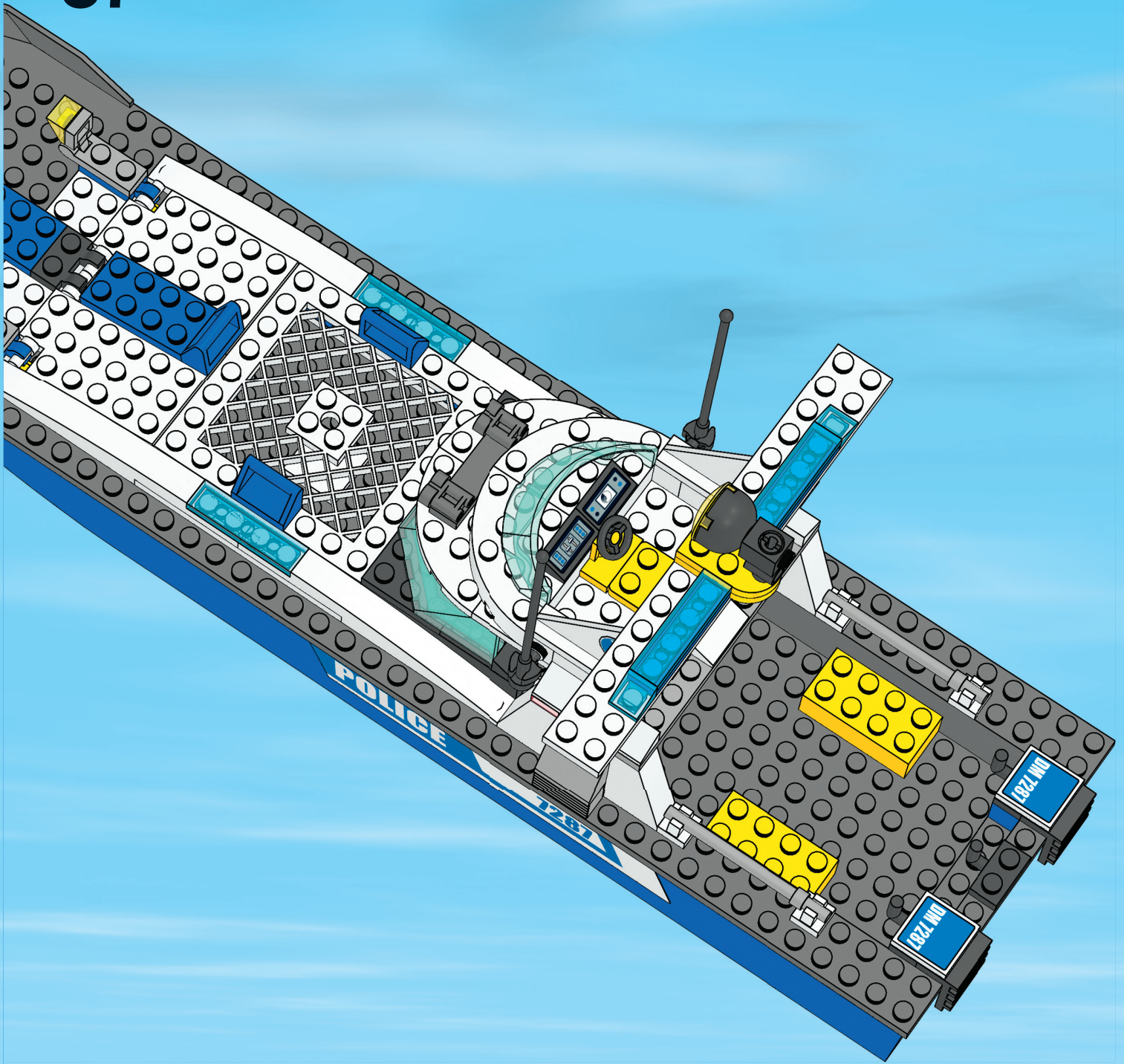

38

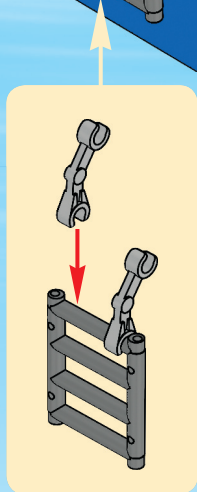
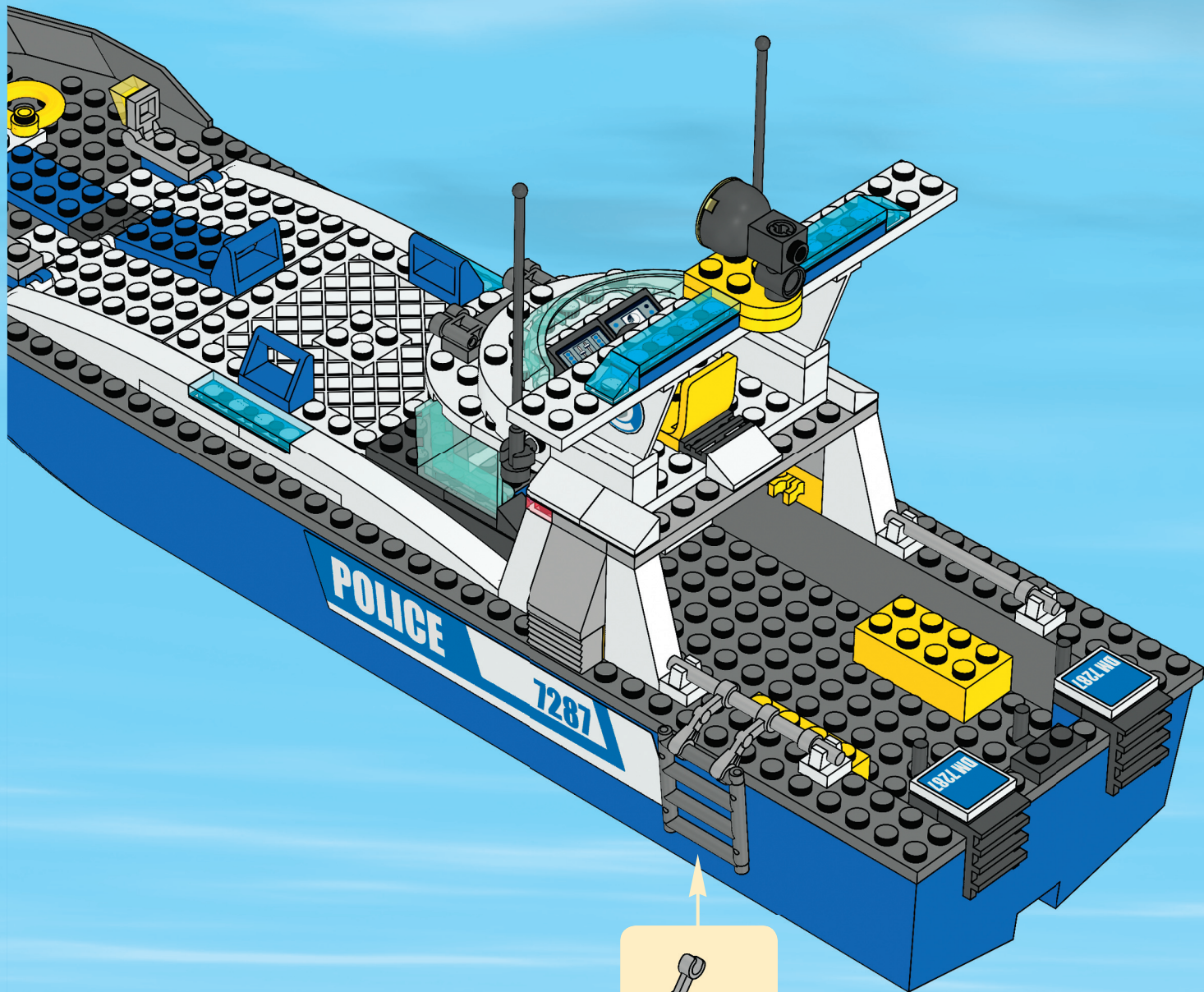

48



39

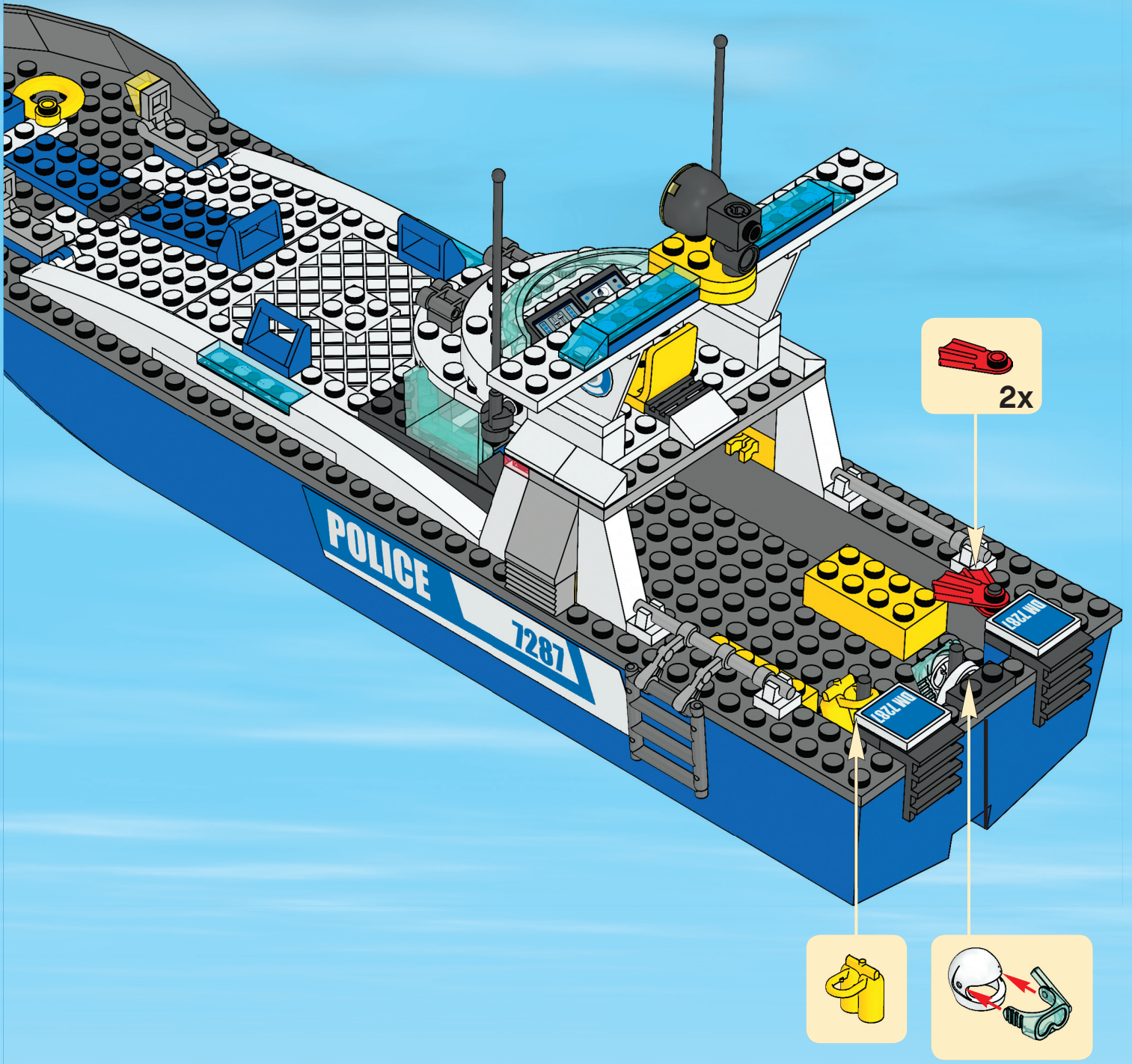

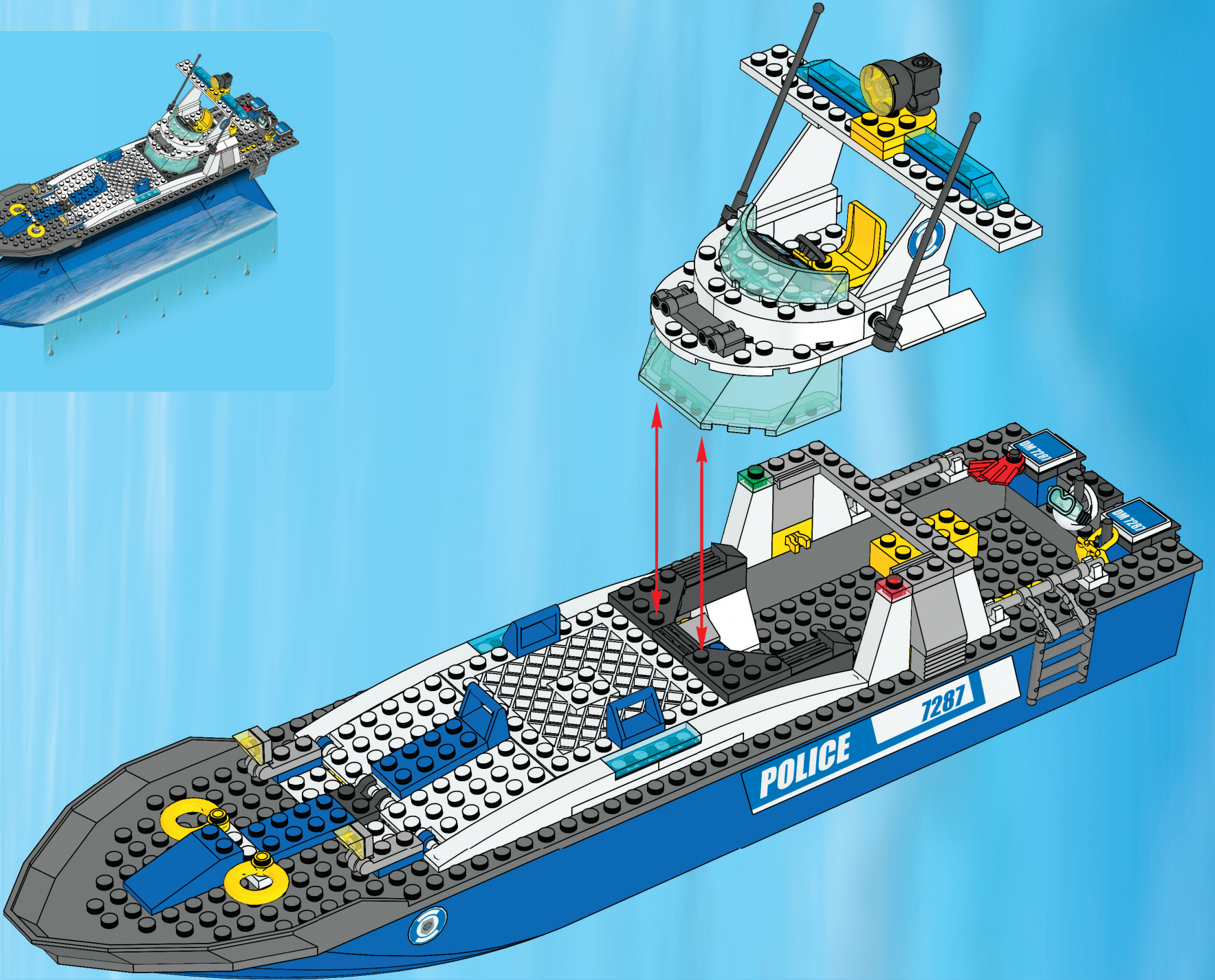
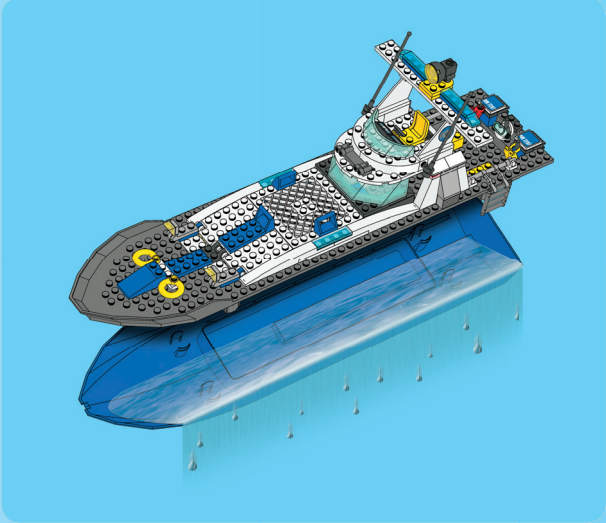

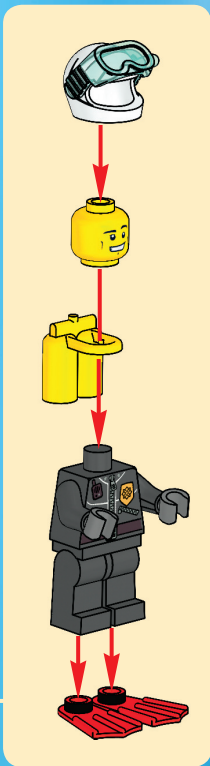
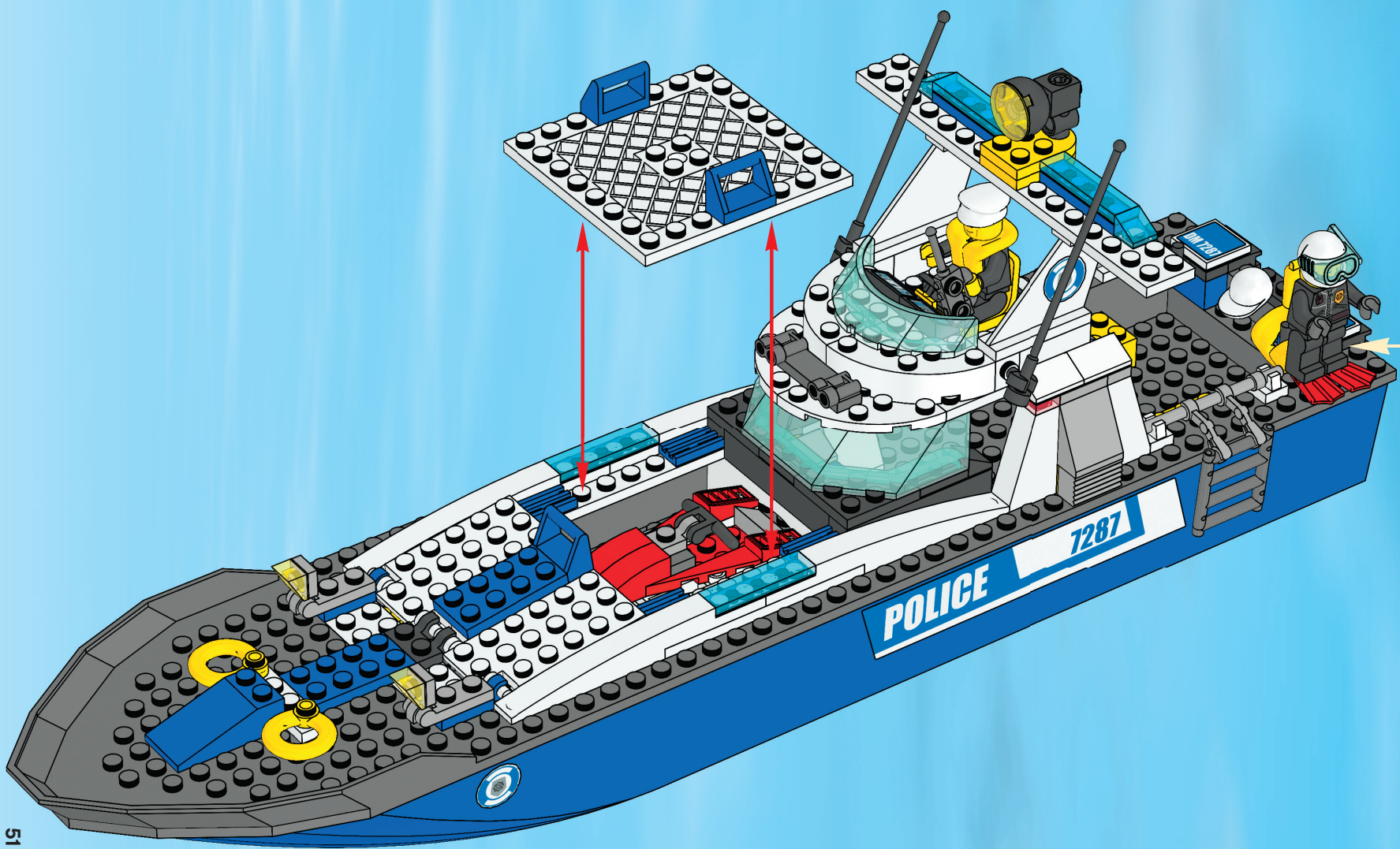

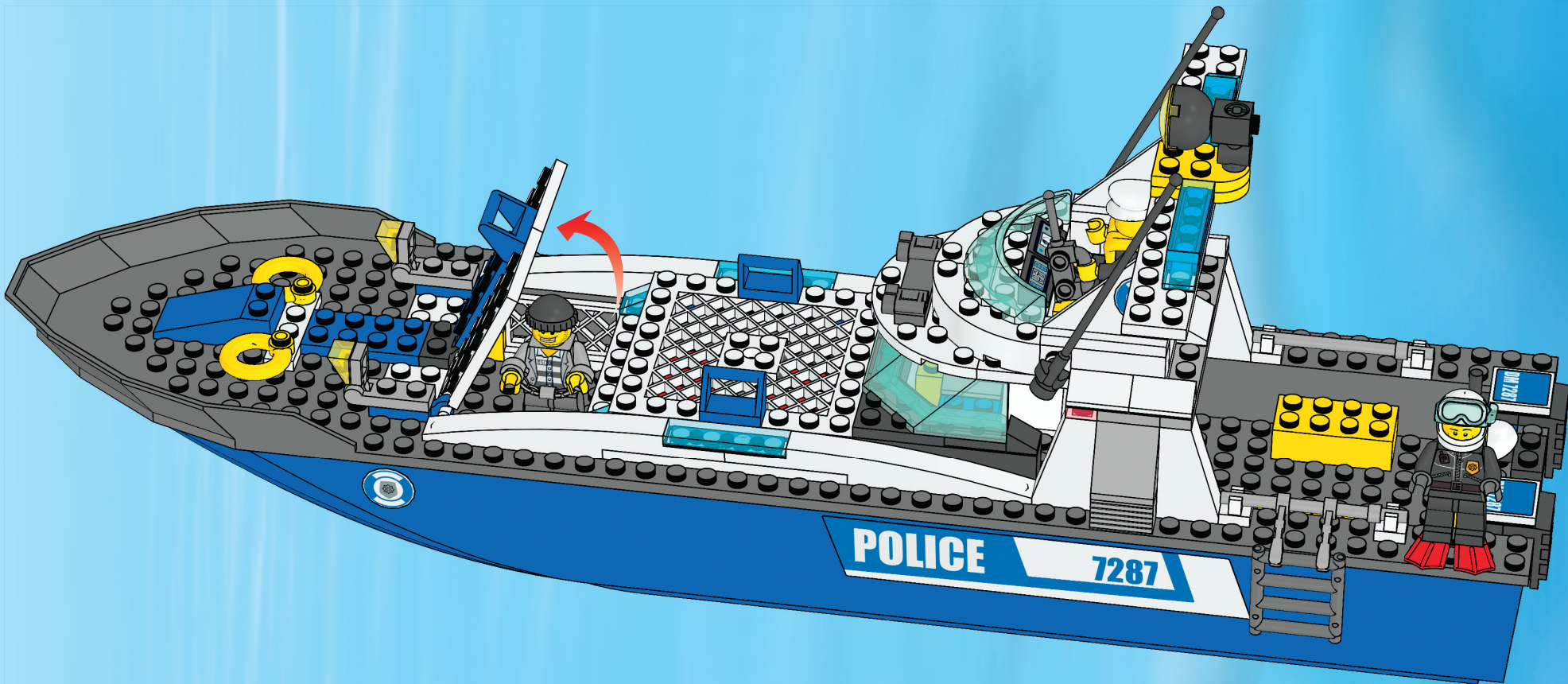

2x  
362201



1x  
300701



2x  
4603243



2x  
4178429

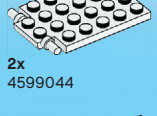

2x  
4599044



1x  
303601

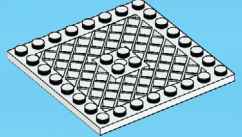

1x  
4603245

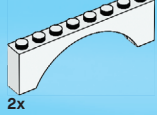

2x  
4160736

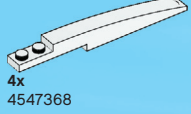

4x  
4547368

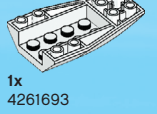

1x  
4261693



1x  
371001

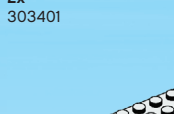

2x  
303401



1x  
4119227

4x  
255501



2x  
4558952



5x  
4547489



4x  
446001

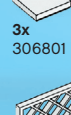

2x  
4234525

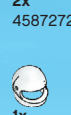

1x  
4173943



3x  
306801



2x  
4587272



1x  
4298609

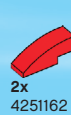

1x  
362401

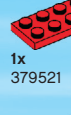

1x  
4567912

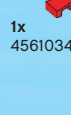

2x  
234001



2x  
4540382



2x  
4251162



1x  
379521



1x  
4561034

1x  
4278006

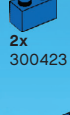

2x  
300423

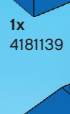

1x  
4181139



1x  
4124107



1x  
302223



2x  
371023

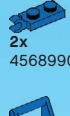

2x  
302023



4x  
241223

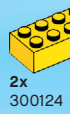

2x  
4568990

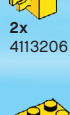

3x  
243223



4x  
362224



2x  
300124



2x  
4113206



2x  
4188313



2x  
4188313



1x  
9553

1x  
407924

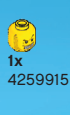

1x  
4259915



1x  
4215503

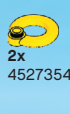

1x  
4586454



2x  
4527354



1x  
383824



2x  
4260843

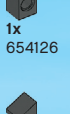

3x  
300926



1x  
4216660

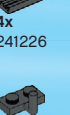

1x  
654126

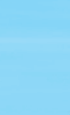

2x  
4504382



2x  
4548180



4x  
241226



3x  
4569733

1x  
4556158

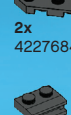

2x  
4227684



2x  
4603502



2x  
256926

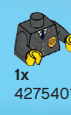

2x  
9339

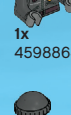

1x  
4275401



1x  
4598864

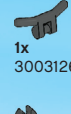

1x  
4157108



1x  
396226

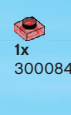

1x  
3003126



2x  
4289538

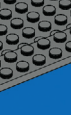

1x  
4560174



1x  
3000841

1x  
4499885



1x  
4599045



1x  
4525032



4x  
4244366



4x  
4590989



2x  
4260942

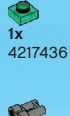

1x  
4278415



1x  
4217436



2x  
4211051

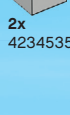

2x  
4211383



2x  
4568637



2x  
4234535

1x  
4251149



3x  
4541978



2x  
4211568

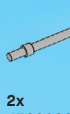

2x  
4515369



2x  
4538098



1x  
4600359



2x  
4211658



1x  
4518282



1x  
4598769

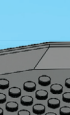

1x  
4211119



1x  
4521886



1x  
4222693

1x  
4603000



Customer Service  
Kundenservice  
Service Consommateurs  
Servicio Al Consumidor  
[www.lego.com/service](http://www.lego.com/service) or dial



: 00800 5346 5555  
: 1-800-422-5346

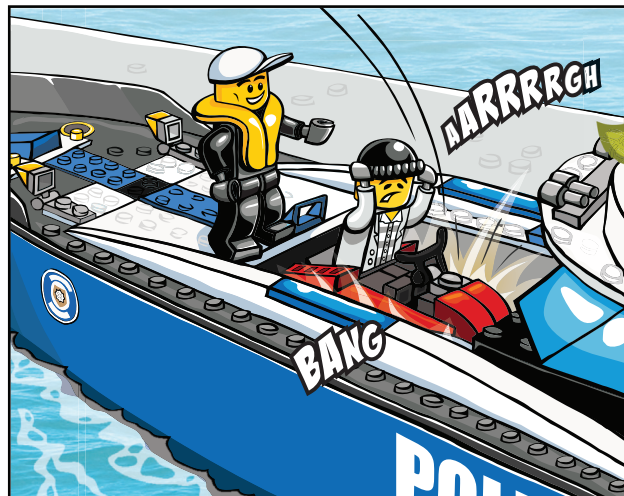
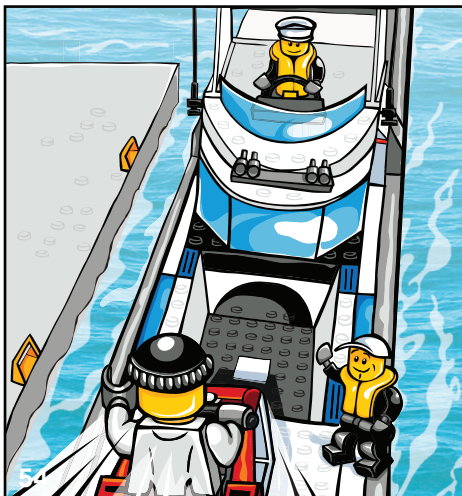
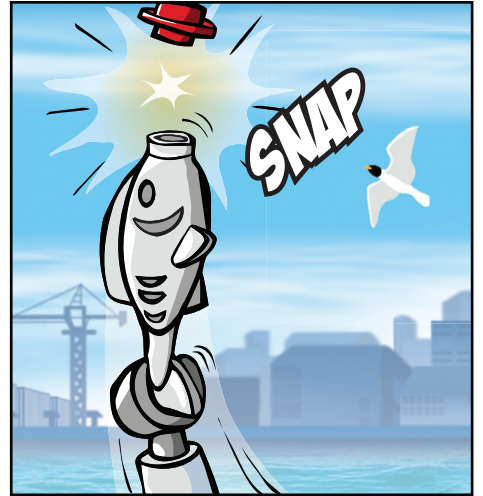
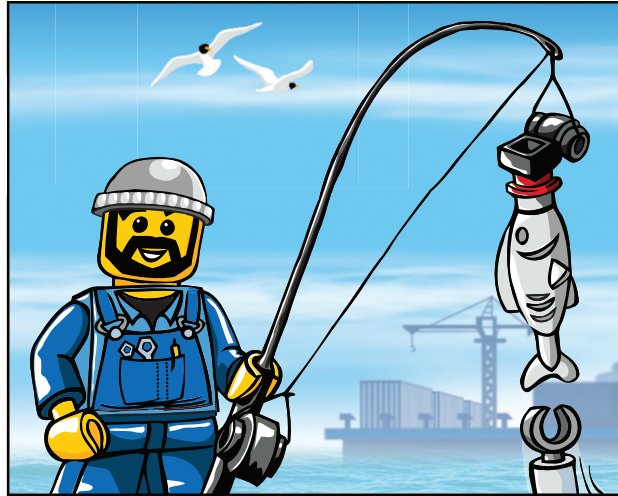

City.LEGO.com/comicbuilder



# CITY



**WWW.LEGO.COM**

USE THIS KEY TO UNLOCK SECRET CONTENT!  
UTILISE CETTE CLÉ POUR DÉVERROUILLER LE CONTENU SECRET !  
¡USA ESTA CLAVE PARA ACCEDER AL CONTENIDO SECRETO!

**A9ZAX9**



**CITY.LEGO.COM/COMICBUILDER**



# CITY



7279



7285



7286



7287



7288



7498





**LEGO**

**CITY**



3366



3366



3367



3368



# CITY



7208



7207



7239



7942



[www.LEGOclub.com](http://www.LEGOclub.com)

**LEGO club**

**FREE! GRATIS! GRATUIT!**



**LEGO® Club Magazine**



**LEGO® Club Email**

**SIGN UP ONLINE!**

[www.LEGOclub.com](http://www.LEGOclub.com)

VISIT THE WORLD'S  
BIGGEST LEGO® SHOP!  
[www.LEGOshop.com](http://www.LEGOshop.com)

GO TO  
[www.LEGOclub.com](http://www.LEGOclub.com)

00800 5346 5555\*

1-866-534-6258 • 1-877-518-5346

US & Canada only Canada seulement



\* Freephone. Mobile charges may apply. \* Numéro sans frais. Des frais peuvent s'appliquer avec les téléphones cellulaires. \* Gebührenfrei. Kosten für Anrufe aus Mobilfunknetzen können abweichen. \* Gratis telefoonnummer vanaf vaste lijn. \* Det er et gratis nummer, når du ringer fra fasttelefon. \* Det är gratis, när du ringer från en fast telefon. \* Numéro sans frais. Des frais peuvent s'appliquer avec les téléphones portables.



# WIN!



Go to [www.LEGOsurvey.com/product](http://www.LEGOsurvey.com/product) to fill out a survey for a chance to win a cool LEGO® Product. No purchase necessary. Open to all residents where not prohibited.

 [www.LEGO.com](http://www.LEGO.com)

## [www.LEGOsurvey.com/product](http://www.LEGOsurvey.com/product)

### GEWINNE!

Nimm an der Umfrage auf [www.LEGOsurvey.com/product](http://www.LEGOsurvey.com/product) teil und hab die Chance ein cooles LEGO® Produkt zu gewinnen!  
Die Teilnahme am Gewinnspiel führt zu keinerlei Kaufverpflichtungen. Teilnahme in allen nicht ausgeschlossenen Ländern möglich.

4656089

### WIN!

Ga naar [www.LEGOsurvey.com/product](http://www.LEGOsurvey.com/product), vul een enquêteformulier in en maak kans op een cool LEGO® product.  
Geen aankoopverplichting.  
Iedereen mag deelnemen, uitgezonderd ingezetenden van landen waar een enquêteverbod geldt.

### GAGNE!

Visite [www.LEGOsurvey.com/product](http://www.LEGOsurvey.com/product) pour répondre à un questionnaire et avoir une chance de gagner un produit LEGO® très cool!  
Aucune obligation d'achat.  
Ouvert à tous les résidents des pays autorisés.

### 当てよう!

[www.LEGOsurvey.com/product](http://www.LEGOsurvey.com/product) にアクセスして、アンケートにご記入ください。当選者にはレゴ製品を差し上げます。  
お買い上げの必要はありません。  
禁止されていない限り、すべての皆様にご利用いただけます。

LEGO and the LEGO logo are trademarks of the LEGO Group. ©2011 The LEGO Group. © 2011 Lucasfilm Ltd. & TM. All rights reserved.