



PHARAOH'S QUEST



7327



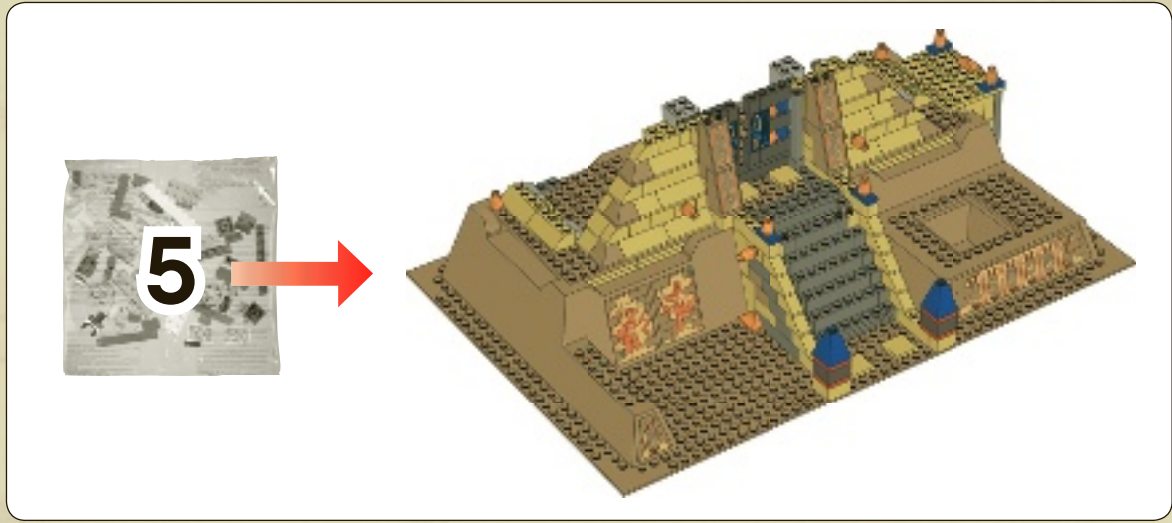

36

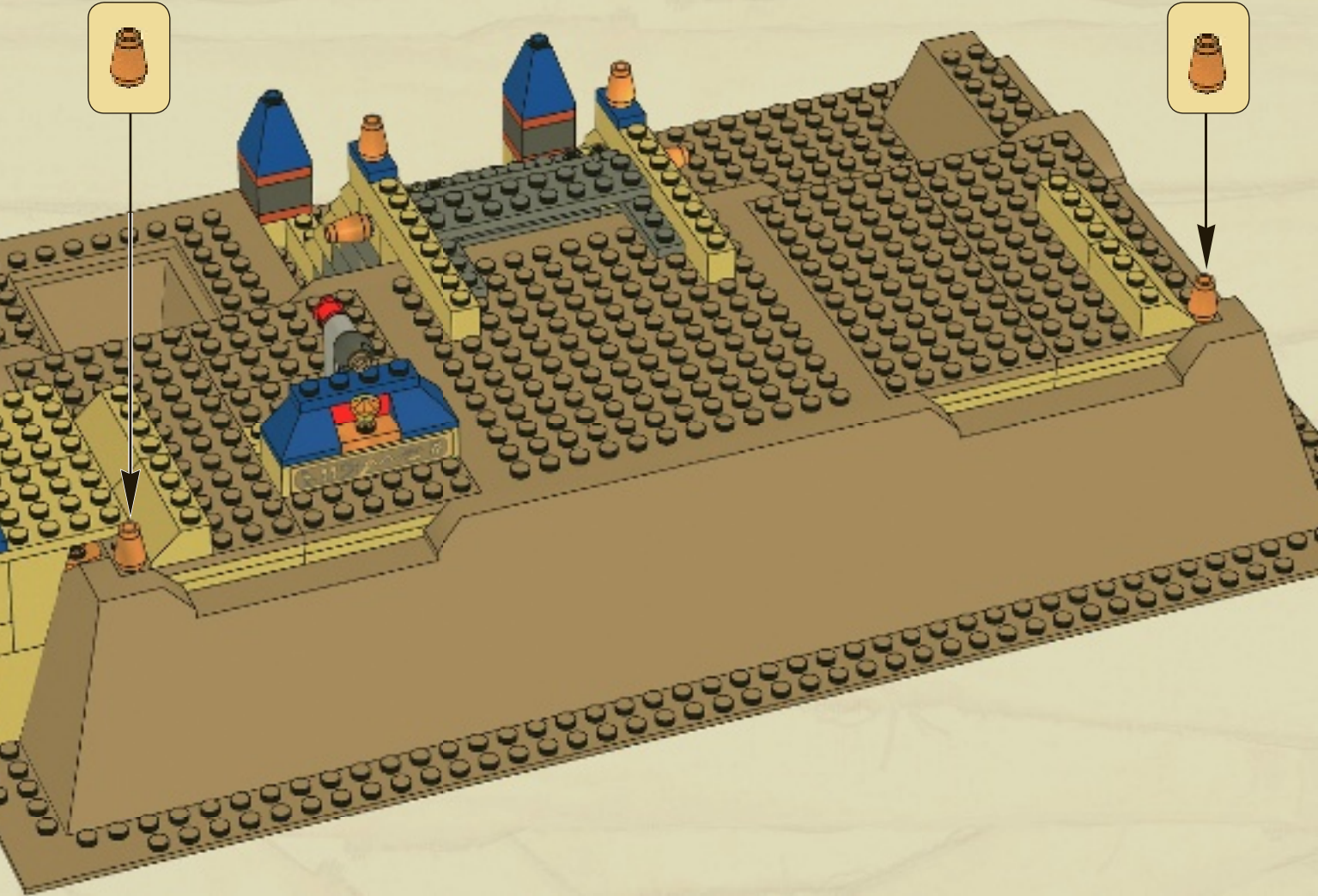

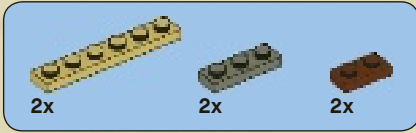

37

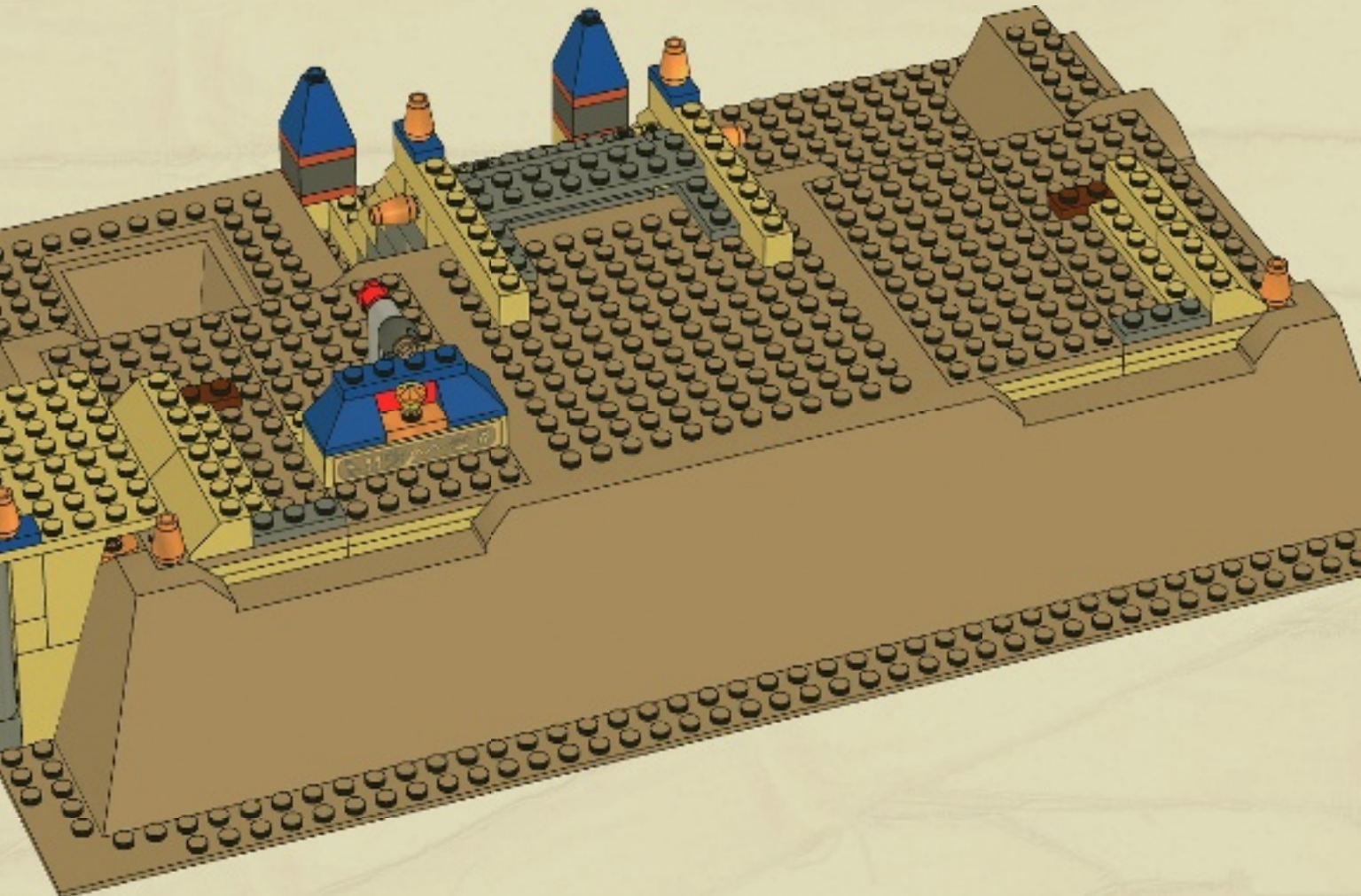



4x

38

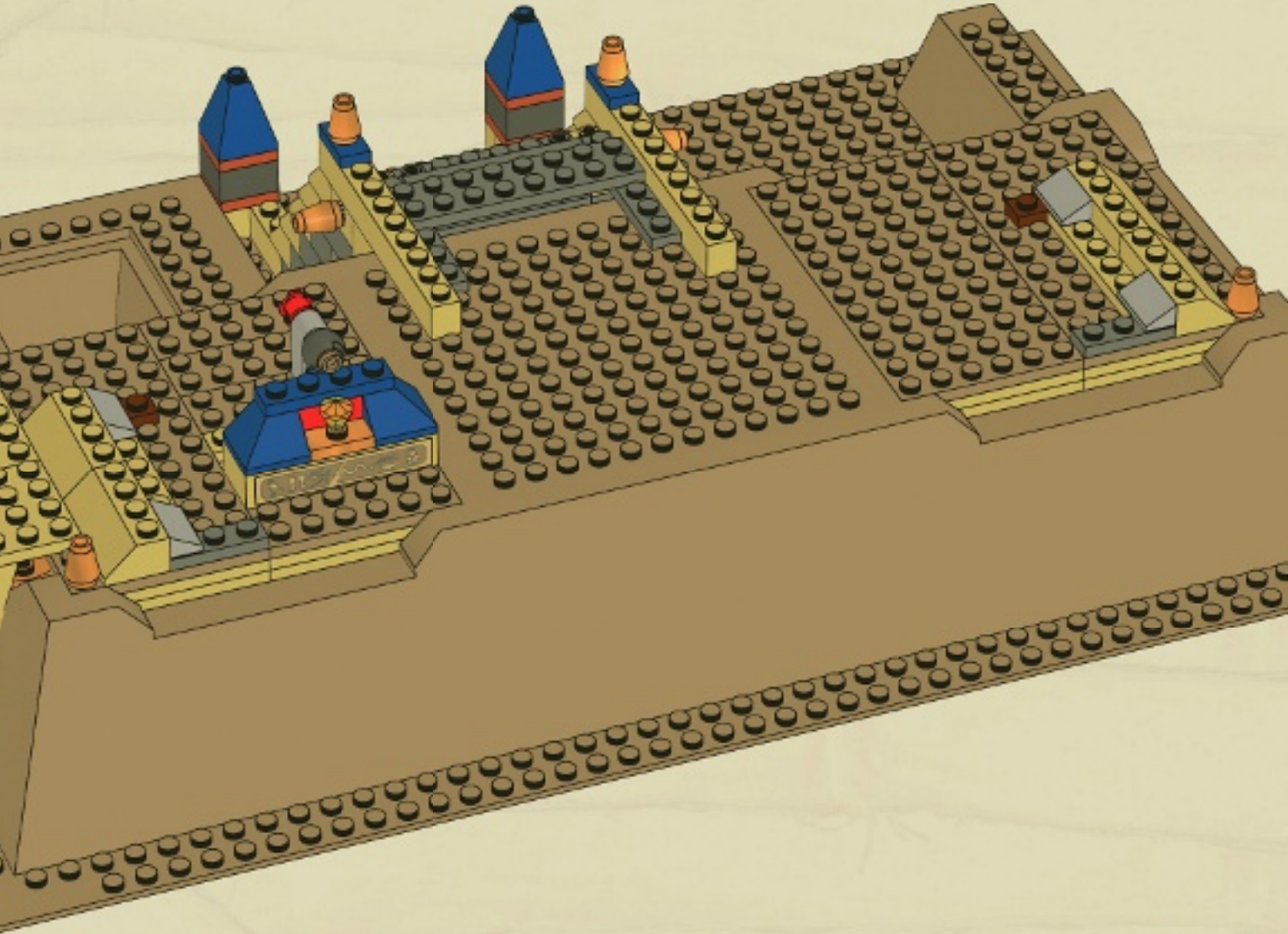

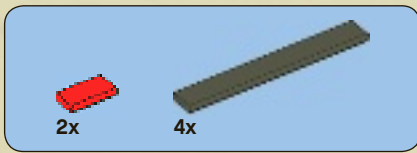

39

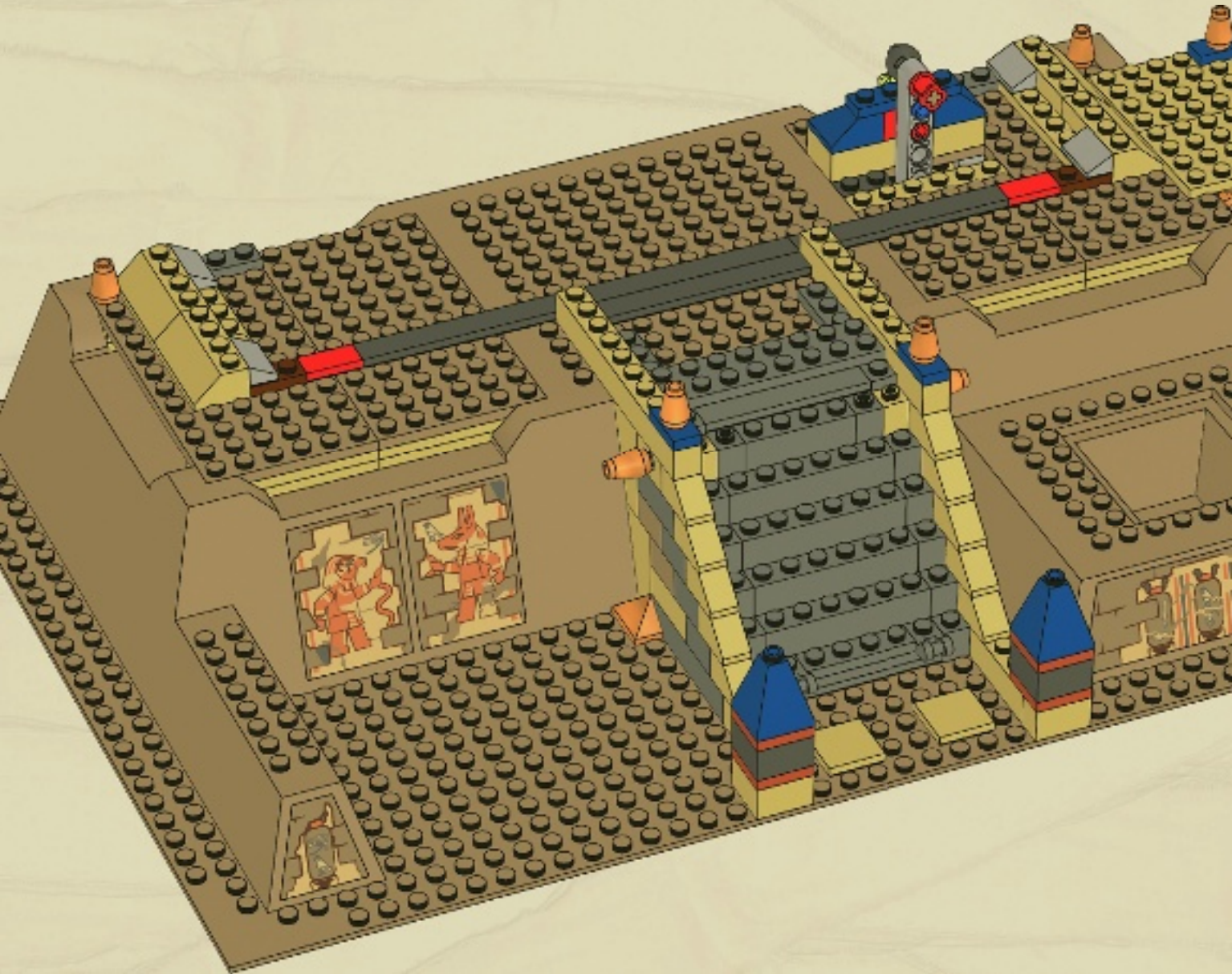

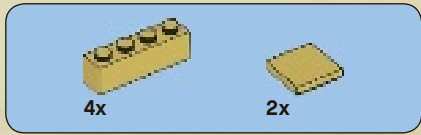

40

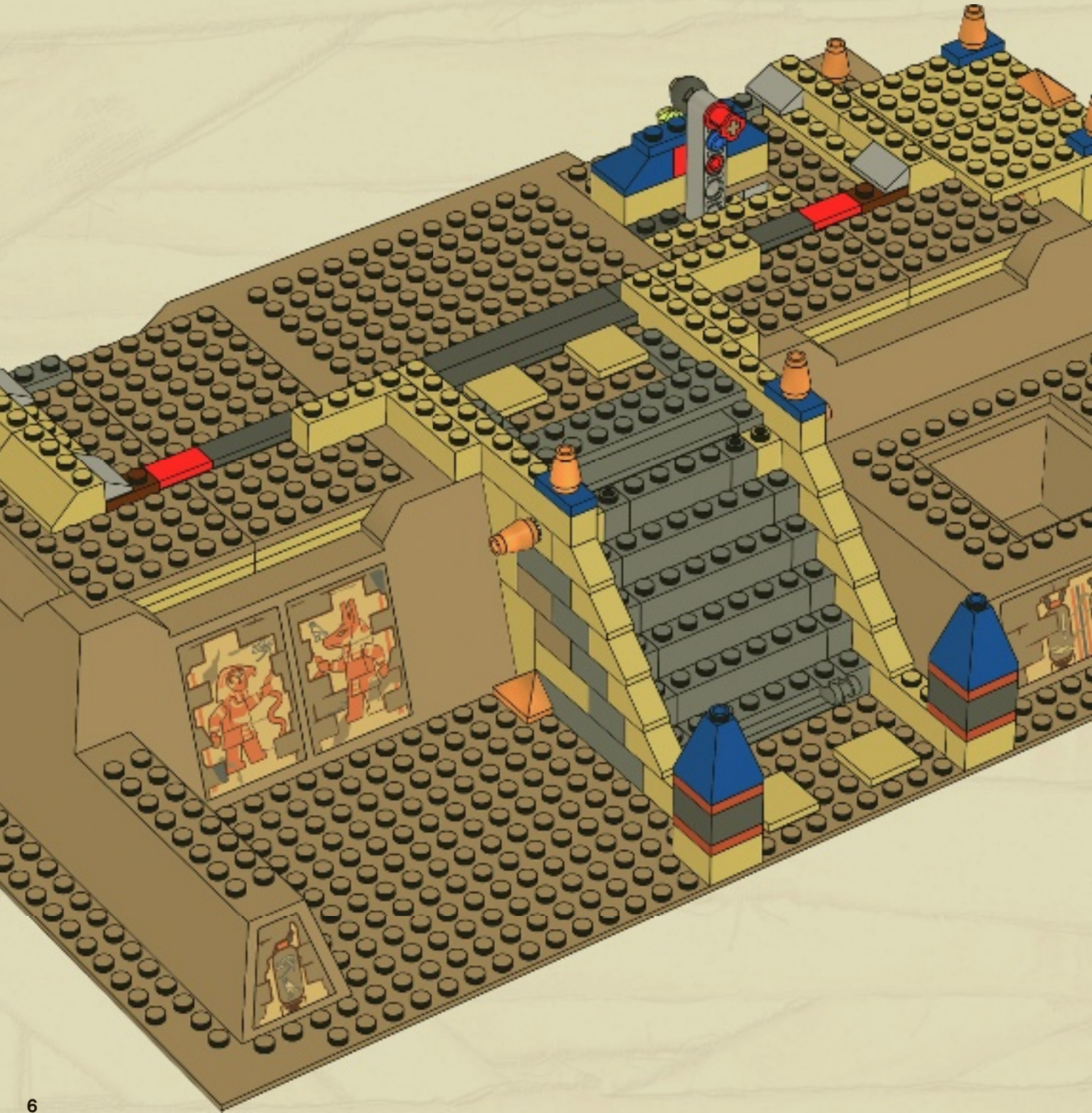

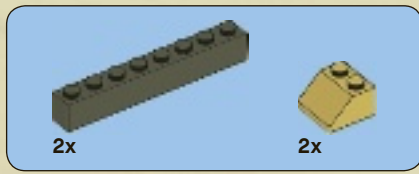

41

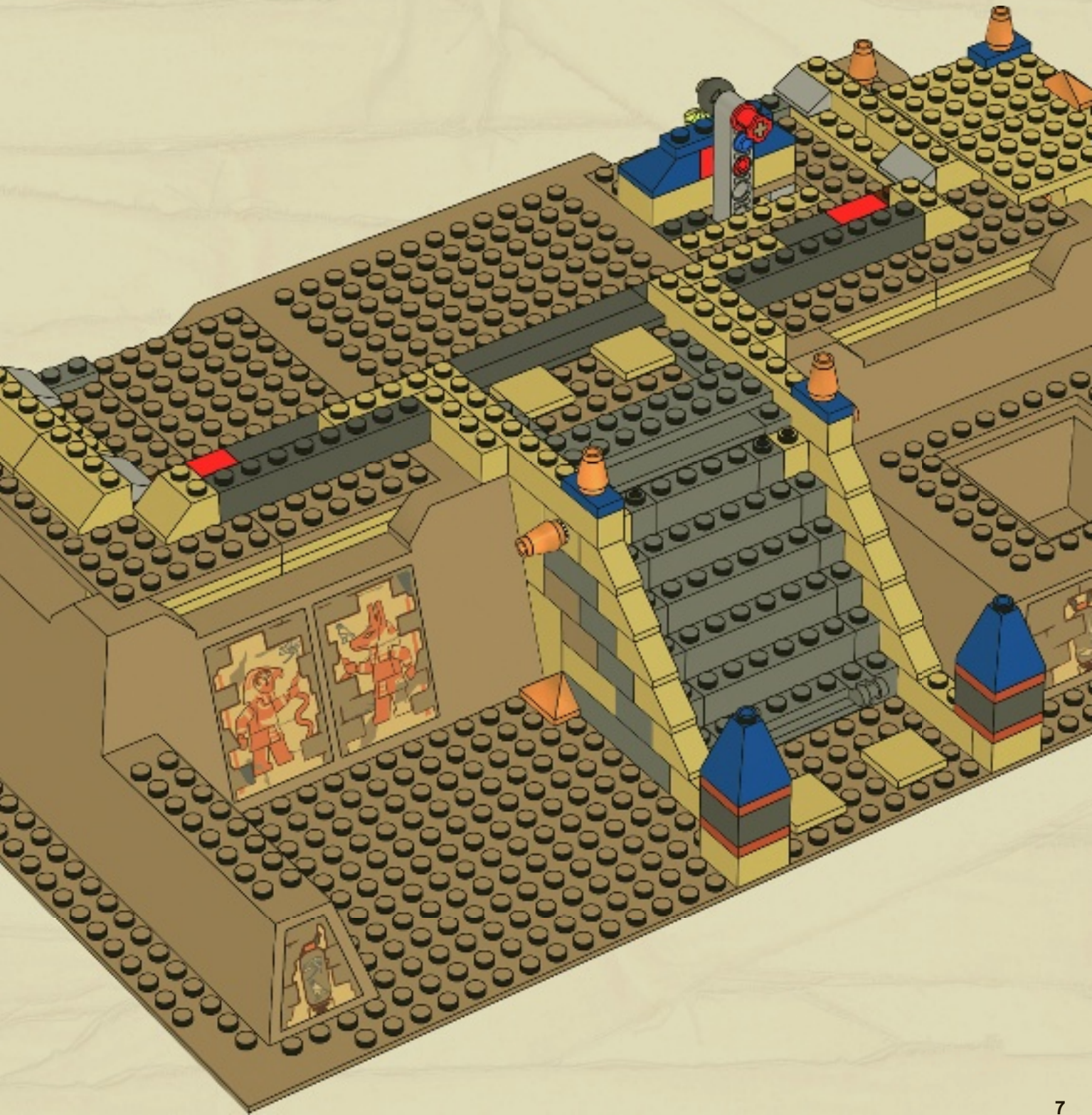

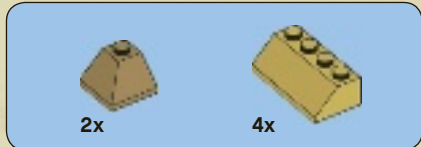

42





43

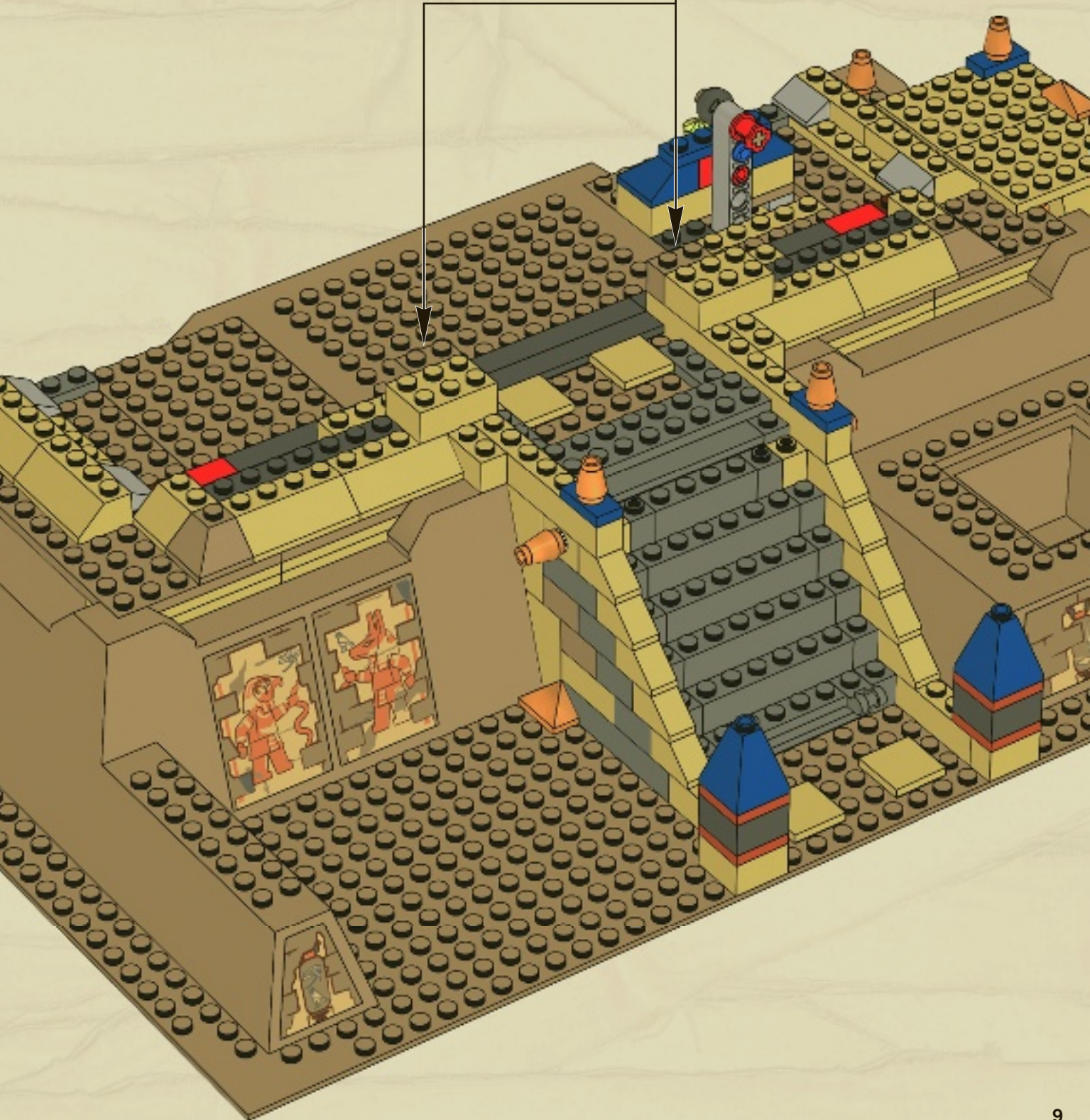
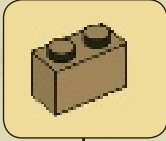



6x

44

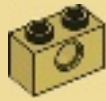



3x

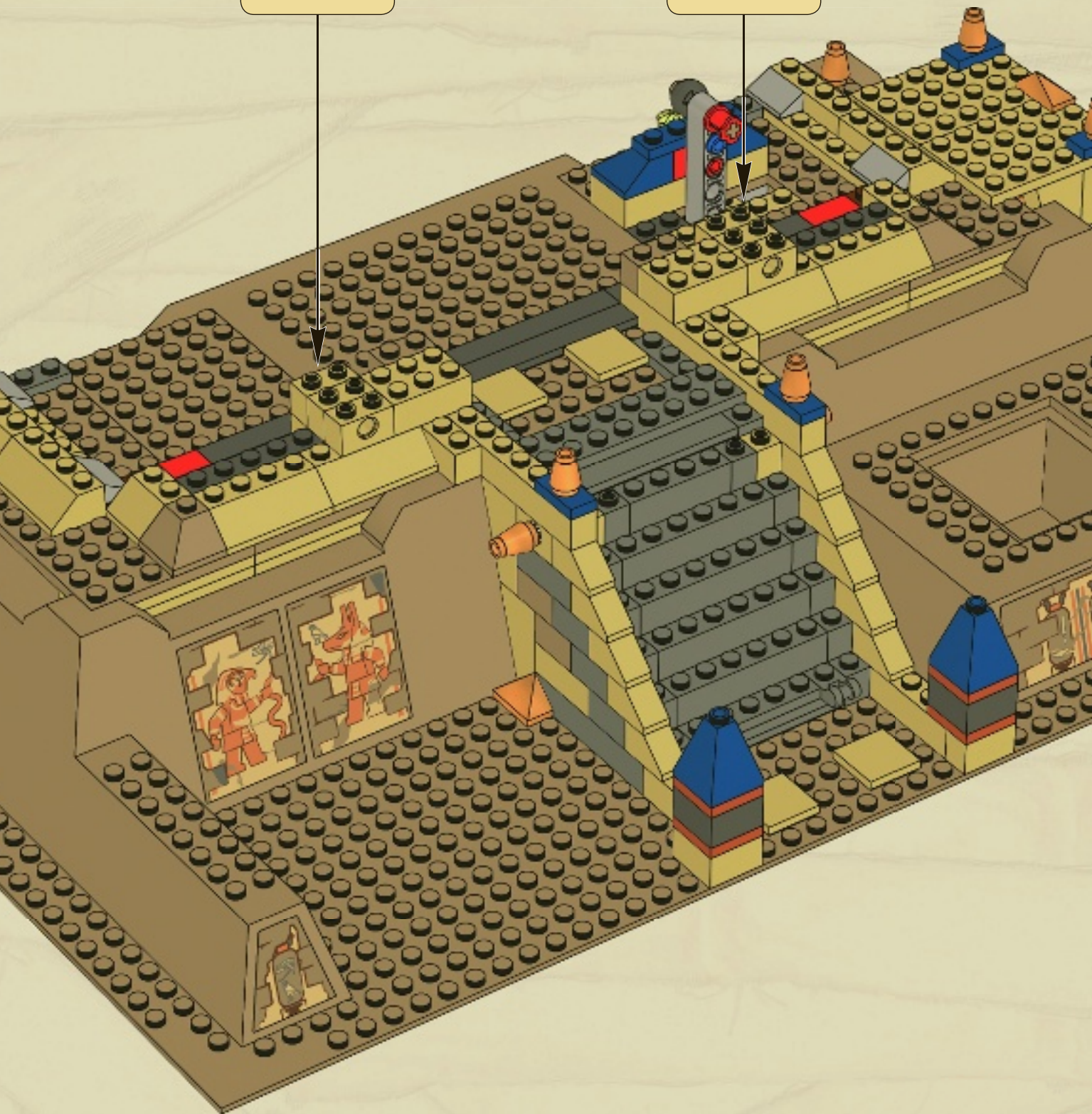

3x



		
2x	2x	2x

45

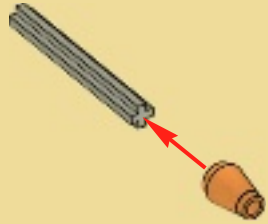



2x

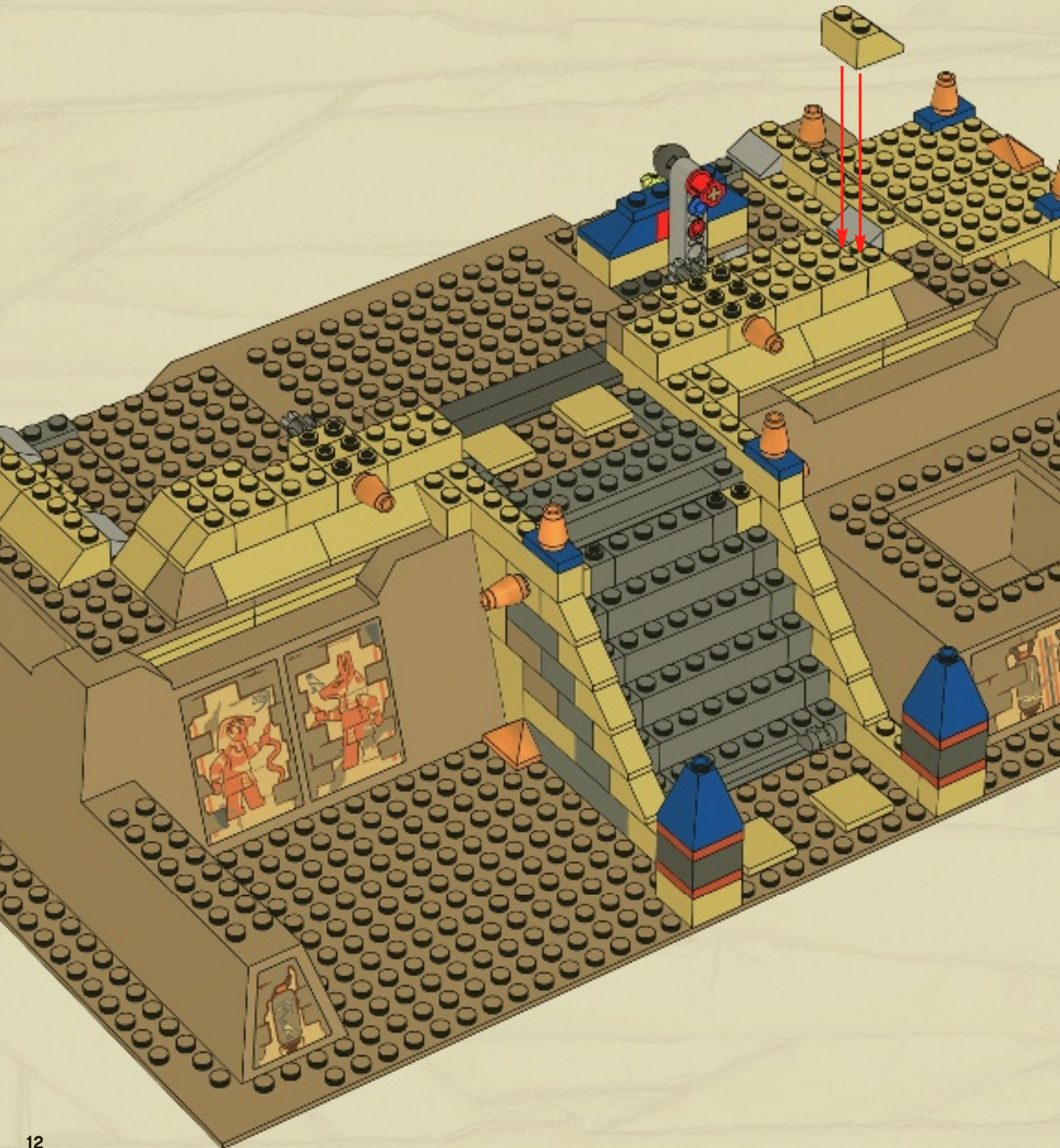

46

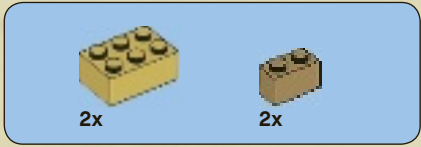



47

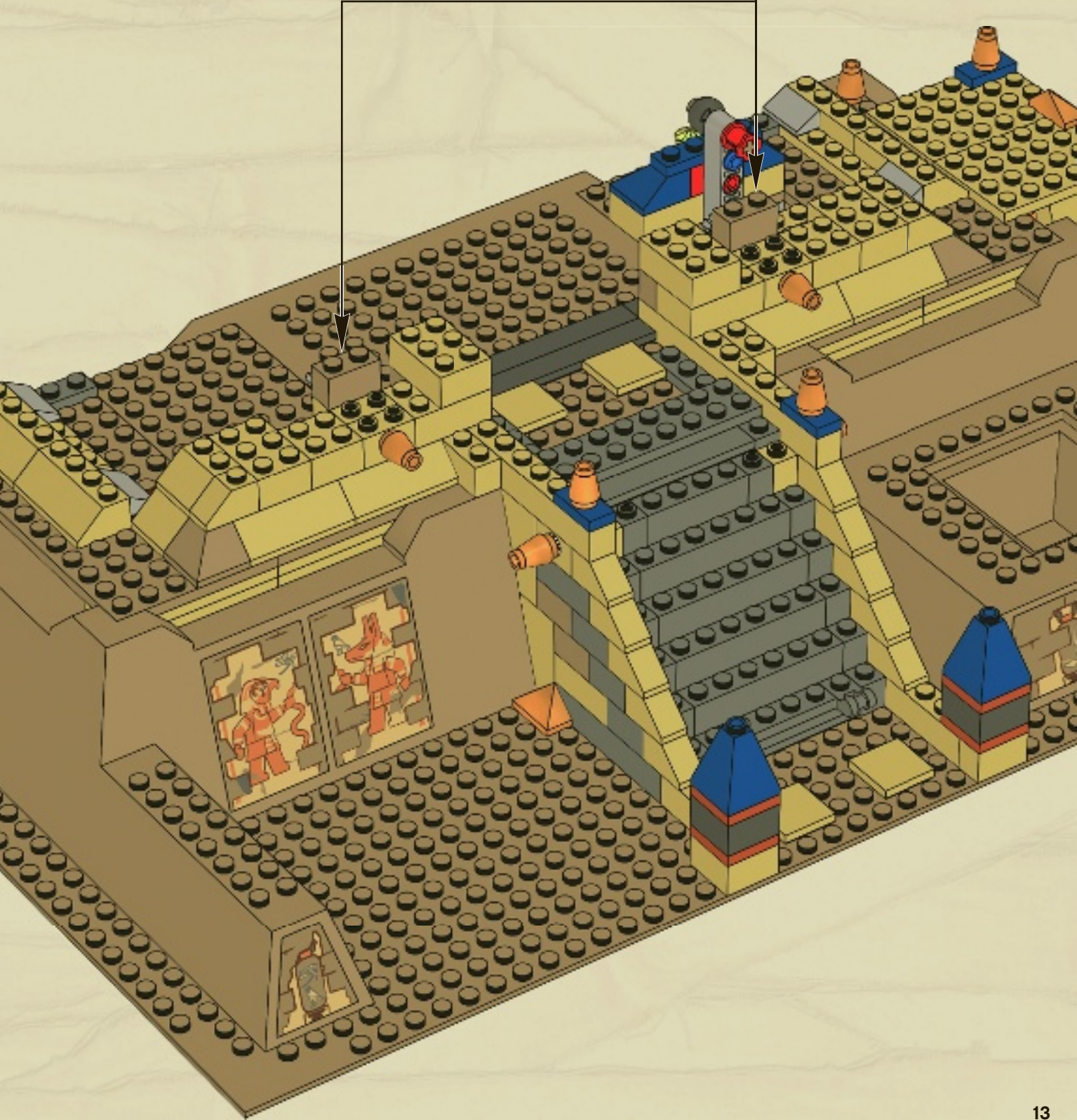
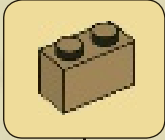

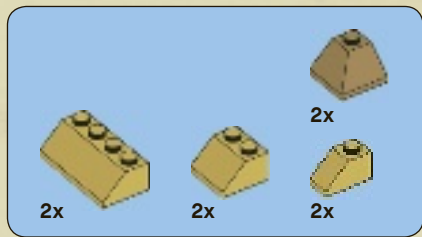

48

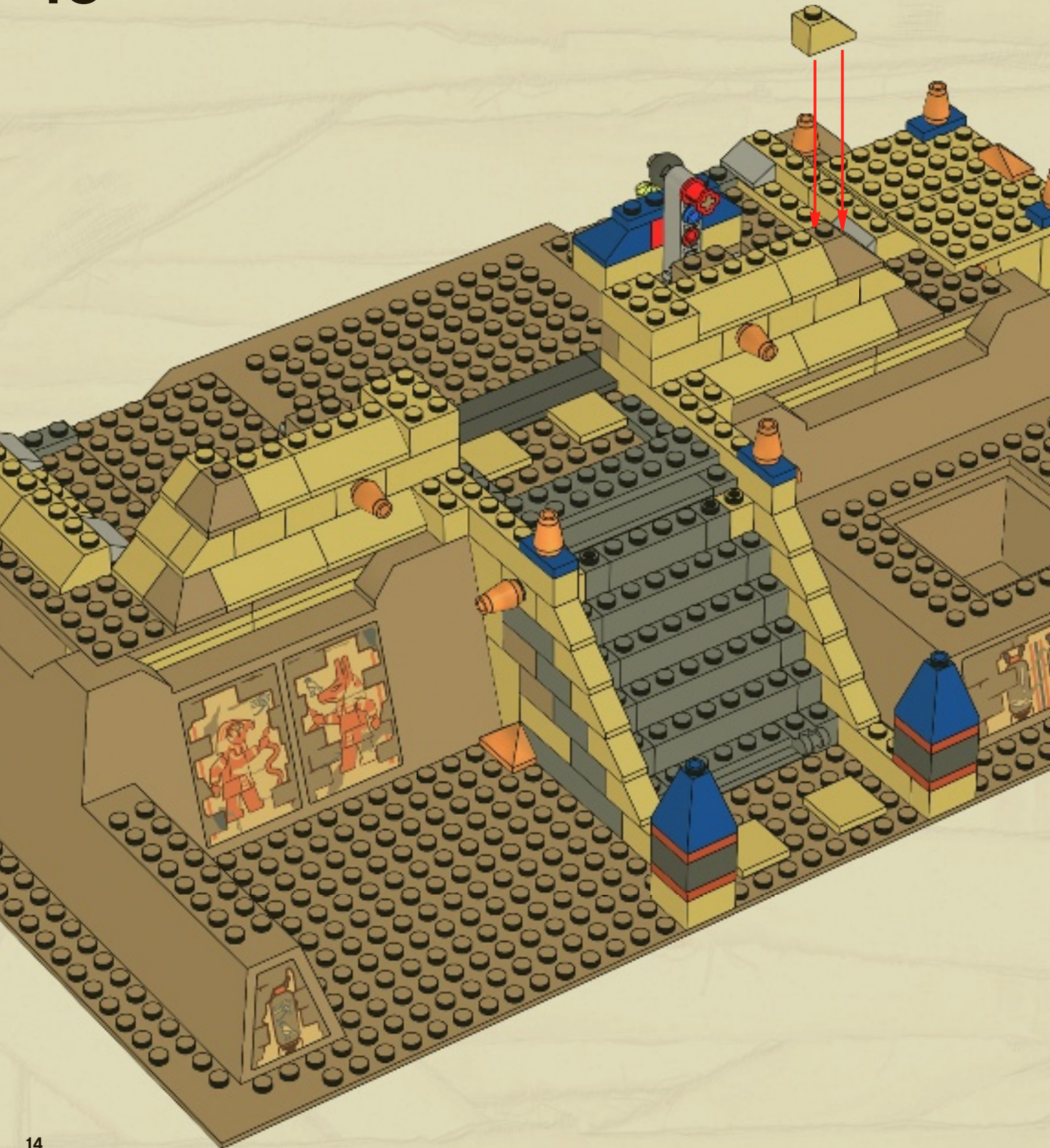

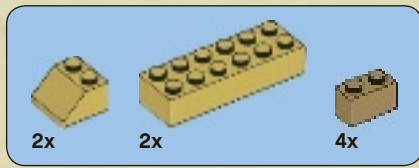

49

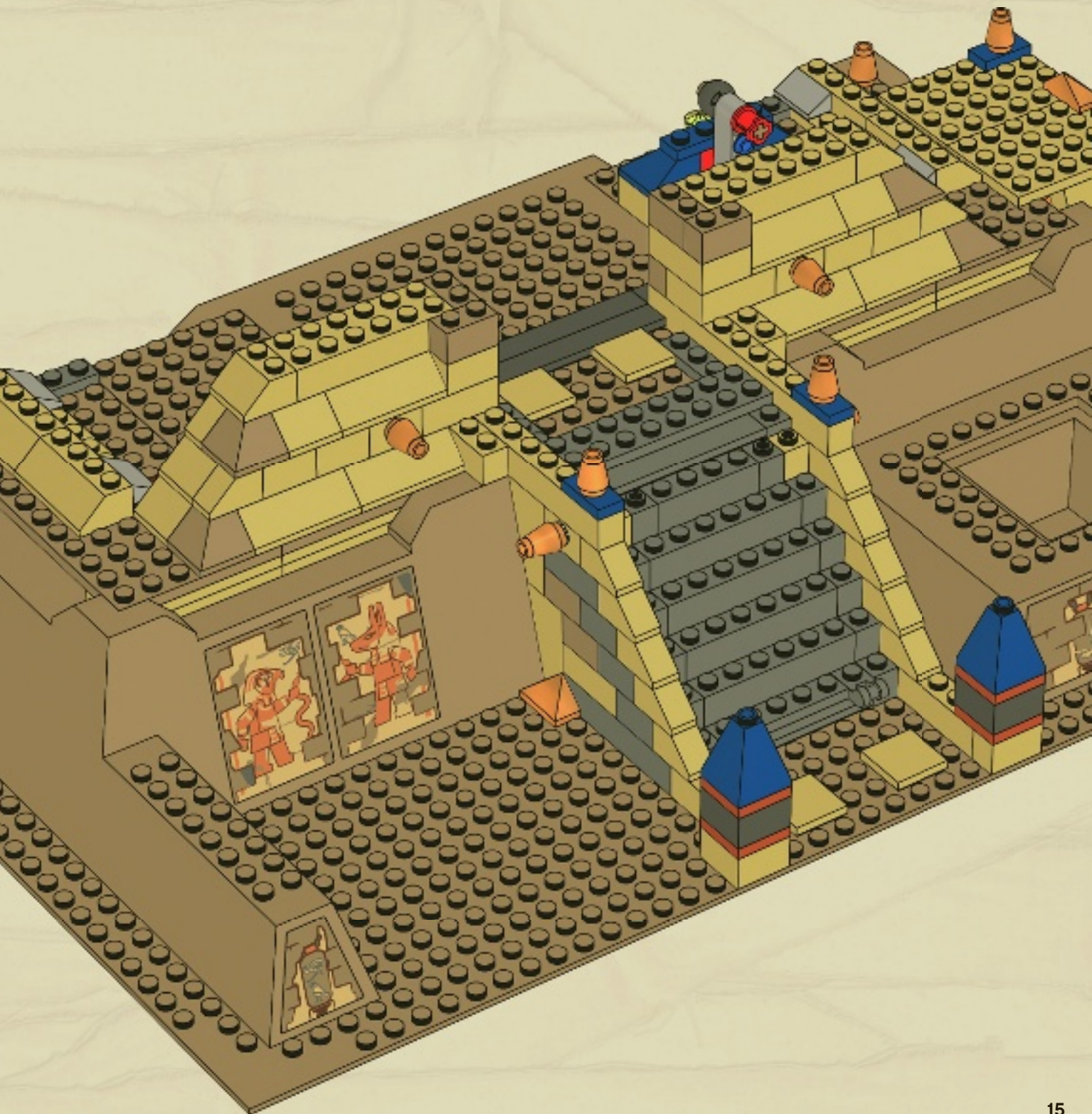

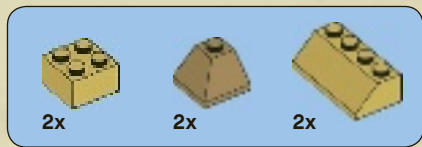

50

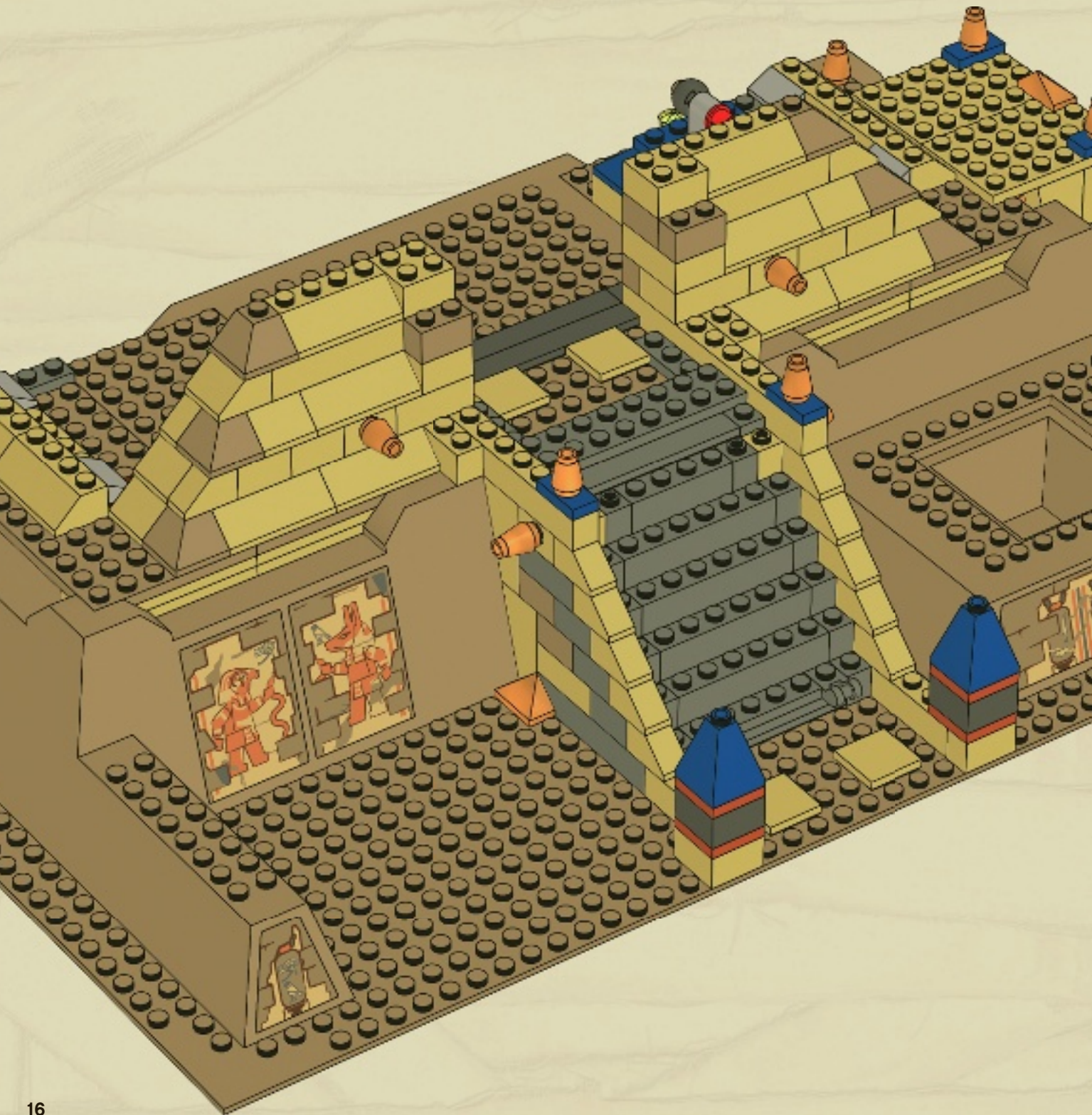

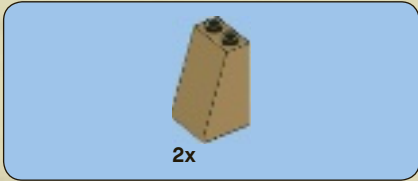

51

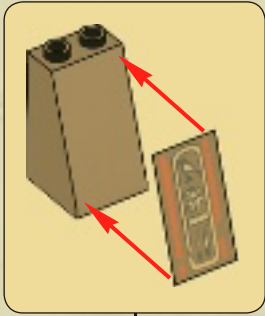
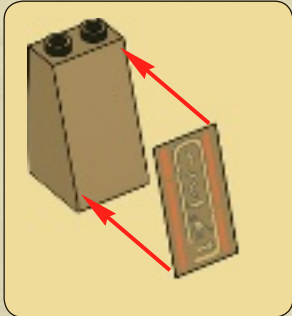

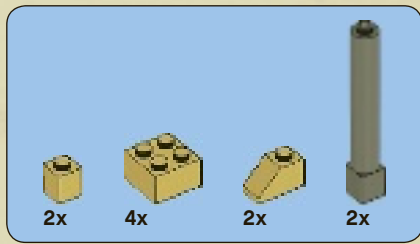

52

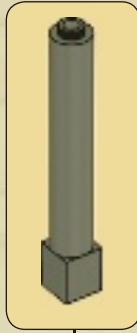

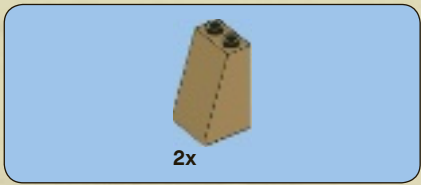

53

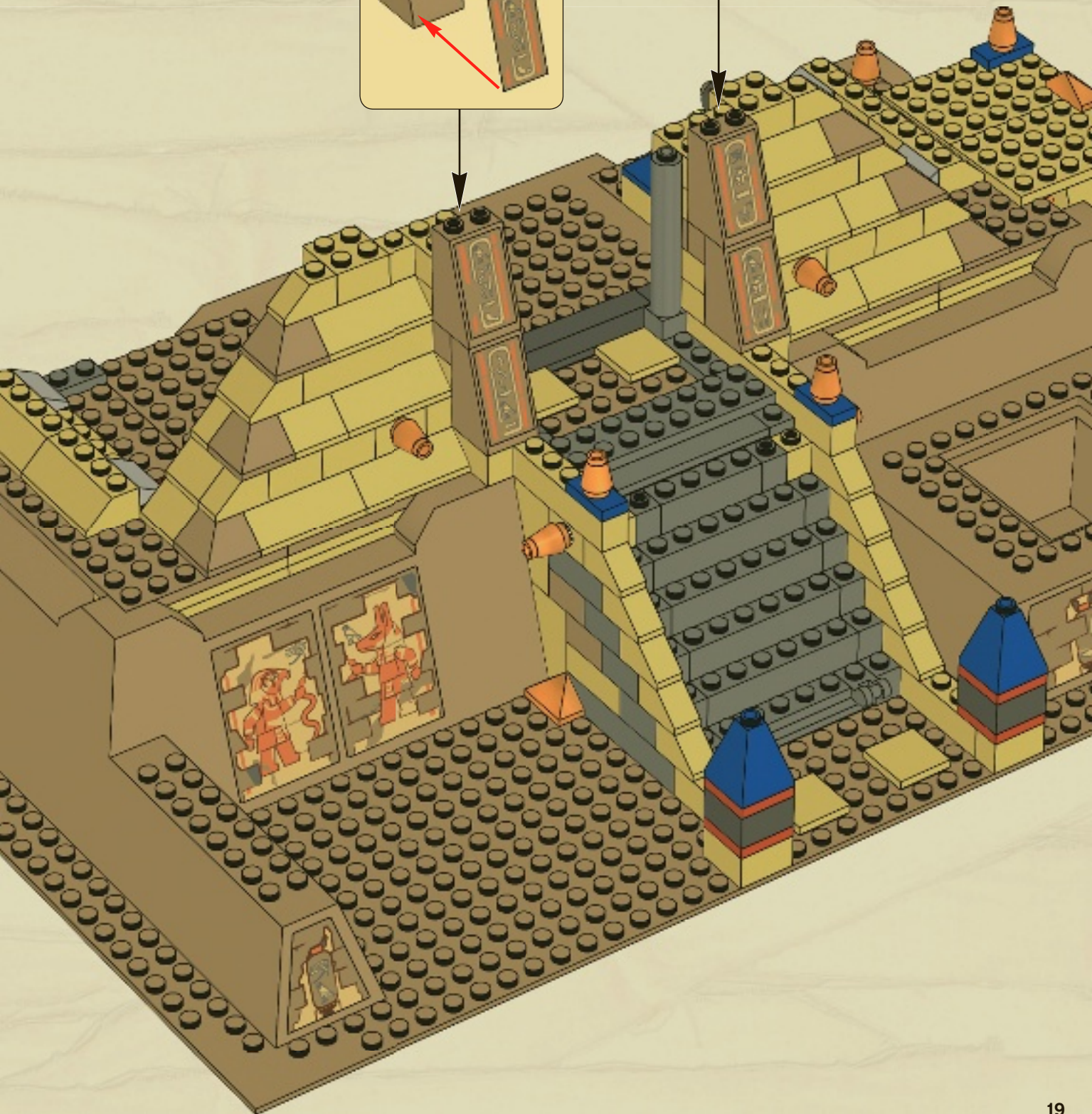
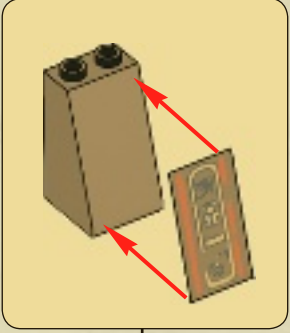
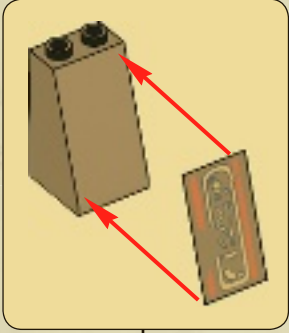

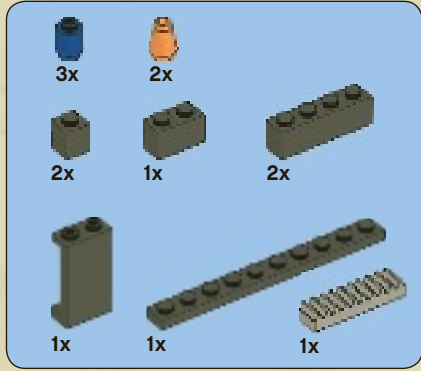
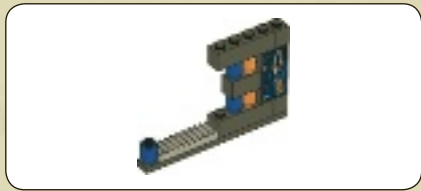

54

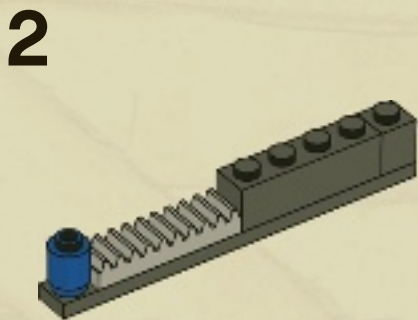
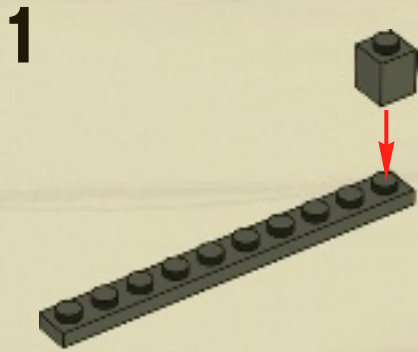

3

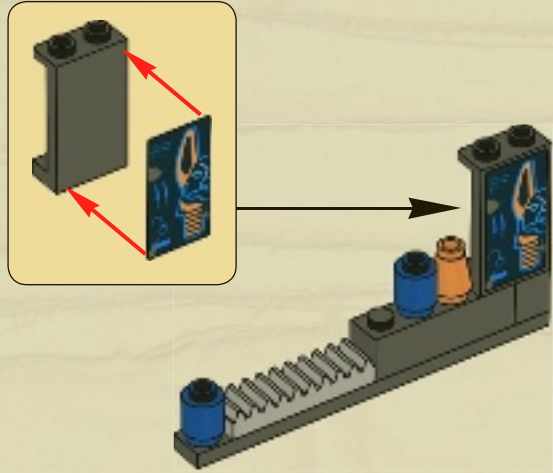

4

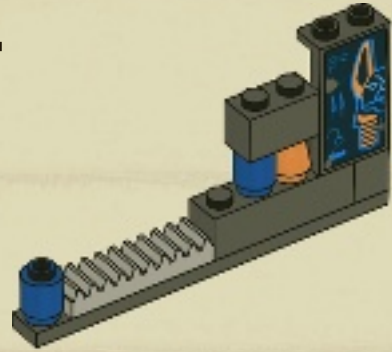

5

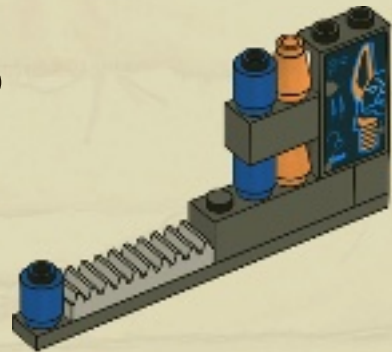

6

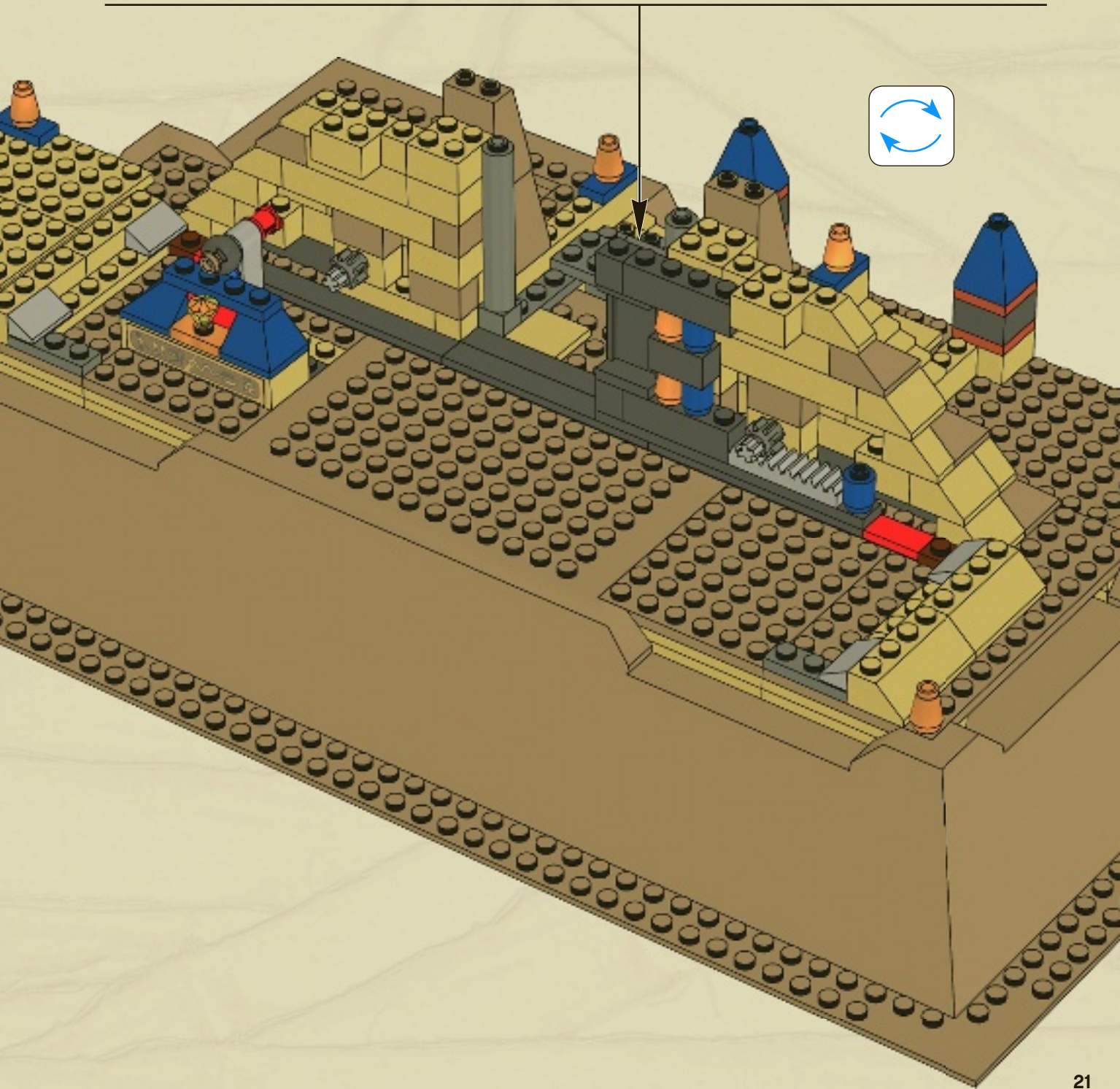
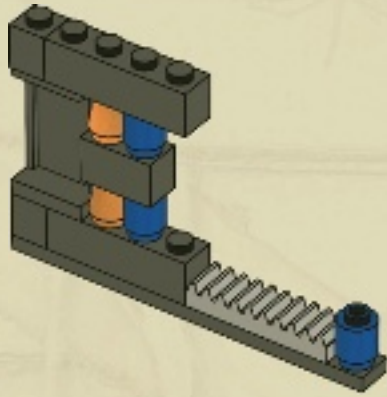



1x

55

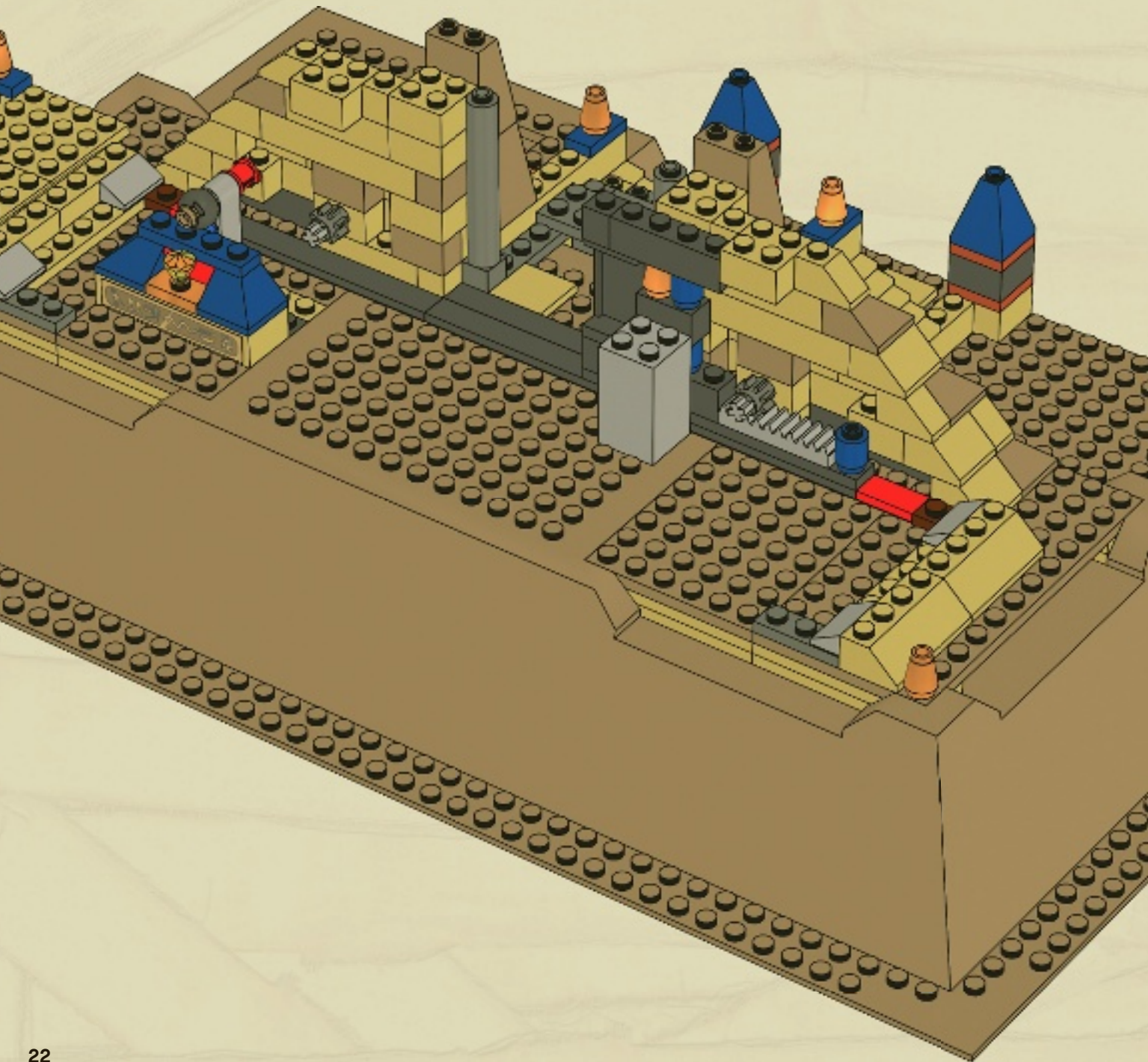

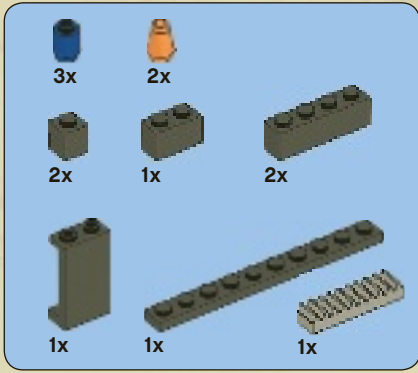
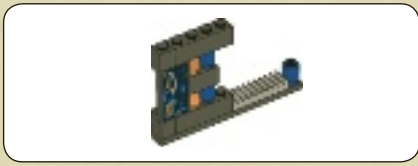

56

1

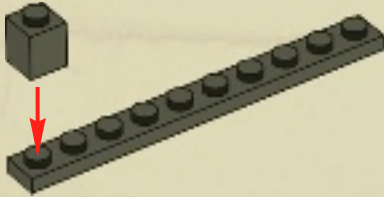

2

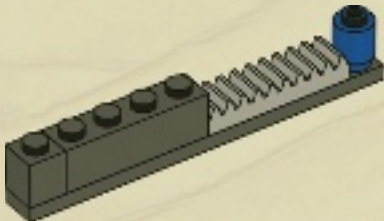

3

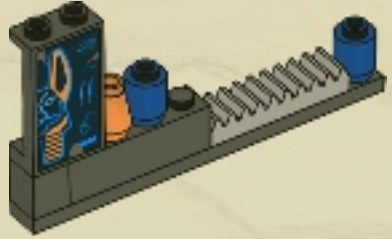

4

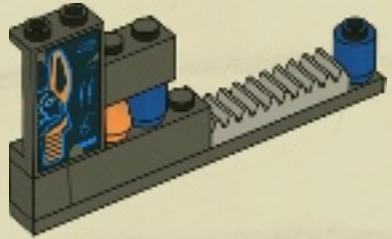

5

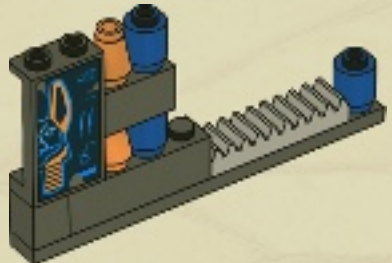

6

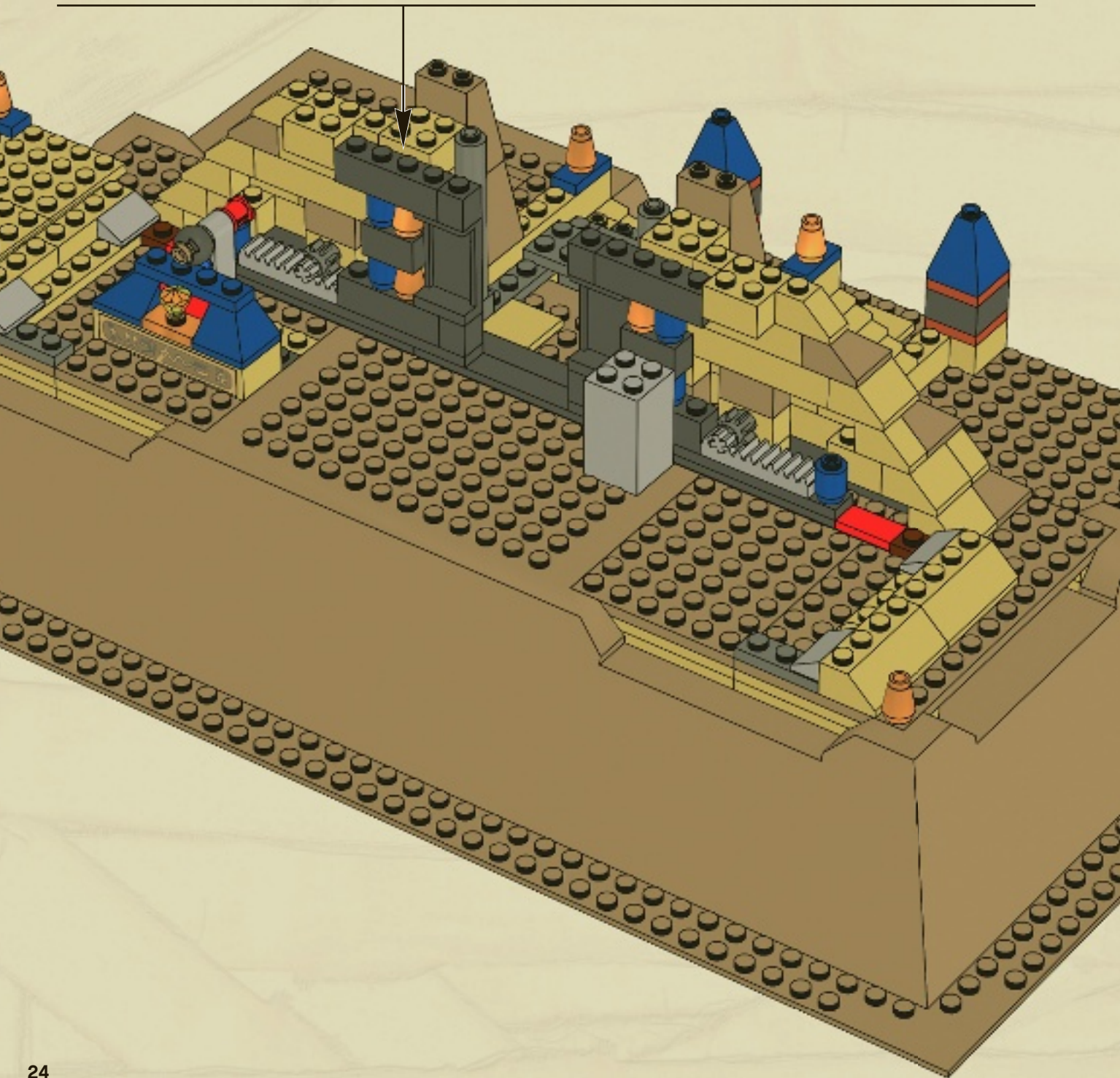
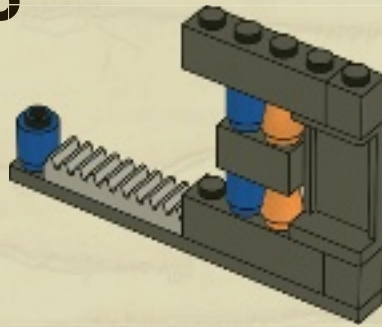

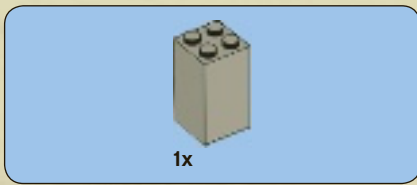

57

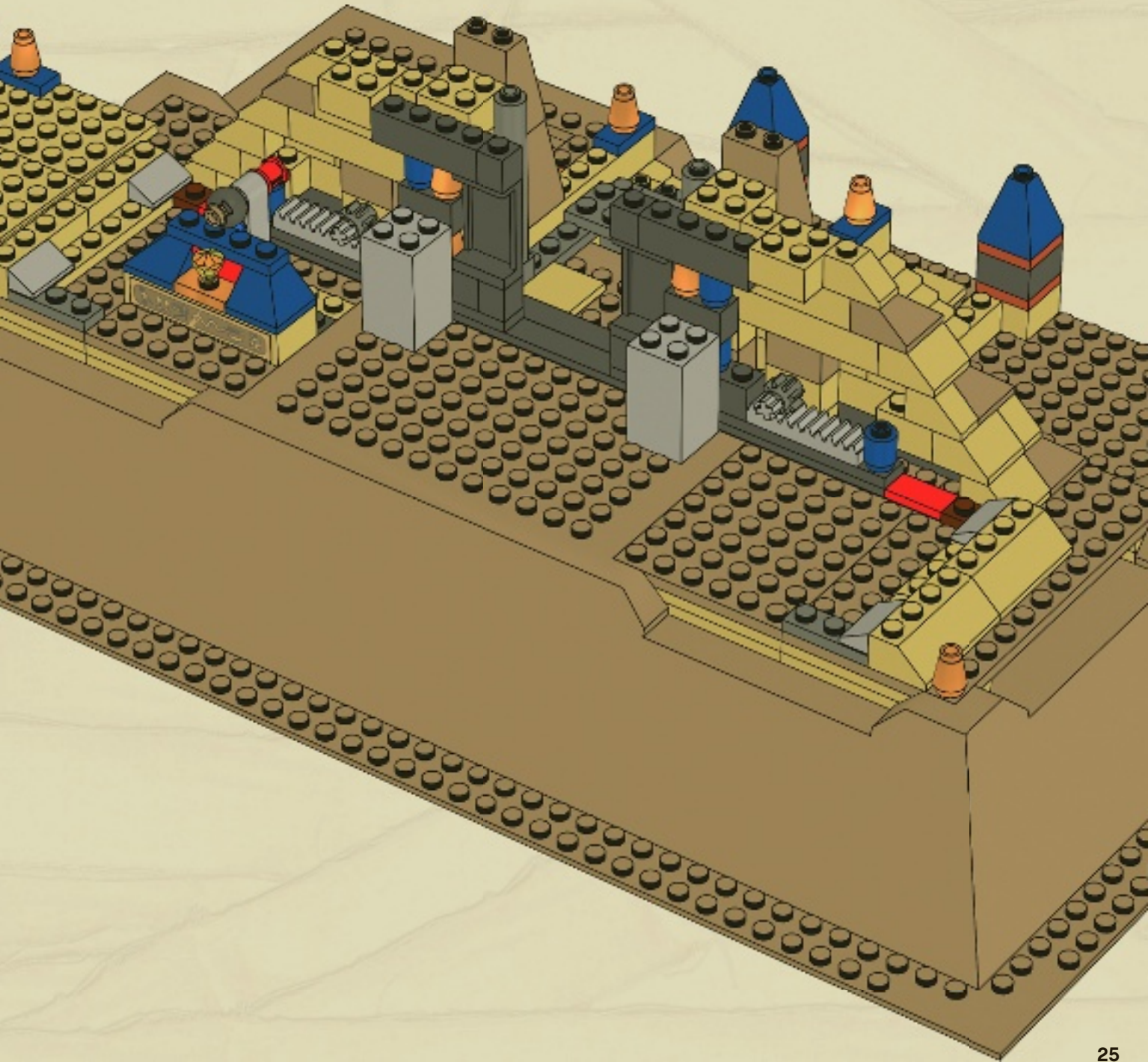



58

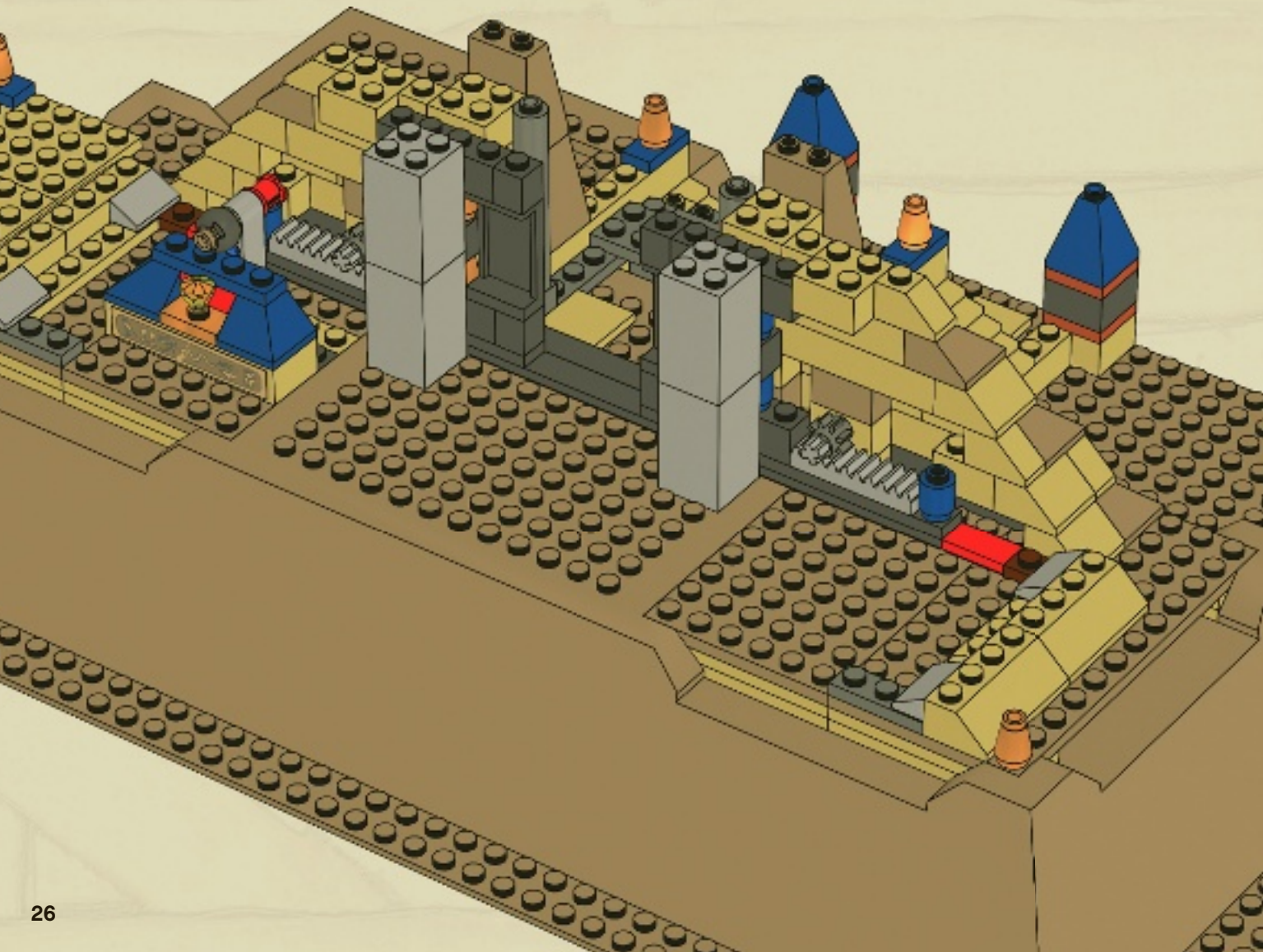
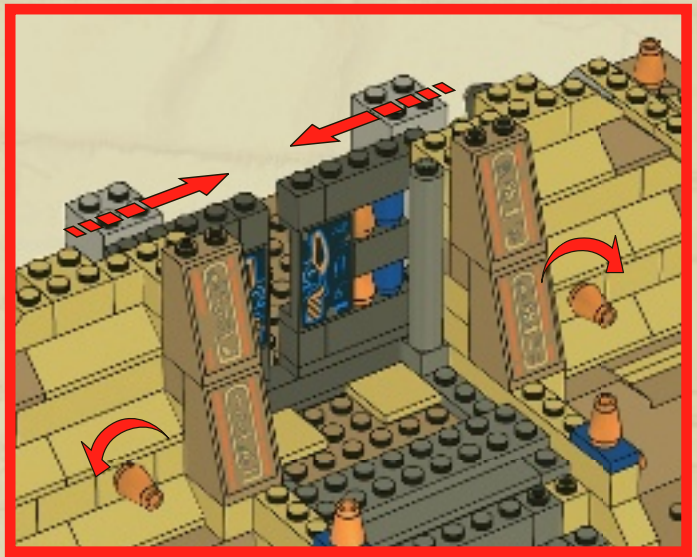

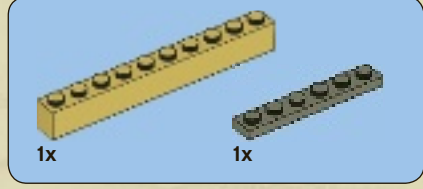

59

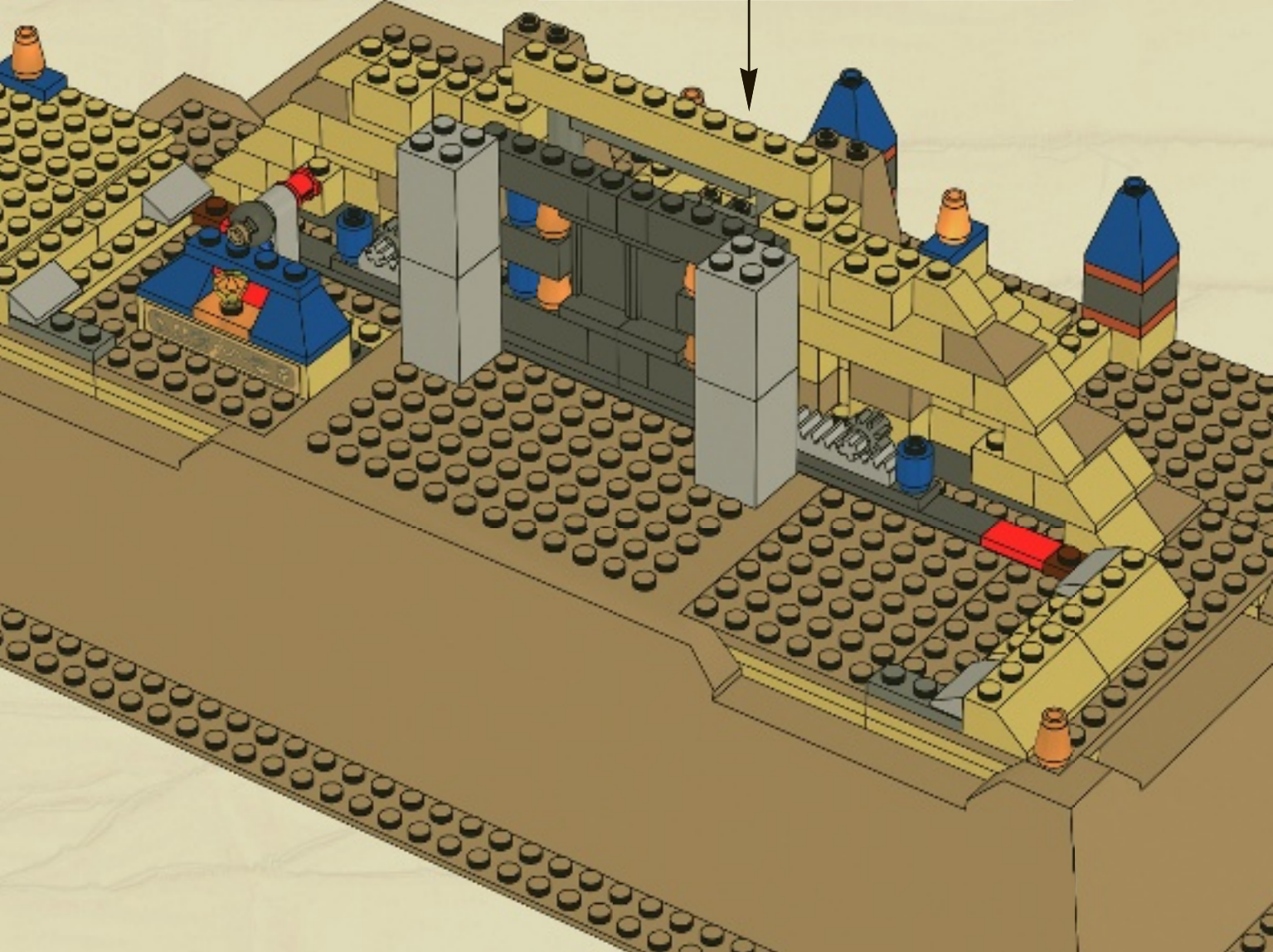

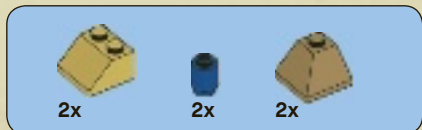

60

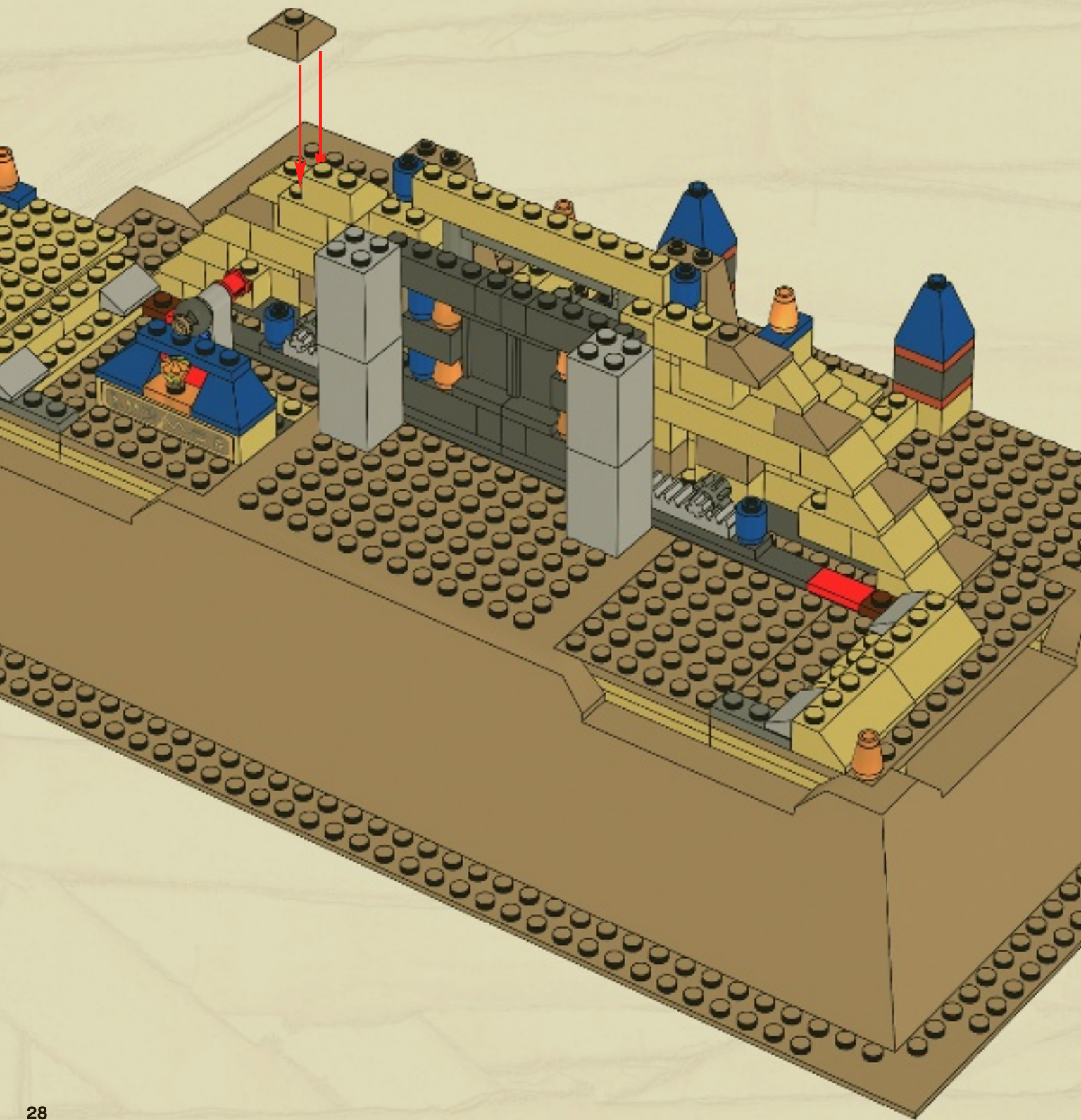

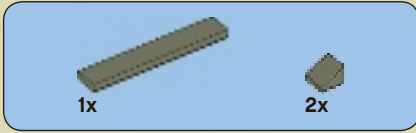

61

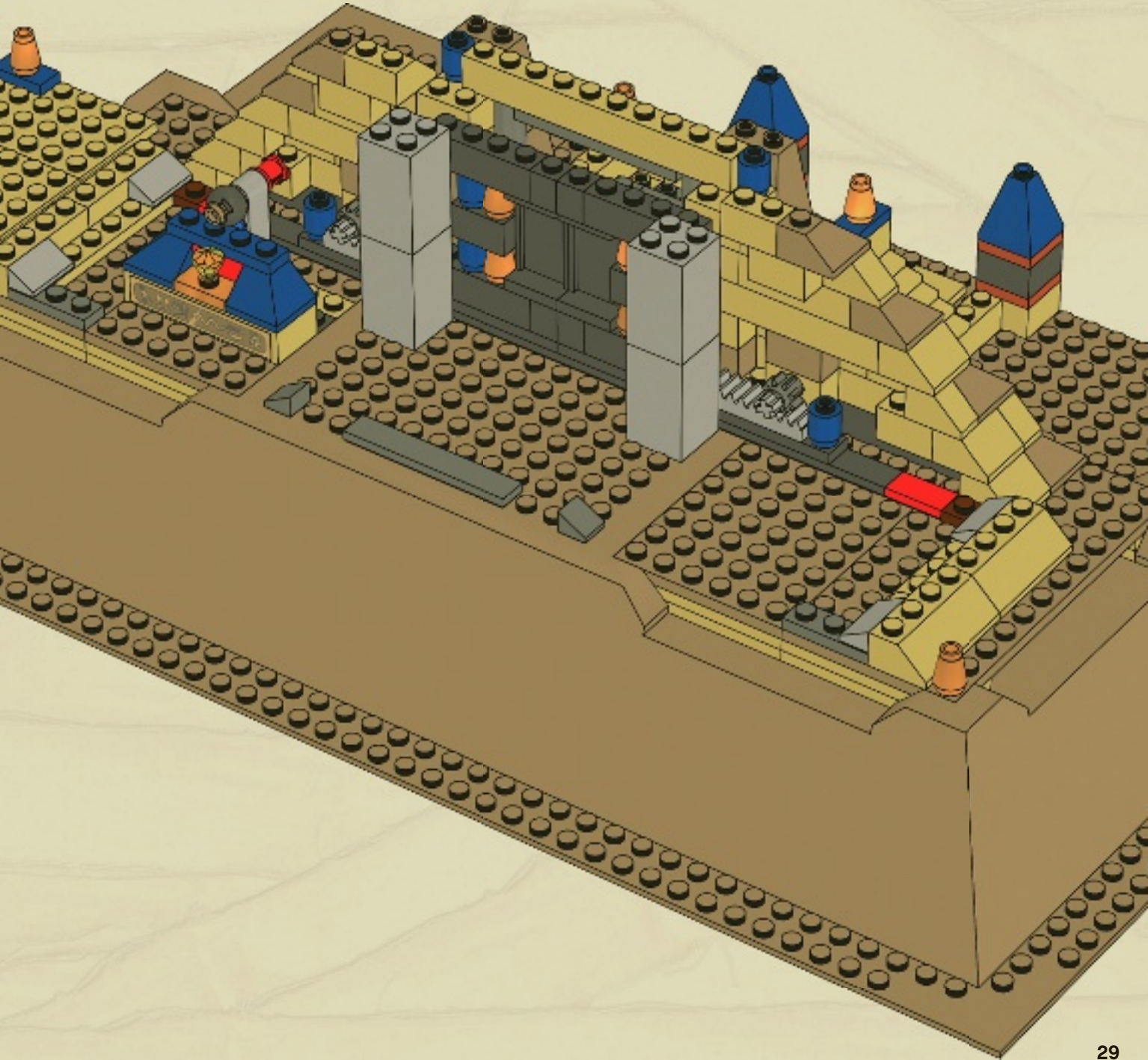

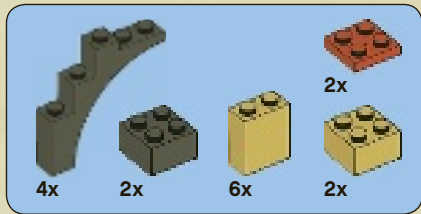

62

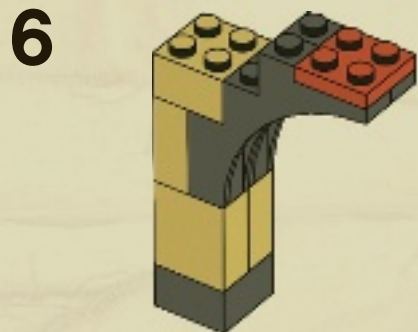

2x

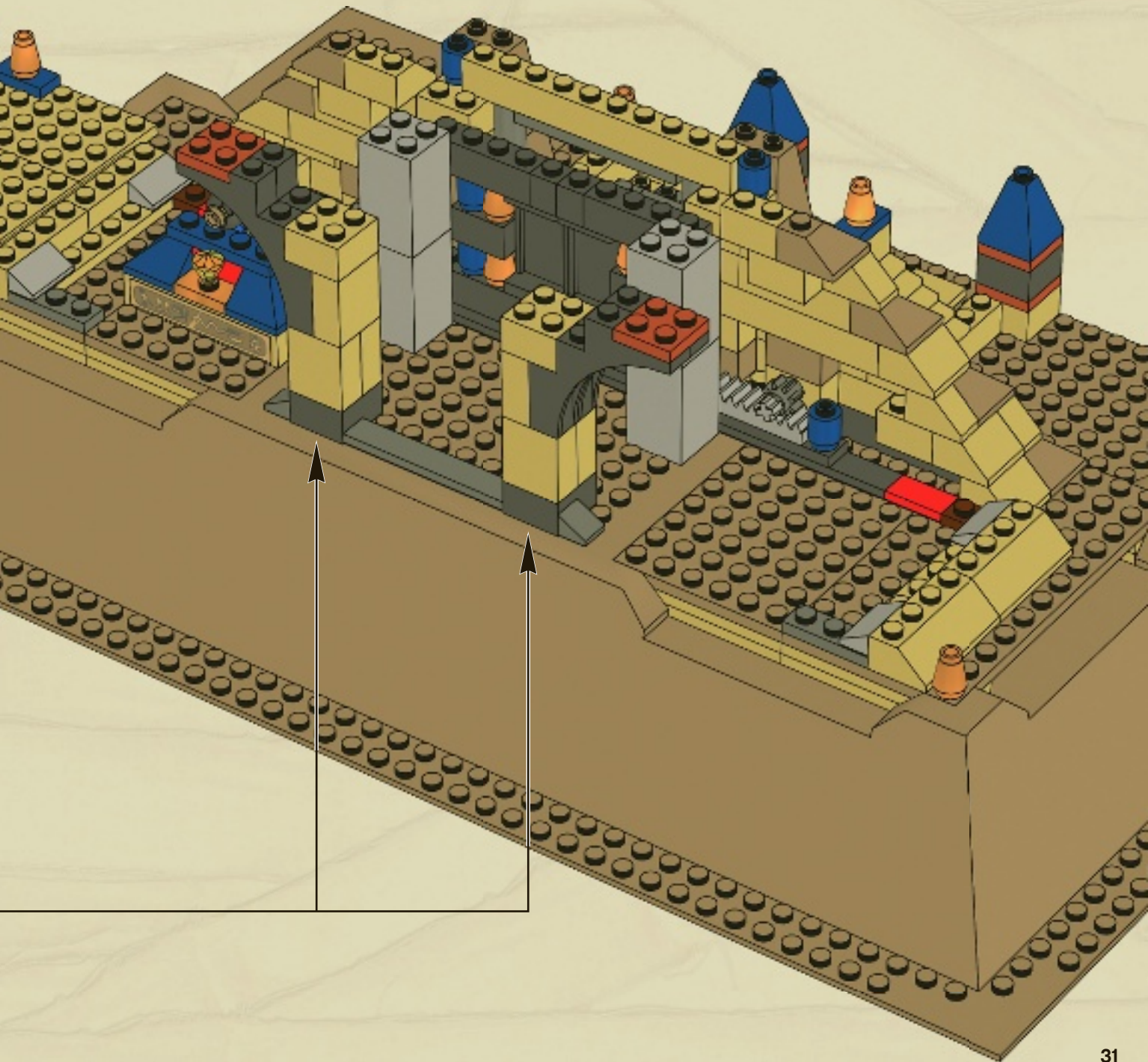



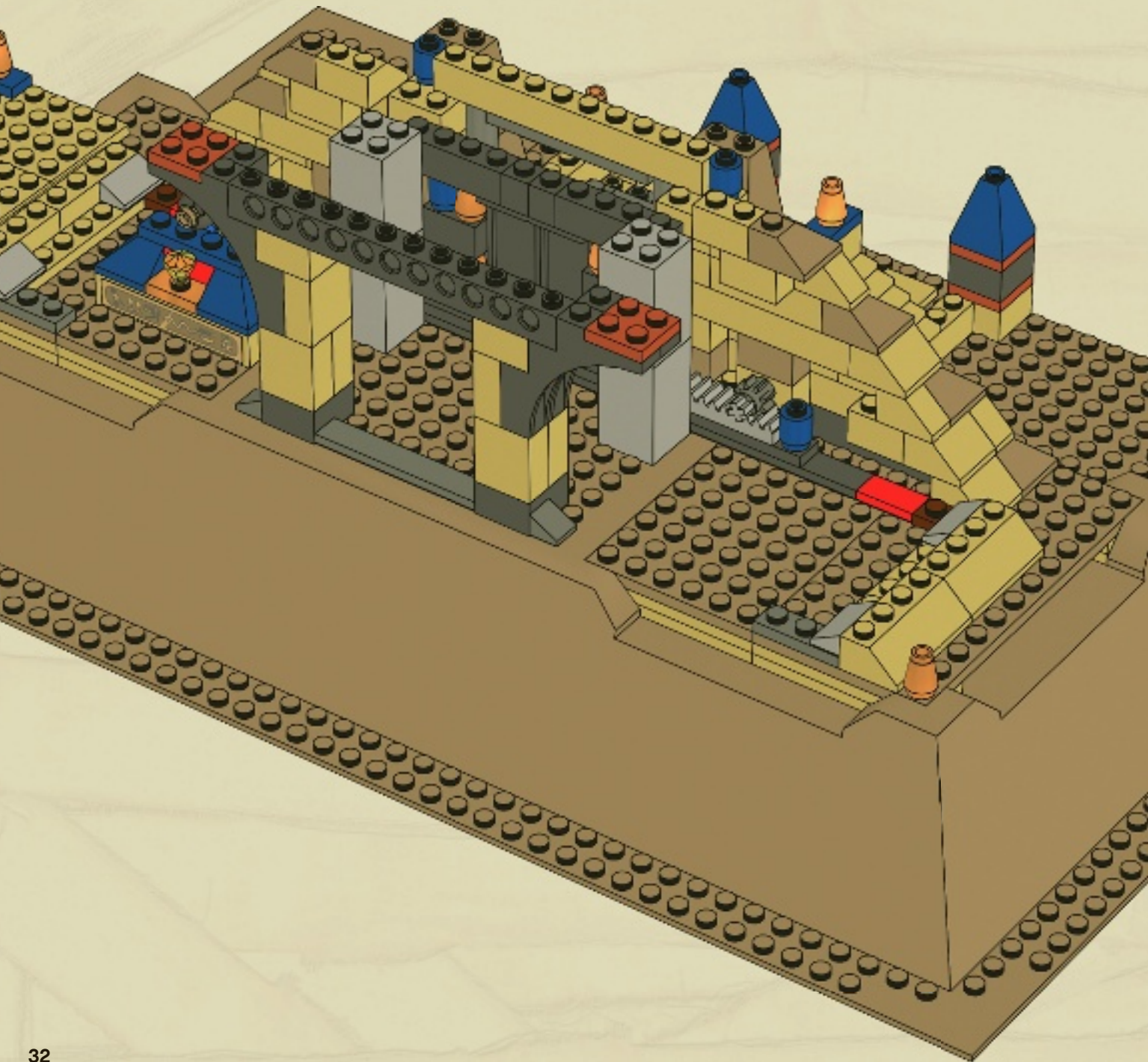

63

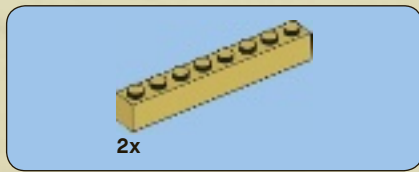

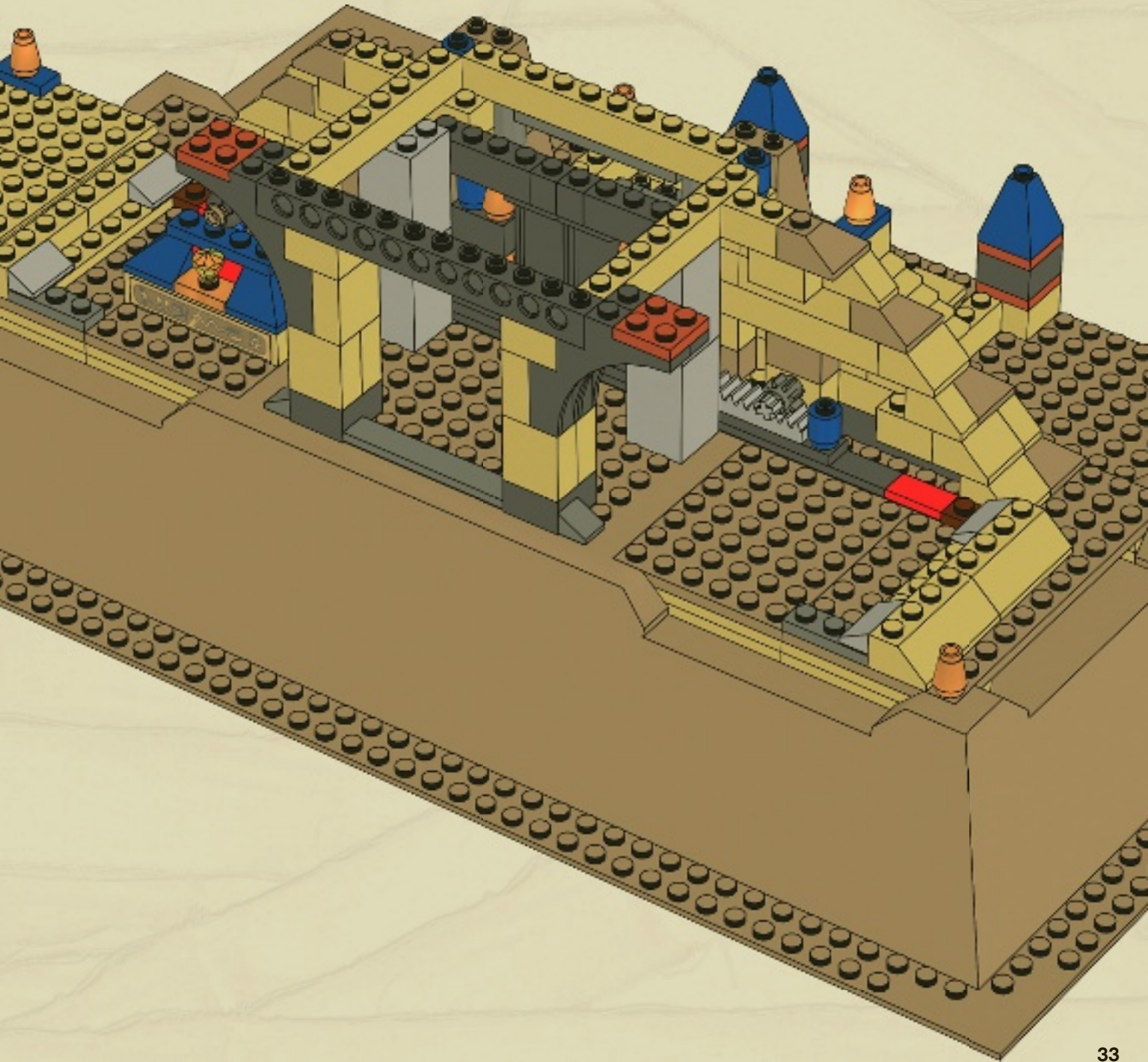

64



4x  2x 

65

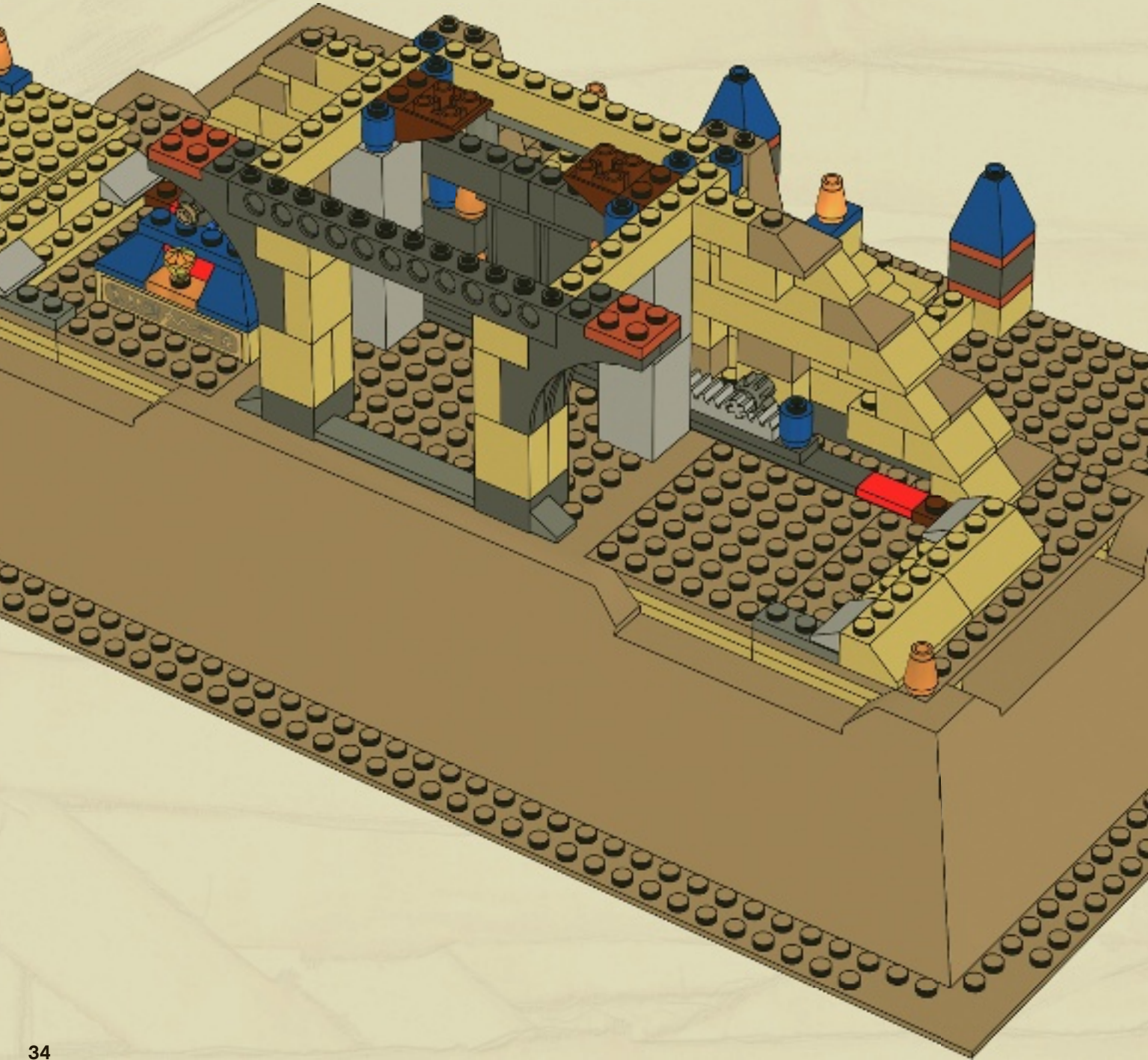

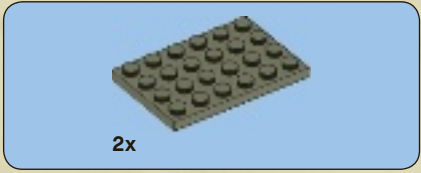

66

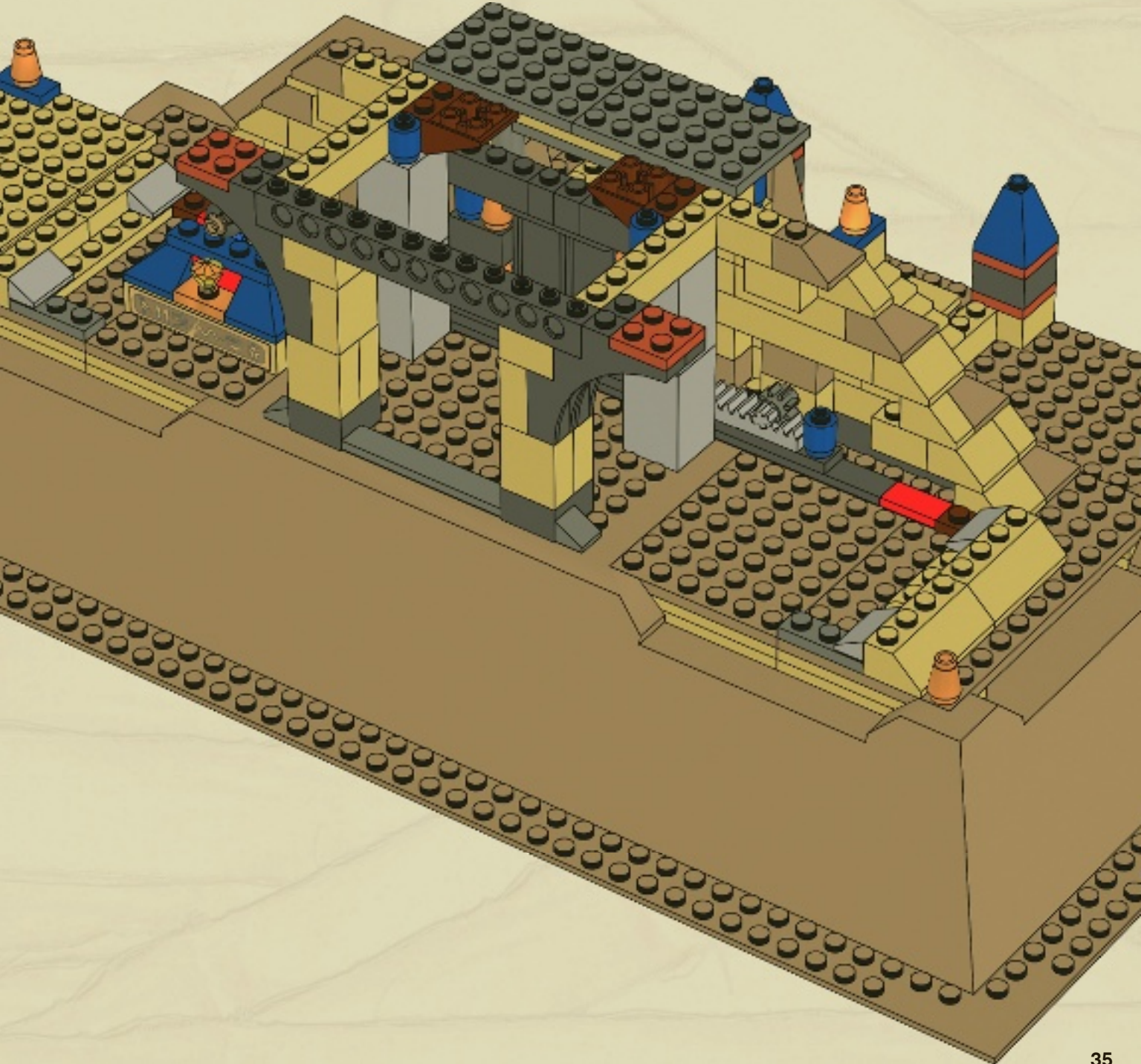

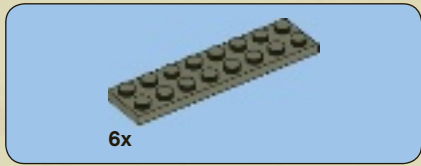

67

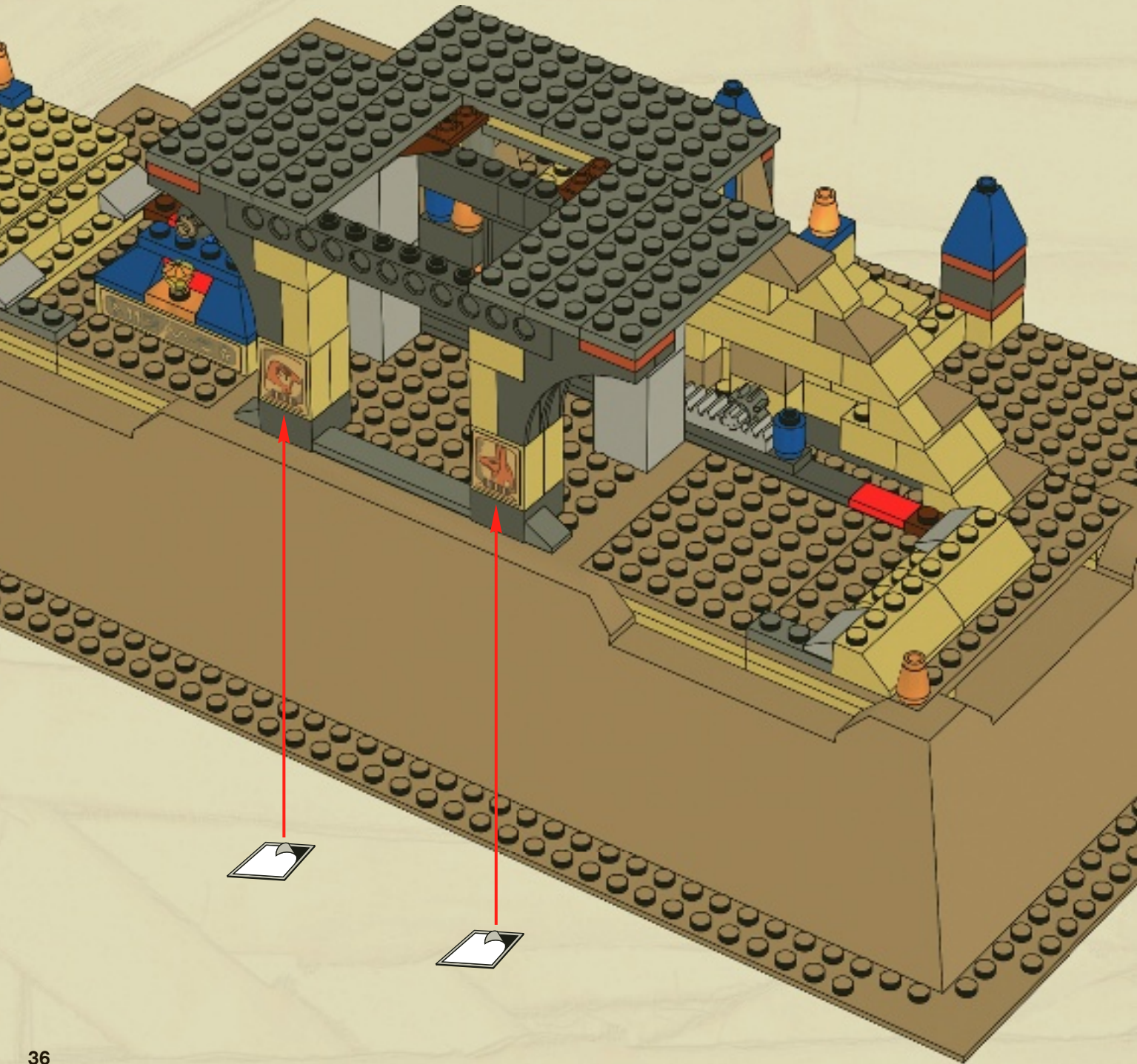

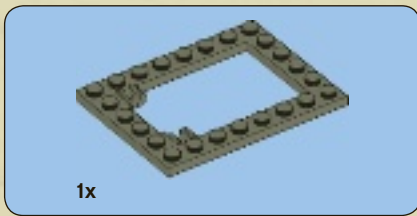

68

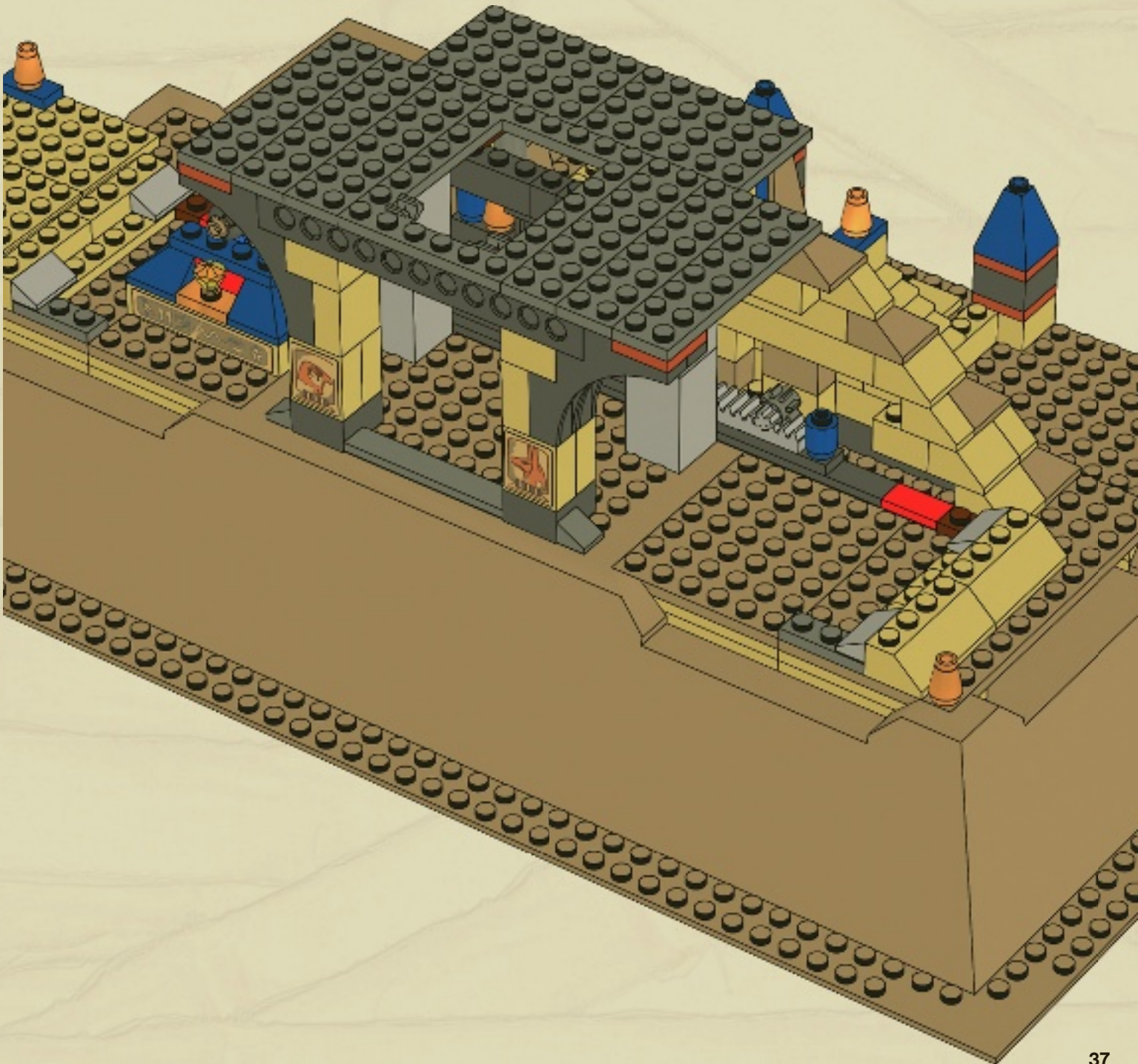



69

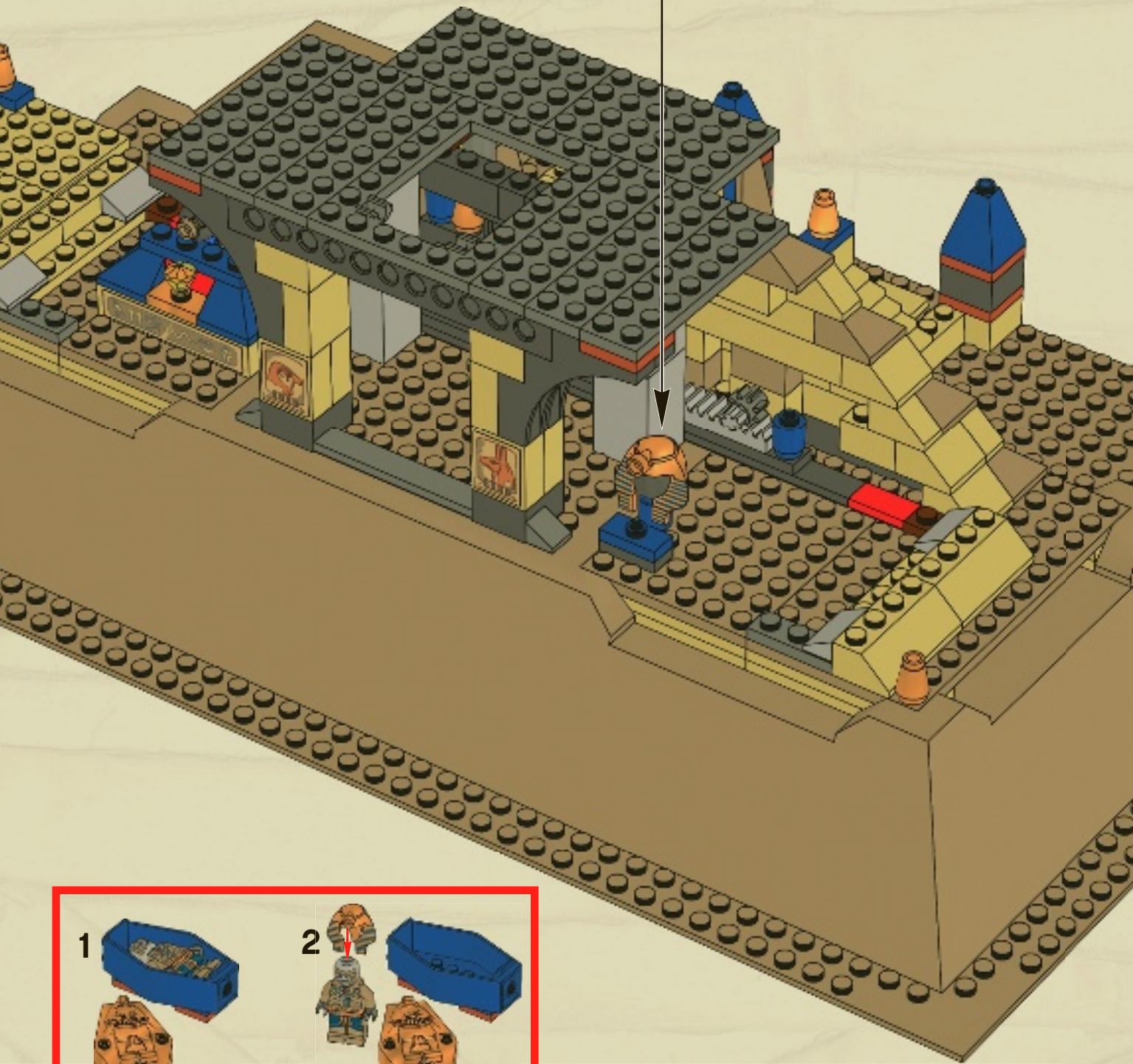
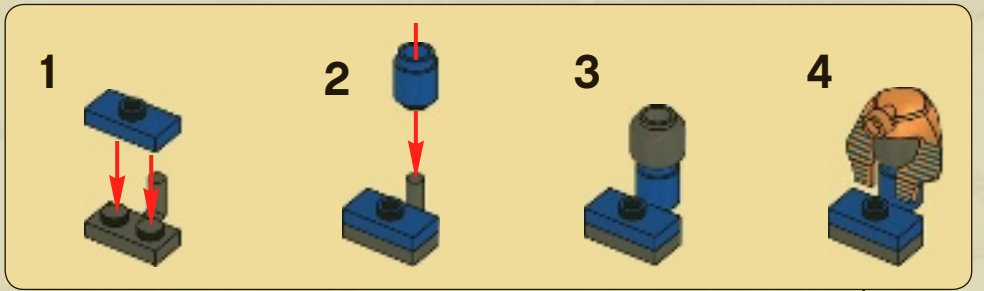

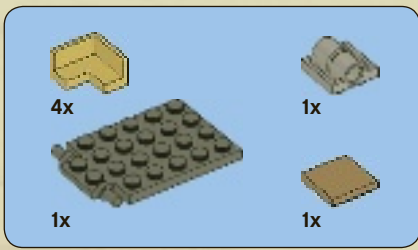

70

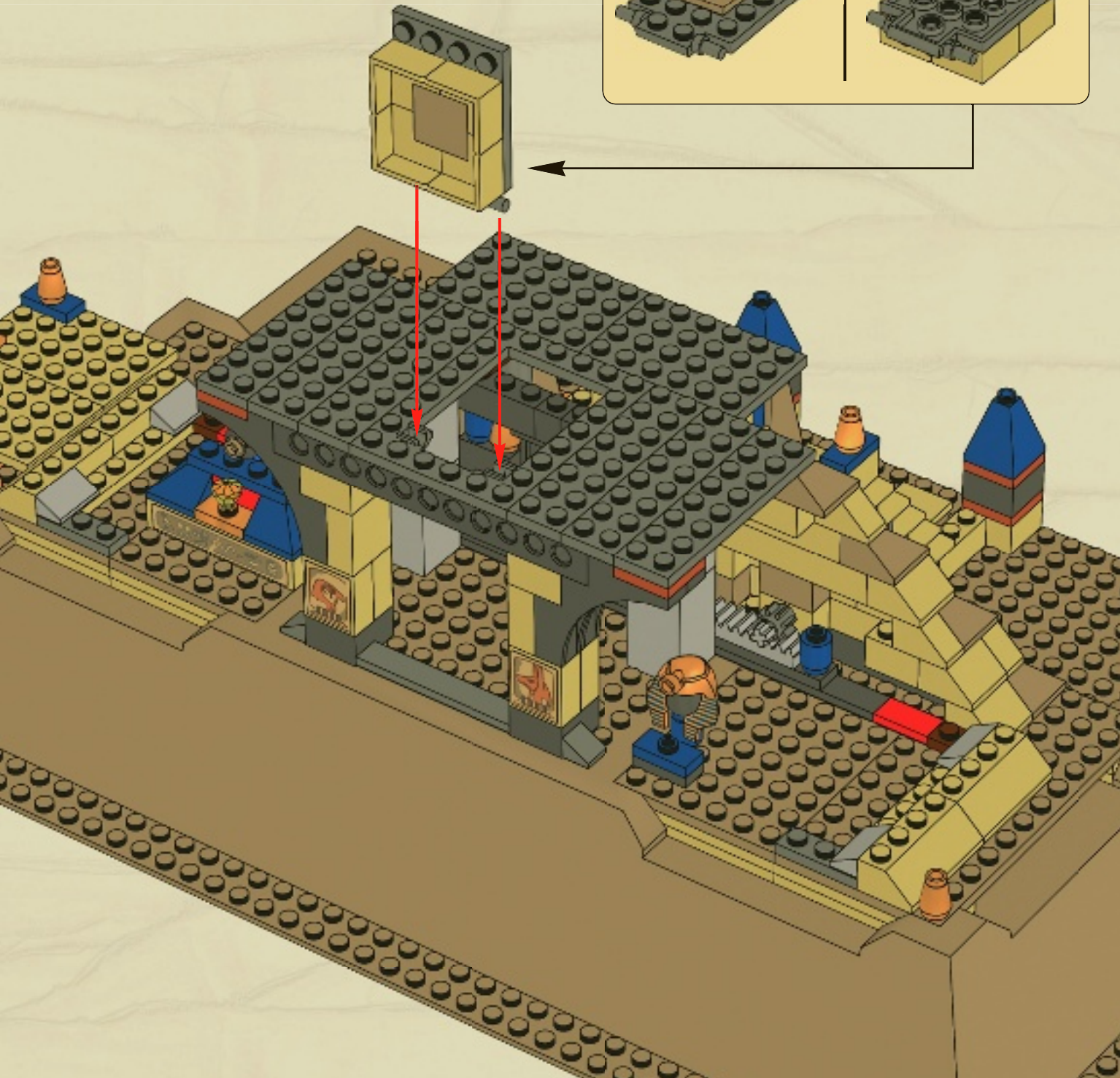
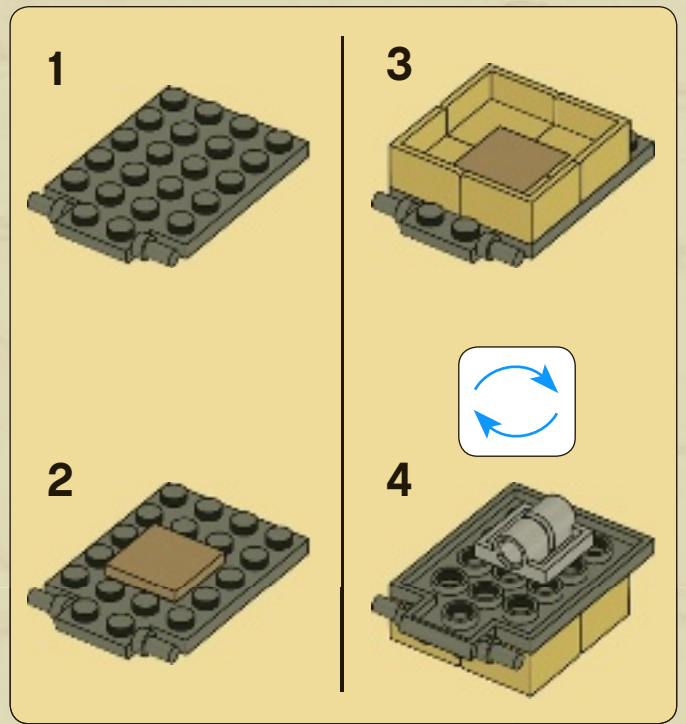

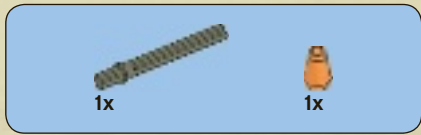

71

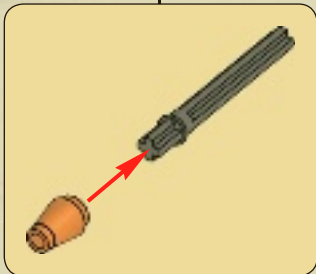
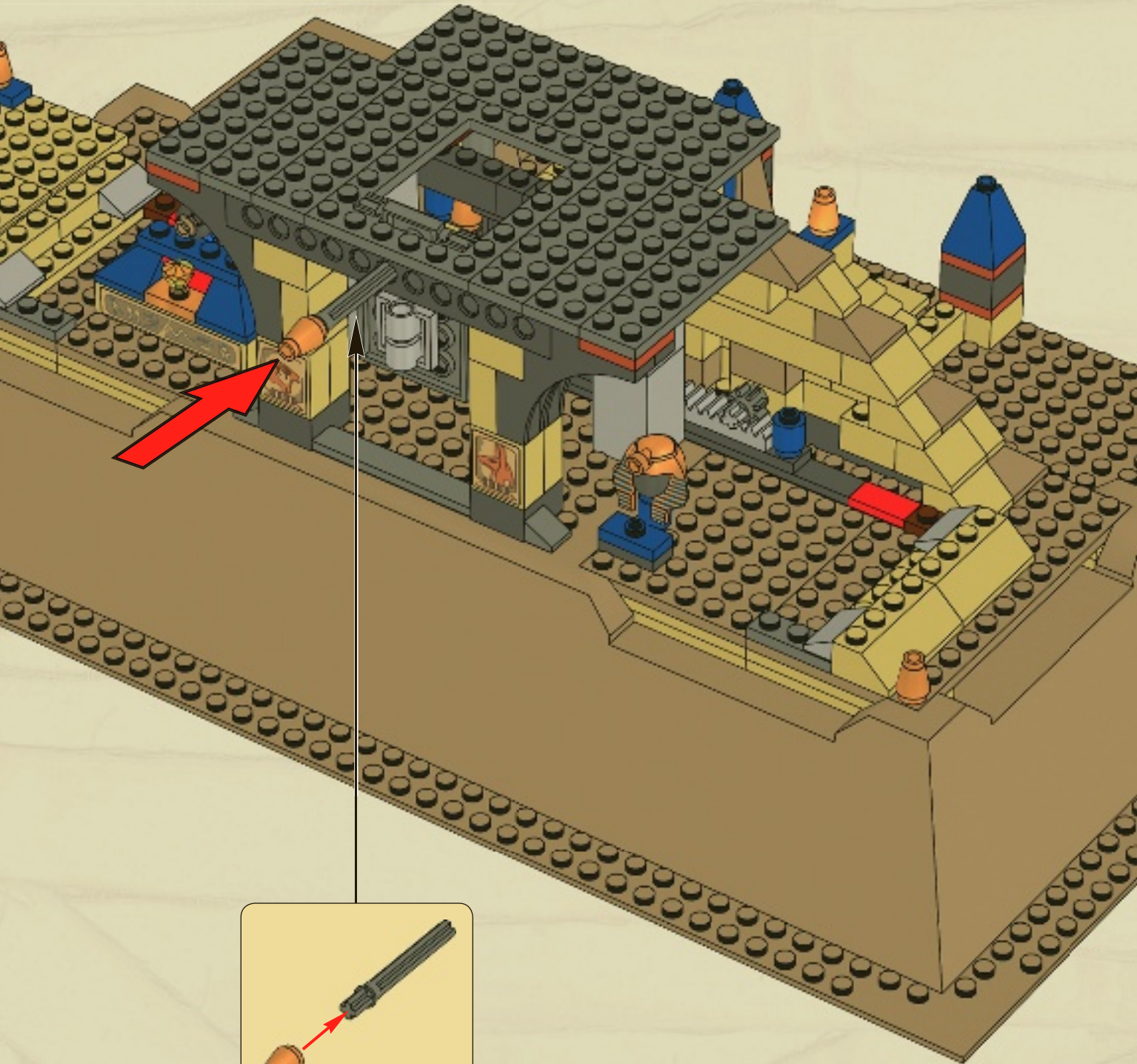

3x

72

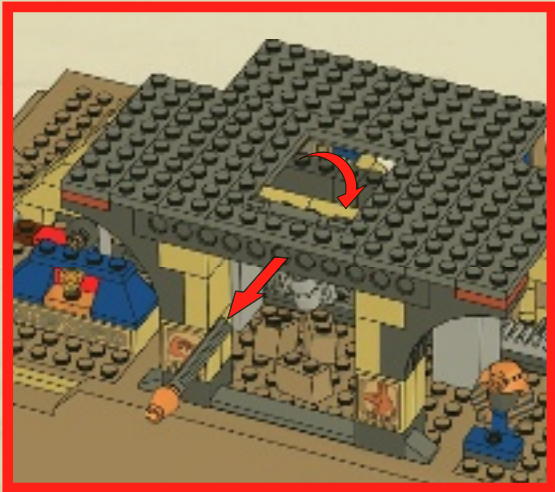
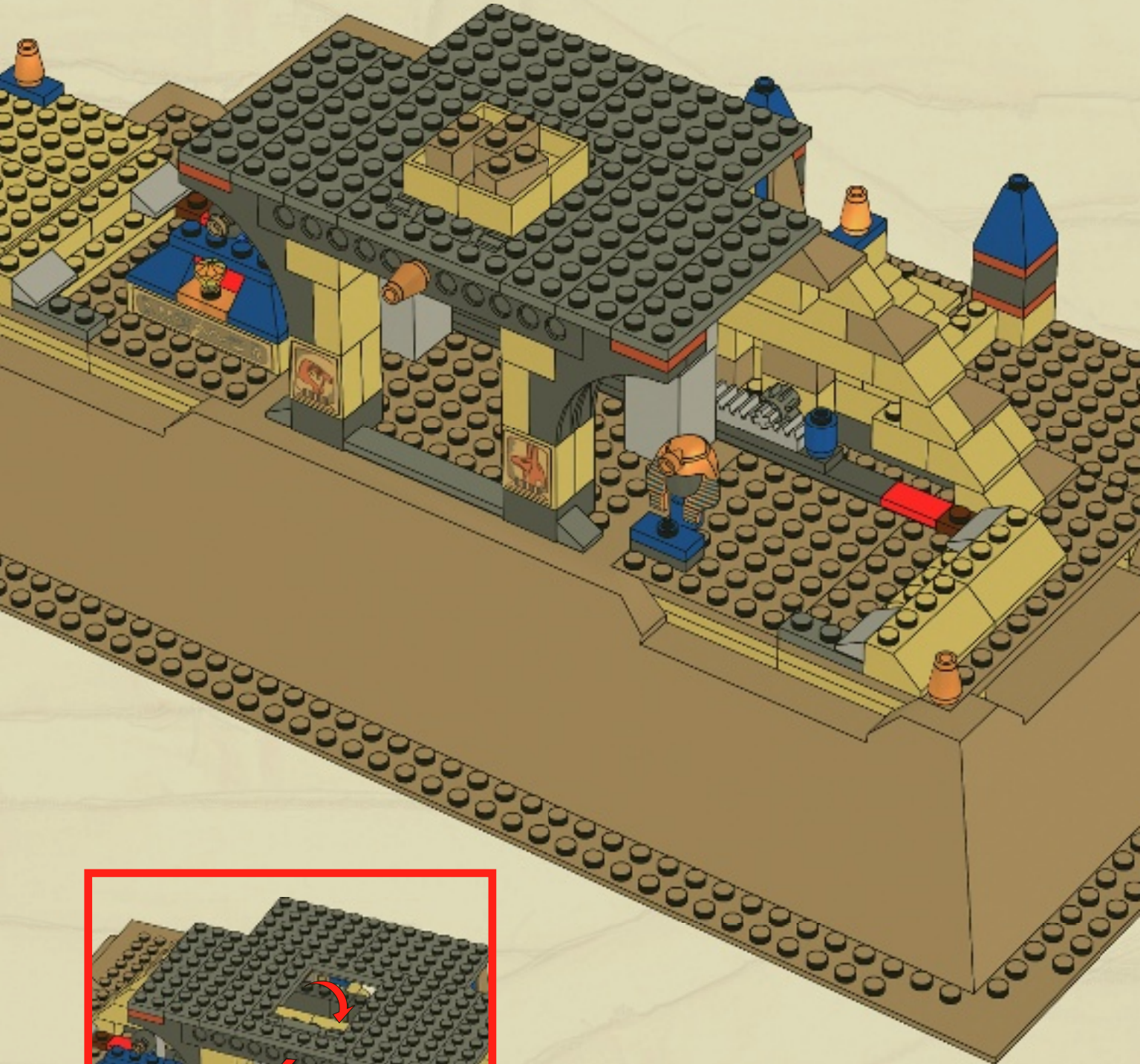

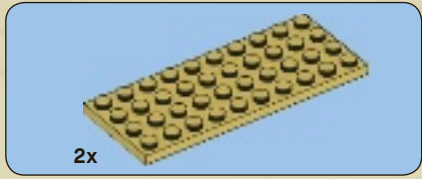

1

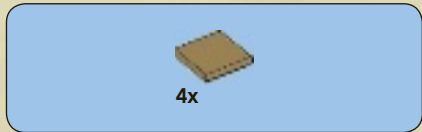
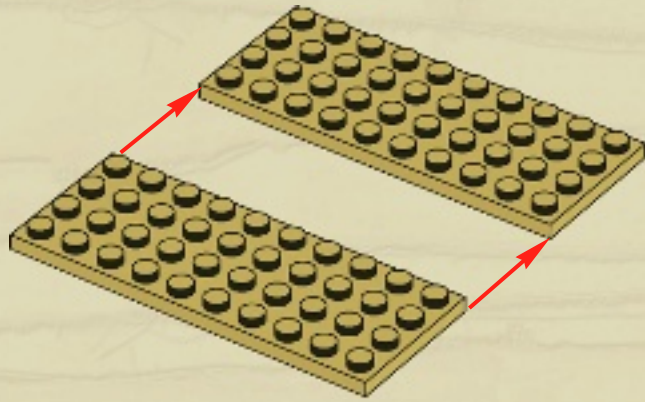

2

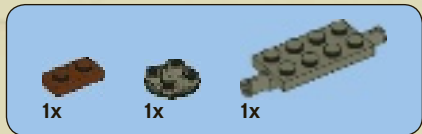
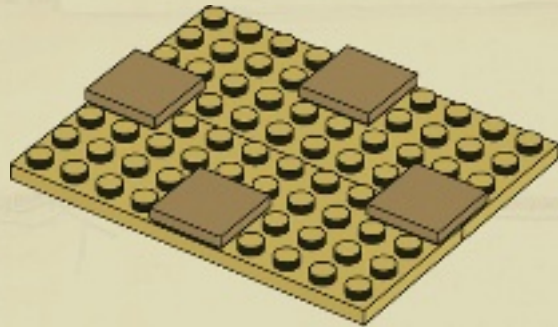

3

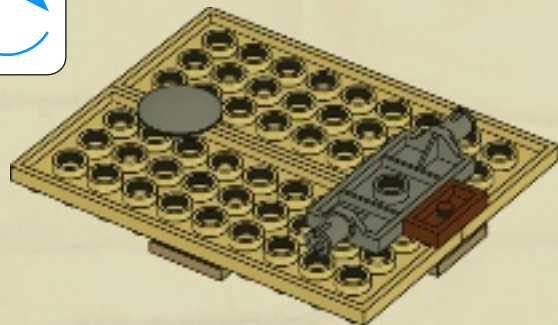
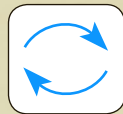

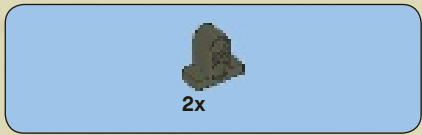

4

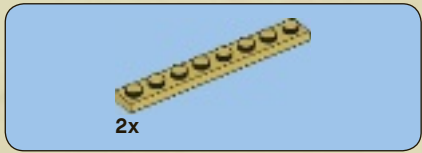
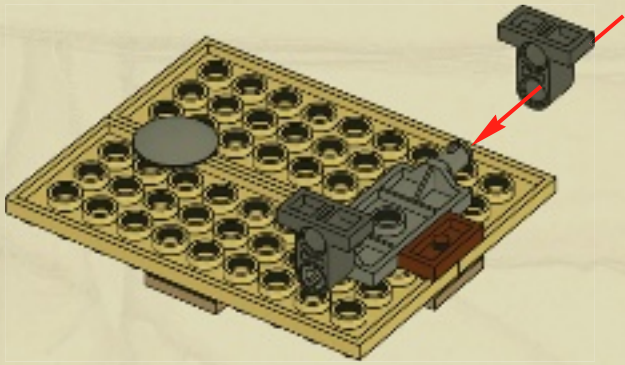

5

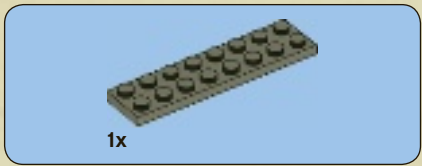
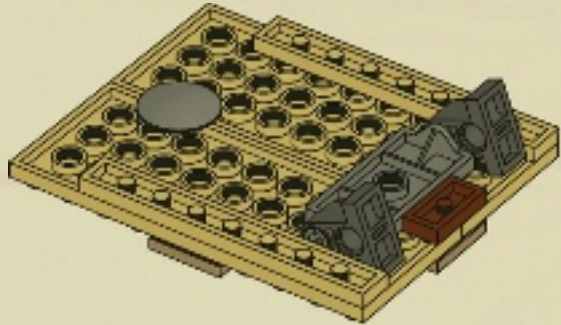

6

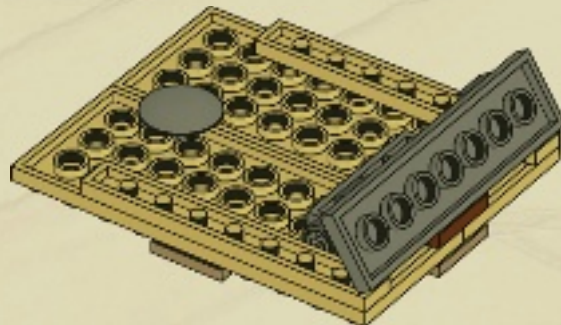

7

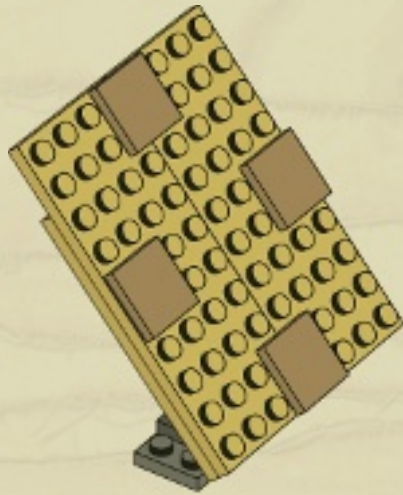
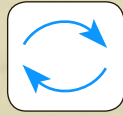

2x

73

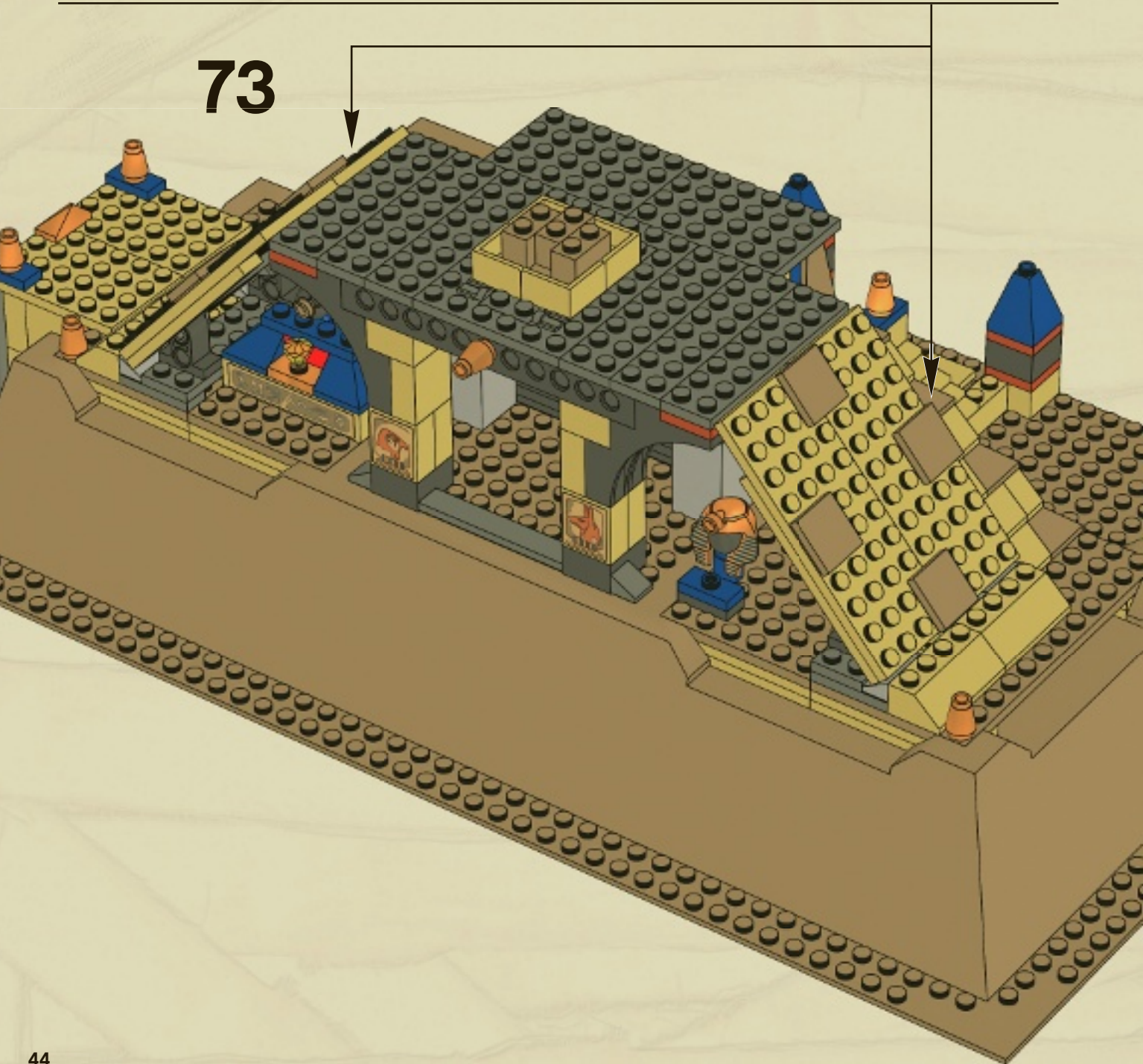

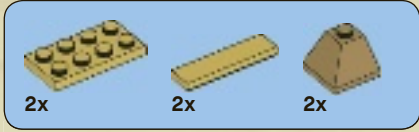

74





75

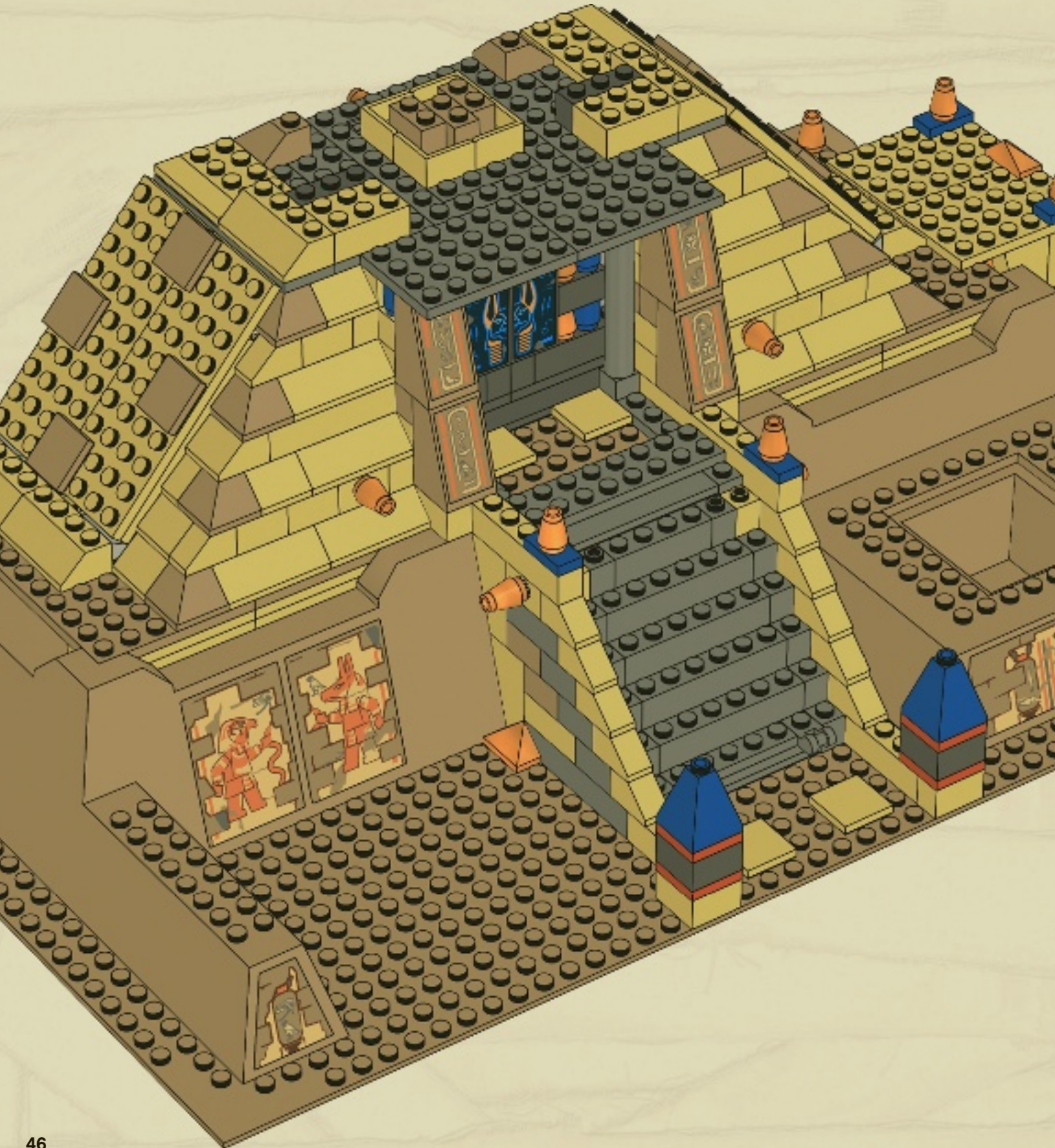

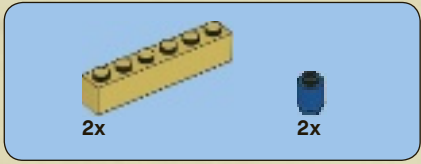

76

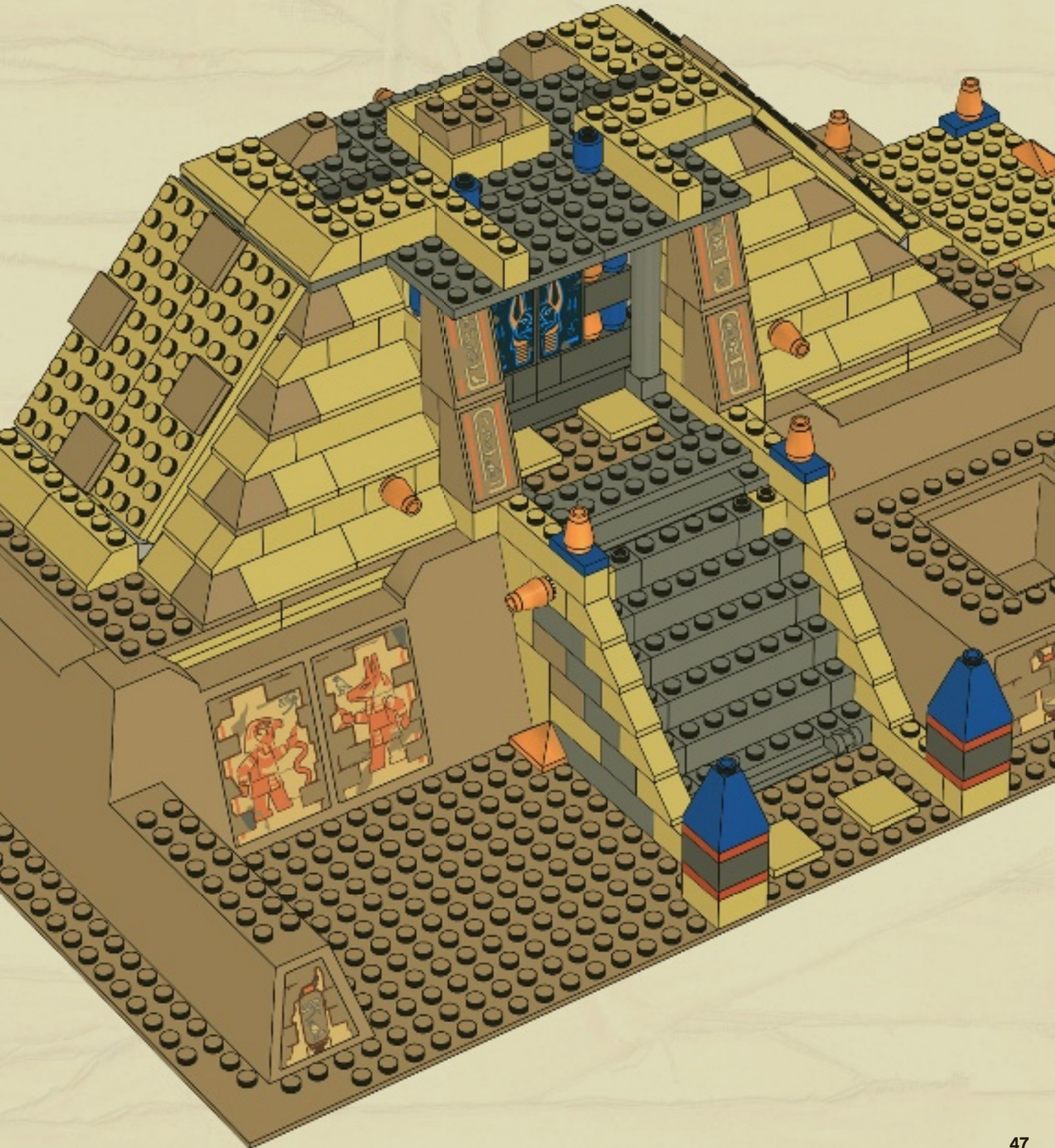

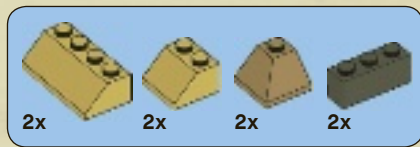

77

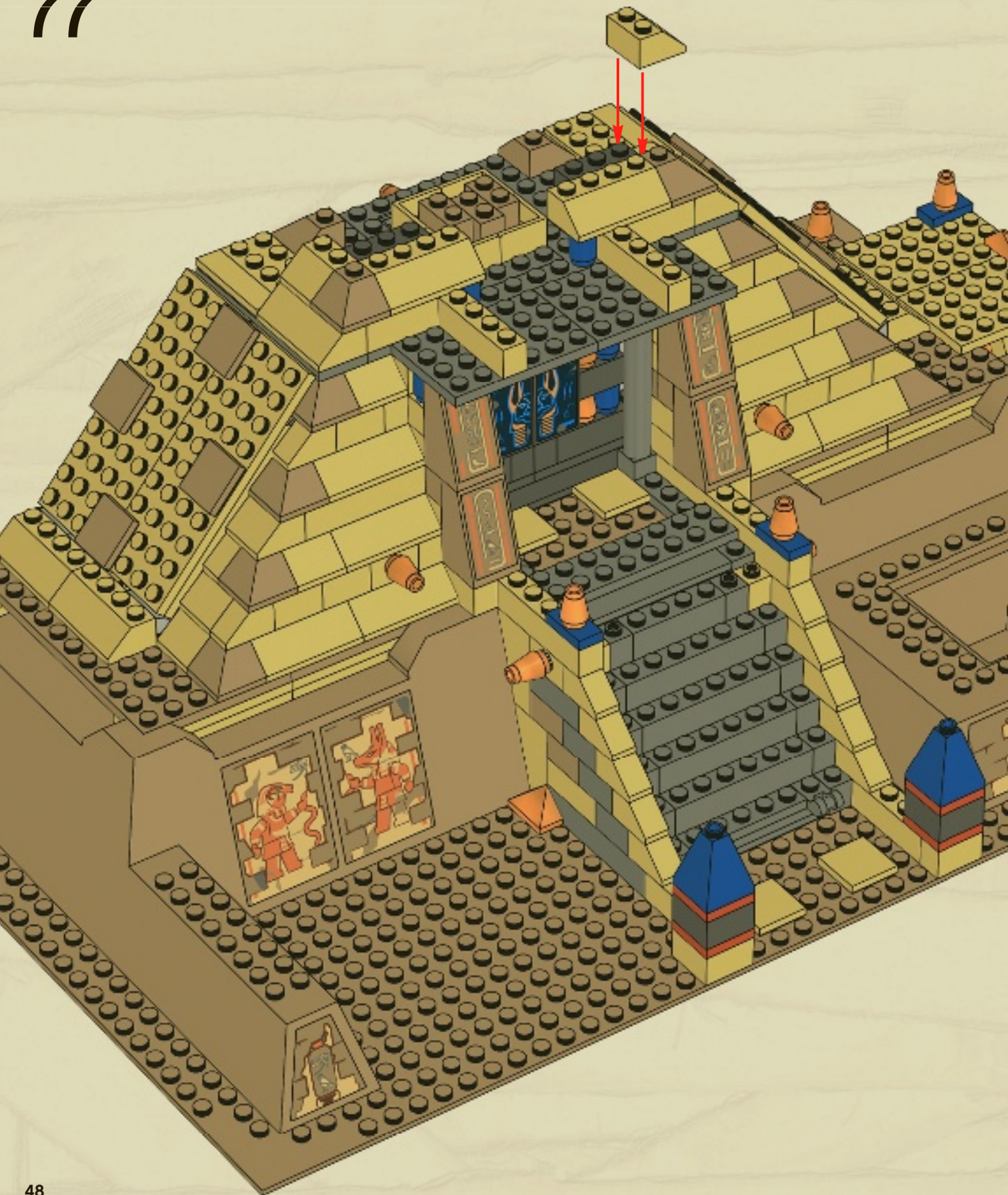

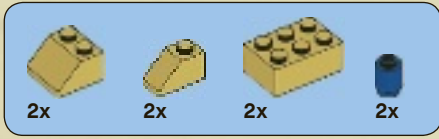

78

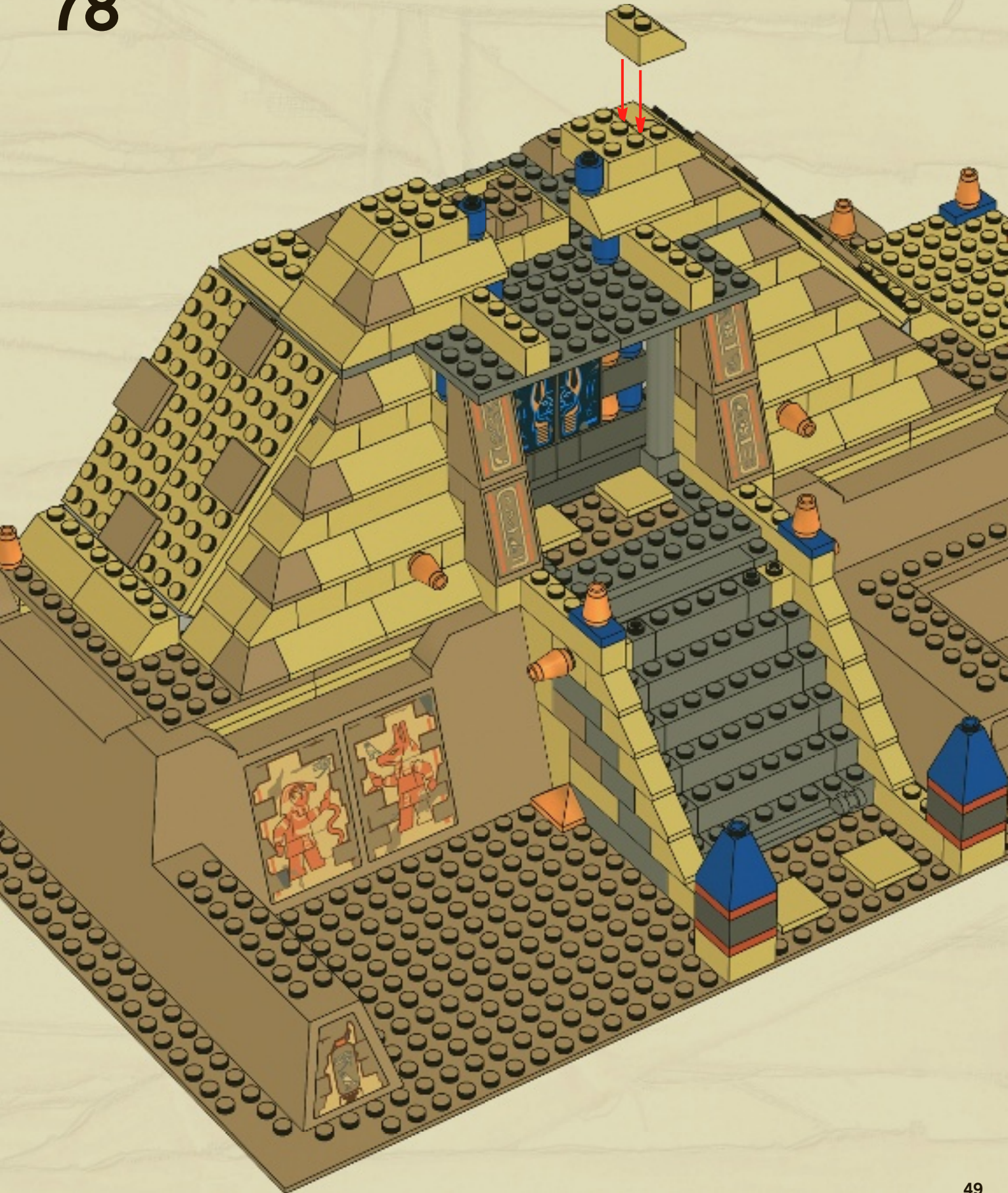



79



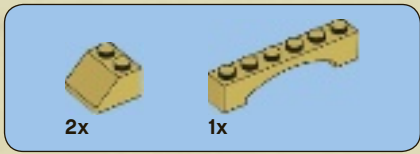

80

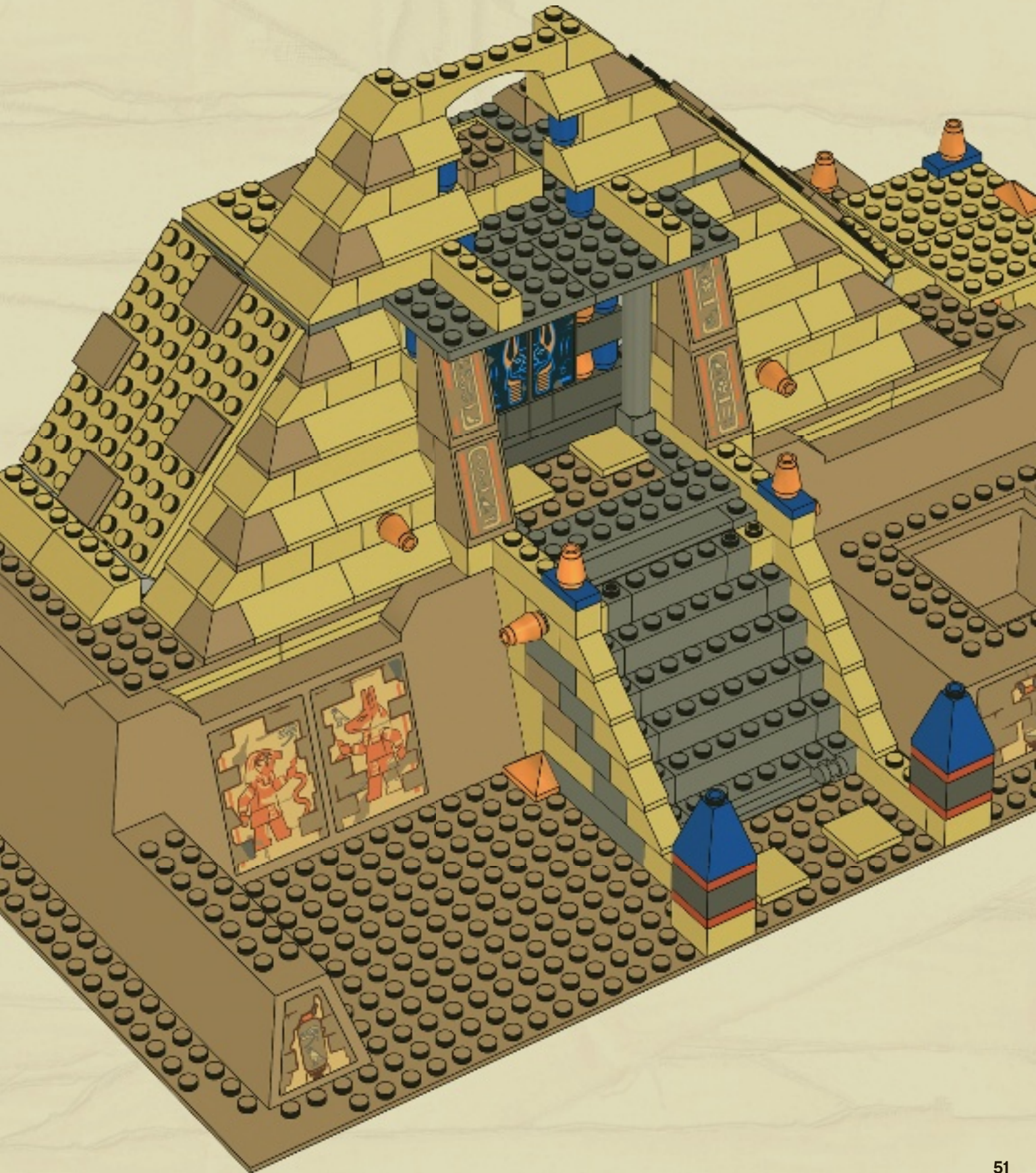

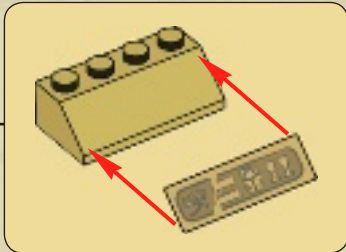
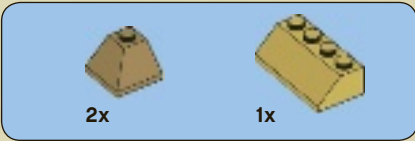

81

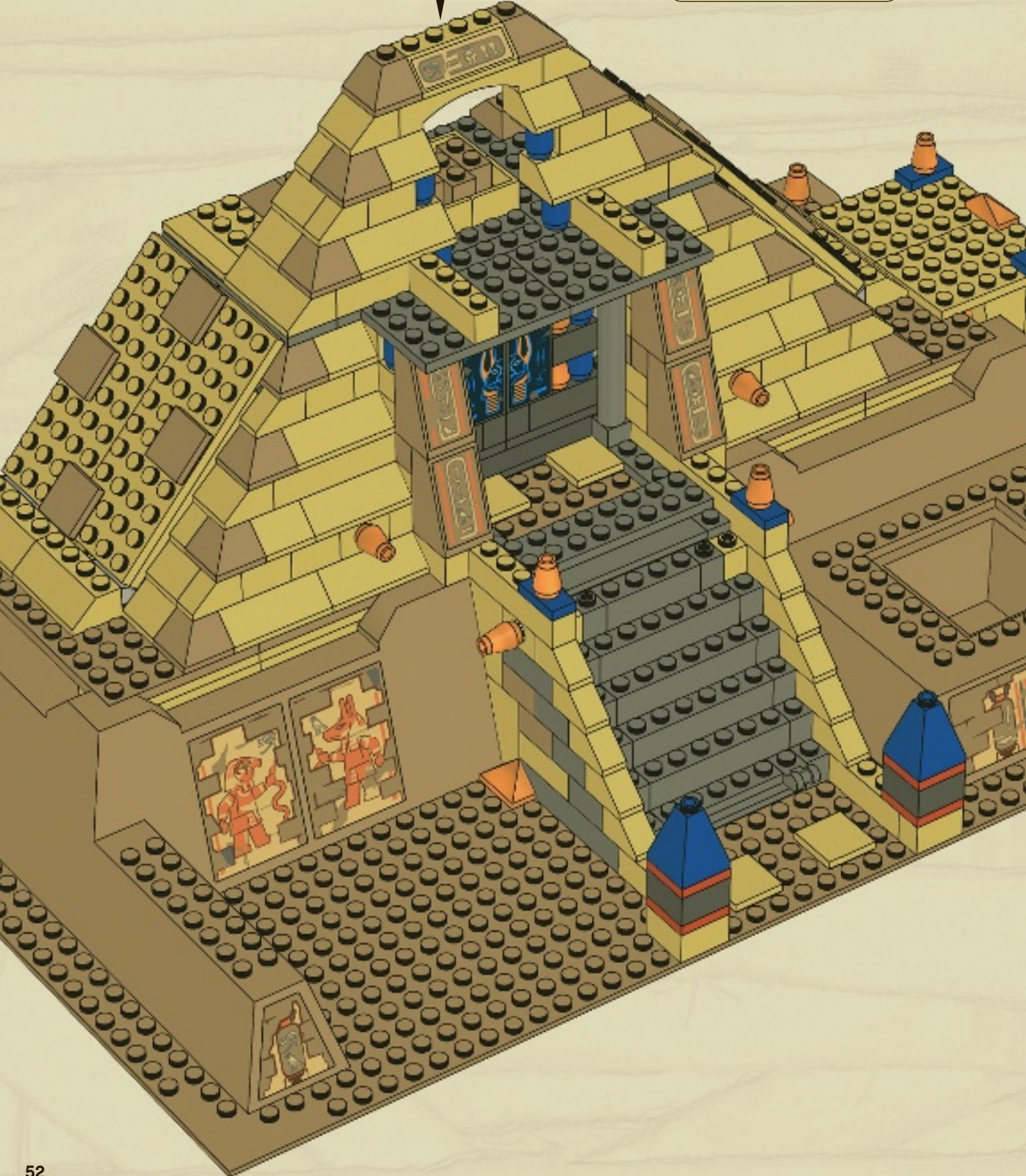



82



2x  2x 

83

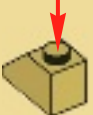
  2x

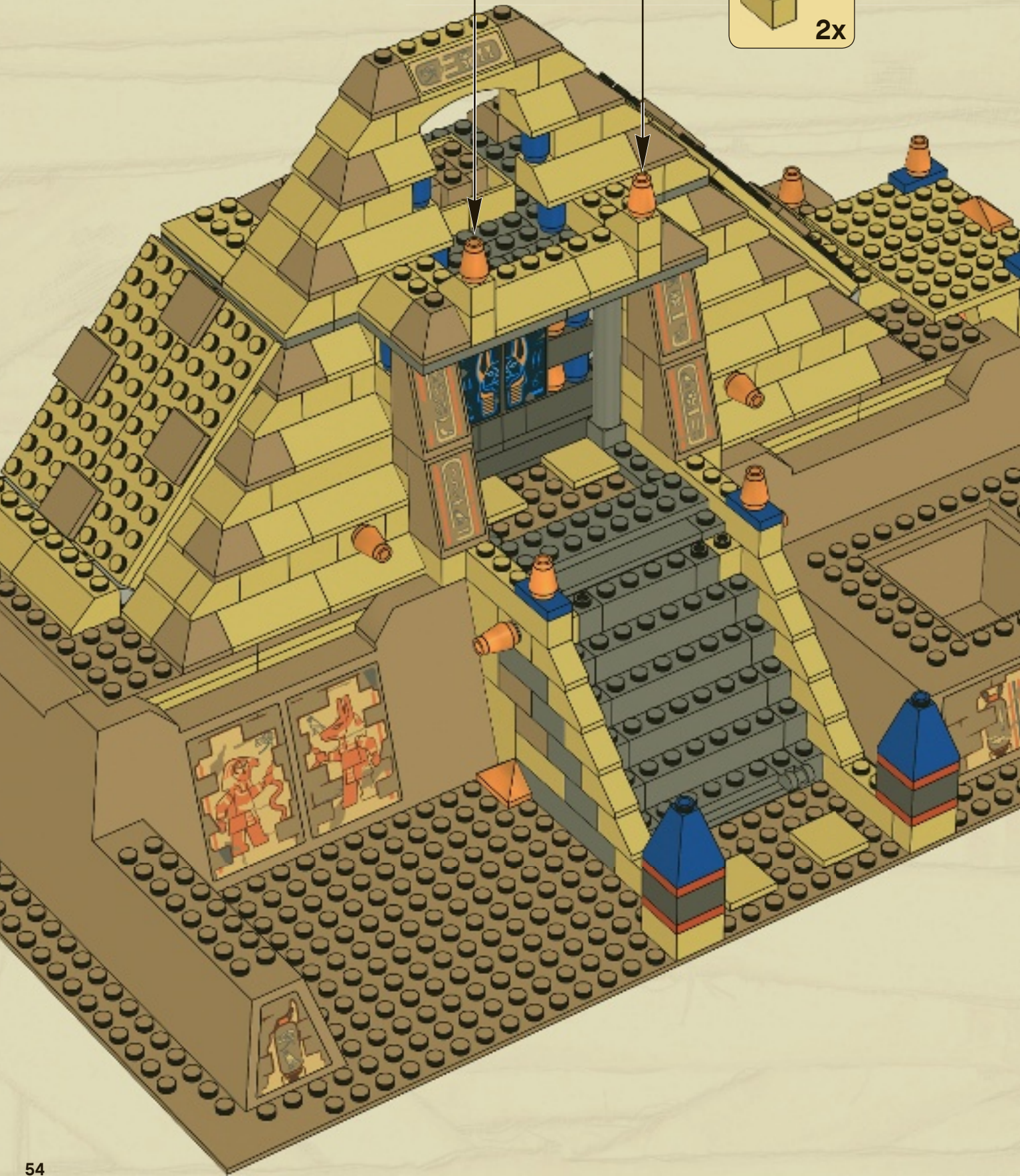

2x

84

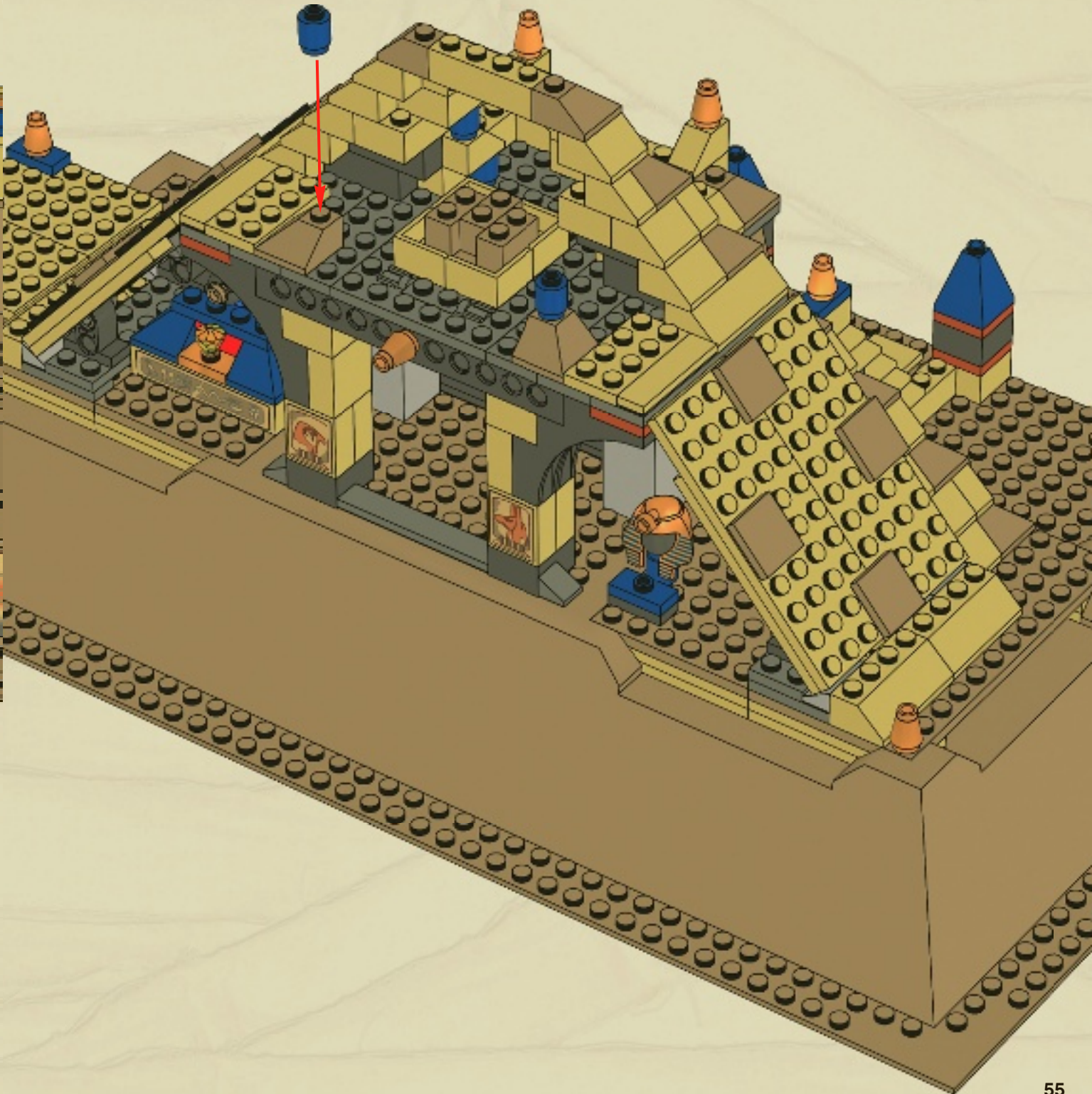

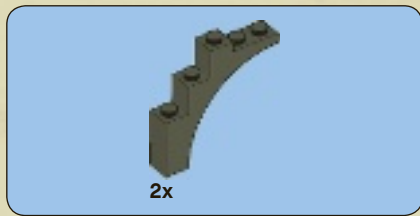

85

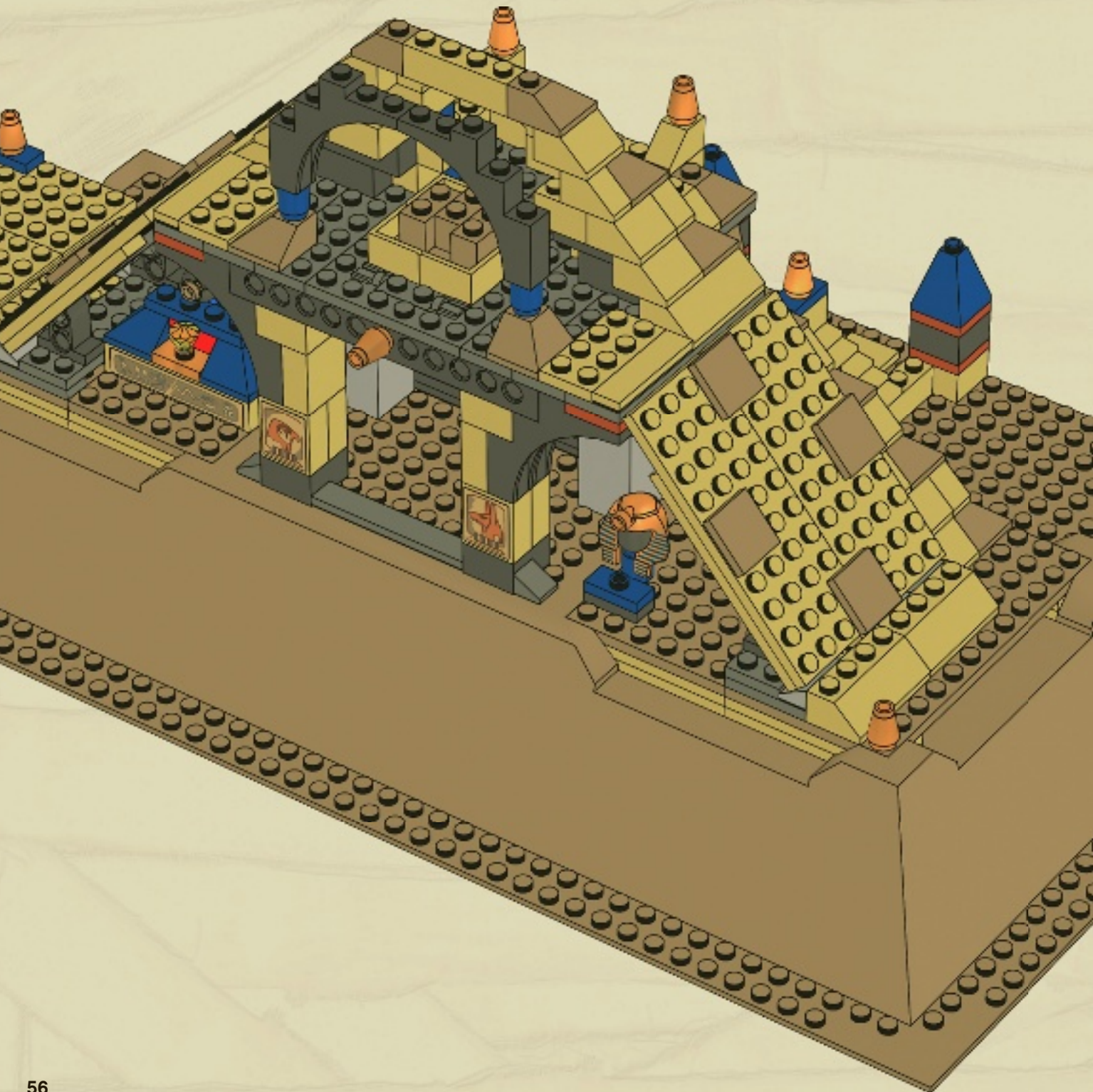



1x

86

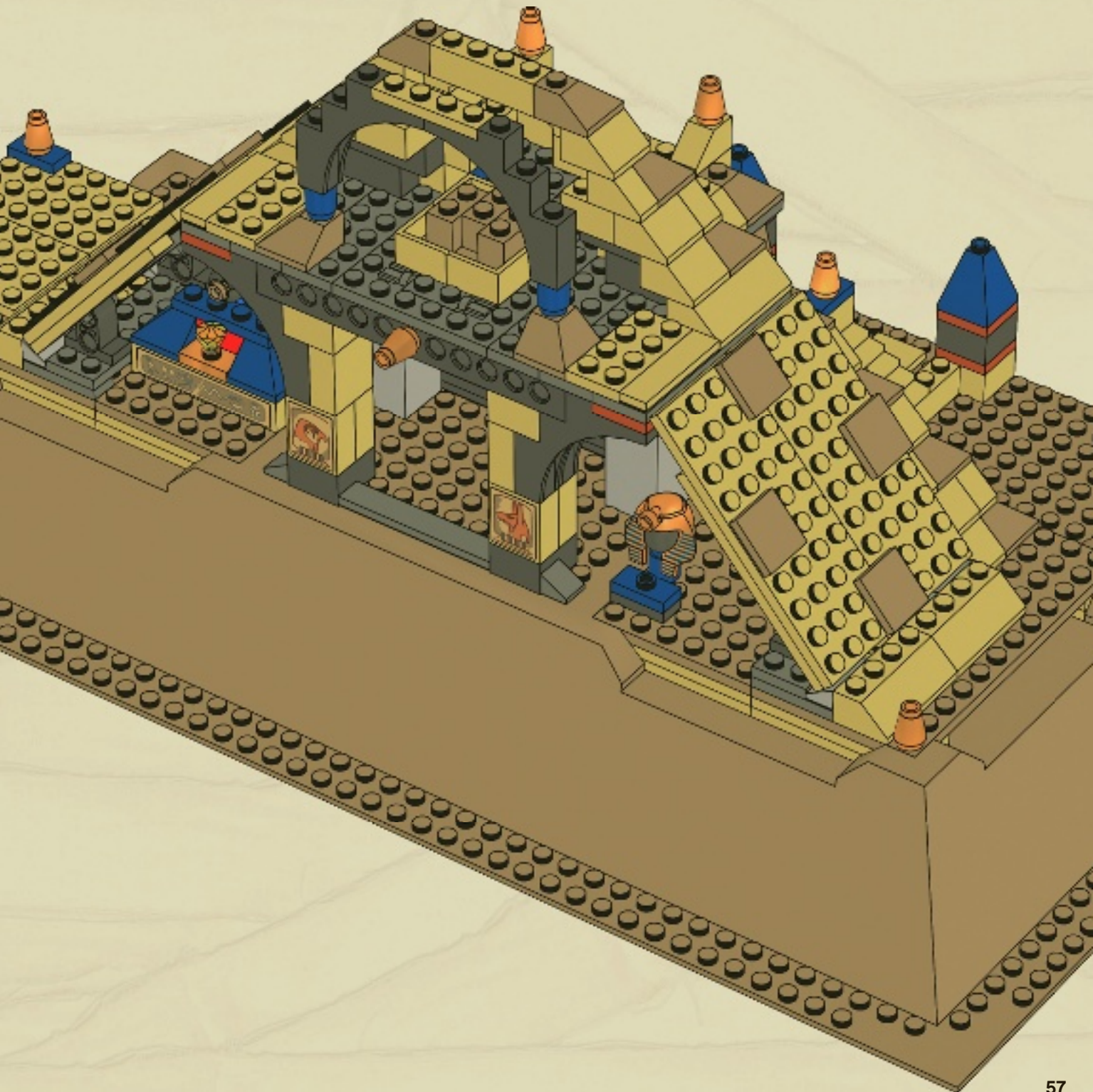



87

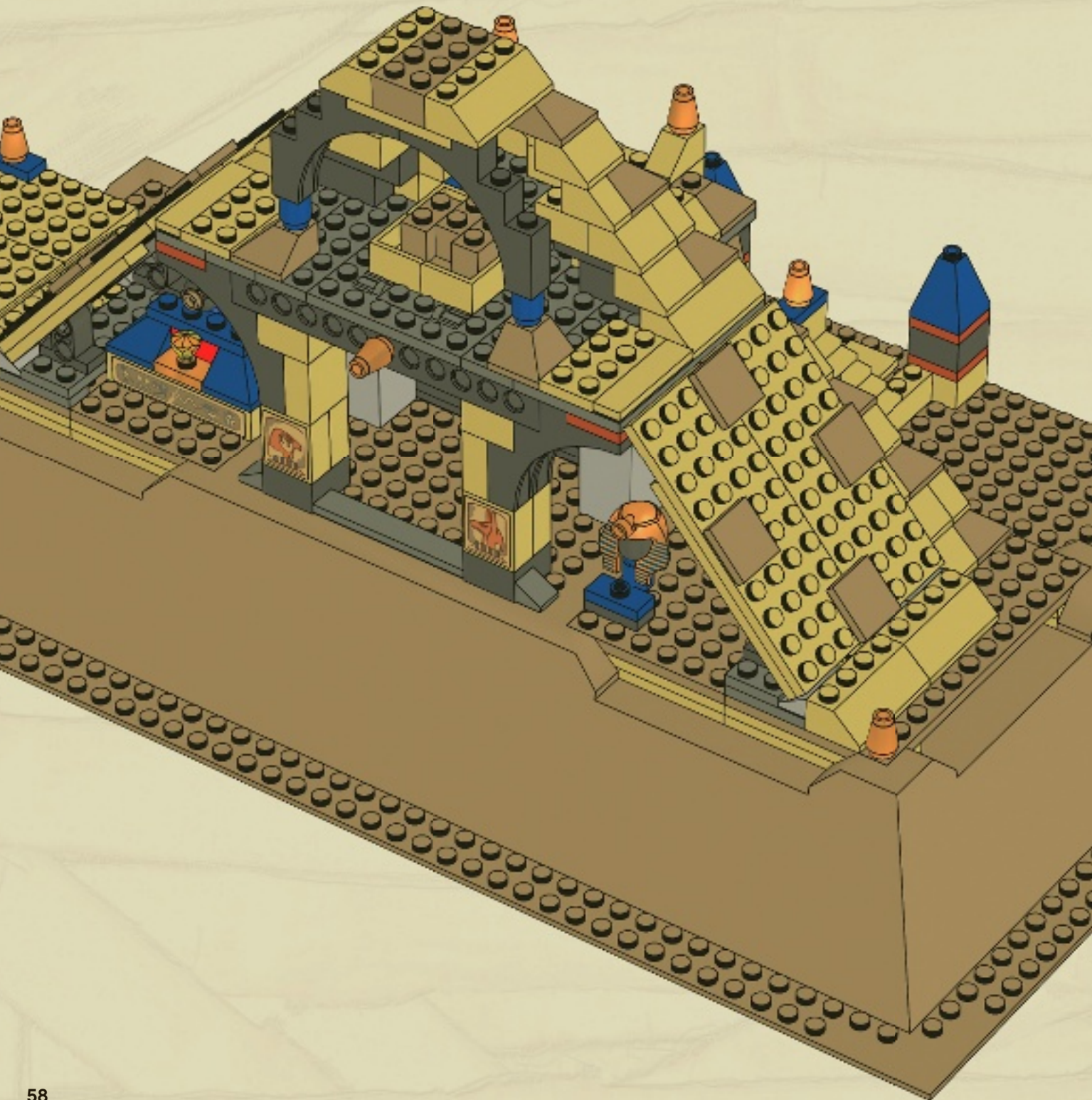



2x

88

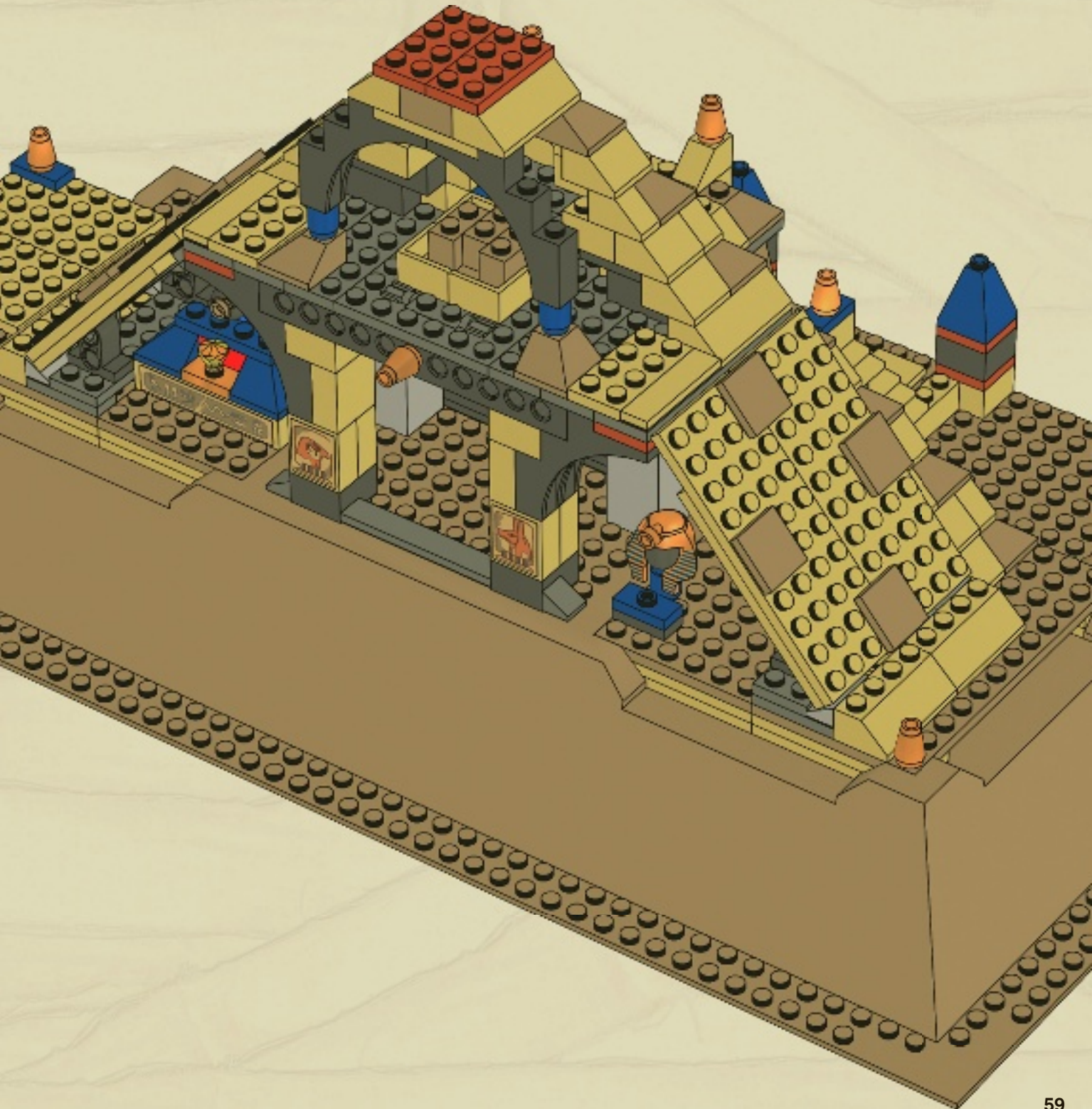



4x

89

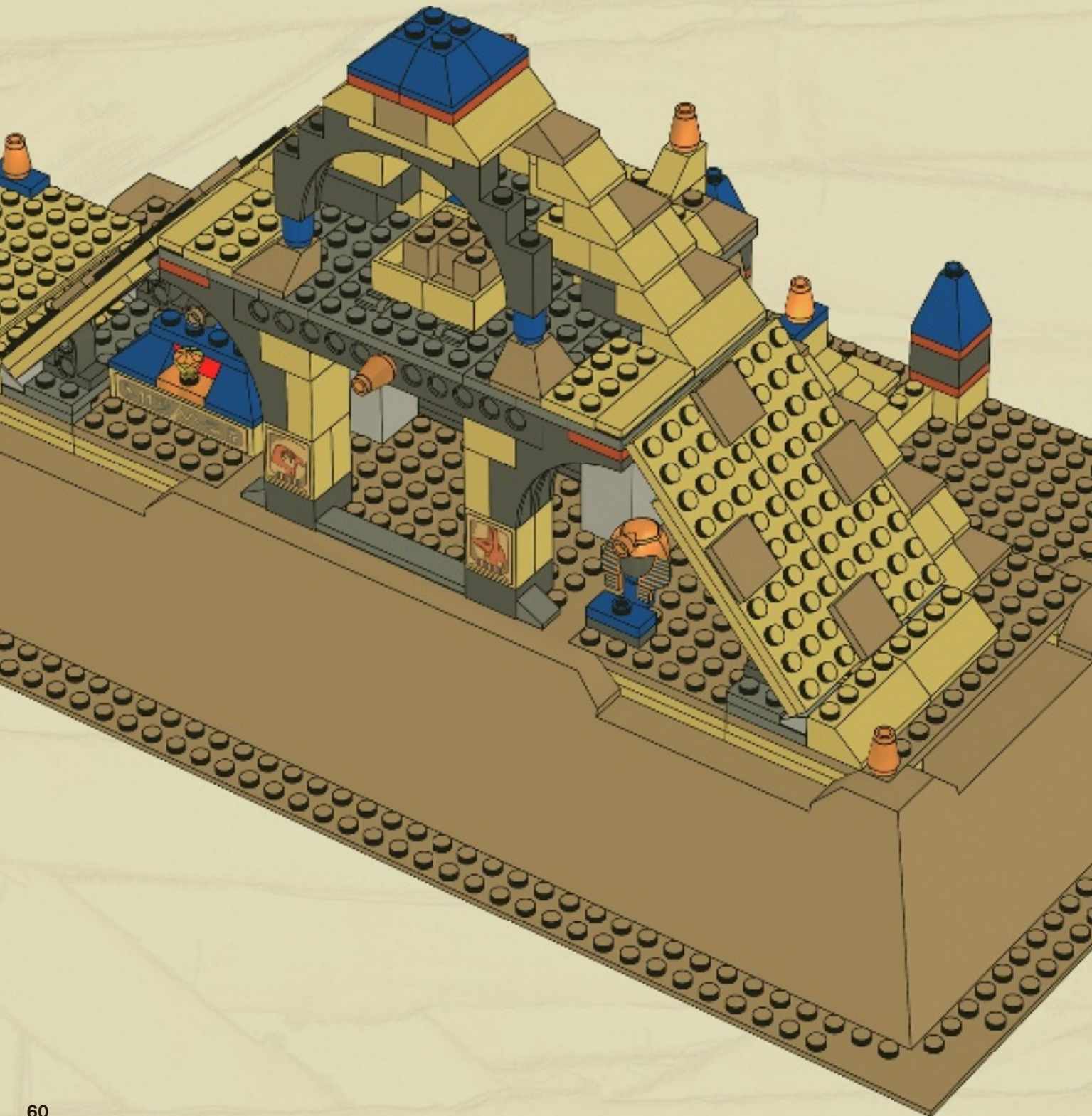



2x

90

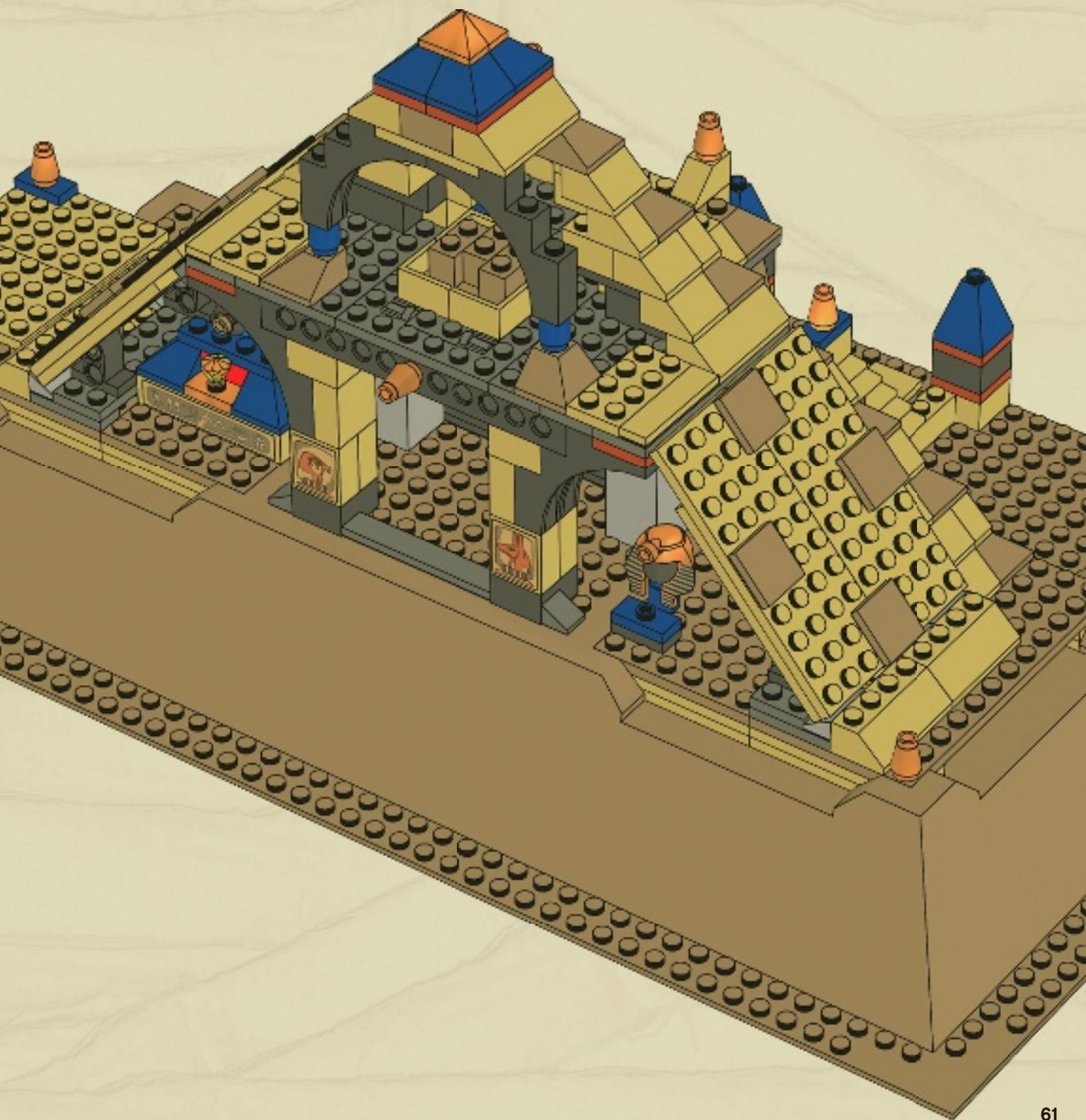



1

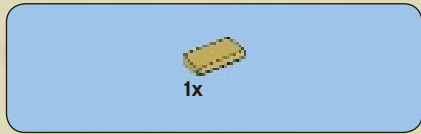
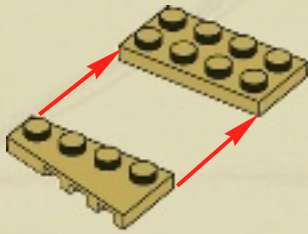

2

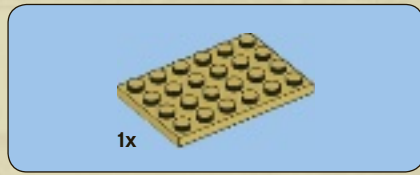

3

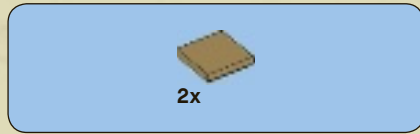
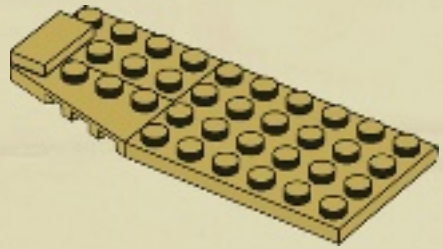

4

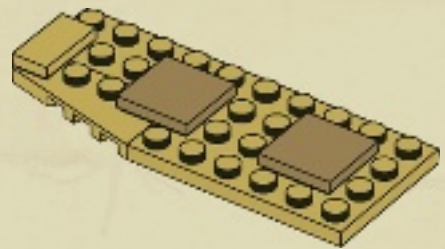



5

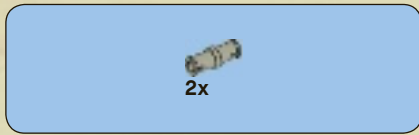
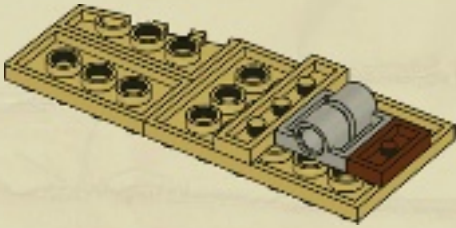

7

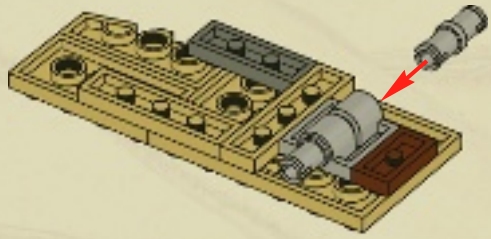

6

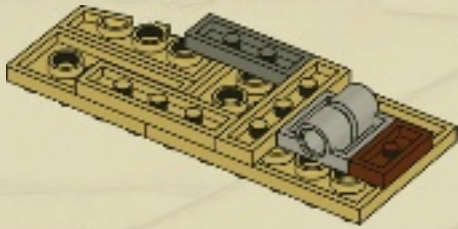

8

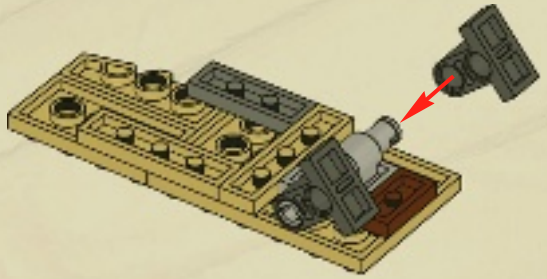

9

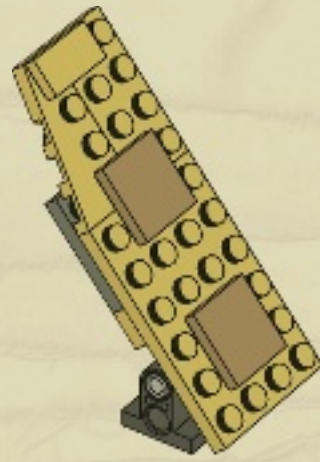
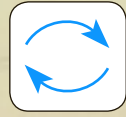

91

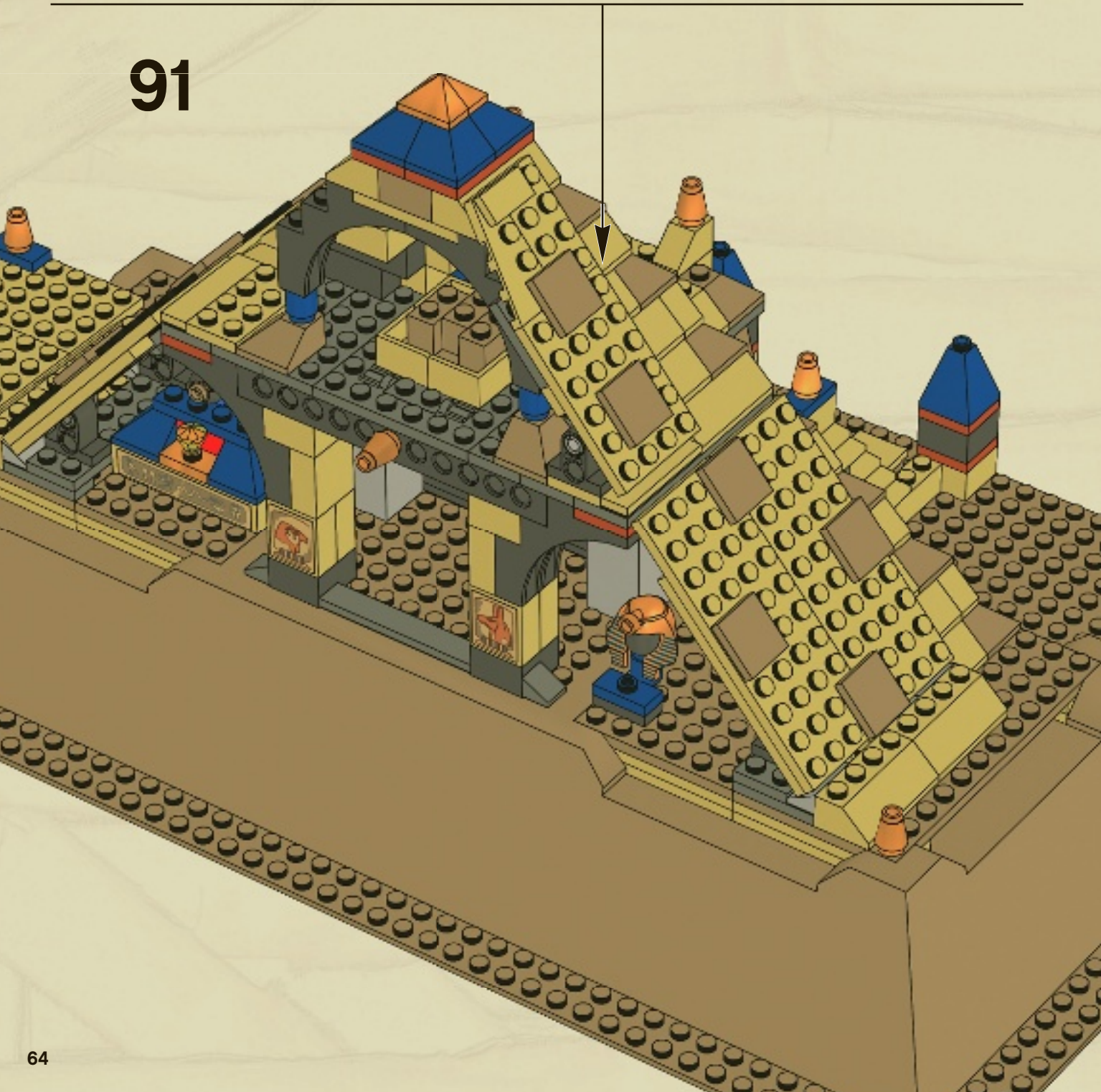

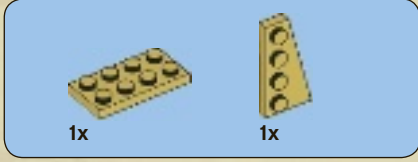

1

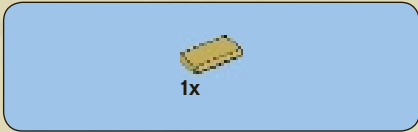
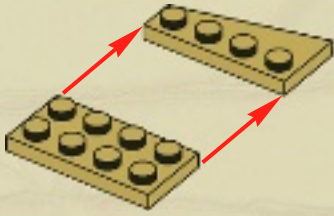

2

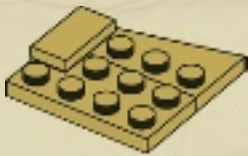

3

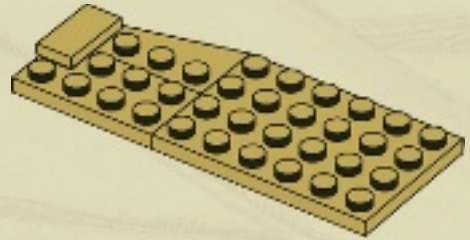

4

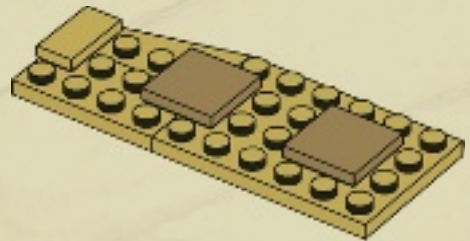



5

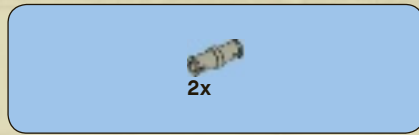
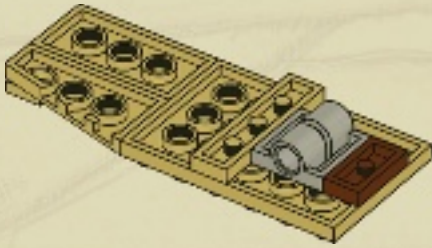

7

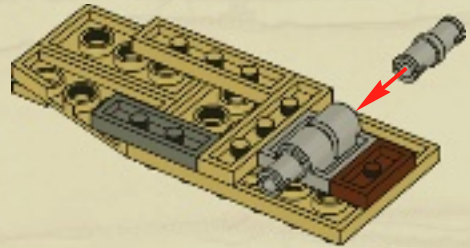

6

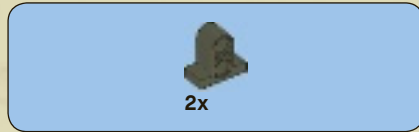
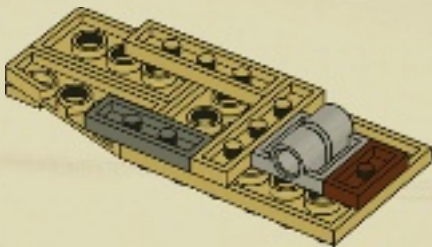

8

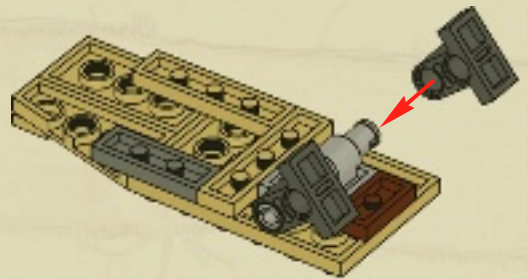

9

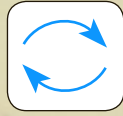

92

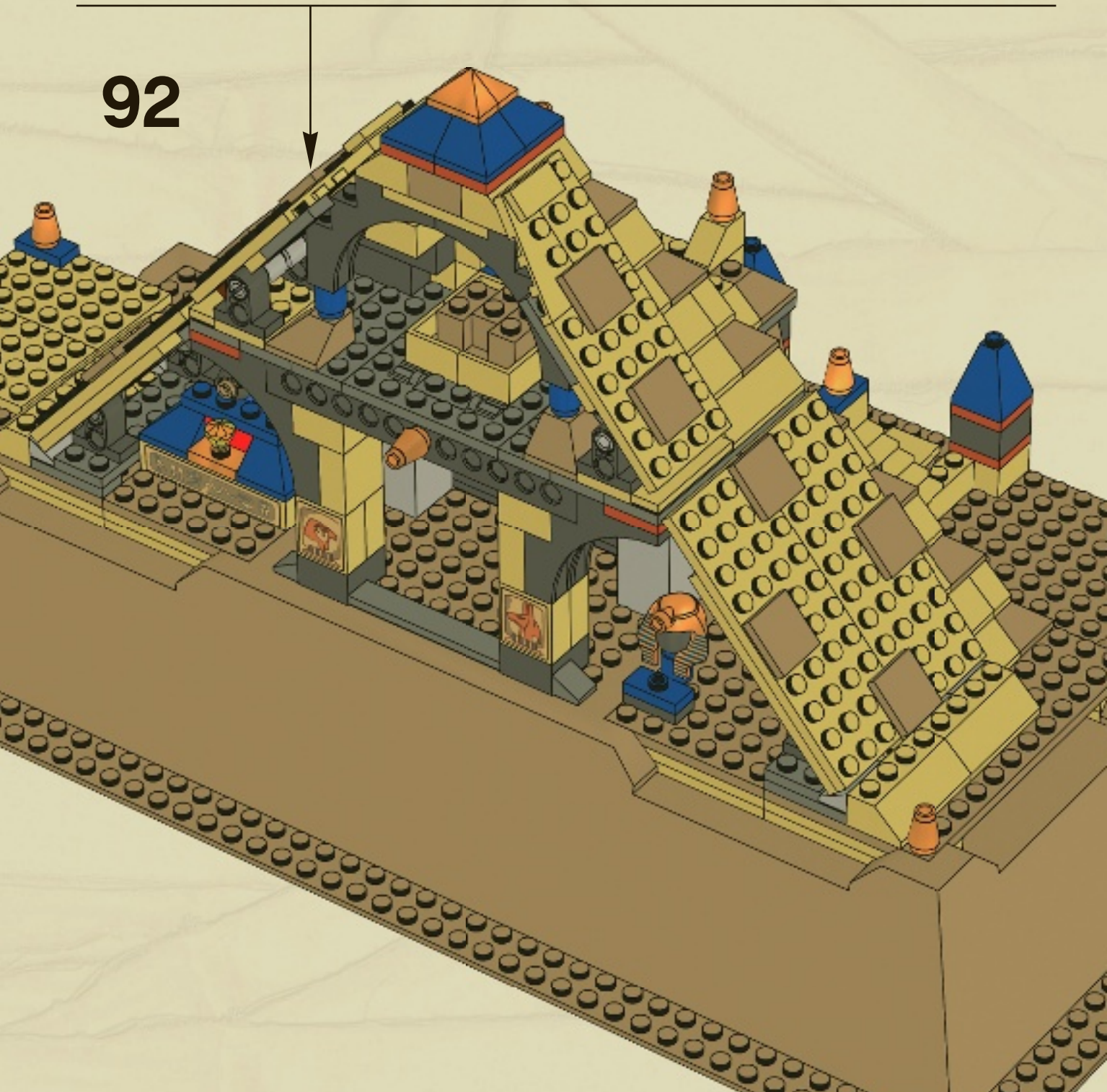



93

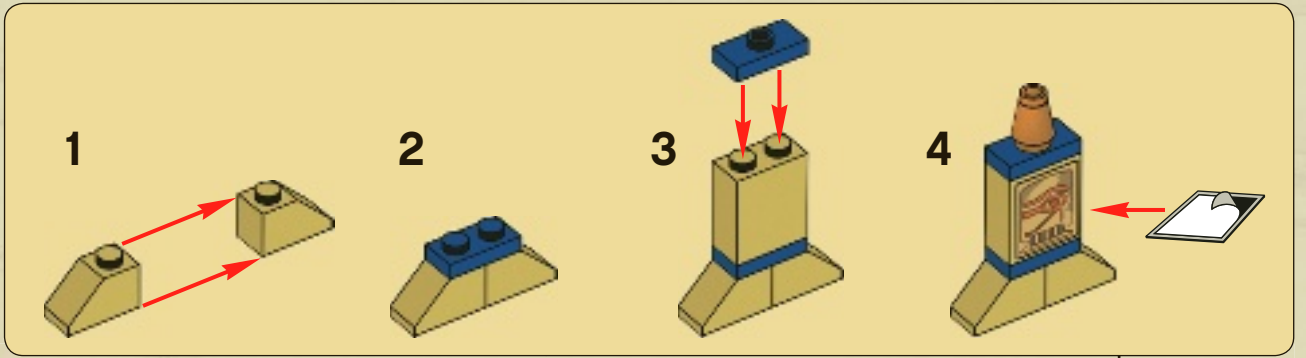



1x



3x

94

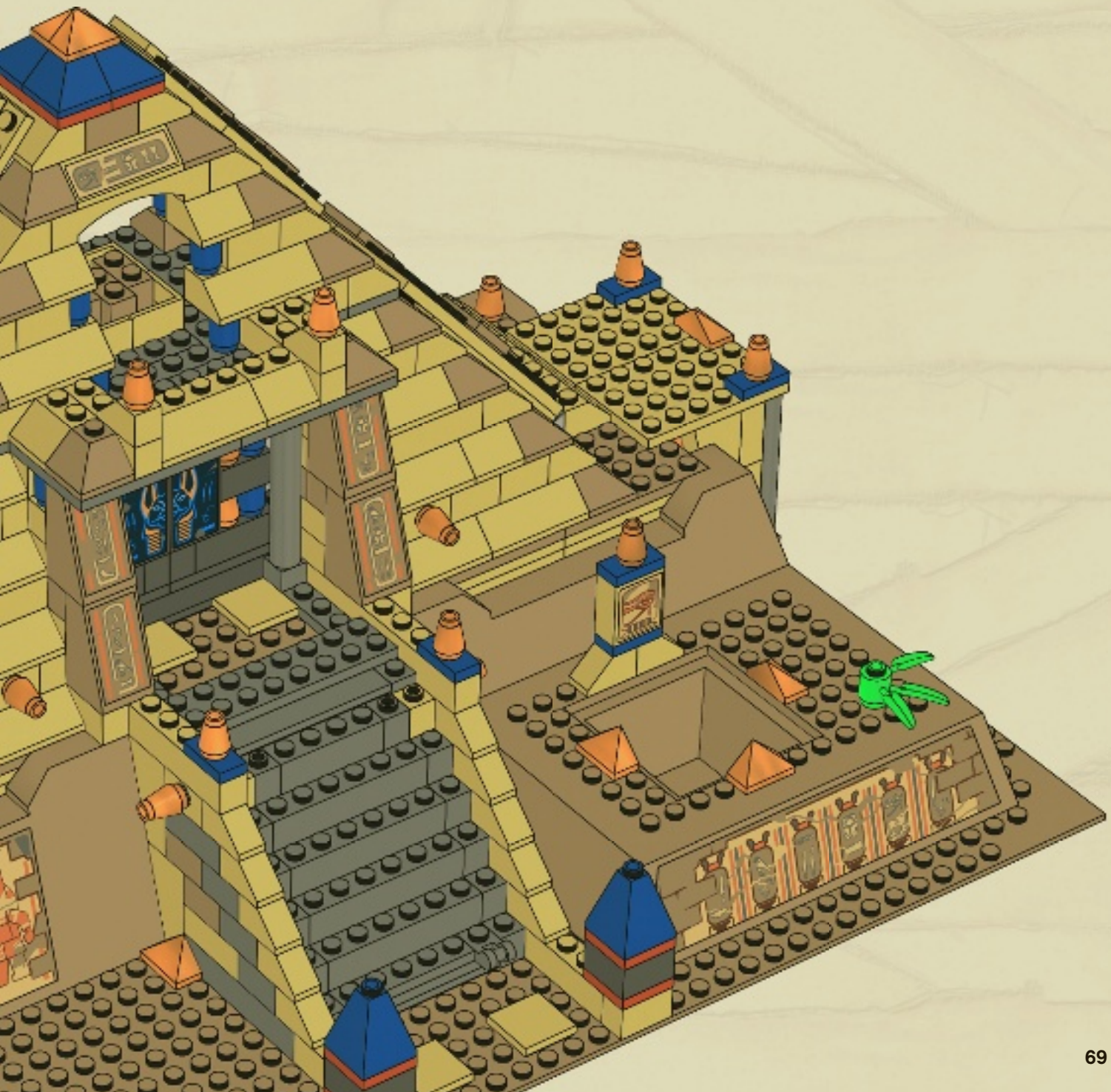



4x

95

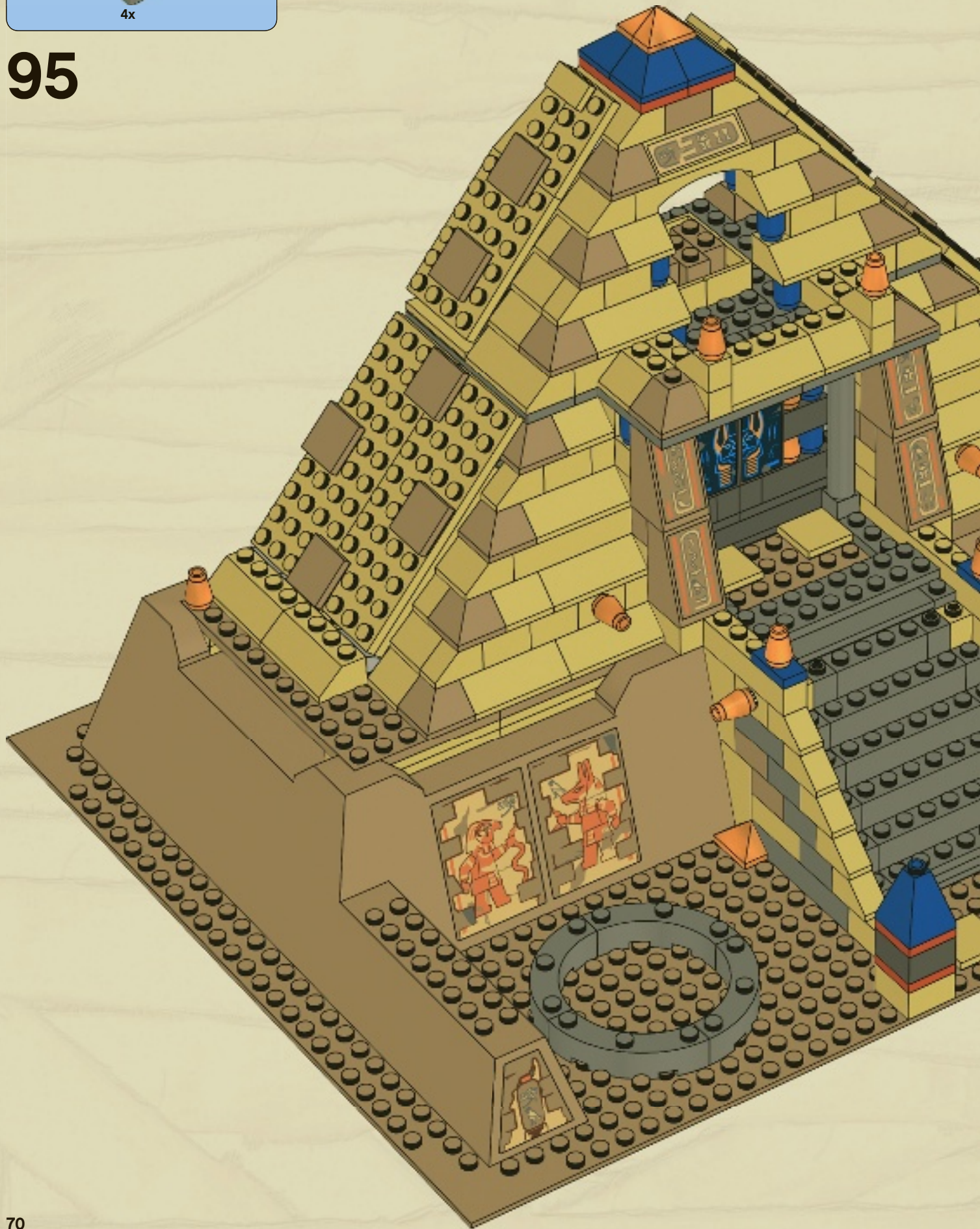



1x



4x

96



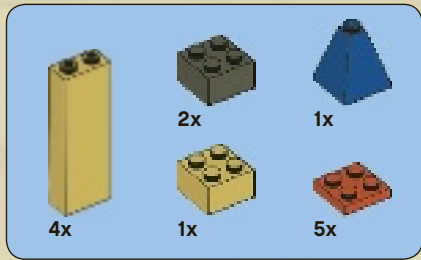

97

1

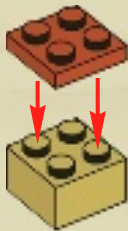

2

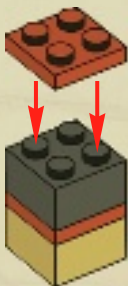

3



4

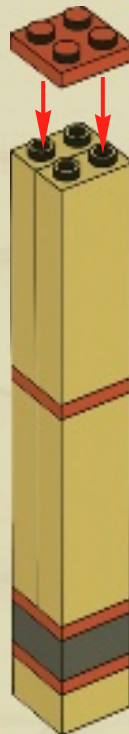



5

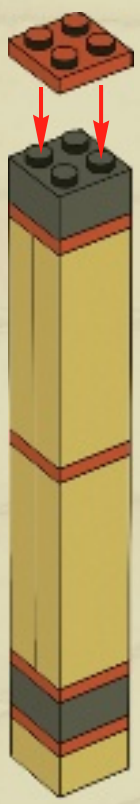

6

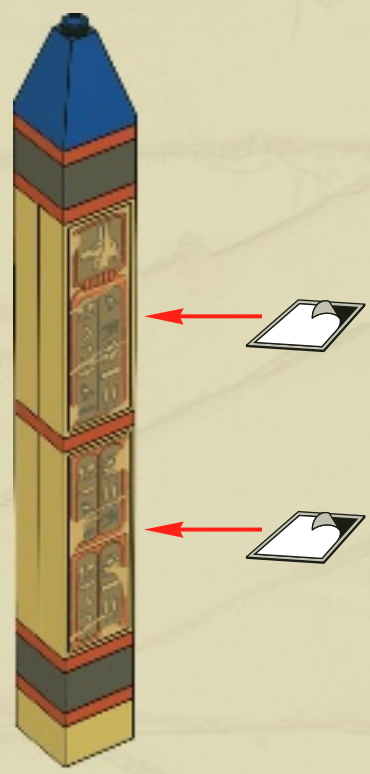



1x
2x
3x
1x

98



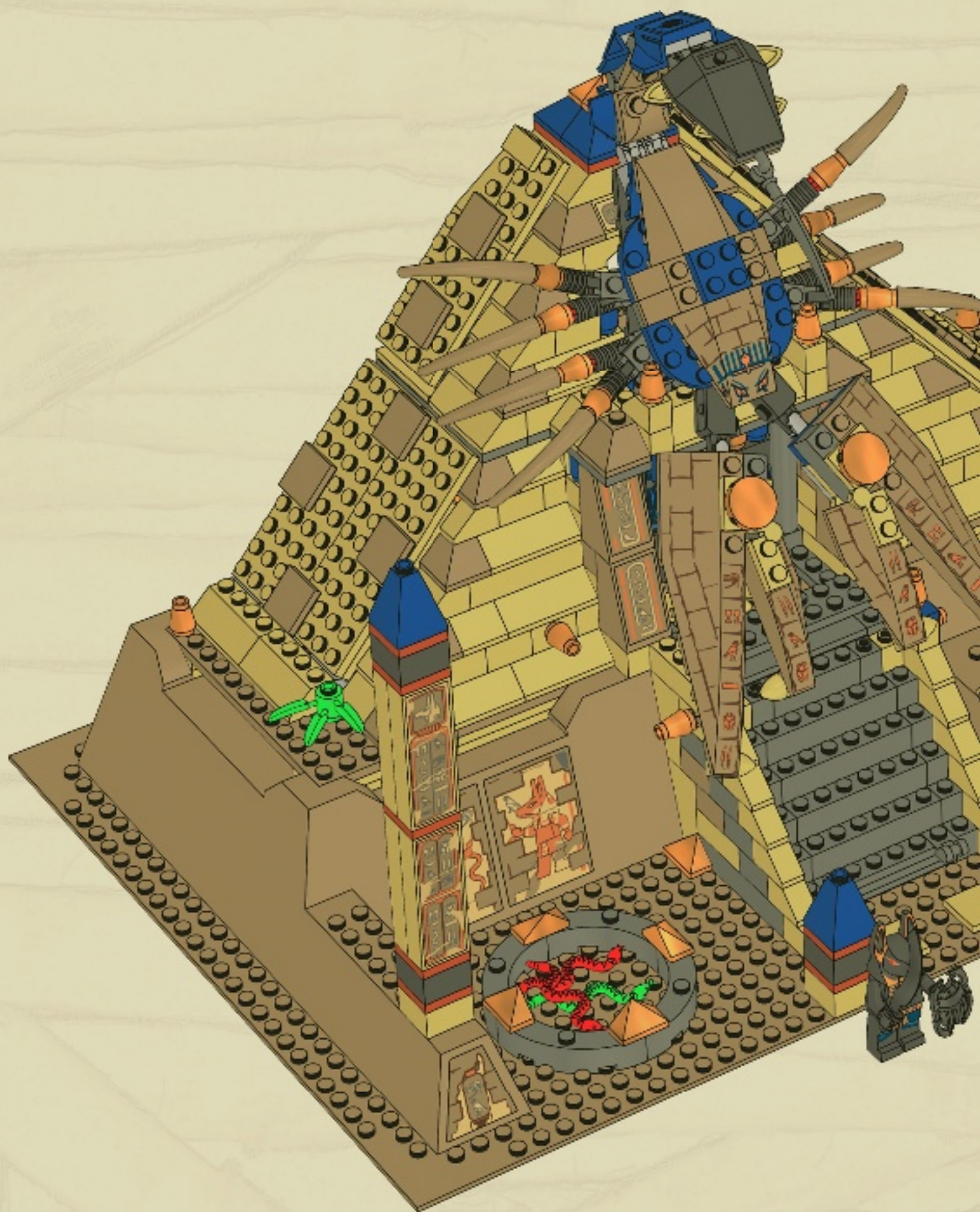

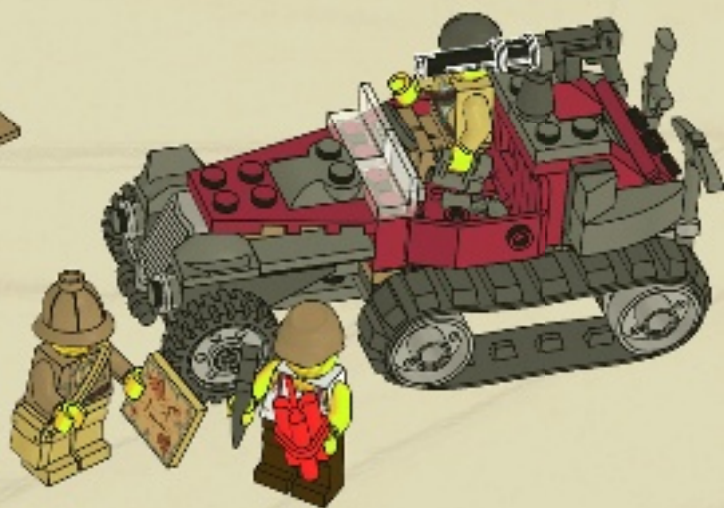



7307

7326

7325

7327



7305



7306





1x 4613468
 8x 4113915
 1x 4596319
 11x 4114306
 2x 4124455
 2x 4162465
 10x 4159739
 6x 4113916
 3x 4112962
 3x 4181134
 2x 4159774
 3x 4166138
 1x 4249019
 4x 4609328
 1x 4125217

1x 4618876
 7x 4159279
 4x 4114064
 2x 4114026
 6x 4113917
 4x 4185177
 1x 4614253
 2x 4550324
 5x 4113233
 4x 4114309
 9x 4124067
 12x 4113993
 4x 4114324
 5x 4114001
 24x 4121972
 21x 4114322









1x 4545384
 1x 4616490
 4x 4593748
 1x 4107623
 1x 4613488
 4x 4227507
 4x 4161734
 20x 4614739
 8x 4616212
 1x 4550632
 10x 4224793
 10x 4205107
 1x 4613585
 1x 4613418
 1x 4613411
 2x 4153707

2x 4609477
 4x 300526
 2x 300426
 6x 300326
 4x 362226
 4x 301026
 2x 300826
 6x 4558954
 1x 4118624
 2x 4167106
 1x 4529236
 1x 4569733
 2x 428726
 1x 4550004
 6x 4519925
 13x 302326
 2x 371026
 2x 4541455
 3x 4551360

2x 4180576
 2x 4614788
 6x 416226
 2x 447726
 1x 389526
 8x 4158848
 1x 4140588
 1x 4251393
 1x 4251394
 2x 4613611
 2x 4613604
 1x 362626
 1x 4526110
 1x 400626
 1x 4549989
 1x 449726
 8x 4144024

1x 4124096
 1x 4286267
 1x 4140801
 2x 370526
 2x 4114348
 1x 4249063
 13x 4615606
 2x 4535928
 2x 3005740
 2x 4113106
 1x 4128576
 1x 245821
 2x 4507196
 2x 306921
 1x 4538780
 2x 4114052
 1x 4227155
 8x 4142865
 1x 4143005
 2x 4206482
 2x 4514553
 6x 4211150
 2x 4508616

1x 4566927
 8x 4611758
 1x 4614288
 1x 4614571
 1x 4524098
 1x 4613597
 1x 4613601
 13x 4507045
 3x 4267874
 5x 4550329
 1x 4522668
 3x 4614858
 19x 4521914
 1x 4247145
 3x 4520257
 4x 4530678
 4x 4613790
 18x 4613007
 2x 4293756

Customer Service
Kundenservice
Service Consommateurs
Servicio Al Consumidor
www.lego.com/service or dial
 00800 5346 5555 :     
 1-800-422-5346 :  

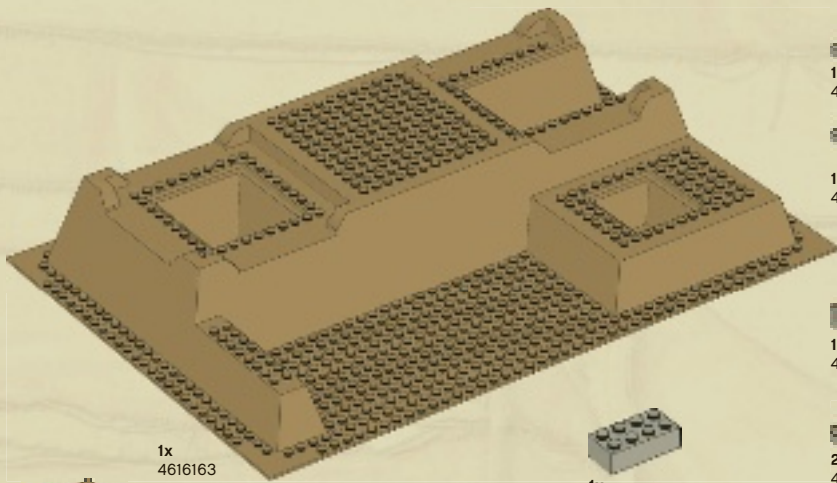

1x
4616163



1x
4614200



1x
4613281



1x
4613280



1x
4613274

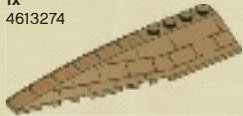

1x
4613275



3x
4266897



1x
4613269



2x
4541526



2x
4539090



1x
4539061



1x
4541544



1x
4561032



1x
70501



1x
4612822



8x
4186627



3x
4613003



4x
4614554



1x
4613335



1x
4614793



1x
4609504



1x
4296785



23x
4177741



6x
4196736



3x
4614791



1x
4528981



5x
4502089

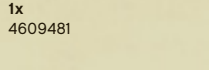

1x
4609481



1x
4211385



2x
4211694



4x
4568637



6x
4211437



1x
4211429

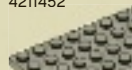

1x
4211452

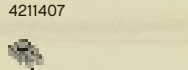

1x
4211407



2x
4594238



6x
4211803



5x
4211376



1x
4613494



1x
4613454



1x
4613425



1x
4613588



2x
4499259



4x
4299119

2x
4222047



1x
4226995



1x
4523369



1x
4211469



2x
4211450



1x
4234240



4x
4211807



2x
4211639



4x
4211650



6x
4211060



2x
4211104



2x
4211105



1x
4211085



6x
4210875



2x
4211099



2x
4210935



2x
4210723



4x
418081



4x
4535931



2x
4246896



1x
4620760



2x
4210635



2x
4568734



4x
4211133



1x
4211065



5x
4211056



6x
4210651



1x
4211002



3x
4211115



9x
4210997



2x
4211067



1x
4611703



14x
4210884



2x
4521187



5x
4509884



1x
4595710



1x
4595708



6x
4504378



2x
4514559



2x
4278274



1x
4211029



1x
4211051



1x
4211007



1x
4523773



1x
4509194



2x
4218750



1x
4218696



1x
4289542



1x
4508553



1x
4529672



30x
4529247



12x
4295174



1x
4523157



2x
4579099



1x
4614590



2x
4610904

2x
4610956

LEGO® Glyphs

 A	 B	 C	 D	 E	 F	
 G	 H	 I	 J	 K	 L	 M
 N	 O	 P	 Q	 R	 S	 T
 U	 V	 W	 X	 Y	 Z	



Solve the code above and enter pharaohsquest.LEGO.com

Déchiffre le code ci-dessus et viens sur pharaohsquest.LEGO.com

Entschlüssel den Code und gib das Lösungswort auf PharaohsQuest.LEGO.de ein.

Déchiffre le code ci-dessus et entre dans pharaohsquest.LEGO.com

Resuelve el jeroglífico y visita pharaohsquest.LEGO.com

Decifra o código acima e entra em pharaohsquest.LEGO.com

Fejtsd meg a fenti kódot, és lépj be a pharaohsquest.LEGO.com oldalra.

© 2005 LEGO SYSTEMS A/S. ALL RIGHTS RESERVED. LEGO and the LEGO logo are registered trademarks of LEGO SYSTEMS A/S.

LEGO and the LEGO logo are registered trademarks of LEGO SYSTEMS A/S.



pharaohsquest.LEGO.com



www.LEGOclub.com

LEGO club™

FREE! GRATIS! GRATUIT!



LEGO® Club Magazine



LEGO® Club Email

VISIT THE WORLD'S
BIGGEST LEGO® SHOP!
www.LEGOshop.com

GO TO
www.LEGOclub.com

00800 5346 5555*

1-866-534-6258 • 1-877-518-5346

US & Canada only

Canada seulement



* Freephone. Mobile charges may apply. * Numéro sans frais. Des frais peuvent s'appliquer avec les téléphones cellulaires. * Gebührenfrei. Kosten für Anrufe aus Mobilfunknetzen können abweichen. * Gratis telefoonnummer vanaf vaste lijn. * Det er et gratis nummer, når du ringer fra fasttelefon. * Det är gratis, när du ringer från en fast telefon. * Numéro sans frais. Des frais peuvent s'appliquer avec les téléphones portables.



WIN!

Go to www.LEGOsurvey.com/product to fill out a survey for a chance to win a cool LEGO® Product.

No purchase necessary.
Open to all residents where not prohibited.



www.LEGOsurvey.com/product

GEWINNER!

Nimm an der Umfrage auf www.LEGOsurvey.com/product teil und hab die Chance ein cooles LEGO® Produkt zu gewinnen!

Die Teilnahme am Gewinnspiel führt zu keinerlei Kauverpflichtungen. Teilnahme in allen nicht ausgeschlossenen Ländern möglich.

4624533 / 4624540

WIN!

Ga naar www.LEGOsurvey.com/product, vul een enquêteformulier in en maak kans op een cool LEGO® product.

Geen aankoopverplichting. Iedereen mag deelnemen, uitgezonderd ingezetenden van landen waar een enquêteverbod geldt.

GAGNE!

Visite www.LEGOsurvey.com/product pour répondre à un questionnaire et avoir une chance de gagner un produit LEGO® très cool!

Aucune obligation d'achat. Ouvert à tous les résidents des pays autorisés.

GET IT!

www.LEGOsurvey.com/product to access and complete the survey. Winners will receive a cool LEGO® product.

No purchase necessary. Open to all residents where not prohibited.

LEGO and the LEGO logo are trademarks of the LEGO Group. ©2011 The LEGO Group. All rights reserved.